

ENGINEERING
TOMORROW

Danfoss

Save with VLT® Pump Control

– less water, energy
and maintenance

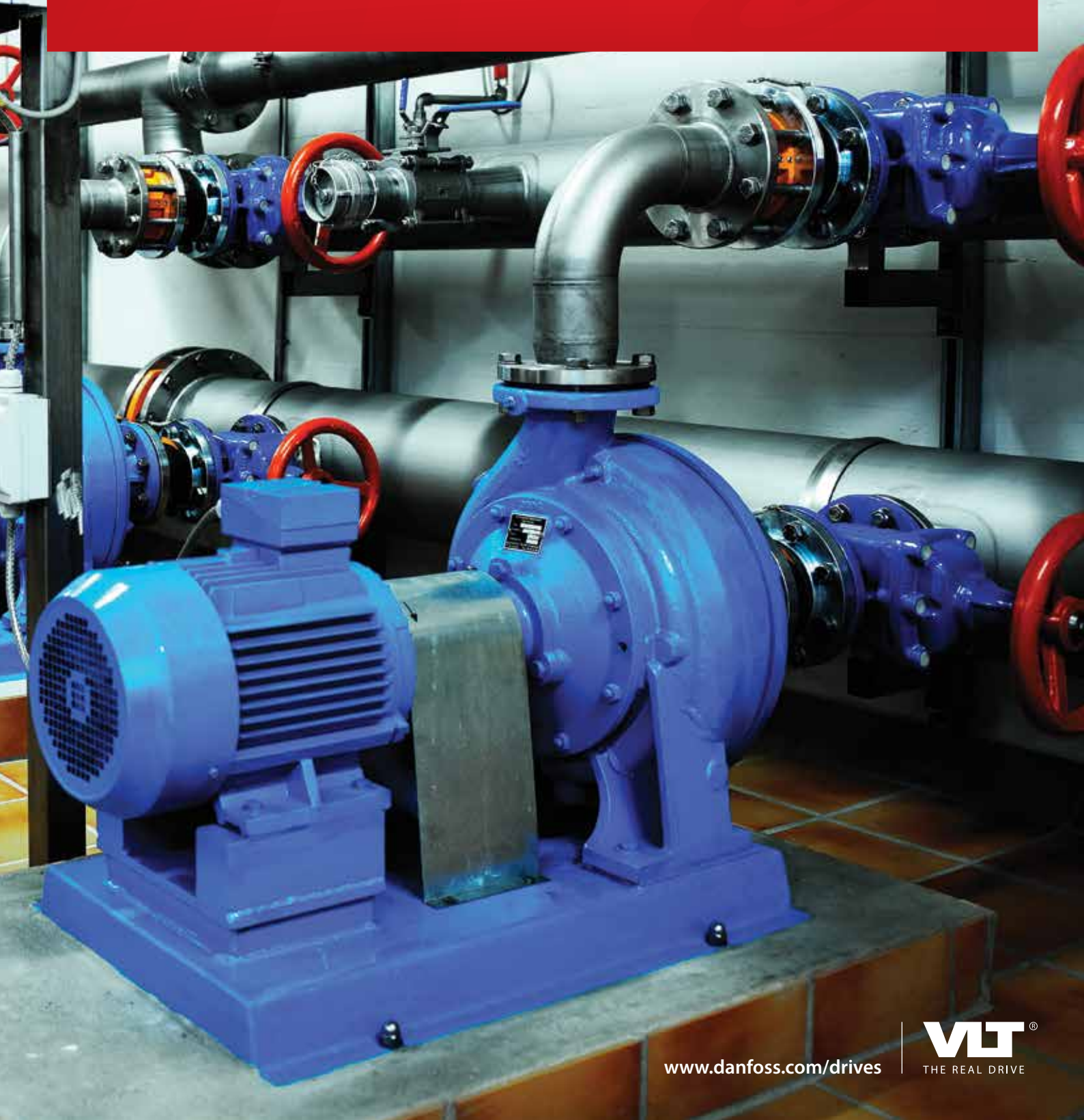

www.danfoss.com/drives

VLT®
THE REAL DRIVE

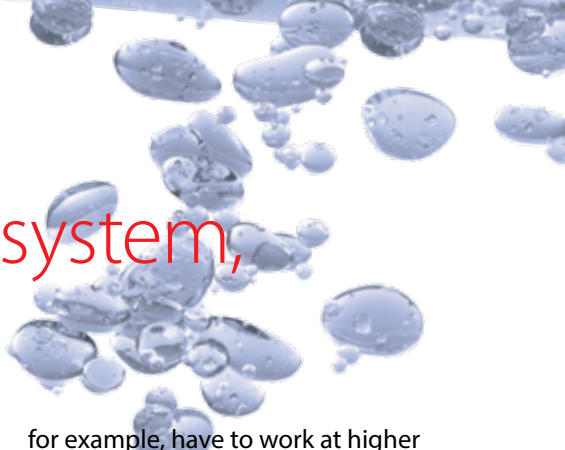

VLT[®] pump control

– reduces the costs of your system, installation and operation

Swirl flaps, throttles or three-way valves are often used on pumps to regulate the pressure or volumetric flow of an application. If a centrifugal pump is controlled using a throttle valve, throttling moves the machine's operating point along the pump characteristic. The reduction in energy requirement achieved is minimal compared with the pump's nominal operating point.

If a pump is speed-controlled, the operating point moves along the system characteristic. The energy requirement is reduced by the cube of the flow. So at half speed, for example, the pump only needs an eighth of the power. This applies for all pumps with variable torque characteristic.

In addition to the pump and system characteristics the graph below also

shows the efficiency limits. From these we can see that in the case of both throttle control and speed control, the operating point moves out of the optimum efficiency range.

In the case of speed control on a typical pump, the effect of the change in efficiency is evident from the specific energy consumption curve on the graph.

At approximately 32 Hz the additional pump losses start to exceed the savings. Accordingly, the optimum energy efficiency frequency in the system considered is 38 Hz. If the pump was not speed-controlled, the energy balance would be even worse.

Experience shows that pumps often can't work at the optimum operating point. Air conditioning systems,

for example, have to work at higher cooling capacities in summer than in winter. However, as the system has to be sized in line with the maximum power required, it is forced to operate at part-load much of the time.

Some pump manufacturers have started to take this into account. They are designing their units so that optimum efficiency is achieved at approximately 70% of delivery rate.

With VLT[®] drives, the BMS system can remotely request data about duty cycles and energy consumptions from the drives, making it easy to monitor your energy savings and return on investment. Monitoring via fieldbus often makes energy meters omissible.

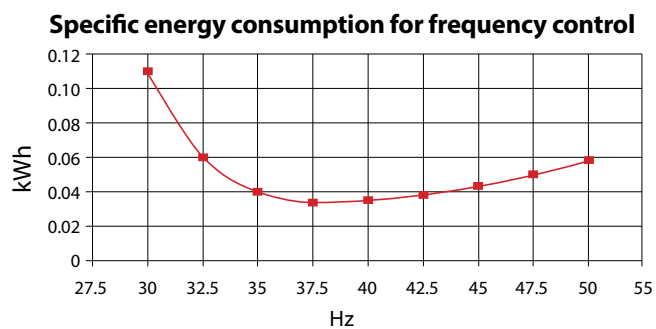

The curve shows the energy consumed by a typical pump under speed control. At approx. 32 Hz the additional pump losses start to exceed the savings. Accordingly, the optimum energy efficiency frequency in the system considered is 38 Hz. If the pump was not speed-controlled, the energy balance would be even worse.

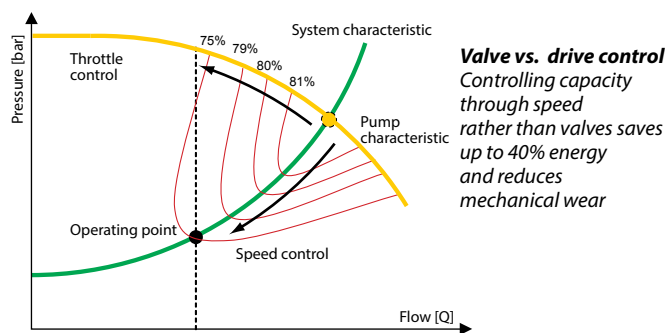

In addition to the pump and system characteristics, the graph also shows efficiency lines. Both throttle control and speed control cause the operating point to move out of the optimum efficiency range.

Valve vs. drive control
Controlling capacity through speed rather than valves saves up to 40% energy and reduces mechanical wear

Motor efficiency performance

For the purpose of implementing the Eco-design Directive 2005/32/EC, the EU has adopted new Minimum Efficiency Performance Std. (MEPS) for three-phase induction motors. The table below shows the required efficiency levels and effective dates.

Effective Date	Power	DOL efficiency	Alternatives level
As of 16/06/2011	0.75 – 375 kW	IE 2	–
As of 01/01/2015	0.75 – 7.5 kW	IE 2	–
	7.5 – 375 kW	IE 3	IE 2 + converter
As of 01/01/2017	0.75 – 375 kW	IE 3	IE 2 + converter

Comparison to current efficiency levels

IEC 60034-30	eff Classes
IE 1 (standard efficiency)	Comparable eff2
IE 2 (high efficiency)	Comparable eff1
IE 3 (premium efficiency)	Approx. 3-5% better than IE 2

Danfoss offers you a global team of engineers dedicated to the pump business; experts within variable speed pumping as well as power electronics and motor control.

This global staff helps you achieve cost reductions and optimised pump operation through higher system efficiency, easier installation and more reliable operation.

With factory installed package solutions, pump OEM's will save installation time, cost and obtain better quality. With a wide range of powerful standard and optional features, the VLT® drives provide the lowest overall cost of ownership for pump applications.

Save energy

The VLT® drives offers considerable energy savings:

- VLT® efficiency (up to 98%)
- Sleep Mode
- Automatic Energy Optimisation AEO: Typically 3-5% energy saving
- Flow compensation, lowering pressure set point and thus energy consumption under low flow conditions

Save space

The compact design of the VLT® drives make them fit even in small installation spaces.

- Built-in DC coils for harmonic suppression. No need for external AC coils
- Optional, built-in RFI filters in the whole power range
- Intelligent cooling concept reduces need for installation space.

Save cost and protect your system with a series of pump-specific features:

- Cascade controller
- Dry run detection
- End of curve detection
- Motor alternation
- 2-step ramps (initial and final ramp)
- Check valve protection
- Safe stop
- Low flow detection
- Pipe fill mode
- Sleep mode
- Real-time clock
- Password protection
- Overload trip protection
- Smart logic controller

Save cabinet

IP54/55(NEMA 12) enclosure solutions are available 24/7 across the whole power range. VLT® drives can even be delivered in an IP 66 version up to 90 kW.

Save time

VLT® drives are designed with the installer and operator in mind in order to save time on installation, commissioning and maintenance.

- Intuitive user interface with the award-winning control panel (LCP)
- One drive type for the full power range
- Modular VLT® design enables fast installation of options
- Auto tuning of PI controllers
- Robust design and efficient monitoring make the VLT® AQUA Drive maintenance free.

Dedicated to the pump business

The pump business is a global area for Danfoss Drives and you will find our dedicated sales and service staff all over the world 24 hours a day.

Reduce Water Loss

VLT® Pump control enables reduction of pressure as per system requirement, reducing water leakage and non-revenue water.

The graph below shows the impact of a 4 mm hole:

- At 50% flow pressure is 25%
- Water loss 100%: 16,000 m³/year
- Water loss 25%: 6,000 m³/year

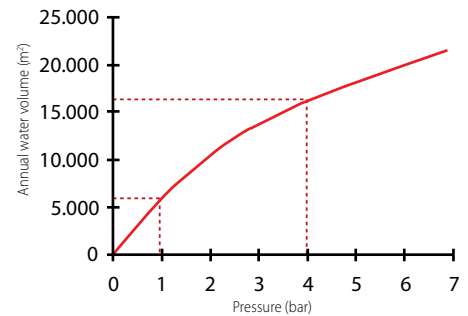

Improved pump control – lower energy consumption

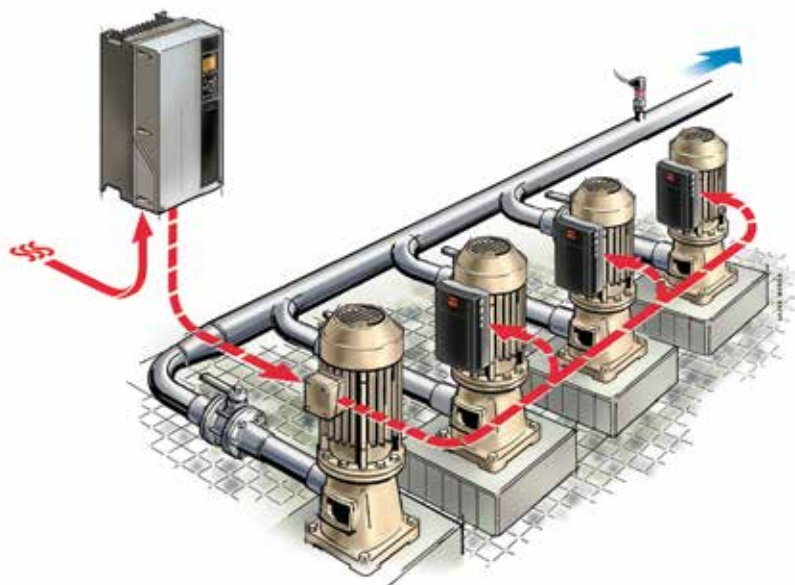

Pressure Booster Application

The primary function of a pressure booster pump is to maintain the desired system pressure over the entire design flow range. Water supply through booster pumps with Danfoss VFD allows operation in cascade and stable pressure, giving

significant energy savings, extended lifetime, reduction in water losses and the dedicated features also reduce installed costs. Due to reductions in pressure variations, the size of hydrofons can be reduced significantly and water towers completely eliminated.

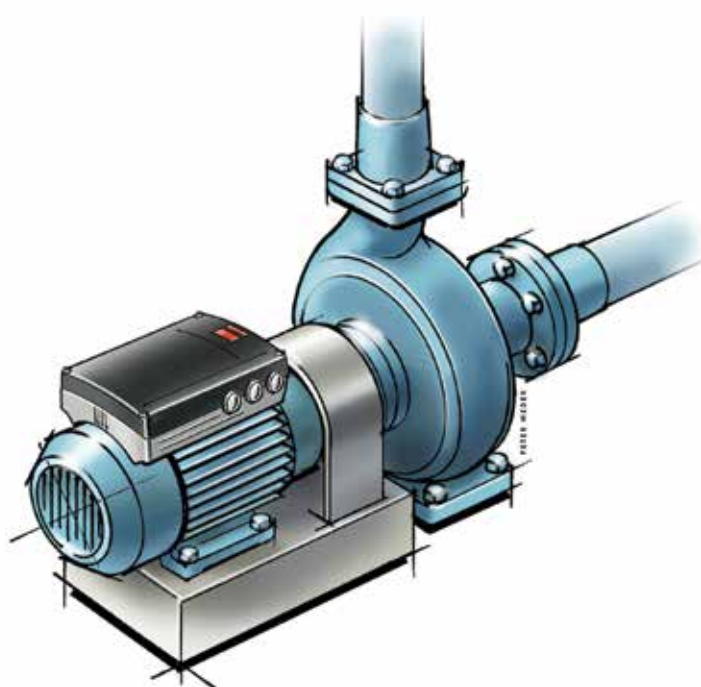

Single Stage Centrifugal Pumps

Pressurize fluids at a given flow rate, enabling the design of systems that meet the process goals of flow and pressure at the desired locations.

A Danfoss VFD covers applications on multiple centrifugal pumps allowing energy savings, increased lifetime, flow compensation and overall reduction in installed costs.

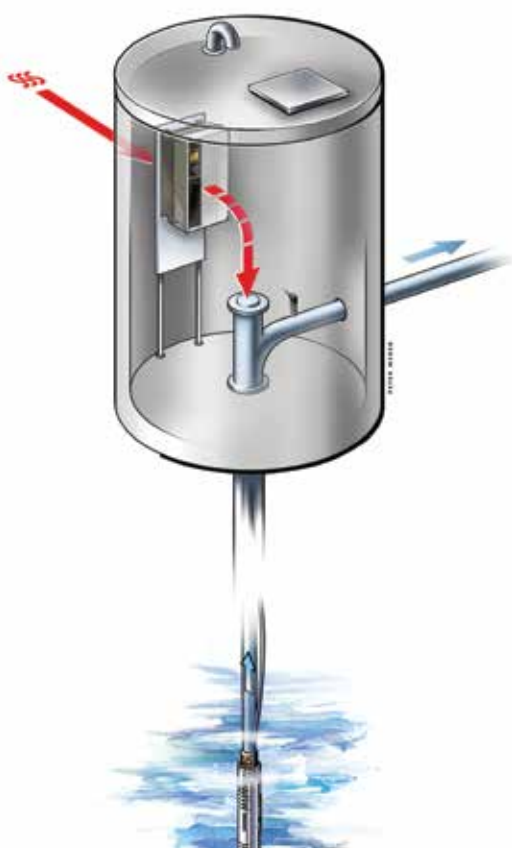
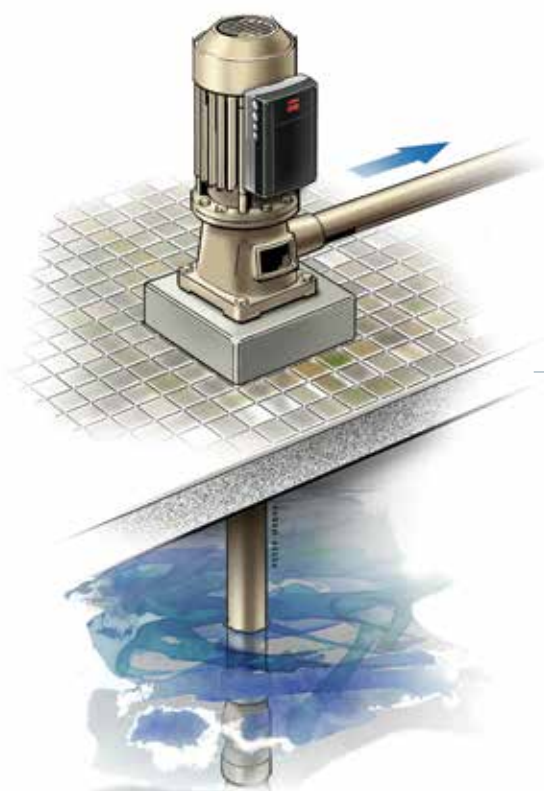

Deep-well shaft and submersible pumps

The deep-well pump is used to lift water from underground before further treatment, filtering and/or distribution. For such pumps with varying head, VLT could bring energy savings, control the pressure or flow as required, reduce water hammer, wear and tear and water loss. It will also extend the time between well renovations, due to reduced sedimentation.

Dedicated pump features

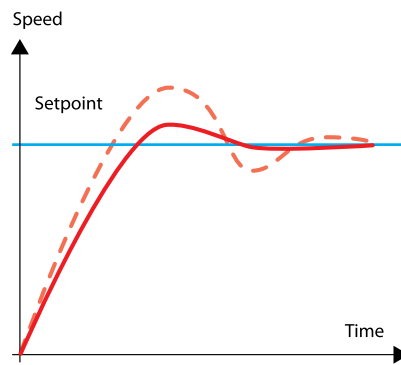

Auto tuning of the PI controllers

With auto tuning of the PI controllers, the drive monitors how the system reacts on corrections made by the drive – and learns from it, so that precise and stable operation is achieved quickly.

Gain factors for PI are continuously changed to compensate for changing load characteristics.

This applies to each PI controller in the 4-menu sets individually.

Exact P and I settings at start-up will not be necessary – which lowers the commissioning costs.

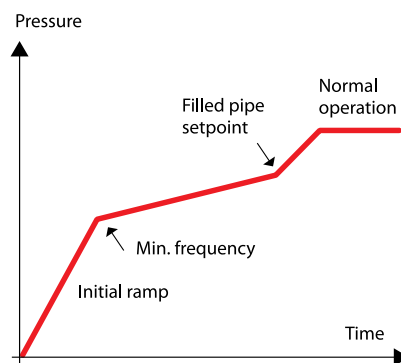

Pipe-Fill Mode

Enables controlled (closed loop) filling of pipes.

Prevents water hammer, pipe bursts or sprinkler head blow-off.

The new pipe-fill mode is usable in both vertical and horizontal pipe systems.

Useful in all applications where controlled pipe filling is demanded, such as irrigation systems, water supply systems, etc.

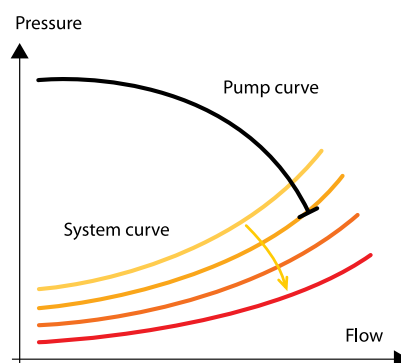

End-of-Pump Curve detects breaks and leakage

The feature detects breaks and leakage. End-of-curve triggers an alarm, shuts off the pump, or performs another programmed action whenever a pump is found running at full speed without creating the desired pressure – a situation that can arise when a pipe breaks or leakage occurs.

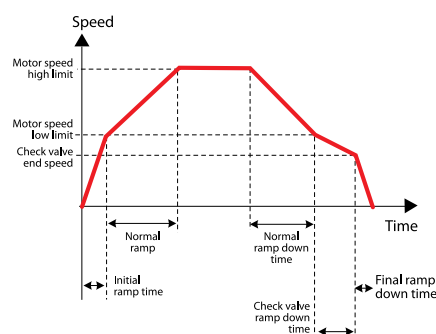

Check Valve Ramp

The Check Valve Ramp prevents water hammer as the pump stops and the check valve closes.

The Check Valve Ramp slowly ramps down the pump speed around the value where the check valve ball is about to shut.

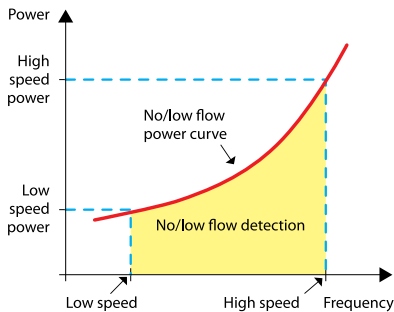

Dry Pump Protection lowers maintenance costs

The VLT® drive constantly evaluates the condition of the pump, based on internal frequency/power measurements.

In case of a too-low power consumption – indicating a no-or low-flow situation – the VLT® drive will stop.

Sleep Mode

Sleep Mode keeps pump wear and power consumption to an absolute minimum. In low flow situations, the pump will boost the system pressure and then stop.

Monitoring the pressure, the VLT® drive will restart when the pressure falls below the required level.

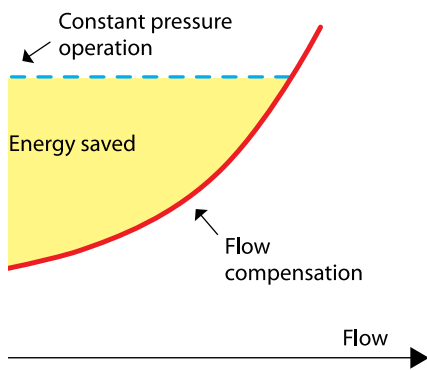

Flow compensation

The flow compensation feature in VLT® drives exploits the fact that flow resistance decreases with reduced flow.

The pressure set-point is accordingly reduced – which saves energy.

Motion of the stand-by pump prevents sticking of the pump. An internal timer ensures equal usage of the pumps.

With an option card it is possible to control alternations between up to 8 pumps.

Motor Alternation

This built-in logic controls alternation between two pumps in duty/stand-by applications.

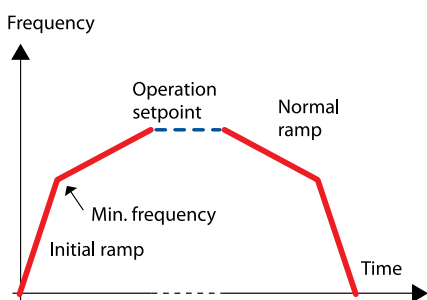

Initial/Final Ramp

The initial ramp provides fast acceleration of pumps to minimum speed, from where the normal ramp takes over. This prevents damage to the thrust bearings on the pump.

The final ramp decelerates pumps from min. speed to stop.

Payback time indication

One of the major reasons for applying a VLT® drive is the very short payback time due to energy savings. The VLT® drive comes with a unique feature which continuously shows the remaining payback time for the investment.

VLT® Energy Box

With VLT® Energy Box software you can both theoretically estimate your energy consumption in the design phase and afterwards validate your real energy savings and reductions in your carbon footprint – from your desk.

VLT® Energy Box makes energy consumption calculations of HVAC pumps and cooling tower applications driven by Danfoss VLT® drives and compares them with alternative methods of flow control.

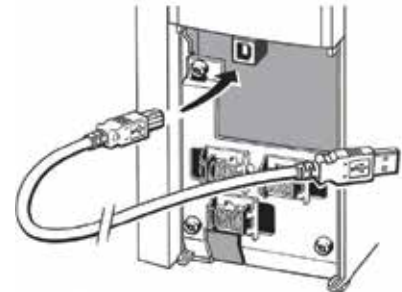

The program compares the total operational costs of various traditional systems compared to operation of the same system with a VLT® drive.

This data can be used to validate the energy performance against the original estimate

The VLT® Energy Box communicates with the drives through the USB/RS 485 protocol and can read all the data about duty cycle and energy consumption data that is recorded and stored in the drive.

The software allows you to upload real trend and energy data, to present multiple systems in one report and to calculate energy consumption for cooling towers.

Perfect

tool for:

- ROI calculations
- Obtaining energy savings
- Calculating pay-back time

Complete financial analysis

VLT® Energy Box provides a complete financial analysis including:

- Initial cost for the drive system and the alternative system
- Installation and hardware costs
- Annual maintenance costs and any utility company incentives for installation of energy conservation products
- Payback time and accumulated savings are calculated
- Post-installation validation of energy performance

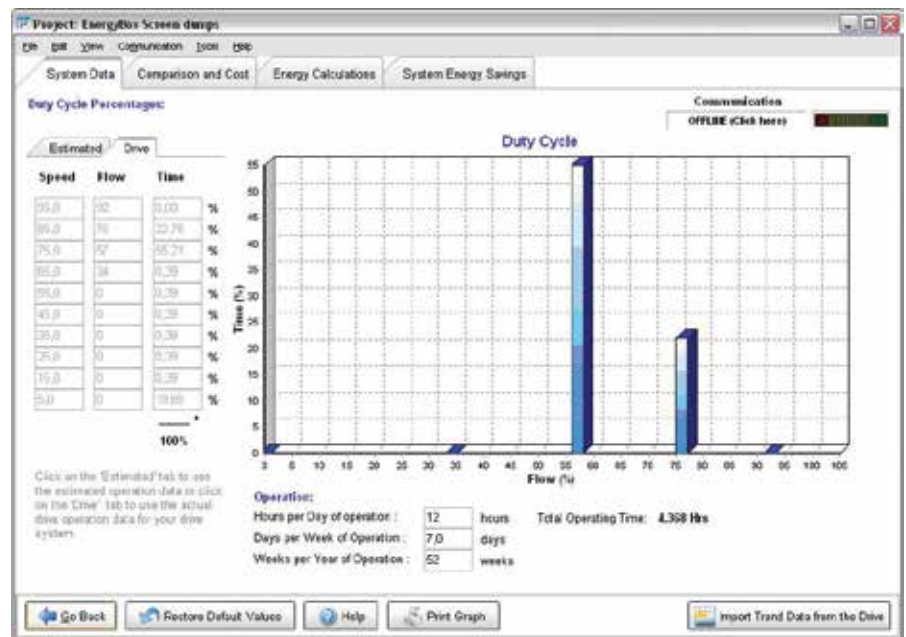

Feature	Benefit
Estimate savings	Simplify purchasing decision
Calculates pay back based on investments and annual costs	Economical overview
Generates a report	Easy communication and documentation
Special cooling tower mode based on climate data	Easy calculation
Possible to adjust climate region to local conditions	More accurate calculations
Download of energy data from the drive via serial communication and USB	Facilitates the drives payback function Visualize actual load profile
Covers several projects and systems in same file	Generation of common project report
ROI validation	Economical documentation
Energy savings validation	Environmental documentation

Simple and effective

Since VLT® Energy Box both estimates, and afterwards measures, the real energy savings, it is a very effective and trustworthy means for calculating project energy consumption profiles involving many pumps and cooling towers. You can simply install a VLT® drive and check the actual savings to exactly calculate the benefits from installing VLT® drives on the other applications.

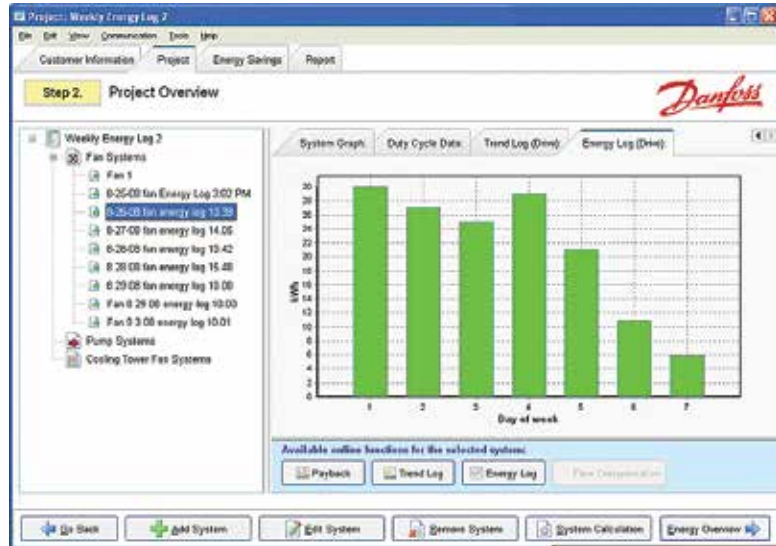

Considers local conditions

- VLT® Energy Box uses local weather data in its calculations for cooling towers. Data from weather zones around the globe are pre-installed, but the user is free to adjust these data according to local conditions.
- The new VLT® Energy Box shows its results for each application – one by one – and also for the total building or project.
- The layout and content of the report is flexible and user friendly.



Specify the curve

- Energy Box offers an advanced mode to specify the fan or pump curve in more detail.
- The fan or pump (equipment) curve can be adjusted to match almost any shape.

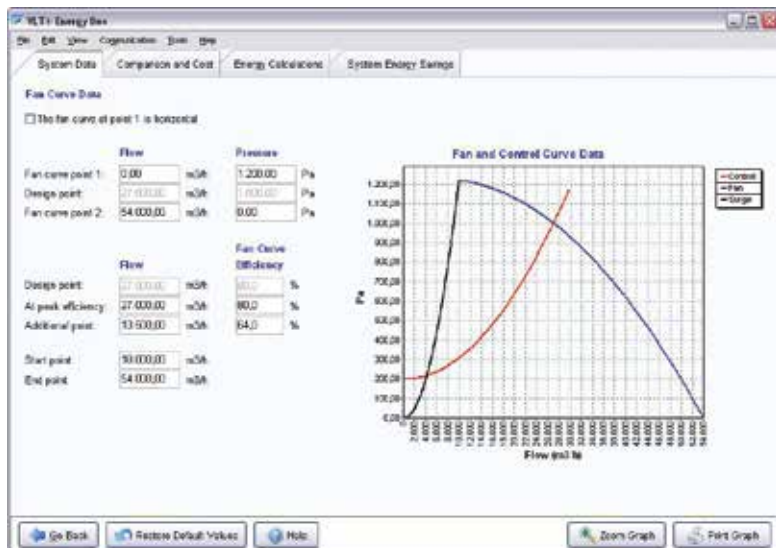

Maximum flexibility with VLT® Cascade Controller – customised for up to 3, 6 or 8 pumps

3 Basic

The Basic Cascade Controller is built in to VTL® drives. It controls up to three pumps

6 Extended

The VLT® Extended Cascade Controller option MCO 101 controls up to six pumps. As an extension of the Basic Cascade Controller
– or for Mixed pump applications
– or for Master follower applications

8 Advanced

The VLT® Advanced Cascade Controller option MCO 102 controls up to eight pumps. As an extension of the Basic Cascade Controller
– or for Mixed pump applications
– or for Master follower applications

The controller provides accurate flow, pressure, and level control that make your multiple pump systems work in an optimised efficient way.

The VLT® drives have a basic cascade function embedded in the drive itself that controls up to three pumps. Cascade control of more than three pumps requires the Multi-function Cascade Controller option.

The VLT® Cascade Controller controls speed and sequence of up to eight pumps or blowers in three modes.

Standard cascade mode

- Variable speed of one motor and on/off control of the remainder

Mixed pump mode

- Variable speed of a few pumps and on/off control of the remainder
- Support of unequal size pumps.

Master/Follower mode

- Controls all pumps with optimised speed. This mode is the most energy optimised solution.
- Ensures maximum performance with minimum pressure surges.

In all three modes, pumps are staged on or off depending on the need.

Run-time balancing

The cascade controller can be used to balance the run-time for each pump in a system.

Energy consumption [kWh]

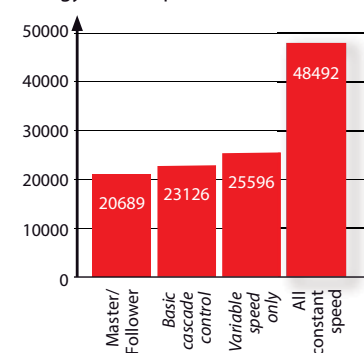

Using Master/Follower mode can reduce the energy consumption to less than half compared to traditional across the line on/off cycling of pumps/blowers and valve throttling.

Same hardware up to 1.4 MW

The same cascade controller hardware is common to the entire power range up to 1.4 MW.

Lead pump alternation is possible with all VLT® Cascade Controllers, even the built-in Basic Cascade Controller.

The feature ensures that up to eight pumps or blowers are used equally and ensures that pumps will not run for extended periods.

Alternation can be programmed to take place on digital input, when in sleep mode, when a pump is destaged, or at preset times.

Pump Interlocking

In case a pump or blower is out of order or being serviced the VLT® Cascade Controller can be set – manually or by digital input – in "Pump Interlocking".

The cascade controller will then skip the specific pump or blower in its staging sequences.

Easy commissioning and service

The VLT® Cascade controller can be commissioned from the drive display or using MCT10 PC software in its free-of-charge download version. The MCT10 configuration tool makes setup of the cascade controller parameters very easy.

The pump status can be followed in the drive display during operation and the run-time of each pump together with the number of starts are logged. System performance is easily tracked.

Built-in

The Multi-function Cascade Controller option is mounted directly within the drive and includes a host of pump control features. This often eliminates the need for PLC's and other external control equipment.

Easy upgrade

With the VLT® plug and play flexibility in adding option cards in the drive, it is very easy to expand the Basic Cascade Controller. Minimum time and no extra space is required.

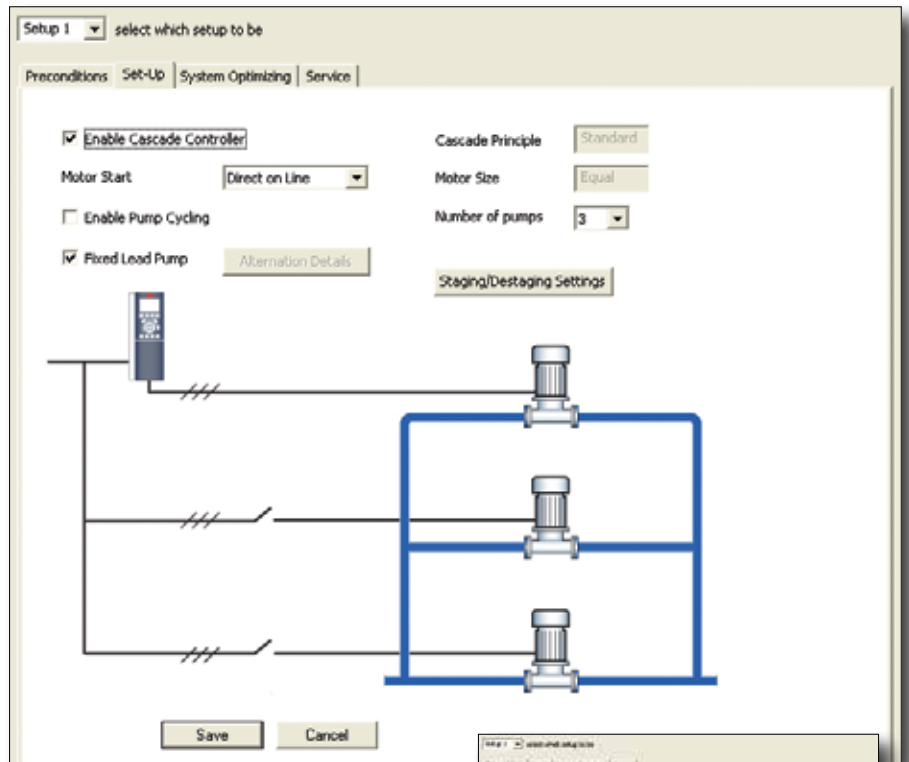

Screen shot of MCT 10 Cascade Controller configuration tool. A wizard to set up the controller.

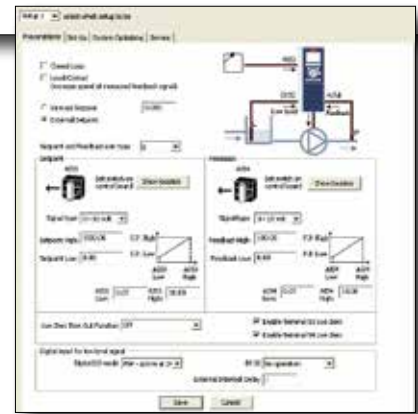

Mark the number of pumps and whether the lead pump has fixed speed etc. – and all parameters in the drive are set.

Installed value

Pump OEMs prefer a factory pack solution. Compared to field installation, a factory packed solution costs less, is more reliable and saves time.

Example:

Buy three VLT® AQUA Drives with extended cascade controller, and you need not buy soft starters, controllers, disconnects, check valves, dry-run flow switches and you save commissioning time.

For only an addition 7% of the cost, you get all the benefits of advanced VLT control.

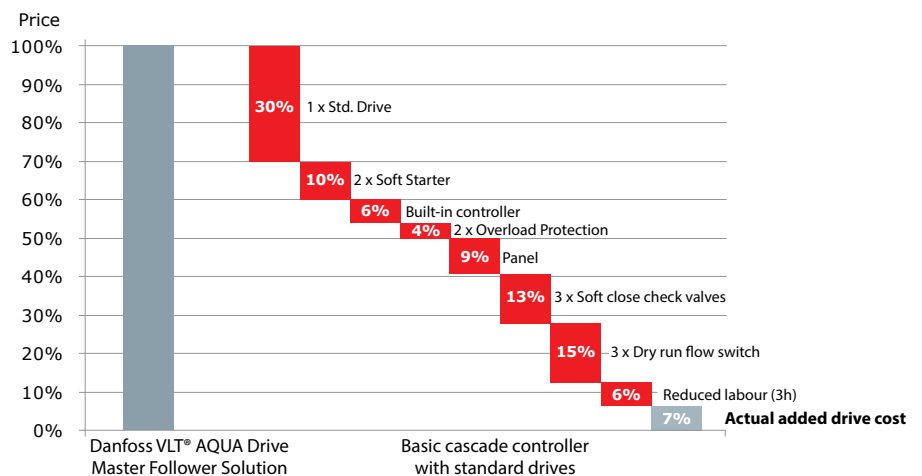

VLT® Motion Control Tool MCT 10

The VLT® Motion Control Tool, MCT 10, is ideal for commissioning and servicing the drive including guided programming of cascade controller, real-time clock, smart logic controller and preventive maintenance.

The set-up software provides easy control of details as well as a general overview of drive systems, large or small. The tool handles all drive related data.

More efficient service organization

- Scope & logging: Analyses problems easily
- Read-off-site out alarms, warnings and fault log in one view.
- Compare saved project with on-line drive

More efficient commissioning

- Off-line commissioning offsite
- Save/send/mail projects anywhere
- Easy field-bus handling, multiple drives in project file. Enables service organization to be more efficient

Internet download

The MCT 10 software can be downloaded free of charge at <http://www.danfoss.com/drives> or <http://www.vlt-software.com>.

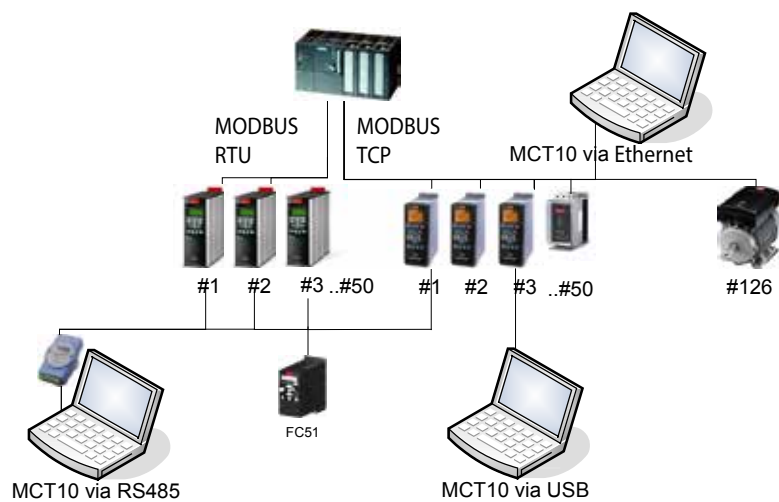

Feature	Benefit
• "Explorer-like" view	• Easy to use
• Option programming	• Saves time
• On-line and off-line commissioning	• Saves costs
• Scope & logging	• Easy analysis – less downtime
• Alarm history	• Easy fault-finding
• Multiple interfaces	• Easy connection
• USB connection	• Easy connection

Advanced version:

- Scope & Graph
- Alarm history in saved projects
- No limitation in number of drives

System Requirements:

MS Windows® XP and Windows® 7
 Pentium III 350 MHz or better
 512 Mb RAM or better
 Free hard disk space: 200 Mb
 CD-ROM drive: Yes
 VGA or XGA graphic adapter: Yes
 Mouse: Yes

VLT® Harmonic Calculation Tool MCT31

Avoiding a problem is better than curing it after the installation is done. Use VLT® Harmonic Calculation Tool MCT31 for free of charge evaluation of harmonic distortion.

Save money and reduce running costs

On the basis that it is better to avoid a problem rather than cure one after it happens, it is preferable to calculate the effect of installing non-linear loads before doing so, to estimate the degree of harmonic distortion that may result.

Trying to achieve this on a spreadsheet basis can be time consuming and inaccurate.

To help, Danfoss offers free to download, the VLT® Harmonic Calculation Tool MCT 31, a simple-to-use and fast software tool for calculating the harmonic disruption from your existing or intended drives installation.

A fast estimate is vital as, in this case, more is not better, simply more costly, so the MCT 31 can help save money when selecting harmonic mitigation solutions.

Simply over-specifying a harmonic mitigation solution will lead to unnecessary initial cost escalation and increased running expenses.

Calculate the harmonic disturbance

The MCT 31 tool can easily be used to evaluate the expected grid quality and includes a range of passive and active counter-measures which can be selected to ease system stress.

The power quality impact of electronic devices can be estimated in the frequency range up to 2.5 kHz, depending on the system configuration and standard limits.

The analysis includes indication of compliance with various standards and recommendations. The Windows-like interface of the MCT 31 tool

makes possible intuitive operation of the software. It is built with a focus on user-friendliness and the complexity is limited to system parameters that are normally accessible.

The Danfoss VLT® drives and mitigation equipment data is already pre-loaded, allowing fast data entry.

Your local Danfoss consultant will be very happy to provide all the assistance you need to evaluate your power quality and advice in the selection of the correct mitigation for your circumstances.

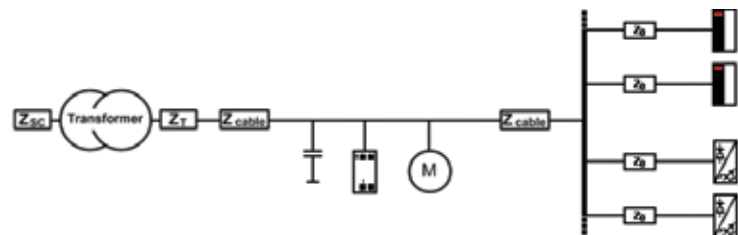

Calculation results			
RMS current	756.4 A	Transformer load percentage	113.8
Displacement power factor	0.97	Short circuit ratio	14.3
True power factor	0.94	Harmonic resonance number	0.0
		Transformer voltage THD	11.0 %
		Transformer current THD	25.5 %
		Total Demand Distortion (TDD)	24.7 %

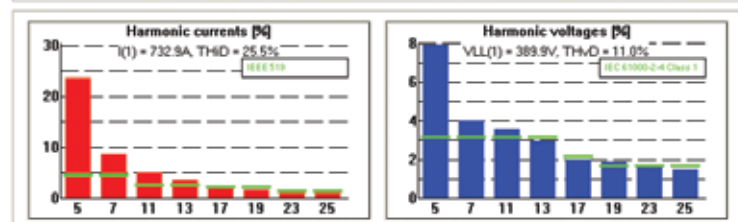

Proven pump experience – world wide



Monterrey City, Mexico

Agua y Drenaje de Monterrey in Mexico is installing Danfoss VLT® drives in wastewater treatment plants, boost pump stations and water wells for both residential and commercial areas in Monterrey – the largest industrial city in Mexico with 3.5 million people. Benefits from VLT® operation of the pumps are energy savings of about 30% and also reduction of water leakage.

Izmir Geothermal District Heating System, Turkey
VLT® drives operate the deep well and supply pumps in Izmir geothermal district heating. Applying VLT® drives leads to a very low electricity cost.



Xi'An No.3 Waste Water treatment, China

Danfoss provided VLT® AQUA Drives and MCD soft starters for Xi'An No.3 Wastewater treatment plant. It is one of three bundles of a retrofit project to improve the environment in Xi'An City of Shanxi province, China. The treatment capacity is 100,000 tons of sewage and 50,000 tons of recycled water per day.

Vienna's Main Sewage Treatment Plant, Austria

At Vienna's lowest point, where the Danube Canal meets the Danube, lies Vienna's Main Sewage Treatment Plant. Here around 90% of Vienna's wastewater is purified. VLT® drives were chosen to operate the pumps that handle more than 500,000 cubic metres per day, which corresponds to the flow of a medium-size river. It takes about five hours for the wastewater to pass through the mechanical and biological purification stages before it is purified and discharged into the Danube Canal.



Changi Water Reclamation Plant, Singapore

The Changi Water Reclamation plant is the cornerstone of the first phase of the Singapore Deep Tunnel Sewerage System. The plant is to replace six existing water reclamation plants in the long term. Danfoss VLT® drives and AHF filters were supplied for chemical and carbon scrubbers for the odour control, sedimentation tanks, bio-reactors, sedimentation tanks and solids building.

Wastewater pumping station, Columbia

Danfoss Water & Wastewater division's expertise in the application of variable speed drives to pump systems, provided major dividends in offering a cost-effective, efficient pumping solution to this wastewater treatment plant retrofit in South America.





Power options

Danfoss Drives offers a wide range of external power options for use together with our drives in critical networks or applications:

- **Sine Wave filters** (LC filters): For noiseless motor and low dU/dt. Sine Wave filters are recommended for deep well pumps.
- **dU/dt filters:** For providing motor isolation protection
- **Advanced Harmonic Filters:** for applications where reducing harmonic distortion is critical (hospitals, airports, etc.)

Application options

A wide range of integrated water application options can be fitted into the drive:

General purpose I/O option:

3 digital inputs, 2 digital outputs, 1 analog current output, 2 analog voltage inputs

Relay option/cascade controller option:

3 relay outputs

External 24 VDC supply option:

24 VDC external supply can be connected to supply control and option cards

PC software

- **VLT Energy Box**
– a comprehensive energy analysis tool, it shows the drive payback time.
- **MCT 10**
– ideal for commissioning and servicing the drive including guided programming of cascade controller, real time clock, smart logic controller and preventive maintenance.
- **MCT 31**
– harmonics calculations tool.

Sales and Service Contacts worldwide

Find your local expert team on www.danfoss.com/drives

- 24/7 availability
- Local hotlines, local language and local stock

Danfoss service organisation is present in more than 100 countries – ready to respond whenever and wherever you need, around the clock, 7 days a week.

Pick your dedicated solution from the VLT® service menu:

Keep you running

- Current drives update
- Commissioning and regular adjustments
- Preventive maintenance

Keep you fit:

- Training
- Stock maintenance & consignment
- Harmonic Survey
- Environmental Disposal

Fix your costs

- Fixed Price
- Post warranty agreement
- Transport insurance
- Response time

VLT® AQUA Drive

Danfoss VLT drives' unequalled experience was used to make VLT® AQUA Drive the perfect match for AC motor driven applications in modern water and wastewater systems – also for retrofitting.

Danfoss VLT® AQUA Drive is dedicated to water and wastewater applications. With a wide range of powerful standard and optional features, VLT® AQUA Drive provides the lowest overall cost of ownership for water and wastewater applications.

Available enclosure ratings:

IP 00/Chassis: 110 – 630 kW
 IP 20/Chassis: 0.25 – 90 kW
 IP 21/UL Type 1: 0.25– 1400 kW
 IP 54/UL Type 12: 110 – 1400 kW
 IP 55/UL Type 12: 0.25– 90 kW
 IP 66/UL Type 4X: 0.25– 90 kW
 Optional coating providing extra protection for aggressive environments.

Power range:

1 x 200 – 240 V AC: 1.1 – 22 kW
 1 x 380 – 480 V AC: 7.5 – 37 kW
 3 x 200 – 240 V AC: 0.25 – 45 kW
 3 x 380 – 480 V AC: 0.37 – 1000 kW
 3 x 525 – 600 V AC: 0.75 – 90 kW
 3 x 525 – 690 V AC: 11– 1400 kW

Features	Benefits
Dedicated features	
• Dry run detection	• Protects the pump
• Flow compensation function	• Saves energy
• 2 step ramps (initial ramp)	• Protects deep well pumps
• Check valve ramp	• Protects against water hammer and saves installed cost on soft close valves
• Pipe fill mode	• Eliminates water hammering
• Built-in motor alternation feature	• Duty-stand by operation, cost reduction
• Sleep Mode	• Saves energy
• No/low flow detection	• Protects the pump
• End of pump-curve detection	• Protects the pump, leakage detection
• Pump cascade controller	• Lower equipment cost
Energy saving	
• VLT® efficiency (98%)	• Saves energy
• Automatic Energy Optimisation (AEO)	• Saves 3–8% energy
• Sleep Mode function	• Saves energy
• Master/follower control	• Saves up to 15% energy
• Auto Tuning of Staging Speeds	• Smoothens the staging and saves energy
Reliable	
• IP 20 – IP 66 enclosures	• Outdoor mounting
• All power sizes available in IP 54/55 enclosures	• Broad usability in standard factory supplied enclosure
• Password protection	• Reliable operation
• Mains disconnect switch	• No need for external switch
• Optional, built-in RFI suppression	• No need for external modules
• Built-in Smart Logic Controller	• Often makes PLC omissible
• One Wire safe stop	• Safe operation/less wiring
• Max. ambient temperature up to 50° C without derating	• Reduced need for cooling
User-friendly	
• Award winning control panel (LCP)	• Effective commissioning and operation
• One drive type for the full power range	• Less learning required
• Intuitive user interface	• Time saved
• Integrated Real Time Clock	• Lower equipment cost
• Modular design	• Enables fast installation of options
• Auto tuning of PI-controllers	• Time saved
• Payback time indication	• Less worries

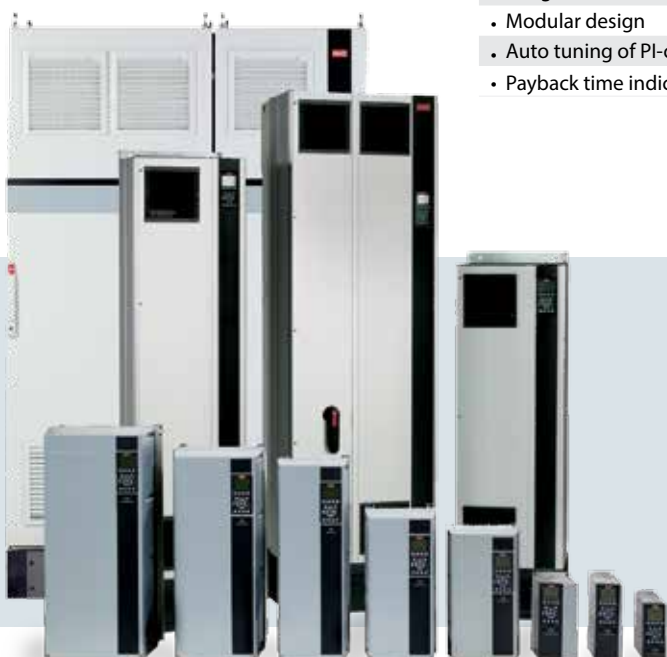

VLT® HVAC Drive

The VLT® HVAC Drive series is available in a wide power range designed for all HVAC applications. This is an advanced drive built on HVAC dedication and knowledge.

The VLT® HVAC Drive is a full-featured, HVAC dedicated drive with built-in intelligence.

The VLT® HVAC Drive has a vast number of functions developed to meet the diverse needs of the HVAC business.

It is the perfect match for pumps and compressors in modern buildings that are fitted with increasingly sophisticated solutions.

Available enclosure ratings:

IP 00/Chassis:..... 45 – 630 kW

IP 20/Chassis:..... 1.1 – 90 kW

IP 21/UL Type 1:..... 1.1 – 1400 kW

IP 54/UL Type 12:..... 45– 1400 kW

IP 55/UL Type 12:..... 1.1 – 90 kW

IP 66/UL Type 4X:..... 1.1 – 90 kW

Optional coating providing extra protection for aggressive environments.

Power range:

3 x 200 – 240 V:..... 1.1 – 45 kW

3 x 380 – 480 V:..... 1.1 – 1000 kW

3 x 525 – 600 V:..... 1.1 – 90 kW

3 x 525 – 690 V:..... 1.1 – 1400 kW

Feature	Benefit
All built-in – low investment	
• Modular product concept with a wide range of options	• Low initial investment – max. flexibility, later upgrade possible
• Dedicated HVAC I/O functionality for temperature sensors etc.	• External conversion saved
• Decentral I/O control via serial communication	• Reduced wiring costs, and external controller I/O saved
• Wide range of HVAC protocols for BMS controller connectivity	• Fewer gateway solutions needed
• 4 x auto tuned PID's	• No external PID controller needed
• Smart Logic Controller	• Often makes PLC unnecessary
• Real Time Clock	• Enables daily and weekly settings
• Integrated fan, pump and compressor functionality i.e.	• Reduces external control and conversion equipment
• Fire Override Mode, Dry run Detection Constant Torque etc.	• Protects equipment and saves energy
Save energy – less operation cost	
• Automatic Energy Optimizer function, advanced version	• Saves 5 – 15% of motor losses
• Advanced energy monitoring	• Overview of energy consumption
• Energy saving functions i.e. flow compensation, sleep mode etc.	• Energy and extended lifetime
Unequaled robustness – maximum uptime	
• Robust single enclosure	• Maintenance-free
• Unique cooling concept with no ambient air flow over electronics	• Problem-free operation in harsh environments
• Max ambient temp. 50° C without derating	• No external cooling or oversize necessary
User friendly – save commissioning and operating cost	
• Smart start	• Quick and precise start-up
• Awarded graphical display, 27 languages	• Effective commissioning and operation
• USB plug and play connection	• Easy to use PC software tools
• Global HVAC support organisation	• Local service – globally
Built-in DC coils and RFI filters – no EMC concerns	
• Integrated DC link harmonic filters	• Small power cables. Meets EN 61000-3-12
• Integrated EMC filters	• Meets EN 55011 Class B, A1 or A2



Product overview



VLT® AQUA Drive

VLT® AQUA Drive is the perfect match for pumps and blowers in modern water and wastewater systems, offering advanced application protective features.

Available with cascade control of up to 8 pumps in fixed speed mode or master/follower mode.

- 1 x 200 – 240 V, 1.1 – 22 kW
- 1 x 380 – 480 V, 7.5 – 37 kW

- 3 x 200 – 240 V, 0.25 – 45 kW
- 3 x 380 – 480 V, 0.37 – 1000 kW
- 3 x 525 – 600 V, 0.75 – 90 kW
- 3 x 525 – 690 V, 45 – 1400 kW
- Built-in DC coils and RFI-filter (optional)
- Integrated communication options (Modbus RTU, Profibus, DeviceNet, EtherNet IP)
- Multiple PID loops for advanced AQUA control
- Platinum and Nickel temperature sensor inputs
- Application specific menus for quick and easy programming
- Capability for constant torque loads
- Preventive maintenance scheduling



VLT® HVAC Drive

The VLT® HVAC Drive continues Danfoss' leadership in dedicated HVAC features and applications for drives.

Advancements in energy monitoring, trending, system maintenance and operation are combined with a modular platform to make the drive easy to operate while feeding back all the operation information you need.

- 3 x 200 – 240 V, 1.1 – 45 kW
- 3 x 380 – 480 V, 1.1 – 1000 kW
- 3 x 525 – 600 V, 1.1 – 1000 kW
- 3 x 525 – 690 V, 45 – 1400 kW
- Built-in DC coils and RFI-filter (optional)
- Integrated communication options (Modbus RTU, BACnet, LonWorks and more)
- Multiple PID loops for advanced HVAC control
- Platinum and Nickel temperature sensor inputs
- Application specific menus for quick and easy programming
- Capability for compressor control
- Preventive maintenance scheduling



VLT® DriveMotor FCM 300

The VLT® DriveMotor FCM 300 is a very compact alternative to the traditional solution with a VLT® drive and motor as separate units.

Power range:
0.55 – 7.5 kW, 3 x 380 – 480 V

Enclosure:
IP 55 (IP 65, IP 66)

Also available:
2-pole or 4-pole motors
Sensorless pump control software



VLT® Micro Drive

A compact general purpose drive for AC motors up to 22 kW.

It performs perfectly even in complex application set-ups and optimises energy efficiency and operation.

- 1 x 200 – 240 V, 0.18 – 2.2 kW
- 3 x 200 – 240 V, 0.25 – 3.7 kW
- 3 x 380 – 480 V, 0.37 – 22 kW
- Multipurpose
- Process PI-controller
- Automatic Energy Optimiser (AEO)
- Automatic Motor Adaptation (AMA)
- 150% motor torque up to 1 minute
- Smart Logic Controller



VLT® Soft Starter MCD 500

VLT® Soft Starter MCD 500 is a total motor starting solution. Current transformers measure motor current and provide feedback for controlled motor ramp profiles.

Adaptive Acceleration Control (AAC), automatically employs the best starting and stopping profile for the application.

Power range:
21 – 1600 A, 7.5 – 850 kW
(1,2 MW inside Delta Connection)
Versions for 200 – 690 VAC



The VLT® Compact Starter MCD 200

is a compact and cost effective soft starter range for applications where direct-on-line starting is undesirable.

MCD 200 is the perfect alternative to other reduced voltage starting methods, such as star/delta starters, due to its compact size and full functionality.

- Versions for 200 – 575 V AC, 7.5 – 110 kW, max. 200 A
- Voltage ramps or current limit ramp soft start
- Built-in motor protection
- Compact design with internal bypass system for minimum power loss
- Add-on modules for remote operation and serial communication

VLT® drive accessories

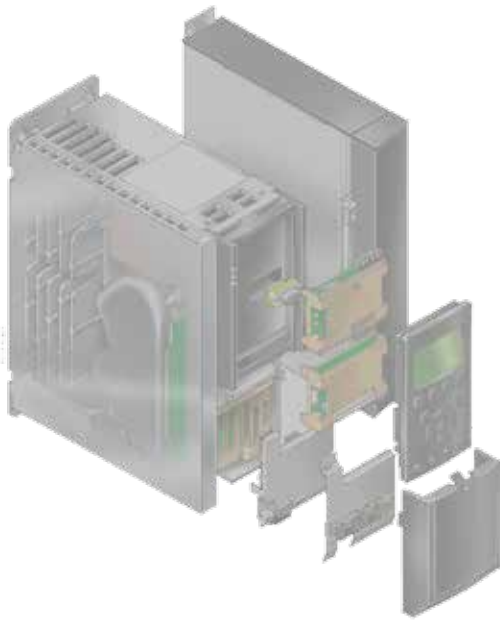

VLT® Harmonic Filter AHF 005/010 MCE

Easy, effective harmonic distortion reduction by connecting the AHF 005/010 harmonic filter in front of a Danfoss drive.

- AHF 005 reduces total harmonic current distortion to 5%
- AHF 010 reduces total harmonic current distortion to 10%
- Small compact housing that can be fitted into a panel
- Easy to use in retrofit applications
- User-friendly start-up – no adjustment necessary
- No routine maintenance required



VLT® Sine-Wave Filter MCC 101

Sine-wave filters are placed between the drive and the motor to optimise the motor power current.

It provides a sinusoidal phase-to-phase motor voltage. The filters reduce motor insulation stress, acoustic noise from the motor, and bearing currents (especially in large motors).

Sine-Wave filters are recommended for deep-well pumps

- Reduces motor insulation stress
- Reduces acoustic noise from the motor
- Reduces bearing currents (especially in large motors)
- Enables the use of longer motor cables
- Reduces losses in the motor
- Prolongs service lifetime
- IP 20 or IP 21



VLT® dU/dt filter MCC 102

VLT® dU/dt filters are placed between the drive and the motor to eliminate very fast voltage changes.

The motor terminal phase-to-phase voltage is still pulse shaped but its dU/dt values are reduced.

- These filters reduce stress on the motor's insulation and are recommended in applications with older motors, aggressive environments or frequent braking which cause increased DC link voltage.
- IP 20 or IP 21



What VLT[®] is all about

Danfoss VLT Drives is the world leader among dedicated drives providers – and still gaining market share.

Environmentally responsible

VLT[®] products are manufactured with respect for the safety and well-being of people and the environment.

All activities are planned and performed taking into account the individual employee, the work environment and the external environment. Production takes place with a minimum of noise, smoke or other pollution and environmentally safe disposal of the products is pre-prepared.

UN Global Compact

Danfoss has signed the UN Global Compact on social and environmental responsibility and our companies act responsibly towards local societies.

EU Directives

All factories are certified according to ISO 14001 standard. All products fulfil the EU Directives for General Product Safety and the Machinery directive. Danfoss VLT Drives is, in all product series, implementing the EU Directive concerning Hazardous Substances in Electrical and Electrical Equipment (RoHS) and is designing all new product series according to the EU Directive on Waste Electrical and Electronic Equipment (WEEE).

Impact on energy savings

One year's energy savings from our annual production of VLT[®] drives will save the energy equivalent to the energy production from a major power plant. Better process control at the same time improves product quality and reduces waste and wear on equipment.

Dedicated to drives

Dedication has been a key word since 1968, when Danfoss introduced the world's first mass produced variable speed drive for AC motors – and named it VLT[®].

Twenty five hundred employees develop, manufacture, sell and service drives and soft starters in more than one hundred countries, focused only on drives and soft starters.

Intelligent and innovative

Developers at Danfoss VLT Drives have fully adopted modular principles in development as well as design, production and configuration.

Tomorrow's features are developed in parallel using dedicated technology platforms. This allows the development of all elements to take place in parallel, at the same time reducing time to market and ensuring that customers always enjoy the benefits of the latest features.

Rely on the experts

We take responsibility for every element of our products. The fact that we develop and produce our own features, hardware, software, power modules, printed circuit boards, and accessories is your guarantee of reliable products.

Local backup – globally

VLT[®] motor controllers are operating in applications all over the world and Danfoss VLT Drives' experts located in more than 100 countries are ready to support our customers with application advice and service wherever they may be.

Danfoss VLT Drives experts don't stop until the customer's drive challenges are solved.

