

**VACON NXP**  
AC DRIVES

**OPTCG**  
S2 OPTION BOARD  
SELMA APPLICATION (APFIEN04)

**USER MANUAL**

## INDEX

Document code: DPD00894A

Date:17.01.2012

1.	GENERAL .....	4
2.	INSTALLATION .....	5
3.	CONNECTIONS .....	7
3.1	Jumper settings .....	7
3.1.1	Jumper settings of <b>4CM0</b> board with OPT-CG: .....	7
3.1.2	Jumper settings of <b>4CM</b> board with OPT-CG:.....	8
4.	COMMISSIONING.....	9
4.1	Parameters.....	9
4.2	LED indications.....	9
5.	OPT-CG Config tool .....	10
6.	Selma application (APFIEN04).....	12
6.1	Introduction .....	12
6.2	Control I/O .....	13
6.3	“Terminal to function” (TTF) programming principle .....	14
6.3.1	Defining an input/output for a certain function on keypad .....	14
6.3.2	Defining a terminal for a certain function with NCDrive programming tool .....	15
6.4	Selma Application – Parameter lists .....	16
6.4.1	M1 > V1.1 Monitor page 1 .....	17
6.4.2	M1>V1.2 Monitor Page 2.....	17
6.4.3	Basic parameters .....	19
6.4.4	Input signals (Control keypad: Menu M2 → G2.2).....	20
6.4.5	Output signals (Control keypad: Menu M2 → G2.3) .....	24
6.4.6	Reference handling (Control keypad: Menu M2 → G2.4) .....	26
6.4.7	Ramp functions (Control keypad: Menu M2 → G2.5) .....	27
6.4.8	Drive control (Control keypad: Menu M2 → G2.6).....	28
6.4.9	Motor control (Control keypad: Menu M2 → G2.7).....	30
6.4.10	Limit settings (Control keypad: Menu M2 → G2.8).....	32
6.4.11	Speed control (Control keypad: Menu M2 → G2.9) .....	33
6.4.12	Oscillation damp (Control keypad: Menu M2 → G2.10).....	34
6.4.13	Brake & fan control (Control keypad: Menu M2 → G2.11).....	34
6.4.14	Master Follower (Control keypad: Menu M2 → G2.12) .....	35
6.4.15	Protections (Control keypad: Menu M2 → G2.13) .....	35
6.4.16	Flux reference handling (Control keypad: Menu M2 → G2.14) .....	37
6.4.17	Startup torque (Control keypad: Menu M2 → G2.15) .....	37
6.4.18	DAC (Control keypad: Menu M2 → G2.16).....	38
6.4.19	Data mapping (Control keypad: Menu M2 → G2.17) .....	38
6.4.20	Keypad control (Control keypad: Menu M3 → R3.1) .....	38
6.4.21	Expander boards (Control keypad: Menu M7).....	38
6.5	Description of parameters .....	39
6.5.1	Basic parameters .....	39
6.5.2	Input signals .....	42
6.5.3	Output signals.....	49

6.5.4	Reference handling .....	50
6.5.5	Ramp functions.....	52
6.5.6	Drive control.....	53
6.5.7	Motor control.....	57
6.5.8	PMSM control.....	60
6.5.9	Limit settings.....	61
6.5.10	Speed control .....	62
6.5.11	Oscillation damp.....	66
6.5.12	Brake and fan control.....	66
6.5.13	Master Follower .....	67
6.5.14	Protections .....	69
6.5.15	Flux reference handling .....	74
6.5.16	Startup torque .....	75
6.5.17	Monitor settings .....	76
6.5.18	Data mapping .....	76
6.6	Fieldbus profile.....	77
6.6.1	Process data signals from overriding system to Vacon drive.....	77
6.6.2	Process data signals from Vacon drive to overriding system.....	77
6.6.3	Main control word, par. 2.17.17 (FB Mode) = 1-3 .....	78
6.6.4	Selma Control Word, par. 2.17.17 (FB Mode) = 4 .....	78
6.6.5	Main status word .....	79
6.6.6	Selma Status Word.....	79
6.6.7	Micro Status Word .....	80
6.6.8	Auxiliary control word .....	80
6.6.9	Auxiliary status word.....	81
6.6.10	Fault word 1.....	81
6.6.11	Fault word 2.....	82
6.6.12	Selma fault word 0 .....	82
6.6.13	Selma fault word 1 .....	83
6.6.14	Selma fault word 2 .....	83
6.6.15	Alarm word 1 .....	84
6.6.16	Digital input status word 1 .....	85
6.6.17	Digital input status word 2 .....	85
6.7	BLOCK DIAGRAMS.....	86
6.8	FAULT TRACING.....	91
<b>7.</b>	<b>Appendix 1 .....</b>	<b>95</b>
<b>8.</b>	<b>Appendix 2.....</b>	<b>96</b>

## 1. GENERAL

Vacon NXP frequency converters can be connected to the Selma System (S2) using a fieldbus board. The converter can then be controlled, monitored and programmed from the host system.

If you purchase your S2 option board separately, please note that it shall be installed in **slot E or D** on the control board of the frequency converter.

For retrofit projects where existing software in the Selma System is to be used without changes, APFIEN04 application can be used.

**Note!** S2 option board can only be used with Vacon **NXP frequency converters**

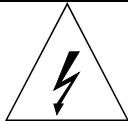



**WARNING!**



*Internal components and circuit boards are at high potential when the frequency converter is connected to the power source. This voltage is extremely dangerous and may cause death or severe injury if you come into contact with it.*

2. INSTALLATION

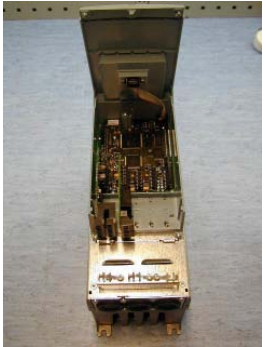
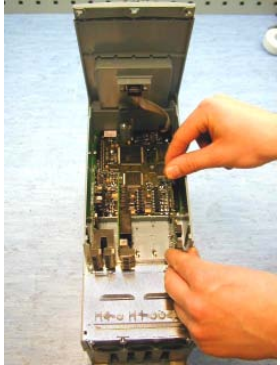
 <b>NOTE</b>	<p>It is <b>not allowed</b> to add or replace option boards or fieldbus boards on a frequency converter with the power switched on. This may damage the boards.</p>
--	---

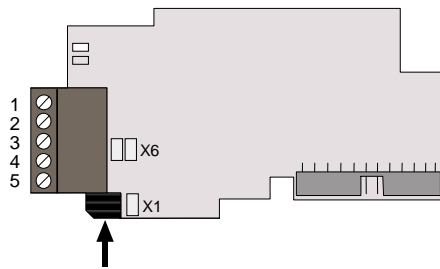
<p><b>A</b></p>	<p>Vacon NX frequency converter</p>	
<p><b>B</b></p>	<p>Remove the cable cover.</p>	
<p><b>C</b></p>	<p>Open the cover of the control unit.</p>	
<p><b>D</b></p>	<p>Install S2 option board in slot E or D on the control board of the frequency converter. Make sure that the grounding plate (see below) fits tightly in the clamp.</p>	

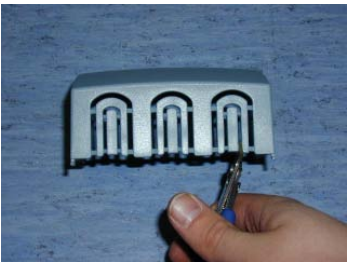

E	Make a sufficiently wide opening for your cable by cutting the grid as wide as necessary.	
F	Close the cover of the control unit and the cable cover.	

**NOTE!** Ground the OPT-CG cable shield as shown below:

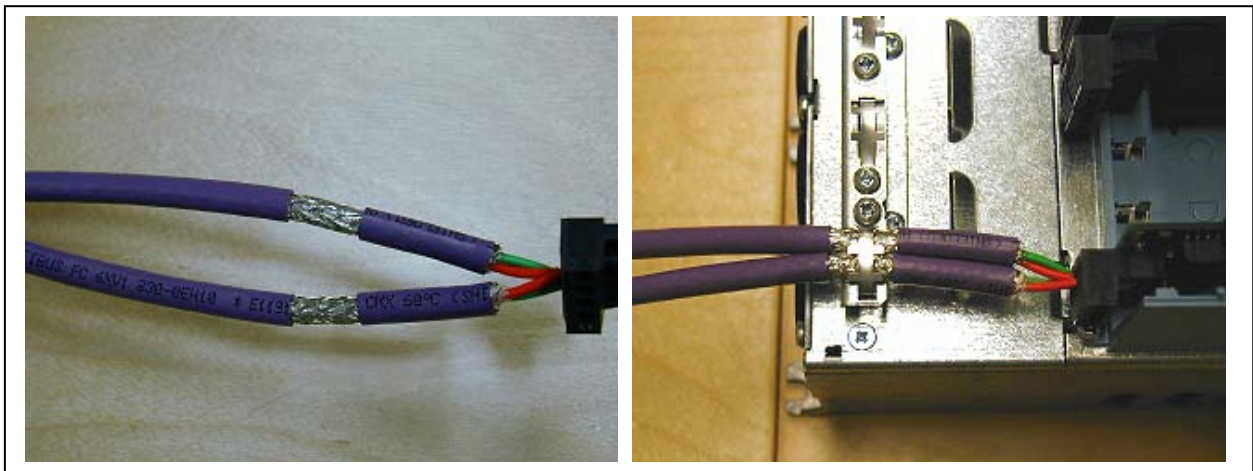

**NOTE!** Perform this grounding only at Vacon's end!

### 3. CONNECTIONS

Vacon S2 option board is connected to the Selma System through a 4-pin pluggable bus connector. The communication with the control board of the frequency converter takes place through the standard Vacon Interface Board Connector.

Vacon OPT-CG		4CM/4CM0			
		Ch 0	Ch 1	Ch 2	Ch 3
T+	1	1	5	9	13
T-	2	2/4	6/8	10/12	14/16
R+	3	17	21	25	29
R-	4	18	22	26	30

Table 3-1. Connections

#### 3.1 Jumper settings

There are two different I/O terminal boards that OPT-CG can be connected to.

**Note!** Wrong “jumping” may damage the boards.

##### 3.1.1 Jumper settings of 4CM0 board with OPT-CG:

In this setting, the OPT-CG board is **active** and the 4CM0 board is **passive**:

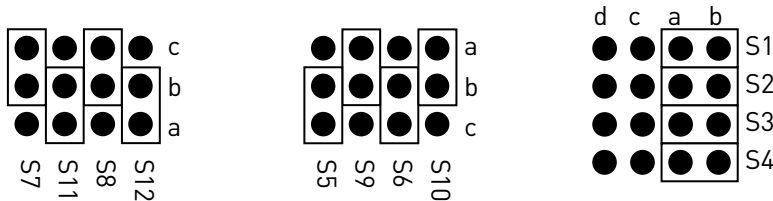

4CM0 board

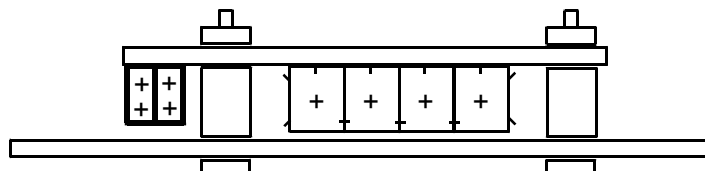

OPT-CG board

3.1.2 Jumper settings of 4CM board with OPT-CG:

In this setting, the OPT-CG board is **passive** and the 4CM board is **active**:

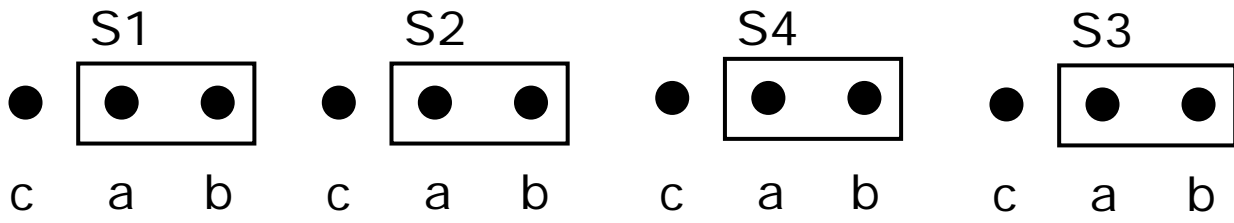

4CM board

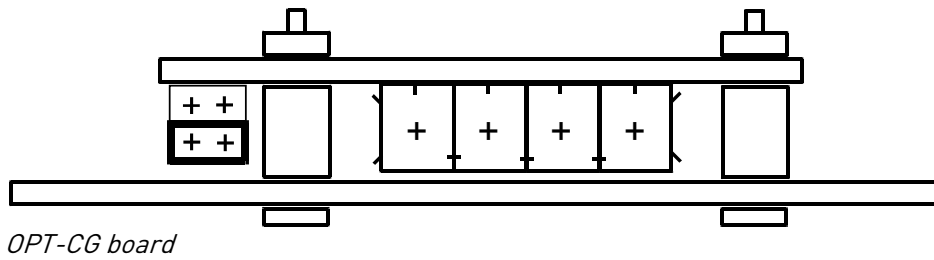

OPT-CG board



## 4. COMMISSIONING

### 4.1 Parameters

Parameters are visible in keypad in menu M7/Expander boards in the corresponding slot in which S2 option board is installed (D/E).

#	Name	Default	Range	Description
1	BAUD RATE	6	5 – 4800 baud 6 – 9600 baud	Communication speed
2	COMMUNICATION TIMEOUT	20	1–600 s	See below

Table 4-1. The Parameters of S2

#### **Communication timeout**

In case S2 option board doesn't receive any messages from Selma System for the time defined by parameter Communication Timeout, Vacon drive will trip on Fieldbus Communication (FB Comm.) fault.

### 4.2 LED indications

#### **Status LED of S2      YELLOW**

LED is:	Meaning:
OFF	Option board is not active
ON	Option board is in configuration mode and waiting a permission from the frequency converter to move on to the normal operating mode
Blinking fast (once/sec)	Option board is in normal operating mode receiving messages from the field (See Parametres and Time-Out)
Blinking slow (once/5 secs)	Option board did not receive any messages during the Time-Out and is in the fault mode

#### **Status LED of S2      GREEN**

LED is:	Meaning:
OFF	Option board is in fault mode
ON	Option board is active.

## 5. OPT-CG CONFIG TOOL

With the help of OPT-CG Config Tool, signals coming to and from Selma can be connected to any signal or parameter in Vacon drive. This is done by using the address of the signals in Selma System and ID number of signal or parameter in the Vacon drive.

### Output Board: Signals from Vacon Drive to Selma

Interval:

Update time period for the signal. 1 = 10ms.

Address in PLC:

The address in the overriding system where the signal will be written.

Address in Drive:

The address of a signal to be sent from the drive.

Multiplier:

The multiplication factor before the signal is sent to the overriding system (if any).

Divider:

The divider for signal before sent to the overriding system (if any).

**Note:** The signals sent from Vacon drive to Selma addresses can be scaled to any value using Multiplier and divider factors, if required.

### Input Board: Signals from Selma to Vacon Drive

Address in PLC:

The address of a signal sent from the overriding system.

Drive Item

This has two options:

Process Data: The signal coming from Selma can be written to any of the process data. List of process data is available in the "Address in the drive" field. The process data can be configured to any of the parameter in the application.

Parameter: With this selection, the signal coming from the Selma can be written directly to any of the parameter or signal available in the drive using ID numbers. ID numbers are then selected from the "Address in Drive" field.

Address in drive:

The received signal will be written to this address in drive. It is same as the ID number of a signal or parameter in the Vacon drive where the value of a signal coming from Selma to be written.

Multiplier:

The signal value coming from Selma is multiplied by this factor before writing to the ID number in the drive.

Divider:

The signal value coming from Selma is divided by this factor before writing to the ID number in the drive.

**Note:** The signals sent from Selma System to Vacon drive can be scaled to any value using multiplier and divider factors, if required.

Eeprom Saved

This value can be set TRUE/FALSE. When the signal value received from Selma is written to drive parameter, then it can also be saved to Eeprom, if set TRUE.

Save:

The tables can be saved as a text file thru File->Save action.

Open:

The saved configurations can be opened thru File->Open action.

Write:

Writes both tables into S2 option board.

Read:

Reads the tables from S2 option board.

HEX/DEC:

Changes the addresses of PLC into hex/dec format.

ComPort:

Selects the communication port to be used by the OPT-CG Config tool to communicate between computer and S2 option board. RS232 serial cable received with Vacon drive is connected between this port on a computer and Vacon drive (at the palce of keypad).

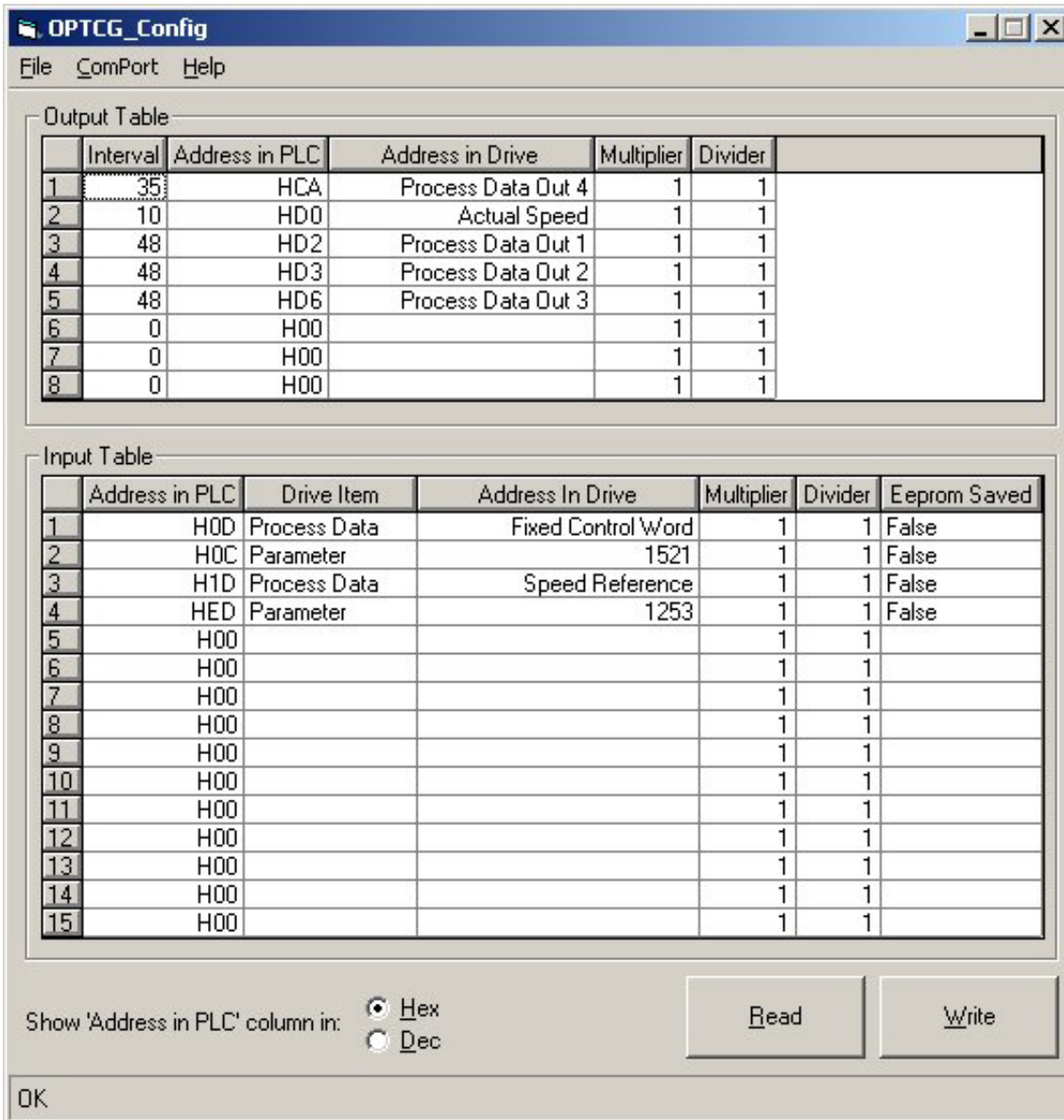

Figure 1. OPT-CG configuration tool, default values

**Note!** These parameters are saved on the OPT-CG board only!

## 6. SELMA APPLICATION (APFIEN04)

### 6.1 Introduction

The Selma Application is typically used in coordinated drives with overriding control system. The recommended interface to control the system is a fieldbus communication though hardwired analogue and digital signals as well as keypad and PC control can be used.

**The Selma Application utilises most advanced functions in NXP motor control software** and is suitable for demanding drive systems like paper machines and drives in metal industry and processing lines. It can also be used for any other standard applications. Following applications are working with this application.

- Pulp and paper machine drives like dryer, press section, wire section, pope reel, winder and unwinder.
- Drives in metal industry like casting machine, melt shop or preparing line
- Standard drives like pump and fan, lifts, cranes, conveyors, etc.

Additional functions:

- Flexible speed and torque reference chains.
- Advanced drive control profile for fieldbus communication
- Flexible fieldbus data connections.
- Adaptive speed controller.
- Inertia compensation and oscillation damping features.
- System Bus support for master follower applications with speed/torque follower.
- Fast and multi drive monitoring tool (NCDrive) support.
- Programmable U/f curve and flux curve.
- Speed /torque-selector options, window control
- Automatic identification run
- Support to permanent magnet motors and multiple winding motors

6.2 Control I/O

Terminal	Signal	Description
1	+10V	Reference output Voltage for potentiometer, etc.
2	AI1+	Analogue input, voltage range 0—10V DC Voltage input frequency reference
3	AI1-	I/O Ground Ground for reference and controls
4	AI2+	Analogue input, current range 0—20mA Current input frequency reference
5	AI2-	
6	+24V	Control voltage output Voltage for switches, etc. max 0.1 A
7	GND	I/O ground Ground for reference and controls
8	DIN1	Start forward (Programmable) Contact closed = start forward
9	DIN2	Start reverse (Programmable) Contact closed = start reverse
10	DIN3	External fault input (programmable) Contact open = no fault Contact closed = fault
11	CMA	Common for DIN 1— DIN 3 Connect to GND or +24V
12	+24V	Control voltage output Voltage for switches (see #6)
13	GND	I/O ground Ground for reference and controls
14	DIN4	Run Enable Contact closed = Run Enable Contact Open =Run Disable
15	DIN5	Main Switch Ack. Contact closed = Switch is closed. Contact Open= Switch is open.
16	DIN6	Emergency Stop Contact open= EmstopActive. Con- tact Close = Emstop not active.
17	CMB	Common for DIN4— DIN6 Connect to GND or +24V
18	AOA1+	Programmable Range 0—20 mA/R <sub>L</sub> , max. 500Ω
19	AOA1-	
20	DOA1	Digital output READY Programmable Open collector, I <sub>L</sub> ≤50mA, U <sub>L</sub> ≤48 VDC
21	R01	Relay output 1 RUN Programmable
22	R01	
23	R01	
24	R02	Relay output 2 DC bus Charging OK Programmable
25	R02	
26	R02	

Table 2. Selma Application default I/O configuration.

**Note:** The above I/O configuration is an example. Most of the I/Os are programmable.

### 6.3 “Terminal to function” (TTF) programming principle

The programming principle of the input and output signals in the **Multipurpose Control Application** as well as in the **Pump and Fan Control Application** (and partly in this application as well) is different compared to the conventional method used in other Vacon NX applications.

In the conventional programming method, *Function to Terminal Programming Method (FTT)*, you have a fixed input or output that you define a certain function for. The applications mentioned above, however, use the *Terminal to Function Programming method (TTF)* in which the programming process is carried out the other way round: Functions appear as parameters which the operator defines a certain input/output for. See *Warning* on page 15.

#### 6.3.1 Defining an input/output for a certain function on keypad

Connecting a certain input or output with a certain function (parameter) is done by giving the parameter an appropriate value. The value is formed of the *Board slot* on the Vacon NX control board (see the product’s user’s manual) and the *respective signal number*, see below.

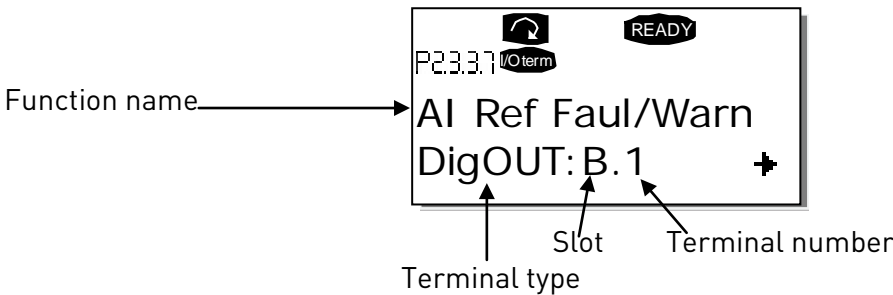

**Example:** You want to connect the digital output function *Reference fault/warning* (parameter 2.3.3.7) to the digital output DO1 on the basic board OPT-A1 (see the product’s user’s manual).

First find the parameter 2.3.3.7 on the keypad. Press the *Menu button right* once to enter the edit mode. On the *value line*, you will see the terminal type on the left (DigIN, DigOUT, An.IN, An.OUT) and on the right, the present input/output the function is connected to (B.3, A.2 etc.), or if not connected, a value (0.#).

When the value is blinking, hold down the *Browser button up* or *down* to find the desired board slot and signal number. The program will scroll the board slots starting from 0 and proceeding from A to E and the I/O selection from 1 to 10.

Once you have set the desired value, press the *Enter button* once to confirm the change.

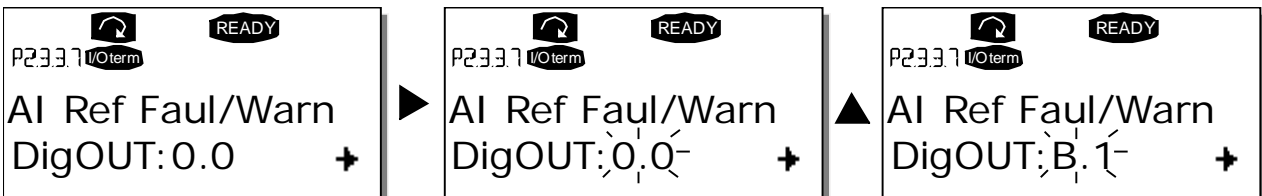

### 6.3.2 Defining a terminal for a certain function with NCDrive programming tool

If you use the NCDrive Programming Tool for parametrizing you will have to establish the connection between the function and input/output in the same way as with the control panel. Just pick the address code from the drop-down menu in the *Value* column (see the Figure below).

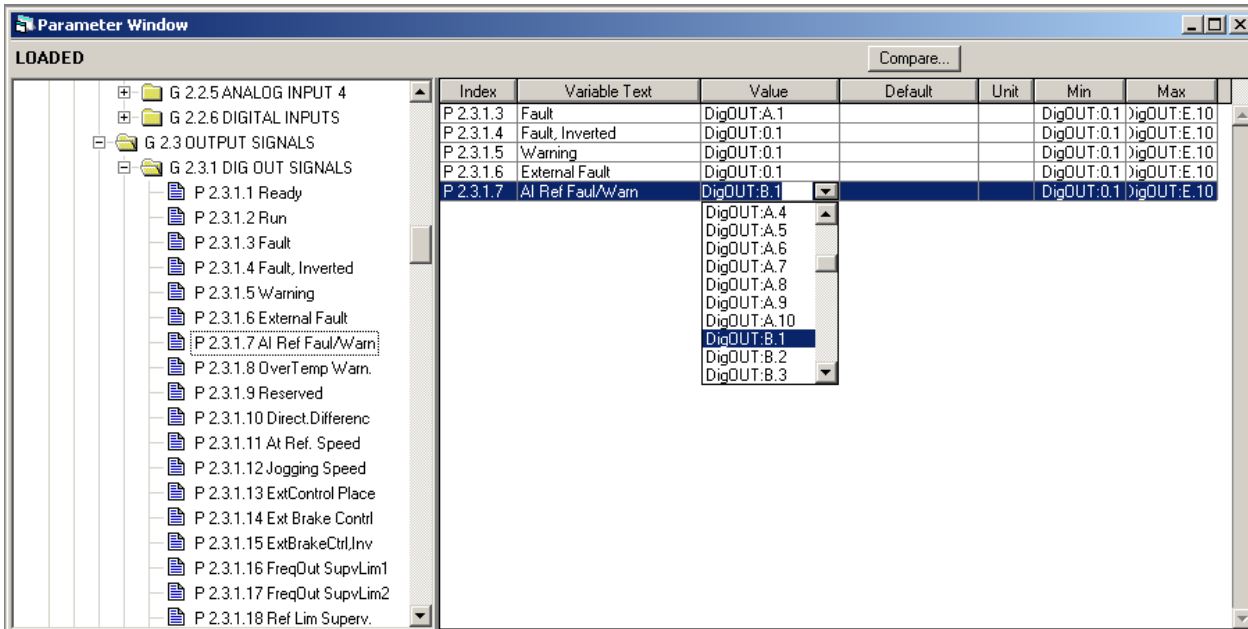



Figure 6-1. Screenshot of NCDrive programming tool; Entering the address code

 <b>WARNING</b>	<p>Be <b>ABSOLUTELY</b> sure not to connect two functions to one and same <b>output</b> in order to avoid function overruns and to ensure flawless operation.</p>
---	---

**Note:** The *inputs*, unlike the *outputs*, cannot be changed in RUN state.

## 6.4 Selma Application – Parameter lists

On the next pages you will find the lists of monitoring signals and parameters. The parameter descriptions are given on pages **Error! Bookmark not defined.** to **Error! Bookmark not defined.**

### Column explanations:

Code	=	Location indication on the keypad; Shows the operator the present parameter number
Parameter	=	Name of parameter
Min	=	Minimum value of parameter
Max	=	Maximum value of parameter
Unit	=	Unit of parameter value; given if available
Step	=	Accuracy of smallest possible change of value
Default	=	Value preset by factory
ID	=	ID number of the parameter (used with PC tools)



**6.4.1 M1 > V1.1 Monitor page 1**

Code	Parameter	Unit	ID	Description
V1.1.1	Output frequency	Hz	1	Frequency output from the drive to the motor.
V1.1.2	Speed	Rpm	2	Motor speed in rpm. In open loop this is the calculated speed of the motor and in closed loop this is the filtered value of the speed measured from the encoder.
V1.1.3	Freq. Reference	Hz	25	Frequency reference to the ramp generator.
V1.1.4	Current	A	3	Filtered motor current.
V1.1.5	Torque	%	4	Filtered motor torque in percentage of motor nominal torque.
V1.1.6	Power	%	5	Power in percentage of motor nominal power.
V1.1.7	Motor voltage	V	6	Motor terminal voltage.
V1.1.8	DC-link voltage	V	7	DC link voltage.
V1.1.9	Unit tempertaure	°C	8	Heat sink temperature.
V1.1.10	DIN Status Word1		15	See 6.5.10
V1.1.11	DIN Status Word2		16	See 6.5.11
V1.1.12	MotorTempCalc	%	9	Calculated motor temperature . 100.0% = nominal temperature of the motor.
V1.1.13	PT100(1) Temp.	°C	50	Temperature of the PT100 type temperature sensor1 connected to Analogue input.
V1.1.14	PT100(2) Temp.	°C	51	Temperature of the PT100 type temperature sensor2 connected to Analogue input.
V1.1.15	PT100(3) Temp.		52	
V1.1.16	Unit nom. voltage	V	1117	Nominal voltage rating of the drive unit.
V1.1.17	Unit nom. current	A	1118	Nominal current rating of the drive unit. This is same as IL current rating of the unit.
V1.1.18	DC nom. Voltage	V	1120	Nominal DC link voltage of the drive unit.
V1.1.19	ID Run status		49	Bitwise status of automatic identification after ID run. B0= Stator resistance and U7f curve B1= Reserved B2= Magnetisation current. B3= Flux linearization curve.
V1.1.20	Analogue Input 3		%	
V1.1.21	Analogue Input 4		%	

Table 3. Monitoring page 1

**6.4.2 M1>V1.2 Monitor Page 2**

Code	Parameter	Unit	ID	Description
V1.2.1	Speed Measured	rpm	1124	Speed measured from the encoder.
V1.2.2	Torque Unfilt.	%	1125	Unfiltered torque calculated by the drive.100% equals to motor nominal torque.
V1.2.3	Current Unfilt.	%	1113	Unfiltered Motor current in Amperes.
V1.2.4	Speed Reference1	rpm	1126	Speed reference selected as per the control place selection.
V1.2.5	Speed Reference2	rpm	1127	Speed reference after speed share logic.
V1.2.6	Speed Reference3	rpm	1128	Speed reference at the input of the ramp generator.
V1.2.7	Speed Ramp Out	rpm	1129	Final speed reference after Ramp generator
V1.2.8	Speed Reference4	rpm	1130	Speed reference after the speed correction is added to the Speed Ramp Out. 1)
V1.2.9	Used Speed Ref	rpm	1131	Final speed reference after the speed step logic. 1)
V1.2.10	Speed Error	rpm	1132	Speed error=Speed Act -Speed Ref 1)
V1.2.11	SPC OUT	%	1134	Iq Reference from the speed controller output. 1)
V1.2.12	Speed Limit Pos	rpm	1135	Positive speed limit on the speed reference
V1.2.13	Speed Lim Neg	rpm	1136	Negative speed limit on the speed reference
V1.2.14	TC Speed Lim Pos	rpm	1137	Positive speed limit when Torque Select is 2/3/4/5 and Motor Ctrl Mode =3.
V1.2.15	TC Speed Lim Neg	rpm	1138	Negative speed limit when Torque Select is 2/3/4/5 and Motor Ctrl Mode =3.
V1.2.16	Master TorqueRef	%	1139	Torque reference from Master Drive in case of master Follower comm.

Code	Parameter	Unit	ID	Description
				-300.0....+300.0% of the motor nominal torque
V1.2.17	FB Torque Ref	%	1140	Torque Reference from the Fieldbus. -300.0...300.0%. of motor nominal torque
V1.2.18	I/O Torque Ref	%	1141	Torque Reference from the analogue Input -300.0...300.0%. of motor nominal torque
V1.2.19	Torque Ref1	%	1142	Torque reference after Torque Reference selector (Master, Fieldbus, analogue I/P)
V1.2.20	Torque Ref2	%	1143	Scaled Torque Reference
V1.2.21	Torque Ref3	%	1144	Torque reference after Load Share logic.
V1.2.22	Used Torque Ref	%	1145	Final, limited torque reference for speed/torque controller
V1.2.23	Acc Comp Out	%	1146	Acceleration compensation used in terms of IqReference. 100.0% equals to motor nominal current. 1)
V1.2.24	Droop Speed RPM	rpm	1147	Speed droop used in rpm.
V1.2.25	Startup TorqAct	A	1148	startup torque in use, 100.0 %= motor nominal torque.
V1.2.26	Iq Current Lim +	%	1152	Final upper IqCurrentLimit 100.0 %= motor nominal current (unsigned)
V1.2.27	Iq Current Lim -	%	1153	Final lower IqCurrentLimit 100.0 %= motor nominal current (unsigned)
V1.2.28	Iq Reference	%	1154	Final IqReference, 100.0% = motor nominal current
V1.2.29	Iq Actual	%	1155	Measured Iq 100.0% = motor nominal current
V1.2.30	Id Reference	%	1156	Final IdReference 100.0% = motor nominal current
V1.2.31	Id Actual	%	1157	Measured Id 100.0 %= motor nominal current.
V1.2.32	Flux	%	1158	Estimated rotor flux in percentage of the motor nominal flux.
V1.2.33	Rotor Time Const	ms	1159	Rotor Time Constant in ms
V1.2.34	MainControlWord		1160	See 6.5.3
V1.2.35	AuxControlWord1		1161	See 6.5.8
V1.2.36	MainStatusWord		1162	See 6.5.5
V1.2.37	AuxStatusWord		1163	See 6.5.9
V1.2.38	Fault Word 1		1172	See 6.5.10
V1.2.39	Fault Word 2		1173	See 6.5.11
V1.2.40	Alarm Word 1		1174	See 6.5.15
V1.2.41	Max Brake Ramp		1168	Calculated ramp time in constant power emergency stop.
V1.2.42	Shaft Position		1169	Position of the motor shaft in 0...360 Degrees.
V1.2.43	Shaft Rounds		1170	No. of rounds of the motor shaft.
V1.2.44	Pole Pair Number		58	Number of pole pairs in the motor estimated from the motor data.
V1.2.45	Selma Status Word		69	See 6.5.6
V1.2.46	Selma Fault Word 0		1540	See 6.5.12
V1.2.47	Selma Fault Word 1		1541	See 6.5.13
V1.2.48	Selma Fault Word 2		1542	See 6.5.14
V1.2.49	Micro Status Word		1555	See 6.5.7
	Selma Control Word			See 6.5.4
V1.2.50	Drive output power		1508	

Table 4. Monitoring page 2

### 6.4.3 Basic parameters

Code	Parameter	Min	Max	Unit	Step	Default	ID	Note
P2.1.1	Supply Voltage	0	1000	V	1	500	1201	Supply Voltage in Volts. If unknown then parameter should be zero.
P2.1.2	Motor Nom Volts	180	690	V	1	400	110	Nominal Voltage of the Motor in volts as per Rating Plate
P2.1.3	Motor Nom Freq	30.00	320.00	Hz	0.01	50.00	111	Nominal Frequency of the Motor ##. ## Hz as per Rating Plate
P2.1.4	Motor Nom Current	Motor_Cur- rent_Min	Motor_ Cur- rent_Max	A	0.1		113	Nominal Current of the Motor. in #####.# A
P2.1.5	Motor Nom Speed	300	Motor- Nom- Speed- Max	rpm	1	1440	112	Nominal Speed of the Motor as per Rating Plate
P2.1.6	Motor Cos Phi	0.30	1.00		0.01	0.85	120	Rated value of cos phi as per Rating Plate
P2.1.7	Process Speed	0.0	3200.0	rpm	0.1	14400	1203	Process Speed limit in RPM scale
P2.1.8	Magn. Current	0.0	Motor Nom Current	A	0.1	0.5	612	Nominal magnetizing current of the motor in amps (Current Format)
P2.1.9	Field Weakng Pnt	8.00	320.00	Hz	0.01	50.00	602	Frequency at which Field Weakening should start. Applicable only in Open Loop Control
P2.1.10	Voltage at FWP	5.00	200.00	%	0.01	100.00	603	Motor Voltage Limit in Field weakening. Applicable only in Open Loop Control
P2.1.11	ID Run	0	2		1	0	631	Automatic Identification run for the motor. 0 = None 1 = Identification without motor running. Identifies the stator resistance and U/f curve. 2 = Identification with motor running. Identifies stator resistance/f curve, magnetising current and flux linearization curve.
P2.1.12	Motor Type	0	3		1	0	650	Motor type 0= Induction motor 1= Multiple wind induction motor 2= Permanent magnet motor 3= Multiple wind permanent magnet motor.

Table 5. Basic parameters G2.1

#### 6.4.4 Input signals (Control keypad: Menu M2→ G2.2)

##### 6.4.4.1 Digital input (Control keypad: Menu M2→ G2.2.1)

Code	Parameter	Min	Max	Unit	Step	Default	ID	Note
P2.2.1.1	Run Forward	0	Max. No of DIN installed		1	0	1206	Digital input selection for the Run Forward command when the Control Place=IO control.
P2.2.1.2	Run Reverse	0	Max. No of DIN installed		1	0	1207	Digital input selection for Run Reverse command when the control place=IO control
P2.2.1.3	IO Ctrl	0	Max. No of DIN installed		1	0	1404	Digital input selection to activate the IO control.
P2.2.1.4	Reset	0	Max. No of DIN installed		1	0	1208	Digital input Selection for Fault Resetting. The transition from Off to On will Reset the Fault if the cause of the fault is removed
P2.2.1.5	Brake Open	0	Max. No of DIN installed		1	0	1210	Input Selection for Acknowledgement of Motor Mechanical Brake. Off=Brake Closed, On=Brake Opened. If the brake does not open after Start Command after Brake Lift Delay then Fault 57 ``Mech. Brake)
P2.2.1.6	Brake Open Logic	0	1		1	0	1379	The connection type for brake open acknowledgement. 0= Normally Open. 1= Normally closed.
P2.2.1.7	Motor Fan Ack.	0	Max. No of DIN installed		1	0	1211	Input selection for Motor Fan Acknowledgement. If no acknowledgement for 1 Sec after Fan On command then Alarm F56 ``Motor Fan``
P2.2.1.8	Input Switch Ack	0	Max. No of DIN installed		1	5	1209	Input selection for input switch acknowledgement. If not acknowledged then Fault 64 "Input Switch Open"
P2.2.1.9	Run Enable	0	Max. No of DIN installed		1	4	1212	Input selection For Run Enable. If input is missing then warning 26 "Run Disable".
P2.2.1.10	Run Enable Logic	0	1		1	0	1380	Connection type for Run Enable. 0= Normally Open 1= Normally closed.
P2.2.1.11	Prevent. Of Start	0	1		1	0	1420	The function is to be enabled when SPU024 or any external device is used to cut the DC Voltage to gate drive and /or ASIC board. 0= Disable, 1= Enable
P2.2.1.12	Emstop	0	Max. No of DIN installed		1	6	1213	Input For Emergency Stop. Low=Emergency stop Active

P2.2.1.13	External Fault	0	Max. No of DIN installed		1	0	1214	Digital input selection for External Fault signal connection.
P2.2.1.14	Ext. Fault Logic	0	0		1	0	1381	Connection type for external fault input connection. 0= Normally open 1= Normally closed.
P2.2.1.15	Motor 1 Or 2 Sel	0	Max. No of DIN installed		1	0	1215	Select parameter set for Motor 1 or Motor 2 with the selected digital input. High=Motor2.Low=Motor1
P2.2.1.16	Fault Reset	0.1	D.10	TTF	1	0.1	414	
P2.2.1.17	Micro start command	0	D.10		1	0	1550	Start command for FB Mode 5 (= Microstar) Rising edge required after fault or Emergency stop. Use OPT-CG Config tool for this ID
P2.2.1.18	Micro stop command	0	D.10		1	0	1551	Stop command for FB Mode 5 (= Microstar) Rising edge required after fault or Emergency stop. Use OPT-CG Config tool for this ID

Table 6. Digital Input parameters, G2.2.1

## 6.4.4.2 Analogue input (Control keypad: Menu M2→ G2.2.2)

Code	Parameter	Min	Max	Unit	Step	Default	ID	Note
P2.2.2.1	I/O SpeedRef Sel	0	5		1	0	1219	Analogue Input selection for Speed reference when Control Place=1 (IO ctrl)
P2.2.2.2	I/O TorqRef Sel	0	3		1	0	1220	Analogue Input selection for Torque reference when Control Place=1 (Local IO Control)
P2.2.2.3	PT100(1) AI Sel	0	2		1	0	1221	Analogue Input selection for PT100 type temperature sensor 1.
P2.2.2.4	PT100 (1) Sel	0	2		1	0	1222	No of PT100 elements in series.
P2.2.2.5	PT100(2) AI Sel	0	2		1	0	1223	Analogue Input selection for PT100 type temperature sensor 2.
P2.2.2.6	PT100 (2) Sel	0	2		1	0	1224	No of PT100 elements in series. 0=1*PT100, 1=2*PT100, 2=3*PT100.
P2.2.2.7	AI1 Ref Scale Min	-30000	30000		1	0	1226	Min. value of signal selected for AI1. This corresponds to +0V/0/4mA
P2.2.2.8	AI1 RefScale Max	-30000	30000		1	1440	1225	Max. value of signal selected for AI1. This corresponds to +10V/20mA
P2.2.2.9	AI1 Minimum	0	1		1	0	1227	Minimum voltage or Current at AI1.0=0V/0mA, 1=4mA
P2.2.2.10	AI1 Filter Time	0.01	10.00	s	0.01	1	1228	Filter time for AI1 in ###. ## Sec
P2.2.2.11	AI2 RefScale Min	-30000	30000		1	0	1230	Min. Value of Signal selected for AI2. This corresponds to +0V/0/4mA
P2.2.2.12	AI2 RefScale Max	-30000	30000		1	1000	1229	Max. Value of Signal selected for AI2. This corresponds to +10V/20mA

P2.2.2.13	AI2 Minimum	0	1		1	0	1231	Minimum Voltage or Current at AI2.0=0V/0mA, 1=4mA
P2.2.2.14	AI2 Filter Time	0.01	10.00	s	0.01	1	1232	Filter time for AI2 in ###.## Sec.
P2.2.2.15	AI1 signal selection	0	D.10		1	10	377	TTF programming. See chapter 6.3
P2.2.2.16	AI2 signal selection	0	D.10		1	11		TTF programming. See chapter 6.3

Table 7. Analogue Input parameters, G2.2.2

#### 6.4.4.3 Analogue input 3 (Control keypad: Menu M2 → G2.2.4)

Code	Parameter	Min	Max	Unit	Default	Cust	ID	Note
P2.2.4.1	AI3 signal selection	0.1	E.10		0.1		141	Slot . Board input No. If 0.1 ID61 can be controlled from FB
P2.2.4.2	AI3 filter time	0,000	32,000	s	0,000		142	0=No filtering
P2.2.4.3	AI3 custom minimum setting	-160,00	160,00	%	0,00		144	Custom range always active. See ID326
P2.2.4.4	AI3 custom maximum setting	-160,00	160,00	%	100,00		145	Custom range always active. See ID327
P2.2.4.5	AI3 signal inversion	0	1		0		151	0=Not inverted 1=Inverted
P2.2.4.6	AI3 reference scaling, minimum value	-32000	32000		0		1037	Selects the value that corresponds to the min. reference signal
P2.2.4.7	AI3 reference scaling, maximum value	-32000	32000		0		1038	Selects the value that corresponds to the max. reference signal
P2.2.4.8	AI3 Controlled ID	0	10000		0		1509	Select parameter that you want to control by ID number.

Table 4-8. Analogue input 3 parameters, G2.2.4

\*\*Remember to place jumpers of block X2 accordingly.  
See NX User's Manual, chapter 6.2.2.2

#### 6.4.4.4 Analogue input 4 (Control keypad: Menu M2 → G2.2.5)

Code	Parameter	Min	Max	Unit	Default	Cust	ID	Note
P2.2.5.1	AI4 signal selection	0.1	E.10		0.1		152	Slot . Board input No. If 0.1 ID61 can be controlled from FB
P2.2.5.2	AI4 filter time	0,000	32,000	s	0,000		153	0=No filtering
P2.2.5.3	AI4 custom minimum setting	-160,00	160,00	%	0,00		155	Custom range always active. See ID326
P2.2.5.4	AI4 custom maximum setting	-160,00	160,00	%	100,00		156	Custom range always active. See ID327
P2.2.5.5	AI4 signal inversion	0	1		0		162	0=Not inverted 1=Inverted
P2.2.5.6	AI3 reference scaling, minimum value	-32000	-32000		0		1039	Selects the value that corresponds to the min. reference signal
P2.2.5.7	AI3 reference scaling, maximum value	-32000	32000		0		1040	Selects the value that corresponds to the max. reference signal
P2.2.5.8	AI4 Controlled ID	0	10000		0		1510	Select parameter that you want to control by ID number.

Table 4-9. Analogue input 4 parameters, G2.2.5

### 6.4.5 Output signals (Control keypad: Menu M2 → G2.3)

#### 6.4.5.1 Digital output (Control keypad: Menu M2 → G2.3.1)

Code	Parameter	Min	Max	Unit	Step	Default	ID	Note
P2.3.1.1	DO1 (ID.BitNo.)	0.00	2000.15		0.01	1162.00	1216	Select the signal for controlling DO1. The parameter is set in a format xxxx.yy where xxxx is the ID number of a signal (in this case 1162 is ID number of Main status word) and yy is the bit no. (in this case bit 0). Thus the default value is programmed to ID1162 bit 00 means Drive Ready.
P2.3.1.2	DO2 (ID.BitNo.)	0.00	2000.15		0.01	1162.00	1217	Select the signal for controlling DO2. The parameter is set in a format xxxx.yy where xxxx is the ID number of a signal (in this case 1162 is ID number of Main status word) and yy is the bit no. (in this case bit 02). Thus the default value is programmed to ID1162 bit 02 means Drive Running.
P2.3.1.3	DO3 (ID.BitNo.)	0.00	2000.15		0.01	1163.00	1218	Select the signal for controlling DO3. The parameter is set in a format xxxx.yy where xxxx is the ID number of a signal (in this case 1163 is ID number of auxiliary status word) and yy is the bit no. (in this case bit 03). Thus the default value is programmed to ID1163 bit 03 means DC Bus charging OK (pulse).
P2.3.1.4	DO4 (ID.BitNo.)	0.00	2000.15		0.01	0000.00	1385	Select the signal for controlling DO4.
P2.3.1.5	DO5 (ID.BitNo.)	0.00	2000.15		0.01	0000.00	1386	Select the signal for controlling DO5.
P2.3.1.6	DO6 (ID.BitNo.)	0.00	2000.15		0.01	0000.00	1390	Select the signal for controlling DO6.
P2.3.1.7	DO7 (ID.BitNo.)	0.00	2000.15		0.01	0000.00	1391	Select the signal for controlling DO7.
P2.3.1.8	DO8 (ID.BitNo.)	0.00	2000.15		0.01	0000.00	1395	Select the signal for controlling DO8.
P2.3.1.9	DO9 (ID.BitNo.)	0.00	2000.15		0.01	0000.00	1396	Select the signal for controlling DO9.
P2.3.1.10	DO10 (ID.BitNo.)	0.00	2000.15		0.01	0000.00	1423	Select the signal for controlling DO10.
P2.3.1.11	DO11 (ID.BitNo.)	0.00	2000.15		0.01	0000.00	1427	Select the signal for controlling DO11.
P2.3.1.12	DO12 (ID.BitNo.)	0.00	2000.15		0.01	0000.00	1428	Select the signal for controlling DO12.
P2.3.1.13	DO13 (ID.BitNo.)	0.00	2000.15		0.01	0000.00	1429	Select the signal for controlling DO13.

Table 10 Digital Output parameters, G2.3.1



#### 6.4.5.2 Analogue output 1 (Control keypad: Menu M2 → G2.3.2)

Code	Parameter	Min	Max	Unit	Step	Default	ID	Note
P2.3.2.1	A01 terminal	0	59		1	10	463	TTF programming. See chapter 6.3
P2.3.2.2	A01 Signal ID	0	2000		1	0	1233	Set the ID no. Of a signal to be connected to A01.
P2.3.2.3	A01 Offset	0	1		1	0	1234	Minimum voltage or current at A01. 0= 0V/0mA. 1= 2V/4mA
P2.3.2.4	A01 Filter	0.02	10.00	S	0.01	10.00	1235	Filter time for A01
P2.3.2.5	A01 Max Value	-30000	30000		1	1500	1236	Maximum value of the signal selected for A01. This will correspond to +10V/20mA.
P2.3.2.6	A01 Min Value	-30000	30000		1	0	1237	Minimum value of the signal selected for A01. This will correspond to 0V/0mA or 2V/4mA depending on A01 Offset.

Table 11. Analogue output parameters, G2.3.2

#### 6.4.5.3 Analogue output 2 (Control keypad: Menu M2 → G2.3.3)

Code	Parameter	Min	Max	Unit	Step	Default	ID	Note
P2.3.3.1	A02 terminal	0	59		1	10	471	TTF programming. See chapter 6.3
P2.3.3.2	A02 Signal ID	0	2000		1	0	1500	Set the ID no. Of a signal to be connected to A02.
P2.3.3.3	A02 Offset	0	1		1	0	475	Minimum voltage or current at A02. 0= 0V/0mA. 1= 2V/4mA
P2.3.3.4	A02 Filter	0.02	10.00	S	0.01	10.00	472	Filter time for A02
P2.3.3.5	A02 Max Value	-30000	30000		1	1500	1501	Maximum value of the signal selected for A02. This will correspond to +10V/20mA.
P2.3.3.6	A02 Min Value	-30000	30000		1	0	1502	Minimum value of the signal selected for A02. This will correspond to 0V/0mA or 2V/4mA depending on A02 Offset.

Table 12 Analogue output parameters, G2.3.3

#### 6.4.5.4 Analogue output 3 (Control keypad: Menu M2 → G2.3.4)

Code	Parameter	Min	Max	Unit	Step	Default	ID	Note
P2.3.4.1	A03 terminal	0	59		1	10	478	TTF programming. See chapter 6.3
P2.3.4.2	A03 Signal ID	0	2000		1	0	1503	Set the ID no. Of a signal to be connected to A01.
P2.3.4.3	A03 Offset	0	1		1	0	482	Minimum voltage or current at A03. 0= 0V/0mA. 1= 2V/4mA
P2.3.4.4	A03 Filter	0.02	10.00	S	0.01	10.00	480	Filter time for A03
P2.3.4.5	A03 Max Value	-30000	30000		1	1500	1504	Maximum value of the signal selected for A03. This will correspond to +10V/20mA.
P2.3.4.6	A03 Min Value	-30000	30000		1	0	1505	Minimum value of the signal selected for A03. This will correspond to 0V/0mA or 2V/4mA depending on A03 Offset.

Table 13 Analogue output parameters, G2.3.4

#### 6.4.6 Reference handling (Control keypad: Menu M2 → G2.4)

Code	Parameter	Min	Max	Unit	Step	Default	ID	Note
P2.4.1	Spd Ref Filter	0	5000	ms	1	0	324	Filter time for the speed reference in ms
P2.4.2	Const Ref 1	Speed_Min	Speed_Max	rpm	1	0	1239	Constant speed reference 1. Normally used for forward inching
P2.4.3	Const Ref 2	Speed_Min	Speed_Max	rpm	1	0	1240	Constant speed reference 2. Normally used for reverse inching
P2.4.4	CriticalSpeedLow	0	Max_Speed	Rpm	1	0	509	Low limit for critical speed range
P2.4.5	CriticalSpeedHigh	0	Max_Speed	Rpm	1	0	510	High limit for critical speed range
P2.4.6	Speed Share	-300.00	300.00	%	0.01	100.00	1241	Speed share as percentage of speed reference.
P2.4.7	FBRef Scale	10	30000		1	20000	1242	This will correspond to par. G3.1 Process Speed.
P2.4.8	Tref Source Sel	0	3		1	0	641	Source for the torque reference. 0=None 1=Master 2=Fieldbus 3=Analogue I/P
P2.4.9	Tref Filter	0	5000	ms	1	0	1244	Filter time for the torque reference in ms
P2.4.10	Tref Hysteresis	-300.0	300.0	%	0.1	0.0	1245	Hysteresis for the torque reference in ####.# %.100.0% ~motor nominal torque.
P2.4.11	Tref Dead Zone	-300.0	300.0	%	0.1	0.0	1246	Dead zone in % where the torque reference will be considered as zero. 100.0% ~motor nominal torque.

P2.4.12	TorqueRef Scale	0	1		1	0	1247	The scale for the torque reference chain and all signals related to torque. 0= 1000 corresponds to motor nominal torque. 1= 10000 corresponds to motor nominal torque
P2.4.13	Load Share	0.0	400.0	%	0.1	100.0	1248	Load share for the torque reference in %. E.g. 50% means 50% of the given torque reference is used by the torque reference chain.
P2.4.14	Tref Ramp Time	0.0	30000	ms	1	0	1249	The ramp time in ms for nominal torque reference change.
P2.4.15	Flux Reference	10.0	150.0	%	0.1	100.0	1250	Flux reference in %.100% equals rated flux of the drive.
P2.4.16	Above Spd Limit	0	Speed_Max	rpm	1	0	1251	The speed limit above which bit10 of the status word will be TRUE
P2.4.17	Speed Step	-2000	2000		1	0	1252	Step speed refer. relative to process speed. 20000 = P2.1.7 Process speed
P2.4.18	Torque Step	-300.0	300.0	%	0.1	0.0	1253	Torque step in % of nom. torque of the motor

Table 14 Ref Handling parameters, G2.4

#### 6.4.7 Ramp functions (Control keypad: Menu M2 → G2.5)

Code	Parameter	Min	Max	Unit	Step	Default	ID	Note
P2.5.1	Accel Time 1	0.0	3000.0	s	0.1	10.0	103	Acceleration Time in sec
P2.5.2	Decel Time 1	0.0	3000.0	s	0.1	10.0	104	Deceleration Time in sec
P2.5.3	S Ramp AccDec	0	100	%	1	0	500	Smooth ratio for S curves for Acc Dec Ramp 0=Linear Ramps 100=Full Acc/Dec inc/dec times.
P2.5.4	Emstop Ramp	0.0	3000.0	s	0.1	10.0	1256	Deceleration time in Emergency Stop
P2.5.5	Emstop Delay	0.00	320.00	s	0.01	0	1254	Delay in activation of emergency stop ramp after emergency stop is active
P2.5.6	ConstSpd Acc-Time	0.0	3000.0	s	0.1	5.0	1257	Acceleration time for Constant Speed 1 and 2
P2.5.7	ConstSpd Dec-Time	0.0	3000.0	s	0.1	5.0	1258	Deceleration time for Constant Speed 1 and 2
P2.5.8	S Ramp Const Spd	0	100	%	1	0	1259	Smooth ratio for S-curves of Const Speed ramp 0=Linear ramps 100=Full Acc/Dec inc/dec times 0=linear ramps 100=full acc/dec inc/dec times

Table 15 Ramp Function parameters, G2.5

### 6.4.8 Drive control (Control keypad: Menu M2 → G2.6)

Code	Parameter	Min	Max	Unit	Step	Default	ID	Note
P2.6.1	Control Place	0	2	1	1	2	125	Place to control the drive operation. 0=FieldBus 1=IO 2=Panel/ PC Tool
P2.6.2	Brake Chopper	0	3		1	0	504	
P2.6.3	BrkChopper Level	0	1500	V	1	1.15*nom DC Volt	1267	Brake chopper operation level in volts
P2.6.4	Brk Res Load Lim	0.0	300.0	%	0.1	5.0	1268	Generator side torque limit to avoid overheating of the brake resistor during continuous braking. This is active when Brake Chopper is selected and there is no emergency stop active and drive is not decelerating.
P2.6.7	Restart Delay	0.000	60.000	s	0.001		1424	After coast stop the re-starting of the drive is disabled for this time.
P2.6.8	PWM Synch	0	1		1	0	1399	Enables or disables the PWM synchronisation for multiple winding master follower.

Table 16 Drive Control parameters, G2.6

#### 6.4.8.1 Drive control/Open Loop Ctrl (Control keypad: Menu M2 → G2.6.5)

Code	Parameter	Min	Max	Unit	Step	Default	ID	Note
P2.6.5.1	U/f Ratio Select	0	3		1	0	108	U/F ratio selection. 0=Linear 1=Squared 2=Programmable
P2.6.5.2	U/f Zero Point V	0.00	105.00	%	0.01	0.00	606	Motor voltage (%*Motor Nominal Voltage) at programmable U/F curve zero point 10.0 ...105.00 % * MotorNomVoltage
P2.6.5.3	U/f Mid Point V	0.00	105.00	%	0.01	100.00	605	Motor voltage (%*Motor Nominal Voltage) at programmable U/F curve middle point (1000...10500) equals (10.0 ...105.00) % * MotorNomVoltage
P2.6.5.4	U/f Mid Freq	0.00	320.00	Hz	0.01	50.00	604	Programmable U/F curve middle point, f[Hz] = UF-MidPoint/FreqScale Range [0...FieldWeakeningPoint] If FreqScale=100 then 5000 equals 50.00 Hz
P2.6.5.5	U/f Optimization	0	1		1	0	109	U/F optimization control
P2.6.5.6	DC Brake Speed	0	MotorNom Speed	rpm	1	0	515	Below this speed DC braking will be active.
P2.6.5.7	DC Brake Current	0	Motor CurrentMax	A			507	DC Braking current

P2.6.5.8	DC Brake Time	0	20000	ms	1	0	508	
P2.6.5.9	Flux Brake	0	1		1	0	520	Flux braking control 0 = Disable 1 = Enable
P2.6.5.10	FluxBrakeCurrent	0	Motor CurrentMax	A		0	519	Flux braking current
P2.6.5.11	TorqStab Kp	0	1000		1		1412	Gain for torque stabilator
P2.6.5.12	TorqStab Damp TC	0	1000		1		1413	Damping time constant for torque stabilator
P2.6.5.13	TorqStab Kp FWP	0	1000		1		1414	Gain for torque stabilator at FWP
P2.6.5.14	Flux Stab Kp	0	32000		1		1410	Gain for flux stabilator
P2.6.5.15	Flux Stab Filt	0	32000		1		1411	Filter time constant for flux stabilator
P2.6.5.16	Make Flux Time	0.000	60.000	s	0.001	0.200	660	Time to magnetise the motor
P2.6.5.17	MakeFluxVoltage	0.00	120.00	%	0.01	2.01	661	Magnetising voltage in ###.## % of motor nominal voltage.
P2.6.5.18	MeasRsVolt Drop	0	65535		1	0	662	Measured voltage drop at stator resistance between two phases with nominal current of the motor. This is estimated during ID Run.

Table 17 Drive Control/Open Loop Ctrl parameters, G2.6.5

6.4.8.2 Drive control/UV/OV ctrl, stab (Control keypad: Menu M2 → G2.6.6)

Code	Parameter	Min	Max	Unit	Step	Default	ID	Note
P2.6.6.1	Undervolt Ctrl	0	1		1	0	608	Under voltage controller 0=Off, 1=On. Applicable in open loop and closed loop control.
P2.6.6.2	Uvolt Ref Sel	0	1		1	1	1260	Selection of under voltage Reference for Under-voltage Controller. 1= UnderVoltageRef =0.8* EstimatedDCNomVoltage
P2.6.6.3	Undervolt Kp	0	32767		1		1415	Gain for the P term of Under voltage controller
P2.6.6.4	Undervolt Ti	0	32767		1		1416	Gain for I term of under voltage controller
P2.6.6.5	Over volt Ctrl	0	2		1	0	607	Over voltage controller 0=Off, 1=On with no Ramp, 2=On with ramp. Applicable in Open Loop and closed loop Control.
P2.6.6.6	Overvolt Ref Sel	0	2		1	1	1262	(BrCh=ON <=> Brake-Chopper is in use BrCh=OFF <=> Brake-Chopper is not in use) 0 = OverVoltageRef = OverVoltageRefMax, if BrCh=ON = BrakeChopperLevelMax, if BrCh=OFF BrakeChopperRef = BrakeChopperLevelMax 1 = OverVoltageRef = 1.25*EstimatedDCNo

P2.6.6.7	OverVolt Kp						1468	Gain for P term of over-voltage controller
P2.6.6.8	OverVolt Kp Add						1425	Addition gain for P term of overvoltage controller till FWP.
P2.6.6.9	OverVolt Ti						1409	Gain for I term of the over-voltage controller.
P2.6.6.10	VoltStab Kp						1417	Gain for the voltage stabilator
P2.6.6.11	VoltStab TC						1418	Damping rate for the voltage stabilator.

Table 18. Drive Control/UV/OV Ctrl, Stab Parameters, G2.6.6

#### 6.4.9 Motor control (Control keypad: Menu M2 → G2.7)

Code	Parameter	Min	Max	Unit	Step	Default	ID	Note
P2.7.1	Start Function	0	1		1	0	505	0=Starts from 0-speed, 1=Flying start
P2.7.2	Stop Function	0	1		1	0	506	0=Coast stop 1=Ramp stop
P2.7.3	Emstop Mode	0	3		1	1	1276	Stop function in Emergency Stop 0=Coast Stop 1=Ramp stop 2=Torque limit Stop 3=Constant Power Stop
P2.7.4	Motor Ctrl Mode	0	5		1	0	600	0=Open Loop Freq ctrl, 1=Open Loop Speed ctrl 2=Open Loop Torque ctrl 3=Closed Loop speed/ torque Control as per P2.7.5 4=AOL Speed Control 5=AOL Torque Control
P2.7.5	Torque Select	1	5		1	1	1278	1=Speed Control 2=Torque Control 3=Min of torque ref and SPC Out 4=Max of torque ref and SPC Out 5=Window Control
P2.7.6	CurrentControlKp	1	10000		1	4000	617	Current controller p-gain (0 ... 10000)
P2.7.7	CurrentControlTi	0.1	100.0	ms	0.1	1.5	1400	Current controller integrator time constant (0 ... 1000) = 0...100.0 ms
P2.7.8	Switching Freq	1.0	Switching FreqMax	KHz	0.1		601	Switching frequency.
P2.7.9	Dynamic Damp Kp	0.00	100.00	%	0.01	0	1406	Dynamic damping gain when parameter 2.7.5 Torque Select is greater than 1. 1.00 means nominal torque for nominal speed difference.
P2.7.10	Dynamic Damp TC	0	32000	ms	1	0	1407	Bandpass filter time constant for dynamic damping. 0 means static damping proportional to frequency error.
P2.7.11	DC Magn Current	0.0	Motor Nom Current	A			627	Constant DC Magnetization Current

Code	Parameter	Min	Max	Unit	Step	Default	ID	Note
P2.7.12	DC Magn Time	0	10000	ms	1	0	628	Constant DC magn. time [ms] in ramp start
P2.7.13	Start 0Speed Time	0	32000	ms	1	100	615	Time of zero speed ref at start in ms, (0 ...32000)
P2.7.14	Stop 0SpeedTime	0	32000	ms	1	100	616	Time of zero speed ref at ramp stop in ms, (0 ...32000)
P2.7.15	Stop State Flux	0	150.0	%	1	100.0	1401	The % of rated flux maintained after the motor is stopped for the time Flux Off Delay.
P2.7.16	Flux Off Delay	-1	32000	s	1	0	1402	The time in seconds for which the flux will be maintained in the motor. Setting this value to -1 will keep the Stop State Flux continuously.

Table 19. Motor control parameters, G2.7

#### 6.4.9.1 PMSM Control (Control keypad: Menu M2 → G2.7.17)

Code	Parameter	Min	Max	Unit	Step	Default	ID	Note
P2.7.17.1	Flux Control Kp	0.00	320.00	%	0.01	5.00	651	Gain for the flux controller in %.
P2.7.17.2	Flux Control Ti	0.0	100.0	ms	0.1	5.0	652	Integral time constant for flux current controller in ms.
P2.7.17.3	RsIdentification	0	1		1	0	654	Stator resistance identification during every start. 0= Disabled 1=Enabled.
P2.7.17.4	Modulation Index	0	200	%	1	100	655	Modulation index in % for closed loop operation.
P2.7.17.5	EncAngleOffset	0	65535		1	0	649	Low word of (endat) encoder angle corresponding to shaft 0 position. This parameter is only for monitoring and back up purpose. It is used only with absolute encoders .

Table 20. PMSM control parameters, G2.7.17

#### 6.4.10 Limit settings (Control keypad: Menu M2 → G2.8)

Code	Parameter	Min	Max	Unit	Step	Default	ID	Note
P2.8.1	Zero Speed Level	0	Motor NomSpeed	rpm	1	15	1283	Speed below which Bit 11 of Auxiliary Status Word becomes TRUE
P2.8.2	Zero Speed Mon	0	1		1	1	1284	Monitoring of Zero speed is based on 0=Speed Ref, 1=Speed Actual
P2.8.3	Speed Maximum	-10000	10000	rpm	1	1440	1285	Maximum limit of the Speed reference
P2.8.4	Speed Minimum	-10000	10000	rpm	1	0	1286	Minimum Limit for the Speed Reference
P2.8.5	Current Limit	Motor Cur- rentMin	Motor CurrMax	A	0.1		107	Maximum Total Current Limit.
P2.8.6	Torque Limit Mot	0.0	300.0	%	0.1	300.0	1287	Torque limit for the motoring side.
P2.8.7	Torque Limit Gen	0.0	300.0	%	0.1	300.0	1288	Torque limit for the generator side.
P2.8.8	SPC OUT Limit	0.0	300.0	%	0.1	300.0	1382	Absolute maximum limit for the speed controller output in closed loop control in % of motor nominal torque.
P2.8.9	Power Limit Mot	0.0	300.0	%	0.1	300.0	1289	Power limit for motor side
P2.8.10	Power Limit Gen	0.0	300.0	%	0.1	300.0	1290	Power limit for generator side
P2.8.11	PullOutTorque	0.0	1000.0	%	0.1	250.0	1291	Pull Out Torque limit of the motor
P2.8.12	System Inertia	0	30000	kgm <sup>2</sup>	1	0	1292	Inertia of the system in kgm <sup>2</sup> .
P2.8.13	Max Brake Power	0.000	30.000	kW	0.00 1	0.000	1293	Max Braking Power Limit in Constant Power Emergency Stop
P2.8.14	Max Braking Torq	1	30000	Nm	1	1	1294	Max Braking Torque of the motor in Constant Power Emergency Stop

Table 21 Limit setting parameters, G2.8



### 6.4.11 Speed control (Control keypad: Menu M2 → G2.9)

Code	Parameter	Min	Max	Unit	Step	Default	ID	Note
P2.9.1	SPC Kp	1	1000		1	30	613	Speed controller P gain (0 ...1000)
P2.9.2	SPC Ti	0	32000	ms	1	300	614	Speed controller integrator time constant 0...32000ms
P2.9.3	Kp Min	0	100	%	1	100	1295	Relative gain (%)of SPC Kp if torque is below G2.9
P2.9.4	Min Point	0	100.0	%	0.1	0.0	1296	Torque Limit for adaptive SpeedControl_Kp (1000 = nominal)
P2.9.5	Min Filt	0	1000	ms	1	0	1297	Filtering TC for Speed Control_Kp in ms
P2.9.6	SPC Kp FWP	1	200	%	1	100	1298	Relative final gain of speed controller at field weakening in % of SPC Kp.<100 reduces gain, >100 increases gain above FWP
P2.9.7	SPC Kp N0	0	100	%	1	100	1299	Relative gain (%) below SPC Kp N0 Point Init:=100
P2.9.8	N0 Point	Speed_Min	Speed_Max	rpm	1	0	1300	Below this speed N0 the speed controller gain will be SPC Kp N0
P2.9.9	N1Point	Speed_Min	Speed_Max	rpm	1	0	1301	Above this speed N1 speed controller gain will be SPC Kp
P2.9.10	Mech AccComp TC	0.00	300.00	s	0.01	0.00	1302	Mechanical time constant for acceleration compensation in Sec (0...300 s)
P2.9.11	Accel Comp Filt	0	1000	ms	1	0	1303	Filter time constant for Acceleration compensation in ms
P2.9.12	Load Drooping	0.00	100.00	%	0.01	0.00	620	Load Drooping = 0 ... 100.00% of nominal speed at nominal torque
P2.9.13	Drooping Time	0.00	327.67	s	0.01	0.00	656	Load drooping time in ms. Value 0 means static or continuous drooping.
P2.9.14	Window Pos RPM	0	Motor-NomSpeed	rpm	1	0	1304	Window width in RPM for positive direction
P2.9.15	Window Neg RPM	0	Motor-NomSpeed	rpm	1	0	1305	Window width in RPM for negative direction
P2.9.16	Window Off Pos	0	Window_Width_Positive	rpm	1	0	1306	Window OFF limit in RPM for hysteresis in Window ctrl in positive direction
P2.9.17	Window Off Neg	0	Window_Width_Negative	rpm	1	0	1307	Window OFF limit in RPM for hysteresis in Window ctrl in Negative direction
P2.9.18	Slip Adjust	0	500	%	1	100	619	Slip adjust 0...500%
P2.9.19	Warm Motor Slip	0	500	%	1	100	1405	Relative slip adjust for the motor at nominal temp.
P2.9.20	Speed Error Filt	0	1000	ms	1	0	1311	Filter time for the speed error
P2.9.21	Speed Act Filter	0.0	250.0	ms	0.1	0.0	1308	Filter time for the measured speed from the encoder.

Table 22 Speed control parameters, G2.9

#### 6.4.12 Oscillation damp (Control keypad: Menu M2 → G2.10)

Code	Parameter	Min	Max	Unit	Step	Default	ID	Note
P2.10.1	Oscill Damp Sel	0	2		1	0	1310	Resonance damper selector 0 = Not in Use 1 = BandPass 2 = BandStop + BandPass
P2.10.2	Oscill Freq	0.0	450.0	Hz	0.1	0.0	1313	Resonance damper natural frequency 1.0...450.0 Hz 0 = Not in use
P2.10.3	Oscill Damp Gain	0.0	100.0	%	0.1	0.0	1314	Resonance damper damping gain at notch frequency 0 ... 100.0%
P2.10.4	Phase Shift	0	360	Deg	1	0	1315	Resonance Damper Phase shift at Notch frequency 0...360 deg

Table 23. Oscillation damping parameters, G2.10

#### 6.4.13 Brake & fan control (Control keypad: Menu M2 → G2.11)

Code	Parameter	Min	Max	Unit	Step	Default	ID	Note
P2.11.1	Brake Lift Delay	0	1000	ms	1	100	352	Delay for getting the acknowledgement of mech. brake open
P2.11.2	Brake In Emstop	0	1		1	0	1318	Selection of mechanical brakes closing on emergency stop. 0=Brakes applied at zero speed (par. 3.8.1) 1=brakes are applied immediately on emergency stop
P2.11.3	Brake In Fault	0	1		1	0	1319	Selection of mechanical brakes closing on fault in drive 0=Brakes applied at zero speed (par. 3.8.1) 1=brakes are applied immediately on Fault
P2.11.4	Mot Fan OffDelay	0.00	300.00	s	0.01	20.00	1320	Motor fan off delay ###.## Seconds

Table 24. Brake and fan control parameters, G2.11

**6.4.14 Master Follower (Control keypad: Menu M2 → G2.12)**

Code	Parameter	Min	Max	Unit	Step	Default	ID	Note
P2.12.1	M/F Mode	0	2		1	0	1324	0=None 1=Master 2=Follower (Speed or Torque follower mode can be selected using the parameter P3.7.5 Torque Select).
P2.12.2	Follower SpRef	0	2		1	0	1327	Source of speed reference for the drive if Par 3.14.1=2 Follower 0=Drive 's own reference 1=Master speed reference before Ramp 2=Master speed reference after Ramp.(Follower Drive ramp is bypassed in this case)
P2.12.3	Follower Start Delay	0.00	327.67	s	0.10	0.00	1398	Delay in starting the multiple wind current follower after the master is started.

Table 25 Master Follower parameters, G2.12

**6.4.15 Protections (Control keypad: Menu M2 → G2.13)**

Code	Parameter	Min	Max	Unit	Step	Default	ID	Note
P2.13.1	AI <4mA	0	2		1	0	700	Operation in case of Analogue Input less than its Minimum value
P2.13.2	Panel Commn.	1	2		1	1	1329	Operation in case Control Place=2 and keypad stops communicating
P2.13.3	External Fault	0	2		1	2	701	Select the action in case of External fault
P2.13.4	Input Ph. Superv	0	1		1	0	730	Operation in case of Input Phase loss. 0 = supervision OFF 1 = supervision ON
P2.13.5	Output Ph. Superv	0	2		1	0	702	Operation in case of motor phase loss
P2.13.6	Earth Fault	0	1		1	0	703	Operation in case of Earth Fault
P2.13.7	Earth Fault Curr	0.0	100.0	%	0.1	50.0	1333	Max. level for Earth current in % of unit current.
P2.13.8	Earth Fault Delay	0	5000	ms	1	800	1334	Earth fault wait time in ms
P2.13.9	Motor Stall	0	2		1	1	709	Operation in case of Motor stall. 0=OFF 1=Warning 2=Trip
P2.13.10	Stall Current	0.0	Motor NomCurr	A	0.1	10.0	710	Current limit of motor stall protection
P2.13.11	Stall Freq Lim	0.00	Motor NomFreq	Hz	0.01	25.00	712	Max frequency for stall protection, f[Hz] = Stall-Frequency/FreqScale
P2.13.12	Stall Time Lim	1.00	120.00	s	0.01	15.00	711	Max time for stall protection to operate in seconds

P2.13.13	Thermistor	0	2		1	0	732	Action on thermistor fault 0= No Action 1= Warnig 2= Fault
P2.13.14	Encoder Fault	0	1		1	0	1353	Encoder fault 0=Disable 1=Enable
P2.13.15	Mech Brake Fault	1	2		1	2	1316	Action on mechanical brake fault. This fault is enabled only if digital input for mechanical brake acknowledgement is selected. 1= Warning 2= Fault
P2.13.16	Follower TimeOut	0.10	5.00	s	0.01	0.10	1352	Delay time for master follower communication Fault.
P2.13.17	FB WatchdogDelay	0	2.00	s	0.01	0.05	1354	Fieldbus watchdog delay.If set to 0 watchdog function is disabled.
P2.13.18	PT100 Num In Use	0	3		1	0	739	Select the number of PT100 channels used on OPTB8 board. There are three channels.
P2.13.19	PT100 AlarmLimit	-30	200	°C	1	110	1347	Select the temp. limit for PT100 sensor above which PT100 Temp. alarm is generated. Note that PT100 can be connected through analogue input as explained in the manual or through OPTB8 card for PT100. The limit is common for all.
P2.13.20	PT100 Fault Limit	PT100 Alarm Limit	200	°C	1	120	1348	Select the temp. limit for PT100 sensor above which PT100 Temp. fault is generated. Note that PT100 can be connected through analogue input as explained in the manual or through OPTB8 card for PT100. The limit is common for all.
P2.13.21	MotTempCompen	0	2		1	0	1426	Motor temperature compensation. 0= Disabled 1= From TS1 temp 2= From Ts2 temp.
P2.13.22	Motor CalcTempProt	0	2		1	0	704	Operation in case of Motor thermal protection
P2.13.23	ThermalTime Const	1	200	min	1	45	707	Motor Thermal Time Constant in minutes, (1... 200)
P2.13.24	Zero Spd Cooling	0.0	100.0	%	0.1	40.0	706	Motor cooling ability at zero speed unit in %
P2.13.25	Motor Duty Cycle	0	300	%	1	100	708	Motor Duty Cycle in %
P2.13.26	Underload Prot	0	2		1	0	713	Operation in case of Underload. 0=OFF, 1=warning, 2=trip
P2.13.27	Speed Zero Load	0.0	300.0	%	0.1	0.0	714	Underload load curve at zero freq,unit

P2.13.28	Speed Nom Load	0.0	300.0	%	0.1	0.0	1341	Underload load curve at nominal freq,unit
P2.13.29	UnderLdSpeed Nom	0	Motor Nom-SpeedMax	rpm	1	1440	1342	Speed limit value for Underload protection

Table 26. Protection parameters, G2.13

#### 6.4.16 Flux reference handling (Control keypad: Menu M2 → G2.14)

Code	Parameter	Min	Max	Unit	Step	Default	ID	Note
P2.14.1	Flux Curve 10%	0.0	200.0	%	0.1	10.0	1355	Flux linearisation point 1
P2.14.2	Flux Curve 20%	0.0	200.0	%	0.1	20.0	1356	Flux linearisation point 2
P2.14.3	Flux Curve 30%	0.0	200.0	%	0.1	30.0	1357	Flux linearisation point 3
P2.14.4	Flux Curve 40%	0.0	200.0	%	0.1	40.0	1358	Flux linearisation point 4
P2.14.5	Flux Curve 50%	0.0	200.0	%	0.1	50.0	1359	Flux linearisation point 5
P2.14.6	Flux Curve 60%	0.0	200.0	%	0.1	60.0	1360	Flux linearisation point 6
P2.14.7	Flux Curve 70%	0.0	200.0	%	0.1	70.0	1361	Flux linearization point 7
P2.14.8	Flux Curve 80%	0.0	200.0	%	0.1	80.0	1362	Flux linearization point 8
P2.14.9	Flux Curve 90%	0.0	200.0	%	0.1	90.0	1363	Flux linearization point 9
P2.14.10	Flux Curve 100%	0.0	200.0	%	0.1	100.0	1364	Flux linearization point 10
P2.14.11	Flux Curve 110%	0.0	200.0	%	0.1	110.0	1365	Flux linearization point 11
P2.14.12	Flux Curve 120%	0.0	200.0	%	0.1	120.0	1366	Flux linearization point 12
P2.14.13	Flux Curve 130%	0.0	200.0	%	0.1	130.0	1367	Flux linearization point 13
P2.14.14	Flux Curve 140%	0.0	200.0	%	0.1	140.0	1368	Flux linearization point 14
P2.14.15	Flux Curve 150%	0.0	200.0	%	0.1	150.0	1369	Flux linearization point 15

Table 27. Flux reference handling parameters, G2.14

#### 6.4.17 Startup torque (Control keypad: Menu M2 → G2.15)

Code	Parameter	Min	Max	Unit	Step	Default	ID	Note
P2.15.1	Startup TorqueSel	0	3		1	0	621	0 = Not in use 1 = Torque Memory, 2 = Torque Reference 3 = Startup Torque FWD/REV
P2.15.2	Startup Torq Time	0	10000	ms	1	0	1371	Maximum time for startup torque in ms, (0 ...10000)
P2.15.3	Startup Torq FWD	-300.0	300.0	%	0.1	0.0	633	StartupTorqueReference to forward direction -300.0 ...300.0% of motor nominal torque
P2.15.4	Startup Torq REV	-300.0	300.0	%	0.1	0.0	634	StartupTorqueReference to reverse direction -300.0 ...300.0%.
P2.15.5	Torq Memory Srce	0	2		1	1	1374	Source for torque memory. At the next start the same startup torque reference will be used.
P2.15.6	Torq Memory Ref	-300.0	300.0	%	0.1	0.0	1375	Fixed reference for the torque memory

Table 28. Start-up Torque parameters, G2.15

#### 6.4.18 DAC (Control keypad: Menu M2 → G2.16)

Code	Parameter	Min	Max	Unit	Step	Default	ID	Note
P2.16.1	Speed Mon Filter	20	2000	ms	1	20	1376	Filter in ms for monitoring signal V1.1.2 Motor Speed.
P2.16.2	Curr Mon Filter	20	2000	ms	1	20	1377	Filter in ms for monitoring signal V1.1.4 Motor Curr
P2.16.3	Torq Mon Filter	20	2000	ms	1	20	1378	Filter in ms for monitoring signal V1.1.5 Motor Torque

Table 29 DAC parameters, PG.16

#### 6.4.19 Data mapping (Control keypad: Menu M2 → G2.17)

Code	Parameter	Min	Max	Unit	Step	Default	ID	Note
P2.17.1	PD IN1 ID	0	65535		1	0	876	
P2.17.2	PD IN2 ID	0	65535		1	0	877	
P2.17.3	PD IN3 ID	0	65535		1	0	878	
P2.17.4	PD IN4 ID	0	65535		1	0	879	
P2.17.5	PD IN5 ID	0	65535		1	0	880	
P2.17.6	PD IN6 ID	0	65535		1	0	881	
P2.17.7	PD IN7 ID	0	65535		1	0	882	
P2.17.8	PD IN8 ID	0	65535		1	0	883	
P2.17.9	PD OUT1 ID	0	65535		1	4	852	Torque
P2.17.10	PD OUT2 ID	0	65535		1	1163	853	Aux Control Word
P2.17.11	PD OUT3 ID	0	65535		1	1172	854	Fault Word 1
P2.17.12	PD OUT4 ID	0	65535		1	1173	855	Fault Word 2
P2.17.13	PD OUT5 ID	0	65535		1	15	856	DIN Status Word 1
P2.17.14	PD OUT6 ID	0	65535		1	1174	857	Alarm Word
P2.17.15	PD OUT7 ID	0	65535		1	1170	858	Motor Shaft Rounds
P2.17.16	PD OUT8 ID	0	65535		1	1169	859	Motor Shaft Position
P2.17.17	FB Mode	1	5			4	896	1= Profidrive mode 2= Bypass mode 3= Not used 4= Selma mode 5= MicroStar mode

Table 30. Data mapping parameters, G2.17

#### 6.4.20 Keypad control (Control keypad: Menu M3 → R3.1)

The reference from the keypad when control place is selected as keypad is listed below. See the [Keypad control menu](#) in the product's User's Manual.

Code	Parameter	Min	Max	Unit	Step	Default	ID	Note
R2.1	Keypad reference	P2.8.4 Speed Min	P2.8.3 Speed Max	rpm	1			Local speed reference in rpm when control place is keypad.

Table 31. Keypad control parameters, M3

#### 6.4.21 Expander boards (Control keypad: Menu M7)

The **M7** menu shows the expander and option boards attached to the control board and board-related information. For more information, see the product's User's Manual.

## 6.5 Description of parameters

### 6.5.1 Basic parameters

#### 2.1.1 Supply voltage

Nominal value of the mains incoming voltage in volts.

#### 2.1.2 Motor nominal voltage

Nominal value of motor voltage in volts as per the motor nameplate data.

#### 2.1.3 Motor nominal frequency

Nominal value of motor frequency in Hz as per the motor nameplate data.

#### 2.1.4 Motor nominal current

Nominal value of the motor current in amperes as per the motor nameplate data.

#### 2.1.5 Motor nominal speed

Nominal value of the motor speed in rpm as per the motor nameplate data.

#### 2.1.6 Motor cos phi

Nominal value of the cos phi as per the motor nameplate data.

#### 2.1.7 Process speed

This parameter is used to scale the speed signal in terms of the process speed. This speed value corresponds to value of the parameter P2.4.5 FBRef Scale for the speed reference written from the fieldbus. For e.g. If P2.4.5 FB Ref Scale =20000 and P2.1.7 Process Speed = 1600 then drive will run with the speed reference of 1600rpm when the speed reference from fieldbus is written as 20000.

#### 2.1.8 Magnetising current

Defines the nominal magnetising current for the motor corresponding to 100% flux. The value of the parameter (if not known) can be found out by performing following test on the motor.

Please note that the motor must be decoupled from the gearbox and the load while doing the following test.

- Set all the nameplate parameters of the motor P3.1.2 to P3.1.6.
- Set P3.7.4 Motor Ctrl Mode =0(Open Loop Frequency control)
- Run the motor with no load on the shaft with approx.  $0.66 \times \text{Rated Frequency}$ . (33Hz for 50Hz motor).
- Wait for 10seconds and then note the value of signal V1.1.5Motor Current.
- Set this value to P2.1.8 Magn. Current.

### 2.1.9 *Field weakening point*

The field weakening point is the output frequency at which the motor voltage reaches the value of P2.1.10 Voltage at FWP in percentage. This parameter is applicable during open loop control of the motor. Normally this parameter is set equal to motor nominal frequency.

### 2.1.10 *Voltage at field weakening point*

Percentage value of the motor voltage at the field weakening point defined by P2.1.9. Above the field weakening point frequency the voltage remains to the value set by this parameter. This parameter is applicable during open loop control of the motor. Normally this parameter is set to 100.00% of motor nominal voltage.

### 2.1.11 *Identification run*

This parameter defines the different modes of the automatic motor identification run. Set the parameter and give the run command within 20 seconds to activate the identification. The result of the identification is seen in **V1.1.19 ID Run Status**. The parameter is reset to zero (None) after the identification is complete. In case of failure Alarm **57 ID Run Fail** is generated.

0 None

1 Identification without motor running

The identification is performed with motor at standstill. In this mode motor stator resistance and parameters for U/F curve are identified. At the end of the identification the parameter P2.6.5.1 U/f Ratio Select is set equal to 2 (programmable). This identification mode is used when it is not possible to decouple the motor from the gearbox and load. The identification optimises the performance for open loop motor control mode i.e.  $P2.7.4 = 0/1/2$ .

After the successful identification B0 of variable ID Run Status is Set.

2 Identification with motor running

The identification is performed with motor running. It is recommended to decouple the motor from the gearbox and the load. In addition to the motor parameters for open loop motor control, magnetising current (P2.1.8) and flux linearization curve (P2.14.1 to P2.14.15) are identified.

After the successful identification B0, B2 and B3 of variable ID Run Status is Set.

3 Encoder ID

The motor may rotate during the identification. The function is primarily used to identify the shaft zero position for PMSM motor when absolute encoder is used.

4 Magnetisation current calculation

In this identification, the magnetisation current of the motor for a given motor data (P2.1.2...P2.1.6) is calculated. **Note:** The motor is not subjected to any voltage or current. Giving a run command.



### 2.1.12 *Motor type*

This parameter defines the type of the motor connected to the frequency converter. It is possible to connect the following motor types to VACON NXP frequency converters.

- 0 Normal Induction motor
- 1 Multiple winding induction motor  
Motors with multiple and galvanically isolated phase windings.
- 2 Permanent magnet induction motor
- 3 Multiple winding permanent magnet induction motor.

**Note:** Please consult with Vacon technical support to use options 1...3.

## 6.5.2 *Input signals*

### 6.5.2.1 *Digital input*

#### 2.2.1.1 *Run forward*

Select the digital input for starting the motor when P3.6.1 Control Place =1 (I/O). Drive starts running when digital is high and it stops when low.

0 Not selected

1 DIN1

2 DIN2

.

.

n = DINn where n is the maximum no. of DINs installed.

#### 2.2.1.2 *Run reverse*

Select the digital input for reversing the direction of the motor when P3.6.1 Control Place=1 (I/O). The motor runs with positive speed reference when selected digital input is low and with negative reference when high.

0 Not selected

1 DIN1

2 DIN2

.

.

n = DINn where n is the maximum no. of DINs installed.

#### 2.2.1.3 *IO control*

Select the condition to be able to control the drive from IO i.e. P2.6.1 Control Place = 1(I/O).

0 Not selected

1 DIN1

2 DIN2

.

.

n = DINn where n is the maximum no. of DINs installed.

#### 2.2.1.4 *Reset*

Select the digital input for resetting the drive fault. The rising edge of the digital input resets the fault if the cause of the fault is disappeared.

0 Not selected

1 DIN1

2 DIN2

.

.

n = DINn where n is the maximum no. of DINs installed.

### 2.2.1.5 Brake open

This parameter can be used by the drive to select digital input to acknowledge the status of the motor mechanical brake (if any). The drive can control the brake through relay output (programmable) and external hardware. The status of the brake is wired to digital input selected by above parameter. When run request to the motor is released, drive first opens the brake through the digital output and keeps the reference zero. When the brake open acknowledgement is received then drive releases the reference. When the run request to the motor is removed, drive closes the brakes at zero speed. In case of emergency stop and fault the brakes are closed as per the setting of parameters P2.11.2 and P2.11.3 resp. If the acknowledgement is not received at the digital input within the time set by parameter P2.11.1 after the run request then drive trips on F57 Mech. Brake fault.

- 0 Not selected
- 1 DIN1
- 2 DIN2

.

n = DINn where n is the maximum no. of DINs installed.

### 2.2.1.6 Brake open logic

This parameter enables to connect the Brake open acknowledgement wiring in normally open (NO) or normally close type.

- 0 Normally open
- 1 Normally close

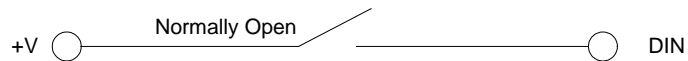

Note: Closed when brake is opened or released.

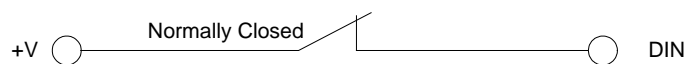

Note: Open when brake is opened or released.

### 2.2.1.7 Motor fan acknowledgement

Select the digital input to acknowledge the status of the motor external fan (if any). The drive can start/stop the motor fan through one of the programmable relay output. The status of the fan (ON/OFF) is wired to the digital input. With run request the motor fan starts and if the acknowledgement is not received within 5 seconds after the run request then drive gives warning **56 Motor Fan**. When run request is removed the fan stops after the delay set by P2.11.4 Mot Fan Off Delay.

- 0 Not selected
- 1 DIN1
- 2 DIN2

.

n = DINn where n is the maximum no. of DINs installed.

### 2.2.1.8 *Input switch acknowledgement*

Select the digital input to acknowledge the status of input switch. The input switch is normally switch fuse unit or main contactor with which the power is fed to the drive. If the input switch acknowledgement is missing, drive trips on " F64 Input Switch open" fault.

- 0 Not selected
- 1 DIN1
- 2 DIN2

.

n = DINn where n is the maximum no. of DINs installed.

### 2.2.1.9 *Run enable*

Select the digital input to activate the Run Enable input to the drive. When run Enable is low, the drive coasts to stop with "OFF" indication on the keypad and "F26 Run Disable" warning. Normally the motor load switch or prevention of false start relay status is used as Run Enable.

- 0 Not selected
- 1 DIN1
- 2 DIN2

.

n = DINn where n is the maximum no. of DINs installed.

### 2.2.1.10 *Run enable logic*

This parameter enables to connect the Run Enable wiring in normally open (NO) or normally close type.

- 0 Normally open
- 1 Normally close

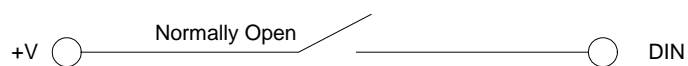

Note: Run Enabled when closed.

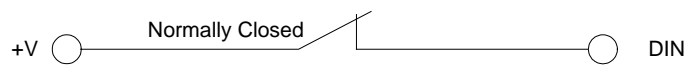

Note: Run Enabled when Open.

### 2.2.1.11 *Prevention of start*

This parameter is enabled when external device like SPU-024 is used for cutting the power supply to the gate driver and or ASIC board to activate the prevention of false start circuit. This is a safety function and is used to ensure the safety of personnel working in the process during the maintenance. Please note that during the maintenance of the drive the main power has to be switched off.

- 0 Enable
- 1 Disable

When this function is enabled and Run Enable is low the alarm F26 Prevention of start is activated.

**Note:** The DC bus voltage and Unit temperature measurements are not active during Prevention of start. Also the analogue input measurements are not active.

### 2.2.1.12 *Emergency stop*

Select the digital input to activate the emergency stop input to the drive. When digital input is low the drive stops as per the parameter definition of P3.7.3 Emergency stop mode.

- 0 Not selected
- 1 DIN1
- 2 DIN2

.

n = DINn where n is the maximum no. of DINs installed.

### 2.2.1.13 *External fault*

Select the digital input to activate the external fault in the drive. When the selected digital input is high the drive trips on F51External fault and coasts to stop.

- 0 Not selected
- 1 DIN1
- 2 DIN2

.

n = DINn where n is the maximum no. of DINs installed.

### 2.2.1.14 External fault logic

This parameter enables to connect the external fault wiring in normally open (NO) or normally close type.

- 0 Normally open
- 1 Normally closed

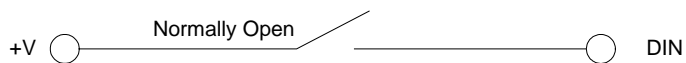

Note: External fault when closed.

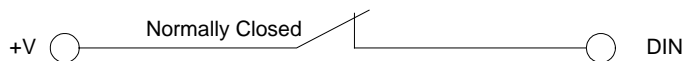

Note: External fault when open.

### 2.2.1.15 Motor 1 or 2 selection

Select the digital input to load the parameters from Set1 or Set2.

Low = Set1  
High = Set2

- 0 Not selected
- 1 DIN1
- 2 DIN2

n = DINn where n is the maximum no. of DINs installed.

Two sets of parameters can be saved as Set1 and Set2 through system menu S6.3.1 from the keypad. With this feature one drive can be used to run two different motors alternatively.

### 2.2.1.16 Fault reset

### 2.2.1.17 Micro start command

### 2.2.1.18 Micro stop command

See the data for these parameters in Table 7. Digital Input parameters, G2.2.1

### 6.5.2.2 *Analogue input*

#### 2.2.2.1 *I/O speed reference selection*

Select the analogue input for giving the speed reference to the drive when drive is in I/O control i.e. control place = 2 I/O control.

- 0 Not used
- 1 AI1
- 2 AI2
- 3 AI1 joystick. The internal logic simulates the joystick reference.
- 4 Const Ref 1,2R. Parameter P2.4.2 Const Ref1 will be used as speed reference when Run Forward Input is active and P2.4.3 Const Ref2 will be used as speed reference when Run Reverse Input is active.
- 5 Fieldbus. Speed reference coming from fieldbus will be used as the speed reference in I/O control.

#### 2.2.2.2 *I/O torque reference selection*

Selects the analogue input for giving the torque reference to the drive when parameter P3.4.6 Tref Source Sel = 3 (Analogue I/P).

- 0 Not used
- 1 AI1
- 2 AI2
- 3 Fieldbus. Torque reference from fieldbus V1.2.17 FB Torque Ref is used.

#### 2.2.2.3 *PT100 (1) AI selection*

Selects the analogue input to be used for temperature measurement using PT100 sensor 1. Two PT100 sensors can be connected to NXP to analogue inputs AI1 and AI2. They are referred as PT100(1) and PT100(2).

- 0 Not used
- 1 AI1
- 2 AI2

#### 2.2.2.4 *PT100 (1) selection*

Selects the no. of PT100 elements in series for PT100 (1) sensor.

- 0 1 PT100
- 1 2 PT100
- 2 3 PT100

#### 2.2.2.5 *PT100 (2) AI selection*

Selects the analogue input to be used for temperature measurement using PT100 (2) sensor.

- 0 Not used
- 1 AI1
- 2 AI2

### 2.2.2.6 *PT100 (2) selection*

Selects the number of PT100 elements in series for PT100 (2) sensor.

- 0 1 PT100
- 1 2 PT100
- 2 3 PT100

### 2.2.2.7, 2.2.2.11 *AI1 reference scale min, AI2 reference scale min*

Minimum value of the signal selected for AI1 (or AI2). This value corresponds to the minimum voltage/current (0V/0mA or 2V/4mA) depending on the setting of parameter P2.3.9 AI1 minimum (or P2.3.13 AI2 minimum).

This parameter is not valid if AI1(or AI2) is used for temperature measurement using PT100 sensor.

### 2.2.2.8, 2.2.2.12 *AI1 reference scale max, AI2 reference scale max*

Maximum value of the signal selected for AI1 (or AI2). This value corresponds to the maximum voltage/current (10V/20mA) depending on the setting of jumpers on the OPT-A1 board.

This parameter is not valid if AI1 (or AI2) is used for temperature measurement using PT100 sensor.

### 2.2.2.9, 2.2.2.13 *AI1 minimum, AI2 minimum*

Minimum voltage/current on the AI1(or AI2) terminal on OPT-A1 board.

- 0 0V/0mA
- 1 2V/4mA

### 2.2.2.10, 2.2.2.14 *AI1 filter time, AI2 filter time*

Filter time in seconds for the filtering of signal connected to AI1(or AI2). The range of the time can be selected from 0.01 sec to 10.00 sec.

### 2.2.3.1 *DIN Selection*

Select digital input that you want to use to control selected parameter.

### 2.2.3.2 *ID Selection*

Select parameter ID number that is controlled with P2.2.3.1 DIN Selection.

### 2.2.3.3 *DIN Low Value*

Give value that is written to parameter ID selected by P2.2.3.2 when selected digital input P2.2.3.1 is low.

### 2.2.3.4 *DIN High Value*

Give value that is written to parameter ID selected by P2.2.3.2 when selected digital input P2.2.3.1 is high.



### 6.5.3 Output signals

#### 6.5.3.1 Digital output

##### 2.3.1.1 D01 (ID BitNo)

Select the signal for controlling the D01. The parameter is to be set in a format xxxx.yy where xxxx is ID number of a signal and yy is bit number. For e.g. Default value for D01 control is 1162.00 where 1162 is the ID number of main status word. So D01 is ON when bit number 00 of main status word (id no. 1162) i.e. Drive ready is high.

##### 2.3.1.1... 2.3.1.13 D02 (ID. BitNo)... D013 (ID. BitNo)

Same as P2.3.1.1.

#### 6.5.3.2 Analogue output

##### 2.3.2.1 A01 Terminal

This parameter is set according to TTF programming method, see Table 12 and chapter 6.3

##### 2.3.2.2 A01 signal ID

ID number of a signal to be connected to A01. Any analogue signal from the application defined with ID no. can be selected.

Please note that if temperature measurement using PT100 sensor is selected with analogue inputs then the A01 is forced internally to generate 10mA and any setting to A01 related parameters is then not valid.

##### 2.3.2.3 A01 offset

Minimum voltage/current at A01 terminal.

- 0 0V/0mA
- 1 2V/4mA

##### 2.3.2.4 A01 filter

Filter time for the signal connected to A01. The range of the time can be selected from 0.02 to 10.00 seconds.

##### 2.3.2.5 A01 max value

Maximum value of the signal connected to A01. This value corresponds to the maximum voltage/current (10V/4mA).

##### 2.3.2.6 A01 Min value

Minimum value of the signal connected to A01. This value corresponds to minimum voltage/current on A01 depending on the setting of parameter P2.3.16. In case of option board supporting to +/-10V at A01 this value corresponds to -10V.

## 6.5.4 Reference handling

### 2.4.1 Speed reference filter

Filter time for the speed reference in the range of 0 to 5000 ms. This filtered speed reference is V1.2.6 Speed reference 3.

### 2.4.2 Constant reference 1

Constant speed reference in the range of P3.8.4 Speed minimum to P3.8.3 Speed maximum for the inching function. This is used for Inch1 function through fieldbus when V1.2.37 MainControlWord.bit8 is set. The same reference can be used as a fixed speed reference when the drive is in IO control.

### 2.4.3 Constant reference 2

Constant speed reference in the range of P3.8.4 Speed minimum to P3.8.3 Speed maximum for the inching function. This is used for Inch2 function through fieldbus when V1.2.37 MainControlWord.bit 9 is set. The same reference can be used as a fixed speed reference when the drive is in IO control.

### 2.4.4 Critical speed low

Lower limit of critical speed window for speed reference. It is to avoid running the drive in a critical speed window in case of mechanical resonance.

### 2.4.5 Critical speed high

Upper limit of critical speed window for speed reference. It is to avoid running the drive in a critical speed window in case of mechanical resonance.

### 2.4.6 Speed share

Percentage of V1.2.4 Speed reference1 to be taken as the speed reference in the speed reference chain. The selected speed reference is seen as V1.2.5 Speed reference 2. With this the two drives with different gear box ratio can have a common speed reference and the individual scaling of the speed reference can be done using this parameter.

### 2.4.7 Fieldbus reference scale

The speed reference from the fieldbus is in counts ranging from -32767 to 32767. It can be scaled to P3.1.7 Process speed with this parameter. The value of this parameter corresponds to the RPM value in P3.1.7. The default value is 20000. Hence the speed reference of 20000 counts from fieldbus corresponds to P3.1.7 Process speed rpm reference.

### 2.4.8 Torque reference source selection

Select the source of torque reference for the drive with this parameter.

- 0 None
- 1 Master. The torque reference comes from the speed controller output of the Master drive through System Bus. This torque reference is seen as V1.2.16 Master TorqueRef in follower drive.
- 2 Fieldbus
- 3 Analogue I/P

#### 2.4.9 *Torque reference filter*

Filter time in 0...5000ms for the torque reference.

#### 2.4.10 *Torque reference hysteresis*

Hysteresis band for the torque reference in percentage of motor nominal current.

#### 2.4.11 *Torque reference dead zone*

Dead zone band for the torque reference on percentage of motor nominal torque. Torque reference below this value in both direction (+ve and -ve) is taken as zero torque reference.

#### 2.4.12 *Torque reference scale*

With this parameter the default resolution of torque reference 1000=motor nominal torque can be changed to 10000= motor nominal torque.

0 1000  
1 10000

All the torque related signals and parameters are changed and displayed automatically in same scale.

#### 2.4.13 *Load share*

Shares the percentage of external torque reference to be taken as torque reference to the drive. Normally this parameter is used by follower drive in case of master follower configuration to share the load torque. For example:

100.0% = Torque reference is equal to the external torque reference.  
50.0% = Torque reference is 50% of the external torque reference.

#### 2.4.14 *Torque reference ramp time*

Ramp time in ms for the nominal torque reference change.

#### 2.4.15 *Flux reference*

Flux reference as a percentage of motor nominal flux in closed loop motor control operation.

#### 2.4.16 *Above speed limit*

Speed limit so that when motor speed is above this limit then V1.2.39 MainStatus-Word.Bit10 is set.

#### 2.4.17 *Speed step*

Step speed reference in counts (0.....P2.4.7 FB ref scale corresponds to 0.....P2.1.7 process speed). This reference is converted to rpm and added to speed reference after the ramp generator V1.2.8 Speed reference 4.

This step reference is normally used to give speed steps during the speed controller tuning in closed loop motor control operation and can also be used as fast speed correction from fieldbus.

### 2.4.18 *Torque step*

Step torque reference in percentage of motor nominal torque. This reference is added to torque reference V1.2.21 Torque reference 3.

This step reference is normally used for the inertia/friction compensation of the drive system through fieldbus in fieldbus control. E.g. the inertia compensation for winder or unwinder roll can be written from fieldbus to this parameter.

## 6.5.5 *Ramp functions*

### 2.5.1 *Acceleration time*

Acceleration ramp time for the speed ramp generator. The drive accelerates in this time from 0 to maximum speed.

### 2.5.2 *Deceleration time*

Deceleration time for the speed ramp generator. The drive decelerates in this time from maximum speed to zero.

### 2.5.3 *S ramp acceleration/deceleration*

The S-curve ratio to smoothen the speed reference during acceleration and deceleration.

### 2.5.4 *Emergency stop ramp*

Deceleration ramp time in case of emergency stop. The drive decelerates from maximum speed to zero speed if P2.7.3 Emergency stop mode = 1 Ramp stop.

### 2.5.5 *Emergency stop delay*

Delay time in seconds to activate the emergency stop action in the drive after the emergency stop is active from DIN6. If the drive is in fieldbus control, it monitors the speed reference from the fieldbus. If the speed reference does not start decelerate within 500ms after the emergency stop is active then drive stops with its own EmStop sequence defined by P2.5.4 Emergency stop ramp and P2.7.3 Emergency stop mode. If the drive is not stopped within Emergency stop delay time then drive stops with its own Emergency stop sequence.

### 2.5.6 *Constant speed acceleration time*

Acceleration ramp time for the speed ramp generator. This acceleration time is used when inching function is used from fieldbus or constant speed operation is used in I/O control. The drive accelerates in this time from 0 to maximum speed.

### 2.5.7 *Constant speed deceleration time*

Deceleration time for the speed ramp generator. This deceleration time is used when inching function is used from the fieldbus or constant speed operation is used in I/O control. The drive decelerates in this time from maximum speed to zero speed.

### 2.5.8 *S ramp constant speed*

S-curve ratio to smoothen the speed reference during acceleration deceleration. This parameter is used when inching function is used from the fieldbus or constant speed operation is used in I/O control.

## 6.5.6 Drive control

### 2.6.1 Control place

Select the control place to control the drive.

- 0 Fieldbus
- 1 I/O
- 2 Local (keypad)

The drive can also be controlled from PC tool through NCDrive when PC control box is checked in the operating window. The drive has to be in Keypad control i.e. control place = Local to be able to control the drive from the PC tool.

### 2.6.2 Brake chopper

Selects the mode of brake chopper operation. This parameter is to be set only if internal brake chopper is used.

- 0 Not used
- 1 On. Internal brake chopper is enabled.

### 2.6.3 Brake chopper level

Brake chopper control activation level in volts.

For 400V Supply:  $400 \times 1.35 \times 1.18 = 638V$

For 500V Supply:  $500 \times 1.35 \times 1.18 = 808V$

For 690V Supply:  $690 \times 1.35 \times 1.18 = 1100V$ .

Please note that when brake chopper is used the over voltage controller can be switched OFF or the over voltage reference level can be set above the brake chopper level.

### 2.6.4 Brake resistor load limit

It is same as generator side torque limit to avoid the overheating of brake resistor during continuous braking. This is active only when P2.6.2 Brake chopper is selected and emergency stop is not active and drive is not decelerating. Braking during normal deceleration or emergency stop is done with P2.8.7 Torque limit generator. This parameter is used only in closed motor control operation.

### 2.6.7 Restart delay

Delay time within which the drive cannot be restarted after the coast stop. The time can be set up to 60.000 seconds.

### 2.6.8 PWM synchronisation

This parameter enables or disables the PWM synchronisation for multiple winding current follower system. The parameter is visible on keypad only if motor type is multiple winding.

### 6.5.6.1 *Open loop control*

#### 2.6.5.1 *U/f ratio selection*

Select the U/f ratio in case of open loop control operation.

- 0 Linear
- 1 Squared
- 2 Programmable. Parameters P2.6.5.2 U/f zero point voltage, P2.6.5.3 U/f mid point voltage, P2.6.5.4 U/f mid point frequency are required to be adjusted in this selection. If the ID run is successfully done then it optimises these parameters and set P2.6.5.1 U/f ratio selection equal to 2 = Programmable.

#### 2.6.5.2 *U/f zero point voltage*

Motor voltage as a percentage of motor nominal voltage at zero frequency reference. This can be set to produce motor current equal to 80...100% of nominal magnetising current at zero frequency reference.

#### 2.6.5.3 *U/f mid point voltage*

Motor voltage as a percentage of motor nominal voltage at frequency reference equal to P2.6.5.4 U/f mid point frequency. This can be set as  $1.41 * P2.6.5.2$  U/f zero point voltage.

#### 2.6.5.4 *U/f mid point frequency*

Mid point frequency reference in case of programmable U/f curve. This can be set as  $(P2.6.5.2 \text{ U/f zero point voltage} * P2.1.3 \text{ Motor nominal frequency}) / 100$ .

#### 2.6.5.5 *U/f optimisation*

Auto torque boost in case of open loop control operation can be enabled with parameter.

- 0 None
- 1 Auto torque boost (Auto torque boost is enabled).

It is recommended to enable auto torque boost only if successful ID run is performed during the commissioning.

#### 2.6.5.6 *DC brake speed*

Speed limit below which the DC braking is activated in open loop motor control operation.

#### 2.6.5.7 *DC brake current*

The amount of current that will be injected in the motor when DC braking is active.

#### 2.6.5.8 *DC brake time*

Time in ms for which the DC braking will be active when the speed is below P2.6.5.6 DC brake speed.

#### 2.6.5.9 *Flux brake*

The flux braking can be activated by this parameter.

- 0 Disabled
- 1 Enabled

**2.6.5.10 Flux brake current**

Amount of flux braking current when the flux braking is active.

**2.6.5.11 Torque stabilator Kp**

Gain for the torque stabilator in open loop motor control operation. The range for the gain value is 0...1000.

**2.6.5.12 Torque stabilator damp TC**

Damping rate for the torque stabilator in open loop motor control operation. The range is 0...1000.

**2.6.5.13 Torque stab Kp field weakening point**

Gain of the torque stabilator at field weakening point in open loop motor control operation. The range is 0...1000.

**2.6.5.14 Flux stabilator Kp**

Gain of the flux stabilator in open loop motor control operation. The range is 0...32000.

**2.6.5.15 Flux stabilator filter time**

Filter time in ms for flux stabilator in open loop control operation. The range is 0...32000.

**2.6.5.16 Make flux time**

Set the time to magnetise the motor so that enough flux is available while starting to run the motor.

**2.6.5.17 Make flux voltage**

Magnetising voltage in percentage of motor nominal voltage.

**2.6.5.18 Measured resistance voltage drop**

Measured voltage at stator resistance between two phases at nominal motor current value. This is measured by injecting current into the motor at standstill during ID Run.

**6.5.6.2 Undervoltage / overvoltage control, stabilator****2.6.6.1 Undervoltage control**

Undervoltage controller can be activated with this parameter.

0 Off

1 On

The drive corrects the frequency reference internally when the DC link voltage falls below the Undervoltage reference level selected by parameter P2.6.6.2 Undervoltage reference selection. The correction in the frequency reference can be seen in V1.1.1 Output frequency when under voltage controller is active and the DC link voltage is below the undervoltage reference.

**2.6.6.2 Undervoltage reference selection**

Selects the undervoltage reference for the undervoltage controller.

- 0 Undervoltage reference min. Minimum undervoltage reference calculated internally by the drive is used as undervoltage reference.
- 1 0.8 estimated DC nom. 80% of estimated DC nominal voltage is used as undervoltage reference for the undervoltage controller.

### 2.6.6.3 *Undervoltage Kp*

Gain for the P-term of the PI type undervoltage controller.

### 2.6.6.4 *Undervoltage Ti*

Gain for the I-term of the PI type undervoltage controller.

### 2.6.6.5 *Overvoltage control*

Overvoltage controller can be activated with this parameter.

- 0 Off
- 1 On, no ramp. (Overvoltage controller is P type controller)
- 2 On with ramp. (Overvoltage controller is PI type controller).

The drive corrects the frequency reference internally when the DC link voltage rises above the overvoltage reference level selected by parameter P2.6.6.6 Overvoltage reference selection. The correction in the frequency reference can be seen in V1.1.1 Output frequency when over voltage controller is active and the DC link voltage is above the overvoltage reference.

### 2.6.6.6 *Overvoltage reference selection*

Overvoltage reference level depending on the status of the brake chopper.

P2.6.6.6 Overvoltage reference selection	Brake chopper in use	Brake chopper is not is use
0	Overvoltage reference maximum calculated internally by the drive	Brake chopper level maximum calculated internally by the drive
1	1.25*Estimated DC nominal voltage	1.18*Estimated DC nominal voltage
2	1.07*brake chopper level	Brake chopper level

Table 32. Overvoltage reference handling

### 2.6.6.7 *Overvoltage Kp*

Gain of the P-term of the PI type overvoltage controller. The range is 0...32767.

### 2.6.6.8 *Overvoltage Kp additional gain*

Additional gain of the P-term of the PI type overvoltage controller at field weakening point.

### 2.6.6.9 *Overvoltage Ti*

Gain for the I-term of the PI type overvoltage controller.

### 2.6.6.10 *Voltage stabilator Kp*

Gain for the voltage stabilator. The range is 0...1000.



The function of the voltage stabilator is to stabilise the variations in the DC link voltage caused due to load or incoming supply variations.

#### 2.6.6.11 *Voltage stabilator TC*

Damping rate for the voltage stabilator. The range is 0...1000.

### 6.5.7 *Motor control*

#### 2.7.1 *Start function*

Selects the mode of starting of the motor.

- 0 Normal ramp. The drive is started from zero reference with the acceleration ramp times.
- 1 Flying start. The drive finds the motor speed either from encoder speed in closed loop or by performing a fast test and internal calculation in open loop motor control operation.

During normal running P2.5.1 Acceleration time 1 is used and in constant speed / inching operation P2.5.6 Constant speed acceleration time is used.

Please note that in closed loop motor control operation the starting of the motor is always like a flying start independent of the parameter settings.

#### 2.7.2 *Stop function*

Selects the mode of stopping the motor except in case of emergency stop.

- 0 Coast stop. The motor is allowed to stop on its own inertia. The drive control is stopped and the drive current is zero as soon as the runrequest is removed.
- 1 Ramp stop. The motor is stopped by the deceleration ramp time selected.

During normal running P2.5.2 Deceleration time 1 is used and in constant speed / inching operation P2.5.7 Constant speed deceleration time is used.

#### 2.7.3 *Emergency stop mode*

Selects the mode of stopping the drive when emergency stop is active.

- 0 Coast stop. The motor is allowed to stop on its own inertia.
- 1 Ramp stop. The motor is stopped by the deceleration ramp time selected by P2.5.4 Emergency stop ramp.
- 2 Torque limit stop. The speed ramp generator output is forced to zero and the drive is allowed to stop against its torque limits.
- 3 Constant power stop. The deceleration ramp time is internally updated so that the drive stops at constant power if the parameters P2.8.13 System inertia in Kg.m<sup>2</sup>, P2.8.14 Max brake power in kW and P2.8.14 Max braking torque in Nm is set correctly for the system. This stop mode is used to be able to stop the drive as fast as possible in case of emergency stop when braking is done using limited braking power. It can also be used for coordinated emergency stop for common DC bus drives.

#### 2.7.4 *Motor control mode*

Selects the motor control mode.

- 0 OL frequency. This is normal U/f control mode without encoder.

- 1 OL speed. This is normal U/f control mode without encoder with slip compensation based on the calculated torque of the motor V1.1.5 Torque.
- 2 OL torque. This is current vector control with U and f references without encoder.
- 3 CL speed/torque. This is rotor flux vector control mode and it needs digital encoder connected to the motor shaft.

### 2.7.5 *Torque selection*

Selects the different configurations possible for speed and torque control when P2.7.4 Motor control mode = 3.

- 0 None. This can be used for closed loop speed control.
- 1 Speed. Closed loop speed control. The inertia/friction compensation can be given to P2.4.19 Torque step. The P2.4.8 Torque reference source selection is internally set to zero (None) to avoid any external torque reference.
- 2 Torque. This is the closed loop torque control. P2.4.8 Torque reference source selection selects the torque reference source. The torque reference can be V1.2.16 Master torque reference from the master drive in case of master follower application, V1.2.17 Fieldbus torque reference from fieldbus or V1.2.18 I/O torque reference from analogue input.
- 3 Min. In this mode minimum of speed controller output V1.2.11 SPC OUT and external torque reference is selected as final torque reference V1.2.22 Used torque reference. This is typically used in winder control applications. External torque reference is calculated from the required tension and system parameters like roll diameter, gearbox ratio, web width and motor data. The overspend reference is added to the normal web speed reference.
- 4 Max. In this mode maximum of speed controller output V1.2.11 SPC OUT and external torque reference is selected as final torque reference V1.2.22 Used torque reference. This is typically used in unwinder control applications. External torque reference is calculated from the required tension and system parameters like roll diameter, gearbox ratio, web width and motor data. The under speed reference is added to the normal web speed reference.
- 5 Window. The drive is allowed to run in torque control as long as the speed is within the speed window around the speed reference. The speed window is defined by parameters P2.9.13 Window positive RPM and P2.9.14 Window negative RPM. When the speed is out of window the drive is switch to speed control to correct the error between V1.2.9 Used speed reference and V1.2.1 Speed measured. The drive remains in the speed control till the speed measured falls in a window around the speed reference. The hysteresis for the window is defined by P2.9.15 Window off positive and P2.9.16 Window off negative.

### 2.7.6 *Current control Kp*

Gain for the current controller in closed loop motor control operation. Range 1...10000. Please note that in normal cases the default value is sufficient and there is no need to change this parameter.

### 2.7.7 *Current control Ti*

Integral time constant for the current controller in closed loop motor control operations. Range 0...100.0 ms. Please note that in normal cases the default value is sufficient and there is no need to change this parameter.

### 2.7.8 *Switching frequency*

Switching frequency in KHz for the IGBTs for the motor control. Please note that the default value is decided by the drive depending on the power size of the drive. For all the drives with 690V supply voltage the maximum switching frequency is 1.5KHz.

The switching frequency can be reduced in case of long motor cables (100m for <1.5kW and 300m for >1.5kW) or very small motors.

### 2.7.9 *Dynamic damp Kp*

Dynamic damping gain when P2.7.5 Torque select is either Torque/Min/Max/Window. The value 1.00 means nominal torque for nominal speed difference. Dynamic damping is intended to reduce mechanical resonance by adding damping torque proportional to speed error.

### 2.7.10 *Dynamic damp TC*

Decaying time for damping torque in ms.  
0= Static damping.

### 2.7.11 *DC magnetisation current*

This parameter can be set to quickly magnetise the motor during starting. DC current of the amount set by this parameter is injected into the motor windings.

### 2.7.12 *DC magnetisation time*

The DC magnetisation current set by P2.7.11 DC magnetisation current is injected in the motor for this time. The speed reference to the ramp generator is then released.

### 2.7.13 *Start 0 speed time*

The time delay to release the speed reference to the ramp generator after the run request is given to the drive.

### 2.7.14 *Stop 0 speed time*

Time for which the zero speed reference is applied to the drive after ramp stop.

### 2.7.15 *Stop state flux*

The amount of flux as a percentage of motor nominal flux maintained in the motor after the drive is stopped. The flux is maintained for the time set by P2.7.16 Flux off delay. This parameter can be used only in closed loop motor control operation.

### 2.7.16 *Flux off delay*

The flux defined by P2.7.15 Stop state flux is maintained in the motor for the set time after the drive is stopped.

0 No flux after the motor is topped. Normal stop.

>0 The flux off delay in seconds.

<0 The flux is maintained in the motor after stop till the next run request is given to the drive. After the run request the flux is equal to the P2.4.16 Flux reference.

### 6.5.8 PMSM control

The parameters in this group can be adjusted only when permanent magnet motor is used.

#### 2.7.17.1 Flux control $K_p$

Gain for the flux current controller in %. It can be adjusted if instability near or in the field weakening area is observed.

#### 2.7.17.2 Flux control $T_i$

Integral time constant for flux current controller in ms.

#### 2.7.17.3 Resistance identification

Stator resistance identification can be done during every start by enabling this parameter.

#### 2.7.17.4 Modulation index

Modulation index in % for closed loop operation. Higher values of motor terminal voltage can be achieved by increasing this value.

#### 2.7.17.5 Encoder angle offset

Low word of absolute encoder angle corresponding to shaft zero position is indicated in this parameter. This parameter is identified during ID Run =3 when absolute encoder is used with PMSM motor. This parameter is only for monitoring and back up purposes and should not be changed manually.

## **6.5.9**     *Limit settings*

### **2.8.1**     *Zero speed level*

Absolute speed below which the bit 11 of the auxiliary status word is set.

### **2.8.2**     *Zero speed monitoring*

Zero speed can be monitored either from V1.2.7 Speed ramp out or from V1.1.2 Speed.

0 Speed ramp out

1 Speed Act. In case of open loop motor control operation it is calculated motor speed and in case of closed loop motor control operation it is speed measured from the encoder.

### **2.8.3**     *Speed maximum*

Maximum speed limit for the drive.

### **2.8.4**     *Speed minimum*

Minimum speed limit for the drive.

### **2.8.5**     *Current limit*

The current limit to the drive. The default value of this parameter depends on the power size of the drive.

### **2.8.6**     *Motoring torque limit*

Motoring side torque limit for the drive as a percentage of the motor nominal torque.

### **2.8.7**     *Generator torque limit*

Generator side torque limit of the drive as a percentage of the motor nominal torque.

### **2.8.8**     *Speed controller out max*

Maximum torque limit for the speed controller output as a percentage of the motor nominal torque.

### **2.8.9**     *Speed controller out min*

Minimum torque limit for the speed controller output as a percentage of the motor nominal torque.

### **2.8.10**    *Motoring power limit*

Power limit for the motor side operation as a percentage of nominal power of the motor.

### **2.8.11**    *Generator power limit*

Power limit for the generator side operation as a percentage of nominal power of the motor.

### **2.8.12**    *Pullout torque*

Amount of maximum torque (breakaway torque) the motor can produce. It can be set as a percentage of motor nominal torque.

### 2.8.13 System inertia

Inertia of the complete drive system in Kg.m<sup>2</sup> including inertia of motor, gearbox and fixed load. This parameter is set when P2.7.3 Emergency stop mode = 3 Constant power stop.

### 2.8.14 Max brake power

Maximum braking power limit in KW in case of emergency stop when P2.7.3 Emergency stop mode = 3 Constant power stop

### 2.8.15 Max braking torque

Maximum braking torque in case of emergency stop when P2.7.3 Emergency stop mode =3 Constant power stop.

## 6.5.10 Speed control

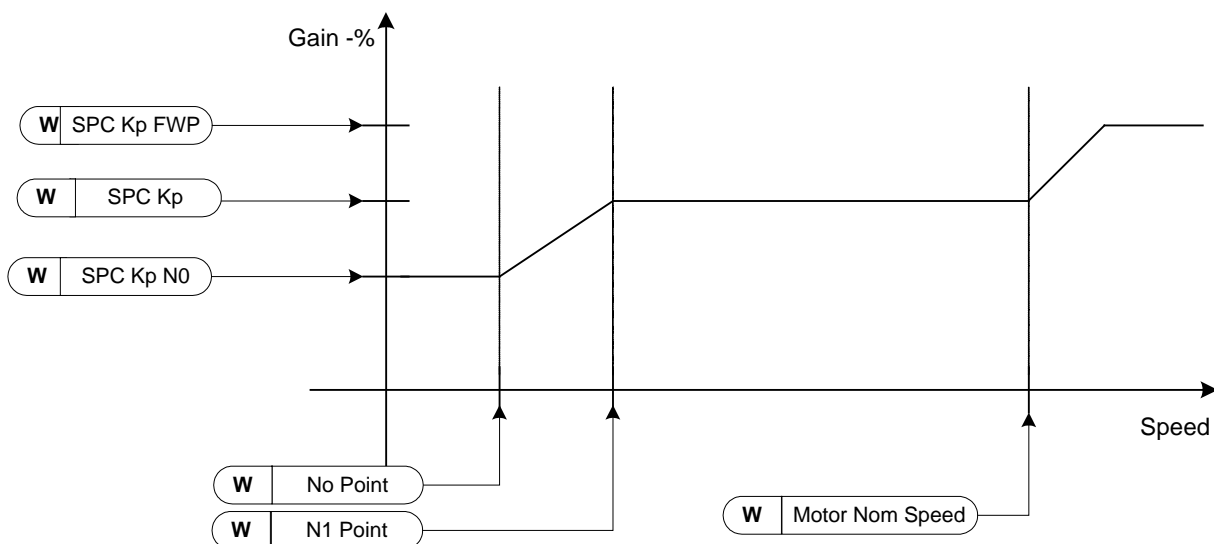

Figure 2. Speed controller adaptive gain

The transfer function for the speed controller is as given below.

$$\text{SPC OUT}(k) = \text{SPC OUT}(k-1) + \text{SPc Kp} * [\text{Speed Error}(k) - \text{Speed Error}(k-1)] + \text{Ki} * \text{Speed error}(k).$$

Where  $\text{Ki} = \text{SPC Kp} * \text{Ts} / \text{SPC Ti}$ .

### 2.9.1 Speed controller Kp

Gain for the speed controller in closed loop motor control operation. Gain value 100 means nominal torque reference is produced at the speed controller output for the frequency error of 1Hz.

### 2.9.2 Speed controller Ti

Integral time constant in ms for the speed controller in closed loop motor control operation.

**2.9.3 Kp Min**

Relative gain as a percentage of P2.9.1 SPC Kp of the speed controller when torque reference or speed control output V1.2.11 SPC out is less than P2.9.4 Min point. This parameter is normally used to stabilise the speed controller for a drive system with gear backlash.

**2.9.4 Min point**

Level of torque reference or speed controller output V1.2.11 SPC out below which the speed controller gain is changed to P2.9.3 Kp Min through a filter set by P2.9.5 Min filter time. This is in percentage of motor nominal torque.

**2.9.5 Min filter time**

Filter time in ms used when the speed controller gain is changed from P2.9.1 SPC Kp to P2.9.3 Kp Min.

**2.9.6 Speed controller Kp field weakening point**

Relative gain of the speed controller in field weakening area as a percentage of P2.9.1 SPC Kp.

**2.9.7 Speed controller Kp N0**

Relative gain of the speed controller as a percentage of P2.9.1 SPC Kp when the speed is below the level defined by P2.9.8 N0 Point.

**2.9.8 N0 point**

The speed level in rpm below which the speed controller gain is P2.9.8 SPC Kp N0.

**2.9.9 N1 point**

The speed level in rpm above which the speed controller gain is P2.9.1 SPC Kp. From speed defined by P2.9.8 N0 point to speed defined by P2.9.9 N1 Point the speed controller gain changes linearly from P2.9.7 SPC Kp N0 to P2.9.1 SPC Kp and vice versa.

**2.9.10 Mech acceleration compensation TC**

Time constant for the acceleration compensation of the fixed inertia of the drive system in closed loop motor control operation. It can be calculated as follows.

$$\text{AccelCompensationTC} = J \cdot \frac{2\pi \cdot f_{\text{nom}}}{T_{\text{nom}}} = J \cdot \frac{(2\pi \cdot f_{\text{nom}})^2}{P_{\text{nom}}}$$

where

J = total system inertia in kg\*m<sup>2</sup>

f<sub>nom</sub> = motor nominal frequency in Hz

T<sub>nom</sub> = motor nominal torque.

P<sub>nom</sub> = motor nominal power in kW.

The final Iq reference is added with additional Iq reference V1.2.23 Acceleration compensation Out proportional to inertia torque during acceleration deceleration.

Please note that fixed inertia like Σ[motor inertia, gear box inertia, basic roll inertia] only can be compensated with this parameter. Variable load inertia like inertia of winder or unwinder can be compensated by the overriding system through fieldbus.

### **2.9.11**     *Acceleration compensation filter time*

Filter time constant in ms for the mechanical inertia compensation.

### **2.9.12**     *Load drooping*

Load drooping as a percentage of nominal speed at nominal torque. Load drooping allows the static speed error as a function of a load torque. For e.g. If Load drooping is set as 10% then for 100% motor torque the drive will allow actual speed less than 10% Nominal speed of the motor. It can be used to smoothen out the load torque variation or also to share the load torque between the two drive systems when the coupling between the drive systems is not rigid.

### **2.9.13**     *Drooping time*

Load drooping time in ms. When the time is set to zero, the drooping is used as static or continuous drooping. Any non zero value activates the dynamic drooping and is active for the time specified.

### **2.9.14**     *Window positive RPM*

This parameter is required to be set when P2.7.5 Torque select = 5. It defines the window area above the speed reference in rpm. The drive remains in torque control as long as speed is within the window area. For the speed out of the window area the drive is switched to speed control to correct the error between speed reference and speed measured.

### **2.9.15**     *Window negative RPM*

This parameter is required to be set when P2.7.5 Torque select = 5. It defines the window area below the speed reference in rpm. The drive remains in torque control as long as speed is within the window area. For the speed out of the window area the drive is switched to speed control to correct the error between speed reference and speed measured.

### **2.9.16**     *Window off positive*

This parameter is required to be set when P2.7.5 Torque select = 5. It defines the upper half hysteresis for the window defined by P2.9.13 Window positive RPM.

### **2.9.17**     *Window off negative*

This parameter is required to be set when P2.7.5 Torque select = 5. It defines the lower half hysteresis for the window defined by P2.9.14 Window negative RPM.

### **2.9.18**     *Slip adjust*

This parameter can be tuned to compensate for inaccuracies in the motor nominal speed data on the motor nameplate. Also the V1.2.36 Rotor time constant estimated by the motor model can be adjusted with this parameter. The rotor time constant varies with the motor temperature. The compensation for the rotor time constant as a function of measured motor temperature using either TS1 or TS2 (PT100 temperature sensor) can be given by setting P2.13.29 Motor temperature compensation. The P2.9.17 Slip adjust is then internally modified as a function of measured motor temperature.



**2.9.19**    *Warm motor slip*

Relative slip as a percentage of P2.9.17 Slip adjust for the warm motor. This is set when internal thermal model for motor temperature calculation is used. The calculated motor temperature is seen as V1.1.21 Motor temperature calculation as a percentage of motor nominal temperature.

**2.9.20**    *Speed error filter time*

Filter time in ms for the speed error between V1.2.9 Used speed reference and V1.2.1 Speed measured. The filtered error is then fed to the speed controller.

**2.9.21**    *Actual speed filter time*

Filter time in ms for speed measured from the encoder. The filtered speed is used to calculate V1.2.10 Speed error, which is fed to speed controller.

### 6.5.11 *Oscillation damp*

#### 2.10.1 *Oscillation damp selection*

Oscillation damping feature of the drive can be enabled using this parameter. This feature can be used to dampen the constant frequency torque oscillations in the drive system.

- 0 Not in use
- 1 Band pass. Oscillation damping with band pass filter.
- 2 BandStop+BandPass. Oscillation damping with band stop and band pass filter.

#### 2.10.2 *Oscillation frequency*

Frequency of torque oscillations to be damped in Hz.

#### 2.10.3 *Oscillation damp gain*

The gain for the oscillation damping. This changes the amplitude of compensating signal used for oscillation damping.

#### 2.10.4 *Phase shift*

The compensating signal used for oscillation damping can be phase shifted 0 to 360 degrees using this parameter.

### 6.5.12 *Brake and fan control*

#### 2.11.1 *Brake lift delay*

Delay in receiving the feedback from the mechanical brake after giving a brake open request from the digital/relay output. The speed reference is not released till the brake lift is acknowledged.

If the brake lift acknowledgement does not come within the Brake lift delay time then the drive trips on F57 Mechanical brake.

#### 2.11.2 *Brake in emergency stop*

Defines the action of the mechanical brakes controlled through drive in case of emergency stop.

- 0 At zero speed. The mechanical brake is closed at zero speed after the emergency stop is active.
- 1 Immediate. The brake is closed immediately after the emergency stop is active.

#### P2.11.3 *Brake in fault*

Defines the action of the mechanical brakes controlled through drive in case of fault in the drive.

- 0 At zero speed. The mechanical brake is closed at zero speed after the fault in the drive.
- 1 Immediate. The brake is closed immediately after the fault in the drive.

#### 2.11.4 *Motor fan off delay*

The external fan can be controlled by setting digital/relay output parameters. The fan is started with the run request and stopped when the motor is stopped and the Motor fan off delay time is elapsed.

### 6.5.13 Master Follower

The master follower in VACON NXP drives is implemented by adding an OPT-D1/OPT-D2 board in slot D or slot E. The master and follower drives are then connected using optic fibre cable network. The OPT-D2 card with optic fibre link in NXP uses Vacon system bus for fast drive-to-drive communication.

#### 2.12.1 M/F mode

When drive is required to be configured in master follower application this parameter can be set.

- 0 None. Drive runs as individual drive.
- 1 Master. Drive runs as a master.
- 2 Follower. Drive runs as follower and share either speed or torque from the follower drive or both. When the drive is controlled from fieldbus P2.6.1 Control place = 0 then V1.2.37 Main control word from the fieldbus is used for controlling the drive. When P2.6.1 Control place is 1 = I/O or 2 = Local (Keypad) or 3 = PC Control, then follower drive is controlled by the internal control word from the master drive on the system bus. The follower drive then starts running with the master drive.

#### 2.12.2 Follower speed reference

Sets the source of speed reference for the follower drive. This parameter is to be set only in the follower drive.

- 0 Follower. Speed reference is generated in the follower drive itself depending on active control place as per P2.6.1 Control place.
- 1 Master reference. Speed reference is taken from master drive V1.2.4 Speed ref. 1.
- 2 Master ramp. Speed reference is taken from master drive V1.2.9 Used speed reference. The ramp generator of the follower drive is then bypassed internally.

The parameter settings for master and follower drives are to be done as per the table below.

#### 2.12.3 Follower start delay

The delay time in starting multiple wind follower after the master is started. As the name suggests, the parameter is valid only if the drive is defined as follower.

Parameter	Master	Follower	Remarks
P2.12.1 M/F Mode	1 Master	2 Follower	Sets the master follower mode
P2.7.4 Motor Control mode	= 0 OL Freq = 1 OL Speed = 3 CL Speed/Torq		If set = 0/1 then only speed follower is possible.
P2.7.5 Torque Select	0= None 1= Speed 2 = Torque 3 = Min 4 = Max 5 = Window		To be set as per the application requirement.

P2.4.8 TRef Source Sel		0 = None	External torque reference is not used.
		1 = Master	Torque reference from the master drive.
		2 = Fieldbus	Torque reference from the fieldbus.
		3 = Analogue I/P	Torque reference from the analogue I/P 1 or 2.
P2.12.4 Follower SpRef			This parameter is to be set only in follower drive.
		0 = Follower	Speed reference is generated in the follower drive itself depending on active control place as per P2.6.1 Control Place.
		1 = Master Ref	Speed reference is taken from master drive V1.2.4 Speed Reference 1.
		2 = Master Ramp	Speed reference is taken from master drive V1.2.9 Used Speed Ref. The ramp generator of the follower drive is then bypassed internally.
If System software <NXP00002V134	If system software >= NXP00002V134	For system software less than NXP00002V134 the speed is always selected as 12Mbps. For system software greater than equal to NXP00002V134 0 = 1 = 2 = 3 = 4 = 5 = 6 =	System software less than NXP00002V134 do not show the parameters for NXOPTD2 card in M7 Expander Boards menu.
P2.12.2 SB Node ID	P7.4.1.2.3 System bus Id		Node ID no. for the master drive. Possible values are 1...63.
P2.12.3 SB Next Node ID	P7.4.1.2.4 System bus NextId		Node ID for the next drive in the master follower communication. Possible values are 1...63.
	P7.4.1.2.1 System bus in use =1		For system software less than NXP00002V134 this signal is internally set to 1 if P2.12.2 and P2.12.3 are non-zero.
	P7.4.1.2.2 System Bus speed		

Table 33. Master Follower parameters

## 6.5.14 Protections

### 2.13.1 *AI<4mA*

Action in case of Analogue input fault. If the voltage or current at the analogue input terminal is less than a minimum value specified by P2.3.9 AI1 Minimum and P2.3 13 AI2 Minimum then analogue input fault is triggered.

- 0 No action.
- 1 Warning. Drive operation continues with F50 Anlg Lin<4mA. V1.2.44 Alarm word 1.Bit9 is set.
- 2 Fault. Drive trips on fault F50 Anlg Lin<4mA and V1.2.42 Fault Word 1 .Bit15 is set.

### 2.13.2 *Panel communication*

Action in case of loss off communication between drive control unit and keypad.

- 1 Warning. Drive operation continues with F52 Keypad communication warning and V1.2.44 Alarm word 1 .Bit15 is set.
- 2 Fault. The drive trips if P2.6.1 Control Place = 2 (Local) i.e. if the drive is running from keypad and V1.2.42 Fault Word 1.Bit11 is set.

### 2.13.3 *External fault*

Action when external fault is activated by digital input.

- 1 Warning. Drive operation continues with F51 External fault warning.
- 2 Fault. The drive trips on F51 External fault with fault word 2. Bit6 is set.

### 2.13.4 *Input phase supervision*

Action in case of loss of one or more input phase supply to the frequency converter. The parameter is to be set to zero for inverter.

- 0 No action. Drive operation continues with no warning or fault indication.
- 1 Fault. Drive trips with F10 Input phase fault and V1.2.42 Fault word 1. Bit8 is set.

### 2.13.5 *Output phase supervision*

Action in case of loss of one or more output phases connected between drive output and motor.

- 0 No action.
- 1 Warning. Drive operation continues with warning F11 Output phase and V1.2.44 Alarm word 1. Bit4 is set.
- 2 Fault. Drive trips on F11 Output phase and V1.2.43 Fault word 2. Bit0 is set.

Please note that this protection cannot find the loss of motor connection in case of multimotor connection to one drive output.

### 2.13.6 *Earth fault*

Action in case of Earth fault in the motor or motor cables.

- 0 No action
- 1 Fault. Drive trips on F3 Earth fault and V1.2.42.Bit4 is set.

### 2.13.7 *Earth fault current*

If the sum of the motor phase currents is higher than the level set by this parameter then earth fault is triggered and the action is taken as per the setting of P2.13.5 Earth fault and P2.13.7 Earth fault delay. The typical value for earth fault current monitoring is 5% of drive nominal current V1.1.17 Unit nominal current.

### 2.13.8 *Earth fault delay*

Earth fault is triggered if the sum of motor phase currents remains higher than the level set by P2.13.6 Earth fault current for the time set by this parameter.

### 2.13.9 *Motor stall*

Action in case of motor stall condition. Motor is said to be in stall condition if the motor current is higher than the P2.13.9 Stall current and output frequency is less than P2.13.10 Stall frequency limit and motor remains in this condition for a time higher than P.13.11 Stall time limit in seconds.

- 0 No action. Drive continues operation with no warning or fault indication.
- 1 Warning. The drive continues operation with F15 Motor stall warning and V1.2.44 Alarm word 1.Bit0 is set.
- 2 Fault. The drive trips on F15 Motor stall and V1.2.42. Bit3 is set.

### 2.13.10 *Stall current*

The current level in amperes for monitoring stall condition of the motor.

### 2.13.11 *Stall frequency limit*

The output frequency level below which monitoring of motor stall condition is active.

### 2.13.12 *Stall time limit*

If the motor remains in stall condition defined by P2.13.9 Stall current and P2.13.10 Stall frequency limit for a time higher than the time set by this parameter then motor stall fault is triggered.

### 2.13.13 *Thermistor*

If the drive is installed with OPT-A3 board in slot B then one thermistor can be connected to the drive through it for motor over temperature indication to the drive.

This parameter sets the action by the drive in case of motor over temperature through thermistor.

- 0 No action
- 1 Warning. The drive continues its operation with warning F61 Thermistor and V1.2.44 Alarm word 1. Bit1 is set.
- 2 Fault. Drive trips on fault F61 Thermistor and V1.2.42 Fault word 1. Bit7 is set.

### 2.13.14 *Encoder fault*

The action in case of loss of encoder signal when drive is running in closed loop control. The drive generates fault or alarm F43 Encoder and V1.2.43 fault word 2. Bit2 is set if the encoder connected to OPT-A5 in slot C is faulty or wrongly connected.

- 0 No action
- 1 Warning
- 2 Fault

Following are the sub codes generated with the fault in different fault conditions.

- Sub code 1. Channel A is missing
- Sub code 2. Channel B is missing
- Sub code 3. Both channel are missing
- Sub code 4. Encoder reversed
- Sub code 5. Card is missing

### 2.13.15 *Mechanical brake fault*

Mechanical brake fault monitoring is automatically enabled if P2.2.6 Mechanical brake acknowledgement is (non zero) set to 1...8. i.e. either if DIN1...4 or inverted DIN1...4 is selected to acknowledge the brake status.

The brakes are lifted through the digital/relay output when run request is given and 70% of motor flux is generated (only in closed loop motor control operation). If the brake lift acknowledgement does not arrive at selected digital input with time specified by P2.11.1 Brake lift delay then the mechanical brake fault is triggered and drive takes action as per the setting of this parameter.

- 1 Warning. Drive continues operation with warning F57 Mech. brake and V1.2.44 Alarm word 1. Bit14 is set.
- 2 Fault. Drive trips on F57 Mechanical brake and V1.2.43 Fault word 2. Bit10 is set.

### 2.13.16 *Follower timeout*

This parameter is to be set in case of master follower application. The parameter is to be set only in follower drives. The master drive sends a watchdog (1 second ON/OFF square wave) to the follower drive. If the follower drive does not receive the watchdog signal for a time higher than that defined by this parameter then drive trips on fault F55 Follower communication and V1.2.42 Fault word 1. Bit13 is set. This indicates that the follower drive has lost the communication with master drive.

Please note that this fault is detected only in follower drive.

### 2.13.17 *Fieldbus watchdog delay*

Delay time to indicate loss of data on fieldbus from overriding system. The overriding system sends the watchdog signal (square wave of 1 second time period) at V1.2.37 Main control word. Bit11. If the drive does not receive this signal for a time higher than the time defined by this parameter then the drive trips on fault F53 Fieldbus communication and V1.2.42 Fault word 1. Bit12 is set. The fault occurs only if P2.6.1 Control place = 0 Fieldbus i.e. the drive is controlled from fieldbus.

The same watchdog signal is sent back to the overriding system at V1.2.39 Main status word. Bit15.

Setting this parameter to zero will disable this watchdog monitoring function. In addition to this the fieldbus option card monitors the communication with fieldbus master and is

always active. In case of loss of communication with the master, the drive trips on F53 Fieldbus communication fault.

### 2.13.18 *PT100 number in use*

PT100 sensors can be connected to Vacon drive for temperature measurement using the OPT-B8 card. Totally three channels are available for connection. With this parameter, select the number of inputs channels used to connect the PT100 sensors.

### 2.13.19 *PT100 alarm limit*

Two PT100 temperature sensors can be connected to the drive using two analogue inputs AI1 and AI2 and AO1 (10mA). These two sensors are referred as PT100 (1) and PT100 (2). Or PT100 sensors can be connected using OPT-B8 card.

This parameter sets the temperature level in celsius above which the drive generates the warning F56 PT100 temperature. The drive continues its operation and V1.2.44 Alarm word 1. Bit1 is set. Note that the alarm limit is common for all PT100 sensors connected to the system.

### 2.13.20 *PT100 fault limit*

This parameter sets the temperature level in celcius above which the drive trips on fault F56 PT100 temperature and V1.2.42 Fault word 1. Bit7 is set.

### 2.13.21 *Motor temperature compensation*

Two PT100 temperature sensors can be connected using analogue inputs AI1 and AI2 and AO1 (10mA) and they are referred as PT100 (1) and PT100 (2). One of the sensors is used normally to measure the motor winding temperature. This measured temperature can be used to compensate the slip adjust P2.9.17 Slip adjust internally. This is needed to adjust the motor model for the variation in rotor time constant as a function of temperature to acquire better torque accuracy.

This parameter selects the temperature sensor to be used for compensation.

0 Compensation to slip adjust is not used.

1 Motor temperature for the slip adjust compensation is read from PT100 (1) sensor.

2 Motor temperature for the slip adjust compensation is read from PT100 (2) sensor.

The function work as follows.

For e.g. If P2.9.17 Slip adjust is set to 100% and P2.13.29 Motor temperature compensation = 1 (Compensation from PT100(1)sensor).

Internal slip adjust =  $[(PT100 (1) \text{ Temp. in celsius} * 40)/100+60] * P2.9.17 \text{ Slip adjust}/100$ .

For temperature varying from 25 to 100 degrees celsius the slip adjust will vary internally from 70 to 100 %.



### 2.13.22 *Motor calculated temperature protection*

Drive has internal temperature calculation for the motor based on motor data and setting of P2.13.17 Thermal time constant, P2.13.18 Zero speed cooling and P2.13.19 Motor duty cycle. The calculated motor temperature can be seen as V1.1.21 Motor temperature calculation as a percentage of motor nominal temperature. The overheating of the motor is monitored by this function. This parameter sets the action in case of motor overheating triggered by calculated motor temperature.

- 0 No action
- 1 Warning. The drive continues operation with warning F16 Motor overtemperature and V1.2.44 Alarm word1. Bit1 is set.
- 2 Fault. Drive trips on F16 Motor overtemperature and V1.2.42 Fault word 1. Bit7 is set.

### 2.13.23 *Thermal time constant*

Thermal time constant of the motor in minutes for the internal motor temperature calculation.

### 2.13.24 *Zero speed cooling*

Motor cooling ability at zero speed as a percentage of that at full speed or its nominal cooling ability. This parameter is used in internal motor temperature calculation.

### 2.13.25 *Motor duty cycle*

Motor duty cycle for internal motor temperature calculation.

### 2.13.26 *Underload protection*

Action in case of underload condition. The drive is in underload condition if the load is less than the minimum load defined by the underload curve by P2.13.13 Speed zero load, P2.13.14 Speed nominal load and P2.13.15 Underload speed nominal.

- 0 No action
- 1 Warning. Drive continues operation with F17 Motor underload warning and V1.2.44 Alarm word1. Bit2 is set.
- 2 Fault. Drive trips on F17 Motor underload fault and V1.2.42 Fault word 1. Bit5 is set.

### 2.13.27 *Speed zero load*

Load level for underload monitoring at zero speed as a percentage of motor nominal torque.

### 2.13.28 *Speed nominal load*

Load level for underload monitoring for speed up to nominal speed defined by P2.13.15 Underload speed nominal.

### 2.13.29 *Underload speed nominal*

Speed limit below which the underload function is activated.

### 6.5.15 Flux reference handling

This parameter group is used in closed loop motor control operation to set the flux linearization curve of the motor. With parameter P2.1.11 ID Run =2 With motor run , the parameters in this group are automatically set. These parameters can also be set when flux linearization curve for the motor is done manually as explained below.

Note: There should not be any load connected to the drive including gearbox while doing this test.

Set **P2.7.5 Torque selection** = 1 i.e. Speed control.

Set **P2.4.16 Flux reference** =100.0%.

Monitor the signals **V1.1.4 Current** , **V1.1.7 Motor voltage** and **V1.1.1 Output frequency**.

Run the motor with 50% of the nominal motor speed.

Note the value of the **V1.1.7 Motor voltage** (V100).

While keeping the speed reference constant change **P2.4.16 Flux reference** to 90.0% and note the value of **V1.1.7 Motor voltage** (V90). Set **P2.14.9 Flux curve 9** = (V90/V100)\*100.

Reduce the **P2.4.16 Flux reference** in steps of 10% as 80%, 70%,.....,30 and note the value of **V1.1.7 Motor voltage** as V80,V70, ...,V30 respectively. Set the values of **P2.14.8 Flux curve 8**, **P2.14.7 Flux curve 7**,..., **P2.14.3 Flux curve 3** calculating the same way as in step f.

Repeat this step by changing **P2.4.16 Flux reference** to 110%,120%,130% and note down

**V1.1.7 Motor voltage** V110,V120,and V130 respectively. Set **P2.14.11 Flux curve 11** ,

**P2.14.12 Flux curve 12** , **P2.14.13 Flux curve 13** calculating the same way as in step f.

Interpolate values for 140% - 150% to set parameters **P2.14.14**, **P2.14.15**.

#### 2.14.1- 1.14.15 Flux curve 10%, ....., Flux curve 150%

Motor voltage corresponding to 10%....150% of flux as a percentage of Nominal flux voltage.

### 6.5.16 *Startup torque*

The parameters in this group can be used in closed loop motor control operation. It enables the drive to produce programmable startup torque as soon as run request is given to the drive.

#### 2.15.1 *Startup torque selection*

Select the source for producing the startup torque.

- 0 None. Programmable startup torque is not used.
- 1 Torque Memory. The drive memorises V1.1.5 Torque at the time previous stop and the same torque is produced with the run request is given.
- 2 Torque reference. The torque reference for the startup torque is derived from external torque reference selected by P2.4.8 Torque reference source selection.
- 3 FWD/REV. The torque reference for the startup torque is derived from P2.15.3 Startup torque FWD in forward or positive direction of speed reference and P2.15.4 Startup torque REV in reverse or negative direction of speed reference.

#### 2.15.2 *Startup torque time*

The startup torque is maintained after the run request for the time defined by this parameter in 0.....10000 ms.

#### 2.15.3 *Startup torque FWD*

Amount of startup torque to be produced with the run request as a percentage of motor nominal torque when the drive is run in forward or positive direction of speed reference. This parameter is applicable only if P2.15.1 Startup torque selection = 3 FWD/REV.

#### 2.15.4 *Startup torq REV*

Amount of startup torque to be produced with the run request as a percentage of motor nominal torque when the drive is run in reverse or negative direction of speed reference. This parameter is applicable only if P2.15.1 Startup torque selection = 3 FWD/REV.

#### 2.15.5 *Torque memory source*

When P2.15.1 Startup torque selection = 1 (Torque memory), then this parameter selects the source for memorising the torque to be produced at next run request.

- 0 Actual torque. V1.1.5 Torque is used as memory source for startup torque reference at next start.
- 1 Torque reference. This is reserved for future development and is not used in the present application.
- 2 External torque reference. The value defined by parameter P2.15.6 Torque memory reference is used as memory source for startup torque reference at next start.

#### 2.15.6 *Torque memory reference*

When P2.15.5 Torque memory source = 2 then this parameter defines the amount of torque as a percentage of motor nominal torque used as memory source for startup torque reference at next start.

### 6.5.17 *Monitor settings*

The parameters in this group are used for testing of the drives. These parameters are for factory use only and are not required to be changed on site.

#### 2.16.1 *Speed monitoring filter*

Filter in ms for signal V1.1.2 Speed.

#### 2.16.2 *Current monitoring filter*

Filter in ms for signal V1.1.4 Current.

#### 2.16.3 *Torque monitoring filter*

Filter in ms for signal V1.2.5 Torque.

### 6.5.18 *Data mapping*

The parameters in this group are use when the drive has a communication with overriding system. The parameters or signals with ID nos. defined in this application can be connected to the signals to and from the overriding system for reading and writing purpose respectively.

#### 2.17.1- 2.17.8 *PD IN1 ID, ....., PD IN8 ID*

ID no. of any signal or parameter defined in the application. The parameter or signal of this ID number is then connected to process data IN 1....IN10, written from overriding system to the drive.

#### 2.17.9-2.17.16 *PD OUT1 ID, ....., PD OUT8 ID*

ID no. of any signal or parameter defined in the application. The parameter or signal of this ID number is then connected to process data OUT1....OUT10, read by the overriding system from the drive.

#### 2.17.17 *FB Mode*

Defines, which mode is used in fieldbus control

- 1 ProfiDrive mode. Sets also ProfiBus board mode to ProfiDrive. Powers off the drive after change
- 2 Bypass mode. Sets also ProfiBus board mode to ProfiDrive. Powers off the drive after change.
- 3 Not used
- 4 Selma mode
- 5 MicroStar mode

## 6.6 Fieldbus profile

**Note:** Please note that the process data can be freely configured to any parameter or signal defined in the application using ID nos. The process data configuration shown below is just for example.

### 6.6.1 Process data signals from overriding system to Vacon drive.

Profibus data name	Signal name	Min	Max	Def	FB scale	Scaling description
Main Control Word	Main Control Word					See bitwise description below
Speed Reference	Speed Reference	-32000	32000	0		20000 corresponds to speed defined By param. Process speed
Process Data IN1	Torque Reference	-3000	3000	0	10=1%	100% equals Motor Nominal Torque
Process Data IN2	Aux. Control Word 1					See bitwise description below
Process Data IN3	Aux. Control Word 2					See bitwise description below
Process Data IN4	Load Share	-4000	4000	1000	10=1%	This scales the % of Torque Reference to Follower
Process Data IN5	Torque Step	-3000	3000	0	10=1%	100% equals Motor Nominal Torque
Process Data IN6	Torque Select	0	5	0		0=none,1=speed,2=torque,3=min,4=max,5=win
Process Data IN7						Positioning will be added In future releases
Process Data IN8	Master Follower Mode	0	2	0		0=none,1=master,2=slave

Table 34.

### 6.6.2 Process data signals from Vacon drive to overriding system.

Profibus data name	Signal name	Min	Max	FB scale	Scaling description
Main Status Word	Main Status Word				See bitwise description below
Motor Speed	Motor Speed				20000 correspond to speed defined by P2.1.7 Process Speed
ProcessDat Out1	Motor Torque			10=1%	100% equals Motor Nominal Torque
ProcessDataOut2	Aux. Status Word				See bit words below
ProcessDataOut3	Fault Word1				See bit words below
ProcessDataOut4	Fault Word2				See bit words below
ProcessDataOut5	Digital Input Status Word				See bit words below
ProcessDataOut6	Alarm Word				See bit words below
ProcessDataOut7	Motor Shaft Rounds	-32768	32767		No of Rounds of the motor Shaft after Pos reset is done
ProcessDataOut8	Motor Shaft Position	0	360		Position of the motor shaft in degrees

Table 35.

### 6.6.3 Main control word, par. 2.17.17 (FB Mode) = 1-3

Bit 0	On	0>1 will reset the Switch On Inhibit state and bring the drive to Rdy Run. Should be reset after fault and EmStop .
Bit 1	Coast Stop	0=Coast stop Active 1=Coast Stop not Active
Bit 2	Emergency Stop	0=Emergency stop active 1=Emergency stop not active EmStop Mode is selected by P2.7.3
Bit 3	Run	0= stops the drive as per Stop Mode P2.7.2 1= Run
Bit 4	Ramp Out Zero	0=Ramp Output forced to 0. 1=Ramp Output is released
Bit 5	Ramp Hold	0=Ramp is hold 1=ramp release
Bit 6	Ramp input Zero	0=Ramp input forced to 0.Stop by Ramp 1=Ramp input is released
Bit 7	Reset	0>1 Reset fault.
Bit 8	Inching 1	0=No Action 1=Run forward with Constant Speed set by P2.4.2
Bit 9	Inching 2	0=No Action 1=Run backward with Constant Speed set by P2.4.3
Bit 10	Fieldbus Control Enable	0=No control from Fieldbus possible 1=Drive control from profibus if P2.6.1 =0 Fieldbus
Bit 11	Watchdog	0>1>0>1...1 sec square wave clock. This is used to check data communication between profibus master and the drive. Used to generate FB Communication. Fault. This monitoring can be switched off by setting P2.14.26 PB Watchdog Delay =0.Drive 's internal communication monitoring is still active at this time.
Bit 12	Low	not used
Bit 13	Low	not used
Bit 14	Low	not used
Bit 15	Low	not used

Table 36.

### 6.6.4 Selma Control Word, par. 2.17.17 (FB Mode) = 4

Bit 0	Ramp stop	0 = Stop by Ramp Not active 1 = Stop by Ramp active
Bit 1	Emergency stop	0 = Emergency stop Not active 1 = Emergency stop active Note! EmStop Mode is selected by P2.7.3
Bit 2	Run Enable	0 = Run Enable Not active 1 = Run Enable active and Drive stop by Coast
Bit 3	Reserved	Not used
Bit 4	Reserved	Not used
Bit 5	Reserved	Not used
Bit 6	Run	0 = Stops the drive as per Stop mode P2.7.2 1 = Run
Bit 7	Inching 1	0=No Action 1=Run forward with Constant Speed set by P2.4.2
Bit 8	Inching 2	0=No Action 1=Run backward with Constant Speed set by P2.4.3
Bit 9	Reserved	Not used
Bit 10	Reserved	Not used
Bit 11	Reserved	Not used
Bit 12	Reserved	Not used
Bit 13	Reserved	Not used
Bit 14	Reserved	Not used
Bit 15	Reserved	Not used

Table 37

### 6.6.5 Main status word

Bit 0	Rdy On	0=Drive not ready to switch on 1=Drive ready to switch on
Bit 1	Rdy Run	0=Drive not ready to run 1=Drive ready to run
Bit 2	Rdy Ref	0=Drive not running 1=Drive running and ready to release the reference
Bit 3	Fault	0=No active fault 1=Fault is active
Bit 4	Off2 Status	0=Coast Stop Active 1=Coast stop not active
Bit 5	Off3 Status	0=Emergency Stop active 1=Emergency stop not active
Bit 6	Drive Not Ready to Switch On	0=No inhibit 1=drive is out of fault or EmStop state. The ON bit in the main control word is then has to be reset.
Bit 7	Alarm	0=No alarm 1=Alarm active
Bit 8	At Set point	0= Speed Ref and Speed Actual are not same
Bit 9	Fieldbus Control Active	0=Fieldbus control not active 1=Fieldbus control active .P2.6.1 Control Place=0 Fieldbus and bit 10 of the Main control word is set.
Bit 10	Above Limit	0= Speed is below the limit specified by P2.4.14 1=The speed actual of the drive is above the set speed limit set by P2.4.14 Above Speed Limit.
Bit 11	Reserved	
Bit 12	Reserved	
Bit 13	Reserved	
Bit 14	Reserved	
Bit 15	Watchdog	Same as received on bit 11 of the main control word.

Table 38.

### 6.6.6 Selma Status Word

Bit 0	Run	0 = Drive not running 1 = Drive running and ready to release the reference
Bit 1	Ready	0 = Drive not ready to run 1 = Drive ready to run
Bit 2	Fault	0 = No active Fault 1 = Fault is Active
Bit 3	Fieldbus Control	0 = Fieldbus control not active 1 = Fieldbus control active
Bit 4	Reserved	Not used
Bit 5	Start prevention	0 = External Run Enable not active 1 = External Run Enable active
Bit 6	Reserved	Not used
Bit 7	Reserved	Not used
Bit 8	Reserved	Not used
Bit 9	Reserved	Not used
Bit 10	Reserved	Not used
Bit 11	Reserved	Not used
Bit 12	Reserved	Not used
Bit 13	Reserved	Not used
Bit 14	Reserved	Not used
Bit 15	Reserved	Not used

Table 39.

### 6.6.7 Micro Status Word

Bit 0	Run	0 = Drive not running 1 = Drive running and ready to release the reference
Bit 1	Reserved	Not used
Bit 2	Reserved	Not used
Bit 3	Reserved	Not used
Bit 4	Reserved	Not used
Bit 5	Reserved	Not used
Bit 6	Reserved	Not used
Bit 7	Reserved	Not used
Bit 8	Reserved	Not used
Bit 9	Reserved	Not used
Bit 10	Reserved	Not used
Bit 11	Reserved	Not used
Bit 12	Reserved	Not used
Bit 13	Reserved	Not used
Bit 14	Reserved	Not used
Bit 15	Reserved	Not used

Table 40.

### 6.6.8 Auxiliary control word

Bit 0	Data logger restart	
Bit 1	Data logger force trigger	
Bit 2	Ramp bypass	Ramp generator of the drive is bypassed if set high.
Bit 3	Reference from IO when control place is Fieldbus.	
Bit 4	DC Braking Active	When ramp generator output is less than P2.8.1 Zero Speed Level then DC braking is active if set to high.
Bit 5	Free	
Bit 6	Free	
Bit 7	Mech. Brake Ctrl	Mech Brake control thro' Fieldbus.
Bit 8	Free	
Bit 9	Reset position	Resets the Shaft Position V1.2.45 & Shaft Rounds V1.2.46 to zero.
Bit 10	Free	
Bit 11	Free	
Bit 12	Enable inching	When set high constant speed inching/running can be done with bit 8&9 of the Main Control Word
Bit 13	DO1 control	Activates the Digital output 1 if parameter DO1 = 1161.13
Bit 14	DO2 control	Activates the Relay output 1 if parameter DO2 = 1161.14
Bit 15	DO3 control	Activates the Relay output 2 if parameter DO3 = 1161.15

Table 41.



### 6.6.9 Auxiliary status word

Bit 0	Datalogger triggered	
Bit 1	Window Control active and Speed is out of Window	
Bit 2	Motor/Generator torque/current limit active	
Bit 3	Undervoltage/Overvoltage controller active	
Bit 4	Reverse direction	
Bit 5	IO Control Active	
Bit 6	Motor Fan ON command	
Bit 7	Mechanical brake lift command	
Bit 8	DC Charging OK (Pulse)	
Bit 9	DC Charging OK (continuous)	
Bit 10	Drive in Torque control	
Bit 11	Speed Zero	
Bit 12	Reserved	
Bit 13	Reserved	
Bit 14	Reserved	
Bit 15	Reserved	

Table 42.

### 6.6.10 Fault word 1

Bit 0	OverCurrent	
Bit 1	Overvoltage	
Bit 2	Undervoltage	
Bit 3	Motor Stall	See parameter P2.14.8, P2.14.9, P2.14.10, P2.14.11
Bit 4	Earth Fault	See parameter P2.14.5, P2.14.6, P2.14.7
Bit 5	UnderLoad	See parameter P2.14.12, P2.14.13, P2.14.14, P2.14.15
Bit 6	Unit Over Temperature	
Bit 7	Motor Temperature	This can be because of the following reasons. Thermistor as set by P2.14.24 PT100 Temp. measurement using PT100 type sensor. See parameters P2.2.2.3 to P2.2.2.6, P2.13.18 to P2.13.20 Calculated Overtemp as set by P2.13.22 to P2.13.24.
Bit 8	Input Phase Loss	See parameter P2.14.3 Input Ph. Supervision
Bit 9	Internal Brake Resistor Protection	
Bit 10	Device Fault	Device (slot cards)Removed,Added,changed,Unknown
Bit 11	Keypad Communication Fault	See parameter P2.14.2
Bit 12	Fieldbus communication Fault	
Bit 13	Follower communication	Master follower communication. See parameters P2.13.1, P2.13.2, P2.13.3.
Bit 14	Slot communication.	slot comm. fault. One of the slot cards is faulty.
Bit 15	Analogue Input Fault	See parameter P2.14.1

Table 43.

**6.6.11 Fault word 2**

Bit 0	Output Phase Fault	See parameter P2.14.4
Bit 1	Charging Switch Fault	
Bit 2	Encoder Fault	See parameter P2.14.27
Bit 3	Drive Hardware fault	
Bit 4	Unit Under Temperature	
Bit 5	EEPROM Fault +Checksum Fault	
Bit 6	External fault	See parameter P2.2.10
Bit 7	Brake chopper fault	
Bit 8	Internal Communication	
Bit 9	IGBT Temperature	
Bit 10	Motor Brake Fault	See parameter P2.2.6 ,P2.11.1
Bit 11	Reserved.	
Bit 12	Application fault	
Bit 13	Drive Internal fault	
Bit 14	Main Switch Open	DIN5 is not high. Ack from Main switch .
Bit 15		Not used

Table 44.

**6.6.12 Selma fault word 0**

Bit 0	Brake chopper supervision	
Bit 1		Not used
Bit 2		Not used
Bit 3	Frequency converter overtemperature	
Bit 4	Overcurrent	
Bit 5	Overvoltage	
Bit 6	Undervoltage	
Bit 7		Not used
Bit 8		Not used
Bit 9		Not used
Bit 10		Not used
Bit 11		Not used
Bit 12		Not used
Bit 13		Not used
Bit 14		Not used
Bit 15		Not used

Table 45.

**6.6.13 Selma fault word 1**

Bit 0		Not used
Bit 1		Not used
Bit 2		Not used
Bit 3		Not used
Bit 4	Earth fault	
Bit 5	Motor Over temperature, PT100 Thermistor	
Bit 6		Not used
Bit 7		Not used
Bit 8	External fault	
Bit 9	IGBT fault	
Bit 10		Not used
Bit 11	System fault	
Bit 12	Fieldbus communication fault	
Bit 13	Panel communication fault	
Bit 14	Motor stall fault	
Bit 15	Encoder fault	

Table 46.

**6.6.14 Selma fault word 2**

Bit 0		Not used
Bit 1		Not used
Bit 2		Not used
Bit 3		Not used
Bit 4		Not used
Bit 5	Undervoltage controller active	
Bit 6		Not used
Bit 7	Switch On Inhibit	
Bit 8	Motor Over temperature, PT100 Thermistor	
Bit 9		Not used
Bit 10		Not used
Bit 11		Not used
Bit 12		Not used
Bit 13		Not used
Bit 14		Not used
Bit 15		Not used

Table 47.

**6.6.15 Alarm word 1**

Bit 0	Motor stalled	See parameter P2.14.8, P2.14.9, P2.14.10, P2.14.11
Bit 1	Motor over temperature	This can be because of the following reasons. Thermistor as set by P2.13.13 measurement using PT100 type sensor. See parameters P2.2.2.3 to P2.2.2.6, P2.13.18 to P2.13.20 Calculated Overtemp as set by P2.13.22 to P2.13.24.
Bit 2	Motor under load	See parameter P2.14.12, P2.14.13, P2.14.14, P2.14.15
Bit 3	Input phase loss	See parameter P2.14.3 Input Phase Supervision
Bit 4	output phase loss	See parameter P2.14.4
Bit 5	Start Prevention	F26 Prevention of start. This warning comes when the Run Enable input is low and P2.2.1.11 Prevention of start is enabled. Normally it is enabled when the external device for prevention of false start is used.
Bit 6	Main Switch Open	See parameter P2.2.8 Run Enable Ctrl. If set =5 or 6 and DI5 is low then this alarm occurs.
Bit 7	not used	
Bit 8	Vacon over temperature	
Bit 9	Analogue input < 4mA	See parameter P2.14.1
Bit 10	Motor fan warning	See parameter P2.2.7
Bit 11	Emergency stop	See parameter P2.2.9. If set = 1 DI6 and DI6 is low then this alarm occurs.
Bit 12	Run disabled	
Bit 13	Inching disabled	
Bit 14	Motor Brake	See parameter P2.2.6 ,P2.11.1
Bit 15	Panel comm. Alarm	See parameter P2.14.2

Table 48.

**6.6.16 Digital input status word 1**

Bit 0	DIN1	Status of Digital input 1
Bit 1	DIN2	Status of Digital input 2
Bit 2	DIN3	Status of Digital input 3
Bit 3	DIN4	Status of Digital input 4
Bit 4	DIN5	Status of Digital input 5
Bit 5	DIN6	Status of Digital input 6
Bit 6	TIB (A3)	Thermistor Input Status
Bit 7	DIN7	Status of Digital input 7
Bit 8	DIN8	Status of Digital input 8
Bit 9	DIN9	Status of Digital input 9
Bit 10	DIN10	Status of Digital input 10
Bit 11	DIN11	Status of Digital input 11
Bit 12	DIN12	Status of Digital input 12
Bit 13	DIN13	Status of Digital input 13
Bit 14	DIN14	Status of Digital input 14
Bit 15	DIN15	Status of Digital input 15 NOTE! Bit7 ...15 are updated only if option DI card is installed

Table 49.

**6.6.17 Digital input status word 2**

Bit 0	DIN16	Status of Digital input 16
Bit 1	DIN17	Status of Digital input 17
Bit 2	DIN18	Status of Digital input 18
Bit 3	DIN19	Status of Digital input 19
Bit 4	DIN20	Status of Digital input 20
Bit 5	DIN21	Status of Digital input 21
Bit 6	DIN22	Status of Digital input 22
Bit 7	DIN23	Status of Digital input 23
Bit 8	DIN24	Status of Digital input 13
Bit 9	DIN25	Status of Digital input 13
Bit 10	DIN26	Status of Digital input 13
Bit 11	DIN27	Status of Digital input 13
Bit 12	DIN28	Status of Digital input 13
Bit 13	DIN29	Status of Digital input 13
Bit 14	DIN30	Status of Digital input 13 NOTE:Bit 0...15 are updated only if optional DI card is installed
Bit 15		Not used

Table 50.

6.7 BLOCK DIAGRAMS

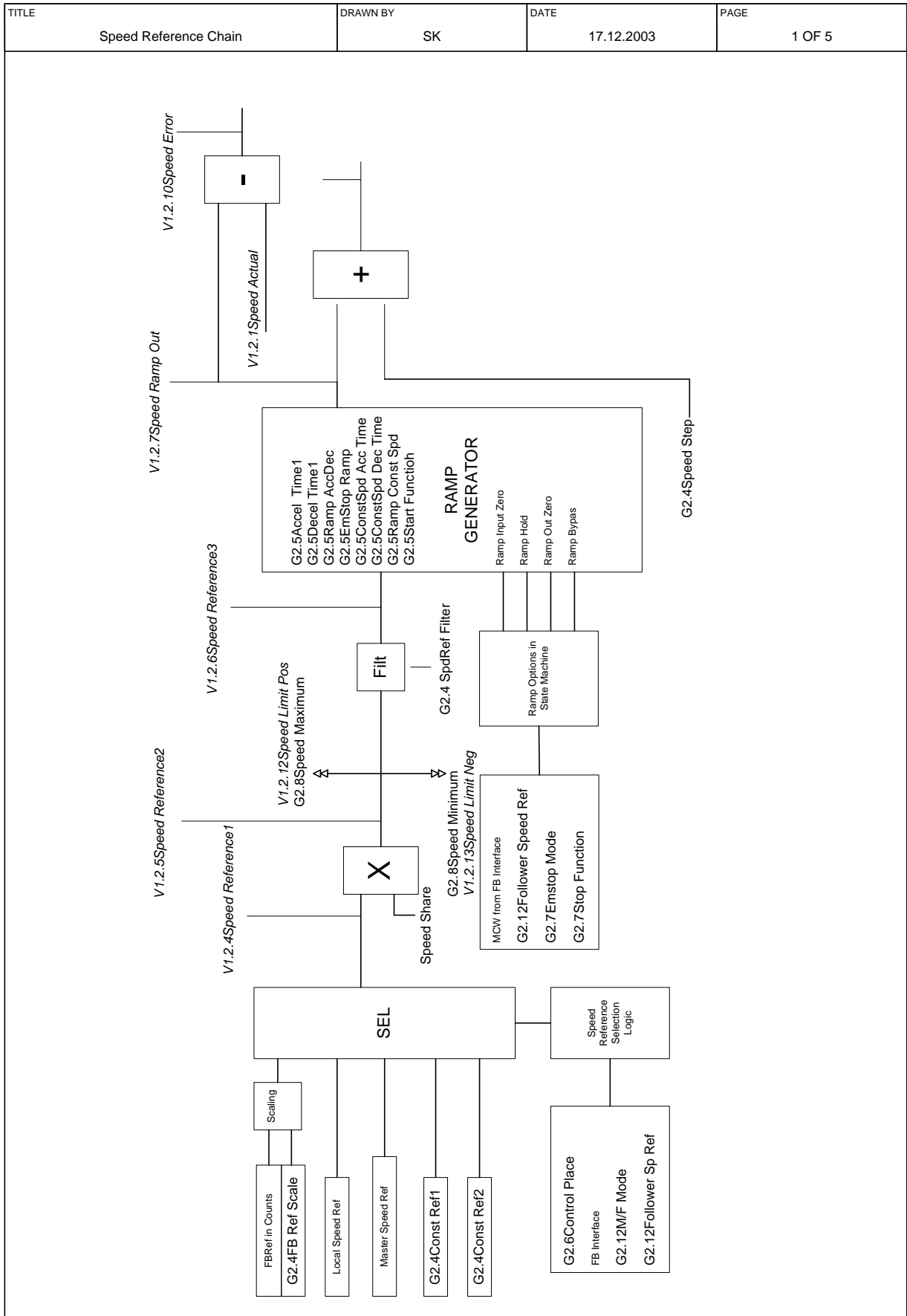

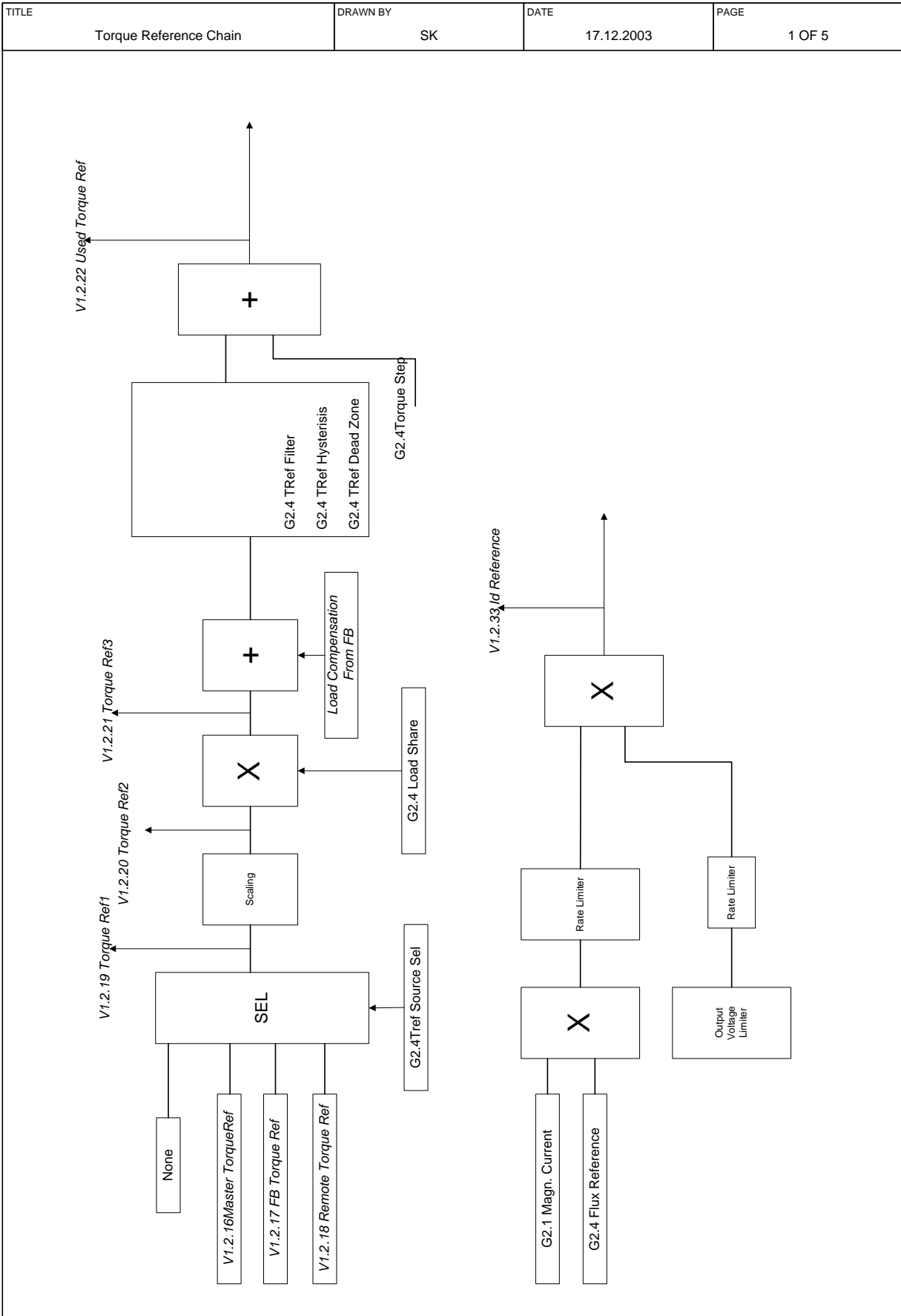

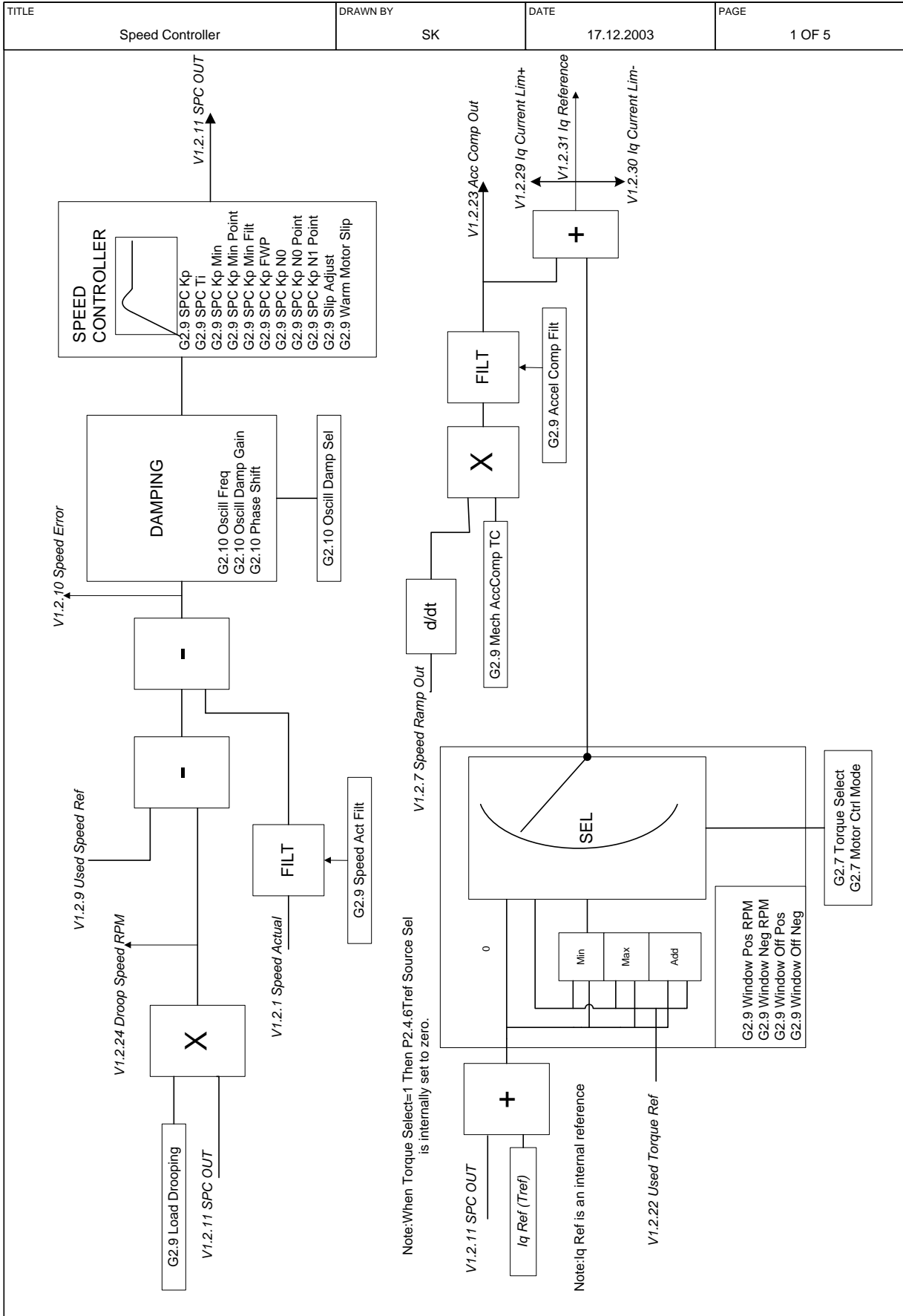



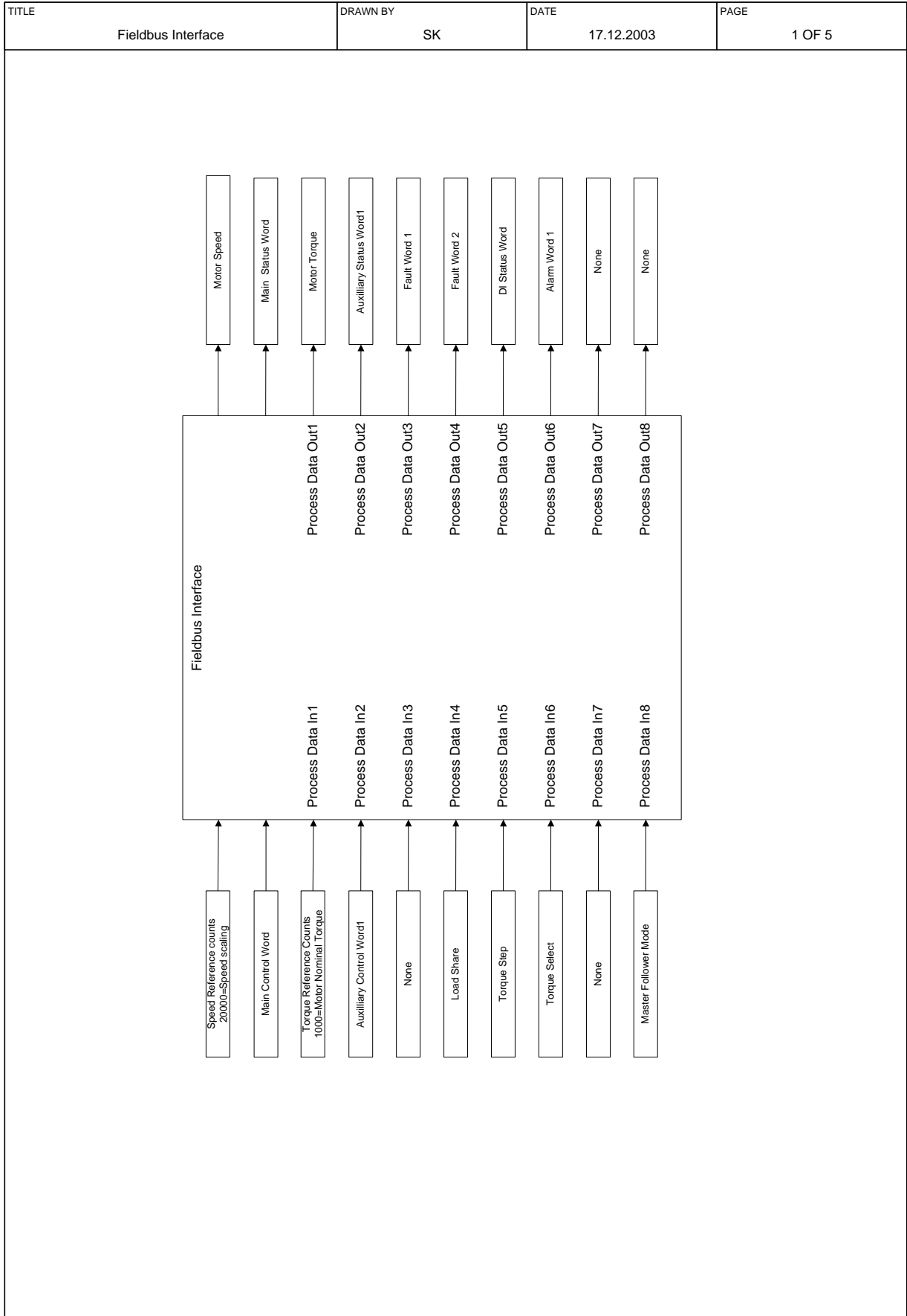

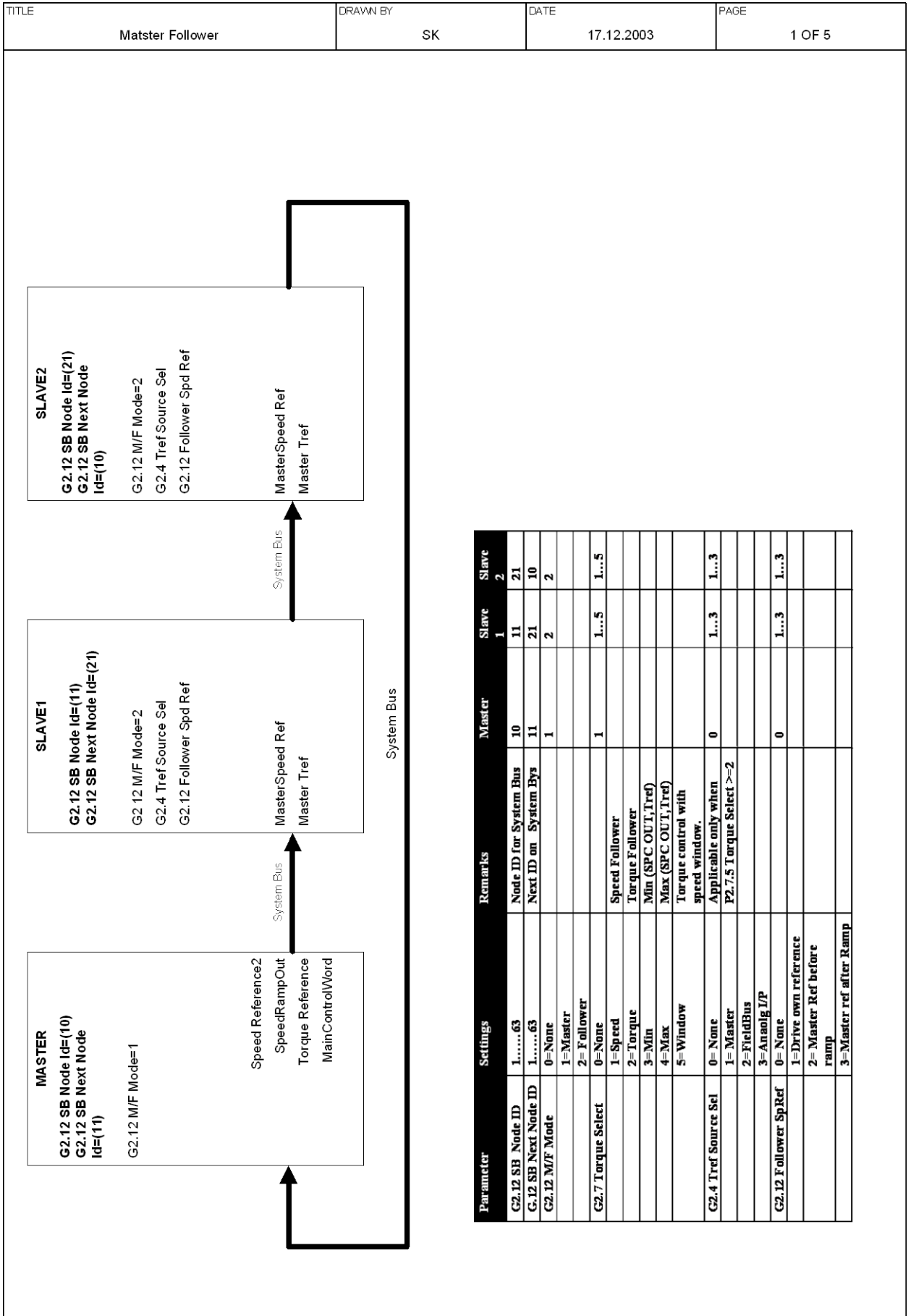

## 6.8 FAULT TRACING

When a fault is detected by the frequency converter control electronics, the drive is stopped and the symbol **F** together with the ordinal number of the fault, the fault code and a short fault description appear on the display. The fault can be reset with the *Reset button* on the control keypad or via the I/O terminal. The faults are stored in the fault history which can be browsed. The different fault codes you will find in the table below.

The fault codes, their causes and correcting actions are presented in the table below. The shadowed faults are A faults only. The items written in white on black background present faults for which you can program different responses in the application. See parameter group Protections.

**Note:** When contacting distributor or factory because of a fault condition, always write down all texts and codes on the keypad display.

Fault code	Fault	Possible cause	Correcting measures
1	Overcurrent	Frequency converter has detected too high a current ( $>4 \cdot I_n$ ) in the motor cable: <ul style="list-style-type: none"> <li>– sudden heavy load increase</li> <li>– short circuit in motor cables</li> <li>– unsuitable motor</li> </ul>	Check loading. Check motor. Check cables.
2	Overvoltage	The DC-link voltage has exceeded the limits. <ul style="list-style-type: none"> <li>– too short a deceleration time</li> <li>– high overvoltage spikes in supply</li> </ul>	Make the deceleration time longer. Use brake chopper or brake resistor (available as options)
3	Earth fault	Current measurement has detected that the sum of motor phase current is not zero. <ul style="list-style-type: none"> <li>– insulation failure in cables or motor</li> </ul>	Check motor cables and motor.
5	Charging switch	The charging switch is open, when the START command has been given. <ul style="list-style-type: none"> <li>– faulty operation</li> <li>– component failure</li> </ul>	Reset the fault and restart. Should the fault re-occur, contact the distributor near to you.
7	Saturation trip	Various causes, e.g. defective component	Cannot be reset from the keypad. Switch off power. <b>DO NOT RE-CONNECT POWER!</b> Contact factory. If this fault appears simultaneously with Fault 1, check motor cables and motor
8	System fault	- component failure - faulty operation Note exceptional fault data record.	Reset the fault and restart. Should the fault re-occur, contact the distributor near to you.
9	Undervoltage	DC-link voltage is under the voltage limits. <ul style="list-style-type: none"> <li>– most probable cause: too low a supply voltage</li> <li>– frequency converter internal fault</li> </ul>	In case of temporary supply voltage break reset the fault and restart the frequency converter. Check the supply voltage. If it is adequate, an internal failure has occurred. Contact the distributor near to you.
10	Input line supervision	Input line phase is missing.	Check supply voltage and cable.

11	Output phase supervision	Current measurement has detected that there is no current in one motor phase.	Check motor cable and motor.
12	Brake chopper supervision	<ul style="list-style-type: none"> <li>– no brake resistor installed</li> <li>– brake resistor is broken</li> <li>– brake chopper failure</li> </ul>	Check brake resistor. If the resistor is ok, the chopper is faulty. Contact the distributor near to you.
13	Frequency converter under-temperature	Heat sink temperature is under $-10^{\circ}\text{C}$	
14	Frequency converter over-temperature	Heat sink temperature is over $90^{\circ}\text{C}$ .  Over temperature warning is issued when the heat sink temperature exceeds $85^{\circ}\text{C}$ .	Check the correct amount and flow of cooling air. Check the heat sink for dust. Check the ambient temperature. Make sure that the switching frequency is not too high in relation to ambient temperature and motor load.
15	Motor stalled	Motor stall protection has tripped.	Check motor.
16	Motor over temperature	Motor overheating has been detected by frequency converter motor temperature model. Motor is overloaded.	Decrease the motor load. If no motor overload exists, check the temperature model parameters.
17	Motor under-load	Motor underload protection has tripped.	
25	Microprocessor watchdog fault	<ul style="list-style-type: none"> <li>– faulty operation</li> <li>– component failure</li> </ul>	Reset the fault and restart. Should the fault re-occur, contact the distributor near to you.
26	Prevent of start	Start-up of the drive has been prevented. This warning occurs when the Run enable input is low and P2.2.1.11 Prevention of start is enabled, This is normally enabled when the external device for the prevention of false is start is used.	Reset the prevention of start switch if active.
30	Safe disable	Safe Disable inputs SD1 & SD2 are activated through the OPT-AF option board.	See details from Safe Disable & Atex manual ud1066
31	IGBT temperature (hardware)	IGBT Inverter Bridge over temperature protection has detected too high a short term overload current	Check loading. Check motor size.
32	Fan cooling	Cooling fan of the frequency converter does not start, when ON command is given	Contact the distributor near to you.
34	CAN bus communication	Sent message not acknowledged.	Ensure that there is another device on the bus with the same configuration.
35	Application	Application task overload or CPU overload.	Reset the power to the control box.
36	Control unit	NXS control unit can not control NXP Power Unit and vice versa	Change control unit
37	Device changed (same type)	Option board or control unit changed. Same type of board or same power rating of drive.	Reset <b>Note:</b> No fault time data record!
38	Device added (same type)	Option board or drive added. Drive of same power rating or same type of board added.	Reset <b>Note:</b> No fault time data record!
39	Device removed	Option board removed. Drive removed.	Reset <b>Note:</b> No fault time data record!
40	Device un-	Unknown option board or drive.	Contact the distributor near to you.

	known		
41	IGBT temperature	IGBT inverter bridge overtemperature protection has detected too high a short term overload current	Check loading. Check motor size.
42	Brake resistor over temperature	Brake resistor over temperature protection has detected too heavy braking	Set the deceleration time longer. Use external brake resistor.
43	Encoder fault	Note the exceptional fault data record. Additional codes: 1 = Encoder 1 channel A is missing 2 = Encoder 1 channel B is missing 3 = Both encoder 1 channels are missing 4 = Encoder reversed	Check encoder channel connections. Check the encoder board.
44	Device changed (different type)	Option board or control unit changed. Option board of different type or different power rating of drive.	Reset <b>Note:</b> No fault time data record! <b>Note:</b> Application parameter values restored to default.
45	Device added (different type)	Option board or drive added. Option board of different type or drive of different power rating added.	Reset <b>Note:</b> No fault time data record! <b>Note:</b> Application parameter values restored to default.
50	Analogue input $I_{in} < 4\text{mA}$ (sel. signal range 4 to 20 mA)	Current at the analogue input is $< 4\text{mA}$ . – control cable is broken or loose – signal source has failed	Check the current loop circuitry.
51	External fault	Digital input fault.	
52	Keypad communication fault	The connection between the control keypad and the frequency converter is broken.	Check keypad connection and possible keypad cable.
53	Fieldbus fault	The data connection between the fieldbus Master and the fieldbus board is broken	Check installation. If installation is correct contact the nearest Vacon distributor.
54	Slot fault	Defective option board or slot	Check board and slot. Contact the nearest Vacon distributor.
55	Follower communication	This fault can occur only in Follower drive P2.12.1 M/Fmode =2 (Follower). Follower drive is not able to receive data from Master drive on system bus(optical link).	Check the setting of P2.13.25 SBFault Delay. The default is 0.10sec. Check the optical link between MasterFollower and jumper settings on OPT-D2 board in Vacon option board manual. OPT-D2 board can be installed only in slot D or slot E.
56	PT100 Temp. overtemperature	PT100(1) element/s has sensed overtemperature.	Check the temperature of the part where the PT100 is mounted. Check parameters P2.2.2.3 to P2.2.2.6, P2.13.18 to P2.13.20.
57	ID run failure	ID run could not be completed successfully.	Check monitoring signal V1.1.19 ID run status to find out which part of the ID run is failed. Redo the ID run.

58	Mechanical brake fault	Mechanical brake lifted signal is not received within time defined by P2.11.1 Brake life delay after the Run command. The digital input is selected by P2.2.6 Motor brake acknowledgement OR Brake open signal is acknowledged when there is no run command given.	Check the parameters P2.13.28 Mechanical brake fault P2.2.6 Motor brake acknowledgement P2.11.1 Brake lift delay Check the Motor brake circuit.
59	Motor fan fault	Motor fan acknowledgement is not received within 5 seconds after run command.	Check P2.2.1.7 . Check motor fan connection.
61	Thermistor	Thermistor overtemperature. Thermistor is connected to OPT-A3 board in slot B.	Check the temperature of the area where the thermistor is mounted. Check the connection of the thermistor to OPT-A3.
62	Run disabled	Run Enable digital input is gone low.	Check P2.2.1.9,P2.2.1.10. Reset the run enable input.
63	Emergency stop	DIN6 is inactive /low.	Check the emergency stop push button connected to DIN6. Check P2.210 Emergency stop control.
64	Input SW Open	The drive main power is switched off and DIN5 is inactive/low.	Check the main power switch of the drive. Check P2.2.8 Run Enable control as per the description in the manual.

Table 51. Fault codes

## 7. APPENDIX 1

If the communication does not work, check the type of the resistors described below:

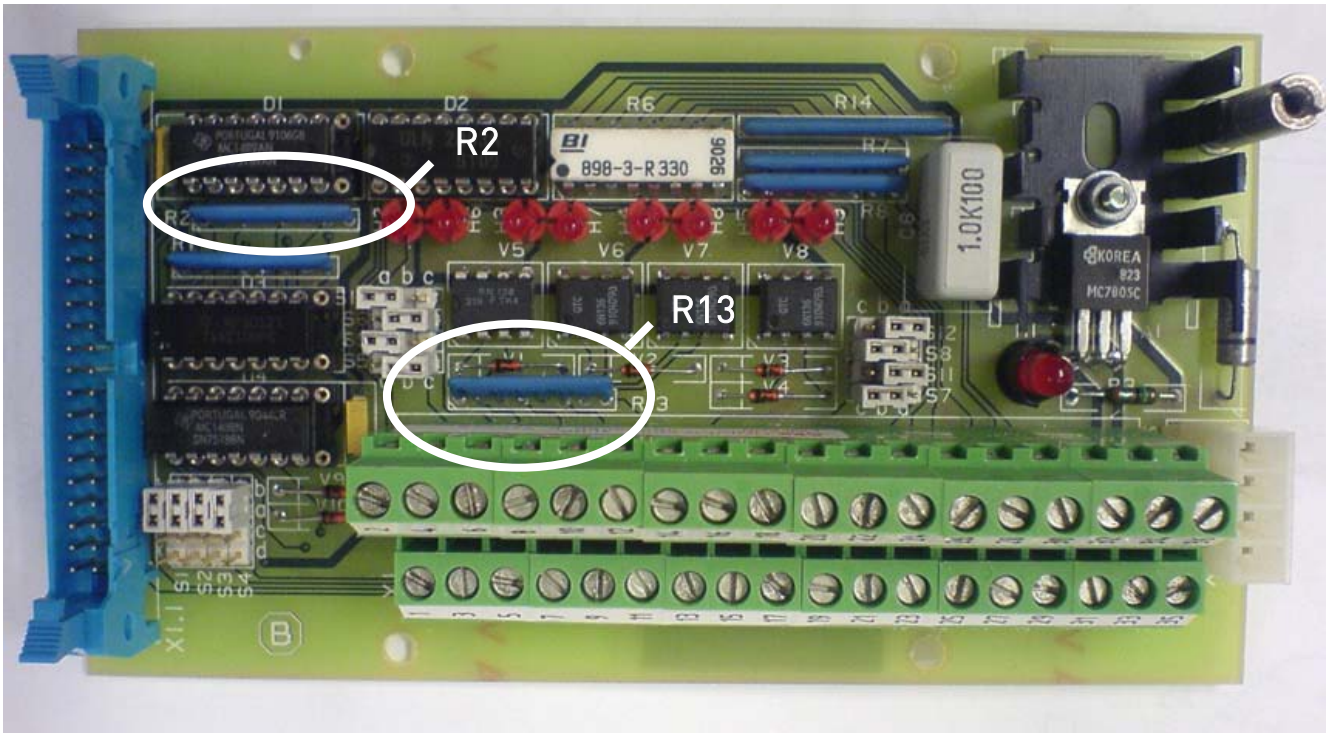

Selma 4CMO board

Resistors  
R2 and R13

Size	Code
100 $\Omega$ =	4Y101G (Wrong size)
1 k $\Omega$ =	4Y102G (Right size)

Some 4CMO boards may have wrong resistors, the correct size is **1k $\Omega$**  and type **4Y102G**.

8. APPENDIX 2

4CM0 board jumper settings: (see also chapter 3.1.1)

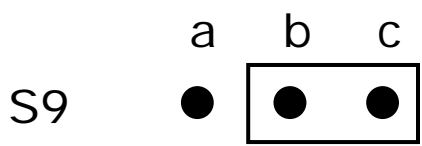

= ACTIVE

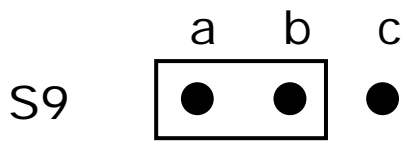
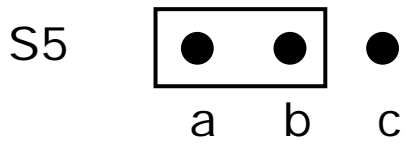

= PASSIVE

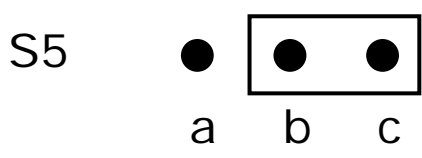





# VACON

DRIVEN BY DRIVES

Find your nearest Vacon office  
on the Internet at:

[www.vacon.com](http://www.vacon.com)

Manual authoring:  
[documentation@vacon.com](mailto:documentation@vacon.com)

Vacon Plc.  
Runsorintie 7  
65380 Vaasa  
Finland

Subject to change without prior notice  
© 2011 Vacon Plc.

Document ID:



Rev. A