

VACON NX
AC DRIVES

OPTCP
PROFINET OPTION BOARD

USER MANUAL

INDEX

Document code: DPD00895A
Last edited: 27.01.2012

1.	Introduction	3
2.	Ethernet board technical data.....	4
2.1.	Overview	4
2.2.	LED indications	5
2.3.	Ethernet	6
2.4.	Connections and wiring.....	7
3.	Installation.....	8
3.1.	Installing the Ethernet Option Board in a Vacon NX Unit	8
3.2.	NCDrive	10
3.3.	IP Tool NCIPConfig.....	10
3.4.	Example with Siemens PLC	14
4.	Commissioning	23
4.1.	Expander board menu (M7).....	23
4.2.	Profinet parameters.....	23
4.3.	IP Address	23
4.4.	Start-up test.....	24
5.	Profinet IO.....	25
5.1.	Vendor profile.....	25
5.2.	Bypass profile	30
5.3.	Profidrive profile	31
5.4.	Parameter channel	35
5.5.	Parameter data transfer examples	39
6.	APPENDIX	40

1. INTRODUCTION

Vacon NX frequency converters can be connected to Ethernet using an Ethernet fieldbus board OPTCP.

The OPTCP can be installed in board slots D or E.

Every appliance connected to an Ethernet network has two identifiers; a MAC address and an IP address. The MAC address (Address format: xx:xx:xx:xx:xx:xx) is unique to the appliance and cannot be changed. The Ethernet board's MAC address can be found on the sticker attached to the board or by using the Vacon IP tool software NCIPConfig. You can find the software installation at www.vacon.com

In a local network, IP addresses can be defined by the user as long as all units connected to the network are given the same network portion of the address. For more information about IP addresses, contact your Network Administrator. Overlapping IP addresses cause conflicts between appliances. For more information about setting IP addresses, see Section 3, Installation.

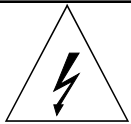

WARNING!

Internal components and circuit boards are at high potential when the frequency converter is connected to the power source. This voltage is extremely dangerous and may cause death or severe injury if you come into contact with it.

2. ETHERNET BOARD TECHNICAL DATA

2.1. Overview

General	Board name	OPTCP
Ethernet connections	Interface	RJ-45 connector
Communications	Transfer cable	Shielded Twisted Pair (STP) CAT5e
	Speed	10 / 100 Mb
	Duplex	half / full
	Default IP-address	192.168.0.10
Protocol	Profinet I/O	
Environment	Ambient operating temperature	-10°C...50°C
	Storing temperature	-40°C...70°C
	Humidity	<95%, no condensation allowed
	Altitude	Max. 1000 m
	Vibration	0.5 G at 9...200 Hz
Safety	Fulfils EN50178 standard	

Table 1. Ethernet board technical data

2.2. LED indications

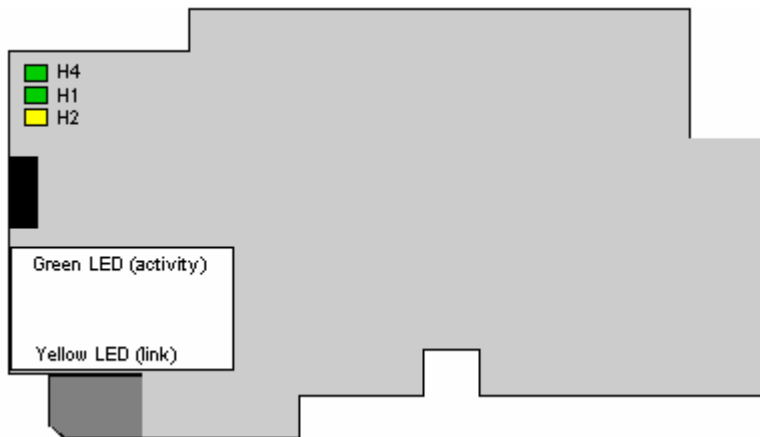

Figure 1-2, LED indications on the OPTCP board

LED:	Meaning:
H4	LED in ON when board is powered
H1	Blinking 0.25s ON / 0.25s OFF when board firmware is corrupted (chapter 3.2.1 NOTE). OFF when board is operational.
H2	Blinking 2.5s ON / 2.5s OFF when board is ready for external communication. OFF when board is not operational.

Using the "Node Flashing Test" function you can determine to which device you are directly connected. For example in Siemens S7, by using the menu command "PLC > Diagnostics/Setting > Node Flashing Test..." you can identify the station connected directly to the PG/PC by the FORCE LED that flashes.

2.3. Ethernet

Common-use cases of Ethernet devices are 'human to machine' and 'machine to machine'. Basic features of these two cases are presented in the pictures below.

1. Human to machine (Graphical User interface, relatively slow communication)

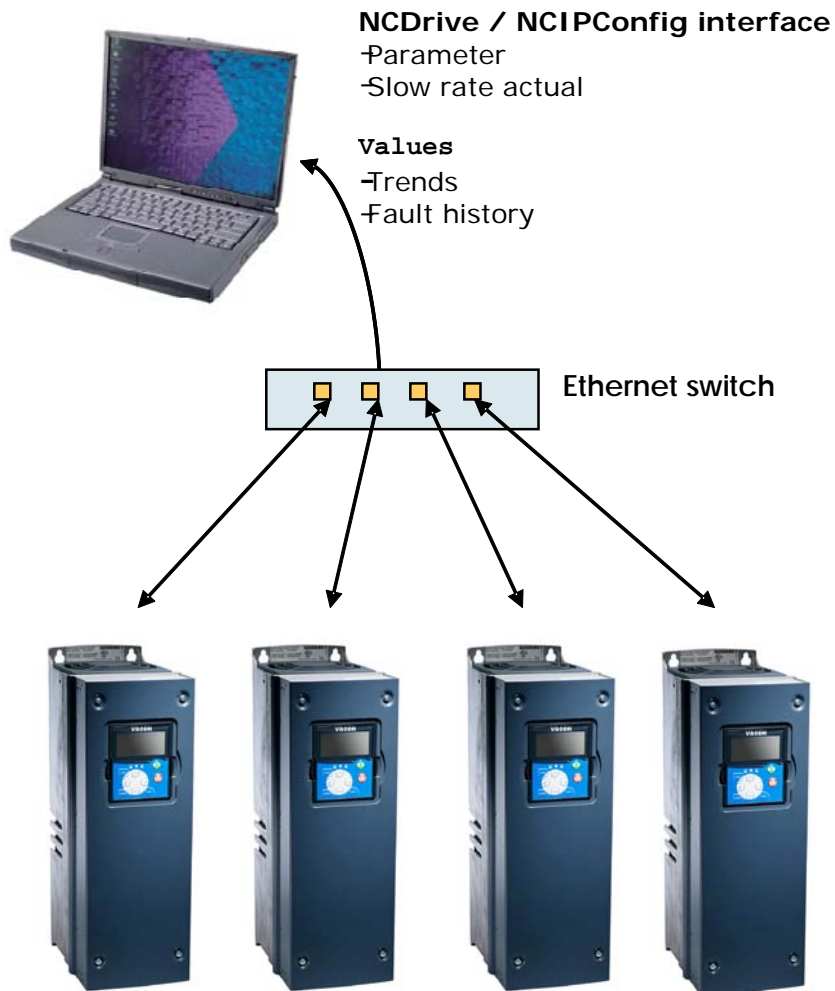

Note! NCDrive can be used in NXS and NXP drives via Ethernet. In NXL drives this is not possible.

2. Machine to machine (Industrial environment, fast communication)

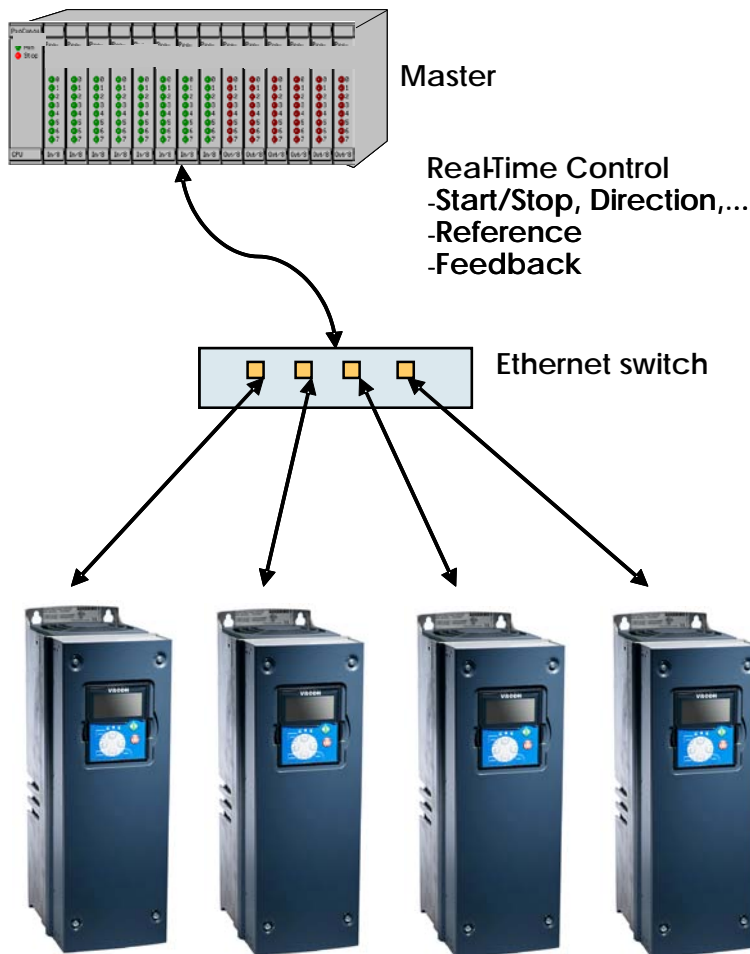

2.4. Connections and wiring

The Ethernet board supports 10/100Mb speeds in both Full- and Half-duplex modes. However, using Profinet requires the Full-duplex mode and the 100-megabit speed. The boards must be connected to the Ethernet network with a Shielded Twisted Pair (STP) CAT-5e cable. Use a so-called crossover cable if you want to connect the Ethernet option board directly to the master device.



Use only industrial standard components in the network and avoid complex structures to minimize the length of response time and the amount of incorrect dispatches.



More information on Ethernet can be found at www.odva.org.

3. INSTALLATION

3.1. Installing the Ethernet Option Board in a Vacon NX Unit

 NOTE	MAKE SURE THAT THE FREQUENCY CONVERTER IS SWITCHED OFF BEFORE AN OPTION OR FIELDBUS BOARD IS CHANGED OR ADDED!
--	---

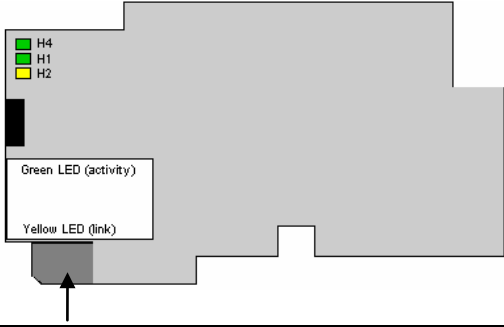
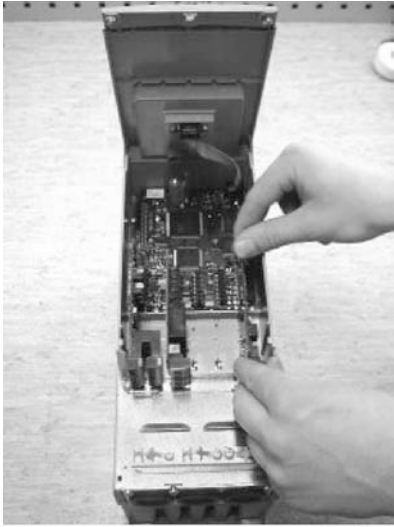
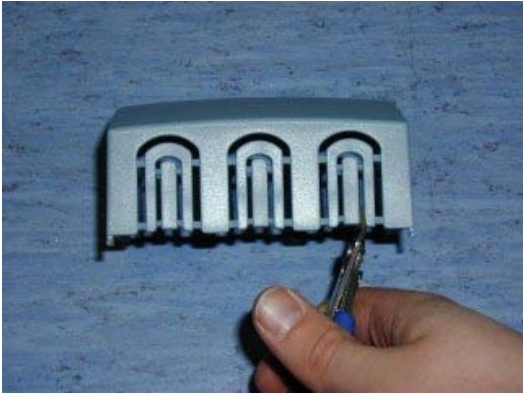
A	Vacon NX frequency converter.	 A photograph of a tall, grey Vacon NX frequency converter unit standing on four small feet. It has a control panel at the top with a display and several buttons. A 'CAUTION' warning label with a lightning bolt symbol is visible on the front panel. The image is labeled '2233.jpg' in the bottom right corner.
B	Remove the cable cover.	 A close-up photograph showing a hand using a screwdriver to remove a screw from the front panel of the Vacon NX unit, specifically the cable cover area. The 'CAUTION' label is visible above the screw. The image is labeled '2234.jpg' in the bottom right corner.
C	Open the cover of the control unit.	 A photograph showing the Vacon NX unit with its front cover removed and hinged open at the top. The internal electronic components, including a control board and various connectors, are visible. The image is labeled '2235.jpg' in the bottom right corner.

<p>D</p>	<p>Install EtherNet option board in slot D or E on the control board of the frequency converter. Make sure that the grounding plate (see below) fits tightly in the clamp.</p> 	 <p style="text-align: right; font-size: small;">7238.jpg</p>
<p>E</p>	<p>Make a sufficiently wide opening for your cable by cutting the grid as wide as necessary.</p>	
<p>F</p>	<p>Close the cover of the control unit and the cable cover.</p>	 <p style="text-align: right; font-size: small;">7234.jpg</p>

3.2. NCDrive

NCDrive software can be used with the Ethernet board in NXS and NXP drives.

NOTE! Does not work with NXL

NCDrive software is recommended to be used in LAN (Local Area Network) only.

NOTE! If OPTCI Ethernet Option board is used for NC Tools connection, like NCDrive, the OPTD3 board can not be used.

NOTE! NCLoad does not work via Ethernet. See NCDrive help for further information

3.3. IP Tool NCIPConfig

To begin using the Vacon Ethernet board, you need to set an IP address. The factory default IP address is 192.168.0.10. Before connecting the board to the network, its IP addresses must be set according to the network. For more information about IP addresses, contact your network administrator.

You need a PC with an Ethernet connection and the NCIPConfig tool installed to set the Ethernet board's IP addresses. To install the NCIPConfig tool, start the installation program from CD or download it from www.vacon.com website. After starting the installation program, follow the on-screen instructions.

Once the program is installed successfully, you can launch it by selecting it in the Windows Start menu. Follow these instructions to set the IP addresses. Select **Help --> Manual** if you want more information about the software features.

Step 1. Connect your PC to the Ethernet network with an Ethernet cable. You can also connect the PC directly to the device using a crossover cable. This option may be needed if your PC does not support Automatic crossover function.

Step 2. Scan network nodes. Select **Configuration --> Scan** and wait until the devices connected to the bus in the tree structure are displayed to the left of the screen.

NOTE!

Some switches block broadcast messages. In this case, each network node must be scanned separately.

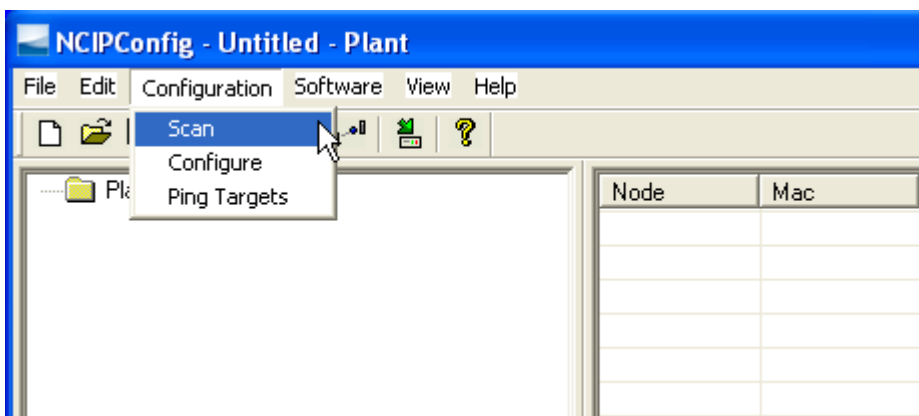

Step 3. Set names. Select the cell in column 'Node' and enter the name of the node.

Step 4. Set IP addresses. Change the node's IP settings according to the network IP settings. The program will report conflicts with a red color in a table cell.

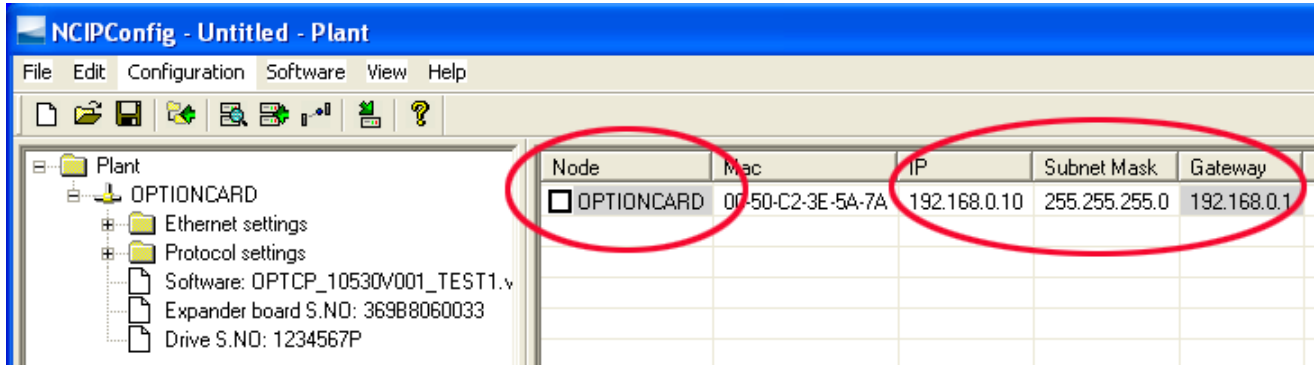

Step 5. Send configuration to boards. In the table view, check the boxes for boards whose configuration you want to send and select Configuration, then Configure. Your changes are sent to the network and will be valid immediately.

NOTE! Only **A-Z, a-z and 0-9** symbols can be used in the drive name, **no** special characters, or Scandinavian letters (ä, ö, etc.)! The drive name can be freely formed using the allowed characters.

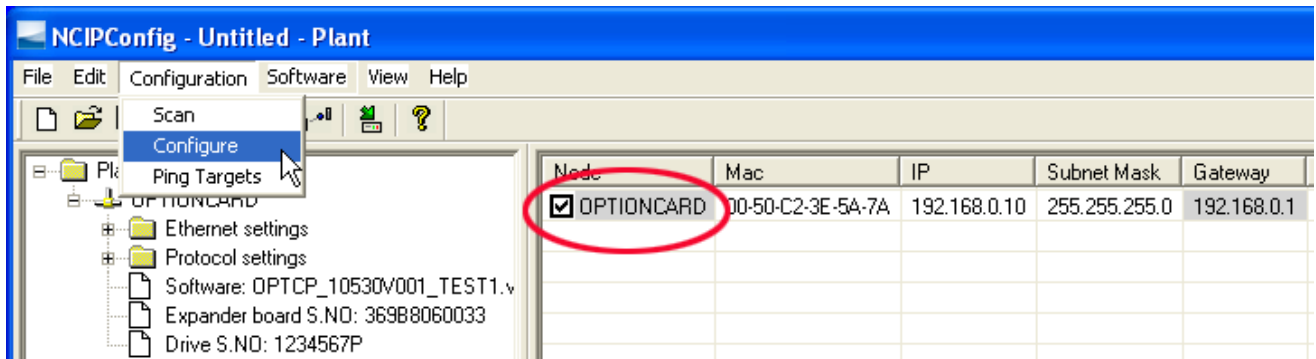

3.3.1. Update OPTCP Option Board program with the NCIPConfig Tool

In some cases it may be necessary to update the option board's firmware. Differing from other Vacon option boards, the Ethernet option board's firmware is updated with the NCIPConfig tool.

To start the firmware update, scan the nodes in the network according to the instructions in section 3.2. Once you can see all nodes in the view, you can update the new firmware by clicking the **VCN packet** field in NCIPCONFIG 's table view on the right.

NOTE! The PC's IP address must be chosen in the same IP address space as the Ethernet board's.

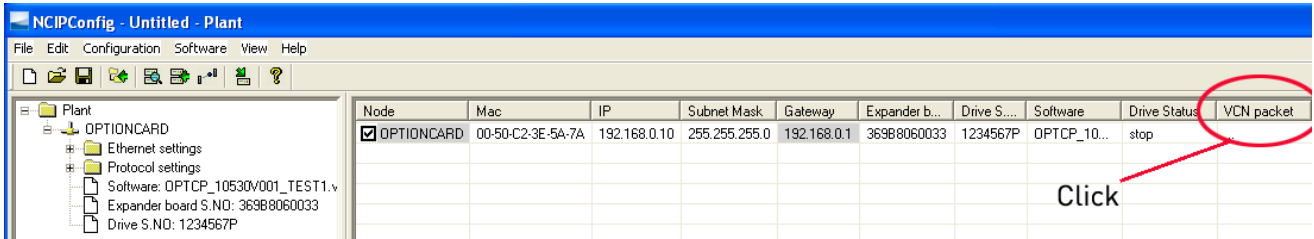

After clicking the **VCN packet** field, a file open window where you can choose a new firmware packet is displayed.

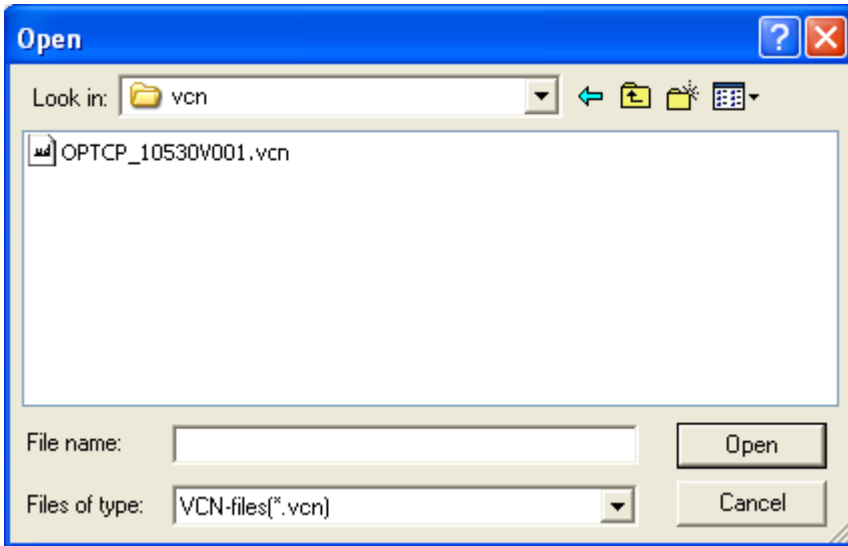

Select the desired packet and click Open.

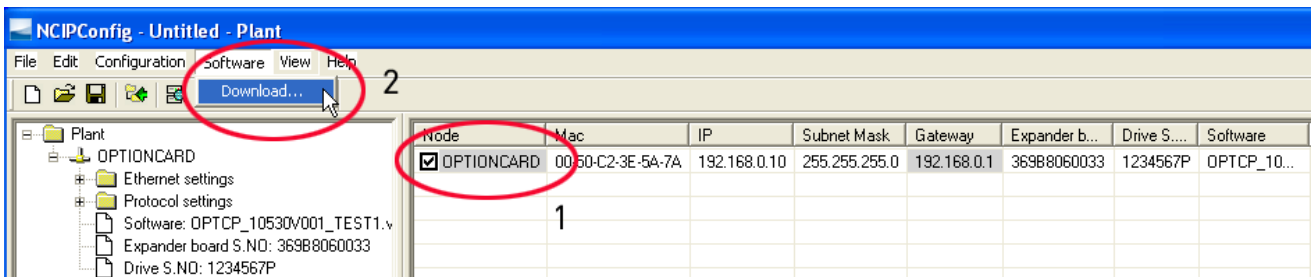

NOTE!

Do not do a power up cycle after downloading the option board software or installing a new option board to the drive within 1 minute. This may cause the option board to go to “Safe Mode”. This situation can only be solved by re-downloading the software. The Safe Mode triggers a fault code (F54). The Board slot error F54 may also appear due to a faulty board, a temporary malfunction of the board or disturbance in the environment.

3.3.2. Configure Option board parameters

These features are available from NCIPConfig tool version 1.6.

In the tree-view, expand the folders until you reach the board parameters. Slowly double-click the parameter (*Comm. Time-out* in figure below) and enter new value. New parameter values are automatically sent to the option board after the modification is complete.

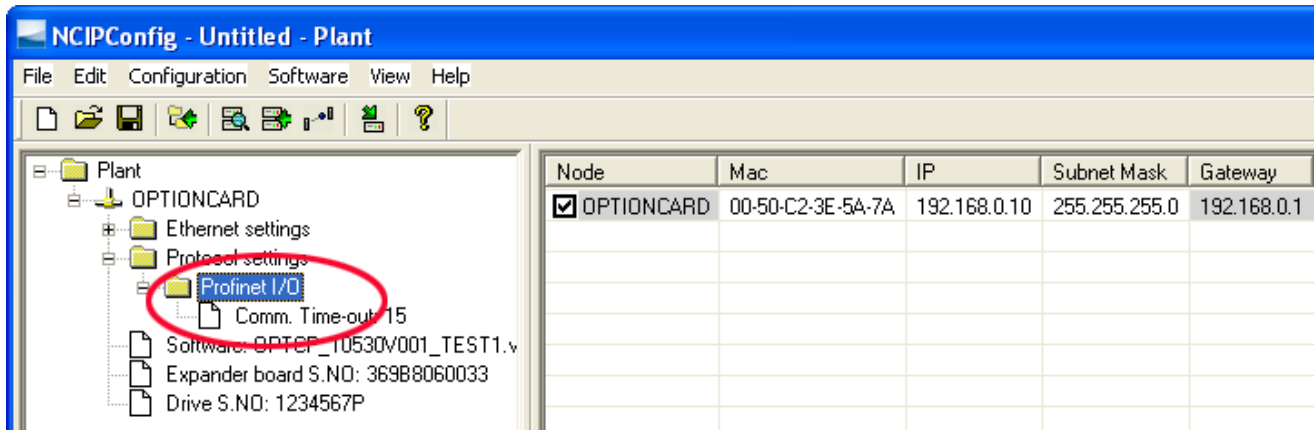

NOTE! If the fieldbus cable is broken at the Ethernet board end or removed, a fieldbus error is immediately generated.

3.4. Example with Siemens PLC

1. Create project

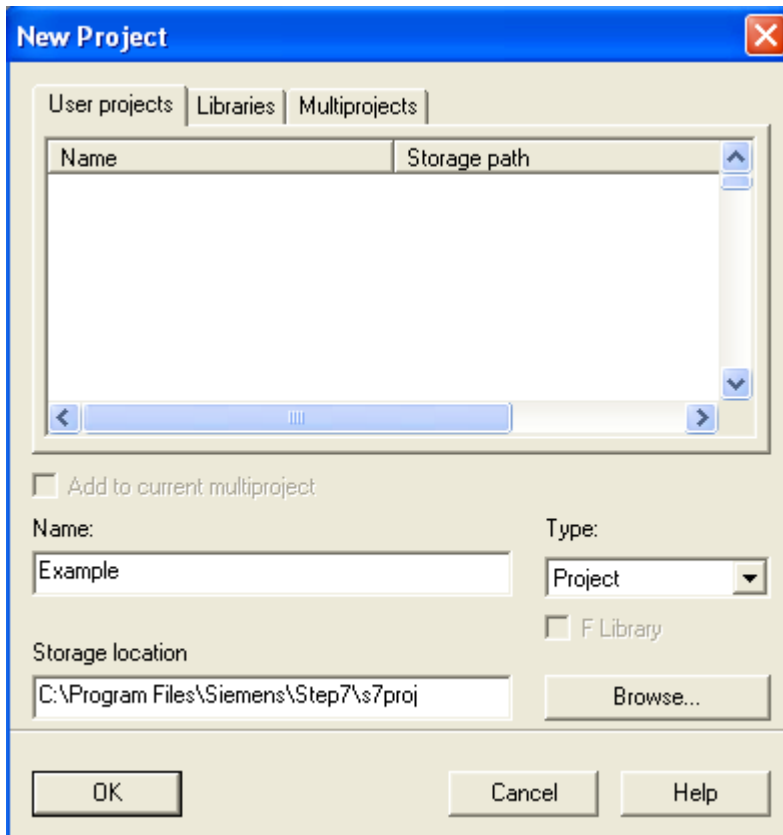

2. Insert station

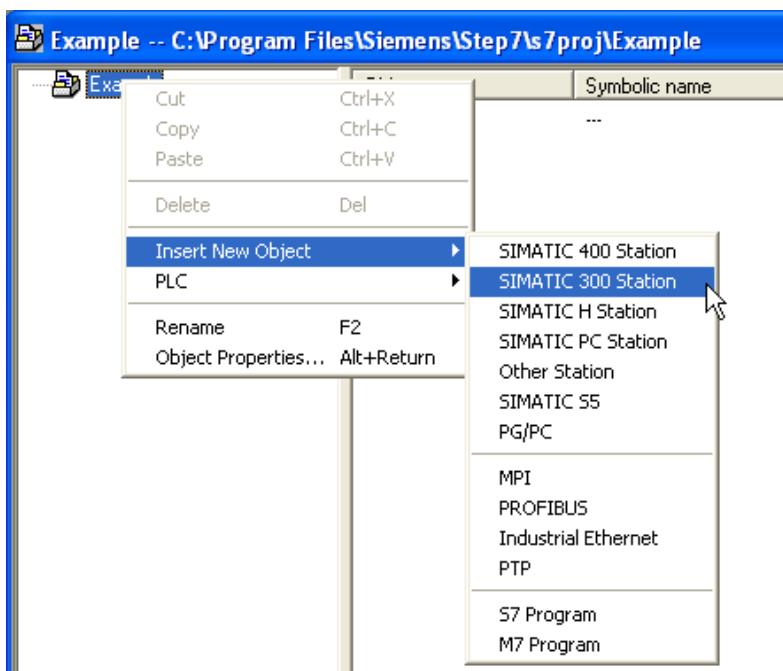

3. Double-click hardware to open HW config window.

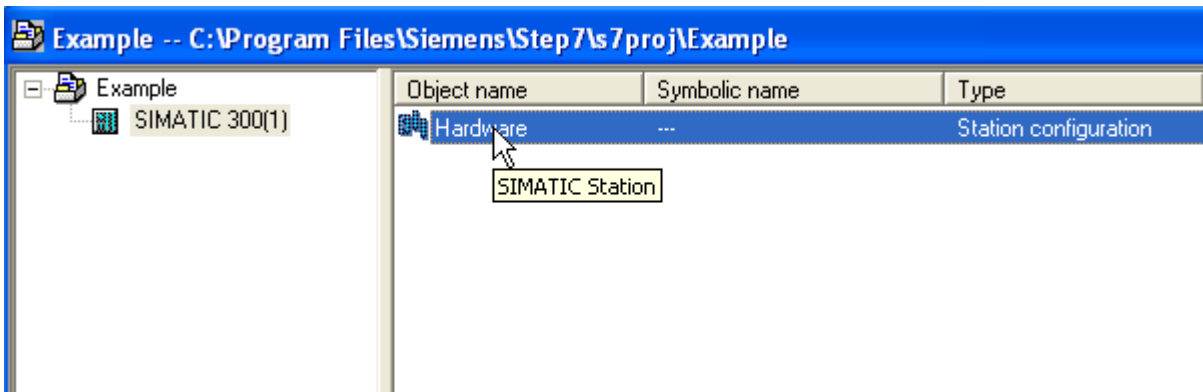

4. Insert rail

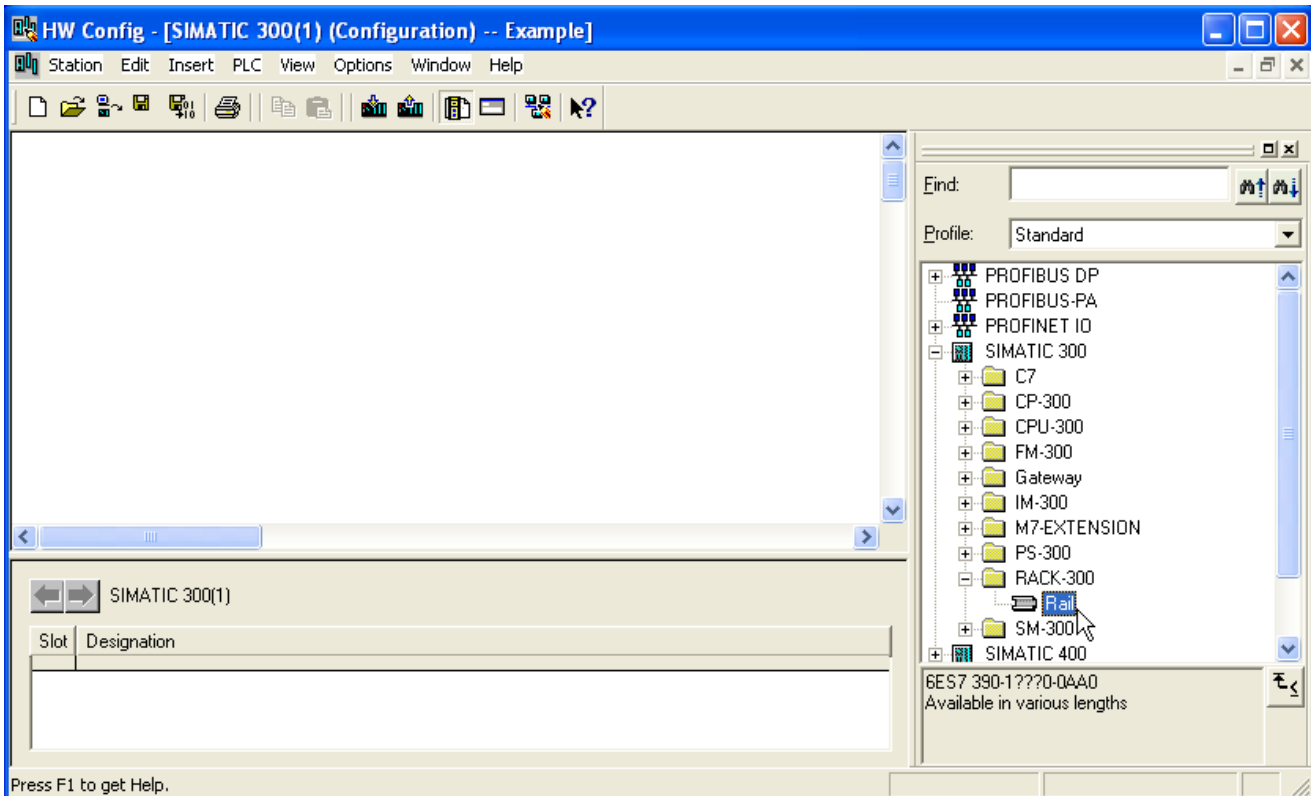

5. Insert power supply

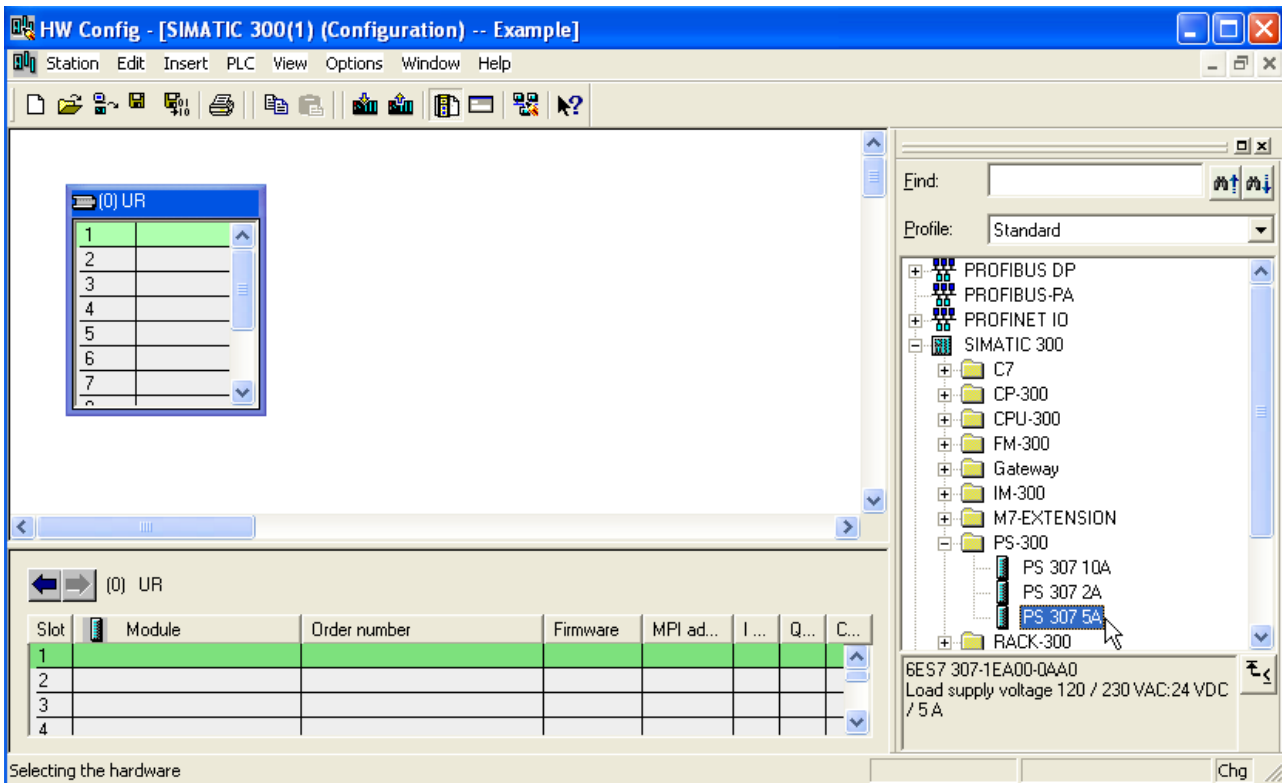

6. Insert CPU

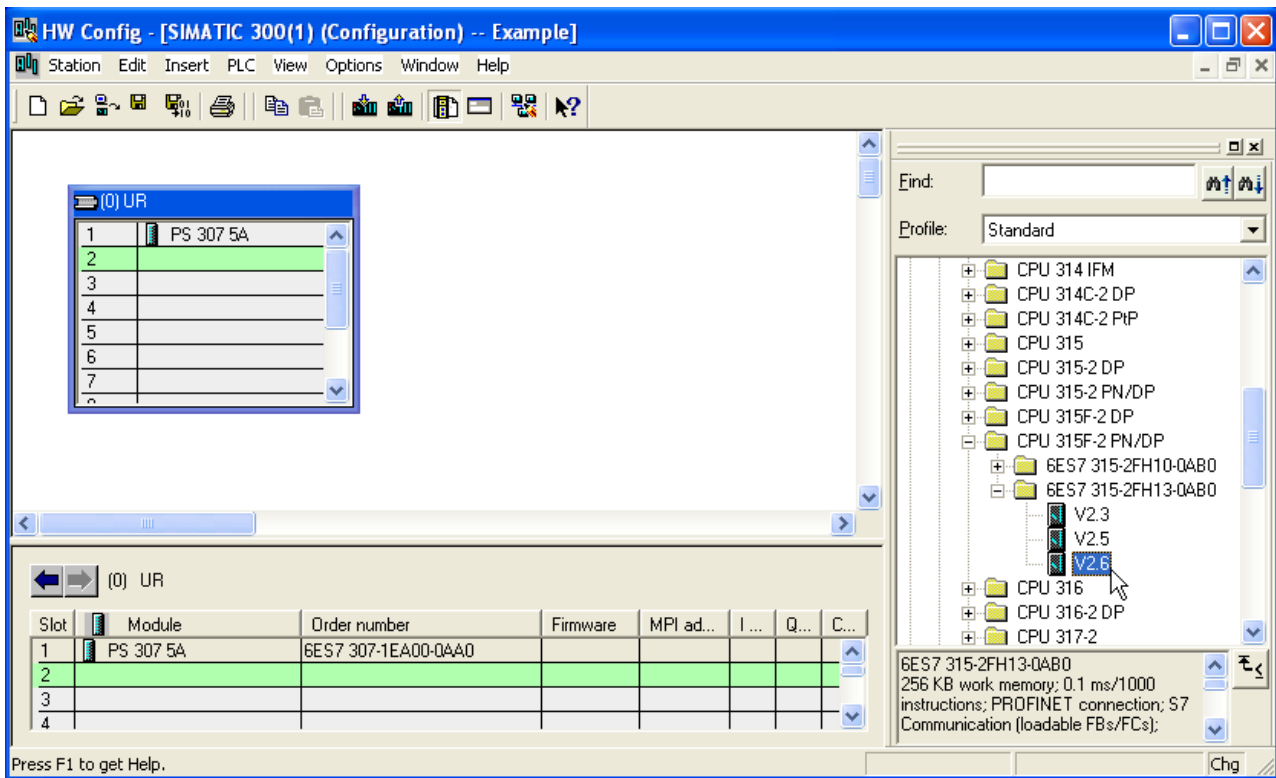

7. Change IP address and select subnet by clicking **New**.

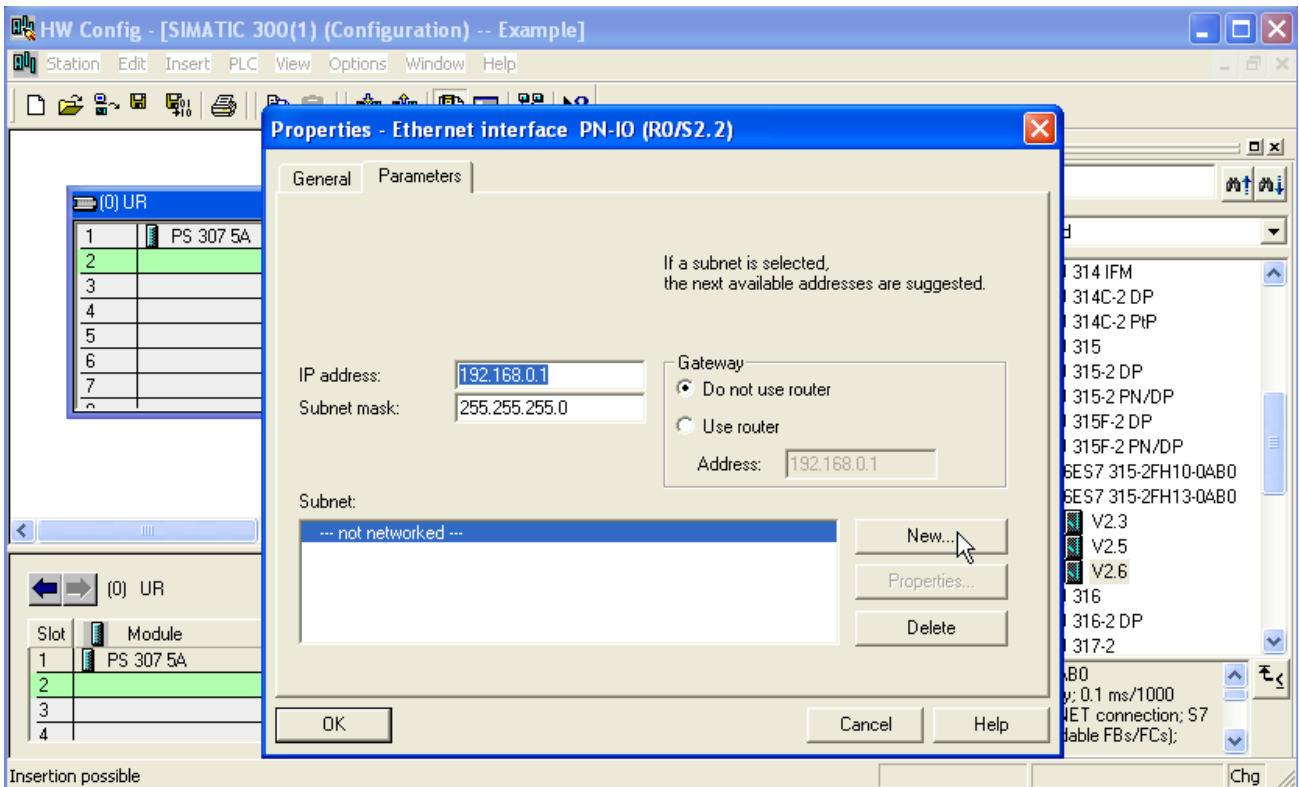

8. Click **OK**

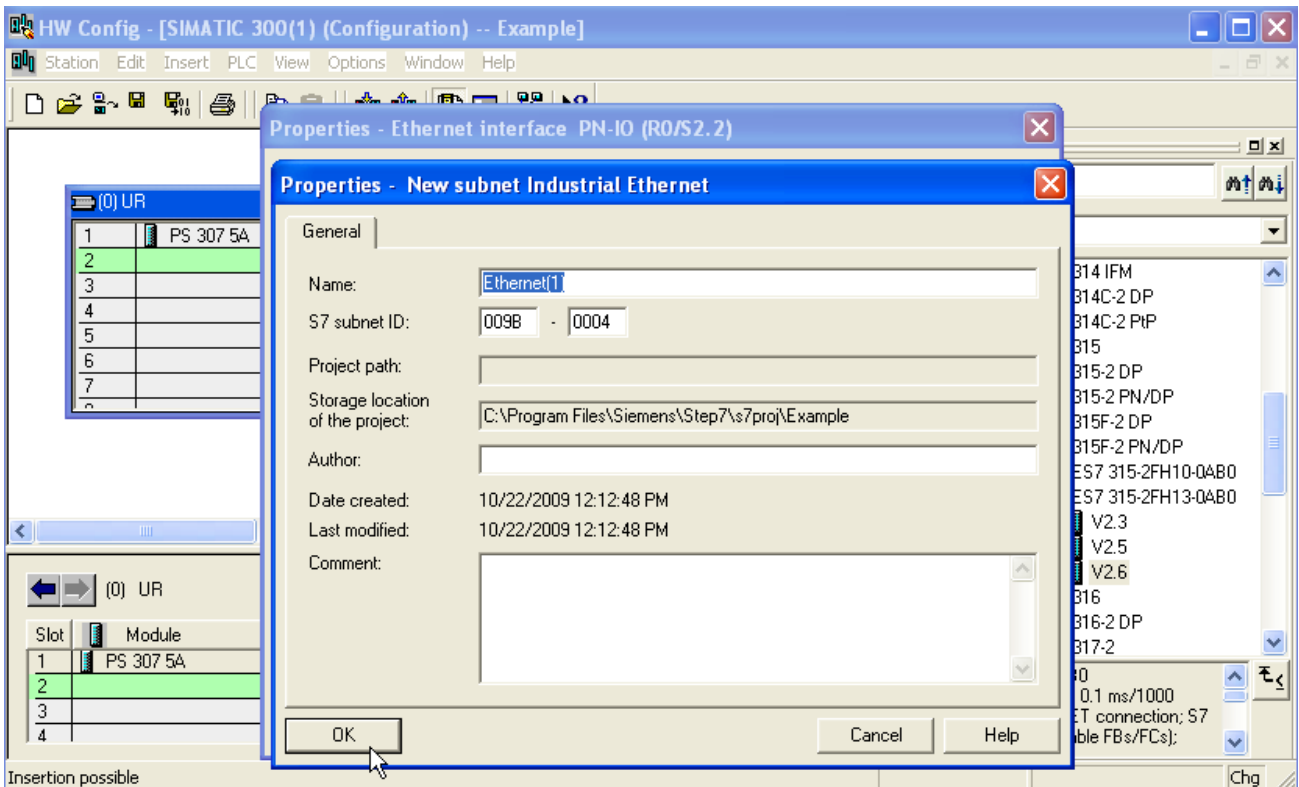

9. Click OK

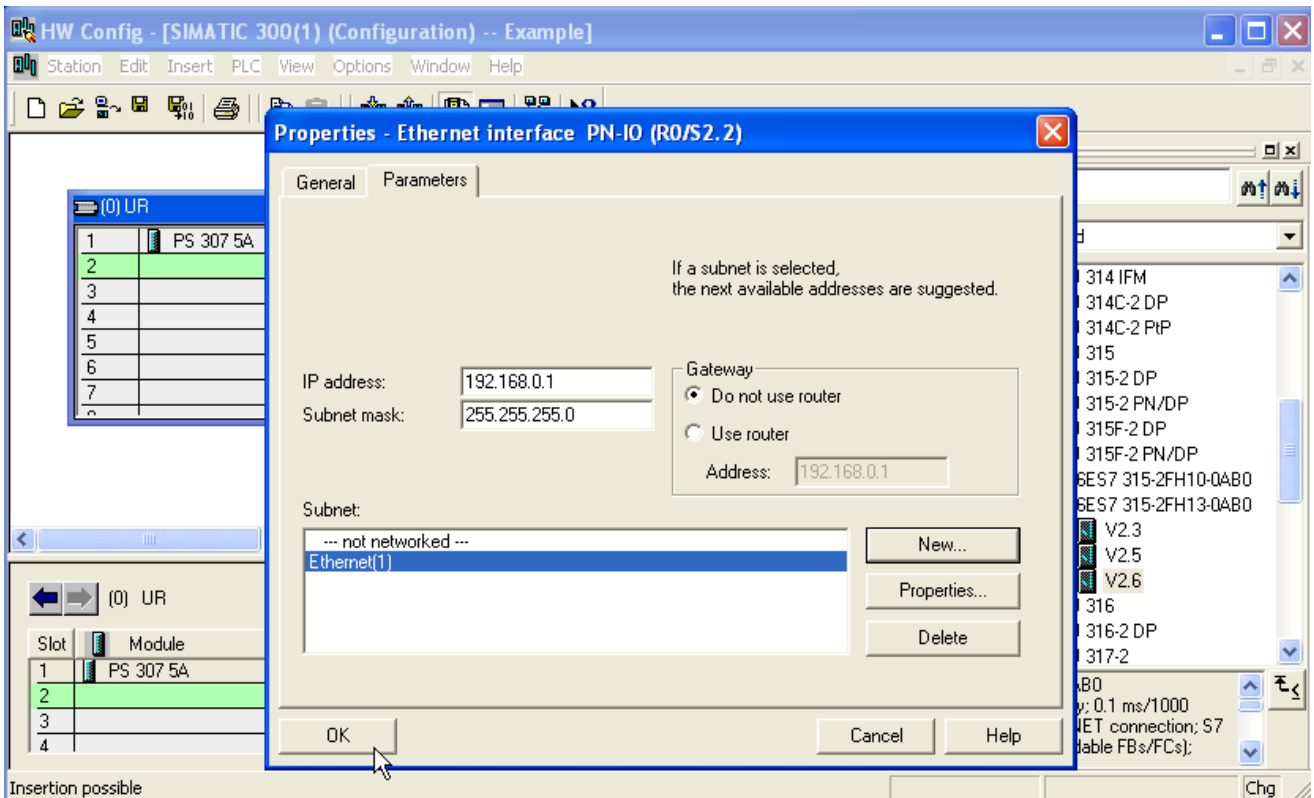

10. Now configuration should look like this

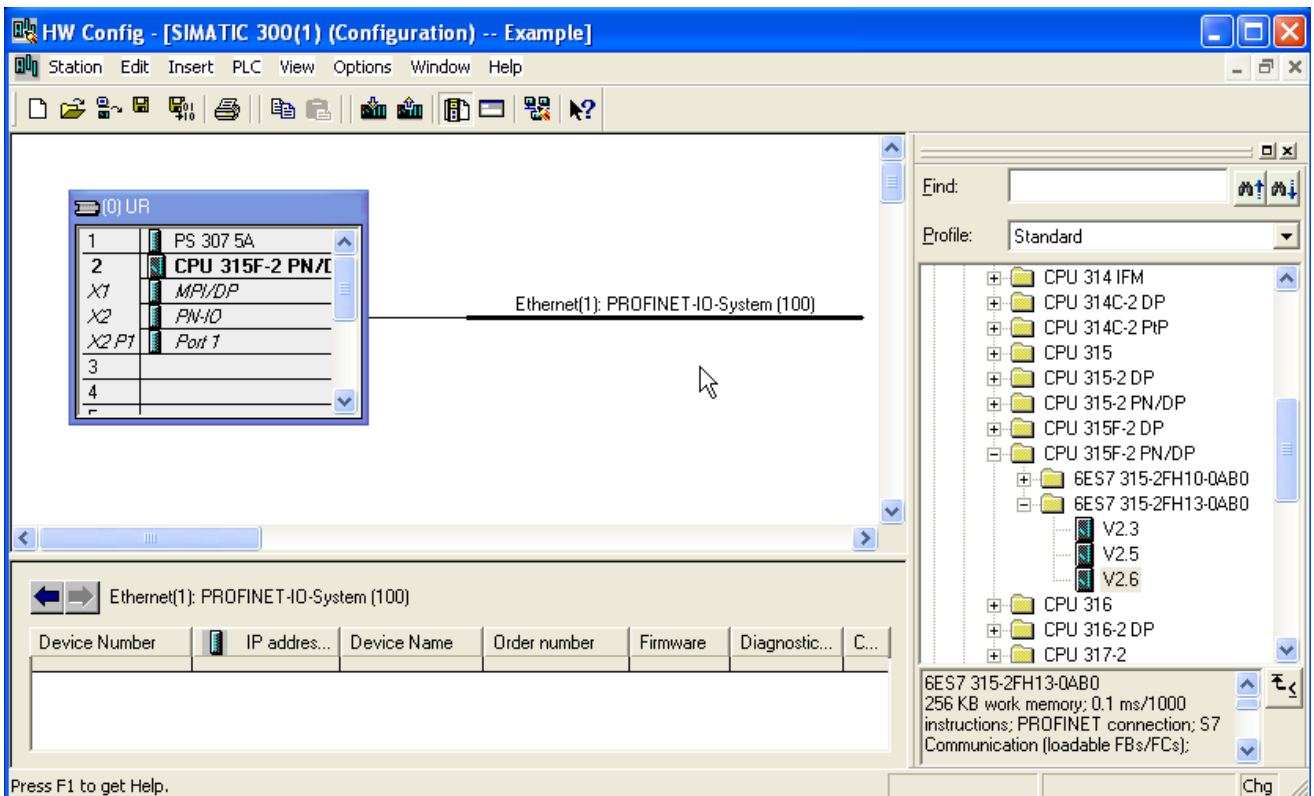

11. Drag and drop OPTCP to Profinet IO system

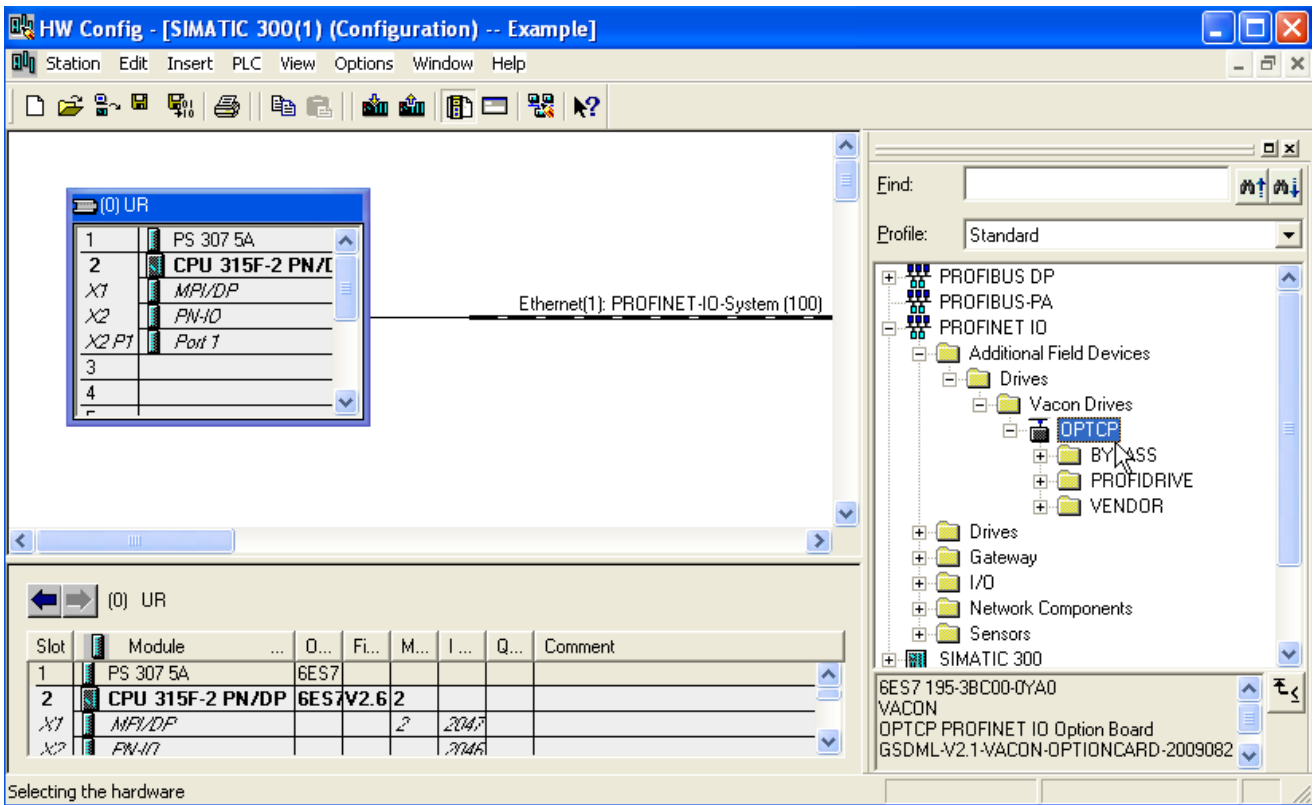

12. Select communication profile

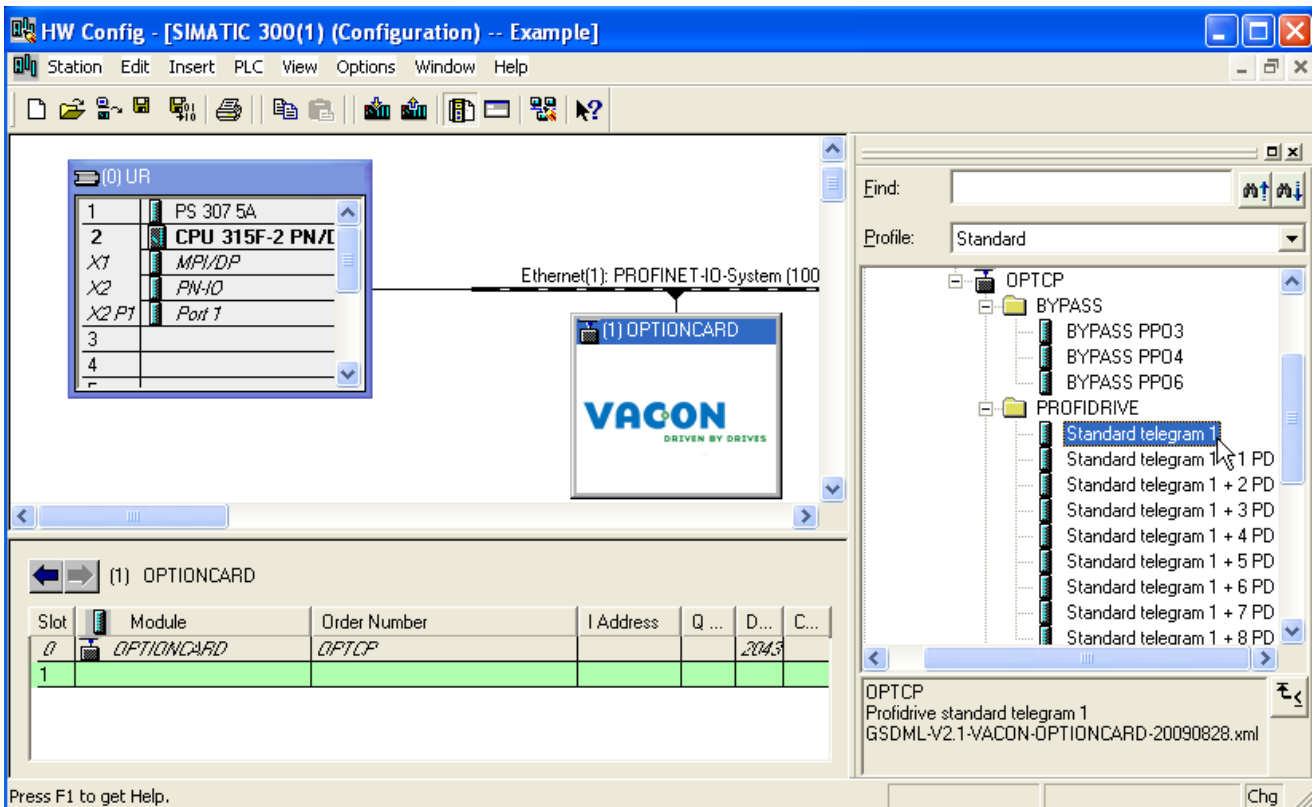

13. Change Optioncard properties

Properties - OPTIONCARD

General | ID Cycle

Short description: OPTIONCARD
OPTCP PROFINET IO Option Board

Order no.: OPTCP
Family: Vacon Drives

Device name: OPTIONCARD

GSD file: GSDML-V2.1-VACON-OPTIONCARD-20090828.xml
Change Release Number...

Node / PN IO system

Device number: 1 PROFINET-IO-System (100)

IP address: 192.168.0.10 Ethernet...

Assign IP address via IO controller

Comment:

OK Cancel Help

14. Verify Device Name.

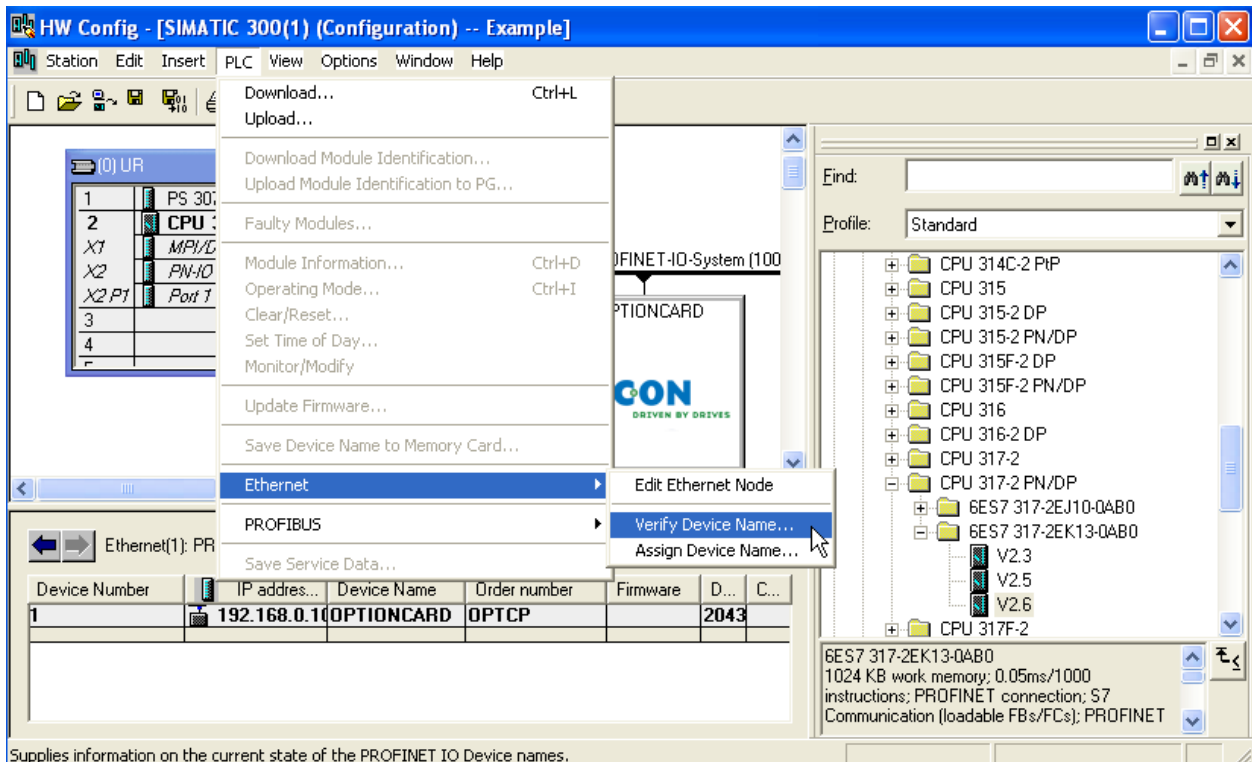

Supplies information on the current state of the PROFINET IO Device names.

15. Close window.

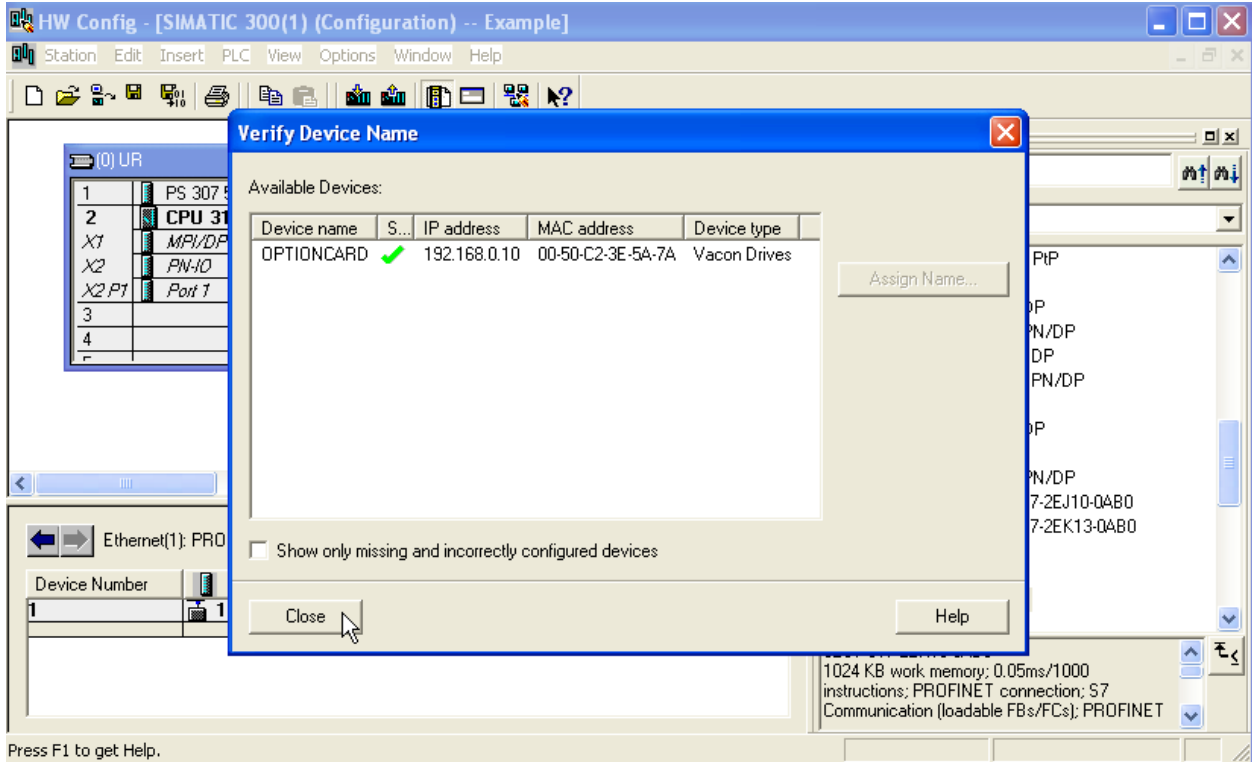

Press F1 to get Help.

16. Change IO cycle to 16 ms (minimum) or greater.

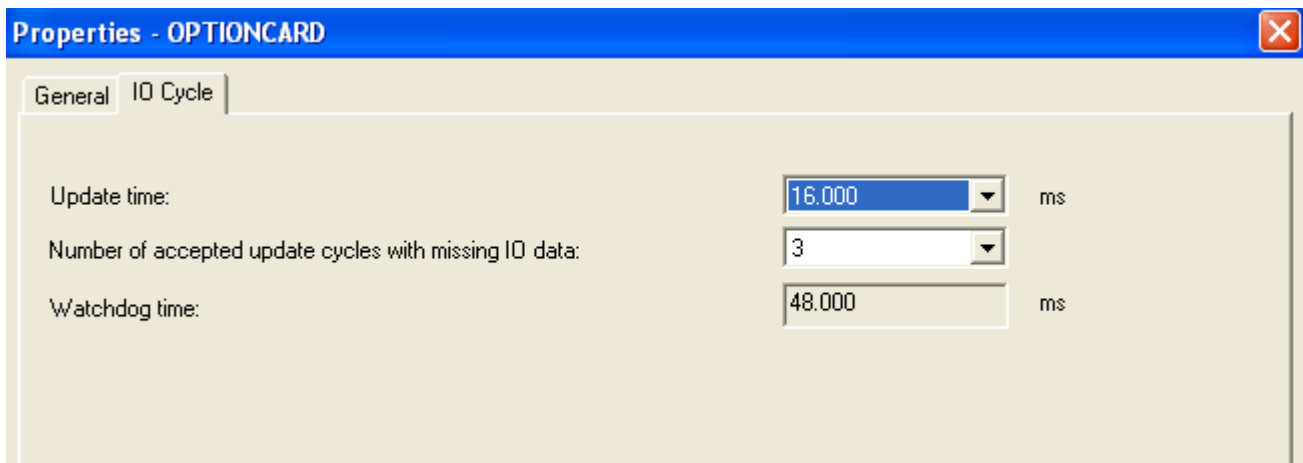

The screenshot shows a software configuration window titled "Properties - OPTIONCARD" with a close button in the top right corner. The window has two tabs: "General" and "IO Cycle", with "IO Cycle" currently selected. The configuration is as follows:

Parameter	Value	Unit
Update time:	16.000	ms
Number of accepted update cycles with missing IO data:	3	
Watchdog time:	48.000	ms

4. COMMISSIONING

The Vacon Ethernet board is commissioned with the control keypad by giving values to appropriate parameters in menu M7 (or with NCIPConfig tool, read chapter IP Tool NCIPConfig). Keypad commissioning is only possible with NXS and NXP series AC drives. AC drives of the NXL series can only be commissioned with the NCIPConfig tool.

4.1. Expander board menu (M7)

The *Expander board menu* makes it possible for the user to see which expander boards are connected to the control board and to reach and edit the parameters associated with the expander board.

Enter the following menu level (G#) with the *Menu button right*. At this level, you can browse through slots A to E with the *Browser buttons* to see what expander boards are connected. On the lowermost line of the display you see the number of parameter groups associated with the board. If you still press the *Menu button right* once you will reach the parameter group level where there are one group in the Ethernet board case: Parameters. A further press on the *Menu button right* takes you to Parameter group.

4.2. Profinet parameters

#	Name	Default	Range	Description
1	Comm. Timeout	10	0...255 s	
2	IP Part 1	192	1...223	IP Address Part 1
3	IP Part 2	168	0...255	IP Address Part 2
4	IP Part 3	0	0...255	IP Address Part 3
5	IP Part 4	10	0...255	IP Address Part 4
6	SubNet Part 1	255	0...255	Subnet Mask Part 1
7	SubNet Part 2	255	0...255	Subnet Mask Part 2
8	SubNet Part 3	0	0...255	Subnet Mask Part 3
9	SubNet Part 4	0	0...255	Subnet Mask Part 4
10	DefGW Part 1	192	0...255	Default Gateway Part 1
11	DefGW Part 2	168	0...255	Default Gateway Part 2
12	DefGW Part 3	0	0...255	Default Gateway Part 3
13	DefGW Part 4	1	0...255	Default Gateway Part 4
14	<i>InputAssembly</i>	-	-	<i>NOT USED in Profinet</i>
15	<i>OutputAssembly</i>	-	-	<i>NOT USED in Profinet</i>

Table 2. Ethernet parameters

4.3. IP Address

IP is divided into 4 parts. (Part = Octet) Default IP Address is 192.168.0.10.

Communication timeout

Defines how much time can pass from the last received message from the Master Device before fieldbus fault is generated. Communication timeout is disabled when given the value 0. The communication timeout value can be changed from the keypad or with NCIPConfig tool (see chapter IP Tool NCIPConfig).

NOTE!

If the fieldbus cable is broken at the Ethernet board end or removed a fieldbus error is immediately generated.

All Ethernet parameters are saved to the Ethernet board (not to the control board). If the Ethernet board is replaced by a new one you must re-configure the new Ethernet board. Option board parameters can also be saved to the keypad using the NCIPConfig tool or the NCDrive.

4.4. Start-up test

In the AC drive application:

Choose Fieldbus (Bus/Comm) as the active control place (see Vacon NX User's Manual, Chapter 7.3.3).

In the Master software:

1. Set Control Word value to 0hex.
2. Set Control Word value to 47Ehex.
3. Set Control Word value to 47Fhex.
4. Frequency converter status is RUN.
5. Set Reference value to 5000 (=50.00%).
6. The Actual value is 5000 and the frequency converter output frequency is 25.00 Hz.
7. Set Control Word value to 477hex.
8. Frequency converter status is STOP.

5. PROFINET I0

PROFINET is the Ethernet-based automation standard of PROFIBUS International for the implementation of an integrated and consistent automation solution based on Industrial Ethernet. PROFINET supports the integration of simple distributed field devices and time-critical applications in (switched) Ethernet communication, as well as the integration of component-based distributed automation systems for vertical and horizontal integration of networks.

5.1. Vendor profile

In vendor mode there are three PPO types; PP03, PP04, PP06. These PPO types should have same functionality than Vacon NX Profibus. In PPO mode control word and status word goes through state machine.

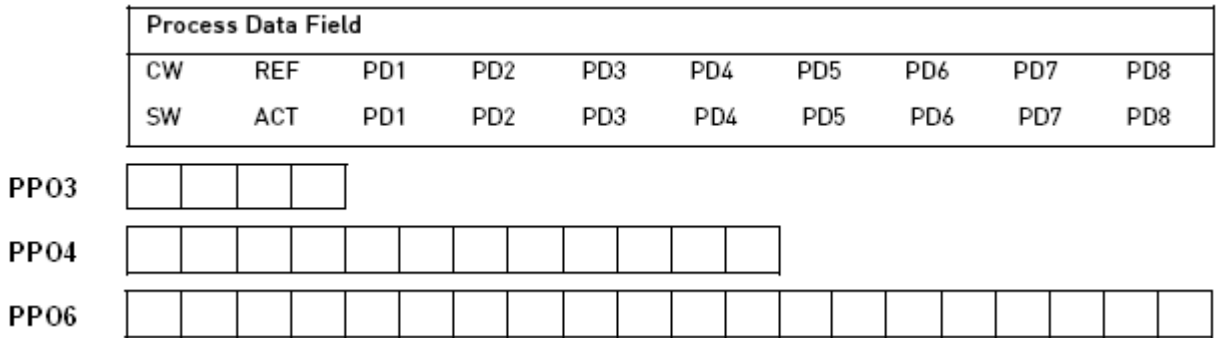

Descriptions

- Byte
- CW Control Word
- SW Status Word
- REF Reference value
- ACT Actual value
- PD Process Data

5.1.1. Control word (Vendor profile)

The Control command for the state machine (see Figure 2) The state machine describes the device status and the possible control sequence of the frequency converter.

The control word is composed of 16 bits that have the following meanings:

Bit	Description	
	Value = 0	Value = 1
0	STOP 1 (by ramp)	ON 1
1	STOP 2 (by coast)	ON 2
2	STOP 3 (by ramp)	ON 3
3	RUN DISABLE	ENABLE
4	No action	START
5	No action	START
6	No action	START
7	No action	FAULT RESET (0 ->1)
8	No action	No action
9	No action	No action
10	Disable fieldbus control	Enable fieldbus control
11	Fieldbus DIN1=OFF	Fieldbus DIN1=ON
12	Fieldbus DIN2=OFF	Fieldbus DIN2=ON
13	Fieldbus DIN3=OFF	Fieldbus DIN3=ON
14	Fieldbus DIN4=OFF	Fieldbus DIN4=ON
15	Fieldbus DIN5=OFF	Fieldbus DIN5=ON

Table 3.

5.1.2. Status word (Vendor profile)

Information about the status of the device and messages is indicated in the Status word. The Status word is composed of 16 bits that have the following meanings:

Bit	Description	
	Value = 0	Value = 1
0	Not Ready (initial)	READY 1 **
1	Not Ready	READY 2 **
2	DISABLE	ENABLE **
3	NO FAULT	FAULT ACTIVE *
4	STOP 2	NO STOP 2 **
5	STOP 3	NO STOP 3 **
6	START ENABLE	START DISABLE **
7	No Warning	Warning *
8	Reference \neq Actual value	Reference = Actual value *
9	Fieldbus control OFF	Fieldbus control ON *
10	Not used	Not used
11	Not used	Not used
12	FC stopped	Running *
13	FC not ready	FC ready *
14	Not used	Not used
15	Not used	Not used

Table 4.

*Comes straight from the frequency converter

**Bits of the State Machine

5.1.3. State Machine

The state machine describes the device status and the possible control sequence of the frequency converter. The state transitions can be generated by using the "Control word". The "Status word" indicates the current status of the state machine. The modes INIT, STOP, RUN and FAULT correspond to the actual mode of the Frequency converter.

NOTE! Always set CW bit0 to 0 after fault reset before proceeding!

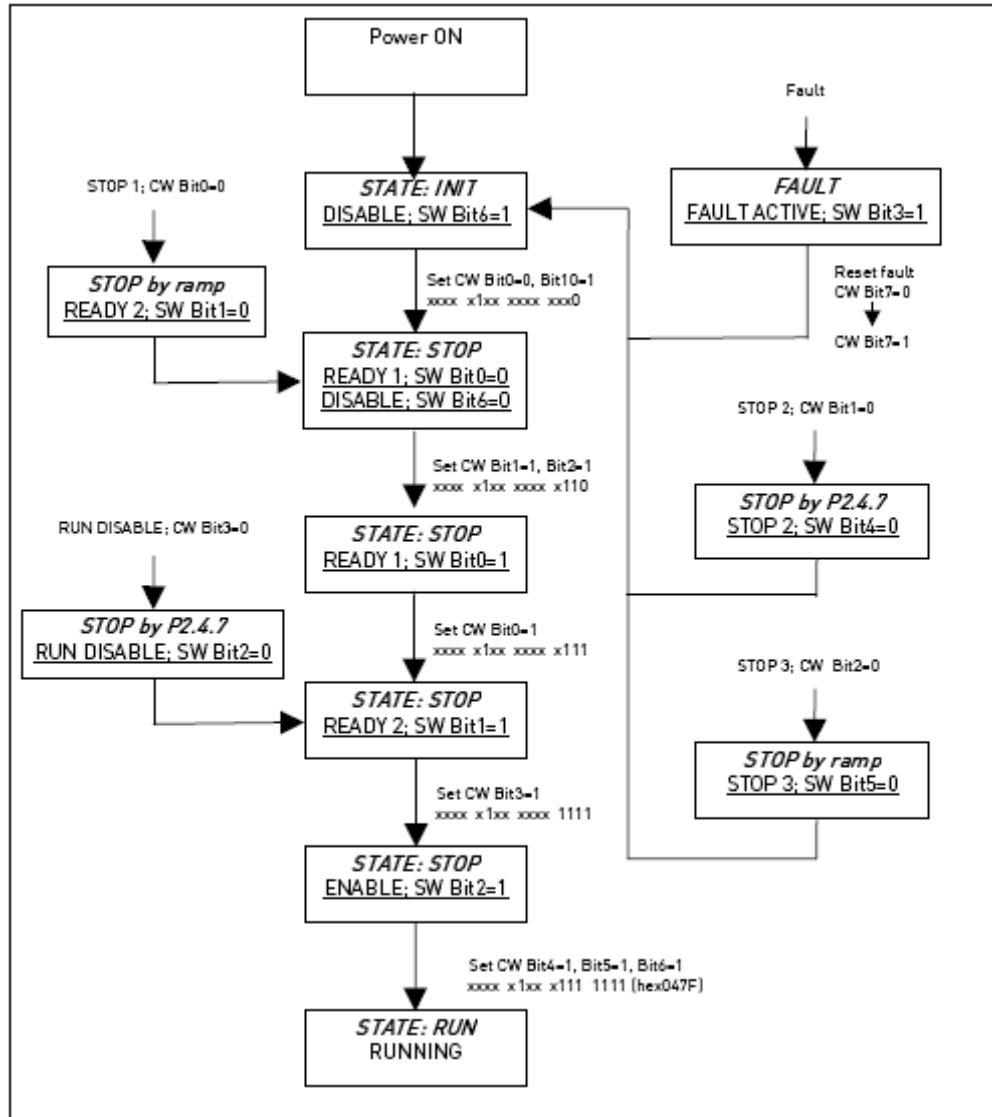

Figure 2.

5.1.4. Reference

CW		REF		PD1		PD2		PD3		PD4		PD5		PD6		PD7		PD8	

This is the reference 1 to the frequency converter. Used normally as Speed reference. The allowed scaling is -10000...10000. In the application, the value is scaled in percentage of the frequency area between set minimum and maximum frequency.

- 10000 = 100,00 % (Direction reverse)
- 0 = 0,00 % (Direction forward)
- 10000 = 100,00 % (Direction forward)

5.1.5. Actual value

SW		ACT		PD1		PD2		PD3		PD4		PD5		PD6		PD7		PD8	

This is the actual value from the frequency converter. Value between -10000...10000. In the application, the value is scaled in percentage of frequency area between set minimum and maximum frequency.

- 10000 = 100,00 % (Direction reverse)
- 0 = 0,00 % (Direction forward)
- 10000 = 100,00 % (Direction forward)

5.1.6. Process data in

CW		REF		PD1		PD2		PD3		PD4		PD5		PD6		PD7		PD8	

ProcessData Master -> Slave
 The Master can write max. 8 additional setting values to the device with the help of the Process Data. How these setting values are used is totally dependent on the application in use.

5.1.7. Process data out

SW		ACT		PD1		PD2		PD3		PD4		PD5		PD6		PD7		PD8	

ProcessData Slave -> Master
 The master can read the frequency converter's actual values using the process data variables. Depending on the used application, the contents are either standard or can be selected with a parameter.

5.2. Bypass profile

In BYPASS mode there are three types.

Process Data Field									
CW	REF	PD1	PD2	PD3	PD4	PD5	PD6	PD7	PD8
SW	ACT	PD1	PD2	PD3	PD4	PD5	PD6	PD7	PD8

PP03



PP04



PP06



Descriptions



Byte

CW Control Word

SW Status Word

REF Reference value

ACT Actual value

PD Process Data

5.2.1. Control Word (Bypass profile)

The meanings of the Control Word bits is application-dependent.

5.2.2. Status Word (Bypass profile)

The meanings of the Status Word bits are application-dependent.

5.3. Profidrive profile

Process Data field									
STW1	NSOLL_A	PDI1	PDI2	PDI3	PDI4	PDI5	PDI6	PDI7	PDI8
ZSW1	NIST_A	PDO1	PDO2	PDO3	PDO4	PDO5	PDO6	PDO7	PDO8

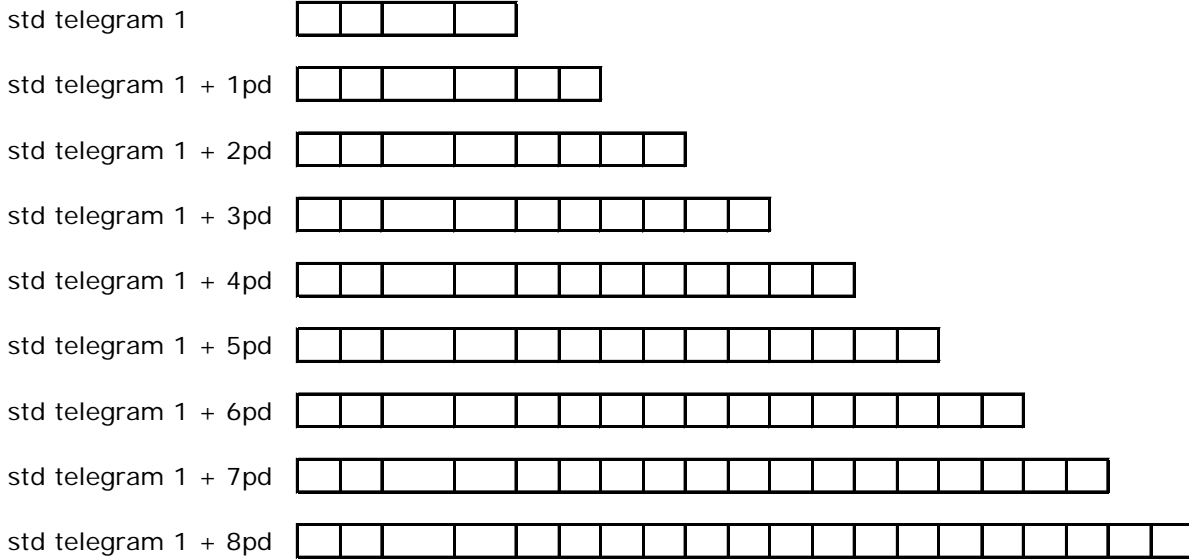

The PROFIDRIVE profile has been jointly defined by drive manufacturers. The profile specifies aspects of drive parameterization and how the setpoints and actual values should be transmitted. This makes drives in a fieldbus vendor-independent and possible to be replaced by a drive from a different vendor. The profile contains specifications needed for speed control and positioning and it specifies the basic drive functions while leaving sufficient freedom for application-specific expansions and further developments.

5.3.1. Application class 1

The Profinet board supports Application Class 1 of the Profidrive profile (version 4.1). Application Class 1 defines Standard Telegram 1. The standard telegrams have the following structure:

I/O data number	1	2
Setpoint	STW1	NSOLL_A
Actual value	ZSW1	NIST_A

Table 5.

5.3.1.1. STW1

STW1 is the Profidrive profile’s control word. The control word is for controlling the drive from a fieldbus. It is sent by the fieldbus master to the drive. The drive switches between its states according to the bit-coded instructions on the control word. Because the STW1 and the drive’s own control words are different the STW1 has to be written to Drive Interface through state machine. Some of the STW1 bits go straight to Drive Interface.

The STW1 is composed of 16 bits that have the following meanings:

Bits	Description	
	Value = 0	Value = 1
0	OFF	ON
1	Coast stop (No OFF2 / OFF2)	No coast stop
2	Quick stop (No OFF3 / OFF3)	No quick stop
3	Disable operation	Enable operation
4	Reset ramp generator ^b	Enable ramp generator ^b
5	Freeze ramp generator ^b	Unfreeze ramp generator ^b
6	Disable setpoint	Enable setpoint
7		Fault acknowledgement (0->1)
8	Jog 1 OFF ^a	Jog 1 ON ^a
9	Jog 2 OFF ^a	Jog 2 ON ^a
10	No control by PLC	Control by PLC
11		Device-specific
12-15		Device-specific
^a Optional; depends on application		
^b Depends on application		

5.3.1.2. ZSW1

ZSW1 is the Profidrive profile's status word. Status word indicates information about the status of the device. Also messages are indicated in the Status word. The ZSW1 Status word is composed of 16 bits that have the following meanings:

Bits	Description	
	Value = 0	Value = 1
0	Not ready to switch on	Ready to switch on
1	Not ready to operate	Ready to operate
2	Operation disabled	Operation enabled (drive follows setpoint)
3	No fault	Fault present
4	Coast stop activated (No OFF2 / OFF2)	Coast stop not activated
5	Quick stop activated (No OFF3 / OFF3)	Quick stop not activated
6	Switching on not inhibited	Switching on inhibited
7	No warning	Warning present
8	Speed error out of tolerance range	Speed error within tolerance range
9	No control requested	Control requested
10	f or n not reached	f or n reached or exceeded
11		Device-specific
12		Device-specific
13		Device-specific
14-15		Device-specific

5.3.1.3. NSOLL_A

NSOLL_A is the reference to the drive. It is used normally as Speed reference. Reference is a 16-bit word containing a sign bit and a 15-bit integer. A negative reference (indicating reversed direction of rotation) is formed by calculating the two's complement from the corresponding positive reference. The allowed scaling is -10000...10000. In the drive application, the value is scaled in percentage of the frequency area between set minimum and maximum frequency.

-10000 = 100,00 % (Direction reverse)
0 = 0, 00 % (Direction forward)
10000 = 100,00 % (Direction forward)

5.3.1.4. NIST_A

NIST_A is the actual value from the frequency converter. It contains values between -10000...10000. In the application, the value is scaled in percentage of frequency area between set minimum and maximum frequency.

-10000 = 100,00 % (Direction reverse)
0 = 0, 00 % (Direction forward)
10000 = 100,00 % (Direction forward)

5.3.1.5. State Machine

The state machine describes the device status and the possible control sequence of the frequency converter. The state transitions can be generated by using the "Control word". The "Status word" indicates the current status of the state machine. The modes INIT, STOP, RUN and FAULT correspond to the actual mode of the Frequency converter

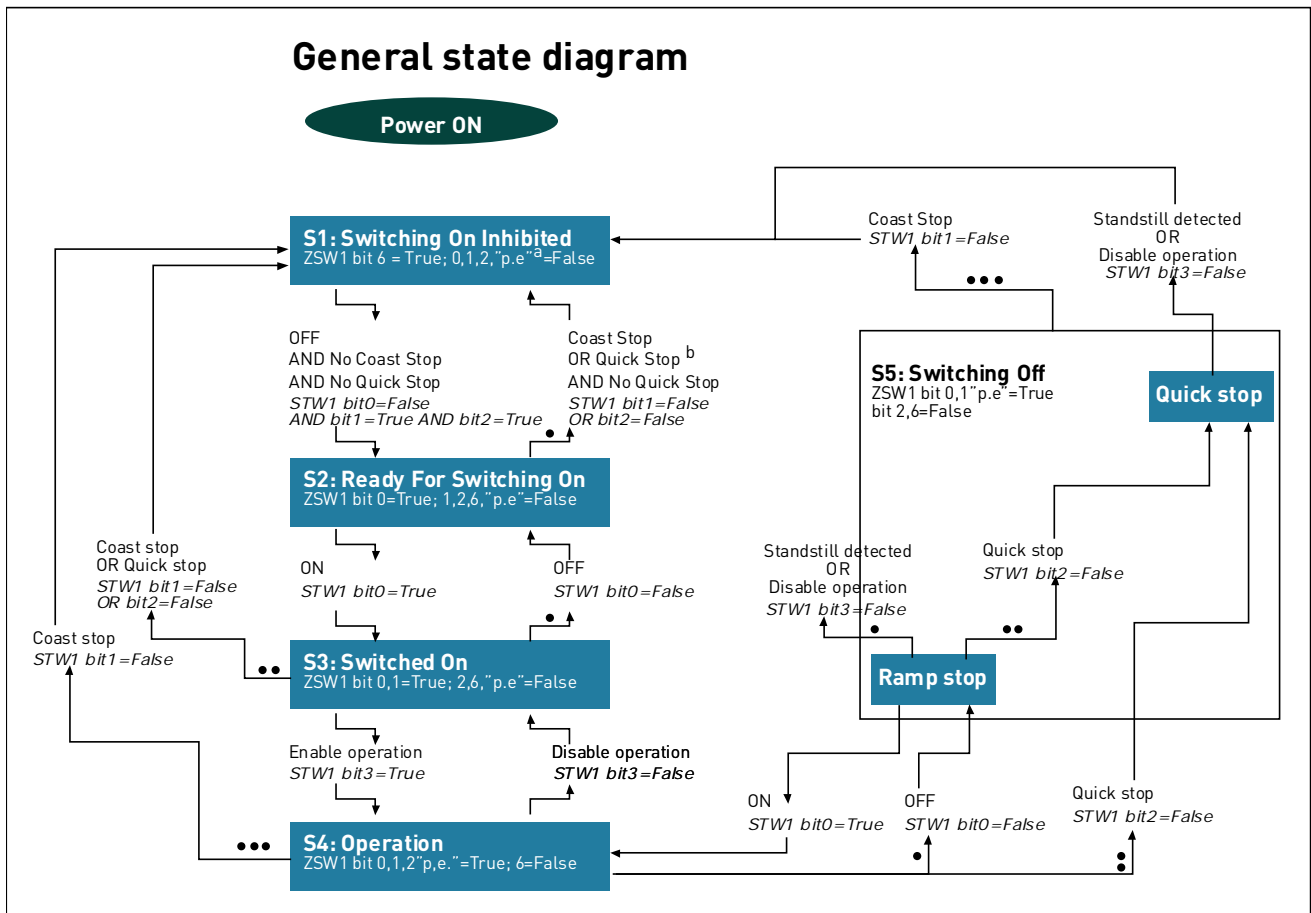

Figure 3.

5.3.1.6. Additional Process data in

ProcessData Master -> Slave

The Master can write max. 8 additional setting values to the device with the help of the Process Data. How these setting values are used is totally dependent on the application in use.

5.3.1.7. Additional Process data out

ProcessData Slave -> Master

The master can read the frequency converter's actual values using the process data variables. Depending on the used application, the contents are either standard or can be selected with a parameter.

5.4. Parameter channel

The Parameter channel can be used to access the Drive’s parameters and the PROFIDRIVE’s parameters.

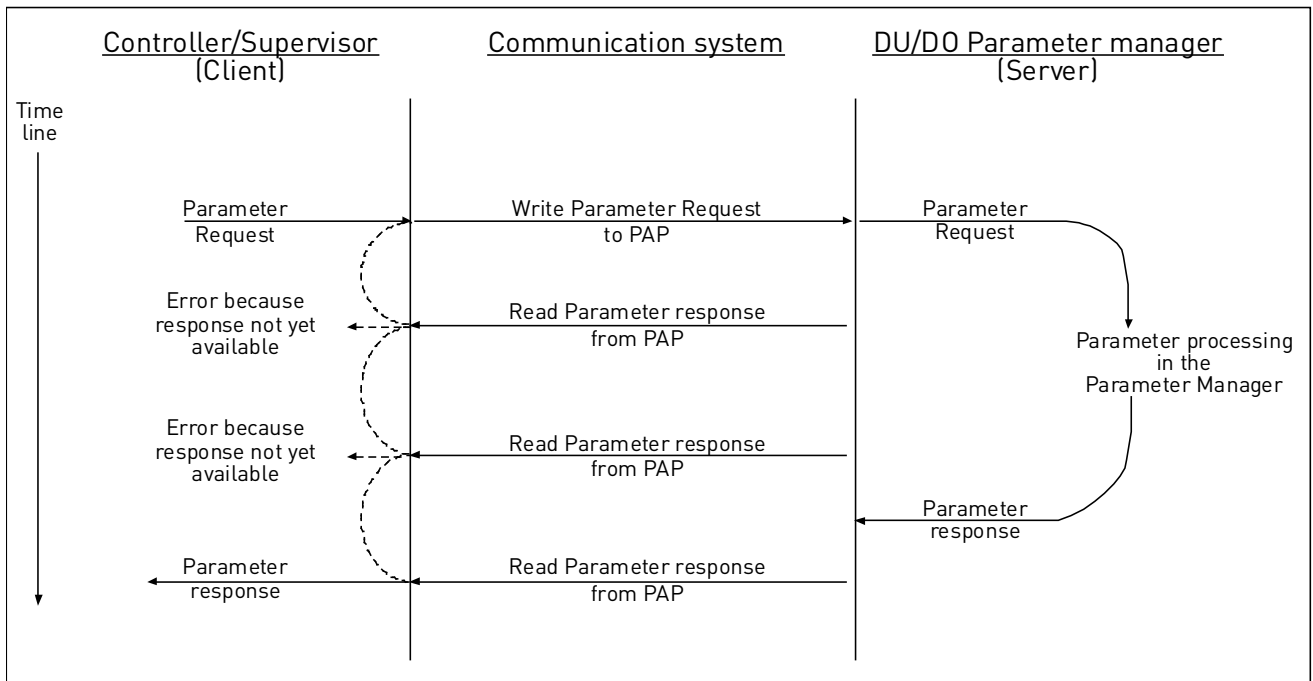
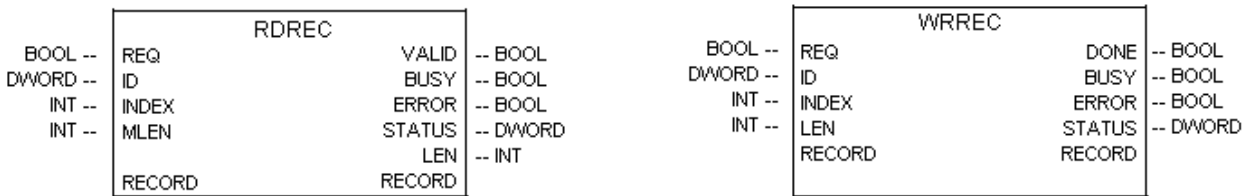

Figure 4. Data flow for Base Mode Parameter Access

Parameters are read/written with function blocks in Siemens PLC. Function block SFB 52 “RDREC” is for reading and SFB53 “WRREC” for writing. See more detailed information in document *Communication Function Blocks for PROFIBUS and PROFINET* on www.profibus.com.



Parameter Access Service	Index
Base Mode Parameter – Global	0xB02F

Global Parameters

Global parameters are related to the complete device.

Supported parameter accesses:

- Request parameter value, single
- Change parameter value, single
- Request parameter value, multi-parameter
- Change parameter value, multi-parameter
- Request parameter value, several array elements
- Change parameter value, several array elements
- Change parameter value, several array elements, Format Byte

It is possible to read and write parameters from and to the drive. In order to process them through the Base Mode Parameter Access mechanism, you should:

- set requested PNU to 10001 (0x2711)
- set requested subindex with the drive parameter ID

NOTE:

Parameters which are read from the drive have always the format set to “Word” – 0x42.

Error Value	Meaning
0x00	Impermissible PNU
0x01	Cannot change value
0x02	Low or high limit exceeded
0x03	Faulty subindex
0x04	No array
0x05	Incorrect data type
0x06	Setting not permitted
0x07	Cannot change description
0x09	No description
0x0B	No operation priority
0x0F	No text array available
0x11	Cannot execute the request. Reason not specified
0x14	Value impermissible
0x15	Response too long
0x16	Parameter address impermissible
0x17	Illegal format
0x18	Number of values inconsistent
0x19	Axis/DO nonexistent
0x20	Cannot change text
0x65	Invalid Request Reference
0x66	Invalid Request ID
0x67	Invalid Axis number / DO-ID
0x68	Invalid number of parameters
0x69	Invalid attribute
0x6B	Request too short

Table 6 PROFIDRIVE parameter request error codes

PROFIDRIVE's profile-specific parameters

PNU	Signification	Datatype
922	Telegram Selection	
930	Operating Mode	
944	Fault Message Counter	
947	Fault Number	
950	Scaling of the Fault Buffer	
964	Drive Unit Identification	
965	Profile Identification Number	
975	DO Identification	
980 to 989	Number List of Defined Parameter	

Request Header, Meaning of the fields

Field	Meaning	Range
Request Reference	Master sets unique identification for every query.	1...255
Request ID	Defines the type of the message.	0x01 = Request Parameter 0x02 = Change Parameter
DO-ID	Set to "1".	0...255
Number of Parameters	Specifies the number of parameters in request.	1...38
Attribute	Type of object being accessed.	0x10 = Value
Number of Elements	Number of array elements or length of string accessed.	1...234
Parameter Number	Addresses of the accessed PROFIDrive parameter.	1...65535 (0x2711) Access to drive parameters
Subindex	Addresses of the first array element of the accessed parameter.	0...65535
Format	Format of the request.	0x00 = Reserved 0x01 - 0x36 = Data types 0x37 - 0x3F = Reserved 0x40 = Zero 0x41 = Byte 0x42 = Word 0x43 = Double word 0x44 = Error 0x45 - 0xFF = Reserved
Number of Values	Number of following values or number of following data type elements.	0...234
Error Number	See Table 6 on page 36.	

Response Header, Meaning of the fields

Field	Meaning	Range
Request Reference	Mirrored from request.	1...255
Response ID	Slave's response.	0x01 = Request OK 0x02 = Change OK 0x81 = Request Failed 0x82 = Change Failed
DO-ID	Mirrored from request.	-
Number of Parameters	Number of parameters in response.	1...38
Format	Data type of response value.	0x00 = Reserved 0x01 - 0x36 = Data types 0x37 - 0x3F = Reserved 0x40 = Zero 0x41 = Byte 0x42 = Word 0x43 = Double word 0x44 = Error 0x45 - 0xFF = Reserved
Number of Values	Number of values in response.	1...234
Value	Value of request.	-

5.5. Parameter data transfer examples

Reading parameter:

Request parameter value, single:

Request Header					Parameter Address				
05	01	01	01	10	01	27	11	00	65

- 05 = Request Reference
- 01 = Request ID
- 01 = DO-ID
- 01 = No. of parameters
- 10 = Attribute
- 01 = No. of elements
- 2711 = Parameter number (0x2711 Request Drive Parameters)
- 0065 = Subindex (0x65 = ID 101 Min Frequency)

Response:

Request Header				Parameter Address			
05	01	01	01	42	01	00	00

- 05 = Request Reference. Mirrored
- 01 = Request ID
- 01 = DO-ID. Mirrored
- 01 = No. of parameters. Mirrored
- 42 = Format (42 = word)
- 01 = No. of values
- 0000 = Value

Request parameter value, single:

Request Header					Parameter Address				
06	01	01	01	20	01	27	11	00	65

- 06 = Request Reference
- 01 = Request ID
- 01 = DO-ID
- 01 = No. of parameters
- 20 = Attribute
- 01 = No. of elements
- 2711 = Parameter number (0x2711 Request Drive Parameters)
- 0065 = Subindex (0x65 = ID 101 Min Frequency)

Error Response:

Request Header				Parameter Address			
06	81	01	01	44	01	00	09

- 06 = Request Reference. Mirrored
- 81 = Request ID (Bit7 = 1, Error Response)
- 01 = DO-ID. Mirrored
- 01 = No. of parameters. Mirrored
- 44 = Format (44 = word)
- 01 = No. of values
- 0009 = Error Value (9 = No Description data available)

6. APPENDIX

Process Data OUT (Slave → Master)

The fieldbus master can read the frequency converter's actual values using process data variables. *Basic, Standard, Local/Remote, Multi-Step, PID control and Pump and fan control* applications use process data as follows:

Data	Value	Unit	Scale
Process data OUT 1	Output Frequency	Hz	0,01 Hz
Process data OUT 2	Motor Speed	rpm	1 rpm
Process data OUT 3	Motor Current	A	0,1 A
Process data OUT 4	Motor Torque	%	0,1 %
Process data OUT 5	Motor Power	%	0,1 %
Process data OUT 6	Motor Voltage	V	0,1 V
Process data OUT 7	DC link voltage	V	1 V
Process data OUT 8	Active Fault Code	-	-

The *Multipurpose* application has a selector parameter for every Process Data. The monitoring values and drive parameters can be selected using the ID number (see NX All in One Application Manual, Tables for monitoring values and parameters). Default selections are as in the table above.

Process Data IN (Master -> Slave)

ControlWord, Reference and Process Data are used with All-in One applications as follows:

Basic, Standard, Local/Remote, Multi-Step applications

Data	Value	Unit	Scale
Reference	Speed Reference	%	0.01%
ControlWord	Start/Stop Command Fault reset Command	-	-
PD1 – PD8	Not used	-	-

Multipurpose control application

Data	Value	Unit	Scale
Reference	Speed Reference	%	0.01%
ControlWord	Start/Stop Command Fault reset Command	-	-
Process Data IN1	Torque Reference	%	0.1%
Process Data IN2	Free Analogue INPUT	%	0.01%
Process Data IN3	Adjust Input	%	0.01%
PD3 – PD8	Not Used	-	-

PID control and Pump and fan control applications

Data	Value	Unit	Scale
Reference	Speed Reference	%	0.01%
ControlWord	Start/Stop Command Fault reset Command	-	-
Process Data IN1	Reference for PID controller	%	0.01%
Process Data IN2	Actual Value 1 to PID controller	%	0.01%
Process Data IN3	Actual Value 2 to PID controller	%	0.01%
PD4–PD8	Not Used	-	-

License for LWIP

Copyright (c) 2001, 2002 Swedish Institute of Computer Science.

All rights reserved.

Redistribution and use in source and binary forms, with or without modification, are permitted provided that the following conditions are met:

1. Redistributions of source code must retain the above copyright notice, this list of conditions and the following disclaimer.
2. Redistributions in binary form must reproduce the above copyright notice, this list of conditions and the following disclaimer in the documentation and/or other materials provided with the distribution.
3. The name of the author may not be used to endorse or promote products derived from this software without specific prior written permission.

THIS SOFTWARE IS PROVIDED BY THE AUTHOR "AS IS" AND ANY EXPRESS OR IMPLIED WARRANTIES, INCLUDING, BUT NOT LIMITED TO, THE IMPLIED WARRANTIES OF MERCHANTABILITY AND FITNESS FOR A PARTICULAR PURPOSE ARE DISCLAIMED. IN NO EVENT SHALL THE AUTHOR BE LIABLE FOR ANY DIRECT, INDIRECT, INCIDENTAL, SPECIAL, EXEMPLARY, OR CONSEQUENTIAL DAMAGES (INCLUDING, BUT NOT LIMITED TO, PROCUREMENT OF SUBSTITUTE GOODS OR SERVICES; LOSS OF USE, DATA, OR PROFITS; OR BUSINESS INTERRUPTION) HOWEVER CAUSED AND ON ANY THEORY OF LIABILITY, WHETHER IN CONTRACT, STRICT LIABILITY, OR TORT (INCLUDING NEGLIGENCE OR OTHERWISE) ARISING IN ANY WAY OUT OF THE USE OF THIS SOFTWARE, EVEN IF ADVISED OF THE POSSIBILITY OF SUCH DAMAGE.

VACON

DRIVEN BY DRIVES

Find your nearest Vacon office
on the Internet at:

www.vacon.com

Manual authoring:
documentation@vacon.com

Vacon Plc.
Runsorintie 7
65380 Vaasa
Finland

Subject to change without prior notice
© 2012 Vacon Plc.

Document ID:



Rev. A