

SCALE 1:10

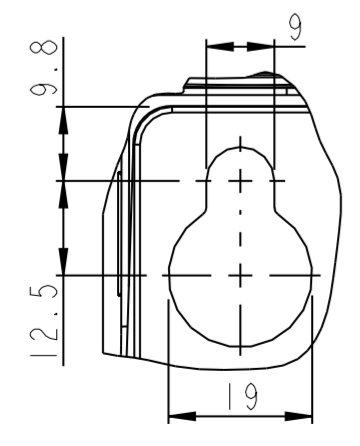

DETAIL A
SCALE 1:1

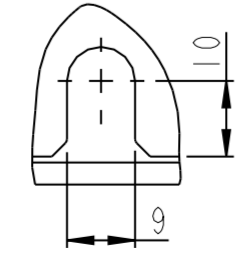

DETAIL B
SCALE 1:1

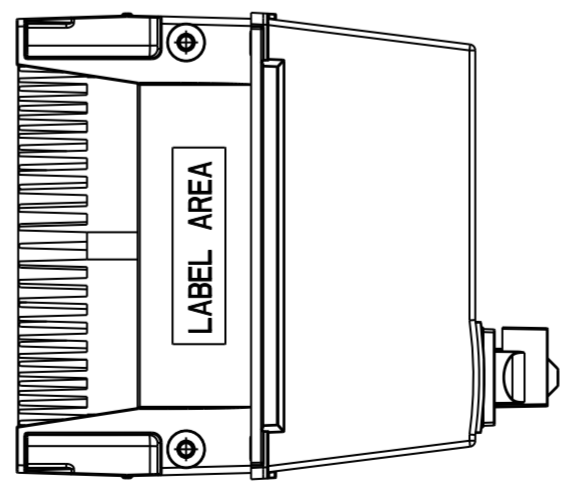

Projection 	Scale / Paper size 1:5 / A2		Matr. /Spec. ---
Last revised by -	Date 2008.09.18		Designation DANFOSS DRIVES A/S ENCLOSURE-CI-IP21-SWITCH
Confidential: Property of Danfoss Drives A/S. Not to be handed over to, copied or used by third party. Two- or three dimensional reproduction of contents to be authorized by Danfoss Drives A/S.		Part no. DANFOSS-FC300-CI-IP21SWITCH-175	Sb. 1 of 1
PDM controlled drawing. - Hard copy not valid without frozen date in ID stamp.		Rev. 001	