

ENGINEERING
TOMORROW

Danfoss

Desalination

Core technologies to increase
the **energy efficiency** of your
desalination system

One supplier of four core technologies.

65%

energy savings at your
desalination plant

desalination.danfoss.com



A growing demand for **freshwater**

Management of water resources has long been a concern for countries with water scarcity. Fortunately, strides in technology over recent decades have made desalination a viable way to provide freshwater to arid and remote places.

Danfoss is uniquely positioned to help solve water scarcity with high-performance, cost-effective, and energy-efficient desalination solutions. In addition to our range of desalination products, Danfoss has a dedicated team of experts to help design and implement solutions to provide freshwater – wherever the need arises.

Rising needs for desalination

More than 70% of the globe is covered in water, but only 1% is drinkable. Fresh, clean water is vital to everyone but unfortunately availability is shrinking due to pollution and climate changes. At the same time, worldwide consumption of drinking water is doubling every 20 years.

One of the ways to provide clean water is to turn seawater and brackish water into fresh, clean water using reverse osmosis. The process is simple and compact, and it requires less energy than other desalination techniques.

1%

Today, only 1% of the world's population receives water from desalination, and this is expected to increase

57%

The past five years have seen a 57% increase in desalination plant capacity

14.4%

Frost & Sullivan expects the global mobile treatment market to grow at a compound annual growth rate (CAGR) of 14.4% by 2020



Less than

1%

of the world's water
is drinkable

By land, by sea – anywhere

At large scale, reverse osmosis plants are capable of providing freshwater to entire cities while compact solutions are ideal for supplying hotels and resorts, ships, and offshore facilities with clean water.



Land-based



Marine & Offshore



**Mobile &
Containerized**

Clear benefits

- Extremely low energy consumption
- Ultra-low maintenance costs
- Simple to operate
- Minimal service and long service intervals
- Small footprint but effective, compact and light in weight

1

Offering four core technologies, Danfoss is uniquely positioned to support customers across the desalination market

65%

Experience combined with optimized technologies can provide up to 65% more energy efficiency

365

Year-round customer service availability

Four **core technologies**

Desalination typically demands a substantial amount of energy to produce fresh, clean water. This is because salt forms a strong chemical bond with water that is difficult to break and requires a significant effort to discard.

Danfoss combines four core technologies to provide superior and energy-efficient desalination solutions: High-pressure pumps, drives, energy-recovery devices, and pressure and fluid control devices. These combine into highly efficient, cost-effective, and lasting water purification solutions.

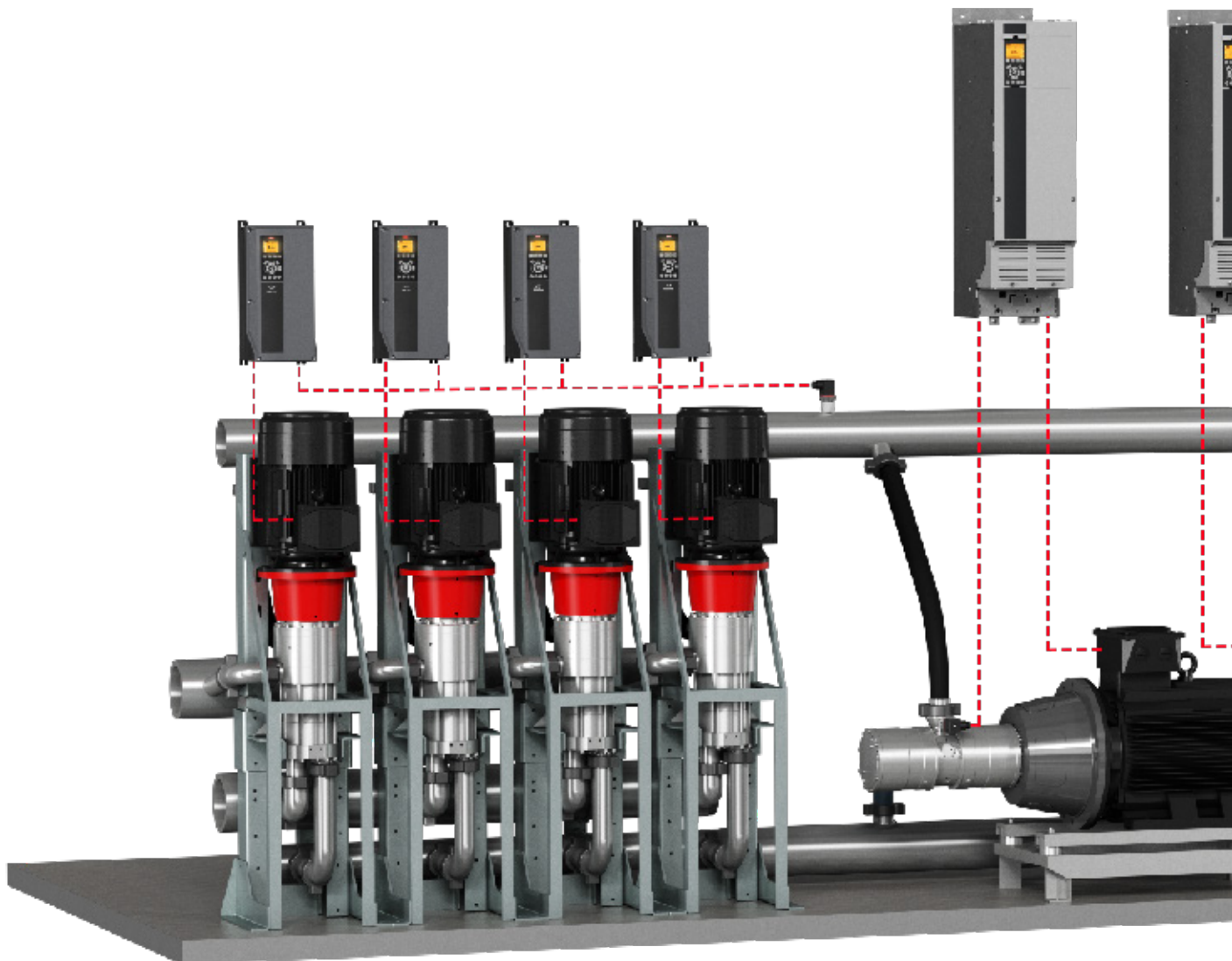



Reduce your desalination costs with Danfoss' four core technologies

Up to 15-25% of energy savings:

Savings on desalination systems with Danfoss high-pressure pumps, Danfoss pressure transmitters, and Danfoss drives compared to centrifugal pumps with drive. Energy savings depend on the size of the plant.

Up to 65% of energy savings:

Savings on desalination systems with Danfoss high-pressure pumps, Danfoss pressure transmitters, Danfoss drives and Danfoss energy-recovery devices (iSave) compared to desalination plants with centrifugal pumps and without energy-recovery devices and drives.

Our dedicated team of experts is committed to advising you and optimizing your system.

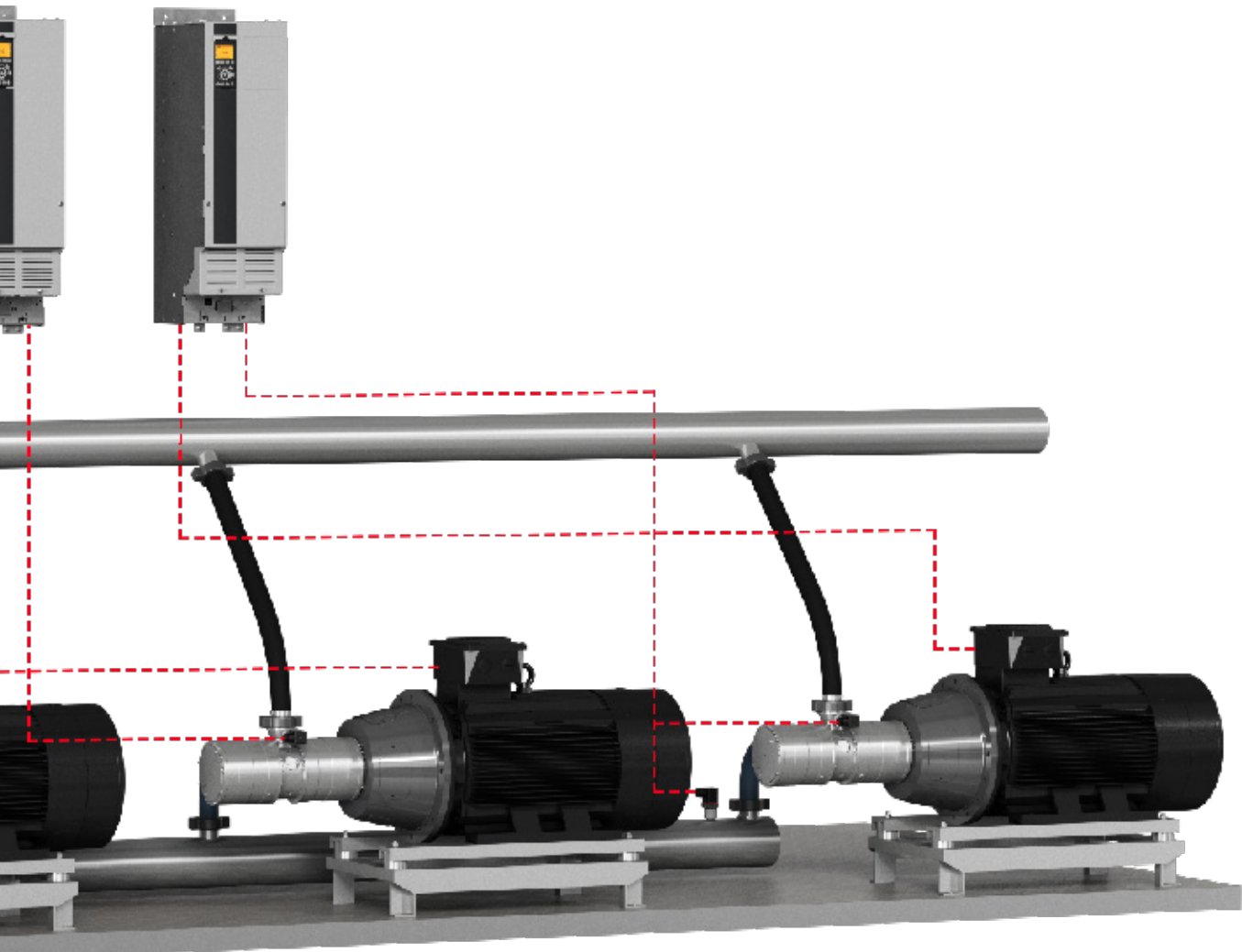

Dedicated APP high-pressure pumps

Danfoss APP pumps are at the heart of more than 20,000 seawater reverse osmosis systems around the world – often used at remote hotels and resorts. A simple design with few moving parts ensures easy maintenance, long service intervals, and the highest efficiency rates – with up to 92% efficiency, depending on pump sizes.

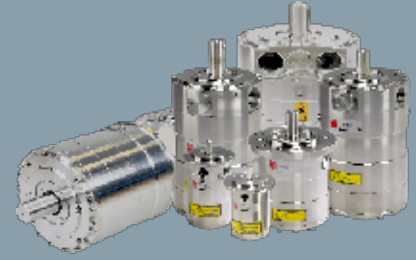

Easy installation

Small and compact pump in a light design. The pump is powered directly by electric motors and offers easy installation that requires little space and minimum piping.



Energy efficiency

The highly efficient pump design provides the lowest energy consumption of any comparable pump on the market. It offers energy-efficiency rates of up to 92% and constant efficiency regardless of flow and pressure.



Simple and flexible design

The pump design consists of few moving parts, which makes it less complex. The small and compact design is lighter than alternatives, which makes transport to remote areas much easier.



Low maintenance

The simplicity of the design increases the interval between service visits. No oil is required as the pumped medium provides the necessary lubrication, making the pump easy to service.



Easy to use

The pumps offer constant flow regardless of pressure changes. The simple pump design makes on-site servicing possible, which is especially useful in remote areas. Additionally, the pumps are easy to run in parallel.



Long service life

All pumps are made of highly corrosion-resistant materials (Duplex/Super Duplex) enabling a long service life. The proven and reliable technology is currently installed in thousands of SWRO plants worldwide.



Powerful Danfoss iSave ERDs

The Danfoss iSave energy recovery devices are designed and optimized for sea water reverse osmosis applications – on land, at sea or on the move. Based on patented and field-proven technology, Danfoss iSave is a fully integrated 3-in-1 solution that can be scaled to provide unrivalled energy savings and constant flows in SWRO applications of any size and type.



Effortless installation

Danfoss iSave is much simpler to install than other ERDs. As a compact and integrated 3-in-1 solution that can be installed both horizontally and vertically, iSave requires less installation space, less lifting and less pipework.



Smart and flexible design

System designers get more freedom with Danfoss iSave. The compact iSave provides greater design flexibility with less pipework and boasts a wide range of flow options, which can safely be extended to cover even larger flows by running two or more iSaves in parallel.



Simple to use

Danfoss iSave is designed for automatic operation and is virtually fail-safe. Rotor-spin is controlled by the electric motor, completely eliminating the risk of overflow/overspin during start-up and operation. This makes iSave the ideal solution if your SWRO application is operated by changing staff with varying skill levels.



Low maintenance

Danfoss iSave is a very reliable and low-maintenance performer. With its direct-drive electric motor and its self-lubricating and pipe-free 3-in-1 design, the iSave is not only very easy to service – it can also be done on site. Expected service interval is minimum 2 years within our specified parameters.



Long service life

The Danfoss iSave is based on a field-proven recovery principle and built from corrosion-resistant high-grade Duplex/Super Duplex stainless steel or polymer components. The design also eliminates the need for a high-pressure shaft seal and uses a single low-pressure mechanical shaft seal instead. All design decisions have been made to ensure that the Danfoss iSave range boasts an impressively long service life.



Constant flow

Using a positive displacement pump as a booster pump ensures that the iSave will provide constant flows at all times – regardless of pressure changes. Where other isobaric ERDs will struggle to produce even flows in the concentrate line if differential pressure changes, the iSave will just keep on supplying the perfect membrane feed.





30%
cost reduction in
first year compared
to traditional drive
systems

Optimal performance in demanding environments

The VLT® AQUA Drive FC 202 is designed to provide the highest level of performance of AC-motor-driven water and wastewater applications. The drive offers a wide range of powerful standard features and a host of expandable features, making it equally suited for new and retrofit projects. Additionally, the VLT® AQUA Drive FC 202 offers first year cost savings of 10-30% compared to traditional drives – as well as easy installation, low energy consumption and economical cost of ownership.



Cost benefits

- Energy-efficient design
- Intelligent heat management
- Automatic adaption to application
- Energy-efficient harmonic mitigation
- Optimal control of all motor types



Installation benefits

- Less panel space
- Direct outdoor installation
- Long cable capability as standard
- Reduced air-conditioning investment
- Integrated harmonic mitigation
- Printed circuit board protection as standard
- Easy commissioning
- Minimum 10-year lifetime



Lifetime benefits

- User friendliness
- Flexibility
- Reliability
- Energy savings
- Pipe and plant asset protection
- Reduced maintenance

Maximum energy efficiency

Danfoss VLT® AQUA Drive FC 202

The substantial daily load variations in freshwater and wastewater treatment plants make it economically advantageous to install AC drives on rotation equipment such as pumps and fans. The Danfoss VLT® AQUA Drive FC 202 offers a quick and user-friendly setup of water and pump settings that significantly reduces installation time and ensures maximum energy efficiency.



Protected by software

Assets are protected thanks to a specially designed software that prevents various forms of wear action, for example, water hammering.



Less heat loss – greater energy efficiency

Energy efficiency is maximized as a result of the drives' control algorithms and design which focus on reducing heat loss.



Unique back-channel cooling

High energy savings related to air conditioning due to the unique back-channel cooling concept that transfers 90% of heat away from the room.

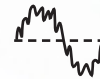

Reduced interference and distortion

Electromagnetic interference and harmonic distortion are reduced thanks to the built-in, scalable RFI filter and integrated DC link chokes.



Freely programmable alerts

Perfect system integration and adaptation to the application are possible due to freely programmable warnings and alerts.



Automatic energy optimization

3-8% energy savings are achieved as a result of automatic energy optimization.



Pressure transmitters for freshwater

MBS 3000 pressure transmitter is a compact, heavy-duty pressure transmitter with optional pulse-snubber when used on the suction side of the pump.

MBS 3000 is designed for use in freshwater applications with severe medium influences, such as cavitation, liquid hammering or pressure peaks.



DST P40I pressure transmitter

The Danfoss DST P40I is a robust and accurate pressure transmitter designed specifically to meet requirements in corrosive industrial environments – such as desalination systems, sea water cooling, and chemical processing.

The transmitter housing is machined from a single titanium rod to eliminate any structural weakness. The pressure-sensing element is made from 96% Al_2O_3 ceramic with superior chemical immunity. The pressure transmitter uses the piezo resistive principle, and the Wheatstone Bridge is printed directly on the inside of the ceramic diaphragm to ensure fast response time and a high degree of measurement precision.



Solutions for harsh environments

DST P40I is designed to perform under pressure. Full titanium body and ceramic pressure elements ensure high resistance to corrosion from salt water, acids, alkalis, and chlorates.



Longer lifetime expectations

Built from selected materials, the pressure transmitter offers high tolerance to mechanical shocks and vibrations – resulting in longer lifetime performance.



Superior quality

Highest enclosure degree (IP67) ensures peak level of water ingress protection resulting in minimal maintenance.



High burst and over-pressure abilities

The body of the DST P40I is processed from a single bar of titanium to avoid any structural weakness in the transition between the pressure connection and the transmitter house.



Excellent stability

Zero drift due to excellent long-term stability ensures the safety of the machine.



Robust design

High resistance to continuous vibrations and cavitation in reverse osmosis desalination pump systems. Tested by FORCE according to IEC 600068-2-6 & 27.





KP/KPI pressure switches for critical installations

Some installations are particularly critical – either because of safety or from an economic perspective. In these cases, the use of fail-safe pressure switches like the KP and KPI are recommended.



Servo-operated solenoid valves

For desalination, reliable valve control for filter protection and full flow with minimum pressure loss are key factors. Danfoss offers a simple valve selection based on a modular construction and a design with complete flexibility.

The sealed interchangeable coils guard against expensive plant shutdown and come in an encapsulated version meeting IP67 protection levels that avoid water damage. Designed for water applications, our comprehensive solenoid valve program delivers quality at a lower cost.

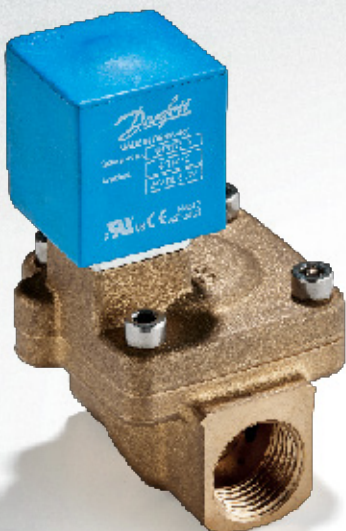

Four core technologies – one partner

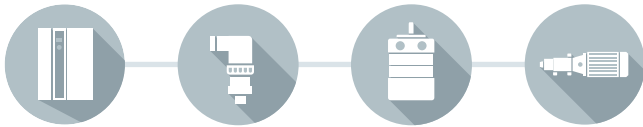

With global customer service and exceptional industry know-how, Danfoss is uniquely positioned to support our customers within the desalination industry. Our dedicated team of experts is committed to designing and producing the best possible solutions for our customers.

Our global sales and service organization offers quick and reliable maintenance for all our applications, whether they are fixed or mobile, land or sea-based – anywhere in the world.

Desalination pioneers

Based on decades of experience developing components for critical applications, including many pioneering developments like the axial pump technology, we use our extensive knowledge of seawater reverse osmosis to lead the industry in advanced desalination solutions.

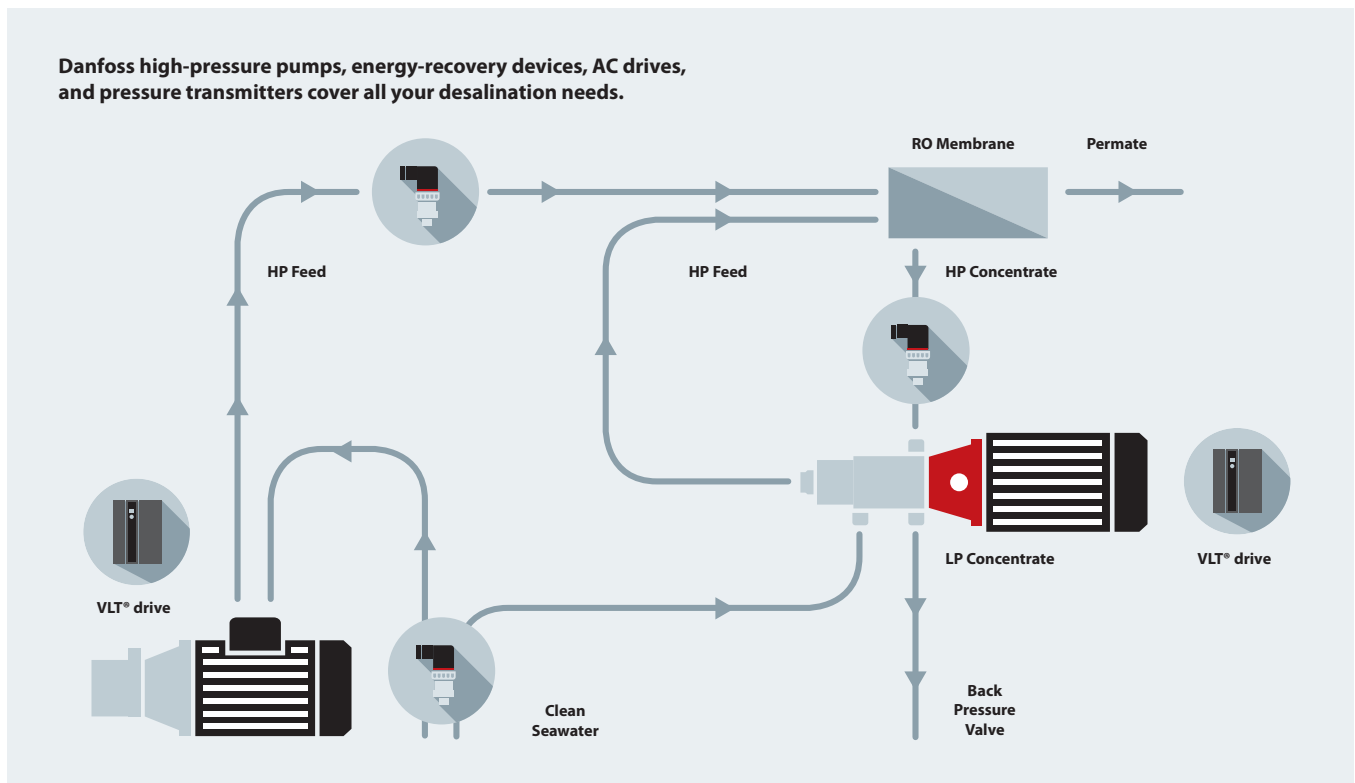

Learn more about our products and services,
or contact us at desalination.danfoss.com

Danfoss A/S

Nordborgvej 81 · 6430 Nordborg · Denmark · Tlf: +45 7488 2222 · danfoss.com

Danfoss can accept no responsibility for possible errors in catalogues, brochures and other printed material. Danfoss reserves the right to alter its products without notice. This also applies to products already on order provided that such alterations can be made without subsequential changes being necessary in specifications already agreed. All trademarks in this material are property of the respective companies. Danfoss and the Danfoss logotype are trademarks of Danfoss A/S. All rights reserved.