

Type	Value
Max Weight	5.3 kg / 11.7 lb
IP Class	IP21
Nema Class	Type 1

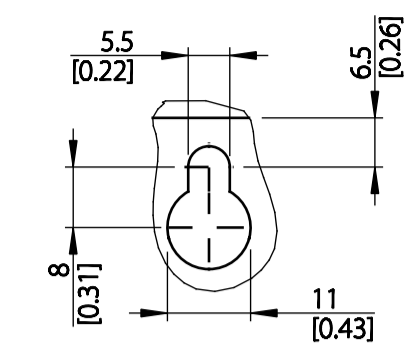

DETAIL A
SCALE 1:1

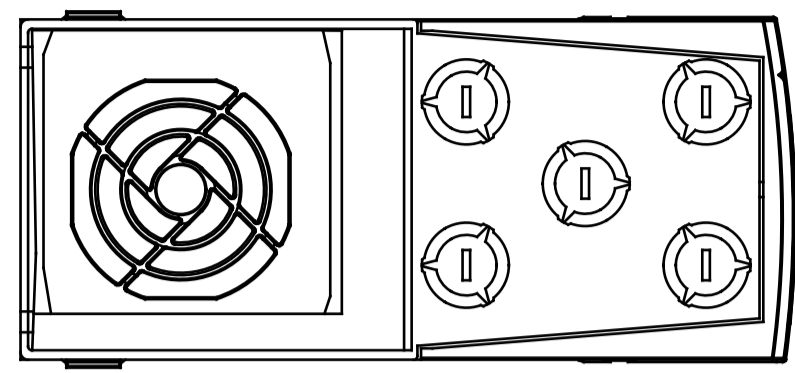
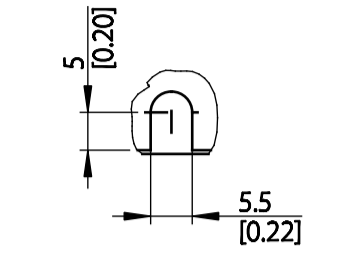

DETAIL B
SCALE 1:1

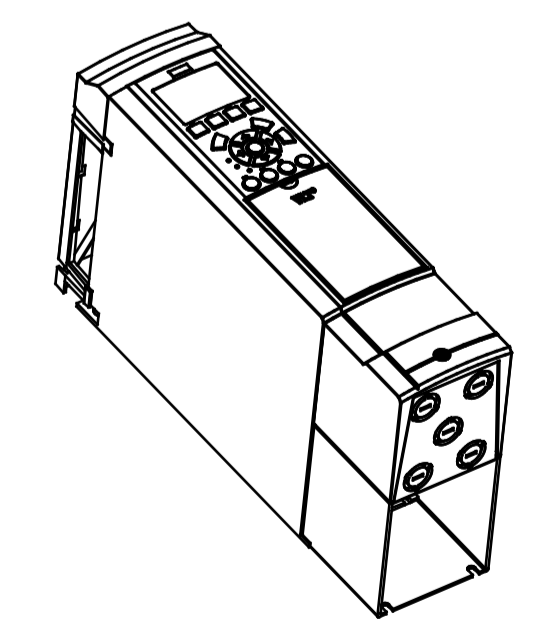
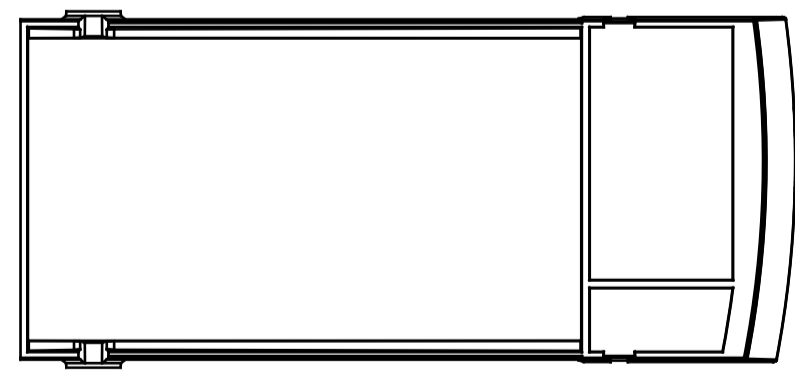
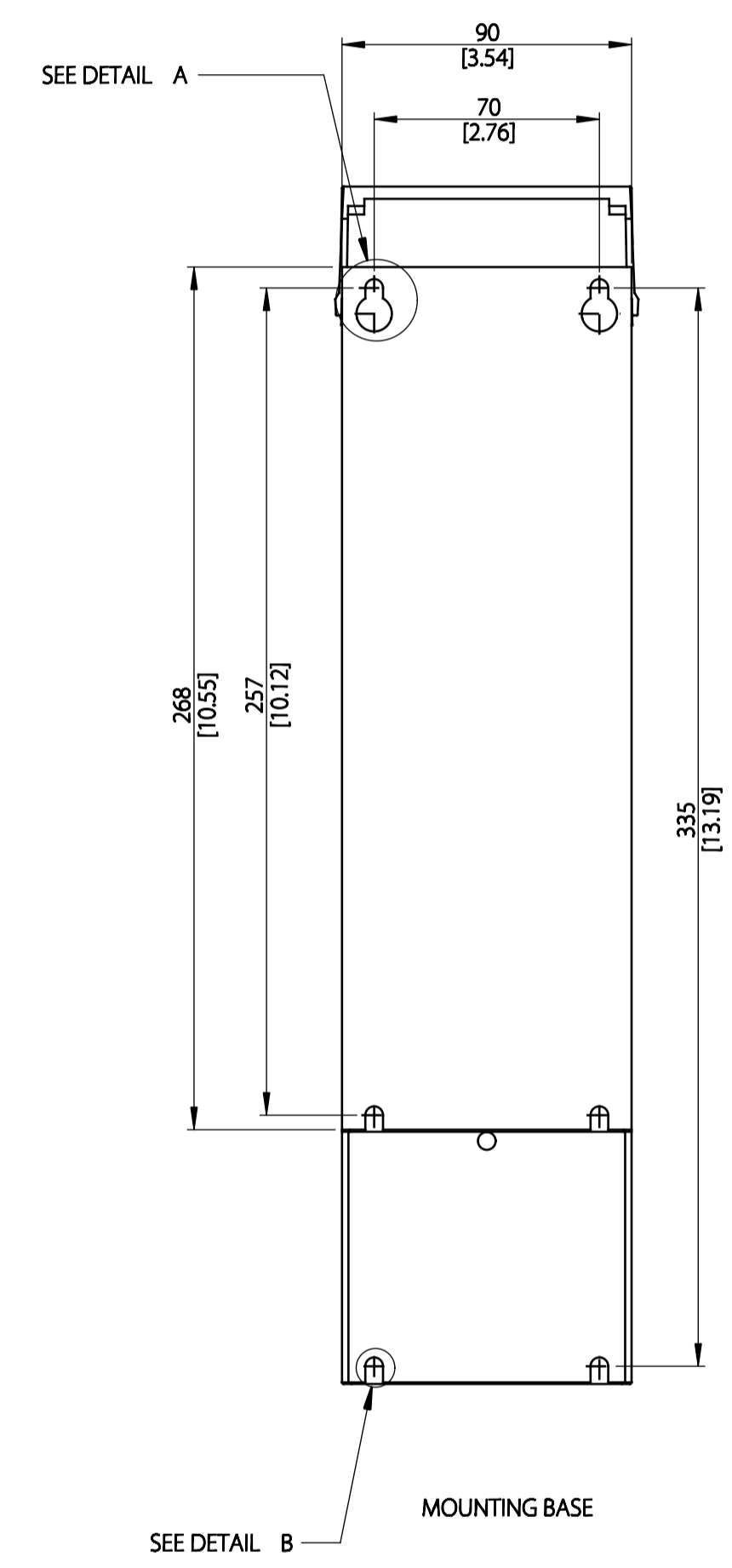
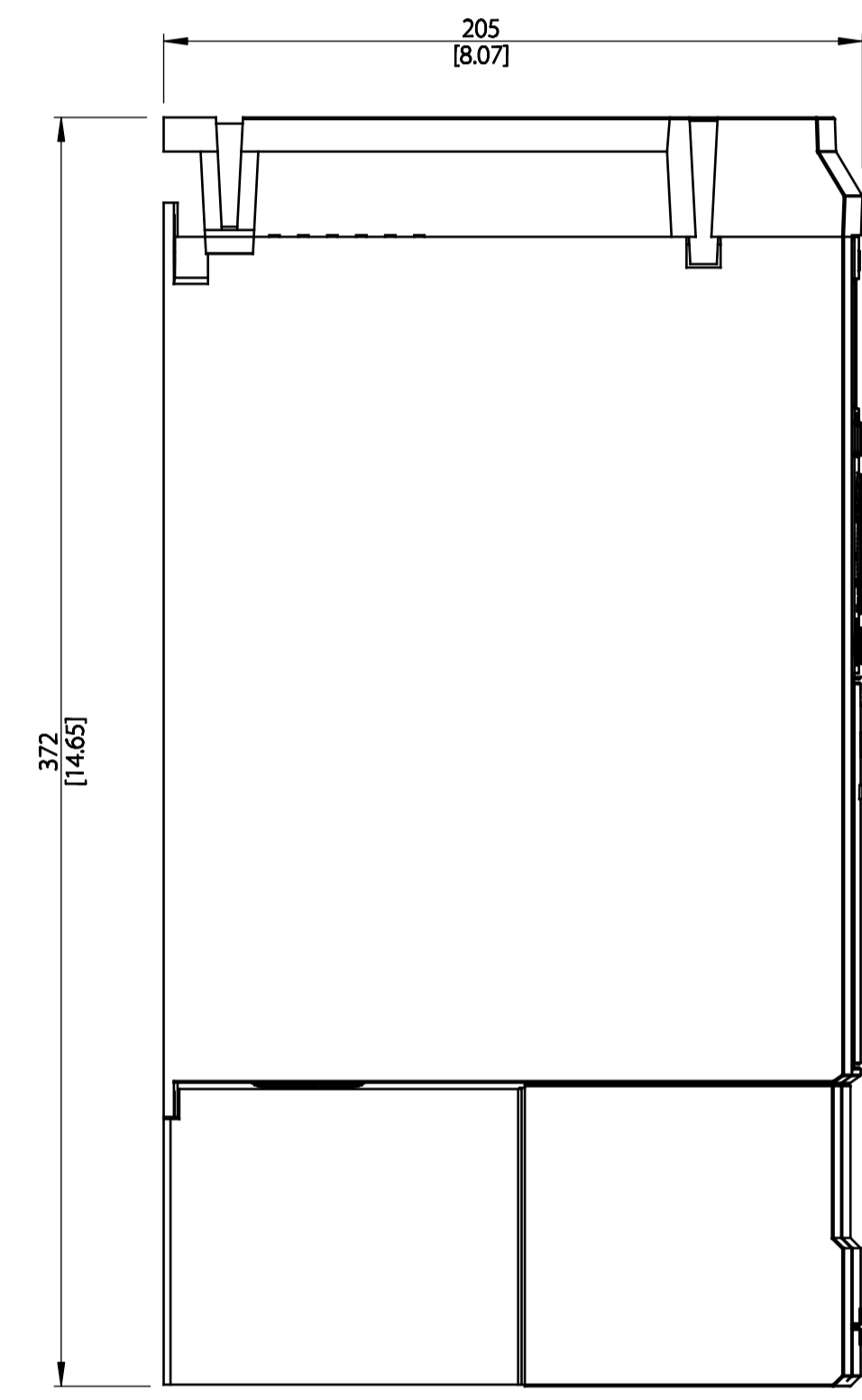
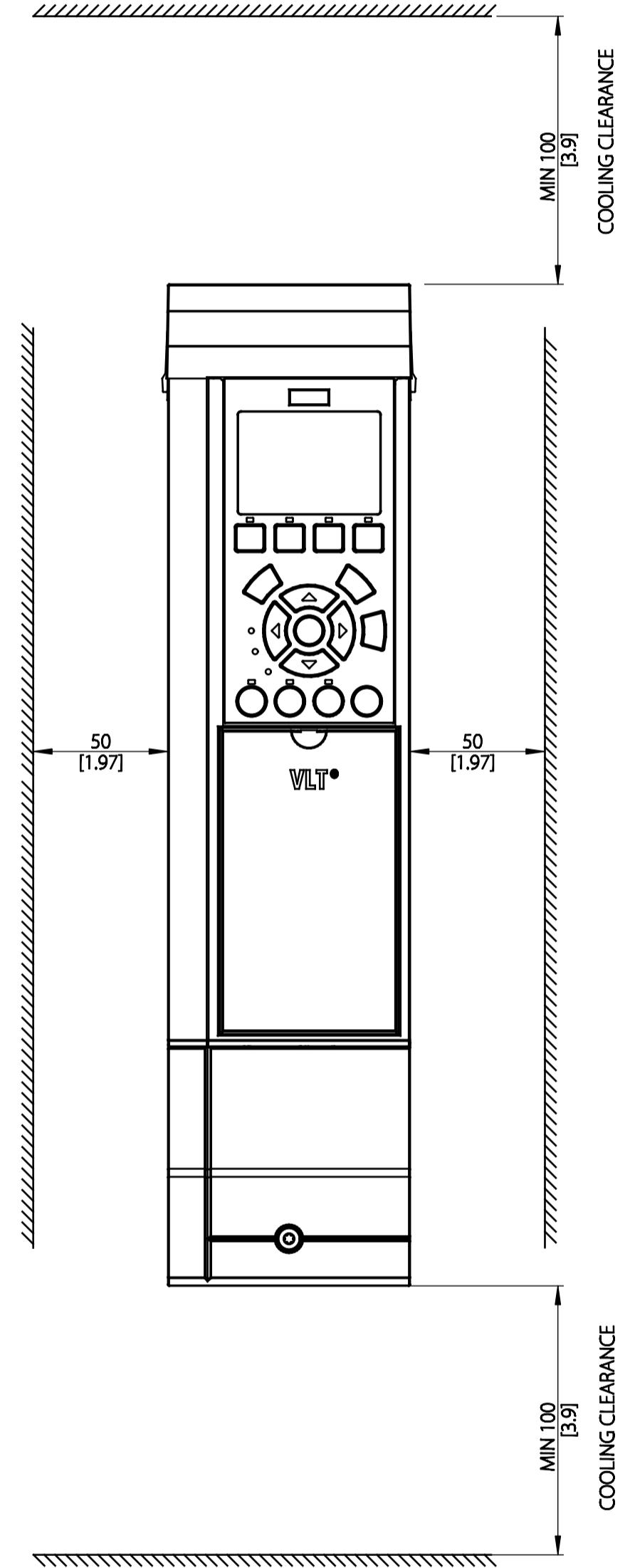

THIS DRAWING SHOWS THE MOST COMMON VERSION OF THIS PRODUCT VARIANT.
SMALL DIFFERENCES MAY OCCUR DEPENDING ON THE FINAL PRODUCT CONFIGURATION.

CENTER OF GRAVITY:
FOR REFERENCE ONLY, THE PRODUCT CONFIGURATION MAY INFLUENCE THE CG IN ALL THREE AXES.

UNLESS OTHERWISE SPECIFIED THE TOLERANCE IS ± 1MM (0.4 INCH). ALL DIMENSIONS ARE IN MILLIMETERS (INCH)		FIRST ANGLE PROJECTION	SCALE 1:2	DRAWING SIZE A1	MATERIAL FINISH	
CHANGED				DESCRIPTION MCAD A2 IP21		
DESIGNED	DANFOSS					30-12-2015
CHECKED						
PROPERTY OF DANFOSS A/S NORDBORG, DENMARK. TWO OR THREE DIMENSIONAL REPRODUCTION OF CONTENTS TO BE AUTHORIZED BY DANFOSS A/S.		DRAWING NUMBER MCAD-A2-IP21	REV 001	SHEET 1 OF 1		