



Design Guide

VLT[®] Midi Drive FC 280



Contents

1 Introduction	5
1.1 Purpose of the Design Guide	5
1.2 Additional Resources	5
1.3 Definitions	5
1.4 Document and Software Version	8
1.5 Approvals and Certifications	8
1.6 Safety	9
2 Product Overview	10
2.1 Enclosure Size Overview	10
2.2 Electrical Installation	12
2.2.1 Motor Connection	14
2.2.2 AC Mains Connection	15
2.2.3 Control Terminal Types	16
2.2.4 Wiring to Control Terminals	17
2.3 Control Structures	18
2.3.1 Control Modes	18
2.3.2 Control Principle	19
2.3.3 Control Structure in VVC ⁺	19
2.3.4 Internal Current Control in VVC ⁺ Mode	21
2.3.5 Local (Hand On) and Remote (Auto On) Control	21
2.4 Reference Handling	22
2.4.1 Reference Limits	23
2.4.2 Scaling of Preset References and Bus References	24
2.4.3 Scaling of Analog and Pulse References and Feedback	24
2.4.4 Dead Band Around Zero	25
2.5 PID Control	28
2.5.1 Speed PID Control	28
2.5.2 Process PID Control	31
2.5.3 Process Control Relevant Parameters	32
2.5.4 Example of Process PID Control	33
2.5.5 Process Controller Optimization	35
2.5.6 Ziegler Nichols Tuning Method	36
2.6 EMC Emission and Immunity	36
2.6.1 General Aspects of EMC Emission	36
2.6.2 EMC Emission	38
2.6.3 EMC Immunity	40
2.7 Galvanic Isolation	41
2.8 Ground Leakage Current	41

2.9 Brake Functions	42
2.9.1 Mechanical Holding Brake	42
2.9.2 Dynamic Braking	43
2.9.3 Brake Resistor Selection	43
2.10 Motor Insulation	44
2.10.1 Sine-wave Filters	44
2.10.2 dU/dt Filters	45
2.11 Smart Logic Controller	45
2.12 Extreme Running Conditions	46
2.12.1 Motor Thermal Protection	46
3 Application Examples	48
3.1 Introduction	48
3.1.1 Encoder Connection	48
3.1.2 Encoder Direction	48
3.1.3 Closed-loop Drive System	48
3.2 Application Examples	49
3.2.1 AMA	49
3.2.2 Speed	49
3.2.3 Start/Stop	50
3.2.4 External Alarm Reset	51
3.2.5 Motor Thermistor	51
3.2.6 SLC	51
4 Safe Torque Off (STO)	52
5 RS485 Installation and Set-up	53
5.1 Introduction	53
5.1.1 Overview	53
5.1.2 Network Connection	53
5.1.3 Hardware Set-up	54
5.1.4 Parameter Settings for Modbus Communication	54
5.1.5 EMC Precautions	54
5.2 FC Protocol	54
5.2.1 Overview	54
5.2.2 FC with Modbus RTU	55
5.3 Network Configuration	55
5.4 FC Protocol Message Framing Structure	55
5.4.1 Content of a Character (byte)	55
5.4.2 Telegram Structure	55
5.4.3 Telegram Length (LGE)	55

5.4.4 Frequency Converter Address (ADR)	56
5.4.5 Data Control Byte (BCC)	56
5.4.6 The Data Field	56
5.4.7 The PKE Field	56
5.4.8 Parameter Number (PNU)	57
5.4.9 Index (IND)	57
5.4.10 Parameter Value (PWE)	57
5.4.11 Data Types Supported by the Frequency Converter	57
5.4.12 Conversion	57
5.4.13 Process Words (PCD)	58
5.5 Examples	58
5.5.1 Writing a Parameter Value	58
5.5.2 Reading a Parameter Value	58
5.6 Modbus RTU	59
5.6.1 Prerequisite Knowledge	59
5.6.2 Overview	59
5.6.3 Frequency Converter with Modbus RTU	59
5.7 Network Configuration	59
5.8 Modbus RTU Message Framing Structure	60
5.8.1 Introduction	60
5.8.2 Modbus RTU Telegram Structure	60
5.8.3 Start/Stop Field	60
5.8.4 Address Field	60
5.8.5 Function Field	60
5.8.6 Data Field	61
5.8.7 CRC Check Field	61
5.8.8 Coil Register Addressing	61
5.8.9 How to Control the Frequency Converter	63
5.8.10 Function Codes Supported by Modbus RTU	63
5.8.11 Modbus Exception Codes	63
5.9 How to Access Parameters	63
5.9.1 Parameter Handling	63
5.9.2 Storage of Data	64
5.9.3 IND (Index)	64
5.9.4 Text Blocks	64
5.9.5 Conversion Factor	64
5.9.6 Parameter Values	64
5.10 Examples	64
5.10.1 Read Coil Status (01 hex)	64
5.10.2 Force/Write Single Coil (05 hex)	65

5.10.3 Force/Write Multiple Coils (0F hex)	65
5.10.4 Read Holding Registers (03 hex)	65
5.10.5 Preset Single Register (06 hex)	66
5.10.6 Preset Multiple Registers (10 hex)	66
5.11 Danfoss FC Control Profile	67
5.11.1 Control Word According to FC Profile (8-10 Protocol = FC Profile)	67
5.11.2 Status Word According to FC Profile (STW)	68
5.11.3 Bus Speed Reference Value	70
6 Type Code and Selection	71
6.1 Type Code	71
6.2 Ordering Numbers: Options, Accessories, and Spare Parts	71
6.3 Ordering Numbers: Brake Resistors	73
6.3.1 Ordering Numbers: Brake Resistors 10%	73
6.3.2 Ordering Numbers: Brake Resistors 40%	75
6.4 Ordering Numbers: Sine-wave Filters	76
6.5 Ordering Numbers: dU/dt Filters	77
6.6 Ordering Numbers: External EMC Filters	77
7 Specifications	80
7.1 Electrical Data	80
7.2 Mains Supply	83
7.3 Motor Output and Motor Data	83
7.4 Ambient Conditions	84
7.5 Cable Specifications	84
7.6 Control Input/Output and Control Data	85
7.7 Connection Tightening Torques	88
7.8 Fuses and Circuit Breakers	89
7.9 Efficiency	90
7.10 Acoustic Noise	91
7.11 dU/dt Conditions	91
7.12 Special Conditions	92
7.12.1 Manual Derating	93
7.12.2 Automatic Derating	95
7.13 Enclosure Sizes, Power Ratings, and Dimensions	96
Index	99

1 Introduction

1.1 Purpose of the Design Guide

This design guide is intended for project and systems engineers, design consultants, and application and product specialists. Technical information is provided to understand the capabilities of the frequency converter for integration into motor control and monitoring systems. Details concerning operation, requirements, and recommendations for system integration are described. Information is provided for input power characteristics, output for motor control, and ambient operating conditions for the frequency converter.

Also included are:

- Safety features.
- Fault condition monitoring.
- Operational status reporting.
- Serial communication capabilities.
- Programmable options and features.

Design details such as site requirements, cables, fuses, control wiring, the size and weight of units, and other critical information necessary to plan for system integration are also provided.

Reviewing the detailed product information in the design stage enables developing a well-conceived system with optimal functionality and efficiency.

VLT® is a registered trademark.

1.2 Additional Resources

Resources available to understand operations and programming of the frequency converter:

- *VLT® Midi Drive FC 280 Operating Guide*, provides information about the installation, commissioning, application, and maintenance of the frequency converter.
- *VLT® Midi Drive FC 280 Programming Guide*, provides information on how to program and includes complete parameter descriptions.

Supplementary publications and manuals are available from Danfoss. See drives.danfoss.com/knowledge-center/technical-documentation/ for listings.

1.3 Definitions

1.3.1 Frequency Converter

Coast

The motor shaft is in free mode. No torque on the motor.

$I_{VLT,MAX}$

Maximum output current.

$I_{VLT,N}$

Rated output current supplied by the frequency converter.

$U_{VLT,MAX}$

Maximum output voltage.

1.3.2 Input

Control commands

Start and stop the connected motor with LCP and digital inputs.

Functions are divided into 2 groups.

Functions in group 1 have higher priority than functions in group 2.

Group 1	Precise stop, coast and reset stop, precise stop and coast stop, quick stop, DC braking, stop, and [OFF].
Group 2	Start, pulse start, reversing, start reversing, jog, and freeze output.

Table 1.1 Function Groups

1.3.3 Motor

Motor running

Torque generated on the output shaft and speed from 0 RPM to maximum speed on the motor.

f_{JOG}

Motor frequency when the jog function is activated (via digital terminals or bus).

f_M

Motor frequency.

f_{MAX}

Maximum motor frequency.

f_{MIN}

Minimum motor frequency.

$f_{M,N}$

Rated motor frequency (nameplate data).

I_M

Motor current (actual).

$I_{M,N}$

Nominal motor current (nameplate data).

n_{M,N}

Nominal motor speed (nameplate data).

n_s

Synchronous motor speed.

$$n_s = \frac{2 \times \text{Parameter 1-23} \times 60 \text{ s}}{\text{Parameter 1-39}}$$

n_{slip}

Motor slip.

P_{M,N}

Rated motor power (nameplate data in kW or hp).

T_{M,N}

Rated torque (motor).

U_M

Instantaneous motor voltage.

U_{M,N}

Rated motor voltage (nameplate data).

Break-away torque

Illustration 1.1 Break-away Torque

η_{VLT}

The efficiency of the frequency converter is defined as the ratio between the power output and the power input.

Start-disable commandA start-disable command belonging to the control commands in group 1. See *Table 1.1* for more details.**Stop command**A stop command belonging to the control commands in group 1. See *Table 1.1* for more details.**1.3.4 References****Analog reference**

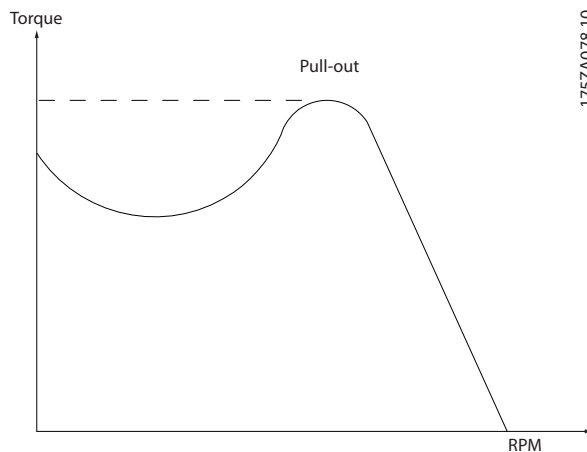
A signal transmitted to the analog inputs 53 or 54 can be voltage or current.

Binary reference

A signal transmitted via the serial communication port.

Preset reference

A defined preset reference to be set from -100% to +100% of the reference range. Selection of 8 preset references via the digital terminals. Selection of 4 preset references via the bus.

Pulse reference

A pulse frequency signal transmitted to the digital inputs (terminal 29 or 33).

Ref_{MAX}Determines the relationship between the reference input at 100% full scale value (typically 10 V, 20 mA) and the resulting reference. The maximum reference value is set in *parameter 3-03 Maximum Reference*.**Ref_{MIN}**Determines the relationship between the reference input at 0% value (typically 0 V, 0 mA, 4 mA) and the resulting reference. The minimum reference value is set in *parameter 3-02 Minimum Reference*.**1.3.5 Miscellaneous****Analog inputs**

The analog inputs are used for controlling various functions of the frequency converter.

There are 2 types of analog inputs:

- Current input: 0–20 mA and 4–20 mA.
- Voltage input: 0–10 V DC.

Analog outputs

The analog outputs can supply a signal of 0–20 mA, or 4–20 mA.

Automatic motor adaptation, AMA

The AMA algorithm determines the electrical parameters for the connected motor at standstill.

Brake resistor

The brake resistor is a module capable of absorbing the brake power generated in regenerative braking. This regenerative brake power increases the DC-link voltage, and a brake chopper ensures that the power is transmitted to the brake resistor.

CT characteristics

Constant torque characteristics used for all applications such as conveyor belts, displacement pumps, and cranes.

Digital inputs

The digital inputs can be used for controlling various functions of the frequency converter.

Digital outputs

The frequency converter features 2 solid-state outputs that can supply a 24 V DC (maximum 40 mA) signal.

DSP

Digital signal processor.

ETR

Electronic thermal relay is a thermal load calculation based on present load and time. Its purpose is to estimate the motor temperature.

FC standard bus

Includes RS485 bus with FC protocol or MC protocol. See *parameter 8-30 Protocol*.

Initializing

If initializing is carried out (*parameter 14-22 Operation Mode*), the frequency converter returns to the default setting.

Intermittent duty cycle

An intermittent duty rating refers to a sequence of duty cycles. Each cycle consists of an on-load and an off-load period. The operation can be either periodic duty or non-periodic duty.

LCP

The local control panel makes up a complete interface for control and programming of the frequency converter. The LCP is detachable. With the installation kit option, the LCP can be installed up to 3 m (9.8 ft) from the frequency converter in a front panel.

NLCP

The numerical local control panel interface for control and programming of the frequency converter. The display is numerical and the panel is used to show process values. The NLCP has storing and copy functions.

GLCP

The graphic local control panel interface for control and programming of the frequency converter. The display is graphic and the panel is used to show process values. The GLCP has storing and copy functions.

lsb

Least significant bit.

msb

Most significant bit.

MCM

Short for mille circular mil, an American measuring unit for cable cross-section. 1 MCM = 0.5067 mm².

On-line/off-line parameters

Changes to on-line parameters are activated immediately after the data value is changed. To activate changes to off-line parameters, press [OK].

Process PID

The PID control maintains speed, pressure, and temperature by adjusting the output frequency to match the varying load.

PCD

Process control data.

PFC

Power factor correction.

Power cycle

Switch off the mains until the display (LCP) is dark, then turn power on again.

Power factor

The power factor is the relation between I_1 and I_{RMS} .

$$\text{Power factor} = \frac{\sqrt{3} \times U \times I_1 \cos\phi_1}{\sqrt{3} \times U \times I_{RMS}}$$

For FC 280 frequency converters, $\cos\phi_1 = 1$, therefore:

$$\text{Power factor} = \frac{I_1 \times \cos\phi_1}{I_{RMS}} = \frac{I_1}{I_{RMS}}$$

The power factor indicates to which extent the frequency converter imposes a load on the mains supply.

The lower the power factor, the higher the I_{RMS} for the same kW performance.

$$I_{RMS} = \sqrt{I_1^2 + I_5^2 + I_7^2 + \dots + I_n^2}$$

In addition, a high power factor indicates that the different harmonic currents are low.

The built-in DC coils (T2/T4) and PFC (S2) produce a high power factor, minimizing the imposed load on the mains supply.

Pulse input/incremental encoder

An external, digital pulse transmitter used for feeding back information on motor speed. The encoder is used in applications where great accuracy in speed control is required.

RCD

Residual current device.

Set-up

Save parameter settings in 4 set-ups. Change among the 4 parameter set-ups and edit 1 set-up while this set-up is inactive.

SFAVM

Acronym describing the switching pattern stator flux-oriented asynchronous vector modulation.

Slip compensation

The frequency converter compensates for the motor slip by giving the frequency a supplement that follows the measured motor load, keeping the motor speed almost constant.

Smart logic control (SLC)

The SLC is a sequence of user-defined actions executed when the smart logic controller evaluates the associated user-defined events as true (*Parameter group 13-** Smart Logic Control*).

STW

Status word.

THD

Total harmonic distortion states the total contribution of harmonic distortion.

Thermistor

A temperature-dependent resistor placed where the temperature is monitored (frequency converter or motor).

Trip

Trip is a state entered in fault situations. Examples of fault situations:

- The frequency converter is subject to an over voltage.
- The frequency converter protects the motor, process, or mechanism.

Restart is prevented until the cause of the fault has disappeared, and the trip state is canceled by activating reset or, in some cases, by being programmed to reset automatically. Do not use trip for personal safety.

Trip lock

Trip lock is a state entered in fault situations when the frequency converter is protecting itself and requiring physical intervention. For example, a short circuit on the output triggers a trip lock. A locked trip can only be canceled by cutting off mains, removing the cause of the fault, and reconnecting the frequency converter. Restart is prevented until the trip state is canceled by activating reset or, sometimes, by being programmed to reset automatically. Do not use trip lock for personal safety.

VT characteristics

Variable torque characteristics used for pumps and fans.

VVC⁺

If compared with standard voltage/frequency ratio control, voltage vector control (VVC⁺) improves the dynamics and stability, both when the speed reference is changed and in relation to the load torque.

60° AVM

Refer to the switching pattern 60° asynchronous vector modulation.

1.4 Document and Software Version

This manual is regularly reviewed and updated. All suggestions for improvement are welcome. *Table 1.2* shows the document version and the corresponding software version.

Edition	Remarks	Software version
MG07B3	More information for POWERLINK and software update.	1.3

Table 1.2 Document and Software Version

1.5 Approvals and Certifications

Frequency converters are designed in compliance with the directives described in this section.

1.5.1 CE Mark

The CE mark (Communauté européenne) indicates that the product manufacturer conforms to all applicable EU directives.

The EU directives applicable to the design and manufacture of frequency converters are:

- The Low Voltage Directive.
- The EMC Directive.
- The Machinery Directive (for units with an integrated safety function).

The CE mark is intended to eliminate technical barriers to free trade between the EC and EFTA states inside the ECU. The CE mark does not regulate the quality of the product. Technical specifications cannot be deduced from the CE mark.

1.5.2 Low Voltage Directive

Frequency converters are classified as electronic components and must be CE labeled in accordance with the Low Voltage Directive. The directive applies to all electrical equipment in the 50–1000 V AC and the 75–1500 V DC voltage ranges.

The directive mandates that the equipment design must ensure the safety and health of people and livestock, and the preservation of material by ensuring the equipment is properly installed, maintained, and used as intended. Danfoss CE labels comply with the Low Voltage Directive, and Danfoss provides a declaration of conformity at request.

1.5.3 EMC Directive

Electromagnetic compatibility (EMC) means that electromagnetic interference between pieces of equipment does not hinder their performance. The basic protection requirement of the EMC Directive 2014/30/EU states that devices that generate electromagnetic interference (EMI) or whose operation could be affected by EMI must be designed to limit the generation of electromagnetic interference and shall have a suitable degree of immunity to EMI when properly installed, maintained, and used as intended.

A frequency converter can be used as standalone device or as part of a more complex installation. Devices in either of these cases must bear the CE mark. Systems must not be CE marked but must comply with the basic protection requirements of the EMC directive.

1.5.4 UL Compliance

UL-listed



Illustration 1.2 UL

Applied standards and compliance for STO

Using STO on terminals 37 and 38 requires fulfillment of all provisions for safety including relevant laws, regulations, and guidelines. The integrated STO function complies with the following standards:

- IEC/EN 61508:2010, SIL2
- IEC/EN 61800-5-2:2007, SIL2
- IEC/EN 62061:2015, SILCL of SIL2
- EN ISO 13849-1:2015, Category 3 PL d

Frequency converters can be subject to regional and/or national export control regulations.

An ECCN number is used to classify all frequency converters that are subject to export control regulations.

The ECCN number is provided in the documents accompanying the frequency converter.

In case of re-export, it is the responsibility of the exporter to ensure compliance with the relevant export control regulations.

1.6 Safety

Frequency converters contain high-voltage components and have the potential for fatal injury if handled improperly. Only qualified personnel are allowed to install and operate the equipment. Do not attempt repair work without first removing power from the frequency converter and waiting the designated duration of time for stored electrical energy to dissipate.

Refer to the operating instructions shipped with the unit, and available online for:

- Discharge time.
- Detailed safety instructions and warnings.

Strict adherence to safety precautions and notices is mandatory for safe operation of the frequency converter.

2 Product Overview

2

2.1 Enclosure Size Overview

Enclosure size depends on power range. For details about dimensions, refer to *chapter 7.13 Enclosure Sizes, Power Ratings, and Dimensions*.

Enclosure size	K1	K2	K3	K4	K5
	 130BA870.10	 130BA809.10	 130BA810.10	 130BA810.10	 130BA810.10
Enclosure protection ¹⁾	IP20	IP20	IP20	IP20	IP20
Power range [kW (hp)] 3-phase 380–480 V	0.37–2.2 (0.5–3.0)	3.0–5.5 (5.0–7.5)	7.5 (10)	11–15 (15–20)	18.5–22 (25–30)
Power range [kW (hp)] 3-phase 200–240 V	0.37–1.5 (0.5–2.0)	2.2 (3.0)	3.7 (5.0)	–	–
Power range [kW (hp)] single-phase 200–240 V	0.37–1.5 (0.5–2.0)	2.2 (3.0)	–	–	–

Table 2.1 Enclosure Sizes

1) IP21 is available for some variants of VLT® Midi Drive FC 280. With IP21 kit options mounted, all power sizes can be IP21.

Enclosure size is used throughout this guide whenever procedures or components differ between frequency converters based on physical size.

Find the enclosure size using the following steps:

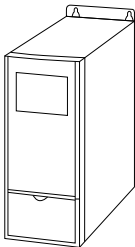
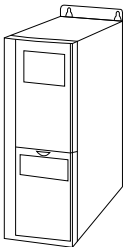
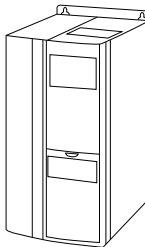
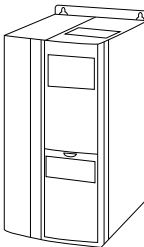
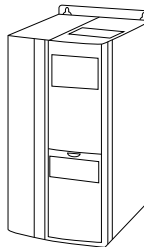
1. Obtain the following information from the type code on the nameplate. Refer to *Illustration 2.1*.
 - 1a Product group and frequency converter series (characters 1–6), for example FC 280.
 - 1b Power rating (characters 7–10), for example PK37.
 - 1c Voltage rating (phases and mains) (characters 11–12), for example T4.
2. Within *Table 2.2*, find the power rating and voltage rating, and look up the enclosure size of FC 280.



1308F709:10

1	Product group and frequency converter series
2	Power rating
3	Voltage rating (phases and mains)

Illustration 2.1 Using the Nameplate to Find the Enclosure Size

Power rating in nameplate	Power [kW (hp)]	Voltage rating in nameplate	Phases and mains voltage	Enclosure size	Frequency converter		
PK37	0.37 (0.5)	T4	3-phase 380–480 V	K1	K1T4		
PK55	0.55 (0.75)						
PK75	0.75 (1.0)						
P1K1	1.1 (1.5)						
P1K5	1.5 (2.0)						
P2K2	2.2 (3.0)			K2	K2T4		
P3K0	3 (4.0)						
P4K0	4 (5.0)						
P5K5	5.5 (7.5)			K3	K3T4		
P7K5	7.5 (10)						
P11K	11 (15)						
P15K	15 (20)						
P18K	18.5 (25)						
P22K	22 (30)	K5	K5T4				
PK37	0.37 (0.5)						
PK55	0.55 (0.75)						
PK75	0.75 (1.0)	T2	3-phase 200–240 V	K1	K1T2		
P1K1	1.1 (1.5)						
P1K5	1.5 (2.0)						
P2K2	2.2 (3.0)			K2	K2T2		
P3K7	3.7 (5.0)						
PK37	0.37 (0.5)			S2	Single phase 200–240 V	K1	K1S2
PK55	0.55 (0.75)						
PK75	0.75 (1.0)						
P1K1	1.1 (1.5)						
P1K5	1.5 (2.0)	K2	K2S2				
P2K2	2.2 (3.0)						

Table 2.2 Enclosure Size of FC 280

2.2 Electrical Installation

This section describes how to wire the frequency converter.

2

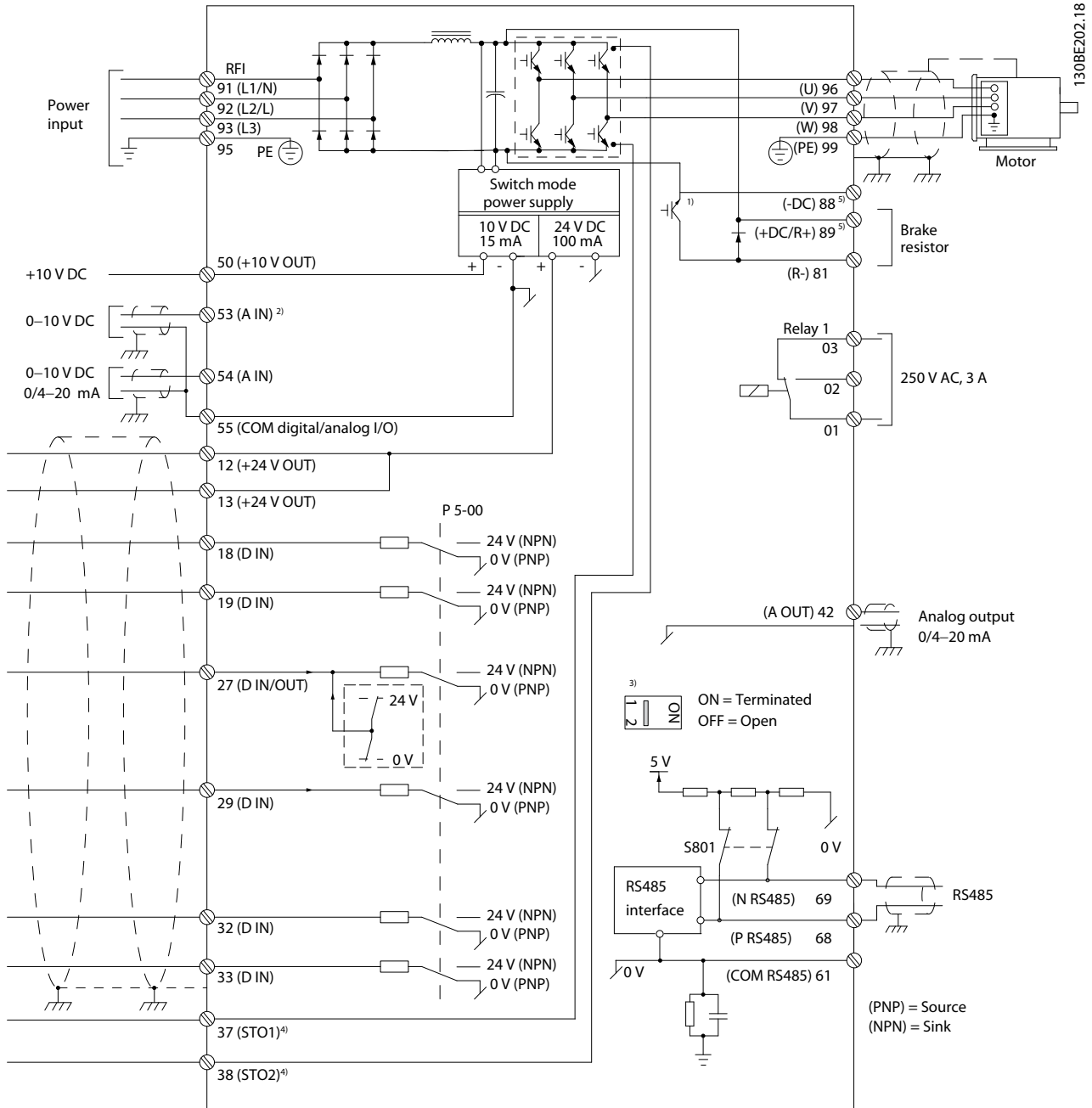

Illustration 2.2 Basic Wiring Schematic Drawing

A = Analog, D = Digital

1) Built-in brake chopper is only available on 3-phase units.

2) Terminal 53 can also be used as digital input.

3) Switch S801 (bus terminal) can be used to enable termination on the RS485 port (terminals 68 and 69).

4) Refer to chapter 4 Safe Torque Off (STO) for the correct STO wiring.

5) The S2 (single-phase 200–240 V) frequency converter does not support load sharing application.

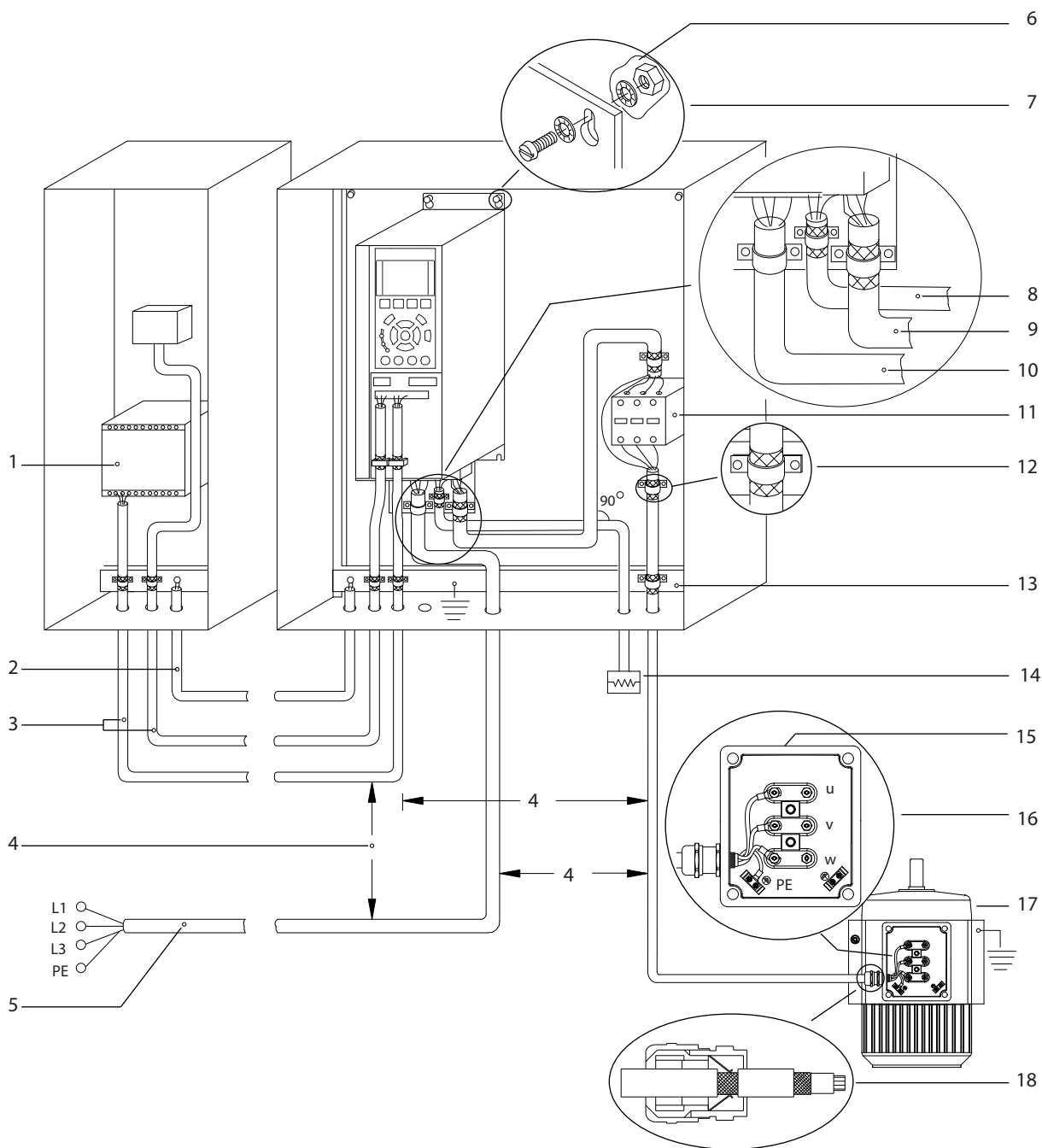

1	PLC	10	Mains cable (unshielded)
2	Minimum 16 mm ² (6 AWG) equalizing cable	11	Output contactor, and so on.
3	Control cables	12	Cable insulation stripped
4	Minimum 200 mm (656 ft) between control cables, motor cables, and mains cables.	13	Common ground busbar. Follow local and national requirements for cabinet grounding.
5	Mains supply	14	Brake resistor
6	Bare (unpainted) surface	15	Metal box
7	Star washers	16	Connection to motor
8	Brake cable (shielded)	17	Motor
9	Motor cable (shielded)	18	EMC cable gland

Illustration 2.3 Typical Electrical Connection

WARNING**INDUCED VOLTAGE**

Induced voltage from output motor cables that run together can charge equipment capacitors, even when the equipment is turned off and locked out. Failure to run output motor cables separately or use shielded cables could result in death or serious injury.

- Run output motor cables separately.
- Use shielded cables.
- Comply with local and national electrical codes for cable sizes. For maximum cable sizes, see *chapter 7.1 Electrical Data*.
- Follow motor manufacturer wiring requirements.
- Motor wiring knockouts or access panels are provided at the base of IP21 (NEMA type 1) units.
- Do not wire a starting or pole-changing device (for example Dahlander motor or slip ring induction motor) between the frequency converter and the motor.

Procedure

1. Strip a section of the outer cable insulation. Recommended length is 10–15 mm (0.4–0.6 in).
2. Position the stripped cable under the cable clamp to establish mechanical fixation and electrical contact between the cable shield and ground.
3. Connect the ground cable to the nearest grounding terminal in accordance with the grounding instructions provided in *chapter Grounding* in the *VLT® Midi Drive FC 280 Operating Guide*. See *Illustration 2.4*.
4. Connect the 3-phase motor wiring to terminals 96 (U), 97 (V), and 98 (W), as shown in *Illustration 2.4*.
5. Tighten the terminals in accordance with the information provided in *chapter 7.7 Connection Tightening Torques*.

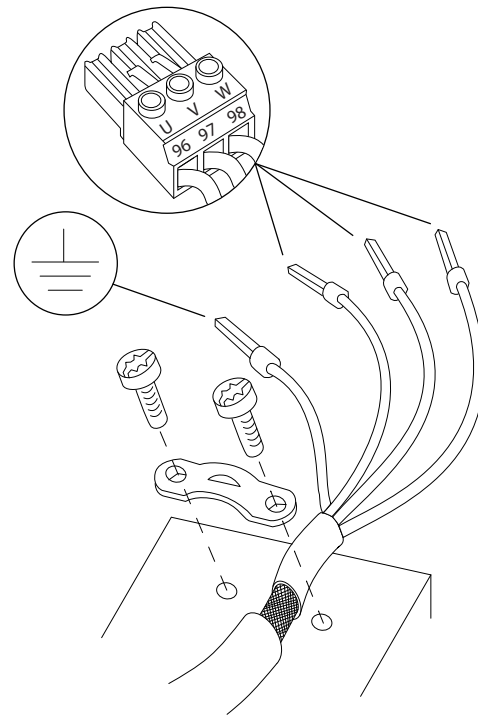
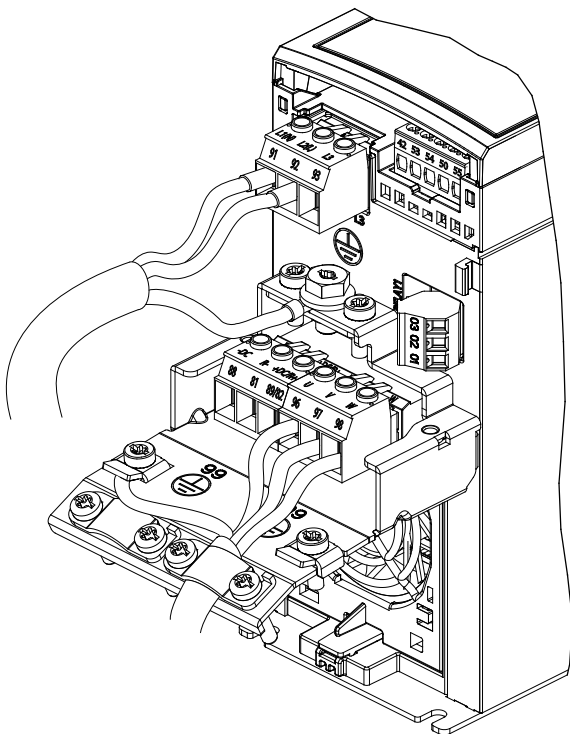

Illustration 2.4 Motor Connection

The mains, motor, and grounding connection for single-phase and 3-phase frequency converters are shown in *Illustration 2.5*, *Illustration 2.6*, and *Illustration 2.7*, respectively. Actual configurations vary with unit types and optional equipment.

NOTICE

In motors without phase insulation, paper, or other insulation reinforcement suitable for operation with voltage supply, use a sine-wave filter on the output of the frequency converter.



130BE232.11

Illustration 2.5 Mains, Motor, and Grounding Connection for Single-phase Units (K1, K2)

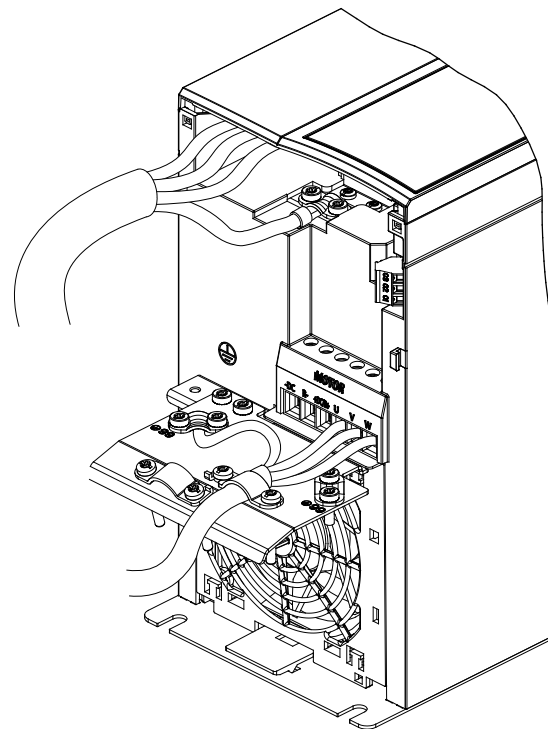

130BE804.10

Illustration 2.7 Mains, Motor, and Grounding Connection for 3-phase Units (K4, K5)

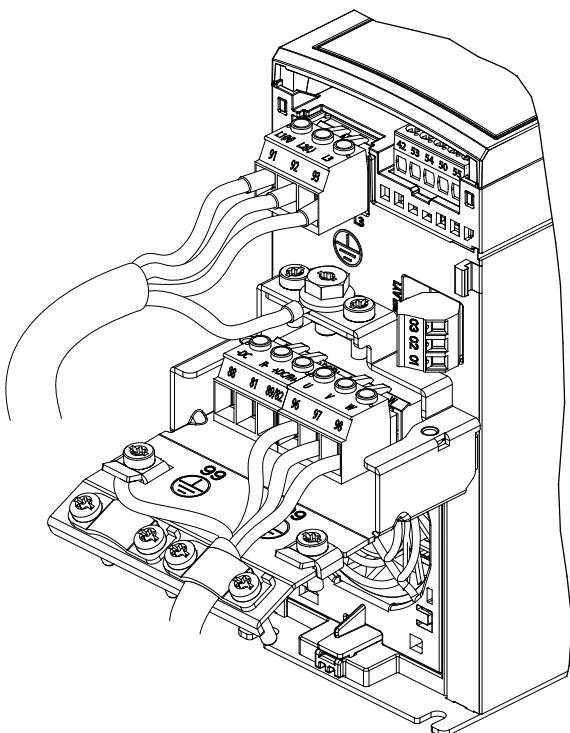

130BE231.11

Illustration 2.6 Mains, Motor, and Grounding Connection for 3-phase Units (K1, K2, K3)

2.2.2 AC Mains Connection

- Size the wiring based on the input current of the frequency converter. For maximum wire sizes, see *chapter 7.1 Electrical Data*.
- Comply with local and national electrical codes for cable sizes.

Procedure

1. Connect the AC input power cables to terminals N and L for single-phase units (see *Illustration 2.5*), or to terminals L1, L2, and L3 for 3-phase units (see *Illustration 2.6* and *Illustration 2.7*).
2. Depending on the configuration of the equipment, connect the input power to the mains input terminals or the input disconnect.
3. Ground the cable in accordance with the grounding instructions in *chapter Grounding* in the *VLT® Midi Drive FC 280 Operating Guide*.
4. When supplied from an isolated mains source (IT mains or floating delta) or TT/TN-S mains with a grounded leg (grounded delta), ensure that the RFI filter screw is removed. Removing the RFI screw prevents damage to the DC link and reduces ground capacity currents in accordance with IEC 61800-3 (see *Illustration 7.13*, the RFI screw locates on the side of the frequency converter).

2.2.3 Control Terminal Types

Illustration 2.8 shows the removable frequency converter connectors. Terminal functions and default settings are summarized in Table 2.3 and Table 2.4.

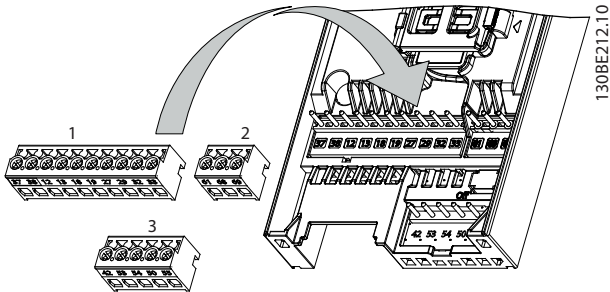

Illustration 2.8 Control Terminal Locations

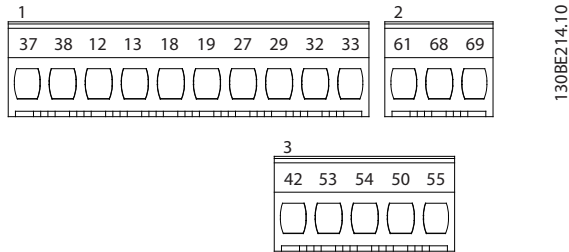

Illustration 2.9 Terminal Numbers

See chapter 7.6 Control Input/Output and Control Data for terminal ratings details.

Terminal	Parameter	Default setting	Description
Digital I/O, pulse I/O, encoder			
12, 13	-	+24 V DC	24 V DC supply voltage. Maximum output current is 100 mA for all 24 V loads.
18	Parameter 5-10 Terminal 18 Digital Input	[8] Start	Digital inputs.
19	Parameter 5-11 Terminal 19 Digital Input	[10] Reversing	
27	Parameter 5-01 Terminal 27 Mode Parameter 5-12 Terminal 27 Digital Input Parameter 5-30 Terminal 27 Digital Output	DI [2] Coast inverse DO [0] No operation	Selectable for either digital input, digital output, or pulse output. The default setting is digital input.

Terminal	Parameter	Default setting	Description
29	Parameter 5-13 Terminal 29 Digital Input	[14] Jog	Digital input.
32	Parameter 5-14 Terminal 32 Digital Input	[0] No operation	Digital input, 24 V encoder. Terminal 33 can be used for pulse input.
33	Parameter 5-15 Terminal 33 Digital Input	[0] No operation	
37, 38	-	STO	Functional safety inputs.
Analog inputs/outputs			
42	Parameter 6-91 Terminal 42 Analog Output	[0] No operation	Programmable analog output. The analog signal is 0– 20 mA or 4– 20 mA at a maximum of 500 Ω. Can also be configured as digital outputs.
50	-	+10 V DC	10 V DC analog supply voltage. 15 mA maximum commonly used for potentiometer or thermistor.
53	Parameter group 6-1* Analog input 53	-	Analog input. Only voltage mode is supported. It can also be used as digital input.
54	Parameter group 6-2* Analog input 54	-	Analog input. Selectable between voltage or current mode.
55	-	-	Common for digital and analog inputs.

Table 2.3 Terminal Descriptions - Digital Inputs/Outputs, Analog Inputs/Outputs

Terminal	Parameter	Default setting	Description
Serial communication			
61	-	-	Integrated RC filter for cable shield. ONLY for connecting the shield when experiencing EMC problems.
68 (+)	<i>Parameter group 8-3* FC port settings</i>	-	RS485 interface. A control card switch is provided for termination resistance.
69 (-)	<i>Parameter group 8-3* FC port settings</i>	-	
Relays			
01, 02, 03	<i>Parameter 5-40 Function Relay</i>	<i>[1] Control Ready</i>	Form C relay output. These relays are in various locations depending on the frequency converter configuration and size. Usable for AC or DC voltage and resistive or inductive loads.

Table 2.4 Terminal Descriptions - Serial Communication

2.2.4 Wiring to Control Terminals

Control terminal connectors can be unplugged from the frequency converter for ease of installation, as shown in *Illustration 2.8*.

For details about STO wiring, refer to *chapter 4 Safe Torque Off (STO)*.

NOTICE

Keep control cables as short as possible and separate them from high-power cables to minimize interference.

1. Loosen the screws for the terminals.
2. Insert sleeved control cables into the slots.
3. Fasten the screws for the terminals.
4. Ensure that the contact is firmly established and not loose. Loose control wiring can be the source of equipment faults or less than optimal operation.

See *chapter 7.5 Cable Specifications* for control terminal cable sizes and *chapter 3 Application Examples* for typical control cable connections.

2.3 Control Structures

A frequency converter rectifies AC voltage from mains into DC voltage. Then the DC voltage is converted into an AC current with a variable amplitude and frequency.

The motor is supplied with variable voltage/current and frequency, enabling infinitely variable speed control of 3-phased standard AC motors and permanent magnet synchronous motors.

2.3.1 Control Modes

The frequency converter controls either the speed or the torque on the motor shaft. The frequency converter also controls the process for some applications which use process data as reference or feedback, for example, temperature and pressure. Setting *parameter 1-00 Configuration Mode* determines the type of control.

Speed control

There are 2 types of speed control:

- Speed open-loop control, which does not require any feedback from the motor (sensorless).
- Speed closed-loop PID control, which requires a speed feedback to an input. A properly optimized speed closed-loop control has higher accuracy than a speed open-loop control.

Select which input to use as speed PID feedback in *parameter 7-00 Speed PID Feedback Source*.

Torque control

The torque control function is used in applications where the torque on motor output shaft controls the application as tension control. Select [2] *Torque closed loop* or [4] *Torque open loop* in *parameter 1-00 Configuration Mode*. Torque setting is done by setting an analog, digital, or bus-controlled reference. When running torque control, it is recommended to run a full AMA procedure, because correct motor data is important in achieving optimal performance.

- Closed loop in VVC⁺ mode. This function is used in applications with low to medium dynamic variation of shaft and offers excellent performance in all 4 quadrants and at all motor speeds. The speed feedback signal is mandatory. Ensure that the encoder resolution is at least 1024 PPR, and the shield cable of the encoder is properly grounded, because the accuracy of the speed feedback signal is important. Tune *parameter 7-06 Speed PID Lowpass Filter Time* to get the best speed feedback signal.
- Open loop in VVC⁺ mode. The function is used in mechanically robust applications, but the accuracy is limited. Open-loop torque function

works for 2 directions. The torque is calculated from the internal current measurement in the frequency converter.

Speed/torque reference

The reference to these controls can be either a single reference or the sum of various references including relatively scaled references. Reference handling is explained in detail in *chapter 2.4 Reference Handling*.

Process control

There are 2 types of process control:

- Process closed-loop control, which runs speed open-loop to control the motor internally, is a basic process PID controller.
- Extended PID speed open-loop control, which also runs speed open-loop to control the motor internally, extends the function of the basic process PID controller by adding more functions. For example, feed forward control, clamping, reference/feedback filter, and gain scaling.

2.3.2 Control Principle

VL^T® Midi Drive FC 280 is a general-purpose frequency converter for variable speed applications. The control principle is based on VVC⁺.

FC 280 frequency converters can handle asynchronous motors and permanent magnet synchronous motors up to 22 kW (30 hp).

The current-sensing principle in FC 280 frequency converters is based on the current measurement by a resistor in the DC link. The ground fault protection and short circuit behavior are handled by the same resistor.

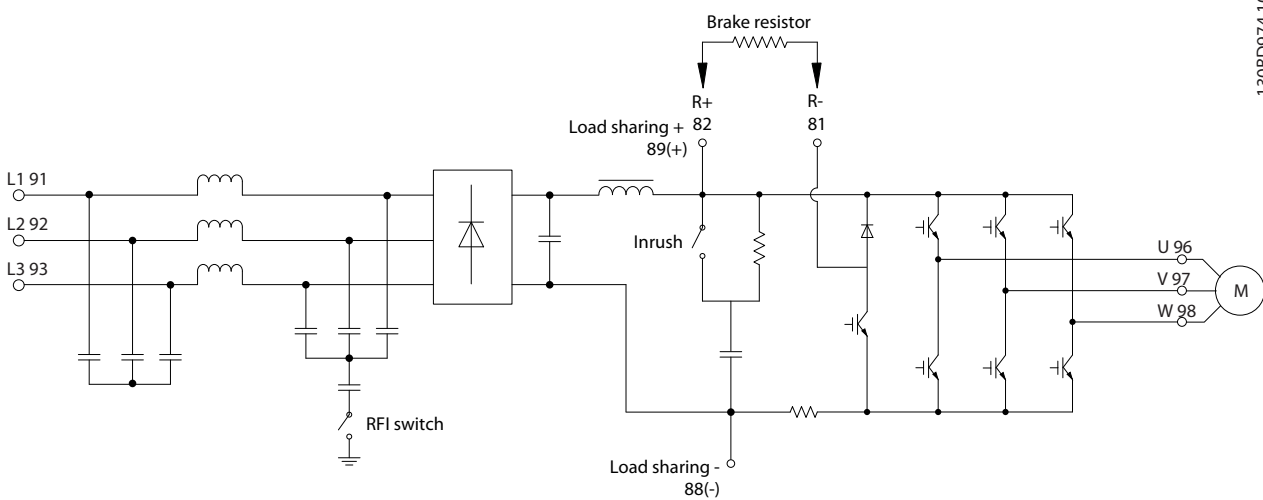

130BD974.10

Illustration 2.10 Control Diagram

2.3.3 Control Structure in VVC⁺

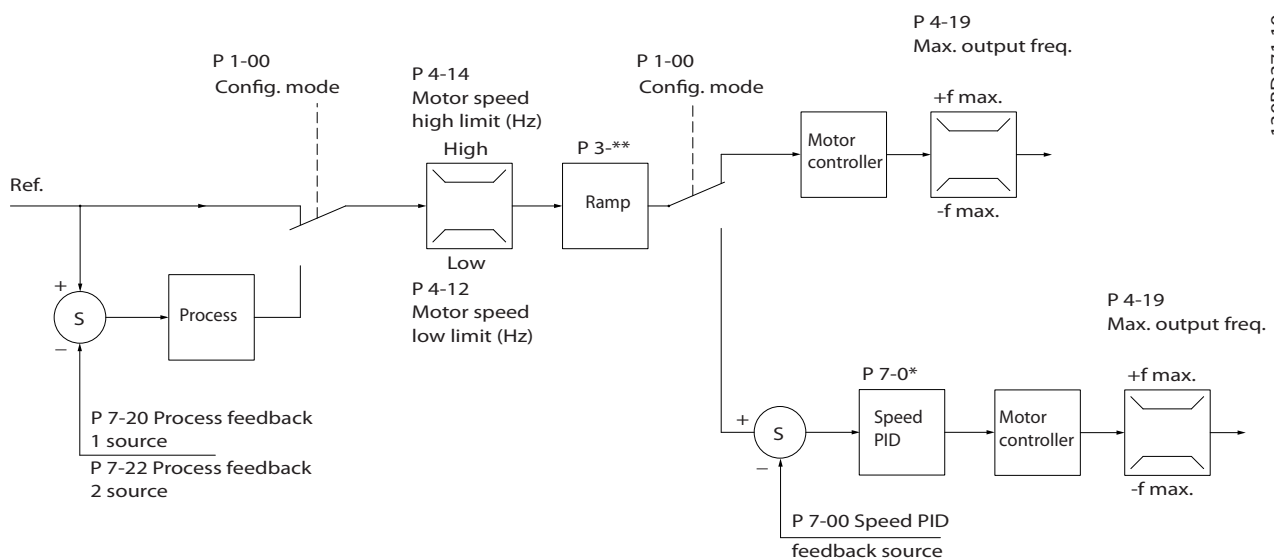

130BD371.10

Illustration 2.11 Control Structure in VVC⁺ Open-loop Configurations and Closed-loop Configurations

In the configuration shown in *Illustration 2.11*, parameter 1-01 Motor Control Principle is set to [1] VVC⁺ and parameter 1-00 Configuration Mode is set to [0] Speed open loop. The resulting reference from the reference handling system

2

is received and fed through the ramp limitation and speed limitation before being sent to the motor control. The output of the motor control is then limited by the maximum frequency limit.

If *parameter 1-00 Configuration Mode* is set to [1] *Speed closed loop*, the resulting reference is passed from the ramp limitation and speed limitation into a speed PID control. The speed PID control parameters are in *parameter group 7-0* Speed PID Ctrl*. The resulting reference from the speed PID control is sent to the motor control limited by the frequency limit.

Select [3] *Process* in *parameter 1-00 Configuration Mode* to use the process PID control for closed-loop control of speed or pressure in the controlled application. The process PID parameters are in *parameter groups 7-2* Process Ctrl. Feedb* and *7-3* Process PID Ctrl*.

2.3.4 Internal Current Control in VVC⁺ Mode

The frequency converter features an integral current limit control. This feature is activated when the motor current, and thus the torque, is higher than the torque limits set in *parameter 4-16 Torque Limit Motor Mode*, *parameter 4-17 Torque Limit Generator Mode*, and *parameter 4-18 Current Limit*.

When the frequency converter is at the current limit during motor operation or regenerative operation, the frequency converter tries to get below the preset torque limits as quickly as possible without losing control of the motor.

2.3.5 Local (Hand On) and Remote (Auto On) Control

Operate the frequency converter manually via the local control panel (graphic LCP or numerical LCP) or remotely via analog/digital inputs or fieldbus.

Start and stop the frequency converter by pressing the [Hand On] and [Reset] keys on the LCP. Set-up is required via the following parameters:

- *Parameter 0-40 [Hand on] Key on LCP.*
- *Parameter 0-44 [Off/Reset] Key on LCP.*
- *Parameter 0-42 [Auto on] Key on LCP.*

Reset alarms via the [Reset] key or via a digital input, when the terminal is programmed to *Reset*.

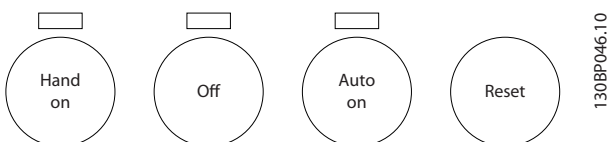

Illustration 2.12 GLCP Control Keys

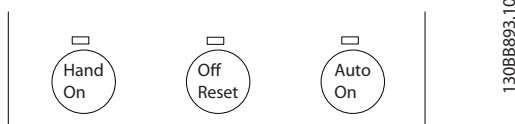

Illustration 2.13 NLCP Control Keys

Local reference forces the configuration mode to open loop, independent of the setting in *parameter 1-00 Configuration Mode*.

Local reference is restored when the frequency converter powers down.

2.4 Reference Handling

2

Local reference

The local reference is active when the frequency converter is operated with [Hand On] active. Adjust the reference by [▲]/[▼] and [◀]/[▶].

Remote reference

The reference handling system for calculating the remote reference is shown in *Illustration 2.14*.

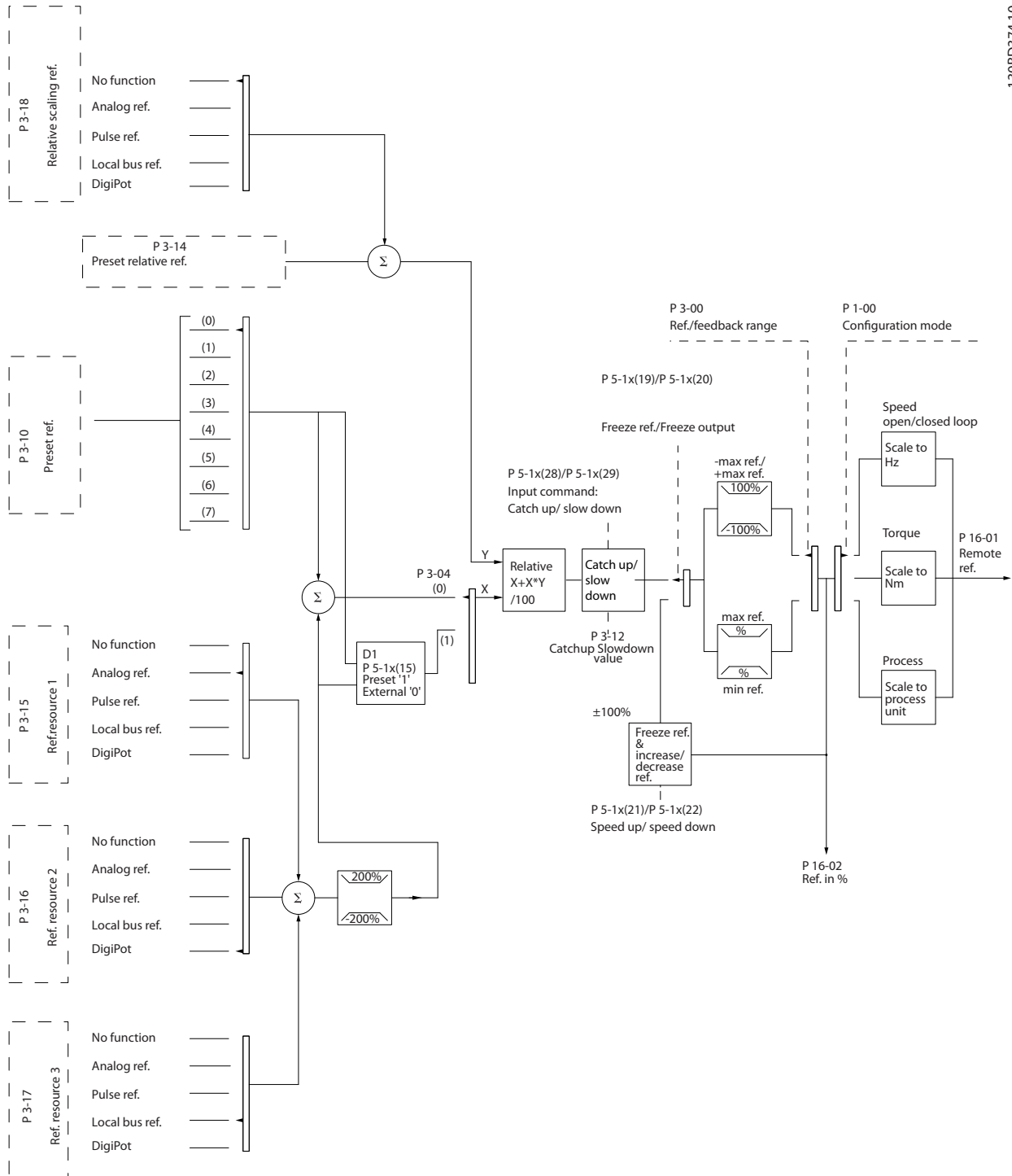

1.30BD374.10

Illustration 2.14 Remote Reference

The remote reference is calculated once in every scan interval and initially consists of 2 types of reference inputs:

1. X (the external reference): A sum (see *parameter 3-04 Reference Function*) of up to 4 externally selected references, comprising any combination (determined by the setting of *parameter 3-15 Reference 1 Source*, *parameter 3-16 Reference 2 Source*, and *parameter 3-17 Reference 3 Source*) of a fixed preset reference (*parameter 3-10 Preset Reference*), variable analog references, variable digital pulse references, and various fieldbus references in any unit the frequency converter is monitoring ([Hz], [RPM], [Nm], and so on).
2. Y (the relative reference): A sum of 1 fixed preset reference (*parameter 3-14 Preset Relative Reference*) and 1 variable analog reference (*parameter 3-18 Relative Scaling Reference Resource*) in [%].

The 2 types of reference inputs are combined in the following formula:

$$\text{Remote reference} = X + X * Y / 100\%$$

If relative reference is not used, set *parameter 3-18 Relative Scaling Reference Resource* to [0] No function and *parameter 3-14 Preset Relative Reference* to 0%. The digital inputs on the frequency converter can activate both the catch up/slow down function and the freeze reference function. The functions and parameters are described in the *VLT® Midi Drive FC 280 Programming Guide*.

The scaling of analog references is described in *parameter groups 6-1* Analog Input 53* and *6-2* Analog Input 54*, and the scaling of digital pulse references is described in *parameter group 5-5* Pulse Input*.

Reference limits and ranges are set in *parameter group 3-0* Reference Limits*.

2.4.1 Reference Limits

Parameter 3-00 Reference Range, *parameter 3-02 Minimum Reference*, and *parameter 3-03 Maximum Reference* define the allowed range of the sum of all references. The sum of all references is clamped when necessary. The relation between the resulting reference (after clamping) and the sum of all references are shown in *Illustration 2.15* and *Illustration 2.16*.

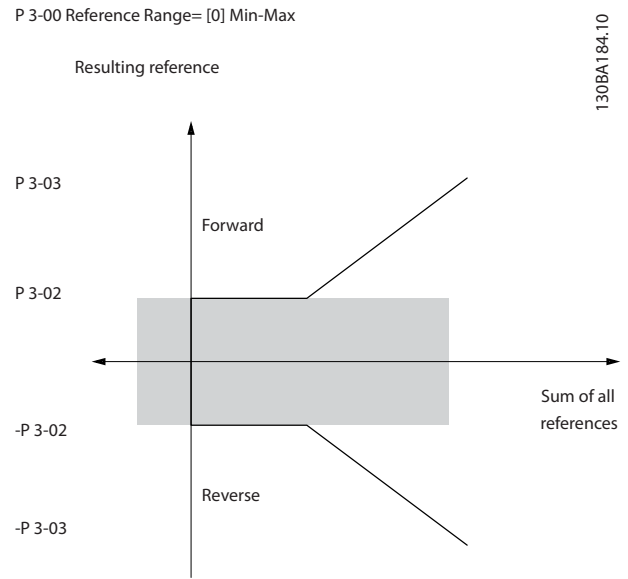

Illustration 2.15 Sum of All References When Reference Range is Set to 0

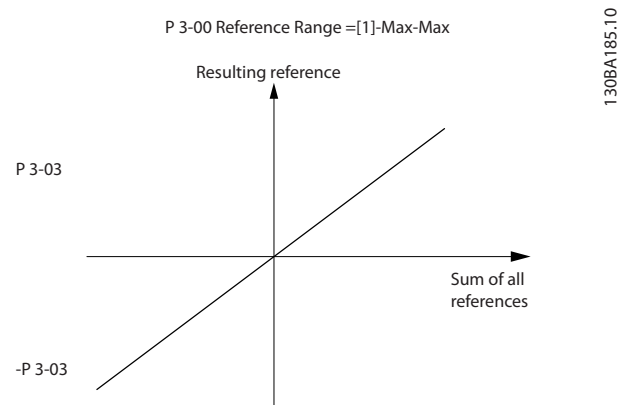
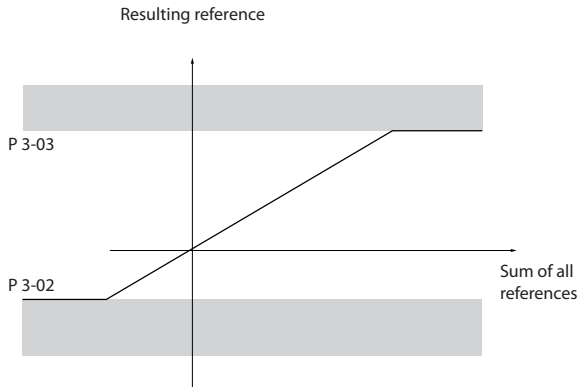

Illustration 2.16 Sum of All References When Reference Range is Set to 1

The value of *parameter 3-02 Minimum Reference* cannot be set to less than 0, unless *parameter 1-00 Configuration Mode* is set to [3] Process. In that case, the following relations between the resulting reference (after clamping) and the sum of all references are as shown in *Illustration 2.17*.

P 3-00 Reference Range= [0] Min to Max



130BA186.11

Illustration 2.17 Sum of All References When Minimum Reference is Set to a Minus Value

2.4.2 Scaling of Preset References and Bus References

Preset references are scaled according to the following rules:

- When *parameter 3-00 Reference Range* is set to [0] *Min-Max*, 0% reference equals 0 [unit] where unit can be any unit, for example RPM, m/s, and bar. 100% reference equals the maximum (absolute value of *parameter 3-03 Maximum Reference*, absolute value of *parameter 3-02 Minimum Reference*).
- When *parameter 3-00 Reference Range* is set to [1] *-Max+Max*, 0% reference equals 0 [unit], and 100% reference equals maximum reference.

Bus references are scaled according to the following rules:

- When *parameter 3-00 Reference Range* is set to [0] *Min-Max*, 0% reference equals minimum reference and 100% reference equals maximum reference.
- When *parameter 3-00 Reference Range* is set to [1] *-Max+Max*, -100% reference equals -maximum reference, and 100% reference equals maximum reference.

2.4.3 Scaling of Analog and Pulse References and Feedback

References and feedback are scaled from analog and pulse inputs in the same way. The only difference is that a reference above or below the specified minimum and maximum endpoints (P1 and P2 in *Illustration 2.18*) are clamped while feedbacks above or below are not.

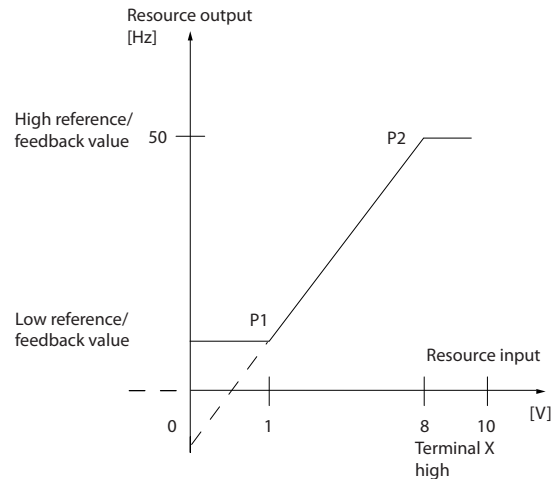

130BD431.10

Illustration 2.18 Minimum and Maximum Endpoints

The endpoints P1 and P2 are defined in Table 2.5 depending on the choice of input.

Input	Analog 53 voltage mode	Analog 54 voltage mode	Analog 54 current mode	Pulse input 29	Pulse input 33
P1=(Minimum input value, minimum reference value)					
Minimum reference value	Parameter 6-14 Terminal 53 Low Ref./Feedb. Value	Parameter 6-24 Terminal 54 Low Ref./Feedb. Value	Parameter 6-24 Terminal 54 Low Ref./Feedb. Value	Parameter 5-52 Terminal 29 Low Ref./Feedb. Value	Parameter 5-57 Terminal 33 Low Ref./Feedb. Value
Minimum input value	Parameter 6-10 Terminal 53 Low Voltage [V]	Parameter 6-20 Terminal 54 Low Voltage [V]	Parameter 6-22 Terminal 54 Low Current [mA]	Parameter 5-50 Terminal 29 Low Frequency [Hz]	Parameter 5-55 Terminal 33 Low Frequency [Hz]
P2=(Maximum input value, maximum reference value)					
Maximum reference value	Parameter 6-15 Terminal 53 High Ref./Feedb. Value	Parameter 6-25 Terminal 54 High Ref./Feedb. Value	Parameter 6-25 Terminal 54 High Ref./Feedb. Value	Parameter 5-53 Terminal 29 High Ref./Feedb. Value	Parameter 5-58 Terminal 33 High Ref./Feedb. Value
Maximum input value	Parameter 6-11 Terminal 53 High Voltage [V]	Parameter 6-21 Terminal 54 High Voltage [V]	Parameter 6-23 Terminal 54 High Current [mA]	Parameter 5-51 Terminal 29 High Frequency [Hz]	Parameter 5-56 Terminal 33 High Frequency [Hz]

Table 2.5 P1 and P2 Endpoints

2.4.4 Dead Band Around Zero

Sometimes, the reference (in rare cases also the feedback) should have a dead band around 0 to ensure that the machine is stopped when the reference is near 0.

To make the dead band active and to set the amount of dead band, do the following:

- Set either the minimum reference value (see Table 2.5 for relevant parameter) or maximum reference value at 0. In other words, either P1 or P2 must be on the X-axis in Illustration 2.19.
- Ensure that both points defining the scaling graph are in the same quadrant.

P1 or P2 defines the size of the dead band as shown in Illustration 2.19.

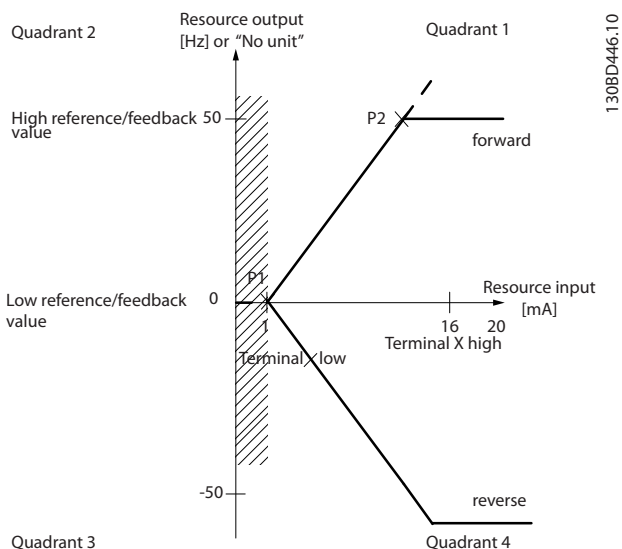
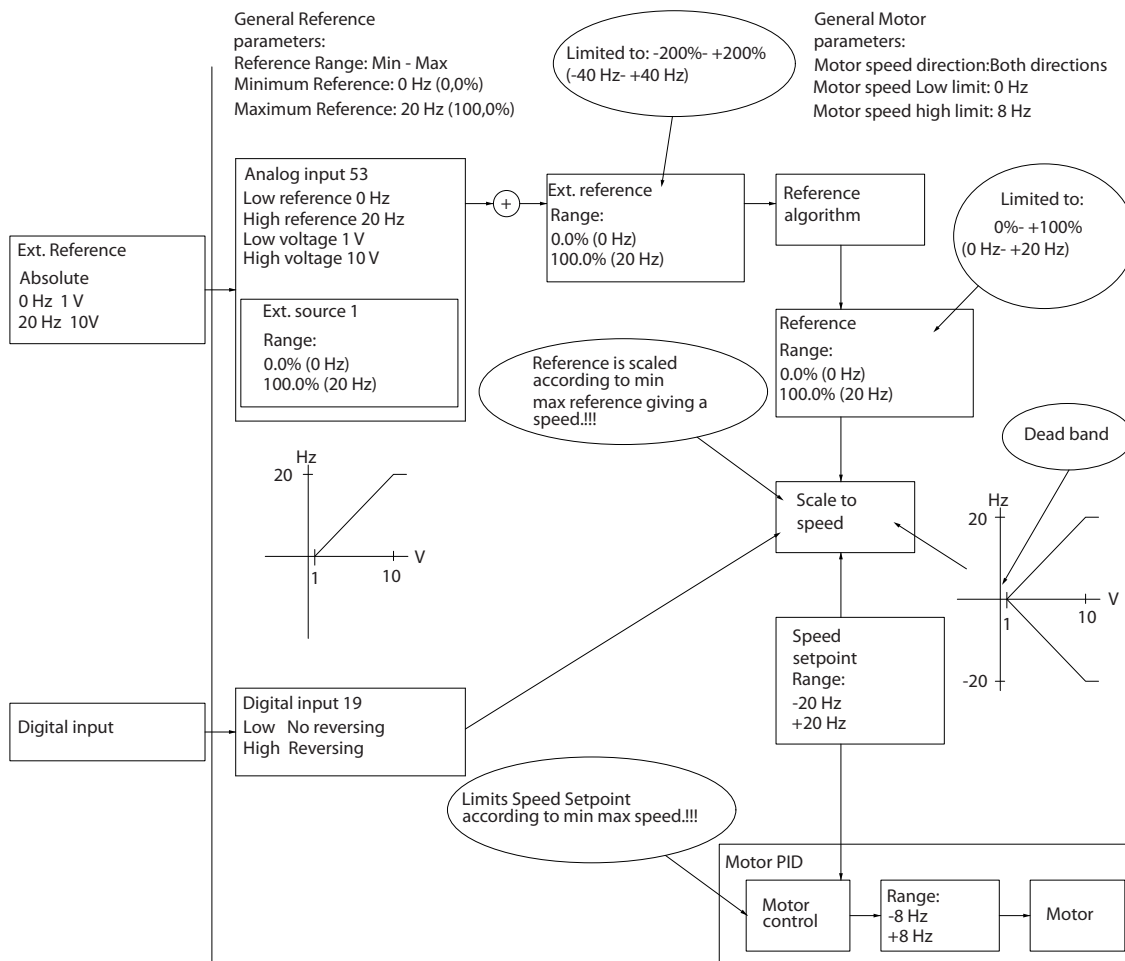

Illustration 2.19 Size of Dead Band

Case 1: Positive reference with dead band, digital input to trigger reverse, part I

Illustration 2.20 shows how reference input with limits inside minimum to maximum limits clamps.

2



130BD454.10

Illustration 2.20 Clamping of Reference Input with Limits inside Minimum to Maximum

Case 2: Positive reference with dead band, digital input to trigger reverse, part II

Illustration 2.21 shows how reference input with limits outside -maximum to +maximum limits clamps to the input low and high limits before adding to external reference, and how the external reference is clamped to -maximum to +maximum by the reference algorithm.

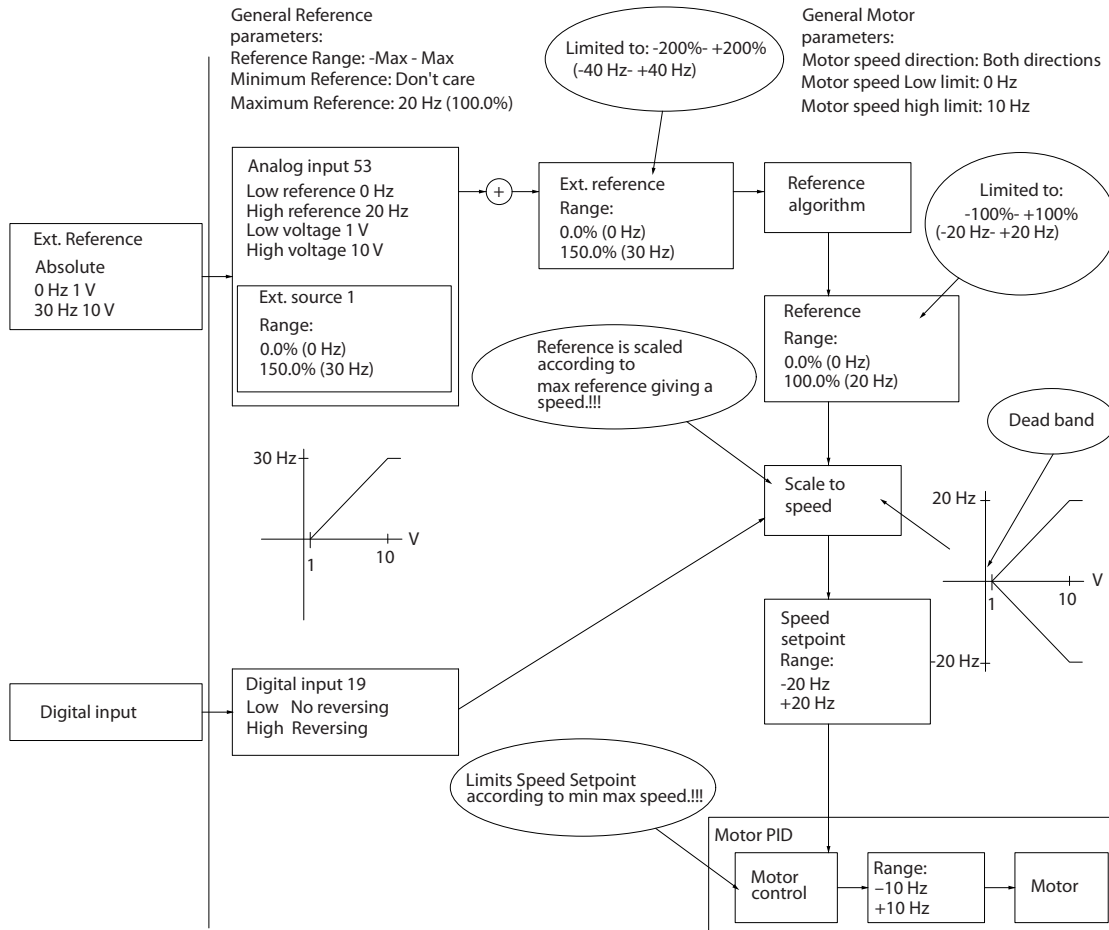

130BD433.11

Illustration 2.21 Clamping of Reference Input with Limits outside -Maximum to +Maximum

2.5 PID Control

2.5.1 Speed PID Control

Parameter 1-00 Configuration Mode	Parameter 1-01 Motor Control Principle	
	U/f	VVC+
[1] Speed closed loop	Not available ¹⁾	Active

Table 2.6 Control Configurations, Active Speed Control

1) Not available indicates that the specific mode is not available at all.

Parameter	Description of function	
Parameter 7-00 Speed PID Feedback Source	Select from which input the speed PID gets its feedback.	
Parameter 7-02 Speed PID Proportional Gain	The higher the value, the quicker the control. However, too high a value may lead to oscillations.	
Parameter 7-03 Speed PID Integral Time	Eliminates steady state speed error. Lower values mean quicker reaction. However, too low a value may lead to oscillations.	
Parameter 7-04 Speed PID Differentiation Time	Provides a gain proportional to the rate of change of the feedback. A setting of 0 disables the differentiator.	
Parameter 7-05 Speed PID Diff. Gain Limit	If there are quick changes in reference or feedback in a given application, which means that the error changes swiftly, the differentiator may soon become too dominant. This is because it reacts to changes in the error. The quicker the error changes, the stronger the differentiator gain is. The differentiator gain can thus be limited to allow setting of the reasonable differentiation time for slow changes and a suitably quick gain for quick changes.	
Parameter 7-06 Speed PID Lowpass Filter Time	A low-pass filter that dampens oscillations on the feedback signal and improves steady state performance. However, too long a filter time deteriorates the dynamic performance of the speed PID control. Practical settings of <i>parameter 7-06 Speed PID Lowpass Filter Time</i> taken from the number of pulses per revolution on from encoder (PPR):	
	Encoder PPR	Parameter 7-06 Speed PID Lowpass Filter Time
	512	10 ms
	1024	5 ms
	2048	2 ms
4096	1 ms	

Table 2.7 Speed Control Parameters

Example of programming the speed control

In this example, the speed PID control is used to maintain a constant motor speed regardless of the changing load on the motor. The required motor speed is set via a potentiometer connected to terminal 53. The speed range is 0–1500 RPM corresponding to 0–10 V over the potentiometer. A switch connected to terminal 18 controls starting and stopping. The speed PID monitors the actual RPM of the motor by using a 24 V (HTL) incremental encoder as feedback. The feedback sensor is an encoder (1024 pulses per revolution) connected to terminals 32 and 33. The pulse frequency range to terminals 32 and 33 is 4 Hz–32 kHz.

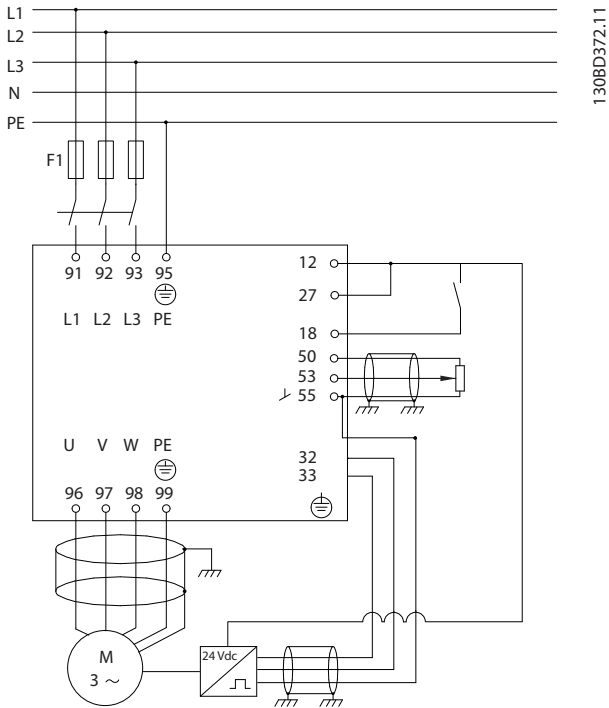

Illustration 2.22 Speed Control Programming

Follow the steps in *Table 2.8* to program the speed control (see explanation of settings in the *programming guide*) In *Table 2.8*, it is assumed that all other parameters and switches remain at their default setting.

Function	Parameter number	Setting
1) Make sure that the motor runs properly. Do the following:		
Set the motor parameters using the data on the nameplate.	<i>Parameter group 1-2*</i> <i>Motor Data</i>	As specified by motor nameplate.
Perform an AMA.	<i>Parameter 1-29 Automatic</i> <i>Motor Adaption (AMA)</i>	[1] Enable complete AMA
2) Check that the motor is running and that the encoder is attached properly. Do the following:		
Press [Hand On]. Check that the motor is running and note the rotation direction (referred to as the positive direction).		Set a positive reference.
3) Make sure that the frequency converter limits are set to safe values:		
Set acceptable limits for the references.	<i>Parameter 3-02 Minimum</i> <i>Reference</i>	0
	<i>Parameter 3-03 Maximum</i> <i>Reference</i>	50
Check that the ramp settings are within frequency converter capabilities and allowed application operating specifications.	<i>Parameter 3-41 Ramp 1</i> <i>Ramp Up Time</i>	Default setting
	<i>Parameter 3-42 Ramp 1</i> <i>Ramp Down Time</i>	Default setting

Set acceptable limits for the motor speed and frequency.	<i>Parameter 4-12 Motor Speed Low Limit [Hz]</i>	0 Hz
	<i>Parameter 4-14 Motor Speed High Limit [Hz]</i>	50 Hz
	<i>Parameter 4-19 Max Output Frequency</i>	60 Hz
4) Configure the speed control and select the motor control principle:		
Activation of speed control	<i>Parameter 1-00 Configuration Mode</i>	[1] Speed closed loop
Selection of motor control principle	<i>Parameter 1-01 Motor Control Principle</i>	[1] VVC ⁺
5) Configure and scale the reference to the speed control:		
Set up analog input 53 as a reference source.	<i>Parameter 3-15 Reference 1 Source</i>	Not necessary (default)
Scale analog input 53 0 Hz (0 V) to 50 Hz (10 V)	<i>Parameter group 6-1* Analog Input 1</i>	Not necessary (default)
6) Configure the 24 V HTL encoder signal as feedback for the motor control and the speed control:		
Set up digital input 32 and 33 as encoder inputs.	<i>Parameter 5-14 Terminal 32 Digital Input</i>	[82] Encoder input B
	<i>Parameter 5-15 Terminal 33 Digital Input</i>	[83] Encoder input A
Select terminal 32/33 as speed PID feedback.	<i>Parameter 7-00 Speed PID Feedback Source</i>	[1] 24 V Encoder
7) Tune the speed control PID parameters:		
Use the tuning guidelines when relevant or tune manually.	<i>Parameter group 7-0* Speed PID Ctrl.</i>	
8) Finish:		
Save the parameter setting to the LCP for safe keeping.	<i>Parameter 0-50 LCP Copy</i>	[1] All to LCP

Table 2.8 Programming Order for Speed PID Control

2.5.2 Process PID Control

The process PID control can be used to control application parameters that can be measured by a sensor (for example pressure, temperature, flow) and affected by the connected motor through a pump, fan, or other connected devices.

Table 2.9 shows the control configurations in which the process control is possible. Refer to *chapter 2.3 Control Structures* to see where the speed control is active.

Parameter 1-00 Configuration Mode	Parameter 1-01 Motor Control Principle	
	U/f	VVC+
[3] Process	Process	Process

Table 2.9 Control Configuration

NOTICE

The process control PID works under the default parameter setting, but tuning the parameters is recommended to optimize the application control performance.

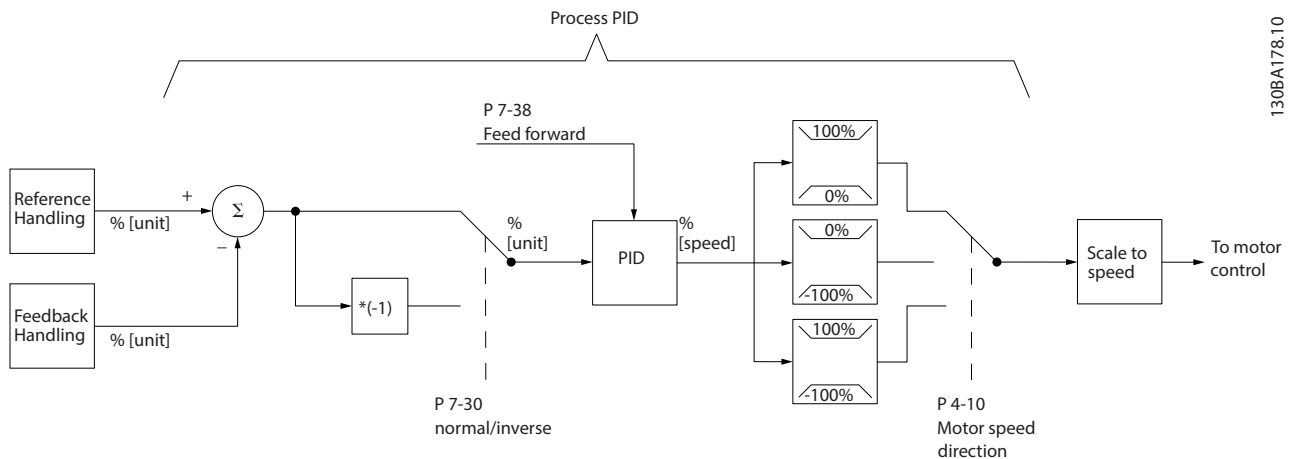

Illustration 2.23 Process PID Control Diagram

2.5.3 Process Control Relevant Parameters

2

Parameter	Description of function
<i>Parameter 7-20 Process CL Feedback 1 Resource</i>	Select from which source (analog or pulse input) the process PID gets its feedback.
<i>Parameter 7-22 Process CL Feedback 2 Resource</i>	Optional: Determine if (and from where) the process PID gets an additional feedback signal. If an additional feedback source is selected, the 2 feedback signals are added before being used in the process PID control.
<i>Parameter 7-30 Process PID Normal/ Inverse Control</i>	Under [0] <i>Normal</i> operation, the process control responds with an increase of the motor speed if the feedback is lower than the reference. Under [1] <i>Inverse</i> operation, the process control responds with a decreasing motor speed instead.
<i>Parameter 7-31 Process PID Anti Windup</i>	The anti-windup function ensures that when either a frequency limit or a torque limit is reached, the integrator is set to a gain that corresponds to the actual frequency. This avoids integrating on an error that cannot be compensated for by a speed change. Press [0] <i>Off</i> to disable this function.
<i>Parameter 7-32 Process PID Start Speed</i>	In some applications, reaching the required speed/setpoint can take a long time. In such applications, it may be an advantage to set a fixed motor speed from the frequency converter before the process control is activated. Set a fixed motor speed by setting a process PID start value (speed) in <i>parameter 7-32 Process PID Start Speed</i> .
<i>Parameter 7-33 Process PID Proportional Gain</i>	The higher the value, the quicker the control. However, too large a value may lead to oscillations.
<i>Parameter 7-34 Process PID Integral Time</i>	Eliminates steady state speed error. A lower value means a quicker reaction. However, too small a value may lead to oscillations.
<i>Parameter 7-35 Process PID Differentiation Time</i>	Provides a gain proportional to the rate of feedback change. A setting of 0 disables the differentiator.
<i>Parameter 7-36 Process PID Diff. Gain Limit</i>	If there are quick changes in reference or feedback in a given application (which means that the error changes swiftly), the differentiator may soon become too dominant. This is because it reacts to changes in the error. The quicker the error changes, the stronger the differentiator gain is. The differentiator gain can thus be limited to allow setting of the reasonable differentiation time for slow changes.
<i>Parameter 7-38 Process PID Feed Forward Factor</i>	In applications where there is a good (and approximately linear) correlation between the process reference and the motor speed necessary for obtaining that reference, use the feed forward factor to achieve better dynamic performance of the process PID control.
<ul style="list-style-type: none"> • <i>Parameter 5-54 Pulse Filter Time Constant #29 (Pulse term. 29)</i> • <i>Parameter 5-59 Pulse Filter Time Constant #33 (Pulse term. 33)</i> • <i>Parameter 6-16 Terminal 53 Filter Time Constant (Analog term 53)</i> • <i>Parameter 6-26 Terminal 54 Filter Time Constant (Analog term. 54)</i> 	<p>If there are oscillations of the current/voltage feedback signal, use a low-pass filter to dampen these oscillations. The pulse filter time constant represents the speed limit of the ripples occurring on the feedback signal.</p> <p>Example: If the low-pass filter has been set to 0.1 s, the limit speed is 10 RAD/s (the reciprocal of 0.1 s), corresponding to $(10/(2 \times \pi))=1.6$ Hz. This means that the filter dampens all currents/voltages that vary by more than 1.6 oscillations per second. The control is only carried out on a feedback signal that varies by a frequency (speed) of less than 1.6 Hz.</p> <p>The low-pass filter improves steady state performance, but selecting a too long filter time deteriorates the dynamic performance of the process PID control.</p>

Table 2.10 Process Control Parameters

2.5.4 Example of Process PID Control

Illustration 2.24 is an example of a process PID control used in a ventilation system:

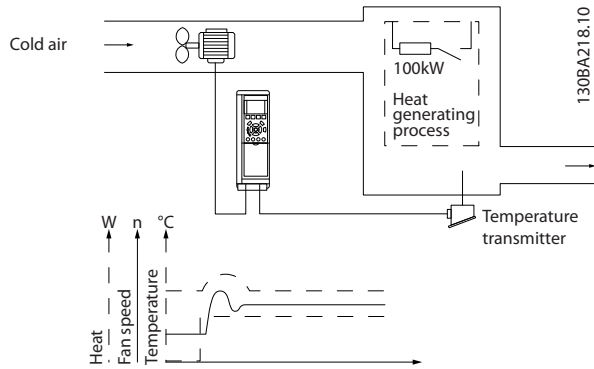

Illustration 2.24 Process PID Control in a Ventilation System

In a ventilation system, the temperature can be set from -5 to +35 °C (23–95 °F) with a potentiometer of 0–10 V. To keep the set temperature constant, use the process control.

The control is inverse, which means that when the temperature increases, the ventilation speed is increased as well to generate more air. When the temperature drops, the speed is reduced. The transmitter used is a temperature sensor with a working range of -10 to +40 °C (14–104 °F), 4–20 mA.

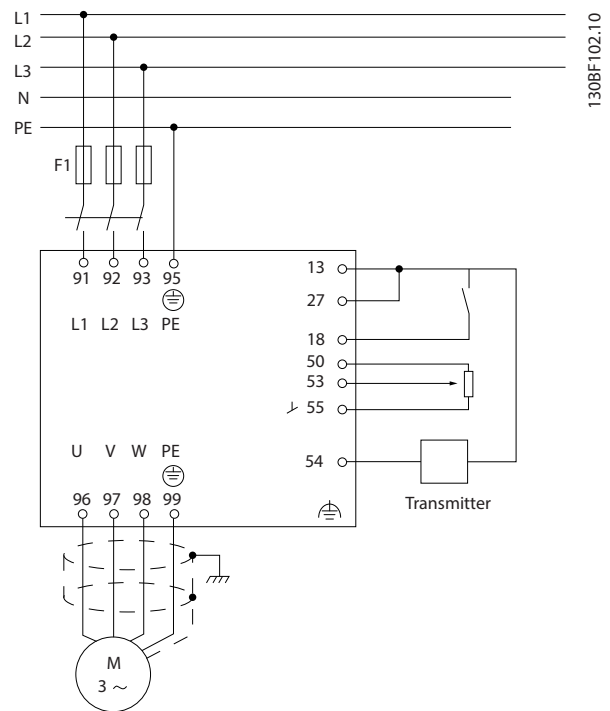

Illustration 2.25 2-wire Transmitter

1. Start/stop via the switch connected to terminal 18.
2. Temperature reference via potentiometer (-5 to +35 °C (23–95 °F), 0–10 V DC) connected to terminal 53.
3. Temperature feedback via transmitter (-10 to +40 °C (14–104 °F), 4–20 mA) connected to terminal 54.

Function	Parameter number	Setting
Initialize the frequency converter.	Parameter 14-2 2 Operation Mode	[2] Initialisation - make a power cycling - press reset.
1) Set motor parameters:		
Set the motor parameters according to nameplate data.	Parameter group 1-2* Motor Data	As stated on motor nameplate.
Perform a full AMA.	Parameter 1-29 Automatic Motor Adaption (AMA)	[1] Enable complete AMA.
2) Check that motor is running in the correct direction. When the motor is connected to the frequency converter with straight forward phase order as U-U; V-V; W-W, the motor shaft usually turns clockwise seen into shaft end.		
Press [Hand On]. Check the shaft direction by applying a manual reference.		

Function	Parameter number	Setting
If the motor turns opposite of required direction: 1. Change motor direction in <i>parameter 4-10 Motor Speed Direction</i> . 2. Turn off mains, and wait for DC link to discharge. 3. Switch 2 of the motor phases.	<i>Parameter 4-10 Motor Speed Direction</i>	Select correct motor shaft direction.
Set configuration mode.	<i>Parameter 1-00 Configuration Mode</i>	[3] Process.
3) Set reference configuration, that is the range for reference handling. Set scaling of analog input in <i>parameter group 6-** Analog In/Out</i> .		
Set reference/feedback units. Set minimum reference (10 °C (50 °F)). Set maximum reference (80 °C (176 °F)). If the set value is determined from a preset value (array parameter), set other reference sources to [0] No Function.	<i>Parameter 3-01 Reference/Feedback Unit</i> <i>Parameter 3-02 Minimum Reference</i> <i>Parameter 3-03 Maximum Reference</i> <i>Parameter 3-10 Preset Reference</i>	[60] °C Unit shown on display. -5 °C (23 °F). 35 °C (95 °F). [0] 35%. $Ref = \frac{Par. 3 - 10_{[0]}}{100} \times ((Par. 3 - 03) - (par. 3 - 02)) = 24,5^{\circ}C$ Parameter 3-14 Preset Relative Reference to parameter 3-18 Relative Scaling Reference Resource [0] = No Function.
4) Adjust limits for the frequency converter:		
Set ramp times to an appropriate value as 20 s.	<i>Parameter 3-41 Ramp 1 Ramp Up Time</i> <i>Parameter 3-42 Ramp 1 Ramp Down Time</i>	20 s 20 s
Set minimum speed limits. Set motor speed maximum limit. Set maximum output frequency.	<i>Parameter 4-12 Motor Speed</i> Low Limit [Hz] <i>Parameter 4-14 Motor Speed</i> High Limit [Hz] <i>Parameter 4-19 Max Output Frequency</i>	10 Hz 50 Hz 60 Hz
Set <i>parameter 6-19 Terminal 53 mode</i> and <i>parameter 6-29 Terminal 54 mode</i> to voltage or current mode.		
5) Scale analog inputs used for reference and feedback:		

Function	Parameter number	Setting
Set terminal 53 low voltage. Set terminal 53 high voltage. Set terminal 54 low feedback value. Set terminal 54 high feedback value. Set feedback source.	<i>Parameter 6-10</i> <i>Terminal 53</i> <i>Low Voltage</i> <i>Parameter 6-11</i> <i>Terminal 53</i> <i>High Voltage</i> <i>Parameter 6-24</i> <i>Terminal 54</i> <i>Low Ref./Feedb. Value</i> <i>Parameter 6-25</i> <i>Terminal 54</i> <i>High Ref./Feedb. Value</i> <i>Parameter 7-20</i> <i>Process CL</i> <i>Feedback 1</i> <i>Resource</i>	0 V 10 V -5 °C (23 °F) 35 °C (95 °F) [2] Analog input 54
6) Basic PID settings:		
Process PID normal/inverse.	<i>Parameter 7-30</i> <i>Process PID</i> <i>Normal/</i> <i>Inverse Control</i>	[0] Normal
Process PID anti wind-up.	<i>Parameter 7-31</i> <i>Process PID</i> <i>Anti Windup</i>	[1] On
Process PID start speed.	<i>Parameter 7-32</i> <i>Process PID</i> <i>Start Speed</i>	300 RPM
Save parameters to LCP.	<i>Parameter 0-50</i> <i>LCP Copy</i>	[1] All to LCP

Table 2.11 Example of Process PID Control Set-up

2.5.5 Process Controller Optimization

After configuring the basic settings as described in *chapter 2.5.5 Programming Order*, optimize the proportional gain, the integration time, and the differentiation time (*parameter 7-33 Process PID Proportional Gain*, *parameter 7-34 Process PID Integral Time*, and *parameter 7-35 Process PID Differentiation Time*). In most processes, complete the following procedure:

1. Start the motor.
2. Set *parameter 7-33 Process PID Proportional Gain* to 0.3 and increase it until the feedback signal again begins to vary continuously. Reduce the value until the feedback signal has stabilized. Lower the proportional gain by 40–60%.
3. Set *parameter 7-34 Process PID Integral Time* to 20 s and reduce the value until the feedback signal again begins to vary continuously. Increase

the integration time until the feedback signal stabilizes, followed by an increase of 15–50%.

4. Only use *parameter 7-35 Process PID Differentiation Time* for fast-acting systems (differentiation time). The typical value is 4 times the set integration time. Use the differentiator when the setting of the proportional gain and the integration time has been fully optimized. Make sure that the lowpass filter dampens the oscillations on the feedback signal sufficiently.

NOTICE

If necessary, start/stop can be activated several times to provoke a variation of the feedback signal.

2.5.6 Ziegler Nichols Tuning Method

To tune the PID controls of the frequency converter, Danfoss recommends the Ziegler Nichols tuning method.

NOTICE

Do not use the Ziegler Nichols Tuning method in applications that could be damaged by the oscillations created by marginally stable control settings.

The criteria for adjusting the parameters are based on evaluating the system at the limit of stability rather than on taking a step response. Increase the proportional gain until observing continuous oscillations (as measured on the feedback), that is, until the system becomes marginally stable. The corresponding gain (K_u) is called the ultimate gain and is the gain, at which the oscillation is obtained. The period of the oscillation (P_u) (called the ultimate period) is determined as shown in *Illustration 2.26* and should be measured when the amplitude of oscillation is small.

1. Select only proportional control, meaning that the integral time is set to the maximum value, while the differentiation time is set to 0.
2. Increase the value of the proportional gain until the point of instability is reached (sustained oscillations) and the critical value of gain, K_u , is reached.
3. Measure the period of oscillation to obtain the critical time constant, P_u .

4. Use *Table 2.12* to calculate the necessary PID control parameters.

The process operator can do the final tuning of the control iteratively to yield satisfactory control.

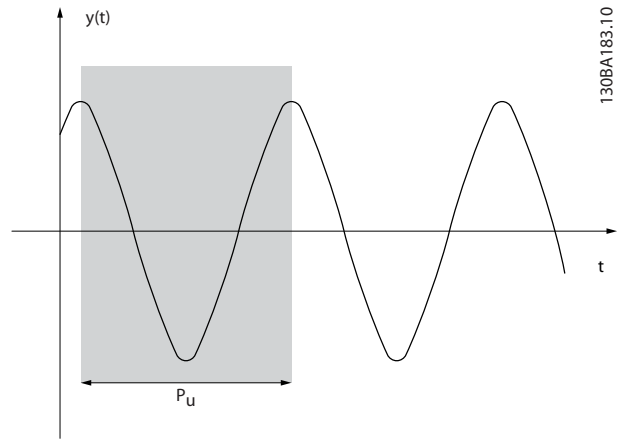

Illustration 2.26 Marginally Stable System

Type of control	Proportional gain	Integral time	Differentiation time
PI-control	$0.45 \times K_u$	$0.833 \times P_u$	–
PID tight control	$0.6 \times K_u$	$0.5 \times P_u$	$0.125 \times P_u$
PID some overshoot	$0.33 \times K_u$	$0.5 \times P_u$	$0.33 \times P_u$

Table 2.12 Ziegler Nichols Tuning for Regulator

2.6 EMC Emission and Immunity

2.6.1 General Aspects of EMC Emission

Burst transient is conducted at frequencies in the range 150 kHz to 30 MHz. Airborne interference from the frequency converter system in the range 30 MHz to 1 GHz is generated from the frequency converter, motor cable, and motor. Capacitive currents in the motor cable coupled with a high dU/dt from the motor voltage generate leakage currents. Using a shielded motor cable increases the leakage current (see *Illustration 2.27*) because shielded cables have higher capacitance to ground than unshielded cables. If the leakage current is not filtered, it causes greater interference on the mains in the radio frequency range below approximately 5 MHz. Since the leakage current (I_1) is carried back to the unit through the shield (I_3), there is only a small electro-magnetic field (I_4) from the shielded motor cable.

The shield reduces the radiated interference but increases the low-frequency interference on the mains. Connect the motor cable shield to the frequency converter enclosure and the motor enclosure. This is best done by using integrated shield clamps to avoid twisted shield ends (pigtailed). The shield clamps increase the shield impedance at higher frequencies, which reduces the shield effect and increases the leakage current (I_4).

Mount the shield on the enclosure at both ends if a shielded cable is used for the following purposes:

- Fieldbus
- Network
- Relay

- Control cable
- Signal interface
- Brake

In some situations, however, it is necessary to break the shield to avoid current loops.

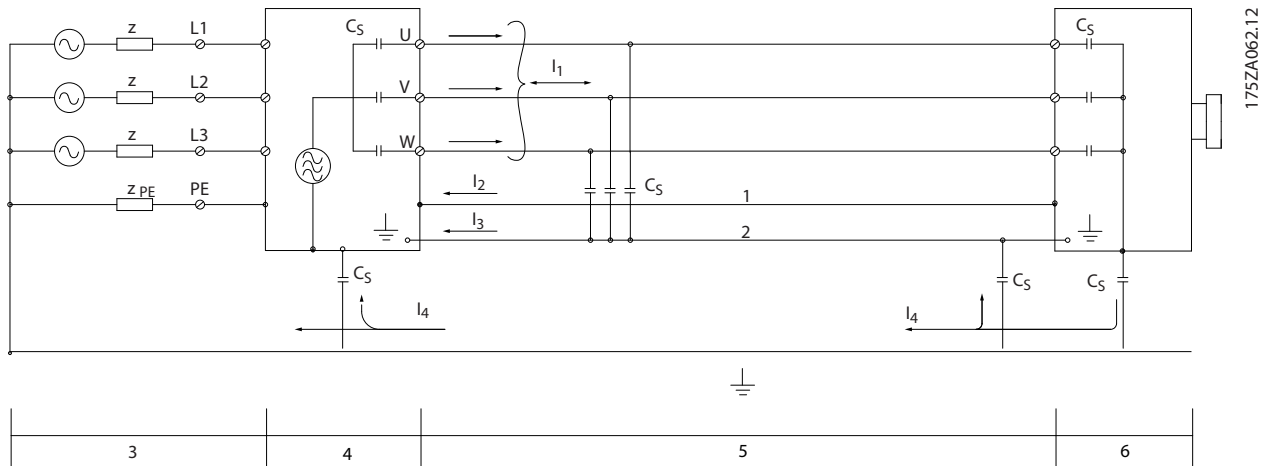

1	Ground cable
2	Shield
3	AC mains supply
4	Frequency converter
5	Shielded motor cable
6	Motor

Illustration 2.27 EMC Emission

If placing the shield on a mounting plate for the frequency converter, use a metal mounting plate to convey the shield currents back to the unit. Ensure good electrical contact from the mounting plate through the mounting screws to the frequency converter chassis.

When using unshielded cables, some emission requirements are not complied with, although the immunity requirements are observed.

To reduce the interference level from the entire system (unit and installation), make motor and brake cables as short as possible. Avoid placing cables with a sensitive signal level alongside mains, motor, and brake cables. Radio interference higher than 50 MHz (airborne) is especially generated by the control electronics.

2.6.2 EMC Emission

2

The test results in *Table 2.13* have been obtained using a system with a frequency converter (with the mounting plate), a motor, and shielded motor cables.

Filter type (internal)	Supply voltage/rated power			Class A2/EN 55011		Class A1/EN 55011		Class B/EN 55011	
	3x380–480 V	3x200–240 V	1x200–240 V	Conducted	Radiated	Conducted	Radiated	Conducted	Radiated
A2 filter	0.37–22 kW (0.5–30 hp)	–	–	25 m (82 ft)	Yes ¹⁾	–	–	–	–
	–	0.37–4 kW (0.5–5.4 hp)	–	25 m (82 ft)	Yes ¹⁾	–	–	–	–
	–	–	0.37–2.2 kW (0.5–3 hp)	–	–	–	–	–	–
A1 filter	0.37–7.5 kW (0.5–10 hp)	–	–	25 m (82 ft)	Yes ¹⁾	25 m (82 ft)	Yes	–	–
	11–22 kW (15–30 hp)	–	–	50 m (164 ft)	Yes ¹⁾	50 m (164 ft)	Yes	–	–
	–	–	0.37–2.2 kW (0.5–3 hp)	40 m (131 ft)	Yes ¹⁾	40 m (131 ft)	Yes	15 m (49.2 ft)	–
A2 filter EMC screw removed ²⁾	0.37–22 kW (0.5–30 hp)	–	–	–	–	–	–	–	–
	–	0.37–4 kW (0.5–5.4 hp)	–	–	–	–	–	–	–
	–	–	0.37–2.2 kW (0.5–3 hp)	–	–	–	–	–	–
A1 filter EMC screw removed ²⁾	0.37–7.5 kW (0.5–10 hp)	–	–	5 m (16.4 ft)	Yes ¹⁾	–	–	–	–
	11–22 kW (15–30 hp)	–	–	5 m (16.4 ft)	Yes ¹⁾	–	–	–	–
	–	–	0.37–2.2 kW (0.5–3 hp)	5 m (16.4 ft)	Yes ¹⁾	–	–	–	–

Table 2.13 EMC Emission (Filter type: internal)

1) Frequency range from 150 kHz to 30 MHz is not harmonized between IEC/EN 61800-3 and EN 55011 and not mandatorily included.

2) Low ground leakage current. Compatible to run on ELCB/IT mains.

The test results in *Table 2.14* have been obtained using a system with a frequency converter (with the mounting plate), an external filter, a motor, and shielded motor cables. 3-phase 380–480 V frequency converter should be with internal A1 filter.

Filter type (external)	Supply voltage/rated power			Class A2/EN 55011		Class A1/EN 55011		Class B/EN 55011	
	3x380–480 V	3x200–240 V	1x200–240 V	Conducted	Radiated	Conducted	Radiated	Conducted	Radiated
EMC filter	0.37–22 kW (0.5–30 hp)	–	–	100 m (328 ft)	Yes ¹⁾	100 m (328 ft)	Yes	25 m (82 ft)	–
	–	0.37–4 kW (0.5–5.4 hp)	–	–	–	–	–	–	–
	–	–	0.37–2.2 kW (0.5–3 hp)	100 m (328 ft)	Yes ¹⁾	100 m (328 ft)	Yes	40 m (131 ft)	–
dU/dt filter	0.37–7.5 kW (0.5–10 hp)	–	–	–	–	–	–	–	–
	11–22 kW (15–30 hp)	–	–	150 m (492 ft)	Yes ¹⁾	40 m (131 ft)	Yes	–	–
	–	0.37–4 kW (0.5–5.4 hp)	–	–	–	–	–	–	–
	–	–	0.37–2.2 kW (0.5–3 hp)	–	–	–	–	–	–
Sine-wave filter	0.37–7.5 kW (0.5–10 hp)	–	–	50 m (164 ft)	Yes ¹⁾	50 m (164 ft)	Yes	–	–
	11–15 kW (15–20 hp)	–	–	150 m (492 ft)	Yes ¹⁾	50 m (164 ft)	Yes	–	–
	18.5–22 kW (25–30 hp)	–	–	150 m (492 ft)	Yes ¹⁾	100 m (328 ft)	Yes	–	–
	–	0.37–4 kW (0.5–5.4 hp)	–	–	–	–	–	–	–
	–	–	0.37–2.2 kW (0.5–3 hp)	50 m (164 ft)	Yes ¹⁾	50 m (164 ft)	Yes	–	–
EMC filter + sine-wave filter	0.37–15 kW (0.5–20 hp)	–	–	150 m (492 ft)	Yes ¹⁾	100 m (328 ft)	Yes	–	–
	18.5–22 kW (25–30 hp)	–	–	–	–	–	–	–	–
	–	0.37–4 kW (0.5–5.4 hp)	–	–	–	–	–	–	–
	–	–	0.37–2.2 kW (0.5–3 hp)	150 m (492 ft)	Yes ¹⁾	100 m (328 ft)	Yes	–	–

Table 2.14 EMC Emission (Filter type: external)

1) Frequency range from 150 kHz to 30 MHz is not harmonized between IEC/EN 61800-3 and EN 55011 and not mandatorily included.

2.6.3 EMC Immunity

2

VLT® Midi Drive FC 280 complies with the industrial environment requirements, which are higher than the requirements for the home and office environments. Therefore, FC 280 also complies with the lower requirements for home and office environments with a large safety margin.

To document immunity against burst transient from electrical phenomena, the following immunity tests have been made on a system consisting of:

- A frequency converter (with options if relevant).
- A shielded control cable.
- A control box with potentiometer, motor cable, and motor.

The tests were performed in accordance with the following basic standards:

- **EN 61000-4-2 (IEC 61000-4-2) Electrostatic discharges (ESD):** Simulation of electrostatic discharges from human beings.
- **EN 61000-4-3 (IEC 61000-4-3) Radiated immunity:** Amplitude modulated simulation of the effects of radar and radio communication equipment and mobile communications equipment.
- **EN 61000-4-4 (IEC 61000-4-4) Burst transients:** Simulation of interference caused by switching a contactor, relay, or similar devices.
- **EN 61000-4-5 (IEC 61000-4-5) Surge transients:** Simulation of transients caused by, for example, lightning that strikes near installations.
- **EN 61000-4-6 (IEC 61000-4-6) Conducted immunity:** Simulation of the effect from radio-transmission equipment joined by connection cables.

FC 280 follows IEC 61800-3 standard. See *Table 2.15* for details.

Voltage range: 380–480 V					
Product standard	61800-3				
Test	ESD	Radiated immunity	Burst	Surge	Conducted immunity
Acceptance criterion	B	B	B	A	A
Mains cable	–	–	2 kV CN	2 kV/2 Ω DM 2 kV/12 Ω CM	10 V _{RMS}
Motor cable	–	–	4 kV CCC	–	10 V _{RMS}
Brake cable	–	–	4 kV CCC	–	10 V _{RMS}
Load sharing cable	–	–	4 kV CCC	–	10 V _{RMS}
Relay cable	–	–	4 kV CCC	–	10 V _{RMS}
Control cable	–	–	Length >2 m (6.6 ft) 1 kV CCC	Unshielded: 1 kV/42 Ω CM	10 V _{RMS}
Standard/fieldbus cable	–	–	Length >2 m (6.6 ft) 1 kV CCC	Unshielded: 1 kV/42 Ω CM	10 V _{RMS}
LCP cable	–	–	Length >2 m (6.6 ft) 1 kV CCC	–	10 V _{RMS}
Enclosure	4 kV CD 8 kV AD	10 V/m	–	–	–
Definitions					
CD: Contact discharge AD: Air discharge		DM: Differential mode CM: Common mode		CN: Direct injection through coupling network CCC: Injection through capacitive coupling clamp	

Table 2.15 EMC Immunity

2.7 Galvanic Isolation

PELV offers protection through extra low voltage. Protection against electric shock is ensured when the electrical supply is of the PELV type and the installation is made as described in local/national regulations on PELV supplies.

All control terminals and relay terminals 01–03 comply with PELV (protective extra low voltage). This does not apply to grounded Delta leg above 400 V.

Galvanic (ensured) isolation is obtained by fulfilling requirements for higher isolation and by providing the relevant creepage/clearance distances. These requirements are described in the EN 61800-5-1 standard.

The components that make up the electrical isolation, as shown in *Illustration 2.28*, also comply with the requirements for higher isolation and the relevant test as described in EN 61800-5-1.

The PELV galvanic isolation can be shown in 3 locations (see *Illustration 2.28*):

To maintain PELV, all connections made to the control terminals must be PELV, for example, the thermistor must be reinforced/double insulated.

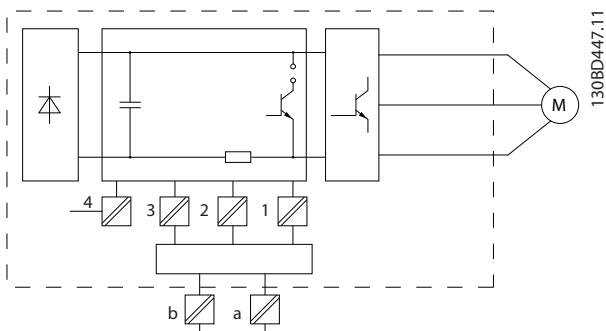

1	Power supply (SMPS) for control cassette
2	Communication between power card and control cassette
3	Isolation between STO inputs and IGBT circuit
4	Customer relay

Illustration 2.28 Galvanic Isolation

The functional galvanic isolation (a and b on *Illustration 2.28*) is for the 24 V back-up option and the RS485 standard bus interface.

⚠ WARNING

Before touching any electrical parts, ensure that other voltage inputs have been disconnected, such as load sharing (linkage of DC intermediate circuit) and the motor connection for kinetic back-up. Observe the discharge time stated in *chapter Safety* in the *VLT® Midi Drive FC 280 Operating Guide*. Failure to follow recommendations could result in death or serious injury.

2.8 Ground Leakage Current

Follow national and local codes regarding protective grounding of equipment with a leakage current >3.5 mA. Frequency converter technology implies high frequency switching at high power. This switching generates a leakage current in the ground connection. A fault current in the frequency converter at the output power terminals might contain a DC component, which can charge the filter capacitors and cause a transient ground current. The ground leakage current is made up of several contributions and depends on various system configurations including RFI filtering, shielded motor cables, and frequency converter power.

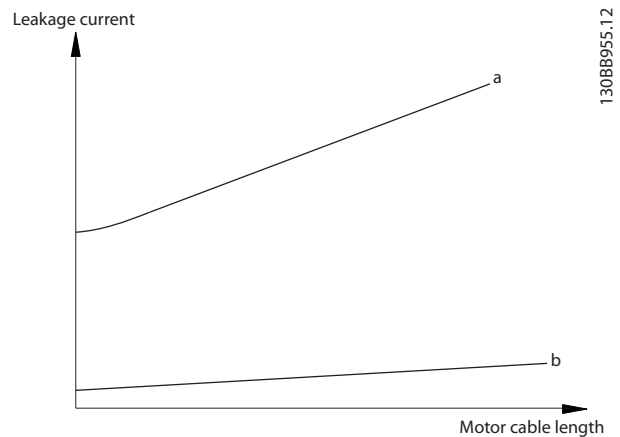

Illustration 2.29 Influence the Cable Length and Power Size on Leakage Current, $P_a > P_b$

The leakage current also depends on the line distortion.

2

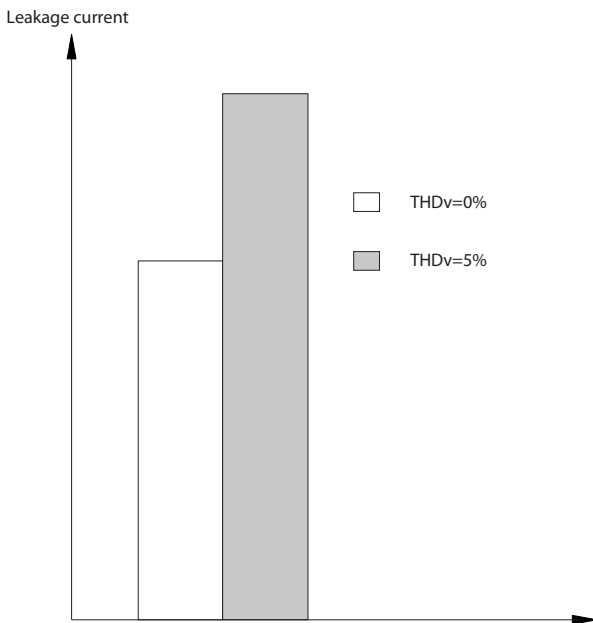

Illustration 2.30 Influence of Line Distortion on Leakage Current

NOTICE

High leakage current may cause the RCDs to switch off. To avoid this problem, remove the RFI screw when a filter is being charged.

EN/IEC61800-5-1 (Power Drive System Product Standard) requires special care if the leakage current exceeds 3.5 mA. Grounding must be reinforced in 1 of the following ways:

- Ground wire (terminal 95) of at least 10 mm² (8 AWG).
- 2 separate ground wires that comply with the dimensioning rules.

See EN/IEC61800-5-1 for further information.

Using RCDs

Where residual current devices (RCDs), also known as earth leakage circuit breakers (ELCBs), are used, comply with the following:

- Use RCDs of type B only, which are capable of detecting AC and DC currents.
- Use RCDs with an inrush delay to prevent faults caused by transient ground currents.
- Dimension RCDs according to the system configuration and environmental considerations.

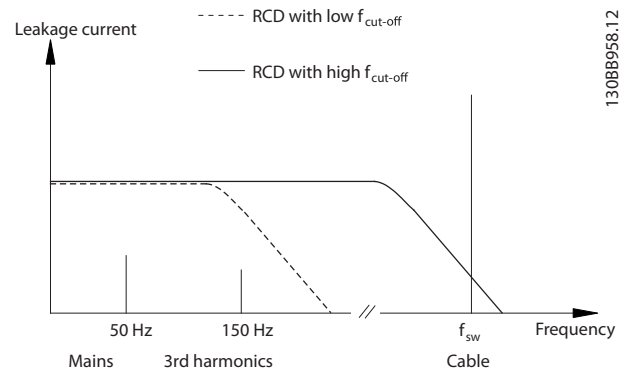

Illustration 2.31 Mains Contributions to Leakage Current

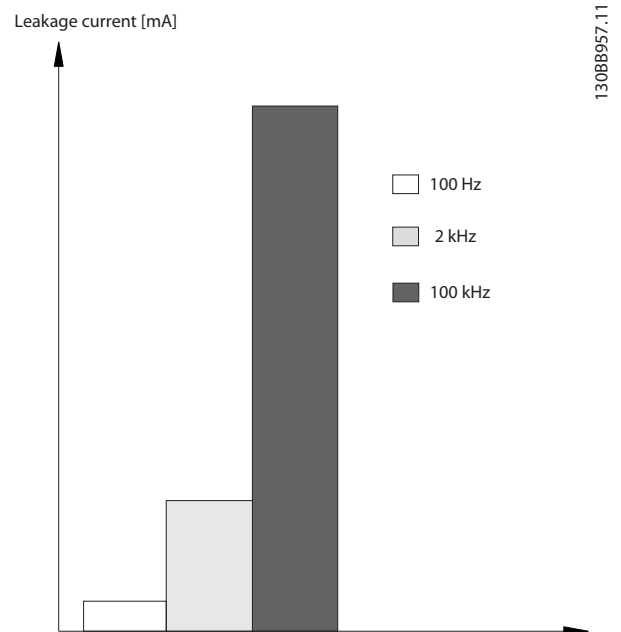

Illustration 2.32 Influence of Cut-off Frequency of the RCD on what is Responded to/Measured

For more details, refer to the *RCD Application Note*.

2.9 Brake Functions

2.9.1 Mechanical Holding Brake

A mechanical holding brake mounted directly on the motor shaft normally performs static braking.

NOTICE

When the holding brake is included in a safety chain, a frequency converter cannot provide a safe control of a mechanical brake. Include a redundancy circuitry for the brake control in the total installation.

2.9.2 Dynamic Braking

Dynamic braking is established by:

- Resistor brake: A brake IGBT keeps the overvoltage under a certain threshold by directing the brake energy from the motor to the connected brake resistor (*parameter 2-10 Brake Function = [1] Resistor brake*). Adjust the threshold in *parameter 2-14 Brake voltage reduce*, with 70 V range for 3x380–480 V.
- AC brake: The brake energy is distributed in the motor by changing the loss conditions in the motor. The AC brake function cannot be used in applications with high cycling frequency as this overheats the motor (*parameter 2-10 Brake Function = [2] AC brake*).
- DC brake: An overmodulated DC current added to the AC current works as an eddy current brake (*parameter 2-02 DC Braking Time≠0 s*).

2.9.3 Brake Resistor Selection

To handle higher demands by generative braking, a brake resistor is necessary. Using a brake resistor ensures that the heat is absorbed in the brake resistor and not in the frequency converter. For more information, see the *VLT® Brake Resistor MCE 101 Design Guide*.

If the amount of kinetic energy transferred to the resistor in each braking period is not known, calculate the average power based on the cycle time and braking time. The resistor intermittent duty cycle is an indication of the duty cycle at which the resistor is active. *Illustration 2.33* shows a typical braking cycle.

The intermittent duty cycle for the resistor is calculated as follows:

$$\text{Duty cycle} = t_b/T$$

t_b is the braking time in seconds.

T = cycle time in seconds.

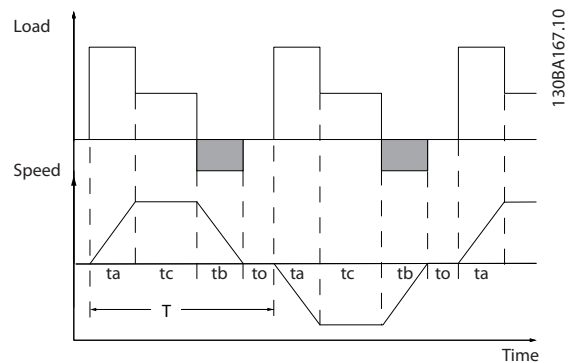

Illustration 2.33 Typical Braking Cycle

Power range:	
0.37–22 kW (0.5–30 hp) 3x380–480 V	
0.37–3.7 kW (0.5–5 hp) 3x200–240 V	
Cycle time (s)	120
Braking duty cycle at 100% torque	Continuous
Braking duty cycle at overtorque (150/160%)	40%

Table 2.16 Braking at High Overload Torque Level

Danfoss offers brake resistors with duty cycles of 10% and 40%. If a 10% duty cycle is applied, the brake resistors are able to absorb brake power for 10% of the cycle time. The remaining 90% of the cycle time is used for dissipating excess heat.

NOTICE

Make sure that the resistor is designed to handle the required braking time.

The maximum allowed load on the brake resistor is stated as a peak power at a given intermittent duty cycle and can be calculated as:

Brake resistance calculation

$$R_{br} [\Omega] = \frac{U_{dc,br}^2 \times 0.83}{P_{peak}}$$

where

$$P_{peak} = P_{motor} \times M_{br} [\%] \times \eta_{motor} \times \eta_{VLT} [W]$$

As shown, the brake resistance depends on the DC-link voltage (U_{dc}).

Size	Brake active $U_{dc,br}$	Warning before cutout	Cutout (trip)
FC 280 3x380–480 V	770 V	800 V	800 V
FC 280 3x200–240 V	390 V	410 V	410 V

Table 2.17 Threshold of the Brake Resistance

The threshold can be adjusted in *parameter 2-14 Brake voltage reduce*, with 70 V range.

NOTICE

The greater the reduction value, the faster the reaction to a generator overload. Should only be used if there are problems with overvoltage in the DC-link voltage.

NOTICE

Make sure that the brake resistor can cope with a voltage of 410 V or 800 V.

Danfoss recommends calculating the brake resistance R_{rec} according to the following formula. The recommended brake resistance guarantees that the frequency converter is able to brake at the highest braking torque ($M_{br(\%)}$) of 160%.

$$R_{rec} [\Omega] = \frac{U_{dc}^2 \times 100 \times 0.83}{P_{motor} \times M_{br(\%)} \times \eta_{VLT} \times \eta_{motor}}$$

η_{motor} is typically at 0.80 (≤ 7.5 kW (10 hp)); 0.85 (11–22 kW (15–30 hp))

η_{VLT} is typically at 0.97

For FC 280, R_{rec} at 160% braking torque is written as:

$$480V : R_{rec} = \frac{396349}{P_{motor}} [\Omega] ^1$$

$$480V : R_{rec} = \frac{397903}{P_{motor}} [\Omega] ^2$$

1) For frequency converters ≤ 7.5 kW (10 hp) shaft output.

2) For frequency converters 11–22 kW (15–30 hp) shaft output.

NOTICE

The resistance of the brake resistor should not be higher than the value recommended by Danfoss. For brake resistors with a higher ohmic value, the 160% braking torque may not be achieved because the frequency converter might cut out for safety reasons. The resistance should be bigger than R_{min} .

NOTICE

If a short circuit in the brake transistor occurs, prevent power dissipation in the brake resistor by using a mains switch or contactor to disconnect the mains for the frequency converter. The frequency converter can control the contactor.

NOTICE

Do not touch the brake resistor because it can get hot during braking. To avoid fire risk, place the brake resistor in a secure environment.

2.9.4 Control with Brake Function

The brake is protected against short-circuiting of the brake resistor, and the brake transistor is monitored to ensure that short-circuiting of the transistor is detected. A relay/digital output can be used for protecting the brake resistor from overloading caused by a fault in the frequency converter.

In addition, the brake enables readout of the momentary power and the mean power for the latest 120 s. The brake can also monitor the power energizing and make sure that it does not exceed a limit selected in *parameter 2-12 Brake Power Limit (kW)*.

NOTICE

Monitoring the brake power is not a safety function. A thermal switch is required to prevent the brake power from exceeding the limit. The brake resistor circuit is not ground leakage protected.

Overvoltage control (OVC) (exclusive brake resistor) can be selected as an alternative brake function in *parameter 2-17 Over-voltage Control*. This function is active for all units. The function ensures that a trip can be avoided if the DC-link voltage increases. This is done by increasing the output frequency to limit the voltage from the DC link. It is a useful function, for example if the ramp-down time is too short to avoid tripping of the frequency converter. In this situation, the ramp-down time is extended.

NOTICE

OVC can be activated when running a PM motor (when *parameter 1-10 Motor Construction* is set to [1] PM non-salient SPM).

2.10 Motor Insulation

Modern design of motors for use with frequency converters have a high degree of insulation to account for new generation high-efficiency IGBTs with high dU/dt. For retrofit in old motors it is necessary to confirm the motor insulation or to mitigate with a dU/dt filter or if necessary a sine-wave filter.

2.10.1 Sine-wave Filters

When a frequency converter controls a motor, resonance noise is heard from the motor. This noise, which is the result of the motor design, occurs every time an inverter switch in the frequency converter is activated. The frequency of the resonance noise thus corresponds to the switching frequency of the frequency converter.

Danfoss supplies a sine-wave filter to dampen the acoustic motor noise.

The filter reduces the ramp-up time of the voltage, the peak load voltage U_{PEAK} , and the ripple current ΔI to the motor, which means that current and voltage become almost sinusoidal. So, the acoustic motor noise is reduced to a minimum.

The ripple current in the sine-wave filter coils also causes some noise. Solve the problem by integrating the filter in a cabinet or similar.

2.10.2 dU/dt Filters

Danfoss supplies dU/dt filters. dU/dt filters are differential mode, low-pass filters that reduce motor terminal phase-to-phase peak voltages and reduce the rise time to a level that lowers the stress on the insulation at the motor windings. This is especially an issue with short motor cables.

Compared to the sine-wave filters (see *chapter 2.10.1 Sine-wave Filters*), the dU/dt filters have a cut-off frequency above the switching frequency.

2.11 Smart Logic Controller

Smart logic control (SLC) is a sequence of user-defined actions (see *parameter 13-52 SL Controller Action [x]*) executed by the SLC when the associated user-defined event (see *parameter 13-51 SL Controller Event [x]*) is evaluated as true by the SLC.

The condition for an event can be a particular status or that the output from a logic rule or a comparator operand becomes true. That leads to an associated action as shown in *Illustration 2.34*.

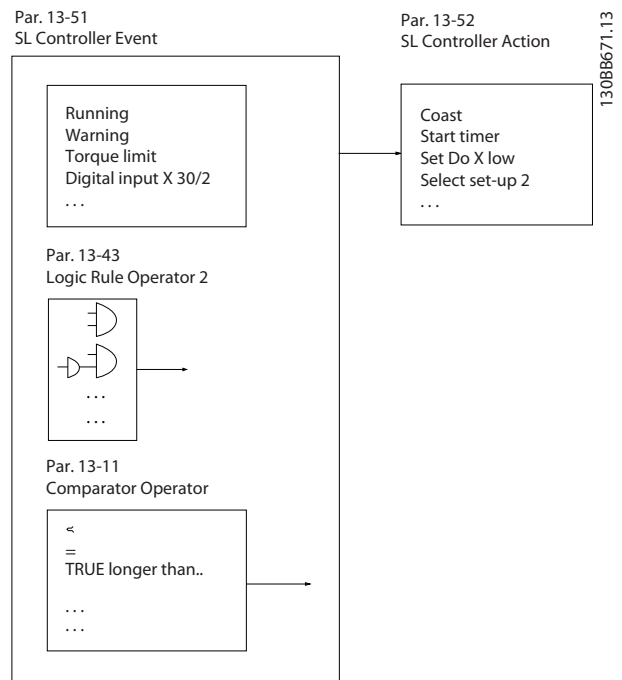

Illustration 2.34 Associated Action

Events and actions are each numbered and linked in pairs (states). This means that when event [0] is fulfilled (attains the value true), action [0] is executed. After this, the conditions of event [1] are evaluated and if evaluated true, action [1] is executed, and so on. Only 1 event is evaluated at any time. If an event is evaluated as false, nothing happens (in the SLC) during the current scan interval, and no other events are evaluated. When the SLC starts, it evaluates event [0] (and only event [0]) each scan interval. Only when event [0] is evaluated true, the SLC executes action [0] and starts evaluating event [1]. It is possible to program 1–20 events and actions.

When the last event/action has been executed, the sequence starts over again from event [0]/action [0].

Illustration 2.35 shows an example with 3 event/actions:

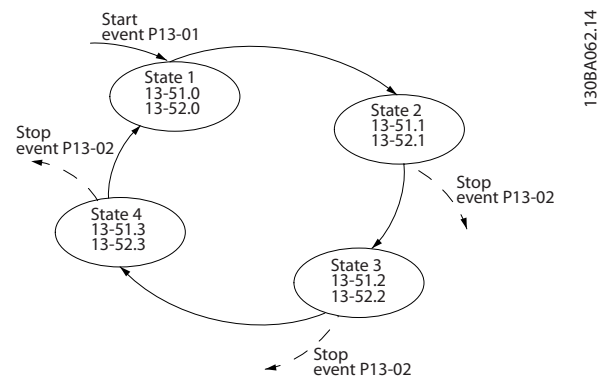

Illustration 2.35 Sequence with 3 Events/Actions

Comparators

Comparators are used for comparing continuous variables (for example output frequency, output current, and analog input) to fixed preset values.

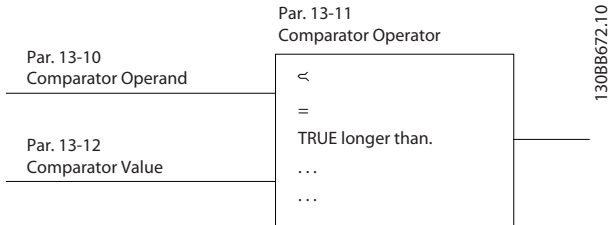

Illustration 2.36 Comparators

Logic rules

Combine up to 3 boolean inputs (true/false inputs) from timers, comparators, digital inputs, status bits, and events using the logical operators and, or, and not.

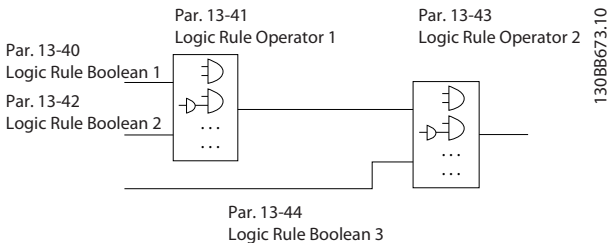

Illustration 2.37 Logic Rules

2.12 Extreme Running Conditions

Short circuit (motor phase-to-phase)

The frequency converter is protected against short circuits by current measurement in each of the 3 motor phases or in the DC link. A short circuit between 2 output phases causes an overcurrent in the frequency converter. The frequency converter is turned off individually when the short-circuit current exceeds the allowed value (*alarm 16, trip lock*).

Switching on the output

Switching on the output between the motor and the frequency converter is fully allowed, and does not damage the frequency converter. However, fault messages may appear.

Motor-generated overvoltage

The voltage in the DC link is increased when the motor acts as a generator. This occurs in following cases:

- The load drives the motor (at constant output frequency from the frequency converter).
- If the inertia moment is high during deceleration (ramp-down), the friction is low and the ramp-down time is too short for the energy to be dissipated as a loss in the frequency converter, the motor, and the installation.

- Incorrect slip compensation setting may cause higher DC-link voltage.

The control unit may attempt to correct the ramp if possible (*parameter 2-17 Over-voltage Control*).

The frequency converter turns off to protect the transistors and the DC link capacitors when a certain voltage level is reached.

To select the method used for controlling the DC-link voltage level, see *parameter 2-10 Brake Function* and *parameter 2-17 Over-voltage Control*.

Mains drop-out

During a mains drop-out, the frequency converter keeps running until the DC-link voltage drops below the minimum stop level, which is:

- 314 V for 3x380–480 V.
- 202 V for 3x200–240 V.
- 225 V for 1x200–240 V.

The mains voltage before the drop-out and the motor load determines how long it takes for the inverter to coast.

Static overload in VVC+ mode

When the frequency converter is overloaded, the torque limit in *parameter 4-16 Torque Limit Motor Mode*/*parameter 4-17 Torque Limit Generator Mode* is reached, the control unit reduces the output frequency to reduce the load.

If the overload is excessive, a overcurrent which makes the frequency converter cut out after approximately 5–10 s may occur.

Operation within the torque limit is limited in time (0–60 s) in *parameter 14-25 Trip Delay at Torque Limit*.

2.12.1 Motor Thermal Protection

To protect the application from serious damage, VLT® Midi Drive FC 280 offers several dedicated features.

Torque limit

The torque limit protects the motor from being overloaded independent of the speed. Torque limit is controlled in *parameter 4-16 Torque Limit Motor Mode* and *parameter 4-17 Torque Limit Generator Mode*. *Parameter 14-25 Trip Delay at Torque Limit* controls the time before the torque limit warning trips.

Current limit

Parameter 4-18 Current Limit controls the current limit, and *parameter 14-24 Trip Delay at Current Limit* controls the time before the current limit warning trips.

Minimum speed limit

Parameter 4-12 Motor Speed Low Limit [Hz] sets the minimum output speed that the frequency converter can provide.

Maximum speed limit

Parameter 4-14 Motor Speed High Limit [Hz] or parameter 4-19 Max Output Frequency sets the maximum output speed that the frequency converter can provide.

ETR (electronic thermal relay)

The frequency converter ETR function measures the actual current, speed, and time to calculate motor temperature. The function also protects the motor from being overheated (warning or trip). An external thermistor input is also available. ETR is an electronic feature that simulates a bimetal relay based on internal measurements. The characteristic is shown in *Illustration 2.38*.

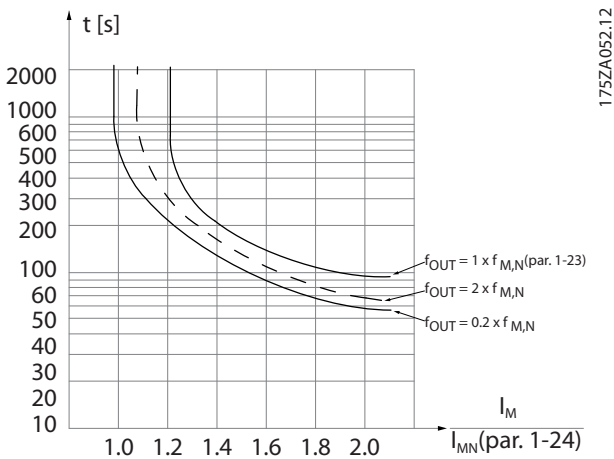

Illustration 2.38 ETR

The X-axis shows the ratio between I_{motor} and I_{motor} nominal. The Y-axis shows the time in seconds before the ETR cuts off and trips the frequency converter. The curves show the characteristic nominal speed at twice the nominal speed and at 0.2 x the nominal speed. At lower speed, the ETR cuts off at lower heat due to less cooling of the motor. In that way, the motor is protected from being overheated even at low speed. The ETR feature calculates the motor temperature based on actual current and speed. The calculated temperature is visible as a readout parameter in *parameter 16-18 Motor Thermal*.

3 Application Examples

3.1 Introduction

3

3.1.1 Encoder Connection

The purpose of this guideline is to ease the set-up of encoder connection to the frequency converter. Before setting up the encoder, the basic settings for a closed-loop speed control system are shown.

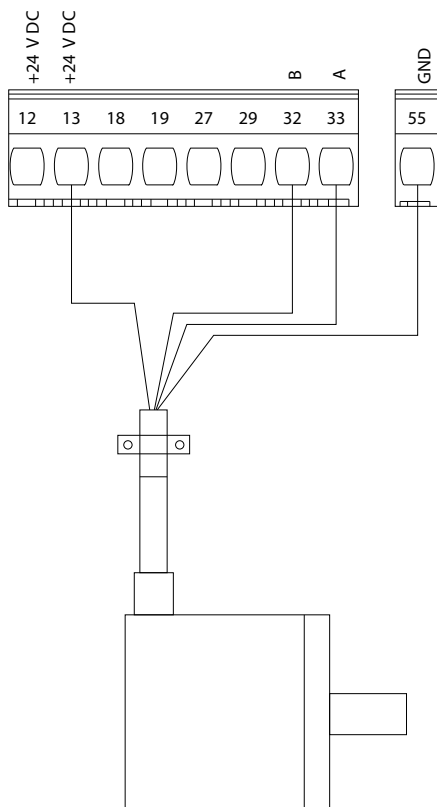

Illustration 3.1 24 V Encoder

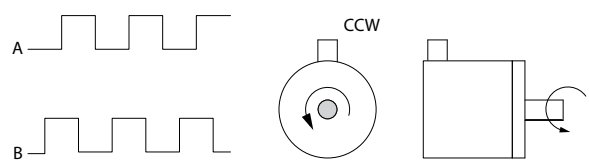
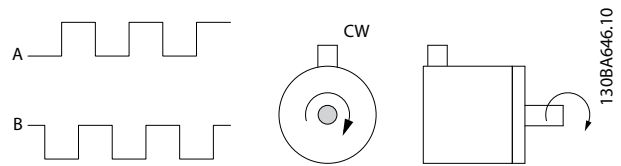

Illustration 3.2 24 V Incremental Encoder, Maximum Cable Length 5 m (16.4 ft)

3.1.2 Encoder Direction

The order in which the pulses enter the frequency converter determines the direction of the encoder. Clockwise direction means that channel A is 90 electrical degrees before channel B. Counterclockwise direction means that channel B is 90 electrical degrees before A. The direction is determined by looking into the shaft end.

3.1.3 Closed-loop Drive System

A drive system usually consists of more elements such as:

- Motor.
- Brake (gearbox, mechanical brake).
- Frequency converter.
- Encoder as feedback system.
- Brake resistor for dynamic brake.
- Transmission.
- Load.

Applications demanding mechanical brake control usually need a brake resistor.

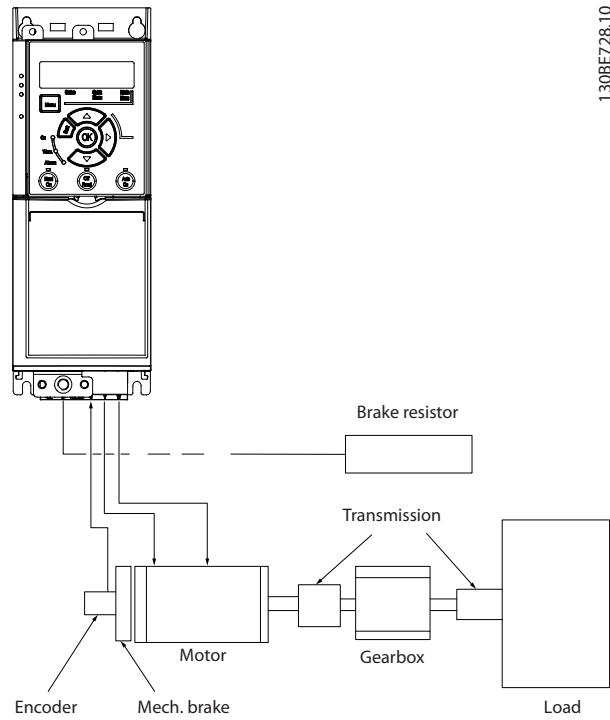

Illustration 3.3 Basic Set-up for Closed-loop Speed Control

3.2.2 Speed

FC		Parameters	
		Function	Setting
+24 V	12	Parameter 6-10 Terminal 53 Low Voltage	0.07 V*
+24 V	13		10 V*
D IN	18		0
D IN	19		50
D IN	27		[1] Voltage
D IN	29		* = Default value
D IN	32		Notes/comments:
D IN	33		
+10 V	50	Parameter 6-15 Terminal 53 High Ref./Feedb. Value	50
A IN	53		
A IN	54		
COM	55	Parameter 6-19 Terminal 53 mode	[1] Voltage
A OUT	42	0 ~ 10 V	

Table 3.2 Analog Speed Reference (Voltage)

3.2 Application Examples

3.2.1 AMA

FC		Parameters	
		Function	Setting
+24 V	12	Parameter 1-29 Automatic Motor Adaptation (AMA)	[1] Enable complete AMA
+24 V	13		*[2] Coast inverse
D IN	18		* = Default value
D IN	19		Notes/comments: Set parameter group 1-2* Motor Data according to motor specifications.
D IN	27		NOTICE
D IN	29		If terminal 13 and 27 are not connected, set parameter 5-12 Terminal 27 Digital Input to [0] No operation.
D IN	32		
D IN	33		
+10 V	50		
A IN	53		
A IN	54		
COM	55		
A OUT	42		

Table 3.1 AMA with T27 Connected

FC		Parameters	
		Function	Setting
+24 V	12	Parameter 6-22 Terminal 54 Low Current	4 mA*
+24 V	13		20 mA*
D IN	18		0
D IN	19		50
D IN	27		[0] Current
D IN	29		* = Default value
D IN	32		Notes/comments:
D IN	33		
+10 V	50	Parameter 6-25 Terminal 54 High Ref./Feedb. Value	50
A IN	53		
A IN	54		
COM	55	Parameter 6-29 Terminal 54 mode	[0] Current
A OUT	42	4 - 20mA	

Table 3.3 Analog Speed Reference (Current)

		Parameters	
FC		Function	Setting
+24 V	12	Parameter 6-10 Terminal 53 Low Voltage	0.07 V*
+24 V	13		
D IN	18		
D IN	19		
D IN	27		
D IN	29		
D IN	32	Parameter 6-11 Terminal 53 High Voltage	10 V*
D IN	33	Parameter 6-14 Terminal 53 Low Ref./Feedb. Value	0
+10 V	50	Parameter 6-15 Terminal 53 High Ref./Feedb. Value	50
A IN	53	Parameter 6-19 Terminal 53 mode	[1] Voltage
A IN	54	* = Default value	
COM	55	Notes/comments:	
A OUT	42		

Table 3.4 Speed Reference (Using a Manual Potentiometer)

		Parameters	
FC		Function	Setting
+24 V	12	Parameter 5-10 Terminal 18 Digital Input	*[8] Start
+24 V	13		
D IN	18		
D IN	19		
D IN	27		
D IN	29		
D IN	32	Parameter 5-12 Terminal 27 Digital Input	[19] Freeze Reference
D IN	33	Parameter 5-13 Terminal 29 Digital Input	[21] Speed Up
+10 V	50	Parameter 5-14 Terminal 32 Digital Input	[22] Speed Down
A IN	53	* = Default value	
A IN	54	Notes/comments:	
COM	55		
A OUT	42		

Table 3.5 Speed Up/Speed Down

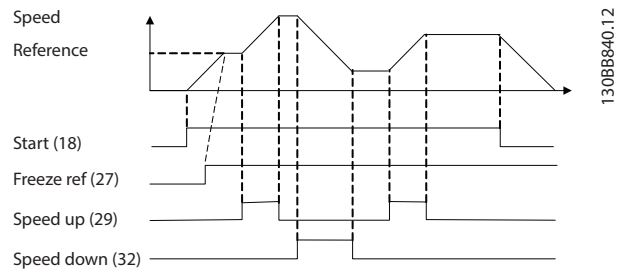

Illustration 3.4 Speed Up/Speed Down

3.2.3 Start/Stop

		Parameters	
FC		Function	Setting
+24 V	12	Parameter 5-10 Terminal 18 Digital Input	[8] Start
+24 V	13		
D IN	18		
D IN	19		
D IN	27		
D IN	29		
D IN	32	Parameter 5-11 Terminal 19 Digital Input	*[10] Reversing
D IN	33	Parameter 5-12 Terminal 27 Digital Input	[0] No operation
+10 V	50	Parameter 5-14 Terminal 32 Digital Input	[16] Preset ref bit 0
A IN	53	Parameter 5-15 Terminal 33 Digital Input	[17] Preset ref bit 1
A IN	54	Parameter 3-10 Preset Reference	
COM	55	Preset ref. 0	25%
A OUT	42	Preset ref. 1	50%
		Preset ref. 2	75%
		Preset ref. 3	100%
		* = Default value	
		Notes/comments:	

Table 3.6 Start/Stop with Reversing and 4 Preset Speeds

3.2.4 External Alarm Reset

		Parameters	
FC		Function	Setting
+24 V	12	Parameter 5-11 Terminal 19 Digital Input	[1] Reset
+24 V	13		
D IN	18	* = Default value	
D IN	19	Notes/comments:	
D IN	27		
D IN	29		
D IN	32		
D IN	33		
D IN	33		
+10 V	50		
A IN	53		
A IN	54		
COM	55		
A OUT	42		

Table 3.7 External Alarm Reset

3.2.5 Motor Thermistor

NOTICE

To meet PELV insulation requirements, use reinforced or double insulation on the thermistors.

		Parameters	
FC		Function	Setting
+24 V	12	Parameter 1-90 Motor Thermal Protection	[2] Thermistor trip
+24 V	13		
D IN	18		
D IN	19	Parameter 1-93 Thermistor Source	[1] Analog input 53
D IN	27	Parameter 6-19 Terminal 53 mode	[1] Voltage
D IN	29	* = Default value	
D IN	32	Notes/comments: If only a warning is needed, set parameter 1-90 Motor Thermal Protection to [1] Thermistor warning.	
D IN	33		
+10 V	50		
A IN	53		
A IN	54		
COM	55		
A OUT	42		

Table 3.8 Motor Thermistor

3.2.6 SLC

		Parameters	
FC		Function	Setting
+24 V	12	Parameter 4-30 Motor Feedback Loss Function	[1] Warning
+24 V	13		
D IN	18	Parameter 4-31 Motor Feedback Speed Error	50
D IN	19	Parameter 4-32 Motor Feedback Loss Timeout	5 s
D IN	27	Parameter 7-00 Speed PID Feedback Source	[1] 24 V encoder
D IN	29	Parameter 5-70 Terminal 32/33 Pulses Per Revolution	1024*
D IN	32	Parameter 13-00 SL Controller Mode	[1] On
D IN	33	Parameter 13-01 Start Event	[19] Warning
		Parameter 13-02 Stop Event	[44] Reset key
		Parameter 13-10 Comparator Operand	[21] Warning no.
		Parameter 13-11 Comparator Operator	*[1] ≈
		Parameter 13-12 Comparator Value	61
		Parameter 13-51 SL Controller Event	[22] Comparator 0
		Parameter 13-52 SL Controller Action	[32] Set digital out A low
		Parameter 5-40 Function Relay	[80] SL digital output A
		* = Default value	
		Notes/comments: If the limit in the feedback monitor is exceeded, warning 61, feedback monitor is issued. The SLC monitors warning 61, feedback monitor. If warning 61, feedback monitor becomes true, relay 1 is triggered. External equipment could indicate that service is required. If the feedback error goes below the limit again within 5 s, the frequency converter continues, and the warning disappears. Relay 1 persists until [Off/Reset] is pressed.	

Table 3.9 Using SLC to Set a Relay

4 Safe Torque Off (STO)

The Safe Torque Off (STO) function is a component in a safety control system. STO prevents the unit from generating the energy that is required to rotate the motor, thus ensuring safety in emergency situations.

4

The STO function is designed and approved suitable for the requirements of:

- IEC/EN 61508: SIL2
- IEC/EN 61800-5-2: SIL2
- IEC/EN 62061: SILCL of SIL2
- EN ISO 13849-1: Category 3 PL d

To achieve the required level of operational safety, select and apply the components in the safety control system appropriately. Before using STO, carry out a thorough risk analysis on the installation to determine whether the STO function and safety levels are appropriate and sufficient.

For more information on safe torque off (STO), see *chapter 6 Safe Torque Off (STO)* in the *VLT® Midi Drive FC 280 Operating Guide*.

5 RS485 Installation and Set-up

5.1 Introduction

5.1.1 Overview

RS485 is a 2-wire bus interface compatible with multi-drop network topology. The nodes can be connected as a bus, or via drop cables from a common trunk line. A total of 32 nodes can be connected to 1 network segment. Repeaters divide network segments, see *Illustration 5.1*.

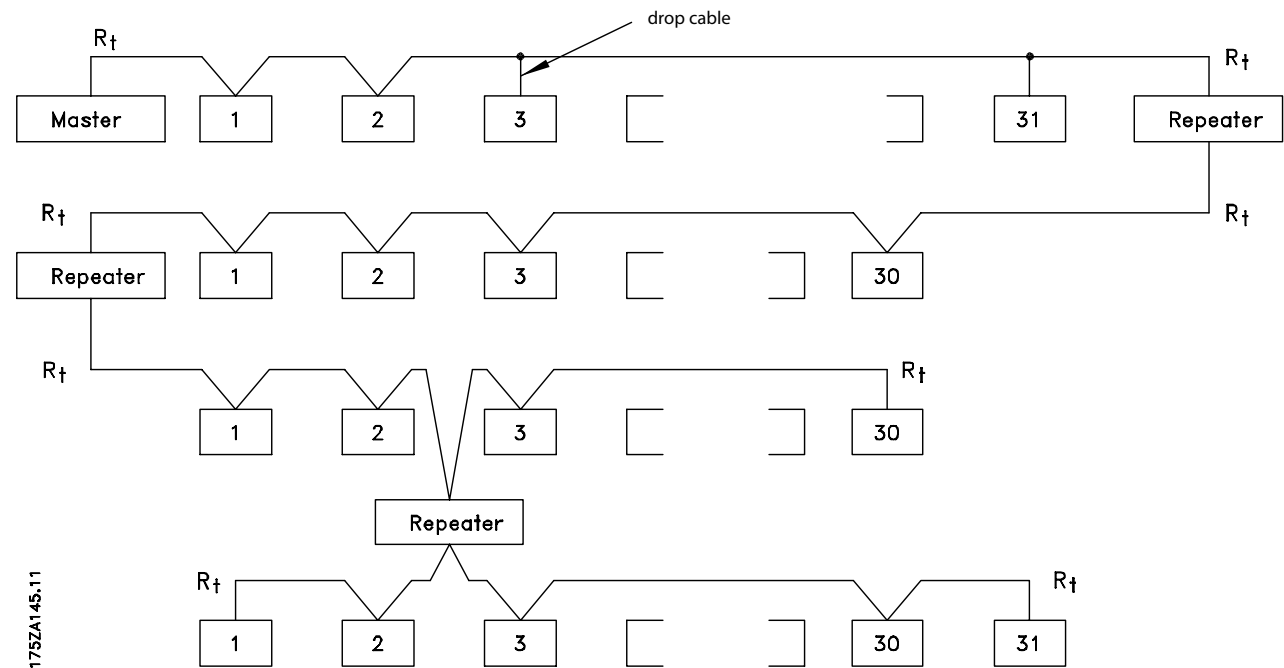

Illustration 5.1 RS485 Bus Interface

NOTICE

Each repeater functions as a node within the segment in which it is installed. Each node connected within a given network must have a unique node address across all segments.

Terminate each segment at both ends, using either the termination switch (S801) of the frequency converters or a biased termination resistor network. Always use shielded twisted pair (STP) cable for bus cabling and follow good common installation practice.

Low-impedance ground connection of the shield at every node is important, including at high frequencies. Thus, connect a large surface of the shield to ground, for example with a cable clamp or a conductive cable gland. Sometimes, it is necessary to apply potential-equalizing cables to maintain the same ground potential throughout the network, particularly in installations with long cables.

To prevent impedance mismatch, use the same type of cable throughout the entire network. When connecting a motor to the frequency converter, always use shielded motor cable.

Cable	Shielded twisted pair (STP)
Impedance [Ω]	120
Cable length [m (ft)]	Maximum 1200 (3937) (including drop lines). Maximum 500 (1640) station-to-station.

Table 5.1 Cable Specifications

5.1.2 Network Connection

Connect the frequency converter to the RS485 network as follows (see also *Illustration 5.2*):

1. Connect signal wires to terminal 68 (P+) and terminal 69 (N-) on the main control board of the frequency converter.
2. Connect the cable shield to the cable clamps.

NOTICE

To reduce noise between conductors, use shielded, twisted-pair cables.

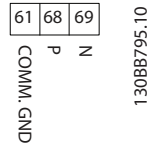

Illustration 5.2 Network Connection

5

5.1.3 Hardware Set-up

To terminate the RS485 bus, use the terminator switch on the main control board of the frequency converter.

The factory setting for the switch is OFF.

5.1.4 Parameter Settings for Modbus Communication

Parameter	Function
Parameter 8-30 Protocol	Select the application protocol to run for the RS485 interface.
Parameter 8-31 Address	Set the node address. NOTICE The address range depends on the protocol selected in parameter 8-30 Protocol.
Parameter 8-32 Baud Rate	Set the baud rate. NOTICE The default baud rate depends on the protocol selected in parameter 8-30 Protocol.
Parameter 8-33 Parity / Stop Bits	Set the parity and number of stop bits. NOTICE The default selection depends on the protocol selected in parameter 8-30 Protocol.
Parameter 8-35 Minimum Response Delay	Specify a minimum delay time between receiving a request and transmitting a response. This function is for overcoming modem turnaround delays.
Parameter 8-36 Maximum Response Delay	Specify a maximum delay time between transmitting a request and receiving a response.

Table 5.2 Modbus Communication Parameter Settings

5.1.5 EMC Precautions

To achieve interference-free operation of the RS485 network, Danfoss recommends the following EMC precautions.

NOTICE

Observe relevant national and local regulations, for example regarding protective earth connection. To avoid coupling of high-frequency noise between the cables, keep the RS485 communication cable away from motor and brake resistor cables. Normally, a distance of 200 mm (8 in) is sufficient. Maintain the greatest possible distance between the cables, especially where cables run in parallel over long distances. When crossing is unavoidable, the RS485 cable must cross motor and brake resistor cables at an angle of 90°.

5.2 FC Protocol

5.2.1 Overview

The FC protocol, also referred to as FC bus or standard bus, is the Danfoss standard fieldbus. It defines an access technique according to the master/slave principle for communications via a fieldbus.

One master and a maximum of 126 slaves can be connected to the bus. The master selects the individual slaves via an address character in the telegram. A slave itself can never transmit without first being requested to do so, and direct telegram transfer between the individual slaves is not possible. Communications occur in the half-duplex mode.

The master function cannot be transferred to another node (single-master system).

The physical layer is RS485, thus utilizing the RS485 port built into the frequency converter. The FC protocol supports different telegram formats:

- A short format of 8 bytes for process data.
- A long format of 16 bytes that also includes a parameter channel.
- A format used for texts.

5.2.2 FC with Modbus RTU

The FC protocol provides access to the control word and bus reference of the frequency converter.

The control word allows the Modbus master to control several important functions of the frequency converter:

- Start.
- Stop of the frequency converter in various ways:
 - Coast stop.
 - Quick stop.
 - DC brake stop.
 - Normal (ramp) stop.
- Reset after a fault trip.
- Run at various preset speeds.
- Run in reverse.
- Change of the active set-up.
- Control of the 2 relays built into the frequency converter.

The bus reference is commonly used for speed control. It is also possible to access the parameters, read their values, and where possible, write values to them. Accessing the parameters offers a range of control options, including controlling the setpoint of the frequency converter when its internal PI controller is used.

5.3 Network Configuration

To enable the FC protocol for the frequency converter, set the following parameters.

Parameter	Setting
Parameter 8-30 Protocol	FC
Parameter 8-31 Address	1-126
Parameter 8-32 Baud Rate	2400-115200
Parameter 8-33 Parity / Stop Bits	Even parity, 1 stop bit (default)

Table 5.3 Parameters to Enable the Protocol

5.4 FC Protocol Message Framing Structure

5.4.1 Content of a Character (byte)

Each character transferred begins with a start bit. Then 8 data bits are transferred, corresponding to a byte. Each character is secured via a parity bit. This bit is set at 1 when it reaches parity. Parity is when there are an equal number of 1s in the 8 data bits and the parity bit in total. A stop bit completes a character, consisting of 11 bits in all.



Illustration 5.3 Content of a Character

195NA036.10

5.4.2 Telegram Structure

Each telegram has the following structure:

- Start character (STX) = 02 hex.
- A byte denoting the telegram length (LGE).
- A byte denoting the frequency converter address (ADR).

Several data bytes (variable, depending on the type of telegram) follow.

A data control byte (BCC) completes the telegram.



Illustration 5.4 Telegram Structure

195NA099.10

5.4.3 Telegram Length (LGE)

The telegram length is the number of data bytes plus the address byte ADR and the data control byte BCC.

4 data bytes	LGE=4+1+1=6 bytes
12 data bytes	LGE=12+1+1=14 bytes
Telegrams containing texts	10 ¹ +n bytes

Table 5.4 Length of Telegrams

1) The 10 represents the fixed characters, while the n is variable (depending on the length of the text).

5.4.4 Frequency Converter Address (ADR)

Address format 1–126

- Bit 7 = 1 (address format 1–126 active).
- Bit 0–6 = frequency converter address 1–126.
- Bit 0–6 = 0 broadcast.

The slave returns the address byte unchanged to the master in the response telegram.

5.4.5 Data Control Byte (BCC)

The checksum is calculated as an XOR-function. Before the first byte in the telegram is received, the calculated checksum is 0.

5.4.6 The Data Field

The structure of data blocks depends on the type of telegram. There are 3 telegram types, and the type applies for both control telegrams (master→slave) and response telegrams (slave→master).

The 3 types of telegram are:

Process block (PCD)

The PCD is made up of a data block of 4 bytes (2 words) and contains:

- Control word and reference value (from master to slave)
- Status word and present output frequency (from slave to master)

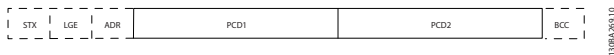

Illustration 5.5 Process Block

Parameter block

The parameter block is used to transfer parameters between master and slave. The data block is made up of 12 bytes (6 words) and also contains the process block.



Illustration 5.6 Parameter Block

Text block

The text block is used to read or write texts via the data block.

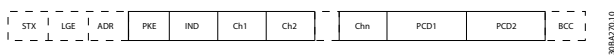

Illustration 5.7 Text Block

5.4.7 The PKE Field

The PKE field contains 2 subfields:

- Parameter command and response (AK)
- Parameter number (PNU)

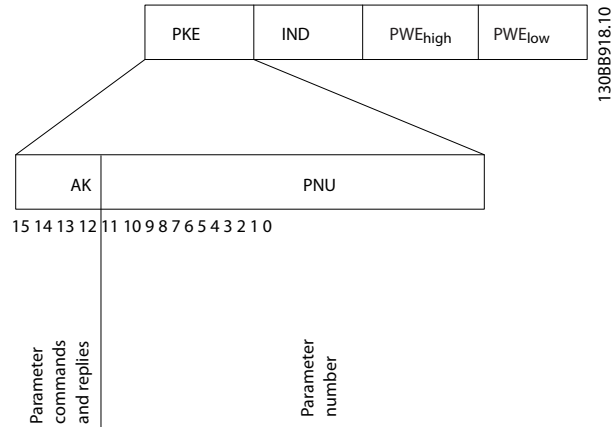

Illustration 5.8 PKE Field

Bits 12–15 transfer parameter commands from master to slave and return processed slave responses to the master.

Parameter commands master→slave				
Bit number				Parameter command
15	14	13	12	
0	0	0	0	No command.
0	0	0	1	Read parameter value.
0	0	1	0	Write parameter value in RAM (word).
0	0	1	1	Write parameter value in RAM (double word).
1	1	0	1	Write parameter value in RAM and EEPROM (double word).
1	1	1	0	Write parameter value in RAM and EEPROM (word).
1	1	1	1	Read text.

Table 5.5 Parameter Commands

Response slave→master				
Bit number				Response
15	14	13	12	
0	0	0	0	No response.
0	0	0	1	Parameter value transferred (word).
0	0	1	0	Parameter value transferred (double word).
0	1	1	1	Command cannot be performed.
1	1	1	1	Text transferred.

Table 5.6 Response

If the command cannot be performed, the slave sends 0111 *Command cannot be performed* response and issues the following fault reports in Table 5.7.

Fault code	FC specification
0	Illegal parameter number.
1	Parameter cannot be changed.
2	Upper or lower limit is exceeded.
3	Subindex is corrupted.
4	No array.
5	Wrong data type.
6	Not used.
7	Not used.
9	Description element is not available.
11	No parameter write access.
15	No text available.
17	Not applicable while running.
18	Other errors.
100	–
>100	–
130	No bus access for this parameter.
131	Write to factory set-up is not possible.
132	No LCP access.
252	Unknown viewer.
253	Request is not supported.
254	Unknown attribute.
255	No error.

Table 5.7 Slave Report

5.4.8 Parameter Number (PNU)

Bits 0–11 transfer parameter numbers. The function of the relevant parameter is defined in the parameter description in the *VLT® Midi Drive FC 280 Programming Guide*.

5.4.9 Index (IND)

The index is used with the parameter number to read/write access parameters with an index, for example, *parameter 15-30 Alarm Log: Error Code*. The index consists of 2 bytes: a low byte and a high byte.

Only the low byte is used as an index.

5.4.10 Parameter Value (PWE)

The parameter value block consists of 2 words (4 bytes), and the value depends on the defined command (AK). The master prompts for a parameter value when the PWE block contains no value. To change a parameter value (write), write the new value in the PWE block and send from the master to the slave.

When a slave responds to a parameter request (read command), the present parameter value in the PWE block is transferred and returned to the master. If a parameter contains several data options, for example

parameter 0-01 Language, select the data value by entering the value in the PWE block. Serial communication is only capable of reading parameters containing data type 9 (text string).

Parameter 15-40 FC Type to parameter 15-53 Power Card Serial Number contain data type 9.

For example, read the unit size and mains voltage range in *parameter 15-40 FC Type*. When a text string is transferred (read), the length of the telegram is variable, and the texts are of different lengths. The telegram length is defined in the 2nd byte of the telegram (LGE). When using text transfer, the index character indicates whether it is a read or a write command.

To read a text via the PWE block, set the parameter command (AK) to F hex. The index character high-byte must be 4.

5.4.11 Data Types Supported by the Frequency Converter

Unsigned means that there is no operational sign in the telegram.

Data types	Description
3	Integer 16
4	Integer 32
5	Unsigned 8
6	Unsigned 16
7	Unsigned 32
9	Text string

Table 5.8 Data Types

5.4.12 Conversion

The *programming guide* contains the descriptions of attributes of each parameter. Parameter values are transferred as whole numbers only. Conversion factors are used to transfer decimals.

Parameter 4-12 Motor Speed Low Limit [Hz] has a conversion factor of 0.1. To preset the minimum frequency to 10 Hz, transfer the value 100. A conversion factor of 0.1 means that the value transferred is multiplied by 0.1. The value 100 is thus perceived as 10.0.

Conversion index	Conversion factor
74	3600
2	100
1	10
0	1
-1	0.1
-2	0.01
-3	0.001
-4	0.0001
-5	0.00001

Table 5.9 Conversion

5.4.13 Process Words (PCD)

The block of process words is divided into 2 blocks of 16 bits, which always occur in the defined sequence.

PCD 1	PCD 2
Control telegram (master⇒slave control word)	Reference value
Control telegram (slave⇒master) status word	Present output frequency

Table 5.10 Process Words (PCD)

5.5 Examples

5.5.1 Writing a Parameter Value

Change *parameter 4-14 Motor Speed High Limit [Hz]* to 100 Hz.

Write the data in EEPROM.

PKE = E19E hex - Write single word in *parameter 4-14 Motor Speed High Limit [Hz]*:

- IND = 0000 hex.
- PWE_{HIGH} = 0000 hex.
- PWE_{LOW} = 03E8 hex.

Data value 1000, corresponding to 100 Hz, see *chapter 5.4.12 Conversion*.

The telegram looks like *Illustration 5.9*.

E19E	H	0000	H	0000	H	03E8	H
PKE		IND		PWE _{high}		PWE _{low}	

Illustration 5.9 Telegram

130BA092.10

NOTICE

Parameter 4-14 Motor Speed High Limit [Hz] is a single word, and the parameter command for write in EEPROM is E. *Parameter 4-14 Motor Speed High Limit [Hz]* is 19E in hexadecimal.

The response from the slave to the master is shown in *Illustration 5.10*.

119E	H	0000	H	0000	H	03E8	H
PKE		IND		PWE _{high}		PWE _{low}	

Illustration 5.10 Response from Master

130BA093.10

5.5.2 Reading a Parameter Value

Read the value in *parameter 3-41 Ramp 1 Ramp Up Time*.

PKE = 1155 hex - Read parameter value in *parameter 3-41 Ramp 1 Ramp Up Time*:

- IND = 0000 hex.
- PWE_{HIGH} = 0000 hex.
- PWE_{LOW} = 0000 hex.

1155	H	0000	H	0000	H	0000	H
PKE		IND		PWE _{high}		PWE _{low}	

Illustration 5.11 Telegram

130BA094.10

If the value in *parameter 3-41 Ramp 1 Ramp Up Time* is 10 s, the response from the slave to the master is shown in *Illustration 5.12*.

1155	H	0000	H	0000	H	03E8	H
PKE		IND		PWE _{high}		PWE _{low}	

Illustration 5.12 Response

130BA267.10

3E8 hex corresponds to 1000 decimal. The conversion index for *parameter 3-41 Ramp 1 Ramp Up Time* is -2, that is, 0.01.

Parameter 3-41 Ramp 1 Ramp Up Time is of the type *Unsigned 32*.

5.6 Modbus RTU

5.6.1 Prerequisite Knowledge

Danfoss assumes that the installed controller supports the interfaces in this manual, and strictly observes all requirements and limitations stipulated in the controller and frequency converter.

The built-in Modbus RTU (remote terminal unit) is designed to communicate with any controller that supports the interfaces defined in this manual. It is assumed that the user has full knowledge of the capabilities and limitations of the controller.

5.6.2 Overview

Regardless of the type of physical communication networks, this section describes the process that a controller uses to request access to another device. This process includes how the Modbus RTU responds to requests from another device, and how errors are detected and reported. It also establishes a common format for the layout and contents of telegram fields.

During communications over a Modbus RTU network, the protocol:

- Determines how each controller learns its device address.
- Recognizes a telegram addressed to it.
- Determines which actions to take.
- Extracts any data or other information contained in the telegram.

If a reply is required, the controller constructs the reply telegram and sends it.

Controllers communicate using a master/slave technique in which only the master can initiate transactions (called queries). Slaves respond by supplying the requested data to the master, or by acting as requested in the query. The master can address individual slaves, or initiate a broadcast telegram to all slaves. Slaves return a response to queries that are addressed to them individually. No responses are returned to broadcast queries from the master.

The Modbus RTU protocol establishes the format for the master query by providing the following information:

- The device (or broadcast) address.
- A function code defining the requested action.
- Any data to be sent.
- An error-checking field.

The response telegram of the slave device is also constructed using Modbus protocol. It contains fields confirming the action taken, any data to be returned, and

an error-checking field. If an error occurs in receipt of the telegram, or if the slave is unable to perform the requested action, the slave constructs and sends an error message. Alternatively, a timeout occurs.

5.6.3 Frequency Converter with Modbus RTU

The frequency converter communicates in Modbus RTU format over the built-in RS485 interface. Modbus RTU provides access to the control word and bus reference of the frequency converter.

The control word allows the Modbus master to control several important functions of the frequency converter:

- Start.
- Various stops:
 - Coast stop.
 - Quick stop.
 - DC brake stop.
 - Normal (ramp) stop.
- Reset after a fault trip.
- Run at various preset speeds.
- Run in reverse.
- Change the active set-up.
- Control built-in relay of the frequency converter.

The bus reference is commonly used for speed control. It is also possible to access the parameters, read their values, and, where possible, write values to them. Accessing the parameters offers a range of control options, including controlling the setpoint of the frequency converter when its internal PI controller is used.

5.7 Network Configuration

To enable Modbus RTU on the frequency converter, set the following parameters:

Parameter	Setting
<i>Parameter 8-30 Protocol</i>	Modbus RTU
<i>Parameter 8-31 Address</i>	1-247
<i>Parameter 8-32 Baud Rate</i>	2400-115200
<i>Parameter 8-33 Parity / Stop Bits</i>	Even parity, 1 stop bit (default)

Table 5.11 Network Configuration

5.8 Modbus RTU Message Framing Structure

5.8.1 Introduction

The controllers are set up to communicate on the Modbus network using RTU (remote terminal unit) mode, with each byte in a telegram containing 2 4-bit hexadecimal characters. The format for each byte is shown in *Table 5.12*.

Start bit	Data byte						Stop/parity	Stop

Table 5.12 Format for Each Byte

Coding system	8-bit binary, hexadecimal 0–9, A–F. 2 hexadecimal characters contained in each 8-bit field of the telegram.
Bits per byte	<ul style="list-style-type: none"> • 1 start bit. • 8 data bits, least significant bit sent first. • 1 bit for even/odd parity; no bit for no parity. • 1 stop bit if parity is used; 2 bits if no parity.
Error check field	Cyclic redundancy check (CRC).

Table 5.13 Byte Details

5.8.2 Modbus RTU Telegram Structure

The transmitting device places a Modbus RTU telegram into a frame with a known beginning and ending point. This allows receiving devices to begin at the start of the telegram, read the address portion, determine which device is addressed (or all devices, if the telegram is broadcast), and to recognize when the telegram is completed. Partial telegrams are detected and errors set as a result. Characters for transmission must be in hexadecimal 00–FF format in each field. The frequency converter continuously monitors the network bus, also during silent intervals. When the first field (the address field) is received, each frequency converter or device decodes it to determine which device is being addressed. Modbus RTU telegrams addressed to 0 are broadcast telegrams. No response is permitted for broadcast telegrams. A typical telegram frame is shown in *Table 5.14*.

Start	Address	Function	Data	CRC check	End
T1-T2-T3-T4	8 bits	8 bits	N x 8 bits	16 bits	T1-T2-T3-T4

Table 5.14 Typical Modbus RTU Telegram Structure

5.8.3 Start/Stop Field

Telegrams start with a silent period of at least 3.5 character intervals. The silent period is implemented as a multiple of character intervals at the selected network baud rate (shown as Start T1-T2-T3-T4). The first field to be transmitted is the device address. Following the last transmitted character, a similar period of at least 3.5 character intervals marks the end of the telegram. A new telegram can begin after this period.

Transmit the entire telegram frame as a continuous stream. If a silent period of more than 1.5 character intervals occurs before completion of the frame, the receiving device flushes the incomplete telegram and assumes that the next byte is the address field of a new telegram. Similarly, if a new telegram begins before 3.5 character intervals after a previous telegram, the receiving device considers it a continuation of the previous telegram. This behavior causes a timeout (no response from the slave), since the value in the final CRC field is not valid for the combined telegrams.

5.8.4 Address Field

The address field of a telegram frame contains 8 bits. Valid slave device addresses are in the range of 0–247 decimal. The individual slave devices are assigned addresses in the range of 1–247. 0 is reserved for broadcast mode, which all slaves recognize. A master addresses a slave by placing the slave address in the address field of the telegram. When the slave sends its response, it places its own address in this address field to let the master know which slave is responding.

5.8.5 Function Field

The function field of a telegram frame contains 8 bits. Valid codes are in the range of 1–FF. Function fields are used to send telegrams between master and slave. When a telegram is sent from a master to a slave device, the function code field tells the slave what kind of action to perform. When the slave responds to the master, it uses the function code field to indicate either a normal (error-free) response, or that some kind of error occurred (called an exception response).

For a normal response, the slave simply echoes the original function code. For an exception response, the slave returns a code that is equivalent to the original function code with its most significant bit set to logic 1. In addition, the slave places a unique code into the data field of the response telegram. This code tells the master what kind of error occurred, or the reason for the exception. Also refer to *chapter 5.8.10 Function Codes Supported by Modbus RTU* and *chapter 5.8.11 Modbus Exception Codes*.

5.8.6 Data Field

The data field is constructed using sets of 2 hexadecimal digits, in the range of 00–FF hexadecimal. These digits are made up of 1 RTU character. The data field of telegrams sent from a master to a slave device contains additional information which the slave must use to perform accordingly.

The information can include items such as:

- Coil or register addresses.
- The quantity of items to be handled.
- The count of actual data bytes in the field.

5.8.7 CRC Check Field

Telegrams include an error-checking field, operating based on a cyclic redundancy check (CRC) method. The CRC field checks the contents of the entire telegram. It is applied regardless of any parity check method used for the individual characters of the telegram. The transmitting device calculates the CRC value and appends the CRC as the last field in the telegram. The receiving device recalculates a CRC during receipt of the telegram and compares the calculated value to the actual value received in the CRC field. 2 unequal values result in bus timeout. The error-checking field contains a 16-bit binary value implemented as 2 8-bit bytes. After the implementation, the low-order byte of the field is appended first, followed by the high-order byte. The CRC high-order byte is the last byte sent in the telegram.

5.8.8 Coil Register Addressing

In Modbus, all data is organized in coils and holding registers. Coils hold a single bit, whereas holding registers hold a 2 byte word (that is 16 bits). All data addresses in Modbus telegrams are referenced to 0. The first occurrence of a data item is addressed as item number 0. For example: The coil known as coil 1 in a programmable controller is addressed as coil 0000 in the data address field of a Modbus telegram. Coil 127 decimal is addressed as coil 007Ehex (126 decimal).

Holding register 40001 is addressed as register 0000 in the data address field of the telegram. The function code field already specifies a holding register operation. Therefore, the 4XXXX reference is implicit. Holding register 40108 is addressed as register 006Bhex (107 decimal).

Coil number	Description	Signal direction
1–16	Frequency converter control word (see Table 5.16).	Master to slave
17–32	Frequency converter speed or setpoint reference range 0x0–0xFFFF (-200% ... ~200%).	Master to slave
33–48	Frequency converter status word (see Table 5.17).	Slave to master
49–64	Open-loop mode: Frequency converter output frequency. Closed-loop mode: Frequency converter feedback signal.	Slave to master
65	Parameter write control (master to slave).	Master to slave
	0 = Parameter changes are written to the RAM of the frequency converter.	
	1 = Parameter changes are written to the RAM and EEPROM of the frequency converter.	
66–65536	Reserved.	–

Table 5.15 Coil Register

Coil	0	1
01	Preset reference lsb	
02	Preset reference msb	
03	DC brake	No DC brake
04	Coast stop	No coast stop
05	Quick stop	No quick stop
06	Freeze frequency	No freeze frequency
07	Ramp stop	Start
08	No reset	Reset
09	No jog	Jog
10	Ramp 1	Ramp 2
11	Data not valid	Data valid
12	Relay 1 off	Relay 1 on
13	Relay 2 off	Relay 2 on
14	Set up lsb	
15	–	
16	No reversing	Reversing

Table 5.16 Frequency Converter Control Word (FC Profile)

Coil	0	1
33	Control not ready	Control ready
34	Frequency converter not ready	Frequency converter ready
35	Coast stop	Safety closed
36	No alarm	Alarm
37	Not used	Not used
38	Not used	Not used
39	Not used	Not used
40	No warning	Warning
41	Not at reference	At reference
42	Hand mode	Auto mode
43	Out of frequency range	In frequency range
44	Stopped	Running
45	Not used	Not used
46	No voltage warning	Voltage warning
47	Not in current limit	Current limit
48	No thermal warning	Thermal warning

Table 5.17 Frequency Converter Status Word (FC Profile)

Bus address	Bus register ¹⁾	PLC register	Content	Access	Description
0	1	40001	Reserved	-	Reserved for legacy frequency converters VLT® 5000 and VLT® 2800.
1	2	40002	Reserved	-	Reserved for legacy frequency converters VLT® 5000 and VLT® 2800.
2	3	40003	Reserved	-	Reserved for legacy frequency converters VLT® 5000 and VLT® 2800.
3	4	40004	Free	-	-
4	5	40005	Free	-	-
5	6	40006	Modbus configuration	Read/Write	TCP only. Reserved for Modbus TCP (<i>parameter 12-28 Store Data Values</i> and <i>parameter 12-29 Store Always</i> - stored in, for example, EEPROM).
6	7	40007	Last fault code	Read only	Fault code received from parameter database, refer to WHAT 38295 for details.
7	8	40008	Last error register	Read only	Address of register with which last error occurred, refer to WHAT 38296 for details.
8	9	40009	Index pointer	Read/Write	Subindex of parameter to be accessed. Refer to WHAT 38297 for details.
9	10	40010	<i>Parameter 0-01 Language</i>	Dependent on parameter access	<i>Parameter 0-01 Language</i> (Modbus register = 10 parameter number) 20 bytes space reserved for parameter in Modbus map.
19	20	40020	<i>Parameter 0-02 Motor Speed Unit</i>	Dependent on parameter access	<i>Parameter 0-02 Motor Speed Unit</i> 20 bytes space reserved for parameter in Modbus map.
29	30	40030	<i>Parameter 0-03 Regional Settings</i>	Dependent on parameter access	<i>Parameter 0-03 Regional Settings</i> 20 bytes space reserved for parameter in Modbus map.

Table 5.18 Address/Registers

1) Value written in the Modbus RTU telegram must be 1 or less than the register number. For example, Read Modbus Register 1 by writing value 0 in the telegram.

5.8.9 How to Control the Frequency Converter

This section describes codes which can be used in the function and data fields of a Modbus RTU telegram.

5.8.10 Function Codes Supported by Modbus RTU

Modbus RTU supports use of the following function codes in the function field of a telegram:

Function	Function code (hex)
Read coils	1
Read holding registers	3
Write single coil	5
Write single register	6
Write multiple coils	F
Write multiple registers	10
Get comm. event counter	B
Report slave ID	11

Table 5.19 Function Codes

Function	Function code	Subfunction code	Subfunction
Diagnostics	8	1	Restart communication.
		2	Return diagnostic register.
		10	Clear counters and diagnostic register.
		11	Return bus message count.
		12	Return bus communication error count.
		13	Return slave error count.
		14	Return slave message count.

Table 5.20 Function Codes

5.8.11 Modbus Exception Codes

For a full explanation of the structure of an exception code response, refer to *chapter 5.8.5 Function Field*.

Code	Name	Meaning
1	Illegal function	The function code received in the query is not an allowable action for the server (or slave). This may be because the function code is only applicable to newer devices and was not implemented in the unit selected. It could also indicate that the server (or slave) is in the wrong state to process a request of this type, for example because it is not configured and is being asked to return register values.
2	Illegal data address	The data address received in the query is not an allowable address for the server (or slave). More specifically, the combination of reference number and transfer length is invalid. For a controller with 100 registers, a request with offset 96 and length 4 succeeds, while a request with offset 96 and length 5 generates exception 02.
3	Illegal data value	A value contained in the query data field is not an allowable value for server (or slave). This indicates a fault in the structure of the remainder of a complex request, such as that the implied length is incorrect. It does NOT mean that a data item submitted for storage in a register has a value outside the expectation of the application program, since the Modbus protocol is unaware of the significance of any value of any register.
4	Slave device failure	An unrecoverable error occurred while the server (or slave) was attempting to perform the requested action.

Table 5.21 Modbus Exception Codes

5.9 How to Access Parameters

5.9.1 Parameter Handling

The PNU (parameter number) is translated from the register address contained in the Modbus read or write telegram. The parameter number is translated to Modbus as (10 x parameter number) *decimal*.

Examples

Reading *parameter 3-12 Catch up/slow Down Value* (16 bit):
The holding register 3120 holds the parameters value. A value of 1352 (decimal), means that the parameter is set to 12.52%.

Reading *parameter 3-14 Preset Relative Reference* (32 bit):
The holding registers 3410 and 3411 hold the parameters

values. A value of 11300 (*decimal*), means that the parameter is set to 1113.00.

For information on the parameters, size, and conversion index, see the *VLT® Midi Drive FC 280 Programming Guide*.

5.9.2 Storage of Data

The coil 65 decimal determines whether data written to the frequency converter is stored in EEPROM and RAM (coil 65 = 1), or only in RAM (coil 65 = 0).

5

5.9.3 IND (Index)

Some parameters in the frequency converter are array parameters, for example *parameter 3-10 Preset Reference*. Since the Modbus does not support arrays in the holding registers, the frequency converter has reserved the holding register 9 as pointer to the array. Before reading or writing an array parameter, set the holding register 9. Setting holding register to the value of 2 causes all following read/write to array parameters to be to the index 2.

5.9.4 Text Blocks

Parameters stored as text strings are accessed in the same way as the other parameters. The maximum text block size is 20 characters. If a read request for a parameter is for more characters than the parameter stores, the response is truncated. If the read request for a parameter is for fewer characters than the parameter stores, the response is space filled.

5.9.5 Conversion Factor

A parameter value can only be transferred as a whole number. To transfer decimals, use a conversion factor.

5.9.6 Parameter Values

Standard data types

Standard data types are int 16, int 32, uint 8, uint 16, and uint 32. They are stored as 4x registers (40001–4FFFF). The parameters are read using function 03 hex read holding registers. Parameters are written using the function 6 hex preset single register for 1 register (16 bits), and the function 10 hex preset multiple registers for 2 registers (32 bits). Readable sizes range from 1 register (16 bits) up to 10 registers (20 characters).

Non-standard data types

Non-standard data types are text strings and are stored as 4x registers (40001–4FFFF). The parameters are read using function 03 hex read holding registers and written using function 10 hex preset multiple registers. Readable sizes range from 1 register (2 characters) up to 10 registers (20 characters).

5.10 Examples

The following examples show various Modbus RTU commands.

5.10.1 Read Coil Status (01 hex)

Description

This function reads the ON/OFF status of discrete outputs (coils) in the frequency converter. Broadcast is never supported for reads.

Query

The query telegram specifies the starting coil and quantity of coils to be read. Coil addresses start at 0, that is, coil 33 is addressed as 32.

Example of a request to read coils 33–48 (status word) from slave device 01.

Field name	Example (hex)
Slave address	01 (frequency converter address)
Function	01 (read coils)
Starting address HI	00
Starting address LO	20 (32 decimals) coil 33
Number of points HI	00
Number of points LO	10 (16 decimals)
Error check (CRC)	–

Table 5.22 Query

Response

The coil status in the response telegram is packed as 1 coil per bit of the data field. Status is indicated as: 1 = ON; 0 = OFF. The lsb of the first data byte contains the coil addressed in the query. The other coils follow toward the high-order end of this byte, and from low order to high order in subsequent bytes.

If the returned coil quantity is not a multiple of 8, the remaining bits in the final data byte are padded with values 0 (toward the high-order end of the byte). The byte count field specifies the number of complete bytes of data.

Field name	Example (hex)
Slave address	01 (frequency converter address)
Function	01 (read coils)
Byte count	02 (2 bytes of data)
Data (coils 40–33)	07
Data (coils 48–41)	06 (STW = 0607hex)
Error check (CRC)	–

Table 5.23 Response

NOTICE

Coils and registers are addressed explicitly with an offset of -1 in Modbus.

For example, coil 33 is addressed as coil 32.

5.10.2 Force/Write Single Coil (05 hex)

Description

This function forces the coil to either ON or OFF. When broadcast, the function forces the same coil references in all attached slaves.

Query

The query telegram specifies the coil 65 (parameter write control) to be forced. Coil addresses start at 0, that is, coil 65 is addressed as 64. Force data = 00 00 hex (OFF) or FF 00 hex (ON).

Field name	Example (hex)
Slave address	01 (Frequency converter address)
Function	05 (write single coil)
Coil address HI	00
Coil address LO	40 (64 decimal) Coil 65
Force data HI	FF
Force data LO	00 (FF 00 = ON)
Error check (CRC)	-

Table 5.24 Query

Response

The normal response is an echo of the query, returned after the coil state has been forced.

Field name	Example (hex)
Slave address	01
Function	05
Force data HI	FF
Force data LO	00
Quantity of coils HI	00
Quantity of coils LO	01
Error check (CRC)	-

Table 5.25 Response

5.10.3 Force/Write Multiple Coils (0F hex)

Description

This function forces each coil in a sequence of coils to either on or off. When broadcasting, the function forces the same coil references in all attached slaves.

Query

The query telegram specifies the coils 17–32 (speed setpoint) to be forced.

NOTICE

Coil addresses start at 0, that is, coil 17 is addressed as 16.

Field name	Example (hex)
Slave address	01 (frequency converter address)
Function	0F (write multiple coils)
Coil address HI	00
Coil address LO	10 (coil address 17)
Quantity of coils HI	00
Quantity of coils LO	10 (16 coils)
Byte count	02
Force data HI (Coils 8–1)	20
Force data LO (Coils 16–9)	00 (reference = 2000 hex)
Error check (CRC)	-

Table 5.26 Query

Response

The normal response returns the slave address, function code, starting address, and quantity of coils forced.

Field name	Example (hex)
Slave address	01 (frequency converter address)
Function	0F (write multiple coils)
Coil address HI	00
Coil address LO	10 (coil address 17)
Quantity of coils HI	00
Quantity of coils LO	10 (16 coils)
Error check (CRC)	-

Table 5.27 Response

5.10.4 Read Holding Registers (03 hex)

Description

This function reads the contents of holding registers in the slave.

Query

The query telegram specifies the starting register and quantity of registers to be read. Register addresses start at 0, that is, registers 1–4 are addressed as 0–3.

Example: Read *parameter 3-03 Maximum Reference*, register 03030.

Field name	Example (hex)
Slave address	01
Function	03 (Read holding registers)
Starting address HI	0B (Register address 3029)
Starting address LO	D5 (Register address 3029)
Number of points HI	00
Number of points LO	02 – (<i>parameter 3-03 Maximum Reference</i> is 32 bits long, that is, 2 registers)
Error check (CRC)	-

Table 5.28 Query

Response

The register data in the response telegram is packed as 2 bytes per register, with the binary contents right justified within each byte. For each register, the 1st byte contains the high-order bits, and the 2nd contains the low-order bits.

Example: hex 000088B8 = 35.000 = 35 Hz.

Field name	Example (hex)
Slave address	01
Function	03
Byte count	04
Data HI (register 3030)	00
Data LO (register 3030)	16
Data HI (register 3031)	E3
Data LO (register 3031)	60
Error check (CRC)	-

Table 5.29 Response

5.10.5 Preset Single Register (06 hex)

Description

This function presets a value into a single holding register.

Query

The query telegram specifies the register reference to be preset. Register addresses start at 0, that is, register 1 is addressed as 0.

Example: Write to *parameter 1-00 Configuration Mode*, register 1000.

Field name	Example (hex)
Slave address	01
Function	06
Register address HI	03 (register address 999)
Register address LO	E7 (register address 999)
Preset data HI	00
Preset data LO	01
Error check (CRC)	-

Table 5.30 Query

Response

The normal response is an echo of the query, returned after the register contents have been passed.

Field name	Example (hex)
Slave address	01
Function	06
Register address HI	03
Register address LO	E7
Preset data HI	00
Preset data LO	01
Error check (CRC)	-

Table 5.31 Response

5.10.6 Preset Multiple Registers (10 hex)

Description

This function presets values into a sequence of holding registers.

Query

The query telegram specifies the register references to be preset. Register addresses start at 0, that is, register 1 is addressed as 0. Example of a request to preset 2 registers (set *parameter 1-24 Motor Current* to 738 (7.38 A)):

Field name	Example (hex)
Slave address	01
Function	10
Starting address HI	04
Starting address LO	07
Number of registers HI	00
Number of registers LO	02
Byte count	04
Write data HI (Register 4: 1049)	00
Write data LO (Register 4: 1049)	00
Write data HI (Register 4: 1050)	02
Write data LO (Register 4: 1050)	E2
Error check (CRC)	-

Table 5.32 Query

Response

The normal response returns the slave address, function code, starting address, and quantity of registers preset.

Field name	Example (hex)
Slave address	01
Function	10
Starting address HI	04
Starting address LO	19
Number of registers HI	00
Number of registers LO	02
Error check (CRC)	-

Table 5.33 Response

5.11 Danfoss FC Control Profile

5.11.1 Control Word According to FC Profile (8-10 Protocol = FC Profile)

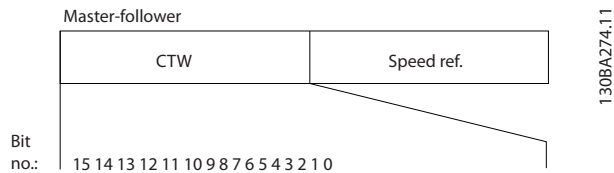

Illustration 5.13 Control Word According to FC Profile

Bit	Bit value = 0	Bit value = 1
00	Reference value	External selection lsb
01	Reference value	External selection msb
02	DC brake	Ramp
03	Coasting	No coasting
04	Quick stop	Ramp
05	Hold output frequency	Use ramp
06	Ramp stop	Start
07	No function	Reset
08	No function	Jog
09	Ramp 1	Ramp 2
10	Data invalid	Data valid
11	Relay 01 open	Relay 01 active
12	Relay 02 open	Relay 02 active
13	Parameter set-up	Selection lsb
15	No function	Reverse

Table 5.34 Control Word According to FC Profile

Explanation of the control bits

Bits 00/01

Bits 00 and 01 are used to select among the 4 reference values, which are preprogrammed in *parameter 3-10 Preset Reference* according to *Table 5.35*.

Programmed reference value	Parameter	Bit 01	Bit 00
1	<i>Parameter 3-10 Preset Reference</i> [0]	0	0
2	<i>Parameter 3-10 Preset Reference</i> [1]	0	1
3	<i>Parameter 3-10 Preset Reference</i> [2]	1	0
4	<i>Parameter 3-10 Preset Reference</i> [3]	1	1

Table 5.35 Control Bits

NOTICE

In *parameter 8-56 Preset Reference Select*, define how bit 00/01 gates with the corresponding function on the digital inputs.

Bit 02, DC brake

Bit 02 = 0: Leads to DC braking and stop. Set braking current and duration in *parameter 2-01 DC Brake Current* and *parameter 2-02 DC Braking Time*.

Bit 02 = 1: Leads to ramping.

Bit 03, Coasting

Bit 03 = 0: The frequency converter immediately releases the motor (the output transistors are shut off), and it coasts to a standstill.

Bit 03 = 1: If the other starting conditions are met, the frequency converter starts the motor.

In *parameter 8-50 Coasting Select*, define how bit 03 gates with the corresponding function on a digital input.

Bit 04, Quick stop

Bit 04 = 0: Makes the motor speed ramp down to stop (set in *parameter 3-81 Quick Stop Ramp Time*).

Bit 05, Hold output frequency

Bit 05 = 0: The present output frequency (in Hz) freezes. Change the frozen output frequency only with the digital inputs programmed to [21] *Speed up* and [22] *Speed down* (*parameter 5-10 Terminal 18 Digital Input* to *parameter 5-13 Terminal 29 Digital Input*).

NOTICE

If freeze output is active, the frequency converter can only be stopped in 1 of the following ways:

- Bit 03 coast stop.
- Bit 02 DC brake.
- Digital input programmed to [5] *DC brake inverse*, [2] *Coast inverse*, or [3] *Coast and reset inv* (*parameter 5-10 Terminal 18 Digital Input* to *parameter 5-13 Terminal 29 Digital Input*).

Bit 06, Ramp stop/start

Bit 06 = 0: Causes a stop and makes the motor speed ramp down to stop via the selected ramp-down parameter.

Bit 06 = 1: Allows the frequency converter to start the motor if the other starting conditions are met.

In *parameter 8-53 Start Select*, define how bit 06 ramp stop/start gates with the corresponding function on a digital input.

Bit 07, Reset

Bit 07 = 0: No reset.

Bit 07 = 1: Resets a trip. Reset is activated on the leading signal edge, that is, when changing from logic 0 to logic 1.

Bit 08, Jog

Bit 08 = 1: *Parameter 3-11 Jog Speed [Hz]* determines the output frequency.

Bit 09, Selection of ramp 1/2

Bit 09 = 0: Ramp 1 is active (*parameter 3-41 Ramp 1 Ramp Up Time* to *parameter 3-42 Ramp 1 Ramp Down Time*).

Bit 09 = 1: Ramp 2 (*parameter 3-51 Ramp 2 Ramp Up Time* to *parameter 3-52 Ramp 2 Ramp Down Time*) is active.

Bit 10, Data not valid/Data valid

Tell the frequency converter whether to use or ignore the control word.

Bit 10 = 0: The control word is ignored.

Bit 10 = 1: The control word is used. This function is relevant because the telegram always contains the control word, regardless of the telegram type. If the control word is not needed when updating or reading parameter, turn it off.

Bit 11, Relay 01

Bit 11 = 0: Relay not activated.

Bit 11 = 1: Relay 01 activated if [36] Control word bit 11 is selected in parameter 5-40 Function Relay.

Bit 12, Relay 02

Bit 12 = 0: Relay 02 is not activated.

Bit 12 = 1: Relay 02 is activated if [37] Control word bit 12 is selected in parameter 5-40 Function Relay.

Bit 13, Set-up selection

Use bit 13 to select from the 2 menu set-ups according to Table 5.36.

Set-up	Bit 13
1	0
2	1

Table 5.36 Menu Set-ups

The function is only possible when [9] Multi set-ups is selected in parameter 0-10 Active Set-up.

To define how bit 13 gates with the corresponding function on the digital inputs, use parameter 8-55 Set-up Select.

Bit 15 Reverse

Bit 15 = 0: No reversing.

Bit 15 = 1: Reversing. In the default setting, reversing is set to digital in parameter 8-54 Reversing Select. Bit 15 causes reversing only when serial communication, [2] Logic OR or [3] Logic AND is selected.

5.11.2 Status Word According to FC Profile (STW)

Set parameter 8-30 Protocol to [0] FC.

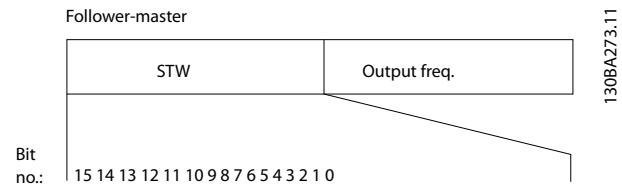

Illustration 5.14 Status Word

Bit	Bit=0	Bit=1
00	Control not ready	Control ready
01	Frequency converter not ready	Frequency converter ready
02	Coasting	Enable
03	No error	Trip
04	No error	Error (no trip)
05	Reserved	-
06	No error	Triplock
07	No warning	Warning
08	Speed≠reference	Speed=reference
09	Local operation	Bus control
10	Out of frequency limit	Frequency limit OK
11	No operation	In operation
12	Frequency converter OK	Stopped, auto start
13	Voltage OK	Voltage exceeded
14	Torque OK	Torque exceeded
15	Timer OK	Timer exceeded

Table 5.37 Status Word According to FC Profile

Explanation of the status bits

Bit 00, Control not ready/ready

Bit 00=0: The frequency converter trips.

Bit 00=1: The frequency converter controls are ready but the power component does not necessarily receive any supply (if there is 24 V external supply to controls).

Bit 01, Frequency converter ready

Bit 01=0: The frequency converter is not ready.

Bit 01=1: The frequency converter is ready for operation.

Bit 02, Coast stop

Bit 02=0: The frequency converter releases the motor.

Bit 02=1: The frequency converter starts the motor with a start command.

Bit 03, No error/trip

Bit 03=0: The frequency converter is not in fault mode.

Bit 03=1: The frequency converter trips. To re-establish operation, press [Reset].

Bit 04, No error/error (no trip)

Bit 04=0: The frequency converter is not in fault mode.

Bit 04=1: The frequency converter shows an error but does not trip.

Bit 05, Not used

Bit 05 is not used in the status word.

Bit 06, No error/triplock

Bit 06=0: The frequency converter is not in fault mode.

Bit 06=1: The frequency converter is tripped and locked.

Bit 07, No warning/warning

Bit 07=0: There are no warnings.

Bit 07=1: A warning has occurred.

Bit 08, Speed reference/speed=reference

Bit 08=0: The motor runs, but the present speed is different from the preset speed reference. It might happen when the speed ramps up/down during start/stop.

Bit 08=1: The motor speed matches the preset speed reference.

Bit 09, Local operation/bus control

Bit 09=0: [Off/Reset] is activated on the control unit or [2] *Local* in *parameter 3-13 Reference Site* is selected. It is not possible to control the frequency converter via serial communication.

Bit 09=1: It is possible to control the frequency converter via the fieldbus/serial communication.

Bit 10, Out of frequency limit

Bit 10=0: The output frequency has reached the value in *parameter 4-12 Motor Speed Low Limit [Hz]* or *parameter 4-14 Motor Speed High Limit [Hz]*.

Bit 10=1: The output frequency is within the defined limits.

Bit 11, No operation/in operation

Bit 11=0: The motor is not running.

Bit 11=1: The frequency converter has a start signal without coast.

Bit 12, Frequency converter OK/stopped, auto start

Bit 12=0: There is no temporary overtemperature on the frequency converter.

Bit 12=1: The frequency converter stops because of overtemperature but the unit does not trip and resumes operation once the overtemperature normalizes.

Bit 13, Voltage OK/limit exceeded

Bit 13=0: There are no voltage warnings.

Bit 13=1: The DC voltage in the frequency converter's DC link is too low or too high.

Bit 14, Torque OK/limit exceeded

Bit 14=0: The motor current is lower than the current limit selected in *parameter 4-18 Current Limit*.

Bit 14=1: The current limit in *parameter 4-18 Current Limit* is exceeded.

Bit 15, Timer OK/limit exceeded

Bit 15=0: The timers for motor thermal protection and thermal protection are not exceeded 100%.

Bit 15=1: 1 of the timers exceeds 100%.

5.11.3 Bus Speed Reference Value

Speed reference value is transmitted to the frequency converter in a relative value in %. The value is transmitted in the form of a 16-bit word. The integer value 16384 (4000 hex) corresponds to 100%. Negative figures are formatted using 2's complement. The actual output frequency (MAV) is scaled in the same way as the bus reference.

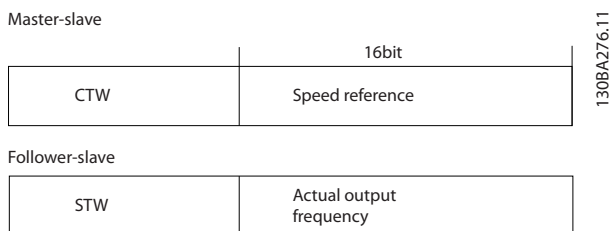

Illustration 5.15 Actual Output Frequency (MAV)

The reference and MAV are scaled as follows:

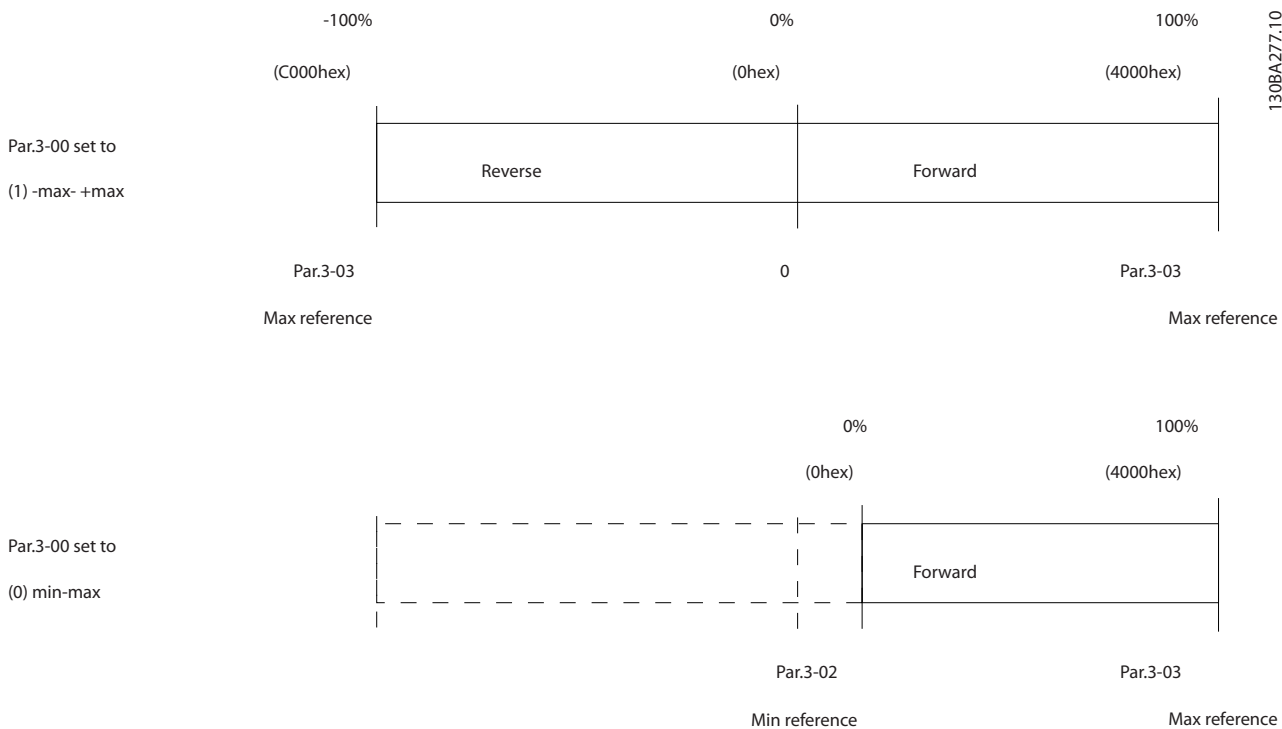

Illustration 5.16 Reference and MAV

6 Type Code and Selection

6.1 Type Code

The type code is a string of characters describing the frequency converter's configuration, see *Illustration 6.1*.

1
3
7
11
13
16
18
20
24
29
FC-280PK37T4E20H1BXCXXSXXXXXAX

130BF710.10

Illustration 6.1 Type Code

The numbers shown in *Table 6.1* refer to the letter/figure position in the type code string, read from left to right.

Product groups	1–2
Frequency converter series	4–6
Power rating	7–10
Phases	11
Mains voltage	12
Enclosure	13–15
RFI filter	16–17
Brake	18
Display (LCP)	19
Coating PCB	20
Mains option	21
Adaptation A	22
Adaptation B	23
Software release	24–27
Software language	28
A options	29–30

Table 6.1 Type Code Character Positions

From the online Drive Configurator, a customer can configure the right frequency converter for a given application and generate the type code string. The Drive Configurator automatically generates an 8-digit sales number to be delivered to the local sales office. Another option is to establish a project list with several products and send it to a Danfoss sales representative.

The Drive Configurator can be found on the global internet site: vltconfig.danfoss.com.

6.2 Ordering Numbers: Options, Accessories, and Spare Parts

Options and accessories	Ordering number
VLT® Memory Module MCM 102	132B0359
VLT® Memory Module Programmer MCM 101 ¹⁾	134B0792
VLT® Control Panel LCP 21 (Numeric)	132B0254
VLT® Control Panel LCP 102 (Graphical)	130B1107
Graphical LCP adapter	132B0281
VLT® Control Panel LCP Blind Cover	132B0262
IP21/Type 1 conversion kit, K1	132B0335
IP21/Type 1 conversion kit, K2	132B0336
IP21/Type 1 conversion kit, K3	132B0337
IP21/Type 1 conversion kit, K4	132B0338
IP21/Type 1 conversion kit, K5	132B0339
Adapter plate, VLT® 2800 size A	132B0363
Adapter plate, VLT® 2800 size B	132B0364
Adapter plate, VLT® 2800 size C	132B0365
Adapter plate, VLT® 2800 size D	132B0366
VLT® 24 V DC supply MCB 106 ¹⁾	132B0368
LCP Remote Mounting Kit, w/3 m (10 ft) cable	132B0102
LCP Mounting Kit, w/no LCP	130B1117

Table 6.2 Ordering Numbers for Options and Accessories

¹⁾ Available in the middle of 2017.

Spare parts	Ordering number
Accessory bag FC 280 plugs	132B0350
Fan 50x20 IP21 PWM	132B0351
Fan 60x20 IP21 PWM	132B0352
Fan 70x20 IP21 PWM	132B0353
Fan 92x38 IP21 PWM	132B0371
Fan 120x38 IP21 PWM	132B0372
Terminal cover enclosure size K1	132B0354
Terminal cover enclosure size K2	132B0355
Terminal cover enclosure size K3	132B0356
Terminal cover enclosure size K4	132B0357
Terminal cover enclosure size K5	132B0358
Bus cable decoupling kit, FC 280	132B0369
Decoupling kit, power I/O, K1	132B0373
Decoupling kit, power I/O, K2/K3	132B0374
Decoupling kit, power I/O, K4/K5	132B0375
VLT® Cassette control - Standard	132B0345
VLT® Cassette control - CANopen	132B0346
VLT® Cassette control - PROFIBUS	132B0347
VLT® Cassette control - PROFINET	132B0348
VLT® Cassette control - EtherNet/IP	132B0349
VLT® Cassette control - POWERLINK	132B0378

Table 6.3 Ordering Numbers for Spare Parts

6.3 Ordering Numbers: Brake Resistors

Danfoss offers a wide variety of different resistors that are specially designed for our frequency converters. See *chapter 2.9.4 Control with Brake Function* for the dimensioning of brake resistors. This section lists the ordering numbers for the brake resistors. The resistance of the brake resistor given by ordering number may be bigger than R_{rec} . In this case, the actual braking torque could be smaller than the highest braking torque which the frequency converter can provide.

6.3.1 Ordering Numbers: Brake Resistors 10%

Power rating	P_m (HO)	R_{min}	$R_{br. nom}$	R_{rec}	$P_{br avg}$	Ordering number	Period	Cable cross-section ¹⁾	Thermal relay	Maximum brake torque with resistor
3-phase 380–480 V (T4)	[kW (hp)]	[Ω]	[Ω]	[Ω]	[kW (hp)]	175Uxxxx	[s]	[mm ² (AWG)]	[A]	[%]
PK37	0.37 (0.5)	890	1041.98	989	0.030 (0.040)	3000	120	1.5 (16)	0.3	139
PK55	0.55 (0.75)	593	693.79	659	0.045 (0.060)	3001	120	1.5 (16)	0.4	131
PK75	0.75 (1.0)	434	508.78	483	0.061 (0.080)	3002	120	1.5 (16)	0.4	129
P1K1	1.1 (1.5)	288	338.05	321	0.092 (0.120)	3004	120	1.5 (16)	0.5	132
P1K5	1.5 (2.0)	208	244.41	232	0.128 (0.172)	3007	120	1.5 (16)	0.8	145
P2K2	2.2 (3.0)	139	163.95	155	0.190 (0.255)	3008	120	1.5 (16)	0.9	131
P3K0	3 (4.0)	100	118.86	112	0.262 (0.351)	3300	120	1.5 (16)	1.3	131
P4K0	4 (5.0)	74	87.93	83	0.354 (0.475)	3335	120	1.5 (16)	1.9	128
P5K5	5.5 (7.5)	54	63.33	60	0.492 (0.666)	3336	120	1.5 (16)	2.5	127
P7K5	7.5 (10)	38	46.05	43	0.677 (0.894)	3337	120	1.5 (16)	3.3	132
P11K	11 (15)	27	32.99	31	0.945 (1.267)	3338	120	1.5 (16)	5.2	130
P15K	15 (20)	19	24.02	22	1.297 (1.739)	3339	120	1.5 (16)	6.7	129
P18K	18.5 (25)	16	19.36	18	1.610 (2.158)	3340	120	1.5 (16)	8.3	132
P22K	22 (30)	16	18.00	17	1.923 (2.578)	3357	120	1.5 (16)	10.1	128

Table 6.4 FC 280 - Mains: 3-phase 380–480 V (T4), 10% Duty Cycle

Power rating	P _m (H0)	R _{min}	R _{br. nom}	R _{rec}	P _{br avg}	Ordering number	Period	Cable cross-section ¹⁾	Thermal relay	Maximum brake torque with resistor
3-phase 200–240 V (T2)	[kW (hp)]	[Ω]	[Ω]	[Ω]	[kW (hp)]	175Uxxxx	[s]	[mm ² (AWG)]	[A]	[%]
PK37	0.37 (0.5)	225	263.22	250	0.030 (0.040)	3006	120	1.5 (16)	0.6	140
PK55	0.55 (0.75)	151	176.90	168	0.045 (0.060)	3011	120	1.5 (16)	0.7	142
PK75	0.75 (1.0)	110	129.92	123	0.062 (0.083)	3016	120	1.5 (16)	0.8	143
P1K1	1.1 (1.5)	73	86.77	82	0.092 (0.120)	3021	120	1.5 (16)	0.9	139
P1K5	1.5 (2.0)	53	62.70	59	0.128 (0.172)	3026	120	1.5 (16)	1.6	143
P2K2	2.2 (3.0)	35	42.06	39	0.190 (0.255)	3031	120	1.5 (16)	1.9	140
P3K7	3.7 (5.0)	20	24.47	23	0.327 (0.439)	3326	120	1.5 (16)	3.5	145

Table 6.5 FC 280 - Mains: 3-phase 200–240 V (T2), 10% Duty Cycle

1) All cabling must comply with national and local regulations on cable cross-sections and ambient temperature.

6.3.2 Ordering Numbers: Brake Resistors 40%

Power rating	P _m (H0)	R _{min}	R _{br. nom}	R _{rec}	P _{br avg}	Ordering number	Period	Cable cross-section ¹⁾	Thermal relay	Maximum brake torque with resistor
3-phase 380–480 V (T4)	[kW (hp)]	[Ω]	[Ω]	[Ω]	[kW (hp)]	175Uxxxx	[s]	[mm ²]	[A]	[%]
PK37	0.37 (0.5)	890	1041.98	989	0.127 (0.170)	3101	120	1.5 (16)	0.4	139
PK55	0.55 (0.75)	593	693.79	659	0.191 (0.256)	3308	120	1.5 (16)	0.5	131
PK75	0.75 (1.0)	434	508.78	483	0.260 (0.349)	3309	120	1.5 (16)	0.7	129
P1K1	1.1 (1.5)	288	338.05	321	0.391 (0.524)	3310	120	1.5 (16)	1	132
P1K5	1.5 (2.0)	208	244.41	232	0.541 (0.725)	3311	120	1.5 (16)	1.4	145
P2K2	2.2 (3.0)	139	163.95	155	0.807 (1.082)	3312	120	1.5 (16)	2.1	131
P3K0	3 (4.0)	100	118.86	112	1.113 (1.491)	3313	120	1.5 (16)	2.7	131
P4K0	4 (5.0)	74	87.93	83	1.504 (2.016)	3314	120	1.5 (16)	3.7	128
P5K5	5.5 (7.5)	54	63.33	60	2.088 (2.799)	3315	120	1.5 (16)	5	127
P7K5	7.5 (10)	38	46.05	43	2.872 (3.850)	3316	120	1.5 (16)	7.1	132
P11K	11 (15)	27	32.99	31	4.226 (5.665)	3236	120	2.5 (14)	11.5	130
P15K	15 (20)	19	24.02	22	5.804 (7.780)	3237	120	2.5 (14)	14.7	129
P18K	18.5 (25)	16	19.36	18	7.201 (9.653)	3238	120	4 (12)	19	132
P22K	22 (30)	16	18.00	17	8.604 (11.534)	3203	120	4 (12)	23	128

Table 6.6 FC 280 - Mains: 3-phase 380–480 V (T4), 40% Duty Cycle

Power rating	P _m (H0)	R _{min}	R _{br. nom}	R _{rec}	P _{br avg}	Ordering number	Period	Cable cross-section ¹⁾	Thermal relay	Maximum brake torque with resistor
3-phase 200–240 V (T2)	[kW (hp)]	[Ω]	[Ω]	[Ω]	[kW (hp)]	175Uxxxx	[s]	[mm ² (AWG)]	[A]	[%]
PK37	0.37 (0.5)	225	263.22	250	0.129 (0.173)	3096	120	1.5 (16)	0.8	140
PK55	0.55 (0.75)	151	176.90	168	0.192 (0.257)	3008	120	1.5 (16)	0.9	142
PK75	0.75 (1.0)	110	129.92	123	0.261 (0.350)	3300	120	1.5 (16)	1.3	143
P1K1	1.1 (1.5)	73	86.77	82	0.391 (0.524)	3301	120	1.5 (16)	2	139
P1K5	1.5 (2.0)	53	62.70	59	0.541 (0.725)	3302	120	1.5 (16)	2.7	143
P2K2	2.2 (3.0)	35	42.06	39	0.807 (1.082)	3303	120	1.5 (16)	4.2	140
P3K7	3.7 (5.0)	20	24.47	23	1.386 (1.859)	3305	120	1.5 (16)	6.8	145

Table 6.7 FC 280 - Mains: 3-phase 200–240 V (T2), 40% Duty Cycle

1) All cabling must comply with national and local regulations on cable cross-sections and ambient temperature.

6.4 Ordering Numbers: Sine-wave Filters

Frequency converter power and current ratings						Filter current rating			Switching frequency ¹⁾	Ordering number	
[kW (hp)]	[A]	[kW (hp)]	[A]	[kW (hp)]	[A]	[A]	[A]	[A]	[kHz]	-	-
200–240 V		200–240 V		200–240 V		50 Hz	60 Hz	100 Hz	-	IP00	IP20
-	-	0.37 (0.5)	1.2	0.37 (0.5)	1.1	2.5	2.5	2	6	130B2404	130B2439
-	-	0.55 (0.75)	1.7	0.55 (0.75)	1.6						
0.37 (0.5)	2.2	0.75 (1)	2.2	0.75 (1)	2.1						
-	-	1.1 (1.5)	3	1.1 (1.5)	2.8	4.5	4	3.5	6	130B2406	130B2441
0.55 (0.75)	3.2	1.5 (2)	3.7	1.5 (2)	3.4						
0.75 (1)	4.2	2.2 (3)	5.3	2.2 (3)	4.8	8	7.5	5.5	6	130B2408	130B2443
1.1 (1.5)	6	3 (4)	7.2	3 (4)	6.3						
1.5 (2)	6.8	-	-	-	-						
-	-	4 (5.5)	9	4 (5.5)	8.2	10	9.5	7.5	6	130B2409	130B2444
2.2 (3)	9.6	5.5 (7.5)	12	5.5 (7.5)	11	17	16	13	6	130B2411	130B2446
3.7 (5)	15.2	7.5 (10)	15.5	7.5 (10)	14						
-	-	11 (15)	23	11 (15)	21	24	23	18	5	130B2412	130B2447
-	-	15 (20)	31	15 (20)	27	38	36	28.5	5	130B2413	130B2448
-	-	18.5 (25)	37	18.5 (25)	34						
-	-	22 (30)	42.5	22 (30)	40						
-	-	-	-	-	-	48	45.5	36	5	130B2281	130B2307

Table 6.8 Sine-wave Filters for Frequency Converters with 380-480 V

1) The switching frequency could be derated to 3 kHz due to the output speed (less than 60% normal speed), over load, or over temperature. The customer could notice the noise change of the filter.

Suggested parameter settings for operation with sine-wave filter are as follows:

- Set [1] *Sine-Wave Filter* in *parameter 14-55 Output Filter*.
- Set suitable value for individual filter in *parameter 14-01 Switching Frequency*. When [1] *Sine-Wave Filter* is set in *parameter 14-55 Output Filter*, the options which are lower than 5 kHz in *parameter 14-01 Switching Frequency* are removed automatically.

6.5 Ordering Numbers: dU/dt Filters

Frequency converter power and current ratings				Filter current rating		Ordering number		
380-440 V		441-480 V		380@ 60 Hz 200–400/440 @ 50 Hz	460/480 @ 60 Hz 500/525 @ 50 Hz	IP00	IP20	IP54
[kW (hp)]	[A]	[kW (hp)]	[A]	[A]	[A]	–	–	–
11 (15)	23	11 (15)	21	44	40	130B2835	130B2836	130B2837
15 (20)	31	15 (20)	27					
18.5 (25)	37	18.5 (25)	34					
22 (30)	42.5	22 (30)	40					

Table 6.9 dU/dt Filters for Frequency Converters with 380-480 V

6.6 Ordering Numbers: External EMC Filters

For K1S2 and K2S2, with external EMC filters listed in *Table 6.10*, the maximum shielded cable length of 100 m (328 ft) according to EN/IEC 61800-3 C2 (EN 55011 A1), or 40 m (131.2 ft) according to EN/IEC 61800-3 C1 (EN 55011 B) can be achieved.

For K1T4, K2T4 and K3T4 with internal A1 filter, with external EMC filters listed in *Table 6.10*, the maximum shielded cable length of 100 m (328 ft) according to EN/IEC 61800-3 C2 (EN 55011 A1), or 25 m (82 ft) according to EN/IEC 61800-3 C1 (EN 55011 B) can be achieved.

EMC filter ordering number	134B5466	134B5467	134B5463	134B5464	134B5465
Frequency converter enclosure size	K1S2	K2S2	K1T4	K2T4	K3T4
Dimensions A [mm (in)]	250 (9.8)	312.5 (12.3)	250 (9.8)	312.5 (12.3)	
Dimensions a1 [mm (in)]	234 (9.2)	303 (11.9)	234 (9.2)	303 (11.9)	
Dimensions a2 [mm (in)]	19.5 (0.77)	21.3 (0.84)	19.5 (0.77)	21.3 (0.84)	
Dimensions am [mm (in)]	198 (7.8)	260 (10.2)	198 (7.8)	260 (10.2)	
Dimensions B [mm (in)]	75 (2.95)	90 (3.54)	75 (2.95)	90 (3.54)	115 (4.53)
Dimensions b1 [mm (in)]	55 (2.17)	70 (2.76)	55 (2.17)	70 (2.76)	90 (3.54)
Dimensions bm [mm (in)]	60 (2.36)	70 (2.76)	60 (2.36)	70 (2.76)	90 (3.54)
Dimensions C [mm (in)]	50 (1.97)				
Dimensions c1 [mm (in)]	22.7 (0.89)				
Dimensions D1 [mm (in)]	Ø5.3 (Ø0.21)				
Dimensions Dm [mm (in)]	M4	M5	M4	M5	
Dimensions e1 [mm (in)]	6.5 (0.26)	5 (0.20)	6.5 (0.26)	5 (0.20)	
Dimensions f1 [mm (in)]	10 (0.39)				12.5 (0.49)
Dimensions fm [mm (in)]	7.5 (0.30)	10 (0.39)	7.5 (0.30)	10 (0.39)	12.5 (0.49)
Mounting screws for EMC filter	M5				
Mounting screws for frequency converter	M4	M5	M4	M5	
Weight [kg (lb)]	1.10 (2.43)	1.50 (3.31)	1.20 (2.65)	1.90 (4.19)	2.10 (4.63)

Table 6.10 Details of EMC Filter for K1–K3

130BF872.10

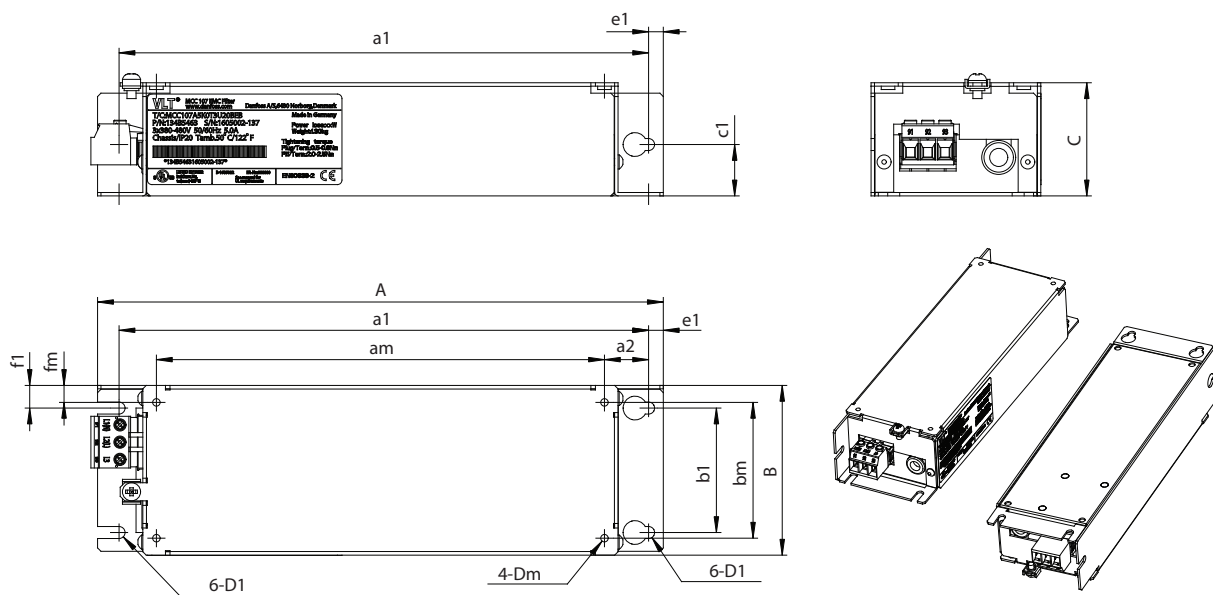

6

Illustration 6.2 Dimensions of EMC Filter for K1-K3

For K4T4 and K5T4 with internal A1 filter, with external EMC filters listed in Table 6.11, the maximum shielded cable length of 100 m (328 ft) according to EN/IEC 61800-3 C2 (EN 55011 A1), or 25 m (82 ft) according to EN/IEC 61800-3 C1 (EN 55011 B) can be achieved.

Power [kW (hp)] Size 380-480 V	Type	A	B	C	D	E	F	G	H	I	J	K	L1	Torque [Nm (in-lb)]	Weight [kg (lb)]	Ordering Number
11-15 (15-20)	FN3258-30-47	270	50	85	240	255	30	5.4	1	10.6	M5	25	40	1.9-2.2 (16.8-19.5)	1.2 (2.6)	132B0246
18.5-22 (25-30)	FN3258-42-47	310	50	85	280	295	30	5.4	1	10.6	M5	25	40	1.9-2.2 (16.8-19.5)	1.4 (3.1)	132B0247

Table 6.11 Details of EMC Filter for K4-K5

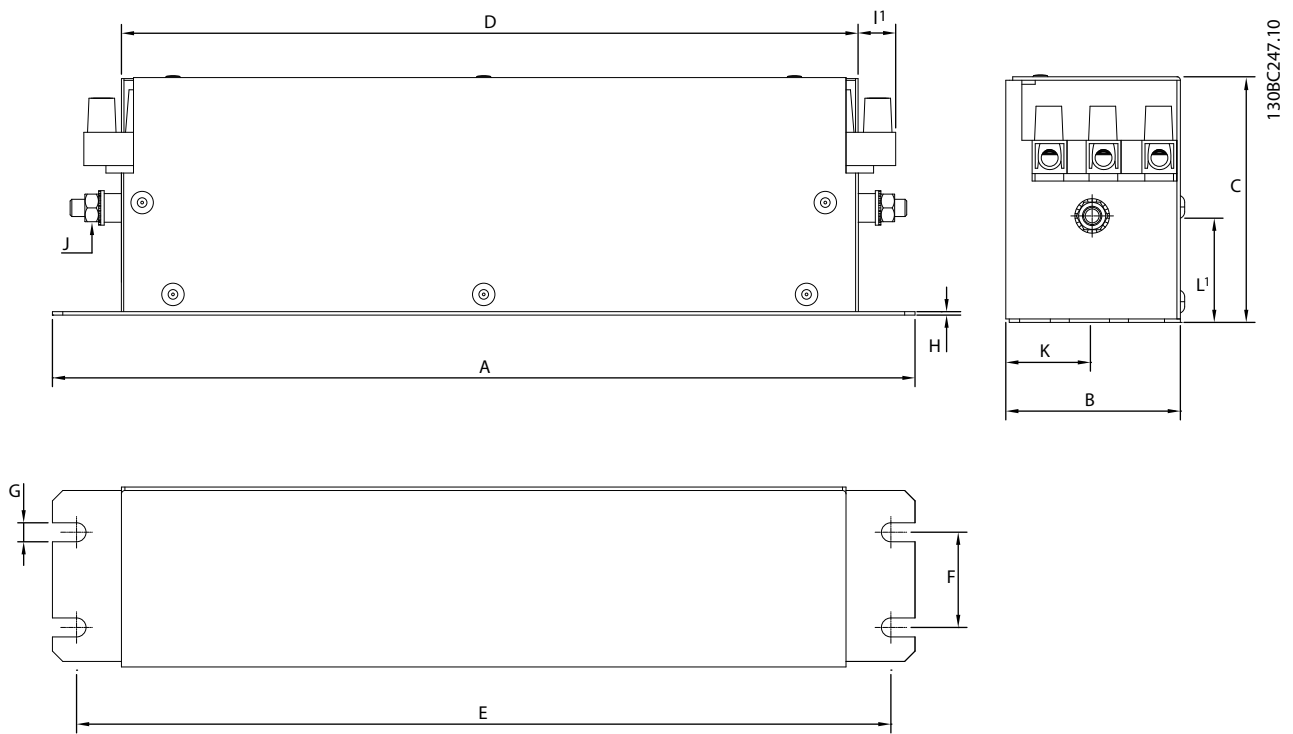

Illustration 6.3 Dimensions of EMC Filter for K4-K5

7 Specifications

7.1 Electrical Data

Frequency converter typical shaft output [kW (hp)]	PK37 0.37 (0.5)	PK55 0.55 (0.75)	PK75 0.75 (1.0)	P1K1 1.1 (1.5)	P1K5 1.5 (2.0)	P2K2 2.2 (3.0)	P3K0 3.0 (4.0)
Enclosure protection rating IP20 (IP21/Type 1 as option)	K1	K1	K1	K1	K1	K1	K2
Output current							
Shaft output [kW]	0.37	0.55	0.75	1.1	1.5	2.2	3
Continuous (3x380–440 V) [A]	1.2	1.7	2.2	3	3.7	5.3	7.2
Continuous (3x441–480 V) [A]	1.1	1.6	2.1	2.8	3.4	4.8	6.3
Intermittent (60 s overload) [A]	1.9	2.7	3.5	4.8	5.9	8.5	11.5
Continuous kVA (400 V AC) [kVA]	0.9	1.2	1.5	2.1	2.6	3.7	5.0
Continuous kVA (480 V AC) [kVA]	0.9	1.3	1.7	2.5	2.8	4.0	5.2
Maximum input current							
Continuous (3x380–440 V) [A]	1.2	1.6	2.1	2.6	3.5	4.7	6.3
Continuous (3x441–480 V) [A]	1.0	1.2	1.8	2.0	2.9	3.9	4.3
Intermittent (60 s overload) [A]	1.9	2.6	3.4	4.2	5.6	7.5	10.1
More specifications							
Maximum cable cross-section (mains, motor, brake, and load sharing) [mm ² (AWG)]	4 (12)						
Estimated power loss at rated maximum load [W] ¹⁾	20.9	25.2	30	40	52.9	74	94.8
Weight, enclosure protection rating IP20 [kg (lb)]	2.3 (5.1)	2.3 (5.1)	2.3 (5.1)	2.3 (5.1)	2.3 (5.1)	2.5 (5.5)	3.6 (7.9)
Weight, enclosure protection rating IP21 [kg (lb)]	4.0 (8.8)	4.0 (8.8)	4.0 (8.8)	4.0 (8.8)	4.0 (8.8)	4.0 (8.8)	5.5 (12.1)
Efficiency [%] ²⁾	96.0	96.6	96.8	97.2	97.0	97.5	98.0

Table 7.1 Mains Supply 3x380–480 V AC

Frequency converter typical shaft output [kW (hp)]	P4K0 4 (5.4)	P5K5 5.5 (7.5)	P7K5 7.5 (10)	P11K 11 (15)	P15K 15 (20)	P18K 18.5 (25)	P22K 22 (30)
Enclosure protection rating IP20 (IP21/Type 1 as option)	K2	K2	K3	K4	K4	K5	K5
Output current							
Shaft output	4	5.5	7.5	11	15	18.5	22
Continuous (3x380–440 V) [A]	9	12	15.5	23	31	37	42.5
Continuous (3x441–480 V) [A]	8.2	11	14	21	27	34	40
Intermittent (60 s overload) [A]	14.4	19.2	24.8	34.5	46.5	55.5	63.8
Continuous kVA (400 V AC) [kVA]	6.2	8.3	10.7	15.9	21.5	25.6	29.5
Continuous kVA (480 V AC) [kVA]	6.8	9.1	11.6	17.5	22.4	28.3	33.3
Maximum input current							
Continuous (3x380–440 V) [A]	8.3	11.2	15.1	22.1	29.9	35.2	41.5
Continuous (3x441–480 V) [A]	6.8	9.4	12.6	18.4	24.7	29.3	34.6
Intermittent (60 s overload) [A]	13.3	17.9	24.2	33.2	44.9	52.8	62.3
More specifications							
Maximum cable cross-section (mains, motor, brake, and load sharing) [mm ² (AWG)]	4 (12)			16 (6)			
Estimated power loss at rated maximum load [W] ¹⁾	115.5	157.5	192.8	289.5	393.4	402.8	467.5
Weight enclosure protection rating IP20 [kg (lb)]	3.6 (7.9)	3.6 (7.9)	4.1 (9.0)	9.4 (20.7)	9.5 (20.9)	12.3 (27.1)	12.5 (27.6)
Weight enclosure protection rating IP21 [kg (lb)]	5.5 (12.1)	5.5 (12.1)	6.5 (14.3)	10.5 (23.1)	10.5 (23.1)	14.0 (30.9)	14.0 (30.9)
Efficiency [%] ²⁾	98.0	97.8	97.7	98.0	98.1	98.0	98.0

Table 7.2 Mains Supply 3x380–480 V AC

Frequency converter typical shaft output [kW (hp)]	PK37 0.37 (0.5)	PK55 0.55 (0.75)	PK75 0.75 (1.0)	P1K1 1.1 (1.5)	P1K5 1.5 (2.0)	P2K2 2.2 (3.0)	P3K7 3.7 (5.0)
Enclosure protection rating IP20 (IP21/Type 1 as option)	K1	K1	K1	K1	K1	K2	K3
Output current							
Continuous (3x200–240 V) [A]	2.2	3.2	4.2	6	6.8	9.6	15.2
Intermittent (60 s overload) [A]	3.5	5.1	6.7	9.6	10.9	15.4	24.3
Continuous kVA (230 V AC) [kVA]	0.9	1.3	1.7	2.4	2.7	3.8	6.1
Maximum input current							
Continuous (3x200–240 V) [A]	1.8	2.7	3.4	4.7	6.3	8.8	14.3
Intermittent (60 s overload) [A]	2.9	4.3	5.4	7.5	10.1	14.1	22.9
More specifications							
Maximum cable cross-section (mains, motor, brake, and load sharing) [mm ² (AWG)]	4 (12)						
Estimated power loss at rated maximum load [W] ¹⁾	29.4	38.5	51.1	60.7	76.1	96.1	147.5
Weight enclosure protection rating IP20 [kg (lb)]	2.3 (5.1)	2.3 (5.1)	2.3 (5.1)	2.3 (5.1)	2.3 (5.1)	2.5 (5.5)	3.6 (7.9)
Weight enclosure protection rating IP21 [kg (lb)]	4.0 (8.8)	4.0 (8.8)	4.0 (8.8)	4.0 (8.8)	4.0 (8.8)	5.5 (12.1)	6.5 (14.3)
Efficiency [%] ²⁾	96.4	96.6	96.3	96.6	96.5	96.7	96.7

Table 7.3 Mains Supply 3x200–240 V AC

Frequency converter typical shaft output [kW (hp)]	PK37 0.37 (0.5)	PK55 0.55 (0.74)	PK75 0.75 (1.0)	P1K1 1.1 (1.5)	P1K5 1.5 (2.0)	P2K2 2.2 (3.0)
Enclosure protection rating IP20 (IP21/Type 1 as option)	K1	K1	K1	K1	K1	K2
Output current						
Continuous (3x200–240 V) [A]	2.2	3.2	4.2	6	6.8	9.6
Intermittent (60 s overload) [A]	3.5	5.1	6.7	9.6	10.9	15.4
Continuous kVA (230 V AC) [kVA]	0.9	1.3	1.7	2.4	2.7	3.8
Maximum input current						
Continuous (1x200–240 V) [A]	2.9	4.4	5.5	7.7	10.4	14.4
Intermittent (60 s overload) [A]	4.6	7.0	8.8	12.3	16.6	23.0
More specifications						
Maximum cable cross-section (mains and motor) [mm ² (AWG)]	4 (12)					
Estimated power loss at rated maximum load [W] ¹⁾	37.7	46.2	56.2	76.8	97.5	121.6
Weight enclosure protection rating IP20 [kg (lb)]	2.3 (5.1)	2.3 (5.1)	2.3 (5.1)	2.3 (5.1)	2.3 (5.1)	2.5 (5.5)
Weight enclosure protection rating IP21 [kg (lb)]	4.0 (8.8)	4.0 (8.8)	4.0 (8.8)	4.0 (8.8)	4.0 (8.8)	5.5 (12.1)
Efficiency [%] ²⁾	94.4	95.1	95.1	95.3	95.0	95.4

Table 7.4 Mains Supply 1x200–240 V AC

1) The typical power loss is at nominal load conditions and expected to be within $\pm 15\%$ (tolerance relates to variety in voltage and cable conditions).

Values are based on a typical motor efficiency (IE2/IE3 border line). Motors with lower efficiency add to the power loss in the frequency converter, and motors with high efficiency reduce power loss.

Applies to dimensioning of frequency converter cooling. If the switching frequency is higher than the default setting, the power losses sometimes rise. LCP and typical control card power consumptions are included. Further options and customer load sometimes add up to 30 W to the losses (though typically only 4 W extra for a fully loaded control card or fieldbus).

For power loss data according to EN 50598-2, refer to www.danfoss.com/vltenergyefficiency.

2) Measured using 50 m (164 ft) shielded motor cables at rated load and rated frequency. For energy efficiency class, see chapter 7.4 Ambient Conditions. For part load losses, see www.danfoss.com/vltenergyefficiency.

7.2 Mains Supply

Mains supply (L1/N, L2/L, L3)

Supply terminals	(L1/N, L2/L, L3)
Supply voltage	380–480 V: -15% (-25%) ¹⁾ to +10%
Supply voltage	200–240 V: -15% (-25%) ¹⁾ to +10%

1) The frequency converter can run at -25% input voltage with reduced performance. The maximum output power of the frequency converter is 75% if input voltage is -25%, and 85% if input voltage is -15%.

Full torque cannot be expected at mains voltage lower than 10% below the lowest rated supply voltage of the frequency converter.

Supply frequency	50/60 Hz \pm 5%
Maximum imbalance temporary between mains phases	3.0% of rated supply voltage
True power factor (λ)	\geq 0.9 nominal at rated load
Displacement power factor ($\cos \phi$)	Near unity ($>$ 0.98)
Switching on input supply (L1/N, L2/L, L3) (power-ups) \leq 7.5 kW (10 hp)	Maximum 2 times/minute
Switching on input supply (L1/N, L2/L, L3) (power-ups) 11–22 kW (15–30 hp)	Maximum 1 time/minute

7.3 Motor Output and Motor Data

Motor output (U, V, W)

Output voltage	0–100% of supply voltage
Output frequency	0–500 Hz
Output frequency in VVC ⁺ mode	0–200 Hz
Switching on output	Unlimited
Ramp time	0.01–3600 s

Torque characteristics

Starting torque (constant torque)	Maximum 160% for 60 s ¹⁾
Overload torque (constant torque)	Maximum 160% for 60 s ¹⁾
Starting current	Maximum 200% for 1 s
Torque rise time in VVC ⁺ mode (independent of f_{sw})	Maximum 50 ms

1) Percentage relates to the nominal torque. It is 150% for 11–22 kW (15–30 hp) frequency converters.

7.4 Ambient Conditions

Ambient conditions

IP class	IP20 (IP21/NEMA type 1 as option)
Vibration test, all enclosure sizes	1.14 g
Relative humidity	5–95% (IEC 721-3-3; Class 3K3 (non-condensing) during operation)
Ambient temperature (at DPWM switching mode)	
- with derating	Maximum 55 °C (131 °F) ¹⁾²⁾³⁾
- at full constant output current	Maximum 45 °C (113 °F) ⁴⁾
Minimum ambient temperature during full-scale operation	0 °C (32 °F)
Minimum ambient temperature at reduced performance	-10 °C (14 °F)
Temperature during storage/transport	-25 to +65/70 °C (-13 to +149/158 °F)
Maximum altitude above sea level without derating	1000 m (3280 ft)
Maximum altitude above sea level with derating	3000 m (9243 ft)
EMC standards, emission	EN 61800-3, EN 61000-3-2, EN 61000-3-3, EN 61000-3-11, EN 61000-3-12, EN 61000-6-3/4, EN 55011, IEC 61800-3
EMC standards, immunity	EN 61800-3, EN 61000-6-1/2, EN 61000-4-2, EN 61000-4-3, EN 61000-4-4, EN 61000-4-5, EN 61000-4-6, EN 61326-3-1
Energy efficiency class ⁵⁾	IE2

1) Refer to chapter 7.12 Special Conditions for:

- Derating for high ambient temperature.
- Derating for high altitude.

2) For PROFIBUS, PROFINET, EtherNet/IP, and POWERLINK variant of VLT® Midi Drive FC 280, to prevent the control card from overtemperature, avoid full digital/analog I/O load at ambient temperature higher than 45 °C (113 °F).

3) Ambient temperature for K1S2 with derating is maximum 50 °C (122 °F).

4) Ambient temperature for K1S2 at full constant output current is maximum 40 °C (104 °F).

5) Determined according to EN 50598-2 at:

- Rated load.
- 90% rated frequency.
- Switching frequency factory setting.
- Switching pattern factory setting.
- Open type: Surrounding air temperature 45 °C (113 °F).
- Type 1 (NEMA kit): Ambient temperature 45 °C (113 °F).

7.5 Cable Specifications

Cable lengths¹⁾

Maximum motor cable length, shielded	50 m (164 ft)
Maximum motor cable length, unshielded	75 m (246 ft)
Maximum cross-section of control terminals, flexible/rigid wire	2.5 mm ² /14 AWG
Minimum cross-section of control terminals	0.55 mm ² /30 AWG
Maximum STO input cable length, unshielded	20 m (66 ft)

1) For power cables cross-sections, see Table 7.1, Table 7.2, Table 7.3, and Table 7.4.

When complying with EN 55011 1A and EN 55011 1B the motor cable must in certain instances be reduced. See chapter 2.6.2 EMC Emission for more details.

7.6 Control Input/Output and Control Data

Digital inputs

Terminal number	18, 19, 27 ¹⁾ , 29, 32, 33
Logic	PNP or NPN
Voltage level	0–24 V DC
Voltage level, logic 0 PNP	<5 V DC
Voltage level, logic 1 PNP	>10 V DC
Voltage level, logic 0 NPN	>19 V DC
Voltage level, logic 1 NPN	<14 V DC
Maximum voltage on input	28 V DC
Pulse frequency range	4–32 kHz
(Duty cycle) minimum pulse width	4.5 ms
Input resistance, R _i	Approximately 4 kΩ

1) Terminal 27 can also be programmed as output.

STO inputs

Terminal number	37, 38
Voltage level	0–30 V DC
Voltage level, low	<1.8 V DC
Voltage level, high	>20 V DC
Maximum voltage on input	30 V DC
Minimum input current (each pin)	6 mA

Analog inputs

Number of analog inputs	2
Terminal number	53 ¹⁾ , 54
Modes	Voltage or current
Mode select	Software
Voltage level	0–10 V
Input resistance, R_i	Approximately 10 k Ω
Maximum voltage	-15 V to +20 V
Current level	0/4 to 20 mA (scaleable)
Input resistance, R_i	Approximately 200 Ω
Maximum current	30 mA
Resolution for analog inputs	11 bit
Accuracy of analog inputs	Maximum error 0.5% of full scale
Bandwidth	100 Hz

The analog inputs are galvanically isolated from the supply voltage (PELV) and other high-voltage terminals.

1) Terminal 53 supports only voltage mode and can also be used as digital input.

7

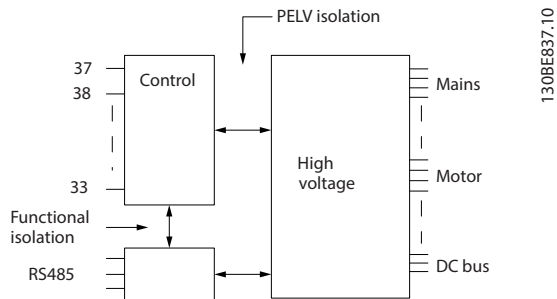

Illustration 7.1 Galvanic Isolation

NOTICE

HIGH ALTITUDE

For installation at altitudes above 2000 m (6562 ft), contact Danfoss hotline regarding PELV.

Pulse inputs

Programmable pulse inputs	2
Terminal number pulse	29, 33
Maximum frequency at terminal 29, 33	32 kHz (push-pull driven)
Maximum frequency at terminal 29, 33	5 kHz (open collector)
Minimum frequency at terminal 29, 33	4 Hz
Voltage level	See the section on digital input
Maximum voltage on input	28 V DC
Input resistance, R_i	Approximately 4 k Ω
Pulse input accuracy	Maximum error: 0.1% of full scale

Digital outputs

Programmable digital/pulse outputs	1
Terminal number	27 ¹⁾
Voltage level at digital/frequency output	0–24 V
Maximum output current (sink or source)	40 mA
Maximum load at frequency output	1 k Ω
Maximum capacitive load at frequency output	10 nF
Minimum output frequency at frequency output	4 Hz
Maximum output frequency at frequency output	32 kHz
Accuracy of frequency output	Maximum error: 0.1% of full scale
Resolution of frequency output	10 bit

1) Terminal 27 can also be programmed as input.

The digital output is galvanically isolated from the supply voltage (PELV) and other high-voltage terminals.

Analog outputs

Number of programmable analog outputs	1
Terminal number	42
Current range at analog output	0/4–20 mA
Maximum resistor load to common at analog output	500 Ω
Accuracy on analog output	Maximum error: 0.8% of full scale
Resolution on analog output	10 bit

The analog output is galvanically isolated from the supply voltage (PELV) and other high-voltage terminals.

Control card, 24 V DC output

Terminal number	12, 13
Maximum load	100 mA

The 24 V DC supply is galvanically isolated from the supply voltage (PELV). However, the supply has the same potential as the analog and digital inputs and outputs.

Control card, +10 V DC output

Terminal number	50
Output voltage	10.5 V \pm 0.5 V
Maximum load	15 mA

The 10 V DC supply is galvanically isolated from the supply voltage (PELV) and other high-voltage terminals.

Control card, RS485 serial communication

Terminal number	68 (P,TX+, RX+), 69 (N,TX-, RX-)
Terminal number 61	Common for terminals 68 and 69

The RS485 serial communication circuit is galvanically isolated from the supply voltage (PELV).

Control card, USB serial communication

USB standard	1.1 (full speed)
USB plug	USB type B plug

Connection to PC is carried out via a standard host/device USB cable.

The USB connection is galvanically isolated from the supply voltage (PELV) and other high-voltage terminals.

The USB ground connection is not galvanically isolated from protective earth. Use only an isolated laptop as PC connection to the USB connector on the frequency converter.

Relay outputs

Programmable relay outputs	1
Relay 01	01-03 (NC), 01-02 (NO)
Maximum terminal load (AC-1) ¹⁾ on 01-02 (NO) (resistive load)	250 V AC, 3 A
Maximum terminal load (AC-15) ¹⁾ on 01-02 (NO) (inductive load @ cosφ 0.4)	250 V AC, 0.2 A
Maximum terminal load (DC-1) ¹⁾ on 01-02 (NO) (resistive load)	30 V DC, 2 A
Maximum terminal load (DC-13) ¹⁾ on 01-02 (NO) (inductive load)	24 V DC, 0.1 A
Maximum terminal load (AC-1) ¹⁾ on 01-03 (NC) (resistive load)	250 V AC, 3 A
Maximum terminal load (AC-15) ¹⁾ on 01-03 (NC) (inductive load @ cosφ 0.4)	250 V AC, 0.2 A
Maximum terminal load (DC-1) ¹⁾ on 01-03 (NC) (resistive load)	30 V DC, 2 A
Minimum terminal load on 01-03 (NC), 01-02 (NO)	24 V DC 10 mA, 24 V AC 20 mA

1) IEC 60947 parts 4 and 5

The relay contacts are galvanically isolated from the rest of the circuit by reinforced isolation.

Control card performance

Scan interval	1 ms
---------------	------

Control characteristics

Resolution of output frequency at 0–500 Hz	±0.003 Hz
System response time (terminals 18, 19, 27, 29, 32, and 33)	≤2 ms
Speed control range (open loop)	1:100 of synchronous speed
Speed accuracy (open loop)	±0.5% of nominal speed
Speed accuracy (closed loop)	±0.1% of nominal speed

All control characteristics are based on a 4-pole asynchronous motor.

7.7 Connection Tightening Torques

Make sure to use the right torques when tightening all electrical connections. Too low or too high torque sometimes causes electrical connection problems. To ensure that correct torques are applied, use a torque wrench. Recommended slot screwdriver type is SZS 0.6x3.5 mm.

Enclosure type	Power [kW (hp)]	Torque [Nm (in-lb)]						
		Mains	Motor	DC connection	Brake	Ground	Control	Relay
K1	0.37–2.2 (0.5–3.0)	0.8 (7.1)	0.8 (7.1)	0.8 (7.1)	0.8 (7.1)	1.6 (14.2)	0.4 (3.5)	0.5 (4.4)
K2	3.0–5.5 (4.0–7.5)	0.8 (7.1)	0.8 (7.1)	0.8 (7.1)	0.8 (7.1)	1.6 (14.2)	0.4 (3.5)	0.5 (4.4)
K3	7.5 (10)	0.8 (7.1)	0.8 (7.1)	0.8 (7.1)	0.8 (7.1)	1.6 (14.2)	0.4 (3.5)	0.5 (4.4)
K4	11–15 (15–20)	1.2 (10.6)	1.2 (10.6)	1.2 (10.6)	1.2 (10.6)	1.6 (14.2)	0.4 (3.5)	0.5 (4.4)
K5	18.5–22 (25–30)	1.2 (10.6)	1.2 (10.6)	1.2 (10.6)	1.2 (10.6)	1.6 (14.2)	0.4 (3.5)	0.5 (4.4)

Table 7.5 Tightening Torques

7.8 Fuses and Circuit Breakers

Use fuses and/or circuit breakers on the supply side to protect service personnel and equipment from injuries and damage if there is component breakdown inside the frequency converter (first fault).

Branch circuit protection

Protect all branch circuits in an installation (including switch gear and machines) against short circuit and overcurrent according to national/international regulations.

NOTICE

Integral solid-state short-circuit protection does not provide branch circuit protection. Provide branch circuit protection in accordance with the national and local rules and regulations.

Table 7.6 lists the recommended fuses and circuit breakers that have been tested.

CAUTION

PERSONAL INJURY AND EQUIPMENT DAMAGE RISK

Malfunction or failing to follow the recommendations may result in personal risk and damage to the frequency converter and other equipment.

- Select fuses according to recommendations. Possible damage can be limited to be inside the frequency converter.

NOTICE

EQUIPMENT DAMAGE

Using fuses and/or circuit breakers is mandatory to ensure compliance with IEC 60364 for CE. Failure to follow the protection recommendations can result in damage to the frequency converter.

Danfoss recommends using the fuses and circuit breakers in *Table 7.6* to ensure compliance with UL 508C or IEC 61800-5-1. For non-UL applications, design circuit breakers for protection in a circuit capable of delivering a maximum of 50000 A_{rms} (symmetrical), 240 V/400 V maximum. The frequency converter short-circuit current rating (SCCR) is suitable for use on a circuit capable of delivering not more than 100000 A_{rms} , 240 V/480 V maximum when protected by Class T fuses.

Enclosure size		Power [kW (hp)]	Non-UL fuse	Non-UL circuit breaker (Eaton)	UL fuse (Bussmann, class T)
3-phase 380–480 V	K1	0.37 (0.5)	gG-10	PKZM0-16	JJS-6
		0.55–0.75 (0.74–1.0)			
		1.1–1.5 (1.48–2.0)	gG-20		JJS-10
		2.2 (3.0)			JJS-15
	K2	3.0–5.5 (4.0–7.5)	gG-25	PKZM0-20	JJS-25
	K3	7.5 (10)		PKZM0-25	
	K4	11–15 (15–20)	gG-50	–	JJS-50
	K5	18.5–22 (25–30)	gG-80	–	JJS-80
3-phase 200–240 V	K1	0.37 (0.5)	gG-10	PKZM0-16	JJN-6
		0.55 (0.74)			JJN-10
		0.75 (1.0)	gG-20		JJN-15
		1.1 (1.48)			JJN-20
		1.5 (2.0)			
	K2	2.2 (3.0)	gG-25	PKZM0-20	JJN-25
	K3	3.7 (5.0)		PKZM0-25	
Single-phase 200–240 V	K1	0.37 (0.5)	gG-10	PKZM0-16	JJN-6
		0.55 (0.74)			JJN-10
		0.75 (1.0)	gG-20		JJN-15
		1.1 (1.48)			JJN-20
	K2	1.5 (2.0)	gG-25	PKZM0-20	JJN-25
		2.2 (3.0)			

Table 7.6 Fuse and Circuit Breaker

7.9 Efficiency

Efficiency of the frequency converter (η_{VLT})

The load on the frequency converter has little effect on its efficiency. In general, the efficiency is the same at the rated motor frequency $f_{M,N}$. This rule also applies even if the motor supplies 100% of the rated shaft torque or only 75%, for example if there is part loads.

This also means that the efficiency of the frequency converter does not change even if other U/f characteristics are selected.

However, the U/f characteristics influence the efficiency of the motor.

The efficiency declines a little when the switching frequency is set to a value above the default value. If the mains voltage is 480 V, or if the motor cable is longer than 30 m (98.4 ft), the efficiency is also slightly reduced.

Frequency converter efficiency calculation

Calculate the efficiency of the frequency converter at different loads based on *Illustration 7.2*. Multiply the factor in *Illustration 7.2* by the specific efficiency factor listed in the specification tables in *chapter 7.1 Electrical Data*:

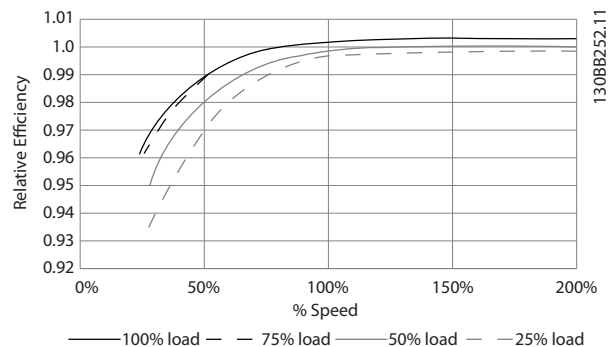

Illustration 7.2 Typical Efficiency Curves

Efficiency of the motor (η_{MOTOR})

The efficiency of a motor connected to the frequency converter depends on the magnetizing level. In general, the efficiency is as good as with mains operation. The efficiency of the motor depends on the type of motor.

In the range of 75–100% of the rated torque, the efficiency of the motor is practically constant, both when controlled by the frequency converter and when running directly on mains.

In small motors, the influence from the U/f characteristic on efficiency is marginal. However, in motors from 11 kW (14.8 hp) and up, the advantages are significant.

In general, the switching frequency does not affect the efficiency of small motors. Motors from 11 kW (14.8 hp) and up have their efficiency improved 1–2% because the sine shape of the motor current is almost perfect at high switching frequency.

Efficiency of the system (η_{SYSTEM})

To calculate the system efficiency, the efficiency of the frequency converter (η_{VLT}) is multiplied by the efficiency of the motor (η_{MOTOR}):

$$\eta_{SYSTEM} = \eta_{VLT} \times \eta_{MOTOR}$$

7.10 Acoustic Noise

The acoustic noise from the frequency converter comes from 3 sources:

- DC intermediate circuit coils.
- Integral fan.
- RFI filter choke.

The typical values measured at a distance of 1 m (3.3 ft) from the unit:

Enclosure size [kW (hp)]	80% fan speed [dBA]	Full fan speed [dBA]	Background noise
K1 0.37–2.2 (0.5–3.0)	41.4	42.7	33
K2 3.0–5.5 (4.0–7.5)	50.3	54.3	32.9
K3 7.5 (10)	51	54.2	33
K4 11–15 (15–20)	59	61.1	32.9
K5 18.5–22 (25–30)	64.6	65.6	32.9

Table 7.7 Typical Measured Values

7.11 dU/dt Conditions

When a transistor in the frequency converter bridge switches, the voltage across the motor increases by a dU/dt ratio depending on the following factors:

- The motor cable type.
- The cross-section of the motor cable.
- The length of the motor cable.
- Whether the motor cable is shielded or not.
- Inductance.

The natural induction causes an overshoot U_{PEAK} in the motor voltage before it stabilizes itself at a level depending on the voltage in the DC link. The rise time and the peak voltage U_{PEAK} affect the service life of the motor.

If the peak voltage is too high, motors without phase coil insulation are affected. The longer the motor cable, the higher the rise time and peak voltage.

Switching of the IGBTs cause peak voltage on the motor terminals. The VLT® Midi Drive FC 280 complies with IEC 60034-25 regarding motors designed to be controlled by frequency converters. The FC 280 also complies with IEC 60034-17 regarding Norm motors controlled by frequency converters.

The following dU/dt data are measured at the motor terminal side:

Cable length [m (ft)]	Mains voltage [V]	Rise time [µsec]	U_{PEAK} [kV]	dU/dt [kV/µsec]
5 (16.4)	400	0.0904	0.718	6.41
50 (164)	400	0.292	1.05	2.84
5 (16.4)	480	0.108	0.835	6.20
50 (164)	480	0.32	1.25	3.09

Table 7.8 dU/dt Data for FC 280, 2.2 kW (3.0 hp), 3x380–480 V

Cable length [m (ft)]	Mains voltage [V]	Rise time [µsec]	U_{PEAK} [kV]	dU/dt [kV/µsec]
5 (16.4)	400	0.096	0.632	5.31
50 (164)	400	0.306	0.99	2.58
5 (16.4)	480	0.118	0.694	4.67
50 (164)	480	0.308	1.18	3.05

Table 7.9 dU/dt Data for FC 280, 5.5 kW (7.5 hp), 3x380–480 V

Cable length [m (ft)]	Mains voltage [V]	Rise time [µsec]	U_{PEAK} [kV]	dU/dt [kV/µsec]
5 (16.4)	400	0.128	0.732	4.54
50 (164)	400	0.354	1.01	2.27
5 (16.4)	480	0.134	0.835	5.03
50 (164)	480	0.36	1.21	2.69

Table 7.10 dU/dt Data for FC 280, 7.5 kW (10 hp), 3x380–480 V

Cable length [m (ft)]	Mains voltage [V]	Rise time [µsec]	U_{PEAK} [kV]	dU/dt [kV/µsec]
5 (16.4)	400	0.26	0.84	2.57
50 (164)	400	0.738	1.07	1.15
5 (16.4)	480	0.334	0.99	2.36
50 (164)	480	0.692	1.25	1.44

Table 7.11 dU/dt Data for FC 280, 15 kW (20 hp), 3x380–480 V



Cable length [m (ft)]	Mains voltage [V]	Rise time [μsec]	U _{PEAK} [kV]	dU/dt [kV/μsec]
5 (16.4)	400	0.258	0.652	2.01
50 (164)	400	0.38	1.03	2.15
5 (16.4)	480	0.258	0.752	2.34
50 (164)	480	0.4	1.23	2.42

Table 7.12 dU/dt Data for FC 280, 22 kW (30 hp), 3x380–480 V

Cable length [m (ft)]	Mains voltage [V]	Rise time [μsec]	U _{PEAK} [kV]	dU/dt [kV/μsec]
5 (16.4)	240	0.0712	0.484	5.44
50 (164)	240	0.224	0.594	2.11

Table 7.13 dU/dt Data for FC 280, 1.5 kW (2.0 hp), 3x200–240 V

Cable length [m (ft)]	Mains voltage [V]	Rise time [μsec]	U _{PEAK} [kV]	dU/dt [kV/μsec]
5 (16.4)	240	0.072	0.468	5.25
50 (164)	240	0.208	0.592	2.28

Table 7.14 dU/dt Data for FC 280, 2.2 kW (3.0 hp), 3x200–240 V

Cable length [m (ft)]	Mains voltage [V]	Rise time [μsec]	U _{PEAK} [kV]	dU/dt [kV/μsec]
5 (16.4)	240	0.092	0.526	4.56
50 (164)	240	0.28	0.6	1.72

Table 7.15 dU/dt Data for FC 280, 3.7 kW (5.0 hp), 3x200–240 V

Cable length [m (ft)]	Mains voltage [V]	Rise time [μsec]	U _{PEAK} [kV]	dU/dt [kV/μsec]
5 (16.4)	240	0.088	0.414	3.79
50 (164)	240	0.196	0.593	2.41

Table 7.16 dU/dt Data for FC 280, 1.5 kW (2.0 hp), 1x200–240 V

Cable length [m (ft)]	Mains voltage [V]	Rise time [μsec]	U _{PEAK} [kV]	dU/dt [kV/μsec]
5 (16.4)	240	0.112	0.368	2.64
50 (164)	240	0.116	0.362	2.51

Table 7.17 dU/dt Data for FC 280, 2.2 kW (3.0 hp), 1x200–240 V

7.12 Special Conditions

Under some special conditions, where the operation of the frequency converter is challenged, consider derating. In some conditions, derating must be done manually.

In other conditions, the frequency converter automatically performs a degree of derating when necessary. Derating is done to ensure the performance at critical stages where the alternative could be a trip.

7.12.1 Manual Derating

Manual derating must be considered for:

- Air pressure – for installation at altitudes above 1000 m (3281 ft).
- Motor speed – at continuous operation at low RPM in constant torque applications.
- Ambient temperature – above 45 °C (113 °F), for details, see from *Illustration 7.3* to *Illustration 7.12*.

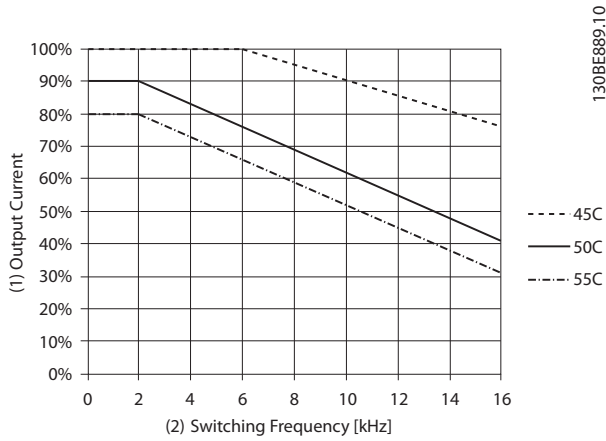

(1)	Output current
(2)	Switching frequency [kHz]

Illustration 7.3 K1T4 Derating Curve

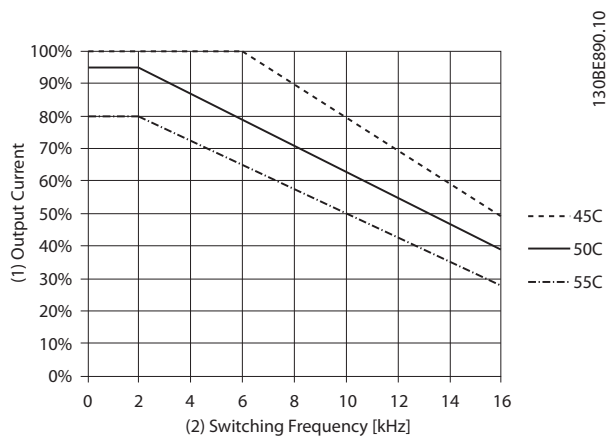

(1)	Output current
(2)	Switching frequency [kHz]

Illustration 7.4 K2T4 Derating Curve

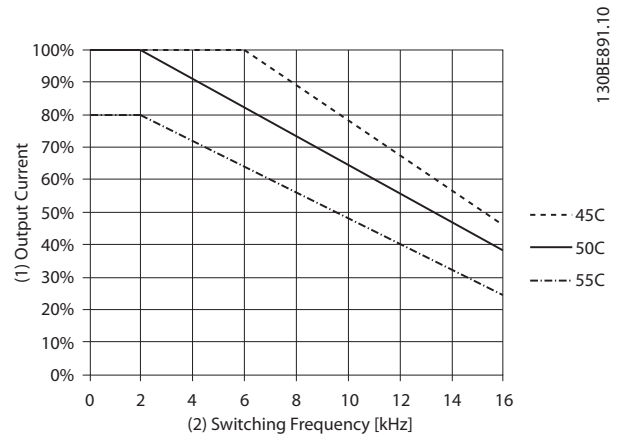

(1)	Output current
(2)	Switching frequency [kHz]

Illustration 7.5 K3T4 Derating Curve

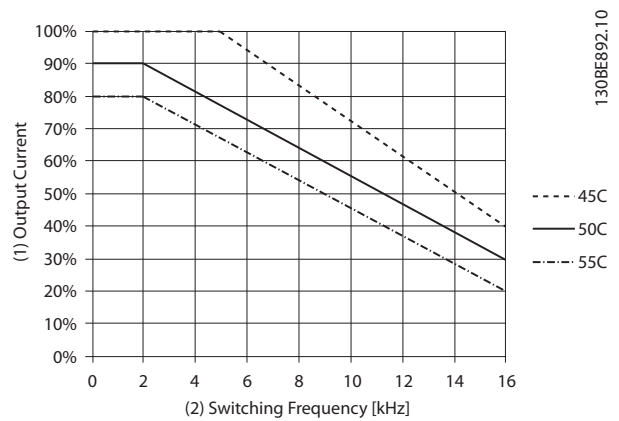

(1)	Output current
(2)	Switching frequency [kHz]

Illustration 7.6 K4T4 Derating Curve

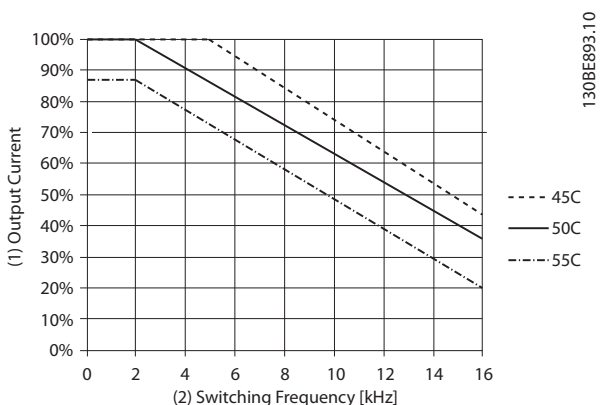

(1)	Output current
(2)	Switching frequency [kHz]

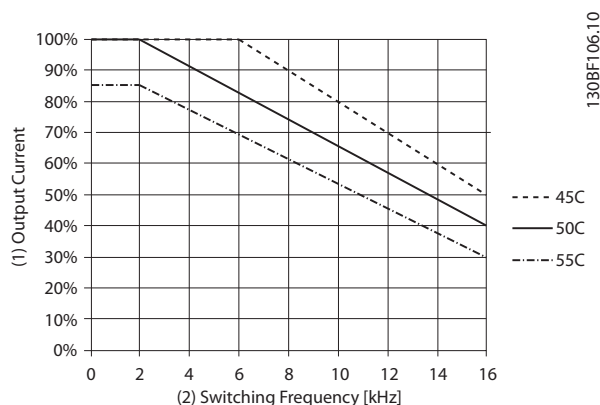

(1)	Output current
(2)	Switching frequency [kHz]

Illustration 7.7 K5T4 Derating Curve

Illustration 7.10 K3T2 Derating Curve

7

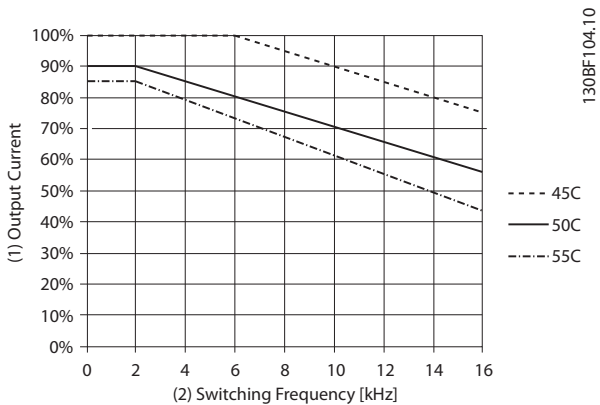

(1)	Output current
(2)	Switching frequency [kHz]

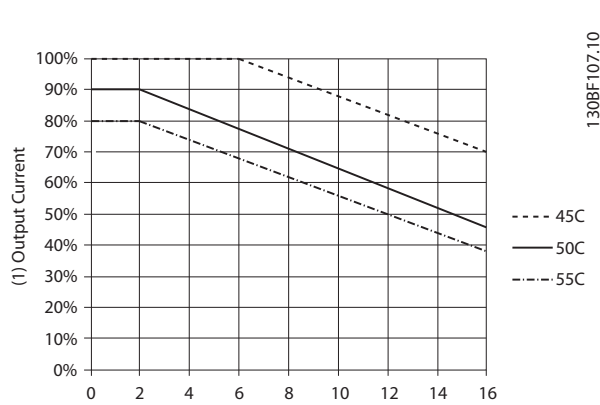

(1)	Output current
(2)	Switching frequency [kHz]

Illustration 7.8 K1T2 Derating Curve

Illustration 7.11 K1S2 Derating Curve

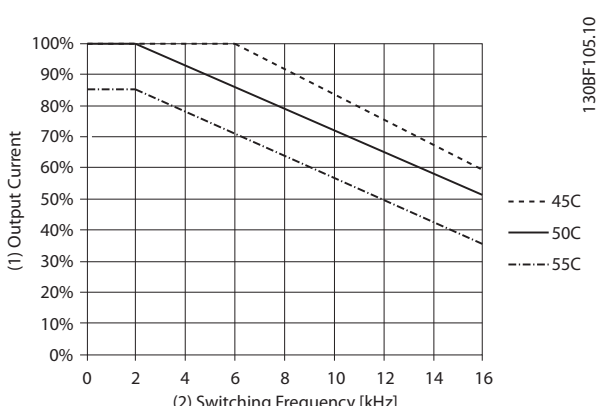

(1)	Output current
(2)	Switching frequency [kHz]

Illustration 7.9 K2T2 Derating Curve

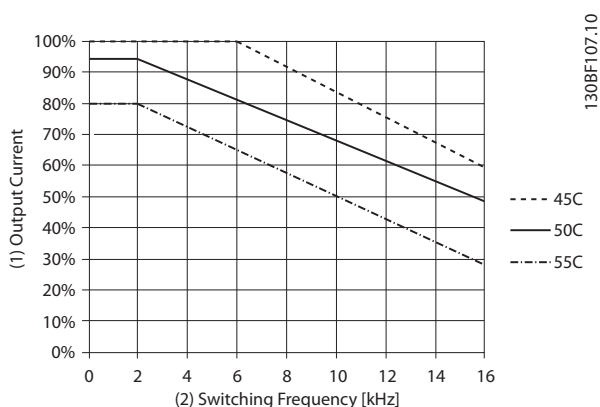

(1)	Output current
(2)	Switching frequency [kHz]

Illustration 7.12 K2S2 Derating Curve

NOTICE

Rated switching frequency is 6 kHz for K1–K3, 5 kHz for K4–K5.

7.12.2 Automatic Derating

The frequency converter constantly checks for critical levels:

- Critical high temperature on the heat sink.
- High motor load.
- Low motor speed.
- Protection signals (overvoltage/undervoltage, overcurrent, ground fault, and short circuit) are triggered.

As a response to a critical level, the frequency converter adjusts the switching frequency.

7.13 Enclosure Sizes, Power Ratings, and Dimensions

	Enclosure size	K1					K2			K3	K4		K5	
		0.37 (0.5)	0.55 (0.75)	0.75 (1.0)	1.1 (1.5)	1.5 (2.0)	2.2 (3.0)			-	-	-		
Power size [kW (hp)]	Single-phase 200–240 V	0.37 (0.5)	0.55 (0.75)	0.75 (1.0)	1.1 (1.5)	1.5 (2.0)	2.2 (3.0)			-	-	-		
	3-phase 200–240 V	0.37 (0.5)	0.55 (0.75)	0.75 (1.0)	1.1 (1.5)	1.5 (2.0)	2.2 (3.0)		3.7 (5.0)	-	-	-		
	3-phase 380–480 V	0.37 (0.5)	0.55 (0.75)	0.75 (1.0)	1.1 (1.5)	1.5 (2.0)	2.2 (3.0)	3 (4.0)	4 (5.5)	5.5 (7.5)	7.5 (10)	11 (15)	15 (20)	18.5 (25)
Dimensions [mm (in)]	FC 280 IP20													
	Height A1	210 (8.3)					272.5 (10.7)			272.5 (10.7)	317.5 (12.5)	410 (16.1)		
	Height A2	278 (10.9)					340 (13.4)			341.5 (13.4)	379.5 (14.9)	474 (18.7)		
	Width B	75 (3.0)					90 (3.5)			115 (4.5)	133 (5.2)	150 (5.9)		
	Depth C	168 (6.6)					168 (6.6)			168 (6.6)	245 (9.6)	245 (9.6)		
	FC 280 with IP21/UL/Type 1 kit													
	Height A	338.5 (13.3)					395 (15.6)			395 (15.6)	425 (16.7)	520 (20.5)		
	Width B	100 (3.9)					115 (4.5)			130 (5.1)	153 (6.0)	170 (6.7)		
	Depth C	183 (7.2)					183 (7.2)			183 (7.2)	260 (10.2)	260 (10.2)		
	FC 280 with bottom cable entry cover (w/o top cover)													
	Height A	294 (11.6)					356 (14)			357 (14.1)	391 (15.4)	486 (19.1)		
	Width B	75 (3.0)					90 (3.5)			115 (4.5)	133 (5.2)	150 (5.9)		
Depth C	168 (6.6)					168 (6.6)			168 (6.6)	245 (9.6)	245 (9.6)			
Weight [kg (lb)]	IP20	2.5 (5.5)					3.6 (7.9)			4.6 (10.1)	8.2 (18.1)	11.5 (25.4)		
	IP21	4.0 (8.8)					5.5 (12.1)			6.5 (14.3)	10.5 (23.1)	14.0 (30.9)		
Mounting holes [mm (in)]	a	198 (7.8)					260 (10.2)			260 (10.2)	297.5 (11.7)	390 (15.4)		
	b	60 (2.4)					70 (2.8)			90 (3.5)	105 (4.1)	120 (4.7)		
	c	5 (0.2)					6.4 (0.25)			6.5 (0.26)	8 (0.32)	7.8 (0.31)		
	d	9 (0.35)					11 (0.43)			11 (0.43)	12.4 (0.49)	12.6 (0.5)		
	e	4.5 (0.18)					5.5 (0.22)			5.5 (0.22)	6.8 (0.27)	7 (0.28)		
	f	7.3 (0.29)					8.1 (0.32)			9.2 (0.36)	11 (0.43)	11.2 (0.44)		

Table 7.18 Enclosure Sizes, Power Ratings, and Dimensions

7

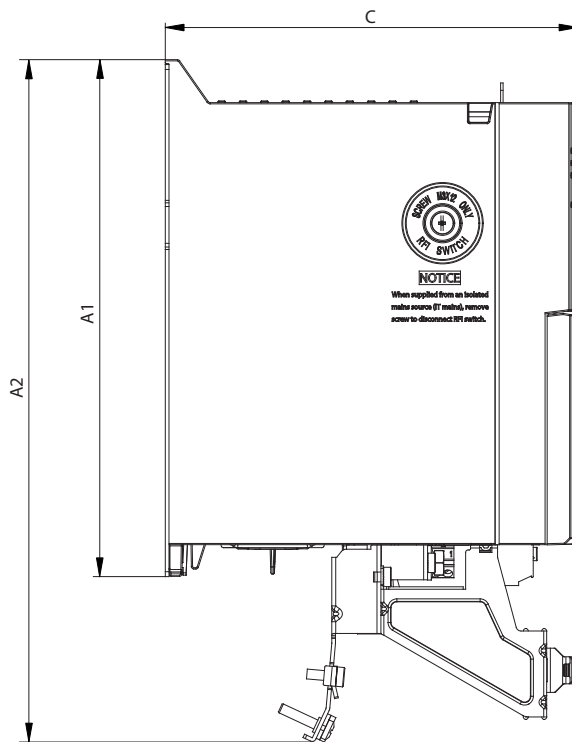
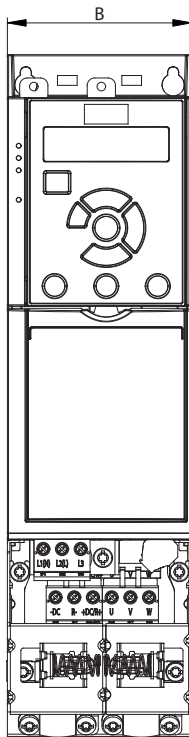

130BE84.11

Illustration 7.13 Standard with Decoupling Plate

7

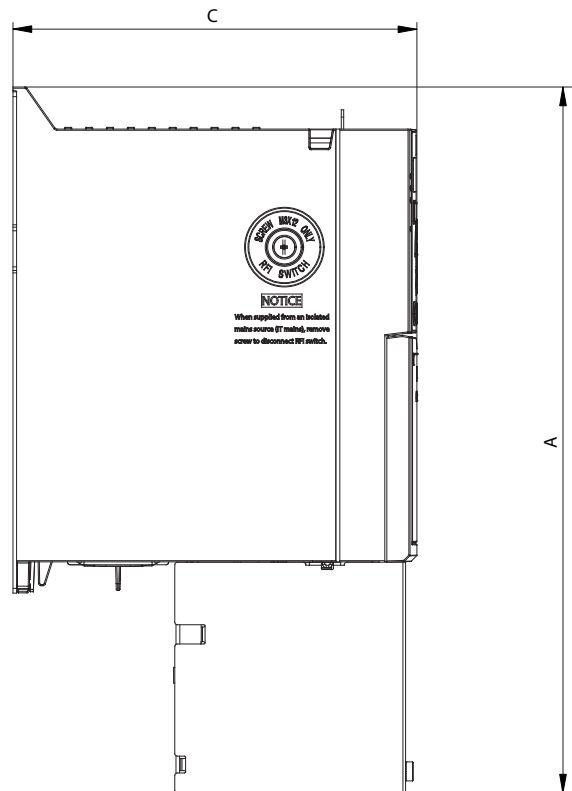
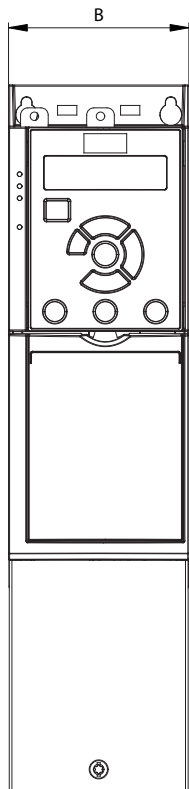

130BE846.10

Illustration 7.14 Standard with Bottom Cable Entry Cover (w/o Top Cover)

7

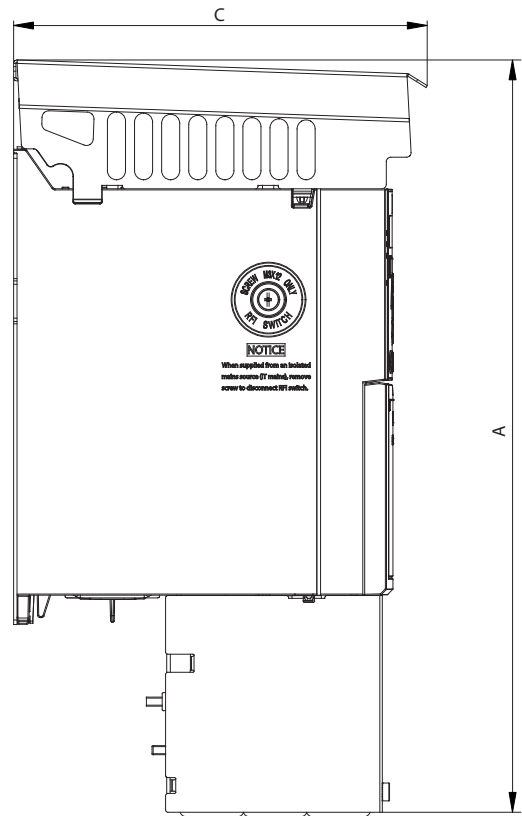
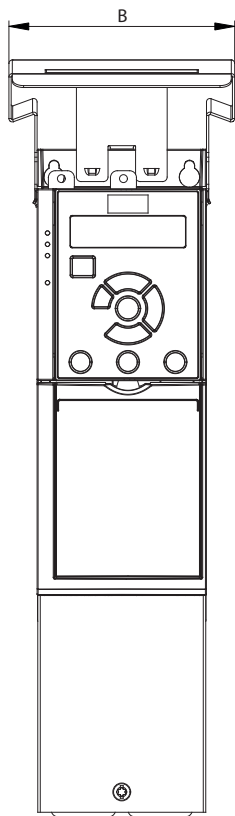

1308E845.10

Illustration 7.15 Standard with IP21/UL/Type 1 kit

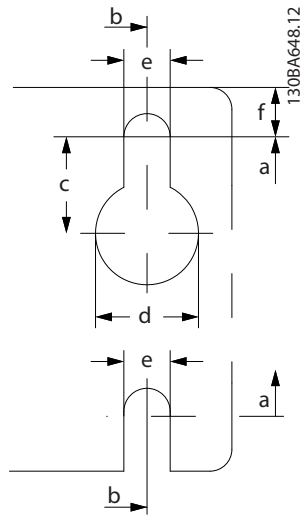
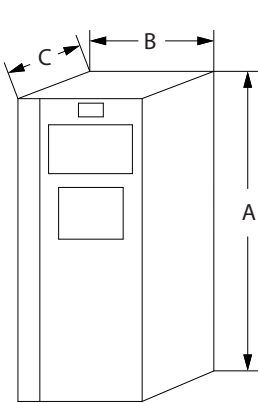

Illustration 7.16 Top and Bottom Mounting Holes

Index

A

AC input.....	15
Acoustic noise.....	91
Additional resources.....	5
AMA.....	6
AMA with T27 connected.....	49
Ambient condition.....	84
Analog feedback.....	24
Analog reference.....	24
Automatic motor adaptation.....	6

B

Brake function.....	44
Brake power.....	6, 44
Brake resistor.....	6, 43, 73
Branch circuit protection.....	89
Break-away torque.....	6
Bus reference.....	24

C

Cable	
length.....	84
size.....	14
Motor cable.....	45
Catch up/slow down.....	23
CE mark.....	8
Coast.....	5
Coasting.....	67, 68
Coil.....	64
Compliance	
UL-listed.....	9
Control	
Characteristic.....	88
word.....	67
Wiring.....	17
Control card	
+10 V DC output.....	87
Performance.....	88
RS485 serial communication.....	87
USB serial communication.....	87
Control structure	
Open loop.....	21
Cross-section.....	84
Current	
Ripple current.....	45

D

Data type, supported.....	57
---------------------------	----

DC brake.....	67
Dead band.....	25
Dead band around 0.....	25
Derating.....	84
Directive, EMC.....	8
Directive, Low Voltage.....	8
Directive, Machinery.....	8
Discharge time.....	9

E

Efficiency.....	90
Electronic thermal relay.....	7
see also <i>ETR</i>	
EMC.....	84
EMC Directive.....	8
EMC emission introduction.....	37
EMC immunity requirement.....	40
EMC precaution.....	54
EMC test result.....	38
Energy efficiency.....	80, 81, 82
Energy efficiency class.....	84
ETR.....	7, 47
see also <i>Electronic thermal relay</i>	
Export control regulations.....	9
Extreme running condition.....	46

F

FC profile	
FC profile.....	67
FC with Modbus RTU.....	55
Protocol overview.....	54
Filter	
DU/dt.....	45
Sine-wave.....	44, 45
Floating delta.....	15
Freeze output.....	5
Freeze reference.....	23
Function code.....	63
Fuse.....	89

G

GLCP control key.....	21
Grounded delta.....	15
Grounding.....	14, 15

H

Hardware set-up.....	54
Hold output frequency.....	67

I	
IEC 61800-3.....	15, 84
IND.....	57
Index (IND).....	57
Input	
Current.....	15
Power.....	15
Terminal.....	15
Inputs	
Analog input.....	6, 86
Digital input.....	21, 85
Pulse input.....	86
Intermediate circuit.....	46, 91
Intermittent duty cycle.....	7
Internal current control, VVC+ mode.....	21
J	
Jog.....	5, 67
L	
LCP.....	5, 7, 21
Leakage current.....	41
Low Voltage Directive.....	8
M	
Machinery Directive.....	8
Mains	
AC mains.....	15
Isolated mains.....	15
drop-out.....	46
Supply.....	7
Supply (L1/N, L2/L, L3).....	83
Supply data.....	80
Mechanical holding brake.....	42
Modbus communication.....	54
Modbus exception code.....	63
Modbus RTU.....	59
Modbus RTU commands.....	64
Modbus RTU overview.....	59
Moment of inertia.....	46
Motor	
Cable.....	14
output.....	83
phase.....	46
thermal protection.....	46, 69
voltage.....	91
Motor-generated overvoltage.....	46
N	
Network configuration.....	59
Network connection.....	53
NLCP control key.....	21
O	
Open loop.....	88
Ordering	
DU/dt.....	77
Sine-wave filter.....	76
Output current.....	87
Outputs	
Analog output.....	6, 87
Digital output.....	87
P	
Parameter number (PNU).....	57
PELV.....	51, 87
PELV, protective extra low voltage.....	41
Power cycle.....	7
Preset reference.....	24
Process PID control.....	31
Protection.....	41
Pulse feedback.....	24
Pulse reference.....	6, 24
Q	
Qualified personnel.....	9
R	
Rated motor current.....	5
Rated motor speed.....	6
RCD.....	7
Read coil.....	64
Read holding registers (03 hex).....	65
Reference limit.....	23
Registers.....	64
Relay output.....	88
Reset alarm.....	21
RFI filter.....	15
Rise time.....	91
RS485	
RS485.....	53, 55
installation and set-up.....	53
S	
Safety precautions.....	9
Serial communication	
Serial communication.....	6, 87
USB serial communication.....	87

Short circuit.....	46
SIL2.....	9
SILCL of SIL2.....	9
Slip compensation.....	7
Special conditions.....	92
Speed PID.....	18, 20
Speed PID control.....	28
Speed reference.....	49
Standard and compliance for STO.....	9
Static overload in VVC+ mode.....	46
Status word.....	68
Supply voltage.....	87
Switching	
frequency.....	44, 45, 76
Switching on the output.....	46
Synchronous motor speed.....	6
T	
Telegram length (LGE).....	55
Terminal tightening torque.....	88
Thermistor.....	7, 51
Torque	
characteristic.....	83
control.....	18
Trip.....	8
V	
Voltage level.....	85
VVC+.....	8, 20



.....
Danfoss can accept no responsibility for possible errors in catalogues, brochures and other printed material. Danfoss reserves the right to alter its products without notice. This also applies to products already on order provided that such alterations can be made without subsequential changes being necessary in specifications already agreed. All trademarks in this material are property of the respective companies. Danfoss and the Danfoss logotype are trademarks of Danfoss A/S. All rights reserved.
.....

Danfoss A/S
Ulsnaes 1
DK-6300 Graasten
vlt-drives.danfoss.com

