



# Programming Guide

## VLT<sup>®</sup> PROFINET

VLT<sup>®</sup> Midi Drive FC 280





## Contents

<b>1 Introduction</b>	<b>3</b>
1.1 Purpose of the Manual	3
1.2 Additional Resources	3
1.3 Document and Software Version	3
1.4 Product Overview	3
1.5 Approvals and Certifications	4
1.6 Symbols, Abbreviations and Conventions	4
<b>2 Safety</b>	<b>5</b>
2.1 Safety Symbols	5
2.2 Qualified Personnel	5
2.3 Safety Precautions	5
<b>3 Configuration</b>	<b>7</b>
3.1 Configure the PROFINET Network	7
3.2 Configure the Controller	7
3.3 Configure the Frequency Converter	9
<b>4 Control</b>	<b>10</b>
4.1 PPO Types	10
4.2 Process Data	11
4.3 Control Profile	13
4.4 PROFIdrive Control Profile	14
4.5 FCDrive Control Profile	18
<b>5 Acyclic Communication (DP-V1)</b>	<b>21</b>
5.1 Features of an IO Controller System	21
5.2 Features of an IO Supervisor System	21
5.3 Addressing Scheme	22
5.4 Acyclic Read/Write Request Sequence	23
5.5 Data Structure in the Acyclic Telegrams	24
5.6 Header	24
5.7 Parameter Block	24
5.8 Data Block	24
<b>6 Parameters</b>	<b>26</b>
6.1 Parameter Group 0-** Operation/Display	26
6.2 Parameter Group 8-** Communication and Option	26
6.3 Parameter Group 9-** PROFIdrive	28
6.4 Parameter Group 12-** Ethernet	32
6.5 PROFINET-specific Parameters	34

---

6.6 Supported Object and Data Types	38
<b>7 Application Examples</b>	<b>40</b>
7.1 Example: Process Data with PPO Type 6	40
7.2 Example: Control Word Telegram Using Standard Telegram 1/PPO3	41
7.3 Example: Status Word Telegram Using Standard Telegram 1/PPO3	42
7.4 Example: PLC Programming	43
<b>8 Troubleshooting</b>	<b>44</b>
8.1 No Response to Control Signals	44
8.2 Warnings and Alarms	46
<b>Index</b>	<b>53</b>

# 1 Introduction

## 1.1 Purpose of the Manual

The *VLT® PROFINET Programming Guide* provides information about configuring the system, controlling the frequency converter, parameter access, programming, troubleshooting, as well as some typical application examples.

The *programming guide* is intended for use by qualified personnel, who are familiar with the VLT® frequency converters, PROFINET technology, and the PC or PLC that is used as a master in the system.

Read the instructions before programming and follow the procedures in this manual.

VLT® is a registered trademark.

## 1.2 Additional Resources

### Resources available for the frequency converter and optional equipment are:

- The *VLT® Midi Drive FC 280 Operating Guide* provides the necessary information for getting the frequency converter up and running.
- The *VLT® Midi Drive FC 280 Design Guide* provides detailed information about capabilities and functionality to design motor control systems.
- The *VLT® Midi Drive FC 280 Programming Guide* provides more details on working with parameters and many application examples.

Supplementary publications and manuals are available from Danfoss. See [drives.danfoss.com/knowledge-center/technical-documentation/](http://drives.danfoss.com/knowledge-center/technical-documentation/) for listings.

## 1.3 Document and Software Version

This manual is regularly reviewed and updated. All suggestions for improvement are welcome. *Table 1.1* shows the document version and the corresponding software version.

Edition	Remarks	Software version
MG07G1xx	The first edition of this manual.	3.0x

Table 1.1 Document and Software Version

## 1.4 Product Overview

This *programming guide* relates to PROFINET interface for VLT® Midi Drive FC 280.

The PROFINET interface is designed to communicate with any system complying with the PROFINET schema version 2.2 and 2.3 standards.

Since the introduction in 2001, PROFINET has been updated to handle low and medium performance requirements supported by PROFINET RT up to high-end servo performance in PROFINET IRT. PROFINET is the Ethernet-based Fieldbus offering and is the most scalable and versatile technology today.

PROFINET provides the network tools to deploy standard Ethernet technology for manufacturing applications while enabling Internet and enterprise connectivity.

VLT® PROFINET control cassette is intended for use with VLT® Midi Drive FC 280.

### Terminology

In this manual, several terms for Ethernet are used.

- *PROFINET* is the term used to describe the PROFINET protocol.
- *Ethernet* is a common term used to describe the physical layer of the network, and does not relate to the application protocol.

## 1.5 Approvals and Certifications

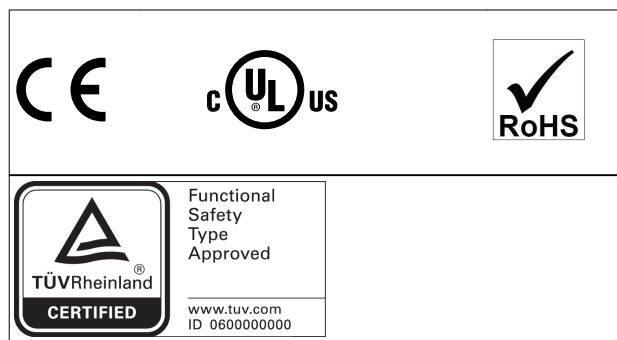

More approvals and certifications are available. For more information, contact a local Danfoss partner.

## 1.6 Symbols, Abbreviations and Conventions

Abbreviation	Definition
CC	Control card
CTW	Control word
DCP	Discovery and configuration protocol
DHCP	Dynamic host configuration protocol
EMC	Electromagnetic compatibility
GSDML	General station description mark-up language
I/O	Input/Output
IP	Internet protocol
IRT	Isochronous real time
LCP	Local control panel
LED	Light emitting diode
LSB	Least significant bit
MAV	Main actual value (actual speed)
MSB	Most significant bit
MRV	Main reference value
PC	Personal computer
PCD	Process control data
PLC	Programmable logic controller
PNU	Parameter number
PPO	Process parameter object
REF	Reference (=MRV)
RT	Real time
STW	Status word

Table 1.2 Symbols and Abbreviations

### Conventions

Numbered lists indicate procedures.

Bullet lists indicate other information and description of illustrations.

Italicized text indicates:

- Cross reference.
- Link.
- Parameter name.

## 2 Safety

### 2.1 Safety Symbols

The following symbols are used in this guide:

#### **⚠️ WARNING**

Indicates a potentially hazardous situation that could result in death or serious injury.

#### **⚠️ CAUTION**

Indicates a potentially hazardous situation that could result in minor or moderate injury. It can also be used to alert against unsafe practices.

#### **NOTICE**

Indicates important information, including situations that can result in damage to equipment or property.

### 2.2 Qualified Personnel

Correct and reliable transport, storage, installation, operation, and maintenance are required for the trouble-free and safe operation of the frequency converter. Only qualified personnel are allowed to install or operate this equipment.

Qualified personnel are defined as trained staff, who are authorized to install, commission, and maintain equipment, systems, and circuits in accordance with pertinent laws and regulations. Additionally, the qualified personnel must be familiar with the instructions and safety measures described in this document.

### 2.3 Safety Precautions

#### **⚠️ WARNING**

##### **HIGH VOLTAGE**

Frequency converters contain high voltage when connected to AC mains input, DC supply, or load sharing. Failure to perform installation, start-up, and maintenance by qualified personnel can result in death or serious injury.

- Only qualified personnel must perform installation, start-up, and maintenance.

#### **⚠️ WARNING**

##### **UNINTENDED START**

When the frequency converter is connected to AC mains, DC supply, or load sharing, the motor may start at any time. Unintended start during programming, service, or repair work can result in death, serious injury, or property damage. The motor can start with an external switch, a fieldbus command, an input reference signal from the LCP or LOP, via remote operation using MCT 10 Set-up Software, or after a cleared fault condition.

To prevent unintended motor start:

- Press [Off/Reset] on the LCP before programming parameters.
- Disconnect the frequency converter from the mains.
- Completely wire and assemble the frequency converter, motor, and any driven equipment before connecting the frequency converter to AC mains, DC supply, or load sharing.

#### **⚠️ WARNING**

##### **DISCHARGE TIME**

The frequency converter contains DC-link capacitors, which can remain charged even when the frequency converter is not powered. High voltage can be present even when the warning LED indicator lights are off. Failure to wait the specified time after power has been removed before performing service or repair work can result in death or serious injury.

- Stop the motor.
- Disconnect AC mains and remote DC-link supplies, including battery back-ups, UPS, and DC-link connections to other frequency converters.
- Disconnect or lock PM motor.
- Wait for the capacitors to discharge fully. The minimum waiting time is specified in the *chapter Safety* in the *operating instructions* supplied with the frequency converter.
- Before performing any service or repair work, use an appropriate voltage measuring device to make sure that the capacitors are fully discharged.

**⚠ WARNING****LEAKAGE CURRENT HAZARD**

Leakage currents exceed 3.5 mA. Failure to ground the frequency converter properly can result in death or serious injury.

- Ensure the correct grounding of the equipment by a certified electrical installer.

**⚠ WARNING****EQUIPMENT HAZARD**

Contact with rotating shafts and electrical equipment can result in death or serious injury.

- Ensure that only trained and qualified personnel perform installation, start-up, and maintenance.
- Ensure that electrical work conforms to national and local electrical codes.
- Follow the procedures in this document.

**⚠ CAUTION****INTERNAL FAILURE HAZARD**

An internal failure in the frequency converter can result in serious injury when the frequency converter is not properly closed.

- Ensure that all safety covers are in place and securely fastened before applying power.



## 3 Configuration

### 3.1 Configure the PROFINET Network

Ensure that all PROFINET devices connected to the same bus network have a unique station name (host name).

Set the PROFINET host name of the frequency converter via *parameter 12-08 Host Name* or hardware switches.

### 3.2 Configure the Controller

#### 3.2.1 GSDML File

To configure a PROFINET controller, the configuration tool needs a GSDML file for each type of device on the network. The GSDML file is a PROFINET xml file containing the necessary communication set-up data for a device. Download the latest version of GSDML files for the FC 280 frequency converter at [www.danfoss.com/BusinessAreas/DrivesSolutions/profinet](http://www.danfoss.com/BusinessAreas/DrivesSolutions/profinet). The name of the GSDML file may differ from what is described in this manual. The following example shows how to configure the controller for FC 280.

Frequency converter	GSDML file
FC 280	GSDML-V2.3-Danfoss-FC280-20151210.xml

Table 3.1 GSDML file

When configuring the PROFINET controller, the first step is to import the GSDML file in the configuration tool. The following steps, outlined in *Illustration 3.1*, *Illustration 3.2*, and *Illustration 3.3*, show how to add a new GSDML file to the Simatic Manager software tool. For each frequency converter, a GSDML file is typically imported once only, following the initial installation of the software tool.

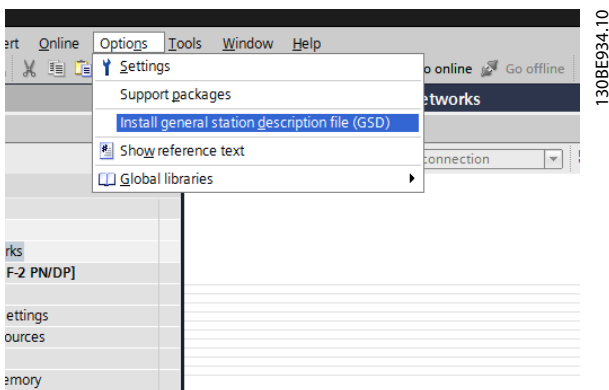

Illustration 3.1 Import the GSDML File in the Configuration Tool

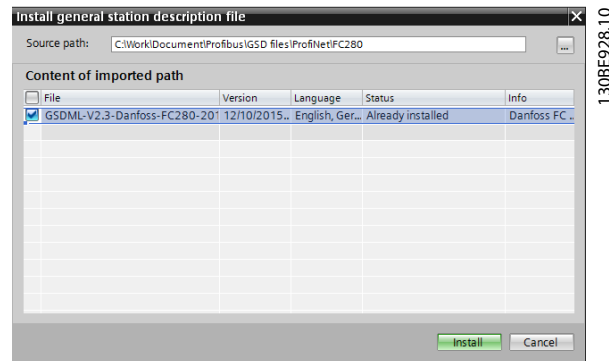

Illustration 3.2 Add a New GSDML File to the Simatic Manager Software Tool

The FC 280 GSDML file is now imported and is accessible via the following path in the hardware catalog:

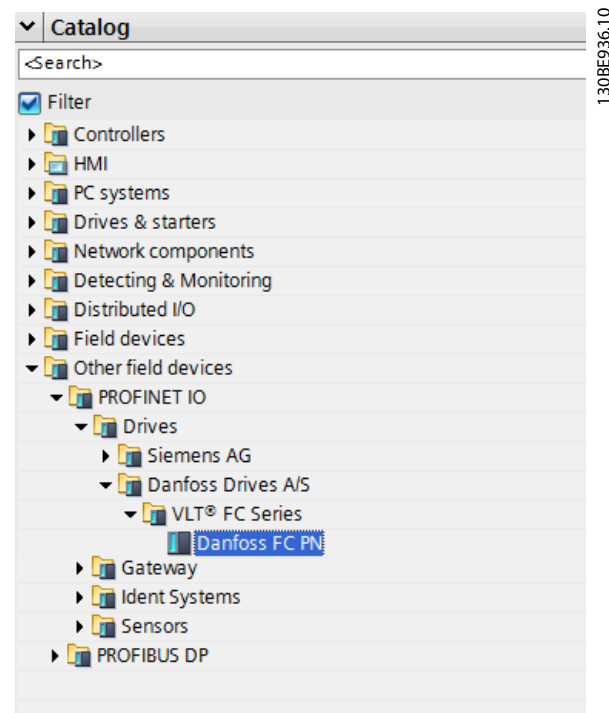

Illustration 3.3 Path in the Hardware Catalog

Open a project, set up the hardware, and add a PROFINET Master system. Select Danfoss FC PN, then drag and drop it onto the PROFINET IO system.

To enter the device name, open the properties for the inserted frequency converter. See *Illustration 3.4*.

3

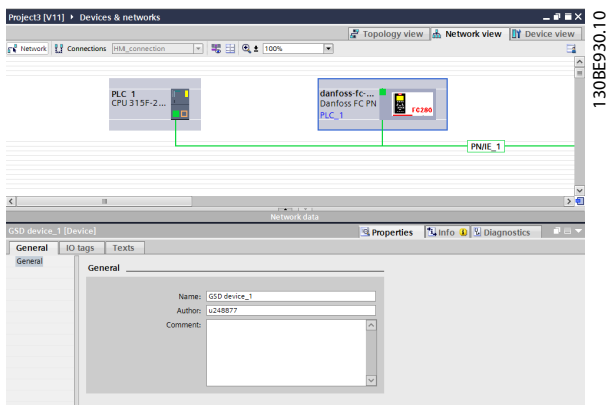

Illustration 3.4 Open the Properties for the Inserted Frequency Converter to Enter the Device Name

**NOTICE**

The name must match the name in *parameter 12-08 Host Name*. If the check mark *Assign IP address via the IO controller* is set, the controller downloads the IP address to the IO device with the corresponding device name. The IP address is stored in the non-volatile memory of the frequency converter.

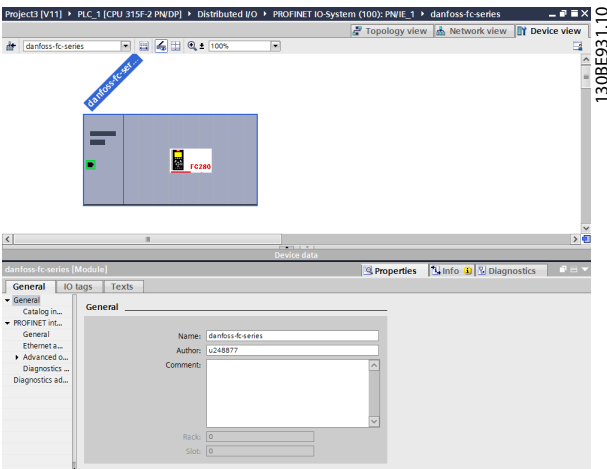

Illustration 3.5 Set Up the Hardware and Add a PROFINET Master System

The next step is to set up the peripheral input and output data. Data set-up in the peripheral area is transmitted cyclically via telegrams/PPO types. In the example below, a PPO type 6 is dragged and dropped to slot 1.

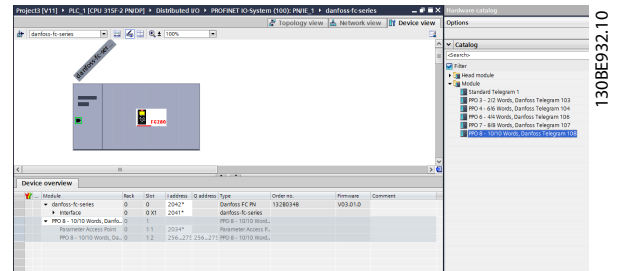

Illustration 3.6 Set up the Peripheral Input and Output Data

The configuration tool automatically assigns addresses in the peripheral address area. In this example, the input and output area have the following configuration:

PPO type 6

PCD word number	0	1	2	3
Input address	256–257	258–259	260–261	262–263
Set-up	STW	MAV	Parameter 9-16 PCD Read Configuration	Parameter 9-16 PCD Read Configuration

Table 3.2 PCD Read (VLT to PLC)

PCD word number	0	1	2	3
Output address	256–257	258–259	260–261	262–263
Set-up	CTW	MRV	Parameter 9-15 PCD Write Configuration	Parameter 9-15 PCD Write Configuration

Table 3.3 PCD Write (PLC to VLT)

Assign the PCDs via *parameter 9-16 PCD Read Configuration* for inputs and *parameter 9-15 PCD Write Configuration* for outputs.

Download the configuration file to the PLC. The PROFINET system starts data exchange when the PLC is set to *Run* mode.

## 3.3 Configure the Frequency Converter

### 3.3.1 VLT Parameters

The following parameters are important when configuring the frequency converter with a PROFINET interface.

- *Parameter 0-40 [Hand on] Key on LCP.* If [Hand On] is activated, control of the frequency converter via the PROFINET interface is disabled.
- After an initial power-up, the frequency converter automatically detects whether a fieldbus option is installed in slot A and sets *parameter 8-02 Control Word Source* to [Option A]. When an option is added, changed, or removed from an already commissioned frequency converter, it does not change *parameter 8-02 Control Word Source* but enters *Trip* mode, and the frequency converter displays an error.
- *Parameter 8-10 Control Word Profile.* Select between the Danfoss frequency converter profile and the PROFIdrive profile.
- *Parameter 8-50 Coasting Select* to *parameter 8-58 Profdrive OFF3 Select.* Select how to gate PROFINET control commands with the digital input command of the control card.

#### **NOTICE**

When *parameter 8-01 Control Site* is set to [2] *Control word only*, the settings from *parameter 8-50 Coasting Select* to *parameter 8-58 Profdrive OFF3 Select* are overruled and only act on bus control.

## 4 Control

### 4.1 PPO Types

The PROFINET profile for frequency converters specifies a number of standard telegrams and provides space for vendor-specific telegrams. The PROFIdrive profile for frequency converters is suitable for data exchange between a process controller (for example PLC) and a frequency converter. All telegrams are defined for cyclic data transfer of high-priority data.

#### Pure process data objects

PPO types 3, 4, 6, 7, and 8 are pure process data objects for applications requiring no cyclic parameter access. The PLC sends out process control data, and the frequency converter then responds with a PPO of the same length, containing process status data.

Illustration 4.1 shows the available PPO types:

- PCD 1: The first 2 bytes of the process data area (PCD 1) comprise a fixed part present in all PPO types.
- PCD 2: The next 2 bytes are fixed for PCD write entries (see *parameter 9-15 PCD Write Configuration* [1]), but configurable for PCD read entries (see *parameter 9-16 PCD Read Configuration* [1]).
- PCD 3–10: In the remaining bytes, the process data can be parameterized with process signals, see *parameter 9-23 Parameters for Signals*.

The setting in *parameter 9-15 PCD Write Configuration* determines the signals for transmission (request) from the master to the frequency converter.

The setting in *parameter 9-16 PCD Read Configuration* determines the signals for transmission (response) from the frequency converter to the master.

Select the PPO type in the master configuration. The selection is automatically recorded in the frequency converter. No manual setting of PPO types in the frequency converter is required. Read the current PPO type in *parameter 9-22 Telegram Selection*. The setting [1] *Standard telegram 1* is equivalent to PPO type 3.

In addition, all PPO types can be set up as word-consistent or module-consistent. The process data area can be word- or module-consistent, whereas the parameter channel must always be module-consistent.

- Word-consistent data is transmitted as individual, independent words between the PLC and the frequency converter.
- Module-consistent data is transmitted as sets of interrelated words transferred simultaneously between the PLC and the frequency converter.

Standard telegram	1	CTW/STW		REF/MAV		(The old PPO type 3)							
Danfoss telegram	PPO 3	CTW/STW		REF/MAV									
	PPO 4	CTW/STW		REF/MAV		PCD 2 Read/ Write	PCD 3 Read/ Write	PCD 4 Read/ Write	PCD 5 Read/ Write				
	PPO 6	CTW/STW		REF/MAV		PCD 2 Read/ Write	PCD 3 Read/ Write						
	PPO 7	CTW/STW		REF/MAV		PCD 2 Read/ Write	PCD 3 Read/ Write	PCD 4 Read/ Write	PCD 5 Read/ Write	PCD 6 Read/ Write	PCD 7 Read/ Write		
	PPO 8	CTW/STW		REF/MAV		PCD 2 Read/ Write	PCD 3 Read/ Write	PCD 4 Read/ Write	PCD 5 Read/ Write	PCD 6 Read/ Write	PCD 7 Read/ Write	PCD 8 Read/ Write	PCD 9 Read/ Write

130BE941.10

Illustration 4.1 Available PPO Types

## 4.2 Process Data

Use the process data part of the PPO to control and monitor the frequency converter via the PROFIBUS.

### 4.2.1 PCD

Control word (CTW) according to PROFIdrive profile: Control words consist of 16 bits. The meaning of each bit is explained in *chapter 4.4.1 Control Word According to PROFIdrive Profile (CTW)* and *chapter 4.4.2 Status Word According to PROFIdrive Profile (STW)*. The following bit pattern sets all necessary start commands:

0000 0100 0111 1111 = 047F hex.<sup>1)</sup>  
 0000 0100 0111 1110 = 047E hex.<sup>1)</sup>  
 0000 0100 0111 1111 = 047F hex.

1) For restart after power-up:

- Set bits 1 and 2 of the CTW to 1.
- Toggle bit 0 0–1.

These values are for bytes 9 and 10 in *Table 4.1*.  
 Quick stop: 0000 0100 0110 1111 = 046F hex.  
 Stop: 0000 0100 0011 1111 = 043F hex.

### 4.2.2 MRV

MRV is the speed reference, with data format *Standardized value*. 0 hex = 0% and 4000 hex = 100%. In the example, 2000 hex is used, corresponding to 50% of the maximum frequency in *parameter 3-03 Maximum Reference*. See the values for bytes 11 and 12 in *Table 4.1*. The whole PPO therefore has the following values in hex:

		Byte	Value
PCD	CTW	9	04
	CTW	10	7F
	MRV	11	20
	MVR	12	00

Table 4.1 Request Example: PPO Values in Hex

The process data within the PCD part acts immediately upon the frequency converter and can be updated from the master as quickly as possible.

*Table 4.2* shows a positive response to the request example from *Table 4.1*.

		Byte	Value
PCD	STW	9	0F
	STW	10	07
	MAV	11	20
	MAR	12	00

Table 4.2 Response Example: Positive Response

The PCD part responds according to the state and parameterization of the frequency converter.

PCD part response:

- STW: 0F07 hex means that the motor is running and there are no warnings or faults.
- MAV: 2000 hex indicates that the output frequency is 50% of the maximum reference.

*Table 4.3* shows a negative response to the request example from *Table 4.1*.

		Byte	Value
PCD	STW	9	0F
	STW	10	07
	MAV	11	20
	MAR	12	00

Table 4.3 Response Example: Negative Response

### 4.2.3 Process Control Data

Process control data (PCD) is the process data sent from the PLC to the frequency converter.

Master/slave				
1	2	3	.....	10
CTW	MRV	PCD	.....	PCD
PCD write				

Table 4.4 Process Control Data

PCD 1 contains a 16-bit control word, and each bit controls a specific function of the frequency converter. See *chapter 4.3 Control Profile*.

PCD 2 contains a 16-bit speed setpoint in percentage format. See *chapter 4.2.5 Reference Handling*.

The settings in *parameter 9-15 PCD Write Configuration* and *parameter 9-16 PCD Read Configuration* define the content of PCD 3 to PCD 10.

### 4.2.4 Process Status Data

Process status data is the process data sent from the frequency converter and contains information about the current state.

Slave/master				
1	2	3	.....	10
STW	MAV	PCD	.....	PCD
PCD read				

Table 4.5 Process Status Data

PCD 1 contains a 16-bit status word, and each bit contains information regarding a possible state of the frequency converter.

PCD 2 contains each default value of the frequency converter's current speed in percentage format (see *chapter 4.2.5 Reference Handling*). PCD 2 can be configured to contain other process signals.

The settings in *parameter 9-16 PCD Read Configuration* define the content of PCD 3 to PCD 10.

### 4.2.5 Reference Handling

The reference handling is an advanced mechanism that sums up references from different sources, as shown in *Illustration 4.2*.

For more information on reference handling, refer to the *design guide* of the relevant frequency converter.

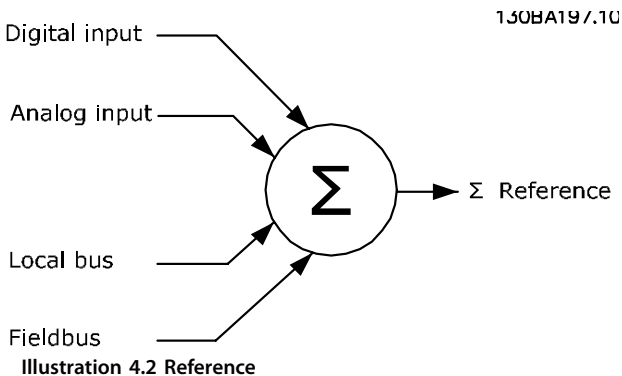

The reference or speed setpoint is sent via PROFIBUS and is always transmitted to the frequency converter in percentage format as integers shown in hexadecimal (0–4000 hex).

The reference (MRV) and feedback (MAV) are always scaled equally. The setting of *parameter 3-00 Reference Range* determines the scaling of the reference and feedback (MAV), see *Illustration 4.3*.

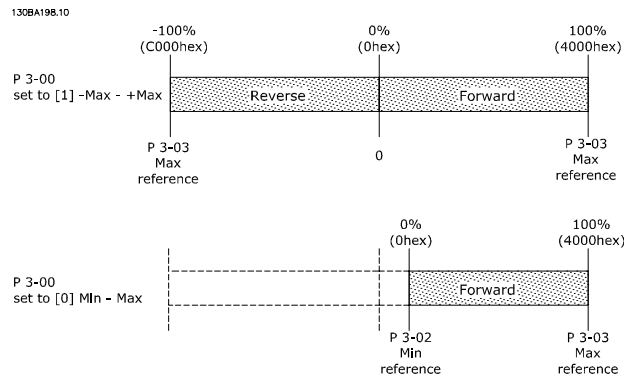

Illustration 4.3 Reference (MRV) and Feedback (MAV), Scaled

### NOTICE

When *parameter 3-00 Reference Range* is set to [0] Min - Max, a negative reference is handled as 0%.

The actual output of the frequency converter is limited by the speed limit parameters *Motor Low/High Speed Limit [RPM/Hz]* in *parameter 4-11 Motor Speed Low Limit [RPM]* to *parameter 4-14 Motor Speed High Limit [Hz]*. The final speed limit is set in *parameter 4-19 Max Output Frequency*.

*Table 4.6* lists the reference (MRV) and the feedback (MAV) formats.

MRV/MAV	Integer in hex	Integer in decimal
100%	4000	16384
75%	3000	12288
50%	2000	8192
25%	1000	4096
0%	0	0
-25%	F000	-4096
-50%	E000	-8192
-75%	D000	-12288
-100%	C000	-16384

Table 4.6 Reference/Feedback (MRV/MAV) Format

### NOTICE

Negative numbers are formed as complement of 2.

### NOTICE

The data type for MRV and MAV is an N2 16-bit standardized value, expressing a range from -200% to +200% (8001 to 7FFF).

**Example**

The following settings determine the speed, as shown in Table 4.7:

- Parameter 1-00 Configuration Mode set to [0] Speed open loop.
- Parameter 3-00 Reference Range set to [0] Min-Max.
- Parameter 3-02 Minimum Reference set to 0 Hz.
- Parameter 3-03 Maximum Reference set to 50 Hz.

MRV/MAV		Actual speed [Hz]
0%	0 hex	0
25%	1000 hex	12.5
50%	2000 hex	25
75%	3000 hex	37.5
100%	4000 hex	50

Table 4.7 Actual Speed for MRV/MAV

**4.2.6 Process Control Operation**

In process control operation, parameter 1-00 Configuration Mode is set to [3] Process.

The reference range in parameter 3-00 Reference Range is always [0] Min - Max.

- MRV is the process setpoint.
- MAV expresses the actual process feedback (range  $\pm 200\%$ ).

**4.2.7 Influence of the Digital Input Terminals on FC Control Mode**

In parameter 8-50 Coasting Select to parameter 8-58 Profdrive OFF3 Select, set the influence of the digital input terminals on the control of the frequency converter.

**NOTICE**

The setting of parameter 8-01 Control Site overrules the settings in parameter 8-50 Coasting Select to parameter 8-58 Profdrive OFF3 Select.

Program each of the digital input signals to logic AND, logic OR, or to have no relation to the corresponding bit in the control word. In this way, the following signal sources initiate a specific control command, for example stop/coast:

- Fieldbus only.
- Fieldbus AND digital input.
- Either fieldbus OR digital input terminal.

**NOTICE**

To control the frequency converter via PROFIBUS, set parameter 8-50 Coasting Select to either [1] Bus or [2] Logic AND. Then set parameter 8-01 Control Site to [0] Digital and ctrl.word or [2] Controlword only.

For more detailed information and examples of logical relationship options, see chapter 8 Troubleshooting.

**4.3 Control Profile**

Control the frequency converter according to:

- The PROFdrive profile, see chapter 4.4 PROFdrive Control Profile, or
- The Danfoss FC control, see chapter 4.5 FCDrive Control Profile.

Select the control profile in parameter 8-10 Control Word Profile. The choice of profile affects the control word and status word only.

Chapter 4.4 PROFdrive Control Profile and chapter 4.5 FCDrive Control Profile provide a detailed description of control and status data.

## 4.4 PROFIdrive Control Profile

This section describes the functionality of the control word and status word in the PROFIdrive profile.

### 4.4.1 Control Word According to PROFIdrive Profile (CTW)

The control word is used to send commands from a master (for example a PC) to a slave.

Bit	Bit = 0	Bit = 1
00	OFF 1	ON 1
01	OFF 2	ON 2
02	OFF 3	ON 3
03	Coasting	No coasting
04	Quick stop	Ramp
05	Hold frequency output	Use ramp
06	Ramp stop	Start
07	No function	Reset
08	Jog 1 OFF	Jog 1 ON
09	Jog 2 OFF	Jog 2 ON
10	Data invalid	Data valid
11	No function	Slow down
12	No function	Catch up
13	Parameter set-up	Selection lsb
14	Parameter set-up	Selection msb
15	No function	Reverse

Table 4.8 Control Word Bits

#### Explanation of the control bits

##### Bit 00, OFF 1/ON 1

Normal ramp stops using the ramp times of the actual selected ramp.

Bit 00 = 0 stops and activates the output relay 1 or 2 if the output frequency is 0 Hz, and if [31] Relay 123 is selected in *parameter 5-40 Function Relay*.

When bit 0 = 1, the frequency converter is in state 1, Switching on inhibited.

Refer to *Illustration 4.4*.

##### Bit 01, OFF 2/ON 2

Coast stop.

Bit 01 = 0 coast stops and activates the output relay 1 or 2 if the output frequency is 0 Hz, and if [31] Relay 123 is selected in *parameter 5-40 Function Relay*.

When bit 01 = 1, the frequency converter is in state 1, Switching on inhibited. Refer to *Illustration 4.4*.

##### Bit 02, OFF 3/ON 3

Quick stop using the ramp time of *parameter 3-81 Quick Stop Ramp Time*.

Bit 02 = 0 quick stops and activates the output relay 1 or 2 if the output frequency is 0 Hz, and if [31] Relay 123 is selected in *parameter 5-40 Function Relay*.

When bit 02 = 1, the frequency converter is in state 1, Switching on inhibited.

Refer to *Illustration 4.4*.

##### Bit 03, coasting/no coasting

Bit 03 = 0 leads to a coast stop.

When bit 03 = 1, if the other start conditions are fulfilled, the frequency converter can start.

#### NOTICE

The selection in *parameter 8-50 Coasting Select* determines how bit 03 is linked with the corresponding function of the digital inputs.

##### Bit 04, quick stop/ramp

Quick stop using the ramp time of *parameter 3-81 Quick Stop Ramp Time*.

When bit 04 = 0, a quick stop occurs.

When bit 04 = 1, if the other start conditions are fulfilled, the frequency converter can start.

#### NOTICE

The selection in *parameter 8-51 Quick Stop Select* determines how bit 04 is linked with the corresponding function of the digital inputs.

##### Bit 05, hold frequency output/use ramp

When bit 05 = 0, the present output frequency is maintained, even if the reference value is modified.

When bit 05 = 1, the frequency converter can perform its regulating function again according to the respective reference value.

##### Bit 06, ramp stop/start

Normal ramp stop using the ramp times of the actual ramp selected. In addition, if [31] Relay 123 is selected in *parameter 5-40 Function Relay*, and if the output frequency is 0 Hz, this bit activates output relay 01 or 04.

Bit 06 = 0 stops the frequency converter.

When bit 06 = 1, if the other start conditions are fulfilled, the frequency converter can start.

#### NOTICE

The selection in *parameter 8-53 Start Select* determines how bit 06 is linked with the corresponding function of the digital inputs.

##### Bit 07, no function/reset

Reset after switching off. Acknowledges event in fault buffer.

When bit 07 = 0, no reset occurs.

When there is a slope change of bit 07 to 1, a reset occurs after switching off.

##### Bit 08, jog 1 OFF/ON

Activation of the pre-programmed speed in *parameter 8-90 Bus Jog 1 Speed*. Jog 1 is only possible if bit 04 = 0 and bits 00–03 = 1.

##### Bit 09, jog 2 OFF/ON

Activation of the pre-programmed speed in *parameter 8-91 Bus Jog 2 Speed*. Jog 2 is only possible if bit 04 = 0 and bits 00–03 = 1.



**Bit 10, data invalid/valid**

Tells the frequency converter whether to use or ignore the control word.

Bit 10 = 0 ignores the control word, making it possible to turn off the control word when updating/reading parameters.

Bit 10 = 1 uses the control word. This function is relevant because the control word is always contained in the telegram, regardless of which type of telegram is used.

**Bit 11, no function/slow down**

Used to reduce the speed reference value by the amount given in *parameter 3-12 Catch up/slow Down Value*.

When bit 11 = 0, no modification of the reference value occurs.

When bit 11 = 1, the reference value is reduced.

**Bit 12, no function/catch up**

Used to increase the speed reference value by the amount given in *parameter 3-12 Catch up/slow Down Value*.

When bit 12 = 0, no modification of the reference value occurs.

When bit 12 = 1, the reference value is increased.

If both slowing down and accelerating are activated (bits 11 and 12 = 1), slowing down has priority, and the speed reference value is reduced.

**Bits 13/14, set-up selection**

Bits 13 and 14 are used to select between the 4 parameter set-ups according to *Table 4.9*. (Bit 14 is not available for frequency converters which only have 2 set-ups.)

The function is only possible if [9] *Multi Set-up* has been selected in *parameter 0-10 Active Set-up*. The selection in *parameter 8-55 Set-up Select* determines how bits 13 and 14 are linked with the corresponding function of the digital inputs. Changing set-up while the frequency converter is running is only possible if the set-ups have been linked in *parameter 0-12 This Set-up Linked to*.

Set-up	Bit 13
1	0
2	1

Table 4.9 Parameter Set-ups

**Bit 15, no function/reverse**

Bit 15 = 0 causes no reversing.

Bit 15 = 1 causes reversing.

**NOTICE**

In the factory setting, reversing is set to [0] *Digital* in *parameter 8-54 Reversing Select*.

**NOTICE**

Bit 15 causes reversing only when *Ser. communication, Logic or, or Logic and* is selected.

**4.4.2 Status Word According to PROFIdrive Profile (STW)**

The status word is used to notify a master (for example a PC) about the status of a slave.

Bit	Bit = 0	Bit = 1
00	Control not ready	Control ready
01	Frequency converter not ready	Frequency converter ready
02	Coasting	Enable
03	No error	Trip
04	OFF 2	ON 2
05	OFF 3	ON 3
06	Start possible	Start not possible
07	No warning	Warning
08	Speed ≠ reference	Speed = reference
09	Local operation	Bus control
10	Out of frequency limit	Frequency limit ok
11	No operation	In operation
12	Frequency converter OK	Stopped, auto start
13	Voltage OK	Voltage exceeded
14	Torque OK	Torque exceeded
15	Timer OK	Timer exceeded

Table 4.10 Status Word Bits

**Explanation of the status bits**

**Bit 00, control not ready/ready**

When bit 00 = 0, bit 00, 01, or 02 of the control word is 0 (OFF 1, OFF 2, or OFF 3) - or the frequency converter is switched off (tripped).

When bit 00 = 1, the frequency converter control is ready, but power is not necessarily supplied to the unit (in case of a 24 V external supply of the control system).

**Bit 01, VLT not ready/ready**

Same significance as bit 00, however, power is supplied to the unit. The frequency converter is ready when it receives the necessary start signals.

**Bit 02, coasting/enable**

When bit 02 = 0, bit 00, 01, or 02 of the control word is 0 (OFF 1, OFF 2, OFF 3, or coasting) - or the frequency converter is switched off (trip).

When bit 02 = 1, bit 00, 01, or 02 of the control word is 1, and the frequency converter has not tripped.

**Bit 03, no error/trip**

When bit 03 = 0, no error condition exists in the frequency converter.

When bit 03 = 1, the frequency converter has tripped and requires a reset signal before it can start.

**Bit 04, ON 2/OFF 2**

When bit 01 of the control word is 0, bit 04 = 0.

When bit 01 of the control word is 1, bit 04 = 1.

**Bit 05, ON 3/OFF 3**

When bit 02 of the control word is 0, bit 05 = 0.  
When bit 02 of the control word is 1, bit 05 = 1.

**Bit 06, start possible/start not possible**

If [1] PROFdrive has been selected in *parameter 8-10 Control Word Profile*, bit 06 is 1 after a switch-off acknowledgement, after activation of OFF2 or OFF3, and after switching on the mains voltage. To reset *Start not possible*, set bit 00 of the control word to 0, and bits 01, 02, and 10 to 1.

**Bit 07, no warning/warning**

Bit 07 = 0 means that there are no warnings.  
Bit 07 = 1 means that a warning has occurred.

**Bit 08, speed ≠ reference/speed = reference**

When bit 08 = 0, the current speed of the motor deviates from the set speed reference value. The deviation may occur, for example, when the speed is being changed during start/stop through ramp up/down.  
When bit 08 = 1, the current speed of the motor corresponds to the set speed reference value.

**Bit 09, local operation/bus control**

Bit 09 = 0 indicates that the frequency converter has been stopped with [Stop] on the LCP, or that [0] *Linked to hand* or [2] *Local* has been selected in *parameter 3-13 Reference Site*.

When bit 09 = 1, the frequency converter can be controlled through the serial interface.

**Bit 10, out of frequency limit/frequency limit OK**

When bit 10 = 0, the output frequency is outside the limits set in *parameter 4-52 Warning Speed Low* and *parameter 4-53 Warning Speed High*.

When bit 10 = 1, the output frequency is within the indicated limits.

**Bit 11, no operation/operation**

When bit 11 = 0, the motor does not turn.  
When bit 11 = 1, the frequency converter has a start signal, or the output frequency is higher than 0 Hz.

**Bit 12, drive OK/stopped, auto start**

When bit 12 = 0, there is no temporary overload of the inverter.

When bit 12 = 1, the frequency converter has stopped due to overload. However, the frequency converter has not switched off (tripped) and starts again after the overload has ended.

**Bit 13, voltage OK/voltage exceeded**

When bit 13 = 0, the voltage limits of the frequency converter are not exceeded.

When bit 13 = 1, the direct voltage in the DC link of the frequency converter is too low or too high.

**Bit 14, torque OK/torque exceeded**

When bit 14 = 0, the motor torque is below the limit selected in *parameter 4-16 Torque Limit Motor Mode* and *parameter 4-17 Torque Limit Generator Mode*.

When bit 14 = 1, the limit selected in *parameter 4-16 Torque Limit Motor Mode* or *parameter 4-17 Torque Limit Generator Mode* is exceeded.

**Bit 15, timer OK/timer exceeded**

When bit 15 = 0, the timers for the motor thermal protection and thermal frequency converter protection have not exceeded 100%.

When bit 15 = 1, a timer has exceeded 100%.

### 4.4.3 PROFdrive State Transition Diagram

In the PROFdrive control profile, the control bits:

- 0–3 perform the basic start-up/power-down functions.
- 4–15 perform application-oriented control.

Illustration 4.4 shows the basic state transition diagram where control bits 0–3 control the transitions, and the corresponding status bit indicates the actual state. The black bullets indicate the priority of the control signals where fewer bullets indicate lower priority, and more bullets indicate higher priority.

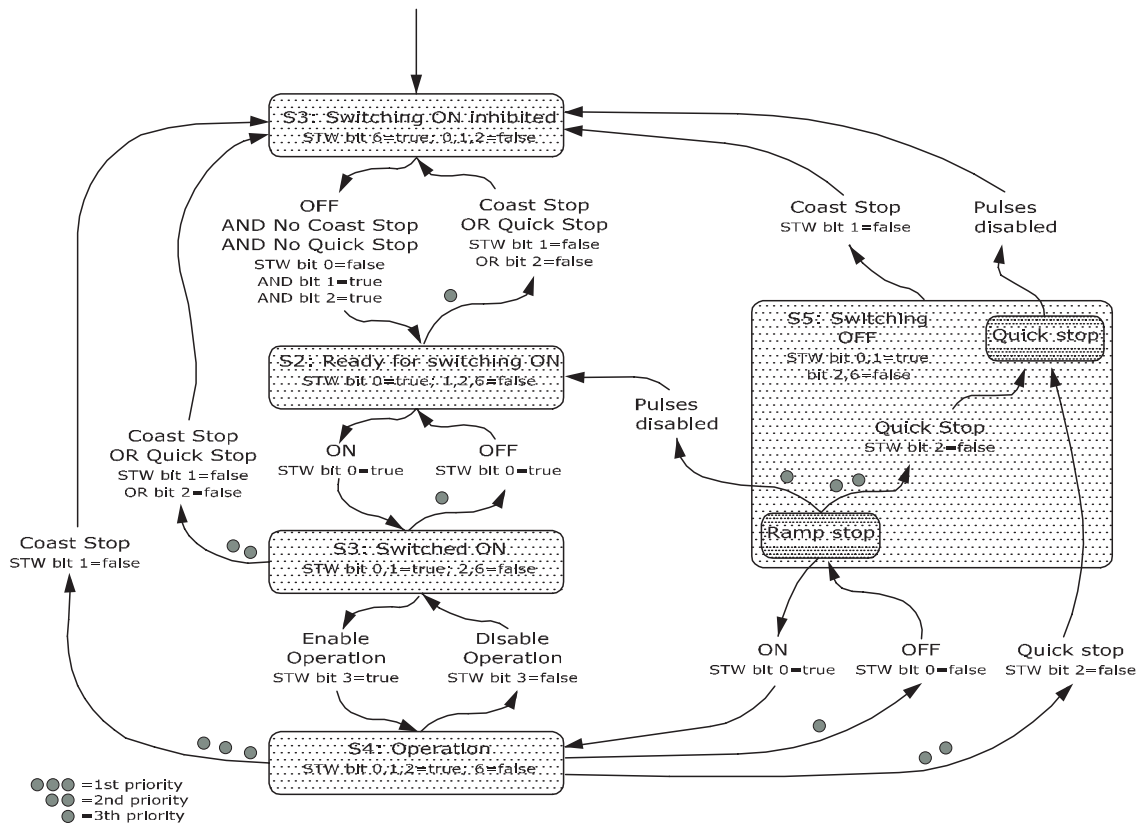

Illustration 4.4 PROFdrive State Transition Diagram

130BD806:10

## 4.5 FC Drive Control Profile

### 4.5.1 Control Word According to FC Profile (CTW)

To select Danfoss FC protocol in the control word, set *parameter 8-10 Control Word Profile* to [0] *Frequency converter profile*. Use the control word to send commands from a master (PLC or PC) to a slave (frequency converter).

Bit	Bit value = 0	Bit value = 1
00	Reference value	External selection lsb
01	Reference value	External selection msb
02	DC brake	Ramp
03	Coasting	No coasting
04	Quick stop	Ramp
05	Hold output frequency	Use ramp
06	Ramp stop	Start
07	No function	Reset
08	No function	Jog
09	Ramp 1	Ramp 2
10	Data invalid	Data valid
11	No function	Relay 01 active
12	No function	Relay 04 active
13	Parameter set-up	Selection lsb
14	Parameter set-up	Selection msb
15	No function	Reverse

Table 4.11 Bit Values for FC Control Word

#### Explanation of the control bits

##### Bits 00/01 reference value

Use bits 00 and 01 to select between the 4 reference values, which are pre-programmed in *parameter 3-10 Preset Reference* according to *Table 4.12*.

#### **NOTICE**

In *parameter 8-56 Preset Reference Select*, a selection is made to define how bit 00/01 gates with the corresponding function on the digital inputs.

Bit 01	Bit 00	Programmed reference value	Parameter
0	0	1	[0] <i>Parameter 3-10 Preset Reference</i>
0	1	2	[1] <i>Parameter 3-10 Preset Reference</i>
1	0	3	[2] <i>Parameter 3-10 Preset Reference</i>
1	1	4	[3] <i>Parameter 3-10 Preset Reference</i>

Table 4.12 Programmed Reference Values for Bits

##### Bit 02, DC brake

Bit 02 = 0 leads to DC braking and stop. Braking current and duration are set in *parameter 2-01 DC Brake Current* and *parameter 2-02 DC Braking Time*.

Bit 02 = 1 leads to ramping.

##### Bit 03, coasting

Bit 03 = 0 causes the frequency converter immediately to coast the motor to a standstill.

Bit 03 = 1 enables the frequency converter to start the motor if the other starting conditions have been fulfilled.

#### **NOTICE**

In *parameter 8-50 Coasting Select*, a selection is made to define how bit 03 gates with the corresponding function on a digital input.

##### Bit 04, quick stop

Bit 04 = 0 quick stops the frequency converter and ramps the motor speed down to stop via *parameter 3-81 Quick Stop Ramp Time*.

Bit 04 = 1 makes the frequency converter ramp the motor speed down to stop via *parameter 3-42 Ramp 1 Ramp Down Time* or *parameter 3-52 Ramp 2 Ramp Down Time*.

##### Bit 05, hold output frequency

Bit 05 = 0 freezes the present output frequency (in Hz). The frozen output frequency can only be changed with the digital inputs (*parameter 5-10 Terminal 18 Digital Input* to *parameter 5-15 Terminal 33 Digital Input*) programmed to [21] *Speed up* and [22] *Speed down*.

Bit 05 = 1 uses ramp.

**NOTICE**

If freeze output is active, stop the frequency converter with

- Bit 03 coast stop.
- Bit 02 DC brake.
- Digital input (*parameter 5-10 Terminal 18 Digital Input to parameter 5-15 Terminal 33 Digital Input*) programmed to DC braking, coasting stop, or reset and coasting stop.

**Bit 06, ramp stop/start**

Bit 06 = 0 stops the frequency converter and the motor speed ramps down to stop via the selected ramp-down parameter.

Bit 06 = 1 allows the frequency converter to start the motor if the other starting conditions have been fulfilled.

**NOTICE**

In *parameter 8-53 Start Select*, define how bit 06 ramp stop/start gates with the corresponding function on a digital input.

**Bit 07, reset**

Bit 07 = 0 does not cause a reset.

Bit 07 = 1 resets a trip. Reset is activated on the signal's leading edge, that is, when changing from logic 0 to logic 1.

**Bit 08, jog**

Bit 08 = 0, no function.

Bit 08 = 1, *parameter 3-19 Jog Speed [RPM]* determines the output frequency.

**Bit 09, selection of ramp 1/2**

Bit 09 = 0, ramp 1 is active (*parameter 3-40 Ramp 1 Type to parameter 3-47 Ramp 1 S-ramp Ratio at Decel. Start*).

Bit 09 = 1, ramp 2 is active (*parameter 3-50 Ramp 2 Type to parameter 3-57 Ramp 2 S-ramp Ratio at Decel. Start*).

**Bit 10, data not valid/data valid**

Tells the frequency converter to use or ignore the control word.

Bit 10 = 0 ignores the control word.

Bit 10 = 1 uses the control word. This function is relevant because the control word is always contained in the telegram, regardless of which type of telegram is used.

Thus, it is possible to turn off the control word if it is not needed when updating or reading parameters.

**Bit 11, relay 01**

Bit 11 = 0, relay 01 is not activated.

Bit 11 = 1, relay 01 is activated, provided control word bit 11 is selected in *parameter 5-40 Function Relay*.

**Bit 12, relay 04**

Bit 12 = 0, relay 04 is not activated.

Bit 12 = 1, relay 04 is activated, provided [37] Control word bit 12 is selected in *parameter 5-40 Function Relay*.

**Bits 13/14, set-up selection**

Use bits 13 and 14 to select from the 4 menu set-ups according to *Table 4.13*. (Bit 14 is not available for frequency converters which only have 2 set-ups.)

The function is only possible when [9] *Multi Set-ups* is selected in *parameter 0-10 Active Set-up*.

Set-up	Bit 13
1	0
2	1

Table 4.13 Set-up selection

**NOTICE**

In *parameter 8-55 Set-up Select*, define how bit 13/14 gates with the corresponding function on the digital inputs.

**Bit 15 reverse**

Bit 15 = 0 means no reversing.

Bit 15 = 1 means reversing.

### 4.5.2 Status Word According to FC Profile (STW)

The status word is used to inform the master (for example a PC) of the operating mode of the slave (frequency converter).

Refer to *chapter 7 Application Examples* for an example of a status word telegram using PPO type 3.

4

Bit	Bit = 0	Bit = 1
00	Control not ready	Control ready
01	Frequency converter not ready	Frequency converter ready
02	Coasting	Enable
03	No error	Trip
04	No error	Error (no trip)
05	Reserved	–
06	No error	Triplock
07	No warning	Warning
08	Speed ≠ reference	Speed = reference
09	Local operation	Bus control
10	Out of frequency limit	Frequency limit OK
11	No operation	In operation
12	Frequency converter OK	Stopped, auto start
13	Voltage OK	Voltage exceeded
14	Torque OK	Torque exceeded
15	Timer OK	Timer exceeded

Table 4.14 Definition of Status Bits

#### Explanation of the status bits

##### Bit 00, control not ready/ready

Bit 00 = 0, the frequency converter has tripped.  
 Bit 00 = 1, the frequency converter controls are ready, but the power component is not necessarily receiving any power (in case of a 24 V external supply to controls).

##### Bit 01, frequency converter ready

Bit 01 = 0, the frequency converter is not ready for operation.  
 Bit 01 = 1, the frequency converter is ready for operation, but there is an active coasting command via the digital inputs or via serial communication.

##### Bit 02, coasting stop

Bit 02 = 0, the frequency converter has released the motor.  
 Bit 02 = 1, the frequency converter can start the motor when a start command is given.

##### Bit 03, no error/trip

Bit 03 = 0, the frequency converter is not in fault mode.  
 Bit 03 = 1, the frequency converter is tripped, and a reset signal is required to re-establish operation.

##### Bit 04, no error/error (no trip)

Bit 04 = 0, the frequency converter is not in fault mode.  
 Bit 04 = 1, there is a frequency converter error but no trip.

##### Bit 05, not used

Bit 05 is not used in the status word.

##### Bit 06, no error/triplock

Bit 06 = 0, the frequency converter is not in fault mode.  
 Bit 06 = 1, the frequency converter is tripped and locked.

##### Bit 07, no warning/warning

Bit 07 = 0, there are no warnings.  
 Bit 07 = 1, a warning has occurred.

##### Bit 08, speed ≠ reference/speed = reference

Bit 08 = 0, the motor runs, but the present speed is different from the preset speed reference. It could, for example, be the case while the speed ramps up/down during start/stop.  
 Bit 08 = 1, the present motor speed matches the preset speed reference.

##### Bit 09, local operation/bus control

Bit 09 = 0, [Stop/Reset] is pressed on the LCP, or [2] Local is selected in *parameter 3-13 Reference Site*. It is not possible to control the frequency converter via serial communication.  
 Bit 09 = 1, it is possible to control the frequency converter via the fieldbus/serial communication.

##### Bit 10, out of frequency limit

Bit 10 = 0, the output frequency has reached the value in *parameter 4-11 Motor Speed Low Limit [RPM]* or *parameter 4-13 Motor Speed High Limit [RPM]*.  
 Bit 10 = 1, the output frequency is within the defined limits.

##### Bit 11, no operation/in operation

Bit 11 = 0, the motor does not run.  
 Bit 11 = 1, the frequency converter has a start signal or the output frequency is higher than 0 Hz.

##### Bit 12, frequency converter OK/stopped, auto start

Bit 12 = 0, there is no temporary overtemperature in the frequency converter.  
 Bit 12 = 1, the frequency converter has stopped because of overtemperature, but it has not tripped and resumes operation once the overtemperature stops.

##### Bit 13, voltage OK/limit exceeded

Bit 13 = 0, there are no voltage warnings.  
 Bit 13 = 1, the DC voltage in the frequency converter's DC link is too low or too high.

##### Bit 14, torque OK/limit exceeded

Bit 14 = 0, the motor current is lower than the torque limit selected in *parameter 4-16 Torque Limit Motor Mode* or *parameter 4-17 Torque Limit Generator Mode*.  
 Bit 14 = 1, the torque limits in *parameter 4-16 Torque Limit Motor Mode* and *parameter 4-17 Torque Limit Generator Mode* are exceeded.

##### Bit 15, timer OK/limit exceeded

Bit 15 = 0, the timers for motor thermal protection and frequency converter thermal protection have not exceeded 100%.  
 Bit 15 = 1, 1 of the timers has exceeded 100%.

## 5 Acyclic Communication (DP-V1)

PROFINET offers a cyclical communication to enhance the cyclical data communication. This feature is possible via an IO controller (for example, PLC), as well as an IO Supervisor (for example, PC Tool).

Cyclical communication means that data transfer takes place all the time at a certain update rate. It is a common function used for quick update of I/O process data. Acyclic communication means a one-time event, used mainly for read/write on parameters from process controllers, PC-based tools, or monitoring systems.

### 5.1 Features of an IO Controller System

Cyclic data exchange.

Acyclic read/write on parameters.

The acyclic connection is fixed and cannot be changed during operation.

In general, an IO controller is used as process controller, responsible for commands, speed reference, status of the application, and so on (PLC or PC-based controller).

In the IO controller, the acyclic connection can be used for general parameter access in the slaves.

### 5.2 Features of an IO Supervisor System

Initiate/abort acyclic connection.

Acyclic read/write on parameters.

The acyclic connection can be established dynamically (initiated) or removed (aborted) even though an IO controller is active on the network.

The acyclic connection is typically used for configuration or commissioning tools for easy access to each parameter in any slave in the system.

### 5.3 Addressing Scheme

The structure of a PROFINET IO device is shown in *Illustration 5.1*.

An IO device consists of a number of physical or virtual slots. Slot 0 is always present and represents the basic unit. Each slot contains a number of data blocks addressed by an index.

The master must address a variable in the slave as follows: /Slave address/Slot #/Index #

5

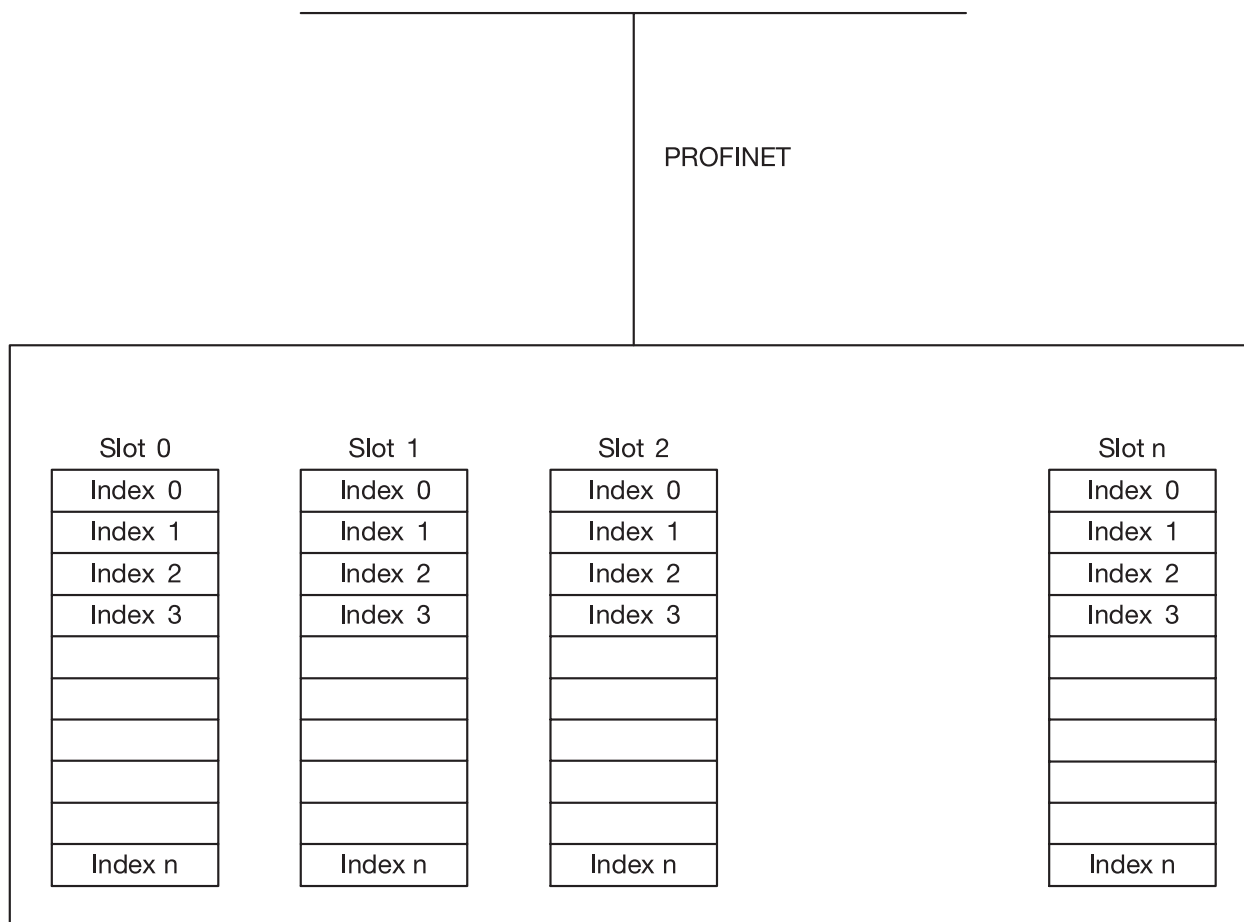

130BX339.10

Illustration 5.1 PROFINET IO Device Structure



### 5.4 Acyclic Read/Write Request Sequence

A read or write service on a frequency converter parameter takes place as illustrated in *Illustration 5.2*.

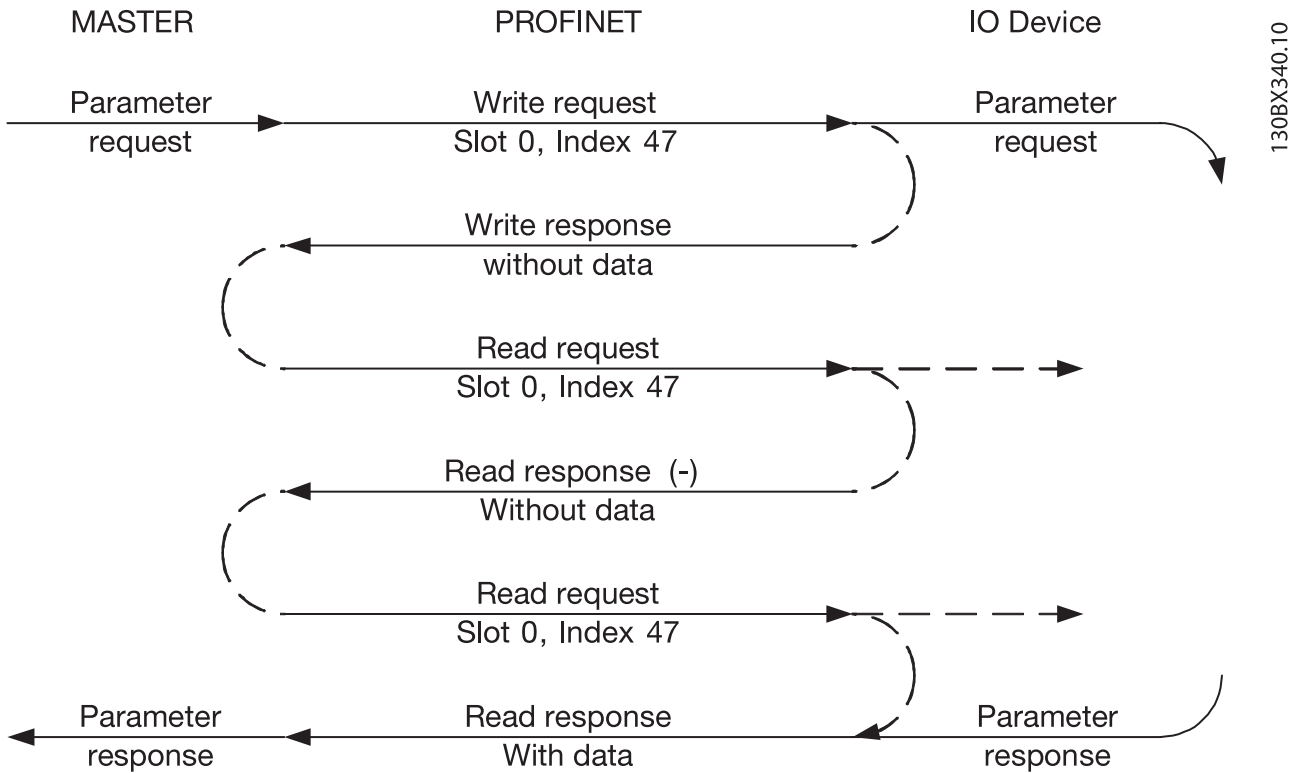

Illustration 5.2 Acyclic Read/Write Request Sequence

Initiate a read or write on a frequency converter parameter by an acyclic write service on slot 0, index 47. If this write request is valid, a positive write response without data is returned from the frequency converter immediately. If not, a negative write response is returned from the frequency converter.

The frequency converter now interprets the PROFdrive parameter channel part of the data unit and starts to perform this command internally in the frequency converter.

As the next step, the master sends a read request. If the frequency converter is still busy performing the internal parameter request, a negative response without data is returned from the frequency converter. This request is repeated by the master, until the frequency converter has the response data ready for the frequency converter parameter request.

The following example shows the details of the telegrams needed for the read/write service.

## 5.5 Data Structure in the Acyclic Telegrams

The data structure for a write/read parameter request consists of 3 main blocks:

- Header block.
- Parameter block.
- Data block.

Arrange according to *Table 5.1*:

Word number		
1 Header	Request #	Request ID
2 Header	Axis	# Param.
3 (Param. 1)	Attribute	# Elements
4 (Param. 1)	Parameter number	
5 (Param. 1)	Subindex number	
6 (Param. 2)	Attribute	# Elements
7 (Param. 2)	Parameter number	
8 (Param. 2)	Subindex number	
9 (Param. 3)	Attribute	# Elements
10 (Param. 3)	Parameter number	
11 (Param. 3)	Subindex number	
...		
N (Data Param. 1)	Format	# Elements
N+1 (Data Param. 1)	Data	Data
N (Data Param. 2)	Format	# Elements
N+1 (Data Param. 2)	Data	Data
N (Data Param. 3)	Format	# Elements
N+1 (Data Param. 3)	Data	Data
N+1 (Data Param. 3)	Data	Data
N+1 (Data Param. 3)	Data	Data

**Table 5.1 Request Telegram**

## 5.6 Header

### Request number

The master uses request # to handle the response from the IO device. The IO device mirrors this number in its response.

### Request ID

- 1 = request parameter
- 2 = change parameter

### Axis

Always leave this to 0 (zero).  
Only used in multi-axis system.

### Number of parameters

Number of parameters to read or write.

## 5.7 Parameter Block

Provide the following 5 values for each parameter to read.

### Attribute

- Attribute to be read
- 10 = Value

20 = Description

30 = Text

### Number of elements

The number of elements to read when parameter is indexed.

### Attribute

Read attribute.

### Parameter number

The number of the parameter to read.

### Subindex

Pointer to the index.

## 5.8 Data Block

The data block is only needed for write commands. Set up the data block information for each parameter to write.

### Format

The format of the information to write:

- 2: Integer 8
- 3: Integer 16
- 4: Integer 32
- 5: Unsigned 8
- 6: Unsigned 16
- 7: Unsigned 32
- 9: Visible string
- 33: Normalized value 2 bytes
- 35: Bit sequence of 16 boolean variables
- 54: Time difference without date

For the individual frequency converter series, the *programming guide* of the frequency converter contains a table with parameter number, format, and other relevant information.

### Data

The actual value to transfer. The amount of data has to be exactly the size requested in the parameter block. If the size differs, the request generates an error.

On a successful transmission of a request command, the master can read the response from the frequency converter. The response does look very much like the request command. The response only consists of 2 blocks, the header and the data block.

1 Header	Request #	Request ID
2 Header	Axis	# Param.
3 (Data Param. 1)	Format	Error code
4 (Data Param. 1)	Data	Data
5 (Data Param. 2)	Format	Error code
6 (Data Param. 2)	Data	Data
7 (Data Param. 3)	Format	Error code
8 (Data Param. 3)	Data	Data
9 (Data Param. 3)	Data	Data
10 (Data Param. 3)	Data	Data

**Table 5.2 Response Telegram**

**Error code**

If the IO device discovers an error during the execution of the command, it sets the error code to the following values:

0x00	Unknown parameter
0x01	Parameter is read-only
0x02	Value out of range due to max/min value
0x03	Wrong subindex
0x04	Parameter is no array
0x05	Wrong data type (wrong data length)
0x06	It is not allowed to set this parameter (only reset)
0x07	Descriptive element is read-only
0x09	No description available (only value)
0x0b	Process control not possible
0x0f	No text array available (only value)
0x11	Not possible in current state
0x14	Value out of range due to the frequency converter state/ configuration
0x15	Reply too long (more than 240 bytes)
0x16	Wrong parameter address (unknown or unsupported value for attribute, element, parameter number, subindex, or illegal combination)
0x17	Illegal format (for writing)
0x18	Value amount not consistent
0x65	Wrong axis: action not possible with this axis
0x66	Unknown service request
0x67	This service is not possible with multi-parameter access
0x68	Parameter value cannot be read from bus

**Table 5.3 Error Code**

## 6 Parameters

### 6.1 Parameter Group 0-\*\* Operation/ Display

0-37 Display Text 1		
Range:	Function:	
0* [0 - 25 ]	<p>In this parameter, it is possible to write an individual text string to be shown in the LCP or to be read via serial communication. To show the text permanently, select [37] Display Text 1 in 1 of the following parameters:</p> <ul style="list-style-type: none"> <li>Parameter 0-20 Display Line 1.1 Small.</li> <li>Parameter 0-21 Display Line 1.2 Small.</li> <li>Parameter 0-22 Display Line 1.3 Small.</li> <li>Parameter 0-23 Display Line 2 Large.</li> <li>Parameter 0-24 Display Line 3 Large.</li> <li>Parameter 0-37 Display Text 1.</li> </ul> <p>Changing parameter 12-08 Host Name changes parameter 0-37 Display Text 1 - but not vice versa.</p>	

### 6.2 Parameter Group 8-\*\* Communication and Option

8-01 Control Site		
Option:	Function:	
	The setting in this parameter overrides the settings in parameter 8-50 Coasting Select to parameter 8-56 Preset Reference Select.	
[0] Digital and ctrl.word	Use both digital input and control word.	
[1] Digital only	Use digital inputs only.	
[2] Controlword only	Use control word only.	

8-02 Control Source		
Option:	Function:	
	<p><b>NOTICE</b> This parameter cannot be adjusted while the motor is running.</p> <p>Select the source of the control word: 1 of 2 serial interfaces or 4 installed options. During initial power-up, the frequency converter automatically sets this parameter to [3] Option A if it detects a valid fieldbus option installed in slot A. When the option is removed, the frequency converter detects a configuration change, sets parameter 8-02 Control Word Source to default setting [1] FC RS485, and trips. If an option is installed after initial power-up, the setting of parameter 8-02 Control Word Source</p>	

8-02 Control Source		
Option:	Function:	
	<p>does not change, but the frequency converter trips and shows: Alarm 67, Option Changed.</p> <p>When retrofitting a bus option into a frequency converter that did not have a bus option installed earlier, change the control to bus-based. This change is required for safety reasons to avoid an unintended change.</p>	
[0] None		
[1] FC Port		
[2] FC USB		
[3] Option A		

8-03 Control Timeout Time		
Range:	Function:	
1 s* [0.1 - 6000 s]	<p>Enter the maximum time expected to pass between the reception of 2 consecutive telegrams. If this time is exceeded, it indicates that the telegram communication has stopped. The function selected in parameter 8-04 Control Word Timeout Function is then carried out. A valid control word triggers the timeout counter.</p>	

8-04 Control Timeout Function		
Option:	Function:	
	<p>Select the timeout function. The timeout function activates when the control word fails to be updated within the time period specified in parameter 8-03 Control Word Timeout Time.</p> <p><b>NOTICE</b> To change the set-up after a timeout, configure as follows:</p> <ol style="list-style-type: none"> <li>Set parameter 0-10 Active Set-up to [9] Multi set-up.</li> <li>Select the relevant link in parameter 0-12 This Set-up Linked to.</li> </ol>	
[0] * Off	Resumes control via fieldbus (fieldbus or standard), using the most recent control word.	
[1] Freeze output	Freezes output frequency until communication resumes.	
[2] Stop	Stops with auto restart when communication resumes.	
[3] Jogging	Runs the motor at jog frequency until communication resumes.	
[4] Max. speed	Runs the motor at maximum frequency until communication resumes.	

8-04 Control Timeout Function		
Select the timeout function. The timeout function activates when the control word fails to be updated within the time period specified in <i>parameter 8-03 Control Word Timeout Time</i> .		
<b>Option:</b>		<b>Function:</b>
[5]	Stop and trip	Stops the motor, then resets the frequency converter to restart: <ul style="list-style-type: none"> <li>• Via the fieldbus.</li> <li>• Via [Reset].</li> <li>• Via a digital input.</li> </ul>

8-07 Diagnosis Trigger		
<b>Option:</b>		<b>Function:</b>
		Enables and controls the frequency converter diagnosis function.
[0] *	Disable	Extended diagnosis data is not sent even if the data appears in the frequency converter.
[1]	Trigger on alarms	Extended diagnosis data is sent when 1 or more alarms appear.
[2]	Trigger alarm/warn.	Extended diagnosis data is sent if 1 or more alarms/warnings appear.

8-10 Control Word Profile		
Select the interpretation of the control and status words corresponding to the installed fieldbus. Only the selections valid for the fieldbus installed are visible in the LCP display. For guidelines in selection of [0] <i>Frequency converter profile</i> and [1] <i>PROFdrive profile</i> , refer to the <i>design guide</i> of the related product. For more guidelines in the selection of [1] <i>PROFdrive profile</i> , [5] <i>ODVA</i> , and [7] <i>CANopen DSP 402</i> , see the <i>installation guide</i> for the installed fieldbus.		
<b>Option:</b>		<b>Function:</b>
[0] *	FC profile	
[1]	PROFdrive profile	
[5]	ODVA	
[7]	CANopen DSP 402	

8-14 Configurable Control Word CTW		
<b>Option:</b>		<b>Function:</b>
		Selection of control word bit 10 if it is active low or active high.
[0]	None	
[1] *	Profile default	
[2]	CTW Valid, active low	
[4]	PID error inverse	
[5]	PID reset I part	
[6]	PID enable	

8-19 Product Code		
<b>Range:</b>		<b>Function:</b>
Size related*	[0 - 2147483647]	Select 0 to read out the actual fieldbus product code according to the mounted fieldbus option. Select 1 to read out the actual vendor ID.

8-50 Coasting Select		
<b>Option:</b>		<b>Function:</b>
		Select the trigger for the coasting function.
[0]	Digital input	A digital input triggers the coasting function.
[1]	Bus	A serial communication port or the fieldbus triggers the coasting function.
[2]	Logic AND	The fieldbus/serial communication port and a digital input trigger the coasting function.
[3] *	Logic OR	The fieldbus/serial communication port or a digital input triggers the coasting function.

8-51 Quick Stop Select		
Select the trigger for the quick stop function.		
<b>Option:</b>		<b>Function:</b>
[0]	Digital input	
[1]	Bus	
[2]	Logic AND	
[3] *	Logic OR	

8-52 DC Brake Select		
<b>Option:</b>		<b>Function:</b>
		Select control of the DC brake via the terminals (digital input) and/or via the fieldbus. <b>NOTICE</b> When <i>parameter 1-10 Motor Construction</i> is set to [1] <i>PM non-salient SPM</i> , only selection [0] <i>Digital input</i> is available.
[0]	Digital input	Activates a start command via a digital input.
[1]	Bus	Activates a start command via the serial communication port or fieldbus option.
[2]	Logic AND	Activates a start command via the fieldbus/serial communication port, and also via 1 of the digital inputs.
[3]	Logic OR	Activates a start command via the fieldbus/serial communication port, or via 1 of the digital inputs.

8-53 Start Select		
<b>Option:</b>		<b>Function:</b>
		Select the trigger for the start function.
[0]	Digital input	A digital input triggers the start function.

8-53 Start Select		
Option:	Function:	
[1]	Bus	A serial communication port or the fieldbus triggers the start function.
[2]	Logic AND	The fieldbus/serial communication port and a digital input trigger the start function.
[3] *	Logic OR	The fieldbus/serial communication port or a digital input triggers the start function.

8-54 Reversing Select		
Option:	Function:	
		Select the trigger for the reversing function.
[0]	Digital input	A digital input triggers the reversing function.
[1]	Bus	A serial communication port or the fieldbus triggers the reversing function.
[2]	Logic AND	The fieldbus/serial communication port and a digital input trigger the reversing function.
[3]	Logic OR	The fieldbus/serial communication port or a digital input triggers the reversing function.

8-55 Set-up Select		
Option:	Function:	
		Select the trigger for the set-up selection.
[0]	Digital input	A digital input triggers the set-up selection.
[1]	Bus	A serial communication port or the fieldbus triggers the set-up selection.
[2]	Logic AND	The fieldbus/serial communication port and a digital input trigger the set-up selection.
[3] *	Logic OR	The fieldbus/serial communication port or a digital input triggers the set-up selection.

8-56 Preset Reference Select		
Option:	Function:	
		Select the trigger for the preset reference selection.
[0]	Digital input	A digital input triggers the preset reference selection.
[1]	Bus	A serial communication port or the fieldbus triggers the preset reference selection.
[2]	Logic AND	The fieldbus/serial communication port and a digital input trigger the preset reference selection.
[3] *	Logic OR	The fieldbus/serial communication port or a digital input triggers the preset reference selection.

8-57 Profdrive OFF2 Select		
Option:	Function:	
[0]	Digital input	
[1]	Bus	
[2]	Logic AND	
[3] *	Logic OR	

8-58 Profdrive OFF3 Select		
Option:	Function:	
[0]	Digital input	
[1]	Bus	
[2]	Logic AND	
[3] *	Logic OR	

8-90 Bus Jog 1 Speed		
Range:	Function:	
100 RPM*	[ 0 - 1500 RPM]	Enter the jog speed. Activate this fixed jog speed via the serial port or fieldbus option.

8-91 Bus Jog 2 Speed		
Range:	Function:	
200 RPM*	[ 0 - 1500 RPM]	Enter the jog speed. Activate this fixed jog speed via the serial port or fieldbus option.

### 6.3 Parameter Group 9-\*\* PROFIdrive

#### 9-15 PCD Write Configuration

Array [10]

**Option: Function:**

	Select the parameters to be assigned to PCD 3-10 of the telegrams. The number of available PCDs depends on the telegram type. The values in PCD 3-10 are then written to the selected parameters as data values. Alternatively, specify a standard PROFIBUS telegram in <i>parameter 9-22 Telegram Selection</i> .
--	--

#### 9-16 PCD Read Configuration

Array [10]

**Option: Function:**

	Select the parameters to be assigned to PCD 3-10 of the telegrams. The number of available PCDs depends on the telegram type. PCDs 3-10 contain the actual data values of the selected parameters. For standard PROFIBUS telegram, see <i>parameter 9-22 Telegram Selection</i> .
--	---

#### 9-22 Telegram Selection

Option:	Function:
	This parameter shows the selected standard PROFIBUS telegram that the PROFINET IO controller has sent to the frequency converter. At

9-22 Telegram Selection		
Option:	Function:	
		power-up, or if a non-supported telegram is sent from the IO controller, this parameter shows None in the display.
[1]	Standard telegram 1	
[100] *	None	
[101]	PPO 1	
[102]	PPO 2	
[103]	PPO 3	
[104]	PPO 4	
[105]	PPO 5	
[106]	PPO 6	
[107]	PPO 7	
[108]	PPO 8	

9-23 Parameters for Signals		
Array [1000] Read only		
Option:	Function:	
		This parameter contains a list of signals available for selection in <i>parameter 9-15 PCD Write Configuration</i> and <i>parameter 9-16 PCD Read Configuration</i> .
[0] *		
[302]	Minimum Reference	
[303]	Maximum Reference	
[312]	Catch up/slow Down Value	
[341]	Ramp 1 Ramp Up Time	
[342]	Ramp 1 Ramp Down Time	
[351]	Ramp 2 Ramp Up Time	
[352]	Ramp 2 Ramp Down Time	
[380]	Jog Ramp Time	
[381]	Quick Stop Ramp Time	
[412]	Motor Speed Low Limit [Hz]	
[414]	Motor Speed High Limit [Hz]	
[416]	Torque Limit Motor Mode	
[417]	Torque Limit Generator Mode	
[553]	Term. 29 High Ref./Feedb. Value	
[558]	Term. 33 High Ref./Feedb. Value	
[590]	Digital & Relay Bus Control	
[593]	Pulse Out 27 Bus Control	
[615]	Terminal 53 High Ref./Feedb. Value	
[625]	Terminal 54 High Ref./Feedb. Value	
[696]	Terminal 42 Output Bus Control	
[748]	PCD Feed Forward	
[890]	Bus Jog 1 Speed	

9-23 Parameters for Signals		
Array [1000] Read only		
Option:	Function:	
[891]	Bus Jog 2 Speed	
[1500]	Operating hours	
[1501]	Running Hours	
[1502]	kWh Counter	
[1600]	Control Word	
[1601]	Reference [Unit]	
[1602]	Reference [%]	
[1603]	Status Word	
[1605]	Main Actual Value [%]	
[1609]	Custom Readout	
[1610]	Power [kW]	
[1611]	Power [hp]	
[1612]	Motor Voltage	
[1613]	Frequency	
[1614]	Motor current	
[1615]	Frequency [%]	
[1616]	Torque [Nm]	
[1618]	Motor Thermal	
[1620]	Motor Angle	
[1622]	Torque [%]	
[1630]	DC Link Voltage	
[1633]	Brake Energy /2 min	
[1634]	Heatsink Temp.	
[1635]	Inverter Thermal	
[1638]	SL Controller State	
[1639]	Control Card Temp.	
[1650]	External Reference	
[1652]	Feedback[Unit]	
[1653]	Digi Pot Reference	
[1657]	Feedback [RPM]	
[1660]	Digital Input	
[1661]	Terminal 53 Setting	
[1662]	Analog input 53	
[1663]	Terminal 54 Setting	
[1664]	Analog input 54	
[1665]	Analog output 42 [mA]	
[1667]	Pulse input 29[Hz]	
[1668]	Pulse Input 33 [Hz]	
[1669]	Pulse Output 27 [Hz]	
[1671]	Relay output	
[1672]	Counter A	
[1673]	Counter B	
[1674]	Prec. Stop Counter	
[1680]	Fieldbus CTW 1	
[1682]	Fieldbus REF 1	
[1684]	Comm. Option STW	
[1685]	FC Port CTW 1	
[1690]	Alarm Word	
[1691]	Alarm Word 2	
[1692]	Warning Word	

9-23 Parameters for Signals		
Array [1000]		
Read only		
<b>Option:</b>	<b>Function:</b>	
[1693]	Warning Word 2	
[1694]	Ext. Status Word	
[1695]	Ext. Status Word 2	
[1697]	Alarm Word 3	
[3401]	PCD 1 Write For Application	
[3402]	PCD 2 Write For Application	
[3403]	PCD 3 Write For Application	
[3404]	PCD 4 Write For Application	
[3405]	PCD 5 Write For Application	
[3406]	PCD 6 Write For Application	
[3407]	PCD 7 Write For Application	
[3408]	PCD 8 Write For Application	
[3409]	PCD 9 Write For Application	
[3410]	PCD 10 Write For Application	
[3421]	PCD 1 Read For Application	
[3422]	PCD 2 Read For Application	
[3423]	PCD 3 Read For Application	
[3424]	PCD 4 Read For Application	
[3425]	PCD 5 Read For Application	
[3426]	PCD 6 Read For Application	
[3427]	PCD 7 Read For Application	
[3428]	PCD 8 Read For Application	
[3429]	PCD 9 Read For Application	
[3430]	PCD 10 Read For Application	
[3450]	Actual Position	
[3456]	Track Error	

9-27 Parameter Edit		
<b>Option:</b>	<b>Function:</b>	
		Parameters can be edited via PROFIBUS, the standard RS485 interface, or the LCP.
[0]	Disabled	Disables editing via PROFIBUS.
[1] *	Enabled	Enables editing via PROFIBUS.

9-28 Process Control		
<b>Option:</b>	<b>Function:</b>	
		Process control (setting of control word, speed reference, and process data) is possible via either PROFINET or standard fieldbus, but not both simultaneously. Local control is always possible via the LCP. Control via process control is possible via either terminals or fieldbus depending on the settings in <i>parameter 8-50 Coasting Select</i> to <i>parameter 8-58 Profdrive OFF3 Select</i> .
[0]	Disable	Disables process control via PROFINET and enables process control via standard fieldbus or PROFINET IO supervisor.

9-28 Process Control		
<b>Option:</b>	<b>Function:</b>	
[1] *	Enable cyclic master	Enables process control via IO controller and disables process control via standard fieldbus or PROFINET IO supervisor.

9-53 Profibus Warning Word		
<b>Range:</b>	<b>Function:</b>	
0*	[0 - 65535 ]	This parameter displays PROFINET communication warnings.

Read only

Bit	Condition when bit is active
0	Connection with IO controller is not OK
1	Reserved for status of connection with second IO controller
2	Not used
3	Clear data command received
4	Actual value is not updated
5	No link on both ports
6	Not used
7	Initializing of PROFINET is not OK
8	Frequency converter is tripped
9	Internal CAN error
10	Wrong configuration data from IO controller
11	Not used
12	Internal error occurred
13	Not configured
14	Timeout active
15	Warning 34 active

Table 6.1 PROFINET Communication Warnings

9-65 Profile Number		
<b>Range:</b>	<b>Function:</b>	
0*	[0 - 0 ]	This parameter contains the profile identification. Byte 1 contains the profile number and byte 2 the version number of the profile.

9-70 Programming Set-up		
This parameter is unique for LCP and fieldbus. See <i>parameter 0-11 Programming Set-up</i> .		
<b>Option:</b>	<b>Function:</b>	
		Select the set-up to edit.
[0]	Factory setup	Uses default data. This option can be used as a data source to return the other set-ups to a known state.
[1]	Set-up 1	Edits set-up 1.
[2]	Set-up 2	Edits set-up 2.
[3]	Set-up 3	Edits set-up 3.
[4]	Set-up 4	Edits set-up 4.



9-70 Programming Set-up		
This parameter is unique for LCP and fieldbus. See <i>parameter 0-11 Programming Set-up</i> .		
<b>Option:</b>	<b>Function:</b>	
[9] *	Active Set-up	Follows the active set-up selected in <i>parameter 0-10 Active Set-up</i> .

9-71 Profibus Save Data Values		
<b>Option:</b>	<b>Function:</b>	
		Parameter values changed via PROFINET are not automatically stored in the non-volatile memory. Use this parameter to activate a function that stores parameter values in the EEPROM non-volatile memory, so changed parameter values are retained at power-down.
[0]	Off	Deactivates the non-volatile storage function.
[1]	Store all setups	Stores all parameter values for all set-ups in the non-volatile memory. When all parameter values have been stored, the selection returns to [0] Off.
[2]	Store all setups	Stores all parameter values for all set-ups in the non-volatile memory. When all parameter values have been stored, the selection returns to [0] Off.

9-72 ProfibusDriveReset		
<b>Option:</b>	<b>Function:</b>	
[0] *	No action	
[1]	Power-on reset	Resets frequency converter upon power-up, as for power-cycle.
[3]	Comm option reset	Resets the PROFINET option only, the PROFINET option goes through a power-up sequence. When reset, the frequency converter disappears from the fieldbus, which may cause a communication error from the master.

9-80 Defined Parameters (1)		
Array [116] No LCP access Read only		
<b>Range:</b>	<b>Function:</b>	
0*	[0 - 9999 ]	This parameter displays a list of all the defined frequency converter parameters available for PROFINET.

9-81 Defined Parameters (2)		
Array [116] No LCP access Read only		
<b>Range:</b>	<b>Function:</b>	
0*	[0 - 9999 ]	This parameter displays a list of all the defined frequency converter parameters available for PROFINET.

9-82 Defined Parameters (3)		
Array [116] No LCP access Read only		
<b>Range:</b>	<b>Function:</b>	
0*	[0 - 9999 ]	This parameter displays a list of all the defined frequency converter parameters available for PROFINET.

9-83 Defined Parameters (4)		
Array [116] No LCP access Read only		
<b>Range:</b>	<b>Function:</b>	
0*	[0 - 9999 ]	This parameter displays a list of all the defined frequency converter parameters available for PROFINET.

9-84 Defined Parameters (5)		
Array [115] No LCP access Read only		
<b>Range:</b>	<b>Function:</b>	
0*	[0 - 9999]	This parameter displays a list of all the defined frequency converter parameters available for PROFINET.

9-90 Changed Parameters (1)		
Array [116] No LCP access Read only		
<b>Range:</b>	<b>Function:</b>	
0*	[0 - 9999 ]	This parameter shows a list of all the frequency converter parameters deviating from default setting.

9-91 Changed Parameters (2)		
Array [116] No LCP access Read only		
<b>Range:</b>	<b>Function:</b>	
0*	[0 - 9999 ]	This parameter shows a list of all the frequency converter parameters deviating from default setting.

9-92 Changed Parameters (3)		
Array [116] No LCP access Read only		
<b>Range:</b>	<b>Function:</b>	
0*	[0 - 9999 ]	This parameter shows a list of all the frequency converter parameters deviating from default setting.

9-94 Changed Parameters (5)		
Array [116] No LCP Address Read only		
<b>Range:</b>		<b>Function:</b>
0*	[0 - 9999 ]	This parameter shows a list of all the frequency converter parameters deviating from default setting.

## 6.4 Parameter Group 12-\*\* Ethernet

### 6.4.1 12-0\* IP Settings

12-00 IP Address Assignment		
Option:	Function:	
[0]	MANUAL	Select the IP address assignment method. IP address can be set in <i>parameter 12-01 IP Address IP Address</i> .
[1]	DHCP	IP address is assigned via DHCP server.
[2]	BOOTP	IP address is assigned via BOOTP server.
[10] *	DCP	DCP is assigned via the DCP protocol.

12-01 IP Address		
Range:	Function:	
0*	[0 - 2147483647 ]	Configure the IP address of the option. Read-only, if <i>parameter 12-00 IP Address Assignment</i> is set to DHCP or BOOTP. In POWERLINK, the IP address follows the <i>parameter 12-60 Node ID</i> last byte and the first part is fixed to 192.168.100 (node ID).

12-02 Subnet Mask		
Range:	Function:	
0*	[0 - 4244635647 ]	Configure the IP subnet mask of the option. Read-only, if <i>parameter 12-00 IP Address Assignment</i> is set to DHCP or BOOTP. In POWERLINK, it is fixed to 255.255.255.0.

12-03 Default Gateway		
Range:	Function:	
0*	[0 - 2147483647 ]	Configure the IP default gateway of the option. Read-only, if <i>parameter 12-00 IP Address Assignment</i> is set to DHCP or BOOTP. In a non-routed network, this address is set to the IP address of the IO Device.

12-04 DHCP Server		
Range:	Function:	
0*	[0 - 2147483647 ]	Read-only. Displays the IP address of the found DHCP or BOOTP server.

12-05 Lease Expires		
Range:	Function:	
Size related*	[0 - 0]	Read-only. Shows the lease time left for the current DHCP-assigned IP address.

12-06 Name Servers		
Range:	Function:	
0*	[0 - 2147483647]	IP addresses of domain name servers. Can be automatically assigned when using DHCP.

12-07 Domain Name		
Range:	Function:	
0	[0 - 48]	Domain name of the attached network. Can be automatically assigned when using DHCP network.

12-08 Host Name		
Range:	Function:	
0*	[0 - 48 ]	Logical (given) name of option.  <b>NOTICE</b> The display of the frequency converter only shows the first 19 characters, but the remaining characters are stored in the frequency converter. If hardware switches are different from all ON or all OFF, the switches have priority.

12-09 Physical Address		
Range:	Function:	
0*	[0 - 17]	Read-only. Shows the physical (MAC) address of the option.

### 6.4.2 12-1\* Ethernet Link Parameters

Applies to the whole parameter group.

Index [0] is used for port 1, and index [1] is used for port 2.

12-10 Link Status		
Option:	Function:	
		Read-only. Shows the link status of the Ethernet ports.
[0] *	No Link	
[1]	Link	

12-11 Link Duration		
Range:	Function:	
Size related*	[0 - 0]	Read-only. Shows the duration of the present link on each port in dd:hh:mm:ss.

12-12 Auto Negotiation		
Option:	Function:	
		Configures auto negotiation of Ethernet link parameters, for each port: ON or OFF.
[0]	Off	Link Speed and Link Duplex can be configured in parameter 12-13 Link Speed and parameter 12-14 Link Duplex.
[1] *	On	

12-13 Link Speed		
Option:	Function:	
		Forces the link speed for each port in 10 Mbps or 100 Mbps. If parameter 12-12 Auto Negotiation is set to [1] On, this parameter is read-only and displays the actual link speed. If no link is present, None is displayed.
[0] *	None	
[1]	10 Mbps	
[2]	100 Mbps	

**NOTICE**

In POWERLINK, this parameter is locked to 100 Mbs.

12-14 Link Duplex		
Option:	Function:	
		<b>NOTICE</b> In POWERLINK, this parameter is locked to half duplex.
		Forces the duplex for each port to full or half duplex. If parameter 12-12 Auto Negotiation is set to [1] On, this parameter is read-only.
[0]	Half Duplex	
[1]	Full Duplex	

6.4.3 12-8\* Other Ethernet Services

12-80 FTP Server		
Option:	Function:	
[0] *	Disabled	Disables the built-in FTP server.
[1]	Enabled	Enables the built-in FTP server.

12-81 HTTP Server		
Option:	Function:	
[0] *	Disabled	
[1]	Enabled	Enables the built-in HTTP (web) server.

12-82 SMTP Service		
Option:	Function:	
[0] *	Disabled	
[1]	Enabled	Enables the SMTP (e-mail) service on the option.

12-89 Transparent Socket Channel Port		
Range:	Function:	
Size related*	[0 - 65535 ]	Configures the TCP port number for the transparent socket channel. This configuration enables FC telegrams to be sent transparently on Ethernet via TCP. Default value is 4000, 0 means disabled. The MCT 10 Set-up Software uses this port.

6.4.4 12-9\* Advanced Ethernet Settings

12-90 Cable Diagnostic		
Option:	Function:	
		<b>NOTICE</b> The cable diagnostics function is only issued on ports where there is no link (see parameter 12-10 Link Status, Link Status).  Enables/disables advanced cable diagnosis function. If enabled, the distance to cable errors can be read out in parameter 12-93 Cable Error Length. The parameter resumes to the default setting of disable after the diagnostics have finished.
[0] *	Disabled	
[1]	Enabled	

12-91 Auto Cross Over		
Option:	Function:	
[0]	Disabled	Disables the auto cross over function.
[1] *	Enabled	Enables the auto cross over function.

12-92 IGMP Snooping		
Option:	Function:	
		This prevents flooding of the Ethernet protocol stack by only forwarding multicast packets to ports that are member of the multicast group. In PROFINET, this function is disabled.
[0]	Disabled	Disables the IGMP snooping function.
[1] *	Enabled	Enables the IGMP snooping function.

12-93 Cable Error Length		
Range:	Function:	
0*	[0 - 65535]	If cable diagnostics is enabled in parameter 12-90 Cable Diagnostic, the built-in switch is possible via time domain reflectometry (TDR). This measurement technique detects common cabling problems such as open circuits, short circuits, and impedance mismatches or breaks in transmission cables. The distance from the option to the error is shown in meters with an

12-93 Cable Error Length		
Range:	Function:	
		accuracy of ±2 m. The value 0 means that no errors are detected.

12-94 Broadcast Storm Protection		
Range:	Function:	
-1 % *	[-1 - 20 %]	The built-in switch is capable of protecting the switch system from receiving too many broadcast packages, which can use up network resources. The value indicates the percentage of the total bandwidth that is allowed for broadcast messages.  Example: OFF means that the filter is disabled: all broadcast messages pass through. The value 0% means that no broadcast messages pass through. A value of 10% means that 10% of the total bandwidth is allowed for broadcast messages. If the number of broadcast messages increases above the 10% threshold, they are blocked.

12-95 Inactivity timeout		
Range:	Function:	
120*	[0 - 3600]	

12-96 Port Config		
Enables/disables port-mirroring function. For troubleshooting with a network analyzer tool.		
Option:	Function:	
[0]	Normal	No port-mirroring.
[1]	Mirror Port 1 to 2	All network traffic on port 1 is mirrored to port 2.
[2]	Mirror Port 2 to 1	All network traffic on port 2 is mirrored to port 1.
[10]	Port 1 disabled	
[11]	Port 2 disabled	
[254]	Mirror Int. Port to 1	
[255]	Mirror Int. Port to 2	

12-98 Interface Counters		
Range:	Function:	
4000*	[0 - 4294967295]	Read-only. Advanced interface counters from built-in switch can be used for low-level troubleshooting. The parameter shows a sum of port 1+port 2.

12-99 Media Counters		
Range:	Function:	
0*	[0 - 4294967295]	Read-only. Advanced interface counters from built-in switch can be used for low-level troubleshooting. The parameter shows a sum of port 1+port 2.

## 6.5 PROFINET-specific Parameters

### 6.5.1 Setting Communication Parameters

All basic communication parameters are located in *parameter group 12-0\* IP Settings*. The parameters are all set to PROFINET standard values, so that only a minimum change is necessary.

- *Parameter 12-00 IP Address Assignment.*
- *Parameter 12-01 IP Address.*
- *Parameter 12-02 Subnet Mask.*
- *Parameter 12-03 Default Gateway.*
- *Parameter 12-04 DHCP Server.*
- *Parameter 12-05 Lease Expires.*
- *Parameter 12-06 Name Servers.*
- *Parameter 12-07 Domain Name.*
- *Parameter 12-08 Host Name.*
- *Parameter 12-09 Physical Address.*

The PROFINET interface offers several ways of address assignment. Typically, DCP is used, and then the PLC assigns the IP address, subnet mask, and other relevant parameters when the communication is established. The following examples show the settings if the PROFINET DCP assignment is used.

Parameter	Value
<i>Parameter 12-00 IP Address Assignment</i>	[10] DCP
<i>Parameter 12-01 IP Address</i>	0.0.0.0 (From PLC)
<i>Parameter 12-02 Subnet Mask</i>	0.0.0.0 (From PLC)
<i>Parameter 12-03 Default Gateway</i>	0.0.0.0 (From PLC)
<i>Parameter 12-04 DHCP Server</i>	*

**Table 6.2 Setting up Frequency Converter with Manually Assigned IP Address**

\*= *Host Name* can be set via the LCP, through DCP command or by setting the DIP Switches on the PROFINET interface.

Parameter	Value
<i>Parameter 12-00 IP Address Assignment</i>	[1] DHCP/[2] BOOTP
<i>Parameter 12-01 IP Address</i>	Read-only
<i>Parameter 12-02 Subnet Mask</i>	Read-only
<i>Parameter 12-03 Default Gateway</i>	Read-only

**Table 6.3 Setting up the Frequency Converter with Automatically (BOOTP/DHCP) Assigned IP Address**

By IP address assigned by DHCP/BOOTP/DCP server, the assigned IP address and subnet mask can be read out in *parameter 12-01 IP Address* and *parameter 12-02 Subnet Mask*. In *parameter 12-04 DHCP Server*, the IP address of the found DHCP or BOOTP server is displayed. For DHCP only: The remaining lease time can be read out in

*parameter 12-05 Lease Expires.* If lease time is set to 0 (zero), the timer never expires.

*Parameter 12-09 Physical Address* reads out the MAC address of the option, which is also printed on the label of the option.

*Parameter 12-03 Default Gateway* is optional and only used in routed networks.

*Parameter 12-13 Link Speed* displays/sets the link speed for each port. If no link is present, None is displayed.

*Parameter 12-14 Link Duplex* displays/sets the duplex mode for each port.

## NOTICE

It is only possible to assign valid class A, B, and C IP addresses to the option. The valid ranges are shown in *Table 6.4*.

Class A	1.0.0.1-126.255.255.254
Class B	128.1.0.1-191.255.255.254
Class C	192.0.1.1-223.255.254.254

**Table 6.4** Valid Ranges for IP Address to the Option

## 6.5.2 Ethernet Link Parameters

*Parameter group 12-1\* Ethernet Link Parameters:*

- *Parameter 12-10 Link Status.*
- *Parameter 12-11 Link Duration.*
- *Parameter 12-12 Auto Negotiation.*
- *Parameter 12-13 Link Speed.*
- *Parameter 12-14 Link Duplex.*

Each port has unique Ethernet Link Parameters.

*Parameter 12-10 Link Status* and *parameter 12-11 Link Duration* display information on the link status, per port.

*Parameter 12-10 Link Status* displays Link or No Link according to the status of the present port.

*Parameter 12-11 Link Duration* displays the duration of the link on the present port. If the link is lost, the counter is reset.

*Parameter 12-12 Auto Negotiation* enables 2 connected Ethernet devices to select common transmission parameters, such as speed and duplex mode. In this process, the connected devices first share their capabilities and then select the fastest transmission mode they both support.

Incapability between the connected devices could lead to decreased communication performance.

To prevent this, auto negotiation can be disabled.

If *parameter 12-12 Auto Negotiation* is set to OFF, link speed and duplex mode can be configured manually in *parameter 12-13 Link Speed* and *parameter 12-12 Auto Negotiation*.

**6.5.3 PROFINET-specific Parameter List**
**6**

Parameter	Default value	Range	Conversion index	Data type
Parameter 0-37 Display Text 1	0	[0-25]	0	Visible string 21
Parameter 8-01 Control Site	[0] Dig. & ctrl. word	[0-2]	-	UInt8
Parameter 8-02 Control Source	-	[0-3]	-	UInt8
Parameter 8-03 Control Timeout Time	1	0.1-6000	-1	UInt16
Parameter 8-04 Control Timeout Function	[0] Off	[0-5]	-	UInt8
Parameter 8-07 Diagnosis Trigger	[0] Disable	[0-2]	-	UInt8
Parameter 8-10 Control Word Profile	[0] FC profile	[0-7]	-	UInt8
Parameter 8-14 Configurable Control Word CTW	[1] Profile default	[0-6]	-	UInt8
Parameter 8-19 Product Code	-	0-2147483647	0	UInt32
Parameter 8-50 Coasting Select	[3] Logic OR	[0-3]	-	UInt8
Parameter 8-51 Quick Stop Select	[3] Logic OR	[0-3]	-	UInt8
Parameter 8-52 DC Brake Select	[3] Logic OR	[0-3]	-	UInt8
Parameter 8-53 Start Select	[3] Logic OR	[0-3]	-	UInt8
Parameter 8-54 Reversing Select	[3] Logic OR	[0-3]	-	UInt8
Parameter 8-55 Set-up Select	[3] Logic OR	[0-3]	-	UInt8
Parameter 8-56 Preset Reference Select	[3] Logic OR	[0-3]	-	UInt8
Parameter 8-57 Profidrive OFF2 Select	[3] Logic OR	[0-3]	-	UInt8
Parameter 8-58 Profidrive OFF3 Select	[3] Logic OR	[0-3]	-	UInt8
Parameter 8-90 Bus Jog 1 Speed	100 RPM	0-1500 RPM	0	UInt16
Parameter 8-91 Bus Jog 2 Speed	200 RPM	0-1500 RPM	0	UInt16
Parameter 9-15 PCD Write Configuration	-	-	-	UInt16
Parameter 9-16 PCD Read Configuration	-	-	-	UInt16
Parameter 9-22 Telegram Selection	[100] None	[1-108]	-	UInt8
Parameter 9-23 Parameters for Signals	[0]	0-3456	-	UInt16
Parameter 9-27 Parameter Edit	[1] Enabled	[0-1]	-	UInt16
Parameter 9-28 Process Control	[1] Enable cyclic master	[0-1]	-	UInt16
Parameter 9-53 Profibus Warning Word	0	0-65535	0	V2
Parameter 9-65 Profile Number	0	0-0	0	Oct. string 2
Parameter 9-70 Edit Set-up	[9] Active set-up	[0-9]	-	UInt8
Parameter 9-71 Profibus Save Data Values	[0] Off	[0-2]	-	UInt8
Parameter 9-72 ProfibusDriveReset	[0] No action	[0-3]	-	UInt8
Parameter 9-80 Defined Parameters (1)	0	0-9999	0	UInt16
Parameter 9-81 Defined Parameters (2)	0	0-9999	0	UInt16
Parameter 9-82 Defined Parameters (3)	0	0-9999	0	UInt16
Parameter 9-83 Defined Parameters (4)	0	0-9999	0	UInt16
Parameter 9-84 Defined Parameters (5)	0	0-9999	0	UInt16
Parameter 9-90 Changed Parameters (1)	0	0-9999	0	UInt16
Parameter 9-91 Changed Parameters (2)	0	0-9999	0	UInt16
Parameter 9-92 Changed Parameters (3)	0	0-9999	0	UInt16
Parameter 9-94 Changed Parameters (5)	0	0-9999	0	UInt16
Parameter 12-00 IP Address Assignment	[10] DCP	[0-10]	-	UInt8
Parameter 12-01 IP Address	0	0-2147483647	-	Oct. string 4
Parameter 12-02 Subnet Mask	0	0-4244635647	-	Oct. string 4
Parameter 12-03 Default Gateway	0	0-2147483647	-	Oct. string 4
Parameter 12-04 DHCP Server	0	0-2147483647	-	Oct. string 4
Parameter 12-05 Lease Expires	-	0-2147483647	-	Time diff. w/date
Parameter 12-06 Name Servers	0	0-255	-	Oct. string 4
Parameter 12-07 Domain Name	0	0-48	-	Visible string 48
Parameter 12-08 Host Name	0	0-48	-	Visible string 48

Parameter	Default value	Range	Conversion index	Data type
Parameter 12-09 Physical Address	0	0-17	-	Visible string 17
Parameter 12-10 Link Status	[0] No Link	[0-1]	-	Uin8
Parameter 12-11 Link Duration	-	0-0	-	Time diff. w/date
Parameter 12-12 Auto Negotiation	[1] On	[0-1]	-	Uin8
Parameter 12-13 Link Speed	[0] None	[0-2]	-	Uin8
Parameter 12-14 Link Duplex	[1] Full Duplex	[0-1]	-	Uin8
Parameter 12-80 FTP Server	[0] Disabled	[0-1]	-	Uin8
Parameter 12-81 HTTP Server	[0] Disabled	[0-1]	-	Uin8
Parameter 12-82 SMTP Service	[0] Disabled	[0-1]	-	Uin8
Parameter 12-89 Transparent Socket Channel Port	-	0-65535	0	Uin16
Parameter 12-90 Cable Diagnostic	[0] Disabled	[0-1]	-	Uin8
Parameter 12-91 Auto Cross Over	[1] Enabled	[0-1]	-	Uin8
Parameter 12-92 IGMP Snooping	[1] Enabled	[0-1]	-	Uin8
Parameter 12-93 Cable Error Length	0	0-65535	0	Uin16
Parameter 12-94 Broadcast Storm Protection	-1%	-1-20%	0	Int8
Parameter 12-95 Broadcast Storm Filter	[0] Broadcast only	[0-1]	-	Uin8
Parameter 12-96 Port Config	-	[0-255]	-	Uin8
Parameter 12-98 Interface Counters	4000	0-4294967295	0	Uin32
Parameter 12-99 Media Counters	0	0-4294967295	0	Uin32

Table 6.5 PROFINET-specific Parameter List

Refer to the relevant operating guide for a comprehensive parameter list.

## 6.6 Supported Object and Data Types

### 6.6.1 Parameter Description

PROFINET has a number of describing attributes.

### 6.6.2 Size Attribute

The size index and the conversion index for each parameter can be taken from the parameter list in the respective *operating guide*.

Physical unit	Size index	Measuring unit	Designation	Conversion index	Conversion factor
	0	No dimension			
Time	4	second	s	0	1
		millisecond	ms	-1	0.1
		minute	min	-2	0.01
		hour	h	-3	0.001
		day	d	70	60
Energy	8	watthour	Wh	74	3600
		kilowatthour	kWh	77	86400
		megawatthour	MWh	0	1
Power	9	milliwatt	mW	3	1000
		watt	W	6	10 <sup>6</sup>
		kilowatt	kW	-3	0.001
		megawatt	MW	0	1
Rotation	11	rotation per minute	RPM	3	1000
Torque	16	newtonmetre	Nm	0	1
		kilonewtonmetre	kNm	3	1000
Temperature	17	degree Celsius	°C	0	1
Voltage	21	millivolt	mV	-3	0.001
		volt	V	0	1
		kilovolt	kV	3	1000
Current	22	milliampere	mA	-3	0.001
		ampere	A	0	1
		kiloampere	kA	3	1000
Resistance	23	milliohm	mOhm	-3	0.001
		ohm	Ohm	0	1
		kiloohm	kOhm	3	1000
Ratio	24	per cent	%	0	1
Relative change	27	per cent	%	0	1
Frequency	28	hertz	Hz	0	1
		kilohertz	kHz	3	1000
		megahertz	MHz	6	10 <sup>6</sup>
		gigahertz	GHz	9	10 <sup>9</sup>

Table 6.6 Size Index and Conversion Index



## 6.6.3 Supported Object and Data Types

Data type	Short name	Description	Date type 2
3	I2	Integer 16	Int16
4	I4	Integer 32	Int32
5	-	Unsigned 8	UInt8
6	O2	Unsigned 16	UInt16
7	O4	Unsigned 32	UInt32
9	-	Visible string	VisStr
10	-	Byte string	-
33	N2	Standardized value (16 bit)	N2
35	V2	Bit sequence	V2
54	-	Time difference without date indication	TimD

Table 6.7 Supported Data Types

## 7 Application Examples

### 7.1 Example: Process Data with PPO Type 6

This example shows how to work with PPO type 6, which consists of control word/status word and reference/main actual value. The PPO also has 2 additional words, which can be programmed to monitor process signals, see *Table 7.1*:

	0		1		2		3	
	CTW		MRV		PCD [2]		PCD	
From controller	04	7C	20	00	00	00	00	00
	STW		MAV		PCD [2]		PCD [3]	
From frequency converter	0F	07	20	00	3F	A6	00	08
Byte #	1	2	3	4	5	6	7	8

Table 7.1 Example: Process Data with PPO Type 6

The application requires monitoring of the motor torque and digital input, so PCD 2 is set up to read the current motor torque. PCD 3 is set up to monitor the state of an external sensor via the process signal digital input. The sensor is connected to digital input 18.

An external device is also controlled via control word bit 11 and the built-in relay of the frequency converter. Reversing is permitted only when the reversing bit 15 in the control word and the digital input 19 are set to high.

For safety reasons, the frequency converter stops the motor if the PROFINET cable is broken, the master has a system failure, or the PLC is in stop mode.

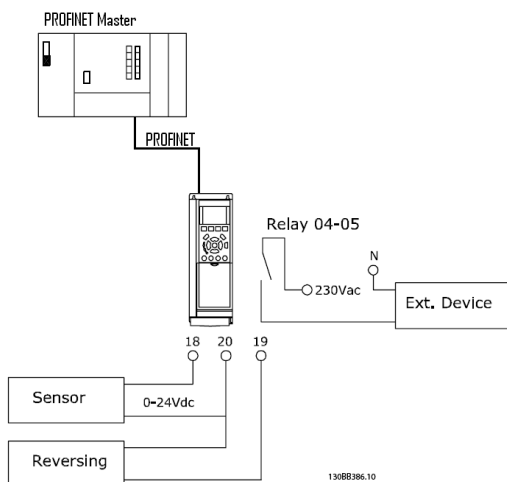

Illustration 7.1 Wiring Diagram

Program the frequency converter as shown in *Table 7.2*:

Parameter	Setting
Parameter 4-10 Motor Speed Direction	[2] Both directions
Parameter 5-10 Terminal 18 Digital Input	[0] No operation
Parameter 5-11 Terminal 19 Digital Input	[10] Reversing
Parameter 5-40 Function Relay	[36/37] Control word bit 11/12
Parameter 8-03 Control Word Timeout Time	1 s
Parameter 8-04 Control Word Timeout Function	[2] Stop
Parameter 8-10 Control Word Profile	[0] FC Profile
Parameter 8-50 Coasting Select	[1] Bus
Parameter 8-51 Quick Stop Select	[1] Bus
Parameter 8-52 DC Brake Select	[1] Bus
Parameter 8-53 Start Select	[1] Bus
Parameter 8-54 Reversing Select	[2] Logic AND
Parameter 8-55 Set-up Select	[1] Bus
Parameter 8-56 Preset Reference Select	[1] Bus
Parameter 9-16 PCD Read Configuration	[2] Sub-index parameter 16-16 Torque [Nm] [3] Sub-index parameter 16-60 Digital Input

Table 7.2 Parameter Settings

## 7.2 Example: Control Word Telegram Using Standard Telegram 1/PPO3

This example shows how the control word telegram relates to the controller and the frequency converter, using FC control profile.

The control word telegram is sent from the PLC to the frequency converter. Standard telegram 1 is used in the example to demonstrate the full range of modules. All the values shown are arbitrary and are provided for demonstration purposes only.

	0		1		2		3																									
	CTW		MRV		PCD		PCD																									
	04	7C	20	00																												
PQW:	256		258		260		262																									
	CTW		MRV																													
Bit no.:	31	30	29	28	27	26	25	24	23	22	21	20	19	18	17	16	15	14	13	12	11	10	9	8	7	6	5	4	3	2	1	0
	0	0	0	0	0	1	0	0	0	1	1	1	1	1	0	0	0	0	0	1	0	0	0	0	0	0	0	0	0	0	0	0
	0				4				7				C				2				0				0				0			

Table 7.3 PCD

Table 7.3 indicates the bits contained within the control word and how they are presented as process data in standard telegram 1 in this example.

Table 7.4 indicates which bit functions and which corresponding bit values are active in this example.

Bit	Bit value = 0	Bit value = 1	Bit value	
00	Reference value	External selection lsb	0	C
01	Reference value	External selection msb	0	
02	DC brake	Ramp	1	
03	Coasting	Enable	1	
04	Quick stop	Ramp	1	7
05	Freeze output	Ramp enable	1	
06	Ramp stop	Start	1	
07	No function	Reset	0	
08	No function	Jog	0	4
09	Ramp 1	Ramp 2	0	
10	Data not valid	Valid	1	
11	No function	Relay 01 active	0	
12	No function	Relay 02 active	0	0
13	Parameter set-up	Selection lsb	0	
14	Parameter set-up	Selection msb	0	
15	No function	Reversing	0	
	Function active			
	Function inactive			

Table 7.4 Control Word Telegram Using Standard Telegram 1/PPO3



### 7.3 Example: Status Word Telegram Using Standard Telegram 1/PPO3

This example shows how the control word telegram relates to the PLC and the frequency converter, using FC control profile.

The control word telegram is sent from the frequency converter to the controller. Standard telegram 1 is used in the example to demonstrate the full range of modules. All the values shown are arbitrary and are provided for demonstration purposes only.

	0		1		2		3																									
	STW		MAV		PCD		PCD																									
	0F	07	20	00																												
PIW:	256		258		260		262																									
	STW		MAV																													
Bit no.:	31	30	29	28	27	26	25	24	23	22	21	20	19	18	17	16	15	14	13	12	11	10	9	8	7	6	5	4	3	2	1	0
	0	0	0	0	0	1	0	0	0	1	1	1	1	1	0	0	0	0	1	0	0	0	0	0	0	0	0	0	0	0	0	0
	0				F				0				7				2				0				0				0			

Table 7.5 PCD

7

Table 7.5 indicates the bits contained within the status word and how they are presented as process data in standard telegram 1 in this example.

Table 7.6 indicates which bit functions and which corresponding bit values are active in this example.

Bit	Bit value = 0	Bit value = 1	Bit value	
00	Control not ready	Control ready	1	7
01	Frequency converter not ready	Frequency converter ready	1	
02	Coasting	Enable	1	
03	No error	Trip	0	
04	No error	Error (no trip)	0	0
05	Reserved	-	0	
06	No error	Triplock	0	
07	No warning	Warning	0	
08	Speed reference	Speed#=#reference	1	F
09	Local operation	Bus control	1	
10	Outside frequency range	Within frequency range	1	
11	No operation	In operation	1	
12	Frequency converter OK	Stopped, auto start	0	0
13	Voltage OK	Voltage exceeded	0	
14	Torque OK	Torque exceeded	0	
15	Timers OK	Timers exceeded	0	
	Function active			
	Function inactive			

Table 7.6 Status Word Telegram Using Standard Telegram 1/PPO3

### 7.4 Example: PLC Programming

In this example, PPO type 6 is placed in the following input/output address:

...	Module	Rack	Slot	I address	Q address	Type	Order no.	Firmware	Comment
▼	danfoss-fc-series	0	0	2042*		Danfoss FC PN	132B0348	V03.01.0	
▶	Interface	0	0 X1	2041*		danfoss-fc-series			
▼	PPO 6 - 4/4 Words, Danfoss ...	0	1			PPO 6 - 4/4 Words, ...			
	Parameter Access Point	0	1 1	2034*		Parameter Access P..			
	PPO 6 - 4/4 Words, Danf...	0	1 2	256...263	256...263	PPO 6 - 4/4 Words, ...			

130BE933.10

Input address	256–257	258–259	260–261	262–263	Output address	256–257	258–259	260–261	262–263
Set-up	Status word	MAV	Motor torque	Digital input	Set-up	Control word	Reference	Not used	Not used

Illustration 7.2 PPO Type 6 Placed in the Input/Output Address

This network sends a start command (047C hex) and a reference (2000 hex) of 50% to the frequency converter.

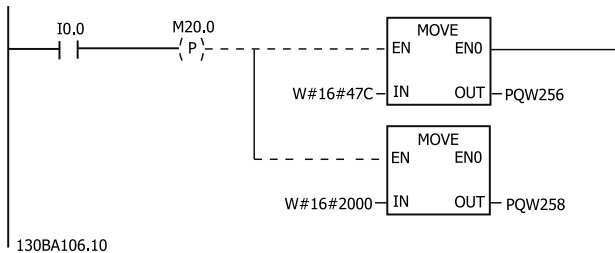

Illustration 7.3 Network Sends Start Command and Reference

This network reads the motor torque from the frequency converter. A new reference is sent to the frequency converter because the motor torque (86.0%) is higher than the compared value.

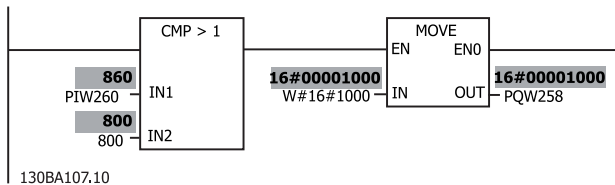

Illustration 7.4 Network Reads the Motor Torque

This network reads the status on the digital inputs from the frequency converter. If digital input 18 is ON, it stops the frequency converter.

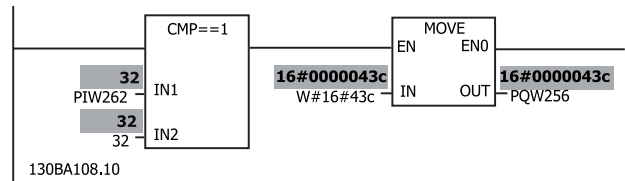

Illustration 7.5 Network Reads the Status on the Digital Inputs

This network reverses the motor when digital input 19 is ON, because *parameter 8-54 Reversing Select* is programmed to Logic AND.

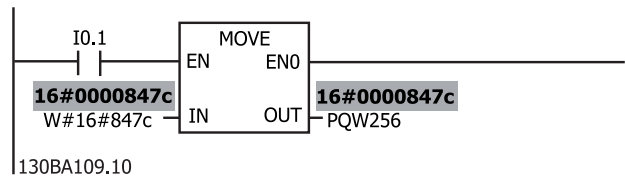

Illustration 7.6 Network Reverses the Motor

This network activates relay 02.

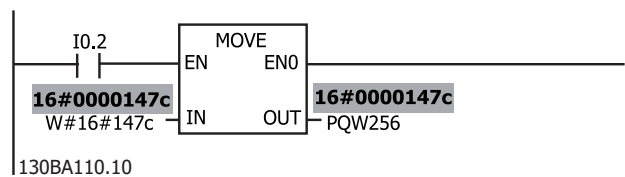

Illustration 7.7 Network Activates Relay 02

## 8 Troubleshooting

### 8.1 No Response to Control Signals

**Check 1: Is the control word valid?**

If bit 10 = 0 in the control word, the frequency converter does not accept the control word.

**Check 2: Is the relationship between bits in the control word and the terminal I/Os correct?**

Check the logical relationship in the frequency converter.

Define the desired logical relationship in *parameter 8-50 Coasting Select* to *parameter 8-58 Profdrive OFF3 Select* according to the following range of options. Select the FC control mode, digital input and/or serial communication, using *parameter 8-50 Coasting Select* to *parameter 8-58 Profdrive OFF3 Select*.

If *parameter 8-01 Control Site* is set to digital only, the frequency converter does not react to commands sent via the control word.

*Table 8.1* to *Table 8.8* show a coast command's effect on the frequency converter for the full range of *parameter 8-50 Coasting Select* settings.

The effect of control mode on the function of *parameter 8-50 Coasting Select*, *parameter 8-51 Quick Stop Select*, and *parameter 8-52 DC Brake Select* is as follows:

If [0] *Digital input* is selected, the terminals control the coast and DC brake functions.

**NOTICE**

**Coasting, quick stop, and DC brake functions are active for logic 0.**

Terminal	Bits 02/03/04	Function
0	0	Coast/DC brake/Q-Stop
0	1	Coast/DC brake/Q-Stop
1	0	No Coast/DC brake/Q-Stop
1	1	No Coast/DC brake/Q-Stop

Table 8.1 [0] Digital Input

If [1] *Serial communication* is selected, commands are activated only when given via serial communication.

Terminal	Bits 02/03/04	Function
0	0	Coast/DC brake/Q-Stop
0	1	No Coast/DC brake/Q-Stop
1	0	Coast/DC brake/Q-Stop
1	1	No Coast/DC brake/Q-Stop

Table 8.2 [1] Serial Communication

If [2] *Logic AND* is selected, both signals must be activated to perform the function.

Terminal	Bits 02/03/04	Function
0	0	Coast/DC brake/Q-Stop
0	1	No Coast/DC brake/Q-Stop
1	0	No Coast/DC brake/Q-Stop
1	1	No Coast/DC brake/Q-Stop

Table 8.3 [2] Logic AND

If [3] *Logic OR* is selected, activation of 1 signal activates the function.

Terminal	Bits 02/03/04	Function
0	0	Coast/DC brake/Q-Stop
0	1	Coast/DC brake/Q-Stop
1	0	Coast/DC brake/Q-Stop
1	1	No Coast/DC brake/Q-Stop

Table 8.4 [3] Logic OR

The effect of control mode on the function of *parameter 8-53 Start Select* and *parameter 8-54 Reversing Select*:

If [0] *Digital input* is selected, the terminals control the start and reversing functions.

Terminal	Bits 06/15	Function
0	0	Stop/Counterclockwise
0	1	Stop/Counterclockwise
1	0	Start/Clockwise
1	1	Start/Clockwise

Table 8.5 [0] Digital input

If [1] *Serial communication* is selected, commands are activated only when given via serial communication.

Terminal	Bits 02/03/04	Function
0	0	Stop/Counterclockwise
0	1	Start/Clockwise
1	0	Stop/Counterclockwise
1	1	Start/Clockwise

Table 8.6 [1] Serial Communication

If [2] *Logic AND* is selected, both signals must be activated to perform the function.

Terminal	Bits 02/03/04	Function
0	0	Stop/Counterclockwise
0	1	Stop/Counterclockwise
1	0	Stop/Counterclockwise
1	1	Start/Clockwise

Table 8.7 [2] Logic AND

If [3] Logic OR is selected, activation of 1 signal activates the function.

Terminal	Bits 02/03/04	Function
0	0	Stop/Counterclockwise
0	1	Start/Clockwise
1	0	Start/Clockwise
1	1	Start/Clockwise

Table 8.8 [3] Logic OR

The effect of control mode on the function of parameter 8-55 Set-up Select and parameter 8-56 Preset Reference Select:

If [0] Digital input is selected, the terminals control the set-up and preset reference functions.

Terminal		Bits 00/01, 13/14		Function
Msb	Lsb	Msb	Lsb	Preset ref. set-up number
0	0	0	0	1
0	0	0	1	1
0	0	1	0	1
0	0	1	1	1
0	1	0	0	2
0	1	0	1	2
0	1	1	0	2
0	1	1	1	2
1	0	0	0	3
1	0	0	1	3
1	0	1	0	3
1	0	1	1	3
1	1	0	0	4
1	1	0	1	4
1	1	1	0	4
1	1	1	1	4

Table 8.9 [0] Digital Input

If [1] Serial communication is selected, commands are activated only when given via serial communication.

Terminal		Bits 00/01, 13/14		Function
Msb	Lsb	Msb	Lsb	Preset ref. set-up number
0	0	0	0	1
0	0	0	1	2
0	0	1	0	3
0	0	1	1	4
0	1	0	0	1
0	1	0	1	2
0	1	1	0	3
0	1	1	1	4
1	0	0	0	1
1	0	0	1	2
1	0	1	0	3
1	0	1	1	4
1	1	0	0	1
1	1	0	1	2
1	1	1	0	3
1	1	1	1	4

Table 8.10 [1] Serial Communication

If [2] Logic AND is selected, both signals must be activated to perform the function.

Terminal		Bits 00/01, 13/14		Function
Msb	Lsb	Msb	Lsb	Preset ref. set-up number
0	0	0	0	1
0	0	0	1	1
0	0	1	0	1
0	0	1	1	1
0	1	0	0	1
0	1	0	1	2
0	1	1	0	1
0	1	1	1	2
1	0	0	0	1
1	0	0	1	1
1	0	1	0	3
1	0	1	1	3
1	1	0	0	1
1	1	0	1	2
1	1	1	0	3
1	1	1	1	4

Table 8.11 [2] Logic AND

If [3] Logic OR is selected, activation of 1 signal activates the function.

Terminal		Bits 00/01, 13/14		Function
Msb	Lsb	Msb	Lsb	Preset ref. set-up number
0	0	0	0	1
0	0	0	1	2
0	0	1	0	3
0	0	1	1	4
0	1	0	0	2
0	1	0	1	2
0	1	1	0	4
0	1	1	1	4
1	0	0	0	3
1	0	0	1	4
1	0	1	0	3
1	0	1	1	4
1	1	0	0	4
1	1	0	1	4
1	1	1	0	4

Table 8.12 [3] Logic OR

8

## 8.2 Warnings and Alarms

PROFINET alarm words and warning words are shown on the display in hex format. If there is more than 1 warning or alarm, a sum of all warnings or alarms is shown. Alarm word, warning word, and, PROFINET warning word can also be displayed using the serial bus in *parameter 16-90 Alarm Word*, *parameter 16-92 Warning Word*, and *parameter 9-53 Profibus Warning Word*.

Bit (hex)	Unit diagnose bit	Alarm word ( <i>parameter 16-90 Alarm Word</i> )	Alarm number
00000001	48	Brake check	28
00000002	49	Power card overtemperature	29
00000004	50	Earth fault	14
00000008	51	Control card overtemperature	65
00000010	52	Control word timeout	18
00000020	53	Overcurrent	13
00000040	54	Torque limit	12
00000080	55	Motor thermistor overtemperature	11
00000100	40	Motor ETR overtemperature	10
00000200	41	Inverter overloaded	9
00000400	42	DC-link undervoltage	8
00000800	43	DC-link overvoltage	7
00001000	44	Short circuit	16
00002000	45	Inrush fault	33
00004000	46	Mains phase loss	4
00008000	47	AMA not OK	50
00010000	32	Live zero error	2
00020000	33	Internal fault	38
00040000	34	Brake overload	26
00080000	35	Motor phase U is missing	30
00100000	36	Motor phase V is missing	31
00200000	37	Motor phase W is missing	32
00400000	38	Fieldbus comm. fault	34
00800000	39	24 V supply fault	47
01000000	24	Mains failure	36
02000000	25	1.8 V supply fault	48
04000000	26	Brake resistor short circuit	25
08000000	27	Brake chopper fault	27
10000000	28	Option change	67
20000000	29	Frequency converter initialization	80
40000000	30	Safe stop	68
80000000	31	Mechanical brake low	63

Table 8.13 Parameter 16-90 Alarm Word



Bit (hex)	Unit diagnose bit	Warning word (parameter 16-92 Warning Word)	Alarm number
00000001	112	Brake check	28
00000002	113	Power card overtemperature	29
00000004	114	Earth fault	14
00000008	115	Control card	65
00000010	116	Control word timeout	18
00000020	117	Overcurrent	13
00000040	118	Torque limit	12
00000080	119	Motor thermistor overtemperature	11
00000100	104	Motor ETR overtemperature	10
00000200	105	Inverter overloaded	9
00000400	106	DC-link undervoltage	8
00000800	107	DC-link overvoltage	7
00001000	108	DC-link voltage low	6
00002000	109	DC-link voltage high	5
00004000	110	Mains phase loss	4
00008000	111	No motor	3
00010000	96	Live zero error	2
00020000	97	10 V low	1
00040000	98	Brake overload	26
00080000	99	Brake resistor short circuit	25
00100000	100	Brake chopper fault	27
00200000	101	Speed limit	49
00400000	102	Fieldbus comm. fault	34
00800000	103	24 V supply fault	47
01000000	88	Mains failure	36
02000000	89	Current limit	59
04000000	90	Low temperature	66
08000000	91	Voltage limit	64
10000000	92	Encoder loss	61
20000000	93	Output frequency limit	62
40000000	94	Unused	-
80000000	95	Warning word 2 (ext. stat. word)	-

Table 8.14 Parameter 16-92 Warning Word

Bit (hex)	Unit diagnose bit	PROFIBUS warning word (parameter 9-53 Profibus Warning Word)
00000001	160	Connection with DP-master is not OK
00000002	161	Unused
00000004	162	FDL (Fieldbus Data link Layer) is not OK
00000008	163	Clear data command received
00000010	164	Actual value is not updated
00000020	165	Baudrate search
00000040	166	PROFIBUS ASIC is not transmitting
00000080	167	Initializing of PROFIBUS is not OK
00000100	152	Frequency converter is tripped
00000200	153	Internal CAN error
00000400	154	Wrong configuration data from PLC
00000800	155	Wrong ID sent by PLC
00001000	156	Internal error occurred
00002000	157	Not configured
00004000	158	Timeout active
00008000	159	Warning 34 active

Table 8.15 Parameter 9-53 Profibus Warning Word

Bit (Hex)	Comm. option STW (parameter 16-84 Comm. Option STW)
00000001	Parameterization OK
00000002	Configuration OK
00000004	Clearmode active
00000008	Baudrate search
00000010	Waiting for parameterization
00000020	Waiting for configuration
00000040	In data exchange
00000080	Not used
00000100	Not used
00000200	Not used
00000400	Not used
00000800	MCL2/1 connected
00001000	MCL2/2 connected
00002000	MCL2/3 connected
00004000	Data transport active
00008000	Not used

Table 8.16 Parameter 16-84 Comm. Option STW

**NOTICE**

Parameter 16-84 Comm. Option STW is not part of extended diagnosis.

### 8.2.1 Warning and Alarm Messages

The LEDs on the LCP signal a warning or an alarm. A code in the display is also shown.

A warning remains active until its cause is no longer present. Under certain circumstances, operation of the motor can still be continued. Warning messages are not necessarily critical.

An alarm makes the frequency converter trip. Alarms must be reset to restart operation once their cause has been rectified.

#### 3 ways of resetting alarms

- By pressing [Reset].
- Via a digital input with the Reset function.
- Via serial communication/optional fieldbus.

#### **NOTICE**

After a manual reset pressing [Reset], press [Auto On] to restart the motor.

If an alarm cannot be reset, the reason could be that its cause has not been rectified, or the alarm is triplocked (see also Table 8.17).

Alarms that are triplocked offer additional protection, meaning that the mains supply must be switched off before the alarm can be reset. After being switched back on, the frequency converter is no longer blocked and can be reset as described, once the cause has been rectified.

Alarms that are not triplocked can also be reset using the automatic reset function in *parameter 14-20 Reset Mode*. (Warning: automatic wake-up is possible!)

When a warning or alarm is marked against a code in Table 8.17, this means that either a warning occurs before an alarm, or that it is possible to specify whether it is a warning or an alarm that is displayed for a given fault.

For instance, this is possible in *parameter 1-90 Motor Thermal Protection*. After an alarm or trip, the motor continues coasting, and the alarm and warning flash. Once the problem has been rectified, only the alarm continues flashing until the frequency converter is reset.

8

### 8.2.2 Alarm and Warning List

Number	Description	Warning	Alarm/trip	Alarm/triplock	Parameter reference
1	10 V low	X			
2	Live zero error	(X)	(X)		<i>Parameter 6-01 Live Zero Timeout Function</i>
3	No motor	(X)			<i>Parameter 1-80 Function at Stop</i>
4	Mains phase loss	(X)	(X)	(X)	<i>Parameter 14-12 Function at Mains Imbalance</i>
5	DC link voltage high	X			
6	DC link voltage low	X			
7	DC overvoltage	X	X		
8	DC undervoltage	X	X		
9	Inverter overloaded	X	X		
10	Motor ETR overtemperature	(X)	(X)		<i>Parameter 1-90 Motor Thermal Protection</i>
11	Motor thermistor overtemperature	(X)	(X)		<i>Parameter 1-90 Motor Thermal Protection</i>
12	Torque limit	X	X		
13	Overcurrent	X	X	X	
14	Earth fault	X	X	X	
15	Hardware mismatch		X	X	
16	Short circuit		X	X	
17	Control word timeout	(X)	(X)		<i>Parameter 8-04 Control Word Timeout Function</i>
22	Hoist mech. brake				
23	Internal fan fault	X			

Number	Description	Warning	Alarm/trip	Alarm/triplock	Parameter reference
24	External fan fault	X			Parameter 14-53 Fan Monitor
25	Brake resistor short-circuited	X			
26	Brake resistor power limit	(X)	(X)		Parameter 2-13 Brake Power Monitoring
27	Brake chopper short-circuited	X	X		
28	Brake check	(X)	(X)		Parameter 2-15 Brake Check
29	Heat sink temp	X	X	X	
30	Motor phase U missing	(X)	(X)	(X)	Parameter 4-58 Missing Motor Phase Function
31	Motor phase V missing	(X)	(X)	(X)	Parameter 4-58 Missing Motor Phase Function
32	Motor phase W missing	(X)	(X)	(X)	Parameter 4-58 Missing Motor Phase Function
33	Inrush fault		X	X	
34	Fieldbus communication fault	X	X		
36	Mains failure	X	X		
38	Internal fault		X	X	
39	Heat sink sensor		X	X	
40	Overload of digital output terminal 27	(X)			Parameter 5-00 Digital I/O Mode, parameter 5-01 Terminal 27 Mode
41	Overload of digital output terminal 29	(X)			Parameter 5-00 Digital I/O Mode, parameter 5-02 Terminal 29 Mode
42	Overload of digital output on X30/6	(X)			Parameter 5-32 Term X30/6 Digi Out (MCB 101)
42	Overload of digital output on X30/7	(X)			Parameter 5-33 Term X30/7 Digi Out (MCB 101)
46	Pwr. card supply		X	X	
47	24 V supply low	X	X	X	
48	1.8 V supply low		X	X	
49	Speed limit	X			
50	AMA calibration failed		X		
51	AMA check $U_{nom}$ and $I_{nom}$		X		
52	AMA low $I_{nom}$		X		
53	AMA motor too big		X		
54	AMA motor too small		X		
55	AMA parameter out of range		X		
56	AMA interrupted by user		X		
57	AMA timeout		X		
58	AMA internal fault	X	X		
59	Current limit	X			
61	Tracking error	(X)	(X)		Parameter 4-30 Motor Feedback Loss Function
62	Output frequency at maximum limit	X			
63	Mechanical brake low		(X)		Parameter 2-20 Release Brake Current
64	Voltage limit	X			
65	Control board overtemperature	X	X	X	
66	Heat sink temperature low	X			
67	Option configuration has changed		X		
68	Safe stop	(X)	(X) <sup>1)</sup>		Parameter 5-19 Terminal 37 Safe Stop
69	Pwr. card temp		X	X	
70	Illegal FC configuration			X	
71	PTC 1 safe stop	X	X <sup>1)</sup>		Parameter 5-19 Terminal 37 Safe Stop

Number	Description	Warning	Alarm/trip	Alarm/triplock	Parameter reference
72	Dangerous failure			X <sup>1)</sup>	Parameter 5-19 Terminal 37 Safe Stop
73	Safe stop auto restart				
77	Reduced power mode	X			Parameter 14-59 Actual Number of Inverter Units
79	Illegal PS config		X	X	
80	Frequency converter initialized to default value		X		
81	CSIV corrupt				
82	CSIV parameter error				
85	Profibus/Profisafe error				
90	Encoder loss	(X)	(X)		Parameter 17-61 Feedback Signal Monitoring
91	Analog input 54 wrong settings			X	S202
100-199	See <i>Operating Instructions for MCO 305</i>				
243	Brake IGBT	X	X		
244	Heat sink temp	X	X	X	
245	Heat sink sensor		X	X	
246	Pwr.card supply		X	X	
247	Pwr.card temp		X	X	
248	Illegal PS config		X	X	
250	New spare part			X	Parameter 14-23 Typecode Setting
251	New type code		X	X	

**Table 8.17 Alarm/Warning Code List**

(X) Dependent on parameter.

1) Cannot be auto reset via parameter 14-20 Reset Mode.

A trip is the action when an alarm has appeared. The trip coasts the motor and can be reset by pressing [Reset] or by making a reset by a [1] digital input (parameter group 5-1\* Digital I/O Mode ). The event that caused an alarm cannot damage the frequency converter or cause dangerous conditions. A triplock is an action when an alarm occurs, that can damage the frequency converter or connected parts. A triplock situation can only be reset by a power cycling.

Warning	yellow
Alarm	flashing red
Triplocked	yellow and red

**Table 8.18 LED Indication**

Bit	Hex	Dec	Alarm word (parameter 1 6-90 Alarm Word)	Alarm word 2 (parameter 1 6-91 Alarm Word 2)	Alarm word 3 (parameter 1 6-97 Alarm Word 3)	Warning word (parameter 16 -92 Warning Word)	Warning word 2 (parameter 16 -93 Warning Word 2)	Extended status word (parameter 16-9 4 Ext. Status Word)	Extended status word 2 (parameter 16-95 Ext. Status Word 2)
0	000000 01	1	Brake check	Reserved	STO function fault	Reserved	Reserved	Ramping	Off
1	000000 02	2	Pwr. card temp	Gate drive voltage fault	MM alarm	Pwr. card temp	Reserved	AMA tuning	Hand/Auto
2	000000 04	4	Earth fault	Reserved	Reserved	Earth fault	Reserved	Start CW/CCW	Profibus OFF1 active
3	000000 08	8	Ctrl. card temp	Reserved	Sync. fault	Ctrl. card temp	Reserved	Slowdown	Profibus OFF2 active

Bit	Hex	Dec	Alarm word (parameter 1 6-90 Alarm Word)	Alarm word 2 (parameter 1 6-91 Alarm Word 2)	Alarm word 3 (parameter 1 6-97 Alarm Word 3)	Warning word (parameter 16 -92 Warning Word)	Warning word 2 (parameter 16 -93 Warning Word 2)	Extended status word (parameter 16-9 4 Ext. Status Word)	Extended status word 2 (parameter 16-95 Ext. Status Word 2)
4	000000 10	16	Ctrl. word TO	Reserved	Reserved	Ctrl. word TO	Reserved	Catchup	Profibus OFF3 active
5	000000 20	32	Overcurrent	Reserved	Reserved	Overcurrent	Reserved	Feedback high	Reserved
6	000000 40	64	Torque limit	Reserved	Reserved	Torque limit	Reserved	Feedback low	Reserved
7	000000 80	128	Motor Th. over	Reserved	Reserved	Motor Th. over	Reserved	Output current high	Control ready
8	000001 00	256	Motor ETR over	Broken belt	Reserved	Motor ETR over	Broken belt	Output current low	Frequency converter ready
9	000002 00	512	Inverter overld.	Reserved	Reserved	Inverter overld.	Reserved	Output freq. high	Quick stop
10	000004 00	1024	DC undervolt.	Start failed	Reserved	DC undervolt.	Reserved	Output freq. low	DC brake
11	000008 00	2048	DC overvolt.	Speed limit	Reserved	DC overvolt.	Reserved	Brake check OK	Stop
12	000010 00	4096	Short circuit	External interlock	Reserved	Reserved	Reserved	Braking max	Reserved
13	000020 00	8192	Reserved	Reserved	Reserved	Reserved	Reserved	Braking	Freeze output request
14	000040 00	16384	Mains ph. loss	Reserved	Reserved	Mains ph. loss	Reserved	Reserved	Freeze output
15	000080 00	32768	AMA not OK	Reserved	Reserved	No motor	Auto DC braking	OVC active	Jog request
16	000100 00	65536	Live zero error	Reserved	Reserved	Live zero error	Reserved	AC brake	Jog
17	000200 00	131072	Internal fault	Reserved	Reserved	Reserved	Reserved	Reserved	Start request
18	000400 00	262144	Brake overload	Reserved	Reserved	Brake resistor power limit	Reserved	Reserved	Start
19	000800 00	524288	U phase loss	Reserved	Reserved	Reserved	Reserved	Reference high	Reserved
20	001000 00	1048576	V phase loss	Option detection	Reserved	Reserved	Overload T27	Reference low	Start delay
21	002000 00	2097152	W phase loss	Option fault	Reserved	Reserved	Reserved	Reserved	Sleep
22	004000 00	4194304	Fieldbus fault	Locked rotor	Reserved	Fieldbus fault	Memory module	Reserved	Sleep boost
23	008000 00	8388608	24 V supply low	Position ctrl. fault	Reserved	24 V supply low	Reserved	Reserved	Running
24	010000 00	16777216	Mains failure	Reserved	Reserved	Mains failure	Reserved	Reserved	Bypass
25	020000 00	33554432	Reserved	Current limit	Reserved	Current limit	Reserved	Reserved	Reserved
26	040000 00	67108864	Brake resistor	Reserved	Reserved	Reserved	Reserved	Reserved	External interlock

Bit	Hex	Dec	Alarm word (parameter 1 6-90 Alarm Word)	Alarm word 2 (parameter 1 6-91 Alarm Word 2)	Alarm word 3 (parameter 1 6-97 Alarm Word 3)	Warning word (parameter 16 -92 Warning Word)	Warning word 2 (parameter 16 -93 Warning Word 2)	Extended status word (parameter 16-9 4 Ext. Status Word)	Extended status word 2 (parameter 16-95 Ext. Status Word 2)
27	080000 00	13421772 8	Brake IGBT	Reserved	Reserved	Reserved	Reserved	Reserved	Reserved
28	100000 00	26843545 6	Option change	Feedback fault	Reserved	Encoder loss	Feedback fault	Reserved	FlyStart active
29	200000 00	53687091 2	Frequency converter initialized	Encoder loss	Reserved	Reserved	Back EMF too high	Reserved	Heat sink clean warning
30	400000 00	10737418 24	Safe Torque Off	Reserved	Reserved	Safe Torque Off	Reserved	Reserved	Reserved
31	800000 00	21474836 48	Mech. brake low	Reserved	Reserved	Reserved	Reserved	Database busy	Reserved

Table 8.19 Description of Alarm Word, Warning Word, and Extended Status Word

8

The alarm words, warning words and extended status words can be read out via serial bus or optional fieldbus for diagnosis. See also *parameter 16-94 Ext. Status Word*.

## Index

<b>A</b>		<b>N</b>	
Abbreviation.....	4	Network.....	34
Acyclic.....	21	No response to control signals.....	44
Additional resources.....	3	<b>P</b>	
Alarm.....	48	Parameter.....	34, 35
Alarm word.....	46	PCD.....	11
Approval and certification.....	4	PPO types.....	10
Approvals.....	4	Process control data.....	11
<b>C</b>		Process control operation.....	13
Cabling.....	34	Process data.....	11
Certifications.....	4	Process status data.....	11
Configuration.....	4, 26	PROFIdrive profile (CTW).....	14
Control profile.....	13	PROFIdrive state transition diagram.....	17
Control word.....	14	<b>Q</b>	
Convention.....	4	Qualified personnel.....	5
CTW.....	14	<b>R</b>	
<b>D</b>		Reference.....	4
Data block.....	24	Reference handling.....	12
Discharge time.....	5	<b>S</b>	
<b>E</b>		Safety.....	6
Ethernet.....	32, 33, 35	Size attribute.....	38
<b>F</b>		Status word.....	15
FC control mode		Supported data types.....	39
Digital input terminals.....	13	Symbol.....	4
<b>G</b>		<b>U</b>	
GSDML file.....	7	Unintended start.....	5
<b>H</b>		<b>V</b>	
High voltage.....	5	VLT parameter.....	9
<b>I</b>		<b>W</b>	
I/O.....	4	Warning.....	48
<b>L</b>		Warning word.....	46
Leakage current.....	6		
LED.....	4		
Load sharing.....	5		
<b>M</b>			
MRV.....	11		



.....  
Danfoss can accept no responsibility for possible errors in catalogues, brochures and other printed material. Danfoss reserves the right to alter its products without notice. This also applies to products already on order provided that such alterations can be made without subsequential changes being necessary in specifications already agreed. All trademarks in this material are property of the respective companies. Danfoss and the Danfoss logotype are trademarks of Danfoss A/S. All rights reserved.  
.....

Danfoss A/S  
Ulsnaes 1  
DK-6300 Graasten  
vlt-drives.danfoss.com

