



# Operating Instructions

## VLT<sup>®</sup> Refrigeration Drive FC 103, 75-400 kW





## Safety

### **⚠ WARNING**

#### **HIGH VOLTAGE!**

Frequency converters contain high voltage when connected to AC mains input power. Installation, start up, and maintenance should be performed by qualified personnel only. Failure to perform installation, start up, and maintenance by qualified personnel could result in death or serious injury.

#### **High Voltage**

Frequency converters are connected to hazardous mains voltages. Extreme care should be taken to protect against shock. Only trained personnel familiar with electronic equipment should install, start, or maintain this equipment.

### **⚠ WARNING**

#### **UNINTENDED START!**

When the frequency converter is connected to AC mains, the motor may start at any time. The frequency converter, motor, and any driven equipment must be in operational readiness. Failure to be in operational readiness when the frequency converter is connected to AC mains could result in death, serious injury, equipment, or property damage.

#### **Unintended Start**

When the frequency converter is connected to the AC mains, the motor may be started by means of an external switch, a serial bus command, an input reference signal, or a cleared fault condition. Use appropriate cautions to guard against an unintended start.

### **⚠ WARNING**

#### **DISCHARGE TIME!**

Frequency converters contain DC-link capacitors that can remain charged even when the frequency converter is not powered. To avoid electrical hazards, disconnect AC mains, any permanent magnet type motors, and any remote DC-link power supplies, including battery backups, UPS and DC-link connections to other frequency converters. Wait for the capacitors to fully discharge before performing any service or repair work. The amount of wait time is listed in the *Discharge Time* table. Failure to wait the specified time after power has been removed before doing service or repair could result in death or serious injury.

Voltage [V]	Power range [kW]	Minimum waiting time [min]
3x400	90-250	20
3x400	110-315	20
3x480	110-315	20
3x480	132-355	20
3x550	55-315	20
3x690	75-400	20

#### **Discharge Time**

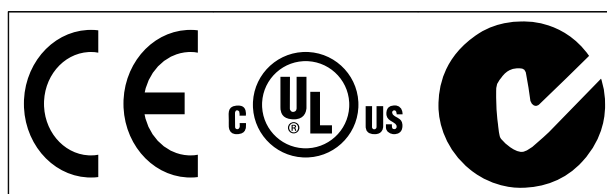

#### **Approvals**

### **NOTICE**

#### **Imposed limitations on the output frequency (due to export control regulations):**

From software version 6.72 the output frequency of the frequency converter is limited to 590 Hz. Software versions 6x.xx also limit the maximum output frequency to 590 Hz, but these versions cannot be flashed, i.e. neither downgraded nor upgraded.



**Contents**

<b>1 Introduction</b>	<b>4</b>
1.1 Product Overview	4
1.1.1 Interior Views	4
1.2 Purpose of the Manual	5
1.3 Additional Resources	5
1.4 Product Overview	5
1.5 Internal Controller Functions	5
1.6 Frame Sizes and Power Ratings	7
<b>2 Installation</b>	<b>8</b>
2.1 Planning the Installation Site	8
2.1.2 Planning the Installation Site	8
2.2 Pre-Installation Check List	8
2.3 Mechanical Installation	9
2.3.1 Cooling	9
2.3.2 Lifting	9
2.3.3 Wall Mounting - IP21 (NEMA 1) and IP54 (NEMA 12) Units	10
2.4 Electrical Installation	10
2.4.1 General Requirements	10
2.4.2 Earth (Grounding) Requirements	13
2.4.2.1 Leakage Current (>3.5 mA)	13
2.4.2.2 Earthing (Grounding) IP20 Enclosures	14
2.4.2.3 Earthing (Grounding) IP21/54 Enclosures	14
2.4.3 Motor Connection	15
2.4.3.1 Terminal Locations: D1h-D4h	15
2.4.4 Motor Cable	19
2.4.5 Motor Rotation Check	19
2.4.6 AC Mains Connection	19
2.5 Control Wiring Connection	19
2.5.1 Access	20
2.5.2 Using Screened Control Cables	20
2.5.3 Earthing (Grounding) of Screened Control Cables	20
2.5.4 Control Terminal Types	21
2.5.5 Wiring to Control Terminals	22
2.5.6 Control Terminal Functions	22
2.6 Serial Communication	22
2.7 Optional Equipment	23
2.7.1 Load Share Terminals	23
2.7.2 Regeneration Terminals	23

2.7.3 Anti-condensation Heater	23
2.7.4 Brake Chopper	23
2.7.5 Mains Shield	23
<b>3 Start Up and Functional Testing</b>	<b>24</b>
3.1 Pre-start	24
3.1.1 Safety Inspection	24
3.2 Applying Power	25
3.3 Basic Operational Programming	26
3.3.1 Set-up Wizard	26
3.4 Automatic Motor Adaptation	32
3.5 Check Motor Rotation	32
3.6 Local-control Test	32
3.7 System Start Up	33
<b>4 User Interface</b>	<b>34</b>
4.1 Local Control Panel	34
4.1.1 LCP Layout	34
4.1.2 Setting LCP Display Values	35
4.1.3 Display Menu Keys	35
4.1.4 Navigation Keys	36
4.1.5 Operation Keys	36
4.2 Back Up and Copying Parameter Settings	36
4.2.1 Uploading Data to the LCP	37
4.2.2 Downloading Data from the LCP	37
4.3 Restoring Default Settings	37
4.3.1 Recommended Initialisation	37
4.3.2 Manual Initialisation	37
<b>5 Programming</b>	<b>38</b>
5.1 Introduction	38
5.2 Programming Example	38
5.3 Control Terminal Programming Examples	39
5.4 International/North American Default Parameter Settings	40
5.5 Parameter Menu Structure	41
5.5.1 Main Menu Structure	42
5.6 Remote Programming with MCT 10 Set-up Software	45
<b>6 Application Examples</b>	<b>46</b>
6.1 Introduction	46
6.2 Application Examples	46

<b>7 Status Messages</b>	51
7.1 Status Messages	51
7.2 Status Message Definitions	51
<b>8 Warnings and Alarms</b>	54
8.1 System Monitoring	54
8.2 Warning and Alarm Types	54
8.2.1 Warnings	54
8.2.2 Alarm Trip	54
8.2.3 Alarm Trip-lock	54
8.3 Warning and Alarm Displays	54
8.4 Warning and Alarm Definitions	56
8.5 Fault Messages	58
<b>9 Basic Troubleshooting</b>	64
9.1 Start Up and Operation	64
<b>10 Specifications</b>	67
10.1 Power-dependent Specifications	67
10.2 General Technical Data	69
10.3 Fuse Tables	75
10.3.1 Protection	75
10.3.2 Fuse Selection	75
10.3.3 Short Circuit Current Rating (SCCR)	76
10.3.4 Connection Tightening Torques	76
<b>Index</b>	77

# 1 Introduction

## 1

### 1.1 Product Overview

#### 1.1.1 Interior Views

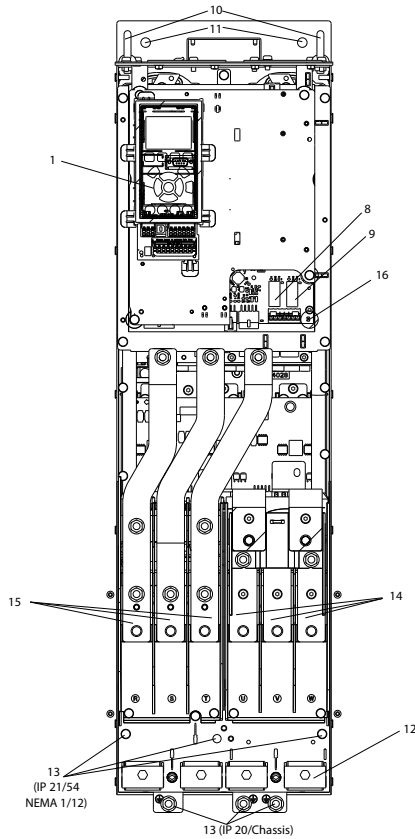

Illustration 1.1 D1 Interior Components

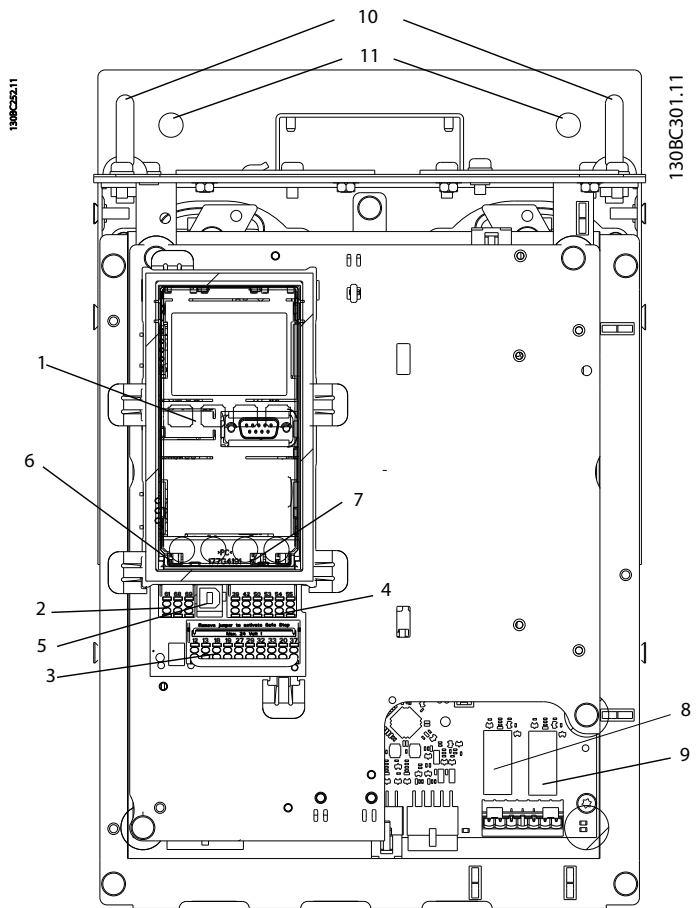

Illustration 1.2 Close-up View: LCP and Control Functions

1	LCP (Local Control Panel)	9	Relay 2 (04, 05, 06)
2	RS-485 serial bus connector	10	Lifting ring
3	Digital I/O and 24 V power supply	11	Mounting slot
4	Analog I/O connector	12	Cable clamp (PE)
5	USB connector	13	Earth (ground)
6	Serial bus terminal switch	14	Motor output terminals 96 (U), 97 (V), 98 (W)
7	Analog switches (A53), (A54)	15	Mains input terminals 91 (L1), 92 (L2), 93 (L3)
8	Relay 1 (01, 02, 03)	16	TB5 (IP21/54 only). Terminal block for anti-condensation heater

Table 1.1



## 1.2 Purpose of the Manual

This manual is intended to provide detailed information for the installation and start up of the frequency converter. *chapter 2 Installation* provides requirements for mechanical and electrical installation, including input, motor, control and serial communications wiring and control terminal functions. *chapter 3 Start Up and Functional Testing* provides detailed procedures for start up, basic operational programming, and functional testing. The remaining chapters provide supplementary details. These details include user interface, detailed programming, application examples, start-up troubleshooting, and specifications.

## 1.3 Additional Resources

Other resources are available to understand advanced frequency converter functions and programming.

- The *VLT® Programming Guide* provides greater detail on working with parameters and many application examples.
- The *VLT® Design Guide* is intended to provide detailed capabilities and functionality to design motor control systems.
- Supplemental publications and manuals are available from Danfoss. See [www.danfoss.com/BusinessAreas/DrivesSolutions/Documentations/VLT+Technical+Documentation.htm](http://www.danfoss.com/BusinessAreas/DrivesSolutions/Documentations/VLT+Technical+Documentation.htm) for listings.
- Optional equipment is available that may change some of the procedures described. Reference the instructions supplied with those options for specific requirements. Contact the local Danfoss supplier or visit the Danfoss website: [www.danfoss.com/BusinessAreas/DrivesSolutions/Documentations/VLT+Technical+Documentation.htm](http://www.danfoss.com/BusinessAreas/DrivesSolutions/Documentations/VLT+Technical+Documentation.htm), for downloads or additional information.

## 1.4 Product Overview

A frequency converter is an electronic motor controller that converts AC mains input into a variable AC waveform output. The frequency and voltage of the output are regulated to control the motor speed or torque. The frequency converter can vary the speed of the motor in response to system feedback, such as position sensors on a conveyor belt. The frequency converter can also regulate the motor by responding to remote commands from external controllers.

In addition, the frequency converter monitors the system and motor status, issues warnings or alarms for fault conditions, starts and stops the motor, optimizes energy efficiency, and offers many more control, monitoring, and efficiency functions. Operation and monitoring functions are available as status indications to an outside control system or serial communication network.

## 1.5 Internal Controller Functions

*Illustration 1.3* is a block diagram of the frequency converter's internal components. See *Table 1.2* for their functions.

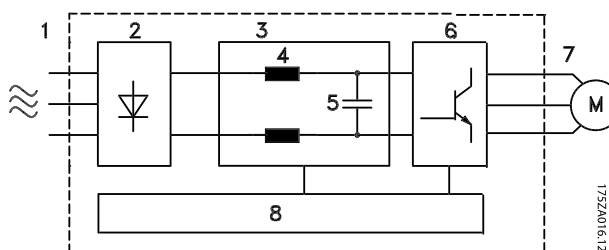

Illustration 1.3 Frequency Converter Block Diagram

1

Area	Title	Functions
1	Mains input	<ul style="list-style-type: none"> <li>• Three-phase AC mains power supply to the frequency converter</li> </ul>
2	Rectifier	<ul style="list-style-type: none"> <li>• The rectifier bridge converts the AC input to DC current to supply inverter power</li> </ul>
3	DC bus	<ul style="list-style-type: none"> <li>• Intermediate DC-bus circuit handles the DC current</li> </ul>
4	DC reactors	<ul style="list-style-type: none"> <li>• Filter the intermediate DC circuit voltage</li> <li>• Provide line transient protection</li> <li>• Reduce RMS current</li> <li>• Raise the power factor reflected back to the line</li> <li>• Reduce harmonics on the AC input</li> </ul>
5	Capacitor bank	<ul style="list-style-type: none"> <li>• Stores the DC power</li> <li>• Provides ride-through protection for short power losses</li> </ul>
6	Inverter	<ul style="list-style-type: none"> <li>• Converts the DC into a controlled PWM AC waveform for a controlled variable output to the motor</li> </ul>
7	Output to motor	<ul style="list-style-type: none"> <li>• Regulated three-phase output power to the motor</li> </ul>
8	Control circuitry	<ul style="list-style-type: none"> <li>• Input power, internal processing, output, and motor current are monitored to provide efficient operation and control</li> <li>• User interface and external commands are monitored and performed</li> <li>• Status output and control can be provided</li> </ul>

Table 1.2 Legend to *Illustration 1.3*

## 1.6 Frame Sizes and Power Ratings

Normal Overload [kW]	90	110	132	160	200	250	315	355	400
400 V		D3h	D3h	D3h	D4h	D4h	D4h		
480 V			D3h	D3h	D3h	D4h	D4h	D4h	
525 V	D3h	D3h	D3h	D4h	D4h	D4h	D4h		
690 V		D3h	D3h	D3h	D4h	D4h	D4h		D4h

Table 1.3 kW Rated Frequency Converters

Normal Overload [HP ]	125	150	200	250	300	350	400	450
460 V		D3h	D3h	D3h	D4h	D4h		D4h
575 V	D3h	D3h	D3h	D4h	D4h	D4h	D4h	

Table 1.4 HP Rated Frequency Converters



## 2 Installation

### 2

### 2.1 Planning the Installation Site

#### **NOTICE**

Before performing the installation it is important to plan the installation of the frequency converter. Neglecting this may result in extra work during and after installation.

Select the best possible operation site by considering the following (see details on the following pages and the respective Design Guides):

- Ambient operating temperature
- Installation method
- How to cool the unit
- Position of the frequency converter
- Cable routing
- Ensure the power source supplies the correct voltage and necessary current
- Ensure that the motor current rating is within the maximum current from the frequency converter
- If the frequency converter is without built-in fuses, ensure that the external fuses are rated correctly

Voltage [V]	Altitude restrictions
380-500	At altitudes above 3 km, contact Danfoss regarding PELV
525-690	At altitudes above 2 km, contact Danfoss regarding PELV

Table 2.1 Installation in High Altitudes

#### 2.1.2 Planning the Installation Site

#### **NOTICE**

Before performing the installation it is important to plan the installation of the frequency converter. Neglecting this may result in extra work during and after installation.

Select the best possible operation site by considering the following (see details on the following pages and the respective Design Guides):

- Ambient operating temperature
- Installation method
- How to cool the unit
- Position of the frequency converter
- Cable routing

- Ensure the power source supplies the correct voltage and necessary current
- Ensure that the motor current rating is within the maximum current from the frequency converter
- If the frequency converter is without built-in fuses, ensure that the external fuses are rated correctly

Voltage [V]	Altitude restrictions
380-480	At altitudes above 3 km, contact Danfoss regarding PELV
525-690	At altitudes above 2 km, contact Danfoss regarding PELV

Table 2.2 Installation in High Altitudes

### 2.2 Pre-Installation Check List

- Before unpacking the frequency converter, ensure the packaging is intact. If any damage has occurred, immediately contact the shipping company to claim the damage.
- Before unpacking the frequency converter, locate it as close as possible to the final installation site
- Compare the model number on the nameplate to what was ordered to verify the proper equipment
- Ensure each of the following are rated for the same voltage:
  - Mains (power)
  - Frequency converter
  - Motor
- Ensure that frequency converter output current rating is equal to or greater than motor full load current for peak motor performance
  - Motor size and frequency converter power must match for proper overload protection
  - If frequency converter rating is less than motor, full motor output cannot be achieved

## 2.3 Mechanical Installation

### 2.3.1 Cooling

- Top and bottom clearance for air cooling must be provided. Generally, 225 mm (9 in) is required.
- Improper mounting can result in over heating and reduced performance
- Derating for temperatures starting between 45 °C (113 °F) and 50 °C (122 °F) and elevation 1000 m (3300 ft) above sea level must be considered. See *VLT® Design Guide* for detailed information.

The high power frequency converters utilise a back-channel cooling concept that removes heatsink cooling air, which carries approximately 90% of the heat out of the back channel of the frequency converters. The back-channel air can be redirected from the panel or room using one of the kits below.

#### Duct cooling

A back-channel cooling kit is available to direct the heatsink cooling air out of the panel when an IP20/chassis frequency converters is installed in a Rittal enclosure. Use of this kit reduces the heat in the panel and smaller door fans can be specified on the enclosure.

#### Cooling out the back (top and bottom covers)

The back channel cooling air can be ventilated out of the room so that the heat from the back channel is not dissipated into the control room.

A door fan(s) is required on the enclosure to remove the heat not contained in the backchannel of the frequency converters and any additional losses generated by other components inside the enclosure. The total required air flow must be calculated so that the appropriate fans can be selected.

#### Airflow

The necessary airflow over the heat sink must be secured. The flow rate is shown in *Table 2.3*.

The fan runs for the following reasons:

- AMA
- DC Hold
- Pre-Mag
- DC Brake
- 60% of nominal current is exceeded
- Specific heatsink temperature exceeded (power size dependent)
- Specific Power Card ambient temperature exceeded (power size dependent)
- Specific Control Card ambient temperature exceeded

Frame	Door fan/top fan	Heatsink fan
D1h/D3h	102 m <sup>3</sup> /hr (60 CFM)	420 m <sup>3</sup> /hr (250 CFM)
D2h/D4h	204 m <sup>3</sup> /hr (120 CFM)	840 m <sup>3</sup> /hr (500 CFM)

Table 2.3 Airflow

### 2.3.2 Lifting

Always lift the frequency converter using the dedicated lifting eyes. Use a bar to avoid bending the lifting holes.

## CAUTION

The angle from the top of the frequency converter to the lifting cables should be 60° or greater.

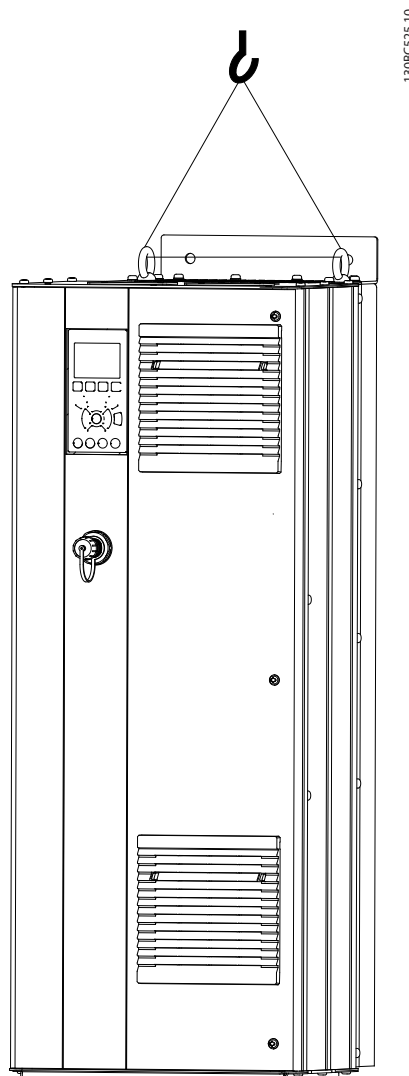

Illustration 2.1 Recommended Lifting Method

### 2.3.3 Wall Mounting - IP21 (NEMA 1) and IP54 (NEMA 12) Units

Consider the following before selecting the final installation site:

- Free space for cooling
- Access to open the door
- Cable entry from the bottom

## 2.4 Electrical Installation

### 2.4.1 General Requirements

This section contains detailed instructions for wiring the frequency converter. The following tasks are described:

- Wiring the motor to the frequency converter output terminals
- Wiring the AC mains to the frequency converter input terminals
- Connecting control and serial communication wiring
- After power has been applied, checking input and motor power; programming control terminals for their intended functions

## **⚠ WARNING**

### **EQUIPMENT HAZARD!**

Rotating shafts and electrical equipment can be hazardous. All electrical work must conform to national and local electrical codes. It is strongly recommended that installation, start up, and maintenance be performed only by trained and qualified personnel. Failure to follow these guidelines could result in death or serious injury.

## **CAUTION**

### **WIRING ISOLATION!**

Run input power, motor wiring and control wiring in three separate metallic conduits or use separated shielded cable for high frequency noise isolation. Failure to isolate power, motor and control wiring could result in less than optimum frequency converter and associated equipment performance.

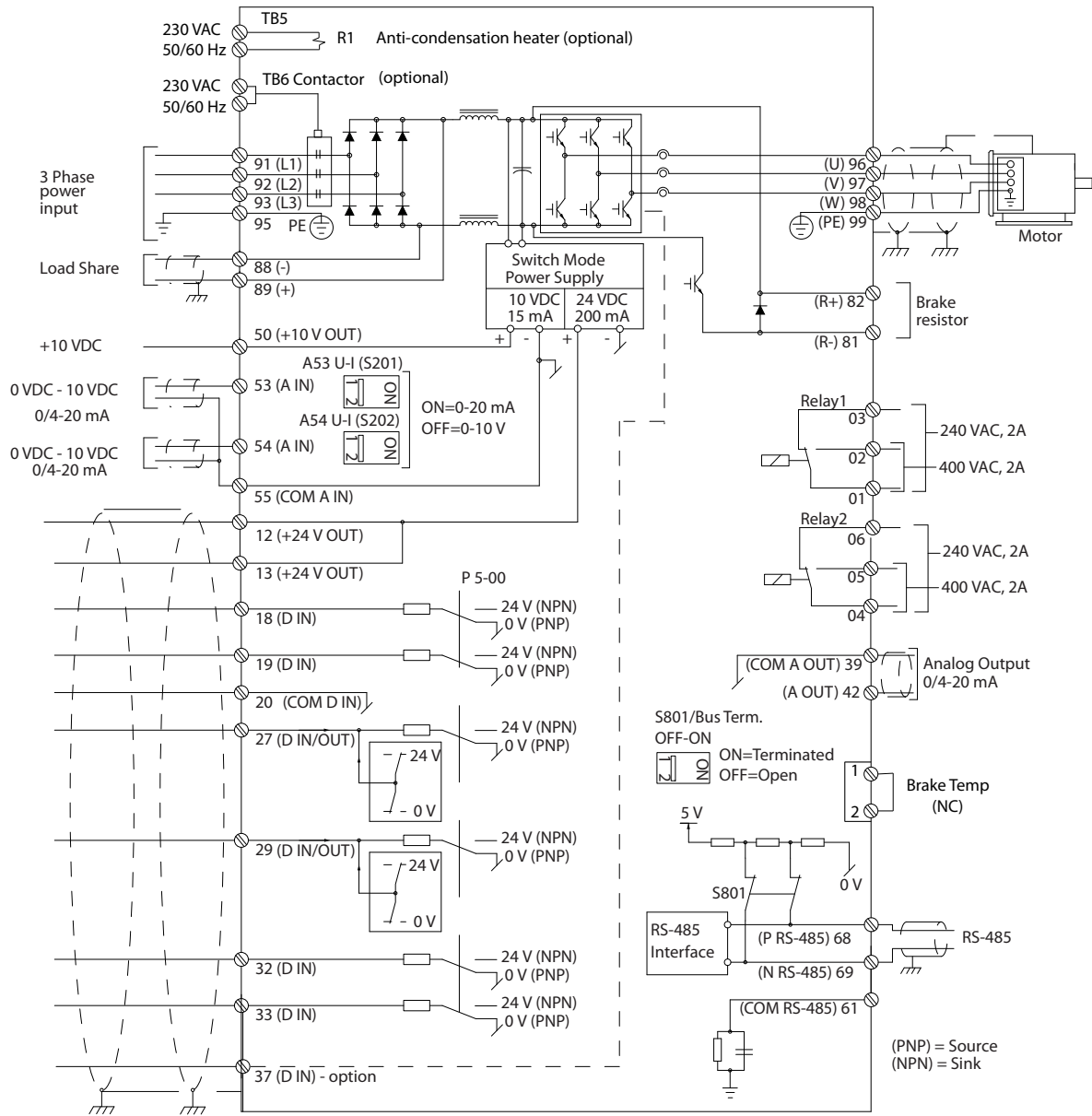

130BC548.12

Illustration 2.2 Interconnect Diagram

### For your safety, comply with the following requirements

- Electronic controls equipment is connected to hazardous mains voltage. Extreme care should be taken to protect against electrical hazards when applying power to the unit.
- Run motor cables from multiple frequency converters multiple frequency converters separately. Induced voltage from output motor cables run together can charge equipment capacitors even with the equipment turned off and locked out.
- Field wiring terminals are not intended to receive a conductor one size larger.

### Overload and Equipment Protection

- An electronically activated function within the frequency converter provides overload protection for the motor. The overload calculates the level of increase to activate timing for the trip (controller output stop) function. The higher the current draw, the quicker the trip response. The overload provides Class 20 motor protection. See *chapter 8 Warnings and Alarms* for details on the trip function.
- Because the motor wiring carries high frequency current, it is important that wiring for mains, motor power, and control are run separately. Use metallic conduit or separated shielded wire. See *Illustration 2.3*. Failure to isolate power, motor, and control wiring could result in less than optimum equipment performance.
- All frequency converters must be provided with short-circuit and over-current protection. Input fusing is required to provide this protection, see *Illustration 2.4*. If not factory supplied, fuses must be provided by the installer as part of installation. See maximum fuse ratings in *chapter 10.3.1 Protection*.

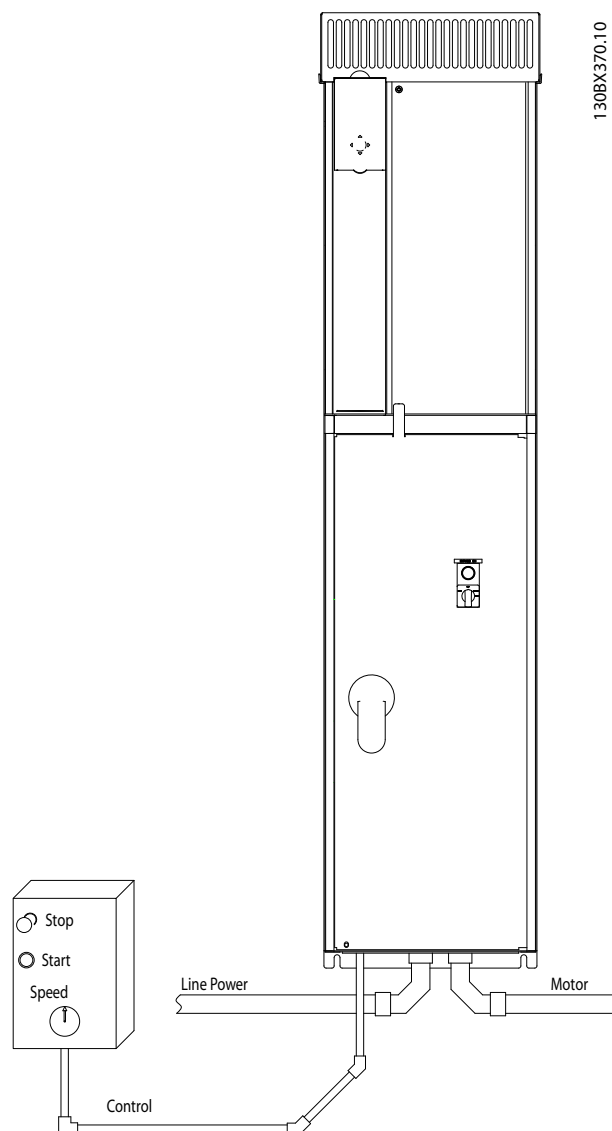

**Illustration 2.3 Example of Proper Electrical Installation Using Conduit**



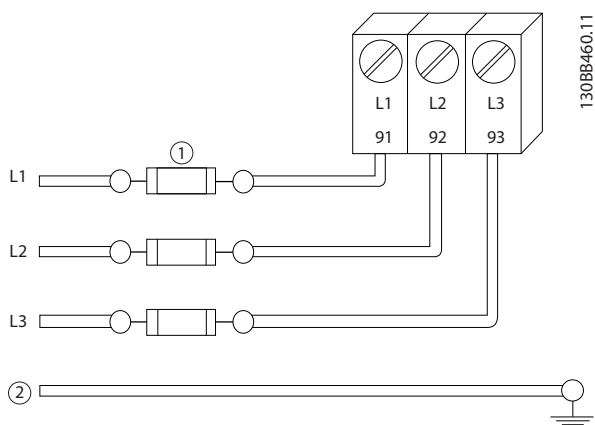

Illustration 2.4 Frequency Converter Fuses

Wire Type and Ratings

- All wiring must comply with local and national regulations regarding cross-section and ambient temperature requirements.
- Danfoss recommends that all power connections be made with a minimum 75 °C rated copper wire.

2.4.2 Earth (Grounding) Requirements

**WARNING**

**EARTHING (GROUNDING) HAZARD!**

For operator safety, it is important to earth (ground) the frequency converter properly in accordance with national and local electrical codes as well as instructions contained within this document. Do not use conduit connected to the frequency converter as a replacement for proper grounding. Earth (ground) currents are higher than 3.5 mA. Failure to earth (ground) the frequency converter properly could result in death or serious injury.

**NOTICE**

It is the responsibility of the user or certified electrical installer to ensure correct earthing (grounding) of the equipment in accordance with national and local electrical codes and standards.

- Follow all local and national electrical codes to earth (ground) electrical equipment properly
- Proper protective earthing (grounding) for equipment with earth (ground) currents higher than 3.5 mA must be established, see chapter 2.4.2.1 Leakage Current (>3.5 mA)
- A dedicated earth wire (ground wire) is required for input power, motor power and control wiring
- Use the clamps provided with the equipment for proper earth connections (ground connections)

- Do not earth (ground) one frequency converter to another in a “daisy chain” fashion
- Keep the earth (ground) wire connections as short as possible
- Using high-strand wire to reduce electrical noise is recommended
- Follow motor manufacturer wiring requirements

2.4.2.1 Leakage Current (>3.5 mA)

Follow national and local codes regarding protective earthing of equipment with a leakage current >3.5 mA. Frequency converter technology implies high frequency switching at high power. This will generate a leakage current in the earth connection. A fault current in the frequency converter at the output power terminals might contain a DC component, which can charge the filter capacitors and cause a transient earth current. The earth leakage current depends on various system configurations including RFI filtering, screened motor cables, and frequency converter power.

EN/IEC61800-5-1 (Power Drive System Product Standard) requires special care if the leakage current exceeds 3.5 mA. Earthing (grounding) must be reinforced in one of the following ways:

- Earth (ground) wire of at least 10 mm<sup>2</sup>
- Two separate earth (ground) wires both complying with the dimensioning rules

See EN 60364-5-54 § 543.7 for further information.

Using RCDs

Where residual current devices (RCDs)—also known as earth leakage circuit breakers (ELCBs)—are used, comply with the following: residual current devices (RCDs)

- Use RCDs of type B only, which are capable of detecting AC and DC currents
- Use RCDs with an inrush delay to prevent faults due to transient earth currents
- Dimension RCDs according to the system configuration and environmental considerations

2.4.2.2 Earthing (Grounding) IP20 Enclosures

The frequency converter can be earthed (grounded) using conduit or shielded cable. For earthing (grounding) of the power connections, use the dedicated earthing (grounding) points as shown in *Illustration 2.5*.

2

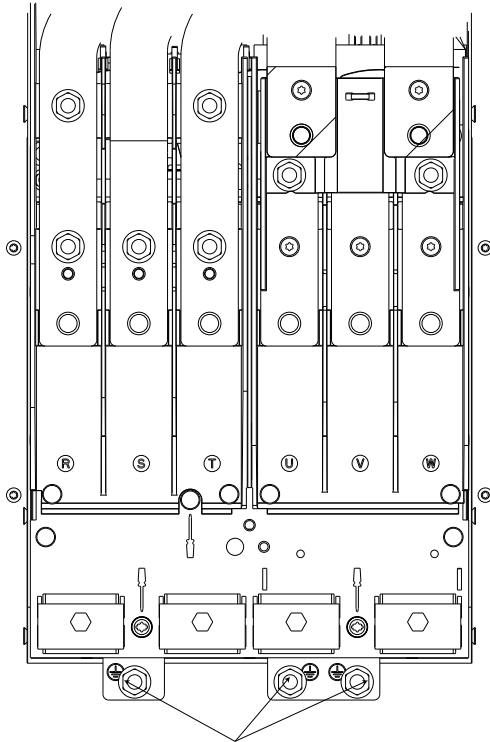

Illustration 2.5 Earthing (Grounding) Points for IP20 (Chassis) Enclosures

2.4.2.3 Earthing (Grounding) IP21/54 Enclosures

The frequency converter can be earthed (grounded) using conduit or shielded cable. For earthing (grounding) of the power connections, use the dedicated earthing (grounding) points as shown in *Illustration 2.6*.

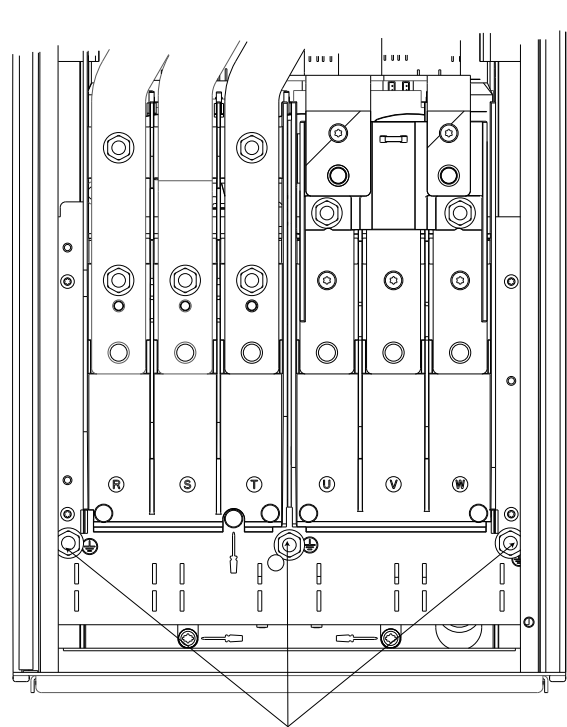

Illustration 2.6 Earthing (Grounding) for IP21/54 Enclosures.

2.4.3 Motor Connection

**WARNING**

**INDUCED VOLTAGE!**

Run output motor cables from multiple frequency converters separately. Induced voltage from output motor cables run together can charge equipment capacitors even with the equipment turned off and locked out. Failure to run output motor cables separately could result in death or serious injury.

- For maximum cable sizes, see *chapter 10.1 Power-dependent Specifications*
- Comply with local and national electrical codes for cable sizes
- Gland plates are provided at the base of IP21/54 and higher (NEMA1/12) units
- Do not install power factor correction capacitors between the frequency converter and the motor
- Do not wire a starting or pole-changing device between the frequency converter and the motor
- Connect the 3-phase motor wiring to terminals 96 (U), 97 (V), and 98 (W)
- Earth (ground) the cable in accordance with the instructions provided
- Torque terminals in accordance with the information provided in *chapter 10.3.4 Connection Tightening Torques*
- Follow motor manufacturer wiring requirements

2.4.3.1 Terminal Locations: D1h-D4h

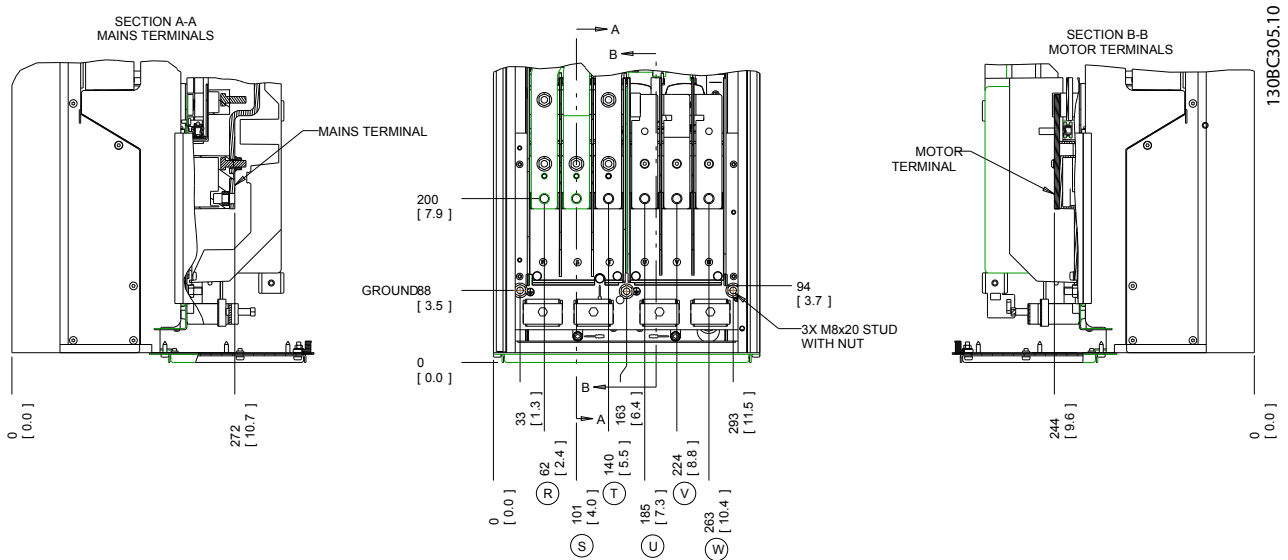

Illustration 2.7 Terminal Locations D1h

2

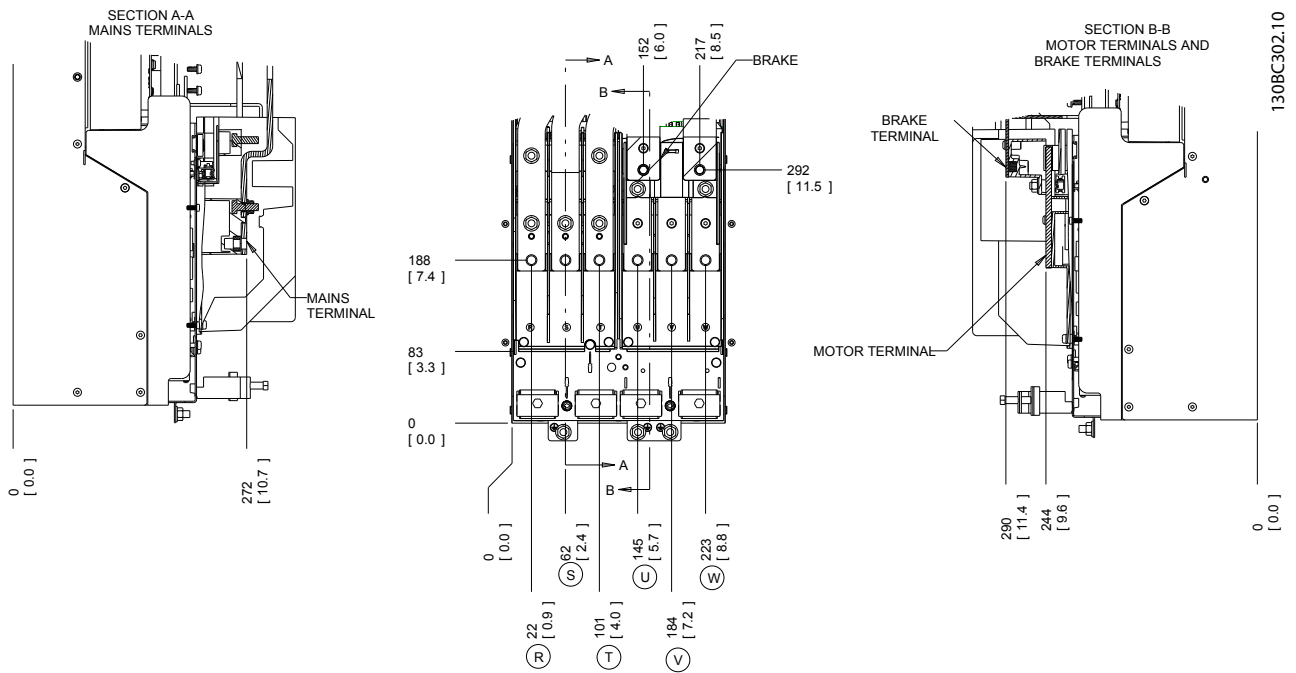

Illustration 2.8 Terminal Locations D3h

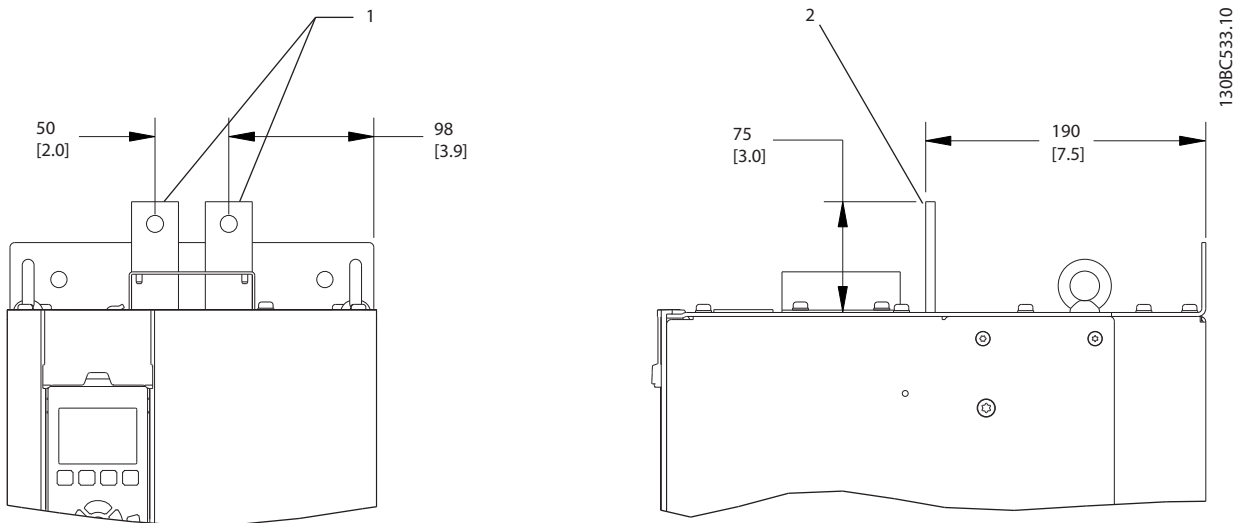

Illustration 2.9 Loadshare or Regeneration Terminals, D3h

1	Front view
2	Side view

Table 2.4

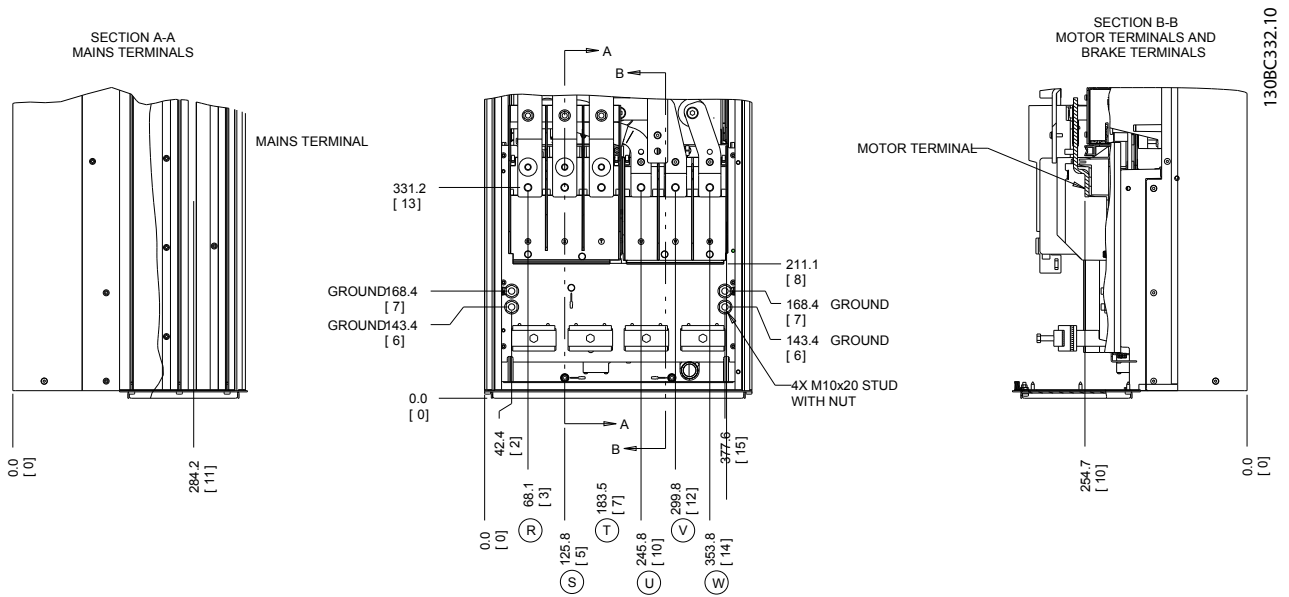

Illustration 2.10 Terminal Locations D2h

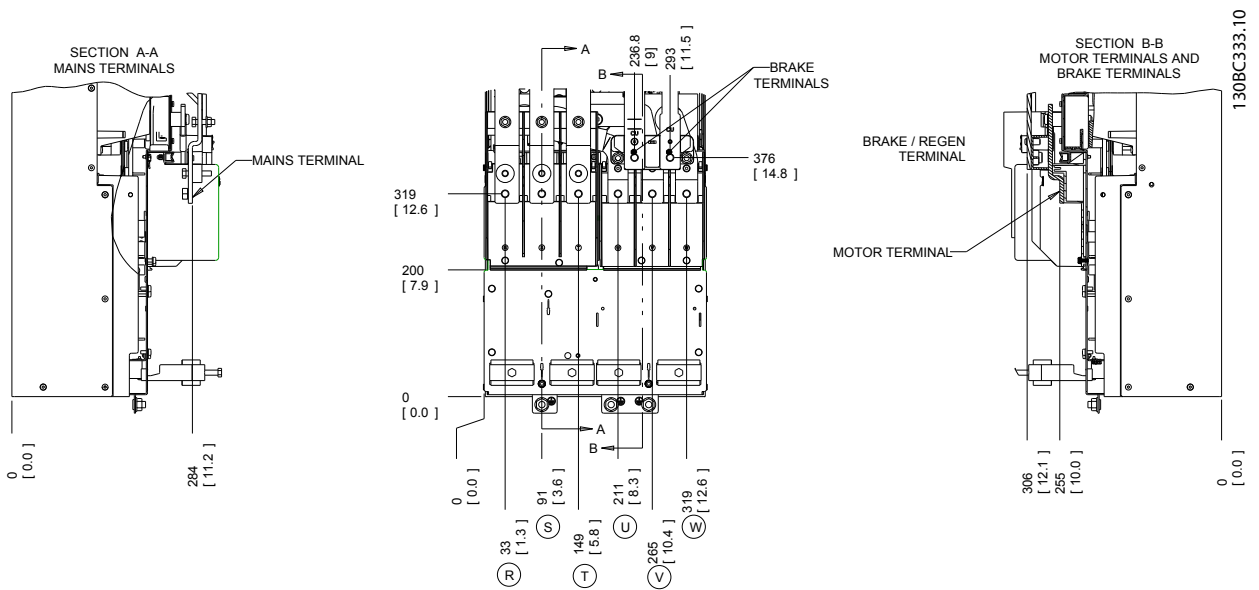
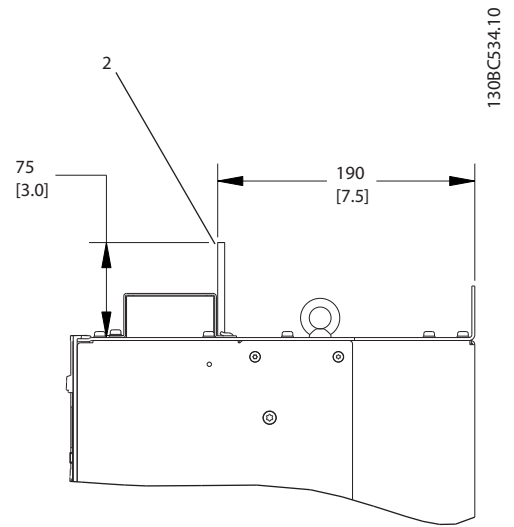
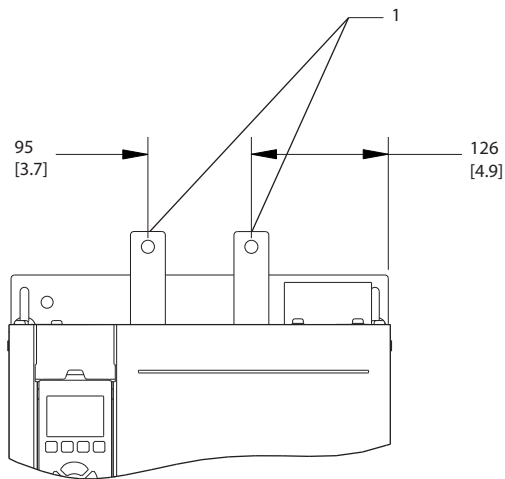

Illustration 2.11 Terminal Locations D4h

2



1308C534.10

Illustration 2.12 Load share and Regeneration Terminals, D4h

1	Front view
2	Side view

Table 2.5

### 2.4.4 Motor Cable

The motor must be connected to terminals U/T1/96, V/T2/97, W/T3/98. Earth (ground) to terminal 99. All types of three-phase asynchronous standard motors can be used with a frequency converter unit. The factory setting is for clockwise rotation with the frequency converter output connected as follows:

Terminal no.	Function
96, 97, 98, 99	Mains U/T1, V/T2, W/T3 Earth (ground)

Table 2.6

### 2.4.5 Motor Rotation Check

The direction of rotation can be changed by switching two phases in the motor cable or by changing the setting of 4-10 Motor Speed Direction.

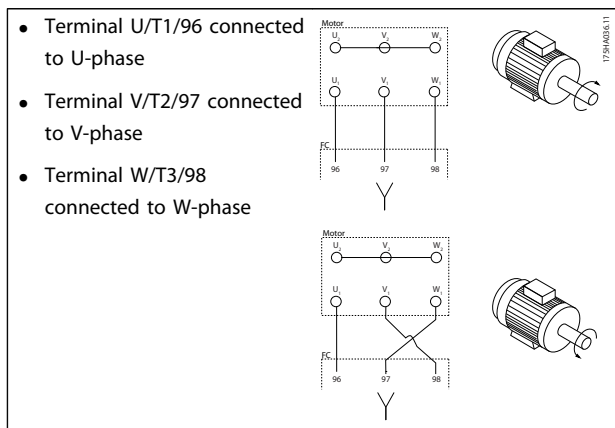

Table 2.7

A motor rotation check can be performed using 1-28 Motor Rotation Check and following the steps shown in the display.

### 2.4.6 AC Mains Connection

- Size wiring is based upon the input current of the frequency converter
- Comply with local and national electrical codes for cable sizes
- Connect 3-phase AC input power wiring to terminals L1, L2, and L3 (see Illustration 2.13)

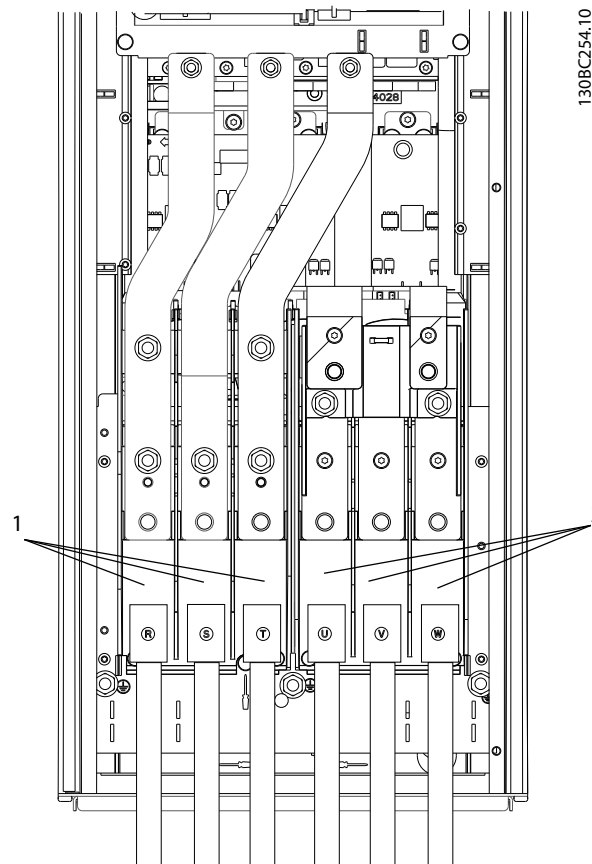

Illustration 2.13 Connecting to AC Mains

1	Mains connection
2	Motor connection

Table 2.8

- Earth (ground) the cable in accordance with the instructions provided
- All frequency converters may be used with an isolated input source as well as with earth (ground) reference power lines. When supplied from an isolated mains source (IT mains or floating delta) or TT/TN-S mains with a grounded leg (grounded delta), set 14-50 RFI Filter to OFF. When off, the internal RFI filter capacitors between the chassis and the intermediate circuit are isolated to avoid damage to the intermediate circuit and to reduce earth (ground) capacity currents in accordance with IEC 61800-3.

### 2.5 Control Wiring Connection

- Isolate control wiring from high power components in the frequency converter
- If the frequency converter is connected to a thermistor, for PELV isolation, optional thermistor control wiring must be reinforced/double

insulated. A 24 V DC supply voltage is recommended.

### 2.5.1 Access

All terminals to the control cables are located underneath the LCP on the inside of the frequency converter. To access, open the door (IP21/54) or remove the front panel (IP20).

### 2.5.2 Using Screened Control Cables

Danfoss recommends braided screened/armoured cables to optimise EMC immunity of the control cables and the EMC emission from the motor cables.

The ability of a cable to reduce the incoming and outgoing radiation of electric noise depends on the transfer impedance ( $Z_T$ ). The screen of a cable is normally designed to reduce the transfer of electric noise; however, a screen with a lower transfer impedance ( $Z_T$ ) value is more effective than a screen with a higher transfer impedance ( $Z_T$ ).

Transfer impedance ( $Z_T$ ) is rarely stated by cable manufacturers but it is often possible to estimate transfer impedance ( $Z_T$ ) by assessing the physical design of the cable.

**Transfer impedance ( $Z_T$ ) can be assessed on the basis of the following factors:**

- The conductivity of the screen material
  - The contact resistance between the individual screen conductors
  - The screen coverage, i.e. the physical area of the cable covered by the screen - often stated as a percentage value
  - Screen type, i.e. braided or twisted pattern
- a. Aluminium-clad with copper wire
  - b. Twisted copper wire or armoured steel wire cable
  - c. Single-layer braided copper wire with varying percentage screen coverage.  
This is the typical Danfoss reference cable.
  - d. Double-layer braided copper wire
  - e. Twin layer of braided copper wire with a magnetic, screened/armoured intermediate layer
  - f. Cable that runs in copper tube or steel tube
  - g. Lead cable with 1.1 mm wall thickness

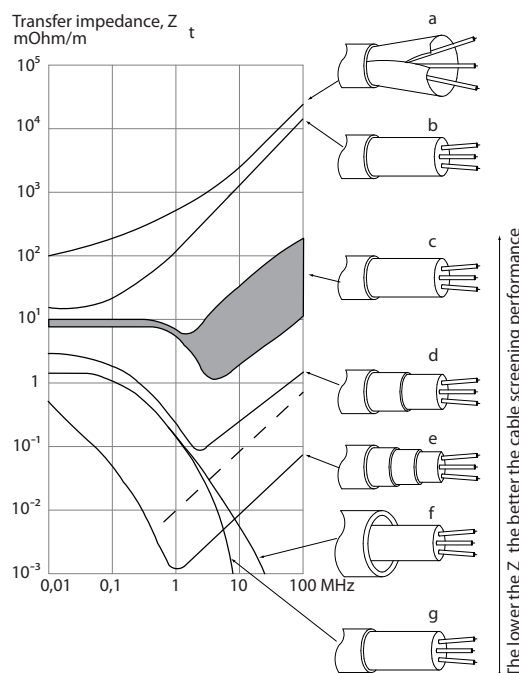

Illustration 2.14

### 2.5.3 Earthing (Grounding) of Screened Control Cables

#### Correct screening

The preferred method in most cases is to secure control and serial communication cables with screening clamps provided at both ends to ensure best possible high frequency cable contact. If the earth (ground) potential between the frequency converter and the PLC is different, electric noise may occur that will disturb the entire system. Solve this problem by fitting an equalizing cable next to the control cable. Minimum cable cross section: 16 mm<sup>2</sup>.

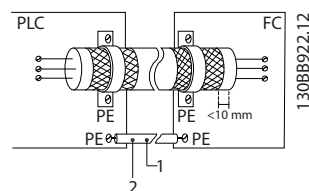

Illustration 2.15

1	Min. 16 mm <sup>2</sup>
2	Equalizing cable

Table 2.9

#### 50/60 Hz earth (ground) loops

With very long control cables, earth loops (ground loops) may occur. To eliminate earth (ground) loops, connect one end of the screen-to-earth (ground) with a 100 nF capacitor (keeping leads short).



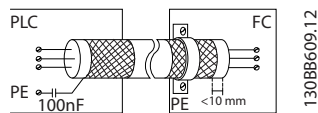

Illustration 2.16

**Avoid EMC noise on serial communication**

This terminal is connected to earth (ground) via an internal RC link. Use twisted-pair cables to reduce interference between conductors. The recommended method is shown below:

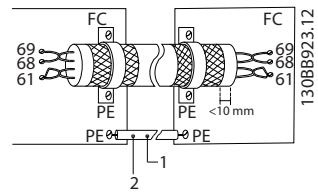

Illustration 2.17

1	Min. 16 mm <sup>2</sup>
2	Equalizing cable

Table 2.10

Alternatively, the connection to terminal 61 can be omitted:

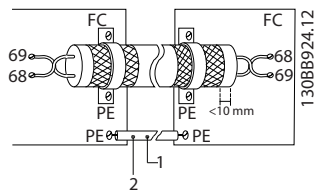

Illustration 2.18

1	Min. 16 mm <sup>2</sup>
2	Equalizing cable

Table 2.11

2.5.4 Control Terminal Types

Terminal functions and default settings are summarized in chapter 2.5.6 Control Terminal Functions.

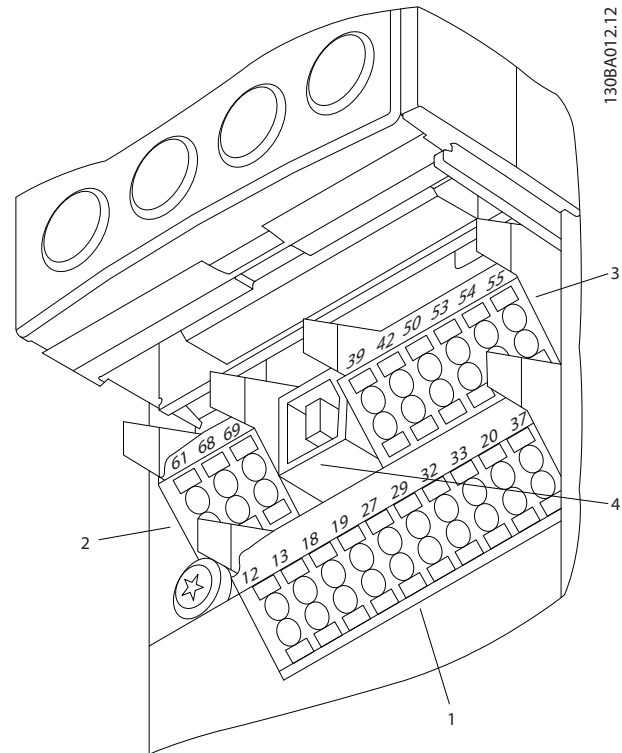

Illustration 2.19 Control Terminal Locations

- **Connector 1** provides four programmable digital input terminals, two additional digital terminals programmable as either input or output, a 24 V DC terminal supply voltage, and a common for optional customer supplied 24 V DC voltage
- **Connector 2** terminals (+)68 and (-)69 are for an RS-485 serial communications connection
- **Connector 3** provides two analog inputs, one analog output, 10 V DC supply voltage, and commons for the inputs and output
- **Connector 4** is a USB port available for use with the MCT 10 Set-up Software
- Also provided are two Form C relay outputs that are located on the power card
- Some options available for ordering with the unit may provide additional terminals. See the manual provided with the equipment option

## 2.5.5 Wiring to Control Terminals

Terminal plugs can be removed for easy access.

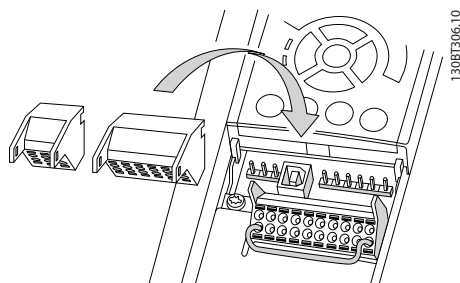

Illustration 2.20 Removal of Control Terminals

## 2.5.6 Control Terminal Functions

Frequency converter functions are commanded by receiving control input signals.

- Each terminal must be programmed for the function it will be supporting in the parameters associated with that terminal. See *chapter 5 Programming* and *chapter 6 Application Examples* for terminals and associated parameters.
- It is important to confirm that the control terminal is programmed for the correct function. See *chapter 5 Programming* for details on accessing parameters and programming.
- The default terminal programming is intended to initiate frequency converter functioning in a typical operational mode

### 2.5.6.1 Terminal 53 and 54 Switches

- Analog input terminals 53 and 54 can select either voltage (0 to 10 V) or current (0/4-20 mA) input signals
- Remove power to the frequency converter before changing switch positions
- Set switches A53 and A54 to select the signal type. U selects voltage, I selects current
- The switches are accessible when the LCP has been removed (see *Illustration 2.21*).

#### **NOTICE**

Some option cards available for the unit may cover these switches and must be removed to change switch settings. Always remove power to the unit before removing option cards.

- Terminal 53 default is for a speed reference signal in open loop set in *16-61 Terminal 53 Switch Setting*

- Terminal 54 default is for a feedback signal in closed loop set in *16-63 Terminal 54 Switch Setting*

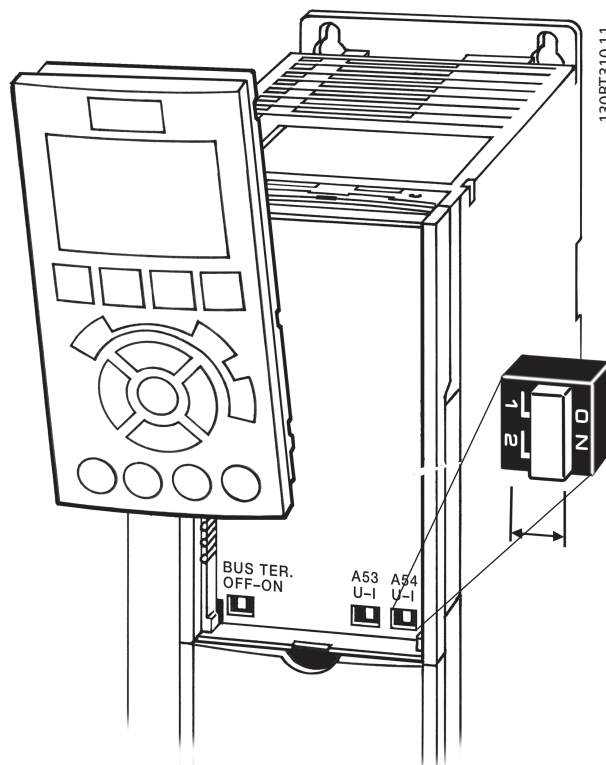

Illustration 2.21 Location of Terminals 53 and 54 Switches and Bus Termination Switch

## 2.6 Serial Communication

RS-485 is a two-wire bus interface compatible with multi-drop network topology, i.e. nodes can be connected as a bus, or via drop cables from a common trunk line. A total of 32 nodes can be connected to one network segment. Repeaters divide network segments. Each repeater functions as a node within the segment in which it is installed. Each node connected within a given network must have a unique node address across all segments. Terminate each segment at both ends, using either the termination switch (S801) of the frequency converter or a biased termination resistor network. Always use screened twisted pair (STP) cable for bus cabling, and always follow good common installation practice.

Low-impedance earth (ground) connection of the screen at every node is important, including at high frequencies. Thus, connect a large surface of the screen to earth (ground), for example with a cable clamp or a conductive cable gland. It may be necessary to apply potential-equalizing cables to maintain the same earth (ground) potential throughout the network. Particularly in installations with long cables.

To prevent impedance mismatch, always use the same type of cable throughout the entire network. When

connecting a motor to the frequency converter, always use screened motor cable.

Cable	Screened twisted pair (STP)
Impedance	120 Ω
Max. cable length	1200 m (including drop lines) 500 m station-to-station

Table 2.12

## 2.7 Optional Equipment

### 2.7.1 Load Share Terminals

Load share terminals enable the connection of the DC circuits of several frequency converters. Load share terminals are available in IP20 frequency converters and extend out the top of the frequency converter. A terminal cover, supplied with the frequency converter, must be installed to maintain the IP20 rating of the enclosure. *Illustration 2.22* shows both the covered and uncovered terminals.

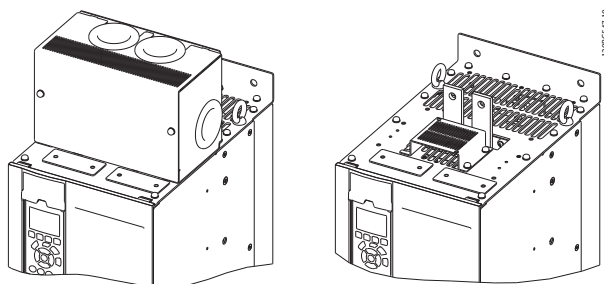

Illustration 2.22 Load Share or Regeneration Terminal with Cover (L) and without Cover (R)

### 2.7.2 Regeneration Terminals

Regen (regeneration) terminals can be supplied for applications that have a regenerative load. A regenerative unit, supplied by a third party, connects to the regen terminals so that power can be regenerated back onto the mains, resulting in energy savings. Regen terminals are available in IP20 frequency converters and extend out the top of the frequency converter. A terminal cover, supplied with the frequency converter, must be installed to maintain the IP20 rating of the enclosure. *Illustration 2.22* shows both the covered and uncovered terminals.

### 2.7.3 Anti-condensation Heater

An anti-condensation heater can be installed inside the frequency converter to prevent condensation from forming inside the enclosure when the unit is turned off. The heater is controlled by customer-supplied 230 V AC. For best results, operate the heater only when the unit is not running and turn the heater off when the unit is running.

### 2.7.4 Brake Chopper

A brake chopper can be supplied for applications that have a regenerative load. The brake chopper connects to a brake resistor, which consumes the braking energy, preventing an overvoltage fault on the DC bus. The braking chopper is automatically activated when the DC bus voltage exceeds a specified level, depending on the nominal voltage of the frequency converter.

### 2.7.5 Mains Shield

The mains shield is a Lexan cover installed inside the enclosure to provide protection according to VBG-4 accident-prevention requirements.

## 3 Start Up and Functional Testing

### 3.1 Pre-start

#### 3.1.1 Safety Inspection

#### **⚠ WARNING**

##### **HIGH VOLTAGE!**

If input and output connections have been connected improperly, there is potential for high voltage on these terminals. If power leads for multiple motors are improperly run in same conduit, there is potential for leakage current to charge capacitors within the frequency converter, even when disconnected from mains input. For initial start up, make no assumptions about power components. Follow pre-start procedures. Failure to follow pre-start procedures could result in personal injury or damage to equipment.

1. Input power to the unit must be OFF and locked out. Do not rely on the frequency converter disconnect switches for input power isolation.
2. Verify that there is no voltage on input terminals L1 (91), L2 (92), and L3 (93), phase-to-phase and phase-to-ground,
3. Verify that there is no voltage on output terminals 96 (U), 97 (V), and 98 (W), phase-to-phase and phase-to-ground.
4. Confirm continuity of the motor by measuring ohm values on U-V (96-97), V-W (97-98), and W-U (98-96).
5. Check for proper grounding of the frequency converter as well as the motor.
6. Inspect the frequency converter for loose connections on terminals.
7. Record the following motor-nameplate data: power, voltage, frequency, full load current, and nominal speed. These values are needed to program motor nameplate data later.
8. Confirm that the supply voltage matches voltage of frequency converter and motor.

## CAUTION

Before applying power to the unit, inspect the entire installation as detailed in *Table 3.1*. Check mark those items when completed.

Inspect for	Description	<input checked="" type="checkbox"/>
Auxiliary equipment	<ul style="list-style-type: none"> <li>Look for auxiliary equipment, switches, disconnects, or input fuses/circuit breakers that may reside on the input power side of the frequency converter or output side to the motor. Ensure that they are ready for full speed operation.</li> <li>Check function and installation of any sensors used for feedback to the frequency converter</li> <li>Remove power factor correction caps on motor(s), if present</li> </ul>	
Cable routing	<ul style="list-style-type: none"> <li>Ensure that input power, motor wiring and control wiring are separated or in three separate metallic conduits for high frequency noise isolation</li> </ul>	
Control wiring	<ul style="list-style-type: none"> <li>Check for broken or damaged wires and loose connections</li> <li>Check that control wiring is isolated from power and motor wiring for noise immunity</li> <li>Check the voltage source of the signals, if necessary</li> <li>The use of shielded cable or twisted pair is recommended. Ensure that the shield is terminated correctly</li> </ul>	
Cooling clearance	<ul style="list-style-type: none"> <li>Measure that top and bottom clearance is adequate to ensure proper air flow for cooling</li> </ul>	
EMC considerations	<ul style="list-style-type: none"> <li>Check for proper installation regarding electromagnetic compatibility</li> </ul>	
Environmental considerations	<ul style="list-style-type: none"> <li>See equipment label for the maximum ambient operating temperature limits</li> <li>Humidity levels must be 5-95% non-condensing</li> </ul>	
Fusing and circuit breakers	<ul style="list-style-type: none"> <li>Check for proper fusing or circuit breakers</li> <li>Check that all fuses are inserted firmly and in operational condition and that all circuit breakers are in the open position</li> </ul>	
Earthing (Grounding)	<ul style="list-style-type: none"> <li>The unit requires an earth wire (ground wire) from its chassis to the building earth (ground)</li> <li>Check for good earth connections (ground connections) that are tight and free of oxidation</li> <li>Earthing (grounding) to conduit or mounting the back panel to a metal surface is not a suitable earth (ground)</li> </ul>	
Input and output power wiring	<ul style="list-style-type: none"> <li>Check for loose connections</li> <li>Check that motor and mains are in separate conduit or separated screened cables</li> </ul>	
Panel interior	<ul style="list-style-type: none"> <li>Inspect that the unit interior is free of dirt, metal chips, moisture, and corrosion</li> </ul>	
Switches	<ul style="list-style-type: none"> <li>Ensure that all switch and disconnect settings are in the proper positions</li> </ul>	
Vibration	<ul style="list-style-type: none"> <li>Check that the unit is mounted solidly or that shock mounts are used, as necessary</li> <li>Check for an unusual amount of vibration</li> </ul>	

Table 3.1 Start Up Check List

### 3.2 Applying Power

#### **⚠WARNING**

##### **HIGH VOLTAGE!**

Frequency converters contain high voltage when connected to AC mains. Installation, start-up and maintenance should be performed by qualified personnel only. Failure to comply could result in death or serious injury.

#### **⚠WARNING**

##### **UNINTENDED START!**

When the frequency converter is connected to AC mains, the motor may start at any time. The frequency converter, motor, and any driven equipment must be in operational readiness. Failure to comply could result in death, serious injury, equipment, or property damage.

1. Confirm that the input voltage is balanced within 3%. If not, correct input voltage imbalance before proceeding. Repeat this procedure after the voltage correction.
2. Ensure that optional equipment wiring, if present, matches the installation application.
3. Ensure that all operator devices are in the OFF position. Panel doors should be closed or cover mounted.
4. Apply power to the unit. DO NOT start the frequency converter at this time. For units with a disconnect switch, turn to the ON position to apply power to the frequency converter.

**NOTICE**

If the status line at the bottom of the LCP reads **AUTO REMOTE COASTING** or **Alarm 60 External Interlock** is displayed, this indicates that the unit is ready to operate but is missing an input signal on terminal 27.

### 3.3 Basic Operational Programming

#### 3.3.1 Set-up Wizard

The built-in "wizard" menu guides the installer through the set-up of the frequency converter in a clear and structured manner, and has been constructed with reference to the industries refrigeration engineers, to ensure that the text and language used makes complete sense to the installer.

At start-up the FC 103 asks the user run the VLT Drive Application Guide or to skip it (until it has been run, the FC 103 will ask every time at start-up), thereafter in the event of power failure the application guide is accessed through the Quick menu screen.

If [Cancel] is pressed, the FC 103 will return to the status screen. An automatic timer will cancel the wizard after 5 min. of inactivity (no keys pressed). The wizard must be re-entered through the Quick Menu when it has been run once.

Answering the questions on the screens takes the user through a complete set-up for the FC 103. Most standard refrigeration applications can be setup by using this Application Guide. Advanced features must be accessed through the menu structure (Quick Menu or Main Menu) in the frequency converter.

The FC 103 Wizard covers all standard settings for:

- Compressors
- Single fan and pump
- Condenser fans

These applications are then further expanded to allow control of the frequency converter to be controlled via the

frequency converter's own internal PID controllers or from an external control signal.

After completing set-up, choose to re-run wizard or start application

The Application Guide can be cancelled at any time by pressing [Back]. The Application Guide can be re-entered through the Quick Menu. When re-entering the Application Guide, the user will be asked to keep previous changes to the factory set-up or to restore default values.

The FC 103 will start up initially with the Application guide thereafter in the event of power failure the application guide is accessed through the Quick menu screen. The following screen will be presented:

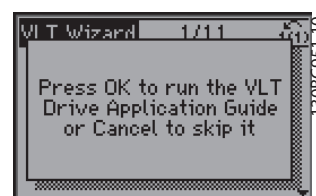

Illustration 3.1

If [Cancel] is pressed, the FC 103 will return to the status screen. An automatic timer will cancel the wizard after 5 min. of inactivity (no keys pressed). The wizard must be re-entered through the Quick Menu as described below. If [OK] is pressed, the Application Guide will start with the following screen:



Illustration 3.2

**NOTICE**

**Numbering of steps in wizard (e.g. 1/12) can change depending on choices in the workflow.**

This screen will automatically change to the first input screen of the Application Guide:



Illustration 3.3



Illustration 3.4

**Compressor pack set-up**

As an example, see screens below for a compressor pack set-up:

**Voltage and frequency set-up**

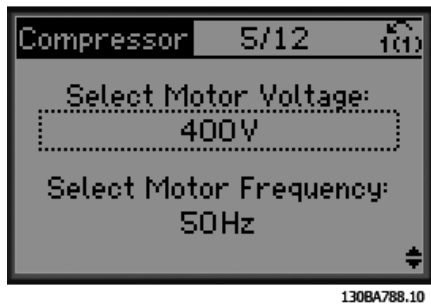

Illustration 3.5

**Current and nominal speed set-up**

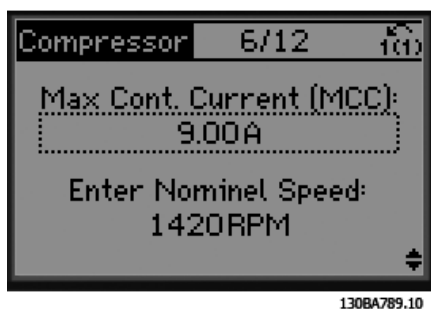

Illustration 3.6

**Min. and max. frequency set-up**

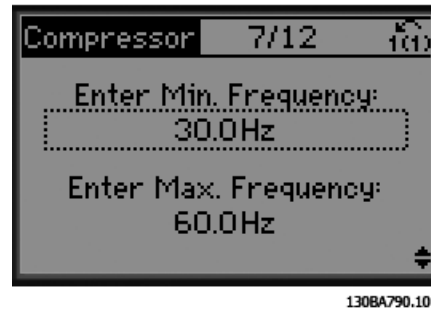

Illustration 3.7

**Min. time between two starts**



Illustration 3.8

3

Choose with/without bypass valve

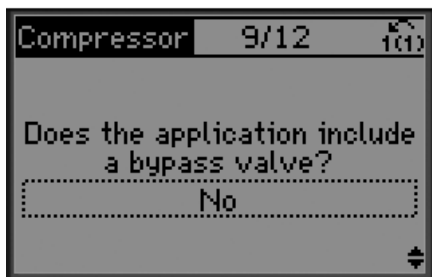

130BA792.10

Illustration 3.9

Select sensor type

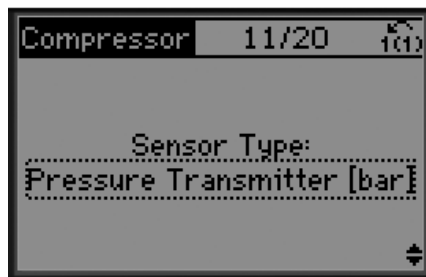

130BA794.10

Illustration 3.11

Select open or closed loop

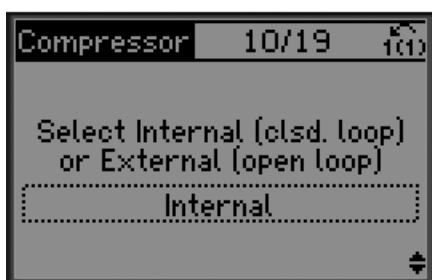

130BA793.10

Illustration 3.10

Settings for sensor



130BA795.10

Illustration 3.12

**NOTICE**

Internal/Closed loop: The FC 103 will control the application directly using the internal PID control within the frequency converter and needs an input from an external input such as a temperature or other sensor which is wired directly into the frequency converter and controls from the sensor signal.

External/Open loop: The FC 103 takes its control signal from another controller (such as a pack controller) which gives the frequency converter e.g. 0-10 V, 4-20 mA or FC 103 Lon. The frequency converter will change its speed depending upon this reference signal.

Info: 4-20 mA feedback chosen - connect accordingly



130BA796.10

Illustration 3.13



Info: Set switch accordingly



130BA797.10

Illustration 3.14

Set setpoint

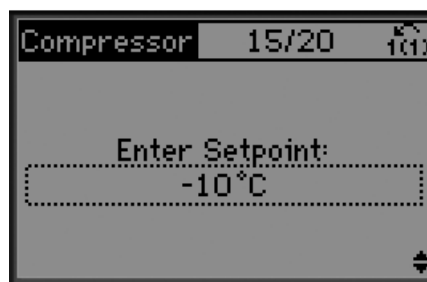

130BA800.10

Illustration 3.17

Select unit and conversion from pressure



130BA798.10

Illustration 3.15

Set high/low limit for setpoint

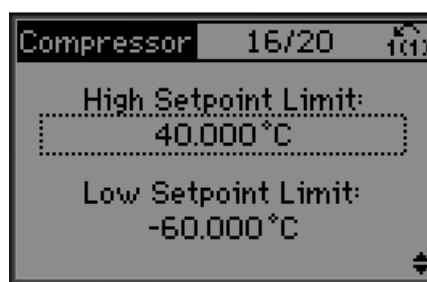

130BA801.10

Illustration 3.18

Select fixed or floating setpoint

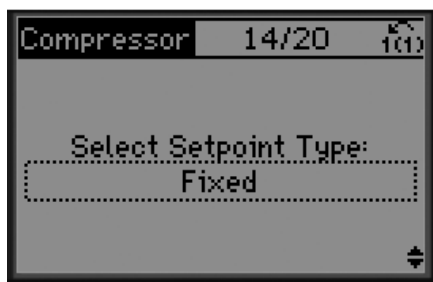

130BA799.10

Illustration 3.16

Set cut out/in value

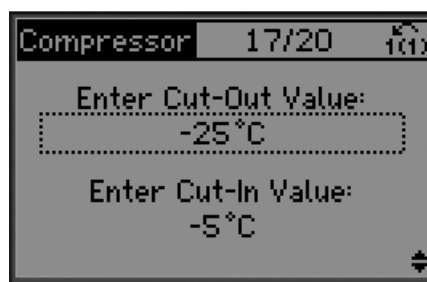

130BA802.10

Illustration 3.19

3

3

Choose pack control set-up

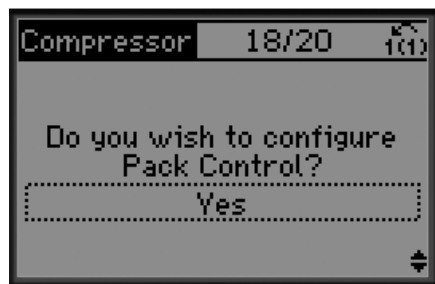

130BA803.10

Illustration 3.20

Info: Setup completed



130BA806.10

Illustration 3.23

Set number of compressors in pack

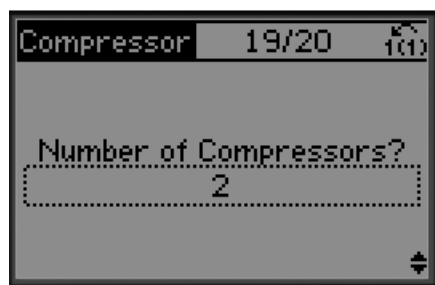

130BA804.10

Illustration 3.21

After completing set-up, choose to re-run wizard or start application. Select between the following options:

- Re-run wizard
- Go to main menu
- Go to status
- Run AMA - Note this is a reduced AMA if compressor application is selected and full AMA if single fan and pump is selected.
- If condenser fan is selected in application NO AMA can be run.
- Run application- this mode starts the frequency converter in either hand/local mode or via an external control signal if open loop is selected in an earlier screen

Info: Connect accordingly

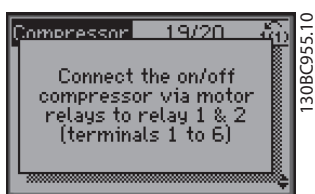

130BC955.10

Illustration 3.22

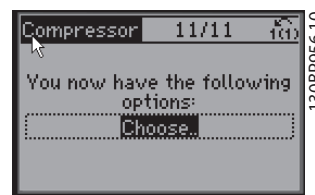

130BP956.10

Illustration 3.24

The Application Guide can be cancelled at any time by pressing [Back]. The Application Guide can be re-entered through the Quick Menu:



130BC957.10

Illustration 3.25

When re-entering the Application Guide, select between previous changes to the factory set-up or restore default values.

**NOTICE**

If the system requirement is to have the internal pack controller for 3 compressors plus by-pass valve connected, there is the need to specify FC 103 with the extra relay card (MCB 105) mounted inside the frequency converter.

The bypass valve must be programmed to operate from one of the extra relay outputs on the MCB 105 board. This is needed because the standard relay outputs in the FC 103 are used to control the compressors in the pack.

3.3.2 Required Initial Frequency Converter Programming

**NOTICE**

If the wizard is run, ignore the following.

Frequency converters require basic operational programming before running for best performance. Basic operational programming requires entering motor-nameplate data for the motor being operated and the minimum and maximum motor speeds. Enter data in accordance with the following procedure. Parameter settings recommended are intended for start up and checkout purposes. Application settings may vary. See chapter 4 User Interface for detailed instructions on entering data through the LCP.

Enter data with power ON, but before operating the frequency converter.

1. Press [Main Menu] twice on the LCP.
2. Use the navigation keys to scroll to parameter group 0-\*\* Operation/Display and press [OK].

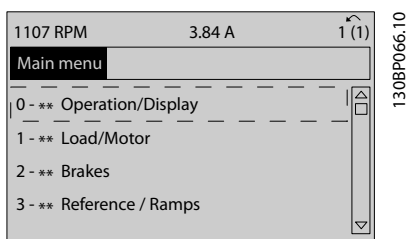

Illustration 3.26 Main Menu

3. Use navigation keys to scroll to parameter group 0-0\* Basic Settings and press [OK].

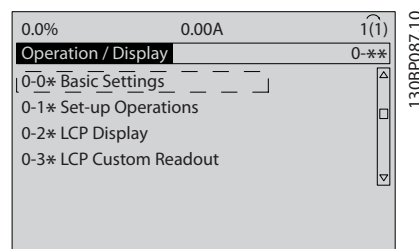

Illustration 3.27 Operation/Display

4. Use navigation keys to scroll to 0-03 Regional Settings and press [OK].

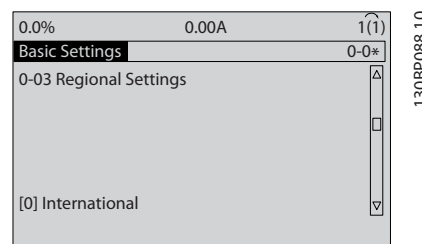

Illustration 3.28 Basic Settings

5. Use navigation keys to select [0] International or [1] North America as appropriate and press [OK]. (This changes the default settings for a number of basic parameters. See chapter 5.4 International/ North American Default Parameter Settings for a complete list.)
6. Press [Quick Menu] on the LCP.
7. Use the navigation keys to scroll to parameter group Q2 Quick Setup and press [OK].

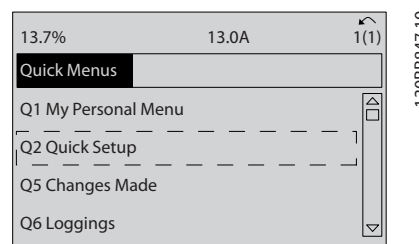

Illustration 3.29 Quick Menu

8. Select language and press [OK].
9. A jumper wire should be in place between control terminals 12 and 27. If this is the case, leave 5-12 Terminal 27 Digital Input at factory default. Otherwise select No Operation. For frequency converters with an optional Danfoss bypass, no jumper wire is required.
10. 3-02 Minimum Reference
11. 3-03 Maximum Reference
12. 3-41 Ramp 1 Ramp Up Time

13. 3-42 Ramp 1 Ramp Down Time
14. 3-13 Reference Site. Linked to Hand/Auto\* Local Remote.

### 3.4 Automatic Motor Adaptation

Automatic motor adaptation (AMA) is a test procedure that measures the electrical characteristics of the motor to optimize compatibility between the frequency converter and the motor.

- The frequency converter builds a mathematical model of the motor for regulating output motor current. The procedure also tests the input phase balance of electrical power. It compares the motor characteristics with the data entered in parameters 1-20 to 1-25.
- It does not cause the motor to run or harm to the motor
- Some motors may be unable to run the complete version of the test. In that case, select [2] Enable reduced AMA
- If an output filter is connected to the motor, select *Enable reduced AMA*
- If warnings or alarms occur, see *chapter 8 Warnings and Alarms*
- Run this procedure on a cold motor for best results

#### NOTICE

The AMA algorithm does not work when using PM motors.

#### To run AMA

1. Press [Main Menu] to access parameters.
2. Scroll to parameter group 1-\*\* *Load and Motor*.
3. Press [OK].
4. Scroll to parameter group 1-2\* *Motor Data*.
5. Press [OK].
6. Scroll to 1-29 *Automatic Motor Adaptation (AMA)*.
7. Press [OK].
8. Select [1] *Enable complete AMA*.
9. Press [OK].
10. Follow on-screen instructions.
11. The test will run automatically and indicate when it is complete.

### 3.5 Check Motor Rotation

Before running the frequency converter, check the motor rotation. The motor will run briefly at 5 Hz or the minimum frequency set in 4-12 *Motor Speed Low Limit [Hz]*.

1. Press [Quick Menu].
2. Scroll to Q2 *Quick Setup*.
3. Press [OK].
4. Scroll to 1-28 *Motor Rotation Check*.
5. Press [OK].
6. Scroll to [1] *Enable*.

The following text will appear: *Note! Motor may run in wrong direction.*

7. Press [OK].
8. Follow the on-screen instructions.

To change the direction of rotation, remove power to the frequency converter and wait for power to discharge. Reverse the connection of any two of the three motor cables on the motor or frequency converter side of the connection.

### 3.6 Local-control Test

#### CAUTION

#### MOTOR START!

Ensure that the motor, system and any attached equipment are ready for start. It is the responsibility of the user to ensure safe operation under any condition. Failure to ensure that the motor, system, and any attached equipment is ready for start could result in personal injury or equipment damage.

#### NOTICE

The [Hand On] key provides a local start command to the frequency converter. The [Off] key provides the stop function.

When operating in local mode, [▲] and [▼] increase and decrease the speed output of the frequency converter. [◀] and [▶] move the display cursor in the numeric display.

1. Press [Hand On].
2. Accelerate the frequency converter by pressing [▲] to full speed. Moving the cursor left of the decimal point provides quicker input changes.
3. Note any acceleration problems.
4. Press [Off].
5. Note any deceleration problems.

If acceleration problems were encountered

- If warnings or alarms occur, see *chapter 8 Warnings and Alarms*
- Check that motor data is entered correctly
- Increase the ramp-up time accel time in *3-41 Ramp 1 Ramp Up Time*
- Increase current limit in *4-18 Current Limit*
- Increase torque limit in *4-16 Torque Limit Motor Mode*

4. Adjust the speed reference> throughout the speed range.
5. Remove the external run command.
6. Note any problems.

If warnings or alarms occur, see *chapter 8 Warnings and Alarms*.

If deceleration problems were encountered

- If warnings or alarms occur, see *chapter 8 Warnings and Alarms*.
- Check that motor data is entered correctly.
- Increase the ramp-down time decel time in *3-42 Ramp 1 Ramp Down Time*.
- Enable overvoltage control in *2-17 Over-voltage Control*.

See *chapter 4.1.1 Local Control Panel* for resetting the frequency converter after a trip.

**NOTICE**

*chapter 3.2 Applying Power to chapter 3.3 Basic Operational Programming* conclude the procedures for applying power to the frequency converter, basic programming, set-up and functional testing.

### 3.7 System Start Up

The procedure in this section requires user-wiring and application programming to be completed. *chapter 6 Application Examples* is intended to help with this task. Other aids to application set-up are listed in *chapter 1.3 Additional Resources*. The following procedure is recommended after application set-up by the user is completed.

**CAUTION**

**MOTOR START!**

Ensure that the motor, system and any attached equipment is ready for start. It is the responsibility of the user to ensure safe operation under any condition. Failure to do so could result in personal injury or equipment damage.

1. Press [Auto On].
2. Ensure that external control functions are properly wired to the frequency converter and all programming is completed.
3. Apply an external run command.

## 4 User Interface

### 4.1 Local Control Panel

The local control panel (LCP) is the combined display and keypad on the front of the unit. The LCP is the user interface to the frequency converter.

The LCP has several user functions.

- Start, stop, and control speed when in local control
- Display operational data, status, warnings and cautions
- Programming frequency converter functions
- Manually reset the frequency converter after a fault when auto-reset is inactive

An optional numeric LCP (NLCP) is also available. The NLCP operates in a manner similar to the LCP. See the *Programming Guide*, for details on use of the NLCP.

#### 4.1.1 LCP Layout

The LCP is divided into four functional groups (see *Illustration 4.1*).

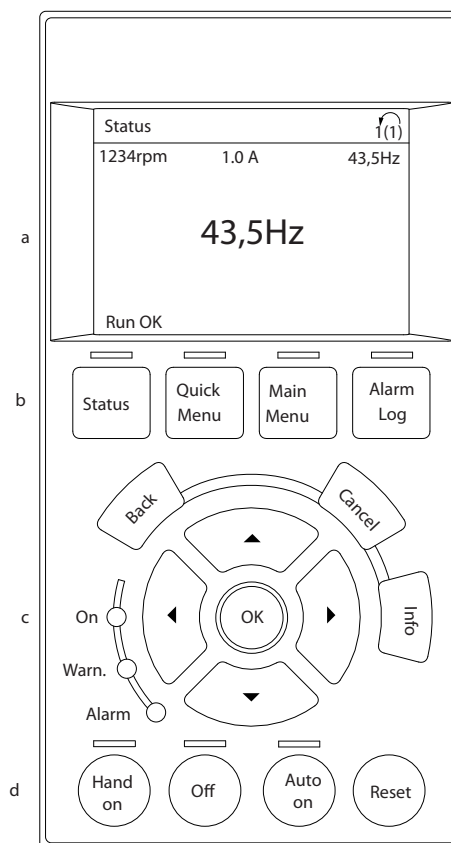

130BC362.10

**Illustration 4.1 LCP**

- Display area.
- Display menu keys for changing the display to show status options, programming, or error message history.
- Navigation keys for programming functions, moving the display cursor, and speed control in local operation. Also included are the status indicator lights.
- Operational mode keys and reset.

### 4.1.2 Setting LCP Display Values

The display area is activated when the frequency converter receives power from mains voltage, a DC bus terminal, or an external 24 V DC supply.

The information displayed on the LCP can be customized for user application.

- Each display readout has a parameter associated with it
- Options are selected in the quick menu Q3-13 *Display Settings*
- Display 2 has an alternate larger display option
- The frequency converter status at the bottom line of the display is generated automatically and is not selectable

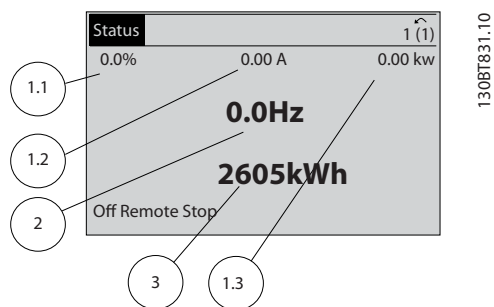

Illustration 4.2 Display Readouts

Display	Parameter number	Default setting
1.1	0-20	Reference %
1.2	0-21	Motor current
1.3	0-22	Power [kW]
2	0-23	Frequency
3	0-24	kWh counter

Table 4.1 Legend to Illustration 4.2

### 4.1.3 Display Menu Keys

Menu keys are used for menu access for parameter set-up, toggling through status display modes during normal operation, and viewing fault log data.

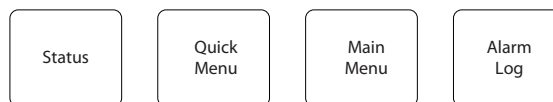

Illustration 4.3 Menu Keys

Key	Function
<b>Status</b>	Shows operational information. <ul style="list-style-type: none"> <li>• In Auto mode, press to toggle between status read-out displays</li> <li>• Press repeatedly to scroll through each status display</li> <li>• Press [Status] plus [▲] or [▼] to adjust the display brightness</li> <li>• The symbol in the upper right corner of the display shows the direction of motor rotation and which set-up is active. This is not programmable.</li> </ul>
<b>Quick Menu</b>	Allows access to programming parameters for initial set up instructions and many detailed application instructions. <ul style="list-style-type: none"> <li>• Press to access Q2 <i>Quick Setup</i> for sequenced instructions to program the basic frequency controller set up</li> <li>• Follow the sequence of parameters as presented for the function set up</li> </ul>
<b>Main Menu</b>	Allows access to all programming parameters. <ul style="list-style-type: none"> <li>• Press twice to access top-level index</li> <li>• Press once to return to the last location accessed</li> <li>• Press to enter a parameter number for direct access to that parameter</li> </ul>
<b>Alarm Log</b>	Displays a list of current warnings, the last 10 alarms, and the maintenance log. <ul style="list-style-type: none"> <li>• For details about the frequency converter before it entered the alarm mode, select the alarm number using the navigation keys and press [OK].</li> </ul>

Table 4.2 Function Description Menu Keys

### 4.1.4 Navigation Keys

Navigation keys are used for programming functions and moving the display cursor. The navigation keys also provide speed control in local (hand) operation. Three frequency converter status indicator lights are also located in this area.

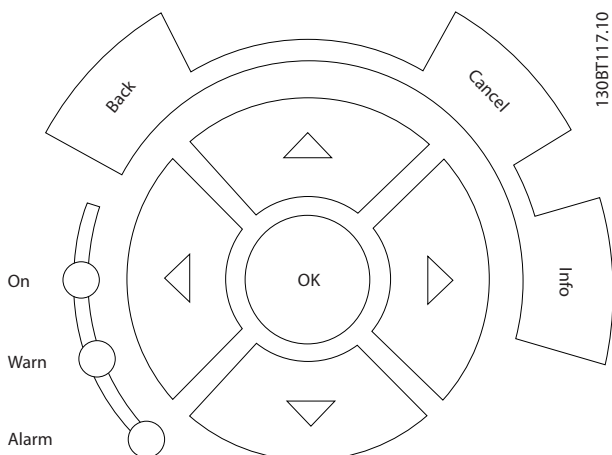

130BT117.10

Illustration 4.4 Navigation Keys

Key	Function
<b>Back</b>	Reverts to the previous step or list in the menu structure.
<b>Cancel</b>	Cancels the last change or command as long as the display mode has not changed.
<b>Info</b>	Press for a definition of the function being displayed.
<b>Navigation Keys</b>	Use the four navigation keys to move between items in the menu.
<b>OK</b>	Use to access parameter groups or to enable a choice.

Table 4.3 Navigation Keys Functions

Light	Indicator	Function
Green	ON	The ON light activates when the frequency converter receives power from mains voltage, a DC bus terminal, or an external 24 V supply.
Yellow	WARN	When warning conditions are met, the yellow WARN light comes on and text appears in the display area identifying the problem.
Red	ALARM	A fault condition causes the red alarm light to flash and an alarm text is displayed.

Table 4.4 Indicator Lights Functions

### 4.1.5 Operation Keys

Operation keys are found at the bottom of the LCP.

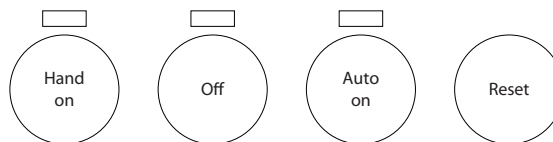

130BF046.10

Illustration 4.5 Operation Keys

Key	Function
<b>Hand On</b>	Starts the frequency converter in local control. <ul style="list-style-type: none"> <li>Use the navigation keys to control frequency converter speed</li> <li>An external stop signal by control input or serial communication overrides the local hand on</li> </ul>
<b>Off</b>	Stops the motor but does not remove power to the frequency converter.
<b>Auto On</b>	Puts the system in remote operational mode. <ul style="list-style-type: none"> <li>Responds to an external start command by control terminals or serial communication</li> <li>Speed reference is from an external source</li> </ul>
<b>Reset</b>	Resets the frequency converter manually after a fault has been cleared.

Table 4.5 Operation Keys Functions

## 4.2 Back Up and Copying Parameter Settings

Programming data is stored internally in the frequency converter.

- The data can be uploaded into the LCP memory as a storage back up
- Once stored in the LCP, the data can be downloaded back into the frequency converter
- Data can also be downloaded into other frequency converters by connecting the LCP into those units and downloading the stored settings. (This is a quick way to program multiple units with the same settings).
- Initialisation of the frequency converter to restore factory default settings does not change data stored in the LCP memory



**⚠ WARNING****UNINTENDED START!**

When the frequency converter is connected to AC mains, the motor may start at any time. The frequency converter, motor, and any driven equipment must be in operational readiness. Failure to be in operational readiness when the frequency converter is connected to AC mains could result in death, serious injury, or equipment or property damage.

## 4.2.1 Uploading Data to the LCP

1. Press [Off] to stop the motor before uploading or downloading data.
2. Go to *0-50 LCP Copy*.
3. Press [OK].
4. Select *All to LCP*.
5. Press [OK]. A progress bar shows the uploading process.
6. Press [Hand On] or [Auto On] to return to normal operation.

## 4.2.2 Downloading Data from the LCP

1. Press [Off] to stop the motor before uploading or downloading data.
2. Go to *0-50 LCP Copy*.
3. Press [OK].
4. Select *All from LCP*.
5. Press [OK]. A progress bar shows the downloading process.
6. Press [Hand On] or [Auto On] to return to normal operation.

## 4.3 Restoring Default Settings

**CAUTION**

Initialisation restores the unit to factory default settings. Any programming, motor data, localization, and monitoring records will be lost. Uploading data to the LCP provides a backup before initialisation.

Restoring the frequency converter parameter settings back to default values is done by initialisation of the frequency converter. Initialisation can be through *14-22 Operation Mode* or manually.

- Initialisation using *14-22 Operation Mode* does not change frequency converter data such as operating hours, serial communication selections,

personal menu settings, fault log, alarm log, and other monitoring functions

- Using *14-22 Operation Mode* is generally recommended
- Manual initialisation erases all motor, programming, localization, and monitoring data and restores factory default settings

## 4.3.1 Recommended Initialisation

1. Press [Main Menu] twice to access parameters.
2. Scroll to *14-22 Operation Mode*.
3. Press [OK].
4. Scroll to *Initialisation*.
5. Press [OK].
6. Remove power to the unit and wait for the display to turn off.
7. Apply power to the unit.

Default parameter settings are restored during start up. This may take slightly longer than normal.

8. Alarm 80 is displayed.
9. Press [Reset] to return to operation mode.

## 4.3.2 Manual Initialisation

1. Remove power to the unit and wait for the display to turn off.
2. Press and hold [Status], [Main Menu], and [OK] at the same time and apply power to the unit.

Factory default parameter settings are restored during start up. This may take slightly longer than normal.

Manual initialisation does reset not the following frequency converter information

- *15-00 Operating hours*
- *15-03 Power Up's*
- *15-04 Over Temp's*
- *15-05 Over Volt's*

## 5 Programming

### 5.1 Introduction

The frequency converter is programmed for its application functions using parameters. Parameters are accessed by pressing either [Quick Menu] or [Main Menu] on the LCP. (See *chapter 4.1 Local Control Panel* for details on using the LCP function keys). Parameters may also be accessed through a PC using the MCT 10 Set-up Software (see *chapter 5.6.1 Remote Programming with MCT 10 Set-up Software*).

5

The quick menu is intended for initial start up (Q2-\*\* *Quick Set Up*) and detailed instructions for common frequency converter applications (Q3-\*\* *Function Set Up*). Step-by-step instructions are provided. These instructions enable the user to walk through the parameters used for programming applications in their proper sequence. Data entered in a parameter can change the options available in the parameters following that entry. The quick menu presents easy guidelines for getting most systems up and running.

The main menu accesses all parameters and allows for advanced frequency converter applications.

### 5.2 Programming Example

Here is an example for programming the frequency converter for a common application in open loop using the quick menu.

- This procedure programs the frequency converter to receive a 0-10 V DC analog control signal on input terminal 53
- The frequency converter will respond by providing 6-60 Hz output to the motor proportional to the input signal (0-10 V DC = 6-60 Hz)

Select the following parameters using the navigation keys to scroll to the titles and press [OK] after each action.

1. 3-15 *Reference Resource 1*

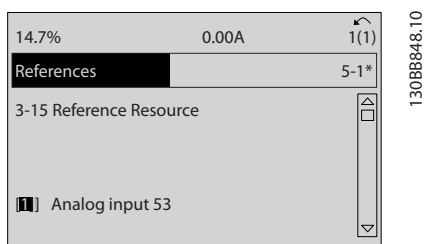

Illustration 5.1

2. 3-02 *Minimum Reference*. Set minimum internal frequency converter reference to 0 Hz. (This sets the minimum frequency converter speed at 0 Hz.)

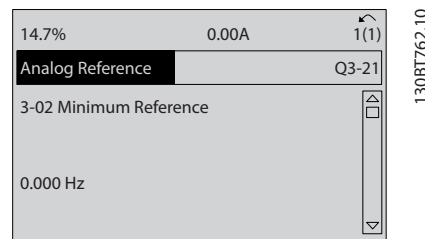

Illustration 5.2

3. 3-03 *Maximum Reference*. Set maximum internal frequency converter reference to 60 Hz. (This sets the maximum frequency converter speed at 60 Hz. Note that 50/60 Hz is a regional variation.)

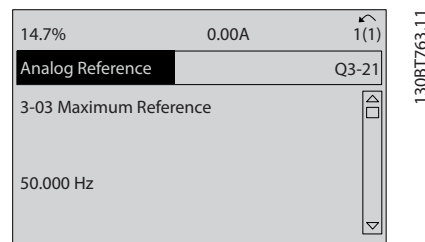

Illustration 5.3

4. 6-10 *Terminal 53 Low Voltage*. Set minimum external voltage reference on Terminal 53 at 0 V. (This sets the minimum input signal at 0 V.)

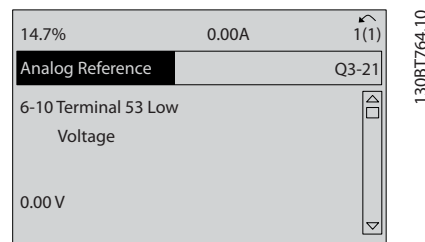

Illustration 5.4

- 6-11 Terminal 53 High Voltage. Set maximum external voltage reference on Terminal 53 at 10 V. (This sets the maximum input signal at 10 V.)

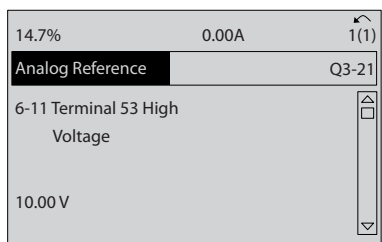

Illustration 5.5

- 6-14 Terminal 53 Low Ref./Feedb. Value. Set minimum speed reference on Terminal 53 at 6Hz. (This tells the frequency converter that the minimum voltage received on Terminal 53 (0 V) equals 6 Hz output.)

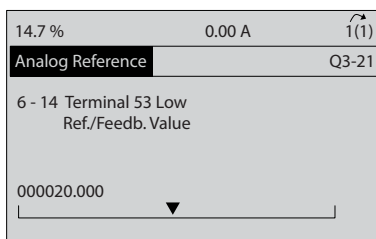

Illustration 5.6

- 6-15 Terminal 53 High Ref./Feedb. Value. Set maximum speed reference on Terminal 53 at 60 Hz. (This tells the frequency converter that the maximum voltage received on Terminal 53 (10 V) equals 60 Hz output.)

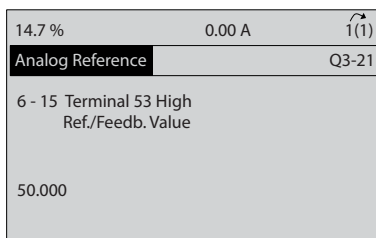

Illustration 5.7

With an external device providing a 0-10 V control signal connected to frequency converter terminal 53, the system is now ready for operation. Note that the scroll bar on the right in the last illustration of the display is at the bottom, indicating the procedure is complete.

Illustration 5.8 shows the wiring connections used to enable this set up.

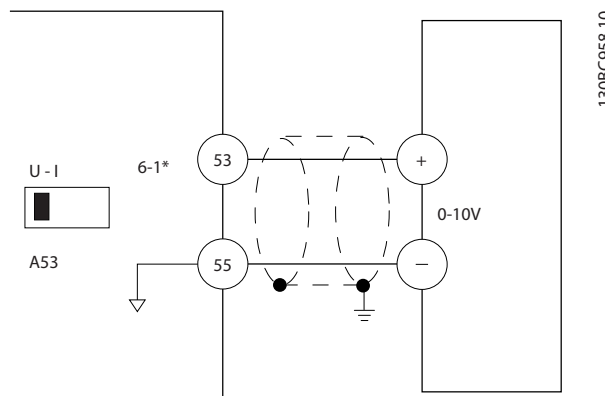

Illustration 5.8 Wiring Example for External Device Providing 0-10 V Control Signal (Frequency Converter Left, External Device Right)

### 5.3 Control Terminal Programming Examples

Control terminals can be programmed.

- Each terminal has specified functions it is capable of performing
- Parameters associated with the terminal enable the function
- For proper frequency converter functioning, the control terminals must be wired properly
- Control terminals must be programmed for the intended function receiving a signal

See Table 5.1 for control terminal parameter number and default setting. (Default setting can change based on the selection in 0-03 Regional Settings).

The following example shows accessing Terminal 18 to see the default setting.

- Press [Main Menu] twice, scroll to parameter group 5-\*\* Digital In/Out Parameter Data Set and press [OK].

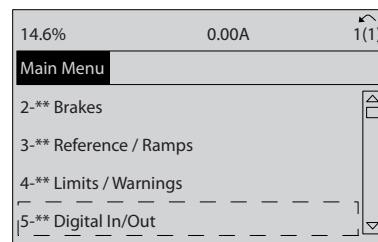

Illustration 5.9

2. Scroll to parameter group 5-1\* *Digital Inputs* and press [OK].

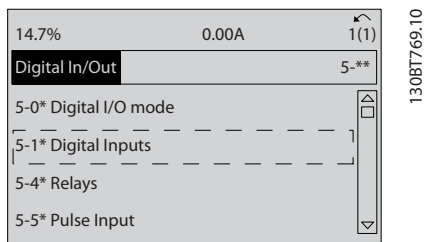

Illustration 5.10

3. Scroll to 5-10 *Terminal 18 Digital Input*. Press [OK] to access function choices. The default setting *Start* is shown.

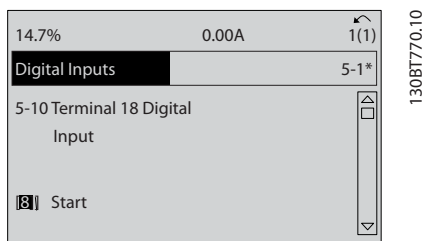

Illustration 5.11

5

## 5.4 International/North American Default Parameter Settings

Setting 0-03 *Regional Settings* to [0] *International* or [1] *North America* changes the default settings for some parameters. Table 5.1 lists those parameters that are effected.

Parameter	International default parameter value	North American default parameter value
0-03 Regional Settings	International	North America
0-71 Date Format	DD-MM-YYYY	MM/DD/YYYY
0-72 Time Format	24 h	12 h
1-20 Motor Power [kW]	See Note 1	See Note 1
1-21 Motor Power [HP]	See Note 2	See Note 2
1-22 Motor Voltage	230 V/400 V/575 V	208 V/460 V/575 V
1-23 Motor Frequency	50 Hz	60 Hz
3-03 Maximum Reference	50 Hz	60 Hz
3-04 Reference Function	Sum	External/Preset

Parameter	International default parameter value	North American default parameter value
4-13 Motor Speed High Limit [RPM] See Note 3	1500 RPM	1800 RPM
4-14 Motor Speed High Limit [Hz] See Note 4	50 Hz	60 Hz
4-19 Max Output Frequency	100 Hz	120 Hz
4-53 Warning Speed High	1500 RPM	1800 RPM
5-12 Terminal 27 Digital Input	Coast inverse	External interlock
5-40 Function Relay	[2] Drive ready	No alarm
6-15 Terminal 53 High Ref./Feedb. Value	50	60
6-50 Terminal 42 Output	Output frequency	Speed 4-20 mA
14-20 Reset Mode	Manual reset	Infinite auto reset
22-85 Speed at Design Point [RPM] See Note 3	1500 RPM	1800 RPM
22-86 Speed at Design Point [Hz]	50 Hz	60 Hz

Table 5.1 International/North American Default Parameter Settings

Note 1: 1-20 Motor Power [kW] is only visible when 0-03 *Regional Settings* is set to [0] *International*.

Note 2: 1-21 Motor Power [HP], is only visible when 0-03 *Regional Settings* is set to [1] *North America*.

Note 3: This parameter is only visible when 0-02 *Motor Speed Unit* is set to [0] *RPM*.

Note 4: This parameter is only visible when 0-02 *Motor Speed Unit* is set to [1] *Hz*.

Note 5: The default value depends on the number of motor poles. For a 4 poled motor the international default value is 1500 RPM and for a 2 poled motor 3000 RPM. The corresponding values for North America is 1800 and 3600 RPM, respectively.

Changes made to default settings are stored and available for viewing in the quick menu along with any programming entered into parameters.

1. Press [Quick Menu].
2. Scroll to Q5 *Changes Made* and press [OK].
3. Select Q5-2 *Since Factory Setting* to view all programming changes or Q5-1 *Last 10 Changes* for the most recent.

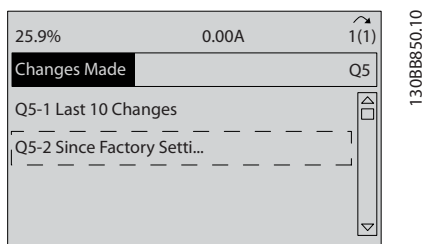

Illustration 5.12 Changes Made

### 5.4.1 Parameter Data Check

1. Press [Quick Menu].
2. Scroll to *Q5 Changes Made* and press [OK].

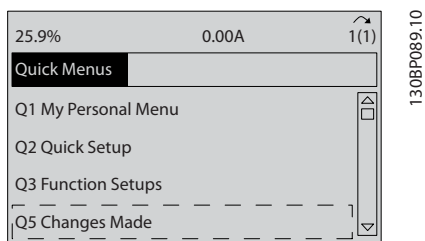

Illustration 5.13 Q5 Changes Made

3. Select *Q5-2 Since Factory Setting* to view all programming changes or *Q5-1 Last 10 Changes* for the most recent.

### 5.5 Parameter Menu Structure

Establishing the correct programming for applications often requires setting functions in several related parameters. These parameter settings provide the frequency converter with system details it needs to operate properly. System details may include such things as input and output signal types, programming terminals, minimum and maximum signal ranges, custom displays, automatic restart, and other features.

- See the LCP display to view detailed parameter programming and setting options
- Press [Info] in any menu location to view additional details for that function
- Press and hold [Main Menu] to enter a parameter number for direct access to that parameter
- Details for common application set ups are provided in *chapter 6 Application Examples*

### 5.5.1 Main Menu Structure

Operation / Display	General Settings	1-9* Motor Temperature	4-5* Adj. Warnings	5-9* Bus Controlled
0-0* Basic Settings	1-00 Configuration Mode	1-90 Motor Thermal Protection	4-50 Warning Current Low	5-90 Digital & Relay Bus Control
0-01 Language	1-03 Torque Characteristics	1-91 Motor External Fan	4-51 Warning Current High	5-93 Pulse Out #27 Bus Control
0-02 Motor Speed Unit	1-10 Motor Construction	1-93 Thermistor Source	4-52 Warning Speed Low	5-94 Pulse Out #27 Timeout Preset
0-03 Regional Settings	2-0* Brakes	2-00 DC Brake	4-53 Warning Speed High	5-95 Pulse Out #29 Bus Control
0-04 Operating State at Power-up	2-01 DC Brake	2-01 DC Hold/Preheat Current	4-54 Warning Reference Low	5-96 Pulse Out #29 Timeout Preset
0-05 Local Mode Unit	2-02 DC Braking Time	2-02 DC Brake Cut In Speed [RPM]	4-55 Warning Reference High	5-97 Pulse Out #X30/6 Bus Control
0-1* Set-up Operations	2-03 DC Brake Cut In Speed [Hz]	2-04 DC Brake Cut In Speed [Hz]	4-56 Warning Feedback Low	5-98 Pulse Out #X30/6 Timeout Preset
0-10 Active Set-up	2-06 Parking Current	2-06 Parking Time	4-57 Warning Feedback High	6-0* Analog In/Out
0-11 Programming Set-up	2-07 Brake Energy Funct.	2-07 Brake Function	4-58 Missing Motor Phase Function	6-0* Analog I/O Mode
0-12 This Set-up Linked to	2-10 Motor Voltage	2-10 AC brake Max. Current	4-60 Bypass Speed From [RPM]	6-00 Live Zero Timeout Time
0-13 Readout: Linked Set-ups	2-12 Motor Current	2-12 Over-voltage Control	4-61 Bypass Speed From [Hz]	6-01 Live Zero Timeout Function
0-14 Readout: Prog. Set-ups / Channel	2-15 Motor Nominal Speed	3-0* Reference / Ramps	4-62 Bypass Speed To [Hz]	6-02 Fire Mode Live Zero Timeout Function
0-2* LCP Display	2-16 Motor Cont. Rated Torque	3-01 Reference Limits	4-63 Bypass Speed To [Hz]	6-1* Analog Input 53
0-20 Display Line 1.1 Small	1-28 Motor Rotation Check	3-02 Minimum Reference	5-0* Digital In/Out	6-10 Terminal 53 Low Voltage
0-21 Display Line 1.2 Small	1-29 Automatic Motor Adaptation (AMA)	3-03 Maximum Reference	5-01 Terminal 27 Mode	6-11 Terminal 53 High Voltage
0-22 Display Line 1.3 Small	1-3* Adv. Motor Data	3-04 Reference Function	5-02 Terminal 29 Mode	6-12 Terminal 53 Low Current
0-23 Display Line 2 Large	1-30 Stator Resistance (Rs)	3-1* References	5-1* Digital Inputs	6-13 Terminal 53 High Current
0-24 Display Line 3 Large	1-31 Rotor Resistance (Rr)	3-10 Preset Reference	5-10 Terminal 18 Digital Input	6-14 Terminal 53 Low Ref./Feedb. Value
0-25 My Personal Menu	1-35 Main Reactance (Xh)	3-11 Jog Speed [Hz]	5-11 Terminal 19 Digital Input	6-15 Terminal 53 High Ref./Feedb. Value
0-30 LCP Custom Readout	1-36 Iron Loss Resistance (Re)	3-13 Reference Site	5-12 Terminal 29 Digital Input	6-16 Terminal 53 Filter Time Constant
0-31 Custom Readout Min Value	1-37 d-axis Inductance (Ld)	3-14 Preset Relative Reference	5-13 Terminal 29 Digital Input	6-17 Terminal 53 Live Zero
0-32 Custom Readout Max Value	1-39 Motor Poles	3-15 Reference 1 Source	5-14 Terminal 32 Digital Input	6-2* Analog Input 54
0-37 Display Text 1	1-40 Back EMF at 1000 RPM	3-16 Reference 2 Source	5-15 Terminal 33 Digital Input	6-20 Terminal 54 Low Voltage
0-38 Display Text 2	1-5* Load Indep. Setting	3-17 Reference 3 Source	5-16 Terminal X30/3 Digital Input	6-21 Terminal 54 High Voltage
0-41 [Off] Key on LCP	1-50 Motor Magnetisation at Zero Speed	3-19 Jog Speed [RPM]	5-17 Terminal X30/3 Digital Input	6-22 Terminal 54 Low Current
0-42 [Auto on] Key on LCP	1-51 Min Speed Normal Magnetising [RPM]	3-4* Ramp 1	5-18 Terminal X30/4 Digital Input	6-23 Terminal 54 High Current
0-43 [Reset] Key on LCP	1-52 Min Speed Normal Magnetising [Hz]	3-41 Ramp 1 Ramp Up Time	5-19 Terminal 37 Safe Stop	6-24 Terminal 54 Low Ref./Feedb. Value
0-5* Copy/Save	1-58 Flystart Test Pulses Current	3-42 Ramp 1 Ramp Down Time	5-3* Digital Outputs	6-25 Terminal 54 High Ref./Feedb. Value
0-50 LCP Copy	1-59 Flystart Test Pulses Frequency	3-5* Ramp 2	6-30 Terminal X30/11 Low Voltage	6-26 Terminal 54 Filter Time Constant
0-51 Set-up Copy	1-60 Low Speed Load Compensation	3-51 Ramp 2 Ramp Up Time	6-31 Terminal X30/11 High Voltage	6-27 Terminal 54 Live Zero
0-6* Password	1-61 High Speed Load Compensation	3-52 Ramp 2 Ramp Down Time	6-34 Term. X30/11 Low Ref./Feedb. Value	6-30 Terminal X30/11 Low Voltage
0-60 Main Menu Password	1-62 Slip Compensation	3-53 Other Ramps	6-35 Term. X30/11 High Ref./Feedb. Value	6-31 Terminal X30/11 High Voltage
0-61 Access to Main Menu w/o Password	1-63 Slip Compensation Time Constant	3-8* Jog Ramp Time	6-36 Term. X30/11 Filter Time Constant	6-32 Term. X30/11 Live Zero
0-65 Personal Menu Password	1-64 Resonance Dampening	3-81 Quick Stop Ramp Time	6-37 Term. X30/11 Live Zero	6-33 Term. X30/12 High Voltage
0-66 Access to Personal Menu w/o Password	1-65 Resonance Dampening Time Constant	3-82 Starting Ramp Up Time	6-40 Terminal X30/12 Low Voltage	6-34 Term. X30/12 High Voltage
0-67 Bus Password Access	1-7* Start Adjustments	3-90 Step Size	6-41 Terminal X30/12 High Voltage	6-35 Term. X30/12 Low Ref./Feedb. Value
0-7* Clock Settings	1-70 PM Start Mode	3-91 Ramp Time	6-44 Term. X30/12 High Ref./Feedb. Value	6-36 Term. X30/12 Live Zero
0-70 Set Date and Time	1-71 Start Delay	3-92 Power Restore	6-45 Term. X30/12 High Ref./Feedb. Value	6-37 Term. X30/12 Live Zero
0-71 Date Format	1-72 Start Function	3-93 Maximum Limit	6-46 Term. X30/12 Filter Time Constant	6-38 Term. X30/12 Live Zero
0-72 Time Format	1-73 Flying Start	3-94 Minimum Limit	6-47 Term. X30/12 Filter Time Constant	6-39 Term. X30/12 Live Zero
0-74 DST/Summertime	1-75 Start Speed [Hz]	3-95 Ramp Delay	6-48 Term. X30/12 Live Zero	6-40 Terminal X30/12 Low Voltage
0-76 DST/Summertime Start	1-76 Start Current	4-1* Motor Limits	6-50 Terminal X30/12 Live Zero	6-41 Terminal X30/12 High Voltage
0-77 DST/Summertime End	1-77 Compressor Start Max Speed [RPM]	4-10 Motor Speed Direction	6-51 Terminal 42 Output	6-42 Terminal X30/12 High Voltage
0-79 Clock Fault	1-78 Compressor Start Max Speed [Hz]	4-11 Motor Speed Low Limit [RPM]	6-52 Terminal 42 Output Max Scale	6-43 Term. X30/12 Low Ref./Feedb. Value
0-81 Working Days	1-8* Stop Adjustments	4-12 Motor Speed Low Limit [Hz]	6-53 Terminal 42 Output Bus Control	6-44 Term. X30/12 High Ref./Feedb. Value
0-82 Additional Working Days	1-80 Function at Stop	4-13 Motor Speed High Limit [RPM]	6-54 Terminal 42 Output Timeout Preset	6-45 Term. X30/12 High Ref./Feedb. Value
0-83 Additional Non-Working Days	1-81 Min Speed for Function at Stop [RPM]	4-14 Motor Speed High Limit [Hz]	6-55 Pulse Filter Time Constant #29	6-46 Term. X30/12 Filter Time Constant
0-89 Date and Time Readout	1-82 Min Speed for Function at Stop [Hz]	4-16 Torque Limit Motor Mode	6-56 Pulse Filter Time Constant #33	6-47 Term. X30/12 Live Zero
1-1** Load and Motor	1-86 Compressor Min. Speed for Trip [RPM]	4-17 Torque Limit Generator Mode	6-60 Terminal 42 Output	6-48 Term. X30/12 Live Zero
	1-87 Compressor Min. Speed for Trip [Hz]	4-18 Current Limit	6-51 Terminal 42 Output Min Scale	6-49 Terminal X30/12 High Voltage
		4-19 Max Output Frequency	6-52 Terminal 42 Output Max Scale	6-50 Terminal X30/12 High Voltage
			6-53 Terminal 42 Output Bus Control	6-51 Terminal X30/12 High Voltage
			6-54 Terminal 42 Output Timeout Preset	6-52 Terminal X30/12 High Voltage
			6-55 Pulse Filter Time Constant #29	6-53 Terminal X30/12 High Voltage
			6-56 Pulse Filter Time Constant #33	6-54 Terminal X30/12 High Voltage
			6-57 Pulse Output	6-55 Terminal X30/12 High Voltage
			6-58 Terminal 27 Pulse Output Variable	6-56 Terminal X30/12 High Voltage
			6-59 Pulse Output Max Freq #27	6-57 Terminal X30/12 High Voltage
			6-60 Pulse Output Max Freq #29	6-58 Terminal X30/12 High Voltage
			6-61 Terminal X30/8 Output	6-59 Terminal X30/12 High Voltage
			6-62 Terminal X30/8 Max. Scale	6-60 Terminal X30/12 High Voltage
			6-63 Terminal X30/8 Output Bus Control	6-61 Terminal X30/12 High Voltage
			6-64 Terminal X30/8 Output Timeout Preset	6-62 Terminal X30/12 High Voltage
			6-65 Pulse Output Max Freq #29	6-63 Terminal X30/12 High Voltage
			6-66 Terminal X30/6 Pulse Output Variable	6-64 Terminal X30/12 High Voltage
			6-67 Pulse Output Max Freq #X30/6	6-65 Terminal X30/12 High Voltage

<b>8-8*</b> Comm. and Options	<b>13-2*</b> Timers	15-11 Logging Interval	16-22 Torque [%]	18-10 FireMode Log:Event
<b>8-0*</b> General Settings	13-20 SL Controller Timer	15-12 Trigger Event	<b>16-3*</b> Drive Status	18-11 Fire Mode Log: Time
8-01 Control Site	<b>13-4*</b> Logic Rules	15-13 Logging Mode	16-30 DC Link Voltage	18-12 Fire Mode Log: Date and Time
8-02 Control Source	13-40 Logic Rule Boolean 1	15-14 Samples Before Trigger	16-32 Brake Energy /s	<b>18-3*</b> Inputs & Outputs
8-03 Control Timeout Time	13-41 Logic Rule Operator 1	<b>15-2*</b> Historic Log	16-33 Brake Energy /2 min	18-30 Analog Input X42/1
8-04 Control Timeout Function	13-42 Logic Rule Boolean 2	15-20 Historic Log: Event	16-34 Heatsink Temp.	18-31 Analog Input X42/3
8-05 End-of-Timeout Function	13-43 Logic Rule Operator 2	15-21 Historic Log: Value	16-35 Inverter Thermal	18-32 Analog Input X42/5
8-06 Reset Control Timeout	13-44 Logic Rule Boolean 3	15-22 Historic Log: Time	16-36 Inv. Nom. Current	18-33 Analog Out X42/7 [V]
8-07 Diagnosis Trigger	<b>13-5*</b> States	15-23 Historic log: Date and Time	16-37 Inv. Max. Current	18-34 Analog Out X42/9 [V]
8-1* Control Settings	13-51 SL Controller Event	<b>15-3*</b> Alarm Log	16-38 SL Controller State	<b>20-3*</b> Drive Closed Loop
8-10 Control Profile	13-52 SL Controller Action	15-30 Alarm Log: Error Code	16-39 Control Card Temp.	<b>20-0*</b> Feedback
8-13 Configurable Status Word STW	<b>14-*</b> Special Functions	15-31 Alarm Log: Value	16-41 LCP Bottom Statusline	20-00 Feedback 1 Source
<b>8-3*</b> FC Port Settings	<b>14-0*</b> Inverter Switching	15-32 Alarm Log: Time	<b>16-5*</b> Ref. & Feeds.	20-01 Feedback 1 Conversion
8-30 Protocol	14-00 Switching Pattern	15-33 Alarm Log: Date and Time	16-50 External Reference	20-02 Feedback 1 Source Unit
8-31 Address	14-01 Switching Frequency	15-34 Alarm Log: Status	16-52 Feedback[Unit]	20-03 Feedback 2 Source
8-32 Baud Rate	14-03 Overmodulation	15-35 Alarm Log: Alarm Text	16-53 Digi Pot Reference	20-04 Feedback 2 Conversion
8-33 Parity / Stop Bits	14-04 PWM Random	<b>15-4*</b> Drive Identification	16-54 Feedback 1 [Unit]	20-05 Feedback 2 Source Unit
8-35 Minimum Response Delay	<b>14-1*</b> Mains On/Off	15-40 FC Type	16-55 Feedback 2 [Unit]	20-06 Feedback 3 Source
8-36 Maximum Response Delay	14-12 Function at Mains Imbalance	15-41 Power Section	16-56 Feedback 3 [Unit]	20-07 Feedback 3 Conversion
8-37 Maximum Inter-Char Delay	<b>14-2*</b> Reset Functions	15-42 Voltage	<b>16-6*</b> Inputs & Outputs	20-08 Feedback 3 Source Unit
<b>8-4*</b> Adv. Protocol Set.	14-20 Reset Mode	15-43 Software Version	16-60 Digital Input	20-12 Reference/Feedback Unit
8-45 Telegram Selection	14-21 Automatic Restart Time	15-44 Ordered Typecode String	16-61 Terminal 53 Switch Setting	20-20 Feedback Function
8-46 BTM Transaction Command	14-22 Operation Mode	15-45 Actual Typecode String	16-62 Analog Input 53	20-21 Setpoint 1
8-47 BTM Transaction Status	14-23 Typecode Setting	15-46 Frequency Converter Ordering No	16-63 Terminal 54 Switch Setting	20-22 Setpoint 2
<b>8-5*</b> Digital/Bus	14-25 Trip Delay at Torque Limit	15-48 LCP Id No	16-64 Analog Input 54	20-23 Setpoint 3
8-50 Coasting Select	14-26 Trip Delay at Inverter Fault	15-49 SW ID Control Card	16-65 Analog Output 42 [mA]	<b>20-3*</b> Feedback Adv. Conv
8-52 DC Brake Select	14-28 Production Settings	15-50 SW ID Power Card	16-66 Digital Output [bin]	20-30 Refrigerant
8-53 Start Select	14-29 Service Code	<b>15-51</b> Frequency Converter Serial Number	16-67 Pulse Input #29 [Hz]	20-31 User Defined Refrigerant A1
8-54 Reversing Select	<b>14-3*</b> Current Limit Ctrl.	15-53 Power Card Serial Number	16-68 Pulse Input #33 [Hz]	20-32 User Defined Refrigerant A2
8-55 Set-up Select	14-30 Current Lim Ctrl, Proportional Gain	<b>15-6*</b> Option Ident	16-69 Pulse Output #27 [Hz]	20-33 User Defined Refrigerant A3
8-56 Preset Reference Select	14-31 Current Lim Ctrl, Integration Time	15-60 Option Mounted	16-70 Pulse Output #29 [Hz]	<b>20-4*</b> Thermostat/Pressostat
<b>8-8*</b> FC Port Diagnostics	14-32 Current Lim Ctrl, Filter Time	15-61 Option SW Version	16-71 Relay Output [bin]	20-40 Thermostat/Pressostat Function
8-80 Bus Message Count	<b>14-4*</b> Energy Optimising	15-62 Option Ordering No	16-72 Counter A	20-41 Cut-out Value
8-81 Bus Error Count	14-40 VT Level	15-63 Option Serial No	16-73 Counter B	20-42 Cut-in Value
8-82 Slave Message Count	14-41 AEO Minimum Magnetisation	<b>15-8*</b> Operating Data II	16-76 Analog In X30/11	<b>20-7*</b> PID Autotuning
8-83 Slave Error Count	14-42 Minimum AEO Frequency	15-80 Fan Running Hours	16-77 Analog Out X30/8 [mA]	20-70 Closed Loop Type
<b>8-9*</b> Bus Jog / Feedback	14-43 Motor Cosphi	<b>15-9*</b> Parameter Info	<b>16-8*</b> Fieldbus & FC Port	20-71 PID Performance
8-94 Bus Feedback 1	<b>14-5*</b> Environment	15-92 Defined Parameters	16-80 Fieldbus CTW 1	20-72 PID Output Change
8-95 Bus Feedback 2	14-50 RFI Filter	15-93 Modified Parameters	16-82 Fieldbus REF 1	20-73 Minimum Feedback Level
8-96 Bus Feedback 3	14-52 Fan Control	15-99 Parameter Metadata	16-84 Comm. Option STW	20-74 Maximum Feedback Level
<b>11-*</b> LonWorks	14-53 Fan Monitor	<b>16-*</b> Data Readouts	16-85 FC Port CTW 1	20-79 PID Autotuning
<b>11-2*</b> LON Param. Access	14-55 Output Filter	<b>16-0*</b> General Status	16-86 FC Port REF 1	<b>20-8*</b> PID Basic Settings
11-21 Store Data Values	<b>14-6*</b> Auto Derate	16-00 Control Word	<b>16-9*</b> Diagnosis Readouts	20-81 PID Normal/ Inverse Control
<b>11-9*</b> AK LonWorks	14-60 Function at Over Temperature	16-01 Reference [Unit]	16-90 Alarm Word	20-82 PID Start Speed [RPM]
11-90 VLT Network Address	14-61 Function at Inverter Overload	16-02 Reference [%]	16-91 Alarm Word 2	20-83 PID Start Speed [Hz]
11-91 AK Service Pin	14-62 Inv. Overload Derate Current	16-03 Status Word	16-92 Warning Word	20-84 On Reference Bandwidth
11-98 Alarm Text	<b>15-0*</b> Drive Information	16-05 Main Actual Value [%]	16-93 Warning Word 2	<b>20-9*</b> PID Controller
11-99 Alarm Status	<b>15-0*</b> Operating Data	16-09 Custom Readout	16-94 Ext. Status Word	20-91 PID Anti Windup
<b>13-*</b> Smart Logic	15-00 Operating hours	<b>16-1*</b> Motor Status	16-95 Ext. Status Word 2	20-93 PID Proportional Gain
<b>13-0*</b> SLC Settings	15-01 Running Hours	16-10 Power [kW]	16-96 Maintenance Word	20-94 PID Integral Time
13-00 SL Controller Mode	15-02 kWh Counter	16-11 Power [hp]	<b>18-*</b> Info & Readouts	20-95 PID Differentiation Time
13-01 Start Event	15-03 Power Up's	16-12 Motor Voltage	<b>18-0*</b> Maintenance Log	20-96 PID Diff. Gain Limit
13-02 Stop Event	15-04 Over Temp's	16-13 Frequency	18-00 Maintenance Log: Item	21-0* Ext. Closed Loop
13-03 Reset SLC	15-05 Over Volt's	16-14 Motor current	18-01 Maintenance Log: Action	21-0* Ext. CL Autotuning
<b>13-1*</b> Comparators	15-06 Reset kWh Counter	16-15 Frequency [%]	18-02 Maintenance Log: Time	21-00 Closed Loop Type
13-10 Comparator Operand	15-07 Reset Running Hours Counter	16-16 Torque [Nm]	18-03 Maintenance Log: Date and Time	21-01 PID Performance
13-11 Comparator Operator	<b>15-1*</b> Data Log Settings	16-17 Speed [RPM]	<b>18-1*</b> Fire Mode Log	
13-12 Comparator Value	15-10 Logging Source	16-18 Motor Thermal		

21-02	PID Output Change	22-23	No-Flow Function	23-13	Maintenance Time Interval	25-86	Reset Relay Counters	28-71	Day/Night Bus Indicator
21-03	Minimum Feedback Level	22-24	No-Flow Delay	23-14	Maintenance Date and Time	25-87	Inverse Interlock	28-72	Enable Day/Night Via Bus
21-04	Maximum Feedback Level	22-26	Dry Pump Function	23-15	<b>Maintenance Reset</b>	25-88	Pack capacity [%]	28-73	Night Setback
21-09	PID Autotuning	22-27	Dry Pump Delay	23-16	Maintenance Text	25-90	Compressor Interlock	28-74	Night Speed Drop [RPM]
21-1*	Ext. CL 1 Ref./Fb.	22-3*	<b>No-Flow Power Tuning</b>	23-5*	<b>Energy Log</b>	25-91	Manual Alternation	28-76	Night Speed Drop [Hz]
21-10	Ext. 1 Ref./Feedback Unit	22-30	No-Flow Power	23-50	Energy Log Resolution	26-0*	<b>Analog I/O Mode</b>	28-8*	<b>P0 Optimization</b>
21-11	Ext. 1 Minimum Reference	22-31	Power Correction Factor	23-51	Period Start	26-00	Terminal X42/1 Mode	28-82	P0
21-12	Ext. 1 Maximum Reference	22-32	Low Speed [RPM]	23-53	Energy Log	26-01	Terminal X42/1 Mode	28-83	P0 Setpoint
21-13	Ext. 1 Reference Source	22-33	Low Speed [Hz]	23-54	Reset Energy Log	26-02	Terminal X42/5 Mode	28-84	P0 Reference
21-14	Ext. 1 Feedback Source	22-34	Low Speed Power [kW]	23-6*	<b>Trending</b>	26-1*	<b>Analog Input X42/1</b>	28-85	P0 Minimum Reference
21-15	Ext. 1 Setpoint	22-35	Low Speed Power [HP]	23-60	Trend Variable	26-10	Terminal X42/1 Low Voltage	28-86	P0 Maximum Reference
21-17	Ext. 1 Reference [Unit]	22-36	High Speed [RPM]	23-61	Continuous Bin Data	26-11	Terminal X42/1 High Voltage	28-87	Most Loaded Controller
21-18	Ext. 1 Feedback [Unit]	22-37	High Speed [Hz]	23-62	Timed Bin Data	26-14	Term. X42/1 Low Ref./Feedb. Value	28-9*	<b>Injection Control</b>
21-19	Ext. 1 Output [%]	22-38	High Speed Power [kW]	23-63	Timed Bin Data	26-15	Term. X42/1 High Ref./Feedb. Value	28-90	Injection On
21-2*	Ext. CL 1 PID	22-39	High Speed Power [HP]	23-64	Timed Period Start	26-16	Term. X42/1 Filter Time Constant	28-91	Delayed Compressor Start
21-20	Ext. 1 Normal/Inverse Control	22-4*	<b>Sleep Mode</b>	23-65	Timed Period Stop	26-17	Term. X42/1 Live Zero		
21-21	Ext. 1 Proportional Gain	22-40	Minimum Run Time	23-66	Reset Continuous Bin Data	26-2*	<b>Analog Input X42/3</b>		
21-22	Ext. 1 Integral Time	22-41	Minimum Sleep Time	23-67	Reset Timed Bin Data	26-20	Terminal X42/3 Low Voltage		
21-23	Ext. 1 Differentiation Time	22-42	Wake-up Speed [RPM]	23-80	Power Reference Factor	26-21	Terminal X42/3 High Voltage		
21-24	Ext. 1 Dif. Gain Limit	22-43	Wake-up Speed [Hz]	23-81	Energy Cost	26-24	Term. X42/3 Low Ref./Feedb. Value		
21-3*	Ext. CL 2 Ref./Fb.	22-44	Wake-up Ref./FB Difference	23-82	Investment	26-25	Term. X42/3 High Ref./Feedb. Value		
21-30	Ext. 2 Ref./Feedback Unit	22-45	Setpoint Boost	23-83	Energy Savings	26-26	Term. X42/3 Filter Time Constant		
21-31	Ext. 2 Minimum Reference	22-46	Maximum Boost Time	23-84	Cost Savings	26-27	Term. X42/3 Live Zero		
21-32	Ext. 2 Maximum Reference	22-5*	<b>End of Curve</b>	25-0*	<b>System Settings</b>	26-3*	<b>Analog Input X42/5</b>		
21-33	Ext. 2 Reference Source	22-50	End of Curve Function	25-00	Pack Controller	26-30	Terminal X42/5 Low Voltage		
21-34	Ext. 2 Feedback Source	22-51	End of Curve Delay	25-04	Compressor Cycling	26-31	Terminal X42/5 High Voltage		
21-35	Ext. 2 Setpoint	22-52	Broken Belt Detection	25-06	Number of Compressors	26-34	Term. X42/5 Low Ref./Feedb. Value		
21-37	Ext. 2 Reference [Unit]	22-53	Broken Belt Function	25-20	<b>Zone Settings</b>	26-35	Term. X42/5 High Ref./Feedb. Value		
21-38	Ext. 2 Feedback [Unit]	22-54	Broken Belt Torque	25-21	Neutral Zone [unit]	26-36	Term. X42/5 Filter Time Constant		
21-39	Ext. 2 Output [%]	22-55	Short Cycle Protection	25-22	- Zone [unit]	26-37	Term. X42/5 Live Zero		
21-4*	Ext. CL 2 PID	22-56	Short Cycle Protection	25-23	Fixed Speed neutral Zone [unit]	26-4*	<b>Analog Out X42/7</b>		
21-40	Ext. 2 Normal/Inverse Control	22-57	Short Cycle Protection	25-24	Zone Delay	26-41	Terminal X42/7 Min. Scale		
21-41	Ext. 2 Proportional Gain	22-76	Interval between Starts	25-25	- Zone Delay	26-42	Terminal X42/7 Max. Scale		
21-42	Ext. 2 Integral Time	22-77	Minimum Run Time	25-26	++ Zone Delay	26-43	Terminal X42/7 Bus Control		
21-43	Ext. 2 Differentiation Time	22-78	Minimum Run Time Override	25-27	-- Zone Delay	26-44	Terminal X42/7 Timeout Preset		
21-44	Ext. 2 Dif. Gain Limit	22-79	Minimum Run Time Override Value	25-3*	<b>Staging Functions</b>	26-5*	<b>Analog Out X42/9</b>		
21-5*	Ext. CL 3 Ref./Fb.	22-8*	<b>Flow Compensation</b>	25-30	Staging At No-Flow	26-50	Terminal X42/9 Output		
21-50	Ext. 3 Ref./Feedback Unit	22-80	Flow Compensation	25-31	Stage Function	26-51	Terminal X42/9 Min. Scale		
21-51	Ext. 3 Minimum Reference	22-81	Square-linear Curve Approximation	25-32	Stage Function Time	26-52	Terminal X42/9 Max. Scale		
21-52	Ext. 3 Maximum Reference	22-82	Work Point Calculation	25-33	Destage Function	26-53	Terminal X42/9 Bus Control		
21-53	Ext. 3 Reference Source	22-83	Speed at No-Flow [RPM]	25-34	Destage Function Time	26-54	Terminal X42/9 Timeout Preset		
21-54	Ext. 3 Feedback Source	22-84	Speed at No-Flow [Hz]	25-42	<b>Staging Settings</b>	26-6*	<b>Analog Out X42/11</b>		
21-55	Ext. 3 Setpoint	22-85	Speed at Design Point [RPM]	25-43	Staging Threshold	26-60	Terminal X42/11 Output		
21-57	Ext. 3 Reference [Unit]	22-86	Speed at Design Point [Hz]	25-44	Destaging Threshold	26-61	Terminal X42/11 Min. Scale		
21-58	Ext. 3 Feedback [Unit]	22-87	Pressure at No-Flow Speed	25-45	Staging Speed [RPM]	26-62	Terminal X42/11 Max. Scale		
21-59	Ext. 3 Output [%]	22-88	Pressure at Rated Speed	25-46	Staging Speed [Hz]	26-63	Terminal X42/11 Bus Control		
21-6*	Ext. CL 3 PID	22-89	Flow at Design Point	25-47	Destaging Speed [RPM]	26-64	Terminal X42/11 Timeout Preset		
21-60	Ext. 3 Normal/Inverse Control	22-90	Flow at Rated Speed	25-48*	<b>Status</b>	28-2*	<b>Compressor Functions</b>		
21-61	Ext. 3 Proportional Gain	23-0*	<b>Time-based Functions</b>	25-80	Pack Status	28-2*	<b>Discharge Temperature Monitor</b>		
21-62	Ext. 3 Integral Time	23-00	ON Time	25-81	Compressor Status	28-20	Temperature Source		
21-63	Ext. 3 Differentiation Time	23-01	ON Action	25-82	Lead Compressor	28-21	Temperature Unit		
21-64	Ext. 3 Dif. Gain Limit	23-02	OFF Time	25-83	Relay Status	28-22	Warning Level		
22-0*	<b>Miscellaneous</b>	23-03	OFF Action	25-84	Compressor ON Time	28-23	Warning Action		
22-00	External Interlock Delay	23-04	Occurrence	25-85	Relay ON Time	28-24	Emergency Level		
22-2*	<b>No-Flow Detection</b>	23-1*	<b>Maintenance</b>	25-86	Compressor ON Time	28-25	Discharge Temperature		
22-20	Low Power Auto Set-up	23-10	Maintenance Item			28-26	Day/Night Settings		
22-21	Low Power Detection	23-11	Maintenance Action			28-27			
22-22	Low Speed Detection	23-12	Maintenance Time Base			28-28			



## 5.6 Remote Programming with MCT 10 Set-up Software

Danfoss has a software program available for developing, storing, and transferring frequency converter programming. The MCT 10 Set-up Software allows the user to connect a PC to the frequency converter and perform live programming rather than using the LCP. Additionally, all frequency converter programming can be done off-line and simply downloaded to the frequency converter. Or the entire frequency converter profile can be loaded onto the PC for back up storage or analysis.

The USB connector or RS-485 terminal are available for connecting to the frequency converter.

## 6 Application Examples

### 6.1 Introduction

#### NOTICE

When the optional safe stop feature is used, a jumper wire may be required between terminal 12 (or 13) and terminal 37 for the frequency converter to operate when using factory default programming values.

The examples in this section are intended as a quick reference for common applications.

- Parameter settings are the regional default values unless otherwise indicated (selected in *0-03 Regional Settings*)
- Parameters associated with the terminals and their settings are shown next to the drawings
- Where switch settings for analog terminals A53 or A54 are required, these are also shown

### 6.2 Application Examples

FC		Parameters	
		Function	Setting
+24 V	12	130BB929.10	1-29 Automatic Motor Adaptation (AMA)
+24 V	13		
D IN	18		
D IN	19		5-12 Terminal 27 Digital Input
COM	20		
D IN	27		[1] Enable complete AMA
D IN	29		[2]* Coast inverse
D IN	32		* = Default Value
D IN	33		Notes/comments: Parameter group 1-2* must be set according to motor
D IN	37		
+10 V	50		
A IN	53		
A IN	54		
COM	55		
A OUT	42		
COM	39		

Table 6.1 AMA with T27 Connected

FC		Parameters	
		Function	Setting
+24 V	12	130BB930.10	1-29 Automatic Motor Adaptation (AMA)
+24 V	13		
D IN	18		
D IN	19		5-12 Terminal 27 Digital Input
COM	20		
D IN	27		[1] Enable complete AMA
D IN	29		[0] No operation
D IN	32		* = Default Value
D IN	33		Notes/comments: Parameter group 1-2* must be set according to motor
D IN	37		
+10 V	50		
A IN	53		
A IN	54		
COM	55		
A OUT	42		
COM	39		

Table 6.2 AMA without T27 Connected

FC		Parameters	
		Function	Setting
+24 V	12	130BB926.10	6-10 Terminal 53 Low Voltage
+24 V	13		
D IN	18		6-11 Terminal 53 High Voltage
D IN	19		
COM	20		6-14 Terminal 53 Low Ref./Feedb. Value
D IN	27		
D IN	29		6-15 Terminal 53 High Ref./Feedb. Value
D IN	32		
D IN	33		* = Default Value
D IN	37		Notes/comments:
+10 V	50		
A IN	53		
A IN	54		
COM	55		
A OUT	42		
COM	39		

Table 6.3 Analog Speed Reference (Voltage)

		Parameters	
FC		Function	Setting
+24 V	12		
+24 V	13		
D IN	18	6-12 Terminal 53	4 mA*
D IN	19	6-13 Terminal 53	20 mA*
COM	20	6-14 Terminal 53	0 Hz
D IN	27	6-15 Terminal 53	50 Hz
D IN	29		
D IN	32		
D IN	33		
D IN	37		
+10 V	50	* = Default Value	
A IN	53	Notes/comments:	
A IN	54		
COM	55		
A OUT	42		
COM	39		

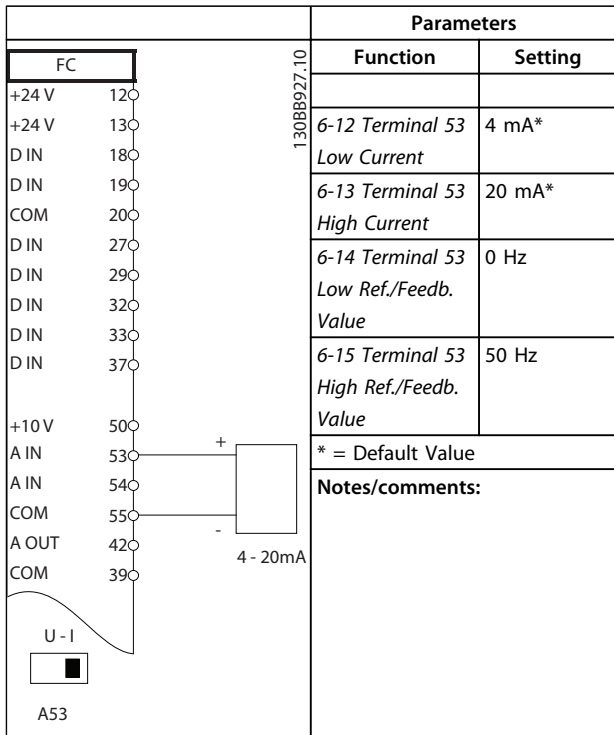

Table 6.4 Analog Speed Reference (Current)

		Parameters	
FC		Function	Setting
+24 V	12		
+24 V	13		
D IN	18	5-10 Terminal 18	[8] Start*
D IN	19	5-12 Terminal 27	[0] No operation
COM	20	5-19 Terminal 37	[1] Safe Stop Alarm
D IN	27		
D IN	29		
D IN	32		
D IN	33		
D IN	37		
+10 V	50	* = Default Value	
A IN	53	Notes/comments:	
A IN	54	If 5-12 Terminal 27 Digital Input is set to [0] No operation, a jumper wire to terminal 27 is not needed.	
COM	55		
A OUT	42		
COM	39		

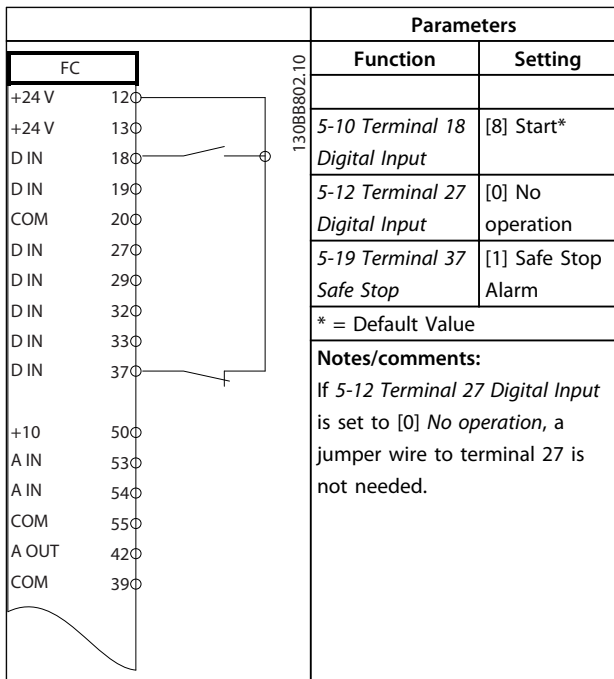

Table 6.5 Start/Stop Command with Safe Stop

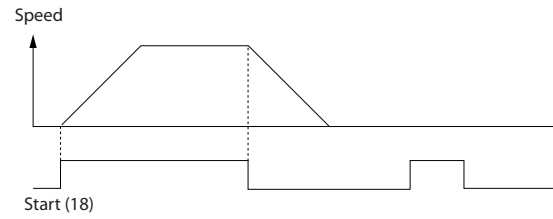

Illustration 6.1 Start/Stop Command with Safe Stop

		Parameters	
FC		Function	Setting
+24 V	12		
+24 V	13		
D IN	18	5-10 Terminal 18	[9] Latched Digital Input Start
D IN	19	5-12 Terminal 27	[6] Stop Inverse Digital Input
COM	20		
D IN	27		
D IN	29		
D IN	32		
D IN	33		
D IN	37		
+10 V	50	* = Default Value	
A IN	53	Notes/comments:	
A IN	54	If 5-12 Terminal 27 Digital Input is set to [0] No operation, a jumper wire to terminal 27 is not needed.	
COM	55		
A OUT	42		
COM	39		

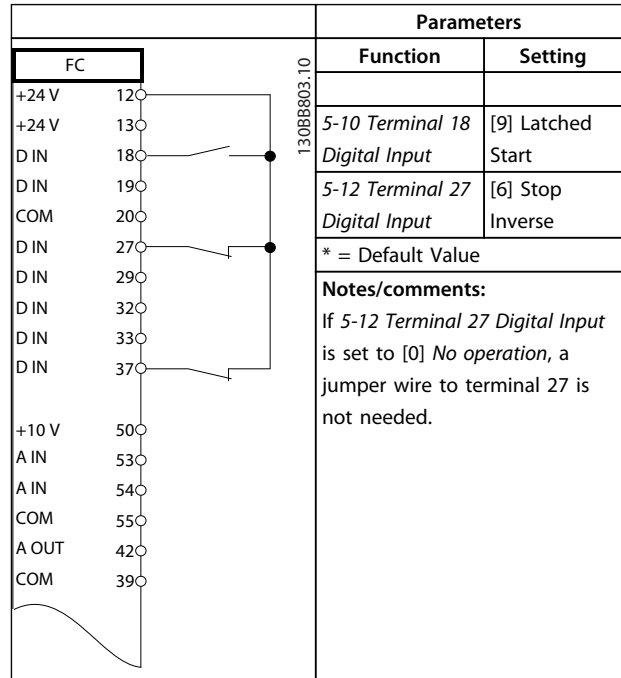

Table 6.6 Pulse Start/Stop

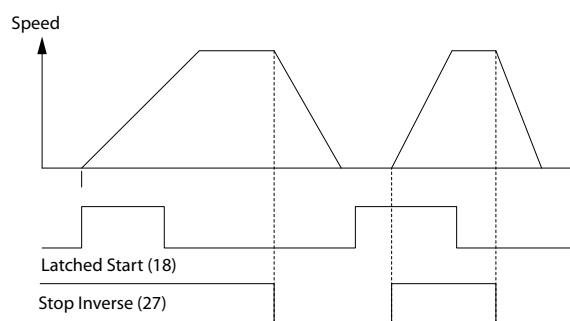

Illustration 6.2 Latched Start/Stop Inverse

		Parameters	
		Function	Setting
		5-10 Terminal 18 <i>Digital Input</i>	[8] Start
		5-11 Terminal 19 <i>Digital Input</i>	[10] Reversing*
		5-12 Terminal 27 <i>Digital Input</i>	[0] No operation
		5-14 Terminal 32 <i>Digital Input</i>	[16] Preset ref bit 0
		5-15 Terminal 33 <i>Digital Input</i>	[17] Preset ref bit 1
		3-10 Preset <i>Reference</i>	
		Preset ref. 0	25%
		Preset ref. 1	50%
		Preset ref. 2	75%
		Preset ref. 3	100%
		* = Default Value	
		Notes/comments:	

Table 6.7 Start/Stop with Reversing and 4 Preset Speeds

		Parameters	
		Function	Setting
		5-11 Terminal 19 <i>Digital Input</i>	[1] Reset
		* = Default Value	
		Notes/comments:	

Table 6.8 External Alarm Reset

		Parameters	
		Function	Setting
		6-10 Terminal 53 <i>Low Voltage</i>	0.07 V*
		6-11 Terminal 53 <i>High Voltage</i>	10 V*
		6-14 Terminal 53 <i>Low Ref./Feedb. Value</i>	0 Hz
		6-15 Terminal 53 <i>High Ref./Feedb. Value</i>	1500 Hz
		* = Default Value	
		Notes/comments:	

Table 6.9 Speed Reference (using a Manual Potentiometer)

		Parameters	
		Function	Setting
		5-10 Terminal 18 <i>Digital Input</i>	[8] Start*
		5-12 Terminal 27 <i>Digital Input</i>	[19] Freeze Reference
		5-13 Terminal 29 <i>Digital Input</i>	[21] Speed Up
		5-14 Terminal 32 <i>Digital Input</i>	[22] Speed Down
		* = Default Value	
		Notes/comments:	

Table 6.10 Speed Up/Down

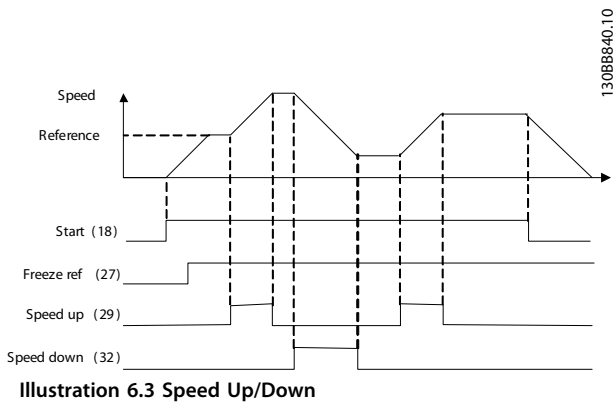

Illustration 6.3 Speed Up/Down

		Parameters	
FC		Function	Setting
+24 V	12		
+24 V	13		
D IN	18	8-30 Protocol	FC*
D IN	19	8-31 Address	1*
COM	20	8-32 Baud Rate	9600*
D IN	27	* = Default Value	
D IN	29	<b>Notes/comments:</b>	
D IN	32	Select protocol, address and	
D IN	33	baud rate in the above	
D IN	37	mentioned parameters.	
+10 V	50		
A IN	53		
A IN	54		
COM	55		
A OUT	42		
COM	39		
R1	01-03		
R2	04-06		
	61-69	RS-485	

130BB685.10

Table 6.11 RS-485 Network Connection

## CAUTION

Thermistors must use reinforced or double insulation to meet PELV insulation requirements.

		Parameters	
VLT		Function	Setting
+24 V	12		
+24 V	13		
D IN	18	1-90 Motor Thermal Protection	[2] Thermistor trip
COM	20	1-93 Thermistor Source	[1] Analog input 53
D IN	27	* = Default Value	
D IN	29	<b>Notes/comments:</b>	
D IN	32	If only a warning is desired,	
D IN	33	1-90 Motor Thermal Protection	
D IN	37	should be set to [1] Thermistor	
		warning.	
+10 V	50		
A IN	53		
A IN	54		
COM	55		
A OUT	42		
COM	39		
		U - I	
		A53	

130BB686.12

Table 6.12 Motor Thermistor



## 7 Status Messages

### 7.1 Status Messages

When the frequency converter is in status mode, status messages are generated automatically from within the frequency converter and appear in the bottom line of the display (see *Illustration 7.1*.)

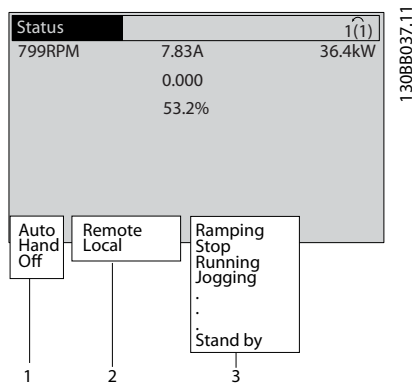

Illustration 7.1 Status Display

- The first part of the status line indicates where the stop/start command originates.
- The second part of the status line indicates where the speed control originates.
- The last part of the status line gives the present frequency converter status. These show the operational mode the frequency converter is in.

**NOTICE**

In auto/remote mode, the frequency converter requires external commands to execute functions.

### 7.2 Status Message Definitions

Table 7.1, Table 7.2 and Table 7.3 define the meaning of the status message display words.

Off	The frequency converter does not react to any control signal until [Auto On] or [Hand On] is pressed.
Auto On	The frequency converter is controlled from the control terminals and/or the serial communication.
Hand On	The frequency converter can be controlled by the navigation keys on the LCP. Stop commands, reset, reversing, DC brake, and other signals applied to the control terminals can override local control.

Table 7.1 Operation Mode

Remote	The speed reference is given from external signals, serial communication, or internal preset references.
Local	The frequency converter uses [Hand On] control or reference values from the LCP.

Table 7.2 Reference Site

AC Brake	AC Brake was selected in 2-10 Brake Function. The AC brake over-magnetizes the motor to achieve a controlled slow down.
AMA finish OK	Automatic motor adaptation (AMA) was carried out successfully.
AMA ready	AMA is ready to start. Press [Hand On] to start.
AMA running	AMA process is in progress.
Braking	The brake chopper is in operation. Generative energy is absorbed by the brake resistor.
Braking max.	The brake chopper is in operation. The power limit for the brake resistor defined in 2-12 Brake Power Limit (kW) is reached.
Coast	<ul style="list-style-type: none"> <li>Coast inverse was selected as a function for a digital input (parameter group 5-1* Digital Inputs). The corresponding terminal is not connected.</li> <li>Coast activated by serial communication</li> </ul>
Ctrl. Ramp-down	Control Ramp-down was selected in 14-10 Mains Failure. <ul style="list-style-type: none"> <li>The mains voltage is below the value set in 14-11 Mains Voltage at Mains Fault at mains fault</li> <li>The frequency converter ramps down the motor using a controlled ramp-down</li> </ul>

7

Current High	The frequency converter output current is above the limit set in 4-51 <i>Warning Current High</i> .
Current Low	The frequency converter output current is below the limit set in 4-52 <i>Warning Speed Low</i> .
DC Hold	DC hold is selected in 1-80 <i>Function at Stop</i> and a stop command is active. The motor is held by a DC current set in 2-00 <i>DC Hold/Preheat Current</i> .
DC Stop	The motor is held with a DC current (2-01 <i>DC Brake Current</i> ) for a specified time (2-02 <i>DC Braking Time</i> ). <ul style="list-style-type: none"> <li>DC Brake is activated in 2-03 <i>DC Brake Cut In Speed [RPM]</i> and a Stop command is active</li> <li>DC Brake (inverse) is selected as a function for a digital input (parameter group 5-1* <i>Digital Inputs</i>). The corresponding terminal is not active.</li> <li>The DC Brake is activated via serial communication</li> </ul>
Feedback high	The sum of all active feedbacks is above the feedback limit set in 4-57 <i>Warning Feedback High</i> .
Feedback low	The sum of all active feedbacks is below the feedback limit set in 4-56 <i>Warning Feedback Low</i> .
Freeze output	The remote reference is active, which holds the present speed. <ul style="list-style-type: none"> <li>Freeze output was selected as a function for a digital input (parameter group 5-1* <i>Digital Inputs</i>). The corresponding terminal is active. Speed control is only possible via the terminal functions speed up and speed down.</li> <li>Hold ramp is activated via serial communication</li> </ul>
Freeze output request	A freeze output command has been given, but the motor will remain stopped until a run permissive signal is received.
Freeze ref.	<i>Freeze Reference</i> was chosen as a function for a digital input (parameter group 5-1* <i>Digital Inputs</i> ). The corresponding terminal is active. The frequency converter saves the actual reference. Changing the reference is now only possible via terminal functions speed up and speed down.
Jog request	A jog command has been given, but the motor will be stopped until a run permissive signal is received via a digital input.

Jogging	The motor is running as programmed in 3-19 <i>Jog Speed [RPM]</i> . <ul style="list-style-type: none"> <li><i>Jog</i> was selected as function for a digital input (parameter group 5-1* <i>Digital Inputs</i>). The corresponding terminal (e.g. Terminal 29) is active.</li> <li>The Jog function is activated via the serial communication</li> <li>The Jog function was selected as a reaction for a monitoring function (e.g. No signal). The monitoring function is active</li> </ul>
Motor check	In 1-80 <i>Function at Stop, Motor Check</i> was selected. A stop command is active. To ensure that a motor is connected to the frequency converter, a permanent test current is applied to the motor.
OVC control	<i>Overvoltage</i> control was activated in 2-17 <i>Overvoltage Control</i> . The connected motor is supplying the frequency converter with generative energy. The overvoltage control adjusts the V/Hz ratio to run the motor in controlled mode and to prevent the frequency converter from tripping.
PowerUnit Off	(For frequency converters with an external 24 V power supply installed only). Mains supply to the frequency converter is removed, but the control card is supplied by the external 24 V.
Protection md	Protection mode is active. The unit has detected a critical status (an overcurrent or overvoltage). <ul style="list-style-type: none"> <li>To avoid tripping, switching frequency is reduced to 4 kHz</li> <li>If possible, protection mode ends after approximately 10 s</li> <li>Protection mode can be restricted in 14-26 <i>Trip Delay at Inverter Fault</i></li> </ul>
Ramping	The motor is accelerating/decelerating using the active Ramp Up/Down. The reference, a limit value or a standstill is not yet reached.
Ref. high	The sum of all active references is above the reference limit set in 4-55 <i>Warning Reference High</i> .
Ref. low	The sum of all active references is below the reference limit set in 4-54 <i>Warning Reference Low</i> .
Run on ref.	The frequency converter is running in the reference range. The feedback value matches the setpoint value.
Run request	A start command has been given, but the motor is stopped until a run permissive signal is received via digital input.
Running	The motor is driven by the frequency converter.



Speed high	Motor speed is above the value set in 4-53 <i>Warning Speed High</i> .
Speed low	Motor speed is below the value set in 4-52 <i>Warning Speed Low</i> .
Standby	In Auto On Auto mode, the frequency converter will start the motor with a start signal from a digital input or serial communication.
Start delay	In 1-71 <i>Start Delay</i> , a delay starting time was set. A start command is activated and the motor will start after the start delay time expires.
Start fwd/rev	Start forward and start reverse were selected as functions for two different digital inputs (parameter group 5-1* <i>Digital Inputs</i> ). The motor will start in forward or reverse depending on which corresponding terminal is activated.
Stop	The frequency converter has received a stop command from the LCP, digital input or serial communication.
Trip	An alarm occurred and the motor is stopped. Once the cause of the alarm is cleared, the frequency converter can be reset manually by pressing [Reset] or remotely by control terminals or serial communication.
Trip lock	An alarm occurred and the motor is stopped. Once the cause of the alarm is cleared, power must be cycled to the frequency converter. The frequency converter can then be reset manually by pressing [Reset] or remotely by control terminals or serial communication.

**Table 7.3 Operation Status**

## 8 Warnings and Alarms

### 8.1 System Monitoring

The frequency converter monitors the condition of its input power, output, and motor factors as well as other system performance indicators. A warning or alarm may not necessarily indicate a problem internal to the frequency converter itself. In many cases, it indicates failure conditions from input voltage, motor load or temperature, external signals, or other areas monitored by the frequency converter's internal logic. Be sure to investigate those areas exterior to the frequency converter as indicated in the alarm or warning.

### 8.2 Warning and Alarm Types

#### 8.2.1 Warnings

A warning is issued when an alarm condition is impending or when an abnormal operating condition is present and may result in the frequency converter issuing an alarm. A warning clears by itself when the abnormal condition is removed.

#### 8.2.2 Alarm Trip

An alarm is issued when the frequency converter is tripped, that is, the frequency converter suspends operation to prevent frequency converter or system damage. The motor will coast to a stop. The frequency converter logic will continue to operate and monitor the frequency converter status. After the fault condition is remedied, the frequency converter can be reset. It will then be ready to start operation again.

A trip can be reset in any of 4 ways:

- Press [Reset]
- Digital reset input command
- Serial communication reset input command
- Auto reset

### 8.2.3 Alarm Trip-lock

An alarm that causes the frequency converter to trip-lock requires that input power be cycled. The motor will coast to a stop. The frequency converter logic will continue to operate and monitor the frequency converter status. Remove input power to the frequency converter and correct the cause of the fault, then restore power. This action puts the frequency converter into a trip condition as described above and may be reset in any of those 4 ways.

### 8.3 Warning and Alarm Displays

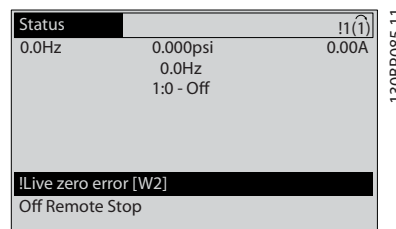

Illustration 8.1

An alarm or trip-lock alarm will flash on the display along with the alarm number.

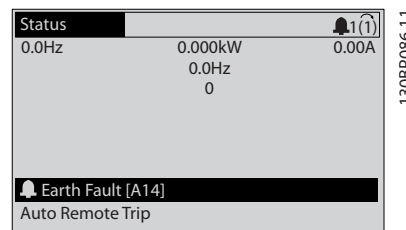

Illustration 8.2

In addition to the text and alarm code on the frequency converter display, there are three status indicator lights.

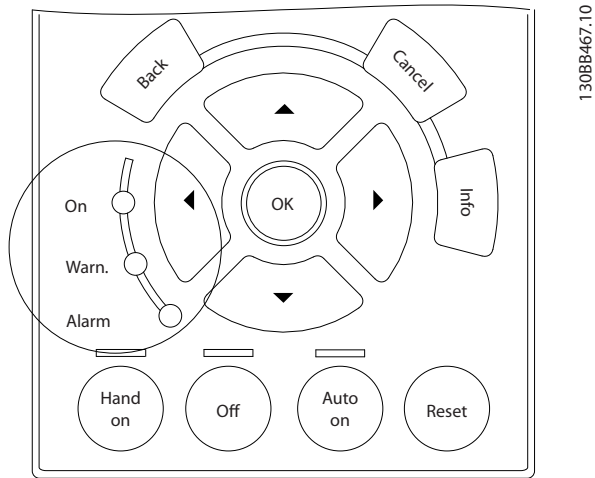

Illustration 8.3

	Warn. LED	Alarm LED
Warning	ON	OFF
Alarm	OFF	ON (Flashing)
Trip-Lock	ON	ON (Flashing)

Table 8.1

## 8.4 Warning and Alarm Definitions

Table 8.2 defines whether a warning is issued before an alarm, and whether the alarm trips the unit or trip locks the unit.

No.	Description	Warning	Alarm/Trip	Alarm/Trip lock	Parameter reference
1	10 Volts low	X			
2	Live zero error	(X)	(X)		6-01 Live Zero Timeout Function
4	Mains phase loss	(X)	(X)	(X)	14-12 Function at Mains Imbalance
5	DC link voltage high	X			
6	DC link voltage low	X			
7	DC over voltage	X	X		
8	DC under voltage	X	X		
9	Inverter overloaded	X	X		
10	Motor ETR over temperature	(X)	(X)		1-90 Motor Thermal Protection
11	Motor thermistor over temperature	(X)	(X)		1-90 Motor Thermal Protection
12	Torque limit	X	X		
13	Over Current	X	X	X	
14	Earth (ground) fault	X	X	X	
15	Hardware mismatch		X	X	
16	Short Circuit		X	X	
17	Control word timeout	(X)	(X)		8-04 Control Timeout Function
18	Start Failed				
23	Internal Fan Fault	X			
24	External Fan Fault	X			14-53 Fan Monitor
25	Brake resistor short-circuited	X			
26	Brake resistor power limit	(X)	(X)		2-13 Brake Power Monitoring
27	Brake chopper short-circuited	X	X		
28	Brake check	(X)	(X)		2-15 Brake Check
29	Drive over temperature	X	X	X	
30	Motor phase U missing	(X)	(X)	(X)	4-58 Missing Motor Phase Function
31	Motor phase V missing	(X)	(X)	(X)	4-58 Missing Motor Phase Function
32	Motor phase W missing	(X)	(X)	(X)	4-58 Missing Motor Phase Function
33	Inrush fault		X	X	
34	Fieldbus communication fault	X	X		
35	Out of frequency range	X	X		
36	Mains failure	X	X		
37	Phase Imbalance	X	X		
38	Internal fault		X	X	
39	Heatsink sensor		X	X	
40	Overload of Digital Output Terminal 27	(X)			5-00 Digital I/O Mode, 5-01 Terminal 27 Mode
41	Overload of Digital Output Terminal 29	(X)			5-00 Digital I/O Mode, 5-02 Terminal 29 Mode
42	Overload of Digital Output On X30/6	(X)			5-32 Term X30/6 Digi Out (MCB 101)
42	Overload of Digital Output On X30/7	(X)			5-33 Term X30/7 Digi Out (MCB 101)
46	Pwr. card supply		X	X	

No.	Description	Warnin g	Alarm/Trip	Alarm/Trip lock	Parameter reference
47	24 V supply low	X	X	X	
48	1.8 V supply low		X	X	
49	Speed limit	X	(X)		1-86 Trip Speed Low [RPM]
50	AMA calibration failed		X		
51	AMA check U <sub>nom</sub> and I <sub>nom</sub>		X		
52	AMA low I <sub>nom</sub>		X		
53	AMA motor too big		X		
54	AMA motor too small		X		
55	AMA Parameter out of range		X		
56	AMA interrupted by user		X		
57	AMA timeout		X		
58	AMA internal fault	X	X		
59	Current limit	X			
60	External Interlock	X			
62	Output Frequency at Maximum Limit	X			
64	Voltage Limit	X			
65	Control board overtemperature	X	X	X	
66	Heat sink Temperature Low	X			
67	Option Configuration has Changed		X		
70	Illegal FC configuration			X	
71	PTC 1 Safe Stop	X	X <sup>1)</sup>		
72	Dangerous Failure			X <sup>1)</sup>	
73	Safe Stop Auto Restart				
76	Power Unit Setup	X			
77	Reduced Power Mode				
79	Illegal PS config		X	X	
80	Drive Initialized to Default Value		X		
91	Analog input 54 wrong settings			X	
92	NoFlow	X	X		22-2* No-Flow Detection
93	Dry Pump	X	X		22-2* No-Flow Detection
94	End of Curve	X	X		22-5* End of Curve
95	Broken Belt	X	X		22-6* Broken Belt Detection
96	Start Delayed	X			22-7* Short Cycle Protection
97	Stop Delayed	X			22-7* Short Cycle Protection
98	Clock Fault	X			0-7* Clock Settings
104	Mixing Fan Fault	X	X		14-53 Fan Monitor
203	Missing Motor				
204	Locked Rotor				
243	Brake IGBT	X	X		
244	Heatsink temp	X	X	X	
245	Heatsink sensor		X	X	
246	Pwr.card supply		X	X	
247	Pwr.card temp		X	X	
248	Illegal PS config		X	X	
250	New spare parts			X	
251	New Type Code		X	X	

**Table 8.2 Alarm/Warning Code List**
*(X) Dependent on parameter*
*<sup>1)</sup> Cannot be Auto reset via 14-20 Reset Mode*

## 8.5 Fault Messages

The warning/alarm information below defines each warning/alarm condition, provides the probable cause for the condition, and details a remedy or troubleshooting procedure.

### WARNING 1, 10 Volts low

The control card voltage is below 10 V from terminal 50. Remove some of the load from terminal 50, as the 10 V supply is overloaded. Max. 15 mA or minimum 590 Ω.

This condition can be caused by a short in a connected potentiometer or improper wiring of the potentiometer.

#### Troubleshooting

Remove the wiring from terminal 50. If the warning clears, the problem is with the customer wiring. If the warning does not clear, replace the control card.

### WARNING/ALARM 2, Live zero error

This warning or alarm only appears if programmed by the user in *6-01 Live Zero Timeout Function*. The signal on one of the analog inputs is less than 50% of the minimum value programmed for that input. Broken wiring or faulty device sending the signal can cause this condition.

#### Troubleshooting

- Check connections on all the analog input terminals. Control card terminals 53 and 54 for signals, terminal 55 common. MCB 101 terminals 11 and 12 for signals, terminal 10 common. MCB 109 terminals 1, 3, 5 for signals, terminals 2, 4, 6 common).
- Check that the frequency converter programming and switch settings match the analog signal type
- Perform Input Terminal Signal Test

### WARNING/ALARM 3, No motor

No motor has been connected to the output of the frequency converter.

### WARNING/ALARM 4, Mains phase loss

A phase is missing on the supply side, or the mains voltage imbalance is too high. This message also appears for a fault in the input rectifier on the frequency converter. Options are programmed at *14-12 Function at Mains Imbalance*.

#### Troubleshooting

Check the supply voltage and supply currents to the frequency converter.

### WARNING 5, DC link voltage high

The intermediate circuit voltage (DC) is higher than the high voltage warning limit. The limit is dependent on the frequency converter voltage rating. The unit is still active.

### WARNING 6, DC link voltage low

The intermediate circuit voltage (DC) is lower than the low voltage warning limit. The limit is dependent on the frequency converter voltage rating. The unit is still active.

### WARNING/ALARM 7, DC overvoltage

If the intermediate circuit voltage exceeds the limit, the frequency converter trips after a time.

#### Troubleshooting

- Connect a brake resistor
- Extend the ramp time
- Change the ramp type
- Activate the functions in *2-10 Brake Function*
- Increase *14-26 Trip Delay at Inverter Fault*

### WARNING/ALARM 8, DC under voltage

If the intermediate circuit voltage (DC link) drops below the under voltage limit, the frequency converter checks if a 24 V DC backup supply is connected. If no 24 V DC backup supply is connected, the frequency converter trips after a fixed time delay. The time delay varies with unit size.

#### Troubleshooting

- Check that the supply voltage matches the frequency converter voltage
- Perform input voltage test
- Perform soft charge circuit test

### WARNING/ALARM 9, Inverter overload

The frequency converter is about to cut out because of an overload (too high current for too long). The counter for electronic, thermal inverter protection gives a warning at 98% and trips at 100%, while giving an alarm. The frequency converter *cannot* be reset until the counter is below 90%.

The fault is that the frequency converter is overloaded by more than 100% for too long.

#### Troubleshooting

- Compare the output current shown on the LCP with the frequency converter rated current
- Compare the output current shown on the LCP with measured motor current
- Display the Thermal Drive Load on the LCP and monitor the value. When running above the frequency converter continuous current rating, the counter should increase. When running below the frequency converter continuous current rating, the counter should decrease.

### WARNING/ALARM 10, Motor overload temperature

According to the electronic thermal protection (ETR), the motor is too hot. Select whether the frequency converter gives a warning or an alarm when the counter reaches 100% in *1-90 Motor Thermal Protection*. The fault occurs when the motor is overloaded by more than 100% for too long.

**Troubleshooting**

- Check for motor overheating
- Check if the motor is mechanically overloaded
- Check that the motor current set in *1-24 Motor Current* is correct
- Ensure that Motor data in parameters 1-20 to 1-25 are set correctly
- If an external fan is in use, check in *1-91 Motor External Fan* that it is selected
- Running AMA in *1-29 Automatic Motor Adaptation (AMA)* tunes the frequency converter to the motor more accurately and reduces thermal loading

**WARNING/ALARM 11, Motor thermistor over temp**

The thermistor might be disconnected. Select whether the frequency converter gives a warning or an alarm in *1-90 Motor Thermal Protection*.

**Troubleshooting**

- Check for motor overheating
- Check if the motor is mechanically overloaded
- Check that the thermistor is connected correctly between either terminal 53 or 54 (analog voltage input) and terminal 50 (+10 V supply) and that the terminal switch for 53 or 54 is set for voltage. Check *1-93 Thermistor Source* selects terminal 53 or 54.
- When using digital inputs 18 or 19, check that the thermistor is connected correctly between either terminal 18 or 19 (digital input PNP only) and terminal 50
- If using a thermal switch or thermistor, check that the programming if *1-93 Thermistor Resource* matches sensor wiring

**WARNING/ALARM 12, Torque limit**

The torque has exceeded the value in *4-16 Torque Limit Motor Mode* or the value in *4-17 Torque Limit Generator Mode*. *14-25 Trip Delay at Torque Limit* can change this from a warning only condition to a warning followed by an alarm.

**Troubleshooting**

- If the motor torque limit is exceeded during ramp up, extend the ramp up time
- If the generator torque limit is exceeded during ramp down, extend the ramp down time
- If torque limit occurs while running, possibly increase the torque limit. Be sure the system can operate safely at a higher torque.
- Check the application for excessive current draw on the motor

**WARNING/ALARM 13, Over current**

The inverter peak current limit (approximately 200% of the rated current) is exceeded. The warning lasts about 1.5 secs., then the frequency converter trips and issues an alarm. This fault may be caused by shock loading or fast acceleration with high inertia loads. If extended mechanical brake control is selected, trip can be reset externally.

**Troubleshooting**

- Remove power and check if the motor shaft can be turned
- Check that the motor size matches the frequency converter
- Check parameters 1-20 to 1-25 for correct motor data

**ALARM 14, Earth (ground) fault**

There is current from the output phases to earth, either in the cable between the frequency converter and the motor or in the motor itself.

**Troubleshooting:**

- Remove power to the frequency converter and repair the earth fault
- Check for earth faults in the motor by measuring the resistance to ground of the motor leads and the motor with a megohmmeter
- Perform current sensor test

**ALARM 15, Hardware mismatch**

A fitted option is not operational with the present control board hardware or software.

Record the value of the following parameters and contact the Danfoss supplier:

- *15-40 FC Type*
- *15-41 Power Section*
- *15-42 Voltage*
- *15-43 Software Version*
- *15-45 Actual Typecode String*
- *15-49 SW ID Control Card*
- *15-50 SW ID Power Card*
- *15-60 Option Mounted*
- *15-61 Option SW Version* (for each option slot)

**ALARM 16, Short circuit**

There is short-circuiting in the motor or motor wiring.

Remove power to the frequency converter and repair the short circuit.

**WARNING/ALARM 17, Control word timeout**

There is no communication to the frequency converter. The warning will only be active when *8-04 Control Word Timeout Function* is NOT set to OFF.

If *8-04 Control Word Timeout Function* is set to *Stop and Trip*, a warning appears and the frequency converter ramps down until it trips then displays an alarm.

**Troubleshooting:**

- Check connections on the serial communication cable
- Increase *8-03 Control Word Timeout Time*
- Check the operation of the communication equipment
- Verify a proper installation based on EMC requirements

**WARNING 23, Internal fan fault**

The fan warning function is an extra protective function that checks if the fan is running/mounted. The fan warning can be disabled in *14-53 Fan Monitor ([0] Disabled)*.

**Troubleshooting**

- Check fan resistance
- Check soft charge fuses

**WARNING 24, External fan fault**

The fan warning function is an extra protective function that checks if the fan is running/mounted. The fan warning can be disabled in *14-53 Fan Monitor ([0] Disabled)*.

**Troubleshooting**

- Check fan resistance.
- Check soft charge fuses.

**WARNING 25, Brake resistor short circuit**

The brake resistor is monitored during operation. If a short circuit occurs, the brake function is disabled and the warning appears. The frequency converter is still operational but without the brake function. Remove power to the frequency converter and replace the brake resistor (see *2-15 Brake Check*).

**WARNING/ALARM 26, Brake resistor power limit**

The power transmitted to the brake resistor is calculated as a mean value over the last 120 s of run time. The calculation is based on the intermediate circuit voltage and the brake resistance value set in *2-16 AC brake Max. Current*. The warning is active when the dissipated braking is higher than 90% of the brake resistance power. If *[2] Trip* is selected in *2-13 Brake Power Monitoring*, the frequency converter will trip when the dissipated braking power reaches 100%.

**⚠ WARNING**

There is a risk of substantial power being transmitted to the brake resistor if the brake transistor is short-circuited.

**WARNING/ALARM 27, Brake chopper fault**

The brake transistor is monitored during operation and if a short circuit occurs, the brake function is disabled and a warning is issued. The frequency converter is still operational but, since the brake transistor has short-circuited, substantial power is transmitted to the brake resistor, even if it is inactive.

Remove power to the frequency converter and remove the brake resistor.

This alarm/warning could also occur should the brake resistor overheat. Terminals 104 and 106 are available as brake resistors Klixon inputs.

**WARNING/ALARM 28, Brake check failed**

The brake resistor is not connected or not working. Check *2-15 Brake Check*.

**ALARM 29, Heatsink temp**

The maximum temperature of the heatsink has been exceeded. The temperature fault will not reset until the temperature falls below a defined heatsink temperature. The trip and reset points are different based on the frequency converter power size.

**Troubleshooting**

Check for the following conditions

- Ambient temperature too high
- Motor cable too long
- Incorrect airflow clearance above and below the frequency converter
- Blocked airflow around the frequency converter
- Damaged heatsink fan
- Dirty heatsink

This alarm is based on the temperature measured by the heatsink sensor mounted inside the IGBT modules.

**Troubleshooting**

- Check fan resistance
- Check soft charge fuses
- IGBT thermal sensor

**ALARM 30, Motor phase U missing**

Motor phase U between the frequency converter and the motor is missing.

Remove power from the frequency converter and check motor phase U.

**ALARM 31, Motor phase V missing**

Motor phase V between the frequency converter and the motor is missing.

Remove power from the frequency converter and check motor phase V.

**ALARM 32, Motor phase W missing**

Motor phase W between the frequency converter and the motor is missing.

Remove power from the frequency converter and check motor phase W.

**ALARM 33, Inrush fault**

Too many power-ups have occurred within a short time period. Let the unit cool to operating temperature.

**WARNING/ALARM 34, Fieldbus communication fault**

The fieldbus on the communication option card is not working.



**WARNING/ALARM 36, Mains failure**

This warning/alarm is only active if the supply voltage to the frequency converter is lost and *14-10 Mains Failure* is NOT set to [0] *No Function*. Check the fuses to the frequency converter and mains power supply to the unit.

**ALARM 38, Internal fault**

When an internal fault occurs, a code number defined in the table below is displayed.

**Troubleshooting**

- Cycle power
- Check that the option is properly installed
- Check for loose or missing wiring

It may be necessary to contact the Danfoss supplier or service department. Note the code number for further troubleshooting directions.

No.	Text
0	Serial port cannot be initialised. Contact the Danfoss supplier or Danfoss Service Department.
256-258	Power EEPROM data is defective or too old.
512	Control board EEPROM data is defective or too old.
513	Communication time out reading EEPROM data
514	Communication time out reading EEPROM data
515	Application oriented control cannot recognize the EEPROM data.
516	Cannot write to the EEPROM because a write command is on progress.
517	Write command is under time out
518	Failure in the EEPROM
519	Missing or invalid barcode data in EEPROM
783	Parameter value outside of min/max limits
1024-1279	A centelegram that has to be sent can not be sent.
1281	Digital signal processor flash timeout
1282	Power micro software version mismatch
1283	Power EEPROM data version mismatch
1284	Cannot read digital signal processor software version
1299	Option SW in slot A is too old
1300	Option SW in slot B is too old
1301	Option SW in slot C0 is too old
1302	Option SW in slot C1 is too old
1315	Option SW in slot A is not supported (not allowed)
1316	Option SW in slot B is not supported (not allowed)
1317	Option SW in slot C0 is not supported (not allowed)
1318	Option SW in slot C1 is not supported (not allowed)
1379	Option A did not respond when calculating platform version
1380	Option B did not respond when calculating platform version

No.	Text
1381	Option C0 did not respond when calculating platform version.
1382	Option C1 did not respond when calculating platform version.
1536	An exception in the application oriented control is registered. Debug information written in LCP
1792	DSP watchdog is active. Debugging of power part data, motor oriented control data not transferred correctly.
2049	Power data restarted
2064-2072	H081x: option in slot x has restarted
2080-2088	H082x: option in slot x has issued a powerup-wait
2096-2104	H983x: option in slot x has issued a legal powerup-wait
2304	Could not read any data from power EEPROM
2305	Missing SW version from power unit
2314	Missing power unit data from power unit
2315	Missing SW version from power unit
2316	Missint lo_statepage from power unit
2324	Power card configuration is determined to be incorrect at power up
2325	A power card has stopped communicating while main power is applied
2326	Power card configuration is determined to be incorrect after the delay for power cards to register.
2327	Too many power card locations have been registered as present.
2330	Power size information between the power cards does not match.
2561	No communication from DSP to ATACD
2562	No communication from ATACD to DSP (state running)
2816	Stack overflow control board module
2817	Scheduler slow tasks
2818	Fast tasks
2819	Parameter thread
2820	LCP stack overflow
2821	Serial port overflow
2822	USB port overflow
2836	cfListMempool too small
3072-5122	Parameter value is outside its limits
5123	Option in slot A: Hardware incompatible with control board hardware
5124	Option in slot B: Hardware incompatible with Control board hardware.
5125	Option in slot C0: Hardware incompatible with control board hardware.
5126	Option in slot C1: Hardware incompatible with control board hardware.
5376-6231	Out of memory

Table 8.3

**ALARM 39, Heatsink sensor**

No feedback from the heatsink temperature sensor.

The signal from the IGBT thermal sensor is not available on the power card. The problem could be on the power card, on the gate drive card, or the ribbon cable between the power card and gate drive card.

**WARNING 40, Overload of digital output terminal 27**

Check the load connected to terminal 27 or remove short-circuit connection. Check *5-00 Digital I/O Mode* and *5-01 Terminal 27 Mode*.

**WARNING 41, Overload of digital output terminal 29**

Check the load connected to terminal 29 or remove short-circuit connection. Check *5-00 Digital I/O Mode* and *5-02 Terminal 29 Mode*.

**WARNING 42, Overload of digital output on X30/6 or overload of digital output on X30/7**

For X30/6, check the load connected to X30/6 or remove the short-circuit connection. Check *5-32 Term X30/6 Digi Out (MCB 101)*.

For X30/7, check the load connected to X30/7 or remove the short-circuit connection. Check *5-33 Term X30/7 Digi Out (MCB 101)*.

**ALARM 46, Power card supply**

The supply on the power card is out of range.

There are three power supplies generated by the switch mode power supply (SMPS) on the power card: 24 V, 5 V,  $\pm 18$  V. When powered with 24 V DC with the MCB 107 option, only the 24 V and 5 V supplies are monitored. When powered with three phase mains voltage, all three supplies are monitored.

**WARNING 47, 24 V supply low**

The 24 V DC is measured on the control card. The external 24 V DC backup power supply may be overloaded, otherwise contact the Danfoss supplier.

**WARNING 48, 1.8 V supply low**

The 1.8 V DC supply used on the control card is outside of allowable limits. The power supply is measured on the control card. Check for a defective control card. If an option card is present, check for an overvoltage condition.

**WARNING 49, Speed limit**

When the speed is not within the specified range in *4-11 Motor Speed Low Limit [RPM]* and *4-13 Motor Speed High Limit [RPM]*, the frequency converter shows a warning. When the speed is below the specified limit in *1-86 Trip Speed Low [RPM]* (except when starting or stopping) the frequency converter will trip.

**ALARM 50, AMA calibration failed**

Contact the Danfoss supplier or Danfoss Service Department.

**ALARM 51, AMA check  $U_{nom}$  and  $I_{nom}$** 

The settings for motor voltage, motor current, and motor power are wrong. Check the settings in parameters 1-20 to 1-25.

**ALARM 52, AMA low  $I_{nom}$** 

The motor current is too low. Check the settings.

**ALARM 53, AMA motor too big**

The motor is too big for the AMA to operate.

**ALARM 54, AMA motor too small**

The motor is too small for the AMA to operate.

**ALARM 55, AMA Parameter out of range**

The parameter values of the motor are outside of the acceptable range. AMA will not run.

**ALARM 56, AMA interrupted by user**

The user has interrupted the AMA.

**ALARM 57, AMA internal fault**

Try to restart AMA again a number of times, until the AMA is carried out. Note that repeated runs may heat the motor to a level where the resistance  $R_s$  and  $R_r$  are increased. In most cases, however, this is not critical.

**ALARM 58, AMA internal fault**

Contact the Danfoss supplier.

**WARNING 59, Current limit**

The current is higher than the value in *4-18 Current Limit*. Ensure that Motor data in parameters 1-20 to 1-25 are set correctly. Possibly increase the current limit. Be sure that the system can operate safely at a higher limit.

**WARNING 60, External interlock**

External interlock has been activated. To resume normal operation, apply 24 V DC to the terminal programmed for external interlock and reset the frequency converter (via serial communication, digital I/O, or by pressing [Reset]).

**WARNING 62, Output frequency at maximum limit**

The output frequency is higher than the value set in *4-19 Max Output Frequency*.

**ALARM 64, Voltage Limit**

The load and speed combination demands a motor voltage higher than the actual DC link voltage.

**WARNING/ALARM 65, Control card over temperature**

The control card has reached its trip temperature of 75 °C.

**WARNING 66, Heatsink temperature low**

The frequency converter is too cold to operate. This warning is based on the temperature sensor in the IGBT module.

Increase the ambient temperature of the unit. Also, a trickle amount of current can be supplied to the frequency converter whenever the motor is stopped by setting *2-00 DC Hold/Preheat Current* at 5% and *1-80 Function at Stop*

**Troubleshooting**

The heatsink temperature measured as 0 °C could indicate that the temperature sensor is defective, causing the fan speed to increase to the maximum. If the sensor wire between the IGBT and the gate drive card is disconnected, this warning would result. Also, check the IGBT thermal sensor.

**ALARM 67, Option module configuration has changed**

One or more options have either been added or removed since the last power-down. Check that the configuration change is intentional and reset the unit.

**ALARM 68, Safe Stop activated**

Safe stop has been activated. To resume normal operation, apply 24 V DC to terminal 37, then send a reset signal (via Bus, Digital I/O, or by pressing [Reset]).

**ALARM 69, Power card temperature**

The temperature sensor on the power card is either too hot or too cold.

**Troubleshooting**

- Check the operation of the door fans
- Check that the filters for the door fans are not blocked
- Check that the gland plate is properly installed on IP21/IP54 (NEMA 1/12) frequency converters

**ALARM 70, Illegal FC configuration**

The control card and power card are incompatible. Contact the supplier with the type code of the unit from the nameplate and the part numbers of the cards to check compatibility.

**WARNING 73, Safe stop auto restart**

Safe stopped. With automatic restart enabled, the motor may start when the fault is cleared.

**WARNING 76, Power unit setup**

The required number of power units does not match the detected number of active power units.

**Troubleshooting:**

When replacing an F-frame module, this will occur if the power specific data in the module power card does not match the rest of the frequency converter. Confirm the spare part and its power card are the correct part number.

**WARNING 77, Reduced power mode**

This warning indicates that the frequency converter is operating in reduced power mode (i.e. less than the allowed number of inverter sections). This warning will be generated on power cycle when the frequency converter is set to run with fewer inverters and will remain on.

**ALARM 79, Illegal power section configuration**

The scaling card is the incorrect part number or not installed. Also MK102 connector on the power card could not be installed.

**ALARM 80, Drive initialised to default value**

Parameter settings are initialised to default settings after a manual reset. Reset the unit to clear the alarm.

**ALARM 81, CSIV corrupt**

CSIV file has syntax errors.

**ALARM 82, CSIV parameter error**

CSIV failed to init a parameter.

**ALARM 85, Dang fail PB**

Profibus/Profisafe Error.

**WARNING/ALARM 104, Mixing fan fault**

The fan monitor checks that the fan is spinning at drive power-up or whenever the mixing fan is turned on. If the fan is not operating, then the fault is annunciated. The mixing-fan fault can be configured as a warning or an alarm trip by *14-53 Fan Monitor*.

**Troubleshooting**

Cycle power to the frequency converter to determine if the warning/alarm returns.

**WARNING 250, New spare part**

A component in the frequency converter has been replaced. Reset the frequency converter for normal operation.

**WARNING 251, New typecode**

The power card or other components have been replaced and the typecode changed. Reset to remove the warning and resume normal operation.

## 9 Basic Troubleshooting

### 9.1 Start Up and Operation

Symptom	Possible cause	Test	Solution
Display dark/No function	Missing input power	See <i>Table 3.1</i>	Check the input power source
	Missing or open fuses or circuit breaker tripped	See open fuses and tripped circuit breaker in this table for possible causes	Follow the recommendations provided
	No power to the LCP	Check the LCP cable for proper connection or damage	Replace the faulty LCP or connection cable
	Shortcut on control voltage (terminal 12 or 50) or at control terminals	Check the 24 V control voltage supply for terminals 12/13 to 20-39 or 10 V supply for terminals 50 to 55	Wire the terminals properly
	Wrong LCP (LCP from VLT® 2800 or 5000/6000/8000/ FCD or FCM)		Use only LCP 101 (P/N 130B1124) or LCP 102 (P/N 130B1107)
	Wrong contrast setting		Press [Status] + [▲]/[▼] to adjust the contrast
	Display (LCP) is defective	Test using a different LCP	Replace the faulty LCP or connection cable
	Internal voltage supply fault or SMPS is defective		Contact supplier
Intermittent display	Overloaded power supply (SMPS) due to improper control wiring or a fault within the frequency converter	To rule out a problem in the control wiring, disconnect all control wiring by removing the terminal blocks.	If the display stays lit, then the problem is in the control wiring. Check the wiring for shorts or incorrect connections. If the display continues to cut out, follow the procedure for display dark.
Motor not running	Service switch open or missing motor connection	Check if the motor is connected and the connection is not interrupted (by a service switch or other device).	Connect the motor and check the service switch
	No mains power with 24 V DC option card	If the display is functioning but no output, check that mains power is applied to the frequency converter.	Apply mains power to run the unit
	LCP Stop	Check if [Off] has been pressed	Press [Auto On] or [Hand On] (depending on operation mode) to run the motor
	Missing start signal (Standby)	Check <i>5-10 Terminal 18 Digital Input</i> for correct setting for terminal 18 (use default setting)	Apply a valid start signal to start the motor
	Motor coast signal active (Coasting)	Check <i>5-12 Coast inv.</i> for correct setting for terminal 27 (use default setting)..	Apply 24 V on terminal 27 or program this terminal to <i>No operation</i>
	Wrong reference signal source	Check reference signal: Local, remote or bus reference? Preset reference active? Terminal connection correct? Scaling of terminals correct? Reference signal available?	Program correct settings. Check <i>3-13 Reference Site</i> . Set preset reference active in parameter group <i>3-1* References</i> . Check for correct wiring. Check scaling of terminals. Check reference signal.

Symptom	Possible cause	Test	Solution
Motor running in wrong direction	Motor rotation limit	Check that 4-10 <i>Motor Speed Direction</i> is programmed correctly.	Program correct settings
	Active reversing signal	Check if a reversing command is programmed for the terminal in parameter group 5-1* <i>Digital inputs</i> .	Deactivate reversing signal
	Wrong motor phase connection		See chapter 2.4.5 <i>Motor Rotation Check</i> in this manual
Motor is not reaching maximum speed	Frequency limits set wrong	Check output limits in 4-13 <i>Motor Speed High Limit [RPM]</i> , 4-14 <i>Motor Speed High Limit [Hz]</i> and 4-19 <i>Max Output Frequency</i> .	Program correct limits
	Reference input signal not scaled correctly	Check reference input signal scaling in 6-0* <i>Analog I/O Mode</i> and parameter group 3-1* <i>References</i> . Reference limits in parameter group 3-0* <i>Reference Limit</i> .	Program correct settings
Motor speed unstable	Possible incorrect parameter settings	Check the settings of all motor parameters, including all motor compensation settings. For closed loop operation, check PID settings.	Check settings in parameter group 1-6* <i>Analog I/O mode</i> . For closed loop operation, check settings in parameter group 20-0* <i>Feedback</i> .
Motor runs rough	Possible over-magnetization	Check for incorrect motor settings in all motor parameters	Check motor settings in parameter groups 1-2* <i>Motor Data</i> , 1-3* <i>Adv Motor Data</i> , and 1-5* <i>Load Indep. Setting</i> .
Motor will not brake	Possible incorrect settings in the brake parameters. Possible too short ramp down times	Check brake parameters. Check ramp time settings	Check parameter group 2-0* <i>DC Brake</i> and 3-0* <i>Reference Limits</i> .
Open power fuses or circuit breaker trip	Phase to phase short	Motor or panel has a short phase to phase. Check motor and panel phase for shorts	Eliminate any shorts detected
	Motor overload	Motor is overloaded for the application	Perform startup test and verify motor current is within specifications. If motor current is exceeding nameplate full load current, motor may run only with reduced load. Review the specifications for the application.
	Loose connections	Perform pre-startup check for loose connections	Tighten loose connections
Mains current imbalance greater than 3%	Problem with mains power (See <i>Alarm 4 Mains phase loss</i> description)	Rotate input power leads into the frequency converter one position: A to B, B to C, C to A.	If imbalanced leg follows the wire, it is a power problem. Check mains power supply.
	Problem with the frequency converter	Rotate input power leads into the frequency converter one position: A to B, B to C, C to A.	If imbalance leg stays on same input terminal, it is a problem with the unit. Contact the supplier.
Motor current imbalance greater than 3%	Problem with motor or motor wiring	Rotate output motor leads one position: U to V, V to W, W to U.	If imbalanced leg follows the wire, the problem is in the motor or motor wiring. Check motor and motor wiring.
	Problem with the frequency converters	Rotate output motor leads one position: U to V, V to W, W to U.	If imbalance leg stays on same output terminal, it is a problem with the unit. Contact the supplier.

Symptom	Possible cause	Test	Solution
Acoustic noise or vibration (e.g. a fan blade is making noise or vibrations at certain frequencies)	Resonances, e.g. in the motor/fan system	Bypass critical frequencies by using parameters in parameter group 4-6* <i>Speed Bypass</i>	Check if noise and/or vibration have been reduced to an acceptable limit
		Turn off over-modulation in 14-03 <i>Overmodulation</i>	
		Change switching pattern and frequency in parameter group 14-0* <i>Inverter Switching</i>	
		Increase Resonance Dampening in 1-64 <i>Resonance Dampening</i>	

Table 9.1 Troubleshooting

## 10 Specifications

### 10.1 Power-dependent Specifications

	N110	N132	N160	N200	N250	N315
<b>Normal Load*</b>	<b>NO</b>	<b>NO</b>	<b>NO</b>	<b>NO</b>	<b>NO</b>	<b>NO</b>
Typical Shaft output at 400 V [kW]	110	132	160	200	250	315
Typical Shaft output at 460 V [hp]	150	200	250	300	350	450
Typical Shaft output at 480 V [kW]	132	160	200	250	315	355
Enclosure IP21	D1h	D1h	D1h	D2h	D2h	D2h
Enclosure IP54	D1h	D1h	D1h	D2h	D2h	D2h
Enclosure IP20	D3h	D3h	D3h	D4h	D4h	D4h
<b>Output current</b>						
Continuous (at 400 V) [A]	212	260	315	395	480	588
Intermittent (60 s overload) (at 400 V)[A]	233	286	347	435	528	647
Continuous (at 460/480 V) [A]	190	240	302	361	443	535
Intermittent (60 s overload) (at 460/480 V) [kVA]	209	264	332	397	487	588
Continuous kVA (at 400 V) [kVA]	147	180	218	274	333	407
Continuous kVA (at 460 V) [kVA]	151	191	241	288	353	426
<b>Max. Input current</b>						
Continuous (at 400 V) [A]	204	251	304	381	463	567
Continuous (at 460/480 V) [A]	183	231	291	348	427	516
Max. cable size: mains, motor, brake and load share mm (AWG)	2 x95 (2x3/0)			2x185 (2x350)		
Max. external mains fuses [A]	315	350	400	550	630	800
Estimated power loss at 400 V [W]	2555	2949	3764	4109	5129	6663
Estimated power loss at 460 V [W]	2257	2719	3622	3561	4558	5703
Weight, enclosure IP21, IP54 kg (lbs.)	62 (135)			125 (275)		
Weight, enclosure IP20 kg (lbs.)	62 (135)			125 (275)		
Efficiency	0.98					
Output frequency	0-590 Hz					
*Normal overload=110% current for 60 s						

10

Table 10.1 Mains Supply 3x380-480 V AC

	N75K	N90K	N110	N132	N160	N200
<b>Normal Load*</b>	<b>NO</b>	<b>NO</b>	<b>NO</b>	<b>NO</b>	<b>NO</b>	<b>NO</b>
Typical Shaft output at 550 V [kW]	55	75	90	110	132	160
Typical Shaft output at 575 V [hp]	75	100	125	150	200	250
Typical Shaft output at 690 V [kW]	75	90	110	132	160	200
Enclosure IP21	D1h	D1h	D1h	D1h	D1h	D2h
Enclosure IP54	D1h	D1h	D1h	D1h	D1h	D2h
Enclosure IP20	D3h	D3h	D3h	D3h	D3h	D4h
<b>Output current</b>						
Continuous (at 550 V) [A]	90	113	137	162	201	253
Intermittent (60 s overload) (at 550 V)[A]	99	124	151	178	221	278
Continuous (at 575/690 V) [A]	86	108	131	155	192	242
Intermittent (60 s overload) (at 575/690 V) [kVA]	95	119	144	171	211	266
Continuous kVA (at 550 V) [kVA]	86	108	131	154	191	241
Continuous kVA (at 575 V) [kVA]	86	108	130	154	191	241
Continuous kVA (at 690 V) [kVA]	103	129	157	185	229	289
<b>Max. Input current</b>						
Continuous (at 550 V) [A]	89	110	130	158	198	245
Continuous (at 575 V) [A]	85	106	124	151	189	234
Continuous (at 690 V) [A]	87	109	128	155	197	240
Max. cable size: mains, motor, brake and load share [mm (AWG)]	2x95 (2x3/0)					2x185 (2x350 mcm)
Max. external mains fuses [A]	160	315	315	315	350	350
Estimated power loss at 575 V [W]	1161	1426	1739	2099	2646	3071
Estimated power loss at 690 V [W]	1203	1476	1796	2165	2738	3172
Weight, enclosure IP21, IP54 kg (lbs.)	62 (135)					125 (275)
Weight, enclosure IP20 kg (lbs.)	62 (135)					125 (275)
Efficiency	0.98					
Output frequency	0-590 Hz					
Heatsink overtemp. trip	110 °C					
Power card ambient trip	75 °C					
*Normal overload=110% current for 60 s						

**Table 10.2 Mains Supply 3x525-690 V AC**



	N250	N315	N400
<b>Normal Load*</b>	<b>NO</b>	<b>NO</b>	<b>NO</b>
Typical Shaft output at 550 V [kW]	200	250	315
Typical Shaft output at 575 V [hp]	300	350	400
Typical Shaft output at 690 V [kW]	250	315	400
Enclosure IP21	D2h	D2h	D2h
Enclosure IP54	D2h	D2h	D2h
Enclosure IP20	D4h	D4h	D4h
<b>Output current</b>			
Continuous (at 550 V) [A]	303	360	418
Intermittent (60 s overload) (at 550 V)[A]	333	396	460
Continuous (at 575/690 V) [A]	290	344	400
Intermittent (60 s overload) (at 575/690 V) [kVA]	319	378	440
Continuous kVA (at 550 V) [kVA]	289	343	398
Continuous kVA (at 575 V) [kVA]	289	343	398
Continuous kVA (at 690 V) [kVA]	347	411	478
<b>Max. Input current</b>			
Continuous (at 550 V) [A]	299	355	408
Continuous (at 575 V) [A]	286	339	390
Continuous (at 690 V) [A]	296	352	400
Max. cable size: mains, motor, brake and load share, mm (AWG)	2x185 (2x350 mcm)		
Max. external mains fuses [A]	400	500	550
Estimated power loss at 575 V [W]	3719	4460	5023
Estimated power loss at 690 V [W]	3848	4610	5150
Weight, enclosure IP21, IP54 kg (lbs.)	125 (275)		
Weight, enclosure IP20 kg (lbs.)	125 (275)		
Efficiency	0.98		
Output frequency	0-590 Hz		
Heatsink overtemp. trip	110 °C		
Power card ambient trip	75 °C		
*Normal overload=110% current for 60 s			

10

**Table 10.3 Mains Supply 3x525-690 V AC**

The typical power loss is at nominal load conditions and expected to be within ±15% (tolerance relates to variety in voltage and cable conditions).

The losses are based on the default switching frequency. The losses increase significantly at higher switching frequencies.

The options cabinet adds weight to the frequency converter. The maximum weights of the D5h–D8h frames is shown in *Table 10.4*

Frame size	Description	Maximum weight [kg] ([lbs.])
D5h	D1h ratings+disconnect and/or brake chopper	166 (255)
D6h	D1h ratings+contactor and/or circuit breaker	129 (285)
D7h	D2h ratings+disconnect and/or brake chopper	200 (440)
D8h	D2h ratings+contactor and/or circuit breaker	225 (496)

**Table 10.4 D5h–D8h Weights**

## 10.2 General Technical Data

Mains supply (L1, L2, L3)

Supply voltage 380–480 V ±10%, 525–690 V±10%

*Mains voltage low/mains voltage drop-out:*

During low mains voltage or a mains drop-out, the frequency converter continues until the intermediate circuit voltage drops below the minimum stop level, which corresponds typically to 15% below the frequency converter's lowest rated supply voltage. Power-up and full torque cannot be expected at mains voltage lower than 10% below the frequency converter's lowest rated supply voltage.

Supply frequency	50/60 Hz ±5%
Max. imbalance temporary between mains phases	3.0% of rated supply voltage
True Power Factor ( $\lambda$ )	≥0.9 nominal at rated load
Displacement Power Factor (cos $\Phi$ ) near unity	(>0.98)
Switching on input supply L1, L2, L3 (power ups)	maximum one time/2 min
Environment according to EN60664-1	overvoltage category III/pollution degree 2

The unit is suitable for use on a circuit capable of delivering not more than 100,000 RMS symmetrical Amperes, 480/600 V

**Motor Output (U, V, W)**

Output voltage	0-100% of supply voltage
Output frequency	0-590 Hz*
Switching on output	Unlimited
Ramp times	0.01-3600 s

\* Dependent on voltage and power

**Torque Characteristics**

Starting torque (Constant torque)	maximum 110% for 60 s*
Starting torque	maximum 135% up to 0.5 s*
Overload torque (Constant torque)	maximum 110% for 60 s*

\*) Percentage relates to the frequency converter's nominal torque

**Cable lengths and cross sections**

Max. motor cable length, screened/armoured	150 m
Max. motor cable length, unscreened/unarmoured	300 m
Max. cross section to motor, mains, load sharing and brake *	
Maximum cross section to control terminals, rigid wire	1.5 mm <sup>2</sup> /16 AWG (2x0.75 mm <sup>2</sup> )
Maximum cross section to control terminals, flexible cable	1 mm <sup>2</sup> /18 AWG
Maximum cross section to control terminals, cable with enclosed core	0.5 mm <sup>2</sup> /20 AWG
Minimum cross section to control terminals	0.25 mm <sup>2</sup>

\*) Depending on voltage and power.

**Digital inputs**

Programmable digital inputs	4 (6)
Terminal number	18, 19, 27 <sup>1)</sup> , 29 <sup>1)</sup> , 32, 33
Logic	PNP or NPN
Voltage level	0-24 V DC
Voltage level, logic '0' PNP	<5 V DC
Voltage level, logic '1' PNP	>10 V DC
Voltage level, logic '0' NPN	>19 V DC
Voltage level, logic '1' NPN	<14V DC
Maximum voltage on input	28 V DC
Input resistance, R <sub>i</sub>	approx. 4 kΩ

All digital inputs are galvanically isolated from the supply voltage (PELV) and other high-voltage terminals.

<sup>1)</sup> Terminals 27 and 29 can also be programmed as output.

**Analog inputs**

Number of analog inputs	2
Terminal number	53, 54
Modes	Voltage or current
Mode select	Switches A53 and A54
Voltage mode	Switch A53/A54=(U)
Voltage level	0 V to 10 V (scaleable)
Input resistance, R <sub>i</sub>	approx. 10 kΩ
Max. voltage	±20 V

Current mode	Switch A53/A54=(I)
Current level	0/4 to 20 mA (scaleable)
Input resistance, $R_i$	approx. 200 $\Omega$
Max. current	30 mA
Resolution for analog inputs	10 bit (+sign)
Accuracy of analog inputs	Max. error 0.5% of full scale
Bandwidth	100 Hz

The analog inputs are galvanically isolated from the supply voltage (PELV) and other high-voltage terminals.

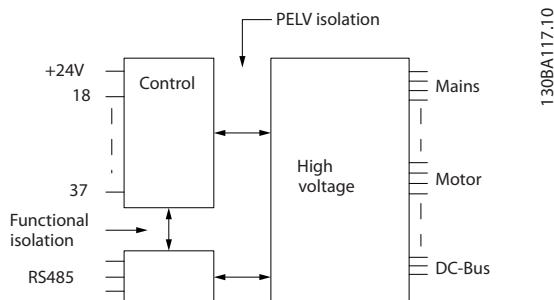

Illustration 10.1

Pulse inputs	
Programmable pulse inputs	2
Terminal number pulse	29, 33
Max. frequency at terminal, 29, 33	110 kHz (Push-pull driven)
Max. frequency at terminal, 29, 33	5 kHz (open collector)
Min. frequency at terminal 29, 33	4 Hz
Voltage level	see chapter 10.2.1 Digital Inputs:
Maximum voltage on input	28 V DC
Input resistance, $R_i$	approx. 4 k $\Omega$
Pulse input accuracy (0.1-1 kHz)	Max. error: 0.1% of full scale
Analog output	
Number of programmable analog outputs	1
Terminal number	42
Current range at analog output	0/4-20 mA
Max. resistor load to common at analog output	500 $\Omega$
Accuracy on analog output	Max. error: 0.8 % of full scale
Resolution on analog output	8 bit

The analog output is galvanically isolated from the supply voltage (PELV) and other high-voltage terminals.

Control card, RS-485 serial communication	
Terminal number	68 (P,TX+, RX+), 69 (N,TX-, RX-)
Terminal number 61	Common for terminals 68 and 69

The RS-485 serial communication circuit is functionally seated from other central circuits and galvanically isolated from the supply voltage (PELV).

Digital output	
Programmable digital/pulse outputs	2
Terminal number	27, 29 <sup>1)</sup>
Voltage level at digital/frequency output	0-24 V
Max. output current (sink or source)	40 mA
Max. load at frequency output	1 k $\Omega$
Max. capacitive load at frequency output	10 nF
Minimum output frequency at frequency output	0 Hz
Maximum output frequency at frequency output	32 kHz
Accuracy of frequency output	Max. error: 0.1 % of full scale

Resolution of frequency outputs ..... 12 bit

<sup>1)</sup> Terminal 27 and 29 can also be programmed as input.

The digital output is galvanically isolated from the supply voltage (PELV) and other high-voltage terminals.

**Control card, 24 V DC output**

Terminal number ..... 12, 13

Max. load ..... 200 mA

The 24 V DC supply is galvanically isolated from the supply voltage (PELV), but has the same potential as the analog and digital inputs and outputs.

**Relay outputs**

Programmable relay outputs ..... 2

**Relay 01 Terminal number** ..... 1-3 (break), 1-2 (make)

Max. terminal load (AC-1)<sup>1)</sup> on 1-2 (NO) (Resistive load)<sup>2)3)</sup> ..... 400 V AC, 2 A

Max. terminal load (AC-15)<sup>1)</sup> on 1-2 (NO) (Inductive load @ cosφ 0.4) ..... 240 V AC, 0.2 A

Max. terminal load (DC-1)<sup>1)</sup> on 1-2 (NO) (Resistive load) ..... 80 V DC, 2 A

Max. terminal load (DC-13)<sup>1)</sup> on 1-2 (NO) (Inductive load) ..... 24 V DC, 0.1 A

Max. terminal load (AC-1)<sup>1)</sup> on 1-3 (NC) (Resistive load) ..... 240 V AC, 2 A

Max. terminal load (AC-15)<sup>1)</sup> on 1-3 (NC) (Inductive load @ cosφ 0.4) ..... 240 V AC, 0.2 A

Max. terminal load (DC-1)<sup>1)</sup> on 1-3 (NC) (Resistive load) ..... 50 V DC, 2 A

Max. terminal load (DC-13)<sup>1)</sup> on 1-3 (NC) (Inductive load) ..... 24 V DC, 0.1 A

Min. terminal load on 1-3 (NC), 1-2 (NO) ..... 24 V DC 10 mA, 24V AC 2 mA

Environment according to EN 60664-1 ..... overvoltage category III/pollution degree 2

**Relay 02 Terminal number** ..... 4-6 (break), 4-5 (make)

Max. terminal load (AC-1)<sup>1)</sup> on 4-5 (NO) (Resistive load)<sup>2)3)</sup> ..... 400 V AC, 2 A

Max. terminal load (AC-15)<sup>1)</sup> on 4-5 (NO) (Inductive load @ cosφ 0.4) ..... 240 V AC, 0.2 A

Max. terminal load (DC-1)<sup>1)</sup> on 4-5 (NO) (Resistive load) ..... 80 V DC, 2 A

Max. terminal load (DC-13)<sup>1)</sup> on 4-5 (NO) (Inductive load) ..... 24 V DC, 0.1 A

Max. terminal load (AC-1)<sup>1)</sup> on 4-6 (NC) (Resistive load) ..... 240 V AC, 2 A

Max. terminal load (AC-15)<sup>1)</sup> on 4-6 (NC) (Inductive load @ cosφ 0.4) ..... 240 V AC, 0.2 A

Max. terminal load (DC-1)<sup>1)</sup> on 4-6 (NC) (Resistive load) ..... 50 V DC, 2 A

Max. terminal load (DC-13)<sup>1)</sup> on 4-6 (NC) (Inductive load) ..... 24 V DC, 0.1 A

Min. terminal load on 4-6 (NC), 4-5 (NO) ..... 24 V DC 10 mA, 24V AC 2 mA

Environment according to EN 60664-1 ..... overvoltage category III/pollution degree 2

<sup>1)</sup> IEC 60947 t 4 and 5

The relay contacts are galvanically isolated from the rest of the circuit by reinforced isolation (PELV).

<sup>2)</sup> Overvoltage Category II

<sup>3)</sup> UL applications 300 V AC 2 A

**Control card, 10 V DC output**

Terminal number ..... 50

Output voltage ..... 10.5 V ±0.5 V

Max. load ..... 25 mA

The 10 V DC supply is galvanically isolated from the supply voltage (PELV) and other high-voltage terminals.

**Control characteristics**

Resolution of output frequency at 0-590 Hz ..... ± 0.003 Hz

System response time (terminals 18, 19, 27, 29, 32, 33) ..... ≤2 ms

Speed control range (open loop) ..... 1:100 of synchronous speed

Speed accuracy (open loop) ..... 30-4000 rpm: Maximum error of ±8 rpm

All control characteristics are based on a 4-pole asynchronous motor.

**Surroundings**

Enclosure type D1h/D2h/D5h/D6h/D7h/D8h ..... IP21/Type 1, IP54/Type12

Enclosure type D3h/D4h ..... IP20/Chassis

Vibration test all enclosure types ..... 1.0 g

Relative humidity ..... 5%-95% (IEC 721-3-3; Class 3K3 (non-condensing) during operation

Aggressive environment (IEC 60068-2-43) H <sub>2</sub> S test	class Kd
Test method according to IEC 60068-2-43 H <sub>2</sub> S (10 days)	
Ambient temperature (at 60 AVM switching mode)	
- with derating	max. 55 °C <sup>1)</sup>
- with full output power of typical EFF2 motors (up to 90% output current)	max. 50 °C <sup>1)</sup>
- at full continuous FC output current	max. 45 °C <sup>1)</sup>

<sup>1)</sup> For more information on derating see the Design Guide, section on Special Conditions.

Minimum ambient temperature during full-scale operation	0 °C
Minimum ambient temperature at reduced performance	-10 °C
Temperature during storage/transport	-25 to +65/70 °C
Maximum altitude above sea level without derating	1000 m
Maximum altitude above sea level with derating	3000 m

<sup>1)</sup> For more information on derating see the Design Guide, section on Special Conditions.

EMC standards, Emission	EN 61800-3, EN 61000-6-3/4, EN 55011, IEC 61800-3 EN 61800-3, EN 61000-6-1/2,
EMC standards, Immunity	EN 61000-4-2, EN 61000-4-3, EN 61000-4-4, EN 61000-4-5, EN 61000-4-6

See the Design Guide, section on Special Conditions.

Control card performance	
Scan interval	5 ms

Control card, USB Serial Communication	
USB standard	1.1 (Full speed)
USB plug	USB type B "device" plug

**CAUTION**

Connection to PC is carried out via a standard host/device USB cable.  
 The USB connection is galvanically isolated from the supply voltage (PELV) and other high-voltage terminals.  
 The USB connection is not galvanically isolated from protection earth (ground). Use only isolated laptop/PC as connection to the USB connector on frequency converter or an isolated USB cable/converter.

---

**Protection and Features**

---

- Electronic thermal motor protection against overload.
- Temperature monitoring of the heatsink ensures that the frequency converter trips if the temperature reaches  $95\text{ }^{\circ}\text{C}\pm 5\text{ }^{\circ}\text{C}$ . An overload temperature cannot be reset until the temperature of the heatsink is below  $70\text{ }^{\circ}\text{C}\pm 5\text{ }^{\circ}\text{C}$  (Guideline - these temperatures may vary for different power sizes, enclosures etc.). The frequency converter has an auto derating function to avoid its heatsink reaching  $95\text{ }^{\circ}\text{C}$ .
- The frequency converter is protected against short-circuits on motor terminals U, V, W.
- If a mains phase is missing, the frequency converter trips or issues a warning (depending on the load).
- Monitoring of the intermediate circuit voltage ensures that the frequency converter trips if the intermediate circuit voltage is too low or too high.
- The frequency converter is protected against earth (ground) faults on motor terminals U, V, W.

### 10.3 Fuse Tables

#### 10.3.1 Protection

##### Branch Circuit Protection

In order to protect the installation against electrical and fire hazard, all branch circuits in an installation, switch gear, machines etc., must be short-circuited and over-current protected according to national/international regulations.

##### Short-circuit Protection

The frequency converter must be protected against short-circuit to avoid electrical or fire hazard. Danfoss recommends using the fuses mentioned below to protect service personnel and equipment in case of an internal failure in the frequency converter. The frequency converter provides full short-circuit protection in case of a short-circuit on the motor output.

##### Over-current Protection

Provide overload protection to avoid fire hazard due to overheating of the cables in the installation. The frequency converter is equipped with an internal over-current protection that can be used for upstream overload

protection (UL-applications excluded). See *4-18 Current Limit*. Moreover, fuses or circuit breakers can be used to provide the over-current protection in the installation. Over-current protection must always be carried out according to national regulations.

#### 10.3.2 Fuse Selection

Danfoss recommends using the following fuses which will ensure compliance with EN50178. In case of malfunction, not following the recommendation may result in unnecessary damage to the frequency converter.

The fuses below are suitable for use on a circuit capable of delivering 100,000 Arms (symmetrical).

N110-N315	380–480 V	type aR
N75K-N400	525–690 V	type aR

Table 10.5

Power Size	Fuse options							
	Bussman PN	Littelfuse PN	Littelfuse PN	Bussmann PN	Siba PN	Ferraz-Shawmut PN	Ferraz-Shawmut PN (Europe)	Ferraz-Shawmut PN (North America)
N110	170M2619	LA50QS300-4	L50S-300	FWH-300A	20 610 31.315	A50QS300-4	6,9URD31D08A0315	A070URD31KI0315
N132	170M2620	LA50QS350-4	L50S-350	FWH-350A	20 610 31.350	A50QS350-4	6,9URD31D08A0350	A070URD31KI0350
N160	170M2621	LA50QS400-4	L50S-400	FWH-400A	20 610 31.400	A50QS400-4	6,9URD31D08A0400	A070URD31KI0400
N200	170M4015	LA50QS500-4	L50S-500	FWH-500A	20 610 31.550	A50QS500-4	6,9URD31D08A0550	A070URD31KI0550
N250	170M4016	LA50QS600-4	L50S-600	FWH-600A	20 610 31.630	A50QS600-4	6,9URD31D08A0630	A070URD31KI0630
N315	170M4017	LA50QS800-4	L50S-800	FWH-800A	20 610 31.800	A50QS800-4	6,9URD32D08A0800	A070URD31KI0800

Table 10.6 Fuse Options for 380-480 V Frequency Converters

OEM		Fuse options		
VLT Model	Bussmann PN	Siba PN	Ferraz-Shawmut European PN	Ferraz-Shawmut North American PN
N75k T7	170M2616	20 610 31.160	6,9URD30D08A0160	A070URD30KI0160
N90k T7	170M2619	20 610 31.315	6,9URD31D08A0315	A070URD31KI0315
N110 T7	170M2619	20 610 31.315	6,9URD31D08A0315	A070URD31KI0315
N132 T7	170M2619	20 610 31.315	6,9URD31D08A0315	A070URD31KI0315
N160 T7	170M2619	20 610 31.315	6,9URD31D08A0315	A070URD31KI0315
N200 T7	170M4015	20 620 31.550	6,9URD32D08A0550	A070URD32KI0550
N250 T7	170M4015	20 620 31.550	6,9URD32D08A0550	A070URD32KI0550
N315 T7	170M4015	20 620 31.550	6,9URD32D08A0550	A070URD32KI0550
N400 T7	170M4015	20 620 31.550	6,9URD32D08A0550	A070URD32KI0550

Table 10.7 Fuse Options for 525-690 V Frequency Converters

For UL compliance, for units supplied without a contactor-only option, the Bussmann 170M series fuses must be used.

### 10.3.3 Short Circuit Current Rating (SCCR)

The Short Circuit Current Rating (SCCR) of the frequency converters is 100,000 amps at all voltages (380–690 V).

If the frequency converter is supplied with a mains disconnect, the SCCR of the frequency converter is 100,000 amps at all voltages (380–690 V).

### 10.3.4 Connection Tightening Torques

When tightening all electrical connections it is very important to tighten with the correct torque. Too low or too high torque results in a bad electrical connection. Use a torque wrench to ensure correct torque. Always use a torque wrench to tighten the bolts.

Frame Size	Terminal	Torque	Bolt size
D1h/D3h/D5h/D6h	Mains Motor Load sharing Regen	19-40 Nm (168-354 in-lbs)	M10
	Earth (Ground) Brake	8.5-20.5 Nm (75-181 in-lbs)	M8
D2h/D4h/D7h/D8h	Mains Motor Regen Load sharing Earth (ground)	19-40 Nm (168-354 in-lbs)	M10
	Brake	8.5-20.5 Nm (75-181 in-lbs)	M8

**Table 10.8 Torque for Terminals**



**Index**

**A**

**AC**

- input..... 6, 19
- mains..... 5, 6
- Mains Connection..... 19
- waveform..... 5, 6

**Accel time**..... 32

**Airflow**..... 9

**Alarm**

- Log..... 35
- Trip..... 54

**Alarm/Warning Code List**..... 57

**AMA**

- AMA..... 59, 62
- with T27 Connected..... 46
- without T27 Connected..... 46

**Analog**

- inputs..... 21, 58
- Inputs..... 70
- output..... 21, 71
- signal..... 58

**Application Examples**..... 46

**Auto**

- Auto..... 36, 51
- mode..... 35
- on..... 51
- On..... 36, 51

**Automatic motor adaptation**..... 32, 51

**Auto-reset**..... 34

**B**

**Basic Operational Programming**..... 26

**Braking**..... 60, 51

**C**

- Cable lengths and cross sections..... 70
- Circuit breakers..... 25
- Closed loop..... 22
- Communication option..... 60
- Conduit..... 12, 25

**Control**

- cables..... 20
- card..... 58
- Card performance..... 73
- card, 10 V DC output..... 72
- Card, 24 V DC output..... 72
- Card, RS-485 Serial Communication..... 71
- card, USB Serial Communication..... 73
- characteristics..... 72
- signal..... 38, 39, 51
- system..... 5
- Terminal Functions..... 22
- Terminal Types..... 21
- terminals..... 31, 36, 51, 39
- Terminals..... 22
- wiring..... 10, 12, 13, 25
- Wiring Connection..... 19

**Cooling**

- Cooling..... 9
- clearance..... 25

**Copying Parameter Settings**..... 36

**Current**

- limit..... 32
- rating..... 8, 58

**D**

**DC**

- current..... 6, 51
- link..... 58

**Derating**..... 72, 74, 9

**Digital**

- input..... 21, 51, 59
- inputs..... 51
- Inputs..... 39, 70
- output..... 71

**Disconnect**

- switch..... 26
- switches..... 24

**Downloading Data from the LCP**..... 37

**Duct cooling**..... 9

**E**

**Earth**

- connections..... 13, 25
- loops..... 20
- wire..... 25

**Earthing**

- Earthing..... 25
- (Grounding)..... 25
- (Grounding) IP20 Enclosures..... 14
- (Grounding) IP21/54 Enclosures..... 14
- (Grounding) of Screened Control Cables..... 20

**'Earthing (grounding) hazard**..... 13

<b>Electrical</b>	
Installation.....	10
noise.....	13
<b>EMC</b> .....	21, 25, 72
<b>Equalizing cable</b> .....	20
<b>External</b>	
commands.....	6, 51
controllers.....	5
interlock.....	40
voltage.....	38
<b>F</b>	
<b>Fault</b>	
log.....	35
Messages.....	58
<b>Feedback</b> .....	22, 25, 62, 51
<b>Floating delta</b> .....	19
<b>Frame Sizes and Power Ratings</b> .....	7
<b>Frequency Converter Block Diagram</b> .....	5
<b>Full load current</b> .....	8, 24
<b>Functional testing</b> .....	5, 32
<b>Fuses</b> .....	25, 61, 64
<b>Fusing</b> .....	12, 25
<b>G</b>	
<b>Ground</b>	
connections.....	13, 25
loops.....	20
wire.....	13, 25
<b>Grounded delta</b> .....	19
<b>Grounding</b> .....	13, 24, 25
<b>H</b>	
<b>Hand</b>	
Hand.....	32, 36, 51
on.....	51
On.....	32, 36
<b>Harmonics</b> .....	6
<b>I</b>	
<b>IEC 61800-3</b> .....	73
<b>Induced voltage</b> .....	12
<b>Initialisation</b> .....	37
<b>Input</b>	
current.....	19
power.....	10, 13, 24, 25, 54, 64, 6
signal.....	39
signals.....	22
terminals.....	22, 24, 58
voltage.....	26, 54
<b>Installation</b>	
Installation.....	5, 12, 25
Site.....	8
<b>Isolated mains</b> .....	19
<b>L</b>	
<b>Leakage</b>	
current.....	24
Current (>3.5 mA).....	13
<b>Lifting</b> .....	9
<b>Local</b>	
control.....	34, 36, 51
Control Panel.....	34
mode.....	32
operation.....	34
start.....	32
<b>Local-control Test</b> .....	32
<b>M</b>	
<b>Main</b>	
menu.....	38
Menu.....	35
<b>Mains</b>	
Mains.....	12
supply (L1, L2, L3).....	69
voltage.....	35, 36, 51
<b>Manual Initialisation</b> .....	37
<b>Mechanical Installation</b> .....	9
<b>Menu</b>	
keys.....	34, 35
Keys.....	35
structure.....	36
Structure.....	41
<b>Motor</b>	
Cable.....	19
cables.....	12, 15, 32
Connection.....	15
current.....	6, 32, 62, 35
data.....	32, 59, 62
Data.....	32
frequency.....	35
output (U, V, W).....	70
power.....	12, 62, 35
protection.....	12, 74
rotation.....	32, 35
Rotation Check.....	19
speeds.....	31
status.....	5
wiring.....	10, 12, 25
<b>Mounting</b> .....	25
<b>Multiple</b>	
frequency converters.....	12, 15
motors.....	24
<b>N</b>	
<b>Navigation</b>	
keys.....	31, 38, 51, 34, 36
Keys.....	36
<b>Noise isolation</b> .....	10, 25

<b>O</b>	
Open loop.....	22, 38, 72
<b>Operation</b>	
keys.....	36
Keys.....	36
<b>Optional equipment</b> .....	26, 5
<b>Output</b>	
current.....	51, 58, 71
signal.....	41
terminals.....	24
<b>Overcurrent</b> .....	51
<b>Overload protection</b> .....	8, 12
<b>Overvoltage</b> .....	32, 51
<b>P</b>	
Parameter Settings.....	36, 40
PELV.....	19, 49, 72
Phase loss.....	58
<b>Power</b>	
Power.....	13
connections.....	13
factor.....	6, 15, 25
<b>Pre-Installation Check List</b> .....	8
<b>Product Overview</b> .....	4
<b>Programming</b> .....	5, 32, 35, 40, 41, 45, 58, 34, 36
<b>Protection</b>	
Protection.....	75
and features.....	74
<b>Pulse inputs</b> .....	71
<b>Q</b>	
<b>Quick</b>	
menu.....	35, 38, 40
Menu.....	35
<b>R</b>	
<b>Ramp-down time</b> .....	32
<b>Ramp-up time</b> .....	32
<b>Reference</b> .....	iii, 46, 51, 35
<b>Relay outputs</b> .....	21, 72
<b>Remote</b>	
commands.....	5
Programming.....	45
reference.....	51
<b>Reset</b> .....	34, 37, 51, 54, 58, 63, 74, 36
<b>Residual current devices (RCDs)</b> .....	13
<b>Restoring Default Settings</b> .....	37
<b>RFI filter</b> .....	19
<b>RMS current</b> .....	6
<b>RS-485</b> .....	22
<b>Run</b>	
command.....	33
permissive.....	51
<b>S</b>	
<b>Safety Inspection</b> .....	24
<b>Screened Control Cables</b> .....	20
<b>Serial</b>	
communication.....	5, 20, 21, 36, 51, 54
Communication.....	22
<b>Set up</b> .....	35
<b>Setpoint</b> .....	51
<b>Set-up</b> .....	33, 35
<b>Shielded</b>	
cable.....	10, 25
wire.....	12
<b>Short circuit</b> .....	59
<b>Specifications</b> .....	5
<b>Speed reference</b> .....	22, 33, 39, 46, 0, 51
<b>Start</b>	
up.....	5, 37, 38
Up.....	64
<b>Status</b>	
Messages.....	51
mode.....	51
<b>Stop command</b> .....	51
<b>Supply voltage</b> .....	19, 21, 24, 61, 71
<b>Surroundings</b> .....	72
<b>Switching frequency</b> .....	51
<b>System feedback</b> .....	5
<b>T</b>	
<b>Temperature limits</b> .....	25
<b>Terminal</b>	
53.....	38, 22, 38
54.....	22
Locations D1h.....	15
Locations D2h.....	17
programming.....	22
Programming Examples.....	39
<b>Thermistor</b>	
Thermistor.....	19, 49, 59
control wiring.....	19
<b>Torque</b>	
Characteristics.....	70
for Terminals.....	76
limit.....	32
<b>Transient protection</b> .....	6
<b>Trip function</b> .....	12
<b>Troubleshooting</b> .....	5, 58, 64

U

Uploading Data to the LCP..... 37

Using Screened Control Cables..... 20

V

Voltage imbalance..... 58

W

Warning and Alarm Definitions..... 56

Wire Type and Ratings..... 13

Wiring to Control Terminals..... 22





[www.danfoss.com/drives](http://www.danfoss.com/drives)

.....  
Danfoss can accept no responsibility for possible errors in catalogues, brochures and other printed material. Danfoss reserves the right to alter its products without notice. This also applies to products already on order provided that such alterations can be made without subsequential changes being necessary in specifications already agreed. All trademarks in this material are property of the respective companies. Danfoss and the Danfoss logotype are trademarks of Danfoss A/S. All rights reserved.  
.....

