



# Programming Guide VLT® AQUA Drive FC 202





## Contents

<b>1 Introduction</b>	<b>4</b>
1.1 Purpose of the Manual	4
1.2 Additional Resources	4
1.3 Software Version	4
1.4 Approvals	4
1.5 Symbols	4
1.6 Definitions	4
1.6.1 Frequency Converter	4
1.6.2 Input	4
1.6.3 Motor	5
1.6.4 References	5
1.6.5 Miscellaneous	6
1.7 Abbreviations, Symbols and Conventions	7
1.8 Safety	8
1.9 Electrical Wiring	10
<b>2 How to Programme</b>	<b>13</b>
2.1 The Graphical and Numerical Local Control Panel	13
2.2 How to Programme on the Graphical LCP	13
2.2.1 The LCP Display	14
2.2.2 Quick Transfer of Parameter Settings between Multiple Frequency Converters	16
2.2.3 Display Mode	16
2.2.4 Display Mode - Selection of Readouts	16
2.2.5 Parameter Set-Up, General Information	17
2.2.6 Quick Menu Key Functions	17
2.2.7 Quick Menu, Q3 Function Set-ups	19
2.2.8 Main Menu Mode	21
2.2.9 Parameter Selection	21
2.2.10 Changing Data	21
2.2.11 Changing a Text Value	21
2.2.12 Changing a Group of Numeric Data Values	22
2.2.13 Infinitely Variable Change of Numeric Data Value	22
2.2.14 Value, Step-by-Step	22
2.2.15 Readout and Programming of Indexed Parameters	22
2.3 How to Programme on the Numerical LCP	22
2.3.1 LCP Keys	23
2.4 Initialisation to Default Settings	24
<b>3 Parameter Description</b>	<b>25</b>
3.1 Parameter Selection	25

3.2 Parameters 0-** Operation and Display	26
3.3 Parameters 1-** Load and Motor	38
3.4 Parameters 2-** Brakes	53
3.5 Parameters 3-** Reference/Ramps	56
3.6 Parameters 4-** Limits/Warnings	62
3.7 Parameters 5-** Digital In/Out	66
3.8 Parameters 6-** Analog In/Out	81
3.9 Parameters 8-** Communications and Options	89
3.10 Parameters 9-** Profibus	97
3.11 Parameters 10-** CAN Fieldbus	98
3.12 Parameters 13-** Smart Logic Control	101
3.13 Parameters 14-** Special Functions	112
3.14 Parameters 15-** Frequency Converter Information	119
3.15 Parameters 16-** Data Readouts	125
3.16 Parameters 18-** Data Readouts 2	131
3.17 Parameters 20-** FC Closed Loop	133
3.18 Parameters 21-** Extended Closed Loop	142
3.19 Parameters 22-** Application Functions	150
3.20 Parameters 23-** Time-based Functions	162
3.21 Parameters 24-** Application Functions 2	172
3.22 Parameters 25-** Cascade Controller	173
3.23 Parameters 26-** Analog I/O Option MCB 109	183
3.24 Parameters 29-** Water Application Functions	189
3.25 Parameters 30-** Special Features	194
3.26 Parameters 31-** Bypass Option	194
3.27 Parameters 35-** Sensor Input Option	196
<b>4 Parameter Lists</b>	<b>198</b>
4.1 Parameter Options	198
4.1.1 Default Settings	198
4.1.2 0-** Operation/Display	199
4.1.3 1-** Load/Motor	201
4.1.4 2-** Brakes	203
4.1.5 3-** Reference/Ramps	204
4.1.6 4-** Limits/Warnings	205
4.1.7 5-** Digital In/Out	206
4.1.8 6-** Analog In/Out	208
4.1.9 8-** Comm. and Options	210
4.1.10 9-** Profibus	212
4.1.11 10-** CAN Fieldbus	213
4.1.12 13-** Smart Logic	214

4.1.13 14-** Special Functions	215
4.1.14 15-** FC Information	216
4.1.15 16-** Data Readouts	218
4.1.16 18-** Data Readouts 2	220
4.1.17 20-** FC Closed Loop	221
4.1.18 21-** Ext. Closed Loop	222
4.1.19 22-** Application Functions	224
4.1.20 23-** Timed Actions	226
4.1.21 24-** Application Functions 2	227
4.1.22 25-** Cascade Controller	228
4.1.23 26-** Analog I/O Option MCB 109	230
4.1.24 27-** Cascade CTL Option	231
4.1.25 29-** Water Application Functions	233
4.1.26 30-** Special Features	234
4.1.27 31-** Bypass Option	234
4.1.28 35-** Sensor Input Option	234
<b>5 Troubleshooting</b>	<b>236</b>
5.1 Status Messages	236
5.1.1 Warnings/Alarm Messages	236
<b>Index</b>	<b>241</b>

# 1 Introduction

## 1.1 Purpose of the Manual

The Programming Guide provides information required for programming the frequency converter in a diversity of applications.

VLT® is a registered trademark.

## 1.2 Additional Resources

Other resources are available to understand advanced frequency converter operation, programming, and directives compliance.

- The *Operating Instructions* provide detailed information for the installation and start up of the frequency converter.
- The *Design Guide* provides information required for integration of the frequency converter in a diversity of applications.
- The VLT® Safe Torque Off Operating Instructions describe how to use Danfoss frequency converters in functional safety applications.
- Supplemental publications and manuals are available from Danfoss. See [danfoss.com/Product/Literature/Technical+Documentation.htm](http://danfoss.com/Product/Literature/Technical+Documentation.htm) for listings.
- Optional equipment is available, that may change some of the information described in these publications. Be sure to see the instructions supplied with the options for specific requirements.

Contact a Danfoss supplier or go to [www.danfoss.com](http://www.danfoss.com) for additional information.

## 1.3 Software Version

**Programming Guide**  
**Software version: 2.1x**

This Programming Guide can be used for all FC 200 frequency converters with software version 2.1x. The software version number can be seen from *parameter 15-43 Software Version*.

## 1.4 Approvals

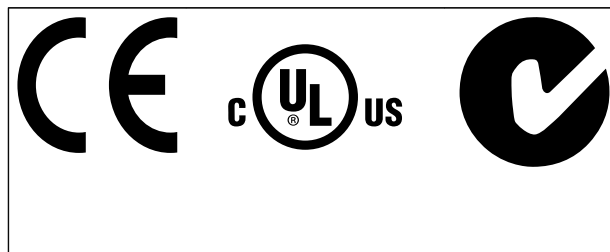

## 1.5 Symbols

The following symbols are used in this document:



Indicates a potentially hazardous situation which could result in death or serious injury.



Indicates a potentially hazardous situation which could result in minor or moderate injury. It may also be used to alert against unsafe practices.



Indicates important information, including situations that may result in damage to equipment or property.

## 1.6 Definitions

### 1.6.1 Frequency Converter

**I<sub>VLT,MAX</sub>**  
 Maximum output current.

**I<sub>VLT,N</sub>**  
 Rated output current supplied by the frequency converter.

**U<sub>VLT,MAX</sub>**  
 Maximum output voltage.

### 1.6.2 Input

#### Control command

Start and stop the connected motor by means of LCP and digital inputs.

Functions are divided into 2 groups.

Functions in group 1 have higher priority than functions in group 2.

Group 1	Reset, Coasting stop, Reset and Coasting stop, Quick-stop, DC braking, Stop and the [OFF] key.
Group 2	Start, Pulse start, Reversing, Start reversing, Jog and Freeze output

Table 1.1 Function Groups

### 1.6.3 Motor

#### Motor Running

Torque generated on output shaft and speed from zero RPM to max. speed on motor.

$f_{JOG}$

Motor frequency when the jog function is activated (via digital terminals).

$f_M$

Motor frequency.

$f_{MAX}$

Maximum motor frequency.

$f_{MIN}$

Minimum motor frequency.

$f_{M,N}$

Rated motor frequency (nameplate data).

$I_M$

Motor current (actual).

$I_{M,N}$

Rated motor current (nameplate data).

$n_{M,N}$

Rated motor speed (nameplate data).

$n_s$

Synchronous motor speed

$$n_s = \frac{2 \times par. 1 - 23 \times 60 \text{ s}}{par. 1 - 39}$$

$n_{slip}$

Motor slip.

$P_{M,N}$

Rated motor power (nameplate data in kW or hp).

$T_{M,N}$

Rated torque (motor).

$U_M$

Instantaneous motor voltage.

$U_{M,N}$

Rated motor voltage (nameplate data).

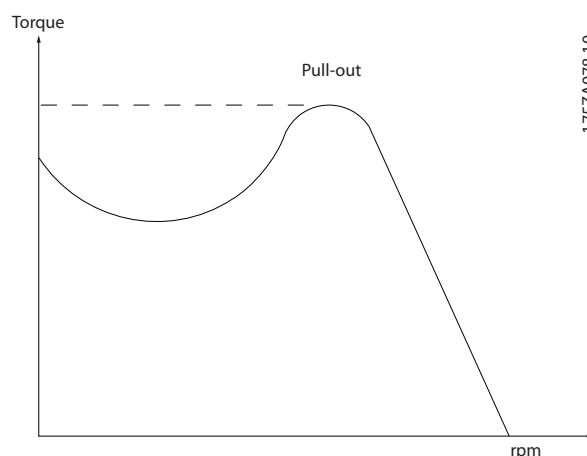

175ZA078.10

Illustration 1.1 Break-away Torque

#### Break-away torque

$\eta_{VLT}$

The efficiency of the frequency converter is defined as the ratio between the power output and the power input.

#### Start-disable command

A stop command belonging to the group 1 control commands - see *Table 1.1*.

#### Stop command

See Control commands.

### 1.6.4 References

#### Analog Reference

A signal transmitted to the analog inputs 53 or 54, can be voltage or current.

#### Binary Reference

A signal transmitted to the serial communication port.

#### Preset Reference

A defined preset reference to be set from -100% to +100% of the reference range. Selection of 8 preset references via the digital terminals.

#### Pulse Reference

A pulse frequency signal transmitted to the digital inputs (terminal 29 or 33).

#### Ref<sub>MAX</sub>

Determines the relationship between the reference input at 100% full scale value (typically 10 V, 20 mA) and the resulting reference. The maximum reference value set in *3-03 Maximum Reference*.

#### Ref<sub>MIN</sub>

Determines the relationship between the reference input at 0% value (typically 0 V, 0 mA, 4 mA) and the resulting reference. The minimum reference value set in *3-02 Minimum Reference*.

## 1.6.5 Miscellaneous

### Analog Inputs

The analog inputs are used for controlling various functions of the frequency converter.

There are 2 types of analog inputs:

Current input, 0-20 mA and 4-20 mA

Voltage input, -10 to +10 V DC.

### Analog Outputs

The analog outputs can supply a signal of 0-20 mA, 4-20 mA.

### Automatic Motor Adaptation, AMA

AMA algorithm determines the electrical parameters for the connected motor at standstill.

### Brake Resistor

The brake resistor is a module capable of absorbing the brake power generated in regenerative braking. This regenerative braking power increases the intermediate circuit voltage and a brake chopper ensures that the power is transmitted to the brake resistor.

### CT Characteristics

Constant torque characteristics used for all applications such as conveyor belts, displacement pumps and cranes.

### Digital Inputs

The digital inputs can be used for controlling various functions of the frequency converter.

### Digital Outputs

The frequency converter features 2 Solid State outputs that can supply a 24 V DC (max. 40 mA) signal.

### DSP

Digital Signal Processor.

### ETR

Electronic Thermal Relay is a thermal load calculation based on present load and time. Its purpose is to estimate the motor temperature.

### Hiperface®

Hiperface® is a registered trademark by Stegmann.

### Initialising

If initialising is carried out (*14-22 Operation Mode*), the frequency converter returns to the default setting.

### Intermittent Duty Cycle

An intermittent duty rating refers to a sequence of duty cycles. Each cycle consists of an on-load and an off-load period. The operation can be either periodic duty or non-periodic duty.

### LCP

The Local Control Panel makes up a complete interface for control and programming of the frequency converter. The control panel is detachable and can be installed up to 3 m from the frequency converter, i.e. in a front panel with the installation kit option.

### NLCP

Numerical Local Control Panel interface for control and programming of the frequency converter. The display is numerical and the panel is used to display process values. The NLCP has no storing and copy functions.

### lsb

Least significant bit.

### msb

Most significant bit.

### MCM

Short for Mille Circular Mil, an American measuring unit for cable cross-section. 1 MCM = 0.5067mm<sup>2</sup>.

### On-line/Off-line Parameters

Changes to on-line parameters are activated immediately after the data value is changed. Press [OK] to activate changes to off-line parameters.

### Process PID

The PID control maintains the desired speed, pressure, temperature, etc. by adjusting the output frequency to match the varying load.

### PCD

Process Control Data

### Power Cycle

Switch off the mains until display (LCP) is dark – then turn power on again.

### Pulse Input/Incremental Encoder

An external, digital pulse transmitter used for feeding back information on motor speed. The encoder is used in applications where great accuracy in speed control is required.

### RCD

Residual Current Device.

### Set-up

Save parameter settings in 4 Set-ups. Change between the 4 parameter Set-ups and edit one Set-up, while another Set-up is active.

### SFAVM

Switching pattern called Stator Flux oriented Asynchronous Vector Modulation (*14-00 Switching Pattern*).

### Slip Compensation

The frequency converter compensates for the motor slip by giving the frequency a supplement that follows the measured motor load keeping the motor speed almost constant.

### Smart Logic Control (SLC)

The SLC is a sequence of user-defined actions executed when the associated user-defined events are evaluated as true by the Smart Logic Control. (Parameter group 13-\*\* *Smart Logic Control (SLC)*).

### STW

Status Word



**FC Standard Bus**

Includes RS-485 bus with FC protocol or MC protocol. See *parameter 8-30 Protocol*.

**THD**

**Total Harmonic Distortion** states the total contribution of harmonic.

**Thermistor**

A temperature-dependent resistor placed where the temperature is to be monitored (frequency converter or motor).

**Trip**

A state entered in fault situations, e.g. if the frequency converter is subject to an over-temperature or when the frequency converter is protecting the motor, process or mechanism. Restart is prevented until the cause of the fault has disappeared and the trip state is cancelled by activating reset or, in some cases, by being programmed to reset automatically. Trip may not be used for personal safety.

**Trip Locked**

A state entered in fault situations when the frequency converter is protecting itself and requiring physical intervention, e.g. if the frequency converter is subject to a short circuit on the output. A locked trip can only be cancelled by disconnecting mains, removing the cause of the fault, and reconnecting the frequency converter. Restart is prevented until the trip state is cancelled by activating reset or, in some cases, by being programmed to reset automatically. The Trip Locked state may not be used for personal safety.

**VT Characteristics**

Variable torque characteristics used for pumps and fans.

**VVC<sup>+</sup>**

If compared with standard voltage/frequency ratio control, Voltage Vector Control (VVC<sup>+</sup>) improves the dynamics and the stability, both when the speed reference is changed and in relation to the load torque.

**60° AVM**

Switching pattern called 60° Asynchronous Vector Modulation (*14-00 Switching Pattern*).

**Power Factor**

The power factor is the relation between I<sub>1</sub> and I<sub>RMS</sub>.

$$Power\ factor = \frac{\sqrt{3} \times U \times I_1 \cos\phi}{\sqrt{3} \times U \times I_{RMS}}$$

The power factor for 3-phase control:

$$= \frac{I_1 \times \cos\phi}{I_{RMS}} = \frac{I_1}{I_{RMS}} \text{ since } \cos\phi = 1$$

The power factor indicates to which extent the frequency converter imposes a load on the mains supply.

The lower the power factor, the higher the I<sub>RMS</sub> for the same kW performance.

$$I_{RMS} = \sqrt{I_1^2 + I_5^2 + I_7^2 + \dots + I_n^2}$$

In addition, a high power factor indicates that the different harmonic currents are low.

The frequency converters' built-in DC coils produce a high power factor, which minimizes the imposed load on the mains supply.

**1.7 Abbreviations, Symbols and Conventions**

AC	Alternating current
AWG	American wire gauge
A	Ampere/AMP
AMA	Automatic Motor Adaptation
I <sub>LIM</sub>	Current limit
°C	Degrees Celsius
DC	Direct current
D-TYPE	Drive Dependent
EMC	Electro Magnetic Compatibility
ETR	Electronic Thermal Relay
FC	Frequency converter
g	Gram
Hz	Hertz
hp	Horsepower
kHz	Kilohertz
LCP	Local Control Panel
m	Meter
mH	Millihenry Inductance
mA	Milliamper
ms	Millisecond
min	Minute
MCT	Motion Control Tool
nF	Nanofarad
Nm	Newton Meters
I <sub>M,N</sub>	Nominal motor current
f <sub>M,N</sub>	Nominal motor frequency
P <sub>M,N</sub>	Nominal motor power
U <sub>M,N</sub>	Nominal motor voltage
PM motor	Permanent Magnet motor
PELV	Protective Extra Low Voltage
PCB	Printed Circuit Board
I <sub>INV</sub>	Rated Inverter Output Current
RPM	Revolutions Per Minute
Regen	Regenerative terminals
sec.	Second
n <sub>s</sub>	Synchronous Motor Speed
T <sub>LIM</sub>	Torque limit
V	Volts
I <sub>VLT,MAX</sub>	The maximum output current
I <sub>VLT,N</sub>	The rated output current supplied by the frequency converter

## 1.8 Safety

### **⚠️ WARNING**

The voltage of the frequency converter is dangerous whenever connected to mains. Incorrect installation of the motor, frequency converter or fieldbus may cause death, serious personal injury or damage to the equipment. Consequently, the instructions in this manual, as well as national and local rules and safety regulations, must be complied with.

#### Safety Regulations

- Disconnect mains supply to the frequency converter whenever repair work is to be carried out. Check that the mains supply has been disconnected and that the necessary time has elapsed before removing motor and mains supply plugs.
- [Off] does not disconnect the mains supply and consequently, it must not be used as a safety switch.
- Ground the equipment properly, protect the user against supply voltage and protect the motor against overload in accordance with applicable national and local regulations.
- The ground leakage current exceeds 3.5 mA.
- Protection against motor overload is not included in the factory setting. If this function is desired, set *1-90 Motor Thermal Protection* to data value [4] *ETR trip 1* or data value [3] *ETR warning 1*.
- Do not remove the plugs for the motor and mains supply while the frequency converter is connected to mains. Check that the mains supply has been disconnected and that the necessary time has elapsed before removing motor and mains plugs.
- The frequency converter has more voltage sources than L1, L2 and L3, when load sharing (linking of DC intermediate circuit) or external 24 V DC are installed. Check that all voltage sources have been disconnected and that the necessary time has elapsed before commencing repair work.

#### Warning against unintended start

- The motor can be stopped with digital commands, bus commands, references or a local stop, while the frequency converter is connected to mains. These stop functions are not sufficient to prevent unintended motor start and thus prevent personal injury caused by e.g. contact with moving parts. To consider personal safety, disconnect the mains supply or activate the Safe Torque Off function.
- The motor may start while setting the parameters. If this compromises personal safety

(e.g. personal injury caused by contact with moving machine parts), prevent motor starting, for instance by use of the Safe Torque Off function or secure disconnection of the motor connection.

- A motor that has been stopped with the mains supply connected may start if faults occur in the electronics of the frequency converter, through temporary overload, or if a fault in the power supply grid or motor connection is remedied. If unintended start must be prevented for personal safety reasons (e.g. risk of injury caused by contact with moving machine parts), the normal stop functions of the frequency converter are not sufficient. In such cases, disconnect mains supply or activate Safe Torque Off.

### **NOTICE**

When using Safe Torque Off, always follow the instructions in *VLT® Frequency Converters - Safe Torque Off Operating Instructions*.

- Control signals from, or internally within, the frequency converter may in rare cases be activated in error, be delayed or fail to occur entirely. When used in situations where safety is critical, these control signals must not be relied on exclusively.

**⚠ WARNING****High Voltage**

Touching the electrical parts may be fatal - even after the equipment has been disconnected from mains. Also make sure that other voltage inputs have been disconnected, such as external 24 V DC, load sharing (linkage of DC intermediate circuit), as well as the motor connection for kinetic back-up.

Systems where frequency converters are installed must, if necessary, be equipped with additional monitoring and protective devices according to the valid safety regulations, e.g. law on mechanical tools, regulations for the prevention of accidents etc. Modifications on the frequency converters by means of the operating software are allowed.

**NOTICE**

Hazardous situations shall be identified by the machine builder/integrator who is responsible for taking necessary preventive means into consideration. Additional monitoring and protective devices may be included, always according to valid national safety regulations, e.g. law on mechanical tools, regulations for the prevention of accidents.

**Protection mode**

Once a hardware limit on motor current or DC link voltage is exceeded, the frequency converter enters the protection mode. Protection mode means a change of the PWM modulation strategy and a low switching frequency to minimise losses. This continues for 10 s after the last fault and increases the reliability and the robustness of the frequency converter while re-establishing full control of the motor.

## 1.9 Electrical Wiring

### 1.9.1 Electrical Wiring - Control Cables

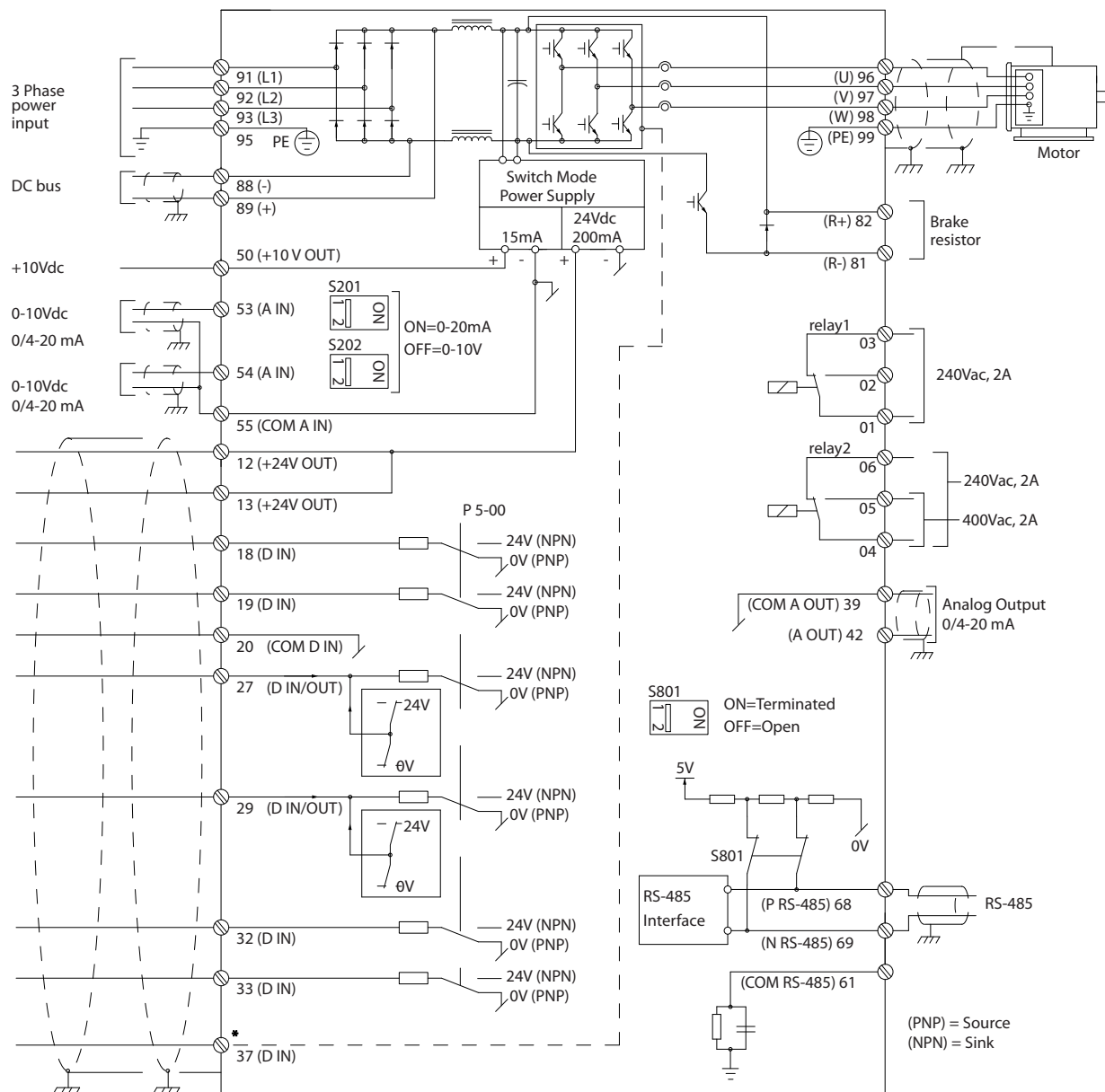

Illustration 1.2 Basic Wiring Schematic Drawing

A=Analog, D=Digital

Terminal 37 is used for Safe Torque Off. For Safe Torque Off installation instructions, refer to the *Operating Instructions*.

\* Terminal 37 is not included in FC 202 (except enclosure type A1). Relay 2 and terminal 29 have no function in FC 202.

\*\* Do not connect cable screen.

Very long control cables and analog signals may in rare cases and depending on installation result in 50/60 Hz ground loops due to noise from mains supply cables.

If this occurs, it may be necessary to break the screen or insert a 100 nF capacitor between screen and chassis.

The digital and analog inputs and outputs must be connected separately to the common inputs (terminal 20, 55, 39) of the frequency converter to avoid ground currents from both groups to affect other groups. For example, switching on the digital input may disturb the analog input signal.

**Input polarity of control terminals**

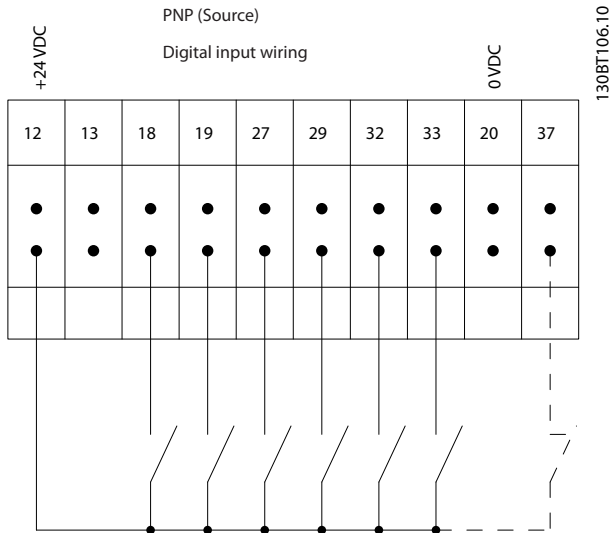

Illustration 1.3 PNP (Source)

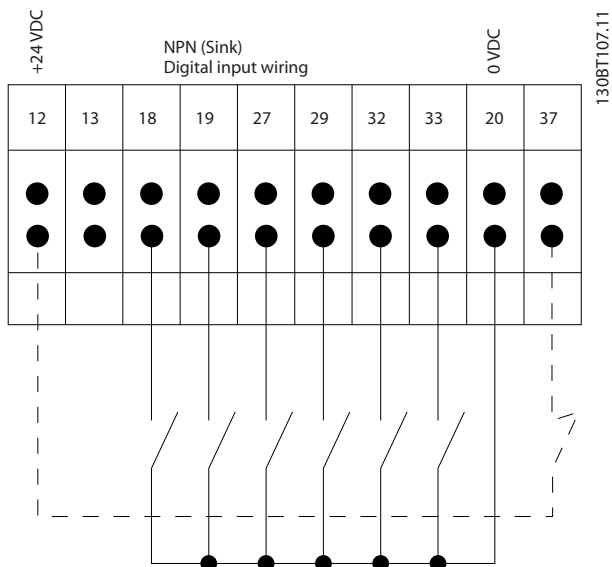

Illustration 1.4 NPN (Sink)

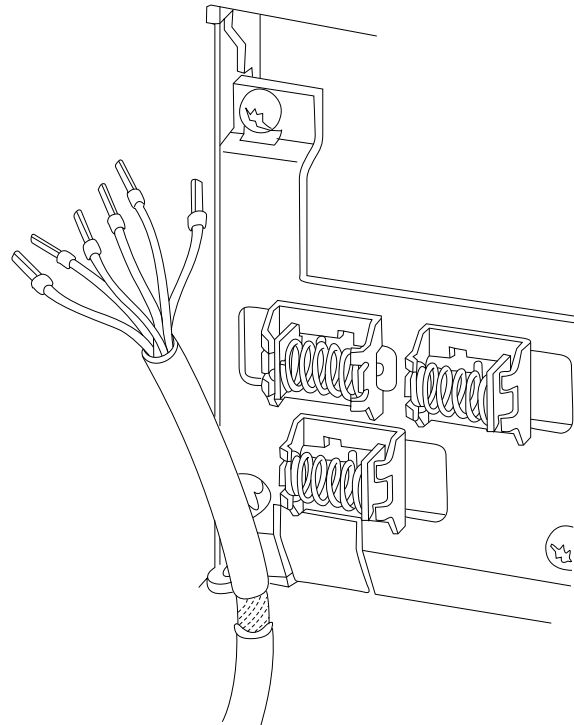

Illustration 1.5 Grounding of Screened/Armoured Control Cables

**1.9.2 Start/Stop**

- Terminal 18 = 5-10 Terminal 18 Digital Input [8] Start
- Terminal 27 = 5-12 Terminal 27 Digital Input [0] No operation (Default coast inverse)
- Terminal 37 = Safe Torque Off (where available)

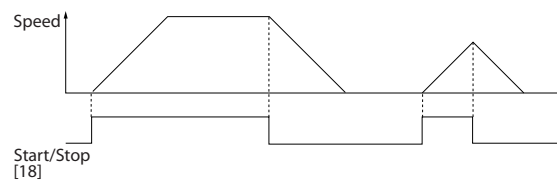
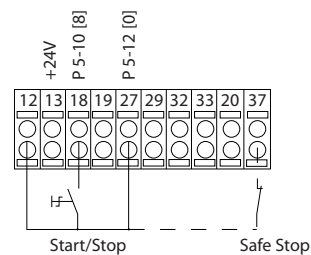

Illustration 1.6 Start/Stop

**NOTICE**

Control cables must be screened/armoured.

See section *Grounding of Screened Control Cables* in the *Design Guide* for the correct termination of control cables.

### 1.9.3 Pulse Start/Stop

Terminal 18 = 5-10 Terminal 18 Digital Input [9] Latched start

Terminal 27 = 5-12 Terminal 27 Digital Input [6] Stop inverse

Terminal 37 = Safe Torque Off (where available)

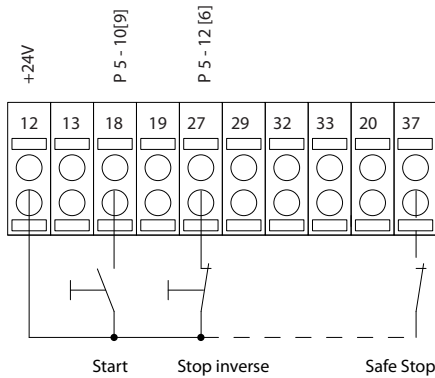

130BA156.12

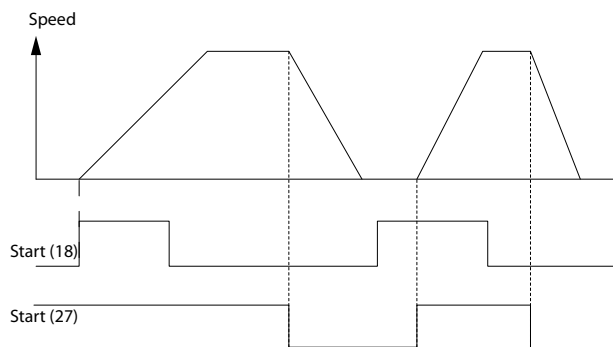

Illustration 1.7 Pulse Start/Stop

### 1.9.4 Speed Up/Down

#### Terminals 29/32 = Speed up/down

Terminal 18 = 5-10 Terminal 18 Digital Input [9] Start (default)

Terminal 27 = 5-12 Terminal 27 Digital Input [19] Freeze reference

Terminal 29 = 5-13 Terminal 29 Digital Input [21] Speed up

Terminal 32 = 5-14 Terminal 32 Digital Input [22] Speed down

Terminal 29 only in FC x02 (x = series type).

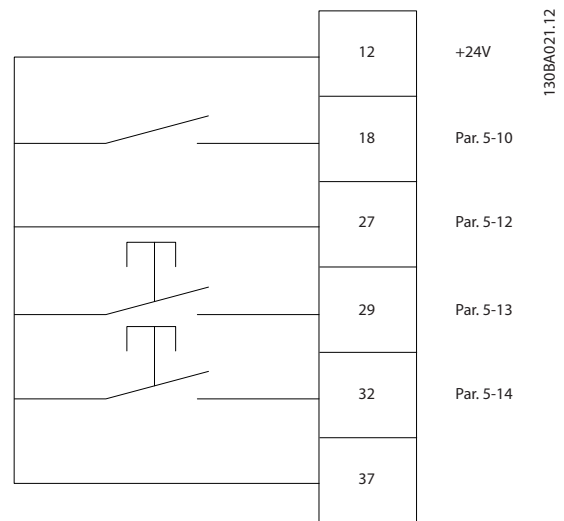

Illustration 1.8 Speed Up/Down

### 1.9.5 Potentiometer Reference

#### Voltage reference via a potentiometer

Reference Source 1 = [1] Analog input 53 (default)

Terminal 53, Low Voltage = 0 V

Terminal 53, High Voltage = 10 V

Terminal 53, Low Ref./Feedback = 0 RPM

Terminal 53, High Ref./Feedback = 1500 RPM

Switch S201 = OFF (U)

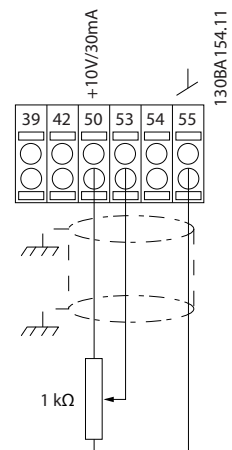
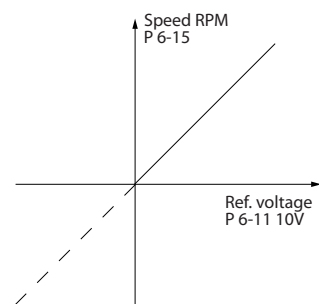

Illustration 1.9 Potentiometer Reference

## 2 How to Programme

### 2.1 The Graphical and Numerical Local Control Panel

The easiest programming of the frequency converter is performed with the graphical LCP (LCP 102).

### 2.2 How to Programme on the Graphical LCP

The control panel is divided into 4 functional groups:

1. Graphical display with Status lines.
2. Menu keys and indicator lights - changing parameters and switching between display functions.
3. Navigation keys and indicator lights (LEDs).
4. Operation keys and indicator lights (LEDs).

All data is displayed in a graphical LCP display, which can show up to 5 items of operating data while displaying [Status].

Display lines:

- a. **Status line:** Status messages displaying icons and graphic.
- b. **Line 1-2:** Operator data lines displaying data defined or selected by the user. By pressing [Status], up to one extra line can be added.
- c. **Status line:** Status messages displaying text.

**NOTICE**

If some operation is delaying the start-up, the LCP displays the INITIALISING message until it is ready. Adding or removing options may delay the start-up.

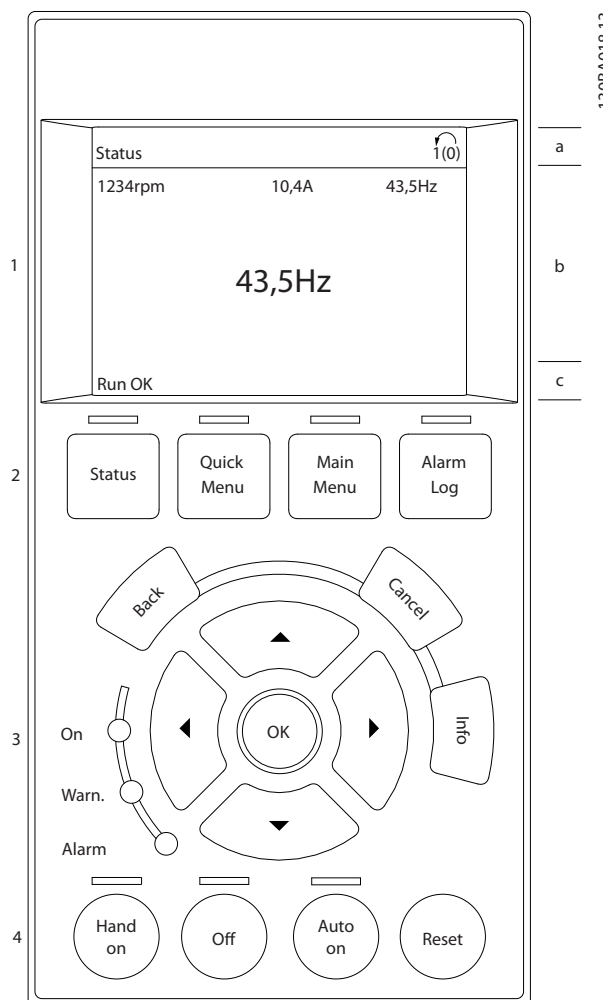

Illustration 2.1 Control Panel (LCP)

130BA018.13

2

### 2.2.1 The LCP Display

The LCP display has backlight and a total of 6 alpha-numeric lines. The display lines show the direction of rotation (arrow), the selected set-up as well as the programming set-up. The display is divided into 3 sections.

**Top section**

shows up to 2 measurements in normal operating status.

**Middle section**

The top line shows up to 5 measurements with related unit, regardless of status (except in the case of alarm/warning).

**Bottom section**

always shows the state of the frequency converter in Status mode.

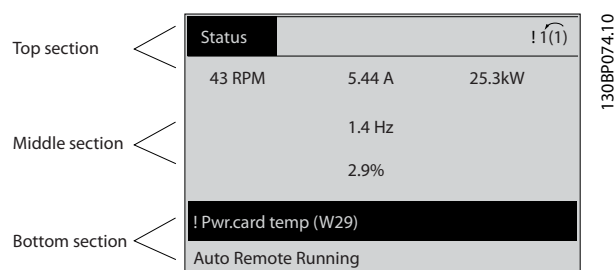

Illustration 2.2 Bottom Section

The active set-up (selected as the active set-up in 0-10 Active Set-up) is shown. When programming another set-up than the active set-up, the number of the programmed set-up appears to the right.

**Display Contrast Adjustment**

Press [Status] and [▲] for darker display  
 Press [Status] and [▼] for brighter display

Most parameter set-ups can be changed immediately via the LCP, unless a password has been created via parameter 0-60 Main Menu Password or via 0-65 Personal Menu Password.

**Indicator lights (LEDs)**

If certain threshold values are exceeded, the alarm and/or warning LED lights up. A status and alarm text appear on the LCP.

The ON LED is activated when the frequency converter receives mains voltage or via a DC bus terminal or 24 V external supply. At the same time, the backlight is on.

- Green LED/On: Control section is working.
- Yellow LED/Warn.: Indicates a warning.
- Flashing Red LED/Alarm: Indicates an alarm.

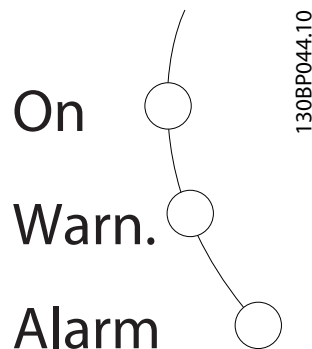

Illustration 2.3 Indicator lights (LEDs)

**LCP Keys**

The control keys are divided into functions. The keys below the display and indicator lamps are used for parameter Set-up, including choice of display indication during normal operation.



Illustration 2.4 LCP Keys

**[Status]**

indicates the status of the frequency converter and/or the motor. Select between 3 different readouts by pressing [Status]: 5 line readouts, 4 line readouts or Smart Logic Control.

Press [Status] for selecting the mode of display or for changing back to Display mode from either the Quick Menu mode, the Main Menu mode or Alarm mode. Also use [Status] to toggle single or double readout mode.

**[Quick Menu]**

Provides quick access to the most common functions of the frequency converter.

The [Quick Menu] consists of:

- Q1: My Personal Menu
- Q2: Quick Setup
- Q3: Function Setups
- Q5: Changes Made
- Q6: Loggings

The function set-up provides quick access to all parameters required for the majority of water and wastewater applications including variable torque, constant torque, pumps, dosing pumps, well pumps, booster pumps, mixer pumps, aeration blowers and other pump and fan applications. Amongst other features it also includes



parameters for selecting which variables to display on the LCP, digital preset speeds, scaling of analog references, closed loop single-zone and multi-zone applications and specific functions related to water and wastewater applications.

The Quick Menu parameters can be accessed immediately unless a password has been created via *parameter 0-60 Main Menu Password, parameter 0-61 Access to Main Menu w/o Password, parameter 0-65 Personal Menu Password or parameter 0-66 Access to Personal Menu w/o Password.*

It is possible to switch directly between Quick Menu mode and Main Menu mode.

**[Main Menu]**

This section is used for programming all parameters. The Main Menu parameters can be accessed immediately unless a password has been created via *parameter 0-60 Main Menu Password, parameter 0-61 Access to Main Menu w/o Password, parameter 0-65 Personal Menu Password or parameter 0-66 Access to Personal Menu w/o Password.* For the majority of water and wastewater applications it is not necessary to access the Main Menu parameters. The Quick Menu, Quick Set-up and Function Set-ups provide the simplest and quickest access to the typical required parameters.

It is possible to switch directly between Main Menu mode and Quick Menu mode.

Parameter shortcut can be carried out by pressing [Main Menu] for 3 s. The parameter shortcut allows direct access to any parameter.

**[Alarm Log]**

displays an Alarm list of the 5 latest alarms (numbered A1 - A5). To obtain additional details about an alarm, use the navigation keys to navigate to the alarm number and press [OK]. Right before entering the alarm mode information about the condition of the frequency converter is provided.

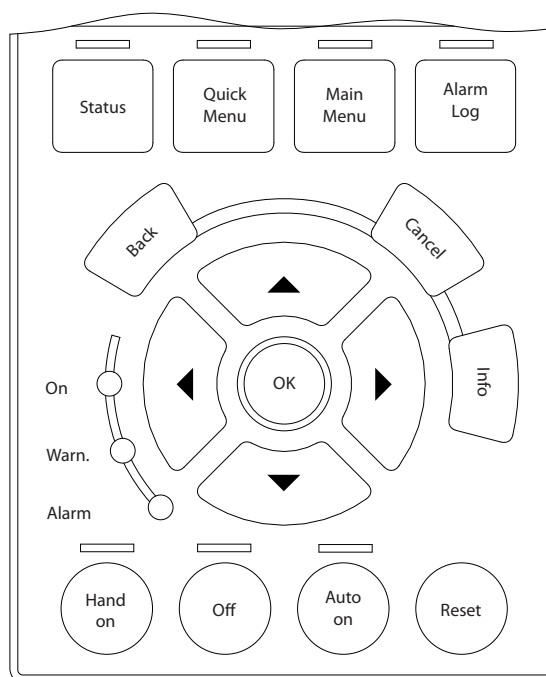

130BA027.10

Illustration 2.5 LCP

**[Back]**

reverts to the previous step or layer in the navigation structure.

**[Cancel]**

last change or command is cancelled as long as the display has not been changed.

**[Info]**

supplies information about a command, parameter, or function in any display window. [Info] provides detailed information whenever help is needed.

Exit info mode by pressing either [Info], [Back], or [Cancel].



Illustration 2.6 Back



Illustration 2.7 Cancel



Illustration 2.8 Info

### Navigation Keys

The 4 navigation keys are used to navigate between the different choices available in [Quick Menu], [Main Menu] and [Alarm Log]. Use the keys to move the cursor.

### [OK]

is used for selecting a parameter marked by the cursor and for enabling the change of a parameter.

### Local Control Keys

for local control are found at the bottom of the LCP.

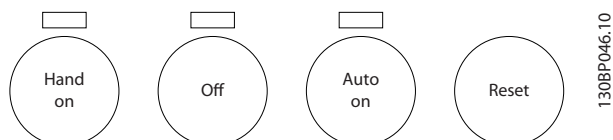

Illustration 2.9 Local Control Keys

### [Hand On]

enables control of the frequency converter via the LCP. [Hand On] also starts the motor, and it is now possible to enter the motor speed data with the arrow keys. The key can be selected as [1] Enable or [0] Disable via parameter 0-40 [Hand on] Key on LCP

External stop signals activated with control signals or a serial bus override a "start" command via the LCP.

The following control signals are still active when [Hand On] is activated

- [Hand on] - [Off] - [Auto On]
- Reset
- Coasting stop inverse
- Reversing
- Set-up select bit 0 - Set-up select bit 1
- Stop command from serial communication
- Quick stop
- DC brake

### [Off]

stops the connected motor. The key can be selected as [1] Enable or [0] Disable via 0-41 [Off] Key on LCP. If no external stop function is selected and the [Off] key is inactive the motor can be stopped by disconnecting the voltage.

### [Auto On]

enables the frequency converter to be controlled via the control terminals and/or serial communication. When a start signal is applied on the control terminals and/or the bus, the frequency converter starts. The key can be selected as [1] Enable or [0] Disable via 0-42 [Auto on] Key on LCP.

## NOTICE

An active HAND-OFF-AUTO signal via the digital inputs has higher priority than the control keys [Hand On] – [Auto On].

### [Reset]

is used for resetting the frequency converter after an alarm (trip). It can be selected as [1] Enable or [0] Disable via 0-43 [Reset] Key on LCP.

The parameter shortcut can be carried out by pressing [Main Menu] for 3 seconds. The parameter shortcut allows direct access to any parameter.

## 2.2.2 Quick Transfer of Parameter Settings between Multiple Frequency Converters

Once the set-up of a frequency converter is complete, store the data in the LCP or on a PC via MCT 10 Set-up Software Tool.

### Data storage in LCP

## NOTICE

Stop the motor before performing this operation.

1. Go to parameter 0-50 LCP Copy
2. Press the [OK] key
3. Select [1] All to LCP
4. Press the [OK] key

All parameter settings are now stored in the LCP indicated by the progress bar. When 100% is reached, press [OK].

Connect the LCP to another frequency converter and copy the parameter settings to this frequency converter as well.

### Data transfer from LCP to frequency converter

## NOTICE

Stop the motor before performing this operation.

1. Go to parameter 0-50 LCP Copy
2. Press the [OK] key
3. Select [2] All from LCP
4. Press the [OK] key

The parameter settings stored in the LCP are now transferred to the frequency converter indicated by the progress bar. When 100% is reached, press [OK].

## 2.2.3 Display Mode

In normal operation, up to 5 different operating variables can be indicated continuously in the middle section: 1.1, 1.2, and 1.3 as well as 2 and 3.

## 2.2.4 Display Mode - Selection of Readouts

Press [Status] to toggle between 3 status readout screens. Operating variables with different formatting are shown in each status screen - see examples below.

Several values or measurements can be linked to each of the displayed operating variables. The values or measurements to be displayed can be defined via the following parameters: *parameter 0-20 Display Line 1.1 Small, 0-21 Display Line 1.2 Small, 0-22 Display Line 1.3 Small, 0-23 Display Line 2 Large, and 0-24 Display Line 3 Large*, which can be accessed via [QUICK MENU], "Q3 Function Set-ups", "Q3-1 General Settings", "Q3-13 Display Settings".

Each readout parameter selected in *parameter 0-20 Display Line 1.1 Small to 0-24 Display Line 3 Large* has its own scale and digits after a decimal point. By larger numeric value of a parameter fewer digits are displayed after the decimal point.  
 Ex.: Current readout 5.25A; 15.2A 105A.

See parameter group *0-2\* LCP Display* for further details.

**Status screen I**

This readout state is standard after start-up or initialisation. Press [Info] to obtain information about the measurement links to the displayed operating variables (1.1, 1.2, 1.3, 2 and 3).

See the operating variables shown in the screen below.

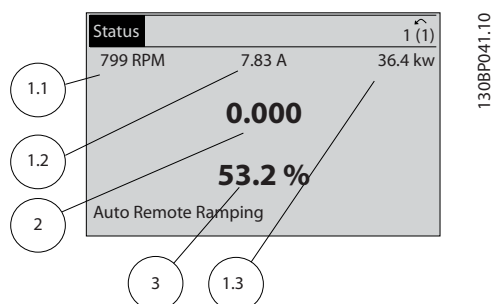

Illustration 2.10 Status Screen I

**Status screen II**

See the operating variables (1.1, 1.2, 1.3 and 2) shown in the screen below.

In the example, Speed, Motor current, Motor power and Frequency are selected as variables in the first and second line.

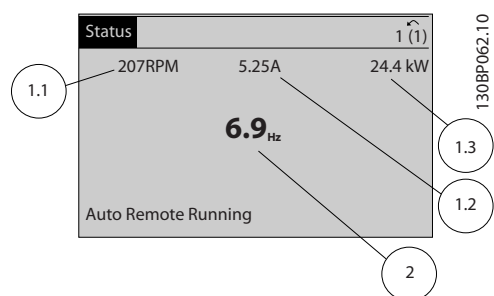

Illustration 2.11 Status Screen II

**Status screen III**

This state displays the event and action of the Smart Logic Control. For further information, see *chapter 3.12 Parameters 13-\*\* Smart Logic Control*.

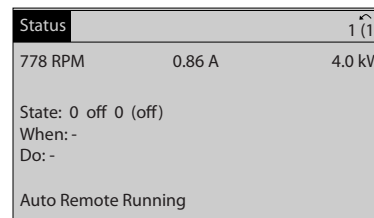

Illustration 2.12 Status Screen III

**2.2.5 Parameter Set-Up, General Information**

The frequency converter can be used for practically all assignments, which is why the number of parameters is quite large. The frequency converter offers a choice between 2 programming modes - a Main Menu and a Quick Menu mode.

The former provides access to all parameters. The latter takes the user through a few parameters making it possible to program the majority of water/wastewater applications.

Regardless of the mode of programming, parameters can be changed in both the Main Menu mode and the Quick Menu mode.quick menu mode

**2.2.6 Quick Menu Key Functions**

Press [Quick Menus] to see a list of different areas contained in the Quick menu.

Select *My Personal Menu* to display the selected personal parameters. These parameters are selected in *parameter 0-25 My Personal Menu*. Up to 50 different parameters can be added in this menu.

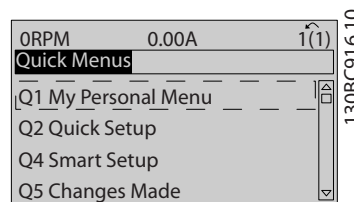

Illustration 2.13 Quick Menu

Select *Q2 Quick Setup* to go through a limited amount of parameters to get the motor running almost optimally. The default setting for the other parameters considers the desired control functions and the configuration of signal inputs/outputs (control terminals).

The parameter selection is effected with the navigation keys. The parameters in *Table 2.1* are accessible.

Parameter	Setting
Parameter 0-01 Language	
1-20 Motor Power [kW]	[kW]
Parameter 1-22 Motor Voltage	[V]
1-23 Motor Frequency	[Hz]
1-24 Motor Current	[A]
1-25 Motor Nominal Speed	[RPM]
5-12 Terminal 27 Digital Input	[0] No function*
1-29 Automatic Motor Adaptation (AMA)	[1] Enable complete AMA
3-02 Minimum Reference	[RPM]
3-03 Maximum Reference	[RPM]
3-41 Ramp 1 Ramp Up Time	[s]
3-42 Ramp 1 Ramp Down Time	[s]
Parameter 3-13 Reference Site	

**Table 2.1 Selection of Parameter**

\* If terminal 27 is set to [0] No function, no connection to +24 V on terminal 27 is necessary.

Select *Changes made* to get information about:

- the last 10 changes. Use the [▲] [▼] navigation keys to scroll between the last 10 changed parameters.
- the changes made since default setting.

Select *Loggings* to get information about the display line read-outs. The information is shown as graphs.

Only display parameters selected in *parameter 0-20 Display Line 1.1 Small* and *0-24 Display Line 3 Large* can be viewed. It is possible to store up to 120 samples in the memory for later reference.

### 2.2.7 Quick Menu, Q3 Function Set-ups

The function set-up provides quick access to all parameters required for the majority of water and wastewater applications including variable torque, constant torque, pumps, dosing pumps, well pumps, booster pumps, mixer pumps, aeration blowers and other pump and fan applications. Amongst other features it also includes parameters for selecting which variables to display on the LCP, digital preset speeds, scaling of analog references, closed loop single zone and multi-zone applications and specific functions related to water and wastewater applications.

The Function Set-up parameters are grouped in the following way:

Q3-1 General Settings			
Q3-10 Clock Settings	Q3-11 Display Settings	Q3-12 Analog Output	Q3-13 Relays
Parameter 0-70 Date and Time	Parameter 0-20 Display Line 1.1 Small	Parameter 6-50 Terminal 42 Output	Relay 1⇒Parameter 5-40 Function Relay
Parameter 0-71 Date Format	0-21 Display Line 1.2 Small	Parameter 6-51 Terminal 42 Output Min Scale	Relay 2⇒Parameter 5-40 Function Relay
Parameter 0-72 Time Format	0-22 Display Line 1.3 Small	Parameter 6-52 Terminal 42 Output Max Scale	Option relay 7⇒Parameter 5-40 Function Relay
Parameter 0-74 DST/Summertime	0-23 Display Line 2 Large		Option relay 8⇒Parameter 5-40 Function Relay
Parameter 0-76 DST/Summertime Start	0-24 Display Line 3 Large		Option relay 9⇒Parameter 5-40 Function Relay
Parameter 0-77 DST/Summertime End	Parameter 0-37 Display Text 1		
	Parameter 0-38 Display Text 2		
	Parameter 0-39 Display Text 3		

Table 2.2 Q3-1 General Settings

Q3-2 Open Loop Settings	
Q3-20 Digital Reference	Q3-21 Analog Reference
Parameter 3-02 Minimum Reference	Parameter 3-02 Minimum Reference
Parameter 3-03 Maximum Reference	Parameter 3-03 Maximum Reference
Parameter 3-10 Preset Reference	Parameter 6-10 Terminal 53 Low Voltage
5-13 Terminal 29 Digital Input	Parameter 6-11 Terminal 53 High Voltage
5-14 Terminal 32 Digital Input	Parameter 6-14 Terminal 53 Low Ref./Feedb. Value
5-15 Terminal 33 Digital Input	Parameter 6-15 Terminal 53 High Ref./Feedb. Value

Table 2.3 Q3-2 Open Loop Settings

Q3-3 Closed Loop Settings	
Q3-30 Feedback Settings	Q3-31 PID Settings
Parameter 1-00 Configuration Mode	Parameter 20-81 PID Normal/ Inverse Control
Parameter 20-12 Reference/Feedback Unit	Parameter 20-82 PID Start Speed [RPM]
Parameter 3-02 Minimum Reference	Parameter 20-21 Setpoint 1
	Parameter 20-93 PID Proportional Gain
Parameter 6-20 Terminal 54 Low Voltage	Parameter 20-94 PID Integral Time
Parameter 6-21 Terminal 54 High Voltage	
Parameter 6-25 Terminal 54 High Ref./Feedb. Value	
Parameter 6-00 Live Zero Timeout Time	
Parameter 6-01 Live Zero Timeout Function	

Table 2.4 Q3-3 Closed Loop Settings

### 2.2.8 Main Menu Mode

Press [Main Menu] to enter the Main Menu mode. The readout shown below appears on the display. The middle and bottom sections on the display show a list of parameter groups which can be selected by toggling [▲] and [▼] keys.

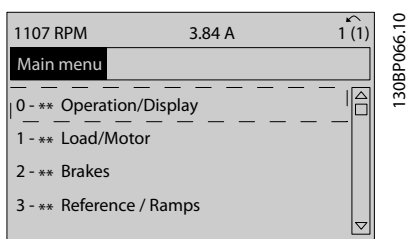

Illustration 2.14 Main Menu Mode

Each parameter has a name and number which remain the same regardless of the programming mode. In the Main Menu mode, the parameters are divided into groups. The first digit of the parameter number (from the left) indicates the parameter group number.

All parameters can be changed in the Main Menu. However, depending on the choice of configuration (1-00 Configuration Mode), some parameters can be "missing". E.g. open loop hides all the PID parameters, and other enabled options make more parameter groups visible.

### 2.2.9 Parameter Selection

In the Main Menu mode, the parameters are divided into groups. Select a parameter group with the navigation keys. The following parameter groups are accessible:

Group no.	Parameter group
0-**	Operation/Display
1-**	Load/Motor
2-**	Brakes
3-**	References/Ramps
4-**	Limits/Warnings
5-**	Digital In/Out
6-**	Analog In/Out
7-**	Controls
8-**	Comm. and Options
9-**	Profibus
10-**	CAN Fieldbus
11-**	Reserved Com. 1
12-**	Ethernet
13-**	Smart Logic
14-**	Special Functions
15-**	Drive Information

Group no.	Parameter group
16-**	Data Readouts
17-**	Motor Feedb. Option
18-**	Data Readouts 2
20-**	FC Closed Loop
21-**	Extended Closed Loop
22-**	Application Functions
23-**	Time-based Functions
24-**	Application Functions 2
25-**	Cascade Controller
26-**	Analog I/O Option MCB 109
29-**	Water Application Functions
30-**	Special Features
32-**	MCO Basic Settings
33-**	MCO Adv. Settings
34-**	MCO Data Readouts
35-**	Sensor Input Option

Table 2.5 Accessible Parameter Groups

After selecting a parameter group, select a parameter with the navigation keys.

The middle section on the display shows the parameter number and name as well as the selected parameter value.

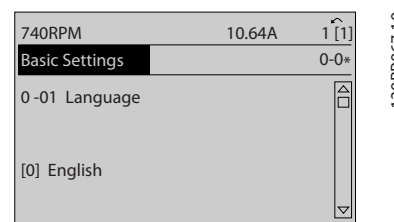

Illustration 2.15 Parameter Selection

### 2.2.10 Changing Data

### 2.2.11 Changing a Text Value

If the selected parameter is a text value, change the text value with the [▲] [▼] keys.

Place the cursor on the value that should be saved and press [OK].

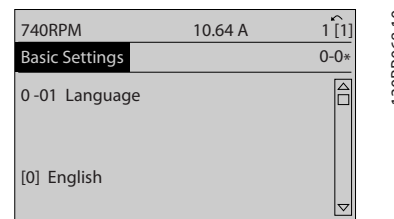
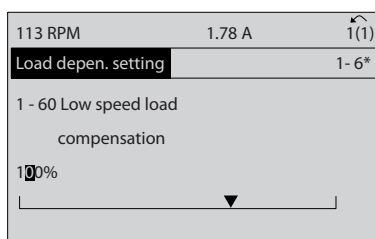

Illustration 2.16 Changing a Text Value

2

### 2.2.12 Changing a Group of Numeric Data Values

If the selected parameter represents a numeric data value, change the data value using the [◀] [▶] navigation keys as well as the [▲] [▼] navigation keys. Press [◀] [▶] keys to move the cursor horizontally.



130BP069.10

Illustration 2.17 Changing a Group of Numeric Data Values

Press [▲] [▼] keys to change the data value. [▲] increases the data value, and [▼] decreases the data value. Place the cursor on the value to save and press [OK].

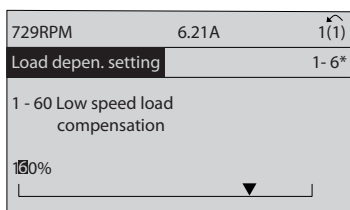

130BP070.10

Illustration 2.18 Changing a Group of Numeric Data Values

### 2.2.13 Infinitely Variable Change of Numeric Data Value

If the selected parameter represents a numeric data value, select a digit with [◀] [▶].

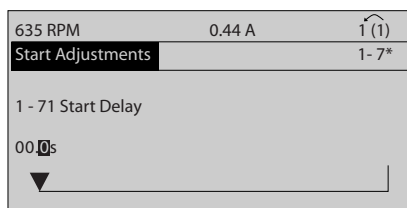

130BP073.10

Illustration 2.19 Selecting a Digit

Change the selected digit infinitely variably with [▲] [▼]. The selected digit is indicated by the cursor. Place the cursor on the digit to save and press [OK].

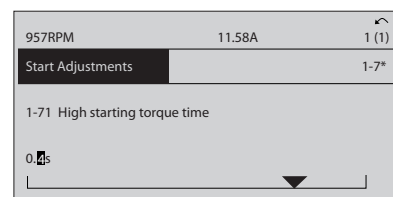

130BP072.10

Illustration 2.20 Saving

### 2.2.14 Value, Step-by-Step

Certain parameters can be changed step by step. This applies to *parameter 1-20 Motor Power [kW]*, *1-22 Motor Voltage* and *parameter 1-23 Motor Frequency*. The parameters are changed both as a group of numeric data values and as numeric data values that are infinitely varying.

### 2.2.15 Readout and Programming of Indexed Parameters

Parameters are indexed when placed in a rolling stack. *15-30 Alarm Log: Error Code* to *parameter 15-32 Alarm Log: Time* contain a fault log which can be read out. Select a parameter, press [OK], and press the keys [▲] [▼] to scroll through the value log.

For example, this is how *3-10 Preset Reference* is changed: Select the parameter, press [OK], and press [▲] [▼] to scroll through the indexed values. To change the parameter value, select the indexed value and press [OK]. Change the value by pressing [▲] [▼]. Press [OK] to accept the new setting. Press [Cancel] to abort. Press [Back] to leave the parameter.

## 2.3 How to Programme on the Numerical LCP

The following instructions are valid for the Numerical LCP (LCP 101).

The control panel is divided into 4 functional groups:

1. Numerical display.
2. Menu keys and indicator lights - changing parameters and switching between display functions.
3. Navigation keys and indicator lights (LEDs).
4. Operation keys and indicator lights (LEDs).

**Display line: Status messages displaying icons and numeric value**

**Indicator lights (LEDs)**

- Green LED/On: Indicates if control section is on.
- Yellow LED/Wrn.: Indicates a warning.
- Flashing red LED/Alarm: Indicates an alarm.



LCP keys

[Menu]

Select one of the following modes:

- Status
- Quick Setup
- Main Menu

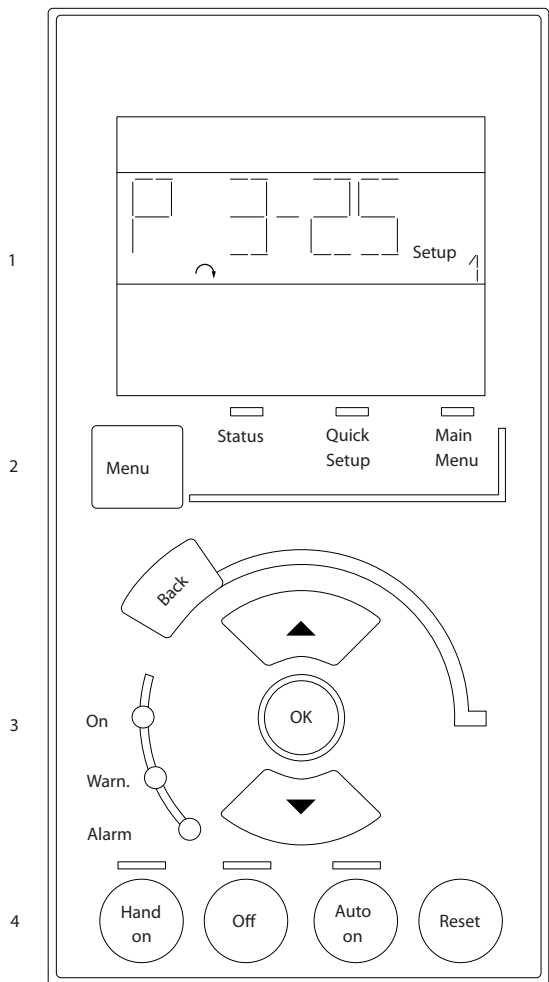

Illustration 2.21 LCP Keys

Status Mode

Displays the status of the frequency converter or the motor.

If an alarm occurs the NLCP automatically switches to status mode.

A number of alarms can be displayed.

**NOTICE**

Parameter copy is not possible with LCP 101 Numerical Local Control Panel.



Illustration 2.22 Status Mode



Illustration 2.23 Alarm

Main Menu/Quick Setup

is used for programming all parameters or only the parameters in the Quick Menu (see also description of the LCP 102 earlier in chapter 2.3 How to Programme on the Numerical LCP).

When the value flashes, press [▲] or [▼] to change parameter values.

Select Main Menu by pressing [Menu] a number of times.

Select the parameter group [xx-\_] and press [OK]

Select the parameter [\_-xx] and press [OK]

If the parameter is an array parameter select the array number and press [OK]

Select the wanted data value and press [OK]

Parameters with functional choices display values such as [1], [2], etc. For a description of the different choices, see the individual description of the parameters in chapter 3 Parameter Description

[Back]

for stepping backwards

[▲] [▼] are used for manoeuvring between commands and within parameters.

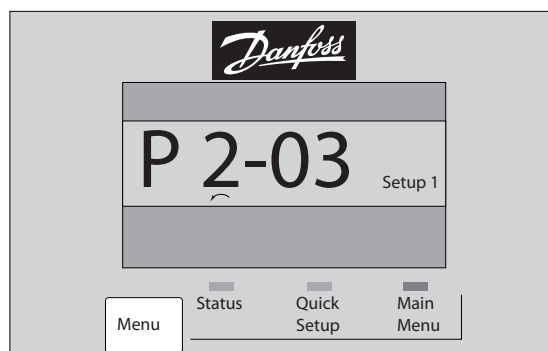

Illustration 2.24 Main Menu/Quick Setup

2.3.1 LCP Keys

Keys for local control are found at the bottom of the LCP.

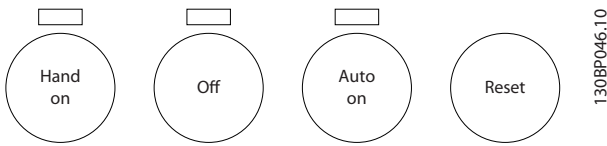

Illustration 2.25 LCP Keys

**[Hand On]**

enables control of the frequency converter via the LCP. [Hand On] also starts the motor and it is now possible to enter the motor speed data with the arrow keys. The key can be selected as [1] Enable or [0] Disable via parameter 0-40 [Hand on] Key on LCP.

External stop signals activated with control signals or a serial bus overrides a 'start' command via the LCP.

The following control signals are still active when [Hand On] is activated:

- [Hand On] - [Off] - [Auto On]
- Reset
- Coasting stop inverse
- Reversing
- Set-up select lsb - Set-up select msb
- Stop command from serial communication
- Quick stop
- DC brake

**[Off]**

stops the connected motor. The key can be selected as [1] Enable or [0] Disable via 0-41 [Off] Key on LCP.

If no external stop function is selected and the [Off] key is inactive the motor can be stopped by disconnecting the voltage.

**[Auto On]**

enables control of the frequency converter via the control terminals and/or serial communication. When a start signal is applied on the control terminals and/or the bus, the frequency converter starts. The key can be selected as [1] Enable or [0] Disable via 0-42 [Auto on] Key on LCP.

**NOTICE**

An active HAND-OFF-AUTO signal via the digital inputs has higher priority than the control keys [Hand On] [Auto On].

**[Reset]**

is used for resetting the frequency converter after an alarm (trip). It can be selected as [1] Enable or [0] Disable via 0-43 [Reset] Key on LCP.

## 2.4 Initialisation to Default Settings

Initialise the frequency converter to default settings in 2 ways.

**Recommended initialisation (via 14-22 Operation Mode)**

1. Select parameter 14-22 Operation Mode
2. Press [OK]
3. Select [2] Initialisation
4. Press [OK]
5. Disconnect the mains supply and wait until the display turns off.
6. Reconnect the mains supply - the frequency converter is now reset.

Parameter 14-22 Operation Mode initialises all except:

- 14-50 RFI Filter
- Parameter 8-30 Protocol
- Parameter 8-31 Address
- 8-32 Baud Rate
- 8-35 Minimum Response Delay
- 8-36 Max Response Delay
- 8-37 Maximum Inter-Char Delay
- Parameter 15-00 Operating hours to parameter 15-05 Over Volt's
- Parameter 15-20 Historic Log: Event to parameter 15-22 Historic Log: Time
- 15-30 Alarm Log: Error Code to parameter 15-32 Alarm Log: Time

**Manual initialisation**

1. Disconnect from mains and wait until the display turns off.
2.
  - 2a Press [Status] - [Main Menu] - [OK] at the same time while power up for LCP 102, Graphical Display
  - 2b Press [Menu] - [OK] while power up for LCP 101, Numerical Display
3. Release the keys after 5 s.
4. The frequency converter is now programmed according to default settings.

This procedure initialises all except:

- Parameter 15-00 Operating hours
- Parameter 15-03 Power Up's
- Parameter 15-04 Over Temp's
- Parameter 15-05 Over Volt's

**NOTICE**

A manual initialisation also resets serial communication, RFI filter settings (14-50 RFI Filter) and fault log settings.

## 3 Parameter Description

### 3.1 Parameter Selection

The parameters are grouped into various parameter groups for easy selection of the correct parameter for optimised frequency converter operation.

#### Overview of parameter groups

Group	Title	Function
0-**	Operation/Display	Parameters related to the fundamental functions of the frequency converter, function of the LCP keys and configuration of the LCP display.
1-**	Load/Motor	Parameter group for motor settings.
2-**	Brakes	Parameter group for setting brake features in the frequency converter.
3-**	Reference/Ramps	Parameters for reference handling, definitions of limitations, and configuration of the reaction of the frequency converter to changes.
4-**	Limits/Warnings	Parameter group for configuring limits and warnings.
5-**	Digital In/Out	Parameter group for configuring the digital inputs and outputs.
6-**	Analog In/Out	Parameter group for configuration of the analog inputs and outputs.
8-**	Communication and Options	Parameter group for configuring communications and options.
9-**	Profibus	Parameter group for Profibus-specific parameters (requires profibus option).
10-**	DeviceNet Fieldbus	Parameter group for DeviceNet-specific parameters (requires DeviceNet option).
13-**	Smart Logic	Parameter group for Smart Logic Control
14-**	Special Functions	Parameter group for configuring special frequency converter functions.
15-**	Drive Information	Parameter group containing frequency converter information such as operating data, hardware configuration and software versions.
16-**	Data Readouts	Parameter group for data read-outs, e.g. actual references, voltages, control, alarm, warning and status words.
18-**	Info and Readouts	This parameter group contains the last 10 Preventive Maintenance logs.
20-**	Drive Closed Loop	This parameter group is used for configuring the closed loop PID Controller that controls the output frequency of the unit.
21-**	Extended Closed Loop	Parameters for configuring the three Extended Closed Loop PID Controllers.
22-**	Application Functions	These parameters monitor water applications.
23-**	Time-based Functions	These parameters are for actions needed to be performed on a daily or weekly basis, e.g. different references for working hours/non-working hours.
24-**	Application Functions 2	Parameters for the Drive Bypass.
25-**	Basic Cascade Controller Functions	Parameters for configuring the Basic Cascade Controller for sequence control of multiple pumps.
26-**	Analog I/O Option MCB 109	Parameters for configuring the Analog I/O Option MCB 109.
27-**	Extended Cascade Control	Parameters for configuring the Extended Cascade Control (MCO 101/MCO 102).
29-**	Water Application Functions	Parameters for setting water specific functions.
30-**	Special Features	Parameters for configuring the brake resistor value.
31-**	Bypass Option	Parameters for configuring the Bypass Option (MCO 104).
35-**	Sensor Input Option	Parameters for configuring the Sensor Input Option (MCB 114)

**Table 3.1 Parameter Groups**

Parameter descriptions and selections are displayed on the graphic (GLCP) or numeric (NLCP) in the display area. (See *chapter 2 How to Programme* for details.) Access the parameters by pressing the [Quick Menu] or [Main Menu] key on the control panel. The quick menu is used primarily for commissioning the unit at start-up by providing those parameters necessary to start operation. The main menu provides access to all parameters for detailed application programming.

All digital input/output and analog input/output terminals are multifunctional. All terminals have factory default functions suitable for the majority of water applications but if other special functions are required, they must be programmed in parameter group 5-\*\* *Digital In/out* or 6-\*\* *Analog In/out*.

## 3.2 Parameters 0-\*\* Operation and Display

Parameters related to the fundamental functions of the frequency converter, function of the LCP keys and configuration of the LCP display.

### 3.2.1 0-0\* Basic Settings

0-01 Language		
Option:	Function:	
		Defines the language to be used in the display. The frequency converter can be delivered with 2 different language packages. English and German are included in both packages. English cannot be erased or manipulated.
[0]	English	Part of Language packages 1 - 2
[1]	Deutsch	Part of Language packages 1 - 2
[2]	Francais	Part of Language package 1
[3]	Dansk	Part of Language package 1
[4]	Spanish	Part of Language package 1
[5]	Italiano	Part of Language package 1
[6]	Svenska	Part of Language package 1
[7]	Nederlands	Part of Language package 1
[10]	Chinese	Language package 2
[20]	Suomi	Part of Language package 1
[22]	English US	Part of Language package 1
[27]	Greek	Part of Language package 1
[28]	Bras.port	Part of Language package 1
[36]	Slovenian	Part of Language package 1
[39]	Korean	Part of Language package 2
[40]	Japanese	Part of Language package 2
[41]	Turkish	Part of Language package 1
[42]	Trad.Chinese	Part of Language package 2
[43]	Bulgarian	Part of Language package 1
[44]	Srpski	Part of Language package 1
[45]	Romanian	Part of Language package 1
[46]	Magyar	Part of Language package 1
[47]	Czech	Part of Language package 1
[48]	Polski	Part of Language package 1
[49]	Russian	Part of Language package 1
[50]	Thai	Part of Language package 2
[51]	Bahasa Indonesia	Part of Language package 2

0-01 Language		
Option:	Function:	
[52]	Hrvatski	Part of Language package 2

0-02 Motor Speed Unit		
Option:	Function:	
		<p><b>NOTICE</b></p> <p>This parameter cannot be adjusted while the motor is running.</p> <p>The display showing depends on settings in <i>parameter 0-02 Motor Speed Unit</i> and <i>parameter 0-03 Regional Settings</i>. The default setting of <i>parameter 0-02 Motor Speed Unit</i> and <i>parameter 0-03 Regional Settings</i> depends on which region of the world the frequency converter is supplied to, but can be re-programmed as required.</p> <p><b>NOTICE</b></p> <p>Changing the Motor Speed Unit resets certain parameters to their initial value. It is recommended to select the motor speed unit first, before modifying other parameters.</p>
[0]	RPM	Selects display of motor speed variables and parameters (i.e. references, feedbacks and limits) in terms of motor speed (RPM).
[1]	Hz	Selects display of motor speed variables and parameters (i.e. references, feedbacks and limits) in terms of output frequency to the motor (Hz).

0-03 Regional Settings		
Option:	Function:	
		<p>This parameter cannot be adjusted while the motor is running.</p> <p>The display showing depends on settings in <i>parameter 0-02 Motor Speed Unit</i> and <i>parameter 0-03 Regional Settings</i>. The default setting of <i>parameter 0-02 Motor Speed Unit</i> and <i>parameter 0-03 Regional Settings</i> depends on which region of the world the frequency converter is supplied to but can be re-programmed as required.</p> <p>The settings not used are made invisible.</p>
[0]	International	Sets <i>parameter 1-20 Motor Power [kW]</i> units to [kW] and the default value of <i>parameter 1-23 Motor Frequency</i> [50 Hz].
[1]	North America	Sets <i>parameter 1-21 Motor Power [HP]</i> units to HP and the default value of <i>parameter 1-23 Motor Frequency</i> to 60 Hz.

0-04 Operating State at Power-up		
Option:	Function:	
		Select the operating mode upon reconnection of the frequency converter to mains voltage after power down when operating in Hand (local) mode.
[0]	Resume	Resumes operation of the frequency converter maintaining the same local reference and the same start/stop condition (applied by [Hand On]/[Off] on the LCP or Hand Start via a digital input as before the frequency converter was powered down.
[1]	Forced stop, ref=old	Uses [1] <i>Forced stop, ref=old</i> to stop the frequency converter but at the same time retain in memory the local speed reference before power down. After mains voltage is reconnected and after receiving a start command (pressing [Hand On] or Hand Start command via a digital input) the frequency converter restarts and operates at the retained speed reference.

0-05 Local Mode Unit		
Option:	Function:	
		Defines if the local reference unit should be displayed in terms of the motor shaft speed (in RPM/Hz) or as percent.
[0]	As Motor Speed Unit	
[1]	%	

### 3.2.2 0-1\* Set-up Operations

Define and control the individual parameter set-ups. The frequency converter has 4 parameter set-ups that can be programmed independently of each other. This makes the frequency converter very flexible and able to meet the requirements of many different AQUA system control schemes often saving the cost of external control equipment. For example these can be used to programme the frequency converter to operate according to one control scheme in one set-up (e.g. daytime operation) and another control scheme in another set-up (e.g. night set-back). Alternatively, they can be used by an AHU or packaged unit OEM to identically program all their factory fitted frequency converters for different equipment models within a range to have the same parameters and then during production/commissioning simply select a specific set-up depending on which model within that range the frequency converter is installed on.

The active set-up (i.e. the set-up in which the frequency converter is currently operating) can be selected in *parameter 0-10 Active Set-up* and is displayed in the LCP. Using Multi set-up it is possible to switch between set-ups with the frequency converter running or stopped, via digital input or serial communication commands (e.g. for night set back). If it is necessary to change set-ups whilst running, ensure *parameter 0-12 This Set-up Linked to* is programmed as required. For the majority of water/wastewater applications it is not necessary to program *parameter 0-12 This Set-up Linked to* even if change of set up is required when running, but for very complex applications, using the full flexibility of the multiple set-ups, it may be required. Using *parameter 0-11 Programming Set-up* it is possible to edit parameters within any of the set-ups whilst continuing the frequency converter operation in its active set-up which can be a different set-up to that being edited. Using *parameter 0-51 Set-up Copy* it is possible to copy parameter settings between the set-ups to enable quicker commissioning if similar parameter settings are required in different set-ups.

0-10 Active Set-up		
Option:	Function:	
		Select the set-up in which the frequency converter is to operate. Use <i>parameter 0-51 Set-up Copy</i> to copy a set-up to one or all other set-ups. To avoid conflicting settings of the same parameter within 2 different set-ups, link the set-ups together using <i>parameter 0-12 This Set-up Linked to</i> . Stop the frequency converter before switching between set-ups where parameters marked 'not changeable during operation' have different values. Parameters which are 'not changeable during operation' are marked FALSE in <i>chapter 4 Parameter Lists</i> .
[0]	Factory setup	Cannot be changed. It contains the Danfoss data set, and can be used as a data source when returning the other set-ups to a known state.
[1]	Set-up 1	[1] Set-up 1 to [4] Set-up 4 are the 4 parameter set-ups within which all parameters can be programmed.
[2]	Set-up 2	
[3]	Set-up 3	
[4]	Set-up 4	
[9]	Multi Set-up	Is used for remote selection of set-ups using digital inputs and the serial communication port. This set-up uses the settings from <i>parameter 0-12 This Set-up Linked to</i> .

0-11 Programming Set-up		
Option:	Function:	
		Select the set-up to be edited (i.e. programmed) during operation; either the active set-up or one of the inactive set-ups. The set-up number being edited is displayed in the LCP in (brackets).
[0]	Factory setup	Cannot be edited but it is useful as a data source to return the other set-ups to a known state.
[1]	Set-up 1	[1] Set-up 1 to [4] Set-up 4 can be edited freely during operation, independently of the active set-up.
[2]	Set-up 2	
[3]	Set-up 3	
[4]	Set-up 4	
[9]	Active Set-up	(i.e. the set-up in which the frequency converter is operating) can also be edited during operation. Editing parameters in the chosen set-up would normally be done from the LCP, but it is also possible from any of the serial communication ports.

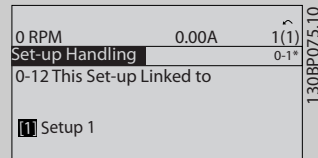
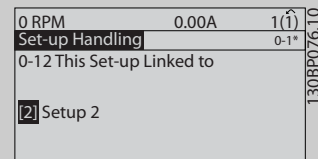
0-12 This Set-up Linked to	
Option:	Function:
	<p>This parameter only needs to be programmed if changing set-ups is required whilst the motor is running. It ensures that parameters which are "not changeable during operation" have the same setting in all relevant set-ups.</p> <p>To enable conflict-free changes from one set-up to another whilst the frequency converter is running, link set-ups containing parameters which are not changeable during operation. The link ensures synchronising of the 'not changeable during operation' parameter values when moving from one set-up to another during operation. 'Not changeable during operation' parameters can be identified by the label FALSE in the parameter lists in <i>chapter 4 Parameter Lists</i>.</p> <p>The <i>parameter 0-12 This Set-up Linked to</i> feature is used when Multi set-up in <i>parameter 0-10 Active Set-up</i> is selected. Multi set-up can be used to move from one set-up to another during operation (i.e. while the motor is running). Example: Use Multi set-up to shift from Set-up 1 to Set-up 2 whilst the motor is running. Programme parameters in Set-up 1 first, then ensure that Set-up 1 and Set-up 2 are synchronised (or 'linked'). Synchronisation can be performed in 2 ways: 1. Change the edit set-up to [2] Set-up 2 in <i>parameter 0-11 Programming Set-up</i> and set <i>parameter 0-12 This Set-up Linked to</i> to [1] Set-up 1. This starts the linking (synchronising) process.</p>
	
	<p><b>Illustration 3.1</b></p>
	<p>OR</p> <p>2. While still in Set-up 1, using <i>parameter 0-50 LCP Copy</i>, copy Set-up 1 to Set-up 2. Then set <i>parameter 0-12 This Set-up Linked to</i> to [2] Set-up 2. This starts the linking process.</p>
	
	<p><b>Illustration 3.2</b></p>

0-12 This Set-up Linked to		
Option:	Function:	
		After the link is complete, <i>parameter 0-13 Readout: Linked Set-ups</i> reads set-ups 1 and 2 to indicate that all 'not changeable during operation' parameters are now the same in Set-up 1 and Set-up 2. If there are changes to a 'not changeable during operation' parameter, e.g. <i>parameter 1-30 Stator Resistance (Rs)</i> , in Set-up 2, they are also changed automatically in Set-up 1. A switch between Set-up 1 and Set-up 2 during operation is now possible.
[0]	Not linked	
[1]	Set-up 1	
[2]	Set-up 2	
[3]	Set-up 3	
[4]	Set-up 4	

0-13 Readout: Linked Set-ups														
Range:	Function:													
0 * [0 - 255 ]	View a list of all the set-ups linked by means of <i>parameter 0-12 This Set-up Linked to</i> . The parameter has one index for each parameter set-up. The parameter value displayed for each index represents which set-ups are linked to that parameter set-up.													
	<table border="1"> <thead> <tr> <th>Index</th> <th>LCP value</th> </tr> </thead> <tbody> <tr> <td>0</td> <td>{0}</td> </tr> <tr> <td>1</td> <td>{1,2}</td> </tr> <tr> <td>2</td> <td>{1,2}</td> </tr> <tr> <td>3</td> <td>{3}</td> </tr> <tr> <td>4</td> <td>{4}</td> </tr> </tbody> </table>	Index	LCP value	0	{0}	1	{1,2}	2	{1,2}	3	{3}	4	{4}	
Index	LCP value													
0	{0}													
1	{1,2}													
2	{1,2}													
3	{3}													
4	{4}													
	<p><b>Table 3.3 Example: Set-up 1 and Set-up 2 are linked</b></p>													

0-14 Readout: Prog. Set-ups / Channel		
Range:	Function:	
0 * [-2147483648 - 2147483647 ]	View the setting of <i>parameter 0-11 Programming Set-up</i> for each of the four different communication channels. When the number is displayed in hex, as it is in the LCP, each number represents one channel. Numbers 1-4 represent a set-up number; 'F' means factory setting; and 'A' means active set-up. The channels are, from right to left: LCP, FC-bus, USB, HPFB1.5. Example: The number AAAAAA21h means that the FC-bus selected Set-up 2 in <i>parameter 0-11 Programming Set-up</i> , the LCP selected Set-up 1 and all others used the active set-up.	

### 3.2.3 0-2\* LCP Display

Define the variables displayed in the Graphical Local Control Panel.

#### NOTICE

Refer to *parameter 0-37 Display Text 1*, *parameter 0-38 Display Text 2* and *parameter 0-39 Display Text 3* for information on how to write display texts.

0-20 Display Line 1.1 Small		
Option:	Function:	
		Select a variable for display in line 1, left position.
[0]	None	No display value selected
[37]	Display Text 1	Present control word
[38]	Display Text 2	Enables an individual text string to be written, for display in the LCP or to be read via serial communication.
[39]	Display Text 3	Enables an individual text string to be written, for display in the LCP or to be read via serial communication.
[89]	Date and Time Readout	Displays the current date and time.
[953]	Profibus Warning Word	Displays Profibus communication warnings.
[1005]	Readout Transmit Error Counter	View the number of CAN control transmission errors since the last power-up.
[1006]	Readout Receive Error Counter	View the number of CAN control receipt errors since the last power-up.
[1007]	Readout Bus Off Counter	View the number of bus off events since the last power-up.
[1013]	Warning Parameter	View a DeviceNet-specific warning word. One separate bit is assigned to every warning.
[1230]	Warning Parameter	
[1500]	Operating hours	View the number of running hours of the frequency converter.
[1501]	Running Hours	View the number of running hours of the motor.
[1502]	kWh Counter	View the mains power consumption in kWh.
[1580]	Fan Running Hours	
[1600]	Control Word	View the control word sent from the frequency converter via the serial communication port in hex code.

0-20 Display Line 1.1 Small		
Option:	Function:	
[1601]	Reference [Unit]	Total reference (sum of digital/analog/preset/bus/freeze ref./catch up and slow-down) in selected unit.
[1602]	Reference [%]	Total reference (sum of digital/analog/preset/bus/freeze ref./catch up and slow-down) in percent.
[1603]	Status Word	Present status word
[1605]	Main Actual Value [%]	One or more warnings in a hex code
[1609]	Custom Readout	View the user-defined readouts as defined in <i>parameter 0-30 Custom Readout Unit</i> , <i>parameter 0-31 Custom Readout Min Value</i> and <i>parameter 0-32 Custom Readout Max Value</i> .
[1610]	Power [kW]	Actual power consumed by the motor in kW.
[1611]	Power [hp]	Actual power consumed by the motor in hp.
[1612]	Motor Voltage	Voltage supplied to the motor.
[1613]	Frequency	Motor frequency, i.e. the output frequency from the frequency converter in Hz.
[1614]	Motor current	Phase current of the motor measured as effective value.
[1615]	Frequency [%]	Motor frequency, i.e. the output frequency from the frequency converter in percent.
[1616]	Torque [Nm]	Present motor load as a percentage of the rated motor torque.
[1617]	Speed [RPM]	Speed in RPM (revolutions per minute) i.e. the motor shaft speed in closed loop based on the entered motor nameplate data, the output frequency and the load on the frequency converter.
[1618]	Motor Thermal	Thermal load on the motor, calculated by the ETR function. See also parameter group <i>1-9* Motor Temperature</i> .
[1622]	Torque [%]	Shows the actual torque produced, in percentage.
[1630]	DC Link Voltage	Intermediate circuit voltage in the frequency converter.
[1632]	Brake Energy /s	Present brake power transferred to an external brake resistor. Stated as an instantaneous value.

0-20 Display Line 1.1 Small		
Option:	Function:	
[1633]	Brake Energy /2 min	Brake power transferred to an external brake resistor. The mean power is calculated continuously for the most recent 120 s.
[1634]	Heatsink Temp.	Present heat sink temperature of the frequency converter. The cut-out limit is $95 \pm 5$ °C; cutting back in occurs at $70 \pm 5$ °C.
[1635]	Inverter Thermal	Percentage load of the inverters
[1636]	Inv. Nom. Current	Nominal current of the frequency converter
[1637]	Inv. Max. Current	Maximum current of the frequency converter
[1638]	SL Controller State	State of the event executed by the control
[1639]	Control Card Temp.	Temperature of the control card.
[1650]	External Reference	Sum of the external reference as a percentage, i.e. the sum of analog/pulse/bus.
[1652]	Feedback[Unit]	Signal value in units from the programmed digital input(s).
[1653]	Digi Pot Reference	View the contribution of the digital potentiometer to the actual reference Feedback.
[1654]	Feedback 1 [Unit]	View the value of Feedback 1. See also parameter group <i>20-0* Feedback</i> .
[1655]	Feedback 2 [Unit]	View the value of Feedback 2. See also parameter group <i>20-0* Feedback</i> .
[1656]	Feedback 3 [Unit]	View the value of Feedback 3. See also parameter group <i>20-0* Feedback</i> .
[1658]	PID Output [%]	Returns the Drive Closed Loop PID controller output value in percent.
[1659]	Adjusted Setpoint	Displays the actual operating setpoint after it is modified by flow compensation. See parameter group <i>22-8* Flow Compensation</i> .
[1660]	Digital Input	Displays the status of the digital inputs. Signal low = 0; Signal high = 1. Regarding order, see <i>16-60 Digital Input</i> . Bit 0 is at the extreme right.
[1661]	Terminal 53 Switch Setting	Setting of input terminal 53. Current = 0; Voltage = 1.
[1662]	Analog Input 53	Actual value at input 53 either as a reference or protection value.
[1663]	Terminal 54 Switch Setting	Setting of input terminal 54. Current = 0; Voltage = 1.



0-20 Display Line 1.1 Small		
Option:	Function:	
[1664]	Analog Input 54	Actual value at input 54 either as reference or protection value.
[1665]	Analog Output 42 [mA]	Actual value at output 42 in mA. Use <i>parameter 6-50 Terminal 42 Output</i> to select the variable to be represented by output 42.
[1666]	Digital Output [bin]	Binary value of all digital outputs.
[1667]	Pulse Input #29 [Hz]	Actual value of the frequency applied at terminal 29 as a pulse input.
[1668]	Pulse Input #33 [Hz]	Actual value of the frequency applied at terminal 33 as a pulse input.
[1669]	Pulse Output #27 [Hz]	Actual value of pulses applied to terminal 27 in digital output mode.
[1670]	Pulse Output #29 [Hz]	Actual value of pulses applied to terminal 29 in digital output mode.
[1671]	Relay Output [bin]	View the setting of all relays.
[1672]	Counter A	View the present value of Counter A.
[1673]	Counter B	View the present value of Counter B.
[1675]	Analog In X30/11	Actual value of the signal on input X30/11 (General Purpose I/O Card. Option)
[1676]	Analog In X30/12	Actual value of the signal on input X30/12 (General Purpose I/O Card. Optional)
[1677]	Analog Out X30/8 [mA]	Actual value at output X30/8 (General Purpose I/O Card. Optional) Use <i>6-60 Terminal X30/8 Output</i> to select the variable to be shown.
[1678]	Analog Out X45/1 [mA]	
[1679]	Analog Out X45/3 [mA]	
[1680]	Fieldbus CTW 1	Control word (CTW) received from the Bus Master.
[1682]	Fieldbus REF 1	Main reference value sent with control word via the serial communications network e.g. from the BMS, PLC or other master controller.
[1684]	Comm. Option STW	Extended fieldbus communication option status word.
[1685]	FC Port CTW 1	Control word (CTW) received from the Bus Master.
[1686]	FC Port REF 1	Status word (STW) sent to the Bus Master.
[1690]	Alarm Word	One or more alarms in a hex code (used for serial communications)

0-20 Display Line 1.1 Small		
Option:	Function:	
[1691]	Alarm Word 2	One or more alarms in a hex code (used for serial communications)
[1692]	Warning Word	One or more warnings in a hex code (used for serial communications)
[1693]	Warning Word 2	One or more warnings in a hex code (used for serial communications)
[1694]	Ext. Status Word	One or more status conditions in a hex code (used for serial communications)
[1695]	Ext. Status Word 2	One or more status conditions in a hex code (used for serial communications)
[1696]	Maintenance Word	The bits reflect the status for the programmed Preventive Maintenance Events in parameter group 23-1* <i>Maintenance</i> .
[1830]	Analog Input X42/1	Shows the value of the signal applied to terminal X42/1 on the Analog I/O card.
[1831]	Analog Input X42/3	Shows the value of the signal applied to terminal X42/3 on the Analog I/O card.
[1832]	Analog Input X42/5	Shows the value of the signal applied to terminal X42/5 on the Analog I/O card.
[1833]	Analog Out X42/7 [V]	Shows the value of the signal applied to terminal X42/7 on the Analog I/O card.
[1834]	Analog Out X42/9 [V]	Shows the value of the signal applied to terminal X42/9 on the Analog I/O card.
[1835]	Analog Out X42/11 [V]	Shows the value of the signal applied to terminal X42/11 on the Analog I/O card.
[1836]	Analog Input X48/2 [mA]	
[1837]	Temp. Input X48/4	
[1838]	Temp. Input X48/7	
[1839]	Temp. Input X48/10	
[1860]	Digital Input 2	
[2117]	Ext. 1 Reference [Unit]	The value of the reference for extended Closed Loop Controller 1
[2118]	Ext. 1 Feedback [Unit]	The value of the feedback signal for extended Closed Loop Controller 1
[2119]	Ext. 1 Output [%]	The value of the output from extended Closed Loop Controller 1

0-20 Display Line 1.1 Small		
Option:	Function:	
[2137]	Ext. 2 Reference [Unit]	The value of the reference for extended Closed Loop Controller 2
[2138]	Ext. 2 Feedback [Unit]	The value of the feedback signal for extended Closed Loop Controller 2
[2139]	Ext. 2 Output [%]	The value of the output from extended Closed Loop Controller 2
[2157]	Ext. 3 Reference [Unit]	The value of the reference for extended Closed Loop Controller 3
[2158]	Ext. 3 Feedback [Unit]	The value of the feedback signal for extended Closed Loop Controller 3
[2159]	Ext. 3 Output [%]	The value of the output from extended Closed Loop Controller 3
[2230]	No-Flow Power	The calculated No Flow Power for the actual operating speed
[2316]	Maintenance Text	
[2580]	Cascade Status	Status for the operation of the Cascade Controller
[2581]	Pump Status	Status for the operation of each individual pump controlled by the Cascade Controller
[2791]	Cascade Reference	Reference output for use with follower drives.
[2792]	% Of Total Capacity	Readout parameter to show the system operating point as a % capacity of total system capacity.
[2793]	Cascade Option Status	Readout parameter to show the status of the cascade system.
[2794]	Cascade System Status	
[2795]	Advanced Cascade Relay Output [bin]	
[2796]	Extended Cascade Relay Output [bin]	
[2920]	Derag Power[kW]	
[2921]	Derag Power[HP]	
[3110]	Bypass Status Word	
[3111]	Bypass Running Hours	
[9920]	HS Temp. (PC1)	
[9921]	HS Temp. (PC2)	
[9922]	HS Temp. (PC3)	
[9923]	HS Temp. (PC4)	
[9924]	HS Temp. (PC5)	
[9925]	HS Temp. (PC6)	
[9926]	HS Temp. (PC7)	
[9927]	HS Temp. (PC8)	

0-20 Display Line 1.1 Small		
Option:	Function:	
[9951]	PC Debug 0	
[9952]	PC Debug 1	
[9953]	PC Debug 2	
[9954]	PC Debug 3	
[9955]	PC Debug 4	
[9956]	Fan 1 Feedback	
[9957]	Fan 2 Feedback	
[9958]	PC Auxiliary Temp	
[9959]	Power Card Temp.	

0-21 Display Line 1.2 Small		
Option:	Function:	
		Select a variable for display in line 1, middle position.
[1601] *	Analog input 53	The options are the same as those listed for 0-20 Display Line 1.1 Small.

0-22 Display Line 1.3 Small		
Option:	Function:	
		Select a variable for display in line 1, right position.
[1614] *	Motor Current	The options are the same as those listed for 0-20 Display Line 1.1 Small.

0-23 Display Line 2 Large		
Option:	Function:	
		Select a variable for display in line 2.
[1613] *	Frequency	The options are the same as those listed for 0-20 Display Line 1.1 Small.

0-24 Display Line 3 Large		
Option:	Function:	
[1652] *	Feedback [Unit]	The options are the same as those listed for 0-20 Display Line 1.1 Small.
		Select a variable for display in line 2.

0-25 My Personal Menu		
Array [20]		
Range:	Function:	
Size related*	[0 - 9999 ]	Define up to 20 parameters to appear in the Q1 Personal Menu, accessible via the [Quick Menu] key on the LCP. The parameters are displayed in the Q1 Personal Menu in the order they are programmed into this array parameter. Delete parameters by setting the value to '0000'. For example, this can be used to provide quick, simple access to just one or up to 50 parameters which require changing on a regular basis.

### 3.2.4 0-3\* LCP Custom Readout

It is possible to customise the display elements for various purposes: \*Custom Readout. Value proportional to speed (Linear, squared or cubed depending on unit selected in *parameter 0-30 Custom Readout Unit*) \*Display Text. Text string stored in a parameter.

#### Custom readout

The calculated value to be displayed is based on settings in

- *parameter 0-30 Custom Readout Unit*
- *parameter 0-31 Custom Readout Min Value* (linear only)
- *parameter 0-32 Custom Readout Max Value*
- *parameter 4-13 Motor Speed High Limit [RPM]*
- *parameter 4-14 Motor Speed High Limit [Hz]*
- and actual speed

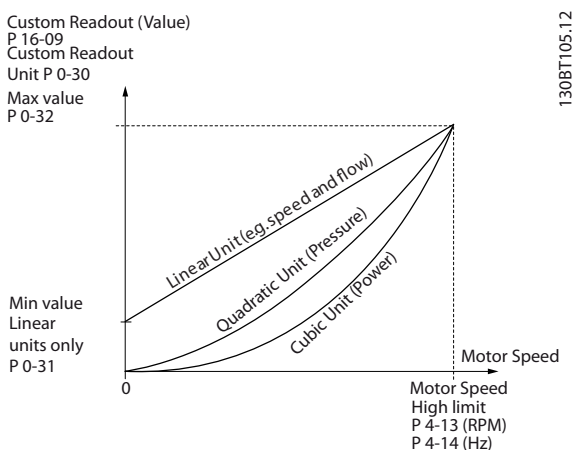

Illustration 3.3 Custom Readout

The relation depends on the type of unit selected in *parameter 0-30 Custom Readout Unit*:

Unit Type	Speed Relation
Dimensionless	Linear
Speed	
Flow, volume	
Flow, mass	
Velocity	
Length	
Temperature	Quadratic
Pressure	
Power	Cubic

Table 3.4 Speed Relations for Different Unit Types

0-30 Custom Readout Unit	
Option:	Function:
	Program a value to be shown in the display of the LCP. The value has a linear, squared or cubed relation to speed. This relation depends on the unit selected (see Table 3.4). The actual calculated value can be read in <i>parameter 16-09 Custom Readout</i> , and/or shown in the display by selecting [1609 Custom Readout] in 0-20 Display Line 1.1 Small to 0-24 Display Line 3 Large.
[0]	-
[1]	%
[5]	PPM
[10]	1/min
[11]	RPM
[12]	Pulse/s
[20]	l/s
[21]	l/min
[22]	l/h
[23]	m <sup>3</sup> /s
[24]	m <sup>3</sup> /min
[25]	m <sup>3</sup> /h
[30]	kg/s
[31]	kg/min
[32]	kg/h
[33]	t/min
[34]	t/h
[40]	m/s
[41]	m/min
[45]	m
[60]	°C
[70]	mbar
[71]	bar
[72]	Pa
[73]	kPa
[74]	m WG
[75]	mm Hg
[80]	kW
[120]	GPM
[121]	gal/s
[122]	gal/min
[123]	gal/h
[124]	CFM
[125]	ft <sup>3</sup> /s
[126]	ft <sup>3</sup> /min
[127]	ft <sup>3</sup> /h
[130]	lb/s
[131]	lb/min
[132]	lb/h
[140]	ft/s
[141]	ft/min
[145]	ft
[160]	°F
[170]	psi

0-30 Custom Readout Unit		
Option:	Function:	
[171]	lb/in <sup>2</sup>	
[172]	in WG	
[173]	ft WG	
[174]	in Hg	
[180]	HP	

0-31 Custom Readout Min Value		
Range:	Function:	
Size related* [-999999.99 - 100.00 CustomReadoutUnit]	This parameter allows the choice of the min. value of the custom defined readout (occurs at zero speed). It is only possible to select a value different to 0 when selecting a linear unit in <i>parameter 0-30 Custom Readout Unit</i> . For Quadratic and Cubic units the minimum value is 0.	

0-32 Custom Readout Max Value		
Range:	Function:	
100 Custom-ReadoutUnit* [ par. 0-31 - 999999.99 CustomReadoutUnit]	This parameter sets the max value to be shown when the speed of the motor has reached the set value for <i>parameter 4-13 Motor Speed High Limit [RPM]</i> or <i>parameter 4-14 Motor Speed High Limit [Hz]</i> (depends on setting in <i>parameter 0-02 Motor Speed Unit</i> ).	

0-37 Display Text 1		
Range:	Function:	
0 * [0 - 25 ]	In this parameter it is possible to write an individual text string for display in the LCP or to be read via serial communication. If to be displayed permanently select Display Text 1 in <i>0-20 Display Line 1.1 Small</i> , <i>0-21 Display Line 1.2 Small</i> , <i>0-22 Display Line 1.3 Small</i> , <i>0-23 Display Line 2 Large</i> or <i>0-24 Display Line 3 Large</i> . Press [▲] or [▼] to change a character. Press [◀] and [▶] to move the cursor. When a character is highlighted, it can be changed. Press [▲] or [▼] to change a character. A character can be inserted by placing the cursor between 2 characters and pressing [▲] or [▼].	

0-38 Display Text 2		
Range:	Function:	
0 * [0 - 25 ]	In this parameter it is possible to write an individual text string for display in the LCP or to be read via serial communication. If to be displayed permanently select Display Text 2 in <i>0-20 Display Line 1.1 Small</i> , <i>0-21 Display Line 1.2 Small</i> , <i>0-22 Display Line 1.3 Small</i> , <i>0-23 Display Line 2 Large</i>	

0-38 Display Text 2		
Range:	Function:	
	or <i>0-24 Display Line 3 Large</i> . Press [▲] or [▼] to change a character. Press [◀] and [▶] to move the cursor. When a character is highlighted by the cursor, this character can be changed. A character can be inserted by placing the cursor between 2 characters and pressing [▲] or [▼].	

0-39 Display Text 3		
Range:	Function:	
0 * [0 - 25 ]	In this parameter it is possible to write an individual text string for display in the LCP or to be read via serial communication. If to be displayed permanently select Display Text 3 in <i>0-20 Display Line 1.1 Small</i> , <i>0-21 Display Line 1.2 Small</i> , <i>0-22 Display Line 1.3 Small</i> , <i>0-23 Display Line 2 Large</i> or <i>0-24 Display Line 3 Large</i> . Press [▲] or [▼] to change a character. Press [◀] and [▶] to move the cursor. When a character is highlighted by the cursor, this character can be changed. A character can be inserted by placing the cursor between 2 characters and pressing [▲] or [▼].	

### 3.2.5 0-4\* LCP Keypad

Enable, disable and password protect individual keys on the LCP.

0-40 [Hand on] Key on LCP		
Option:	Function:	
[0] Disabled	Key disabled avoids accidental usage of the key.	
[1] Enabled	[Hand On] key enabled	
[2] Password	Avoid unauthorized start in Hand mode. If <i>parameter 0-40 [Hand on] Key on LCP</i> is included in the My Personal Menu, then define the password in <i>parameter 0-65 Personal Menu Password</i> . Otherwise define the password in <i>parameter 0-60 Main Menu Password</i> .	

0-41 [Off] Key on LCP		
Option:	Function:	
[0] Disabled	Key disabled avoids accidental usage of the key.	
[1] Enabled	[Off] key is enabled	
[2] Password	Avoid unauthorized stop. If <i>parameter 0-41 [Off] Key on LCP</i> is included in the My Personal Menu, then define the password in <i>parameter 0-65 Personal Menu Password</i> . Otherwise define the password in <i>parameter 0-60 Main Menu Password</i> .	

0-42 [Auto on] Key on LCP		
Option:	Function:	
[0]	Disabled	Key disabled avoids accidental usage of the key.
[1]	Enabled	[Auto On] key is enabled
[2]	Password	Avoid unauthorized start in Auto mode. If <i>parameter 0-42 [Auto on] Key on LCP</i> is included in the My Personal Menu, then define the password in <i>parameter 0-65 Personal Menu Password</i> . Otherwise define the password in <i>parameter 0-60 Main Menu Password</i> .

0-43 [Reset] Key on LCP		
Option:	Function:	
[0]	Disabled	Key disabled avoids accidental usage of the key.
[1]	Enabled	[Reset] key is enabled
[2]	Password	Avoid unauthorized resetting. If <i>parameter 0-43 [Reset] Key on LCP</i> is included in the <i>0-25 My Personal Menu</i> , then define the password in <i>parameter 0-65 Personal Menu Password</i> . Otherwise define the password in <i>parameter 0-60 Main Menu Password</i> .
[3]	Enabled without OFF	
[4]	Password without OFF	
[5]	Enabled with OFF	Pressing the key resets the frequency converter but does not start it.
[6]	Password with OFF	Prevents unauthorized reset. Upon authorized reset, the frequency converter does not start. See option [2] <i>Password</i> for information on how to set the password.

0-44 [Off/Reset] Key on LCP		
Option:	Function:	
[0]	Disabled	Key disabled avoids accidental usage of the key.
[1]	Enabled	
[2]	Password	

0-45 [Drive Bypass] Key on LCP		
Press [Off] and select [0] <i>Disabled</i> to avoid accidental stop of the frequency converter. Press [Off] and select [2] <i>Password</i> to avoid unauthorised bypass of the frequency converter. If <i>0-45 [Drive Bypass] Key on LCP</i> is included in the Quick Menu, then define the password in <i>parameter 0-65 Personal Menu Password</i> .		
Option:	Function:	
[0]	Disabled	Key disabled avoids accidental usage of the key.
[1]	Enabled	
[2]	Password	

### 3.2.6 0-5\* Copy/Save

Copy parameters from and to the LCP. Use these parameters for saving and copying set-ups from one frequency converter to another.

0-50 LCP Copy		
Option:	Function:	
[0]	No copy	<b>NOTICE</b> This parameter cannot be adjusted while the motor is running.  No function
[1]	All to LCP	Copies all parameters in all set-ups from the frequency converter memory to the LCP memory. For service purposes it is recommended to copy all parameters to the LCP after commissioning.
[2]	All from LCP	Copies all parameters in all set-ups from the LCP memory to the frequency converter memory.
[3]	Size indep. from LCP	Copies only the parameters that are independent of the motor size. The latter selection can be used to programme several frequency converters with the same function without disturbing motor data which are already set.

0-51 Set-up Copy		
Option:	Function:	
[0]	No copy	No function
[1]	Copy to set-up 1	Copies all parameters in the present Programming Set-up (defined in <i>parameter 0-11 Programming Set-up</i> ) to Set-up 1.
[2]	Copy to set-up 2	Copies all parameters in the present Programming Set-up (defined in <i>parameter 0-11 Programming Set-up</i> ) to Set-up 2.
[3]	Copy to set-up 3	Copies all parameters in the present Programming Set-up (defined in <i>parameter 0-11 Programming Set-up</i> ) to Set-up 3.
[4]	Copy to set-up 4	Copies all parameters in the present Programming Set-up (defined in <i>parameter 0-11 Programming Set-up</i> ) to Set-up 4.
[9]	Copy to all	Copies the parameters in the present set-up over to each of the set-ups 1 to 4.

## 3.2.7 0-6\* Password

0-60 Main Menu Password		
Range:	Function:	
100 *	[-9999 - 9999 ]	Define the password for access to the Main Menu via the [Main Menu] key. If <i>parameter 0-61 Access to Main Menu w/o Password</i> is set to [0] Full access, this parameter is ignored.

0-61 Access to Main Menu w/o Password		
Option:	Function:	
[0]	Full access	Disables password defined in <i>parameter 0-60 Main Menu Password</i> .
[1]	LCP: Read only	Prevent unauthorized editing of Main Menu parameters.
[2]	LCP: No access	Prevent unauthorized viewing and editing of Main Menu parameters.
[3]	Bus: Read only	
[4]	Bus: No access	
[5]	All: Read only	
[6]	All: No access	

If [0] Full access is selected, *parameter 0-60 Main Menu Password*, *parameter 0-65 Personal Menu Password* and *parameter 0-66 Access to Personal Menu w/o Password* are ignored.

0-65 Personal Menu Password		
Range:	Function:	
200 *	[0 - 999 ]	Define the password for access to the My Personal Menu via the [Quick Menu] key. If <i>parameter 0-66 Access to Personal Menu w/o Password</i> is set to [0] Full access, this parameter is ignored.

0-66 Access to Personal Menu w/o Password		
Option:	Function:	
[0]	Full access	Disables password defined in <i>parameter 0-65 Personal Menu Password</i> .
[1]	LCP: Read only	Prevents unauthorized editing of My Personal Menu parameters.
[2]	LCP: No access	Prevents unauthorized viewing and editing of My Personal Menu parameters.
[3]	Bus: Read only	
[4]	Bus: No access	
[5]	All: Read only	
[6]	All: No access	

If *parameter 0-61 Access to Main Menu w/o Password* is set to [0] Full access, this parameter is ignored.

0-67 Bus Password Access		
Range:	Function:	
0 *	[0 - 9999 ]	Writing to this parameter enables users to unlock the frequency converter from bus/MCT 10 Set-up Software.

## 3.2.8 0-7\* Clock Settings

Set the time and date of the internal clock. The internal clock can be used for e.g. timed actions, energy log, trend analysis, date/time stamps on alarms, logged data and preventive maintenance.

It is possible to program the clock for daylight saving time/summertime, weekly working days/non-working days including 20 exceptions (holidays etc.). Although the clock settings can be set via the LCP, they can also be set along with timed actions and preventative maintenance functions using the MCT 10 Set-up Software software tool.

**NOTICE**

The frequency converter has no back-up of the clock function and the set date/time resets to default (2000-01-01 00:00) after a power down unless a Real Time Clock module with back-up is installed. If no module with back up is installed, it is recommended the clock function is only used if the frequency converter is integrated into an external system using serial communications, with the system maintaining synchronisation of control equipment clock times. In *parameter 0-79 Clock Fault* it is possible to program for a Warning in case clock has not been set properly, e.g. after a power down.

**NOTICE**

When mounting an Analog I/O MCB 109 option card, a battery back-up of the date and time is included.

0-70 Date and Time		
Range:	Function:	
Size related*	[0 - 0 ]	Sets the date and time of the internal clock. The format to be used is set in <i>0-71 Date Format</i> and <i>parameter 0-72 Time Format</i> .

0-71 Date Format		
Option:	Function:	
[0]	YYYY-MM-DD	Sets the date format to be used in the LCP.
[1]	DD-MM-YYYY	Sets the date format to be used in the LCP.
[2]	MM/DD/YYYY	Sets the date format to be used in the LCP.

0-72 Time Format		
Option:	Function:	
		Sets the time format to be used in the LCP.
[0]	24 h	
[1]	12 h	

0-74 DST/Summertime		
Option:	Function:	
		Select how daylight saving time/summertime should be handled. For manual DST/summertime enter the start date and end date in <i>parameter 0-76 DST/Summertime Start</i> and <i>parameter 0-77 DST/Summertime End</i> .
[0]	Off	
[2]	Manual	

0-76 DST/Summertime Start		
Range:	Function:	
Size related*	[ 0 - 0 ]	Sets the date and time when DST/summertime starts. The date is programmed in the format selected in <i>0-71 Date Format</i> .

0-77 DST/Summertime End		
Range:	Function:	
Size related*	[ 0 - 0 ]	Sets the date and time when DST/summertime ends. The date is programmed in the format selected in <i>0-71 Date Format</i> .

0-79 Clock Fault		
Option:	Function:	
		Enables or disables the clock warning, when the clock has not been set or has been reset due to a power-down and no back-up is installed. If MCB 109 is installed, [1] <i>Enabled</i> is default.
[0]	Disabled	
[1]	Enabled	

0-81 Working Days		
Array with 7 elements [0] - [6] displayed below parameter number in display. Press [OK] and step between elements with [▲] and [▼].		
Option:	Function:	
		Set for each weekday if it is a working day or a non-working day. First element of the array is Monday. The working days are used for timed actions.
[0]	No	
[1]	Yes	

0-82 Additional Working Days		
Array with 5 elements [0] - [4] displayed below parameter number in display. Press [OK] and step between elements with [▲] and [▼].		
Range:	Function:	
Size related*	[ 0 - 0 ]	Defines dates for additional working days that normally would be non-working days according to <i>parameter 0-81 Working Days</i> .

0-83 Additional Non-Working Days		
Array with 15 elements [0] - [14] displayed below parameter number in display. Press [OK] and step between elements with [▲] and [▼].		
Range:	Function:	
Size related*	[ 0 - 0 ]	Defines dates for additional working days that normally would be non-working days according to <i>parameter 0-81 Working Days</i> .

0-89 Date and Time Readout		
Range:	Function:	
0 *	[ 0 - 25 ]	Displays the current date and time. The date and time is updated continuously. The clock does not begin counting until a setting different from default has been made in <i>0-70 Date and Time</i> .

### 3.3 Parameters 1-\*\* Load and Motor

#### 3.3.1 1-0\* General Settings

Define whether the frequency converter operates in open loop or closed loop.

1-00 Configuration Mode		
Option:	Function:	
		<b>NOTICE</b> This parameter cannot be adjusted while the motor is running.
[0]	Open Loop	Motor speed is determined by applying a speed reference or by setting desired speed when in Hand Mode. Open Loop is also used if the frequency converter is of a closed loop control system based on an external PID controller providing a speed reference signal as output.
[3]	Closed Loop	Motor Speed is determined by a reference from the built-in PID controller varying the motor speed as of a closed loop control process (e.g. constant pressure or flow). The PID controller must be configured in parameter group 20-** Feedback or via the Function Set-ups accessed by pressing [Quick Menus].

#### NOTICE

When set for Closed Loop, the commands Reversing and Start Reversing do not reverse the direction of the motor.

1-01 Motor Control Principle		
Option:	Function:	
		<b>NOTICE</b> This parameter cannot be adjusted while the motor is running.  Select which motor control principle to employ.
[0]	U/f	Special motor mode, for parallel connected motors in special motor applications. When U/f is selected the characteristic of the control principle can be edited in <i>parameter 1-55 V/f Characteristic - V</i> and <i>parameter 1-56 V/f Characteristic - f</i> .
[1]	VVC+	Voltage Vector Control principle suitable for most applications. The main benefit of VVC <sup>+</sup> operation is that it uses a robust motor model.

1-03 Torque Characteristics		
Option:	Function:	
[0]	Constant torque	For speed control of constant torque applications like axial pumps, positive displacement pumps

1-03 Torque Characteristics		
Option:	Function:	
		and blowers. Provides a voltage which is optimised for a constant torque load characteristic of the motor in the entire range speed.
[1]	Variable torque	For speed control of centrifugal pumps and fans. Also to be used when controlling more than one motor from the same frequency converter (e.g. multiple condenser fans or cooling tower fans). Provides a voltage which is optimised for a squared torque load characteristic of the motor.
[2]	Auto Energy Optim. CT	For optimum energy-efficient speed control of screw and scroll compressors. Provides a voltage which is optimised for a constant torque load characteristic of the motor in the entire range down to 15 Hz, but in addition the AEO feature adapts the voltage exactly to the current load situation, thereby reducing energy consumption and audible noise from the motor. To obtain optimal performance, the motor power factor cos phi must be set correctly. This value is set in <i>14-43 Motor Cosphi</i> . The parameter has a default value which is automatically adjusted when the motor data is programmed. These settings typically ensure optimum motor voltage but if the motor power factor cos phi requires tuning, an AMA function can be carried out using <i>parameter 1-29 Automatic Motor Adaptation (AMA)</i> . It is very rarely necessary to adjust the motor power factor parameter manually.
[3]	Auto Energy Optim. VT	For optimum energy efficient speed control of centrifugal pumps and fans. Provides a voltage which is optimised for a squared torque load characteristic of the motor, but in addition the AEO feature adapts the voltage exactly to the current load situation, thereby reducing energy consumption and audible noise from the motor. To obtain optimal performance, the motor power factor cos phi must be set correctly. This value is set in <i>14-43 Motor Cosphi</i> . The parameter has a default value and is automatically adjusted when the motor data is programmed. These settings typically ensure optimum motor voltage, but if the motor power factor cos phi requires tuning, an AMA function can be carried out using <i>parameter 1-29 Automatic Motor Adaptation (AMA)</i> . It is very rarely necessary to adjust the motor power factor parameter manually.

#### NOTICE

1-03 Torque Characteristics does not have effect when *parameter 1-10 Motor Construction* = [1] PM, non-salient SPM.



1-06 Clockwise Direction		
Option:	Function:	
		<p><b>NOTICE</b></p> <p>This parameter cannot be adjusted while the motor is running.</p> <p>This parameter defines the term "Clockwise" corresponding to the LCP direction arrow. Used for easy change of direction of shaft rotation without swapping motor wires.</p>
[0]	Normal	Motor shaft turns in clockwise direction when the frequency converter is connected U⇒U; V⇒V, and W⇒W to motor.
[1]	Inverse	Motor shaft turns in counter clockwise direction when the frequency converter is connected U⇒U; V⇒V, and W⇒W to motor.

### 3.3.2 1-10 Motor Selection

**NOTICE**

This parameter group cannot be adjusted while the motor is running.

The following parameters are active ('x') depending on the setting of *parameter 1-10 Motor Construction*

Parameter 1-10 Motor Construction	[0] Asynchron	[1] PM Motor non-salient
Parameter 1-00 Configuration Mode	x	x
Parameter 1-03 Torque Characteristics	x	
Parameter 1-06 Clockwise Direction	x	x
Parameter 1-14 Damping Gain		x
Parameter 1-15 Low Speed Filter Time Const.		x
Parameter 1-16 High Speed Filter Time Const.		x
Parameter 1-17 Voltage filter time const.		x
Parameter 1-20 Motor Power [kW]	x	
Parameter 1-21 Motor Power [HP]	x	
Parameter 1-22 Motor Voltage	x	
Parameter 1-23 Motor Frequency	x	
Parameter 1-24 Motor Current	x	x
Parameter 1-25 Motor Nominal Speed	x	x
Parameter 1-26 Motor Cont. Rated Torque		x

Parameter 1-10 Motor Construction	[0] Asynchron	[1] PM Motor non-salient
Parameter 1-28 Motor Rotation Check	x	x
Parameter 1-29 Automatic Motor Adaptation (AMA)	x	
Parameter 1-30 Stator Resistance (Rs)	x	x
Parameter 1-31 Rotor Resistance (Rr)	x	
Parameter 1-35 Main Reactance (Xh)	x	
Parameter 1-37 d-axis Inductance (Ld)		x
Parameter 1-39 Motor Poles	x	x
Parameter 1-40 Back EMF at 1000 RPM		x
Parameter 1-50 Motor Magnetisation at Zero Speed	x	
Parameter 1-51 Min Speed Normal Magnetising [RPM]	x	
Parameter 1-52 Min Speed Normal Magnetising [Hz]	x	
Parameter 1-58 Flystart Test Pulses Current	x	x
Parameter 1-59 Flystart Test Pulses Frequency	x	x
Parameter 1-60 Low Speed Load Compensation	x	
Parameter 1-61 High Speed Load Compensation	x	
Parameter 1-62 Slip Compensation	x	
Parameter 1-63 Slip Compensation Time Constant	x	
Parameter 1-64 Resonance Damping	x	
Parameter 1-65 Resonance Damping Time Constant	x	
Parameter 1-66 Min. Current at Low Speed		x
Parameter 1-70 PM Start Mode		x
Parameter 1-71 Start Delay	x	x
Parameter 1-72 Start Function	x	x
Parameter 1-73 Flying Start	x	x
Parameter 1-80 Function at Stop	x	x
Parameter 1-81 Min Speed for Function at Stop [RPM]	x	x
Parameter 1-82 Min Speed for Function at Stop [Hz]	x	x
Parameter 1-86 Trip Speed Low [RPM]	x	x
Parameter 1-87 Trip Speed Low [Hz]	x	x

Parameter 1-10 Motor Construction	[0] Asynchron	[1] PM Motor non-salient
Parameter 1-90 Motor Thermal Protection	x	x
Parameter 1-91 Motor External Fan	x	x
Parameter 1-93 Thermistor Source	x	x
Parameter 2-00 DC Hold/Preheat Current	x	
Parameter 2-01 DC Brake Current	x	x
Parameter 2-02 DC Braking Time	x	
Parameter 2-03 DC Brake Cut In Speed [RPM]	x	
Parameter 2-04 DC Brake Cut In Speed [Hz]	x	
Parameter 2-06 Parking Current		x
Parameter 2-07 Parking Time		x
Parameter 2-10 Brake Function	x	x
Parameter 2-11 Brake Resistor (ohm)	x	x
Parameter 2-12 Brake Power Limit (kW)	x	x
Parameter 2-13 Brake Power Monitoring	x	x
Parameter 2-15 Brake Check	x	x
Parameter 2-16 AC brake Max. Current	x	
Parameter 2-17 Over-voltage Control	x	
Parameter 4-10 Motor Speed Direction	x	x
Parameter 4-11 Motor Speed Low Limit [RPM]	x	x
Parameter 4-12 Motor Speed Low Limit [Hz]	x	x
Parameter 4-13 Motor Speed High Limit [RPM]	x	x
Parameter 4-14 Motor Speed High Limit [Hz]	x	x
Parameter 4-16 Torque Limit Motor Mode	x	x
Parameter 4-17 Torque Limit Generator Mode	x	x
Parameter 4-18 Current Limit	x	x
Parameter 4-19 Max Output Frequency	x	x
4-58 Missing Motor Phase Function	x	
Parameter 14-40 VT Level	x	
Parameter 14-41 AEO Minimum Magnetisation	x	
Parameter 14-42 Minimum AEO Frequency	x	
Parameter 14-43 Motor Cosphi	x	

Table 3.5

1-10 Motor Construction	
Select the motor construction type.	
<b>Option:</b>	<b>Function:</b>
[0] Asynchron	For asynchronous motors.
[1] PM, non salient SPM	For permanent magnet (PM) motors. Note that PM motors are divided into 2 groups, with either surface mounted (non-salient) or interior (salient) magnets. <b>NOTICE</b> Only available up to 22 kW motor power.

**NOTICE**

Motor construction can either be asynchronous or permanent magnet (PM) motor.

### 3.3.3 1-14 - 1-17 VVC<sup>+</sup> PM

The default control parameters for VVC<sup>+</sup> PMSM control core are optimised for applications and inertia load in range of  $50 > J_l/J_m > 5$ , where  $J_l$  is load inertia from the application and  $j_m$  is machine inertia.

For low inertia applications  $J_l/J_m < 5$  it is recommended that *parameter 1-17 Voltage filter time const.* is increased with a factor of 5-10 and in some cases *1-14 Damping Gain* should be reduced to improve performance and stability. For high-inertia applications  $J_l/J_m \gg 50$  it is recommended that *parameter 1-15 Low Speed Filter Time Const.*, *parameter 1-16 High Speed Filter Time Const.* and *1-14 Damping Gain* are increased to improve performance and stability.

For high load at low speed [ $< 30\%$  of rated speed] it is recommended that *parameter 1-17 Voltage filter time const.* is increased due to nonlinearity in the inverter at low speed.

1-14 Damping Gain	
<b>Range:</b>	<b>Function:</b>
120 %* [0 - 250 %]	The parameter stabilises the PM motor to run it smooth and stable. The value of damping gain controls the dynamic performance of the PM motor. Low damping gain results in high dynamic and a high value results in a low dynamic performance. If the damping gain is too high or low, the control becomes unstable. The resulting dynamic performance is related to the machine data and load type.

1-15 Low Speed Filter Time Const.	
<b>Range:</b>	<b>Function:</b>
Size related* [0.01 - 20 s]	High pass-filter damping time constant determines the response time to load steps. Obtain quick control through a

1-15 Low Speed Filter Time Const.		
Range:		Function:
		short damping time constant. However, if this value is too short, the control gets unstable. This time constant is used below 10% rated speed.

1-16 High Speed Filter Time Const.		
Range:		Function:
Size related*	[0.01 - 20 s]	High pass-filter damping time constant determines the response time to load steps. Obtain quick control through a short damping time constant. However, if this value is too short, the control gets unstable. This time constant is used above 10% rated speed.

1-17 Voltage filter time const.		
Range:		Function:
Size related*	[0.001 - 1 s]	Machine Supply Voltage Filter Time constant is used for reducing the influence of high frequency ripples and system resonances in the calculation of machine supply voltage. Without this filter, the ripples in the currents can distort the calculated voltage and affects the stability of the system.

1-20 Motor Power [kW]		
Range:		Function:
		[kW] or parameter 1-21 Motor Power [HP] is made invisible.

1-21 Motor Power [HP]		
Range:		Function:
Size related*	[ 0.09 - 500.00 hp]	Enter the nominal motor power in hp according to the motor nameplate data. The default value corresponds to the nominal rated output of the unit. Depending on the selections made in parameter 0-03 Regional Settings, either parameter 1-20 Motor Power [kW] or parameter 1-21 Motor Power [HP] is made invisible.

1-22 Motor Voltage		
Range:		Function:
Size related*	[ 10 - 1000 V]	<p><b>NOTICE</b></p> <p>This parameter cannot be adjusted while the motor is running.</p> <p>Enter the nominal motor voltage according to the motor nameplate data. The default value corresponds to the nominal rated output of the unit.</p>

### 3.3.4 1-2\* Motor Data

This parameter group contains input data from the nameplate on the connected motor.

#### **NOTICE**

Changing the value of these parameters affects the setting of other parameters.

#### **NOTICE**

Parameter 1-20 Motor Power [kW], parameter 1-21 Motor Power [HP], 1-22 Motor Voltage and parameter 1-23 Motor Frequency have no effect when parameter 1-10 Motor Construction = [1] PM, non-salient SPM.

1-20 Motor Power [kW]		
Range:		Function:
Size related*	[ 0.09 - 2000.00 kW]	Enter the nominal motor power in kW according to the motor nameplate data. The default value corresponds to the nominal rated output of the unit. This parameter cannot be adjusted while the motor is running. Depending on the selections made in parameter 0-03 Regional Settings, either parameter 1-20 Motor Power

1-23 Motor Frequency		
Range:		Function:
Size related*	[20 - 1000 Hz]	Select the motor frequency value from the motor nameplate data. For 87 Hz operation with 230/400 V motors, set the nameplate data for 230 V/50 Hz. Adapt parameter 4-13 Motor Speed High Limit [RPM] and parameter 3-03 Maximum Reference to the 87 Hz application.

1-24 Motor Current		
Range:		Function:
Size related*	[ 0.10 - 10000.00 A]	Enter the nominal motor current value from the motor nameplate data. This data is used for calculating motor torque, motor thermal protection etc.

1-25 Motor Nominal Speed		
Range:		Function:
Size related*	[100 - 60000 RPM]	Enter the nominal motor speed value from the motor nameplate data. This data is used for calculating automatic motor compensations.

1-26 Motor Cont. Rated Torque		
Range:		Function:
Size related*	[1 - 10000 Nm]	Enter the value from the motor nameplate data. The default value corresponds to the nominal rated output. This parameter is available when <i>parameter 1-10 Motor Construction</i> is set to [1] PM, non-salient SPM, i.e. the parameter is valid for PM and nonsalient SPM motors only.

1-28 Motor Rotation Check		
Option:		Function:
		Following installation and connection of the motor, this function allows the correct motor rotation direction to be verified. Enabling this function overrides any bus commands or digital inputs, except External Interlock and Safe Stop (if included).
[0]	Off	Motor Rotation Check is not active.
[1]	Enabled	Motor Rotation Check is enabled.

**NOTICE**

Once the motor rotation check is enabled the display shows: *Note! Motor may run in wrong direction.* Pressing [OK], [Back] or [Cancel] dismisses the message and displays a new message: "Press [Hand On] to start the motor. Press [Cancel] to abort". Pressing [Hand On] starts the motor at 5 Hz in forward direction and the display shows: "Motor is running. Check if motor rotation direction is correct. Press [Off] to stop the motor". Pressing [Off] stops the motor and resets *parameter 1-28 Motor Rotation Check*. If motor rotation direction is incorrect, interchange 2 motor phase cables.

**!WARNING**

Remove mains power before disconnecting motor phase cables.

1-29 Automatic Motor Adaptation (AMA)		
Option:		Function:
		The AMA function optimises dynamic motor performance by automatically optimising the advanced motor <i>parameter 1-30 Stator Resistance (Rs)</i> to <i>parameter 1-35 Main Reactance (Xh)</i> while the motor is stationary.
[0]	Off	No function
[1]	Enable Complete AMA	Performs AMA of the stator resistance $R_s$ , the rotor resistance $R_r$ , the stator leakage reactance $X_1$ , the rotor leakage reactance $X_2$ and the main reactance $X_h$ .
[2]	Enable Reduced AMA	Performs a reduced AMA of the stator resistance $R_s$ in the system only. Select this

1-29 Automatic Motor Adaptation (AMA)		
Option:		Function:
		option if an LC filter is used between the frequency converter and the motor.

**NOTICE**

*Parameter 1-29 Automatic Motor Adaptation (AMA) does not have effect when parameter 1-10 Motor Construction = [1] PM, non-salient SPM.*

Activate the AMA function by pressing [Hand On] after selecting [1] *Enable complete AMA* or [2] *Enable reduced AMA*. See also the item *Automatic Motor Adaptation* in the Design Guide. After a normal sequence, the display reads: "Press [OK] to finish AMA". After pressing [OK] the frequency converter is ready for operation.

**NOTICE**

- For the best adaptation of the frequency converter, run AMA on a cold motor
- AMA cannot be performed while the motor is running

**NOTICE**

Avoid generating external torque during AMA.

**NOTICE**

If one of the settings in parameter group 1-2\* *Motor Data* is changed, *parameter 1-30 Stator Resistance (Rs)* to *parameter 1-39 Motor Poles*, the advanced motor parameters, returns to default setting. This parameter cannot be adjusted while the motor is running.

**NOTICE**

Full AMA should be run without filter only while reduced AMA should be run with filter.

See section: *Application Examples > Automatic Motor Adaptation* in the *VLT® AQUA Drive FC 202 Design Guide*.

3.3.5 1-3\* Adv. Motor Data

Parameters for advanced motor data. The motor data in *parameter 1-30 Stator Resistance (Rs)* to *parameter 1-39 Motor Poles* must match the relevant motor to run the motor optimally. The default settings are figures based on common motor parameter values from normal standard motors. If the motor parameters are not set correctly, a malfunction of the frequency converter system may occur. If the motor data is not known, running an AMA (Automatic Motor Adaptation) is recommended. See

section: *Application Examples > Automatic Motor Adaptation* in the *VLT® AQUA Drive FC 202 Design Guide*. The AMA sequence adjusts all motor parameters except the moment of inertia of the rotor and the iron loss resistance (*parameter 1-36 Iron Loss Resistance (Rfe)*).

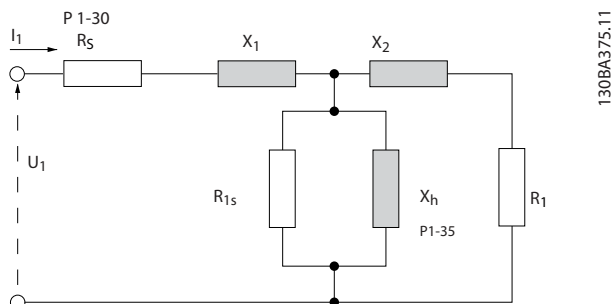

Illustration 3.4 Motor Equivalent Diagram for an Asynchronous Motor

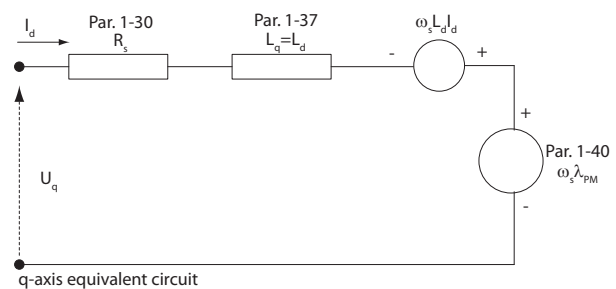
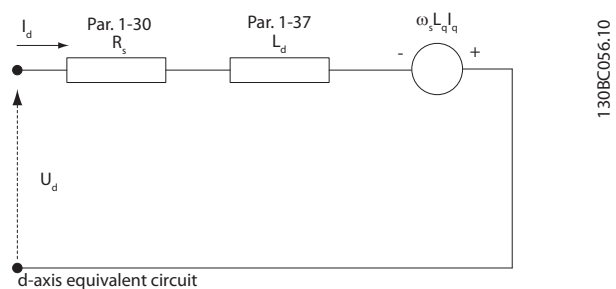

Illustration 3.5 Motor Equivalent Circuit Diagram for a PM non-salient Motor

1-30 Stator Resistance (Rs)		
Range:	Function:	
Size related*	[ 0.0140 - 140.0000 Ohm]	Set the stator resistance value. Enter the value from a motor data sheet or perform an AMA on a cold motor.

1-31 Rotor Resistance (Rr)		
Range:	Function:	
Size related*	[ 0.0100 - 100.0000 Ohm]	Set the rotor resistance value R <sub>r</sub> to improve shaft performance.

1-31 Rotor Resistance (Rr)		
Range:	Function:	
		<ol style="list-style-type: none"> <li>Run an AMA on a cold motor. The frequency converter measures the value from the motor. All compensations are reset to 100%.</li> <li>Enter the R<sub>r</sub> value manually. Obtain the value from the motor supplier.</li> <li>Use the R<sub>r</sub> default setting. The frequency converter establishes the setting based on the motor nameplate data.</li> </ol>

**NOTICE**

Parameter 1-31 Rotor Resistance (Rr) does not have effect when parameter 1-10 Motor Construction = [1] PM, non-salient SPM.

1-33 Stator Leakage Reactance (X1)		
Range:	Function:	
Size related*	[ 0.0400 - 400.0000 Ohm]	Set the stator leakage reactance of the motor using one of these methods: <ol style="list-style-type: none"> <li>Run an AMA on a cold motor. The frequency converter measures the value from the motor.</li> <li>Enter the X<sub>1</sub> value manually. Obtain the value from the motor supplier.</li> <li>Use the X<sub>1</sub> default setting. The frequency converter establishes the setting based on the motor nameplate data.</li> </ol>
		See Illustration 3.4.
		<b>NOTICE</b> The parameter value is updated after each torque calibration if option [3] 1st start with store or option [4] Every start with store is selected in parameter 1-47 Torque Calibration.
		<b>NOTICE</b> This parameter is only relevant for ASM.

1-34 Rotor Leakage Reactance (X <sub>2</sub> )		
Range:		Function:
Size related*	[ 0.0400 - 400.0000 Ohm]	<p>Set the rotor leakage reactance of the motor using one of these methods:</p> <ol style="list-style-type: none"> <li>1. Run an AMA on a cold motor. The frequency converter measures the value from the motor.</li> <li>2. Enter the X<sub>2</sub> value manually. Obtain the value from the motor supplier.</li> <li>3. Use the X<sub>2</sub> default setting. The frequency converter establishes the setting based on the motor nameplate data.</li> </ol> <p>See <i>Illustration 3.4</i>.</p> <p><b>NOTICE</b></p> <p>The parameter value is updated after each torque calibration if option [3] 1st start with store or option [4] Every start with store is selected in parameter 1-47 Torque Calibration.</p> <p><b>NOTICE</b></p> <p>This parameter is only relevant for ASM.</p>

1-35 Main Reactance (X <sub>h</sub> )		
Range:		Function:
Size related*	[ 1.0000 - 10000.0000 Ohm]	<p><b>NOTICE</b></p> <p>This parameter cannot be adjusted while running.</p> <p>Set the main reactance of the motor using one of these methods:</p> <ol style="list-style-type: none"> <li>1. Run an AMA on a cold motor. The frequency converter measures the value from the motor.</li> <li>2. Enter the X<sub>h</sub> value manually. Obtain the value from the motor supplier.</li> <li>3. Use the X<sub>h</sub> default setting. The frequency converter establishes the setting on the basis of the motor name plate data.</li> </ol>

**NOTICE**

Parameter 1-35 Main Reactance (X<sub>h</sub>) does not have effect when parameter 1-10 Motor Construction = [1] PM, non-salient SPM.

1-36 Iron Loss Resistance (R <sub>fe</sub> )		
Range:		Function:
Size related*	[ 0 - 10000.000 Ohm]	<p><b>NOTICE</b></p> <p>This parameter cannot be adjusted while the motor is running.</p> <p>Enter the equivalent iron loss resistance (R<sub>Fe</sub>) value to compensate for iron losses in the motor. The R<sub>Fe</sub> value cannot be found by performing an AMA. The R<sub>Fe</sub> value is especially important in torque control applications. If R<sub>Fe</sub> is unknown, leave parameter 1-36 Iron Loss Resistance (R<sub>fe</sub>) on default setting.</p>

**NOTICE**

This parameter is not available from the LCP.

1-37 d-axis Inductance (L <sub>d</sub> )		
Range:		Function:
Size related*	[ 0.000 - 1000 mH]	<p><b>NOTICE</b></p> <p>This parameter is only active when parameter 1-10 Motor Construction has the value PM, non-salient SPM [1] (Permanent Magnet Motor).</p> <p>Enter the value of the d-axis inductance. Obtain the value from the PM motor data sheet.</p>

Stator resistance and d-axis Inductance values are normally, for asynchronous motors, described in technical specifications as between line and common (starpoint). For PM motors they are typically described in technical specifications as between line-line. PM motors are typically built for star connection.

Parameter 1-30 Stator Resistance (Rs) (Line to common)	This parameter gives stator winding resistance (Rs) similar to Asynchronous Motor Stator resistance. The stator resistance is defined for line to common measurement. For line-line data, where stator resistance is measured between any 2 lines, divide by 2.
Parameter 1-37 d-axis Inductance (Ld) (Line to common)	This parameter gives direct axis inductance of the PM motor. The d-axis inductance is defined for phase-to-common measurement. For line-line data, where stator resistance is measured between any 2 lines, divide by 2.
Parameter 1-40 Back EMF at 1000 RPM RMS (Line to Line Value )	This parameter gives back EMF across stator terminal of PM Motor at 1000 RPM mechanical speed specifically. It is defined between line-to-line and expressed in RMS Value

Table 3.6 Parameters related to PM Motors

**NOTICE**

Motor manufacturers provide values for stator resistance (*parameter 1-30 Stator Resistance (Rs)*) and d-axis Inductance (*parameter 1-37 d-axis Inductance (Ld)*) in technical specifications as between line and common (starpoint) or between line-line. There is no general standard. The different set-ups of Stator Winding Resistance and Induction are shown in *Illustration 3.6*. Danfoss frequency converters always require the line to common value. The back EMF of PM motor is defined as 'Induced EMF developed across any of 2 phases of stator winding of free running Motor'. Danfoss frequency converters always require the line to line RMS value measured at 1000 rpm, mechanical speed of rotation. This is shown in *Illustration 3.7*

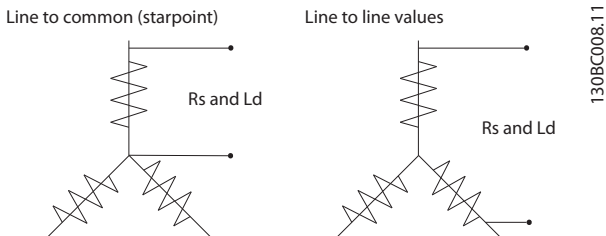

Illustration 3.6 Motor parameters are provided in different formats. Danfoss frequency converters always require the line to common value.

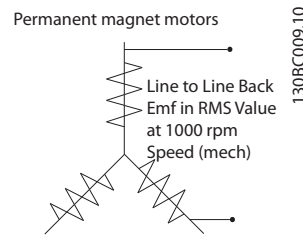

Illustration 3.7 Machine parameter definitions of Back EMF of permanent magnet motors

1-39 Motor Poles			
Range:		Function:	
Size related*	[ 2 - 100 ]	Enter the number of motor poles.	
		<b>Poles</b>	<b>~n<sub>n</sub>@ 50 Hz</b>
		2	2700-2880
		4	1350-1450
		6	700-960
			<b>~n<sub>n</sub>@ 60 Hz</b>
			3250-3460
			1625-1730
			840-1153

**Table 3.8 Pole Counts and Related Frequencies**

The table shows the number of poles for normal speed ranges of various motor types. Define motors designed for other frequencies setely. The motor pole value is always an even number, because it refers to the total number of poles, not pairs of poles. The frequency converter creates the initial setting of *parameter 1-39 Motor Poles* based on *parameter 1-23 Motor Frequency Motor Frequency* and *parameter 1-25 Motor Nominal Speed Motor Nominal Speed*.

**NOTICE**

This parameter cannot be adjusted while the motor is running.

1-40 Back EMF at 1000 RPM		
Range:		Function:
Size related*	[ 10 - 9000 V ]	Set the nominal back EMF for the motor when running at 1000 RPM. This parameter is only active when <i>parameter 1-10 Motor Construction</i> is set to PM motor [1] (Permanent Magnet Motor).

3.3.6 1-5\* Load Indep. Setting

3

1-50 Motor Magnetisation at Zero Speed		
Range:	Function:	
100 %* [0 - 300 %]	Use this parameter along with <i>parameter 1-51 Min Speed Normal Magnetising [RPM]</i> to obtain a different thermal load on the motor when running at low speed. Enter a value which is a percentage of the rated magnetising current. If the setting is too low, the torque on the motor shaft may be reduced.	

Illustration 3.8 Magnetising current

**NOTICE**

*Parameter 1-50 Motor Magnetisation at Zero Speed does not have effect when parameter 1-10 Motor Construction = [1] PM, non-salient SPM.*

1-51 Min Speed Normal Magnetising [RPM]		
Range:	Function:	
Size related* [10 - 300 RPM]	Set the required speed for normal magnetising current. If the speed is set lower than the motor slip speed, <i>parameter 1-50 Motor Magnetisation at Zero Speed</i> and <i>parameter 1-51 Min Speed Normal Magnetising [RPM]</i> are of no significance. Use this parameter along with <i>parameter 1-50 Motor Magnetisation at Zero Speed</i> . See Table 3.8.	

**NOTICE**

*Parameter 1-51 Min Speed Normal Magnetising [RPM] does not have effect when parameter 1-10 Motor Construction = [1] PM, non-salient SPM.*

1-52 Min Speed Normal Magnetising [Hz]		
Range:	Function:	
Size related* [0.3 - 10.0 Hz]	Set the required frequency for normal magnetising current. If the frequency is set lower than the motor slip frequency, <i>parameter 1-50 Motor Magnetisation at Zero Speed</i> and <i>parameter 1-51 Min Speed Normal Magnetising [RPM]</i> are inactive. Use this parameter along with <i>parameter 1-50 Motor Magnetisation at Zero Speed</i> . See Table 3.8.	

**NOTICE**

*Parameter 1-52 Min Speed Normal Magnetising [Hz] does not have effect when parameter 1-10 Motor Construction = [1] PM, non-salient SPM.*

1-55 V/f Characteristic - V		
Range:	Function:	
Size related* [0 - 1000 V]	Enter the voltage at each frequency point to manually form a U/f characteristic matching the motor. The frequency points are defined in <i>parameter 1-56 V/f Characteristic - f</i> . This parameter is an array parameter [0-5] and is only accessible when <i>parameter 1-01 Motor Control Principle</i> is set to [0] U/f.	

1-56 V/f Characteristic - f		
Range:	Function:	
Size related* [0 - 1000.0 Hz]	Enter the frequency points to manually form a U/f-characteristic matching the motor. The voltage at each point is defined in <i>parameter 1-55 V/f Characteristic - V</i> . This parameter is an array parameter [0-5] and is only accessible when <i>parameter 1-01 Motor Control Principle</i> is set to [0] U/f.	

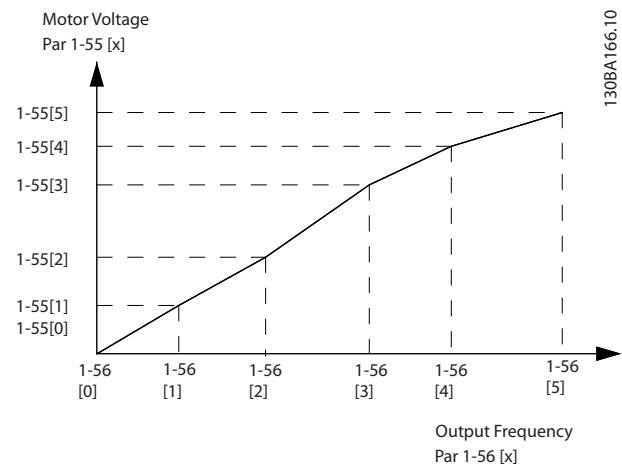

Illustration 3.9 U/f Characteristic

1-58 Flystart Test Pulses Current		
Range:	Function:	
Size related* [0 - 200 %]	Set the magnitude of the magnetising current for the pulses used to detect the motor direction. The value range and function depends on <i>parameter 1-10 Motor Construction</i> : [0] Asynchron: [0-200%]	



1-58 Flystart Test Pulses Current	
Range:	Function:
	<p>Reducing this value reduces the generated torque. 100% means full nominal motor current. In this case the default value is 30%.                      [1] PM non-salient: [0-40%]                      A general setting of 20% is recommended on PM motors. Higher values can give increased performance. However, on motors with back EMF higher than 300VLL (rms) at nominal speed and high winding inductance (more than 10 mH) a lower value is recommended to avoid wrong speed estimation. The parameter is active when <i>parameter 1-73 Flying Start</i> is enabled.</p>

**NOTICE**

See description of *parameter 1-70 PM Start Mode* for an overview of the relation between the PM Flying Start parameters.

1-59 Flystart Test Pulses Frequency	
Range:	Function:
Size related* [0 - 500 %]	<p>The value range and function depends on <i>parameter 1-10 Motor Construction</i>:                      [0] Asynchron: [0-500%]                      Control the percentage of the frequency for the pulses used to detect the motor direction. Increasing this value reduces the generated torque. In this mode 100% means 2 times the slip frequency.                      [1] PM non-salient: [0-10%]                      This parameter defines the motor speed (in % of nominal motor speed) below which the Parking function (see <i>parameter 2-06 Parking Current</i> and <i>parameter 2-07 Parking Time</i> becomes active. This parameter is only active when <i>parameter 1-70 PM Start Mode</i> is set to [1] Parking and only after starting the motor.</p>

3.3.7 1-6\* Load Depend. Setting

1-60 Low Speed Load Compensation	
Range:	Function:
100 %* [0 - 300 %]	<p>Enter the % value to compensate voltage in relation to load when the motor is running at low speed and obtain the optimum U/f characteristic. The motor size determines the frequency range within which this parameter is active.</p>

1-60 Low Speed Load Compensation									
Range:	Function:								
	<table border="1"> <thead> <tr> <th>Motor size [kW]</th> <th>Change-over [Hz]</th> </tr> </thead> <tbody> <tr> <td>0.25-7.5</td> <td>&lt; 10</td> </tr> <tr> <td>11-45</td> <td>&lt; 5</td> </tr> <tr> <td>55-550</td> <td>&lt; 3-4</td> </tr> </tbody> </table>	Motor size [kW]	Change-over [Hz]	0.25-7.5	< 10	11-45	< 5	55-550	< 3-4
Motor size [kW]	Change-over [Hz]								
0.25-7.5	< 10								
11-45	< 5								
55-550	< 3-4								

**NOTICE**

*Parameter 1-60 Low Speed Load Compensation* does not have effect when *parameter 1-10 Motor Construction* = [1] PM, non-salient SPM.

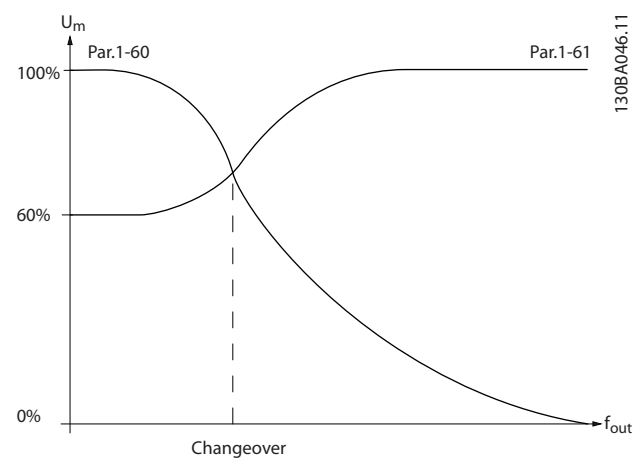

Illustration 3.10 Low Speed Load Compensation

1-61 High Speed Load Compensation									
Range:	Function:								
100 %* [0 - 300 %]	<p>Enter the % value to compensate voltage in relation to load when the motor is running at high speed and obtain the optimum U/f characteristic. The motor size determines the frequency range within which this parameter is active.</p> <table border="1"> <thead> <tr> <th>Motor size [kW]</th> <th>Change-over [Hz]</th> </tr> </thead> <tbody> <tr> <td>0.25-7.5</td> <td>&gt; 10</td> </tr> <tr> <td>11-45</td> <td>&lt; 5</td> </tr> <tr> <td>55-550</td> <td>&lt; 3-4</td> </tr> </tbody> </table>	Motor size [kW]	Change-over [Hz]	0.25-7.5	> 10	11-45	< 5	55-550	< 3-4
Motor size [kW]	Change-over [Hz]								
0.25-7.5	> 10								
11-45	< 5								
55-550	< 3-4								

**NOTICE**

*Parameter 1-61 High Speed Load Compensation* does not have effect when *parameter 1-10 Motor Construction* = [1] PM, non-salient SPM.

1-62 Slip Compensation		
Range:		Function:
0 %*	[-500 - 500 %]	Enter the % value for slip compensation, to compensate for tolerances in the value of $n_{M,N}$ . Slip compensation is calculated automatically, i.e. on the basis of the rated motor speed $n_{M,N}$ .

### NOTICE

Parameter 1-62 Slip Compensation does not have effect when parameter 1-10 Motor Construction = [1] PM, non-salient SPM.

1-63 Slip Compensation Time Constant		
Range:		Function:
Size related*	[0.05 - 5 s]	Enter the slip compensation reaction speed. A high value results in slow reaction, and a low value results in quick reaction. If low-frequency resonance problems arise, use a longer time setting.

### NOTICE

Parameter 1-63 Slip Compensation Time Constant does not have effect when parameter 1-10 Motor Construction = [1] PM, non-salient SPM.

1-64 Resonance Damping		
Range:		Function:
100 %*	[0 - 500 %]	Enter the resonance dampening value. Set parameter 1-64 Resonance Damping and parameter 1-65 Resonance Damping Time Constant to help eliminate high-frequency resonance problems. To reduce resonance oscillation, increase the value of parameter 1-64 Resonance Damping.

### NOTICE

Parameter 1-64 Resonance Damping does not have effect when parameter 1-10 Motor Construction = [1] PM, non-salient SPM.

1-65 Resonance Damping Time Constant		
Range:		Function:
5 ms*	[5 - 50 ms]	Set parameter 1-64 Resonance Damping and parameter 1-65 Resonance Damping Time Constant to help eliminate high-frequency resonance problems. Enter the time constant that provides the best dampening.

### NOTICE

Parameter 1-65 Resonance Damping Time Constant does not have effect when parameter 1-10 Motor Construction = [1] PM, non-salient SPM.

1-66 Min. Current at Low Speed		
Range:		Function:
Size related*	[1 - 200 %]	Enter the minimum motor current at low speed. Increasing this current improves developed motor torque at low speed. Low speed is here defined as speeds below 6% of the Nominal Speed of Motor (parameter 1-25 Motor Nominal Speed) in VVC+ PM Control

### NOTICE

Parameter 1-66 Min. Current at Low Speed does not have affect if parameter 1-10 Motor Construction=[0]

## 3.3.8 1-7\* Start Adjustments

1-70 PM Start Mode		
Option:		Function:
[0]	Rotor Detection	Suitable for all applications where the motor is known to be standing still when starting (e.g. conveyors, pumps and non wind milling fans).
[1]	Parking	If the motor turns at a slight speed (i.e. lower than 2-5% of the nominal speed) e.g. due to fans with light wind milling, select [1] Parking and adjust parameter 2-06 Parking Current and parameter 2-07 Parking Time accordingly.

1-71 Start Delay		
Range:		Function:
00 s*	[0 - 300 s]	When the frequency converter receives the start command, it delays the motor start for the period of time specified in this parameter. The function selected in parameter 1-80 Function at Stop is active in the delay period.

1-72 Start Function		
Option:		Function:
		Select the start function during start delay. This parameter is linked to parameter 1-71 Start Delay.
[0]	DC Hold/ Motor Preheat	Energises motor with a DC holding current (parameter 2-00 DC Hold/Preheat Current) during the start delay time.
[2]	Coast	Motor coasted during the start delay time (inverter off).  Available selections depend on parameter 1-10 Motor Construction: [0] Asynchron:

1-72 Start Function	
Option:	Function:
	[2] coast
	[0] DC-hold
[1] PM non-salient:	
	[2] coast

1-73 Flying Start	
Option:	Function:
	<p>This function makes it possible to catch a motor which is spinning freely due to a mains drop-out.</p> <p>When <i>parameter 1-73 Flying Start</i> is enabled, <i>parameter 1-71 Start Delay</i> has no function. Search direction for flying start is linked to the setting in <i>4-10 Motor Speed Direction</i>.</p> <p>[0] Clockwise: Flying start search in clockwise direction. If not successful, a DC brake is carried out.</p> <p>[2] Both Directions: The flying start first makes a search in the direction determined by the last reference (direction). If not finding the speed it makes a search in the other direction. If not successful, a DC brake is activated in the time set in <i>parameter 2-02 DC Braking Time</i>. Start then takes place from 0 Hz.</p>
[0] Disabled	Select [0] Disable if this function is not required
[1] Enabled	<p>Select [1] Enable to enable the frequency converter to "catch" and control a spinning motor.</p> <p>The parameter is always set to [1] Enable when <i>parameter 1-10 Motor Construction</i> = [1] PM non-salient.</p> <p>Important related parameters:</p> <ul style="list-style-type: none"> <li>• <i>1-58 Flystart Test Pulses Current</i></li> <li>• <i>1-59 Flystart Test Pulses Frequency</i></li> <li>• <i>Parameter 1-70 PM Start Mode</i></li> <li>• <i>Parameter 2-06 Parking Current</i></li> <li>• <i>Parameter 2-07 Parking Time</i></li> <li>• <i>Parameter 2-03 DC Brake Cut In Speed [RPM]</i></li> <li>• <i>2-04 DC Brake Cut In Speed [Hz]</i></li> <li>• <i>Parameter 2-06 Parking Current</i></li> <li>• <i>Parameter 2-07 Parking Time</i></li> </ul>

When *parameter 1-73 Flying Start* is enabled, *parameter 1-71 Start Delay* has no function.

Search direction for flying start is linked to the setting in *4-10 Motor Speed Direction*.

[0] Clockwise: Flying start search in clockwise direction. If not successful, a DC brake is carried out.

[2] Both Directions: The flying start first makes a search in the direction determined by the last reference (direction). If not finding the speed it makes a search in the other direction. If not successful, a DC brake is activated in the time set in *parameter 2-02 DC Braking Time*. Start then takes place from 0 Hz.

The flying start function used for PM motors is based on an initial speed estimation. The speed is always estimated as the first thing after an active start signal is given. Based on the setting of *parameter 1-70 PM Start Mode* the following happens:

*Parameter 1-70 PM Start Mode* = [0] Rotor Detection:

If the speed estimate comes out as greater than 0 Hz the frequency converter catches the motor at that speed and resume normal operation. Otherwise, the frequency converter estimates the rotor position and start normal operation from there.

*Parameter 1-70 PM Start Mode* = [1] Parking:

If the speed estimate comes out lower than the setting in *1-59 Flystart Test Pulses Frequency* then the parking function is engaged (see *parameter 2-06 Parking Current* and *parameter 2-07 Parking Time*). Otherwise, the frequency converter catches the motor at that speed and resumes normal operation. Refer to description of *parameter 1-70 PM Start Mode* for recommended settings.

Current limitations of the flying start principle used for PM motors:

- The speed range is up to 100% Nominal Speed or the field weakening speed (which ever is lowest).
- PMSM with high back EMF (>300 VLL(rms)) and high-winding inductance (>10 mH) needed more time for reducing short circuit current to zero and may be susceptible to error in estimation.
- Current testing limited to a speed range up to 300 Hz. For certain units the limit is 250 Hz; all 200-240 V units up to and including 2.2 kW and all 380-480 V units up to and including 4 kW.
- Current testing limited to a machine power size up to 22 kW.
- Prepared for salient pole machine (IPMSM) but not yet verified on those types of machine.
- For high-inertia applications (i.e. where the load inertia is more than 30 times larger than the motor inertia) a brake resistor is recommended to avoid over-voltage trip during high speed engagement of the flying start function.

1-79 Pump Start Max Time to Trip		
Range:	Function:	
0 s* s]	[0 - 10	If the motor does not reach the speed specified in <i>1-86 Trip Speed Low [RPM]</i> within the time

1-79 Pump Start Max Time to Trip	
Range:	Function:
	specified in this parameter, the frequency converter trips. The time in this parameter includes the time specified in <i>1-71 Start Delay</i> . For instance, this means that if the value in <i>1-71 Start Delay</i> is more or equal to value in <i>parameter 1-79 Pump Start Max Time to Trip</i> , the frequency converter never starts.

### 3.3.9 1-8\* Stop Adjustments

1-80 Function at Stop	
Option:	Function:
	Select the frequency converter function after a stop command or after the speed is ramped down to the settings in <i>parameter 1-81 Min Speed for Function at Stop [RPM]</i> .  Available selections depend on <i>parameter 1-10 Motor Construction</i> : [0] Asynchron: <ul style="list-style-type: none"> <li>[0] coast</li> <li>[1] DC-hold</li> </ul> [1] PM non-salient: <ul style="list-style-type: none"> <li>[0] coast</li> </ul>
[0]	Coast Leaves motor in free mode.
[1]	DC Hold/ Motor Preheat Energises motor with a DC holding current (see <i>parameter 2-00 DC Hold/Preheat Current</i> ).

1-81 Min Speed for Function at Stop [RPM]	
Range:	Function:
Size related* [0 - 600 RPM]	Set the speed at which to activate <i>parameter 1-80 Function at Stop</i> .

1-82 Min Speed for Function at Stop [Hz]	
Range:	Function:
Size related* [0 - 20.0 Hz]	Set the output frequency at which to activate <i>parameter 1-80 Function at Stop</i> .

### 3.3.10 Advanced Minimum Speed Monitoring for Submersible Pumps

Some pumps are very sensitive to operating at low speed. Typical reasons for this are insufficient cooling or lubrication at low speed.

Under overload conditions, the frequency converter protects itself using its integral protection features, which include lowering the speed. For example, the current limit controller can lower the speed. This means that in some cases the speed may go lower than the speed specified in

*4-11 Motor Speed Low Limit [RPM]* and *4-12 Motor Speed Low Limit [Hz]*.

The advanced minimum speed monitoring feature trips the frequency converter if the speed drops below a certain value:

If the motor of the pump does not reach the speed specified in *1-86 Trip Speed Low [RPM]* within the time specified in *parameter 1-79 Pump Start Max Time to Trip* (ramping up takes too long), the frequency converter trips. Timers for *1-71 Start Delay* and *parameter 1-79 Pump Start Max Time to Trip* start at the same time when the start command is issued. For instance, this means that if the value in *1-71 Start Delay* is more or equal to value in *parameter 1-79 Pump Start Max Time to Trip*, the frequency converter will never start.

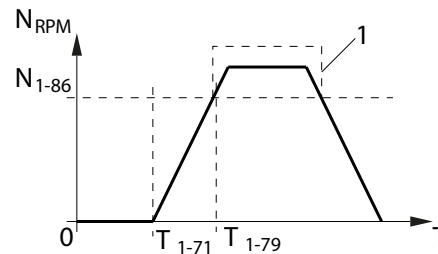

T <sub>1-71</sub>	<i>1-71 Start Delay</i> .
T <sub>1-79</sub>	<i>Parameter 1-79 Pump Start Max Time to Trip</i> . This time includes the time in T <sub>1-71</sub> .
N <sub>1-86</sub>	<i>1-86 Trip Speed Low [RPM]</i> . If the speed drops below this value during normal operation, the frequency converter trips.
1	Normal operation.

Illustration 3.11 Advanced Minimum Speed Monitoring

1-86 Trip Speed Low [RPM]	
Range:	Function:
Size related* [0 - par. 4-13 RPM]	<b>NOTICE</b>  <b>This parameter is only available if <i>parameter 0-02 Motor Speed Unit</i> is set to [RPM].</b>  Enter the low limit for the motor speed at which the frequency converter trips. If the value is 0, the function is not active. If the speed at any time after the start (or during a stop) falls below the value in the parameter, the frequency converter trips with the alarm <i>Speed Limit</i> .

1-87 Trip Speed Low [Hz]	
Range:	Function:
Size related* [0 - par. 4-14 Hz]	<p><b>NOTICE</b></p> <p>This parameter is only available if <i>parameter 0-02 Motor Speed Unit</i> is set to [Hz].</p> <p>Enter the low limit for the motor speed at which the frequency converter trips. If the value is 0, the function is not active. If the speed at any time after the start (or during a stop) falls below the value in the parameter, the frequency converter trips with the alarm <i>Speed Limit</i>.</p>

1-90 Motor Thermal Protection	
Option:	Function:
[7] ETR warning 3	
[8] ETR trip 3	
[9] ETR warning 4	
[10] ETR trip 4	

ETR (Electronic Thermal Relay) functions 1-4 calculate the load when set-up where they were selected is active. For example ETR-3 starts calculating when set-up 3 is selected. For the North American market: The ETR functions provide class 20 motor overload protection in accordance with NEC.

### 3.3.11 1-9\* Motor Temperature

1-90 Motor Thermal Protection	
Option:	Function:
	<p>The frequency converter determines the motor temperature for motor protection in 2 different ways:</p> <ul style="list-style-type: none"> <li>Via a thermistor sensor connected to one of the analog or digital inputs (<i>parameter 1-93 Thermistor Source</i>).</li> <li>Via calculation (ETR = Electronic Thermal Relay) of the thermal load, based on the actual load and time. The calculated thermal load is compared with the rated motor current <math>I_{M,N}</math> and the rated motor frequency <math>f_{M,N}</math>. The calculations estimate the need for a lower load at lower speed due to less cooling from the fan incorporated in the motor.</li> </ul>
[0] No protection	If the motor is continuously overloaded and no warning or trip of frequency converter is wanted.
[1] Thermistor warning	Activates a warning when the connected thermistor in the motor reacts in the event of motor overtemperature.
[2] Thermistor trip	Stops (trips) the frequency converter when the connected thermistor in the motor reacts in the event of motor overtemperature.
[3] ETR warning 1	
[4] ETR trip 1	
[5] ETR warning 2	
[6] ETR trip 2	

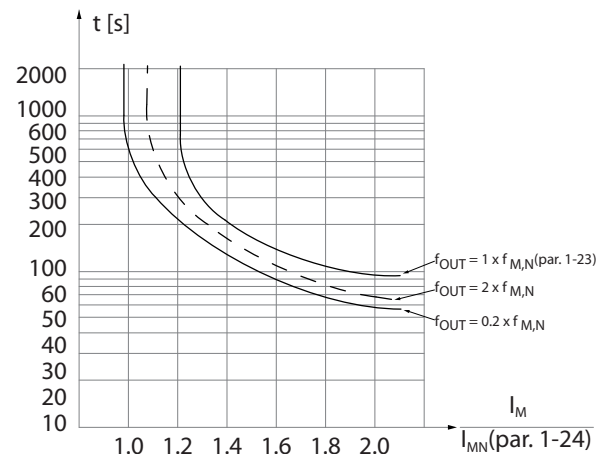

Illustration 3.12 Motor Overload Protection

**WARNING**

To maintain PELV, all connections made to the control terminals must be PELV, e.g. thermistor must be reinforced/double insulated

**NOTICE**

Danfoss recommends using 24 V DC as thermistor supply voltage.

**NOTICE**

The ETR timer function does not work when *parameter 1-10 Motor Construction* = [1] PM, non-salient SPM.

**NOTICE**

For correct operation of ETR function setting in *1-03 Torque Characteristics* must fit the application (see description of *1-03 Torque Characteristics*).

1-91 Motor External Fan		
Option:	Function:	
[0]	No	No external fan is required, i.e. the motor is derated at low speed.
[1]	Yes	Applies an external motor fan (external ventilation), so no derating of the motor is required at low speed. The upper curve in <i>Illustration 3.12</i> ( $f_{out} = 1 \times f_{M,N}$ ) is followed if the motor current is lower than nominal motor current (see <i>parameter 1-24 Motor Current</i> ). If the motor current exceeds nominal current, the operation time still decreases as if no fan were installed.

1-93 Thermistor Source		
Option:	Function:	
		<p><b>NOTICE</b></p> <p>This parameter cannot be adjusted while the motor is running.</p> <p>Select the input to which the thermistor (PTC sensor) should be connected. An analog input option [1] <i>Analog Input 53</i> or [2] <i>Analog Input 54</i> cannot be selected if the analog input is already in use as a reference source (selected in <i>parameter 3-15 Reference 1 Source</i>, <i>parameter 3-16 Reference 2 Source</i> or <i>parameter 3-17 Reference 3 Source</i>). When using MCB 112, [0] <i>None</i> must always be selected.</p>
[0]	None	
[1]	Analog Input 53	
[2]	Analog Input 54	
[3]	Digital input 18	
[4]	Digital input 19	
[5]	Digital input 32	
[6]	Digital input 33	

**NOTICE**

Digital input should be set to [0] *PNP - Active at 24 V* in *parameter 5-00 Digital I/O Mode*.

### 3.4 Parameters 2-\*\* Brakes

#### 3.4.1 2-0\* DC-Brakes

Parameter group for configuring the DC brake and DC hold functions.

2-00 DC Hold/Preheat Current		
Range:		Function:
50 %*	[ 0 - 160 %]	Enter a value for holding current as a percentage of the rated motor current $I_{M,N}$ set in <i>parameter 1-24 Motor Current</i> . 100% DC holding current corresponds to $I_{M,N}$ . This parameter holds the motor (holding torque) or pre-heats the motor. This parameter is active if [1] DC hold/Preheat is selected in <i>parameter 1-80 Function at Stop</i> .

#### NOTICE

*Parameter 2-00 DC Hold/Preheat Current does not have effect when parameter 1-10 Motor Construction = [1] PM, non-salient SPM.*

#### NOTICE

The maximum value depends on the rated motor current.  
Avoid 100 % current for too long. It may damage the motor.

2-01 DC Brake Current		
Range:		Function:
50 %*	[ 0 - 1000 %]	Enter a value for current as a percentage of the rated motor current $I_{M,N}$ , see <i>parameter 1-24 Motor Current</i> . 100% DC braking current corresponds to $I_{M,N}$ . DC brake current is applied on a stop command, when the speed is lower than the limit set in <i>parameter 2-03 DC Brake Cut In Speed [RPM]</i> ; when the DC Brake Inverse function is active; or via the serial communication port. The braking current is active during the time period set in <i>parameter 2-02 DC Braking Time</i> .

#### NOTICE

The maximum value depends on the rated motor current. Avoid 100 % current for too long. It may damage the motor.

2-02 DC Braking Time		
Range:		Function:
10 s*	[ 0 - 60 s]	Set the duration of the DC braking current set in <i>parameter 2-01 DC Brake Current</i> , once activated.

2-03 DC Brake Cut In Speed [RPM]		
Range:		Function:
Size related*	[ 0 - 0 RPM]	Set the DC brake cut-in speed for activation of the DC braking current set in <i>parameter 2-01 DC Brake Current</i> , upon a stop command.  When <i>parameter 1-10 Motor Construction</i> is set to [1] PM non-salient SPM this value is limited to 0 rpm (OFF)

#### NOTICE

*Parameter 2-03 DC Brake Cut In Speed [RPM] does not have effect when parameter 1-10 Motor Construction = [1] PM, non-salient SPM.*

2-04 DC Brake Cut In Speed [Hz]		
Range:		Function:
Size related*	[ 0 - 0.0 Hz]	Set the DC brake cut-in speed for activation of the DC braking current set in <i>2-01 DC Brake Current</i> , upon a stop command.

#### NOTICE

*Parameter 2-04 DC Brake Cut In Speed [Hz] has no effect when parameter 1-10 Motor Construction = [1] PM, non-salient SPM.*

2-06 Parking Current		
Range:		Function:
50 %*	[ 0 - 1000 %]	Set current as percentage of rated motor current, <i>parameter 1-24 Motor Current</i> . Active in connection with <i>parameter 1-73 Flying Start</i> . The parking current is active during the time period set in <i>parameter 2-07 Parking Time</i> .

#### NOTICE

*parameter 2-06 Parking Current and parameter 2-07 Parking Time: Only active if PM motor construction is selected in parameter 1-10 Motor Construction.*

2-07 Parking Time		
Range:		Function:
3 s*	[ 0.1 - 60 s]	Set the duration of the parking current time set in <i>parameter 2-06 Parking Current</i> . Active in connection with <i>parameter 1-73 Flying Start</i> .  <b>NOTICE</b> <i>Parameter 2-07 Parking Time is only active when [1] PM, non salient SPM is selected in 1-10 Motor Construction</i>

### 3.4.2 2-1\* Brake Energy Funct.

Parameter group for selecting dynamic braking parameters. Only valid for frequency converters with brake chopper.

2-10 Brake Function		
Option:	Function:	
	Available selections depend on <i>parameter 1-10 Motor Construction</i> : [0] Asynchron: [0] Off [1] Resistor brake [2] AS brake [1] PM non-salient: [0] Off [1] Resistor brake	
[0]	Off	No brake resistor installed.
[1]	Resistor brake	Brake resistor incorporated in the system, for dissipation of surplus brake energy as heat. Connecting a brake resistor allows a higher DC-link voltage during braking (generating operation). The resistor brake function is only active in frequency converters with an integral dynamic brake.
[2]	AC brake	AC Brake only works in Compressor Torque mode in <i>1-03 Torque Characteristics</i> .

2-11 Brake Resistor (ohm)		
Range:	Function:	
Size related*	[ 5 - 65535 Ohm]	Set the brake resistor value in Ω. This value is used for monitoring the power to the brake resistor in <i>parameter 2-13 Brake Power Monitoring</i> . This parameter is only active in frequency converters with an integral dynamic brake.  Use this parameter for values without decimals. For a selection with 2 decimals, use <i>parameter 30-81 Brake Resistor (ohm)</i> .

2-12 Brake Power Limit (kW)		
Range:	Function:	
Size related*	[ 0.001 - 2000.000 kW]	<b>NOTICE</b> <b>This parameter is only active in frequency converters with an integral dynamic brake.</b>  Set the monitoring limit of the brake power transmitted to the resistor. The monitoring limit is a product of the maximum duty cycle (120 s) and the maximum power of the brake resistor at that duty cycle. See the formulas below.

2-12 Brake Power Limit (kW)		
Range:	Function:	
	For 200-240 V units: $Presistor = \frac{390^2 \times dutytime}{R \times 120}$ For 380-480 V units: $Presistor = \frac{778^2 \times dutytime}{R \times 120}$ For 525-600 V units: $Presistor = \frac{943^2 \times dutytime}{R \times 120}$	

2-13 Brake Power Monitoring		
Option:	Function:	
	<b>NOTICE</b> <b>This parameter is only active in frequency converters with an integral dynamic brake.</b>  This parameter enables monitoring of the power to the brake resistor. The power is calculated on the basis of the resistance ( <i>parameter 2-11 Brake Resistor (ohm)</i> ), the DC-link voltage, and the resistor duty time.	
[0]	Off	No brake power monitoring is required.
[1]	Warning	Activates a warning in the display when the power transmitted over 120 s exceeds 100% of the monitoring limit ( <i>parameter 2-12 Brake Power Limit (kW)</i> ).  The warning disappears when the transmitted power falls below 80% of the monitoring limit.
[2]	Trip	Trips the frequency converter and displays an alarm when the calculated power exceeds 100% of the monitoring limit.
[3]	Warning and trip	Activates both of the above, including warning, trip and alarm.

If power monitoring is set to [0] Off or [1] Warning, the brake function remains active even if the monitoring limit is exceeded. This may lead to thermal overload of the resistor. It is also possible to generate a warning via a relay/digital output. The measuring accuracy of the power monitoring depends on the accuracy of the resistance of the resistor (better than ±20%).

2-15 Brake Check		
Option:	Function:	
	Select type of test and monitoring function to check the connection to the brake resistor, or whether a brake resistor is present, and then display a warning or an alarm in the event of a fault. The brake resistor disconnection function is tested during power-up. However, the brake IGBT test is performed when there is no braking. A warning or trip disconnects the brake function.	



2-15 Brake Check		
Option:	Function:	
		The testing sequence is as follows: <ol style="list-style-type: none"> <li>The DC-link ripple amplitude is measured for 300 ms without braking.</li> <li>The DC-link ripple amplitude is measured for 300 ms with the brake turned on.</li> <li>If the DC-link ripple amplitude while braking is lower than the DC-link ripple amplitude before braking +1%. Brake check failed, return a warning or alarm.</li> <li>If the DC-link ripple amplitude while braking is higher than the DC-link ripple amplitude before braking +1%. Brake check OK.</li> </ol>
[0]	Off	Monitors brake resistor and brake IGBT for a short-circuit during operation. If a short-circuit occurs, a warning appears.
[1]	Warning	Monitors brake resistor and brake IGBT for a short-circuit, and to run a test for brake resistor disconnection during power-up
[2]	Trip	Monitors for a short-circuit or disconnection of the brake resistor, or a short-circuit of the brake IGBT. If a fault occurs, the frequency converter cuts out while displaying an alarm (trip locked).
[3]	Stop and trip	Monitors for a short-circuit or disconnection of the brake resistor, or a short-circuit of the brake IGBT. If a fault occurs the frequency converter ramps down to coast and then trips. A trip lock alarm is displayed.
[4]	AC brake	

### NOTICE

Remove a warning arising in connection with [0] Off or [1] Warning by cycling the mains supply. The fault must be corrected first. For [0] Off or [1] Warning, the frequency converter keeps running even if a fault is located.

2-16 AC brake Max. Current		
Range:	Function:	
100 %* [0 - 1000.0 %]	Enter the maximum permissible current when using AC brake to avoid overheating of motor windings. The AC brake function is available in Flux mode only.	

### NOTICE

Parameter 2-16 AC brake Max. Current has no effect when parameter 1-10 Motor Construction = [1] PM, non-salient SPM.

2-17 Over-voltage Control		
Option:	Function:	
[0]	Disabled	No OVC required.
[2]	Enabled	Activates OVC.

### NOTICE

Parameter 2-17 Over-voltage Control has no effect when parameter 1-10 Motor Construction = [1] PM, non-salient SPM.

### NOTICE

The ramp time is automatically adjusted to avoid tripping of the frequency converter.

### 3.5 Parameters 3-\*\* Reference/Ramps

#### 3.5.1 3-0\* Reference Limits

3-02 Minimum Reference		
Range:		Function:
Size related*	[-999999.999 - par. 3-03 ReferenceFeedbackUnit]	Enter the desired minimum value for the remote reference. The minimum reference value and unit matches the configuration selection made in <i>parameter 1-00 Configuration Mode</i> and <i>20-12 Reference/Feedback Unit</i> .

3-03 Maximum Reference		
Range:		Function:
Size related*	[ par. 3-02 - 999999.999 ReferenceFeedbackUnit]	Enter the maximum acceptable value for the remote reference. The maximum reference value and unit matches the configuration choice made in <i>parameter 1-00 Configuration Mode</i> and <i>20-12 Reference/Feedback Unit</i> .

3-04 Reference Function		
Option:		Function:
[0]	Sum	Sums both external and preset reference sources.
[1]	External/Preset	Use either the preset or the external reference source. Shift between external and preset via a command or a digital input.

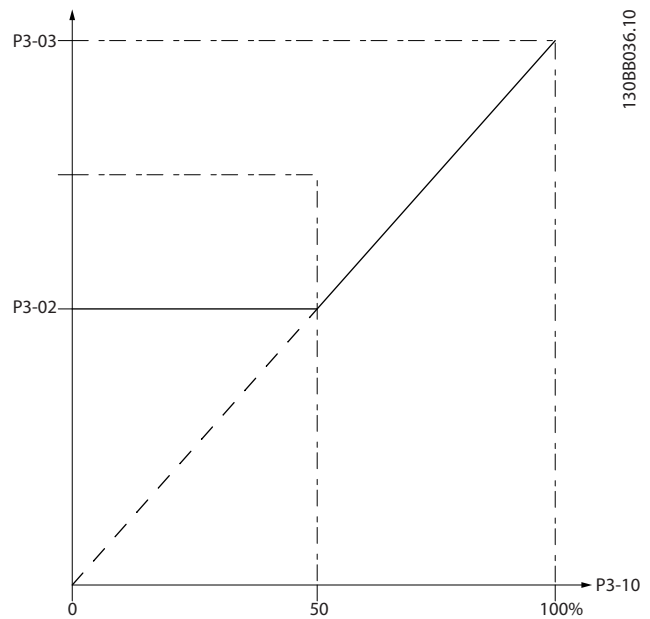

Illustration 3.13 Preset Reference

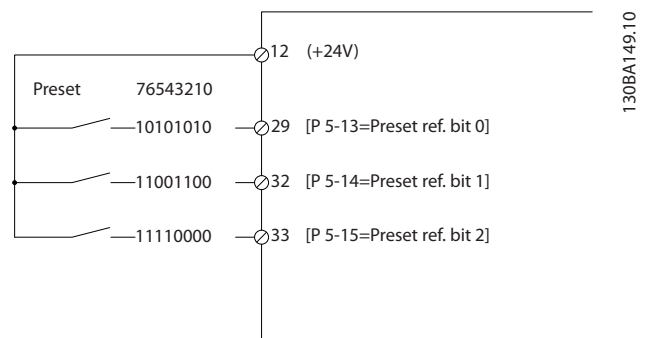

Illustration 3.14 Preset Reference Scheme

#### 3.5.2 3-1\* References

Select the preset reference(s). Select Preset ref. bit 0/1/2 [16], [17] or [18] for the corresponding digital inputs in parameter group *5-1\* Digital Inputs*.

3-10 Preset Reference		
Array [8]		
Range:		Function:
0 %*	[-100 - 100 %]	Enter up to 8 different preset references (0-7) in this parameter, using array programming. The preset reference is stated as a percentage of the value Ref <sub>MAX</sub> ( <i>parameter 3-03 Maximum Reference</i> ). When using preset references, select Preset ref. bit 0/1/2 [16], [17] or [18] for the corresponding digital inputs in parameter group <i>5-1* Digital Inputs</i> .

3-11 Jog Speed [Hz]		
Range:		Function:
Size related*	[ 0 - par. 4-14 Hz]	The jog speed is a fixed output speed at which the frequency converter is running when the jog function is activated. See also <i>parameter 3-80 Jog Ramp Time</i> .

3-13 Reference Site		
Option:	Function:	
		Select which reference site to activate.
[0]	Linked to Hand / Auto	Use local reference when in Hand mode; or remote reference when in Auto mode.
[1]	Remote	Use remote reference in both Hand mode and Auto mode.
[2]	Local	Use local reference in both Hand mode and Auto mode.  <b>NOTICE</b> When set to [2] Local, the frequency converter starts with this setting again following a 'power down'.

3-14 Preset Relative Reference		
Range:	Function:	
0 %* [-100 - 100 %]	The actual reference, X, is increased or decreased with the percentage Y, set in parameter 3-14 Preset Relative Reference. This results in the actual reference Z. Actual reference (X) is the sum of the inputs selected in parameter 3-15 Reference 1 Source, parameter 3-16 Reference 2 Source, parameter 3-17 Reference 3 Source and 8-02 Control Source.	

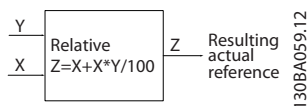

Illustration 3.15 Preset Relative Reference

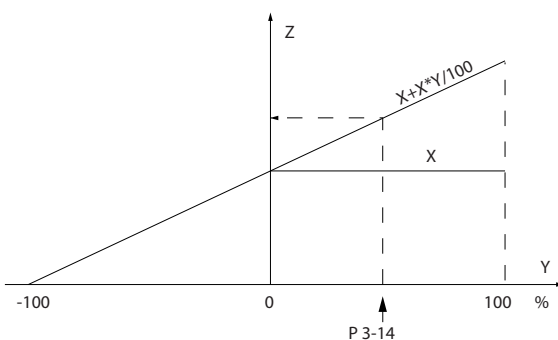

Illustration 3.16 Actual Reference

3-15 Reference 1 Source		
Option:	Function:	
	<b>NOTICE</b> This parameter cannot be adjusted while the motor is running.	

3-15 Reference 1 Source		
Option:	Function:	
		Select the reference input to be used for the first reference signal. <i>Parameter 3-15 Reference 1 Source, parameter 3-16 Reference 2 Source and parameter 3-17 Reference 3 Source define up to 3 different reference signals. The sum of these reference signals defines the actual reference.</i>
[0]	No function	
[1]	Analog Input 53	
[2]	Analog Input 54	
[7]	Pulse input 29	
[8]	Pulse input 33	
[20]	Digital pot.meter	
[21]	Analog input X30/11	
[22]	Analog input X30/12	
[23]	Analog Input X42/1	
[24]	Analog Input X42/3	
[25]	Analog Input X42/5	
[29]	Analog Input X48/2	
[30]	Ext. Closed Loop 1	
[31]	Ext. Closed Loop 2	
[32]	Ext. Closed Loop 3	
[35]	Digital input select	The frequency converter selects AI53 or AI54 as the reference source based on the input signal defined in option [42] Ref source bit 0 of one of the digital inputs. For more information, see parameter group 5-1* Digital Inputs, option [42] Ref source bit 0.

3-16 Reference 2 Source		
Option:	Function:	
	<b>NOTICE</b> This parameter cannot be adjusted while the motor is running.  Select the reference input to be used for the second reference signal. <i>parameter 3-15 Reference 1 Source, parameter 3-16 Reference 2 Source and parameter 3-17 Reference 3 Source define up to 3 different reference signals. The</i>	

3-16 Reference 2 Source		
Option:	Function:	
		sum of these reference signals defines the actual reference.
[0]	No function	
[1]	Analog Input 53	
[2]	Analog Input 54	
[7]	Pulse input 29	
[8]	Pulse input 33	
[20]	Digital pot.meter	
[21]	Analog input X30/11	
[22]	Analog input X30/12	
[23]	Analog Input X42/1	
[24]	Analog Input X42/3	
[25]	Analog Input X42/5	
[29]	Analog Input X48/2	
[30]	Ext. Closed Loop 1	
[31]	Ext. Closed Loop 2	
[32]	Ext. Closed Loop 3	
[35]	Digital input select	The frequency converter selects AI53 or AI54 as the reference source basing on the input signal defined in option [42] <i>Ref source bit 0</i> of one of the digital inputs. For more information, see parameter group 5-1* <i>Digital Inputs</i> , option [42] <i>Ref source bit 0</i> .

3-17 Reference 3 Source		
Option:	Function:	
		<b>NOTICE</b> This parameter cannot be adjusted while the motor is running.  Select the reference input to be used for the third reference signal. <i>parameter 3-15 Reference 1 Source, parameter 3-16 Reference 2 Source and parameter 3-17 Reference 3 Source</i> define up to 3 different reference signals. The sum of these reference signals defines the actual reference.
[0]	No function	
[1]	Analog Input 53	
[2]	Analog Input 54	
[7]	Pulse input 29	

3-17 Reference 3 Source		
Option:	Function:	
[8]	Pulse input 33	
[20]	Digital pot.meter	
[21]	Analog input X30/11	
[22]	Analog input X30/12	
[23]	Analog Input X42/1	
[24]	Analog Input X42/3	
[25]	Analog Input X42/5	
[29]	Analog Input X48/2	
[30]	Ext. Closed Loop 1	
[31]	Ext. Closed Loop 2	
[32]	Ext. Closed Loop 3	
[35]	Digital input select	The frequency converter selects AI53 or AI54 as the reference source basing on the input signal defined in option [42] <i>Ref source bit 0</i> of one of the digital inputs. For more information, see parameter group 5-1* <i>Digital Inputs</i> , option [42] <i>Ref source bit 0</i> .

3-19 Jog Speed [RPM]		
Range:	Function:	
Size related*	[ 0 - par. 4-13 RPM]	Enter a value for the jog speed $n_{JOG}$ , which is a fixed output speed. The frequency converter runs at this speed when the jog function is activated. The maximum limit is defined in <i>parameter 4-13 Motor Speed High Limit [RPM]</i> . See also <i>parameter 3-80 Jog Ramp Time</i> .

### 3.5.3 3-4\* Ramp 1

Configure the ramp parameter, ramping times, for each of the 2 ramps (parameter group 3-4\* *Ramp 1* and parameter group 3-5\* *Ramp 2*).

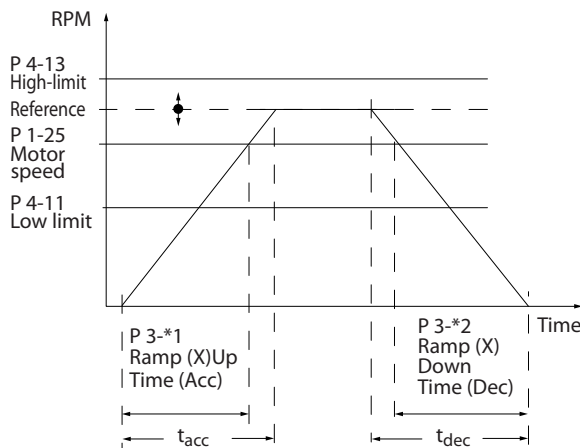

Illustration 3.17 Ramp 1

3-41 Ramp 1 Ramp Up Time		
Range:	Function:	
Size related*	[ 0.10 - 3600 s]	Enter the ramp-up time, i.e. the acceleration time from 0 RPM to <i>parameter 1-25 Motor Nominal Speed</i> . Select a ramp-up time such that the output current does not exceed the current limit in <i>4-18 Current Limit</i> during ramping. See ramp-down time in <i>parameter 3-42 Ramp 1 Ramp Down Time</i> .

$$par.3-41 = \frac{t_{acc} \times n_{nom} [par.1-25]}{ref [rpm]} [s]$$

3-42 Ramp 1 Ramp Down Time		
Range:	Function:	
Size related*	[ 0.10 - 3600 s]	Enter the ramp-down time, i.e. the deceleration time from <i>parameter 1-25 Motor Nominal Speed</i> to 0 RPM. Select a ramp-down time such that no overvoltage arises in the inverter due to regenerative operation of the motor, and such that the generated current does not exceed the current limit set in <i>4-18 Current Limit</i> . See ramp-up time in <i>parameter 3-41 Ramp 1 Ramp Up Time</i> .

$$par.3-42 = \frac{t_{dec} \times n_{nom} [par.1-25]}{ref [rpm]} [s]$$

### 3.5.4 3-5\* Ramp 2

To select ramp parameters, see parameter group 3-4\* Ramp 1.

3-51 Ramp 2 Ramp Up Time		
Range:	Function:	
Size related*	[ 0.10 - 3600 s]	Enter the ramp-up time, i.e. the acceleration time from 0 RPM to <i>parameter 1-25 Motor Nominal Speed</i> . Select a ramp-up time such that the output

130BA169.11

3-51 Ramp 2 Ramp Up Time		
Range:	Function:	
		current does not exceed the current limit in <i>4-18 Current Limit</i> during ramping. See ramp-down time in <i>parameter 3-52 Ramp 2 Ramp Down Time</i> .
		$par.3-51 = \frac{t_{acc} \times n_{nom} [par.1-25]}{ref [rpm]} [s]$

3-52 Ramp 2 Ramp Down Time		
Range:	Function:	
Size related*	[ 0.10 - 3600 s]	Enter the ramp-down time, i.e. the deceleration time from <i>parameter 1-25 Motor Nominal Speed</i> to 0 RPM. Choose a ramp-down time such that no overvoltage arises in the inverter due to regenerative operation of the motor, and such that the generated current does not exceed the current limit set in <i>4-18 Current Limit</i> . See ramp-up time in <i>parameter 3-51 Ramp 2 Ramp Up Time</i> .
		$par.3-52 = \frac{t_{dec} \times n_{nom} [par.1-25]}{ref [rpm]} [s]$

### 3.5.5 3-8\* Other Ramps

3-80 Jog Ramp Time		
Range:	Function:	
Size related*	[ 0.1 - 3600 s]	Enter the jog ramp time, i.e. the acceleration/ deceleration time between 0 RPM and the rated motor speed ( $n_{M,N}$ ) (set in <i>parameter 1-25 Motor Nominal Speed</i> ). Ensure that the resultant output current required for the given jog ramp time does not exceed the current limit in <i>4-18 Current Limit</i> . The jog ramp time starts upon activation of a jog signal via the control panel, a selected digital input, or the serial communication port.
		$par.3-80 = \frac{t_{jog} \times n_{nom} [par.1-25]}{jog\ speed [par.3-19]} [s]$

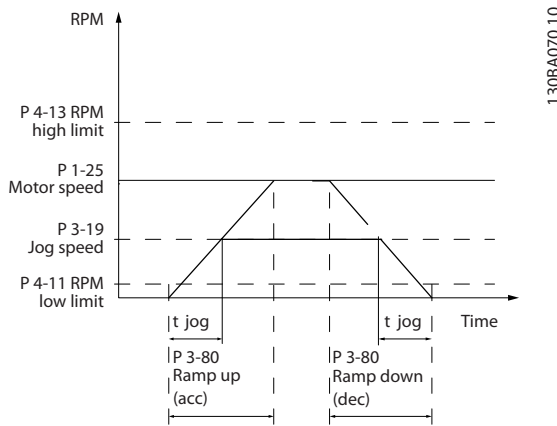

Illustration 3.18 Jog Ramp Time

3-85 Check Valve Ramp Time	
Range:	Function:
	3-87 Check Valve Ramp End Speed [HZ]. See Illustration 3.20.

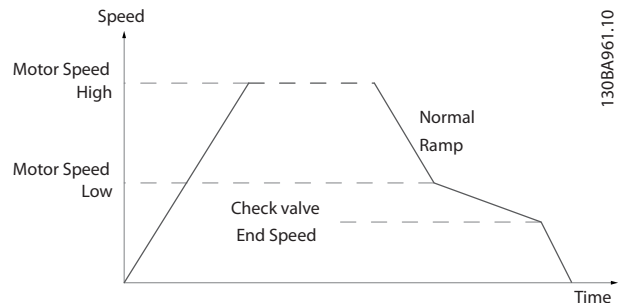

Illustration 3.20 Check Valve Ramp

3-84 Initial Ramp Time	
Range:	Function:
0 s* [0 - 60 s]	Enter the initial ramp up time from zero speed to Motor Speed Low Limit, parameter 4-11 Motor Speed Low Limit [RPM] or parameter 4-12 Motor Speed Low Limit [Hz]. Submersible deep well pumps can be damaged by running below minimum speed. A fast ramp time below minimum pump speed is recommended. This parameter may be applied as a fast ramp rate from zero speed to Motor Speed Low Limit. See Illustration 3.19.

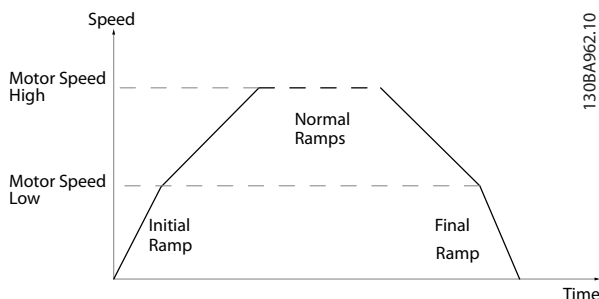

Illustration 3.19 Initial and Final Ramp Time

3-86 Check Valve Ramp End Speed [RPM]	
Range:	Function:
Size related* [0 - par. 4-11 RPM]	Set the speed in [RPM] below motor speed low limit where the check valve is expected to be closed and the check valve no longer shall be active. See Illustration 3.20.

3-87 Check Valve Ramp End Speed [HZ]	
Range:	Function:
Size related* [0 - par. 4-12 Hz]	Set the speed in [Hz] below motor speed low limit where the check valve ramp is no longer be active. See Illustration 3.20.

3-88 Final Ramp Time	
Range:	Function:
0 s* [0 - 60 s]	Enter the final ramp time to be used when ramping down from parameter 4-11 Motor Speed Low Limit [RPM] or parameter 4-12 Motor Speed Low Limit [Hz], to zero speed. Submersible deep well pumps can be damaged by running below minimum speed. A fast ramp time below minimum pump speed is recommended. This parameter may be applied as a fast ramp rate from parameter 4-11 Motor Speed Low Limit [RPM] or parameter 4-12 Motor Speed Low Limit [Hz] to zero speed. See Illustration 3.19.

3-85 Check Valve Ramp Time	
Range:	Function:
0 s* [0 - 60 s]	To protect ball check valves in a stop situation, the check valve ramp can be utilised as a slow ramp rate from parameter 4-11 Motor Speed Low Limit [RPM] or parameter 4-12 Motor Speed Low Limit [Hz], to check valve ramp end speed, set by the user in 3-86 Check Valve Ramp End Speed [RPM] or 3-87 Check Valve Ramp End Speed [HZ]. When 3-85 Check Valve Ramp Time is different from 0 s, the check valve ramp time is effectuated and is used to ramp down the speed from motor speed low limit to the check valve end speed in 3-86 Check Valve Ramp End Speed [RPM] or

### 3.5.6 3-9\* Digital Pot.Meter

The digital potentiometer function allows the user to increase or decrease the actual reference by adjusting the set-up of the digital inputs using the functions INCREASE, DECREASE or CLEAR. To activate the function, at least one digital input must be set up to INCREASE or DECREASE.

3-90 Step Size		
Range:		Function:
0.10 %*	[0.01 - 200 %]	Enter the increment size required for INCREASE/DECREASE, as a percentage of the synchronous motor speed, $n_s$ . If INCREASE/DECREASE is activated, the resulting reference is increased/decreased by the amount set in this parameter.

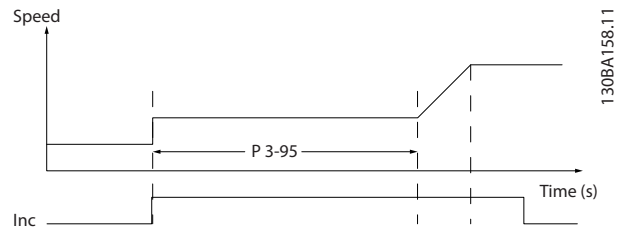

Illustration 3.21 Ramp Delay Case 1

3-91 Ramp Time		
Range:		Function:
1 s	[0 - 3600 s]	Enter the ramp time, i.e. the time for adjustment of the reference from 0% to 100% of the specified digital potentiometer function (INCREASE, DECREASE or CLEAR). If INCREASE/DECREASE is activated for longer than the ramp delay period specified in <i>parameter 3-95 Ramp Delay</i> the actual reference is ramped up/down according to this ramp time. The ramp time is defined as the time used to adjust the reference by the step size specified in <i>parameter 3-90 Step Size</i> .

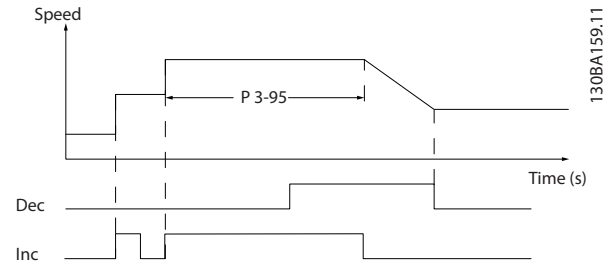

Illustration 3.22 Ramp Delay Case 2

3-92 Power Restore		
Option:		Function:
[0]	Off	Resets the digital potentiometer reference to 0% after power up.
[1]	On	Restores the most recent digital potentiometer reference at power up.

3-93 Maximum Limit		
Range:		Function:
100 %*	[-200 - 200 %]	Set the maximum permissible value for the resultant reference. This is advisable if the digital potentiometer is used for fine tuning of the resulting reference.

3-94 Minimum Limit		
Range:		Function:
0 %*	[-200 - 200 %]	Set the minimum permissible value for the resultant reference. This is advisable if the digital potentiometer is used for fine tuning of the resulting reference.

3-95 Ramp Delay		
Range:		Function:
Size related*	[0 - 0]	Enter the delay required from activation of the digital potentiometer function until the frequency converter starts to ramp the reference. With a delay of 0 ms, the reference starts to ramp as soon as INCREASE/DECREASE is activated. See also <i>parameter 3-91 Ramp Time</i> .

### 3.6 Parameters 4-\*\* Limits/Warnings

#### 3.6.1 4-1\* Motor Limits

Define torque, current and speed limits for the motor, and the reaction of the frequency converter when the limits are exceeded.

A limit may generate a message on the display. A warning always generates a message in the display or on the fieldbus. A monitoring function may initiate a warning or a trip, upon which the frequency converter stops and generates an alarm message.

4-10 Motor Speed Direction		
Option:	Function:	
		Selects the motor speed direction required. When <i>parameter 1-00 Configuration Mode</i> is set to [3] <i>Closed loop</i> , the parameter default is changed to [0] <i>Clockwise</i> . If both directions are selected, running in counter clockwise direction cannot be selected from the LCP.
[0]	Clockwise	
[2]	Both directions	

4-11 Motor Speed Low Limit [RPM]		
Range:	Function:	
Size related*	[ 0 - par. 4-13 RPM]	Enter the minimum limit for motor speed in RPM. The motor speed low limit can be set to correspond to the manufacturer's recommended minimum motor speed. The motor speed low limit must not exceed the setting in <i>parameter 4-13 Motor Speed High Limit [RPM]</i> .

4-12 Motor Speed Low Limit [Hz]		
Range:	Function:	
Size related*	[ 0 - par. 4-14 Hz]	Enter the minimum limit for motor speed in Hz. The motor speed low limit can be set to correspond to the minimum output frequency of the motor shaft. The speed low limit must not exceed the setting in <i>parameter 4-14 Motor Speed High Limit [Hz]</i> .

4-13 Motor Speed High Limit [RPM]		
Range:	Function:	
Size related*	[ 0 - 60000 RPM]	Enter the maximum limit for motor speed in RPM. The motor speed high limit can be set to correspond to the manufacturer's maximum rated motor. The motor speed high limit must exceed the setting in <i>parameter 4-11 Motor Speed Low Limit [RPM]</i> . Only <i>parameter 4-11 Motor Speed Low Limit [RPM]</i> or <i>parameter 4-12 Motor Speed Low</i>

4-13 Motor Speed High Limit [RPM]		
Range:	Function:	
		<i>Limit [Hz]</i> is displayed depending on other parameters in the Main Menu and depending on default settings dependant on global location.

#### NOTICE

Max. output frequency cannot exceed 10% of the inverter switching frequency (*parameter 14-01 Switching Frequency*).

#### NOTICE

Any changes in *parameter 4-13 Motor Speed High Limit [RPM]* reset the value in *parameter 4-53 Warning Speed High* to the same value as set in *parameter 4-13 Motor Speed High Limit [RPM]*.

4-14 Motor Speed High Limit [Hz]		
Range:	Function:	
Size related*	[ .1 - par. 4-19 Hz]	Enter the max limit for motor speed in Hz. <i>Parameter 4-14 Motor Speed High Limit [Hz]</i> can match the manufacturer's recommended maximum motor speed. The Motor Speed High Limit must exceed the value in <i>parameter 4-12 Motor Speed Low Limit [Hz]</i> . The output frequency must not exceed 10% of the switching frequency.

#### NOTICE

Max. output frequency cannot exceed 10% of the inverter switching frequency (*parameter 14-01 Switching Frequency*).

4-16 Torque Limit Motor Mode		
Range:	Function:	
Size related*	[ 0 - 1000.0 %]	Enter the maximum torque limit for motor operation. The torque limit is active in the speed range up to and including the rated motor speed set in <i>parameter 1-25 Motor Nominal Speed</i> . To protect the motor from reaching the stalling torque, the default setting is 1.1 x the rated motor torque (calculated value). See also <i>parameter 14-25 Trip Delay at Torque Limit</i> for further details. If a setting in <i>parameter 1-00 Configuration Mode</i> to <i>parameter 1-28 Motor Rotation Check</i> is changed, <i>parameter 4-16 Torque Limit Motor Mode</i> is not automatically reset to the default setting.



4-17 Torque Limit Generator Mode		
Range:		Function:
100 %*	[ 0 - 1000.0 %]	Enter the maximum torque limit for generator mode operation. The torque limit is active in the speed range up to and including the rated motor speed ( <i>parameter 1-25 Motor Nominal Speed</i> ). Refer to <i>parameter 14-25 Trip Delay at Torque Limit</i> for further details. If a setting in <i>parameter 1-00 Configuration Mode</i> to <i>parameter 1-28 Motor Rotation Check</i> is changed, <i>parameter 4-17 Torque Limit Generator Mode</i> is not automatically reset to the default settings.

4-18 Current Limit		
Range:		Function:
Size related*	[ 1.0 - 1000.0 %]	Enter the current limit for motor and generator operation. To protect the motor from reaching the stalling torque, the default setting is 1.1 x the rated motor torque (calculated value). If a setting in <i>parameter 1-00 Configuration Mode</i> to <i>1-26 Motor Cont. Rated Torque</i> is changed, <i>4-18 Current Limit</i> is not automatically reset to the default setting.

4-19 Max Output Frequency		
Range:		Function:
Size related*	[ 1 - 590 Hz]	<b>NOTICE</b> <b>This parameter cannot be adjusted while the motor is running.</b>  Enter the maximum output frequency value. <i>Parameter 4-19 Max Output Frequency</i> specifies the absolute limit on the frequency converter output frequency for improved safety in applications where accidental overspeeding must be avoided. This absolute limit applies to all configurations and is independent of the setting in <i>parameter 1-00 Configuration Mode</i> .

### NOTICE

When *parameter 1-10 Motor Construction* is set to [1] PM, non-salient SPM, the maximum value is limited to 300 Hz

### 3.6.2 4-5\* Adj. Warnings

Define adjustable warning limits for current, speed, reference and feedback.

### NOTICE

Not visible in display, only in MCT 10 Set-up Software.

4-50 Warning Current Low		
Range:		Function:
0 A*	[ 0 - par. 4-51 A]	Enter the $I_{LOW}$ value. When the motor current falls below this limit ( $I_{LOW}$ ), the display reads CURRENT LOW. The signal outputs can be programmed to produce a status signal on terminal 27 or 29 and on relay output 01 or 02. Refer to <i>Illustration 3.23</i> .

4-51 Warning Current High		
Range:		Function:
Size related*	[ par. 4-50 - par. 16-37 A]	Enter the $I_{HIGH}$ value. When the motor current exceeds this limit ( $I_{HIGH}$ ), the display reads CURRENT HIGH. The signal outputs can be programmed to produce a status signal on terminal 27 or 29 and on relay output 01 or 02. Refer to <i>Illustration 3.23</i> .

4-52 Warning Speed Low		
Range:		Function:
0 RPM*	[ 0 - par. 4-53 RPM]	Enter the $n_{LOW}$ value. When the motor speed falls below this limit ( $n_{LOW}$ ) the display reads SPEED LOW. The signal outputs can be programmed to produce a status signal on terminal 27 or 29 and on relay output 01 or 02. Programme the lower signal limit of the motor speed, $n_{LOW}$ , within the normal working range of the frequency converter. Refer to the <i>Illustration 3.23</i> .

4-53 Warning Speed High		
Range:		Function:
Size related*	[ par. 4-52 - par. 4-13 RPM]	Enter the $n_{HIGH}$ value. When the motor speed exceeds this limit ( $n_{HIGH}$ ), the display reads SPEED HIGH. The signal outputs can be programmed to produce a status signal on terminal 27 or 29 and on relay output 01 or 02. Programme the upper signal limit of the motor speed, $n_{HIGH}$ , within the normal working range of the frequency converter. Refer to <i>Illustration 3.23</i> .

### NOTICE

Any changes in *parameter 4-13 Motor Speed High Limit [RPM]* reset the value in *parameter 4-53 Warning Speed High* to the same value as set in *parameter 4-13 Motor Speed High Limit [RPM]*.

If a different value is needed in *parameter 4-53 Warning Speed High*, it must be set after programming of *parameter 4-13 Motor Speed High Limit [RPM]*

4-54 Warning Reference Low		
Range:		Function:
-999999.999 *	[ -999999.999 - par. 4-55 ]	Enter the lower reference limit. When the actual reference falls below this limit, the display indicates Ref <sub>Low</sub> . The signal outputs can be programmed to produce a status signal on terminal 27 or 29 and on relay output 01 or 02.

4-55 Warning Reference High		
Range:		Function:
999999.999 *	[ par. 4-54 - 999999.999 ]	Enter the upper reference limit. When the actual reference exceeds this limit, the display reads Ref <sub>High</sub> . The signal outputs can be programmed to produce a status signal on terminal 27 or 29 and on relay output 01 or 02.

4-56 Warning Feedback Low		
Range:		Function:
-999999.999 ReferenceFeed-backUnit*	[ -999999.999 - par. 4-57 ReferenceFeed-backUnit ]	Enter the lower feedback limit. When the feedback falls below this limit, the display reads Feedb <sub>Low</sub> . The signal outputs can be programmed to produce a status signal on terminal 27 or 29 and on relay output 01 or 02.

4-57 Warning Feedback High		
Range:		Function:
999999.999 ReferenceFeed-backUnit*	[ par. 4-56 - 999999.999 ReferenceFeed-backUnit ]	Enter the upper feedback limit. When the feedback exceeds this limit, the display reads Feedb <sub>High</sub> . The signal outputs can be programmed to produce a status signal on terminal 27 or 29 and on relay output 01 or 02.

4-58 Missing Motor Phase Function		
Option:	Function:	
	<b>NOTICE</b> This parameter cannot be adjusted while the motor is running.  Displays an alarm in the event of a missing motor phase.	
[0] Disabled	No alarm is displayed if a missing motor phase occurs.	

4-58 Missing Motor Phase Function		
Option:	Function:	
[1] Trip 100 ms	An alarm is displayed if a missing motor phase occurs.	
[2] Trip 1000 ms		
[5] Motor Check		

### 3.6.3 4-6\* Speed Bypass

Some systems call for avoiding certain output frequencies or speeds, due to resonance problems in the system. A maximum of 4 frequency or speed ranges can be avoided.

4-60 Bypass Speed From [RPM]		
Array [4]		
Range:		Function:
Size related*	[ 0 - par. 4-13 RPM ]	Some systems call for avoiding certain output speeds due to resonance problems in the system. Enter the lower limits of the speeds to be avoided.

4-61 Bypass Speed From [Hz]		
Array [4]		
Range:		Function:
Size related*	[ 0 - par. 4-14 Hz ]	Some systems call for avoiding certain output speeds due to resonance problems in the system. Enter the lower limits of the speeds to be avoided.

4-62 Bypass Speed To [RPM]		
Array [4]		
Range:		Function:
Size related*	[ 0 - par. 4-13 RPM ]	Some systems call for avoiding certain output speeds due to resonance problems in the system. Enter the upper limits of the speeds to be avoided.

4-63 Bypass Speed To [Hz]		
Array [4]		
Range:		Function:
Size related*	[ 0 - par. 4-14 Hz ]	Some systems call for avoiding certain output speeds due to resonance problems in the system. Enter the upper limits of the speeds to be avoided.

### 3.6.4 Semi-Automatic Bypass Speed Set-up

The Semi-Automatic Bypass Speed Setup can be used to facilitate the programming of the frequencies to be skipped due to resonances in the system.

Carry out following process

1. Stop the motor.
2. Select Enabled in *parameter 4-64 Semi-Auto Bypass Set-up*.
3. Press *Hand On* on the LCP to start the search for frequency bands causing resonances. The motor will ramp up according to the ramp set.
4. When sweeping through a resonance band, press *OK* on the LCP when leaving the band. The actual frequency is stored as the first element in *parameter 4-62 Bypass Speed To [RPM]* or *parameter 4-63 Bypass Speed To [Hz]* (array). Repeat this for each resonance band identified at the ramp-up (maximum four can be adjusted).
5. When maximum speed has been reached, the motor automatically begins to ramp down. Repeat the above procedure when speed is leaving the resonance bands during the deceleration. The actual frequencies registered when pressing *OK* are stored in *parameter 4-60 Bypass Speed From [RPM]* or *parameter 4-61 Bypass Speed From [Hz]*.
6. When the motor has ramped down to stop, press *OK*. *Parameter 4-64 Semi-Auto Bypass Set-up* automatically resets to Off. The frequency converter stays in *Hand* mode until *Off* or *Auto On* is pressed on the LCP.

If the frequencies for a certain resonance band are not registered in the right order (frequency values stored in *By Pass Speed To* are higher than those in *By Pass Speed From*) or if they do not have the same numbers of registrations for the *By Pass From* and *By Pass To*, all registrations will be cancelled and the following message is displayed: *Collected speed areas overlapping or not completely determined. Press [Cancel] to abort.*

4-64 Semi-Auto Bypass Set-up		
Option:	Function:	
[0]	Off	No function
[1]	Enabled	Starts the Semi-Automatic Bypass set-up and continue with the procedure described above.

### 3.7 Parameters 5-\*\* Digital In/Out

Parameter group for configuring the digital input and output.

Options [120] - [138] are related to the Cascade Controller functionality. For more information, see parameter group 25-\*\* *Cascade Controller*.

3

#### 3.7.1 5-0\* Digital I/O Mode

Parameters for configuring the input and output using NPN and PNP.

5-00 Digital I/O Mode		
Option:	Function:	
	<p><b>NOTICE</b></p> <p>This parameter cannot be adjusted while the motor is running.</p> <p>Digital inputs and programmed digital outputs are pre-programmable for operation either in PNP or NPN systems.</p>	
[0]	PNP - Active at 24V	Action on positive directional pulses (0). PNP systems are pulled down to GND.
[1]	NPN - Active at 0V	Action on negative directional pulses (1). NPN systems are pulled up to +24 V, internally in the frequency converter.

5-01 Terminal 27 Mode		
Option:	Function:	
	<p><b>NOTICE</b></p> <p>This parameter cannot be adjusted while the motor is running.</p>	
[0]	Input	Defines terminal 27 as a digital input.
[1]	Output	Defines terminal 27 as a digital output.

5-02 Terminal 29 Mode		
Option:	Function:	
	<p><b>NOTICE</b></p> <p>This parameter cannot be adjusted while the motor is running.</p>	
[0]	Input	Defines terminal 29 as a digital input.
[1]	Output	Defines terminal 29 as a digital output.

#### 3.7.2 5-1\* Digital Inputs

Parameters for configuring the input functions for the input terminals.

The digital inputs are used for selecting various functions in the frequency converter. All digital inputs can be set to the following functions:

Digital input function	Option	Terminal
No operation	[0]	All *term 32, 33, 29, 19
Reset	[1]	All
Coast inverse	[2]	All * term 27
Coast and reset inverse	[3]	All
DC-brake inverse	[5]	All
Stop inverse	[6]	All
External interlock	[7]	All
Start	[8]	All
Latched start	[9]	All
Reversing	[10]	All
Start reversing	[11]	All
Jog	[14]	All
Preset reference on	[15]	All
Preset ref bit 0	[16]	All
Preset ref bit 1	[17]	All
Preset ref bit 2	[18]	All
Freeze reference	[19]	All
Freeze output	[20]	All
Speed up	[21]	All
Speed down	[22]	All
Set-up select bit 0	[23]	All
Set-up select bit 1	[24]	All
Pulse input	[32]	term 29, 33
Ramp bit 0	[34]	All
Mains failure inverse	[36]	All
Ref source bit 0	[42]	All
Hand/Auto Start	[51]	All
Run Permissive	[52]	All
Hand start	[53]	All
Auto start	[54]	All
DigiPot Increase	[55]	All
DigiPot Decrease	[56]	All
DigiPot Clear	[57]	All
Counter A (up)	[60]	29, 33
Counter A (down)	[61]	29, 33
Reset Counter A	[62]	All
Counter B (up)	[63]	29, 33
Counter B (down)	[64]	29, 33
Reset Counter B	[65]	All
Sleep Mode	[66]	All
Reset Maintenance Word	[78]	All
PTC Card 1	[80]	All
Latched Pump Derag	[85]	All
Lead Pump Start	[120]	All
Lead Pump Alternation	[121]	All
Pump 1 Interlock	[130]	All
Pump 2 Interlock	[131]	All
Pump 3 Interlock	[132]	All

Table 3.9 Functions for Digital Inputs

All = Terminals 18, 19, 27, 29, 32, X30/2, X30/3, X30/4. X30/ are the terminals on MCB 101.

Functions dedicated to only one digital input are stated in the associated parameter.

All digital inputs can be programmed to these functions:

[0]	No operation	No reaction to signals transmitted to terminal.
[1]	Reset	Resets frequency converter after a TRIP/ALARM. Not all alarms can be reset.
[2]	Coast inverse	Leaves motor in free mode. Logic '0' ⇒ coasting stop. (Default Digital input 27): Coasting stop, inverted input (NC).
[3]	Coast and reset inverse	Reset and coasting stop Inverted input (NC). Leaves motor in free mode and resets the frequency converter. Logic '0' ⇒ coasting stop and reset.
[5]	DC-brake inverse	Inverted input for DC braking (NC). Stops motor by energising it with a DC current for a certain time period. See <i>parameter 2-01 DC Brake Current</i> to <i>parameter 2-03 DC Brake Cut In Speed [RPM]</i> . The function is only active when the value in <i>parameter 2-02 DC Braking Time</i> is different from 0. Logic '0' ⇒ DC braking. This selection is not possible when <i>parameter 1-10 Motor Construction</i> is set to [1] PM, non salient SPM.
[6]	Stop inverse	Stop Inverted function. Generates a stop function when the selected terminal goes from logical level '1' to '0'. The stop is performed according to the selected ramp time ( <i>parameter 3-42 Ramp 1 Ramp Down Time</i> and <i>parameter 3-52 Ramp 2 Ramp Down Time</i> ). <b>NOTICE</b> When the frequency converter is at the torque limit and has received a stop command, it may not stop by itself. To ensure that the frequency converter stops, configure a digital output to [27] Torque limit & stop and connect this digital output to a digital input that is configured as coast.
[7]	External Interlock	Same function as Coasting stop, inverse, but External Interlock generates the alarm message 'external fault' in the display when the terminal which is programmed for Coast Inverse is logic '0'. The alarm message is also active via digital outputs and relay outputs, if programmed for External Interlock. The alarm can be reset using a digital input or the [Reset] key if the cause for the External Interlock has been removed. A delay can be programmed in <i>parameter 22-00 External Interlock Delay</i> . After applying a signal to the

		input, the reaction described above will be delayed with the time set in <i>parameter 22-00 External Interlock Delay</i> .																																				
[8]	Start	Select start value for a start/stop command. '1' = start, '0' = stop. (Default Digital input 18)																																				
[9]	Latched start	Motor starts, if a pulse is applied for min. 2 ms. Motor stops when Stop inverse is activated																																				
[10]	Reversing	Changes direction of motor shaft rotation. Select Logic '1' to reverse. The reversing signal only changes the direction of rotation. It does not activate the start function. Select both directions in <i>4-10 Motor Speed Direction</i> . (Default Digital input 19).																																				
[11]	Start reversing	Used for start/stop and for reversing on the same wire. Signals on start are not allowed at the same time.																																				
[14]	Jog	Used for activating jog speed. See <i>parameter 3-11 Jog Speed [Hz]</i> . (Default Digital input 29)																																				
[15]	Preset reference on	Used for shifting between external reference and preset reference. It is assumed that [1] <i>External/preset</i> has been selected in <i>parameter 3-04 Reference Function</i> . Logic '0' = external reference active; logic '1' = one of the 8 preset references is active.																																				
[16]	Preset ref bit 0	Enables a selection of one of the 8 preset references according to <i>Table 3.10</i> .																																				
[17]	Preset ref bit 1	Enables a selection of one of the 8 preset references according to <i>Table 3.10</i> .																																				
[18]	Preset ref bit 2	Enables a selection of one of the 8 preset references according to <i>Table 3.10</i> . <table border="1" data-bbox="354 1368 774 1675"> <thead> <tr> <th>Preset ref. bit</th> <th>2</th> <th>1</th> <th>0</th> </tr> </thead> <tbody> <tr> <td>Preset ref. 0</td> <td>0</td> <td>0</td> <td>0</td> </tr> <tr> <td>Preset ref. 1</td> <td>0</td> <td>0</td> <td>1</td> </tr> <tr> <td>Preset ref. 2</td> <td>0</td> <td>1</td> <td>0</td> </tr> <tr> <td>Preset ref. 3</td> <td>0</td> <td>1</td> <td>1</td> </tr> <tr> <td>Preset ref. 4</td> <td>1</td> <td>0</td> <td>0</td> </tr> <tr> <td>Preset ref. 5</td> <td>1</td> <td>0</td> <td>1</td> </tr> <tr> <td>Preset ref. 6</td> <td>1</td> <td>1</td> <td>0</td> </tr> <tr> <td>Preset ref. 7</td> <td>1</td> <td>1</td> <td>1</td> </tr> </tbody> </table> <p style="text-align: center;"><b>Table 3.10 Preset Ref. Bit</b></p>	Preset ref. bit	2	1	0	Preset ref. 0	0	0	0	Preset ref. 1	0	0	1	Preset ref. 2	0	1	0	Preset ref. 3	0	1	1	Preset ref. 4	1	0	0	Preset ref. 5	1	0	1	Preset ref. 6	1	1	0	Preset ref. 7	1	1	1
Preset ref. bit	2	1	0																																			
Preset ref. 0	0	0	0																																			
Preset ref. 1	0	0	1																																			
Preset ref. 2	0	1	0																																			
Preset ref. 3	0	1	1																																			
Preset ref. 4	1	0	0																																			
Preset ref. 5	1	0	1																																			
Preset ref. 6	1	1	0																																			
Preset ref. 7	1	1	1																																			
[19]	Freeze ref	Freezes actual reference. The frozen reference is now the point of enable/condition for speed up and speed down to be used. If speed up/down is used, the speed change always follows ramp 2 ( <i>parameter 3-51 Ramp 2 Ramp Up Time</i> and <i>parameter 3-52 Ramp 2 Ramp Down Time</i> ) in the range 0 - <i>parameter 3-03 Maximum Reference Maximum Reference</i> .																																				

[20]	Freeze output	Freezes actual motor frequency (Hz). The frozen motor frequency is now the point of enable/condition for speed up and speed down to be used. If speed up/down is used, the speed change always follows ramp 2 ( <i>parameter 3-51 Ramp 2 Ramp Up Time</i> and <i>parameter 3-52 Ramp 2 Ramp Down Time</i> ) in the range 0 - <i>parameter 1-23 Motor Frequency</i> . <b>NOTICE</b> When [20] Freeze output is active, the frequency converter cannot be stopped via a low 'start [13]' signal. Stop the frequency converter via a terminal programmed for [2] Coast inverse or [3] Coast and reset, inverse.
[21]	Speed up	For digital control of the up/down speed (motor potentiometer). Activate this function by selecting either [19] Freeze reference or [20] Freeze output. When [21] Speed up is activated for less than 400 ms the resulting reference is increased by 0.1%. If [21] Speed up is activated for more than 400 ms the resulting reference ramps according to Ramp 1 in <i>parameter 3-41 Ramp 1 Ramp Up Time</i> .
[22]	Speed down	Same as [21] Speed up.
[23]	Set-up select bit 0	Selects one of the 4 set-ups. Set <i>parameter 0-10 Active Set-up</i> to Multi Set-up.
[24]	Set-up select bit 1	Same as [23] Set-up select bit 0. (Default Digital input 32)
[32]	Pulse input	Select [32] Pulse input when using a pulse sequence as either reference or feedback. Scaling is done in parameter group 5-5* Pulse Input.
[34]	Ramp bit 0	Select which ramp to use. Logic "0" selects ramp 1 while logic "1" selects ramp 2.
[36]	Mains failure inverse	Activates <i>parameter 14-10 Mains Failure</i> . Mains failure inverse is active in the Logic "0" situation.
[42]	Ref source bit 0	An active input in bit 0 selects AI54 as the reference source (see parameter group 3-1* References, option [35] Digital input select). An inactive input selects AI53.
[51]	Hand/Auto Start	Selects Hand or Auto Start. High = Auto On only, Low = Hand on only.
[52]	Run Permissive	The input terminal, for which the [52] Run Permissive has been programmed must be logic "1" before a start command can be accepted. Run permissive has a logic 'AND' function related to the terminal which is programmed for [8] Start, [14] Jog or [20] Freeze Output. This means that to start running the motor, both conditions must be fulfilled. If [52] Run Permissive is programmed

		on multiple terminals, it only needs to be logic '1' on one of the terminals to carry out the function. The digital output signal for Run Request ([8] Start, [14] Jog or [20] Freeze output) programmed in parameter group 5-3* Digital Outputs, or parameter group 5-4* Relays, will not be affected by [52] Run Permissive.
[53]	Hand start	A signal applied puts the frequency converter into Hand mode as if [Hand On] has been pressed and a normal stop command is overridden. If disconnecting the signal, the motor stops. To make any other start commands valid, assign another digital input to Auto Start and apply a signal to this. [Hand On] and [Auto On] have no impact. [Off] overrides Hand Start and Auto Start. Press either [Hand On] or [Auto On] to make Hand Start and Auto Start active again. If there is no signal on neither Hand Start nor Auto Start, the motor stops regardless of any normal Start command applied. If a signal is applied to both Hand Start and Auto Start, the function is Auto Start. If pressing [Off], the motor stops regardless of signals on Hand Start and Auto Start.
[54]	Auto start	A signal applied puts the frequency converter into Auto mode as if [Auto On] has been pressed. See also [53] Hand Start.
[55]	DigiPot Increase	Uses the input as an INCREASE signal to the digital potentiometer function described in parameter group 3-9* Digital Pot.Meter.
[56]	DigiPot Decrease	Uses the input as a DECREASE signal to the digital potentiometer function described in parameter group 3-9* Digital Pot.Meter
[57]	DigiPot Clear	Uses the input to CLEAR the digital potentiometer reference described in parameter group 3-9* Digital Pot.Meter
[60]	Counter A (up)	(Terminal 29 or 33 only) Input for increment counting in the SLC counter.
[61]	Counter A (down)	(Terminal 29 or 33 only) Input for decrement counting in the SLC counter.
[62]	Reset Counter A	Input for reset of counter A.
[63]	Counter B (up)	(Terminal 29 and 33 only) Input for increment counting in the SLC counter.
[64]	Counter B (down)	(Terminal 29 and 33 only) Input for decrement counting in the SLC counter.
[65]	Reset Counter B	Input for reset of counter B.
[66]	Sleep Mode	Forces the frequency converter into sleep mode (see parameter group 22-4* Sleep Mode). Reacts on the rising edge of signal applied.
[78]	Reset Preventive	Resets all data in parameter 16-96 Maintenance Word to 0.

	Maintenance Word	
[80]	PTC Card1	All digital inputs can be set to [80] PTC Card 1. However, only one digital input must be set to this choice.
[85]	Latched Pump Derag	Starts deragging.

Options [120] - [138] are related to the cascade controller functionality. For more information, see parameter group 25-\*\* Cascade Controller.

[120]	Lead Pump Start	Starts/Stops the lead pump (controlled by the frequency converter). A start also requires applying a system start signal e.g. to one of the digital inputs set for [8] Start.
[121]	Lead Pump Alternation	Forces alternation of the lead pump in a cascade controller. Parameter 25-50 Lead Pump Alternation must be set to either [2] At Command or [3] At Staging or At Command. Parameter 25-51 Alternation Event can be set to any of the four options.
[130] - [138]	Pump1 Interlock - Pump9 Interlock	The function depends on the setting in parameter 25-06 Number of Pumps. If set to [0] No, then Pump1 refers to the pump controlled by relay RELAY1 etc. If set to [1] Yes, Pump1 refers to the pump controlled by the frequency converter only (without any of the build in relays involved) and Pump2 to the pump controlled by the relay RELAY1. Variable speed pump (lead) cannot be interlocked in the basic Cascade Controller. See Table 3.11

Setting in parameter group 5-1*	Setting in parameter 25-06 Number of Pumps	
	[0] No	[1] Yes
[130] Pump1 Interlock	Controlled by RELAY1 (only if not lead pump)	Frequency Converter controlled (cannot be interlocked)
[131] Pump2 Interlock	Controlled by RELAY2	Controlled by RELAY1
[132] Pump3 Interlock	Controlled by RELAY3	Controlled by RELAY2
[133] Pump4 Interlock	Controlled by RELAY4	Controlled by RELAY3
[134] Pump5 Interlock	Controlled by RELAY5	Controlled by RELAY4
[135] Pump6 Interlock	Controlled by RELAY6	Controlled by RELAY5
[136] Pump7 Interlock	Controlled by RELAY7	Controlled by RELAY6
[137] Pump8 Interlock	Controlled by RELAY8	Controlled by RELAY7
[138] Pump9 Interlock	Controlled by RELAY9	Controlled by RELAY8

**5-10 Terminal 18 Digital Input**

The parameter contains all options and functions listed in parameter group *chapter 3.7.2 5-1\* Digital Inputs* except for option [32] Pulse input.

**5-11 Terminal 19 Digital Input**

The parameter contains all options and functions listed in parameter group *chapter 3.7.2 5-1\* Digital Inputs* except for option [32] Pulse input.

**5-12 Terminal 27 Digital Input**

The parameter contains all options and functions listed in parameter group *chapter 3.7.2 5-1\* Digital Inputs* except for option [32] Pulse input.

**5-13 Terminal 29 Digital Input**

The parameter contains all options and functions listed in parameter group *chapter 3.7.2 5-1\* Digital Inputs*.

**5-14 Terminal 32 Digital Input**

The parameter contains all options and functions listed in parameter group *chapter 3.7.2 5-1\* Digital Inputs* except for option [32] Pulse input.

**5-15 Terminal 33 Digital Input**

The parameter contains all options and functions listed in parameter group *chapter 3.7.2 5-1\* Digital Inputs*.

**5-16 Terminal X30/2 Digital Input**

Option:	Function:
[0] * No operation	This parameter is active when option module MCB 101 is installed in the frequency converter. The parameter contains all options and functions listed in parameter group <i>chapter 3.7.2 5-1* Digital Inputs</i> except for option [32] Pulse input.

**5-17 Terminal X30/3 Digital Input**

Option:	Function:
[0] * No operation	This parameter is active when option module MCB 101 is installed in the frequency converter. The parameter contains all options and functions listed in parameter group <i>chapter 3.7.2 5-1* Digital Inputs</i> except for option [32] Pulse input.

**5-18 Terminal X30/4 Digital Input**

Option:	Function:
[0] * No operation	This parameter is active when option module MCB 101 is installed in the frequency converter. The parameter contains all options and functions listed in parameter group <i>chapter 3.7.2 5-1* Digital Inputs</i> except for option [32] Pulse input.

**5-20 Terminal X46/1 Digital Input**

This parameter is related to the digital input on relay card MCB 113. The parameter contains all options and functions listed in parameter group *chapter 3.7.2 5-1\* Digital Inputs* except for option [32] Pulse input.

**5-21 Terminal X46/3 Digital Input**

This parameter is related to the digital input on relay card MCB 113. The parameter contains all options and functions listed in parameter group *chapter 3.7.2 5-1\* Digital Inputs* except for option [32] Pulse input.

**5-22 Terminal X46/5 Digital Input**

This parameter is related to the digital input on relay card MCB 113. The parameter contains all options and functions listed in parameter group *chapter 3.7.2 5-1\* Digital Inputs* except for option [32] Pulse input.

**5-23 Terminal X46/7 Digital Input**

This parameter is related to the digital input on relay card MCB 113. The parameter contains all options and functions listed in parameter group *chapter 3.7.2 5-1\* Digital Inputs* except for option [32] Pulse input.

**5-24 Terminal X46/9 Digital Input**

This parameter is related to the digital input on relay card MCB 113. The parameter contains all options and functions listed in parameter group *chapter 3.7.2 5-1\* Digital Inputs* except for option [32] Pulse input.



**5-25 Terminal X46/11 Digital Input**

This parameter is related to the digital input on relay card MCB 113. The parameter contains all options and functions listed in parameter group *chapter 3.7.2 5-1\* Digital Inputs* except for option [32] *Pulse input*.

**5-26 Terminal X46/13 Digital Input**

This parameter is related to the digital input on relay card MCB 113. The parameter contains all options and functions listed in parameter group *chapter 3.7.2 5-1\* Digital Inputs* except for option [32] *Pulse input*.

**3.7.3 5-3\* Digital Outputs**

Parameters for configuring the output functions for the output terminals. The 2 solid-state digital outputs are common for terminals 27 and 29. Set the I/O function for terminal 27 in *parameter 5-01 Terminal 27 Mode* and set the I/O function for terminal 29 in *parameter 5-02 Terminal 29 Mode*.

**NOTICE**

These parameters cannot be adjusted while the motor is running.

		The digital outputs can be programmed with these functions:
[0]	No operation	Default for all digital outputs and relay outputs
[1]	Control ready	The control board receives supply voltage.
[2]	Drive ready	The frequency converter is ready for operation and applies a supply signal on the control board.
[3]	Drive ready / remote control	The frequency converter is ready for operation and is in Auto On mode.
[4]	Stand-by / no warning	The frequency converter is ready for operation. No start or stop command has been given (start/disable). There are no warnings.
[5]	Running	Motor is running.
[6]	Running / no warning	The output speed is higher than the speed set in <i>parameter 1-81 Min Speed for Function at Stop [RPM]</i> . The motor is running and there are no warnings.
[8]	Run on reference / no warning	Motor runs at reference speed.
[9]	Alarm	An alarm activates the output. There are no warnings.
[10]	Alarm or warning	An alarm or a warning activates the output.
[11]	At torque limit	The torque limit set in <i>parameter 4-16 Torque Limit Motor Mode</i> has been exceeded.

[12]	Out of current range	The motor current is outside the range set in <i>4-18 Current Limit</i> .
[13]	Below current, low	Motor current is lower than set in <i>parameter 4-50 Warning Current Low</i> .
[14]	Above current, high	Motor current is higher than set in <i>parameter 4-51 Warning Current High</i> .
[15]	Out of speed range	Output speed is outside the range set in <i>parameter 4-52 Warning Speed Low</i> and <i>parameter 4-53 Warning Speed High</i> .
[16]	Below speed, low	Output speed is lower than the setting in <i>parameter 4-52 Warning Speed Low</i> .
[17]	Above speed, high	Output speed is higher than the setting in <i>parameter 4-53 Warning Speed High</i> .
[18]	Out of feedback range	Feedback is outside the range set in <i>parameter 4-56 Warning Feedback Low</i> and <i>parameter 4-57 Warning Feedback High</i> .
[19]	Below feedback low	Feedback is below the limit set in <i>parameter 4-52 Warning Speed Low</i> .
[20]	Above feedback high	The feedback is above the limit set in <i>parameter 4-56 Warning Feedback Low</i> .
[21]	Thermal warning	The thermal warning turns on when the temperature exceeds the limit in the motor, the frequency converter, the brake resistor, or the thermistor.
[25]	Reverse	<i>Reversing</i> . Logic '1' = relay activated, 24 V DC when CW rotation of the motor. Logic '0' = relay not activated, no signal, when CCW rotation of the motor.
[26]	Bus OK	Active communication (no time-out) via the serial communication port.
[27]	Torque limit and stop	Used in performing a coasting stop and in torque limit condition. If the frequency converter has received a stop signal and is at the torque limit, the signal is Logic '0'.
[28]	Brake, no warning	The brake is active and there are no warnings.
[29]	Brake ready, no fault	The brake is ready for operation and there are no faults.
[30]	Brake fault (IGBT)	The output is Logic '1' when the brake IGBT is short-circuited. Use this function to protect the frequency converter if there is a fault on the brake modules. Use the output/relay to cut out the main voltage from the frequency converter.
[35]	External Interlock	External Interlock function has been activated via one of the digital inputs.
[40]	Out of ref range	
[41]	Below reference low	
[42]	Above reference high	
[45]	Bus Ctrl	
[46]	Bus Ctrl 1 if timeout	

[47]	Bus Ctrl 0 if timeout	
[55]	Pulse output	
[60]	Comparator 0	See parameter group 13-1* <i>Comparators</i> . If Comparator 0 is evaluated as TRUE, the output goes high. Otherwise, it is low.
[61]	Comparator 1	See parameter group 13-1* <i>Comparators</i> . If Comparator 1 is evaluated as TRUE, the output goes high. Otherwise, it is low.
[62]	Comparator 2	See parameter group 13-1* <i>Comparators</i> . If Comparator 2 is evaluated as TRUE, the output goes high. Otherwise, it is low.
[63]	Comparator 3	See parameter group 13-1* <i>Comparators</i> . If Comparator 3 is evaluated as TRUE, the output goes high. Otherwise, it is low.
[64]	Comparator 4	See parameter group 13-1* <i>Comparators</i> . If Comparator 4 is evaluated as TRUE, the output goes high. Otherwise, it is low.
[65]	Comparator 5	See parameter group 13-1* <i>Comparators</i> . If Comparator 5 is evaluated as TRUE, the output goes high. Otherwise, it is low.
[70]	Logic Rule 0	See parameter group 13-4* <i>Logic Rules</i> . If Logic Rule 0 is evaluated as TRUE, the output goes high. Otherwise, it is low.
[71]	Logic Rule 1	See parameter group 13-4* <i>Logic Rules</i> . If Logic Rule 1 is evaluated as TRUE, the output goes high. Otherwise, it is low.
[72]	Logic Rule 2	See parameter group 13-4* <i>Logic Rules</i> . If Logic Rule 2 is evaluated as TRUE, the output goes high. Otherwise, it is low.
[73]	Logic Rule 3	See parameter group 13-4* <i>Logic Rules</i> . If Logic Rule 3 is evaluated as TRUE, the output goes high. Otherwise, it is low.
[74]	Logic Rule 4	See parameter group 13-4* <i>Logic Rules</i> . If Logic Rule 4 is evaluated as TRUE, the output goes high. Otherwise, it is low.
[75]	Logic Rule 5	See parameter group 13-4* <i>Logic Rules</i> . If Logic Rule 5 is evaluated as TRUE, the output goes high. Otherwise, it is low.
[80]	SL Digital Output A	See <i>parameter 13-52 SL Controller Action</i> . The output goes high whenever the Smart Logic Action [38] <i>Set digital out A high</i> is executed. The output goes low whenever the Smart Logic Action [32] <i>Set digital out A low</i> is executed.
[81]	SL Digital Output B	See <i>parameter 13-52 SL Controller Action</i> . The output goes high whenever the Smart Logic Action [39] <i>Set digital out B high</i> is executed. The output goes low whenever the Smart Logic Action [33] <i>Set digital out B low</i> is executed.
[82]	SL Digital Output C	See <i>parameter 13-52 SL Controller Action</i> . The output goes high whenever the Smart Logic Action [40] <i>Set digital out C high</i> is executed. The output goes low whenever the Smart Logic Action [34] <i>Set digital out C low</i> is executed.

[83]	SL Digital Output D	See <i>parameter 13-52 SL Controller Action</i> . The output goes high whenever the Smart Logic Action [41] <i>Set digital out D high</i> is executed. The output goes low whenever the Smart Logic Action [35] <i>Set digital out D low</i> is executed.
[84]	SL Digital Output E	See <i>parameter 13-52 SL Controller Action</i> . The output goes high whenever the Smart Logic Action [42] <i>Set digital out E high</i> is executed. The output goes low whenever the Smart Logic Action [36] <i>Set digital out E low</i> is executed.
[85]	SL Digital Output F	See <i>parameter 13-52 SL Controller Action</i> . The output goes high whenever the Smart Logic Action [43] <i>Set digital out F high</i> is executed. The output goes low whenever the Smart Logic Action [37] <i>Set digital out F low</i> is executed.
[160]	No alarm	Output is high when no alarm is present.
[161]	Running reverse	The output is high when the frequency converter is running counter clockwise (the logical product of the status bits 'running' AND 'reverse').
[165]	Local reference active	Output is high when <i>parameter 3-13 Reference Site = [2] Local</i> or when <i>parameter 3-13 Reference Site = [0] Linked to hand auto</i> at the same time as the LCP is in Hand on mode.
[166]	Remote reference active	Output is high when <i>parameter 3-13 Reference Site</i> is set to [1] <i>Remote</i> or [0] <i>Linked to hand/auto</i> while the LCP is in Auto On mode.
[167]	Start command active	Output is high when there is an active Start command. (i.e.[Auto On] and a start command via digital input or bus is active, or [Hand On]). <b>NOTICE</b> <b>All inverse Stop/Coast commands must be inactive.</b>
[168]	Drive in hand mode	Output is high when the frequency converter is in Hand mode (as indicated by the LED light above [Hand on]).
[169]	Drive in auto mode	Output is high when the frequency converter is in Auto mode (as indicated by the LED light above [Auto on]).
[180]	Clock Fault	The clock function has been reset to default (2000-01-01) because of a power failure.
[181]	Preventive Maintenance	One or more of the Preventive Maintenance Events programmed in <i>parameter 23-10 Maintenance Item</i> has passed the time for the specified action in <i>parameter 23-11 Maintenance Action</i> .
[182]	Deragging	Deragging is active.
[188]	AHF Capacitor Connect	See <i>parameter 5-80 AHF Cap Reconnect Delay</i> .

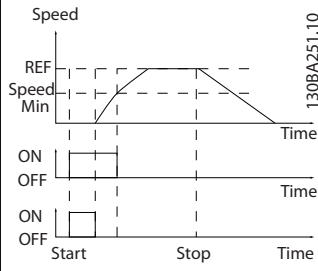
[189]	External Fan Control	External fan control is active.
[190]	No-Flow	A No-Flow situation or Minimum Speed situation has been detected if enabled in <i>Low Power Detection</i> . Parameter 22-21 <i>Low Power Detection</i> , parameter 22-22 <i>Low Speed Detection</i> .
[191]	Dry Pump	A Dry Pump condition has been detected. This function must be enabled in parameter 22-26 <i>Dry Pump Function</i> .
[192]	End of Curve	Active when an End of Curve condition is present.
[193]	Sleep Mode	The frequency converter/system has turned into sleep mode. See parameter group 22-4* <i>Sleep Mode</i> .
[194]	Broken Belt	A broken belt condition has been detected. Enable this function in parameter 22-60 <i>Broken Belt Function</i> .
[195]	Bypass Valve Control	<p>The bypass valve control (Digital/Relay output in the frequency converter) is used for compressor systems to unload the compressor during start-up by using a bypass valve. After the start command is given the bypass valve is open until the frequency converter reaches parameter 4-11 <i>Motor Speed Low Limit [RPM]</i>. After the limit has been reached the bypass valve is closed, allowing the compressor to operate normally. This procedure is not activated again before a new start is initiated and the frequency converter speed is zero during the receiving of start signal. <i>Start Delay</i>, parameter 1-71 <i>Start Delay</i> can be used in order to delay the motor start.</p>  <p><b>Illustration 3.24 Bypass Valve Control Principle</b></p>
[199]	Pipe Filling	Active when the pipe fill function is operating. See parameter group 29-0* <i>Water Application Functions</i> .
		The below setting options are all related to the Cascade Controller. See parameter group 25-** <i>Cascade Controller</i> for more details.
[200]	Full Capacity	All pumps running at full speed

[201]	Pump1 Running	One or more of the pumps controlled by the cascade controller are running. The function also depends on the setting in parameter 25-05 <i>Fixed Lead Pump</i> . If set to [0] No Pump 1 refers to the pump controlled by relay RELAY1 etc. If set to [1] Yes Pump 1 refers to the pump controlled by the frequency converter only (without any of the built in relays involved) and Pump 2 to the pump controlled by the relay RELAY1. See Table 3.11
[202]	Pump2 Running	See [201]
[203]	Pump3 Running	See [201]

Setting in parameter group 5-3* Digital Outputs	Setting in parameter 25-05 Fixed Lead Pump	
	[0] No	[1] Yes
[201] Pump 1 Running	Controlled by RELAY1	Frequency Converter controlled
[202] Pump 2 Running	Controlled by RELAY2	Controlled by RELAY1
[203] Pump 3 Running		Controlled by RELAY2

Table 3.11 Pumps Controlled by the Cascade Controller

5-30 Terminal 27 Digital Output		
Option:	Function:	
[0]	No operation	
[1]	Control Ready	
[2]	Drive ready	
[3]	Drive rdy/rem ctrl	
[4]	Stand-by / no warning	
[5]	Running	
[6]	Running / no warning	
[8]	Run on ref/no warn	
[9]	Alarm	
[10]	Alarm or warning	
[11]	At torque limit	
[12]	Out of current range	
[13]	Below current, low	
[14]	Above current, high	
[15]	Out of speed range	
[16]	Below speed, low	
[17]	Above speed, high	
[18]	Out of feedb. range	
[19]	Below feedback, low	
[20]	Above feedback, high	
[21]	Thermal warning	
[25]	Reverse	
[26]	Bus OK	
[27]	Torque limit & stop	
[28]	Brake, no brake war	
[29]	Brake ready, no fault	
[30]	Brake fault (IGBT)	

5-30 Terminal 27 Digital Output		
Option:	Function:	
[33]	Safe stop active	
[35]	External Interlock	
[40]	Out of ref range	
[41]	Below reference, low	
[42]	Above ref, high	
[45]	Bus ctrl.	
[46]	Bus ctrl, 1 if timeout	
[47]	Bus ctrl, 0 if timeout	
[55]	Pulse output	
[60]	Comparator 0	
[61]	Comparator 1	
[62]	Comparator 2	
[63]	Comparator 3	
[64]	Comparator 4	
[65]	Comparator 5	
[70]	Logic rule 0	
[71]	Logic rule 1	
[72]	Logic rule 2	
[73]	Logic rule 3	
[74]	Logic rule 4	
[75]	Logic rule 5	
[80]	SL digital output A	
[81]	SL digital output B	
[82]	SL digital output C	
[83]	SL digital output D	
[84]	SL digital output E	
[85]	SL digital output F	
[90]	kWh counter pulse	Creates a pulse on the digital output every time when the frequency converter uses 1 kWh.
[155]	Verifying Flow	
[160]	No alarm	
[161]	Running reverse	
[164]	Local ref active, not OFF	
[165]	Local ref active	
[166]	Remote ref active	
[167]	Start command activ	
[168]	Hand mode	
[169]	Auto mode	
[180]	Clock Fault	
[181]	Prev. Maintenance	
[182]	Deragging	
[183]	Pre/Post Lube	
[188]	AHF Capacitor Connect	
[189]	External Fan Control	
[190]	No-Flow	
[191]	Dry Pump	
[192]	End Of Curve	
[193]	Sleep Mode	
[194]	Broken Belt	
[195]	Bypass Valve Control	
[198]	Drive Bypass	

5-30 Terminal 27 Digital Output		
Option:	Function:	
[199]	Pipe Filling	
[200]	Full capacity	
[201]	Pump 1 running	
[202]	Pump 2 running	
[203]	Pump 3 running	
[204]	Pump 4 running	
[205]	Pump 5 running	
[206]	Pump 6 running	
[207]	Pump 7 running	
[208]	Pump 8 running	
[209]	Pump 9 running	

**5-31 Terminal 29 Digital Output**

Option:	Function:	
[0] *	No operation	Same options and functions as parameter group 5-3*.

**5-32 Term X30/6 Digi Out (MCB 101)**

Option:	Function:	
[0] *	No operation	This parameter is active when option module MCB 101 is mounted in the frequency converter. Same options and functions as parameter group 5-3*.

**5-33 Term X30/7 Digi Out (MCB 101)**

Option:	Function:	
[0] *	No operation	This parameter is active when option module MCB 101 is mounted in the frequency converter. Same options and functions as parameter group 5-3* <i>Digital Outputs</i> .

**3.7.4 5-4\* Relays**

Parameters for configuring the timing and the output functions for the relays.

**5-40 Function Relay**

Option:	Function:	
		Select options to define the function of the relays. The selection of each mechanical relay is realised in an array parameter.
[0]	No operation	
[1]	Control Ready	
[2]	Drive ready	
[3]	Drive rdy/rem ctrl	
[4]	Stand-by / no warning	
[5]	Running	
[6]	Running / no warning	
[8]	Run on ref/no warn	
[9]	Alarm	
[10]	Alarm or warning	

5-40 Function Relay		
Option:	Function:	
[11]	At torque limit	
[12]	Out of current range	
[13]	Below current, low	
[14]	Above current, high	
[15]	Out of speed range	
[16]	Below speed, low	
[17]	Above speed, high	
[18]	Out of feedb. range	
[19]	Below feedback, low	
[20]	Above feedback, high	
[21]	Thermal warning	
[25]	Reverse	
[26]	Bus OK	
[27]	Torque limit & stop	
[28]	Brake, no brake war	
[29]	Brake ready, no fault	
[30]	Brake fault (IGBT)	
[33]	Safe stop active	
[35]	External Interlock	
[36]	Control word bit 11	
[37]	Control word bit 12	
[40]	Out of ref range	
[41]	Below reference, low	
[42]	Above ref, high	
[45]	Bus ctrl.	
[46]	Bus ctrl, 1 if timeout	
[47]	Bus ctrl, 0 if timeout	
[60]	Comparator 0	
[61]	Comparator 1	
[62]	Comparator 2	
[63]	Comparator 3	
[64]	Comparator 4	
[65]	Comparator 5	
[70]	Logic rule 0	
[71]	Logic rule 1	
[72]	Logic rule 2	
[73]	Logic rule 3	
[74]	Logic rule 4	
[75]	Logic rule 5	
[80]	SL digital output A	
[81]	SL digital output B	
[82]	SL digital output C	
[83]	SL digital output D	
[84]	SL digital output E	
[85]	SL digital output F	
[155]	Verifying Flow	
[160]	No alarm	
[161]	Running reverse	
[164]	Local ref active, not OFF	
[165]	Local ref active	
[166]	Remote ref active	
[167]	Start command activ	

5-40 Function Relay		
Option:	Function:	
[168]	Hand mode	
[169]	Auto mode	
[180]	Clock Fault	
[181]	Prev. Maintenance	
[183]	Pre/Post Lube	
[188]	AHF Capacitor Connect	
[189]	External Fan Control	
[190]	No-Flow	
[191]	Dry Pump	
[192]	End Of Curve	
[193]	Sleep Mode	
[194]	Broken Belt	
[195]	Bypass Valve Control	
[198]	Drive Bypass	
[199]	Pipe Filling	
[211]	Cascade Pump 1	
[212]	Cascade Pump 2	
[213]	Cascade Pump 3	
[214]	Cascade Pump 4	
[215]	Cascade Pump 5	
[216]	Cascade Pump 6	
[217]	Cascade Pump 7	
[218]	Cascade Pump 8	
[219]	Cascade Pump 9	
[230]	Ext. Cascade Ctrl	

5-41 On Delay, Relay		
Array [9], (Relay 1 [0], Relay 2 [1], Relay 3 [2], Relay 4 [3], Relay 5 [4], Relay 6 [5], Relay 7 [6], Relay 8 [7], Relay 9 [8])		
Range:	Function:	
0.01 s*	[0.01 - 600 s]	Enter the delay of the relay cut-in time. The relay only cuts in if the condition in <i>5-40 Function Relay</i> is uninterrupted during the specified time. Select one of available mechanical relays and Relay Option MCB 105 in an array function. See <i>5-40 Function Relay</i> . Relay 3-6 are included in Extended Relay Card MCB 113.

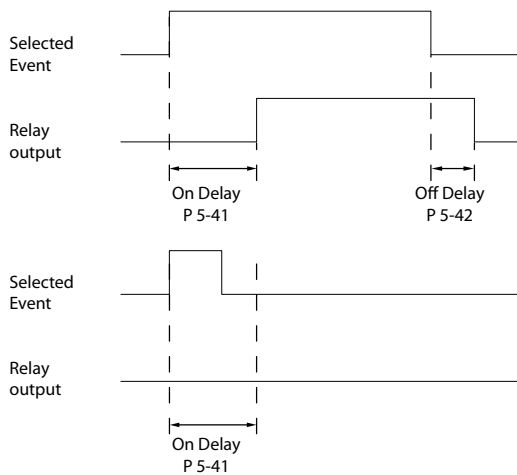

130BA171.10

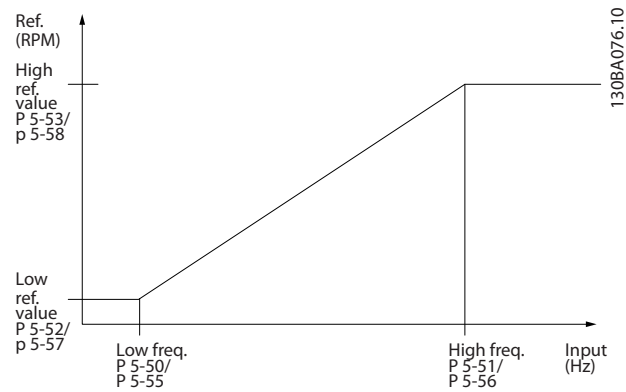

130BA076.10

Illustration 3.27 Pulse Input

Illustration 3.25 On Delay, Relay

5-42 Off Delay, Relay		
Array[2]: Relay1[0], Relay2[1]		
Range:	Function:	
0.01 s* [0.01 - 600 s]	Enter the delay of the relay cut-out time. Select one of available mechanical relays and MCB 105 in an array function. See 5-40 Function Relay.	

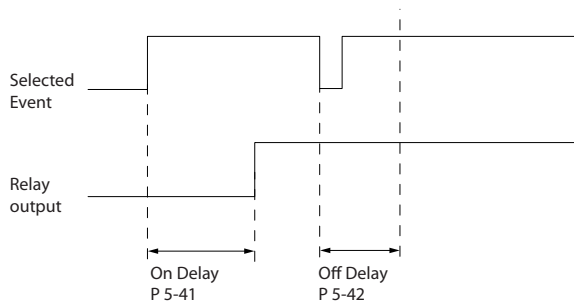

130BA172.10

Illustration 3.26 Off Delay, Relay

If the selected Event condition changes before the on- or off delay timer expires, the relay output is unaffected.

### 3.7.5 5-5\* Pulse Input

The pulse input parameters are used to define an appropriate window for the impulse reference area by configuring the scaling and filter settings for the pulse inputs. Input terminals 29 or 33 act as frequency reference inputs. Set terminal 29 (5-13 Terminal 29 Digital Input) or terminal 33 (5-15 Terminal 33 Digital Input) to [32] Pulse input. If terminal 29 is used as an input, then set parameter 5-02 Terminal 29 Mode to [0] Input.

#### 5-50 Term. 29 Low Frequency

Range:	Function:	
100 Hz* [0 - 110000 Hz]	Enter the low frequency limit corresponding to the low motor shaft speed (i.e. low reference value) in parameter 5-52 Term. 29 Low Ref./Feedb. Value. Refer to the diagram in this section.	

#### 5-51 Term. 29 High Frequency

Range:	Function:	
100 Hz* [0 - 110000 Hz]	Enter the high frequency limit corresponding to the high motor shaft speed (i.e. high reference value) in parameter 5-53 Term. 29 High Ref./Feedb. Value.	

#### 5-52 Term. 29 Low Ref./Feedb. Value

Range:	Function:	
0 * [-999999.999 - 999999.999 ]	Enter the low reference value limit for the motor shaft speed [RPM]. This is also the lowest feedback value, see also parameter 5-57 Term. 33 Low Ref./Feedb. Value.	

#### 5-53 Term. 29 High Ref./Feedb. Value

Range:	Function:	
100 * [-999999.999 - 999999.999 ]	Enter the high reference value [RPM] for the motor shaft speed and the high feedback value, see also parameter 5-58 Term. 33 High Ref./Feedb. Value.	

5-54 Pulse Filter Time Constant #29		
Range:		Function:
100 ms*	[1 - 1000 ms]	<p><b>NOTICE</b></p> <p>This parameter cannot be adjusted while the motor is running.</p> <p>Enter the pulse filter time constant. The pulse filter dampens oscillations of the feedback signal, which is an advantage if there is a lot of noise in the system. A high time constant value results in better dampening but also increases the time delay through the filter.</p>

5-55 Term. 33 Low Frequency		
Range:		Function:
100 Hz*	[0 - 110000 Hz]	Enter the low frequency corresponding to the low motor shaft speed (i.e. low reference value) in <i>parameter 5-57 Term. 33 Low Ref./Feedb. Value.</i>

5-56 Term. 33 High Frequency		
Range:		Function:
100 Hz*	[0 - 110000 Hz]	Enter the high frequency corresponding to the high motor shaft speed (i.e. high reference value) in <i>parameter 5-58 Term. 33 High Ref./Feedb. Value.</i>

5-57 Term. 33 Low Ref./Feedb. Value		
Range:		Function:
0 *	[-999999.999 - 999999.999 ]	Enter the low reference value [RPM] for the motor shaft speed. This is also the low feedback value, see also <i>parameter 5-52 Term. 29 Low Ref./Feedb. Value.</i>

5-58 Term. 33 High Ref./Feedb. Value		
Range:		Function:
100 *	[-999999.999 - 999999.999 ]	Enter the high reference value [RPM] for the motor shaft speed. See also <i>parameter 5-53 Term. 29 High Ref./Feedb. Value.</i>

5-59 Pulse Filter Time Constant #33		
Range:		Function:
100 ms*	[1 - 1000 ms]	Enter the pulse filter time constant. The low-pass filter reduces the influence on and dampens oscillations on the feedback signal from the control. This is an advantage, e.g. if there is a great amount on noise in the system.

### 3.7.6 5-6\* Pulse Outputs

Parameters for configuring the scaling and output functions of pulse outputs. The pulse outputs are designated to terminals 27 or 29. Select terminal 27 output in *parameter 5-01 Terminal 27 Mode* and terminal 29 output in *parameter 5-02 Terminal 29 Mode*.

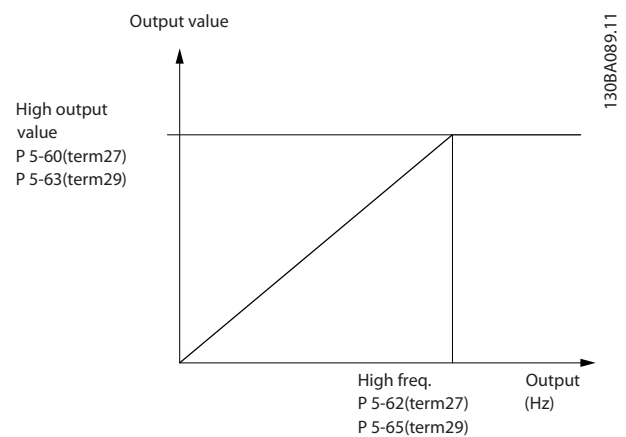

Illustration 3.28 Pulse Output

5-60 Terminal 27 Pulse Output Variable		
Option:	Function:	
[0]	No operation	Select the operation variable assigned for terminal 27 readouts. <b>NOTICE</b> This parameter cannot be adjusted while the motor is running.
[45]	Bus ctrl.	
[48]	Bus ctrl., timeout	
[100]	Output freq. 0-100	
[101]	Reference Min-Max	
[102]	Feedback +-200%	
[103]	Motor cur. 0-I <sub>max</sub>	
[104]	Torque 0-T <sub>lim</sub>	
[105]	Torque 0-T <sub>nom</sub>	
[106]	Power 0-P <sub>nom</sub>	
[107]	Speed 0-HighLim	
[108]	Torque +-160%	
[109]	Out frq 0-F <sub>max</sub>	
[113]	Ext. Closed Loop 1	
[114]	Ext. Closed Loop 2	
[115]	Ext. Closed Loop 3	
[116]	Cascade Reference	

5-62 Pulse Output Max Freq #27		
Range:		Function:
5000 Hz*	[0 - 32000 Hz]	<p><b>NOTICE</b></p> <p>This parameter cannot be adjusted while the motor is running.</p> <p>Set the maximum frequency for terminal 27, corresponding to the output variable selected in <i>5-60 Terminal 27 Pulse Output Variable</i>.</p>

5-63 Terminal 29 Pulse Output Variable		
Option:		Function:
		<p><b>NOTICE</b></p> <p>This parameter cannot be adjusted while the motor is running.</p> <p>Select the variable for viewing on the terminal 29 display. Same options and functions as parameter group 5-6* <i>Pulse Output</i>.</p>
[0]	No operation	
[45]	Bus ctrl.	
[48]	Bus ctrl., timeout	
[100]	Output freq. 0-100	
[101]	Reference Min-Max	
[102]	Feedback +-200%	
[103]	Motor cur. 0-I <sub>max</sub>	
[104]	Torque 0-T <sub>lim</sub>	
[105]	Torque 0-T <sub>nom</sub>	
[106]	Power 0-P <sub>nom</sub>	
[107]	Speed 0-HighLim	
[108]	Torque +-160%	
[109]	Out frq 0-F <sub>max</sub>	
[113]	Ext. Closed Loop 1	
[114]	Ext. Closed Loop 2	
[115]	Ext. Closed Loop 3	
[116]	Cascade Reference	

5-65 Pulse Output Max Freq #29		
Range:		Function:
5000 Hz*	[0 - 32000 Hz]	Set the maximum frequency for terminal 29 corresponding to the output variable set in <i>parameter 5-63 Terminal 29 Pulse Output Variable</i> .

5-66 Terminal X30/6 Pulse Output Variable		
Select the variable for read-out on terminal X30/6. This parameter is active when option module MCB 101 is installed in the frequency converter. Same options and functions as parameter group 5-6* <i>Pulse Outputs</i> .		
Option:		Function:
[0]	No operation	
[45]	Bus ctrl.	
[48]	Bus ctrl., timeout	
[100]	Output freq. 0-100	
[101]	Reference Min-Max	
[102]	Feedback +-200%	
[103]	Motor cur. 0-I <sub>max</sub>	
[104]	Torque 0-T <sub>lim</sub>	
[105]	Torque 0-T <sub>nom</sub>	
[106]	Power 0-P <sub>nom</sub>	
[107]	Speed 0-HighLim	
[108]	Torque +-160%	
[109]	Out frq 0-F <sub>max</sub>	
[113]	Ext. Closed Loop 1	
[114]	Ext. Closed Loop 2	
[115]	Ext. Closed Loop 3	
[116]	Cascade Reference	

5-68 Pulse Output Max Freq #X30/6		
Range:		Function:
5000 Hz*	[0 - 32000 Hz]	<p>Select the maximum frequency on terminal X30/6 referring to the output variable in <i>5-66 Terminal X30/6 Pulse Output Variable</i>.</p> <p>This parameter is active when option module MCB 101 is mounted in the frequency converter.</p>

5-80 AHF Cap Reconnect Delay		
Range:		Function:
25 s*	[1 - 120 s]	Delay time between 2 consecutive AHF capacitor connections. Timer starts once the AHF capacitor disconnects, and connects back once delay expires and drives power above 20% and below 30% of nominal power (see detailed description below).

#### AHF capacitor connect output function for digital and relay outputs

##### Functional Description:

1. Connect capacitors at 20% nominal power
2. Hysteresis  $\pm 50\%$  of the 20% nominal power (=min. 10% and max. 30% nominal power)
3. Off delay timer = 10 s. The nominal power must be below 10% for 10 s to disconnect the capacitors. If the nominal power exceeds 10% during the 10 s delay, the timer (10 s) restarts.



4. The capacitor reconnect delay (default= 25 s with a range from 1 s to 120 s, see *parameter 5-80 AHF Cap Reconnect Delay*) is used for the minimum off-time for the AHF Capacitor Output Function.
5. In case of power loss, the frequency converter guarantees that the minimum off-time is satisfied when power is restored.

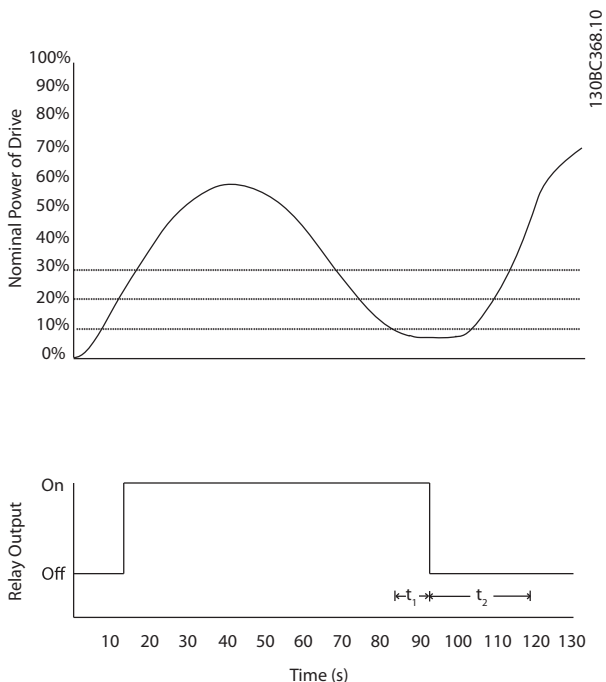

Illustration 3.29 Example of the Output Function

$t_1$  represents the off delay timer (10 s).  
 $t_2$  represents the Capacitor Reconnect Delay (*parameter 5-80 AHF Cap Reconnect Delay*).

When the nominal power of the frequency converter exceeds 20%, the output function turns on. When the power goes below 10% there is an off delay timer that needs to expire before the output goes low, this is represented by  $t_1$ . After the output goes low, the capacitor reconnect delay timer needs to expire before the output is allowed to be on again, represented by  $t_2$ . When  $t_2$  expires, the nominal power is above 30% and the relay does not turn on.

### 3.7.7 5-9\* Bus Controlled

This parameter group selects digital and relay outputs via a fieldbus setting.

5-90 Digital & Relay Bus Control		
Range:	Function:	
0 * [0 - 2147483647 ]	This parameter holds the state of the digital outputs and relays that is controlled by bus.	

5-90 Digital & Relay Bus Control		
Range:	Function:	
	A logical '1' indicates that the output is high or active. A logical '0' indicates that the output is low or inactive.	
Bit 0	CC Digital Output Terminal 27	
Bit 1	CC Digital Output Terminal 29	
Bit 2	GPIO Digital Output Terminal X 30/6	
Bit 3	GPIO Digital Output Terminal X 30/7	
Bit 4	CC Relay 1 output terminal	
Bit 5	CC Relay 2 output terminal	
Bit 6	Option B Relay 1 output terminal	
Bit 7	Option B Relay 2 output terminal	
Bit 8	Option B Relay 3 output terminal	
Bit 9-15	Reserved for future terminals	
Bit 16	Option C Relay 1 output terminal	
Bit 17	Option C Relay 2 output terminal	
Bit 18	Option C Relay 3 output terminal	
Bit 19	Option C Relay 4 output terminal	
Bit 20	Option C Relay 5 output terminal	
Bit 21	Option C Relay 6 output terminal	
Bit 22	Option C Relay 7 output terminal	
Bit 23	Option C Relay 8 output terminal	
Bit 24-31	Reserved for future terminals	

**Table 3.12 Digital Output Bits**

5-93 Pulse Out #27 Bus Control		
Range:	Function:	
0 %* [0 - 100 %]	Contains the frequency to apply to the digital output terminal 27, when it is configured as [Bus Controlled].	

5-94 Pulse Out #27 Timeout Preset		
Range:	Function:	
0 %* [0 - 100 %]	Contains the frequency to apply to the digital output terminal 27, when it is configured as [Bus Controlled Timeout] and time-out is detected.	

5-95 Pulse Out #29 Bus Control		
Range:	Function:	
0 %* [0 - 100 %]	Contains the frequency to apply to the digital output terminal 29, when it is configured as [Bus Controlled].	

5-96 Pulse Out #29 Timeout Preset		
Range:		Function:
0 %*	[0 - 100 %]	Contains the frequency to apply to the digital output terminal 29, when it is configured as [Bus Controlled Timeout] and time-out is detected

5-97 Pulse Out #X30/6 Bus Control		
Range:		Function:
0 %*	[0 - 100 %]	Contains the frequency to apply to the digital output terminal 27, when it is configured as [Bus Controlled].

5-98 Pulse Out #X30/6 Timeout Preset		
Range:		Function:
0 %*	[0 - 100 %]	Contains the frequency to apply to the digital output terminal 6, when it is configured as [Bus Controlled Timeout] and time-out is detected.

### 3.8 Parameters 6-\*\* Analog In/Out

#### 3.8.1 6-0\* Analog I/O Mode

Parameter group for setting up the analog I/O configuration.

The frequency converter is equipped with 2 analog inputs: Terminal 53 and 54. The analog inputs can freely be allocated to either voltage (0-10 V) or current input (0/4-20 mA)

#### NOTICE

Thermistors may be connected to either an analog or a digital input.

6-00 Live Zero Timeout Time		
Range:	Function:	
10 s* [1 - 99 s]	Enter the Live Zero Time-out time period. Live Zero Time-out Time is active for analog inputs, i.e. terminal 53 or terminal 54, used as reference or feedback sources. If the reference signal value associated with the selected current input falls below 50% of the value set in <i>parameter 6-10 Terminal 53 Low Voltage</i> , <i>parameter 6-12 Terminal 53 Low Current</i> , <i>parameter 6-20 Terminal 54 Low Voltage</i> or <i>parameter 6-22 Terminal 54 Low Current</i> for a time period longer than the time set in <i>parameter 6-00 Live Zero Timeout Time</i> , the function selected in <i>parameter 6-01 Live Zero Timeout Function</i> is activated.	

6-01 Live Zero Timeout Function		
Option:	Function:	
	Select the time-out function. The function set in <i>parameter 6-01 Live Zero Timeout Function</i> is activated if the input signal on terminal 53 or 54 is below 50% of the value in <i>parameter 6-10 Terminal 53 Low Voltage</i> , <i>parameter 6-12 Terminal 53 Low Current</i> , <i>parameter 6-20 Terminal 54 Low Voltage</i> or <i>parameter 6-22 Terminal 54 Low Current</i> for a time period defined in <i>parameter 6-00 Live Zero Timeout Time</i> . If several time-outs occur simultaneously, the frequency converter prioritises the time-out functions as follows	
	<ol style="list-style-type: none"> <li><i>Parameter 6-01 Live Zero Timeout Function</i></li> <li><i>Parameter 8-04 Control Timeout Function</i></li> </ol>	
	The output frequency of the frequency converter can be:	

6-01 Live Zero Timeout Function		
Option:	Function:	
	<ul style="list-style-type: none"> <li>[1] frozen at the present value</li> <li>[2] overruled to stop</li> <li>[3] overruled to jog speed</li> <li>[4] overruled to max. speed</li> <li>[5] overruled to stop with subsequent trip</li> </ul>	
[0]	Off	
[1]	Freeze output	
[2]	Stop	
[3]	Jogging	
[4]	Max. speed	
[5]	Stop and trip	

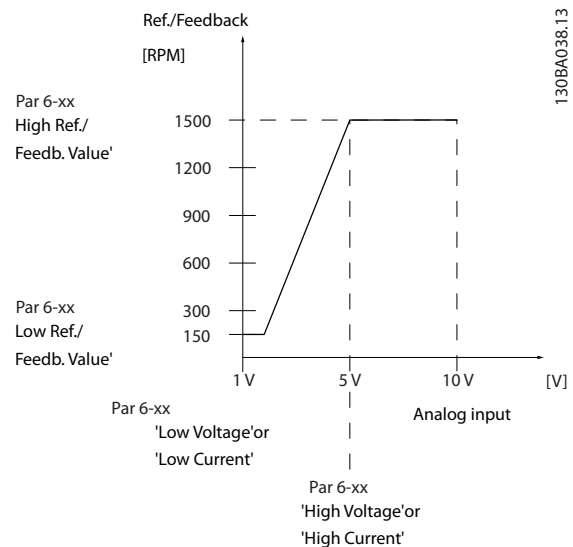

Illustration 3.30 Live Zero Conditions

#### 3.8.2 6-1\* Analog Input 1

Parameters for configuring the scaling and limits for analog input 1 (terminal 53).

6-10 Terminal 53 Low Voltage		
Range:	Function:	
0.07 V* [0 - par. 6-11 V]	Enter the low voltage value. This analog input scaling value should correspond to the low reference/feedback value set in <i>parameter 6-14 Terminal 53 Low Ref./Feedb. Value</i> .	

6-11 Terminal 53 High Voltage		
Range:	Function:	
10 V* [ par. 6-10 - 10 V ]	Enter the high voltage value. This analog input scaling value should correspond to the high reference/feedback value set in <i>parameter 6-15 Terminal 53 High Ref./Feedb. Value</i> .	

6-12 Terminal 53 Low Current		
Range:	Function:	
4 mA* [ 0 - par. 6-13 mA ]	Enter the low current value. This reference signal should correspond to the low reference/feedback value, set in <i>parameter 6-14 Terminal 53 Low Ref./Feedb. Value</i> . The value must be set at >2 mA in order to activate the Live Zero Time-out Function in <i>parameter 6-01 Live Zero Timeout Function</i> .	

6-13 Terminal 53 High Current		
Range:	Function:	
20 mA* [ par. 6-12 - 20 mA ]	Enter the high current value corresponding to the high reference/feedback set in <i>parameter 6-15 Terminal 53 High Ref./Feedb. Value</i> .	

6-14 Terminal 53 Low Ref./Feedb. Value		
Range:	Function:	
0 * [ -999999.999 - 999999.999 ]	Enter the analog input scaling value that corresponds to the low voltage/low current set in <i>parameter 6-10 Terminal 53 Low Voltage</i> and <i>parameter 6-12 Terminal 53 Low Current</i> .	

6-15 Terminal 53 High Ref./Feedb. Value		
Range:	Function:	
Size related* [ -999999.999 - 999999.999 ]	Enter the analog input scaling value that corresponds to the high voltage/high current value set in <i>parameter 6-11 Terminal 53 High Voltage</i> and <i>parameter 6-13 Terminal 53 High Current</i> .	

6-16 Terminal 53 Filter Time Constant		
Range:	Function:	
0.001 s* [ 0.001 - 10 s ]	<p><b>NOTICE</b></p> <p>This parameter cannot be adjusted while the motor is running.</p> <p>Enter the time constant. This is a first-order digital low pass filter time constant for suppressing electrical noise in terminal 53. A high time constant value improves</p>	

6-16 Terminal 53 Filter Time Constant		
Range:	Function:	
	dampening, but also increases the time delay through the filter.	

6-17 Terminal 53 Live Zero		
Option:	Function:	
	This parameter makes it possible to disable the Live Zero monitoring. E.g. to be used if the analog outputs are used as part of a decentral I/O system (e.g. when not part of any frequency converter related control functions, but feeding an external control system with data)	
[0]	Disabled	
[1]	Enabled	

### 3.8.3 6-2\* Analog Input 2

Parameters for configuring the scaling and limits for analog input 2 (terminal 54).

6-20 Terminal 54 Low Voltage		
Range:	Function:	
0.07 V* [ 0 - par. 6-21 V ]	Enter the low voltage value. This analog input scaling value should correspond to the low reference/feedback value, set in <i>parameter 6-24 Terminal 54 Low Ref./Feedb. Value</i> .	

6-21 Terminal 54 High Voltage		
Range:	Function:	
10 V* [ par. 6-20 - 10 V ]	Enter the high voltage value. This analog input scaling value should correspond to the high reference/feedback value set in <i>parameter 6-25 Terminal 54 High Ref./Feedb. Value</i> .	

6-22 Terminal 54 Low Current		
Range:	Function:	
4 mA* [ 0 - par. 6-23 mA ]	Enter the low current value. This reference signal should correspond to the low reference/feedback value, set in <i>parameter 6-24 Terminal 54 Low Ref./Feedb. Value</i> . The value must be set at >2 mA to activate the Live Zero Time-out Function in <i>parameter 6-01 Live Zero Timeout Function</i> .	

6-23 Terminal 54 High Current		
Range:	Function:	
20 mA* [ par. 6-22 - 20 mA ]	Enter the high current value corresponding to the high reference/feedback value set in <i>parameter 6-25 Terminal 54 High Ref./Feedb. Value</i> .	

6-24 Terminal 54 Low Ref./Feedb. Value		
Range:	Function:	
0 * [ -999999.999 - 999999.999 ]	Enter the analog input scaling value that corresponds to the low voltage/low current value set in <i>parameter 6-20 Terminal 54 Low Voltage</i> and <i>parameter 6-22 Terminal 54 Low Current</i> .	

6-25 Terminal 54 High Ref./Feedb. Value		
Range:	Function:	
100 * [ -999999.999 - 999999.999 ]	Enter the analog input scaling value that corresponds to the high voltage/high current value set in <i>parameter 6-21 Terminal 54 High Voltage</i> and <i>parameter 6-23 Terminal 54 High Current</i> .	

6-26 Terminal 54 Filter Time Constant		
Range:	Function:	
0.001 s* [ 0.001 - 10 s ]	<p><b>NOTICE</b></p> <p>This parameter cannot be adjusted while the motor is running.</p> <p>Enter the time constant. This is a first-order digital low pass filter time constant for suppressing electrical noise in terminal 54. A high time constant value improves dampening but also increases the time delay through the filter.</p>	

6-27 Terminal 54 Live Zero		
Option:	Function:	
[0] Disabled		
[1] Enabled	This parameter makes it possible to disable the Live Zero monitoring. E.g. to be used if the analog outputs are used as part of a decentral I/O system (e.g. when not part of any frequency converter related control functions, but feeding an external control system with data)	

### 3.8.4 6-3\* Analog Input 3 MCB 101

Parameter group for configuring the scale and limits for analog input 3 (X30/11) placed on option module MCB 101.

6-30 Terminal X30/11 Low Voltage		
Range:	Function:	
0.07 V* [ 0 - par. 6-31 V ]	Sets the analog input scaling value to correspond to the low reference/feedback value (set in <i>parameter 6-34 Term. X30/11 Low Ref./Feedb. Value</i> ).	

6-31 Terminal X30/11 High Voltage		
Range:	Function:	
10 V* [ par. 6-30 - 10 V ]	Sets the analog input scaling value to correspond to the high reference/feedback value (set in <i>parameter 6-35 Term. X30/11 High Ref./Feedb. Value</i> ).	

6-34 Term. X30/11 Low Ref./Feedb. Value		
Range:	Function:	
0 * [ -999999.999 - 999999.999 ]	Sets the analog input scaling value to correspond to the low voltage value (set in <i>parameter 6-30 Terminal X30/11 Low Voltage</i> ).	

6-35 Term. X30/11 High Ref./Feedb. Value		
Range:	Function:	
100 * [ -999999.999 - 999999.999 ]	Sets the analog input scaling value to correspond to the high voltage value (set in <i>parameter 6-31 Terminal X30/11 High Voltage</i> ).	

6-36 Term. X30/11 Filter Time Constant		
Range:	Function:	
0.001 s* [ 0.001 - 10 s ]	<p><b>NOTICE</b></p> <p>This parameter cannot be adjusted while the motor is running.</p> <p>A first-order digital low pass filter time constant for suppressing electrical noise on terminal X30/11.</p>	

6-37 Term. X30/11 Live Zero		
Option:	Function:	
[0] Disabled		
[1] Enabled	This parameter makes it possible to disable the Live Zero monitoring. E.g. to be used if the analog outputs are used as part of a decentral I/O system (e.g. when not part of any frequency converter related control functions, but feeding an external control system with data)	

### 3.8.5 6-4\* Analog Input 4 MCB 101

Parameter group for configuring the scale and limits for analog input 4 (X30/12) placed on option module MCB 101.

6-40 Terminal X30/12 Low Voltage		
Range:	Function:	
0.07 V* [ 0 - par. 6-41 V ]	Sets the analog input scaling value to correspond to the low reference/feedback value set in <i>parameter 6-44 Term. X30/12 Low Ref./Feedb. Value</i> .	

6-41 Terminal X30/12 High Voltage		
Range:	Function:	
10 V* [ par. 6-40 - 10 V ]	Sets the analog input scaling value to correspond to the high reference/feedback value set in <i>parameter 6-45 Term. X30/12 High Ref./Feedb. Value</i> .	

6-44 Term. X30/12 Low Ref./Feedb. Value		
Range:	Function:	
0 * [-999999.999 - 999999.999 ]	Sets the analog output scaling value to correspond to the low voltage value set in <i>parameter 6-40 Terminal X30/12 Low Voltage</i> .	

6-45 Term. X30/12 High Ref./Feedb. Value		
Range:	Function:	
100 * [-999999.999 - 999999.999 ]	Sets the analog input scaling value to correspond to the high voltage value set in <i>parameter 6-41 Terminal X30/12 High Voltage</i> .	

6-46 Term. X30/12 Filter Time Constant		
Range:	Function:	
0.001 s* [0.001 - 10 s]	<p><b>NOTICE</b></p> <p>This parameter cannot be adjusted while the motor is running.</p> <p>A first-order digital low pass filter time constant for suppressing electrical noise on terminal X30/12.</p>	

6-47 Term. X30/12 Live Zero		
Option:	Function:	
	This parameter makes it possible to disable the Live Zero monitoring. E.g. to be used if the analog outputs are used as part of a decentral I/O system (e.g. when not part of any frequency converter related control functions, but feeding an external control system with data)	
[0]	Disabled	
[1]	Enabled	

### 3.8.6 6-5\* Analog Output 1

Parameters for configuring the scaling and limits for analog output 1, i.e. Terminal 42. Analog outputs are current outputs: 0/4-20 mA. Common terminal (terminal 39) is the same terminal and has the same electrical potential for analog common and digital common connection. Resolution on analog output is 12 bit.

6-50 Terminal 42 Output		
Option:	Function:	
		Select the function of Terminal 42 as an analog current output. A motor current of 20 mA corresponds to $I_{max}$ .
[0]	No operation	
[100]	Output freq. 0-100	0 - 100 Hz, (0-20 mA)
[101]	Reference Min-Max	Minimum reference - Maximum reference, (0-20 mA)
[102]	Feedback +-200%	-200% to +200% of <i>parameter 3-03 Maximum Reference</i> , (0-20 mA)
[103]	Motor cur. 0- $I_{max}$	0 - Inverter Max. Current ( <i>parameter 16-37 Inv. Max. Current</i> ), (0-20 mA)
[104]	Torque 0-Tlim	0 - Torque limit ( <i>parameter 4-16 Torque Limit Motor Mode</i> ), (0-20 mA)
[105]	Torque 0-Tnom	0 - Motor rated torque, (0-20 mA)
[106]	Power 0-Pnom	0 - Motor rated power, (0-20 mA)
[107]	Speed 0-HighLim	0 - Speed High Limit ( <i>parameter 4-13 Motor Speed High Limit [RPM]</i> and <i>parameter 4-14 Motor Speed High Limit [Hz]</i> ), (0-20 mA)
[108]	Torque +-160%	(0-20 mA)
[109]	Out frq 0-Fmax	
[113]	Ext. Closed Loop 1	0 - 100%, (0-20 mA)
[114]	Ext. Closed Loop 2	0 - 100%, (0-20 mA)
[115]	Ext. Closed Loop 3	0 - 100%, (0-20 mA)
[116]	Cascade Reference	
[130]	Out frq 0-100 4-20mA	0 - 100 Hz
[131]	Reference 4-20mA	Minimum Reference - Maximum Reference
[132]	Feedback 4-20mA	-200% to +200% of <i>parameter 3-03 Maximum Reference</i>
[133]	Motor cur. 4-20mA	0 - Inverter Max. Current ( <i>parameter 16-37 Inv. Max. Current</i> )
[134]	Torq.0-lim 4-20 mA	0 - Torque limit ( <i>parameter 4-16 Torque Limit Motor Mode</i> )
[135]	Torq.0-nom 4-20mA	0 - Motor rated torque
[136]	Power 4-20mA	0 - Motor rated power

6-50 Terminal 42 Output										
Option:	Function:									
[137]	Speed 4-20mA	0 - Speed High Limit (4-13 Motor Speed High Limit [RPM] and parameter 4-14 Motor Speed High Limit [Hz])								
[138]	Torque 4-20mA									
[139]	Bus ctrl.	0 - 100%, (0-20 mA)								
[140]	Bus ctrl. 4-20 mA	0 - 100%								
[141]	Bus ctrl t.o.	0 - 100%, (0-20 mA)								
[142]	Bus ctrl t.o. 4-20mA	0 - 100%								
[143]	Ext. CL 1 4-20mA	0 - 100%								
[144]	Ext. CL 2 4-20mA	0 - 100%								
[145]	Ext. CL 3 4-20mA	0 - 100%								
[146]	Cascade Ref. 4-20mA									
[147]	Main act val 0-20mA									
[148]	Main act val 4-20mA									
[150]	Out frq 0-Fmax 4-20mA									
[254]	DC Link 0-20mA	<p>With this parameter selected, the terminal output represents the scaled DC Link voltage. <i>Table 3.13</i> shows the relationship between the DC Link voltage and the terminal output.</p> <table border="1"> <thead> <tr> <th>DC Link voltage (V)</th> <th>Terminal output</th> </tr> </thead> <tbody> <tr> <td><math>V \leq</math> undervoltage limit</td> <td>0 %</td> </tr> <tr> <td><math>V \geq</math> overvoltage limit</td> <td>100 %</td> </tr> <tr> <td>Voltage within range: undervoltage &lt; V &lt; overvoltage</td> <td>Linearly interpolated</td> </tr> </tbody> </table> <p><b>Table 3.13 Relationship between the DC Link voltage and the terminal output</b></p> <p><i>Table 3.14</i> shows the undervoltage and overvoltage limits for different frequency converter sizes.</p>	DC Link voltage (V)	Terminal output	$V \leq$ undervoltage limit	0 %	$V \geq$ overvoltage limit	100 %	Voltage within range: undervoltage < V < overvoltage	Linearly interpolated
DC Link voltage (V)	Terminal output									
$V \leq$ undervoltage limit	0 %									
$V \geq$ overvoltage limit	100 %									
Voltage within range: undervoltage < V < overvoltage	Linearly interpolated									

6-50 Terminal 42 Output									
Option:	Function:								
	Frequency Converter Size	Undervoltage Limit	Overvoltage Limit						
	T2/S2	185 V	410 V						
	T4/S4	373 V	855 V						
	T6/T7	553 V	1130 V						
	<p><b>Table 3.14 Undervoltage and overvoltage limits for different frequency converter sizes</b></p> <table border="1"> <tr> <td>1</td> <td>Analog output.</td> </tr> <tr> <td>2</td> <td>Undervoltage limit.</td> </tr> <tr> <td>3</td> <td>Overvoltage limit.</td> </tr> </table> <p><b>Illustration 3.31 Example: The analogue output of Terminal 42 on the T4 frequency converter with option [254] DC Link 0-20mA selected</b></p>			1	Analog output.	2	Undervoltage limit.	3	Overvoltage limit.
1	Analog output.								
2	Undervoltage limit.								
3	Overvoltage limit.								
[255]	DC Link 4-20mA	The function is the same as [254] DC Link 0-20mA.							

**NOTICE**

Values for setting the Minimum Reference is found in *parameter 3-02 Minimum Reference* and values for maximum reference in *parameter 3-03 Maximum Reference*.

6-51 Terminal 42 Output Min Scale		
Range:	Function:	
0 %* [0 - 200 %]	Scale for the minimum output (0 or 4 mA) of the analog signal at terminal 42. Set the value to be the percentage of the full range of the variable selected in <i>parameter 6-50 Terminal 42 Output</i> .	

6-52 Terminal 42 Output Max Scale		
Range:	Function:	
100 %*	[0 - 200 %]	Scale for the maximum output (20mA) of the analog signal at terminal 42. Set the value to be the percentage of the full range of the variable selected in <i>parameter 6-50 Terminal 42 Output</i> .

**Illustration 3.32 Output Current vs Reference Variable**

It is possible to get a value lower than 20mA at full scale by programming values >100% by using a formula as follows:

$$20 \text{ mA} \mid \text{desired maximum current} \times 100\%$$
*i. e.*  $10 \text{ mA} : \frac{20 \text{ mA}}{10 \text{ mA}} \times 100\% = 200\%$

**Example 1:**

Variable value= OUTPUT FREQUENCY, range = 0-100 Hz  
 Range needed for output = 0-50 Hz  
 Output signal 0 or 4mA is needed at 0 Hz (0% of range) - set *parameter 6-51 Terminal 42 Output Min Scale* to 0%  
 Output signal 20 mA is needed at 50 Hz (50% of range) - set *parameter 6-52 Terminal 42 Output Max Scale* to 50%

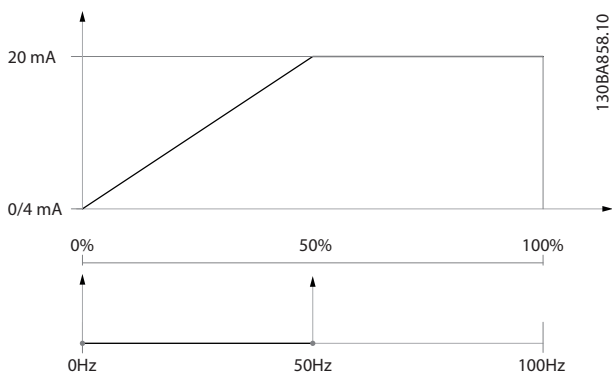

**Illustration 3.33 Example 1**

**Example 2:**

Variable= FEEDBACK, range= -200% to +200%  
 Range needed for output= 0-100%  
 Output signal 0 or 4 mA is needed at 0% (50% of range) - set *parameter 6-51 Terminal 42 Output Min Scale* to 50%  
 Output signal 20 mA is needed at 100% (75% of range) - set *parameter 6-52 Terminal 42 Output Max Scale* to 75%

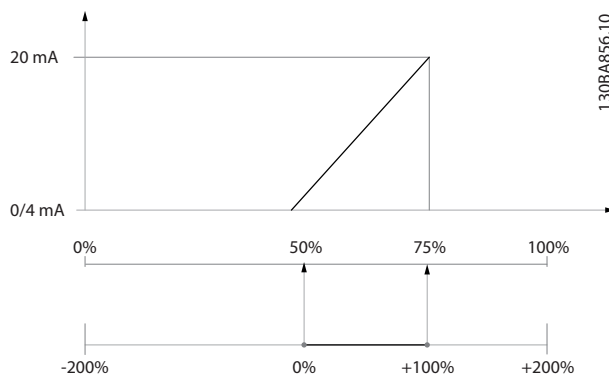

**Illustration 3.34 Example 2**

**Example 3:**

Variable value= REFERENCE, range= Min ref - Max ref  
 Range needed for output= Min ref (0%) - Max ref (100%), 0-10 mA  
 Output signal 0 or 4 mA is needed at Min ref - set *parameter 6-51 Terminal 42 Output Min Scale* to 0%  
 Output signal 10 mA is needed at Max ref (100% of range) - set *parameter 6-52 Terminal 42 Output Max Scale* to 200% (20 mA/10 mA x 100%=200%).

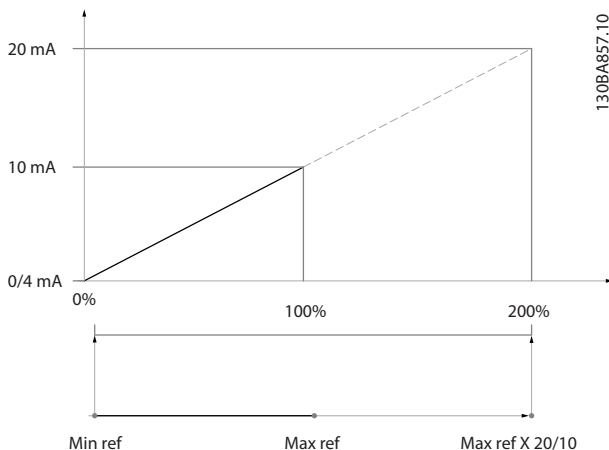

**Illustration 3.35 Example 3**

6-53 Terminal 42 Output Bus Control		
Range:	Function:	
0 %*	[0 - 100 %]	Holds the level of Output 42 if controlled by bus.

6-54 Terminal 42 Output Timeout Preset		
Range:	Function:	
0 %*	[0 - 100 %]	Holds the preset level of Output 42. In case of a bus timeout and a timeout function is selected in <i>parameter 6-50 Terminal 42 Output</i> , the output is preset to this level.



6-55 Terminal 42 Output Filter		
Option:	Function:	
	The following readout analog parameters from selection in 6-50 Terminal 42 Output have a filter selected when parameter 6-55 Terminal 42 Output Filter is on:	
	<b>Selection</b>	<b>0-20 mA</b> <b>4-20 mA</b>
	Motor current (0 - I <sub>max</sub> )	[103]    [133]
	Torque limit (0 - T <sub>lim</sub> )	[104]    [134]
	Rated torque (0 - T <sub>nom</sub> )	[105]    [135]
	Power (0 - P <sub>nom</sub> )	[106]    [136]
	Speed (0 - Speed <sub>max</sub> )	[107]    [137]
<b>Table 3.15 Readout Analog Parameters</b>		
[0]	Off	Filter off
[1]	On	Filter on

### 3.8.7 6-6\* Analog Output 2 MCB 101

Analog outputs are current outputs: 0/4 - 20 mA. Common terminal (terminal X30/8) is the same terminal and electrical potential for analog common connection. Resolution on analog output is 12 bit.

6-60 Terminal X30/8 Output		
Same options and functions as parameter 6-50 Terminal 42 Output.		
Option:	Function:	
[0] *	No operation	

6-61 Terminal X30/8 Min. Scale		
Range:	Function:	
0 %*    [0 - 200 %]	Scales the minimum output of the selected analog signal on terminal X30/8. Scale the minimum value as a percentage of the maximum signal value, i.e. 0 mA (or 0 Hz) is desired at 25% of the maximum output value and 25% is programmed. The value can never be higher than the corresponding setting in parameter 6-62 Terminal X30/8 Max. Scale if value is below 100%.  This parameter is active when option module MCB 101 is mounted in the frequency converter.	

6-62 Terminal X30/8 Max. Scale		
Range:	Function:	
100 %*    [0 - 200 %]	Scales the maximum output of the selected analog signal on terminal X30/8. Scale the value to the desired maximum value of the current signal output. Scale the output to give a lower current than 20 mA at full scale or 20 mA at an output below 100% of the maximum signal value. If 20 mA is the desired output current at a value between 0 - 100% of the full-scale output, program the percentage value in the parameter,	

6-62 Terminal X30/8 Max. Scale		
Range:	Function:	
	i.e. 50% = 20 mA. If a current between 4 and 20 mA is desired at maximum output (100%), calculate the percentage value as follows:  $20 \text{ mA} / \text{desired maximum current} \times 100\%$  i. e. 10 mA: $\frac{20 \text{ mA}}{10 \text{ mA}} \times 100\% = 200\%$	

6-63 Terminal X30/8 Output Bus Control		
Range:	Function:	
0 %*    [0 - 100 %]	Contains the value to apply to the output terminal, when it is configured as Bus Controlled.	

6-64 Terminal X30/8 Output Timeout Preset		
Range:	Function:	
0 %*    [0 - 100 %]	Contains the value to apply to the output terminal, when it is configured as Bus Controlled Timeout and time-out is detected.	

6-70 Terminal X45/1 Output		
Analog output of the VLT® Extended Relay Card MCB 113.		
Option:	Function:	
[0]	No operation	
[100]	Output freq. 0-100	
[101]	Reference Min-Max	
[102]	Feedback +-200%	
[103]	Motor cur. 0-I <sub>max</sub>	
[104]	Torque 0-T <sub>lim</sub>	
[105]	Torque 0-T <sub>nom</sub>	
[106]	Power 0-P <sub>nom</sub>	
[107]	Speed 0-HighLim	
[108]	Torque +-160%	
[109]	Out frq 0-F <sub>max</sub>	
[113]	Ext. Closed Loop 1	
[114]	Ext. Closed Loop 2	
[115]	Ext. Closed Loop 3	
[116]	Cascade Reference	
[130]	Out frq 0-100 4-20mA	
[131]	Reference 4-20mA	
[132]	Feedback 4-20mA	
[133]	Motor cur. 4-20mA	
[134]	Torq,0-lim 4-20 mA	
[135]	Torq,0-nom 4-20mA	
[136]	Power 4-20mA	
[137]	Speed 4-20mA	
[138]	Torque 4-20mA	
[139]	Bus ctrl.	
[140]	Bus ctrl. 4-20 mA	
[141]	Bus ctrl t.o.	
[142]	Bus ctrl t.o. 4-20mA	
[143]	Ext. CL 1 4-20mA	
[144]	Ext. CL 2 4-20mA	
[145]	Ext. CL 3 4-20mA	

6-70 Terminal X45/1 Output		
Analog output of the VLT® Extended Relay Card MCB 113.		
Option:	Function:	
[146]	Cascade Ref. 4-20mA	
[147]	Main act val 0-20mA	
[148]	Main act val 4-20mA	
[150]	Out frq 0-Fmax 4-20mA	
[254]	DC Link 0-20mA	
[255]	DC Link 4-20mA	

6-71 Terminal X45/1 Min. Scale		
Range:	Function:	
0 %*	[0 - 200 %]	

6-72 Terminal X45/1 Max. Scale		
Range:	Function:	
100 %*	[0 - 200 %]	

6-73 Terminal X45/1 Bus Control		
Range:	Function:	
0 %*	[0 - 100 %]	

6-74 Terminal X45/1 Output Timeout Preset		
Range:	Function:	
0 %*	[0 - 100 %]	

6-80 Terminal X45/3 Output		
Option:	Function:	
[0]	No operation	
[100]	Output freq. 0-100	
[101]	Reference Min-Max	
[102]	Feedback +-200%	
[103]	Motor cur. 0-lmax	
[104]	Torque 0-Tlim	
[105]	Torque 0-Tnom	
[106]	Power 0-Pnom	
[107]	Speed 0-HighLim	
[108]	Torque +-160%	
[109]	Out frq 0-Fmax	
[113]	Ext. Closed Loop 1	
[114]	Ext. Closed Loop 2	
[115]	Ext. Closed Loop 3	
[116]	Cascade Reference	
[130]	Out frq 0-100 4-20mA	
[131]	Reference 4-20mA	
[132]	Feedback 4-20mA	
[133]	Motor cur. 4-20mA	
[134]	Torq.0-lim 4-20 mA	
[135]	Torq.0-nom 4-20mA	
[136]	Power 4-20mA	
[137]	Speed 4-20mA	
[138]	Torque 4-20mA	
[139]	Bus ctrl.	
[140]	Bus ctrl. 4-20 mA	
[141]	Bus ctrl t.o.	

6-80 Terminal X45/3 Output		
Option:	Function:	
[142]	Bus ctrl t.o. 4-20mA	
[143]	Ext. CL 1 4-20mA	
[144]	Ext. CL 2 4-20mA	
[145]	Ext. CL 3 4-20mA	
[146]	Cascade Ref. 4-20mA	
[147]	Main act val 0-20mA	
[148]	Main act val 4-20mA	
[150]	Out frq 0-Fmax 4-20mA	
[254]	DC Link 0-20mA	
[255]	DC Link 4-20mA	

6-81 Terminal X45/3 Min. Scale		
Analog output of the VLT® Extended Relay Card MCB 113. For information about configuring this terminal, see <i>chapter 3.8.2 6-1* Analog Input 1</i> .		
Range:	Function:	
0 %*	[0 - 200 %]	

6-82 Terminal X45/3 Max. Scale		
Range:	Function:	
100 %*	[0 - 200 %]	

6-83 Terminal X45/3 Bus Control		
Range:	Function:	
0 %*	[0 - 100 %]	

6-84 Terminal X45/3 Output Timeout Preset		
Range:	Function:	
0 %*	[0 - 100 %]	

### 3.9 Parameters 8-\*\* Communications and Options

#### 3.9.1 8-0\* General Settings

8-01 Control Site		
Option:	Function:	
		The setting in this parameter overrides the settings in <i>parameter 8-50 Coasting Select</i> to <i>parameter 8-56 Preset Reference Select</i> .
[0]	Digital and ctrl.word	Control by using both digital input and control word.
[1]	Digital only	Control by using digital inputs only.
[2]	Controlword only	Control by using control word only.

8-02 Control Source		
Option:	Function:	
		Select the source of the control word: one of 2 serial interfaces or 4 installed options. During initial power-up, the frequency converter automatically sets this parameter to [3] <i>Option A</i> if it detects a valid fieldbus option installed in slot A. If the option is removed, the frequency converter detects a change in the configuration, sets <i>8-02 Control Source</i> back to default setting <i>FC Port</i> , and the frequency converter then trips. If an option is installed after initial power-up, the setting of <i>8-02 Control Source</i> does not change, but the frequency converter trips and displays: Alarm 67 <i>Option Changed</i> .
		<b>NOTICE</b> This parameter cannot be adjusted while the motor is running.
[0]	None	
[1]	FC Port	
[2]	USB Port	
[3]	Option A	
[4]	Option B	
[5]	Option C0	
[6]	Option C1	
[30]	External Can	

8-03 Control Timeout Time		
Range:	Function:	
Size related*	[1 - 18000 s]	Enter the maximum time expected to pass between the reception of 2 consecutive telegrams. If this time is exceeded, it indicates that the serial communication has stopped. The function selected in <i>parameter 8-04 Control Timeout Function Control Time-out Function</i> is then carried out.

8-03 Control Timeout Time		
Range:	Function:	
		In BACnet, the control time-out is only triggered if some specific objects are written. The object list hold information on the objects that triggers the control timeout:
		Analog Outputs
		Binary Outputs
		AV0
		AV1
		AV2
		AV4
		BV1
		BV2
		BV3
		BV4
		BV5
		Multistate Outputs

8-04 Control Timeout Function		
Option:	Function:	
		Select the time-out function. The time-out function is activated when the control word fails to be updated within the time period specified in <i>parameter 8-03 Control Timeout Time</i> . [20] <i>N2 Override Release</i> only appears after setting the Metasys N2 protocol.
[0]	Off	
[1]	Freeze output	
[2]	Stop	
[3]	Jogging	
[4]	Max. speed	
[5]	Stop and trip	
[7]	Select setup 1	
[8]	Select setup 2	
[9]	Select setup 3	
[10]	Select setup 4	
[20]	N2 Override Release	

8-05 End-of-Timeout Function		
Option:	Function:	
		Select the action after receiving a valid control word following a time-out. This parameter is active only when <i>parameter 8-04 Control Timeout Function</i> is set to [7] <i>Set-up 1</i> , [8] <i>Set-up 2</i> , [9] <i>Set-up 3</i> or [10] <i>Set-up 4</i> .
[0]	Hold set-up	Retains the set-up selected in <i>parameter 8-04 Control Timeout Function</i> and displays a warning, until <i>parameter 8-06 Reset</i>

8-05 End-of-Timeout Function		
Option:	Function:	
		Control Timeout toggles. Then the frequency converter resumes its original set-up.
[1]	Resume set-up	Resumes the set-up active before the time-out.

8-06 Reset Control Timeout		
Option:	Function:	
		This parameter is active only when the choice [0] Hold set-up has been selected in parameter 8-05 End-of-Timeout Function.
[0]	Do not reset	Retains the set-up specified in parameter 8-04 Control Timeout Function, [7] Set-up 1, [8] Set-up 2, [9] Set-up 3 and [10] Set-up 4 following a control time-out.
[1]	Do reset	Returns the frequency converter to the original set-up following a control word time-out. When the value is set to [1] Do reset, the frequency converter performs the reset and then immediately reverts to the [0] Do not reset setting.

8-07 Diagnosis Trigger		
Option:	Function:	
		This parameter has no function for BACnet.
[0]	Disable	
[1]	Trigger on alarms	
[2]	Trigger alarm/warn.	

8-08 Readout Filtering		
If the speed feedback value readouts on fieldbus are fluctuating, this function is used. Select filtered, if the function is required. A power-cycle is required for changes to take effect.		
Option:	Function:	
[0]	Motor Data Std-Filt.	Select [0] for normal bus readouts.
[1]	Motor Data LP-Filter	Select [1] for filtered bus readouts of the following parameters: 16-10 Power [kW] 16-11 Power [hp] 16-12 Motor Voltage 16-14 Motor current 16-16 Torque [Nm] 16-17 Speed [RPM] 16-22 Torque [%] 16-25 Torque [Nm] High

### 3.9.2 8-1\* Ctrl. Word Settings

8-10 Control Profile		
Option:	Function:	
		Select the interpretation of the control and status words corresponding to the installed fieldbus. Only the selections valid for the fieldbus installed in slot A is visible in the LPC display.
[0]	FC profile	
[1]	PROFIdrive profile	
[5]	ODVA	
[7]	CANopen DSP 402	

8-13 Configurable Status Word STW		
Option:	Function:	
		This parameter enables configuration of bits 12–15 in the status word.
[0]	No function	
[1] *	Profile Default	Function corresponds to the profile default selected in parameter 8-10 Control Profile.
[2]	Alarm 68 Only	Only set in case of an Alarm 68.
[3]	Trip excl. Alarm 68	Set in case of a trip, except if Alarm 68 executes the trip.
[10]	T18 DI status.	The bit indicates the status of terminal 18. "0" indicates that the terminal is low "1" indicates that the terminal is high
[11]	T19 DI status.	The bit indicates the status of terminal 19. "0" indicates that the terminal is low "1" indicates that the terminal is high
[12]	T27 DI status.	The bit indicates the status of terminal 27. "0" indicates that the terminal is low "1" indicates that the terminal is high
[13]	T29 DI status.	The bit indicates the status of terminal 29. "0" indicates that the terminal is low "1" indicates that the terminal is high
[14]	T32 DI status.	The bit indicates the status of terminal 32. "0" indicates that the terminal is low "1" indicates that the terminal is high
[15]	T33 DI status.	The bit indicates the status of terminal 33. "0" indicates that the terminal is low "1" indicates that the terminal is high
[16]	T37 DI status	The bit indicates the status of terminal 37. "0" indicates T37 is low (safe stop) "1" indicates T37 is high (normal)
[21]	Thermal warning	The thermal warning turns on when the temperature exceeds the limit in the motor, the frequency converter, the brake resistor, or the thermistor.
[30]	Brake fault (IGBT)	Output is Logic '1' when the brake IGBT is short-circuited. Use this function to protect the frequency converter if there is a fault on the brake modules. Use the output/relay

8-13 Configurable Status Word STW		
Option:	Function:	
		to cut out the main voltage from the frequency converter.
[40]	Out of ref. range	
[60]	Comparator 0	See parameter group 13-1* <i>Comparators</i> . If Comparator 0 is evaluated as TRUE, the output goes high. Otherwise, it is low.
[61]	Comparator 1	See parameter group 13-1* <i>Comparators</i> . If Comparator 1 is evaluated as TRUE, the output goes high. Otherwise, it is low.
[62]	Comparator 2	See parameter group 13-1* <i>Comparators</i> . If Comparator 2 is evaluated as TRUE, the output goes high. Otherwise, it is low.
[63]	Comparator 3	See parameter group 13-1* <i>Comparators</i> . If Comparator 3 is evaluated as TRUE, the output goes high. Otherwise, it is low.
[64]	Comparator 4	See parameter group 13-1* <i>Comparators</i> . If Comparator 4 is evaluated as TRUE, the output goes high. Otherwise, it is low.
[65]	Comparator 5	See parameter group 13-1* <i>Comparators</i> . If Comparator 5 is evaluated as TRUE, the output goes high. Otherwise, it is low.
[70]	Logic Rule 0	See parameter group 13-4* <i>Logic Rules</i> . If Logic Rule 0 is evaluated as TRUE, the output goes high. Otherwise, it is low.
[71]	Logic Rule 1	See parameter group 13-4* <i>Logic Rules</i> . If Logic Rule 1 is evaluated as TRUE, the output goes high. Otherwise, it is low.
[72]	Logic Rule 2	See parameter group 13-4* <i>Logic Rules</i> . If Logic Rule 2 is evaluated as TRUE, the output goes high. Otherwise, it is low.
[73]	Logic Rule 3	See parameter group 13-4* <i>Logic Rules</i> . If Logic Rule 3 is evaluated as TRUE, the output goes high. Otherwise, it is low.
[74]	Logic Rule 4	See parameter group 13-4* <i>Logic Rules</i> . If Logic Rule 4 is evaluated as TRUE, the output goes high. Otherwise, it is low.
[75]	Logic Rule 5	See parameter group 13-4* <i>Logic Rules</i> . If Logic Rule 5 is evaluated as TRUE, the output goes high. Otherwise, it is low.
[80]	SL Digital Output A	See <i>parameter 13-52 SL Controller Action</i> . The output goes high whenever the Smart Logic Action [38] <i>Set digital out A high</i> is executed. The output goes low whenever the Smart Logic Action [32] <i>Set digital out A low</i> is executed.
[81]	SL Digital Output B	See <i>parameter 13-52 SL Controller Action</i> . The input goes high whenever the Smart Logic Action [39] <i>Set digital out B high</i> is executed. The input goes low whenever the Smart Logic Action [33] <i>Set digital out B low</i> is executed.
[82]	SL Digital Output C	See <i>parameter 13-52 SL Controller Action</i> . The input goes high whenever the Smart

8-13 Configurable Status Word STW		
Option:	Function:	
		Logic Action [40] <i>Set digital out C high</i> is executed. The input goes low whenever the Smart Logic Action [34] <i>Set digital out C low</i> is executed.
[83]	SL Digital Output D	See <i>parameter 13-52 SL Controller Action</i> . The input goes high whenever the Smart Logic Action [41] <i>Set digital out D high</i> is executed. The input goes low whenever the Smart Logic Action [35] <i>Set digital out D low</i> is executed.
[84]	SL Digital Output E	See <i>parameter 13-52 SL Controller Action</i> . The input goes high whenever the Smart Logic Action [42] <i>Set digital out E high</i> is executed. The input goes low whenever the Smart Logic Action [36] <i>Set digital out E low</i> is executed.
[85]	SL Digital Output F	See <i>parameter 13-52 SL Controller Action</i> . The input goes high whenever the Smart Logic Action [43] <i>Set digital out F high</i> is executed. The input goes low whenever the Smart Logic Action [37] <i>Set digital out F low</i> is executed.

8-14 Configurable Control Word CTW		
Option:	Function:	
		Selection of control word bit 10, if it is active low or active high.
[0]	None	
[1]	Profile default	
[2]	CTW Valid, active low	

### 3.9.3 8-3\* FC Port Settings

8-30 Protocol		
Option:	Function:	
		Protocol selection for the integrated FC (standard) Port (RS-485) on the control card.
[0]	FC	Communication according to the FC Protocol as described in <i>RS-485 Installation and Set-up</i> in the relevant Design Guide.
[1]	FC MC	Same as [0] FC but to be used when downloading SW to the frequency converter or uploading dll file (covering information regarding parameters available in the frequency converter and their inter-dependencies) to MCT 10 Set-up Software.
[2]	Modbus RTU	Communication according to the Modbus RTU protocol.
[3]	Metasys N2	
[9]	FC Option	

8-31 Address		
Range:	Function:	
Size related*	[ 1 - 255 ]	Enter the address for the FC (standard) port. Valid range: 1-126.

8-32 Baud Rate		
Option:	Function:	
		Baud rates 9600, 19200, 38400 and 76800 baud are valid for BACnet only.
[0]	2400 Baud	
[1]	4800 Baud	
[2]	9600 Baud	
[3]	19200 Baud	
[4]	38400 Baud	
[5]	57600 Baud	
[6]	76800 Baud	
[7]	115200 Baud	

The default value depends on the FC Protocol.

8-33 Parity / Stop Bits		
Option:	Function:	
		Parity and Stop Bits for the protocol 8-30 Protocol using the FC Port. For

8-33 Parity / Stop Bits		
Option:	Function:	
		some of the protocols, not all options are visible. Default depends on the protocol selected.
[0]	Even Parity, 1 Stop Bit	
[1]	Odd Parity, 1 Stop Bit	
[2]	No Parity, 1 Stop Bit	
[3]	No Parity, 2 Stop Bits	

8-35 Minimum Response Delay		
Range:	Function:	
Size related*	[ 5 - 10000 ms]	Specify the minimum delay time between receiving a request and transmitting a response. This is used for overcoming modem turnaround delays.

8-36 Max Response Delay		
Range:	Function:	
Size related*	[ 11 - 10001 ms]	Specify the maximum permissible delay time between transmitting a request and receiving a response. Exceeding this delay time causes control word time-out.

8-37 Maximum Inter-Char Delay		
Range:	Function:	
Size related*	[ 0.00 - 35.01 ms]	Specify the maximum permissible time interval between receipt of 2 bytes. This parameter activates time-out if transmission is interrupted.

### 3.9.4 8-4\* Telegram Selection

8-40 Telegram Selection		
Option:	Function:	
		Enables use of freely configurable telegrams or standard telegrams for the FC port.
[1]	Standard telegram 1	
[100]	None	
[101]	PPO 1	
[102]	PPO 2	
[103]	PPO 3	
[104]	PPO 4	
[105]	PPO 5	
[106]	PPO 6	
[107]	PPO 7	
[108]	PPO 8	
[200]	Custom telegram 1	
[202]	Custom telegram 3	

8-42 PCD Write Configuration		
Option:	Function:	
[0]	None	Select the parameters to be assigned to PCD's telegrams. The number of available PCDs depends on the telegram type. The values in PCDs are then written to the selected parameters as data values.
[302]	Minimum Reference	
[303]	Maximum Reference	
[341]	Ramp 1 Ramp Up Time	
[342]	Ramp 1 Ramp Down Time	
[351]	Ramp 2 Ramp Up Time	
[352]	Ramp 2 Ramp Down Time	
[380]	Jog Ramp Time	
[381]	Quick Stop Ramp Time	
[411]	Motor Speed Low Limit [RPM]	
[412]	Motor Speed Low Limit [Hz]	
[413]	Motor Speed High Limit [RPM]	
[414]	Motor Speed High Limit [Hz]	
[416]	Torque Limit Motor Mode	
[417]	Torque Limit Generator Mode	
[590]	Digital & Relay Bus Control	
[593]	Pulse Out #27 Bus Control	
[595]	Pulse Out #29 Bus Control	
[597]	Pulse Out #X30/6 Bus Control	
[653]	Terminal 42 Output Bus Control	
[663]	Terminal X30/8 Output Bus Control	
[673]	Terminal X45/1 Bus Control	
[683]	Terminal X45/3 Bus Control	
[890]	Bus Jog 1 Speed	
[891]	Bus Jog 2 Speed	
[894]	Bus Feedback 1	
[895]	Bus Feedback 2	
[896]	Bus Feedback 3	
[1680]	Fieldbus CTW 1	
[1682]	Fieldbus REF 1	
[1685]	FC Port CTW 1	
[1686]	FC Port REF 1	
[2643]	Terminal X42/7 Bus Control	
[2653]	Terminal X42/9 Bus Control	
[2663]	Terminal X42/11 Bus Control	
[2950]	Validation Time	
[2951]	Verification Time	

8-43 PCD Read Configuration		
Option:	Function:	
[0]	None	Select the parameters to be assigned to PCDs of the telegrams. The number of available PCDs depends on the telegram type. PCDs contain the actual data values of the selected parameters.
[894]	Bus Feedback 1	
[895]	Bus Feedback 2	
[896]	Bus Feedback 3	
[1500]	Operating hours	
[1501]	Running Hours	
[1502]	kWh Counter	
[1600]	Control Word	
[1601]	Reference [Unit]	
[1602]	Reference [%]	
[1603]	Status Word	
[1605]	Main Actual Value [%]	
[1609]	Custom Readout	
[1610]	Power [kW]	
[1611]	Power [hp]	
[1612]	Motor Voltage	
[1613]	Frequency	
[1614]	Motor current	
[1615]	Frequency [%]	
[1616]	Torque [Nm]	
[1617]	Speed [RPM]	
[1618]	Motor Thermal	
[1622]	Torque [%]	
[1630]	DC Link Voltage	
[1632]	Brake Energy /s	
[1633]	Brake Energy /2 min	
[1634]	Heatsink Temp.	
[1635]	Inverter Thermal	
[1638]	SL Controller State	
[1639]	Control Card Temp.	
[1650]	External Reference	
[1652]	Feedback[Unit]	
[1653]	Digi Pot Reference	
[1654]	Feedback 1 [Unit]	
[1655]	Feedback 2 [Unit]	
[1656]	Feedback 3 [Unit]	
[1660]	Digital Input	
[1661]	Terminal 53 Switch Setting	
[1662]	Analog Input 53	
[1663]	Terminal 54 Switch Setting	
[1664]	Analog Input 54	

8-43 PCD Read Configuration		
Option:	Function:	
[1665]	Analog Output 42 [mA]	
[1666]	Digital Output [bin]	
[1667]	Pulse Input #29 [Hz]	
[1668]	Pulse Input #33 [Hz]	
[1669]	Pulse Output #27 [Hz]	
[1670]	Pulse Output #29 [Hz]	
[1671]	Relay Output [bin]	
[1672]	Counter A	
[1673]	Counter B	
[1675]	Analog In X30/11	
[1676]	Analog In X30/12	
[1677]	Analog Out X30/8 [mA]	
[1678]	Analog Out X45/1 [mA]	
[1679]	Analog Out X45/3 [mA]	
[1684]	Comm. Option STW	
[1690]	Alarm Word	
[1691]	Alarm Word 2	
[1692]	Warning Word	
[1693]	Warning Word 2	
[1694]	Ext. Status Word	
[1695]	Ext. Status Word 2	
[1696]	Maintenance Word	
[1830]	Analog Input X42/1	
[1831]	Analog Input X42/3	
[1832]	Analog Input X42/5	
[1833]	Analog Out X42/7 [V]	
[1834]	Analog Out X42/9 [V]	
[1835]	Analog Out X42/11 [V]	
[1836]	Analog Input X48/2 [mA]	
[1837]	Temp. Input X48/4	
[1838]	Temp. Input X48/7	
[1839]	Temp. Input X48/10	
[1860]	Digital Input 2	
[2795]	Advanced Cascade Relay Output [bin]	
[2796]	Extended Cascade Relay Output [bin]	

### 3.9.5 8-5\* Digital/Bus

Parameters for configuring the control word Digital/Bus merging.

#### **NOTICE**

These parameters are active only when *parameter 8-01 Control Site* is set to [0] *Digital and control word*.

8-50 Coasting Select		
Option:	Function:	
	Select control of the coasting function via the terminals (digital input) and/or via the bus.	

8-50 Coasting Select		
Option:	Function:	
[0]	Digital input	Activates Start command via a digital input.
[1]	Bus	Activates Start command via the serial communication port or fieldbus option.
[2]	Logic AND	Activates Start command via the fieldbus/serial communication port, AND additionally via one of the digital inputs.
[3]	Logic OR	Activates Start command via the fieldbus/serial communication port OR via one of the digital inputs.

8-52 DC Brake Select		
Option:	Function:	
	Select control of the DC brake via the terminals (digital input) and/or via the fieldbus. <b>NOTICE</b> Only selection [0] Digital Input is available when <i>parameter 1-10 Motor Construction</i> is set to [1] <i>PM, non-salient SPM</i>	
[0]	Digital input	Activates start command via a digital input.
[1]	Bus	Activates start command via the serial communication port or fieldbus option.
[2]	Logic AND	Activates start command via the fieldbus/serial communication port, AND additionally via one of the digital inputs.
[3]	Logic OR	Activates Start command via the fieldbus/serial communication port OR via one of the digital inputs.

8-53 Start Select		
Option:	Function:	
	Select control of the frequency converter start function via the terminals (digital input) and/or via the fieldbus.	
[0]	Digital input	Activates start command via a digital input.
[1]	Bus	Activates start command via the serial communication port or fieldbus option.
[2]	Logic AND	Activates start command via the fieldbus/serial communication port, AND additionally via one of the digital inputs.
[3]	Logic OR	Activates start command via the fieldbus/serial communication port OR via one of the digital inputs.



8-54 Reversing Select		
Option:	Function:	
		Select control of the frequency converter reverse function via the terminals (digital input) and/or via the fieldbus.
[0]	Digital input	Activates reverse command via a digital input.
[1]	Bus	Activates reverse command via the serial communication port or fieldbus option.
[2]	Logic AND	Activates reverse command via the fieldbus/serial communication port, AND additionally via one of the digital inputs.
[3]	Logic OR	Activates reverse command via the fieldbus/serial communication port OR via one of the digital inputs.

**NOTICE**

This parameter is active only when parameter 8-01 Control Site is set to [0] Digital and control word.

8-55 Set-up Select		
Option:	Function:	
		Select control of the frequency converter set-up selection via the terminals (digital input) and/or via the fieldbus.
[0]	Digital input	Activates the set-up selection via a digital input.
[1]	Bus	Activates the set-up selection via the serial communication port or fieldbus option.
[2]	Logic AND	Activates the set-up selection via the fieldbus/serial communication port, AND additionally via one of the digital inputs.
[3]	Logic OR	Activate the set-up selection via the fieldbus/serial communication port OR via one of the digital inputs.

8-56 Preset Reference Select		
Option:	Function:	
		Select control of the preset reference selection via the terminals (digital input) and/or via the fieldbus.
[0]	Digital input	Activates preset reference selection via a digital input.
[1]	Bus	Activates preset reference selection via the serial communication port or fieldbus option.
[2]	Logic AND	Activates preset reference selection via the fieldbus/serial communication port, AND additionally via one of the digital inputs.

8-56 Preset Reference Select		
Option:	Function:	
[3]	Logic OR	Activates the preset reference selection via the fieldbus/serial communication port OR via one of the digital inputs.

3.9.6 8-8\* FC Port Diagnostics

These parameters are used for monitoring the bus communication via the FC Port.

8-80 Bus Message Count		
Range:	Function:	
0 *	[0 - 0 ]	This parameter shows the number of valid telegrams detected on the bus.

8-81 Bus Error Count		
Range:	Function:	
0 *	[0 - 0 ]	This parameter shows the number of telegrams with faults (e.g. CRC fault), detected on the bus.

8-82 Slave Message Rcvd		
Range:	Function:	
0 *	[0 - 0 ]	This parameter shows the number of valid telegrams addressed to the slave, sent by the frequency converter.

8-83 Slave Error Count		
Range:	Function:	
0 *	[0 - 0 ]	This parameter shows the number of error telegrams, which could not be executed by the frequency converter.

3.9.7 8-9\* Bus Jog

8-90 Bus Jog 1 Speed		
Range:	Function:	
100 RPM*	[ 0 - par. 4-13 RPM]	Enter the jog speed. Activate this fixed jog speed via the serial port or fieldbus option.

8-91 Bus Jog 2 Speed		
Range:	Function:	
Size related*	[ 0 - par. 4-13 RPM]	Enter the jog speed. Activate this fixed jog speed via the serial port or fieldbus option.

8-94 Bus Feedback 1		
Range:		Function:
0 *	[-200 - 200 ]	Write a feedback to this parameter via the serial communication port or fieldbus option. This parameter must be selected in <i>parameter 20-00 Feedback 1 Source</i> , <i>parameter 20-03 Feedback 2 Source</i> or <i>parameter 20-06 Feedback 3 Source</i> as a feedback source.

8-95 Bus Feedback 2		
Range:		Function:
0 *	[-200 - 200 ]	See <i>parameter 8-94 Bus Feedback 1</i> for further details.

8-96 Bus Feedback 3		
Range:		Function:
0 *	[-200 - 200 ]	See <i>parameter 8-94 Bus Feedback 1</i> for further details.

### 3.10 Parameters 9-\*\* Profibus

For Profibus parameter descriptions, see the *VL<sup>T</sup>® Profibus Operating Instructions*.

### 3.11 Parameters 10-\*\* CAN Fieldbus

#### 3.11.1 10-0\* Common Settings

10-00 CAN Protocol		
Option:	Function:	
[1] DeviceNet	<b>NOTICE</b> The parameter options depend on installed option.  View the active CAN protocol.	

10-01 Baud Rate Select		
Option:	Function:	
		Select the fieldbus transmission speed. The selection must correspond to the transmission speed of the master and the other fieldbus nodes.
[16]	10 Kbps	
[17]	20 Kbps	
[18]	50 Kbps	
[19]	100 Kbps	
[20]	125 Kbps	
[21]	250 Kbps	
[22]	500 Kbps	
[23]	800 Kbps	
[24]	1000 Kbps	

10-02 MAC ID		
Range:	Function:	
Size related*	[ 0 - 63 ]	Selection of station address. Every station connected to the same DeviceNet network must have an unambiguous address.

10-05 Readout Transmit Error Counter		
Range:	Function:	
0 *	[ 0 - 255 ]	View the number of CAN control transmission errors since the last power-up.

10-06 Readout Receive Error Counter		
Range:	Function:	
0 *	[ 0 - 255 ]	View the number of CAN control receipt errors since the last power-up.

10-07 Readout Bus Off Counter		
Range:	Function:	
0 *	[ 0 - 255 ]	View the number of Bus Off events since the last power-up.

#### 3.11.2 10-1\* DeviceNet

10-10 Process Data Type Selection		
Option:	Function:	
		Select the Instance (telegram) for data transmission. The Instances available are dependent upon the setting of <i>parameter 8-10 Control Profile</i> . When <i>parameter 8-10 Control Profile</i> is set to [0] FC profile, <i>parameter 10-10 Process Data Type Selection</i> options [0] INSTANCE 100/150 and [1] INSTANCE 101/151 are available. When <i>parameter 8-10 Control Profile</i> is set to [5] ODVA, <i>parameter 10-10 Process Data Type Selection</i> options [2] INSTANCE 20/70 and [3] INSTANCE 21/71 are available. Instances 100/150 and 101/151 are Danfoss-specific. Instances 20/70 and 21/71 are ODVA-specific AC Drive profiles. For guidelines in telegram selection, refer to the <i>DeviceNet Operating Instructions</i> .  <b>NOTICE</b> A change to this parameter is executed immediately.
[0]	INSTANCE 100/150	
[1]	INSTANCE 101/151	
[2]	INSTANCE 20/70	
[3]	INSTANCE 21/71	
[6]	INSTANCE 102/152	

10-11 Process Data Config Write		
Option:	Function:	
		Select the process write data for I/O Assembly Instances 101/151. Elements [2] and [3] of this array can be selected. Elements [0] and [1] of the array are fixed.
[0]	None	
[302]	Minimum Reference	
[303]	Maximum Reference	
[341]	Ramp 1 Ramp Up Time	
[342]	Ramp 1 Ramp Down Time	
[351]	Ramp 2 Ramp Up Time	
[352]	Ramp 2 Ramp Down Time	
[380]	Jog Ramp Time	
[381]	Quick Stop Ramp Time	

10-11 Process Data Config Write		
Option:	Function:	
[411]	Motor Speed Low Limit [RPM]	
[412]	Motor Speed Low Limit [Hz]	
[413]	Motor Speed High Limit [RPM]	
[414]	Motor Speed High Limit [Hz]	
[416]	Torque Limit Motor Mode	
[417]	Torque Limit Generator Mode	
[590]	Digital & Relay Bus Control	
[593]	Pulse Out #27 Bus Control	
[595]	Pulse Out #29 Bus Control	
[597]	Pulse Out #X30/6 Bus Control	
[653]	Terminal 42 Output Bus Control	
[663]	Terminal X30/8 Output Bus Control	
[673]	Terminal X45/1 Bus Control	
[683]	Terminal X45/3 Bus Control	
[890]	Bus Jog 1 Speed	
[891]	Bus Jog 2 Speed	
[894]	Bus Feedback 1	
[895]	Bus Feedback 2	
[896]	Bus Feedback 3	
[1680]	Fieldbus CTW 1	
[1682]	Fieldbus REF 1	
[1685]	FC Port CTW 1	
[1686]	FC Port REF 1	

10-12 Process Data Config Read		
Option:	Function:	
	Select the process read data for I/O Assembly Instances 101/151. Elements [2] and [3] of this array can be selected. Elements [0] and [1] of the array are fixed.	

10-13 Warning Parameter		
Range:	Function:	
0 *	[0 - 65535 ]	View a DeviceNet-specific Warning word. One bit is assigned to every warning. Refer to the <i>DeviceNet Operating Instructions (MG33D)</i> for further information.

Bit	Meaning
0	Bus not active
1	Explicit connection timeout
2	I/O connection
3	Retry limit reached
4	Actual is not updated
5	CAN bus off
6	I/O send error
7	Initialisation error
8	No bus supply
9	Bus off
10	Error passive
11	Error warning
12	Duplicate MAC ID Error
13	RX queue overrun
14	TX queue overrun
15	CAN overrun

Table 3.16 Warning Bits

10-14 Net Reference		
Option:	Function:	
	Read only from LCP	
	Select the reference source in Instance 21/71 and 20/70.	
[0]	Off	Enables reference via analog/digital inputs.
[1]	On	Enables reference via the fieldbus.

10-15 Net Control		
Option:	Function:	
	Read only from LCP	
	Select the control source in Instance 21/71 and 20/70.	
[0]	Off	Enables control via analog/digital inputs.
[1]	On	Enable control via the fieldbus.

### 3.11.3 10-2\* COS Filters

10-20 COS Filter 1		
Range:	Function:	
0 *	[0 - 65535 ]	Enter the value for COS Filter 1 to set up the filter mask for the status word. When operating in COS (Change-Of-State), this function filters out bits in the status word that should not be sent if they change.

10-21 COS Filter 2		
Range:	Function:	
0 *	[0 - 65535 ]	Enter the value for COS Filter 2, to set up the filter mask for the Main Actual Value. When operating in COS (Change-Of-State), this function filters out bits in the Main Actual Value that should not be sent if they change.

10-22 COS Filter 3		
Range:	Function:	
0 * [0 - 65535 ]	Enter the value for COS Filter 3, to set up the filter mask for PCD 3. When operating in COS (Change-Of-State), this function filters out bits in PCD 3 that should not be sent if they change.	

10-23 COS Filter 4		
Range:	Function:	
0 * [0 - 65535 ]	Enter the value for COS Filter 4 to set up the filter mask for PCD 4. When operating in COS (Change-Of-State), this function filters out bits in PCD 4 that should not be sent if they change.	

10-34 DeviceNet Product Code		
Range:	Function:	
Size related*	[0 - 65535 ]	

10-39 Devicenet F Parameters		
Array [1000] No LCP access		
Range:	Function:	
0 * [0 - 0 ]	This parameter is used to configure the frequency converter via DeviceNet and build the EDS-file.	

### 3.11.4 10-3\* Parameter Access

Parameter group providing access to indexed parameters and defining programming set-up.

10-30 Array Index		
Range:	Function:	
0 * [0 - 255 ]	View array parameters. This parameter is valid only when a DeviceNet fieldbus is installed.	

10-31 Store Data Values		
Option:	Function:	
		Parameter values changed via DeviceNet are not automatically stored in non-volatile memory. Use this parameter to activate a function that stores parameter values in the EEPROM non-volatile memory, so changed parameter values are retained at power-down.
[0]	Off	Deactivates the non-volatile storage function.
[1]	Store edit setup	Stores all parameter values from the active set-up in the non-volatile memory. The selection returns to [0] Off when all values have been stored.
[2]	Store all setups	Stores all parameter values for all set-ups in the non-volatile memory. The selection returns to [0] Off when all parameter values have been stored.

10-32 Devicenet Revision		
Range:	Function:	
Size related*	[0 - 65535 ]	View the DeviceNet revision number. This parameter is used for EDS file creation.

10-33 Store Always		
Option:	Function:	
[0]	Off	Deactivates non-volatile storage of data.
[1]	On	Stores parameter data received via DeviceNet in EEPROM non-volatile memory as default.

### 3.12 Parameters 13-\*\* Smart Logic Control

Smart Logic Control (SLC) is essentially a sequence of user defined actions (see *parameter 13-52 SL Controller Action [x]*) executed by the SLC when the associated user defined event (see *parameter 13-51 SL Controller Event [x]*) is evaluated as TRUE by the SLC. Events and actions are each numbered and linked in pairs. This means that when the first event is fulfilled (attains the value TRUE), the first action is executed. After this, the conditions of the second event is evaluated and if evaluated TRUE, the second action is executed and so on. Only one event is evaluated at any time. If an event is evaluated as FALSE, nothing happens (in the SLC) during the current scan interval and no other events is evaluated. This means that when the SLC starts, it evaluates the first event (and only the first event) each scan interval. Only when the first event is evaluated TRUE, the SLC executes the first action and start evaluating the second event. It is possible to programme from 1 to 20 events and actions.

When the last event/action has been executed, the sequence starts over again from the first event/the first action. Illustration 3.36 shows an example with 3 event/actions.

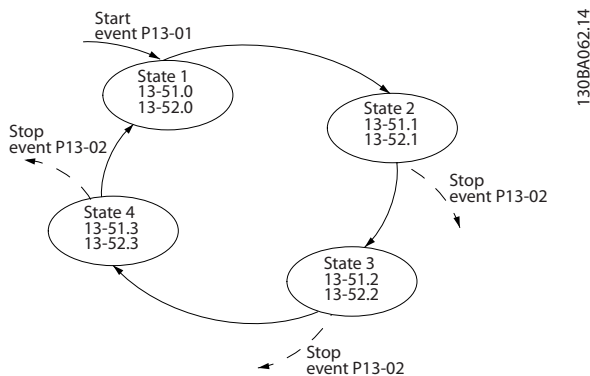

Illustration 3.36 Smart Logic Event Actions

#### Starting and stopping the SLC

Starting and stopping the SLC can be done by selecting [1] On or [0] Off in *parameter 13-00 SL Controller Mode*. The SLC always starts in state 0 (where it evaluates the first event). The SLC starts when the Start Event (defined in *parameter 13-01 Start Event*) is evaluated as TRUE (provided that [1] On is selected in *parameter 13-00 SL Controller Mode*). The SLC stops when the Stop Event (*parameter 13-02 Stop Event*) is TRUE. 13-03 Reset SLC resets all SLC parameters and starts programming from scratch.

#### 3.12.1 13-0\* SLC Settings

Use the SLC settings to activate, deactivate and reset the Smart Logic Control sequence. The logic functions and comparators are always running in the background, which opens for separate control of digital inputs and outputs.

13-00 SL Controller Mode		
Option:	Function:	
[0]	Off	Disables the Smart Logic Controller.
[1]	On	Enables the Smart Logic Controller.

13-01 Start Event		
Option:	Function:	
		Select the boolean (TRUE or FALSE) input to activate Smart Logic Control.
[0]	False	Enters the fixed value of FALSE in the logic rule.
[1]	True	Enters the fixed value TRUE in the logic rule.
[2]	Running	See parameter group 5-3* Digital Outputs for further description.
[3]	In range	See parameter group 5-3* Digital Outputs for further description.
[4]	On reference	See parameter group 5-3* Digital Outputs for further description.
[5]	Torque limit	See parameter group 5-3* Digital Outputs for further description.
[6]	Current Limit	See parameter group 5-3* Digital Outputs for further description.
[7]	Out of current range	See parameter group 5-3* Digital Outputs for further description.
[8]	Below I low	See parameter group 5-3* Digital Outputs for further description.
[9]	Above I high	See parameter group 5-3* Digital Outputs for further description.
[10]	Out of speed range	
[11]	Below speed low	See parameter group 5-3* Digital Outputs for further description.
[12]	Above speed high	See parameter group 5-3* Digital Outputs for further description.
[13]	Out of feedb. range	
[14]	Below feedb. low	
[15]	Above feedb. high	
[16]	Thermal warning	See parameter group 5-3* Digital Outputs for further description.
[17]	Mains out of range	See parameter group 5-3* Digital Outputs for further description.
[18]	Reversing	See parameter group 5-3* Digital Outputs for further description.
[19]	Warning	See parameter group 5-3* Digital Outputs for further description.

13-01 Start Event		
Option:	Function:	
[20]	Alarm (trip)	See parameter group 5-3* <i>Digital Outputs</i> for further description.
[21]	Alarm (trip lock)	See parameter group 5-3* <i>Digital Outputs</i> for further description.
[22]	Comparator 0	Use the result of comparator 0 in the logic rule.
[23]	Comparator 1	Use the result of comparator 1 in the logic rule.
[24]	Comparator 2	Use the result of comparator 2 in the logic rule.
[25]	Comparator 3	Use the result of comparator 3 in the logic rule.
[26]	Logic rule 0	Use the result of logic rule 0 in the logic rule.
[27]	Logic rule 1	Use the result of logic rule 1 in the logic rule.
[28]	Logic rule 2	Use the result of logic rule 2 in the logic rule.
[29]	Logic rule 3	Use the result of logic rule 3 in the logic rule.
[33]	Digital input DI18	Use the value of DI18 in the logic rule (High = TRUE).
[34]	Digital input DI19	Use the value of DI19 in the logic rule (High = TRUE).
[35]	Digital input DI27	Use the value of DI27 in the logic rule (High = TRUE).
[36]	Digital input DI29	Use the value of DI29 in the logic rule (High = TRUE).
[37]	Digital input DI32	Use the value of DI32 in the logic rule (High = TRUE).
[38]	Digital input DI33	Use the value of DI33 in the logic rule (High = TRUE).
[39]	Start command	This event is TRUE if the frequency converter is started (either via digital input, fieldbus or other).
[40]	Drive stopped	This event is TRUE if the frequency converter is stopped or coasted (either via digital input, fieldbus or other).
[41]	Reset Trip	This event is TRUE if the frequency converter is tripped (but not trip-locked) and [Reset] is pressed.
[42]	Auto Reset Trip	This event is TRUE if the frequency converter is tripped (but not trip-locked) and an Automatic Reset is issued.
[43]	OK Key	This event is TRUE if [OK] is pressed.

13-01 Start Event		
Option:	Function:	
[44]	Reset Key	This event is TRUE if [Reset] is pressed.
[45]	Left Key	This event is TRUE if [◀] is pressed.
[46]	Right Key	This event is TRUE if [▶] is pressed.
[47]	Up Key	This event is TRUE if [▲] is pressed.
[48]	Down Key	This event is TRUE if [▼] is pressed.
[50]	Comparator 4	Use the result of comparator 4 in the logic rule.
[51]	Comparator 5	Use the result of comparator 5 in the logic rule.
[60]	Logic rule 4	Use the result of logic rule 4 in the logic rule.
[61]	Logic rule 5	Use the result of logic rule 5 in the logic rule.
[102]	Verifying Flow	

13-02 Stop Event		
Option:	Function:	
		Select the boolean (TRUE or FALSE) input to deactivate Smart Logic Control.
[0]	False	Enters the fixed value of FALSE in the logic rule.
[1]	True	Enters the fixed value TRUE in the logic rule.
[2]	Running	See parameter group 5-3* <i>Digital Outputs</i> for further description.
[3]	In range	See parameter group 5-3* <i>Digital Outputs</i> for further description.
[4]	On reference	See parameter group 5-3* <i>Digital Outputs</i> for further description.
[5]	Torque limit	See parameter group 5-3* <i>Digital Outputs</i> for further description.
[6]	Current Limit	See parameter group 5-3* <i>Digital Outputs</i> for further description.
[7]	Out of current range	See parameter group 5-3* <i>Digital Outputs</i> for further description.
[8]	Below I low	See parameter group 5-3* <i>Digital Outputs</i> for further description.
[9]	Above I high	See parameter group 5-3* <i>Digital Outputs</i> for further description.
[10]	Out of speed range	
[11]	Below speed low	See parameter group 5-3* <i>Digital Outputs</i> for further description.
[12]	Above speed high	See parameter group 5-3* <i>Digital Outputs</i> for further description.



13-02 Stop Event		
Option:	Function:	
[13]	Out of feedb. range	See parameter group 5-3* <i>Digital Outputs</i> for further description.
[14]	Below feedb. low	See parameter group 5-3* <i>Digital Outputs</i> for further description.
[15]	Above feedb. high	See parameter group 5-3* <i>Digital Outputs</i> for further description.
[16]	Thermal warning	See parameter group 5-3* <i>Digital Outputs</i> for further description.
[17]	Mains out of range	See parameter group 5-3* <i>Digital Outputs</i> for further description.
[18]	Reversing	See parameter group 5-3* <i>Digital Outputs</i> for further description.
[19]	Warning	See parameter group 5-3* <i>Digital Outputs</i> for further description.
[20]	Alarm (trip)	See parameter group 5-3* <i>Digital Outputs</i> for further description.
[21]	Alarm (trip lock)	See parameter group 5-3* <i>Digital Outputs</i> for further description.
[22]	Comparator 0	Use the result of comparator 0 in the logic rule.
[23]	Comparator 1	Use the result of comparator 1 in the logic rule.
[24]	Comparator 2	Use the result of comparator 2 in the logic rule.
[25]	Comparator 3	Use the result of comparator 3 in the logic rule.
[26]	Logic rule 0	Use the result of logic rule 0 in the logic rule.
[27]	Logic rule 1	Use the result of logic rule 1 in the logic rule.
[28]	Logic rule 2	Use the result of logic rule 2 in the logic rule.
[29]	Logic rule 3	Use the result of logic rule 3 in the logic rule.
[30]	SL Time-out 0	Use the result of timer 0 in the logic rule.
[31]	SL Time-out 1	Use the result of timer 1 in the logic rule.
[32]	SL Time-out 2	Use the result of timer 2 in the logic rule.
[33]	Digital input DI18	Use the value of DI18 in the logic rule (High = TRUE).
[34]	Digital input DI19	Use the value of DI19 in the logic rule (High = TRUE).
[35]	Digital input DI27	Use the value of DI27 in the logic rule (High = TRUE).

13-02 Stop Event		
Option:	Function:	
[36]	Digital input DI29	Use the value of DI29 in the logic rule (High = TRUE).
[37]	Digital input DI32	Use the value of DI32 in the logic rule (High = TRUE).
[38]	Digital input DI33	Use the value of DI33 in the logic rule (High = TRUE).
[39]	Start command	This event is TRUE if the frequency converter is started (either via digital input, fieldbus or other).
[40]	Drive stopped	This event is TRUE if the frequency converter is stopped or coasted (either via digital input, fieldbus or other).
[41]	Reset Trip	This event is TRUE if the frequency converter is tripped (but not trip-locked) and [Reset] is pressed.
[42]	Auto Reset Trip	This event is TRUE if the frequency converter is tripped (but not trip-locked) and an Automatic Reset is issued.
[43]	OK Key	This event is TRUE if [OK] is pressed.
[44]	Reset Key	This event is TRUE if [Reset] is pressed.
[45]	Left Key	This event is TRUE if [←] is pressed.
[46]	Right Key	This event is TRUE if [→] is pressed.
[47]	Up Key	This event is TRUE if [▲] is pressed.
[48]	Down Key	This event is TRUE if [▼] is pressed.
[50]	Comparator 4	Use the result of comparator 4 in the logic rule.
[51]	Comparator 5	Use the result of comparator 5 in the logic rule.
[60]	Logic rule 4	Use the result of logic rule 4 in the logic rule.
[61]	Logic rule 5	Use the result of logic rule 5 in the logic rule.
[70]	SL Time-out 3	Use the result of timer 3 in the logic rule.
[71]	SL Time-out 4	Use the result of timer 4 in the logic rule.
[72]	SL Time-out 5	Use the result of timer 5 in the logic rule.
[73]	SL Time-out 6	Use the result of timer 6 in the logic rule.
[74]	SL Time-out 7	Use the result of timer 7 in the logic rule.
[80]	No Flow	
[81]	Dry Pump	
[82]	End of Curve	

### 3.12.2 13-1\* Comparators

Comparators are used for comparing continuous variables (i.e. output frequency, output current, analog input etc.) to fixed preset values.

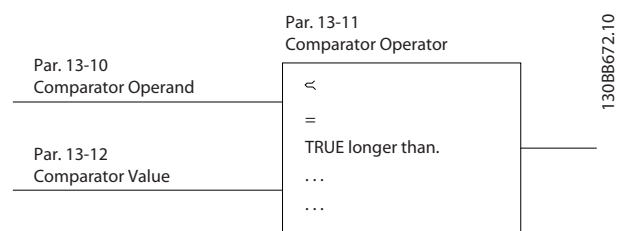

Illustration 3.37 Comparators

In addition, there are digital values that are compared to fixed time values. See explanation in *13-10 Comparator Operand*. Comparators are evaluated once in each scan interval. Use the result (TRUE or FALSE) directly. All parameters in this parameter group are array parameters with index 0 to 5. Select index 0 to programme comparator 0, select index 1 to programme comparator 1, and so on.

13-10 Comparator Operand		
Array [4]		
Option:	Function:	
	Select the variable to be monitored by the comparator.	
[0]	DISABLED	
[1]	Reference	
[2]	Feedback	
[3]	Motor speed	
[4]	Motor Current	
[5]	Motor torque	
[6]	Motor power	
[7]	Motor voltage	
[8]	DC-link voltage	
[9]	Motor Thermal	
[10]	Drive thermal	
[11]	Heat sink temp.	
[12]	Analog input AI53	
[13]	Analog input AI54	
[14]	Analog input AIFB10	
[15]	Analog input AIS24V	
[17]	Analog input AICCT	
[18]	Pulse input FI29	
[19]	Pulse input FI33	

13-10 Comparator Operand		
Array [4]		
Option:	Function:	
[20]	Alarm number	
[21]	Warning number	
[22]	Analog input x30 11	
[23]	Analog input x30 12	
[30]	Counter A	
[31]	Counter B	
[40]	Analog input x42/1	
[41]	Analog input x42/3	
[42]	Analog input x42/5	
[46]	AI53 scaled	
[47]	AI54 scaled	
[48]	AI53 unit	
[49]	AI54 unit	
[50]	FALSE	
[51]	TRUE	
[52]	Control ready	
[53]	Drive ready	
[54]	Running	
[55]	Reversing	
[56]	In range	
[60]	On reference	
[61]	Below reference, low	
[62]	Above ref, high	
[65]	Torque limit	
[66]	Current Limit	
[67]	Out of current range	
[68]	Below I low	
[69]	Above I high	
[70]	Out of speed range	
[71]	Below speed low	
[72]	Above speed high	
[75]	Out of feedback range	
[76]	Below feedback low	
[77]	Above feedback high	
[80]	Thermal warning	
[82]	Mains out of range	
[85]	Warning	
[86]	Alarm (trip)	
[87]	Alarm (trip lock)	
[90]	Bus OK	
[91]	Torque limit & stop	
[92]	Brake fault (IGBT)	
[94]	Safe stop active	
[100]	Comparator 0	
[101]	Comparator 1	
[102]	Comparator 2	
[103]	Comparator 3	
[104]	Comparator 4	
[105]	Comparator 5	
[110]	Logic rule 0	
[111]	Logic rule 1	

13-10 Comparator Operand		
Array [4]		
Option:	Function:	
[112]	Logic rule 2	
[113]	Logic rule 3	
[114]	Logic rule 4	
[115]	Logic rule 5	
[120]	SL Time-out 0	
[121]	SL Time-out 1	
[122]	SL Time-out 2	
[123]	SL Time-out 3	
[124]	SL Time-out 4	
[125]	SL Time-out 5	
[126]	SL Time-out 6	
[127]	SL Time-out 7	
[130]	Digital input DI18	
[131]	Digital input DI19	
[132]	Digital input DI27	
[133]	Digital input DI29	
[134]	Digital input DI32	
[135]	Digital input DI33	
[150]	SL digital output A	
[151]	SL digital output B	
[152]	SL digital output C	
[153]	SL digital output D	
[154]	SL digital output E	
[155]	SL digital output F	
[160]	Relay 1	
[161]	Relay 2	
[180]	Local reference active	
[181]	Remote reference active	
[182]	Start command	
[183]	Drive stopped	
[185]	Drive in hand mode	
[186]	Drive in auto mode	
[187]	Start command given	
[190]	Digital input x30/2	
[191]	Digital input x30/3	
[192]	Digital input x30/4	

13-11 Comparator Operator		
Array [6]		
Option:	Function:	
[0]	<	Select [0] < for the result of the evaluation to be TRUE, when the variable selected in <i>parameter 13-10 Comparator Operand</i> is smaller than the fixed value in <i>parameter 13-12 Comparator Value</i> . The result is FALSE, if the variable selected in <i>parameter 13-10 Comparator Operand</i> is greater than the fixed value in <i>parameter 13-12 Comparator Value</i> .

13-11 Comparator Operator		
Array [6]		
Option:	Function:	
[1]	≈ (equal)	Select [1] ≈ for the result of the evaluation to be TRUE, when the variable selected in <i>parameter 13-10 Comparator Operand</i> is approximately equal to the fixed value in <i>parameter 13-12 Comparator Value</i> .
[2]	>	Select [2] > for the inverse logic of option [0] <.
[5]	TRUE longer than..	
[6]	FALSE longer than..	
[7]	TRUE shorter than..	
[8]	FALSE shorter than..	

13-12 Comparator Value		
Array [6]		
Range:	Function:	
Size related* [-100000 - 100000 ]	Enter the 'trigger level' for the variable that is monitored by this comparator. This is an array parameter containing comparator values 0 to 5.	

### 3.12.3 13-2\* Timers

Use the result (TRUE or FALSE) from *timers* directly to define an *event* (see *parameter 13-51 SL Controller Event*), or as boolean input in a *logic rule* (see *parameter 13-40 Logic Rule Boolean 1*, *parameter 13-42 Logic Rule Boolean 2* or *parameter 13-44 Logic Rule Boolean 3*). A timer is only FALSE when started by an action (i.e. [29] *Start timer 1*) until the timer value entered in this parameter is elapsed. Then it becomes TRUE again.

All parameters in this parameter group are array parameters with index 0 to 2. Select index 0 to program Timer 0, select index 1 to program Timer 1, and so on.

13-20 SL Controller Timer		
Array [3]		
Range:	Function:	
Size related* [ 0 - 0 ]	Enter the value to define the duration of the FALSE output from the programmed timer. A timer is only FALSE if it is started by an action (i.e. [29] <i>Start timer 1</i> ) and until the given timer value has elapsed.	

### 3.12.4 13-4\* Logic Rules

Combine up to 3 boolean inputs (TRUE/FALSE inputs) from timers, comparators, digital inputs, status bits and events using the logical operators AND, OR, and NOT. Select boolean inputs for the calculation in *parameter 13-40 Logic Rule Boolean 1*, *parameter 13-42 Logic Rule Boolean 2* and *parameter 13-44 Logic Rule Boolean 3*. Define the operators used to logically combine the selected inputs in *parameter 13-41 Logic Rule Operator 1* and *parameter 13-43 Logic Rule Operator 2*.

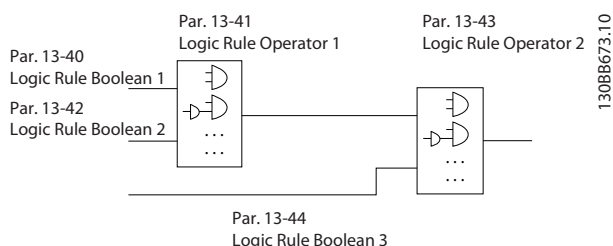

Illustration 3.38 Logic Rules

#### Priority of calculation

The results of *parameter 13-40 Logic Rule Boolean 1*, *parameter 13-41 Logic Rule Operator 1* and *parameter 13-42 Logic Rule Boolean 2* are calculated first. The outcome (TRUE/FALSE) of this calculation is combined with the settings of *parameter 13-43 Logic Rule Operator 2* and *parameter 13-44 Logic Rule Boolean 3*, yielding the final result (TRUE/FALSE) of the logic rule.

13-40 Logic Rule Boolean 1		
Array [6]		
Option:	Function:	
[0]	False	Enters the fixed value of FALSE in the logic rule.
[1]	True	Enters the fixed value TRUE in the logic rule.
[2]	Running	See parameter group 5-3* <i>Digital Outputs</i> for further description.
[3]	In range	See parameter group 5-3* <i>Digital Outputs</i> for further description.
[4]	On reference	See parameter group 5-3* <i>Digital Outputs</i> for further description.
[5]	Torque limit	See parameter group 5-3* <i>Digital Outputs</i> for further description.
[6]	Current Limit	See parameter group 5-3* <i>Digital Outputs</i> for further description.
[7]	Out of current range	See parameter group 5-3* <i>Digital Outputs</i> for further description.
[8]	Below I low	See parameter group 5-3* <i>Digital Outputs</i> for further description.

13-40 Logic Rule Boolean 1		
Array [6]		
Option:	Function:	
[9]	Above I high	See parameter group 5-3* <i>Digital Outputs</i> for further description.
[10]	Out of speed range	
[11]	Below speed low	See parameter group 5-3* <i>Digital Outputs</i> for further description.
[12]	Above speed high	See parameter group 5-3* <i>Digital Outputs</i> for further description.
[13]	Out of feedb. range	See parameter group 5-3* <i>Digital Outputs</i> for further description.
[14]	Below feedb. low	See parameter group 5-3* <i>Digital Outputs</i> for further description.
[15]	Above feedb. high	See parameter group 5-3* <i>Digital Outputs</i> for further description.
[16]	Thermal warning	See parameter group 5-3* <i>Digital Outputs</i> for further description.
[17]	Mains out of range	See parameter group 5-3* <i>Digital Outputs</i> for further description.
[18]	Reversing	See parameter group 5-3* <i>Digital Outputs</i> for further description.
[19]	Warning	See parameter group 5-3* <i>Digital Outputs</i> for further description.
[20]	Alarm (trip)	See parameter group 5-3* <i>Digital Outputs</i> for further description.
[21]	Alarm (trip lock)	See parameter group 5-3* <i>Digital Outputs</i> for further description.
[22]	Comparator 0	Use the result of comparator 0 in the logic rule.
[23]	Comparator 1	Use the result of comparator 1 in the logic rule.
[24]	Comparator 2	Use the result of comparator 2 in the logic rule.
[25]	Comparator 3	Use the result of comparator 3 in the logic rule.
[26]	Logic rule 0	Use the result of logic rule 0 in the logic rule.
[27]	Logic rule 1	Use the result of logic rule 1 in the logic rule.
[28]	Logic rule 2	Use the result of logic rule 2 in the logic rule.
[29]	Logic rule 3	Use the result of logic rule 3 in the logic rule.
[30]	SL Time-out 0	Use the result of timer 0 in the logic rule.

13-40 Logic Rule Boolean 1		
Array [6]		
Option:	Function:	
[31]	SL Time-out 1	Use the result of timer 1 in the logic rule.
[32]	SL Time-out 2	Use the result of timer 2 in the logic rule.
[33]	Digital input DI18	Use the value of DI18 in the logic rule (High = TRUE).
[34]	Digital input DI19	Use the value of DI19 in the logic rule (High = TRUE).
[35]	Digital input DI27	Use the value of DI27 in the logic rule (High = TRUE).
[36]	Digital input DI29	Use the value of DI29 in the logic rule (High = TRUE).
[37]	Digital input DI32	Use the value of DI32 in the logic rule (High = TRUE).
[38]	Digital input DI33	Use the value of DI33 in the logic rule (High = TRUE).
[39]	Start command	This logic rule is TRUE if the frequency converter is started by any means (either via digital input, fieldbus or other).
[40]	Drive stopped	This logic rule is TRUE if the frequency converter is stopped or coasted by any means (either via digital input, fieldbus or other).
[41]	Reset Trip	This logic rule is TRUE if the frequency converter is tripped (but not trip-locked) and [Reset] is pressed.
[42]	Auto Reset Trip	This logic rule is TRUE if the frequency converter is tripped (but not trip-locked) and an Automatic Reset is issued.
[43]	OK Key	This logic rule is TRUE if [OK] is pressed.
[44]	Reset Key	This logic rule is TRUE if [Reset] is pressed.
[45]	Left Key	This logic rule is TRUE if [◀] is pressed.
[46]	Right Key	This logic rule is TRUE if [▶] is pressed.
[47]	Up Key	This logic rule is TRUE if [▲] is pressed.
[48]	Down Key	This logic rule is TRUE if [▼] is pressed.
[50]	Comparator 4	Use the result of comparator 4 in the logic rule.
[51]	Comparator 5	Use the result of comparator 5 in the logic rule.
[60]	Logic rule 4	Use the result of logic rule 4 in the logic rule.

13-40 Logic Rule Boolean 1		
Array [6]		
Option:	Function:	
[61]	Logic rule 5	Use the result of logic rule 5 in the logic rule.
[70]	SL Time-out 3	Use the result of timer 3 in the logic rule.
[71]	SL Time-out 4	Use the result of timer 4 in the logic rule.
[72]	SL Time-out 5	Use the result of timer 5 in the logic rule.
[73]	SL Time-out 6	Use the result of timer 6 in the logic rule.
[74]	SL Time-out 7	Use the result of timer 7 in the logic rule.
[80]	No Flow	
[81]	Dry Pump	
[82]	End of Curve	
[83]	Broken Belt	
[102]	Verifying Flow	

13-41 Logic Rule Operator 1		
Array [6]		
Option:	Function:	
		Select the first logical operator to use on the Boolean inputs from <i>parameter 13-40 Logic Rule Boolean 1</i> and <i>parameter 13-42 Logic Rule Boolean 2</i> . Parameter numbers in square brackets stand for the boolean inputs of parameters in group 13-**. <i>Smart Logic Control</i> .
[0]	DISABLED	Ignores <i>parameter 13-42 Logic Rule Boolean 2</i> , <i>parameter 13-43 Logic Rule Operator 2</i> , and <i>parameter 13-44 Logic Rule Boolean 3</i> .
[1]	AND	Evaluates the expression [13-40] AND [13-42].
[2]	OR	Evaluates the expression [13-40] OR [13-42].
[3]	AND NOT	Evaluates the expression [13-40] AND NOT [13-42].
[4]	OR NOT	Evaluates the expression [13-40] OR NOT [13-42].
[5]	NOT AND	Evaluates the expression NOT [13-40] AND [13-42].
[6]	NOT OR	Evaluates the expression NOT [13-40] OR [13-42].
[7]	NOT AND NOT	Evaluates the expression NOT [13-40] AND NOT [13-42].
[8]	NOT OR NOT	Evaluates the expression NOT [13-40] OR NOT [13-42].

13-42 Logic Rule Boolean 2		
Array [6]		
Option:	Function:	
		Select the second boolean (TRUE or FALSE) input for the selected logic rule.  See <i>parameter 13-40 Logic Rule Boolean 1</i> for further descriptions of choices and their functions.
[0]	False	
[1]	True	
[2]	Running	
[3]	In range	
[4]	On reference	
[5]	Torque limit	
[6]	Current Limit	
[7]	Out of current range	
[8]	Below I low	
[9]	Above I high	
[10]	Out of speed range	
[11]	Below speed low	
[12]	Above speed high	
[13]	Out of feedb. range	
[14]	Below feedb. low	
[15]	Above feedb. high	
[16]	Thermal warning	
[17]	Mains out of range	
[18]	Reversing	
[19]	Warning	
[20]	Alarm (trip)	
[21]	Alarm (trip lock)	
[22]	Comparator 0	
[23]	Comparator 1	
[24]	Comparator 2	
[25]	Comparator 3	
[26]	Logic rule 0	
[27]	Logic rule 1	
[28]	Logic rule 2	
[29]	Logic rule 3	
[30]	SL Time-out 0	
[31]	SL Time-out 1	
[32]	SL Time-out 2	
[33]	Digital input DI18	
[34]	Digital input DI19	
[35]	Digital input DI27	
[36]	Digital input DI29	
[37]	Digital input DI32	
[38]	Digital input DI33	
[39]	Start command	
[40]	Drive stopped	
[41]	Reset Trip	
[42]	Auto Reset Trip	
[43]	OK Key	

13-42 Logic Rule Boolean 2		
Array [6]		
Option:	Function:	
[44]	Reset Key	
[45]	Left Key	
[46]	Right Key	
[47]	Up Key	
[48]	Down Key	
[50]	Comparator 4	
[51]	Comparator 5	
[60]	Logic rule 4	
[61]	Logic rule 5	
[70]	SL Time-out 3	
[71]	SL Time-out 4	
[72]	SL Time-out 5	
[73]	SL Time-out 6	
[74]	SL Time-out 7	
[80]	No Flow	
[81]	Dry Pump	
[82]	End of Curve	
[83]	Broken Belt	
[102]	Verifying Flow	

13-43 Logic Rule Operator 2		
Array [6]		
Option:	Function:	
		Select the second logical operator to be used on the boolean input calculated in <i>parameter 13-40 Logic Rule Boolean 1</i> , <i>parameter 13-41 Logic Rule Operator 1</i> , and <i>parameter 13-42 Logic Rule Boolean 2</i> , and the boolean input coming from <i>parameter 13-42 Logic Rule Boolean 2</i> . [13-44] signifies the boolean input of <i>parameter 13-44 Logic Rule Boolean 3</i> . [13-40/13-42] signifies the boolean input calculated in <i>parameter 13-40 Logic Rule Boolean 1</i> , <i>parameter 13-41 Logic Rule Operator 1</i> , and <i>parameter 13-42 Logic Rule Boolean 2</i> . [0] Disabled (factory setting). select this option to ignore <i>parameter 13-44 Logic Rule Boolean 3</i> .
[0]	DISABLED	
[1]	AND	
[2]	OR	
[3]	AND NOT	
[4]	OR NOT	
[5]	NOT AND	
[6]	NOT OR	
[7]	NOT AND NOT	
[8]	NOT OR NOT	

13-44 Logic Rule Boolean 3		
Array [6]		
Option:	Function:	
		Select the third boolean (TRUE or FALSE) input for the selected logic rule.  See <i>parameter 13-40 Logic Rule Boolean 1</i> for further descriptions of choices and their functions.
[0]	False	
[1]	True	
[2]	Running	
[3]	In range	
[4]	On reference	
[5]	Torque limit	
[6]	Current Limit	
[7]	Out of current range	
[8]	Below I low	
[9]	Above I high	
[10]	Out of speed range	
[11]	Below speed low	
[12]	Above speed high	
[13]	Out of feedb. range	
[14]	Below feedb. low	
[15]	Above feedb. high	
[16]	Thermal warning	
[17]	Mains out of range	
[18]	Reversing	
[19]	Warning	
[20]	Alarm (trip)	
[21]	Alarm (trip lock)	
[22]	Comparator 0	
[23]	Comparator 1	
[24]	Comparator 2	
[25]	Comparator 3	
[26]	Logic rule 0	
[27]	Logic rule 1	
[28]	Logic rule 2	
[29]	Logic rule 3	
[30]	SL Time-out 0	
[31]	SL Time-out 1	
[32]	SL Time-out 2	
[33]	Digital input DI18	
[34]	Digital input DI19	
[35]	Digital input DI27	
[36]	Digital input DI29	
[37]	Digital input DI32	
[38]	Digital input DI33	
[39]	Start command	
[40]	Drive stopped	
[41]	Reset Trip	
[42]	Auto Reset Trip	
[43]	OK Key	
[44]	Reset Key	

13-44 Logic Rule Boolean 3		
Array [6]		
Option:	Function:	
[45]	Left Key	
[46]	Right Key	
[47]	Up Key	
[48]	Down Key	
[50]	Comparator 4	
[51]	Comparator 5	
[60]	Logic rule 4	
[61]	Logic rule 5	
[70]	SL Time-out 3	
[71]	SL Time-out 4	
[72]	SL Time-out 5	
[73]	SL Time-out 6	
[74]	SL Time-out 7	
[80]	No Flow	
[81]	Dry Pump	
[82]	End of Curve	
[83]	Broken Belt	
[102]	Verifying Flow	

3.12.5 13-5\* States

13-51 SL Controller Event		
Array [20]		
Option:	Function:	
		Select the boolean input (TRUE or FALSE) to define the Smart Logic Controller event.  See <i>parameter 13-02 Stop Event</i> for further descriptions of choices and their functions.
[0]	False	
[1]	True	
[2]	Running	
[3]	In range	
[4]	On reference	
[5]	Torque limit	
[6]	Current Limit	
[7]	Out of current range	
[8]	Below I low	
[9]	Above I high	
[10]	Out of speed range	
[11]	Below speed low	
[12]	Above speed high	
[13]	Out of feedb. range	
[14]	Below feedb. low	
[15]	Above feedb. high	
[16]	Thermal warning	
[17]	Mains out of range	
[18]	Reversing	
[19]	Warning	

13-51 SL Controller Event		
Array [20]		
Option:	Function:	
[20]	Alarm (trip)	
[21]	Alarm (trip lock)	
[22]	Comparator 0	
[23]	Comparator 1	
[24]	Comparator 2	
[25]	Comparator 3	
[26]	Logic rule 0	
[27]	Logic rule 1	
[28]	Logic rule 2	
[29]	Logic rule 3	
[30]	SL Time-out 0	
[31]	SL Time-out 1	
[32]	SL Time-out 2	
[33]	Digital input DI18	
[34]	Digital input DI19	
[35]	Digital input DI27	
[36]	Digital input DI29	
[37]	Digital input DI32	
[38]	Digital input DI33	
[39]	Start command	
[40]	Drive stopped	
[41]	Reset Trip	
[42]	Auto Reset Trip	
[43]	OK Key	
[44]	Reset Key	
[45]	Left Key	
[46]	Right Key	
[47]	Up Key	
[48]	Down Key	
[50]	Comparator 4	
[51]	Comparator 5	
[60]	Logic rule 4	
[61]	Logic rule 5	
[70]	SL Time-out 3	
[71]	SL Time-out 4	
[72]	SL Time-out 5	
[73]	SL Time-out 6	
[74]	SL Time-out 7	
[80]	No Flow	
[81]	Dry Pump	
[82]	End of Curve	
[83]	Broken Belt	
[102]	Verifying Flow	

13-52 SL Controller Action		
Array [20]		
Option:	Function:	
		Select the action corresponding to the SLC event. Actions are executed when the corresponding event (defined in <i>parameter 13-51 SL Controller Event</i> ) is

13-52 SL Controller Action		
Array [20]		
Option:	Function:	
		evaluated as true. The following actions are available for selection:
[0]	Disabled	
[1]	No action	
[2]	Select set-up 1	Changes the active set-up ( <i>parameter 0-10 Active Set-up</i> ) to '1'.
[3]	Select set-up 2	Changes the active set-up ( <i>parameter 0-10 Active Set-up</i> ) to '2'.
[4]	Select set-up 3	Changes the active set-up ( <i>parameter 0-10 Active Set-up</i> ) to '3'.
[5]	Select set-up 4	Changes the active set-up ( <i>parameter 0-10 Active Set-up</i> ) to '4'. If the set-up is changed, it will merge with other set-up commands coming from either the digital inputs or via a fieldbus.
[10]	Select preset ref 0	Selects preset reference 0.
[11]	Select preset ref 1	Selects preset reference 1.
[12]	Select preset ref 2	Selects preset reference 2.
[13]	Select preset ref 3	Selects preset reference 3.
[14]	Select preset ref 4	Selects preset reference 4.
[15]	Select preset ref 5	Selects preset reference 5.
[16]	Select preset ref 6	Selects preset reference 6.
[17]	Select preset ref 7	Selects preset reference 7. If the active preset reference is changed, it will merge with other preset reference commands coming from either the digital inputs or via a fieldbus.
[18]	Select ramp 1	Selects ramp 1
[19]	Select ramp 2	Selects ramp 2
[22]	Run	Issues a start command to the frequency converter.
[23]	Run reverse	Issues a start reverse command to the frequency converter.
[24]	Stop	Issues a stop command to the frequency converter.
[26]	DC Brake	Issues a DC stop command to the frequency converter.
[27]	Coast	The frequency converter coasts immediately. All stop commands including the coast command stop the SLC.



13-52 SL Controller Action		
Array [20]		
Option:	Function:	
[28]	Freeze output	Freezes the output frequency of the frequency converter.
[29]	Start timer 0	Starts timer 0, see <i>parameter 13-20 SL Controller Timer</i> for further description.
[30]	Start timer 1	Starts timer 1, see <i>parameter 13-20 SL Controller Timer</i> for further description.
[31]	Start timer 2	Starts timer 2, see <i>parameter 13-20 SL Controller Timer</i> for further description.
[32]	Set digital out A low	Any output with 'digital output 1' selected is low (off).
[33]	Set digital out B low	Any output with 'digital output 2' selected is low (off).
[34]	Set digital out C low	Any output with 'digital output 3' selected is low (off).
[35]	Set digital out D low	Any output with 'digital output 4' selected is low (off).
[36]	Set digital out E low	Any output with 'digital output 5' selected is low (off).
[37]	Set digital out F low	Any output with 'digital output 6' selected is low (off).
[38]	Set digital out A high	Any output with 'digital output 1' selected is high (closed).
[39]	Set digital out B high	Any output with 'digital output 2' selected is high (closed).
[40]	Set digital out C high	Any output with 'digital output 3' selected is high (closed).
[41]	Set digital out D high	Any output with 'digital output 4' selected is high (closed).
[42]	Set digital out E high	Any output with 'digital output 5' selected is high (closed).
[43]	Set digital out F high	Any output with 'digital output 6' selected is high (closed).
[60]	Reset Counter A	Resets Counter A to zero.
[61]	Reset Counter B	Resets Counter A to zero.
[70]	Start Timer 3	Starts timer 3, see <i>parameter 13-20 SL Controller Timer</i> for further description.
[71]	Start Timer 4	Starts timer 4, see <i>parameter 13-20 SL Controller Timer</i> for further description.
[72]	Start Timer 5	Starts timer 5, see <i>parameter 13-20 SL Controller Timer</i> for further description.
[73]	Start Timer 6	Starts timer 6, see <i>parameter 13-20 SL Controller Timer</i> for further description.

13-52 SL Controller Action		
Array [20]		
Option:	Function:	
[74]	Start Timer 7	Starts timer 7, see <i>parameter 13-20 SL Controller Timer</i> for further description.
[80]	Sleep Mode	Starts the Sleep Mode.
[81]	Derag	Starts Deragging (see parameter groups 29-1* <i>Deragging Function</i> to 29-3* for further information)

### 3.13 Parameters 14-\*\* Special Functions

#### 3.13.1 14-0\* Inverter Switching

14-00 Switching Pattern		
Option:	Function:	
		Select the switching pattern: 60° AVM or SFAVM.
[0]	60 AVM	
[1]	SFAVM	

14-01 Switching Frequency		
Option:	Function:	
		Select the inverter switching frequency. Changing the switching frequency can help to reduce acoustic noise from the motor.  <b>NOTICE</b> The output frequency value of the frequency converter must never exceed 1/10 of the switching frequency. When the motor is running, adjust the switching frequency in <i>parameter 14-01 Switching Frequency</i> until the motor is as noiseless as possible. See also <i>parameter 14-00 Switching Pattern</i> and section <i>Derating in the FC 302 Design Guide</i> .
[0]	1.0 kHz	
[1]	1.5 kHz	
[2]	2.0 kHz	
[3]	2.5 kHz	
[4]	3.0 kHz	
[5]	3.5 kHz	
[6]	4.0 kHz	
[7]	5.0 kHz	
[8]	6.0 kHz	
[9]	7.0 kHz	
[10]	8.0 kHz	
[11]	10.0 kHz	
[12]	12.0kHz	
[13]	14.0 kHz	
[14]	16.0kHz	

14-03 Overmodulation		
Option:	Function:	
[0]	Off	Selects no over-modulation of the output voltage in order to avoid torque ripple on the motor shaft.
[1]	On	The over-modulation function generates an extra voltage of up-to 8% of $U_{max}$ output voltage without over-modulation, which results in an extra torque of 10-12% in the middle of the over-synchronous range (from 0% at nominal speed rising to approximately 12% at double nominal speed).

14-04 PWM Random		
Option:	Function:	
[0]	Off	No change of the acoustic motor switching noise.
[1]	On	Transforms the acoustic motor switching noise from a clear ringing tone to a less noticeable 'white' noise. This is achieved by slightly and randomly altering the synchronism of the pulse width modulated output phases.

#### 3.13.2 14-1\* Mains On/Off

Parameters for configuring mains failure monitoring and handling.

14-10 Mains Failure		
Option:	Function:	
		Select the function at which the frequency converter must act, when the threshold set in <i>parameter 14-11 Mains Voltage at Mains Fault</i> has been reached or a <i>Mains Failure Inverse</i> command is activated via one of the digital inputs (parameter group 5-1* <i>Digital Inputs</i> ).  Only selection [0] <i>No function</i> , [3] <i>Coasting</i> or [6] <i>Alarm</i> is available when <i>parameter 1-10 Motor Construction</i> is set to [1] <i>PM</i> , non-salient SPM.
[0]	No function	The energy left in the capacitor bank is used to run the motor, but is discharged.
[1]	Ctrl. ramp-down	The frequency converter performs a controlled ramp down. <i>Parameter 2-10 Brake Function</i> must be set to [0] <i>Off</i> .
[3]	Coasting	The frequency converter turns off and the capacitor bank backs up the control card then ensuring a faster restart when mains reconnected (at short power zags).
[4]	Kinetic back-up	The frequency converter rides through by controlling speed for generative operation of the motor utilising the moment of inertia of the system as long as sufficient energy is present.
[6]	Alarm	

#### NOTICE

For best performance of controlled ramp down and kinetic back-up *1-03 Torque Characteristics* should be set to *Compressor* [0] or *Variable Torque* [1] (no automatic energy optimization should be active).

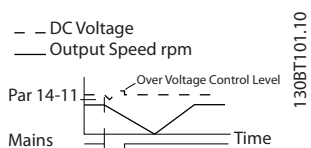

**Illustration 3.39 Controlled Ramp Down - Short Mains Failure.**  
Ramping down to stop followed by ramping up to reference.

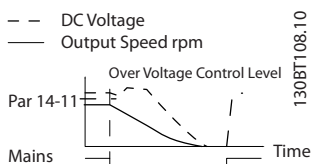

**Illustration 3.40 Controlled Ramp Down, Longer Mains Failure.**  
Ramping down as long as the energy in the system allows for it, then the motor is coasted.

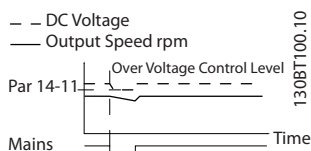

**Illustration 3.41 Kinetic Back-up, Short Mains Failure.**  
Ride through as long as the energy in the system allows for it.

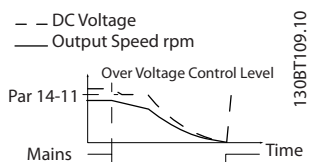

**Illustration 3.42 Kinetic Back-up, Longer Mains Failure.**  
The motor is coasted as soon as the energy in the system is too low.

14-11 Mains Voltage at Mains Fault		
Range:	Function:	
Size related*	[180 - 600 V]	This parameter defines the threshold voltage at which the selected function in <i>parameter 14-10 Mains Failure</i> should be activated. The detection level is at a factor <sup>2</sup> of the value in <i>parameter 14-11 Mains Voltage at Mains Fault</i> .

14-12 Function at Mains Imbalance	
Option:	Function:
	Operation under severe mains imbalance conditions reduces the lifetime of the motor. Conditions are considered severe if the motor is operated continuously near nominal load (e.g. a pump or fan running near full speed).

14-12 Function at Mains Imbalance		
Option:	Function:	
	When a severe mains imbalance is detected:	
[0]	Trip	Select [0] <i>Trip</i> to trip the frequency converter.
[1]	Warning	Select [1] <i>Warning</i> to issue a warning.
[2]	Disabled	Select [2] <i>Disabled</i> for no action.
[3]	Derate	Select [3] <i>Derate</i> for derating the frequency converter.

### 3.13.3 14-2\* Trip Reset

Parameters for configuring auto reset handling, special trip handling and control card self test or initialisation.

14-20 Reset Mode		
Option:	Function:	
[0]	Manual reset	
[1]	Automatic reset x 1	
[2]	Automatic reset x 2	
[3]	Automatic reset x 3	
[4]	Automatic reset x 4	
[5]	Automatic reset x 5	
[6]	Automatic reset x 6	
[7]	Automatic reset x 7	
[8]	Automatic reset x 8	
[9]	Automatic reset x 9	
[10]	Automatic reset x 10	
[11]	Automatic reset x 15	
[12]	Automatic reset x 20	
[13]	Infinite auto reset	Select the reset function after tripping. Once reset, the frequency converter can be restarted. Select [0] <i>Manual reset</i> , to perform a reset via [Reset] or via the digital inputs. Select [1]-[12] <i>Automatic reset x 1...x20</i> to perform between one and twenty automatic resets after tripping. Select [13] <i>Infinite Automatic Reset</i> for continuous resetting after tripping.

14-20 Reset Mode	
Option:	Function:
	<p><b>NOTICE</b></p> <p>The motor may start without warning. If the specified number of AUTOMATIC RESETs is reached within 10 minutes, the frequency converter enters [0] Manual reset mode. After the Manual reset is performed, the setting of 14-20 Reset Mode reverts to the original selection. If the number of automatic resets is not reached within 10 minutes, or when a Manual reset is performed, the internal AUTOMATIC RESET counter returns to zero.</p>
14-21 Automatic Restart Time	
Range:	Function:
10 s* [0 - 600 s]	Enter the time interval from trip to start of the automatic reset function. This parameter is active when 14-20 Reset Mode is set to [1] - [13] Automatic reset.
14-22 Operation Mode	
Option:	Function:
	Use this parameter to specify normal operation, to perform tests or to initialise all parameters except parameter 15-03 Power Up's, parameter 15-04 Over Temp's and parameter 15-05 Over Volt's. This function is active only when the power is cycled (power off-power on) to the frequency converter.
[0]	Normal operation Select [0] Normal operation for normal operation of the frequency converter with the motor in the selected application.
[1]	Control card test Select [1] Control card test to test the analog and digital inputs and outputs and the +10 V control voltage. The test requires a test connector with internal connections.  Use the following procedure for the control card test:  <ol style="list-style-type: none"> <li>Select [1] Control card test.</li> <li>Disconnect the mains supply and wait for the light in the display to go out.</li> <li>Set switches S201 (A53) and S202 (A54) = 'ON'/I.</li> <li>Insert the test plug (see Illustration 3.43).</li> </ol>

14-22 Operation Mode	
Option:	Function:
	<ol style="list-style-type: none"> <li>Connect to mains supply.</li> <li>Carry out various tests.</li> <li>The results are displayed on the LCP and the frequency converter moves into an infinite loop.</li> <li>Parameter 14-22 Operation Mode is automatically set to [0] Normal operation. Carry out a power cycle to start up in Normal operation after a control card test.</li> </ol> <p><b>If the test is OK</b> LCP read-out: Control Card OK. Disconnect the mains supply and remove the test plug. The green LED on the control card lights up.</p> <p><b>If the test fails</b> LCP read-out: Control Card I/O failure. Replace the frequency converter or control card. The red LED on the control card is turned on. To test the plugs, connect/group the following terminals as shown in Illustration 3.43: (18 - 27 - 32), (19 - 29 - 33) and (42 - 53 - 54).</p> <p><b>Illustration 3.43 Wiring Control Card Test</b></p>
[2]	Initialisation Select [2] Initialisation to reset all parameter values to default settings, except for parameter 15-03 Power Up's, parameter 15-04 Over Temp's and parameter 15-05 Over Volt's. The frequency converter resets during the next power-up. Parameter 14-22 Operation Mode also reverts to the default setting [0] Normal operation.
[3]	Boot mode
14-23 Typecode Setting	
Option:	Function:
	Typecode re-writing. Use this parameter to set the typecode matching the specific frequency converter.

14-25 Trip Delay at Torque Limit		
Range:		Function:
60 s*	[0 - 60 s]	Enter the torque limit trip delay in seconds. When the output torque reaches the torque limits ( <i>parameter 4-16 Torque Limit Motor Mode</i> and <i>parameter 4-17 Torque Limit Generator Mode</i> ), a warning is triggered. When the torque limit warning has been continuously present for the period specified in this parameter, the frequency converter trips. Disable the trip delay by setting the parameter to 60 s = OFF. Thermal frequency converter monitoring remains active.

14-26 Trip Delay at Inverter Fault		
Range:		Function:
Size related*	[0 - 35 s]	When the frequency converter detects an overvoltage in the set time, trip is effected after the set time.

### 3.13.4 14-3\* Current Limit Control

The frequency converter features an integral current limit controller which is activated when the motor current, and thus the torque, is higher than the torque limits set in *parameter 4-16 Torque Limit Motor Mode* and *parameter 4-17 Torque Limit Generator Mode*.

When the current limit is reached during motor operation or regenerative operation, the frequency converter tries to reduce torque below the preset torque limits as quickly as possible without losing control of the motor.

While the current control is active, the frequency converter can only be stopped by setting a digital input to [2] *Coast inverse* or [3] *Coast and reset inv.* Any signal on terminals 18 to 33 are not active until the frequency converter is no longer near the current limit.

By using a digital input set to [2] *Coast inverse* or [3] *Coast and reset inv.*, the motor does not use the ramp-down time, since the frequency converter is coasted.

14-30 Current Lim Ctrl, Proportional Gain		
Range:		Function:
100 %*	[5 - 500 %]	Enter the proportional gain value for the current limit controller. Selection of a high value makes the controller react faster. Too high a setting leads to controller instability.

14-31 Current Lim Ctrl, Integration Time		
Range:		Function:
Size related*	[0.002 - 2 s]	Controls the current limit control integration time. Setting it to a lower value makes it react faster. A setting too low leads to control instability.

14-32 Current Lim Ctrl, Filter Time		
Range:		Function:
Size related*	[1 - 100 ms]	Sets a time constant for the current limit controller low-pass filter.

### 3.13.5 14-4\* Energy Optimising

Parameters for adjusting the energy optimisation level in both Variable Torque (VT) and Automatic Energy Optimization (AEO) mode.

Automatic Energy Optimisation is only active if *1-03 Torque Characteristics*, is set for either [2] *Auto Energy Optim. CT* or [3] *Auto Energy Optim. VT*.

14-40 VT Level		
Range:		Function:
66 %*	[40 - 90 %]	<p><b>NOTICE</b></p> <p>This parameter cannot be adjusted while the motor is running.</p> <p>Enter the level of motor magnetisation at low speed. Selection of a low value reduces energy loss in the motor, but also reduces load capability.</p>

#### NOTICE

This parameter is not active when *parameter 1-10 Motor Construction* is set to [1] *PM, non-salient SPM*.

14-41 AEO Minimum Magnetisation		
Range:		Function:
Size related*	[40 - 75 %]	Enter the minimum allowable magnetisation for AEO. Selection of a low value reduces energy loss in the motor, but can also reduce resistance to sudden load changes.

#### NOTICE

This parameter is not active when *parameter 1-10 Motor Construction* is set to [1] *PM, non-salient SPM*.

14-42 Minimum AEO Frequency		
Range:		Function:
10 Hz*	[5 - 40 Hz]	Enter the minimum frequency at which the Automatic Energy Optimisation (AEO) is to be active.

#### NOTICE

This parameter is not active when *parameter 1-10 Motor Construction* is set to [1] *PM, non-salient SPM*.

14-43 Motor Cosphi		
Range:		Function:
Size related*	[0.40 - 0.95 ]	The Cos(phi) setpoint is automatically set for optimum AEO performance during AMA. This parameter should normally not be altered. However in some situations it may be necessary to enter a new value to fine-tune.

### NOTICE

This parameter is not active when *parameter 1-10 Motor Construction* is set to [1] PM, non-salient SPM.

### 3.13.6 14-5\* Environment

These parameters help the frequency converter to operate under special environmental conditions.

14-50 RFI Filter		
Option:		Function:
[0]	Off	Select [0] Off only when the frequency converter is supplied from an isolated mains source, i.e. IT mains. In this mode, the internal RFI capacities (filter capacitors) between chassis and the Mains RFI Filter circuit are cut off to avoid damage to the intermediate circuit and to reduce the ground capacity currents (according to IEC 61800-3).
[1]	On	Select [1] On to ensure the frequency converter complies with EMC standards.

14-51 DC Link Compensation		
Option:		Function:
		The rectified AC-DC voltage at the frequency converter's DC-link is associated with voltage ripples. These ripples can increase in magnitude with increased load. These ripples are undesirable because they can generate current and torque ripples. A compensation method is used to reduce these voltage ripples at DC-link. In general, DC-link compensation is recommended for most applications, but care must be taken when operating in field weakening as it can generate speed oscillations at the motor shaft. In field weakening, it is recommended to turn DC-link compensation off.
[0]	Off	Disables DC-link Compensation.
[1]	On	Enables DC-link Compensation.

14-52 Fan Control		
Option:		Function:
		Select the minimum speed of the main fan.
[0]	Auto	Select [0] Auto to run the fan only when the internal temperature of the frequency converter is in the range +35 °C to approximately +55 °C. The fan runs at low speed at

14-52 Fan Control		
Option:		Function:
		+35 °C and at full speed at approximately +55 °C.
[1]	On 50%	
[2]	On 75%	
[3]	On 100%	
[4]	Auto (Low temp env.)	

14-53 Fan Monitor		
Option:		Function:
		Select which reaction the frequency converter should take in case a fan fault is detected.
[0]	Disabled	
[1]	Warning	
[2]	Trip	

14-55 Output Filter		
Option:		Function:
		<b>NOTICE</b> This parameter cannot be adjusted while motor is running.  Select the type of output filter connected.
[0]	No Filter	
[1]	Sine-Wave Filter	
[2]	Sine-Wave Filter Fixed	If a Danfoss Sine-wave filter is connected to the output, this option secures that the switching frequency is fixed above the design frequency of the filter (to be set in <i>parameter 14-01 Switching Frequency</i> ) in the specific power size. This prevents the filter from being noisy, overheated and damaged.  <b>NOTICE</b> The switching frequency will still be automatically controlled by the TAS feature depending on the temperature but limited to always be above the critical level for the Danfoss filter.

14-59 Actual Number of Inverter Units		
Range:		Function:
Size related*	[ 1 - 1 ]	Sets the actual number of operating inverter units.

### 3.13.7 14-6\* Auto Derate

This group contains parameters for derating the frequency converter in case of high temperature.

14-60 Function at Over Temperature		
If either heat sink or control card temperature exceeds a programmed temperature limit, a warning is activated. If the temperature increases further, select whether the frequency converter should trip (trip locked) or derate the output current.		
Option:	Function:	
[0]	Trip	The frequency converter trips (trip locked) and generates an alarm. Power must be cycled to reset the alarm, but does not allow restart of the motor until the heat sink temperature has dropped below the alarm limit.
[1]	Derate	If the critical temperature is exceeded the output current is reduced until the allowable temperature has been reached.

### 3.13.8 No Trip at Inverter Overload

In some pump systems, the frequency converter has not been sized properly to yield the current needed in all points of the operational flow-head characteristic. At these points, the pump needs a current higher than the rated current of the frequency converter. The frequency converter can yield 110% of the rated current continuously for 60 s. If still overloaded, the frequency converter normally trips (causing the pump to stop by coasting) and provides an alarm.

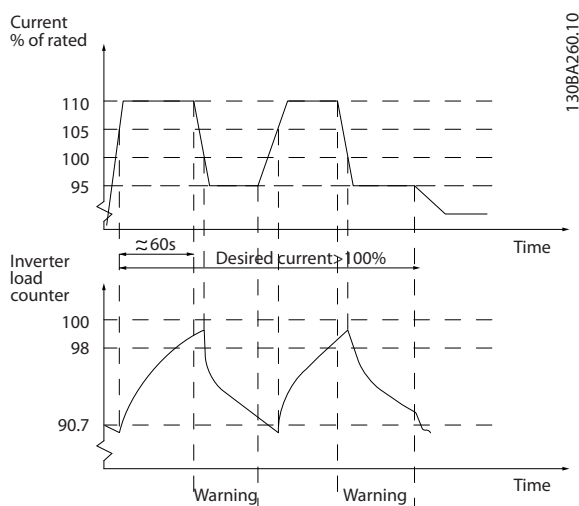

Illustration 3.44 Output Current in Overload Condition

It may be preferable to run the pump at reduced speed for a while in case it is not possible to run continuously with demanded capacity.

Select *14-61 Function at Inverter Overload* to automatically reduce pump speed until the output current is below 100% of the rated current (set in *parameter 14-62 Inv. Overload Derate Current*).

*14-61 Function at Inverter Overload* is an alternative to letting the frequency converter trip.

The frequency converter estimates the load on the power section by means of an inverter load counter, which causes a warning at 98% and a reset of the warning at 90%. At the value 100%, the frequency converter trips and provides an alarm.

Status for the counter can be read in *parameter 16-35 Inverter Thermal*.

If *14-61 Function at Inverter Overload* is set to [3] *Derate*, the pump speed is reduced when the counter exceeds 98, and stays reduced until the counter has dropped below 90.7. If *parameter 14-62 Inv. Overload Derate Current* is set e.g. to 95%, a steady overload causes the pump speed to fluctuate between values corresponding to 110% and 95% of rated output current for the frequency converter.

14-61 Function at Inverter Overload		
Is used in case of steady overload beyond the thermal limits (110% for 60 s).		
Option:	Function:	
[0]	Trip	The frequency converter trips and provides an alarm.
[1]	Derate	Reduces pump speed to decrease the load on the power section and allowing this to cool down.

14-62 Inv. Overload Derate Current		
Range:	Function:	
95 %*	[50 - 100 %]	Defines the desired current level (in % of rated output current for the frequency converter) when running with reduced pump speed after load on the frequency converter has exceeded the allowable limit (110% for 60 s).

### 3.13.9 14-9\* Fault Settings

14-90 Fault Level		
Option:	Function:	
[0]	Off	Use this parameter to customise fault levels. Use [0] <i>Off</i> with caution as it ignores all warnings and alarms for the selected source.
[1]	Warning	
[2]	Trip	
[3]	Trip Lock	
[4]	Trip w. delayed reset	

Failure	Parameter	Alarm	Off	Warning	Trip	Trip Lock
10 V low	1490.0	1	X	D		
24 V low	1490.1	47	X			D
1.8 V supply low	1490.2	48	X			D
Voltage limit	1490.3	64	X	D		
Earth Fault	1490.4 <sup>1)</sup>	14			D	X
Earth Fault 2	1490.5 <sup>1)</sup>	45			D	X
Derag Limit Fault	1490.16 <sup>1, 2)</sup>	100			D	X

**Table 3.17 Table for Selection of Choice of Action when Selected Alarm Appears**

*D = Default setting. x = possible selection.*

*1) Only these faults are configurable on the FC 202. Due to a software limitation with array parameters, all of the other show in the MCT 10 Set-up Software. For the other parameter indices, writing any other value than its current value (i.e. the default value) returns a "value out of range" error. Thus, it is not allowed to change the fault level for the non-configurable ones.*

*2) This parameter has been 1490.6 in all firmware versions up to 1.86.*



### 3.14 Parameters 15-\*\* Frequency Converter Information

Parameter group containing frequency converter information such as operating data, hardware configuration and software versions.

#### 3.14.1 15-0\* Operating Data

15-00 Operating hours		
Range:	Function:	
0 h*	[0 - 2147483647 h]	View how many hours the frequency converter has run. The value is saved when the frequency converter is turned off.

15-01 Running Hours		
Range:	Function:	
0 h*	[0 - 2147483647 h]	View how many hours the motor has run. Reset the counter in <i>parameter 15-07 Reset Running Hours Counter</i> . The value is saved when the frequency converter is turned off.

15-02 kWh Counter		
Range:	Function:	
0 kWh*	[0 - 2147483647 kWh]	Registering the power consumption of the motor as a mean value over one hour. Reset the counter in <i>parameter 15-06 Reset kWh Counter</i> .

15-03 Power Up's		
Range:	Function:	
0 *	[0 - 2147483647 ]	View the number of times the frequency converter has been powered up.

15-04 Over Temp's		
Range:	Function:	
0 *	[0 - 65535 ]	View the number of frequency converter temperature faults which have occurred.

15-05 Over Volt's		
Range:	Function:	
0 *	[0 - 65535 ]	View the number of frequency converter overvoltages which have occurred.

15-06 Reset kWh Counter		
Option:	Function:	
[0]	Do not reset	No reset of the kWh counter is desired.
[1]	Reset counter	Press [OK] to reset the kWh counter to zero (see <i>parameter 15-02 kWh Counter</i> ).

### NOTICE

The reset is carried out by pressing [OK].

15-07 Reset Running Hours Counter		
Option:	Function:	
[0]	Do not reset	No reset of the Running Hours counter is desired.
[1]	Reset counter	Select [1] <i>Reset counter</i> and press [OK] to reset the Running Hours counter ( <i>parameter 15-01 Running Hours</i> ) and <i>parameter 15-08 Number of Starts</i> to zero (see also <i>parameter 15-01 Running Hours</i> ).

15-08 Number of Starts		
Range:	Function:	
0 *	[0 - 2147483647 ]	This is a read out parameter only. The counter shows the numbers of starts and stops caused by a normal Start/Stop command and/or when entering/leaving sleep mode.

### NOTICE

This parameter is reset when resetting *parameter 15-07 Reset Running Hours Counter*.

#### 3.14.2 15-1\* Data Log Settings

The Data Log enables continuous logging of up to 4 data sources (*15-10 Logging Source*) at individual rates (*parameter 15-11 Logging Interval*). A trigger event (*parameter 15-12 Trigger Event*) and window (*parameter 15-14 Samples Before Trigger*) are used to start and stop the logging conditionally.

14-10 Mains Failure		
Option:	Function:	
		Select the function at which the frequency converter must act, when the threshold set in <i>parameter 14-11 Mains Voltage at Mains Fault</i> has been reached or a <i>Mains Failure Inverse</i> command is activated via one of the digital inputs (parameter group 5-1*).
		Only selection [0] No function, [3] Coasting or [6] Alarm is available when <i>parameter 1-10 Motor Construction</i> is set to [1] PM, non salient SPM.
[0]	No function	The energy left in the capacitor bank will be used to run the motor, but will be discharged.
[1]	Ctrl. ramp-down	The frequency converter will perform a controlled ramp down. <i>Parameter 2-10 Brake Function</i> must be set to [0] Off.
[3]	Coasting	The inverter will turn off and the capacitor bank will back up the control card then ensuring a faster restart when mains reconnected (at short power zags).
[4]	Kinetic back-up	The frequency converter will ride through by controlling speed for generative operation of the motor utilizing the moment of inertia of the system as long as sufficient energy is present.
[6]	Alarm	

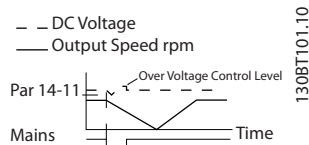

Illustration 3.45 Controlled Ramp Down - Short Mains Failure. Ramping down to stop followed by ramping up to reference.

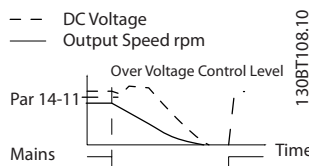

Illustration 3.46 Controlled Ramp Down, Longer Mains Failure. Ramping down as long as the energy in the system allows for it, then the motor is coasted.

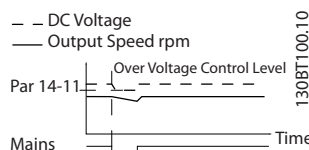

Illustration 3.47 Kinetic Back-up, Short Mains Failure. Ride through as long as the energy in the system allows for it.

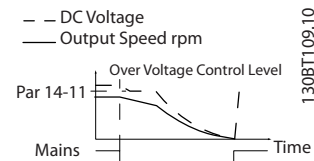

Illustration 3.48 Kinetic Back-up, Longer Mains Failure. The motor is coasted as soon as the energy in the system is too low.

15-11 Logging Interval		
Array [4]		
Range:	Function:	
Size related*	[ 0 - 0 ]	Enter the interval in ms between each sampling of the variables to be logged.

15-12 Trigger Event		
Option:	Function:	
		Selects the trigger event. When the trigger event occurs, a window is applied to freeze the log. The log then retains a specified percentage of samples before the occurrence of the trigger event ( <i>parameter 15-14 Samples Before Trigger</i> ).
[0]	False	
[1]	True	
[2]	Running	
[3]	In range	
[4]	On reference	
[5]	Torque limit	
[6]	Current Limit	
[7]	Out of current range	
[8]	Below I low	
[9]	Above I high	
[10]	Out of speed range	
[11]	Below speed low	
[12]	Above speed high	
[13]	Out of feedb. range	
[14]	Below feedb. low	
[15]	Above feedb. high	
[16]	Thermal warning	
[17]	Mains out of range	
[18]	Reversing	
[19]	Warning	
[20]	Alarm (trip)	
[21]	Alarm (trip lock)	
[22]	Comparator 0	
[23]	Comparator 1	
[24]	Comparator 2	
[25]	Comparator 3	
[26]	Logic rule 0	
[27]	Logic rule 1	

15-12 Trigger Event		
Option:	Function:	
[28]	Logic rule 2	
[29]	Logic rule 3	
[33]	Digital input DI18	
[34]	Digital input DI19	
[35]	Digital input DI27	
[36]	Digital input DI29	
[37]	Digital input DI32	
[38]	Digital input DI33	
[50]	Comparator 4	
[51]	Comparator 5	
[60]	Logic rule 4	
[61]	Logic rule 5	

15-13 Logging Mode		
Option:	Function:	
[0]	Log always	Select [0] Log always for continuous logging.
[1]	Log once on trigger	Select [1] Log once on trigger to conditionally start and stop logging using parameter 15-12 Trigger Event and parameter 15-14 Samples Before Trigger.

15-14 Samples Before Trigger		
Range:	Function:	
50 *	[0 - 100 ]	Enter the percentage of all samples before a trigger event which are to be retained in the log. See also parameter 15-12 Trigger Event and parameter 15-13 Logging Mode.

### 3.14.3 15-2\* Historic Log

View up to 50 logged data items via the array parameters in this parameter group. For all parameters in the group, [0] is the most recent data and [49] the oldest data. Data is logged every time an *event* occurs (not to be confused with SLC events). *Events* in this context are defined as a change in one of the following areas

1. Digital input
2. Digital outputs (not monitored in this SW release)
3. Warning word
4. Alarm word
5. Status word
6. Control word
7. Extended status word

*Events* are logged with value, and time stamp in ms. The time interval between 2 events depends on how often *events* occur (maximum once every scan time). Data logging is continuous, but if an alarm occurs, the log is saved and the values can be viewed on the display. This feature is useful, for example when carrying out service

following a trip. View the historic log contained in this parameter via the serial communication port or via the display.

15-20 Historic Log: Event		
Array [50]		
Range:	Function:	
0 *	[0 - 255 ]	View the event type of the logged events.

15-21 Historic Log: Value		
Array [50]		
Range:	Function:	
0 *	[0 - 2147483647 ]	View the value of the logged event. Interpret the event values according to this table:
	Digital input	Decimal value. See 16-60 Digital Input for description after converting to binary value.
	Digital output (not monitored in this SW release)	Decimal value. See 16-66 Digital Output [bin] for description after converting to binary value.
	Warning word	Decimal value. See 16-92 Warning Word for description.
	Alarm word	Decimal value. See 16-90 Alarm Word for description.
	Status word	Decimal value. See parameter 16-03 Status Word for description after converting to binary value.
	Control word	Decimal value. See parameter 16-00 Control Word for description.
	Extended status word	Decimal value. See 16-94 Ext. Status Word for description.

15-22 Historic Log: Time		
Array [50]		
Range:	Function:	
0 ms*	[0 - 2147483647 ms]	View the time at which the logged event occurred. Time is measured in ms since frequency converter start. The max. value corresponds to approx. 24 days which means that the count restarts at zero after this time period.

15-23 Historic log: Date and Time		
Array [50]		
<b>Range:</b>	<b>Function:</b>	
Size related* [0 - 0]	Array parameter; Date & Time 0 - 49: This parameter shows at which time the logged event occurred.	

### 3.14.4 15-3\* Alarm Log

Parameters in this group are array parameters, where up to 10 fault logs can be viewed. [0] is the most recent logged data, and [9] the oldest. Error codes, values, and time stamp can be viewed for all logged data.

15-30 Alarm Log: Error Code		
Array [10]		
<b>Range:</b>	<b>Function:</b>	
0 * [0 - 255]	View the error code and look up its meaning in <i>chapter 5 Troubleshooting</i> .	

15-31 Alarm Log: Value		
Array [10]		
<b>Range:</b>	<b>Function:</b>	
0 * [-32767 - 32767]	View an extra description of the error. This parameter is mostly used in combination with alarm 38 'internal fault'.	

15-32 Alarm Log: Time		
Array [10]		
<b>Range:</b>	<b>Function:</b>	
0 s* [0 - 2147483647 s]	View the time when the logged event occurred. Time is measured in seconds from frequency converter start-up.	

15-33 Alarm Log: Date and Time		
Array [10]		
<b>Range:</b>	<b>Function:</b>	
Size related* [0 - 0]	Array parameter; Date & Time 0 - 9: This parameter shows at which time the logged event occurred.	

15-34 Alarm Log: Setpoint		
Array [10]		
<b>Range:</b>	<b>Function:</b>	
0 ProcessCtrlUnit* [-999999.999 - 999999.999 ProcessCtrlUnit]	Array parameter, status value 0 - 9. This parameter shows the status of the alarm: 0: Alarm inactive 1: Alarm active	

15-35 Alarm Log: Feedback		
Array [10]		
<b>Range:</b>	<b>Function:</b>	
0 ProcessCtrlUnit* [-999999.999 - 999999.999 ProcessCtrlUnit]		

15-36 Alarm Log: Current Demand		
Array [10]		
<b>Range:</b>	<b>Function:</b>	
0 %* [0 - 100 %]		

15-37 Alarm Log: Process Ctrl Unit		
Array [10]		
<b>Option:</b>	<b>Function:</b>	
[0]	-	
[1]	%	
[5]	PPM	
[10]	l/min	
[11]	RPM	
[12]	Pulse/s	
[20]	l/s	
[21]	l/min	
[22]	l/h	
[23]	m <sup>3</sup> /s	
[24]	m <sup>3</sup> /min	
[25]	m <sup>3</sup> /h	
[30]	kg/s	
[31]	kg/min	
[32]	kg/h	
[33]	t/min	
[34]	t/h	
[40]	m/s	
[41]	m/min	
[45]	m	
[60]	°C	
[70]	mbar	
[71]	bar	
[72]	Pa	
[73]	kPa	
[74]	m WG	
[75]	mm Hg	
[80]	kW	
[120]	GPM	
[121]	gal/s	
[122]	gal/min	
[123]	gal/h	
[124]	CFM	
[125]	ft <sup>3</sup> /s	
[126]	ft <sup>3</sup> /min	
[127]	ft <sup>3</sup> /h	
[130]	lb/s	
[131]	lb/min	
[132]	lb/h	
[140]	ft/s	

15-37 Alarm Log: Process Ctrl Unit		
Array [10]		
Option:	Function:	
[141]	ft/min	
[145]	ft	
[160]	°F	
[170]	psi	
[171]	lb/in <sup>2</sup>	
[172]	in WG	
[173]	ft WG	
[174]	in Hg	
[180]	HP	

### 3.14.5 15-4\* Drive Identification

Parameters containing read only information about the hardware and software configuration of the frequency converter.

15-40 FC Type		
Range:	Function:	
0 * [0 - 6]	View the FC type. The read-out is identical to the VLT AQUA Drive Series power field of the type code definition, characters 1-6.	

15-41 Power Section		
Range:	Function:	
0 * [0 - 20]	View the FC type. The read-out is identical to the VLT AQUA Drive Series power field of the type code definition, characters 7-10.	

15-42 Voltage		
Range:	Function:	
0 * [0 - 20]	View the FC type. The read-out is identical to the VLT AQUA Drive Series power field of the type code definition, characters 11-12.	

15-43 Software Version		
Range:	Function:	
0 * [0 - 5]	View the combined SW version (or 'package version') consisting of power SW and control SW.	

15-44 Ordered Typecode String		
Range:	Function:	
0 * [0 - 40]	View the type code string used for re-ordering the frequency converter in its original configuration.	

15-45 Actual Typecode String		
Range:	Function:	
0 * [0 - 40]	View the actual type code string.	

15-46 Frequency Converter Ordering No		
Range:	Function:	
0 * [0 - 8]	View the 8-digit ordering number used for re-ordering the frequency converter in its original configuration.	

15-47 Power Card Ordering No		
Range:	Function:	
0 * [0 - 8]	View the power card ordering number.	

15-48 LCP Id No		
Range:	Function:	
0 * [0 - 20]	View the LCP ID number.	

15-49 SW ID Control Card		
Range:	Function:	
0 * [0 - 20]	View the control card software version number.	

15-50 SW ID Power Card		
Range:	Function:	
0 * [0 - 20]	View the power card software version number.	

15-51 Frequency Converter Serial Number		
Range:	Function:	
0 * [0 - 10]	View the frequency converter serial number.	

15-53 Power Card Serial Number		
Range:	Function:	
0 * [0 - 19]	View the power card serial number.	

15-59 CSIV Filename		
Range:	Function:	
Size related* [0 - 16]	Shows the currently used CSIV (Customer Specific Initial Values) filename.	

### 3.14.6 15-6\* Option Ident.

This read-only parameter group contains information about the hardware and software configuration of the options installed in slots A, B, C0 and C1.

15-60 Option Mounted		
Array [8]		
Range:	Function:	
0 * [0 - 30]	View the installed option type.	

15-61 Option SW Version		
Array [8]		
Range:	Function:	
0 * [0 - 20]	View the installed option software version.	

15-62 Option Ordering No		
Array [8]		
<b>Range:</b>	<b>Function:</b>	
0 *	[0 - 8 ]	Shows the ordering number for the installed options.

15-63 Option Serial No		
Array [8]		
<b>Range:</b>	<b>Function:</b>	
0 *	[0 - 18 ]	View the installed option serial number.

15-70 Option in Slot A		
<b>Range:</b>	<b>Function:</b>	
0 *	[0 - 30 ]	View the type code string for the option installed in slot A, and a translation of the type code string. E.g. for type code string 'AX' the translation is 'No option'.

15-71 Slot A Option SW Version		
<b>Range:</b>	<b>Function:</b>	
0 *	[0 - 20 ]	View the software version for the option installed in slot A.

15-72 Option in Slot B		
<b>Range:</b>	<b>Function:</b>	
0 *	[0 - 30 ]	View the type code string for the option installed in slot B, and a translation of the type code string. E.g. for type code string 'BX' the translation is 'No option'.

15-73 Slot B Option SW Version		
<b>Range:</b>	<b>Function:</b>	
0 *	[0 - 20 ]	View the software version for the option installed in slot B.

15-74 Option in Slot C0/E0		
<b>Range:</b>	<b>Function:</b>	
0 *	[0 - 30 ]	View the type code string for the option installed in slot C, and a translation of the type code string. E.g. for type code string 'CXXX' the translation is 'No option'.

15-75 Slot C0/E0 Option SW Version		
<b>Range:</b>	<b>Function:</b>	
0 *	[0 - 20 ]	View the software version for the option installed in slot C.

15-76 Option in Slot C1/E1		
<b>Range:</b>	<b>Function:</b>	
0 *	[0 - 30 ]	Shows the typecode string for the options (CXXXX if no option) and the translation i.e. >No option<.

15-77 Slot C1/E1 Option SW Version		
<b>Range:</b>	<b>Function:</b>	
0 *	[0 - 20 ]	Software version for the installed option in option slot C.

15-80 Fan Running Hours		
<b>Range:</b>	<b>Function:</b>	
0 h*	[0 - 2147483647 h]	This parameter shows how many hours the external fan has run. The value is saved when the frequency converter is turned off.

### 3.14.7 15-9\* Parameter Info

15-92 Defined Parameters		
Array [1000]		
<b>Range:</b>	<b>Function:</b>	
0 *	[0 - 9999 ]	View a list of all defined parameters in the frequency converter. The list ends with 0.

15-93 Modified Parameters		
Array [1000]		
<b>Range:</b>	<b>Function:</b>	
0 *	[0 - 9999 ]	View a list of the parameters that have been changed from their default setting. The list ends with 0. Changes may not be visible until up to 30 s after implementation.

15-98 Drive Identification		
<b>Range:</b>	<b>Function:</b>	
0 *	[0 - 40 ]	

15-99 Parameter Metadata		
Array [23]		
<b>Range:</b>	<b>Function:</b>	
0 *	[0 - 9999 ]	This parameter contains data used by the MCT 10 Set-up Software software tool.

### 3.15 Parameters 16-\*\* Data Readouts

16-00 Control Word		
Range:	Function:	
0 * [0 - 65535]	View the Control word sent from the frequency converter via the serial communication port in hex code.	

16-01 Reference [Unit]		
Range:	Function:	
0 ReferenceFeed-backUnit*	[-999999 - 999999 ReferenceFeed-backUnit]	View the present reference value applied on impulse or analog basis in the unit resulting from the configuration selected in <i>parameter 1-00 Configuration Mode</i> (Hz, Nm, or RPM).

16-02 Reference [%]		
Range:	Function:	
0 %* [-200 - 200 %]	View the total reference. The total reference is the sum of digital, analog, preset, bus, and freeze references, plus catch-up and slow-down.	

16-03 Status Word		
Range:	Function:	
0 * [0 - 65535]	View the status word sent from the frequency converter via the serial communication port in hex code.	

16-05 Main Actual Value [%]		
Range:	Function:	
0 %* [-100 - 100 %]	View the 2-byte word sent with the status word to the bus master reporting the Main Actual Value. Refer to the <i>VLT® Profibus Operating Instructions</i> for further details.	

16-09 Custom Readout		
Range:	Function:	
0 CustomReadoutUnit*	[-999999.99 - 999999.99 CustomReadoutUnit]	View the user-defined readouts as defined in <i>parameter 0-30 Custom Readout Unit</i> , <i>parameter 0-31 Custom Readout Min Value</i> and <i>parameter 0-32 Custom Readout Max Value</i> .

#### 3.15.1 16-1\* Motor Status

16-10 Power [kW]		
Range:	Function:	
0 kW* [0 - 10000 kW]	Displays motor power in kW. The value shown is calculated based on the actual motor voltage and motor current. The value is filtered, and therefore approx. 30 ms may pass from when an input value changes to when the data readout values change. The resolution of readout value on fieldbus is in 10 W steps.	

16-11 Power [hp]		
Range:	Function:	
0 hp* [0 - 10000 hp]	View the motor power in hp. The value shown is calculated based on the actual motor voltage and motor current. The value is filtered, and therefore approximately 30 ms may pass from when an input value changes to when the data readout values change.	

16-12 Motor Voltage		
Range:	Function:	
0 V* [0 - 6000 V]	View the motor voltage, a calculated value used for controlling the motor.	

16-13 Frequency		
Range:	Function:	
0 Hz* [0 - 6500 Hz]	View the motor frequency, without resonance dampening.	

16-14 Motor current		
Range:	Function:	
0 A* [0 - 10000 A]	View the motor current measured as a mean value, $I_{RMS}$ . The value is filtered, and thus approximately 30 ms may pass from when an input value changes to when the data readout values change.	

16-15 Frequency [%]		
Range:	Function:	
0 %* [-100 - 100 %]	View a 2-byte word reporting the actual motor frequency (without resonance dampening) as a percentage (scale 0000-4000 hex) of <i>parameter 4-19 Max Output Frequency</i> . Set <i>parameter 9-16 PCD Read Configuration</i> index 1 to send it with the status word instead of the MAV.	

3

16-16 Torque [Nm]		
Range:	Function:	
0 Nm* [-30000 - 30000 Nm]	View the torque value with sign, applied to the motor shaft. Linearity is not exact between 110% motor current and torque in relation to the rated torque. Some motors supply more than 160% torque. Consequently, the min. value and the max. value will depend on the max. motor current as well as the motor used. The value is filtered, and thus approx. 1.3 s may pass from when an input changes value to when the data read-out values change.	

16-17 Speed [RPM]		
Range:	Function:	
0 RPM* [-30000 - 30000 RPM]	View the actual motor RPM.	

16-18 Motor Thermal		
Range:	Function:	
0 %* [0 - 100 %]	View the calculated thermal load on the motor. The cut-out limit is 100%. The basis for calculation is the ETR function selected in <i>parameter 1-90 Motor Thermal Protection</i> .	

16-22 Torque [%]		
Range:	Function:	
0 %* [-200 - 200 %]	This is a read out parameter only. Shows the actual torque yielded in percentage of the rated torque, based on the setting of the motor size and rated speed in <i>parameter 1-20 Motor Power [kW]</i> or <i>parameter 1-21 Motor Power [HP]</i> and <i>parameter 1-25 Motor Nominal Speed</i> . This is the value monitored by the <i>Broken Belt Function</i> set in parameter group 22-6*.	

### 3.15.2 16-3\* Drive Status

16-30 DC Link Voltage		
Range:	Function:	
0 V* [0 - 10000 V]	View a measured value. The value is filtered with a 30 ms time constant.	

16-32 Brake Energy /s		
Range:	Function:	
0 kW* [0 - 10000 kW]	View the brake power transmitted to an external brake resistor, stated as an instantaneous value.	

16-33 Brake Energy /2 min		
Range:	Function:	
0 kW* [0 - 10000 kW]	View the brake power transmitted to an external brake resistor. The mean power	

16-33 Brake Energy /2 min		
Range:	Function:	
	is calculated on an average basis for the most recent 120 s.	

16-34 Heatsink Temp.		
Range:	Function:	
0 °C* [0 - 255 °C]	View the frequency converter heatsink temperature. The cut-out limit is 90 ±5 °C, and the motor cuts back in at 60 ±5 °C.	

16-35 Inverter Thermal		
Range:	Function:	
0 %* [0 - 100 %]	View the percentage load on the inverter.	

16-36 Inv. Nom. Current		
Range:	Function:	
Size related* [0.01 - 10000 A]	View the inverter nominal current, which should match the nameplate data on the connected motor. The data are used for calculation of torque, motor protection, etc.	

16-37 Inv. Max. Current		
Range:	Function:	
Size related* [0.01 - 10000 A]	View the inverter maximum current, which should match the nameplate data on the connected motor. The data are used for calculation of torque, motor protection, etc.	

16-38 SL Controller State		
Range:	Function:	
0 * [0 - 100 ]	View the state of the event under execution by the SL controller.	

16-39 Control Card Temp.		
Range:	Function:	
0 °C* [0 - 100 °C]	View the temperature on the control card, stated in °C	

16-40 Logging Buffer Full		
Option:	Function:	
	View whether the logging buffer is full (see parameter group 15-1* <i>Data Log Settings</i> ). The logging buffer is never full when setting <i>parameter 15-13 Logging Mode</i> to [0] <i>Log always</i> .	
[0]	No	
[1]	Yes	

16-49 Current Fault Source		
Range:	Function:	
0 * [0 - 8 ]	Value indicates source of current fault, including: short circuit, over current and phase imbalance	



16-49 Current Fault Source		
Range:	Function:	
	(from left): [1-4] Inverter, [5-8] Rectifier, [0] No fault recorded	

After a short circuit alarm ( $I_{max2}$ ) or overcurrent alarm ( $I_{max1}$  or phase imbalance) this contains the power card number associated with the alarm. It only holds one number so it indicates the highest priority power card number (master first). The value persists on power cycle, but if a new alarm occurs it is overwritten with the new power card number (even if it a lower priority number). The value is only cleared when the alarm log is cleared (i.e. a 3-finger reset would reset the readout to 0).

### 3.15.3 16-5\* Ref. & Feedb.

16-50 External Reference		
Range:	Function:	
0 * [-200 - 200 ]	View the total reference, the sum of digital, analog, preset, bus and freeze references, plus catch-up and slow-down.	

16-52 Feedback[Unit]		
Range:	Function:	
0 ProcessCtrlUnit*	[-999999.999 - 999999.999 ProcessCtrlUnit]	View value of resulting feedback value after processing of Feedback 1-3 (see <i>parameter 16-54 Feedback 1 [Unit]</i> , <i>parameter 16-55 Feedback 2 [Unit]</i> and <i>parameter 16-56 Feedback 3 [Unit]</i> ) in the feedback manager.  See parameter group 20-0* <i>Feedback</i> .  The value is limited by settings in 20-13 <i>Minimum Reference/Feedb.</i> and 20-14 <i>Maximum Reference/Feedb.</i> Units as set in 20-12 <i>Reference/Feedback Unit</i> .

16-53 Digi Pot Reference		
Range:	Function:	
0 * [-200 - 200 ]	View the contribution of the Digital Potentiometer to the actual reference.	

16-54 Feedback 1 [Unit]		
Range:	Function:	
0 ProcessCtrlUnit*	[-999999.999 - 999999.999 ProcessCtrlUnit]	View value of Feedback 1, see

16-54 Feedback 1 [Unit]		
Range:	Function:	
	parameter group 20-0* <i>Feedback</i> .	

16-55 Feedback 2 [Unit]		
Range:	Function:	
0 ProcessCtrlUnit*	[-999999.999 - 999999.999 ProcessCtrlUnit]	View value of Feedback 2, see parameter group 20-0* <i>Feedback</i> .  The value is limited by settings in 20-13 <i>Minimum Reference/Feedb.</i> and 20-14 <i>Maximum Reference/Feedb.</i> Units as set in 20-12 <i>Reference/Feedback Unit</i> .

16-56 Feedback 3 [Unit]		
Range:	Function:	
0 ProcessCtrlUnit*	[-999999.999 - 999999.999 ProcessCtrlUnit]	View value of Feedback 3, see parameter group 20-0* <i>Feedback</i> .

16-58 PID Output [%]		
Range:	Function:	
0 %* [0 - 100 %]	This parameter returns the Drive Closed Loop PID controller output value in percent.	

16-59 Adjusted Setpoint		
Range:	Function:	
0 ProcessCtrlUnit*	[-999999.999 - 999999.999 ProcessCtrlUnit]	View value of the adjusted set point according to par. 20-29.

### 3.15.4 16-6\* Inputs and Outputs

16-60 Digital Input		
Range:	Function:	
0 * [0 - 65535 ]	View the signal states from the active digital inputs. Input 18 corresponds for example to bit 5. '0' = NO signal, '1' = connected signal.	

16-60 Digital Input		
Range:	Function:	
	Bit 0	Digital input term. 33
	Bit 1	Digital input term. 32
	Bit 2	Digital input term. 29
	Bit 3	Digital input term. 27
	Bit 4	Digital input term. 19
	Bit 5	Digital input term. 18
	Bit 6	Digital input term. 37
	Bit 7	Digital input GP I/O term. X30/2
	Bit 8	Digital input GP I/O term. X30/3
	Bit 9	Digital input GP I/O term. X30/4
	Bit 10-63	Reserved for future terminals
Table 3.18 Digital Input Bits		

16-61 Terminal 53 Switch Setting		
Option:	Function:	
		View the setting of input terminal 53.
[0]	Current	
[1]	Voltage	

16-62 Analog Input 53		
Range:	Function:	
0 *	[-20 - 20 ]	View the actual value at input 53.

16-63 Terminal 54 Switch Setting		
Option:	Function:	
		View the setting of input terminal 54.
[0]	Current	
[1]	Voltage	

16-64 Analog Input 54		
Range:	Function:	
0 *	[-20 - 20 ]	View the actual value at input 54.

16-65 Analog Output 42 [mA]		
Range:	Function:	
0 *	[0 - 30 ]	View the actual value at output 42 in mA. The value shown reflects the selection in <i>parameter 6-50 Terminal 42 Output</i> .

16-66 Digital Output [bin]		
Range:	Function:	
0 *	[0 - 15 ]	View the binary value of all digital outputs.

16-67 Pulse Input #29 [Hz]		
Range:	Function:	
0 *	[0 - 130000 ]	View the actual frequency rate on terminal 29.

16-68 Pulse Input #33 [Hz]		
Range:	Function:	
0 *	[0 - 130000 ]	View the actual frequency rate on terminal 33.

16-69 Pulse Output #27 [Hz]		
Range:	Function:	
0 *	[0 - 40000 ]	View the actual value on terminal 27 in digital output mode.

16-70 Pulse Output #29 [Hz]		
Range:	Function:	
0 *	[0 - 40000 ]	View the actual value of pulses on terminal 29 in digital output mode.

16-71 Relay Output [bin]		
Range:	Function:	
0 *	[0 - 65535 ]	View the settings of all relays.

Readout choice (Par. 16-71):  
Relay output (bin):

0 0 0 0 0 bin

130BA195.10

Illustration 3.50 Relay Settings

16-72 Counter A		
Range:	Function:	
0 *	[-2147483648 - 2147483647 ]	View the present value of Counter A. Counters are useful as comparator operands, see <i>parameter 13-10 Comparator Operand</i> . The value can be reset or changed either via digital inputs (parameter group 5-1* <i>Digital Inputs</i> ) or by using an SLC action ( <i>parameter 13-52 SL Controller Action</i> ).

16-73 Counter B		
Range:	Function:	
0 *	[-2147483648 - 2147483647 ]	View the present value of Counter B. Counters are useful as comparator operands ( <i>parameter 13-10 Comparator Operand</i> ). The value can be reset or changed either via digital inputs (parameter group 5-1* <i>Digital Inputs</i> ) or by using an SLC action ( <i>parameter 13-52 SL Controller Action</i> ).

16-75 Analog In X30/11		
Range:	Function:	
0 * [ -20 - 20 ]	View the actual value at input X30/11 of MCB 101.	

16-76 Analog In X30/12		
Range:	Function:	
0 * [ -20 - 20 ]	View the actual value at input X30/12 of MCB 101.	

16-77 Analog Out X30/8 [mA]		
Range:	Function:	
0 * [ 0 - 30 ]	View the actual value at input X30/8 in mA.	

### 3.15.5 16-8\* Fieldbus & FC Port

Parameters for reporting the BUS references and control words.

16-80 Fieldbus CTW 1		
Range:	Function:	
0 * [ 0 - 65535 ]	View the 2-byte control word (CTW) received from the bus master. Interpretation of the control word depends on the fieldbus option installed and the control word profile selected in <i>parameter 8-10 Control Profile</i> . For more information, refer to the relevant fieldbus manual.	

16-82 Fieldbus REF 1		
Range:	Function:	
0 * [ -200 - 200 ]	View the 2-byte word sent with the control word from the bus master to set the reference value. For more information, refer to the relevant fieldbus manual.	

16-84 Comm. Option STW		
Range:	Function:	
0 * [ 0 - 65535 ]	View the extended fieldbus comm. option status word. For more information, refer to the relevant fieldbus manual.	

16-85 FC Port CTW 1		
Range:	Function:	
0 * [ 0 - 65535 ]	View the 2-byte control word (CTW) received from the bus master. Interpretation of the control word depends on the fieldbus option installed and the control word profile selected in <i>parameter 8-10 Control Profile</i> .	

16-86 FC Port REF 1		
Range:	Function:	
0 * [ -200 - 200 ]	View the 2-byte status word (STW) sent to the bus master. Interpretation of the status word depends on the fieldbus option installed and the control word profile selected in <i>parameter 8-10 Control Profile</i> .	

### 3.15.6 16-9\* Diagnosis Read-Outs

#### **NOTICE**

When using MCT 10 Set-up Software, the readout parameters can only be read online, i.e. as the actual status. This means that the status is not stored in the MCT 10 Set-up Software file.

16-90 Alarm Word		
Range:	Function:	
0 * [ 0 - 4294967295 ]	View the alarm word sent via the serial communication port in hex code.	

16-91 Alarm Word 2		
Range:	Function:	
0 * [ 0 - 4294967295 ]	View the alarm word 2 sent via the serial communication port in hex code.	

16-92 Warning Word		
Range:	Function:	
0 * [ 0 - 4294967295 ]	View the warning word sent via the serial communication port in hex code.	

16-93 Warning Word 2		
Range:	Function:	
0 * [ 0 - 4294967295 ]	View the warning word 2 sent via the serial communication port in hex code.	

16-94 Ext. Status Word		
Range:	Function:	
0 * [ 0 - 4294967295 ]	Returns the extended status word sent via the serial communication port in hex code.	

16-95 Ext. Status Word 2		
Range:	Function:	
0 * [ 0 - 4294967295 ]	Returns the extended warning word 2 sent via the serial communication port in hex code.	

16-96 Maintenance Word		
Range:	Function:	
0 * [ 0 - 4294967295 ]	Readout of the preventive maintenance word. The bits reflect the status for the programmed preventive maintenance events	

16-96 Maintenance Word	
Range:	Function:
	<p>in parameter group 23-1* <i>Maintenance</i>. 13 bits represent combinations of all the possible items:</p> <ul style="list-style-type: none"> <li>• Bit 0: Motor bearings</li> <li>• Bit 1: Pump bearings</li> <li>• Bit 2: Fan bearings</li> <li>• Bit 3: Valve</li> <li>• Bit 4: Pressure transmitter</li> <li>• Bit 5: Flow transmitter</li> <li>• Bit 6: Temperature transmitter</li> <li>• Bit 7: Pump seals</li> <li>• Bit 8: Fan belt</li> <li>• Bit 9: Filter</li> <li>• Bit 10: Drive cooling fan</li> <li>• Bit 11: Drive system health check</li> <li>• Bit 12: Warranty</li> <li>• Bit 13: Maintenance Text 0</li> <li>• Bit 14: Maintenance Text 1</li> <li>• Bit 15: Maintenance Text 2</li> <li>• Bit 16: Maintenance Text 3</li> <li>• Bit 17: Maintenance Text 4</li> </ul>

16-96 Maintenance Word				
Range:	Function:			
Position 4⇒	Valve	Fan bearings	Pump bearings	Motor bearings
Position 3 ⇒	Pump seals	Temperature transmitter	Flow transmitter	Pressure transmitter
Position 2 ⇒	Drive system health check	Drive cooling fan	Filter	Fan belt
Position 1⇒				Warranty
0 <sub>hex</sub>	-	-	-	-
1 <sub>hex</sub>	-	-	-	+
2 <sub>hex</sub>	-	-	+	-
3 <sub>hex</sub>	-	-	+	+
4 <sub>hex</sub>	-	+	-	-
5 <sub>hex</sub>	-	+	-	+
6 <sub>hex</sub>	-	+	+	-
7 <sub>hex</sub>	-	+	+	+
8 <sub>hex</sub>	+	-	-	-
9 <sub>hex</sub>	+	-	-	+
A <sub>hex</sub>	+	-	+	-
B <sub>hex</sub>	+	-	+	+
C <sub>hex</sub>	+	+	-	-
D <sub>hex</sub>	+	+	-	+
E <sub>hex</sub>	+	+	+	-
F <sub>hex</sub>	+	+	+	+

**Table 3.19 Maintenance Word**

Example:

The preventive maintenance word shows 040A<sub>hex</sub>.

Position	1	2	3	4
hex-value	0	4	0	A

**Table 3.20 Example**

The first digit 0 indicates that no items from the fourth row requires maintenance  
 The second digit 4 refers to the third row indicating that the drive cooling fan requires maintenance  
 The third digit 0 indicates that no items from the second row requires maintenance  
 The fourth digit A refers to the top row indicating that the valve and the pump bearings require maintenance

### 3.16 Parameters 18-\*\* Data Readouts 2

#### 3.16.1 18-0\* Maintenance Log

This group contains the last 10 preventive maintenance events. Maintenance log 0 is the latest and maintenance log 9 the oldest.

By selecting one of the logs and pressing [OK], the maintenance item, action and time of the occurrence can be found in *parameter 18-00 Maintenance Log: Item* – *parameter 18-03 Maintenance Log: Date and Time*.

The alarm log key allows access to both alarm log and maintenance log.

18-00 Maintenance Log: Item		
Array [10]. Array parameter; Error code 0-9: The meaning of the error code can be found in the chapter <i>Troubleshooting</i> in the <i>Design Guide</i> .		
<b>Range:</b>		<b>Function:</b>
0 *	[0 - 255 ]	Locate the meaning of the maintenance item in the description of <i>parameter 23-10 Maintenance Item</i> .

18-01 Maintenance Log: Action		
Array [10]. Array parameter; Error code 0-9: The meaning of the error code can be found in the chapter <i>Troubleshooting</i> in the <i>Design Guide</i>		
<b>Range:</b>		<b>Function:</b>
0 *	[0 - 255 ]	Locate the meaning of the maintenance item in the description of <i>parameter 23-11 Maintenance Action</i>

18-02 Maintenance Log: Time		
Array [10]. Array parameter; Time 0-9: This parameter shows at which time the logged event occurred. Time is measured in seconds since start of the frequency converter.		
<b>Range:</b>		<b>Function:</b>
0 s*	[0 - 2147483647 s]	Shows when the logged event occurred. Time is measured in seconds since last power-up.

18-03 Maintenance Log: Date and Time		
Array [10]		
<b>Range:</b>		<b>Function:</b>
Size related*	[0 - 0 ]	Shows when the logged event occurred. <b>NOTICE</b> This requires that the date and time is programmed in <i>0-70 Date and Time</i> .  Date format depends on the setting in <i>0-71 Date Format</i> , while the time format

18-03 Maintenance Log: Date and Time		
Array [10]		
<b>Range:</b>		<b>Function:</b>
		depends on the setting in <i>parameter 0-72 Time Format</i> . <b>NOTICE</b> The frequency converter has no back up of the clock function and the set date/time resets to default (2000-01-01 00:00) after a power down unless a Real Time Clock module with back-up is installed. In <i>parameter 0-79 Clock Fault</i> it is possible to program for a warning in case the clock has not been set properly, e.g. after a power down. Incorrect setting of the clock affects the time stamps for the maintenance events.

**NOTICE**

When mounting an Analog I/O MCB 109 option card, a battery back-up of date and time is included.

#### 3.16.2 18-3\* Analog Readouts

18-30 Analog Input X42/1		
<b>Range:</b>		<b>Function:</b>
0 *	[-20 - 20 ]	Read-out of the value of the signal applied to terminal X42/1 on the Analog I/O Card (MCB 109). The units of the value shown in the LCP will correspond to the mode selected in <i>parameter 26-00 Terminal X42/1 Mode</i> .

18-31 Analog Input X42/3		
<b>Range:</b>		<b>Function:</b>
0 *	[-20 - 20 ]	Read-out of the value of the signal applied to terminal X42/3 on the Analog I/O Card (MCB 109). The units of the value shown in the LCP will correspond to the mode selected in <i>parameter 26-01 Terminal X42/3 Mode</i> .

18-32 Analog Input X42/5		
<b>Range:</b>		<b>Function:</b>
0 *	[-20 - 20 ]	Read-out of the value of the signal applied to terminal X42/5 on the Analog I/O Card (MCB 109). The units of the value shown in the LCP will correspond to the mode selected in <i>parameter 26-02 Terminal X42/5 Mode</i> .

18-33 Analog Out X42/7 [V]		
Range:	Function:	
0 * [0 - 30 ]	Read-out of the value of the signal applied to terminal X42/7 on the Analog I/O Card (MCB 109). The value shown reflects the selection in <i>parameter 26-40 Terminal X42/7 Output</i> .	

18-34 Analog Out X42/9 [V]		
Range:	Function:	
0 * [0 - 30 ]	Read-out of the value of the signal applied to terminal X42/9 on the Analog I/O Card (MCB 109). The value shown reflects the selection in <i>parameter 26-50 Terminal X42/9 Output</i> .	

18-35 Analog Out X42/11 [V]		
Range:	Function:	
0 * [0 - 30 ]	Read-out of the value of the signal applied to terminal X42/11 on the Analog I/O Card (MCB 109). The value shown reflects the selection in <i>parameter 26-60 Terminal X42/11 Output</i> .	

18-36 Analog Input X48/2 [mA]		
Range:	Function:	
0 * [-20 - 20 ]	View the actual current measured at input X48/2 (MCB 114).	

18-37 Temp. Input X48/4		
Range:	Function:	
0 * [-500 - 500 ]	View the actual temperature measured at input X48/4 (MCB 114). The temperature unit is based on the selection in <i>parameter 35-00 Term. X48/4 Temperature Unit</i> .	

18-38 Temp. Input X48/7		
Range:	Function:	
0 * [-500 - 500 ]	View the actual temperature measured at input X48/7 (MCB 114). The temperature unit is based on the selection in <i>parameter 35-02 Term. X48/7 Temperature Unit</i> .	

18-39 Temp. Input X48/10		
Range:	Function:	
0 * [-500 - 500 ]	View the actual temperature measured at input X48/10 (MCB 114). The temperature unit is based on the selection in <i>parameter 35-04 Term. X48/10 Temperature Unit</i> .	

### 3.16.3 18-6\* Inputs & Outputs 2

18-60 Digital Input 2		
Range:	Function:	
0 * [0 - 65535 ]	View the signal states from the active digital inputs on the MCO 102 (Advanced Cascade Controller): Counting from right to left the positions in the binary are: DI7...DI1 → pos. 2 ...pos. 8.	

### 3.17 Parameters 20-\*\* FC Closed Loop

This parameter group is used for configuring the closed loop PID Controller, that controls the output frequency of the frequency converter.

Loop Mode or Open Loop Mode, the feedback signals can be shown on the frequency converter's display. It can also be used to control a frequency converter analog output, and be transmitted over various serial communication protocols.

#### 3.17.1 20-0\* Feedback

This parameter group is used to configure the feedback signal for the frequency converter's closed loop PID Controller. Whether the frequency converter is in Closed

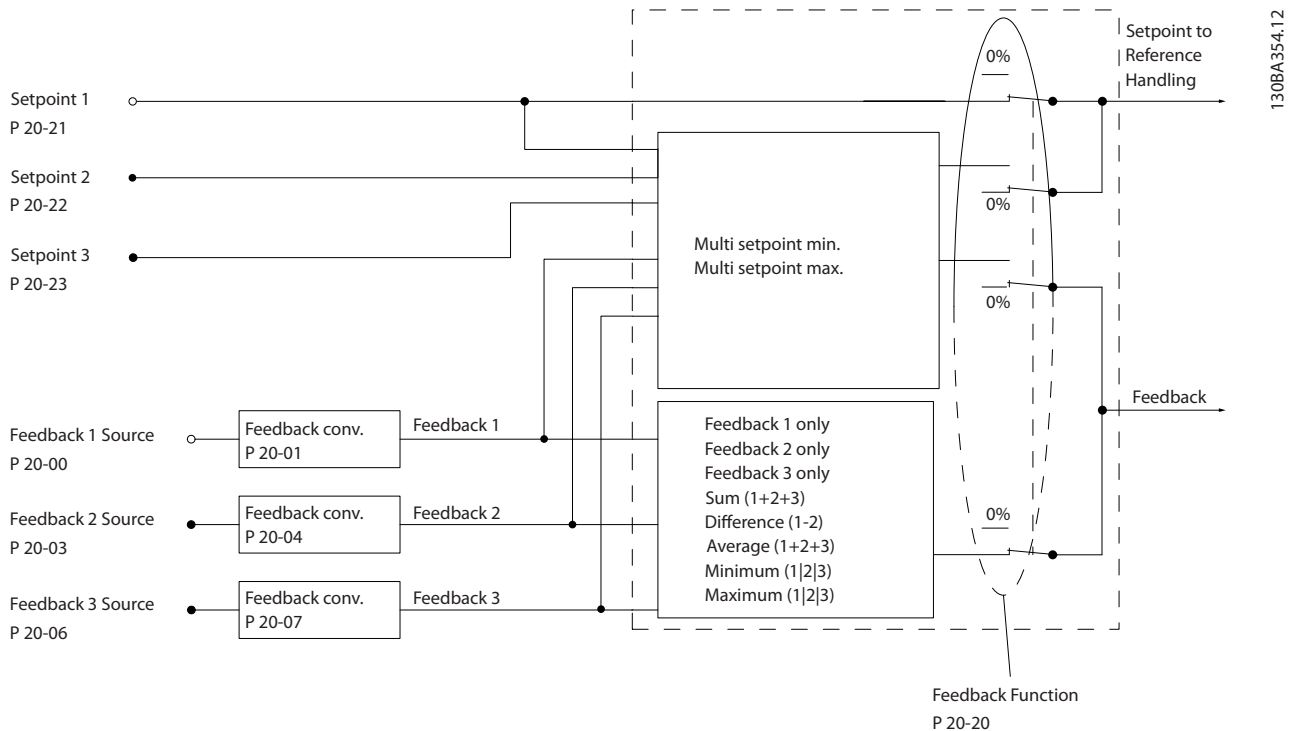

Illustration 3.51 Input Signals in Closed Loop PID Controller

20-00 Feedback 1 Source	
Option:	Function:
[0]	No function
[1]	Analog Input 53
[2]	Analog Input 54
[3]	Pulse input 29
[4]	Pulse input 33
[7]	Analog Input X30/11

20-00 Feedback 1 Source	
Option:	Function:
[8]	Analog Input X30/12
[9]	Analog Input X42/1
[10]	Analog Input X42/3
[11]	Analog Input X42/5
[15]	Analog Input X48/2
[100]	Bus Feedback 1
[101]	Bus Feedback 2
[102]	Bus feedback 3
[200]	Ext. Closed Loop 1
[201]	Ext. Closed Loop 2
[202]	Ext. Closed Loop 3

**NOTICE**

If a feedback is not used, its source must be set to [0] *No Function*. Parameter 20-20 Feedback Function determines how the 3 possible feedbacks are used by the PID Controller.

20-01 Feedback 1 Conversion		
Option:	Function:	
[0]	Linear	
[1]	Square root	This parameter allows a conversion function to be applied to Feedback 1. [0] <i>Linear</i> has no effect on the feedback. [1] <i>Square root</i> is commonly used when a pressure sensor is used to provide flow feedback (( $flow \propto \sqrt{pressure}$ )).

20-02 Feedback 1 Source Unit		
Option:	Function:	
		This parameter determines the unit that is used for this feedback source, before applying the feedback conversion of 20-01 Feedback 1 Conversion. This unit is not used by the PID Controller.
[0]	-	
[1]	%	
[5]	PPM	
[10]	1/min	
[11]	RPM	
[12]	Pulse/s	
[20]	l/s	
[21]	l/min	
[22]	l/h	
[23]	m <sup>3</sup> /s	
[24]	m <sup>3</sup> /min	
[25]	m <sup>3</sup> /h	
[30]	kg/s	
[31]	kg/min	
[32]	kg/h	
[33]	t/min	
[34]	t/h	
[40]	m/s	
[41]	m/min	
[45]	m	
[60]	°C	
[70]	mbar	
[71]	bar	
[72]	Pa	
[73]	kPa	
[74]	m WG	
[75]	mm Hg	
[80]	kW	
[120]	GPM	
[121]	gal/s	
[122]	gal/min	

20-02 Feedback 1 Source Unit		
Option:	Function:	
[123]	gal/h	
[124]	CFM	
[125]	ft <sup>3</sup> /s	
[126]	ft <sup>3</sup> /min	
[127]	ft <sup>3</sup> /h	
[130]	lb/s	
[131]	lb/min	
[132]	lb/h	
[140]	ft/s	
[141]	ft/min	
[145]	ft	
[160]	°F	
[170]	psi	
[171]	lb/in <sup>2</sup>	
[172]	in WG	
[173]	ft WG	
[174]	in Hg	
[180]	HP	

**NOTICE**

This parameter is only available when using pressure to temperature feedback conversion. If the choice [0] *Linear* is selected in 20-01 Feedback 1 Conversion, the setting of any choice in parameter 20-02 Feedback 1 Source Unit does not matter as a conversion is one-to-one.

20-03 Feedback 2 Source		
Option:	Function:	
		See parameter 20-00 Feedback 1 Source for details.
[0]	No function	
[1]	Analog Input 53	
[2]	Analog Input 54	
[3]	Pulse input 29	
[4]	Pulse input 33	
[7]	Analog Input X30/11	
[8]	Analog Input X30/12	
[9]	Analog Input X42/1	
[10]	Analog Input X42/3	
[11]	Analog Input X42/5	
[15]	Analog Input X48/2	
[100]	Bus Feedback 1	
[101]	Bus Feedback 2	
[102]	Bus feedback 3	
[200]	Ext. Closed Loop 1	
[201]	Ext. Closed Loop 2	
[202]	Ext. Closed Loop 3	



20-04 Feedback 2 Conversion		
Option:	Function:	
		See 20-01 Feedback 1 Conversion for details.
[0]	Linear	
[1]	Square root	

20-05 Feedback 2 Source Unit		
See parameter 20-02 Feedback 1 Source Unit for details.		
Option:	Function:	
[0] *	Linear	

20-06 Feedback 3 Source		
Option:	Function:	
		See parameter 20-00 Feedback 1 Source for details.
[0]	No function	
[1]	Analog Input 53	
[2]	Analog Input 54	
[3]	Pulse input 29	
[4]	Pulse input 33	
[7]	Analog Input X30/11	
[8]	Analog Input X30/12	
[9]	Analog Input X42/1	
[10]	Analog Input X42/3	
[11]	Analog Input X42/5	
[15]	Analog Input X48/2	
[100]	Bus Feedback 1	
[101]	Bus Feedback 2	
[102]	Bus feedback 3	
[200]	Ext. Closed Loop 1	
[201]	Ext. Closed Loop 2	
[202]	Ext. Closed Loop 3	

20-07 Feedback 3 Conversion		
Option:	Function:	
		See 20-01 Feedback 1 Conversion for details.
[0]	Linear	
[1]	Square root	

20-08 Feedback 3 Source Unit		
See parameter 20-02 Feedback 1 Source Unit for details.		
Option:	Function:	
[0]	-	
[1]	%	
[5]	PPM	
[10]	1/min	
[11]	RPM	
[12]	Pulse/s	
[20]	l/s	
[21]	l/min	
[22]	l/h	
[23]	m <sup>3</sup> /s	
[24]	m <sup>3</sup> /min	
[25]	m <sup>3</sup> /h	

20-08 Feedback 3 Source Unit		
See parameter 20-02 Feedback 1 Source Unit for details.		
Option:	Function:	
[30]	kg/s	
[31]	kg/min	
[32]	kg/h	
[33]	t/min	
[34]	t/h	
[40]	m/s	
[41]	m/min	
[45]	m	
[60]	°C	
[70]	mbar	
[71]	bar	
[72]	Pa	
[73]	kPa	
[74]	m WG	
[75]	mm Hg	
[80]	kW	
[120]	GPM	
[121]	gal/s	
[122]	gal/min	
[123]	gal/h	
[124]	CFM	
[125]	ft <sup>3</sup> /s	
[126]	ft <sup>3</sup> /min	
[127]	ft <sup>3</sup> /h	
[130]	lb/s	
[131]	lb/min	
[132]	lb/h	
[140]	ft/s	
[141]	ft/min	
[145]	ft	
[160]	°F	
[170]	psi	
[171]	lb/in <sup>2</sup>	
[172]	in WG	
[173]	ft WG	
[174]	in Hg	
[180]	HP	

20-12 Reference/Feedback Unit		
Option:	Function:	
[0]	-	
[1]	%	
[5]	PPM	
[10]	1/min	
[11]	RPM	
[12]	Pulse/s	
[20]	l/s	
[21]	l/min	
[22]	l/h	
[23]	m <sup>3</sup> /s	
[24]	m <sup>3</sup> /min	

20-12 Reference/Feedback Unit		
Option:	Function:	
[25]	m <sup>3</sup> /h	
[30]	kg/s	
[31]	kg/min	
[32]	kg/h	
[33]	t/min	
[34]	t/h	
[40]	m/s	
[41]	m/min	
[45]	m	
[60]	°C	
[70]	mbar	
[71]	bar	
[72]	Pa	
[73]	kPa	
[74]	m WG	
[75]	mm Hg	
[80]	kW	
[120]	GPM	
[121]	gal/s	
[122]	gal/min	
[123]	gal/h	
[124]	CFM	
[125]	ft <sup>3</sup> /s	
[126]	ft <sup>3</sup> /min	
[127]	ft <sup>3</sup> /h	
[130]	lb/s	
[131]	lb/min	
[132]	lb/h	
[140]	ft/s	
[141]	ft/min	
[145]	ft	
[160]	°F	
[170]	psi	
[171]	lb/in <sup>2</sup>	
[172]	in WG	
[173]	ft WG	
[174]	in Hg	
[180]	HP	This parameter determines the unit that is used for the setpoint reference and feedback that the PID Controller uses for controlling the output frequency of the frequency converter.

feedback signals to control the output frequency of the frequency converter. This group is also used to store the 3 internal setpoint references.

#### 20-20 Feedback Function

This parameter determines how the 3 possible feedbacks are used to control the output frequency of the frequency converter.

#### **NOTICE**

**Any unused feedback must be set to "No function" in its Feedback Source parameter 20-00 Feedback 1 Source, parameter 20-03 Feedback 2 Source or parameter 20-06 Feedback 3 Source.**

The feedback resulting from the function selected in *parameter 20-20 Feedback Function* is used by the PID Controller to control the output frequency of the frequency converter. This feedback can also be shown on the frequency converter's display, be used to control a frequency converter's analog output, and be transmitted over various serial communication protocols.

The frequency converter can be configured to handle multi-zone applications. 2 different multi-zone applications are supported:

- Multi-zone, single setpoint
- Multi-zone, multi setpoint

The difference between the 2 is illustrated by the following examples:

#### **Example 1 – Multi-zone, single setpoint**

In an office building, a VAV (variable air volume) water system must ensure a minimum pressure at selected VAV boxes. Due to the varying pressure losses in each duct, the pressure at each VAV box cannot be assumed to be the same. The minimum pressure required is the same for all VAV boxes. This control method can be set up by setting *Feedback Function, parameter 20-20 Feedback Function* to option [3] *Minimum* and entering the desired pressure in *parameter 20-21 Setpoint 1*. The PID Controller increases the speed of the fan if any one feedback is below the setpoint and decrease the speed of the fan if all feedbacks are above the setpoint.

### 3.17.2 20-2\* Feedback & Setpoint

This parameter group is used to determine how the frequency converter's PID Controller uses the 3 possible

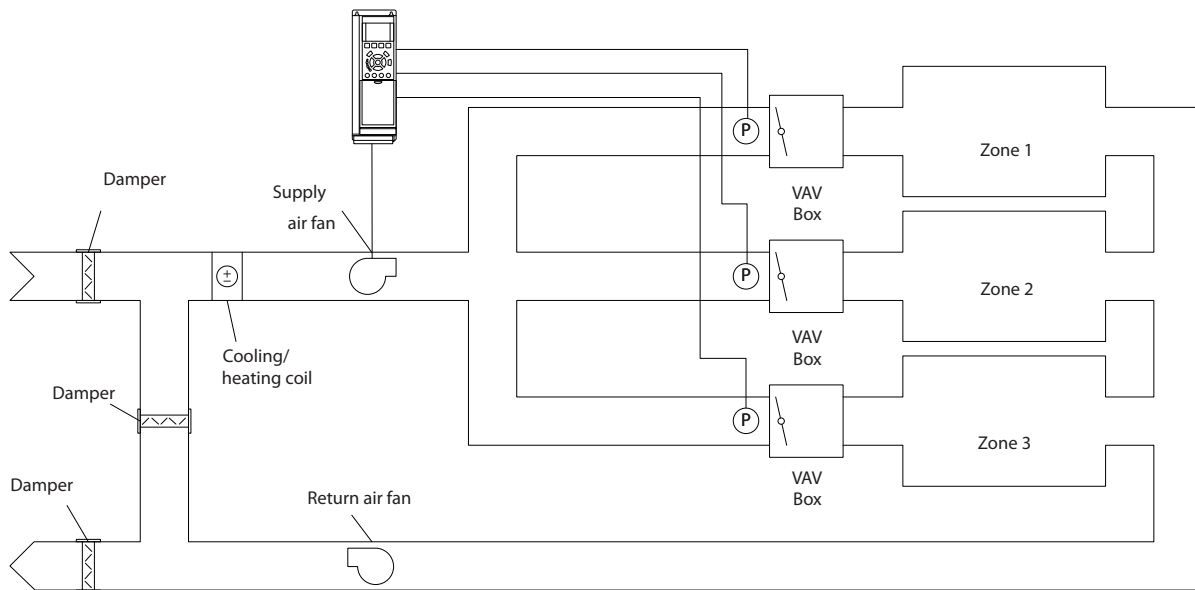

Illustration 3.52 Multi-zone Application Scheme

**Example 2 – Multi-zone, multi setpoint**

The previous example can be used to illustrate the use of multi-zone, multi-setpoint control. If the zones require different pressures for each VAV box, each setpoint may be specified in *parameter 20-21 Setpoint 1*, *parameter 20-22 Setpoint 2* and *20-23 Setpoint 3*. By selecting [5] *Multi setpoint minimum* in *parameter 20-20 Feedback Function*, the PID Controller increases the speed of the fan if any one of the feedbacks is below its setpoint and decrease the speed of the fan if all feedbacks are above their individual setpoints.

20-20 Feedback Function		
Option:	Function:	
[0]	Sum	Sets up the PID Controller to use the sum of Feedback 1, Feedback 2 and Feedback 3 as the feedback.  The sum of Setpoint 1 and any other references that are enabled (see parameter group 3-1* <i>References</i> ) is used as the PID Controller's setpoint reference.
[1]	Difference	Sets up the PID Controller to use the difference between Feedback 1 and Feedback 2 as the feedback. Feedback 3 is not used with this selection. Only setpoint 1 is used. The sum of Setpoint 1 and any other references that are enabled (see parameter group 3-1* <i>References</i> ) is used as the PID Controller's setpoint reference.
[2]	Average	Sets up the PID Controller to use the average of Feedback 1, Feedback 2 and Feedback 3 as the feedback.
[3]	Minimum	Sets up the PID Controller to compare Feedback 1, Feedback 2 and Feedback 3 and use the

20-20 Feedback Function		
Option:	Function:	
		lowest value as the feedback. Only setpoint 1 is used. The sum of Setpoint 1 and any other references that are enabled (see parameter group 3-1* <i>References</i> ) is used as the PID Controller's setpoint reference.
[4]	Maximum	Sets up the PID Controller to compare Feedback 1, Feedback 2 and Feedback 3 and use the highest value as the feedback.  Only Setpoint 1 is used. The sum of Setpoint 1 and any other references that are enabled (see parameter group 3-1* <i>References</i> ) is used as the PID Controller's setpoint reference.
[5]	Multi Setpoint Min	Sets up the PID Controller to calculate the difference between Feedback 1 and Setpoint 1, Feedback 2 and Setpoint 2, and Feedback 3 and Setpoint 3. It uses the feedback/setpoint pair in which the feedback is the farthest below its corresponding setpoint reference. If all feedback signals are above their corresponding setpoints, the PID Controller uses the feedback/setpoint pair in which the difference between the feedback and setpoint is the least.

20-20 Feedback Function		
Option:	Function:	
		<p><b>NOTICE</b></p> <p>If only 2 feedback signals are used, the feedback that is not to be used must be set to <i>No Function</i> in <i>parameter 20-00 Feedback 1 Source</i>, <i>parameter 20-03 Feedback 2 Source</i>, or <i>parameter 20-06 Feedback 3 Source</i>. Note that each setpoint reference is the sum of its respective parameter value and any other references that are enabled (see <i>parameter group 3-1* References</i>).</p>
[6]	Multi Setpoint Max	<p>Sets up the PID Controller to calculate the difference between Feedback 1 and Setpoint 1, Feedback 2 and Setpoint 2, and Feedback 3 and Setpoint 3. It uses the feedback/setpoint pair in which the feedback is farthest above its corresponding setpoint reference. If all feedback signals are below their corresponding setpoints, the PID Controller uses the feedback/setpoint pair in which the difference between the feedback and the setpoint reference is the least.</p> <p><b>NOTICE</b></p> <p>If only 2 feedback signals are used, the feedback that is not to be used must be set to <i>No Function</i> in <i>parameter 20-00 Feedback 1 Source</i>, <i>parameter 20-03 Feedback 2 Source</i>, or <i>parameter 20-06 Feedback 3 Source</i>. Note that each setpoint reference is the sum of its respective parameter value (<i>parameter 20-21 Setpoint 1</i>, <i>parameter 20-22 Setpoint 2</i> and <i>20-23 Setpoint 3</i>) and any other references that are enabled (see <i>parameter group 3-1* References</i>).</p>

20-21 Setpoint 1		
Range:	Function:	
0 ProcessCtrlUnit*	[-999999.999 - 999999.999 ProcessCtrlUnit]	Setpoint 1 is used in Closed Loop Mode to enter a setpoint reference that is used by the frequency converter's PID Controller. See the description of <i>parameter 20-20 Feedback Function</i> .

20-21 Setpoint 1		
Range:	Function:	
		<p><b>NOTICE</b></p> <p>The setpoint reference entered here is added to any other references that are enabled (see <i>parameter group 3-1* References</i>).</p>

20-22 Setpoint 2		
Range:	Function:	
0 ProcessCtrlUnit*	[-999999.999 - 999999.999 ProcessCtrlUnit]	Setpoint 2 is used in Closed Loop Mode to enter a setpoint reference that may be used by the frequency converter's PID Controller. See the description of <i>Feedback Function</i> , <i>parameter 20-20 Feedback Function</i> .
		<p><b>NOTICE</b></p> <p>The setpoint reference entered here is added to any other references that are enabled (see <i>parameter group 3-1* References</i>).</p>

20-23 Setpoint 3		
Range:	Function:	
0 ProcessCtrlUnit*	[-999999.999 - 999999.999 ProcessCtrlUnit]	Setpoint 3 is used in Closed Loop Mode to enter a setpoint reference that may be used by the frequency converter's PID Controller. See the description of <i>parameter 20-20 Feedback Function</i> .
		<p><b>NOTICE</b></p> <p>If the min and max references are altered, a new PI - Autotune may be needed.</p>

20-23 Setpoint 3	
Range:	Function:
	<p><b>NOTICE</b></p> <p>The setpoint reference entered here is added to any other references that are enabled (see parameter group 3-1* References).</p>

### 3.17.3 20-7\* PID Autotuning

The frequency converter PID Closed Loop controller (parameter group 20-\*\*, FC Drive Closed Loop) can be auto-tuned, simplifying and saving time during commissioning, whilst ensuring accurate PID control adjustment. To use auto-tuning it is necessary for the frequency converter to be configured for closed loop in *parameter 1-00 Configuration Mode*.

A Graphical Local Control Panel (LCP) must be used in order to react on messages during the auto-tuning sequence.

Enabling *parameter 20-79 PID Autotuning*, puts the frequency converter into auto-tuning mode. The LCP then directs the user with on-screen instructions.

The fan/pump is started by pressing [Auto On] and applying a start signal. The speed is adjusted manually by pressing [▲] or [▼] to a level where the feedback is around the system set-point.

**NOTICE**

It is not possible to run the motor at maximum or minimum speed, when manually adjusting the motor speed due to the need of giving the motor a step in the speed during auto-tuning.

PID auto-tuning functions by introducing step changes whilst operating at a steady state and then monitoring the feedback. From the feedback response, the required values for *parameter 20-93 PID Proportional Gain* and *parameter 20-94 PID Integral Time* are calculated. *Parameter 20-95 PID Differentiation Time* is set to value 0 (zero). *Parameter 20-81 PID Normal/ Inverse Control* is determined during tuning process.

These calculated values are presented in the LCP and the user can decide whether to accept or reject them. Once accepted, the values are written to the relevant parameters and auto-tuning mode is disabled in *parameter 20-79 PID Autotuning*. Depending on the system being controlled, the

time required to carry out auto-tuning could be several minutes.

It is advised to set the ramp times in *parameter 3-41 Ramp 1 Ramp Up Time*, *parameter 3-42 Ramp 1 Ramp Down Time* or *parameter 3-51 Ramp 2 Ramp Up Time* and *parameter 3-52 Ramp 2 Ramp Down Time* according to the load inertia before carrying out PID autotuning. If PID autotuning is carried out with slow ramp times, the auto-tuned parameters typically results in very slow control. Excessive feedback sensor noise should be removed using the input filter (parameter groups 6-\*\* *Analog In/Out*, 5-5\* *Pulse Input* and 26-\*\* *Analog I/O Option MCB 109*, Terminal 53/54 Filter Time Constant/Pulse Filter Time Constant #29/33) before activating PID autotuning. To obtain the most accurate controller parameters, it is advised to carry out PID autotuning, when the application is running in typical operation, i.e. with a typical load.

20-70 Closed Loop Type	
Option:	Function:
	This parameter defines the application response. The default mode should be sufficient for most applications. If the application response speed is known, it can be selected here. This decreases the time needed for carrying out PID autotuning. The setting has no impact on the value of the tuned parameters and is used only for the autotuning sequence.
[0]	Auto
[1]	Fast Pressure
[2]	Slow Pressure
[3]	Fast Temperature
[4]	Slow Temperature

20-71 PID Performance		
Option:	Function:	
[0]	Normal	Normal setting of this parameter is suitable for pressure control in fan systems.
[1]	Fast	Fast setting would generally be used in pumping systems, where a faster control response is desirable.

20-72 PID Output Change	
Range:	Function:
0.10 * [0.01 - 0.50 ]	This parameter sets the magnitude of step change during autotuning. The value is a percentage of full speed. I.e. if maximum output frequency in <i>parameter 4-13 Motor Speed High Limit [RPM]</i> / <i>parameter 4-14 Motor Speed High Limit [Hz]</i> is set to 50 Hz, 0.10 is 10% of 50 Hz, which is 5 Hz. This parameter should be set to a value resulting in feedback changes of between 10% and 20% for best tuning accuracy.

20-73 Minimum Feedback Level		
Range:		Function:
-999999 ProcessCtrlUnit*	[ -999999.999 - par. 20-74 ProcessCtrlUnit]	The minimum allowable feedback level should be entered here in user units as defined in <i>20-12 Reference/ Feedback Unit</i> . If the level falls below <i>parameter 20-73 Minimum Feedback Level</i> , autotuning is aborted and an error message appears in the LCP.

20-74 Maximum Feedback Level		
Range:		Function:
999999 ProcessCtrlUnit*	[ par. 20-73 - 999999.999 ProcessCtrlUnit]	The maximum allowable feedback level should be entered here in user units as defined in <i>20-12 Reference/ Feedback Unit</i> . If the level rises above <i>parameter 20-74 Maximum Feedback Level</i> , autotuning is aborted and an error message appears in the LCP.

20-79 PID Autotuning		
Option:	Function:	
	This parameter starts the PID autotuning sequence. Once the autotuning has successfully completed and the settings have been accepted or rejected by the user, by pressing [OK] or [Cancel] at the end of tuning, this parameter is reset to [0] Disabled.	
[0]	Disabled	
[1]	Enabled	

### 3.17.4 20-8\* PID Basic Settings

This parameter group is used to configure the basic operation of the frequency converter's PID Controller, including how it responds to a feedback that is above or below the setpoint, the speed at which it first starts functioning, and when it indicates that the system has reached the setpoint.

20-81 PID Normal/ Inverse Control		
Option:	Function:	
[0]	Normal	The frequency converter's output frequency decreases when the feedback is greater than the setpoint reference. This is common for pressure-controlled supply fan and pump applications.
[1]	Inverse	The frequency converter's output frequency increases when the feedback is greater than the setpoint reference.

20-82 PID Start Speed [RPM]		
Range:		Function:
Size related*	[ 0 - par. 4-13 RPM]	When the frequency converter is first started, it initially ramps up to this output speed in open loop mode, following the active ramp up time. When the output speed programmed is reached, the frequency converter automatically switches to closed loop mode and the PID Controller begins to function. This is useful in applications that require quick acceleration to a minimum speed at start-up.  <b>NOTICE</b> <b>This parameter is only visible if parameter 0-02 Motor Speed Unit is set to [0] RPM.</b>

20-83 PID Start Speed [Hz]		
Range:		Function:
Size related*	[ 0 - par. 4-14 Hz]	When the frequency converter is first started, it initially ramps up to this output frequency in open loop mode, following the active ramp up time. When the output frequency programmed here is reached, the frequency converter will automatically switch to closed loop mode and the PID Controller begins to function. This is useful in applications that require quick acceleration to a minimum speed at start-up.  <b>NOTICE</b> <b>This parameter is only visible if parameter 0-02 Motor Speed Unit is set to [1] Hz.</b>

20-84 On Reference Bandwidth		
Range:		Function:
5 %*	[0 - 200 %]	When the difference between the feedback and the setpoint reference is less than the value of this parameter, the frequency converter's display shows "Run on Reference". This status can be communicated externally by programming the function of a digital output for [8] <i>Run on Reference/No Warning</i> . In addition, for serial communications, the On Reference status bit of the frequency converter's status word is high (1). The <i>On Reference Bandwidth</i> is calculated as a percentage of the setpoint reference.

### 3.17.5 20-9\* PID Controller

Use these parameters to adjust the PID controller manually. By adjusting the PID Controller parameters the control performance may be improved. See the *Introduction to VLT AQUA Drive* in the *VLT® AQUA Drive FC 202 Design Guide* for guidelines on adjusting the PID Controller parameters.

20-91 PID Anti Windup		
Option:	Function:	
[0]	Off	The integrator continues to change value also after output has reached one of the extremes. This can afterwards cause a delay of change of the output of the controller.
[1]	On	The integrator is locked if the output of the built-in PID controller has reached one of the extremes (min or max value) and therefore is not able to add further change to the value of the process parameter controlled. This allows the controller to respond more quickly when it again can control the system.

20-93 PID Proportional Gain		
Range:	Function:	
2 *	[0 - 10 ]	The proportional gain indicates the number of times the error between the set point and the feedback signal is to be applied.

If (Error x Gain) jumps with a value equal to what is set in *parameter 3-03 Maximum Reference* the PID controller tries to change the output speed equal to what is set in *parameter 4-13 Motor Speed High Limit [RPM]*/*parameter 4-14 Motor Speed High Limit [Hz]*, but in practice of course limited by this setting.

The proportional band (error causing output to change from 0-100%) can be calculated by means of the formula

$$\left(\frac{1}{\text{Proportional Gain}}\right) \times (\text{Max Reference})$$

**NOTICE**

Always set the desired value for *parameter 3-03 Maximum Reference* before setting the values for the PID controller in parameter group 20-9\* PID Controller.

20-94 PID Integral Time		
Range:	Function:	
8 s*	[0.01 - 10000 s]	Over time, the integrator accumulates a contribution to the output from the PID controller as long as there is a deviation between the reference/setpoint and feedback signals. The contribution is proportional to the size of the deviation. This ensures that the deviation (error) approaches zero. Quick response on any deviation is obtained when the integral time is set to a low value.

20-94 PID Integral Time		
Range:	Function:	
		Setting it too low, however, may cause the control to become unstable. The value set is the time needed for the integrator to add the same contribution as the proportional for a certain deviation. If the value is set to 10,000, the controller acts as a pure proportional controller with a P-band based on the value set in <i>parameter 20-93 PID Proportional Gain</i> . When no deviation is present, the output from the proportional controller is 0.

20-95 PID Differentiation Time		
Range:	Function:	
0 s*	[0 - 10 s]	The differentiator monitors the rate of change of the feedback. If the feedback is changing quickly, it adjusts the output of the PID controller to reduce the rate of change of the feedback. Quick PID controller response is obtained when this value is large. However, if too large of a value is used, the frequency converter's output frequency may become unstable.  Differentiation time is useful in situations where extremely fast frequency converter response and precise speed control are required. It can be difficult to adjust this for proper system control. Differentiation time is not commonly used in water/wastewater applications. Therefore, it is generally best to leave this parameter at 0 or OFF.

20-96 PID Diff. Gain Limit		
Range:	Function:	
5 *	[1 - 50 ]	The differential function of a PID controller responds to the rate of change of the feedback. As a result, an abrupt change in the feedback can cause the differential function to make a very large change in the PID controller's output. This parameter limits the maximum effect that the PID controller's differential function can produce. A smaller value reduces the maximum effect of the PID Controller's differential function.  This parameter is only active when <i>parameter 20-95 PID Differentiation Time</i> is not set to OFF (0 s).

### 3.18 Parameters 21-\*\* Extended Closed Loop

The FC 202 offers 3 extended closed loop PID controllers in addition to the PID controller. These can be configured independently to control either external actuators (valves, dampers etc.) or be used together with the internal PID controller to improve the dynamic responses to setpoint changes or load disturbances.

The extended closed loop PID controllers may be interconnected or connected to the PID closed loop controller to form a dual loop configuration.

To control a modulating device (e.g. a valve motor), this device must be a positioning servo motor with built-in electronics accepting either a 0-10 V (signal from Analog I/O card MCB 109) or a 0/4-20 mA (signal from Control Card and/or General Purpose I/O card MCB 101) control signal.

The output function can be programmed in the following parameters:

- Control Card, terminal 42: *Parameter 6-50 Terminal 42 Output* (setting [113]...[115] or [149]...[151], Ext. Closed Loop 1/2/3
- General Purpose I/O card MCB 101, terminal X30/8: *6-60 Terminal X30/8 Output*, (setting [113]...[115] or [149]...[151], Ext. Closed Loop 1/2/3
- Analog I/O card MCB 109, terminal X42/7...11: *Parameter 26-40 Terminal X42/7 Output*, *parameter 26-50 Terminal X42/9 Output*, *parameter 26-60 Terminal X42/11 Output* (setting [113]...[115], Ext. Closed Loop 1/2/3

General Purpose I/O card and Analog I/O card are optional cards.

#### 3.18.1 21-0\* Extended CL Autotuning

The extended PID closed loop PID controllers can each be auto-tuned, simplifying and saving time during commissioning, whilst ensuring accurate PID control adjustment.

To use PID autotuning it is necessary for the relevant extended PID controller to have been configured for the application.

A graphical LCP must be used to react on messages during the autotuning sequence.

Enabling autotuning, *parameter 21-09 PID Auto Tuning* puts the relevant PID controller into PID autotuning mode. The LCP then directs the user with on-screen instructions.

PID autotuning functions by introducing step changes and then monitoring the feedback. From the feedback response, the required values for PID Proportional Gain, *parameter 21-21 Ext. 1 Proportional Gain* for EXT CL 1, *parameter 21-41 Ext. 2 Proportional Gain* for EXT CL 2 and *parameter 21-61 Ext. 3 Proportional Gain* for EXT CL 3 and Integral Time, *parameter 21-22 Ext. 1 Integral Time* for EXT CL 1, *parameter 21-42 Ext. 2 Integral Time* for EXT CL 2 and *parameter 21-62 Ext. 3 Integral Time* for EXT CL 3 are calculated. PID Differentiation Time, *parameter 21-23 Ext. 1 Differentiation Time* for EXT CL 1, *parameter 21-43 Ext. 2 Differentiation Time* for EXT CL 2 and *parameter 21-63 Ext. 3 Differentiation Time* for EXT CL 3 are set to value 0 (zero). Normal/Inverse, *parameter 21-20 Ext. 1 Normal/Inverse Control* for EXT CL 1, *parameter 21-40 Ext. 2 Normal/Inverse Control* for EXT CL 2 and *parameter 21-60 Ext. 3 Normal/Inverse Control* for EXT CL 3 are determined during the tuning process.

These calculated values are presented on the LCP and the user can decide whether to accept or reject them. Once accepted, the values are written to the relevant parameters and PID autotuning mode is disabled in *parameter 21-09 PID Auto Tuning*. Depending on the system being controlled, the time required to carry out PID autotuning could be several minutes.

Excessive feedback sensor noise should be removed using the input filter (parameter groups 5-5\* *Pulse Input*, 6-\*\* *Analog In/Out*, and 26-\*\* *Analog I/O Option MCB 109*, Terminal 53/54 *Filter Time Constant/Pulse Filter Time Constant #29/33*) before activating PID autotuning.

21-00 Closed Loop Type		
Option:		Function:
[0]	Auto	This parameter defines the application response. The default mode should be sufficient for most applications. If the relative application speed is known, it can be selected here. This decreases the time needed for carrying out PID Autotuning. The setting has no impact on the value of the tuned parameters and is used only for the PID auto-tuning sequence.
[1]	Fast Pressure	
[2]	Slow Pressure	
[3]	Fast Temperature	
[4]	Slow Temperature	



21-01 PID Performance		
Option:	Function:	
[0]	Normal	Normal setting of this parameter is suitable for pressure control in fan systems.
[1]	Fast	Fast setting would generally be used in pumping systems, where a faster control response is desirable.

21-02 PID Output Change		
Range:	Function:	
0.10 *	[0.01 - 0.50 ]	This parameter sets the magnitude of step change during autotuning. The value is a percentage of full operating range. I.e. if maximum analog output voltage is set to 10 V, 0.10 is 10% of 10 V, which is 1 V. This parameter should be set to a value resulting in feedback changes of between 10% and 20% for best tuning accuracy.

21-03 Minimum Feedback Level		
Range:	Function:	
-999999 *	[ -999999.999 - par. 21-04 ]	Enter the minimum allowable feedback level in user units as defined in <i>parameter 21-10 Ext. 1 Ref./Feedback Unit</i> for EXT CL 1, <i>parameter 21-30 Ext. 2 Ref./Feedback Unit</i> for EXT CL 2 or <i>parameter 21-50 Ext. 3 Ref./Feedback Unit</i> for EXT CL 3. If the level falls below <i>parameter 21-03 Minimum Feedback Level</i> , PID autotuning is aborted and an error message appears on the LCP.

21-04 Maximum Feedback Level		
Range:	Function:	
999999 *	[ par. 21-03 - 999999.999 ]	Enter the maximum allowable feedback level in user units as defined in <i>parameter 21-10 Ext. 1 Ref./Feedback Unit</i> for EXT CL 1, <i>parameter 21-30 Ext. 2 Ref./Feedback Unit</i> for EXT CL 2 or <i>parameter 21-50 Ext. 3 Ref./Feedback Unit</i> for EXT CL 3. If the level rises above <i>parameter 21-04 Maximum Feedback Level</i> , PID autotuning is aborted and an error message appears on the LCP.

21-09 PID Auto Tuning		
Option:	Function:	
		This parameter enables selection of the Extended PID controller to be autotuned and starts the PID autotuning for that controller. Once the autotuning has successfully completed and the settings have been accepted or rejected by the user, by pressing [OK] or [Cancel] at the

21-09 PID Auto Tuning		
Option:	Function:	
		end of tuning, this parameter is reset to [0] Disabled.
[0]	Disabled	
[1]	Enabled Ext CL1 PID	
[2]	Enabled Ext CL 2 PID	
[3]	Enabled Ext CL 3 PID	

3.18.2 21-1\* Closed Loop 1 Ref/Feedback

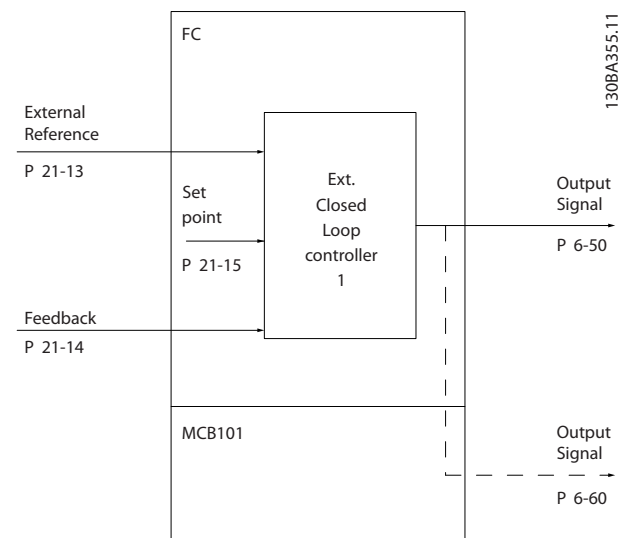

Illustration 3.53 Closed Loop 1 Ref/Feedback

21-10 Ext. 1 Ref./Feedback Unit		
Option:	Function:	
		Select the unit for the reference and feedback.
[0]	-	
[1]	%	
[5]	PPM	
[10]	1/min	
[11]	RPM	
[12]	Pulse/s	
[20]	l/s	
[21]	l/min	
[22]	l/h	
[23]	m <sup>3</sup> /s	
[24]	m <sup>3</sup> /min	
[25]	m <sup>3</sup> /h	
[30]	kg/s	
[31]	kg/min	
[32]	kg/h	
[33]	t/min	
[34]	t/h	

21-10 Ext. 1 Ref./Feedback Unit		
Option:	Function:	
[40]	m/s	
[41]	m/min	
[45]	m	
[60]	°C	
[70]	mbar	
[71]	bar	
[72]	Pa	
[73]	kPa	
[74]	m WG	
[75]	mm Hg	
[80]	kW	
[120]	GPM	
[121]	gal/s	
[122]	gal/min	
[123]	gal/h	
[124]	CFM	
[125]	ft <sup>3</sup> /s	
[126]	ft <sup>3</sup> /min	
[127]	ft <sup>3</sup> /h	
[130]	lb/s	
[131]	lb/min	
[132]	lb/h	
[140]	ft/s	
[141]	ft/min	
[145]	ft	
[160]	°F	
[170]	psi	
[171]	lb/in <sup>2</sup>	
[172]	in WG	
[173]	ft WG	
[174]	in Hg	
[180]	HP	

21-11 Ext. 1 Minimum Reference		
Range:	Function:	
0 ExtPID1Unit*	[-999999.999 - par. 21-12 ExtPID1Unit]	Select the minimum reference for the Closed Loop 1 Controller.

21-12 Ext. 1 Maximum Reference		
Range:	Function:	
100 ExtPID1Unit*	[ par. 21-11 - 999999.999 ExtPID1Unit]	Select the maximum reference for the Closed Loop 1 Controller.  The dynamics of the PID controller depend on the value set in this parameter. See also <i>parameter 21-21 Ext. 1 Proportional Gain</i> .

**NOTICE**

Always set the desired value for *parameter 21-12 Ext. 1 Maximum Reference* before setting the values for the PID controller in parameter group 20-9\* *PID Controller*.

21-13 Ext. 1 Reference Source		
Option:	Function:	
		This parameter defines which input on the frequency converter should be treated as the source of the reference signal for the Closed Loop 1 Controller. Analog input X30/11 and Analog input X30/12 refer to inputs on the General Purpose I/O.
[0]	No function	
[1]	Analog Input 53	
[2]	Analog Input 54	
[7]	Pulse input 29	
[8]	Pulse input 33	
[20]	Digital pot.meter	
[21]	Analog input X30/11	
[22]	Analog input X30/12	
[23]	Analog Input X42/1	
[24]	Analog Input X42/3	
[25]	Analog Input X42/5	
[29]	Analog Input X48/2	
[30]	Ext. Closed Loop 1	
[31]	Ext. Closed Loop 2	
[32]	Ext. Closed Loop 3	
[35]	Digital input select	

21-14 Ext. 1 Feedback Source		
Option:	Function:	
		This parameter defines which input on the frequency converter should be treated as the source of the feedback signal for the Closed Loop 1 controller. Analog input X30/11 and Analog input X30/12 refer to inputs on the General Purpose I/O.
[0]	No function	
[1]	Analog Input 53	
[2]	Analog Input 54	
[3]	Pulse input 29	
[4]	Pulse input 33	
[7]	Analog Input X30/11	
[8]	Analog Input X30/12	
[9]	Analog Input X42/1	
[10]	Analog Input X42/3	
[11]	Analog Input X42/5	
[15]	Analog Input X48/2	
[100]	Bus Feedback 1	
[101]	Bus Feedback 2	
[102]	Bus feedback 3	
[200]	Ext. Closed Loop 1	
[201]	Ext. Closed Loop 2	
[202]	Ext. Closed Loop 3	

21-15 Ext. 1 Setpoint		
Range:	Function:	
0 ExtPID1Unit*	[-999999.999 - 999999.999 ExtPID1Unit]	The setpoint reference is used in extended 1 closed loop. Ext.1 Setpoint is added to the value from the Ext.1 Reference source selected in <i>parameter 21-13 Ext. 1 Reference Source</i> .

21-17 Ext. 1 Reference [Unit]		
Range:	Function:	
0 ExtPID1Unit*	[-999999.999 - 999999.999 ExtPID1Unit]	Readout of the reference value for the Closed Loop 1 Controller.

21-18 Ext. 1 Feedback [Unit]		
Range:	Function:	
0 ExtPID1Unit*	[-999999.999 - 999999.999 ExtPID1Unit]	Readout of the feedback value for the Closed Loop 1 Controller.

21-19 Ext. 1 Output [%]		
Range:	Function:	
0 %*	[0 - 100 %]	Readout of the output value for the Closed Loop 1 Controller.

### 3.18.3 21-2\* Closed Loop 1 PID

21-20 Ext. 1 Normal/Inverse Control		
Option:	Function:	
[0]	Normal	Select [0] <i>Normal</i> if the output should be reduced when feedback is higher than the reference.
[1]	Inverse	Select [1] <i>Inverse</i> if the output should be increased when feedback is higher than the reference.

21-21 Ext. 1 Proportional Gain		
Range:	Function:	
0.50 *	[0 - 10 ]	The proportional gain indicates the number of times the error between the setpoint and the feedback signal is to be applied.

If (Error x Gain) jumps with a value equal to what is set in *parameter 3-03 Maximum Reference*, the PID controller tries to change the output speed equal to what is set in *parameter 4-13 Motor Speed High Limit [RPM]/ parameter 4-14 Motor Speed High Limit [Hz]* but in practice of course limited by this setting.

The proportional band (error causing output to change from 0-100%) can be calculated with the formula

$$\left(\frac{1}{\text{Proportional Gain}}\right) \times (\text{Max Reference})$$

**NOTICE**

Always set the desired value for *parameter 3-03 Maximum Reference* before setting the values for the PID controller in parameter group 20-9\* PID Controller.

21-22 Ext. 1 Integral Time		
Range:	Function:	
20 s*	[0.01 - 10000 s]	Over time, the integrator accumulates a contribution to the output from the PID controller as long as there is a deviation between the Reference/Setpoint and feedback signals. The contribution is proportional to the size of the deviation. This ensures that the deviation (error) approaches zero. Quick response on any deviation is obtained when the integral time is set to a low value. Setting it too low, however, may cause the control to become unstable. The value set, is the time needed for the integrator to add the same contribution as the proportional for a certain deviation. If the value is set to 10,000, the controller acts as a pure proportional controller with a P-band based on the value set in <i>parameter 20-93 PID Proportional Gain</i> . When no deviation is present, the output from the proportional controller is 0.

21-23 Ext. 1 Differentiation Time		
Range:	Function:	
0 s* [0 - 10 s]	The differentiator does not react to a constant error. It only provides a gain when the feedback changes. The quicker the feedback changes, the stronger the gain from the differentiator.	

21-24 Ext. 1 Dif. Gain Limit		
Range:	Function:	
5 * [1 - 50]	Set a limit for the differentiator gain (DG). The DG will increase if there are fast changes. Limit the DG to obtain a pure differentiator gain at slow changes and a constant differentiator gain where quick changes occur.	

### 3.18.4 21-3\* Closed Loop 2 Ref/Fb

21-30 Ext. 2 Ref./Feedback Unit		
Option:	Function:	
	See parameter 21-10 Ext. 1 Ref./Feedback Unit for details	
[0]	-	
[1]	%	
[5]	PPM	
[10]	1/min	
[11]	RPM	
[12]	Pulse/s	
[20]	l/s	
[21]	l/min	
[22]	l/h	
[23]	m <sup>3</sup> /s	
[24]	m <sup>3</sup> /min	
[25]	m <sup>3</sup> /h	
[30]	kg/s	
[31]	kg/min	
[32]	kg/h	
[33]	t/min	
[34]	t/h	
[40]	m/s	
[41]	m/min	
[45]	m	
[60]	°C	
[70]	mbar	
[71]	bar	
[72]	Pa	
[73]	kPa	
[74]	m WG	
[75]	mm Hg	
[80]	kW	
[120]	GPM	
[121]	gal/s	
[122]	gal/min	
[123]	gal/h	

21-30 Ext. 2 Ref./Feedback Unit		
Option:	Function:	
[124]	CFM	
[125]	ft <sup>3</sup> /s	
[126]	ft <sup>3</sup> /min	
[127]	ft <sup>3</sup> /h	
[130]	lb/s	
[131]	lb/min	
[132]	lb/h	
[140]	ft/s	
[141]	ft/min	
[145]	ft	
[160]	°F	
[170]	psi	
[171]	lb/in <sup>2</sup>	
[172]	in WG	
[173]	ft WG	
[174]	in Hg	
[180]	HP	

21-31 Ext. 2 Minimum Reference		
Range:	Function:	
0 ExtPID2Unit*	[-999999.999 - par. 21-32 ExtPID2Unit]	See parameter 21-11 Ext. 1 Minimum Reference for details.

21-32 Ext. 2 Maximum Reference		
Range:	Function:	
100 ExtPID2Unit*	[ par. 21-31 - 999999.999 ExtPID2Unit]	See parameter 21-12 Ext. 1 Maximum Reference for details.

21-33 Ext. 2 Reference Source		
Option:	Function:	
		See parameter 21-13 Ext. 1 Reference Source for details.
[0]	No function	
[1]	Analog Input 53	
[2]	Analog Input 54	
[7]	Pulse input 29	
[8]	Pulse input 33	
[20]	Digital pot.meter	
[21]	Analog input X30/11	
[22]	Analog input X30/12	
[23]	Analog Input X42/1	
[24]	Analog Input X42/3	
[25]	Analog Input X42/5	
[29]	Analog Input X48/2	
[30]	Ext. Closed Loop 1	
[31]	Ext. Closed Loop 2	
[32]	Ext. Closed Loop 3	
[35]	Digital input select	

21-34 Ext. 2 Feedback Source		
Option:	Function:	
		See parameter 21-14 Ext. 1 Feedback Source for details.
[0]	No function	
[1]	Analog Input 53	
[2]	Analog Input 54	
[3]	Pulse input 29	
[4]	Pulse input 33	
[7]	Analog Input X30/11	
[8]	Analog Input X30/12	
[9]	Analog Input X42/1	
[10]	Analog Input X42/3	
[11]	Analog Input X42/5	
[15]	Analog Input X48/2	
[100]	Bus Feedback 1	
[101]	Bus Feedback 2	
[102]	Bus feedback 3	
[200]	Ext. Closed Loop 1	
[201]	Ext. Closed Loop 2	
[202]	Ext. Closed Loop 3	

21-35 Ext. 2 Setpoint		
Range:	Function:	
0 ExtPID2Unit*	[-999999.999 - 999999.999 ExtPID2Unit]	See parameter 21-15 Ext. 1 Setpoint for details.

21-37 Ext. 2 Reference [Unit]		
Range:	Function:	
0 ExtPID2Unit*	[-999999.999 - 999999.999 ExtPID2Unit]	See parameter 21-17 Ext. 1 Reference [Unit], Ext. 1 Reference [Unit], for details.

21-38 Ext. 2 Feedback [Unit]		
Range:	Function:	
0 ExtPID2Unit*	[-999999.999 - 999999.999 ExtPID2Unit]	See parameter 21-18 Ext. 1 Feedback [Unit] for details.

21-39 Ext. 2 Output [%]		
Range:	Function:	
0 %*	[0 - 100 %]	See parameter 21-19 Ext. 1 Output [%] for details.

### 3.18.5 21-4\* Closed Loop 2 PID

21-40 Ext. 2 Normal/Inverse Control		
Option:	Function:	
		See parameter 21-20 Ext. 1 Normal/Inverse Control for details.
[0]	Normal	
[1]	Inverse	

21-41 Ext. 2 Proportional Gain		
Range:	Function:	
0.50 *	[0 - 10 ]	See parameter 21-21 Ext. 1 Proportional Gain for details.

21-42 Ext. 2 Integral Time		
Range:	Function:	
20 s*	[0.01 - 10000 s]	See parameter 21-22 Ext. 1 Integral Time for details.

21-43 Ext. 2 Differentiation Time		
Range:	Function:	
0 s*	[0 - 10 s]	See parameter 21-23 Ext. 1 Differentiation Time for details.

21-44 Ext. 2 Dif. Gain Limit		
Range:	Function:	
5 *	[1 - 50 ]	See parameter 21-24 Ext. 1 Dif. Gain Limit for details.

### 3.18.6 21-5\* Closed Loop 3 Ref/Fb

21-50 Ext. 3 Ref./Feedback Unit		
Option:	Function:	
		See parameter 21-10 Ext. 1 Ref./Feedback Unit for details.
[0]	-	
[1]	%	
[5]	PPM	
[10]	1/min	
[11]	RPM	
[12]	Pulse/s	
[20]	l/s	
[21]	l/min	
[22]	l/h	
[23]	m <sup>3</sup> /s	
[24]	m <sup>3</sup> /min	
[25]	m <sup>3</sup> /h	
[30]	kg/s	
[31]	kg/min	
[32]	kg/h	
[33]	t/min	
[34]	t/h	
[40]	m/s	
[41]	m/min	
[45]	m	
[60]	°C	
[70]	mbar	
[71]	bar	
[72]	Pa	
[73]	kPa	
[74]	m WG	
[75]	mm Hg	

21-50 Ext. 3 Ref./Feedback Unit		
Option:	Function:	
[80]	kW	
[120]	GPM	
[121]	gal/s	
[122]	gal/min	
[123]	gal/h	
[124]	CFM	
[125]	ft <sup>3</sup> /s	
[126]	ft <sup>3</sup> /min	
[127]	ft <sup>3</sup> /h	
[130]	lb/s	
[131]	lb/min	
[132]	lb/h	
[140]	ft/s	
[141]	ft/min	
[145]	ft	
[160]	°F	
[170]	psi	
[171]	lb/in <sup>2</sup>	
[172]	in WG	
[173]	ft WG	
[174]	in Hg	
[180]	HP	

21-51 Ext. 3 Minimum Reference		
Range:	Function:	
0 ExtPID3Unit*	[-999999.999 - par. 21-52 ExtPID3Unit]	See parameter 21-11 Ext. 1 Minimum Reference for details.

21-52 Ext. 3 Maximum Reference		
Range:	Function:	
100 ExtPID3Unit*	[ par. 21-51 - 999999.999 ExtPID3Unit]	See parameter 21-12 Ext. 1 Maximum Reference for details.

21-53 Ext. 3 Reference Source		
Option:	Function:	
		See parameter 21-13 Ext. 1 Reference Source for details.
[0]	No function	
[1]	Analog Input 53	
[2]	Analog Input 54	
[7]	Pulse input 29	
[8]	Pulse input 33	
[20]	Digital pot.meter	
[21]	Analog input X30/11	
[22]	Analog input X30/12	
[23]	Analog Input X42/1	
[24]	Analog Input X42/3	
[25]	Analog Input X42/5	
[29]	Analog Input X48/2	
[30]	Ext. Closed Loop 1	

21-53 Ext. 3 Reference Source		
Option:	Function:	
[31]	Ext. Closed Loop 2	
[32]	Ext. Closed Loop 3	
[35]	Digital input select	

21-54 Ext. 3 Feedback Source		
Option:	Function:	
		See parameter 21-14 Ext. 1 Feedback Source for details.
[0]	No function	
[1]	Analog Input 53	
[2]	Analog Input 54	
[3]	Pulse input 29	
[4]	Pulse input 33	
[7]	Analog Input X30/11	
[8]	Analog Input X30/12	
[9]	Analog Input X42/1	
[10]	Analog Input X42/3	
[11]	Analog Input X42/5	
[15]	Analog Input X48/2	
[100]	Bus Feedback 1	
[101]	Bus Feedback 2	
[102]	Bus feedback 3	
[200]	Ext. Closed Loop 1	
[201]	Ext. Closed Loop 2	
[202]	Ext. Closed Loop 3	

21-55 Ext. 3 Setpoint		
Range:	Function:	
0 ExtPID3Unit*	[-999999.999 - 999999.999 ExtPID3Unit]	See parameter 21-15 Ext. 1 Setpoint for details.

21-57 Ext. 3 Reference [Unit]		
Range:	Function:	
0 ExtPID3Unit*	[-999999.999 - 999999.999 ExtPID3Unit]	See parameter 21-17 Ext. 1 Reference [Unit] for details.

21-58 Ext. 3 Feedback [Unit]		
Range:	Function:	
0 ExtPID3Unit*	[-999999.999 - 999999.999 ExtPID3Unit]	See parameter 21-18 Ext. 1 Feedback [Unit] for details.

21-59 Ext. 3 Output [%]		
Range:	Function:	
0 %*	[0 - 100 %]	See parameter 21-19 Ext. 1 Output [%] for details.

## 3.18.7 21-6\* Closed Loop 3 PID

21-60 Ext. 3 Normal/Inverse Control		
Option:	Function:	
		See <i>parameter 21-20 Ext. 1 Normal/Inverse Control</i> for details.
[0]	Normal	
[1]	Inverse	

21-61 Ext. 3 Proportional Gain		
Range:	Function:	
0.50 *	[0 - 10 ]	See <i>parameter 21-21 Ext. 1 Proportional Gain</i> for details.

21-62 Ext. 3 Integral Time		
Range:	Function:	
20 s*	[0.01 - 10000 s]	See <i>parameter 21-22 Ext. 1 Integral Time</i> for details.

21-63 Ext. 3 Differentiation Time		
Range:	Function:	
0 s*	[0 - 10 s]	See <i>parameter 21-23 Ext. 1 Differentiation Time</i> for details.

21-64 Ext. 3 Dif. Gain Limit		
Range:	Function:	
5 *	[1 - 50 ]	See <i>parameter 21-24 Ext. 1 Dif. Gain Limit</i> for details.

### 3.19 Parameters 22-\*\* Application Functions

#### 3.19.1 22-0\* Miscellaneous

This group contains parameters used for monitoring water/wastewater applications.

22-00 External Interlock Delay		
Range:	Function:	
0 s* [0 - 600 s]	Only relevant if one of the digital inputs in parameter group 5-1* <i>Digital Inputs</i> has been programmed for [7] <i>External Interlock</i> . The external interlock timer will introduce a delay after the signal has been removed from the digital input programmed for external interlock, before reaction takes place.	

#### 3.19.2 22-2\* No-Flow Detection

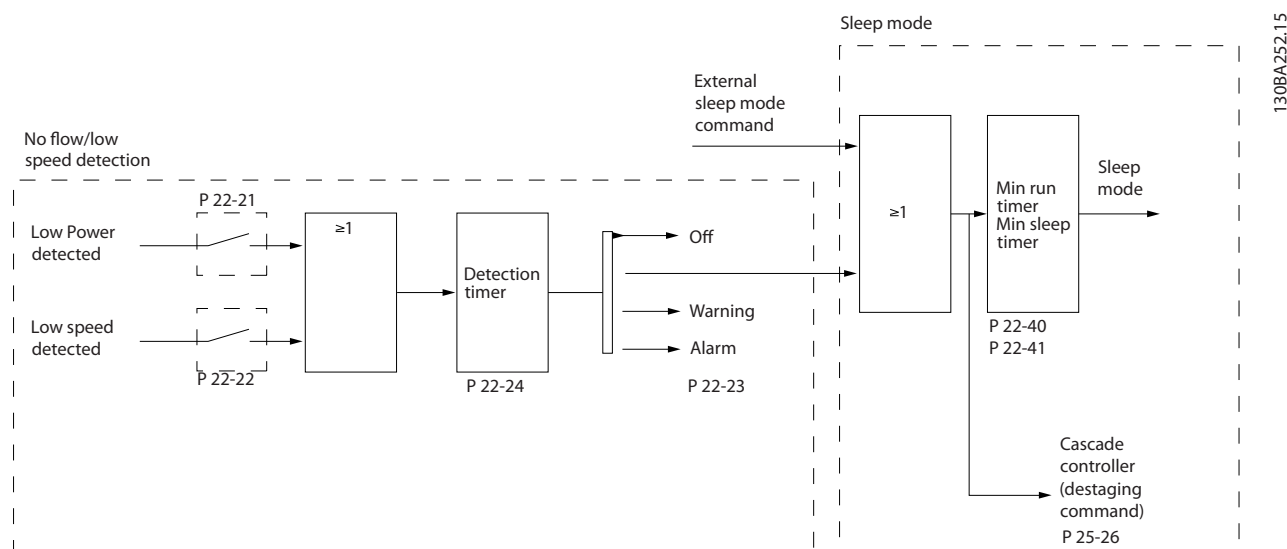

Illustration 3.54 Signal Flow Chart

The VLT AQUA Drive includes functions for detecting if the load conditions in the system allow the motor to be stopped:

\*Low Power Detection

\*Low Speed Detection

One of these 2 signals must be active for a set time (*parameter 22-24 No-Flow Delay*) before selected action takes place. Possible actions to select (*parameter 22-23 No-Flow Function*): No action, Warning, Alarm, Sleep Mode.

#### No Flow Detection

This function is used for detecting a no flow situation in pump systems where all valves can be closed. Can be used both when controlled by the integrated PI controller in VLT AQUA Drive or an external PI controller. Actual configuration must be programmed in *parameter 1-00 Configuration Mode*.

Configuration mode for

- Integrated PI Controller: Closed Loop
- External PI Controller: Open Loop



**CAUTION**

Carry out No Flow tuning before setting the PI controller parameters!

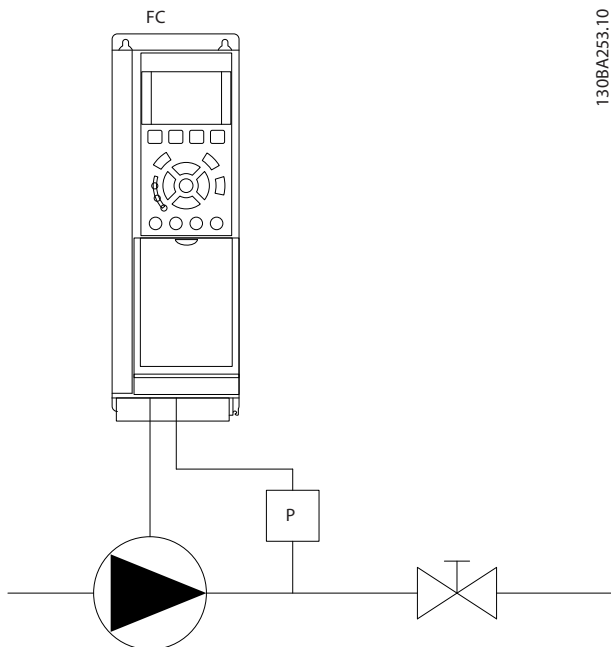

Illustration 3.55 No Flow Detection Scheme

130BA253.10

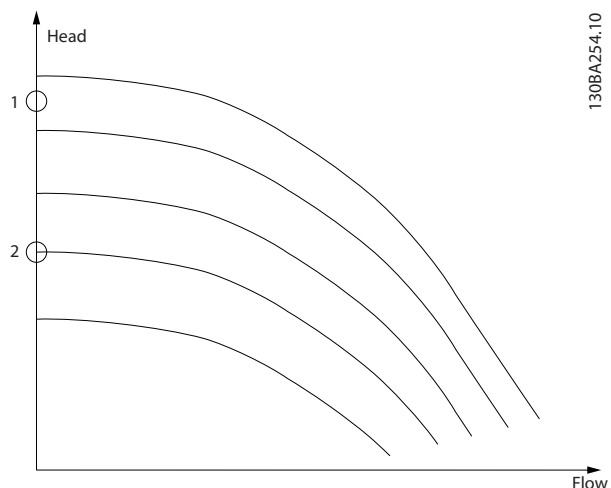

Illustration 3.56 No Flow Detection Graph

130BA254.10

No Flow Detection is based on the measurement of speed and power. For a certain speed the frequency converter calculates the power at no flow. This coherence is based on the adjustment of 2 sets of speed and associated power at no flow. By monitoring the power it is possible to detect no flow conditions in systems with fluctuating suction pressure or if the pump has a flat characteristic towards low speed. The 2 sets of data must be based on measurement of power at approx. 50% and 85% of maximum speed with

the valve(s) closed. The data are programmed in the parameter group 22-3\* No Flow Power Tuning. It is also possible to run a parameter 22-20 Low Power Auto Set-up, automatically stepping through the commissioning process and also automatically storing the data measured. The frequency converter must be set for open loop in parameter 1-00 Configuration Mode, when carrying out the Auto Set-Up (See parameter group 22-3\* No-Flow Power Tuning).

**CAUTION**

When using the integrated PI controller, carry out No Flow tuning before setting the PI controller parameters!

**Low speed detection**

Low Speed Detection gives a signal if the motor is operating with minimum speed as set in parameter 4-11 Motor Speed Low Limit [RPM] or parameter 4-12 Motor Speed Low Limit [Hz]. Actions are common with No Flow Detection (individual selection not possible).

The use of Low Speed Detection is not limited to systems with a no flow situation, but can be used in any system where operation at minimum speed allows for a stop of the motor until the load calls for a speed higher than minimum speed, e.g. systems with fans and compressors.

**NOTICE**

In pump systems, ensure that the minimum speed in parameter 4-11 Motor Speed Low Limit [RPM] or parameter 4-12 Motor Speed Low Limit [Hz] has been set high enough for detection as the pump can run with a rather high speed even with valves closed.

**Dry pump detection**

No Flow Detection can also be used for detecting if the pump has run dry (low power consumption-high speed). Can be used with both the integrated PI controller and an external PI controller.

The condition for dry pump signal:

- Power consumption below no flow level
- and
- Pump running at maximum speed or maximum reference open loop, whichever is lowest.

The signal must be active for a set time (parameter 22-27 Dry Pump Delay) before selected the action takes place.

Possible Actions to select (parameter 22-26 Dry Pump Function):

- Warning
- Alarm

Enable the low power detection in parameter 22-21 Low Power Detection. Perform the tuning using parameter group 22-3\*, No-Flow Power Tuning.

In a dry pump detection setup, select [0] Off in parameter 22-23 No-Flow Function. Otherwise make sure that the options in that parameter do not prevent the dry pump detection.

22-20 Low Power Auto Set-up		
Start of auto set-up of power data for No-Flow Power tuning.		
Option:	Function:	
[0]	Off	
[1]	Enabled	When set for <i>Enabled</i> , an auto set-up sequence is activated, automatically setting speed to approx. 50 and 85% of rated motor speed ( <i>parameter 4-13 Motor Speed High Limit [RPM]</i> , <i>parameter 4-14 Motor Speed High Limit [Hz]</i> ). At those 2 speeds, the power consumption is automatically measured and stored. Before enabling Auto Set-Up: <ol style="list-style-type: none"> <li>Close valve(s) to create a no flow condition</li> <li>The frequency converter must be set for Open Loop (<i>parameter 1-00 Configuration Mode</i>). Note that it is important also to set <i>1-03 Torque Characteristics</i>.</li> </ol>

**NOTICE**

Auto Set-up must be done when the system has reached normal operating temperature!

**NOTICE**

It is important that the *parameter 4-13 Motor Speed High Limit [RPM]* or *parameter 4-14 Motor Speed High Limit [Hz]* is set to the max. operational speed of the motor!  
It is important to do the Auto Set-up before configuring the integrated PI Controller as settings are reset when changing from closed to open loop in *parameter 1-00 Configuration Mode*.

**NOTICE**

Carry out the tuning with the same settings in *1-03 Torque Characteristics*, as for operation after the tuning.

22-21 Low Power Detection		
Option:	Function:	
[0]	Disabled	
[1]	Enabled	The Low Power Detection commissioning must be carried out to set the parameters in parameter group 22-3* <i>No-Flow Power Tuning</i> for proper operation.

22-22 Low Speed Detection		
Option:	Function:	
[0]	Disabled	

22-22 Low Speed Detection		
Option:	Function:	
[1]	Enabled	Detects when the motor operates with a speed as set in <i>parameter 4-11 Motor Speed Low Limit [RPM]</i> or <i>parameter 4-12 Motor Speed Low Limit [Hz]</i> .

22-23 No-Flow Function		
Common actions for Low Power Detection and Low Speed Detection (Individual selections not possible).		
Option:	Function:	
[0]	Off	
[1]	Sleep Mode	The frequency converter enters sleep mode and stops when a no flow condition is detected. See parameter group 22-4* <i>Sleep Mode</i> for programming options for sleep mode.
[2]	Warning	The frequency converter continues to run, but activates a no-flow warning [W92]. A digital output or a serial communication bus can communicate a warning to other equipment.
[3]	Alarm	The frequency converter stops running and activates a no-flow alarm [A 92]. A frequency converter digital output or a serial communication bus can communicate an alarm to other equipment.

**NOTICE**

Do not set *14-20 Reset Mode*, to [13] *Infinite auto reset*, when *parameter 22-23 No-Flow Function* is set to [3] *Alarm*. Doing so causes the frequency converter to continuously cycle between running and stopping when a no flow condition is detected.

**NOTICE**

If the frequency converter is equipped with a constant speed bypass with an automatic bypass function that starts the bypass if the frequency converter experiences a persistent alarm condition, be sure to disable the bypass's automatic bypass function, if [3] *Alarm* is selected as the No-Flow Function.

22-24 No-Flow Delay		
Range:	Function:	
10 s*	[1 - 600 s]	Set the time low power/low speed must stay detected to activate signal for actions. If detection disappears before run out of the timer, the timer is reset.

22-26 Dry Pump Function		
Select desired action for dry pump operation.		
Option:	Function:	
[0]	Off	
[1]	Warning	The frequency converter continues to run, but activates a dry pump warning [W93]. A frequency converter digital output or a serial communication bus can communicate a warning to other equipment.
[2]	Alarm	The frequency converter stops running and activates a dry pump alarm [A93]. A frequency converter digital output or a serial communication bus can communicate an alarm to other equipment.
[3]	Manual Reset Alarm	The frequency converter stops running and activates a dry pump alarm [A93]. A frequency converter digital output or a serial communication bus can communicate an alarm to other equipment.

**NOTICE**

Low Power Detection must be Enabled (parameter 22-21 Low Power Detection) and commissioned (using either parameter group 22-3\* No-flow Power Tuning No Flow Power Tuning, or parameter 22-20 Low Power Auto Set-up) to use Dry Pump Detection.

**NOTICE**

Do not set 14-20 Reset Mode, to [13] Infinite auto reset, when parameter 22-26 Dry Pump Function is set to [2] Alarm. Doing so causes the frequency converter to continuously cycle between running and stopping when a dry pump condition is detected.

**NOTICE**

If the frequency converter is equipped with a constant speed bypass with an automatic bypass function that starts the bypass if the frequency converter experiences a persistent alarm condition, be sure to disable the bypass's automatic bypass function, if [2] Alarm or [3] Man. Reset Alarm is selected as the dry pump function.

22-27 Dry Pump Delay		
Range:	Function:	
10 s*	[0 - 600 s]	Defines for how long the dry pump condition must be active before activating warning or alarm. The frequency converter waits for the no-flow delay time (parameter 22-24 No-Flow Delay) to expire before the timer for the dry pump delay starts.

22-28 No-Flow Low Speed [RPM]		
Range:	Function:	
Size related*	[0 - par. 4-13 RPM]	Used to set the speed for no-flow low speed detection. If a low speed detection at a speed different from the motor minimum speed is needed, this parameter may be used.

22-29 No-Flow Low Speed [Hz]		
Range:	Function:	
Size related*	[0 - par. 4-14 Hz]	Used to set the speed for no-flow low speed detection. If a low speed detection at a speed different from the motor minimum speed is needed, this parameter may be used.

3.19.3 22-3\* No-Flow Power Tuning

Tuning sequence, if not selecting Auto Set Up in parameter 22-20 Low Power Auto Set-up:

1. Close the main valve to stop flow.
2. Run with motor until the system has reached normal operating temperature.
3. Press [Hand On] and adjust speed for approx. 85% of rated speed. Note the exact speed.
4. Read power consumption either by looking for actual power in the data line in the LCP or call
  - 4a parameter 16-10 Power [kW] or
  - 4b parameter 16-11 Power [hp] in Main Menu.
 Note the power read out.
5. Change speed to approx. 50% of rated speed. Note the exact speed.
6. Read power consumption either by looking for actual power in the data line in the LCP or call
  - 6a parameter 16-10 Power [kW] or
  - 6b parameter 16-11 Power [hp] in Main Menu.
 Note the power read.
7. Program the speeds used in
  - 7a parameter 22-32 Low Speed [RPM]
  - 7b parameter 22-33 Low Speed [Hz]
  - 7c parameter 22-36 High Speed [RPM]
  - 7d parameter 22-37 High Speed [Hz]

8. Program the associated power values in
  - 8a *parameter 22-34 Low Speed Power [kW]*
  - 8b *parameter 22-35 Low Speed Power [HP]*
  - 8c *parameter 22-38 High Speed Power [kW]*
  - 8d *parameter 22-39 High Speed Power [HP]*
9. Switch back with of [Auto On] or [Off].

### NOTICE

Set 1-03 Torque Characteristics before tuning takes place.

22-30 No-Flow Power		
Range:		Function:
0 kW*	[0 - 0 kW]	Read out of calculated no flow power at actual speed. If power drops to the display value, the frequency converter considers the condition as a no flow situation.

22-31 Power Correction Factor		
Range:		Function:
100 %*	[1 - 400 %]	Make corrections to the calculated power at <i>parameter 22-30 No-Flow Power</i> . If no flow is detected, when it should not be detected, decrease the setting. However, if no flow is not detected, when it should be detected, increase the setting to above 100%.

22-32 Low Speed [RPM]		
Range:		Function:
Size related*	[0 - par. 22-36 RPM]	To be used if <i>parameter 0-02 Motor Speed Unit</i> has been set for RPM (parameter not visible if Hz selected). Set used speed for the 50% level. This function is used for storing values needed to tune no flow detection.

22-33 Low Speed [Hz]		
Range:		Function:
Size related*	[0 - par. 22-37 Hz]	To be used if <i>parameter 0-02 Motor Speed Unit</i> has been set for Hz (parameter not visible if RPM selected). Set used speed for the 50% level. The function is used for storing values needed to tune no flow detection.

22-34 Low Speed Power [kW]		
Range:		Function:
Size related*	[0 - 5.50 kW]	To be used if <i>parameter 0-03 Regional Settings</i> has been set for International (parameter not visible if North America selected). Set power consumption at 50% speed level. This function is used for storing values needed to tune no flow detection.

22-35 Low Speed Power [HP]		
Range:		Function:
Size related*	[0 - 7.50 hp]	To be used if <i>parameter 0-03 Regional Settings</i> has been set for North America (parameter not visible if International selected). Set power consumption at 50% speed level. This function is used for storing values needed to tune no flow detection.

22-36 High Speed [RPM]		
Range:		Function:
Size related*	[0 - par. 4-13 RPM]	To be used if <i>parameter 0-02 Motor Speed Unit</i> has been set for RPM (parameter not visible if Hz selected). Set used speed for the 85% level. The function is used for storing values needed to tune no flow detection.

22-37 High Speed [Hz]		
Range:		Function:
Size related*	[0 - par. 4-14 Hz]	To be used if <i>parameter 0-02 Motor Speed Unit</i> has been set for Hz (parameter not visible if RPM selected). Set used speed for the 85% level. The function is used for storing values needed to tune no flow detection.

22-38 High Speed Power [kW]		
Range:		Function:
Size related*	[0 - 5.50 kW]	To be used if <i>parameter 0-03 Regional Settings</i> has been set for International (parameter not visible if North America selected). Set power consumption at 85% speed level. This function is used for storing values needed to tune no flow detection.

22-39 High Speed Power [HP]		
Range:		Function:
Size related*	[0 - 7.50 hp]	To be used if <i>parameter 0-03 Regional Settings</i> has been set for North America (parameter not visible if International selected). Set power consumption at 85% speed level. This function is used for storing values needed to tune no flow detection.

### 3.19.4 22-4\* Sleep Mode

If the load on the system allows for stop of the motor and the load is monitored, the motor can be stopped by activating the sleep mode function. This is not a normal stop command, but ramps the motor down to 0 RPM and

stops energizing the motor. When in sleep mode, certain conditions are monitored to find out when load has been applied to the system again.

Sleep mode can be activated either from the no flow detection/minimum speed detection or via an external signal applied to one of the digital inputs (must be programmed via the parameters for configuration of the digital inputs, parameter group 5-1\* *Digital Inputs*). To make it possible to use e.g. an electro-mechanical flow switch to detect a no flow condition and activate Sleep Mode, the action takes place at raising edge of the external signal applied (otherwise the frequency converter would never come out of Sleep Mode again as the signal would be steady connected).

If parameter 25-26 *Destage At No-Flow*, is set for [1] *Enabled*, activating sleep mode applies a command to the cascade controller (if enabled) to start de-staging of lag pumps (fixed speed) before stopping the lead pump (variable speed).

When entering sleep mode, the lower status line in the LCP shows Sleep Mode.

See also signal flow chart, *Illustration 3.54*.

There are 3 different ways of using the sleep mode function:

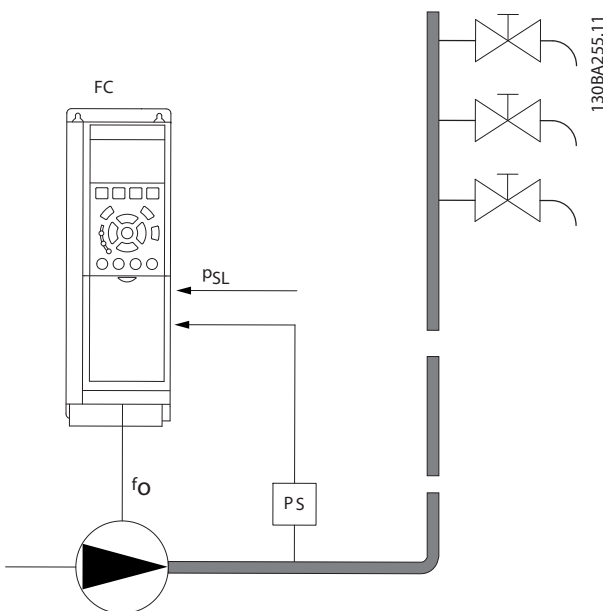
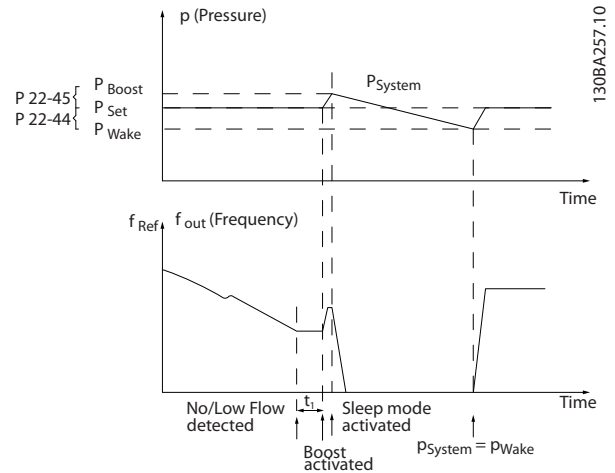

**Illustration 3.57 Legend:** FC=frequency converter; f<sub>o</sub>=frequency out; P<sub>s</sub>=P system; P<sub>SL</sub>=P setpoint

1) Systems where the integrated PI controller is used for controlling pressure or temperature e.g. boost systems with a pressure feed back signal applied to the frequency converter from a pressure transducer.

*Parameter 1-00 Configuration Mode*, must be set for Closed Loop and the PI Controller configured for desired reference and feed back signals.

Example: Boost system.



**Illustration 3.58 Boost System with Pressure Feedback**

If no flow is detected, the frequency converter increases the set point for pressure to ensure a slight over pressure in the system (boost to be set in *parameter 22-45 Setpoint Boost*).

The feedback from the pressure transducer is monitored and when this pressure has dropped with a set percentage below the normal set point for pressure (P<sub>set</sub>), the motor ramps up again and pressure is controlled for reaching the set value (P<sub>set</sub>).

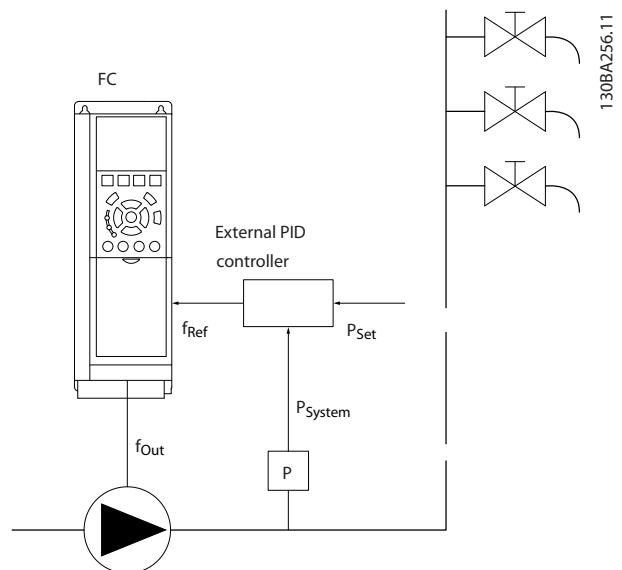

**Illustration 3.59 System with Pressure Feedback**

2) In systems where the pressure or temperature is controlled by an external PI controller, the wake up

conditions cannot be based on feedback from the pressure/temperature transducer as the setpoint is not known. In the example with a boost system, desired pressure  $P_{set}$  is not known. *Parameter 1-00 Configuration Mode*, must be set for Open Loop.

Example: Boost system.

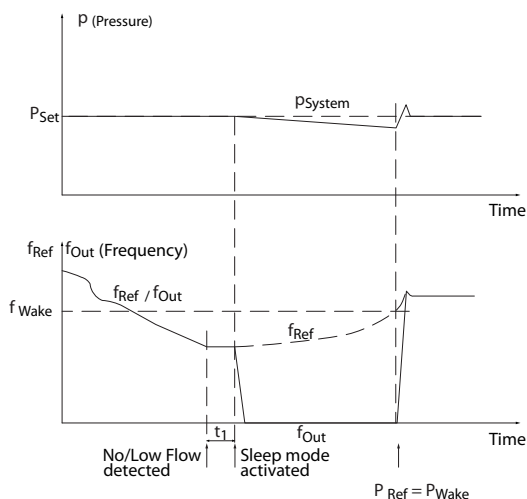

Illustration 3.60 Boost System without Pressure Feedback

When low power or low speed is detected, the motor is stopped, but the reference signal ( $f_{ref}$ ) from the external controller is still monitored and because of the low pressure created, the controller increases the reference signal to gain pressure. When the reference signal has reached a set value  $f_{wake}$ , the motor restarts.

The speed is set manually by an external reference signal (Remote Reference). The settings (parameter group 22-3\* *No-Flow Power Tuning*) for tuning of the no-flow function must be set to default.

	Internal PI Controller (Parameter 1-00 Configuration Mode)		External PI Controller or manual control (Parameter 1-00 Configuration Mode)	
	Sleep mode	Wake up	Sleep mode	Wake up
No Flow detection (pumps only)	Yes		Yes (except manual setting of speed)	
Low speed detection	Yes		Yes	
External signal	Yes		Yes	
Pressure/Temperature (transmitter connected)		Yes		No
Output frequency		No		Yes

Table 3.21 Configuration Possibilities, Overview

**NOTICE**

Sleep mode is not active when local reference is active (set speed manually with the navigation keys on the LCP). See *parameter 3-13 Reference Site*. Does not work in Hand mode. Carry out auto set-up in open loop before setting input/output in closed loop.

22-40 Minimum Run Time		
Range:	Function:	
60 s*	[0 - 600 s]	Set the desired minimum running time for the motor after a start command (digital input or Bus) before entering sleep mode.

22-41 Minimum Sleep Time		
Range:	Function:	
30 s*	[0 - 600 s]	Set the desired minimum time for staying in sleep mode. This overrides any wake up conditions.

22-42 Wake-up Speed [RPM]		
Range:	Function:	
Size related*	[0 - par. 4-13 RPM]	To be used if <i>parameter 0-02 Motor Speed Unit</i> has been set for RPM (parameter not visible if Hz selected). Only to be used if <i>parameter 1-00 Configuration Mode</i> is set for open loop and speed reference is applied by an external controller. Set the reference speed at which the sleep mode should be cancelled.

22-43 Wake-up Speed [Hz]		
Range:	Function:	
Size related*	[0 - 4-14 Hz]	To be used if <i>parameter 0-02 Motor Speed Unit</i> , has been set for Hz (parameter not visible if RPM selected). Only to be used if <i>parameter 1-00 Configuration Mode</i> , is set for [0] <i>Open Loop</i> and speed reference is applied by an external controller controlling the pressure. Set the reference speed at which the sleep mode should be cancelled.

22-44 Wake-up Ref./FB Difference		
Range:	Function:	
10 %*	[0 - 100 %]	Only to be used if <i>parameter 1-00 Configuration Mode</i> , is set for [3] <i>Closed Loop</i> and the integrated PI controller is used for controlling the pressure. Set the pressure drop allowed in percentage of set point for the pressure ( $P_{set}$ ) before cancelling the sleep mode. <b>NOTICE</b> If used in application where the integrated PI controller is set for inverse control in <i>parameter 20-71 PID Performance</i> , the value set in <i>22-44 Wake-up Ref./FB Difference</i> will automatically be added.

22-45 Setpoint Boost		
Range:	Function:	
0 %*	[-100 - 100 %]	Only to be used if <i>parameter 1-00 Configuration Mode</i> , is set for [3] <i>Closed Loop</i> and the integrated PI controller is used. In systems with e.g. constant pressure control, it is advantageous to increase the system pressure before the motor is stopped. This extends the time in which the motor is stopped and help to avoid frequent start/stop. Set the desired over pressure/temperature in percentage of set point for the pressure ( $P_{set}$ )/temperature before entering the sleep mode. If setting for 5%, the boost pressure is $P_{set} * 1.05$ . The negative values can be used for e.g. cooling tower control where a negative change is needed.

22-46 Maximum Boost Time		
Range:	Function:	
60 s*	[0 - 600 s]	Only to be used if <i>parameter 1-00 Configuration Mode</i> is set for <i>Closed Loop</i> and the integrated PI controller is used for controlling the pressure. Set the maximum time for which boost mode is allowed. If the set time is exceeded, Sleep Mode is entered, not waiting for the set boost pressure to be reached.

### 3.19.5 22-5\* End of Curve

The end of curve conditions occur when a pump is yielding a too large volume to ensure the set pressure. This can occur if there is a leakage in the distribution pipe system after the pump causing the pump to operate at the end of the pump characteristic, valid for the max. speed set in *parameter 4-13 Motor Speed High Limit [RPM]* or *parameter 4-14 Motor Speed High Limit [Hz]*.

In case the feed back is 2.5% of the programmed value in *parameter 3-03 Maximum Reference* below the set point for the desired pressure for a set time (*parameter 22-51 End of Curve Delay*), and the pump is running with max. speed set in *parameter 4-13 Motor Speed High Limit [RPM]* or *parameter 4-14 Motor Speed High Limit [Hz]*, - the function selected in *parameter 22-50 End of Curve Function* takes place.

It is possible to get a signal on one of the digital outputs by selecting End of Curve [192] in parameter group 5-3\* *Digital Outputs* and/or parameter group 5-4\* *Relays*. The signal is present, when an end of curve condition occurs and the selection in *parameter 22-50 End of Curve Function*, is different from Off. The end of curve function can only be used when operating with the built-in PID controller ([3] *Closed Loop* in *parameter 1-00 Configuration Mode*).

22-50 End of Curve Function		
Option:	Function:	
[0]	Off	End-of-curve monitoring not active.
[1]	Warning	The frequency converter continues to run, but activates an end-of-curve warning [W94]. A frequency converter digital output or a serial communication bus can communicate a warning to other equipment.
[2]	Alarm	The frequency converter stops running and activates an end-of-curve alarm [A 94]. A frequency converter digital output or a serial communication bus can communicate an alarm to other equipment.
[3]	Manual Reset Alarm	The frequency converter stops running and activates an end-of-curve alarm [A 94]. A frequency converter digital output or a serial communication bus can communicate an alarm to other equipment.

#### NOTICE

Automatic restart resets the alarm and restarts the system.

#### NOTICE

Do not set *14-20 Reset Mode*, to [13] *Infinite auto reset*, when *parameter 22-50 End of Curve Function* is set to [2] *Alarm*. Doing so causes the frequency converter to continuously cycle between running and stopping when an end-of-curve condition is detected.

**NOTICE**

If the frequency converter is equipped with a constant speed bypass with an automatic bypass function that starts the bypass if the frequency converter experiences a persistent alarm condition, be sure to disable the bypass's automatic bypass function, if [2] *Alarm* or [3] *Man. Reset Alarm* is selected as the end-of-curve function.

22-51 End of Curve Delay		
Range:	Function:	
10 s* [0 - 600 s]	When an end-of-curve condition is detected, a timer is activated. When the time set in this parameter expires, and the end-of-curve condition has been steady in the entire period, the function set in <i>parameter 22-50 End of Curve Function</i> is activated. If the condition disappears before the timer expires, the timer is reset.	

3.19.6 22-6\* Broken Belt Detection

The broken belt detection can be used in both closed and open loop systems for pumps and fans. If the estimated motor torque is below the broken belt torque value (*parameter 22-61 Broken Belt Torque*) and the frequency converter output frequency is above or equal to 15 Hz, the broken belt function (*parameter 22-60 Broken Belt Function*) is performed. Broken Belt Detection, 22-6\*

22-60 Broken Belt Function		
Selects the action to be performed if the broken belt condition is detected		
Option:	Function:	
[0] Off		
[1] Warning	The frequency converter continues to run, but activates a broken belt warning [W95]. A frequency converter digital output or a serial communication bus can communicate a warning to other equipment.	
[2] Trip	The frequency converter stops running and activates a broken belt alarm [A 95]. A frequency converter digital output or a serial communication bus can communicate an alarm to other equipment.	

**NOTICE**

Do not set 14-20 *Reset Mode*, to [13] *Infinite auto reset*, when *parameter 22-60 Broken Belt Function* is set to [2] *Trip*. Doing so causes the frequency converter to continuously cycle between running and stopping when a broken belt condition is detected.

**NOTICE**

If the frequency converter is equipped with a constant speed bypass with an automatic bypass function that starts the bypass if the frequency converter experiences a persistent alarm condition, be sure to disable the bypass's automatic bypass function, if [2] *Trip* is selected as the broken belt function.

22-61 Broken Belt Torque		
Range:	Function:	
10 %* [0 - 100 %]	Sets the broken belt torque as a percentage of the rated motor torque.	

22-62 Broken Belt Delay		
Range:	Function:	
10 s [0 - 600 s]	Sets the time for which the broken belt conditions must be active before carrying out the action selected in <i>parameter 22-60 Broken Belt Function</i> .	

3.19.7 22-7\* Short Cycle Protection

In some applications, there is often a need for limiting the numbers of starts. One way to do this is to ensure a minimum run time (time between a start and a stop) and a minimum interval between starts. This means that any normal stop command can be overridden by *parameter 22-77 Minimum Run Time* and any normal start command (Start/Jog/Freeze) can be overridden by *parameter 22-76 Interval between Starts*. None of the 2 functions are active if *Hand On* or *Off* modes have been activated via the LCP. If selecting *Hand On* or *Off*, the 2 timers are reset to 0, and do not start counting until [Auto On] is pressed and an active start command applied.

22-75 Short Cycle Protection		
Option:	Function:	
[0] Disabled	Timer set in <i>parameter 22-76 Interval between Starts</i> is disabled.	
[1] Enabled	Timer set in <i>parameter 22-76 Interval between Starts</i> is enabled.	

22-76 Interval between Starts		
Range:	Function:	
Size related* [ par. 22-77 - 3600 s]	Sets the time desired as minimum time between 2 starts. Any normal start command (Start/Jog/Freeze) is disregarded until the timer has expired.	



22-77 Minimum Run Time		
Range:	Function:	
0 s* [0 - par. 22-76 s]	Sets the time desired as minimum run time after a normal start command (start/jog/freeze). Any normal stop command is disregarded until the set time has expired. The timer starts counting following a normal start command (start/jog/freeze).  The timer is overridden by a coast (inverse) or an external interlock command.	

**NOTICE**

Does not work in cascade mode.

22-78 Minimum Run Time Override		
Option:	Function:	
[0]	Disabled	
[1]	Enabled	

22-79 Minimum Run Time Override Value		
Range:	Function:	
0 ProcessCtrlUnit* [-999999.999 - 999999.999 ProcessCtrlUnit]		

3.19.8 22-8\* Flow Compensation

Sometimes it is not possible for a pressure transducer to be placed at a remote point in the system and it can only be located close to the fan/pump outlet. Flow compen-

sation operates by adjusting the set-point according to the output frequency, which is almost proportional to flow, thus compensating for higher losses at higher flow rates.

H<sub>DESIGN</sub> (Required pressure) is the setpoint for closed loop (PI) operation of the frequency converter and is set as for closed loop operation without flow compensation.

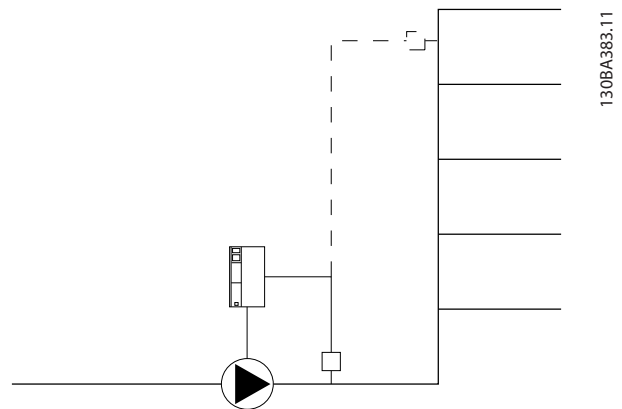

Illustration 3.61 Flow Compensation Setup

There are 2 methods which can be employed, depending upon whether or not the Speed at System design Working Point is known.

Parameter used	Speed at Design Point KNOWN	Speed at Design Point UNKNOWN
Parameter 22-80 Flow Compensation	+	+
Parameter 22-81 Square-linear Curve Approximation	+	+
Parameter 22-82 Work Point Calculation	+	+
Parameter 22-83 Speed at No-Flow [RPM]/parameter 22-84 Speed at No-Flow [Hz]	+	+
Parameter 22-85 Speed at Design Point [RPM]/parameter 22-86 Speed at Design Point [Hz]	+	-
Parameter 22-87 Pressure at No-Flow Speed	+	+
Parameter 22-88 Pressure at Rated Speed	-	+
Parameter 22-89 Flow at Design Point	-	+
Parameter 22-90 Flow at Rated Speed	-	+

Table 3.22 Speed at Design Point Known/Unknown

22-80 Flow Compensation		
Option:	Function:	
[0]	Disabled	Set-Point compensation not active.
[1]	Enabled	Set-Point compensation is active. Enabling this parameter allows the Flow Compensated Setpoint operation.

22-81 Square-linear Curve Approximation		
Range:	Function:	
100 %* [0 - 100 %]	<b>Example 1:</b> Adjustment of this parameter allows the shape of the control curve to be adjusted. 0 = Linear 100% = Ideal shape (theoretical).	

**NOTICE**

Not visible when running in cascade.

3

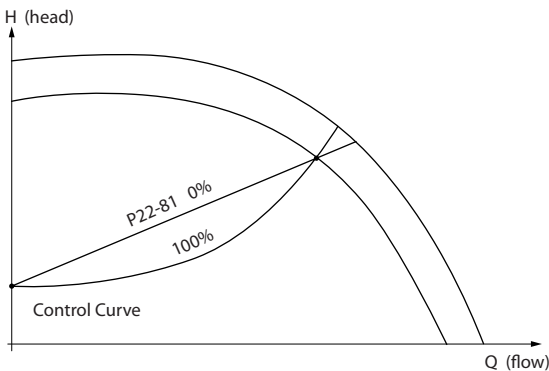

130BA388.11

Illustration 3.62 Square-linear Curve Approximation

22-82 Work Point Calculation	
Option:	Function:
	<p><b>Example 1:</b></p> <p><b>Illustration 3.63 Speed at System Design Working Point is Known</b></p> <p>From the data sheet showing characteristics for the specific equipment at different speeds, simply reading across from the <math>H_{DESIGN}</math> point and the <math>Q_{DESIGN}</math> point allows us to find point A, which is the System Design Working Point. The pump characteristics at this point should be identified and the associated speed programmed. Closing the valves and adjusting the speed until <math>H_{MIN}</math> has been achieved allows the speed at the no flow point to be identified.</p> <p>Adjustment of <i>parameter 22-81 Square-linear Curve Approximation</i> then allows the shape of the control curve to be adjusted infinitely.</p> <p><b>Example 2:</b></p> <p>Speed at System Design Working Point is not known: Where the Speed at System Design Working Point is unknown, another reference point on the control curve needs to be determined by means of the data sheet. By looking at the curve for the rated speed and plotting the design pressure (<math>H_{DESIGN}</math>, Point C) the flow at that pressure</p>

22-82 Work Point Calculation	
Option:	Function:
	<p><math>Q_{RATED}</math> can be determined. Similarly, by plotting the design flow (<math>Q_{DESIGN}</math>, Point D). The pressure <math>H_{DESIGN}</math> at that flow can be determined. Knowing these 2 points on the pump curve, along with <math>H_{MIN}</math> as described above, allows the frequency converter to calculate the reference point B and thus to plot the control curve which will also include the System design Working Point A.</p> <p><b>Illustration 3.64 Speed at System Design Working Point is not Known</b></p>
[0]	<p>Disabled Work Point Calculation not active. To be used if speed at design point is known.</p>
[1]	<p>Enabled Work Point Calculation is active. Enabling this parameter allows the calculation of the unknown System Design Working Point at 50/60 Hz speed, from the input data set in <i>parameter 22-83 Speed at No-Flow [RPM]</i> <i>parameter 22-84 Speed at No-Flow [Hz]</i>, <i>parameter 22-87 Pressure at No-Flow Speed</i>, <i>parameter 22-88 Pressure at Rated Speed</i>, <i>parameter 22-89 Flow at Design Point</i> and <i>parameter 22-90 Flow at Rated Speed</i>.</p>

22-83 Speed at No-Flow [RPM]	
Range:	Function:
Size related* [ 0 - par. 22-85 RPM]	<p>Resolution 1 RPM.</p> <p>The speed of the motor at which flow is zero and minimum pressure <math>H_{MIN}</math> is achieved should be entered here in RPM. Alternatively, the speed in Hz can be entered in <i>parameter 22-84 Speed at No-Flow [Hz]</i>. If it has been decided to use RPM in <i>parameter 0-02 Motor Speed Unit</i> then <i>parameter 22-85 Speed at Design Point [RPM]</i> should also be used. Closing the valves and reducing the speed until minimum pressure <math>H_{MIN}</math> is achieved determines this value.</p>

22-84 Speed at No-Flow [Hz]		
Range:		Function:
Size related*	[ 0 - par. 22-86 Hz]	Resolution 0.033 Hz. Enter the motor speed in Hz at which flow has effectively stopped and minimum pressure $H_{MIN}$ is achieved. Alternatively, the speed in RPM can be entered in <i>parameter 22-83 Speed at No-Flow [RPM]</i> . If it has been decided to use Hz in <i>parameter 0-02 Motor Speed Unit</i> , <i>parameter 22-86 Speed at Design Point [Hz]</i> should also be used. Closing the valves and reducing the speed until minimum pressure $H_{MIN}$ is achieved determines this value.

22-85 Speed at Design Point [RPM]		
Range:		Function:
Size related*	[ 0 - 60000 RPM]	Resolution 1 RPM. Only visible when <i>parameter 22-82 Work Point Calculation</i> is set to <i>Disable</i> . Enter the motor speed in RPM at which the system design working point is achieved. Alternatively, the speed in Hz can be entered in <i>parameter 22-86 Speed at Design Point [Hz]</i> . If it has been decided to use RPM in <i>parameter 0-02 Motor Speed Unit</i> then <i>parameter 22-83 Speed at No-Flow [RPM]</i> should also be used.

22-86 Speed at Design Point [Hz]		
Range:		Function:
Size related*	[ 0.0 - par. 4-19 Hz]	Resolution 0.033 Hz. Only visible when <i>parameter 22-82 Work Point Calculation</i> is set to <i>Disable</i> . Enter the motor speed in Hz at which the system design working point is achieved. Alternatively, the speed in RPM can be entered in <i>parameter 22-85 Speed at Design Point [RPM]</i> . If it has been decided to use Hz in <i>parameter 0-02 Motor Speed Unit</i> , then <i>parameter 22-83 Speed at No-Flow [RPM]</i> should also be used.

22-87 Pressure at No-Flow Speed		
Range:		Function:
0 *	[ 0 - par. 22-88 ]	Enter the pressure $H_{MIN}$ corresponding to Speed at No Flow in Reference/Feedback Units.

Also see *parameter 22-82 Work Point Calculation* point D.

22-88 Pressure at Rated Speed		
Range:		Function:
999999.999 *	[ par. 22-87 - 999999.999 ]	Enter the value corresponding to the Pressure at Rated Speed, in Reference/Feedback Units. This value can be defined using the pump datasheet.

See *parameter 22-88 Pressure at Rated Speed* point A.

22-89 Flow at Design Point		
Range:		Function:
0 *	[ 0 - 999999.999 ]	Flow at design point (no units).

Also see *parameter 22-82 Work Point Calculation* point C.

22-90 Flow at Rated Speed		
Range:		Function:
0 *	[ 0 - 999999.999 ]	Enter the value corresponding to Flow at Rated Speed. This value can be defined using the pump datasheet.

## 3.20 Parameters 23-\*\* Time-based Functions

### 3.20.1 23-0\* Timed Actions

Use *Timed Actions* for actions needing to be performed on a daily or weekly basis, e.g. different references for working hours/non-working hours. Up to 10 timed actions can be programmed in the frequency converter. The timed action number is selected from the list when entering parameter group 23-0\* *Timed Actions* from the LCP.

*Parameter 23-00 ON Time* – *parameter 23-04 Occurrence* then refer to the selected timed action number. Each timed action is divided into an ON time and an OFF time, in which 2 different actions may be performed.

The clock control (parameter group 0-7\* *Clock Settings*) of Timed Actions can be overridden from *Timed Actions Auto* (Clock Controlled) to *Timed Actions Disabled*, *Constant OFF Actions* or *Constant ON Actions* either in 23-08 *Timed Actions Mode* or with commands applied to the digital inputs ([68] *Timed Actions Disabled*, [69] *Constant OFF Actions* or [70] *Constant ON Actions*, in parameter group 5-1\* *Digital Inputs*).

Display lines 2 and 3 in the LCP show the status for timed actions mode (0-23 *Display Line 2 Large* and 0-24 *Display Line 3 Large*, setting [1643] *Timed Actions Status*).

#### NOTICE

A change in mode via the digital inputs can only take place if 23-08 *Timed Actions Mode* is set for [0] *Times Actions Auto*.

If commands are applied simultaneously to the digital inputs for Constant OFF and Constant ON, the timed actions mode changes to timed actions auto and the 2 commands are disregarded.

If 0-70 *Date and Time* is not set or the frequency converter is set to HAND or OFF mode (e.g. via the LCP), the timed actions mode is changed to *Timed Actions Disabled*.

The timed actions have a higher priority than the same actions/commands activated by the digital inputs or the Smart Logic Controller.

The actions programmed in timed actions are merged with corresponding actions from digital inputs, control word via bus and Smart Logic Controller, according to merge rules set up in parameter group 8-5\* *Digital/Bus*.

#### NOTICE

The clock (parameter group 0-7\* *Clock Settings*) must be correctly programmed for timed actions to function correctly.

#### NOTICE

When mounting an Analog I/O MCB 109 option card, a battery back-up of the date and time is included.

#### NOTICE

The PC-based Configuration Tool MCT 10 Set-up Software comprises a special guide for easy programming of timed actions.

23-00 ON Time		
Array [10]		
<b>Range:</b>		<b>Function:</b>
Size related*	[ 0 - 0 ]	Sets the ON time for the timed action.
<b>NOTICE</b>		
The frequency converter has no back-up of the clock function and the set date/time resets to default (2000-01-01 00:00) after a power down unless a Real Time Clock module with back-up is installed. In parameter 0-79 <i>Clock Fault</i> it is possible to program for a Warning in case clock has not been set properly, e.g. after a power down.		

23-01 ON Action		
Arra [10]		
<b>Option:</b>		<b>Function:</b>
		Select the action during ON Time. See parameter 13-52 <i>SL Controller Action</i> for descriptions of the options.
[0]	Disabled	
[1]	No action	
[2]	Select set-up 1	
[3]	Select set-up 2	
[4]	Select set-up 3	
[5]	Select set-up 4	
[10]	Select preset ref 0	
[11]	Select preset ref 1	
[12]	Select preset ref 2	
[13]	Select preset ref 3	
[14]	Select preset ref 4	
[15]	Select preset ref 5	
[16]	Select preset ref 6	
[17]	Select preset ref 7	
[18]	Select ramp 1	
[19]	Select ramp 2	
[22]	Run	
[23]	Run reverse	
[24]	Stop	
[26]	DC Brake	

23-01 ON Action		
Arra [10]		
<b>Option:</b>	<b>Function:</b>	
[27]	Coast	
[28]	Freeze output	
[29]	Start timer 0	
[30]	Start timer 1	
[31]	Start timer 2	
[32]	Set digital out A low	
[33]	Set digital out B low	
[34]	Set digital out C low	
[35]	Set digital out D low	
[36]	Set digital out E low	
[37]	Set digital out F low	
[38]	Set digital out A high	
[39]	Set digital out B high	
[40]	Set digital out C high	
[41]	Set digital out D high	
[42]	Set digital out E high	
[43]	Set digital out F high	
[60]	Reset Counter A	
[61]	Reset Counter B	
[70]	Start Timer 3	
[71]	Start Timer 4	
[72]	Start Timer 5	
[73]	Start Timer 6	
[74]	Start Timer 7	
[80]	Sleep Mode	
[81]	Derag	

**NOTICE**

For choices [32] - [43], see also parameter group 5-3\* *Digital Outputs and 5-4\* Relays.*

23-02 OFF Time		
Array [10]		
<b>Range:</b>	<b>Function:</b>	
Size related*	[ 0 - 0 ]	Sets the OFF time for the timed action.

23-02 OFF Time		
Array [10]		
<b>Range:</b>	<b>Function:</b>	
		<b>NOTICE</b> The frequency converter has no back-up of the clock function and the set date/time is reset to default (2000-01-01 00:00) after a power down unless a Real Time Clock module with back-up is installed. In <i>parameter 0-79 Clock Fault</i> it is possible to program for a Warning in case clock has not been set properly, e.g. after a power down.

23-03 OFF Action		
Array [10]		
See <i>parameter 23-01 ON Action</i> for available actions.		
<b>Option:</b>	<b>Function:</b>	
[0] *	Disabled	

23-04 Occurrence		
Array [10]		
<b>Option:</b>	<b>Function:</b>	
		Select which day(s) the timed action applies to. Specify working/non-working days in <i>parameter 0-81 Working Days</i> , <i>parameter 0-82 Additional Working Days</i> and <i>parameter 0-83 Additional Non-Working Days</i> .
[0]	All days	
[1]	Working days	
[2]	Non-working days	
[3]	Monday	
[4]	Tuesday	
[5]	Wednesday	
[6]	Thursday	
[7]	Friday	
[8]	Saturday	
[9]	Sunday	

3.20.2 23-1\* Maintenance

Wear and tear calls for periodic inspection and service of elements in the application, e.g. motor bearings, feedback sensors and seals or filters. With preventive maintenance the service intervals may be programmed into the frequency converter. The frequency converter gives a message when maintenance is required. 20 preventive maintenance events can be programmed into the frequency converter. Specify the following for each event:

- Maintenance item (e.g. "Motor Bearings")
- Maintenance action (e.g. "Replace")
- Maintenance Time Base (e.g. "Running Hours" or a specific date and time)
- Maintenance Time Interval or the date and time of next maintenance

**NOTICE**

To disable a preventive maintenance event the associated *parameter 23-12 Maintenance Time Base* must be set to [0] Disabled.

Preventive maintenance can be programmed from the LCP, but use of the PC-based VLT Motion Control Tool MCT 10 Set-up Software is recommended.

3

ID	Name	Setup 1	Setup 2	Setup 3	Setup 4
2310.0	Maintenance Item	Motor bearings	Motor bearings	Motor bearings	Motor bearings
2310.1	Maintenance Item	Motor bearings	Motor bearings	Motor bearings	Motor bearings
2310.2	Maintenance Item	Motor bearings	Motor bearings	Motor bearings	Motor bearings
2310.3	Maintenance Item	Motor bearings	Motor bearings	Motor bearings	Motor bearings
2310.4	Maintenance Item	Motor bearings	Motor bearings	Motor bearings	Motor bearings
2310.5	Maintenance Item	Motor bearings	Motor bearings	Motor bearings	Motor bearings
2310.6	Maintenance Item	Motor bearings	Motor bearings	Motor bearings	Motor bearings
2310.7	Maintenance Item	Motor bearings	Motor bearings	Motor bearings	Motor bearings
2310.8	Maintenance Item	Motor bearings	Motor bearings	Motor bearings	Motor bearings
2310.9	Maintenance Item	Motor bearings	Motor bearings	Motor bearings	Motor bearings
2310.10	Maintenance Item	Motor bearings	Motor bearings	Motor bearings	Motor bearings
2310.11	Maintenance Item	Motor bearings	Motor bearings	Motor bearings	Motor bearings
2310.12	Maintenance Item	Motor bearings	Motor bearings	Motor bearings	Motor bearings
2310.13	Maintenance Item	Motor bearings	Motor bearings	Motor bearings	Motor bearings
2310.14	Maintenance Item	Motor bearings	Motor bearings	Motor bearings	Motor bearings
2310.15	Maintenance Item	Motor bearings	Motor bearings	Motor bearings	Motor bearings
2310.16	Maintenance Item	Motor bearings	Motor bearings	Motor bearings	Motor bearings
2310.17	Maintenance Item	Motor bearings	Motor bearings	Motor bearings	Motor bearings
2310.18	Maintenance Item	Motor bearings	Motor bearings	Motor bearings	Motor bearings
2310.19	Maintenance Item	Motor bearings	Motor bearings	Motor bearings	Motor bearings
2311.0	Maintenance Action	Lubricate	Lubricate	Lubricates	Lubricate
2311.2	Maintenance Action	Lubricate	Lubricate	Lubricates	Lubricate
2311.3	Maintenance Action	Lubricate	Lubricate	Lubricates	Lubricate
2311.4	Maintenance Action	Lubricate	Lubricate	Lubricates	Lubricate
2311.5	Maintenance Action	Lubricate	Lubricate	Lubricates	Lubricate
2311.6	Maintenance Action	Lubricate	Lubricate	Lubricates	Lubricate

Illustration 3.65 MCT 10 Set-up Software

The LCP indicates (with a wrench-icon and an “M”) when it is time for a preventive maintenance action, and can be programmed to be indicated on a digital output in parameter group 5-3\* *Digital Outputs*. The Preventive maintenance status may be read in *parameter 16-96 Maintenance Word*. A preventive maintenance indication can be reset from a digital input, the FC bus or manually from the LCP through *parameter 23-15 Reset Maintenance Word*.

A maintenance log with the latest 10 loggings can be read from parameter group 18-0\* *Maintenance Log* and via the alarm log key on the LCP after selecting maintenance log.

**NOTICE**

The preventive maintenance events are defined in a 20 element array. Hence each preventive maintenance event must use the same array element index in *parameter 23-10 Maintenance Item* to *parameter 23-14 Maintenance Date and Time*.

23-10 Maintenance Item	
Array [20]	
<b>Option:</b>	<b>Function:</b>
	Array with 20 elements displayed below parameter number in the display. Press [OK] and step between elements with [←], [→], [▲] and [▼].

23-10 Maintenance Item	
Array [20]	
<b>Option:</b>	<b>Function:</b>
	Select the item to be associated with the preventive maintenance event.
[1]	Motor bearings
[2]	Fan bearings
[3]	Pump bearings

23-10 Maintenance Item		
Array [20]		
Option:	Function:	
[4]	Valve	
[5]	Pressure transmitter	
[6]	Flow transmitter	
[7]	Temperature transm.	
[8]	Pump seals	
[9]	Fan belt	
[10]	Filter	
[11]	Drive cooling fan	
[12]	System health check	
[13]	Warranty	

23-11 Maintenance Action		
Array [20]		
Option:	Function:	
		Select the action to be associated with the preventive maintenance event.
[1]	Lubricate	
[2]	Clean	
[3]	Replace	
[4]	Inspect/Check	
[5]	Overhaul	
[6]	Renew	
[7]	Check	
[20]	Maintenance Text 0	
[21]	Maintenance Text 1	
[22]	Maintenance Text 2	
[23]	Maintenance Text 3	
[24]	Maintenance Text 4	
[25]	Maintenance Text 5	

23-12 Maintenance Time Base		
Array [20]		
Option:	Function:	
		Select the time base to be associated with the preventive maintenance event.
[0]	Disabled	Disables the preventive maintenance event.
[1]	Running Hours	The number of hours the motor has been running. Running hours are not reset at power-on. The <i>Maintenance Time Interval</i> must be specified in <i>parameter 23-13 Maintenance Time Interval</i> .
[2]	Operating Hours	The number of hours the frequency converter has been running. Operating hours are not reset at power-on. The <i>Maintenance Time Interval</i> must be specified in <i>parameter 23-13 Maintenance Time Interval</i> .
[3]	Date & Time	Uses the internal clock. The date and time of the next maintenance occurrence must be specified in <i>parameter 23-14 Maintenance Date and Time</i> .

23-13 Maintenance Time Interval		
Array [20]		
Range:	Function:	
1 h*	[1 - 2147483647 h]	Set the interval associated with the current preventive maintenance event. This parameter is only used if [1] <i>Running Hours</i> or [2] <i>Operating Hours</i> is selected in <i>parameter 23-12 Maintenance Time Base</i> . The timer is reset from <i>parameter 23-15 Reset Maintenance Word</i> .
<b>Example</b>		
A preventive maintenance event is set up Monday at 8:00. <i>Parameter 23-12 Maintenance Time Base</i> is [2] <i>Operating hours</i> and <i>parameter 23-13 Maintenance Time Interval</i> is 7 x 24 hours=168 hours. Next maintenance event is indicated the following Monday at 8:00. If this maintenance event is not reset until Tuesday at 9:00, the next occurrence is the following Tuesday at 9:00.		

23-14 Maintenance Date and Time		
Array [20]		
Range:	Function:	
Size related*	[ 0 - 0 ]	Set the date and time for next maintenance occurrence if the preventive maintenance event is based on date/time. Date format depends on the setting in <i>0-71 Date Format</i> while the time format depends on the setting in <i>parameter 0-72 Time Format</i> .
<b>NOTICE</b>		
The frequency converter has no back-up of the clock function and the set date/time is reset to default (2000-01-01 00:00) after a power down. In <i>parameter 0-79 Clock Fault</i> it is possible to program for a Warning in case the clock has not been set properly, e.g. after a power down. The time set must be at least one hour from the actual time!		
<b>NOTICE</b>		
When mounting an Analog I/O MCB 109 option card, a battery back-up of the date and time is included.		

23-15 Reset Maintenance Word		
Option:	Function:	
		Set this parameter to [1] Do reset to reset the Maintenance Word in parameter 16-96 Maintenance Word and reset the message displayed in the LCP. This parameter changes back to [0] Do not reset when pressing [OK].
[0]	Do not reset	
[1]	Do reset	

**NOTICE**

When messages are reset - Maintenance Item, Action and Maintenance Date/Time are not cancelled.

Parameter 23-12 Maintenance Time Base is set to [0] Disabled.

23-16 Maintenance Text		
Array [6]		
Range:	Function:	
0 * [0 - 20 ]	6 individual texts (Maintenance Text 0...Maintenance Text 5) can be written for use in either parameter 23-10 Maintenance Item or parameter 23-11 Maintenance Action. The text is written according to the guidelines in parameter 0-37 Display Text 1.	

3.20.3 23-5\* Energy Log

The frequency converter is continuously accumulating the consumption of the motor controlled, based on the actual power yielded by the frequency converter.

These data can be used for an energy log function allowing the user to compare and structure the information about the energy consumption related to time.

There are basically 2 functions:

- Data related to a pre-programmed period, defined by a set date and time for start
- Data related to a predefined period back in time e.g. last 7 days within the pre-programmed period

For each of the above 2 functions, the data are stored in a number of counters allowing for selecting time frame and a split on hours, days or weeks.

The period/split (resolution) can be set in parameter 23-50 Energy Log Resolution.

The data are based on the value registered by the kWh counter in the frequency converter. This counter value can be read in parameter 15-02 kWh Counter containing the

accumulated value since the first power up or latest reset of the counter (parameter 15-06 Reset kWh Counter).

All data for the energy log are stored in counters which can be read from parameter 23-53 Energy Log.

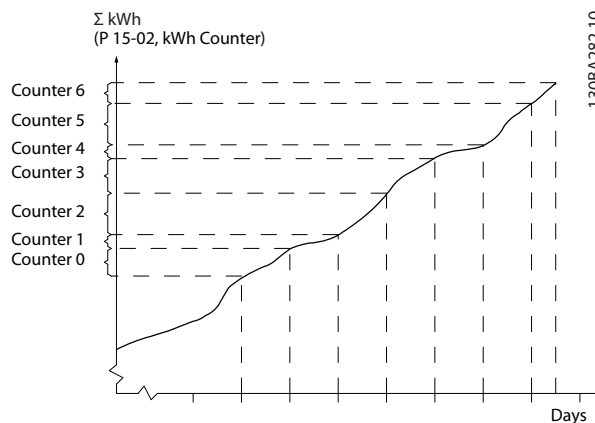

Illustration 3.66 Energy Log Graph

Counter 00 always contains the oldest data. A counter covers a period from XX:00 to XX:59 if hours or 00:00 to 23:59 if days.

If logging either the last hours or last days, the counters shift contents at XX:00 every hour or at 00:00 every day. The counter with highest index is always subject to update (containing data for the actual hour since XX:00 or the actual day since 00:00).

The contents of counters can be displayed as bars on LCP. Select Quick Menu, Loggings, Energy Log: Trending Continued Bin/Trending Timed Bin/Trending Comparison.

23-50 Energy Log Resolution		
Option:	Function:	
		Select the desired type of period for logging of consumption. [0] Hour of Day, [1] Day of Week or [2] Day of Month. The counters contain the logging data from the programmed date/time for start (parameter 23-51 Period Start) and the numbers of hours/days as programmed for (parameter 23-50 Energy Log Resolution). The logging starts on the date programmed in parameter 23-51 Period Start, and continues until one day/week/month has gone. [5] Last 24 Hours, [6] Last 7 Days or [7] Last 5 Weeks. The counters contain data for one day, one week or 5 weeks back in time and up to the actual time. The logging starts at the date programmed in parameter 23-51 Period Start. In all cases the period split refers to Operating Hours (time where frequency converter is powered up).
[0]	Hour of Day	



23-50 Energy Log Resolution		
Option:	Function:	
[1]	Day of Week	
[2]	Day of Month	
[5]	Last 24 Hours	
[6]	Last 7 Days	
[7]	Last 5 Weeks	

**NOTICE**

The frequency converter has no back-up of the clock function and the set date/time resets to default (2000-01-01 00:00) after a power down unless a Real Time Clock module with back-up is installed. Consequently, the logging is stopped until date/time is readjusted in *0-70 Date and Time*. In *parameter 0-79 Clock Fault* it is possible to program for a warning in case the clock not has been set properly, e.g. after a power down.

23-51 Period Start		
Range:	Function:	
Size related* [ 0 - 0 ]	Set the date and time at which the energy log starts updating the counters. First data will be stored in counter [00] and start at the time/date programmed in this parameter.  Date format depends on setting in <i>0-71 Date Format</i> and time format on setting in <i>parameter 0-72 Time Format</i> .	

**NOTICE**

When mounting an Analog I/O MCB 109 option card, a battery back-up of the date and time is included.

23-53 Energy Log		
Array [31]		
Range:	Function:	
0 * [0 - 4294967295 ]	Array with a number of elements equal to the number of counters ([00]-[xx] below parameter number in display). Press [OK] and Step between elements with [▲] and [▼].  Array elements:	

23-53 Energy Log		
Array [31]		
Range:	Function:	
	<p><b>Illustration 3.68</b></p> <p>Data from latest period is stored in the counter with the highest index. At power down all counter values are stored and resumed at next power up.</p>	

3

**NOTICE**

All counters are automatically reset when changing the setting in *parameter 23-50 Energy Log Resolution*. At overflow, the update of the counters stops at maximum value.

**NOTICE**

When mounting an Analog I/O MCB 109 option card, a battery back-up of the date and time is included.

23-54 Reset Energy Log		
Option:	Function:	
	Select [1] Do reset to reset all values in the Energy Log counters shown in <i>parameter 23-53 Energy Log</i> . After pressing OK, the setting of the parameter value automatically changes to [0] Do not reset.	
[0]	Do not reset	
[1]	Do reset	

3.20.4 23-6\* Trending

Trending is used to monitor a process variable over a period of time and record how often the data falls into each of ten user-defined data ranges. This is a convenient

tool to get a quick overview indicating where to focus on improvement of operation.

2 sets of data for Trending can be created to make it possible to compare current values for a selected operating variable with data for a certain reference period, for the same variable. This reference period can be pre-programmed (*parameter 23-63 Timed Period Start* and *parameter 23-64 Timed Period Stop*). The 2 sets of data can be read from *parameter 23-61 Continuous Bin Data* (current) and *parameter 23-62 Timed Bin Data* (reference).

It is possible to create trending for following operation variables:

- Power
- Current
- Output frequency
- Motor Speed

The trending function includes 10 counters (forming a bin) for each set of data containing the numbers of registrations reflecting how often the operating variable is within each of ten pre-defined intervals. The sorting is based on a relative value of the variable.

The relative value for the operating variable is

$$\text{Actual/Rated} * 100\%$$

for Power and Current and

$$\text{Actual/Max} * 100\%$$

for Output Frequency and Motor Speed.

The size of each interval can be adjusted individually, but will default be 10% for each. Power and Current can exceed rated value, but those registrations are included in 90%-100% (MAX) counter.

Once a second, the value of the operating variable selected is registered. If a value has been registered to equal 13%, the counter "10% - <20%" is updated with the value "1". If the value stays at 13% for 10s, then "10" is added to the counter value.

The contents of counters can be displayed as bars on LCP. Select *Quick Menu*⇒*Loggings: Trending Continued Bin/Trending Timed Bin/Trending Comparison*.

**NOTICE**

The counters starts counting whenever the frequency converter is powered-up. Power cycle shortly after a reset zeros the counters. EEPROM data are updated once per hour.

23-60 Trend Variable		
Option:		Function:
		Select the desired operating variable to be monitored for Trending.
[0]	Power [kW]	Power yielded to the motor. Reference for the relative value is the rated motor power programmed in <i>parameter 1-20 Motor Power [kW]</i> or <i>parameter 1-21 Motor Power [HP]</i> . Actual value can be read in <i>parameter 16-10 Power [kW]</i> or <i>parameter 16-11 Power [hp]</i> .
[1]	Current [A]	Output current to the motor. Reference for the relative value is the rated motor current programmed in <i>parameter 1-24 Motor Current</i> . Actual value can be read in <i>parameter 16-14 Motor current</i> .
[2]	Frequency [Hz]	Output frequency to the motor. Reference for the relative value is the maximum output frequency programmed in <i>parameter 4-14 Motor Speed High Limit [Hz]</i> . Actual value can be read in <i>parameter 16-13 Frequency</i> .
[3]	Motor Speed [RPM]	Speed of the motor. Reference for relative value is the maximum motor speed programmed in <i>parameter 4-13 Motor Speed High Limit [RPM]</i> .

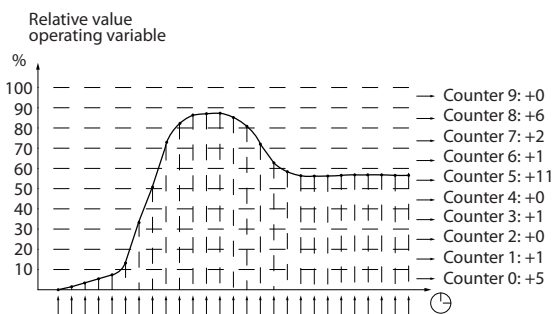

Illustration 3.69 Time and Relative Values

130BA281.10

23-61 Continuous Bin Data		
Range:	Function:	
0 * [0 - 4294967295 ]	<p>Array with 10 elements ([0]-[9] below parameter number in display). Press [OK] and step between elements with [▲] and [▼].</p> <p>10 counters with the frequency of occurrence for the operating variable monitored, sorted according to the following intervals:</p> <p style="padding-left: 40px;">Counter [0]: 0% - &lt;10%</p> <p style="padding-left: 40px;">Counter [1]: 10% - &lt;20%</p> <p style="padding-left: 40px;">Counter [2]: 20% - &lt;30%</p> <p style="padding-left: 40px;">Counter [3]: 30% - &lt;40%</p> <p style="padding-left: 40px;">Counter [4]: 40% - &lt;50%</p> <p style="padding-left: 40px;">Counter [5]: 50% - &lt;60%</p> <p style="padding-left: 40px;">Counter [6]: 60% - &lt;70%</p> <p style="padding-left: 40px;">Counter [7]: 70% - &lt;80%</p> <p style="padding-left: 40px;">Counter [8]: 80% - &lt;90%</p> <p style="padding-left: 40px;">Counter [9]: 90% - &lt;100% or Max</p> <p>The above minimum limits for the intervals are the default limits. These can be changed in <i>parameter 23-65 Minimum Bin Value</i>.</p> <p>Starts to count when the frequency converter is powered up for the first time. All counters can be reset to 0 in <i>parameter 23-66 Reset Continuous Bin Data</i>.</p>	

23-62 Timed Bin Data		
Range:	Function:	
0 * [0 - 4294967295 ]	<p>Array with 10 elements ([0]-[9] below parameter number in display). Press [OK] and step between elements with [▲] and [▼].</p> <p>10 counters with the frequency of occurrence for the operating data monitored sorted according to the intervals as for <i>parameter 23-61 Continuous Bin Data</i>.</p> <p>Starts to count at the date/time programmed in <i>parameter 23-63 Timed Period Start</i>, and stops at the time/date programmed in <i>parameter 23-64 Timed Period Stop</i>. All counters can be reset to 0 in <i>parameter 23-67 Reset Timed Bin Data</i>.</p>	

23-63 Timed Period Start		
Range:	Function:	
Size related* [0 - 0 ]	Set the date and time at which the trending starts the update of the timed bin counters.	

23-63 Timed Period Start		
Range:	Function:	
	Date format depends on setting in <i>0-71 Date Format</i> , and time format on setting in <i>parameter 0-72 Time Format</i> .	

**NOTICE**

The frequency converter has no back-up of the clock function and the set date/time is reset to default (2000-01-01 00:00) after a power down unless a Real Time Clock module with back-up is installed. Consequently, the logging is stopped until date/time is readjusted in *0-70 Date and Time*. In *parameter 0-79 Clock Fault* it is possible to program for a warning in case clock not has been set properly, e.g. after a power down.

**NOTICE**

When mounting an Analog I/O MCB 109 option card, a battery back-up of the date and time is included.

23-64 Timed Period Stop		
Range:	Function:	
Size related* [0 - 0 ]	Set the date and time at which the trend analyses must stop updating the timed bin counters.	
	Date format depends on setting in <i>0-71 Date Format</i> , and time format on setting in <i>parameter 0-72 Time Format</i> .	

**NOTICE**

When mounting an Analog I/O MCB 109 option card, a battery back-up of the date and time is included.

23-65 Minimum Bin Value		
Range:	Function:	
Size related* [0 - 100 %]	Array with 10 elements ([0]-[9] below parameter number in display). Press [OK] and step between elements with [▲] and [▼].	
	Set the minimum limit for each interval in <i>parameter 23-61 Continuous Bin Data</i> and <i>parameter 23-62 Timed Bin Data</i> . Example: If selecting [1] counter and changing setting from 10% to 12%, [0] counter is based on the interval 0 - <12% and [1] counter on interval 12% - <20%.	

23-66 Reset Continuous Bin Data		
Option:	Function:	
[0] Do not reset	Select [1] Do reset to reset all values in <i>parameter 23-61 Continuous Bin Data</i> . After pressing [OK], the setting of the parameter value automatically changes to [0] Do not reset.	
[1] Do reset		

23-67 Reset Timed Bin Data	
Option:	Function:
	Select [1] Do reset to reset all counters in parameter 23-62 Timed Bin Data. After pressing [OK] the setting of the parameter value automatically changes to [0] Do not reset.
[0]	Do not reset
[1]	Do reset

### 3.20.5 23-8\* Payback counter

The VLT® AQUA Drive includes a feature which can give a rough calculation on payback in cases where the frequency converter has been installed in an existing plant to ensure energy saving by changing from fixed to variable speed control. Reference for the savings is a set value to represent the average power yielded before the upgrade with variable speed control.

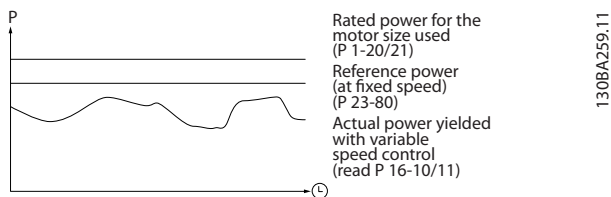

Illustration 3.70 Comparison of the Reference Power and Actual Power

The difference between the reference power at fixed speed and the actual power yielded with speed control represent the actual saving.

As value for the fixed speed case, the rated motor size (kW) is multiplied with a factor (set in %) representing the power yielded at fixed speed. The difference between this reference power and the actual power is accumulated and stored. The difference in energy can be read in parameter 23-83 Energy Savings.

The accumulated value for the difference in power consumption is multiplied with the energy cost in local currency and the investment is subtracted. This calculation for cost savings can also be read in parameter 23-84 Cost Savings.

$$\text{Cost Savings} = (\sum (\text{Reference Power} - \text{Actual Power})) * \text{Energy Cost} - \text{Additional Cost}$$

Break even (payback) occurs when the value read in the parameter turns from negative to positive.

It is not possible to reset the energy savings counter, but the counter can be stopped any time by setting parameter 23-80 Power Reference Factor, to 0.

Parameter for settings	
Rated Motor Power	1-20 Motor Power [kW]
Power Reference Factor in %	Parameter 23-80 Power Reference Factor
Energy Cost per kWh	Parameter 23-81 Energy Cost
Investment	Parameter 23-82 Investment
Parameters for readout	
Energy Savings	Parameter 23-83 Energy Savings
Actual Power	Parameter 16-10 Power [kW]/ parameter 16-11 Power [hp]
Cost Savings	Parameter 23-84 Cost Savings

Table 3.23 Parameter Overview

23-80 Power Reference Factor		
Range:	Function:	
100 %*	[0 - 100 %]	Set the percentage of the rated motor size (set in parameter 1-20 Motor Power [kW] or parameter 1-21 Motor Power [HP]) which is supposed to represent the average power yielded at the time running with fixed speed (before upgrade with variable speed control). Must be set to a value different from zero to start counting.

23-81 Energy Cost		
Range:	Function:	
1 *	[0 - 999999.99 ]	Set the actual cost for a kWh in local currency. If the energy cost is changed later on it will impact the calculation for the entire period.

23-82 Investment		
Range:	Function:	
0 *	[0 - 99999999 ]	Set the value of the investment spent on upgrading the plant with speed control, in same currency as used in parameter 23-81 Energy Cost.

23-83 Energy Savings		
Range:	Function:	
0 kWh*	[0 - 0 kWh]	This parameter allows a readout of the accumulated difference between the reference power and the actual output power. If motor size set in hp (parameter 1-21 Motor Power [HP]), the equivalent kW value is used for the energy savings.

23-84 Cost Savings		
Range:		Function:
0 *	[0 - 2147483647 ]	This parameter allows a readout of the calculation based on the above equation (in local currency).

### 3.21 Parameters 24-\*\* Application Functions 2

Parameter group for application monitoring functions.

#### 3.21.1 24-1\* Drive Bypass

Function for activation of external contactors to bypass the frequency converter for direct on-line operation of the motor, in case of trip.

24-10 Drive Bypass Function	
Option:	Function:
[0]	Disabled
[1]	Enabled

This parameter determines, what circumstances will activate the drive bypass function:

If in normal operation, the automatic drive bypass function is activated at following conditions:

- At a Trip Lock or a Trip.
- After the programmed number of reset attempts, programmed in *14-20 Reset Mode* or if the Bypass Delay Timer (*parameter 24-11 Drive Bypass Delay Time*) expires before reset attempts have been completed.

### CAUTION

**Important! After enabling the drive bypass function, the Safe Stop function (in versions, where included) is not complying with standard EN 954-1, Cat. 3 installations anymore.**

24-11 Drive Bypass Delay Time	
Range:	Function:
	which has been programmed for Bypass in <i>5-40 Function Relay</i> . If a relay delay has also been programmed in <i>parameter 5-41 On Delay, Relay</i> or <i>parameter 5-42 Off Delay, Relay, [Relay]</i> , this time must also elapse before the relay action is performed.

24-11 Drive Bypass Delay Time	
Range:	Function:
0 s* [0 - 600 s]	<p>Programmable in 1 s increments. Once the bypass function is activated in accordance with the setting in <i>parameter 24-10 Drive Bypass Function</i>, the bypass delay timer begins to operate. If the frequency converter has been set for a number of restart attempts, the timer will continue to run while the frequency converter tries to restart. Should the motor have restarted within the time period of the bypass delay timer, then the timer is reset.</p> <p>Should the motor fail to restart at the end of the bypass delay time, the drive bypass relay is activated, which has been programmed for Bypass in <i>5-40 Function Relay</i>. If a [Relay Delay] has also been programmed in <i>parameter 5-41 On Delay, Relay, [Relay]</i> or <i>parameter 5-42 Off Delay, Relay, [Relay]</i>, this time must also elapse before the relay action is performed.</p> <p>Where no restart attempts are programmed, the timer runs for the delay period set in this parameter and activates the drive bypass relay,</p>

### 3.22 Parameters 25-\*\* Cascade Controller

Parameters for configuring the Basic Cascade Controller for sequence control of multiple pumps. For a more application oriented description and wiring examples, see Chapter *Application Examples, item Basic Cascade Controller* in the Design Guide.

To configure the Cascade Controller to the actual system and the desired control strategy, it is recommended to follow the below sequence, starting with parameter group 25-0\* *System Settings* and next parameter group 25-5\* *Alternation Settings*. These parameter can normally be set in advance.

Parameters in 25-2\* *Bandwidth Settings* and 25-4\* *Staging Settings*, will often be dependent on the dynamic of the system and final adjustment to be done at the commissioning of the plant.

#### NOTICE

The Cascade Controller is supposed to operate in closed loop controlled by the built-in PI controller (Closed Loop selected in *parameter 1-00 Configuration Mode*). If *Open Loop* is selected in *parameter 1-00 Configuration Mode*, all fixed speed pumps will be destaged, but the variable speed pump will still be controlled by the frequency converter, now as an open loop configuration:

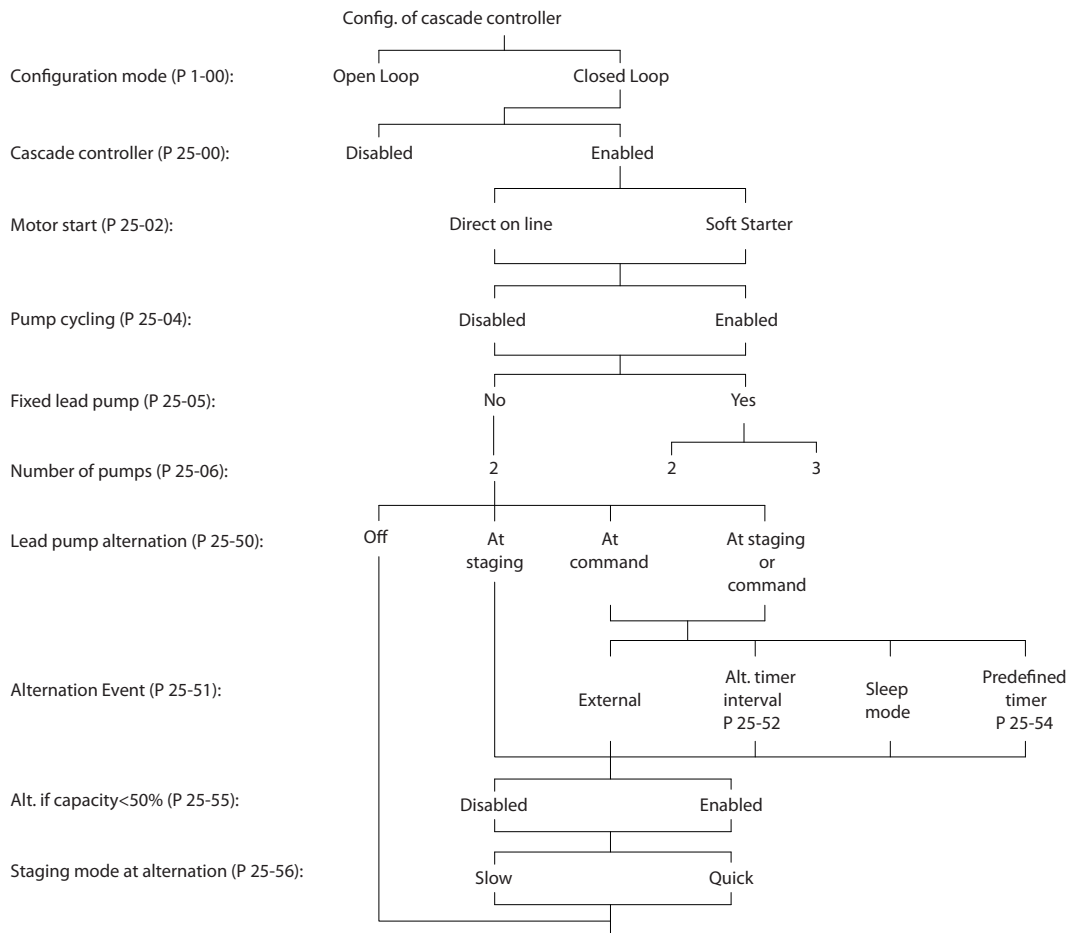

130BA279.12

Illustration 3.71 Cascade Controller Sample Set-up

### 3.22.1 25-0\* System Settings

Parameters related to control principles and configuration of the system.

25-00 Cascade Controller		
Option:	Function:	
		For operation of multiple devices (pump/fan) systems where capacity is adapted to actual load by means of speed control combined with on/off control of the devices. For simplicity only pump systems are described.
[0]	Disabled	The cascade controller is not active. All built-in relays assigned to pump motors in the cascade function are de-energised. If a variable speed pump is connected to the frequency converter directly (not controlled by a built-in relay); this pump/fan is controlled as a single pump system.
[1]	Basic Cascade Ctrl	The cascade controller is active and stages/destages pumps according to load on the system.
[2]	Motor Alternation Only	

25-02 Motor Start		
Option:	Function:	
		Motors are connected to the mains directly with a contactor or with a soft starter. When the value of <i>parameter 25-02 Motor Start</i> is set to an option other than [0] <i>Direct on Line</i> , then <i>parameter 25-50 Lead Pump Alternation</i> is automatically set to the default of [0] <i>Direct on Line</i> .
[0]	Direct on Line	Each fixed speed pump is connected to line directly via a contactor.
[1]	Soft Starter	Each fixed speed pump is connected to line via a soft starter.
[2]	Star Delta	Fixed pumps connected with star delta starters are staged in the same way as pumps connected with soft starters. They are destaged in the same way as pumps connected directly to line.

25-04 Pump Cycling		
Option:	Function:	
		To provide equal hours of operation with fixed speed pumps, the pump use can be cycled. The selection of pump cycling is either "first in – last out" or equal running hours for each pump.
[0]	Disabled	The fixed speed pumps are connected in the order 1–2 and disconnected in the order 2–1. (First in–last out).

25-04 Pump Cycling		
Option:	Function:	
[1]	Enabled	The fixed speed pumps are connected/disconnected to have equal running hours for each pump.

25-05 Fixed Lead Pump		
Option:	Function:	
		Fixed lead pump means that the variable speed pump is connected directly to the frequency converter and if a contactor is applied between frequency converter and pump, this contactor is not controlled by the frequency converter. If operating with <i>parameter 25-50 Lead Pump Alternation</i> set to other than [0] <i>Off</i> , set this parameter to [0] <i>No</i> .
[0]	No	The lead pump function can alternate between the pumps controlled by the 2 built-in relays. One pump must be connected to the built-in RELAY 1, and the other pump to RELAY 2. The pump function (Cascade Pump1 and Cascade Pump2) is automatically assigned to the relays (maximum 2 pumps can in this case be controlled from the frequency converter).
[1]	Yes	The lead pump is fixed (no alternation) and connected directly to the frequency converter. The <i>parameter 25-50 Lead Pump Alternation</i> is automatically set to [0] <i>Off</i> . Built-in relays Relay 1 and Relay 2 can be assigned to separate fixed speed pumps. In total 3 pumps can be controlled by the frequency converter.

25-06 Number of Pumps		
Range:	Function:	
2 * [ 2 - 9 ]		The number of pumps connected to the cascade controller including the variable speed pump. If the variable speed pump is connected directly to the frequency converter and the other fixed speed pumps (lag pumps) are controlled by the 2 built-in relays, 3 pumps can be controlled. If both the variable speed and fixed speed pumps are to be controlled by built-in relays, only 2 pumps can be connected.  If <i>parameter 25-05 Fixed Lead Pump</i> , is set to [0] <i>No</i> : one variable speed pump and one fixed speed pump; both controlled by built in relay. If <i>parameter 25-05 Fixed Lead Pump</i> is set to [1] <i>Yes</i> : one variable speed pump and one fixed speed pump controlled by built-in relay.  One lead pump, see <i>parameter 25-05 Fixed Lead Pump</i> . 2 fixed speed pumps controlled by built-in relays.



### 3.22.2 25-2\* Bandwidth Settings

Parameters for setting the bandwidth within which the pressure is allowed to operate before staging/destaging fixed speed pumps. Also includes various timers to stabilise the control.

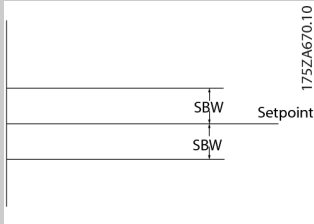
25-20 Staging Bandwidth		
Range:	Function:	
Size related* [ 1 - par. 25-21 %]	<p>Set the staging bandwidth (SBW) percentage to accommodate normal system pressure fluctuation. In cascade control systems, to avoid frequent switching of fixed speed pumps, the desired system pressure is typically kept within a bandwidth rather than at a constant level.</p> <p>The SBW is programmed as a percentage of <i>parameter 3-03 Maximum Reference</i>. For example, if the maximum reference is 6 bar, the setpoint is 5 bar and the SBW is set to 10%, a system pressure between 4.5 and 5.5 bar is tolerated. No staging or de-staging will occur within this bandwidth.</p>  <p><b>Illustration 3.72 Staging Bandwidth</b></p>	
Size related* [ 1 - par. 25-21 %]	<p>Set the staging bandwidth (SBW) percentage to accommodate normal system pressure fluctuation. In cascade control systems, to avoid frequent switching of fixed speed pumps, the desired system pressure is typically kept within a bandwidth rather than at a constant level.</p> <p>The SBW is programmed as a percentage of <i>20-13 Minimum Reference</i> and <i>20-14 Maximum Reference</i>. For example, if the setpoint is 5 bar and the SBW is set to 10%, a system pressure between 4.5 and 5.5 bar is tolerated. No staging or de-staging will occur within this bandwidth.</p>	

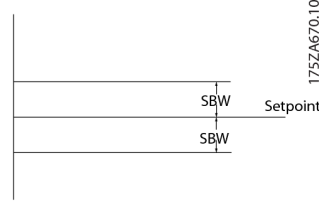
25-20 Staging Bandwidth		
Range:	Function:	
	 <p><b>Illustration 3.73 Staging Bandwidth</b></p>	

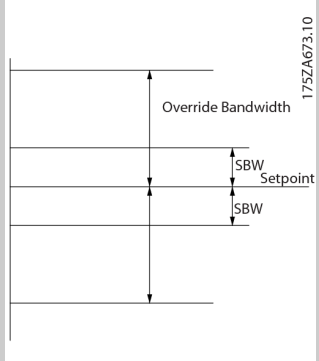
25-21 Override Bandwidth		
Range:	Function:	
100 %*	[ par. 25-20 - 100 %]	<p>When a large and quick change in the system demand occurs (such as a sudden water demand), the system pressure rapidly changes and an immediate staging or destaging of a fixed speed pump becomes necessary to match the requirement. The override bandwidth (OBW) is programmed to override the staging/destaging timer (<i>parameter 25-23 SBW Staging Delay</i> and <i>parameter 25-24 SBW Destaging Delay</i>) for immediate response.</p> <p>The OBW must always be programmed to a higher value than the value set in <i>parameter 25-20 Staging Bandwidth</i>. The OBW is a percentage of <i>parameter 3-02 Minimum Reference</i> and <i>parameter 3-03 Maximum Reference</i>.</p>  <p><b>Illustration 3.75</b></p> <p>Setting the OBW too close to the SBW could defeat the purpose with frequent staging at momentary pressure changes. Setting the OBW too high might lead to unacceptably high or low pressure in the system while the SBW timers are running. The value can be optimized with increased familiarity with the system. See <i>parameter 25-25 OBW Time</i>.</p> <p>To avoid unintended staging during the commissioning phase and fine tuning of the</p>

25-21 Override Bandwidth	
Range:	Function:
	controller, initially leave the OBW at the factory setting of 100% (Off). When the fine tuning is completed, the OBW should be set to the desired value. An initial value of 10% is suggested.

25-22 Fixed Speed Bandwidth	
Range:	Function:
Size related* [ par. 25-20 - par. 25-21 %]	When the cascade control system is running normally and the frequency converter issues a trip alarm, it is important to maintain the system head. The cascade controller does this by continuing to stage/destage the fixed speed pump on and off. Due to the fact that keeping the head at the setpoint would require frequent staging and destaging when only a fixed speed pump is running, a wider Fixed Speed Bandwidth (FSBW) is used instead of SBW. It is possible to stop the fixed speed pumps, in case of an alarm situation, by pressing [Off] or [Hand On] or if the signal programmed for Start on digital input goes low.  In case the issued alarm is a trip-lock alarm then the cascade controller must stop the system immediately by cutting out all the fixed speed pumps. This is basically the same as Emergency Stop (Coast/Coast inverse Command) for the cascade controller.

25-23 SBW Staging Delay	
Range:	Function:
15 s* [0 - 3000 s]	Immediate staging of a fixed speed pump is not desirable when a momentary pressure drop in the system exceeds the Staging Bandwidth (SBW). Staging is delayed by the length of time programmed. If the pressure increases to within the SBW before the timer has elapsed, the timer is reset.
	<p>175ZA672.11</p>
	<b>Illustration 3.76 SBW Staging Delay</b>

25-24 SBW Destaging Delay	
Range:	Function:
15 s* [0 - 3000 s]	Immediate destaging of a fixed speed pump is not desirable when a momentary pressure increase in the system that exceeds the Staging Bandwidth (SBW). Destaging is delayed by the length of time programmed. If the pressure decreases to within the SBW before the timer has elapsed, the timer is reset.
	<p>175ZA671.11</p>
	<b>Illustration 3.77 SBW Destaging Delay</b>

25-25 OBW Time	
Range:	Function:
10 s* [0 - 300 s]	Staging a fixed speed pump creates a momentary pressure peak in the system, which might exceed the Override Bandwidth (OBW). It is not desirable to destage a pump in response to a staging pressure peak. The OBW Time can be programmed to prevent staging until the system pressure has stabilised and normal control established. Set the timer to a value that allows the system to stabilise after staging. The 10 s factory setting is appropriate in most applications. In highly dynamic systems, a shorter time may be desirable.

	<p>130BA370.11</p>
	<b>Illustration 3.78 OBW Time</b>

25-26 Destage At No-Flow		
Option:	Function:	
		The Destage at No-Flow parameter ensures that when a no-flow situation occurs, the fixed speed pumps are destaged one-by-one until the no-flow signal disappears. This requires that No Flow Detection is active. See parameter group 22-2* <i>No-Flow Detection</i> . If [0] <i>Disabled</i> is selected, the cascade controller does not change the normal behavior of the system.
[0]	Disabled	
[1]	Enabled	

25-27 Stage Function		
Option:	Function:	
		If the Stage Function is set to [0] <i>Disabled</i> , parameter 25-28 <i>Stage Function Time</i> is not activated.
[0]	Disabled	
[1]	Enabled	

25-28 Stage Function Time		
Range:	Function:	
15 s*	[0 - 300 s]	The Stage Function Time is programmed to avoid frequent staging of the fixed speed pumps. The Stage Function Time starts if it is [1] <i>Enabled</i> by parameter 25-27 <i>Stage Function</i> , and when the variable speed pump is running at <i>Motor Speed High Limit</i> , parameter 4-13 <i>Motor Speed High Limit [RPM]</i> or parameter 4-14 <i>Motor Speed High Limit [Hz]</i> , with at least one fixed speed pump in the stop position. When the programmed value of the timer expires, a fixed speed pump is staged.

25-29 Destage Function		
Option:	Function:	
		The destage function ensures that the lowest numbers of pumps are running to save energy and to avoid dead head water circulation in the variable speed pump. If the destage function is set to [0] <i>Disabled</i> , parameter 25-30 <i>Destage Function Time</i> is not activated.
[0]	Disabled	
[1]	Enabled	

25-30 Destage Function Time		
Range:	Function:	
15 s*	[0 - 300 s]	The destage function timer is programmable to avoid frequent staging/destaging of the fixed speed pumps. The destage function time starts when the adjustable speed pump is running at parameter 4-11 <i>Motor Speed Low Limit [RPM]</i> or parameter 4-12 <i>Motor Speed Low Limit [Hz]</i> , with one or more fixed speed pumps in operation and

25-30 Destage Function Time		
Range:	Function:	
		system requirements satisfied. In this situation, the adjustable speed pump contributes a little to the system. When the programmed value of the timer expires, a stage is removed, avoiding dead head water circulation in the adjustable speed pump.

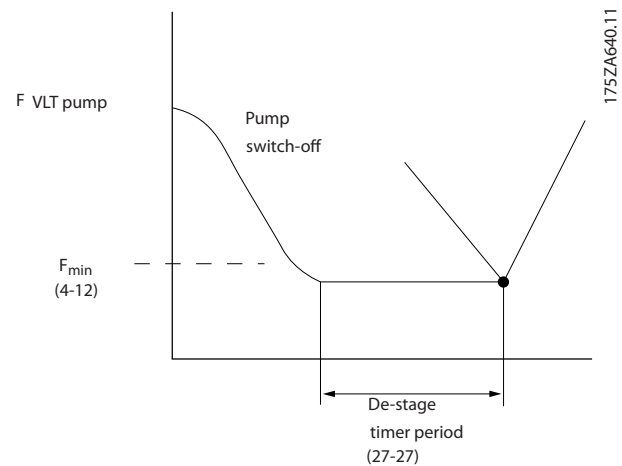

Illustration 3.79 Destage Function Time

### 3.22.3 25-4\* Staging Settings

Parameters determining conditions for staging/destaging the pumps.

25-40 Ramp Down Delay		
Range:	Function:	
10 s*	[0 - 120 s]	When adding a fixed speed pump controlled by a soft starter or a star delta starter, it is possible to delay the ramp down of the lead pump until a preset time after the start of the fixed speed pump to eliminate pressure surges or water hammer in the system.  Use this option only if [1] <i>Soft Starter</i> or [2] <i>Star Delta</i> is selected in parameter 25-02 <i>Motor Start</i> .

25-41 Ramp Up Delay		
Range:	Function:	
2 s*	[0 - 12 s]	When removing a fixed speed pump controlled by a soft starter, it is possible to delay the ramp up of the lead pump until a preset time after the stopping of the fixed speed pump to eliminate pressure surges or water hammer in the system.  Only to be used if [1] <i>Soft Starter</i> is selected in parameter 25-02 <i>Motor Start</i> .

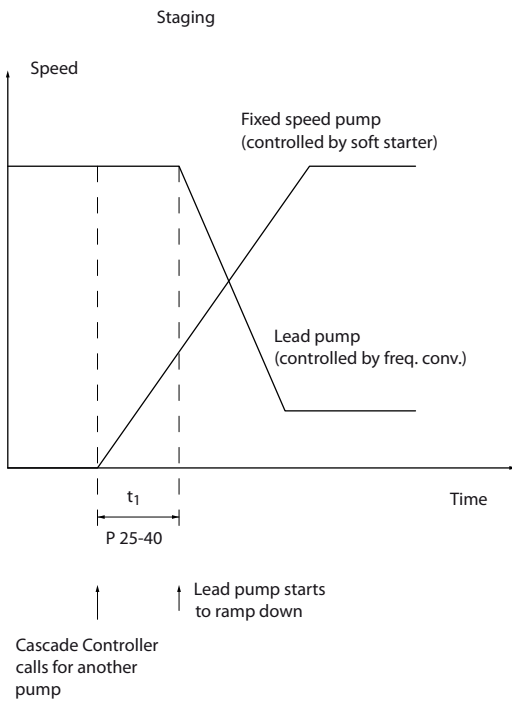

Illustration 3.80 Staging

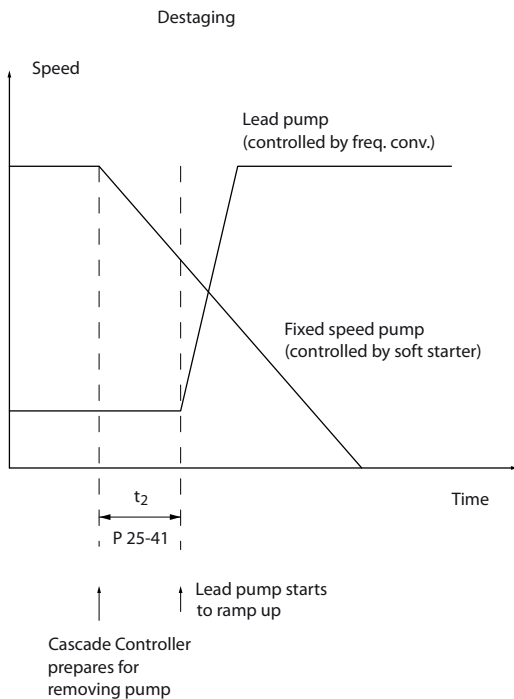

Illustration 3.81 Destaging

130BC371.10

**NOTICE**

Fixed pumps connected with star delta starters are staged in the same way as pumps connected with soft starters. They are destaged in the same way as pumps connected directly to line.

25-42 Staging Threshold		
Range:	Function:	
Size related* [ 0 - 100 %]	When adding a fixed speed pump, to prevent an overshoot of pressure, the variable speed pump ramps down to a lower speed. When the variable speed pump reaches the "Staging Speed" the fixed speed pump is staged on. The staging threshold is used to calculate the speed of the variable speed pump when the "cut-in point" of the fixed speed pump occurs. The calculation of the staging threshold is the ratio of <i>parameter 4-11 Motor Speed Low Limit [RPM]</i> or <i>parameter 4-12 Motor Speed Low Limit [Hz]</i> , to the <i>parameter 4-13 Motor Speed High Limit [RPM]</i> or <i>parameter 4-14 Motor Speed High Limit [Hz]</i> , expressed in percent.  Staging threshold must range from $STAGE\% = \frac{LOW}{HIGH} \times 100\%$ to 100%, where $n_{LOW}$ is motor speed low limit and $n_{HIGH}$ is Motor Speed High Limit.	

130BC372.10

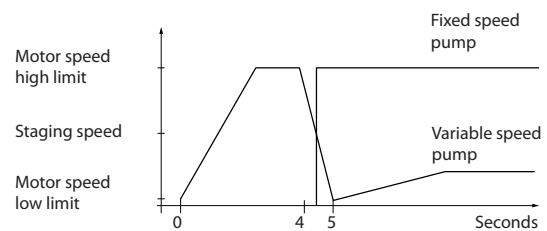

Illustration 3.82 Staging Threshold

1.30BA366.10

**NOTICE**

If the set-point is reached after staging before the variable speed pump reaches its minimum speed - the system will enter the state closed loop as soon as the feedback pressure is crossing the set-point.

25-43 Destaging Threshold		
Range:	Function:	
Size related* [ 0 - 100 %]	<p>When removing a fixed speed pump to prevent an undershoot of pressure, the variable speed pump ramps up to a higher speed. When the variable speed pump reaches the "Destaging Speed" the fixed speed pump is destaged. The destaging threshold is used to calculate the speed of the variable speed pump when the destaging of the fixed speed pump occurs. The calculation of the destaging threshold is the ratio of <i>parameter 4-11 Motor Speed Low Limit [RPM]</i> or <i>parameter 4-12 Motor Speed Low Limit [Hz]</i>, to the <i>parameter 4-13 Motor Speed High Limit [RPM]</i> or <i>parameter 4-14 Motor Speed High Limit [Hz]</i>, expressed in percent.</p> <p>Destaging threshold must range from <math>STAGE\% = \frac{LOW}{HIGH} \times 100\%</math> to 100%, where <math>n_{LOW}</math> is motor speed low limit and <math>n_{HIGH}</math> is Motor Speed High Limit.</p>	

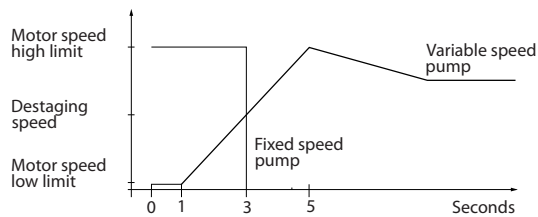

Illustration 3.83 Destaging Threshold

**NOTICE**

If the setpoint is reached after staging before the variable speed pump reaches its maximum speed, the system will enter the state closed loop as soon as the feedback pressure is crossing the setpoint.

25-44 Staging Speed [RPM]		
Range:	Function:	
0 RPM* [000 - 0 RPM]	<p>Readout of the below calculated value for staging speed. When adding a fixed speed pump to prevent an overshoot of pressure, the variable speed pump ramps down to a lower speed. When the variable speed pump reaches the "Staging Speed", the fixed speed pump is staged on. Staging speed calculation is based on <i>parameter 25-42 Staging Threshold</i>, and <i>parameter 4-13 Motor Speed High Limit [RPM]</i>.</p> <p>Staging speed is calculated with the following formula:</p> $STAGE = HIGH \frac{STAGE\%}{100}$ <p>where <math>n_{HIGH}</math> is motor speed high limit and <math>n_{STAGE100\%}</math> is the value of staging threshold.</p>	

25-45 Staging Speed [Hz]		
Range:	Function:	
0 Hz* [0 - 0 Hz]	<p>Readout of the below calculated value for staging speed. When adding a fixed speed pump to prevent an overshoot of pressure, the variable speed pump ramps down to a lower speed. When the variable speed pump reaches the "Staging Speed" the fixed speed pump is staged on. Staging speed calculation is based on <i>parameter 25-42 Staging Threshold</i>, and <i>parameter 4-14 Motor Speed High Limit [Hz]</i>.</p> <p>Staging speed is calculated with the following formula:</p> $STAGE = HIGH \frac{STAGE\%}{100}$ <p>where <math>n_{HIGH}</math> is motor speed high limit and <math>n_{STAGE100\%}</math> is the value of staging threshold.</p>	

25-46 Destaging Speed [RPM]		
Range:	Function:	
0 RPM* [000 - 0 RPM]	<p>Readout of the below calculated value for destaging speed. When removing a fixed speed pump to prevent an undershoot of pressure, the variable speed pump ramps up to a higher speed. When the variable speed pump reaches the "Destaging Speed", the fixed speed pump is destaged. Destaging speed is calculated based on <i>parameter 25-43 Destaging Threshold</i>, and <i>parameter 4-13 Motor Speed High Limit [RPM]</i>.</p> <p>Destaging speed is calculated with the following formula:</p> $DESTAGE = HIGH \frac{DESTAGE\%}{100}$ <p>where <math>n_{HIGH}</math> is motor speed high limit and <math>n_{DESTAGE100\%}</math> is the value of destaging threshold.</p>	

25-47 Destaging Speed [Hz]		
Range:	Function:	
0 Hz* [0 - 0 Hz]	<p>Readout of the below calculated value for destaging speed. When removing a fixed speed pump to prevent an undershoot of pressure, the variable speed pump ramps up to a higher speed. When the variable speed pump reaches the "Destaging Speed", the fixed speed pump is destaged. Destaging speed is calculated based on <i>parameter 25-43 Destaging Threshold</i>, and <i>parameter 4-14 Motor Speed High Limit [Hz]</i>.</p> <p>Destaging speed is calculated with the following formula:</p> $DESTAGE = HIGH \frac{DESTAGE\%}{100}$ <p>where <math>n_{HIGH}</math> is motor speed high limit and <math>n_{DESTAGE100\%}</math> is the value of destaging threshold.</p>	

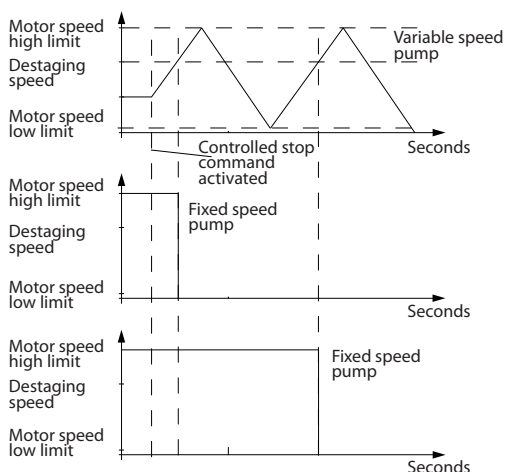

130BA368.10

Illustration 3.84 Destaging Speed

### 3.22.4 25-5\* Alternation Settings

Parameters for defining the conditions for alternation of the variable speed pump (lead), if selected as of the control strategy.

25-50 Lead Pump Alternation		
Option:	Function:	
		Lead pump alternation equalizes the use of pumps by periodically changing the pump that is speed controlled. This ensures that pumps are equally used over time. Alternation equalizes the usage of pumps by always selecting the pump with the lowest number of used hours to stage on next.
[0]	Off	No alternation of lead pump function takes place. It is not possible to set this parameter to options other than [0] Off if <i>parameter 25-02 Motor Start</i> is set other than [0] Direct on Line.
[1]	At staging	Alternation of the lead pump function takes place when staging another pump.
[2]	At command	Alternation of the lead pump function takes place at an external command signal or a pre-programmed event. See <i>parameter 25-51 Alternation Event</i> for available options.
[3]	At staging or command	Alternation of the variable speed (lead) pump takes place at staging or the "At Command" signal. (See above.)

#### NOTICE

It is not possible to select other than [0] Off if *parameter 25-05 Fixed Lead Pump* is set to [1] Yes.

25-51 Alternation Event		
Option:	Function:	
		This parameter is only active if the options [2] At Command or [3] At Staging or Command have been selected in <i>parameter 25-50 Lead Pump Alternation</i> . If an Alternation Event is selected, the alternation of lead pump takes place every time the event occurs.
[0]	External	Alternation takes place when a signal is applied to one of the digital inputs on the terminal strip and this input has been assigned to [121] Lead Pump Alternation in <i>parameter group 5-1*, Digital Inputs</i> .
[1]	Alternation Time Interval	Alternation takes place every time <i>parameter 25-52 Alternation Time Interval</i> , expires.
[2]	Sleep Mode	Alternation takes place each time the lead pump goes into sleep mode. <i>20-23 Setpoint 3</i> must be set to [1] Sleep Mode or an external signal applied for this function.
[3]	Predefined Time	Alternation takes place at a defined time of the day. If <i>parameter 25-54 Alternation Predefined Time</i> , is set, the alternation is carried out every day at the specified time. Default time is midnight (00:00 or 12:00AM depending on the time format).

25-52 Alternation Time Interval		
Range:	Function:	
24 h*	[1 - 999 h]	If [1] Alternation Time Interval option in <i>parameter 25-51 Alternation Event</i> , is selected, the alternation of the variable speed pump takes place every time the Alternation Time Interval expires (can be checked out in <i>parameter 25-53 Alternation Timer Value</i> ).

25-53 Alternation Timer Value		
Range:	Function:	
0 *	[0 - 7]	Readout parameter for the Alternation Time Interval value set in <i>parameter 25-52 Alternation Time Interval</i> .

25-54 Alternation Predefined Time		
Range:	Function:	
Size related*	[0 - 0]	If option [3] Predefined Time in <i>parameter 25-51 Alternation Event</i> , is selected, the variable speed pump alternation is carried out every day at the specified time set in Alternation Predefined Time. Default time is midnight (00:00 or 12:00AM depending on the time format).

25-55 Alternate if Load < 50%		
Option:	Function:	
		<p>If [1] Enabled is selected, the pump alternation can only occur if the capacity is equal to or below 50%. The capacity calculation is the ratio of running pumps (including the variable speed pump) to the total number of available pumps (including variable speed pump, but not those interlocked).</p> $Capacity = \frac{NRUNNING}{NTOTAL} \times 100\%$ <p>For the Basic cascade controller all pumps are equal size.</p>
[0]	Disabled	The lead pump alternation will take place at any pump capacity.
[1]	Enabled	The lead pump function will be alternated only if the numbers of pumps running are providing less than 50% of total pump capacity.

**NOTICE**

Only valid if *parameter 25-50 Lead Pump Alternation* is different from [0] Off.

25-56 Staging Mode at Alternation		
Option:	Function:	
[0]	Slow	
[1]	Quick	<p>This parameter is only active if the option selected in <i>parameter 25-50 Lead Pump Alternation</i> is different from [0] Off.</p> <p>2 types of staging and destaging of pumps are possible. Slow transfer makes staging and destaging smooth. Quick Transfer makes staging and destaging as fast as possible; the variable speed pump is just cut out (coasted).</p> <p>[0] Slow: At alternation, the variable speed pump is ramped up to maximum speed and then ramped down to a stand still.</p> <p>[1] Quick: At alternation, the variable speed pump is ramped up to maximum speed and then coasted to stand still.</p> <p><i>Illustration 3.85</i> and <i>Illustration 3.86</i> show Alternation in both Quick and Slow configurations.</p>

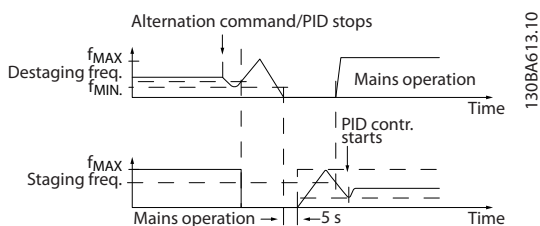

Illustration 3.85 Slow Configuration

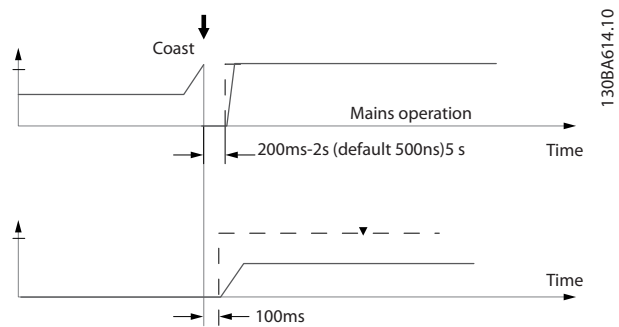

Illustration 3.86 Quick Configuration

25-58 Run Next Pump Delay		
Range:	Function:	
0.1 s* 5 s]	[0.1 - 5 s]	<p>This parameter is only active if the option selected in <i>parameter 25-50 Lead Pump Alternation</i>, is different from [0] Off.</p> <p>This parameter sets the time between stopping the old variable speed pump and starting another pump as a new variable speed pump. Refer to <i>25-56 Staging Mode at Alternation</i>, the illustration for description of staging and alternation.</p>

25-59 Run on Mains Delay		
Range:	Function:	
0.5 s* 5 s]	[ par. 25-58 - 5 s]	<p>This parameter is only active if the option selected in <i>parameter 25-50 Lead Pump Alternation</i>, is different from [0] Off.</p> <p>This parameter sets the time between stopping the old variable speed pump and starting this pump as a new fixed speed pump. Refer to <i>Illustration 3.85</i> for description of staging and alternation.</p>

3.22.5 25-8\* Status

Readout parameters informing about the operating status of the cascade controller and the pumps controlled.

25-80 Cascade Status		
Range:	Function:	
0 *	[0 - 25 ]	Read out of the status of the cascade controller.

25-81 Pump Status		
Range:	Function:	
0 * [0 - 25 ]	Pump Status shows the status for the number of pumps selected in <i>parameter 25-06 Number of Pumps</i> . It is a readout of the status for each of the pumps showing a string, which consists of pump number and the current status of the pump. Example: Readout is with the abbreviation like "1:D 2:O" This means that pump 1 is running and speed controlled by the frequency converter and pump 2 is stopped.	

25-82 Lead Pump		
Range:	Function:	
0 * [0 - par. 25-06 ]	Readout parameter for the actual variable speed pump in the system. The Lead Pump parameter is updated to reflect the current variable speed pump in the system when an alternation takes place. If no lead pump is selected (cascade controller disabled or all pumps interlocked) the display will show NONE.	

25-83 Relay Status		
Range:	Function:	
0 * [0 - 4 ]	Read out of the status for each of the relays assigned to control the pumps. Every element in the array represents a relay. If a relay is activated, the corresponding element is set to "On". If a relay is deactivated, the corresponding element is set to "Off".	

25-84 Pump ON Time		
Range:	Function:	
0 h* [0 - 2147483647 h]	Readout of the value for Pump ON Time. The cascade controller has separate counters for the pumps and for the relays that control the pumps. Pump ON Time monitors the "operating hours" of each pump. The value of each Pump ON Time counter can be reset to 0 by writing in the parameter, e.g. if the pump is replaced in case of service.	

25-85 Relay ON Time		
Range:	Function:	
0 h* [0 - 2147483647 h]	Readout of the value for Relay ON time. The cascade controller has separate counters for the pumps and for the relays that control the pumps. Pump cycling is always done based on the relay counters, otherwise it would always use the new pump if a pump is replaced and its value in <i>parameter 25-84 Pump ON Time</i> is reset. To use <i>parameter 25-04 Pump Cycling</i> , the	

25-85 Relay ON Time		
Range:	Function:	
	cascade controller is monitoring the Relay ON time.	

25-86 Reset Relay Counters		
Option:	Function:	
	Resets all elements in <i>parameter 25-85 Relay ON Time</i> counters.	
[0]	Do not reset	
[1]	Do reset	

### 3.22.6 25-9\* Service

Parameters used in case of service on one or more of the pumps controlled.

25-90 Pump Interlock		
Option:	Function:	
	In this parameter, it is possible to disable one or more of the fixed lead pumps. For example, the pump will not be selected for staging on even if it is the next pump in the operation sequence. It is not possible to disable the lead pump with the Pump Interlock command. The digital input interlocks are selected as <i>Pump 1-3 Interlock [130-132]</i> in parameter group 5-1*, <i>Digital Inputs</i> .	
[0]	Off	The pump is active for staging/destaging.
[1]	On	The Pump Interlock command is given. If a pump is running it is immediately destaged. If the pump is not running it is not allowed to stage on.

25-91 Manual Alternation		
Range:	Function:	
0 * [0 - par. 25-06 ]	Readout parameter for the actual variable speed pump in the system. The Lead Pump parameter is updated to reflect the current variable speed pump in the system when an alternation takes place. If no lead pump is selected (cascade controller disabled or all pumps interlocked) the display will show NONE.	



### 3.23 Parameters 26-\*\* Analog I/O Option MCB 109

The Analog I/O Option MCB 109 extends the functionality of VLT® AQUA Drive FC 202 Series frequency converters, by adding a number of additional, programmable analog inputs and outputs. This could be especially useful in control installations where the frequency converter may be used as decentral I/O, obviating the need for an outstation and thus reducing cost. It also gives flexibility in project planning.

**NOTICE**

The maximum current for the analog outputs 0-10 V is 1 mA.

**NOTICE**

Where Live Zero Monitoring is used, it is important that any analog inputs not being used for the frequency controller, i.e. being used as part of the Building Management System decentral I/O, should have their Live Zero function disabled.

Terminal	Parameters
Analog inputs	
X42/1	26-00, 26-1*
X42/3	26-01, 26-2*
X42/5	26-02, 26-3*
Analog outputs	
X42/7	26-4*
X42/9	26-5*
X42/11	26-6*
Analog inputs	
53	6-1*
54	6-2*
Analog output	
42	6-5*
Relays	
Relay 1 Term 1, 2, 3	5-4*
Relay 2 Term 4, 5, 6	5-4*

Table 3.24 Relevant Parameters

It is also possible to read the analog inputs, write to the analog outputs and control the relays, using communication via the serial bus. In this instance, these are the relevant parameters.

Terminal	Parameters
Analog inputs (read)	
X42/1	18-30
X42/3	18-31
X42/5	18-32
Analog outputs (write)	
X42/7	18-33
X42/9	18-34
X42/11	18-35
Analog inputs (read)	
53	16-62
54	16-64
Analog output	
42	6-63
Relays	
Relay 1 Term 1, 2, 3	16-71
Relay 2 Term 4, 5, 6	16-71

**NOTICE**  
The relay outputs must be enabled via Control Word Bit 11 (Relay 1) and Bit 12 (Relay 2)

Table 3.25 Relevant Parameters

Setting of on-board Real Time Clock.

The Analog I/O option incorporates a real time clock with battery back-up. This can be used as back up of the clock function included in the frequency converter as standard. See parameter group 0-7\*, *Clock Settings*.

The Analog I/O option can be used for the control of devices such as actuators or valves, using the Extended Closed loop facility, thus removing control from the existing control system. See *chapter 3.18 Parameters 21-\*\* Extended Closed Loop*. There are three independent closed loop PID controllers.

26-00 Terminal X42/1 Mode	
Option:	Function:
	<p>Terminal X42/1 can be programmed as an analog input accepting a voltage or input from either Pt1000 (1000 Ω at 0 °C) or Ni 1000 (1000 Ω at 0 °C) temperature sensors. Select the desired mode.</p> <p>[2] Pt 1000 [°C] and [4] Ni 1000 [°C] if operating in Celsius - [3] Pt 1000 [°F] and [5] Ni 1000 [°F] if operating in Fahrenheit.</p> <p><b>NOTICE</b></p> <p>If the input is not in use, it must be set for Voltage!</p> <p>If set for temperature and used as feedback, the unit must be set for either Celsius or Fahrenheit (20-12 Reference/Feedback Unit, parameter 21-10 Ext. 1 Ref./Feedback Unit, parameter 21-30 Ext. 2 Ref./Feedback Unit or parameter 21-50 Ext. 3 Ref./Feedback Unit).</p>
[1]	Voltage
[2]	Pt 1000 [°C]
[3]	Pt 1000 [°F]
[4]	Ni 1000 [°C]
[5]	Ni 1000 [°F]

26-01 Terminal X42/3 Mode	
Option:	Function:
	<p>Terminal X42/3 can be programmed as an analog input accepting a voltage or input from either Pt 1000 or Ni 1000 temperature sensors. Select the desired mode.</p> <p>[2] Pt 1000 [°C] and [4] Ni 1000 [°C] if operating in Celsius - [3] Pt 1000 [°F] and [5] Ni 1000 [°F] if operating in Fahrenheit.</p> <p><b>WARNING</b></p> <p>If the input is not in use, it must be set for Voltage!</p> <p>If set for temperature and used as feedback, the unit must be set for either Celsius or Fahrenheit (20-12 Reference/Feedback Unit, parameter 21-10 Ext. 1 Ref./Feedback Unit, parameter 21-30 Ext. 2 Ref./Feedback Unit or parameter 21-50 Ext. 3 Ref./Feedback Unit).</p>
[1]	Voltage
[2]	Pt 1000 [°C]
[3]	Pt 1000 [°F]
[4]	Ni 1000 [°C]

26-01 Terminal X42/3 Mode	
Option:	Function:
[5]	Ni 1000 [°F]

26-02 Terminal X42/5 Mode	
Option:	Function:
	<p>Terminal X42/5 can be programmed as an analog input accepting a voltage or input from either Pt 1000 (1000 Ω at 0 °C) or Ni 1000 (1000 Ω at 0 °C) temperature sensors. Select the desired mode.</p> <p>[2] Pt 1000 [°C] and [4] Ni 1000 [°C] if operating in Celsius - [3] Pt 1000 [°F] and [5] Ni 1000 [°F] if operating in Fahrenheit.</p> <p><b>NOTICE</b></p> <p>If the input is not in use, it must be set for Voltage!</p> <p>If set for temperature and used as feedback, the unit must be set for either Celsius or Fahrenheit (20-12 Reference/Feedback Unit, parameter 21-10 Ext. 1 Ref./Feedback Unit, parameter 21-30 Ext. 2 Ref./Feedback Unit or parameter 21-50 Ext. 3 Ref./Feedback Unit).</p>
[1]	Voltage
[2]	Pt 1000 [°C]
[3]	Pt 1000 [°F]
[4]	Ni 1000 [°C]
[5]	Ni 1000 [°F]

26-10 Terminal X42/1 Low Voltage	
Range:	Function:
0.07 V* [ 0 - par. 6-31 V ]	Enter the low voltage value. This analog input scaling value should correspond to the low reference/feedback value set in parameter 26-14 Term. X42/1 Low Ref./Feedb. Value.

26-11 Terminal X42/1 High Voltage	
Range:	Function:
10 V* [ par. 6-30 - 10 V ]	Enter the high voltage value. This analog input scaling value should correspond to the high reference/feedback value set in parameter 26-15 Term. X42/1 High Ref./Feedb. Value.

26-14 Term. X42/1 Low Ref./Feedb. Value	
Range:	Function:
0 * [ -999999.999 - 999999.999 ]	Enter the analog input scaling value that corresponds to the low voltage value set in parameter 26-10 Terminal X42/1 Low Voltage.

26-15 Term. X42/1 High Ref./Feedb. Value		
Range:	Function:	
100 * [-999999.999 - 999999.999 ]	Enter the analog input scaling value that corresponds to the high voltage value set in <i>parameter 26-11 Terminal X42/1 High Voltage</i> .	

26-16 Term. X42/1 Filter Time Constant		
Range:	Function:	
0.001 s* [0.001 - 10 s]	Enter the time constant. This is a first-order digital low pass filter time constant for suppressing noise in terminal X42/1. A high time constant value improves dampening but also increases the time delay through the filter.	
	<p><b>NOTICE</b></p> <p>This parameter cannot be adjusted while the motor is running.</p>	

26-17 Term. X42/1 Live Zero		
Option:	Function:	
	This parameter makes it possible to enable the Live Zero monitoring. E.g. where the analog input is a of the frequency converter control, rather than being used as of a decentral I/O system, such as a Building Management System.	
[0]	Disabled	
[1]	Enabled	

26-20 Terminal X42/3 Low Voltage		
Range:	Function:	
0.07 V* [ 0 - par. 6-31 V]	Enter the low voltage value. This analog input scaling value should correspond to the low reference/feedback value set in <i>parameter 26-24 Term. X42/3 Low Ref./Feedb. Value</i> .	

26-21 Terminal X42/3 High Voltage		
Range:	Function:	
10 V* [ par. 6-30 - 10 V]	Enter the high voltage value. This analog input scaling value should correspond to the high reference/feedback value set in <i>parameter 26-25 Term. X42/3 High Ref./Feedb. Value</i> .	

26-24 Term. X42/3 Low Ref./Feedb. Value		
Range:	Function:	
0 * [-999999.999 - 999999.999 ]	Enter the analog input scaling value that corresponds to the low voltage value set in <i>parameter 26-20 Terminal X42/3 Low Voltage</i> .	

26-25 Term. X42/3 High Ref./Feedb. Value		
Range:	Function:	
100 * [-999999.999 - 999999.999 ]	Enter the analog input scaling value that corresponds to the high voltage value set in <i>parameter 26-21 Terminal X42/3 High Voltage</i> .	

26-26 Term. X42/3 Filter Time Constant		
Range:	Function:	
0.001 s* [0.001 - 10 s]	Enter the time constant. This is a first-order digital low pass filter time constant for suppressing noise in terminal X42/3. A high time constant value improves dampening but also increases the time delay through the filter.	
	<p><b>NOTICE</b></p> <p>This parameter cannot be adjusted while the motor is running.</p>	

26-27 Term. X42/3 Live Zero		
Option:	Function:	
	This parameter makes it possible to enable the Live Zero monitoring. E.g. where the analog input is a of the frequency converter control, rather than being used as of a decentral I/O system, such as a Building Management System.	
[0]	Disabled	
[1]	Enabled	

26-30 Terminal X42/5 Low Voltage		
Range:	Function:	
0.07 V* [ 0 - par. 6-31 V]	Enter the low voltage value. This analog input scaling value should correspond to the low reference/feedback value set in <i>parameter 26-34 Term. X42/5 Low Ref./Feedb. Value</i> .	

26-31 Terminal X42/5 High Voltage		
Range:	Function:	
10 V* [ par. 6-30 - 10 V]	Enter the high voltage value. This analog input scaling value should correspond to the high reference/feedback value set in <i>parameter 26-35 Term. X42/5 High Ref./Feedb. Value</i> .	

26-34 Term. X42/5 Low Ref./Feedb. Value		
Range:	Function:	
0 * [-999999.999 - 999999.999 ]	Enter the analog input scaling value that corresponds to the low voltage value set in <i>parameter 26-30 Terminal X42/5 Low Voltage</i> .	

26-35 Term. X42/5 High Ref./Feedb. Value		
Range:	Function:	
100 * [-999999.999 - 999999.999 ]	Enter the analog input scaling value that corresponds to the high voltage value set in <i>parameter 26-21 Terminal X42/3 High Voltage</i> .	

26-36 Term. X42/5 Filter Time Constant		
Range:	Function:	
0.001 s* [0.001 - 10 s]	Enter the time constant. This is a first-order digital low pass filter time constant for suppressing noise in terminal X42/5. A high time constant value improves dampening but also increases the time delay through the filter.	
<p><b>NOTICE</b></p> <p>This parameter cannot be adjusted while the motor is running.</p>		

26-37 Term. X42/5 Live Zero		
Option:	Function:	
	This parameter makes it possible to enable the Live Zero monitoring. E.g. where the analog input is a of the frequency converter control, rather than being used as of a decentral I/O system, such as a Building Management System.	
[0]	Disabled	
[1]	Enabled	

26-40 Terminal X42/7 Output		
Option:	Function:	
	Set the function of terminal X42/7 as an analog voltage output.	
[0]	No operation	
[100]	Output freq. 0-100	0-100 Hz, (0-20 mA)
[101]	Reference Min-Max	Minimum reference - Maximum reference, (0-20 mA)
[102]	Feedback +200%	-200% to +200% of <i>parameter 3-03 Maximum Reference</i> , (0-20 mA)
[103]	Motor cur. 0-Imax	0 - Inverter Max. Current ( <i>parameter 16-37 Inv. Max. Current</i> ), (0-20 mA)
[104]	Torque 0-Tlim	0 - Torque limit ( <i>parameter 4-16 Torque Limit Motor Mode</i> ), (0-20 mA)
[105]	Torque 0-Tnom	0 - Motor rated torque, (0-20 mA)
[106]	Power 0-Pnom	0 - Motor rated power, (0-20 mA)
[107]	Speed 0-HighLim	0 - Speed High Limit ( <i>parameter 4-13 Motor Speed High Limit</i> )

26-40 Terminal X42/7 Output		
Option:	Function:	
	[RPM] and <i>parameter 4-14 Motor Speed High Limit [Hz]</i> , (0-20 mA)	
[108]	Torque +-160%	
[109]	Out freq 0-Fmax	
[113]	Ext. Closed Loop 1	0-100%, (0-20 mA)
[114]	Ext. Closed Loop 2	0-100%, (0-20 mA)
[115]	Ext. Closed Loop 3	0-100%, (0-20 mA)
[139]	Bus ctrl.	0-100%, (0-20 mA)
[141]	Bus ctrl t.o.	0-100%, (0-20 mA)

26-41 Terminal X42/7 Min. Scale		
Range:	Function:	
0 %* [0 - 200 %]	Scale the minimum output of the selected analog signal at terminal X42/7, as a percentage of the maximum signal level. E.g. if a 0 V (or 0 Hz) is desired at 25% of the maximum output value. Then programme 25%. Scaling values up to 100% can never be higher than the corresponding setting in <i>parameter 26-42 Terminal X42/7 Max. Scale</i> . See principle graph for <i>parameter 6-51 Terminal 42 Output Min Scale</i> .	

26-42 Terminal X42/7 Max. Scale		
Range:	Function:	
100 %* [0 - 200 %]	Scale the maximum output of the selected analog signal at terminal X42/7. Set the value to the maximum value of the voltage signal output. Scale the output to give a voltage lower than 10 V at full scale; or 10 V at an output below 100% of the maximum signal value. If 10 V is the desired output current at a value between 0-100% of the full-scale output, programme the percentage value in the parameter, i.e. 50% = 10 V. If a voltage between 0 and 10 V is desired at maximum output, calculate the percentage as follows: $\left( \frac{10V}{\text{desired maximum voltage}} \right) \times 100\%$ i.e. 5V: $\frac{10V}{5V} \times 100\% = 200\%$	

See principle graph for *parameter 6-52 Terminal 42 Output Max Scale*.

26-43 Terminal X42/7 Bus Control		
Range:	Function:	
0 %* [0 - 100 %]	Holds the level of terminal X42/7 if controlled by bus.	

26-44 Terminal X42/7 Timeout Preset		
Range:	Function:	
0 %* [0 - 100 %]	Holds the preset level of terminal X42/7. In case of a bus timeout and a timeout function is selected in <i>parameter 26-50 Terminal X42/9 Output</i> the output will preset to this level.	

26-50 Terminal X42/9 Output		
Option:	Function:	
		Set the function of terminal X42/9.
[0]	No operation	
[100]	Output freq. 0-100	0-100 Hz, (0-20 mA)
[101]	Reference Min-Max	Minimum reference - Maximum reference, (0-20 mA)
[102]	Feedback +200%	-200% to +200% of <i>parameter 3-03 Maximum Reference</i> , (0-20 mA)
[103]	Motor cur. 0-lmax	0 - Inverter Max. Current ( <i>parameter 16-37 Inv. Max. Current</i> ), (0-20 mA)
[104]	Torque 0-Tlim	0 - Torque limit ( <i>parameter 4-16 Torque Limit Motor Mode</i> ), (0-20 mA)
[105]	Torque 0-Tnom	0 - Motor rated torque, (0-20 mA)
[106]	Power 0-Pnom	0 - Motor rated power, (0-20 mA)
[107]	Speed 0-HighLim	0 - Speed High Limit ( <i>parameter 4-13 Motor Speed High Limit [RPM]</i> and <i>parameter 4-14 Motor Speed High Limit [Hz]</i> ), (0-20 mA)
[108]	Torque +-160%	
[109]	Out frq 0-Fmax	
[113]	Ext. Closed Loop 1	0 - 100%, (0-20 mA)
[114]	Ext. Closed Loop 2	0 - 100%, (0-20 mA)
[115]	Ext. Closed Loop 3	0 - 100%, (0-20 mA)
[139]	Bus ctrl.	0 - 100%, (0-20 mA)
[141]	Bus ctrl t.o.	0 - 100%, (0-20 mA)

26-51 Terminal X42/9 Min. Scale		
Range:	Function:	
0 %* [0 - 200 %]	Scale the minimum output of the selected analog signal at terminal X42/9, as a percentage of the maximum signal level. E.g. if a 0 V is desired at 25% of the maximum output value. Then programme 25%. Scaling values up to 100% can never be higher than the corresponding setting in <i>parameter 26-52 Terminal X42/9 Max. Scale</i> .	

See principle graph for *parameter 6-51 Terminal 42 Output Min Scale*.

26-52 Terminal X42/9 Max. Scale		
Range:	Function:	
100 %* [0 - 200 %]	Scale the maximum output of the selected analog signal at terminal X42/9. Set the value to the maximum value of the voltage signal output. Scale the output to give a voltage lower than 10 V at full scale; or 10 V at an output below 100% of the maximum signal value. If 10 V is the desired output current at a value between 0-100% of the full-scale output, programme the percentage value in the parameter, i.e. 50% = 10 V. If a voltage between 0 and 10V is desired at maximum output, calculate the percentage as follows:  i.e. $5V: \frac{10V}{5V} \times 100\% = 200\%$	

See principle graph for *parameter 6-52 Terminal 42 Output Max Scale*.

26-53 Terminal X42/9 Bus Control		
Range:	Function:	
0 %* [0 - 100 %]	Holds the level of terminal X42/9 if controlled by bus.	

26-54 Terminal X42/9 Timeout Preset		
Range:	Function:	
0 %* [0 - 100 %]	Holds the preset level of terminal X42/9. In case of a bus timeout and a timeout function is selected in <i>parameter 26-60 Terminal X42/11 Output</i> the output will preset to this level.	

26-60 Terminal X42/11 Output		
Option:	Function:	
		Set the function of terminal X42/11.
[0]	No operation	
[100]	Output freq. 0-100	0-100 Hz, (0-20 mA)
[101]	Reference Min-Max	Minimum reference - Maximum reference, (0-20 mA)
[102]	Feedback +200%	-200% to +200% of <i>parameter 3-03 Maximum Reference</i> , (0-20 mA)
[103]	Motor cur. 0-lmax	0 - Inverter Max. Current ( <i>parameter 16-37 Inv. Max. Current</i> ), (0-20 mA)
[104]	Torque 0-Tlim	0 - Torque limit ( <i>parameter 4-16 Torque Limit Motor Mode</i> ), (0-20 mA)
[105]	Torque 0-Tnom	0 - Motor rated torque, (0-20 mA)
[106]	Power 0-Pnom	0 - Motor rated power, (0-20 mA)
[107]	Speed 0-HighLim	0 - Speed High Limit ( <i>parameter 4-13 Motor Speed High Limit</i>

26-60 Terminal X42/11 Output		
Option:	Function:	
		[RPM] and parameter 4-14 Motor Speed High Limit [Hz]), (0-20 mA)
[108]	Torque +-160%	
[109]	Out frq 0-Fmax	
[113]	Ext. Closed Loop 1	0-100%, (0-20 mA)
[114]	Ext. Closed Loop 2	0-100%, (0-20 mA)
[115]	Ext. Closed Loop 3	0-100%, (0-20 mA)
[139]	Bus ctrl.	0-100%, (0-20 mA)
[141]	Bus ctrl t.o.	0-100%, (0-20 mA)

26-64 Terminal X42/11 Timeout Preset		
Range:	Function:	
0 %*	[0 - 100 %]	Holds the preset level of terminal X42/11. In case a bus time-out and a time-out function are selected, the output will preset to this level.

26-61 Terminal X42/11 Min. Scale		
Range:	Function:	
0 %*	[0 - 200 %]	Scale the minimum output of the selected analog signal at terminal X42/11, as a percentage of the maximum signal level. E.g. if a 0 V is desired at 25% of the maximum output value. Then programme 25%. Scaling values up to 100% can never be higher than the corresponding setting in parameter 26-62 Terminal X42/11 Max. Scale.

See principle graph for parameter 6-51 Terminal 42 Output Min Scale.

26-62 Terminal X42/11 Max. Scale		
Range:	Function:	
100 %*	[0 - 200 %]	Scale the maximum output of the selected analog signal at terminal X42/9. Set the value to the maximum value of the voltage signal output. Scale the output to give a voltage lower than 10 V at full scale; or 10 V at an output below 100% of the maximum signal value. If 10 V is the desired output current at a value between 0-100% of the full-scale output, programme the percentage value in the parameter, i.e. 50% = 10 V. If a voltage between 0 and 10 V is desired at maximum output, calculate the percentage as follows: $\left(\frac{10V}{\text{desired maximum voltage}}\right) \times 100\%$ i.e. $5V: \frac{10V}{5V} \times 100\% = 200\%$

See principle graph for parameter 6-52 Terminal 42 Output Max Scale.

26-63 Terminal X42/11 Bus Control		
Range:	Function:	
0 %*	[0 - 100 %]	Holds the level of terminal X42/11 if controlled by bus.

### 3.24 Parameters 29-\*\* Water Application Functions

The group contains parameters used for monitoring water/wastewater applications.

#### 3.24.1 29-0\* Pipe Fill function

In water supply systems water hammering can occur when filling the pipes too fast. It is therefore desirable to limit the filling rate. Pipe Fill Mode eliminates the occurrence of water hammering associated with the rapid exhausting of air from the piping system by filling the pipes at a low rate.

This function is used in horizontal, vertical and mixed piping systems. Due to the fact that the pressure in horizontal pipe systems does not climb as the system fills, filling horizontal pipe systems requires a user specified speed to fill, for a user specified time and/or until a user specified pressure set-point is reached.

The best way to fill a vertical pipe system is to use the PID function to ramp the pressure at a user specified rate between the motor speed low limit and a user specified pressure.

The Pipe Fill function uses a combination of above to ensure a safe filling in any system.

No matter which system - the pipe fill-mode will start using the constant speed set in 29-01 Pipe Fill Speed [RPM] until the pipe fill-time in 29-03 Pipe Fill Time has expired, thereafter filling will continue with the filling ramp set in 29-04 Pipe Fill Rate until the filling set-point specified in 29-05 Filled Setpoint is reached.

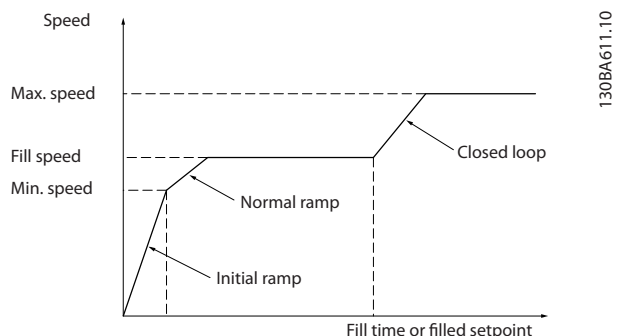

Illustration 3.87 Horizontal Pipe System

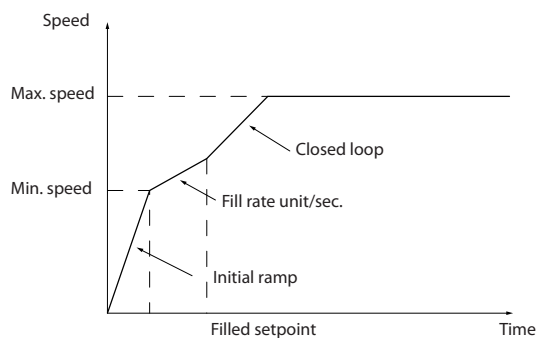

Illustration 3.88 Vertical Pipe System

29-00 Pipe Fill Enable		
Option:	Function:	
[0]	Disabled	Select Enabled to fill pipes at a user specified rate.
[1]	Enabled	Select Enabled to fill pipes with a user specified rate.

29-01 Pipe Fill Speed [RPM]		
Range:	Function:	
Size related*	[ par. 4-11 - par. 4-13 RPM]	Set the filling speed for filling horizontal pipe systems. The speed can be selected in Hz or RPM depending on the choices made in <i>parameter 4-11 Motor Speed Low Limit [RPM]/parameter 4-13 Motor Speed High Limit [RPM]</i> or in <i>parameter 4-12 Motor Speed Low Limit [Hz]/parameter 4-14 Motor Speed High Limit [Hz]</i> .

29-02 Pipe Fill Speed [Hz]		
Range:	Function:	
Size related*	[ par. 4-12 - par. 4-14 Hz]	Set the filling speed for filling horizontal pipe systems. The speed can be selected in Hz or RPM depending on the choices made in <i>parameter 4-11 Motor Speed Low Limit [RPM]/parameter 4-13 Motor Speed High Limit [RPM]</i> or in <i>parameter 4-12 Motor Speed Low Limit [Hz]/parameter 4-14 Motor Speed High Limit [Hz]</i> .

29-03 Pipe Fill Time		
Range:	Function:	
0 s*	[0 - 3600 s]	Set the specified time for pipe filling of horizontal pipe systems.

29-04 Pipe Fill Rate		
Range:	Function:	
0.001 ProcessCtrlUnit*	[0.001 - 999999.999 ProcessCtrlUnit]	Specifies the filling rate in units/second using the PI controller. Filling rate units are feedback units/second. This function is used for

29-04 Pipe Fill Rate		
Range:		Function:
		filling-up vertical pipe systems but will be active when the filling-time has expired, no matter what , until the pipe fill-set-point set in 29-05 Filled Setpoint is reached.

29-05 Filled Setpoint		
Range:		Function:
0 ProcessCtrlUnit*	[-999999.999 - 999999.999 ProcessCtrlUnit]	Specifies the Filled Setpoint at which the Pipe Fill Function will be disabled and the PID controller will take control. This function can be used both for horizontal and vertical pipe systems.

29-06 No-Flow Disable Timer		
Range:		Function:
0 s*	[0 - 3600 s]	

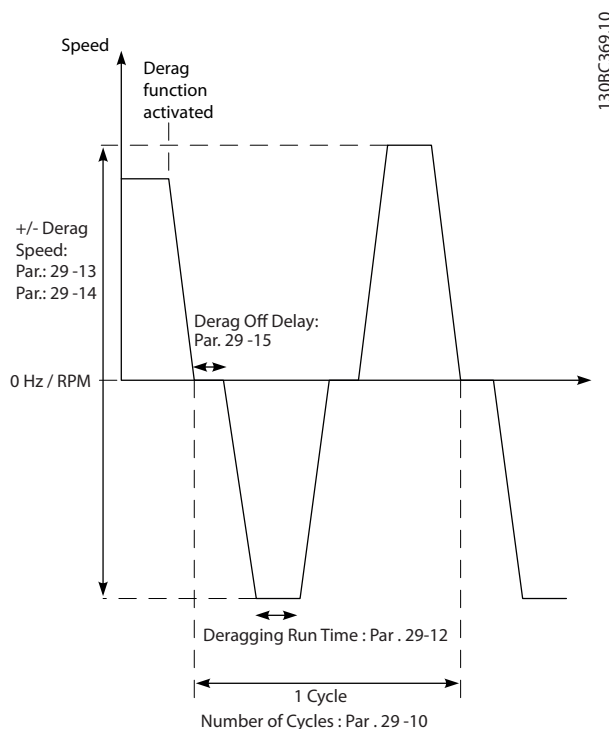

Illustration 3.89 Derag Function

### 3.24.2 29-1\* Deragging Function

The purpose of the deragging feature is to free the pump blade of debris in waste water applications so that the pump operates normally.

A deragging event is defined as the time when the frequency converter starts to derag to when the deragging finishes. When a derag is started, the frequency converter ramps first to a stop and then an Off Delay expires before the first cycle begins.

If a derag is triggered from a drive stopped state, the first Off Delay is skipped. The deragging event may consist of several cycles; one cycle consists of one pulse in the reverse direction followed by one pulse in the forward direction. Deragging is considered finished after the specified number of cycles has completed. More specifically, on the last pulse (it will always be forward) of the last cycle, the derag is considered finished after the Deragging Run Time expires (the frequency converter will be running at Derag Speed). In between pulses, the frequency converter output coasts for a specified Off Delay time to let debris in the pump settle.

#### NOTICE

**Do not enable deragging if the pump cannot operate in reverse direction.**

There are three different notifications for an ongoing deragging event:

- Status in the LCP: "Auto Remote Derag"
- A bit in the Extended Status Word (Bit 23 , 80 0000 hex)
- A digital output can be configured to reflect the active deragging status.

Depending on the application and on the purpose of using it, this feature can be used as preventative or reactive measure and can be triggered/started in the following different ways:



- On each Start Command (parameter 29-11 Derag at Start/Stop)
- On each Stop Command (parameter 29-11 Derag at Start/Stop)
- On each Start/Stop Command (parameter 29-11 Derag at Start/Stop)
- On Digital Input (parameter group 5-1\*)
- On Drive Action with the Smart Logic Controller (parameter 13-52 SL Controller Action)
- As Timed Action (parameter group 23-\*\*)
- On High Power (parameter group 29-2\*)

### 3.24.3 29-2\* Derag Power Tuning

The derag feature monitors drive power in a similar fashion as no-flow. Based on two user defined points and an offset value, the monitor calculates a derag power curve. It uses the exact same calculations as No-Flow with the difference being that derag monitors for high-power and not low-power.

Commissioning the No-Flow user points via the No-Flow Auto Setup will also set the points of the derag curve to the same value.

29-10 Derag Cycles		
Range:	Function:	
Size related*	[0 - 10 ]	The number of cycles the frequency converter will derag.

29-11 Derag at Start/Stop		
Option:	Function:	
	Derag function when starting and stopping the frequency converter.	
[0]	Off	
[1]	Start	
[2]	Stop	
[3]	Start and stop	

29-12 Deragging Run Time		
Range:	Function:	
0 s*	[0 - 3600 s]	The time that the frequency converter will dwell at the derag speed.

29-13 Derag Speed [RPM]		
Range:	Function:	
Size related*	[0 - par. 4-13 RPM]	The speed at which the frequency converter will derag in RPM.

29-14 Derag Speed [Hz]		
Range:	Function:	
Size related*	[0.0 - par. 4-14 Hz]	The speed at which the frequency converter will derag in Hertz.

29-15 Derag Off Delay		
Range:	Function:	
10 s*	[1 - 600 s]	The time that the frequency converter will remain off before starting another derag pulse. Allows contents of the pump to settle.

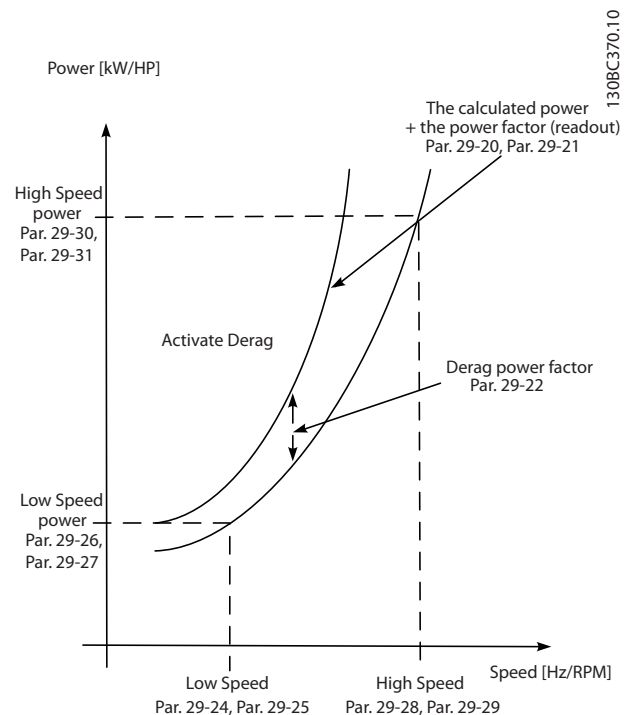

Illustration 3.90 Derag Power Tuning

29-20 Derag Power[kW]		
Range:	Function:	
0 kW*	[0 - 0 kW]	Readout of calculated derag power at actual speed.

29-21 Derag Power[HP]		
Range:	Function:	
0 hp*	[0 - 0 hp]	Readout of calculated derag power at actual speed.

29-22 Derag Power Factor		
Range:	Function:	
200 %*	[1 - 400 %]	Set a correction if Derag Detection reacts on too low a power value.

29-23 Derag Power Delay		
Range:		Function:
601 s*	[1 - 601 s]	The time that the frequency converter must remain on reference and a high power condition for a derag to occur.

29-24 Low Speed [RPM]		
Range:		Function:
Size related*	[0 - par. 29-28 RPM]	Set output speed used for registration of derag power at low speed in RPM.

29-25 Low Speed [Hz]		
Range:		Function:
Size related*	[0 - par. 29-29 Hz]	Set output speed used for registration of derag power at low speed in Hz.

29-26 Low Speed Power [kW]		
Range:		Function:
Size related*	[0 - 5.50 kW]	Set derag power at low speed in kW.

29-27 Low Speed Power [HP]		
Range:		Function:
Size related*	[0 - 7.50 hp]	Set derag power at low speed in hp.

29-28 High Speed [RPM]		
Range:		Function:
Size related*	[0.0 - par. 4-13 RPM]	Set output speed used for registration of derag power at high speed in RPM.

29-29 High Speed [Hz]		
Range:		Function:
Size related*	[0.0 - par. 4-14 Hz]	Set output speed used for registration of derag power at high speed in Hz.

29-30 High Speed Power [kW]		
Range:		Function:
Size related*	[0 - 5.50 kW]	Set derag power at high speed in kW.

29-31 High Speed Power [HP]		
Range:		Function:
Size related*	[0 - 7.50 hp]	Set derag power at high speed in hp.

29-32 Derag On Ref Bandwidth		
Range:		Function:
5 %*	[1 - 100 %]	Set the bandwidth percentage of motor speed high limit to accommodate system pressure fluctuation.

29-33 Power Derag Limit		
Range:		Function:
3 *	[0 - 10 ]	The number of times the power monitor can trigger consecutive derags before a fault is reported.

29-34 Consecutive Derag Interval		
Range:		Function:
Size related*	[Size related]	Derags are considered to be consecutive if they happen within the interval specified in this parameter.

### 3.24.4 29-4\* Pre/Post Lube Function

Use the Pre/Post Lube function in the following applications:

- A motor requires lubrication of its mechanical parts before and while it runs to prevent damage and wear. This is especially the case when the motor has not been running for a long period of time.
- An application requires external fans to run.

The function makes the frequency converter signal an external device for a user-defined period of time. A start delay can be configured with parameter *1-71 Start Delay*. With this delay the pre-lube function runs while the motor is stopped.

For information about the Pre/Post Lube function options, see the following parameters:

- *Parameter 29-40 Pre/Post Lube Function*
- *Parameter 29-41 Pre Lube Time*
- *Parameter 29-42 Post Lube Time*

Consider the following use case:

- A lubricating device starts the lubrication at the time when the frequency converter receives the start command.
- The frequency converter starts the motor. The lubrication device is still running.
- After a certain time, the frequency converter stops the lubrication device.

See *Illustration 3.91*

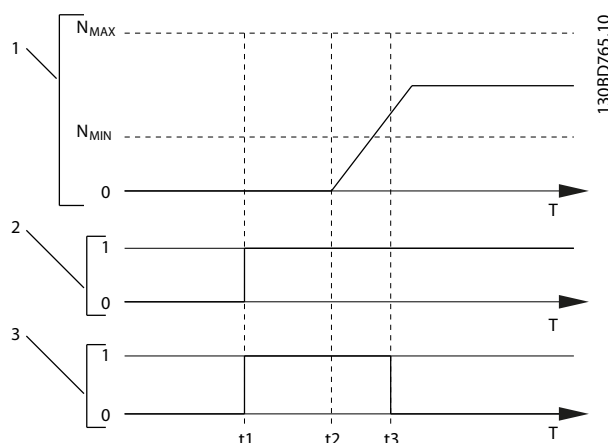

1	Speed curve
2	Start command (e.g. terminal 18)
3	Pre Lube Output Signal
t <sub>1</sub>	Start command issued (e.g. terminal 18 is set active). The Start Delay timer ( <i>1-71 Start Delay</i> ) and the Pre Lube timer ( <i>parameter 29-41 Pre Lube Time</i> ).
t <sub>2</sub>	The Start Delay timer expires. The frequency converter starts to ramp up.
t <sub>3</sub>	The Pre Lube timer ( <i>parameter 29-41 Pre Lube Time</i> ) expires.

Illustration 3.91 Pre/Post Lube Function Example

#### 29-40 Pre/Post Lube Function

Select when the Pre/Post Lube function is active. Use *1-71 Start Delay* to set the delay before the frequency converter starts to ramp up.

**Option:** **Function:**

[0]	Disabled	
[1]	Pre Lube Only	
[2]	Pre & Running	
[3]	Pre & Running & Post	

#### 29-41 Pre Lube Time

Enter how long the Pre Lube function is active. Use only when option [1] *Pre Lube Only* is selected in *parameter 29-40 Pre/Post Lube Function*.

**Range:** **Function:**

10 s*	[0 - 600 s]	
-------	-------------	--

#### 29-42 Post Lube Time

Enter how long the Post Lube function is on after the motor stops. Use only when option [3] *Pre & Running & Post* is selected in *parameter 29-40 Pre/Post Lube Function*.

**Range:** **Function:**

10 s*	[0 - 600 s]	
-------	-------------	--

### 3.24.5 29-5\* Flow Confirmation

The Flow Confirmation feature is designed for applications where there is a need for the motor/pump to run while waiting for an external event. The Flow Confirmation monitor expects to get a digital input from a sensor on a gate valve, flow switch, or a similar external device indicating that the device is in the open position and flow is possible. In *parameter 29-50 Validation Time* a user defines how long the VLT® AQUA Drive FC 202 waits for the digital input signal from the external device to confirm the flow. After the flow is confirmed, the frequency converter checks the signal again after the flow verification time and then runs normally. The LCP status reads "Verifying flow" while the flow monitor is active. The frequency converter trips with the alarm "Flow Not Confirmed", if the expected digital input signal becomes inactive before either the flow validation time or the flow verification time expires.

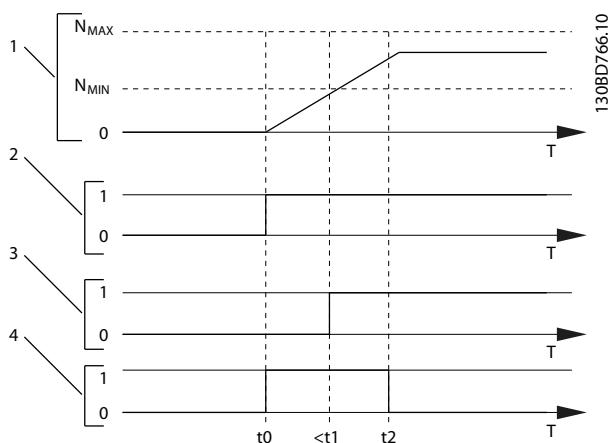

1	Speed curv.
2	Start command (e.g. terminal 18)
3	Digital signal from an external device that confirms that the flow is possible.
4	Flow verification
t <sub>0</sub>	Start command issued (e.g. terminal 18 is set active)
t <sub>1</sub>	Digital signal from an external device gets active before <i>parameter 29-50 Validation Time</i> expires.
t <sub>2</sub>	When <i>parameter 29-51 Verification Time</i> passes, the frequency converter checks the signal from the external device again and then runs normally.

Illustration 3.92 Flow Confirmation

29-50 Validation Time		
Range:		Function:
Size related*	[ 0 - 999 s]	<b>NOTICE</b> <i>Parameter 29-50 Validation Time</i> is only visible in the LCP if a digital input is set to [86] <i>Flow Confirmation</i> (see parameter group chapter 3.7.2 5-1* <i>Digital Inputs</i> ).  The digital input from an external device must be active during the validation time.

29-51 Verification Time		
Range:		Function:
15 s*	[ 0.10 - 255 s]	<b>NOTICE</b> <i>Parameter 29-51 Verification Time</i> is only visible in the LCP if a digital input is set to [86] <i>Flow Confirmation</i> (see parameter group chapter 3.7.2 5-1* <i>Digital Inputs</i> ).  When the time in this parameter passes, the frequency converter checks the signal from the external device. If the signal is active, the frequency converter runs normally.

### 3.25 Parameters 30-\*\* Special Features

#### 3.25.1 30-8\* Compatibility

30-81 Brake Resistor (ohm)		
Range:		Function:
Size related*	[ 5 - 65535.00 Ohm]	Set the brake resistor value in Ω with 2 decimals. This value is used for monitoring the power to the brake resistor in 2-13 <i>Brake Power Monitoring</i> .

#### 3.26 Parameters 31-\*\* Bypass Option

Parameter group for the configuration of the electronically controlled bypass option board, MCO 104.

31-00 Bypass Mode		
Option:	Function:	
[0]	Drive	Select the operating mode of the bypass: [0] <i>Drive</i> : the motor is operated by the frequency converter.
[1]	Bypass	Select the operating mode of the bypass: [1] <i>Bypass</i> : motor can be run at full speed in bypass mode.

31-01 Bypass Start Time Delay		
Range:		Function:
30 s*	[0 - 60 s]	Set the time delay within the time when the bypass receives a run command and the time when it starts the motor at full speed. A countdown timer will display time left.

31-02 Bypass Trip Time Delay		
Range:		Function:
0 s*	[0 - 300 s]	Set the time delay within the time that the drive experiences an alarm that stops it and the time when the motor is automatically switched to bypass control. If the time delay is set to zero, a drive alarm will not automatically switch the motor to bypass control.

31-03 Test Mode Activation		
Option:		Function:
[0]	Disabled	[0] <i>Disabled</i> means that the Test Mode is disabled.
[1]	Enabled	[1] <i>Enabled</i> means that the motor runs in bypass, while the frequency converter can be tested in an open circuit. In this mode the LCP will not control start/stop of the bypass.

31-10 Bypass Status Word		
Range:		Function:
0 *	[0 - 65535 ]	Views the status of the bypass as a hexadecimal value.

31-11 Bypass Running Hours		
Range:		Function:
0 h*	[0 - 2147483647 h]	Views the number of hours in which the motor has run in Bypass Mode. The counter can be reset in <i>parameter 15-07 Reset Running Hours Counter</i> . The value is saved, when the frequency converter is turned off.

31-19 Remote Bypass Activation		
Option:		Function:
[0]	Disabled	
[1]	Enabled	Feature: Unknown.

## 3.27 Parameters 35-\*\* Sensor Input Option

### 3.27.1 35-0\* Temp. Input Mode (MCB 114)

35-00 Term. X48/4 Temperature Unit		
Select the unit to be used with temperature input X48/4 settings and readouts:		
<b>Option:</b>	<b>Function:</b>	
[60]	°C	
[160]	°F	

35-01 Term. X48/4 Input Type		
View the temperature sensor type detected at input X48/4:		
<b>Option:</b>	<b>Function:</b>	
[0]	Not Connected	
[1]	PT100 2-wire	
[3]	PT1000 2-wire	
[5]	PT100 3-wire	
[7]	PT1000 3-wire	

35-02 Term. X48/7 Temperature Unit		
Select the unit to be used with temperature input X48/7 settings and readouts:		
<b>Option:</b>	<b>Function:</b>	
[60]	°C	
[160]	°F	

35-03 Term. X48/7 Input Type		
View the temperature sensor type detected at input X48/7:		
<b>Option:</b>	<b>Function:</b>	
[0]	Not Connected	
[1]	PT100 2-wire	
[3]	PT1000 2-wire	
[5]	PT100 3-wire	
[7]	PT1000 3-wire	

35-04 Term. X48/10 Temperature Unit		
Select the unit to be used with temperature input X48/10 settings and readouts:		
<b>Option:</b>	<b>Function:</b>	
[60]	°C	
[160]	°F	

35-05 Term. X48/10 Input Type		
View the temperature sensor type detected at input X48/10:		
<b>Option:</b>	<b>Function:</b>	
[0]	Not Connected	
[1]	PT100 2-wire	
[3]	PT1000 2-wire	
[5]	PT100 3-wire	
[7]	PT1000 3-wire	

35-06 Temperature Sensor Alarm Function		
Select the alarm function:		
<b>Option:</b>	<b>Function:</b>	
[0]	Off	
[2]	Stop	
[5]	Stop and trip	

### 3.27.2 35-1\* Temp. Input X48/4 (MCB 114)

35-14 Term. X48/4 Filter Time Constant		
<b>Range:</b>	<b>Function:</b>	
0.001 s* s]	[0.001 - 10	Enter the filter time constant. This is a first-order digital low pass filter time constant for suppressing electrical noise in terminal X48/4. A high time constant value improves dampening but also increases the time delay through the filter.

35-15 Term. X48/4 Temp. Monitor		
This parameter gives the possibility of enabling or disabling the temperature monitor for terminal X48/4. The temperature limits can be set in <i>parameter 35-16 Term. X48/4 Low Temp. Limit</i> and <i>parameter 35-17 Term. X48/4 High Temp. Limit</i> .		
<b>Option:</b>	<b>Function:</b>	
[0]	Disabled	
[1]	Enabled	

35-16 Term. X48/4 Low Temp. Limit		
<b>Range:</b>	<b>Function:</b>	
Size related*	[-50 - par. 35-17 ]	

35-17 Term. X48/4 High Temp. Limit		
<b>Range:</b>	<b>Function:</b>	
Size related*	[ par. 35-16 - 204 ]	

### 3.27.3 35-2\* Temp. Input X48/7 (MCB 114)

35-24 Term. X48/7 Filter Time Constant		
<b>Range:</b>	<b>Function:</b>	
0.001 s* s]	[0.001 - 10	Enter the filter time constant. This is a first-order digital low pass filter time constant for suppressing electrical noise in terminal X48/7. A high time constant value improves dampening but also increases the time delay through the filter.

35-25 Term. X48/7 Temp. Monitor		
This parameter gives the possibility of enabling or disabling the temperature monitor for terminal X48/7. The temperature limits can be set in <i>parameter 35-26 Term. X48/7 Low Temp. Limit</i> and <i>parameter 35-27 Term. X48/7 High Temp. Limit</i> .		
<b>Option:</b>	<b>Function:</b>	
[0]	Disabled	
[1]	Enabled	

35-26 Term. X48/7 Low Temp. Limit		
<b>Range:</b>	<b>Function:</b>	
Size related*	[-50 - par. 35-27 ]	Enter the minimum temperature reading that is expected for normal operation of the temperature sensor at terminal X48/7.

35-27 Term. X48/7 High Temp. Limit		
<b>Range:</b>	<b>Function:</b>	
Size related*	[ par. 35-26 - 204 ]	Enter the maximum temperature reading that is expected for normal operation of the temperature sensor at terminal X48/7.

### 3.27.4 35-3\* Temp. Input X48/10 (MCB 114)

35-34 Term. X48/10 Filter Time Constant		
<b>Range:</b>	<b>Function:</b>	
0.001 s*	[0.001 - 10 s]	Enter the filter time constant. This is a first-order digital low pass filter time constant for suppressing electrical noise in terminal X48/10. A high time constant value improves dampening but also increases the time delay through the filter.

35-35 Term. X48/10 Temp. Monitor		
This parameter gives the possibility of enabling or disabling the temperature monitor for terminal X48/10. The temperature limits can be set in <i>parameter 35-36 Term. X48/10 Low Temp. Limit/parameter 35-37 Term. X48/10 High Temp. Limit</i> .		
<b>Option:</b>	<b>Function:</b>	
[0]	Disabled	
[1]	Enabled	

35-36 Term. X48/10 Low Temp. Limit		
<b>Range:</b>	<b>Function:</b>	
Size related*	[-50 - par. 35-37 ]	

35-37 Term. X48/10 High Temp. Limit		
<b>Range:</b>	<b>Function:</b>	
Size related*	[ par. 35-36 - 204 ]	

### 3.27.5 35-4\* Analog Input X48/2 (MCB 114)

35-42 Term. X48/2 Low Current		
<b>Range:</b>	<b>Function:</b>	
4 mA*	[ 0 - par. 35-43 mA]	Enter the current (mA) that corresponds to the low reference value, set in <i>parameter 35-44 Term. X48/2 Low Ref./Feedb. Value</i> . The value must be set at > 2mA in order to activate the Live Zero Time-out Function in <i>6-01 Live Zero Timeout Function</i> .

35-43 Term. X48/2 High Current		
<b>Range:</b>	<b>Function:</b>	
20 mA*	[ par. 35-42 - 20 mA]	Enter the current (mA) that corresponds to the high reference value (set in <i>parameter 35-45 Term. X48/2 High Ref./Feedb. Value</i> ).

35-44 Term. X48/2 Low Ref./Feedb. Value		
<b>Range:</b>	<b>Function:</b>	
0 *	[-999999.999 - 999999.999 ]	Enter the reference or feedback value (in RPM, Hz, bar, etc.) that corresponds to the voltage or current set in <i>parameter 35-42 Term. X48/2 Low Current</i> .

35-45 Term. X48/2 High Ref./Feedb. Value		
<b>Range:</b>	<b>Function:</b>	
100 *	[-999999.999 - 999999.999 ]	Enter the reference or feedback value (in RPM, Hz, bar, etc.) that corresponds to the voltage or current set in <i>parameter 35-43 Term. X48/2 High Current</i> .

35-46 Term. X48/2 Filter Time Constant		
<b>Range:</b>	<b>Function:</b>	
0.001 s*	[0.001 - 10 s]	Enter the filter time constant. This is a first-order digital low pass filter time constant for suppressing electrical noise in terminal X48/2. A high time constant value improves dampening but also increases the time delay through the filter.

## 4 Parameter Lists

### 4.1 Parameter Options

#### 4.1.1 Default Settings

##### Changes during operation

"TRUE" means that the parameter can be changed while the frequency converter is in operation and "FALSE" means that the frequency converter must be stopped before a change can be made.

##### 4-Set-up

'All set-up': the parameter can be set individually in each of the four set-ups, i. e. one single parameter can have four different data values.

'1 set-up': data value will be the same in all set-ups.

##### SR

Size related

##### N/A

No default value available.

##### Conversion index

This number refers to a conversion figure used when writing or reading by means of a frequency converter.

Conv. index	100	75	74	70	67	6	5	4	3	2	1	0	-1	-2	-3	-4	-5	-6
Conv. factor	1	3600000	3600	60	1/60	100000 0	10000 0	10000	1000	100	10	1	0.1	0.01	0.001	0.000 1	0.00001	0.00000 1

Table 4.1 Conversion Indices

Data type	Description	Type
2	Integer 8	Int8
3	Integer 16	Int16
4	Integer 32	Int32
5	Unsigned 8	UInt8
6	Unsigned 16	UInt16
7	Unsigned 32	UInt32
9	Visible String	VisStr
33	Normalized value 2 bytes	N2
35	Bit sequence of 16 boolean variables	V2
54	Time difference w/o date	TimD

Table 4.2 Data Types



## 4.1.2 0-\*\* Operation/Display

Par. No. #	Parameter description	Default value	4-set-up	FC 302 only	Change during operation	Conversion index	Type
<b>0-0* Basic Settings</b>							
0-01	Language	[0] English	1 set-up		TRUE	-	UInt8
0-02	Motor Speed Unit	[0] RPM	2 set-ups		FALSE	-	UInt8
0-03	Regional Settings	[0] International	2 set-ups		FALSE	-	UInt8
0-04	Operating State at Power-up	[0] Resume	All set-ups		TRUE	-	UInt8
0-05	Local Mode Unit	[0] As Motor Speed Unit	2 set-ups		FALSE	-	UInt8
<b>0-1* Set-up Operations</b>							
0-10	Active Set-up	[1] Set-up 1	1 set-up		TRUE	-	UInt8
0-11	Programming Set-up	[9] Active Set-up	All set-ups		TRUE	-	UInt8
0-12	This Set-up Linked to	[0] Not linked	All set-ups		FALSE	-	UInt8
0-13	Readout: Linked Set-ups	0 N/A	All set-ups		FALSE	0	UInt16
0-14	Readout: Prog. Set-ups / Channel	0 N/A	All set-ups		TRUE	0	Int32
<b>0-2* LCP Display</b>							
0-20	Display Line 1.1 Small	1601	All set-ups		TRUE	-	UInt16
0-21	Display Line 1.2 Small	1662	All set-ups		TRUE	-	UInt16
0-22	Display Line 1.3 Small	1614	All set-ups		TRUE	-	UInt16
0-23	Display Line 2 Large	1613	All set-ups		TRUE	-	UInt16
0-24	Display Line 3 Large	1652	All set-ups		TRUE	-	UInt16
0-25	My Personal Menu	ExpressionLimit	1 set-up		TRUE	0	UInt16
<b>0-3* LCP Custom Readout</b>							
0-30	Custom Readout Unit	[1] %	All set-ups		TRUE	-	UInt8
0-31	Custom Readout Min Value	ExpressionLimit	All set-ups		TRUE	-2	Int32
0-32	Custom Readout Max Value	100 CustomReadoutUnit	All set-ups		TRUE	-2	Int32
0-37	Display Text 1	0 N/A	1 set-up		TRUE	0	VisStr[25]
0-38	Display Text 2	0 N/A	1 set-up		TRUE	0	VisStr[25]
0-39	Display Text 3	0 N/A	1 set-up		TRUE	0	VisStr[25]
<b>0-4* LCP Keypad</b>							
0-40	[Hand on] Key on LCP	[1] Enabled	All set-ups		TRUE	-	UInt8
0-41	[Off] Key on LCP	[1] Enabled	All set-ups		TRUE	-	UInt8
0-42	[Auto on] Key on LCP	[1] Enabled	All set-ups		TRUE	-	UInt8
0-43	[Reset] Key on LCP	[1] Enabled	All set-ups		TRUE	-	UInt8
0-44	[Off/Reset] Key on LCP	[1] Enabled	All set-ups		TRUE	-	UInt8
0-45	[Drive Bypass] Key on LCP	[1] Enabled	All set-ups		TRUE	-	UInt8
<b>0-5* Copy/Save</b>							
0-50	LCP Copy	[0] No copy	All set-ups		FALSE	-	UInt8
0-51	Set-up Copy	[0] No copy	All set-ups		FALSE	-	UInt8
<b>0-6* Password</b>							
0-60	Main Menu Password	100 N/A	1 set-up		TRUE	0	Int16
0-61	Access to Main Menu w/o Password	[0] Full access	1 set-up		TRUE	-	UInt8
0-65	Personal Menu Password	200 N/A	1 set-up		TRUE	0	UInt16
0-66	Access to Personal Menu w/o Password	[0] Full access	1 set-up		TRUE	-	UInt8
0-67	Bus Password Access	0 N/A	All set-ups		TRUE	0	UInt16
<b>0-7* Clock Settings</b>							
0-70	Date and Time	ExpressionLimit	All set-ups		TRUE	0	TimeOfDay
0-71	Date Format	[0] YYYY-MM-DD	1 set-up		TRUE	-	UInt8

0-72	Time Format	[0] 24 h	1 set-up		TRUE	-	Uin8
0-74	DST/Summertime	[0] Off	1 set-up		TRUE	-	Uin8
0-76	DST/Summertime Start	ExpressionLimit	1 set-up		TRUE	0	TimeOfDay
0-77	DST/Summertime End	ExpressionLimit	1 set-up		TRUE	0	TimeOfDay
0-79	Clock Fault	ExpressionLimit	1 set-up		TRUE	-	Uin8
0-81	Working Days	ExpressionLimit	1 set-up		TRUE	-	Uin8
0-82	Additional Working Days	ExpressionLimit	1 set-up		TRUE	0	TimeOfDay
0-83	Additional Non-Working Days	ExpressionLimit	1 set-up		TRUE	0	TimeOfDay
0-89	Date and Time Readout	0 N/A	All set-ups		TRUE	0	VisStr[25]

## 4.1.3 1-\*\* Load/Motor

Par. No. #	Parameter description	Default value	4-set-up	FC 302 only	Change during operation	Conversion index	Type
<b>1-0* General Settings</b>							
1-00	Configuration Mode	ExpressionLimit	All set-ups		TRUE	-	Uint8
1-01	Motor Control Principle	[1] VVC+	All set-ups		FALSE	-	Uint8
1-03	Torque Characteristics	[3] Auto Energy Optim. VT	All set-ups		TRUE	-	Uint8
1-06	Clockwise Direction	[0] Normal	All set-ups		FALSE	-	Uint8
<b>1-1* Motor Selection</b>							
1-10	Motor Construction	[0] Asynchron	All set-ups		FALSE	-	Uint8
<b>1-1* VVC+ PM</b>							
1-14	Damping Gain	120 %	All set-ups		TRUE	0	Int16
1-15	Low Speed Filter Time Const.	ExpressionLimit	All set-ups		TRUE	-2	Uint16
1-16	High Speed Filter Time Const.	ExpressionLimit	All set-ups		TRUE	-2	Uint16
1-17	Voltage filter time const.	ExpressionLimit	All set-ups		TRUE	-3	Uint16
<b>1-2* Motor Data</b>							
1-20	Motor Power [kW]	ExpressionLimit	All set-ups		FALSE	1	Uint32
1-21	Motor Power [HP]	ExpressionLimit	All set-ups		FALSE	-2	Uint32
1-22	Motor Voltage	ExpressionLimit	All set-ups		FALSE	0	Uint16
1-23	Motor Frequency	ExpressionLimit	All set-ups		FALSE	0	Uint16
1-24	Motor Current	ExpressionLimit	All set-ups		FALSE	-2	Uint32
1-25	Motor Nominal Speed	ExpressionLimit	All set-ups		FALSE	67	Uint16
1-26	Motor Cont. Rated Torque	ExpressionLimit	All set-ups		FALSE	-1	Uint32
1-28	Motor Rotation Check	[0] Off	All set-ups		FALSE	-	Uint8
1-29	Automatic Motor Adaptation (AMA)	[0] Off	All set-ups		FALSE	-	Uint8
<b>1-3* Adv. Motor Data</b>							
1-30	Stator Resistance (Rs)	ExpressionLimit	All set-ups		FALSE	-4	Uint32
1-31	Rotor Resistance (Rr)	ExpressionLimit	All set-ups		FALSE	-4	Uint32
1-33	Stator Leakage Reactance (X1)	ExpressionLimit	All set-ups		FALSE	-4	Uint32
1-34	Rotor Leakage Reactance (X2)	ExpressionLimit	All set-ups		FALSE	-4	Uint32
1-35	Main Reactance (Xh)	ExpressionLimit	All set-ups		FALSE	-4	Uint32
1-36	Iron Loss Resistance (Rfe)	ExpressionLimit	All set-ups		FALSE	-3	Uint32
1-37	d-axis Inductance (Ld)	ExpressionLimit	All set-ups		FALSE	-6	Int32
1-39	Motor Poles	ExpressionLimit	All set-ups		FALSE	0	Uint8
1-40	Back EMF at 1000 RPM	ExpressionLimit	All set-ups		FALSE	0	Uint16
1-46	Position Detection Gain	100 %	All set-ups		TRUE	0	Uint16
<b>1-5* Load Indep. Setting</b>							
1-50	Motor Magnetisation at Zero Speed	100 %	All set-ups		TRUE	0	Uint16
1-51	Min Speed Normal Magnetising [RPM]	ExpressionLimit	All set-ups		TRUE	67	Uint16
1-52	Min Speed Normal Magnetising [Hz]	ExpressionLimit	All set-ups		TRUE	-1	Uint16
1-55	V/f Characteristic - V	ExpressionLimit	All set-ups		TRUE	-1	Uint16
1-56	V/f Characteristic - f	ExpressionLimit	All set-ups		TRUE	-1	Uint16
1-58	Flystart Test Pulses Current	ExpressionLimit	All set-ups		FALSE	0	Uint16
1-59	Flystart Test Pulses Frequency	ExpressionLimit	All set-ups		FALSE	0	Uint16
<b>1-6* Load Depen. Setting</b>							
1-60	Low Speed Load Compensation	100 %	All set-ups		TRUE	0	Int16
1-61	High Speed Load Compensation	100 %	All set-ups		TRUE	0	Int16
1-62	Slip Compensation	0 %	All set-ups		TRUE	0	Int16
1-63	Slip Compensation Time Constant	ExpressionLimit	All set-ups		TRUE	-2	Uint16
1-64	Resonance Damping	100 %	All set-ups		TRUE	0	Uint16
1-65	Resonance Damping Time Constant	5 ms	All set-ups		TRUE	-3	Uint8
1-66	Min. Current at Low Speed	ExpressionLimit	All set-ups		TRUE	0	Uint8

1-7* Start Adjustments							
1-70	PM Start Mode	[1] Parking	All set-ups		TRUE	-	Uint8
1-71	Start Delay	00 s	All set-ups		TRUE	-1	Uint16
1-72	Start Function	ExpressionLimit	All set-ups		TRUE	-	Uint8
1-73	Flying Start	ExpressionLimit	All set-ups		FALSE	-	Uint8
1-77	Compressor Start Max Speed [RPM]	ExpressionLimit	All set-ups		TRUE	67	Uint16
1-78	Compressor Start Max Speed [Hz]	ExpressionLimit	All set-ups		TRUE	-1	Uint16
1-79	Pump Start Max Time to Trip	0 s	All set-ups		TRUE	-1	Uint8
1-8* Stop Adjustments							
1-80	Function at Stop	[0] Coast	All set-ups		TRUE	-	Uint8
1-81	Min Speed for Function at Stop [RPM]	ExpressionLimit	All set-ups		TRUE	67	Uint16
1-82	Min Speed for Function at Stop [Hz]	ExpressionLimit	All set-ups		TRUE	-1	Uint16
1-86	Trip Speed Low [RPM]	ExpressionLimit	All set-ups		TRUE	67	Uint16
1-87	Trip Speed Low [Hz]	ExpressionLimit	All set-ups		TRUE	-1	Uint16
1-9* Motor Temperature							
1-90	Motor Thermal Protection	ExpressionLimit	All set-ups		TRUE	-	Uint8
1-91	Motor External Fan	[0] No	All set-ups		TRUE	-	Uint16
1-93	Thermistor Source	[0] None	All set-ups		TRUE	-	Uint8

## 4.1.4 2-\*\* Brakes

Par. No. #	Parameter description	Default value	4-set-up	Change during operation	Conversion index	Type
<b>2-0* DC-Brake</b>						
2-00	DC Hold/Preheat Current	50 %	All set-ups	TRUE	0	Uint8
2-01	DC Brake Current	50 %	All set-ups	TRUE	0	Uint16
2-02	DC Braking Time	10.0 s	All set-ups	TRUE	-1	Uint16
2-03	DC Brake Cut In Speed [RPM]	ExpressionLimit	All set-ups	TRUE	67	Uint16
2-04	DC Brake Cut In Speed [Hz]	ExpressionLimit	All set-ups	TRUE	-1	Uint16
<b>2-1* Brake Energy Funct.</b>						
2-10	Brake Function	[0] Off	All set-ups	TRUE	-	Uint8
2-11	Brake Resistor (ohm)	ExpressionLimit	All set-ups	TRUE	0	Uint16
2-12	Brake Power Limit (kW)	ExpressionLimit	All set-ups	TRUE	0	Uint32
2-13	Brake Power Monitoring	[0] Off	All set-ups	TRUE	-	Uint8
2-15	Brake Check	[0] Off	All set-ups	TRUE	-	Uint8
2-16	AC brake Max. Current	100.0 %	All set-ups	TRUE	-1	Uint32
2-17	Over-voltage Control	[2] Enabled	All set-ups	TRUE	-	Uint8

## 4.1.5 3-\*\* Reference/Ramps

4

Par. No. #	Parameter description	Default value	4-set-up	Change during operation	Conversion index	Type
<b>3-0* Reference Limits</b>						
3-02	Minimum Reference	ExpressionLimit	All set-ups	TRUE	-3	Int32
3-03	Maximum Reference	ExpressionLimit	All set-ups	TRUE	-3	Int32
3-04	Reference Function	[0] Sum	All set-ups	TRUE	-	UInt8
<b>3-1* References</b>						
3-10	Preset Reference	0.00 %	All set-ups	TRUE	-2	Int16
3-11	Jog Speed [Hz]	ExpressionLimit	All set-ups	TRUE	-1	UInt16
3-13	Reference Site	[0] Linked to Hand / Auto	All set-ups	TRUE	-	UInt8
3-14	Preset Relative Reference	0.00 %	All set-ups	TRUE	-2	Int32
3-15	Reference 1 Source	[1] Analog input 53	All set-ups	TRUE	-	UInt8
3-16	Reference 2 Source	[0] No function	All set-ups	TRUE	-	UInt8
3-17	Reference 3 Source	[0] No function	All set-ups	TRUE	-	UInt8
3-19	Jog Speed [RPM]	ExpressionLimit	All set-ups	TRUE	67	UInt16
<b>3-4* Ramp 1</b>						
3-41	Ramp 1 Ramp Up Time	ExpressionLimit	All set-ups	TRUE	-2	UInt32
3-42	Ramp 1 Ramp Down Time	ExpressionLimit	All set-ups	TRUE	-2	UInt32
<b>3-5* Ramp 2</b>						
3-51	Ramp 2 Ramp Up Time	ExpressionLimit	All set-ups	TRUE	-2	UInt32
3-52	Ramp 2 Ramp Down Time	ExpressionLimit	All set-ups	TRUE	-2	UInt32
<b>3-8* Other Ramps</b>						
3-80	Jog Ramp Time	ExpressionLimit	All set-ups	TRUE	-2	UInt32
3-81	Quick Stop Ramp Time	ExpressionLimit	2 set-ups	TRUE	-2	UInt32
3-84	Initial Ramp Time	0.00 s	All set-ups	TRUE	-2	UInt16
3-85	Check Valve Ramp Time	0.00 s	All set-ups	TRUE	-2	UInt16
3-86	Check Valve Ramp End Speed [RPM]	ExpressionLimit	All set-ups	TRUE	67	UInt16
3-87	Check Valve Ramp End Speed [HZ]	ExpressionLimit	All set-ups	TRUE	-1	UInt16
3-88	Final Ramp Time	0.00 s	All set-ups	TRUE	-2	UInt16
<b>3-9* Digital Pot.Meter</b>						
3-90	Step Size	0.10 %	All set-ups	TRUE	-2	UInt16
3-91	Ramp Time	1.00 s	All set-ups	TRUE	-2	UInt32
3-92	Power Restore	[0] Off	All set-ups	TRUE	-	UInt8
3-93	Maximum Limit	100 %	All set-ups	TRUE	0	Int16
3-94	Minimum Limit	0 %	All set-ups	TRUE	0	Int16
3-95	Ramp Delay	ExpressionLimit	All set-ups	TRUE	-3	TimD

## 4.1.6 4-\*\* Limits/Warnings

Par. No. #	Parameter description	Default value	4-set-up	Change during operation	Conversion index	Type
<b>4-1* Motor Limits</b>						
4-10	Motor Speed Direction	[0] Clockwise	All set-ups	FALSE	-	Uint8
4-11	Motor Speed Low Limit [RPM]	ExpressionLimit	All set-ups	TRUE	67	Uint16
4-12	Motor Speed Low Limit [Hz]	ExpressionLimit	All set-ups	TRUE	-1	Uint16
4-13	Motor Speed High Limit [RPM]	ExpressionLimit	All set-ups	TRUE	67	Uint16
4-14	Motor Speed High Limit [Hz]	ExpressionLimit	All set-ups	TRUE	-1	Uint16
4-16	Torque Limit Motor Mode	ExpressionLimit	All set-ups	TRUE	-1	Uint16
4-17	Torque Limit Generator Mode	100.0 %	All set-ups	TRUE	-1	Uint16
4-18	Current Limit	ExpressionLimit	All set-ups	TRUE	-1	Uint32
4-19	Max Output Frequency	ExpressionLimit	All set-ups	FALSE	-1	Uint16
<b>4-5* Adj. Warnings</b>						
4-50	Warning Current Low	0.00 A	All set-ups	TRUE	-2	Uint32
4-51	Warning Current High	I <sub>maxVLT</sub> (P1637)	All set-ups	TRUE	-2	Uint32
4-52	Warning Speed Low	0 RPM	All set-ups	TRUE	67	Uint16
4-53	Warning Speed High	outputSpeedHighLimit (P413)	All set-ups	TRUE	67	Uint16
4-54	Warning Reference Low	-999999.999 N/A	All set-ups	TRUE	-3	Int32
4-55	Warning Reference High	999999.999 N/A	All set-ups	TRUE	-3	Int32
4-56	Warning Feedback Low	-999999.999 Reference-FeedbackUnit	All set-ups	TRUE	-3	Int32
4-57	Warning Feedback High	999999.999 Reference-FeedbackUnit	All set-ups	TRUE	-3	Int32
4-58	Missing Motor Phase Function	[2] Trip 1000 ms	All set-ups	TRUE	-	Uint8
<b>4-6* Speed Bypass</b>						
4-60	Bypass Speed From [RPM]	ExpressionLimit	All set-ups	TRUE	67	Uint16
4-61	Bypass Speed From [Hz]	ExpressionLimit	All set-ups	TRUE	-1	Uint16
4-62	Bypass Speed To [RPM]	ExpressionLimit	All set-ups	TRUE	67	Uint16
4-63	Bypass Speed To [Hz]	ExpressionLimit	All set-ups	TRUE	-1	Uint16
4-64	Semi-Auto Bypass Set-up	[0] Off	All set-ups	FALSE	-	Uint8

## 4.1.7 5-\*\* Digital In/Out

4

Par. No. #	Parameter description	Default value	4-set-up	FC 302 only	Change during operation	Conversion index	Type
<b>5-0* Digital I/O mode</b>							
5-00	Digital I/O Mode	[0] PNP - Active at 24V	All set-ups		FALSE	-	Uint8
5-01	Terminal 27 Mode	[0] Input	All set-ups		TRUE	-	Uint8
5-02	Terminal 29 Mode	[0] Input	All set-ups		TRUE	-	Uint8
<b>5-1* Digital Inputs</b>							
5-10	Terminal 18 Digital Input	ExpressionLimit	All set-ups		TRUE	-	Uint8
5-11	Terminal 19 Digital Input	ExpressionLimit	All set-ups		TRUE	-	Uint8
5-12	Terminal 27 Digital Input	ExpressionLimit	All set-ups		TRUE	-	Uint8
5-13	Terminal 29 Digital Input	ExpressionLimit	All set-ups		TRUE	-	Uint8
5-14	Terminal 32 Digital Input	ExpressionLimit	All set-ups		TRUE	-	Uint8
5-15	Terminal 33 Digital Input	ExpressionLimit	All set-ups		TRUE	-	Uint8
5-16	Terminal X30/2 Digital Input	ExpressionLimit	All set-ups		TRUE	-	Uint8
5-17	Terminal X30/3 Digital Input	ExpressionLimit	All set-ups		TRUE	-	Uint8
5-18	Terminal X30/4 Digital Input	ExpressionLimit	All set-ups		TRUE	-	Uint8
5-19	Terminal 37 Digital Input	[1] Safe Stop Alarm	1 set-up		TRUE	-	Uint8
5-20	Terminal X46/1 Digital Input	ExpressionLimit	All set-ups		TRUE	-	Uint8
5-21	Terminal X46/3 Digital Input	ExpressionLimit	All set-ups		TRUE	-	Uint8
5-22	Terminal X46/5 Digital Input	ExpressionLimit	All set-ups		TRUE	-	Uint8
5-23	Terminal X46/7 Digital Input	ExpressionLimit	All set-ups		TRUE	-	Uint8
5-24	Terminal X46/9 Digital Input	ExpressionLimit	All set-ups		TRUE	-	Uint8
5-25	Terminal X46/11 Digital Input	ExpressionLimit	All set-ups		TRUE	-	Uint8
5-26	Terminal X46/13 Digital Input	ExpressionLimit	All set-ups		TRUE	-	Uint8
<b>5-3* Digital Outputs</b>							
5-30	Terminal 27 Digital Output	[0] No operation	All set-ups		TRUE	-	Uint8
5-31	Terminal 29 Digital Output	[0] No operation	All set-ups		TRUE	-	Uint8
5-32	Term X30/6 Digi Out (MCB 101)	[0] No operation	All set-ups		TRUE	-	Uint8
5-33	Term X30/7 Digi Out (MCB 101)	[0] No operation	All set-ups		TRUE	-	Uint8
<b>5-4* Relays</b>							
5-40	Function Relay	ExpressionLimit	All set-ups		TRUE	-	Uint8
5-41	On Delay, Relay	0.01 s	All set-ups		TRUE	-2	Uint16
5-42	Off Delay, Relay	0.01 s	All set-ups		TRUE	-2	Uint16
<b>5-5* Pulse Input</b>							
5-50	Term. 29 Low Frequency	100 Hz	All set-ups		TRUE	0	Uint32
5-51	Term. 29 High Frequency	100 Hz	All set-ups		TRUE	0	Uint32
5-52	Term. 29 Low Ref./Feedb. Value	0 N/A	All set-ups		TRUE	-3	Int32
5-53	Term. 29 High Ref./Feedb. Value	100 N/A	All set-ups		TRUE	-3	Int32
5-54	Pulse Filter Time Constant #29	100 ms	All set-ups		FALSE	-3	Uint16
5-55	Term. 33 Low Frequency	100 Hz	All set-ups		TRUE	0	Uint32
5-56	Term. 33 High Frequency	100 Hz	All set-ups		TRUE	0	Uint32
5-57	Term. 33 Low Ref./Feedb. Value	0 N/A	All set-ups		TRUE	-3	Int32
5-58	Term. 33 High Ref./Feedb. Value	100 N/A	All set-ups		TRUE	-3	Int32
5-59	Pulse Filter Time Constant #33	100 ms	All set-ups		FALSE	-3	Uint16
<b>5-6* Pulse Output</b>							
5-60	Terminal 27 Pulse Output Variable	[0] No operation	All set-ups		TRUE	-	Uint8
5-62	Pulse Output Max Freq #27	5000 Hz	All set-ups		TRUE	0	Uint32
5-63	Terminal 29 Pulse Output Variable	[0] No operation	All set-ups		TRUE	-	Uint8
5-65	Pulse Output Max Freq #29	5000 Hz	All set-ups		TRUE	0	Uint32
5-66	Terminal X30/6 Pulse Output Variable	[0] No operation	All set-ups		TRUE	-	Uint8
5-68	Pulse Output Max Freq #X30/6	5000 Hz	All set-ups		TRUE	0	Uint32



5-8* I/O Options							
5-80	AHF Cap Reconnect Delay	25 s	2 set-ups		TRUE	0	Uint16
5-9* Bus Controlled							
5-90	Digital & Relay Bus Control	0 N/A	All set-ups		TRUE	0	Uint32
5-93	Pulse Out #27 Bus Control	0 %	All set-ups		TRUE	-2	N2
5-94	Pulse Out #27 Timeout Preset	0 %	1 set-up		TRUE	-2	Uint16
5-95	Pulse Out #29 Bus Control	0 %	All set-ups		TRUE	-2	N2
5-96	Pulse Out #29 Timeout Preset	0 %	1 set-up		TRUE	-2	Uint16
5-97	Pulse Out #X30/6 Bus Control	0 %	All set-ups		TRUE	-2	N2
5-98	Pulse Out #X30/6 Timeout Preset	0 %	1 set-up		TRUE	-2	Uint16

## 4.1.8 6-\*\* Analog In/Out

4

Par. No. #	Parameter description	Default value	4-set-up	FC 302 only	Change during operation	Conversion index	Type
<b>6-0* Analog I/O Mode</b>							
6-00	Live Zero Timeout Time	10 s	All set-ups		TRUE	0	Uint8
6-01	Live Zero Timeout Function	[0] Off	All set-ups		TRUE	-	Uint8
<b>6-1* Analog Input 53</b>							
6-10	Terminal 53 Low Voltage	0.07 V	All set-ups		TRUE	-2	Int16
6-11	Terminal 53 High Voltage	10 V	All set-ups		TRUE	-2	Int16
6-12	Terminal 53 Low Current	4 mA	All set-ups		TRUE	-5	Int16
6-13	Terminal 53 High Current	20 mA	All set-ups		TRUE	-5	Int16
6-14	Terminal 53 Low Ref./Feedb. Value	0 N/A	All set-ups		TRUE	-3	Int32
6-15	Terminal 53 High Ref./Feedb. Value	ExpressionLimit	All set-ups		TRUE	-3	Int32
6-16	Terminal 53 Filter Time Constant	0.001 s	All set-ups		TRUE	-3	Uint16
6-17	Terminal 53 Live Zero	[1] Enabled	All set-ups		TRUE	-	Uint8
<b>6-2* Analog Input 54</b>							
6-20	Terminal 54 Low Voltage	0.07 V	All set-ups		TRUE	-2	Int16
6-21	Terminal 54 High Voltage	10 V	All set-ups		TRUE	-2	Int16
6-22	Terminal 54 Low Current	4 mA	All set-ups		TRUE	-5	Int16
6-23	Terminal 54 High Current	20 mA	All set-ups		TRUE	-5	Int16
6-24	Terminal 54 Low Ref./Feedb. Value	0 N/A	All set-ups		TRUE	-3	Int32
6-25	Terminal 54 High Ref./Feedb. Value	100 N/A	All set-ups		TRUE	-3	Int32
6-26	Terminal 54 Filter Time Constant	0.001 s	All set-ups		TRUE	-3	Uint16
6-27	Terminal 54 Live Zero	[1] Enabled	All set-ups		TRUE	-	Uint8
<b>6-3* Analog Input X30/11</b>							
6-30	Terminal X30/11 Low Voltage	0.07 V	All set-ups		TRUE	-2	Int16
6-31	Terminal X30/11 High Voltage	10 V	All set-ups		TRUE	-2	Int16
6-34	Term. X30/11 Low Ref./Feedb. Value	0 N/A	All set-ups		TRUE	-3	Int32
6-35	Term. X30/11 High Ref./Feedb. Value	100 N/A	All set-ups		TRUE	-3	Int32
6-36	Term. X30/11 Filter Time Constant	0.001 s	All set-ups		TRUE	-3	Uint16
6-37	Term. X30/11 Live Zero	[1] Enabled	All set-ups		TRUE	-	Uint8
<b>6-4* Analog Input X30/12</b>							
6-40	Terminal X30/12 Low Voltage	0.07 V	All set-ups		TRUE	-2	Int16
6-41	Terminal X30/12 High Voltage	10 V	All set-ups		TRUE	-2	Int16
6-44	Term. X30/12 Low Ref./Feedb. Value	0 N/A	All set-ups		TRUE	-3	Int32
6-45	Term. X30/12 High Ref./Feedb. Value	100 N/A	All set-ups		TRUE	-3	Int32
6-46	Term. X30/12 Filter Time Constant	0.001 s	All set-ups		TRUE	-3	Uint16
6-47	Term. X30/12 Live Zero	[1] Enabled	All set-ups		TRUE	-	Uint8
<b>6-5* Analog Output 42</b>							
6-50	Terminal 42 Output	[100] Output freq. 0-100	All set-ups		TRUE	-	Uint8
6-51	Terminal 42 Output Min Scale	0 %	All set-ups		TRUE	-2	Int16
6-52	Terminal 42 Output Max Scale	100 %	All set-ups		TRUE	-2	Int16
6-53	Terminal 42 Output Bus Control	0 %	All set-ups		TRUE	-2	N2
6-54	Terminal 42 Output Timeout Preset	0 %	1 set-up		TRUE	-2	Uint16
6-55	Terminal 42 Output Filter	[0] Off	1 set-up		TRUE	-	Uint8
<b>6-6* Analog Output X30/8</b>							
6-60	Terminal X30/8 Output	[0] No operation	All set-ups		TRUE	-	Uint8
6-61	Terminal X30/8 Min. Scale	0 %	All set-ups		TRUE	-2	Int16
6-62	Terminal X30/8 Max. Scale	100 %	All set-ups		TRUE	-2	Int16
6-63	Terminal X30/8 Output Bus Control	0 %	All set-ups		TRUE	-2	N2
6-64	Terminal X30/8 Output Timeout Preset	0 %	1 set-up		TRUE	-2	Uint16
<b>6-7* Analog Output X45/1</b>							

6-70	Terminal X45/1 Output	[0] No operation	All set-ups		TRUE	-	Uint8
6-71	Terminal X45/1 Min. Scale	0 %	All set-ups		TRUE	-2	Int16
6-72	Terminal X45/1 Max. Scale	100 %	All set-ups		TRUE	-2	Int16
6-73	Terminal X45/1 Bus Control	0 %	All set-ups		TRUE	-2	N2
6-74	Terminal X45/1 Output Timeout Preset	0 %	1 set-up		TRUE	-2	Uint16
<b>6-8* Analog Output X45/3</b>							
6-80	Terminal X45/3 Output	[0] No operation	All set-ups		TRUE	-	Uint8
6-81	Terminal X45/3 Min. Scale	0 %	All set-ups		TRUE	-2	Int16
6-82	Terminal X45/3 Max. Scale	100 %	All set-ups		TRUE	-2	Int16
6-83	Terminal X45/3 Bus Control	0 %	All set-ups		TRUE	-2	N2
6-84	Terminal X45/3 Output Timeout Preset	0 %	1 set-up		TRUE	-2	Uint16

## 4.1.9 8-\*\* Comm. and Options

4

Par. No. #	Parameter description	Default value	4-set-up	Change during operation	Conversion index	Type
<b>8-0* General Settings</b>						
8-01	Control Site	null	All set-ups	TRUE	-	UInt8
8-02	Control Source	null	All set-ups	TRUE	-	UInt8
8-03	Control Timeout Time	ExpressionLimit	1 set-up	TRUE	-1	UInt32
8-04	Control Timeout Function	[0] Off	1 set-up	TRUE	-	UInt8
8-05	End-of-Timeout Function	[1] Resume set-up	1 set-up	TRUE	-	UInt8
8-06	Reset Control Timeout	[0] Do not reset	All set-ups	TRUE	-	UInt8
8-07	Diagnosis Trigger	[0] Disable	2 set-ups	TRUE	-	UInt8
8-08	Readout Filtering	null	All set-ups	TRUE	-	UInt8
<b>8-1* Control Settings</b>						
8-10	Control Profile	[0] FC profile	All set-ups	TRUE	-	UInt8
8-13	Configurable Status Word STW	[1] Profile Default	All set-ups	TRUE	-	UInt8
8-14	Configurable Control Word CTW	[1] Profile default	All set-ups	TRUE	-	UInt8
<b>8-3* FC Port Settings</b>						
8-30	Protocol	[0] FC	1 set-up	TRUE	-	UInt8
8-31	Address	ExpressionLimit	1 set-up	TRUE	0	UInt8
8-32	Baud Rate	null	1 set-up	TRUE	-	UInt8
8-33	Parity / Stop Bits	null	1 set-up	TRUE	-	UInt8
8-35	Minimum Response Delay	ExpressionLimit	1 set-up	TRUE	-3	UInt16
8-36	Max Response Delay	ExpressionLimit	1 set-up	TRUE	-3	UInt16
8-37	Maximum Inter-Char Delay	ExpressionLimit	1 set-up	TRUE	-5	UInt16
<b>8-4* FC MC protocol set</b>						
8-40	Telegram Selection	[1] Standard telegram 1	2 set-ups	TRUE	-	UInt8
8-42	PCD Write Configuration	ExpressionLimit	2 set-ups	TRUE	-	UInt16
8-43	PCD Read Configuration	ExpressionLimit	2 set-ups	TRUE	-	UInt16
<b>8-5* Digital/Bus</b>						
8-50	Coasting Select	[3] Logic OR	All set-ups	TRUE	-	UInt8
8-52	DC Brake Select	[3] Logic OR	All set-ups	TRUE	-	UInt8
8-53	Start Select	[3] Logic OR	All set-ups	TRUE	-	UInt8
8-54	Reversing Select	null	All set-ups	TRUE	-	UInt8
8-55	Set-up Select	[3] Logic OR	All set-ups	TRUE	-	UInt8
8-56	Preset Reference Select	[3] Logic OR	All set-ups	TRUE	-	UInt8
<b>8-7* BACnet</b>						
8-70	BACnet Device Instance	1 N/A	1 set-up	TRUE	0	UInt32
8-72	MS/TP Max Masters	127 N/A	1 set-up	TRUE	0	UInt8
8-73	MS/TP Max Info Frames	1 N/A	1 set-up	TRUE	0	UInt16
8-74	"I-Am" Service	[0] Send at power-up	1 set-up	TRUE	-	UInt8
8-75	Initialisation Password	ExpressionLimit	1 set-up	TRUE	0	VisStr[20]
<b>8-8* FC Port Diagnostics</b>						
8-80	Bus Message Count	0 N/A	All set-ups	TRUE	0	UInt32
8-81	Bus Error Count	0 N/A	All set-ups	TRUE	0	UInt32
8-82	Slave Message Rcvd	0 N/A	All set-ups	TRUE	0	UInt32
8-83	Slave Error Count	0 N/A	All set-ups	TRUE	0	UInt32

Par. No. #	Parameter description	Default value	4-set-up	Change during operation	Conversion index	Type
<b>8-9* Bus Jog / Feedback</b>						
8-90	Bus Jog 1 Speed	100 RPM	All set-ups	TRUE	67	Uint16
8-91	Bus Jog 2 Speed	200 RPM	All set-ups	TRUE	67	Uint16
8-94	Bus Feedback 1	0 N/A	1 set-up	TRUE	0	N2
8-95	Bus Feedback 2	0 N/A	1 set-up	TRUE	0	N2
8-96	Bus Feedback 3	0 N/A	1 set-up	TRUE	0	N2

## 4.1.10 9-\*\* Profibus

4

Par. No. #	Parameter description	Default value	4-set-up	FC 302 only	Change during operation	Conversion index	Type
9-00	Setpoint	0 N/A	All set-ups		TRUE	0	Uint16
9-07	Actual Value	0 N/A	All set-ups		FALSE	0	Uint16
9-15	PCD Write Configuration	ExpressionLimit	1 set-up		TRUE	-	Uint16
9-16	PCD Read Configuration	ExpressionLimit	2 set-ups		TRUE	-	Uint16
9-18	Node Address	126 N/A	1 set-up		TRUE	0	Uint8
9-22	Telegram Selection	[100] None	1 set-up		TRUE	-	Uint8
9-23	Parameters for Signals	0	All set-ups		TRUE	-	Uint16
9-27	Parameter Edit	[1] Enabled	2 set-ups		FALSE	-	Uint16
9-28	Process Control	[1] Enable cyclic master	2 set-ups		FALSE	-	Uint8
9-31	Safe Address	0 N/A	1 set-up		TRUE	0	Uint16
9-44	Fault Message Counter	0 N/A	All set-ups		TRUE	0	Uint16
9-45	Fault Code	0 N/A	All set-ups		TRUE	0	Uint16
9-47	Fault Number	0 N/A	All set-ups		TRUE	0	Uint16
9-52	Fault Situation Counter	0 N/A	All set-ups		TRUE	0	Uint16
9-53	Profibus Warning Word	0 N/A	All set-ups		TRUE	0	V2
9-63	Actual Baud Rate	[255] No baudrate found	All set-ups		TRUE	-	Uint8
9-64	Device Identification	0 N/A	All set-ups		TRUE	0	Uint16
9-65	Profile Number	0 N/A	All set-ups		TRUE	0	OctStr[2]
9-67	Control Word 1	0 N/A	All set-ups		FALSE	0	V2
9-68	Status Word 1	0 N/A	All set-ups		TRUE	0	V2
9-70	Programming Set-up	[9] Active Set-up	All set-ups		TRUE	-	Uint8
9-71	Profibus Save Data Values	[0] Off	All set-ups		TRUE	-	Uint8
9-72	ProfibusDriveReset	[0] No action	1 set-up		FALSE	-	Uint8
9-75	DO Identification	0 N/A	All set-ups		TRUE	0	Uint16
9-80	Defined Parameters (1)	0 N/A	All set-ups		FALSE	0	Uint16
9-81	Defined Parameters (2)	0 N/A	All set-ups		FALSE	0	Uint16
9-82	Defined Parameters (3)	0 N/A	All set-ups		FALSE	0	Uint16
9-83	Defined Parameters (4)	0 N/A	All set-ups		FALSE	0	Uint16
9-84	Defined Parameters (5)	0 N/A	All set-ups		FALSE	0	Uint16
9-85	Defined Parameters (6)	0 N/A	All set-ups		FALSE	0	Uint16
9-90	Changed Parameters (1)	0 N/A	All set-ups		FALSE	0	Uint16
9-91	Changed Parameters (2)	0 N/A	All set-ups		FALSE	0	Uint16
9-92	Changed Parameters (3)	0 N/A	All set-ups		FALSE	0	Uint16
9-93	Changed Parameters (4)	0 N/A	All set-ups		FALSE	0	Uint16
9-94	Changed Parameters (5)	0 N/A	All set-ups		FALSE	0	Uint16
9-99	Profibus Revision Counter	0 N/A	All set-ups		TRUE	0	Uint16

## 4.1.11 10-\*\* CAN Fieldbus

Par. No. #	Parameter description	Default value	4-set-up	Change during operation	Conversion index	Type
<b>10-0* Common Settings</b>						
10-00	CAN Protocol	null	2 set-ups	FALSE	-	Uint8
10-01	Baud Rate Select	null	2 set-ups	TRUE	-	Uint8
10-02	MAC ID	ExpressionLimit	2 set-ups	TRUE	0	Uint8
10-05	Readout Transmit Error Counter	0 N/A	All set-ups	TRUE	0	Uint8
10-06	Readout Receive Error Counter	0 N/A	All set-ups	TRUE	0	Uint8
10-07	Readout Bus Off Counter	0 N/A	All set-ups	TRUE	0	Uint8
<b>10-1* DeviceNet</b>						
10-10	Process Data Type Selection	null	All set-ups	TRUE	-	Uint8
10-11	Process Data Config Write	ExpressionLimit	2 set-ups	TRUE	-	Uint16
10-12	Process Data Config Read	ExpressionLimit	2 set-ups	TRUE	-	Uint16
10-13	Warning Parameter	0 N/A	All set-ups	TRUE	0	Uint16
10-14	Net Reference	[0] Off	2 set-ups	TRUE	-	Uint8
10-15	Net Control	[0] Off	2 set-ups	TRUE	-	Uint8
<b>10-2* COS Filters</b>						
10-20	COS Filter 1	0 N/A	All set-ups	FALSE	0	Uint16
10-21	COS Filter 2	0 N/A	All set-ups	FALSE	0	Uint16
10-22	COS Filter 3	0 N/A	All set-ups	FALSE	0	Uint16
10-23	COS Filter 4	0 N/A	All set-ups	FALSE	0	Uint16
<b>10-3* Parameter Access</b>						
10-30	Array Index	0 N/A	2 set-ups	TRUE	0	Uint8
10-31	Store Data Values	[0] Off	All set-ups	TRUE	-	Uint8
10-32	Devicenet Revision	ExpressionLimit	All set-ups	TRUE	0	Uint16
10-33	Store Always	[0] Off	1 set-up	TRUE	-	Uint8
10-34	DeviceNet Product Code	ExpressionLimit	1 set-up	TRUE	0	Uint16
10-39	Devicenet F Parameters	0 N/A	All set-ups	TRUE	0	Uint32

## 4.1.12 13-\*\* Smart Logic

Par. No. #	Parameter description	Default value	4-set-up	Change during operation	Conversion index	Type
<b>13-0* SLC Settings</b>						
13-00	SL Controller Mode	null	2 set-ups	TRUE	-	UInt8
13-01	Start Event	null	2 set-ups	TRUE	-	UInt8
13-02	Stop Event	null	2 set-ups	TRUE	-	UInt8
13-03	Reset SLC	[0] Do not reset SLC	All set-ups	TRUE	-	UInt8
<b>13-1* Comparators</b>						
13-10	Comparator Operand	null	2 set-ups	TRUE	-	UInt8
13-11	Comparator Operator	null	2 set-ups	TRUE	-	UInt8
13-12	Comparator Value	ExpressionLimit	2 set-ups	TRUE	-3	Int32
<b>13-2* Timers</b>						
13-20	SL Controller Timer	ExpressionLimit	1 set-up	TRUE	-3	TimD
<b>13-4* Logic Rules</b>						
13-40	Logic Rule Boolean 1	null	2 set-ups	TRUE	-	UInt8
13-41	Logic Rule Operator 1	null	2 set-ups	TRUE	-	UInt8
13-42	Logic Rule Boolean 2	null	2 set-ups	TRUE	-	UInt8
13-43	Logic Rule Operator 2	null	2 set-ups	TRUE	-	UInt8
13-44	Logic Rule Boolean 3	null	2 set-ups	TRUE	-	UInt8
<b>13-5* States</b>						
13-51	SL Controller Event	null	2 set-ups	TRUE	-	UInt8
13-52	SL Controller Action	null	2 set-ups	TRUE	-	UInt8



## 4.1.13 14-\*\* Special Functions

Par. No. #	Parameter description	Default value	4-set-up	Change during operation	Conversion index	Type
<b>14-0* Inverter Switching</b>						
14-00	Switching Pattern	null	All set-ups	TRUE	-	Uint8
14-01	Switching Frequency	null	All set-ups	TRUE	-	Uint8
14-03	Overmodulation	[1] On	All set-ups	FALSE	-	Uint8
14-04	PWM Random	[0] Off	All set-ups	TRUE	-	Uint8
<b>14-1* Mains On/Off</b>						
14-10	Mains Failure	[0] No function	All set-ups	FALSE	-	Uint8
14-11	Mains Voltage at Mains Fault	ExpressionLimit	All set-ups	TRUE	0	Uint16
14-12	Function at Mains Imbalance	[3] Derate	All set-ups	TRUE	-	Uint8
<b>14-2* Reset Functions</b>						
14-20	Reset Mode	[10] Automatic reset x 10	All set-ups	TRUE	-	Uint8
14-21	Automatic Restart Time	10 s	All set-ups	TRUE	0	Uint16
14-22	Operation Mode	[0] Normal operation	All set-ups	TRUE	-	Uint8
14-23	Typecode Setting	null	2 set-ups	FALSE	-	Uint8
14-25	Trip Delay at Torque Limit	60 s	All set-ups	TRUE	0	Uint8
14-26	Trip Delay at Inverter Fault	ExpressionLimit	All set-ups	TRUE	0	Uint8
14-28	Production Settings	[0] No action	All set-ups	TRUE	-	Uint8
14-29	Service Code	0 N/A	All set-ups	TRUE	0	Int32
<b>14-3* Current Limit Ctrl.</b>						
14-30	Current Lim Ctrl, Proportional Gain	100 %	All set-ups	FALSE	0	Uint16
14-31	Current Lim Ctrl, Integration Time	0.020 s	All set-ups	FALSE	-3	Uint16
14-32	Current Lim Ctrl, Filter Time	27.0 ms	All set-ups	FALSE	-4	Uint16
<b>14-4* Energy Optimising</b>						
14-40	VT Level	66 %	All set-ups	FALSE	0	Uint8
14-41	AEO Minimum Magnetisation	ExpressionLimit	All set-ups	TRUE	0	Uint8
14-42	Minimum AEO Frequency	10 Hz	All set-ups	TRUE	0	Uint8
14-43	Motor Cosphi	ExpressionLimit	All set-ups	TRUE	-2	Uint16
<b>14-5* Environment</b>						
14-50	RFI Filter	[1] On	1 set-up	FALSE	-	Uint8
14-51	DC Link Compensation	[1] On	1 set-up	TRUE	-	Uint8
14-52	Fan Control	[0] Auto	All set-ups	TRUE	-	Uint8
14-53	Fan Monitor	[1] Warning	All set-ups	TRUE	-	Uint8
14-55	Output Filter	[0] No Filter	1 set-up	FALSE	-	Uint8
14-59	Actual Number of Inverter Units	ExpressionLimit	1 set-up	FALSE	0	Uint8
<b>14-6* Auto Derate</b>						
14-60	Function at Over Temperature	[1] Derate	All set-ups	TRUE	-	Uint8
14-61	Function at Inverter Overload	[1] Derate	All set-ups	TRUE	-	Uint8
14-62	Inv. Overload Derate Current	95 %	All set-ups	TRUE	0	Uint16
<b>14-8* Options</b>						
14-80	Option Supplied by External 24VDC	[0] No	2 set-ups	FALSE	-	Uint8
<b>14-9* Fault Settings</b>						
14-90	Fault Level	null	1 set-up	TRUE	-	Uint8

## 4.1.14 15-\*\* FC Information

4

Par. No. #	Parameter description	Default value	4-set-up	FC 302 only	Change during operation	Conversion index	Type
<b>15-0* Operating Data</b>							
15-00	Operating hours	0 h	All set-ups		FALSE	74	Uint32
15-01	Running Hours	0 h	All set-ups		FALSE	74	Uint32
15-02	kWh Counter	0 kWh	All set-ups		FALSE	75	Uint32
15-03	Power Up's	0 N/A	All set-ups		FALSE	0	Uint32
15-04	Over Temp's	0 N/A	All set-ups		FALSE	0	Uint16
15-05	Over Volt's	0 N/A	All set-ups		FALSE	0	Uint16
15-06	Reset kWh Counter	[0] Do not reset	All set-ups		TRUE	-	Uint8
15-07	Reset Running Hours Counter	[0] Do not reset	All set-ups		TRUE	-	Uint8
15-08	Number of Starts	0 N/A	All set-ups		FALSE	0	Uint32
<b>15-1* Data Log Settings</b>							
15-10	Logging Source	0	2 set-ups		TRUE	-	Uint16
15-11	Logging Interval	ExpressionLimit	2 set-ups		TRUE	-3	TimD
15-12	Trigger Event	[0] False	1 set-up		TRUE	-	Uint8
15-13	Logging Mode	[0] Log always	2 set-ups		TRUE	-	Uint8
15-14	Samples Before Trigger	50 N/A	2 set-ups		TRUE	0	Uint8
<b>15-2* Historic Log</b>							
15-20	Historic Log: Event	0 N/A	All set-ups		FALSE	0	Uint8
15-21	Historic Log: Value	0 N/A	All set-ups		FALSE	0	Uint32
15-22	Historic Log: Time	0 ms	All set-ups		FALSE	-3	Uint32
15-23	Historic log: Date and Time	ExpressionLimit	All set-ups		FALSE	0	TimeOfDay
<b>15-3* Alarm Log</b>							
15-30	Alarm Log: Error Code	0 N/A	All set-ups		FALSE	0	Uint16
15-31	Alarm Log: Value	0 N/A	All set-ups		FALSE	0	Int16
15-32	Alarm Log: Time	0 s	All set-ups		FALSE	0	Uint32
15-33	Alarm Log: Date and Time	ExpressionLimit	All set-ups		FALSE	0	TimeOfDay
15-34	Alarm Log: Setpoint	0 ProcessCtrlUnit	All set-ups		FALSE	-3	Int32
15-35	Alarm Log: Feedback	0 ProcessCtrlUnit	All set-ups		FALSE	-3	Int32
15-36	Alarm Log: Current Demand	0 %	All set-ups		FALSE	0	Uint8
15-37	Alarm Log: Process Ctrl Unit	[0] -	All set-ups		FALSE	-	Uint8
<b>15-4* Drive Identification</b>							
15-40	FC Type	0 N/A	All set-ups		FALSE	0	VisStr[6]
15-41	Power Section	0 N/A	All set-ups		FALSE	0	VisStr[20]
15-42	Voltage	0 N/A	All set-ups		FALSE	0	VisStr[20]
15-43	Software Version	0 N/A	All set-ups		FALSE	0	VisStr[5]
15-44	Ordered Typecode String	0 N/A	All set-ups		FALSE	0	VisStr[40]
15-45	Actual Typecode String	0 N/A	All set-ups		FALSE	0	VisStr[40]
15-46	Frequency Converter Ordering No	0 N/A	All set-ups		FALSE	0	VisStr[8]
15-47	Power Card Ordering No	0 N/A	All set-ups		FALSE	0	VisStr[8]

15-48	LCP Id No	0 N/A	All set-ups		FALSE	0	VisStr[20]
15-49	SW ID Control Card	0 N/A	All set-ups		FALSE	0	VisStr[20]
15-50	SW ID Power Card	0 N/A	All set-ups		FALSE	0	VisStr[20]
15-51	Frequency Converter Serial Number	0 N/A	All set-ups		FALSE	0	VisStr[10]
15-53	Power Card Serial Number	0 N/A	All set-ups		FALSE	0	VisStr[19]
15-58	SmartStart Filename	ExpressionLimit	All set-ups		TRUE	0	VisStr[20]
15-59	CSIV Filename	ExpressionLimit	1 set-up		FALSE	0	VisStr[16]
<b>15-6* Option Ident</b>							
15-60	Option Mounted	0 N/A	All set-ups		FALSE	0	VisStr[30]
15-61	Option SW Version	0 N/A	All set-ups		FALSE	0	VisStr[20]
15-62	Option Ordering No	0 N/A	All set-ups		FALSE	0	VisStr[8]
15-63	Option Serial No	0 N/A	All set-ups		FALSE	0	VisStr[18]
15-70	Option in Slot A	0 N/A	All set-ups		FALSE	0	VisStr[30]
15-71	Slot A Option SW Version	0 N/A	All set-ups		FALSE	0	VisStr[20]
15-72	Option in Slot B	0 N/A	All set-ups		FALSE	0	VisStr[30]
15-73	Slot B Option SW Version	0 N/A	All set-ups		FALSE	0	VisStr[20]
15-74	Option in Slot C0/E0	0 N/A	All set-ups		FALSE	0	VisStr[30]
15-75	Slot C0/E0 Option SW Version	0 N/A	All set-ups		FALSE	0	VisStr[20]
15-76	Option in Slot C1/E1	0 N/A	All set-ups		FALSE	0	VisStr[30]
15-77	Slot C1/E1 Option SW Version	0 N/A	All set-ups		FALSE	0	VisStr[20]
<b>15-8* Operating Data II</b>							
15-80	Fan Running Hours	0 h	All set-ups		TRUE	74	Uint32
15-81	Preset Fan Running Hours	0 h	All set-ups		TRUE	74	Uint32
<b>15-9* Parameter Info</b>							
15-92	Defined Parameters	0 N/A	All set-ups		FALSE	0	Uint16
15-93	Modified Parameters	0 N/A	All set-ups		FALSE	0	Uint16
15-98	Drive Identification	0 N/A	All set-ups		FALSE	0	VisStr[40]
15-99	Parameter Metadata	0 N/A	All set-ups		FALSE	0	Uint16

## 4.1.15 16-\*\* Data Readouts

4

Par. No. #	Parameter description	Default value	4-set-up	FC 302 only	Change during operation	Conversion index	Type
<b>16-0* General Status</b>							
16-00	Control Word	0 N/A	All set-ups		TRUE	0	V2
16-01	Reference [Unit]	0 ReferenceFeedbackUnit	All set-ups		TRUE	-3	Int32
16-02	Reference [%]	0 %	All set-ups		TRUE	-1	Int16
16-03	Status Word	0 N/A	All set-ups		TRUE	0	V2
16-05	Main Actual Value [%]	0 %	All set-ups		TRUE	-2	N2
16-09	Custom Readout	0 CustomReadoutUnit	All set-ups		TRUE	-2	Int32
<b>16-1* Motor Status</b>							
16-10	Power [kW]	0 kW	All set-ups		TRUE	1	Int32
16-11	Power [hp]	0 hp	All set-ups		TRUE	-2	Int32
16-12	Motor Voltage	0 V	All set-ups		TRUE	-1	UInt16
16-13	Frequency	0 Hz	All set-ups		TRUE	-1	UInt16
16-14	Motor current	0 A	All set-ups		TRUE	-2	Int32
16-15	Frequency [%]	0 %	All set-ups		TRUE	-2	N2
16-16	Torque [Nm]	0 Nm	All set-ups		TRUE	-1	Int32
16-17	Speed [RPM]	0 RPM	All set-ups		TRUE	67	Int32
16-18	Motor Thermal	0 %	All set-ups		TRUE	0	UInt8
16-20	Motor Angle	0 N/A	All set-ups		TRUE	0	UInt16
16-22	Torque [%]	0 %	All set-ups		TRUE	0	Int16
<b>16-3* Drive Status</b>							
16-30	DC Link Voltage	0 V	All set-ups		TRUE	0	UInt16
16-32	Brake Energy /s	0 kW	All set-ups		TRUE	0	UInt32
16-33	Brake Energy /2 min	0 kW	All set-ups		TRUE	0	UInt32
16-34	Heatsink Temp.	0 °C	All set-ups		TRUE	100	UInt8
16-35	Inverter Thermal	0 %	All set-ups		TRUE	0	UInt8
16-36	Inv. Nom. Current	ExpressionLimit	All set-ups		TRUE	-2	UInt32
16-37	Inv. Max. Current	ExpressionLimit	All set-ups		TRUE	-2	UInt32
16-38	SL Controller State	0 N/A	All set-ups		TRUE	0	UInt8
16-39	Control Card Temp.	0 °C	All set-ups		TRUE	100	UInt8
16-40	Logging Buffer Full	[0] No	All set-ups		TRUE	-	UInt8
16-49	Current Fault Source	0 N/A	All set-ups	x	TRUE	0	UInt8
<b>16-5* Ref. &amp; Feedb.</b>							
16-50	External Reference	0 N/A	All set-ups		TRUE	-1	Int16
16-52	Feedback[Unit]	0 ProcessCtrlUnit	All set-ups		TRUE	-3	Int32
16-53	Digi Pot Reference	0 N/A	All set-ups		TRUE	-2	Int16
16-54	Feedback 1 [Unit]	0 ProcessCtrlUnit	All set-ups		TRUE	-3	Int32
16-55	Feedback 2 [Unit]	0 ProcessCtrlUnit	All set-ups		TRUE	-3	Int32
16-56	Feedback 3 [Unit]	0 ProcessCtrlUnit	All set-ups		TRUE	-3	Int32
16-58	PID Output [%]	0 %	All set-ups		TRUE	-1	Int16
16-59	Adjusted Setpoint	0 ProcessCtrlUnit	All set-ups		TRUE	-3	Int32
<b>16-6* Inputs &amp; Outputs</b>							
16-60	Digital Input	0 N/A	All set-ups		TRUE	0	UInt16
16-61	Terminal 53 Switch Setting	[0] Current	All set-ups		TRUE	-	UInt8
16-62	Analog Input 53	0 N/A	All set-ups		TRUE	-3	Int32
16-63	Terminal 54 Switch Setting	[0] Current	All set-ups		TRUE	-	UInt8
16-64	Analog Input 54	0 N/A	All set-ups		TRUE	-3	Int32
16-65	Analog Output 42 [mA]	0 N/A	All set-ups		TRUE	-3	Int16
16-66	Digital Output [bin]	0 N/A	All set-ups		TRUE	0	Int16
16-67	Pulse Input #29 [Hz]	0 N/A	All set-ups		TRUE	0	Int32

16-68	Pulse Input #33 [Hz]	0 N/A	All set-ups		TRUE	0	Int32
16-69	Pulse Output #27 [Hz]	0 N/A	All set-ups		TRUE	0	Int32
16-70	Pulse Output #29 [Hz]	0 N/A	All set-ups		TRUE	0	Int32
16-71	Relay Output [bin]	0 N/A	All set-ups		TRUE	0	UInt16
16-72	Counter A	0 N/A	All set-ups		TRUE	0	Int32
16-73	Counter B	0 N/A	All set-ups		TRUE	0	Int32
16-75	Analog In X30/11	0 N/A	All set-ups		TRUE	-3	Int32
16-76	Analog In X30/12	0 N/A	All set-ups		TRUE	-3	Int32
16-77	Analog Out X30/8 [mA]	0 N/A	All set-ups		TRUE	-3	Int16
16-78	Analog Out X45/1 [mA]	0 N/A	All set-ups		FALSE	-3	Int16
16-79	Analog Out X45/3 [mA]	0 N/A	All set-ups		FALSE	-3	Int16
<b>16-8* Fieldbus &amp; FC Port</b>							
16-80	Fieldbus CTW 1	0 N/A	All set-ups		TRUE	0	V2
16-82	Fieldbus REF 1	0 N/A	All set-ups		TRUE	0	N2
16-84	Comm. Option STW	0 N/A	All set-ups		TRUE	0	V2
16-85	FC Port CTW 1	0 N/A	All set-ups		FALSE	0	V2
16-86	FC Port REF 1	0 N/A	All set-ups		FALSE	0	N2
<b>16-9* Diagnosis Readouts</b>							
16-90	Alarm Word	0 N/A	All set-ups		TRUE	0	UInt32
16-91	Alarm Word 2	0 N/A	All set-ups		TRUE	0	UInt32
16-92	Warning Word	0 N/A	All set-ups		TRUE	0	UInt32
16-93	Warning Word 2	0 N/A	All set-ups		TRUE	0	UInt32
16-94	Ext. Status Word	0 N/A	All set-ups		TRUE	0	UInt32
16-95	Ext. Status Word 2	0 N/A	All set-ups		TRUE	0	UInt32
16-96	Maintenance Word	0 N/A	All set-ups		TRUE	0	UInt32

## 4.1.16 18-\*\* Data Readouts 2

4

Par. No. #	Parameter description	Default value	4-set-up	Change during operation	Conversion index	Type
<b>18-0* Maintenance Log</b>						
18-00	Maintenance Log: Item	0 N/A	All set-ups	FALSE	0	UInt8
18-01	Maintenance Log: Action	0 N/A	All set-ups	FALSE	0	UInt8
18-02	Maintenance Log: Time	0 s	All set-ups	FALSE	0	UInt32
18-03	Maintenance Log: Date and Time	ExpressionLimit	All set-ups	FALSE	0	TimeOfDay
<b>18-3* Analog Readouts</b>						
18-30	Analog Input X42/1	0.000 N/A	All set-ups	FALSE	-3	Int32
18-31	Analog Input X42/3	0.000 N/A	All set-ups	FALSE	-3	Int32
18-32	Analog Input X42/5	0.000 N/A	All set-ups	FALSE	-3	Int32
18-33	Analog Out X42/7 [V]	0.000 N/A	All set-ups	FALSE	-3	Int16
18-34	Analog Out X42/9 [V]	0.000 N/A	All set-ups	FALSE	-3	Int16
18-35	Analog Out X42/11 [V]	0.000 N/A	All set-ups	FALSE	-3	Int16
18-36	Analog Input X48/2 [mA]	0.000 N/A	All set-ups	TRUE	-3	Int32
18-37	Temp. Input X48/4	0 N/A	All set-ups	TRUE	0	Int16
18-38	Temp. Input X48/7	0 N/A	All set-ups	TRUE	0	Int16
18-39	Temp. Input X48/10	0 N/A	All set-ups	TRUE	0	Int16
<b>18-6* Inputs &amp; Outputs 2</b>						
18-60	Digital Input 2	0 N/A	All set-ups	TRUE	0	UInt16

## 4.1.17 20-\*\* FC Closed Loop

Par. No. #	Parameter description	Default value	4-set-up	Change during operation	Conversion index	Type
<b>20-0* Feedback</b>						
20-00	Feedback 1 Source	[2] Analog input 54	All set-ups	TRUE	-	UInt8
20-01	Feedback 1 Conversion	[0] Linear	All set-ups	FALSE	-	UInt8
20-02	Feedback 1 Source Unit	null	All set-ups	TRUE	-	UInt8
20-03	Feedback 2 Source	[0] No function	All set-ups	TRUE	-	UInt8
20-04	Feedback 2 Conversion	[0] Linear	All set-ups	FALSE	-	UInt8
20-05	Feedback 2 Source Unit	null	All set-ups	TRUE	-	UInt8
20-06	Feedback 3 Source	[0] No function	All set-ups	TRUE	-	UInt8
20-07	Feedback 3 Conversion	[0] Linear	All set-ups	FALSE	-	UInt8
20-08	Feedback 3 Source Unit	null	All set-ups	TRUE	-	UInt8
20-12	Reference/Feedback Unit	null	All set-ups	TRUE	-	UInt8
<b>20-2* Feedback/Setpoint</b>						
20-20	Feedback Function	[4] Maximum	All set-ups	TRUE	-	UInt8
20-21	Setpoint 1	0.000 ProcessCtrlUnit	All set-ups	TRUE	-3	Int32
20-22	Setpoint 2	0.000 ProcessCtrlUnit	All set-ups	TRUE	-3	Int32
20-23	Setpoint 3	0.000 ProcessCtrlUnit	All set-ups	TRUE	-3	Int32
<b>20-7* PID Autotuning</b>						
20-70	Closed Loop Type	[0] Auto	2 set-ups	TRUE	-	UInt8
20-71	PID Performance	[0] Normal	2 set-ups	TRUE	-	UInt8
20-72	PID Output Change	0.10 N/A	2 set-ups	TRUE	-2	UInt16
20-73	Minimum Feedback Level	-999999.000 ProcessCtrlUnit	2 set-ups	TRUE	-3	Int32
20-74	Maximum Feedback Level	999999.000 ProcessCtrlUnit	2 set-ups	TRUE	-3	Int32
20-79	PID Autotuning	[0] Disabled	All set-ups	TRUE	-	UInt8
<b>20-8* PID Basic Settings</b>						
20-81	PID Normal/ Inverse Control	[0] Normal	All set-ups	TRUE	-	UInt8
20-82	PID Start Speed [RPM]	ExpressionLimit	All set-ups	TRUE	67	UInt16
20-83	PID Start Speed [Hz]	ExpressionLimit	All set-ups	TRUE	-1	UInt16
20-84	On Reference Bandwidth	5 %	All set-ups	TRUE	0	UInt8
<b>20-9* PID Controller</b>						
20-91	PID Anti Windup	[1] On	All set-ups	TRUE	-	UInt8
20-93	PID Proportional Gain	2.00 N/A	All set-ups	TRUE	-2	UInt16
20-94	PID Integral Time	8.00 s	All set-ups	TRUE	-2	UInt32
20-95	PID Differentiation Time	0.00 s	All set-ups	TRUE	-2	UInt16
20-96	PID Diff. Gain Limit	5.0 N/A	All set-ups	TRUE	-1	UInt16

4.1.18 21-\*\* Ext. Closed Loop

4

Par. No. #	Parameter description	Default value	4-set-up	Change during operation	Conversion index	Type
<b>21-0* Ext. CL Autotuning</b>						
21-00	Closed Loop Type	[0] Auto	2 set-ups	TRUE	-	UInt8
21-01	PID Performance	[0] Normal	2 set-ups	TRUE	-	UInt8
21-02	PID Output Change	0.10 N/A	2 set-ups	TRUE	-2	UInt16
21-03	Minimum Feedback Level	-999999.000 N/A	2 set-ups	TRUE	-3	Int32
21-04	Maximum Feedback Level	999999.000 N/A	2 set-ups	TRUE	-3	Int32
21-09	PID Auto Tuning	[0] Disabled	All set-ups	TRUE	-	UInt8
<b>21-1* Ext. CL 1 Ref./Fb.</b>						
21-10	Ext. 1 Ref./Feedback Unit	[0]	All set-ups	TRUE	-	UInt8
21-11	Ext. 1 Minimum Reference	0.000 ExtPID1Unit	All set-ups	TRUE	-3	Int32
21-12	Ext. 1 Maximum Reference	100.000 ExtPID1Unit	All set-ups	TRUE	-3	Int32
21-13	Ext. 1 Reference Source	[0] No function	All set-ups	TRUE	-	UInt8
21-14	Ext. 1 Feedback Source	[0] No function	All set-ups	TRUE	-	UInt8
21-15	Ext. 1 Setpoint	0.000 ExtPID1Unit	All set-ups	TRUE	-3	Int32
21-17	Ext. 1 Reference [Unit]	0.000 ExtPID1Unit	All set-ups	TRUE	-3	Int32
21-18	Ext. 1 Feedback [Unit]	0.000 ExtPID1Unit	All set-ups	TRUE	-3	Int32
21-19	Ext. 1 Output [%]	0 %	All set-ups	TRUE	0	Int32
<b>21-2* Ext. CL 1 PID</b>						
21-20	Ext. 1 Normal/Inverse Control	[0] Normal	All set-ups	TRUE	-	UInt8
21-21	Ext. 1 Proportional Gain	0.50 N/A	All set-ups	TRUE	-2	UInt16
21-22	Ext. 1 Integral Time	20.00 s	All set-ups	TRUE	-2	UInt32
21-23	Ext. 1 Differentiation Time	0.00 s	All set-ups	TRUE	-2	UInt16
21-24	Ext. 1 Dif. Gain Limit	5.0 N/A	All set-ups	TRUE	-1	UInt16
<b>21-3* Ext. CL 2 Ref./Fb.</b>						
21-30	Ext. 2 Ref./Feedback Unit	[0]	All set-ups	TRUE	-	UInt8
21-31	Ext. 2 Minimum Reference	0.000 ExtPID2Unit	All set-ups	TRUE	-3	Int32
21-32	Ext. 2 Maximum Reference	100.000 ExtPID2Unit	All set-ups	TRUE	-3	Int32
21-33	Ext. 2 Reference Source	[0] No function	All set-ups	TRUE	-	UInt8
21-34	Ext. 2 Feedback Source	[0] No function	All set-ups	TRUE	-	UInt8
21-35	Ext. 2 Setpoint	0.000 ExtPID2Unit	All set-ups	TRUE	-3	Int32
21-37	Ext. 2 Reference [Unit]	0.000 ExtPID2Unit	All set-ups	TRUE	-3	Int32
21-38	Ext. 2 Feedback [Unit]	0.000 ExtPID2Unit	All set-ups	TRUE	-3	Int32
21-39	Ext. 2 Output [%]	0 %	All set-ups	TRUE	0	Int32
<b>21-4* Ext. CL 2 PID</b>						
21-40	Ext. 2 Normal/Inverse Control	[0] Normal	All set-ups	TRUE	-	UInt8
21-41	Ext. 2 Proportional Gain	0.50 N/A	All set-ups	TRUE	-2	UInt16
21-42	Ext. 2 Integral Time	20.00 s	All set-ups	TRUE	-2	UInt32
21-43	Ext. 2 Differentiation Time	0.00 s	All set-ups	TRUE	-2	UInt16
21-44	Ext. 2 Dif. Gain Limit	5.0 N/A	All set-ups	TRUE	-1	UInt16
<b>21-5* Ext. CL 3 Ref./Fb.</b>						
21-50	Ext. 3 Ref./Feedback Unit	[0]	All set-ups	TRUE	-	UInt8
21-51	Ext. 3 Minimum Reference	0.000 ExtPID3Unit	All set-ups	TRUE	-3	Int32
21-52	Ext. 3 Maximum Reference	100.000 ExtPID3Unit	All set-ups	TRUE	-3	Int32
21-53	Ext. 3 Reference Source	[0] No function	All set-ups	TRUE	-	UInt8
21-54	Ext. 3 Feedback Source	[0] No function	All set-ups	TRUE	-	UInt8
21-55	Ext. 3 Setpoint	0.000 ExtPID3Unit	All set-ups	TRUE	-3	Int32
21-57	Ext. 3 Reference [Unit]	0.000 ExtPID3Unit	All set-ups	TRUE	-3	Int32
21-58	Ext. 3 Feedback [Unit]	0.000 ExtPID3Unit	All set-ups	TRUE	-3	Int32
21-59	Ext. 3 Output [%]	0 %	All set-ups	TRUE	0	Int32



Par. No. #	Parameter description	Default value	4-set-up	Change during operation	Conversion index	Type
<b>21-6* Ext. CL 3 PID</b>						
21-60	Ext. 3 Normal/Inverse Control	[0] Normal	All set-ups	TRUE	-	Uint8
21-61	Ext. 3 Proportional Gain	0.50 N/A	All set-ups	TRUE	-2	Uint16
21-62	Ext. 3 Integral Time	20.00 s	All set-ups	TRUE	-2	Uint32
21-63	Ext. 3 Differentiation Time	0.00 s	All set-ups	TRUE	-2	Uint16
21-64	Ext. 3 Dif. Gain Limit	5.0 N/A	All set-ups	TRUE	-1	Uint16

## 4.1.19 22-\*\* Application Functions

Par. No. #	Parameter description	Default value	4-set-up	Change during operation	Conversion index	Type
<b>22-0* Miscellaneous</b>						
22-00	External Interlock Delay	0 s	All set-ups	TRUE	0	Uint16
<b>22-2* No-Flow Detection</b>						
22-20	Low Power Auto Set-up	[0] Off	All set-ups	FALSE	-	Uint8
22-21	Low Power Detection	[0] Disabled	All set-ups	TRUE	-	Uint8
22-22	Low Speed Detection	[0] Disabled	All set-ups	TRUE	-	Uint8
22-23	No-Flow Function	[0] Off	All set-ups	TRUE	-	Uint8
22-24	No-Flow Delay	10 s	All set-ups	TRUE	0	Uint16
22-26	Dry Pump Function	[0] Off	All set-ups	TRUE	-	Uint8
22-27	Dry Pump Delay	10 s	All set-ups	TRUE	0	Uint16
22-28	No-Flow Low Speed [RPM]	ExpressionLimit	All set-ups	TRUE	67	Uint16
22-29	No-Flow Low Speed [Hz]	ExpressionLimit	All set-ups	TRUE	-1	Uint16
<b>22-3* No-Flow Power Tuning</b>						
22-30	No-Flow Power	0.00 kW	All set-ups	TRUE	1	Uint32
22-31	Power Correction Factor	100 %	All set-ups	TRUE	0	Uint16
22-32	Low Speed [RPM]	ExpressionLimit	All set-ups	TRUE	67	Uint16
22-33	Low Speed [Hz]	ExpressionLimit	All set-ups	TRUE	-1	Uint16
22-34	Low Speed Power [kW]	ExpressionLimit	All set-ups	TRUE	1	Uint32
22-35	Low Speed Power [HP]	ExpressionLimit	All set-ups	TRUE	-2	Uint32
22-36	High Speed [RPM]	ExpressionLimit	All set-ups	TRUE	67	Uint16
22-37	High Speed [Hz]	ExpressionLimit	All set-ups	TRUE	-1	Uint16
22-38	High Speed Power [kW]	ExpressionLimit	All set-ups	TRUE	1	Uint32
22-39	High Speed Power [HP]	ExpressionLimit	All set-ups	TRUE	-2	Uint32
<b>22-4* Sleep Mode</b>						
22-40	Minimum Run Time	60 s	All set-ups	TRUE	0	Uint16
22-41	Minimum Sleep Time	30 s	All set-ups	TRUE	0	Uint16
22-42	Wake-up Speed [RPM]	ExpressionLimit	All set-ups	TRUE	67	Uint16
22-43	Wake-up Speed [Hz]	ExpressionLimit	All set-ups	TRUE	-1	Uint16
22-44	Wake-up Ref./FB Difference	10 %	All set-ups	TRUE	0	Int8
22-45	Setpoint Boost	0 %	All set-ups	TRUE	0	Int8
22-46	Maximum Boost Time	60 s	All set-ups	TRUE	0	Uint16
<b>22-5* End of Curve</b>						
22-50	End of Curve Function	[0] Off	All set-ups	TRUE	-	Uint8
22-51	End of Curve Delay	10 s	All set-ups	TRUE	0	Uint16
<b>22-6* Broken Belt Detection</b>						
22-60	Broken Belt Function	[0] Off	All set-ups	TRUE	-	Uint8
22-61	Broken Belt Torque	10 %	All set-ups	TRUE	0	Uint8
22-62	Broken Belt Delay	10 s	All set-ups	TRUE	0	Uint16
<b>22-7* Short Cycle Protection</b>						
22-75	Short Cycle Protection	[0] Disabled	All set-ups	TRUE	-	Uint8
22-76	Interval between Starts	start_to_start_min_on_time (P2277)	All set-ups	TRUE	0	Uint16
22-77	Minimum Run Time	0 s	All set-ups	TRUE	0	Uint16
22-78	Minimum Run Time Override	[0] Disabled	All set-ups	FALSE	-	Uint8
22-79	Minimum Run Time Override Value	0.000 ProcessCtrlUnit	All set-ups	TRUE	-3	Int32

Par. No. #	Parameter description	Default value	4-set-up	Change during operation	Conversion index	Type
<b>22-8* Flow Compensation</b>						
22-80	Flow Compensation	[0] Disabled	All set-ups	TRUE	-	UInt8
22-81	Square-linear Curve Approximation	100 %	All set-ups	TRUE	0	UInt8
22-82	Work Point Calculation	[0] Disabled	All set-ups	TRUE	-	UInt8
22-83	Speed at No-Flow [RPM]	ExpressionLimit	All set-ups	TRUE	67	UInt16
22-84	Speed at No-Flow [Hz]	ExpressionLimit	All set-ups	TRUE	-1	UInt16
22-85	Speed at Design Point [RPM]	ExpressionLimit	All set-ups	TRUE	67	UInt16
22-86	Speed at Design Point [Hz]	ExpressionLimit	All set-ups	TRUE	-1	UInt16
22-87	Pressure at No-Flow Speed	0.000 N/A	All set-ups	TRUE	-3	Int32
22-88	Pressure at Rated Speed	999999.999 N/A	All set-ups	TRUE	-3	Int32
22-89	Flow at Design Point	0.000 N/A	All set-ups	TRUE	-3	Int32
22-90	Flow at Rated Speed	0.000 N/A	All set-ups	TRUE	-3	Int32

## 4.1.20 23-\*\* Timed Actions

Par. No. #	Parameter description	Default value	4-set-up	Change during operation	Conversion index	Type
<b>23-0* Timed Actions</b>						
23-00	ON Time	ExpressionLimit	2 set-ups	TRUE	0	TimeOfDay-WoDate
23-01	ON Action	[0] Disabled	2 set-ups	TRUE	-	UInt8
23-02	OFF Time	ExpressionLimit	2 set-ups	TRUE	0	TimeOfDay-WoDate
23-03	OFF Action	[0] Disabled	2 set-ups	TRUE	-	UInt8
23-04	Occurrence	[0] All days	2 set-ups	TRUE	-	UInt8
<b>23-1* Maintenance</b>						
23-10	Maintenance Item	[1] Motor bearings	1 set-up	TRUE	-	UInt8
23-11	Maintenance Action	[1] Lubricate	1 set-up	TRUE	-	UInt8
23-12	Maintenance Time Base	[0] Disabled	1 set-up	TRUE	-	UInt8
23-13	Maintenance Time Interval	1 h	1 set-up	TRUE	74	UInt32
23-14	Maintenance Date and Time	ExpressionLimit	1 set-up	TRUE	0	TimeOfDay
<b>23-1* Maintenance Reset</b>						
23-15	Reset Maintenance Word	[0] Do not reset	All set-ups	TRUE	-	UInt8
23-16	Maintenance Text	0 N/A	1 set-up	TRUE	0	VisStr[20]
<b>23-5* Energy Log</b>						
23-50	Energy Log Resolution	[5] Last 24 Hours	2 set-ups	TRUE	-	UInt8
23-51	Period Start	ExpressionLimit	2 set-ups	TRUE	0	TimeOfDay
23-53	Energy Log	0 N/A	All set-ups	TRUE	0	UInt32
23-54	Reset Energy Log	[0] Do not reset	All set-ups	TRUE	-	UInt8
<b>23-6* Trending</b>						
23-60	Trend Variable	[0] Power [kW]	2 set-ups	TRUE	-	UInt8
23-61	Continuous Bin Data	0 N/A	All set-ups	TRUE	0	UInt32
23-62	Timed Bin Data	0 N/A	All set-ups	TRUE	0	UInt32
23-63	Timed Period Start	ExpressionLimit	2 set-ups	TRUE	0	TimeOfDay
23-64	Timed Period Stop	ExpressionLimit	2 set-ups	TRUE	0	TimeOfDay
23-65	Minimum Bin Value	ExpressionLimit	2 set-ups	TRUE	0	UInt8
23-66	Reset Continuous Bin Data	[0] Do not reset	All set-ups	TRUE	-	UInt8
23-67	Reset Timed Bin Data	[0] Do not reset	All set-ups	TRUE	-	UInt8
<b>23-8* Payback Counter</b>						
23-80	Power Reference Factor	100 %	2 set-ups	TRUE	0	UInt8
23-81	Energy Cost	1.00 N/A	2 set-ups	TRUE	-2	UInt32
23-82	Investment	0 N/A	2 set-ups	TRUE	0	UInt32
23-83	Energy Savings	0 kWh	All set-ups	TRUE	75	Int32
23-84	Cost Savings	0 N/A	All set-ups	TRUE	0	Int32

#### 4.1.21 24-\*\* Application Functions 2

Par. No. #	Parameter description	Default value	4-set-up	Change during operation	Conversion index	Type
<b>24-1* Drive Bypass</b>						
24-10	Drive Bypass Function	[0] Disabled	2 set-ups	TRUE	-	Uint8
24-11	Drive Bypass Delay Time	0 s	2 set-ups	TRUE	0	Uint16

## 4.1.22 25-\*\* Cascade Controller

Par. No. #	Parameter description	Default value	4-set-up	Change during operation	Conversion index	Type
<b>25-0* System Settings</b>						
25-00	Cascade Controller	ExpressionLimit	2 set-ups	FALSE	-	UInt8
25-02	Motor Start	[0] Direct on Line	2 set-ups	FALSE	-	UInt8
25-04	Pump Cycling	ExpressionLimit	All set-ups	TRUE	-	UInt8
25-05	Fixed Lead Pump	ExpressionLimit	2 set-ups	FALSE	-	UInt8
25-06	Number of Pumps	2 N/A	2 set-ups	FALSE	0	UInt8
<b>25-2* Bandwidth Settings</b>						
25-20	Staging Bandwidth	ExpressionLimit	All set-ups	TRUE	0	UInt8
25-21	Override Bandwidth	100 %	All set-ups	TRUE	0	UInt8
25-22	Fixed Speed Bandwidth	casco_staging_bandwidth (P2520)	All set-ups	TRUE	0	UInt8
25-23	SBW Staging Delay	15 s	All set-ups	TRUE	0	UInt16
25-24	SBW Destaging Delay	15 s	All set-ups	TRUE	0	UInt16
25-25	OBW Time	10 s	All set-ups	TRUE	0	UInt16
25-26	Destage At No-Flow	[0] Disabled	All set-ups	TRUE	-	UInt8
25-27	Stage Function	ExpressionLimit	All set-ups	TRUE	-	UInt8
25-28	Stage Function Time	15 s	All set-ups	TRUE	0	UInt16
25-29	Destage Function	ExpressionLimit	All set-ups	TRUE	-	UInt8
25-30	Destage Function Time	15 s	All set-ups	TRUE	0	UInt16
<b>25-4* Staging Settings</b>						
25-40	Ramp Down Delay	10 s	All set-ups	TRUE	-1	UInt16
25-41	Ramp Up Delay	2 s	All set-ups	TRUE	-1	UInt16
25-42	Staging Threshold	ExpressionLimit	All set-ups	TRUE	0	UInt8
25-43	Destaging Threshold	ExpressionLimit	All set-ups	TRUE	0	UInt8
25-44	Staging Speed [RPM]	0 RPM	All set-ups	TRUE	67	UInt16
25-45	Staging Speed [Hz]	0 Hz	All set-ups	TRUE	-1	UInt16
25-46	Destaging Speed [RPM]	0 RPM	All set-ups	TRUE	67	UInt16
25-47	Destaging Speed [Hz]	0 Hz	All set-ups	TRUE	-1	UInt16
<b>25-5* Alternation Settings</b>						
25-50	Lead Pump Alternation	ExpressionLimit	All set-ups	TRUE	-	UInt8
25-51	Alternation Event	[0] External	All set-ups	TRUE	-	UInt8
25-52	Alternation Time Interval	24 h	All set-ups	TRUE	74	UInt16
25-53	Alternation Timer Value	0 N/A	All set-ups	TRUE	0	VisStr[7]
25-54	Alternation Predefined Time	ExpressionLimit	All set-ups	TRUE	0	TimeOfDay-WoDate
25-55	Alternate if Load < 50%	[1] Enabled	All set-ups	TRUE	-	UInt8
25-56	Staging Mode at Alternation	[0] Slow	All set-ups	TRUE	-	UInt8
25-58	Run Next Pump Delay	0.1 s	All set-ups	TRUE	-1	UInt16
25-59	Run on Mains Delay	0.5 s	All set-ups	TRUE	-1	UInt16
<b>25-8* Status</b>						
25-80	Cascade Status	0 N/A	All set-ups	TRUE	0	VisStr[25]
25-81	Pump Status	0 N/A	All set-ups	TRUE	0	VisStr[25]
25-82	Lead Pump	0 N/A	All set-ups	TRUE	0	UInt8
25-83	Relay Status	0 N/A	All set-ups	TRUE	0	VisStr[4]
25-84	Pump ON Time	0 h	All set-ups	TRUE	74	UInt32
25-85	Relay ON Time	0 h	All set-ups	TRUE	74	UInt32
25-86	Reset Relay Counters	[0] Do not reset	All set-ups	TRUE	-	UInt8
<b>25-9* Service</b>						
25-90	Pump Interlock	[0] Off	All set-ups	TRUE	-	UInt8

Par. No. #	Parameter description	Default value	4-set-up	Change during operation	Conversion index	Type
25-91	Manual Alternation	0 N/A	All set-ups	TRUE	0	Uint8

## 4.1.23 26-\*\* Analog I/O Option MCB 109

4

Par. No. #	Parameter description	Default value	4-set-up	Change during operation	Conversion index	Type
<b>26-0* Analog I/O Mode</b>						
26-00	Terminal X42/1 Mode	[1] Voltage	All set-ups	TRUE	-	Uint8
26-01	Terminal X42/3 Mode	[1] Voltage	All set-ups	TRUE	-	Uint8
26-02	Terminal X42/5 Mode	[1] Voltage	All set-ups	TRUE	-	Uint8
<b>26-1* Analog Input X42/1</b>						
26-10	Terminal X42/1 Low Voltage	0.07 V	All set-ups	TRUE	-2	Int16
26-11	Terminal X42/1 High Voltage	10.00 V	All set-ups	TRUE	-2	Int16
26-14	Term. X42/1 Low Ref./Feedb. Value	0.000 N/A	All set-ups	TRUE	-3	Int32
26-15	Term. X42/1 High Ref./Feedb. Value	100.000 N/A	All set-ups	TRUE	-3	Int32
26-16	Term. X42/1 Filter Time Constant	0.001 s	All set-ups	TRUE	-3	Uint16
26-17	Term. X42/1 Live Zero	[1] Enabled	All set-ups	TRUE	-	Uint8
<b>26-2* Analog Input X42/3</b>						
26-20	Terminal X42/3 Low Voltage	0.07 V	All set-ups	TRUE	-2	Int16
26-21	Terminal X42/3 High Voltage	10.00 V	All set-ups	TRUE	-2	Int16
26-24	Term. X42/3 Low Ref./Feedb. Value	0.000 N/A	All set-ups	TRUE	-3	Int32
26-25	Term. X42/3 High Ref./Feedb. Value	100.000 N/A	All set-ups	TRUE	-3	Int32
26-26	Term. X42/3 Filter Time Constant	0.001 s	All set-ups	TRUE	-3	Uint16
26-27	Term. X42/3 Live Zero	[1] Enabled	All set-ups	TRUE	-	Uint8
<b>26-3* Analog Input X42/5</b>						
26-30	Terminal X42/5 Low Voltage	0.07 V	All set-ups	TRUE	-2	Int16
26-31	Terminal X42/5 High Voltage	10.00 V	All set-ups	TRUE	-2	Int16
26-34	Term. X42/5 Low Ref./Feedb. Value	0.000 N/A	All set-ups	TRUE	-3	Int32
26-35	Term. X42/5 High Ref./Feedb. Value	100.000 N/A	All set-ups	TRUE	-3	Int32
26-36	Term. X42/5 Filter Time Constant	0.001 s	All set-ups	TRUE	-3	Uint16
26-37	Term. X42/5 Live Zero	[1] Enabled	All set-ups	TRUE	-	Uint8
<b>26-4* Analog Out X42/7</b>						
26-40	Terminal X42/7 Output	[0] No operation	All set-ups	TRUE	-	Uint8
26-41	Terminal X42/7 Min. Scale	0.00 %	All set-ups	TRUE	-2	Int16
26-42	Terminal X42/7 Max. Scale	100.00 %	All set-ups	TRUE	-2	Int16
26-43	Terminal X42/7 Bus Control	0.00 %	All set-ups	TRUE	-2	N2
26-44	Terminal X42/7 Timeout Preset	0.00 %	1 set-up	TRUE	-2	Uint16
<b>26-5* Analog Out X42/9</b>						
26-50	Terminal X42/9 Output	[0] No operation	All set-ups	TRUE	-	Uint8
26-51	Terminal X42/9 Min. Scale	0.00 %	All set-ups	TRUE	-2	Int16
26-52	Terminal X42/9 Max. Scale	100.00 %	All set-ups	TRUE	-2	Int16
26-53	Terminal X42/9 Bus Control	0.00 %	All set-ups	TRUE	-2	N2
26-54	Terminal X42/9 Timeout Preset	0.00 %	1 set-up	TRUE	-2	Uint16
<b>26-6* Analog Out X42/11</b>						
26-60	Terminal X42/11 Output	[0] No operation	All set-ups	TRUE	-	Uint8
26-61	Terminal X42/11 Min. Scale	0.00 %	All set-ups	TRUE	-2	Int16
26-62	Terminal X42/11 Max. Scale	100.00 %	All set-ups	TRUE	-2	Int16
26-63	Terminal X42/11 Bus Control	0.00 %	All set-ups	TRUE	-2	N2
26-64	Terminal X42/11 Timeout Preset	0.00 %	1 set-up	TRUE	-2	Uint16



## 4.1.24 27-\*\* Cascade CTL Option

Par. No. #	Parameter description	Default value	4-set-up	Change during operation	Conversion index	Type
<b>27-0* Control &amp; Status</b>						
27-01	Pump Status	[0] Ready	All set-ups	TRUE	-	UInt8
27-02	Manual Pump Control	[0] No Operation	2 set-ups	TRUE	-	UInt8
27-03	Current Runtime Hours	0 h	All set-ups	TRUE	74	UInt32
27-04	Pump Total Lifetime Hours	0 h	All set-ups	TRUE	74	UInt32
<b>27-1* Configuration</b>						
27-10	Cascade Controller	null	2 set-ups	FALSE	-	UInt8
27-11	Number Of Drives	ExpressionLimit	2 set-ups	FALSE	0	UInt8
27-12	Number Of Pumps	ExpressionLimit	2 set-ups	FALSE	0	UInt8
27-14	Pump Capacity	100 %	2 set-ups	FALSE	0	UInt16
27-16	Runtime Balancing	[0] Balanced Priority 1	2 set-ups	TRUE	-	UInt8
27-17	Motor Starters	[0] Direct Online	2 set-ups	FALSE	-	UInt8
27-18	Spin Time for Unused Pumps	ExpressionLimit	All set-ups	TRUE	0	UInt16
27-19	Reset Current Runtime Hours	[0] Do not reset	All set-ups	TRUE	-	UInt8
<b>27-2* Bandwidth Settings</b>						
27-20	Normal Operating Range	ExpressionLimit	All set-ups	TRUE	0	UInt8
27-21	Override Limit	100 %	All set-ups	TRUE	0	UInt8
27-22	Fixed Speed Only Operating Range	ExpressionLimit	All set-ups	TRUE	0	UInt8
27-23	Staging Delay	15 s	All set-ups	TRUE	0	UInt16
27-24	Destaging Delay	15 s	All set-ups	TRUE	0	UInt16
27-25	Override Hold Time	10 s	All set-ups	TRUE	0	UInt16
27-27	Min Speed Destage Delay	ExpressionLimit	All set-ups	TRUE	0	UInt16
<b>27-3* Staging Speed</b>						
27-30	Auto Tune Staging Speeds	[1] Enabled	All set-ups	TRUE	-	UInt8
27-31	Stage On Speed [RPM]	ExpressionLimit	All set-ups	TRUE	67	UInt16
27-32	Stage On Speed [Hz]	ExpressionLimit	All set-ups	TRUE	-1	UInt16
27-33	Stage Off Speed [RPM]	ExpressionLimit	All set-ups	TRUE	67	UInt16
27-34	Stage Off Speed [Hz]	ExpressionLimit	All set-ups	TRUE	-1	UInt16
<b>27-4* Staging Settings</b>						
27-40	Auto Tune Staging Settings	[0] Disabled	All set-ups	TRUE	-	UInt8
27-41	Ramp Down Delay	10.0 s	All set-ups	TRUE	-1	UInt16
27-42	Ramp Up Delay	2.0 s	All set-ups	TRUE	-1	UInt16
27-43	Staging Threshold	ExpressionLimit	All set-ups	TRUE	0	UInt8
27-44	Destaging Threshold	ExpressionLimit	All set-ups	TRUE	0	UInt8
27-45	Staging Speed [RPM]	0 RPM	All set-ups	TRUE	67	UInt16
27-46	Staging Speed [Hz]	0.0 Hz	All set-ups	TRUE	-1	UInt16
27-47	Destaging Speed [RPM]	0 RPM	All set-ups	TRUE	67	UInt16
27-48	Destaging Speed [Hz]	0.0 Hz	All set-ups	TRUE	-1	UInt16
<b>27-5* Alternate Settings</b>						
27-50	Automatic Alternation	[0] Disabled	All set-ups	FALSE	-	UInt8
27-51	Alternation Event	null	All set-ups	TRUE	-	UInt8
27-52	Alternation Time Interval	0 min	All set-ups	TRUE	70	UInt16
27-53	Alternation Timer Value	0 min	All set-ups	TRUE	70	UInt16
27-54	Alternation At Time of Day	[0] Disabled	All set-ups	TRUE	-	UInt8
27-55	Alternation Predefined Time	ExpressionLimit	All set-ups	TRUE	0	TimeOfDay-WoDate
27-56	Alternate Capacity is <	0 %	All set-ups	TRUE	0	UInt8
27-58	Run Next Pump Delay	0.1 s	All set-ups	TRUE	-1	UInt16
<b>27-6* Digital Inputs</b>						

Par. No. #	Parameter description	Default value	4-set-up	Change during operation	Conversion index	Type
27-60	Terminal X66/1 Digital Input	[0] No operation	All set-ups	TRUE	-	Uint8
27-61	Terminal X66/3 Digital Input	[0] No operation	All set-ups	TRUE	-	Uint8
27-62	Terminal X66/5 Digital Input	[0] No operation	All set-ups	TRUE	-	Uint8
27-63	Terminal X66/7 Digital Input	[0] No operation	All set-ups	TRUE	-	Uint8
27-64	Terminal X66/9 Digital Input	[0] No operation	All set-ups	TRUE	-	Uint8
27-65	Terminal X66/11 Digital Input	[0] No operation	All set-ups	TRUE	-	Uint8
27-66	Terminal X66/13 Digital Input	[0] No operation	All set-ups	TRUE	-	Uint8
<b>27-7* Connections</b>						
27-70	Relay	[0] Standard Relay	2 set-ups	FALSE	-	Uint8
<b>27-9* Readouts</b>						
27-91	Cascade Reference	0.0 %	All set-ups	TRUE	-1	Int16
27-92	% Of Total Capacity	0 %	All set-ups	TRUE	0	Uint16
27-93	Cascade Option Status	[0] Disabled	All set-ups	TRUE	-	Uint8
27-94	Cascade System Status	0 N/A	All set-ups	TRUE	0	VisStr[25]
27-95	Advanced Cascade Relay Output [bin]	0 N/A	All set-ups	TRUE	0	Uint16

## 4.1.25 29-\*\* Water Application Functions

Par. No. #	Parameter description	Default value	4-set-up	FC 302 only	Change during operation	Conversion index	Type
<b>29-0* Pipe Fill</b>							
29-00	Pipe Fill Enable	[0] Disabled	2 set-ups		FALSE	-	Uint8
29-01	Pipe Fill Speed [RPM]	ExpressionLimit	All set-ups		TRUE	67	Uint16
29-02	Pipe Fill Speed [Hz]	ExpressionLimit	All set-ups		TRUE	-1	Uint16
29-03	Pipe Fill Time	0 s	All set-ups		TRUE	-2	Uint32
29-04	Pipe Fill Rate	0.001 ProcessCtrlUnit	All set-ups		TRUE	-3	Int32
29-05	Filled Setpoint	0 ProcessCtrlUnit	All set-ups		TRUE	-3	Int32
29-06	No-Flow Disable Timer	0 s	All set-ups		TRUE	-2	Uint16
<b>29-1* Deragging Function</b>							
29-10	Derag Cycles	ExpressionLimit	2 set-ups		FALSE	0	Uint32
29-11	Derag at Start/Stop	[0] Off	1 set-up		TRUE	-	Uint8
29-12	Deragging Run Time	0 s	All set-ups		TRUE	0	Uint16
29-13	Derag Speed [RPM]	ExpressionLimit	All set-ups		TRUE	67	Uint16
29-14	Derag Speed [Hz]	ExpressionLimit	All set-ups		TRUE	-1	Uint16
29-15	Derag Off Delay	10 s	All set-ups		TRUE	0	Uint16
<b>29-2* Derag Power Tuning</b>							
29-20	Derag Power[kW]	0 kW	All set-ups		TRUE	1	Uint32
29-21	Derag Power[HP]	0 hp	All set-ups		TRUE	-2	Uint32
29-22	Derag Power Factor	200 %	All set-ups		TRUE	0	Uint16
29-23	Derag Power Delay	601 s	All set-ups		TRUE	0	Uint16
29-24	Low Speed [RPM]	ExpressionLimit	All set-ups		TRUE	67	Uint16
29-25	Low Speed [Hz]	ExpressionLimit	All set-ups		TRUE	-1	Uint16
29-26	Low Speed Power [kW]	ExpressionLimit	All set-ups		TRUE	1	Uint32
29-27	Low Speed Power [HP]	ExpressionLimit	All set-ups		TRUE	-2	Uint32
29-28	High Speed [RPM]	ExpressionLimit	All set-ups		TRUE	67	Uint16
29-29	High Speed [Hz]	ExpressionLimit	All set-ups		TRUE	-1	Uint16
29-30	High Speed Power [kW]	ExpressionLimit	All set-ups		TRUE	1	Uint32
29-31	High Speed Power [HP]	ExpressionLimit	All set-ups		TRUE	-2	Uint32
29-32	Derag On Ref Bandwidth	5 %	All set-ups		TRUE	0	Uint8
29-33	Power Derag Limit	3 N/A	2 set-ups		FALSE	0	Uint8
29-34	Consecutive Derag Interval	ExpressionLimit	All set-ups		FALSE	0	Uint16
<b>29-4* Pre/Post Lube</b>							
29-40	Pre/Post Lube Function	[0] Disabled	All set-ups		TRUE	-	Uint8
29-41	Pre Lube Time	10 s	All set-ups		TRUE	0	Uint16
29-42	Post Lube Time	10 s	All set-ups		TRUE	0	Uint16
<b>29-5* Flow Confirmation</b>							
29-50	Validation Time	ExpressionLimit	All set-ups		TRUE	-2	Uint32
29-51	Verification Time	15 s	All set-ups		TRUE	-2	Uint32

## 4.1.26 30-\*\* Special Features

Par. No. #	Parameter description	Default value	4-set-up	Change during operation	Conversion index	Type
<b>30-8* Compatibility (I)</b>						
30-81	Brake Resistor (ohm)	App.Dependent	1 set-up	TRUE	-2	Uint32

## 4

## 4.1.27 31-\*\* Bypass Option

Par. No. #	Parameter description	Default value	4-set-up	Change during operation	Conversion index	Type
31-00	Bypass Mode	[0] Drive	All set-ups	TRUE	-	Uint8
31-01	Bypass Start Time Delay	30 s	All set-ups	TRUE	0	Uint16
31-02	Bypass Trip Time Delay	0 s	All set-ups	TRUE	0	Uint16
31-03	Test Mode Activation	[0] Disabled	All set-ups	TRUE	-	Uint8
31-10	Bypass Status Word	0 N/A	All set-ups	FALSE	0	V2
31-11	Bypass Running Hours	0 h	All set-ups	FALSE	74	Uint32
31-19	Remote Bypass Activation	[0] Disabled	2 set-ups	TRUE	-	Uint8

## 4.1.28 35-\*\* Sensor Input Option

Par. No. #	Parameter description	Default value	4-set-up	Change during operation	Conversion index	Type
<b>35-0* Temp. Input Mode</b>						
35-00	Term. X48/4 Temp. Unit	[60] °C	All set-ups	TRUE	-	Uint8
35-01	Term. X48/4 Input Type	[0] Not Connected	All set-ups	TRUE	-	Uint8
35-02	Term. X48/7 Temp. Unit	[60] °C	All set-ups	TRUE	-	Uint8
35-03	Term. X48/7 Input Type	[0] Not Connected	All set-ups	TRUE	-	Uint8
35-04	Term. X48/10 Temp. Unit	[60] °C	All set-ups	TRUE	-	Uint8
35-05	Term. X48/10 Input Type	[0] Not Connected	All set-ups	TRUE	-	Uint8
35-06	Temperature Sensor Alarm Function	[5] Stop and trip	All set-ups	TRUE	-	Uint8
<b>35-1* Temp. Input X48/4</b>						
35-14	Term. X48/4 Filter Time Constant	0.001 s	All set-ups	TRUE	-3	Uint16
35-15	Term. X48/4 Temp. Monitor	[0] Disabled	All set-ups	TRUE	-	Uint8
35-16	Term. X48/4 Low Temp. Limit	ExpressionLimit	All set-ups	TRUE	0	Int16
35-17	Term. X48/4 High Temp. Limit	ExpressionLimit	All set-ups	TRUE	0	Int16
<b>35-2* Temp. Input X48/7</b>						
35-24	Term. X48/7 Filter Time Constant	0.001 s	All set-ups	TRUE	-3	Uint16
35-25	Term. X48/7 Temp. Monitor	[0] Disabled	All set-ups	TRUE	-	Uint8
35-26	Term. X48/7 Low Temp. Limit	ExpressionLimit	All set-ups	TRUE	0	Int16
35-27	Term. X48/7 High Temp. Limit	ExpressionLimit	All set-ups	TRUE	0	Int16
<b>35-3* Temp. Input X48/10</b>						
35-34	Term. X48/10 Filter Time Constant	0.001 s	All set-ups	TRUE	-3	Uint16
35-35	Term. X48/10 Temp. Monitor	[0] Disabled	All set-ups	TRUE	-	Uint8
35-36	Term. X48/10 Low Temp. Limit	ExpressionLimit	All set-ups	TRUE	0	Int16
35-37	Term. X48/10 High Temp. Limit	ExpressionLimit	All set-ups	TRUE	0	Int16
<b>35-4* Analog Input X48/2</b>						
35-42	Term. X48/2 Low Current	4.00 mA	All set-ups	TRUE	-5	Int16
35-43	Term. X48/2 High Current	20.00 mA	All set-ups	TRUE	-5	Int16
35-44	Term. X48/2 Low Ref./Feedb. Value	0.000 N/A	All set-ups	TRUE	-3	Int32

35-45	Term. X48/2 High Ref./Feedb. Value	100.000 N/A	All set-ups	TRUE	-3	Int32
35-46	Term. X48/2 Filter Time Constant	0.001 s	All set-ups	TRUE	-3	UInt16
35-47	Term. X48/2 Live Zero	[1] Enabled	All set-ups	TRUE	-	UInt8

## 5 Troubleshooting

### 5.1 Status Messages

#### 5.1.1 Warnings/Alarm Messages

A warning or an alarm is signalled by the relevant LED on the front of the frequency converter and indicated by a code on the display.

A warning remains active until its cause is no longer present. Under certain circumstances operation of the motor may still be continued. Warning messages may be critical, but are not necessarily so.

An alarm trips the frequency converter. Reset alarms to restart operation once their cause has been rectified.

#### This may be done in three ways

- By pressing [Reset].
- Via a digital input with the "Reset" function.
- Via serial communication/optional fieldbus.

#### **NOTICE**

After a manual reset pressing [Reset], [Auto On] must be pressed to restart the motor.

If an alarm cannot be reset, the reason may be that its cause has not been rectified, or the alarm is trip-locked (see also *Table 5.1*).

Alarms that are trip-locked offer additional protection, meaning that the mains supply must be switched off before the alarm can be reset. After being switched back on, the frequency converter is no longer blocked and may be reset as described above once the cause has been rectified.

Alarms that are not trip-locked can also be reset using the automatic reset function in *14-20 Reset Mode* (Warning: automatic wake-up is possible!)

If a warning and alarm is marked against a code in *Table 5.1*, this means that either a warning occurs before an alarm, or else that it is possible to specify whether it is a warning or an alarm that is to be displayed for a given fault.

This is possible, for instance, in *1-90 Motor Thermal Protection*. After an alarm or trip, the motor carries on coasting, and the alarm and warning flash. Once the problem has been rectified, only the alarm continues flashing until the frequency converter is reset.

#### **NOTICE**

No missing motor phase detection (no 30-32) and no stall detection is active when *parameter 1-10 Motor Construction* is set to [1] *PM non salient SPM*.

No.	Description	Warning	Alarm/Trip	Alarm/Trip Lock	Parameter Reference
1	10 Volts low	X			
2	Live zero error	(X)	(X)		6-01 Live Zero Timeout Function
3	No motor	(X)			1-80 Function at Stop
4	Mains phase loss	(X)	(X)	(X)	14-12 Function at Mains Imbalance
5	DC link voltage high	X			
6	DC link voltage low	X			
7	DC over-voltage	X	X		
8	DC under voltage	X	X		
9	Inverter overloaded	X	X		
10	Motor ETR over temperature	(X)	(X)		1-90 Motor Thermal Protection
11	Motor thermistor over temperature	(X)	(X)		1-90 Motor Thermal Protection
12	Torque limit	X	X		
13	Over Current	X	X	X	

No.	Description	Warning	Alarm/Trip	Alarm/Trip Lock	Parameter Reference
14	Earth Fault	X	X	X	
15	Hardware mismatch		X	X	
16	Short Circuit		X	X	
17	Control word time-out	(X)	(X)		8-04 Control Timeout Function
18	Start Failed		X		1-77 Compressor Start Max Speed [RPM] and 1-79 Pump Start Max Time to Trip
20	Temp. Input Error				
21	Param Error				
22	Hoist Mech. Brake	(X)	(X)		Parameter group 2-2*
23	Internal Fans	X			
24	External Fans	X			
25	Brake resistor short-circuited	X			
26	Brake resistor power limit	(X)	(X)		2-13 Brake Power Monitoring
27	Brake chopper short-circuited	X	X		
28	Brake check	(X)	(X)		2-15 Brake Check
29	Heatsink temp	X	X	X	
30	Motor phase U missing	(X)	(X)	(X)	4-58 Missing Motor Phase Function
31	Motor phase V missing	(X)	(X)	(X)	4-58 Missing Motor Phase Function
32	Motor phase W missing	(X)	(X)	(X)	4-58 Missing Motor Phase Function
33	Inrush Fault		X	X	
34	Fieldbus communication fault	X	X		
35	Option Fault				
36	Mains failure	X	X		
37	Phase imbalance		X		
38	Internal Fault		X	X	
39	Heatsink sensor		X	X	
40	Overload of Digital Output Terminal 27	(X)			5-00 Digital I/O Mode, parameter 5-01 Terminal 27 Mode
41	Overload of Digital Output Terminal 29	(X)			5-00 Digital I/O Mode, 5-02 Terminal 29 Mode
42	Ovrlid X30/6-7	(X)			
43	Ext. Supply (option)				
45	Earth Fault 2	X	X	X	
46	Pwr. card supply		X	X	
47	24 V supply low	X	X	X	
48	1.8 V supply low		X	X	
49	Speed limit		X		Parameter 1-86 Trip Speed Low [RPM]
50	AMA calibration failed		X		
51	AMA check $U_{nom}$ and $I_{nom}$		X		
52	AMA low $I_{nom}$		X		
53	AMA motor too big		X		
54	AMA motor too small		X		
55	AMA parameter out of range		X		

No.	Description	Warning	Alarm/Trip	Alarm/Trip Lock	Parameter Reference
56	AMA interrupted by user		X		
57	AMA time-out		X		
58	AMA internal fault	X	X		
59	Current limit	X			
60	External Interlock	X	X		
61	Feedback Error	(X)	(X)		4-30 Motor Feedback Loss Function
62	Output Frequency at Maximum Limit	X			
63	Mechanical Brake Low		(X)		2-20 Release Brake Current
64	Voltage Limit	X			
65	Control Board Over-temperature	X	X	X	
66	Heat sink Temperature Low	X			
67	Option Configuration has Changed		X		
68	Safe Stop	(X)	(X) <sup>1)</sup>		5-19 Terminal 37 Digital Input
69	Pwr. Card Temp		X	X	
70	Illegal FC configuration			X	
71	PTC 1 Safe Stop				
72	Dangerous failure				
73	Safe Stop Auto Restart	(X)	(X)		5-19 Terminal 37 Digital Input
74	PTC Thermistor			X	
75	Illegal Profile Sel.		X		
76	Power Unit Setup	X			
77	Reduced power mode	X			14-59 Actual Number of Inverter Units
78	Tracking Error	(X)	(X)		4-34 Tracking Error Function
79	Illegal PS config		X	X	
80	Drive Initialized to Default Value		X		
81	CSIV corrupt		X		
82	CSIV parameter error		X		
83	Illegal Option Combination			X	
84	No Safety Option		X		
88	Option Detection			X	
89	Mechanical Brake Sliding	X			
90	Feedback Monitor	(X)	(X)		17-61 Feedback Signal Monitoring
91	Analog input 54 wrong settings			X	S202
163	ATEX ETR cur.lim.warning	X			
164	ATEX ETR cur.lim.alarm		X		
165	ATEX ETR freq.lim.warning	X			
166	ATEX ETR freq.lim.alarm		X		
250	New spare parts			X	
251	New Type Code		X	X	

**Table 5.1 Alarm/Warning Code List**

(X) Dependent on parameter

1) Can not be Auto reset via 14-20 Reset Mode

A trip is the action when an alarm has appeared. The trip coasts the motor and can be reset by pressing [Reset] or make a reset by a digital input (parameter group 5-1\* *Digital Inputs* [1]). The origin event that caused an alarm



cannot damage the frequency converter or cause dangerous conditions. A trip lock is an action when an alarm occurs, which may damage the frequency converter or connected parts. A Trip Lock situation can only be reset by a power cycling.

Warning	yellow
Alarm	flashing red
Trip locked	yellow and red

**Table 5.2 LED Indication**

Bit	Hex	Dec	Alarm Word	Alarm Word 2	Warning Word	Warning Word 2	Extended Status Word
<b>Alarm Word Extended Status Word</b>							
0	00000001	1	Brake Check (A28)	ServiceTrip, Read/Write	Brake Check (W28)	reserved	Ramping
1	00000002	2	Heatsink temp. (A29)	ServiceTrip, (reserved)	Heatsink temp. (W29)	reserved	AMA Running
2	00000004	4	Earth Fault (A14)	ServiceTrip, Typecode/ Sparepart	Earth Fault (W14)	reserved	Start CW/CCW start_possible is active, when the DI selections [12] OR [13] are active and the requested direction matches the reference sign
3	00000008	8	Ctrl.Card Temp (A65)	ServiceTrip, (reserved)	Ctrl.Card Temp (W65)	reserved	Slow Down slow down command active, e.g. via CTW bit 11 or DI
4	00000010	16	Ctrl. Word TO (A17)	ServiceTrip, (reserved)	Ctrl. Word TO (W17)		Catch Up catch up command active, e.g. via CTW bit 12 or DI
5	00000020	32	Over Current (A13)	reserved	Over Current (W13)	reserved	Feedback High feedback > 4-57
6	00000040	64	Torque Limit (A12)	reserved	Torque Limit (W12)	reserved	Feedback Low feedback < 4-56
7	00000080	128	Motor Th Over (A11)	reserved	Motor Th Over (W11)	reserved	Output Current High current > 4-51
8	00000100	256	Motor ETR Over (A10)	reserved	Motor ETR Over (W10)	reserved	Output Current Low current < 4-50
9	00000200	512	Inverter Overld. (A9)	reserved	Inverter Overld (W9)	reserved	Output Freq High speed > 4-53
10	00000400	1024	DC under Volt (A8)	reserved	DC under Volt (W8)		Output Freq Low speed < 4-52
11	00000800	2048	DC over Volt (A7)	reserved	DC over Volt (W7)		Brake Check OK brake test NOT ok
12	00001000	4096	Short Circuit (A16)	reserved	DC Voltage Low (W6)	reserved	Braking Max BrakePower > BrakePowerLimit (2-12)
13	00002000	8192	Inrush Fault (A33)	reserved	DC Voltage High (W5)		Braking
14	00004000	16384	Mains ph. Loss (A4)	reserved	Mains ph. Loss (W4)		Out of Speed Range
15	00008000	32768	AMA Not OK	reserved	No Motor (W3)		OVC Active
16	00010000	65536	Live Zero Error (A2)	reserved	Live Zero Error (W2)		AC Brake

Bit	Hex	Dec	Alarm Word	Alarm Word 2	Warning Word	Warning Word 2	Extended Status Word
17	00020000	131072	Internal Fault (A38)	KTY error	10V Low (W1)	KTY Warn	Password Timelock number of allowed password trials exceeded - timelock active
18	00040000	262144	Brake Overload (A26)	Fans error	Brake Overload (W26)	Fans Warn	Password Protection 0-61 = ALL_NO_ACCESS OR BUS_NO_ACCESS OR BUS_READONLY
19	00080000	524288	U phase Loss (A30)	ECB error	Brake Resistor (W25)	ECB Warn	Reference High reference > 4-55
20	00100000	1048576	V phase Loss (A31)	reserved	Brake IGBT (W27)	reserved	Reference Low reference < 4-54
21	00200000	2097152	W phase Loss (A32)	reserved	Speed Limit (W49)	reserved	Local Reference reference site = REMOTE -> auto on pressed & active
22	00400000	4194304	Fieldbus Fault (A34)	reserved	Fieldbus Fault (W34)	reserved	Protection Mode
23	00800000	8388608	24 V Supply Low (A47)	reserved	24V Supply Low (W47)	reserved	Unused
24	01000000	16777216	Mains Failure (A36)	reserved	Mains Failure (W36)	reserved	Unused
25	02000000	33554432	1.8V Supply Low (A48)	reserved	Current Limit (W59)	reserved	Unused
26	04000000	67108864	Brake Resistor (A25)	reserved	Low Temp (W66)	reserved	Unused
27	08000000	134217728	Brake IGBT (A27)	reserved	Voltage Limit (W64)	reserved	Unused
28	10000000	268435456	Option Change (A67)	reserved	Encoder loss (W90)	reserved	Unused
29	20000000	536870912	Drive Initialized(A80)	Feedback Fault (A61, A90)	Feedback Fault (W61, W90)		Unused
30	40000000	1073741824	Safe Stop (A68)	PTC 1 Safe Stop (A71)	Safe Stop (W68)	PTC 1 Safe Stop (W71)	Unused
31	80000000	2147483648	Mech. brake low (A63)	Dangerous Failure (A72)	Extended Status Word		Unused

Table 5.3 Description of Alarm Word, Warning Word and Extended Status Word

The alarm words, warning words and extended status words can be read out via serial bus or optional fieldbus for diagnose. See also 16-94 *Ext. Status Word*.

**Index**

**A**

Abbreviations..... 0

Adv. Motor Data, 1-3\*..... 43

Alarm Log, 15-3\*..... 122

Alarm message..... 236

Analog I/O Mode, 6-0\*..... 81

Analog I/O option MCB 109..... 230

Analog I/O Option MCB 109, 26-\*\*..... 183

Analog in/out..... 208

Analog input..... 5

Analog Input 2, 6-2\*..... 82

Analog Input 3 MCB 101, 6-3\*..... 83

Analog Input 4 MCB 101, 6-4\*..... 83

Analog input scaling value..... 185

Analog Output 2 MCB 101, 6-6\*..... 87

Application function..... 224

Application function 2..... 227

Auto Derate, 14-6\*..... 117

**B**

Brake Energy Funct., 2-1\*..... 54

Brake power..... 6

Brakes..... 203

Break-away torque..... 5

Broken Belt Detection, 22-6\*..... 158

Bus Controlled, 5-9\*..... 79

Bus Jog, 8-9\*..... 95

Bypass option..... 234

**C**

CAN Fieldbus..... 213

Cascade controller..... 228

Cascade Controller, 25-\*\*..... 173

Cascade CTL option..... 231

Changing a group of numeric data values..... 22

Changing a text value..... 21

Changing data..... 21

Clock setting..... 36

Coasting..... 5, 16

Comm. and options..... 210

Comparators, 13-1\*..... 104

Configuration..... 90

Control cable..... 11

Cooling..... 51

Copy/Save, 0-5\*..... 35

Ctrl. Word Settings, 8-1\*..... 90

Current Limit Control, 14-3\*..... 115

**D**

Data Log Settings, 15-1\*..... 119

Data readout..... 218

Data readout 2..... 220

Data Readouts, 16-\*\*..... 125

DC-Brake..... 53

Default setting..... 24, 198

DeviceNet..... 98

Diagnosis Read-Outs, 16-9\*..... 129

Digital I/O Mode, 5-0\*..... 66

Digital In/out..... 206

Digital/Bus, 8-5\*..... 94

Display Line 1.2 Small, 0-21..... 32

Display Line 1.3 Small, 0-22..... 32

Display Line 2 large, 0-23..... 32

Display Line 3 Large, 0-24..... 32

Display mode..... 16

Display mode, selection of read-outs..... 16

Drive Closed Loop, 20-\*\*..... 133

Drive Identification, 15-4\*..... 123

Drive Information, 15-\*\*..... 119

Drive Status, 16-3\*..... 126

Dry pump function..... 153

**E**

End of Curve, 22-5\*..... 157

Energy Log, 23-5\*..... 166

Energy Optimising, 14-4\*..... 115

Environment, 14-5\*..... 116

ETR..... 126

Ext. closed loop..... 222

Extended CL Autotuning, 21-0\*..... 142

**F**

FC closed loop..... 221

FC information..... 216

FC Port Diagnostics, 8-8\*..... 95

Feedback & Setpoint, 20-2\*..... 136

Feedback, 20-0\*..... 133

Fieldbus & FC Port, 16-8\*..... 129

Flow Compensation, 22-8\*..... 159

Flow confirmation..... 194

Freeze output.....	5	MCB 114.....	196
Frequency Converter Information, 15-** .....	119	Motor Data, 1-2* .....	41
<b>G</b>		Motor Limits, 4-1* .....	62
General Settings, 1-0* .....	38	Motor protection.....	51
General Settings, 8-0* .....	89	Motor Status, 16-1* .....	125
General Status, 16-0* .....	125	Motor Temperature, 1-9* .....	51
Graphical display.....	13	Multiple frequency converters.....	16
<b>H</b>		<b>N</b>	
Historic Log, 15-2* .....	121	Numerical local control panel.....	22
<b>I</b>		<b>O</b>	
Indexed parameter.....	22	Operating Data, 15-0* .....	119
Indicator light.....	14	Operating mode.....	27
Initialisation.....	24	Operation/display.....	199
Inputs and Outputs, 16-6* .....	127	Operation/Display, 0-** .....	26
Inverter overload, no trip.....	117	Option Ident. , 15*6* .....	123
Inverter Switching, 14-0* .....	112	Other Ramps, 3-8* .....	59
<b>J</b>		<b>P</b>	
Jog.....	5	Parameter Access, 10-3* .....	100
<b>L</b>		Parameter Info, 15-9* .....	124
Language package 2.....	26	Parameter option.....	198
LCP.....	4, 6, 13, 16, 22	Parameter selection.....	21, 25
LCP Custom Readout, 0-3* .....	33	Parameter set-up.....	25
LCP Display, 0-2* .....	29	Parameter set-Up.....	17
LCP key.....	23	Password, 0-6* .....	36
LCP Keypad, 0-4* .....	34	PID autotuning.....	139
LED.....	13	PID Basic Settings, 20-8* .....	140
Limit/warning.....	205	PID Controller, 20-9* .....	141
Load Depend. Setting, 1-6* .....	47	Pipe Fill function, 29-0* .....	189
Load/motor.....	201	Pipe fill mode.....	189
Local reference.....	27, 59	Potentiometer reference.....	12
Logic Rules, 13-4* .....	106	Pre lube.....	193
Low power detection.....	152	Profibus.....	212
Low speed detection.....	152	Protection mode.....	9
<b>M</b>		Pulse start/stop.....	12
Main menu.....	17, 25	<b>Q</b>	
Main menu mode.....	15, 21	Q3 function set-up.....	19
Main reactance.....	42	Quick menu.....	14, 17, 25
Mains On/Off, 14-1* .....	112	Quick menu mode.....	15, 17
Mains RFI filter circuit.....	116	Quick transfer, parameter settings.....	16
Mains supply.....	7	<b>R</b>	
		Ramp 2, 3-5* .....	59

Rated motor speed..... 5  
 RCD..... 6  
 Ref. & Feedb., 16-5\*..... 127  
 Reference Limits, 3-0\*..... 56  
 Reference/ramps..... 204  
 References, 3-1\*..... 56  
 Relay output..... 71  
 Reset..... 16

**S**

Safety..... 8  
 Screened/armoured..... 11  
 Sensor input option..... 234  
 Serial communication..... 5  
 Short Cycle Protection, 22-7\*..... 158  
 Sleep Mode, 22-4\*..... 155  
 Smart Logic..... 214  
 Special feature..... 234  
 Special function..... 215  
 Speed Bypass, 4-6\*..... 64  
 Speed up/down..... 12  
 Start Adjustments, 1-7\*..... 48  
 Start delay..... 48  
 Start function..... 48  
 Start/stop..... 11  
 States, 13-5\*..... 109  
 Stator leakage reactance..... 42  
 Status..... 14  
 Status message..... 13  
 Step-by-step..... 22  
 Stop Adjustments, 1-8\*..... 50  
 Synchronous motor speed..... 5

**T**

Thermal load..... 46, 126  
 Thermistor..... 7, 51  
 Timed action..... 226  
 Timed Actions, 23-0\*..... 162  
 Timers, 13-2\*..... 105  
 Trending, 23-6\*..... 168  
 Trip Reset, 14-2\*..... 113

**V**

Value..... 22  
 Voltage reference via a potentiometer..... 12  
 VVC+..... 7

**W**

Warning..... 236  
 Water application function..... 233  
 Water Application Functions..... 189



[www.danfoss.com/drives](http://www.danfoss.com/drives)

.....  
Danfoss can accept no responsibility for possible errors in catalogues, brochures and other printed material. Danfoss reserves the right to alter its products without notice. This also applies to products already on order provided that such alterations can be made without subsequential changes being necessary in specifications already agreed. All trademarks in this material are property of the respective companies. Danfoss and the Danfoss logotype are trademarks of Danfoss A/S. All rights reserved.  
.....

