



Programming Guide

VLT[®] AutomationDrive FC 301/302

Software versions, control card MK I: 7.62, 48.2X

Software version, control card MK II: 8.10



Contents

1 Introduction	4
1.1 Software Version	4
1.2 Approvals	4
1.3 Definitions	4
1.3.1 Frequency Converter	4
1.3.2 Input	4
1.3.3 Motor	4
1.3.4 References	5
1.3.5 Miscellaneous	5
1.4 Safety	7
1.5 Electrical Wiring	9
1.6 Integrated Motion Controller	12
2 How to Program	13
2.1 Graphical and Numerical Local Control Panels	13
2.1.1 LCD Display	14
2.1.2 Quick Transfer of Parameter Settings between Multiple Frequency Con- verters	16
2.1.3 Display Mode	16
2.1.4 Display Mode - Selection of Readouts	16
2.1.5 Parameter Set-up	18
2.1.6 Quick Menu Key Functions	18
2.1.7 Initial Commissioning	19
2.1.8 Main Menu Mode	20
2.1.9 Parameter Selection	20
2.1.10 Changing Data	20
2.1.11 Changing a Text Value	21
2.1.12 Changing a Data Value	21
2.1.13 Infinitely Variable Change of Numeric Data Value	21
2.1.14 Value, Step by Step	21
2.1.15 Readout and Programming of Indexed Parameters	22
2.1.16 How to Program on the Numerical Local Control Panel	22
2.1.17 LCP Keys	23
3 Parameter Descriptions	25
3.1 Parameters: 0-** Operation and Display	25
3.2 Parameters: 1-** Load and Motor	37
3.3 Parameters: 2-** Brakes	64

3.4 Parameters: 3-** Reference/Ramps	71
3.5 Parameters: 4-** Limits/Warnings	84
3.6 Parameters: 5-** Digital In/Out	95
3.7 Parameters: 6-** Analog In/Out	120
3.8 Parameters: 7-** Controllers	130
3.9 Parameters: 8-** Communications and Options	141
3.10 Parameters: 9-** PROFIBUS	151
3.11 Parameters: 10-** DeviceNet CAN Fieldbus	151
3.12 Parameters: 12-** Ethernet	151
3.13 Parameters: 13-** Smart Logic Control	152
3.14 Parameters: 14-** Special Functions	176
3.15 Parameters: 15-** Drive Information	188
3.16 Parameters: 16-** Data Readouts	196
3.17 Parameters: 17-** Feedback	204
3.18 Parameters: 18-** Data Readouts 2	212
3.19 Parameters: 19-** Application Parameters	215
3.20 Parameters: 23-** Time-based Functions	215
3.21 Parameters: 30-** Special Features	223
3.22 Parameters: 32-** MCO Basic Settings	227
3.23 Parameters: 33-** MCO Advanced Settings	227
3.24 Parameters: 34-** MCO Data Readouts	227
3.25 Parameters: 35-** Sensor Input Option	227
3.26 Parameters: 36-** Programmable I/O Option	230
3.27 Parameters: 40-** Special Settings	233
3.28 Parameters: 42-** Safety Functions	233
3.29 Parameters: 43-** Unit Readouts	233
4 Integrated Motion Controller	236
4.1 Introduction	236
4.2 Positioning, Homing, Synchronization	237
4.3 Control	239
5 Parameter Lists	242
5.1 Introduction	242
5.2 Parameter Lists and Options, Software Version 8.10 (Standard)	243
5.3 Parameter Lists and Options, Software Version 48.20 (IMC)	274
6 Troubleshooting	297
6.1 Status Messages	297

7 Appendix	312
7.1 Symbols, Abbreviations, and Conventions	312
Index	314

1 Introduction

1.1 Software Version

<p>Programming Guide Software versions: Control card MK I: 7.62, 48.2X, and earlier versions Control card MK II: 8.10</p> <p>The software version number can be read from <i>parameter 15-43 Software Version.</i></p>
--

Table 1.1 Software Version

1.1.1 Control Card MK II

Software version 8.03 and later can only be installed on control card MK II. Software version 7.62 and earlier can only be installed on control card MK I. Identify the control card version by the color of the USB port:

MK I: Black USB port.

MK II: White USB port.

1.2 Approvals

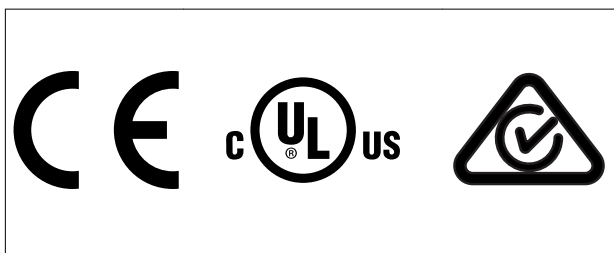

1.3 Definitions

1.3.1 Frequency Converter

$I_{VLT,MAX}$

Maximum output current.

$I_{VLT,N}$

Rated output current supplied by the frequency converter.

$U_{VLT,MAX}$

Maximum output voltage.

1.3.2 Input

Control command

Start and stop the connected motor with LCP and digital inputs.

Functions are divided into 2 groups.

Functions in group 1 have higher priority than functions in group 2.

Group 1	Reset, coast stop, reset and coast stop, quick stop, DC brake, stop, the [OFF] key.
Group 2	Start, pulse start, reversing, start reversing, jog, freeze output.

Table 1.2 Function Groups

1.3.3 Motor

Motor running

Torque generated on output shaft and speed from 0 RPM to maximum speed on motor.

f_{JOG}

Motor frequency when the jog function is activated (via digital terminals).

f_M

Motor frequency.

f_{MAX}

Maximum motor frequency.

f_{MIN}

Minimum motor frequency.

$f_{M,N}$

Rated motor frequency (nameplate data).

I_M

Motor current (actual).

$I_{M,N}$

Rated motor current (nameplate data).

$n_{M,N}$

Nominal motor speed (nameplate data).

n_s

Synchronous motor speed.

$$n_s = \frac{2 \times \text{par. } 1 - 23 \times 60 \text{ s}}{\text{par. } 1 - 39}$$

n_{slip}

Motor slip.

$P_{M,N}$

Rated motor power (nameplate data in kW or hp).

$T_{M,N}$

Rated torque (motor).

U_M

Instant motor voltage.

$U_{M,N}$

Rated motor voltage (nameplate data).

Break-away torque

Figure 1.1 Break-away Torque

 η_{VLT}

The efficiency of the frequency converter is defined as the ratio between the power output and the power input.

Start-disable command

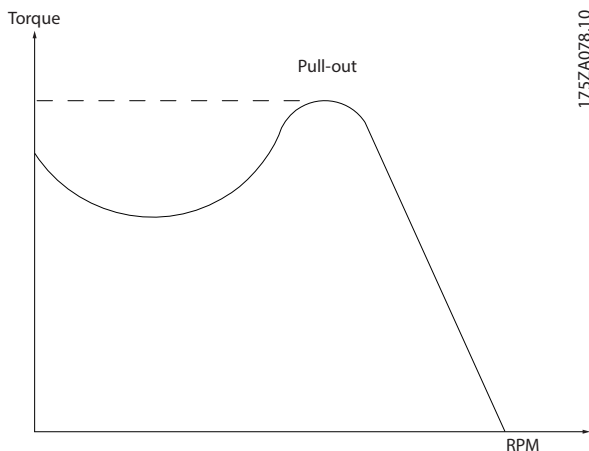
A stop command belonging to Group 1 control commands - see Table 1.2.

Stop command

A stop command belonging to Group 1 control commands - see Table 1.2.

1.3.4 References**Analog reference**

A signal transmitted to the analog inputs 53 or 54 (voltage or current).

Binary reference

A signal transmitted to the serial communication port.

Preset reference

A defined preset reference to be set from -100% to +100% of the reference range. Selection of 8 preset references via the digital terminals.

Pulse reference

A pulse frequency signal transmitted to the digital inputs (terminal 29 or 33).

Ref_{MAX}

Determines the relationship between the reference input at 100% full scale value (typically 10 V, 20 mA) and the resulting reference. The maximum reference value is set in parameter 3-03 Maximum Reference.

Ref_{MIN}

Determines the relationship between the reference input at 0% value (typically 0 V, 0 mA, 4 mA) and the resulting reference. The minimum reference value is set in parameter 3-02 Minimum Reference.

1.3.5 Miscellaneous**Analog inputs**

The analog inputs are used for controlling various functions of the frequency converter.

There are 2 types of analog inputs:

Current input, 0–20 mA, and 4–20 mA

Voltage input, -10 V DC to +10 V DC.

Analog outputs

The analog outputs can supply a signal of 0–20 mA, 4–20 mA.

Automatic motor adaptation, AMA

AMA algorithm determines the electrical parameters for the connected motor at standstill.

Brake resistor

The brake resistor is a module capable of absorbing the brake power generated in regenerative braking. This regenerative brake power increases the DC-link voltage and a brake chopper ensures that the power is transmitted to the brake resistor.

CT characteristics

Constant torque characteristics used for all applications such as conveyor belts, displacement pumps, and cranes.

Digital inputs

The digital inputs can be used for controlling various functions of the frequency converter.

Digital outputs

The frequency converter features 2 solid-state outputs that can supply a 24 V DC (maximum 40 mA) signal.

DSP

Digital signal processor.

ETR

Electronic thermal relay is a thermal load calculation based on present load and time. Its purpose is to estimate the motor temperature.

Hiperface®

Hiperface® is a registered trademark by Stegmann.

Initializing

If initializing is carried out (parameter 14-22 Operation Mode), the frequency converter returns to the default setting.

Intermittent duty cycle

An intermittent duty rating refers to a sequence of duty cycles. Each cycle consists of an on-load and an off-load period. The operation can be either periodic duty or non-periodic duty.

LCP

The local control panel makes up a complete interface for control and programming of the frequency converter. The control panel is detachable and can be installed up to 3 m (10 ft) from the frequency converter, that is, in a front panel with the installation kit option.

NLCP

Numerical local control panel interface for control and programming of the frequency converter. The display is numerical and the panel is used to show process values. The NLCP has no storage and copy functions.

lsb

Least significant bit.

msb

Most significant bit.

MCM

Short for mille circular mil, an American measuring unit for cable cross-section. 1 MCM=0.5067 mm².

Online/offline parameters

Changes to online parameters are activated immediately after the data value is changed. Press [OK] to activate changes to off-line parameters.

Process PID

The PID control maintains the required speed, pressure, temperature, and so on, by adjusting the output frequency to match the varying load.

PCD

Process control data.

Power cycle

Switch off the mains until display (LCP) is dark, then turn power on again.

Pulse input/incremental encoder

An external, digital pulse transmitter used for feeding back information on motor speed. The encoder is used in applications where great accuracy in speed control is required.

RCD

Residual current device.

Set-up

Save parameter settings in 4 set-ups. Change between the 4 parameter set-ups and edit 1 set-up, while another set-up is active.

SFAVM

Switching pattern called stator flux-oriented asynchronous vector modulation (*parameter 14-00 Switching Pattern*).

Slip compensation

The frequency converter compensates for the motor slip by giving the frequency a supplement that follows the measured motor load keeping the motor speed almost constant.

SLC

The SLC (smart logic control) is a sequence of user-defined actions executed when the associated user-defined events are evaluated as true by the SLC. (See *chapter 3.13 Parameters: 13-** Smart Logic Control*).

STW

Status word.

FC standard bus

Includes RS485 bus with FC protocol or MC protocol. See *parameter 8-30 Protocol*.

THD

Total harmonic distortion states the total contribution of harmonic.

Thermistor

A temperature-dependent resistor placed on the frequency converter or the motor.

Trip

A state entered in fault situations, for example if the frequency converter is subject to an overtemperature or when the frequency converter is protecting the motor, process, or mechanism. The frequency converter prevents a restart until the cause of the fault has disappeared. To cancel the trip state, restart the frequency converter. Do not use the trip state for personal safety.

Trip lock

The frequency converter enters this state in fault situations to protect itself. The frequency converter requires physical intervention, for example when there is a short circuit on the output. A trip lock can only be canceled by disconnecting mains, removing the cause of the fault, and reconnecting the frequency converter. Restart is prevented until the trip state is canceled by activating reset or, sometimes, by being programmed to reset automatically. Do not use the trip lock state for personal safety.

VT characteristics

Variable torque characteristics used for pumps and fans.

VVC+

If compared with standard voltage/frequency ratio control, voltage vector control (VVC+) improves the dynamics and the stability, both when the speed reference is changed and in relation to the load torque.

60° AVM

60° asynchronous vector modulation (*parameter 14-00 Switching Pattern*).

Power factor

The power factor is the relation between I_1 and I_{RMS} .

$$\text{Power factor} = \frac{\sqrt{3} \times U \times I_1 \cos\phi}{\sqrt{3} \times U \times I_{RMS}}$$

The power factor for 3-phase control:

$$\text{Power factor} = \frac{I_1 \times \cos\phi_1}{I_{RMS}} = \frac{I_1}{I_{RMS}} \text{ since } \cos\phi_1 = 1$$

The power factor indicates to which extent the frequency converter imposes a load on the mains supply.

The lower the power factor, the higher the I_{RMS} for the same kW performance.

$$I_{RMS} = \sqrt{I_1^2 + I_5^2 + I_7^2 + \dots + I_n^2}$$

In addition, a high-power factor indicates that the different harmonic currents are low.

The DC coils in the frequency converters produce a high-power factor, which minimizes the imposed load on the mains supply.

Target position

The final target position specified by positioning commands. The profile generator uses this position to calculate the speed profile.

Commanded position

The actual position reference calculated by the profile generator. The frequency converter uses the commanded position as setpoint for position PI.

Actual position

The actual position from an encoder, or a value that the motor control calculates in open loop. The frequency converter uses the actual position as feedback for position PI.

Position error

Position error is the difference between the actual position and the commanded position. The position error is the input for the position PI controller.

Position unit

The physical unit for position values.

1.4 Safety**⚠ WARNING****HIGH VOLTAGE**

Frequency converters contain high voltage when connected to AC mains input, DC supply, or load sharing. Failure to perform installation, start-up, and maintenance by qualified personnel can result in death or serious injury.

- Only qualified personnel must perform installation, start-up, and maintenance.
- Before performing any service or repair work, use an appropriate voltage measuring device to make sure that there is no remaining voltage on the drive.

Safety regulations

- Disconnect mains supply to the frequency converter whenever repair work is to be carried out. Check that the mains supply has been disconnected and that the necessary time has elapsed before removing motor and mains supply plugs. For information about the discharge time, see *Table 1.3*.
- [Off] does not disconnect the mains supply and must not be used as a safety switch.
- Ground the equipment properly, protect the user against supply voltage, and protect the motor against overload in accordance with applicable national and local regulations.
- The ground leakage current exceeds 3.5 mA. Ensure correct grounding of the equipment by a certified electrical installer.
- Do not remove the plugs for the motor and mains supply while the frequency converter is connected to mains. Check that the mains supply has been disconnected and that the necessary time has elapsed before removing motor and mains plugs.
- The frequency converter has more voltage sources than L1, L2, and L3, when load sharing (linking of DC intermediate circuit) or external 24 V DC is installed. Check that all voltage sources have been disconnected and that the necessary time has elapsed before commencing repair work. For information about the discharge time, see *Table 1.3*.

⚠ WARNING

UNINTENDED START

When the frequency converter is connected to AC mains, DC supply, or load sharing, the motor may start at any time. Unintended start during programming, service, or repair work can result in death, serious injury, or property damage. The motor can start via an external switch, a fieldbus command, an input reference signal from the LCP, or after a cleared fault condition.

To prevent unintended motor start:

- Disconnect the frequency converter from the mains.
- Press [Off/Reset] on the LCP before programming parameters.
- Completely wire and assemble the frequency converter, motor, and any driven equipment before connecting the frequency converter to AC mains, DC supply, or load sharing.

⚠ WARNING

DISCHARGE TIME

The frequency converter contains DC-link capacitors, which can remain charged even when the frequency converter is not powered. High voltage can be present even when the warning LED indicator lights are off. Failure to wait the specified time after power has been removed before performing service or repair work can result in death or serious injury.

- Stop the motor.
- Disconnect AC mains and remote DC-link power supplies, including battery back-ups, UPS, and DC-link connections to other frequency converters.
- Disconnect or lock PM motor.
- Wait for the capacitors to discharge fully. The minimum duration of waiting time is specified in *Table 1.3* and is also visible on the product label on top of the frequency converter.
- Before performing any service or repair work, use an appropriate voltage measuring device to make sure that the capacitors are fully discharged.

Voltage [V]	Minimum waiting time (minutes)		
	4	7	15
200–240	0.25–3.7 kW (0.34–5 hp)	–	5.5–37 kW (7.5–50 hp)
380–500	0.25–7.5 kW (0.34–10 hp)	–	11–75 kW (15–100 hp)
525–600	0.75–7.5 kW (1–10 hp)	–	11–75 kW (15–100 hp)
525–690	–	1.5–7.5 kW (2–10 hp)	11–75 kW (15–100 hp)

Table 1.3 Discharge Time

NOTICE!

When using the Safe Torque Off, always follow the instructions in *VLT® Frequency Converters - Safe Torque Off Operating Instructions*.

NOTICE!

Control signals from, or internally within, the frequency converter may in rare cases be activated in error, be delayed, or fail to occur entirely. When used in situations where safety is critical, for example when controlling the electromagnetic brake function of a hoist application, do not rely on these control signals exclusively.

NOTICE!

Hazardous situations must be identified by the machine builder/integrator who is responsible for considering the necessary preventive means. More monitoring and protective devices may be included, always according to valid national safety regulations, for example law on mechanical tools and regulations for the prevention of accidents.

Crane, lifts, and hoists

The controlling of external brakes must always have a redundant system. The frequency converter can in no circumstances be the primary safety circuit. Comply with relevant standards, for example:

Hoists and cranes: IEC 60204-32

Lifts: EN 81

Protection mode

Once a hardware limit on motor current or DC-link voltage is exceeded, the frequency converter enters the protection mode. Protection mode means a change of the PWM modulation strategy and a low switching frequency to minimize losses. This continues for 10 s after the last fault and increases the reliability and the robustness of the frequency converter while re-establishing full control of the motor.

In hoist applications, protection mode is not usable because the frequency converter is unable to leave this mode again and therefore it extends the time before activating the brake, which is not recommended. Protection mode can be disabled by setting parameter 14-26 Trip Delay at Inverter Fault to 0, which means that the frequency converter trips immediately if 1 of the hardware limits is exceeded.

NOTICE!

Disabling protection mode in hoisting applications (parameter 14-26 Trip Delay at Inverter Fault = 0) is recommended.

1.5 Electrical Wiring

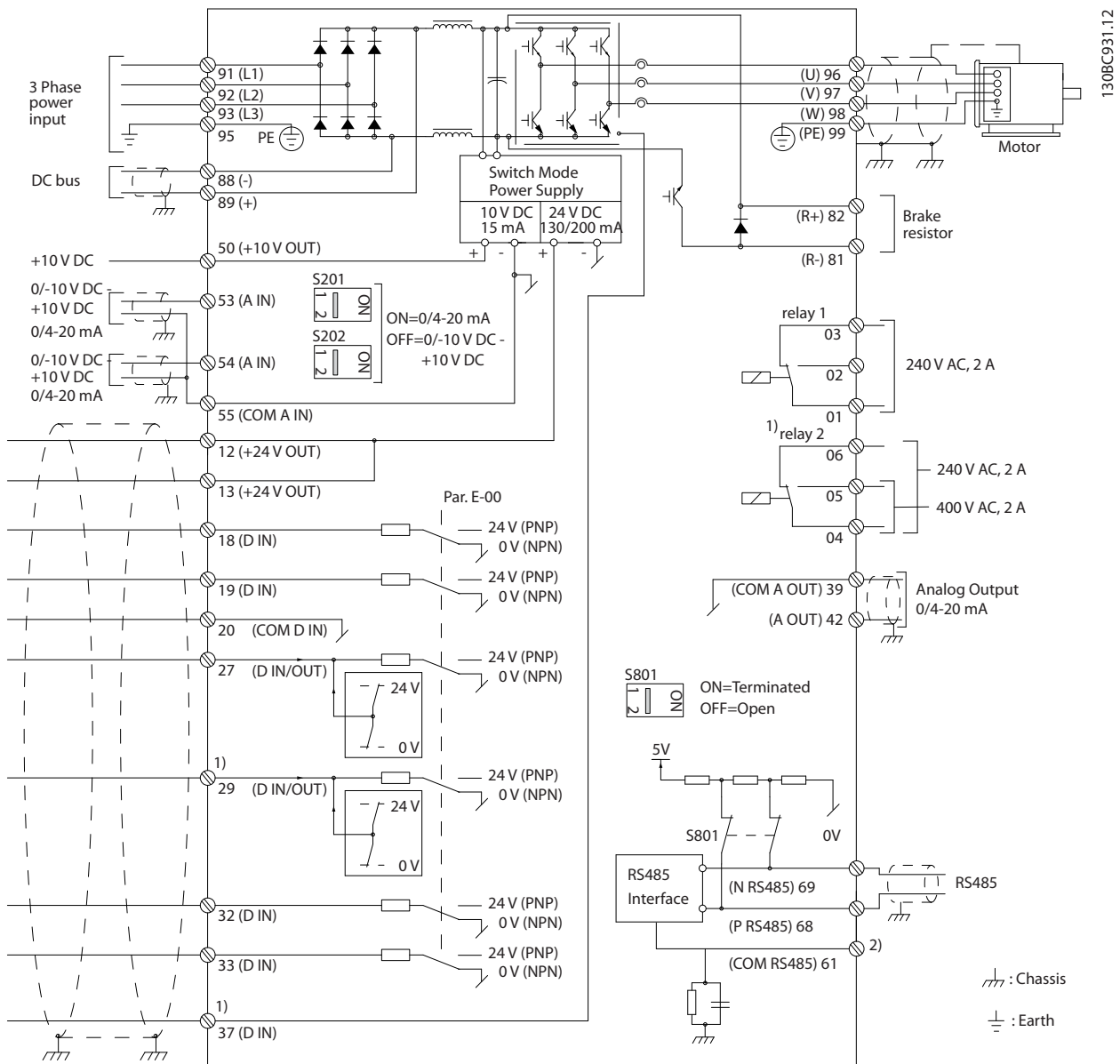

Figure 1.2 Basic Wiring Schematic Drawing

A=Analog, D=Digital

Terminal 37 is used for Safe Torque Off. For Safe Torque Off installation instructions, refer to the VLT® Frequency Converters - Safe Torque Off Operating Instructions.

- 1) Terminal 37 is not included in FC 301 (except enclosure type A1). Relay 2 and terminal 29 have no function in FC 301.
- 2) Do not connect cable shield.

Very long control cables and analog signals may in rare cases, and depending on installation, result in 50/60 Hz ground loops due to noise from mains supply cables.

If 50/60 Hz ground loops occur, consider breaking the shield or insert a 100 nF capacitor between shield and enclosure.

To avoid ground currents from both groups to affect other groups, connect the digital and analog inputs and outputs separately to the common inputs (terminals 20, 55, and 39) of the frequency converter. For example, switching on the digital input may disturb the analog input signal.

Input polarity of control terminals

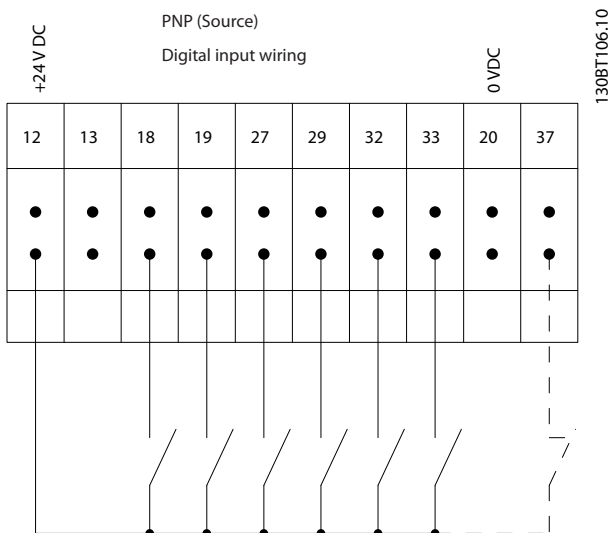

Figure 1.3 PNP (Source)

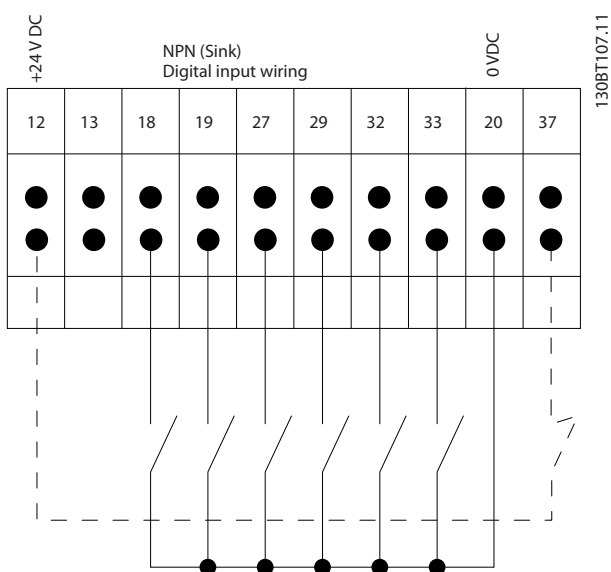

Figure 1.4 NPN (Sink)

NOTICE!

Control cables must be shielded/armored.

See the section *Grounding of Shielded Control Cables* in the design guide for the correct termination of control cables.

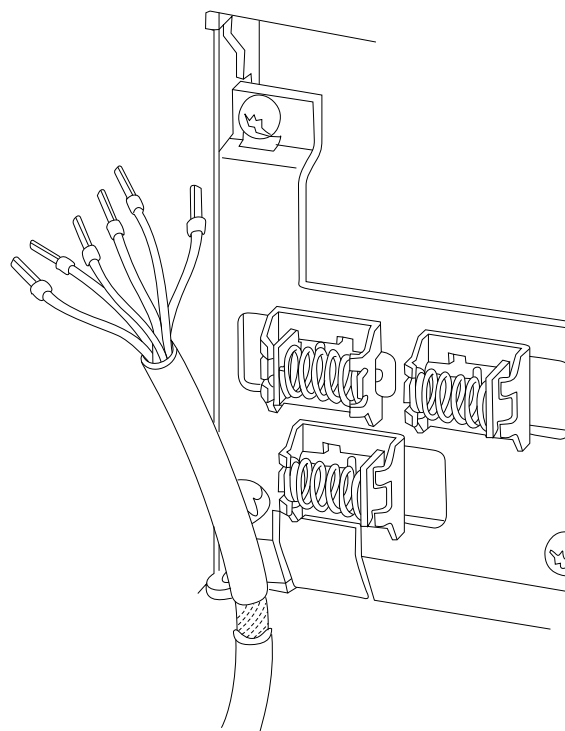

Figure 1.5 Grounding of Shielded/Armored Control Cables

1.5.1 Start/Stop

Terminal 18 = Parameter 5-10 Terminal 18 Digital Input [8] Start.

Terminal 27 = Parameter 5-12 Terminal 27 Digital Input [0] No operation (Default [2] Coast inverse).

Terminal 37 = Safe Torque Off (where available).

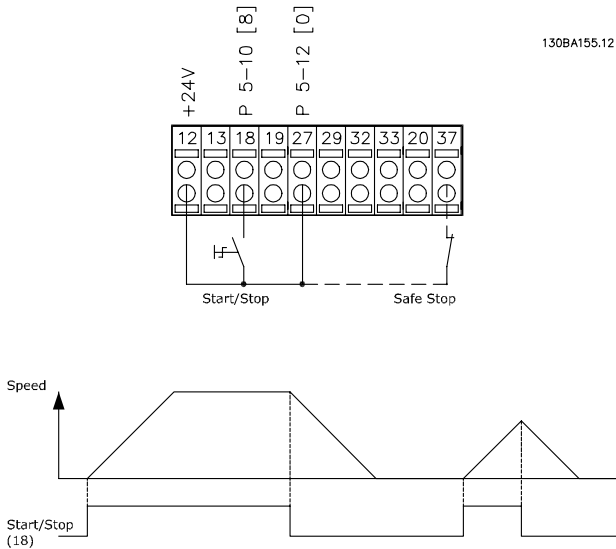

Figure 1.6 Start/Stop

1.5.2 Pulse Start/Stop

Terminal 18 = Parameter 5-10 Terminal 18 Digital Input, [9] Latched start.

Terminal 27 = Parameter 5-12 Terminal 27 Digital Input, [6] Stop inverse.

Terminal 37 = Safe Torque Off (where available).

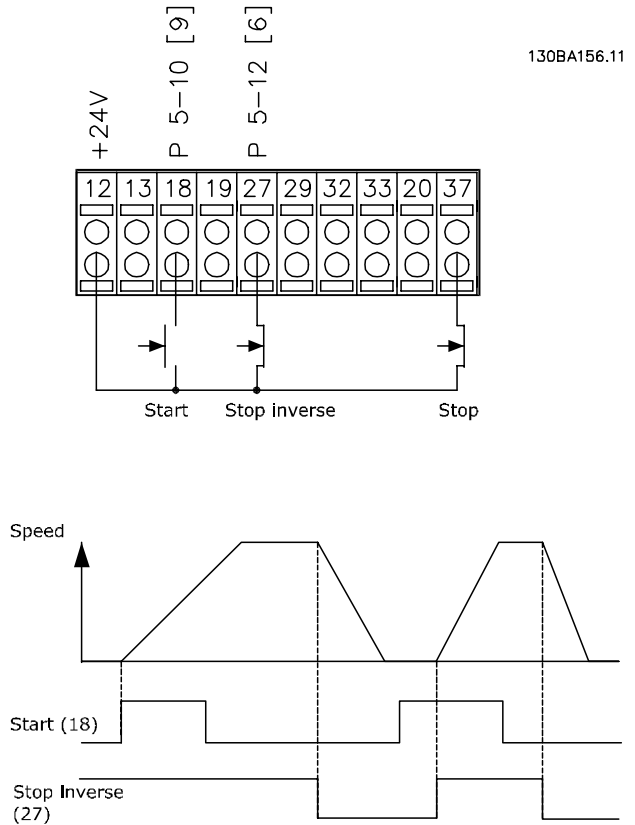

Figure 1.7 Pulse Start/Stop

1.5.3 Speed up/Speed Down

Terminals 29/32 = Speed up/Speed down

Terminal 18 = *Parameter 5-10 Terminal 18 Digital Input [9] Start* (default).

Terminal 27 = *Parameter 5-12 Terminal 27 Digital Input [19] Freeze reference*.

Terminal 29 = *Parameter 5-13 Terminal 29 Digital Input [21] Speed up*.

Terminal 32 = *Parameter 5-14 Terminal 32 Digital Input [22] Speed down*.

NOTICE!

Terminal 29 only in FC x02 (x=series type).

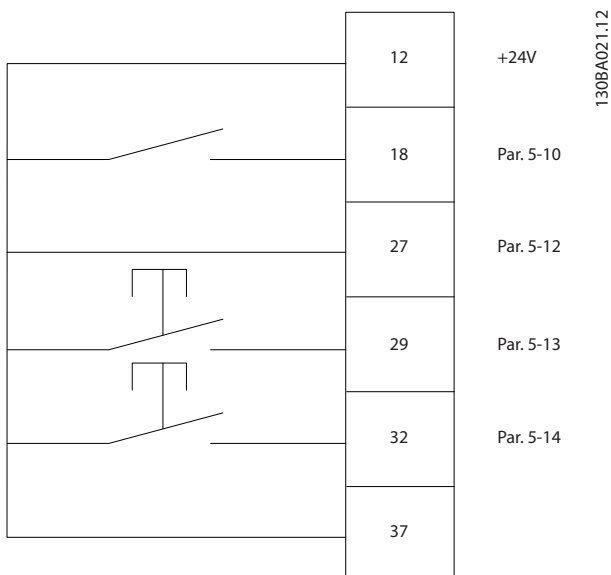

Figure 1.8 Speed up/Speed down

1.5.4 Potentiometer Reference

Voltage reference via a potentiometer

Reference source 1 = [1] *Analog input 53* (default).

Terminal 53, low voltage = 0 V.

Terminal 53, high voltage = 10 V.

Terminal 53, low reference/feedback = 0 RPM.

Terminal 53, high reference/feedback = 1500 RPM.

Switch S201 = OFF (U)

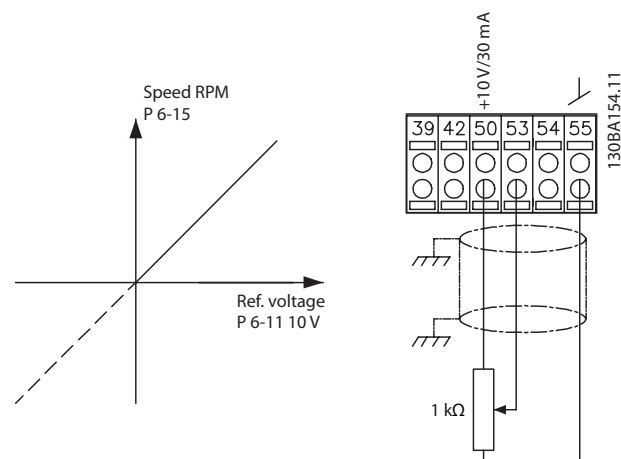

Figure 1.9 Potentiometer Reference

1.6 Integrated Motion Controller

The integrated motion controller (IMC) enables position control. For more information about IMC, see *chapter 4 Integrated Motion Controller*.

2 How to Program

2.1 Graphical and Numerical Local Control Panels

Easy programming of the frequency converter is done via the graphical LCP (LCP 102). For information about using the numerical local control panel (LCP 101), see chapter 2.1.16 *How to Program on the Numerical Local Control Panel*.

The LCP is divided into 4 functional groups:

1. Graphical display with status lines.
2. Menu keys and indicator lights - changing parameters and switching between display functions.
3. Navigation keys and indicator lights.
4. Operation keys and indicator lights.

The LCP display can show up to 5 items of operating data while showing *Status*.

Display lines:

- a. **Status line:** Status messages showing icons and graphics.
- b. **Line 1-2:** Operator data lines showing data defined or selected. Add up to 1 extra line by pressing [Status].
- c. **Status line:** Status messages showing text.

NOTICE!

If start-up is delayed, the LCP shows the INITIALIZING message until it is ready. Adding or removing options can delay the start-up.

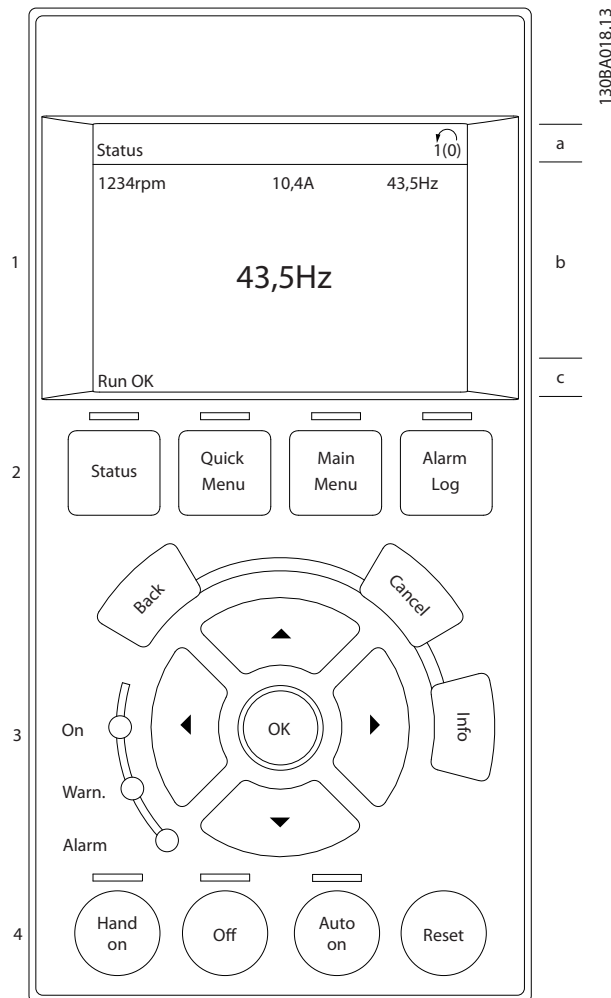

Figure 2.1 LCP

2.1.1 LCD Display

The display has backlight and a total of 6 alpha-numeric lines. The display lines show the direction of rotation (arrow), the selected set-up, and the programming set-up. The display is divided into 3 sections.

Top section

The top section shows up to 2 measurements in normal operating status.

Middle section

The top line shows up to 5 measurements with related unit, regardless of status (except in the case of alarm/warning).

Bottom section

The bottom section always shows the state of the frequency converter in *Status* mode.

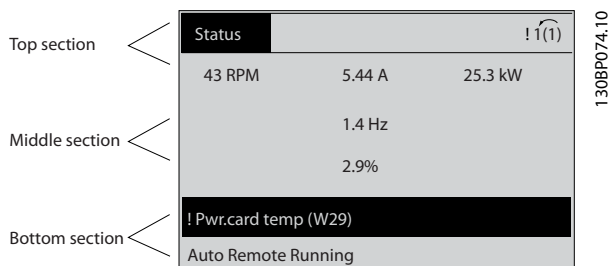

Figure 2.2 Display

The active set-up (selected as the active set-up in *parameter 0-10 Active Set-up*) is shown. When programming another set-up than the active set-up, the number of the programmed set-up appears to the right.

Display contrast adjustment

Press [Status] and [▲] for darker display.
Press [Status] and [▼] for brighter display.

Most parameter set-ups can be changed immediately via the LCP, unless a password has been created via *parameter 0-60 Main Menu Password* or via *parameter 0-65 Quick Menu Password*.

Indicator lights

If certain threshold values are exceeded, the alarm and/or warning indicator lights up. A status and alarm text appear on the LCP.

The ON indicator light is activated when the frequency converter receives mains voltage or via a DC bus terminal or 24 V external supply. At the same time, the back indicator light is on.

- Green LED/On: Control section is working.
- Yellow LED/Warn: Indicates a warning.

- Flashing Red LED/Alarm: Indicates an alarm.

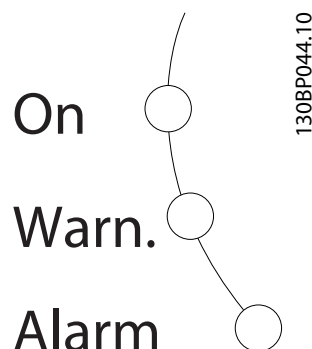

Figure 2.3 Indicator Lights

LCP keys

The control keys are divided into functions. The keys below the display and indicator lights are used for parameter set-up, including option of display indication during normal operation.



Figure 2.4 LCP Keys

[Status]

Indicates the status of the frequency converter and/or the motor. Select between 3 different readouts by pressing [Status]: 5 line readouts, 4 line readouts, or smart logic control.

Press [Status] for selecting the mode of display or for changing back to display mode from either the quick menu mode, the main menu mode, or the alarm mode. Also use [Status] to toggle single or double readout mode.

[Quick Menu]

Allows quick access to different quick menus such as:

- My personal menu.
- Quick set-up.
- Changes made.
- Loggings.

Press [Quick Menu] to program the parameters belonging to the Quick Menu. It is possible to switch directly between quick menu mode and main menu mode.

[Main Menu]

Is used for programming all parameters. It is possible to switch directly between main menu mode and quick menu mode.

Parameter shortcut can be carried out by pressing down [Main Menu] for 3 s. The parameter shortcut allows direct access to any parameter.

[Alarm Log]

Shows an alarm list of the 5 latest alarms (numbered A1–A5). To obtain extra details about an alarm, press the navigation keys to maneuver to the alarm number and press [OK]. Information is shown about the condition of the frequency converter before it enters the alarm mode.

[Back]

Returns to the previous step or layer in the navigation structure.

[Cancel]

Last change or command is canceled as long as the display has not been changed.

[Info]

Supplies information about a command, parameter, or function in any display window. [Info] provides detailed information whenever help is needed.

Exit *Info* mode by pressing either [Info], [Back], or [Cancel].



Figure 2.5 Back



Figure 2.6 Cancel



Figure 2.7 Info

Navigation keys

The 4 navigation keys are used to navigate between the different options available in Quick Menu, Main Menu, and Alarm Log. Press the keys to move the cursor.

[OK]

Press for selecting a parameter marked by the cursor and for enabling the change of a parameter.

Local control keys

Local control keys are at the bottom of the LCP.

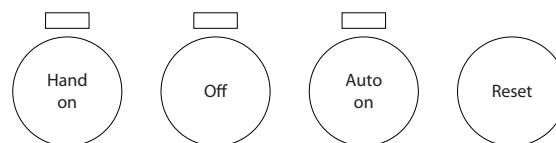

Figure 2.8 Local Control Keys

130BP046.10

[Hand On]

Enables control of the frequency converter via the LCP. [Hand On] also starts the motor, and it is now possible to enter the motor speed data with the navigation keys. The key can be selected as [1] *Enable* or [0] *Disable* via parameter 0-40 [Hand on] Key on LCP.

External stop signals activated with control signals or a fieldbus override a start command via the LCP.

The following control signals are still active when [Hand On] is activated:

- [Hand on] - [Off] - [Auto On].
- Reset.
- Coast stop inverse.
- Reversing.
- Set-up select bit 0 - Set-up select bit 1.
- Stop command from serial communication.
- Quick stop.
- DC brake.

[Off]

Stops the connected motor. The key can be selected as [1] *Enable* or [0] *Disable* via parameter 0-41 [Off] Key on LCP. If no external stop function is selected and the [Off] key is inactive, the motor can be stopped by disconnecting the voltage.

[Auto On]

Enables the frequency converter to be controlled via the control terminals and/or serial communication. When a start signal is applied on the control terminals and/or the bus, the frequency converter starts. The key can be selected as [1] *Enable* or [0] *Disable* via parameter 0-42 [Auto on] Key on LCP.

NOTICE!

An active HAND-OFF-AUTO signal via the digital inputs has higher priority than the control keys [Hand On] – [Auto On].

[Reset]

Is used for resetting the frequency converter after an alarm (trip). It can be selected as [1] *Enable* or [0] *Disable* via parameter 0-43 [Reset] Key on LCP.

The parameter shortcut can be carried out by pressing down the [Main Menu] key for 3 s. The parameter shortcut provides direct access to any parameter.

2.1.2 Quick Transfer of Parameter Settings between Multiple Frequency Converters

Once the set-up of a frequency converter is complete, store the data in the LCP or on a PC via MCT 10 Set-up Software.

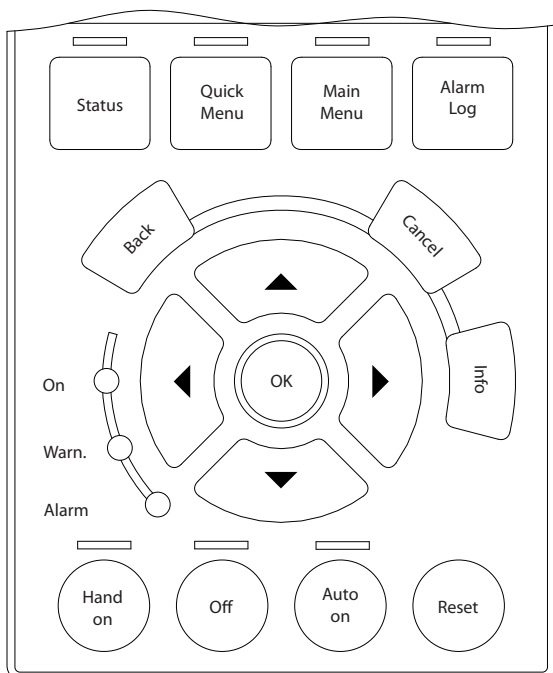

Figure 2.9 LCP

Data storage in LCP

NOTICE!

Stop the motor before performing this operation.

To store the data in the LCP:

1. Go to *parameter 0-50 LCP Copy*.
2. Press the [OK] key.
3. Select [1] All to LCP.
4. Press the [OK] key.

All parameter settings are now stored in the LCP indicated by the progress bar. When 100% is reached, press [OK].

Connect the LCP to another frequency converter and copy the parameter settings to this frequency converter as well.

Data transfer from LCP to frequency converter

NOTICE!

Stop the motor before performing this operation. To transfer the data from the LCP to the frequency converter:

1. Go to *parameter 0-50 LCP Copy*.
2. Press the [OK] key.
3. Select [2] All from LCP.
4. Press the [OK] key.

The parameter settings stored in the LCP are now transferred to the frequency converter indicated by the progress bar. When 100% is reached, press [OK].

2.1.3 Display Mode

In normal operation, up to 5 different operating variables can be indicated continuously in the middle section: 1.1, 1.2, and 1.3, as well as 2 and 3.

2.1.4 Display Mode - Selection of Readouts

It is possible to toggle between 3 status readout screens by pressing [Status].

Operating variables with different formatting are shown in each status view further in this section.

Table 2.1 shows the measurements that can be linked to each of the operating variables. When options are mounted, additional measurements are available.

Define the links via

- *Parameter 0-20 Display Line 1.1 Small.*
- *Parameter 0-21 Display Line 1.2 Small.*
- *Parameter 0-22 Display Line 1.3 Small.*
- *Parameter 0-23 Display Line 2 Large.*
- *Parameter 0-24 Display Line 3 Large.*

Each readout parameter selected in *parameter 0-20 Display Line 1.1 Small* to *parameter 0-24 Display Line 3 Large* has its own scale and digits after a possible decimal point. The larger the numeric value of a parameter is, the fewer digits are shown after the decimal point.

Example: Current readout 5.25 A, 15.2 A, 105 A.

Operating variable	Unit
<i>Parameter 16-00 Control Word</i>	hex
<i>Parameter 16-01 Reference [Unit]</i>	[Unit]
<i>Parameter 16-02 Reference [%]</i>	%
<i>Parameter 16-03 Status Word</i>	hex
<i>Parameter 16-05 Main Actual Value [%]</i>	%

Operating variable	Unit
Parameter 16-10 Power [kW]	[kW]
Parameter 16-11 Power [hp]	[hp]
Parameter 16-12 Motor Voltage	[V]
Parameter 16-13 Frequency	[Hz]
Parameter 16-14 Motor current	[A]
Parameter 16-16 Torque [Nm]	Nm
Parameter 16-17 Speed [RPM]	[RPM]
Parameter 16-18 Motor Thermal	%
Parameter 16-20 Motor Angle	
Parameter 16-30 DC Link Voltage	V
Parameter 16-32 Brake Energy /s	kW
Parameter 16-33 Brake Energy Average	kW
Parameter 16-34 Heatsink Temp.	°C
Parameter 16-35 Inverter Thermal	%
Parameter 16-36 Inv. Nom. Current	A
Parameter 16-37 Inv. Max. Current	A
Parameter 16-38 SL Controller State	
Parameter 16-39 Control Card Temp.	°C
Parameter 16-40 Logging Buffer Full	
Parameter 16-50 External Reference	
Parameter 16-51 Pulse Reference	
Parameter 16-52 Feedback [Unit]	[Unit]
Parameter 16-53 Digi Pot Reference	
Parameter 16-60 Digital Input	bin
Parameter 16-61 Terminal 53 Switch Setting	V
Parameter 16-62 Analog Input 53	
Parameter 16-63 Terminal 54 Switch Setting	V
Parameter 16-64 Analog Input 54	
Parameter 16-65 Analog Output 42 [mA]	[mA]
Parameter 16-66 Digital Output [bin]	[bin]
Parameter 16-67 Pulse Input #29 [Hz]	[Hz]
Parameter 16-68 Freq. Input #33 [Hz]	[Hz]
Parameter 16-69 Pulse Output #27 [Hz]	[Hz]
Parameter 16-70 Pulse Output #29 [Hz]	[Hz]
Parameter 16-71 Relay Output [bin]	
Parameter 16-72 Counter A	
Parameter 16-73 Counter B	
Parameter 16-80 Fieldbus CTW 1	hex
Parameter 16-82 Fieldbus REF 1	hex
Parameter 16-84 Comm. Option Status	hex
Parameter 16-85 FC Port CTW 1	hex
Parameter 16-86 FC Port REF 1	hex
Parameter 16-90 Alarm Word	
Parameter 16-92 Warning Word	
Parameter 16-94 Ext. Status Word	

Table 2.1 Units

Status view I

This readout state is standard after start-up or initialization. Press [Info] to obtain information about the units linked to the shown operating variables (1.1, 1.2, 1.3, 2 and 3). See the operating variables shown in *Figure 2.10*.

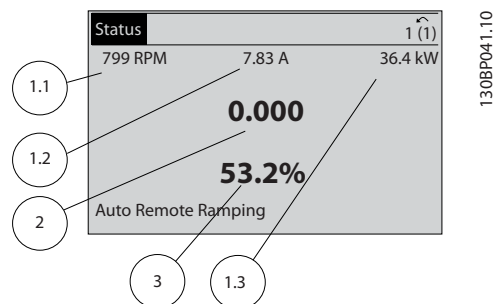

Figure 2.10 Status View I

Status view II

See the operating variables (1.1, 1.2, 1.3, and 2) shown in *Figure 2.11*. In the example, speed, motor current, motor power, and frequency are selected as variables in the 1st and 2nd lines.

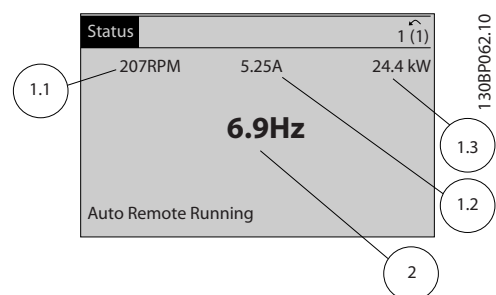

Figure 2.11 Status View II

Status view III

This state shows the event and action of the smart logic control. For further information, see *chapter 3.13 Parameters: 13-** Smart Logic Control*.

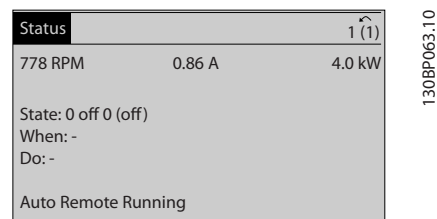

Figure 2.12 Status View III

2.1.5 Parameter Set-up

The frequency converter can be used for practically all assignments. The frequency converter offers an option between 2 programming modes:

- Main menu mode.
- Quick menu mode.

Main menu provides access to all parameters. Quick menu takes the user through a few parameters, making it possible to start operating the frequency converter. Change a parameter in either main menu mode or quick menu mode.

2.1.6 Quick Menu Key Functions

Press [Quick Menu] to enter a list of different areas contained in the *Quick Menu*.

Select *Q1 My Personal Menu* to show the selected personal parameters. These parameters are selected in *parameter 0-25 My Personal Menu*. Up to 50 different parameters can be added in this menu.

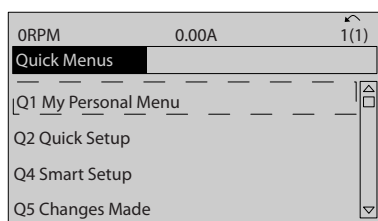

Figure 2.13 Quick Menus

Select *Q2 Quick Setup* to go through a selection of parameters to get the motor running almost optimally. The default settings for the other parameters consider the required control functions and the configuration of signal inputs/outputs (control terminals).

The parameter selection is effected with the navigation keys. The parameters in *Table 2.2* are accessible.

Parameter	Setting
Parameter 0-01 LanguageParameter 0-01 Language	
Parameter 1-20 Motor Power [kW]	[kW]
Parameter 1-22 Motor Voltage	[V]
Parameter 1-23 Motor Frequency	[Hz]
Parameter 1-24 Motor Current	[A]
Parameter 1-25 Motor Nominal Speed	[RPM]
Parameter 5-12 Terminal 27 Digital Input	[0] No function ¹⁾
Parameter 1-29 Automatic Motor Adaptation (AMA)	[1] Enable complete AMA
Parameter 3-02 Minimum Reference	[RPM]
Parameter 3-03 Maximum Reference	[RPM]
Parameter 3-41 Ramp 1 Ramp-up Time	[s]
Parameter 3-42 Ramp 1 Ramp-down Time	[s]
Parameter 3-13 Reference Site	

Table 2.2 Selection of Parameter

1) If terminal 27 is set to [0] No function, no connection to +24 V on terminal 27 is necessary.

Select *Changes made* to get information about:

- The last 10 changes. Use the [▲] [▼] navigation keys to scroll between the last 10 changed parameters.
- The changes made since default setting.

Select *Loggings* to get information about the show line readouts. The information is shown as graphs.

Only parameters selected in *parameter 0-20 Display Line 1.1 Small* and *parameter 0-24 Display Line 3 Large* can be viewed. It is possible to store up to 120 samples in the memory for later reference.

2.1.7 Initial Commissioning

The easiest way of carrying out the initial commissioning is by pressing [Quick Menu] and following the quick set-up procedure using LCP 102 (read *Table 2.3* from left to right). The example applies to open-loop applications.

Press				
		Q2 Quick Menu.		
Parameter 0-01 Language		Set language.		
Parameter 1-20 Motor Power [kW]		Set motor nameplate power.		
Parameter 1-22 Motor Voltage		Set nameplate voltage.		
Parameter 1-23 Motor Frequency		Set nameplate frequency.		
Parameter 1-24 Motor Current		Set nameplate current.		
Parameter 1-25 Motor Nominal Speed		Set nameplate speed in RPM.		
Parameter 5-12 Terminal 27 Digital Input		If terminal default is [2] Coast inverse, it is possible to change this setting to [0] No function. No connection to terminal 27 is then needed for running AMA.		
Parameter 1-29 Automatic Motor Adaptation (AMA)		Set desired AMA function. Enable complete AMA is recommended.		
Parameter 3-02 Minimum Reference		Set the minimum speed of the motor shaft.		
Parameter 3-03 Maximum Reference		Set the maximum speed of the motor shaft.		
Parameter 3-41 Ramp 1 Ramp-up Time		Set the ramp-up time with reference to synchronous motor speed, n_s .		
Parameter 3-42 Ramp 1 Ramp-down Time		Set the ramp-down time with reference to synchronous motor speed, n_s .		
Parameter 3-13 Reference Site		Set the site from where the reference must work.		

Table 2.3 Quick Set-up Procedure

2

Another easy way of commissioning the frequency converter is by using the smart application set-up (SAS), which can also be found by pressing [Quick Menu]. To set up the applications listed, follow the instructions on the successive screens.

The [Info] key can be used throughout the SAS to see help information for various selections, settings, and messages.

The following 3 applications are included:

- Mechanical brake.
- Conveyor.
- Pump/fan.

The following 4 fieldbusses can be selected:

- PROFIBUS.
- PROFINET.
- DeviceNet.
- EtherNet/IP.

NOTICE!

The frequency converter ignores the start conditions when SAS is active.

NOTICE!

The smart set-up runs automatically on the first power-up of the frequency converter or after a reset to factory settings. If no action is taken, the SAS screen automatically disappears after 10 minutes.

2.1.8 Main Menu Mode

Press [Main Menu] to enter the main menu mode. The readout in *Figure 2.14* appears on the display. The middle and bottom sections in the display show a list of parameter groups, which can be selected by toggling the [▲] and [▼] keys.

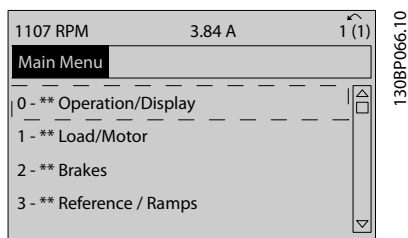

Figure 2.14 Main Menu Mode

Each parameter has a name and number which remain the same regardless of the programming mode. In the main menu mode, the parameters are divided into groups. The first digit of the parameter number (from the left) indicates the parameter group number.

All parameters can be changed in the Main Menu. However, depending on the choice of configuration (*parameter 1-00 Configuration Mode*), some parameters can be hidden. For example, open loop hides all the PID parameters, and other enabled options make more parameter groups visible.

2.1.9 Parameter Selection

In the main menu mode, the parameters are divided into groups. Select a parameter group with the navigation keys.

After selecting a parameter group, select a parameter with the navigation keys.

The middle section on the display shows the parameter number and name, and the selected parameter value.

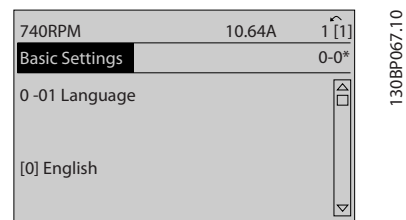

Figure 2.15 Parameter Selection

2.1.10 Changing Data

The procedure for changing data is the same in the quick menu mode and the main menu mode. Press [OK] to change the selected parameter.

The procedure for changing data depends on whether the selected parameter represents a numeric data value or a text value.

2.1.11 Changing a Text Value

If the selected parameter is a text value, change the text value with the [▲] [▼] keys.

Place the cursor on the value to save and press [OK].

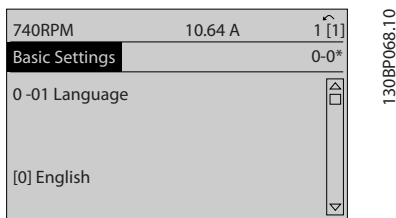

Figure 2.16 Changing a Text Value

2.1.12 Changing a Data Value

If the selected parameter shows a numeric data value, change the selected data value with the [◀] [▶] navigation keys and the [▲] [▼] navigation keys. Press [◀] [▶] keys to move the cursor horizontally.

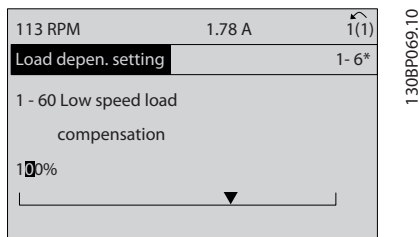

Figure 2.17 Changing a Data Value

Press [▲] [▼] keys to change the data value. [▲] increases the data value, and [▼] decreases the data value. Place the cursor on the value to save and press [OK].

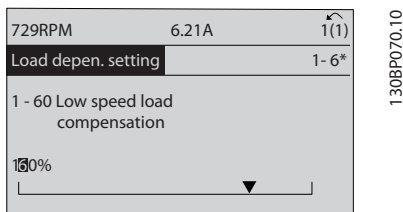

Figure 2.18 Saving a Data Value

2.1.13 Infinitely Variable Change of Numeric Data Value

If the selected parameter shows a numeric data value, select a digit with [◀] [▶].



Figure 2.19 Selecting a Digit

Change the selected digit infinitely variably with [▲] [▼]. The cursor indicates the selected digit. Place the cursor on the digit to save and press [OK].

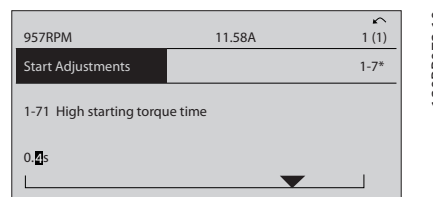

Figure 2.20 Saving

2.1.14 Value, Step by Step

Certain parameters can be changed step by step. This applies to:

- Parameter 1-20 Motor Power [kW].
- Parameter 1-22 Motor Voltage.
- Parameter 1-23 Motor Frequency.

The parameters are changed both as a group of numeric data values and as numeric data values that are infinitely varying.

2.1.15 Readout and Programming of Indexed Parameters

Parameters are indexed when placed in a rolling stack.

Parameter 15-30 Fault Log: Error Code to

parameter 15-32 Alarm Log: Time contain a fault log, which can be read out. Select a parameter, press [OK], and press the keys [▲] [▼] to scroll through the value log.

For example, *parameter 3-10 Preset Reference* is changed as follows:

1. Select the parameter, press [OK], and press [▲] [▼] to scroll through the indexed values.
2. To change the parameter value, select the indexed value and press [OK].
3. Change the value by pressing [▲] [▼].
4. Press [OK] to accept the new setting.
5. Press [Cancel] to abort. Press [Back] to leave the parameter.

2.1.16 How to Program on the Numerical Local Control Panel

The following instructions are valid for the numerical LCP (LCP 101).

The control panel is divided into 4 functional groups:

- Numerical display.
- Menu keys and indicator lights - changing parameters and switching between display functions.
- Navigation keys and indicator lights.
- Operation keys and indicator lights.

Display line

Status messages showing icons and numeric value.

Indicator lights

- Green LED/On: Indicates if control section is on.
- Yellow LED/Wrn: Indicates a warning.
- Flashing red LED/Alarm: Indicates an alarm.

LCP keys

[Menu]

Select 1 of the following modes:

- Status.
- Quick set-up.
- Main menu.

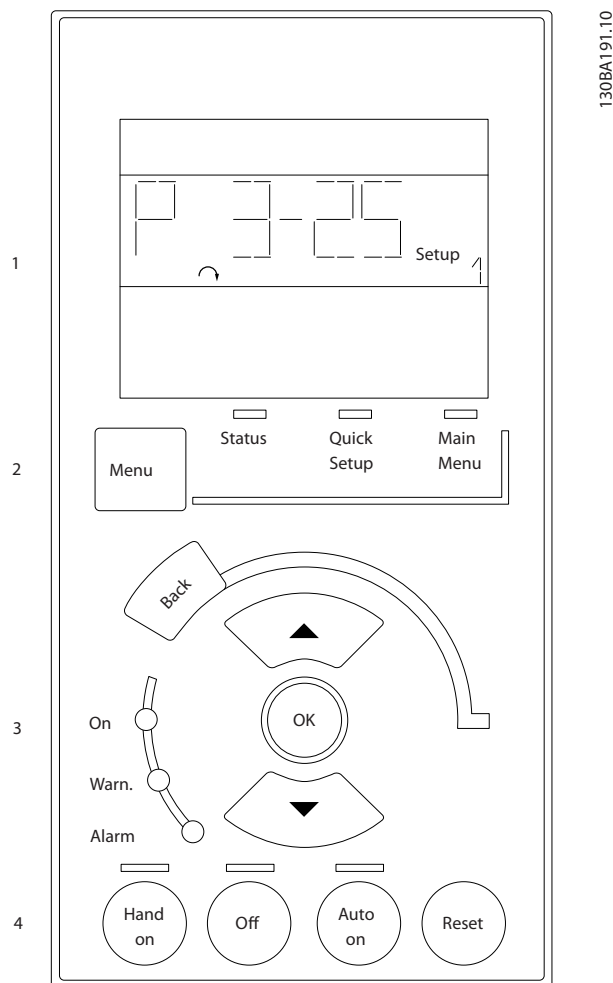

Figure 2.21 LCP Keys

Status mode

Status mode shows the status of the frequency converter or the motor.

If an alarm occurs, the NLCP automatically switches to status mode.

Several alarms can be shown.

NOTICE!

Parameter copy is not possible with LCP 101 numerical local control panel.

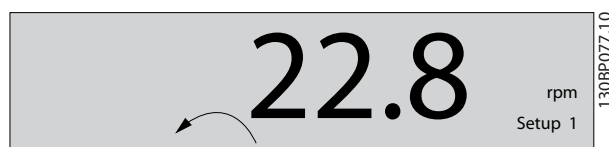

Figure 2.22 Status Mode



Figure 2.23 Alarm

Main Menu/Quick Set-up

Are used for programming all parameters or only the parameters in the Quick Menu (see also description of the LCP 102 in *chapter 2.1 Graphical and Numerical Local Control Panels*).

When the value flashes, press [▲] or [▼] to change parameter values.

1. Press [Main Menu] to select main menu.
2. Select the parameter group [xx-__] and press [OK].
3. Select the parameter [__-xx] and press [OK].
4. If the parameter is an array parameter, select the array number and press [OK].
5. Select the required data value and press [OK].

Parameters with functional options show values such as [1], [2], and so on. For a description of the different options, see the individual parameter descriptions in *chapter 3 Parameter Descriptions*.

[Back]

Used for stepping backwards.

[▲] [▼] are used for maneuvering between commands and within parameters.

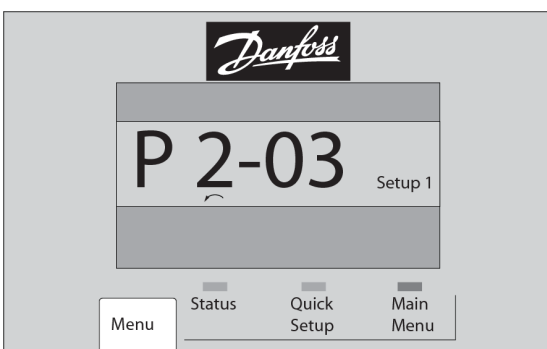

Figure 2.24 Main Menu/Quick Set-up

2.1.17 LCP Keys

Keys for local control are at the bottom of the LCP.

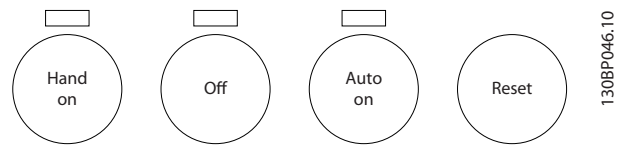

Figure 2.25 LCP Keys

[Hand On]

Enables control of the frequency converter via the LCP. [Hand On] also starts the motor and it is now possible to enter the motor speed data with the navigation keys. The key can be selected as [1] Enable or [0] Disable via *parameter 0-40 [Hand on] Key on LCP*.

External stop signals activated with control signals, or a fieldbus, override a start command via the LCP.

The following control signals are still active when [Hand On] is activated:

- [Hand On] - [Off] - [Auto On].
- Reset.
- Coast stop inverse.
- Reversing.
- Set-up select lsb - Set-up select msb.
- Stop command from serial communication.
- Quick stop.
- DC brake.

[Off]

Stops the connected motor. The key can be selected as [1] Enable or [0] Disable via *parameter 0-41 [Off] Key on LCP*. If no external stop function is selected and the [Off] key is inactive, stop the motor by disconnecting the voltage.

[Auto On]

Enables control of the frequency converter via the control terminals and/or serial communication. When a start signal is applied on the control terminals and/or the bus, the frequency converter starts. The key can be selected as [1] *Enable* or [0] *Disable* via *parameter 0-42 [Auto on] Key on LCP*.

NOTICE!

An active **HAND-OFF-AUTO** signal via the digital inputs has higher priority than the control keys [Hand On] and [Auto On].

[Reset]

Is used for resetting the frequency converter after an alarm (trip). It can be selected as [1] *Enable* or [0] *Disable* via *parameter 0-43 [Reset] Key on LCP*.

2.1.18 Initialization to Default Settings

Initialize the frequency converter to default settings in 2 ways.

Recommended initialization (via *parameter 14-22 Operation Mode*)

1. Select *parameter 14-22 Operation Mode*.
2. Press [OK].
3. Select [2] *initialization*.
4. Press [OK].
5. Disconnect the mains supply and wait until the display turns off.
6. Reconnect the mains supply. The frequency converter is now reset.

Parameter 14-22 Operation Mode initializes all except:

- *Parameter 14-50 RFI Filter*.
- *Parameter 8-30 Protocol*.
- *Parameter 8-31 Address*.
- *Parameter 8-32 FC Port Baud Rate*.
- *Parameter 8-35 Minimum Response Delay*.
- *Parameter 8-36 Max Response Delay*.
- *Parameter 8-37 Max Inter-Char Delay*.
- *Parameter 15-00 Operating hours* to *parameter 15-05 Over Volt's*.
- *Parameter 15-20 Historic Log: Event* to *parameter 15-22 Historic Log: Time*.
- *Parameter 15-30 Fault Log: Error Code* to *parameter 15-32 Alarm Log: Time*.

Manual initialization

1. Disconnect from mains and wait until the display turns off.
2.
 - 2a Press [Status] - [Main Menu] - [OK] at the same time while powering up the LCP 102, graphical display.
 - 2b Press [Menu] - [OK] while powering up the LCP 101, numerical display.
3. Release the keys after 5 s.
4. The frequency converter is now programmed according to default settings.

This procedure initializes all except:

- *Parameter 15-00 Operating hours*.
- *Parameter 15-03 Power Up's*.
- *Parameter 15-04 Over Temp's*.
- *Parameter 15-05 Over Volt's*.

NOTICE!

A manual initialization also resets serial communication, RFI filter settings (*parameter 14-50 RFI Filter*), and fault log settings.

3 Parameter Descriptions

3.1 Parameters: 0-** Operation and Display

Parameters related to the fundamental functions of the frequency converter, function of the LCP keys, and configuration of the LCP display.

0-01 Language		
Option:	Function:	
		Defines display language. The frequency converter is delivered with 4 different language packages. English and German are included in all packages. English cannot be erased or manipulated.
[0] *	English	Part of language packages 1–4
[1]	Deutsch	Part of language packages 1–4
[2]	Francais	Part of language package 1
[3]	Dansk	Part of language package 1
[4]	Spanish	Part of language package 1
[5]	Italiano	Part of language package 1
[6]	Svenska	Part of language package 1
[7]	Nederlands	Part of language package 1
[10]	Chinese	Part of language package 2
[20]	Suomi	Part of language package 1
[22]	English US	Part of language package 4
[27]	Greek	Part of language package 4
[28]	Bras.port	Part of language package 4
[36]	Slovenian	Part of language package 3
[39]	Korean	Part of language package 2
[40]	Japanese	Part of language package 2
[41]	Turkish	Part of language package 4
[42]	Trad.Chinese	Part of language package 2
[43]	Bulgarian	Part of language package 3
[44]	Srpski	Part of language package 3
[45]	Romanian	Part of language package 3
[46]	Magyar	Part of language package 3
[47]	Czech	Part of language package 3
[48]	Polski	Part of language package 4

0-01 Language		
Option:	Function:	
[49]	Russian	Part of language package 3
[50]	Thai	Part of language package 2
[51]	Bahasa Indonesia	Part of language package 2
[52]	Hrvatski	Part of language package 3
[53]	Arabic	

0-02 Motor Speed Unit		
Option:	Function:	
		<p>NOTICE! This parameter cannot be adjusted while the motor is running.</p> <p>The information shown in the display depends on settings in <i>parameter 0-02 Motor Speed Unit</i> and <i>parameter 0-03 Regional Settings</i>. The default settings of <i>parameter 0-02 Motor Speed Unit</i> and <i>parameter 0-03 Regional Settings</i> depend on to which region of the world the frequency converter is supplied.</p> <p>NOTICE! Changing the motor speed unit resets certain parameters to their initial value. Select the motor speed unit before modifying other parameters.</p>
[0]	RPM	Select to show motor speed variables and parameters using motor speed (RPM).
[1] *	Hz	Select to show motor speed variables and parameters using output frequency (Hz).

0-03 Regional Settings		
Option:	Function:	
		<p>NOTICE! This parameter cannot be adjusted while the motor is running.</p>
[0] *	International	Activate <i>parameter 1-20 Motor Power [kW]</i> for setting the motor power in kW and set the default value of <i>parameter 1-23 Motor Frequency</i> to 50 Hz.
[1]	US	Activate <i>parameter 1-20 Motor Power [kW]</i> for setting the motor power in hp and set the

0-03 Regional Settings		
Option:	Function:	
		default value of <i>parameter 1-23 Motor Frequency</i> to 60 Hz.

0-04 Operating State at Power-up (Hand)		
Option:	Function:	
		Select the operating mode upon reconnection of the frequency converter to mains voltage after power down in hand-on mode.
[0]	Resume	Restart the frequency converter, maintaining the start/stop settings (applied by [Hand On/Off]) selected before the power-down of the frequency converter.
[1] *	Forced stop, ref=old	Restart the frequency converter with a saved local reference after mains voltage reappears and after pressing [Hand On].
[2]	Forced stop, ref=0	Reset the local reference to 0 upon restarting the frequency converter.

3.1.1 0-1* Set-up Operations

Define and control the individual parameter set-ups.

The frequency converter has 4 parameter set-ups that can be programmed independently of each other. This makes the frequency converter very flexible and able to solve advanced control functionality problems, often saving the cost of external control equipment. Parameter set-ups can be used to program the frequency converter to operate according to 1 control scheme in 1 set-up (for example motor 1 for horizontal movement) and another control scheme in another set-up (for example motor 2 for vertical movement). Alternatively, parameter set-ups can be used by an OEM machine builder to identically program all their factory-fitted frequency converters for different machine types within a range to have the same parameters. During production/commissioning, simply select a specific set-up depending on which machine the frequency converter is installed on.

The active set-up (that is the set-up in which the frequency converter is currently operating) can be selected in *parameter 0-10 Active Set-up* and is shown in the LCP. By using multi set-up, it is possible to switch between set-ups with the frequency converter running, or it can be stopped via digital input or serial communication commands. If it is necessary to change set-ups while the frequency converter is running, ensure that *parameter 0-12 This Set-up Linked to* is programmed as required. By using *parameter 0-11 Edit Set-up*, it is possible to edit parameters within any of the set-ups while continuing the operation of the frequency converter in its active set-up, which can be a different set-

up to the one being edited. By using *parameter 0-51 Set-up Copy*, it is possible to copy parameter settings between the set-ups to enable quicker commissioning if similar parameter settings are required in different set-ups.

0-10 Active Set-up		
Option:	Function:	
		Select the set-up to control the frequency converter functions.
[0]	Factory setup	Cannot be changed. It contains the Danfoss data set and can be used as a data source when returning the other set-ups to a known state.
[1] *	Set-up 1	[1] Set-up 1 to [4] Set-up 4 are the 4 separate parameter set-ups within which all parameters can be programmed.
[2]	Set-up 2	
[3]	Set-up 3	
[4]	Set-up 4	
[9]	Multi setup	Remote set-up selections using digital inputs and the serial communication port. This set-up uses the settings from <i>parameter 0-12 This Set-up Linked to</i> . Stop the frequency converter before making changes to open and closed-loop functions.

Use *parameter 0-51 Set-up Copy* to copy a set-up to 1 or all other set-ups. Stop the frequency converter before switching between set-ups where parameters marked *not changeable during operation* have different values. To avoid conflicting settings of the same parameter within 2 different set-ups, link the set-ups together using *parameter 0-12 This Set-up Linked to*. Parameters which are *not changeable during operation* are marked FALSE in the parameter lists in *chapter 5 Parameter Lists*.

0-11 Edit Set-up		
Option:	Function:	
		Select the set-up to be edited (that is programmed) during operation; either the active set-up or 1 of the inactive set-ups.
[0]	Factory setup	Cannot be edited but it is useful as a data source to return the other set-ups to a known state.
[1] *	Set-up 1	[1] Set-up 1 to [4] Set-up 4 can be edited freely during operation, independently of the active set-up.
[2]	Set-up 2	
[3]	Set-up 3	
[4]	Set-up 4	

0-11 Edit Set-up		
Option:	Function:	
[9]	Active Set-up	Can also be edited during operation. Edit the selected set-up from a range of sources: LCP, FC RS485, FC USB, or up to 5 fieldbus sites.

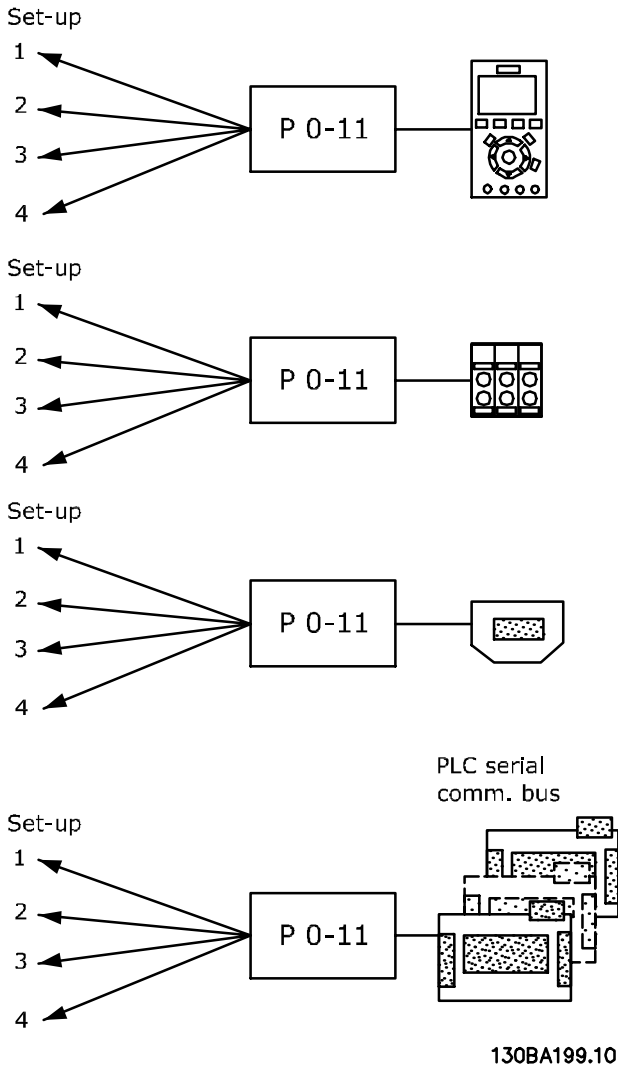

Figure 3.1 Edit Set-up

0-12 This Set-up Linked to		
Option:	Function:	
		To enable conflict-free changes from 1 set-up to another during operation, link set-ups containing parameters which are <i>not changeable during operation</i> . The link ensures synchronizing of the <i>not changeable during operation</i> -parameter values when moving from 1 set-up to another during operation. <i>Not changeable during operation</i> -parameters can be identified

0-12 This Set-up Linked to

Option:	Function:
---------	-----------

by the label FALSE in the parameter lists in *chapter 5 Parameter Lists*.

Parameter 0-12 This Set-up Linked to is used by [9] *Multi set-up* in *parameter 0-10 Active Set-up*. Multi set-up is used to move from 1 set-up to another during operation (that is while the motor runs).

Example:
Use multi set-up to shift from set-up 1 to set-up 2 while the motor runs. Program in set-up 1 first, then ensure that set-up 1 and set-up 2 are synchronized (or linked). Synchronization can be performed in 2 ways:

1. Select the following options:
 - [2] *Set-up 2* in *parameter 0-11 Edit Set-up*.
 - *parameter 0-12 This Set-up Linked to* to [1] *Set-up 1*.

This starts the linking (synchronizing) process.

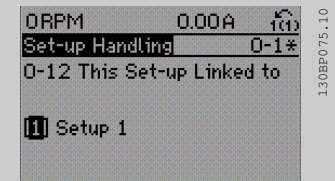

Figure 3.2 Set-up 1

OR

2. While still in set-up 1, copy set-up 1 to set-up 2. Then set *parameter 0-12 This Set-up Linked to* to [2] *Set-up 2*. This starts the linking process.



Figure 3.3 Set-up 2

When completed, *parameter 0-13 Readout: Linked Set-ups* reads {1,2} to indicate that all *not changeable during operation*-parameters are now the same in set-up 1 and set-up 2. If there are changes to a *not changeable during operation*-parameter, for example *parameter 1-30 Stator Resistance (Rs)*, in set-up 2, they are also changed automatically in set-up 1. A switch

0-12 This Set-up Linked to		
Option:	Function:	
		between set-up 1 and set-up 2 during operation is now possible.
[0] *	Not linked	
[1]	Set-up 1	
[2]	Set-up 2	
[3]	Set-up 3	
[4]	Set-up 4	

0-15 Readout: actual setup		
Range:	Function:	
0*	[0 - 255]	Makes it possible to read out the active set-up, also when [9] Multi set-up is selected in parameter 0-10 Active Set-up.

0-13 Readout: Linked Set-ups														
Array [5]														
Range:	Function:													
0*	[0 - 255]	View a list of all the set-ups linked by parameter 0-12 This Set-up Linked to. The parameter has 1 index for each parameter set-up. The value for each index shows which set-ups are linked to that parameter set-up.												
		<table border="1"> <thead> <tr> <th>Index</th> <th>LCP value</th> </tr> </thead> <tbody> <tr> <td>0</td> <td>{0}</td> </tr> <tr> <td>1</td> <td>{1,2}</td> </tr> <tr> <td>2</td> <td>{1,2}</td> </tr> <tr> <td>3</td> <td>{3}</td> </tr> <tr> <td>4</td> <td>{4}</td> </tr> </tbody> </table>	Index	LCP value	0	{0}	1	{1,2}	2	{1,2}	3	{3}	4	{4}
Index	LCP value													
0	{0}													
1	{1,2}													
2	{1,2}													
3	{3}													
4	{4}													
<p>Table 3.1 Set-up Link Example</p>														

0-14 Readout: Edit Set-ups / Channel		
Range:	Function:	
0 N/A*	[-2147483648 - 2147483647 N/A]	<p>View the setting of parameter 0-11 Edit Set-up for each of the 4 different communication channels. When the number is shown as a hex number, as it is in the LCP, each number represents 1 channel.</p> <p>Numbers 1–4 represent a set-up number; F means factory setting; and A means active set-up. The channels are, from right to left: LCP, FC bus, USB, HPFB1-5. Example: The number AAAAAA21h means the following:</p> <ul style="list-style-type: none"> The frequency converter received the setting set-up 2 via a fieldbus channel. This selection is reflected in parameter 0-11 Edit Set-up. A user selected set-up 1 via the LCP. All other channels are using the active set-up.

3.1.2 0-2* LCP Display

Define the variables shown in the LCP.

NOTICE!

For information on how to write display texts, refer to:

- *Parameter 0-37 Display Text 1.*
- *Parameter 0-38 Display Text 2.*
- *Parameter 0-39 Display Text 3.*

0-20 Display Line 1.1 Small		
Option:	Function:	
		Select a variable for display in line 1, left position.
[0]	None	No display value selected.
[9]	Performance Monitor	
[15]	Readout: actual setup	
[37]	Display Text 1	
[38]	Display Text 2	
[39]	Display Text 3	
[953]	Profibus Warning Word	
[1005]	Readout Transmit Error Counter	
[1006]	Readout Receive Error Counter	
[1007]	Readout Bus Off Counter	
[1013]	Warning Parameter	
[1230]	Warning Parameter	
[1472]	Legacy Alarm Word	
[1473]	Legacy Warning Word	
[1474]	Leg. Ext. Status Word	
[1501]	Running Hours	
[1502]	kWh Counter	
[1580]	Fan Running Hours	
[1600]	Control Word	Present control word.
[1601]	Reference [Unit]	Total reference (sum of digital/analog/preset/bus/freeze reference/catch up and slow down) in selected unit.
[1602]	Reference %	Total reference (sum of digital/analog/preset/bus/freeze reference/catch up and slow down) in percent.

0-20 Display Line 1.1 Small		
Option:	Function:	
[1603]	Status Word	Present status word.
[1605]	Main Actual Value [%]	Actual value as a percentage.
[1606]	Actual Position	Actual position in position units selected in <i>parameter 17-70 Position Unit</i> .
[1607]	Target Position	Active target position in position units selected in <i>parameter 17-70 Position Unit</i> .
[1608]	Position Error	Actual position PI error in position units selected in <i>parameter 17-70 Position Unit</i> .
[1609]	Custom Readout	
[1610]	Power [kW]	Actual power consumed by the motor in kW.
[1611]	Power [hp]	Actual power consumed by the motor in hp.
[1612]	Motor Voltage	Voltage supplied to the motor.
[1613]	Frequency	Motor frequency, that is the output frequency from the frequency converter in Hz.
[1614]	Motor current	Phase current of the motor measured as effective value.
[1615]	Frequency [%]	Motor frequency, that is the output frequency from the frequency converter in percent.
[1616]	Torque [Nm]	Actual motor torque in Nm.
[1617]	Speed [RPM] *	Speed in RPM (revolutions per minute), that is the motor shaft speed in closed loop.
[1618]	Motor Thermal	Thermal load on the motor, calculated by the ETR function.
[1619]	KTY sensor temperature	
[1620]	Motor Angle	
[1621]	Torque [%] High Res.	
[1622]	Torque [%]	Present motor load as a percentage of the rated motor torque.
[1623]	Motor Shaft Power [kW]	
[1624]	Calibrated Stator Resistance	
[1625]	Torque [Nm] High	
[1630]	DC Link Voltage	DC-link voltage in the frequency converter.

0-20 Display Line 1.1 Small		
Option:	Function:	
[1632]	Brake Energy /s	Present brake power transferred to an external brake resistor. Stated as an instant value.
[1633]	Brake Energy Average	Brake power transferred to an external brake resistor. The mean power is calculated continuously for the most recent 120 s.
[1634]	Heatsink Temp.	Present heat sink temperature of the frequency converter. The cutout limit is 95 ± 5 °C (203 ± 9 °F); cutting back in occurs at 70 ± 5 °C (203 ± 9 °F).
[1635]	Inverter Thermal	Percentage load of the inverters.
[1636]	Inv. Nom. Current	Nominal current of the frequency converter.
[1637]	Inv. Max. Current	Maximum current of the frequency converter.
[1638]	SL Controller State	State of the event executed by the control.
[1639]	Control Card Temp.	Temperature of the control card.
[1644]	Speed Error [RPM]	
[1645]	Motor Phase U Current	
[1646]	Motor Phase V Current	
[1647]	Motor Phase W Current	
[1648]	Speed Ref. After Ramp [RPM]	
[1650]	External Reference	Sum of the external reference as a percentage, that is the sum of analog/pulse/bus.
[1651]	Pulse Reference	Frequency in Hz connected to the digital inputs (18, 19 or 32, 33).
[1652]	Feedback[Unit]	Reference value from programmed digital inputs.
[1653]	Digi Pot Reference	
[1657]	Feedback [RPM]	
[1660]	Digital Input	Signal states from the 6 digital terminals (18, 19, 27, 29, 32, and 33). There are 16 bits in total, but only 6 of them are used. Input 18 corresponds to the far left of the used bits. Signal low = 0; Signal high = 1.

0-20 Display Line 1.1 Small		
Option:	Function:	
[1661]	Terminal 53 Switch Setting	Setting of input terminal 54. Current = 0; Voltage = 1.
[1662]	Analog Input 53	Actual value at input 53 either as a reference or protection value.
[1663]	Terminal 54 Switch Setting	Setting of input terminal 54. Current = 0; Voltage = 1.
[1664]	Analog Input 54	Actual value at input 54 either as reference or protection value.
[1665]	Analog Output 42 [mA]	Actual value at output 42 in mA. Use <i>parameter 6-50 Terminal 42 Output</i> to select the value to be shown.
[1666]	Digital Output [bin]	Binary value of all digital outputs.
[1667]	Freq. Input #29 [Hz]	Actual value of the frequency applied at terminal 29 as an impulse input.
[1668]	Freq. Input #33 [Hz]	Actual value of the frequency applied at terminal 33 as an impulse input.
[1669]	Pulse Output #27 [Hz]	Actual value of impulses applied to terminal 27 in digital output mode.
[1670]	Pulse Output #29 [Hz]	Actual value of impulses applied to terminal 29 in digital output mode.
[1671]	Relay Output [bin]	
[1672]	Counter A	Application-dependent (for example SLC control).
[1673]	Counter B	Application-dependent (for example SLC control).
[1675]	Analog In X30/11	Actual value at input X30/11 either as reference or protection value.
[1676]	Analog In X30/12	Actual value at input X30/12 either as reference or protection value.
[1677]	Analog Out X30/8 [mA]	Actual value at output X30/8 in mA. Use <i>parameter 6-60 Terminal X30/8 Output</i> to select the value to be shown.
[1678]	Analog Out X45/1 [mA]	
[1679]	Analog Out X45/3 [mA]	
[1680]	Fieldbus CTW 1	Control word (CTW) received from the bus master.
[1682]	Fieldbus REF 1	Main reference value sent with control word from the bus master.

0-20 Display Line 1.1 Small		
Option:	Function:	
[1684]	Comm. Option STW	Extended fieldbus communication option status word.
[1685]	FC Port CTW 1	Control word (CTW) received from the bus master.
[1686]	FC Port REF 1	Status word (STW) sent to the bus master.
[1687]	Bus Readout Alarm/Warning	
[1689]	Configurable Alarm/Warning Word	
[1690]	Alarm Word	1 or more alarms in a hex code.
[1691]	Alarm Word 2	1 or more alarms in a hex code.
[1692]	Warning Word	1 or more warnings in a hex code.
[1693]	Warning Word 2	1 or more warnings in a hex code.
[1694]	Ext. Status Word	1 or more status conditions in a hex code.
[1836]	Analog Input X48/2 [mA]	
[1837]	Temp. Input X48/4	
[1838]	Temp. Input X48/7	
[1839]	Temp. Input X48/10	
[1860]	Digital Input 2	
[3110]	Bypass Status Word	
[3111]	Bypass Running Hours	
[4235]	S-CRC Value	
[4282]	Safe Control Word	
[4283]	Safe Status Word	
[4285]	Active Safe Func.	
[4286]	Safe Option Info	
[9913]	Idle time	
[9914]	Paramdb requests in queue	
[9917]	tCon1 time	
[9918]	tCon2 time	
[9919]	Time Optimize Measure	
[9920]	HS Temp. (PC1)	
[9921]	HS Temp. (PC2)	
[9922]	HS Temp. (PC3)	
[9923]	HS Temp. (PC4)	
[9924]	HS Temp. (PC5)	
[9925]	HS Temp. (PC6)	
[9926]	HS Temp. (PC7)	
[9927]	HS Temp. (PC8)	
[9951]	PC Debug 0	

0-20 Display Line 1.1 Small		
Option:	Function:	
[9952]	PC Debug 1	
[9953]	PC Debug 2	
[9954]	PC Debug 3	
[9955]	PC Debug 4	
[9956]	Fan 1 Feedback	
[9957]	Fan 2 Feedback	
[9958]	PC Auxiliary Temp	
[9959]	Power Card Temp.	

0-21 Display Line 1.2 Small

Select a variable for display in line 1, middle position. The options are the same as those listed for *parameter 0-20 Display Line 1.1 Small*.

0-22 Display Line 1.3 Small

Select a variable for display in line 1, right position. The options are the same as those listed for *parameter 0-20 Display Line 1.1 Small*.

0-23 Display Line 2 Large

Select a variable for display in line 2. The options are the same as listed for *parameter 0-20 Display Line 1.1 Small*.

0-24 Display Line 3 Large

Select a variable for display in line 3.

0-25 My Personal Menu

Range:	Function:	
0	[0 -	Define up to 50 parameters to appear in the <i>Q1 Personal Menu</i> , accessible via the [Quick Menu] key on the LCP. The parameters are shown in the <i>Q1 Personal Menu</i> in the order they are programmed into this array parameter. Delete parameters by setting the value to 0000. For example, this can be used to provide quick, simple access to just 1 or up to 50 parameters, which require changing on a regular basis (for example, for plant maintenance reasons) or by an OEM to enable simple commissioning of their equipment.
N/A	9999	
*	N/A]	

3.1.3 0-3* LCP Custom Readout

It is possible to customize the display elements for various purposes:

- Custom readout. Value proportional to speed (linear, squared, or cubed depending on unit selected in *parameter 0-30 Custom Readout Unit*).
- Display text. Text string stored in a parameter.

Custom readout

The calculated value to be shown is based on the settings in:

- Parameter 0-30 Custom Readout Unit.
- Parameter 0-31 Custom Readout Min Value (linear only).
- Parameter 0-32 Custom Readout Max Value.
- Parameter 4-13 Motor Speed High Limit [RPM].
- Parameter 4-14 Motor Speed High Limit [Hz].
- Actual speed.

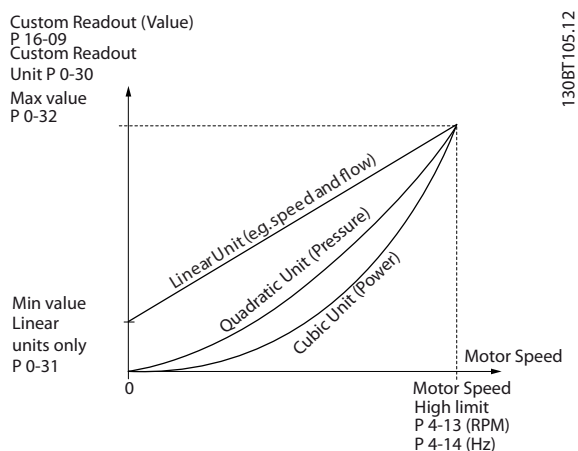

Figure 3.4 Custom Readout

The relation depends on the type of unit selected in parameter 0-30 Custom Readout Unit:

Unit type	Speed relation
Dimensionless	Linear
Speed	
Flow, volume	
Flow, mass	
Velocity	
Length	
Temperature	Quadratic
Pressure	
Power	Cubic

Table 3.2 Speed Relations for Different Unit Types

0-30 Unit for User-defined Readout	
Option:	Function:
	It is possible to program a value to be shown in the display of the LCP. The value has a linear, squared, or cubed relation to speed. This relation depends on the unit selected (see Table 3.2). The actual calculated

0-30 Unit for User-defined Readout	
Option:	Function:
	value can be read in parameter 16-09 Custom Readout, and/or shown in the display by selecting [16-09] Custom Readout in parameter 0-20 Display Line 1.1 Small to parameter 0-24 Display Line 3 Large.
[0] *	None
[1]	%
[5]	PPM
[10]	min
[11]	RPM
[12]	PULSE/s
[20]	liter / sec.
[21]	liter / min
[22]	liter / hr.
[23]	m ³ / sec.
[24]	m ³ /min
[25]	m ³ / hr.
[30]	kg / sec.
[31]	kg/min
[32]	kg / hr.
[33]	ton / min
[34]	ton / hr.
[40]	m / sec.
[41]	m/min
[45]	m
[60]	°C
[70]	mbar
[71]	bar
[72]	Pa
[73]	kPa
[74]	m WG
[80]	kW
[120]	GPM
[121]	gal / sec.
[122]	gal/min
[123]	gal / hr.
[124]	CFM
[125]	ft ³ /s
[126]	ft ³ /min
[127]	ft ³ /h
[130]	lbs / sec.
[131]	lbs / min.
[132]	lbs / hr.
[140]	ft/s
[141]	ft/min
[145]	ft
[160]	°F
[170]	psi
[171]	lb/in ²

0-30 Unit for User-defined Readout		
Option:	Function:	
[172]	in. wtr. gage	
[173]	ft WG	
[180]	HP	

0-31 Min Value of User-defined Readout		
Range:	Function:	
0.00 Custom-ReadoutUnit*	[-999999.99 - par. 0-32 CustomReadoutUnit]	This parameter sets the minimum value of the custom-defined readout (occurs at 0 speed). Only possible to set different from 0 when selecting a linear unit in <i>parameter 0-30 Unit for User-defined Readout</i> . For quadratic and cubic units, the minimum value is 0.

0-32 Custom Readout Max Value		
Range:	Function:	
100 Custom-ReadoutUnit*	[par. 0-31 - 999999.99 CustomReadoutUnit]	This parameter sets the maximum value to be shown when the speed of the motor has reached the set value for <i>parameter 4-13 Motor Speed High Limit [RPM]</i> or <i>parameter 4-14 Motor Speed High Limit [Hz]</i> (depends on setting in <i>parameter 0-02 Motor Speed Unit</i>).

0-33 Source for User-defined Readout		
Option:	Function:	
		Enter the source of the user-defined readout.
[105]	Torq relate to rated	
[240] *	Default Source	

0-37 Display Text 1		
Range:	Function:	
0*	[0 - 25]	Enter a text which can be viewed in the graphical display by selecting [37] <i>Display Text 1</i> in <ul style="list-style-type: none"> Parameter 0-20 <i>Display Line 1.1 Small</i>, Parameter 0-21 <i>Display Line 1.2 Small</i>, Parameter 0-22 <i>Display Line 1.3 Small</i>, Parameter 0-23 <i>Display Line 2 Large</i>, or Parameter 0-24 <i>Display Line 3 Large</i>.

0-38 Display Text 2		
Range:	Function:	
0*	[0 - 25]	Enter a text which can be viewed in the graphical display by selecting [38] <i>Display Text 2</i> in <ul style="list-style-type: none"> Parameter 0-20 <i>Display Line 1.1 Small</i>, Parameter 0-21 <i>Display Line 1.2 Small</i>, Parameter 0-22 <i>Display Line 1.3 Small</i>, Parameter 0-23 <i>Display Line 2 Large</i>, or Parameter 0-24 <i>Display Line 3 Large</i>.

0-39 Display Text 3		
Range:	Function:	
0*	[0 - 25]	Enter a text which can be viewed in the graphical display by selecting [39] <i>Display Text 3</i> in <ul style="list-style-type: none"> Parameter 0-20 <i>Display Line 1.1 Small</i>, Parameter 0-21 <i>Display Line 1.2 Small</i>, Parameter 0-22 <i>Display Line 1.3 Small</i>, Parameter 0-23 <i>Display Line 2 Large</i>, or Parameter 0-24 <i>Display Line 3 Large</i>.

3.1.4 0-4* LCP Keypad

Enable, disable, and password protect individual keys on the LCP.

0-40 [Hand on] Key on LCP		
Option:	Function:	
[0]	Disabled	No effect when [Hand On] is pressed. Select [0] <i>Disabled</i> to avoid accidental start of the frequency converter in hand-on mode.
[1] *	Enabled	The LCP switches to hand-on mode directly when [Hand On] is pressed.
[2]	Password	After pressing [Hand On] a password is required. If <i>parameter 0-40 [Hand on] Key on LCP</i> is included in <i>My Personal Menu</i> , define the password in <i>parameter 0-65 Quick Menu Password</i> . Otherwise define the password in <i>parameter 0-60 Main Menu Password</i> .

0-41 [Off] Key on LCP		
Option:	Function:	
[0]	Disabled	Avoids accidental stop of the frequency converter.
[1] *	Enabled	
[2]	Password	Avoids unauthorized stop. If <i>parameter 0-41 [Off] Key on LCP</i> is included in the <i>Quick Menu</i> , then define the password in <i>parameter 0-65 Quick Menu Password</i> .

0-42 [Auto on] Key on LCP		
Option:	Function:	
[0]	Disabled	Avoids accidental start of the frequency converter in auto-on mode.
[1] *	Enabled	
[2]	Password	Avoids unauthorized start in auto-on mode. If <i>parameter 0-42 [Auto on] Key on LCP</i> is included in the <i>Quick Menu</i> , then define the password in <i>parameter 0-65 Quick Menu Password</i> .

0-43 [Reset] Key on LCP		
Option:	Function:	
[0]	Disabled	No effect when [Reset] is pressed. Avoids accidental alarm reset.
[1] *	Enabled	
[2]	Password	Avoids unauthorized resetting. If <i>parameter 0-43 [Reset] Key on LCP</i> is included in the <i>Quick Menu</i> , then define the password in <i>parameter 0-65 Quick Menu Password</i> .

0-44 [Off/Reset] Key on LCP		
Enable or disable the [Off/Reset] key.		
Option:	Function:	
[0]	Disabled	
[1] *	Enabled	
[2]	Password	

0-45 [Drive Bypass] Key on LCP		
Press [Off] and select [0] <i>Disabled</i> to avoid unintended stop of the frequency converter. Press [Off] and select [2] <i>Password</i> to avoid unauthorized bypass of the frequency converter. If <i>parameter 0-45 [Drive Bypass] Key on LCP</i> is included in the <i>Quick Menu</i> , define the password in <i>parameter 0-65 Personal Menu Password</i> .		
Option:	Function:	
[0]	Disabled	Select to disable the key.
[1] *	Enabled	
[2]	Password	

3.1.5 0-5* Copy/Save

Copy parameters from and to the LCP. Use these parameters for saving and copying set-ups from 1 frequency converter to another.

0-50 LCP Copy		
Option:	Function:	
		NOTICE! This parameter cannot be adjusted while the motor is running.
[0] *	No copy	
[1]	All to LCP	Copies all parameters in all set-ups from the frequency converter memory to the LCP memory.
[2]	All from LCP	Copies all parameters in all set-ups from the LCP memory to the frequency converter memory.
[3]	Size indep. of LCP	Copy only the parameters that are independent of the motor size. The latter selection can be used to program several frequency converters with the same function without disturbing motor data.
[4]	File from MCO to LCP	
[5]	File from LCP to MCO	

0-51 Set-up Copy		
Option:	Function:	
[0] *	No copy	No function.
[1]	Copy to set-up 1	Copies all parameters in the present programming set-up (defined in <i>parameter 0-11 Programming Set-up</i>) to set-up 1.
[2]	Copy to set-up 2	Copies all parameters in the present programming set-up (defined in <i>parameter 0-11 Programming Set-up</i>) to set-up 2.
[3]	Copy to set-up 3	Copies all parameters in the present programming set-up (defined in <i>parameter 0-11 Programming Set-up</i>) to set-up 3.
[4]	Copy to set-up 4	Copies all parameters in the present programming set-up (defined in <i>parameter 0-11 Programming Set-up</i>) to set-up 4.
[9]	Copy to all	Copies the parameters in the present set-up to each of the set-ups 1 to 4.

3.1.6 0-6* Password

0-60 Main Menu Password		
Range:	Function:	
100* [-9999 - 9999]	Define the password for access to the Main Menu via the [Main Menu] key. If <i>parameter 0-61 Access to Main Menu w/o Password</i> is set to [0] Full access, this parameter is ignored.	

0-61 Access to Main Menu w/o Password		
Option:	Function:	
[0] *	Full access	Disables password defined in <i>parameter 0-60 Main Menu Password</i> .
[1]	Read-only	Prevent unauthorized editing of <i>Main Menu</i> parameters.
[2]	No access	Prevent unauthorized viewing and editing of <i>Main Menu</i> parameters.
[3]		Read-only functions for parameters on fieldbus and/or FC standard bus.
[4]		No access to parameters is allowed via fieldbus and/or FC standard bus.
[5]		Read-only function for parameters on LCP, fieldbus, or FC standard bus.
[6]		No access from LCP, fieldbus, or FC standard bus is allowed.

If [0] Full access is selected, *parameter 0-60 Main Menu Password*, *parameter 0-65 Personal Menu Password*, and *parameter 0-66 Access to Personal Menu w/o Password* are ignored.

NOTICE!

A more complex password protection is available for OEMs upon request.

0-65 Quick Menu Password		
Range:	Function:	
200 N/A*	[-9999 - 9999 N/A]	Define the password for access to the Quick Menu via the [Quick Menu] key. If <i>parameter 0-66 Access to Quick Menu w/o Password</i> is set to [0] Full access, this parameter is ignored.

0-66 Access to Quick Menu w/o Password		
If <i>parameter 0-61 Access to Main Menu w/o Password</i> is set to [0] Full access, then this parameter is ignored.		
Option:	Function:	
[0] *	Full access	Disables the password defined in <i>parameter 0-65 Quick Menu Password</i> .

0-66 Access to Quick Menu w/o Password		
If <i>parameter 0-61 Access to Main Menu w/o Password</i> is set to [0] Full access, then this parameter is ignored.		
Option:	Function:	
[1]	Read-only	Prevents unauthorized editing of <i>Quick Menu</i> parameters.
[2]	No access	
[3]		Read-only functions for <i>Quick Menu</i> parameters on fieldbus and/or FC standard bus.
[4]		
[5]		Read-only function for <i>Quick Menu</i> parameters on LCP, fieldbus, or frequency converter standard bus.
[6]		

0-67 Bus Password Access		
Range:	Function:	
0 N/A*	[0 - 9999 N/A]	Use this parameter to unlock the frequency converter via fieldbus or MCT 10 Set-up Software.

0-68 Safety Parameters Password		
Range:	Function:	
300*	[0 - 9999]	Enter the password for the safety parameters access. If <i>parameter 0-69 Password Protection of Safety Parameters</i> is set to [0] Disabled, this parameter is ignored.

0-69 Password Protection of Safety Parameters		
Option:	Function:	
[0] *	Disabled	
[1]	Enabled	

0-70 Date and Time		
Range:	Function:	
Size related*	[0 - 0]	Sets the date and time of the internal clock. The format to be used is set in <i>parameter 0-71 Date Format</i> and <i>parameter 0-72 Time Format</i> .

0-73 Time Zone Offset		
Range:	Function:	
0 min*	[-780 - 780 min]	Enter the time zone offset relative to UTC. This parameter is required for the automatic daylight saving time adjustment.

0-74 DST/Summertime		
Option:	Function:	
		Select how to handle daylight saving time/summertime. For manual setting of DST/summertime, enter the start date and end date in <i>parameter 0-76 DST/Summertime Start</i> and <i>parameter 0-77 DST/Summertime End</i> .
[0] *	Off	
[2]	Manual	

0-76 DST/Summertime Start		
Range:	Function:	
Size related*	[0 - 0]	Sets the date and time when DST/summertime starts. The date is programmed in the format selected in <i>parameter 0-71 Date Format</i> .

0-77 DST/Summertime End		
Range:	Function:	
Size related*	[0 - 0]	Sets the date and time when DST/summertime ends. The date is programmed in the format selected in <i>parameter 0-71 Date Format</i> .

0-79 Clock Fault		
Option:	Function:	
		Enables or disables the clock warning when the clock has not been set, or has been reset due to a power-down and no back-up is installed. If VLT® Analog I/O Option MCB 109 is installed, [1] Enabled is default.
[0]	Disabled	
[1]	Enabled	

0-81 Working Days		
Array [7] Array with 7 elements [0]–[6] shown below the parameter number in the display. Press [OK] and step between elements with [▲] and [▼].		
Option:	Function:	
		Set for each weekday if it is a working day or a non-working day. First element of the array is Monday. The working days are used for timed actions.
[0]	No	
[1]	Yes	

0-82 Additional Working Days		
Array [5] Array with 5 elements [0]–[4] shown below the parameter number in the display. Press [OK] and step between elements with [▲] and [▼].		
Range:	Function:	
Size related*	[0 - 0]	Defines dates for additional working days that would normally be non-working days according to <i>parameter 0-81 Working Days</i> .

0-83 Additional Non-Working Days		
Array [15] Array with 15 elements [0]–[14] shown below the parameter number in the display. Press [OK] and step between elements with [▲] and [▼].		
Range:	Function:	
Size related*	[0 - 0]	Defines dates for additional working days that would normally be non-working days according to <i>parameter 0-81 Working Days</i> .

0-84 Time for Fieldbus		
Range:	Function:	
0*	[0 - 4294967295]	Shows the time for fieldbus.

0-85 Summer Time Start for Fieldbus		
Range:	Function:	
0*	[0 - 4294967295]	Shows the summer time start for fieldbus.

0-86 Summer Time End for Fieldbus		
Range:	Function:	
0*	[0 - 4294967295]	Shows the summer time end for fieldbus.

0-89 Date and Time Readout		
Range:	Function:	
0*	[0 - 25]	Shows the current date and time. The date and time is updated continuously. The clock does not begin counting until a setting different from default has been made in <i>parameter 0-70 Date and Time</i> .

3.2 Parameters: 1-0** Load and Motor

3.2.1 1-0* General Settings

Define whether the frequency converter operates in speed mode or torque mode, and whether the internal PID control should be active or not.

1-00 Configuration Mode		
Option:	Function:	
		Select the application control principle to be used when a remote reference (that is via analog input or fieldbus) is active. A remote reference can only be active when <i>parameter 3-13 Reference Site</i> is set to [0] <i>Linked to Hand/Auto</i> or [1] <i>Remote</i> .
[0]	Speed open loop	Enables speed control (without feedback signal from motor) with automatic slip compensation for almost constant speed at varying loads. Compensations are active, but can be disabled in <i>parameter group 1-0* Load/Motor</i> . Set the speed control parameters in <i>parameter group 7-0* Speed PID Ctrl.</i>
[1]	Speed closed loop	Enables speed closed-loop control with feedback. Obtain full holding torque at 0 RPM. For increased speed accuracy, provide a feedback signal and set the speed PID control. Set the speed control parameters in <i>parameter group 7-0* Speed PID Ctrl.</i>
[2]	Torque	Enables torque closed-loop control with feedback. Only possible with <i>Flux with motor feedback</i> option, <i>parameter 1-01 Motor Control Principle</i> . NOTICE! This is valid for FC 302 only.
[3]	Process	Enables the use of process control in the frequency converter. Set the process control parameters in <i>parameter groups 7-2* Process Ctrl. Feedb.</i> and <i>7-3* Process PID Ctrl.</i>
[4]	Torque open loop	Enables the use of torque open loop in VVC+ mode (<i>parameter 1-01 Motor Control Principle</i>). Set the torque PID parameters in <i>parameter group 7-1* Torque PI Control</i> .
[5]	Wobble	Enables the wobble functionality in <i>parameter 30-00 Wobble Mode</i> to <i>parameter 30-19 Wobble Delta Freq. Scaled</i> .

1-00 Configuration Mode		
Option:	Function:	
[6]	Surface Winder	Enables the surface winder control specific parameters in <i>parameter groups 7-2* Process Ctrl. Feedb.</i> and <i>7-3* Process PID Ctrl.</i>
[7]	Extended PID Speed OL	Specific parameters in <i>parameter groups 7-2* Process Ctrl. Feedb.</i> to <i>7-5* Ext. Process PID Ctrl.</i>
[8]	Extended PID Speed CL	Specific parameters in <i>parameter groups 7-2* Process Ctrl. Feedb.</i> to <i>7-5* Ext. Process PID Ctrl.</i>
[9]	Positioning	NOTICE! This option is available only with software version 48.XX. Activates the positioning mode.
[10]	Synchronization	NOTICE! This option is available only with software version 48.XX. Activates the synchronization mode.

1-01 Motor Control Principle		
Option:	Function:	
		<p>NOTICE!</p> <p>This parameter cannot be adjusted while the motor is running.</p> <p>Select which motor control principle to employ.</p>
[0] *	U/f	Special motor mode, for parallel connected motors in special motor applications. When U/f is selected, the characteristic of the control principle can be edited in <i>parameter 1-55 U/f Characteristic - U</i> and <i>parameter 1-56 U/f Characteristic - F</i> .
[1]	VVC+	Voltage vector control principle is suitable for most applications. The main benefit of VVC ⁺ operation is that it uses a robust motor model.
[2]	Flux sensorless	Flux vector control without encoder feedback, for simple installation and robustness against sudden load changes. <p>NOTICE!</p> <p>This is valid for FC 302 only.</p>
[3]	Flux w/ motor feedb	High accuracy speed and torque control, suitable for the most demanding applications. <p>NOTICE!</p> <p>This is valid for FC 302 only.</p>

The best shaft performance is normally achieved using either of the 2 flux vector control modes [2] *Flux sensorless* and [3] *Flux with encoder feedback*.

1-02 Flux Motor Feedback Source		
Option:	Function:	
		<p>NOTICE!</p> <p>This parameter cannot be adjusted while the motor is running.</p> <p>Select the interface for which to receive feedback from the motor.</p>
[0]	Motor feedb. P1-02	
[1] *	24V encoder	A and B channel encoder, which can be connected to the digital input terminals 32/33 only. Program Terminals 32/33 to <i>No operation</i> .

1-02 Flux Motor Feedback Source		
Option:	Function:	
[2]	MCB 102	Encoder module option, which can be configured in <i>parameter group 17-1* Inc. Enc. Interface</i> . <p>NOTICE!</p> <p>This is valid for FC 302 only.</p>
[3]	MCB 103	Optional resolver interface module, which can be configured in <i>parameter group 17-5* Resolver Interface</i> .
[5]	MCO Encoder 2	Encoder interface 2 of the optional VLT® Motion Control MCO 305.
[6]		
[7]		
[8]		
[9]		

1-03 Torque Characteristics		
Option:	Function:	
		<p>NOTICE!</p> <p>This parameter cannot be adjusted while the motor is running.</p> <p>Select the torque characteristic required. VT and AEO are both energy-saving operations.</p>
[0] *	Constant torque	Motor shaft output provides constant torque under variable speed control.
[1]	Variable torque	Motor shaft output provides variable torque under variable speed control. Set the variable torque level in <i>parameter 14-40 VT Level</i> .
[2]	Auto Energy Optim.	Automatically optimizes energy consumption by minimizing magnetization and frequency via <i>parameter 14-41 AEO Minimum Magnetization</i> and <i>parameter 14-42 Minimum AEO Frequency</i> .

1-04 Overload Mode		
Option:	Function:	
		<p>NOTICE!</p> <p>This parameter cannot be adjusted while the motor is running.</p> <p>Use this parameter to configure the frequency converter for either high or normal overload. When selecting the frequency converter size, always review the technical data in the</p>

1-04 Overload Mode		
Option:	Function:	
		<i>operating guide</i> or the <i>design guide</i> to know the available output current.
[0] *	High torque	Allows up to 160% over torque.
[1]	Normal torque	For oversized motor - allows up to 110% over torque.

1-05 Local Mode Configuration		
Option:	Function:	
		Select which application configuration mode (<i>parameter 1-00 Configuration Mode</i>), that is application control principle, to use when a local (LCP) reference is active. A local reference can be active only when <i>parameter 3-13 Reference Site</i> is set to [0] <i>Linked to Hand/Auto</i> or [2] <i>Local</i> . By default the local reference is active in hand-on mode only.
[0]	Speed open-loop	
[1]	Speed closed-loop	
[2] *	As mode par 1-00	

1-06 Clockwise Direction		
Option:	Function:	
		<p>NOTICE! This parameter cannot be adjusted while the motor is running.</p> <p>This parameter defines the term clockwise corresponding to the LCP direction arrow. Used for easy change of direction of shaft rotation without swapping motor wires.</p>
[0] *	Normal	The motor shaft turns in clockwise direction when the frequency converter is connected U⇒U, V⇒V, and W⇒W to the motor.
[1]	Inverse	Motor shaft turns in counterclockwise direction when the frequency converter is connected U⇒U, V⇒V, and W⇒W to the motor.

1-07 Motor Angle Offset Adjust		
Range:	Function:	
		<p>NOTICE! This parameter is only valid for FC 302 and only in combination with a PM motor with feedback.</p>

1-07 Motor Angle Offset Adjust		
Range:	Function:	
0*	[Manual]	The functionality of this option depends on the type of the feedback device. This option sets the frequency converter to use the motor angle offset entered in <i>parameter 1-41 Motor Angle Offset</i> , if an absolute feedback device is used. If an incremental feedback device is selected, the frequency converter automatically adjusts the motor angle offset on the first start after power-up, or when the motor data is changed.
[1]	Auto	The frequency converter adjusts the motor angle offset automatically on the first start after power-up, or when the motor data is changed no matter what feedback device is selected. This means that options <i>Manual</i> and <i>Auto</i> are identical for the incremental encoder.
[2]	Auto Every Start	The frequency converter adjusts the motor angle offset automatically on every start, or when the motor data is changed.
[3]	Off	Selecting this option turns the automatic offset adjustment off.
[4]	Once with Store	This option updates <i>parameter 1-41 Motor Angle Offset</i> automatically when the angle value is 0. This option is valid only for absolute feedback devices. The function uses rotor detection and then applies DC hold to make the offset adjustment more accurate.

3.2.2 1-1* Special Settings

NOTICE!

The parameters within this parameter group cannot be adjusted while the motor is running.

3.2.3 Asynchronous Motor Set-up

Enter the following motor data. Find the information on the motor nameplate.

1. *Parameter 1-20 Motor Power [kW]* or *parameter 1-21 Motor Power [HP]*.
2. *Parameter 1-22 Motor Voltage*.
3. *Parameter 1-23 Motor Frequency*.
4. *Parameter 1-24 Motor Current*.
5. *Parameter 1-25 Motor Nominal Speed*.

When running in flux control principle, or for optimum performance in VVC⁺ mode, extra motor data is required to set up the following parameters. Find the data in the motor datasheet (this data is typically not available on the motor nameplate). Run a complete automatic motor adaptation (AMA) using *parameter 1-29 Automatic Motor Adaptation (AMA) [1] Enable Complete AMA* or enter the parameters manually. *Parameter 1-36 Iron Loss Resistance (Rfe)* is always entered manually.

1. *Parameter 1-30 Stator Resistance (Rs).*
2. *Parameter 1-31 Rotor Resistance (Rr).*
3. *Parameter 1-33 Stator Leakage Reactance (X1).*
4. *Parameter 1-34 Rotor Leakage Reactance (X2).*
5. *Parameter 1-35 Main Reactance (Xh).*
6. *Parameter 1-36 Iron Loss Resistance (Rfe).*

Application-specific adjustment when running VVC⁺

VVC⁺ is the most robust control mode. In most situations, it provides optimum performance without further adjustments. Run a complete AMA for best performance.

Application-specific adjustment when running flux

Flux control principle is the preferred control principle for optimum shaft performance in dynamic applications. Perform an AMA since this control mode requires precise motor data. Depending on the application, further adjustments may be required.

See *Table 3.3* for application-related recommendations.

Application	Settings
Low-inertia applications	Keep calculated values.
High-inertia applications	<i>Parameter 1-66 Min. Current at Low Speed.</i> Increase current to a value between default and maximum depending on the application. Set ramp times matching the application. Too fast ramp up causes an overcurrent or overtorque. Too fast ramp down causes an overvoltage trip.
High load at low speed	<i>Parameter 1-66 Min. Current at Low Speed.</i> Increase current to a value between default and maximum depending on the application.
No-load application	Adjust <i>parameter 1-18 Min. Current at No Load</i> to achieve smoother motor operation by reducing torque ripple and vibration.

Application	Settings
Flux sensorless control principle only	Adjust <i>parameter 1-53 Model Shift Frequency</i> . Example 1: If the motor oscillates at 5 Hz, and dynamics performance is required at 15 Hz, set <i>parameter 1-53 Model Shift Frequency</i> to 10 Hz. Example 2: If the application involves dynamic load changes at low speed, reduce <i>parameter 1-53 Model Shift Frequency</i> . Observe the motor behavior to make sure that the model shift frequency is not reduced too much. Symptoms of inappropriate model shift frequency are motor oscillations or frequency converter tripping.

Table 3.3 Recommendations for Flux Applications

3.2.4 PM Motor Set-up

NOTICE!

Valid for FC 302 only.

This section describes how to set up a PM motor.

Initial programming steps

To activate PM motor operation, select *[1] PM, non-salient SPM* in *parameter 1-10 Motor Construction*.

Programming motor data

After selecting a PM motor, the PM motor-related parameters in *parameter groups 1-2* Motor Data, 1-3* Adv. Motor Data, and 1-4* Adv. Motor Data II* are active. The necessary data is on the motor nameplate and on the motor datasheet.

Program the following parameters in the order listed:

1. *Parameter 1-24 Motor Current.*
2. *Parameter 1-25 Motor Nominal Speed.*
3. *Parameter 1-26 Motor Cont. Rated Torque.*
4. *Parameter 1-39 Motor Poles.*

Run a complete AMA using *parameter 1-29 Automatic Motor Adaptation (AMA) [1] Enable Complete AMA*.

If a complete AMA is not performed, configure the following parameters manually:

1. *Parameter 1-30 Stator Resistance (Rs)*
Enter the line-to-common stator winding resistance (Rs). If only line-line data is available,

divide the line-line value by 2 to get the line-common value.

2. **Parameter 1-37 d-axis Inductance (Ld)**
Enter the line-to-common direct axis inductance of the PM motor.
If only line-line data is available, divide the line-line value by 2 to get the line-common value.
3. **Parameter 1-40 Back EMF at 1000 RPM.**
Enter the line-to-line back EMF of the PM Motor at 1000 RPM (RMS value). Back EMF is the voltage generated by a PM motor when no frequency converter is connected and the shaft is turned externally. It is normally specified for nominal motor speed or for 1000 RPM measured between 2 lines. If the value is not available for a motor speed of 1000 RPM, calculate the correct value as follows:
If back EMF is, for example, 320 V at 1800 RPM, it can be calculated at 1000 RPM as follows:
Back EMF = (Voltage/RPM)x1000 =
(320/1800)x1000 = 178.

Test motor operation

1. Start the motor at low speed (100–200 RPM). If the motor does not turn, check the installation, general programming, and motor data.
2. Check if the start function in *parameter 1-70 Start Mode* fits the application requirements.

Rotor detection

This function is the recommended selection for applications where the motor starts from standstill, for example pumps or conveyors. On some motors, a sound is heard when the frequency converter performs the rotor detection. This does not harm the motor.

Parking

This function is the recommended selection for applications where the motor is rotating at slow speed, for example windmilling in fan applications.
Parameter 2-06 Parking Current and *parameter 2-07 Parking Time* can be adjusted. Increase the factory setting of these parameters for applications with high inertia.

Application-specific adjustment when running VVC+

VVC+ is the most robust control mode. In most situations, it provides optimum performance without further adjustments. Run a complete AMA for best performance.
Start the motor at nominal speed. If the application does not run well, check the VVC+ PM settings. *Table 3.4* contains recommendations for various applications.

Application	Settings
Low-inertia applications $I_{Load}/I_{Motor} < 5$	Increase <i>parameter 1-17 Voltage filter time const.</i> by factor 5–10. Reduce <i>parameter 1-14 Damping Gain</i> . Reduce <i>parameter 1-66 Min. Current at Low Speed (<100%)</i> .
Low-inertia applications $50 > I_{Load}/I_{Motor} > 5$	Keep the default values.
High-inertia applications $I_{Load}/I_{Motor} > 50$	Increase <i>parameter 1-14 Damping Gain</i> , <i>parameter 1-15 Low Speed Filter Time Const.</i> , and <i>parameter 1-16 High Speed Filter Time Const.</i>
High load at low speed <30% (rated speed)	Increase <i>parameter 1-17 Voltage filter time const.</i> Increase <i>parameter 1-66 Min. Current at Low Speed</i> to adjust the starting torque. 100% current provides nominal torque as starting torque. This parameter is independent of <i>parameter 30-20 High Starting Torque Time [s]</i> and <i>parameter 30-21 High Starting Torque Current [%]</i> . Working at a current level higher than 100% for a prolonged time can cause the motor to overheat.

Table 3.4 Recommendations for Various Applications

If the motor starts oscillating at a certain speed, increase *parameter 1-14 Damping Gain*. Increase the value in small steps. Depending on the motor, this parameter can be set to 10–100% higher than the default value.

Application-specific adjustment when running flux

Flux control principle is the preferred control principle for optimum shaft performance in dynamic applications. Perform an AMA because this control mode requires precise motor data. Depending on the application, further adjustments may be required.
See *chapter 3.2.3 Asynchronous Motor Set-up* for application-specific recommendations.

3.2.5 SynRM Motor Set-up with VVC+

This section describes how to set up a SynRM motor with VVC+.

NOTICE!

The SmartStart wizard covers the basic configuration of SynRM motors.

Initial programming steps

To activate SynRM motor operation, select [5] *SynC. Reluctance* in *parameter 1-10 Motor Construction*.

Programming motor data

After performing the initial programming steps, the SynRM motor-related parameters in *parameter groups 1-2* Motor Data*, *1-3* Adv. Motor Data*, and *1-4* Adv. Motor Data II* are active.

Use the motor nameplate data and the motor datasheet to program the following parameters in the order listed:

1. *Parameter 1-23 Motor Frequency.*
2. *Parameter 1-24 Motor Current.*
3. *Parameter 1-25 Motor Nominal Speed.*
4. *Parameter 1-26 Motor Cont. Rated Torque.*

Run a complete AMA using *parameter 1-29 Automatic Motor Adaptation (AMA) [1] Enable Complete AMA* or enter the following parameters manually:

1. *Parameter 1-30 Stator Resistance (Rs).*
2. *Parameter 1-37 d-axis Inductance (Ld).*
3. *Parameter 1-44 d-axis Inductance Sat. (LdSat).*
4. *Parameter 1-45 q-axis Inductance Sat. (LqSat).*
5. *Parameter 1-48 Inductance Sat. Point.*

Application-specific adjustments

Start the motor at nominal speed. If the application does not run well, check the VVC+ SynRM settings. *Table 3.5* provides application-specific recommendations:

Application	Settings
Low-inertia applications $I_{Load}/I_{Motor} < 5$	Increase <i>parameter 1-17 Voltage filter time const.</i> by factor 5–10. Reduce <i>parameter 1-14 Damping Gain</i> . Reduce <i>parameter 1-66 Min. Current at Low Speed (<100%)</i> .
Low-inertia applications $50 > I_{Load}/I_{Motor} > 5$	Keep the default values.
High-inertia applications $I_{Load}/I_{Motor} > 50$	Increase <i>parameter 1-14 Damping Gain</i> , <i>parameter 1-15 Low Speed Filter Time Const.</i> , and <i>parameter 1-16 High Speed Filter Time Const.</i>

Application	Settings
High-load at low speed <30% (rated speed)	Increase <i>parameter 1-17 Voltage filter time const.</i> Increase <i>parameter 1-66 Min. Current at Low Speed</i> to adjust the starting torque. 100% current provides nominal torque as starting torque. This parameter is independent of <i>parameter 30-20 High Starting Torque Time [s]</i> and <i>parameter 30-21 High Starting Torque Current [%]</i> . Working at a current level higher than 100% for a prolonged time can cause the motor to overheat.
Dynamic applications	Increase <i>parameter 14-41 AEO Minimum Magnetization</i> for highly dynamic applications. Adjusting <i>parameter 14-41 AEO Minimum Magnetization</i> ensures a good balance between energy efficiency and dynamics. Adjust <i>parameter 14-42 Minimum AEO Frequency</i> to specify the minimum frequency at which the frequency converter should use minimum magnetization.
Motor sizes less than 18 kW (24 hp)	Avoid short ramp-down times.

Table 3.5 Recommendations for Various Applications

If the motor starts oscillating at a certain speed, increase *parameter 1-14 Damping Gain*. Increase the damping gain value in small steps. Depending on the motor, this parameter can be set to 10–100% higher than the default value.

1-10 Motor Construction		
Option:		Function:
		Select the motor design type.
[0] *	Asynchron	Use for asynchronous motors.
[1]	PM, non salient SPM	Use for salient or non-salient PM motors. PM motors are divided into 2 groups, with either surface-mounted (SPM)/non-salient magnets or interior-mounted (IPM)/salient magnets. NOTICE! This option is valid for FC 302 only.

1-11 Motor Model		
Option:	Function:	
		Automatically sets the factory values for the selected motor. If the default value <i>Std. Asynchron</i> is used, determine settings manually according to the selection <i>parameter 1-10 Motor Construction</i> .
[1]	Std. Asynchron	Default motor model when [0] <i>Asynchron</i> is selected in <i>parameter 1-10 Motor Construction</i> .
[2]	Std. PM, non salient	Selectable when [1] <i>PM, non-salient SPM</i> is selected in <i>parameter 1-10 Motor Construction</i> .
[10]	Danfoss OGD LA10	Selectable when [1] <i>PM, non-salient SPM</i> is selected in <i>parameter 1-10 Motor Construction</i> . Only available for T4, T5 in 1.5–3 kW. Settings are loaded automatically for this specific motor.
[11]	Danfoss OGD V210	Selectable when [1] <i>PM, non-salient SPM</i> is selected in <i>parameter 1-10 Motor Construction</i> . Only available for T4, T5 in 0.75–3 kW. Settings are loaded automatically for this specific motor.

1-14 Damping Gain		
Range:	Function:	
140 %*	[0 - 250 %]	The damping gain stabilizes the PM machine to run smoothly and with stability. The value of damping gain controls the dynamic performance of the PM machine. High damping gain gives high dynamic performance and low damping gain gives low dynamic performance. The dynamic performance is related to the machine data and load type. If the damping gain is too high or low, the control becomes unstable.

1-15 Low Speed Filter Time Const.		
Range:	Function:	
Size related*	[0.01 - 20 s]	This time constant is used below 10% rated speed. Obtain quick control through a short damping time constant. However, if this value is too short, the control becomes unstable.

1-16 High Speed Filter Time Const.		
Range:	Function:	
Size related*	[0.01 - 20 s]	This time constant is used above 10% rated speed. Obtain quick control through a short damping time constant. However, if this value is too short, the control becomes unstable.

1-17 Voltage filter time const.		
Range:	Function:	
Size related*	[0.001 - 1 s]	Reduces the influence of high frequency ripple and system resonance in the calculation of supply voltage. Without this filter, the ripples in the currents can distort the calculated voltage and affect the stability of the system.

1-18 Min. Current at No Load		
Range:	Function:	
0 %*	[0 - 50 %]	Adjust this parameter to achieve a smoother motor operation.

3.2.6 1-2* Motor Data

This parameter group contains input data from the nameplate on the connected motor.

NOTICE!

Changing the value of these parameters affects the setting of other parameters.

NOTICE!

The following parameters have no effect when *parameter 1-10 Motor Construction* is set to [1] *PM, non-salient SPM*, [2] *PM, salient IPM*, [5] *Sync. Reluctance*:

- *Parameter 1-20 Motor Power [kW]*.
- *Parameter 1-21 Motor Power [HP]*.
- *Parameter 1-22 Motor Voltage*.
- *Parameter 1-23 Motor Frequency*.

1-20 Motor Power [kW]		
Range:	Function:	
4.00 kW*	[0.09 - 3000.00 kW]	<p>NOTICE!</p> <p>This parameter cannot be adjusted while the motor is running.</p> <p>Enter the nominal motor power in kW according to the motor nameplate data. The default value corresponds to the nominal rated output of the frequency converter. This parameter is visible in the LCP if <i>parameter 0-03 Regional Settings</i> is set to [0] <i>International</i>.</p>

1-21 Motor Power [HP]		
Range:		Function:
4.00 hp*	[0.09 - 3000.00 hp]	Enter the nominal motor power in hp according to the motor nameplate data. The default value corresponds to the nominal rated output of the unit. This parameter is visible in the LCP if <i>parameter 0-03 Regional Settings</i> is [1] US.

1-22 Motor Voltage		
Range:		Function:
500. V*	[10. - 1000. V]	Enter the nominal motor voltage according to the motor nameplate data. The default value corresponds to the nominal rated output of the unit.

1-23 Motor Frequency		
Range:		Function:
50. Hz*	[20 - 1000 Hz]	<p>NOTICE! From software version 6.72 onwards, the output frequency of the frequency converter is limited to 590 Hz.</p> <p>Select the motor frequency value from the motor nameplate data. If a value other than 50 Hz or 60 Hz is selected, adapt the load-independent settings in <i>parameter 1-50 Motor Magnetisation at Zero Speed</i> to <i>parameter 1-53 Model Shift Frequency</i>. For 87 Hz operation with 230/400 V motors, set the nameplate data for 230 V/50 Hz. To run at 87 Hz, adapt <i>parameter 4-13 Motor Speed High Limit [RPM]</i> and <i>parameter 3-03 Maximum Reference</i>.</p>

1-24 Motor Current		
Range:		Function:
7.20 A*	[0.10 - 10000.00 A]	Enter the nominal motor current value from the motor nameplate data. The data is used for calculating torque, motor overload protection, and so on.

1-25 Motor Nominal Speed		
Range:		Function:
1420. RPM*	[10 - 60000 RPM]	Enter the nominal motor speed value from the motor nameplate data. The data is used for calculating motor compensations. $n_{m,n} = n_s - n_{slip}$.

1-26 Motor Cont. Rated Torque		
Range:		Function:
0 Nm*	[0.1 - 10000.0 Nm]	Enter the value from the motor nameplate data. The default value corresponds to the nominal rated output. This parameter is available when <i>parameter 1-10 Motor Construction</i> is set to [1] PM, non-salient SPM, that is the parameter is valid for PM and non-salient SPM motors only.

1-29 Automatic Motor Adaptation (AMA)		
Option:	Function:	
	<p>NOTICE! This parameter cannot be adjusted while the motor is running.</p> <p>The AMA function optimizes dynamic motor performance by automatically optimizing the advanced motor parameters (<i>parameter 1-30 Stator Resistance (Rs)</i> to <i>parameter 1-35 Main Reactance (Xh)</i>) at motor standstill.</p> <p>Activate the AMA function by pressing [Hand on] after selecting <i>Enable Complete AMA</i> or [2] <i>Enable Reduced AMA</i>. See also the section <i>Automatic Motor Adaptation</i> in the <i>design guide</i>. After a normal sequence, the display reads: <i>Press [OK] to finish AMA</i>. After pressing [OK], the frequency converter is ready for operation.</p> <p>NOTICE! Ensure that a value is set in <i>parameter 14-43 Motor Cos-Phi</i> before running AMA II.</p>	
[0]	Off	
*		
[1]	Enable complete AMA	<p>Performs</p> <ul style="list-style-type: none"> • AMA of the stator resistance R_s, • The rotor resistance R_r, • The stator leakage reactance $X_{1,}$ • The rotor leakage reactance $X_{2,}$ and • The main reactance X_h. <p>Do not select this option if an LC filter is used between the frequency converter and the motor.</p> <p>FC 301: The complete AMA does not include X_h measurement for FC 301. Instead, the X_h value is determined from the motor database. R_s is the best adjustment method (see <i>parameter group 1-3* Adv. Motor Data</i>).</p>

1-29 Automatic Motor Adaptation (AMA)		
Option:	Function:	
		For best performance, it is recommended to obtain the advanced motor data from the motor manufacturer to enter into <i>parameter 1-31 Rotor Resistance (Rr)</i> through <i>parameter 1-36 Iron Loss Resistance (Rfe)</i> . Complete AMA cannot be performed on permanent magnet motors.
[2]	Enable reduced AMA	Performs a reduced AMA of the stator resistance R_s in the system only. This option is available for standard asynchronous motors and non-salient PM motors.

NOTICE!

- For the best adaptation of the frequency converter, run AMA on a cold motor.
- AMA cannot be performed while the motor is running.
- AMA cannot run with a sine-wave filter connected.

NOTICE!

It is important to set motor *parameter group 1-2* Motor Data* correctly, since these form part of the AMA algorithm. Perform an AMA to achieve optimum dynamic motor performance. It may take up to 10 minutes, depending on the power rating of the motor.

NOTICE!

Avoid generating external torque during AMA.

NOTICE!

If 1 of the settings in *parameter group 1-2* Motor Data* is changed, *parameter 1-30 Stator Resistance (Rs)* to *parameter 1-39 Motor Poles*, the advanced motor parameters, return to default setting.

NOTICE!

AMA works problem-free on 1 motor size down, typically works on 2 motor sizes down, rarely works on 3 sizes down, and never work on 4 sizes down. Keep in mind that the accuracy of the measured motor data is poorer when operating on motors smaller than the nominal frequency converter size.

3.2.7 1-3* Adv. Motor Data

Parameters for advanced motor data. Ensure that the motor data in *parameter 1-30 Stator Resistance (Rs)* to *parameter 1-39 Motor Poles* matches the motor. The default settings are based on standard motor values. If the motor parameters are not set correctly, a malfunction of the frequency converter system may occur. If the motor data is unknown, running an AMA (automatic motor adaptation) is recommended. See *parameter 1-29 Automatic Motor Adaptation (AMA)*.

Parameter groups 1-3 Adv. Motor Data* and *1-4* Adv. Motor Data II* cannot be adjusted while the motor is running.

NOTICE!

A simple check of the $X_1 + X_h$ sum value is to divide the line-to-line motor voltage by the $\sqrt{3}$ and divide this value by the motor no load current. $[V_{L-L}/\sqrt{3}]/I_{NL} = X_1 + X_h$, see *Figure 3.6*. These values are important to magnetize the motor properly. For high-pole motors, it is highly recommended to perform this check.

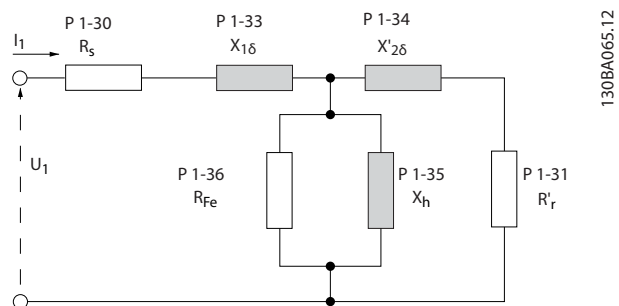

Figure 3.6 Motor Equivalent Diagram of an Asynchronous Motor

1-30 Stator Resistance (Rs)		
Range:	Function:	
1.4000 Ohm*	[0.0140 - 140.0000 Ohm]	<p>Set the line-to-common stator resistance value. Enter the value from a motor datasheet or perform an AMA on a cold motor.</p> <p>NOTICE!</p> <p>For salient PM motors: AMA is not available. If only line-line data is available, divide the line-line value by 2 to achieve the line-to-common (star point) value. Alternatively, measure the value with an ohmmeter. This also takes the resistance of the cable into account. Divide the measured value by 2 and enter the result.</p> <p>NOTICE!</p> <p>The parameter value is updated after each torque calibration if option [3] 1st start with store or option [4] Every start with store is selected in parameter 1-47 Torque Calibration.</p>

1-31 Rotor Resistance (Rr)		
Range:	Function:	
1.0000 Ohm*	[0.0100 - 100.0000 Ohm]	<p>NOTICE!</p> <p>Parameter 1-31 Rotor Resistance (Rr) does not have effect when parameter 1-10 Motor Construction is set to [1] PM, non-salient SPM, [5] Sync. Reluctance.</p> <p>Set the rotor resistance value R_r to improve shaft performance using 1 of these methods:</p> <ul style="list-style-type: none"> Run an AMA on a cold motor. The frequency converter measures the value from the motor. All compensations are reset to 100%. Enter the R_r value manually. Obtain the value from the motor supplier. Use the R_r default setting. The frequency converter establishes the setting based on the motor nameplate data.

1-33 Stator Leakage Reactance (X1)		
Range:	Function:	
4.0000 Ohm*	[0.0400 - 400.0000 Ohm]	<p>NOTICE!</p> <p>This parameter is only relevant for asynchronous motors.</p> <p>Set the stator leakage reactance of the motor using 1 of these methods:</p> <ul style="list-style-type: none"> Run an AMA on a cold motor. The frequency converter measures the value from the motor. Enter the X_1 value manually. Obtain the value from the motor supplier. Use the X_1 default setting. The frequency converter establishes the setting based on the motor nameplate data. <p>See Figure 3.6.</p> <p>NOTICE!</p> <p>The parameter value is updated after each torque calibration if option [3] 1st start with store or option [4] Every start with store is selected in parameter 1-47 Torque Calibration.</p>

1-34 Rotor Leakage Reactance (X2)		
Range:	Function:	
4.0000 Ohm*	[0.0400 - 400.0000 Ohm]	<p>NOTICE!</p> <p>This parameter is only relevant for asynchronous motors.</p> <p>Set the rotor leakage reactance of the motor using 1 of these methods:</p> <ul style="list-style-type: none"> Run an AMA on a cold motor. The frequency converter measures the value from the motor. Enter the X_2 value manually. Obtain the value from the motor supplier. Use the X_2 default setting. The frequency converter establishes the setting based on the motor nameplate data. <p>See Figure 3.6.</p>

1-34 Rotor Leakage Reactance (X2)		
Range:		Function:
		<p>NOTICE!</p> <p>The parameter value is updated after each torque calibration if option [3] <i>1st start with store</i> or option [4] <i>Every start with store</i> is selected in <i>parameter 1-47 Torque Calibration</i>.</p>

1-35 Main Reactance (Xh)		
Range:		Function:
100.0000 Ohm*	[1.0000 - 10000.0000 Ohm]	<p>Set the main reactance of the motor using 1 of these methods:</p> <ol style="list-style-type: none"> 1. Run an AMA on a cold motor. The frequency converter measures the value from the motor. 2. Enter the X_h value manually. Obtain the value from the motor supplier. 3. Use the X_h default setting. The frequency converter establishes the setting based on the motor nameplate data.

1-36 Iron Loss Resistance (Rfe)		
Range:		Function:
10000.000 Ohm*	[0 - 10000.000 Ohm]	<p>Enter the equivalent iron loss resistance (R_{Fe}) value to compensate for iron loss in the motor. The R_{Fe} value cannot be found by performing an AMA. The R_{Fe} value is especially important in torque control applications. If R_{Fe} is unknown, leave <i>parameter 1-36 Iron Loss Resistance (Rfe)</i> on default setting.</p>

1-37 d-axis Inductance (Ld)		
Range:		Function:
0 mH*	[0 - 0 mH]	<p>Enter line-to-common direct axis inductance of the PM motor. Obtain the value from the permanent magnet motor datasheet. If only line-line data is available, divide the line-line value by 2 to achieve the line-common (star point) value. Alternatively, measure the value with an inductance meter. This also takes the inductance of the cable into account.</p>

1-37 d-axis Inductance (Ld)		
Range:		Function:
		<p>Divide the measured value by 2 and enter the result. This parameter is only active when <i>parameter 1-10 Motor Construction</i> is set to [1] <i>PM, non-salient SPM</i> (Permanent Magnet Motor) or [5] <i>Sync. Reluctance</i>. For a selection with 1 decimal, use this parameter. For a selection with 3 decimals, use <i>parameter 30-80 d-axis Inductance (Ld)</i>. FC 302 only.</p> <p>NOTICE!</p> <p>The parameter value is updated after each torque calibration if option [3] <i>1st start with store</i> or option [4] <i>Every start with store</i> is selected in <i>parameter 1-47 Torque Calibration</i>.</p>

1-38 q-axis Inductance (Lq)		
Range:		Function:
Size related*	[0.000 - 1000 mH]	Set the value of the q-axis inductance. See the motor datasheet.

1-39 Motor Poles		
Range:		Function:
4. N/A*	[2 - 100 N/A]	Enter the number of motor poles.

Poles	~n _n @ 50 Hz	~n _n @ 60 Hz
2	2700–2880	3250–3460
4	1350–1450	1625–1730
6	700–960	840–1153

Table 3.6 Pole Number for Normal Speed Ranges

Table 3.6 shows the pole number for normal speed ranges of various motor types. Define motors designed for other frequencies separately. The motor pole value is always an even number because it refers to the total pole number, not pairs of poles. The frequency converter creates the initial setting of *parameter 1-39 Motor Poles* based on *parameter 1-23 Motor Frequency* and *parameter 1-25 Motor Nominal Speed*.

1-40 Back EMF at 1000 RPM		
Range:	Function:	
500. V* [10. - 9000 V]	<p>NOTICE! This parameter is only active when <i>parameter 1-10 Motor Construction</i> is set to options that enable PM (permanent magnet) motors.</p> <p>Set the nominal back EMF for the motor when running at 1000 RPM. Back EMF is the voltage generated by a PM motor when no frequency converter is connected and the shaft is turned externally. Back EMF is normally specified for nominal motor speed or for 1000 RPM measured between 2 lines. If the value is not available for a motor speed of 1000 RPM, calculate the correct value as follows. If back EMF is for example 320 V at 1800 RPM, it can be calculated at 1000 RPM: Example Back EMF 320 V at 1800 RPM. Back EMF=(Voltage/RPM)*1000=(320/1800)*1000=178.</p> <p>NOTICE! When using PM motors, it is recommended to use brake resistors.</p>	

1-41 Motor Angle Offset		
Range:	Function:	
0 N/A * [-32768 - 32767 N/A]	<p>NOTICE! This parameter is only active when <i>parameter 1-10 Motor Construction</i> is set to [1] PM, non-salient SPM (Permanent Magnet Motor).</p> <p>Enter the correct offset angle between the PM motor and the index position (single-turn) of the attached encoder or resolver. The value range of 0–32768 corresponds to 0–2 x pi (radians). To obtain the offset angle value: After frequency converter start-up, apply DC hold and enter the value of <i>parameter 16-20 Motor Angle</i> into this parameter.</p>	

1-44 d-axis Inductance Sat. (LdSat)		
Range:	Function:	
Size related* [0 - 1000 mH]	<p>This parameter corresponds to the inductance saturation of Ld. Ideally, this parameter has the same value as <i>parameter 1-37 d-axis Inductance (Ld)</i>. If the motor supplier provides an induction</p>	

1-44 d-axis Inductance Sat. (LdSat)		
Range:	Function:	
	<p>curve, enter the induction value at 200% of the nominal value.</p>	

1-45 q-axis Inductance Sat. (LqSat)		
Range:	Function:	
Size related* [0 - 1000 mH]	<p>This parameter corresponds to the inductance saturation of Lq. Ideally, this parameter has the same value as <i>parameter 1-38 q-axis Inductance (Lq)</i>. If the motor supplier provides an induction curve, enter the induction value at 200% of the nominal value.</p>	

1-46 Position Detection Gain		
Range:	Function:	
120 %* [20 - 200 %]	<p>Adjusts the amplitude of the test pulse during position detection at start. Adjust this parameter to improve the position measurement.</p>	

1-47 Torque Calibration		
Option:	Function:	
	<p>Use this parameter to optimize the torque estimate in the full speed range. The estimated torque is based on the shaft power, $P_{\text{shaft}} = P_m - R_s \times I^2$. Make sure that the R_s value is correct. The R_s value in this formula is equal to the power loss in the motor, the cable, and the frequency converter. When this parameter is active, the frequency converter calculates the R_s value during power-up, ensuring the optimal torque estimate and optimal performance. Use this feature in cases when it is not possible to adjust <i>parameter 1-30 Stator Resistance (Rs)</i> on each frequency converter to compensate for the cable length, frequency converter losses, and the temperature deviation on the motor.</p>	
[0]	Off	
[1]	1st start after pwr-up	Calibrates at the first start-up after power-up and keeps this value until reset by a power cycle.
[2]	Every start	Calibrates at every start-up, compensating for a possible change in motor temperature since last start-up. The value is reset after a power cycle.
[3]	1st start with store	The frequency converter calibrates the torque at the first start-up after power-up. This option is used to update motor parameters:

1-47 Torque Calibration		
Option:	Function:	
	<ul style="list-style-type: none"> Parameter 1-30 Stator Resistance (Rs). Parameter 1-33 Stator Leakage Reactance (X1). Parameter 1-34 Rotor Leakage Reactance (X2). Parameter 1-37 d-axis Inductance (Ld). 	
[4]	Every start with store	<p>The frequency converter calibrates the torque at every start-up, compensating for a possible change in motor temperature since last start-up. This option is used to update motor parameters:</p> <ul style="list-style-type: none"> Parameter 1-30 Stator Resistance (Rs). Parameter 1-33 Stator Leakage Reactance (X1). Parameter 1-34 Rotor Leakage Reactance (X2). Parameter 1-37 d-axis Inductance (Ld).

1-48 Inductance Sat. Point		
Range:	Function:	
Size related* [1 - 500 %]	<p>NOTICE! Run an AMA to set the value of this parameter. Edit the value manually only when the application requires a value other than determined by AMA.</p> <p>Select the d-axis inductance saturation point. The frequency converter uses this value to optimize the performance of SynRM motors.</p> <p>Select the value that matches the point where the inductance equals the mean value of parameter 1-37 d-axis Inductance (Ld) and parameter 1-44 d-axis Inductance Sat. (LdSat), as percentage of nominal current.</p>	

1-49 q-Axis Inductance Saturation Point		
Range:	Function:	
Size related* [0 - 200 %]	<p>NOTICE! Run an AMA to set the value of this parameter. Edit the value manually only when the application requires a value other than determined by AMA.</p> <p>Enter the q-Axis inductance saturation point. The frequency converter uses this value to optimize the performance of IPM motors.</p> <p>Select the value that matches the point where the inductance equals the average value of parameter 1-38 q-axis Inductance</p>	

1-49 q-Axis Inductance Saturation Point		
Range:	Function:	
	<p>(Lq) and parameter 1-45 q-axis Inductance Sat. (LqSat), as percentage of nominal current.</p>	

3.2.8 1-5* Load Indep. Setting

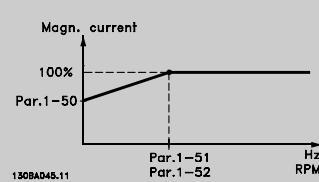
1-50 Motor Magnetisation at Zero Speed		
This parameter is not visible on the LCP.		
Range:	Function:	
100 %* [0 - 300 %]	<p>NOTICE! Parameter 1-50 Motor Magnetisation at Zero Speed has no effect when parameter 1-10 Motor Construction = [1] PM, non-salient SPM.</p> <p>Use this parameter along with parameter 1-51 Min Speed Normal Magnetising [RPM] to obtain a different thermal load on the motor when running at low speed. Enter a value which is a percentage of the rated magnetizing current. If the setting is too low, the torque on the motor shaft may be reduced.</p>  <p>Figure 3.7 Motor Magnetization</p>	

1-51 Min Speed Normal Magnetising [RPM]		
This parameter is not visible on the LCP.		
Range:		Function:
Size related*	[10 - 300 RPM]	<p>NOTICE!</p> <p><i>Parameter 1-51 Min Speed Normal Magnetising [RPM] has no effect when parameter 1-10 Motor Construction=[1] PM, non-salient SPM.</i></p> <p>Set the required speed for normal magnetizing current. If the speed is set lower than the motor slip speed, parameter 1-50 Motor Magnetisation at Zero Speed and parameter 1-51 Min Speed Normal Magnetising [RPM] are of no significance.</p> <p>Use this parameter along with parameter 1-50 Motor Magnetisation at Zero Speed. See Table 3.6.</p>

1-52 Min Speed Normal Magnetizing [Hz]		
Range:		Function:
12.5 Hz*	[0 - 250.0 Hz]	<p>Set the required frequency for normal magnetizing current. If the frequency is set lower than the motor slip frequency, parameter 1-50 Motor Magnetisation at Zero Speed is inactive.</p> <p>Use this parameter along with parameter 1-50 Motor Magnetisation at Zero Speed. See Figure 3.7.</p>

1-53 Model Shift Frequency		
Range:		Function:
0 Hz*	[4.0 - 0 Hz]	<p>NOTICE!</p> <p>This parameter cannot be adjusted while the motor is running.</p> <p>Flux model shift</p> <p>Enter the frequency value for shift between 2 models for determining motor speed. Select the value based on settings in parameter 1-00 Configuration Mode and parameter 1-01 Motor Control Principle.</p> <p>There are the following options:</p> <ul style="list-style-type: none"> • Shift between flux model 1 and flux model 2. • Shift between variable current mode and flux model 2.

1-53 Model Shift Frequency	
Range:	Function:
	<ul style="list-style-type: none"> • No shift between models at low speed if parameter 40-50 Flux Sensorless Model Shift is set to option [0] Off. <p>NOTICE!</p> <p>This is valid for FC 302 only.</p> <p>Flux model 1 – flux model 2</p> <p>This model is used when parameter 1-00 Configuration Mode is set to [1] Speed closed loop or [2] Torque, and parameter 1-01 Motor Control Principle is set to [3] Flux w/motor feedback. With this parameter, it is possible to make an adjustment of the shifting point where the frequency converter changes between flux model 1 and flux model 2, which is useful in some sensitive speed and torque control applications.</p> <p>Figure 3.8 Parameter 1-00 Configuration Mode = [1] Speed closed loop or [2] Torque and parameter 1-01 Motor Control Principle = [3] Flux w/motor feedback</p> <p>Variable current - flux model - sensorless</p> <p>This model is used when parameter 1-00 Configuration Mode is set to [0] Speed open loop and parameter 1-01 Motor Control Principle is set to [2] Flux sensorless.</p> <p>In speed open loop in flux mode, the speed is determined from the current measurement. Below $f_{norm} \times 0.1$, the frequency converter runs on a variable current model. Above $f_{norm} \times 0.125$ the frequency converter runs on a flux model.</p> <p>Figure 3.9 Parameter 1-00 Configuration Mode = [0] Speed open loop, parameter 1-01 Motor Control Principle = [2] Flux sensorless</p>

1-54 Voltage reduction in fieldweakening		
Range:	Function:	
0 V* [0 - 100 V]	The value of this parameter reduces the maximum voltage available for the flux of the motor in field weakening, providing more voltage for torque. Increasing the value increases the risk of stalling at high speed.	

1-55 U/f Characteristic - U		
Array [6]		
Range:	Function:	
0 V* [0.0 - 1000.0 V]	Enter the voltage at each frequency point to manually form a U/f characteristic matching the motor. The frequency points are defined in <i>parameter 1-56 U/f Characteristic - F</i> . This parameter is an array parameter [0-5] and is only accessible when <i>parameter 1-01 Motor Control Principle</i> is set to [0] U/f.	

1-56 U/f Characteristic - F		
Array [6]		
Range:	Function:	
0 Hz* [0 - 1000.0 Hz]	Enter the frequency points to manually form a U/f characteristic matching the motor. The voltage at each point is defined in <i>parameter 1-55 U/f Characteristic - U</i> . This parameter is an array parameter [0-5] and is only accessible when <i>parameter 1-01 Motor Control Principle</i> is set to [0] U/f.	

Motor Voltage
Par 1-55 [x] 130BA166.10

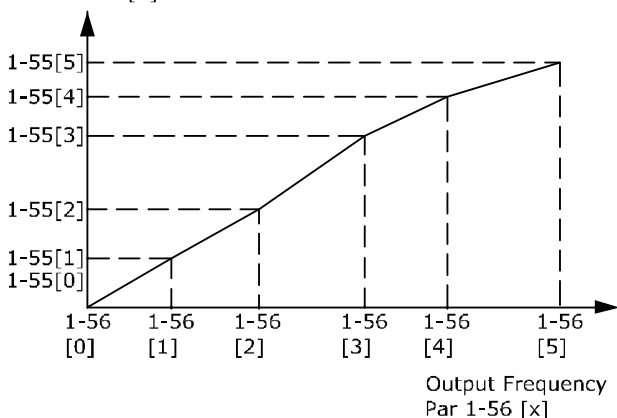

Figure 3.10 U/f Characteristic

1-57 Torque Estimation Time Constant		
Range:	Function:	
150 ms* [50 - 1000 ms]	NOTICE! This parameter is only valid with software version 48.XX. Enter the time constant for the torque estimation below model change point in flux sensorless control principle.	

1-58 Flying Start Test Pulses Current		
Range:	Function:	
Size related* [0 - 200 %]	NOTICE! This parameter is only available in VVC+. NOTICE! This parameter has effect on PM motors only. Sets the current level for the flying start test pulses that are used to detect the motor direction. 100% means $I_{m,n}$. Adjust the value to be high enough to avoid noise influence, but low enough to avoid affecting the accuracy (current must be able to drop to 0 before the next pulse). Reduce the value to reduce the generated torque. Default is 30% for asynchronous motors, but may vary for PM motors. For adjusting PM motors, the value tunes for back EMF and d-axis inductance of the motor.	

1-59 Flying Start Test Pulses Frequency		
Range:	Function:	
Size related* [0 - 500 %]	Asynchronous motor: Set the frequency of the flying start test pulses that are used to detect the motor direction. For asynchronous motors, the value 100% means that the slip is doubled. Increase this value to reduce the generated torque. For synchronous motors, this value is the percentage $n_{m,n}$ of the free-running motor. Above this value, flying start is always performed. Below this value, the start mode is selected in <i>parameter 1-70 Start Mode</i>	

3

3.2.9 1-6* Load Depend. Setting

1-60 Low Speed Load Compensation		
Range:	Function:	
100 %* [0 - 300 %]	Enter the % value to compensate voltage in relation to load when the motor is running at low speed and obtain the optimum U/f characteristic. The motor size determines the frequency range within which this parameter is active.	

Motor size	Changeover
0.25–7.5 kW	<10 Hz

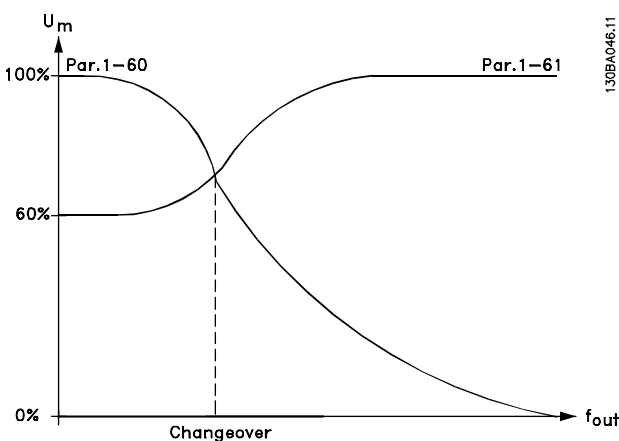

Figure 3.11 Changeover

1-61 High Speed Load Compensation		
Range:	Function:	
100 %* [0 - 300 %]	Enter the % value to compensate voltage in relation to load when the motor is running at high speed and obtain the optimum U/f characteristic. The motor size determines the frequency range within which this parameter is active.	

Motor size	Changeover
0.25–7.5 kW	>10 Hz

Table 3.7 Changeover Frequency

1-62 Slip Compensation		
Range:	Function:	
100 %* [-500 - 500 %]	Enter the % value for slip compensation to compensate for tolerances in the value of $n_{M,N}$. Slip compensation is calculated automatically, that is on the basis of the nominal motor speed $n_{M,N}$. This function is not active when parameter 1-00 Configuration Mode is set to [1] Speed closed loop or [2] Torque torque control with speed feedback or when parameter 1-01 Motor Control Principle is set to [0] U/f special motor mode.	

1-63 Slip Compensation Time Constant		
Range:	Function:	
Size related* [0.05 - 5 s]	<p>NOTICE!</p> <p>Parameter 1-63 Slip Compensation Time Constant has no effect when parameter 1-10 Motor Construction = [1] PM, non-salient SPM.</p> <p>Enter the slip compensation reaction speed. A high value results in slow reaction, and a low value results in quick reaction. If low-frequency resonance problems arise, use a longer time setting.</p>	

1-64 Resonance Dampening		
Range:	Function:	
Size related* [0 - 500 %]	<p>NOTICE!</p> <p>Parameter 1-64 Resonance Dampening has no effect when parameter 1-10 Motor Construction=[1] PM, non-salient SPM.</p> <p>Enter the resonance damping value. Set parameter 1-64 Resonance Dampening and parameter 1-65 Resonance Dampening Time Constant to help eliminate high frequency resonance problems. To reduce resonance oscillation, increase the value of parameter 1-64 Resonance Dampening.</p>	

1-65 Resonance Dampening Time Constant		
Range:	Function:	
5 ms* [5 - 50 ms]	<p>NOTICE! Parameter 1-65 Resonance Dampening Time Constant has no effect when parameter 1-10 Motor Construction = [1] PM, non-salient SPM.</p> <p>Set parameter 1-64 Resonance Dampening and parameter 1-65 Resonance Dampening Time Constant to help eliminate high frequency resonance problems. Enter the time constant that provides the best dampening.</p>	

1-66 Min. Current at Low Speed		
Range:	Function:	
100 %* [1. - 200. %]	<p>NOTICE! If parameter 40-50 Flux Sensorless Model Shift is set to [0] Off, this parameter is ignored.</p> <p>Enter the minimum motor current at low speed, see parameter 1-53 Model Shift Frequency. Increasing this current improves motor torque at low speed.</p> <p>Parameter 1-66 Min. Current at Low Speed is enabled when parameter 1-00 Configuration Mode [0] Speed open loop only. The frequency converter runs with constant current through motor for speeds below 10 Hz.</p> <p>For speeds above 10 Hz, the motor flux model in the frequency converter controls the motor.</p> <p>Parameter 4-16 Torque Limit Motor Mode and/or parameter 4-17 Torque Limit Generator Mode automatically adjust parameter 1-66 Min. Current at Low Speed. The parameter with the highest value adjusts parameter 1-66 Min. Current at Low Speed. The current setting in parameter 1-66 Min. Current at Low Speed is composed of the torque generating current and the magnetizing current. Example: Set parameter 4-16 Torque Limit Motor Mode to 100% and set parameter 4-17 Torque Limit Generator Mode to 60%. Parameter 1-66 Min. Current at Low Speed automatically adjusts to about 127%, depending on the motor size.</p>	

1-67 Load Type		
This parameter is valid for FC 302 only.		
Option:	Function:	
[0] * Passive load	For conveyors, fan, and pump applications.	
[1]	Active load	For hoisting applications. This option allows the frequency converter to ramp up at 0 RPM. When [1] Active Load is selected, set parameter 1-66 Min. Current at Low Speed to a level which corresponds to maximum torque.

1-68 Minimum Inertia		
Range:	Function:	
0.0048 kgm ² * [0.0001 - par. 1-69 kgm ²]	<p>NOTICE! This parameter cannot be adjusted while motor is running.</p> <p>Needed for average inertia calculation. Enter the minimum inertia moment of the mechanical system. Parameter 1-68 Minimum Inertia and parameter 1-69 Maximum Inertia are used for pre-adjustment of the Proportional Gain in the speed control, see parameter 30-83 Speed PID Proportional Gain. FC 302 only.</p>	

1-69 Maximum Inertia		
Range:	Function:	
0.0048 kgm ² *	[par. 1-68 - 0.4800 kgm ²]	

3.2.10 1-7* Start Adjustments

1-70 Start Mode		
Select the start-up mode. This is done to initialize the VVC ⁺ control core for previously free-running motor. Both selections estimate the speed and angle. Active for PM and SynRM motors in VVC ⁺ only.		
Option:	Function:	
[0] * Rotor Detection	Estimates the electrical angle of the rotor and uses this as a starting point. Standard selection for VLT [®] AutomationDrive applications.	
[1]	Parking	The parking function applies DC current across the stator winding and rotates the rotor to electrical 0 position (typically selected for HVAC applications). Parking current and time are configured in parameter 2-06 Parking Current and parameter 2-07 Parking Time.
[2]	Rotor Det. w/ Parking	

1-71 Start Delay		
Range:		Function:
0.0 s*	[0.0 - 10.0 s]	This parameter refers to the start function selected in <i>parameter 1-72 Start Function</i> . Enter the time delay required before commencing acceleration.

1-72 Start Function		
Option:	Function:	
		Select the start function during start delay. This parameter is linked to <i>parameter 1-71 Start Delay</i> .
[0]	DC Hold/delay time	Energizes motor with a DC hold current (<i>parameter 2-00 DC Hold Current</i>) during the start delay time.
[1]	DC Brake/delay time	Energizes motor with a DC brake current (<i>parameter 2-01 DC Brake Current</i>) during the start delay time.
[2]	Coast/delay time*	Motor coasted during the start delay time (inverter off).
[3]	Start speed cw	Only possible with VVC ⁺ . Connect the function described in <i>parameter 1-74 Start Speed [RPM]</i> and <i>parameter 1-76 Start Current</i> in the start delay time. Regardless of the value applied by the reference signal, the output speed applies the setting of the start speed in <i>parameter 1-74 Start Speed [RPM]</i> or <i>parameter 1-75 Start Speed [Hz]</i> , and the output current corresponds to the setting of the start current in <i>parameter 1-76 Start Current</i> . This function is typically used in hoisting applications without counterweight and especially in applications with a cone-motor where the start is clockwise, followed by rotation in the reference direction.
[4]	Horizontal operation	Only possible with VVC ⁺ . For obtaining the function described in <i>parameter 1-74 Start Speed [RPM]</i> and <i>parameter 1-76 Start Current</i> during the start delay time. The motor rotates in the reference direction. If the reference signal equals 0, <i>parameter 1-74 Start Speed [RPM]</i> is ignored and the output speed equals 0. The output current corresponds to the setting of the start current in <i>parameter 1-76 Start Current</i> .
[5]	VVC ⁺ /Flux clockwise	For the function described in <i>parameter 1-74 Start Speed [RPM]</i> only. The start current is calculated automatically. This function uses the start speed in the start delay

1-72 Start Function		
Option:	Function:	
		time only. Regardless of the value set by the reference signal, the output speed equals the setting of the start speed in <i>parameter 1-74 Start Speed [RPM]</i> . [3] Start speed/current clockwise and [5] VVC ⁺ /Flux clockwise are typically used in hoisting applications. [4] Start speed/current in reference direction is particularly used in applications with counterweight and horizontal movement.
[6]		For utilizing mechanical brake control functions (<i>parameter 2-24 Stop Delay</i> to <i>parameter 2-28 Gain Boost Factor</i>). This parameter is only active in flux control principle, in a mode with motor feedback or sensorless mode.

1-73 Flying Start		
Option:	Function:	
		NOTICE! This parameter cannot be adjusted while the motor is running. This function makes it possible to catch a motor which is spinning freely due to a mains dropout.
[0]	Disabled*	No function
[1]	Enabled	Enables the frequency converter to catch and control a spinning motor. When <i>parameter 1-73 Flying Start</i> is enabled, <i>parameter 1-71 Start Delay</i> and <i>parameter 1-72 Start Function</i> have no function. When <i>parameter 1-73 Flying Start</i> is enabled, <i>parameter 1-58 Flying Start Test Pulses Current</i> and <i>parameter 1-59 Flying Start Test Pulses Frequency</i> are used for specifying the conditions for the flying start.

NOTICE!

This function is not recommended for hoisting applications.

For power levels above 55 kW, flux mode must be used to achieve the best performance.

NOTICE!

To obtain the best flying start performance, the advanced motor data, *parameter 1-30 Stator Resistance (Rs)* to *parameter 1-35 Main Reactance (Xh)*, must be correct.

1-74 Start Speed [RPM]		
Range:	Function:	
0 RPM* [0 - 600 RPM]	Set a motor start speed. After the start signal, the output speed leaps to set value. Set the start function in <i>parameter 1-72 Start Function</i> to [3] <i>Start speed cw</i> , [4] <i>Horizontal operation</i> , or [5] <i>VVC+ /Flux clockwise</i> , and set a start delay time in <i>parameter 1-71 Start Delay</i> .	

1-75 Start Speed [Hz]		
Range:	Function:	
0 Hz* [0.0 - 500.0 Hz]	This parameter can be used for hoist applications (cone rotor). Set a motor start speed. After the start signal, the output speed leaps to the set value. Set the start function in <i>parameter 1-72 Start Function</i> to [3] <i>Start speed cw</i> , [4] <i>Horizontal operation</i> , or [5] <i>VVC+ /Flux clockwise</i> , and set a start delay time in <i>parameter 1-71 Start Delay</i> .	

1-76 Start Current		
Range:	Function:	
0.00 A* [0.00 - par. 1-24 A]	Some motors, for example cone rotor motors, need extra current/starting speed to disengage the rotor. To obtain this boost, set the required current in <i>parameter 1-76 Start Current</i> . Set <i>parameter 1-74 Start Speed [RPM]</i> . Set <i>parameter 1-72 Start Function</i> to [3] <i>Start speed cw</i> or [4] <i>Horizontal operation</i> , and set a start delay time in <i>parameter 1-71 Start Delay</i> . This parameter can be used for hoist applications (cone rotor).	

3.2.11 1-8* Stop Adjustments

1-80 Function at Stop		
Option:	Function:	
	Select the frequency converter function after a stop command or after the speed is ramped down to the settings in <i>parameter 1-81 Min Speed for Function at Stop [RPM]</i> .	
[0]	Coast	Leaves motor in free mode. The motor is disconnected from the frequency converter.
[1]	DC hold	Energizes the motor with a DC hold current (see <i>parameter 2-00 DC Hold Current</i>).
[2]	Motor check	Checks if a motor has been connected.
[3]	Pre-magnetizing	Builds up a magnetic field while the motor is stopped. This allows the motor to produce torque quickly at subsequent start

1-80 Function at Stop		
Option:	Function:	
	<p>commands (asynchronous motors only). This premagnetizing function does not help the very first start command.</p> <p>Two different solutions are available to premagnetize the machine for the first start command:</p> <ul style="list-style-type: none"> Start the frequency converter with a 0 RPM reference and wait 2-4 rotor time constants before increasing the speed reference. Use the start delay with DC hold: <ul style="list-style-type: none"> Set <i>parameter 1-71 Start Delay</i> to the required premagnetizing time (2-4 rotor time constants. See the time constants description further in this section). Set <i>parameter 1-72 Start Function</i> to either [0] <i>DC hold</i> or [1] <i>DC Brake</i>. Set the DC hold or DC brake current magnitude (<i>parameter 2-00 DC Hold Current</i> or <i>parameter 2-01 DC Brake Current</i>) to be equal to $I_{pre-mag} = U_{nom}/(1.73 \times X_h)$ <p>Sample rotor time constants = $(X_h + X_2)/(6.3 * Freq_{nom} * R_r)$ 1 kW = 0.2 s 10 kW = 0.5 s 100 kW = 1.7 s 1000 kW = 2.5 s</p>	
[4]	DC Voltage U0	When the motor is stopped, the <i>parameter 1-55 U/f Characteristic - U [0]</i> defines the voltage at 0 Hz.

1-81 Min Speed for Function at Stop [RPM]		
Range:	Function:	
Size related* [0 - 600 RPM]	Set the speed at which to activate <i>parameter 1-80 Function at Stop</i> .	

1-82 Min Speed for Function at Stop [Hz]		
Range:	Function:	
Size related* [0 - 20.0 Hz]	Set the output frequency at which to activate <i>parameter 1-80 Function at Stop</i> .	

1-83 Precise Stop Function		
Option:	Function:	
		<p>NOTICE!</p> <p>This parameter cannot be adjusted while the motor is running. Valid for FC 302 only.</p>
[0]	Precise ramp stop	Only optimal when the operational speed, for example the operational speed of a conveyor belt, is constant. This is an open-loop control. Achieves high repetitive precision at the stop point.
[1]	Cnt stop with reset	Counts the number of pulses, typically from an encoder, and generates a stop signal after a pre-programmed number of pulses, defined in <i>parameter 1-84 Precise Stop Counter Value</i> , has been received at <i>terminal 29</i> or <i>terminal 33</i> . This is direct feedback with one-way closed-loop control. The counter function is activated (starts timing) at the edge of the start signal (when it changes from stop to start). After each precise stop, the number of pulses counted during ramp down to 0 RPM is reset.
[2]	Cnt stop w/o reset	Same as [2] <i>Cnt stop with reset</i> but the number of pulses counted during ramp down to 0 RPM is deducted from the counter value entered in <i>parameter 1-84 Precise Stop Counter Value</i> . This reset function can be used to compensate for the extra distance done during ramping down and to reduce the impacts of gradual wear of mechanical parts.
[3]	Speed comp stop	Stops at precisely the same point, regardless of the present speed. The stop signal is delayed internally when the present speed is lower than the maximum speed (set in <i>parameter 4-19 Max Output Frequency</i>). The delay is calculated on the basis of the reference speed of the frequency converter and not on the basis of the actual speed. Make sure that the frequency converter has ramped up before activating the speed compensated stop.
[4]	Com cnt stop w/rst	Same as <i>Speed comp stop</i> but after each precise stop, the number of pulses counted during ramp down to 0 RPM is reset.
[5]	Comp cnt stop w/o r	Same as <i>Speed comp stop</i> but the number of pulses counted during ramp down to 0 RPM is deducted from the counter value entered in <i>parameter 1-84 Precise Stop Counter Value</i> . This reset function can be used to compensate for the extra distance done during ramping down

1-83 Precise Stop Function		
Option:	Function:	
		and to reduce the impacts of gradual wear of mechanical parts.

The precise stop functions are advantageous in applications where high precision is required. If using a standard stop command, the accuracy is determined by the internal task time. That is not the case when using the precise stop function. It eliminates the task time dependence and increases the accuracy substantially. The frequency converter tolerance is normally given by its task time. However, by using its special precise stop function, the tolerance is independent of the task time because the stop signal immediately interrupts the execution of the frequency converter program. The precise stop function gives a highly reproducible delay from the stop signal is given until the ramping down starts. Run a test to find this delay as it is a sum of sensor, PLC, frequency converter, and mechanical parts.

To ensure optimum accuracy, there should be at least 10 cycles during ramping down, see:

- *Parameter 3-42 Ramp 1 Ramp-down Time.*
- *Parameter 3-52 Ramp 2 Ramp-down Time.*
- *Parameter 3-62 Ramp 3 Ramp-down Time.*
- *Parameter 3-72 Ramp 4 Ramp-down Time.*

The precise stop function is set up here and enabled from DI at terminal 29 or terminal 33.

1-84 Precise Stop Counter Value		
Range:	Function:	
100000 N/A*	[0 - 999999999 N/A]	Enter the counter value to be used in the integrated precise stop function, <i>parameter 1-83 Precise Stop Function</i> . The maximum permissible frequency at terminal 29 or 33 is 110 kHz. NOTICE! Not used for selections [0] <i>Precise ramp stop</i> and [3] <i>Speed comp stop</i> in <i>parameter 1-83 Precise Stop Function</i> .

1-85 Precise Stop Speed Compensation Delay		
Range:	Function:	
10 ms*	[0 - 100 ms]	Enter the delay time for sensors, PLCs, and so on for use in <i>parameter 1-83 Precise Stop Function</i> . In speed compensated stop mode, the delay time at different frequencies has a major influence on the stop function.

1-85 Precise Stop Speed Compensation Delay	
Range:	Function:
	<p>NOTICE!</p> <p>Not used for selections [0] <i>Precise ramp stop</i>, [1] <i>Cnt stop with reset</i>, and [2] <i>Cnt stop w/o reset in parameter 1-83 Precise Stop Function</i>.</p>

3.2.12 1-9* Motor Temperature

1-90 Motor Thermal Protection	
Option:	Function:
	<p>Motor thermal protection can be implemented using a range of techniques:</p> <ul style="list-style-type: none"> Via a PTC sensor in the motor windings connected to 1 of the analog or digital inputs (<i>parameter 1-93 Thermistor Source</i>). See <i>chapter 3.2.13 PTC Thermistor Connection</i>. Via a KTY sensor in the motor winding connected to an analog input (<i>parameter 1-96 KTY Thermistor Resource</i>). See <i>chapter 3.2.14 KTY Sensor Connection</i>. Via calculation (ETR = Electronic Thermal Relay) of the thermal load, based on the actual load and time. The calculated thermal load is compared with the rated motor current $I_{M,N}$ and the rated motor frequency $f_{M,N}$. See <i>chapter 3.2.15 ETR</i> and <i>chapter 3.2.16 ATEX ETR</i>. Via a mechanical thermal switch (Klixon type). See <i>chapter 3.2.17 Klixon</i>. <p>For the North American market: The ETR functions provide class 20 motor overload protection in accordance with NEC.</p>
[0] *	<p>No protection</p> <p>Continuously overloaded motor when no warning or trip of the frequency converter is required.</p>
[1]	<p>Thermistor warning</p> <p>Activates a warning when the connected thermistor or KTY sensor in the motor reacts in the event of motor overtemperature.</p>
[2]	<p>Thermistor trip</p> <p>Stops (trips) the frequency converter when connected thermistor or KTY sensor in the motor reacts in the event of motor overtemperature.</p>

1-90 Motor Thermal Protection	
Option:	Function:
	<p>The thermistor cutout value must be more than 3 kΩ.</p> <p>Integrate a thermistor (PTC sensor) in the motor for winding protection.</p>
[3]	<p>ETR warning 1</p> <p>Calculates the load when set-up 1 is active and activates a warning on the display when the motor is overloaded. Program a warning signal via 1 of the digital outputs.</p>
[4]	<p>ETR trip 1</p> <p>Calculates the load when set-up 1 is active and stops (trips) the frequency converter when the motor is overloaded. Program a warning signal via 1 of the digital outputs. The signal appears in the event of a warning and if the frequency converter trips (thermal warning).</p>
[5]	<p>ETR warning 2</p>
[6]	<p>ETR trip 2</p>
[7]	<p>ETR warning 3</p>
[8]	<p>ETR trip 3</p>
[9]	<p>ETR warning 4</p>
[10]	<p>ETR trip 4</p>

NOTICE!

If [20] *ATEX ETR* is selected, follow the instructions in the dedicated chapter of the *design guide* and the instructions provided by the motor manufacturer.

NOTICE!

If [20] *ATEX ETR* is selected, set *parameter 4-18 Current Limit* to 150%.

3

3.2.13 PTC Thermistor Connection

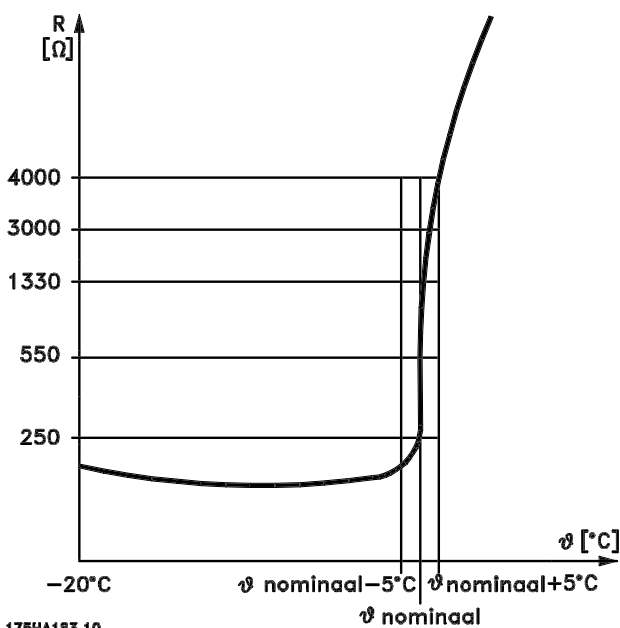

175HA183.10
Figure 3.12 PTC Profile

Using a digital input and 10 V as supply:
Example: The frequency converter trips when the motor temperature is too high.

- Parameter set-up
- Set parameter 1-90 Motor Thermal Protection to [2] Thermistor Trip.
 - Set parameter 1-93 Thermistor Source to [6] Digital Input.

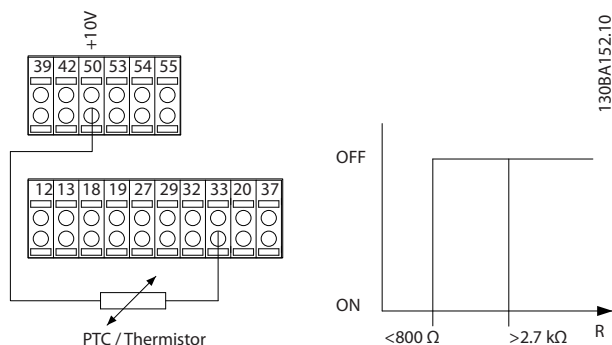

Figure 3.13 PTC Thermistor Connection - Digital Input

Using an analog input and 10 V as supply:
Example: The frequency converter trips when the motor temperature is too high.
Parameter set-up:

- Set parameter 1-90 Motor Thermal Protection to [2] Thermistor Trip.
- Set parameter 1-93 Thermistor Source to [2] Analog Input 54.

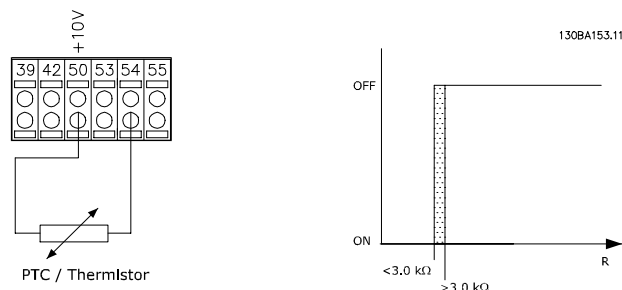

Figure 3.14 PTC Thermistor Connection - Analog Input

Input digital/analog	Supply voltage	Threshold cutout values
Digital	10 V	<800 Ω⇒2.7 kΩ
Analog	10 V	<3.0 kΩ⇒3.0 kΩ

Table 3.8 Threshold Cutout Values

NOTICE!

Check that the selected supply voltage follows the specification of the used thermistor element.

3.2.14 KTY Sensor Connection

NOTICE!

FC 302 only.

KTY sensors are used especially in permanent magnet servo motors (PM motors) for dynamic adjusting of motor parameters as stator resistance (*parameter 1-30 Stator Resistance (Rs)*) for PM motors and also rotor resistance (*parameter 1-31 Rotor Resistance (Rr)*) for asynchronous motors, depending on winding temperature. The calculation is:

$$R_s = R_{s20^{\circ}C} \times (1 + \alpha_{cu} \times \Delta T) [\Omega] \text{ where } \alpha_{cu} = 0.00393$$

KTY sensors can be used for motor protecting (*parameter 1-97 KTY Threshold level*). FC 302 can handle 3 types of KTY sensors, defined in *parameter 1-95 KTY Sensor Type*. The actual sensor temperature can be read out from *parameter 16-19 KTY sensor temperature*.

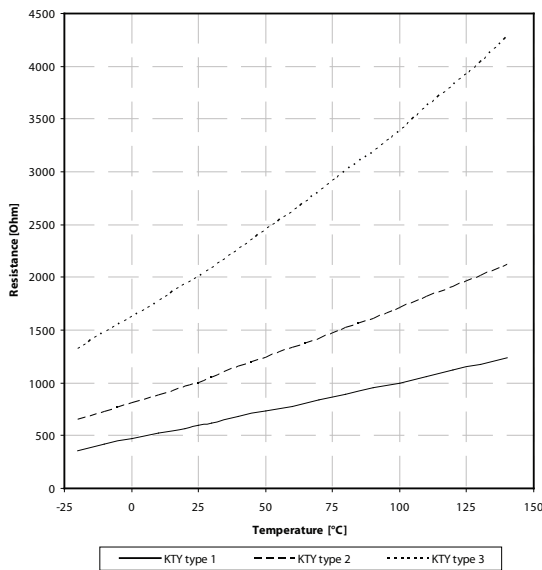

Figure 3.15 KTY Type Selection

- KTY Sensor 1: 1 kΩ at 100 °C (212 °F) (for example Philips KTY 84-1)
- KTY Sensor 2: 1 kΩ at 25 °C (77 °F) (for example Philips KTY 83-1)
- KTY Sensor 3: 2 kΩ at 25 °C (77 °F) (for example Infineon KTY-10)

NOTICE!

If the temperature of the motor is utilized through a thermistor or KTY sensor, the PELV is not complied with if there are short circuits between motor windings and the sensor. Put extra isolation on the sensor to comply with PELV.

3.2.15 ETR

The calculations estimate the need for a lower load at lower speed due to less cooling from the fan incorporated in the motor.

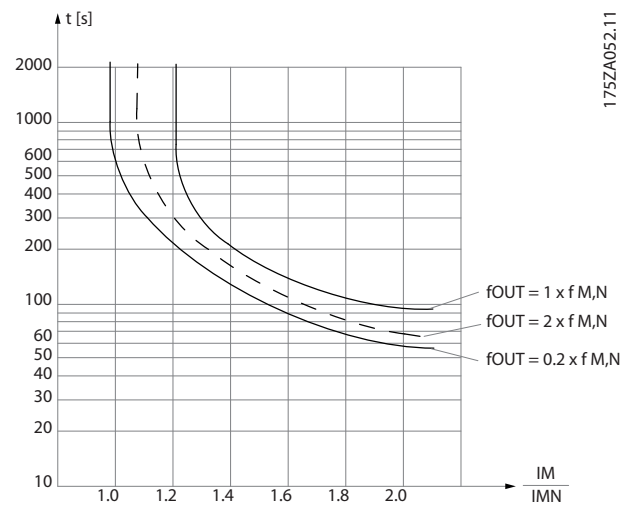

Figure 3.16 ETR Profile

3.2.16 ATEX ETR

The VLT® PTC Thermistor Card MCB 112 offers ATEX-approved monitoring of motor temperature. Alternatively, an external ATEX-approved PTC protection device can be used.

NOTICE!

Only use ATEX Ex-e-approved motors for this function. See motor nameplate, approval certificate, datasheet, or contact motor supplier.

When controlling an Ex-e motor with increased safety, it is important to ensure certain limitations. The parameters that must be programmed are presented in Table 3.9.

Function	Setting
Parameter 1-90 Motor Thermal Protection	[20] ATEX ETR
Parameter 1-94 ATEX ETR cur.lim. speed reduction	20%
Parameter 1-98 ATEX ETR interpol. points freq.	Motor nameplate.
Parameter 1-99 ATEX ETR interpol. points current	
Parameter 1-23 Motor Frequency	Enter the same value as for parameter 4-19 Max Output Frequency.
Parameter 4-19 Max Output Frequency	Motor nameplate, possibly reduced for long motor cables, sine-wave filter, or reduced supply voltage.
Parameter 4-18 Current Limit	Forced to 150% by 1-90 [20]
Parameter 5-15 Terminal 33 Digital Input	[80] PTC Card 1
Parameter 5-19 Terminal 37 Safe Stop	[4] PTC 1 Alarm
Parameter 14-01 Switching Frequency	Check that the default value fulfills the requirement from motor nameplate. If not, use a sine-wave filter.
Parameter 14-26 Trip Delay at Inverter Fault	0

Table 3.9 Parameters

NOTICE!

Compare the minimum switching frequency requirement stated by the motor manufacturer to the minimum switching frequency of the frequency converter, the default value in *parameter 14-01 Switching Frequency*. If the frequency converter does not meet this requirement, use a sine-wave filter.

More information about ATEX ETR thermal monitoring can be found in *Application Note for FC 300 ATEX ETR Thermal Monitoring Function*.

3.2.17 Klixon

The Klixon type thermal circuit breaker uses a KLIXON® metal dish. At a predetermined overload, the heat caused by the current through the disc causes a trip.

Using a digital input and 24 V as supply:
Example: The frequency converter trips when the motor temperature is too high.

Parameter set-up:

- Set parameter 1-90 Motor Thermal Protection to [2] Thermistor Trip.
- Set parameter 1-93 Thermistor Source to [6] Digital Input.

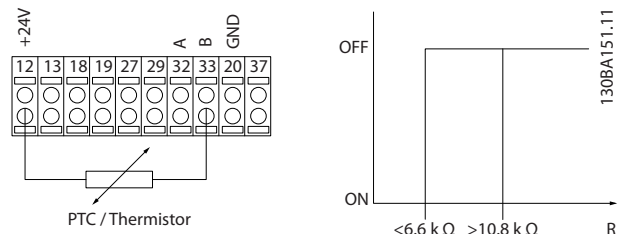

Figure 3.17 Thermistor Connection

1-91 Motor External Fan		
Option:	Function:	
[0] *	No	No external fan is required, that is the motor is derated at low speed.
[1]	Yes	Applies an external motor fan (external ventilation), so no derating of the motor is required at low speed. The upper curve in <i>Figure 3.16</i> ($f_{out} = 1 \times f_{M,N}$) is followed if the motor current is lower than nominal motor current (see <i>parameter 1-24 Motor Current</i>). If the motor current exceeds nominal current, the operation time still decreases as if no fan was installed.

1-93 Thermistor Source		
Option:	Function:	
		<p>NOTICE! This parameter cannot be adjusted while the motor is running.</p> <p>NOTICE! Set digital input to [0] PNP - Active at 24 V in <i>parameter 5-00 Digital I/O Mode</i>.</p> <p>Select the input to which the thermistor (PTC sensor) should be connected. An analog input option [1] Analog Input 53 or [2] Analog Input 54 cannot be selected if the analog input is already in use as a reference source (selected in <i>parameter 3-15 Reference 1 Source</i>, <i>parameter 3-16 Reference 2 Source</i>, or <i>parameter 3-17 Reference 3 Source</i>). When using VLT® PTC Thermistor Card MCB 112, always select [0] None.</p>
[0] *	None	

1-93 Thermistor Source		
Option:	Function:	
[1]	Analog Input 53	
[2]	Analog Input 54	
[3]	Digital input 18	
[4]	Digital input 19	
[5]	Digital input 32	
[6]	Digital input 33	

1-94 ATEX ETR cur.lim. speed reduction		
Range:	Function:	
0 %* [0 - 100 %]	<p>NOTICE! Valid for FC 302 only.</p> <p>Only visible if parameter 1-90 Motor Thermal Protection is set to [20] ATEX ETR.</p>	

Configure the reaction for operating in Ex-e current limit.
 0%: The frequency converter does not change anything besides issuing *warning 163, ATEX ETR cur.lim.warning*.
 >0%: The frequency converter issues *warning 163, ATEX ETR cur.lim.warning* and reduces motor speed following ramp 2 (parameter group 3-5* Ramp 2).

Example:

Actual reference = 50 RPM

Parameter 1-94 ATEX ETR cur.lim. speed reduction = 20%

Resulting reference = 40 RPM

1-95 KTY Sensor Type		
Option:	Function:	
	<p>NOTICE! Valid for FC 302 only.</p> <p>Select the used type of thermistor sensor.</p>	
[0] *	KTY Sensor 1	1 kΩ at 100 °C (212 °F).
[1]	KTY Sensor 2	1 kΩ at 25 °C (77 °F).
[2]	KTY Sensor 3	2 kΩ at 25 °C (77 °F).

1-96 KTY Thermistor Resource		
Option:	Function:	
	<p>NOTICE! Valid for FC 302 only.</p> <p>Selecting analog input terminal 54 to be used as thermistor sensor input. Terminal 54 cannot be selected as thermistor source if otherwise used as reference (see parameter 3-15 Reference Resource 1 to parameter 3-17 Reference Resource 3).</p> <p>NOTICE! Connection of thermistor sensor between terminals 54 and 55 (GND). See Figure 3.15.</p>	
[0] *	None	
[2]	Analog input 54	

1-97 KTY Threshold level		
Range:	Function:	
80 °C* [-40 - 140 °C]	Select the thermistor sensor threshold level for motor thermal protection.	

1-98 ATEX ETR interpol. points freq.		
Range:	Function:	
Size related* [0 - 1000.0 Hz]	<p>NOTICE! Valid for FC 302 only.</p> <p>Only visible if parameter 1-90 Motor Thermal Protection is set to [20].</p>	

Enter the 4 frequency points [Hz] from the motor nameplate into this array. Table 3.10 shows the example of frequency/current points.

3

NOTICE!

All frequency/current limit points from the motor nameplate or motor datasheet must be programmed.

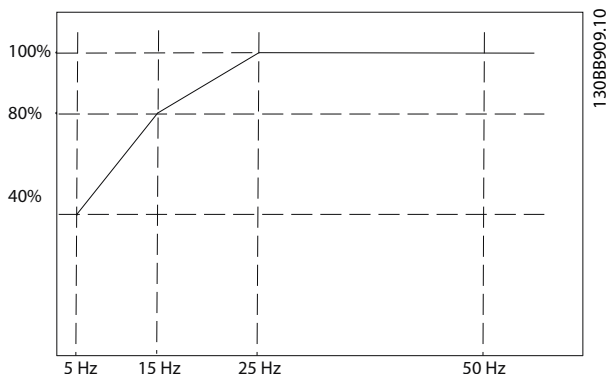

Figure 3.18 Example of ATEX ETR Thermal Limitation Curve

x-axis: f_m [Hz]
y-axis: $I_m/I_{m,n} \times 100$ [%]

Parameter 1-98 ATEX ETR interpol. points freq.	Parameter 1-99 ATEX ETR interpol points current
[0]=5 Hz	[0]=40%
[1]=15 Hz	[1]=80%
[2]=25 Hz	[2]=100%
[3]=50 Hz	[3]=100%

Table 3.10 Interpolation Points

All operating points underneath the curve are allowed continuously. Above the line, however, these are only allowed for a limited time calculated as a function of the overload. In the event of a machine current greater than 1.5 times the rated current, shutdown is immediate.

1-99 ATEX ETR interpol points current	
Only visible if parameter 1-90 Motor Thermal Protection is set to [20] or [21].	
Range:	Function:
Size related* [0 - 100 %]	NOTICE! Valid for FC 302 only. Definition of thermal limitation curve. For example, see parameter 1-98 ATEX ETR interpol. points freq.

Use the 4 current points [A] from the motor nameplate. Calculate the values as percentage of nominal motor current, $I_m/I_{m,n} \times 100$ [%], and enter into this array.

Together with parameter 1-98 ATEX ETR interpol. points freq., these constitute a table (f [Hz],I [%]).

NOTICE!

All frequency/current limit points from the motor nameplate or motor datasheet must be programmed.

3.2.18 PM Settings

If [2] Std. PM, non-salient is selected in parameter 1-10 Motor Construction, enter the motor parameters manually in the following order:

1. Parameter 1-24 Motor Current.
2. Parameter 1-26 Motor Cont. Rated Torque.
3. Parameter 1-25 Motor Nominal Speed.
4. Parameter 1-39 Motor Poles.
5. Parameter 1-30 Stator Resistance (Rs).
6. Parameter 1-37 d-axis Inductance (Ld).
7. Parameter 1-40 Back EMF at 1000 RPM.

The following parameters have been added for PM motors.

1. Parameter 1-41 Motor Angle Offset.
2. Parameter 1-07 Motor Angle Offset Adjust.
3. Parameter 1-14 Damping Gain.
4. Parameter 1-47 Torque Calibration.
5. Parameter 1-58 Flying Start Test Pulses Current.
6. Parameter 1-59 Flying Start Test Pulses Frequency.
7. Parameter 1-70 Start Mode.
8. Parameter 30-20 High Starting Torque Time [s].
9. Parameter 30-21 High Starting Torque Current [%].

NOTICE!

Standard parameters still need configuration (for example *parameter 4-19 Max Output Frequency*).

Application	Settings
Low inertia applications $I_{Load}/I_{Motor} < 5$	Increase <i>parameter 1-17 Voltage filter time const.</i> by factor 5–10. Reduce <i>parameter 1-14 Damping Gain</i> . Reduce <i>parameter 1-66 Min. Current at Low Speed</i> (<100%).
Low inertia applications $50 > I_{Load}/I_{Motor} > 5$	Keep calculated values.
High inertia applications $I_{Load}/I_{Motor} > 50$	Increase <i>parameter 1-14 Damping Gain</i> , <i>parameter 1-15 Low Speed Filter Time Const.</i> , and <i>parameter 1-16 High Speed Filter Time Const.</i>
High load at low speed <30% (rated speed)	Increase <i>parameter 1-17 Voltage filter time const.</i> Increase <i>parameter 1-66 Min. Current at Low Speed</i> (>100% for longer time can overheat the motor).

Table 3.11 Recommendations for VVC+ Applications

If the motor starts oscillating at a certain speed, increase *parameter 1-14 Damping Gain*. Increase the value in small steps. Depending on the motor, a good value for this parameter can be 10% or 100% higher than the default value.

Adjust starting torque in *parameter 1-66 Min. Current at Low Speed*. 100% provides nominal torque as starting torque.

Application	Settings
Low inertia applications	Keep calculated values.
High inertia applications	<i>Parameter 1-66 Min. Current at Low Speed</i> . Increase speed to a value between default and maximum depending on application. Set ramp times matching the application. Too fast ramp-up causes an overcurrent/overtorque. Too fast ramp-down causes an overvoltage trip.
High load at low speed	<i>Parameter 1-66 Min. Current at Low Speed</i> . Increase speed to a value between default and maximum depending on application.

Table 3.12 Recommendations for Flux Applications

3.3 Parameters: 2-** Brakes

3.3.1 2-0* DC brakes

Parameter group for configuring the DC brake and DC hold functions.

2-00 DC Hold Current		
Range:		Function:
50 %*	[0 - 160. %]	<p>NOTICE!</p> <p>The maximum value depends on the rated motor current. Avoid 100% current for too long. It may damage the motor. Low values of DC hold produce larger than expected currents with larger motor power sizes. This error increases as the motor power increases.</p> <p>Enter a value for holding current as a percentage of the rated motor current $I_{M,N}$ set in <i>parameter 1-24 Motor Current</i>. 100% DC hold current corresponds to $I_{M,N}$. This parameter holds the motor function (holding torque) or preheats the motor. This parameter is active if <i>DC hold</i> is selected in <i>parameter 1-72 Start Function [0]</i> or <i>parameter 1-80 Function at Stop [1]</i>.</p>

2-01 DC Brake Current		
Range:		Function:
50 %*	[0 - 1000. %]	<p>NOTICE!</p> <p>The maximum value depends on the rated motor current. Avoid 100% current for too long. It may damage the motor.</p> <p>Enter a value for current as a percentage of the rated motor current $I_{M,N}$, see <i>parameter 1-24 Motor Current</i>. 100% DC brake current corresponds to $I_{M,N}$. DC brake current is applied on a stop command, when the speed is lower than the limit set in <i>parameter 2-03 DC Brake Cut-in Speed [RPM]</i>; when the DC Brake Inverse function is active, or via the serial communication port. The braking current is active during the time period set in <i>parameter 2-02 DC Braking Time</i>.</p>

2-02 DC Braking Time		
Range:		Function:
10 s*	[0 - 60 s]	Set the duration of the DC brake current set in <i>parameter 2-01 DC Brake Current</i> , once activated.

2-03 DC Brake Cut-in Speed [RPM]		
Range:		Function:
0 RPM*	[0 - par. 4-13 RPM]	Set the DC brake cut-in speed for activation of the DC brake current set in <i>parameter 2-01 DC Brake Current</i> , upon a stop command.

2-04 DC Brake Cut-in Speed [Hz]		
Range:		Function:
0.0 Hz*	[0.0 - par. 4-14 Hz]	<p>NOTICE!</p> <p><i>Parameter 2-04 DC Brake Cut-in Speed [Hz]</i> is not effective when <i>parameter 1-10 Motor Construction = [1] PM, non-salient SPM</i>.</p> <p>Set the DC brake cut-in speed for activation of the DC brake current set in <i>parameter 2-01 DC Brake Current</i> after a stop command.</p>

2-05 Maximum Reference		
Range:		Function:
Size related*	[par. 3-02 - 999999.999 ReferenceFeed-backUnit]	This is an access parameter to <i>parameter 3-03 Maximum Reference</i> for legacy products. The maximum reference is the highest value obtainable by summing all references. The maximum reference unit matches the option selected in <i>parameter 1-00 Configuration Mode</i> and the unit in <i>parameter 3-01 Reference/Feedback Unit</i> .

2-06 Parking Current		
Range:		Function:
50 %*	[0 - 1000 %]	Set current as percentage of rated motor current, <i>parameter 1-24 Motor Current</i> . Is used when enabled in <i>parameter 1-70 Start Mode</i> .

2-07 Parking Time		
Range:		Function:
3 s*	[0.1 - 60 s]	Set the duration of the parking current set in <i>parameter 2-06 Parking Current</i> , once activated.

2-07 Parking Time	
Range:	Function:

3.3.2 2-1* Brake Energy Funct.

Parameter group for selecting dynamic brake parameters. Only valid for frequency converters with brake chopper.

2-10 Brake Function		
Option:	Function:	
[0] *	Off	No brake resistor is installed.
[1]	Resistor brake	A brake resistor is incorporated in the system, for dissipation of surplus brake energy as heat. Connecting a brake resistor allows a higher DC-link voltage during braking (generating operation). The resistor brake function is only active in frequency converters with an integral dynamic brake.
[2]	AC brake	Improves braking without using a brake resistor. This parameter controls an overmagnetization of the motor when running with a generative load. This function can improve the OVC function. Increasing the electrical losses in the motor allows the OVC function to increase the braking torque without exceeding the overvoltage limit. NOTICE! The AC brake is not as efficient as dynamic braking with resistor. AC brake is for VVC+ mode in both open and closed loop.

2-11 Brake Resistor (ohm)		
Range:	Function:	
Size related* [5.00 - 65535.00 Ohm]	Set the brake resistor value in Ω. This value is used for monitoring the power to the brake resistor in <i>parameter 2-13 Brake Power Monitoring</i> . This parameter is only active in frequency converters with an integral dynamic brake. Use this parameter for values without decimals. For a selection with 2 decimals, use <i>parameter 30-81 Brake Resistor (ohm)</i> .	

2-12 Brake Power Limit (kW)		
Range:	Function:	
Size related* [0.001 - 2000.000 kW]	<i>Parameter 2-12 Brake Power Limit (kW)</i> is the expected average power dissipated in the brake resistor over a period of 120 s. It is used as the monitoring limit for	

2-12 Brake Power Limit (kW)		
Range:	Function:	
	<p><i>parameter 16-33 Brake Energy /2 min</i> and thereby specifies when a warning/alarm is to be given.</p> <p>To calculate <i>parameter 2-12 Brake Power Limit (kW)</i>, the following formula can be used.</p> $P_{br,avg}[W] = \frac{U_{br}^2[LV] \times t_{br}[s]}{R_{br}[\Omega] \times T_{br}[s]}$ <p>$P_{br,avg}$ is the average power dissipated in the brake resistor, R_{br} is the resistance of the brake resistor. t_{br} is the active braking time within the 120 s period, T_{br}.</p> <p>U_{br} is the DC voltage where the brake resistor is active. This depends on the unit as follows: T2 units: 390 V T4 units: 810 V T5 units: 810 V T6 units: 943 V/1099 V for D – F frames T7 units: 1099 V</p> <p>NOTICE! If R_{br} is not known, or if T_{br} is different from 120 s, the practical approach is to run the brake application, read <i>parameter 16-33 Brake Energy /2 min</i> and then enter this + 20% in <i>parameter 2-12 Brake Power Limit (kW)</i>.</p>	

2-13 Brake Power Monitoring		
Option:	Function:	
	<p>This parameter is only active in frequency converters with a brake.</p> <p>This parameter enables monitoring of the power to the brake resistor. The power is calculated based on the resistance (<i>parameter 2-11 Brake Resistor (ohm)</i>), the DC-link voltage, and the resistor duty time.</p>	
[0] *	Off	No brake power monitoring required.
[1]	Warning	Activates a warning on the display when the power transmitted during the duty time exceeds 100% of the monitoring limit (<i>parameter 2-12 Brake Power Limit (kW)</i>). The warning disappears when the transmitted power drops below 80% of the monitoring limit.

2-13 Brake Power Monitoring		
Option:	Function:	
[2]	Trip	Trips the frequency converter and shows an alarm when the calculated power exceeds 100% of the monitoring limit.
[3]	Warning and trip	Activates both of the above, including warning, trip, and alarm.

If power monitoring is set to [0] Off or [1] Warning, the brake function remains active, even if the monitoring limit is exceeded. This may lead to thermal overload of the resistor. It is also possible to generate a warning via a relay/digital output. The measuring accuracy of the power monitoring depends on the accuracy of the resistance of the resistor (better than $\pm 20\%$).

2-15 Brake Check		
Option:	Function:	
		<p><i>Parameter 2-15 Brake Check</i> is only active in frequency converters with an integral dynamic brake.</p> <p>Select type of test and monitoring function to check the connection to the brake resistor, or whether a brake resistor is present, and then show a warning or an alarm in the event of a fault.</p> <p>NOTICE! The brake resistor disconnection function is tested during power-up. However, the brake IGBT test is performed when there is no braking. A warning or trip disconnects the brake function.</p> <p>The testing sequence is as follows:</p> <ol style="list-style-type: none"> 1. The DC-link ripple amplitude is measured for 300 ms without braking. 2. The DC-link ripple amplitude is measured for 300 ms with the brake turned on. 3. If the DC-link ripple amplitude while braking is lower than the DC-link ripple amplitude before braking + 1%: <i>Brake check has failed by returning a warning or alarm.</i> 4. If the DC-link ripple amplitude while braking is higher than the DC-link ripple amplitude before braking + 1%: <i>Brake check is OK.</i>
[0] *	Off	Monitors brake resistor and brake IGBT for a short circuit during operation. If a short circuit occurs, <i>Warning 25 Brake resistor short-circuited</i> appears.

2-15 Brake Check		
Option:	Function:	
[1]	Warning	Monitors brake resistor and brake IGBT for a short circuit and runs a test for brake resistor disconnection during power-up.
[2]	Trip	Monitors for a short circuit or disconnection of the brake resistor, or a short circuit of the brake IGBT. If a fault occurs, the frequency converter cuts out while showing an alarm (trip lock).
[3]	Stop and trip	Monitors for a short circuit or disconnection of the brake resistor, or a short circuit of the brake IGBT. If a fault occurs, the frequency converter ramps down to coast and then trips. A trip lock alarm is shown (for example, warnings 25, 27, or 28).
[4]	AC brake	Monitors for a short circuit or disconnection of the brake resistor, or a short circuit of the brake IGBT. If a fault occurs, the frequency converter performs a controlled ramp-down. This option is available for FC 302 only.

NOTICE!

Remove a warning arising with [0] Off or [1] Warning by cycling the mains supply. The fault must be corrected first. For [0] Off or [1] Warning, the frequency converter keeps running even if a fault is located.

2-16 AC Brake Max. Current		
Range:	Function:	
100.0 %*	[0.0 - 1000.0 %]	Enter the maximum allowed current when using AC braking to avoid overheating of motor windings.

NOTICE!

Parameter 2-16 AC Brake Max. Current has no effect when *parameter 1-10 Motor Construction*=[1] PM, non salient SPM.

2-17 Over-voltage Control		
Option:	Function:	
		Overvoltage control (OVC) reduces the risk of the frequency converter tripping due to an overvoltage on the DC-link caused by generative power from the load.
[0] *	Disabled	No OVC required.
[1]	Enabled (not at stop)	Activates OVC except when using a stop signal to stop the frequency converter.
[2]	Enabled	Activates OVC.

NOTICE!

Do not enable OVC in hoisting applications.

2-18 Brake Check Condition		
Range:	Function:	
[0] *	At Power Up	Brake check is performed at power-up.
[1]	After Coast Situations	Brake check is performed after coast situations.

2-19 Over-voltage Gain		
Range:	Function:	
100 %*	[10 - 200 %]	Select overvoltage gain.

during periods when the frequency converter is unable to hold the motor, for example due to an excessive load. Select [32] Mechanical Brake Control for applications with an electro-magnetic brake in parameter 5-40 Function Relay, parameter 5-30 Terminal 27 Digital Output, or parameter 5-31 Terminal 29 digital Output. When selecting [32] Mechanical brake control, the mechanical braking is closed from start-up until the output current is above the level selected in parameter 2-20 Release Brake Current. During stop, the mechanical braking activates when the speed drops below the level specified in parameter 2-21 Activate Brake Speed [RPM]. If the frequency converter enters an alarm condition, an overcurrent, or overvoltage situation, the mechanical braking immediately cuts in. This is also the case during Safe Torque Off.

3.3.3 2-2* Mechanical Brake

Parameters for controlling operation of an electro-magnetic (mechanical) brake, typically required in hoisting applications.

To control a mechanical braking, a relay output (relay 01 or relay 02) or a programmed digital output (terminal 27 or 29) is required. Normally, this output must be closed

NOTICE!

Protection mode and trip delay features (parameter 14-25 Trip Delay at Torque Limit and parameter 14-26 Trip Delay at Inverter Fault) may delay the activation of the mechanical braking in an alarm condition. These features must be disabled in hoisting applications.

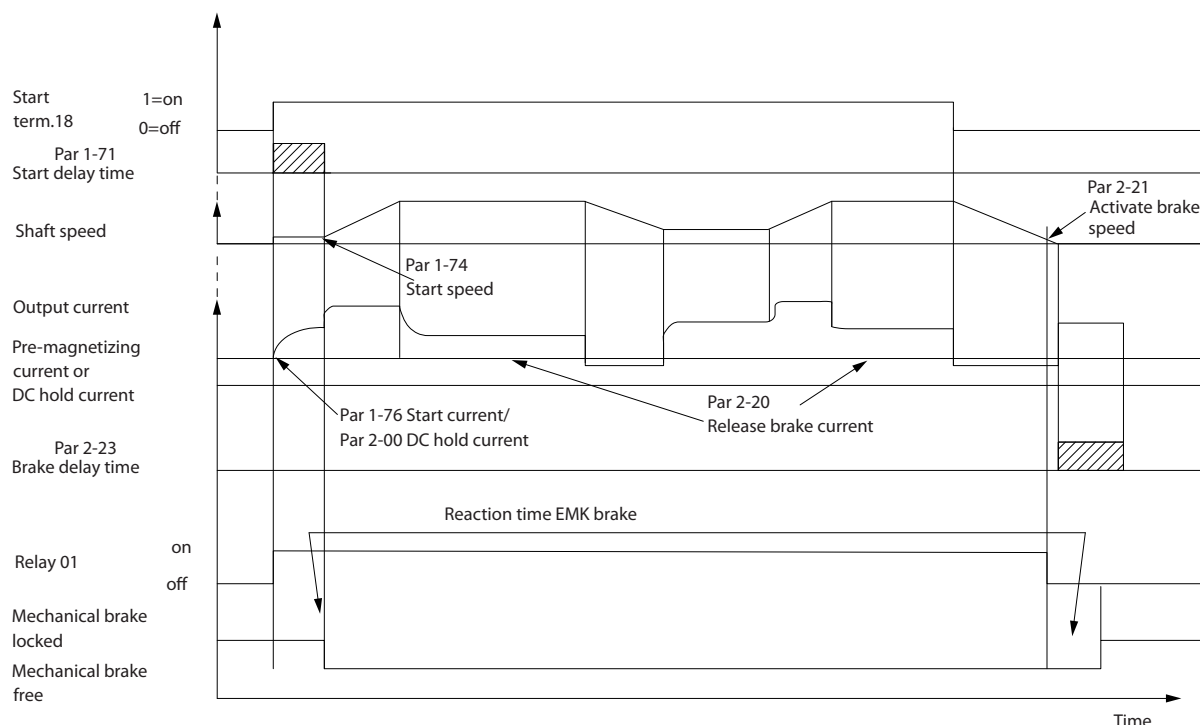

130BA074.12

Figure 3.19 Mechanical Braking

2-20 Release Brake Current		
Range:		Function:
par. 16-37 A*	[0.00 - par. 16-37 A]	Set the motor current for release of the mechanical braking when a start condition is present. The default value is the maximum current the inverter can provide for the particular power size. The upper limit is specified in <i>parameter 16-37 Inv. Max. Current</i> .
<p>NOTICE!</p> <p>When mechanical brake control output is selected, but no mechanical braking is connected, the function does not work by default setting due to too low motor current.</p>		

2-21 Activate Brake Speed [RPM]		
Range:		Function:
0 RPM*	[0 - 30000 RPM]	Set the motor speed for activation of the mechanical braking, when a stop condition is present. The upper speed limit is specified in <i>parameter 4-53 Warning Speed High</i> .

2-22 Activate Brake Speed [Hz]		
Range:		Function:
0 Hz*	[0.0 - 5000.0 Hz]	Set the motor frequency for activation of the mechanical braking when a stop condition is present.

2-23 Activate Brake Delay		
Range:		Function:
0.0 s*	[0.0 - 5.0 s]	<p>Enter the brake delay time of the coast after ramp-down time. The shaft is held at 0 speed with full holding torque. Ensure that the mechanical braking has locked the load before the motor enters coast mode. See <i>Mechanical Brake Control</i> section in the <i>design guide</i>.</p> <p>To adjust transition of the load to the mechanical braking, set <i>parameter 2-23 Activate Brake Delay</i> and <i>parameter 2-24 Stop Delay</i>.</p> <p>Setting of brake delay parameters does not affect the torque. The frequency converter does not register that mechanical braking is holding the load.</p> <p>After setting <i>parameter 2-23 Activate Brake Delay</i>, the torque drops to 0 after a few minutes. The sudden torque change leads to movement and noise.</p>

2-24 Stop Delay		
Range:		Function:
0.0 s*	[0.0 - 5.0 s]	<p>Set the time interval from the moment when the motor is stopped until the brake closes.</p> <p>To adjust transition of the load to the mechanical braking, set <i>parameter 2-23 Activate Brake Delay</i> and <i>parameter 2-24 Stop Delay</i>.</p> <p>This parameter is a part of the stop function.</p>

2-25 Brake Release Time		
Range:		Function:
0.20 s*	[0.00 - 5.00 s]	This value defines the time it takes for the mechanical brake to open. This parameter must act as a timeout when brake feedback is activated.

3.3.4 Hoist Mechanical Brake

The hoist mechanical brake control supports the following functions:

- 2 channels for mechanical braking feedback to offer further protection against unintended behavior resulting from broken cable.
- Monitoring of mechanical braking feedback throughout the complete cycle. This helps protect the mechanical brake, especially if more frequency converters are connected to the same shaft.
- No ramp-up until feedback confirms that mechanical brake is open.
- Improved load control at stop. If the value of *parameter 2-23 Activate Brake Delay* is too low, *Warning 22 Hoist mech. brake* is activated and the torque is not allowed to ramp down.
- The transition when motor takes over the load from the brake can be configured. *Parameter 2-28 Gain Boost Factor* can be increased to minimize the movement. To achieve smooth transition, change the setting from the speed control to the position control during the changeover.
 - Set *parameter 2-28 Gain Boost Factor* to 0 to enable position control during *parameter 2-02 DC Braking Time*. This enables *parameter 2-30 Position P Start Proportional Gain* to *parameter 2-33 Speed PID Start Lowpass Filter Time*, which are PID parameters for the position control.

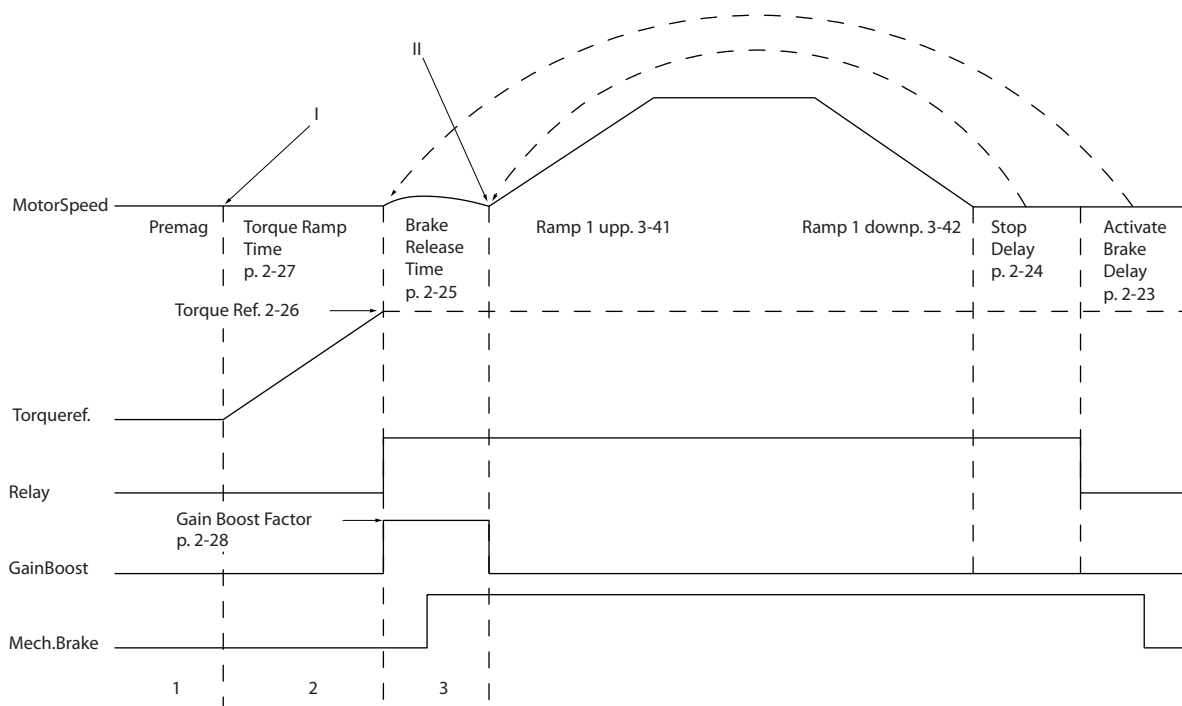

Figure 3.20 Brake Release Sequence for Hoist Mechanical Brake Control

Parameter 2-26 Torque Ref to parameter 2-33 Speed PID Start Lowpass Filter Time are only available for the hoist mechanical brake control (flux with motor feedback).

2-26 Torque Ref		
Range:	Function:	
0.00 %*	[0 - 0 %]	The value defines the torque applied against the closed mechanical brake before release. The torque/load on a crane is positive and is 10–160%. To obtain the best starting point, set <i>parameter 2-26 Torque Ref</i> to approximately 70%. The torque/load on a lift can be both positive and negative and between -160% and +160%. To obtain the best starting point, set <i>parameter 2-26 Torque Ref</i> to 0%. The higher the torque error is (<i>parameter 2-26 Torque Ref</i> vs. actual torque), the more movement during load takeover.

2-27 Torque Ramp Time		
Range:	Function:	
0.2 s*	[0.0 - 5.0 s]	The value defines the duration of the torque ramp in clockwise direction. Value 0 enables very fast magnetization in flux control principle.

2-28 Gain Boost Factor		
Range:	Function:	
1.00 N/A*	[1.00 - 4.00 N/A]	Only active in flux closed loop. The function ensures a smooth transition from torque control mode to speed control mode when the motor takes over the load from the brake. Increase to minimize the movement. Activate the advanced mechanical braking (<i>parameter group 2-3* Adv. Mech Brake</i>) by setting <i>parameter 2-28 Gain Boost Factor</i> to 0.

2-29 Torque Ramp Down Time		
Range:	Function:	
0 s*	[0 - 5 s]	Torque ramp-down time.

3.3.5 2-3* Adv. Mech Brake

Parameter 2-30 Position P Start Proportional Gain to parameter 2-33 Speed PID Start Lowpass Filter Time can be set up for very smooth transition change from speed control to position control during parameter 2-25 Brake Release Time - the time when the load is transferred from the mechanical brake to the frequency converter.

Parameter 2-30 Position P Start Proportional Gain to parameter 2-33 Speed PID Start Lowpass Filter Time are activated when parameter 2-28 Gain Boost Factor is set to 0. See Figure 3.20 for more information.

2-30 Position P Start Proportional Gain		
Range:	Function:	
0.0000*	[0.0000 - 1.0000]	

2-31 Speed PID Start Proportional Gain		
Range:	Function:	
0.0150*	[0.0000 - 1.0000]	

2-32 Speed PID Start Integral Time		
Range:	Function:	
200.0 ms*	[1.0 - 20000.0 ms]	

2-33 Speed PID Start Lowpass Filter Time		
Range:	Function:	
10.0 ms*	[0.1 - 100.0 ms]	

2-34 Zero Speed Position P Proportional Gain		
Range:	Function:	
0.0000*	[0.0000 - 1.0000]	<p>NOTICE!</p> <p>This parameter is available only with software version 48.XX.</p> <p>Enter the proportional gain for position control at standstill in speed mode.</p>

3.4 Parameters: 3-** Reference/Ramps

Parameters for handling of reference, definition of limitations, and configuration of the reaction of the frequency converter to changes.

3.4.1 3-0* Reference Limits

3-00 Reference Range		
Option:	Function:	
		Select the range of the reference signal and the feedback signal. Signal values can be positive only, or positive and negative. The minimum limit may have a negative value, unless [1] <i>Speed closed loop control</i> or [3] <i>Process</i> is selected in <i>parameter 1-00 Configuration Mode</i> .
[0]	Min to Max	Select the range of the reference signal and the feedback signal. Signal values can be positive only, or positive and negative. The minimum limit may have a negative value, unless [1] <i>Speed closed loop control</i> or [3] <i>Process</i> is selected in <i>parameter 1-00 Configuration Mode</i> .
[1]	-Max to +Max	For both positive and negative values (both directions, relative to <i>parameter 4-10 Motor Speed Direction</i>).

3-01 Reference/Feedback Unit		
Option:	Function:	
		Select the unit to be used in process PID control references and feedbacks. <i>Parameter 1-00 Configuration Mode</i> must be either [3] <i>Process</i> or [8] <i>Extended PID Control</i> .
[0] *	None	
[1]	%	
[2]	rpm	
[3]	Hz	
[4]	Nm	
[5]	PPM	
[10]	min	
[12]	PULSE/s	
[20]	liter / sec.	
[21]	liter / min	
[22]	liter / hr.	
[23]	m ³ / sec.	
[24]	m ³ /min	
[25]	m ³ / hr.	
[30]	kg / sec.	
[31]	kg/min	
[32]	kg / hr.	
[33]	ton / min	
[34]	ton / hr.	

3-01 Reference/Feedback Unit		
Option:	Function:	
[40]	m / sec.	
[41]	m/min	
[45]	m	
[60]	°C	
[70]	mbar	
[71]	bar	
[72]	Pa	
[73]	kPa	
[74]	m WG	
[80]	kW	
[120]	GPM	
[121]	gal / sec.	
[122]	gal/min	
[123]	gal / hr.	
[124]	CFM	
[125]	ft ³ /s	
[126]	ft ³ /min	
[127]	ft ³ /h	
[130]	lbs / sec.	
[131]	lbs / min.	
[132]	lbs / hr.	
[140]	ft/s	
[141]	ft/min	
[145]	ft	
[150]	lb ft	
[160]	°F	
[170]	psi	
[171]	lb/in ²	
[172]	in. wtr. gage	
[173]	ft WG	
[180]	HP	

3-02 Minimum Reference		
Range:	Function:	
0 Reference-FeedbackUnit*	[-999999.999 - par. 3-03 ReferenceFeed-backUnit]	Enter the minimum reference. The minimum reference is the lowest value obtainable by summing all references. Minimum reference is active only when <i>parameter 3-00 Reference Range</i> is set to [0] <i>Min.- Max</i> . The minimum reference unit matches: <ul style="list-style-type: none"> The configuration of <i>parameter 1-00 Configuration Mode</i>: for [1]

3-02 Minimum Reference		
Range:		Function:
		<p>Speed closed loop, RPM; for [2] Torque, Nm.</p> <ul style="list-style-type: none"> The unit selected in parameter 3-01 Reference/Feedback Unit. <p>If option [10] Synchronization is selected in parameter 1-00 Configuration Mode, this parameter defines the maximum speed deviation when performing the position offset defined in parameter 3-26 Master Offset.</p>

3-03 Maximum Reference		
Range:		Function:
1500.000 ReferenceFeed-backUnit*	[par. 3-02 - 999999.999 ReferenceFeed-backUnit]	<p>Enter the maximum reference. The maximum reference is the highest value obtainable by summing all references.</p> <p>The maximum reference unit matches:</p> <ul style="list-style-type: none"> The configuration selected in parameter 1-00 Configuration Mode: For [1] Speed closed loop, RPM; for [2] Torque, Nm. The unit selected in parameter 3-00 Reference Range. <p>If [9] Positioning is selected in parameter 1-00 Configuration Mode, this parameter defines the default speed for positioning.</p>

3-04 Reference Function		
Option:	Function:	
[0] Sum	Sums both external and preset reference sources.	
[1] External/Preset	Use either the preset or the external reference source. Shift between external and preset via a command or a digital input.	

3-05 On Reference Window		
Range:		Function:
Size related*	[0 - 999999.999 ReferenceFeed-backUnit]	<p>NOTICE!</p> <p>This parameter is only available with software version 48.XX.</p> <p>Enter the tolerance window for on reference or on target status. Depending on the option selected in parameter 1-00 Configuration Mode, this parameter defines the following:</p> <ul style="list-style-type: none"> Speed mode: Speed window for on reference status. Torque mode: Torque window for on reference status. Position mode: Speed window for on target status. See also parameter 3-08 On Target Window.

3-06 Minimum Position		
Range:		Function:
-100000 CustomRea-doutUnit2*	[-2147483648 - 2147483647 CustomRea-doutUnit2]	<p>NOTICE!</p> <p>This parameter is only available with software version 48.XX.</p> <p>Enter the minimum position. This parameter defines the position range in linear axis mode (parameter 17-76 Position Axis Mode) and in the position limit function (parameter 4-73 Position Limit Function).</p>

3-07 Maximum Position		
Range:		Function:
100000 CustomRea-doutUnit2*	[-2147483647 - 2147483647 CustomRea-doutUnit2]	<p>NOTICE!</p> <p>This parameter is only available with software version 48.XX.</p> <p>Enter the maximum position. This parameter defines the position range in linear and axis modes</p>

3-07 Maximum Position	
Range:	Function:
	<p>(parameter 17-76 Position Axis Mode).</p> <p>Position range limits:</p> <ul style="list-style-type: none"> Linear: <ul style="list-style-type: none"> Parameter 3-06 Minimum Position to parameter 3-07 Maximum Position. Rotary: 0–parameter 3-07 Maximum Position. <p>The position limit function uses this parameter (parameter 4-73 Position Limit Function).</p>

3-08 On Target Window	
Range:	Function:
5 CustomReadoutUnit2* [0 - 2147483647 CustomReadoutUnit2]	<p>NOTICE!</p> <p>This parameter is only available with software version 48.XX.</p> <p>The frequency converter considers the positioning completed and sends the on target signal when the actual position is within parameter 3-08 On Target Window for the duration of parameter 3-09 On Target Time and the actual speed is less than parameter 3-05 On Reference Window.</p>

3-09 On Target Time	
Range:	Function:
1 ms* [0 - 60000 ms]	<p>NOTICE!</p> <p>This parameter is only available with software version 48.XX.</p> <p>Enter the time for evaluating the on target window, see also parameter 3-08 On Target Window.</p>

3.4.2 3-1* References

Select the preset reference(s). Select *Preset ref. bit 0/1/2 [16], [17], or [18]* for the corresponding digital inputs in parameter group 5-1* Digital Inputs.

3-10 Preset Reference	
Array [8]	
Range: 0-7	
Range:	Function:
0.00 [%* [-100.00 - 100.00 %]	<p>Enter up to 8 different preset references (0–7) in this parameter, using array programming. The preset reference is stated as a percentage of the value Ref_{MAX} (parameter 3-03 Maximum Reference). If a Ref_{MIN} different from 0 (parameter 3-02 Minimum Reference) is programmed, the preset reference is calculated as a percentage of the full reference range, that is on the basis of the difference between Ref_{MAX} and Ref_{MIN}. Afterwards, the value is added to Ref_{MIN}. When using preset references, select preset reference bit 0/1/2 [16], [17] or [18] for the corresponding digital inputs in parameter group 5-1* Digital Inputs.</p>

130BA149.10

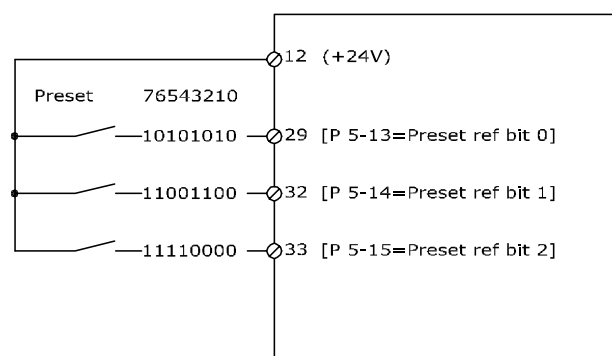

Figure 3.21 Preset Reference

Preset ref. bit	2	1	0
Preset ref. 0	0	0	0
Preset ref. 1	0	0	1
Preset ref. 2	0	1	0
Preset ref. 3	0	1	1
Preset ref. 4	1	0	0
Preset ref. 5	1	0	1
Preset ref. 6	1	1	0
Preset ref. 7	1	1	1

Table 3.13 Preset Reference Bits

3-11 Jog Speed [Hz]		
Range:	Function:	
0 Hz* [0.0 - par. 4-14 Hz]	The jog speed is a fixed output speed at which the frequency converter is running when the jog function is activated. See also <i>parameter 3-80 Jog Ramp Time</i> .	

3-12 Catch up/slow-down Value		
Range:	Function:	
0.00 %* [0.00 - 100.00 %]	Enter a percentage (relative) value to be either added to or deducted from the actual reference for catch up or slow down. If <i>catch up</i> is selected via 1 of the digital inputs (<i>parameter 5-10 Terminal 18 Digital Input</i> to <i>parameter 5-15 Terminal 33 Digital Input</i>), the percentage (relative) value is added to the total reference. If <i>slow down</i> is selected via 1 of the digital inputs (<i>parameter 5-10 Terminal 18 Digital Input</i> to <i>parameter 5-15 Terminal 33 Digital Input</i>), the percentage (relative) value is deducted from the total reference. Obtain extended functionality with the DigiPot function. See <i>parameter group 3-9* Digital Potentiometer</i> .	

3-13 Reference Site		
Option:	Function:	
		Select which reference site to activate.
[0] *	Linked to Hand / Auto	Use local reference when in hand-on mode, or remote reference when in auto-on mode.
[1]	Remote	Use remote reference in both hand-on mode and auto-on mode.
[2]	Local	Use local reference in both hand-on mode and auto-on mode. NOTICE! When set to [2] Local, the frequency converter starts with this setting again after a power-down.

3-14 Preset Relative Reference		
Range:	Function:	
0 %* [-100 - 100 %]	The actual reference, X, is increased or decreased with the percentage Y, set in <i>parameter 3-14 Preset Relative Reference</i> . This results in the actual reference Z. Actual reference (X) is the sum of the inputs selected in: <ul style="list-style-type: none"> Parameter 3-15 Reference 1 Source. Parameter 3-16 Reference 2 Source. Parameter 3-17 Reference 3 Source. 	

3-14 Preset Relative Reference		
Range:	Function:	
	<ul style="list-style-type: none"> Parameter 8-02 Control Source. 	

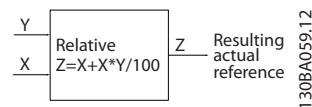

Figure 3.22 Preset Relative Reference

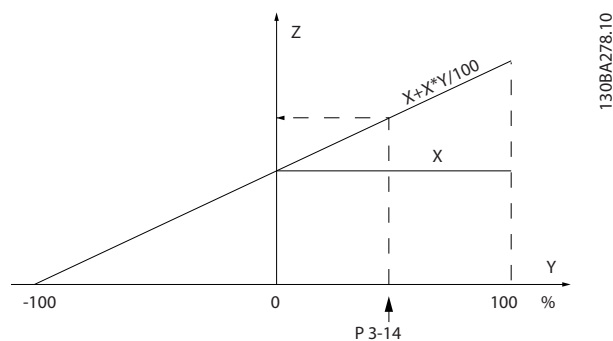

Figure 3.23 Actual Reference

3-15 Reference Resource 1		
Option:	Function:	
		Select the reference input to be used for the first reference signal. <i>Parameter 3-15 Reference Resource 1</i> , <i>parameter 3-16 Reference Resource 2</i> , and <i>parameter 3-17 Reference Resource 3</i> define up to 3 different reference signals. The sum of these reference signals defines the actual reference.
[0]	No function	
[1] *	Analog input 53	
[2]	Analog input 54	
[7]	Frequency input 29	
[8]	Frequency input 33	
[11]	Local bus reference	Reference from terminals 68 and 69.
[20]	Digital pot.meter	
[21]	Analog input X30-11	VLT® General Purpose I/O MCB 101
[22]	Analog input X30-12	VLT® General Purpose I/O MCB 101

3-16 Reference Resource 2		
Option:	Function:	
		Select the reference input to be used for the 2 nd reference signal. <i>Parameter 3-15 Reference Resource 1, parameter 3-16 Reference Resource 2, and parameter 3-17 Reference Resource 3</i> define up to 3 different reference signals. The sum of these reference signals defines the actual reference.
[0]	No function	
[1]	Analog input 53	
[2]	Analog input 54	
[7]	Frequency input 29	
[8]	Frequency input 33	
[11]	Local bus reference	Reference from terminals 68 and 69.
[20] *	Digital pot.meter	
[21]	Analog input X30-11	
[22]	Analog input X30-12	

3-17 Reference Resource 3		
Option:	Function:	
		Select the reference input to be used for the 3 rd reference signal. <i>Parameter 3-15 Reference Resource 1, parameter 3-16 Reference Resource 2, and parameter 3-17 Reference Resource 3</i> define up to 3 different reference signals. The sum of these reference signals defines the actual reference.
[0]	No function	
[1]	Analog input 53	
[2]	Analog input 54	
[7]	Frequency input 29	
[8]	Frequency input 33	
[11] *	Local bus reference	Reference from terminals 68 and 69.
[20]	Digital pot.meter	
[21]	Analog input X30-11	
[22]	Analog input X30-12	

3-18 Relative Scaling Reference Resource		
Option:	Function:	
		<p>NOTICE!</p> <p>This parameter cannot be adjusted while the motor is running.</p> <p>Select a variable value to be added to the fixed value (defined in <i>parameter 3-14 Preset Relative Reference</i>). The sum of the fixed and variable values (labeled Y in <i>Figure 3.24</i>) is multiplied by the actual reference (labeled X in <i>Figure 3.24</i>). This product is then added to the actual reference (X+X*Y/100) to give the resulting actual reference.</p> <div style="text-align: center;"> <p style="text-align: right; font-size: small;">130BA059.12</p> </div> <p>Figure 3.24 Resulting Actual Reference</p>
[0] *	No function	
[1]	Analog input 53	
[2]	Analog input 54	
[7]	Frequency input 29	
[8]	Frequency input 33	
[11]	Local bus reference	Reference from terminals 68 and 69.
[20]	Digital pot.meter	
[21]	Analog input X30-11	
[22]	Analog input X30-12	

3-19 Jog Speed [RPM]		
Range:	Function:	
150 RPM*	[0 - par. 4-13 RPM]	Enter a value for the jog speed n _{JOG} , which is a fixed output speed. The frequency converter runs at this speed when the jog function is activated. The maximum limit is defined in <i>parameter 4-13 Motor Speed High Limit [RPM]</i> . See also <i>parameter 3-80 Jog Ramp Time</i> .

3.4.3 3-2* References II

3-20 Preset Target		
Range:	Function:	
0 CustomReadoutUnit2*	[-2147483648 - 2147483647 CustomReadoutUnit2]	<p>NOTICE! This parameter is only available with software version 48.XX.</p> <p>Array [8] Set up to 8 target positions. Select from the 8 preset positions using digital inputs or the fieldbus control word.</p>

3-21 Touch Target		
Range:	Function:	
0 CustomReadoutUnit2*	[-2147483648 - 2147483647 CustomReadoutUnit2]	<p>NOTICE! This parameter is only available with software version 48.XX.</p> <p>Enter the target position in touch probe positioning mode. This parameter defines the distance from the detection event of the touch probe sensor to the final target position in position units.</p>

3-22 Master Scale Numerator		
Range:	Function:	
1* [-2147483648 - 2147483647]	<p>NOTICE! This parameter is only available with software version 48.XX.</p> <p>Parameter 3-22 Master Scale Numerator and parameter 3-23 Master Scale Denominator define the gear ratio between the master and the slave in synchronization mode.</p> $\text{Master revolutions} = \frac{\text{Par. 3-22}}{\text{Par. 3-23}} \times \text{Slave revolutions}$	

3-23 Master Scale Denominator		
Range:	Function:	
1* [-2147483648 - 2147483647]	<p>NOTICE! This parameter is only available with software version 48.XX.</p> <p>See parameter 3-22 Master Scale Numerator.</p>	

3-24 Master Lowpass Filter Time		
Range:	Function:	
20 ms*	[1 - 2000 ms]	<p>NOTICE! This parameter is only available with software version 48.XX.</p> <p>Enter the time constant for master speed calculation in synchronizing mode.</p>

3-25 Master Bus Resolution		
Range:	Function:	
65536*	[128 - 65536]	<p>NOTICE! This parameter is only available with software version 48.XX.</p> <p>Enter the resolution of the fieldbus master signal (fieldbus reference 1) in synchronization mode.</p>

3-26 Master Offset		
Range:	Function:	
0 CustomReadoutUnit2*	[-2147483648 - 2147483647 CustomReadoutUnit2]	<p>NOTICE! This parameter is only available with software version 48.XX.</p> <p>Enter the position offset between the master and the slave in synchronization mode. This value is added to the follower position at each activation of a digital input with option [113] Enable Reference or bit 5 of the fieldbus control word. Parameter 3-02 Minimum Reference defines the maximum deviation from the actual master speed during the execution of the offset.</p>

3-27 Virtual Master Max Ref		
Range:	Function:	
50.0 Hz*	[0.0 - 590.0 Hz]	<p>NOTICE!</p> <p>This parameter is available only with software version 48.XX.</p> <p>Enter the maximum reference for the virtual master. The actual reference is set relative to this value using the source selected in <i>parameter 3-15 Reference Resource 1</i> or fieldbus reference 1. The rotation direction is controlled by the forward/reverse signal on a digital input or fieldbus. Use <i>parameter group 3-6* Ramp 3</i> to configure acceleration and deceleration.</p>

3-28 Master Offset Speed Ref		
Range:	Function:	
1500 RPM*	[0 - 65000 RPM]	<p>NOTICE!</p> <p>This parameter is only available with software version 48.XX.</p> <p>Enter the speed reference for changing the master offset in synchronization mode. To ensure compatibility with software versions 48.01 and 48.10, this parameter is only active when <i>parameter 3-02 Minimum Reference</i> is set to 0.</p>

3.4.4 Ramps 3-4* Ramp 1

For each of the 4 ramps (*parameter groups 3-4* Ramp 1, 3-5* Ramp 2, 3-6* Ramp 3, and 3-7* Ramp 4*) configure the ramp parameters:

- Ramp type,
- Ramping times (duration of acceleration and deceleration), and
- Level of jerk compensation for S-ramps.

Start by setting the linear ramping times corresponding to *Figure 3.25* and *Figure 3.26*.

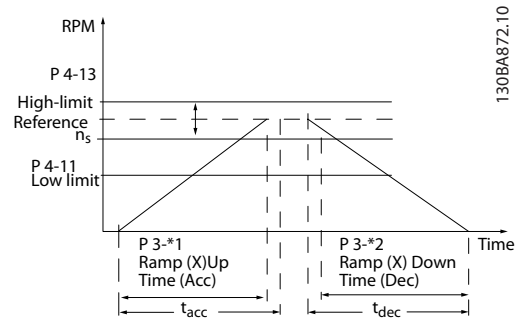

Figure 3.25 Linear Ramping Times

If S-ramps are selected, set the level of non-linear jerk compensation required. Set jerk compensation by defining the proportion of ramp-up and ramp-down times where acceleration and deceleration are variable (that is, increasing or decreasing). The S-ramp acceleration and deceleration settings are defined as a percentage of the actual ramp time.

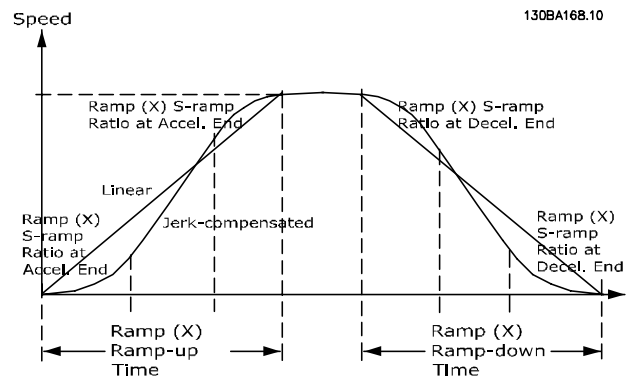

Figure 3.26 Linear Ramping Times

3-40 Ramp 1 Type		
Option:	Function:	
[0] *	Linear	<p>NOTICE!</p> <p>If [1] <i>S-ramp Const Jerk</i> is selected and the reference during ramping is changed, the ramp time may be prolonged to realize a jerk-free movement, which may result in a longer start or stop time.</p> <p>Extra adjustment of the S-ramp ratios or switching initiators may be necessary.</p> <p>Select the ramp type, depending on requirements for acceleration/deceleration.</p> <p>A linear ramp gives constant acceleration during ramping. An S-ramp gives non-linear acceleration, compensating for jerk in the application.</p>

3-40 Ramp 1 Type		
Option:	Function:	
[1]	S-ramp	Acceleration with lowest possible jerk.
[2]		S-ramp based on the values set in <i>parameter 3-41 Ramp 1 Ramp-up Time</i> and <i>parameter 3-42 Ramp 1 Ramp-down Time</i> .

3-41 Ramp 1 Ramp-up Time		
Range:	Function:	
3.00 s*	[0.01 - 3600.00 s]	Enter the ramp-up time, that is the acceleration time from 0 RPM to the synchronous motor speed n_s . Select a ramp-up time which prevents the output current from exceeding the current limit in <i>parameter 4-18 Current Limit</i> during ramping. The value 0.00 corresponds to 0.01 s in speed mode. See ramp-down time in <i>parameter 3-42 Ramp 1 Ramp-down Time</i> . $Par. 3 - 41 = \frac{t_{acc} [s] \times n_s [RPM]}{ref [RPM]}$

3-42 Ramp 1 Ramp-down Time		
Range:	Function:	
3.00 s*	[0.01 - 3600.00 s]	Enter the ramp-down time, that is the deceleration time from the synchronous motor speed n_s to 0 RPM. Select a ramp-down time such that no overvoltage occurs in the inverter due to regenerative operation of the motor, and such that the generated current does not exceed the current limit set in <i>parameter 4-18 Current Limit</i> . The value 0.00 corresponds to 0.01 s in speed mode. See ramp-up time in <i>parameter 3-41 Ramp 1 Ramp-up Time</i> . $Par. 3 - 42 = \frac{t_{dec} [s] \times n_s [RPM]}{ref [RPM]}$

3-45 Ramp 1 S-ramp Ratio at Accel. Start		
Range:	Function:	
50 %*	[1 - 99. %]	Enter the proportion of the total ramp-up time (<i>parameter 3-41 Ramp 1 Ramp-up Time</i>) in which the acceleration torque increases. The larger the percentage value, the greater the jerk compensation achieved, and thus the lower the torque jerks occurring in the application.

3-46 Ramp 1 S-ramp Ratio at Accel. End		
Range:	Function:	
50 %*	[1 - 99. %]	Enter the proportion of the total ramp-up time (<i>parameter 3-41 Ramp 1 Ramp-up Time</i>) in which the acceleration torque decreases. The larger the percentage value, the greater the

3-46 Ramp 1 S-ramp Ratio at Accel. End		
Range:	Function:	
		jerk compensation achieved, and thus the lower the torque jerks in the application.

3-47 Ramp 1 S-ramp Ratio at Decel. Start		
Range:	Function:	
50 %*	[1 - 99. %]	Enter the proportion of the total ramp-down time (<i>parameter 3-42 Ramp 1 Ramp-down Time</i>) where the deceleration torque increases. The larger the percentage value, the greater the jerk compensation achieved, and thus the lower the torque jerks in the application.

3-48 Ramp 1 S-ramp Ratio at Decel. End		
Range:	Function:	
50 %*	[1 - 99. %]	Enter the proportion of the total ramp-down time (<i>parameter 3-42 Ramp 1 Ramp-down Time</i>) where the deceleration torque decreases. The larger the percentage value, the greater the jerk compensation achieved, and thus the lower the torque jerks in the application.

3.4.5 3-5* Ramp 2

To select ramp parameters, see *parameter group 3-4* Ramp 1*.

3-50 Ramp 2 Type		
Option:	Function:	
		Select the ramp type, depending on requirements for acceleration/deceleration. A linear ramp gives constant acceleration during ramping. An S-ramp gives non-linear acceleration, compensating for jerk in the application.
[0] *	Linear	
[1]	S-ramp	Acceleration with lowest possible jerk.
[2]		S-ramp based on the values set in <i>parameter 3-51 Ramp 2 Ramp-up Time</i> and <i>parameter 3-52 Ramp 2 Ramp-down Time</i> .

NOTICE!

If [1] *S-ramp Const Jerk* is selected and the reference during ramping is changed, the ramp time may be prolonged to realize a jerk-free movement, which may result in a longer start or stop time.

Additional adjustment of the S-ramp ratios or switching initiators may be necessary.

3-51 Ramp 2 Ramp-up Time		
Range:	Function:	
3.00 s*	[0.01 - 3600.00 s]	Enter the ramp-up time, that is the acceleration time from 0 RPM to the nominal motor speed n_s . Select a ramp-up time such that the output current does not exceed the current limit in <i>parameter 4-18 Current Limit</i> during ramping. The value 0.00 corresponds to 0.01 s in speed mode. See ramp-down time in <i>parameter 3-52 Ramp 2 Ramp-down Time</i> .
$Par. 3-51 = \frac{t_{acc} [s] \times n_s [RPM]}{ref [RPM]}$		

3-52 Ramp 2 Ramp-down Time		
Range:	Function:	
3.00 s*	[0.01 - 3600.00 s]	Enter the ramp-down time, that is the deceleration time from the nominal motor speed n_s to 0 RPM. Select a ramp-down time such that no overvoltage occurs in the frequency converter due to regenerative operation of the motor, and such that the generated current does not exceed the current limit set in <i>parameter 4-18 Current Limit</i> . The value 0.00 corresponds to 0.01 s in speed mode. See ramp-up time in <i>parameter 3-51 Ramp 2 Ramp-up Time</i> .
$Par. 3-52 = \frac{t_{dec} [s] \times n_s [RPM]}{ref [RPM]}$		

3-55 Ramp 2 S-ramp Ratio at Accel. Start		
Range:	Function:	
50 %*	[1 - 99. %]	Enter the proportion of the total ramp-up time (<i>parameter 3-51 Ramp 2 Ramp-up Time</i>) in which the acceleration torque increases. The larger the percentage value, the greater the jerk compensation achieved, and thus the lower the torque jerks in the application.

3-56 Ramp 2 S-ramp Ratio at Accel. End		
Range:	Function:	
50 %*	[1 - 99. %]	Enter the proportion of the total ramp-up time (<i>parameter 3-51 Ramp 2 Ramp-up Time</i>) in which the acceleration torque decreases. The larger the percentage value, the greater the jerk compensation achieved, and thus the lower the torque jerks in the application.

3-57 Ramp 2 S-ramp Ratio at Decel. Start		
Range:	Function:	
50 %*	[1 - 99. %]	Enter the proportion of the total ramp-down time (<i>parameter 3-52 Ramp 2 Ramp-down Time</i>) where the deceleration torque increases. The larger the percentage value, the greater the

3-57 Ramp 2 S-ramp Ratio at Decel. Start		
Range:	Function:	
		jerk compensation achieved, and thus the lower the torque jerks in the application.

3-58 Ramp 2 S-ramp Ratio at Decel. End		
Range:	Function:	
50 %*	[1 - 99. %]	Enter the proportion of the total ramp-down time (<i>parameter 3-52 Ramp 2 Ramp-down Time</i>) where the deceleration torque decreases. The larger the percentage value, the greater the jerk compensation achieved, and thus the lower the torque jerks in the application.

3.4.6 3-6* Ramp 3

Configure ramp parameters, see *parameter group 3-4* Ramp 1*.

3-60 Ramp 3 Type		
Option:	Function:	
		Select the ramp type, depending on requirements for acceleration and deceleration. A linear ramp gives constant acceleration during ramping. An S-ramp gives non-linear acceleration, compensating for jerk in the application.
[0] *	Linear	
[1]	S-ramp	Accelerates with lowest possible jerk.
[2]		S-ramp based on the values set in <i>parameter 3-61 Ramp 3 Ramp-up Time</i> and <i>parameter 3-62 Ramp 3 Ramp-down Time</i> .

NOTICE!

If [1] *S-ramp Const Jerk* is selected and the reference during ramping is changed, the ramp time may be prolonged to realize a jerk-free movement, which may result in a longer start or stop time.

Extra adjustment of the S-ramp ratios or switching initiators may be necessary.

3-61 Ramp 3 Ramp-up Time		
Range:	Function:	
3.00 s*	[0.01 - 3600.00 s]	Enter the ramp-up time, which is the acceleration time from 0 RPM to the nominal motor speed n_s . Select a ramp-up time such that the output current does not exceed the current limit in <i>parameter 4-18 Current Limit</i> during ramping. The value 0.00 corresponds to 0.01 s in speed mode. See ramp-down time in <i>parameter 3-62 Ramp 3 Ramp-down Time</i> .

3-62 Ramp 3 Ramp-down Time		
Range:	Function:	
3.00 s*	[0.01 - 3600.00 s]	Enter the ramp-down time, which is the deceleration time from the nominal motor speed n_s to 0 RPM. Select a ramp-down time such that no overvoltage occurs in the inverter due to regenerative operation of the motor, and such that the generated current does not exceed the current limit set in <i>parameter 4-18 Current Limit</i> . The value 0.00 corresponds to 0.01 s in speed mode. See ramp-up time in <i>parameter 3-61 Ramp 3 Ramp-up Time</i> . $Par. 3 - 62 = \frac{t_{dec} [s] \times n_s [RPM]}{ref [RPM]}$

3-65 Ramp 3 S-ramp Ratio at Accel. Start		
Range:	Function:	
50 %*	[1 - 99. %]	Enter the proportion of the total ramp-up time (<i>parameter 3-61 Ramp 3 Ramp-up Time</i>) in which the acceleration torque increases. The larger the percentage value, the greater the jerk compensation achieved, and thus the lower the torque jerks in the application.

3-66 Ramp 3 S-ramp Ratio at Accel. End		
Range:	Function:	
50 %*	[1 - 99. %]	Enter the proportion of the total ramp-up time (<i>parameter 3-61 Ramp 3 Ramp-up Time</i>) in which the acceleration torque decreases. The larger the percentage value, the greater the jerk compensation achieved, and thus the lower the torque jerks in the application.

3-67 Ramp 3 S-ramp Ratio at Decel. Start		
Range:	Function:	
50 %*	[1 - 99. %]	Enter the proportion of the total ramp-down time (<i>parameter 3-62 Ramp 3 Ramp-down Time</i>) where the deceleration torque increases. The larger the percentage value, the greater the jerk compensation achieved, and thus the lower the torque jerks in the application.

3-68 Ramp 3 S-ramp Ratio at Decel. End		
Range:	Function:	
50 %*	[1 - 99. %]	Enter the proportion of the total ramp-down decel time (<i>parameter 3-62 Ramp 3 Ramp-down Time</i>) where the deceleration torque decreases. The larger the percentage value, the greater the jerk compensation achieved, and thus the lower the torque jerks in the application.

3.4.7 3-7* Ramp 4

Configure ramp parameters, see *parameter group 3-4* Ramp 1*.

3-70 Ramp 4 Type		
Option:	Function:	
		Select the ramp type, depending on requirements for acceleration and deceleration. A linear ramp gives constant acceleration during ramping. An S-ramp gives non-linear acceleration, compensating for jerk in the application.
[0] *	Linear	
[1]	S-ramp	Accelerates with lowest possible jerk.
[2]		S-ramp based on the values set in <i>parameter 3-71 Ramp 4 Ramp-up Time</i> and <i>parameter 3-72 Ramp 4 Ramp-down Time</i> .

NOTICE!

If [1] *S-ramp Const Jerk* is selected and the reference during ramping is changed, the ramp time may be prolonged to realize a jerk-free movement, which may result in a longer start or stop time.

More adjustments of the S-ramp ratios or switching initiators may be necessary.

3-71 Ramp 4 Ramp-up Time		
Range:	Function:	
3.00 s*	[0.01 - 3600.00 s]	Enter the ramp-up time, which is the acceleration time from 0 RPM to the rated motor speed n_s . Select a ramp-up time such that the output current does not exceed the current limit in <i>parameter 4-18 Current Limit</i> during ramping. The value 0.00 corresponds to 0.01 s in speed mode. See ramp-down time in <i>parameter 3-72 Ramp 4 Ramp-down Time</i> . $Par. 3 - 71 = \frac{t_{acc} [s] \times n_s [RPM]}{ref [RPM]}$

3-72 Ramp 4 Ramp-down Time		
Range:	Function:	
3.00 s*	[0.01 - 3600.00 s]	Enter the ramp-down time, which is the deceleration time from the nominal motor speed n_s to 0 RPM. Select a ramp-down time such that no overvoltage occurs in the inverter due to regenerative operation of the motor, and such that the generated current does not exceed the current limit set in <i>parameter 4-18 Current Limit</i> . The value 0.00 corresponds to 0.01 s in speed mode. See

3-72 Ramp 4 Ramp-down Time		
Range:	Function:	
	ramp-up time in <i>parameter 3-71 Ramp 4 Ramp-up Time</i> .	
	$Par. 3 - 72 = \frac{t_{dec} [s] \times n_s [RPM]}{ref [RPM]}$	

3-75 Ramp 4 S-ramp Ratio at Accel. Start		
Range:	Function:	
50 %*	[1 - 99. %]	Enter the proportion of the total ramp-up time (<i>parameter 3-71 Ramp 4 Ramp-up Time</i>) in which the acceleration torque increases. The larger the percentage value, the greater the jerk compensation achieved, and thus the lower the torque jerks in the application.

3-76 Ramp 4 S-ramp Ratio at Accel. End		
Range:	Function:	
50 %*	[1 - 99. %]	Enter the proportion of the total ramp-up time (<i>parameter 3-71 Ramp 4 Ramp-up Time</i>) in which the acceleration torque decreases. The larger the percentage value, the greater the jerk compensation achieved, and thus the lower the torque jerks in the application.

3-77 Ramp 4 S-ramp Ratio at Decel. Start		
Range:	Function:	
50 %*	[1 - 99. %]	Enter the proportion of the total ramp-down time (<i>parameter 3-72 Ramp 4 Ramp-down Time</i>) where the deceleration torque increases. The larger the percentage value, the greater the jerk compensation achieved, and thus the lower the torque jerks in the application.

3-78 Ramp 4 S-ramp Ratio at Decel. End		
Range:	Function:	
50 %*	[1 - 99. %]	Enter the proportion of the total ramp-down time (<i>parameter 3-72 Ramp 4 Ramp-down Time</i>) where the deceleration torque decreases. The larger the percentage value, the greater the jerk compensation achieved, and thus the lower the torque jerks in the application.

3.4.8 3-8* Other Ramps

3-80 Jog Ramp Time		
Range:	Function:	
3.00 s*	[0.01 - 3600.00 s]	Enter the jog ramp time, that is the acceleration/deceleration time between 0 RPM and the rated motor frequency n_s . Ensure that the resulting output current required for the given jog ramp time does not exceed the current limit in <i>parameter 4-18 Current Limit</i> . The jog ramp time starts after activation of a jog signal via the LCP, a selected digital input, or the serial communication port. When jog state is disabled, then the normal ramping times are valid.

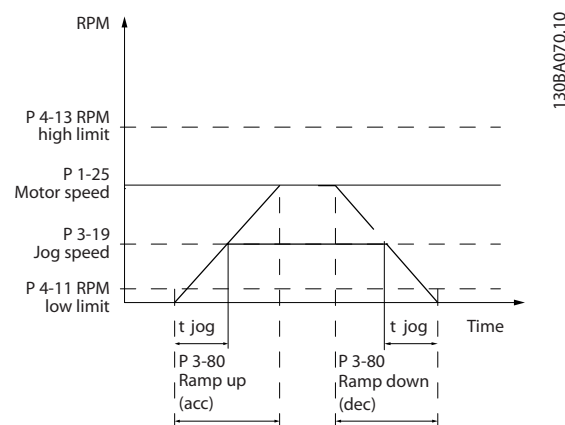

Figure 3.27 Jog Ramp Time

$$Par. 3 - 80 = \frac{t_{jog} [s] \times n_s [RPM]}{\Delta jog\ speed (par. 3 - 19) [RPM]}$$

3-81 Quick Stop Ramp Time		
Range:	Function:	
3.00 s*	[0.01 - 3600.00 s]	Enter the quick-stop ramp-down time, that is the deceleration time from the synchronous motor speed to 0 RPM. Ensure that no resulting overvoltage occurs in the inverter due to regenerative operation of the motor required to achieve the given ramp-down time. Ensure also that the generated current required to achieve the given ramp-down time does not exceed the current limit (set in <i>parameter 4-18 Current Limit</i>). Quick stop is activated with a signal on a selected digital input, or via the serial communication port.

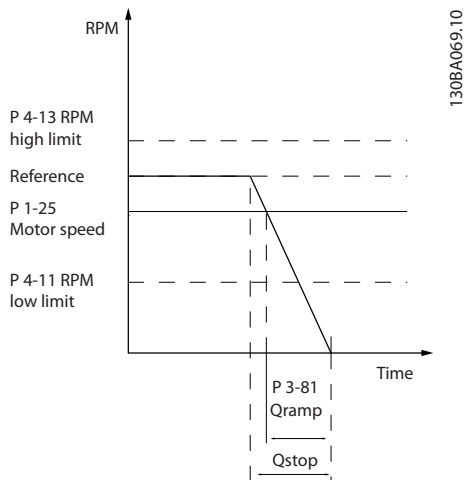

Figure 3.28 Quick Stop Ramp Time

3-82 Quick Stop Ramp Type		
Option:		Function:
		Select the ramp type, depending on requirements for acceleration and deceleration. A linear ramp gives constant acceleration during ramping. An S-ramp gives non-linear acceleration, compensating for jerk in the application.
[0] *	Linear	
[1]	S-ramp Const Jerk	
[2]	S-ramp Const Time	

3-83 Quick Stop S-ramp Ratio at Decel. Start		
Range:		Function:
50 %*	[1 - 99 %]	Enter the proportion of the total ramp-down time (<i>parameter 3-42 Ramp 1 Ramp-down Time</i>) where the deceleration torque increases. The larger the percentage value, the greater the jerk compensation achieved, and thus the lower the torque jerks in the application.

3-84 Quick Stop S-ramp Ratio at Decel. End		
Range:		Function:
50 %*	[1 - 99 %]	Enter the proportion of the total ramp-down time (<i>parameter 3-42 Ramp 1 Ramp Down Time</i>) where the deceleration torque decreases. The larger the percentage value, the greater the jerk compensation achieved, and thus the lower the torque jerks in the application.

3-89 Ramp Lowpass Filter Time		
Range:		Function:
1 ms*	[1 - 200 ms]	Use this parameter to set how smoothly the speed changes.

3.4.9 3-9* Digital Pot.Meter

The digital potentiometer enables increase or decrease of the actual reference by adjusting the set-up of the digital inputs using the functions increase, decrease, or clear. To activate the function, set at least 1 digital input to increase or decrease.

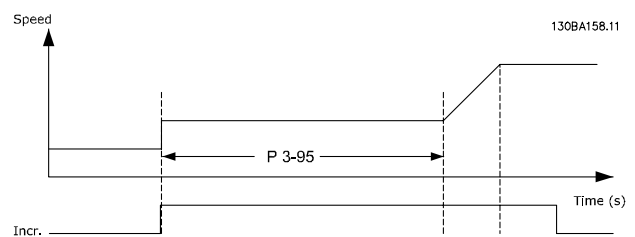

Figure 3.29 Increase Actual Reference

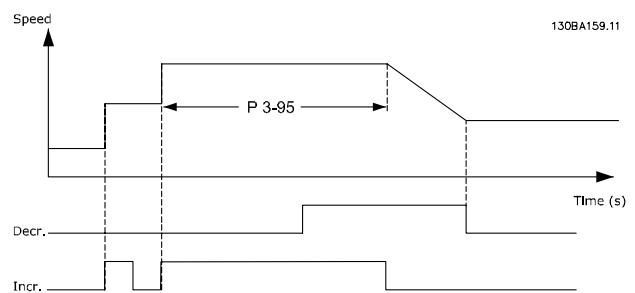

Figure 3.30 Increase/Decrease Actual Reference

3-90 Step Size		
Range:		Function:
0.10 %*	[0.01 - 200 %]	Enter the increment size required for increase/decrease as a percentage of the synchronous motor speed, n_s . If increase/decrease is activated, the resulting reference is increased or decreased by the value set in this parameter.

3-91 Ramp Time		
Range:		Function:
1.00 s*	[0.00 - 3600.00 s]	Enter the ramp time, that is the time for adjustment of the reference 0–100% of the specified digital potentiometer function (increase, decrease, or clear). If increase/decrease is activated for longer than the ramp delay period specified in <i>parameter 3-95 Ramp Delay</i> , the actual reference is ramped up/down according to this ramp time. The ramp time is defined as the time used to adjust the reference by the step size specified in <i>parameter 3-90 Step Size</i> .

3-92 Power Restore		
Option:		Function:
[0] *	Off	Resets the digital potentiometer reference to 0% after power-up.
[1]	On	Restores the most recent digital potentiometer reference at power-up.

3-93 Maximum Limit		
Range:		Function:
100 %*	[-200 - 200 %]	Set the maximum allowed value for the resulting reference. This is recommended if the digital potentiometer is used for fine-tuning of the resulting reference.

3-94 Minimum Limit		
Range:		Function:
-100 %*	[-200 - 200 %]	Set the minimum allowed value for the resulting reference. This is recommended if the digital potentiometer is used for fine-tuning of the resulting reference.

3-95 Ramp Delay		
Range:		Function:
0 N/A*	[0 - 0 N/A]	Enter the delay required from activation of the digital potentiometer function until the frequency converter starts to ramp the reference. With a delay of 0 ms, the reference starts to ramp when increase/decrease is activated. See also <i>parameter 3-91 Ramp Time</i> .

3.5 Parameters: 4-** Limits/Warnings

3.5.1 4-1* Motor Limits

3

Define torque, current, and speed limits for the motor, and the reaction of the frequency converter when the limits are exceeded.

A limit may generate a message in the display. A warning always generates a message in the display or on the fieldbus. A monitoring function may initiate a warning or a trip, after which the frequency converter stops and generates an alarm message.

4-10 Motor Speed Direction		
Option:	Function:	
	<p>NOTICE! This parameter cannot be adjusted while the motor is running.</p> <p>Select the motor speed direction(s) required. Use this parameter to prevent unwanted reversing. When <i>parameter 1-00 Configuration Mode</i> is set to [3] <i>Process</i>, <i>parameter 4-10 Motor Speed Direction</i> is set to [0] <i>Clockwise</i> as default. The setting in <i>parameter 4-10 Motor Speed Direction</i> does not limit options for setting <i>parameter 4-13 Motor Speed High Limit [RPM]</i>.</p>	
[0]	Clockwise *	The reference is set to CW rotation. Reversing input (default terminal 19) must be open.
[1]	Counter-clockwise	The reference is set to CCW rotation. Reversing input (default terminal 19) must be closed. If reversing is required with <i>reverse</i> input open, the motor direction can be changed by <i>parameter 1-06 Clockwise Direction</i> .
[2]	Both directions	Allows the motor to rotate in both directions.

4-11 Motor Speed Low Limit [RPM]		
Range:	Function:	
0 RPM*	[0 - par. 4-13 RPM]	Enter the minimum limit for motor speed. The motor speed low limit can be set to correspond to the manufacturer's recommended minimum motor speed. The motor speed low limit must not exceed the setting in <i>parameter 4-13 Motor Speed High Limit [RPM]</i> .

4-12 Motor Speed Low Limit [Hz]		
Range:	Function:	
0 Hz*	[0.0 - par. 4-14 Hz]	Enter the minimum limit for motor speed. The motor speed low limit can be set to correspond to the minimum output frequency

4-12 Motor Speed Low Limit [Hz]		
Range:	Function:	
	of the motor shaft. The motor speed low limit must not exceed the setting in <i>parameter 4-14 Motor Speed High Limit [Hz]</i> .	

4-13 Motor Speed High Limit [RPM]		
Range:	Function:	
3600. RPM*	[par. 4-11 - 60000. RPM]	Enter the maximum limit for motor speed. The motor speed high limit can be set to correspond to the manufacturer's maximum nominal motor speed. The motor speed high limit must exceed the setting in <i>parameter 4-11 Motor Speed Low Limit [RPM]</i> .

4-14 Motor Speed High Limit [Hz]		
Range:	Function:	
Size related*	[par. 4-12 - par. 4-19 Hz]	Enter the maximum limit for motor speed in Hz. <i>Parameter 4-14 Motor Speed High Limit [Hz]</i> can be set to correspond to the manufacturer's recommended maximum motor speed. The motor speed high limit must exceed the value in <i>parameter 4-12 Motor Speed Low Limit [Hz]</i> . The output frequency must not exceed 10% of the switching frequency (<i>parameter 14-01 Switching Frequency</i>).

4-16 Torque Limit Motor Mode		
Range:	Function:	
160.0 %* Application dependent*	[0.0 - 1000.0 %] [Application dependent]	This function limits the torque on the shaft to protect the mechanical installation.

NOTICE!

Changing *parameter 4-16 Torque Limit Motor Mode* when *parameter 1-00 Configuration Mode* is set to [0] *Speed open loop*, *parameter 1-66 Min. Current at Low Speed* is automatically readjusted.

NOTICE!

The torque limit reacts to the actual, non-filtered torque, including torque spikes. This is not the torque that is seen from the LCP or the fieldbus as that torque is filtered.

4-17 Torque Limit Generator Mode		
Range:		Function:
100.0 %*	[0.0 - 1000.0 %]	This function limits the torque on the shaft to protect the mechanical installation.

4-18 Current Limit		
Range:		Function:
160.0 %*	[1.0 - 1000.0 %]	<p>NOTICE! If [20] ATEX ETR is selected in parameter 1-90 Motor Thermal Protection, set parameter 4-18 Current Limit current limit to 150%.</p> <p>This is a true current limit function that continues in the oversynchronous range. However, due to field weakening the motor torque at current limit will drop accordingly when the voltage increase stops above the synchronized speed of the motor.</p>

4-19 Max Output Frequency		
Range:		Function:
132.0 Hz*	[1.0 - 1000.0 Hz]	<p>NOTICE! This parameter cannot be adjusted while the motor is running.</p> <p>NOTICE! Maximum output frequency cannot exceed 10% of the inverter switching frequency (parameter 14-01 Switching Frequency).</p> <p>Provides a final limit on the output frequency for improved safety in applications where overspeeding is to be avoided. This limit is final in all configurations (independent of the setting in parameter 1-00 Configuration Mode).</p>

4-20 Torque Limit Factor Source		
Option:	Function:	
	Select an analog input for scaling the settings in parameter 4-16 Torque Limit Motor Mode and parameter 4-17 Torque Limit Generator Mode 0–100% (or inverse). The signal levels corresponding to 0% and 100% are defined in the analog input scaling, for example parameter group 6-1* Analog Input 1. This parameter is only active when	

4-20 Torque Limit Factor Source		
Option:	Function:	
	<i>parameter 1-00 Configuration Mode is in Speed Open Loop or Speed Closed Loop.</i>	
[0] *	No function	
[2]	Analog in 53	
[4]	Analog in 53 inv	
[6]	Analog in 54	
[8]	Analog in 54 inv	
[10]	Analog in X30-11	
[12]	Analog in X30-11 inv	
[14]	Analog in X30-12	
[16]	Analog in X30-12 inv	

4-21 Speed Limit Factor Source		
Option:	Function:	
	Select an analog input for scaling the settings in parameter 4-19 Max Output Frequency 0–100% (or the other way around). The signal levels corresponding to 0% and 100% are defined in the analog input scaling, for example parameter group 6-1* Analog Input 1. This parameter is only active when parameter 1-00 Configuration Mode is in [4] Torque Open Loop.	
[0] *	No function	
[2]	Analog in 53	
[4]	Analog in 53 inv	
[6]	Analog in 54	
[8]	Analog in 54 inv	
[10]	Analog in X30-11	
[12]	Analog in X30-11 inv	
[14]	Analog in X30-12	
[16]	Analog in X30-12 inv	

4-23 Brake Check Limit Factor Source		
Option:	Function:	
	Select the input source for the function in parameter 2-15 Brake Check. If several frequency converters are carrying out a brake check simultaneously, the resistance in the grid leads to a voltage drop on the mains or DC-link and a false brake check can occur. Use an external current sensor on every brake resistor. If an application requires a 100% valid brake check, connect the sensor to an analog input.	
[0] *	DC-link voltage	The frequency converter performs the brake check by monitoring the DC-link

4-23 Brake Check Limit Factor Source		
<p>Select the input source for the function in <i>parameter 2-15 Brake Check</i>. If several frequency converters are carrying out a brake check simultaneously, the resistance in the grid leads to a voltage drop on the mains or DC-link and a false brake check can occur. Use an external current sensor on every brake resistor. If an application requires a 100% valid brake check, connect the sensor to an analog input.</p>		
Option:		Function:
		voltage. The frequency converter injects current in the brake resistor which lowers the DC-link voltage.
[1]	Analog Input 53	Select to use an external current sensor for brake monitoring.
[2]	Analog Input 54	Select to use an external current sensor for brake monitoring.

4-24 Brake Check Limit Factor		
Range:	Function:	
98 %*	[0 - 100 %]	<p>Enter the limit factor that <i>parameter 2-15 Brake Check</i> uses when performing the brake check. The frequency converter uses the limit factor depending on the selection in <i>parameter 4-23 Brake Check Limit Factor Source</i>: [0] <i>DC-link voltage</i> - the frequency converter applies the factor to the EEPROM data in the DC-link. [1] <i>Analog Input 53</i> or [2] <i>Analog Input 54</i> - the brake check fails if the input current on the analog input is lower than the maximum input current multiplied by the limit factor.</p> <p>For example, in the following configuration the brake check fails if the input current is lower than 16 mA:</p> <ul style="list-style-type: none"> A current transducer with a range of 4-20 mA is connected to analog input 53. <i>Parameter 4-24 Brake Check Limit Factor</i> is set to 80%.

4-25 Power Limit Motor Factor Source		
<p>Select the input that scales the value in <i>parameter 4-82 Power Limit Motor Mode</i> from 0% to 100%.</p>		
Option:		Function:
[0] *	No function	
[2]	Analog in 53	
[4]	Analog in 53 inv	
[6]	Analog in 54	
[8]	Analog in 54 inv	

4-25 Power Limit Motor Factor Source		
<p>Select the input that scales the value in <i>parameter 4-82 Power Limit Motor Mode</i> from 0% to 100%.</p>		
Option:		Function:
[10]	Analog in X30-11	
[12]	Analog in X30-11 inv	
[14]	Analog in X30-12	
[16]	Analog in X30-12 inv	

4-26 Power Limit Gener. Factor Source		
<p>Select the input that scales the value in <i>parameter 4-83 Power Limit Generator Mode</i> from 0% to 100%.</p>		
Option:		Function:
[0] *	No function	
[2]	Analog in 53	
[4]	Analog in 53 inv	
[6]	Analog in 54	
[8]	Analog in 54 inv	
[10]	Analog in X30-11	
[12]	Analog in X30-11 inv	
[14]	Analog in X30-12	
[16]	Analog in X30-12 inv	

3.5.2 4-3* Motor Feedback Monitoring

The parameter group includes monitoring and handling of motor feedback devices, such as encoders, resolvers, and so on.

4-30 Motor Feedback Loss Function		
Option:	Function:	
		<p>This function is used to monitor consistency in the feedback signal, that is if the feedback signal is available.</p> <p>Select which action the frequency converter should take if a feedback fault is detected. The selected action is to take place when the feedback signal differs from the output speed by the value set in <i>parameter 4-31 Motor Feedback Speed Error</i> for longer than the value set in <i>parameter 4-32 Motor Feedback Loss Timeout</i>.</p>
[0]	Disabled	
[1]	Warning	
[2] *	Trip	
[3]		
[4]		
[5]		
[6]		
[7]		
[8]		
[9]		
[10]		

4-30 Motor Feedback Loss Function		
Option:	Function:	
[11]		

Warning 90, Feedback monitor is active as soon as the value in parameter 4-31 Motor Feedback Speed Error is exceeded, regardless of the setting in parameter 4-32 Motor Feedback Loss Timeout. Warning/Alarm 61, Feedback Error is related to the motor feedback loss function.

4-31 Motor Feedback Speed Error		
Range:	Function:	
300 RPM*	[1 - 600 RPM]	Select the maximum allowed error in speed (output speed vs. feedback).

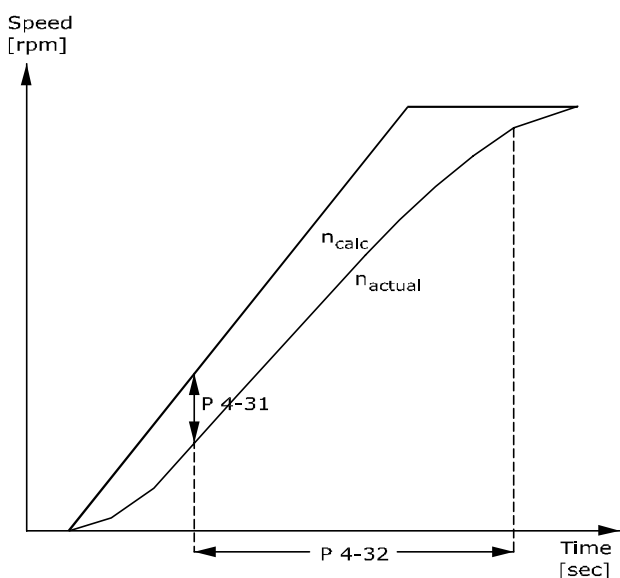

130BA221.10

Figure 3.31 Motor Feedback Speed Error

4-32 Motor Feedback Loss Timeout		
Range:	Function:	
0.05 s*	[0.00 - 60.00 s]	Set the timeout value allowing the speed error set in parameter 4-31 Motor Feedback Speed Error to be exceeded before enabling the function selected in parameter 4-30 Motor Feedback Loss Function.

4-34 Tracking Error Function	
Option:	Function:
	This function is used to monitor that the application follows the expected speed profile. In closed loop, the speed reference to the PID is compared to the encoder feedback (filtered). In open loop, the speed reference to the PID is compensated for slip and compared to the

4-34 Tracking Error Function	
Option:	Function:
	frequency that is sent to the motor (parameter 16-13 Frequency). The reaction is activated if the measured difference is more than the value specified in parameter 4-35 Tracking Error for the time specified in parameter 4-36 Tracking Error Timeout. A tracking error in closed loop does not imply that there is a problem with the feedback signal. A tracking error can be the result of torque limit at too heavy loads.
[0]	Disable
[1]	Warning
[2]	Trip
[3]	Trip after stop

Warning/Alarm 78, Tracking Error is related to the tracking error function.

4-35 Tracking Error		
Range:	Function:	
10 RPM*	[1 - 600 RPM]	Enter the maximum allowed speed error between the motor speed and the output of the ramp when not ramping. In open loop, the motor speed is estimated and in closed loop, it is the feedback from encoder/resolver.

4-36 Tracking Error Timeout		
Range:	Function:	
1 s*	[0 - 60 s]	Enter the timeout period during which an error greater than the value set in parameter 4-35 Tracking Error is allowed.

4-37 Tracking Error Ramping		
Range:	Function:	
100 RPM*	[1 - 600 RPM]	Enter the maximum allowed speed error between the motor speed and the output of the ramp when ramping. In open loop, the motor speed is estimated and in closed loop, the encoder measures the speed.

4-38 Tracking Error Ramping Timeout		
Range:	Function:	
1 s*	[0 - 60 s]	Enter the timeout period during which an error greater than the value set in parameter 4-37 Tracking Error Ramping while ramping is allowed.

4-39 Tracking Error After Ramping Timeout	
Range:	Function:
5 s* [0 - 60 s]	Enter the timeout period after ramping where <i>parameter 4-37 Tracking Error Ramping</i> and <i>parameter 4-38 Tracking Error Ramping Timeout</i> are still active.

3.5.3 4-4* Speed Monitor

4-43 Motor Speed Monitor Function					
Option:	Function:				
	<p>NOTICE!</p> <p>This parameter is only available in the flux control principle.</p> <p>Select how the frequency converter reacts when the motor speed monitor-function detects overspeed or wrong rotation direction. When the motor speed monitor is active, the frequency converter detects an error if the following conditions are true for a time period specified in <i>parameter 4-45 Motor Speed Monitor Timeout</i>:</p> <ul style="list-style-type: none"> The actual speed differs from the reference speed in <i>parameter 16-48 Speed Ref. After Ramp [RPM]</i>. The difference between the speeds exceeds the value in <i>parameter 4-44 Motor Speed Monitor Max</i>. <p>In speed closed loop, the actual speed is the feedback from the encoder measured during the time defined in <i>parameter 7-06 Speed PID Lowpass Filter Time</i>. In open loop, the actual speed is the estimated motor speed.</p> <table border="1"> <tr> <td>Solid line</td> <td><i>Parameter 16-48 Speed Ref. After Ramp [RPM]</i></td> </tr> <tr> <td>Dotted line</td> <td><i>Parameter 4-44 Motor Speed Monitor Max</i></td> </tr> </table> <p>Figure 3.32 Speed Reference and Maximum Allowed Speed Difference</p>	Solid line	<i>Parameter 16-48 Speed Ref. After Ramp [RPM]</i>	Dotted line	<i>Parameter 4-44 Motor Speed Monitor Max</i>
Solid line	<i>Parameter 16-48 Speed Ref. After Ramp [RPM]</i>				
Dotted line	<i>Parameter 4-44 Motor Speed Monitor Max</i>				

4-43 Motor Speed Monitor Function		
Option:	Function:	
[0]	Disabled	
[1]	Warning	The frequency converter reports <i>warning 101, Speed monitor</i> when the speed is outside the limit.
[2]	Trip	The frequency converter trips and reports <i>alarm 101, Speed monitor</i> .
[3]	Jog	
[4]	Freeze Output	
[5]	Max Speed	
[6]	Switch to Open Loop	
[7]	Select Setup 1	
[8]	Select Setup 2	
[9]	Select Setup 3	
[10]	Select Setup 4	
[11]	Stop & Trip	
[12]	Trip/Warning	The frequency converter reports <i>alarm 101, Speed monitor</i> in running mode and <i>warning 101, Speed monitor</i> in stop or coast mode. This option is only available in closed-loop operation.
[13]	Trip/Catch	Select when there is a need to catch a load, for example when mechanical braking fails. This option is available in closed loop only. The frequency converter trips and reports <i>alarm 101, Speed monitor</i> in running mode. In stop mode, the frequency converter catches the flying load and reports <i>warning 101, Speed monitor</i> . In catch mode, the frequency converter applies holding torque to control the 0 speed on a potentially malfunctioning brake (closed loop). To exit this mode, send a new start signal to the frequency converter. A coast or Safe Torque Off also terminates the function.

4-44 Motor Speed Monitor Max	
Range:	Function:
300 RPM* [10 - 500 RPM]	<p>NOTICE!</p> <p>Only available in flux control principle.</p> <p>Enter the maximum allowable speed deviation between the actual mechanical</p>

4-44 Motor Speed Monitor Max		
Range:	Function:	
	shaft speed and the value in parameter 16-48 Speed Ref. After Ramp [RPM].	

4-45 Motor Speed Monitor Timeout		
Range:	Function:	
0.1 s* [0 - 60 s]	<p>NOTICE! Only available in flux control principle.</p> <p>Enter the timeout period during which a deviation defined in parameter 4-44 Motor Speed Monitor Max is allowable. The timer for this parameter is reset if the deviation stops exceeding the value in parameter 4-44 Motor Speed Monitor Max.</p>	

3.5.4 4-5* Adjustable Warnings

Use these parameters to adjust warning limits for current, speed, reference, and feedback.

Warnings are shown on the LCP and can be programmed to be outputs or to be read out via fieldbus in the extended status word.

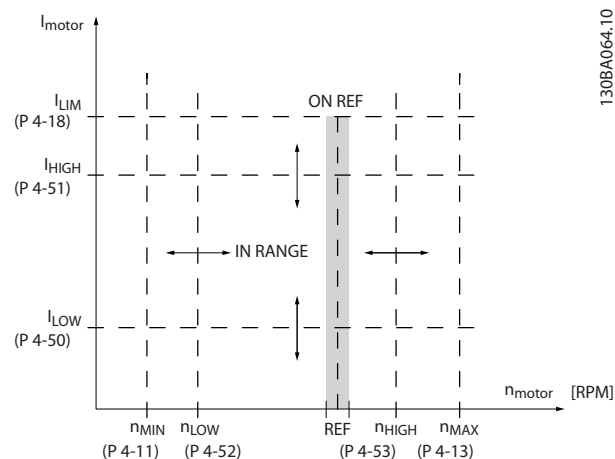

130BA064.10

Figure 3.33 Adjustable Warnings

4-50 Warning Current Low		
Range:	Function:	
0.00 A* [0.00 - par. 4-51 A]	Enter the I_{LOW} value. When the motor current falls below this limit, the display reads <i>Current Low</i> . The signal outputs can be programmed to produce a status signal on terminal 27 or 29 (FC 302 only) and on relay	

4-50 Warning Current Low		
Range:	Function:	
	output 01 or 02 (FC 302 only). Refer to Figure 3.33.	

4-51 Warning Current High		
Range:	Function:	
par. 16-37 A* [par. 4-50 - par. 16-37 A]	Enter the I_{HIGH} value. When the motor current exceeds this limit, the display reads <i>Current High</i> . The signal outputs can be programmed to produce a status signal on terminal 27 or 29 (FC 302 only) and on relay output 01 or 02 (FC 302 only). Refer to Figure 3.33.	

4-52 Warning Speed Low		
Range:	Function:	
0 RPM* [0 - par. 4-53 RPM]	Enter the n_{LOW} value. When the motor speed exceeds this limit, the display reads <i>Speed low</i> . The signal outputs can be programmed to produce a status signal on terminal 27 or 29 (FC 302 only) and on relay output 01 or 02 (FC 302 only).	

4-53 Warning Speed High		
Range:	Function:	
par. 4-13 RPM* [par. 4-52 - par. 4-13 RPM]	Enter the n_{HIGH} value. When the motor speed exceeds this value, the display reads <i>Speed high</i> . The signal outputs can be programmed to produce a status signal on terminals 27 or 29 and on relay outputs 01 or 02. Refer to Figure 3.33.	

4-54 Warning Reference Low		
Range:	Function:	
-999999.999 N/A* [-999999.999 - par. 4-55 N/A]	Enter the lower reference limit. When the actual reference drops below this limit, the display indicates <i>Ref_{low}</i> . The signal outputs can be programmed to produce a status signal on terminal 27 or 29 (FC 302 only) and on relay output 01 or 02 (FC 302 only).	

4-55 Warning Reference High		
Range:	Function:	
999999.999 N/A* [par. 4-54 - 999999.999 N/A]	Enter the upper reference limit. When the actual reference exceeds this limit, the display reads <i>Ref_{high}</i> . The signal outputs can be programmed to produce a	

4-55 Warning Reference High		
Range:	Function:	
		status signal on terminal 27 or 29 (FC 302 only) and on relay output 01 or 02 (FC 302 only).

4-56 Warning Feedback Low		
Range:	Function:	
-999999.999 ReferenceFeed- backUnit*	[-999999.999 - par. 4-57 ReferenceFeed- backUnit]	Enter the lower feedback limit. When the feedback drops below this limit, the display reads Feedb _{Low} . The signal outputs can be programmed to produce a status signal on terminal 27 or 29 (FC 302 only) and on relay output 01 or 02 (FC 302 only).

4-57 Warning Feedback High		
Range:	Function:	
999999.999 ReferenceFeed- backUnit*	[par. 4-56 - 999999.999 ReferenceFeed- backUnit]	Enter the upper feedback limit. When the feedback exceeds this limit, the display reads Feedb _{High} . The signal outputs can be programmed to produce a status signal on terminal 27 or 29 (FC 302 only) and on relay output 01 or 02 (FC 302 only).

4-58 Missing Motor Phase Function		
Option:	Function:	
	<p>NOTICE! This parameter cannot be adjusted while the motor is running.</p> <p>The missing motor phase function detects whether the motor phase is missing during motor rotation. Shows alarm 30, 31, or 32 in the event of a missing motor phase. Enable this function to avoid motor damage. See also <i>chapter 3.5.5 Combinations of parameters 4-58 and 4-59.</i></p>	
[0] *	The frequency converter does not issue a missing motor phase alarm. Not recommended due to risk of motor damage.	
[1]	For a quick detection time and alarm in the event of a missing motor phase.	
[2]		

4-59 Motor Check At Start		
Option:	Function:	
	<p>NOTICE! This parameter cannot be adjusted while the motor is running.</p> <p>NOTICE! Valid for FC 302 only.</p> <p>Use this parameter to detect the missing motor phase during motor standstill. Shows <i>alarm 30, Motor phase U missing, alarm 31, Motor phase V missing, or alarm 32, Motor phase W missing</i> in the event of a missing motor phase during standstill. Use this function before disengaging a mechanical brake. Enable this function to avoid motor damage. See also <i>chapter 3.5.5 Combinations of parameters 4-58 and 4-59.</i></p>	
[0] *	Off	<p>CAUTION RISK OF MOTOR DAMAGE Using this option may lead to motor damage.</p> <p>The frequency converter does not issue a missing motor phase alarm.</p>
[1]	On	Before each start, the frequency converter checks if all 3 motor phases are present. The check is performed without any movement on ASM motors. For PM and SynRM motors, the check is performed as part of the position detection.

When *parameter 4-59 Motor Check At Start* is set to [1] On, do not set *parameter 4-58 Missing Motor Phase Function* to the following options:

- [0] Disabled.
- [5] Motor check.

3.5.5 4-6* Speed Bypass

Some systems require that certain output frequencies or speeds are avoided due to resonance problems in the system. A maximum of 4 frequency or speed ranges can be avoided.

4-60 Bypass Speed From [RPM]		
Array [4]		
Range:	Function:	
0 RPM*	[0 - par. 4-13 RPM]	Some systems call for avoiding certain output speeds due to resonance

4-60 Bypass Speed From [RPM]		
Array [4]		
Range:	Function:	
	problems in the system. Enter the lower limits of the speeds to be avoided.	

4-61 Bypass Speed From [Hz]		
Array [4]		
Range:	Function:	
Size related* [0 - par. 4-14 Hz]	Some systems require that certain output frequencies or speeds are avoided due to resonance problems in the system. Enter the lower limits of the speeds to be avoided.	

4-62 Bypass Speed to [RPM]		
Array [4]		
Range:	Function:	
0 RPM* [0 - par. 4-13 RPM]	Some systems call for avoiding certain output speeds due to resonance problems in the system. Enter the upper limits of the speeds to be avoided.	

4-63 Bypass Speed To [Hz]		
Array [4]		
Range:	Function:	
0 Hz* [0.0 - par. 4-14 Hz]	Some systems call for avoiding certain output speeds due to resonance problems in the system. Enter the upper limits of the speeds to be avoided.	

3.5.6 4-7* Position Monitor

4-70 Position Error Function		
Option:	Function:	
	NOTICE! This parameter is only available with software version 48.XX. Select the function which is activated when the position error exceeds the maximum allowed value. Position error is the difference between the actual position and the commanded position. The position error is the input for the position PI controller.	
[0] *	Disabled	The frequency converter does not monitor the position error.

4-70 Position Error Function		
Option:	Function:	
[1]	Warning	The frequency converter issues a warning when the maximum allowed position error is exceeded. The frequency converter continues operation.
[2]	Trip	The frequency converter trips when the maximum allowed position error is exceeded.

4-71 Maximum Position Error		
Range:	Function:	
1000 Custom-ReadoutUnit2* [0 - 2147483647 CustomReadoutUnit2]	NOTICE! This parameter is only available with software version 48.XX. Enter the maximum allowed position tracking error in position units defined in <i>parameter group 17-7* Position Scaling</i> . If this value is exceeded during the time set in <i>parameter 4-72 Position Error Timeout</i> the position error function in <i>parameter 4-70 Position Error Function</i> is activated.	

4-72 Position Error Timeout		
Range:	Function:	
0.100 s* [0.000 - 60.000 s]	NOTICE! This parameter is only available with software version 48.XX. If the error defined in <i>parameter 4-71 Maximum Position Error</i> is present longer than the time in this parameter, the frequency converter activates the function selected in <i>parameter 4-70 Position Error Function</i> .	

4-73 Position Limit Function		
Option:	Function:	
	NOTICE! This parameter is only available with software version 48.XX. Select the function which is activated when the position is outside the limits defined in <i>parameter 3-06 Minimum Position</i> and <i>parameter 3-07 Maximum Position</i> .	

4-73 Position Limit Function		
Option:	Function:	
[0]	Disabled	The frequency converter does not monitor the position limits.
[1]	Warning	The frequency converter issues a warning when the position is outside the limits.
[2]	Warning & Trip	The frequency converter issues a warning when the set target is outside the position limits. The frequency converter starts the positioning and then trips when the position limit is reached.
[3]	Abs. Pos. Mode Stop *	The frequency converter monitors position limits only in absolute positioning mode. The frequency converter issues a warning and stops at the position limit when the target position is outside the position limits.
[4]	Abs. Pos. Md. Stop & Trip	The frequency converter monitors position limits only in absolute positioning mode. The frequency converter stops at the position limit and trips when the target position is outside the position limits.
[5]	Position Stop	When the set target is outside the position limits, the frequency converter uses the position limit as target. This option works in all modes of operation including speed and torque control. The frequency converter issues a warning when at limit position.
[6]	Position Stop & Trip	When the set target is outside the position limits, the frequency converter uses the position limit as target. This option works in all modes of operation including speed and torque control. The frequency converter trips when at limit position.
[7]	Speed Stop	When the set target is outside the position limits, the frequency converter performs a ramp down and stops at the limit position. This option works in all modes of operation. The frequency converter issues a warning at stop.
[8]	Speed Stop & Trip	When the set target is outside the position limits, the frequency converter performs a ramp down and stops at the limit position. This option works in all modes of operation. The frequency converter trips at stop.

4-74 Start Fwd/Rev Function		
Option:	Function:	
		NOTICE! This parameter is only available with software version 48.XX.

4-74 Start Fwd/Rev Function		
Option:	Function:	
		Select the action that the frequency converter executes when there is an active signal on a digital input with options [12] <i>Enable Start Forward</i> or [13] <i>Enable Start Reverse</i> selected. The frequency converter executes the function selected in this parameter when running into an end limit switch and then the motion is only allowed in the opposite direction. When an option with trip is selected, the frequency converter can resume motion only after reset.
[0]	Stop *	The frequency converter stops the motor.
[1]	Stop & Warning	The frequency converter stops the motor and shows <i>warning 215, Start Fwd/Rev</i> .
[2]	Stop & Trip	The frequency converter stops the motor and trips with <i>alarm 215, Start Fwd/Rev</i> .
[3]	Qstop	The frequency converter performs the quick stop.
[4]	Qstop & Warning	The frequency converter performs the quick stop and shows <i>warning 215, Start Fwd/Rev</i> .
[5]	Qstop & Trip	The frequency converter performs the quick stop and trips with <i>alarm 215, Start Fwd/Rev</i> .
[6]	Coast	The frequency converter coasts the motor.
[7]	Coast & Warning	The frequency converter coasts the motor and shows <i>warning 215, Start Fwd/Rev</i> .
[8]	Coast & Trip	The frequency converter coasts the motor and trips with <i>alarm 215, Start Fwd/Rev</i> .
[9]	Zero Speed Ref	The frequency converter ramps down and keeps the motor magnetized at 0 speed. In the positioning and the synchronization modes the position controller stays active and retains the actual position.

4-75 Touch Timeout		
Range:	Function:	
6000.0 s*	[0.1 - 6000.0 s]	Enter the timeout for the touch probe positioning. When the touch probe positioning is active, if the frequency converter does not detect the touch probe sensor within this time, the frequency converter trips with <i>alarm 216, Touch Timeout</i> . The value 6000 equals Off.

3.5.7 4-8* Power Limit

Parameters for configuring the power limit function.

4-80 Power Limit Func. Motor Mode		
Select whether the power limit function is enabled. Define the power limit motor mode in <i>parameter 4-82 Power Limit Motor Mode</i> .		
Option:	Function:	
[0] *	Disabled	
[1]	Enabled	
[2]	When Activated	Activation via a digital input or a fieldbus.

4-81 Power Limit Func. Generator Mode		
Select whether the power limit function is enabled in generating mode. Define the power limit motor mode in <i>parameter 4-83 Power Limit Generator Mode</i> .		
Option:	Function:	
[0] *	Disabled	
[1]	Enabled	
[2]	When Activated	Activation via a digital input or a fieldbus.

4-82 Power Limit Motor Mode		
Range:	Function:	
100.0 %* [0.0 - 200.0 %]	Enter the maximum output power when the power limit function is active. Related parameters: <i>parameter 1-20 Motor Power [kW]</i> , <i>parameter 1-21 Motor Power [HP]</i> .	

4-83 Power Limit Generator Mode		
Range:	Function:	
100.0 %* [0.0 - 200.0 %]	Enter the maximum generating power when the power limit function is active. Related parameters: <i>parameter 1-20 Motor Power [kW]</i> , <i>parameter 1-21 Motor Power [HP]</i> .	

3.5.8 4-9* Directional Limits

The directional limits functionality allows to specify different torque and speed limits for different combinations of torque application direction and rotation direction. For example, see *Figure 3.34*. In the illustration, quadrants 1–4 show different combinations of rotation direction and torque application direction, and the parameters that act in different quadrants.

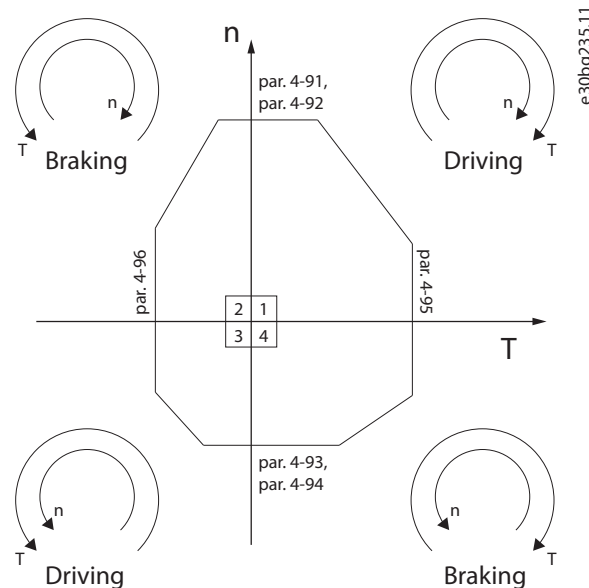

Figure 3.34 Directional Limits

A speed limit value cannot exceed the value of *parameter 4-13 Motor Speed High Limit [RPM]* or *parameter 4-14 Motor Speed High Limit [Hz]*. A torque limit value cannot exceed the value of *parameter 4-16 Torque Limit Motor Mode* or *parameter 4-17 Torque Limit Generator Mode*.

4-90 Directional Limit Mode		
Select whether the directional limits are enabled. With directional limits enabled, it is possible to specify different speed and torque limits for clockwise and counterclockwise rotation directions.		
Option:	Function:	
[0] *	Disabled	Directional limits are disabled.
[1]	Speed	Directional limits are active for the speed values.
[2]	Torque	Directional limits are active for the torque values.
[3]	Speed and Torque	Directional limits are active for both, torque and speed values.

4-91 Positive Speed Limit [RPM]		
Range:	Function:	
Size related* [0 - par. 4-13 RPM]	Enter the limit for the motor speed when the rotation direction is clockwise.	

4-92 Positive Speed Limit [Hz]		
Range:		Function:
Size related*	[0 - par. 4-14 Hz]	Enter the limit for the motor speed when the rotation direction is clockwise.

4-93 Negative Speed Limit [RPM]		
Range:		Function:
Size related*	[0 - par. 4-13 RPM]	Enter the limit for the motor speed when the rotation direction is counterclockwise.

4-94 Negative Speed Limit [Hz]		
Range:		Function:
Size related*	[0 - par. 4-14 Hz]	Enter the limit for the motor speed when the rotation direction is counterclockwise.

4-95 Positive Torque limit		
Range:		Function:
Size related*	[0 - 160.0 %]	Enter the limit for the motor torque when the rotation direction is clockwise.

4-96 Negative Torque limit		
Range:		Function:
Size related*	[0 - 160.0 %]	Enter the limit for the motor torque when the rotation direction is counterclockwise.

3.6 Parameters: 5-** Digital In/Out

3.6.1 5-0* Digital I/O Mode

Parameters for configuring the input and output using NPN and PNP.

5-00 Digital I/O Mode		
Option:	Function:	
		<p>NOTICE! Perform a power cycle to activate the parameter once it has been changed.</p> <p>Digital inputs and programmed digital outputs are pre-programmable for operation either in PNP or NPN systems.</p>
[0] *	PNP	Action on positive directional pulses (‡). PNP systems are pulled down to GND.
[1]	NPN	Action on negative directional pulses (‡). NPN systems are pulled up to +24 V, internally in the frequency converter.

5-01 Terminal 27 Mode		
Option:	Function:	
		<p>NOTICE! This parameter cannot be adjusted while the motor is running.</p>
[0] *	Input	Defines terminal 27 as a digital input.
[1]	Output	Defines terminal 27 as a digital output.

5-02 Terminal 29 Mode		
Option:	Function:	
		<p>NOTICE! This parameter is available for FC 302 only.</p>
[0] *	Input	Defines terminal 29 as a digital input.
[1]	Output	Defines terminal 29 as a digital output.

3.6.2 5-1* Digital Inputs

The digital inputs are used for selecting various functions in the frequency converter. *Table 3.15* shows which functions can be assigned to digital inputs. Functions in group 1 have higher priority than functions in group 2.

Group 1	Reset, coast stop, reset, and coast stop, quick stop, DC brake, stop, and the [Off] key.
Group 2	Start, latched start, reversing, start reversing, jog, and freeze output.

Table 3.14 Function Groups

Digital input function	Select	Terminal
No operation	[0]	All, terminal 32, 33
Reset	[1]	All
Coast inverse	[2]	All, terminal 27
Coast and reset inverse	[3]	All
Quick stop inverse	[4]	All
DC brake inverse	[5]	All
Stop inverse	[6]	All
Start	[8]	All, terminal 18
Latched start	[9]	All
Reversing	[10]	All, terminal 19
Start reversing	[11]	All
Enable start forward	[12]	All
Enable start reverse	[13]	All
Jog	[14]	All, terminal 29
Preset reference on	[15]	All
Preset ref bit 0	[16]	All
Preset ref bit 1	[17]	All
Preset ref bit 2	[18]	All
Freeze reference	[19]	All
Freeze output	[20]	All
Speed up	[21]	All
Speed down	[22]	All
Set-up select bit 0	[23]	All
Set-up select bit 1	[24]	All
Precise stop inverse	[26]	18, 19
Precise start, stop	[27]	18, 19
Catch up	[28]	All
Slow down	[29]	All
Counter input	[30]	29, 33
Pulse input edge triggered	[31]	29, 33
Pulse input time based	[32]	29, 33
Ramp bit 0	[34]	All
Ramp bit 1	[35]	All
Latched precise start	[40]	18, 19
Latched precise stop inverse	[41]	18, 19
External interlock	[51]	-
DigiPot increase	[55]	All
DigiPot decrease	[56]	All
DigiPot clear	[57]	All
DigiPot hoist	[58]	All
Counter A (up)	[60]	29, 33
Counter A (down)	[61]	29, 33

Digital input function	Select	Terminal
Reset Counter A	[62]	All
Counter B (up)	[63]	29, 33
Counter B (down)	[64]	29, 33
Reset counter B	[65]	All
Mech. brake feedb.	[70]	All
Mech. brake feedb. inv.	[71]	All
PID error inv.	[72]	All
PID reset I-part	[73]	All
PID enable	[74]	All
MCO specific	[75]	All
PTC card 1	[80]	All
PROFdrive OFF2	[91]	All
PROFdrive OFF3	[92]	All
Light load detection	[94]	All
Mains Loss	[96]	32, 33
Mains loss inverse	[97]	32, 33
Start edge triggered	[98]	All
Safety option reset	[100]	-
Enable master offset	[108]	All
Start virtual master	[109]	All
Start homing	[110]	All
Activate touch	[111]	All
Relative position	[112]	All
Enable reference	[113]	All
Sync. to Pos. Mode	[114]	All
Home sensor	[115]	18, 32, 33
Home sensor inverse	[116]	18, 32, 33
Touch sensor	[117]	18, 32, 33
Touch sensor inverse	[118]	18, 32, 33
Speed mode	[119]	All
Power Limit Mot.	[231]	All
Power Limit Gen.	[232]	All
Power Limit Both	[233]	All

Table 3.15 Digital Input Function

VLT® AutomationDrive FC 301/FC 302 standard terminals are 18, 19, 27, 29, 32, and 33. VLT® General Purpose I/O MCB 101 terminals are X30/2, X30/3, and X30/4. Terminal 29 functions as an output only in FC 302.

Functions dedicated to only 1 digital input are stated in the associated parameter.

All digital inputs can be programmed to these functions:

[0]	No operation	No reaction to signals transmitted to the terminal.
[1]	Reset	Resets frequency converter after a trip/alarm. Not all alarms can be reset.

[2]	Coast inverse	(Default digital input 27): Coast stop, inverted input (NC). The frequency converter leaves the motor in free mode. Logic 0⇒coast stop.
[3]	Coast and reset inverse	Reset and coast stop inverted input (NC). Leaves motor in free mode and resets frequency converter. Logic 0⇒coast stop and reset.
[4]	Quick stop inverse	Inverted input (NC). Generates a stop in accordance with quick stop ramp time set in <i>parameter 3-81 Quick Stop Ramp Time</i> . When the motor stops, the shaft is in free mode. Logic 0⇒quick stop.
[5]	DC brake inverse	Inverted input for DC brake (NC). Stops motor by energizing it with a DC current for a certain time period. See <i>parameter 2-01 DC Brake Current</i> to <i>parameter 2-03 DC Brake Cut-in Speed [RPM]</i> . The function is only active when the value in <i>parameter 2-02 DC Braking Time</i> is different from 0. Logic 0⇒DC brake.
[6]	Stop inverse	<p>Stop inverted function. Generates a stop function when the selected terminal goes from logical level 1 to logical level 0.</p> <p>The stop is performed according to the selected ramp time:</p> <ul style="list-style-type: none"> • <i>Parameter 3-42 Ramp 1 Ramp-down Time</i>, • <i>Parameter 3-52 Ramp 2 Ramp-down Time</i>, • <i>Parameter 3-62 Ramp 3 Ramp-down Time</i>, and • <i>Parameter 3-72 Ramp 4 Ramp-down Time</i>. <p>NOTICE! When the frequency converter is at the torque limit and has received a stop command, it may not stop by itself. To ensure that the frequency converter stops, configure a digital output to [27] <i>Torque limit and stop</i>. Connect this digital output to a digital input that is configured as coast.</p>
[8]	Start	(Default digital input 18): Select start for a start/stop command. Logic 1 = start, logic 0 = stop.
[9]	Latched start	If a pulse is applied for minimum 2 ms, the motor starts. The motor stops when stop inverse is activated, or a reset command (via DI) is given.
[10]	Reversing	(Default digital input 19). Change the direction of motor shaft rotation. Select logic 1 to reverse. The reversing signal only changes the direction of rotation. It does not activate the

		start function. Select both directions in <i>parameter 4-10 Motor Speed Direction</i> . The function is not active in process closed loop.
[11]	Start reversing	Used for start/stop and for reversing on the same wire. Signals on start are not allowed at the same time.
[12]	Enable start forward	Disengages the counterclockwise movement and allows clockwise direction.
[13]	Enable start reverse	Disengages the clockwise movement and allows counterclockwise direction.
[14]	Jog	(Default digital input 29): Activate jog speed. See <i>parameter 3-11 Jog Speed [Hz]</i> .
[15]	Preset reference on	Shifts between external reference and preset reference. It is assumed that [1] <i>External/preset</i> has been selected in <i>parameter 3-04 Reference Function</i> . Logic 0 = external reference active; logic 1 = 1 of the 8 preset references is active.
[16]	Preset ref bit 0	Preset reference bit 0, 1, and 2 enable a choice between 1 of the 8 preset references according to <i>Table 3.16</i> .
[17]	Preset ref bit 1	Same as [16] <i>Preset ref bit 0</i> .
[18]	Preset ref bit 2	Same as [16] <i>Preset ref bit 0</i> .

Preset ref. bit	2	1	0
Preset ref. 0	0	0	0
Preset ref. 1	0	0	1
Preset ref. 2	0	1	0
Preset ref. 3	0	1	1
Preset ref. 4	1	0	0
Preset ref. 5	1	0	1
Preset ref. 6	1	1	0
Preset ref. 7	1	1	1

Table 3.16 Preset Reference Bit

[19]	Freeze ref	Freezes the actual reference, which is now the point of enable/condition to be used for [21] <i>Speed up</i> and [22] <i>Speed down</i> . If speed up/speed down is used, the speed change always follows ramp 2 (<i>parameter 3-51 Ramp 2 Ramp-up Time</i> and <i>parameter 3-52 Ramp 2 Ramp-down Time</i>) in the range 0– <i>parameter 3-03 Maximum Reference</i> .
[20]	Freeze output	Freezes the actual motor frequency (Hz), which is now the point of enable/condition to be used for [21] <i>Speed up</i> and [22] <i>Speed down</i> . If speed up/speed down is used, the speed change always follows ramp 2 (<i>parameter 3-51 Ramp 2 Ramp-up Time</i> and <i>parameter 3-52 Ramp 2 Ramp-down Time</i>) in the range 0– <i>parameter 1-23 Motor Frequency</i> .

NOTICE!

When freeze output is active, the frequency converter cannot be stopped via a low [8] *Start* signal. Stop the frequency converter via a terminal programmed for [2] *Coasting inverse* or [3] *Coast and reset inverse*.

[21]	Speed up	Select [21] <i>Speed up</i> and [22] <i>Speed down</i> for digital control of the up/down speed (motor potentiometer). Activate this function by selecting either [19] <i>Freeze ref</i> or [20] <i>Freeze output</i> . When speed up/speed down is activated for less than 400 ms, the resulting reference is increased/decreased by 0.1%. If speed up/speed down is activated for more than 400 ms, the resulting reference follows the setting in ramping up/down parameters 3-x1/3-x2.
------	----------	--

	Shut down	Catch up
Unchanged speed	0	0
Reduced by %-value	1	0
Increased by %-value	0	1
Reduced by %-value	1	1

Table 3.17 Shut Down/Catch Up

[22]	Speed down	Same as [21] <i>Speed up</i> .
[23]	Set-up select bit 0	Select [23] <i>Set-up select bit 0</i> or select [24] <i>Set-up select bit 1</i> to select 1 of the 4 set-ups. Set <i>parameter 0-10 Active Set-up to Multi Set-up</i> .
[24]	Set-up select bit 1	(Default digital input 32): Same as [23] <i>Set-up select bit 0</i> .
[26]	Precise stop inv.	Sends an inverted stop signal when the precise stop function is activated in <i>parameter 1-83 Precise Stop Function</i> . Precise stop inverse function is available for terminals 18 or 19.
[27]	Precise start, stop	Use when [0] <i>Precise ramp stop</i> is selected in <i>parameter 1-83 Precise Stop Function</i> . Precise start, stop is available for terminals 18 and 19. Precise start ensures that the rotor turning angle from standing still to reference is the same for each start (for same ramp time, same setpoint). This function is the equivalent to the precise stop where the rotor turning angle from reference to standing still is the same for each stop. When using <i>parameter 1-83 Precise Stop Function</i> option [1] <i>Cnt stop with reset</i> or [2] <i>Cnt stop w/o reset</i> : The frequency converter needs a precise stop-signal before reaching the value of

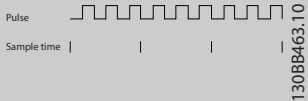
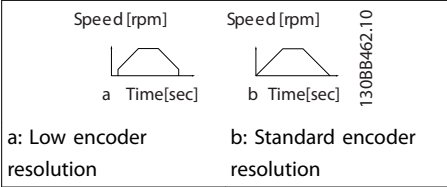
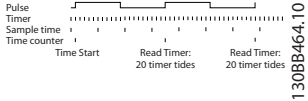
		<p>parameter 1-84 <i>Precise Stop Counter Value</i>. If this signal is not supplied, the frequency converter does not stop when the value in parameter 1-84 <i>Precise Stop Counter Value</i> is reached.</p> <p>Trigger precise start, stop by a digital input. The function is available for terminals 18 and 19.</p>
[28]	Catch up	Increases reference value by percentage (relative) set in parameter 3-12 <i>Catch up/slow-down Value</i> .
[29]	Slow down	Reduces reference value by percentage (relative) set in parameter 3-12 <i>Catch up/slow-down Value</i> .
[30]	Counter input	Precise stop function in parameter 1-83 <i>Precise Stop Function</i> acts as counter stop or speed compensated counter stop with or without reset. The counter value must be set in parameter 1-84 <i>Precise Stop Counter Value</i> .
[31]	Pulse edge triggered	<p>Counts the number of pulse flanks per sample time. This gives a higher resolution at high frequencies, but is not as precise at lower frequencies. Use this pulse principle for encoders with low resolution (for example 30 PPR).</p>  <p>Figure 3.35 Pulse Flanks per Sample Time</p>
[32]	Pulse time-based	<p>Measures the duration between pulse flanks. This gives a higher resolution at lower frequencies, but is not as precise at higher frequencies. This principle has a cutoff frequency, which makes it unsuited for encoders with low resolutions (for example 30 PPR) at low speeds.</p>   <p>Figure 3.36 Duration Between Pulse Flanks</p>
[34]	Ramp bit 0	Enables a selection between 1 of the 4 ramps available, according to Table 3.18.

[35]	Ramp bit 1	Same as [34] Ramp bit 0.
------	------------	--------------------------

Preset ramp bit	1	0
Ramp 1	0	0
Ramp 2	0	1
Ramp 3	1	0
Ramp 4	1	1

Table 3.18 Preset Ramp Bit

[40]	Latched Precise Start	<p>A latched precise start only requires a pulse of 3 ms on terminals 18 or 19.</p> <p>When using for parameter 1-83 <i>Precise Stop Function</i> [1] <i>Cnt stop with reset</i> or [2] <i>Cnt stop w/o reset</i>:</p> <p>When the reference is reached, the frequency converter internally enables the precise stop signal. This means that the frequency converter does the precise stop when the counter value of parameter 1-84 <i>Precise Stop Counter Value</i> is reached.</p>
[41]	Latched Precise Stop inverse	Sends a latched stop signal when the precise stop function is activated in parameter 1-83 <i>Precise Stop Function</i> . The latched precise stop inverse function is available for terminals 18 or 19.
[51]	External interlock	This function makes it possible to give an external fault to the frequency converter. This fault is treated in the same way as an internally generated alarm.
[55]	DigiPot Increase	Increase signal to the digital potentiometer function described in parameter group 3-9* <i>Digital Pot. Meter</i> .
[56]	DigiPot Decrease	Decrease signal to the digital potentiometer function described in parameter group 3-9* <i>Digital Pot. Meter</i> .
[57]	DigiPot Clear	Clears the digital potentiometer reference described in parameter group 3-9* <i>Digital Pot. Meter</i> .
[60]	Counter A	(Terminal 29 or 33 only). Input for increment counting in the SLC counter.
[61]	Counter A	(Terminal 29 or 33 only). Input for decrement counting in the SLC counter.
[62]	Reset Counter A	Input for reset of counter A.
[63]	Counter B	(Terminal 29 or 33 only). Input for increment counting in the SLC counter.
[64]	Counter B	(Terminal 29 or 33 only). Input for decrement counting in the SLC counter.
[65]	Reset Counter B	Input for reset of counter B.

[70]	Mech. Brake Feedback	Brake feedback for hoisting applications: Set <i>parameter 1-01 Motor Control Principle</i> to [3] <i>Flux w/ motor feedback</i> ; set <i>parameter 1-72 Start Function</i> to [6] <i>Hoist mech brake Ref.</i>
[71]	Mech. Brake Feedback inv.	Inverted brake feedback for hoisting applications.
[72]	PID error inverse	When enabled, this option inverts the resulting error from the process PID controller. Available only if <i>parameter 1-00 Configuration Mode</i> is set to [6] <i>Surface Winder</i> , [7] <i>Extended PID Speed OL</i> , or [8] <i>Extended PID Speed CL</i> .
[73]	PID reset I-part	When enabled, this option resets the I-part of the process PID controller. Equivalent to <i>parameter 7-40 Process PID I-part Reset</i> . Available only if <i>parameter 1-00 Configuration Mode</i> is set to [6] <i>Surface Winder</i> , [7] <i>Extended PID Speed OL</i> , or [8] <i>Extended PID Speed CL</i> .
[74]	PID enable	Enables the extended process PID controller. Equivalent to <i>parameter 7-50 Process PID Extended PID</i> . Available only if <i>parameter 1-00 Configuration Mode</i> is set to [7] <i>Extended PID Speed OL</i> or [8] <i>Extended PID Speed CL</i> .
[80]	PTC Card 1	All digital inputs can be set to [80] <i>PTC Card 1</i> . However, only 1 digital input must be set to this option.
[91]	PROFIdrive OFF2	The functionality is the same as the corresponding control word bit of the PROFIBUS/PROFINET option.
[92]	PROFIdrive OFF3	The functionality is the same as the corresponding control word bit of the PROFIBUS/PROFINET option.
[94]	Light Load Detection	Evacuation mode for lifts or elevators. The function magnetizes the motor before opening the mechanical brake. The motion starts in the direction (up or down) defined by VLT® Lift Controller MCO 361 using the speed of <i>parameter 30-27 Light Load Speed [%]</i> . This motion continues for the time specified in <i>parameter 30-25 Light Load Delay [s]</i> while measuring the current. If the motor current exceeds the reference current in <i>parameter 30-26 Light Load Current [%]</i> , the lift is obstructed. The direction is reversed after the delay time specified in <i>parameter 30-25 Light Load Delay [s]</i> . For the feature to run, a start or start reverse command is needed, together with selecting this digital input.

		NOTICE! Flying start overrides light load detection.
[96]	Mains Loss	Select to improve kinetic back-up. When the mains voltage goes back to a level that is close to (but still lower than) the detection level, the output speed increases and kinetic back-up remains active. To avoid this situation, send a status signal to the frequency converter. When the signal on the digital input is low (0), the frequency converter forcibly turns off the kinetic back-up. NOTICE! Only available for pulse inputs at terminals 32/33.
[97]	Mains Loss Inverse	When the signal on the digital input is high (1), the frequency converter forcibly turns off the kinetic back-up. For more details, see the description of [96] <i>Mains loss</i> . NOTICE! Only available for pulse inputs at terminals 32/33.
[98]	Start edge triggered	Edge-triggered start command. Keeps the start command alive. It can be used for a start push key.
[100]	Safe Option Reset	Resets the safety option. Available only when the safety option is mounted.
[107]	Target Inverse	Changes the sign of the set target position. For example, if the set target is 1000, the activation of this option changes the value to -1000.
[108]	Enable Master Offset	NOTICE! This option is available only with software version 48.XX. Activates the master offset selected in <i>parameter 3-26 Master Offset</i> when <i>parameter 17-93 Master Offset Selection</i> has a selection from [1] <i>Absolute</i> to [5] <i>Relative Touch Sensor</i> .
[109]	Start Virtual Master	NOTICE! This option is available only with software version 48.XX. Starts the virtual master configured in <i>parameter 3-27 Virtual Master Max Ref</i> .
[110]	Start Homing	NOTICE! This option is available only with software version 48.XX. Starts the homing function selected in <i>parameter 17-80 Homing Function</i> . Must

		remain high until homing is done, otherwise homing is aborted.
[111]	Activate Touch	NOTICE! This option is available only with software version 48.XX. Activates the monitoring of the touch sensor input.
[112]	Relative Position	NOTICE! This option is available only with software version 48.XX. This option selects between absolute and relative positioning. The option is valid for the next positioning command.
[113]	Enable Reference	NOTICE! This option is available only with software version 48.XX. Positioning mode: The frequency converter activates the selected positioning type and target and starts the motion towards the new target. The motion starts either immediately or when active positioning is completed, depending on settings of <i>parameter 17-90 Absolute Position Mode</i> and <i>parameter 17-91 Relative Position Mode</i> . Synchronization mode: High signal locks the actual follower position to the actual master position. The follower starts and catches up with the master. Low signal stops the synchronization and the follower makes a controlled stop.
[114]	Sync. to Pos. Mode	NOTICE! This option is available only with software version 48.XX. Select positioning in synchronization mode.
[115]	Home Sensor	NOTICE! This option is available only with software version 48.XX. Normally open contact for defining the home position. The function is defined in <i>parameter 17-80 Homing Function</i> . Available only at digital inputs 18, 32, and 33.
[116]	Home Sensor Inv.	NOTICE! This option is available only with software version 48.XX. Normally closed contact for defining the home position. The function is defined in <i>parameter 17-80 Homing Function</i> . Available only at digital inputs 18, 32, and 33.

[117]	Touch Sensor	NOTICE! This option is available only with software version 48.XX. Normally open contact. Serves as a reference for touch probe positioning. Available only at digital inputs 18, 32, and 33.
[118]	Touch Sensor	NOTICE! This option is available only with software version 48.XX. Normally closed contact. Serves as a reference for touch probe positioning. Available only at digital inputs 18, 32, and 33.
[119]	Speed mode	NOTICE! This option is available only with software version 48.XX. Select the speed mode when [9] <i>Positioning</i> or [10] <i>Synchronization</i> is selected in <i>parameter 1-00 Configuration Mode</i> . Speed reference is set by reference resource 1 or fieldbus REF1 relative to <i>parameter 3-03 Maximum Reference</i> .
[231]	Power Limit Mot.	Select this option to activate the power limit function in the motor mode. See <i>parameter group 4-8* Power Limit</i> .
[232]	Power Limit Gen.	Select this option to activate the power limit function in the generating mode. See <i>parameter group 4-8* Power Limit</i> .
[233]	Power Limit Both	Select this option to activate the power limit function in both the motor and the generating mode. See <i>parameter group 4-8* Power Limit</i> .

5-10 Terminal 18 Digital Input

Option: Function:

[8] *	Start	Functions are described in <i>parameter group 5-1* Digital Inputs</i> .
-------	-------	---

5-11 Terminal 19 Digital Input

Option: Function:

[10] *	Reversing	Functions are described in <i>parameter group 5-1* Digital Inputs</i> .
--------	-----------	---

5-12 Terminal 27 Digital Input

Option: Function:

[2] *	Coast inverse	Functions are described in <i>parameter group 5-1* Digital Inputs</i> .
-------	---------------	---

5-13 Terminal 29 Digital Input

Option: Function:

		NOTICE! This parameter is available for FC 302 only.
--	--	--

5-13 Terminal 29 Digital Input		
Option:	Function:	
		Select the function from the available digital input range and the additional options [60] Counter A, [61] Counter A, [63] Counter B, and [64] Counter B. Counters are used in smart logic control functions.
[14] *	Jog	Functions are described in <i>parameter group 5-1* Digital Inputs</i> .

5-14 Terminal 32 Digital Input		
Option:	Function:	
		Select the function from the available digital input range.
	No operation	Functions are described in <i>parameter group 5-1* Digital Inputs</i> .

5-15 Terminal 33 Digital Input		
Option:	Function:	
		Select the function from the available digital input range and the additional options [60] Counter A, [61] Counter A, [63] Counter B and [64] Counter B. Counters are used in smart logic control functions.
[0] *	No operation	Functions are described in <i>parameter group 5-1* Digital Inputs</i> .

5-16 Terminal X30/2 Digital Input		
Option:	Function:	
[0] *	No operation	This parameter is active when option module VLT® General Purpose I/O MCB 101 is installed in the frequency converter. Functions are described in <i>parameter group 5-1* Digital Inputs</i> .

5-17 Terminal X30/3 Digital Input		
Option:	Function:	
[0] *	No operation	This parameter is active when option module VLT® General Purpose I/O MCB 101 is installed in the frequency converter. Functions are described in <i>parameter group 5-1* Digital Inputs</i> .

5-18 Terminal X30/4 Digital Input		
Option:	Function:	
[0] *	No operation	This parameter is active when option module VLT® General Purpose I/O MCB 101 is installed in the frequency converter. Functions are described in <i>parameter group 5-1* Digital Inputs</i> .

5-19 Terminal 37 Safe Stop		
Option:	Function:	
		Use this parameter to configure the Safe Torque Off functionality. A warning message makes the frequency converter coast the motor and enables the automatic restart. An alarm message makes the frequency converter coast the motor and requires a manual restart (via a fieldbus, Digital I/O, or by pressing [RESET] on the LCP). When the VLT® PTC Thermistor Card MCB 112 is mounted, configure the PTC options to get the full benefit from the alarm handling.
[1] *		Coasts the frequency converter when Safe Torque Off is activated. Manual reset from LCP, digital input, or fieldbus.
[3]		Coasts the frequency converter when Safe Torque Off is activated (terminal 37 off). When the Safe Torque Off circuit is re-established, the frequency converter continues without manual reset.
[4]		Coasts the frequency converter when Safe Torque Off is activated. Manual reset from LCP, digital input, or fieldbus.
[5]		Coasts the frequency converter when Safe Torque Off is activated (terminal 37 off). When the Safe Torque Off circuit is re-established, the frequency converter continues without manual reset, unless a digital input set to [80] PTC Card 1 is still enabled.
[6]		This option is used when the VLT® PTC Thermistor Card MCB 112 gates with a stop key through a safety relay to terminal 37. Coasts the frequency converter when Safe Torque Off is activated. Manual reset from LCP, digital input, or fieldbus.
[7]		This option is used when the VLT® PTC Thermistor Card MCB 112 gates with a stop key through a safety relay to terminal 37. Coasts the frequency converter when Safe Torque Off is activated (terminal 37 off). When the Safe Torque Off circuit is re-established, the frequency converter continues without manual reset, unless a digital input set to [80] PTC Card 1 is still enabled.
[8]		This option makes it possible to use a combination of alarm and warning.
[9]		This option makes it possible to use a combination of alarm and warning.

NOTICE!

Options [4] PTC 1 Alarm to [9] PTC 1 & Relay W/A are only available when the MCB 112 is connected.

NOTICE!

Selecting *Auto Reset/Warning* enables automatic restart of the frequency converter.

Function	Number	PTC	Relay
No Function	[0]	–	–
Safe Torque Off Alarm	[1]*	–	Safe Torque Off [A68]
Safe Torque Off Warning	[3]	–	Safe Torque Off [W68]
PTC 1 Alarm	[4]	PTC 1 Safe Torque Off [A71]	–
PTC 1 Warning	[5]	PTC 1 Safe Torque Off [W71]	–
PTC 1 & Relay A	[6]	PTC 1 Safe Torque Off [A71]	Safe Torque Off [A68]
PTC 1 & Relay W	[7]	PTC 1 Safe Torque Off [W71]	Safe Torque Off [W68]
PTC 1 & Relay A/W	[8]	PTC 1 Safe Torque Off [A71]	Safe Torque Off [W68]
PTC 1 & Relay W/A	[9]	PTC 1 Safe Torque Off [W71]	Safe Torque Off [A68]

Table 3.19 Overview of Functions, Alarms, and Warnings

W means warning and *A* means alarm. For further information, see *Alarms and Warnings* in chapter 6 Troubleshooting.

A dangerous failure related to Safe Torque Off issues *alarm 72, Dangerous failure*.

Refer to *Table 6.1*.

5-20 Terminal X46/1 Digital Input

Option: **Function:**

[0] *	No operation	This parameter is active when option module VLT® Extended Relay Card MCB 113 is installed in the frequency converter. Functions are described in <i>parameter group 5-1* Digital Inputs</i> .
-------	--------------	---

5-21 Terminal X46/3 Digital Input

Option: **Function:**

[0] *	No operation	This parameter is active when option module VLT® Extended Relay Card MCB 113 is installed in the frequency converter. Functions are described in <i>parameter group 5-1* Digital Inputs</i> .
-------	--------------	---

5-22 Terminal X46/5 Digital Input

Option: **Function:**

[0] *	No operation	This parameter is active when option module VLT® Extended Relay Card MCB 113 is installed in the frequency converter. Functions are described in <i>parameter group 5-1* Digital Inputs</i> .
-------	--------------	---

5-23 Terminal X46/7 Digital Input

Option: **Function:**

[0] *	No operation	This parameter is active when option module VLT® Extended Relay Card MCB 113 is installed in the frequency converter. Functions are described in <i>parameter group 5-1* Digital Inputs</i> .
-------	--------------	---

5-24 Terminal X46/9 Digital Input

Option: **Function:**

[0] *	No operation	This parameter is active when option module VLT® Extended Relay Card MCB 113 is installed in the frequency converter. Functions are described in <i>parameter group 5-1* Digital Inputs</i> .
-------	--------------	---

5-25 Terminal X46/11 Digital Input

Option: **Function:**

[0] *	No operation	This parameter is active when option module VLT® Extended Relay Card MCB 113 is installed in the frequency converter. Functions are described in <i>parameter group 5-1* Digital Inputs</i> .
-------	--------------	---

5-26 Terminal X46/13 Digital Input

Option: **Function:**

[0] *	No operation	This parameter is active when option module VLT® Extended Relay Card MCB 113 is installed in the frequency converter. Functions are described in <i>parameter group 5-1* Digital Inputs</i> .
-------	--------------	---

3.6.3 5-3* Digital Outputs

The 2 solid-state digital outputs are common for terminals 27 and 29. Set the I/O function for terminal 27 in *parameter 5-01 Terminal 27 Mode*, and set the I/O function for terminal 29 in *parameter 5-02 Terminal 29 Mode*.

NOTICE!

These parameters cannot be adjusted while the motor is running.

[0]	No operation	Default for all digital outputs and relay outputs.
[1]	Control ready	The control card is ready, for example: Feedback from a frequency converter controlled by a 24 V external supply (VLT® 24 V DC Supply MCB 107) and the main power to the unit is not detected.
[2]	Drive ready	The frequency converter is ready for operation and applies a supply signal on the control board.
[3]	Drive ready/ remote control	The frequency converter is ready for operation and is in <i>auto-on</i> mode.
[4]	Enable/no warning	Ready for operation. No start or stop command has been given (start/disable). No warnings are active.
[5]	VLT running	The motor runs and shaft torque is present.
[6]	Running/no warning	The output speed is higher than the speed set in <i>parameter 1-81 Min Speed for Function at Stop [RPM]</i> . The motor runs and there are no warnings.
[7]	Run in range/no warning	Motor runs within the programmed current and speed ranges set in <i>parameter 4-50 Warning Current Low</i> to <i>parameter 4-53 Warning Speed High</i> . There are no warnings.
[8]	Run on reference/no warning	Motor runs at reference speed. No warnings.
[9]	Alarm	An alarm activates the output. There are no warnings.
[10]	Alarm or warning	An alarm or a warning activates the output.
[11]	At torque limit	The torque limit set in <i>parameter 4-16 Torque Limit Motor Mode</i> or <i>parameter 4-17 Torque Limit Generator Mode</i> has been exceeded.
[12]	Out of current range	The motor current is outside the range set in <i>parameter 4-18 Current Limit</i> .
[13]	Below current, low	Motor current is lower than set in <i>parameter 4-50 Warning Current Low</i> .
[14]	Above current, high	Motor current is higher than set in <i>parameter 4-51 Warning Current High</i> .
[15]	Out of range	Output frequency is outside the frequency range set in <i>parameter 4-52 Warning Speed Low</i> and <i>parameter 4-53 Warning Speed High</i> .
[16]	Below speed, low	Output speed is lower than the setting in <i>parameter 4-52 Warning Speed Low</i> .
[17]	Above speed, high	Output speed is higher than the setting in <i>parameter 4-53 Warning Speed High</i> .
[18]	Out of feedback range	Feedback is outside the range set in <i>parameter 4-56 Warning Feedback Low</i> and <i>parameter 4-57 Warning Feedback High</i> .

[19]	Below feedback low	Feedback is below the limit set in <i>parameter 4-56 Warning Feedback Low</i> .
[20]	Above feedback high	Feedback is above the limit set in <i>parameter 4-57 Warning Feedback High</i> .
[21]	Thermal warning	The thermal warning turns on when the temperature exceeds the limit in the motor, the frequency converter, the brake resistor, or the thermistor.
[22]	Ready, no thermal warning	Frequency converter is ready for operation, and there is no overtemperature warning.
[23]	Remote, ready, no thermal warning	Frequency converter is ready for operation and is in <i>auto-on</i> mode. There is no overtemperature warning.
[24]	Ready, no over/ undervoltage	Frequency converter is ready for operation and the mains voltage is within the specified voltage range (see the section <i>General Specifications</i> in the frequency converter <i>design guide</i>).
[25]	Reverse	The motor runs (or is ready to run) clockwise when logic = 0 and counter-clockwise when logic = 1. The output changes when the reversing signal is applied.
[26]	Bus OK	Active communication (no timeout) via the serial communication port.
[27]	Torque limit and stop	Use in performing a coast stop and in torque limit condition. If the frequency converter has received a stop signal and is at the torque limit, the signal is logic 0.
[28]	Brake, no brake warning	Brake is active and there are no warnings.
[29]	Brake ready, no fault	Brake is ready for operation and there are no faults.
[30]	Brake fault (IGBT)	Output is logic 1 when the brake IGBT is short-circuited. Use this function to protect the frequency converter if there is a fault on the brake modules. To cut out the main voltage from the frequency converter, use the output/relay.
[31]	Relay 123	Relay is activated when [0] <i>Control word</i> is selected in <i>parameter group 8-** Communications and Options</i> .
[32]	Mechanical brake control	Enables control of an external mechanical brake. For more information on mechanical brake control, refer to the frequency converter <i>design guide</i> .
[33]	Safe stop activated (FC 302 only)	Indicates that the Safe Torque Off on terminal 37 is activated.
[35]	External Interlock	
[40]	Out of ref range	Active when the actual speed is outside settings in <i>parameter 4-52 Warning Speed</i>

		<i>Low to parameter 4-55 Warning Reference High.</i>
[41]	Below reference low	Active when actual speed is below speed reference setting.
[42]	Above reference high	Active when actual speed is above speed reference setting.
[43]	Extended PID Limit	
[45]	Bus Ctrl	Controls output via bus. The state of the output is set in <i>parameter 5-90 Digital & Relay Bus Control</i> . If a bus timeout occurs, the output state is retained.
[46]	Bus Ctrl On at timeout	Controls output via bus. The state of the output is set in <i>parameter 5-90 Digital & Relay Bus Control</i> . If a bus timeout occurs, the output state is set high (on).
[47]	Bus Ctrl Off at timeout	Controls output via bus. The state of the output is set in <i>parameter 5-90 Digital & Relay Bus Control</i> . If a bus timeout occurs, the output state is set low (off).
[51]	MCO-controlled	Active when a VLT® Advanced Cascade Controller MCO 102 or VLT® Motion Control MCO 305 is connected. The output is controlled from option.
[55]	Pulse output	
[60]	Comparator 0	See <i>parameter group 13-1* Comparators</i> . If comparator 0 is evaluated as true, the output goes high. Otherwise, it is low.
[61]	Comparator 1	See <i>parameter group 13-1* Comparators</i> . If Comparator 1 is evaluated as true, the output goes high. Otherwise, it is low.
[62]	Comparator 2	See <i>parameter group 13-1* Comparators</i> . If comparator 2 is evaluated as true, the output goes high. Otherwise, it is low.
[63]	Comparator 3	See <i>parameter group 13-1* Comparators</i> . If comparator 3 is evaluated as true, the output goes high. Otherwise, it is low.
[64]	Comparator 4	See <i>parameter group 13-1* Comparators</i> . If comparator 4 is evaluated as true, the output goes high. Otherwise, it is low.
[65]	Comparator 5	See <i>parameter group 13-1* Comparators</i> . If comparator 5 is evaluated as true, the output goes high. Otherwise, it is low.
[70]	Logic Rule 0	See <i>parameter group 13-4* Logic Rules</i> . If logic rule 0 is evaluated as true, the output goes high. Otherwise, it is low.
[71]	Logic Rule 1	See <i>parameter group 13-4* Logic Rules</i> . If logic rule 1 is evaluated as true, the output goes high. Otherwise, it is low.
[72]	Logic Rule 2	See <i>parameter group 13-4* Logic Rules</i> . If logic rule 2 is evaluated as true, the output goes high. Otherwise, it is low.

[73]	Logic Rule 3	See <i>parameter group 13-4* Logic Rules</i> . If logic rule 3 is evaluated as true, the output goes high. Otherwise, it is low.
[74]	Logic Rule 4	See <i>parameter group 13-4* Logic Rules</i> . If logic rule 4 is evaluated as true, the output goes high. Otherwise, it is low.
[75]	Logic Rule 5	See <i>parameter group 13-4* Logic Rules</i> . If logic rule 5 is evaluated as true, the output goes high. Otherwise, it is low.
[80]	SL Digital Output A	See <i>parameter 13-52 SL Controller Action</i> . The output goes high whenever the smart logic action [38] <i>Set dig. out. A high</i> is executed. The output goes low whenever the smart logic action [32] <i>Set dig. out. A low</i> is executed.
[81]	SL Digital Output B	See <i>parameter 13-52 SL Controller Action</i> . The input goes high whenever the smart logic action [39] <i>Set dig. out. B high</i> is executed. The input goes low whenever the smart logic action [33] <i>Set dig. out. B low</i> is executed.
[82]	SL Digital Output C	See <i>parameter 13-52 SL Controller Action</i> . The input goes high whenever the smart logic action [40] <i>Set dig. out. C high</i> is executed. The input goes low whenever the smart logic action [34] <i>Set dig. out. C low</i> is executed.
[83]	SL Digital Output D	See <i>parameter 13-52 SL Controller Action</i> . The input goes high whenever the smart logic action [41] <i>Set dig. out. D high</i> is executed. The input goes low whenever the smart logic action [35] <i>Set dig. out. D low</i> is executed.
[84]	SL Digital Output E	See <i>parameter 13-52 SL Controller Action</i> . The input goes high whenever the smart logic action [42] <i>Set dig. out. E high</i> is executed. The input goes low whenever the smart logic action [36] <i>Set dig. out. E low</i> is executed.
[85]	SL Digital Output F	See <i>parameter 13-52 SL Controller Action</i> . The input goes high whenever the smart logic action [43] <i>Set dig. out. F high</i> is executed. The input goes low whenever the smart logic action [37] <i>Set dig. out. F low</i> is executed.
[90]	kWh counter pulse	Sends a pulse (200 ms pulse width) to output terminal whenever kWh counter changes (<i>parameter 15-02 kWh Counter</i>).

[96]	Reverse After Ramp	<p>NOTICE! This option is available only with software version 48.XX.</p> <p>Indicates if the direction of rotation should be reversed. Depends on whether the speed reference is positive or negative after the ramp specified in <i>parameter 16-48 Speed Ref. After Ramp [RPM]</i>.</p>																								
[98]	Virtual Master Dir.	<p>NOTICE! This option is available only with software version 48.XX.</p> <p>A virtual master signal that controls the rotation direction of followers.</p>																								
[120]	Local reference active	<p>Output is high when <i>parameter 3-13 Reference Site = [2] Local</i>.</p> <table border="1" style="width: 100%; border-collapse: collapse;"> <thead> <tr> <th style="text-align: left;">Reference site set in <i>parameter 3-13 Reference Site</i></th> <th style="text-align: center;">Local reference active [120]</th> <th style="text-align: center;">Remote reference active [121]</th> </tr> </thead> <tbody> <tr> <td>Reference site: Local <i>parameter 3-13 Reference Site [2] Local</i></td> <td style="text-align: center;">1</td> <td style="text-align: center;">0</td> </tr> <tr> <td>Reference site: Remote <i>parameter 3-13 Reference Site [1] Remote</i></td> <td style="text-align: center;">0</td> <td style="text-align: center;">1</td> </tr> <tr> <td>Reference site: Linked to Hand/Auto</td> <td></td> <td></td> </tr> <tr> <td>Hand</td> <td style="text-align: center;">1</td> <td style="text-align: center;">0</td> </tr> <tr> <td>Hand⇒off</td> <td style="text-align: center;">1</td> <td style="text-align: center;">0</td> </tr> <tr> <td>Auto⇒off</td> <td style="text-align: center;">0</td> <td style="text-align: center;">0</td> </tr> <tr> <td>Auto</td> <td style="text-align: center;">0</td> <td style="text-align: center;">1</td> </tr> </tbody> </table> <p style="text-align: center;">Table 3.20 Local Reference Active</p>	Reference site set in <i>parameter 3-13 Reference Site</i>	Local reference active [120]	Remote reference active [121]	Reference site: Local <i>parameter 3-13 Reference Site [2] Local</i>	1	0	Reference site: Remote <i>parameter 3-13 Reference Site [1] Remote</i>	0	1	Reference site: Linked to Hand/Auto			Hand	1	0	Hand⇒off	1	0	Auto⇒off	0	0	Auto	0	1
Reference site set in <i>parameter 3-13 Reference Site</i>	Local reference active [120]	Remote reference active [121]																								
Reference site: Local <i>parameter 3-13 Reference Site [2] Local</i>	1	0																								
Reference site: Remote <i>parameter 3-13 Reference Site [1] Remote</i>	0	1																								
Reference site: Linked to Hand/Auto																										
Hand	1	0																								
Hand⇒off	1	0																								
Auto⇒off	0	0																								
Auto	0	1																								
[121]	Remote reference active	Output is high when <i>parameter 3-13 Reference Site = [1] Remote</i> or <i>[0] Linked to hand/auto</i> while the LCP is in <i>auto-on</i> mode. See <i>Table 3.20</i> .																								
[122]	No alarm	Output is high when no alarm is present.																								
[123]	Start command active	Output is high when there is an active start command (that is via digital input bus connection, hand-on, or auto-on), and no stop or start command is active.																								
[124]	Running reverse	Output is high when the frequency converter runs counterclockwise (the logical product of the status bits running AND reverse).																								

[125]	Drive in hand mode	Output is high when the frequency converter is in <i>hand-on</i> mode (as indicated by the LED light above [Hand On]).
[126]	Drive in Auto mode	Output is high when the frequency converter is in <i>auto-on</i> mode (as indicated by the LED light above [Auto On]).
[151]	ATEX ETR cur. alarm	Selectable if <i>parameter 1-90 Motor Thermal Protection</i> is set to <i>[20] ATEX ETR</i> or <i>[21] Advanced ETR</i> . If Alarm 164 <i>ATEX ETR cur.lim.alarm</i> is active, the output is 1.
[152]	ATEX ETR freq. alarm	Selectable if <i>parameter 1-90 Motor Thermal Protection</i> is set to <i>[20] ATEX ETR</i> or <i>[21] Advanced ETR</i> . If Alarm 166 <i>ATEX ETR freq.lim.alarm</i> is active, the output is 1.
[153]	ATEX ETR cur. warning	Selectable if <i>parameter 1-90 Motor Thermal Protection</i> is set to <i>[20] ATEX ETR</i> or <i>[21] Advanced ETR</i> . If Alarm 163, <i>ATEX ETR cur.lim.warning</i> is active, the output is 1.
[154]	ATEX ETR freq. warning	Selectable if <i>parameter 1-90 Motor Thermal Protection</i> is set to <i>[20] ATEX ETR</i> or <i>[21] Advanced ETR</i> . If Warning 165, <i>ATEX ETR freq.lim.warning</i> is active, the output is 1.
[188]	AHF Capacitor Connect	The capacitors are turned on at 20% (hysteresis of 50% gives an interval of 10–30%). The capacitors are disconnected below 10%. The off delay is 10 s and restarts if the nominal power goes above 10% during the delay. <i>Parameter 5-80 AHF Cap Reconnect Delay</i> is used to guarantee a minimum off-time for the capacitors.
[189]	External fan control	The internal logics for the internal fan control is transferred to this output to make it possible to control an external fan (relevant for hp duct cooling).
[190]	Safe Function active	
[191]	Safe Opt. Reset req.	
[192]	RS Flipflop 0	See <i>parameter group 13-1* Comparators</i> .
[193]	RS Flipflop 1	See <i>parameter group 13-1* Comparators</i> .
[194]	RS Flipflop 2	See <i>parameter group 13-1* Comparators</i> .
[195]	RS Flipflop 3	See <i>parameter group 13-1* Comparators</i> .
[196]	RS Flipflop 4	See <i>parameter group 13-1* Comparators</i> .
[197]	RS Flipflop 5	See <i>parameter group 13-1* Comparators</i> .
[198]	RS Flipflop 6	See <i>parameter group 13-1* Comparators</i> .
[199]	RS Flipflop 7	See <i>parameter group 13-1* Comparators</i> .
[221]	IGBT-cooling	Use this option for handling the overcurrent trips. When the frequency converter detects an overcurrent

		condition, it shows <i>alarm 13, Overcurrent</i> and triggers a reset. If the overcurrent condition occurs the third time in a row, the frequency converter shows <i>alarm 13, Overcurrent</i> and initiates a 3-minute delay before the next reset.
[222]	Homing OK	NOTICE! This option is available only with software version 48.XX. Homing is completed with the selected homing function (<i>parameter 17-80 Homing Function</i>).
[223]	On Target	NOTICE! This option is available only with software version 48.XX. Positioning is completed and the on target signal is sent when the actual position is within <i>parameter 3-05 On Reference Window</i> for the duration of <i>parameter 3-09 On Target Time</i> and the actual speed does not exceed <i>parameter 3-05 On Reference Window</i> .
[224]	Position Error	NOTICE! This option is available only with software version 48.XX. The position error exceeds the value in <i>parameter 4-71 Maximum Position Error</i> for the time set in <i>parameter 4-72 Position Error Timeout</i> .
[225]	Position Limit	NOTICE! This option is available only with software version 48.XX. The position is outside the limits set in <i>parameter 3-06 Minimum Position</i> and <i>parameter 3-07 Maximum Position</i> .
[226]	Touch on Target	NOTICE! This option is available only with software version 48.XX. Target position is reached in touch probe position mode.
[227]	Touch Activated	NOTICE! This option is available only with software version 48.XX. Touch probe positioning active. The frequency converter monitors the touch probe sensor input.
[231]	In Power Lim. Mot.	
[232]	In Power Lim. Gen.	
[233]	In Power Limit	

5-30 Terminal 27 Digital Output		
Option:	Function:	
[0] *	No operation	Functions are described in <i>parameter group 5-3* Digital Outputs</i> .
5-31 Terminal 29 Digital Output		
Option:	Function:	
		NOTICE! This parameter is applicable for FC 302 only.
[0] *	No operation	Functions are described in <i>parameter group 5-3* Digital Outputs</i> .
5-32 Term X30/6 Digi Out (MCB 101)		
Option:	Function:	
[0]	No operation	This parameter is active when option module VLT® General Purpose I/O MCB 101 is mounted in the frequency converter. Functions are described in <i>parameter group 5-3* Digital Outputs</i> .
[1]	Control Ready	
[2]	Drive ready	
[3]	Drive rdy/rem ctrl	
[4]	Enable / no warning	
[5]	Running	
[6]	Running / no warning	
[7]	Run in range/no warn	
[8]	Run on ref/no warn	
[9]	Alarm	
[10]	Alarm or warning	
[11]	At torque limit	
[12]	Out of current range	
[13]	Below current, low	
[14]	Above current, high	
[15]	Out of speed range	
[16]	Below speed, low	
[17]	Above speed, high	
[18]	Out of feedb. range	
[19]	Below feedback, low	
[20]	Above feedback, high	
[21]	Thermal warning	
[22]	Ready,no thermal W	
[23]	Remote,ready,no TW	
[24]	Ready, Voltage OK	
[25]	Reverse	
[26]	Bus OK	
[27]	Torque limit & stop	
[28]	Brake, no brake war	
[29]	Brake ready, no fault	

5-32 Term X30/6 Digi Out (MCB 101)		
Option:	Function:	
[30]	Brake fault (IGBT)	
[31]	Relay 123	
[32]	Mech brake ctrl	
[33]	Safe stop active	
[38]	Motor feedback error	
[39]	Tracking error	
[40]	Out of ref range	
[41]	Below reference, low	
[42]	Above ref, high	
[43]	Extended PID Limit	
[45]	Bus ctrl.	
[46]	Bus ctrl, 1 if timeout	
[47]	Bus ctrl, 0 if timeout	
[50]	On Reference	
[55]	Pulse output	
[60]	Comparator 0	
[61]	Comparator 1	
[62]	Comparator 2	
[63]	Comparator 3	
[64]	Comparator 4	
[65]	Comparator 5	
[70]	Logic rule 0	
[71]	Logic rule 1	
[72]	Logic rule 2	
[73]	Logic rule 3	
[74]	Logic rule 4	
[75]	Logic rule 5	
[80]	SL digital output A	
[81]	SL digital output B	
[82]	SL digital output C	
[83]	SL digital output D	
[84]	SL digital output E	
[85]	SL digital output F	
[90]	kWh counter pulse	Sends a pulse (200 ms pulse width) to output terminal whenever kWh counter changes (<i>parameter 15-02 kWh Counter</i>).
[96]	Reverse After Ramp	NOTICE! This option is available only with software version 48.XX.
[98]	Virtual Master Dir.	NOTICE! This option is available only with software version 48.XX.
[120]	Local ref active	
[121]	Remote ref active	
[122]	No alarm	
[123]	Start command activ	

5-32 Term X30/6 Digi Out (MCB 101)		
Option:	Function:	
[124]	Running reverse	
[125]	Drive in hand mode	
[126]	Drive in auto mode	
[151]	ATEX ETR cur. alarm	
[152]	ATEX ETR freq. alarm	
[153]	ATEX ETR cur. warning	
[154]	ATEX ETR freq. warning	
[188]	AHF Capacitor Connect	
[189]	External Fan Control	
[190]	Safe Function active	
[191]	Safe Opt. Reset req.	
[192]	RS Flipflop 0	
[193]	RS Flipflop 1	
[194]	RS Flipflop 2	
[195]	RS Flipflop 3	
[196]	RS Flipflop 4	
[197]	RS Flipflop 5	
[198]	RS Flipflop 6	
[199]	RS Flipflop 7	
[222]	Homing Ok	NOTICE! This option is available only with software version 48.XX.
[223]	On Target	NOTICE! This option is available only with software version 48.XX.
[224]	Position Error	NOTICE! This option is available only with software version 48.XX.
[225]	Position Limit	NOTICE! This option is available only with software version 48.XX.
[226]	Touch on Target	NOTICE! This option is available only with software version 48.XX.
[227]	Touch Activated	NOTICE! This option is available only with software version 48.XX.

5-33 Term X30/7 Digi Out (MCB 101)		
Option:	Function:	
[0] *	No operation	This parameter is active when option module VLT® General

5-33 Term X30/7 Digi Out (MCB 101)		
Option:	Function:	
		Purpose I/O MCB 101 is mounted in the frequency converter. Functions are described in <i>parameter group 5-3* Digital Outputs.</i>
[1]	Control ready	
[2]	Drive ready	
[3]	Drive rdy/rem ctrl	
[4]	Enable / no warning	
[5]	VLT running	
[6]	Running / no warning	
[7]	Run in range/no warn	
[8]	Run on ref/no warn	
[9]	Alarm	
[10]	Alarm or warning	
[11]	At torque limit	
[12]	Out of current range	
[13]	Below current, low	
[14]	Above current, high	
[15]	Out of speed range	
[16]	Below speed, low	
[17]	Above speed, high	
[18]	Out of feedb. range	
[19]	Below feedback, low	
[20]	Above feedback, high	
[21]	Thermal warning	
[22]	Ready,no thermal W	
[23]	Remote,ready,no TW	
[24]	Ready, voltage OK	
[25]	Reverse	
[26]	Bus OK	
[27]	Torque limit stop	
[28]	Brake: No Brake War	
[29]	Brake ready, no fault	
[30]	Brake fault (IGBT)	
[31]	Relay 123	
[32]	Mech brake ctrl	
[33]	Safe stop active	
[40]	Out of ref range	
[41]	Below reference, low	
[42]	Above ref, high	
[45]	Bus ctrl.	
[46]	Bus ctrl, 1 if timeout	
[47]	Bus ctrl, 0 if timeout	
[51]	MCO controlled	
[55]	Pulse output	
[60]	Comparator 0	
[61]	Comparator 1	
[62]	Comparator 2	

5-33 Term X30/7 Digi Out (MCB 101)		
Option:	Function:	
[63]	Comparator 3	
[64]	Comparator 4	
[65]	Comparator 5	
[70]	Logic rule 0	
[71]	Logic rule 1	
[72]	Logic rule 2	
[73]	Logic rule 3	
[74]	Logic rule 4	
[75]	Logic rule 5	
[80]	SL digital output A	
[81]	SL digital output B	
[82]	SL digital output C	
[83]	SL digital output D	
[84]	SL digital output E	
[85]	SL digital output F	
[120]	Local ref active	
[121]	Remote ref active	
[122]	No alarm	
[123]	Start command activ	
[124]	Running reverse	
[125]	Drive in hand mode	
[126]	Drive in auto mode	

3.6.4 5-4* Relays

Parameters for configuring the timing and the output functions for the relays.

5-40 Function Relay		
Option:	Function:	
		Relay 1 [0], Relay 2 [1]. VLT® Extended Relay Card MCB 113: Relay 3 [2], Relay 4 [3], Relay 5 [4], Relay 6 [5]. VLT® Relay Card MCB 105: Relay 7 [6], Relay 8 [7], Relay 9 [8].
[51]	MCO controlled	Active when a VLT® Advanced Cascade Controller MCO 102 or VLT® Motion Control MCO 305 is connected. The output is controlled from option.
[221]	IGBT-cooling	Use this option for handling the overcurrent trips. When the frequency converter detects an overcurrent condition, it shows <i>alarm 13, Overcurrent</i> and triggers a reset. If the overcurrent condition occurs the 3rd time in a row, the frequency converter shows <i>alarm 13, Overcurrent</i> and initiates a 3 minute delay before the next reset.
[0]	No operation	All digital and relay outputs are by default set to <i>No Operation</i> .
[1]	Control Ready	The control card is ready, for example: Feedback from a frequency converter where the control is supplied by an external 24 V supply (VLT® 24 V DC Supply MCB 107) and the main power to frequency converter is not detected.
[2]	Drive ready	The frequency converter is ready to operate. Mains and control supplies are OK.
[3]	Drive rdy/rem ctrl	The frequency converter is ready for operation and is in <i>auto-on</i> mode.
[4]	Enable / no warning	Ready for operation. No start or stop commands have been applied (start/disable). No warnings are active.
[5]	Running	The motor is running, and shaft torque is present.
[6]	Running / no warning	Output speed is higher than the speed set in <i>parameter 1-81 Min Speed for Function at Stop [RPM]</i> . The motor runs and there are no warnings.
[7]	Run in range/no warn	The motor runs within the programmed current and the speed ranges set in <i>parameter 4-50 Warning Current Low</i> and

5-40 Function Relay		
Option:	Function:	
		<i>parameter 4-53 Warning Speed High</i> . No warnings.
[8]	Run on ref/no warn	The motor runs at reference speed. No warnings.
[9]	Alarm	An alarm activates the output. No warnings.
[10]	Alarm or warning	An alarm or a warning activates the output.
[11]	At torque limit	The torque limit set in <i>parameter 4-16 Torque Limit Motor Mode</i> or <i>parameter 4-17 Torque Limit Generator Mode</i> has been exceeded.
[12]	Out of current range	The motor current is outside the range set in <i>parameter 4-18 Current Limit</i> .
[13]	Below current, low	The motor current is lower than set in <i>parameter 4-50 Warning Current Low</i> .
[14]	Above current, high	The motor current is higher than set in <i>parameter 4-51 Warning Current High</i> .
[15]	Out of speed range	Output speed/frequency is outside the frequency range set in <i>parameter 4-52 Warning Speed Low</i> and <i>parameter 4-53 Warning Speed High</i> .
[16]	Below speed, low	Output speed is lower than the setting in <i>parameter 4-52 Warning Speed Low</i> .
[17]	Above speed, high	Output speed is higher than the setting in <i>parameter 4-53 Warning Speed High</i> .
[18]	Out of feedb. range	Feedback is outside the range set in <i>parameter 4-56 Warning Feedback Low</i> and <i>parameter 4-57 Warning Feedback High</i> .
[19]	Below feedback, low	Feedback is below the limit set in <i>parameter 4-56 Warning Feedback Low</i> .
[20]	Above feedback, high	Feedback is above the limit set in <i>parameter 4-57 Warning Feedback High</i> .
[21]	Thermal warning	Thermal warning turns on when the temperature exceeds the limit either in motor, frequency converter, brake resistor, or connected thermistor.
[22]	Ready, no thermal W	The frequency converter is ready for operation and there is no overtemperature warning.
[23]	Remote, ready, no TW	The frequency converter is ready for operation and is in <i>auto-on</i> mode. There is no overtemperature warning.
[24]	Ready, Voltage OK	The frequency converter is ready for operation and the mains voltage is within the specified voltage range (see the <i>General Specifications</i> section in the <i>design guide</i>).

5-40 Function Relay

Option:	Function:
[25] Reverse	The motor runs (or is ready to run) clockwise when logic = 0 and counter-clockwise when logic = 1. The output changes as soon as the reversing signal is applied.
[26] Bus OK	Active communication (no timeout) via the serial communication port.
[27] Torque limit & stop	Use for performing a coasted stop in a torque limit condition. If the frequency converter has received a stop signal and is in torque limit, the signal is logic 0.
[28] Brake, no brake war	Brake is active and there are no warnings.
[29] Brake ready, no fault	Brake is ready for operation and there are no faults.
[30] Brake fault (IGBT)	Output is logic 1 when the brake IGBT is short-circuited. Use this function to protect the frequency converter if there is a fault on the brake module. Use the digital output/relay to cut out the main voltage from the frequency converter.
[31] Relay 123	Digital output/relay is activated when [0] Control Word is selected in parameter group 8-** Comm. and Options.
[32] Mech brake ctrl	Selection of mechanical brake control. When selected parameters in parameter group 2-2* Mechanical Brake are active. The output must be reinforced to carry the current for the coil in the brake. Usually solved by connecting an external relay to the selected digital output.
[33] Safe stop active	NOTICE! This option is applicable for FC 302 only. Indicates that the Safe Torque Off on terminal 37 has been activated.
[36] Control word bit 11	Activate relay 1 by control word from fieldbus. No other functional impact in the frequency converter. Typical application: Controlling auxiliary device from fieldbus. The function is valid when [0] FC profile in parameter 8-10 Control Word Profile is selected.
[37] Control word bit 12	Activate relay 2 (FC 302 only) by control word from fieldbus. No other functional impact in the frequency

5-40 Function Relay

Option:	Function:
	converter. Typical application: Controlling auxiliary device from fieldbus. The function is valid when [0] FC profile in parameter 8-10 Control Word Profile is selected.
[38] Motor feedback error	Failure in the speed feedback loop from motor running in closed loop. The output can eventually be used to prepare switching the frequency converter in open loop in an emergency case.
[39] Tracking error	When the difference between calculated speed and actual speed in parameter 4-35 Tracking Error is larger than selected, the digital output/relay is active.
[40] Out of ref range	Active when the actual speed is outside settings in parameter 4-52 Warning Speed Low to parameter 4-55 Warning Reference High.
[41] Below reference, low	Active when actual speed is below speed reference setting.
[42] Above ref, high	Active when actual speed is above speed reference setting.
[43] Extended PID Limit	
[45] Bus ctrl.	Controls digital output/relay via bus. The state of the output is set in parameter 5-90 Digital & Relay Bus Control. The output state is retained in the event of bus timeout.
[46] Bus ctrl, 1 if timeout	Controls output via bus. The state of the output is set in parameter 5-90 Digital & Relay Bus Control. If a bus timeout occurs, the output state is set high (on).
[47] Bus ctrl, 0 if timeout	Controls output via bus. The state of the output is set in parameter 5-90 Digital & Relay Bus Control. If a bus timeout occurs, the output state is set low (Off).
[50] On Reference	
[51] MCO controlled	
[59] Remote, enable, no TW	
[60] Comparator 0	See parameter group 13-1* Comparators. If comparator 0 in SLC is true, the output goes high. Otherwise, it is low.
[61] Comparator 1	See parameter group 13-1* Comparators. If comparator 1 in SLC is

5-40 Function Relay		
Option:	Function:	
		true, the output goes high. Otherwise, it is low.
[62]	Comparator 2	See <i>parameter group 13-1* Comparators</i> . If comparator 2 in SLC is true, the output goes high. Otherwise, it is low.
[63]	Comparator 3	See <i>parameter group 13-1* Comparators</i> . If comparator 3 in SLC is true, the output goes high. Otherwise, it is low.
[64]	Comparator 4	See <i>parameter group 13-1* Comparators</i> . If comparator 4 in SLC is true, the output goes high. Otherwise, it is low.
[65]	Comparator 5	See <i>parameter group 13-1* Smart Logic Control</i> . If comparator 5 in SLC is true, the output goes high. Otherwise, it is low.
[70]	Logic rule 0	See <i>parameter group 13-4* Smart Logic Control</i> . If logic rule 0 in SLC is true, the output goes high. Otherwise, it is low.
[71]	Logic rule 1	See <i>parameter group 13-4* Smart Logic Control</i> . If logic rule 1 in SLC is true, the output goes high. Otherwise, it is low.
[72]	Logic rule 2	See <i>parameter group 13-4* Smart Logic Control</i> . If logic rule 2 in SLC is true, the output goes high. Otherwise, it is low.
[73]	Logic rule 3	See <i>parameter group 13-4* Smart Logic Control</i> . If logic rule 3 in SLC is true, the output goes high. Otherwise, it is low.
[74]	Logic rule 4	See <i>parameter group 13-4* Smart Logic Control</i> . If logic rule 4 in SLC is true, the output goes high. Otherwise, it is low.
[75]	Logic rule 5	See <i>parameter group 13-4* Smart Logic Control</i> . If logic rule 5 in SLC is true, the output goes high. Otherwise, it is low.
[80]	SL digital output A	See <i>parameter 13-52 SL Controller Action</i> . Output A is low on smart logic action [32]. Output A is high on smart logic action [38].
[81]	SL digital output B	See <i>parameter 13-52 SL Controller Action</i> . Output B is low on smart logic action [33]. Output B is high on smart logic action [39].
[82]	SL digital output C	See <i>parameter 13-52 SL Controller Action</i> . Output C is low on smart logic

5-40 Function Relay		
Option:	Function:	
		action [34]. Output C is high on smart logic action [40].
[83]	SL digital output D	See <i>parameter 13-52 SL Controller Action</i> . Output D is low on smart logic action [35]. Output D is high on smart logic action [41].
[84]	SL digital output E	See <i>parameter 13-52 SL Controller Action</i> . Output E is low on smart logic action [36]. Output E is high on smart logic action [42].
[85]	SL digital output F	See <i>parameter 13-52 SL Controller Action</i> . Output F is low on smart logic action [37]. Output F is high on smart logic action [43].
[96]	Reverse After Ramp	NOTICE! This option is available only with software version 48.XX. See the description in <i>chapter 3.6.3 5-3* Digital Outputs</i> .
[98]	Virtual Master Dir.	NOTICE! This option is available only with software version 48.XX. See the description in <i>chapter 3.6.3 5-3* Digital Outputs</i> .
[120]	Local ref active	Output is high when <i>parameter 3-13 Reference Site = [2] Local</i> or when <i>parameter 3-13 Reference Site = [0] Linked to hand auto</i> at the same time as the LCP is in <i>hand-on</i> mode.

5-40 Function Relay

Option:

Function:

		Reference site set in <i>parameter 3-13 Reference Site</i>	Local reference active [120]	Remote reference active [121]
		Reference site: Local <i>parameter 3-13 Reference Site [2] Local</i>	1	0
		Reference site: Remote <i>parameter 3-13 Reference Site [1] Remote</i>	0	1
		Reference site: Linked to Hand/Auto		
		Hand	1	0
		Hand⇒off	1	0
		Auto⇒off	0	0
		Auto	0	1
Table 3.21 Local Reference Active				
[121]	Remote ref active	Output is high when <i>parameter 3-13 Reference Site = [1] Remote</i> or <i>[0] Linked to hand/auto</i> while the LCP is in <i>auto-on</i> mode. See <i>Table 3.21</i> .		
[122]	No alarm	Output is high when no alarm is present.		
[123]	Start command activ	Output is high when the start command is high (that is via digital input, bus connection, [Hand On], or [Auto On]), and a stop has been last command.		
[124]	Running reverse	Output is high when the frequency converter is running counterclockwise (the logical product of the status bits <i>running AND reverse</i>).		
[125]	Drive in hand mode	Output is high when the frequency converter is in <i>hand-on</i> mode (as indicated by the LED light above [Hand On]).		
[126]	Drive in auto mode	Output is high when the frequency converter is in <i>auto-on</i> mode (as indicated by LED on above [Auto On]).		
[151]	ATEX ETR cur. alarm	Selectable if <i>parameter 1-90 Motor Thermal Protection</i> is set to <i>[20] ATEX ETR</i> or <i>[21] Advanced ETR</i> . If <i>alarm 164</i> ,		

5-40 Function Relay

Option:

Function:

		ATEX ETR <i>cur.lim.alarm</i> is active, the output is 1.
[152]	ATEX ETR freq. alarm	Selectable if <i>parameter 1-90 Motor Thermal Protection</i> is set to <i>[20] ATEX ETR</i> or <i>[21] Advanced ETR</i> . If <i>alarm 166</i> , <i>ATEX ETR freq.lim.alarm</i> is active, the output is 1.
[153]	ATEX ETR cur. warning	Selectable if <i>parameter 1-90 Motor Thermal Protection</i> is set to <i>[20] ATEX ETR</i> or <i>[21] Advanced ETR</i> . If <i>alarm 163</i> , <i>ATEX ETR cur.lim.warning</i> is active, the output is 1.
[154]	ATEX ETR freq. warning	Selectable if <i>parameter 1-90 Motor Thermal Protection</i> is set to <i>[20] ATEX ETR</i> or <i>[21] Advanced ETR</i> . If <i>warning 165</i> , <i>ATEX ETR freq.lim.warning</i> is active, the output is 1.
[188]	AHF Capacitor Connect	
[189]	External Fan Control	The internal logics for the internal fan control is transferred to this output to make it possible to control an external fan (relevant for HP duct cooling).
[190]	Safe Function active	
[191]	Safe Opt. Reset req.	
[192]	RS Flipflop 0	See <i>parameter group 13-1* Comparators</i> .
[193]	RS Flipflop 1	See <i>parameter group 13-1* Comparators</i> .
[194]	RS Flipflop 2	See <i>parameter group 13-1* Comparators</i> .
[195]	RS Flipflop 3	See <i>parameter group 13-1* Comparators</i> .
[196]	RS Flipflop 4	See <i>parameter group 13-1* Comparators</i> .
[197]	RS Flipflop 5	See <i>parameter group 13-1* Comparators</i> .
[198]	RS Flipflop 6	See <i>parameter group 13-1* Comparators</i> .
[199]	RS Flipflop 7	See <i>parameter group 13-1* Comparators</i> .
[222]	Homing Ok	NOTICE! This option is available only with software version 48.XX. Homing is completed with the selected homing function (<i>parameter 17-80 Homing Function</i>).

5-40 Function Relay

Option:	Function:
[223] On Target	<p>NOTICE! This option is available only with software version 48.XX.</p> <p>Positioning is completed and the on target signal is sent when the actual position is within <i>parameter 3-05 On Reference Window</i> for the duration of <i>parameter 3-09 On Target Time</i> and the actual speed does not exceed <i>parameter 3-05 On Reference Window</i>.</p>
[224] Position Error	<p>NOTICE! This option is available only with software version 48.XX.</p> <p>The position error exceeds the value in <i>parameter 4-71 Maximum Position Error</i> for the time set in <i>parameter 4-72 Position Error Timeout</i>.</p>
[225] Position Limit	<p>NOTICE! This option is available only with software version 48.XX.</p> <p>The position is outside the limits set in <i>parameter 3-06 Minimum Position</i> and <i>parameter 3-07 Maximum Position</i>.</p>
[226] Touch on Target	<p>NOTICE! This option is available only with software version 48.XX.</p> <p>Target position is reached in touch probe position mode.</p>
[227] Touch Activated	<p>NOTICE! This option is available only with software version 48.XX.</p> <p>Touch probe positioning active. The frequency converter monitors the touch probe sensor input.</p>

5-41 On Delay, Relay

Range:	Function:
0.01 s* [0.01 - 600 s]	<p>Enter the delay of the relay cut-in time. Select 1 of 2 internal mechanical relays in an array function. See <i>parameter 5-40 Function Relay</i> for details.</p>

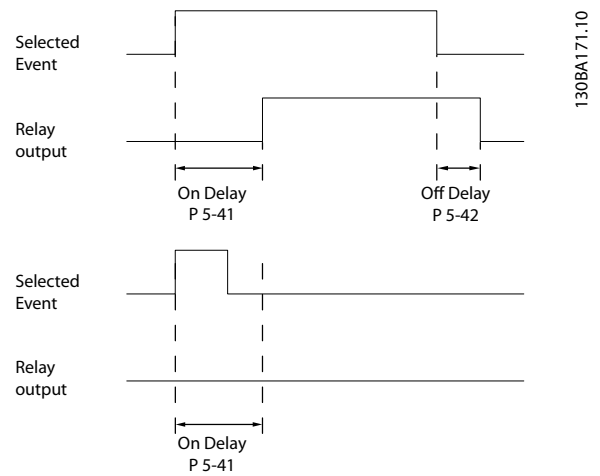

Figure 3.37 On Delay, Relay

5-42 Off Delay, Relay

Range:	Function:
0.01 s* [0.01 - 600 s]	<p>Enter the delay of the relay cutout time. Select 1 of 2 internal mechanical relays in an array function. See <i>parameter 5-40 Function Relay</i> for details. If the selected event condition changes before a delay timer expires, the relay output is unaffected.</p>

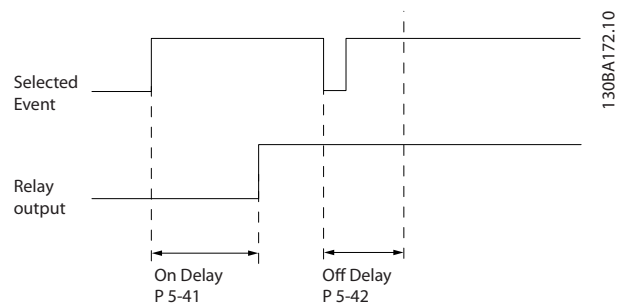

Figure 3.38 Off Delay, Relay

If the selected event condition changes before the on delay or off delay timer expires, the relay output is unaffected.

3.6.5 5-5* Pulse Input

The pulse input parameters are used to define an appropriate window for the impulse reference area by configuring the scaling and filter settings for the pulse inputs. Input terminals 29 or 33 act as frequency reference inputs. Set terminal 29 (*parameter 5-13 Terminal 29 Digital Input*) or terminal 33 (*parameter 5-15 Terminal 33 Digital Input*) to [32] Pulse input. If terminal 29 is used as an input, set *parameter 5-01 Terminal 27 Mode* to [0] Input.

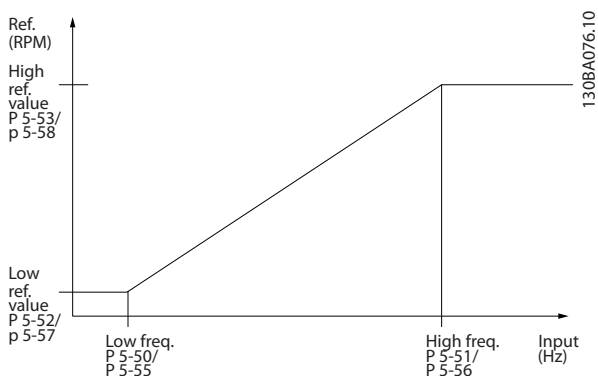

Figure 3.39 Pulse Input

5-50 Term. 29 Low Frequency		
Range:	Function:	
100 Hz*	[0 - 110000 Hz]	Enter the low frequency limit corresponding to the low motor shaft speed (that is low reference value) in <i>parameter 5-52 Term. 29 Low Ref./Feedb. Value</i> . Refer to <i>Figure 3.39</i> .

5-51 Term. 29 High Frequency		
Range:	Function:	
100 Hz*	[0 - 110000 Hz]	Enter the high frequency limit corresponding to the high motor shaft speed (that is high reference value) in <i>parameter 5-53 Term. 29 High Ref./Feedb. Value</i> .

5-52 Term. 29 Low Ref./Feedb. Value		
Range:	Function:	
0.000 Reference-FeedbackUnit*	[-999999.999 - 999999.999 ReferenceFeed-backUnit]	Enter the low reference value limit for the motor shaft speed [RPM]. This is also the lowest feedback value, see also <i>parameter 5-57 Term. 33 Low Ref./Feedb. Value</i> . Set terminal 29 to digital input

5-52 Term. 29 Low Ref./Feedb. Value		
Range:	Function:	
		(<i>parameter 5-02 Terminal 29 Mode = [0] input</i> (default) and <i>parameter 5-13 Terminal 29 Digital Input = applicable value</i>).

5-53 Term. 29 High Ref./Feedb. Value		
Range:	Function:	
1500.000 ReferenceFeed-backUnit*	[-999999.999 - 999999.999 ReferenceFeed-backUnit]	Enter the high reference value [RPM] for the motor shaft speed and the high feedback value, see also <i>parameter 5-58 Term. 33 High Ref./Feedb. Value</i> . Select terminal 29 as a digital input (<i>parameter 5-02 Terminal 29 Mode = [0] input</i> (default) and <i>parameter 5-13 Terminal 29 Digital Input = applicable value</i>). This parameter is available for FC 302 only.

5-54 Pulse Filter Time Constant #29		
Range:	Function:	
100 ms*	[1 - 1000 ms]	Enter the pulse filter time constant. The pulse filter dampens oscillations of the feedback signal, which is an advantage if there is a lot of noise in the system. A high time constant value results in better dampening but also increases the time delay through the filter.

5-55 Term. 33 Low Frequency		
Range:	Function:	
100 Hz*	[0 - 110000 Hz]	Enter the low frequency corresponding to the low motor shaft speed (that is low reference value) in <i>parameter 5-57 Term. 33 Low Ref./Feedb. Value</i> .

5-56 Term. 33 High Frequency		
Range:	Function:	
100 Hz*	[0 - 110000 Hz]	Enter the high frequency corresponding to the high motor shaft speed (that is high reference value) in <i>parameter 5-58 Term. 33 High Ref./Feedb. Value</i> .

5-57 Term. 33 Low Ref./Feedb. Value		
Range:		Function:
0 ReferenceFeed-backUnit*	[-999999.999 - 999999.999 ReferenceFeed-backUnit]	Enter the low reference value [RPM] for the motor shaft speed. This is also the low feedback value, see also <i>parameter 5-52 Term. 29 Low Ref./Feedb. Value.</i>

5-58 Term. 33 High Ref./Feedb. Value		
Range:		Function:
1500.000 ReferenceFeedbackUnit*	[-999999.999 - 999999.999 ReferenceFeed-backUnit]	Enter the high reference value [RPM] for the motor shaft speed. See also <i>parameter 5-53 Term. 29 High Ref./Feedb. Value.</i>

5-59 Pulse Filter Time Constant #33		
Range:		Function:
100 ms*	[1 - 1000 ms]	<p>NOTICE!</p> <p>This parameter cannot be adjusted while the motor is running.</p> <p>Enter the pulse filter time constant. The low-pass filter reduces the influence and dampens oscillations on the feedback signal from the control. This is an advantage if there is a lot of noise in the system.</p>

3.6.6 5-6* Pulse Outputs

NOTICE!

These parameters cannot be adjusted while the motor is running.

These parameters configure pulse outputs with their functions and scaling. Terminals 27 and 29 are allocated to pulse output via *parameter 5-01 Terminal 27 Mode* and *parameter 5-02 Terminal 29 Mode*, respectively.

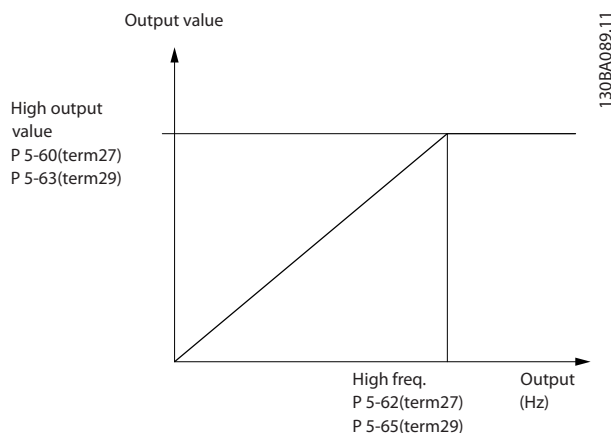

Figure 3.40 Configuration of Pulse Outputs

Options for readout output variables:

		Parameters for configuring the scaling and output functions of pulse outputs. The pulse outputs are designated to terminals 27 or 29. Select terminal 27 output in <i>parameter 5-01 Terminal 27 Mode</i> and terminal 29 output in <i>parameter 5-02 Terminal 29 Mode</i> .
[0]	No operation	
[45]	Bus control	
[48]	Bus control timeout	
[51]	MCO-controlled	
[97]	Reference After Ramp	<p>NOTICE!</p> <p>This option is available only with software version 48.XX.</p> <p>Actual speed reference after the ramp. Use this output as master signal for speed synchronization of follower frequency converters. The reference is set in <i>parameter 16-48 Speed Ref. After Ramp [RPM]</i>.</p>
[99]	Virtual Master Speed	<p>NOTICE!</p> <p>This option is available only with software version 48.XX.</p> <p>Virtual master signal for controlling the speed or position of the followers.</p>
[100]	Output frequency	
[101]	Reference	
[102]	Feedback	
[103]	Motor current	
[104]	Torque relative to limit	

[105]	Torque relative to rated	
[106]	Power	
[107]	Speed	
[108]	Torque	
[109]	Max. out freq	

5-60 Terminal 27 Pulse Output Variable

Option:		Function:
[0]	No operation	Select the display output for terminal 27.
[45]	Bus ctrl.	
[48]	Bus ctrl., timeout	
[97]	Reference After Ramp	<p>NOTICE!</p> <p>This option is available only with software version 48.XX.</p> <p>Actual speed reference after the ramp. Use this output as master signal for speed synchronization of follower frequency converters. The reference is set in <i>parameter 16-48 Speed Ref. After Ramp [RPM]</i>.</p>
[99]	Virtual Master Speed	<p>NOTICE!</p> <p>This option is available only with software version 48.XX.</p> <p>Virtual master signal for controlling the speed or position of the followers.</p>
[100]	Output frequency	
[101]	Reference	
[102]	Feedback	
[103]	Motor Current	
[104]	Torque rel to limit	
[105]	Torq relate to rated	
[106]	Power	
[107]	Speed	
[108]	Torque	
[109]	Max Out Freq	
[119]	Torque % lim	

5-62 Pulse Output Max Freq #27

Range:		Function:
5000. Hz*	[0 - 32000 Hz]	Set the maximum frequency for terminal 27 corresponding to the output variable selected in <i>parameter 5-60 Terminal 27 Pulse Output Variable</i> .

5-63 Terminal 29 Pulse Output Variable

Option:		Function:
		<p>NOTICE!</p> <p>This parameter is available for FC 302 only.</p>
[0]	No operation	Select the display output for terminal 29.
[45]	Bus ctrl.	
[48]	Bus ctrl., timeout	
[97]	Reference After Ramp	<p>NOTICE!</p> <p>This option is available only with software version 48.XX.</p> <p>Actual speed reference after the ramp. Use this output as master signal for speed synchronization of follower frequency converters. The reference is set in <i>parameter 16-48 Speed Ref. After Ramp [RPM]</i>.</p>
[99]	Virtual Master Speed	<p>NOTICE!</p> <p>This option is available only with software version 48.XX.</p> <p>Virtual master signal for controlling the speed or position of the followers.</p>
[100]	Output frequency	
[101]	Reference	
[102]	Feedback	
[103]	Motor Current	
[104]	Torque rel to limit	
[105]	Torq relate to rated	
[106]	Power	
[107]	Speed	
[108]	Torque	
[109]	Max Out Freq	
[119]	Torque % lim	

5-65 Pulse Output Max Freq #29

Range:		Function:
Size related*	[0 - 110000 Hz]	Set the maximum frequency for terminal 29 corresponding to the output variable set in <i>parameter 5-63 Terminal 29 Pulse Output Variable</i> .

5-66 Terminal X30/6 Pulse Output Variable		
Select the variable for readout on terminal X30/6.		
This parameter is active when VLT® General Purpose I/O MCB 101 is installed in the frequency converter.		
Same options and functions as <i>parameter group 5-6* Pulse Outputs</i> .		
Option:	Function:	
[0]	No operation	
[45]	Bus ctrl.	
[48]	Bus ctrl., timeout	
[97]	Reference After Ramp	<p>NOTICE!</p> <p>This option is available only with software version 48.XX.</p> <p>Actual speed reference after the ramp. Use this output as master signal for speed synchronization of follower frequency converters. The reference is set in <i>parameter 16-48 Speed Ref. After Ramp [RPM]</i>.</p>
[99]	Virtual Master Speed	<p>NOTICE!</p> <p>This option is available only with software version 48.XX.</p> <p>Virtual master signal for controlling the speed or position of the followers.</p>
[100]	Output frequency	
[101]	Reference	
[102]	Feedback	
[103]	Motor Current	
[104]	Torque rel to limit	
[105]	Torq relate to rated	
[106]	Power	
[107]	Speed	
[108]	Torque	
[109]	Max Out Freq	
[119]	Torque % lim	

5-68 Pulse Output Max Freq #X30/6		
Range:	Function:	
5000. Hz*	[0 - 32000 Hz]	<p>NOTICE!</p> <p>This parameter cannot be adjusted while the motor is running.</p> <p>Select the maximum frequency on terminal X30/6 referring to the output variable in <i>parameter 5-66 Terminal X30/6 Pulse Output Variable</i>.</p>

5-68 Pulse Output Max Freq #X30/6		
Range:	Function:	
		This parameter is active when VLT® General Purpose I/O MCB 101 is installed in the frequency converter.

3.6.7 5-7* 24 V Encoder Input

Connect the 24 V encoder to terminal 12 (24 V DC supply), terminal 32 (channel A), terminal 33 (channel B), and terminal 20 (GND). The digital inputs 32/33 are active for encoder inputs when [1] 24 V encoder is selected in *parameter 1-02 Flux Motor Feedback Source* and *parameter 7-00 Speed PID Feedback Source*. The encoder used is a dual-channel (A and B) 24 V type. Maximum input frequency: 110 kHz.

Encoder connection to the frequency converter

24 V incremental encoder. Maximum cable length is 5 m (16.4 ft).

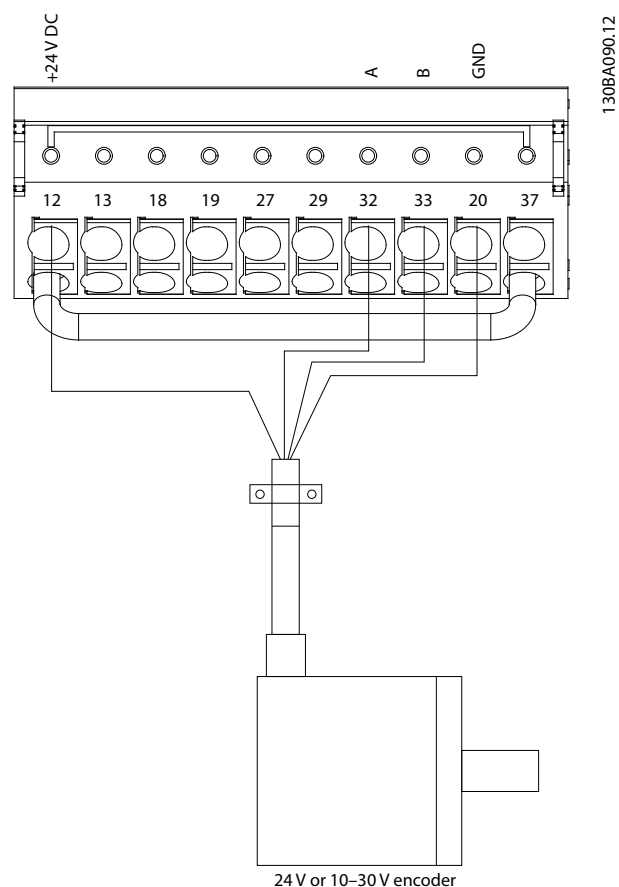

Figure 3.41 Encoder Connection

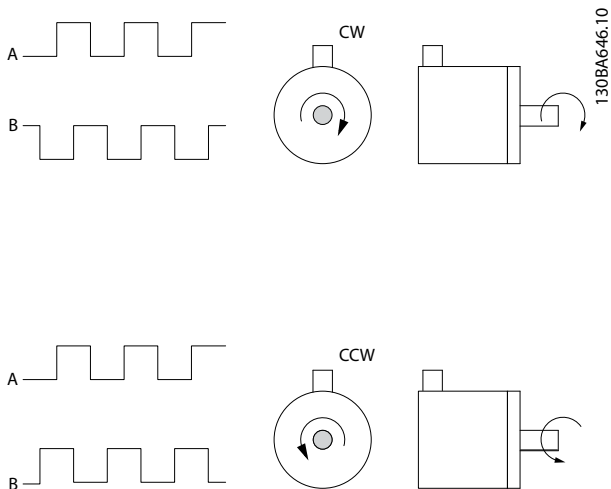

Figure 3.42 Encoder Rotation Direction

5-70 Term 32/33 Pulses per Revolution		
Range:	Function:	
1024 N/A*	[1 - 4096 N/A]	Set the encoder pulses per revolution on the motor shaft. Read the correct value from the encoder.

5-71 Term 32/33 Encoder Direction		
Option:	Function:	
		<p>NOTICE!</p> <p>This parameter cannot be adjusted while the motor is running.</p> <p>Change the detected encoder rotation direction without changing the wiring to the encoder.</p>
[0] *	Clockwise	Sets channel A 90° (electrical degrees) behind channel B upon clockwise rotation of the encoder shaft.
[1]	Counter-clockwise	Sets channel A 90° (electrical degrees) ahead of channel B upon clockwise rotation of the encoder shaft.

5-72 Term 32/33 Encoder Type		
Option:	Function:	
		<p>NOTICE!</p> <p>This parameter is only available with software version 48.XX.</p> <p>Select the signal type of the encoder connected to terminals 32, 33.</p>
[0] *	Quadrature A/B Format	Encoder with 2 tracks: A and B, displaced 90° for detecting the rotational direction.
[1]	Single Channel 33	Encoder with 1 track connected to terminal 33.
[2]	Single Channel w/Dir.	Encoder with 1 track connected to terminal 33. The direction is set with a signal on terminal 32: 0 V = forward/clockwise, 24 V = reverse/counter clockwise.

3.6.8 5-8* I/O Options

5-80 AHF Cap Reconnect Delay		
Range:	Function:	
25 s*	[1 - 120 s]	Guarantees a minimum off-time for the capacitors. The timer starts once the AHF capacitor disconnects and has to expire before the output is allowed to be on again. It only turns on again if the frequency converter power is 20–30%.

3.6.9 5-9* Bus-controlled

This parameter group selects digital and relay outputs via a fieldbus setting.

5-90 Digital & Relay Bus Control		
Range:	Function:	
0 N/A* [0 - 2147483647 N/A]	This parameter holds the state of the digital outputs and relays that is controlled by bus. A logical 1 indicates that the output is high or active. A logical 0 indicates that the output is low or inactive.	

Bit 0	Digital output terminal 27
Bit 1	Digital output terminal 29
Bit 2	Digital output terminal X 30/6
Bit 3	Digital output terminal X 30/7
Bit 4	Relay 1 output terminal
Bit 5	Relay 2 output terminal
Bit 6	Option B relay 1 output terminal
Bit 7	Option B relay 2 output terminal
Bit 8	Option B relay 3 output terminal
Bit 9–15	Reserved for future terminals
Bit 16	Option C relay 1 output terminal
Bit 17	Option C relay 2 output terminal
Bit 18	Option C relay 3 output terminal
Bit 19	Option C relay 4 output terminal
Bit 20	Option C relay 5 output terminal
Bit 21	Option C relay 6 output terminal
Bit 22	Option C relay 7 output terminal
Bit 23	Option C relay 8 output terminal
Bit 24–31	Reserved for future terminals

Table 3.22 Bus-controlled Digital Outputs and Relays

5-93 Pulse Out #27 Bus Control		
Range:	Function:	
0.00 %* [0.00 - 100.00 %]	Set the output frequency transferred to output terminal 27 when the terminal is configured as [45] <i>Bus Controlled</i> in parameter 5-60 <i>Terminal 27 Pulse Output Variable</i> .	

5-94 Pulse Out #27 Timeout Preset		
Range:	Function:	
0.00 %* [0.00 - 100.00 %]	Set the output frequency transferred to output terminal 27 when the terminal is configured as [48] <i>Bus Ctrl Timeout</i> in parameter 5-60 <i>Terminal 27 Pulse Output Variable</i> and a timeout is detected.	

5-95 Pulse Out #29 Bus Control		
Range:	Function:	
0.00 %* [0.00 - 100.00 %]	Set the output frequency transferred to output terminal 29 when the terminal is configured as [45] <i>Bus Controlled</i> in parameter 5-63 <i>Terminal 29 Pulse Output Variable</i> .	

5-96 Pulse Out #29 Timeout Preset		
Range:	Function:	
0.00 %* [0.00 - 100.00 %]	Set the output frequency transferred to output terminal 29 when the terminal is configured as [48] <i>Bus Ctrl Timeout</i> in parameter 5-63 <i>Terminal 29 Pulse Output Variable</i> and a timeout is detected.	

5-97 Pulse Out #X30/6 Bus Control		
Range:	Function:	
0 %* [0 - 100 %]	Set the output frequency transferred to output terminal X30/6 when the terminal is configured as [45] <i>Bus ctrl.</i> in parameter 5-66 <i>Terminal X30/6 Pulse Output Variable</i> .	

5-98 Pulse Out #X30/6 Timeout Preset		
Range:	Function:	
0 %* [0 - 100 %]	Set the output frequency transferred to output terminal X30/6 when the terminal is configured as [48] <i>Bus Ctrl Timeout</i> in parameter 5-66 <i>Terminal X30/6 Pulse Output Variable</i> and a timeout is detected.	

3.7 Parameters: 6-** Analog In/Out

3.7.1 6-0* Analog I/O Mode

The analog inputs can be allocated to be either voltage (FC 301: 0–10 V, FC 302: 0 to ±10 V) or current input (FC 301/FC 302: 0/4–20 mA).

NOTICE!

Thermistors may be connected to either an analog or a digital input.

6-00 Live Zero Timeout Time		
Range:	Function:	
10 s* [1 - 99 s]	Enter the live zero timeout in s. Live zero timeout time is active for analog inputs, that is terminal 53 or terminal 54, used as reference or feedback sources. If the reference signal value associated with the selected current input drops below 50% of the value set in <ul style="list-style-type: none"> Parameter 6-10 Terminal 53 Low Voltage Parameter 6-12 Terminal 53 Low Current Parameter 6-20 Terminal 54 Low Voltage Parameter 6-22 Terminal 54 Low Current for a time period longer than the time set in parameter 6-00 Live Zero Timeout Time, the function selected in parameter 6-01 Live Zero Timeout Function is activated.	

6-01 Live Zero Timeout Function		
Option:	Function:	
	Select the timeout function. If the input signal on terminal 53 or 54 is below 50% of the value in <ul style="list-style-type: none"> Parameter 6-10 Terminal 53 Low Voltage Parameter 6-12 Terminal 53 Low Current Parameter 6-20 Terminal 54 Low Voltage Parameter 6-22 Terminal 54 Low Current for a time period defined in parameter 6-00 Live Zero Timeout Time, then the function set in parameter 6-01 Live Zero Timeout Function is activated. If several timeouts occur simultaneously, the frequency converter prioritizes the timeout functions as follows:	

6-01 Live Zero Timeout Function		
Option:	Function:	
	1. Parameter 6-01 Live Zero Timeout Function. 2. Parameter 8-04 Control Word Timeout Function.	
[0] *	Off	
[1]	Freeze output	Frozen at the present value.
[2]	Stop	Overruled to stop.
[3]	Jogging	Overruled to jog speed.
[4]	Max. speed	Overruled to maximum speed.
[5]	Stop and trip	Overruled to stop with subsequent trip.
[20]		
[21]		

3.7.2 6-1* Analog Input 1

Parameters for configuring the scaling and limits for analog input 1 (terminal 53).

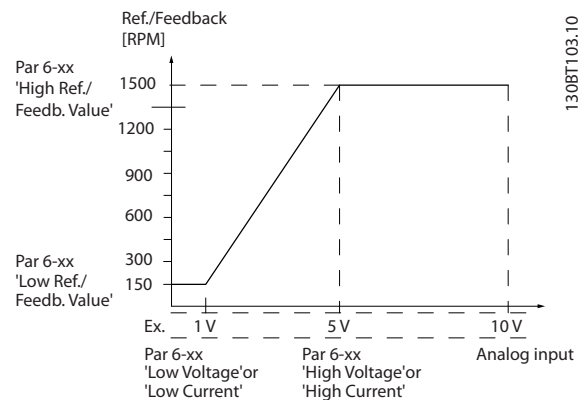

Figure 3.43 Analog Input 1

6-10 Terminal 53 Low Voltage		
Range:	Function:	
0.07 V* [-10.00 - par. 6-11 V]	Enter the low voltage value. This analog input scaling value should correspond to the minimum reference value set in parameter 6-14 Terminal 53 Low Ref./Feedb. Value.	

6-11 Terminal 53 High Voltage		
Range:	Function:	
10 V* [par. 6-10 - 10 V]	Enter the high voltage value. This analog input scaling value should correspond to the high reference feedback value set in <i>parameter 6-15 Terminal 53 High Ref./Feedb. Value</i> .	

6-12 Terminal 53 Low Current		
Range:	Function:	
0.14 mA* [0.00 - par. 6-13 mA]	Enter the low current value. This reference signal should correspond to the minimum reference value, set in <i>parameter 3-02 Minimum Reference</i> . Set the value to exceed 2 mA in order to activate the live zero timeout function in <i>parameter 6-01 Live Zero Timeout Function</i> .	

6-13 Terminal 53 High Current		
Range:	Function:	
20 mA* [par. 6-12 - 20 mA]	Enter the high current value corresponding to the high reference/feedback set in <i>parameter 6-15 Terminal 53 High Ref./Feedb. Value</i> .	

6-14 Terminal 53 Low Ref./Feedb. Value		
Range:	Function:	
0 ReferenceFeed-backUnit* [-999999.999 - 999999.999 ReferenceFeed-backUnit]	Enter the analog input scaling value that corresponds to the low voltage/low current set in <i>parameter 6-10 Terminal 53 Low Voltage</i> and <i>parameter 6-12 Terminal 53 Low Current</i> .	

6-15 Terminal 53 High Ref./Feedb. Value		
Range:	Function:	
1500.000 ReferenceFeed-backUnit* [-999999.999 - 999999.999 ReferenceFeed-backUnit]	Enter the analog input scaling value that corresponds to the maximum reference feedback value set in <i>parameter 6-11 Terminal 53 High Voltage</i> and <i>parameter 6-13 Terminal 53 High Current</i> .	

6-16 Terminal 53 Filter Time Constant		
Range:	Function:	
0.001 s* [0.001 - 10 s]	<p>NOTICE!</p> <p>This parameter cannot be adjusted while the motor is running.</p> <p>Enter the filter time constant. This constant is a first-order digital low-pass filter time for suppressing electrical noise in terminal 53. A high value improves dampening but also increases the delay through the filter.</p>	

3.7.3 6-2* Analog Input 2

Parameters for configuring the scaling and limits for analog input 2 (terminal 54).

6-20 Terminal 54 Low Voltage		
Range:	Function:	
0.07 V* [-10.00 - par. 6-21 V]	Enter the low voltage value. This analog input scaling value should correspond to the minimum reference value set in <i>parameter 3-02 Minimum Reference</i> . See also <i>chapter 3.4 Parameters: 3-** Reference/Ramps</i> .	

6-21 Terminal 54 High Voltage		
Range:	Function:	
10 V* [par. 6-20 - 10 V]	Enter the high voltage value. This analog input scaling value should correspond to the high reference feedback value set in <i>parameter 6-25 Terminal 54 High Ref./Feedb. Value</i> .	

6-22 Terminal 54 Low Current		
Range:	Function:	
0.14 mA* [0.00 - par. 6-23 mA]	Enter the low current value. This reference signal should correspond to the minimum reference value, set in <i>parameter 3-02 Minimum Reference</i> . Enter the value that exceeds 2 mA to activate the live zero timeout function in <i>parameter 6-01 Live Zero Timeout Function</i> .	

6-23 Terminal 54 High Current		
Range:	Function:	
20 mA* [par. 6-22 - 20 mA]	Enter the high current value corresponding to the high reference feedback value set in <i>parameter 6-25 Terminal 54 High Ref./Feedb. Value.</i>	

6-24 Terminal 54 Low Ref./Feedb. Value		
Range:	Function:	
0 ReferenceFeed-backUnit*	[-999999.999 - 999999.999 ReferenceFeed-backUnit]	Enter the analog input scaling value that corresponds to the minimum reference feedback value set in <i>parameter 3-02 Minimum Reference.</i>

6-25 Terminal 54 High Ref./Feedb. Value		
Range:	Function:	
1500.000 ReferenceFeed-backUnit*	[-999999.999 - 999999.999 ReferenceFeed-backUnit]	Enter the analog input scaling value that corresponds to the maximum reference feedback value set in <i>parameter 3-03 Maximum Reference.</i>

6-26 Terminal 54 Filter Time Constant		
Range:	Function:	
0.001 s* [0.001 - 10 s]	<p>NOTICE!</p> <p>This parameter cannot be adjusted while the motor is running.</p> <p>Enter the filter time constant. This is a first-order digital low-pass filter time constant for suppressing electrical noise in terminal 54. Increasing the value improves dampening but also increases the time delay through the filter.</p>	

3.7.4 6-3* Analog Input 3 General Purpose I/O MCB 101

Parameter group for configuring the scale and limits for analog input 3 (X30/11) in VLT® General Purpose I/O MCB 101.

6-30 Terminal X30/11 Low Voltage		
Range:	Function:	
0.07 V* [0 - par. 6-31 V]	Sets the analog input scaling value to correspond to the low reference feedback value (set in <i>parameter 6-34 Term. X30/11 Low Ref./Feedb. Value.</i>)	

6-31 Terminal X30/11 High Voltage		
Range:	Function:	
10 V* [par. 6-30 - 10 V]	Sets the analog input scaling value to correspond to the high reference feedback value (set in <i>parameter 6-35 Term. X30/11 High Ref./Feedb. Value.</i>)	

6-34 Term. X30/11 Low Ref./Feedb. Value		
Range:	Function:	
0 ReferenceFeed-backUnit*	[-999999.999 - 999999.999 ReferenceFeed-backUnit]	Sets the analog input scaling value to correspond to the low voltage value (set in <i>parameter 6-30 Terminal X30/11 Low Voltage.</i>)

6-35 Term. X30/11 High Ref./Feedb. Value		
Range:	Function:	
100 Reference-FeedbackUnit*	[-999999.999 - 999999.999 ReferenceFeed-backUnit]	Sets the analog input scaling value to correspond to the high-voltage value (set in <i>parameter 6-31 Terminal X30/11 High Voltage.</i>)

6-36 Term. X30/11 Filter Time Constant		
Range:	Function:	
0.001 s* [0.001 - 10 s]	<p>NOTICE!</p> <p>This parameter cannot be adjusted while the motor is running.</p> <p>Enter the filter time constant. This constant is a first-order digital low-pass filter time for suppressing electrical noise in terminal X30/11. A high value improves dampening but also increases the delay through the filter.</p>	

3.7.5 6-4* Analog Input X30/12

Parameter group for configuring the scale and limits for analog input 4 (X30/12) placed on VLT[®] General Purpose I/O MCB 101.

6-40 Terminal X30/12 Low Voltage		
Range:	Function:	
0.07 V* [0 - par. 6-41 V]	Sets the analog input scaling value to correspond to the low reference feedback value set in <i>parameter 6-44 Term. X30/12 Low Ref./Feedb. Value</i> .	

6-41 Terminal X30/12 High Voltage		
Range:	Function:	
10 V* [par. 6-40 - 10 V]	Sets the analog input scaling value to correspond to the high reference feedback value set in <i>parameter 6-45 Term. X30/12 High Ref./Feedb. Value</i> .	

6-44 Term. X30/12 Low Ref./Feedb. Value		
Range:	Function:	
0 ReferenceFeed-backUnit*	[-999999.999 - 999999.999 ReferenceFeed-backUnit]	Sets the analog output scaling value to correspond to the low voltage value set in <i>parameter 6-40 Terminal X30/12 Low Voltage</i> .

6-45 Term. X30/12 High Ref./Feedb. Value		
Range:	Function:	
100 Reference-FeedbackUnit*	[-999999.999 - 999999.999 ReferenceFeed-backUnit]	Sets the analog input scaling value to correspond to the high voltage value set in <i>parameter 6-41 Terminal X30/12 High Voltage</i> .

6-46 Term. X30/12 Filter Time Constant		
Range:	Function:	
0.001 s* [0.001 - 10 s]	<p>NOTICE! This parameter cannot be adjusted while the motor is running.</p> <p>Enter the filter time constant. This constant is a first-order digital low-pass filter time for suppressing electrical noise in terminal X30/12. A high value improves dampening but also increases the delay through the filter.</p>	

3.7.6 6-5* Analog Output 1

Parameters for configuring the scaling and limits for analog output 1, that is terminal 42. Analog outputs are current outputs: 0/4–20 mA. Common terminal (terminal 39) is the same terminal and has the same electrical potential for analog common and digital common connection. Resolution on analog output is 12 bit.

6-50 Terminal 42 Output		
Option:	Function:	
		Select the function of terminal 42 as an analog current output. Depending on the selection, the output is either a 0–20 mA or 4–20 mA output. The current value can be read out in the LCP in <i>parameter 16-65 Analog Output 42 [mA]</i> .
[0]	No operation	Indicates no signal on the analog output.
[52]	MCO 0-20mA	
[53]	MCO 4-20mA	
[58]	Actual Position	<p>NOTICE! This option is available only with software version 48.XX.</p> <p>The actual position. 0–20 mA corresponds to <i>parameter 3-06 Minimum Position</i> to <i>parameter 3-07 Maximum Position</i>.</p>
[59]	Actual Position 4-20mA	<p>NOTICE! This option is available only with software version 48.XX.</p> <p>The actual position. 4–20 mA corresponds to <i>parameter 3-06 Minimum Position</i> to <i>parameter 3-07 Maximum Position</i>.</p>
[100]	Output frequency	0 Hz = 0 mA; 100 Hz = 20 mA.
[101]	Reference	<p><i>Parameter 3-00 Reference Range [Min - Max]</i> 0% = 0 mA; 100% = 20 mA</p> <p><i>Parameter 3-00 Reference Range [-Max - Max]</i> -100% = 0 mA; 0% = 10 mA; +100% = 20 mA.</p>
[102]	Feedback	
[103]	Motor Current	<p>The value is taken from <i>parameter 16-37 Inv. Max. Current</i>. The inverter maximum current (160% current) is equal to 20 mA.</p> <p>Example: Inverter normal current (11 kW) is 24 A. 160 %=38.4 A. Motor normal current is 22 A, the readout is 11.46 mA.</p> $\frac{20 \text{ mA} \times 22 \text{ A}}{38.4 \text{ A}} = 11.46 \text{ mA}$ <p>In case the normal motor current is equal to 20 mA, the output setting of</p>

6-50 Terminal 42 Output		
Option:	Function:	
		<p><i>parameter 6-52 Terminal 42 Output Max Scale</i> is:</p> $\frac{I_{VLT_Max} \times 100}{I_{Motor_norm}} = \frac{38.4 \times 100}{22} = 175\%$
[104]	Torque rel to limit	The torque setting is related to the setting in <i>parameter 4-16 Torque Limit Motor Mode</i> .
[105]	Torq relate to rated	The torque is related to the motor torque setting.
[106]	Power	Taken from <i>parameter 1-20 Motor Power [kW]</i> .
[107]	Speed	Taken from <i>parameter 3-03 Maximum Reference</i> . 20 mA equals the value in <i>parameter 3-03 Maximum Reference</i> .
[108]	Torque	Torque reference related to 160% torque.
[109]	Max Out Freq	0 Hz = 0 mA, <i>parameter 4-19 Max Output Frequency</i> = 20 mA.
[113]	PID Clamped Output	
[119]	Torque % lim	
[130]	Output freq. 4-20mA	0 Hz = 4 mA, 100 Hz = 20 mA.
[131]	Reference 4-20mA	<p><i>Parameter 3-00 Reference Range [Min-Max]</i> 0% = 4 mA; 100% = 20 mA <i>Parameter 3-00 Reference Range [-Max-Max]</i> -100% = 4 mA; 0% = 12 mA; +100% = 20 mA.</p>
[132]	Feedback 4-20mA	
[133]	Motor cur. 4-20mA	<p>The value is taken from <i>parameter 16-37 Inv. Max. Current</i>. The inverter maximum current (160% current) is equal to 20 mA. Example: Inverter normal current (11 kW) is 24 A. 160% = 38.4 A. Motor normal current is 22 A, the readout is 11.46 mA. $\frac{16 \text{ mA} \times 22 \text{ A}}{38.4 \text{ A}} + 4 \text{ mA} = 13.17 \text{ mA}$ In case the normal motor current is equal to 20 mA, the output setting of <i>parameter 6-52 Terminal 42 Output Max Scale</i> is:</p> $\frac{I_{VLT_Max} \times 100}{I_{Motor_norm}} = \frac{38.4 \times 100}{22} = 175\%$
[134]	Torq.% lim 4-20 mA	The torque setting is related to the setting in <i>parameter 4-16 Torque Limit Motor Mode</i> .
[135]	Torq.% nom 4-20mA	The torque setting is related to the motor torque setting.
[136]	Power 4-20mA	Taken from <i>parameter 1-20 Motor Power [kW]</i> .
[137]	Speed 4-20mA	Taken from <i>parameter 3-03 Maximum Reference</i> . 20 mA = value in <i>parameter 3-03 Maximum Reference</i> .

6-50 Terminal 42 Output		
Option:	Function:	
[138]	Torque 4-20mA	Torque reference related to 160% torque.
[139]	Bus ctrl. 0-20 mA	An output value set from fieldbus process data. The output works independently of internal functions in the frequency converter.
[140]	Bus ctrl. 4-20 mA	An output value set from fieldbus process data. The output works independently of internal functions in the frequency converter.
[141]	Bus ctrl 0-20mA t.o.	<i>Parameter 4-54 Warning Reference Low</i> defines the behavior of the analog output in case of fieldbus timeout.
[142]	Bus ctrl 4-20mA t.o.	<i>Parameter 4-54 Warning Reference Low</i> defines the behavior of the analog output in case of fieldbus timeout.
[147]	Main act val 0-20mA	
[148]	Main act val 4-20mA	
[149]	Torque % lim 4-20mA	<p>Analog output at 0 torque is 12 mA. Motoring torque increases the output current to maximum torque limit 20 mA (set in <i>parameter 4-16 Torque Limit Motor Mode</i>). Generating torque decreases the output to torque limit in generator mode (set in <i>parameter 4-17 Torque Limit Generator Mode</i>) Example: <i>Parameter 4-16 Torque Limit Motor Mode</i> = 200% and <i>parameter 4-17 Torque Limit Generator Mode</i> = 200%. 20 mA = 200% motoring and 4 mA = 200% generating.</p> <p style="text-align: center;">Figure 3.44 Torque Limit</p>
[150]	Max Out Fr 4-20mA	0 Hz = 0 mA, <i>parameter 4-19 Max Output Frequency</i> = 20 mA.
[158]	Motor Volt. 0-20mA	
[159]	Motor Volt. 4-20mA	

6-51 Terminal 42 Output Min Scale		
Range:	Function:	
0 %* [0 - 200 %]	Scale for the minimum output (0 mA or 4 mA) of the analog signal at terminal 42. Set the value to be the percentage of the full range of the variable selected in <i>parameter 6-50 Terminal 42 Output</i> .	

6-52 Terminal 42 Output Max Scale		
Range:	Function:	
100.00 %* [0.00 - 200.00 %]	Scale the maximum output of the selected analog signal at terminal 42. Set the value to the maximum value of the current signal output. Scale the output to give a current lower than 20 mA at full scale; or 20 mA at an output below 100% of the maximum signal value. If 20 mA is the required output current at a value 0–100% of the full-scale output, program the percentage value in the parameter, that is 50% = 20 mA. If a current 4–20 mA is required at maximum output (100%), calculate the percentage value as follows:	

20 mA / desired maximum current x 100 %

i.e. 10 mA : $\frac{20}{10} \times 100 = 200\%$

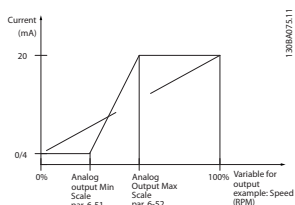

Figure 3.45 Output Max. Scale

6-53 Terminal 42 Output Bus Control		
Range:	Function:	
0 %* [0 - 100 %]	Holds the level of output 42 if controlled by bus.	

6-54 Terminal 42 Output Timeout Preset		
Range:	Function:	
0 %* [0 - 100 %]	Holds the preset level of output 42. If a timeout function is selected in <i>parameter 6-50 Terminal 42 Output</i> , the output is preset to this level if a fieldbus timeout occurs.	

6-55 Analog Output Filter		
Option:	Function:	
	The following readout parameters from selection in <i>parameter 6-50 Terminal 42 Output</i> have a filter	

6-55 Analog Output Filter		
Option:	Function:	
	selected when <i>parameter 6-55 Analog Output Filter</i> is on:	
	Selection	0–20 mA 4–20 mA
	Motor current (0–I _{max})	[103] [133]
	Torque limit (0–T _{lim})	[104] [134]
	Rated torque (0–T _{nom})	[105] [135]
	Power (0–P _{nom})	[106] [136]
	Speed (0–Speed _{max})	[107] [137]
	Table 3.23 Readout Parameters	
[0] *	Off	Filter off.
[1]	On	Filter on.

3.7.7 6-6* Analog Output 2 MCB 101

Analog outputs are current outputs: 0/4–20 mA. Common terminal (terminal X30/8) is the same terminal and electrical potential for analog common connection. Resolution on analog output is 12 bit.

6-60 Terminal X30/8 Output		
Option:	Function:	
		Select the function of terminal X30/8 as an analog current output. Depending on the selection, the output is either a 0–20 mA or 4–20 mA output. The current value can be read out in the LCP in <i>parameter 16-65 Analog Output 42 [mA]</i> .
[0]	No operation	When no signal on the analog output is present.
[52]	MCO 0-20mA	
[100]	Output frequency	0 Hz = 0 mA; 100 Hz = 20 mA.
[101]	Reference	<i>Parameter 3-00 Reference Range</i> [Min. - Max.] 0% = 0 mA; 100% = 20 mA. <i>Parameter 3-00 Reference Range</i> [-Max. - Max.] -100% = 0 mA; 0% = 10 mA; +100% = 20 mA
[102]	Feedback	
[103]	Motor Current	The value is taken from <i>parameter 16-37 Inv. Max. Current</i> . The inverter maximum current (160% current) is equal to 20 mA. Example: Inverter normal current (11 kW) = 24 A. 160% = 38.4 A. Motor normal current = 22 A, readout is 11.46 mA. $\frac{20 \text{ mA} \times 22 \text{ A}}{38.4 \text{ A}} = 11.46 \text{ mA}$

6-60 Terminal X30/8 Output		
Option:	Function:	
		In case the normal motor current is equal to 20 mA, the output setting of <i>parameter 6-62 Terminal X30/8 Max. Scale</i> is: $\frac{I_{VLT_Max} \times 100}{I_{Motor_Norm}} = \frac{38.4 \times 100}{22} = 175\%$
[104]	Torque rel to limit	The torque setting is related to the setting in <i>parameter 4-16 Torque Limit Motor Mode</i> .
[105]	Torq relate to rated	The torque is related to the motor torque setting.
[106]	Power	Taken from <i>parameter 1-20 Motor Power [kW]</i> .
[107]	Speed	Taken from <i>parameter 3-03 Maximum Reference</i> . 20 mA = value in <i>parameter 3-03 Maximum Reference</i> .
[108]	Torque	Torque reference related to 160% torque.
[109]	Max Out Freq	In relation to <i>parameter 4-19 Max Output Frequency</i> .
[113]	PID Clamped Output	
[119]	Torque % lim	
[130]	Output freq. 4-20mA	0 Hz = 4 mA, 100 Hz = 20 mA.
[131]	Reference 4-20mA	<i>Parameter 3-00 Reference Range [Min.-Max.]</i> 0% = 4 mA; 100% = 20 mA. <i>Parameter 3-00 Reference Range [-Max.-Max.]</i> -100% = 4 mA; 0% = 12 mA; +100% = 20 mA.
[132]	Feedback 4-20mA	
[133]	Motor cur. 4-20mA	The value is taken from <i>parameter 16-37 Inv. Max. Current</i> . The inverter maximum current (160% current) is equal to 20 mA. Example: Inverter normal current (11 kW) = 24 A. 160% = 38.4 A. Motor normal current = 22 A Readout 11.46 mA. $\frac{16 \text{ mA} \times 22 \text{ A}}{38.4 \text{ A}} = 9.17 \text{ mA}$ In case the normal motor current is equal to 20 mA, the output setting of <i>parameter 6-62 Terminal X30/8 Max. Scale</i> is: $\frac{I_{VLT_Max} \times 100}{I_{Motor_Norm}} = \frac{38.4 \times 100}{22} = 175\%$
[134]	Torq.% lim 4-20 mA	The torque setting is related to the setting in <i>parameter 4-16 Torque Limit Motor Mode</i> .
[135]	Torq.% nom 4-20mA	The torque setting is related to the motor torque setting.
[136]	Power 4-20mA	Taken from <i>parameter 1-20 Motor Power [kW]</i> .
[137]	Speed 4-20mA	Taken from <i>parameter 3-03 Maximum Reference</i> . 20 mA = value in <i>parameter 3-03 Maximum Reference</i> .

6-60 Terminal X30/8 Output		
Option:	Function:	
[138]	Torque 4-20mA	Torque reference related to 160% torque.
[139]	Bus ctrl. 0-20 mA	An output value set from fieldbus process data. The output works independently of internal functions in the frequency converter.
[140]	Bus ctrl. 4-20 mA	An output value set from fieldbus process data. The output works independently of internal functions in the frequency converter.
[141]	Bus ctrl 0-20mA t.o.	<i>Parameter 4-54 Warning Reference Low</i> defines the behavior of the analog output in case of bus timeout.
[142]	Bus ctrl 4-20mA t.o.	<i>Parameter 4-54 Warning Reference Low</i> defines the behavior of the analog output in case of bus timeout.
[149]	Torque % lim 4-20mA	Torque reference. <i>Parameter 3-00 Reference Range [Min.-Max.]</i> 0% = 4 mA; 100% = 20 mA. <i>Parameter 3-00 Reference Range [-Max. - Max.]</i> -100% = 4 mA; 0% = 12 mA; +100% = 20 mA.
[150]	Max Out Fr 4-20mA	In relation to <i>parameter 4-19 Max Output Frequency</i> .

6-61 Terminal X30/8 Min. Scale		
Range:	Function:	
0 %* [0 - 200 %]		Scales the minimum output of the selected analog signal on terminal X30/8. Scale the minimum value as a percentage of the maximum signal value. For example, enter the value 25% if the output should be 0 mA at 25% of the maximum output value. The value can never exceed the corresponding setting in <i>parameter 6-62 Terminal X30/8 Max. Scale</i> if the value is below 100%. This parameter is active when VLT® General Purpose I/O MCB 101 is mounted in the frequency converter.

6-62 Terminal X30/8 Max. Scale		
Range:	Function:	
100.00 %* [0.00 - 200.00 %]		Scales the maximum output of the selected analog signal on terminal X30/8. Scale the value to the required maximum value of the current signal output. Scale the output to give a lower current than 20 mA at full scale or 20 mA at an output below 100% of the maximum signal value. If 20 mA is the required output current at a value between 0–100% of the full-scale output, program the

6-62 Terminal X30/8 Max. Scale	
Range:	Function:
	percentage value in the parameter, that is 50%=20 mA. If a current 4–20 mA is required at maximum output (100%), calculate the percentage value as follows: $20 \text{ mA} / \text{desired maximum current} \times 100\%$ i. e. 10 mA : $\frac{20 - 4}{10} \times 100 = 160\%$

6-63 Terminal X30/8 Bus Control	
Range:	Function:
0 %* [0 - 100 %]	Holds the level of output X30/8 if controlled by bus.

6-64 Terminal X30/8 Output Timeout Preset	
Range:	Function:
0 %* [0 - 100 %]	Holds the preset level of output X30/8. If there is a fieldbus timeout and a timeout function is selected in <i>parameter 6-60 Terminal X30/8 Output</i> , the output is preset to this level.

3.7.8 6-7* Analog Output 3 MCB 113

Parameters for configuring the scaling and limits for analog output 3, terminals X45/1, and X45/2. Analog outputs are current outputs: 0/4–20 mA. Resolution on analog output is 11 bit.

6-70 Terminal X45/1 Output	
Option:	Function:
	Select the function of terminal X45/1 as an analog current output.
[0]	No operation When no signal on the analog output is present.
[52]	MCO 305 0-20 mA
[53]	MCO 305 4-20 mA
[100]	Output frequency 0-20 mA 0 Hz = 0 mA; 100 Hz = 20 mA.
[101]	Reference 0-20 mA <i>Parameter 3-00 Reference Range</i> [Min. - Max.] 0% = 0 mA; 100% = 20 mA. <i>Parameter 3-00 Reference Range</i> [-Max. - Max.] -100% = 0 mA; 0% = 10 mA; +100% = 20 mA.
[102]	Feedback
[103]	Motor current 0-20 mA The value is taken from <i>parameter 16-37 Inv. Max. Current</i> . The inverter maximum current (160% current) is equal to 20 mA.

6-70 Terminal X45/1 Output	
Option:	Function:
	Example: Inverter normal current (11 kW) = 24 A. 160% = 38.4 A. Motor normal current = 22 A, readout 11.46 mA. $\frac{20 \text{ mA} \times 22 \text{ A}}{38.4 \text{ A}} = 11.46 \text{ mA}$ In case the normal motor current is equal to 20 mA, the output setting of <i>parameter 6-52 Terminal 42 Output Max Scale</i> is: $\frac{I_{VLT_{Max}} \times 100}{I_{Motor_{Norm}}} = \frac{38.4 \times 100}{22} = 175\%$
[104]	Torque rel to lim 0-20 mA The torque setting is related to the setting in <i>parameter 4-16 Torque Limit Motor Mode</i> .
[105]	Torque rel to rated motor torque 0-20 mA The torque is related to the motor torque setting.
[106]	Power 0-20 mA Taken from <i>parameter 1-20 Motor Power [kW]</i> .
[107]	Speed 0-20 mA Taken from <i>parameter 3-03 Maximum Reference</i> . 20 mA = value in <i>parameter 3-03 Maximum Reference</i> .
[108]	Torque ref. 0-20 mA Torque reference related to 160% torque.
[109]	Max. out freq 0-20 mA In relation to <i>parameter 4-19 Max Output Frequency</i> .
[130]	Output freq. 4-20 mA 0 Hz = 4 mA, 100 Hz = 20 mA.
[131]	Reference 4-20 mA <i>Parameter 3-00 Reference Range</i> [Min.-Max.] 0% = 4 mA; 100% = 20 mA. <i>Parameter 3-00 Reference Range</i> [-Max-Max.] -100% = 4 mA; 0% = 12 mA; +100% = 20 mA.
[132]	Feedback 4-20 mA
[133]	Motor cur. 4-20 mA The value is taken from <i>parameter 16-37 Inv. Max. Current</i> . The inverter maximum current (160% current) is equal to 20 mA. Example: Inverter normal current (11 kW) = 24 A. 160% = 38.4 A. Motor normal current = 22 A, readout 11.46 mA. $\frac{16 \text{ mA} \times 22 \text{ A}}{38.4 \text{ A}} = 9.17 \text{ mA}$ In case the normal motor current is equal to 20 mA, the output setting of <i>parameter 6-52 Terminal 42 Output Max Scale</i> is: $\frac{I_{VLT_{Max}} \times 100}{I_{Motor_{Norm}}} = \frac{38.4 \times 100}{22} = 175\%$
[134]	Torque % lim. 4-20 mA The torque setting is related to the setting in <i>parameter 4-16 Torque Limit Motor Mode</i> .

6-70 Terminal X45/1 Output		
Option:	Function:	
[135]	Torque % nom 4-20 mA	The torque setting is related to the motor torque setting.
[136]	Power 4-20 mA	Taken from <i>parameter 1-20 Motor Power [kW]</i> .
[137]	Speed 4-20 mA	Taken from <i>parameter 3-03 Maximum Reference</i> . 20 mA = value in <i>parameter 3-03 Maximum Reference</i> .
[138]	Torque 4-20 mA	Torque reference related to 160% torque.
[139]	Bus ctrl. 0-20 mA	An output value set from fieldbus process data. The output works independently of internal functions in the frequency converter.
[140]	Bus ctrl. 4-20 mA	An output value set from fieldbus process data. The output works independently of internal functions in the frequency converter.
[141]	Bus ctrl. 0-20 mA, timeout	<i>Parameter 4-54 Warning Reference Low</i> defines the behavior of the analog output in case of a fieldbus timeout.
[142]	Bus ctrl. 4-20 mA, timeout	<i>Parameter 4-54 Warning Reference Low</i> defines the behavior of the analog output in case of a fieldbus timeout.
[150]	Max. out freq 4-20 mA	In relation to <i>parameter 4-19 Max Output Frequency</i> .

6-71 Terminal X45/1 Output Min. Scale		
Range:	Function:	
0.00%* [0.00 - 200.00%]	Scale the minimum output of the selected analog signal at terminal X45/1 as a percentage of the maximum signal value. For example, if 0 mA (or 0 Hz) is required at 25% of the maximum output value, then program 25%. Scaling values up to 100% can never exceed the corresponding setting in <i>parameter 6-72 Terminal X45/1 Max. Scale</i> .	

6-72 Terminal X45/1 Output Max. Scale		
Range:	Function:	
100%* [0.00 - 200.00%]	Scale the maximum output of the selected analog signal at terminal X45/1. Set the value to the maximum value of the current signal output. Scale the output to give a current lower than 20 mA at full scale, or 20 mA at an output below 100% of the maximum signal value. If 20 mA is the required output current at a value between 0-100% of the full-scale output, program the percentage value in the parameter, for example 50% = 20 mA. If a current 4-20 mA is required at maximum output (100%),	

6-72 Terminal X45/1 Output Max. Scale		
Range:	Function:	
	calculate the percentage value as follows (example where required maximum output is 10 mA): $\frac{I_{RANGE} [mA]}{I_{DESIRED MAX} [mA]} \times 100\%$ $= \frac{20 - 4 mA}{10 mA} \times 100\% = 160\%$	

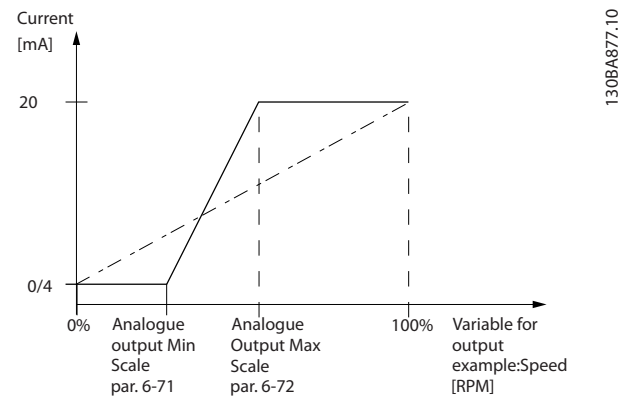

Figure 3.46 Output Maximum Scale

6-73 Terminal X45/1 Output Bus Control		
Range:	Function:	
0.00%* [0.00 - 100.00%]	Holds the level of analog output 3 (terminal X45/1) if controlled by bus.	

6-74 Terminal X45/1 Output Timeout Preset		
Range:	Function:	
0.00%* [0.00 - 100.00%]	Holds the preset level of analog output 3 (terminal X45/1). If there is a fieldbus timeout and a timeout function is selected in <i>parameter 6-70 Terminal X45/1 Output</i> , the output is preset to this level.	

3.7.9 6-8* Analog Output 4 MCB 113

Parameters for configuring the scaling and limits for analog output 4, terminals X45/3 and X45/4. Analog outputs are current outputs: 0/4 to 20 mA. Resolution on analog output is 11 bit.

6-80 Terminal X45/3 Output

Option:	Function:
	Select the function of terminal X45/3 as an analog current output.
[0] *	No operation Same selections available as for <i>parameter 6-70 Terminal X45/1 Output</i> .

6-81 Terminal X45/3 Output Min. Scale

Option:	Function:
[0.00%] *	0.00 - 200.00% Scales the minimum output of the selected analog signal on terminal X45/3. Scale the minimum value as a percentage of the maximum signal value, for example, 0 mA (or 0 Hz) is required at 25% of the maximum output value and 25% is programmed. The value can never exceed the corresponding setting in <i>parameter 6-82 Terminal X45/3 Max. Scale</i> if the value is below 100%. This parameter is active when VLT® Extended Relay Card MCB 113 is mounted in the frequency converter.

6-82 Terminal X45/3 Output Max. Scale

Option:	Function:
[0.00%] *	0.00 - 200.00% Scales the maximum output of the selected analog signal on terminal X45/3. Scale the value to the required maximum value of the current signal output. Scale the output to give a lower current than 20 mA at full scale or 20 mA at an output below 100% of the maximum signal value. If 20 mA is the required output current at a value between 0–100% of the full-scale output, program the percentage value in the parameter, for example, 50% = 20 mA. If a current of 4–20 mA is required at maximum output (100%), calculate the percentage value as follows (example where required maximum output is 10 mA): $\frac{I_{RANGE} [mA]}{I_{DESIRED MAX} [mA]} \times 100\%$ $= \frac{20 - 4 mA}{10 mA} \times 100\% = 160\%$

6-83 Terminal X45/3 Output Bus Control

Option:	Function:
[0.00%] *	0.00 - 100.00% Holds the level of output 4 (X45/3) if controlled by bus.

6-84 Terminal X45/3 Output Timeout Preset

Option:	Function:
[0.00%] *	0.00 - 100.00% Holds the preset level of output 4 (X45/3). If there is a fieldbus timeout and a timeout function is selected in <i>parameter 6-80 Terminal X45/3 Output</i> , the output is preset to this level.

3.8 Parameters: 7-** Controllers

3.8.1 7-0* Speed PID Ctrl.

3

NOTICE!

If separate encoders are used (FC 302 only), adjust the ramp-related parameters according to the gear ratio between the 2 encoders.

7-00 Speed PID Feedback Source		
Option:	Function:	
		<p>NOTICE! This parameter cannot be adjusted while the motor is running.</p> <p>Select the encoder for closed-loop feedback. The feedback may come from a different encoder (typically mounted on the application itself) than the motor-mounted encoder feedback selected in <i>parameter 1-02 Flux Motor Feedback Source</i>.</p>
[0] *	Motor feedb. P1-02	
[1]	24V encoder	
[2]	MCB 102	
[3]	MCB 103	
[5]	MCO Encoder 2	
[6]		
[7]		
[8]		
[9]		

3.8.2 Speed PID Droop

This feature implements precise torque sharing between multiple motors on a common mechanical shaft. Speed PID droop is useful for marine and mining applications, where redundancy and higher dynamics are required. Speed PID droop allows to reduce inertia by utilizing multiple small motors instead of 1 big motor.

Figure 3.47 shows the concept of the feature:

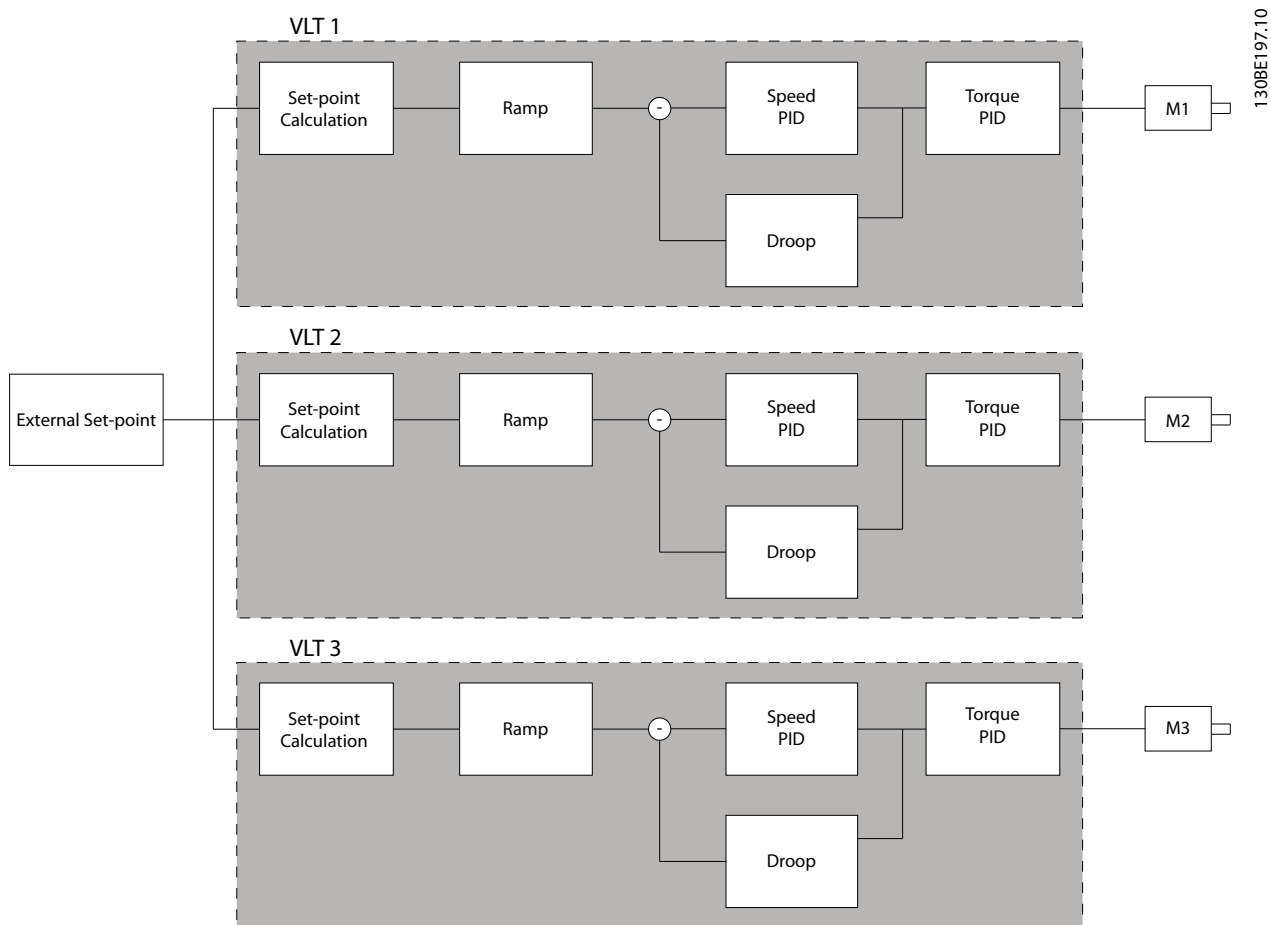

Figure 3.47 Speed PID Droop

The value in *parameter 7-01 Speed PID Droop* ensures that the load is shared equally between the motors. If the torque on the motor is 100% of nominal motor torque, the frequency converter reduces its output to this motor by 100% of the value in *parameter 7-01 Speed PID Droop*. If the torque is 50% of nominal motor torque, the frequency converter reduces its output to this motor by 50% of the value in *parameter 7-01 Speed PID Droop*. This ensures that the motors share the load evenly. A side effect of using speed PID droop is that the actual shaft speed does not match the reference exactly. Speed

PID droop is not efficient in low-speed applications because the adjustment range may be insufficient.

Use speed trim if the application requires the following features:

- Accurate speed (the actual shaft speed matches the reference speed).
- Precise speed adjustment down to 0 RPM.

Enabling PID droop

To enable speed PID droop:

- Run the frequency converter in 1 of the following modes:
 - Flux closed loop (*parameter 1-01 Motor Control Principle, [3] Flux w/ motor feedb*).
 - Flux sensorless (*parameter 1-01 Motor Control Principle, [2] Flux sensorless*).
- Run the frequency converter in speed mode (*parameter 1-00 Configuration Mode, option [0] Speed open loop or [1] Speed closed loop*).
- Ensure that *parameter 1-62 Slip Compensation* contains the default value (0%).
- Ensure that all frequency converters in the torque sharing system use the same speed reference and start and stop signal.
- Ensure that all frequency converters in the torque sharing system use the same parameter settings.
- Adjust the value in *parameter 7-01 Speed PID Droop*.

NOTICE!

Do not use overvoltage control when using the PID droop function (select [0] Disabled in *parameter 2-17 Over-voltage Control*).

NOTICE!

If the speed reference is lower than the value in *parameter 7-01 Speed PID Droop*, the frequency converter makes the PID droop factor equal to the speed reference.

Example for a PM motor

In a set-up with the following configuration:

- Reference speed = 1500 RPM.
- *Parameter 7-01 Speed PID Droop* = 50 RPM.

The frequency converter provides the following output:

Load on the motor	Output
0%	1500 RPM
100%	1450 RPM
100% regenerative load	1550 RPM

Table 3.24 Output with Speed PID Droop

This is why droop is sometimes referred to as negative slip compensation (the frequency converter reduces the output instead of increasing it).

3.8.3 Speed Trim

The speed trim function is an add-on to the speed PID droop. The speed trim provides torque sharing with precise speed down to 0 RPM. The function requires wiring of analog signals.

In speed trim, the master frequency converter runs normal speed PID without droop. The follower frequency converters use the speed PID droop, but instead of reacting on their own load they compare their own load to the load of other frequency converters in the system and then use that data as input for the speed PID droop. A set-up with a single source, where the master frequency converter sends information about torque to all followers, is limited by the number of available analog outputs on the master frequency converter. It is possible to use a cascade principle, which overcomes this limitation but makes the control less fast and less accurate. The master frequency converter operates in speed mode. The follower frequency converters operate in speed mode with the speed trim. The trim function uses torque data from all frequency converters in the system.

130BE998.10

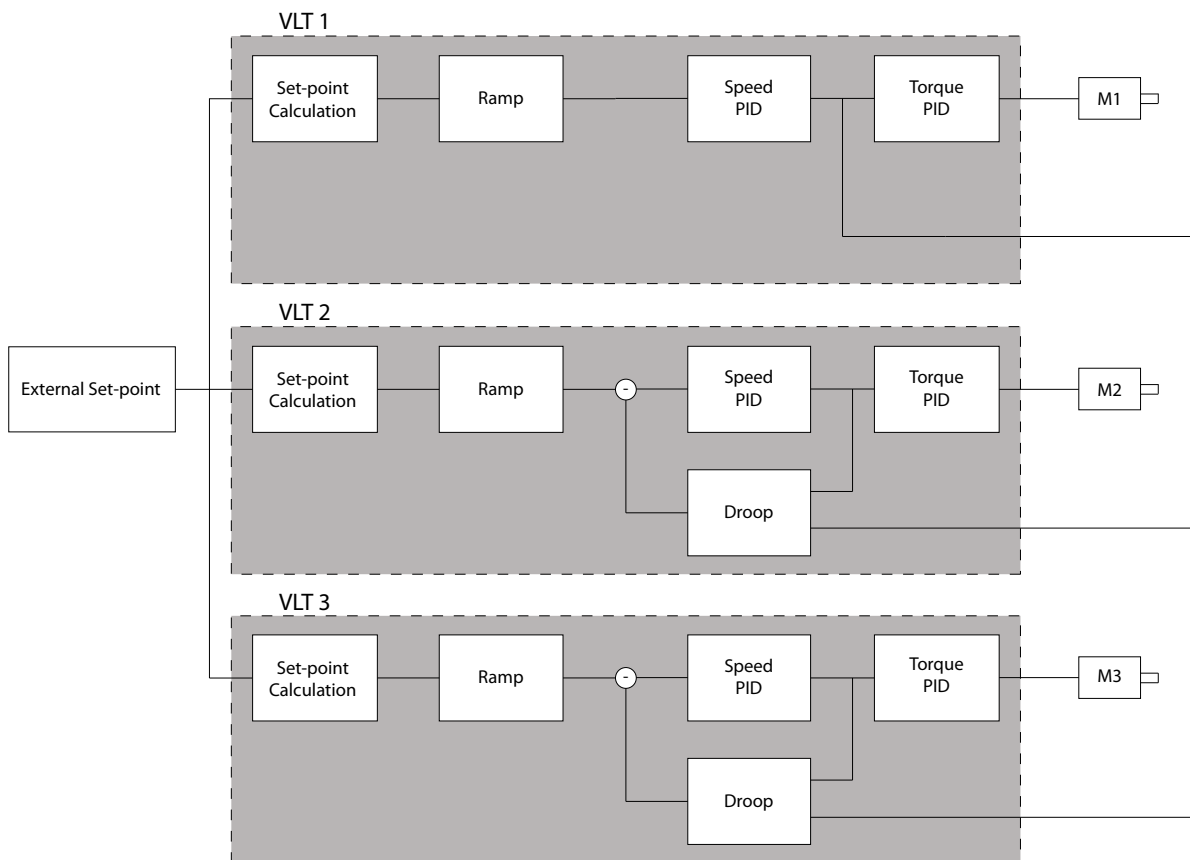

Figure 3.48 Speed Trim

Figure 3.48 shows a single source set-up where the master sends the torque signal to all followers. The number of available analog outputs on the master limits this set-up. To overcome the limitation of the number of analog outputs, use a cascade principle. The cascade principle makes the control slower and less accurate compared with the set-up using analog outputs.

7-01 Speed PID Droop		
The droop function allows the frequency converter to decrease the motor speed proportional to the load. The droop value is directly proportional to the load value. Use the droop function when several motors are mechanically connected and the load on motors can differ.		
Ensure that <i>parameter 1-62 Slip Compensation</i> has a default setting.		
Range:		Function:
0 RPM*	[0 - 200 RPM]	Enter the droop value at 100% load.

7-02 Speed PID Proportional Gain		
Range:		Function:
0	[0.000 -	Enter the speed controller proportional gain. The proportional gain amplifies the error (that is, the deviation between the feedback signal and the setpoint). This parameter is used with <i>parameter 1-00 Configuration Mode [0] Speed open loop</i> and <i>[1] Speed closed loop</i> control. Quick control is obtained at high amplification. Increasing amplification makes the process less stable. Use this parameter for values with 3 decimals. For values with 4 decimals, use <i>parameter 3-83 Quick Stop S-ramp Ratio at Decel. Start</i> .
N/A	1.000	
*	N/A]	

7-03 Speed PID Integral Time		
Range:		Function:
8.0 ms*	[2.0 - 20000.0 ms]	Enter the speed controller integral time, which determines the time the internal PID control takes to correct errors. The greater the error, the more quickly the gain increases. The integral time causes a delay of the signal and therefore a dampening effect and can be used to eliminate steady-state speed error. Obtain quick control through a short integral time, though if the integral time is too short, the process becomes unstable. An excessively long integral time disables the integral action, leading to major deviations from the required reference, since the process regulator takes too long to regulate errors. This parameter is used with [0] Speed open loop and [1] Speed closed loop control, set in parameter 1-00 Configuration Mode.

7-04 Speed PID Differentiation Time		
Range:		Function:
30.0 ms*	[0.0 - 200.0 ms]	Enter the speed controller differentiation time. The differentiator does not react to constant error. It provides gain proportional to the rate of change of the speed feedback. The quicker the error changes, the stronger the gain from the differentiator. The gain is proportional with the speed at which errors change. Setting this parameter to 0 disables the differentiator. This parameter is used with parameter 1-00 Configuration Mode [1] Speed closed loop control.

7-05 Speed PID Diff. Gain Limit		
Range:		Function:
5.0 N/A*	[1.0 - 20.0 N/A]	Set a limit for the gain provided by the differentiator. Consider limiting the gain at higher frequencies. For example, set up a pure D-link at low frequencies and a constant D-link at higher frequencies. This parameter is used with parameter 1-00 Configuration Mode [1] Speed closed loop control.

7-06 Speed PID Lowpass Filter Time												
Range:		Function:										
10.0 ms*	[1.0 - 100.0 ms]	<p>NOTICE!</p> <p>Severe filtering can be detrimental to dynamic performance. This parameter is used with parameter 1-00 Configuration Mode [1] Speed closed loop and [2] Torque control. Adjust the filter time in flux sensorless to 3–5 ms.</p> <p>Set a time constant for the speed control low-pass filter. The low-pass filter improves steady-state performance and dampens oscillations on the feedback signal. This is an advantage if there is a great amount of noise in the system, see Figure 3.49. For example, if a time constant (τ) of 100 ms is programmed, the cut-off frequency for the low-pass filter is $1/0.1 = 10 \text{ RAD/s}$, corresponding to $(10/2 \times \pi) = 1.6 \text{ Hz}$. The PID regulator only regulates a feedback signal that varies by a frequency of less than 1.6 Hz. If the feedback signal varies by a higher frequency than 1.6 Hz, the PID regulator does not react. Practical settings of parameter 7-06 Speed PID Lowpass Filter Time taken from the number of pulses per revolutions from encoder:</p> <table border="1"> <thead> <tr> <th>Encoder PPR</th> <th>Parameter 7-06 Speed PID Lowpass Filter Time</th> </tr> </thead> <tbody> <tr> <td>512</td> <td>10 ms</td> </tr> <tr> <td>1024</td> <td>5 ms</td> </tr> <tr> <td>2048</td> <td>2 ms</td> </tr> <tr> <td>4096</td> <td>1 ms</td> </tr> </tbody> </table>	Encoder PPR	Parameter 7-06 Speed PID Lowpass Filter Time	512	10 ms	1024	5 ms	2048	2 ms	4096	1 ms
Encoder PPR	Parameter 7-06 Speed PID Lowpass Filter Time											
512	10 ms											
1024	5 ms											
2048	2 ms											
4096	1 ms											

Table 3.25 Speed PID Lowpass Filter Time

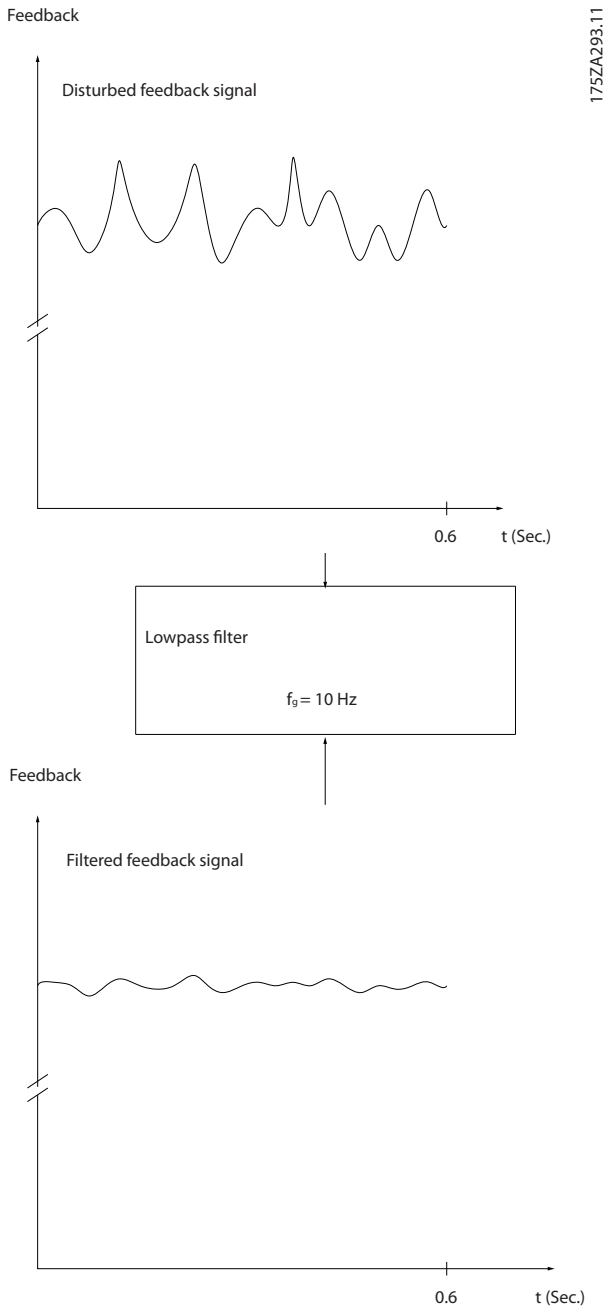

Figure 3.49 Feedback Signal

7-07 Speed PID Feedback Gear Ratio		
Range:	Function:	
1.0000 N/A*	[0.0001 - 32.0000 N/A]	The frequency converter multiplies the speed feedback by this ratio.

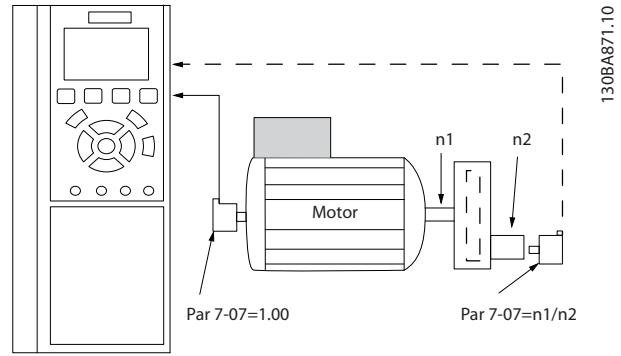

Figure 3.50 Speed PID Feedback Gear Ratio

7-08 Speed PID Feed Forward Factor		
Range:	Function:	
0 %*	[0 - 500 %]	The reference signal bypasses the speed controller by the amount specified. This feature increases the dynamic performance of the speed control loop.

7-09 Speed PID Error Correction w/ Ramp		
Range:	Function:	
Size related*	[10 - 100000 RPM]	The speed error between ramp and actual speed is held up against the setting in this parameter. If the speed error exceeds this parameter entry, the speed error is corrected via ramping in a controlled way.

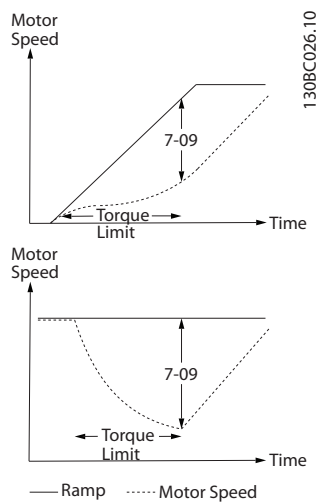

Figure 3.51 Speed Error between Ramp and Actual Speed

3.8.4 7-1* Torque PI Control

Parameters for configuring the torque PI control.

7-10 Torque PI Feedback Source		
Select the feedback source for the torque controller.		
Option:	Function:	
[0] *	Controller Off	Select to operate in open loop.
[1]	Analog Input 53	Select to use torque feedback from the analog input.
[2]	Analog Input 54	Select to use torque feedback from the analog input.
[3]	Estimated Torque	Select to use the torque feedback estimated by the frequency converter.

7-12 Torque PI Proportional Gain		
Range:	Function:	
100 %*	[0 - 500 %]	Enter the proportional gain value for the torque controller. Selection of a high value makes the controller react faster. Too high a setting leads to controller instability.

7-13 Torque PI Integration Time		
Range:	Function:	
0.020 s*	[0.002 - 2.000 s]	Enter the integration time for the torque controller. Selection of a low value makes the controller react faster. Too low a setting leads to controller instability.

7-16 Torque PI Lowpass Filter Time		
Enter the time constant for the torque control low-pass filter.		
Range:	Function:	
5 ms*	[0.1 - 100 ms]	

7-18 Torque PI Feed Forward Factor		
Enter the torque feed forward factor value. The reference signal bypasses the torque controller by this value.		
Range:	Function:	
0 %*	[0 - 100 %]	

7-19 Current Controller Rise Time		
Range:	Function:	
Size related*	[15 - 100 %]	Enter the value for the rise time of the current controller as a percentage of the control period.

3.8.5 7-2* Process Ctrl. Feedb.

Select the feedback sources for the process PID control, and how this feedback should be handled.

7-20 Process CL Feedback 1 Resource		
Option:	Function:	
[0] *	No function	The effective feedback signal is made up of the sum of up to 2 different input signals. Select which frequency converter input should be treated as the source of the first of these signals. The second input signal is defined in <i>parameter 7-22 Process CL Feedback 2 Resource</i> .
[1]	Analog input 53	
[2]	Analog input 54	
[3]	Frequency input 29	
[4]	Frequency input 33	
[7]	Analog input X30/11	
[8]	Analog input X30/12	

7-22 Process CL Feedback 2 Resource		
Option:	Function:	
		The effective feedback signal is made up of the sum of up to 2 different input signals. Select which frequency converter input should be treated as the source of the second of these signals.

7-22 Process CL Feedback 2 Resource		
Option:	Function:	
		The first input signal is defined in <i>parameter 7-20 Process CL Feedback 1 Resource</i> .
[0] *	No function	
[1]	Analog input 53	
[2]	Analog input 54	
[3]	Frequency input 29	
[4]	Frequency input 33	
[7]	Analog input X30/11	
[8]	Analog input X30/12	

7-33 Process PID Proportional Gain		
Range:	Function:	
0.01 N/A*	[0.00 - 10.00 N/A]	Enter the PID proportional gain. The proportional gain multiplies the error between the setpoint and the feedback signal.

7-34 Process PID Integral Time		
Range:	Function:	
10000.00 s*	[0.01 - 10000.00 s]	Enter the PID integral time. The integrator provides an increasing gain at a constant error between the setpoint and the feedback signal. The integral time is the time needed by the integrator to reach the same gain as the proportional gain.

3.8.6 7-3* Process PID Ctrl.

7-30 Process PID Normal/Inverse Control		
Option:	Function:	
		Normal and inverse controls are implemented by introducing a difference between the reference signal and the feedback signal.
[0] *	Normal	Set process control to increase the output frequency.
[1]	Inverse	Set process control to decrease the output frequency.

7-35 Process PID Differentiation Time		
Range:	Function:	
0.00 s*	[0.00 - 10.00 s]	Enter the PID differentiation time. The differentiator does not react to a constant error, but provides a gain only when the error changes. The shorter the PID differentiation time, the stronger the gain from the differentiator.

7-31 Process PID Anti Windup		
Option:	Function:	
[0]	Off	Continue regulation of an error even when the output frequency cannot be increased or decreased.
[1] *	On	Cease regulation of an error when the output frequency can no longer be adjusted.

7-36 Process PID Differentiation Gain Limit		
Range:	Function:	
5.0 N/A*	[1.0 - 50.0 N/A]	Enter a limit for the differentiator gain. If there is no limit, the differentiator gain increases when there are fast changes. To obtain a pure differentiator gain at slow changes and a constant differentiator gain where fast changes occur, limit the differentiator gain.

7-32 Process PID Controller Start Value		
Range:	Function:	
0 RPM*	[0 - 6000 RPM]	Enter the motor speed to be attained as a start signal for commencement of PID control. When the power is switched on, the frequency converter starts to ramp and then operates under speed open-loop control. When the process PID start speed is reached, the frequency converter changes to process PID control.

7-38 Process PID Feed Forward Factor		
Range:	Function:	
0 %*	[0 - 500 %]	Enter the PID feed forward factor. The factor sends a constant fraction of the reference signal to bypass the PID control, so the PID control only affects the remaining fraction of the control signal. Any change to this parameter affects the motor speed. When the feed forward factor is activated, it provides less overshoot and high dynamics when changing the setpoint. <i>Parameter 7-38 Process PID Feed Forward Factor is active when parameter 1-00 Configuration Mode is set to [3] Process.</i>

7-39 On Reference Bandwidth		
Range:	Function:	
5 %* [0 - 200 %]	Enter the on-reference bandwidth. When the PID control error (the difference between the reference and the feedback) is less than the value of this parameter, the on-reference status bit is 1.	

3.8.7 7-4* Advanced Process PID Ctrl.

This parameter group is only used if *parameter 1-00 Configuration Mode* is set to [7] *Extended PID speed CL* or [8] *Extended PID Speed OL*.

7-40 Process PID I-part Reset		
Option:	Function:	
[0] * No		
[1] Yes	Select [1] Yes to reset the I-part of the process PID controller. The selection automatically returns to [0] No. Resetting the I-part makes it possible to start from a well-defined point after changing something in the process, for example changing a textile roll.	

7-41 Process PID Output Neg. Clamp		
Range:	Function:	
-100 %* [-100 - par. 7-42 %]	Enter a negative limit for the process PID controller output.	

7-42 Process PID Output Pos. Clamp		
Range:	Function:	
100 %* [par. 7-41 - 100 %]	Enter a positive limit for the process PID controller output.	

7-43 Process PID Gain Scale at Min. Ref.		
Range:	Function:	
100 %* [0 - 100 %]	Enter a scaling percentage to apply to the process PID output when operating at the minimum reference. The scaling percentage is adjusted linearly between the scale at minimum reference (<i>parameter 7-43 Process PID Gain Scale at Min. Ref.</i>) and the scale at maximum reference (<i>parameter 7-44 Process PID Gain Scale at Max. Ref.</i>).	

7-44 Process PID Gain Scale at Max. Ref.		
Range:	Function:	
100 %* [0 - 100 %]	Enter a scaling percentage to apply to the process PID output when operating at the maximum reference. The scaling percentage is adjusted linearly between the scale at minimum reference (<i>parameter 7-43 Process PID</i>	

7-44 Process PID Gain Scale at Max. Ref.		
Range:	Function:	
	<i>Gain Scale at Min. Ref.</i>) and the scale at maximum reference (<i>parameter 7-44 Process PID Gain Scale at Max. Ref.</i>).	

7-45 Process PID Feed Fwd Resource		
Option:	Function:	
[0] * No function	Select which frequency converter input should be used as the feed-forward factor. The factor is added to the output of the PID controller. This increases dynamic performance.	
[1] Analog Input 53		
[2] Analog Input 54		
[7] Frequency input 29		
[8] Frequency input 33		
[11] Local bus reference		
[20] Digital pot.meter		
[21] Analog input X30/11		
[22] Analog input X30/12		
[29] Analog Input X48/2		
[32] Bus PCD	Selects a fieldbus reference configured by <i>parameter 8-02 Control Word Source</i> . Change <i>parameter 8-42 PCD Write Configuration</i> for the bus used to make the feed forward available in <i>parameter 7-48 PCD Feed Forward</i> . Use index 1 for feed forward [748] (and index 2 for reference [1682]).	

7-46 Process PID Feed Fwd Normal/ Inv. Ctrl.		
Option:	Function:	
[0] * Normal	Select [0] Normal to set the feed-forward factor to treat the FF resource as a positive value.	
[1] Inverse	Select [1] Inverse to treat the feed-forward resource as a negative value.	

7-48 PCD Feed Forward		
Range:	Function:	
0* [0 - 65535]	This parameter contains the value of <i>parameter 7-45 Process PID Feed Fwd Resource [32] Bus PCD</i> .	

7-49 Process PID Output Normal/ Inv. Ctrl.		
Option:	Function:	
[0] *	Normal	Select [0] <i>Normal</i> to use the resulting output from the process PID controller as is.
[1]	Inverse	Select [1] <i>Inverse</i> to invert the resulting output from the process PID controller. This operation is performed after the feed-forward factor is applied.

3.8.8 7-5* Ext. Process PID Ctrl.

This parameter group is only used if *parameter 1-00 Configuration Mode* is set to [7] *Extended PID speed CL* or [8] *Extended PID Speed OL*.

7-50 Process PID Extended PID		
Option:	Function:	
[0]	Disabled	Disable the extended parts of the process PID controller.
[1] *	Enabled	Enable the extended parts of the PID controller.

7-51 Process PID Feed Fwd Gain		
Range:	Function:	
1* [0 - 100]	The feed forward is used to obtain the required level based on a well-known signal available. The PID controller then only takes care of the smaller part of the control, necessary because of unknown characters. The standard feed-forward factor in <i>parameter 7-38 Process PID Feed Forward Factor</i> is always related to the reference, whereas <i>parameter 7-51 Process PID Feed Fwd Gain</i> has more options. In winder applications, the feed-forward factor is typically the line speed of the system.	

7-52 Process PID Feed Fwd Ramp up		
Range:	Function:	
0.01 s* [0.01 - 10 s]	Controls the dynamics of the feed-forward signal when ramping up.	

7-53 Process PID Feed Fwd Ramp down		
Range:	Function:	
0.01 s* [0.01 - 10 s]	Controls the dynamics of the feed-forward signal when ramping down.	

7-56 Process PID Ref. Filter Time		
Range:	Function:	
0.001 s* [0.001 - 1 s]	Set a time constant for the reference first-order low-pass filter. The low-pass filter improves steady-state performance and dampens oscillations on the reference/ feedback signals. However, severe filtering	

7-56 Process PID Ref. Filter Time		
Range:	Function:	
	can be detrimental to dynamic performance.	

7-57 Process PID Fb. Filter Time		
Range:	Function:	
0.001 s* [0.001 - 1 s]	Set a time constant for the feedback first-order low-pass filter. The low-pass filter improves steady-state performance and dampens oscillations on the reference/ feedback signals. However, severe filtering can be detrimental to dynamic performance.	

3.8.9 7-9* Position PI Ctrl.

Parameters for configuring the position controller.

7-90 Position PI Feedback Source		
Option:	Function:	
	NOTICE! This parameter is only available with software version 48.XX. Select the feedback source for the position PI controller.	
[0] *	Motor feedb. P1-02	Use the feedback source selected as motor feedback in <i>parameter 1-02 Flux Motor Feedback Source</i> . In flux sensorless control principle the estimated position from motor control is used.
[1]	24V encoder	A 24 V encoder connected to terminals 32, 33. NOTICE! Set <i>parameter 5-14 Terminal 32 Digital Input</i> and <i>parameter 5-15 Terminal 33 Digital Input</i> to [0] <i>No operation</i> .
[2]	MCB 102	Encoder connected to an encoder option (B-option slot). Configure the encoder in <i>parameter group 17-1* Inc. Enc. Interface</i> .
[3]	MCB 103	Resolver connected to resolver option (B-option slot). Configure the resolver in <i>parameter group 17-5* Resolver Interface</i> .

7-91 Position PI Droop		
Range:	Function:	
0.0 °* [0.0 - 360.0 °]	Enter the motor angle deviation at 100% load in a load sharing system. The system is 2 or more mechanically connected motors in positioning or synchronization mode. In positioning mode, configure <i>parameter 7-01 Speed PID Droop</i> to allow a speed deviation.	

7-92 Position PI Proportional Gain		
Range:	Function:	
0.0150* [0.0000 - 1.0000]	<p>NOTICE! This parameter is only available with software version 48.XX.</p> <p>Enter the proportional gain for the position PI controller. Increasing the gain value makes the control more dynamic but less stable. 0=Off.</p>	

7-97 Position PI Maximum Speed Above Master		
Range:	Function:	
100 RPM* [0 - 65000 RPM]	<p>NOTICE! This parameter is only available with software version 48.XX.</p> <p>Enter the value by which the follower speed is allowed to exceed the actual master speed. Valid only in synchronization mode.</p>	

7-93 Position PI Integral Time		
Range:	Function:	
20000.0 ms* [1.0 - 20000.0 ms]	<p>NOTICE! This parameter is only available with software version 48.XX.</p> <p>Enter the integral time for the position PI controller. Decreasing the value makes the control more dynamic but less stable. 20000=Off.</p>	

7-98 Position PI Feed Forward Factor		
Range:	Function:	
98 %* [0 - 110 %]	<p>NOTICE! This parameter is only available with software version 48.XX.</p> <p>Enter the amount by which the speed reference calculated by the profile generator is allowed to bypass the position PI controller.</p>	

7-94 Position PI Feedback Scale Numerator		
Range:	Function:	
1* [-20000000000 - 20000000000]	<p>NOTICE! This parameter is only available with software version 48.XX.</p> <p>This parameter is the numerator in the equation which defines the gear ratio between the motor and the feedback device when the feedback device is not mounted on the motor shaft.</p> $\text{Encoder revolutions} = \frac{\text{Par. 7-94}}{\text{Par. 7-95}} \times \text{Motor revolutions}$	

7-99 Position PI Minimum Ramp Time		
Range:	Function:	
0.01 s* [0.000 - 3600 s]	<p>NOTICE! This parameter is only available with software version 48.XX.</p> <p>Enter the shortest ramp time for the output of the Position PI controller. Use this parameter to limit acceleration when correcting large position deviations, for example when starting synchronization with a running master or after recovering from an overload situation during positioning.</p>	

7-95 Position PI Feedback Scale Denominator		
Range:	Function:	
1* [-20000000000 - 20000000000]	<p>NOTICE! This parameter is only available with software version 48.XX.</p> <p>See parameter 7-94 Position PI Feedback Scale Numerator.</p>	

3.9 Parameters: 8-** Communications and Options

NOTICE!

Chapter 3.9 Parameters: 8-** Communications and Options covers all the product series included in this operating guide, but the options and parameter range may vary for the different product series. For additional information, consult the product-specific programming guide.

3.9.1 8-0* General Settings

8-01 Control Site

The setting in this parameter overrides the settings in parameter 8-50 Coasting Select to parameter 8-56 Preset Reference Select.

Option:	Function:	
[0]	Digital and ctrl.word	Use both digital input and control word.
[1]	Digital only	Use digital inputs only.
[2]	Controlword only	Use control word only.

8-02 Control Word Source

Select the source of the control word: 1 of 2 serial interfaces or 4 installed options. During initial power-up, the frequency converter automatically sets this parameter to [3] Option A if it detects a valid fieldbus option installed in slot A. When the option is removed, the frequency converter detects a configuration change, sets parameter 8-02 Control Word Source to default setting [1] FC RS485, and trips. If an option is installed after initial power-up, the setting of parameter 8-02 Control Word Source does not change, but the frequency converter trips and shows: Alarm 67, Option Changed.

When retrofitting a bus option into a frequency converter that did not have a bus option installed earlier, change the control to bus-based. This change is required for safety reasons to avoid an unintended change.

Option:	Function:	
		NOTICE! This parameter cannot be adjusted while the motor is running.
[0]	None	
[1]	FC RS-485	
[2]	FC USB	
[3] *	Option A	
[4]	Option B	
[5]	Option C0	
[6]	Option C1	
[30]	External Can	

8-03 Control Word Timeout Time

Range:	Function:	
20 s*	[0.1 - 18000.0 s]	Enter the maximum time expected to pass between the reception of 2 consecutive telegrams. If this time is exceeded, it indicates that the serial communication has stopped. The function selected in parameter 8-04 Control Word Timeout Function is then carried out. A valid control word triggers the timeout counter.

8-04 Control Word Timeout Function

Select the timeout function. The timeout function activates when the control word fails to be updated within the time period specified in parameter 8-03 Control Word Timeout Time.

Option:	Function:	
		NOTICE! To change the set-up after a timeout, configure as follows: <ol style="list-style-type: none"> Set parameter 0-10 Active Set-up to [9] Multi set-up. Select the relevant link in parameter 0-12 This Set-up Linked to.
[0]	Off	Resumes control via fieldbus (fieldbus or standard), using the most recent control word.
[1]	Freeze output	Freezes output frequency until communication resumes.
[2]	Stop	Stops with auto restart when communication resumes.
[3]	Jogging	Runs the motor at jog frequency until communication resumes.
[4]	Max. speed	Runs the motor at maximum frequency until communication resumes.
[5]	Stop and trip	Stops the motor, then resets the frequency converter to restart: <ul style="list-style-type: none"> Via the fieldbus. Via [Reset]. Via a digital input.
[6]	Qstop and trip	NOTICE! This option is available only with software version 48.XX. Stops the motor with the quick stop ramp (parameter 3-81 Quick Stop Ramp Time). Perform a reset to restart the frequency converter.

8-04 Control Word Timeout Function		
Select the timeout function. The timeout function activates when the control word fails to be updated within the time period specified in <i>parameter 8-03 Control Word Timeout Time</i> .		
Option:		Function:
[7]	Select setup 1	Changes the set-up after a control word timeout. If communication resumes after a timeout, <i>parameter 8-05 End-of-Timeout Function</i> either resumes the set-up used before the timeout, or retains the set-up endorsed by the timeout function.
[8]	Select setup 2	See [7] <i>Select setup 1</i> .
[9]	Select setup 3	See [7] <i>Select setup 1</i> .
[10]	Select setup 4	See [7] <i>Select setup 1</i> .
[26]	Trip	

8-05 End-of-Timeout Function		
Select the action after receiving a valid control word following a timeout.		
This parameter is active only when <i>parameter 8-04 Control Timeout Function</i> is set to:		
<ul style="list-style-type: none"> • [7] <i>Set-up 1</i>. • [8] <i>Set-up 2</i>. • [9] <i>Set-up 3</i>. • [10] <i>Set-up 4</i>. 		
Option:		Function:
[0]	Hold set-up	Retains the set-up selected in <i>parameter 8-04 Control Timeout Function</i> and shows a warning until <i>parameter 8-06 Reset Control Timeout</i> toggles. Then the frequency converter resumes its original set-up.
[1] *	Resume set-up	Resumes the set-up that was active before the timeout.

8-06 Reset Control Word Timeout		
This parameter is active only when [0] <i>Hold set-up</i> has been selected in <i>parameter 8-05 End-of-Timeout Function</i> .		
Option:		Function:
[0] *	Do not reset	Retains the set-up specified in <i>parameter 8-04 Control Word Timeout Function</i> , following a control word timeout.
[1]	Do reset	Restores the frequency converter to the original set-up following a control word timeout. The frequency converter performs

8-06 Reset Control Word Timeout		
This parameter is active only when [0] <i>Hold set-up</i> has been selected in <i>parameter 8-05 End-of-Timeout Function</i> .		
Option:		Function:
		the reset and then immediately reverts to the [0] <i>Do not reset</i> setting.

8-07 Diagnosis Trigger		
This parameter has no function for DeviceNet.		
Option:		Function:
[0] *	Disable	
[1]	Trigger on alarms	
[2]	Trigger alarm/warn.	

8-08 Readout Filtering		
Use this function if the speed feedback value readouts on the fieldbus fluctuate. Select [1] <i>Motor Data LP-Filter</i> if the function is required. A power cycle is required for changes to take effect.		
Option:		Function:
[0]	Motor Data Std-Filt.	Normal fieldbus readouts.
[1]	Motor Data LP-Filter	Filtered fieldbus readouts of the following parameters: <ul style="list-style-type: none"> • <i>Parameter 16-10 Power [kW]</i>. • <i>Parameter 16-11 Power [hp]</i>. • <i>Parameter 16-12 Motor voltage</i>. • <i>Parameter 16-14 Motor Current</i>. • <i>Parameter 16-16 Torque [Nm]</i>. • <i>Parameter 16-17 Speed [RPM]</i>. • <i>Parameter 16-22 Torque [%]</i>. • <i>Parameter 16-25 Torque [Nm] High</i>.

3.9.2 8-1* Ctrl. Word Settings

8-10 Control Word Profile		
Select the interpretation of the control and status words corresponding to the installed fieldbus. Only the selections valid for the fieldbus installed in slot A are visible in the LCP display. For guidelines in selection of [0] <i>FC profile</i> and [1] <i>PROFIdrive profile</i> , refer to the <i>design guide</i> . For more guidelines in the selection of [1] <i>PROFIdrive profile</i> , refer to the <i>installation guide</i> for the installed fieldbus.		
Option:		Function:
[0]	FC profile	
[1]	PROFIdrive profile	

8-10 Control Word Profile		
<p>Select the interpretation of the control and status words corresponding to the installed fieldbus. Only the selections valid for the fieldbus installed in slot A are visible in the LCP display. For guidelines in selection of [0] FC profile and [1] PROFdrive profile, refer to the <i>design guide</i>. For more guidelines in the selection of [1] PROFdrive profile, refer to the <i>installation guide</i> for the installed fieldbus.</p>		
Option:		Function:
[3]	FC Motion Profile	<p>NOTICE! This option is available only with software version 48.XX.</p> <p>Assigns motion-specific functions to various control and status word bits. This option is available when [9] Positioning or [10] Synchronization is selected in parameter 1-00 Configuration Mode.</p>
[5]	ODVA	
[7]	CANopen DSP 402	

8-13 Configurable Status Word STW		
<p>This is an array parameter with 16 elements, 1 element for each bit in range 0–15. Elements 5 and 11–15 are configurable. Each of the bits can be configured to any of the following options.</p>		
Option:		Function:
[0]	No function	The input is always low.
[1] *	Profile Default	Depending on the profile set in parameter 8-10 Control Profile.
[2]	Alarm 68 Only	The input goes high whenever alarm 68, Safe Torque Off activated is active and goes low whenever alarm 68, Safe Torque Off activated is not active.
[3]	Trip excl Alarm 68	
[4]	Position Error	<p>NOTICE! This option is available only with software version 48.XX.</p> <p>The position error exceeds the value of parameter 4-71 Maximum Position Error during the time in parameter 4-72 Position Error Timeout.</p>
[5]	Position Limit	<p>NOTICE! This option is available only with software version 48.XX.</p> <p>A position limit is reached.</p>
[6]	Touch on Target	<p>NOTICE! This option is available only with software version 48.XX.</p>

8-13 Configurable Status Word STW		
<p>This is an array parameter with 16 elements, 1 element for each bit in range 0–15. Elements 5 and 11–15 are configurable. Each of the bits can be configured to any of the following options.</p>		
Option:		Function:
[7]	Touch Activated	<p>Target position reached in touch position mode.</p> <p>NOTICE! This option is available only with software version 48.XX. Touch position mode is active.</p>
[10]	T18 DI status	
[11]	T19 DI status	
[12]	T27 DI status	
[13]	T29 DI status	
[14]	T32 DI status	
[15]	T33 DI status	
[16]	T37 DI status	The input goes high whenever terminal 37 has 0 V and goes low whenever terminal 37 has 24 V.
[21]	Thermal warning	
[30]	Brake fault (IGBT)	
[40]	Out of ref range	
[41]	Load throttle active	
[60]	Comparator 0	
[61]	Comparator 1	
[62]	Comparator 2	
[63]	Comparator 3	
[64]	Comparator 4	
[65]	Comparator 5	
[70]	Logic Rule 0	
[71]	Logic Rule 1	
[72]	Logic Rule 2	
[73]	Logic Rule 3	
[74]	Logic Rule 4	
[75]	Logic Rule 5	
[80]	SL digital out A	
[81]	SL digital out B	
[82]	SL digital out C	
[83]	SL digital out D	
[84]	SL digital out E	
[85]	SL digital out F	
[86]	ATEX ETR cur. alarm	
[87]	ATEX ETR freq. alarm	
[88]	ATEX ETR cur. warning	
[89]	ATEX ETR freq. warning	
[90]	Safe Function active	
[91]	Safe Opt. Reset req.	
[92]	IGBT-cooling	See parameter group 5-3* Digital Outputs.

8-13 Configurable Status Word STW

This is an array parameter with 16 elements, 1 element for each bit in range 0–15. Elements 5 and 11–15 are configurable. Each of the bits can be configured to any of the following options.

Option:
Function:

[231]	In Power Lim. Mot.	See <i>parameter group 4-8* Power Limit</i> . Use this option in motor mode only.
[232]	In Power Lim. Gen.	See <i>parameter group 4-8* Power Limit</i> . Use this option in generating mode only.
[233]	In Power Limit	See <i>parameter group 4-8* Power Limit</i> . Use this option in both the motor and the generating modes.

8-14 Configurable Control Word CTW

This is an array parameter with 16 elements, 1 element for each bit in range 0–15. Each of the bits can be configured to any of the following options.

Option:
Function:

		This parameter is not valid in software versions before 4.93.
[0]	None	The frequency converter ignores the information in this bit.
[1] *	Profile default	The functionality of the bit depends on the selection in <i>parameter 8-10 Control Word Profile</i> .
[2]	CTW Valid, active low	If set to 1, the frequency converter ignores the remaining bits of the control word.
[3]	Safe Option Reset	This function is only available in bits 12–15 of the control word if a safety option is mounted in the frequency converter. The reset is executed on a 0→1 transition and resets the safety option as set in <i>parameter 42-24 Restart Behaviour</i> .
[4]	PID error inverse	Inverts the resulting error from the process PID controller. Available only if <i>parameter 1-00 Configuration Mode</i> is set to [6] <i>Surface Winder</i> , [7] <i>Extended PID Speed OL</i> , or [8] <i>Extended PID Speed CL</i> .
[5]	PID reset I part	Resets the I-part of the process PID controller. Equivalent to <i>parameter 7-40 Process PID I-part Reset</i> . Available only if <i>parameter 1-00 Configuration Mode</i> is set to [6] <i>Surface Winder</i> , [7] <i>Extended PID Speed OL</i> , or [8] <i>Extended PID Speed CL</i> .
[6]	PID enable	Enables the extended process PID controller. Equivalent to <i>parameter 7-50 Process PID Extended PID</i> . Available only if <i>parameter 1-00 Configuration Mode</i> is set to [6] <i>Surface Winder</i> , [7] <i>Extended PID Speed OL</i> , or [8] <i>Extended PID Speed CL</i> .

8-14 Configurable Control Word CTW

This is an array parameter with 16 elements, 1 element for each bit in range 0–15. Each of the bits can be configured to any of the following options.

Option:
Function:

[11]	Start Homing	NOTICE! This option is available only with software version 48.XX. Starts the homing function selected in <i>parameter 17-80 Homing Function</i> . Must remain high until homing is completed; otherwise homing is aborted.
[12]	Activate Touch	NOTICE! This option is available only with software version 48.XX. Select touch probe positioning mode. This option activates monitoring of the touch probe sensor input.
[13]	Sync. to Pos. Mode	NOTICE! This option is available only with software version 48.XX. Select positioning in synchronization mode.
[14]	Ramp 2	NOTICE! This option is available only with software version 48.XX. Select between ramp 1 (<i>parameter group 3-4* Ramp 1</i>) and ramp 2 (<i>parameter group 3-5* Ramp 2</i>).
[15]	Relay 1	NOTICE! This option is available only with software version 48.XX. Control relay 1.
[16]	Relay2	NOTICE! This option is available only with software version 48.XX. Control relay 2.
[17]	Speed Mode	NOTICE! This option is available only with software version 48.XX. Select the speed mode when [9] <i>Positioning</i> or [10] <i>Synchronization</i> is selected in <i>parameter 1-00 Configuration Mode</i> . Speed reference is set by reference resource 1 or fieldbus REF1 relative to <i>parameter 3-03 Maximum Reference</i> .

8-14 Configurable Control Word CTW

This is an array parameter with 16 elements, 1 element for each bit in range 0–15. Each of the bits can be configured to any of the following options.

Option:	Function:
[18] Virtual Master	<p>NOTICE! This option is available only with software version 48.XX.</p> <p>Starts the virtual master configured in parameter 3-27 Virtual Master Max Ref.</p>
[19] Enable Master Offset	<p>NOTICE! This option is available only with software version 48.XX.</p> <p>Activates the master offset selected in parameter 3-26 Master Offset when parameter 17-93 Master Offset Selection has a selection from [1] Absolute to [5] Relative Touch Sensor.</p>
[20] Target Inverse	Changes the sign of the set target position. For example, if the set target is 1000, the activation of this option changes the value to -1000.
[231] Power Limit Mot.	See parameter group 4-8* Power Limit. Use this option in the motor mode only.
[232] Power Limit Gen.	See parameter group 4-8* Power Limit. Use this option in the generating mode only.
[233] Power Limit Both	See parameter group 4-8* Power Limit. Use this option in both the motor and the generating modes.

8-17 Configurable Alarm and Warningword

The configurable alarm and warning word has 16 bits (0–15). Each of those bits can be configured to any of the following options.

Option:	Function:
[0] *	Off
[1]	10 Volts low warning
[2]	Live zero warning
[3]	No motor warning
[4]	Mains phase loss warning
[5]	DC link voltage high warning
[6]	DC link voltage low warning
[7]	DC overvoltage warning
[8]	DC undervoltage warning
[9]	Inverter overloaded warning
[10]	Motor ETR overtemp warning
[11]	Motor thermistor overtemp warning
[12]	Torque limit warning
[13]	Over current warning
[14]	Earth fault warning
[17]	Controlword timeout warning
[19]	Discharge temp high warning

8-17 Configurable Alarm and Warningword

The configurable alarm and warning word has 16 bits (0–15). Each of those bits can be configured to any of the following options.

Option:	Function:
[22]	Hoist mech brake warning
[23]	Internal fans warning
[24]	External fans warning
[25]	Brake resistor short circuit warning
[26]	Brake powerlimit warning
[27]	Brake chopper short circuit warning
[28]	Brake check warning
[29]	Heatsink temperature warning
[30]	Motor phase U warning
[31]	Motor phase V warning
[32]	Motor phase W warning
[34]	Fieldbus communication warning
[36]	Mains failure warning
[40]	T27 overload warning
[41]	T29 overload warning
[45]	Earth fault 2 warning
[47]	24V supply low warning
[58]	AMA internal fault warning
[59]	Current limit warning
[60]	External interlock warning
[61]	Feedback error warning
[62]	Frequency max warning
[64]	Voltage limit warning
[65]	Controlboard overtemp warning
[66]	Heatsink temp low warning
[68]	Safe stop warning
[73]	Safe stop autorestart warning
[76]	Power unit setup warning
[77]	Reduced powermode warning
[78]	Tracking error warning
[89]	Mech brake sliding warning
[163]	ATEX ETR cur limit warning
[165]	ATEX ETR freq limit warning
[10002]	Live zero error alarm
[10004]	Mains phase loss alarm
[10007]	DC overvoltage alarm
[10008]	DC undervoltage alarm
[10009]	Inverter overload alarm
[10010]	ETR overtemperature alarm
[10011]	Thermistor overtemp alarm
[10012]	Torque limit alarm
[10013]	Overcurrent alarm
[10014]	Earth fault alarm
[10016]	Short circuit alarm
[10017]	CTW timeout alarm
[10022]	Hoist brake alarm

8-17 Configurable Alarm and Warningword		
The configurable alarm and warning word has 16 bits (0–15). Each of those bits can be configured to any of the following options.		
Option:	Function:	
[10026]	Brake powerlimit alarm	
[10027]	Brakechopper shortcircuit alarm	
[10028]	Brake check alarm	
[10029]	Heatsink temp alarm	
[10030]	Phase U missing alarm	
[10031]	Phase V missing alarm	
[10032]	Phase W missing alarm	
[10033]	Inrush fault alarm	
[10034]	Fieldbus com faul alarm	
[10036]	Mains failure alarm	
[10037]	Phase imbalance alarm	
[10038]	Internal fault	
[10039]	Heatsink sensor alarm	
[10045]	Earth fault 2 alarm	
[10046]	Powercard supply alarm	
[10047]	24V supply low alarm	
[10048]	1.8V supply low alarm	
[10049]	Speed limit alarm	
[10060]	Ext interlock alarm	
[10061]	Feedback error alarm	
[10063]	Mech brake low alarm	
[10065]	Controlboard overtemp alarm	
[10067]	Option config changed alarm	
[10068]	Safe stop alarm	
[10069]	Powercard temp alarm	
[10073]	Safestop auto restart alarm	
[10074]	PTC thermistor alarm	
[10075]	Illegal profile alarm	
[10078]	Tracking error alarm	
[10079]	Illegal PS config alarm	
[10081]	CSIV corrupt alarm	
[10082]	CSIV param error alarm	
[10084]	No safety option alarm	
[10090]	Feedback monitor alarm	
[10091]	AI54 settings alarm	
[10164]	ATEX ETR current lim alarm	
[10166]	ATEX ETR freq limit alarm	

8-19 Product Code		
Range:	Function:	
Size related*	[0 - 2147483647]	Select 0 to read out the actual fieldbus product code according to the mounted fieldbus option. Select 1 to read out the actual vendor ID.

3.9.3 8-3* FC Port Settings

8-30 Protocol		
Option:	Function:	
		Select the protocol to be used. Changing protocol is not effective until after powering off the frequency converter.
[0] *	FC	
[1]	FC MC	
[2]	Modbus RTU	

8-31 Address		
Range:	Function:	
Size related*	[1 - 255]	Enter the address for the frequency converter (standard) port. Valid range: Depends on selected protocol.

8-32 FC Port Baud Rate		
Option:	Function:	
[0]	2400 Baud	Baud rate selection for the FC (standard) port.
[1]	4800 Baud	
[2] *	9600 Baud	
[3]	19200 Baud	
[4]	38400 Baud	
[5]		
[6]		
[7]	115200 Baud	

8-33 Parity / Stop Bits		
Option:	Function:	
[0] *		
[1]		
[2]		
[3]		

8-34 Estimated cycle time		
Range:	Function:	
0 ms*	[0 - 1000000 ms]	In noisy environments, the interface may be blocked due to overload or bad frames. This parameter specifies the time between 2 consecutive frames on the network. If the interface does not detect valid frames in that time, it flushes the receive buffer.

8-35 Minimum Response Delay		
Range:	Function:	
10 ms*	[1 - 10000. ms]	Specify the minimum delay time between receiving a request and

8-35 Minimum Response Delay		
Range:		Function:
		transmitting a response. This is used for overcoming modem turnaround delays.

8-36 Max Response Delay		
Range:		Function:
10001. ms*	[11. - 10001 ms]	Specify the maximum allowed delay time between transmitting a request and receiving a response. If a response from the frequency converter is exceeding the time setting, then it is discarded.

8-37 Max Inter-Char Delay		
Range:		Function:
25.00 ms*	[0.00 - 35.00 ms]	Specify the maximum allowed time interval between receipt of 2 bytes. This parameter activates timeout if transmission is interrupted. This parameter is active only when <i>parameter 8-30 Protocol</i> is set to [1] FC MC protocol.

3.9.4 8-4* FC MC Protocol Set

8-40 Telegram selection		
Option:		Function:
[1] *	Standard telegram 1	Enables use of freely configurable telegrams or standard telegrams for the FC port.
[101]	PPO 1	
[102]	PPO 2	
[103]	PPO 3	
[104]	PPO 4	
[105]	PPO 5	
[106]	PPO 6	
[107]	PPO 7	
[108]	PPO 8	
[200]	Custom telegram 1	Enables use of freely configurable telegrams or standard telegrams for the FC port.

8-41 Parameters for Signals		
Option:		Function:
[0] *	None	This parameter contains a list of signals available for selection in <i>parameter 8-42 PCD Write Configuration</i>

8-41 Parameters for Signals		
Option:		Function:
		and <i>parameter 8-43 PCD Read Configuration</i> .
[15]	Readout: actual setup	
[302]	Minimum Reference	
[303]	Maximum Reference	
[312]	Catch up/slow Down Value	
[341]	Ramp 1 Ramp Up Time	
[342]	Ramp 1 Ramp Down Time	
[351]	Ramp 2 Ramp Up Time	
[352]	Ramp 2 Ramp Down Time	
[380]	Jog Ramp Time	
[381]	Quick Stop Ramp Time	
[411]	Motor Speed Low Limit [RPM]	
[412]	Motor Speed Low Limit [Hz]	
[413]	Motor Speed High Limit [RPM]	
[414]	Motor Speed High Limit [Hz]	
[416]	Torque Limit Motor Mode	
[417]	Torque Limit Generator Mode	
[482]	Power Limit Motor Mode	
[483]	Power Limit Generator Mode	
[491]	Positive Speed Limit [RPM]	
[492]	Positive Speed Limit [Hz]	
[493]	Negative Speed Limit [RPM]	
[494]	Negative Speed Limit [Hz]	
[495]	Positive Torque limit	
[496]	Negative Torque limit	
[553]	Term. 29 High Ref./Feedb. Value	
[558]	Term. 33 High Ref./Feedb. Value	
[590]	Digital & Relay Bus Control	
[593]	Pulse Out #27 Bus Control	
[595]	Pulse Out #29 Bus Control	
[597]	Pulse Out #X30/6 Bus Control	
[615]	Terminal 53 High Ref./Feedb. Value	
[625]	Terminal 54 High Ref./Feedb. Value	
[653]	Term 42 Output Bus Ctrl	
[663]	Terminal X30/8 Bus Control	
[673]	Terminal X45/1 Bus Control	
[683]	Terminal X45/3 Bus Control	
[748]	PCD Feed Forward	
[890]	Bus Jog 1 Speed	
[891]	Bus Jog 2 Speed	
[1397]	Alert Alarm Word	
[1398]	Alert Warning Word	
[1399]	Alert Status Word	
[1472]	Legacy Alarm Word	
[1473]	Legacy Warning Word	
[1474]	Leg. Ext. Status Word	
[1500]	Operating hours	

8-41 Parameters for Signals	
Option:	Function:
[1501]	Running Hours
[1502]	kWh Counter
[1600]	Control Word
[1601]	Reference [Unit]
[1602]	Reference %
[1603]	Status Word
[1605]	Main Actual Value [%]
[1606]	Actual Position
[1609]	Custom Readout
[1610]	Power [kW]
[1611]	Power [hp]
[1612]	Motor Voltage
[1613]	Frequency
[1614]	Motor current
[1615]	Frequency [%]
[1616]	Torque [Nm]
[1617]	Speed [RPM]
[1618]	Motor Thermal
[1619]	Thermistor Sensor Temperature
[1620]	Motor Angle
[1621]	Torque [%] High Res.
[1622]	Torque [%]
[1623]	Motor Shaft Power [kW]
[1624]	Calibrated Stator Resistance
[1625]	Torque [Nm] High
[1630]	DC Link Voltage
[1632]	Brake Energy /s
[1633]	Brake Energy Average
[1634]	Heatsink Temp.
[1635]	Inverter Thermal
[1638]	SL Controller State
[1639]	Control Card Temp.
[1642]	Service Log Counter
[1645]	Motor Phase U Current
[1646]	Motor Phase V Current
[1647]	Motor Phase W Current
[1648]	Speed Ref. After Ramp [RPM]
[1650]	External Reference
[1651]	Pulse Reference
[1652]	Feedback[Unit]
[1653]	Digi Pot Reference
[1657]	Feedback [RPM]
[1660]	Digital Input
[1661]	Terminal 53 Switch Setting
[1662]	Analog Input 53
[1663]	Terminal 54 Switch Setting
[1664]	Analog Input 54
[1665]	Analog Output 42 [mA]
[1666]	Digital Output [bin]

8-41 Parameters for Signals	
Option:	Function:
[1667]	Freq. Input #29 [Hz]
[1668]	Freq. Input #33 [Hz]
[1669]	Pulse Output #27 [Hz]
[1670]	Pulse Output #29 [Hz]
[1671]	Relay Output [bin]
[1672]	Counter A
[1673]	Counter B
[1674]	Prec. Stop Counter
[1675]	Analog In X30/11
[1676]	Analog In X30/12
[1677]	Analog Out X30/8 [mA]
[1678]	Analog Out X45/1 [mA]
[1679]	Analog Out X45/3 [mA]
[1680]	Fieldbus CTW 1
[1682]	Fieldbus REF 1
[1684]	Comm. Option STW
[1685]	FC Port CTW 1
[1686]	FC Port REF 1
[1687]	Bus Readout Alarm/Warning
[1689]	Configurable Alarm/Warning Word
[1690]	Alarm Word
[1691]	Alarm Word 2
[1692]	Warning Word
[1693]	Warning Word 2
[1694]	Ext. Status Word
[1695]	Ext. Status Word 2
[1696]	Maintenance Word
[1827]	Safe Opt. Est. Speed
[1828]	Safe Opt. Meas. Speed
[1829]	Safe Opt. Speed Error
[1836]	Analog Input X48/2 [mA]
[1837]	Temp. Input X48/4
[1838]	Temp. Input X48/7
[1839]	Temp. Input X48/10
[1843]	Analog Out X49/7
[1844]	Analog Out X49/9
[1845]	Analog Out X49/11
[1860]	Digital Input 2
[3310]	Sync Factor Master
[3311]	Sync Factor Slave
[3401]	PCD 1 Write to MCO
[3402]	PCD 2 Write to MCO
[3403]	PCD 3 Write to MCO
[3404]	PCD 4 Write to MCO
[3405]	PCD 5 Write to MCO
[3406]	PCD 6 Write to MCO
[3407]	PCD 7 Write to MCO
[3408]	PCD 8 Write to MCO
[3409]	PCD 9 Write to MCO

8-41 Parameters for Signals		
Option:	Function:	
[3410]	PCD 10 Write to MCO	
[3421]	PCD 1 Read from MCO	
[3422]	PCD 2 Read from MCO	
[3423]	PCD 3 Read from MCO	
[3424]	PCD 4 Read from MCO	
[3425]	PCD 5 Read from MCO	
[3426]	PCD 6 Read from MCO	
[3427]	PCD 7 Read from MCO	
[3428]	PCD 8 Read from MCO	
[3429]	PCD 9 Read from MCO	
[3430]	PCD 10 Read from MCO	
[3440]	Digital Inputs	
[3441]	Digital Outputs	
[3450]	Actual Position	
[3451]	Commanded Position	
[3452]	Actual Master Position	
[3453]	Slave Index Position	
[3454]	Master Index Position	
[3455]	Curve Position	
[3456]	Track Error	
[3457]	Synchronizing Error	
[3458]	Actual Velocity	
[3459]	Actual Master Velocity	
[3460]	Synchronizing Status	
[3461]	Axis Status	
[3462]	Program Status	
[3464]	MCO 302 Status	
[3465]	MCO 302 Control	
[3466]	SPI Error Counter	
[3470]	MCO Alarm Word 1	
[3471]	MCO Alarm Word 2	
[3644]	Terminal X49/7 Bus Control	
[3654]	Terminal X49/9 Bus Control	
[3664]	Terminal X49/11 Bus Control	
[4280]	Safe Option Status	
[4282]	Safe Control Word	
[4283]	Safe Status Word	
[4285]	Active Safe Func.	
[4287]	Time Until Manual Test	

8-42 PCD Write Configuration		
Range:	Function:	
Size related* [0 - 9999]	Select the parameters to be assigned to the PCD's telegrams. The number of available PCDs depends on the telegram type. The values in the PCDs are then written to the selected parameters as data values.	

8-43 PCD Read Configuration		
Range:	Function:	
Size related* [0 - 9999]	Select the parameters to be assigned to the PCDs of the telegrams. The number of available PCDs depends on the telegram type. PCDs contain the actual data values of the selected parameters.	

8-45 BTM Transaction Command		
Option:	Function:	
	NOTICE! This parameter cannot be adjusted while the motor is running.	
[0] *	Off	
[1]	Start Transaction	
[2]	Commit transaction	
[3]	Clear error	

8-46 BTM Transaction Status		
Option:	Function:	
[0] *	Off	
[1]	Transaction Started	
[2]	Transaction Comitting	
[3]	Transaction Timeout	
[4]	Err. Non-existing Par.	
[5]	Err. Par. Out of Range	
[6]	Transaction Failed	
[7]	SO Config Check	
[8]	SO Config Check Done	

8-47 BTM Timeout		
Range:	Function:	
60 s*	[1 - 360 s]	Select the BTM timeout after a BTM transaction has been started.

8-48 BTM Maximum Errors		
Range:	Function:	
21*	[0 - 21]	Selects the maximum allowed number of bulk transfer mode errors before aborting. If it is set to maximum, there is no abort.

8-49 BTM Error Log		
Range:	Function:	
0.255*	[0.000 - 9999.255]	List of parameters that failed during bulk transfer mode. The value after the decimal break is the fault code (255 stands for no error).

3.9.5 8-5* Digital/Bus

Parameters for configuring the control word merging.

NOTICE!

These parameters are active only when parameter 8-01 Control Site is set to [0] Digital and control word.

8-50 Coasting Select		
Select the trigger for the coasting function.		
Option:	Function:	
[0]	Digital input	A digital input triggers the coasting function.
[1]	Bus	A serial communication port or the fieldbus triggers the coasting function.
[2]	Logic AND	The fieldbus/serial communication port and a digital input trigger the coasting function.
[3] *	Logic OR	The fieldbus/serial communication port or a digital input triggers the coasting function.

8-51 Quick Stop Select		
Select the trigger for the quick stop function.		
Option:	Function:	
[0]	Digital input	
[1]	Bus	
[2]	Logic AND	
[3] *	Logic OR	

8-52 DC Brake Select		
Select control of the DC brake via the terminals (digital input) and/or via the fieldbus.		
Option:	Function:	
		NOTICE! When parameter 1-10 Motor Construction is set to [1] PM non-salient SPM, only selection [0] Digital input is available.
[0]	Digital input	Activate a start command via a digital input.
[1]	Bus	Activate a start command via the serial communication port or fieldbus option.
[2]	Logic AND	Activate a start command via the fieldbus/serial communication port and also via 1 of the digital inputs.
[3]	Logic OR	Activate a start command via the fieldbus/serial communication port or via 1 of the digital inputs.

8-53 Start Select		
Select the trigger for the start function.		
Option:	Function:	
[0]	Digital input	A digital input triggers the start function.
[1]	Bus	A serial communication port or the fieldbus triggers the start function.
[2]	Logic AND	The fieldbus/serial communication port and a digital input trigger the start function.
[3] *	Logic OR	The fieldbus/serial communication port or a digital input triggers the start function.

8-54 Reverse Select		
Select the trigger for the reversing function.		
Option:	Function:	
[0]	Digital input	A digital input triggers the reversing function.
[1]	Bus	A serial communication port or the fieldbus triggers the reversing function.
[2]	Logic AND	The fieldbus/serial communication port and a digital input trigger the reversing function.
[3] *	Logic OR	The fieldbus/serial communication port or a digital input triggers the reversing function.

8-55 Set-up Select		
Select the trigger for the set-up selection.		
Option:	Function:	
[0]	Digital input	A digital input triggers the set-up selection.
[1]	Bus	A serial communication port or the fieldbus triggers the set-up selection.
[2]	Logic AND	The fieldbus/serial communication port and a digital input trigger the set-up selection.
[3] *	Logic OR	The fieldbus/serial communication port or a digital input triggers the set-up selection.

8-56 Preset Reference Select		
Option:	Function:	
		Select the trigger for the preset reference selection.
[0]	Digital input	A digital input triggers the preset reference selection.
[1]	Bus	A serial communication port or the fieldbus triggers the preset reference selection.
[2]	Logic AND	The fieldbus/serial communication port and a digital input trigger the preset reference selection.
[3] *	Logic OR	The fieldbus/serial communication port or a digital input triggers the preset reference selection.

8-57 Profdrive OFF2 Select		
Select control of the frequency converter OFF2 selection via the terminals (digital input) and/or via the fieldbus. This parameter is active only when <i>parameter 8-01 Control Site</i> is set to [0] <i>Digital and ctrl. word</i> and <i>parameter 8-10 Control Word Profile</i> is set to [1] <i>PROFdrive profile</i> .		
Option:		Function:
[0]	Digital input	
[1]	Bus	
[2]	Logic AND	
[3] *	Logic OR	

8-58 Profdrive OFF3 Select		
Select control of the frequency converter OFF3 selection via the terminals (digital input) and/or via the fieldbus. This parameter is active only when <i>parameter 8-01 Control Site</i> is set to [0] <i>Digital and ctrl. word</i> , and <i>parameter 8-10 Control Word Profile</i> is set to [1] <i>PROFdrive profile</i> .		
Option:		Function:
[0]	Digital input	
[1]	Bus	
[2]	Logic AND	
[3] *	Logic OR	

3.9.6 8-8* FC Port Diagnostics

These parameters are used for monitoring the bus communication via the frequency converter port.

8-80 Bus Message Count		
Range:		Function:
0*	[0 - 0]	This parameter shows the number of valid telegrams detected on the bus.

8-81 Bus Error Count		
Array [6]		
Range:		Function:
0*	[0 - 0]	This parameter shows the number of telegrams with faults (for example CRC fault) detected on the bus.

8-82 Slave Messages Rcvd		
Range:		Function:
0*	[0 - 0]	This parameter shows the number of valid telegrams addressed to the slave sent by the frequency converter.

8-83 Slave Error Count		
Range:		Function:
0*	[0 - 0]	This parameter shows the number of error telegrams, which are not executed by the frequency converter.

3.9.7 8-9* Bus Jog

8-90 Bus Jog 1 Speed		
Range:		Function:
100 RPM*	[0 - par. 4-13 RPM]	Enter the jog speed. Activate this fixed jog speed via the serial port or fieldbus option.

8-91 Bus Jog 2 Speed		
Range:		Function:
200 RPM*	[0 - par. 4-13 RPM]	Enter the jog speed. Activate this fixed jog speed via the serial port or fieldbus option.

3.10 Parameters: 9-** PROFIBUS

For PROFIBUS parameter descriptions, see the *VLT® PROFIBUS DP MCA 101 Programming Guide*.

3.11 Parameters: 10-** DeviceNet CAN Fieldbus

For DeviceNet parameter descriptions, see the *DeviceNet Operating Instructions*.

3.12 Parameters: 12-** Ethernet

For Ethernet parameter descriptions, see the *VLT® EtherNet/IP MCA 121 Operating Instructions*.

3.13 Parameters: 13-** Smart Logic Control

Smart logic control (SLC) is a sequence of user-defined actions (see *parameter 13-52 SL Controller Action*) executed by the SLC when the associated user-defined event (see *parameter 13-51 SL Controller Event*) is evaluated as true by the SLC.

The condition for an event can be a particular status, or that the output from a logic rule or a comparator operand becomes true. That leads to an associated action as illustrated:

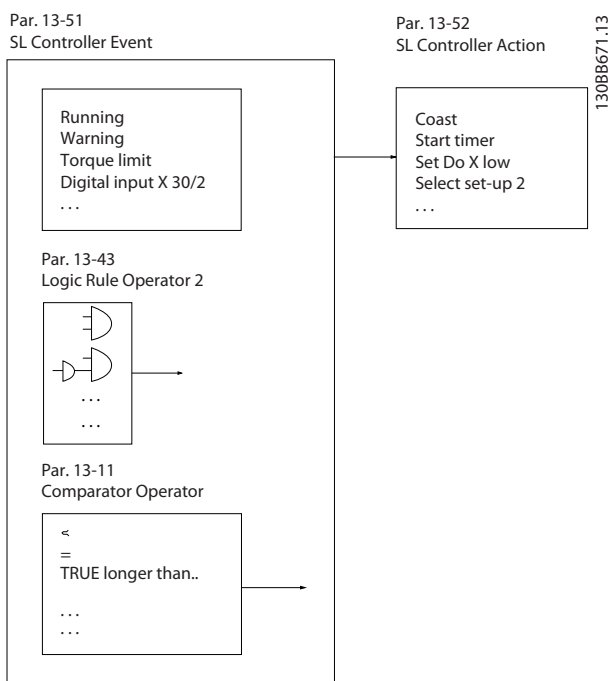

Figure 3.52 Smart Logic Control (SLC)

Events and actions are each numbered and linked in pairs (states). This means that when the 1st event is fulfilled (becomes true), the 1st action is executed. After this, the conditions of the 2nd event are evaluated and if evaluated true, the 2nd action is executed, and so on. Only 1 event is evaluated at any time. If an event is evaluated as false, nothing happens (in the SLC) during the current scan interval and no other events are evaluated. This means that when the SLC starts, it evaluates the 1st event (and only the 1st event) in each scan interval. Only when the 1st event is evaluated true, the SLC executes the 1st action and starts evaluating the 2nd event. It is possible to program 1–20 events and actions. When the last event/action has been executed, the sequence starts over again from the 1st event/action. *Figure 3.53* shows an example with 3 events/actions:

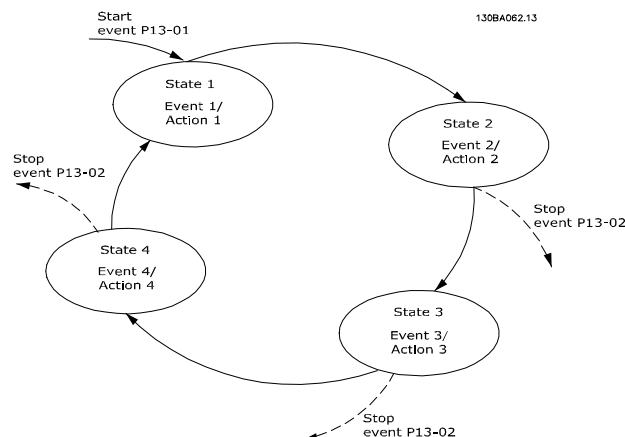

Figure 3.53 Events and Actions

Starting and stopping the SLC

Start and stop the SLC by selecting [1] On or [0] Off in *parameter 13-00 SL Controller Mode*. The SLC always starts in state 0 (where it evaluates event [0]). The SLC starts when the *Start Event* (defined in *parameter 13-01 Start Event*) is evaluated as true (provided that [1] On is selected in *parameter 13-00 SL Controller Mode*). The SLC stops when the *stop event* (*parameter 13-02 Stop Event*) is true. *Parameter 13-03 Reset SLC* resets all SLC parameters and starts programming from scratch.

NOTICE!

SLC is only active in auto-on mode, not hand-on mode.

3.13.1 13-0* SLC Settings

Use the SLC settings to activate, deactivate, and reset the smart logic control sequence. The logic functions and comparators are always running in the background, which opens for separate control of digital inputs and outputs.

13-00 SL Controller Mode		
Option:	Function:	
[0]	Off	Disables the smart logic controller.
[1]	On	Enables the smart logic controller.

13-01 Start Event		
Select the boolean (true or false) input to activate smart logic control.		
Option:	Function:	
[0] *	FALSE	Select the boolean (true or false) input to activate smart logic control. Enters the fixed value - false.
[1]	TRUE	Enters the fixed value - true.
[2]	Running	The motor runs.

13-01 Start Event		
Select the boolean (true or false) input to activate smart logic control.		
Option:	Function:	
[3]	In range	The motor runs within the programmed current and speed ranges set in <i>parameter 4-50 Warning Current Low</i> to <i>parameter 4-53 Warning Speed High</i> .
[4]	On reference	The motor runs on reference.
[5]	Torque limit	The torque limit set in <i>parameter 4-16 Torque Limit Motor Mode</i> or <i>parameter 4-17 Torque Limit Generator Mode</i> is exceeded.
[6]	Current limit	The motor current limit set in <i>parameter 4-18 Current Limit</i> is exceeded.
[7]	Out of current range	The motor current is outside the range set in <i>parameter 4-18 Current Limit</i> .
[8]	Below I low	The motor current is lower than set in <i>parameter 4-50 Warning Current Low</i> .
[9]	Above I high	The motor current is higher than set in <i>parameter 4-51 Warning Current High</i> .
[10]	Out of speed range	The speed is outside the range set in <i>parameter 4-52 Warning Speed Low</i> and <i>parameter 4-53 Warning Speed High</i> .
[11]	Below speed low	The output speed is lower than the setting in <i>parameter 4-52 Warning Speed Low</i> .
[12]	Above speed high	The output speed is higher than the setting in <i>parameter 4-53 Warning Speed High</i> .
[13]	Out of feedb. range	The feedback is outside the range set in <i>parameter 4-56 Warning Feedback Low</i> and <i>parameter 4-57 Warning Feedback High</i> .
[14]	Below feedb. low	The feedback is below the limit set in <i>parameter 4-56 Warning Feedback Low</i> .
[15]	Above feedb. high	The feedback is above the limit set in <i>parameter 4-57 Warning Feedback High</i> .
[16]	Thermal warning	The thermal warning turns on when the temperature exceeds the limit in the motor, the frequency converter, the brake resistor, or the thermistor.
[17]	Mains out of range	The mains voltage is outside the specified voltage range.
[18]	Reverse	The output is high when the frequency converter is running counterclockwise (the logical product of the status bits running AND reverse).
[19]	Warning	A warning is active.

13-01 Start Event		
Select the boolean (true or false) input to activate smart logic control.		
Option:	Function:	
[20]	Alarm (trip)	A (trip) alarm is active.
[21]	Alarm (trip lock)	A (trip lock) alarm is active.
[22]	Comparator 0	Use the result of comparator 0.
[23]	Comparator 1	Use the result of comparator 1.
[24]	Comparator 2	Use the result of comparator 2.
[25]	Comparator 3	Use the result of comparator 3.
[26]	Logic rule 0	Use the result of logic rule 0.
[27]	Logic rule 1	Use the result of logic rule 1.
[28]	Logic rule 2	Use the result of logic rule 2.
[29]	Logic rule 3	Use the result of logic rule 3.
[33]	Digital input DI18	Use the result of digital input 18.
[34]	Digital input DI19	Use the result of digital input 19.
[35]	Digital input DI27	Use the result of digital input 27.
[36]	Digital input DI29	Use the result of digital input 29.
[37]	Digital input DI32	Use the result of digital input 32.
[38]	Digital input DI33	Use the result of digital input 33.
[39]	Start command	A start command is issued.
[40]	Drive stopped	A stop command (jog, stop, quick stop, coast) is issued – and not from the SLC itself.
[41]	Reset Trip	A reset is issued.
[42]	Auto-reset Trip	An auto reset is performed.
[43]	OK key	[OK] is pressed. Only available on the graphical LCP.
[44]	Reset key	[Reset] is pressed. Only available on the graphical LCP.
[45]	Left key	[◀] is pressed. Only available on the graphical LCP.
[46]	Right key	[▶] is pressed. Only available on the graphical LCP.
[47]	Up key	[▲] is pressed. Only available on the graphical LCP.
[48]	Down key	[▼] is pressed. Only available on the graphical LCP.
[50]	Comparator 4	Use the result of comparator 4.

13-01 Start Event		
Select the boolean (true or false) input to activate smart logic control.		
Option:	Function:	
[51]	Comparator 5	Use the result of comparator 5.
[60]	Logic rule 4	Use the result of logic rule 4.
[61]	Logic rule 5	Use the result of logic rule 5.

13-02 Stop Event		
Select the boolean (true or false) input to deactivate smart logic control.		
Option:	Function:	
[0] *	FALSE	For descriptions of options [0] False–[61] Logic rule 5, see parameter 13-01 Start Event.
[1]	TRUE	
[2]	Running	
[3]	In range	
[4]	On reference	
[5]	Torque limit	
[6]	Current limit	
[7]	Out of current range	
[8]	Below I low	
[9]	Above I high	
[10]	Out of speed range	
[11]	Below speed low	
[12]	Above speed high	
[13]	Out of feedb. range	
[14]	Below feedb. low	
[15]	Above feedb. high	
[16]	Thermal warning	
[17]	Mains out of range	
[18]	Reverse	
[19]	Warning	
[20]	Alarm (trip)	
[21]	Alarm (trip lock)	
[22]	Comparator 0	
[23]	Comparator 1	
[24]	Comparator 2	
[25]	Comparator 3	
[26]	Logic rule 0	
[27]	Logic rule 1	
[28]	Logic rule 2	
[29]	Logic rule 3	
[30]	SL Timeout 0	
[31]	SL Timeout 1	
[32]	SL Timeout 2	
[33]	Digital input DI18	
[34]	Digital input DI19	
[35]	Digital input DI27	

13-02 Stop Event		
Select the boolean (true or false) input to deactivate smart logic control.		
Option:	Function:	
[36]	Digital input DI29	
[37]	Digital input DI32	
[38]	Digital input DI33	
[39]	Start command	
[40]	Drive stopped	
[41]	Reset Trip	
[42]	Auto-reset Trip	
[43]	OK key	[OK] is pressed. Only available on the graphical LCP.
[44]	Reset key	[Reset] is pressed. Only available on the graphical LCP.
[45]	Left key	[◀] is pressed. Only available on the graphical LCP.
[46]	Right key	[▶] is pressed. Only available on the graphical LCP.
[47]	Up key	[▲] is pressed. Only available on the graphical LCP.
[48]	Down key	[▼] is pressed. Only available on the graphical LCP.
[50]	Comparator 4	
[51]	Comparator 5	
[60]	Logic rule 4	
[61]	Logic rule 5	
[70]	SL Timeout 3	Smart logic controller timer 3 is timed out.
[71]	SL Timeout 4	Smart logic controller timer 4 is timed out.
[72]	SL Timeout 5	Smart logic controller timer 5 is timed out.
[73]	SL Timeout 6	Smart logic controller timer 6 is timed out.
[74]	SL Timeout 7	Smart logic controller timer 7 is timed out.
[75]		

13-03 Reset SLC		
Option:	Function:	
[0] *	Do not reset SLC	Retain programmed settings in parameter group 13-** Smart Logic.
[1]	Reset SLC	Reset all parameters in parameter group 13-** Smart Logic to default settings.

3.13.2 13-1* Comparators

Comparators are used for comparing continuous variables (that is output frequency, output current, analog input, and so on) to fixed preset values.

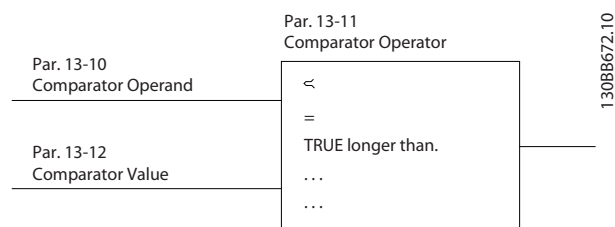

Figure 3.54 Comparators

There are digital values that are compared to fixed time values. See the explanation in *parameter 13-10 Comparator Operand*. Comparators are evaluated once in each scan interval. Use the result (true or false) directly. All parameters in this parameter group are array parameters with index 0–5. Select index 0 to program comparator 0, select index 1 to program comparator 1, and so on.

13-10 Comparator Operand		
Option:	Function:	
		Options [1] Reference % to [31] Counter B are variables which are compared based on their values. Options [50] FALSE to [186] Drive in auto mode are digital values (true/false) where the comparison is based on the amount of time during which they are set to true or false. See <i>parameter 13-11 Comparator Operator</i> . Select the variable to be monitored by the comparator.
[0]	DISABLED	The comparator is disabled.
[1]	Reference %	The resulting remote reference in percent.
[2]	Feedback %	[RPM] or [Hz], as set in <i>parameter 0-02 Motor Speed Unit</i> .
[3]	Motor speed	[RPM] or [Hz], as set in <i>parameter 0-02 Motor Speed Unit</i> .
[4]	Motor Current	
[5]	Motor torque	
[6]	Motor power	
[7]	Motor voltage	
[8]	DC-link voltage	
[9]	Motor Thermal	Value is in percent.
[10]	Drive thermal	Value is in percent.
[11]	Heat sink temp.	Value is in percent.

13-10 Comparator Operand		
Option:	Function:	
[12]	Analog input AI53	Value is in percent.
[13]	Analog input AI54	Value is in percent.
[14]	Analog input AIFB10	AIFB10 is internal 10 V supply.
[15]	Analog input AIS24V	AIS24V is a 24 V switch mode power supply.
[17]	Analog input AICCT	Value is in [°]. AICCT is control card temperature.
[18]	Pulse input FI29	Value is in percent.
[19]	Pulse input FI33	Value is in percent.
[20]	Alarm number	The number of registered alarms.
[21]	Warning number	
[22]	Analog input x30 11	
[23]	Analog input x30 12	
[30]	Counter A	
[31]	Counter B	
[34]	Analog Input x48/2	
[35]	Temp Input x48/4	
[36]	Temp Input x48/7	
[37]	Temp Input x48/10	
[38]	Actual Position	
[50]	FALSE	Use to enter the fixed value of false in the comparator.
[51]	TRUE	Use to enter the fixed value of true in the comparator.
[52]	Control ready	The control board receives supply voltage.
[53]	Drive ready	The frequency converter is ready for operation and applies a signal on the control board.
[54]	Running	The motor runs.
[55]	Reversing	The output is active when the frequency converter runs counterclockwise (the logical product of the status bits running AND reverse).
[56]	In range	The motor runs within the programmed current and speed ranges set in

13-10 Comparator Operand		
Option:	Function:	
		<i>parameter 4-50 Warning Current Low to parameter 4-53 Warning Speed High.</i>
[60]	On reference	The motor runs on reference.
[61]	Below reference, low	The motor runs at a reference which is less than the value in <i>parameter 4-54 Warning Reference Low.</i>
[62]	Above ref, high	The motor runs at a reference which exceeds the value in <i>parameter 4-55 Warning Reference High.</i>
[65]	Torque limit	The torque exceeds the value in <i>parameter 4-16 Torque Limit Motor Mode</i> or <i>parameter 4-17 Torque Limit Generator Mode.</i>
[66]	Current Limit	The motor current exceeds the value in <i>parameter 4-18 Current Limit.</i>
[67]	Out of current range	The motor current is outside the range set in <i>parameter 4-18 Current Limit.</i>
[68]	Below I low	The motor current is lower than the value in <i>parameter 4-50 Warning Current Low.</i>
[69]	Above I high	The motor current is higher than the value in <i>parameter 4-51 Warning Current High.</i>
[70]	Out of speed range	The speed is outside the range set in <i>parameter 4-52 Warning Speed Low</i> and <i>parameter 4-53 Warning Speed High.</i>
[71]	Below speed low	The output speed is lower than the value in <i>parameter 4-52 Warning Speed Low.</i>
[72]	Above speed high	The output speed is higher than the value in <i>parameter 4-53 Warning Speed High.</i>
[75]	Out of feedback range	The feedback is outside the range set in <i>parameter 4-56 Warning Feedback Low</i> and <i>parameter 4-57 Warning Feedback High.</i>
[76]	Below feedback low	The feedback is lower than the limit set in <i>parameter 4-56 Warning Feedback Low.</i>
[77]	Above feedback high	The feedback exceeds the limit set in <i>parameter 4-57 Warning Feedback High.</i>
[80]	Thermal warning	This operand becomes true when the frequency converter detects any thermal warning, for instance when the temperature exceeds the limit in the motor, the frequency converter, the brake resistor, or thermistor.

13-10 Comparator Operand		
Option:	Function:	
[82]	Mains out of range	The mains voltage is outside the specified voltage range.
[85]	Warning	If a warning is triggered, this operand gets the warning number.
[86]	Alarm (trip)	A trip alarm is active.
[87]	Alarm (trip lock)	A trip lock alarm is active.
[90]	Bus OK	Active communication (no timeout) via the serial communication port.
[91]	Torque limit & stop	If the frequency converter has received a stop signal and is at the torque limit, the signal is logic 0.
[92]	Brake fault (IGBT)	The brake IGBT is short-circuited.
[93]	Mech. brake control	The mechanical brake is active.
[94]	Safe stop active	
[100]	Comparator 0	The result of comparator 0.
[101]	Comparator 1	The result of comparator 1.
[102]	Comparator 2	The result of comparator 2.
[103]	Comparator 3	The result of comparator 3.
[104]	Comparator 4	The result of comparator 4.
[105]	Comparator 5	The result of comparator 5.
[110]	Logic rule 0	The result of logic rule 0.
[111]	Logic rule 1	The result of logic rule 1.
[112]	Logic rule 2	The result of logic rule 2.
[113]	Logic rule 3	The result of logic rule 3.
[114]	Logic rule 4	The result of logic rule 4.
[115]	Logic rule 5	The result of logic rule 5.
[120]	SL Time-out 0	The result of SLC timer 0.
[121]	SL Time-out 1	The result of SLC timer 1.
[122]	SL Time-out 2	The result of SLC timer 2.
[123]	SL Time-out 3	The result of SLC timer 3.
[124]	SL Time-out 4	The result of SLC timer 4.
[125]	SL Time-out 5	The result of SLC timer 5.
[126]	SL Time-out 6	The result of SLC timer 6.
[127]	SL Time-out 7	The result of SLC timer 7.
[130]	Digital input DI18	Digital input 18 (high=true).
[131]	Digital input DI19	Digital input 19 (high=true).

13-10 Comparator Operand		
Option:	Function:	
[132]	Digital input DI27	Digital input 27 (high=true).
[133]	Digital input DI29	Digital input 29 (high=true).
[134]	Digital input DI32	Digital input 32 (high=true).
[135]	Digital input DI33	Digital input 33 (high=true).
[150]	SL digital output A	Use the result of the SLC output A.
[151]	SL digital output B	Use the result of the SLC output B.
[152]	SL digital output C	Use the result of the SLC output C.
[153]	SL digital output D	Use the result of the SLC output D.
[154]	SL digital output E	Use the result of the SLC output E.
[155]	SL digital output F	Use the result of the SLC output F.
[160]	Relay 1	Relay 1 is active.
[161]	Relay 2	Relay 2 is active.
[162]	Relay 3	
[163]	Relay 4	
[164]	Relay 5	
[165]	Relay 6	
[166]	Relay 7	
[167]	Relay 8	
[168]	Relay 9	
[180]	Local reference active	Active when <i>parameter 3-13 Reference Site</i> is [2] <i>Local</i> or when <i>parameter 3-13 Reference Site</i> is [0] <i>Linked to hand/auto</i> , at the same time as the LCP is in hand-on mode.
[181]	Remote reference active	Active when <i>parameter 3-13 Reference Site</i> is [1] <i>Remote</i> or [0] <i>Linked to hand/auto</i> , while the LCP is in auto-on mode.
[182]	Start command	Active when there is an active start command and no stop command.
[183]	Drive stopped	A stop command (jog, stop, qstop, coast) is issued – and not from the SLC itself.
[185]	Drive in hand mode	Active when the frequency converter is in hand-on mode.
[186]	Drive in auto mode	Active when the frequency converter is in auto-on mode.
[187]	Start command given	

13-10 Comparator Operand		
Option:	Function:	
[190]	Digital input x30/2	
[191]	Digital input x30/3	
[192]	Digital input x30/4	
[193]	Digital input x46/1	
[194]	Digital input x46/3	
[195]	Digital input x46/5	
[196]	Digital input x46/7	
[197]	Digital input x46/9	
[198]	Digital input x46/11	
[199]	Digital input x46/13	
[222]	Homing Ok	<p>NOTICE! This option is available only with software version 48.20 and newer.</p> <p>Homing is completed with the selected homing function (<i>parameter 17-80 Homing Function</i>).</p>
[223]	On Target	<p>NOTICE! This option is available only with software version 48.20 and newer.</p> <p>Positioning is completed and the on target signal is sent when the actual position is within <i>parameter 3-05 On Reference Window</i> for the duration of <i>parameter 3-09 On Target Time</i> and the actual speed does not exceed <i>parameter 3-05 On Reference Window</i>.</p>
[224]	Position Error	<p>NOTICE! This option is available only with software version 48.20 and newer.</p> <p>The position error exceeds the value in <i>parameter 4-71 Maximum Position Error</i> for the time set in <i>parameter 4-72 Position Error Timeout</i>.</p>

13-10 Comparator Operand		
Option:	Function:	
[225]	Position Limit	<p>NOTICE!</p> <p>This option is available only with software version 48.20 and newer.</p> <p>The position is outside the limits set in <i>parameter 3-06 Minimum Position</i> and <i>parameter 3-07 Maximum Position</i>.</p>
[226]	Touch on Target	<p>NOTICE!</p> <p>This option is available only with software version 48.20 and newer.</p> <p>Target position is reached in touch probe position mode.</p>
[227]	Touch Activated	<p>NOTICE!</p> <p>This option is available only with software version 48.20 and newer.</p> <p>Touch probe positioning active. The frequency converter monitors the touch probe sensor input.</p>

13-11 Comparator Operator		
Option:	Function:	
		Select the operator to be used in the comparison. This is an array parameter containing comparator operators 0–5.
[0]	<	The result of the evaluation is true when the variable selected in <i>parameter 13-10 Comparator Operand</i> is smaller than the fixed value in <i>parameter 13-12 Comparator Value</i> . The result is false if the variable selected in <i>parameter 13-10 Comparator Operand</i> is greater than the fixed value in <i>parameter 13-12 Comparator Value</i> .
[1]	= (equal)	The result of the evaluation is true when the variable selected in <i>parameter 13-10 Comparator Operand</i> is approximately equal to the fixed value in <i>parameter 13-12 Comparator Value</i> .
[2]	>	Inverse logic of option [0] <.
[5]	TRUE longer than..	
[6]	FALSE longer than..	
[7]	TRUE shorter than..	

13-11 Comparator Operator		
Option:	Function:	
[8]	FALSE shorter than..	

13-12 Comparator Value		
Range:	Function:	
Array [6]		
Size related*	[-100000 - 100000]	Enter the trigger level for the variable that is monitored by this comparator. This is an array parameter containing comparator values 0–5.

3.13.3 RS Flip Flops

The reset/set flip flops hold the signal until set/reset.

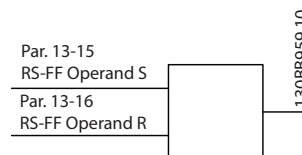

Figure 3.55 Reset/Set Flip Flops

2 parameters are used, and the output can be used in the logic rules and as events.

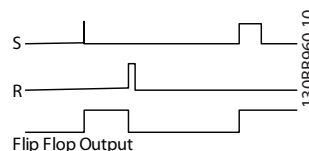

Figure 3.56 Flip Flop Outputs

The 2 operators can be selected from a long list. As a special case, the same digital input can be used as both set and reset, making it possible to use the same digital input as start/stop. The following settings can be used to set up the same digital input (for example, DI32) as start/stop.

Parameter	Setting	Notes
<i>Parameter 13-00 SL Controller Mode</i>	On	–
<i>Parameter 13-01 Start Event</i>	True	–
<i>Parameter 13-02 Stop Event</i>	False	–

Parameter	Setting	Notes
Parameter 13-40 Logic Rule Boolean 1 [0]	[37] Digital Input DI32	-
Parameter 13-42 Logic Rule Boolean 2 [0]	[2] Running	-
Parameter 13-41 Logic Rule Operator 1 [0]	[3] AND NOT	-
Parameter 13-40 Logic Rule Boolean 1 [1]	[37] Digital Input DI32	-
Parameter 13-42 Logic Rule Boolean 2 [1]	[2] Running	-
Parameter 13-41 Logic Rule Operator 1 [1]	[1] AND	-
Parameter 13-15 RS-FF Operand S [0]	[26] Logic rule 0	Output from parameter 13-41 Logic Rule Operator 1 [0].
Parameter 13-16 RS-FF Operand R [0]	[27] Logic rule 1	Output from parameter 13-41 Logic Rule Operator 1 [1].
Parameter 13-51 SL Controller Event [0]	[94] RS Flipflop 0	Output from parameter 13-15 RS-FF Operand S and parameter 13-16 RS-FF Operand R.
Parameter 13-52 SL Controller Action [0]	[22] Run	-
Parameter 13-51 SL Controller Event [1]	[27] Logic rule 1	-
Parameter 13-52 SL Controller Action [1]	[24] Stop	-

Table 3.26 Operators

13-15 RS-FF Operand S		
Option:	Function:	
[0]	False	
[1]	True	
[2]	Running	
[3]	In range	
[4]	On reference	
[5]	Torque limit	
[6]	Current Limit	
[7]	Out of current range	
[8]	Below I low	
[9]	Above I high	
[10]	Out of speed range	
[11]	Below speed low	
[12]	Above speed high	
[13]	Out of feedb. range	

13-15 RS-FF Operand S		
Option:	Function:	
[14]	Below feedb. low	
[15]	Above feedb. high	
[16]	Thermal warning	
[17]	Mains out of range	
[18]	Reversing	
[19]	Warning	
[20]	Alarm (trip)	
[21]	Alarm (trip lock)	
[22]	Comparator 0	
[23]	Comparator 1	
[24]	Comparator 2	
[25]	Comparator 3	
[26]	Logic rule 0	
[27]	Logic rule 1	
[28]	Logic rule 2	
[29]	Logic rule 3	
[30]	SL Time-out 0	
[31]	SL Time-out 1	
[32]	SL Time-out 2	
[33]	Digital input DI18	
[34]	Digital input DI19	
[35]	Digital input DI27	
[36]	Digital input DI29	
[37]	Digital input DI32	
[38]	Digital input DI33	
[39]	Start command	
[40]	Drive stopped	
[41]	Reset Trip	
[42]	Auto-reset Trip	
[43]	Ok key	[OK] is pressed. Only available on the graphical LCP.
[44]	Reset key	[Reset] is pressed. Only available on the graphical LCP.
[45]	Left key	[◀] is pressed. Only available on the graphical LCP.
[46]	Right key	[▶] is pressed. Only available on the graphical LCP.
[47]	Up key	[▲] is pressed. Only available on the graphical LCP.
[48]	Down key	[▼] is pressed. Only available on the graphical LCP.
[50]	Comparator 4	
[51]	Comparator 5	
[60]	Logic rule 4	
[61]	Logic rule 5	
[70]	SL Time-out 3	
[71]	SL Time-out 4	
[72]	SL Time-out 5	

13-15 RS-FF Operand S		
Option:	Function:	
[73]	SL Time-out 6	
[74]	SL Time-out 7	
[75]	Start command given	
[76]	Digital input x30/2	
[77]	Digital input x30/3	
[78]	Digital input x30/4	
[79]	Digital input x46/1	
[80]	Digital input x46/3	
[81]	Digital input x46/5	
[82]	Digital input x46/7	
[83]	Digital input x46/9	
[84]	Digital input x46/11	
[85]	Digital input x46/13	
[90]	ATEX ETR cur. warning	
[91]	ATEX ETR cur. alarm	
[92]	ATEX ETR freq. warning	
[93]	ATEX ETR freq. alarm	
[94]	RS Flipflop 0	
[95]	RS Flipflop 1	
[96]	RS Flipflop 2	
[97]	RS Flipflop 3	
[98]	RS Flipflop 4	
[99]	RS Flipflop 5	
[100]	RS Flipflop 6	
[101]	RS Flipflop 7	
[102]	Relay 1	
[103]	Relay 2	
[104]	Relay 3	X47/VLT® Extended Relay Card MCB 113.
[105]	Relay 4	X47/VLT® Extended Relay Card MCB 113.
[106]	Relay 5	X47/VLT® Extended Relay Card MCB 113.
[107]	Relay 6	X47/VLT® Extended Relay Card MCB 113.
[108]	Relay 7	X34/VLT® Relay Card MCB 105.
[109]	Relay 8	X34/VLT® Relay Card MCB 105.
[110]	Relay 9	X34/VLT® Relay Card MCB 105.
[222]	Homing Ok	NOTICE! This option is available only with software version 48.20 and newer.

13-15 RS-FF Operand S		
Option:	Function:	
		Homing is completed with the selected homing function (<i>parameter 17-80 Homing Function</i>).
[223]	On Target	NOTICE! This option is available only with software version 48.20 and newer. Positioning is completed and the on-target signal is sent when the actual position is within <i>parameter 3-05 On Reference Window</i> for the duration of <i>parameter 3-09 On Target Time</i> and the actual speed does not exceed <i>parameter 3-05 On Reference Window</i> .
[224]	Position Error	NOTICE! This option is available only with software version 48.20 and newer. The position error exceeds the value in <i>parameter 4-71 Maximum Position Error</i> for the time set in <i>parameter 4-72 Position Error Timeout</i> .
[225]	Position Limit	NOTICE! This option is available only with software version 48.20 and newer. The position is outside the limits set in <i>parameter 3-06 Minimum Position</i> and <i>parameter 3-07 Maximum Position</i> .
[226]	Touch on Target	NOTICE! This option is available only with software version 48.20 and newer. Target position is reached in touch probe position mode.

13-15 RS-FF Operand S		
Option:		Function:
[227]	Touch Activated	<p>NOTICE!</p> <p>This option is available only with software version 48.20 and newer.</p> <p>Touch probe positioning active. The frequency converter monitors the touch probe sensor input.</p>

13-16 RS-FF Operand R		
Option:		Function:
[0]	False	
[1]	True	
[2]	Running	
[3]	In range	
[4]	On reference	
[5]	Torque limit	
[6]	Current Limit	
[7]	Out of current range	
[8]	Below I low	
[9]	Above I high	
[10]	Out of speed range	
[11]	Below speed low	
[12]	Above speed high	
[13]	Out of feedb. range	
[14]	Below feedb. low	
[15]	Above feedb. high	
[16]	Thermal warning	
[17]	Mains out of range	
[18]	Reversing	
[19]	Warning	
[20]	Alarm (trip)	
[21]	Alarm (trip lock)	
[22]	Comparator 0	
[23]	Comparator 1	
[24]	Comparator 2	
[25]	Comparator 3	
[26]	Logic rule 0	
[27]	Logic rule 1	
[28]	Logic rule 2	
[29]	Logic rule 3	
[30]	SL Time-out 0	
[31]	SL Time-out 1	
[32]	SL Time-out 2	
[33]	Digital input DI18	
[34]	Digital input DI19	
[35]	Digital input DI27	
[36]	Digital input DI29	
[37]	Digital input DI32	

13-16 RS-FF Operand R		
Option:		Function:
[38]	Digital input DI33	
[39]	Start command	
[40]	Drive stopped	
[41]	Reset Trip	
[42]	Auto-reset Trip	
[43]	Ok key	[OK] is pressed. Only available on the graphical LCP.
[44]	Reset key	[Reset] is pressed. Only available on the graphical LCP.
[45]	Left key	[◀] is pressed. Only available on the graphical LCP.
[46]	Right key	[▶] is pressed. Only available on the graphical LCP.
[47]	Up key	[▲] is pressed. Only available on the graphical LCP.
[48]	Down key	[▼] is pressed. Only available on the graphical LCP.
[50]	Comparator 4	
[51]	Comparator 5	
[60]	Logic rule 4	
[61]	Logic rule 5	
[70]	SL Time-out 3	
[71]	SL Time-out 4	
[72]	SL Time-out 5	
[73]	SL Time-out 6	
[74]	SL Time-out 7	
[75]	Start command given	
[76]	Digital input x30/2	
[77]	Digital input x30/3	
[78]	Digital input x30/4	
[79]	Digital input x46/1	
[80]	Digital input x46/3	
[81]	Digital input x46/5	
[82]	Digital input x46/7	
[83]	Digital input x46/9	
[84]	Digital input x46/11	
[85]	Digital input x46/13	
[90]	ATEX ETR cur. warning	
[91]	ATEX ETR cur. alarm	
[92]	ATEX ETR freq. warning	
[93]	ATEX ETR freq. alarm	
[94]	RS Flipflop 0	
[95]	RS Flipflop 1	
[96]	RS Flipflop 2	
[97]	RS Flipflop 3	
[98]	RS Flipflop 4	

13-16 RS-FF Operand R		
Option:	Function:	
[99]	RS Flipflop 5	
[100]	RS Flipflop 6	
[101]	RS Flipflop 7	
[102]	Relay 1	
[103]	Relay 2	
[104]	Relay 3	X47/VLT® Extended Relay Card MCB 113.
[105]	Relay 4	X47/VLT® Extended Relay Card MCB 113.
[106]	Relay 5	X47/VLT® Extended Relay Card MCB 113.
[107]	Relay 6	X47/VLT® Extended Relay Card MCB 113.
[108]	Relay 7	X34/VLT® Relay Card MCB 105.
[109]	Relay 8	X34/VLT® Relay Card MCB 105.
[110]	Relay 9	X34/VLT® Relay Card MCB 105.
[222]	Homing Ok	<p>NOTICE! This option is available only with software version 48.20 and newer.</p> <p>Homing is completed with the selected homing function (<i>parameter 17-80 Homing Function</i>).</p>
[223]	On Target	<p>NOTICE! This option is available only with software version 48.20 and newer.</p> <p>Positioning is completed and the on-target signal is sent when the actual position is within <i>parameter 3-05 On Reference Window</i> for the duration of <i>parameter 3-09 On Target Time</i> and the actual speed does not exceed <i>parameter 3-05 On Reference Window</i>.</p>
[224]	Position Error	<p>NOTICE! This option is available only with software version 48.20 and newer.</p> <p>The position error exceeds the value in <i>parameter 4-71 Maximum Position Error</i> for the time set in</p>

13-16 RS-FF Operand R		
Option:	Function:	
		<i>parameter 4-72 Position Error Timeout.</i>
[225]	Position Limit	<p>NOTICE! This option is available only with software version 48.20 and newer.</p> <p>The position is outside the limits set in <i>parameter 3-06 Minimum Position</i> and <i>parameter 3-07 Maximum Position</i>.</p>
[226]	Touch on Target	<p>NOTICE! This option is available only with software version 48.20 and newer.</p> <p>Target position is reached in touch probe position mode.</p>
[227]	Touch Activated	<p>NOTICE! This option is available only with software version 48.20 and newer.</p> <p>Touch probe positioning active. The frequency converter monitors the touch probe sensor input.</p>

3.13.4 13-2* Timers

Use the result (true or false) from timers directly to define an event (see *parameter 13-51 SL Controller Event*), or as boolean input in a logic rule (see *parameter 13-40 Logic Rule Boolean 1*, *parameter 13-42 Logic Rule Boolean 2*, or *parameter 13-44 Logic Rule Boolean 3*). A timer is only false when started by an action (for example [29] *Start timer 1*) until the timer value entered in this parameter has elapsed. Then it becomes true again.

All parameters in this parameter group are array parameters with index 0–2. Select index 0 to program timer 0, select index 1 to program timer 1, and so on.

13-20 SL Controller Timer		
Range:	Function:	
0.000 N/A*	[0.000 - 0.000 N/A]	Enter the value to define the duration of the false output from the programmed timer. A timer is only false if it is started by an action (that is [29] <i>Start timer 1</i>) and until the given timer value has elapsed.

3.13.5 13-4* Logic Rules

Combine up to 3 boolean inputs (true/false inputs) from timers, comparators, digital inputs, status bits, and events using the logical operators AND, OR, and NOT. Select boolean inputs for the calculation in *parameter 13-40 Logic Rule Boolean 1*, *parameter 13-42 Logic Rule Boolean 2*, and *parameter 13-44 Logic Rule Boolean 3*. Define the operators used to logically combine the selected inputs in *parameter 13-41 Logic Rule Operator 1* and *parameter 13-43 Logic Rule Operator 2*.

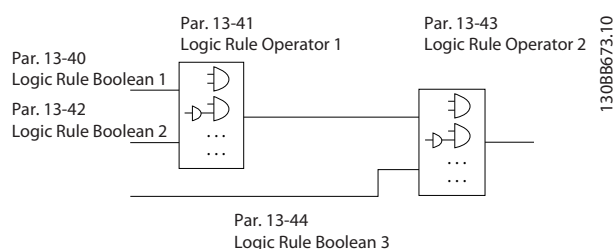

Figure 3.57 Logic Rules

Priority of calculation

The results of *parameter 13-40 Logic Rule Boolean 1*, *parameter 13-41 Logic Rule Operator 1*, and *parameter 13-42 Logic Rule Boolean 2* are calculated first. The outcome (true/false) of this calculation is combined with the settings of *parameter 13-43 Logic Rule Operator 2* and *parameter 13-44 Logic Rule Boolean 3*, yielding the final result (true/false) of the logic rule.

13-40 Logic Rule Boolean 1		
Option:	Function:	
[0]	False	Select the first boolean (true or false) input for the selected logic rule. See <i>parameter 13-01 Start Event</i> and <i>parameter 13-02 Stop Event</i> for more information.
[1]	True	
[2]	Running	
[3]	In range	
[4]	On reference	
[5]	Torque limit	
[6]	Current Limit	
[7]	Out of current range	
[8]	Below I low	
[9]	Above I high	
[10]	Out of speed range	
[11]	Below speed low	
[12]	Above speed high	

13-40 Logic Rule Boolean 1		
Option:	Function:	
[13]	Out of feedb. range	
[14]	Below feedb. low	
[15]	Above feedb. high	
[16]	Thermal warning	
[17]	Mains out of range	
[18]	Reversing	
[19]	Warning	
[20]	Alarm (trip)	
[21]	Alarm (trip lock)	
[22]	Comparator 0	
[23]	Comparator 1	
[24]	Comparator 2	
[25]	Comparator 3	
[26]	Logic rule 0	
[27]	Logic rule 1	
[28]	Logic rule 2	
[29]	Logic rule 3	
[30]	SL Time-out 0	
[31]	SL Time-out 1	
[32]	SL Time-out 2	
[33]	Digital input DI18	
[34]	Digital input DI19	
[35]	Digital input DI27	
[36]	Digital input DI29	
[37]	Digital input DI32	
[38]	Digital input DI33	
[39]	Start command	
[40]	Drive stopped	
[41]	Reset Trip	
[42]	Auto-reset Trip	
[43]	Ok key	[OK] is pressed. Only available on the graphical LCP.
[44]	Reset key	[Reset] is pressed. Only available on the graphical LCP.
[45]	Left key	[◀] is pressed. Only available on the graphical LCP.
[46]	Right key	[▶] is pressed. Only available on the graphical LCP.
[47]	Up key	[▲] is pressed. Only available on the graphical LCP.
[48]	Down key	[▼] is pressed. Only available on the graphical LCP.
[50]	Comparator 4	
[51]	Comparator 5	
[60]	Logic rule 4	
[61]	Logic rule 5	
[70]	SL Time-out 3	

13-40 Logic Rule Boolean 1		
Option:	Function:	
[71]	SL Time-out 4	
[72]	SL Time-out 5	
[73]	SL Time-out 6	
[74]	SL Time-out 7	
[75]	Start command given	
[76]	Digital input x30/2	
[77]	Digital input x30/3	
[78]	Digital input x30/4	
[79]	Digital input x46/1	
[80]	Digital input x46/3	
[81]	Digital input x46/5	
[82]	Digital input x46/7	
[83]	Digital input x46/9	
[84]	Digital input x46/11	
[85]	Digital input x46/13	
[90]	ATEX ETR cur. warning	Available if <i>parameter 1-90 Motor Thermal Protection</i> is set to [20] ATEX ETR or [21] Advanced ETR. If alarm 164, ATEX ETR cur.lim.alarm is active, the output is 1.
[91]	ATEX ETR cur. alarm	Available if <i>parameter 1-90 Motor Thermal Protection</i> is set to [20] ATEX ETR or [21] Advanced ETR. If alarm 166, ATEX ETR freq.lim.alarm is active, the output is 1.
[92]	ATEX ETR freq. warning	Available if <i>parameter 1-90 Motor Thermal Protection</i> is set to [20] ATEX ETR or [21] Advanced ETR. If alarm 163, ATEX ETR cur.lim.warning is active, the output is 1.
[93]	ATEX ETR freq. alarm	Available if <i>parameter 1-90 Motor Thermal Protection</i> is set to [20] ATEX ETR or [21] Advanced ETR. If warning 165, ATEX ETR freq.lim.warning is active, the output is 1.
[94]	RS Flipflop 0	See <i>parameter group 13-1* Comparators</i> .
[95]	RS Flipflop 1	See <i>parameter group 13-1* Comparators</i> .
[96]	RS Flipflop 2	See <i>parameter group 13-1* Comparators</i> .
[97]	RS Flipflop 3	See <i>parameter group 13-1* Comparators</i> .
[98]	RS Flipflop 4	See <i>parameter group 13-1* Comparators</i> .

13-40 Logic Rule Boolean 1		
Option:	Function:	
[99]	RS Flipflop 5	See <i>parameter group 13-1* Comparators</i> .
[100]	RS Flipflop 6	See <i>parameter group 13-1* Comparators</i> .
[101]	RS Flipflop 7	See <i>parameter group 13-1* Comparators</i> .
[102]	Relay 1	
[103]	Relay 2	
[104]	Relay 3	X47/VLT® Extended Relay Card MCB 113.
[105]	Relay 4	X47/VLT® Extended Relay Card MCB 113.
[106]	Relay 5	X47/VLT® Extended Relay Card MCB 113.
[107]	Relay 6	X47/VLT® Extended Relay Card MCB 113.
[108]	Relay 7	X34/VLT® Relay Card MCB 105.
[109]	Relay 8	X34/VLT® Relay Card MCB 105.
[110]	Relay 9	X34/VLT® Relay Card MCB 105.
[222]	Homing Ok	NOTICE! This option is available only with software version 48.20 and newer. Homing is completed with the selected homing function (<i>parameter 17-80 Homing Function</i>).
[223]	On Target	NOTICE! This option is available only with software version 48.20 and newer. Positioning is completed and the on target signal is sent when the actual position is within <i>parameter 3-05 On Reference Window</i> for the duration of <i>parameter 3-09 On Target Time</i> and the actual speed does not exceed <i>parameter 3-05 On Reference Window</i> .

13-40 Logic Rule Boolean 1		
Option:	Function:	
[224]	Position Error	<p>NOTICE!</p> <p>This option is available only with software version 48.20 and newer.</p> <p>The position error exceeds the value in <i>parameter 4-71 Maximum Position Error</i> for the time set in <i>parameter 4-72 Position Error Timeout</i>.</p>
[225]	Position Limit	<p>NOTICE!</p> <p>This option is available only with software version 48.20 and newer.</p> <p>The position is outside the limits set in <i>parameter 3-06 Minimum Position</i> and <i>parameter 3-07 Maximum Position</i>.</p>
[226]	Touch on Target	<p>NOTICE!</p> <p>This option is available only with software version 48.20 and newer.</p> <p>Target position is reached in touch probe position mode.</p>
[227]	Touch Activated	<p>NOTICE!</p> <p>This option is available only with software version 48.20 and newer.</p> <p>Touch probe positioning active. The frequency converter monitors the touch probe sensor input.</p>

13-41 Logic Rule Operator 1		
Array [6]		
Option:	Function:	
[0]	DISABLED	Ignores: <ul style="list-style-type: none"> Parameter 13-42 Logic Rule Boolean 2. Parameter 13-43 Logic Rule Operator 2. Parameter 13-44 Logic Rule Boolean 3.

13-41 Logic Rule Operator 1		
Array [6]		
Option:	Function:	
[1]	AND	Evaluates the expression [13-40] AND [13-42].
[2]	OR	Evaluates the expression [13-40] OR [13-42].
[3]	AND NOT	Evaluates the expression [13-40] AND NOT [13-42].
[4]	OR NOT	Evaluates the expression [13-40] OR NOT [13-42].
[5]	NOT AND	Evaluates the expression NOT [13-40] AND [13-42].
[6]	NOT OR	Evaluates the expression NOT [13-40] OR [13-42].
[7]	NOT AND NOT	Evaluates the expression NOT [13-40] AND NOT [13-42].
[8]	NOT OR NOT	Evaluates the expression NOT [13-40] OR NOT [13-42].

13-42 Logic Rule Boolean 2		
Option:	Function:	
[0]	False	Select the 2 nd boolean (true or false) input for the selected logic rule. See <i>parameter 13-01 Start Event</i> and <i>parameter 13-02 Stop Event</i> for more information.
[1]	True	
[2]	Running	
[3]	In range	
[4]	On reference	
[5]	Torque limit	
[6]	Current Limit	
[7]	Out of current range	
[8]	Below I low	
[9]	Above I high	
[10]	Out of speed range	
[11]	Below speed low	
[12]	Above speed high	
[13]	Out of feedb. range	
[14]	Below feedb. low	
[15]	Above feedb. high	
[16]	Thermal warning	
[17]	Mains out of range	
[18]	Reversing	
[19]	Warning	
[20]	Alarm (trip)	
[21]	Alarm (trip lock)	

13-42 Logic Rule Boolean 2		
Option:	Function:	
[22]	Comparator 0	
[23]	Comparator 1	
[24]	Comparator 2	
[25]	Comparator 3	
[26]	Logic rule 0	
[27]	Logic rule 1	
[28]	Logic rule 2	
[29]	Logic rule 3	
[30]	SL Time-out 0	
[31]	SL Time-out 1	
[32]	SL Time-out 2	
[33]	Digital input DI18	
[34]	Digital input DI19	
[35]	Digital input DI27	
[36]	Digital input DI29	
[37]	Digital input DI32	
[38]	Digital input DI33	
[39]	Start command	
[40]	Drive stopped	
[41]	Reset Trip	
[42]	Auto-reset Trip	
[43]	Ok key	[OK] is pressed. Only available on the graphical LCP.
[44]	Reset key	[Reset] is pressed. Only available on the graphical LCP.
[45]	Left key	[←] is pressed. Only available on the graphical LCP.
[46]	Right key	[→] is pressed. Only available on the graphical LCP.
[47]	Up key	[▲] is pressed. Only available on the graphical LCP.
[48]	Down key	[▼] is pressed. Only available on the graphical LCP.
[50]	Comparator 4	
[51]	Comparator 5	
[60]	Logic rule 4	
[61]	Logic rule 5	
[70]	SL Time-out 3	
[71]	SL Time-out 4	
[72]	SL Time-out 5	
[73]	SL Time-out 6	
[74]	SL Time-out 7	
[75]	Start command given	
[76]	Digital input x30/2	
[77]	Digital input x30/3	
[78]	Digital input x30/4	

13-42 Logic Rule Boolean 2		
Option:	Function:	
[79]	Digital input x46/1	
[80]	Digital input x46/3	
[81]	Digital input x46/5	
[82]	Digital input x46/7	
[83]	Digital input x46/9	
[84]	Digital input x46/11	
[85]	Digital input x46/13	
[90]	ATEX ETR cur. warning	Available if <i>parameter 1-90 Motor Thermal Protection</i> is set to [20] ATEX ETR or [21] Advanced ETR. If alarm 164, ATEX ETR cur.lim.alarm is active, the output is 1.
[91]	ATEX ETR cur. alarm	Available if <i>parameter 1-90 Motor Thermal Protection</i> is set to [20] ATEX ETR or [21] Advanced ETR. If alarm 166, ATEX ETR freq.lim.alarm is active, the output is 1.
[92]	ATEX ETR freq. warning	Available if <i>parameter 1-90 Motor Thermal Protection</i> is set to [20] ATEX ETR or [21] Advanced ETR. If alarm 163, ATEX ETR cur.lim.warning is active, the output is 1.
[93]	ATEX ETR freq. alarm	Available if <i>parameter 1-90 Motor Thermal Protection</i> is set to [20] ATEX ETR or [21] Advanced ETR. If warning 165, ATEX ETR freq.lim.warning is active, the output is 1.
[94]	RS Flipflop 0	See <i>parameter group 13-1* Comparators</i> .
[95]	RS Flipflop 1	See <i>parameter group 13-1* Comparators</i> .
[96]	RS Flipflop 2	See <i>parameter group 13-1* Comparators</i> .
[97]	RS Flipflop 3	See <i>parameter group 13-1* Comparators</i> .
[98]	RS Flipflop 4	See <i>parameter group 13-1* Comparators</i> .
[99]	RS Flipflop 5	See <i>parameter group 13-1* Comparators</i> .
[100]	RS Flipflop 6	See <i>parameter group 13-1* Comparators</i> .
[101]	RS Flipflop 7	See <i>parameter group 13-1* Comparators</i> .
[102]	Relay 1	
[103]	Relay 2	

13-42 Logic Rule Boolean 2		
Option:	Function:	
[104] Relay 3	X47/VLT® Extended Relay Card MCB 113.	
[105] Relay 4	X47/VLT® Extended Relay Card MCB 113.	
[106] Relay 5	X47/VLT® Extended Relay Card MCB 113.	
[107] Relay 6	X47/VLT® Extended Relay Card MCB 113.	
[108] Relay 7	X34/VLT® Relay Card MCB 105.	
[109] Relay 8	X34/VLT® Relay Card MCB 105.	
[110] Relay 9	X34/VLT® Relay Card MCB 105.	
[222] Homing Ok	<p>NOTICE! This option is available only with software version 48.20 and newer.</p> <p>Homing is completed with the selected homing function (<i>parameter 17-80 Homing Function</i>).</p>	
[223] On Target	<p>NOTICE! This option is available only with software version 48.20 and newer.</p> <p>Positioning is completed and the on-target signal is sent when the actual position is within <i>parameter 3-05 On Reference Window</i> for the duration of <i>parameter 3-09 On Target Time</i> and the actual speed does not exceed <i>parameter 3-05 On Reference Window</i>.</p>	
[224] Position Error	<p>NOTICE! This option is available only with software version 48.20 and newer.</p> <p>The position error exceeds the value in <i>parameter 4-71 Maximum Position Error</i> for the time set in <i>parameter 4-72 Position Error Timeout</i>.</p>	
[225] Position Limit	<p>NOTICE! This option is available only with software version 48.20 and newer.</p>	

13-42 Logic Rule Boolean 2		
Option:	Function:	
		The position is outside the limits set in <i>parameter 3-06 Minimum Position</i> and <i>parameter 3-07 Maximum Position</i> .
[226] Touch on Target	<p>NOTICE! This option is available only with software version 48.20 and newer.</p> <p>Target position is reached in touch probe position mode.</p>	
[227] Touch Activated	<p>NOTICE! This option is available only with software version 48.20 and newer.</p> <p>Touch probe positioning active. The frequency converter monitors the touch probe sensor input.</p>	

13-43 Logic Rule Operator 2		
Array [6]		
Option:	Function:	
		<p>Select the 2nd logical operator to be used on the boolean input calculated in:</p> <ul style="list-style-type: none"> Parameter 13-40 Logic Rule Boolean 1. Parameter 13-41 Logic Rule Operator 1. Parameter 13-42 Logic Rule Boolean 2. <p>[13-44] signifies the boolean input of <i>parameter 13-44 Logic Rule Boolean 3</i>. [13-40/13-42] signifies the boolean input calculated in:</p> <ul style="list-style-type: none"> Parameter 13-40 Logic Rule Boolean 1. Parameter 13-41 Logic Rule Operator 1. Parameter 13-42 Logic Rule Boolean 2.
[0] DISABLED	Select this option to ignore <i>parameter 13-44 Logic Rule Boolean 3</i> .	
[1] AND		
[2] OR		
[3] AND NOT		
[4] OR NOT		
[5] NOT AND		
[6] NOT OR		
[7] NOT AND NOT		
[8] NOT OR NOT		

13-44 Logic Rule Boolean 3		
Array [6]		
Option:	Function:	
[0]	False	Select the 3 rd boolean (true or false) input for the selected logic rule. See <i>parameter 13-01 Start Event</i> (options [0] False–[61] Logic rule 5) and <i>parameter 13-02 Stop Event</i> (options [70] SL Time-out 3–[75] Start command given) for more information.
[1]	True	
[2]	Running	
[3]	In range	
[4]	On reference	
[5]	Torque limit	
[6]	Current Limit	
[7]	Out of current range	
[8]	Below I low	
[9]	Above I high	
[10]	Out of speed range	
[11]	Below speed low	
[12]	Above speed high	
[13]	Out of feedb. range	
[14]	Below feedb. low	
[15]	Above feedb. high	
[16]	Thermal warning	
[17]	Mains out of range	
[18]	Reversing	
[19]	Warning	
[20]	Alarm (trip)	
[21]	Alarm (trip lock)	
[22]	Comparator 0	
[23]	Comparator 1	
[24]	Comparator 2	
[25]	Comparator 3	
[26]	Logic rule 0	
[27]	Logic rule 1	
[28]	Logic rule 2	
[29]	Logic rule 3	
[30]	SL Time-out 0	
[31]	SL Time-out 1	
[32]	SL Time-out 2	
[33]	Digital input DI18	
[34]	Digital input DI19	
[35]	Digital input DI27	
[36]	Digital input DI29	
[37]	Digital input DI32	

13-44 Logic Rule Boolean 3		
Array [6]		
Option:	Function:	
[38]	Digital input DI33	
[39]	Start command	
[40]	Drive stopped	
[41]	Reset Trip	
[42]	Auto-reset Trip	
[43]	Ok key	[OK] is pressed. Only available on the graphical LCP.
[44]	Reset key	[Reset] is pressed. Only available on the graphical LCP.
[45]	Left key	[◀] is pressed. Only available on the graphical LCP.
[46]	Right key	[▶] is pressed. Only available on the graphical LCP.
[47]	Up key	[▲] is pressed. Only available on the graphical LCP.
[48]	Down key	[▼] is pressed. Only available on the graphical LCP.
[50]	Comparator 4	
[51]	Comparator 5	
[60]	Logic rule 4	
[61]	Logic rule 5	
[70]	SL Time-out 3	
[71]	SL Time-out 4	
[72]	SL Time-out 5	
[73]	SL Time-out 6	
[74]	SL Time-out 7	
[75]	Start command given	
[76]	Digital input x30/2	
[77]	Digital input x30/3	
[78]	Digital input x30/4	
[79]	Digital input x46/1	
[80]	Digital input x46/3	
[81]	Digital input x46/5	
[82]	Digital input x46/7	
[83]	Digital input x46/9	
[84]	Digital input x46/11	
[85]	Digital input x46/13	
[90]	ATEX ETR cur. warning	Available if <i>parameter 1-90 Motor Thermal Protection</i> is set to [20] ATEX ETR or [21] Advanced ETR. If alarm 164, ATEX ETR cur.lim.alarm is active, the output is 1.

13-44 Logic Rule Boolean 3		
Array [6]		
Option:	Function:	
[91]	ATEX ETR cur. alarm	Available if <i>parameter 1-90 Motor Thermal Protection</i> is set to [20] ATEX ETR or [21] Advanced ETR. If <i>alarm 166, ATEX ETR freq.lim.alarm</i> is active, the output is 1.
[92]	ATEX ETR freq. warning	Available if <i>parameter 1-90 Motor Thermal Protection</i> is set to [20] ATEX ETR or [21] Advanced ETR. If <i>alarm 163, ATEX ETR cur.lim.warning</i> is active, the output is 1.
[93]	ATEX ETR freq. alarm	Available if <i>parameter 1-90 Motor Thermal Protection</i> is set to [20] ATEX ETR or [21] Advanced ETR]. If <i>warning 165, ATEX ETR freq.lim.warning</i> is active, the output is 1.
[94]	RS Flipflop 0	See <i>parameter group 13-1* Comparators</i> .
[95]	RS Flipflop 1	See <i>parameter group 13-1* Comparators</i> .
[96]	RS Flipflop 2	See <i>parameter group 13-1* Comparators</i> .
[97]	RS Flipflop 3	See <i>parameter group 13-1* Comparators</i> .
[98]	RS Flipflop 4	See <i>parameter group 13-1* Comparators</i> .
[99]	RS Flipflop 5	See <i>parameter group 13-1* Comparators</i> .
[100]	RS Flipflop 6	See <i>parameter group 13-1* Comparators</i> .
[101]	RS Flipflop 7	See <i>parameter group 13-1* Comparators</i> .
[102]	Relay 1	
[103]	Relay 2	
[104]	Relay 3	X47/VLT® Extended Relay Card MCB 113.
[105]	Relay 4	X47/VLT® Extended Relay Card MCB 113.
[106]	Relay 5	X47/VLT® Extended Relay Card MCB 113.
[107]	Relay 6	X47/VLT® Extended Relay Card MCB 113.
[108]	Relay 7	X34/VLT® Relay Card MCB 105.
[109]	Relay 8	X34/VLT® Relay Card MCB 105.
[110]	Relay 9	X34/VLT® Relay Card MCB 105.

13-44 Logic Rule Boolean 3		
Array [6]		
Option:	Function:	
[222]	Homing Ok	NOTICE! This option is available only with software version 48.20 and newer. Homing is completed with the selected homing function (<i>parameter 17-80 Homing Function</i>).
[223]	On Target	NOTICE! This option is available only with software version 48.20 and newer. Positioning is completed and the on-target signal is sent when the actual position is within <i>parameter 3-05 On Reference Window</i> for the duration of <i>parameter 3-09 On Target Time</i> and the actual speed does not exceed <i>parameter 3-05 On Reference Window</i> .
[224]	Position Error	NOTICE! This option is available only with software version 48.20 and newer. The position error exceeds the value in <i>parameter 4-71 Maximum Position Error</i> for the time set in <i>parameter 4-72 Position Error Timeout</i> .
[225]	Position Limit	NOTICE! This option is available only with software version 48.20 and newer. The position is outside the limits set in <i>parameter 3-06 Minimum Position</i> and <i>parameter 3-07 Maximum Position</i> .
[226]	Touch on Target	NOTICE! This option is available only with software version 48.20 and newer. Target position is reached in touch probe position mode.

13-44 Logic Rule Boolean 3		
Array [6]		
Option:		Function:
[227]	Touch Activated	<p>NOTICE!</p> <p>This option is available only with software version 48.20 and newer.</p> <p>Touch probe positioning active. The frequency converter monitors the touch probe sensor input.</p>

3.13.6 13-5* States

13-51 SL Controller Event		
Option:		Function:
[0]	False	Select the boolean input (true or false) to define the smart logic controller event. See <i>parameter 13-01 Start Event</i> (options [0] False–[61] Logic rule 5) and <i>parameter 13-02 Stop Event</i> (options [70] SL Time-out 3–[74] SL Time-out 7) for more information.
[1]	True	
[2]	Running	
[3]	In range	
[4]	On reference	
[5]	Torque limit	
[6]	Current Limit	
[7]	Out of current range	
[8]	Below I low	
[9]	Above I high	
[10]	Out of speed range	
[11]	Below speed low	
[12]	Above speed high	
[13]	Out of feedb. range	
[14]	Below feedb. low	
[15]	Above feedb. high	
[16]	Thermal warning	
[17]	Mains out of range	
[18]	Reversing	
[19]	Warning	
[20]	Alarm (trip)	
[21]	Alarm (trip lock)	
[22]	Comparator 0	
[23]	Comparator 1	
[24]	Comparator 2	

13-51 SL Controller Event		
Option:		Function:
[25]	Comparator 3	
[26]	Logic rule 0	
[27]	Logic rule 1	
[28]	Logic rule 2	
[29]	Logic rule 3	
[30]	SL Time-out 0	
[31]	SL Time-out 1	
[32]	SL Time-out 2	
[33]	Digital input DI18	
[34]	Digital input DI19	
[35]	Digital input DI27	
[36]	Digital input DI29	
[37]	Digital input DI32	
[38]	Digital input DI33	
[39]	Start command	
[40]	Drive stopped	
[41]	Reset Trip	
[42]	Auto-reset Trip	
[43]	Ok key	[OK] is pressed. Only available on the graphical LCP.
[44]	Reset key	[Reset] is pressed. Only available on the graphical LCP.
[45]	Left key	[◀] is pressed. Only available on the graphical LCP.
[46]	Right key	[▶] is pressed. Only available on the graphical LCP.
[47]	Up key	[▲] is pressed. Only available on the graphical LCP.
[48]	Down key	[▼] is pressed. Only available on the graphical LCP.
[50]	Comparator 4	
[51]	Comparator 5	
[60]	Logic rule 4	
[61]	Logic rule 5	
[70]	SL Time-out 3	
[71]	SL Time-out 4	
[72]	SL Time-out 5	
[73]	SL Time-out 6	
[74]	SL Time-out 7	
[75]	Start command given	
[76]	Digital input x30/2	
[77]	Digital input x30/3	
[78]	Digital input x30/4	
[79]	Digital input x46/1	
[80]	Digital input x46/3	
[81]	Digital input x46/5	

13-51 SL Controller Event		
Option:	Function:	
[82]	Digital input x46/7	
[83]	Digital input x46/9	
[84]	Digital input x46/11	
[85]	Digital input x46/13	
[90]	ATEX ETR cur. warning	Available if <i>parameter 1-90 Motor Thermal Protection</i> is set to [20] ATEX ETR or [21] Advanced ETR. If alarm 164, ATEX ETR cur.lim.alarm is active, the output is 1.
[91]	ATEX ETR cur. alarm	Available if <i>parameter 1-90 Motor Thermal Protection</i> is set to [20] ATEX ETR or [21] Advanced ETR. If alarm 166, ATEX ETR freq.lim.alarm is active, the output is 1.
[92]	ATEX ETR freq. warning	Available if <i>parameter 1-90 Motor Thermal Protection</i> is set to [20] ATEX ETR or [21] Advanced ETR. If alarm 163, ATEX ETR cur.lim.warning is active, the output is 1.
[93]	ATEX ETR freq. alarm	Available if <i>parameter 1-90 Motor Thermal Protection</i> is set to [20] ATEX ETR or [21] Advanced ETR. If warning 165, ATEX ETR freq.lim.warning is active, the output is 1.
[94]	RS Flipflop 0	See chapter 3.13.2 13-1* Comparators.
[95]	RS Flipflop 1	See chapter 3.13.2 13-1* Comparators.
[96]	RS Flipflop 2	See chapter 3.13.2 13-1* Comparators.
[97]	RS Flipflop 3	See chapter 3.13.2 13-1* Comparators.
[98]	RS Flipflop 4	See chapter 3.13.2 13-1* Comparators.
[99]	RS Flipflop 5	See chapter 3.13.2 13-1* Comparators.
[100]	RS Flipflop 6	See chapter 3.13.2 13-1* Comparators.
[101]	RS Flipflop 7	See chapter 3.13.2 13-1* Comparators.
[102]	Relay 1	
[103]	Relay 2	
[104]	Relay 3	X47/VLT® Extended Relay Card MCB 113.
[105]	Relay 4	X47/VLT® Extended Relay Card MCB 113.
[106]	Relay 5	X47/VLT® Extended Relay Card MCB 113.
[107]	Relay 6	X47/VLT® Extended Relay Card MCB 113.
[108]	Relay 7	X34/VLT® Relay Card MCB 105.

13-51 SL Controller Event		
Option:	Function:	
[109]	Relay 8	X34/VLT® Relay Card MCB 105.
[110]	Relay 9	X34/VLT® Relay Card MCB 105.
[222]	Homing Ok	NOTICE! This option is available only with software version 48.20 and newer. Homing is completed with the selected homing function (<i>parameter 17-80 Homing Function</i>).
[223]	On Target	NOTICE! This option is available only with software version 48.20 and newer. Positioning is completed and the on-target signal is sent when the actual position is within <i>parameter 3-05 On Reference Window</i> for the duration of <i>parameter 3-09 On Target Time</i> and the actual speed does not exceed <i>parameter 3-05 On Reference Window</i> .
[224]	Position Error	NOTICE! This option is available only with software version 48.20 and newer. The position error exceeds the value in <i>parameter 4-71 Maximum Position Error</i> for the time set in <i>parameter 4-72 Position Error Timeout</i> .
[225]	Position Limit	NOTICE! This option is available only with software version 48.20 and newer. The position is outside the limits set in <i>parameter 3-06 Minimum Position</i> and <i>parameter 3-07 Maximum Position</i> .
[226]	Touch on Target	NOTICE! This option is available only with software version 48.20 and newer. Target position is reached in touch probe position mode.

13-51 SL Controller Event		
Option:	Function:	
[227]	Touch Activated	<p>NOTICE!</p> <p>This option is available only with software version 48.20 and newer.</p> <p>Touch probe positioning active. The frequency converter monitors the touch probe sensor input.</p>

13-52 SL Controller Action		
Option:	Function:	
		Select the action corresponding to the SLC event. Actions are executed when the corresponding event (defined in <i>parameter 13-51 SL Controller Event</i>) is evaluated as true.
[0]	DISABLED	
[1]	No action	
[2]	Select set-up 1	Changes the active set-up (<i>parameter 0-10 Active Set-up</i>) to 1. If the set-up is changed, it merges with other set-up commands coming from either the digital inputs or via a fieldbus.
[3]	Select set-up 2	Changes the active set-up (<i>parameter 0-10 Active Set-up</i>) to 2. If the set-up is changed, it merges with other set-up commands coming from either the digital inputs or via a fieldbus.
[4]	Select set-up 3	Changes the active set-up (<i>parameter 0-10 Active Set-up</i>) to 3. If the set-up is changed, it merges with other set-up commands coming from either the digital inputs or via a fieldbus.
[5]	Select set-up 4	Changes the active set-up (<i>parameter 0-10 Active Set-up</i>) to 4. If the set-up is changed, it merges with other set-up commands coming from either the digital inputs or via a fieldbus.
[10]	Select preset ref 0	Selects preset reference 0. If the active preset reference is changed, it merges with other preset reference commands coming from either the digital inputs or via a fieldbus.
[11]	Select preset ref 1	Selects preset reference 1. If the active preset reference is changed, it merges with other preset reference commands coming from either the digital inputs or via a fieldbus.

13-52 SL Controller Action		
Option:	Function:	
[12]	Select preset ref 2	Selects preset reference 2. If the active preset reference is changed, it merges with other preset reference commands coming from either the digital inputs or via a fieldbus.
[13]	Select preset ref 3	Selects preset reference 3. If the active preset reference is changed, it merges with other preset reference commands coming from either the digital inputs or via a fieldbus.
[14]	Select preset ref 4	Selects preset reference 4. If the active preset reference is changed, it merges with other preset reference commands coming from either the digital inputs or via a fieldbus.
[15]	Select preset ref 5	Selects preset reference 5. If the active preset reference is changed, it merges with other preset reference commands coming from either the digital inputs or via a fieldbus.
[16]	Select preset ref 6	Selects preset reference 6. If the active preset reference is changed, it merges with other preset reference commands coming from either the digital inputs or via a fieldbus.
[17]	Select preset ref 7	Selects preset reference 7. If the active preset reference is changed, it merges with other preset reference commands coming from either the digital inputs or via a fieldbus.
[18]	Select ramp 1	Selects ramp 1.
[19]	Select ramp 2	Selects ramp 2.
[20]	Select ramp 3	Selects ramp 3.
[21]	Select ramp 4	Selects ramp 4.
[22]	Run	Issues a start command to the frequency converter.
[23]	Run reverse	Issues a start reverse command to the frequency converter.
[24]	Stop	Issues a stop command to the frequency converter.
[25]	Qstop	Issues a quick stop command to the frequency converter.
[26]	Dcstop	Issues a DC stop command to the frequency converter.

13-52 SL Controller Action		
Option:	Function:	
[27]	Coast	The frequency converter coasts immediately. All stop commands including the coast command stop the SLC.
[28]	Freeze output	Freezes the output frequency of the frequency converter.
[29]	Start timer 0	Starts timer 0, see <i>parameter 13-20 SL Controller Timer</i> for further description.
[30]	Start timer 1	Starts timer 1, see <i>parameter 13-20 SL Controller Timer</i> for further description.
[31]	Start timer 2	Starts timer 2, see <i>parameter 13-20 SL Controller Timer</i> for further description.
[32]	Set digital out A low	Any output with smart logic output A is low.
[33]	Set digital out B low	Any output with smart logic output B is low.
[34]	Set digital out C low	Any output with smart logic output C is low.
[35]	Set digital out D low	Any output with smart logic output D is low.
[36]	Set digital out E low	Any output with smart logic output E is low.
[37]	Set digital out F low	Any output with smart logic output F is low.
[38]	Set digital out A high	Any output with smart logic output A is high.
[39]	Set digital out B high	Any output with smart logic output B is high.
[40]	Set digital out C high	Any output with smart logic output C is high.
[41]	Set digital out D high	Any output with smart logic output D is high.
[42]	Set digital out E high	Any output with smart logic output E is high.
[43]	Set digital out F high	Any output with smart logic output F is high.
[60]	Reset Counter A	Resets counter A to 0.
[61]	Reset Counter B	Resets counter B to 0.
[70]	Start timer 3	Starts timer 3, see <i>parameter 13-20 SL Controller Timer</i> for further description.
[71]	Start timer 4	Starts timer 4, see <i>parameter 13-20 SL Controller Timer</i> for further description.
[72]	Start timer 5	Starts timer 5, see <i>parameter 13-20 SL Controller Timer</i> for further description.

13-52 SL Controller Action		
Option:	Function:	
[73]	Start timer 6	Starts timer 6, see <i>parameter 13-20 SL Controller Timer</i> for further description.
[74]	Start timer 7	Starts timer 7, see <i>parameter 13-20 SL Controller Timer</i> for further description.
[120]	Start Homing	<p>NOTICE! This option is available only with software version 48.20 and newer.</p> <p>Activates the homing mode and starts the homing function selected in <i>parameter 17-80 Homing Function</i>. Must remain active until the homing is completed otherwise the homing is aborted.</p>
[121]	Stop Homing	<p>NOTICE! This option is available only with software version 48.20 and newer.</p> <p>Deactivates the homing mode, an active homing function is aborted if the homing is not completed.</p>
[122]	Enable Reference	<p>NOTICE! This option is available only with software version 48.20 and newer.</p> <p>Sets the enable reference mode.</p>
[123]	Disable Reference	<p>NOTICE! This option is available only with software version 48.20 and newer.</p> <p>Disables the enable reference mode.</p>
[124]	Relative Position	<p>NOTICE! This option is available only with software version 48.20 and newer.</p> <p>Selects the relative position mode instead of the absolute position mode.</p>
[125]	Absolute Position	<p>NOTICE! This option is available only with software version 48.20 and newer.</p> <p>Selects the absolute position mode instead of the relative position mode.</p>

13-52 SL Controller Action		
Option:	Function:	
[126] Activate Touch	NOTICE! This option is available only with software version 48.20 and newer. Activates the touch probe positioning mode.	
[127] Deactivate Touch	NOTICE! This option is available only with software version 48.20 and newer. Deactivates the touch probe positioning mode.	
[128] Target Inverse	NOTICE! This option is available only with software version 48.20 and newer. Changes the sign of the active target position value.	
[129] Target	NOTICE! This option is available only with software version 48.20 and newer. The active target position is not changed.	
[130] Act. Speed Mode	NOTICE! This option is available only with software version 48.20 and newer. Activates the speed mode when option [9] Positioning or option [10] Synchronisation is selected in parameter 1-00 Configuration Mode.	
[131] Deact. Speed Mode	NOTICE! This option is available only with software version 48.20 and newer. Deactivates the speed mode and activates the option selected in parameter 1-00 Configuration Mode.	

3.13.7 13-9* User-defined Alerts and Readouts

Parameters in this group allow the configuration of application-specific messages, warnings, and alarms. Use the following parameters to configure the frequency converter to show a message and perform an action when a specific event occurs:

- *Parameter 13-90 Alert Trigger* – the event that triggers the user-defined action and message.
- *Parameter 13-91 Alert Action* – the action that the frequency converter performs when the event defined in *parameter 13-90 Alert Trigger* occurs.
- *Parameter 13-92 Alert Text* – the text that the frequency converter shows in the display when the event defined in *parameter 13-90 Alert Trigger* occurs.

For example, consider the following use case:

If there is an active signal on digital input 32, the frequency converter shows the message *Valve 5 open* in the display and ramps down to a stop.

To achieve this configuration, make the following settings:

- *Parameter 13-90 Alert Trigger* = [37] Digital input DI32.
- *Parameter 13-91 Alert Action* = [5] Stop & warning.
- *Parameter 13-92 Alert Text* = Valve 5 open.

13-90 Alert Trigger		
Array [10]		
Select the event that triggers the user-defined action and message.		
Option:	Function:	
[0] *	False	
[1]	True	
[18]	Reversing	
[22]	Comparator 0	
[23]	Comparator 1	
[24]	Comparator 2	
[25]	Comparator 3	
[26]	Logic rule 0	
[27]	Logic rule 1	
[28]	Logic rule 2	
[29]	Logic rule 3	
[30]	SL Time-out 0	
[31]	SL Time-out 1	
[32]	SL Time-out 2	
[33]	Digital input DI18	
[34]	Digital input DI19	
[35]	Digital input DI27	
[36]	Digital input DI29	
[37]	Digital input DI32	

13-90 Alert Trigger		
Array [10] Select the event that triggers the user-defined action and message.		
Option:		Function:
[38]	Digital input DI33	
[50]	Comparator 4	
[51]	Comparator 5	
[60]	Logic rule 4	
[61]	Logic rule 5	
[70]	SL Time-out 3	
[71]	SL Time-out 4	
[72]	SL Time-out 5	
[73]	SL Time-out 6	
[74]	SL Time-out 7	
[90]	ECB Drive Mode	
[91]	ECB Bypass Mode	

13-91 Alert Action		
Array [10] Select the action that the frequency converter performs when the event defined in <i>parameter 13-90 Alert Trigger</i> occurs.		
Option:		Function:
[0] *	Info	
[1]	Warning	
[2]	Freeze output	
[3]	Freeze output & warn	
[4]	Stop	
[5]	Stop & warning	
[6]	Jogging	
[7]	Jogging & warning	
[8]	Max speed	
[9]	Max speed & warn	
[10]	Stop and trip	
[11]	Stop and trip w manual reset	
[12]	Trip	
[13]	Trip w manual reset	
[14]	Trip Lock	

13-92 Alert Text		
Range:		Function:
Size related*	[0 - 20]	Array [10] Enter the text that the frequency converter shows in the display when the event defined in <i>parameter 13-90 Alert Trigger</i> occurs.

13-97 Alert Alarm Word		
Range:		Function:
0*	[0 - 4294967295]	Shows the alarm word of a user-defined alarm in hex code.

13-98 Alert Warning Word		
Range:		Function:
0*	[0 - 4294967295]	Shows the warning word of a user-defined alarm in hex code.

13-99 Alert Status Word		
Range:		Function:
0*	[0 - 4294967295]	Shows the status word of a user-defined alarm in hex code.

3.14 Parameters: 14-** Special Functions

3.14.1 14-0* Inverter Switching

3

14-00 Switching Pattern		
Option:	Function:	
		Select the switching pattern: 60° AVM or SFAVM.
		NOTICE! The frequency converter may adjust the switching pattern automatically to avoid a trip.
[0]	60 AVM	
[1] *	SFAVM	

14-01 Switching Frequency		
Select the frequency converter switching frequency. Changing the switching frequency reduces acoustic noise from the motor. Default values depend on power size.		
Option:	Function:	
		NOTICE! The output frequency value of the frequency converter must never exceed 10% of the switching frequency. When the motor is running, adjust the switching frequency in <i>parameter 14-01 Switching Frequency</i> to minimize motor noise.
		NOTICE! To avoid a trip, the frequency converter can adjust the switching frequency automatically.
[0]	1.0 kHz	
[1]	1.5 kHz	Default switching frequency for 355–1200 kW [500–1600 hp], 690 V.
[2]	2.0 kHz	Default switching frequency for 250–800 kW [350–1075 hp], 400 V, and 37–315 kW [50–450 hp], 690 V.
[3]	2.5 kHz	
[4]	3.0 kHz	Default switching frequency for 18.5–37 kW [25–50 hp], 200 V, and 37–200 kW [50–300 hp], 400 V.
[5]	3.5 kHz	
[6]	4.0 kHz	Default switching frequency for 5.5–15 kW [7.5–20 hp], 200 V, and 11–30 kW [15–40], 400 V.
[7] *	5.0 kHz	Default switching frequency for 0.25–3.7 kW [0.34–5 hp], 200 V, and 0.37–7.5 kW [0.5–10 hp], 400 V.
[8]	6.0 kHz	

14-01 Switching Frequency		
Select the frequency converter switching frequency. Changing the switching frequency reduces acoustic noise from the motor. Default values depend on power size.		
Option:	Function:	
[9]	7.0 kHz	
[10]	8.0 kHz	
[11]	10.0 kHz	
[12]	12.0 kHz	
[13]	14.0 kHz	
[14]	16.0 kHz	

14-03 Overmodulation		
Option:	Function:	
[0]	Off	Select [0] Off for no overmodulation of the output voltage to avoid torque ripple on the motor shaft. This feature may be useful for applications such as grinding machines.
[1] *	On	Select [1] On to enable the overmodulation function for the output voltage. This is the right option when it is required that the output voltage is higher than 95% of the input voltage (typically when running over-synchronously). The output voltage is increased according to the degree of overmodulation. NOTICE! Overmodulation leads to increased torque ripple as harmonics increase. Control in flux control principle provides an output current of up to 98% of the input current, regardless of <i>parameter 14-03 Overmodulation</i> .

14-04 Acoustic Noise Reduction		
Option:	Function:	
[0] *	Off	No change of the acoustic motor switching noise.
[1]	On	Select to reduce the acoustic noise from the motor.

14-06 Dead Time Compensation		
Option:	Function:	
[0]	Off	No compensation.
[1] *	On	Activates dead-time compensation.

3.14.2 14-1* Mains On/Off

Parameters for configuring mains failure monitoring and handling. If a mains failure appears, the frequency converter tries to continue in a controlled way until the power in the DC link is exhausted.

14-10 Line Failure		
Options [1] Ctrl. ramp-down, [2] Ctrl. ramp-down, trip, [5] Kinetic back-up, trip, [7] Kin. back-up, trip w recovery are not active when the option [2] Torque is selected in parameter 1-00 Configuration Mode.		
Option:	Function:	
	<p>NOTICE! Parameter 14-10 Line Failure cannot be changed while the motor is running.</p> <p>Parameter 14-10 Line Failure is typically used where very short mains interruptions (voltage dips) are present. At 100% load and a short voltage interruption, the DC voltage on the main capacitors drops quickly. For larger frequency converters, it only takes a few milliseconds before the DC level drops to about 373 V DC, and the IGBTs cut off and lose the control of the motor. When mains is restored, and the IGBTs start again, the output frequency and voltage vector do not correspond to the speed/frequency of the motor, and the result is normally an overvoltage or overcurrent, mostly resulting in a trip lock. Parameter 14-10 Line Failure can be programmed to avoid this situation.</p> <p>Select the function according to which the frequency converter must act when the threshold in parameter 14-11 Mains Fault Voltage Level is reached.</p>	
[0] *	No function	The frequency converter does not compensate for a mains interruption. The voltage on the DC link drops quickly and motor control is lost within milliseconds to seconds. Trip lock is the result.
[1]	Ctrl. ramp-down	Control of the motor remains with the frequency converter, and the frequency converter performs a controlled ramp down from parameter 14-11 Mains Fault Voltage Level. If parameter 2-10 Brake Function is [0] Off or [2] AC brake, the ramp follows the overvoltage ramping. If parameter 2-10 Brake Function is [1] Resistor Brake, the ramp follows the setting in parameter 3-81 Quick Stop Ramp Time. This selection is useful in pump applications, where the inertia is low and the friction is high. When

14-10 Line Failure		
Options [1] Ctrl. ramp-down, [2] Ctrl. ramp-down, trip, [5] Kinetic back-up, trip, [7] Kin. back-up, trip w recovery are not active when the option [2] Torque is selected in parameter 1-00 Configuration Mode.		
Option:	Function:	
		<p>mains is restored, the output frequency ramps the motor up to the reference speed (if the mains interruption is prolonged, the controlled ramp down may bring the output frequency down to 0 RPM, and when the mains is restored, the application is ramped up from 0 RPM to the previous reference speed via the normal ramp up). If the energy in the DC link disappears before the motor is ramped to 0, the motor is coasted.</p> <p>Limitation: See the introduction text in parameter 14-10 Line Failure.</p>
[2]	Ctrl. ramp-down, trip	The functionality is the same as in option [1] Ctrl. ramp-down, except in this option a reset is necessary for starting up after power-up.
[3]	Coasting	Centrifuges can run for 1 hour without supply. In those situations, it is possible to select a coast function at mains interruption, together with a flying start, which occurs when the mains is restored.
[4]	Kinetic backup	Kinetic back-up ensures that the frequency converter keeps running as long as there is energy in the system due to the inertia from motor and load. This is done by converting the mechanical energy to the DC link and maintaining control of the frequency converter and motor. This can extend the controlled operation, depending on the inertia in the system. For fans, it is typically several seconds; for pumps up to 2 s; and for compressors only for a fraction of a second. Many industry applications can extend controlled operation for many seconds, which is often enough time for the mains to return.

14-10 Line Failure											
Options [1] Ctrl. ramp-down, [2] Ctrl. ramp-down, trip, [5] Kinetic back-up, trip, [7] Kin. back-up, trip w recovery are not active when the option [2] Torque is selected in parameter 1-00 Configuration Mode.											
Option:	Function:										
	<table border="1"> <tr><td>A</td><td>Normal operation</td></tr> <tr><td>B</td><td>Mains failure</td></tr> <tr><td>C</td><td>Kinetic back-up</td></tr> <tr><td>D</td><td>Mains return</td></tr> <tr><td>E</td><td>Normal operation: ramping</td></tr> </table> <p>Figure 3.61 Kinetic Back-up</p> <p>The DC level during [4] Kinetic back-up equals parameter 14-11 Mains Fault Voltage Level x 1.35. If the mains does not return, U_{DC} is maintained as long as possible by ramping the speed down towards 0 RPM. Finally, the frequency converter coasts.</p> <p>If the mains returns while in kinetic back-up mode, U_{DC} increases above parameter 14-11 Mains Fault Voltage Level x 1.35. This is detected in 1 of the following ways.</p> <ul style="list-style-type: none"> • If U_{DC} > parameter 14-11 Mains Fault Voltage Level x 1.35 x 1.05. • If the speed is above the reference. This is relevant if the mains comes back at a lower level than before, for example parameter 14-11 Mains Fault Voltage Level x 1.35 x 1.02. This does not fulfil the criterion in point 1, and the frequency converter tries to reduce U_{DC} to parameter 14-11 Mains Fault Voltage Level x 1.35 by increasing the speed. This cannot be done as the mains cannot be lowered. • If running mechanically. The same mechanism as in point 2 applies, but the inertia prevents the speed from going above the reference speed. This leads to the motor running mechanically until the speed is above the 	A	Normal operation	B	Mains failure	C	Kinetic back-up	D	Mains return	E	Normal operation: ramping
A	Normal operation										
B	Mains failure										
C	Kinetic back-up										
D	Mains return										
E	Normal operation: ramping										

14-10 Line Failure									
Options [1] Ctrl. ramp-down, [2] Ctrl. ramp-down, trip, [5] Kinetic back-up, trip, [7] Kin. back-up, trip w recovery are not active when the option [2] Torque is selected in parameter 1-00 Configuration Mode.									
Option:	Function:								
	reference speed and the situation in point 2 occurs. Instead of waiting for that criterion, point 3 is introduced.								
[5]	<p>Kinetic backup, trip</p> <p>The difference between kinetic back-up with and without trip is that the latter always ramps down to 0 RPM and trips, regardless of whether mains returns or not. The function does not detect if mains returns. This is the reason for the relatively high level on the DC link during ramp down.</p> <table border="1"> <tr><td>A</td><td>Normal operation</td></tr> <tr><td>B</td><td>Mains failure</td></tr> <tr><td>C</td><td>Kinetic back-up</td></tr> <tr><td>D</td><td>Trip</td></tr> </table> <p>Figure 3.62 Kinetic Back-up Trip</p>	A	Normal operation	B	Mains failure	C	Kinetic back-up	D	Trip
A	Normal operation								
B	Mains failure								
C	Kinetic back-up								
D	Trip								
[6]	Alarm								

14-11 Mains Fault Voltage Level		
Range:		Function:
Size related*	[180 - 600 V]	This parameter defines the threshold voltage at which the function in <i>parameter 14-10 Mains Failure</i> is activated. Select the detection level depending on the supply quality. For a supply of 380 V, set <i>parameter 14-11 Mains Fault Voltage Level</i> to 342 V. This results in a DC detection level of 462 V (<i>parameter 14-11 Mains Fault Voltage Level</i> x 1.35).
<p>NOTICE!</p> <p>Converting from VLT 5000 to FC 300: Even though the setting of the mains voltage at mains fault is the same for VLT 5000 and FC 300, the detection level is different. Use the following formula to obtain the same detection level as in VLT 5000: <i>Parameter 14-11 Mains Fault Voltage Level</i> (VLT 5000 level) = value used in VLT 5000 x 1.35/sqrt(2).</p>		

14-12 Function at Mains Imbalance		
<p>Operation under severe main imbalance conditions reduces the lifetime of the motor. Conditions are considered severe if the motor is operated continuously near nominal load (for example, a pump or a fan running near full speed).</p>		
Option:		Function:
[0] *	Trip	Trips the frequency converter.
[1]	Warning	Issues a warning.
[2]	Disabled	No action.

14-14 Kin. Back-up Time-out		
Range:		Function:
60 s*	[0 - 60 s]	This parameter defines the kinetic back-up timeout in flux mode when running on low voltage grids. If the supply voltage does not exceed the value defined in <i>parameter 14-11 Line Voltage at Line Fault +5%</i> within the specified time, the frequency converter then automatically runs a controlled ramp-down profile before stop.

14-15 Kin. Back-up Trip Recovery Level		
Range:		Function:
Size related*	[0 - 60000.000 ReferenceFeed-backUnit]	This parameter specifies the kinetic back-up trip recovery level. The unit is defined in <i>parameter 0-02 Motor Speed Unit</i> .

14-16 Kin. Back-up Gain		
Range:		Function:
100 %*	[0 - 500 %]	Enter the kinetic back-up gain value in percent.

3.14.3 14-2* Trip Reset

Parameters for configuring auto reset handling, special trip handling, and control card self-test or initialization.

14-20 Reset Mode	
Option:	Function:
	Select the reset function after tripping. Once reset, the frequency converter can be restarted. NOTICE! The motor may start without warning. If the specified number of automatic resets is reached within 10 minutes, the frequency converter enters [0] Manual reset mode. After the manual reset is performed, the setting of parameter 14-20 Reset Mode returns to the original selection. If the number of automatic resets are not reached within 10 minutes, or when a manual reset is performed, the internal automatic reset counter returns to 0. NOTICE! Automatic reset is also valid for resetting the Safe Torque Off function in firmware version 4.3x or earlier.
[0] *	Select [0] Manual reset to perform a reset via [Reset] or via the digital inputs.
[1]	Select [1]-[12] Automatic reset x 1...x20 to perform 1-20 automatic resets after tripping.
[2]	
[3]	
[4]	
[5]	
[6]	
[7]	
[8]	
[9]	
[10]	
[11]	
[12]	
[13]	Select this option for continuous resetting after tripping.
[14]	

14-21 Automatic Restart Time	
Range:	Function:
10 s* [0 - 600 s]	Enter the time interval from trip to start of the automatic reset function. This parameter is active when parameter 14-20 Reset Mode is set to [1]-[13] Automatic reset.

14-22 Operation Mode	
Option:	Function:
	Use this parameter to specify normal operation; to perform tests; or to initialize all parameters except parameter 15-03 Power Up's, parameter 15-04 Over Temp's, and parameter 15-05 Over Volt's. This function is active only when the power is cycled to the frequency converter. Select [0] Normal operation for normal operation of the frequency converter with the motor in the selected application. Select [1] Control card test to test the analog and digital inputs and outputs and the +10 V control voltage. The test requires a test connector with internal connections. Use the following procedure for the control card test: <ol style="list-style-type: none"> Select [1] Control card test. Disconnect the mains supply and wait for the indicator light in the display to go out. Set switches S201 (A53) and S202 (A54) to ON/I. Insert the test plug (see Figure 3.63). Connect to mains supply. Carry out various tests. The results are shown on the LCP and the frequency converter moves into an infinite loop. Parameter 14-22 Operation Mode is automatically set to normal operation. Carry out a power cycle to start up in normal operation after a control card test. <p>If the test is OK LCP readout: Control card OK. Disconnect the mains supply and remove the test plug. The green indicator light on the control card lights up.</p> <p>If the test fails LCP readout: Control card I/O failure. Replace the frequency converter or control card. The red indicator light on the control card is turned on. Test plugs (connect the following terminals to each other): 18 - 27 - 32; 19 - 29 - 33; 42 - 53 - 54</p>

14-22 Operation Mode	
Option:	Function:
	<p>Figure 3.63 Test Plugs</p> <p>Select [2] <i>Initialisation</i> to reset all parameter values to default settings, except for: <i>Parameter 15-03 Power Up's</i>, <i>parameter 15-04 Over Temp's</i>, and <i>parameter 15-05 Over Volt's</i>. The frequency converter resets during the next power-up. <i>Parameter 14-22 Operation Mode</i> also returns to the default setting [0] <i>Normal operation</i>.</p>
[0]	Normal operation
[1]	Control card test Remember to set switches S201 (A53) and S202 (A54) as specified in the parameter description when performing a control card test. Otherwise, the test fails.
[2]	Initiali- zation Select this option to perform initialization. This option does not clear the service logs.
[3]	Boot mode

14-24 Trip Delay at Current Limit	
Range:	Function:
60 s*	[0 - 60 s] Enter the current limit trip delay in s. When the output current reaches the current limit (<i>parameter 4-18 Current Limit</i>), a warning is triggered. When the current limit warning has been continuously present for the period specified in this parameter, the frequency converter trips. To run continuously in current limit without tripping, set the parameter to 60 s. Thermal monitoring of the frequency converter remains active.

14-25 Trip Delay at Torque Limit	
Range:	Function:
60 s*	[0 - 60 s] Enter the torque limit trip delay in s. When the output torque reaches the torque limits

14-25 Trip Delay at Torque Limit	
Range:	Function:
	(<i>parameter 4-16 Torque Limit Motor Mode</i> and <i>parameter 4-17 Torque Limit Generator Mode</i>), a warning is triggered. When the torque limit warning has been continuously present for the period specified in this parameter, the frequency converter trips. Disable the trip delay by setting the parameter to 60 s. Thermal monitoring of the frequency converter remains active.

14-26 Trip Delay at Inverter Fault	
Range:	Function:
0. s*	[0 - 35 s] When the frequency converter detects an overvoltage in the set time, trip is effected after the set time. If value is 0, protection mode is disabled.
	NOTICE! Disable protection mode in hoisting applications.

14-28 Production Settings	
Range:	Function:
0*	[No action]
1	[Service reset]
[2]	

14-29 Service Code	
Range:	Function:
0 N/A*	[-2147483647 - 2147483647 N/A] For internal use only.

3.14.4 14-3* Current Limit Control

The frequency converter features an integral current limit controller, which is activated when the motor current, and thus the torque, is higher than the torque limits set in *parameter 4-16 Torque Limit Motor Mode* and *parameter 4-17 Torque Limit Generator Mode*. When the current limit is reached during motor operation or regenerative operation, the frequency converter tries to reduce torque below the preset torque limits as quickly as possible without losing control of the motor. While the current control is active, the frequency converter can only be stopped by setting a digital input to [2] *Coast inverse* or [3] *Coast and reset inv.* Any signals on terminals 18–33 are not active until the frequency converter is no longer near the current limit. By using a digital input set to [2] *Coast inverse* or [3] *Coast and reset inv.*, the motor does not use the ramp-down time, since the frequency converter is coasted. If a quick stop is necessary, use the mechanical brake control

function along with an external electro-mechanical brake attached to the application.

14-30 Current Lim Ctrl, Proportional Gain		
Range:	Function:	
100 %*	[0 - 500 %]	Enter the proportional gain value for the current limit controller. Selection of a high value makes the controller react faster. Too high a setting leads to controller instability.

14-31 Current Lim Ctrl, Integration Time		
Range:	Function:	
Size related*	[0.002 - 2 s]	Controls the current limit control integration time. Setting it to a lower value makes it react faster. A setting too low leads to control instability.

14-32 Current Lim Ctrl, Filter Time		
Range:	Function:	
Size related*	[1 - 100 ms]	Controls the current limit control low-pass filter. This makes it possible to react to peak values or to average values. When selecting average values, it is sometimes possible to run with higher output current and instead trip on the hardware limit for current. However, the control reacts slower as it does not react on immediate values.

14-35 Stall Protection		
Option:	Function:	
		<i>Parameter 14-35 Stall Protection</i> is active in flux mode only.
[0]	Disabled	Disables stall protection in field weakening flux mode and might cause the motor to be lost.
[1] *	Enabled	Enables stall protection in field weakening flux mode.

14-36 Field-weakening Function		
Select the field weakening function mode in flux mode.		
Range:	Function:	
0*	[Auto]	In this mode, the frequency converter calculates the optimal torque output. Measured DC-link voltage determines the phase-to-phase motor voltage. Magnetizing reference is based on the actual voltage and utilizes the information about the model of the motor.
1	[1/x]	The frequency converter reduces torque output. The frequency converter sets the magnetizing reference inversely proportional to the speed using a

14-36 Field-weakening Function		
Select the field weakening function mode in flux mode.		
Range:	Function:	
		static curve that shows the relationship between DC-link voltage and the speed.

14-37 Fieldweakening Speed		
Range:	Function:	
Size related*	[10 - 60000 RPM]	NOTICE! This parameter is valid for FC 302 only. Enter the start speed for option [1] [1/x] in <i>parameter 14-36 Field-weakening Function</i> .

3.14.5 14-4* Energy Optimizing

Parameters for adjusting the energy optimization level in both variable torque (VT) and automatic energy optimization (AEO) mode in *parameter 1-03 Torque Characteristics*.

14-40 VT Level		
Range:	Function:	
66 % *	[40 - 90 %]	NOTICE! This parameter cannot be adjusted while the motor is running. NOTICE! This parameter is not active when <i>parameter 1-10 Motor Construction</i> is set to [1] PM non-salient SPM. Enter the level of motor magnetization at low speed. Selection of a low value reduces energy loss in the motor but also reduces load capability.

14-41 AEO Minimum Magnetisation		
Range:	Function:	
Size related*	[40 - 200 %]	NOTICE! This parameter is not active when <i>parameter 1-10 Motor Construction</i> is set to [1] PM non-salient SPM. Enter the minimum allowable magnetization for AEO. Selection of a low value reduces energy loss in the motor but can also reduce resistance to sudden load changes.

14-42 Minimum AEO Frequency		
Range:		Function:
Size related*	[5 - 40 Hz]	<p>NOTICE!</p> <p>This parameter is not active when <i>parameter 1-10 Motor Construction</i> is set to [1] <i>PM non-salient SPM</i>.</p> <p>Enter the minimum frequency at which the automatic energy optimization (AEO) is to be active.</p>

14-43 Motor Cos-Phi		
Range:		Function:
0.66 N/A*	[0.40 - 0.95 N/A]	The Cos(phi) setpoint is automatically set for optimum AEO performance. This parameter should normally not be altered. However, in some situations it may be necessary to enter a new value to fine-tune.

3.14.6 14-5* Environment

NOTICE!

Perform a power cycle after changing any of the parameters in *parameter group 14-5* Environment*.

These parameters help the frequency converter to operate under special environmental conditions.

14-50 RFI 1		
Turn the RFI filter on or off. The RFI filter ensures that the frequency converter complies with EMC standards. Select [0] <i>Off</i> only when the frequency converter is connected to an isolated mains source (IT mains).		
Option:		Function:
[0]	Off	
[1] *	On	

14-51 DC-Link Compensation		
Option: Function:		
		The rectified AC-DC voltage in the frequency converter's DC link is associated with voltage ripples. These ripples can increase in magnitude with increased load. These ripples are undesirable because they can generate current and torque ripples. A compensation method is used to reduce these voltage ripples in the DC link. In general, DC-link compensation is recommended for most applications, but pay attention when operating in field weakening as it can generate speed oscillations at the motor shaft. In field weakening, turn off DC-link compensation.

14-51 DC-Link Compensation		
Option: Function:		
[0]	Off	Disables DC-link compensation.
[1]	On	Enables DC-link compensation.

14-52 Fan Control		
Select minimum speed of the main fan.		
Option:		Function:
[0] *	Auto	Select [0] <i>Auto</i> to run fan only when internal temperature in frequency converter is in range 35 °C (95 °F) to approximately 55 °C (131 °F). Fan runs at low speed below 35 °C (95 °F), and at full speed at approximately 55 °C (131 °F).
[1]	On 50%	The fan always runs at 50% speed or above. The fan runs at 50% speed at 35 °C (95 °F), and at full speed at approximately 55 °C (131 °F).
[2]	On 75%	The fan always runs at 75% speed or above. The fan runs at 75% speed at 35 °C (95 °F), and at full speed at approximately 55 °C (131 °F).
[3]	On 100%	The fan always runs at 100% speed.

14-53 Fan Monitor		
Option: Function:		
		Select the frequency converter action if a fan fault is detected.
[0]	Disabled	
[1] *	Warning	
[2]	Trip	

14-55 Output Filter		
Option:	Function:	
	<p>NOTICE! This parameter cannot be adjusted while the motor is running.</p> <p>NOTICE! Reset the frequency converter after selecting [2] <i>Sine-Wave Filter Fixed</i>.</p> <p>CAUTION OVERHEATING OF FREQUENCY CONVERTER When using sine-wave filters, there is a risk of overheating of the frequency converter, which can result in personal injury and equipment damage. Always set <i>parameter 14-55 Output Filter to [2] Sine-wave fixed</i> when using a sine-wave filter.</p> <p>Select the type of output filter connected.</p>	
[0]	No Filter	This is the default setting and should be used with dU/dt filters or high frequency common mode (HF-CM) filters.
[1]	Sine-Wave Filter	This setting is only for backwards compatibility. It enables operation with flux control principle when <i>parameter 14-56 Capacitance Output Filter</i> and <i>parameter 14-57 Inductance Output Filter</i> are programmed with the output filter capacitance and inductance. It does not limit the range of the switching frequency.

14-56 Capacitance Output Filter		
<p>Compensation function of the LC filter requires the per phase equivalent star-connected capacitance of the filter (3 times the capacity between 2 phases when capacitance is delta connection).</p>		
Range:	Function:	
2.0 uF* [0.1 - 6500.0 uF]	<p>Set the capacitance of the output filter. The value can be found on the filter label.</p> <p>NOTICE! This is required for correct compensation in flux mode (<i>parameter 1-01 Motor Control Principle</i>).</p>	

14-57 Inductance Output Filter		
Range:	Function:	
7.000 mH* [0.001 - 65.000 mH]	<p>Set the inductance of the output filter. The value can be found on the filter label.</p> <p>NOTICE! This is required for correct compensation in flux control principle (<i>parameter 1-01 Motor Control Principle</i>).</p>	

14-59 Actual Number of Inverter Units		
Range:	Function:	
1. N/A*	[1 - N/A]	Set the actual number of power units.

3.14.7 14-6* Auto Derate

This group contains parameters for derating the frequency converter in case of high temperature.

14-60 Function at Over Temperature		
Option:	Function:	
		If either heat sink or control card temperature exceeds a factory-programmed temperature limit, a warning is activated. If the temperature increases further, select whether the frequency converter should trip (trip lock) or derate the output current.
[0] *	Trip	The frequency converter trips (trip lock) and generate an alarm. Cycle power to reset the alarm. The motor restarts when the heat sink temperature has dropped below the alarm limit.
[1]	Derate	If the critical temperature is exceeded, the output current is reduced until the allowable temperature has been reached.

3.14.8 No Trip at Inverter Overload

In some systems, the frequency converter has not been sized properly to yield the current needed in all points of the operational flow-head characteristic. At these points, the motor needs a current higher than the rated current of the frequency converter. The frequency converter can yield 110% of the rated current continuously for 60 s. If still overloaded, the frequency converter normally trips (causing the motor to stop by coasting) and issues an alarm.

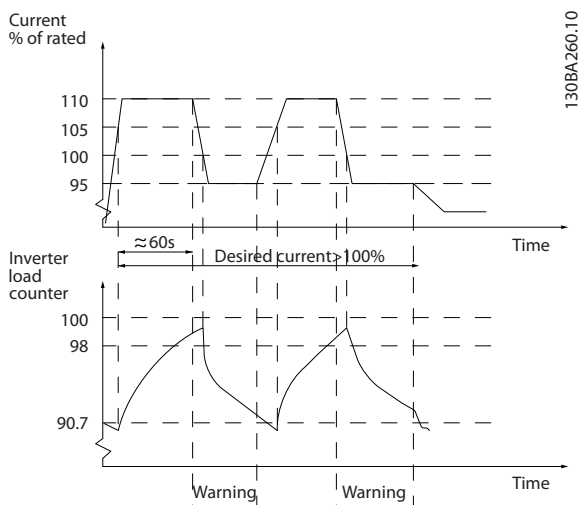

Figure 3.64 Output Current in Overload Condition

If the motor is unable to run continuously with the demanded capacity, run it at reduced speed for a while.

Select *parameter 14-61 Function at Inverter Overload* to automatically reduce motor speed until the output current is below 100% of the rated current (set in *parameter 14-62 Inv. Overload Derate Current*). *Parameter 14-61 Function at Inverter Overload* is an alternative to letting the frequency converter trip.

The frequency converter estimates the load on the power section with an inverter load counter, which causes a warning at 98% and a reset of the warning at 90%. At the value 100%, the frequency converter trips and issue an alarm.

Status for the counter can be read in *parameter 16-35 Inverter Thermal*.

If *parameter 14-61 Function at Inverter Overload* is set to [3] *Derate*, the motor speed is reduced when the counter exceeds 98%, and stays reduced until the counter has dropped below 90.7%.

If *parameter 14-62 Inv. Overload Derate Current* is set to for example 95%, a steady overload causes the pump speed to fluctuate between values corresponding to 110% and 95% of rated output current for the frequency converter.

14-61 Function at Inverter Overload		
Option:	Function:	
		Use in case of steady overload beyond the thermal limits (110% for 60 s).
[0] *	Trip	Select [0] <i>Trip</i> to make the frequency converter trip and issue an alarm.
[1]	Derate	Reduces the motor speed to decrease the load on the power section and allowing it to cool down.

14-62 Inv. Overload Derate Current		
Range:	Function:	
95 %*	[50 - 100 %]	Enter the current level (in % of rated output current for the frequency converter) when running with reduced motor speed after load on the frequency converter has exceeded the allowable limit (110% for 60 s).

3.14.9 14-7* Compatibility

Parameters for compatibility of VLT 3000 and VLT 5000 with FC 300.

14-72 VLT Alarm Word

Option:	Function:
[0]	0 - 4294967295
	Readout of the alarm word corresponding to VLT 5000.

14-73 VLT Warning Word

Option:	Function:
[0]	0 - 4294967295
	Readout of the warning word corresponding to VLT 5000.

14-74 VLT Ext. Status Word

Range:	Function:
0 N/A*	[0 - 4294967295 N/A]
	Readout of the external status word corresponding to VLT 5000.

3.14.10 14-8* Options

14-80 Option Supplied by External 24VDC

Option:	Function:
	NOTICE! This parameter is only changing function by performing a power cycle.
[0]	No
	Select [0] No to use the frequency converter's 24 V DC supply.
[1] *	Yes
	Select [1] Yes if a 24 V DC external supply is used to power the option. Inputs/outputs are galvanically isolated from the frequency converter when operated from an external supply.

14-88 Option Data Storage

Range:	Function:
0*	[0 - 65535]
	This parameter stores information about options over a power cycle.

14-89 Option Detection

Selects the behavior of the frequency converter when a change in the option configuration is detected.

Option:	Function:
[0] *	Protect Option Config.
	Freezes the current settings and prevents unwanted changes when missing or defective options are detected.

14-89 Option Detection

Selects the behavior of the frequency converter when a change in the option configuration is detected.

Option:	Function:
[1]	Enable Option Change
	Changes frequency converter settings and is used when modifying the system configuration. This parameter setting returns to [0] Protect Option Config. after an option change.

3.14.11 14-9* Fault Settings

14-90 Fault Level

This is an array parameter with 26 elements. Each of the bits can be configured to any of the following options. Use this parameter to customize fault levels.

Option:	Function:
[0]	Off
	Use [0] Off with caution as it ignores all warnings and alarms for the selected source.
[1]	Warning
[2]	Trip
	Changing a fault level from default option [3] Trip Lock to [2] Trip leads to the automatic reset of the alarm. For alarms involving overcurrent, the frequency converter has a hardware protection that issues a 3-minute recovery after 2 consecutive overcurrent incidents. This hardware protection cannot be overruled.
[3]	Trip Lock
[4]	Trip w. delayed reset
	This option adds a delay between automatic resets, otherwise it is the same as option [2] Trip. The delay prevents a situation where reset is attempted repeatedly for an overcurrent situation. Hardware protection of the frequency converter forces the 3-minute recovery time after 2 consecutive overcurrents (within a short time window).

Failure	Alarm	Element in parameter 14-90 Fault Level	Off	Warning	Trip	Trip Lock	Trip with delayed reset
10 V low	1	1490.0	X	D	–	–	–
24 V low	47	1490.1	X	–	–	D	–
1.8 V supply low	48	1490.2	X	–	–	D	–
Voltage limit	64	1490.3	X	D	–	–	–
Ground fault during ramping	14	1490.4	–	–	D	X	–
Ground fault 2 during cont. operation	45	1490.5	–	–	D	X	–
Torque limit	12	1490.6	X	D	–	–	–
Overcurrent	13	1490.7	–	–	X	D	–
Short circuit	16	1490.8	–	–	X	D	–
Heat sink temperature	29	1490.9	–	–	X	D	–
Heat sink sensor	39	1490.10	–	–	X	D	–
Control card temperature	65	1490.11	–	–	X	D	–
Power card temperature	69	1490.12	–	2)	X	D	–
Heat sink temperature ¹⁾	244	1490.13	–	–	X	D	–
Heat sink sensor ¹⁾	245	1490.14	–	–	X	D	–
Power card temperature ¹⁾	247	1490.15	–	–	X	D	–
Motor phase missing	30–32	1490.16	–	–	X	D	–
Inverter overloaded	9	1490.18	–	–	–	D	–
Current limit	59	1490.19	–	–	–	D	–
Locked rotor	99	1490.20	–	–	D	X	–
AIC earth fault	407	1490.21	X	X	X	D	X
404 DC link voltage out of range	404	1490.22	X	X	X	D	X
300 mains contactor fault	300	1490.23	X	X	X	D	X

Table 3.27 Selection of Action when Selected Alarm Appears

MCT 10 Set-up Software has the element numbers listed in the column ID. Use this table together with MCT 10 Set-up Software to get information about specific fault levels.

D stands for the default setting.

X stands for a possible option.

1) Only high-power frequency converters.

2) In small and medium power frequency converters, alarm 69, Power card temperature is only a warning.

3.15 Parameters: 15-** Drive Information

3.15.1 15-0* Operating Data

3

15-00 Operating hours		
Range:	Function:	
0 h*	[0 - 2147483647 h]	View how many hours the frequency converter has run. The value is saved when the frequency converter is turned off.

15-01 Running Hours		
Range:	Function:	
0 h*	[0 - 2147483647 h]	View how many hours the motor has run. Reset the counter in <i>parameter 15-07 Reset Running Hours Counter</i> . The value is saved when the frequency converter is turned off.

15-02 kWh Counter		
Range:	Function:	
0 kWh*	[0 - 2147483647 kWh]	Register the power consumption of the motor as an average value over 1 hour. Reset the counter in <i>parameter 15-06 Reset kWh Counter</i> .

15-03 Power Up's		
Range:	Function:	
0*	[0 - 2147483647]	View the number of times the frequency converter has been powered up.

15-04 Over Temp's		
Range:	Function:	
0*	[0 - 65535]	View the number of frequency converter temperature faults.

15-05 Over Volt's		
Range:	Function:	
0*	[0 - 65535]	View the number of frequency converter overvoltages.

15-06 Reset kWh Counter		
Option:	Function:	
[0] *	Do not reset	No reset of the kWh counter is required.
[1]	Reset counter	Press [OK] to reset the kWh counter to 0 (see <i>parameter 15-02 kWh Counter</i>).

15-07 Reset Running Hours Counter		
Option:	Function:	
[0] *	Do not reset	

15-07 Reset Running Hours Counter		
Option:	Function:	
[1]	Reset counter	To reset the running hours counter to 0, select [1] <i>Reset</i> and press [OK] (see <i>parameter 15-01 Running Hours</i>). This parameter cannot be selected via the serial port, RS485. Select [0] <i>Do not reset</i> if no reset of the running-hours counter is required.

3.15.2 15-1* Data Log Settings

The data log enables continuous logging of up to 4 data sources (*parameter 15-10 Logging Source*) at individual rates (*parameter 15-11 Logging Interval*). A trigger event (*parameter 15-12 Trigger Event*) and window (*parameter 15-14 Samples Before Trigger*) are used to start and stop the logging conditionally.

15-10 Logging Source		
Option:	Function:	
		Select which variables are to be logged.
[0] *	None	
[1472]		
[1473]		
[1474]		
[1600]	Control Word	
[1601]	Reference [Unit]	
[1602]	Reference %	
[1603]	Status Word	
[1610]	Power [kW]	
[1611]	Power [hp]	
[1612]	Motor voltage	
[1613]	Frequency	
[1614]	Motor Current	
[1616]	Torque [Nm]	
[1617]	Speed [RPM]	
[1618]	Motor Thermal	
[1622]	Torque [%]	
[1625]		
[1630]	DC Link Voltage	
[1632]	Brake Energy /s	
[1633]	Brake Energy /2 min	
[1634]	Heatsink Temp.	
[1635]	Inverter Thermal	
[1650]	External Reference	
[1651]	Pulse Reference	
[1652]	Feedback [Unit]	
[1660]	Digital Input	
[1662]	Analog Input 53	

15-10 Logging Source		
Option:	Function:	
[1664]	Analog Input 54	
[1665]	Analog Output 42 [mA]	
[1666]	Digital Output [bin]	
[1675]	Analog In X30/11	
[1676]	Analog In X30/12	
[1677]	Analog Out X30/8 [mA]	
[1690]	Alarm Word	
[1692]	Warning Word	
[1694]	Ext. Status Word	
[3470]	MCO Alarm Word 1	
[3471]	MCO Alarm Word 2	

15-11 Logging Interval		
Array [4]		
Range:	Function:	
Size related*	[0.000 - 0.000]	Enter the interval in ms between each sampling of the variables to be logged.

15-12 Trigger Event		
Select the trigger event. When the trigger event occurs, a window is applied to freeze the log. The log then retains a specified percentage of samples before the occurrence of the trigger event (<i>parameter 15-14 Samples Before Trigger</i>).		
Option:	Function:	
[0] *	FALSE	
[1]	TRUE	
[2]	Running	
[3]	In range	
[4]	On reference	
[5]	Torque limit	
[6]	Current limit	
[7]	Out of current range	
[8]	Below l low	
[9]	Above l high	
[10]	Out of speed range	
[11]	Below speed low	
[12]	Above speed high	
[13]	Out of feedb. range	
[14]	Below feedb. low	
[15]	Above feedb. high	
[16]	Thermal warning	
[17]	Mains out of range	
[18]	Reverse	
[19]	Warning	
[20]	Alarm (trip)	
[21]	Alarm (trip lock)	
[22]	Comparator 0	
[23]	Comparator 1	
[24]	Comparator 2	

15-12 Trigger Event		
Select the trigger event. When the trigger event occurs, a window is applied to freeze the log. The log then retains a specified percentage of samples before the occurrence of the trigger event (<i>parameter 15-14 Samples Before Trigger</i>).		
Option:	Function:	
[25]	Comparator 3	
[26]	Logic rule 0	
[27]	Logic rule 1	
[28]	Logic rule 2	
[29]	Logic rule 3	
[33]	Digital input DI18	
[34]	Digital input DI19	
[35]	Digital input DI27	
[36]	Digital input DI29	
[37]	Digital input DI32	
[38]	Digital input DI33	
[50]	Comparator 4	
[51]	Comparator 5	
[60]	Logic rule 4	
[61]	Logic rule 5	

15-13 Logging Mode		
Option:	Function:	
[0] *	Log always	Select [0] <i>Log always</i> for continuous logging.
[1]	Log once on trigger	Select [1] <i>Log once on trigger</i> to conditionally start and stop logging using <i>parameter 15-12 Trigger Event</i> and <i>parameter 15-14 Samples Before Trigger</i> .

15-14 Samples Before Trigger		
Range:	Function:	
50	[0 - 100	Before a trigger event, enter the percentage of all samples which should be retained in the log. See also <i>parameter 15-12 Trigger Event</i> and <i>parameter 15-13 Logging Mode</i> .
N/A*	N/A]	

3.15.3 Service Log

The service log functionality saves detailed log information of a 5-second interval in cases when certain alarms occur. Service technicians can analyze this information to troubleshoot and optimize the frequency converter.

The frequency converter can save up to 24 service log records in the flash memory.

Find the list of alarms that trigger a service log record in *chapter 3.15.6 Alarms that Trigger a Service Log Record*. Application-dependant trips/alarms, for example, Safe Torque Off, do not trigger a service log record.

Sampling rate

There are 2 periods with different sampling rates:

- Slow samples: 20 samples at a rate of 250 ms resulting in 5 s of history before the trip.
- Fast samples: 50 samples at a rate of 5 ms resulting in 250 ms of detailed history before the trip.

NOTICE!

To enable the real-time clock (RTC) stamp, use the real-time clock module. If real-time clock is not available, the operating time in *parameter 15-32 Fault Log: Time* is recorded.

The service log contains the elements shown in *Table 3.28*.

#	Alarm log data	Parameter number
1	Time of trip (1 of the values): <ul style="list-style-type: none"> • Priority real-time clock (if available). • Priority operating time (if RTC is not available). 	<i>Parameter 0-89 Date and Time Readout</i> or <i>parameter 15-32 Fault Log: Time</i>
2	Alarm code	<i>Parameter 15-30 Fault Log: Error Code</i>
3	Frequency	<i>Parameter 16-13 Frequency</i>
4	Speed (RPM)	<i>Parameter 16-17 Speed [RPM]</i>
5	Reference (%)	<i>Parameter 16-02 Reference %</i>
7	DC-link voltage	<i>Parameter 16-30 DC Link Voltage</i>
9	Motor phase U current	<i>Parameter 16-45 Motor Phase U Current</i>
10	Motor phase V current	<i>Parameter 16-46 Motor Phase V Current</i>
11	Motor phase W current	<i>Parameter 16-47 Motor Phase W Current</i>

#	Alarm log data	Parameter number
12	Motor phase voltage	<i>Parameter 16-12 Motor voltage</i>
15	Control word	<i>Parameter 16-00 Control Word</i>
16	Status word	<i>Parameter 16-03 Status Word</i>

Table 3.28 Service Log Data

3.15.4 Clearing the Service Log

The flash memory stores up to 24 records. To save more logs, clear the service log memory.

To clear the service log:

1. In *parameter 14-22 Operation Mode*, select option [5] *Clear Service Log*.
2. Power cycle the frequency converter. Clearing the service log extends the power-up time by approximately 1 s.

Save the service log records using the MCT 10 Set-up Software before clearing the service log.

Clear the service log after a commissioning to remove any alarms that occurred during the testing.

Service log indication

Parameter 16-42 Service Log Counter shows the number of service logs stored in the memory.

The frequency converter indicates a full service log memory in 1 of the following ways:

- The LCP shows the message: Clear logs Service log full: 28 [M26]
- Bit 25 is set high in *parameter 16-96 Maintenance Word* (0x2000000).

Performing the frequency converter initialization does not clear the service log memory.

3.15.5 Reading the Service Log Information

Use MCT 10 Set-up Software to read the service log information.

To read the service information:

1. Open MCT 10 Set-up Software.
2. Select a frequency converter.
3. Select the Service Log plug-in.
4. Click *Read from drive*.

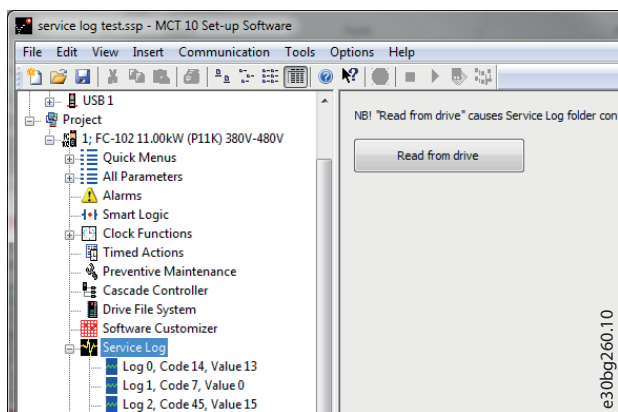

Figure 3.65 MCT10, Read from Drive

Figure 3.66 shows the service log view in MCT 10 Set-up Software. Use the cursor to view the detailed readings at a specific time.

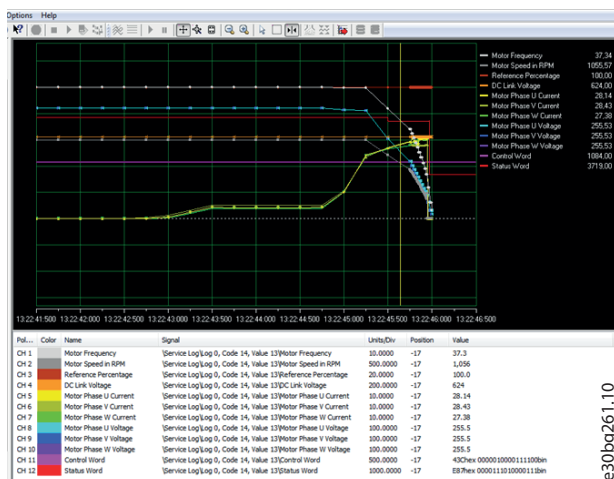

Figure 3.66 Service Log View, 5 s

Use the zoom function to focus on the last 250 ms before the fault. See Figure 3.67.

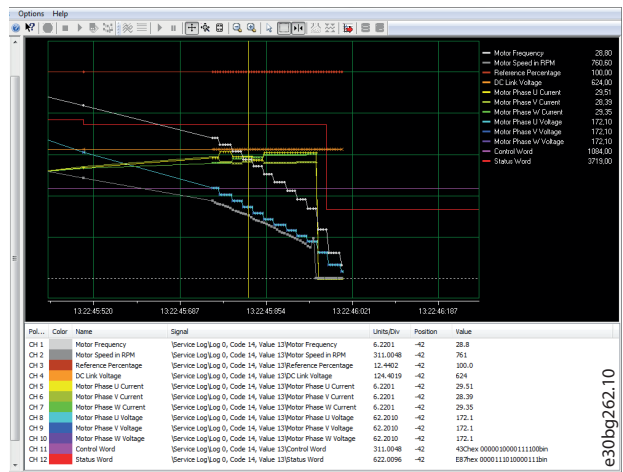

Figure 3.67 Service Log Detailed View, 250 ms

3.15.6 Alarms that Trigger a Service Log Record

#	Alarm title
4	Mains phase loss
5	DC voltage high
6	DC voltage low
7	DC over volt
8	DC under volt 9Inverter overl.
9	Inverter overl.
10	Motor ETR over
12	Torque limit
13	Over Current
14	Earth Fault
16	Short Circuit
18	Start Failed
25	Brake resistor
26	Brake overload
27	Brake IGBT
28	Brake check
30	U phase loss
31	V phase loss
32	W phase loss
36	Mains failure
37	Phase imbalance
44	Earth Fault AL44
45	Earth Fault 2
59	Current limit

Table 3.29 Alarms that Trigger a Service Log Record

NOTICE!

If an alarm has 2 states (warning/alarm), it only triggers a service log record when going into the alarm state

3

3.15.7 15-2* Historic Log

View up to 50 logged data items via the array parameters in this parameter group. Data is logged every time an event occurs (not to be confused with SLC events). Events in this context are defined as a change in 1 of the following areas:

- Digital inputs.
- Digital outputs.
- Warning word.
- Alarm word.
- Status word.
- Control word.
- Extended status word.

Events are logged with value and time stamp in ms. The time interval between 2 events depends on how often events occur (maximum once every scan time). Data logging is continuous, but if an alarm occurs, the log is saved and the values can be viewed on the display. This feature is useful, for example when carrying out service following a trip. View the historic log contained in this parameter via the serial communication port or via the display.

15-20 Historic Log: Event		
Array [50]		
Range:	Function:	
0*	[0 - 255]	View the event type of the logged events.

15-21 Historic Log: Value		
Array [50]		
Range:	Function:	
0*	[0 - 2147483647]	View the value of the logged event. Interpret the event values according to <i>Table 3.30</i> :
	Digital input	Decimal value. See <i>parameter 16-60 Digital Input</i> for description after converting to binary value.
	Digital output (not monitored in this SW release)	Decimal value. See <i>parameter 16-66 Digital Output [bin]</i> for a description after converting to binary value.
	Warning word	Decimal value. See <i>parameter 16-92 Warning Word</i> for a description.
	Alarm word	Decimal value. See <i>parameter 16-90 Alarm Word</i> for a description.

15-21 Historic Log: Value		
Array [50]		
Range:	Function:	
	Status word	Decimal value. See <i>parameter 16-03 Status Word</i> for a description after converting to binary value.
	Control word	Decimal value. See <i>parameter 16-00 Control Word</i> for a description.
	Extended status word	Decimal value. See <i>parameter 16-94 Ext. Status Word</i> for a description.
Table 3.30 Logged Events		

15-22 Historic Log: Time		
Array [50]		
Range:	Function:	
0 ms*	[0 - 2147483647 ms]	View the time at which the logged event occurred. Time is measured in ms since frequency converter start. The maximum value corresponds to approximately 24 days, which means that the count restarts at 0 after this time period.

3.15.8 15-3* Alarm Log

Parameters in this group are array parameters where up to 10 fault logs can be viewed. 0 is the most recent logged data, and 9 is the oldest. Fault codes, values, and time stamp can be viewed for all logged data.

15-30 Fault Log: Error Code		
Range:	Function:	
0 N/A*	[0 - 255 N/A]	View the fault code and look up its meaning in <i>chapter 6 Troubleshooting</i> .

15-31 Alarm Log: Value		
Array [10]		
Range:	Function:	
0*	[-32767 - 32767]	View an extra description of the error. This parameter is mostly used in combination with <i>alarm 38, internal fault</i> .

15-32 Alarm Log: Time		
Array [10]		
Range:	Function:	
0 s* [0 - 2147483647 s]	View the time when the logged event occurred. Time is measured in s from frequency converter start-up.	

15-33 Alarm Log: Date and Time		
Array [10]		
Range:	Function:	
Size related* [0 - 0]	Array parameter; Date & Time 0-9: This parameter shows at which time the logged event occurred.	

3.15.9 15-4* Drive Identification

Parameters containing read-only information about the hardware and software configuration of the frequency converter.

15-40 FC Type		
Range:	Function:	
0 N/A* [0 - 0 N/A]	View the frequency converter type. The readout is identical to the FC 300 power field of the type code definition, characters 1-6.	

15-41 Power Section		
Range:	Function:	
0 N/A* [0 - 0 N/A]	View the frequency converter type. The readout is identical to the FC 300 power field of the type code definition, characters 7-10.	

15-42 Voltage		
Range:	Function:	
0 N/A* [0 - 0 N/A]	View the frequency converter type. The readout is identical to the FC 300 power field of the type code definition, characters 11-12.	

15-43 Software Version		
Range:	Function:	
0* [0 - 5]	View the combined SW version (or package version) consisting of power SW and control SW.	

15-44 Ordered Typecode String		
Range:	Function:	
0* [0 - 40]	View the type code string used for reordering the frequency converter in its original configuration.	

15-45 Actual Typecode String		
Range:	Function:	
0* [0 - 40]	View the actual type code string.	

15-46 Frequency Converter Ordering No		
Range:	Function:	
0* [0 - 8]	View the 8-digit ordering number used for reordering the frequency converter in its original configuration. To restore the ordering number after the power card exchange, see <i>parameter 14-29 Service Code</i> .	

15-47 Power Card Ordering No		
Range:	Function:	
0* [0 - 8]	View the power card ordering number.	

15-48 LCP Id No		
Range:	Function:	
0* [0 - 20]	View the LCP ID number.	

15-49 SW ID Control Card		
Range:	Function:	
0* [0 - 20]	View the control card software version number.	

15-50 SW ID Power Card		
Range:	Function:	
0* [0 - 20]	View the power card software version number.	

15-51 Frequency Converter Serial Number		
Range:	Function:	
0* [0 - 10]	View the frequency converter serial number.	

15-53 Power Card Serial Number		
Range:	Function:	
0* [0 - 19]	View the power card serial number.	

15-54 Config File Name		
Array [5]		
Range:	Function:	
Size related* [0 - 16]	Shows the special configuration file names.	

15-58 Smart Setup Filename		
Range:	Function:	
Size related* [0 - 20]	Shows the SmartStart filename.	

15-59 Filename		
Range:	Function:	
Size related* [0 - 16]	Shows the currently used customer-specific initial values (CSIV) filename.	

3.15.10 15-6* Option Ident.

This read-only parameter group contains information about the hardware and software configuration of the options installed in slots A, B, C0, and C1.

15-60 Option Mounted		
Array [8]		
Range:	Function:	
0*	[0 - 30]	Shows the type of the installed option.

15-61 Option SW Version		
Array [8]		
Range:	Function:	
0*	[0 - 20]	View the installed option software version.

15-62 Option Ordering No		
Array [8]		
Range:	Function:	
0*	[0 - 8]	Shows the ordering number for the installed options.

15-63 Option Serial No		
Array [8]		
Range:	Function:	
0*	[0 - 18]	View the installed option serial number.

15-70 Option in Slot A		
Range:	Function:	
0 N/A*	[0 - 0 N/A]	View the type code string for the option installed in slot A and a translation of the type code string. For example, for type code string AX, the translation is <i>No option</i> .

15-71 Slot A Option SW Version		
Range:	Function:	
0 N/A*	[0 - 0 N/A]	View the software version for the option installed in slot A.

15-72 Option in Slot B		
Range:	Function:	
0 N/A*	[0 - 0 N/A]	View the type code string for the option installed in slot B and a translation of the type code string. For example, for type code string BX, the translation is <i>No option</i> .

15-73 Slot B Option SW Version		
Range:	Function:	
0 N/A*	[0 - 0 N/A]	View the software version for the option installed in slot B.

15-74 Option in Slot C0		
Range:	Function:	
0 N/A*	[0 - 0 N/A]	View the type code string for the option installed in slot C and a translation of the type code string. For example, for type code string CXXX, the translation is <i>No option</i> .

15-75 Slot C0 Option SW Version		
Range:	Function:	
0 N/A*	[0 - 0 N/A]	View the software version for the option installed in slot C.

15-76 Option in Slot C1		
Range:	Function:	
0 N/A*	[0 - 0 N/A]	Shows the type code string for the option in slot C1 (CXXXX if no option) and the translation, that is <i>No option</i> .

15-77 Slot C1 Option SW Version		
Range:	Function:	
0 N/A*	[0 - 0 N/A]	Shows the software version for the installed option in option slot C.

15-80 Fan Running Hours		
Range:	Function:	
0 h*	[0 - 2147483647 h]	View how many hours the heat sink fan has run (increments for every hour). The value is saved when the frequency converter is turned off.

15-81 Preset Fan Running Hours		
Range:	Function:	
0 h*	[0 - 99999 h]	Enter the preset fan running hours counter, see <i>parameter 15-80 Fan Running Hours</i> . This parameter cannot be selected via the serial port, RS485.

15-89 Configuration Change Counter		
Range:	Function:	
0*	[0 - 65535]	NOTICE! This parameter cannot be adjusted while the motor is running.

3.15.11 15-9* Parameter Info

15-92 Defined Parameters		
Range:	Function:	
0*	[0 - 9999]	View a list of all defined parameters in the frequency converter. The list ends with 0.

15-93 Modified Parameters		
Range:	Function:	
0*	[0 - 9999]	View a list of the parameters that have been changed from their default setting. The list ends with 0. Changes may not be visible until up to 30 s after implementation.

15-98 Drive Identification		
Range:	Function:	
0 N/A*	[0 - 0 N/A]	This parameter contains data used by the MCT 10 Set-up Software.

15-99 Parameter Metadata		
Range:	Function:	
0 N/A*	[0 - 9999 N/A]	This parameter contains data used by the MCT 10 Set-up Software.

3.16 Parameters: 16-** Data Readouts

3.16.1 16-0* General Status

16-00 Control Word		
Range:	Function:	
0* [0 - 65535]	View the control word sent from the frequency converter via the serial communication port in hex code.	

16-01 Reference [Unit]		
Range:	Function:	
0 ReferenceFeed-backUnit*	[-999999 - 999999 ReferenceFeed-backUnit]	View the present reference value applied on impulse or analog basis in the unit resulting from the configuration selected in <i>parameter 1-00 Configuration Mode</i> (Hz, Nm, or RPM).

16-02 Reference [%]		
Range:	Function:	
0 %* [-200 - 200 %]	View the total reference. The total reference is the sum of digital, analog, preset, bus, and freeze references, plus catch up and slow down.	

16-03 Status Word		
Range:	Function:	
0* [0 - 65535]	View the status word sent from the frequency converter via the serial communication port in hex code.	

16-05 Main Actual Value [%]		
Range:	Function:	
0 %* [-100 - 100 %]	View the 2-byte word sent with the status word to the fieldbus master reporting the main actual value.	

16-06 Actual Position		
Range:	Function:	
0 CustomReadoutUnit2*	[-2000000000 - 2000000000 CustomReadoutUnit2]	Shows the actual position in position units defined in <i>parameter group 17-7* Position Scaling</i> . The value is based on the encoder feedback in closed loop or on the angle calculated by the motor control in open loop. For information about

16-06 Actual Position		
Range:	Function:	
		configuring the readouts, see <i>chapter 3.17.5 17-7* Position Scaling</i> .

16-07 Target Position		
Range:	Function:	
0 CustomReadoutUnit2*	[-2000000000 - 2000000000 CustomReadoutUnit2]	<p>NOTICE!</p> <p>This parameter is only valid with software version 48.XX.</p> <p>Shows the actual end target position for the active positioning command in position units. Position units are defined in <i>parameter group 17-7* Position Scaling</i>.</p>

16-08 Position Error		
Range:	Function:	
0 CustomReadoutUnit2*	[-2000000000 - 2000000000 CustomReadoutUnit2]	<p>NOTICE!</p> <p>This parameter is only valid with software version 48.XX.</p> <p>Shows the actual position error in position units defined in <i>parameter group 17-7* Position Scaling</i>. Position error is the difference between the actual position and the commanded position. The position error is the input for the position PI controller.</p>

16-09 Custom Readout		
Range:	Function:	
0.00 CustomReadoutUnit*	[0.00 - 0.00 CustomReadoutUnit]	View the value of custom readout from <i>parameter 0-30 Unit for User-defined Readout</i> to <i>parameter 0-32 Custom Readout Max Value</i> .

3.16.2 16-1* Motor Status

16-10 Power [kW]		
Range:	Function:	
0 kW* [0 - 10000 kW]	Shows motor power in kW. The value shown is calculated based on the actual motor voltage and motor current. The value is filtered, and therefore approximately 1.3 s may pass from when an input value changes to when the data readout values change. The resolution of readout value on fieldbus is in 10 W steps.	

16-11 Power [hp]		
Range:	Function:	
0 hp* [0 - 10000 hp]	View the motor power in hp. The value shown is calculated based on the actual motor voltage and motor current. The value is filtered, and therefore approximately 1.3 ms may pass from when an input value changes to when the data readout values change.	

16-12 Motor Voltage		
Range:	Function:	
0 V* [0 - 6000 V]	View the motor voltage, a calculated value used for controlling the motor.	

16-13 Frequency		
Range:	Function:	
0 Hz* [0 - 6500 Hz]	View the motor frequency without resonance damping.	

16-14 Motor current		
Range:	Function:	
0 A* [0 - 10000 A]	View the motor current measured as an average value, I_{RMS} . The value is filtered, and thus approximately 1.3 s may pass from when an input value changes to when the data readout values change.	

16-15 Frequency [%]		
Range:	Function:	
0.00 %* [-100.00 - 100.00 %]	View a 2-byte word reporting the actual motor frequency (without resonance damping) as a percentage (scale 0000–4000 hex) of <i>parameter 4-19 Max Output Frequency</i> . Set <i>parameter 9-16 PCD Read Configuration</i> index 1 to send it with the status word instead of the MAV.	

16-16 Torque [Nm]		
Range:	Function:	
0.0 Nm* [-3000.0 - 3000.0 Nm]	View the torque value with sign, applied to the motor shaft. Linearity is not exact between 160% motor current and torque in relation to the rated torque. Some motors supply more than 160% torque. Therefore, the minimum value and the maximum value depend on the maximum motor current and the motor used. The value is filtered, and thus approximately 30 ms may pass from when an input changes value to when the data readout values change. In flux control principle, this readout is compensated for in <i>parameter 1-68 Minimum Inertia</i> for improved accuracy.	

16-17 Speed [RPM]		
Range:	Function:	
0 RPM* [-30000 - 30000 RPM]	View the actual motor RPM. In open-loop or closed-loop process control, the motor RPM is estimated. In speed closed-loop modes, the motor RPM is measured.	

16-18 Motor Thermal		
Range:	Function:	
0 %* [0 - 100 %]	View the calculated thermal load on the motor. The cutout limit is 100%. The basis for calculation is the ETR function selected in <i>parameter 1-90 Motor Thermal Protection</i> .	

16-19 KTY sensor temperature		
Range:	Function:	
0 °C* [0 - 0 °C]	Returning the actual temperature on KTY sensor built into the motor. See <i>parameter group 1-9* Motor Temperature</i> .	

16-20 Motor Angle		
Range:	Function:	
0 N/A* [0 - 65535 N/A]	View the current encoder/resolver angle offset relative to the index position. The value range of 0–65535 corresponds to 0–2xpi (radian).	

16-21 Torque [%] High Res.		
Range:	Function:	
0 %* [-200 - 200 %]	The value shown is the torque in percent of nominal torque, with sign and 0.1% resolution, applied to the motor shaft.	

16-22 Torque [%]		
Range:	Function:	
0 %*	[-200 - 200 %]	Value shown is the torque in percent of nominal torque, with sign, applied to the motor shaft.

16-23 Motor Shaft Power [kW]		
Range:	Function:	
0 kW*	[0 - 10000 kW]	Readout of the mechanical power applied to the motor shaft.

16-24 Calibrated Stator Resistance		
Range:	Function:	
0.0000 Ohm*	[0.0000 - 100.0000 Ohm]	Shows the calibrated stator resistance.

16-25 Torque [Nm] High		
Range:	Function:	
0.0 Nm*	[-200000000.0 - 200000000.0 Nm]	View the torque value with sign, applied to the motor shaft. Some motors supply more than 160% torque. Therefore, the minimum value and the maximum value depend on the maximum motor current as well as the motor used. This specific readout has been adapted to be able to show higher values than the standard readout in <i>parameter 16-16 Torque [Nm]</i> .

3.16.3 16-3* Drive Status

16-30 DC Link Voltage		
Range:	Function:	
0 V*	[0 - 10000 V]	View a measured value. The value is filtered with a 30 ms time constant.

16-31 System Temp.		
Range:	Function:	
0 °C*	[-128 - 127 °C]	<p>NOTICE! Valid for FC 302 only.</p> <p>Shows the highest internal system temperature. In the smaller enclosure sizes (A–C), the system temperature matches the control card temperature measurement in <i>parameter 16-39 Control Card Temp</i>. In the larger enclosure sizes (D–F), the system temperature is the highest temperature measured on hardware</p>

16-31 System Temp.		
Range:	Function:	
		components with temperature sensors, for example, the power card(s).

16-32 Brake Energy /s		
Range:	Function:	
0 kW*	[0 - 10000 kW]	View the brake power transmitted to an external brake resistor, stated as an instant value.

16-33 Brake Energy Average		
Range:	Function:	
0 kW*	[0 - 10000 kW]	View the brake power transmitted to an external brake resistor. The mean power is calculated on an average level based on the selected time period within <i>parameter 2-13 Brake Power Monitoring</i> .

16-34 Heatsink Temp.		
Range:	Function:	
0 °C*	[0 - 255 °C]	View the frequency converter heat sink temperature. The cutout limit is 90 ±5 °C (194 ±9 °F), and the motor cuts back in at 60 ±5 °C (140 ±9 °F).

16-35 Inverter Thermal		
Range:	Function:	
0 %*	[0 - 100 %]	View the percentage load on the inverter.

16-36 Inv. Nom. Current		
Range:	Function:	
10.00 A*	[0.01 - 10000.00 A]	View the inverter nominal current, which must match the nameplate data on the connected motor. The data is used for calculation of torque, motor overload protection, and so on.

16-37 Inv. Max. Current		
Range:	Function:	
16.00 A*	[0.01 - 10000.00 A]	View the inverter maximum current, which must match the nameplate data on the connected motor. The data is used for calculation of torque, motor overload protection, and so on.

16-38 SL Controller State		
Range:	Function:	
0 N/A*	[0 - 100 N/A]	View the state of the event under execution by the SL controller.

16-39 Control Card Temp.		
Range:		Function:
0 °C*	[0 - 100 °C]	View the temperature on the control card, stated in °C.

16-40 Logging Buffer Full		
Option:		Function:
		View whether the logging buffer is full (see chapter 3.15.2 15-1* Data Log Settings). The logging buffer is never full when parameter 15-13 Logging Mode is set to [0] Log always.
[0] *	No	
[1]	Yes	

16-41 Performance Measurements		
Range:		Function:
0*	[0 - 2147483647]	

16-42 Service Log Counter		
Range:		Function:
0*	[0 - 24]	Shows the number of service logs stored in the ServiceLog file. If the ServiceLog file is full, clear the logged data by selecting option [5] Clear service logs in parameter 14-22 Operation Mode. The logged data is deleted on the next power-up.

16-43 Timed Actions Status		
Select the timed actions view.		
Option:		Function:
[0] *	Timed Actions Auto	
[1]	Timed Actions Disabled	
[2]	Constant On Actions	
[3]	Constant Off Actions	

16-44 Speed Error [RPM]		
Range:		Function:
0 RPM*	[-30000 - 30000 RPM]	<p>NOTICE!</p> <p>This parameter is only valid with software version 48.XX.</p> <p>Shows the difference between the speed reference and the actual speed.</p>

16-45 Motor Phase U Current		
Range:		Function:
0 A*	[0 - 10000 A]	Shows the motor phase U_{RMS} current. Facilitates monitoring of imbalance in the motor currents, detection of weak motor cables or imbalance in motor windings.

16-46 Motor Phase V Current		
Range:		Function:
0 A*	[0 - 10000 A]	Shows the motor phase V_{RMS} current. Facilitates monitoring of imbalance in the motor currents, detection of weak motor cables or imbalance in motor windings.

16-47 Motor Phase W Current		
Range:		Function:
0 A*	[0 - 10000 A]	Shows the motor phase W_{RMS} current. Facilitates monitoring of imbalance in the motor currents, detection of weak motor cables or imbalance in motor windings.

16-48 Speed Ref. After Ramp [RPM]		
Range:		Function:
0 RPM*	[-30000 - 30000 RPM]	This parameter specifies the reference given to the frequency converter after the speed ramp.

16-49 Current Fault Source		
Range:		Function:
0*	[0 - 8]	Value indicates source of current faults including short circuit, overcurrent, and imbalance of supply voltage (from left): 1-4 Inverter 5-8 Rectifier 0 No fault recorded

3.16.4 16-5* Ref. & Feedb.

16-50 External Reference		
Range:		Function:
0.0	[-200.0 - 200.0]	View the total reference, the sum of digital, analog, preset, fieldbus, and freeze references, plus catch up and slow down.
N/A*	N/A]	

16-51 Pulse Reference		
Range:		Function:
0.0	[-200.0 - 200.0 N/A]	View the reference value from programmed digital inputs. The readout can also reflect the impulses from an incremental encoder.
N/A*	N/A]	

16-52 Feedback [Unit]		
Range:		Function:
0.000 Reference-FeedbackUnit*	[-999999.999 - 999999.999 ReferenceFeed-backUnit]	View the feedback unit resulting from the selection of unit and scaling in parameter 3-00 Reference

16-52 Feedback [Unit]	
Range:	Function:
	Range, parameter 3-01 Reference/Feedback Unit, parameter 3-02 Minimum Reference, and parameter 3-03 Maximum Reference.

16-53 Digi Pot Reference	
Range:	Function:
0.00 N/A* [-200.00 - 200.00 N/A]	View the contribution of the digital potentiometer to the actual reference.

16-57 Feedback [RPM]	
Range:	Function:
0 RPM* [-30000 - 30000 RPM]	Readout parameter where the actual motor RPM from the feedback source can be read in both closed loop and open loop. The feedback source is selected by parameter 7-00 Speed PID Feedback Source.

3.16.5 16-6* Inputs and Outputs

16-60 Digital Input	
Range:	Function:
0* [0 - 65535]	View the signal states from the active digital inputs. Example: Input 18 corresponds to bit number 5, 0 = no signal, 1 = connected signal. Bit 6 works in the opposite way, on = 0, off = 1 (Safe Torque Off input).
Bit 0	Digital input terminal 33.
Bit 1	Digital input terminal 32.
Bit 2	Digital input terminal 29.
Bit 3	Digital input terminal 27.
Bit 4	Digital input terminal 19.
Bit 5	Digital input terminal 18.
Bit 6	Digital input terminal 37.
Bit 7	Digital input VLT® General Purpose I/O MCB 101 terminal X30/4.
Bit 8	Digital input VLT® General Purpose I/O MCB 101 terminal X30/3.
Bit 9	Digital input VLT® General Purpose I/O MCB 101 terminal X30/2.
Bit 10-63	Reserved for future terminals.

Table 3.31 Active Digital Inputs

16-60 Digital Input	
Range:	Function:
	Figure 3.68 Relay Settings

16-61 Terminal 53 Switch Setting	
Option:	Function:
	View the setting of input terminal 53.
[0] *	Current
[1]	Voltage

16-62 Analog Input 53	
Range:	Function:
0.000 N/A* [-20.000 - 20.000 N/A]	View the actual value at input 53.

16-63 Terminal 54 Switch Setting	
Option:	Function:
	View the setting of input terminal 54.
[0] *	Current
[1]	Voltage

16-64 Analog Input 54	
Range:	Function:
0.000 N/A* [-20.000 - 20.000 N/A]	View the actual value at input 54.

16-65 Analog Output 42 [mA]	
Range:	Function:
0.000 N/A* [0.000 - 30.000 N/A]	View the actual value at output 42 in mA. The value shown reflects the selection in parameter 6-50 Terminal 42 Output.

16-66 Digital Output [bin]	
Range:	Function:
0 N/A* [0 - 15 N/A]	View the binary value of all digital outputs.

16-67 Pulse Input #29 [Hz]		
Range:	Function:	
0* [0 - 130000]	View the actual frequency rate on terminal 29.	

16-68 Freq. Input #33 [Hz]		
Range:	Function:	
0 N/A* [0 - 130000 N/A]	View the actual value of the frequency applied at terminal 33 as an impulse input.	

16-69 Pulse Output #27 [Hz]		
Range:	Function:	
0 N/A* [0 - 40000 N/A]	View the actual value of pulses applied to terminal 27 in digital output mode.	

16-70 Pulse Output #29 [Hz]		
Range:	Function:	
0 N/A* [0 - 40000 N/A]	<p>NOTICE! This parameter is available for FC 302 only.</p> <p>View the actual value of pulses at terminal 29 in digital output mode.</p>	

16-71 Relay Output [bin]		
Range:	Function:	
0* [0 - 511]	View the settings of all relays.	
<p>Readout choice (Par. 16-71): Relay output (bin):</p> <p>0 0 0 0 0 bin</p> <p>130BA195.10</p> <p>OptionB card relay 09 OptionB card relay 08 OptionB card relay 07 Power card relay 02 Power card relay 01</p> <p>Figure 3.69 Relay Settings</p>		

16-72 Counter A		
Range:	Function:	
0 [-2147483648 N/A - 2147483647 * N/A]	View the present value of counter A. Counters are useful as comparator operands, see <i>parameter 13-10 Comparator Operand</i> . Reset or change the value either via digital inputs (<i>parameter group 5-1* Digital Inputs</i>) or by using an SLC action (<i>parameter 13-52 SL Controller Action</i>).	

16-73 Counter B		
Range:	Function:	
0 [-2147483648 N/A - 2147483647 * N/A]	View the present value of counter B. Counters are useful as comparator operands (<i>parameter 13-10 Comparator Operand</i>). Reset or change the value either via digital inputs (<i>parameter group 5-1* Digital Inputs</i>) or by using an SLC action (<i>parameter 13-52 SL Controller Action</i>).	

16-74 Prec. Stop Counter		
Range:	Function:	
0 N/A* [0 - 2147483647 N/A]	Returns the actual counter value of precise counter (<i>parameter 1-84 Precise Stop Counter Value</i>).	

16-75 Analog In X30/11		
Range:	Function:	
0* [-20 - 20]	View the actual value at input X30/11 of VLT® General Purpose I/O MCB 101.	

16-76 Analog In X30/12		
Range:	Function:	
0* [-20 - 20]	View the actual value at input X30/12 of VLT® General Purpose I/O MCB 101.	

16-77 Analog Out X30/8 [mA]		
Range:	Function:	
0* [0 - 30]	View the actual value at input X30/8 in mA.	

16-78 Analog Out X45/1 [mA]		
Range:	Function:	
0.000 N/A* [0.000 - 30.000 N/A]	Shows the actual output value at terminal X45/1. The value shown reflects the selection in <i>parameter 6-70 Terminal X45/1 Output</i> .	

16-79 Analog Out X45/3 [mA]		
Range:	Function:	
0.000 N/A* [0.000 - 30.000 N/A]	Shows the actual output value at terminal X45/3. The value shown reflects the selection in <i>parameter 6-80 Terminal X45/3 Output</i> .	

3.16.6 16-8* Fieldbus & FC Port

Parameters for reporting the bus references and control words.

16-80 Fieldbus CTW 1		
Range:	Function:	
0* [0 - 65535]	View the 2-byte control word (CTW) received from the fieldbus master. Interpretation of the control word depends on the fieldbus option installed and the control word profile selected in <i>parameter 8-10 Control Profile</i> . For more information, refer to the relevant fieldbus manual.	

16-82 Fieldbus REF 1		
Range:	Function:	
0* [-200 - 200]	View the 2-byte word sent with the control word from the fieldbus master to set the reference value. For more information, refer to the relevant fieldbus manual.	

16-83 Fieldbus REF 2		
Range:	Function:	
0 CustomReadoutUnit2*	[-2147483647 - 2147483647 CustomReadoutUnit2]	<p>NOTICE! This parameter is only valid with software version 48.XX.</p> <p>Shows the 32-bit position reference sent in PCD 2 and PCD 3. In parameters related to PCD 2 and PCD 3, select [1683] <i>Fieldbus REF 2</i> for the fieldbus which is used by the frequency converter. The value is in position units defined in <i>parameter group 17-7* Position Scaling</i>.</p>

16-84 Comm. Option STW		
Range:	Function:	
0* [0 - 65535]	Show the status word of the extended fieldbus communication option. For more information, refer to the relevant fieldbus manual.	

16-85 FC Port CTW 1		
Range:	Function:	
0* [0 - 65535]	View the 2-byte control word (CTW) received from the fieldbus master. Interpretation of the	

16-85 FC Port CTW 1		
Range:	Function:	
	control word depends on the fieldbus option installed and the control word profile selected in <i>parameter 8-10 Control Profile</i> .	

16-86 FC Port REF 1		
Range:	Function:	
0* [-200 - 200]	View the 2-byte status word (STW) sent to the fieldbus master. Interpretation of the status word depends on the fieldbus option installed and the control word profile selected in <i>parameter 8-10 Control Profile</i> .	

16-87 Bus Readout Alarm/Warning		
Range:	Function:	
0* [0 - 65535]	Alarm and warning numbers in hex as shown in the alarm log. The high byte contains the alarm, the low byte contains the warning. The alarm number is the 1st one that occurred after the last reset.	

16-89 Configurable Alarm/Warning Word		
Range:	Function:	
0* [0 - 65535]	This alarm/warning word is configured in <i>parameter 8-17 Configurable Alarm and Warningword</i> to match the actual requirements.	

3.16.7 16-9* Diagnosis Readouts

NOTICE!

When using MCT 10 Set-up Software, the readout parameters can only be read online, that is as the actual status. This means that the status is not stored in the MCT 10 Set-up Software file.

16-90 Alarm Word		
Range:	Function:	
0* [0 - 4294967295]	Show the alarm word sent via the serial communication port in hex code.	

16-91 Alarm word 2		
Range:	Function:	
0 N/A* [0 - 4294967295 N/A]	View the alarm word sent via the serial communication port in hex code.	

16-92 Warning Word		
Range:	Function:	
0* [0 - 4294967295]	Show the warning word sent via the serial communication port in hex code.	

16-93 Warning word 2		
Range:	Function:	
0 N/A* [0 - 4294967295 N/A]	View the warning word sent via the serial communication port in hex code.	

16-94 Ext. Status Word		
Range:	Function:	
0 N/A* [0 - 4294967295 N/A]	Returns the extended warning word sent via the serial communication port in hex code.	

16-96 Maintenance Word		
Range:	Function:	
0* [0 - 4294967295]	<p>Readout of the preventive maintenance word. The bits reflect the status for the programmed preventive maintenance events in <i>parameter group 23-1* Maintenance</i>. 13 bits show combinations of all the possible items:</p> <ul style="list-style-type: none"> • Bit 0: Motor bearings. • Bit 1: Pump bearings. • Bit 2: Fan bearings. • Bit 3: Valve. • Bit 4: Pressure transmitter. • Bit 5: Flow transmitter. • Bit 6: Temperature transmitter. • Bit 7: Pump seals. • Bit 8: Fan belt. • Bit 9: Filter. • Bit 10: Frequency converter cooling fan. • Bit 11: Frequency converter system health check. • Bit 12: Warranty. • Bit 13: Maintenance Text 0. • Bit 14: Maintenance Text 1. • Bit 15: Maintenance Text 2. • Bit 16: Maintenance Text 3. • Bit 17: Maintenance Text 4. • Bit 25: Service log full. 	

16-96 Maintenance Word					
Range:	Function:				
	Position 4⇒	Valve	Fan bearings	Pump bearings	Motor bearings
	Position 3⇒	Pump seals	Temperature transmitter	Flow transmitter	Pressure transmitter
	Position 2⇒	Drive system health check	Drive cooling fan	Filter	Fan belt
	Position 1⇒	-	-	-	Warranty
	0 _{hex}	-	-	-	-
	1 _{hex}	-	-	-	+
	2 _{hex}	-	-	+	-
	3 _{hex}	-	-	+	+
	4 _{hex}	-	+	-	-
	5 _{hex}	-	+	-	+
	6 _{hex}	-	+	+	-
	7 _{hex}	-	+	+	+
	8 _{hex}	+	-	-	-
	9 _{hex}	+	-	-	+
	A _{hex}	+	-	+	-
	B _{hex}	+	-	+	+
	C _{hex}	+	+	-	-
	D _{hex}	+	+	-	+
	E _{hex}	+	+	+	-
	F _{hex}	+	+	+	+

Table 3.32 Maintenance Word

Example:

The preventive maintenance word shows 040A_{hex}.

Position	1	2	3	4
Hex value	0	4	0	A

Table 3.33 Example

The 1st digit 0 indicates that no items from the 4th row require maintenance. The 2nd digit 4 refers to the 3rd row indicating that the frequency converter cooling fan requires maintenance. The 3rd digit 0 indicates that no items from the 2nd row require maintenance. The 4th digit A refers to the top row indicating that the valve and the pump bearings require maintenance.

3.17 Parameters: 17-** Feedback

More parameters to configure the feedback from the encoder (VLT® Encoder Input MCB 102), resolver (VLT® Resolver Input MCB 103), or the frequency converter itself.

3.17.1 17-1* Inc. Enc. Interface

Parameters in this group configure the incremental interface of the VLT® Encoder Input MCB 102. Both the incremental and absolute interfaces are active at the same time.

NOTICE!

Do not use incremental encoders with PM motors. In a closed-loop control, consider absolute encoders or resolvers.

NOTICE!

These parameters cannot be adjusted while the motor is running.

17-10 Signal Type		
Select the incremental type (A/B channel) of the encoder in use. Find the information on the encoder datasheet. Select [0] None if the feedback sensor is an absolute encoder only.		
Option:	Function:	
[0]	None	
[1] *	TTL (5V, RS4222)	
[2]	SinCos	

17-11 Resolution (PPR)		
Range:	Function:	
1024 N/A*	[10 - 10000 N/A]	Enter the resolution of the incremental track, that is the number of pulses or periods per revolution.

3.17.2 17-2* Abs. Enc. Interface

Parameters in this group configure the absolute interface of the VLT® Encoder Input MCB 102. Both the incremental and absolute interfaces are active at the same time.

17-20 Protocol Selection		
Option:	Function:	
		NOTICE! This parameter cannot be adjusted while the motor is running.

17-20 Protocol Selection		
Option:	Function:	
[0] *	None	Select [0] None if the feedback sensor is an incremental encoder only.
[1]	HIPERFACE	Select [1] HIPERFACE if the encoder is absolute only.
[2]	EnDat	
[4]	SSI	

17-21 Resolution (Positions/Rev)		
Range:	Function:	
8192. N/A*	[4. - 131072. N/A]	Select the resolution of the absolute encoder, that is the number of counts per revolution. The value depends on setting in parameter 17-20 Protocol Selection.

17-22 Multiturn Revolutions		
Range:	Function:	
1*	[1 - 16777216]	Select the number of multi-turn revolutions. Select value 1 for single-turn type encoders.

17-24 SSI Data Length		
Range:	Function:	
13 N/A*	[13 - 25 N/A]	Set the number of bits for the SSI telegram. Select 13 bits for single-turn encoders and 25 bits for multi-turn encoders.

17-25 Clock Rate		
Range:	Function:	
0 kHz*	[100 - 0 kHz]	Set the SSI clock rate. With long encoder cables, the clock rate must be reduced.

17-26 SSI Data Format		
Option:	Function:	
[0] *	Gray code	
[1]	Binary code	Set the data format of the SSI data.

17-34 HIPERFACE Baud rate		
Option:	Function:	
		NOTICE! This parameter cannot be adjusted while the motor is running. Select the baud rate of the attached encoder. The parameter is only accessible when parameter 17-20 Protocol Selection is set to [1] HIPERFACE.
[0]	600	

17-34 HIPERFACE Baud rate		
Option:	Function:	
[1]	1200	
[2]	2400	
[3]	4800	
[4] *	9600	
[5]	19200	
[6]	38400	

3.17.3 17-5* Resolver Interface

This parameter group is used for setting parameters for the VLT® Resolver Input MCB 103.

Usually, the resolver feedback is used as motor feedback from permanent magnet motors with *parameter 1-01 Motor Control Principle* set to [3] Flux w/motor feedback.

Resolver parameters cannot be adjusted while the motor is running.

17-50 Poles		
Range:	Function:	
2 N/A*	[2 - 2 N/A]	Set the pole number on the resolver. The value is stated in the datasheet for resolvers.

17-51 Input Voltage		
Range:	Function:	
7.0 V*	[2.0 - 8.0 V]	Set the input voltage to the resolver. The voltage is stated as RMS value. The value is stated in the datasheet for resolvers.

17-52 Input Frequency		
Range:	Function:	
10.0 kHz*	[2.0 - 15.0 kHz]	Set the input frequency to the resolver. The value is stated in the datasheet for resolvers.

17-53 Transformation Ratio		
Range:	Function:	
0.5 N/A*	[0.1 - 1.1 N/A]	Set the transformation ratio for the resolver. The transformation ratio is: $T_{ratio} = \frac{V_{out}}{V_{in}}$ The value is stated in the datasheet for resolvers.

17-56 Encoder Sim. Resolution		
Set the resolution and activate the encoder emulation function (generation of encoder signals from the measured position from a resolver). Use this function to transfer the speed or position information from 1 frequency converter to another. To disable the function, select [0] Disabled.		
Option:	Function:	
[0] *	Disabled	
[1]	512	
[2]	1024	
[3]	2048	
[4]	4096	

17-59 Resolver Interface		
Activate the VLT® Resolver Input MCB 103 when the resolver parameters are selected. To avoid damage to resolvers, adjust <i>parameter 17-50 Poles</i> and <i>parameter 17-53 Transformation Ratio</i> before enabling this parameter.		
Option:	Function:	
[0] *	Disabled	
[1]	Enabled	

3.17.4 17-6* Monitoring and Application

This parameter group is for selecting extra functions when VLT® Encoder Input MCB 102 or VLT® Resolver Input MCB 103 is fitted into option slot B as speed feedback. Monitoring and application parameters cannot be adjusted while the motor is running.

17-60 Feedback Direction		
Option:	Function:	
		NOTICE! This parameter cannot be adjusted while the motor is running. Change the detected encoder rotation direction without changing the wiring to the encoder.
[0] *	Clockwise	
[1]	Counter-clockwise	

17-61 Feedback Signal Monitoring		
Select which action the frequency converter should take if a faulty encoder signal is detected. The encoder function in <i>parameter 17-61 Feedback Signal Monitoring</i> is an electrical check of the hardware circuit in the encoder system.		
Option:	Function:	
[0]	Disabled	

17-61 Feedback Signal Monitoring		
Select which action the frequency converter should take if a faulty encoder signal is detected.		
The encoder function in <i>parameter 17-61 Feedback Signal Monitoring</i> is an electrical check of the hardware circuit in the encoder system.		
Option:	Function:	
[1] *	Warning	
[2]	Trip	
[3]		
[4]		
[5]		
[6]		
[7]		
[8]		
[9]		
[10]		
[11]		

3.17.5 17-7* Position Scaling

Parameters in this group define how the frequency converter scales and handles the position values.

17-70 Position Unit		
Select the physical unit for showing the position values on the LCP.		
Option:	Function:	
[0] *	pu	Position unit.
[1]	m	Meters.
[2]	mm	Millimeters.
[3]	inc	Increments.
[4]	°	Degrees.
[5]	rad	Radian.
[6]	%	Percent.
[7]	qc	Quad count, which is ¼ of an encoder pulse when using quadrature encoder signal.

17-71 Position Unit Scale		
Array [2]		
Enter the scaling factor for the position values. The scaling function multiplies the readout values by 10 ^x , where x is the value of this parameter. For example, if x = 2, the value 5 is shown as 500.		
The elements of the array are:		
<ul style="list-style-type: none"> Index 0 is the scaling factor for readout and settings of position values in parameters or in a fieldbus. Index 1 contains exceptions. Index 1 is the scaling factor for readout of position error (<i>parameter 16-08 Position Error</i>) and for the value of <i>parameter 3-08 On Target Window</i>. 		
Range:	Function:	
0*	[-3 - 3]	

17-72 Position Unit Numerator		
This parameter is the numerator in the equation which defines the relation between 1 motor revolution and physical movement of machine.		
$\text{Position unit} = \frac{\text{Par. 17-72}}{\text{Par. 17-73}} \times \text{Motor revolutions}$		
Example:		
Consider a turn table application. The motor makes 10 revolutions when the table makes 1 revolution. The position unit is a degree. For this set-up, enter the following values:		
<ul style="list-style-type: none"> <i>Parameter 17-72 Position Unit Numerator</i> = 360 <i>Parameter 17-73 Position Unit Denominator</i> = 10 		
Set the physical unit for position values in <i>parameter 17-70 Position Unit</i> .		
Range:	Function:	
1024*	[-2000000000 - 2000000000]	

17-73 Position Unit Denominator		
See <i>parameter 17-72 Position Unit Numerator</i> .		
Range:	Function:	
1*	[-2000000000 - 2000000000]	

17-74 Position Offset		
Enter the absolute encoder position offset. Use this parameter to adjust the 0 position of the encoder without physically moving the encoder.		
Set the physical unit for position values in <i>parameter 17-70 Position Unit</i> .		
Range:	Function:	
0*	[-2000000000 - 2000000000]	

17-75 Position Recovery at Power-up		
Option:	Function:	
		<p>NOTICE!</p> <p>This parameter is only available with software version 48.XX.</p> <p>Select the actual position after power-up when using open loop or incremental encoders.</p>
[0] *	Off	The actual position is 0 after power-up.
[1]	On	The frequency converter stores the actual position at power down and uses it as the actual position when powered up.

17-76 Position Axis Mode		
Option:	Function:	
		<p>NOTICE!</p> <p>This parameter is only available with software version 48.XX.</p> <p>Select the axis type for position counting.</p>
[0] *	Linear Axis	The motion is within a position range defined by <i>parameter 3-06 Minimum Position</i> and <i>parameter 3-07 Maximum Position</i> .
[1]	Rotary 0 - Max	Continuous motion, where the position changes between 0 and <i>parameter 3-07 Maximum Position</i> . When passing the maximum position, the reading restarts from 0.
[2]	Rotary Min - Max	<p>NOTICE!</p> <p>This option is available only with software version 48.20 and newer.</p> <p>Continuous motion, where the position changes between <i>parameter 3-06 Minimum Position</i> and <i>parameter 3-07 Maximum Position</i>. When passing the maximum position, the reading restarts from the minimum position.</p>

17-77 Position Feedback Mode		
Option:	Function:	
		<p>NOTICE!</p> <p>This parameter is only available with software version 48.2X and newer.</p> <p>Select the mode for handling absolute encoders. Select [0] <i>Relative</i> if the application requires to track the position when the position value exceeds the measuring range of the encoder, for example when using single turn encoders for linear motion. Select [1] <i>Absolute</i> if the position</p>

17-77 Position Feedback Mode		
Option:	Function:	
		values are always within the measuring range of the encoder, for example when using a laser distance measuring device.
[0] *	Relative	The actual position is set to the absolute position read from the encoder at power-up, and then the frequency converter uses only the position changes for calculating the actual position. In this mode, the actual position values are between -2147483648 and 2147483647 even when the values exceed the measuring range of the encoder. To save and use the absolute position values outside the measuring range of the encoder after power down, set <i>parameter 17-75 Position Recovery at Power-up</i> to [1] On. The position value is accurate if the encoder does not move by more than half of the encoder measuring range when the frequency converter is powered down.
[1]	Absolute	The frequency converter uses the absolute position from the encoder as actual position continuously. In this mode, the actual position values are between 0 and the maximum position of the encoder. The maximum position is determined by the number of bits, for example, the SSI encoder has 25 bits and its maximum value is $2^{25} = 33554432$. Set <i>parameter 3-07 Maximum Position</i> to the maximum value of the encoder scaled according to <i>parameter 7-94 Position PI Feedback Scale Numerator</i> , <i>parameter 7-95 Position PI Feedback Scale Denominator</i> , <i>parameter 17-72 Position Unit Numerator</i> , and <i>parameter 17-73 Position Unit Denominator</i> . If the position exceeds the measuring range of the encoder, the absolute position reference is lost. For example, use this option if there is a laser distance-measuring device and there is a risk that some external objects may occasionally interfere with the laser beam. In this case, the absolute positioning will work correctly when the external disturbance disappears.

3.17.6 17-8* Position Homing

Parameters for configuring the homing function. The homing function creates a position reference in the physical machine.

17-80 Homing Function		
Option:	Function:	
		<p>NOTICE!</p> <p>This parameter is only available with software version 48.XX.</p> <p>Select the homing function. The homing function creates a position reference in the physical machine. The selected homing function can be activated with a digital input or a fieldbus bit. Homing is not required when using absolute encoders. All homing functions except [2] Home Sync Function require a start homing signal.</p>
[0]	No Homing	No homing function. The actual position is 0 after power-up, independent of the physical machine position.
[1]	Home Position	Actual position is set to the value of <i>parameter 17-82 Home Position</i> , index 0.
[2]	Home Sync Function	Homing position is synchronized with the homing sensor according to the setting in <i>parameter 17-81 Home Sync Function</i> .
[3]	Analog Input 53	Use the value of analog input 53 as the actual position. The value is scaled according to <i>parameter 3-06 Minimum Position</i> and <i>parameter 3-07 Maximum Position</i> .
[4]	Analog Input 54	Same as [3] Analog Input 53, but for analog input 54.
[9]	Direction with Sensor	Perform a search for the homing sensor in the direction defined by the forward/reverse signal on a digital input or fieldbus, using the settings in <i>parameter 17-83 Homing Speed</i> and <i>parameter 17-84 Homing Torque Limit</i> . When the frequency converter detects the homing sensor input (configured in <i>parameter group 5-1* Digital Inputs</i>), it sets the actual position to the value of <i>parameter 17-82 Home Position</i> , index 0. The frequency converter then switches to the positioning mode with a target defined in <i>parameter 17-82 Home Position</i> , index 0 + index 1. If reversing is required for going to the target position, set <i>parameter 4-10 Motor Speed Direction</i> to [2] Both directions.

17-80 Homing Function		
Option:	Function:	
[10]	Forward with sensor	Perform a search for the homing sensor in forward direction using the settings in <i>parameter 17-83 Homing Speed</i> and <i>parameter 17-84 Homing Torque Limit</i> . When the frequency converter detects the homing sensor input (configured in <i>parameter group 5-1* Digital Inputs</i>), it sets the actual position to the value of <i>parameter 17-82 Home Position</i> , index 0. The frequency converter then switches to the positioning mode with a target defined in <i>parameter 17-82 Home Position</i> , index 0 + index 1. If reversing is required for going to the target position, set <i>parameter 4-10 Motor Speed Direction</i> to [2] Both directions.
[11]	Reverse with sensor	Same as [10] Forward with sensor, but with the search in the reverse direction. Set <i>parameter 4-10 Motor Speed Direction</i> to [1] Counter clockwise or [2] Both directions.
[12]	Forward Torque Limit	<p>With this option selected, the frequency converter does the following:</p> <ol style="list-style-type: none"> Runs forward with the set homing speed (<i>parameter 17-83 Homing Speed</i>). When the torque reaches the limit set in <i>parameter 17-84 Homing Torque Limit</i>, and the speed is lower than the value in <i>parameter 3-05 On Reference Window</i>, the actual position is set to the value of <i>parameter 17-82 Home Position</i>, index 0. The frequency converter positions to the target defined in <i>parameter 17-82 Home Position</i>, index 0 + index 1. <p>Only available in flux closed loop. See also <i>parameter 17-85 Homing Timeout</i>.</p>
[13]	Reverse Torque Limit	Same as [12] Forward Torque Limit but in reverse direction. Set <i>parameter 4-10 Motor Speed Direction</i> to [1] Counter clockwise or [2] Both directions. Only available in flux closed loop.

17-81 Home Sync Function		
Option:	Function:	
		<p>NOTICE!</p> <p>This parameter is only available with software version 48.XX.</p> <p>Select the trigger for the homing synchronization function. Only active when [2] Home Sync Function is selected in parameter 17-80 Homing Function. The homing synchronization function sets the actual position to the value of parameter 17-82 Home Position:</p> <ul style="list-style-type: none"> Index 0 if the homing sensor is approached in the forward direction. Index 1 if the homing sensor is approached in the reverse direction.
[0]	1st time after power	After power-up, the first detection of the homing sensor triggers the function.
[1]	1st t. aft.pow. forward	After power-up, the first detection of the homing sensor in the forward direction triggers the function.
[2]	1st t. aft.pow. reverse	After power-up, the first detection of the homing sensor in the reverse direction triggers the function.
[3]	1st time after start	After start, the first detection of the homing sensor triggers the function.
[4]	1st t. aft.str. forward	After start, the first detection of the homing sensor in the forward direction triggers the function.
[5]	1st t. aft.str. reverse	After start, the first detection of the homing sensor in the reverse direction triggers the function.
[6]	Every time	Every detection of the homing sensor triggers the function.
[7]	Every time forward	Every detection of the homing sensor in the forward direction triggers the function.
[8]	Every time reverse	Every detection of the homing sensor in the reverse direction triggers the function.

17-82 Home Position		
Range:	Function:	
0*	[-2147483648 - 2147483647]	<p>NOTICE!</p> <p>This parameter is only available with software version 48.XX.</p> <p>Array [2]</p>

17-82 Home Position		
Range:	Function:	
		<p>Set the homing position in position units defined in parameter group 17-7* Position Scaling. This is an array parameter with 2 elements.</p> <p>Indices in this parameter have a different meaning in the following situations:</p> <ul style="list-style-type: none"> If parameter 17-80 Homing Function is set to options [10]–[13], index 0 of this parameter defines the actual home position and index 1 is used as the homing offset, which defines where to stop. If parameter 17-80 Homing Function is set to [2] Home Sync Function, and parameter 17-81 Home Sync Function is set to [0] 1st time after power, [3] 1st time after start, or [6] Every time, then indices have the following meaning: <ul style="list-style-type: none"> Index 0 is the homing position when the homing sensor is approached in the forward direction. Index 1 is the homing position when the homing sensor is approached in the reverse direction.

17-83 Homing Speed		
Range:	Function:	
150 RPM*	[-32000 - 32000 RPM]	<p>NOTICE!</p> <p>This parameter is only available with software version 48.XX.</p> <p>Enter the speed for the homing functions (parameter 17-80 Homing Function, options [10]–[13]).</p>

17-84 Homing Torque Limit		
Range:	Function:	
160 %*	[0 - 500 %]	<p>NOTICE!</p> <p>This parameter is only available with software version 48.XX.</p> <p>Enter the torque limit for the homing functions (parameter 17-80 Homing Function, options [10]–[13]).</p>

17-85 Homing Timeout		
Range:	Function:	
60 s*	[0.1 - 6000.0 s]	<p>NOTICE! This parameter is only available with software version 48.XX.</p> <p>Enter the timeout for the homing functions (parameter 17-80 Homing Function, options [10]–[13]). If the frequency converter does not detect the homing sensor or does not reach the torque limit within the timeout time, it aborts the homing process and trips.</p>

3.17.7 17-9* Position Configuration

17-90 Absolute Position Mode		
Option:	Function:	
		<p>NOTICE! This parameter is only available with software version 48.XX.</p> <p>Select the behavior when executing consecutive absolute positioning commands.</p>
[0] *	Standard	When the frequency converter receives a new absolute positioning command while the previous positioning command is still in progress, it executes the new positioning command immediately without completing the previous positioning.
[1]	Buffered	When the frequency converter receives a new absolute positioning command while the previous positioning command is still in progress, it completes the previous command first and then executes the new positioning command. Only 1 positioning command can be buffered at a time.

17-91 Relative Position Mode		
Option:	Function:	
		<p>NOTICE! This parameter is only available with software version 48.XX.</p> <p>Select which reference to use for relative positioning commands.</p>
[0] *	Target Position	The frequency converter uses the latest target position as reference for the new positioning command. The frequency converter executes the new positioning

17-91 Relative Position Mode		
Option:	Function:	
		command immediately without completing the previous positioning. The new target is calculated with the formula: New target = previous target + position reference.
[1]	Buffered Target Pos.	The frequency converter uses the latest target position as reference for the new positioning command. The frequency converter executes the new positioning command when it completes the previous command. Only 1 positioning command can be buffered at a time.
[2]	Commanded Position	The frequency converter uses the commanded position as reference for the new positioning command. The frequency converter executes the new positioning command immediately without completing the previous positioning. The new target is calculated with the formula: New target = commanded position + position reference.
[3]	Actual Position	The frequency converter uses the actual position as reference for the new positioning command. The frequency converter executes the new positioning command immediately without completing the previous positioning. The new target is calculated with the formula: New target = actual position + position reference.

17-92 Position Control Selection		
Option:	Function:	
		<p>NOTICE! This parameter is only available with software version 48.XX.</p> <p>This parameter allows to select the position control mode without using a digital input signal or a fieldbus bit.</p>
[0] *	No operation	Use a digital input signal or a fieldbus bit to activate the enable reference mode and the relative position mode.
[1]	Relative Position	This option selects the relative position mode permanently. All positioning commands are considered to be relative. Toggling option [113] Enable Reference on a digital input or the enable reference fieldbus bit triggers relative positioning.

17-92 Position Control Selection		
Option:	Function:	
[2]	Enable Reference	This option selects the enable reference mode permanently. Any new position reference triggers an absolute positioning command with the selected position reference as target. This option cannot be used with relative positioning.

17-93 Master Offset Selection		
Option:	Function:	
		<p>NOTICE!</p> <p>This parameter is available only with software version 48.XX.</p> <p>Select the behavior of the master offset in synchronization mode.</p>
[0]	Absolute * Enabled	The frequency converter adds the master offset (<i>parameter 3-26 Master Offset</i>) to the position at synchronization start. The offset command is executed at every new synchronization start.
[1]	Absolute	The frequency converter adds the master offset (<i>parameter 3-26 Master Offset</i>) to the position at synchronization start. The offset command is executed with every enable master offset signal.
[2]	Relative	The frequency converter adds the master offset (<i>parameter 3-26 Master Offset</i>) to the actual synchronization position with every enable master offset signal.
[3]	Selection	The master offset (<i>parameter 3-26 Master Offset</i>) is relative or absolute depending on the relative position signal on a digital input or the fieldbus bit.
[4]	Relative Home Sensor	The master offset (<i>parameter 3-26 Master Offset</i>) is relative to the home sensor signal. The offset command is executed with the next home sensor signal when the enable master offset signal is active.
[5]	Relative Touch Sensor	The master offset (<i>parameter 3-26 Master Offset</i>) is relative to the touch sensor signal. The offset command is executed with the next touch sensor signal when the enable master offset signal is active.

17-94 Rotary Absolute Direction		
Option:	Function:	
		<p>NOTICE!</p> <p>This parameter is available only with software version 48.XX.</p>

17-94 Rotary Absolute Direction		
Option:	Function:	
		Select the rotation direction for the absolute position mode when <i>parameter 17-76 Position Axis Mode</i> is set to [1] Rotary Axis. To use this parameter, set <i>parameter 4-10 Motor Speed Direction</i> to [2] Both directions.
[0]	* Shortest	The frequency converter selects the rotation direction that provides the shortest route to the target position.
[1]	Forward	Move to the target position in the forward direction.
[2]	Reverse	Move to the target position in the reverse direction.
[3]	Direction	The forward/reverse signal on a digital input or fieldbus determines the rotation direction.

3.18 Parameters: 18-** Data Readouts 2

3.18.1 18-0* Maintenance Log

This group contains the last 10 preventive maintenance events. Maintenance log 0 is the latest and maintenance log 9 the oldest.

By selecting 1 of the logs and pressing [OK], the maintenance item, action, and time of the occurrence are shown in *parameter 18-00 Maintenance Log: Item* – *parameter 18-03 Maintenance Log: Date and Time*.

The alarm log key allows access to both alarm log and maintenance log.

18-00 Maintenance Log: Item		
Array [10]		
Shows the fault code. For information about the fault code, see the <i>design guide</i> .		
Range:	Function:	
0*	[0 - 255]	Find the meaning of the maintenance item in <i>parameter 23-10 Maintenance Item</i> .

18-01 Maintenance Log: Action		
Array [10]		
Shows the fault code. For information about the fault code, see the <i>design guide</i> .		
Range:	Function:	
0*	[0 - 255]	Find the meaning of the maintenance action in <i>parameter 23-11 Maintenance Action</i> .

18-02 Maintenance Log: Time		
Array [10]		
Range:	Function:	
0 s*	[0 - 2147483647 s]	Shows when the logged event occurred. Time is measured in s since last power-up.

18-03 Maintenance Log: Date and Time		
Array [10]		
Range:	Function:	
Size related*	[0 - 0]	Shows when the logged event occurred. NOTICE! This requires that the date and time is programmed in <i>parameter 0-70 Date and Time</i> . Date format depends on the setting in <i>parameter 0-71 Date Format</i> , while the time format depends on the setting in <i>parameter 0-72 Time Format</i> .

18-03 Maintenance Log: Date and Time		
Array [10]		
Range:	Function:	
		NOTICE! The frequency converter has no back-up of the clock function, and the set date/time resets to default (2000-01-01 00:00) after a power-down unless a real-time clock module with back-up is installed. In <i>parameter 0-79 Clock Fault</i> it is possible to program a warning in case the clock has not been set properly, for example after a power-down. Incorrect setting of the clock affects the time stamps for the maintenance events.

NOTICE!

When mounting a VLT® Analog I/O MCB 109 option card, a battery back-up of date and time is included.

18-27 Safe Opt. Est. Speed		
Range:	Function:	
0 RPM*	[-30000 - 30000 RPM]	Shows the speed that the frequency converter estimates and sends to VLT® Safety Option MCB 15X.

18-28 Safe Opt. Meas. Speed		
Range:	Function:	
0 RPM*	[-30000 - 30000 RPM]	Shows the speed measured by VLT® Safety Option MCB 15X.

18-29 Safe Opt. Speed Error		
Range:	Function:	
0 RPM*	[-30000 - 30000 RPM]	Shows the difference between the speed measured by VLT® Safety Option MCB 15X and the speed estimated by frequency converter.

18-36 Analog Input X48/2 [mA]		
Range:	Function:	
0*	[-20 - 20]	View the actual current measured at input X48/2.

18-37 Temp. Input X48/4		
Range:	Function:	
0*	[-500 - 500]	View the actual temperature measured at input X48/4. The temperature unit is based on the selection in <i>parameter 35-00 Term. X48/4 Temperature Unit</i> .

18-38 Temp. Input X48/7		
Range:	Function:	
0* [-500 - 500]	View the actual temperature measured at input X48/7. The temperature unit is based on the selection in <i>parameter 35-02 Term. X48/7 Temperature Unit</i> .	

18-39 Temp. Input X48/10		
Range:	Function:	
0* [-500 - 500]	View the actual temperature measured at input X48/10. The temperature unit is based on the selection in <i>parameter 35-04 Term. X48/10 Temperature Unit</i> .	

3.18.2 18-4* PGIO Data Readouts

Parameters for configuring the readout of VLT® Programmable I/O MCB 115.

18-43 Analog Out X49/7		
Range:	Function:	
0* [0 - 30]	Shows the actual value at output of terminal X49/7 in V or mA. The value reflects the selection in <i>parameter 36-40 Terminal X49/7 Analogue Output</i> .	

18-44 Analog Out X49/9		
Range:	Function:	
0* [0 - 30]	Shows the actual value at output of terminal X49/9 in V or mA. The value reflects the selection in <i>parameter 36-50 Terminal X49/9 Analogue Output</i> .	

18-45 Analog Out X49/11		
Range:	Function:	
0* [0 - 30]	Shows the actual value at output of terminal X49/11 in V or mA. The value reflects the selection in <i>parameter 36-60 Terminal X49/11 Analogue Output</i> .	

3.18.3 18-5* Active Alarms/Warnings

The parameters in this group show the numbers of currently active alarms or warnings.

18-55 Active Alarm Numbers		
Range:	Function:	
0* [0 - 65535]	This parameter contains an array of up to 20 alarms that are currently active. The value 0 means no alarm.	

18-56 Active Warning Numbers		
Range:	Function:	
0* [0 - 65535]	This parameter contains an array of up to 20 warnings that are currently active. The value 0 means no warning.	

18-60 Digital Input 2		
Range:	Function:	
0* [0 - 65535]	Shows the signal states from the active digital inputs. <ul style="list-style-type: none"> • 0 = No signal. • 1 = Connected signal. 	

18-70 Mains Voltage		
Range:	Function:	
0 V* [0 - 1000 V]	Shows the mains line-to-line voltage.	

18-71 Mains Frequency		
Range:	Function:	
0 Hz* [-100 - 100 Hz]	Shows the mains frequency.	

18-72 Mains Imbalance		
Range:	Function:	
0 %* [0 - 100 %]	Shows the maximum imbalance for the 3 mains line-to-line measurements.	

18-75 Rectifier DC Volt.		
Range:	Function:	
0 V* [0 - 10000 V]	Shows the DC voltage measured on the rectifier module.	

18-90 Process PID Error		
Range:	Function:	
0 %* [-200 - 200 %]	Give the present error value used by the process PID controller.	

18-91 Process PID Output		
Range:	Function:	
0 %* [-200 - 200 %]	Give the present raw output value from the process PID controller.	

18-92 Process PID Clamped Output		
Range:	Function:	
0 %* [-200 - 200 %]	Give the present output value from the process PID controller after the clamp limits have been observed.	

3

18-93 Process PID Gain Scaled Output		
Range:		Function:
0 %*	[-200 - 200 %]	Give the present output value from the process PID controller after the clamp limits have been observed, and the resulting value has been gain scaled.

3.19 Parameters: 19-** Application Parameters

Parameters in this group are available when VLT® Motion Control Option MCO 305 is installed in the frequency converter. For information about the option, see the *VLT® Motion Control Option MCO 305 Operating Instructions*.

3.20 Parameters: 23-** Time-based Functions

3.20.1 23-0* Timed Actions

Use timed actions for actions performed on a daily or weekly basis, for example different references for working hours/non-working hours. Up to 10 timed actions can be programmed in the frequency converter. Select the timed action number from the list when entering *parameter group 23-** Time-based Functions* from the LCP. *Parameter 23-00 ON Time* and *parameter 23-04 Occurrence* then refer to the selected timed action number. Each timed action is divided into an ON time and an OFF time, in which 2 different actions may be performed.

Display lines 2 and 3 in the LCP show the status for timed actions mode (*parameter 0-23 Display Line 2 Large* and *parameter 0-24 Display Line 3 Large*, setting [1643] *Timed Actions Status*).

NOTICE!

A change in mode via the digital inputs can only take place if *parameter 23-08 Timed Actions Mode* is set for [0] *Times Actions Auto*.

If commands are applied simultaneously to the digital inputs for constant OFF and constant ON, the timed actions mode changes to timed actions auto and the 2 commands are disregarded.

If *parameter 0-70 Date and Time* is not set or the frequency converter is set to hand-on mode or OFF mode (for example via the LCP), the timed actions mode is changed to [0] *Disabled*.

The timed actions have a higher priority than the same actions/commands activated by the digital inputs or the smart logic controller.

The actions programmed in timed actions are merged with corresponding actions from digital inputs, control word via bus, and smart logic controller, according to merge rules set up in *parameter group 8-5* Digital/Bus*.

NOTICE!

Program the clock (*parameter group 0-7* Clock Settings*) correctly for timed actions to function.

NOTICE!

When mounting VLT® Analog I/O Option MCB 109, a battery back-up of the date and time is included.

NOTICE!

The PC-based configuration tool MCT 10 Set-up Software comprises a special guide for easy programming of timed actions.

23-00 ON Time		
Array [10]		
Range:		Function:
Size related*	[0 - 0]	Sets the ON time for the timed action.
<p>NOTICE!</p> <p>The frequency converter has no back-up of the clock function and the set date/time resets to default (2000-01-01 00:00) after a power-down unless a real-time clock-module with back-up is installed. In <i>parameter 0-79 Clock Fault</i>, it is possible to program a warning if the clock has not been set properly, for example after a power-down.</p>		

23-01 ON Action		
Array [10]		
Option:		Function:
		<p>NOTICE!</p> <p>For options [32] <i>Set digital out A low</i>–[43] <i>Set digital out F high</i>, see also <i>parameter group 5-3* Digital Outputs</i> and <i>parameter group 5-4* Relays</i>.</p> <p>Select the action during ON time. See <i>parameter 13-52 SL Controller Action</i> for descriptions of the options.</p>
[0] *	Disabled	
[1]	No action	
[2]	Select set-up 1	
[3]	Select set-up 2	
[4]	Select set-up 3	
[5]	Select set-up 4	
[10]	Select preset ref 0	
[11]	Select preset ref 1	
[12]	Select preset ref 2	
[13]	Select preset ref 3	
[14]	Select preset ref 4	

23-01 ON Action		
Array [10]		
Option:	Function:	
[15]	Select preset ref 5	
[16]	Select preset ref 6	
[17]	Select preset ref 7	
[18]	Select ramp 1	
[19]	Select ramp 2	
[22]	Run	
[23]	Run reverse	
[24]	Stop	
[26]	DC Brake	
[27]	Coast	
[32]	Set digital out A low	
[33]	Set digital out B low	
[34]	Set digital out C low	
[35]	Set digital out D low	
[36]	Set digital out E low	
[37]	Set digital out F low	
[38]	Set digital out A high	
[39]	Set digital out B high	
[40]	Set digital out C high	
[41]	Set digital out D high	
[42]	Set digital out E high	
[43]	Set digital out F high	
[60]	Reset Counter A	
[61]	Reset Counter B	
[62]	Counter A (up)	
[63]	Counter A (down)	
[64]	Counter B (up)	
[65]	Counter B (down)	
[80]	Sleep Mode	
[90]	Set ECB Bypass Mode	
[91]	Set ECB Drive Mode	
[100]	Reset Alarms	

23-02 OFF Time		
Array [10]		
Range:	Function:	
Size related*	[0 - 0]	Sets the OFF time for the timed action.
<p>NOTICE!</p> <p>The frequency converter has no back-up of the clock function and the set date/time is reset to default (2000-01-01 00:00) after a power-down unless a real-time clock module with back-up is installed. In <i>parameter 0-79 Clock Fault</i>, it is possible to program a warning if the clock has not been set properly, for example after a power-down.</p>		

23-03 OFF Action		
Array [10]		
Option:	Function:	
		Select the action during OFF time. See <i>parameter 13-52 SL Controller Action</i> for descriptions of the options.
[1] *	No action	
[2]	Select set-up 1	
[3]	Select set-up 2	
[4]	Select set-up 3	
[5]	Select set-up 4	
[10]	Select preset ref 0	
[11]	Select preset ref 1	
[12]	Select preset ref 2	
[13]	Select preset ref 3	
[14]	Select preset ref 4	
[15]	Select preset ref 5	
[16]	Select preset ref 6	
[17]	Select preset ref 7	
[18]	Select ramp 1	
[19]	Select ramp 2	
[22]	Run	
[23]	Run reverse	
[24]	Stop	
[26]	DC Brake	
[27]	Coast	
[32]	Set digital out A low	
[33]	Set digital out B low	
[34]	Set digital out C low	
[35]	Set digital out D low	
[36]	Set digital out E low	
[37]	Set digital out F low	
[38]	Set digital out A high	

23-03 OFF Action		
Array [10]		
Option:	Function:	
[39]	Set digital out B high	
[40]	Set digital out C high	
[41]	Set digital out D high	
[42]	Set digital out E high	
[43]	Set digital out F high	
[60]	Reset Counter A	
[61]	Reset Counter B	
[62]	Counter A (up)	
[63]	Counter A (down)	
[64]	Counter B (up)	
[65]	Counter B (down)	
[80]	Sleep Mode	
[90]	Set ECB Bypass Mode	
[91]	Set ECB Drive Mode	
[100]	Reset Alarms	

23-04 Occurrence		
Array [10]		
Option:	Function:	
		Select which day(s) the timed action applies to. Specify working/non-working days in: <ul style="list-style-type: none"> • <i>Parameter 0-81 Working Days.</i> • <i>Parameter 0-82 Additional Working Days.</i> • <i>Parameter 0-83 Additional Non-Working Days.</i>
[0] *	All days	
[1]	Working days	
[2]	Non-working days	
[3]	Monday	
[4]	Tuesday	
[5]	Wednesday	
[6]	Thursday	
[7]	Friday	
[8]	Saturday	
[9]	Sunday	
[10]	Day 1 of month	
[11]	Day 2 of month	
[12]	Day 3 of month	
[13]	Day 4 of month	
[14]	Day 5 of month	
[15]	Day 6 of month	
[16]	Day 7 of month	
[17]	Day 8 of month	
[18]	Day 9 of month	
[19]	Day 10 of month	
[20]	Day 11 of month	

23-04 Occurrence		
Array [10]		
Option:	Function:	
[21]	Day 12 of month	
[22]	Day 13 of month	
[23]	Day 14 of month	
[24]	Day 15 of month	
[25]	Day 16 of month	
[26]	Day 17 of month	
[27]	Day 18 of month	
[28]	Day 19 of month	
[29]	Day 20 of month	
[30]	Day 21 of month	
[31]	Day 22 of month	
[32]	Day 23 of month	
[33]	Day 24 of month	
[34]	Day 25 of month	
[35]	Day 26 of month	
[36]	Day 27 of month	
[37]	Day 28 of month	
[38]	Day 29 of month	
[39]	Day 30 of month	
[40]	Day 31 of month	

23-08 Timed Actions Mode		
Used to enable and disable automatic timed actions.		
Option:	Function:	
[0] *	Timed Actions Auto	Enable timed actions.
[1]	Timed Actions Disabled	Disable timed actions, normal operation according to control commands.
[2]	Constant On Actions	Disable timed actions. Constant On Actions activated.
[3]	Constant Off Actions	Disable timed actions. Constant Off Actions activated.

23-09 Timed Actions Reactivation		
Option:	Function:	
[0]	Disabled	After an update of time/condition <ul style="list-style-type: none"> power cycling setting date time change of summertime change of Hand Auto mode change of Constant ON and OFF set-up change all activated ON actions are overridden to OFF actions until passing the next time for an ON action. Any OFF actions remain unchanged.
[1] *	Enabled	After an update of time/condition On and OFF actions are immediately set to the actual time programming of ON and OFF actions.

See the example of a reactivation test in *Figure 3.70*.

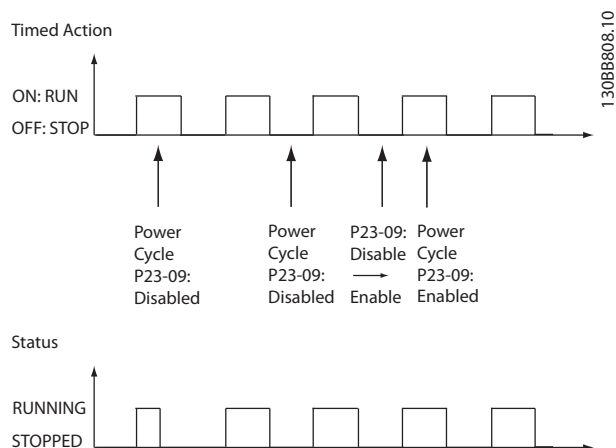

Figure 3.70 Reactivation Test Diagram

3.20.2 23-1* Maintenance

Wear and tear calls for periodic inspection and service of elements in the application, for example motor bearings, feedback sensors, seals, and filters. With preventive maintenance, the service intervals may be programmed into the frequency converter. The frequency converter gives a message when maintenance is required. 20 preventive maintenance events can be programmed into the frequency converter.

Specify the following for each event:

- Maintenance item (for example, motor bearings).
- Maintenance action (for example, replacement).
- Maintenance time base (for example, running hours, or a specific date and time).
- Maintenance time interval or the date and time of next maintenance.

NOTICE!

To disable a preventive maintenance event, set the associated *parameter 23-12 Maintenance Time Base* to [0] Disabled.

Preventive maintenance can be programmed from the LCP, but use of the PC-based MCT 10 Set-up Software is recommended.

ID	Name	Setup 1	Setup 2	Setup 3	Setup 4
2310.0	Maintenance Item	Motor bearings	Motor bearings	Motor bearings	Motor bearings
2310.1	Maintenance Item	Motor bearings	Motor bearings	Motor bearings	Motor bearings
2310.2	Maintenance Item	Motor bearings	Motor bearings	Motor bearings	Motor bearings
2310.3	Maintenance Item	Motor bearings	Motor bearings	Motor bearings	Motor bearings
2310.4	Maintenance Item	Motor bearings	Motor bearings	Motor bearings	Motor bearings
2310.5	Maintenance Item	Motor bearings	Motor bearings	Motor bearings	Motor bearings
2310.6	Maintenance Item	Motor bearings	Motor bearings	Motor bearings	Motor bearings
2310.7	Maintenance Item	Motor bearings	Motor bearings	Motor bearings	Motor bearings
2310.8	Maintenance Item	Motor bearings	Motor bearings	Motor bearings	Motor bearings
2310.9	Maintenance Item	Motor bearings	Motor bearings	Motor bearings	Motor bearings
2310.10	Maintenance Item	Motor bearings	Motor bearings	Motor bearings	Motor bearings
2310.11	Maintenance Item	Motor bearings	Motor bearings	Motor bearings	Motor bearings
2310.12	Maintenance Item	Motor bearings	Motor bearings	Motor bearings	Motor bearings
2310.13	Maintenance Item	Motor bearings	Motor bearings	Motor bearings	Motor bearings
2310.14	Maintenance Item	Motor bearings	Motor bearings	Motor bearings	Motor bearings
2310.15	Maintenance Item	Motor bearings	Motor bearings	Motor bearings	Motor bearings
2310.16	Maintenance Item	Motor bearings	Motor bearings	Motor bearings	Motor bearings
2310.17	Maintenance Item	Motor bearings	Motor bearings	Motor bearings	Motor bearings
2310.18	Maintenance Item	Motor bearings	Motor bearings	Motor bearings	Motor bearings
2310.19	Maintenance Item	Motor bearings	Motor bearings	Motor bearings	Motor bearings
2311.0	Maintenance Action	Lubricate	Lubricate	Lubricates	Lubricate
2311.2	Maintenance Action	Lubricate	Lubricate	Lubricates	Lubricate
2311.3	Maintenance Action	Lubricate	Lubricate	Lubricates	Lubricate
2311.4	Maintenance Action	Lubricate	Lubricate	Lubricates	Lubricate
2311.5	Maintenance Action	Lubricate	Lubricate	Lubricates	Lubricate
2311.6	Maintenance Action	Lubricate	Lubricate	Lubricates	Lubricate

Figure 3.71 MCT 10 Set-up Software

The LCP indicates (with a wrench icon and letter M) when it is time for a preventive maintenance action and can be programmed to be indicated on a digital output in *parameter group 5-3* Digital Outputs*. The preventive maintenance status is shown in *parameter 16-96 Maintenance Word*. A preventive maintenance indication can be reset from a digital input, the FC bus, or manually from the LCP through *parameter 23-15 Reset Maintenance Word*.

A maintenance log with the latest 10 loggings can be read from *parameter group 18-0* Maintenance Log* and via the alarm log key on the LCP after selecting maintenance log.

NOTICE!

The preventive maintenance events are defined in a 20-element array. Hence, each preventive maintenance event must use the same array element index in *parameter 23-10 Maintenance Item* to *parameter 23-14 Maintenance Date and Time*.

3

23-10 Maintenance Item		
Array [20]		
Option:	Function:	
	Array with 20 elements shown below the parameter number in the display. Press [OK] and step between elements with [◀], [▶], [▲], and [▼]. Select the item to be associated with the preventive maintenance event.	
[1] *	Motor bearings	
[2]	Fan bearings	
[3]	Pump bearings	
[4]	Valve	
[5]	Pressure transmitter	
[6]	Flow transmitter	
[7]	Temperature transm.	
[8]	Pump seals	
[9]	Fan belt	
[10]	Filter	
[11]	Drive cooling fan	
[12]	System health check	
[13]	Warranty	
[20]	Maintenance Text 0	
[21]	Maintenance Text 1	
[22]	Maintenance Text 2	
[23]	Maintenance Text 3	
[24]	Maintenance Text 4	
[25]	Maintenance Text 5	
[26]	Service log full	

23-11 Maintenance Action		
Array [20]		
Option:	Function:	
	Select the action to be associated with the preventive maintenance event.	
[1] *	Lubricate	
[2]	Clean	
[3]	Replace	
[4]	Inspect/Check	
[5]	Overhaul	
[6]	Renew	
[7]	Check	
[20]	Maintenance Text 0	

23-11 Maintenance Action		
Array [20]		
Option:	Function:	
[21]	Maintenance Text 1	
[22]	Maintenance Text 2	
[23]	Maintenance Text 3	
[24]	Maintenance Text 4	
[25]	Maintenance Text 5	
[28]	Clear logs	

23-12 Maintenance Time Base		
Array [20]		
Option:	Function:	
	Select the time base to be associated with the preventive maintenance event.	
[0] *	Disabled	Disables the preventive maintenance event.
[1]	Running Hours	The number of hours the motor has run. Running hours are not reset at power-on. Specify the maintenance time interval in <i>parameter 23-13 Maintenance Time Interval</i> .
[2]	Operating Hours	The number of hours the frequency converter has run. Operating hours are not reset at power-on. Specify the maintenance time interval in <i>parameter 23-13 Maintenance Time Interval</i> .
[3]	Date & Time	Uses the internal clock. Specify the date and time of the next maintenance occurrence in <i>parameter 23-14 Maintenance Date and Time</i> .

23-13 Maintenance Time Interval		
Array [20]		
Range:		Function:
1 h*	[1 - 2147483647 h]	<p>Set the interval associated with the current preventive maintenance event. This parameter is only used if [1] <i>Running Hours</i> or [2] <i>Operating Hours</i> is selected in <i>parameter 23-12 Maintenance Time Base</i>. The timer is reset from <i>parameter 23-15 Reset Maintenance Word</i>.</p> <p>Example A preventive maintenance event is set up Monday at 8:00. <i>Parameter 23-12 Maintenance Time Base</i> is [2] <i>Operating hours</i> and <i>parameter 23-13 Maintenance Time Interval</i> is 7 x 24 hours=168 hours. Next maintenance event is indicated the following Monday at 8:00. If this maintenance event is not reset until Tuesday at 9:00, the next occurrence is the following Tuesday at 9:00.</p>

23-14 Maintenance Date and Time		
Array [20]		
Range:		Function:
Size related*	[0 - 0]	<p>Set the date and time for next maintenance occurrence if the preventive maintenance event is based on date/time. Date format depends on the setting in <i>parameter 0-71 Date Format</i> while the time format depends on the setting in <i>parameter 0-72 Time Format</i>.</p> <p>NOTICE! The frequency converter has no back-up of the clock function and the set date/time is reset to default (2000-01-01 00:00) after a power-down. In <i>parameter 0-79 Clock Fault</i>, it is possible to program a warning if the clock has not been set properly, for example after a power-down. Set the time at least 1 hour later than actual time.</p> <p>NOTICE! When mounting a VLT® Analog I/O option MCB 109 option card, a battery back-up of the date and time is included.</p>

23-15 Reset Maintenance Word		
Option:	Function:	
	<p>NOTICE! When messages are reset - maintenance item, action, and maintenance date/time are not canceled. <i>Parameter 23-12 Maintenance Time Base</i> is set to [0] <i>Disabled</i>.</p> <p>Set this parameter to [1] <i>Do reset</i> to reset the maintenance word in <i>parameter 16-96 Maintenance Word</i> and reset the message shown in the LCP. This parameter changes back to [0] <i>Do not reset</i> when pressing [OK].</p>	
[0] *	Do not reset	
[1]	Do reset	

3

23-16 Maintenance Text		
Array [6]		
Range:		Function:
0*	[0 - 20]	6 individual texts (Maintenance Text 0...Maintenance Text 5) can be written for use in either <i>parameter 23-10 Maintenance Item</i> or <i>parameter 23-11 Maintenance Action</i> . The text is written according to the guidelines in <i>parameter 0-37 Display Text 1</i> .

3.21 Parameters: 30-** Special Features

3.21.1 30-0* Wobble Function

The wobble function is primarily used for synthetic yarn winding applications. The wobble option is installed in the frequency converter controlling the traverse frequency converter. The yarn moves back and forth in a diamond pattern across the surface of the yarn package. To prevent a build-up of yarn at the same points at the surface, this pattern must be altered. The wobble option can accomplish this by continuously varying the traverse frequency in a programmable cycle. The wobble function is created by superimposing a delta frequency around a center frequency. To compensate for the inertia in the system, a quick frequency jump can be included. Suitable for elastic yarn applications, the option features a randomized wobble ratio.

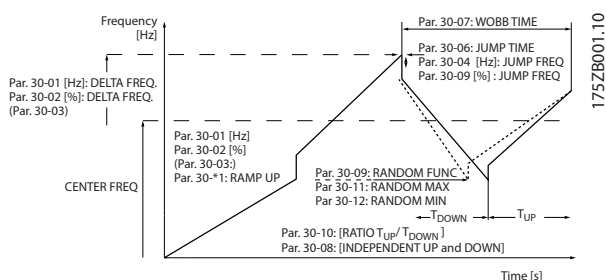

Figure 3.72 Wobble Function

30-00 Wobble Mode	
Option:	Function:
	<p>NOTICE!</p> <p>This parameter cannot be adjusted while the motor is running.</p> <p>The standard speed open-loop mode in <i>parameter 1-00 Configuration Mode</i> is extended with a wobble function. In this parameter, it is possible to select which method to be used for the wobbler. Set the parameters as absolute values (direct frequencies) or as relative values (percentage of other parameter). Set the wobble cycle time as an absolute value or as independent up and down times. When using an absolute cycle time, the up and down times are configured through the wobble ratio.</p>
[0]	Abs. Freq., Abs. Time
[1]	Abs. Freq., Up/ Down Time

30-00 Wobble Mode	
Option:	Function:
[2]	Rel. Freq., Abs. Time
[3]	Rel. Freq., Up/ Down Time

30-01 Wobble Delta Frequency [Hz]	
Range:	Function:
5 Hz* [0 - 25 Hz]	<p>The delta frequency determines the magnitude of the wobble frequency. The delta frequency is superimposed on the center frequency.</p> <p><i>Parameter 30-01 Wobble Delta Frequency [Hz]</i> contains both the positive and negative delta frequency. The setting of <i>parameter 30-01 Wobble Delta Frequency [Hz]</i> must thus not exceed the setting of the center frequency. The initial ramp-up time from standstill until the wobble sequence runs is determined in <i>chapter 3.4.2 3-1* References</i>.</p>

30-02 Wobble Delta Frequency [%]	
Range:	Function:
25 %* [0 - 100 %]	<p>The delta frequency can also be expressed as percentage of the center frequency and can thus be maximum 100%. The function is the same as for <i>parameter 30-01 Wobble Delta Frequency [Hz]</i>.</p>

30-03 Wobble Delta Freq. Scaling Resource	
Option:	Function:
	Select which frequency converter input should be used to scale the delta frequency setting.
[0] *	No function
[1]	Analog Input 53
[2]	Analog Input 54
[3]	Frequency input 29 FC 302 only.
[4]	Frequency input 33
[7]	Analog Input X30/11
[8]	Analog Input X30/12
[15]	Analog Input X48/2

30-04 Wobble Jump Frequency [Hz]	
Range:	Function:
0 Hz* [0 - 20.0 Hz]	<p>The jump frequency is used to compensate for the inertia in the traverse system. If a jump in the output frequency is required at the boundaries of the wobble sequence, the frequency jump is set in this parameter. If the traverse system has a very high inertia, a high jump frequency may create a torque limit</p>

30-04 Wobble Jump Frequency [Hz]		
Range:		Function:
		warning or trip or an overvoltage warning or trip. This parameter can only be changed in stop mode.

30-05 Wobble Jump Frequency [%]		
Range:		Function:
0 %*	[0 - 100 %]	The jump frequency can also be expressed as percentage of the center frequency. The function is the same as for <i>parameter 30-04 Wobble Jump Frequency [Hz]</i> .

30-06 Wobble Jump Time		
Range:		Function:
Size related*	[0.005 - 5.000 s]	This parameter determines the slope of the jump ramp at the maximum and minimum wobble frequency.

30-07 Wobble Sequence Time		
Range:		Function:
10 s*	[1 - 1000 s]	This parameter determines the wobble sequence period. This parameter can only be changed in stop mode. Wobble time = $t_{up} + t_{down}$

30-08 Wobble Up/ Down Time		
Range:		Function:
5 s*	[0.1 - 1000 s]	Defines the individual up and down times for each wobble cycle.

30-09 Wobble Random Function		
Option:		Function:
[0] *	Off	
[1]	On	

3.21.2 Center Frequency

Use *parameter group 3-1* References* to set the center frequency.

30-10 Wobble Ratio		
Range:		Function:
1*	[0.1 - 10]	If the ratio 0.1 is selected: t_{down} is 10 times greater than t_{up} . If the ratio 10 is selected: t_{up} is 10 times greater than t_{down} .

30-11 Wobble Random Ratio Max.		
Range:		Function:
10*	[par. 17-53 - 10]	Enter the maximum allowed wobble ratio.

30-12 Wobble Random Ratio Min.		
Range:		Function:
0.1*	[0.1 - par. 30-11]	Enter the minimum allowed wobble ratio.

30-19 Wobble Delta Freq. Scaled		
Range:		Function:
0 Hz*	[0 - 1000 Hz]	Readout parameter. View the actual wobble delta frequency after scaling has been applied.

3.21.3 30-2* Adv. Start Adjust

30-20 High Starting Torque Time [s]		
Range:		Function:
Size related*	[0 - 60 s]	NOTICE! This parameter is available for FC 302 only. High starting torque time for PM motor in flux control principle without feedback.

30-21 High Starting Torque Current [%]		
Range:		Function:
Size related*	[0 - 200.0 %]	NOTICE! This parameter is available for FC 302 only. High starting torque current for PM motor in VVC ⁺ and flux mode without feedback.

30-22 Locked Rotor Protection		
Option:		Function:
		NOTICE! This parameter is available for FC 302 only. Available for PM motors only, in flux sensorless mode and VVC ⁺ open-loop mode.
[0]	Off	
[1]	On	Protects the motor from the locked rotor condition. The control algorithm detects a possible locked rotor

30-22 Locked Rotor Protection		
Option: Function:		
		condition in the motor and trips the frequency converter to protect the motor.

30-23 Locked Rotor Detection Time [s]		
Range:		Function:
Size related*	[0.05 - 1 s]	Time period for detecting the locked rotor condition. A low parameter value leads to faster detection.

30-24 Locked Rotor Detection Speed Error [%]		
Range:		Function:
25 %*	[0 - 100 %]	NOTICE! This parameter is available for FC 302 only.

30-25 Light Load Delay [s]		
Range:		Function:
0.000 s*	[0.000 - 10.000 s]	Use this parameter when the light load detection is active. Enter the delay before the frequency converter activates the light load detection when the motor speed reaches the reference in <i>parameter 30-27 Light Load Speed [%]</i> .

30-26 Light Load Current [%]		
Range:		Function:
0 %*	[0 - 100 %]	Use this parameter when the light load detection is active. Enter the reference current, which is used to determine if the motion of the lift is obstructed and if the direction is to be changed. The value is a percentage of nominal motor current in <i>parameter 1-24 Motor Current</i> .

30-27 Light Load Speed [%]		
Range:		Function:
0 %*	[0 - 100 %]	Use this parameter when the light load detection is active. Enter the reference speed during the light load detection. The value is a percentage of nominal motor speed in <i>parameter 1-25 Motor Nominal Speed</i> . For standard asynchronous motors, the synchronous speed is used instead of <i>parameter 1-25 Motor Nominal Speed</i> due to slip.

3.21.4 30-5* Unit Configuration

Parameters in this group allow to configure the operation of internal units that communicate with the frequency converter. The settings affect the behavior of hardware components inside the frequency converter.

30-50 Heat Sink Fan Mode		
Option:		Function:
[0]	Simple Profile	NOTICE! This parameter is available in FC 302 only. Select how the heat sink fan responds to operating conditions. Use <i>parameter 14-52 Fan Control</i> to control the minimum fan speed. The simple profile is a passive fan control based on the current temperature state of the frequency converter. This option represents the classic operating behavior of fans.
[1]	Reduced Acoustics	
[2]	Standard	
[3]	Cooler Operation	

3.21.5 30-8* Compatibility (I)

30-80 d-axis Inductance (Ld)		
Range:		Function:
0 mH*	[0 - 0.000 mH]	Enter the value of the d-axis inductance. Obtain the value from the permanent magnet motor datasheet. The d-axis inductance cannot be found by performing an AMA.

30-81 Brake Resistor (ohm)		
Range:		Function:
50. Ohm*	[5. - 32000.0 Ohm]	

30-83 Speed PID Proportional Gain		
Range:		Function:
0 N/A*	[0.0000 - 1.0000 N/A]	Enter the speed controller proportional gain. Quick control is obtained at high amplification. However, if amplification is too great, the process may become unstable.

30-84 Process PID Proportional Gain		
Range:		Function:
Size related*	[0 - 10]	Enter the process controller proportional gain. Quick control is obtained at high amplification. However, if amplification is too great, the process may become unstable.

3.21.6 30-9* Wifi LCP

Parameters for configuring the wireless LCP 103.

3

30-90 SSID		
Range:	Function:	
Size related*	[1 - 32]	Enter the wireless network name (SSID). The default value is: Danfoss_<Serial number of the frequency converter>. The serial number is in <i>parameter 15-51 Adj Freq Dr Serial No.</i> .

30-91 Channel		
Range:	Function:	
5*	[1 - 11]	Enter the wireless channel number. The default channel number is 5. Change the channel number, if there is an interference from other wireless networks. Recommended channels: USA territory: 1, 6, 11. Europe: 1, 7, 13.

30-92 Password		
Range:	Function:	
Size related*	[8 - 48]	Enter the wireless network password. Password length: 8–48 characters.

30-97 Wifi Timeout Action		
Select which action to execute if a local reference (hand-on mode) or a remote reference (auto-on mode) is set via the wireless connection and the connection is lost.		
Option:	Function:	
[0] *	Do Nothing	The frequency converter does not do any extra actions.
[1]	Stop Motor	The frequency converter stops the motor (if the motor was started via a wireless connection).

3.22 Parameters: 32-** MCO Basic Settings

Parameters in this group are available when VLT® Motion Control Option MCO 305 is installed in the frequency converter. For information about the option, see the *VLT® Motion Control Option MCO 305 Operating Instructions*.

3.23 Parameters: 33-** MCO Advanced Settings

Parameters in this group are available when VLT® Motion Control Option MCO 305 is installed in the frequency converter. For information about the option, see the *VLT® Motion Control Option MCO 305 Operating Instructions*.

3.24 Parameters: 34-** MCO Data Readouts

Parameters in this group are available when VLT® Motion Control Option MCO 305 is installed in the frequency converter. For information about the option, see the *VLT® Motion Control Option MCO 305 Operating Instructions*.

3.25 Parameters: 35-** Sensor Input Option

Parameters for configuring the functionality of VLT® Sensor Input MCB 114.

3.25.1 35-0* Temp. Input Mode (MCB 114)

35-00 Term. X48/4 Temperature Unit		
Select the unit to be used with temperature input X48/4 settings and readouts:		
Option:	Function:	
[60] *	°C	
[160]	°F	

35-01 Term. X48/4 Input Type		
View the temperature sensor type detected at input X48/4:		
Option:	Function:	
[0] *	Not Connected	
[1]	PT100 2-wire	
[3]	PT1000 2-wire	
[5]	PT100 3-wire	
[7]	PT1000 3-wire	

35-02 Term. X48/7 Temperature Unit		
Select the unit to be used with temperature input X48/7 settings and readouts:		
Option:	Function:	
[60] *	°C	
[160]	°F	

35-03 Term. X48/7 Input Type		
View the temperature sensor type detected at input X48/7:		
Option:	Function:	
[0] *	Not Connected	
[1]	PT100 2-wire	
[3]	PT1000 2-wire	
[5]	PT100 3-wire	
[7]	PT1000 3-wire	

35-04 Term. X48/10 Temperature Unit		
Select the unit to be used with temperature input X48/10 settings and readouts:		
Option:	Function:	
[60] *	°C	
[160]	°F	

35-05 Term. X48/10 Input Type		
View the temperature sensor type detected at input X48/10:		
Option:	Function:	
[0] *	Not Connected	
[1]	PT100 2-wire	
[3]	PT1000 2-wire	
[5]	PT100 3-wire	
[7]	PT1000 3-wire	

35-06 Temperature Sensor Alarm Function		
Select the alarm function:		
Option:	Function:	
[0]	Off	
[2]	Stop	
[5] *	Stop and trip	
[27]	Forced stop and trip	

3.25.2 35-1* Temp. Input X48/4 (MCB 114)

35-14 Term. X48/4 Filter Time Constant		
Range:	Function:	
0.001 s* [0.001 - 10 s]	Enter the filter time constant. This is a first-order digital low-pass filter time constant for suppressing electrical noise in terminal X48/4. A high time constant value improves dampening but also increases the time delay through the filter.	

35-15 Term. X48/4 Temp. Monitor		
This parameter facilitates the possibility of enabling or disabling the temperature monitor for terminal X48/4. Set the temperature limits in <i>parameter 35-16 Term. X48/4 Low Temp. Limit</i> and <i>parameter 35-17 Term. X48/4 High Temp. Limit</i> .		
Option:		Function:
[0] *	Disabled	
[1]	Enabled	

35-16 Term. X48/4 Low Temp. Limit		
Range:		Function:
Size related*	[-50 - par. 35-17]	Enter the minimum temperature reading that is expected for normal operation of the temperature sensor at terminal X48/4.

35-17 Term. X48/4 High Temp. Limit		
Range:		Function:
Size related*	[par. 35-16 - 204]	Enter the maximum temperature reading that is expected for normal operation of the temperature sensor at terminal X48/4.

3.25.3 35-2* Temp. Input X48/7 (MCB 114)

35-24 Term. X48/7 Filter Time Constant		
Range:		Function:
0.001 s*	[0.001 - 10 s]	Enter the filter time constant. This is a first-order digital low-pass filter time constant for suppressing electrical noise in terminal X48/7. A high time constant value improves dampening but also increases the time delay through the filter.

35-25 Term. X48/7 Temp. Monitor		
This parameter facilitates the possibility of enabling or disabling the temperature monitor for terminal X48/7. Set the temperature limits in <i>parameter 35-26 Term. X48/7 Low Temp. Limit</i> and <i>parameter 35-27 Term. X48/7 High Temp. Limit</i> .		
Option:		Function:
[0] *	Disabled	
[1]	Enabled	

35-26 Term. X48/7 Low Temp. Limit		
Range:		Function:
Size related*	[-50 - par. 35-27]	Enter the minimum temperature reading that is expected for normal operation of the

35-26 Term. X48/7 Low Temp. Limit		
Range:		Function:
		temperature sensor at terminal X48/7.

35-27 Term. X48/7 High Temp. Limit		
Range:		Function:
Size related*	[par. 35-26 - 204]	Enter the maximum temperature reading that is expected for normal operation of the temperature sensor at terminal X48/7.

3.25.4 35-3* Temp. Input X48/10 (MCB 114)

35-34 Term. X48/10 Filter Time Constant		
Range:		Function:
0.001 s*	[0.001 - 10 s]	Enter the filter time constant. This is a first-order digital low-pass filter time constant for suppressing electrical noise in terminal X48/10. A high time constant value improves dampening but also increases the time delay through the filter.

35-35 Term. X48/10 Temp. Monitor		
This parameter facilitates the possibility of enabling or disabling the temperature monitor for terminal X48/10. Set the temperature limits in <i>parameter 35-36 Term. X48/10 Low Temp. Limit/parameter 35-37 Term. X48/10 High Temp. Limit</i> .		
Option:		Function:
[0] *	Disabled	
[1]	Enabled	

35-36 Term. X48/10 Low Temp. Limit		
Range:		Function:
Size related*	[-50 - par. 35-37]	Enter the minimum temperature reading that is expected for normal operation of the temperature sensor at terminal X48/10.

35-37 Term. X48/10 High Temp. Limit		
Range:		Function:
Size related*	[par. 35-36 - 204]	Enter the maximum temperature reading that is expected for normal operation of the temperature sensor at terminal X48/10.

3.25.5 35-4* Analog Input X48/2 (MCB 114)

35-42 Term. X48/2 Low Current		
Range:	Function:	
4 mA* [0 - par. 35-43 mA]	Enter the current (mA) that corresponds to the low reference value, set in <i>parameter 35-44 Term. X48/2 Low Ref./Feedb. Value</i> . The value must be more than 2 mA to activate the live zero timeout function in <i>parameter 6-01 Live Zero Timeout Function</i> .	

35-43 Term. X48/2 High Current		
Range:	Function:	
20 mA* [par. 35-42 - 20 mA]	Enter the current (mA) that corresponds to the high reference value (set in <i>parameter 35-45 Term. X48/2 High Ref./Feedb. Value</i>).	

35-44 Term. X48/2 Low Ref./Feedb. Value		
Range:	Function:	
0 ReferenceFeed-backUnit*	[-999999.999 - 999999.999 ReferenceFeed-backUnit]	Enter the reference or feedback value (in RPM, Hz, bar, and so on) that corresponds to the voltage or current set in <i>parameter 35-42 Term. X48/2 Low Current</i> .

35-45 Term. X48/2 High Ref./Feedb. Value		
Range:	Function:	
100 Reference-FeedbackUnit*	[-999999.999 - 999999.999 ReferenceFeed-backUnit]	Enter the reference or feedback value (in RPM, Hz, bar, and so on) that corresponds to the voltage or current set in <i>parameter 35-43 Term. X48/2 High Current</i> .

35-46 Term. X48/2 Filter Time Constant		
Range:	Function:	
0.001 s* [0.001 - 10 s]	Enter the filter time constant. This is a first-order digital low-pass filter time constant for suppressing electrical noise in terminal X48/2. A high time constant value improves dampening but also increases the time delay through the filter.	

3.26 Parameters: 36-** Programmable I/O Option

Parameters for configuring VLT® Programmable I/O MCB 115.

Parameters in this group are active only when VLT® Programmable I/O MCB 115 is installed.

3.26.1 36-0* I/O Mode

Use the parameters in this group to configure the mode of inputs and outputs of VLT® Programmable I/O MCB 115. Terminals can be programmed to provide voltage, current, or digital output.

36-03 Terminal X49/7 Mode		
Select the output mode of analog terminal X49/7.		
Option:	Function:	
[0] *	Voltage 0-10V	
[1]	Voltage 2-10V	
[2]	Current 0-20mA	
[3]	Current 4-20mA	

36-04 Terminal X49/9 Mode		
Select the output mode of analog terminal X49/9.		
Option:	Function:	
[0] *	Voltage 0-10V	
[1]	Voltage 2-10V	
[2]	Current 0-20mA	
[3]	Current 4-20mA	

36-05 Terminal X49/11 Mode		
Select the output mode of analog terminal X49/11.		
Option:	Function:	
[0] *	Voltage 0-10V	
[1]	Voltage 2-10V	
[2]	Current 0-20mA	
[3]	Current 4-20mA	

3.26.2 36-4* Output X49/7

Use the parameters in this group to configure the mode of inputs and outputs of VLT® Programmable I/O MCB 115.

Select the functionality of terminal X49/7.

36-40 Terminal X49/7 Analogue Output		
Option:	Function:	
[0] *	No operation	
[52]	MCO 0-20mA/0-10V	
[100]	Output frequency	
[101]	Reference	

36-40 Terminal X49/7 Analogue Output		
Option:	Function:	
[102]	Feedback	
[103]	Motor Current	
[104]	Torque rel to limit	
[105]	Torq relate to rated	
[106]	Power	
[107]	Speed	
[108]	Torque	
[109]	Max Out Freq	
[139]	Bus ctrl. 0-20 mA	
[141]	Bus ctrl 0-20mA t.o.	

36-42 Terminal X49/7 Min. Scale		
Match the minimum output of terminal X49/7 with a required value. The required value is defined as a percentage of the value selected in <i>parameter 36-40 Terminal X49/7 Analogue Output</i> . To know more about how this parameter works, see <i>parameter 6-52 Terminal 42 Output Max Scale</i> .		
The following example describes how the frequency converter uses this parameter.		
Example		
<i>Parameter 36-03 Terminal X49/7 Mode=[0] Voltage 0-10 V</i>		
<i>Parameter 36-40 Terminal X49/7 Analogue Output=[100] Output frequency</i>		
<i>Parameter 4-19 Max Output Frequency=200 Hz</i>		
Application requirement: If the output frequency is lower than 20 Hz, the output of terminal X49/7 should be 0 V. To fulfil the example requirement, enter 10% in <i>parameter 36-42 Terminal X49/7 Min. Scale</i> .		
Range:	Function:	
0 %*	[0 - 200 %]	

36-43 Terminal X49/7 Max. Scale		
Range:	Function:	
100 %*	[0 - 200 %]	Scale the maximum output of terminal X49/7. For example, the scaling is done for the following reasons: <ul style="list-style-type: none"> To provide an output value lower than the maximum possible value. To provide the full signal range using output values lower than a certain limit. To know more about how this parameter works, see <i>parameter 6-52 Terminal 42 Output Max Scale</i>
Example		
<i>Parameter 36-03 Terminal X49/7 Mode=[0] Voltage 0-10 V</i>		
<i>Parameter 36-40 Terminal X49/7 Analogue Output=[100] Output frequency</i>		
<i>Parameter 4-19 Max Output Frequency=200 Hz</i>		
Example case 1: 5 V maximum output is required when the output frequency is 200 Hz.		

36-43 Terminal X49/7 Max. Scale		
Range:		Function:
		Parameter 36-43 Terminal X49/7 Max. Scale = $(10 \text{ V}/5 \text{ V}) \times 100\% = 200\%$. Example case 2: 10 V maximum output is required when the output frequency is 150 Hz (75% of the maximum output frequency). Parameter 36-43 Terminal X49/7 Max. Scale = 75%.

36-44 Terminal X49/7 Bus Control		
Range:		Function:
0 %*	[0 - 100 %]	This parameter contains the output level of terminal X49/7 if the terminal is controlled by a fieldbus.

36-45 Terminal X49/7 Timeout Preset		
Range:		Function:
0 %*	[0 - 100 %]	The frequency converter sends the value of this parameter to the output terminal when the terminal is controlled by a fieldbus and a timeout is detected.

3.26.3 36-5* Output X49/9

Use the parameters in this group to configure the mode of inputs and outputs of VLT® Programmable I/O MCB 115.

36-50 Terminal X49/9 Analogue Output		
Select the functionality of terminal X49/9.		
Option:	Function:	
[0] *	No operation	
[52]	MCO 0-20mA/0-10V	
[100]	Output frequency	
[101]	Reference	
[102]	Feedback	
[103]	Motor Current	
[104]	Torque rel to limit	
[105]	Torq relate to rated	
[106]	Power	
[107]	Speed	
[108]	Torque	
[109]	Max Out Freq	
[139]	Bus ctrl. 0-20 mA	
[141]	Bus ctrl 0-20mA t.o.	

36-52 Terminal X49/9 Min. Scale		
Range:		Function:
0 %*	[0 - 200 %]	Match the minimum output of terminal X49/9 with a required value. For more information, see <i>parameter 36-42 Terminal X49/7 Min. Scale</i> .

36-53 Terminal X49/9 Max. Scale		
Range:		Function:
100 %*	[0 - 200 %]	Scale the maximum output of terminal X49/9. For more information, see <i>parameter 36-43 Terminal X49/7 Max. Scale</i> .

36-54 Terminal X49/9 Bus Control		
Range:		Function:
0 %*	[0 - 100 %]	This parameter contains the output level of terminal X49/9 if the terminal is controlled by a fieldbus.

36-55 Terminal X49/9 Timeout Preset		
Range:		Function:
0 %*	[0 - 100 %]	The frequency converter sends the value of this parameter to the output terminal when the terminal is controlled by a fieldbus and a timeout is detected.

3.26.4 36-6* Output X49/11

Use the parameters in this group to configure the mode of inputs and outputs of VLT® Programmable I/O MCB 115.

36-60 Terminal X49/11 Analogue Output		
Select the functionality of terminal X49/11.		
Option:	Function:	
[0] *	No operation	
[52]	MCO 0-20mA/0-10V	
[100]	Output frequency	
[101]	Reference	
[102]	Feedback	
[103]	Motor Current	
[104]	Torque rel to limit	
[105]	Torq relate to rated	
[106]	Power	
[107]	Speed	
[108]	Torque	
[109]	Max Out Freq	
[139]	Bus ctrl. 0-20 mA	
[141]	Bus ctrl 0-20mA t.o.	

36-62 Terminal X49/11 Min. Scale		
Range:		Function:
0 %*	[0 - 200 %]	Match the minimum output of terminal X49/11 with a required value. For more information, see <i>parameter 36-42 Terminal X49/7 Min. Scale</i> .

36-63 Terminal X49/11 Max. Scale		
Range:		Function:
100 %*	[0 - 200 %]	Scale the maximum output of terminal X49/11. For more information, see <i>parameter 36-43 Terminal X49/7 Max. Scale.</i>

36-64 Terminal X49/11 Bus Control		
Range:		Function:
0 %*	[0 - 100 %]	This parameter contains the output level of terminal X49/11 if the terminal is controlled by a fieldbus.

36-65 Terminal X49/11 Timeout Preset		
Range:		Function:
0 %*	[0 - 100 %]	The frequency converter sends the value of this parameter to the output terminal when the terminal is controlled by a fieldbus and a timeout is detected.

3.27 Parameters: 40-** Special Settings

3.27.1 40-5* Advanced Control Settings

Parameters for configuring the advanced motor control settings.

40-50 Flux Sensorless Model Shift		
Use this parameter to enable or disable the shifting between flux model 1 and flux model 2 at low speed. See also <i>parameter 1-66 Min. Current at Low Speed</i> .		
Option:	Function:	
[0]	Off	
[1]	On	

3.28 Parameters: 42-** Safety Functions

The parameters in this parameter group are available when a safety option is installed in the frequency converter. For information about the safety-related parameters, see the operating instructions for the safety options:

- VLT® Safety Option MCB 150/151 Operating Instructions.
- VLT® Safety Option MCB 152 Operating Instructions.

3.29 Parameters: 43-** Unit Readouts

The parameters in this group provide readouts for monitoring the operation of frequency converters in the D-F enclosure sizes.

3.29.1 43-0* Component Status

This parameter group contains read-only information on hardware components in the power section. All parameters in this group are arrays:

- [0]: Power card 1 (the master power card in a parallel frequency converter, or the only power card in a frequency converter with a single inverter section).
- [1]: Power card 2 (inverter connection in a parallel frequency converter).
- [2]: Power card 3 (inverter connection in a parallel frequency converter).
- [3]: Power card 4 (inverter connection in a parallel frequency converter).
- [4]: Power card 5 (rectifier connection in a parallel frequency converter).
- [5]: Power card 6 (rectifier connection in a parallel frequency converter).

- [6]: Power card 7 (rectifier connection in a parallel frequency converter).
- [7]: Power card 8 (rectifier connection in a parallel frequency converter).
- [8]: Inrush card (optional).
- [9]: Fan power card 1 (optional).
- [10]: Fan power card 2 (optional).

43-00 Component Temp.		
Range:	Function:	
0 °C* [-128 - 127 °C]	<p>NOTICE! This parameter is valid for FC 302 only.</p> <p>Shows the temperature of a system component. The elements of the array reference local PCB temperature sensor measurements. <i>Parameter 16-31 System Temp.</i> uses all elements in this array to calculate the system temperature.</p>	

43-01 Auxiliary Temp.		
Range:	Function:	
0 °C* [-128 - 127 °C]	<p>NOTICE! This parameter is valid for FC 302 only.</p> <p>Shows the temperature of an auxiliary component. The elements of the array reference the temperature measurements from the NTC temperature sensors connected to hardware components in the frequency converter. Refer to the <i>operating guide</i> for specifications of temperature sensor placement.</p>	

43-02 Component SW ID		
Range:	Function:	
0* [0 - 20]	Shows the software version of the installed option.	

3.29.2 43-1* Power Card Status

This parameter group contains read-only information on the power card status. All parameters in this group are arrays:

- [0]: Power card 1 (the master power card in a parallel frequency converter, or the only power card in a frequency converter with a single inverter section).
- [1]: Power card 2 (inverter connection in a parallel frequency converter).
- [2]: Power card 3 (inverter connection in a parallel frequency converter).
- [3]: Power card 4 (inverter connection in a parallel frequency converter).
- [4]: Power card 5 (rectifier connection in a parallel frequency converter).
- [5]: Power card 6 (rectifier connection in a parallel frequency converter).
- [6]: Power card 7 (rectifier connection in a parallel frequency converter).
- [7]: Power card 8 (rectifier connection in a parallel frequency converter).

43-10 HS Temp. ph.U		
Range:	Function:	
0 °C* [-128 - 127 °C]	NOTICE! This parameter is valid for FC 302 only. Shows the heat sink temperature at the location of the phase U IGBT power module. This measurement is not available in all enclosure sizes. <i>Parameter 16-34 Heatsink Temp.</i> uses the value in this parameter.	

43-11 HS Temp. ph.V		
Range:	Function:	
0 °C* [-128 - 127 °C]	NOTICE! This parameter is valid for FC 302 only. Shows the heat sink temperature at the location of the phase V IGBT power module. This measurement is not available in all enclosure sizes. <i>Parameter 16-34 Heatsink Temp.</i> uses the value in this parameter.	

43-12 HS Temp. ph.W		
Range:	Function:	
0 °C* [-128 - 127 °C]	NOTICE! This parameter is valid for FC 302 only. Shows the heat sink temperature at the location of the phase W IGBT power module. This measurement is not available in all enclosure sizes. <i>Parameter 16-34 Heatsink Temp.</i> uses the value in this parameter.	

43-13 PC Fan A Speed		
Range:	Function:	
0 RPM* [0 - 65535 RPM]	NOTICE! This parameter is valid for FC 302 only. Shows the measured speed of fan A on the power card. Each power card has up to 3 fan connections. Place the fan in the frequency converter according to the <i>operating guide</i> . A typical placement for fan A is in the backchannel (the external fan). The value of this parameter is: <ul style="list-style-type: none"> • The actual fan speed when there is a DC fan in the frequency converter. • Relative speed when there is an AC fan in the frequency converter. 	

43-14 PC Fan B Speed		
Range:	Function:	
0 RPM* [0 - 65535 RPM]	NOTICE! This parameter is valid for FC 302 only. Shows the measured speed of fan B on the power card. Each power card has up to 3 fan connections. Place the fan in the frequency converter according to the <i>operating instructions</i> . A typical placement for fan B is on the enclosure door (the internal fan). The value of this parameter is: <ul style="list-style-type: none"> • The actual fan speed when there is a DC fan in the frequency converter. • Relative speed when there is an AC fan in the frequency converter. 	

43-15 PC Fan C Speed		
Range:		Function:
0 RPM*	[0 - 65535 RPM]	<p>NOTICE!</p> <p>This parameter is valid for FC 302 only.</p> <p>Shows the measured speed of fan C on the power card. Each power card has up to 3 fan connections. Place the fan in the frequency converter according to the <i>operating guide</i>. A typical placement for fan C is inside the enclosure (the mixing fan).</p> <p>The value of this parameter is:</p> <ul style="list-style-type: none"> The actual fan speed when there is a DC fan in the frequency converter. Relative speed when there is an AC fan in the frequency converter.

43-20 FPC Fan A Speed		
Range:		Function:
0 RPM*	[0 - 65535 RPM]	Shows the speed of the power card fan A.

43-21 FPC Fan B Speed		
Range:		Function:
0 RPM*	[0 - 65535 RPM]	Shows the speed of the power card fan B.

43-22 FPC Fan C Speed		
Range:		Function:
0 RPM*	[0 - 65535 RPM]	Shows the speed of the power card fan C.

43-23 FPC Fan D Speed		
Range:		Function:
0 RPM*	[0 - 65535 RPM]	Shows the speed of the power card fan D.

43-24 FPC Fan E Speed		
Range:		Function:
0 RPM*	[0 - 65535 RPM]	Shows the speed of the power card fan E.

43-25 FPC Fan F Speed		
Range:		Function:
0 RPM*	[0 - 65535 RPM]	Shows the speed of the power card fan F.

4 Integrated Motion Controller

4.1 Introduction

NOTICE!

The integrated motion control is only available with special IMC software version 48.XX. To order the frequency converter with the IMC software, use the type code with software release version S067. The IMC software removes the following features from the frequency converter:

- PM and SynRM motor support in VVC⁺.
- Wobble function.
- Surface winder function.
- Extended process PID.
- VLT® Motion Control Option MCO 305 support.

The integrated motion controller (IMC) enables position control. Position control is available when [0] *U/f*, [2] *Flux sensorless*, or [3] *Flux w/ motor feedb* is selected in parameter 1-01 *Motor Control Principle*.

To activate the IMC functionality, select [9] *Positioning* or [10] *Synchronization* in parameter 1-00 *Configuration Mode*.

IMC enables the following functions:

- Positioning: Absolute, relative, and touch probe.
- Homing.
- Position synchronization.
- Virtual master.

Position control in both positioning and synchronization modes can be either sensorless or with feedback. In the sensorless control principle, the motor angle calculated by the motor controller is used as feedback. In the closed-loop control principle, VLT® AutomationDrive FC 302 supports 24 V encoders as standard. With extra options, the frequency converter supports most standard incremental encoders, absolute encoders, and resolvers. The position controller can handle both linear and rotary systems. The controller can scale positions to any relevant physical unit such as mm or degrees.

4.2 Positioning, Homing, Synchronization

4.2.1 Positioning

The frequency converter supports relative positioning and absolute positioning. A positioning command requires 3 inputs:

- Target position.
- Speed reference.
- Ramp times.

These 3 inputs can come from various sources, see *Figure 4.1*.

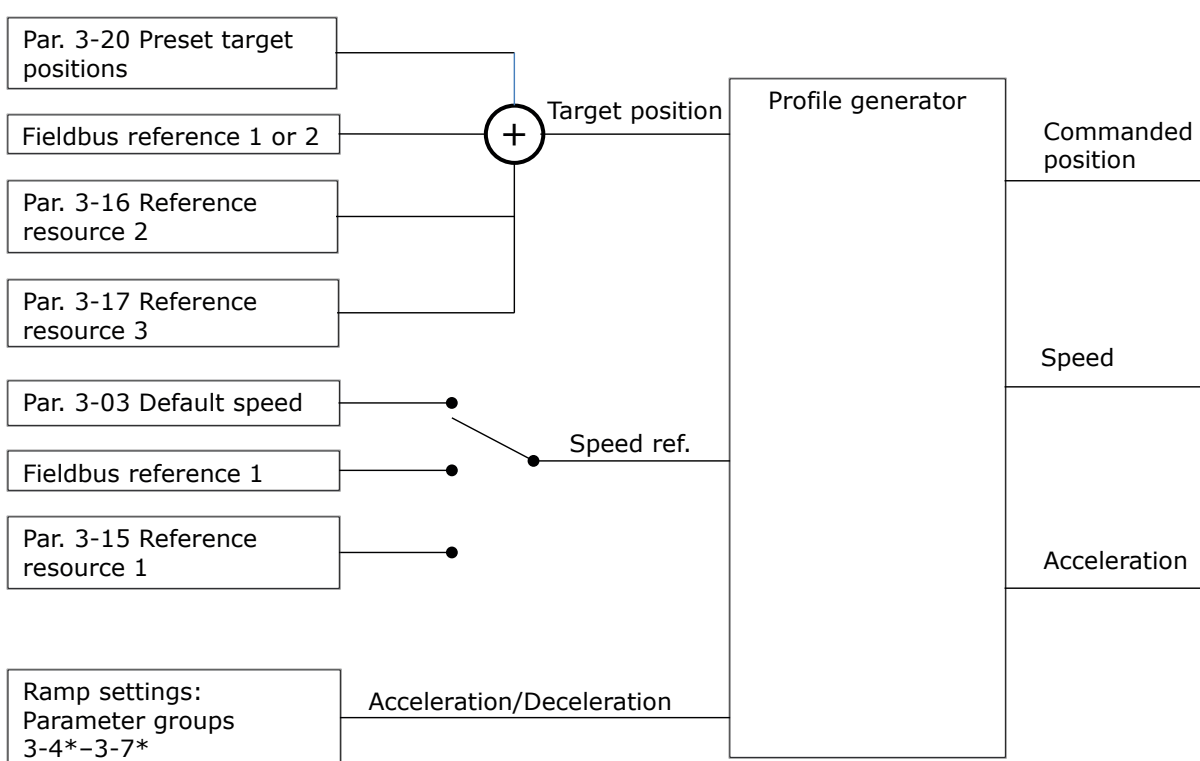

Figure 4.1 Positioning References

In each control cycle (1 ms) the profile generator calculates position, speed, and acceleration required to do the specified movement. The outputs from the profile generator are used at inputs for the position and speed controller as described in *chapter 4.3.1 Control Loops*.

4.2.2 Homing

Homing is required for creating a reference to the physical machine position in closed-loop control principle with incremental encoder or in sensorless control principle. IMC supports various homing functions with or without a homing sensor. Select the homing function in *parameter 17-80 Homing Function*. After selecting a homing function, complete homing before executing absolute positioning.

4.2.3 Synchronization

In synchronization mode, the frequency converter follows the position of a master signal. The master signal and the offset between the master and the follower are handled as shown in *Figure 4.2*.

4

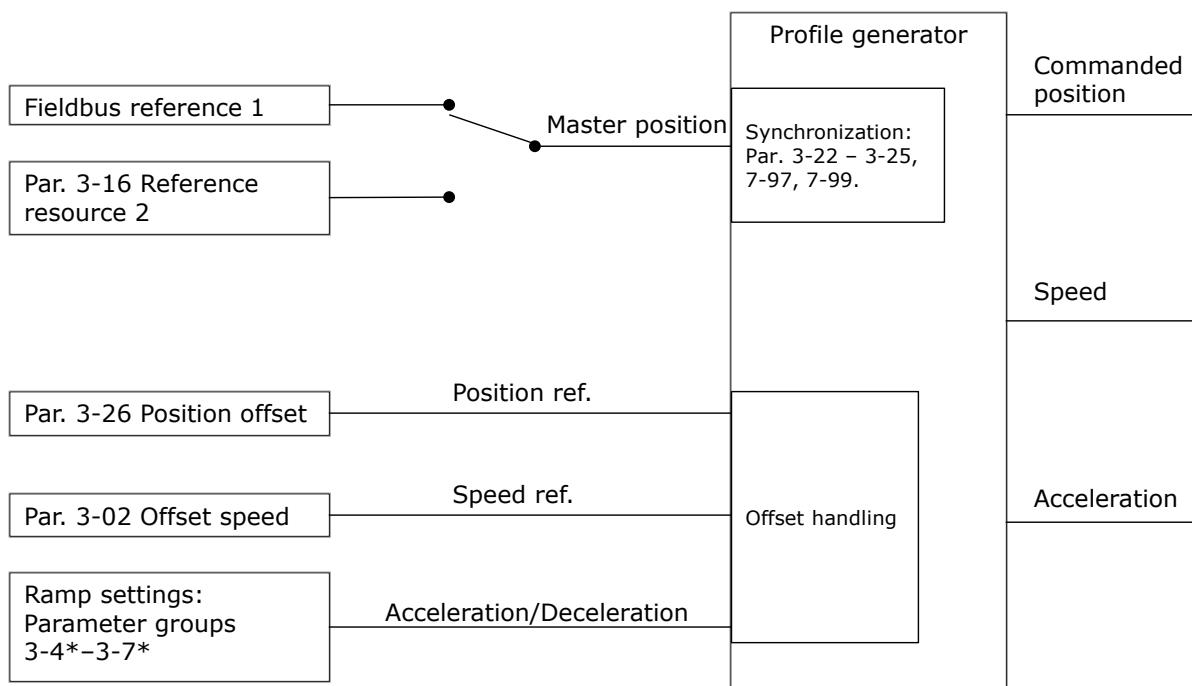

Figure 4.2 Synchronization References

In each control cycle (1 ms) the profile generator calculates position, speed, and acceleration required to do the specified movement. The outputs from the profile generator are used at inputs for the position and speed controller as described in *chapter 4.3.1 Control Loops*.

4.3 Control

4.3.1 Control Loops

In positioning and synchronization mode, 2 extra control loops control the motor in addition to the motor controller running flux control principle, sensorless, or with motor feedback. The position PI controller is the outer loop providing the setpoint for the speed PID, which provides the reference for the motor controller. For a closed loop, feedback source can be selected individually for each of 3 controllers.

For sensorless control principle, select [0] Motor feedb. P1-02 in the following parameters:

- Speed PID: Parameter 7-00 Speed PID Feedback Source.
- Position PI: Parameter 7-90 Position PI Feedback Source.

With this set-up, both controllers use the motor angle calculated by the motor controller. Figure 4.3 shows the control structure and parameters affecting the control behavior:

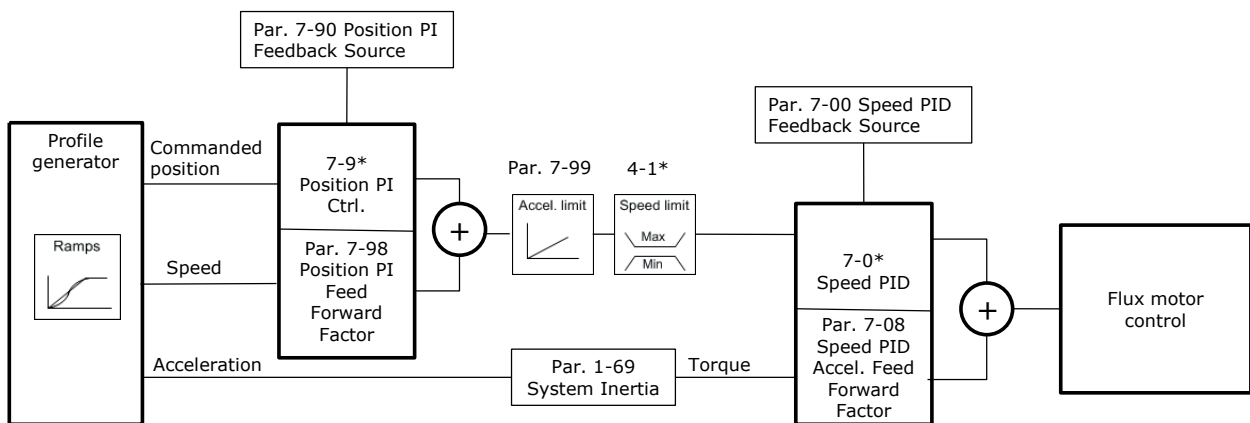

130BE776.10

Figure 4.3 Positioning and Synchronization Mode

4.3.2 Control and Status Signals

IMC control and status signals are available as digital I/O bits and fieldbus bits. *Table 4.1* shows the available options:

Name	Function	Digital input ¹⁾	Control word	Digital output	Status word
Control signals					
Enable master offset	Activates the master offset when <i>parameter 17-93 Master Offset Selection</i> is set to options [0]–[5].	x	x	–	–
Start homing	Starts selected homing function.	x	x	–	–
Start virtual master	Starts the virtual master.	x	x	–	–
Activate touch	Selects touch probe positioning mode.	x	x	–	–
Relative position	Selects between absolute and relative positioning.	x	x	–	–
Enable reference	Starts selected motion.	x	x	–	–
Sync. to position mode	Selects positioning in synchronizing mode.	x	x	–	–
Home sensor	Selects input for home sensor.	x	–	–	–
Home sensor inverse	Selects input for home sensor.	x	–	–	–
Touch sensor	Selects input for touch probe sensor.	x	–	–	–
Touch sensor inverse	Selects input for touch probe sensor.	x	–	–	–
Speed mode	Selects speed mode when <i>parameter 1-00 Configuration Mode</i> is set to [9] <i>Positioning</i> or [10] <i>Synchronization</i> .	x	x	–	–
Target inverse	Changes the sign of the set target position. For example, if the set target is 1000, the activation of this option changes the value to -1000.	x	x	–	–
Status signals					
Reverse after ramp	Indicates the sign of speed reference after the ramp.	–	–	x	–
Virtual master dir.	Controls the direction of followers.	–	–	x	–
Homing OK	Homing is completed with the selected homing function.	–	–	x	x
On target	Positioning: Target position reached. Synchronization: Follower position aligned with master position.	–	–	x	x
Position error	Maximum position error exceeded.	–	–	x	x
Position limit	A position limit is reached (<i>parameter 3-06 Minimum Position</i> or <i>parameter 3-07 Maximum Position</i>).	–	–	x	–
Touch on target	Target position is reached in touch probe position mode.	–	–	x	x
Touch activated	Touch probe positioning active.	–	–	x	x

Table 4.1 Control and Status Signals

1) For best accuracy, use fast digital inputs 18, 32, and 33 for home and touch probe sensors.

When [3] *FC Motion Profile* is selected in *parameter 8-10 Control Word Profile*, the bits in the control word and the status word have the following meaning:

Bit	0	1
0	Preset reference LSB	–
1	Preset reference MSB	–
2 ¹⁾	Preset reference EXB	–
3	Coast stop	No coast stop
4	Quick stop	No quick stop
5 ¹⁾	No reference	Enable reference
6	Ramp stop	Start
7	No reset	Reset
8	No jog	Jog
9 ¹⁾	Absolute	Relative
10	Data not valid	Data valid
11 ¹⁾	No homing	Start homing
12 ¹⁾	No touch	Activate touch
13	Setup select LSB	–
14	Setup select MSB	–
15	No reversing	Reversing

Table 4.2 Control Word

1) Different from [0] FC profile.

Options for bits 0–2, and 12–15 in parameter 8-14 Configurable

Control Word CTW:

- [11] Start Homing
- [12] Activate Touch Probe
- [13] Sync. to Pos. Mode
- [14] Ramp 2
- [15] Relay 1
- [16] Relay 2
- [17] Speed Mode
- [18] Start Virtual Master
- [19] Activate Master Offset
- [20] Target Inverse

Bit	0	1
0	Control not ready	Control ready
1	Frequency converter not ready	Frequency converter ready
2	Coasting	Enable
3	No error	Trip
4 ¹⁾	Not homed	Home done
5	Reserved	Reserved
6	No error	Trip lock
7	No warning	Warning
8 ¹⁾	Not on target position	Target position reached
9	Local operation	Bus control
10	Out of frequency limit	Frequency limit OK
11	No operation	In operation
12	Frequency converter OK	Stopped, auto start
13	Voltage OK	Voltage exceeded
14	Torque OK	Torque exceeded
15	Timer OK	Timer exceeded

Table 4.3 Status Word

1) Different from [0] FC profile.

Options for bits 5 and 12–15 in parameter 8-13 Configurable Status

Word STW:

- [4] Position Error
- [5] Position Limit
- [6] Touch on Target
- [7] Touch Activated

5 Parameter Lists

5.1 Introduction

Frequency converter series

All = valid for FC 301 and FC 302 series

01 = valid for FC 301 only

02 = valid for FC 302 only

Changes during operation

True means that the parameter can be changed while the frequency converter is in operation. False means that the frequency converter must be stopped before a change can be made.

4 set-up

All set-ups: the parameter can be set individually in each of the 4 set-ups, for example 1 single parameter can have 4 different data values.

1 set-up: The data value is the same in all set-ups.

Data type	Description	Type
2	Integer 8	Int8
3	Integer 16	Int16
4	Integer 32	Int32
5	Unsigned 8	UInt8
6	Unsigned 16	UInt16
7	Unsigned 32	UInt32
9	Visible string	VisStr
33	Normalized value 2 bytes	N2
35	Bit sequence of 16 boolean variables	V2
54	Time difference w/o date	TimD

Table 5.1 Data Type

5.1.1 Conversion

The various attributes of each parameter are shown in factory setting. Parameter values are transferred as whole numbers only. Conversion factors are therefore used to transfer decimals.

A conversion factor of 0.1 means that the value transferred is multiplied by 0.1. The value 100 is therefore read as 10.0.

Conversion index	Conversion factor
100	1
75	3600000
74	3600
70	60
67	1/60
6	1000000
5	100000
4	10000
3	1000
2	100
1	10
0	1
-1	0.1
-2	0.01
-3	0.001
-4	0.0001
-5	0.00001
-6	0.000001

Table 5.2 Conversion Table

5.2 Parameter Lists and Options, Software Version 8.10 (Standard)

5.2.1 0-** Operation / Display

Parameter number	Parameter description	Default value	4 set-up	FC 302 only	Change during operation	Conversion index	Type
0-0* Basic Settings							
0-01	Language	[0] English	1 set-up		TRUE	-	UInt8
0-02	Motor Speed Unit	ExpressionLimit	2 set-ups		FALSE	-	UInt8
0-03	Regional Settings	[0] International	2 set-ups		FALSE	-	UInt8
0-04	Operating State at Power-up (Hand)	[1] Forced stop, ref=old	All set-ups		TRUE	-	UInt8
0-09	Performance Monitor	0 %	All set-ups		TRUE	-1	UInt16
0-1* Set-up Operations							
0-10	Active Set-up	[1] Set-up 1	1 set-up		TRUE	-	UInt8
0-11	Edit Set-up	[1] Set-up 1	All set-ups		TRUE	-	UInt8
0-12	This Set-up Linked to	[0] Not linked	All set-ups		FALSE	-	UInt8
0-13	Readout: Linked Set-ups	0 N/A	All set-ups		FALSE	0	UInt16
0-14	Readout: Edit Set-ups / Channel	0 N/A	All set-ups		TRUE	0	Int32
0-15	Readout: actual setup	0 N/A	All set-ups		FALSE	0	UInt8
0-2* LCP Display							
0-20	Display Line 1.1 Small	ExpressionLimit	All set-ups		TRUE	-	UInt16
0-21	Display Line 1.2 Small	1614	All set-ups		TRUE	-	UInt16
0-22	Display Line 1.3 Small	1610	All set-ups		TRUE	-	UInt16
0-23	Display Line 2 Large	1613	All set-ups		TRUE	-	UInt16
0-24	Display Line 3 Large	1602	All set-ups		TRUE	-	UInt16
0-25	My Personal Menu	ExpressionLimit	1 set-up		TRUE	0	UInt16
0-3* LCP Custom Readout							
0-30	Unit for User-defined Readout	[0] None	All set-ups		TRUE	-	UInt8
0-31	Min Value of User-defined Readout	0 CustomReadoutUnit	All set-ups		TRUE	-2	Int32
0-32	Max Value of User-defined Readout	100 CustomReadoutUnit	All set-ups		TRUE	-2	Int32
0-33	Source for User-defined Readout	[240] Default Source	All set-ups		TRUE	-	UInt8
0-37	Display Text 1	0 N/A	1 set-up		TRUE	0	VisStr[25]
0-38	Display Text 2	0 N/A	1 set-up		TRUE	0	VisStr[25]
0-39	Display Text 3	0 N/A	1 set-up		TRUE	0	VisStr[25]
0-4* LCP Keypad							
0-40	[Hand on] Key on LCP	ExpressionLimit	All set-ups		TRUE	-	UInt8
0-41	[Off] Key on LCP	ExpressionLimit	All set-ups		TRUE	-	UInt8
0-42	[Auto on] Key on LCP	ExpressionLimit	All set-ups		TRUE	-	UInt8
0-43	[Reset] Key on LCP	ExpressionLimit	All set-ups		TRUE	-	UInt8
0-44	[Off/Reset] Key on LCP	[1] Enabled	All set-ups		TRUE	-	UInt8
0-45	[Drive Bypass] Key on LCP	[1] Enabled	All set-ups		TRUE	-	UInt8
0-5* Copy/Save							
0-50	LCP Copy	[0] No copy	All set-ups		FALSE	-	UInt8
0-51	Set-up Copy	[0] No copy	All set-ups		FALSE	-	UInt8
0-6* Password							
0-60	Main Menu Password	100 N/A	1 set-up		TRUE	0	Int16

0-61	Access to Main Menu w/o Password	[0] Full access	1 set-up		TRUE	-	UInt8
0-65	Quick Menu Password	200 N/A	1 set-up		TRUE	0	Int16
0-66	Access to Quick Menu w/o Password	[0] Full access	1 set-up		TRUE	-	UInt8
0-67	Bus Password Access	0 N/A	All set-ups		TRUE	0	UInt16
0-68	Safety Parameters Password	300 N/A	1 set-up		TRUE	0	UInt16
0-69	Password Protection of Safety Parameters	[0] Disabled	1 set-up		TRUE	-	UInt8
0-7* Clock Settings							
0-70	Date and Time	ExpressionLimit	All set-ups		TRUE	0	TimeOfDay
0-71	Date Format	ExpressionLimit	1 set-up		TRUE	-	UInt8
0-72	Time Format	ExpressionLimit	1 set-up		TRUE	-	UInt8
0-73	Time Zone Offset	0 min	2 set-ups		FALSE	70	Int16
0-74	DST/Summertime	[0] Off	1 set-up		TRUE	-	UInt8
0-76	DST/Summertime Start	ExpressionLimit	1 set-up		TRUE	0	TimeOfDay
0-77	DST/Summertime End	ExpressionLimit	1 set-up		TRUE	0	TimeOfDay
0-79	Clock Fault	ExpressionLimit	1 set-up		TRUE	-	UInt8
0-81	Working Days	ExpressionLimit	1 set-up		TRUE	-	UInt8
0-82	Additional Working Days	ExpressionLimit	1 set-up		TRUE	0	TimeOfDay
0-83	Additional Non-Working Days	ExpressionLimit	1 set-up		TRUE	0	TimeOfDay
0-84	Time for Fieldbus	0 N/A	All set-ups		TRUE	0	UInt32
0-85	Summer Time Start for Fieldbus	0 N/A	All set-ups		TRUE	0	UInt32
0-86	Summer Time End for Fieldbus	0 N/A	All set-ups		TRUE	0	UInt32
0-89	Date and Time Readout	0 N/A	All set-ups		TRUE	0	VisStr[25]

5.2.2 1- Load and Motor**

Parameter number	Parameter description	Default value	4 set-up	FC 302 only	Change during operation	Conversion index	Type
1-0* General Settings							
1-00	Configuration Mode	ExpressionLimit	All set-ups		TRUE	-	UInt8
1-01	Motor Control Principle	ExpressionLimit	All set-ups		FALSE	-	UInt8
1-02	Flux Motor Feedback Source	[1] 24V encoder	All set-ups	x	FALSE	-	UInt8
1-03	Torque Characteristics	[0] Constant torque	All set-ups		TRUE	-	UInt8
1-04	Overload Mode	[0] High torque	All set-ups		FALSE	-	UInt8
1-05	Local Mode Configuration	[2] As mode par 1-00	All set-ups		TRUE	-	UInt8
1-06	Clockwise Direction	[0] Normal	All set-ups		FALSE	-	UInt8
1-07	Motor Angle Offset Adjust	[0] Manual	All set-ups	x	FALSE	-	UInt8
1-1* Special Settings							
1-10	Motor Construction	[0] Asynchron	All set-ups		FALSE	-	UInt8
1-11	Motor Model	ExpressionLimit	All set-ups	x	FALSE	-	UInt8
1-14	Damping Gain	140 %	All set-ups		TRUE	0	Int16
1-15	Low Speed Filter Time Const.	ExpressionLimit	All set-ups		TRUE	-2	UInt16
1-16	High Speed Filter Time Const.	ExpressionLimit	All set-ups		TRUE	-2	UInt16

1-17	Voltage filter time const.	ExpressionLimit	All set-ups		TRUE	-3	Uint16
1-18	Min. Current at No Load	0 %	All set-ups		TRUE	0	Uint16
1-2* Motor Data							
1-20	Motor Power [kW]	ExpressionLimit	All set-ups		FALSE	1	Uint32
1-21	Motor Power [HP]	ExpressionLimit	All set-ups		FALSE	-2	Uint32
1-22	Motor Voltage	ExpressionLimit	All set-ups		FALSE	0	Uint16
1-23	Motor Frequency	ExpressionLimit	All set-ups		FALSE	0	Uint16
1-24	Motor Current	ExpressionLimit	All set-ups		FALSE	-2	Uint32
1-25	Motor Nominal Speed	ExpressionLimit	All set-ups		FALSE	67	Uint16
1-26	Motor Cont. Rated Torque	ExpressionLimit	All set-ups		FALSE	-1	Uint32
1-29	Automatic Motor Adaptation (AMA)	[0] Off	All set-ups		FALSE	-	Uint8
1-3* Adv. Motor Data							
1-30	Stator Resistance (Rs)	ExpressionLimit	All set-ups		FALSE	-4	Uint32
1-31	Rotor Resistance (Rr)	ExpressionLimit	All set-ups		FALSE	-4	Uint32
1-33	Stator Leakage Reactance (X1)	ExpressionLimit	All set-ups		FALSE	-4	Uint32
1-34	Rotor Leakage Reactance (X2)	ExpressionLimit	All set-ups		FALSE	-4	Uint32
1-35	Main Reactance (Xh)	ExpressionLimit	All set-ups		FALSE	-4	Uint32
1-36	Iron Loss Resistance (Rfe)	ExpressionLimit	All set-ups		FALSE	-3	Uint32
1-37	d-axis Inductance (Ld)	ExpressionLimit	All set-ups	x	FALSE	-4	Int32
1-38	q-axis Inductance (Lq)	ExpressionLimit	All set-ups	x	FALSE	-6	Int32
1-39	Motor Poles	ExpressionLimit	All set-ups		FALSE	0	Uint8
1-40	Back EMF at 1000 RPM	ExpressionLimit	All set-ups	x	FALSE	0	Uint16
1-41	Motor Angle Offset	0 N/A	All set-ups		FALSE	0	Int16
1-44	d-axis Inductance Sat. (LdSat)	ExpressionLimit	All set-ups	x	FALSE	-6	Int32
1-45	q-axis Inductance Sat. (LqSat)	ExpressionLimit	All set-ups	x	FALSE	-6	Int32
1-46	Position Detection Gain	120 %	All set-ups		TRUE	0	Uint16
1-47	Torque Calibration	ExpressionLimit	All set-ups		TRUE	-	Uint8
1-48	Inductance Sat. Point	ExpressionLimit	All set-ups	x	TRUE	0	Int16
1-49	q-Axis Inductance Saturation Point	ExpressionLimit	All set-ups	x	FALSE	0	Uint16
1-5* Load Indep. Setting							
1-50	Motor Magnetisation at Zero Speed	100 %	All set-ups		TRUE	0	Uint16
1-51	Min Speed Normal Magnetising [RPM]	ExpressionLimit	All set-ups		TRUE	67	Uint16
1-52	Min Speed Normal Magnetising [Hz]	ExpressionLimit	All set-ups		TRUE	-1	Uint16
1-53	Model Shift Frequency	ExpressionLimit	All set-ups	x	FALSE	-1	Uint16
1-54	Voltage reduction in fieldweakening	0 V	All set-ups		FALSE	0	Uint8
1-55	U/f Characteristic - U	ExpressionLimit	All set-ups		TRUE	-1	Uint16
1-56	U/f Characteristic - F	ExpressionLimit	All set-ups		TRUE	-1	Uint16
1-58	Flying Start Test Pulses Current	ExpressionLimit	All set-ups		FALSE	0	Uint16
1-59	Flying Start Test Pulses Frequency	ExpressionLimit	All set-ups		FALSE	0	Uint16
1-6* Load Depen. Setting							
1-60	Low Speed Load Compensation	100 %	All set-ups		TRUE	0	Int16
1-61	High Speed Load Compensation	100 %	All set-ups		TRUE	0	Int16
1-62	Slip Compensation	ExpressionLimit	All set-ups		TRUE	0	Int16
1-63	Slip Compensation Time Constant	ExpressionLimit	All set-ups		TRUE	-2	Uint16
1-64	Resonance Damping	ExpressionLimit	All set-ups		TRUE	0	Uint16
1-65	Resonance Damping Time Constant	5 ms	All set-ups		TRUE	-3	Uint8
1-66	Min. Current at Low Speed	ExpressionLimit	All set-ups	x	TRUE	0	Uint32
1-67	Load Type	[0] Passive load	All set-ups	x	TRUE	-	Uint8
1-68	Motor Inertia	0 kgm ²	All set-ups	x	FALSE	-4	Uint32
1-69	System Inertia	ExpressionLimit	All set-ups	x	FALSE	-4	Uint32
1-7* Start Adjustments							

1-70	Start Mode	[0] Rotor Detection	All set-ups		TRUE	-	UInt8
1-71	Start Delay	0 s	All set-ups		TRUE	-1	UInt8
1-72	Start Function	[2] Coast/delay time	All set-ups		TRUE	-	UInt8
1-73	Flying Start	ExpressionLimit	All set-ups		FALSE	-	UInt8
1-74	Start Speed [RPM]	ExpressionLimit	All set-ups		TRUE	67	UInt16
1-75	Start Speed [Hz]	ExpressionLimit	All set-ups		TRUE	-1	UInt16
1-76	Start Current	0 A	All set-ups		TRUE	-2	UInt32
1-8* Stop Adjustments							
1-80	Function at Stop	[0] Coast	All set-ups		TRUE	-	UInt8
1-81	Min Speed for Function at Stop [RPM]	ExpressionLimit	All set-ups		TRUE	67	UInt16
1-82	Min Speed for Function at Stop [Hz]	ExpressionLimit	All set-ups		TRUE	-1	UInt16
1-83	Precise Stop Function	[0] Precise ramp stop	All set-ups		FALSE	-	UInt8
1-84	Precise Stop Counter Value	100000 N/A	All set-ups		TRUE	0	UInt32
1-85	Precise Stop Speed Compensation Delay	10 ms	All set-ups		TRUE	-3	UInt8
1-9* Motor Temperature							
1-90	Motor Thermal Protection	ExpressionLimit	All set-ups		TRUE	-	UInt8
1-91	Motor External Fan	ExpressionLimit	All set-ups		TRUE	-	UInt8
1-93	Thermistor Resource	[0] None	All set-ups		TRUE	-	UInt8
1-94	ATEX ETR cur.lim. speed reduction	0 %	2 set-ups	x	TRUE	-1	UInt16
1-95	Thermistor Sensor Type	[0] KTY Sensor 1	All set-ups		TRUE	-	UInt8
1-96	Thermistor Sensor Resource	[0] None	All set-ups		TRUE	-	UInt8
1-97	Thermistor Threshold level	80 °C	1 set-up		TRUE	100	Int16
1-98	ATEX ETR interpol. points freq.	ExpressionLimit	1 set-up	x	TRUE	-1	UInt16
1-99	ATEX ETR interpol points current	ExpressionLimit	2 set-ups	x	TRUE	0	UInt16

5.2.3 2-** Brakes

Parameter number	Parameter description	Default value	4 set-up	FC 302 only	Change during operation	Conversion index	Type
2-0* DC-Brake							
2-00	DC Hold Current	50 %	All set-ups		TRUE	0	UInt8
2-01	DC Brake Current	50 %	All set-ups		TRUE	0	UInt16
2-02	DC Braking Time	10 s	All set-ups		TRUE	-1	UInt16
2-03	DC Brake Cut In Speed [RPM]	ExpressionLimit	All set-ups		TRUE	67	UInt16
2-04	DC Brake Cut In Speed [Hz]	ExpressionLimit	All set-ups		TRUE	-1	UInt16
2-05	Maximum Reference	MaxReference (P303)	All set-ups		TRUE	-3	Int32
2-06	Parking Current	50 %	All set-ups		TRUE	0	UInt16
2-07	Parking Time	3 s	All set-ups		TRUE	-1	UInt16
2-1* Brake Energy Funct.							
2-10	Brake Function	ExpressionLimit	All set-ups		TRUE	-	UInt8
2-11	Brake Resistor (ohm)	ExpressionLimit	All set-ups		TRUE	0	UInt16
2-12	Brake Power Limit (kW)	ExpressionLimit	All set-ups		TRUE	0	UInt32
2-13	Brake Power Monitoring	[0] Off	All set-ups		TRUE	-	UInt8
2-15	Brake Check	[0] Off	All set-ups		TRUE	-	UInt8
2-16	AC brake Max. Current	100 %	All set-ups		TRUE	-1	UInt32
2-17	Over-voltage Control	[0] Disabled	All set-ups		TRUE	-	UInt8
2-18	Brake Check Condition	[0] At Power Up	All set-ups		TRUE	-	UInt8
2-19	Over-voltage Gain	100 %	All set-ups		TRUE	0	UInt16

2-2* Mechanical Brake							
2-20	Release Brake Current	ImaxVLT (P1637)	All set-ups		TRUE	-2	Uint32
2-21	Activate Brake Speed [RPM]	ExpressionLimit	All set-ups		TRUE	67	Uint16
2-22	Activate Brake Speed [Hz]	ExpressionLimit	All set-ups		TRUE	-1	Uint16
2-23	Activate Brake Delay	0 s	All set-ups		TRUE	-1	Uint8
2-24	Stop Delay	0 s	All set-ups		TRUE	-1	Uint8
2-25	Brake Release Time	0.20 s	All set-ups		TRUE	-2	Uint16
2-26	Torque Ref	0 %	All set-ups		TRUE	-2	Int16
2-27	Torque Ramp Up Time	0.2 s	All set-ups		TRUE	-1	Uint8
2-28	Gain Boost Factor	1 N/A	All set-ups		TRUE	-2	Uint16
2-29	Torque Ramp Down Time	0 s	All set-ups		TRUE	-1	Uint8
2-3* Adv. Mech Brake							
2-30	Position P Start Proportional Gain	0.0000 N/A	All set-ups		TRUE	-4	Uint32
2-31	Speed PID Start Proportional Gain	0.0150 N/A	All set-ups		TRUE	-4	Uint32
2-32	Speed PID Start Integral Time	200.0 ms	All set-ups		TRUE	-4	Uint32
2-33	Speed PID Start Lowpass Filter Time	10.0 ms	All set-ups		TRUE	-4	Uint16

5.2.4 3-** Reference / Ramps

Parameter number	Parameter description	Default value	4 set-up	FC 302 only	Change during operation	Conversion index	Type
3-0* Reference Limits							
3-00	Reference Range	ExpressionLimit	All set-ups		TRUE	-	Uint8
3-01	Reference/Feedback Unit	ExpressionLimit	All set-ups		TRUE	-	Uint8
3-02	Minimum Reference	ExpressionLimit	All set-ups		TRUE	-3	Int32
3-03	Maximum Reference	ExpressionLimit	All set-ups		TRUE	-3	Int32
3-04	Reference Function	[0] Sum	All set-ups		TRUE	-	Uint8
3-1* References							
3-10	Preset Reference	0 %	All set-ups		TRUE	-2	Int16
3-11	Jog Speed [Hz]	ExpressionLimit	All set-ups		TRUE	-1	Uint16
3-12	Catch up/slow Down Value	0 %	All set-ups		TRUE	-2	Int16
3-13	Reference Site	[0] Linked to Hand / Auto	All set-ups		TRUE	-	Uint8
3-14	Preset Relative Reference	0 %	All set-ups		TRUE	-2	Int32
3-15	Reference Resource 1	ExpressionLimit	All set-ups		TRUE	-	Uint8
3-16	Reference Resource 2	ExpressionLimit	All set-ups		TRUE	-	Uint8
3-17	Reference Resource 3	ExpressionLimit	All set-ups		TRUE	-	Uint8
3-18	Relative Scaling Reference Resource	[0] No function	All set-ups		TRUE	-	Uint8
3-19	Jog Speed [RPM]	ExpressionLimit	All set-ups		TRUE	67	Uint16
3-4* Ramp 1							
3-40	Ramp 1 Type	[0] Linear	All set-ups		TRUE	-	Uint8
3-41	Ramp 1 Ramp Up Time	ExpressionLimit	All set-ups		TRUE	-2	Uint32
3-42	Ramp 1 Ramp Down Time	ExpressionLimit	All set-ups		TRUE	-2	Uint32
3-45	Ramp 1 S-ramp Ratio at Accel. Start	50 %	All set-ups		TRUE	0	Uint8
3-46	Ramp 1 S-ramp Ratio at Accel. End	50 %	All set-ups		TRUE	0	Uint8
3-47	Ramp 1 S-ramp Ratio at Decel. Start	50 %	All set-ups		TRUE	0	Uint8
3-48	Ramp 1 S-ramp Ratio at Decel. End	50 %	All set-ups		TRUE	0	Uint8
3-5* Ramp 2							
3-50	Ramp 2 Type	[0] Linear	All set-ups		TRUE	-	Uint8

3-51	Ramp 2 Ramp Up Time	ExpressionLimit	All set-ups		TRUE	-2	Uint32
3-52	Ramp 2 Ramp Down Time	ExpressionLimit	All set-ups		TRUE	-2	Uint32
3-55	Ramp 2 S-ramp Ratio at Accel. Start	50 %	All set-ups		TRUE	0	Uint8
3-56	Ramp 2 S-ramp Ratio at Accel. End	50 %	All set-ups		TRUE	0	Uint8
3-57	Ramp 2 S-ramp Ratio at Decel. Start	50 %	All set-ups		TRUE	0	Uint8
3-58	Ramp 2 S-ramp Ratio at Decel. End	50 %	All set-ups		TRUE	0	Uint8
3-6* Ramp 3							
3-60	Ramp 3 Type	[0] Linear	All set-ups		TRUE	-	Uint8
3-61	Ramp 3 Ramp up Time	ExpressionLimit	All set-ups		TRUE	-2	Uint32
3-62	Ramp 3 Ramp down Time	ExpressionLimit	All set-ups		TRUE	-2	Uint32
3-65	Ramp 3 S-ramp Ratio at Accel. Start	50 %	All set-ups		TRUE	0	Uint8
3-66	Ramp 3 S-ramp Ratio at Accel. End	50 %	All set-ups		TRUE	0	Uint8
3-67	Ramp 3 S-ramp Ratio at Decel. Start	50 %	All set-ups		TRUE	0	Uint8
3-68	Ramp 3 S-ramp Ratio at Decel. End	50 %	All set-ups		TRUE	0	Uint8
3-7* Ramp 4							
3-70	Ramp 4 Type	[0] Linear	All set-ups		TRUE	-	Uint8
3-71	Ramp 4 Ramp up Time	ExpressionLimit	All set-ups		TRUE	-2	Uint32
3-72	Ramp 4 Ramp Down Time	ExpressionLimit	All set-ups		TRUE	-2	Uint32
3-75	Ramp 4 S-ramp Ratio at Accel. Start	50 %	All set-ups		TRUE	0	Uint8
3-76	Ramp 4 S-ramp Ratio at Accel. End	50 %	All set-ups		TRUE	0	Uint8
3-77	Ramp 4 S-ramp Ratio at Decel. Start	50 %	All set-ups		TRUE	0	Uint8
3-78	Ramp 4 S-ramp Ratio at Decel. End	50 %	All set-ups		TRUE	0	Uint8
3-8* Other Ramps							
3-80	Jog Ramp Time	ExpressionLimit	All set-ups		TRUE	-2	Uint32
3-81	Quick Stop Ramp Time	ExpressionLimit	2 set-ups		TRUE	-2	Uint32
3-82	Quick Stop Ramp Type	[0] Linear	All set-ups		TRUE	-	Uint8
3-83	Quick Stop S-ramp Ratio at Decel. Start	50 %	All set-ups		TRUE	0	Uint8
3-84	Quick Stop S-ramp Ratio at Decel. End	50 %	All set-ups		TRUE	0	Uint8
3-89	Ramp Lowpass Filter Time	1 ms	All set-ups		TRUE	-4	Uint16
3-9* Digital Pot.Meter							
3-90	Step Size	0.10 %	All set-ups		TRUE	-2	Uint16
3-91	Ramp Time	1 s	All set-ups		TRUE	-2	Uint32
3-92	Power Restore	[0] Off	All set-ups		TRUE	-	Uint8
3-93	Maximum Limit	100 %	All set-ups		TRUE	0	Int16
3-94	Minimum Limit	-100 %	All set-ups		TRUE	0	Int16
3-95	Ramp Delay	ExpressionLimit	All set-ups		TRUE	-3	TimD

5.2.5 4-** Limits / Warnings

Parameter number	Parameter description	Default value	4 set-up	FC 302 only	Change during operation	Conversion index	Type
4-1* Motor Limits							
4-10	Motor Speed Direction	ExpressionLimit	All set-ups		FALSE	-	Uint8
4-11	Motor Speed Low Limit [RPM]	ExpressionLimit	All set-ups		TRUE	67	Uint16
4-12	Motor Speed Low Limit [Hz]	ExpressionLimit	All set-ups		TRUE	-1	Uint16
4-13	Motor Speed High Limit [RPM]	ExpressionLimit	All set-ups		TRUE	67	Uint16
4-14	Motor Speed High Limit [Hz]	ExpressionLimit	All set-ups		TRUE	-1	Uint16
4-16	Torque Limit Motor Mode	ExpressionLimit	All set-ups		TRUE	-1	Uint16

4-17	Torque Limit Generator Mode	100 %	All set-ups		TRUE	-1	Uint16
4-18	Current Limit	ExpressionLimit	All set-ups		TRUE	-1	Uint32
4-19	Max Output Frequency	ExpressionLimit	All set-ups		FALSE	-1	Uint16
4-2* Limit Factors							
4-20	Torque Limit Factor Source	[0] No function	All set-ups		TRUE	-	Uint8
4-21	Speed Limit Factor Source	[0] No function	All set-ups		TRUE	-	Uint8
4-23	Brake Check Limit Factor Source	[0] DC-link voltage	All set-ups		TRUE	-	Uint8
4-24	Brake Check Limit Factor	98 %	All set-ups		TRUE	0	Uint8
4-25	Power Limit Motor Factor Source	[0] No function	All set-ups	x	TRUE	-	Uint8
4-26	Power Limit Gener. Factor Source	[0] No function	All set-ups	x	TRUE	-	Uint8
4-3* Motor Speed Mon.							
4-30	Motor Feedback Loss Function	ExpressionLimit	All set-ups		TRUE	-	Uint8
4-31	Motor Feedback Speed Error	300 RPM	All set-ups		TRUE	67	Uint16
4-32	Motor Feedback Loss Timeout	ExpressionLimit	All set-ups		TRUE	-2	Uint16
4-34	Tracking Error Function	ExpressionLimit	All set-ups		TRUE	-	Uint8
4-35	Tracking Error	10 RPM	All set-ups		TRUE	67	Uint16
4-36	Tracking Error Timeout	1 s	All set-ups		TRUE	-2	Uint16
4-37	Tracking Error Ramping	100 RPM	All set-ups		TRUE	67	Uint16
4-38	Tracking Error Ramping Timeout	1 s	All set-ups		TRUE	-2	Uint16
4-39	Tracking Error After Ramping Timeout	5 s	All set-ups		TRUE	-2	Uint16
4-4* Speed Monitor							
4-43	Motor Speed Monitor Function	ExpressionLimit	All set-ups		TRUE	-	Uint8
4-44	Motor Speed Monitor Max	300 RPM	All set-ups		TRUE	67	Uint16
4-45	Motor Speed Monitor Timeout	0.1 s	All set-ups		TRUE	-2	Uint16
4-5* Adj. Warnings							
4-50	Warning Current Low	0 A	All set-ups		TRUE	-2	Uint32
4-51	Warning Current High	ImaxVLT (P1637)	All set-ups		TRUE	-2	Uint32
4-52	Warning Speed Low	0 RPM	All set-ups		TRUE	67	Uint16
4-53	Warning Speed High	ExpressionLimit	All set-ups		TRUE	67	Uint16
4-54	Warning Reference Low	-999999.999 N/A	All set-ups		TRUE	-3	Int32
4-55	Warning Reference High	999999.999 N/A	All set-ups		TRUE	-3	Int32
4-56	Warning Feedback Low	ExpressionLimit	All set-ups		TRUE	-3	Int32
4-57	Warning Feedback High	ExpressionLimit	All set-ups		TRUE	-3	Int32
4-58	Missing Motor Phase Function	ExpressionLimit	All set-ups		TRUE	-	Uint8
4-59	Motor Check At Start	[0] Off	All set-ups		TRUE	-	Uint8
4-6* Speed Bypass							
4-60	Bypass Speed From [RPM]	ExpressionLimit	All set-ups		TRUE	67	Uint16
4-61	Bypass Speed From [Hz]	ExpressionLimit	All set-ups		TRUE	-1	Uint16
4-62	Bypass Speed To [RPM]	ExpressionLimit	All set-ups		TRUE	67	Uint16
4-63	Bypass Speed To [Hz]	ExpressionLimit	All set-ups		TRUE	-1	Uint16
4-8* Power Limit							
4-80	Power Limit Func. Motor Mode	[0] Disabled	All set-ups	x	TRUE	-	Uint8
4-81	Power Limit Func. Generator Mode	[0] Disabled	All set-ups	x	TRUE	-	Uint8
4-82	Power Limit Motor Mode	100.0 %	All set-ups	x	TRUE	-1	Uint16
4-83	Power Limit Generator Mode	100.0 %	All set-ups	x	TRUE	-1	Uint16
4-9* Directional Limits							
4-90	Directional Limit Mode	[0] Disabled	All set-ups		TRUE	-	Uint8
4-91	Positive Speed Limit [RPM]	ExpressionLimit	All set-ups		TRUE	67	Uint16
4-92	Positive Speed Limit [Hz]	ExpressionLimit	All set-ups		TRUE	-1	Uint16
4-93	Negative Speed Limit [RPM]	ExpressionLimit	All set-ups		TRUE	67	Uint16
4-94	Negative Speed Limit [Hz]	ExpressionLimit	All set-ups		TRUE	-1	Uint16

4-95	Positive Torque limit	ExpressionLimit	All set-ups		TRUE	-1	Uint16
4-96	Negative Torque limit	ExpressionLimit	All set-ups		TRUE	-1	Uint16

5.2.6 5-** Digital In/Out

Parameter number	Parameter description	Default value	4 set-up	FC 302 only	Change during operation	Conversion index	Type
5-0* Digital I/O mode							
5-00	Digital I/O Mode	[0] PNP	All set-ups		FALSE	-	Uint8
5-01	Terminal 27 Mode	[0] Input	All set-ups		TRUE	-	Uint8
5-02	Terminal 29 Mode	[0] Input	All set-ups	x	TRUE	-	Uint8
5-1* Digital Inputs							
5-10	Terminal 18 Digital Input	ExpressionLimit	All set-ups		TRUE	-	Uint8
5-11	Terminal 19 Digital Input	ExpressionLimit	All set-ups		TRUE	-	Uint8
5-12	Terminal 27 Digital Input	ExpressionLimit	All set-ups		TRUE	-	Uint8
5-13	Terminal 29 Digital Input	ExpressionLimit	All set-ups	x	TRUE	-	Uint8
5-14	Terminal 32 Digital Input	ExpressionLimit	All set-ups		TRUE	-	Uint8
5-15	Terminal 33 Digital Input	ExpressionLimit	All set-ups		TRUE	-	Uint8
5-16	Terminal X30/2 Digital Input	ExpressionLimit	All set-ups		TRUE	-	Uint8
5-17	Terminal X30/3 Digital Input	ExpressionLimit	All set-ups		TRUE	-	Uint8
5-18	Terminal X30/4 Digital Input	ExpressionLimit	All set-ups		TRUE	-	Uint8
5-19	Terminal 37 Safe Stop	ExpressionLimit	1 set-up		TRUE	-	Uint8
5-20	Terminal X46/1 Digital Input	[0] No operation	All set-ups		TRUE	-	Uint8
5-21	Terminal X46/3 Digital Input	[0] No operation	All set-ups		TRUE	-	Uint8
5-22	Terminal X46/5 Digital Input	[0] No operation	All set-ups		TRUE	-	Uint8
5-23	Terminal X46/7 Digital Input	[0] No operation	All set-ups		TRUE	-	Uint8
5-24	Terminal X46/9 Digital Input	[0] No operation	All set-ups		TRUE	-	Uint8
5-25	Terminal X46/11 Digital Input	[0] No operation	All set-ups		TRUE	-	Uint8
5-26	Terminal X46/13 Digital Input	[0] No operation	All set-ups		TRUE	-	Uint8
5-3* Digital Outputs							
5-30	Terminal 27 Digital Output	ExpressionLimit	All set-ups		TRUE	-	Uint8
5-31	Terminal 29 Digital Output	ExpressionLimit	All set-ups	x	TRUE	-	Uint8
5-32	Term X30/6 Digi Out (MCB 101)	ExpressionLimit	All set-ups		TRUE	-	Uint8
5-33	Term X30/7 Digi Out (MCB 101)	ExpressionLimit	All set-ups		TRUE	-	Uint8
5-4* Relays							
5-40	Function Relay	ExpressionLimit	All set-ups		TRUE	-	Uint8
5-41	On Delay, Relay	0.01 s	All set-ups		TRUE	-2	Uint16
5-42	Off Delay, Relay	0.01 s	All set-ups		TRUE	-2	Uint16
5-5* Pulse Input							
5-50	Term. 29 Low Frequency	100 Hz	All set-ups	x	TRUE	0	Uint32
5-51	Term. 29 High Frequency	ExpressionLimit	All set-ups	x	TRUE	0	Uint32
5-52	Term. 29 Low Ref./Feedb. Value	0 ReferenceFeedbackUnit	All set-ups	x	TRUE	-3	Int32
5-53	Term. 29 High Ref./Feedb. Value	ExpressionLimit	All set-ups	x	TRUE	-3	Int32
5-54	Pulse Filter Time Constant #29	100 ms	All set-ups	x	FALSE	-3	Uint16
5-55	Term. 33 Low Frequency	100 Hz	All set-ups		TRUE	0	Uint32
5-56	Term. 33 High Frequency	ExpressionLimit	All set-ups		TRUE	0	Uint32
5-57	Term. 33 Low Ref./Feedb. Value	0 ReferenceFeedbackUnit	All set-ups		TRUE	-3	Int32
5-58	Term. 33 High Ref./Feedb. Value	ExpressionLimit	All set-ups		TRUE	-3	Int32

5-59	Pulse Filter Time Constant #33	100 ms	All set-ups		FALSE	-3	Uint16
5-6* Pulse Output							
5-60	Terminal 27 Pulse Output Variable	ExpressionLimit	All set-ups		TRUE	-	Uint8
5-62	Pulse Output Max Freq #27	ExpressionLimit	All set-ups		TRUE	0	Uint32
5-63	Terminal 29 Pulse Output Variable	ExpressionLimit	All set-ups	x	TRUE	-	Uint8
5-65	Pulse Output Max Freq #29	ExpressionLimit	All set-ups	x	TRUE	0	Uint32
5-66	Terminal X30/6 Pulse Output Variable	ExpressionLimit	All set-ups		TRUE	-	Uint8
5-68	Pulse Output Max Freq #X30/6	ExpressionLimit	All set-ups		TRUE	0	Uint32
5-7* 24V Encoder Input							
5-70	Term 32/33 Pulses Per Revolution	1024 N/A	All set-ups		FALSE	0	Uint16
5-71	Term 32/33 Encoder Direction	[0] Clockwise	All set-ups		FALSE	-	Uint8
5-8* I/O Options							
5-80	AHF Cap Reconnect Delay	25 s	2 set-ups	x	TRUE	0	Uint16
5-9* Bus Controlled							
5-90	Digital & Relay Bus Control	0 N/A	All set-ups		TRUE	0	Uint32
5-93	Pulse Out #27 Bus Control	0 %	All set-ups		TRUE	-2	N2
5-94	Pulse Out #27 Timeout Preset	0 %	1 set-up		TRUE	-2	Uint16
5-95	Pulse Out #29 Bus Control	0 %	All set-ups	x	TRUE	-2	N2
5-96	Pulse Out #29 Timeout Preset	0 %	1 set-up	x	TRUE	-2	Uint16
5-97	Pulse Out #X30/6 Bus Control	0 %	All set-ups		TRUE	-2	N2
5-98	Pulse Out #X30/6 Timeout Preset	0 %	1 set-up		TRUE	-2	Uint16

5.2.7 6-** Analog In/Out

Parameter number	Parameter description	Default value	4 set-up	FC 302 only	Change during operation	Conversion index	Type
6-0* Analog I/O Mode							
6-00	Live Zero Timeout Time	10 s	All set-ups		TRUE	0	Uint8
6-01	Live Zero Timeout Function	[0] Off	All set-ups		TRUE	-	Uint8
6-1* Analog Input 1							
6-10	Terminal 53 Low Voltage	ExpressionLimit	All set-ups		TRUE	-2	Int16
6-11	Terminal 53 High Voltage	10 V	All set-ups		TRUE	-2	Int16
6-12	Terminal 53 Low Current	0.14 mA	All set-ups		TRUE	-5	Int16
6-13	Terminal 53 High Current	20 mA	All set-ups		TRUE	-5	Int16
6-14	Terminal 53 Low Ref./Feedb. Value	0 ReferenceFeedbackUnit	All set-ups		TRUE	-3	Int32
6-15	Terminal 53 High Ref./Feedb. Value	ExpressionLimit	All set-ups		TRUE	-3	Int32
6-16	Terminal 53 Filter Time Constant	0.001 s	All set-ups		TRUE	-3	Uint16
6-2* Analog Input 2							
6-20	Terminal 54 Low Voltage	ExpressionLimit	All set-ups		TRUE	-2	Int16
6-21	Terminal 54 High Voltage	10 V	All set-ups		TRUE	-2	Int16
6-22	Terminal 54 Low Current	ExpressionLimit	All set-ups		TRUE	-5	Int16
6-23	Terminal 54 High Current	20 mA	All set-ups		TRUE	-5	Int16
6-24	Terminal 54 Low Ref./Feedb. Value	0 ReferenceFeedbackUnit	All set-ups		TRUE	-3	Int32
6-25	Terminal 54 High Ref./Feedb. Value	ExpressionLimit	All set-ups		TRUE	-3	Int32
6-26	Terminal 54 Filter Time Constant	0.001 s	All set-ups		TRUE	-3	Uint16
6-3* Analog Input 3							
6-30	Terminal X30/11 Low Voltage	0.07 V	All set-ups		TRUE	-2	Int16
6-31	Terminal X30/11 High Voltage	10 V	All set-ups		TRUE	-2	Int16

6-34	Term. X30/11 Low Ref./Feedb. Value	0 ReferenceFeedbackUnit	All set-ups		TRUE	-3	Int32
6-35	Term. X30/11 High Ref./Feedb. Value	ExpressionLimit	All set-ups		TRUE	-3	Int32
6-36	Term. X30/11 Filter Time Constant	0.001 s	All set-ups		TRUE	-3	Uint16
6-4* Analog Input 4							
6-40	Terminal X30/12 Low Voltage	0.07 V	All set-ups		TRUE	-2	Int16
6-41	Terminal X30/12 High Voltage	10 V	All set-ups		TRUE	-2	Int16
6-44	Term. X30/12 Low Ref./Feedb. Value	0 ReferenceFeedbackUnit	All set-ups		TRUE	-3	Int32
6-45	Term. X30/12 High Ref./Feedb. Value	ExpressionLimit	All set-ups		TRUE	-3	Int32
6-46	Term. X30/12 Filter Time Constant	0.001 s	All set-ups		TRUE	-3	Uint16
6-5* Analog Output 1							
6-50	Terminal 42 Output	ExpressionLimit	All set-ups		TRUE	-	Uint8
6-51	Terminal 42 Output Min Scale	0 %	All set-ups		TRUE	-2	Int16
6-52	Terminal 42 Output Max Scale	100 %	All set-ups		TRUE	-2	Int16
6-53	Term 42 Output Bus Ctrl	0 %	All set-ups		TRUE	-2	N2
6-54	Terminal 42 Output Timeout Preset	0 %	1 set-up		TRUE	-2	Uint16
6-55	Analog Output Filter	[0] Off	1 set-up		TRUE	-	Uint8
6-6* Analog Output 2							
6-60	Terminal X30/8 Output	ExpressionLimit	All set-ups		TRUE	-	Uint8
6-61	Terminal X30/8 Min. Scale	0 %	All set-ups		TRUE	-2	Int16
6-62	Terminal X30/8 Max. Scale	100 %	All set-ups		TRUE	-2	Int16
6-63	Terminal X30/8 Bus Control	0 %	All set-ups		TRUE	-2	N2
6-64	Terminal X30/8 Output Timeout Preset	0 %	1 set-up		TRUE	-2	Uint16
6-7* Analog Output 3							
6-70	Terminal X45/1 Output	ExpressionLimit	All set-ups		TRUE	-	Uint8
6-71	Terminal X45/1 Min. Scale	0 %	All set-ups		TRUE	-2	Int16
6-72	Terminal X45/1 Max. Scale	100 %	All set-ups		TRUE	-2	Int16
6-73	Terminal X45/1 Bus Control	0 %	All set-ups		TRUE	-2	N2
6-74	Terminal X45/1 Output Timeout Preset	0 %	1 set-up		TRUE	-2	Uint16
6-8* Analog Output 4							
6-80	Terminal X45/3 Output	ExpressionLimit	All set-ups		TRUE	-	Uint8
6-81	Terminal X45/3 Min. Scale	0 %	All set-ups		TRUE	-2	Int16
6-82	Terminal X45/3 Max. Scale	100 %	All set-ups		TRUE	-2	Int16
6-83	Terminal X45/3 Bus Control	0 %	All set-ups		TRUE	-2	N2
6-84	Terminal X45/3 Output Timeout Preset	0 %	1 set-up		TRUE	-2	Uint16

5.2.8 7-** Controllers

Parameter number	Parameter description	Default value	4 set-up	FC 302 only	Change during operation	Conversion index	Type
7-0* Speed PID Ctrl.							
7-00	Speed PID Feedback Source	ExpressionLimit	All set-ups		FALSE	-	Uint8
7-01	Speed PID Droop	0 RPM	All set-ups		TRUE	67	Uint16
7-02	Speed PID Proportional Gain	ExpressionLimit	All set-ups		TRUE	-3	Uint16
7-03	Speed PID Integral Time	ExpressionLimit	All set-ups		TRUE	-4	Uint32
7-04	Speed PID Differentiation Time	ExpressionLimit	All set-ups		TRUE	-4	Uint16
7-05	Speed PID Diff. Gain Limit	5 N/A	All set-ups		TRUE	-1	Uint16
7-06	Speed PID Lowpass Filter Time	ExpressionLimit	All set-ups		TRUE	-4	Uint16
7-07	Speed PID Feedback Gear Ratio	1 N/A	All set-ups		FALSE	-4	Uint32

7-08	Speed PID Feed Forward Factor	0 %	All set-ups		FALSE	0	Uint16
7-09	Speed PID Error Correction w/ Ramp	ExpressionLimit	All set-ups		TRUE	67	Uint32
7-1* Torque PI Ctrl.							
7-10	Torque PI Feedback Source	[0] Controller Off	All set-ups		TRUE	-	Uint8
7-12	Torque PI Proportional Gain	100 %	All set-ups		TRUE	0	Uint16
7-13	Torque PI Integration Time	0.020 s	All set-ups		TRUE	-3	Uint16
7-16	Torque PI Lowpass Filter Time	5 ms	All set-ups		TRUE	-4	Uint16
7-18	Torque PI Feed Forward Factor	0 %	All set-ups		TRUE	0	Uint16
7-19	Current Controller Rise Time	ExpressionLimit	All set-ups		TRUE	0	Uint16
7-2* Process Ctrl. Feedb							
7-20	Process CL Feedback 1 Resource	[0] No function	All set-ups		TRUE	-	Uint8
7-22	Process CL Feedback 2 Resource	[0] No function	All set-ups		TRUE	-	Uint8
7-3* Process PID Ctrl.							
7-30	Process PID Normal/ Inverse Control	[0] Normal	All set-ups		TRUE	-	Uint8
7-31	Process PID Anti Windup	[1] On	All set-ups		TRUE	-	Uint8
7-32	Process PID Start Speed	0 RPM	All set-ups		TRUE	67	Uint16
7-33	Process PID Proportional Gain	ExpressionLimit	All set-ups		TRUE	-2	Uint16
7-34	Process PID Integral Time	10000 s	All set-ups		TRUE	-2	Uint32
7-35	Process PID Differentiation Time	0 s	All set-ups		TRUE	-2	Uint16
7-36	Process PID Diff. Gain Limit	5 N/A	All set-ups		TRUE	-1	Uint16
7-38	Process PID Feed Forward Factor	0 %	All set-ups		TRUE	0	Uint16
7-39	On Reference Bandwidth	5 %	All set-ups		TRUE	0	Uint8
7-4* Adv. Process PID I							
7-40	Process PID I-part Reset	[0] No	All set-ups		TRUE	-	Uint8
7-41	Process PID Output Neg. Clamp	-100 %	All set-ups		TRUE	0	Int16
7-42	Process PID Output Pos. Clamp	100 %	All set-ups		TRUE	0	Int16
7-43	Process PID Gain Scale at Min. Ref.	100 %	All set-ups		TRUE	0	Int16
7-44	Process PID Gain Scale at Max. Ref.	100 %	All set-ups		TRUE	0	Int16
7-45	Process PID Feed Fwd Resource	[0] No function	All set-ups		TRUE	-	Uint8
7-46	Process PID Feed Fwd Normal/ Inv. Ctrl.	[0] Normal	All set-ups		TRUE	-	Uint8
7-48	PCD Feed Forward	0 N/A	All set-ups	x	TRUE	0	Uint16
7-49	Process PID Output Normal/ Inv. Ctrl.	[0] Normal	All set-ups		TRUE	-	Uint8
7-5* Adv. Process PID II							
7-50	Process PID Extended PID	[1] Enabled	All set-ups		TRUE	-	Uint8
7-51	Process PID Feed Fwd Gain	1 N/A	All set-ups		TRUE	-2	Uint16
7-52	Process PID Feed Fwd Ramp up	0.01 s	All set-ups		TRUE	-2	Uint32
7-53	Process PID Feed Fwd Ramp down	0.01 s	All set-ups		TRUE	-2	Uint32
7-56	Process PID Ref. Filter Time	0.001 s	All set-ups		TRUE	-3	Uint16
7-57	Process PID Fb. Filter Time	0.001 s	All set-ups		TRUE	-3	Uint16

5.2.9 8-** Comm. and Options

Parameter number	Parameter description	Default value	4 set-up	FC 302 only	Change during operation	Conversion index	Type
8-0* General Settings							
8-01	Control Site	[0] Digital and ctrl.word	All set-ups		TRUE	-	Uint8
8-02	Control Word Source	ExpressionLimit	All set-ups		TRUE	-	Uint8
8-03	Control Word Timeout Time	1 s	1 set-up		TRUE	-1	Uint32

8-04	Control Word Timeout Function	ExpressionLimit	1 set-up		TRUE	-	Uint8
8-05	End-of-Timeout Function	[1] Resume set-up	1 set-up		TRUE	-	Uint8
8-06	Reset Control Word Timeout	[0] Do not reset	All set-ups		TRUE	-	Uint8
8-07	Diagnosis Trigger	[0] Disable	2 set-ups		TRUE	-	Uint8
8-08	Readout Filtering	ExpressionLimit	All set-ups		TRUE	-	Uint8
8-1* Ctrl. Word Settings							
8-10	Control Word Profile	[0] FC profile	All set-ups		TRUE	-	Uint8
8-13	Configurable Status Word STW	ExpressionLimit	All set-ups		TRUE	-	Uint8
8-14	Configurable Control Word CTW	[1] Profile default	2 set-ups		TRUE	-	Uint8
8-17	Configurable Alarm and Warningword	[0] Off	All set-ups		TRUE	-	Uint16
8-19	Product Code	ExpressionLimit	1 set-up		TRUE	0	Uint32
8-3* FC Port Settings							
8-30	Protocol	[0] FC	1 set-up		TRUE	-	Uint8
8-31	Address	1 N/A	1 set-up		TRUE	0	Uint8
8-32	FC Port Baud Rate	ExpressionLimit	1 set-up		TRUE	-	Uint8
8-33	Parity / Stop Bits	[0] Even Parity, 1 Stop Bit	1 set-up		TRUE	-	Uint8
8-34	Estimated cycle time	0 ms	2 set-ups		TRUE	-3	Uint32
8-35	Minimum Response Delay	10 ms	1 set-up		TRUE	-3	Uint16
8-36	Max Response Delay	ExpressionLimit	1 set-up		TRUE	-3	Uint16
8-37	Max Inter-Char Delay	ExpressionLimit	1 set-up		TRUE	-5	Uint16
8-4* FC MC protocol set							
8-40	Telegram Selection	[1] Standard telegram 1	2 set-ups		TRUE	-	Uint8
8-41	Parameters for Signals	0	All set-ups		FALSE	-	Uint16
8-42	PCD Write Configuration	ExpressionLimit	2 set-ups		TRUE	0	Uint16
8-43	PCD Read Configuration	ExpressionLimit	2 set-ups		TRUE	0	Uint16
8-45	BTM Transaction Command	[0] Off	All set-ups		FALSE	-	Uint8
8-46	BTM Transaction Status	[0] Off	All set-ups		TRUE	-	Uint8
8-47	BTM Timeout	60 s	1 set-up		FALSE	0	Uint16
8-48	BTM Maximum Errors	21 N/A	1 set-up		TRUE	0	Uint8
8-49	BTM Error Log	0.255 N/A	All set-ups		TRUE	-3	Uint32
8-5* Digital/Bus							
8-50	Coasting Select	[3] Logic OR	All set-ups		TRUE	-	Uint8
8-51	Quick Stop Select	[3] Logic OR	All set-ups		TRUE	-	Uint8
8-52	DC Brake Select	ExpressionLimit	All set-ups		TRUE	-	Uint8
8-53	Start Select	[3] Logic OR	All set-ups		TRUE	-	Uint8
8-54	Reversing Select	ExpressionLimit	All set-ups		TRUE	-	Uint8
8-55	Set-up Select	[3] Logic OR	All set-ups		TRUE	-	Uint8
8-56	Preset Reference Select	[3] Logic OR	All set-ups		TRUE	-	Uint8
8-57	Profdrive OFF2 Select	[3] Logic OR	All set-ups		TRUE	-	Uint8
8-58	Profdrive OFF3 Select	[3] Logic OR	All set-ups		TRUE	-	Uint8
8-8* FC Port Diagnostics							
8-80	Bus Message Count	0 N/A	All set-ups		TRUE	0	Uint32
8-81	Bus Error Count	0 N/A	All set-ups		TRUE	0	Uint32
8-82	Slave Messages Rcvd	0 N/A	All set-ups		TRUE	0	Uint32
8-83	Slave Error Count	0 N/A	All set-ups		TRUE	0	Uint32
8-9* Bus Jog							
8-90	Bus Jog 1 Speed	ExpressionLimit	All set-ups		TRUE	67	Uint16
8-91	Bus Jog 2 Speed	ExpressionLimit	All set-ups		TRUE	67	Uint16

5.2.10 9-** PROFIdrive

Parameter number	Parameter description	Default value	4 set-up	FC 302 only	Change during operation	Conversion index	Type
9-00	Setpoint	0 N/A	All set-ups		TRUE	0	Uint16
9-07	Actual Value	0 N/A	All set-ups		FALSE	0	Uint16
9-15	PCD Write Configuration	ExpressionLimit	1 set-up		TRUE	-	Uint16
9-16	PCD Read Configuration	ExpressionLimit	2 set-ups		TRUE	-	Uint16
9-18	Node Address	126 N/A	1 set-up		TRUE	0	Uint8
9-19	Drive Unit System Number	1034 N/A	All set-ups		TRUE	0	Uint16
9-22	Telegram Selection	[100] None	1 set-up		TRUE	-	Uint8
9-23	Parameters for Signals	0	All set-ups		TRUE	-	Uint16
9-27	Parameter Edit	[1] Enabled	2 set-ups		FALSE	-	Uint16
9-28	Process Control	[1] Enable cyclic master	2 set-ups		FALSE	-	Uint8
9-44	Fault Message Counter	0 N/A	All set-ups		TRUE	0	Uint16
9-45	Fault Code	0 N/A	All set-ups		TRUE	0	Uint16
9-47	Fault Number	0 N/A	All set-ups		TRUE	0	Uint16
9-52	Fault Situation Counter	0 N/A	All set-ups		TRUE	0	Uint16
9-53	Profibus Warning Word	0 N/A	All set-ups		TRUE	0	V2
9-63	Actual Baud Rate	[255] No baudrate found	All set-ups		TRUE	-	Uint8
9-64	Device Identification	0 N/A	All set-ups		TRUE	0	Uint16
9-65	Profile Number	0 N/A	All set-ups		TRUE	0	OctStr[2]
9-67	Control Word 1	0 N/A	All set-ups		TRUE	0	V2
9-68	Status Word 1	0 N/A	All set-ups		TRUE	0	V2
9-70	Edit Set-up	[1] Set-up 1	All set-ups		TRUE	-	Uint8
9-71	Profibus Save Data Values	[0] Off	All set-ups		TRUE	-	Uint8
9-72	ProfibusDriveReset	[0] No action	1 set-up		FALSE	-	Uint8
9-75	DO Identification	0 N/A	All set-ups		TRUE	0	Uint16
9-80	Defined Parameters (1)	0 N/A	All set-ups		FALSE	0	Uint16
9-81	Defined Parameters (2)	0 N/A	All set-ups		FALSE	0	Uint16
9-82	Defined Parameters (3)	0 N/A	All set-ups		FALSE	0	Uint16
9-83	Defined Parameters (4)	0 N/A	All set-ups		FALSE	0	Uint16
9-84	Defined Parameters (5)	0 N/A	All set-ups		FALSE	0	Uint16
9-85	Defined Parameters (6)	0 N/A	All set-ups		FALSE	0	Uint16
9-90	Changed Parameters (1)	0 N/A	All set-ups		FALSE	0	Uint16
9-91	Changed Parameters (2)	0 N/A	All set-ups		FALSE	0	Uint16
9-92	Changed Parameters (3)	0 N/A	All set-ups		FALSE	0	Uint16
9-93	Changed Parameters (4)	0 N/A	All set-ups		FALSE	0	Uint16
9-94	Changed Parameters (5)	0 N/A	All set-ups		FALSE	0	Uint16
9-99	Profibus Revision Counter	0 N/A	All set-ups		TRUE	0	Uint16

5.2.11 10-** CAN Fieldbus

Parameter number	Parameter description	Default value	4 set-up	FC 302 only	Change during operation	Conversion index	Type
10-0* Common Settings							
10-00	CAN Protocol	ExpressionLimit	2 set-ups		FALSE	-	UInt8
10-01	Baud Rate Select	ExpressionLimit	2 set-ups		TRUE	-	UInt8
10-02	MAC ID	ExpressionLimit	2 set-ups		TRUE	0	UInt8
10-05	Readout Transmit Error Counter	0 N/A	All set-ups		TRUE	0	UInt8
10-06	Readout Receive Error Counter	0 N/A	All set-ups		TRUE	0	UInt8
10-07	Readout Bus Off Counter	0 N/A	All set-ups		TRUE	0	UInt8
10-1* DeviceNet							
10-10	Process Data Type Selection	ExpressionLimit	All set-ups		TRUE	-	UInt8
10-11	Process Data Config Write	ExpressionLimit	All set-ups		TRUE	-	UInt16
10-12	Process Data Config Read	ExpressionLimit	All set-ups		TRUE	-	UInt16
10-13	Warning Parameter	0 N/A	All set-ups		TRUE	0	UInt16
10-14	Net Reference	[0] Off	2 set-ups		TRUE	-	UInt8
10-15	Net Control	[0] Off	2 set-ups		TRUE	-	UInt8
10-2* COS Filters							
10-20	COS Filter 1	0 N/A	All set-ups		FALSE	0	UInt16
10-21	COS Filter 2	0 N/A	All set-ups		FALSE	0	UInt16
10-22	COS Filter 3	0 N/A	All set-ups		FALSE	0	UInt16
10-23	COS Filter 4	0 N/A	All set-ups		FALSE	0	UInt16
10-3* Parameter Access							
10-30	Array Index	0 N/A	2 set-ups		TRUE	0	UInt8
10-31	Store Data Values	[0] Off	All set-ups		TRUE	-	UInt8
10-32	Devicenet Revision	ExpressionLimit	All set-ups		TRUE	0	UInt16
10-33	Store Always	[0] Off	1 set-up		TRUE	-	UInt8
10-34	DeviceNet Product Code	ExpressionLimit	1 set-up		TRUE	0	UInt16
10-39	Devicenet F Parameters	0 N/A	All set-ups		TRUE	0	UInt32
10-5* CANopen							
10-50	Process Data Config Write.	ExpressionLimit	2 set-ups		TRUE	-	UInt16
10-51	Process Data Config Read.	ExpressionLimit	2 set-ups		TRUE	-	UInt16

5.2.12 12-** Ethernet

Parameter number	Parameter description	Default value	4 set-up	FC 302 only	Change during operation	Conversion index	Type
12-0* IP Settings							
12-00	IP Address Assignment	ExpressionLimit	2 set-ups		TRUE	-	UInt8
12-01	IP Address	0 N/A	1 set-up		TRUE	0	OctStr[4]
12-02	Subnet Mask	0 N/A	1 set-up		TRUE	0	OctStr[4]

12-03	Default Gateway	0 N/A	1 set-up		TRUE	0	OctStr[4]
12-04	DHCP Server	0 N/A	2 set-ups		TRUE	0	OctStr[4]
12-05	Lease Expires	ExpressionLimit	All set-ups		TRUE	0	TimD
12-06	Name Servers	0 N/A	1 set-up		TRUE	0	OctStr[4]
12-07	Domain Name	0 N/A	1 set-up		TRUE	0	VisStr[48]
12-08	Host Name	0 N/A	1 set-up		TRUE	0	VisStr[48]
12-09	Physical Address	0 N/A	1 set-up		TRUE	0	VisStr[17]
12-1* Ethernet Link Parameters							
12-10	Link Status	[0] No Link	All set-ups		TRUE	-	UInt8
12-11	Link Duration	ExpressionLimit	All set-ups		TRUE	0	TimD
12-12	Auto Negotiation	ExpressionLimit	2 set-ups		TRUE	-	UInt8
12-13	Link Speed	ExpressionLimit	2 set-ups		TRUE	-	UInt8
12-14	Link Duplex	ExpressionLimit	2 set-ups		TRUE	-	UInt8
12-18	Supervisor MAC	0 N/A	2 set-ups		TRUE	0	OctStr[6]
12-19	Supervisor IP Addr.	0 N/A	2 set-ups		TRUE	0	OctStr[4]
12-2* Process Data							
12-20	Control Instance	ExpressionLimit	1 set-up		TRUE	0	UInt8
12-21	Process Data Config Write	ExpressionLimit	All set-ups		TRUE	-	UInt16
12-22	Process Data Config Read	ExpressionLimit	All set-ups		TRUE	-	UInt16
12-23	Process Data Config Write Size	16 N/A	All set-ups		TRUE	0	UInt32
12-24	Process Data Config Read Size	16 N/A	All set-ups		TRUE	0	UInt32
12-27	Master Address	0 N/A	2 set-ups		FALSE	0	OctStr[4]
12-28	Store Data Values	[0] Off	All set-ups		TRUE	-	UInt8
12-29	Store Always	[0] Off	1 set-up		TRUE	-	UInt8
12-3* EtherNet/IP							
12-30	Warning Parameter	0 N/A	All set-ups		TRUE	0	UInt32
12-31	Net Reference	[0] Off	2 set-ups		TRUE	-	UInt8
12-32	Net Control	[0] Off	2 set-ups		TRUE	-	UInt8
12-33	CIP Revision	ExpressionLimit	All set-ups		TRUE	0	UInt16
12-34	CIP Product Code	ExpressionLimit	1 set-up		TRUE	0	UInt16
12-35	EDS Parameter	0 N/A	All set-ups		TRUE	0	UInt32
12-37	COS Inhibit Timer	0 N/A	All set-ups		TRUE	0	UInt16
12-38	COS Filter	0 N/A	All set-ups		TRUE	0	UInt16
12-4* Modbus TCP							
12-40	Status Parameter	0 N/A	All set-ups		TRUE	0	UInt16
12-41	Slave Message Count	0 N/A	All set-ups		TRUE	0	UInt32
12-42	Slave Exception Message Count	0 N/A	All set-ups		TRUE	0	UInt32
12-5* EtherCAT							
12-50	Configured Station Alias	0 N/A	1 set-up		FALSE	0	UInt16
12-51	Configured Station Address	0 N/A	All set-ups		TRUE	0	UInt16
12-59	EtherCAT Status	0 N/A	All set-ups		TRUE	0	UInt32
12-6* Ethernet PowerLink							
12-60	Node ID	1 N/A	2 set-ups		TRUE	0	UInt8

12-62	SDO Timeout	30000 ms	All set-ups		TRUE	-3	Uint32
12-63	Basic Ethernet Timeout	5000.000 ms	All set-ups		TRUE	-6	Uint32
12-66	Threshold	15 N/A	All set-ups		TRUE	0	Uint32
12-67	Threshold Counters	0 N/A	All set-ups		TRUE	0	Uint32
12-68	Cumulative Counters	0 N/A	All set-ups		TRUE	0	Uint32
12-69	Ethernet PowerLink Status	0 N/A	All set-ups		TRUE	0	Uint32
12-8* Other Ethernet Services							
12-80	FTP Server	[0] Disabled	2 set-ups		TRUE	-	Uint8
12-81	HTTP Server	[0] Disabled	2 set-ups		TRUE	-	Uint8
12-82	SMTP Service	[0] Disabled	2 set-ups		TRUE	-	Uint8
12-83	SNMP Agent	[1] Enabled	2 set-ups		TRUE	-	Uint8
12-84	Address Conflict Detection	[1] Enabled	2 set-ups		TRUE	-	Uint8
12-85	ACD Last Conflict	0 N/A	2 set-ups		TRUE	0	OctStr[35]
12-89	Transparent Socket Channel Port	ExpressionLimit	2 set-ups		TRUE	0	Uint16
12-9* Advanced Ethernet Services							
12-90	Cable Diagnostic	[0] Disabled	2 set-ups		TRUE	-	Uint8
12-91	Auto Cross Over	[1] Enabled	2 set-ups		TRUE	-	Uint8
12-92	IGMP Snooping	[1] Enabled	2 set-ups		TRUE	-	Uint8
12-93	Cable Error Length	0 N/A	1 set-up		TRUE	0	Uint16
12-94	Broadcast Storm Protection	-1 %	2 set-ups		TRUE	0	Int8
12-95	Inactivity timeout	120 N/A	2 set-ups		TRUE	0	Uint16
12-96	Port Config	ExpressionLimit	2 set-ups		TRUE	-	Uint8
12-97	QoS Priority	ExpressionLimit	2 set-ups		TRUE	0	Int8
12-98	Interface Counters	4000 N/A	All set-ups		TRUE	0	Uint32
12-99	Media Counters	0 N/A	All set-ups		TRUE	0	Uint32

5.2.13 13-** Smart Logic

Parameter number	Parameter description	Default value	4 set-up	FC 302 only	Change during operation	Conversion index	Type
13-0* SLC Settings							
13-00	SL Controller Mode	ExpressionLimit	2 set-ups		TRUE	-	UInt8
13-01	Start Event	ExpressionLimit	2 set-ups		TRUE	-	UInt8
13-02	Stop Event	ExpressionLimit	2 set-ups		TRUE	-	UInt8
13-03	Reset SLC	[0] Do not reset SLC	All set-ups		TRUE	-	UInt8
13-1* Comparators							
13-10	Comparator Operand	ExpressionLimit	2 set-ups		TRUE	-	UInt8
13-11	Comparator Operator	ExpressionLimit	2 set-ups		TRUE	-	UInt8
13-12	Comparator Value	ExpressionLimit	2 set-ups		TRUE	-3	Int32
13-1* RS Flip Flops							
13-15	RS-FF Operand S	ExpressionLimit	2 set-ups		TRUE	-	UInt8
13-16	RS-FF Operand R	ExpressionLimit	2 set-ups		TRUE	-	UInt8
13-2* Timers							
13-20	SL Controller Timer	ExpressionLimit	1 set-up		TRUE	-3	TimD
13-4* Logic Rules							
13-40	Logic Rule Boolean 1	ExpressionLimit	2 set-ups		TRUE	-	UInt8
13-41	Logic Rule Operator 1	ExpressionLimit	2 set-ups		TRUE	-	UInt8
13-42	Logic Rule Boolean 2	ExpressionLimit	2 set-ups		TRUE	-	UInt8
13-43	Logic Rule Operator 2	ExpressionLimit	2 set-ups		TRUE	-	UInt8
13-44	Logic Rule Boolean 3	ExpressionLimit	2 set-ups		TRUE	-	UInt8
13-5* States							
13-51	SL Controller Event	ExpressionLimit	2 set-ups		TRUE	-	UInt8
13-52	SL Controller Action	ExpressionLimit	2 set-ups		TRUE	-	UInt8
13-9* User Defined Alerts							
13-90	Alert Trigger	[0] False	2 set-ups		TRUE	-	UInt8
13-91	Alert Action	[0] Info	2 set-ups		TRUE	-	UInt8
13-92	Alert Text	ExpressionLimit	2 set-ups		TRUE	0	VisStr[20]
13-9* User Defined Readouts							
13-97	Alert Alarm Word	0 N/A	All set-ups		FALSE	0	UInt32
13-98	Alert Warning Word	0 N/A	All set-ups		FALSE	0	UInt32
13-99	Alert Status Word	0 N/A	All set-ups		FALSE	0	UInt32

5.2.14 14-** Special Functions

Parameter number	Parameter description	Default value	4 set-up	FC 302 only	Change during operation	Conversion index	Type
14-0* Inverter Switching							
14-00	Switching Pattern	[1] SFAVM	All set-ups		TRUE	-	UInt8
14-01	Switching Frequency	ExpressionLimit	All set-ups		TRUE	-	UInt8
14-03	Overmodulation	ExpressionLimit	All set-ups		FALSE	-	UInt8

14-04	Acoustic Noise Reduction	[0] Off	All set-ups		TRUE	-	Uint8
14-06	Dead Time Compensation	[1] On	All set-ups		TRUE	-	Uint8
14-1* Mains Failure							
14-10	Mains Failure	[0] No function	All set-ups		TRUE	-	Uint8
14-11	Mains Fault Voltage Level	ExpressionLimit	All set-ups		TRUE	0	Uint16
14-12	Response to Mains Imbalance	[0] Trip	All set-ups		TRUE	-	Uint8
14-14	Kin. Back-up Time-out	60 s	All set-ups		TRUE	0	Uint8
14-15	Kin. Back-up Trip Recovery Level	ExpressionLimit	All set-ups		TRUE	-3	Uint32
14-16	Kin. Back-up Gain	100 %	All set-ups	x	TRUE	0	Uint32
14-2* Trip Reset							
14-20	Reset Mode	[0] Manual reset	All set-ups		TRUE	-	Uint8
14-21	Automatic Restart Time	ExpressionLimit	All set-ups		TRUE	0	Uint16
14-22	Operation Mode	[0] Normal operation	All set-ups		TRUE	-	Uint8
14-23	Typecode Setting	ExpressionLimit	2 set-ups		FALSE	-	Uint16
14-24	Trip Delay at Current Limit	60 s	All set-ups		TRUE	0	Uint8
14-25	Trip Delay at Torque Limit	60 s	All set-ups		TRUE	0	Uint8
14-26	Trip Delay at Inverter Fault	ExpressionLimit	All set-ups		TRUE	0	Uint8
14-28	Production Settings	[0] No action	All set-ups		TRUE	-	Uint8
14-29	Service Code	0 N/A	All set-ups		TRUE	0	Int32
14-3* Current Limit Ctrl.							
14-30	Current Lim Ctrl, Proportional Gain	100 %	All set-ups		FALSE	0	Uint16
14-31	Current Lim Ctrl, Integration Time	ExpressionLimit	All set-ups		FALSE	-3	Uint16
14-32	Current Lim Ctrl, Filter Time	ExpressionLimit	All set-ups		TRUE	-4	Uint16
14-35	Stall Protection	[1] Enabled	All set-ups		FALSE	-	Uint8
14-36	Field-weakening Function	[0] Auto	All set-ups	x	TRUE	-	Uint8
14-37	Fieldweakening Speed	ExpressionLimit	All set-ups	x	TRUE	67	Uint16
14-4* Energy Optimising							
14-40	VT Level	66 %	All set-ups		FALSE	0	Uint8
14-41	AEO Minimum Magnetisation	ExpressionLimit	All set-ups		TRUE	0	Uint8
14-42	Minimum AEO Frequency	ExpressionLimit	All set-ups		TRUE	0	Uint8
14-43	Motor Cosphi	ExpressionLimit	All set-ups		TRUE	-2	Uint16
14-5* Environment							
14-50	RFI Filter	[1] On	1 set-up		FALSE	-	Uint8
14-51	DC-Link Compensation	ExpressionLimit	All set-ups		TRUE	-	Uint8
14-52	Fan Control	[0] Auto	All set-ups		TRUE	-	Uint8
14-53	Fan Monitor	[1] Warning	All set-ups		TRUE	-	Uint8
14-55	Output Filter	[0] No Filter	All set-ups		FALSE	-	Uint8
14-56	Capacitance Output Filter	ExpressionLimit	All set-ups		FALSE	-7	Uint16
14-57	Inductance Output Filter	ExpressionLimit	All set-ups		FALSE	-6	Uint16
14-59	Actual Number of Inverter Units	ExpressionLimit	1 set-up	x	FALSE	0	Uint8
14-6* Auto Derate							
14-60	Function at Over Temperature	[0] Trip	All set-ups		TRUE	-	Uint8
14-61	Function at Inverter Overload	[0] Trip	All set-ups		TRUE	-	Uint8
14-62	Inv. Overload Derate Current	95 %	All set-ups		TRUE	0	Uint16
14-7* Compatibility							
14-72	Legacy Alarm Word	0 N/A	All set-ups		FALSE	0	Uint32
14-73	Legacy Warning Word	0 N/A	All set-ups		FALSE	0	Uint32
14-74	Leg. Ext. Status Word	0 N/A	All set-ups		FALSE	0	Uint32
14-8* Options							
14-80	Option Supplied by External 24VDC	[1] Yes	2 set-ups		FALSE	-	Uint8
14-88	Option Data Storage	0 N/A	2 set-ups		TRUE	0	Uint16

14-89	Option Detection	[0] Protect Option Config.	1 set-up		TRUE	-	Uint8
14-9* Fault Settings							
14-90	Fault Level	ExpressionLimit	1 set-up		TRUE	-	Uint8

5.2.15 15-** Drive Information

Parameter number	Parameter description	Default value	4 set-up	FC 302 only	Change during operation	Conversion index	Type
15-0* Operating Data							
15-00	Operating hours	0 h	All set-ups		FALSE	74	Uint32
15-01	Running Hours	0 h	All set-ups		FALSE	74	Uint32
15-02	kWh Counter	0 kWh	All set-ups		FALSE	75	Uint32
15-03	Power Up's	0 N/A	All set-ups		FALSE	0	Uint32
15-04	Over Temp's	0 N/A	All set-ups		FALSE	0	Uint16
15-05	Over Volt's	0 N/A	All set-ups		FALSE	0	Uint16
15-06	Reset kWh Counter	[0] Do not reset	All set-ups		TRUE	-	Uint8
15-07	Reset Running Hours Counter	[0] Do not reset	All set-ups		TRUE	-	Uint8
15-1* Data Log Settings							
15-10	Logging Source	0	2 set-ups		TRUE	-	Uint16
15-11	Logging Interval	ExpressionLimit	2 set-ups		TRUE	-3	TimD
15-12	Trigger Event	[0] False	1 set-up		TRUE	-	Uint8
15-13	Logging Mode	[0] Log always	2 set-ups		TRUE	-	Uint8
15-14	Samples Before Trigger	50 N/A	2 set-ups		TRUE	0	Uint8
15-2* Historic Log							
15-20	Historic Log: Event	0 N/A	All set-ups		FALSE	0	Uint8
15-21	Historic Log: Value	0 N/A	All set-ups		FALSE	0	Uint32
15-22	Historic Log: Time	0 ms	All set-ups		FALSE	-3	Uint32
15-3* Fault Log							
15-30	Fault Log: Error Code	0 N/A	All set-ups		FALSE	0	Uint16
15-31	Fault Log: Value	0 N/A	All set-ups		FALSE	0	Int16
15-32	Fault Log: Time	0 s	All set-ups		FALSE	0	Uint32
15-33	Fault log: Date and Time	ExpressionLimit	All set-ups		FALSE	0	TimeOfDay
15-4* Drive Identification							
15-40	FC Type	0 N/A	All set-ups		FALSE	0	VisStr[6]
15-41	Power Section	0 N/A	All set-ups		FALSE	0	VisStr[20]
15-42	Voltage	0 N/A	All set-ups		FALSE	0	VisStr[20]
15-43	Software Version	0 N/A	All set-ups		FALSE	0	VisStr[5]
15-44	Ordered Typecode String	0 N/A	All set-ups		FALSE	0	VisStr[40]
15-45	Actual Typecode String	0 N/A	All set-ups		FALSE	0	VisStr[40]
15-46	Frequency Converter Ordering No	0 N/A	All set-ups		FALSE	0	VisStr[8]

15-47	Power Card Ordering No	0 N/A	All set-ups		FALSE	0	VisStr[8]
15-48	LCP Id No	0 N/A	All set-ups		FALSE	0	VisStr[20]
15-49	SW ID Control Card	0 N/A	All set-ups		FALSE	0	VisStr[20]
15-50	SW ID Power Card	0 N/A	All set-ups		FALSE	0	VisStr[20]
15-51	Frequency Converter Serial Number	0 N/A	All set-ups		FALSE	0	VisStr[10]
15-53	Power Card Serial Number	0 N/A	All set-ups		FALSE	0	VisStr[19]
15-54	Config File Name	ExpressionLimit	All set-ups		FALSE	0	VisStr[16]
15-58	Smart Setup Filename	ExpressionLimit	All set-ups	x	TRUE	0	VisStr[16]
15-59	Filename	ExpressionLimit	All set-ups		FALSE	0	VisStr[16]
15-6* Option Ident							
15-60	Option Mounted	0 N/A	All set-ups		FALSE	0	VisStr[30]
15-61	Option SW Version	0 N/A	All set-ups		FALSE	0	VisStr[20]
15-62	Option Ordering No	0 N/A	All set-ups		FALSE	0	VisStr[8]
15-63	Option Serial No	0 N/A	All set-ups		FALSE	0	VisStr[18]
15-70	Option in Slot A	0 N/A	All set-ups		FALSE	0	VisStr[30]
15-71	Slot A Option SW Version	0 N/A	All set-ups		FALSE	0	VisStr[20]
15-72	Option in Slot B	0 N/A	All set-ups		FALSE	0	VisStr[30]
15-73	Slot B Option SW Version	0 N/A	All set-ups		FALSE	0	VisStr[20]
15-74	Option in Slot C0/E0	0 N/A	All set-ups		FALSE	0	VisStr[30]
15-75	Slot C0/E0 Option SW Version	0 N/A	All set-ups		FALSE	0	VisStr[20]
15-76	Option in Slot C1/E1	0 N/A	All set-ups		FALSE	0	VisStr[30]
15-77	Slot C1/E1 Option SW Version	0 N/A	All set-ups		FALSE	0	VisStr[20]
15-8* Operating Data II							
15-80	Fan Running Hours	0 h	All set-ups		TRUE	74	Uint32
15-81	Preset Fan Running Hours	0 h	All set-ups		TRUE	74	Uint32
15-89	Configuration Change Counter	0 N/A	All set-ups		FALSE	0	Uint16
15-9* Parameter Info							
15-92	Defined Parameters	0 N/A	All set-ups		FALSE	0	Uint16
15-93	Modified Parameters	0 N/A	All set-ups		FALSE	0	Uint16
15-98	Drive Identification	0 N/A	All set-ups		FALSE	0	VisStr[40]

15-99	Parameter Metadata	0 N/A	All set-ups		FALSE	0	Uint16
-------	--------------------	-------	-------------	--	-------	---	--------

5.2.16 16-** Data Readouts

Parameter number	Parameter description	Default value	4 set-up	FC 302 only	Change during operation	Conversion index	Type
16-0* General Status							
16-00	Control Word	0 N/A	All set-ups		FALSE	0	V2
16-01	Reference [Unit]	0 ReferenceFeedbackUnit	All set-ups		FALSE	-3	Int32
16-02	Reference %	0 %	All set-ups		FALSE	-1	Int16
16-03	Status Word	0 N/A	All set-ups		FALSE	0	V2
16-05	Main Actual Value [%]	0 %	All set-ups		FALSE	-2	N2
16-06	Actual Position	0 CustomReadoutUnit2	All set-ups		FALSE	0	Int32
16-09	Custom Readout	0 CustomReadoutUnit	All set-ups		FALSE	-2	Int32
16-1* Motor Status							
16-10	Power [kW]	0 kW	All set-ups		FALSE	1	Int32
16-11	Power [hp]	0 hp	All set-ups		FALSE	-2	Int32
16-12	Motor Voltage	0 V	All set-ups		FALSE	-1	Uint16
16-13	Frequency	0 Hz	All set-ups		FALSE	-1	Uint16
16-14	Motor current	0 A	All set-ups		FALSE	-2	Int32
16-15	Frequency [%]	0 %	All set-ups		FALSE	-2	N2
16-16	Torque [Nm]	0 Nm	All set-ups		FALSE	-1	Int16
16-17	Speed [RPM]	0 RPM	All set-ups		FALSE	67	Int32
16-18	Motor Thermal	0 %	All set-ups		FALSE	0	Uint8
16-19	Thermistor Sensor Temperature	0 °C	All set-ups		FALSE	100	Int16
16-20	Motor Angle	0 N/A	All set-ups		TRUE	0	Uint16
16-21	Torque [%] High Res.	0 %	All set-ups		FALSE	-1	Int16
16-22	Torque [%]	0 %	All set-ups		FALSE	0	Int16
16-23	Motor Shaft Power [kW]	0 kW	All set-ups		TRUE	1	Int32
16-24	Calibrated Stator Resistance	0.0000 Ohm	All set-ups	x	TRUE	-4	Uint32
16-25	Torque [Nm] High	0 Nm	All set-ups		FALSE	-1	Int32
16-3* Drive Status							
16-30	DC Link Voltage	0 V	All set-ups		FALSE	0	Uint16
16-31	System Temp.	0 °C	All set-ups	x	TRUE	100	Int8
16-32	Brake Energy /s	0 kW	All set-ups		FALSE	0	Uint32
16-33	Brake Energy Average	0 kW	All set-ups		FALSE	0	Uint32
16-34	Heatsink Temp.	0 °C	All set-ups		FALSE	100	Uint8
16-35	Inverter Thermal	0 %	All set-ups		FALSE	0	Uint8
16-36	Inv. Nom. Current	ExpressionLimit	All set-ups		FALSE	-2	Uint32
16-37	Inv. Max. Current	ExpressionLimit	All set-ups		FALSE	-2	Uint32
16-38	SL Controller State	0 N/A	All set-ups		FALSE	0	Uint8
16-39	Control Card Temp.	0 °C	All set-ups		FALSE	100	Uint8
16-40	Logging Buffer Full	[0] No	All set-ups		TRUE	-	Uint8
16-41	Performance Measurements	0 N/A	All set-ups		TRUE	0	VisStr[50]
16-42	Service Log Counter	0 N/A	All set-ups		TRUE	0	Uint8
16-43	Timed Actions Status	[0] Timed Actions Auto	All set-ups		TRUE	-	Uint8
16-45	Motor Phase U Current	0 A	All set-ups		TRUE	-2	Int32

16-46	Motor Phase V Current	0 A	All set-ups		TRUE	-2	Int32
16-47	Motor Phase W Current	0 A	All set-ups		TRUE	-2	Int32
16-48	Speed Ref. After Ramp [RPM]	0 RPM	All set-ups		FALSE	67	Int32
16-49	Current Fault Source	0 N/A	All set-ups	x	TRUE	0	Uint8
16-5* Ref. & Feedb.							
16-50	External Reference	0 N/A	All set-ups		FALSE	-1	Int16
16-51	Pulse Reference	0 N/A	All set-ups		FALSE	-1	Int16
16-52	Feedback[Unit]	0 ReferenceFeedbackUnit	All set-ups		FALSE	-3	Int32
16-53	Digi Pot Reference	0 N/A	All set-ups		FALSE	-2	Int16
16-57	Feedback [RPM]	0 RPM	All set-ups		FALSE	67	Int32
16-6* Inputs & Outputs							
16-60	Digital Input	0 N/A	All set-ups		FALSE	0	Uint16
16-61	Terminal 53 Switch Setting	[0] Current	All set-ups		FALSE	-	Uint8
16-62	Analog Input 53	0 N/A	All set-ups		FALSE	-3	Int32
16-63	Terminal 54 Switch Setting	[0] Current	All set-ups		FALSE	-	Uint8
16-64	Analog Input 54	0 N/A	All set-ups		FALSE	-3	Int32
16-65	Analog Output 42 [mA]	0 N/A	All set-ups		FALSE	-3	Int16
16-66	Digital Output [bin]	0 N/A	All set-ups		FALSE	0	Int16
16-67	Freq. Input #29 [Hz]	0 N/A	All set-ups	x	FALSE	0	Int32
16-68	Freq. Input #33 [Hz]	0 N/A	All set-ups		FALSE	0	Int32
16-69	Pulse Output #27 [Hz]	0 N/A	All set-ups		FALSE	0	Int32
16-70	Pulse Output #29 [Hz]	0 N/A	All set-ups	x	FALSE	0	Int32
16-71	Relay Output [bin]	0 N/A	All set-ups		FALSE	0	Int16
16-72	Counter A	0 N/A	All set-ups		TRUE	0	Int32
16-73	Counter B	0 N/A	All set-ups		TRUE	0	Int32
16-74	Prec. Stop Counter	0 N/A	All set-ups		TRUE	0	Uint32
16-75	Analog In X30/11	0 N/A	All set-ups		FALSE	-3	Int32
16-76	Analog In X30/12	0 N/A	All set-ups		FALSE	-3	Int32
16-77	Analog Out X30/8 [mA]	0 N/A	All set-ups		FALSE	-3	Int16
16-78	Analog Out X45/1 [mA]	0 N/A	All set-ups		FALSE	-3	Int16
16-79	Analog Out X45/3 [mA]	0 N/A	All set-ups		FALSE	-3	Int16
16-8* Fieldbus & FC Port							
16-80	Fieldbus CTW 1	0 N/A	All set-ups		FALSE	0	V2
16-82	Fieldbus REF 1	0 N/A	All set-ups		FALSE	0	N2
16-84	Comm. Option STW	0 N/A	All set-ups		FALSE	0	V2
16-85	FC Port CTW 1	0 N/A	All set-ups		FALSE	0	V2
16-86	FC Port REF 1	0 N/A	All set-ups		FALSE	0	N2
16-87	Bus Readout Alarm/Warning	0 N/A	All set-ups		FALSE	0	Uint16
16-89	Configurable Alarm/Warning Word	0 N/A	All set-ups		FALSE	0	Uint16
16-9* Diagnosis Readouts							
16-90	Alarm Word	0 N/A	All set-ups		FALSE	0	Uint32
16-91	Alarm Word 2	0 N/A	All set-ups		FALSE	0	Uint32
16-92	Warning Word	0 N/A	All set-ups		FALSE	0	Uint32
16-93	Warning Word 2	0 N/A	All set-ups		FALSE	0	Uint32
16-94	Ext. Status Word	0 N/A	All set-ups		FALSE	0	Uint32
16-95	Ext. Status Word 2	0 N/A	All set-ups		FALSE	0	Uint32
16-96	Maintenance Word	0 N/A	All set-ups		FALSE	0	Uint32

5.2.17 17-** Position Feedback

Parameter number	Parameter description	Default value	4 set-up	FC 302 only	Change during operation	Conversion index	Type
17-1* Inc. Enc. Interface							
17-10	Signal Type	[1] RS422 (5V TTL)	All set-ups		FALSE	-	UInt8
17-11	Resolution (PPR)	1024 N/A	All set-ups		FALSE	0	UInt16
17-2* Abs. Enc. Interface							
17-20	Protocol Selection	[0] None	All set-ups		FALSE	-	UInt8
17-21	Resolution (Positions/Rev)	ExpressionLimit	All set-ups		FALSE	0	UInt32
17-22	Multiturn Revolutions	1 N/A	All set-ups		FALSE	0	UInt32
17-24	SSI Data Length	13 N/A	All set-ups		FALSE	0	UInt8
17-25	Clock Rate	260 kHz	All set-ups		FALSE	3	UInt16
17-26	SSI Data Format	[0] Gray code	All set-ups		FALSE	-	UInt8
17-34	HIPERFACE Baudrate	[4] 9600	All set-ups		FALSE	-	UInt8
17-5* Resolver Interface							
17-50	Poles	2 N/A	1 set-up		FALSE	0	UInt8
17-51	Input Voltage	7 V	1 set-up		FALSE	-1	UInt8
17-52	Input Frequency	10 kHz	1 set-up		FALSE	2	UInt8
17-53	Transformation Ratio	0.5 N/A	1 set-up		FALSE	-1	UInt8
17-56	Encoder Sim. Resolution	[0] Disabled	1 set-up		FALSE	-	UInt8
17-59	Resolver Interface	[0] Disabled	2 set-ups		FALSE	-	UInt8
17-6* Monitoring and App.							
17-60	Feedback Direction	[0] Clockwise	All set-ups		FALSE	-	UInt8
17-61	Feedback Signal Monitoring	[1] Warning	All set-ups		TRUE	-	UInt8
17-7* Position Scaling							
17-70	Position Unit	[0] pu	All set-ups		TRUE	-	UInt8
17-71	Position Unit Scale	0 N/A	All set-ups		FALSE	0	Int8
17-72	Position Unit Numerator	1024 N/A	All set-ups		FALSE	0	Int32
17-73	Position Unit Denominator	1 N/A	All set-ups		FALSE	0	Int32
17-74	Position Offset	0 N/A	All set-ups		FALSE	0	Int32

5.2.18 18-** Data Readouts 2

Parameter number	Parameter description	Default value	4 set-up	FC 302 only	Change during operation	Conversion index	Type
18-0* Maintenance Log							
18-00	Maintenance Log: Item	0 N/A	All set-ups	x	FALSE	0	UInt8
18-01	Maintenance Log: Action	0 N/A	All set-ups	x	FALSE	0	UInt8
18-02	Maintenance Log: Time	0 s	All set-ups	x	FALSE	0	UInt32
18-03	Maintenance Log: Date and Time	ExpressionLimit	All set-ups	x	FALSE	0	TimeOfDay
18-2* Motor Readouts							
18-27	Safe Opt. Est. Speed	0 RPM	All set-ups		TRUE	67	Int32
18-28	Safe Opt. Meas. Speed	0 RPM	All set-ups		TRUE	67	Int32

18-29	Safe Opt. Speed Error	0 RPM	All set-ups		TRUE	67	Int32
18-3* Analog Readouts							
18-36	Analog Input X48/2 [mA]	0 N/A	All set-ups		TRUE	-3	Int32
18-37	Temp. Input X48/4	0 N/A	All set-ups		TRUE	0	Int16
18-38	Temp. Input X48/7	0 N/A	All set-ups		TRUE	0	Int16
18-39	Temp. Input X48/10	0 N/A	All set-ups		TRUE	0	Int16
18-4* PGIO Data Readouts							
18-43	Analog Out X49/7	0 N/A	All set-ups		FALSE	-3	Int16
18-44	Analog Out X49/9	0 N/A	All set-ups		FALSE	-3	Int16
18-45	Analog Out X49/11	0 N/A	All set-ups		FALSE	-3	Int16
18-5* Active Alarms/Warnings							
18-55	Active Alarm Numbers	0 N/A	All set-ups		TRUE	0	Uint16
18-56	Active Warning Numbers	0 N/A	All set-ups		TRUE	0	Uint16
18-6* Inputs & Outputs 2							
18-60	Digital Input 2	0 N/A	All set-ups		FALSE	0	Uint16
18-7* Rectifier Status							
18-70	Mains Voltage	0 V	All set-ups	x	TRUE	0	Uint16
18-71	Mains Frequency	0 Hz	All set-ups	x	TRUE	-1	Int16
18-72	Mains Imbalance	0 %	All set-ups	x	TRUE	-1	Uint16
18-75	Rectifier DC Volt.	0 V	All set-ups	x	TRUE	0	Uint16
18-9* PID Readouts							
18-90	Process PID Error	0 %	All set-ups		FALSE	-1	Int16
18-91	Process PID Output	0 %	All set-ups		FALSE	-1	Int16
18-92	Process PID Clamped Output	0 %	All set-ups		FALSE	-1	Int16
18-93	Process PID Gain Scaled Output	0 %	All set-ups		FALSE	-1	Int16

5.2.19 30-** Special Features

Parameter number	Parameter description	Default value	4 set-up	FC 302 only	Change during operation	Conversion index	Type
30-0* Wobbler							
30-00	Wobble Mode	[0] Abs. Freq., Abs. Time	All set-ups		FALSE	-	Uint8
30-01	Wobble Delta Frequency [Hz]	5 Hz	All set-ups		TRUE	-1	Uint8
30-02	Wobble Delta Frequency [%]	25 %	All set-ups		TRUE	0	Uint8
30-03	Wobble Delta Freq. Scaling Resource	[0] No function	All set-ups		TRUE	-	Uint8
30-04	Wobble Jump Frequency [Hz]	0 Hz	All set-ups		TRUE	-1	Uint8
30-05	Wobble Jump Frequency [%]	0 %	All set-ups		TRUE	0	Uint8
30-06	Wobble Jump Time	ExpressionLimit	All set-ups		TRUE	-3	Uint16
30-07	Wobble Sequence Time	10 s	All set-ups		TRUE	-1	Uint16
30-08	Wobble Up/ Down Time	5 s	All set-ups		TRUE	-1	Uint16
30-09	Wobble Random Function	[0] Off	All set-ups		TRUE	-	Uint8
30-10	Wobble Ratio	1 N/A	All set-ups		TRUE	-1	Uint8
30-11	Wobble Random Ratio Max.	10 N/A	All set-ups		TRUE	-1	Uint8
30-12	Wobble Random Ratio Min.	0.1 N/A	All set-ups		TRUE	-1	Uint8
30-19	Wobble Delta Freq. Scaled	0 Hz	All set-ups		FALSE	-1	Uint16
30-2* Adv. Start Adjust							
30-20	High Starting Torque Time [s]	ExpressionLimit	All set-ups	x	TRUE	-2	Uint16
30-21	High Starting Torque Current [%]	ExpressionLimit	All set-ups	x	TRUE	-1	Uint32

30-22	Locked Rotor Protection	ExpressionLimit	All set-ups	x	TRUE	-	UInt8
30-23	Locked Rotor Detection Time [s]	ExpressionLimit	All set-ups	x	TRUE	-2	UInt8
30-24	Locked Rotor Detection Speed Error [%]	25 %	All set-ups	x	TRUE	-1	UInt32
30-25	Light Load Delay [s]	0.000 s	All set-ups	x	TRUE	-3	UInt32
30-26	Light Load Current [%]	0 %	All set-ups	x	TRUE	0	UInt16
30-27	Light Load Speed [%]	0 %	All set-ups	x	TRUE	0	UInt16
30-5* Unit Configuration							
30-50	Heat Sink Fan Mode	ExpressionLimit	2 set-ups	x	TRUE	-	uint8
30-8* Compatibility (I)							
30-80	d-axis Inductance (Ld)	ExpressionLimit	All set-ups	x	FALSE	-6	Int32
30-81	Brake Resistor (ohm)	ExpressionLimit	1 set-up		TRUE	-2	UInt32
30-83	Speed PID Proportional Gain	ExpressionLimit	All set-ups		TRUE	-4	UInt32
30-84	Process PID Proportional Gain	ExpressionLimit	All set-ups		TRUE	-3	UInt16
30-9* Wifi LCP							
30-90	SSID	ExpressionLimit	1 set-up		TRUE	0	VisStr[32]
30-91	Channel	5 N/A	1 set-up		TRUE	0	UInt8
30-92	Password	ExpressionLimit	1 set-up		TRUE	0	VisStr[48]
30-93	Security type	[2] WPA_WPA2	1 set-up		TRUE	-	UInt8
30-94	IP address	ExpressionLimit	1 set-up		TRUE	0	OctStr[4]
30-95	Submask	ExpressionLimit	1 set-up		TRUE	0	OctStr[4]
30-96	Port	5001 N/A	1 set-up		TRUE	0	UInt16
30-97	Wifi Timeout Action	[0] Do Nothing	1 set-up		TRUE	-	UInt8

5.2.20 32- MCO Basic Settings**

Parameter number	Parameter description	Default value	4 set-up	FC 302 only	Change during operation	Conversion index	Type
32-0* Encoder 2							
32-00	Incremental Signal Type	[1] RS422 (5V TTL)	2 set-ups		TRUE	-	UInt8
32-01	Incremental Resolution	1024 N/A	2 set-ups		TRUE	0	UInt32
32-02	Absolute Protocol	[0] None	2 set-ups		TRUE	-	UInt8
32-03	Absolute Resolution	8192 N/A	2 set-ups		TRUE	0	UInt32
32-04	Absolute Encoder Baudrate X55	[4] 9600	All set-ups		FALSE	-	UInt8
32-05	Absolute Encoder Data Length	25 N/A	2 set-ups		TRUE	0	UInt8
32-06	Absolute Encoder Clock Frequency	262 kHz	2 set-ups		TRUE	0	UInt32
32-07	Absolute Encoder Clock Generation	[1] On	2 set-ups		TRUE	-	UInt8
32-08	Absolute Encoder Cable Length	0 m	2 set-ups		TRUE	0	UInt16
32-09	Encoder Monitoring	[0] Off	2 set-ups		TRUE	-	UInt8
32-10	Rotational Direction	[1] No action	2 set-ups		TRUE	-	UInt8
32-11	User Unit Denominator	1 N/A	2 set-ups		TRUE	0	UInt32
32-12	User Unit Numerator	1 N/A	2 set-ups		TRUE	0	UInt32
32-13	Enc.2 Control	[0] No soft changing	2 set-ups		TRUE	-	UInt8
32-14	Enc.2 node ID	127 N/A	2 set-ups		TRUE	0	UInt8
32-15	Enc.2 CAN guard	[0] Off	2 set-ups		TRUE	-	UInt8

32-3* Encoder 1							
32-30	Incremental Signal Type	[1] RS422 (5V TTL)	2 set-ups		TRUE	-	Uint8
32-31	Incremental Resolution	1024 N/A	2 set-ups		TRUE	0	Uint32
32-32	Absolute Protocol	[0] None	2 set-ups		TRUE	-	Uint8
32-33	Absolute Resolution	8192 N/A	2 set-ups		TRUE	0	Uint32
32-35	Absolute Encoder Data Length	25 N/A	2 set-ups		TRUE	0	Uint8
32-36	Absolute Encoder Clock Frequency	262 kHz	2 set-ups		TRUE	0	Uint32
32-37	Absolute Encoder Clock Generation	[1] On	2 set-ups		TRUE	-	Uint8
32-38	Absolute Encoder Cable Length	0 m	2 set-ups		TRUE	0	Uint16
32-39	Encoder Monitoring	[0] Off	2 set-ups		TRUE	-	Uint8
32-40	Encoder Termination	[1] On	2 set-ups		TRUE	-	Uint8
32-43	Enc.1 Control	[0] No soft changing	2 set-ups		TRUE	-	Uint8
32-44	Enc.1 node ID	127 N/A	2 set-ups		TRUE	0	Uint8
32-45	Enc.1 CAN guard	[0] Off	2 set-ups		TRUE	-	Uint8
32-5* Feedback Source							
32-50	Source Slave	[2] Encoder 2 X55	2 set-ups		TRUE	-	Uint8
32-51	MCO 302 Last Will	[1] Trip	2 set-ups		TRUE	-	Uint8
32-52	Source Master	[1] Encoder 1 X56	2 set-ups		TRUE	-	Uint8
32-6* PID Controller							
32-60	Proportional factor	30 N/A	2 set-ups		TRUE	0	Uint32
32-61	Derivative factor	0 N/A	2 set-ups		TRUE	0	Uint32
32-62	Integral factor	0 N/A	2 set-ups		TRUE	0	Uint32
32-63	Limit Value for Integral Sum	1000 N/A	2 set-ups		TRUE	0	Uint16
32-64	PID Bandwidth	1000 N/A	2 set-ups		TRUE	0	Uint16
32-65	Velocity Feed-Forward	0 N/A	2 set-ups		TRUE	0	Uint32
32-66	Acceleration Feed-Forward	0 N/A	2 set-ups		TRUE	0	Uint32
32-67	Max. Tolerated Position Error	20000 N/A	2 set-ups		TRUE	0	Uint32
32-68	Reverse Behavior for Slave	[0] Reversing allowed	2 set-ups		TRUE	-	Uint8
32-69	Sampling Time for PID Control	1 ms	2 set-ups		TRUE	-3	Uint16
32-70	Scan Time for Profile Generator	1 ms	2 set-ups		TRUE	-3	Uint8
32-71	Size of the Control Window (Activation)	0 N/A	2 set-ups		TRUE	0	Uint32
32-72	Size of the Control Window (Deactiv.)	0 N/A	2 set-ups		TRUE	0	Uint32
32-73	Integral limit filter time	0 ms	2 set-ups		TRUE	-3	Int16
32-74	Position error filter time	0 ms	2 set-ups		TRUE	-3	Int16
32-8* Velocity & Accel.							
32-80	Maximum Velocity (Encoder)	1500 RPM	2 set-ups		TRUE	67	Uint32
32-81	Shortest Ramp	1 s	2 set-ups		TRUE	-3	Uint32
32-82	Ramp Type	[0] Linear	2 set-ups		TRUE	-	Uint8
32-83	Velocity Resolution	100 N/A	2 set-ups		TRUE	0	Uint32
32-84	Default Velocity	50 N/A	2 set-ups		TRUE	0	Uint32
32-85	Default Acceleration	50 N/A	2 set-ups		TRUE	0	Uint32
32-86	Acc. up for limited jerk	100 ms	2 set-ups		TRUE	-3	Uint32
32-87	Acc. down for limited jerk	0 ms	2 set-ups		TRUE	-3	Uint32
32-88	Dec. up for limited jerk	0 ms	2 set-ups		TRUE	-3	Uint32
32-89	Dec. down for limited jerk	0 ms	2 set-ups		TRUE	-3	Uint32
32-9* Development							
32-90	Debug Source	[0] Controlcard	2 set-ups		TRUE	-	Uint8

5.2.21 33-** MCO Adv. Settings

Parameter number	Parameter description	Default value	4 set-up	FC 302 only	Change during operation	Conversion index	Type
33-0* Home Motion							
33-00	Force HOME	[0] Home not forced	2 set-ups		TRUE	-	UInt8
33-01	Zero Point Offset from Home Pos.	0 N/A	2 set-ups		TRUE	0	Int32
33-02	Ramp for Home Motion	10 N/A	2 set-ups		TRUE	0	UInt32
33-03	Velocity of Home Motion	10 N/A	2 set-ups		TRUE	0	Int32
33-04	Behaviour during HomeMotion	[0] Revers and index	2 set-ups		TRUE	-	UInt8
33-1* Synchronization							
33-10	Sync Factor Master	1 N/A	2 set-ups		TRUE	0	Int32
33-11	Sync Factor Slave	1 N/A	2 set-ups		TRUE	0	Int32
33-12	Position Offset for Synchronization	0 N/A	2 set-ups		TRUE	0	Int32
33-13	Accuracy Window for Position Sync.	1000 N/A	2 set-ups		TRUE	0	Int32
33-14	Relative Slave Velocity Limit	0 %	2 set-ups		TRUE	0	UInt8
33-15	Marker Number for Master	1 N/A	2 set-ups		TRUE	0	UInt16
33-16	Marker Number for Slave	1 N/A	2 set-ups		TRUE	0	UInt16
33-17	Master Marker Distance	4096 N/A	2 set-ups		TRUE	0	UInt32
33-18	Slave Marker Distance	4096 N/A	2 set-ups		TRUE	0	UInt32
33-19	Master Marker Type	[0] Encoder Z positive	2 set-ups		TRUE	-	UInt8
33-20	Slave Marker Type	[0] Encoder Z positive	2 set-ups		TRUE	-	UInt8
33-21	Master Marker Tolerance Window	0 N/A	2 set-ups		TRUE	0	UInt32
33-22	Slave Marker Tolerance Window	0 N/A	2 set-ups		TRUE	0	UInt32
33-23	Start Behaviour for Marker Sync	[0] Leading marker	2 set-ups		TRUE	-	UInt16
33-24	Marker Number for Fault	10 N/A	2 set-ups		TRUE	0	UInt16
33-25	Marker Number for Ready	1 N/A	2 set-ups		TRUE	0	UInt16
33-26	Velocity Filter	0 us	2 set-ups		TRUE	-6	Int32
33-27	Offset Filter Time	0 ms	2 set-ups		TRUE	-3	UInt32
33-28	Marker Filter Configuration	[0] Marker filter 1	2 set-ups		TRUE	-	UInt8
33-29	Filter Time for Marker Filter	0 ms	2 set-ups		TRUE	-3	Int32
33-30	Maximum Marker Correction	0 N/A	2 set-ups		TRUE	0	UInt32
33-31	Synchronisation Type	[0] Standard	2 set-ups		TRUE	-	UInt8
33-32	Feed Forward Velocity Adaptation	0 N/A	2 set-ups		TRUE	0	UInt32
33-33	Velocity Filter Window	0 N/A	2 set-ups		TRUE	0	UInt32
33-34	Slave Marker filter time	0 ms	2 set-ups		TRUE	-3	UInt32
33-4* Limit Handling							
33-40	Behaviour atEnd Limit Switch	[0] Call error handler	2 set-ups		TRUE	-	UInt8
33-41	Negative Software End Limit	-500000 N/A	2 set-ups		TRUE	0	Int32
33-42	Positive Software End Limit	500000 N/A	2 set-ups		TRUE	0	Int32
33-43	Negative Software End Limit Active	[0] Inactive	2 set-ups		TRUE	-	UInt8
33-44	Positive Software End Limit Active	[0] Inactive	2 set-ups		TRUE	-	UInt8
33-45	Time in Target Window	0 ms	2 set-ups		TRUE	-3	UInt8
33-46	Target Window LimitValue	1 N/A	2 set-ups		TRUE	0	UInt16
33-47	Size of Target Window	0 N/A	2 set-ups		TRUE	0	UInt16
33-5* I/O Configuration							
33-50	Terminal X57/1 Digital Input	[0] No function	2 set-ups		TRUE	-	UInt8
33-51	Terminal X57/2 Digital Input	[0] No function	2 set-ups		TRUE	-	UInt8

33-52	Terminal X57/3 Digital Input	[0] No function	2 set-ups		TRUE	-	UInt8
33-53	Terminal X57/4 Digital Input	[0] No function	2 set-ups		TRUE	-	UInt8
33-54	Terminal X57/5 Digital Input	[0] No function	2 set-ups		TRUE	-	UInt8
33-55	Terminal X57/6 Digital Input	[0] No function	2 set-ups		TRUE	-	UInt8
33-56	Terminal X57/7 Digital Input	[0] No function	2 set-ups		TRUE	-	UInt8
33-57	Terminal X57/8 Digital Input	[0] No function	2 set-ups		TRUE	-	UInt8
33-58	Terminal X57/9 Digital Input	[0] No function	2 set-ups		TRUE	-	UInt8
33-59	Terminal X57/10 Digital Input	[0] No function	2 set-ups		TRUE	-	UInt8
33-60	Terminal X59/1 and X59/2 Mode	[1] Output	2 set-ups		FALSE	-	UInt8
33-61	Terminal X59/1 Digital Input	[0] No function	2 set-ups		TRUE	-	UInt8
33-62	Terminal X59/2 Digital Input	[0] No function	2 set-ups		TRUE	-	UInt8
33-63	Terminal X59/1 Digital Output	[0] No function	2 set-ups		TRUE	-	UInt8
33-64	Terminal X59/2 Digital Output	[0] No function	2 set-ups		TRUE	-	UInt8
33-65	Terminal X59/3 Digital Output	[0] No function	2 set-ups		TRUE	-	UInt8
33-66	Terminal X59/4 Digital Output	[0] No function	2 set-ups		TRUE	-	UInt8
33-67	Terminal X59/5 Digital Output	[0] No function	2 set-ups		TRUE	-	UInt8
33-68	Terminal X59/6 Digital Output	[0] No function	2 set-ups		TRUE	-	UInt8
33-69	Terminal X59/7 Digital Output	[0] No function	2 set-ups		TRUE	-	UInt8
33-70	Terminal X59/8 Digital Output	[0] No function	2 set-ups		TRUE	-	UInt8
33-8* Global Parameters							
33-80	Activated Program Number	-1 N/A	2 set-ups		TRUE	0	Int8
33-81	Power-up State	[1] Motor on	2 set-ups		TRUE	-	UInt8
33-82	Drive Status Monitoring	[1] On	2 set-ups		TRUE	-	UInt8
33-83	Behaviour afterError	[0] Coast	2 set-ups		TRUE	-	UInt8
33-84	Behaviour afterEsc.	[0] Controlled stop	2 set-ups		TRUE	-	UInt8
33-85	MCO Supplied by External 24VDC	[0] No	2 set-ups		TRUE	-	UInt8
33-86	Terminal at alarm	[0] Relay 1	2 set-ups		TRUE	-	UInt8
33-87	Terminal state at alarm	[0] Do nothing	2 set-ups		TRUE	-	UInt8
33-88	Status word at alarm	0 N/A	2 set-ups		TRUE	0	UInt16
33-9* MCO Port Settings							
33-90	X62 MCO CAN node ID	127 N/A	2 set-ups		TRUE	0	UInt8
33-91	X62 MCO CAN baud rate	[20] 125 Kbps	2 set-ups		TRUE	-	UInt8
33-94	X60 MCO RS485 serial termination	[0] Off	2 set-ups		TRUE	-	UInt8
33-95	X60 MCO RS485 serial baud rate	[2] 9600 Baud	2 set-ups		TRUE	-	UInt8

5.2.22 34-** MCO Data Readouts

Parameter number	Parameter description	Default value	4 set-up	FC 302 only	Change during operation	Conversion index	Type
34-0* PCD Write Par.							
34-01	PCD 1 Write to MCO	0 N/A	All set-ups		TRUE	0	UInt16
34-02	PCD 2 Write to MCO	0 N/A	All set-ups		TRUE	0	UInt16
34-03	PCD 3 Write to MCO	0 N/A	All set-ups		TRUE	0	UInt16
34-04	PCD 4 Write to MCO	0 N/A	All set-ups		TRUE	0	UInt16
34-05	PCD 5 Write to MCO	0 N/A	All set-ups		TRUE	0	UInt16
34-06	PCD 6 Write to MCO	0 N/A	All set-ups		TRUE	0	UInt16
34-07	PCD 7 Write to MCO	0 N/A	All set-ups		TRUE	0	UInt16
34-08	PCD 8 Write to MCO	0 N/A	All set-ups		TRUE	0	UInt16

34-09	PCD 9 Write to MCO	0 N/A	All set-ups		TRUE	0	Uint16
34-10	PCD 10 Write to MCO	0 N/A	All set-ups		TRUE	0	Uint16
34-2* PCD Read Par.							
34-21	PCD 1 Read from MCO	0 N/A	All set-ups		TRUE	0	Uint16
34-22	PCD 2 Read from MCO	0 N/A	All set-ups		TRUE	0	Uint16
34-23	PCD 3 Read from MCO	0 N/A	All set-ups		TRUE	0	Uint16
34-24	PCD 4 Read from MCO	0 N/A	All set-ups		TRUE	0	Uint16
34-25	PCD 5 Read from MCO	0 N/A	All set-ups		TRUE	0	Uint16
34-26	PCD 6 Read from MCO	0 N/A	All set-ups		TRUE	0	Uint16
34-27	PCD 7 Read from MCO	0 N/A	All set-ups		TRUE	0	Uint16
34-28	PCD 8 Read from MCO	0 N/A	All set-ups		TRUE	0	Uint16
34-29	PCD 9 Read from MCO	0 N/A	All set-ups		TRUE	0	Uint16
34-30	PCD 10 Read from MCO	0 N/A	All set-ups		TRUE	0	Uint16
34-4* Inputs & Outputs							
34-40	Digital Inputs	0 N/A	All set-ups		TRUE	0	Uint16
34-41	Digital Outputs	0 N/A	All set-ups		TRUE	0	Uint16
34-5* Process Data							
34-50	Actual Position	0 N/A	All set-ups		TRUE	0	Int32
34-51	Commanded Position	0 N/A	All set-ups		TRUE	0	Int32
34-52	Actual Master Position	0 N/A	All set-ups		TRUE	0	Int32
34-53	Slave Index Position	0 N/A	All set-ups		TRUE	0	Int32
34-54	Master Index Position	0 N/A	All set-ups		TRUE	0	Int32
34-55	Curve Position	0 N/A	All set-ups		TRUE	0	Int32
34-56	Track Error	0 N/A	All set-ups		TRUE	0	Int32
34-57	Synchronizing Error	0 N/A	All set-ups		TRUE	0	Int32
34-58	Actual Velocity	0 N/A	All set-ups		TRUE	0	Int32
34-59	Actual Master Velocity	0 N/A	All set-ups		TRUE	0	Int32
34-60	Synchronizing Status	0 N/A	All set-ups		TRUE	0	Int32
34-61	Axis Status	0 N/A	All set-ups		TRUE	0	Int32
34-62	Program Status	0 N/A	All set-ups		TRUE	0	Int32
34-64	MCO 302 Status	0 N/A	All set-ups		TRUE	0	Uint16
34-65	MCO 302 Control	0 N/A	All set-ups		TRUE	0	Uint16
34-66	SPI Error Counter	0 N/A	All set-ups		FALSE	0	Uint32
34-7* Diagnosis readouts							
34-70	MCO Alarm Word 1	0 N/A	All set-ups		FALSE	0	Uint32
34-71	MCO Alarm Word 2	0 N/A	All set-ups		FALSE	0	Uint32

5.2.23 35-** Sensor Input Option

Parameter number	Parameter description	Default value	4 set-up	FC 302 only	Change during operation	Conversion index	Type
35-0* Temp. Input Mode							
35-00	Term. X48/4 Temperature Unit	[60] °C	All set-ups		TRUE	-	Uint8
35-01	Term. X48/4 Input Type	[0] Not Connected	All set-ups		TRUE	-	Uint8
35-02	Term. X48/7 Temperature Unit	[60] °C	All set-ups		TRUE	-	Uint8
35-03	Term. X48/7 Input Type	[0] Not Connected	All set-ups		TRUE	-	Uint8
35-04	Term. X48/10 Temperature Unit	[60] °C	All set-ups		TRUE	-	Uint8
35-05	Term. X48/10 Input Type	[0] Not Connected	All set-ups		TRUE	-	Uint8

35-06	Temperature Sensor Alarm Function	[5] Stop and trip	All set-ups		TRUE	-	UInt8
35-1* Temp. Input X48/4							
35-14	Term. X48/4 Filter Time Constant	0.001 s	All set-ups		TRUE	-3	UInt16
35-15	Term. X48/4 Temp. Monitor	[0] Disabled	All set-ups		TRUE	-	UInt8
35-16	Term. X48/4 Low Temp. Limit	ExpressionLimit	All set-ups		TRUE	0	Int16
35-17	Term. X48/4 High Temp. Limit	ExpressionLimit	All set-ups		TRUE	0	Int16
35-2* Temp. Input X48/7							
35-24	Term. X48/7 Filter Time Constant	0.001 s	All set-ups		TRUE	-3	UInt16
35-25	Term. X48/7 Temp. Monitor	[0] Disabled	All set-ups		TRUE	-	UInt8
35-26	Term. X48/7 Low Temp. Limit	ExpressionLimit	All set-ups		TRUE	0	Int16
35-27	Term. X48/7 High Temp. Limit	ExpressionLimit	All set-ups		TRUE	0	Int16
35-3* Temp. Input X48/10							
35-34	Term. X48/10 Filter Time Constant	0.001 s	All set-ups		TRUE	-3	UInt16
35-35	Term. X48/10 Temp. Monitor	[0] Disabled	All set-ups		TRUE	-	UInt8
35-36	Term. X48/10 Low Temp. Limit	ExpressionLimit	All set-ups		TRUE	0	Int16
35-37	Term. X48/10 High Temp. Limit	ExpressionLimit	All set-ups		TRUE	0	Int16
35-4* Analog Input X48/2							
35-42	Term. X48/2 Low Current	4 mA	All set-ups		TRUE	-5	Int16
35-43	Term. X48/2 High Current	20 mA	All set-ups		TRUE	-5	Int16
35-44	Term. X48/2 Low Ref./Feedb. Value	0 ReferenceFeedbackUnit	All set-ups		TRUE	-3	Int32
35-45	Term. X48/2 High Ref./Feedb. Value	100 ReferenceFeed-backUnit	All set-ups		TRUE	-3	Int32
35-46	Term. X48/2 Filter Time Constant	0.001 s	All set-ups		TRUE	-3	UInt16

5.2.24 36-** Programmable I/O Option

Parameter number	Parameter description	Default value	4 set-up	FC 302 only	Change during operation	Conversion index	Type
36-0* I/O Mode							
36-03	Terminal X49/7 Mode	[0] Voltage 0-10V	All set-ups		TRUE	-	UInt8
36-04	Terminal X49/9 Mode	[0] Voltage 0-10V	All set-ups		TRUE	-	UInt8
36-05	Terminal X49/11 Mode	[0] Voltage 0-10V	All set-ups		TRUE	-	UInt8
36-4* Output X49/7							
36-40	Terminal X49/7 Analogue Output	[0] No operation	All set-ups		TRUE	-	UInt8
36-42	Terminal X49/7 Min. Scale	0 %	All set-ups		TRUE	-2	Int16
36-43	Terminal X49/7 Max. Scale	100 %	All set-ups		TRUE	-2	Int16
36-44	Terminal X49/7 Bus Control	0 %	All set-ups		TRUE	-2	N2
36-45	Terminal X49/7 Timeout Preset	0 %	1 set-up		TRUE	-2	UInt16
36-5* Output X49/9							
36-50	Terminal X49/9 Analogue Output	[0] No operation	All set-ups		TRUE	-	UInt8
36-52	Terminal X49/9 Min. Scale	0 %	All set-ups		TRUE	-2	Int16
36-53	Terminal X49/9 Max. Scale	100 %	All set-ups		TRUE	-2	Int16
36-54	Terminal X49/9 Bus Control	0 %	All set-ups		TRUE	-2	N2
36-55	Terminal X49/9 Timeout Preset	0 %	1 set-up		TRUE	-2	UInt16
36-6* Output X49/11							
36-60	Terminal X49/11 Analogue Output	[0] No operation	All set-ups		TRUE	-	UInt8
36-62	Terminal X49/11 Min. Scale	0 %	All set-ups		TRUE	-2	Int16
36-63	Terminal X49/11 Max. Scale	100 %	All set-ups		TRUE	-2	Int16

36-64	Terminal X49/11 Bus Control	0 %	All set-ups		TRUE	-2	N2
36-65	Terminal X49/11 Timeout Preset	0 %	1 set-up		TRUE	-2	Uint16

5.2.25 40-** Special Settings

Parameter number	Parameter description	Default value	4 set-up	FC 302 only	Change during operation	Conversion index	Type
40-4* Extend. Fault Log							
40-40	Fault Log: Ext. Reference	0 %	All set-ups		FALSE	-1	Int16
40-41	Fault Log: Frequency	0 Hz	All set-ups		FALSE	-1	Uint16
40-42	Fault Log: Current	0 A	All set-ups		FALSE	-2	Int32
40-43	Fault Log: Voltage	0 V	All set-ups		FALSE	-1	Uint16
40-44	Fault Log: DC Link Voltage	0 V	All set-ups		FALSE	0	Uint16
40-45	Fault Log: Control Word	0 N/A	All set-ups		FALSE	0	V2
40-46	Fault Log: Status Word	0 N/A	All set-ups		FALSE	0	V2
40-5* Advanced Control Settings							
40-50	Flux Sensorless Model Shift	ExpressionLimit	All set-ups		FALSE	-	Uint8
40-51	Flux Sensorless Corr. Gain	ExpressionLimit	All set-ups		TRUE	-1	Uint32

5.2.26 43-** Unit Readouts

Parameter number	Parameter description	Default value	4 set-up	FC 302 only	Change during operation	Conversion index	Type
43-0* Component Status							
43-00	Component Temp.	0 °C	All set-ups	x	TRUE	100	Int8
43-01	Auxiliary Temp.	0 °C	All set-ups	x	TRUE	100	Int8
43-02	Component SW ID	0 N/A	All set-ups	x	TRUE	0	VisStr[18]
43-1* Power Card Status							
43-10	HS Temp. ph.U	0 °C	All set-ups	x	TRUE	100	Int8
43-11	HS Temp. ph.V	0 °C	All set-ups	x	TRUE	100	Int8
43-12	HS Temp. ph.W	0 °C	All set-ups	x	TRUE	100	Int8
43-13	PC Fan A Speed	0 RPM	All set-ups	x	TRUE	67	Uint16
43-14	PC Fan B Speed	0 RPM	All set-ups	x	TRUE	67	Uint16
43-15	PC Fan C Speed	0 RPM	All set-ups	x	TRUE	67	Uint16
43-2* Fan Pow.Card Status							
43-20	FPC Fan A Speed	0 RPM	All set-ups	x	TRUE	67	Uint16
43-21	FPC Fan B Speed	0 RPM	All set-ups	x	TRUE	67	Uint16
43-22	FPC Fan C Speed	0 RPM	All set-ups	x	TRUE	67	Uint16
43-23	FPC Fan D Speed	0 RPM	All set-ups	x	TRUE	67	Uint16
43-24	FPC Fan E Speed	0 RPM	All set-ups	x	TRUE	67	Uint16
43-25	FPC Fan F Speed	0 RPM	All set-ups	x	TRUE	67	Uint16

5.3 Parameter Lists and Options, Software Version 48.20 (IMC)

5.3.1 0-** Operation / Display

Parameter #	Parameter description	Default value	4 set-up	FC 302 only	Change during operation	Conversion index	Type
0-0* Basic Settings							
0-01	Language	[0] English	1 set-up		TRUE	-	UInt8
0-02	Motor Speed Unit	[0] RPM	2 set-ups		FALSE	-	UInt8
0-03	Regional Settings	[0] International	2 set-ups		FALSE	-	UInt8
0-04	Operating State at Power-up (Hand)	[1] Forced stop, ref=old	All set-ups		TRUE	-	UInt8
0-09	Performance Monitor	0 %	All set-ups		TRUE	-1	UInt16
0-1* Set-up Operations							
0-10	Active Set-up	[1] Set-up 1	1 set-up		TRUE	-	UInt8
0-11	Edit Set-up	[1] Set-up 1	All set-ups		TRUE	-	UInt8
0-12	This Set-up Linked to	[0] Not linked	All set-ups		FALSE	-	UInt8
0-13	Readout: Linked Set-ups	0 N/A	All set-ups		FALSE	0	UInt16
0-14	Readout: Edit Set-ups / Channel	0 N/A	All set-ups		TRUE	0	Int32
0-15	Readout: actual setup	0 N/A	All set-ups		FALSE	0	UInt8
0-2* LCP Display							
0-20	Display Line 1.1 Small	1617	All set-ups		TRUE	-	UInt16
0-21	Display Line 1.2 Small	1614	All set-ups		TRUE	-	UInt16
0-22	Display Line 1.3 Small	1610	All set-ups		TRUE	-	UInt16
0-23	Display Line 2 Large	1613	All set-ups		TRUE	-	UInt16
0-24	Display Line 3 Large	1602	All set-ups		TRUE	-	UInt16
0-25	My Personal Menu	ExpressionLimit	1 set-up		TRUE	0	UInt16
0-3* LCP Custom Readout							
0-30	Unit for User-defined Readout	[0] None	All set-ups		TRUE	-	UInt8
0-31	Min Value of User-defined Readout	0 CustomReadoutUnit	All set-ups		TRUE	-2	Int32
0-32	Max Value of User-defined Readout	100 CustomReadoutUnit	All set-ups		TRUE	-2	Int32
0-33	Source for User-defined Readout	[240] Default Source	All set-ups		TRUE	-	UInt8
0-37	Display Text 1	0 N/A	1 set-up		TRUE	0	VisStr[25]
0-38	Display Text 2	0 N/A	1 set-up		TRUE	0	VisStr[25]
0-39	Display Text 3	0 N/A	1 set-up		TRUE	0	VisStr[25]
0-4* LCP Keypad							
0-40	[Hand on] Key on LCP	ExpressionLimit	All set-ups		TRUE	-	UInt8
0-41	[Off] Key on LCP	ExpressionLimit	All set-ups		TRUE	-	UInt8
0-42	[Auto on] Key on LCP	ExpressionLimit	All set-ups		TRUE	-	UInt8
0-43	[Reset] Key on LCP	ExpressionLimit	All set-ups		TRUE	-	UInt8
0-44	[Off/Reset] Key on LCP	ExpressionLimit	All set-ups		TRUE	-	UInt8
0-45	[Drive Bypass] Key on LCP	ExpressionLimit	All set-ups		TRUE	-	UInt8
0-5* Copy/Save							
0-50	LCP Copy	[0] No copy	All set-ups		FALSE	-	UInt8
0-51	Set-up Copy	[0] No copy	All set-ups		FALSE	-	UInt8
0-6* Password							
0-60	Main Menu Password	100 N/A	1 set-up		TRUE	0	Int16
0-61	Access to Main Menu w/o Password	[0] Full access	1 set-up		TRUE	-	UInt8

0-65	Quick Menu Password	200 N/A	1 set-up		TRUE	0	Int16
0-66	Access to Quick Menu w/o Password	[0] Full access	1 set-up		TRUE	-	UInt8
0-67	Bus Password Access	0 N/A	All set-ups		TRUE	0	UInt16
0-68	Safety Parameters Password	300 N/A	1 set-up		TRUE	0	UInt16
0-69	Password Protection of Safety Parameters	[0] Disabled	1 set-up		TRUE	-	UInt8

5.3.2 1-** Load and Motor

Parameter #	Parameter description	Default value	4 set-up	FC 302 only	Change during operation	Conversion index	Type
1-0* General Settings							
1-00	Configuration Mode	ExpressionLimit	All set-ups		TRUE	-	UInt8
1-01	Motor Control Principle	ExpressionLimit	All set-ups		FALSE	-	UInt8
1-02	Flux Motor Feedback Source	[1] 24V encoder	All set-ups	x	FALSE	-	UInt8
1-03	Torque Characteristics	[0] Constant torque	All set-ups		TRUE	-	UInt8
1-04	Overload Mode	[0] High torque	All set-ups		FALSE	-	UInt8
1-05	Local Mode Configuration	[2] As mode par 1-00	All set-ups		TRUE	-	UInt8
1-06	Clockwise Direction	[0] Normal	All set-ups		FALSE	-	UInt8
1-07	Motor Angle Offset Adjust	[0] Manual	All set-ups	x	FALSE	-	UInt8
1-1* Special Settings							
1-10	Motor Construction	[0] Asynchron	All set-ups		FALSE	-	UInt8
1-11	Motor Model	ExpressionLimit	All set-ups	x	FALSE	-	UInt8
1-18	Min. Current at No Load	0 %	All set-ups		TRUE	0	UInt16
1-2* Motor Data							
1-20	Motor Power [kW]	ExpressionLimit	All set-ups		FALSE	1	UInt32
1-21	Motor Power [HP]	ExpressionLimit	All set-ups		FALSE	-2	UInt32
1-22	Motor Voltage	ExpressionLimit	All set-ups		FALSE	0	UInt16
1-23	Motor Frequency	ExpressionLimit	All set-ups		FALSE	0	UInt16
1-24	Motor Current	ExpressionLimit	All set-ups		FALSE	-2	UInt32
1-25	Motor Nominal Speed	ExpressionLimit	All set-ups		FALSE	67	UInt16
1-26	Motor Cont. Rated Torque	ExpressionLimit	All set-ups		FALSE	-1	UInt32
1-29	Automatic Motor Adaptation (AMA)	[0] Off	All set-ups		FALSE	-	UInt8
1-3* Adv. Motor Data							
1-30	Stator Resistance (Rs)	ExpressionLimit	All set-ups		FALSE	-4	UInt32
1-31	Rotor Resistance (Rr)	ExpressionLimit	All set-ups		FALSE	-4	UInt32
1-33	Stator Leakage Reactance (X1)	ExpressionLimit	All set-ups		FALSE	-4	UInt32
1-34	Rotor Leakage Reactance (X2)	ExpressionLimit	All set-ups		FALSE	-4	UInt32
1-35	Main Reactance (Xh)	ExpressionLimit	All set-ups		FALSE	-4	UInt32
1-36	Iron Loss Resistance (Rfe)	ExpressionLimit	All set-ups		FALSE	-3	UInt32
1-37	d-axis Inductance (Ld)	ExpressionLimit	All set-ups	x	FALSE	-4	Int32
1-38	q-axis Inductance (Lq)	ExpressionLimit	All set-ups		FALSE	-6	Int32
1-39	Motor Poles	ExpressionLimit	All set-ups		FALSE	0	UInt8
1-40	Back EMF at 1000 RPM	ExpressionLimit	All set-ups	x	FALSE	0	UInt16
1-41	Motor Angle Offset	0 N/A	All set-ups		TRUE	0	Int16
1-44	d-axis Inductance Sat. (LdSat)	ExpressionLimit	All set-ups		FALSE	-6	Int32
1-45	q-axis Inductance Sat. (LqSat)	ExpressionLimit	All set-ups		FALSE	-6	Int32
1-46	Position Detection Gain	100 %	All set-ups		TRUE	0	UInt16
1-47	Torque Calibration	ExpressionLimit	All set-ups		TRUE	-	UInt8
1-48	d-axis Inductance Sat. Point	ExpressionLimit	All set-ups		TRUE	0	Int16

1-49	q-axis Inductance Sat. Point	35 %	All set-ups	x	FALSE	0	Uint16
1-5* Load Indep. Setting							
1-50	Motor Magnetisation at Zero Speed	100 %	All set-ups		TRUE	0	Uint16
1-51	Min Speed Normal Magnetising [RPM]	ExpressionLimit	All set-ups		TRUE	67	Uint16
1-52	Min Speed Normal Magnetising [Hz]	ExpressionLimit	All set-ups		TRUE	-1	Uint16
1-53	Model Shift Frequency	ExpressionLimit	All set-ups	x	FALSE	-1	Uint16
1-54	Voltage reduction in fieldweakening	0 V	All set-ups		FALSE	0	Uint8
1-55	U/f Characteristic - U	ExpressionLimit	All set-ups		TRUE	-1	Uint16
1-56	U/f Characteristic - F	ExpressionLimit	All set-ups		TRUE	-1	Uint16
1-57	Torque Estimation Time Constant	150 ms	All set-ups		TRUE	-3	Uint16
1-58	Flying Start Test Pulses Current	ExpressionLimit	All set-ups		FALSE	0	Uint16
1-59	Flying Start Test Pulses Frequency	ExpressionLimit	All set-ups		FALSE	0	Uint16
1-6* Load Depen. Setting							
1-60	Low Speed Load Compensation	100 %	All set-ups		TRUE	0	Int16
1-61	High Speed Load Compensation	100 %	All set-ups		TRUE	0	Int16
1-62	Slip Compensation	ExpressionLimit	All set-ups		TRUE	0	Int16
1-63	Slip Compensation Time Constant	ExpressionLimit	All set-ups		TRUE	-2	Uint16
1-64	Resonance Damping	ExpressionLimit	All set-ups		TRUE	0	Uint16
1-65	Resonance Damping Time Constant	5 ms	All set-ups		TRUE	-3	Uint8
1-66	Min. Current at Low Speed	ExpressionLimit	All set-ups	x	TRUE	0	Uint32
1-67	Load Type	ExpressionLimit	All set-ups	x	TRUE	-	Uint8
1-68	Motor Inertia	0 kgm ²	All set-ups	x	TRUE	-4	Uint32
1-69	System Inertia	ExpressionLimit	All set-ups	x	TRUE	-4	Uint32
1-7* Start Adjustments							
1-70	PM Start Mode	[0] Rotor Detection	All set-ups		TRUE	-	Uint8
1-71	Start Delay	0 s	All set-ups		TRUE	-1	Uint8
1-72	Start Function	[2] Coast/delay time	All set-ups		TRUE	-	Uint8
1-73	Flying Start	ExpressionLimit	All set-ups		FALSE	-	Uint8
1-74	Start Speed [RPM]	ExpressionLimit	All set-ups		TRUE	67	Uint16
1-75	Start Speed [Hz]	ExpressionLimit	All set-ups		TRUE	-1	Uint16
1-76	Start Current	0 A	All set-ups		TRUE	-2	Uint32
1-8* Stop Adjustments							
1-80	Function at Stop	[0] Coast	All set-ups		TRUE	-	Uint8
1-81	Min Speed for Function at Stop [RPM]	ExpressionLimit	All set-ups		TRUE	67	Uint16
1-82	Min Speed for Function at Stop [Hz]	ExpressionLimit	All set-ups		TRUE	-1	Uint16
1-9* Motor Temperature							
1-90	Motor Thermal Protection	ExpressionLimit	All set-ups		TRUE	-	Uint8
1-91	Motor External Fan	ExpressionLimit	All set-ups		TRUE	-	Uint8
1-93	Thermistor Resource	[0] None	All set-ups		TRUE	-	Uint8
1-94	ATEX ETR cur.lim. speed reduction	0 %	2 set-ups	x	TRUE	-1	Uint16
1-95	KTY Sensor Type	[0] KTY Sensor 1	All set-ups	x	TRUE	-	Uint8
1-96	KTY Thermistor Resource	[0] None	All set-ups	x	TRUE	-	Uint8
1-97	KTY Threshold level	80 °C	1 set-up	x	TRUE	100	Int16
1-98	ATEX ETR interpol. points freq.	ExpressionLimit	1 set-up	x	TRUE	-1	Uint16
1-99	ATEX ETR interpol points current	ExpressionLimit	2 set-ups	x	TRUE	0	Uint16

5.3.3 2-** Brakes

Parameter #	Parameter description	Default value	4 set-up	FC 302 only	Change during operation	Conversion index	Type
-------------	-----------------------	---------------	----------	-------------	-------------------------	------------------	------

2-0* DC-Brake							
2-00	DC Hold Current	50 %	All set-ups		TRUE	0	Uint8
2-01	DC Brake Current	50 %	All set-ups		TRUE	0	Uint16
2-02	DC Braking Time	10 s	All set-ups		TRUE	-1	Uint16
2-03	DC Brake Cut In Speed [RPM]	ExpressionLimit	All set-ups		TRUE	67	Uint16
2-04	DC Brake Cut In Speed [Hz]	ExpressionLimit	All set-ups		TRUE	-1	Uint16
2-05	Maximum Reference	MaxReference (P303)	All set-ups		TRUE	-3	Int32
2-06	Parking Current	50 %	All set-ups		TRUE	0	Uint16
2-07	Parking Time	3 s	All set-ups		TRUE	-1	Uint16
2-1* Brake Energy Funct.							
2-10	Brake Function	ExpressionLimit	All set-ups		TRUE	-	Uint8
2-11	Brake Resistor (ohm)	ExpressionLimit	All set-ups		TRUE	0	Uint16
2-12	Brake Power Limit (kW)	ExpressionLimit	All set-ups		TRUE	0	Uint32
2-13	Brake Power Monitoring	[0] Off	All set-ups		TRUE	-	Uint8
2-15	Brake Check	[0] Off	All set-ups		TRUE	-	Uint8
2-16	AC brake Max. Current	100 %	All set-ups		TRUE	-1	Uint32
2-17	Over-voltage Control	[0] Disabled	All set-ups		TRUE	-	Uint8
2-18	Brake Check Condition	[0] At Power Up	All set-ups		TRUE	-	Uint8
2-19	Over-voltage Gain	100 %	All set-ups		TRUE	0	Uint16
2-2* Mechanical Brake							
2-20	Release Brake Current	I _{maxVLT} (P1637)	All set-ups		TRUE	-2	Uint32
2-21	Activate Brake Speed [RPM]	ExpressionLimit	All set-ups		TRUE	67	Uint16
2-22	Activate Brake Speed [Hz]	ExpressionLimit	All set-ups		TRUE	-1	Uint16
2-23	Activate Brake Delay	ExpressionLimit	All set-ups		TRUE	-1	Uint8
2-24	Stop Delay	0 s	All set-ups		TRUE	-1	Uint8
2-25	Brake Release Time	ExpressionLimit	All set-ups		TRUE	-2	Uint16
2-26	Torque Ref	15 %	All set-ups		TRUE	-2	Int16
2-27	Torque Ramp Up Time	0.2 s	All set-ups		TRUE	-1	Uint8
2-28	Gain Boost Factor	ExpressionLimit	All set-ups		TRUE	-2	Uint16
2-29	Torque Ramp Down Time	0.2 s	All set-ups		TRUE	-1	Uint8
2-3* Adv. Mech Brake							
2-30	Position P Start Proportional Gain	0.05 N/A	All set-ups		TRUE	-4	Uint32
2-31	Speed PID Start Proportional Gain	0.05 N/A	All set-ups		TRUE	-4	Uint32
2-32	Speed PID Start Integral Time	20.0 ms	All set-ups		TRUE	-4	Uint32
2-33	Speed PID Start Lowpass Filter Time	2.0 ms	All set-ups		TRUE	-4	Uint16
2-34	Zero Speed Position P Proportional Gain	0.0000 N/A	All set-ups		TRUE	-4	Uint32

5.3.4 3-** Reference / Ramps

Parameter #	Parameter description	Default value	4 set-up	FC 302 only	Change during operation	Conversion index	Type
3-0* Reference Limits							
3-00	Reference Range	ExpressionLimit	All set-ups		TRUE	-	Uint8
3-01	Reference/Feedback Unit	ExpressionLimit	All set-ups		TRUE	-	Uint8
3-02	Minimum Reference	ExpressionLimit	All set-ups		TRUE	-3	Int32
3-03	Maximum Reference	ExpressionLimit	All set-ups		TRUE	-3	Int32
3-04	Reference Function	[0] Sum	All set-ups		TRUE	-	Uint8
3-05	On Reference Window	ExpressionLimit	All set-ups		TRUE	-3	Int32
3-06	Minimum Position	-100000 CustomRea- doutUnit2	All set-ups		FALSE	0	Int32

3-07	Maximum Position	100000 CustomReadoutUnit2	All set-ups		FALSE	0	Int32
3-08	On Target Window	5 CustomReadoutUnit2	All set-ups		TRUE	0	Int32
3-09	On Target Time	1 ms	All set-ups		TRUE	-3	UInt16
3-1* References							
3-10	Preset Reference	0 %	All set-ups		TRUE	-2	Int16
3-11	Jog Speed [Hz]	ExpressionLimit	All set-ups		TRUE	-1	UInt16
3-12	Catch up/slow Down Value	0 %	All set-ups		TRUE	-2	Int16
3-13	Reference Site	[0] Linked to Hand / Auto	All set-ups		TRUE	-	UInt8
3-14	Preset Relative Reference	0 %	All set-ups		TRUE	-2	Int32
3-15	Reference Resource 1	ExpressionLimit	All set-ups		TRUE	-	UInt8
3-16	Reference Resource 2	ExpressionLimit	All set-ups		TRUE	-	UInt8
3-17	Reference Resource 3	ExpressionLimit	All set-ups		TRUE	-	UInt8
3-18	Relative Scaling Reference Resource	[0] No function	All set-ups		TRUE	-	UInt8
3-19	Jog Speed [RPM]	ExpressionLimit	All set-ups		TRUE	67	UInt16
3-2* References II							
3-20	Preset Target	0 CustomReadoutUnit2	All set-ups		TRUE	0	Int32
3-21	Touch Target	0 CustomReadoutUnit2	All set-ups		TRUE	0	Int32
3-22	Master Scale Numerator	1 N/A	All set-ups		TRUE	0	Int32
3-23	Master Scale Denominator	1 N/A	All set-ups		TRUE	0	Int32
3-24	Master Lowpass Filter Time	20 ms	All set-ups		TRUE	-4	UInt16
3-25	Master Bus Resolution	65536 N/A	All set-ups		FALSE	0	UInt32
3-26	Master Offset	0 CustomReadoutUnit2	All set-ups		TRUE	0	Int32
3-27	Virtual Master Max Ref	50.0 Hz	All set-ups		TRUE	-1	UInt16
3-28	Master Offset Speed Ref	1500 RPM	All set-ups		TRUE	67	UInt16
3-4* Ramp 1							
3-40	Ramp 1 Type	[0] Linear	All set-ups		TRUE	-	UInt8
3-41	Ramp 1 Ramp Up Time	ExpressionLimit	All set-ups		TRUE	-2	UInt32
3-42	Ramp 1 Ramp Down Time	ExpressionLimit	All set-ups		TRUE	-2	UInt32
3-45	Ramp 1 S-ramp Ratio at Accel. Start	50 %	All set-ups		TRUE	0	UInt8
3-46	Ramp 1 S-ramp Ratio at Accel. End	50 %	All set-ups		TRUE	0	UInt8
3-47	Ramp 1 S-ramp Ratio at Decel. Start	50 %	All set-ups		TRUE	0	UInt8
3-48	Ramp 1 S-ramp Ratio at Decel. End	50 %	All set-ups		TRUE	0	UInt8
3-5* Ramp 2							
3-50	Ramp 2 Type	[0] Linear	All set-ups		TRUE	-	UInt8
3-51	Ramp 2 Ramp Up Time	ExpressionLimit	All set-ups		TRUE	-2	UInt32
3-52	Ramp 2 Ramp Down Time	ExpressionLimit	All set-ups		TRUE	-2	UInt32
3-55	Ramp 2 S-ramp Ratio at Accel. Start	50 %	All set-ups		TRUE	0	UInt8
3-56	Ramp 2 S-ramp Ratio at Accel. End	50 %	All set-ups		TRUE	0	UInt8
3-57	Ramp 2 S-ramp Ratio at Decel. Start	50 %	All set-ups		TRUE	0	UInt8
3-58	Ramp 2 S-ramp Ratio at Decel. End	50 %	All set-ups		TRUE	0	UInt8
3-6* Ramp 3							
3-60	Ramp 3 Type	[0] Linear	All set-ups		TRUE	-	UInt8
3-61	Ramp 3 Ramp up Time	ExpressionLimit	All set-ups		TRUE	-2	UInt32
3-62	Ramp 3 Ramp down Time	ExpressionLimit	All set-ups		TRUE	-2	UInt32
3-65	Ramp 3 S-ramp Ratio at Accel. Start	50 %	All set-ups		TRUE	0	UInt8
3-66	Ramp 3 S-ramp Ratio at Accel. End	50 %	All set-ups		TRUE	0	UInt8
3-67	Ramp 3 S-ramp Ratio at Decel. Start	50 %	All set-ups		TRUE	0	UInt8
3-68	Ramp 3 S-ramp Ratio at Decel. End	50 %	All set-ups		TRUE	0	UInt8
3-7* Ramp 4							

3-70	Ramp 4 Type	[0] Linear	All set-ups		TRUE	-	Uint8
3-71	Ramp 4 Ramp up Time	ExpressionLimit	All set-ups		TRUE	-2	Uint32
3-72	Ramp 4 Ramp Down Time	ExpressionLimit	All set-ups		TRUE	-2	Uint32
3-75	Ramp 4 S-ramp Ratio at Accel. Start	50 %	All set-ups		TRUE	0	Uint8
3-76	Ramp 4 S-ramp Ratio at Accel. End	50 %	All set-ups		TRUE	0	Uint8
3-77	Ramp 4 S-ramp Ratio at Decel. Start	50 %	All set-ups		TRUE	0	Uint8
3-78	Ramp 4 S-ramp Ratio at Decel. End	50 %	All set-ups		TRUE	0	Uint8
3-8* Other Ramps							
3-80	Jog/Homing Ramp Time	ExpressionLimit	All set-ups		TRUE	-2	Uint32
3-81	Quick Stop Ramp Time	ExpressionLimit	2 set-ups		TRUE	-2	Uint32
3-82	Quick Stop Ramp Type	[0] Linear	All set-ups		TRUE	-	Uint8
3-83	Quick Stop S-ramp Ratio at Decel. Start	50 %	All set-ups		TRUE	0	Uint8
3-84	Quick Stop S-ramp Ratio at Decel. End	50 %	All set-ups		TRUE	0	Uint8
3-89	Ramp Lowpass Filter Time	1 ms	All set-ups		TRUE	-4	Uint16
3-9* Digital Pot.Meter							
3-90	Step Size	0.10 %	All set-ups		TRUE	-2	Uint16
3-91	Ramp Time	1 s	All set-ups		TRUE	-2	Uint32
3-92	Power Restore	[0] Off	All set-ups		TRUE	-	Uint8
3-93	Maximum Limit	100 %	All set-ups		TRUE	0	Int16
3-94	Minimum Limit	-100 %	All set-ups		TRUE	0	Int16
3-95	Ramp Delay	ExpressionLimit	All set-ups		TRUE	-3	TimD

5.3.5 4-** Limits / Warnings

Parameter #	Parameter description	Default value	4 set-up	FC 302 only	Change during operation	Conversion index	Type
4-1* Motor Limits							
4-10	Motor Speed Direction	ExpressionLimit	All set-ups		FALSE	-	Uint8
4-11	Motor Speed Low Limit [RPM]	ExpressionLimit	All set-ups		TRUE	67	Uint16
4-12	Motor Speed Low Limit [Hz]	ExpressionLimit	All set-ups		TRUE	-1	Uint16
4-13	Motor Speed High Limit [RPM]	ExpressionLimit	All set-ups		TRUE	67	Uint16
4-14	Motor Speed High Limit [Hz]	ExpressionLimit	All set-ups		TRUE	-1	Uint16
4-16	Torque Limit Motor Mode	ExpressionLimit	All set-ups		TRUE	-1	Uint16
4-17	Torque Limit Generator Mode	100 %	All set-ups		TRUE	-1	Uint16
4-18	Current Limit	ExpressionLimit	All set-ups		TRUE	-1	Uint32
4-19	Max Output Frequency	ExpressionLimit	All set-ups		FALSE	-1	Uint16
4-2* Limit Factors							
4-20	Torque Limit Factor Source	[0] No function	All set-ups		TRUE	-	Uint8
4-21	Speed Limit Factor Source	[0] No function	All set-ups		TRUE	-	Uint8
4-23	Brake Check Limit Factor Source	[0] DC-link voltage	All set-ups		TRUE	-	Uint8
4-24	Brake Check Limit Factor	98 %	All set-ups		TRUE	0	Uint8
4-3* Motor Speed Mon.							
4-30	Motor Feedback Loss Function	[2] Trip	All set-ups		TRUE	-	Uint8
4-31	Motor Feedback Speed Error	300 RPM	All set-ups		TRUE	67	Uint16
4-32	Motor Feedback Loss Timeout	0.05 s	All set-ups		TRUE	-2	Uint16
4-34	Tracking Error Function	ExpressionLimit	All set-ups		TRUE	-	Uint8
4-35	Tracking Error	10 RPM	All set-ups		TRUE	67	Uint16
4-36	Tracking Error Timeout	1 s	All set-ups		TRUE	-2	Uint16
4-37	Tracking Error Ramping	100 RPM	All set-ups		TRUE	67	Uint16
4-38	Tracking Error Ramping Timeout	1 s	All set-ups		TRUE	-2	Uint16

4-39	Tracking Error After Ramping Timeout	5 s	All set-ups		TRUE	-2	Uint16
4-4* Speed Monitor							
4-43	Motor Speed Monitor Function	ExpressionLimit	All set-ups		TRUE	-	Uint8
4-44	Motor Speed Monitor Max	300 RPM	All set-ups		TRUE	67	Uint16
4-45	Motor Speed Monitor Timeout	0.1 s	All set-ups		TRUE	-2	Uint16
4-5* Adj. Warnings							
4-50	Warning Current Low	0 A	All set-ups		TRUE	-2	Uint32
4-51	Warning Current High	ImaxVLT (P1637)	All set-ups		TRUE	-2	Uint32
4-52	Warning Speed Low	0 RPM	All set-ups		TRUE	67	Uint16
4-53	Warning Speed High	ExpressionLimit	All set-ups		TRUE	67	Uint16
4-54	Warning Reference Low	-999999.999 N/A	All set-ups		TRUE	-3	Int32
4-55	Warning Reference High	999999.999 N/A	All set-ups		TRUE	-3	Int32
4-56	Warning Feedback Low	-999999.999 Reference-FeedbackUnit	All set-ups		TRUE	-3	Int32
4-57	Warning Feedback High	999999.999 Reference-FeedbackUnit	All set-ups		TRUE	-3	Int32
4-58	Missing Motor Phase Function	ExpressionLimit	All set-ups		TRUE	-	Uint8
4-6* Speed Bypass							
4-60	Bypass Speed From [RPM]	ExpressionLimit	All set-ups		TRUE	67	Uint16
4-61	Bypass Speed From [Hz]	ExpressionLimit	All set-ups		TRUE	-1	Uint16
4-62	Bypass Speed To [RPM]	ExpressionLimit	All set-ups		TRUE	67	Uint16
4-63	Bypass Speed To [Hz]	ExpressionLimit	All set-ups		TRUE	-1	Uint16
4-7* Position Monitor							
4-70	Position Error Function	[0] Disabled	All set-ups		TRUE	-	Uint8
4-71	Maximum Position Error	1000 CustomReadoutUnit2	All set-ups		TRUE	0	Int32
4-72	Position Error Timeout	0.100 s	All set-ups		TRUE	-3	Uint16
4-73	Position Limit Function	[3] Abs. Pos. Mode Stop	All set-ups		TRUE	-	Uint8
4-74	Start Fwd/Rev Function	[0] Stop	All set-ups		TRUE	-	Uint8
4-75	Touch Timeout	6000.0 s	All set-ups		TRUE	-1	Uint16

5.3.6 5-** Digital In/Out

Parameter #	Parameter description	Default value	4 set-up	FC 302 only	Change during operation	Conversion index	Type
5-0* Digital I/O mode							
5-00	Digital I/O Mode	[0] PNP	All set-ups		FALSE	-	Uint8
5-01	Terminal 27 Mode	[0] Input	All set-ups		TRUE	-	Uint8
5-02	Terminal 29 Mode	[0] Input	All set-ups	x	TRUE	-	Uint8
5-1* Digital Inputs							
5-10	Terminal 18 Digital Input	ExpressionLimit	All set-ups		TRUE	-	Uint8
5-11	Terminal 19 Digital Input	ExpressionLimit	All set-ups		TRUE	-	Uint8
5-12	Terminal 27 Digital Input	ExpressionLimit	All set-ups		TRUE	-	Uint8
5-13	Terminal 29 Digital Input	ExpressionLimit	All set-ups	x	TRUE	-	Uint8
5-14	Terminal 32 Digital Input	ExpressionLimit	All set-ups		TRUE	-	Uint8
5-15	Terminal 33 Digital Input	ExpressionLimit	All set-ups		TRUE	-	Uint8
5-16	Terminal X30/2 Digital Input	ExpressionLimit	All set-ups		TRUE	-	Uint8
5-17	Terminal X30/3 Digital Input	ExpressionLimit	All set-ups		TRUE	-	Uint8
5-18	Terminal X30/4 Digital Input	ExpressionLimit	All set-ups		TRUE	-	Uint8
5-19	Terminal 37 Safe Stop	ExpressionLimit	1 set-up		TRUE	-	Uint8

5-20	Terminal X46/1 Digital Input	[0] No operation	All set-ups		TRUE	-	UInt8
5-21	Terminal X46/3 Digital Input	[0] No operation	All set-ups		TRUE	-	UInt8
5-22	Terminal X46/5 Digital Input	[0] No operation	All set-ups		TRUE	-	UInt8
5-23	Terminal X46/7 Digital Input	[0] No operation	All set-ups		TRUE	-	UInt8
5-24	Terminal X46/9 Digital Input	[0] No operation	All set-ups		TRUE	-	UInt8
5-25	Terminal X46/11 Digital Input	[0] No operation	All set-ups		TRUE	-	UInt8
5-26	Terminal X46/13 Digital Input	[0] No operation	All set-ups		TRUE	-	UInt8
5-3* Digital Outputs							
5-30	Terminal 27 Digital Output	ExpressionLimit	All set-ups		TRUE	-	UInt8
5-31	Terminal 29 Digital Output	ExpressionLimit	All set-ups	x	TRUE	-	UInt8
5-32	Term X30/6 Digi Out (MCB 101)	ExpressionLimit	All set-ups		TRUE	-	UInt8
5-33	Term X30/7 Digi Out (MCB 101)	ExpressionLimit	All set-ups		TRUE	-	UInt8
5-4* Relays							
5-40	Function Relay	ExpressionLimit	All set-ups		TRUE	-	UInt8
5-41	On Delay, Relay	0.01 s	All set-ups		TRUE	-2	UInt16
5-42	Off Delay, Relay	0.01 s	All set-ups		TRUE	-2	UInt16
5-5* Pulse Input							
5-50	Term. 29 Low Frequency	100 Hz	All set-ups	x	TRUE	0	UInt32
5-51	Term. 29 High Frequency	100 Hz	All set-ups	x	TRUE	0	UInt32
5-52	Term. 29 Low Ref./Feedb. Value	0 ReferenceFeedbackUnit	All set-ups	x	TRUE	-3	Int32
5-53	Term. 29 High Ref./Feedb. Value	ExpressionLimit	All set-ups	x	TRUE	-3	Int32
5-54	Pulse Filter Time Constant #29	100 ms	All set-ups	x	FALSE	-3	UInt16
5-55	Term. 33 Low Frequency	100 Hz	All set-ups		TRUE	0	UInt32
5-56	Term. 33 High Frequency	100 Hz	All set-ups		TRUE	0	UInt32
5-57	Term. 33 Low Ref./Feedb. Value	0 ReferenceFeedbackUnit	All set-ups		TRUE	-3	Int32
5-58	Term. 33 High Ref./Feedb. Value	ExpressionLimit	All set-ups		TRUE	-3	Int32
5-59	Pulse Filter Time Constant #33	100 ms	All set-ups		FALSE	-3	UInt16
5-6* Pulse Output							
5-60	Terminal 27 Pulse Output Variable	ExpressionLimit	All set-ups		TRUE	-	UInt8
5-62	Pulse Output Max Freq #27	ExpressionLimit	All set-ups		TRUE	0	UInt32
5-63	Terminal 29 Pulse Output Variable	ExpressionLimit	All set-ups	x	TRUE	-	UInt8
5-65	Pulse Output Max Freq #29	ExpressionLimit	All set-ups	x	TRUE	0	UInt32
5-66	Terminal X30/6 Pulse Output Variable	ExpressionLimit	All set-ups		TRUE	-	UInt8
5-68	Pulse Output Max Freq #X30/6	ExpressionLimit	All set-ups		TRUE	0	UInt32
5-7* 24V Encoder Input							
5-70	Term 32/33 Pulses Per Revolution	1024 N/A	All set-ups		FALSE	0	UInt16
5-71	Term 32/33 Encoder Direction	[0] Clockwise	All set-ups		FALSE	-	UInt8
5-72	Term 32/33 Encoder Type	[0] Quadrature A/B Format	All set-ups		FALSE	-	UInt8
5-8* I/O Options							
5-80	AHF Cap Reconnect Delay	25 s	2 set-ups	x	TRUE	0	UInt16
5-9* Bus Controlled							
5-90	Digital & Relay Bus Control	0 N/A	All set-ups		TRUE	0	UInt32
5-93	Pulse Out #27 Bus Control	0 %	All set-ups		TRUE	-2	N2
5-94	Pulse Out #27 Timeout Preset	0 %	1 set-up		TRUE	-2	UInt16
5-95	Pulse Out #29 Bus Control	0 %	All set-ups	x	TRUE	-2	N2
5-96	Pulse Out #29 Timeout Preset	0 %	1 set-up	x	TRUE	-2	UInt16
5-97	Pulse Out #X30/6 Bus Control	0 %	All set-ups		TRUE	-2	N2
5-98	Pulse Out #X30/6 Timeout Preset	0 %	1 set-up		TRUE	-2	UInt16

5.3.7 6-** Analog In/Out

Parameter #	Parameter description	Default value	4 set-up	FC 302 only	Change during operation	Conversion index	Type
6-0* Analog I/O Mode							
6-00	Live Zero Timeout Time	10 s	All set-ups		TRUE	0	Uint8
6-01	Live Zero Timeout Function	[0] Off	All set-ups		TRUE	-	Uint8
6-1* Analog Input 1							
6-10	Terminal 53 Low Voltage	0.07 V	All set-ups		TRUE	-2	Int16
6-11	Terminal 53 High Voltage	10 V	All set-ups		TRUE	-2	Int16
6-12	Terminal 53 Low Current	0.14 mA	All set-ups		TRUE	-5	Int16
6-13	Terminal 53 High Current	20 mA	All set-ups		TRUE	-5	Int16
6-14	Terminal 53 Low Ref./Feedb. Value	0 ReferenceFeedbackUnit	All set-ups		TRUE	-3	Int32
6-15	Terminal 53 High Ref./Feedb. Value	ExpressionLimit	All set-ups		TRUE	-3	Int32
6-16	Terminal 53 Filter Time Constant	0.001 s	All set-ups		TRUE	-3	Uint16
6-2* Analog Input 2							
6-20	Terminal 54 Low Voltage	0.07 V	All set-ups		TRUE	-2	Int16
6-21	Terminal 54 High Voltage	10 V	All set-ups		TRUE	-2	Int16
6-22	Terminal 54 Low Current	0.14 mA	All set-ups		TRUE	-5	Int16
6-23	Terminal 54 High Current	20 mA	All set-ups		TRUE	-5	Int16
6-24	Terminal 54 Low Ref./Feedb. Value	0 ReferenceFeedbackUnit	All set-ups		TRUE	-3	Int32
6-25	Terminal 54 High Ref./Feedb. Value	ExpressionLimit	All set-ups		TRUE	-3	Int32
6-26	Terminal 54 Filter Time Constant	0.001 s	All set-ups		TRUE	-3	Uint16
6-3* Analog Input 3							
6-30	Terminal X30/11 Low Voltage	0.07 V	All set-ups		TRUE	-2	Int16
6-31	Terminal X30/11 High Voltage	10 V	All set-ups		TRUE	-2	Int16
6-34	Term. X30/11 Low Ref./Feedb. Value	0 ReferenceFeedbackUnit	All set-ups		TRUE	-3	Int32
6-35	Term. X30/11 High Ref./Feedb. Value	ExpressionLimit	All set-ups		TRUE	-3	Int32
6-36	Term. X30/11 Filter Time Constant	0.001 s	All set-ups		TRUE	-3	Uint16
6-4* Analog Input 4							
6-40	Terminal X30/12 Low Voltage	0.07 V	All set-ups		TRUE	-2	Int16
6-41	Terminal X30/12 High Voltage	10 V	All set-ups		TRUE	-2	Int16
6-44	Term. X30/12 Low Ref./Feedb. Value	0 ReferenceFeedbackUnit	All set-ups		TRUE	-3	Int32
6-45	Term. X30/12 High Ref./Feedb. Value	ExpressionLimit	All set-ups		TRUE	-3	Int32
6-46	Term. X30/12 Filter Time Constant	0.001 s	All set-ups		TRUE	-3	Uint16
6-5* Analog Output 1							
6-50	Terminal 42 Output	ExpressionLimit	All set-ups		TRUE	-	Uint8
6-51	Terminal 42 Output Min Scale	0 %	All set-ups		TRUE	-2	Int16
6-52	Terminal 42 Output Max Scale	100 %	All set-ups		TRUE	-2	Int16
6-53	Term 42 Output Bus Ctrl	0 %	All set-ups		TRUE	-2	N2
6-54	Terminal 42 Output Timeout Preset	0 %	1 set-up		TRUE	-2	Uint16
6-55	Analog Output Filter	[0] Off	1 set-up		TRUE	-	Uint8
6-6* Analog Output 2							
6-60	Terminal X30/8 Output	ExpressionLimit	All set-ups		TRUE	-	Uint8
6-61	Terminal X30/8 Min. Scale	0 %	All set-ups		TRUE	-2	Int16
6-62	Terminal X30/8 Max. Scale	100 %	All set-ups		TRUE	-2	Int16
6-63	Terminal X30/8 Bus Control	0 %	All set-ups		TRUE	-2	N2
6-64	Terminal X30/8 Output Timeout Preset	0 %	1 set-up		TRUE	-2	Uint16
6-7* Analog Output 3							
6-70	Terminal X45/1 Output	ExpressionLimit	All set-ups		TRUE	-	Uint8

6-71	Terminal X45/1 Min. Scale	0 %	All set-ups		TRUE	-2	Int16
6-72	Terminal X45/1 Max. Scale	100 %	All set-ups		TRUE	-2	Int16
6-73	Terminal X45/1 Bus Control	0 %	All set-ups		TRUE	-2	N2
6-74	Terminal X45/1 Output Timeout Preset	0 %	1 set-up		TRUE	-2	Uint16
6-8* Analog Output 4							
6-80	Terminal X45/3 Output	ExpressionLimit	All set-ups		TRUE	-	Uint8
6-81	Terminal X45/3 Min. Scale	0 %	All set-ups		TRUE	-2	Int16
6-82	Terminal X45/3 Max. Scale	100 %	All set-ups		TRUE	-2	Int16
6-83	Terminal X45/3 Bus Control	0 %	All set-ups		TRUE	-2	N2
6-84	Terminal X45/3 Output Timeout Preset	0 %	1 set-up		TRUE	-2	Uint16

5.3.8 7-** Controllers

Parameter #	Parameter description	Default value	4 set-up	FC 302 only	Change during operation	Conversion index	Type
7-0* Speed PID Ctrl.							
7-00	Speed PID Feedback Source	ExpressionLimit	All set-ups		FALSE	-	Uint8
7-01	Speed PID Droop	0 RPM	All set-ups		TRUE	67	Uint16
7-02	Speed PID Proportional Gain	0.015 N/A	All set-ups		TRUE	-3	Uint16
7-03	Speed PID Integral Time	ExpressionLimit	All set-ups		TRUE	-4	Uint32
7-04	Speed PID Differentiation Time	ExpressionLimit	All set-ups		TRUE	-4	Uint16
7-05	Speed PID Diff. Gain Limit	5 N/A	All set-ups		TRUE	-1	Uint16
7-06	Speed PID Lowpass Filter Time	ExpressionLimit	All set-ups		TRUE	-4	Uint16
7-07	Speed PID Feedback Gear Ratio	1 N/A	All set-ups		FALSE	-4	Uint32
7-08	Speed PID Accel. Feed Forward Factor	0 %	All set-ups		TRUE	0	Uint16
7-09	Speed PID Error Correction w/ Ramp	300 RPM	All set-ups		TRUE	67	Uint32
7-1* Torque PI Ctrl.							
7-10	Torque PI Feedback Source	[0] Controller Off	All set-ups		TRUE	-	Uint8
7-12	Torque PI Proportional Gain	100 %	All set-ups		TRUE	0	Uint16
7-13	Torque PI Integration Time	0.020 s	All set-ups		TRUE	-3	Uint16
7-16	Torque PI Lowpass Filter Time	5 ms	All set-ups		TRUE	-4	Uint16
7-18	Torque PI Feed Forward Factor	0 %	All set-ups		TRUE	0	Uint16
7-19	Current Controller Rise Time	ExpressionLimit	All set-ups		TRUE	0	Uint16
7-2* Process Ctrl. Feedb							
7-20	Process CL Feedback 1 Resource	[0] No function	All set-ups		TRUE	-	Uint8
7-22	Process CL Feedback 2 Resource	[0] No function	All set-ups		TRUE	-	Uint8
7-3* Process PID Ctrl.							
7-30	Process PID Normal/ Inverse Control	[0] Normal	All set-ups		TRUE	-	Uint8
7-31	Process PID Anti Windup	[1] On	All set-ups		TRUE	-	Uint8
7-32	Process PID Start Speed	0 RPM	All set-ups		TRUE	67	Uint16
7-33	Process PID Proportional Gain	0.01 N/A	All set-ups		TRUE	-2	Uint16
7-34	Process PID Integral Time	10000 s	All set-ups		TRUE	-2	Uint32
7-35	Process PID Differentiation Time	0 s	All set-ups		TRUE	-2	Uint16
7-36	Process PID Diff. Gain Limit	5 N/A	All set-ups		TRUE	-1	Uint16
7-38	Process PID Feed Forward Factor	0 %	All set-ups		TRUE	0	Uint16
7-39	On Reference Bandwidth	5 %	All set-ups		TRUE	0	Uint8
7-9* Position PI Ctrl.							
7-90	Position PI Feedback Source	[0] Motor feedb. P1-02	All set-ups		FALSE	-	Uint8
7-91	Position PI Droop	0.0 °	All set-ups		TRUE	-1	Uint16
7-92	Position PI Proportional Gain	0.0150 N/A	All set-ups		TRUE	-4	Uint32

7-93	Position PI Integral Time	20000.0 ms	All set-ups		TRUE	-4	Uint32
7-94	Position PI Feedback Scale Numerator	1 N/A	All set-ups		FALSE	0	Int32
7-95	Position PI Feedback Scale Denominator	1 N/A	All set-ups		FALSE	0	Int32
7-97	Position PI Maximum Speed Above Master	100 RPM	All set-ups		TRUE	67	Uint16
7-98	Position PI Feed Forward Factor	98 %	All set-ups		TRUE	0	Uint16
7-99	Position PI Minimum Ramp Time	0.01 s	All set-ups		TRUE	-3	Uint32

5

5.3.9 8-** Comm. and Options

Parameter #	Parameter description	Default value	4 set-up	FC 302 only	Change during operation	Conversion index	Type
8-0* General Settings							
8-01	Control Site	[0] Digital and ctrl.word	All set-ups		TRUE	-	Uint8
8-02	Control Word Source	ExpressionLimit	All set-ups		TRUE	-	Uint8
8-03	Control Word Timeout Time	1 s	1 set-up		TRUE	-1	Uint32
8-04	Control Word Timeout Function	ExpressionLimit	1 set-up		TRUE	-	Uint8
8-05	End-of-Timeout Function	[1] Resume set-up	1 set-up		TRUE	-	Uint8
8-06	Reset Control Word Timeout	[0] Do not reset	All set-ups		TRUE	-	Uint8
8-07	Diagnosis Trigger	[0] Disable	2 set-ups		TRUE	-	Uint8
8-08	Readout Filtering	ExpressionLimit	All set-ups		TRUE	-	Uint8
8-1* Ctrl. Word Settings							
8-10	Control Word Profile	ExpressionLimit	All set-ups		TRUE	-	Uint8
8-13	Configurable Status Word STW	[1] Profile Default	All set-ups		TRUE	-	Uint8
8-14	Configurable Control Word CTW	[1] Profile default	All set-ups		TRUE	-	Uint8
8-17	Configurable Alarm and Warningword	[0] Off	All set-ups		TRUE	-	Uint16
8-19	Product Code	ExpressionLimit	1 set-up		TRUE	0	Uint32
8-3* FC Port Settings							
8-30	Protocol	[0] FC	1 set-up		TRUE	-	Uint8
8-31	Address	1 N/A	1 set-up		TRUE	0	Uint8
8-32	FC Port Baud Rate	ExpressionLimit	1 set-up		TRUE	-	Uint8
8-33	Parity / Stop Bits	[0] Even Parity, 1 Stop Bit	1 set-up		TRUE	-	Uint8
8-34	Estimated cycle time	0 ms	2 set-ups		TRUE	-3	Uint32
8-35	Minimum Response Delay	10 ms	1 set-up		TRUE	-3	Uint16
8-36	Max Response Delay	ExpressionLimit	1 set-up		TRUE	-3	Uint16
8-37	Max Inter-Char Delay	ExpressionLimit	1 set-up		TRUE	-5	Uint16
8-4* FC MC protocol set							
8-40	Telegram Selection	[1] Standard telegram 1	2 set-ups		TRUE	-	Uint8
8-41	Parameters for Signals	0	All set-ups		FALSE	-	Uint16
8-42	PCD Write Configuration	ExpressionLimit	2 set-ups		TRUE	0	Uint16
8-43	PCD Read Configuration	ExpressionLimit	2 set-ups		TRUE	0	Uint16
8-5* Digital/Bus							
8-50	Coasting Select	[3] Logic OR	All set-ups		TRUE	-	Uint8
8-51	Quick Stop Select	[3] Logic OR	All set-ups		TRUE	-	Uint8
8-52	DC Brake Select	ExpressionLimit	All set-ups		TRUE	-	Uint8
8-53	Start Select	[3] Logic OR	All set-ups		TRUE	-	Uint8
8-54	Reversing Select	[3] Logic OR	All set-ups		TRUE	-	Uint8
8-55	Set-up Select	[3] Logic OR	All set-ups		TRUE	-	Uint8

8-56	Preset Reference Select	[3] Logic OR	All set-ups		TRUE	-	UInt8
8-57	Profdrive OFF2 Select	[3] Logic OR	All set-ups		TRUE	-	UInt8
8-58	Profdrive OFF3 Select	[3] Logic OR	All set-ups		TRUE	-	UInt8
8-8* FC Port Diagnostics							
8-80	Bus Message Count	0 N/A	All set-ups		TRUE	0	UInt32
8-81	Bus Error Count	0 N/A	All set-ups		TRUE	0	UInt32
8-82	Slave Messages Rcvd	0 N/A	All set-ups		TRUE	0	UInt32
8-83	Slave Error Count	0 N/A	All set-ups		TRUE	0	UInt32
8-9* Bus Jog							
8-90	Bus Jog 1 Speed	100 RPM	All set-ups		TRUE	67	UInt16
8-91	Bus Jog 2 Speed	ExpressionLimit	All set-ups		TRUE	67	UInt16

5.3.10 9-** PROFIdrive

Parameter #	Parameter description	Default value	4 set-up	FC 302 only	Change during operation	Conversion index	Type
9-00	Setpoint	0 N/A	All set-ups		TRUE	0	UInt16
9-07	Actual Value	0 N/A	All set-ups		FALSE	0	UInt16
9-15	PCD Write Configuration	ExpressionLimit	1 set-up		TRUE	-	UInt16
9-16	PCD Read Configuration	ExpressionLimit	2 set-ups		TRUE	-	UInt16
9-18	Node Address	126 N/A	1 set-up		TRUE	0	UInt8
9-19	Drive Unit System Number	1034 N/A	All set-ups		TRUE	0	UInt16
9-22	Telegram Selection	[100] None	1 set-up		TRUE	-	UInt8
9-23	Parameters for Signals	0	All set-ups		TRUE	-	UInt16
9-27	Parameter Edit	[1] Enabled	2 set-ups		FALSE	-	UInt16
9-28	Process Control	[1] Enable cyclic master	2 set-ups		FALSE	-	UInt8
9-44	Fault Message Counter	0 N/A	All set-ups		TRUE	0	UInt16
9-45	Fault Code	0 N/A	All set-ups		TRUE	0	UInt16
9-47	Fault Number	0 N/A	All set-ups		TRUE	0	UInt16
9-52	Fault Situation Counter	0 N/A	All set-ups		TRUE	0	UInt16
9-53	Profibus Warning Word	0 N/A	All set-ups		TRUE	0	V2
9-63	Actual Baud Rate	[255] No baudrate found	All set-ups		TRUE	-	UInt8
9-64	Device Identification	0 N/A	All set-ups		TRUE	0	UInt16
9-65	Profile Number	0 N/A	All set-ups		TRUE	0	OctSt r[2]
9-67	Control Word 1	0 N/A	All set-ups		TRUE	0	V2
9-68	Status Word 1	0 N/A	All set-ups		TRUE	0	V2
9-70	Edit Set-up	[1] Set-up 1	All set-ups		TRUE	-	UInt8
9-71	Profibus Save Data Values	[0] Off	All set-ups		TRUE	-	UInt8
9-72	ProfibusDriveReset	[0] No action	1 set-up		FALSE	-	UInt8
9-75	DO Identification	0 N/A	All set-ups		TRUE	0	UInt16
9-80	Defined Parameters (1)	0 N/A	All set-ups		FALSE	0	UInt16
9-81	Defined Parameters (2)	0 N/A	All set-ups		FALSE	0	UInt16
9-82	Defined Parameters (3)	0 N/A	All set-ups		FALSE	0	UInt16
9-83	Defined Parameters (4)	0 N/A	All set-ups		FALSE	0	UInt16
9-84	Defined Parameters (5)	0 N/A	All set-ups		FALSE	0	UInt16
9-85	Defined Parameters (6)	0 N/A	All set-ups		FALSE	0	UInt16
9-90	Changed Parameters (1)	0 N/A	All set-ups		FALSE	0	UInt16
9-91	Changed Parameters (2)	0 N/A	All set-ups		FALSE	0	UInt16
9-92	Changed Parameters (3)	0 N/A	All set-ups		FALSE	0	UInt16

9-93	Changed Parameters (4)	0 N/A	All set-ups		FALSE	0	Uint16
9-94	Changed Parameters (5)	0 N/A	All set-ups		FALSE	0	Uint16
9-99	Profibus Revision Counter	0 N/A	All set-ups		TRUE	0	Uint16

5.3.11 10-** CAN Fieldbus

Parameter #	Parameter description	Default value	4 set-up	FC 302 only	Change during operation	Conversion index	Type
10-0* Common Settings							
10-00	CAN Protocol	ExpressionLimit	2 set-ups		FALSE	-	Uint8
10-01	Baud Rate Select	ExpressionLimit	2 set-ups		TRUE	-	Uint8
10-02	MAC ID	ExpressionLimit	2 set-ups		TRUE	0	Uint8
10-05	Readout Transmit Error Counter	0 N/A	All set-ups		TRUE	0	Uint8
10-06	Readout Receive Error Counter	0 N/A	All set-ups		TRUE	0	Uint8
10-07	Readout Bus Off Counter	0 N/A	All set-ups		TRUE	0	Uint8
10-1* DeviceNet							
10-10	Process Data Type Selection	ExpressionLimit	All set-ups		TRUE	-	Uint8
10-11	Process Data Config Write	ExpressionLimit	All set-ups		TRUE	-	Uint16
10-12	Process Data Config Read	ExpressionLimit	All set-ups		TRUE	-	Uint16
10-13	Warning Parameter	0 N/A	All set-ups		TRUE	0	Uint16
10-14	Net Reference	[0] Off	2 set-ups		TRUE	-	Uint8
10-15	Net Control	[0] Off	2 set-ups		TRUE	-	Uint8
10-2* COS Filters							
10-20	COS Filter 1	0 N/A	All set-ups		FALSE	0	Uint16
10-21	COS Filter 2	0 N/A	All set-ups		FALSE	0	Uint16
10-22	COS Filter 3	0 N/A	All set-ups		FALSE	0	Uint16
10-23	COS Filter 4	0 N/A	All set-ups		FALSE	0	Uint16
10-3* Parameter Access							
10-30	Array Index	0 N/A	2 set-ups		TRUE	0	Uint8
10-31	Store Data Values	[0] Off	All set-ups		TRUE	-	Uint8
10-32	Devicenet Revision	ExpressionLimit	All set-ups		TRUE	0	Uint16
10-33	Store Always	[0] Off	1 set-up		TRUE	-	Uint8
10-34	DeviceNet Product Code	ExpressionLimit	1 set-up		TRUE	0	Uint16
10-39	Devicenet F Parameters	0 N/A	All set-ups		TRUE	0	Uint32
10-5* CANopen							
10-50	Process Data Config Write.	ExpressionLimit	2 set-ups		TRUE	-	Uint16
10-51	Process Data Config Read.	ExpressionLimit	2 set-ups		TRUE	-	Uint16

5.3.12 12-** Ethernet

Parameter #	Parameter description	Default value	4 set-up	FC 302 only	Change during operation	Conversion index	Type
12-0* IP Settings							
12-00	IP Address Assignment	ExpressionLimit	2 set-ups		TRUE	-	Uint8
12-01	IP Address	0 N/A	1 set-up		TRUE	0	OctStr[4]
12-02	Subnet Mask	0 N/A	1 set-up		TRUE	0	OctStr[4]

12-03	Default Gateway	0 N/A	1 set-up		TRUE	0	OctStr[4]
12-04	DHCP Server	0 N/A	2 set-ups		TRUE	0	OctStr[4]
12-05	Lease Expires	ExpressionLimit	All set-ups		TRUE	0	TimD
12-06	Name Servers	0 N/A	1 set-up		TRUE	0	OctStr[4]
12-07	Domain Name	0 N/A	1 set-up		TRUE	0	VisStr[48]
12-08	Host Name	0 N/A	1 set-up		TRUE	0	VisStr[48]
12-09	Physical Address	0 N/A	1 set-up		TRUE	0	VisStr[17]
12-1* Ethernet Link Parameters							
12-10	Link Status	[0] No Link	All set-ups		TRUE	-	UInt8
12-11	Link Duration	ExpressionLimit	All set-ups		TRUE	0	TimD
12-12	Auto Negotiation	ExpressionLimit	2 set-ups		TRUE	-	UInt8
12-13	Link Speed	ExpressionLimit	2 set-ups		TRUE	-	UInt8
12-14	Link Duplex	ExpressionLimit	2 set-ups		TRUE	-	UInt8
12-2* Process Data							
12-20	Control Instance	ExpressionLimit	1 set-up		TRUE	0	UInt8
12-21	Process Data Config Write	ExpressionLimit	All set-ups		TRUE	-	UInt16
12-22	Process Data Config Read	ExpressionLimit	All set-ups		TRUE	-	UInt16
12-23	Process Data Config Write Size	16 N/A	All set-ups		TRUE	0	UInt32
12-24	Process Data Config Read Size	16 N/A	All set-ups		TRUE	0	UInt32
12-27	Master Address	0 N/A	2 set-ups		FALSE	0	OctStr[4]
12-28	Store Data Values	[0] Off	All set-ups		TRUE	-	UInt8
12-29	Store Always	[0] Off	1 set-up		TRUE	-	UInt8
12-3* EtherNet/IP							
12-30	Warning Parameter	0 N/A	All set-ups		TRUE	0	UInt16
12-31	Net Reference	[0] Off	2 set-ups		TRUE	-	UInt8
12-32	Net Control	[0] Off	2 set-ups		TRUE	-	UInt8
12-33	CIP Revision	ExpressionLimit	All set-ups		TRUE	0	UInt16
12-34	CIP Product Code	ExpressionLimit	1 set-up		TRUE	0	UInt16
12-35	EDS Parameter	0 N/A	All set-ups		TRUE	0	UInt32
12-37	COS Inhibit Timer	0 N/A	All set-ups		TRUE	0	UInt16
12-38	COS Filter	0 N/A	All set-ups		TRUE	0	UInt16
12-4* Modbus TCP							
12-40	Status Parameter	0 N/A	All set-ups		TRUE	0	UInt16
12-41	Slave Message Count	0 N/A	All set-ups		TRUE	0	UInt32
12-42	Slave Exception Message Count	0 N/A	All set-ups		TRUE	0	UInt32
12-5* EtherCAT							
12-50	Configured Station Alias	0 N/A	1 set-up		FALSE	0	UInt16
12-51	Configured Station Address	0 N/A	All set-ups		TRUE	0	UInt16
12-59	EtherCAT Status	0 N/A	All set-ups		TRUE	0	UInt32
12-6* Ethernet PowerLink							
12-60	Node ID	1 N/A	2 set-ups		TRUE	0	UInt8
12-62	SDO Timeout	30000 ms	All set-ups		TRUE	-3	UInt32
12-63	Basic Ethernet Timeout	5000.000 ms	All set-ups		TRUE	-6	UInt32
12-66	Threshold	15 N/A	All set-ups		TRUE	0	UInt32
12-67	Threshold Counters	0 N/A	All set-ups		TRUE	0	UInt32

12-68	Cumulative Counters	0 N/A	All set-ups		TRUE	0	Uint32
12-69	Ethernet PowerLink Status	0 N/A	All set-ups		TRUE	0	Uint32
12-8* Other Ethernet Services							
12-80	FTP Server	[0] Disabled	2 set-ups		TRUE	-	Uint8
12-81	HTTP Server	[0] Disabled	2 set-ups		TRUE	-	Uint8
12-82	SMTP Service	[0] Disabled	2 set-ups		TRUE	-	Uint8
12-89	Transparent Socket Channel Port	ExpressionLimit	2 set-ups		TRUE	0	Uint16
12-9* Advanced Ethernet Services							
12-90	Cable Diagnostic	[0] Disabled	2 set-ups		TRUE	-	Uint8
12-91	Auto Cross Over	[1] Enabled	2 set-ups		TRUE	-	Uint8
12-92	IGMP Snooping	[1] Enabled	2 set-ups		TRUE	-	Uint8
12-93	Cable Error Length	0 N/A	1 set-up		TRUE	0	Uint16
12-94	Broadcast Storm Protection	-1 %	2 set-ups		TRUE	0	Int8
12-95	Broadcast Storm Filter	[0] Broadcast only	2 set-ups		TRUE	-	Uint8
12-96	Port Config	ExpressionLimit	2 set-ups		TRUE	-	Uint8
12-98	Interface Counters	4000 N/A	All set-ups		TRUE	0	Uint32
12-99	Media Counters	0 N/A	All set-ups		TRUE	0	Uint32

5.3.13 13-** Smart Logic

Parameter #	Parameter description	Default value	4 set-up	FC 302 only	Change during operation	Conversion index	Type
13-0* SLC Settings							
13-00	SL Controller Mode	ExpressionLimit	2 set-ups		TRUE	-	Uint8
13-01	Start Event	ExpressionLimit	2 set-ups		TRUE	-	Uint8
13-02	Stop Event	ExpressionLimit	2 set-ups		TRUE	-	Uint8
13-03	Reset SLC	[0] Do not reset SLC	All set-ups		TRUE	-	Uint8
13-1* Comparators							
13-10	Comparator Operand	ExpressionLimit	2 set-ups		TRUE	-	Uint8
13-11	Comparator Operator	ExpressionLimit	2 set-ups		TRUE	-	Uint8
13-12	Comparator Value	ExpressionLimit	2 set-ups		TRUE	-3	Int32
13-1* RS Flip Flops							
13-15	RS-FF Operand S	ExpressionLimit	2 set-ups		TRUE	-	Uint8
13-16	RS-FF Operand R	ExpressionLimit	2 set-ups		TRUE	-	Uint8
13-2* Timers							
13-20	SL Controller Timer	ExpressionLimit	1 set-up		TRUE	-3	TimD
13-4* Logic Rules							
13-40	Logic Rule Boolean 1	ExpressionLimit	2 set-ups		TRUE	-	Uint8
13-41	Logic Rule Operator 1	ExpressionLimit	2 set-ups		TRUE	-	Uint8
13-42	Logic Rule Boolean 2	ExpressionLimit	2 set-ups		TRUE	-	Uint8
13-43	Logic Rule Operator 2	ExpressionLimit	2 set-ups		TRUE	-	Uint8
13-44	Logic Rule Boolean 3	ExpressionLimit	2 set-ups		TRUE	-	Uint8
13-5* States							
13-51	SL Controller Event	ExpressionLimit	2 set-ups		TRUE	-	Uint8
13-52	SL Controller Action	ExpressionLimit	2 set-ups		TRUE	-	Uint8

5.3.14 14-** Special Functions

Parameter #	Parameter description	Default value	4 set-up	FC 302 only	Change during operation	Conversion index	Type
14-0* Inverter Switching							
14-00	Switching Pattern	[1] SFAVM	All set-ups		TRUE	-	Uint8
14-01	Switching Frequency	ExpressionLimit	All set-ups		TRUE	-	Uint8
14-03	Overmodulation	[1] On	All set-ups		FALSE	-	Uint8
14-04	PWM Random	[0] Off	All set-ups		TRUE	-	Uint8
14-06	Dead Time Compensation	[1] On	All set-ups		TRUE	-	Uint8
14-1* Mains On/Off							
14-10	Mains Failure	[0] No function	All set-ups		TRUE	-	Uint8
14-11	Mains Voltage at Mains Fault	ExpressionLimit	All set-ups		TRUE	0	Uint16
14-12	Function at Mains Imbalance	[0] Trip	All set-ups		TRUE	-	Uint8
14-14	Kin. Backup Time Out	60 s	All set-ups		TRUE	0	Uint8
14-15	Kin. Backup Trip Recovery Level	ExpressionLimit	All set-ups		TRUE	-3	Uint32
14-16	Kin. Backup Gain	100 %	All set-ups	x	TRUE	0	Uint32
14-2* Trip Reset							
14-20	Reset Mode	[0] Manual reset	All set-ups		TRUE	-	Uint8
14-21	Automatic Restart Time	ExpressionLimit	All set-ups		TRUE	0	Uint16
14-22	Operation Mode	[0] Normal operation	All set-ups		TRUE	-	Uint8
14-23	Typecode Setting	ExpressionLimit	2 set-ups		FALSE	-	Uint8
14-24	Trip Delay at Current Limit	60 s	All set-ups		TRUE	0	Uint8
14-25	Trip Delay at Torque Limit	60 s	All set-ups		TRUE	0	Uint8
14-26	Trip Delay at Inverter Fault	ExpressionLimit	All set-ups		TRUE	0	Uint8
14-28	Production Settings	[0] No action	All set-ups		TRUE	-	Uint8
14-29	Service Code	0 N/A	All set-ups		TRUE	0	Int32
14-3* Current Limit Ctrl.							
14-30	Current Lim Ctrl, Proportional Gain	100 %	All set-ups		FALSE	0	Uint16
14-31	Current Lim Ctrl, Integration Time	ExpressionLimit	All set-ups		FALSE	-3	Uint16
14-32	Current Lim Ctrl, Filter Time	ExpressionLimit	All set-ups		TRUE	-4	Uint16
14-35	Stall Protection	[1] Enabled	All set-ups		FALSE	-	Uint8
14-36	Fieldweakening Function	[0] Auto	All set-ups	x	TRUE	-	Uint8
14-4* Energy Optimising							
14-40	VT Level	66 %	All set-ups		FALSE	0	Uint8
14-41	AEO Minimum Magnetisation	ExpressionLimit	All set-ups		TRUE	0	Uint8
14-42	Minimum AEO Frequency	ExpressionLimit	All set-ups		TRUE	0	Uint8
14-43	Motor Cosphi	ExpressionLimit	All set-ups		TRUE	-2	Uint16
14-5* Environment							
14-50	RFI Filter	[1] On	1 set-up		FALSE	-	Uint8
14-51	DC Link Compensation	ExpressionLimit	All set-ups		TRUE	-	Uint8
14-52	Fan Control	[0] Auto	All set-ups		TRUE	-	Uint8
14-53	Fan Monitor	ExpressionLimit	All set-ups		TRUE	-	Uint8
14-55	Output Filter	[0] No Filter	All set-ups		FALSE	-	Uint8
14-56	Capacitance Output Filter	ExpressionLimit	All set-ups		FALSE	-7	Uint16
14-57	Inductance Output Filter	ExpressionLimit	All set-ups		FALSE	-6	Uint16
14-59	Actual Number of Inverter Units	ExpressionLimit	1 set-up	x	FALSE	0	Uint8
14-7* Compatibility							
14-72	Legacy Alarm Word	0 N/A	All set-ups		FALSE	0	Uint32
14-73	Legacy Warning Word	0 N/A	All set-ups		FALSE	0	Uint32

14-74	Leg. Ext. Status Word	0 N/A	All set-ups		FALSE	0	Uint32
14-8* Options							
14-80	Option Supplied by External 24VDC	[1] Yes	2 set-ups		FALSE	-	Uint8
14-88	Option Data Storage	0 N/A	2 set-ups		TRUE	0	Uint16
14-89	Option Detection	[0] Protect Option Config.	1 set-up		TRUE	-	Uint8
14-9* Fault Settings							
14-90	Fault Level	ExpressionLimit	1 set-up		TRUE	-	Uint8

5
5.3.15 15- Drive Information**

Parameter #	Parameter description	Default value	4 set-up	FC 302 only	Change during operation	Conversion index	Type
15-0* Operating Data							
15-00	Operating hours	0 h	All set-ups		FALSE	74	Uint32
15-01	Running Hours	0 h	All set-ups		FALSE	74	Uint32
15-02	kWh Counter	0 kWh	All set-ups		FALSE	75	Uint32
15-03	Power Up's	0 N/A	All set-ups		FALSE	0	Uint32
15-04	Over Temp's	0 N/A	All set-ups		FALSE	0	Uint16
15-05	Over Volt's	0 N/A	All set-ups		FALSE	0	Uint16
15-06	Reset kWh Counter	[0] Do not reset	All set-ups		TRUE	-	Uint8
15-07	Reset Running Hours Counter	[0] Do not reset	All set-ups		TRUE	-	Uint8
15-1* Data Log Settings							
15-10	Logging Source	0	2 set-ups		TRUE	-	Uint16
15-11	Logging Interval	ExpressionLimit	2 set-ups		TRUE	-3	TimD
15-12	Trigger Event	[0] False	1 set-up		TRUE	-	Uint8
15-13	Logging Mode	[0] Log always	2 set-ups		TRUE	-	Uint8
15-14	Samples Before Trigger	50 N/A	2 set-ups		TRUE	0	Uint8
15-2* Historic Log							
15-20	Historic Log: Event	0 N/A	All set-ups		FALSE	0	Uint8
15-21	Historic Log: Value	0 N/A	All set-ups		FALSE	0	Uint32
15-22	Historic Log: Time	0 ms	All set-ups		FALSE	-3	Uint32
15-3* Fault Log							
15-30	Fault Log: Error Code	0 N/A	All set-ups		FALSE	0	Uint16
15-31	Fault Log: Value	0 N/A	All set-ups		FALSE	0	Int16
15-32	Fault Log: Time	0 s	All set-ups		FALSE	0	Uint32
15-4* Drive Identification							
15-40	FC Type	0 N/A	All set-ups		FALSE	0	VisStr[6]
15-41	Power Section	0 N/A	All set-ups		FALSE	0	VisStr[20]
15-42	Voltage	0 N/A	All set-ups		FALSE	0	VisStr[20]
15-43	Software Version	0 N/A	All set-ups		FALSE	0	VisStr[5]
15-44	Ordered Typecode String	0 N/A	All set-ups		FALSE	0	VisStr[40]
15-45	Actual Typecode String	0 N/A	All set-ups		FALSE	0	VisStr[40]

15-46	Frequency Converter Ordering No	0 N/A	All set-ups		FALSE	0	VisStr[8]
15-47	Power Card Ordering No	0 N/A	All set-ups		FALSE	0	VisStr[8]
15-48	LCP Id No	0 N/A	All set-ups		FALSE	0	VisStr[20]
15-49	SW ID Control Card	0 N/A	All set-ups		FALSE	0	VisStr[20]
15-50	SW ID Power Card	0 N/A	All set-ups		FALSE	0	VisStr[20]
15-51	Frequency Converter Serial Number	0 N/A	All set-ups		FALSE	0	VisStr[10]
15-53	Power Card Serial Number	0 N/A	All set-ups		FALSE	0	VisStr[19]
15-58	Smart Setup Filename	ExpressionLimit	All set-ups		TRUE	0	VisStr[20]
15-59	CSIV Filename	ExpressionLimit	1 set-up		FALSE	0	VisStr[16]
15-6* Option Ident							
15-60	Option Mounted	0 N/A	All set-ups		FALSE	0	VisStr[30]
15-61	Option SW Version	0 N/A	All set-ups		FALSE	0	VisStr[20]
15-62	Option Ordering No	0 N/A	All set-ups		FALSE	0	VisStr[8]
15-63	Option Serial No	0 N/A	All set-ups		FALSE	0	VisStr[18]
15-70	Option in Slot A	0 N/A	All set-ups		FALSE	0	VisStr[30]
15-71	Slot A Option SW Version	0 N/A	All set-ups		FALSE	0	VisStr[20]
15-72	Option in Slot B	0 N/A	All set-ups		FALSE	0	VisStr[30]
15-73	Slot B Option SW Version	0 N/A	All set-ups		FALSE	0	VisStr[20]
15-74	Option in Slot C0/E0	0 N/A	All set-ups		FALSE	0	VisStr[30]
15-75	Slot C0/E0 Option SW Version	0 N/A	All set-ups		FALSE	0	VisStr[20]
15-76	Option in Slot C1/E1	0 N/A	All set-ups		FALSE	0	VisStr[30]
15-77	Slot C1/E1 Option SW Version	0 N/A	All set-ups		FALSE	0	VisStr[20]
15-8* Operating Data II							
15-80	Fan Running Hours	0 h	All set-ups		TRUE	74	Uint32
15-81	Preset Fan Running Hours	0 h	All set-ups		TRUE	74	Uint32
15-89	Configuration Change Counter	0 N/A	All set-ups		FALSE	0	Uint16
15-9* Parameter Info							
15-92	Defined Parameters	0 N/A	All set-ups		FALSE	0	Uint16
15-93	Modified Parameters	0 N/A	All set-ups		FALSE	0	Uint16
15-98	Drive Identification	0 N/A	All set-ups		FALSE	0	VisStr[40]

15-99	Parameter Metadata	0 N/A	All set-ups		FALSE	0	Uint16
-------	--------------------	-------	-------------	--	-------	---	--------

5.3.16 16-** Data Readouts

Parameter #	Parameter description	Default value	4 set-up	FC 302 only	Change during operation	Conversion index	Type
16-0* General Status							
16-00	Control Word	0 N/A	All set-ups		FALSE	0	V2
16-01	Reference [Unit]	0 ReferenceFeedbackUnit	All set-ups		FALSE	-3	Int32
16-02	Reference %	0 %	All set-ups		FALSE	-1	Int16
16-03	Status Word	0 N/A	All set-ups		FALSE	0	V2
16-05	Main Actual Value [%]	0 %	All set-ups		FALSE	-2	N2
16-06	Actual Position	0 CustomReadoutUnit2	All set-ups		FALSE	0	Int32
16-07	Target Position	0 CustomReadoutUnit2	All set-ups		FALSE	0	Int32
16-08	Position Error	0 CustomReadoutUnit2	All set-ups		FALSE	0	Int32
16-09	Custom Readout	0 CustomReadoutUnit	All set-ups		FALSE	-2	Int32
16-1* Motor Status							
16-10	Power [kW]	0 kW	All set-ups		FALSE	1	Int32
16-11	Power [hp]	0 hp	All set-ups		FALSE	-2	Int32
16-12	Motor Voltage	0 V	All set-ups		FALSE	-1	Uint16
16-13	Frequency	0 Hz	All set-ups		FALSE	-1	Uint16
16-14	Motor current	0 A	All set-ups		FALSE	-2	Int32
16-15	Frequency [%]	0 %	All set-ups		FALSE	-2	N2
16-16	Torque [Nm]	0 Nm	All set-ups		FALSE	-1	Int16
16-17	Speed [RPM]	0 RPM	All set-ups		FALSE	67	Int32
16-18	Motor Thermal	0 %	All set-ups		FALSE	0	Uint8
16-19	KTY sensor temperature	0 °C	All set-ups		FALSE	100	Int16
16-20	Motor Angle	0 N/A	All set-ups		TRUE	0	Uint16
16-21	Torque [%] High Res.	0 %	All set-ups		FALSE	-1	Int16
16-22	Torque [%]	0 %	All set-ups		FALSE	0	Int16
16-23	Motor Shaft Power [kW]	0 kW	All set-ups		TRUE	1	Int32
16-24	Calibrated Stator Resistance	0.0000 Ohm	All set-ups	x	TRUE	-4	Uint32
16-25	Torque [Nm] High	0 Nm	All set-ups		FALSE	-1	Int32
16-3* Drive Status							
16-30	DC Link Voltage	0 V	All set-ups		FALSE	0	Uint16
16-32	Brake Energy /s	0 kW	All set-ups		FALSE	0	Uint32
16-33	Brake Energy Average	0 kW	All set-ups		FALSE	0	Uint32
16-34	Heatsink Temp.	0 °C	All set-ups		FALSE	100	Uint8
16-35	Inverter Thermal	0 %	All set-ups		FALSE	0	Uint8
16-36	Inv. Nom. Current	ExpressionLimit	All set-ups		FALSE	-2	Uint32
16-37	Inv. Max. Current	ExpressionLimit	All set-ups		FALSE	-2	Uint32
16-38	SL Controller State	0 N/A	All set-ups		FALSE	0	Uint8
16-39	Control Card Temp.	0 °C	All set-ups		FALSE	100	Uint8
16-40	Logging Buffer Full	[0] No	All set-ups		TRUE	-	Uint8
16-41	LCP Bottom Statusline	0 N/A	All set-ups		TRUE	0	VisStr[50]
16-44	Speed Error [RPM]	0 RPM	All set-ups		FALSE	67	Int32
16-45	Motor Phase U Current	0 A	All set-ups		TRUE	-2	Int32
16-46	Motor Phase V Current	0 A	All set-ups		TRUE	-2	Int32
16-47	Motor Phase W Current	0 A	All set-ups		TRUE	-2	Int32

16-48	Speed Ref. After Ramp [RPM]	0 RPM	All set-ups		FALSE	67	Int32
16-49	Current Fault Source	0 N/A	All set-ups	x	TRUE	0	UInt8
16-5* Ref. & Feedb.							
16-50	External Reference	0 N/A	All set-ups		FALSE	-1	Int16
16-51	Pulse Reference	0 N/A	All set-ups		FALSE	-1	Int16
16-52	Feedback[Unit]	0 ReferenceFeedbackUnit	All set-ups		FALSE	-3	Int32
16-53	Digi Pot Reference	0 N/A	All set-ups		FALSE	-2	Int16
16-57	Feedback [RPM]	0 RPM	All set-ups		FALSE	67	Int32
16-6* Inputs & Outputs							
16-60	Digital Input	0 N/A	All set-ups		FALSE	0	UInt16
16-61	Terminal 53 Switch Setting	[0] Current	All set-ups		FALSE	-	UInt8
16-62	Analog Input 53	0 N/A	All set-ups		FALSE	-3	Int32
16-63	Terminal 54 Switch Setting	[0] Current	All set-ups		FALSE	-	UInt8
16-64	Analog Input 54	0 N/A	All set-ups		FALSE	-3	Int32
16-65	Analog Output 42 [mA]	0 N/A	All set-ups		FALSE	-3	Int16
16-66	Digital Output [bin]	0 N/A	All set-ups		FALSE	0	Int16
16-67	Freq. Input #29 [Hz]	0 N/A	All set-ups	x	FALSE	0	Int32
16-68	Freq. Input #33 [Hz]	0 N/A	All set-ups		FALSE	0	Int32
16-69	Pulse Output #27 [Hz]	0 N/A	All set-ups		FALSE	0	Int32
16-70	Pulse Output #29 [Hz]	0 N/A	All set-ups	x	FALSE	0	Int32
16-71	Relay Output [bin]	0 N/A	All set-ups		FALSE	0	Int16
16-72	Counter A	0 N/A	All set-ups		TRUE	0	Int32
16-73	Counter B	0 N/A	All set-ups		TRUE	0	Int32
16-75	Analog In X30/11	0 N/A	All set-ups		FALSE	-3	Int32
16-76	Analog In X30/12	0 N/A	All set-ups		FALSE	-3	Int32
16-77	Analog Out X30/8 [mA]	0 N/A	All set-ups		FALSE	-3	Int16
16-78	Analog Out X45/1 [mA]	0 N/A	All set-ups		FALSE	-3	Int16
16-79	Analog Out X45/3 [mA]	0 N/A	All set-ups		FALSE	-3	Int16
16-8* Fieldbus & FC Port							
16-80	Fieldbus CTW 1	0 N/A	All set-ups		FALSE	0	V2
16-82	Fieldbus REF 1	0 N/A	All set-ups		FALSE	0	N2
16-83	Fieldbus REF 2	0 CustomReadoutUnit2	1 set-up		TRUE	0	Int32
16-84	Comm. Option STW	0 N/A	All set-ups		FALSE	0	V2
16-85	FC Port CTW 1	0 N/A	All set-ups		FALSE	0	V2
16-86	FC Port REF 1	0 N/A	All set-ups		FALSE	0	N2
16-87	Bus Readout Alarm/Warning	0 N/A	All set-ups		FALSE	0	UInt16
16-89	Configurable Alarm/Warning Word	0 N/A	All set-ups		FALSE	0	UInt16
16-9* Diagnosis Readouts							
16-90	Alarm Word	0 N/A	All set-ups		FALSE	0	UInt32
16-91	Alarm Word 2	0 N/A	All set-ups		FALSE	0	UInt32
16-92	Warning Word	0 N/A	All set-ups		FALSE	0	UInt32
16-93	Warning Word 2	0 N/A	All set-ups		FALSE	0	UInt32
16-94	Ext. Status Word	0 N/A	All set-ups		FALSE	0	UInt32

5.3.17 17-** Position Feedback

Parameter #	Parameter description	Default value	4 set-up	FC 302 only	Change during operation	Conversion index	Type
17-1* Inc. Enc. Interface							
17-10	Signal Type	[1] RS422 (5V TTL)	All set-ups		FALSE	-	UInt8

17-11	Resolution (PPR)	1024 N/A	All set-ups		FALSE	0	Uint16
17-2* Abs. Enc. Interface							
17-20	Protocol Selection	[0] None	All set-ups		FALSE	-	Uint8
17-21	Resolution (Positions/Rev)	ExpressionLimit	All set-ups		FALSE	0	Uint32
17-22	Multiturn Revolutions	1 N/A	All set-ups		FALSE	0	Uint32
17-24	SSI Data Length	13 N/A	All set-ups		FALSE	0	Uint8
17-25	Clock Rate	260 kHz	All set-ups		FALSE	3	Uint16
17-26	SSI Data Format	[0] Gray code	All set-ups		FALSE	-	Uint8
17-34	HIPERFACE Baudrate	[4] 9600	All set-ups		FALSE	-	Uint8
17-5* Resolver Interface							
17-50	Poles	2 N/A	1 set-up		FALSE	0	Uint8
17-51	Input Voltage	7 V	1 set-up		FALSE	-1	Uint8
17-52	Input Frequency	10 kHz	1 set-up		FALSE	2	Uint8
17-53	Transformation Ratio	0.5 N/A	1 set-up		FALSE	-1	Uint8
17-56	Encoder Sim. Resolution	[0] Disabled	1 set-up		FALSE	-	Uint8
17-59	Resolver Interface	[0] Disabled	2 set-ups		FALSE	-	Uint8
17-6* Monitoring and App.							
17-60	Feedback Direction	[0] Clockwise	All set-ups		FALSE	-	Uint8
17-61	Feedback Signal Monitoring	[1] Warning	All set-ups		TRUE	-	Uint8
17-7* Position Scaling							
17-70	Position Unit	[0] pu	All set-ups		TRUE	-	Uint8
17-71	Position Unit Scale	0 N/A	All set-ups		FALSE	0	Int8
17-72	Position Unit Numerator	1024 N/A	All set-ups		FALSE	0	Int32
17-73	Position Unit Denominator	1 N/A	All set-ups		FALSE	0	Int32
17-74	Position Offset	0 CustomReadoutUnit2	All set-ups		FALSE	0	Int32
17-75	Position Recovery at Power-up	[0] Off	All set-ups		TRUE	-	Uint8
17-76	Position Axis Mode	[0] Linear Axis	All set-ups		TRUE	-	Uint8
17-77	Position Feedback Mode	[0] Relative	All set-ups		FALSE	-	Uint8
17-8* Position Homing							
17-80	Homing Function	[0] No Homing	All set-ups		FALSE	-	Uint8
17-81	Home Sync Function	[0] 1st time after power	All set-ups		FALSE	-	Uint8
17-82	Home Position	0 N/A	All set-ups		FALSE	0	Int32
17-83	Homing Speed	150 RPM	All set-ups		TRUE	67	Int16
17-84	Homing Torque Limit	160 %	All set-ups		TRUE	0	Uint16
17-85	Homing Timeout	60 s	All set-ups		TRUE	-1	Uint16
17-9* Position Config							
17-90	Absolute Position Mode	[0] Standard	All set-ups		FALSE	-	Uint8
17-91	Relative Position Mode	[0] Target Position	All set-ups		FALSE	-	Uint8
17-92	Position Control Selection	[0] No operation	All set-ups		FALSE	-	uint8
17-93	Master Offset Selection	[0] Absolute Enabled	All set-ups		FALSE	-	uint8
17-94	Rotary Absolute Direction	[0] Shortest	All set-ups		FALSE	-	uint8

5.3.18 18-** Data Readouts 2

Parameter #	Parameter description	Default value	4 set-up	FC 302 only	Change during operation	Conversion index	Type
18-3* Analog Readouts							
18-36	Analog Input X48/2 [mA]	0 N/A	All set-ups		TRUE	-3	Int32
18-37	Temp. Input X48/4	0 N/A	All set-ups		TRUE	0	Int16
18-38	Temp. Input X48/7	0 N/A	All set-ups		TRUE	0	Int16

18-39	Temp. Input X48/10	0 N/A	All set-ups		TRUE	0	Int16
18-5* Active Alarms/Warnings							
18-55	Active Alarm Numbers	0 N/A	All set-ups		TRUE	0	UInt16
18-56	Active Warning Numbers	0 N/A	All set-ups		TRUE	0	UInt16
18-6* Inputs & Outputs 2							
18-60	Digital Input 2	0 N/A	All set-ups		FALSE	0	UInt16

5.3.19 30-** Special Features

Parameter #	Parameter description	Default value	4 set-up	FC 302 only	Change during operation	Conversion index	Type
30-2* Adv. Start Adjust							
30-20	High Starting Torque Time [s]	ExpressionLimit	All set-ups	x	TRUE	-2	UInt16
30-21	High Starting Torque Current [%]	ExpressionLimit	All set-ups	x	TRUE	-1	UInt32
30-22	Locked Rotor Protection	ExpressionLimit	All set-ups	x	TRUE	-	UInt8
30-23	Locked Rotor Detection Time [s]	ExpressionLimit	All set-ups	x	TRUE	-2	UInt8
30-24	Locked Rotor Detection Speed Error [%]	25 %	All set-ups	x	TRUE	-1	UInt32
30-8* Compatibility (I)							
30-80	d-axis Inductance (Ld)	ExpressionLimit	All set-ups	x	FALSE	-6	Int32
30-81	Brake Resistor (ohm)	ExpressionLimit	1 set-up		TRUE	-2	UInt32
30-83	Speed PID Proportional Gain	0.015 N/A	All set-ups		TRUE	-4	UInt32
30-84	Process PID Proportional Gain	0.100 N/A	All set-ups		TRUE	-3	UInt16

5.3.20 35-** Sensor Input Option

Parameter #	Parameter description	Default value	4 set-up	FC 302 only	Change during operation	Conversion index	Type
35-0* Temp. Input Mode							
35-00	Term. X48/4 Temperature Unit	[60] °C	All set-ups		TRUE	-	UInt8
35-01	Term. X48/4 Input Type	[0] Not Connected	All set-ups		TRUE	-	UInt8
35-02	Term. X48/7 Temperature Unit	[60] °C	All set-ups		TRUE	-	UInt8
35-03	Term. X48/7 Input Type	[0] Not Connected	All set-ups		TRUE	-	UInt8
35-04	Term. X48/10 Temperature Unit	[60] °C	All set-ups		TRUE	-	UInt8
35-05	Term. X48/10 Input Type	[0] Not Connected	All set-ups		TRUE	-	UInt8
35-06	Temperature Sensor Alarm Function	[5] Stop and trip	All set-ups		TRUE	-	UInt8
35-1* Temp. Input X48/4							
35-14	Term. X48/4 Filter Time Constant	0.001 s	All set-ups		TRUE	-3	UInt16
35-15	Term. X48/4 Temp. Monitor	[0] Disabled	All set-ups		TRUE	-	UInt8
35-16	Term. X48/4 Low Temp. Limit	ExpressionLimit	All set-ups		TRUE	0	Int16
35-17	Term. X48/4 High Temp. Limit	ExpressionLimit	All set-ups		TRUE	0	Int16
35-2* Temp. Input X48/7							
35-24	Term. X48/7 Filter Time Constant	0.001 s	All set-ups		TRUE	-3	UInt16
35-25	Term. X48/7 Temp. Monitor	[0] Disabled	All set-ups		TRUE	-	UInt8
35-26	Term. X48/7 Low Temp. Limit	ExpressionLimit	All set-ups		TRUE	0	Int16
35-27	Term. X48/7 High Temp. Limit	ExpressionLimit	All set-ups		TRUE	0	Int16
35-3* Temp. Input X48/10							
35-34	Term. X48/10 Filter Time Constant	0.001 s	All set-ups		TRUE	-3	UInt16
35-35	Term. X48/10 Temp. Monitor	[0] Disabled	All set-ups		TRUE	-	UInt8

35-36	Term. X48/10 Low Temp. Limit	ExpressionLimit	All set-ups		TRUE	0	Int16
35-37	Term. X48/10 High Temp. Limit	ExpressionLimit	All set-ups		TRUE	0	Int16
35-4* Analog Input X48/2							
35-42	Term. X48/2 Low Current	4 mA	All set-ups		TRUE	-5	Int16
35-43	Term. X48/2 High Current	20 mA	All set-ups		TRUE	-5	Int16
35-44	Term. X48/2 Low Ref./Feedb. Value	0 N/A	All set-ups		TRUE	-3	Int32
35-45	Term. X48/2 High Ref./Feedb. Value	100 N/A	All set-ups		TRUE	-3	Int32
35-46	Term. X48/2 Filter Time Constant	0.001 s	All set-ups		TRUE	-3	Uint16

6 Troubleshooting

6.1 Status Messages

A warning or an alarm is signalled by the relevant indicator light on the front of the frequency converter and indicated by a code on the display.

A warning remains active until its cause is no longer present. Under certain circumstances, operation of the motor may still be continued. Warning messages may be critical, but are not necessarily so.

In the event of an alarm, the frequency converter trips. Reset the alarm to resume operation once the cause has been rectified.

3 ways to reset:

- Press [Reset].
- Via a digital input with the reset function.
- Via serial communication/optional fieldbus.

NOTICE!

After a manual reset pressing [Reset], press [Auto On] to restart the motor.

If an alarm cannot be reset, the reason may be that its cause has not been rectified, or the alarm is trip locked (see also *Table 6.1*).

Alarms that are trip locked offer extra protection, meaning that the mains supply must be switched off before the alarm can be reset. After being switched back on, the frequency converter is no longer blocked and can be reset once the cause has been rectified.

Alarms that are not trip locked can also be reset using the automatic reset function in *parameter 14-20 Reset Mode* (Warning: Automatic wake-up is possible.)

If a warning or alarm is marked against a code in *Table 6.1*, this means that either a warning occurs before an alarm, or it is possible to specify whether a warning or an alarm should be shown for a given fault.

This is possible, for instance, in *parameter 1-90 Motor Thermal Protection*. After an alarm or trip, the motor carries on coasting, and the alarm and warning flash. Once the problem has been rectified, only the alarm continues flashing until the frequency converter is reset.

NOTICE!

No missing motor phase detection (numbers 30-32) and no stall detection are active when *parameter 1-10 Motor Construction* is set to [1] *PM non-salient SPM*.

Number	Description	Warning	Alarm/ trip	Alarm/ trip lock	Parameter reference
1	10 volts low	X	-	-	-
2	Live zero error	(X)	(X)	-	<i>Parameter 6-01 Live Zero Timeout Function</i>
3	No motor	(X)	-	-	<i>Parameter 1-80 Function at Stop</i>
4	Mains phase loss	(X)	(X)	(X)	<i>Parameter 14-12 Function at Mains Imbalance</i>
5	DC-link voltage high	X	-	-	-
6	DC-link voltage low	X	-	-	-
7	DC overvoltage	X	X	-	-
8	DC undervoltage	X	X	-	-
9	Inverter overloaded	X	X	-	-
10	Motor ETR overtemperature	(X)	(X)	-	<i>Parameter 1-90 Motor Thermal Protection</i>
11	Motor thermistor overtemperature	(X)	(X)	-	<i>Parameter 1-90 Motor Thermal Protection</i>
12	Torque limit	X	X	-	-
13	Overcurrent	X	X	X	-
14	Ground fault	X	X	-	-
15	Hardware mismatch	-	X	X	-
16	Short circuit	-	X	X	-
17	Control word timeout	(X)	(X)	-	<i>Parameter 8-04 Control Word Timeout Function</i>

Number	Description	Warning	Alarm/ trip	Alarm/ trip lock	Parameter reference
20	Temp. input error	–	X	–	–
21	Param error	–	–	X	–
22	Hoist mech. brake	(X)	(X)	–	<i>Parameter group 2-2* Mechanical Brake</i>
23	Internal fans	X	–	–	–
24	External fans	X	–	–	–
25	Brake resistor short-circuited	X	–	–	–
26	Brake resistor power limit	(X)	(X)	–	<i>Parameter 2-13 Brake Power Monitoring</i>
27	Brake chopper short-circuited	X	X	–	–
28	Brake check	(X)	(X)	–	<i>Parameter 2-15 Brake Check</i>
29	Heat sink temp	X	X	X	–
30	Motor phase U missing	(X)	(X)	(X)	<i>Parameter 4-58 Missing Motor Phase Function</i>
31	Motor phase V missing	(X)	(X)	(X)	<i>Parameter 4-58 Missing Motor Phase Function</i>
32	Motor phase W missing	(X)	(X)	(X)	<i>Parameter 4-58 Missing Motor Phase Function</i>
33	Inrush fault	–	X	X	–
34	Fieldbus communication fault	X	X	–	–
35	Option fault	–	–	X	–
36	Mains failure	X	X	–	–
37	Imbalance of supply voltage	–	X	–	–
38	Internal fault	–	X	X	–
39	Heat sink sensor	–	X	X	–
40	Overload of digital output terminal 27	(X)	–	–	<i>Parameter 5-00 Digital I/O Mode, parameter 5-01 Terminal 27 Mode</i>
41	Overload of digital output terminal 29	(X)	–	–	<i>Parameter 5-00 Digital I/O Mode, parameter 5-02 Terminal 29 Mode</i>
42	Ovrlld X30/6-7	(X)	–	–	–
43	Ext. supply (option)	X	–	–	–
45	Ground fault 2	X	X	–	–
46	Pwr. card supply	–	X	X	–
47	24 V supply low	X	X	X	–
48	1.8 V supply low	–	X	X	–
50	AMA calibration failed	–	X	–	–
51	AMA check U_{nom} and I_{nom}	–	X	–	–
52	AMA low I_{nom}	–	X	–	–
53	AMA motor too big	–	X	–	–
54	AMA motor too small	–	X	–	–
55	AMA parameter out of range	–	X	–	–
56	AMA interrupted by user	–	X	–	–
57	AMA time-out	–	X	–	–
58	AMA internal fault	X	X	–	–
59	Current limit	X	–	–	–
60	External interlock	X	X	–	–
61	Feedback error	(X)	(X)	–	<i>Parameter 4-30 Motor Feedback Loss Function</i>
62	Output frequency at maximum limit	X	X	–	–
63	Mechanical brake low	–	(X)	–	<i>Parameter 2-20 Release Brake Current</i>
64	Voltage limit	X	–	–	–
65	Control board overtemperature	X	X	X	–
66	Heat sink temperature low	X	–	–	–
67	Option configuration has changed	–	X	–	–

Number	Description	Warning	Alarm/ trip	Alarm/ trip lock	Parameter reference
68	Safe stop	(X)	(X) ¹⁾	–	<i>Parameter 5-19 Terminal 37 Safe Stop</i>
69	Pwr. card temp	–	X	X	–
70	Illegal FC configuration	–	–	X	–
71	PTC 1 Safe Stop	–	X	–	–
72	Dangerous failure	–	–	X	–
73	Safe Stop Auto Restart	(X)	(X)	–	<i>Parameter 5-19 Terminal 37 Safe Stop</i>
74	PTC Thermistor	–	–	X	–
75	Illegal Profile Sel.	–	X	–	–
76	Power unit setup	X	–	–	–
77	Reduced power mode	X	–	–	<i>Parameter 14-59 Actual Number of Inverter Units</i>
78	Tracking error	(X)	(X)	–	<i>Parameter 4-34 Tracking Error Function</i>
79	Illegal PS config	–	X	X	–
80	Frequency converter Initialized to default value	–	X	–	–
81	CSIV corrupt	–	X	–	–
82	CSIV parameter error	–	X	–	–
83	Illegal option combination	–	–	X	–
84	No safety option	–	X	–	–
88	Option detection	–	–	X	–
89	Mechanical brake sliding	X	–	–	–
90	Feedback monitor	(X)	(X)	–	<i>Parameter 17-61 Feedback Signal Monitoring</i>
91	Analog input 54 wrong settings	–	–	X	S202
99	Locked rotor	–	X	X	–
101	Speed monitor	X	X	–	–
104	Mixing fans	X	X	–	–
122	Mot. rotat. unexp.	–	X	–	–
123	Motor mod. changed	–	X	–	–
157	Power Limit Mot.	–	X	–	<i>Parameter 4-80 Power Limit Func. Motor Mode, parameter 4-82 Power Limit Motor Mode</i>
158	Power Limit Gen.	–	X	–	<i>Parameter 4-81 Power Limit Func. Generator Mode, parameter 4-83 Power Limit Generator Mode</i>
163	ATEX ETR cur.lim.warning	X	–	–	–
164	ATEX ETR cur.lim.alarm	–	X	–	–
165	ATEX ETR freq.lim.warning	X	–	–	–
166	ATEX ETR freq.lim.alarm	–	X	–	–
210	Position tracking	X	X	–	<i>Parameter 4-70 Position Error Function, parameter 4-71 Maximum Position Error, parameter 4-72 Position Error Timeout</i>
211	Position limit	X	X	–	<i>Parameter 3-06 Minimum Position, parameter 3-07 Maximum Position, parameter 4-73 Position Limit Function</i>
212	Homing not done	–	X	–	<i>Parameter 17-80 Homing Function</i>
213	Homing timeout	–	X	–	<i>Parameter 17-85 Homing Timeout</i>
214	No sensor input	–	X	–	–
215	Start fwd/rev	X	X	–	<i>Parameter 4-74 Start Fwd/Rev Function</i>
216	Touch timeout	–	X	–	<i>Parameter 4-75 Touch Timeout</i>
220	Configuration File Version not supported	X	–	–	–
246	Pwr.card supply	–	–	X	–

Number	Description	Warning	Alarm/ trip	Alarm/ trip lock	Parameter reference
250	New spare part	-	-	X	-
251	New type code	-	X	X	-
430	PWM Disabled	-	X	-	-

Table 6.1 Alarm/Warning Code List

(X) Dependent on parameter.

1) Cannot be auto reset via parameter 14-20 Reset Mode.

A trip is the action following an alarm. The trip coasts the motor and is reset by pressing [Reset] or by a digital input (parameter group 5-1* Digital Inputs). The original event that caused an alarm cannot damage the frequency converter or cause dangerous conditions. A trip lock is an action when an alarm occurs, which could damage the frequency converter or connected parts. A trip lock situation can only be reset by cycling power.

6

Warning	Yellow
Alarm	Flashing red
Trip locked	Yellow and red

Table 6.2 Indicator Light

Bit	Hex	Dec	Alarm word	Alarm word 2	Warning word	Warning word 2	Extended status word
Alarm Word Extended Status Word							
0	00000001	1	Brake check (A28)	Servicetrip, read/write	Brake check (W28)	Start delayed	Ramping
1	00000002	2	Pwr.card temp (A69)	Servicetrip, (reserved)	Pwr.card temp (A69)	Stop delayed	AMA running
2	00000004	4	Earth fault (A14)	Servicetrip, typecode/sparepart	Earth fault (W14)	Reserved	Start CW/CCW start_possible is active, when the DI selections [12] OR [13] are active and the requested direction matches the reference sign
3	00000008	8	Ctrl.card temp (A65)	Servicetrip, (reserved)	Ctrl.card temp (W65)	Reserved	Slow down slow down command active, for example via CTW bit 11 or DI
4	00000010	16	Ctrl. word TO (A17)	Servicetrip, (reserved)	Ctrl. word TO (W17)		Catch up catch up command active, for example via CTW bit 12 or DI
5	00000020	32	Overcurrent (A13)	Reserved	Overcurrent (W13)	Reserved	Feedback high feedback >parameter 4-57 Warning Feedback High
6	00000040	64	Torque limit (A12)	Reserved	Torque limit (W12)	Reserved	Feedback low feedback <parameter 4-56 Warning Feedback Low
7	00000080	128	Motor th over (A11)	Reserved	Motor th over (W11)	Reserved	Output current high current >parameter 4-51 Warning Current High
8	00000100	256	Motor ETR over (A10)	Reserved	Motor ETR over (W10)	Reserved	Output current low current <parameter 4-50 Warning Current Low

Bit	Hex	Dec	Alarm word	Alarm word 2	Warning word	Warning word 2	Extended status word
9	00000200	512	Inverter overld. (A9)	Discharge high	Inverter Overld (W9)	Discharge high	Output freq high speed >parameter 4-53 Warning Speed High
10	00000400	1024	DC under volt (A8)	Start failed	DC under volt (W8)	Multi-motor underload	Output freq low speed <parameter 4-52 Warning Speed Low
11	00000800	2048	DC over volt (A7)	Speed limit	DC over volt (W7)	Multi-motor overload	Brake check OK brake test NOT OK
12	00001000	4096	Short circuit (A16)	External interlock	DC voltage low (W6)	Compressor interlock	Braking max. BrakePower > Brakepowerlimit (2-12)
13	00002000	8192	Inrush fault (A33)	Illegal option combi.	DC voltage high (W5)	Mechanical brake sliding	Braking
14	00004000	16384	Mains ph. loss (A4)	No safety option	Mains ph. loss (W4)	Safe option warning	Out of speed range
15	00008000	32768	AMA not OK	Reserved	No motor (W3)	Auto DC braking	OVC active
16	00010000	65536	Live zero error (A2)	Reserved	Live zero error (W2)		AC brake
17	00020000	131072	Internal fault (A38)	KTY error	10 V low (W1)	KTY warn	Password timelock number of allowed password trials exceeded - timelock active
18	00040000	262144	Brake overload (A26)	Fans error	Brake overload (W26)	Fans warn	Password protection 0-61 = ALL_NO_ACCESS OR BUS_NO_ACCESS OR BUS_READONLY
19	00080000	524288	U phase loss (A30)	ECB error	Brake resistor (W25)	ECB warn	Reference high reference >parameter 4-55 Warning Reference High
20	00100000	1048576	V phase loss (A31)	Hoist mechanical brake (A22)	Brake IGBT (W27)	Hoist mechanical brake (W22)	Reference low reference <parameter 4-54 Warning Reference Low
21	00200000	2097152	W phase Loss (A32)	Reserved	Speed limit (W49)	Reserved	Local reference reference site = REMOTE -> auto on pressed & active
22	00400000	4194304	Fieldbus fault (A34)	Reserved	Fieldbus fault (W34)	Reserved	Protection mode notification
23	00800000	8388608	24 V supply low (A47)	Reserved	24 V supply Low (W47)	Reserved	Unused
24	01000000	16777216	Mains failure (A36)	Reserved	Mains failure (W36)	Reserved	Unused
25	02000000	33554432	1.8 V supply low (A48)	Current limit (A59)	Current limit (W59)	Power Limit Motor	Unused
26	04000000	67108864	Brake resistor (A25)	Motor rotating unexpectedly (A122)	Low temp (W66)	Power Limit Generator	Unused
27	08000000	134217728	Brake IGBT (A27)	Reserved	Voltage limit (W64)	Reserved	Unused
28	10000000	268435456	Option change (A67)	Reserved	Encoder loss (W90)	Reserved	Unused

Bit	Hex	Dec	Alarm word	Alarm word 2	Warning word	Warning word 2	Extended status word
29	20000000	536870912	Drive initialized (A80)	Encoder loss (A90)	Output freq. lim. (W62)	BackEMF too high	Unused
30	40000000	1073741824	Safe stop (A68)	PTC thermistor (A74)	Safe stop (W68)	PTC thermistor (W74)	Unused
31	80000000	2147483648	Mech. brake low (A63)	Dangerous failure (A72)	Extended status word		Protection mode

Table 6.3 Description of Alarm Word, Warning Word, and Extended Status Word

6

The alarm words, warning words and extended status words can be read out via a serial bus or optional fieldbus for diagnostics. See also *parameter 16-94 Ext. Status Word*.

WARNING 1, 10 Volts low

The control card voltage is less than 10 V from terminal 50. Remove some of the load from terminal 50, as the 10 V supply is overloaded. Maximum 15 mA or minimum 590 Ω.

A short circuit in a connected potentiometer or incorrect wiring of the potentiometer can cause this condition.

Troubleshooting

- Remove the wiring from terminal 50. If the warning clears, the problem is with the wiring. If the warning does not clear, replace the control card.

WARNING/ALARM 2, Live zero error

This warning or alarm only appears if programmed in *parameter 6-01 Live Zero Timeout Function*. The signal on 1 of the analog inputs is less than 50% of the minimum value programmed for that input. Broken wiring or a faulty device sending the signal can cause this condition.

Troubleshooting

- Check connections on all analog mains terminals.
 - Control card terminals 53 and 54 for signals, terminal 55 common.
 - VLT® General Purpose I/O MCB 101 terminals 11 and 12 for signals, terminal 10 common.
 - VLT® Analog I/O Option MCB 109 terminals 1, 3, and 5 for signals, terminals 2, 4, and 6 common.
- Check that the drive programming and switch settings match the analog signal type.
- Perform an input terminal signal test.

WARNING/ALARM 3, No motor

No motor is connected to the output of the frequency converter.

WARNING/ALARM 4, Mains phase loss

A phase is missing on the supply side, or the mains voltage imbalance is too high. This message also appears for a fault in the input rectifier. Options are programmed in *parameter 14-12 Response to Mains Imbalance*.

Troubleshooting

- Check the supply voltage and supply currents to the frequency converter.

WARNING 5, DC link voltage high

The DC-link voltage (DC) is higher than the high-voltage warning limit. The limit depends on the drive voltage rating. The unit is still active.

WARNING 6, DC link voltage low

The DC-link voltage (DC) is lower than the low voltage warning limit. The limit depends on the drive voltage rating. The unit is still active.

WARNING/ALARM 7, DC overvoltage

If the DC-link voltage exceeds the limit, the frequency converter trips after a certain time.

Troubleshooting

- Connect a brake resistor.
- Extend the ramp time.
- Change the ramp type.
- Activate the functions in *parameter 2-10 Brake Function*.
- Increase *parameter 14-26 Trip Delay at Inverter Fault*.
- If the alarm/warning occurs during a power sag, use kinetic back-up (*parameter 14-10 Line Failure*).

Table 6.4 shows the limit values for voltage warnings/alarms. The values are the DC-link voltage values of the frequency converter with a tolerance of $\pm 5\%$. The corresponding mains voltage equals the DC-link voltage value divided by 1.35.

	3 x 200–240 V	3 x 380–500 V	3 x 525–600 V
Warning/alarm 8, DC under voltage [VDC]	185	373	532
Warning 6, DC link voltage low [VDC]	205	410	585
Warning 5, DC link voltage high w/o brake [VDC]	390	810	943
Warning 5, DC link voltage high w brake [VDC]	405	840	965
Warning/alarm 7, DC overvoltage [VDC]	410	855	975

Table 6.4 Voltage Warning/Alarm Limits

WARNING/ALARM 8, DC under voltage

If the DC-link voltage drops below the undervoltage limit, the drive checks for 24 V DC back-up supply. If no 24 V DC back-up supply is connected, the drive trips after a fixed time delay. The time delay varies with unit size.

Troubleshooting

- Check that the supply voltage matches the drive voltage.
- Perform an input voltage test.
- Perform a soft-charge circuit test.

WARNING/ALARM 9, Inverter overload

The frequency converter has run with more than 100% overload for too long and is about to cut out. The counter for electronic thermal inverter protection issues a warning at 98% and trips at 100% with an alarm. The frequency converter cannot be reset until the counter is below 90%.

Troubleshooting

- Compare the output current shown on the LCP with the frequency converter rated current.
- Compare the output current shown on the LCP with the measured motor current.
- Show the thermal frequency converter load on the LCP and monitor the value. When running above the frequency converter continuous current rating, the counter increases. When running below the frequency converter continuous current rating, the counter decreases.

WARNING/ALARM 10, Motor overload temperature

According to the electronic thermal protection (ETR), the motor is too hot.

Select 1 of these options:

- The frequency converter issues a warning or an alarm when the counter is $>90\%$ if *parameter 1-90 Motor Thermal Protection* is set to warning options.
- The frequency converter trips when the counter reaches 100% if *parameter 1-90 Motor Thermal Protection* is set to trip options.

The fault occurs when the motor runs with more than 100% overload for too long.

Troubleshooting

- Check for motor overheating.
- Check if the motor is mechanically overloaded.
- Check that the motor current set in *parameter 1-24 Motor Current* is correct.
- Ensure that the motor data in *parameters 1-20 to 1-25* is set correctly.
- If an external fan is in use, check that it is selected in *parameter 1-91 Motor External Fan*.
- Running AMA in *parameter 1-29 Automatic Motor Adaptation (AMA)* tunes the frequency converter to the motor more accurately and reduces thermal loading.

WARNING/ALARM 11, Motor thermistor overtemp

Check whether the thermistor is disconnected. Select whether the frequency converter issues a warning or an alarm in *parameter 1-90 Motor Thermal Protection*.

Troubleshooting

- Check for motor overheating.
- Check if the motor is mechanically overloaded.
- When using terminal 53 or 54, check that the thermistor is connected correctly between either terminal 53 or 54 (analog voltage input) and terminal 50 (+10 V supply). Also check that the terminal switch for 53 or 54 is set for voltage. Check that *parameter 1-93 Thermistor Resource* selects terminal 53 or 54.
- When using terminal 18, 19, 31, 32, or 33 (digital inputs), check that the thermistor is connected correctly between the digital input terminal used (digital input PNP only) and terminal 50. Select the terminal to use in *parameter 1-93 Thermistor Resource*.

WARNING/ALARM 12, Torque limit

The torque has exceeded the value in *parameter 4-16 Torque Limit Motor Mode* or the value in *parameter 4-17 Torque Limit Generator Mode*. *Parameter 14-25 Trip Delay at Torque Limit* can change this warning from a warning-only condition to a warning followed by an alarm.

Troubleshooting

- If the motor torque limit is exceeded during ramp-up, extend the ramp-up time.
- If the generator torque limit is exceeded during ramp-down, extend the ramp-down time.
- If torque limit occurs while running, increase the torque limit. Make sure that the system can operate safely at a higher torque.
- Check the application for excessive current draw on the motor.

WARNING/ALARM 13, Over current

The inverter peak current limit (approximately 200% of the rated current) is exceeded. The warning lasts approximately 1.5 s, then the frequency converter trips and issues an alarm. Shock loading or quick acceleration with high-inertia loads can cause this fault. If the acceleration during ramp-up is quick, the fault can also appear after kinetic back-up. If extended mechanical brake control is selected, a trip can be reset externally.

Troubleshooting

- Remove the power and check if the motor shaft can be turned.
- Check that the motor size matches the frequency converter.
- Check that the motor data is correct in *parameters 1-20 to 1-25*.

ALARM 14, Earth (ground) fault

There is current from the output phase-to-ground, either in the cable between the frequency converter and the motor, or in the motor itself. The current transducers detect the ground fault by measuring current going out from the frequency converter and current going into the frequency converter from the motor. Ground fault is issued if the deviation of the 2 currents is too large. The current going out of the frequency converter must be the same as the current going into the frequency converter.

Troubleshooting

- Remove power to the frequency converter and repair the ground fault.
- Check for ground faults in the motor by measuring the resistance to ground of the motor cables and the motor with a megohmmeter.
- Reset any potential individual offset in the 3 current transducers in the frequency converter. Perform the manual initialization or perform a complete AMA. This method is most relevant after changing the power card.

ALARM 15, Hardware mismatch

A fitted option is not operational with the present control card hardware or software.

Record the value of the following parameters and contact Danfoss.

- *Parameter 15-40 FC Type.*
- *Parameter 15-41 Power Section.*
- *Parameter 15-42 Voltage.*
- *Parameter 15-43 Software Version.*
- *Parameter 15-45 Actual Typecode String.*
- *Parameter 15-49 SW ID Control Card.*
- *Parameter 15-50 SW ID Power Card.*
- *Parameter 15-60 Option Mounted.*
- *Parameter 15-61 Option SW Version (for each option slot).*

ALARM 16, Short circuit

There is short-circuiting in the motor or motor wiring.

Troubleshooting

- Remove the power to the frequency converter and repair the short circuit.

⚠ WARNING**HIGH VOLTAGE**

Frequency converters contain high voltage when connected to AC mains input, DC supply, or load sharing. Failure to use qualified personnel to install, start up, and maintain the frequency converter can result in death or serious injury.

- **Disconnect power before proceeding.**

WARNING/ALARM 17, Control word timeout

There is no communication to the frequency converter. The warning is only active when *parameter 8-04 Control Word Timeout Function* is NOT set to [0] Off.

If *parameter 8-04 Control Word Timeout Function* is set to [5] Stop and trip, a warning appears, and the frequency converter ramps down to a stop and shows an alarm.

Troubleshooting

- Check the connections on the serial communication cable.
- Increase *parameter 8-03 Control Word Timeout Time*.
- Check the operation of the communication equipment.
- Verify that proper EMC installation was performed.

WARNING/ALARM 20, Temp. input error

The temperature sensor is not connected.

WARNING/ALARM 21, Parameter error

The parameter is out of range. The parameter number is shown in the display.

Troubleshooting

- Set the affected parameter to a valid value.

WARNING/ALARM 22, Hoist mechanical brake

The value of this warning/alarm shows the type of warning/alarm.

0 = The torque reference was not reached before timeout (*parameter 2-27 Torque Ramp Time*).

1 = Expected brake feedback was not received before timeout (*parameter 2-23 Activate Brake Delay*, *parameter 2-25 Brake Release Time*).

WARNING 23, Internal fan fault

The fan warning function is a protective function that checks if the fan is running/mounted. The fan warning can be disabled in *parameter 14-53 Fan Monitor ([0] Disabled)*.

For frequency converters with DC fans, a feedback sensor is mounted in the fan. If the fan is commanded to run and there is no feedback from the sensor, this alarm appears. For frequency converters with AC fans, the voltage to the fan is monitored.

Troubleshooting

- Check for proper fan operation.
- Cycle power to the frequency converter and check that the fan operates briefly at start-up.
- Check the sensors on the control card.

WARNING 24, External fan fault

The fan warning function is a protective function that checks if the fan is running/mounted. The fan warning can be disabled in *parameter 14-53 Fan Monitor ([0] Disabled)*.

For frequency converters with DC fans, a feedback sensor is mounted in the fan. If the fan is commanded to run and there is no feedback from the sensor, this alarm appears. For frequency converters with AC fans, the voltage to the fan is monitored.

Troubleshooting

- Check for proper fan operation.
- Cycle power to the frequency converter and check that the fan operates briefly at start-up.
- Check the sensors on the heat sink.

WARNING 25, Brake resistor short circuit

The brake resistor is monitored during operation. If a short circuit occurs, the brake function is disabled and the warning appears. The frequency converter is still operational, but without the brake function.

Troubleshooting

- Remove the power to the frequency converter and replace the brake resistor (refer to *parameter 2-15 Brake Check*).

WARNING/ALARM 26, Brake resistor power limit

The power transmitted to the brake resistor is calculated as a mean value over the last 120 s of run time. The calculation is based on the DC-link voltage and the brake resistor value set in *parameter 2-16 AC brake Max. Current*. The warning is active when the dissipated braking power is higher than 90% of the brake resistor power. If option [2] Trip is selected in *parameter 2-13 Brake Power Monitoring*, the frequency converter trips when the dissipated braking power reaches 100%.

WARNING/ALARM 27, Brake chopper fault

The brake transistor is monitored during operation, and if a short circuit occurs, the brake function is disabled, and a warning is issued. The frequency converter is still operational, but since the brake transistor has short-circuited, substantial power is transmitted to the brake resistor, even if it is inactive.

Troubleshooting

- Remove power to the frequency converter and remove the brake resistor.

WARNING/ALARM 28, Brake check failed

The brake resistor is not connected or not working.

Troubleshooting

- Check *parameter 2-15 Brake Check*.

ALARM 29, Heat Sink temp

The maximum temperature of the heat sink is exceeded. The temperature fault is not reset until the temperature drops below a defined heat sink temperature. The trip and reset points are different based on the frequency converter power size.

Troubleshooting

Check for the following conditions:

- The ambient temperature is too high.
- The motor cables are too long.
- Incorrect airflow clearance above and below the frequency converter.
- Blocked airflow around the frequency converter.
- Damaged heat sink fan.
- Dirty heat sink.

ALARM 30, Motor phase U missing

Motor phase U between the frequency converter and the motor is missing.

⚠ WARNING

HIGH VOLTAGE

Frequency converters contain high voltage when connected to AC mains input, DC supply, or load sharing. Failure to use qualified personnel to install, start up, and maintain the frequency converter can result in death or serious injury.

- Disconnect power before proceeding.

Troubleshooting

- Remove the power from the frequency converter and check motor phase U.

ALARM 31, Motor phase V missing

Motor phase V between the frequency converter and the motor is missing.

⚠ WARNING

HIGH VOLTAGE

Frequency converters contain high voltage when connected to AC mains input, DC supply, or load sharing. Failure to use qualified personnel to install, start up, and maintain the frequency converter can result in death or serious injury.

- Disconnect power before proceeding.

Troubleshooting

- Remove the power from the frequency converter and check motor phase V.

ALARM 32, Motor phase W missing

Motor phase W between the frequency converter and the motor is missing.

⚠ WARNING

HIGH VOLTAGE

Frequency converters contain high voltage when connected to AC mains input, DC supply, or load sharing. Failure to use qualified personnel to install, start up, and maintain the frequency converter can result in death or serious injury.

- Disconnect power before proceeding.

Troubleshooting

- Remove the power from the frequency converter and check motor phase W.

ALARM 33, Inrush fault

Too many power-ups have occurred within a short time period.

Troubleshooting

- Let the unit cool to operating temperature.

WARNING/ALARM 34, Fieldbus communication fault

The fieldbus on the communication option card is not working.

WARNING/ALARM 35, Option fault

An option alarm is received. The alarm is option-specific. The most likely cause is a power-up or a communication fault.

WARNING/ALARM 36, Mains failure

This warning/alarm is only active if the supply voltage to the frequency converter is lost and *parameter 14-10 Mains Failure* is not set to [0] No function.

Troubleshooting

- Check the fuses to the frequency converter and mains supply to the unit.

ALARM 37, Phase imbalance

There is a current imbalance between the power units.

ALARM 38, Internal fault

When an internal fault occurs, a code number defined in *Table 6.5* is shown.

Troubleshooting

- Cycle power.
- Check that the option is properly installed.
- Check for loose or missing wiring.

It may be necessary to contact the Danfoss supplier or service department. Note the code number for further troubleshooting directions.

Number	Text
0	The serial port cannot be initialized. Contact the Danfoss supplier or Danfoss service department.
256–258	The power EEPROM data is defective or too old. Replace the power card.
512–519	Internal fault. Contact the Danfoss supplier or Danfoss service department.
783	Parameter value outside of minimum/maximum limits.
1024–1284	Internal fault. Contact the Danfoss supplier or Danfoss service department.
1299	The option software in slot A is too old.
1300	The option software in slot B is too old.
1302	The option software in slot C1 is too old.
1315	The option software in slot A is not supported/allowed.
1316	The option software in slot B is not supported/allowed.
1318	The option software in slot C1 is not supported/allowed.
1379–2819	Internal fault. Contact the Danfoss supplier or Danfoss service department.
1792	Hardware reset of digital signal processor.

Number	Text
1793	Motor-derived parameters not transferred correctly to the digital signal processor.
1794	Power data not transferred correctly at power-up to the digital signal processor.
1795	The digital signal processor has received too many unknown SPI telegrams. The frequency converter also uses this fault code if the MCO does not power up correctly. This situation can occur due to poor EMC protection or improper grounding.
1796	RAM copy error.
2561	Replace the control card.
2820	LCP stack overflow.
2821	Serial port overflow.
2822	USB port overflow.
3072–5122	Parameter value is outside its limits.
5123	Option in slot A: Hardware incompatible with the control board hardware.
5124	Option in slot B: Hardware incompatible with the control board hardware.
5125	Option in slot C0: Hardware incompatible with the control board hardware.
5126	Option in slot C1: Hardware incompatible with the control board hardware.
5376–6231	Internal fault. Contact the Danfoss supplier or Danfoss service department.

Table 6.5 Internal Fault Codes

ALARM 39, Heat sink sensor

No feedback from the heat sink temperature sensor.

The signal from the IGBT thermal sensor is not available on the power card. The problem could be on the power card, on the gatedrive card, or the ribbon cable between the power card and gatedrive card.

WARNING 40, Overload of digital output terminal 27

Check the load connected to terminal 27 or remove the short-circuit connection. Check *parameter 5-00 Digital I/O Mode* and *parameter 5-01 Terminal 27 Mode*.

WARNING 41, Overload of digital output terminal 29

Check the load connected to terminal 29 or remove the short-circuit connection. Also check *parameter 5-00 Digital I/O Mode* and *parameter 5-02 Terminal 29 Mode*.

WARNING 42, Overload of digital output on X30/6 or overload of digital output on X30/7

For terminal X30/6, check the load connected to terminal X30/6 or remove the short-circuit connection. Also check *parameter 5-32 Term X30/6 Digi Out (MCB 101)* (VLT® General Purpose I/O MCB 101).

For terminal X30/7, check the load connected to terminal X30/7 or remove the short-circuit connection. Check

parameter 5-33 Term X30/7 Digi Out (MCB 101) (VLT® General Purpose I/O MCB 101).

ALARM 43, Ext. supply

VLT® Extended Relay Option MCB 113 is mounted without external 24 V DC. Either connect a 24 V DC external supply or specify that no external supply is used via *parameter 14-80 Option Supplied by External 24VDC*, [0] No. A change in *parameter 14-80 Option Supplied by External 24VDC* requires a power cycle.

ALARM 45, Earth fault 2

Ground fault.

Troubleshooting

- Check for proper grounding and loose connections.
- Check for proper wire size.
- Check the motor cables for short circuits or leakage currents.

ALARM 46, Power card supply

The supply on the power card is out of range. Another reason can be a defective heat sink fan.

There are 3 supplies generated by the switch mode supply (SMPS) on the power card:

- 24 V.
- 5 V.
- ±18 V.

When powered with VLT® 24 V DC Supply MCB 107, only the 24 V and 5 V supplies are monitored. When powered with 3-phase mains voltage, all 3 supplies are monitored.

Troubleshooting

- Check for a defective power card.
- Check for a defective control card.
- Check for a defective option card.
- If a 24 V DC supply is used, verify proper supply power.
- Check for a defective heat sink fan.

WARNING 47, 24 V supply low

The supply on the power card is out of range.

There are 3 supplies generated by the switch mode supply (SMPS) on the power card:

- 24 V.
- 5 V.
- ±18 V.

Troubleshooting

- Check for a defective power card.

WARNING 48, 1.8 V supply low

The 1.8 V DC supply used on the control card is outside of the allowable limits. The supply is measured on the control card.

Troubleshooting

- Check for a defective control card.
- If an option card is present, check for overvoltage.

WARNING 49, Speed limit

The warning is shown when the speed is outside of the specified range in *parameter 4-11 Motor Speed Low Limit [RPM]* and *parameter 4-13 Motor Speed High Limit [RPM]*.

ALARM 50, AMA calibration failed

Contact the Danfoss supplier or Danfoss service department.

ALARM 51, AMA check U_{nom} and I_{nom}

The settings for motor voltage, motor current, and motor power are wrong.

Troubleshooting

- Check the settings in *parameters 1-20 to 1-25*.

ALARM 52, AMA low I_{nom}

The motor current is too low.

Troubleshooting

- Check the settings in *parameter 1-24 Motor Current*.

ALARM 53, AMA motor too big

The motor is too large for the AMA to operate.

ALARM 54, AMA motor too small

The motor is too small for the AMA to operate.

ALARM 55, AMA parameter out of range

The AMA cannot run because the parameter values of the motor are outside of the acceptable range.

ALARM 56, AMA interrupted by user

The AMA is manually interrupted.

ALARM 57, AMA internal fault

Try to restart the AMA. Repeated restarts can overheat the motor.

ALARM 58, AMA Internal fault

Contact the Danfoss supplier.

WARNING 59, Current limit

The current is higher than the value in *parameter 4-18 Current Limit*. Ensure that the motor data in *parameters 1-20 to 1-25* is set correctly. Increase the current limit if necessary. Ensure that the system can operate safely at a higher limit.

WARNING 60, External interlock

A digital input signal indicates a fault condition external to the frequency converter. An external interlock has commanded the frequency converter to trip. Clear the

external fault condition. To resume normal operation, apply 24 V DC to the terminal programmed for external interlock, and reset the frequency converter.

WARNING/ALARM 61, Feedback error

An error between calculated speed and speed measurement from feedback device.

Troubleshooting

- Check the settings for warning/alarm/disabling in *parameter 4-30 Motor Feedback Loss Function*.
- Set the tolerable error in *parameter 4-31 Motor Feedback Speed Error*.
- Set the tolerable feedback loss time in *parameter 4-32 Motor Feedback Loss Timeout*.

WARNING/ALARM 62, Output frequency at maximum limit

If the output frequency reaches the value set in *parameter 4-19 Max Output Frequency*, the frequency converter issues a warning. The warning ceases when the output drops below the maximum limit. If the frequency converter is unable to limit the frequency, it trips and issues an alarm. The latter may happen in the flux mode if the frequency converter loses control of the motor.

Troubleshooting

- Check the application for possible causes.
- Increase the output frequency limit. Ensure that the system can operate safely at a higher output frequency.

ALARM 63, Mechanical brake low

The actual motor current has not exceeded the release brake current within the start delay time window.

WARNING 64, Voltage limit

The combination of load and speed requires a motor voltage higher than the actual DC-link voltage.

WARNING/ALARM 65, Control card over temperature

The cutout temperature of the control card is 85 °C (185 °F).

Troubleshooting

- Check that the ambient operating temperature is within the limits.
- Check for clogged filters.
- Check the fan operation.
- Check the control card.

WARNING 66, Heat sink temperature low

The frequency converter is too cold to operate. This warning is based on the temperature sensor in the IGBT module. Increase the ambient temperature of the unit. Also, a trickle amount of current can be supplied to the frequency converter whenever the motor is stopped by

setting *parameter 2-00 DC Hold/Preheat Current* to 5% and *parameter 1-80 Function at Stop*.

ALARM 67, Option module configuration has changed

One or more options have either been added or removed since the last power-down. Check that the configuration change is intentional and reset the unit.

ALARM 68, Safe Stop activated

Safe Torque Off (STO) has been activated. To resume normal operation, apply 24 V DC to terminal 37, then send a reset signal (via bus, digital I/O, or by pressing [Reset]).

ALARM 69, Power card temperature

The temperature sensor on the power card is either too hot or too cold.

Troubleshooting

- Check that the ambient operating temperature is within limits.
- Check for clogged filters.
- Check fan operation.
- Check the power card.

ALARM 70, Illegal FC configuration

The control card and power card are incompatible. To check compatibility, contact the Danfoss supplier with the type code from the unit nameplate and the part numbers of the cards.

ALARM 71, PTC 1 safe stop

STO has been activated from the VLT® PTC Thermistor Card MCB 112 (motor too warm). Normal operation can be resumed when the MCB 112 applies 24 V DC to terminal 37 again (when the motor temperature reaches an acceptable level), and when the digital input from the MCB 112 is deactivated. When that happens, send a reset signal (via bus or digital I/O, or press [Reset]).

ALARM 72, Dangerous failure

STO with trip lock. An unexpected combination of STO commands has occurred:

- VLT® PTC Thermistor Card MCB 112 enables X44/10, but STO is not enabled.
- MCB 112 is the only device using STO (specified through selection [4] *PTC 1 alarm* or [5] *PTC 1 warning* in *parameter 5-19 Terminal 37 Safe Stop*), STO is activated, and X44/10 is not activated.

WARNING 73, Safe Stop auto restart

STO activated. With automatic restart enabled, the motor can start when the fault is cleared.

ALARM 74, PTC Thermistor

Alarm related to VLT® PTC Thermistor Card MCB 112. The PTC is not working.

ALARM 75, Illegal profile sel.

Do not write the parameter value while the motor is running. Stop the motor before writing the MCO profile to *parameter 8-10 Control Word Profile*.

WARNING 76, Power unit setup

The required number of power units do not match the detected number of active power units.

This warning occurs when replacing a module for an F-size enclosure if the power-specific data in the module power card does not match the rest of the frequency converter.

Troubleshooting

- Confirm that the spare part and its power card are the correct part number.

WARNING 77, Reduced power mode

The frequency converter is operating in reduced power mode (less than the allowed number of inverter sections). This warning is generated on power cycle when the frequency converter is set to run with fewer inverters and remains on.

ALARM 78, Tracking error

The difference between setpoint value and actual value exceeds the value in *parameter 4-35 Tracking Error*.

Troubleshooting

- Disable the function or select an alarm/warning in *parameter 4-34 Tracking Error Function*.
- Investigate the mechanics around the load and motor. Check feedback connections from motor encoder to frequency converter.
- Select motor feedback function in *parameter 4-30 Motor Feedback Loss Function*.
- Adjust the tracking error band in *parameter 4-35 Tracking Error* and *parameter 4-37 Tracking Error Ramping*.

ALARM 79, Illegal power section configuration

The scaling card has an incorrect part number or is not installed. The MK102 connector on the power card could not be installed.

ALARM 80, Drive initialized

Parameter settings are initialized to default settings after a manual reset. To clear the alarm, reset the unit.

ALARM 81, CSIV corrupt

CSIV file has syntax errors.

ALARM 82, CSIV parameter error

CSIV failed to initialize a parameter.

ALARM 83, Illegal option combination

The mounted options are incompatible.

ALARM 84, No safety option

The safety option was removed without applying a general reset. Reconnect the safety option.

ALARM 88, Option detection

A change in the option layout is detected.

Parameter 14-89 Option Detection is set to [0] *Frozen configuration* and the option layout has been changed.

- To apply the change, enable option layout changes in *parameter 14-89 Option Detection*.
- Alternatively, restore the correct option configuration.

WARNING 89, Mechanical brake sliding

The hoist brake monitor detects a motor speed exceeding 10 RPM.

ALARM 90, Feedback monitor

Check the connection to encoder/resolver option and, if necessary, replace VLT® Encoder Input MCB 102 or VLT® Resolver Input MCB 103.

ALARM 91, Analog input 54 wrong settings

Set switch S202 in position OFF (voltage input) when a KTY sensor is connected to analog input terminal 54.

ALARM 99, Locked rotor

The rotor is blocked.

WARNING/ALARM 101, Speed monitor

The motor speed monitor value is out of range. See *parameter 4-43 Motor Speed Monitor Function*.

WARNING/ALARM 104, Mixing fan fault

The fan is not operating. The fan monitor checks that the fan is spinning at power-up or whenever the mixing fan is turned on. The mixing-fan fault can be configured as a warning or an alarm trip in *parameter 14-53 Fan Monitor*.

Troubleshooting

- Cycle power to the frequency converter to determine if the warning/alarm returns.

WARNING/ALARM 122, Mot. rotat. unexp.

The frequency converter performs a function that requires the motor to be at standstill, for example DC hold for PM motors.

WARNING 123, Motor Mod. Changed

The motor selected in *parameter 1-11 Motor Model* is not correct. Check the motor model.

WARNING/ALARM 157, Power Limit Mot.

The output power exceeds the value defined in *parameter 4-82 Power Limit Motor Mode*.

WARNING/ALARM 158, Power Limit Gen.

The generating power exceeds the value defined in *parameter 4-83 Power Limit Generator Mode*.

WARNING 163, ATEX ETR cur.lim.warning

The frequency converter has run above the characteristic curve for more than 50 s. The warning is activated at 83% and deactivated at 65% of the allowed thermal overload.

ALARM 164, ATEX ETR cur.lim.alarm

Operating above the characteristic curve for more than 60 s within a period of 600 s activates the alarm, and the frequency converter trips.

WARNING 165, ATEX ETR freq.lim.warning

The frequency converter is running for more than 50 s below the allowed minimum frequency (*parameter 1-98 ATEX ETR interpol. points freq.*).

ALARM 166, ATEX ETR freq.lim.alarm

The frequency converter has operated for more than 60 s (in a period of 600 s) below the allowed minimum frequency (*parameter 1-98 ATEX ETR interpol. points freq.*).

WARNING/ALARM 210, Position tracking

The actual position error exceeds the value in *parameter 4-71 Maximum Position Error*. *Parameter 4-70 Position Error Function* defines whether this is a warning or an alarm.

WARNING/ALARM 211, Position limit

The position is outside the limits defined in *parameter 3-06 Minimum Position* and *parameter 3-07 Maximum Position*. *Parameter 4-73 Position Limit Function* defines the function for this warning/alarm.

WARNING/ALARM 212, Homing not done

A homing function is selected in *parameter 17-80 Homing Function* and absolute positioning is executed before homing is completed.

ALARM 213, Homing timeout

Homing was started but did not finish within the time defined in *parameter 17-85 Homing Timeout*.

ALARM 214, No sensor input

A homing process with a homing function that requires a sensor, or touch probe positioning is started with no input defined for the sensor.

WARNING/ALARM 215, Start Fwd/Rev

One of the hardware end-limit options, [12] *Enable Start Forward* or [13] *Enable Start Reverse* is active.

WARNING/ALARM 216, Touch Timeout

A touch probe sensor is not found within the time in *parameter 4-75 Touch Timeout*. The timeout timer is started as soon as the touch probe positioning is activated even if the application is not moving.

WARNING 220, Configuration file version not supported

The frequency converter does not support the current configuration file version. Customization is aborted.

ALARM 246, Power card supply

This alarm is only for enclosure size F frequency converters. It is equivalent to *alarm 46, Power card supply*.

The report value in the alarm log indicates which power module generated the alarm:

- 1 = Inverter module to the far left.
- 2 = Middle inverter module in F2 or F4 frequency converter.
- 2 = Right inverter module in F1 or F3 frequency converter.
- 3 = Right inverter module in F2 or F4 frequency converter.
- 5 = Rectifier module.

WARNING 249, Rect. low temperature

The temperature of the rectifier heat sink is lower than expected.

Troubleshooting

- Check the temperature sensor.

WARNING 250, New spare part

The power or switch mode supply has been exchanged. Restore the frequency converter type code in the EEPROM. Select the correct type code in *parameter 14-23 Typecode Setting* according to the label on the frequency converter. Remember to select Save to EEPROM at the end.

WARNING 251, New typecode

The power card or other components are replaced, and the type code has changed.

WARNING 253, Digital output X49/9 overload

Digital output X49/9 is overloaded.

WARNING 254, Digital output X49/11 overload

Digital output X49/11 is overloaded.

WARNING 255, Digital output X49/7 overload

Digital output X49/7 is overloaded.

ALARM 430, PWM Disabled

The PWM on the power card is disabled.

7 Appendix

7.1 Symbols, Abbreviations, and Conventions

°C	Degrees Celsius
°F	Degrees Fahrenheit
AC	Alternating current
AEO	Automatic energy optimization
ASM	Asynchronous motor or standard induction motor
AWG	American wire gauge
AMA	Automatic motor adaptation
DC	Direct current
EMC	Electro-magnetic compatibility
ETR	Electronic thermal relay
$f_{M,N}$	Nominal motor frequency
FC	Frequency converter
I_{INV}	Rated inverter output current
I_{LIM}	Current limit
$I_{M,N}$	Nominal motor current
$I_{VLT,MAX}$	Maximum output current
$I_{VLT,N}$	Rated output current supplied by the frequency converter
IP	Ingress protection
IPM	PM motor with interior-mounted magnets
LCP	Local control panel
MCT	Motion control tool
n_s	Synchronous motor speed
$P_{M,N}$	Nominal motor power
PELV	Protective extra low voltage
PCB	Printed circuit board
PM Motor	Permanent magnet motor
PWM	Pulse width modulation
RPM	Revolutions per minute
Regen	Regenerative terminals
SPM	PM motor with surface-mounted magnets
SynRM	Synchronous reluctance motor
T_{LIM}	Torque limit
$U_{M,N}$	Nominal motor voltage

Table 7.1 Symbols and Abbreviations

Conventions

Numbered lists indicate procedures. Bullet lists indicate other information.

Italicized text indicates:

- Cross-reference.
- Link.
- Parameter name.
- Parameter group name.
- Parameter option.
- Footnote.

All dimensions in drawings are in [mm] (in).

Index

A		Cooling.....	59
Abbreviation.....	312	D	
Adjustable warning.....	89	Data log settings.....	188
Alarm.....	297	Data readout.....	196, 212
Alarm log.....	192	Default settings.....	242
Analog I/O mode.....	120	DeviceNet CAN fieldbus.....	151
Analog input.....	120, 229	Diagnosis.....	202
Analog output.....	123, 125, 127	Digital input.....	95
ASM.....	39	Discharge time.....	8
Auto derate.....	184	Display mode.....	16
Automatic motor adaptation (AMA)		E	
Warning.....	308	Encoder.....	86, 117
B		Ethernet.....	151
Brake		ETR.....	197
energy functions.....	65	F	
power.....	5	Fans	
DC brake.....	64	Warning.....	310
Mechanical brake.....	67	FC MC protocol.....	147
Brake resistor		Fieldbus jog.....	151
Brake resistor.....	302	Flux.....	38, 40, 41, 50
Warning.....	305	Freeze output.....	4, 95
Break-away torque.....	5	Frequency converter identification.....	193
C		Frequency converter status.....	198
Capacitor.....	105	Fuse.....	306
Clockwise.....	54	G	
Coast.....	4	General settings.....	37, 141
Coasting.....	15, 95	General status.....	196
Comparator.....	155	Graphical display.....	13
Compatibility.....	186, 225	Ground	
Configuration.....	141	Warning.....	307
Control		H	
Advanced process PID control.....	138	Heat sink	
principle.....	37, 38	Warning.....	307, 308
Current limit control.....	182	High voltage.....	7
Process control feedback.....	136	I	
Process PID control.....	137	I/O option.....	118
Smart logic control.....	152	Identification, frequency converter.....	193
Speed PID control.....	130	Indexed parameter.....	22
Torque PI control.....	136	Indicator light.....	14
U/f control principle.....	38		
Control cables.....	10		
Control card			
Warning.....	308		
Convention.....	312		

Initialization..... 24

Input
 option..... 271, 295

Inputs
 Analog input..... 5, 121, 123
 Digital I/O mode..... 95

Inverter switching..... 176

J

Jog..... 4

L

Language package..... 25

LCP..... 4, 6, 13, 16, 22

LCP copy/save..... 34

LCP custom readout..... 31

LCP display..... 29

LCP key..... 23

LED..... 13

Load dependent settings..... 52

Load sharing..... 7, 8

Local reference..... 26

Log..... 192

Logic rule..... 163

M

Main menu..... 15, 18, 20

Main reactance..... 45

Mains
 on/off..... 177
 supply..... 7

Maintenance log..... 212

MCB 113..... 102, 127

MCB 114..... 227

Monitoring..... 205

Motor
 Advanced motor data..... 45
 data..... 39, 43
 feedback monitoring..... 86
 limit..... 84
 protection..... 57
 speed, rated..... 4
 speed, synchronous..... 4
 status..... 197
 temperature..... 57
 Overheating..... 303
 PM motor..... 40
 Warning..... 303, 305

N

Numerical local control panel..... 22

O

Operating data..... 188

Operating mode..... 26

Output speed..... 54

Overcurrent trip..... 106

Overload
 Inverter overload, no trip..... 184

P

Parameter information..... 195

Parameter set-up..... 18

Password..... 35

Phase loss..... 302

Port diagnostics..... 151

Port setting..... 146

Potentiometer
 Digital potentiometer..... 82
 reference..... 12
 Voltage reference via a potentiometer..... 12

Power card
 Warning..... 309

PROFIBUS..... 151

Protection mode..... 8

Pulse input..... 114

Pulse output..... 115

Pulse start/stop..... 11

Q

Quick menu..... 14, 18

R

Ramp..... 77, 78, 79, 81

RCD..... 6

Reference..... 71, 199

Reference limit..... 71

Relay..... 109

Relay output..... 103

Reset..... 15, 309

Resolver interface..... 205

Rotor
 Warning..... 310

Rs flip flops..... 158

S	
Safe Torque Off	
Warning.....	309
Safety precautions.....	7
Sensor input option.....	227
Serial communication.....	5
Shielded/armored.....	10
Short circuit.....	304
SLC.....	152
Smart application set-up.....	20
Smart logic control.....	152
Special features.....	223
Special settings.....	39
Speed bypass.....	90
Speed up/Speed down.....	12
Start adjustments.....	53
Start delay.....	54
Start function.....	54
Start/stop.....	11
Stator leakage reactance.....	45
Status message.....	13
Stop adjustments.....	55
Supply voltage.....	306
Symbol.....	312
SynRM.....	42
T	
Terminals	
Terminal 42.....	123
Terminal 53.....	120
Terminal 54.....	121
Terminal X30/11.....	122
Terminal X30/12.....	123
Terminal X30/8.....	125
Terminal X45/1.....	128
Terminal X45/3.....	129
Terminal X48/10.....	228
Terminal X48/2.....	229
Terminal X48/4.....	227
Thermal load.....	49, 197
Thermistor	
Thermistor.....	6, 57
Warning.....	309
Timed actions.....	215
Timer.....	162
Torque	
Limit.....	303
Torque.....	44
Trip reset.....	180
U	
U/f characteristic.....	51
Unintended start.....	8
V	
Voltage imbalance.....	302
VVC+.....	6
W	
Warning.....	297
Wobble function.....	223



Danfoss Drives

4401 N. Bell School Rd.
Loves Park IL 61111 USA
Phone: 1-888-DANFOSS
Fax: 1-815-639-8000
www.danfossdrives.com

Danfoss Drives

8800 W. Bradley Rd.
Milwaukee, WI 53224 USA
Phone: 1-888-DANFOSS
Fax: 1-414-355-6117
www.danfossdrives.com

.....
Danfoss shall not be responsible for any errors in catalogs, brochures or other printed material. Danfoss reserves the right to alter its products at any time without notice, provided that alterations to products already on order shall not require material changes in specifications previously agreed upon by Danfoss and the Purchaser. All trademarks in this material are property of the respective companies. Danfoss and the Danfoss logotype are trademarks of Danfoss A/S. All rights reserved.
.....

Danfoss A/S
Ulsnaes 1
DK-6300 Graasten
vlt-drives.danfoss.com

