



Operating Instructions

VLT® ISD Connection Box

Contents

1 General Information	5
1.1 Important Safety Warnings	5
1.2 Copyright	5
1.3 Product Names and Trademarks	5
1.4 Disclaimer	5
1.5 Approvals	5
1.6 Service and Support	6
2 Introduction	7
2.1 System Overview	7
2.2 Terminology	8
2.3 Purpose of the Operating Instructions	8
2.4 Additional Resources	8
3 Safety instructions	9
3.1 Symbols used in this Manual	9
3.2 General	9
3.3 Safety Instructions and Precautions for the ISD 410 Servo System	9
3.4 Qualified Personnel	11
3.5 Due Diligence	11
3.6 Intended Use	12
3.7 Foreseeable Misuse	12
4 Description	13
4.1 Controller	14
4.2 Display	14
4.3 Connection Cable/Cabling	15
4.3.1 ISD Servo System with 1 ISD Connection Box	15
4.3.2 ISD Servo System with 2 ISD Connection Boxes	17
4.4 Connections	20
4.4.1 Connections on the Front of the Connection Box	20
4.4.1.1 Safety Switch Connectors (Safety I & Safety II)	20
4.4.1.2 Fuse Holders	20
4.4.1.3 CAN Connectors (X11-X15/X22-X25)	21
4.4.2 Connections on the Underside of the Connection Box	21
4.4.2.1 DC Input Terminal (X1)	22
4.4.2.2 Brake Connector (X5)	22
4.4.2.3 24 V DC Power Supply (X4)	23
4.4.2.4 DC Output Terminals (X2 & X3)	23
4.5 Cooling	23

5 Installation/Fitting	24
5.1 Transport and Delivery	24
5.1.1 Scope of Delivery	24
5.1.2 Transport	24
5.1.3 Inspection on Receipt	24
5.2 Safety Measures during Installation	24
5.3 Installation Environment	24
5.4 Preparation for Installation	25
5.5 Mechanical Installation	26
5.5.1 Mounting	26
5.5.2 Dismounting	26
5.6 Electrical Installation	26
5.6.1 Earthing (Grounding) the Connection Box	26
5.6.2 Electrical Environmental Conditions	26
5.6.3 24 V Power Supply Requirements	26
5.6.4 Connecting the CAN Cable	27
5.6.4.1 Overview of CAN Plugs	28
5.6.4.2 CAN Wiring Example 1	29
5.6.4.3 CAN Wiring Example 2	30
5.6.5 Connecting the Power Supply Cable	31
5.6.6 Connecting the Safety Cable	31
5.6.7 Connecting the Brake Cable	31
5.6.8 Connecting/Disconnecting Hybrid Cables (Feed Cable)	31
6 Commissioning	33
6.1 Connecting the Components	33
6.2 CAN-ID Setting	33
6.3 Functional Operation Test	33
6.4 Switching the Connection Box on	34
7 Operation	35
7.1 Operating Display	35
7.1.1 Operating LEDs	35
7.1.2 Display Mode	36
7.1.3 7-Segment Display	36
7.1.4 <SET> Push Button	37
7.1.5 <CAN-ID> BCD Switch	37
7.1.6 Service Interface	37
7.2 Display via Toolbox and CoDeSys	37
7.3 Machine States	37

7.3.1 State "Init" (Initialisation)	38
7.3.2 State "Voltage Disabled"	38
7.3.3 State "Fault Discharged"	38
7.3.4 State "Power Up"	38
7.3.5 State "Power Down"	39
7.3.6 State "Fault Charged"	39
7.3.7 State "Operation Enabled"	39
7.3.8 State "Over Voltage"	39
7.3.9 State "Under Voltage"	39
8 Faults	40
8.1 Emergency	40
8.2 Error History	40
8.3 Debugging	40
8.4 Troubleshooting	41
9 Maintenance and Repair	43
9.1 Maintenance tasks	43
9.2 Inspection during Operation	43
9.3 Repair	43
9.3.1 Replacing the Fuses	43
10 Decommissioning and Disposal	44
10.1 Decommissioning	44
10.2 Dismounting	44
10.3 Recycling and Disposal	44
10.3.1 Recycling	44
10.3.2 Disposal	44
11 Specifications	45
11.1 Nameplate	45
11.2 Storage	45
11.3 Characteristic Data	45
11.4 Dimensions	46
11.4.1 Front View	46
11.4.2 Side View	47
12 Appendix	48
12.1 Glossary	48
12.2 Connection Box Parameters	50
12.2.1 Auto Power-Up (Index 0x2015, sub-index 01)	50
12.2.2 Discharge Resistor Check (Index 0x2015, sub-index 02)	50

12.3 Emergency Codes	51
Index	52

1 General Information

1.1 Important Safety Warnings

⚠ WARNING

HIGH VOLTAGE

The ISD 410 servo system contains components which operate at a high voltage when connected to the electrical supply network. A hazardous voltage is present on the servomotors, the power supply module and the connection box whenever they are connected to the mains network. There are no indicators on the servomotor that indicate the presence of mains voltage. This indication is provided on the connection box. Installation, commissioning and maintenance may only be performed by qualified personnel. Incorrect installation, commissioning or maintenance can lead to death or serious injury.

⚠ WARNING

UNINTENDED START

The ISD 410 servo system contains servomotors which are connected to the electrical supply network and can start running at any time. This may be caused by an external switch, a CAN bus command, a reference signal, or clearing a fault condition. Servomotors and all connected devices must be in good operating condition. A deficient operating condition may lead to death, serious injury, damage to equipment or other material damage when the unit is connected to the electrical supply network. Take suitable measures to prevent unintended starts.

⚠ WARNING

DISCHARGE TIME

The servomotors, the connection box and the power supply module contain DC link capacitors, that remain charged for some time after the mains supply is switched off at the power supply module.

To avoid electrical shock, fully disconnect the power supply module from the mains before carrying out any maintenance on the ISD servo system or its components. Wait for at least the time listed below before carrying out maintenance work:

Number	Minimum waiting time (discharge time)
0-60 servomotors	10 minutes
Note: High voltage may still be present even if the LED on the ISD connection box is not lit!	

Table 1.1 Discharge Time

1.2 Copyright

Disclosure, duplication and sale of this document, as well as communication of its content, are prohibited unless explicitly permitted. Infringement of this prohibition incurs liability for damages. All rights reserved with regard to patents, utility patents and registered designs. ISD is a registered trademark.

1.3 Product Names and Trademarks

VLT® and ISD® are registered trademarks of Danfoss. All other product names and trademarks used in this documentation are trademarks or registered trademarks of their respective titleholders.

1.4 Disclaimer

No liability is assumed for any damage or breakdown resulting from:

- Failure to observe the information in the instruction manuals
- Unauthorised modifications to the ISD servo system or its components
- Operator error
- Improper work on or with the ISD servo system or its components.

1.5 Approvals

1.5.1 ISD 410 Servomotor, ISD Encoder Box and ISD Connection Box

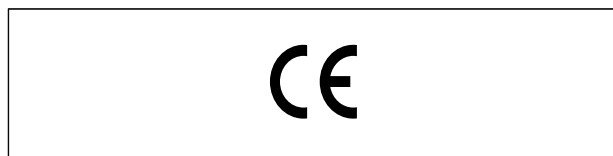

Table 1.2 Approvals for the ISD 410 Servomotor, ISD Encoder Box and ISD Connection Box

1.5.2 ISD Power Supply Module



Table 1.3 Approvals for the ISD Power Supply Module

1.6 Service and Support

Contact your local service representative for service and support:

www.danfoss.com/Contact/Worldwide/

2 Introduction

2.1 System Overview

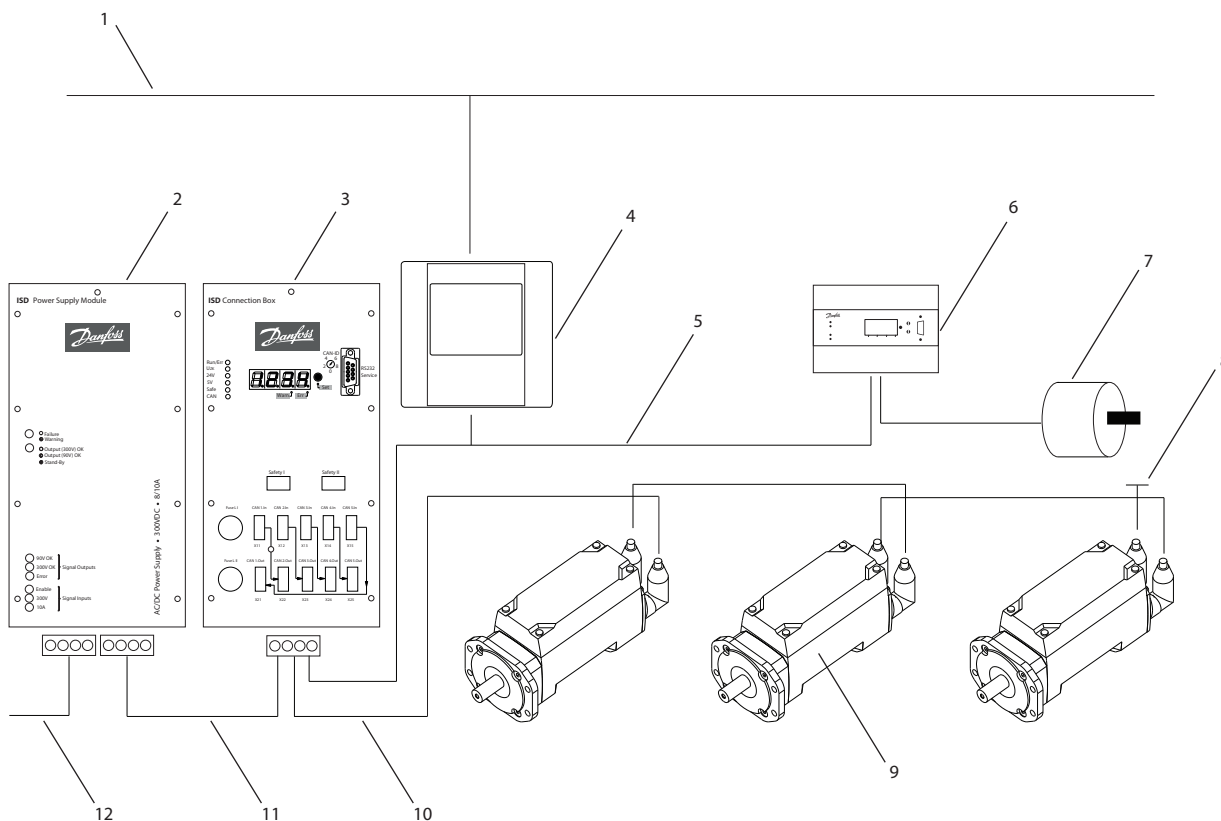

1330BC480.12

Illustration 2.1 ISD Servo System with 3 Servomotors

Number	Description	Number	Description
1	Ethernet	7	Master encoder
2	Power supply module	8	Terminating resistor
3	Connection box	9	ISD servomotor
4	Master	10	Hybrid cable (DC & CAN)
5	CAN line	11	DC line
6	Encoder box	12	AC line

Table 2.1 Legend to Illustration 2.1

The servomotors are self-contained distributed drives, which means that the drive electronics is housed together with the motor in the same casing. The motion control software also runs independently in the servomotor, which reduces the load on the higher-level control system.

A master system controls the servomotors. In this system servomotors operated in a DC group are controlled by a master system.

Several motors can be operated in a group using a hybrid cable. This cable carries the DC supply voltage and the CAN bus signals.

The ISD 410 servo system complies with and is CE marked according to EN 61800-3, class C2 (industrial application).

The ISD 410 servo system is designed to accommodate up to 60 ISD 410 servomotors and consists of:

- 1 Power supply module
- 1 Connection box
- 1 Encoder Box
- Servomotors
- 1 Master
- Hybrid cables

NOTE

**The ISD 410 servomotors cannot be used in other servo systems from other manufacturers!
Motors from other manufacturers cannot be used in the Danfoss ISD 410 servo system!**

2.2 Terminology

ISD	Integrated Servo Drives
ISD servo system	Complete system including all components.
ISD master	Control system hardware
ISD master system	Control system hardware and software
ISD servo drive	ISD servomotor with hybrid cable

Table 2.2 Terminology

2.3 Purpose of the Operating Instructions

The purpose of these operating instructions is to describe the Danfoss ISD connection box exclusively in the context of a Danfoss ISD 410 servo system.

These operating instructions contain information about:

- Installation
- Commissioning
- Operation
- Troubleshooting
- Maintenance and repair

These operating instructions are intended for use by qualified personnel. Read these operating instructions in full in order to use the servo system safely and professionally, and pay particular attention to the safety instructions and general warnings. These operating instructions are an integral part of the ISD connection box. Keep these operating instructions available with the servo system at all times.

Compliance with the information in the operating instructions is a prerequisite for:

- Trouble-free operation
- Recognition of product liability claims

Therefore, read these operating instructions before working with the connection box!

The operating instructions also contain important service information. The operating instructions should therefore be kept close to the connection box.

2.4 Additional Resources

Available documents for the ISD 410 servo system:

Document	Contents
VLT® ISD 410 Servomotor Operating Instructions	Information about the commissioning and operation of the servomotors
VLT® ISD Encoder Box Operating Instructions	Information about the commissioning and operation of the encoder box
VLT® ISD Connection Box Operating Instructions	Information about the commissioning and operation of the connection box
VLT® ISD Power Supply Module Operating Instructions	Information about the commissioning and operation of the power supply module
VLT® ISD 410 Design Guide	Information about the construction and commissioning of the ISD 410 servo system

Table 2.3 Available Documents for the ISD 410 Servo System

Technical literature for Danfoss drives is also available online at <http://www.danfoss.com/BusinessAreas/DrivesSolutions/Documentations/Technical+Documentation.htm>.

Firmware updates may be available. When firmware updates are available, they can be downloaded from the www.danfoss.com website. For further information see the *VLT® ISD 410 Design Guide*.

3 Safety instructions

3.1 Symbols used in this Manual

The following symbols are used in this document.

⚠ WARNING

Indicates a potentially hazardous situation which, if not avoided, could result in death or serious injury.

⚠ CAUTION

Indicates a potentially hazardous situation which, if not avoided, may result in minor or moderate injury. It may also be used to alert against unsafe practices.

CAUTION

Indicates a situation that may result in equipment or property-damage-only accidents.

NOTE

Indicates highlighted information that should be regarded with attention to avoid mistakes or operate equipment at less than optimal performance.

3.2 General

The following safety instructions and precautions relate to the ISD 410 servo system. The number of servomotors in the servo system is not significant.

Read the safety instructions carefully before starting to work in any way with the servo system or its components. Pay particular attention to the safety instructions in the relevant sections of these operating instructions. Also observe the safety instructions and precautions in the operating instructions for the other system components.

⚠ WARNING

HIGH VOLTAGE

The ISD 410 servo system contains components which operate at a high voltage when connected to the electrical supply network.

A hazardous voltage is present on the servomotors, the power supply module and the connection box whenever they are connected to the mains network.

There are no indicators on the servomotor that indicate the presence of mains voltage. This indication is provided on the connection box. Installation, commissioning and maintenance may only be performed by qualified personnel.

Incorrect installation, commissioning or maintenance can lead to death or serious injury.

⚠ WARNING

HAZARDOUS SITUATION

If the servomotor or the bus lines is/are incorrectly connected, there is a risk of death, serious injury or damage to the unit.

Always comply with the instructions within these operating instructions, as well as national and local safety regulations. Also read the operating instructions for the other servo system components.

3.3 Safety Instructions and Precautions for the ISD 410 Servo System

Read the safety instructions carefully before starting to work in any way with the servo system or its components. Compliance with the safety instructions and precautions is necessary at all times.

- Orderly and proper transport, storage, fitting and installation, as well as careful operation and maintenance, are essential for the trouble-free and safe operation of this servo system and its components.
- Only suitably trained and qualified personnel may work on the servo system and its components or in its vicinity. See 3.4 *Qualified Personnel*.
- Use only accessories and spare parts approved by the manufacturer.
- Comply with the specified ambient conditions.
- The information in these operating instructions about the use of available components is

provided solely by way of examples of applications and suggestions.

- The plant engineer or system engineer is personally responsible for checking the suitability of the supplied components and the information provided in this document for the specific application concerned:
 - for compliance with the safety regulations and standards relevant to the specific application.
 - for implementing the necessary measures, changes and extensions.
- Commissioning the servo system or its components is not allowed until it has been ascertained that the machine, system or plant in which they are installed conforms to the statutory provisions, safety regulations and standards that apply in the country of use to that application.
- Operation is allowed only in compliance with the national EMC regulations for the application concerned.
- See the *VLT® ISD 410 Design Guide* for information regarding EMC-compliant installation of the servo system.
- Compliance with the limit values specified by national regulations is the responsibility of the producer of the plant, system or machine.
- Compliance with the specifications, connection conditions and installation conditions in this instruction manual is mandatory.
- The safety regulations and safety provisions of the country in which the equipment is used must be observed.
- Care must be taken to ensure that orderly protective earthing (grounding) of the equipment, which protects the user against the supply voltage and protects the power supply module against overload, is performed in accordance with local and national regulations.
- Overload protection for the servomotor can be programmed using the master system. For more information, see *Programming* in the *VLT® ISD 410 Design Guide*.
- Do not remove or replace the SD card on the encoder box during operation, otherwise the contents of the SD card could be destroyed. Switch the encoder box off and wait 10 seconds before removing the SD card.

⚠ WARNING

EARTHING HAZARD

For reasons of operator safety, the components of the servo system must be earthed correctly in accordance with national or local electrical regulations and the information in these operating instructions. The earth leakage current is greater than 3.5 mA. Improper earthing of the servomotor may result in death or serious injury.

Operational Safety

- Safety-related applications are allowed only if they are explicitly and unambiguously mentioned in the *VLT® ISD 410 Design Guide*. Otherwise they are not allowed.
- All applications that can cause hazards to people or damage to property are safety-related applications.
- The stop functions implemented in the software of the master system do not interrupt the mains voltage supply to the power supply module. Therefore they are not allowed to be used as safety switches for the servo system.
- The motor can be brought to a stop by a software command or a zero speed setpoint, but DC voltage remains present on the servomotor and/or mains voltage in the power supply module. If personal safety considerations (e.g. risk of personal injury caused by contact with moving machine parts after an unintended start) make it necessary to ensure that an unintended start cannot occur, these stop functions are not sufficient. In this case the servo system must be detached from the mains network or a suitable stop function must be implemented.
- When the servomotor is stopped, it may start up again on its own if the circuitry of the servomotor is defective or after the elimination of a temporary overload, a problem with the supply voltage or a problem with the servomotor. If personal safety considerations (e.g. risk of personal injury caused by contact with moving machine parts after an unintentional start) make it necessary to ensure that an unintended start cannot occur, the normal stop functions of the servomotor are not sufficient. In this case the servo system must be disconnected from the mains network or a suitable stop function must be implemented.
- The servomotor may start running unintentionally during parameter configuration or programming. If this can pose a risk to personal safety (e.g. risk of personal injury due to contact with moving machine parts), unintended motor starting must

be prevented, for example by using the Safe Stop function or by safe disconnection of the servomotors.

- Do not disconnect the cables from the servomotor while the servo system is connected to mains voltage. Ensure that the mains supply is disconnected and the required waiting time has elapsed before disconnecting or connecting the hybrid cable or disconnecting cables from the connection box and/or the power supply module.
- In addition to the L1, L2 and L3 supply voltage inputs on the power supply module, the servo system has other supply voltage inputs, including external 24 V DC. Before commencing repair work, check that all supply voltage inputs have been switched off and that the necessary discharge time for the intermediate circuit capacitors has elapsed.
- The supply of power to the servo system must be switched off for repair work. Before disconnecting or connecting the hybrid cable or disconnecting cables from the connection box and/or the power supply module, ensure that the mains supply is disconnected and the necessary discharge time has elapsed.

⚠ WARNING

DISCHARGE TIME

The servomotors, the connection box and the power supply module contain DC link capacitors, that remain charged for some time after the mains supply is switched off at the power supply module.

To avoid electrical shock, fully disconnect the power supply module from the mains before carrying out any maintenance on the ISD servo system or its components. Wait for at least the time listed below before carrying out maintenance work:

Number	Minimum waiting time (discharge time)
0-60 servomotors	10 minutes
Note: High voltage may still be present even if the LED on the ISD connection box is not lit!	

Table 3.1 Discharge Time

CAUTION

Never connect or disconnect the hybrid cable to or from the servomotor when voltage is present. Doing so will damage the electronic circuitry. Observe the discharge time for the DC link capacitors.

3.4 Qualified Personnel

Installation, commissioning and maintenance of the ISD 410 servo system may only be carried out by qualified personnel.

For the purposes of this document and the safety instructions in this document, qualified personnel are trained personnel who are authorised to fit, install, commission, earth and label equipment, systems and circuits in accordance with the standards for safety technology and who are familiar with the safety concepts of automation engineering.

Additionally, the personnel must be familiar with all the instructions and safety measures described in these operating instructions.

They must have suitable safety equipment and be trained in first aid.

3.5 Due Diligence

The operator and/or fabricator must ensure that:

- the servo system and its components are used only as intended.
- the components are operated only in a perfect operational condition.
- the operating instructions are always available near the servo system in complete and readable form.
- the servo system and its components are fitted, installed, commissioned and maintained only by adequately qualified and authorised personnel.
- these personnel are regularly instructed on all relevant matters of occupational safety and environmental protection, as well as the contents of the operating instructions and in particular the instructions it contains.
- the product markings and identification markings applied to the components, as well as safety and warning instructions, are not removed and are always kept in a legible condition.
- the national and international regulations regarding the control of machinery and equipment, that are applicable at the place of use of the servo system, are complied with.
- the users always have all current information relevant to their interests about the servo system and its use and operation.

3.6 Intended Use

The components of the ISD servo system are intended to be installed in machines used in commercial and industrial environments.

To ensure that the product is used as intended, the following conditions must be fulfilled before use:

- everyone who uses Danfoss products in any manner must read and understand the corresponding safety regulations and the description of the intended use.
- hardware must be left in its original state, which means that no structural changes may be made to the hardware.
- software products may not be reverse-engineered and their source code may not be altered.
- damaged or faulty products may not be installed or put into service.
- it must be ensured that the products are installed in conformance with the regulations mentioned in the documentation.
- any specified maintenance and service intervals must be observed.
- all protective measures must be complied with
- only the components described in these operating instructions may be fitted or installed. Third-party devices and equipment may be used only in consultation with Danfoss
- the documentation must be read completely and correctly followed

The servo system **may not** be used in the following application areas:

- areas with potentially explosive atmospheres
- mobile or portable systems
- floating or airborne systems
- inhabited facilities
- sites where radioactive materials are present
- areas with extreme temperature variations or in which the maximum rated temperatures may be exceeded
- under water

3.7 Foreseeable Misuse

Any use not expressly approved by Danfoss constitutes misuse. This also applies to failure to comply with the specified operating conditions and applications.

Danfoss assumes no liability of any sort for damage attributable to improper use.

4 Description

The ISD connection box is the central interface/gateway for the ISD servo system. It provides the link between the power supply module and the servomotor and therefore ensures the 300 V DC power supply to the servomotors via a hybrid cable. Furthermore, the ISD connection box is the central unit, which provides the CAN communication throughout the ISD 410 servo system devices and external CAN slaves, if necessary. The LEDs on the front of the unit display the operating status and warnings.

CAUTION

The connection box has an IP-rating of IP20. It is only designed for use within a control cabinet. The unit may be damaged if exposed to fluids.

All power and signal cables are wired into the connection box and 2 independent groups of servomotors can be connected. It also enables the STO safety function to be realised via an external safety relay.

Furthermore, the connection box guarantees the DC power supply to all the servomotors and their connection to the fieldbus (CAN).

Service functions, such as voltage measuring and CAN diagnostics are also performed by the connection box.

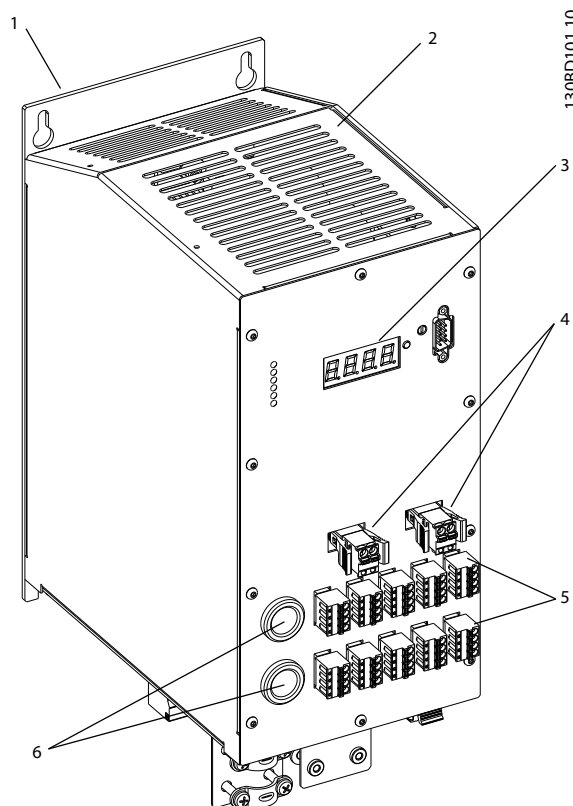

Illustration 4.1 ISD Connection Box

1	Backplate for mounting
2	Vents
3	Display
4	Safety Connectors
5	CAN Connectors
6	Fuses

Table 4.1 Legend to Illustration 4.1

4.1 Controller

The connection box controller performs the following functions:

- monitors voltage levels, currents, temperatures and other variables.
- calculates power and derived values.
- provides all values through its CAN object dictionary.
- ensures the correct behaviour of the connection box in terms of charging and discharging capacities through a state machine.
- handles thermal budget, over-voltage, under-voltage and fault cases.

The connection box controller is equipped with 1 CAN interface for communication with the system master and implements the CANopen DS301 standard.

4.2 Display

The display shows the operating status of the connection box.

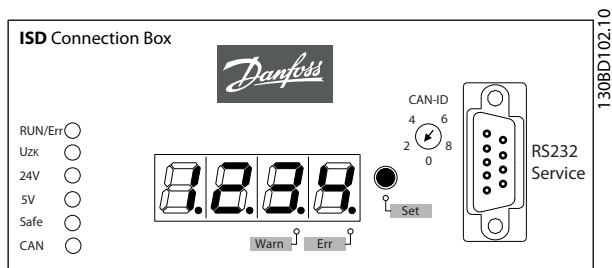

Illustration 4.2 Connection Box Display

See 7.1 *Operating Display* for detailed information on the display.

4.3 Connection Cable/Cabling

Depending on the application, it is possible to set up a servo system with either 1 or 2 connection boxes. These are detailed in the following 2 sections.

4.3.1 ISD Servo System with 1 ISD Connection Box

The ISD servo system is set up with 1 connection box if 1 connection box together with 1 power supply module can provide the power for the application.

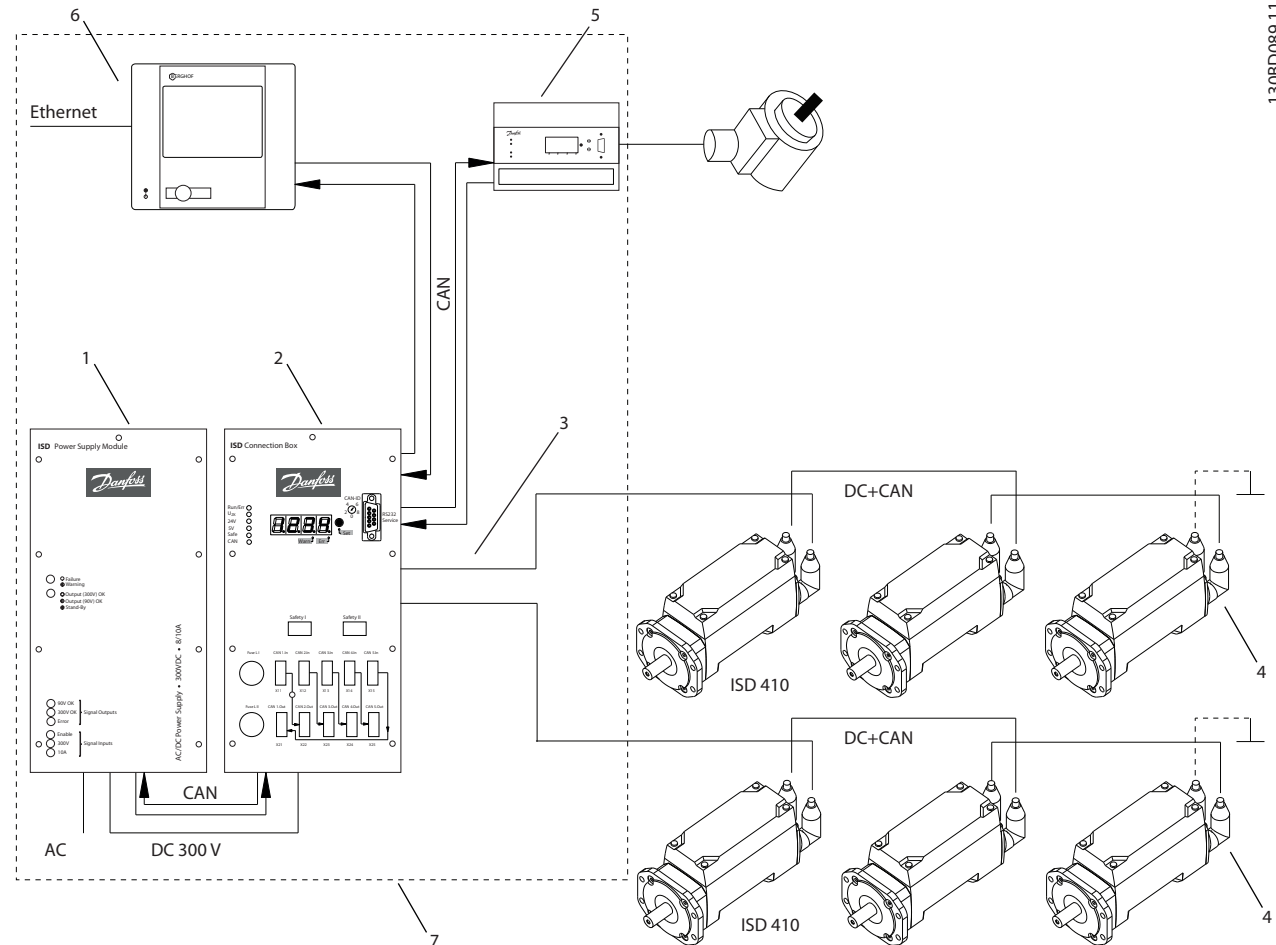

1308D089.11

Illustration 4.3 ISD Servo System with 1 ISD Connection Box

No.	Name	Line Type	Cross-section	Flexible Cable
1	ISD Power Supply Module	–	–	–
2	ISD Connection Box	–	–	–
3	Feed cable	Hybrid cable (DC & CAN)	1 mm ^{2 1)} / 2.5 mm ²	X (only with 2.5 mm ²)
4	Terminating resistor	Connector with terminating resistor	–	–
5	ISD Encoder Box	–	–	–
6	Master	–	–	–
7	Control cabinet	–	–	–
–	Ethernet	Ethernet cable	4 x 2 x 0,27 mm ² , shielded twisted pairs (CAT 5)	X
–	CAN line	CAN cable (screened)	4 x 0.25 mm ²	–
–	Encoder line	Encoder cable	4 x 0.25 mm ²	–
–	Loop cable	Hybrid cable (DC & CAN)	1 mm ^{2 1)} / 2.5 mm ²	X (only with 2.5 mm ²)
–	DC cable	Single wire	1.5 mm ² / 2.5 mm ^{2 2)}	–
–	AC feed	Single wire	1.5 mm ²	–

Table 4.2 Legend to Illustration 4.3

1) Only without STO

2) Depending on the application

4.3.2 ISD Servo System with 2 ISD Connection Boxes

The ISD servo system is set up with 2 connection boxes if the application requires more power than 1 connection box and 1 power supply module can deliver.

The encoder box has 2 different CAN lines (CAN I and CAN II). Both of them use the same CAN-ID.

If there is a machine with ISD 410 servomotors that are split up in 2 separate CAN lines and all of them have to listen to the same encoder value, then encoder box CAN I should be put on the first line and encoder box CAN II on the second line.

Hereby, the drives can operate synchronously with the same guide value. CAN line II can be enabled or disabled via the SD card parameter (*General.SecondCANLineEnable*).

4

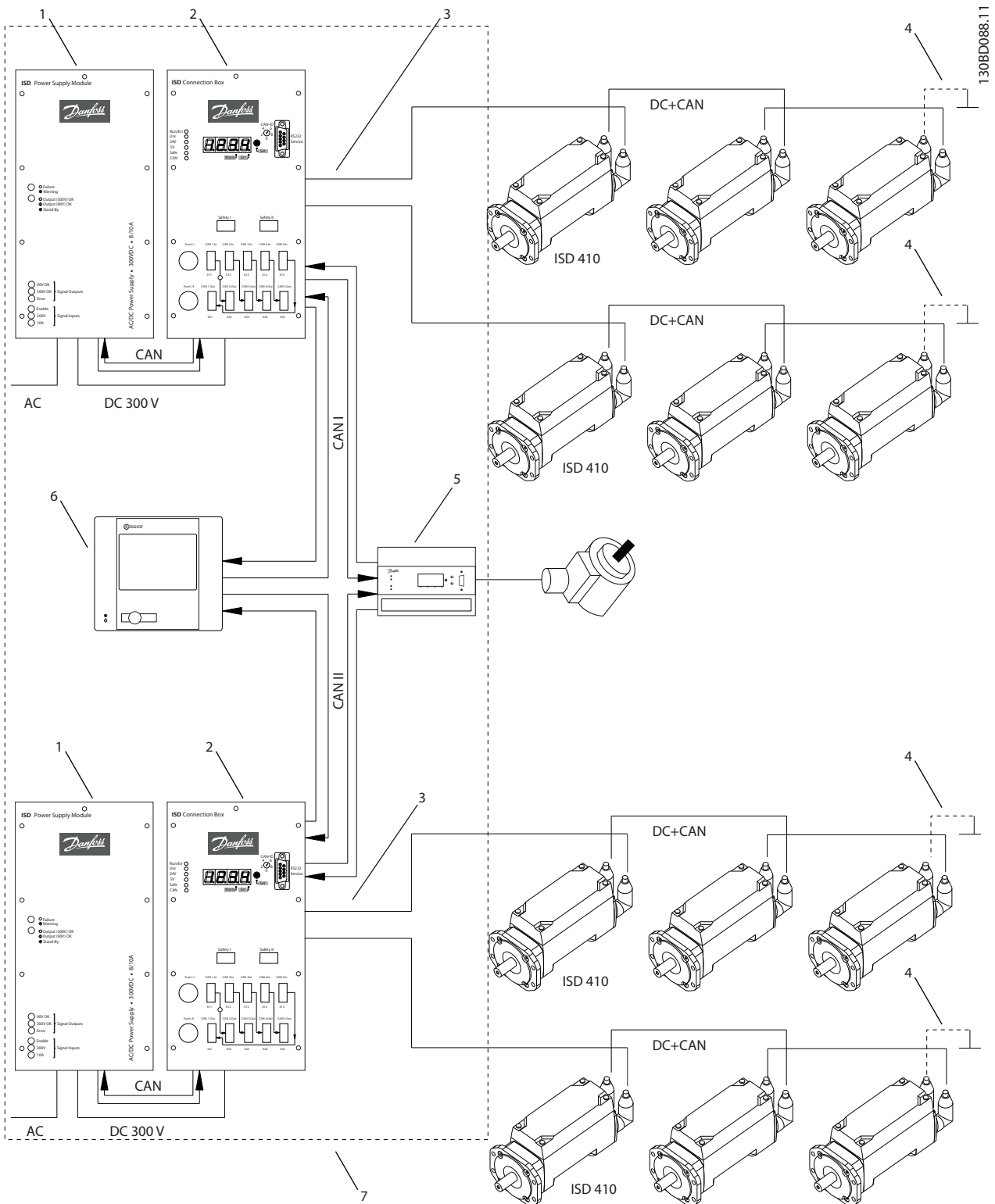

Illustration 4.4 ISD Servo System with 2 ISD Connection Boxes

No.	Name	Line Type	Cross-section	Flexible Cable
1	ISD Power Supply Module	–	–	–
2	ISD Connection Box	–	–	–
3	Feed cable	Hybrid cable (DC & CAN)	1 mm ^{2 1)} / 2.5 mm ²	X (only with 2.5 mm ²)
4	Terminating resistor	Connector with terminating resistor	–	–
5	ISD Encoder Box	–	–	–
6	Master	–	–	–
7	Control Cabinet	–	–	–
–	Ethernet	Ethernet cable	4 x 2 x 0.27 mm ² , shielded twisted pairs (CAT 5)	X
–	CAN line	CAN cable (screened)	4 x 0.25 mm ²	–
–	Encoder line	Encoder cable	4 x 0.25 mm ²	–
–	Loop cable	Hybrid cable (DC & CAN)	1 mm ^{2 1)} / 2.5 mm ²	X (only with 2.5 mm ²)
–	DC cable	Single wire	1.5 mm ² / 2.5 mm ^{2 2)}	–
–	AC feed	Single wire	1.5 mm ²	–

Table 4.3 Legend to Illustration 4.4

- 1) Only without STO
- 2) Depending on the application

4.4 Connections

4.4.1 Connections on the Front of the Connection Box

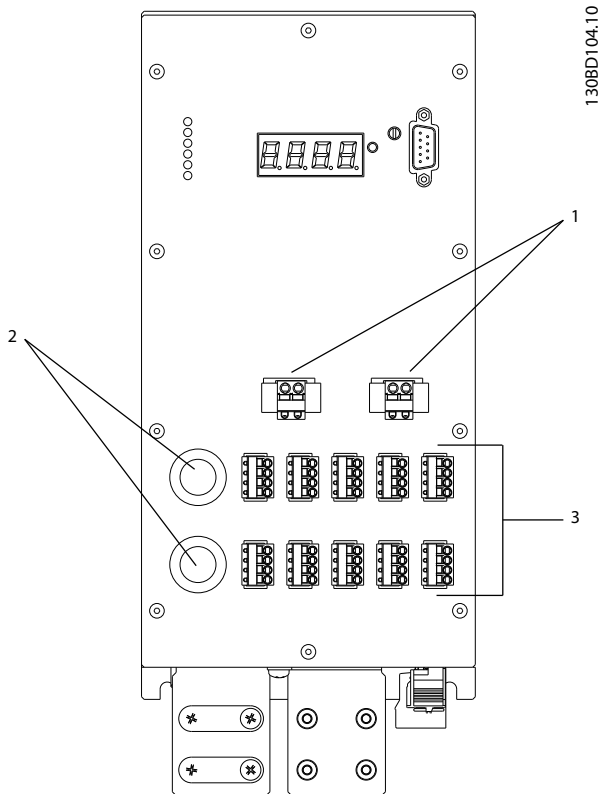

Illustration 4.5 Connections on the Front of the Connection Box

1	Safety switch connectors
2	Fuse holders
3	CAN connectors

Table 4.4 Legend to *Illustration 4.5*

4.4.1.1 Safety Switch Connectors (Safety I & Safety II)

The 24 V supply from the safety switch is connected via connector Safety I and/or Safety II. Use Safety I for line 1 and Safety II for line 2.

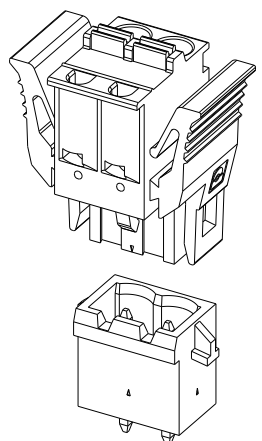

Illustration 4.6 Safety Housing and Plug

The input pin assignment is the same for Safety I and Safety II.

Pin	Signal	Description	Cross-Section
1	GND_24 V	Safety Switch Power Supply Input (Ground)	1 mm ²
2	+24 V	Safety Switch Power Supply Input (24 V DC)	1 mm ²

Table 4.5 Connector Pin Assignment

4.4.1.2 Fuse Holders

Fuses are used on the output side to protect the connection box and the ISD servo system if a short circuit occurs. The fuses sit in screw-in fuse holders Fuse I and Fuse II, which are accessible on the front of the connection box.

Fuse type: 16 A FF, size G (6.3 x 32 mm)

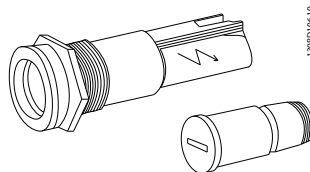

Illustration 4.7 Fuse Holders

4.4.1.3 CAN Connectors (X11-X15/X22-X25)

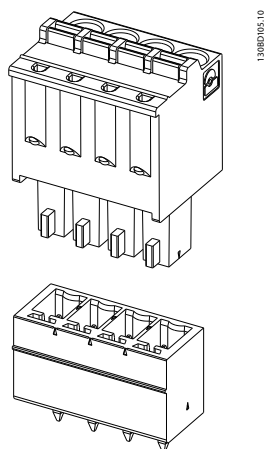

Illustration 4.8 CAN Housing and Plug

The input and output pin assignment of the CAN plug connectors is the same.

Pin	Signal	Description	Cross-Section
1	CAN_GND	CAN Power Supply (Ground)	0.5 mm ²
2	CAN_L	CAN Low Signal	0.5 mm ²
3	CAN_H	CAN High Signal	0.5 mm ²
4	CAN_V _{cc}	CAN Power Supply (+5 V)	0.5 mm ²

Table 4.6 Connector Pin Assignment

4.4.2 Connections on the Underside of the Connection Box

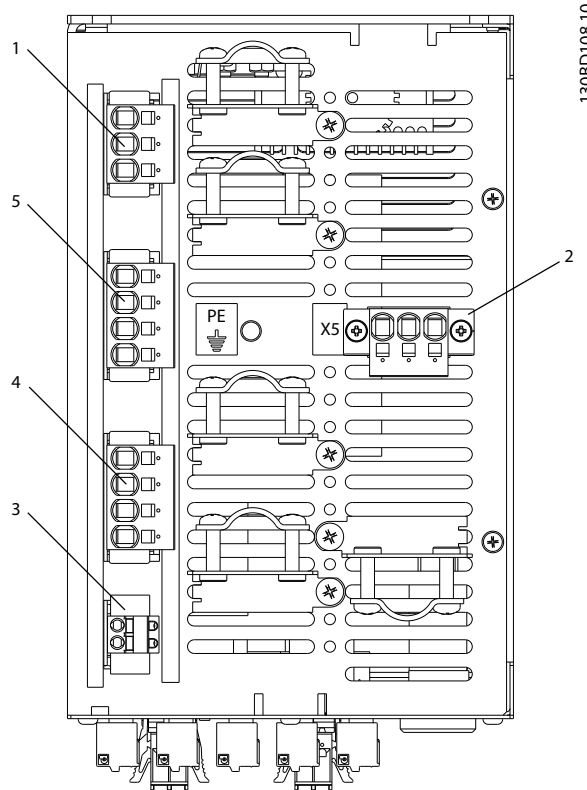

Illustration 4.9 Connections on the Underside

1	DC Input terminal X1
2	Brake connector X5
3	24 V DC Power supply X4
4	DC Output terminal X3
5	DC Output terminal X2

Table 4.7 Legend to Illustration 4.9

4.4.2.1 DC Input Terminal (X1)

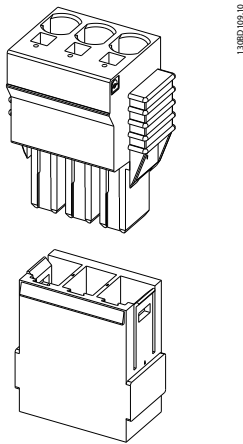

Illustration 4.10 DC Housing and Plug

Pin	Signal	Description	Cross-Section
1	FE	Functional Earth	1.5 mm ² / 2.5 mm ² 1)
2	-U _{DC}	Power Supply Input (Ground)	1.5 mm ² / 2.5 mm ² 1)
3	+U _{DC}	Power Supply Input (300 V DC)	1.5 mm ² / 2.5 mm ² 1)

Table 4.8 Connector Pin Assignment

1) Depending on the application

4.4.2.2 Brake Connector (X5)

An external brake chopper is required for the servo system if the servomotors feed power back. The brake chopper is only required on 1 line.

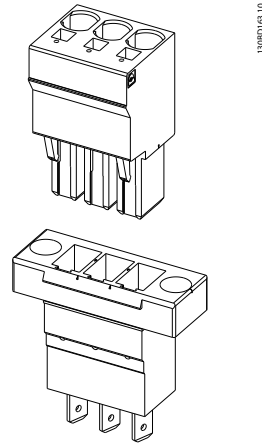

Illustration 4.11 Brake Housing and Plug

Pin	Signal	Description
1	+BR	Brake Chopper Output
2	FE	Functional Earth
3	-BR	Brake Chopper Input

Table 4.9 Connector Pin Assignment

4.4.2.3 24 V DC Power Supply (X4)

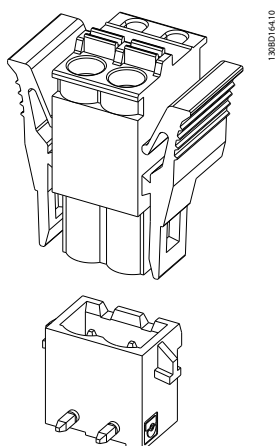

Illustration 4.12 DC Housing and Plug

Pin	Signal	Description	Cross-Section
1	-U _{DC_24IN}	Power Supply Input (Ground)	1 mm ²
2	+U _{DC_24IN}	Power Supply Input (24 V DC)	1 mm ²

Table 4.10 Connector Pin Assignment

4.4.2.4 DC Output Terminals (X2 & X3)

Use X2 for line 1 and X3 for line 2.

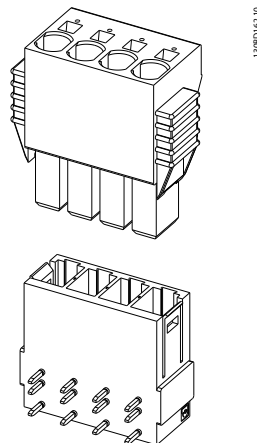

Illustration 4.13 DC Housing and Plug

The output pin assignment of the DC output terminals X2 and X3 is the same.

Pin	Signal	Description	Cross-Section
1	FE	Functional Earth	1.5 mm ² / 2.5 mm ² ¹⁾
2	-U _{DC}	Power Supply Output (Ground)	1 mm ² ²⁾ / 2.5 mm ²
3	+U _{DC}	Power Supply Output (300 V DC)	1 mm ² ²⁾ / 2.5 mm ²
4	24 V_S1/2	24 V DC Safety Output	1 mm ² ²⁾ , shielded with PE

Table 4.11 Connector Pin Assignment

1) Depending on the application

2) Only without STO

4.5 Cooling

Cooling takes place via the vents on the surface of the connection box.

5 Installation/Fitting

5.1 Transport and Delivery

5.1.1 Scope of Delivery

The scope of delivery of the ISD connection box comprises:

- the connection box
- 1 set of plug connectors
- these operating instructions

5.1.2 Transport

The maximum weight of a packaged connection box is approximately 5.5 kg.

- Avoid vibration during transportation.
- Avoid heavy impacts and blows.

5.1.3 Inspection on Receipt

After receiving the delivery, immediately check whether the scope of delivery matches the shipping documents. Danfoss will not honour claims for faults registered at a later time.

Register a complaint immediately:

- with the carrier in case of visible transport damage.
- with the responsible Danfoss representative in case of visible defects or incomplete delivery.

5.2 Safety Measures during Installation

Always observe the safety instructions in 3 *Safety instructions* during installation.

Pay particular attention to ensuring that the following points are observed carefully:

- installation may only be performed by qualified personnel.
- installation must be performed with due care and attention.
- all safety regulations and protective measures are complied with, and the environmental conditions are observed.
- the documentation is read and understood.

5.3 Installation Environment

Environmental Conditions

The installation must provide the following environmental conditions to allow the connection box to be operated safely and efficiently.

- The allowable operating ambient temperature range is not exceeded.
- The relative humidity is 5-85%, non-condensing (according to IEC 60721-3-3).
- The vibration level is $\leq 1 \text{ g}/9.81 \text{ m/s}^2$ without resonance excitation.
- Unrestricted ventilation is available.
- The maximum operating temperature is 40 °C. A control cabinet climate control should be used if necessary.

Contact Danfoss if it is not possible to comply with these environmental conditions.

5.4 Preparation for Installation

Drill the holes for the mounting screws according to the template.
All dimensions are in mm.

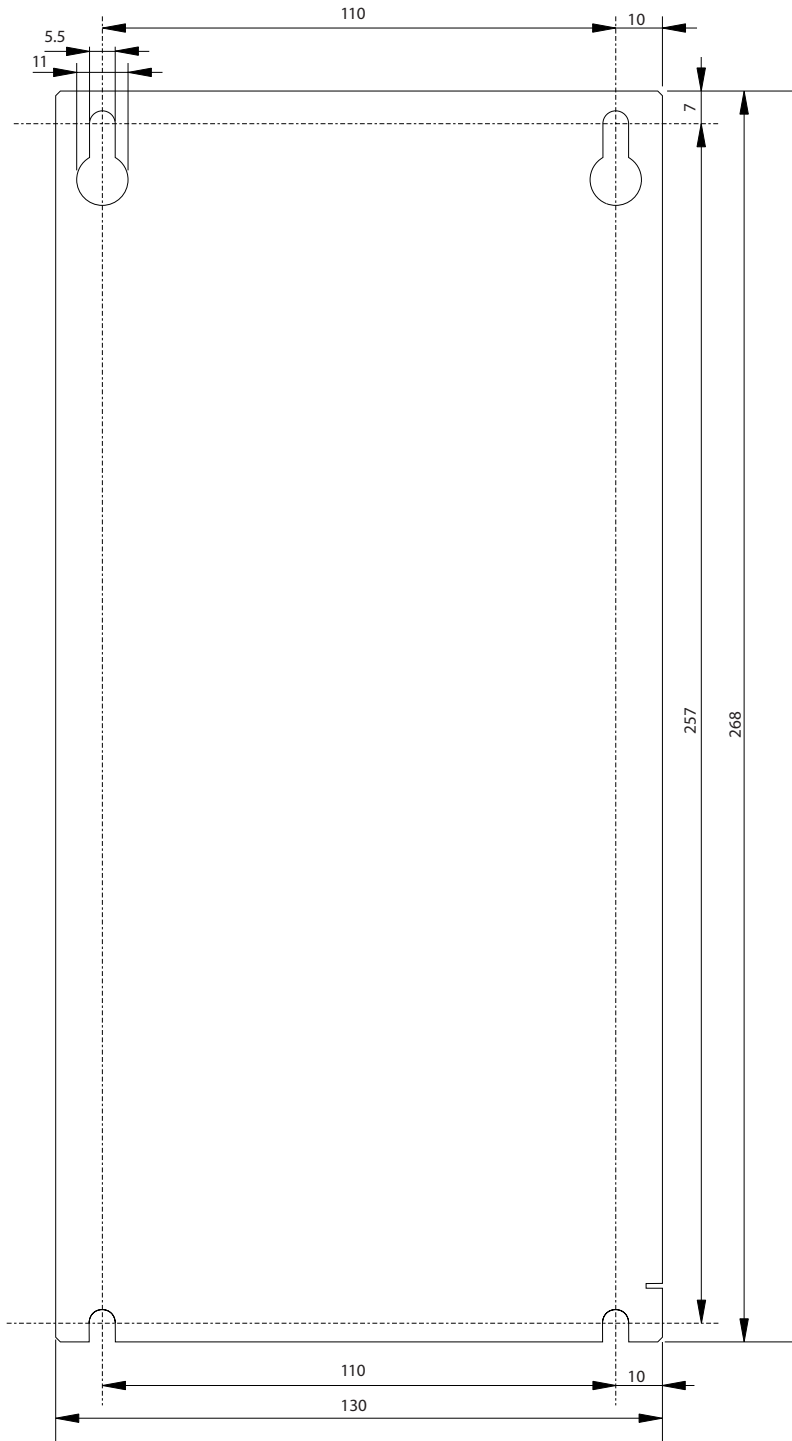

130BD041.10

5

Illustration 5.1 Drilling Template

NOTE

In addition to its own dimensions, the connection box needs space for connecting the cables.

5.5 Mechanical Installation

5.5.1 Mounting

Mount the connection box onto the backplate of the control cabinet using M5 screws (not included). Only use the designated keyways to mount the connection box. No alterations to the back panel are allowed.

1. Screw the holding screws in to the backplate so that there is enough space to hook the connection box onto them.
2. Remove the protective cover from the connection box.
3. Hook the connection box onto the 2 holding screws.
4. Tighten the holding screws.
5. Screw in the safety screws at the bottom of the connection box and tighten them.

The optional strain relief clamps can be mounted to the underside of the connection box by inserting them into the cooling vents and securing them with an M4 screw.

5.5.2 Dismounting

1. Unscrew and remove the safety screws at the bottom of the connection box.
2. Loosen the holding screws.
3. Lift the connection box off the holding screws.

5.6 Electrical Installation

⚠ WARNING

GROUNDING HAZARD

For operator safety, it is important to ground the connection box properly in accordance with national and local electrical codes as well as instructions contained within these operating instructions. Ground currents are higher than 3.5 mA. Failure to ground the power supply module properly could result in death or serious injury.

⚠ WARNING

HIGH VOLTAGE

The connection box contains high voltage when connected to the power supply module. Installation, start up, and maintenance should be performed by qualified personnel only. Failure to perform installation, start up, and maintenance by qualified personnel could result in death or serious injury.

5.6.1 Earthing (Grounding) the Connection Box

Connect the PE lines to the M6 earthing screw on the underside of the unit.

5.6.2 Electrical Environmental Conditions

Compliance with the following electrical environmental conditions is necessary to enable safe and effective operation of the connection box:

- Mounting in a control cabinet.
- Suitable 24 V DC power supply unit (see 5.6.3 24 V Power Supply Requirements).
- 300 V DC with 10 A from the power supply module.
- PE line.
- Pay attention to the leakage current. This is more than 3.5 mA so a circuit breaker is not effective. Therefore use an AC/DC sensitive RCCB (residual current circuit breaker).
- Observe national statutory provisions.

5.6.3 24 V Power Supply Requirements

The connection box must be supplied with 24 V DC power supply with the following properties:

- Output range: 24 V DC $\pm 20\%$
- Power output: 5 A

NOTE

Use a 24 V power supply which is CE marked according to the standards EN 61000-6-2 and EN 61000-6-4 or similar for industrial use. The power supply can only be used for the ISD system.

5.6.4 Connecting the CAN Cable

CAUTION

The 5 V CAN power supply is created by the connection box. No external 5 V power supply can be connected to the connection box CAN plugs. Failure to observe this warning may result in damage to the connection box. If an external 5 V power supply is needed, contact Danfoss Service.

The CAN cable connects the connection box to the ISD servo system.

1. Assemble the CAN cable according to the connector pin assignment in *4.4.1.3 CAN Connectors (X11-X15/X22-X25)*.
2. Lay the CAN cable according to the local conditions.
3. Connect the CAN cable to the encoder box and the connection box.
Use CAN line I if only 1 CAN line is being used.
Pay attention to the correct CAN cable number when 2 CAN cables (for 2 connection boxes) are being used.
Observe the connection diagrams in *4.3 Connection Cable/Cabling*.

NOTE

Closed system

All CAN bus connectors on the front of the connection box must be wired. Bridge plugs can be used.

5.6.4.1 Overview of CAN Plugs

Illustration 5.2 shows the CAN plugs on the front of the connection box. The lines represent the internal connections between the CAN plugs.

5

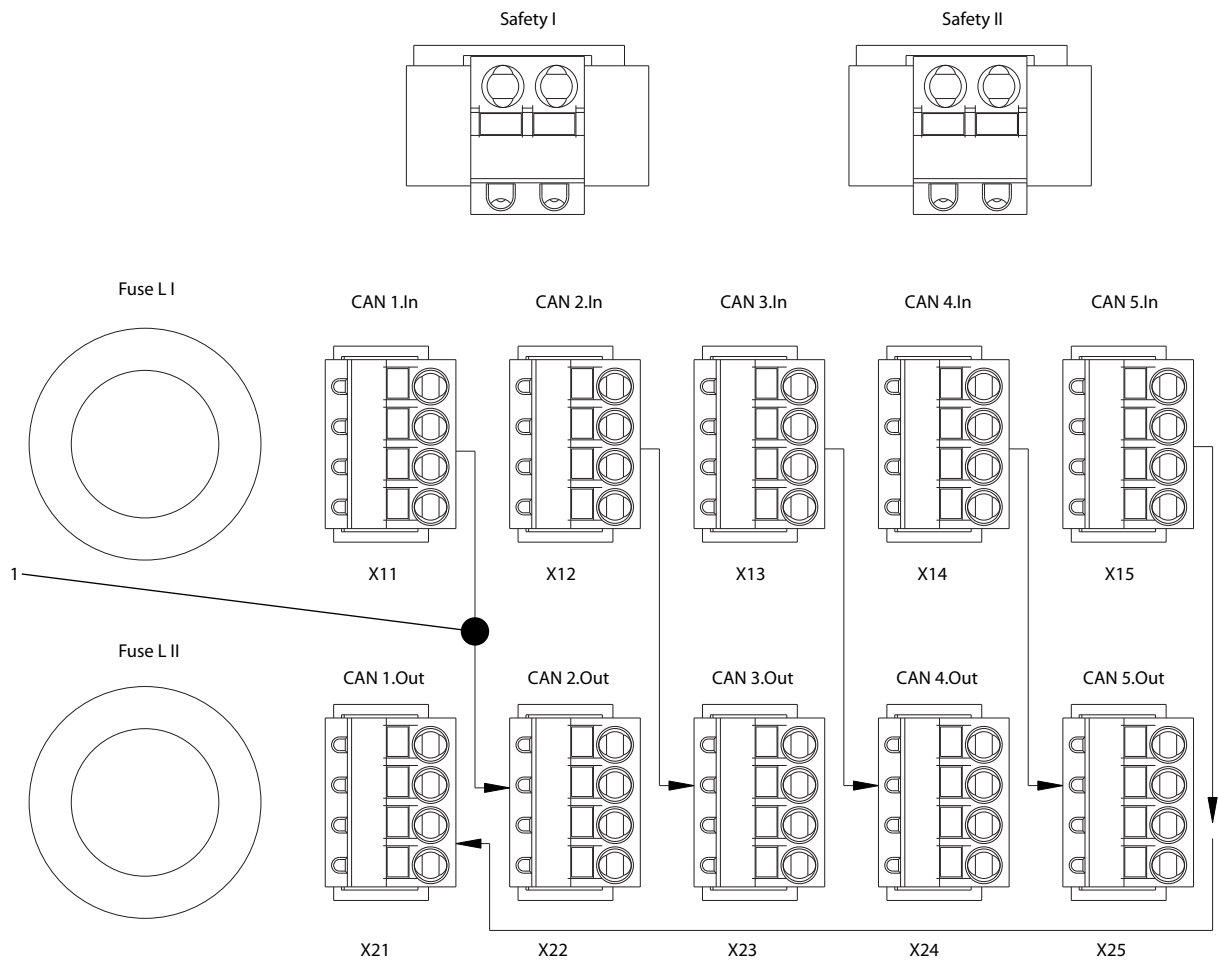

130BD166.10

Illustration 5.2 Overview of CAN Plugs

1	Symbolises the connection box as a node in the CAN network.
---	---

Table 5.1 Legend to Illustration 5.2

5.6.4.2 CAN Wiring Example 1

Illustration 5.3 shows an example of the CAN wiring for an ISD servo system with 1 output line, 1 connection box and 1 power supply module. In this example the CAN wiring starts at plug X11 and ends at plug X25. A CAN terminating resistor (120 Ω) is required at both ends. Use terminating resistor part number 175G7005 for the ISD servomotor.

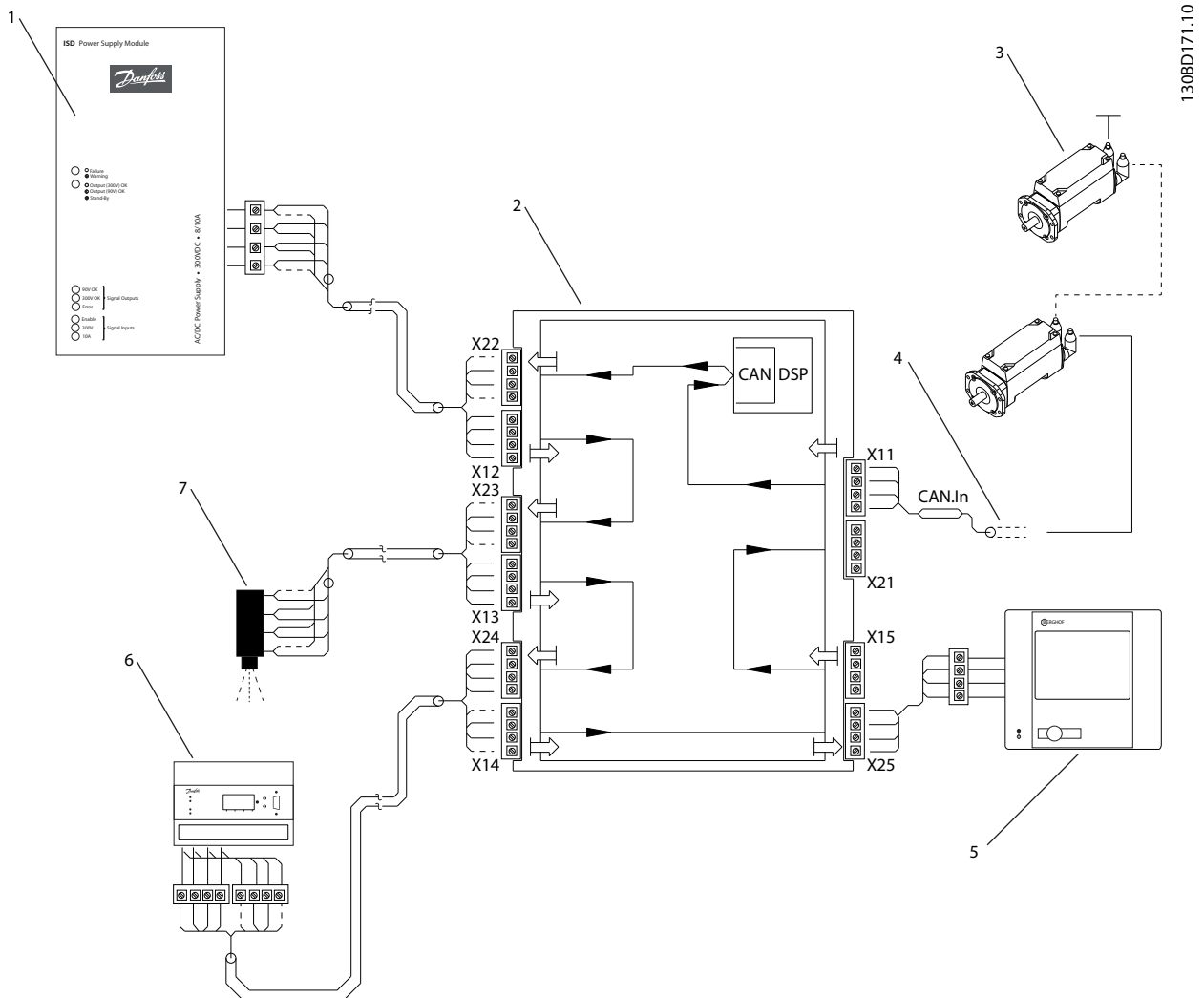

Illustration 5.3 CAN Wiring Example 1

1	ISD Power Supply Module
2	ISD Connection Box
3	Servomotor
4	Hybrid Cable 1 (Output line 1)
5	Master
6	Encoder Box
7	Camera

Table 5.2 Legend to Illustration 5.3

5.6.4.3 CAN Wiring Example 2

Illustration 5.4 shows an example of the CAN wiring for an ISD servo system with 2 output lines, 1 connection box and 1 power supply module. In this example the CAN wiring starts at plug X11 and ends at plug X21. A CAN terminating resistor (120 Ω) is required at both ends. Use terminating resistor part number 175G7005 for both servomotor lines.

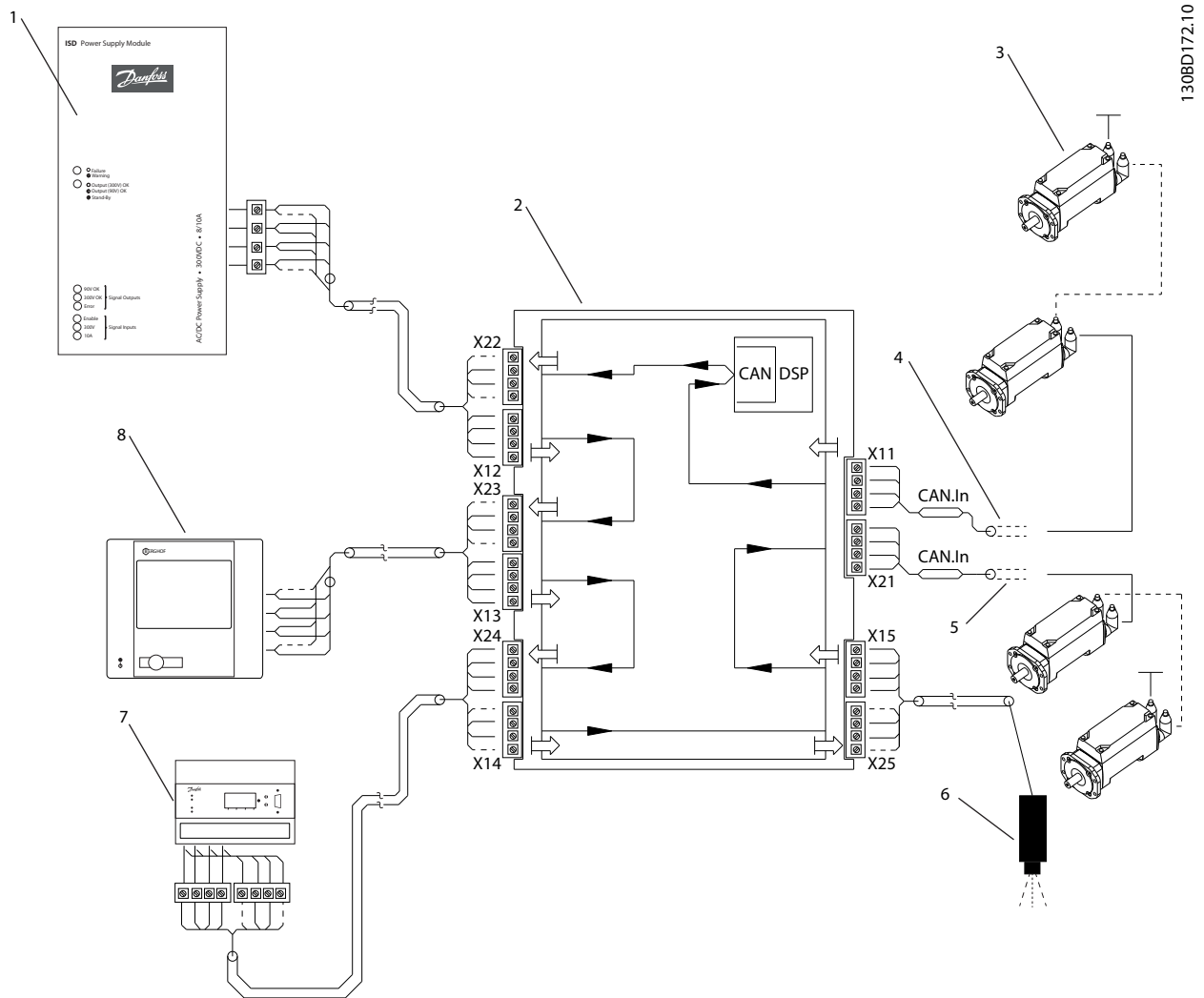

Illustration 5.4 CAN Wiring Example 2

1	ISD Power Supply Module
2	ISD Connection Box
3	Servomotor
4	Hybrid Cable 1 (Output line 1)
5	Hybrid Cable 2 (Output line 2)
6	Camera
7	Encoder Box
8	Master

Table 5.3 Legend to Illustration 5.4

5.6.5 Connecting the Power Supply Cable

1. Assemble the power supply cable according to the connector pin assignment in 4.4.2.3 24 V DC Power Supply (X4).
2. Connect the power supply cable from the power supply module to connector X1.
3. Secure the power supply cable using the strain relief clamps on the underside of the connection box.

5.6.6 Connecting the Safety Cable

The safety cable connects external safety relays to the connection box. Therefore the STO safety function can be realised via an external safety relay.

1. Assemble the safety cable according to the connector pin assignment in 4.4.1.1 Safety Switch Connectors (Safety I & Safety II).
2. Connect the safety cable to connector Safety I or Safety II.
Use connector Safety I for line 1 and Safety II for line 2.
3. Connect the safety cable shield to PE.

5.6.7 Connecting the Brake Cable

The brake cable connects the brake chopper to an external brake resistor.

1. Assemble the brake cable according to the connector pin assignment in 4.4.2.2 Brake Connector (X5).
2. Connect the brake cable to connector X5.

5.6.8 Connecting/Disconnecting Hybrid Cables (Feed Cable)

The hybrid (feed) cable connects the connection box to the first servomotor in the servo system, either directly or via a slip ring for turntable applications. All other servomotors are connected via a loop cable.

⚠ WARNING

HIGH VOLTAGE

Potentially lethal voltage is present on the connectors. Before working on the power connectors (disconnecting or connecting the cable), disconnect the power supply module from the mains and wait for the discharge time to elapse.

⚠ WARNING

DISCHARGE TIME

The servomotors, the connection box and the power supply module contain DC link capacitors, that remain charged for some time after the mains supply is switched off at the power supply module.

To avoid electrical shock, fully disconnect the power supply module from the mains before carrying out any maintenance on the ISD servo system or its components. Wait for at least the time listed below before carrying out maintenance work:

Number	Minimum waiting time (discharge time)
0-60 servomotors	10 minutes
Note: High voltage may still be present even if the LED on the ISD connection box is not lit!	

Table 5.4 Discharge Time

5

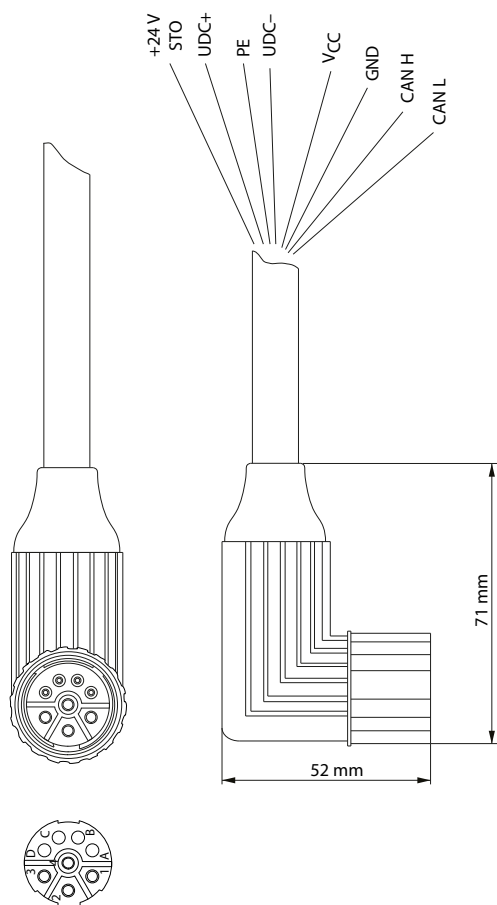

130BC493.10

NOTE

Do not forcefully connect or fit the connectors. Incorrect connection will cause permanent damage to the connector.

1. Connect the wires to the DC output terminal (X2 & X3) as described in 4.4.2.4 DC Output Terminals (X2 & X3).
2. Secure the hybrid cable using the strain relief clamp on the underside of the connection box.

Illustration 5.5 Feed Cable Wires

Pin	Wire	Colour	Description
Power			
1	-U _{DC}	1-Black	Input (DC Ground)
2	PE	Green/yellow	Protective Earth
3	+U _{DC}	2-Black	Input (300 V DC)
4	+24 V STO	3-Black	24 V DC Safety Input
CAN			
A	GND	Black	CAN Power Input (Ground)
B	CAN_Low	White	CAN Low Signal Input
C	CAN_High	Blue	CAN High Signal Input
D	V _{CC}	Red	CAN Power Input (+5 V)

Table 5.5 Wire Assignment for Feed Cable

CAUTION

Never connect or disconnect the hybrid cables to or from the servomotors when the supply voltage is present. Doing so will damage the electronic circuitry. Observe the discharge time for the DC link capacitors.

6 Commissioning

6.1 Connecting the Components

1. Connect the mains supply line to the power supply module and the control terminal strip of the power supply module in accordance with the wiring diagram in the *VLT® ISD 410 Design Guide*.
2. Connect the DC supply from the power supply module to the connection box and wire the safety circuit.
3. Connect the feed cable from the connection box to the first servomotor by connecting the cable leads on the connection box and the servomotor using the threaded connectors.
4. Using the loop cables intended for this purpose, connect the other servomotors in the group.
5. Fit a CAN terminating resistor on the last servomotor.
6. Connect the CAN bus to the connection box.
7. Connect the encoder box (if present) and the power supply module to the CAN network.

6.2 CAN-ID Setting

The default ID of the connection box is preset to 110. All the settings can be read from the object dictionary.

There are several ways to set/change the CAN-ID. The easiest way is setting via the BCD switch. The ID setting should be executed in an unpowered state.

BCD switch is set to 0

- The ISD ID setting protocol can be used to give another ID to the box.

BCD switch is set to between 1 and 9

- The CAN-ID is calculated by the preset value of 110 + the value of BCD switch.

The message for the ID setting over CAN bus is shown in *Table 6.1*. Note that the first 4 bytes have to be 0, otherwise the connection box will ignore the ID setting message. This is also the case if the BCD switch is not set to 0. After this message is sent, the new CAN-ID will start blinking on the connection box display. Press the <SET> button on the connection box to accept the new ID. The connection box will only leave this ID setting mode

following the acceptance of the new ID or after sending an NMT reset communication.

Note that the other ISD servo system components will also be in ID setting mode after this message is sent, so an “NMT reset communication” message has to be sent to release all devices from this mode.

Note that whilst in ID setting mode, it is not possible to communicate with the device. An NMT reset communication leaves the ID setting mode for the connection box without changing any other state. This ensures that drive operation is not interrupted. The new ID is then valid when the connection box has been power cycled or the NMT reset node message has been sent to the connection box.

COB-ID	Byte 0	Byte 1	Byte 2	Byte 3	Byte 4	Byte 5
0x7F2	0		0		New CAN-Node-ID	

Table 6.1 ISD ID Setting Message

6.3 Functional Operation Test

Always check the following items before initial commissioning, before commencing operation after extended downtime, or before commencing operation after motor overhaul:

- Are all threaded connectors of mechanical and electrical components firmly tightened?
- Is the free circulation of cooling air (inlet and outlet) assured?
- Are the devices for protection against overheating (temperature sensor monitoring) operational?
- Are the electrical connections OK?
- Is contact protection in place for rotating parts and surfaces that can become hot?

6.4 Switching the Connection Box on

The components of the ISD servo system must be wired and connected correctly before the connection box is switched on. Read the operating instructions of the other ISD components carefully.

The cabling contains the power supply as well as the communication for the system. The servo system cannot be started until these basic requirements are fulfilled.

Switching on (booting up)

The connection box can be switched on via the CAN communication from the PLC system if the Auto Power-up parameter is enabled.

6

CAUTION

Do not switch the connection box on and off repeatedly. Doing so will damage the internal components. Wait 5 minutes after switching the connection box off before switching it on again.

7 Operation

7.1 Operating Display

The display shows the operating status of the connection box.

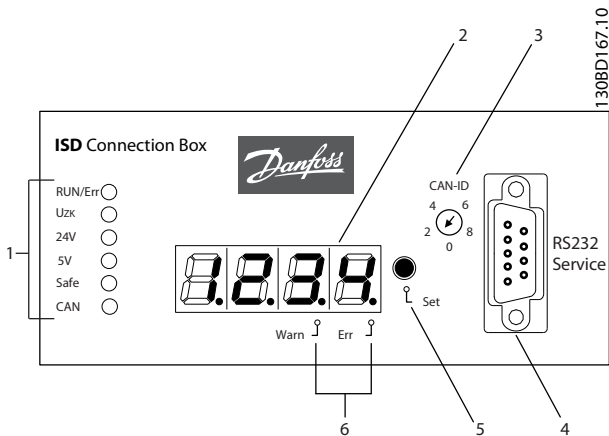

Illustration 7.1 Connection Box Display

1	Operating LEDs	4	Service interface RS232 ¹⁾
2	7-segment display	5	<SET> push button
3	BCD switch	6	Segment dots

Table 7.1 Legend to Illustration 7.1

1) Only for use by Danfoss Service.

7.1.1 Operating LEDs

The operating LEDs show the operating status.

LED	Description
RUN/Err (green/red)	<ul style="list-style-type: none"> Constant light (green): Normal operation. LED is off: Connection box is being initialised. Constant light (red): Active connection box error.
UZK "Power" (green)	<ul style="list-style-type: none"> Constant light (green): Normal operation. Flashing (slowly): Over voltage (Uzk).
24V "Power Supply" (green)	<ul style="list-style-type: none"> Constant light (green): 24 V DC available LED is off: 24 V DC missing.
5V (green)	<ul style="list-style-type: none"> Constant light (green): CAN supply available. LED is off: internal CAN supply missing.
Safe (green)	<ul style="list-style-type: none"> Constant light (green): Safety power is available. Flashing LED (green): Only 1 of 2 safety powers is available. LED is off: No safety power detected.
CAN (green/red)	<ul style="list-style-type: none"> Flashing LED (green): CAN communication. Constant light (red): CAN error.

Table 7.2 Description of the Operating LEDs

7.1.2 Display Mode

The CAN-ID, warnings and error codes can be displayed on the 7-segment display.

A dot at the bottom right of the display segment shows the respective type of indicator. The sequence of the display occurs as demonstrated in the following graphic. Continually pressing the <SET> push button enables scrolling through the display.

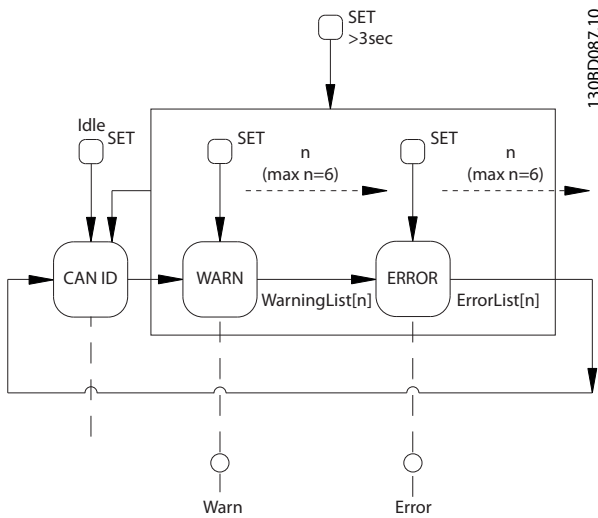

Illustration 7.2 Display Sequence with <SET> Push Button

Display/ Segment Dot	Description
CAN-ID (no segment dot)	Connection box CAN-ID <ul style="list-style-type: none"> Display: decimal. Factory setting: 110. See 6.2 CAN-ID Setting for information on how to change the CAN-ID.
WARN (segment dot "Warn")	Warning about a potential error, e.g. DC input voltage below minimum. <ul style="list-style-type: none"> Display: 4-digit hexadecimal code See 12.3 Emergency Codes for a description of the emergency codes.
ERROR (segment dot "Err")	An error occurred, e.g. CAN emergency error. <ul style="list-style-type: none"> Display: 4-digit hexadecimal code See 12.3 Emergency Codes for a description of the emergency codes.

Table 7.3 Description of the Segment Dots

7.1.3 7-Segment Display

During operation the 7-segment display shows the current connection box CAN-ID. The LED "RUN/Err" is constantly lit green.

The previous 6 warnings and error messages can be called up on the 7-segment display. Press the <SET> push button repeatedly to scroll through the individual lists. These are displayed as a continual loop (see Illustration 7.2):

- CAN-ID
- Warnings
- Errors
- CAN-ID
- Warnings
- Errors
- ...

If an error is active, the LED "RUN/Err" is lit red. All other entries are errors which have been eliminated.

Press the <SET> push button for 3 seconds to jump to the start (CAN-ID).

When a new event occurs, it is displayed as follows:

- the error code is shown on the 7-segment display immediately. The type of event is shown via the "Warn" or "Err" segment dot.
- the LED "RUN/Err" is constantly lit red.
- the error message (CAN emergency message) appears on the CAN bus.
- an entry is made in the error memory. This can be read via SDO (Service Data Object).

Depending on the error, the connection box switches to a different state.

The full list of error codes are detailed in 12.3 Emergency Codes.

NOTE

It is not possible to reset errors or warnings on the connection box itself. An active error can only be deleted by:

- NMT-Reset
- Restarting the connection box
- Error reset via the ISD Toolbox software or CoDeSys

See 12.3 Emergency Codes for further information.

7.1.4 <SET> Push Button

The <SET> push button can be used to scroll through the list of messages and to set IDs. The CAN-ID is shown when the push button is pressed for 3 seconds.

7.1.5 <CAN-ID> BCD Switch

The <CAN-ID> BCD switch is used to assign the ID manually. See 6.2 CAN-ID Setting.

7.1.6 Service Interface

CAUTION

The service interface is only for use by Danfoss Service.

7.2 Display via Toolbox and CoDeSys

In addition to the display on the ISD connection box, it is possible to query the status of the connection box via ISD Toolbox.

In order to do this, it is necessary to connect to the CAN bus network via a PC/laptop. A CAN dongle is required, which realises the physical connection between the CAN bus network and the connection box.

The ISD Toolbox enables the individual ISD components to be displayed directly and thereby information about the ISD components to be attained.

The parameters of the ISD components can also be read via CoDeSys on the master controller.

The ISD Toolbox software, firmware updates, EDS files and CoDeSys libraries can be downloaded from the Danfoss website (www.danfoss.com).

7.3 Machine States

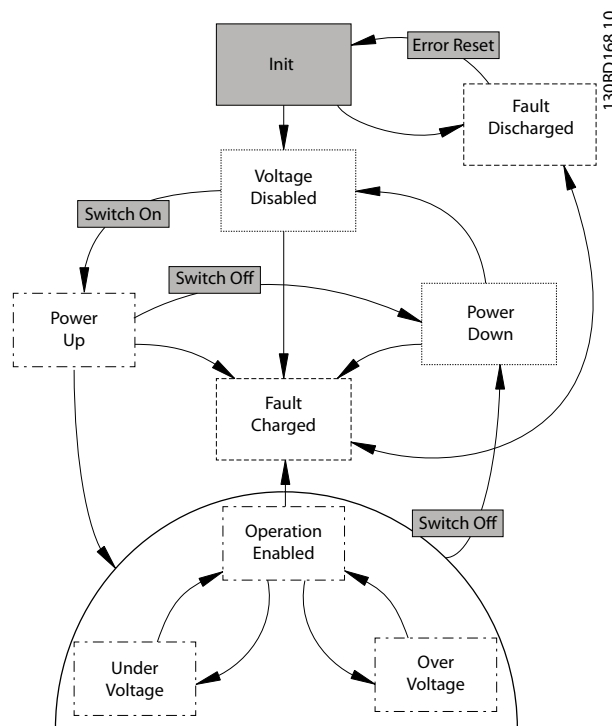

Illustration 7.3 Machine States

Illustration 7.3 shows the main state machine transitions. The states 'Under Voltage' and 'Over Voltage' are sub-states of state 'Operation Enabled'. Therefore these states inherit all transitions of their base state.

State 'Init' performs checks related to state 'Voltage Disabled' and makes a direct transition into state 'Fault Charged' if the capacitors are found charged.

An emergency message is sent whenever the connection box enters into any fault state. Each commanded transition, that has been rejected because proper operation can't be guaranteed, results in a warning emergency message being sent. Emergency messages are added to the history and displayed on the connection box display.

All measurements and derived values are accessible via the CAN object dictionary in all states.

Servicing operations, such as firmware flash, connection box reset or CAN-ID setting are only allowed in unpowered states.

7.3.1 State "Init" (Initialisation)

Controller reboot and transition 'Error Reset' out of state 'Fault Discharged' places the state machine into state 'Init'. In this state, the process is initialized and the supply voltages are checked. The controller is reset if an NMT reset (reset node or reset communication) has been received in this state.

Transitions:

- Into state 'Fault Charged' if hazardous voltage is detected inside the connection box, determined by measuring U_{ZK} .
- Into state 'Fault Discharged' if the 24 V and 5 V CAN power supplies can't be found by reading the digital inputs.
- Into state 'Voltage Disabled' if the NMT state machine has finished its initialization and the 24 V and 5 V CAN power supplies are good.

7.3.2 State "Voltage Disabled"

This is the nominal unpowered state. U_{DC} input supply is detached from the intermediate circuitry and the capacitor battery is not charged. Devices connected to the lines are not powered. The controller is reset if an NMT reset (reset node or reset communication) has been received in this state.

If auto power up is configured in the user configuration and all required conditions are met, the state machine carries out a transition 'Switch On' and proceeds to state 'Power Up'.

Transitions:

- Into state 'Power Up' following a 'Switch On' transition request (either through user command or configuration of the auto power up flag).
Required checks:
 - Improper supply voltages (24 V and/or 5 V CAN supplies) lead to a warning and the state is not changed.
 - Out of nominal range input voltage (U_{DC}) leads to a warning and the state is not changed.
 - Improper heat sink temperature leads to a warning and the state is not changed.
 - Improper safety supplies lead to a warning but allow the transition into state 'Power Up' to allow operation

without safety supplies. Both safety supplies are checked and memorised for comparison. The loss of any safety supply in any charged state is irregular and leads to an emergency warning.

- Into state 'Fault Charged' if hazardous voltage is detected inside the connection box, determined by measuring U_{ZK} .

7.3.3 State "Fault Discharged"

This is the unpowered fault state. This state can either be left through a 'Reset Error' transition, which restarts the state machine, or through an NMT reset (reset node or reset communication), which resets the controller.

Transitions:

- Into state 'Init' following a 'Reset Error' transition user request.
- Into state 'Fault Charged' if hazardous voltage is detected inside the connection box, determined by measuring U_{ZK} .

7.3.4 State "Power Up"

This state charges the internal capacitor battery. Connected devices are not placed into operating state while charging the capacitors. When the battery is charged, the charging resistor is bypassed. If the discharge resistor check flag is set in the user configuration, the resistor is checked for correct operation during this state. If the verification fails, an error is issued and the transition to state 'Fault Charged' is initiated.

Transitions:

- Into state 'Power Down' following a 'Switch Off' transition user request or following an NMT reset (reset node or reset communication) command.
- Into state 'Operation Enabled' if the capacitor battery is charged, determined by measuring the intermediate circuitry voltage U_{ZK} .
- Into state 'Fault Charged':
 - If the capacitors can't be charged within the typical time limit to protect the charge resistor.
 - If the intermediate circuitry voltage (U_{ZK}) is greater than the input voltage (U_{DC}).
 - If the input voltage drops below or exceeds the absolute limits.

- If the discharge resistor check flag has been set and the resistor test was negative.
- If a fuse has blown. The fuses are checked by comparing the voltage level of the intermediate circuitry (U_{ZK}) against the voltage levels of the output lines (ULine1 and ULine2).
- If the 24 V and/or 5 V CAN supply voltages are lost.

7.3.5 State "Power Down"

This state discharges the internal capacitor battery. The intermediate circuitry is detached from the input power supply and the discharge resistor is used to discharge the capacitors.

Transitions:

- Into state 'Voltage Disabled' if the capacitors are discharged and the intermediate circuitry voltage (U_{ZK}) drops below the hazardous level.
- Into state 'Fault Charged' if the capacitors can't be discharged within the typical time limit.

7.3.6 State "Fault Charged"

This is the powered fault state. The intermediate circuitry is detached from the input power supply. The capacitors must be discharged in order to leave this state. Use the discharge resistor to discharge the capacitors.

Transitions:

- Into state 'Fault Discharged' if the capacitors are discharged and the intermediate circuitry voltage (U_{ZK}) drops below the hazardous level.

7.3.7 State "Operation Enabled"

This is the nominal powered state. The intermediate circuitry is connected directly to the input power supply and no resistor is enabled. Fault transitions are initiated if the input voltage (U_{DC}) is outside its maximum limits but no fault action is taken on the intermediate circuitry voltage (U_{ZK}). If U_{ZK} rises above or falls below the defined thresholds, the event is signalled through transitions into the sub-states 'Over Voltage' and 'Under Voltage'.

Basic transitions:

- Into state 'Power Down' following a 'Switch Off' transition user request or in case of an NMT reset (reset node or reset communication) command.
- Into state 'Fault Charged':
 - If the intermediate circuitry voltage (U_{ZK}) drops more than 20 V below the defined minimum power up voltage.
 - If the input voltage drops below or exceeds the absolute limits.
 - In case of a blown fuse. The fuses are checked by comparing the voltage level of the intermediate circuitry (U_{ZK}) against the voltage levels of the output lines (ULine1 and ULine2).
 - If the 24 V and/or 5 V CAN supply voltages are lost.

Specific transitions:

- Into state 'Over Voltage' if the intermediate circuitry voltage (U_{ZK}) rises above the specified maximum.
- Into state 'Under Voltage' if the intermediate circuitry voltage (U_{ZK}) falls below the specified minimum.

7.3.8 State "Over Voltage"

This is a sub-state of state 'Operation Enabled'. Apart from the transitions into states 'Over Voltage' and 'Under Voltage', all transitions of the base state are inherited. In this state the chopper resistor is enabled to reduce the energy in the connection box by heating externally. The state is signaled by the blinking of the U_{ZK} power LED.

Transitions:

- Into state 'Operation Enabled' if the intermediate circuitry voltage (U_{ZK}) is back in nominal U_{DC} range.

7.3.9 State "Under Voltage"

This is a sub-state of state 'Operation Enabled'. Apart from the transitions into states 'Over Voltage' and 'Under Voltage', all transitions of the base state are inherited.

Transitions:

- Into state 'Operation Enabled' if the intermediate circuitry voltage (U_{ZK}) is back in nominal U_{DC} range.

8 Faults

Connection box faults are displayed on the 7-segment display on the connection box (see *7.1 Operating Display*).

The behaviour of the connection box is detailed in the following s. Information on troubleshooting can be found in *8.4 Troubleshooting*.

NOTE

If a fault cannot be eliminated by one of the measures listed, notify Danfoss Service.

Have the following information available to enable Danfoss to help you quickly and effectively:

- Type number
- Error message number
- Firmware version

8

8.1 Emergency

If an error occurs the connection box sends an emergency message. Possible emergencies are listed in *12.3 Emergency Codes*.

8.2 Error History

The connection box keeps an error history with the emergency codes from *12.3 Emergency Codes* along with a timestamp.

The connection box keeps a maximum of 32 emergency messages divided into 16 Errors and 16 Warnings. When the history is full the oldest is replaced. All emergency messages can be accessed via SDO.

8.3 Debugging

For debugging purposes the following information can be read from the ISD Toolbox software or via the CAN:

1. Power on
 - Software version information
 - CAN settings: baud rate and CAN-ID
2. Emergencies

8.4 Troubleshooting

When problems occur in the servo system, they must first be located and properly identified.

Table 8.1 lists potential faults on the connection box, their possible causes and actions for correcting the faults.

Contact Danfoss Service if it is not possible to correct the fault.

Fault/Fault Code on 7-segment Display	Possible Cause	Possible Solution
LED "CAN" is lit red constantly	CAN error.	<ul style="list-style-type: none"> Check cabling Check terminating resistors
LED "CAN" is off	No CAN messages on the bus.	<ul style="list-style-type: none"> Check cabling Check master
LED "RUN/Err" is lit red constantly	Active connection box error.	See error and warning codes below.
LED "UZK" is off although DC 300 V power supply is connected.	<ul style="list-style-type: none"> Cable connected incorrectly. 300 V DC power supply voltage not present. Connection box not switched on. 	<ul style="list-style-type: none"> Check cabling Check DC 300 V power supply Switch connection box on via a command from the master or by configuring parameter <i>autoSwitchOn</i>
Error code 3100 (hex)	Input voltage (U_{DC}) above absolute maximum.	Check stability of 300 V DC power supply
Error code 3101 (hex)	Input voltage (U_{DC}) below absolute minimum.	Check stability of 300 V DC power supply
Error code 3102 (hex)	Input voltage (U_{DC}) below intermediate voltage (U_{zk}) during power up.	<ul style="list-style-type: none"> Check stability of 300 V DC power supply Ensure servomotors are not active during power up so power feedback cannot occur Ensure no power supply is connected on the output side
Error code 3110 (hex)	24 V power supply loss.	<ul style="list-style-type: none"> Check cabling Check 24 V power supply
Error code 3111 (hex)	24 V power supply timeout during initialisation.	<ul style="list-style-type: none"> Check cabling Check 24 V power supply ramp-up time
Error code 3118 (hex)	5 V CAN power supply loss.	<ul style="list-style-type: none"> Check cabling Contact Danfoss Service to check the 5 V internal power supply
Error code 3119 (hex)	5 V CAN power supply timeout during initialisation.	<ul style="list-style-type: none"> Check cabling Contact Danfoss Service to check the 5 V internal power supply ramp-up time
Warning code 3180 (hex)	Switch on, nominal U_{DC} range: Input voltage above maximum.	Check power supply range
Warning code 3181 (hex)	Switch on, nominal U_{DC} range: Input voltage below minimum.	Check power supply range
Warning code 3190 (hex)	Switch on: 24 V power supply bad.	<ul style="list-style-type: none"> Check cabling Check 24 V power supply
Warning code 3191 (hex)	Switch on: 5 V CAN power supply bad.	<ul style="list-style-type: none"> Check cabling Contact Danfoss Service to check the 5 V internal power supply
Error code 3200 (hex)	Hazardous intermediate circuitry voltage.	Contact Danfoss Service

Fault/Fault Code on 7-segment Display	Possible Cause	Possible Solution
Error code 3201 (hex)	Intermediate circuitry voltage (U_{ZK}) drops below absolute minimum U_{DC} during operation.	Contact Danfoss Service
Warning code 3280 (hex)	Intermediate circuitry voltage (U_{ZK}) over voltage during operation.	Contact Danfoss Service
Warning code 4280 (hex)	Switch on: Heat sink temperature above maximum.	<ul style="list-style-type: none"> • Switch connection box off and allow it to cool for 30 minutes before switching it back on • Contact Danfoss Service if error recurs
Error code 5030 (hex)	Fuse 1 blown.	Replace fuse 1
Error code 5031 (hex)	Fuse 2 blown.	Replace fuse 2
Error code FF01 (hex)	Power up timeout.	Check output load
Error code FF02 (hex)	Power down timeout.	Contact Danfoss Service
Warning code FF90 (hex)	Switch on: No safety power.	Check cabling and power supply if safety power needed in application
Warning code FF91 (hex)	Safety power 1 loss.	Check cabling and power supply stability if safety power needed in application
Warning code FF92 (hex)	Safety power 2 loss.	Check cabling and power supply stability if safety power needed in application

Table 8.1 Troubleshooting Overview

9 Maintenance and Repair

9.1 Maintenance tasks

The connection boxes are largely maintenance free.

The maintenance tasks listed in the following table may be performed by the customer. No other tasks are required.

Component	Maintenance Task	Maintenance Interval	Instruction
Vents	Vacuum	Regularly or as necessary	Vacuum the vents with a vacuum cleaner
Connection box	Clean	Regularly or as necessary	Clean the surface with a dry cloth

Table 9.1 Overview of Maintenance Tasks

9.2 Inspection during Operation

Carry out regular inspections during operation. Check the connection box at regular intervals for anything unusual.

Pay particular attention to:

- Loose fastenings
- Condition of electrical wiring and cables

In the event of irregularities or problems, see *8.4 Troubleshooting*.

9.3 Repair

9.3.1 Replacing the Fuses



HIGH VOLTAGE

The connection box contains high voltage when connected to the power supply module. Disconnect the power supply and wait for the discharge time to elapse before changing the fuses.

Number	Minimum waiting time (discharge time)
0-60 servomotors	10 minutes
Note: High voltage may still be present even if the LED on the ISD connection box is not lit!	

Table 9.2 Discharge Time

Fuse type: 16 A FF, size G (6.3 x 32 mm)

NOTE

No other repairs to the connection box are allowed. Always return defective connection boxes to Danfoss.

10 Decommissioning and Disposal

10.1 Decommissioning

The procedure for decommissioning the connection box is the reverse of the installation procedure described in *5.5 Mechanical Installation*.

Proceed as follows:

- Disconnect the power supply and wait for the discharge time to elapse.

10.2 Dismounting

The procedure for dismounting the connection box is the reverse of the fitting procedure described in *5.5 Mechanical Installation*.

Proceed as follows:

1. Disconnect the power supply and wait for the discharge time to elapse.
2. Disconnect the electrical cables.
3. Dismount the connection box.

10.3 Recycling and Disposal

10.3.1 Recycling

Take metals and plastics to recycling stations.

The entire connection box is classified as electronic waste, and the packaging is classified as packaging waste.

10.3.2 Disposal

Devices containing electronic components cannot be disposed of as normal domestic waste.

Dispose of the connection box as hazardous waste, electrical waste, recyclable waste, etc. in accordance with applicable local regulations.

11 Specifications

11.1 Nameplate

Check the nameplate and compare it with the order data. Use the part number for reference.

The part number uniquely identifies the connection box.

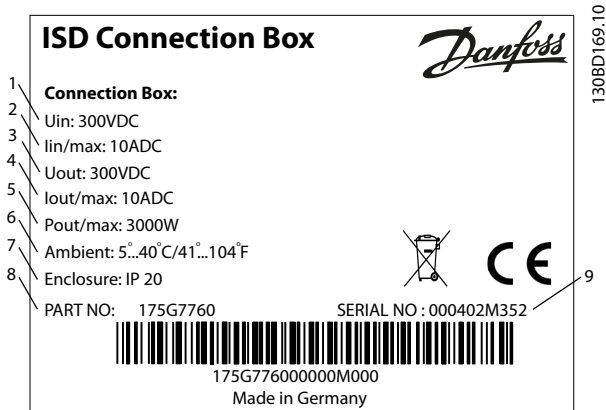

Illustration 11.1 Nameplate

The following data is shown on the nameplate of the ISD connection box:

1	Input voltage	6	Ambient temperature range
2	Max. input current	7	Protection rating
3	Output voltage	8	Part number
4	Max. output current	9	Serial number
5	Max. output power		

Table 11.1 Legend to Illustration 11.1

Ensure that the nameplate is clearly legible.

11.2 Storage

Store the connection box in a dry, dust-free location with low vibration ($V_{eff} \leq 0.2$ mm/s).

The storage location must be free from corrosive gases.

Avoid sudden temperature changes.

11.3 Characteristic Data

Definition	Value and Unit
Input	
Input voltage	300 V DC
Connections	+300 V DC, -300 V DC, PE
Input current	DC 10 A
Fuse protection	External via line protection
Power factor	94%
Output (with use of ISD Power Supply Module)	
Output voltage line 1	300 V DC
Output voltage line 2	300 V DC
Tolerance	±1%
Ripple	1 V _{pp}
Rated power	3.0 kW
Rated current	10 A ¹⁾
Environmental Conditions	
Climatic classification	3K3
Mounting	In a control cabinet
Ambient temperature	5–40 °C
Humidity	5-85%, non-condensing (according to IEC 60721-3-3)
Cooling	Via vents on housing
Protection type	IP20
Protection rating	1 with PE connection
Over-voltage category	III
Vibration rating	3M4
Mechanical Conditions	
Degree of pollution	2
Safety Standards	EN 61508
Housing	
Material	Steel, aluminium for wall mounting
Dimensions (W x H x D)	130 x 268 x 200 mm
Weight	5 kg

Table 11.2 Characteristic Data

1) Only if 10 A is fed in

11.4 Dimensions

11.4.1 Front View

All dimensions are in mm.

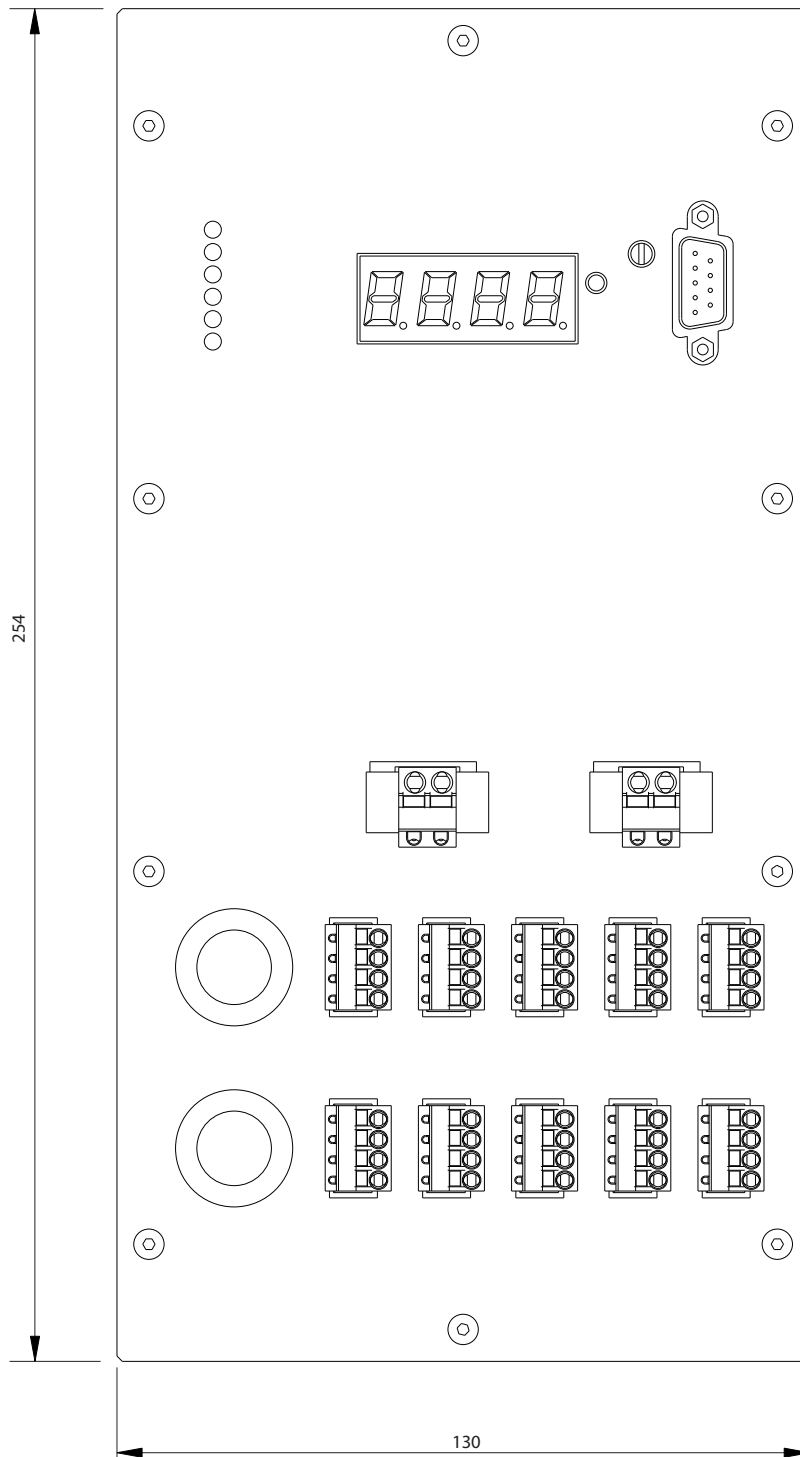

130BD170.10

11

Illustration 11.2 Front View

11.4.2 Side View

All dimensions are in mm.

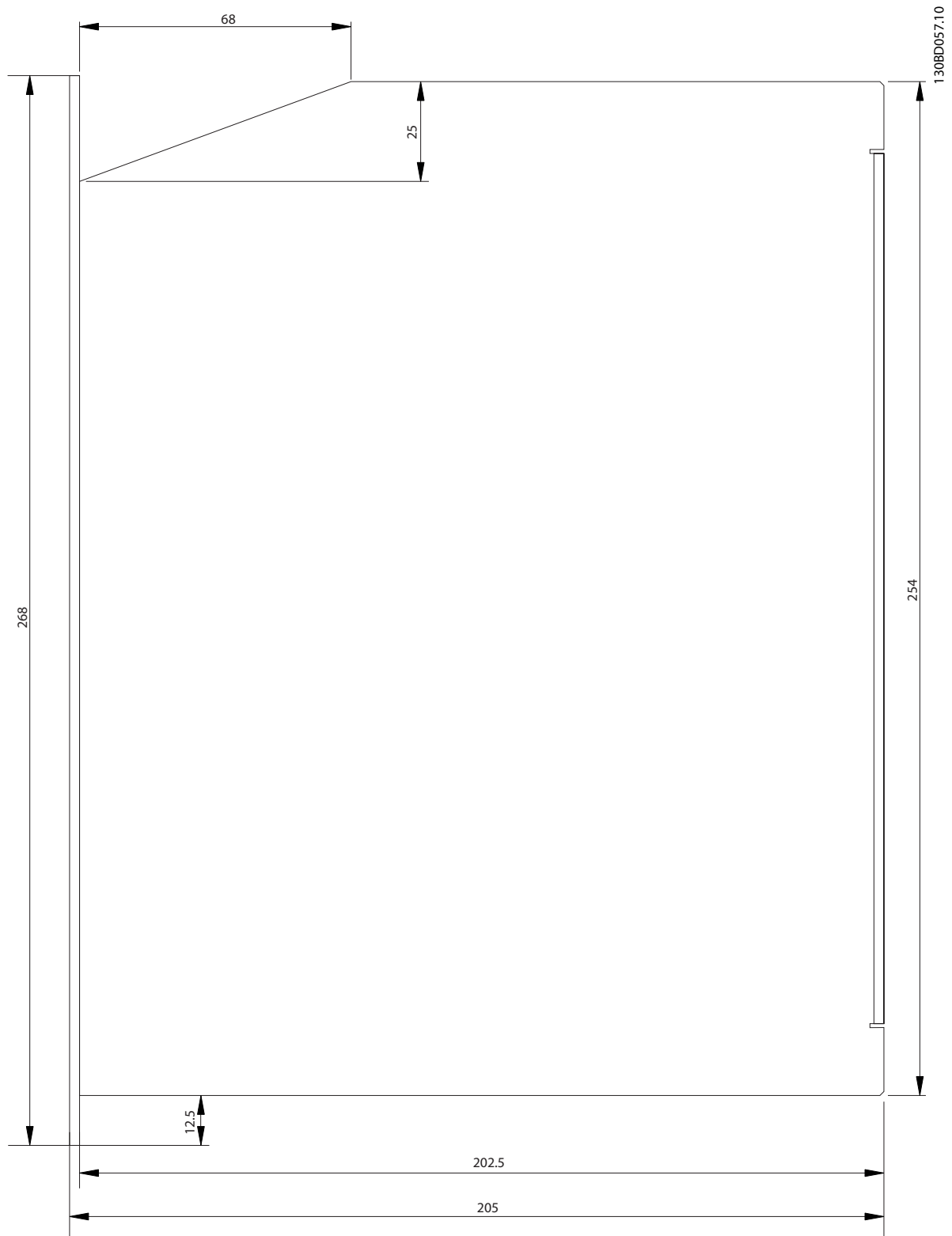

11

Illustration 11.3 Side View

12 Appendix

12.1 Glossary

A flange

The A side is the shaft side of the motor.

Ambient temperature

The temperature in the immediate vicinity of the servo system or component.

Axial force

The force in newton-metres acting on the rotor axis in the axial direction.

BCD

Binary-coded decimal

Bearings

The ball bearings of the servo drive.

B flange

The rear side of the servomotor with the plug-and-socket connectors.

BiSS

Bi-directional Synchronous Serial

Brake

Power-off brake of the ISD servomotor, on the A side of the motor.

CAN

Controller Area Network

CANopen DS301

A standard that specifies the application layer and communication profile.

CANopen DS402

An object-based CAN standard that specifies the device profile for drives and motion control.

CANopen DS406

An object-based CAN standard that specifies the device profile for encoders.

CE

European test and certification mark.

Clamping set

A mechanical device, which, for example, can be used to secure gears to a motor shaft.

CoDeSys

Controller Development System; a development environment for programming controller applications, based on IEC 61131-3 and developed by 3S-Smart Software Solutions GmbH.

Connection box

The connection box provides the link between the power supply module and the servo drives.

Connector (M23)

Servomotor connector.

Cooling

ISD servo drives are cooled by convection, which means without fans.

CRC

Cyclic Redundancy Check

CSA

Canadian test and certification mark.

DC link

Each servomotor has its own DC link, consisting of capacitors.

DC link voltage

A DC voltage shared by several ISD servomotors connected in parallel.

DC voltage

A direct constant voltage.

DSP

Digital signal processor; processor IC on an ISD control board.

Encoder box

The encoder box allows external encoder signals to be sent to the servo drives over the CAN bus with high precision.

Feed cable

Hybrid connection cable between connection box and servomotor, with a connector.

Feedback system

Feedback systems for servomotors in general.

Fieldbus

Communication bus between controller and servo axis; in general between controller and field nodes.

Firmware

Software in the unit; runs on the control board.

Flash

Memory IC on the ISD control board; a form of EPROM.

Function block

Device functionalities are accessible via CoDeSys.

Gear ratio

The speed ratio of the input pinion and the output shaft of the gear unit.

Gear unit

External gear unit used to change the output shaft speed and the torque on the motor shaft.

Hole circle

The hole patterns of the ISD and IEC flanges.

IEC flange

Industry-standard flange

Installation elevation

Installation elevation above normal sea level, typically associated with a derating factor.

ISD

Integrated servo drive, integrated servomotor solution.

ISD flange

The standard flange for ISD servo drives; larger than the IEC flange.

ISD servomotor

Designates the ISD servomotor with hybrid cable.

Loop cable

Hybrid connection cable between two servomotors, with two connectors.

M12 connector

Input connector for connecting the sensor on the B side of the servomotor.

Motor shaft

Rotating shaft on the A side of the servomotor, typically without a key groove.

Multi-turn encoder

Describes a digital absolute encoder, in which the absolute position remains known after several revolutions.

NMT

Network Management

PELV

Low-voltage directive regarding voltage levels and distances between lines.

PDO

Process Data Object (see CANopen DS301).

Planetary gear

A specific type of gearing, typically used with servomotors.

Power-off principle

The brake is normally engaged. It is released by applying a voltage (safety function).

Power supply module

The power supply module provides a regulated 300 V DC from AC 400 V.

QEP

Quadrature Encoder Pulse

Radial force

The force in newton-metres acting at 90° to the longitudinal direction of the rotor axis.

Resolver

A feedback device for servomotors, typically with two analog tracks (sine and cosine).

Safety (STO)

A servomotor safety circuit that switches off the voltages of the driver components for the IGBTs.

Scope

Used for diagnosis. Enables internal signals to be depicted.

SD Card

Secure Digital Card for encoder box.

SDO

Service Data Object (see CANopen DS301).

Segment

A segment refers to a movement within a curve.

SIL 2

Safety Integrated Level II.

Single-turn encoder

Describes a digital absolute encoder, in which the absolute position for one revolution remains known.

SSI

Synchronous Serial Interface

Toolbox

A software tool used for parameter setting and diagnostics of ISD servomotors, the ISD connection box and the ISD encoder box.

12.2 Connection Box Parameters

The object dictionary is detailed in the *VLT® ISD 410 Design Guide*. The following functions can be enabled/disabled by writing to the object dictionary via SDO.

12.2.1 Auto Power-Up (Index 0x2015, sub-index 01)

If auto power-up is configured in the user configuration and if all required conditions are met, the state machine makes a transition 'Switch On' and proceeds to state 'Power Up'. Auto power-up is defined to only initiate this transition once, after the connection box has been rebooted. Subsequent transitions into state 'Voltage disabled' require user interaction.

12.2.2 Discharge Resistor Check (Index 0x2015, sub-index 02)

If the discharge resistor check flag is set in the user configuration the resistor is checked for correct operation during power-up state. If the verification fails an error occurs and a transition to state 'Fault Charged' is initiated.

12.3 Emergency Codes

Code	Severity	Description
0x3100	Error	Input voltage (U_{DC}) above absolute maximum.
0x3101	Error	Input voltage (U_{DC}) below absolute minimum.
0x3102	Error	Input voltage (U_{DC}) below intermediate voltage (U_{ZK}) during power-up.
0x3110	Error	24 V power supply loss.
0x3111	Error	24 V power supply timeout during initialisation.
0x3118	Error	5 V CAN power supply loss.
0x3119	Error	5 V CAN power supply timeout during initialisation.
0x3180	Warning	Switch on, nominal U_{DC} range: Input voltage above maximum.
0x3181	Warning	Switch on, nominal U_{DC} range: Input voltage below minimum.
0x3190	Warning	Switch on: 24 V power supply bad.
0x3191	Warning	Switch on: 5 V CAN power supply bad.
0x3200	Error	Hazardous intermediate circuitry voltage.
0x3201	Error	Intermediate circuitry voltage (U_{ZK}) drop during operation.
0x3280	Warning	Intermediate circuitry voltage (U_{ZK}) over voltage during operation.
0x4280	Warning	Switch on: Heat sink temperature above maximum.
0x5030	Error	Fuse 1 blown.
0x5031	Error	Fuse 2 blown.
0xFF01	Error	Power-up timeout.
0xFF02	Error	Power-down timeout.
0xFF90	Warning	Switch on: No safety power.
0xFF91	Warning	Safety power 1 loss.
0xFF92	Warning	Safety power 2 loss.

Table 12.1 Emergency Codes

Index

A
Ambient Temperature..... 45
Approvals..... 5

B
BCD Switch..... 37
Booting Up..... 34
Brake
 Cable..... 31
 Connector..... 22

C
Cabling..... 15
CAN
 Cable..... 27
 Connectors..... 21
 Plugs..... 28
 Wiring Example 1..... 29
 Wiring Example 2..... 30
CAN-ID
 BCD Switch..... 37
 Setting..... 33
Climatic Classification..... 45
CoDeSys..... 37
Connection..... 15
Connections
 Connections..... 45
 24 V DC Power Supply..... 23
 Brake Connector..... 22
 CAN..... 21
 DC Input Terminal..... 22
 DC Output Terminal..... 23
 Safety Switch..... 20
Cooling..... 23, 45
Copyright..... 5

D
DC
 Input Terminal Connector..... 22
 Output Terminal Connector..... 23
Debugging..... 40
Decommissioning..... 44
Delivery
 Inspection On Receipt..... 24
 Scope Of Delivery..... 24
Demounting..... 44
Description Of ISD Connection Box..... 13
Dimensions
 Front View..... 46
 Side View..... 47
Discharge Time..... 5, 31

Disclaimer..... 5
Dismounting..... 26, 44
Display
 Display..... 14, 35
 Mode..... 36
Disposal..... 44
Documents..... 8
Drilling Template..... 25
Due Diligence..... 11

E
Earthing The Connection Box..... 26
Electrical Environmental Conditions..... 26
Emergency
 Codes..... 51
 Message..... 40
Environmental Conditions..... 24
Error History..... 40

F
Faults
 Faults..... 40
 Correcting Faults..... 41
Foreseeable Misuse..... 12
Functional Operation Test..... 33
Fuses..... 20, 45

G
Glossary..... 48
Grounding..... 26

H
High Voltage..... 5
Housing..... 45
Humidity..... 45
Hybrid Cables Connecting/Disconnecting..... 31

I
Initialisation..... 38
Input
 Current..... 45
 Voltage..... 45
Inspection During Operation..... 43
Installation
 Electrical Installation..... 26
 Mechanical Installation..... 26
 Mounting..... 26
 Preparation For Installation..... 25
Intended Use..... 12
Introduction..... 7

IP-Rating..... 45

ISD Servo System..... 7

L

LEDs

LEDs..... 35

5V..... 35

CAN..... 35

Power Supply..... 35

RUN/Err..... 35

Safe..... 35

UZK Power..... 35

M

Machine States..... 37

Maintenance..... 43

Mass..... 45

Misuse Of The Product..... 12

Monitoring..... 43

Mounting..... 26, 45

N

Nameplate..... 45

O

Operating Display..... 35

Operation Test..... 33

Operational Safety..... 10

Output Voltage..... 45

P

Parameters..... 50

Power

Factor..... 45

Supply..... 31

Supply 24 V..... 26

Protection Rating..... 45

Q

Qualified Personnel..... 11

R

Recycling..... 44

Removal..... 44

Repair..... 43

Resources, Additional Documents..... 8

Returns..... 43

S

Safety

Cable..... 31

Discharge Time..... 5, 31

During Installation..... 24

High Voltage..... 5

Instructions..... 9

Standards..... 45

Switch Connectors..... 20

Unintended Start..... 5

Warnings..... 9, 5

Safety, Operational..... 10

Service

Service..... 6

Interface On Display..... 37

SET Push Button..... 37

Shutdown..... 44

State

"Fault Charged"..... 39

"Fault Discharged"..... 38

"Operation Enabled"..... 39

"Over Voltage"..... 39

"Power Down"..... 39

"Power Up"..... 38

"Under Voltage"..... 39

"Voltage Disabled"..... 38

"Init"..... 38

Storage..... 45

Support..... 6

Switching On..... 34

Symbols..... 9

System Overview..... 7

T

Technical Data..... 45

Terminology..... 8

Toolbox..... 37

Trademarks..... 5

Transport..... 24

Troubleshooting..... 41

U

Unintended Start..... 5

V

Vibration Rating..... 45

Voltage Warning..... 5

W**Warning**

Codes.....	51
Discharge Time.....	5, 31
High Voltage.....	5
Unintended Start.....	5

Weight.....	45
--------------------	-----------

X

X1.....	22
----------------	-----------

X11-X15.....	21, 23
---------------------	---------------

X2/X3.....	23
-------------------	-----------

X22-X25.....	21
---------------------	-----------

X5.....	22
----------------	-----------



www.danfoss.com/drives

Danfoss can accept no responsibility for possible errors in catalogues, brochures and other printed material. Danfoss reserves the right to alter its products without notice. This also applies to products already on order provided that such alterations can be made without subsequential changes being necessary in specifications already agreed. All trademarks in this material are property of the respective companies. Danfoss and the Danfoss logotype are trademarks of Danfoss A/S. All rights reserved.

