



Programming Guide

VLT[®] DeviceNet MCA 104

VLT[®] Frequency Converter Series • FC 102 • FC 202 • FC 301/302



Contents

1 Introduction	3
1.1 Purpose of the Manual	3
1.2 Additional Resources	3
1.3 Document and Software Version	3
1.4 Product Overview	3
1.5 Approvals and Certifications	4
1.6 Symbols, Abbreviations and Conventions	4
2 Safety	5
2.1 Safety Symbols	5
2.2 Qualified Personnel	5
2.3 Safety Precautions	5
3 Configuration	7
3.1 Configure the DeviceNet Network	7
3.2 Configure the Master	8
3.3 Configure the Frequency Converter	8
4 Control	9
4.1 DeviceNet Process Control Modes	9
4.2 I/O Assembly Instances	10
4.3 Process Data	10
4.4 ODVA Control Profile	11
4.5 FC Control Profile	13
5 Parameter Access	17
5.1 Explicit Messages	17
5.2 Object Classes	17
5.3 DeviceNet Object Classes	18
5.4 Danfoss Object Classes	27
6 Parameters	28
6.1 Parameter Description	28
6.2 Parameter List	36
6.3 Data Types Supported	37
7 Application Examples	38
7.1 Example: Working with Instance 101/151 Process	38
8 Troubleshooting	40
8.1 LED Status	40
8.2 No Communication with the Frequency Converter	41

8.3 Frequency Converter Does Not Respond to Control Signals	41
8.4 Warnings and Alarms	44
Index	46

1 Introduction

1.1 Purpose of the Manual

The VLT® DeviceNet MCA 104 Programming Guide provides information about configuring the system, controlling the frequency converter, parameter access, programming, troubleshooting, and some typical application examples. The programming guide is intended for use by qualified personnel who are familiar with the VLT® frequency converter, with DeviceNet technology, and with the PC or PLC that is used as a master in the system. Read the instructions before programming and follow the procedures in this manual.

VLT® is a registered trademark.

1.2 Additional Resources

Resources available for the VLT® frequency converter and optional equipment:

- The *VLT® Operating Instructions* provide the necessary information for getting the VLT® frequency converter up and running.
- The *VLT® Design Guide* provides detailed information about capabilities and functionality to design motor control systems.
- The *VLT® Programming Guide* provides greater detail on working with parameters and many application examples.
- The *VLT® DeviceNet MCA 104 Installation Guide* provides information about installing the DeviceNet and troubleshooting.
- The *VLT® DeviceNet MCA 104 Programming Guide* provides information about configuring the system, controlling the VLT® frequency converter, parameter access, programming, troubleshooting, and some typical application examples.

Supplementary publications and manuals are available from Danfoss. See vlt-drives.danfoss.com/Support/Technical-Documentation/ for listings.

1.3 Document and Software Version

This manual is regularly reviewed and updated. All suggestions for improvement are welcome. *Table 1.1* shows the document version and the corresponding software version.

Edition	Remarks	Software version
MG92F1xx	First edition.	4.4x

Table 1.1 Document and Software Version

1.4 Product Overview

This programming guide relates to the DeviceNet interface. Ordering number:

- 130B1102 (non-coated version).
- 130B1210 (conformal coated version).

DeviceNet is a low-level network that standardizes communications between industrial devices (sensors, limit switches, motor controls) and high-level devices (controllers). DeviceNet follows the Open Systems Interconnection (OSI) model and is based on CAN technology for media access control and physical signaling.

DeviceNet systems can be configured to operate in a master/slave or a distributed control architecture using peer-to-peer communication. Up to 63 nodes in a multi-drop network topology are supported. By using the same cable for communication, communication options can be powered directly from the bus. Nodes can be removed or inserted without powering down the network.

Each node on the network has its own unique media access control identifier (MAC ID) to distinguish it on the network. The access control is based on the CSMA/CA (carrier sense multiple access/collision avoidance) principle, meaning that all nodes may have access to the network at the same time. When 2 nodes attempt to get control of the network bus simultaneously, the CAN protocol resolves the issue by arbitration. In this way, collisions on the network are avoided.

DeviceNet defines device profiles for devices belonging to specific classes. For other devices, define a custom class to make it DeviceNet compatible. All the above enhances the interchangeability and interoperability of the network.

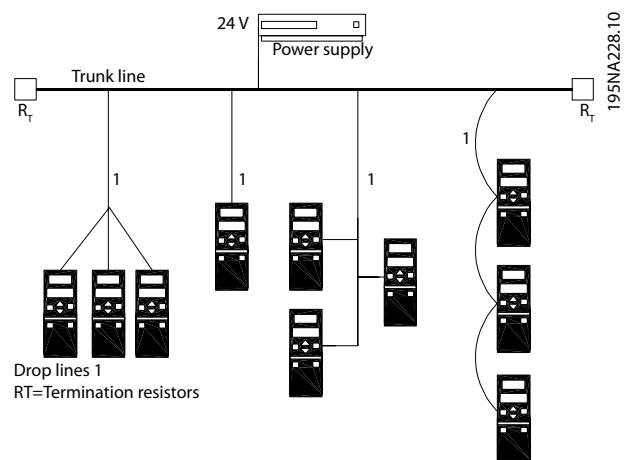

Illustration 1.1 Topology

VLT® DeviceNet MCA 104 is designed to communicate with any master abiding by the DeviceNet standard. It is intended for use with:

- VLT® HVAC Drive FC 102
- VLT® AQUA Drive FC 202
- VLT® AutomationDrive FC 301/FC 302

1.5 Approvals and Certifications



More approvals and certifications are available. For more information, contact a local Danfoss partner.

1.6 Symbols, Abbreviations and Conventions

Abbreviation	Definition
ACK	ACKnowledge
BOC	Bus off counter
BOOL	Boolean expression
CAN	Controller area network
CSMA/CA	Carrier sense multiple access/collision avoidance
COS	Change of state
CTW	Control word
EDS	Electronic data sheet
EMC	Electromagnetic compatibility
ETR	Electronic thermal relay
FIFO	First in first out
HF	High frequency
HPFB	High performance fieldbus
I/O	Input/output
ISO	International standards organization
LCD	Liquid crystal display
LED	Light emitting diode
LSB	Least significant bit
MAC ID	Media access control identifier
MAV	Main actual value
MRV	Main reference value
MSB	Most significant bit
N/A	Not applicable
ODVA	Open DeviceNet Vendor Association
OSI	Open systems interconnection
PC	Personal computer
PCD	Process data
PIW	Peripheral input word
PLC	Programmable logic control
PNU	Parameter number
PPO	Parameter-process data object
QW	Peripheral output word

Abbreviation	Definition
SINT	Signed integer
STW	Status word
VSD	Variable speed drive
UDINT	Unsigned double integer
UNIT	Unsigned integer
USINT	Unsigned short integer

Table 1.2 Symbols and Abbreviations

Conventions

Numbered lists indicate procedures.
 Bullet lists indicate other information.

Italicized text indicates:

- Cross reference.
- Link.
- Parameter name.
- Parameter group name.
- Parameter option.
- Footnote.

2 Safety

2.1 Safety Symbols

The following symbols are used in this manual:

▲WARNING

Indicates a potentially hazardous situation that could result in death or serious injury.

▲CAUTION

Indicates a potentially hazardous situation that could result in minor or moderate injury. It can also be used to alert against unsafe practices.

NOTICE

Indicates important information, including situations that can result in damage to equipment or property.

2.2 Qualified Personnel

Correct and reliable transport, storage, installation, operation, and maintenance are required for the trouble-free and safe operation of the frequency converter. Only qualified personnel are allowed to install and operate this equipment.

Qualified personnel are defined as trained staff, who are authorized to install, commission, and maintain equipment, systems, and circuits in accordance with pertinent laws and regulations. Additionally, the qualified personnel must be familiar with the instructions and safety measures described in these operating instructions.

2.3 Safety Precautions

▲WARNING

HIGH VOLTAGE

Frequency converters contain high voltage when connected to AC mains input, DC supply, or load sharing. Failure to perform installation, start-up, and maintenance by qualified personnel can result in death or serious injury.

- Only qualified personnel must perform installation, start-up, and maintenance.

▲WARNING

UNINTENDED START

When the frequency converter is connected to AC mains, DC supply, or load sharing, the motor may start at any time. Unintended start during programming, service, or repair work can result in death, serious injury, or property damage. The motor can start with an external switch, a fieldbus command, an input reference signal from the LCP or LOP, via remote operation using MCT 10 Set-up Software, or after a cleared fault condition.

To prevent unintended motor start:

- Press [Off/Reset] on the LCP before programming parameters.
- Disconnect the frequency converter from the mains.
- Completely wire and assemble the frequency converter, motor, and any driven equipment before connecting the frequency converter to AC mains, DC supply, or load sharing.

▲WARNING

DISCHARGE TIME

The frequency converter contains DC-link capacitors that can remain charged even when the frequency converter is not powered. Failure to wait the specified time after power has been removed before performing service or repair work can result in death or serious injury.

- Stop the motor.
- Disconnect the AC mains and remote DC-link supplies, including battery back-ups, UPS, and DC-link connections to other frequency converters.
- Disconnect or lock the PM motor.
- Wait for the capacitors to discharge fully before performing any service or repair work. The waiting time is specified in the relevant frequency converter operating instructions, *Chapter 2 Safety*.

▲WARNING

LEAKAGE CURRENT HAZARD

Leakage currents exceed 3.5 mA. Failure to ground the frequency converter properly can result in death or serious injury.

- Ensure the correct grounding of the equipment by a certified electrical installer.

⚠ WARNING**EQUIPMENT HAZARD**

Contact with rotating shafts and electrical equipment can result in death or serious injury.

- Ensure that only trained and qualified personnel perform installation, start-up, and maintenance.
- Ensure that electrical work conforms to national and local electrical codes.
- Follow the procedures in this guide.

⚠ CAUTION**INTERNAL FAILURE HAZARD**

An internal failure in the frequency converter can result in serious injury when the frequency converter is not properly closed.

- Ensure that all safety covers are in place and securely fastened before applying power.

3 Configuration

3.1 Configure the DeviceNet Network

All DeviceNet stations that are connected to the same bus network must have a unique station address. Select the DeviceNet address of the frequency converter via:

- Address switches (default 63).
- *Parameter 10-02 MAC ID* (default 63).
- Class code 0X03, instance 1, attribute 1.

130BA122.10

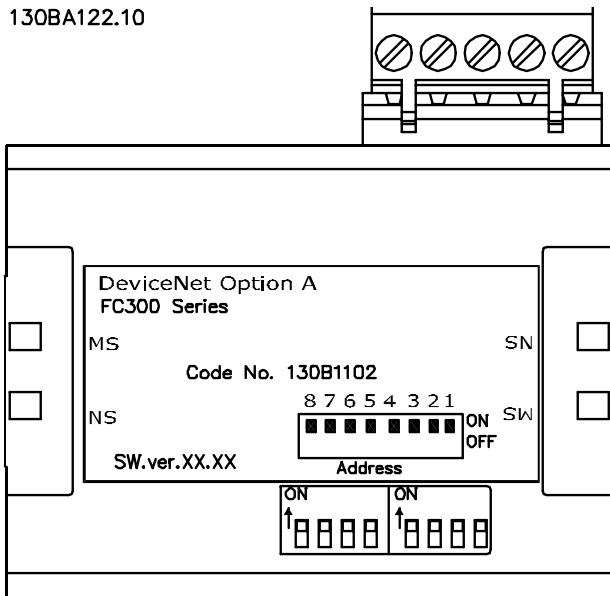

Illustration 3.1 VLT® DeviceNet MCA 104 Interface

3.1.1 Setting the DeviceNet Address using the Address Switches

NOTICE

Switch off the power supply before changing the address switches. The address change comes into effect at the next power-up, and can be read in *parameter 10-02 MAC ID*.

Set the address switches to give the option a unique ID. Select an address range from 0–63 (factory setting 63) according to *Table 3.1*.

Switch	8	7	6	5	4	3	2	1
Address value	-	-	+32	+16	+8	+4	+2	+1
5	-	-	OFF	OFF	OFF	ON	OFF	ON
20	-	-	OFF	ON	OFF	ON	OFF	OFF
35	-	-	ON	OFF	OFF	OFF	ON	ON

Table 3.1 Settings for the Address Switches

3.1.2 Setting the DeviceNet Address via Parameter 10-02 MAC ID

Set the address via *parameter 10-02 MAC ID* if the hardware switches are set to 63 (factory setting). The address change comes into effect at the next power-up.

3.1.3 Setting the DeviceNet Address with the Object Class Code 0x03, Instance 1, Attribute 1

Set the address via the DeviceNet object class code 0x03 attribute 1 command when the address switch is set to 63 (factory setting). A new address becomes effective immediately after the class code 0x03, instance 1, attribute 1 command.

3.1.4 Setting the Baud Rate

All DeviceNet stations connected to the same bus network must have the same baud rate. Select the baud rate of the frequency converter via:

- Address switches.
- *Parameter 10-01 Baud Rate Select* (default 125 kBd).
- Object class code 0x03, instance 1, attribute 2.

3.1.5 Setting the DeviceNet Baud Rate using the Address Switches

NOTICE

Switch off the power supply before changing the address switches. The baud rate change comes into effect at the next power-up, and can be read in *parameter 10-01 Baud Rate Select*.

Use the address switches to select a baud rate of 125 k baud (factory setting), 250 k baud, or 500 k baud, see *Table 3.2*:

Baud rate switch	8	7
<i>Parameter 10-01 Baud Rate Select</i>	1	1
125 kBd	0	0
250 kBd	0	1
500 kBd	1	0

Table 3.2 Address Switches

3.1.6 Setting the DeviceNet Baud Rate via Parameter 10-01 Baud Rate Select

Set the baud rate via *parameter 10-01 Baud Rate Select* if the address switches 1 and 2 are set to ON (factory setting). The baud rate change comes into effect at the next power-up.

3.1.7 Setting the DeviceNet Baud Rate with the Object Class Code 0x03, Attribute 2

Set the baud rate via the DeviceNet object class code 0x03 attribute 2 command, when the address switches 1 and 2 are set to ON (factory setting). A new baud rate becomes effective immediately after the class code 0x03 attribute 2 command.

3.2 Configure the Master

3.2.1 EDS File

A large part area of the system configuration is the setting of application-related parameters. EDS (Electronic Data Sheet) files simplify the setting up of most of the DeviceNet configurable parameters. For off-line configuration, Danfoss provides a generic English EDS file covering all voltage and power sizes. Download the EDS file from www.danfoss.com/drives.

NOTICE

The EDS file does not contain all parameters. It contains only a selected, limited number of parameters with generic minimum, maximum, and default values.

3.3 Configure the Frequency Converter

3.3.1 Frequency Converter Parameters

Note the following parameters when configuring the frequency converter with a DeviceNet interface. Refer to *chapter 6 Parameters* for more details of each parameter.

- *Parameter 0-40 [Hand on] Key on LCP.*
If the Hand key on the frequency converter is activated, control of the frequency converter via the DeviceNet interface is disabled. After initial power-up the frequency converter automatically detects whether a fieldbus option is installed in slot A, and sets *parameter 8-02 Control Word Source* to [3] Option A. If an option is added to, changed in, or removed from an already commissioned frequency converter, it does not change *parameter 8-02 Control Word Source* but enters trip mode, and the frequency converter shows an error.
- *Parameter 8-10 Control Word Profile* (see *chapter 4 Control*). Select between the Danfoss FC Profile and the ODVA profile. Select the desired DeviceNet instance in *parameter 10-10 Process Data Type Selection*.
- *Parameter 8-50 Coasting Select* to *parameter 8-56 Preset Reference Select* (see *chapter 6 Parameters*). Selection of how to gate the DeviceNet control commands with digital input command of the control card.

NOTICE

When *parameter 8-01 Control Site* is set to [2] Control word only, the settings in *parameter 8-50 Coasting Select* to *parameter 8-56 Preset Reference Select* is overruled, and all act on bus control.

- *Parameter 8-03 Control Word Timeout Time* to *parameter 8-05 End-of-Timeout Function*. The reaction in the event of a bus timeout is set via these parameters.
- *Parameter 10-10 Process Data Type Selection*. Default is 125 kbps.
- *Parameter 10-02 MAC ID*. Default is 63.

4 Control

4.1 DeviceNet Process Control Modes

This section describes 2 of 3 possible process control modes:

- Polling.
- Change of state (COS).

The 3rd FC control mode uses the acyclic mode explicit messaging via the standard DeviceNet control supervisory object class 29H. The control supervisory object is described in *chapter 5.3 DeviceNet Object Classes*.

4.1.1 Polling

Table 4.1 is a classic master/slave connection and the standard DeviceNet operating mode. The master controls the data exchange by sending cyclic poll-requests to the connected slave, and the slave answers by sending a poll-response to the master. The master can control and monitor the frequency converter by polling the DeviceNet or Danfoss objects (I/O instances).

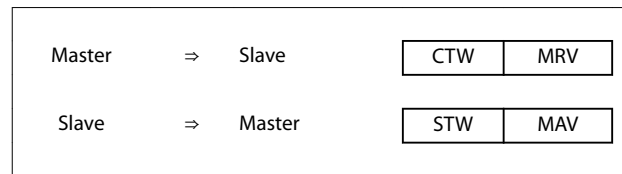

Table 4.1 Standard DeviceNet Operation Mode - Polled I/O

4.1.2 Change of State, COS

COS is an event-controlled operating mode used to minimize network traffic. Messages are transmitted only if a defined state or value has changed. The condition for triggering a COS message is determined by the insertion of COS-filters (*parameter 10-20 COS Filter 1 to parameter 10-23 COS Filter 4*), for each bit in the different PCD words. The filter acts like a logical AND function: If a bit in the filter is set to 1, the COS function triggers after a change to the corresponding bit for the PCD word.

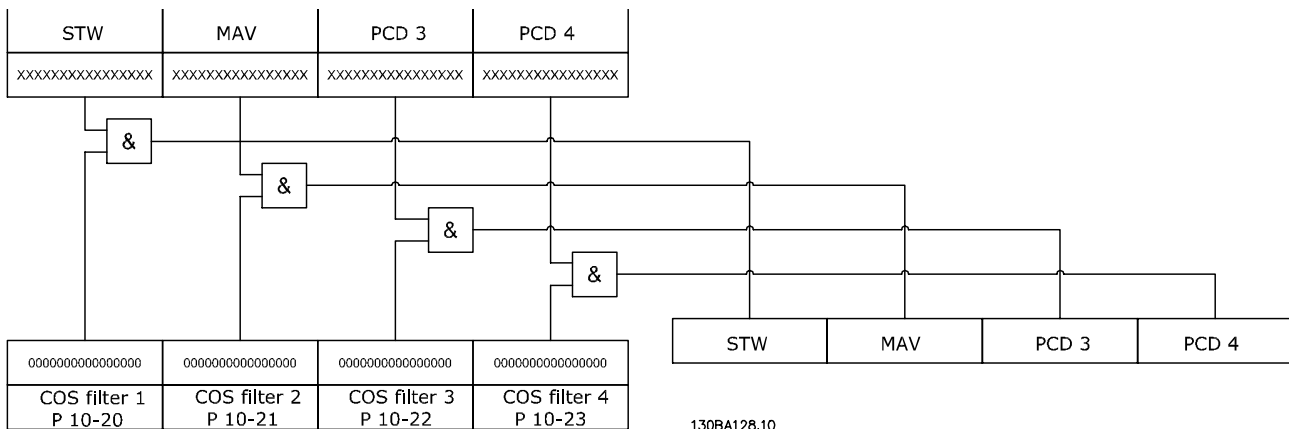

Illustration 4.1 Different PCDs and the Corresponding Filter Parameters

Parameter 10-20 COS Filter 1 to parameter 10-23 COS Filter 4 can be used to filter out undesired events for COS. If a filter bit is set to 0, the corresponding I/O instance bit is unable to produce a COS message. By default, all bits in the COS filters are set to 0.

To signal that the connection has not been interrupted, or the device is not powered off, a heartbeat message is transmitted within a specified time interval (heartbeat interval). This interval is defined in attribute heartbeat time of the connection object, class code 0x05.

To prevent the device from producing heavy network traffic if a value changes frequently, the production inhibit time (an attribute of the connection object) is defined. This parameter defines the minimum time between 2 COS messages.

The attribute expected package rate defines the maximum time between 2 COS messages even when the value is unchanged. In the event of COS connection, the explicit package rate is identical with the heartbeat interval mentioned above. This timer is used both as transmission trigger and inactivity watchdog, depending on whether the connection is producer or consumer.

4.2 I/O Assembly Instances

I/O assembly instances are several defined process control objects with defined content comprising control and status information. *Illustration 4.2* shows the I/O assembly instance options for controlling and monitoring the frequency converter.

4

PCD no.	Output (write)								Input (read)								Drive Profile		
	1		2		3		4		1		2		3		4				
Byte no.	0	1	2	3	4	5	6	7	0	1	2	3	4	5	6	7			
20/70	CTW		Speed ref.						STW		Actual RPM						ODVA		
21/71	CTW		Speed ref.						STW		Actual RPM						ODVA		
100/150	CTW		MRV						STW		MAV						Danfoss		
101/151	CTW		MRV		User defined		PCD 3		PCD 4				User defined		PCD 3		PCD 4		Danfoss

130BA133.10

Illustration 4.2 I/O Assembly Instance Options

4.3 Process Data

Process data comprises the speed control and status data in the I/O assembly instances.

The CTW, MRV, STW, and MAV have defined formats and functions, depending on the I/O instance selected. PCD 3 and PCD 4 are freely configurable, for instance 101/151 via *parameter 10-11 Process Data Config Write* and *parameter 10-12 Process Data Config Read*.

All PCDs are freely configurable for instance 102/152.

DeviceNet provides a flexible way to customize the number of process data (I/O words) and the functionality of each word. To activate the user definable process data, select the I/O instance 101/151 in *parameter 10-10 Process Data Type Selection*. This changes the I/O size to 4 words in the input and output area. This selection uses the Danfoss-specific profile for the control word and status word as well as for the main reference value/main actual value.

The first 2 words are fixed on the DeviceNet, whereas PCD 3 and PCD 4 are user configurable. The number of PCDs active in a system is fixed to 2 words.

NOTICE

To select [1] Instance 101/151 in *parameter 10-10 Process Data Type Selection*, set *parameter 8-10 Control Word Profile* to [0] FC profile.

To enable use of PCD data from the DeviceNet, configure the contents of each single PCD word in *parameter 10-11 Process Data Config Write* and *parameter 10-12 Process Data Config Read*. Changes to *parameter 10-11 Process Data Config Write* and *parameter 10-12 Process Data Config Read* are effected immediately in the PCD data.

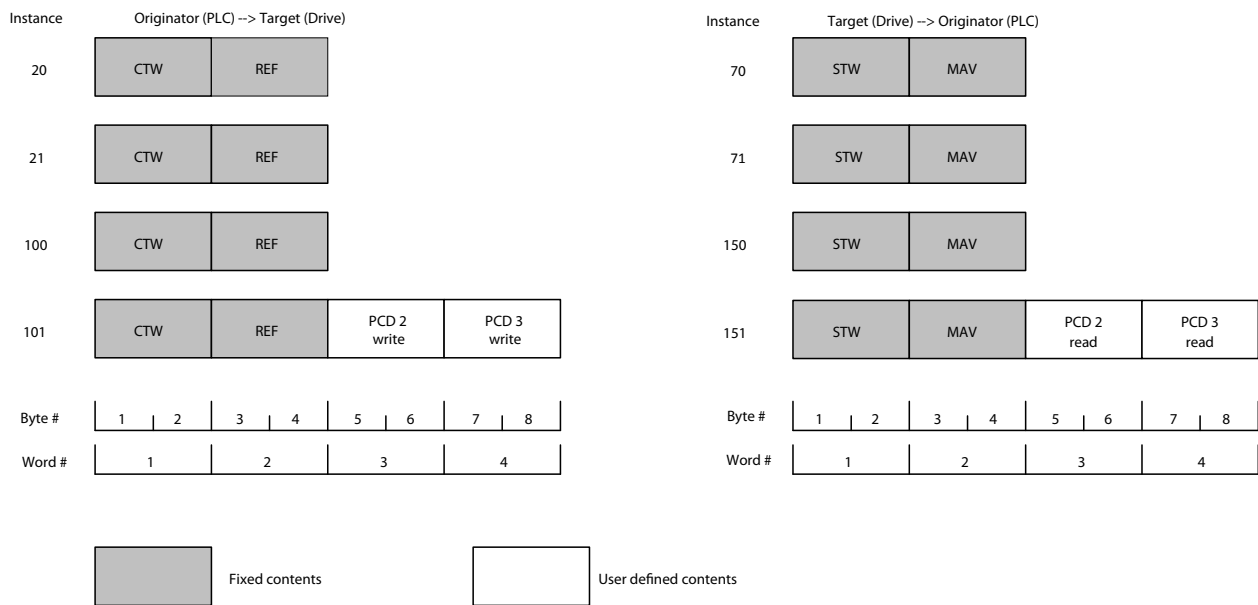

130BE709.10

Illustration 4.3 Process Data

4.4 ODVA Control Profile

4.4.1 Control Word under Instances 20/70 and 21/71

Set *parameter 8-10 Control Word Profile* to ODVA and select the instance in *parameter 10-10 Process Data Type Selection*.

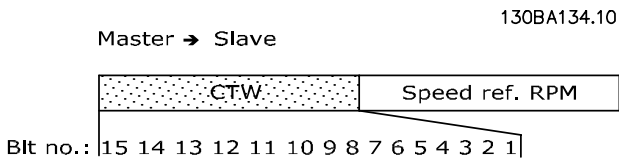

Illustration 4.4 The Control Word in Instances 20 and 21

NOTICE

The bits 00 and 02 in instance 20 are identical with bits 00 and 02 in the more extensive instance 21.

Bit	Instance 20		Instance 21	
	Bit = 0	Bit = 1	Bit = 0	Bit = 1
00	Stop	Run Fwd	Stop	Run Fwd
01	-	-	Stop	Run Rev
02	No function	Fault reset	No function	Fault reset
03	-	-	-	-
04	-	-	-	-
05	-	-	-	Net Ctrl
06	-	-	-	Net Ref
07-15	-	-	-	-

Table 4.2 Bits in Instances 20 and 21

Explanation of the bits:

Bit 0, Run Fwd

Bit 0 = 0: The frequency converter has a stop command.
 Bit 0 = 1: Leads to a start command, and the frequency converter runs the motor clockwise.

Bit 1, Run Rev

Bit 1 = 0: Leads to a stop of the motor.
 Bit 1 = 1: Leads to a start reverse of the motor, and the frequency converter runs the motor counterclockwise.

Bit 2, Fault Reset

Bit 2 = 0: There is no reset of a trip.
 Bit 2 = 1: A trip is reset.

Bit 3, No function

Bit 3: No function.

Bit 4, No function

Bit 4: No function.

Bit 5, Net Control

Bit 5 = 0: The frequency converter is controlled via the standard inputs.
 Bit 5 = 1: The DeviceNet controls the frequency converter.

NOTICE

Changes affect *parameter 8-50 Coasting Select* to *parameter 8-56 Preset Reference Select*.

Bit 6, Net Reference

Bit 6 = 0: Reference is from the standard inputs.
 Bit 6 = 1: Reference is from DeviceNet.

NOTICE

Changes affect parameter 3-15 Reference Resource 1 to parameter 3-17 Reference Resource 3.

For the speed reference, see chapter 4.4.3 Bus Speed Reference Value under Instances 20/70 and 21/71.

4.4.2 Status Word under Instances 20/70 and 21/71

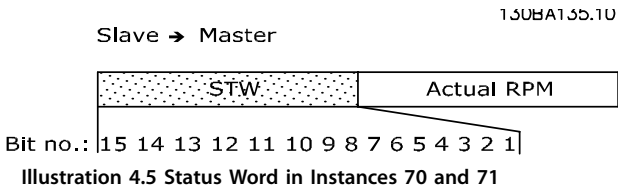

NOTICE

The bits 00 and 02 in instance 70 are identical with bits 00 and 02 in the more extensive instance 71.

Bit	Instance 70		Instance 71	
	Bit = 0	Bit = 1	Bit = 0	Bit = 1
00	-	Fault	-	Fault
01	-	-	-	Warning
02	-	Running 1 Fwd	-	Running 1 Fwd
03	-	-	-	Running 2 Rev.
04	-	-	-	Ready
05	-	-	-	Control from Net
06	-	-	-	Reference from Net
07	-	-	-	At reference
08-15	-	-	State attribute	

Table 4.3 Bits in Instances 70 and 71

Explanation of the bits:

Bit 0, Fault

Bit 0 = 0: There is no fault in the frequency converter.
Bit 0 = 1: There is a fault in the frequency converter.

Bit 1, Warning

Bit 0 = 0: There is no unusual situation.
Bit 0 = 1: An abnormal condition has arisen.

Bit 2, Running 1

Bit 2 = 0: The frequency converter is not in the running forward state, or run 1 is not set.
Bit 2 = 1: The frequency converter state attribute is enabled or stopping, or that fault-stop and bit 0 (run 1) of the control word are set at the same time.

Bit 3, Running 2

Bit 3 = 0: The frequency converter is not in the running reverse state, or run 2 is not set.
Bit 3 = 1: The frequency converter state attribute is enabled or stopping, or fault-stop and bit 0 (run 2) of the control word are set at the same time.

Bit 4, Ready

Bit 4 = 0: The state attribute is in another state.
Bit 4 = 1: The state attribute is ready, enabled, or stopping.

Bit 5, Control from net

Bit 5 = 0: The frequency converter is controlled from the standard inputs.
Bit 5 = 1: The DeviceNet has control (start, stop, reverse) of the frequency converter.

Bit 6, Ref from net

Bit 6 = 0: The reference comes from inputs to the frequency converter.
Bit 6 = 1: The reference comes from the DeviceNet.

Bit 7, At reference

Bit 7 = 0: The motor is running, but the present speed is different from the preset speed reference, for example, the speed is being ramped up/down during start/stop.
Bit 7 = 1: The frequency converter and reference speeds are equal.

Bit 8-15, State attribute

(Instance 71 only)
Represents the state attribute of the frequency converter, as indicated in Table 4.4.

Bit number	Meaning
8	(Vendor specific)
9	Start up
10	Not ready
11	Ready
12	Enabled
13	Stopping
14	Fault stop
15	Faulted

Table 4.4 State Attribute (Instance 71)

For more details of the actual output speed, see chapter 4.4.4 Actual Output Speed under Instances 20/70 and 21/71.

4.4.3 Bus Speed Reference Value under Instances 20/70 and 21/71

The speed reference value is transmitted to the frequency converter as a 16-bit word. The value is transmitted as a whole number. Negative figures are formatted by 2's complement.

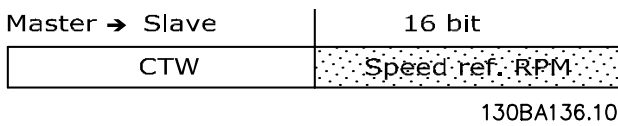

Illustration 4.6 Speed Reference Value

The bus speed reference has the following format:
 Parameter 3-00 Reference Range = 0 [ref_{MIN} to ref_{MAX}] 0 (0000 hex) [RPM] to + 32767 (7FFF hex) [RPM]
 Parameter 3-00 Reference Range = 1 [-ref_{MAX} to +ref_{MAX}] -32767 (8001 hex) to +32767 [RPM] (7FFF hex)

The actual reference [Ref. %] in the frequency converter depends on the settings in the following parameters:
 Parameter 1-23 Motor Frequency
 Parameter 1-25 Motor Nominal Speed
 Parameter 3-03 Maximum Reference

NOTICE

When the bus speed reference is negative, and the control word contains a run reverse signal, the frequency converter runs clockwise (- is +).

Example:

Parameter 1-25 Motor Nominal Speed = 1420 RPM
 Parameter 1-23 Motor Frequency = 50 Hz
 Parameter 3-03 Maximum Reference = 1420 RPM

To run the motor at 25%, the reference transmitted must be: (1420x0.25) = 355 = 16.3 hex
 163 hex ⇒ 25% ⇒ F_{out} = 12.5 Hz

4.4.4 Actual Output Speed under Instances 20/70 and 21/71

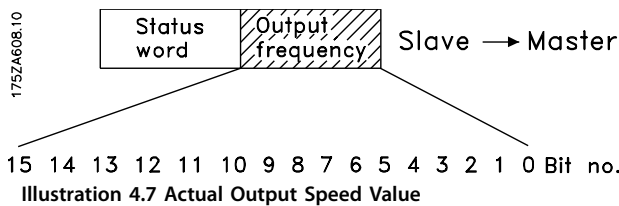

Illustration 4.7 Actual Output Speed Value

The value of the actual speed of the motor, is transmitted in the form of a 16-bit word.

The value is transmitted as a whole number (negative figures are formed with 2's complement).

-32767 (8000 hex) [RPM] to +32767 [RPM] (7FFF hex) [RPM]

4.5 FC Control Profile

4.5.1 Control Word under Instances 100/150, 101/151, and 102/152

To select FC protocol in the control word, set parameter 8-10 Control Word Profile to [0] FC profile. The control word is used to send commands from a master (PLC or PC) to a slave (frequency converter).

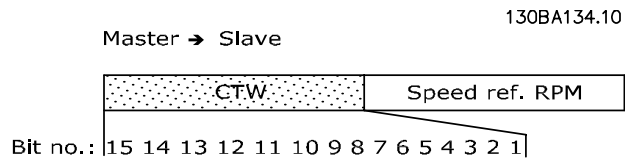

Illustration 4.8 Control Words in Instances 100, 101, and 102

Bit	Bit value = 0	Bit value = 1
00	Reference value	External selection lsb
01	Reference value	External selection msb
02	DC brake	Ramp
03	Coasting	No coasting
04	Quick stop	Ramp
05	Hold output frequency	Use ramp
06	Ramp stop	Start
07	No function	Reset
08	No function	Jog
09	Ramp 1	Ramp 2
10	Data invalid	Data valid
11	No function	Relay 01 active
12	No function	Relay 04 active
13	Parameter set-up	Selection lsb
14	Parameter set-up	Selection msb
15	No function	Reverse

Table 4.5 Bits in Instances 100, 101, and 102

Explanation of the control bits:

Bits 00/01

Bits 00 and 01: Select between the 4 reference values, which are pre-programmed in parameter 3-10 Preset Reference according to Table 4.6.

Programmed reference value	Parameter	Bit 01	Bit 00
1	3-10 [0]	0	0
2	3-10 [1]	0	1
3	3-10 [2]	1	0
4	3-10 [3]	1	1

Table 4.6 Reference Values

NOTICE

In *parameter 8-56 Preset Reference Select*, a selection is made to define how bit 00/01 gates with the corresponding function on the digital inputs.

Bit 02, DC brake

Bit 02 = 0: Leads to DC braking and stop. Braking current and duration are set in *parameter 2-01 DC Brake Current* and *parameter 2-02 DC Braking Time*.

Bit 02 = 1: Leads to ramping.

Bit 03, Coasting

Bit 03 = 0: Causes the frequency converter to immediately release the motor (the output transistors are disabled), and coasts to a standstill.

Bit 03 = 1: Enables the frequency converter to start the motor if the other starting conditions are fulfilled.

NOTICE

In *parameter 8-50 Coasting Select*, a selection is made to define how bit 03 gates with the corresponding function on a digital input.

Bit 04, Quick stop

Bit 04 = 0: Causes a stop, in which the motor speed is ramped down to stop via *parameter 3-81 Quick Stop Ramp Time*.

Bit 05, Hold output frequency

Bit 05 = 0: Causes the present output frequency (in Hz) to freeze. The frozen output frequency can then be changed only with the digital inputs (*parameter 5-10 Terminal 18 Digital Input* to *parameter 5-15 Terminal 33 Digital Input*) programmed to speed up and speed down.

NOTICE

If hold output is active, only the following can stop the frequency converter:

- Bit 03 coasting stop.
- Bit 02 DC braking.
- Digital input (*parameter 5-10 Terminal 18 Digital Input* to *parameter 5-15 Terminal 33 Digital Input*) programmed to DC braking, coasting stop, or reset and coasting stop.

Bit 06, Ramp stop/start

Bit 06 = 0: Causes a stop, in which the motor speed is ramped down to stop via the selected *ramp down* parameter.

Bit 06 = 1: Allows the frequency converter to start the motor, if the other starting conditions are fulfilled.

NOTICE

In *parameter 8-53 Start Select*, a selection is made to define how bit 06 ramp stop/start gates with the corresponding function on a digital input.

Bit 07, Reset

Bit 07 = 0: Does not cause a reset.

Bit 07 = 1: Resets a trip. Reset is activated on the leading edge of the signal, that is, when changing from logic 0 to logic 1.

Bit 08, Jog

Bit 08 = 1: The frequency converter ramps up/ramps down according to the setting in *parameter 3-19 Jog Speed [RPM]*.

Bit 09, Selection of ramp 1/2

Bit 09 = 0: Ramp 1 is active (*parameter 3-40 Ramp 1 Type* to *parameter 3-47 Ramp 1 S-ramp Ratio at Decel. Start*).

Bit 09 = 1: Ramp 2 is active (*parameter 3-50 Ramp 2 Type* to *parameter 3-57 Ramp 2 S-ramp Ratio at Decel. Start*).

Bit 10, Data not valid/Data valid

Tells the frequency converter whether to use or to ignore the control word.

Bit 10 = 0: Ignores the control word.

Bit 10 = 1: Uses the control word to be used. This function is relevant, because the control word is always contained in the telegram, regardless of the type of telegram. It is possible to turn off the control word if you do not wish to use it with updating or reading parameters.

Bit 11, Relay 01

Bit 11 = 0: Relay not activated.

Bit 11 = 1: Relay 01 activated, provided [36] control word bit 11 is selected in *parameter 5-40 Function Relay*.

Bit 12, Relay 04

Bit 12 = 0: Relay 04 is not activated.

Bit 12 = 1: Relay 04 is activated, provided [37] control word bit 12 is selected in *parameter 5-40 Function Relay*.

Bit 13/14, Selection of set-up

Bits 13 and 14 are used to select from the 4 menu set-ups according to *Table 4.7*.

Set-up	Bit 14	Bit 13
1	0	0
2	0	1
3	1	0
4	1	1

Table 4.7 Menu Set-up

The function is only possible when [9] *Multi Set-up* is selected in *parameter 0-10 Active Set-up*.

NOTICE

In *parameter 8-55 Set-up Select*, a selection is made to define how bits 13/14 gate with the corresponding function on the digital inputs.

Bit 15 Reverse

Bit 15 = 0: No reversing.

Bit 15 = 1: Reversing.

4.5.2 Status Word under Instances 100/150, 101/151, and 102/152

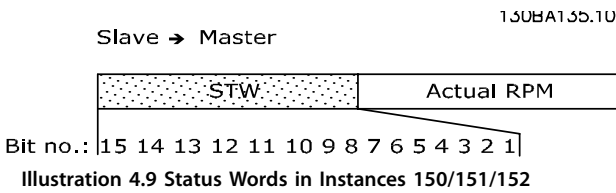

Bit	Bit = 0	Bit = 1
00	Control not ready	Control ready
01	Drive not ready	Drive ready
02	Coasting	Enable
03	No error	Trip
04	No error	Error (no trip)
05	Reserved	-
06	No error	Trip lock
07	No warning	Warning
08	Speed reference	Speed = reference
09	Local operation	Bus control
10	Out of frequency limit	Frequency limit ok
11	No operation	In operation
12	Drive ok	Stopped, auto start
13	Voltage ok	Voltage exceeded
14	Torque ok	Torque exceeded
15	Timer ok	Timer exceeded

Table 4.8 Status Bits

Explanation of the status bits:

Bit 00, Control not ready/ready

Bit 00 = 0: The frequency converter has tripped.
 Bit 00 = 1: The frequency converter controls are ready, but the power component is not necessarily receiving any power supply (if there is 24 V external supply to controls).

Bit 01, Drive ready

Bit 01 = 1: The frequency converter is ready for operation.

Bit 02, Coasting stop

Bit 02 = 0: The frequency converter has released the motor.
 Bit 02 = 1: The frequency converter can start the motor when a start command is given.

Bit 03, No error/trip

Bit 03 = 0: The frequency converter is not in fault mode.
 Bit 03 = 1: The frequency converter is tripped, and a reset signal is required to re-establish operation.

Bit 04, No error/error (no trip)

Bit 04 = 0: The frequency converter is not in fault mode.
 Bit 04 = 1: There is a frequency converter error but no trip.

Bit 05, Not used

Bit 05: Not used in the status word.

Bit 06, No error/trip lock

Bit 06 = 0: The frequency converter is not in fault mode.
 Bit 06 = 1: The frequency converter is tripped and locked.

Bit 07, No warning/warning

Bit 07 = 0: There are no warnings.
 Bit 07 = 1: A warning has occurred.

Bit 08, Speed reference/speed = reference

Bit 08 = 0: The motor is running, but the present speed is different from the preset speed reference. For example, it could be the case while the speed is being ramped up/down during start/stop.
 Bit 08 = 1: The present motor speed matches the preset speed reference.

Bit 09, Local operation/bus control

Bit 09 = 0: [STOP/RESET] is activated on the control unit, or [2] Local in parameter 3-13 Reference Site is selected. It is not possible to control the frequency converter via serial communication.
 Bit 09 = 1: It is possible to control the frequency converter via the fieldbus/serial communication.

Bit 10, Out of frequency limit

Bit 10 = 0: The output frequency has reached the value in parameter 4-52 Warning Speed Low or parameter 4-53 Warning Speed High.
 Bit 10 = 1: The output frequency is within the defined limits.

Bit 11, No operation/in operation

Bit 11 = 0: The motor does not run.
 Bit 11 = 1: The frequency converter has a start signal, or the output frequency is greater than 0 Hz.

Bit 12, Drive OK/stopped, auto start

Bit 12 = 0: There is no temporary overtemperature on the inverter.
 Bit 12 = 1: The inverter has stopped because of overtemperature, but the unit has not tripped and resumes operation once the overtemperature stops.

Bit 13, Voltage OK/limit exceeded

Bit 13 = 0: There are no voltage warnings.
 Bit 13 = 1: The DC voltage in the frequency converters DC link is too low or too high.

Bit 14, Torque OK/limit exceeded

Bit 14 = 0: The motor current is lower than the torque limit selected in parameter 4-16 Torque Limit Motor Mode or parameter 4-17 Torque Limit Generator Mode.
 Bit 14 = 1: The torque limits in parameter 4-16 Torque Limit Motor Mode and parameter 4-17 Torque Limit Generator Mode are exceeded.

Bit 15, Timer OK/limit exceeded

Bit 15 = 0: The timers for motor thermal protection and frequency converter thermal protection, respectively, have not exceeded 100%.
 Bit 15 = 1: One of the timers has exceeded 100%.

4.5.3 Bus Reference Value under Instances 100/150 and 101/151

The frequency reference value is transmitted to the frequency converter in the form of a 16-bit word. The value is transmitted as a whole number (-32767 to +32767). Negative figures are formatted by 2's complement.

Master ⇒ slave	16 bit
CTW	Speed reference RPM

Table 4.9 Speed Reference Value

The bus reference has the following format:

100% = 4000 hex

Parameter 3-00 Reference Range = 0 [ref_{MIN} ⇒ ref_{MAX}] 0 ⇒ 16384 (4000 hex) ~ 0 ⇒ 100%

Parameter 3-00 Reference Range = 1 [- ref_{MAX} ⇒ + ref_{MAX}] -16384 (C000 hex) ⇒ +16384 (4000 hex) ~ -100% ⇒ +100%

4.5.4 Actual Output Frequency under Instances 100/150 and 101/151

The value of the actual output frequency of the frequency converter is transmitted in the form of a 16-bit word. The value is transmitted as a whole number (-32767 to +32767). Negative figures are formed by 2's complement.

Slave ⇒ master	16 bit
STW	Actual reference RPM

Table 4.10 Actual Output Frequency

The actual output frequency has the following format:

-32767 to +32767.

-16384 (C000 hex) corresponds to -100%, and 16384 (4000 hex) corresponds to 100%.

5 Parameter Access

5.1 Explicit Messages

DeviceNet is based on the CAN protocol. Every message contains an 11 bit CAN identifier field to define the connection ID. These CAN identifiers are also used to determine access priority.

The MAC ID is stored in the header of the message, which is split into 4 different message groups, see *Table 5.1*.

10	9	8	7	6	5	4	3	2	1	0	Identifier bits
0	Group 1 ID				Source MAC ID				Message group 1		
1	0	MAC ID				Group 2 ID				Message group 2	
1	1	Group 3 ID			Source MAC ID				Message group 3		
1	1	1	1	1	Group 4 ID						Message group 4
1	1	1	1	1	1	1	X	X	X	X	Invalid CAN identifiers

Table 5.1 MAC ID

It is possible to access frequency converter parameters via the standard DeviceNet service explicit message. Two classes of explicit messages are supported:

Message group 2: Explicit messages take place via pre-defined master/slave connections.

Message group 3: Explicit messages take place via dynamically established lower prioritized connections.

5.2 Object Classes

Access is available to the following standard DeviceNet objects.

Class ID 01h	Identity object	Class ID 10h	Parameter group object
Class ID 03h	DeviceNet object	Class ID 28h	Motor data object
Class ID 04h	Assembly object	Class ID 29h	Control supervisory object
Class ID 05h	Connection object	Class ID 2Ah	AC/DC drive object
Class ID 0Fh	Parameter object	Class ID 2Bh	Acknowledge handler object

Table 5.2 Standard DeviceNet Objects

The following DeviceNet vendor-specific objects are also available:

Class ID 100d to 119d Danfoss classes.

The object classes are described in *chapter 5.3 DeviceNet Object Classes* and *chapter 5.4 Danfoss Object Classes*.

5.3 DeviceNet Object Classes

5.3.1 Class ID 01h Identity Object

Class ID 01h identity object is a standard DeviceNet object for identification of the device (frequency converter). Set the heartbeat interval in this object. The attributes supported for this class are listed in *Table 5.3*.

Attribute	Access	Name	Data type	Minimum/ Maximum	Units	Default	Description
1	Get	Vendor	USINT	–	–	97	Danfoss Drives Vendor code.
2	Get	Device Type	UNIT	–	–	2	AD/DC Motor.
3	Get	Product Code	UNIT	–	–	100	See <i>chapter 3.2.1 EDS File</i> .
4	Get	Revision	UNIT	–	–	–	Software version on FC 102, FC 202, or FC 300.
5	Get	Status	UNIT	–	–	–	
6	Get	Serial Number	UDINT	–	–	–	From frequency converter.
7	Get	Product Name	String	–	–	–	FC 100, FC 202, or FC 300.
10	Get/Set	Heartbeat Interval	USINT	0–255	s	0	Off.

Table 5.3 Class ID 0x01

5.3.2 Class ID 03h DeviceNet Object

Class ID 03h DeviceNet object is a standard DeviceNet object for configuration and status of the DeviceNet connection. The attributes supported for this class are listed in *Table 5.4*.

Attribute	Access	Name	Data type	Minimum/ Maximum	Units	Default	Description
1	Get/Set	MAC ID	USINT	0–63	–	63	Node address.
2	Get/Set	Baud rate	USINT	0–2	–	0	0=125 1=250 2=500
4	Get	BOC	–	–	–	–	Bus-off counter.
5	Get	Allocate information	–	–	–	–	Only required if predefined master/slave is implemented.
6	Get	MAC ID switch changed	BOOL	0–1	–	0	The node address switch has changed since the last power-up/reset.
7	Get	Baud rate switched from last power-up	BOOL	0–1	–	0	The baud rate switch has changed since the last power-up.

Table 5.4 Class ID 0x03

5.3.3 Class ID 04h Assembly Object

Class ID 04h assembly object is a standard DeviceNet object for transfer of the I/O instances (process data) described in *chapter 4 Control*. Using class ID 04h assembly object to send or read any of the defined instances, either by polling or explicit messaging. The attributes supported for this class are listed in *Table 5.5*.

Attribute	Access	Name	Data type	Minimum/ Maximum	Units	Default	Description
3	Set	Data	ARRAY	-	-	-	-

Table 5.5 Class ID 0x04

Instance	Access	Size	Description	Parameter 10-10 selection
20	Set	2 words	DeviceNet AC/DC profile	Instance 20/70
21	Set	2 words	DeviceNet AC/DC profile	Instance 21/71
70	Get	2 words	DeviceNet AC/DC profile	Instance 20/70
71	Get	2 words	DeviceNet AC/DC profile	Instance 21/71
100	Set	2 words	Danfoss specific, no PCD words	Instance 100/150
101	Set	4 words	Danfoss specific, 2 PCD words	Instance 101/151
150	Get	2 words	Danfoss specific, no PCD words	Instance 100/150
151	Get	4 words	Danfoss specific, 2 PCD words	Instance 101/151

Table 5.6 Instances

5.3.4 Class ID 05h Connection Object

Class ID 05h connection object is a standard DeviceNet object for allocation and managing I/O and explicit messaging connections. For this class, 3 instances are supported:

- Explicit messages.
- Polled I/O.
- Change of state.

The attributes supported for the different instances are listed in *Table 5.7*, *Table 5.8*, and *Table 5.9*.

5

Attribute	Access	Name	Data type	Description
1	Get	State	USINT	State of the object.
2	Get	Instance type	USINT	Indicates either I/O or explicit message.
3	Get	Transport class trigger	USINT	Defines behavior of the connection.
4	Get	Produced connection ID	UINT	CAN identifier field when the connection transmits.
5	Get	Consumed connection ID	UINT	CAN identifier field value that denotes message to be received.
6	Get	Initial communication characteristics	USINT	Defines the message group/groups across which productions and consumptions associated with this connection occur.
7	Get	Produced connection size	UINT	Maximum number of bytes transmitted across this connection.
8	Get	Consumed connection size	UINT	Maximum number of bytes received across this connection.
9	Get/Set	Expected package rate	UINT	Defines value used in transmission trigger timer and inactivity/watchdog timer.
12	Get	Watchdog timeout action	USINT	Defines how to handle inactivity/watchdog timeout.
13	Get	Produced connection path length	UINT	Number of bytes in the produced connection path attribute.
14	Get	Produced connection path	Array of USINT	Specifies the application object/objects whose data is to be produced by these connection objects.
15	Get	Consumed connection path length	UINT	Number of bytes in the consumed connection path attribute.
16	Get	Consumed connection path	Array of USINT	Specifies the application object/objects that are to receive the data consumed by this connection object.
17	Get	Production inhibit time	UINT	Defines minimum time between new data production. This attribute is required for I/O client connection.

Table 5.7 Instance 1 Attributes: Explicit Message Instance

Attribute	Access	Name	Data type	Description
1	Get	State	USINT	State of the object.
2	Get	Instance type	USINT	Indicates either I/O or explicit message.
3	Get	Transport class trigger	USINT	Defines behavior of the connection.
4	Get	Produced connection ID	UINT	CAN identifier field when the connection transmits.
5	Get	Consumed connection ID	UINT	CAN identifier field value that denotes message to be received.
6	Get	Initial communication characteristics	USINT	Defines the message group/groups across which productions and consumptions associated with this connection occur.
7	Get	Produced connection size	UINT	Maximum number of bytes transmitted across this connection.
8	Get	Consumed connection size	UINT	Maximum number of bytes received across this connection.
9	Get/Set	Expected package rate	UINT	Defines value used in transmission trigger timer and inactivity/watchdog timer.
12	Get	Watchdog timeout action	USINT	Defines how to handle inactivity/watchdog timeout.
13	Get	Produced connection path length	UINT	Number of bytes in the produced connection path attribute.
14	Get	Produced connection path	Array of USINT	Specifies the application object/objects whose data is to be produced by these connection objects.
15	Get	Consumed connection path length	UINT	Number of bytes in the consumed connection path attribute.
16	Get	Consumed connection path	Array of USINT	Specifies the application object/objects that are to receive the data consumed by this connection object.
17	Get	Production inhibit time	UINT	Defines minimum time between new data production. This attribute is required for I/O client connection.

Table 5.8 Instance 2 Attributes: Polled I/O

Attribute	Access	Name	Data type	Description
1	Get	State	USINT	State of the object.
2	Get	Instance type	USINT	Indicates either I/O or explicit message.
3	Get	Transport class trigger	USINT	Defines behavior of the connection.
4	Get	Produced connection ID	UINT	CAN identifier field when the connection transmits.
5	Get	Consumed connection ID	UINT	CAN identifier field value that denotes message to be received.
6	Get	Initial communication characteristics	USINT	Defines the message group/groups across which productions and consumptions associated with this connection occur.
7	Get	Produced connection size	UINT	Maximum number of bytes transmitted across this connection.
8	Get	Consumed connection size	UINT	Maximum number of bytes received across this connection.
9	Get/Set	Expected package rate	UINT	Defines value used in transmission trigger timer and inactivity/watchdog timer.
12	Get	Watchdog timeout action	USINT	Defines how to handle inactivity/watchdog timeout.
13	Get	Produced connection path length	UINT	Number of bytes in the produced connection path attribute.
14	Get	Produced connection path	Array of USINT	Specifies the application object/objects whose data is to be produced by these connection objects.
15	Get	Consumed connection path length	UINT	Number of bytes in the consumed connection path attribute.
16	Get	Consumed connection path	Array of USINT	Specifies the application object/objects that are to receive the data consumed by this connection object.
17	Get	Production inhibit time	UINT	Defines minimum time between new data production. This attribute is required for I/O client connection.

Table 5.9 Instance 4: Change of State/Cycle

5.3.5 Class ID 0F4 Parameter Object

Class ID 0F4 parameter object is an interface to the parameters of the frequency converter. It identifies configurable parameters and supplies their description, including minimum and maximum values and a descriptive text. The attributes supported are listed in *Table 5.10*.

Attribute	Access	Stub/Full	Name	Data type	Description
1	Set/Get	Stub	Parameter value	Data type ¹⁾	Actual value of parameter.
2	Get	Stub	Link path size	USINT	Size of link path.
3	Get	Stub	Link path	ARRAY	DeviceNet's path to origin of the parameters.
–	–	–	Segment type/port	BYTE	–
–	–	–	Segment address	Path	–
4	Get	Stub	Descriptor	WORD	Description of parameter.
5	Get	Stub	Data type	EPATH	Data type code.
6	Get	Stub	Data size	USINT	Number of bytes in parameter value.
7	Get	Full	Parameter name string	SHORT STRING	Text string representing the parameter name.
8	Get	Full	Units string	SHORT STRING	Text string representing the parameter name.
9	Get/Set	Full	Help string	SHORT STRING	Text string representing the parameter name.
10	Get	Full	Minimum value	Data type ¹⁾	Minimum valid value.
11	Get	Full	Maximum value	Data type ¹⁾	Maximum valid value.
12	Get	Full	Default value	Data type ¹⁾	Parameters default value.
13	Get	Full	Scaling multiplier	UINT	Multiplier for scaling factor.
14	Get	Full	Scaling divisor	UINT	Divisor for scaling factor.
15	Get	Full	Scaling base	UINT	Base for scaling formula.
16	Get	Full	Scaling offset	INT	Offset for scaling formula.
17	Get	Full	Multiplier link	UINT	Parameter instance of multiplier source.
18	Get	Full	Divisor link	UINT	Parameter instance of divisor source.
19	Get	Full	Base link	UINT	Parameter instance of base source.
20	Get	Full	Offset link	UINT	Parameter instance of offset source.
21	Get	Full	Decimal precision	USINT	Specifies parameter value format.

Table 5.10 Attributes Supported for Class ID 0F4 Parameter Object

1) Same data type as the parameter.

5.3.6 Class ID 10h Parameter Group Object

Class ID 10h parameter group object defines 14 parameter groups for all parameters of the frequency converters. One class instance exists for each parameter group. A readout of an instance contains the name of the current parameter group.

Group	Instance	Name (maximum 16 characters)															
0	1	O	P	E	R	A	T	I	O	N		D	I	S	P	L	.
1	2	L	O	A	D	-	M	O	T	O	R	-	-	-	-	-	-
2	3	B	R	A	K	E	S	-	-	-	-	-	-	-	-	-	-
3	4	R	E	F	E	R	E	N	C	E	-	R	A	M	P	S	-
4	5	L	I	M	I	T	S	-	W	A	R	N	I	N	G	S	-
5	6	D	I	G	I	T	A	L	-	I	N	-	O	U	T	-	-
6	7	A	N	A	L	O	G	-	I	N	-	O	U	T	-	-	-
7	8	C	O	N	T	R	O	L	L	E	R	S	-	-	-	-	-
8	9	C	O	M	M	.	-	A	N	D	-	O	P	T	I	O	N
9	10	C	A	N	-	F	I	E	L	D	B	U	S	-	-	-	-
10	11	S	P	E	C	I	A	L	-	F	U	N	C	T	I	O	N

Table 5.11 Class ID 10h Parameter Group Object

5.3.7 Class ID 28h Motor Data Object

In class ID 28h motor data object, the current motor data can be configured and readout. The instances, attributes, and services supported for this class are listed in Table 5.12.

Attribute	Access	Name	Data type	Generic maximum values	Units	Default	Description	Parameter reference
3	Get/set	Motor type	USINT	7	-	7	7 = Squirrel cage asynchronous motor	Parameter 1-10 Motor Construction
6	Get/set	Rated current	UNIT	0-100.00	100 mA	Drive dependent	Stator current rating (from motor nameplate)	Parameter 1-24 Motor Current
7	Get/set	Rated voltage	UNIT	200-500	Volt	Drive dependent	Base voltage rating (from motor nameplate)	Parameter 1-22 Motor Voltage
8	Get/set	Rated power	UDINT	0-18500	Watt	Drive dependent	Power rating at rated frequency (from motor nameplate)	Parameter 1-20 Motor Power [kW]
9	Get/set	Rated frequency	UNIT	1-1000	Hz	Drive dependent	Elec. frequency rating (from motor nameplate)	Parameter 1-23 Motor Frequency
12 ¹⁾	Get/set	Pole count	UINT	-	-	Drive dependent	Pole numbers in the motor	Parameter 1-39 Motor Poles
15	Get/set	Base speed	UNIT	100-60000	RPM	Drive dependent	Nominal motor speed (from motor nameplate)	Parameter 1-25 Motor Nominal Speed

Table 5.12 Class ID 0x28

5.3.8 Class ID 29h Control Supervisory Object

The control supervisory object can be used for process control and monitoring of the frequency converter as an alternative to the I/O instances defined in *chapter 4 Control*. The attributes supported for this class are listed in *Table 5.13*.

Attribute	Access	Name	Data type	Minimum/Maximum	Default	Description
3	Get/Set	Run 1	Bool	0-1	-	Run fwd, see note below
4	Get/Set	Run 2	Bool	0-1	-	Run rev, see note below
5	Get/Set	NetCtrl	Bool	0-1	1	0 = Local control 1 = Control from network
6	Get	State	USINT	0-7	-	0 = Vendor specific 1 = Start-up 2 = Not ready 3 = Ready 4 = Enabled 5 = Stop 6 = Fault stop 7 = Fault
7	Get	Running 1	Bool	0-1	0	0 = Other state 1 = (Enable and Run 1) or (Stopping and Running 1) or (Fault Stop and Running 1)
8	Get	Running 2	Bool	0-1	0	0 = Other state 1 = (Enable and Run 2) or (Stopping and Running 2) or (Fault Stop and Running 2)
9	Get	Ready	Bool	0-1	-	0 = Other state 1 = Ready or Enabled or Stopping
10	Get	Fault	Bool	0-1	0	0 = No faults present 1 = Fault occurred (latched)
12	Get/Set	Fault Rst	Bool	0-1	-	0 = No action 1 ->1 = Reset fault
13	Get	Fault Code	UINT	-	-	
15	Get	Ctrl From Net	Bool	0-1	1	0 = Control is local 1 = Control is from network
16	Get/Set	DN Fault Mode	UINT	0-2	1	Action on loss of DeviceNet 0 = Fault + Stop 1 = Ignore (warning optional) 2 = Danfoss specific

Table 5.13 Class ID 0x29

NOTICE

The ODVA drive profile selected in *parameter 1-10 Motor Construction* is available only when instances 20/70 or 21/71 are selected.

Illustration 5.1 shows how the frequency converter responds to the various command attributes associated with class ID 0x29.

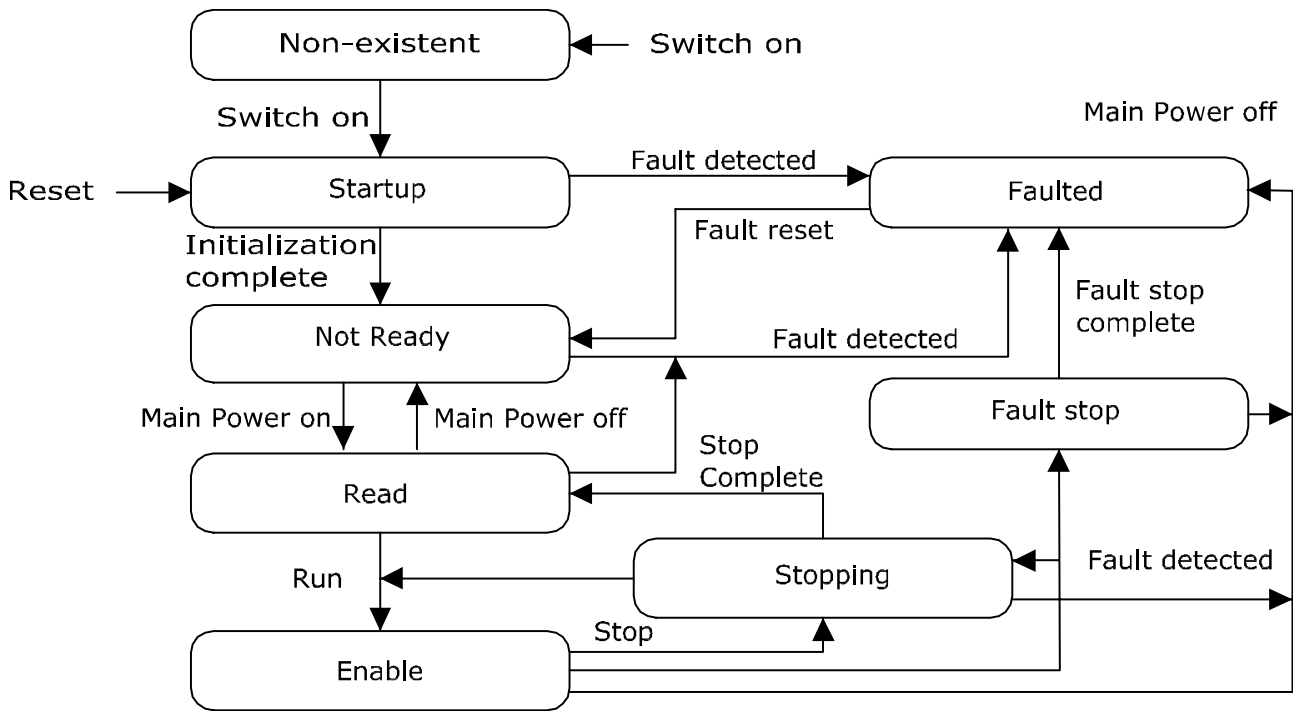

130BA127.10

Illustration 5.1 State - Transition Diagram

5.3.9 Class ID 2Ah AC/DC Drive Object

To set and read out a range of frequency converters control and status information, use this object. The attributes supported for this class are listed in *Table 5.14*.

Attribute	Access	Name	Data type	Minimum/Maximum	Default	Description
3	Get	At reference	Bool	0-1	-	0 = Drive not at reference 1 = Drive at reference
4	Get/Set	Net ref	Bool	0-1	1	0 = Set reference at non-DeviceNet reference 1 = Set reference at DeviceNet reference
6	Get/Set	Drive mode	USINT	0-1	1	0 = Vendor specific mode 1 = Open-loop speed (frequency) 2 = Closed-loop speed control
7	Get	Speed actual	INT	-	RPM/2 ^{Speed Scale}	Actual drive speed (best approximation)
8	Get/Set	Speed ref	INT	-	RPM/2 ^{Speed Scale}	Speed reference
22	Get/Set	Speed scale	SINT	-128-127	-	Speed scaling factor
29	Get	Ref from net	Bool	0-1	-	0 = Local speed reference 1 = DeviceNet speed reference

Table 5.14 Class ID 0x2A

5.3.10 Class ID 2Bh Acknowledge Handler Object

To manage message reception acknowledgements, necessary for change-of-state support, use class ID 2Bh acknowledge handler object. The attributes supported for this class are listed in *Table 5.15*.

Attribute	Access	Name	Data type	Minimum/Maximum	Default	Description
1	Set	ACK timer	UINT	0-65535	16	Time to wait for ACK before resending.
2	Get/Set	Retry timer	USINT	0-255	1	Number of ACK-timeouts to wait before producing. RetryLimit_Reache event.
3	Get/Set	COS	UINT	-	-	Connection instance ID

Table 5.15 Class ID 0x2B

5.4 Danfoss Object Classes

Use the Danfoss classes for read and write of all parameter values of the frequency converters. A corresponding object class is defined for each parameter group. *Table 5.16* shows the classes supported, and their relationship to the parameters.

The class instance and attribute act in the following way:

- 100 added to the parameter group = the value for the class.
- 100 added to the remaining parameter number = the value for the instance.
- 100 added to the array index of the parameter = the value for the attribute.

Parameter range	Class
Parameter 0-00 – 0-99	Class 100
Parameter 1-00 – 1-99	Class 101
Parameter 2-00 – 2-99	Class 102
Parameter 3-00 – 3-99	Class 103
Parameter 4-00 – 4-99	Class 104
Parameter 5-00 – 5-99	Class 105
Parameter 6-00 – 6-99	Class 106
Parameter 7-00 – 7-99	Class 107
Parameter 8-00 – 8-99	Class 108
Parameter 10-00 – 10-99	Class 110
Parameter 11-00 – 11-99	Class 111
Parameter 13-00 – 13-99	Class 113
Parameter 14-00 – 14-99	Class 114
Parameter 15-00 – 15-99	Class 115
Parameter 16-00 – 16-99	Class 116

Table 5.16 Danfoss Classes

5.4.1 Examples

Examples: (fictitious parameters) (all values in decimal)

- *Parameter 0-01 Language* [index 0] = Class 100; instance 101; attribute 100
- *Parameter 1-00 Configuration Mode* [index 0] = Class 101; instance 100; attribute 100
- *Parameter 3-41 Ramp 1 Ramp Up Time* [index 0] = Class 103; instance 141; attribute 100
- *Parameter 1-55 U/f Characteristic - U* [index 3] = Class 101; instance 155; attribute 103
- *Parameter 6-54 Terminal 42 Output Timeout Preset* [index 9] = Class 106; instance 154; attribute 109
- *Parameter 10-01 Baud Rate Select* [index 0] = Class 110; instance 101; attribute 100

6 Parameters

6.1 Parameter Description

6

8-01 Control Site		
Option:	Function:	
		The setting in this parameter overrides the settings in <i>parameter 8-50 Coasting Select</i> to <i>parameter 8-56 Preset Reference Select</i> .
[0]	Digital and ctrl.word	Control by using both digital input and control word.
[1]	Digital only	Control by using digital inputs only.
[2]	Controlword only	Control by using control word only.

8-02 Control Word Source		
Option:	Function:	
		<p>NOTICE This parameter cannot be adjusted while the motor is running.</p> <p>Select the source of the control word: 1 of 2 serial interfaces or 4 installed options. During initial power-up, the frequency converter automatically sets this parameter to [3] Option A, if it detects a valid fieldbus option installed in slot A. When the option is removed, the frequency converter detects a configuration change, sets <i>parameter 8-02 Control Word Source</i> to default setting [1] FC RS485, and trips. If an option is installed after initial power-up, the setting of <i>parameter 8-02 Control Word Source</i> does not change, but the frequency converter trips and shows: <i>Alarm 67, Option Changed</i>. When retrofitting a bus option into a frequency converter that did not have a bus option installed earlier, change the control to bus-based. This change is required for safety reasons to avoid an unintended change.</p>
[0]	None	
[1]	FC RS485	
[2]	FC USB	
[3]	Option A	
[4]	Option B	
[5]	Option C0	
[6]	Option C1	
[30]	External Can	

8-03 Control Word Timeout Time		
Range:	Function:	
1 s* [0.1 - 18000 s]		Enter the maximum time expected to pass between the reception of 2 consecutive telegrams. If this time is exceeded, it indicates that the telegram communication has stopped. The function selected in <i>parameter 8-04 Control Word Timeout Function</i> is then carried out. A valid control word triggers the timeout counter.

8-04 Control Word Timeout Function		
Select the timeout function. The timeout function activates when the control word fails to be updated within the time period specified in <i>parameter 8-03 Control Word Timeout Time</i> .		
Option:	Function:	
		<p>NOTICE To change the set-up after a timeout, configure as follows: Set <i>parameter 0-10 Active Set-up</i> to [9] <i>Multi set-up</i> and select the relevant link in <i>parameter 0-12 This Set-up Linked to</i>.</p>
[0]	Off	Resumes control via fieldbus (fieldbus or standard), using the most recent control word.
[1]	Freeze output	Freezes output frequency until communication resumes.
[2]	Stop	Stops with auto restart when communication resumes.
[3]	Jogging	Runs the motor at jog frequency until communication resumes.
[4]	Max. speed	Runs the motor at maximum frequency until communication resumes.
[5]	Stop and trip	Stops the motor, then resets the frequency converter to restart: <ul style="list-style-type: none"> Via the fieldbus. Via [Reset]. Via a digital input.
[7]	Select setup 1	Changes the set-up after a control word timeout. If communication resumes after a timeout, <i>parameter 8-05 End-of-Timeout Function</i> defines whether to resume the set-up used before the timeout, or to retain the set-up endorsed by the timeout function.
[8]	Select setup 2	See [7] <i>Select set-up 1</i> .
[9]	Select setup 3	See [7] <i>Select set-up 1</i> .
[10]	Select setup 4	See [7] <i>Select set-up 1</i> .

8-04 Control Word Timeout Function		
Select the timeout function. The timeout function activates when the control word fails to be updated within the time period specified in <i>parameter 8-03 Control Word Timeout Time</i> .		
Option:	Function:	
[26]	Trip	

8-05 End-of-Timeout Function		
Option:	Function:	
	Select the action after receiving a valid control word following a timeout. This parameter is active only when <i>parameter 8-04 Control Timeout Function</i> is set to: <ul style="list-style-type: none"> [7] Set-up 1. [8] Set-up 2. [9] Set-up 3. [10] Set-up 4. 	
[0]	Hold set-up	Retains the set-up selected in <i>parameter 8-04 Control Timeout Function</i> and shows a warning until <i>parameter 8-06 Reset Control Timeout</i> toggles. Then the frequency converter resumes its original set-up.
[1] *	Resume set-up	Resumes the set-up that was active before the timeout.

8-06 Reset Control Word Timeout		
This parameter is active only when [0] <i>Hold set-up</i> has been selected in <i>parameter 8-05 End-of-Timeout Function</i> .		
Option:	Function:	
[0] *	Do not reset	Retains the set-up specified in <i>parameter 8-04 Control Word Timeout Function</i> , following a control word timeout.
[1]	Do reset	Restores the frequency converter to the original set-up following a control word timeout. The frequency converter performs the reset and then immediately reverts to the [0] <i>Do not reset</i> setting.

8-07 Diagnosis Trigger		
This parameter has no function for DeviceNet.		
Option:	Function:	
[0] *	Disable	
[1]	Trigger on alarms	
[2]	Trigger alarm/warn.	

8-08 Readout Filtering		
If the speed feedback value readouts on fieldbus are fluctuating, this function is used. Select filtered, if the function is required. A power cycle is required for changes to take effect.		
Option:	Function:	
[0]	Motor Data Std-Filt.	Normal fieldbus readouts.

8-08 Readout Filtering		
If the speed feedback value readouts on fieldbus are fluctuating, this function is used. Select filtered, if the function is required. A power cycle is required for changes to take effect.		
Option:	Function:	
[1]	Motor Data LP-Filter	Filtered fieldbus readouts of the following parameters: <ul style="list-style-type: none"> Parameter 16-10 Power [kW]. Parameter 16-11 Power [hp]. Parameter 16-12 Motor Voltage. Parameter 16-14 Motor current. Parameter 16-16 Torque [Nm]. Parameter 16-17 Speed [RPM]. Parameter 16-22 Torque [%]. Parameter 16-25 Torque [Nm] High.

8-10 Control Word Profile		
Instances 20/70 and 21/71 are selectable in <i>parameter 10-10 Process Data Type Selection</i> .		
Option:	Function:	
[0] *	FC profile	Instances 100/150 and 101/151 are selectable in <i>parameter 10-10 Process Data Type Selection</i> .
[1]	PROFIdrive profile	
[5]	ODVA	
[7]	CANopen DSP 402	
[8]	MCO	

8-13 Configurable Status Word STW		
The status word has 16 bits (0–15). Bits 5 and 12–15 are configurable. Each of these bits can be configured to any of the following options.		
Option:	Function:	
[0]	No function	The input is always low.
[1]	Profile Default	Depending on the profile set in <i>parameter 8-10 Control Profile</i> .
[2]	Alarm 68 Only	The input goes high whenever <i>alarm 68, Safe Stop activated</i> is active, and goes low whenever <i>alarm 68 Safe Stop activated</i> is not activate.
[3]	Trip excl Alarm 68	
[10]	T18 DI status	
[11]	T19 DI status	
[12]	T27 DI status	
[13]	T29 DI status	
[14]	T32 DI status	
[15]	T33 DI status	
[16]	T37 DI status	The input goes high whenever terminal 37 has 0 V and goes low whenever terminal 37 has 24 V.

8-13 Configurable Status Word STW		
The status word has 16 bits (0–15). Bits 5 and 12–15 are configurable. Each of these bits can be configured to any of the following options.		
Option:	Function:	
[21]	Thermal warning	
[30]	Brake fault (IGBT)	
[40]	Out of ref range	
[41]	Load throttle active	
[60]	Comparator 0	
[61]	Comparator 1	
[62]	Comparator 2	
[63]	Comparator 3	
[64]	Comparator 4	
[65]	Comparator 5	
[70]	Logic Rule 0	
[71]	Logic Rule 1	
[72]	Logic Rule 2	
[73]	Logic Rule 3	
[74]	Logic Rule 4	
[75]	Logic Rule 5	
[80]	SL digital out A	
[81]	SL digital out B	
[82]	SL digital out C	
[83]	SL digital out D	
[84]	SL digital out E	
[85]	SL digital out F	
[86]	ATEX ETR cur. alarm	
[87]	ATEX ETR freq. alarm	
[88]	ATEX ETR cur. warning	
[89]	ATEX ETR freq. warning	
[90]	Safe Function active	
[91]	Safe Opt. Reset req.	
[92]	IGBT-cooling	See 5-3* <i>Digital Outputs</i> .

8-14 Configurable Control Word CTW		
Array [15]		
Option:	Function:	
		This parameter is not valid in software versions before 4.93.
[0]	None	The frequency converter ignores the information in this bit.
[1]	Profile default *	The functionality of the bit is depending on the selection <i>parameter 8-10 Control Word Profile</i> .
[2]	CTW Valid, active low	If set to 1, the frequency converter ignores the remaining bits of the control word.
[3]	Safe Option Reset	This function is only available in bits 12–15 of the control word, if a safety option is mounted in the frequency converter. The reset is executed on a 0→1 transition, and resets the safety option as set in <i>parameter 42-24 Restart Behaviour</i> .

8-14 Configurable Control Word CTW		
Array [15]		
Option:	Function:	
[4]	PID error inverse	Inverts the resulting error from the process PID controller. Available only if <i>parameter 1-00 Configuration Mode</i> is set to [6] <i>Surface Winder</i> , [7] <i>Extended PID Speed OL</i> , or [8] <i>Extended PID Speed CL</i> .
[5]	PID reset I part	Resets the I-part of the process PID controller. Equivalent to <i>parameter 7-40 Process PID I-part Reset</i> . Available only if <i>parameter 1-00 Configuration Mode</i> is set to [6] <i>Surface Winder</i> , [7] <i>Extended PID Speed OL</i> , or [8] <i>Extended PID Speed CL</i> .
[6]	PID enable	Enables the extended process PID controller. Equivalent to <i>parameter 7-50 Process PID Extended PID</i> . Available only if <i>parameter 1-00 Configuration Mode</i> is set to [6] <i>Surface Winder</i> , [7] <i>Extended PID Speed OL</i> , or [8] <i>Extended PID Speed CL</i> .

8-19 Product Code		
Range:	Function:	
Size related*	[0 - 2147483647]	Select 0 to read out the actual fieldbus product code according to the mounted fieldbus option. Select 1 to read out the actual vendor ID.

8-46 BTM Transaction Status		
Option:	Function:	
[0] *	Off	
[1]	Transaction Started	
[2]	Transaction Comitting	
[3]	Transaction Timeout	
[4]	Err. Non-existing Par.	
[5]	Err. Par. Out of Range	
[6]	Transaction Failed	

8-47 BTM Timeout		
Range:	Function:	
60 s*	[1 - 360 s]	Select the BTM timeout after a BTM transaction has been started.

8-48 BTM Maximum Errors		
Range:	Function:	
21*	[0 - 21]	Selects the maximum allowed number of bulk transfer mode errors before aborting. If it is set to maximum, there is no abort.

8-49 BTM Error Log		
Range:	Function:	
0.255* [0.000 - 9999.255]	List of parameters that failed during bulk transfer mode. The value after the decimal break is the fault code (255 stands for no error).	

8-50 Coasting Select		
Option:	Function:	
		Select control of the coasting function via the terminals (digital input) and/or via the bus.
[0]	Digital input	Activates start command via a digital input.
[1]	Bus	Activates start command via the serial communication port or fieldbus option.
[2]	Logic AND	Activates start command via the fieldbus/serial communication port and 1 extra digital input.
[3] *	Logic OR	Activates start command via the fieldbus/serial communication port or via 1 of the digital inputs.

8-51 Quick Stop Select		
Select control of the quick stop function via the terminals (digital input) and/or via the bus.		
Option:	Function:	
[0]	Digital input	
[1]	Bus	
[2]	Logic AND	
[3] *	Logic OR	

8-52 DC Brake Select		
Option:	Function:	
		Select control of the DC brake via the terminals (digital input) and/or via the fieldbus. NOTICE When parameter 1-10 Motor Construction is set to [1] PM non-salient SPM, only selection [0] Digital input is available.
[0]	Digital input	Activates a start command via a digital input.
[1]	Bus	Activates a start command via the serial communication port or fieldbus option.
[2]	Logic AND	Activates a start command via the fieldbus/serial communication port, and also via 1 of the digital inputs.
[3]	Logic OR	Activates a start command via the fieldbus/serial communication port, or via 1 of the digital inputs.

8-53 Start Select		
Option:	Function:	
		Select control of the frequency converter start function via the terminals (digital input) and/or via the fieldbus.
[0]	Digital input	Activates a start command via a digital input.
[1]	Bus	Activates a start command via the serial communication port or fieldbus option.
[2]	Logic AND	Activates a start command via the fieldbus/serial communication port and also via 1 of the digital inputs.
[3] *	Logic OR	Activates a start command via the fieldbus/serial communication port or via 1 of the digital inputs.

8-54 Reversing Select		
Option:	Function:	
[0]	Digital input	Select control of the frequency converter reverse function via the terminals (digital input) and/or via the fieldbus.
[1]	Bus	Activates the reverse command via the serial communication port or fieldbus option.
[2]	Logic AND	Activates the reverse command via the fieldbus/serial communication port and also via 1 of the digital inputs.
[3]	Logic OR	Activates the reverse command via the fieldbus/serial communication port or via 1 of the digital inputs.

8-55 Set-up Select		
Option:	Function:	
		Select control of the frequency converter set-up selection via the terminals (digital input) and/or via the fieldbus.
[0]	Digital input	Activates the set-up selection via a digital input.
[1]	Bus	Activates the set-up selection via the serial communication port or fieldbus option.
[2]	Logic AND	Activates the set-up selection via the fieldbus/serial communication port and via 1 of the digital inputs.
[3] *	Logic OR	Activates the set-up selection via the fieldbus/serial communication port or via 1 of the digital inputs.

8-56 Preset Reference Select		
Option:	Function:	
		Select control of the preset reference selection via the terminals (digital input) and/or via the fieldbus.

8-56 Preset Reference Select		
Option:	Function:	
[0]	Digital input	Activates preset reference selection via a digital input.
[1]	Bus	Activates preset reference selection via the serial communication port or fieldbus option.
[2]	Logic AND	Activates preset reference selection via the fieldbus/serial communication port and via 1 of the digital inputs.
[3] *	Logic OR	Activates the preset reference selection via the fieldbus/serial communication port or via 1 of the digital inputs.

8-90 Bus Jog 1 Speed		
Range:	Function:	
100 RPM* [0 - par. 4-13 RPM]	Enter the jog speed. Activate this fixed jog speed via the serial port or fieldbus option.	

8-91 Bus Jog 2 Speed		
Range:	Function:	
200 RPM* [0 - par. 4-13 RPM]	Enter the jog speed. Activate this fixed jog speed via the serial port or fieldbus option.	

10-00 CAN Protocol		
Option:	Function:	
		NOTICE The options depend on the installed option.
[0]	CANopen	
[1]	DeviceNet	View the active CAN protocol.

10-01 Baud Rate Select		
Select the fieldbus transmission speed. The selection must correspond to the transmission speed of the master and the other fieldbus nodes.		
Option:	Function:	
[16]	10 Kbps	
[17]	20 Kbps	
[18]	50 Kbps	
[19]	100 Kbps	
[20]	125 Kbps	
[21]	250 Kbps	
[22]	500 Kbps	

10-02 MAC ID		
Range:	Function:	
Size related* [0 - 63]	Selection of station address. Every station connected to the same DeviceNet network must have an unambiguous address.	

10-05 Readout Transmit Error Counter		
Range:	Function:	
0* [0 - 255]	View the number of CAN control transmission errors since the last power-up.	

10-06 Readout Receive Error Counter		
Range:	Function:	
0* [0 - 255]	View the number of CAN control receipt errors since the last power-up.	

10-07 Readout Bus Off Counter		
Range:	Function:	
0* [0 - 255]	View the number of fieldbus off events since the last power-up.	

10-10 Process Data Type Selection		
Option:	Function:	
	Select the instance (telegram) for data transmission. The instances available depend on the setting of <i>parameter 8-10 Control Profile</i> . When <i>parameter 8-10 Control Profile</i> is set to [0] <i>FC profile</i> , <i>parameter 10-10 Process Data Type Selection</i> options [0] <i>INSTANCE 100/150</i> and [1] <i>INSTANCE 101/151</i> are available. When <i>parameter 8-10 Control Profile</i> is set to [5] <i>ODVA</i> , <i>parameter 10-10 Process Data Type Selection</i> options [2] <i>INSTANCE 20/70</i> and [3] <i>INSTANCE 21/71</i> are available. Instances 100/150 and 101/151 are Danfoss-specific. Instances 20/70 and 21/71 are ODVA-specific AC motor profiles. For guidelines in telegram selection, refer to the <i>VLT® DeviceNet MCA 104 Installation Guide</i> .	
	NOTICE A change to this parameter is executed immediately.	
[0]	INSTANCE 100/150	
[1]	INSTANCE 101/151	
[2]	INSTANCE 20/70	
[3]	INSTANCE 21/71	

10-11 Process Data Config Write		
Select the process write data for I/O assembly instances 101/151. Elements [2] and [3] of this array can be selected. Elements [0] and [1] of the array are fixed.		
Option:	Function:	
[0]	None	
[302]	Minimum Reference	

10-11 Process Data Config Write		
Select the process write data for I/O assembly instances 101/151. Elements [2] and [3] of this array can be selected. Elements [0] and [1] of the array are fixed.		
Option:	Function:	
[303]	Maximum Reference	
[312]	Catch up/slow Down Value	
[341]	Ramp 1 Ramp Up Time	
[342]	Ramp 1 Ramp Down Time	
[351]	Ramp 2 Ramp Up Time	
[352]	Ramp 2 Ramp Down Time	
[380]	Jog Ramp Time	
[381]	Quick Stop Ramp Time	
[411]	Motor Speed Low Limit [RPM]	
[412]	Motor Speed Low Limit [Hz]	
[413]	Motor Speed High Limit [RPM]	
[414]	Motor Speed High Limit [Hz]	
[416]	Torque Limit Motor Mode	
[417]	Torque Limit Generator Mode	
[553]	Term. 29 High Ref./Feedb. Value	
[558]	Term. 33 High Ref./Feedb. Value	
[590]	Digital & Relay Bus Control	
[593]	Pulse Out #27 Bus Control	
[595]	Pulse Out #29 Bus Control	
[597]	Pulse Out #X30/6 Bus Control	
[615]	Terminal 53 High Ref./Feedb. Value	
[625]	Terminal 54 High Ref./Feedb. Value	
[653]	Term 42 Output Bus Ctrl	
[663]	Terminal X30/8 Bus Control	
[673]	Terminal X45/1 Bus Control	
[683]	Terminal X45/3 Bus Control	
[748]	PCD Feed Forward	
[890]	Bus Jog 1 Speed	
[891]	Bus Jog 2 Speed	
[1680]	Fieldbus CTW 1	
[1682]	Fieldbus REF 1	
[1685]	FC Port CTW 1	
[1686]	FC Port REF 1	

10-12 Process Data Config Read		
Select the process read data for I/O assembly instances 101/151. Elements [2] and [3] of this array can be selected. Elements [0] and [1] of the array are fixed.		
Option:	Function:	
[0]	None	
[15]	Readout: actual setup	
[1472]	Legacy Alarm Word	
[1473]	Legacy Warning Word	
[1474]	Leg. Ext. Status Word	
[1500]	Operating hours	
[1501]	Running Hours	
[1502]	kWh Counter	

10-12 Process Data Config Read		
Select the process read data for I/O assembly instances 101/151. Elements [2] and [3] of this array can be selected. Elements [0] and [1] of the array are fixed.		
Option:	Function:	
[1600]	Control Word	
[1601]	Reference [Unit]	
[1602]	Reference %	
[1603]	Status Word	
[1605]	Main Actual Value [%]	
[1606]	Absolute Position	
[1609]	Custom Readout	
[1610]	Power [kW]	
[1611]	Power [hp]	
[1612]	Motor Voltage	
[1613]	Frequency	
[1614]	Motor current	
[1615]	Frequency [%]	
[1616]	Torque [Nm]	
[1617]	Speed [RPM]	
[1618]	Motor Thermal	
[1619]	KTY sensor temperature	
[1620]	Motor Angle	
[1621]	Torque [%] High Res.	
[1622]	Torque [%]	
[1623]	Motor Shaft Power [kW]	
[1624]	Calibrated Stator Resistance	
[1625]	Torque [Nm] High	
[1630]	DC Link Voltage	
[1632]	Brake Energy /s	
[1633]	Brake Energy Average	
[1634]	Heatsink Temp.	
[1635]	Inverter Thermal	
[1638]	SL Controller State	
[1639]	Control Card Temp.	
[1645]	Motor Phase U Current	
[1646]	Motor Phase V Current	
[1647]	Motor Phase W Current	
[1648]	Speed Ref. After Ramp [RPM]	
[1650]	External Reference	
[1651]	Pulse Reference	
[1652]	Feedback[Unit]	
[1653]	Digi Pot Reference	
[1657]	Feedback [RPM]	
[1660]	Digital Input	
[1661]	Terminal 53 Switch Setting	
[1662]	Analog Input 53	
[1663]	Terminal 54 Switch Setting	
[1664]	Analog Input 54	
[1665]	Analog Output 42 [mA]	
[1666]	Digital Output [bin]	
[1667]	Freq. Input #29 [Hz]	
[1668]	Freq. Input #33 [Hz]	
[1669]	Pulse Output #27 [Hz]	

10-12 Process Data Config Read		
Select the process read data for I/O assembly instances 101/151. Elements [2] and [3] of this array can be selected. Elements [0] and [1] of the array are fixed.		
Option:	Function:	
[1670]	Pulse Output #29 [Hz]	
[1671]	Relay Output [bin]	
[1672]	Counter A	
[1673]	Counter B	
[1674]	Prec. Stop Counter	
[1675]	Analog In X30/11	
[1676]	Analog In X30/12	
[1677]	Analog Out X30/8 [mA]	
[1678]	Analog Out X45/1 [mA]	
[1679]	Analog Out X45/3 [mA]	
[1684]	Comm. Option STW	
[1687]	Bus Readout Alarm/Warning	
[1689]	Configurable Alarm/Warning Word	
[1690]	Alarm Word	
[1691]	Alarm Word 2	
[1692]	Warning Word	
[1693]	Warning Word 2	
[1694]	Ext. Status Word	
[1836]	Analog Input X48/2 [mA]	
[1837]	Temp. Input X48/4	
[1838]	Temp. Input X48/7	
[1839]	Temp. Input X48/10	
[1843]	Analog Out X49/7	
[1844]	Analog Out X49/9	
[1845]	Analog Out X49/11	
[1860]	Digital Input 2	
[3421]	PCD 1 Read from MCO	
[3422]	PCD 2 Read from MCO	
[3423]	PCD 3 Read from MCO	
[3424]	PCD 4 Read from MCO	
[3425]	PCD 5 Read from MCO	
[3426]	PCD 6 Read from MCO	
[3427]	PCD 7 Read from MCO	
[3428]	PCD 8 Read from MCO	
[3429]	PCD 9 Read from MCO	
[3430]	PCD 10 Read from MCO	
[3440]	Digital Inputs	
[3441]	Digital Outputs	
[3450]	Actual Position	
[3451]	Commanded Position	
[3452]	Actual Master Position	
[3453]	Slave Index Position	
[3454]	Master Index Position	
[3455]	Curve Position	
[3456]	Track Error	
[3457]	Synchronizing Error	
[3458]	Actual Velocity	
[3459]	Actual Master Velocity	
[3460]	Synchronizing Status	

10-12 Process Data Config Read		
Select the process read data for I/O assembly instances 101/151. Elements [2] and [3] of this array can be selected. Elements [0] and [1] of the array are fixed.		
Option:	Function:	
[3461]	Axis Status	
[3462]	Program Status	
[3464]	MCO 302 Status	
[3465]	MCO 302 Control	
[3470]	MCO Alarm Word 1	
[3471]	MCO Alarm Word 2	
[4280]	Safe Option Status	
[4282]	Safe Control Word	
[4283]	Safe Status Word	
[4285]	Active Safe Func.	
[4287]	Time Until Manual Test	

10-13 Warning Parameter		
Range:	Function:	
0*	[0 - 65535]	View a DeviceNet-specific warning word. One bit is assigned to every warning. Refer to the VLT® MCA 104 DeviceNet Installation Guide for further information.

Bit	Description
0	Bus not active.
1	Explicit connection timeout.
2	I/O connection.
3	Retry limit reached.
4	Actual is not updated.
5	CAN bus off.
6	I/O send error.
7	Initialization error.
8	No bus supply.
9	Bus off.
10	Error passive.
11	Error warning.
12	Duplicate MAC ID error.
13	RX queue overrun.
14	TX queue overrun.
15	CAN overrun.

Table 6.1 Warning Bits

10-14 Net Reference		
Read only from LCP.		
Option:	Function:	
	Select the reference source in instances 21/71 and 20/70.	
[0] *	Off	Enables reference via analog/digital inputs.
[1]	On	Enables reference via the fieldbus.

10-15 Net Control		
Read only from LCP.		
Option: Function:		
		Select the control source in instances 21/71 and 20/70.
[0] *	Off	Enables control via analog/digital inputs.
[1]	On	Enable control via the fieldbus.

10-20 COS Filter 1		
Range: Function:		
0*	[0 - 65535]	Sets up the filter mask for the status word. When operating in COS (change-of-state), it is possible to filter out bits in the status word that should not be sent if they change.

10-21 COS Filter 2		
Range: Function:		
0*	[0 - 65535]	Sets up the filter mask for the main actual value. When operating in COS (change-of-state), it is possible to filter out bits in the main actual value that should not be sent if they change.

10-22 COS Filter 3		
Range: Function:		
0*	[0 - 65535]	Sets up the filter mask for PCD 3. When operating in COS (change-of-state), it is possible to filter out bits in PCD 3 that should not be sent if they change.

10-23 COS Filter 4		
Range: Function:		
0*	[0 - 65535]	Sets up the filter mask for PCD 4. When operating in COS (change-pf-state), it is possible to filter out bits in PCD 4 that should not be sent if they change.

10-30 Array Index		
Range: Function:		
0*	[0 - 255]	View array parameters. This parameter is valid only when a VLT® DeviceNet MCA 104 is installed.

10-31 Store Data Values		
Option: Function:		
		This parameter is used to activate a function that stores all parameter values in the non-volatile memory thus retaining changed parameter values at power down.
[0]	Off	The store function is inactive.
[1]	Store all setups	All parameter values in the set-up selected are stored in the non-volatile memory. The value returns to [0] Off when all values are stored.

10-31 Store Data Values		
Option: Function:		
[2]	Store all setups	All parameter values are stored in the non-volatile memory. The value returns to [0] Off when all parameter values are stored.

10-32 Devicenet Revision		
Range: Function:		
0*	[0 - 65535]	View the DeviceNet revision number. This parameter is used for EDS file creation.

10-33 Store Always		
This parameter is used to select whether parameter data received via the DeviceNet option should always be stored in non-volatile memory.		
Option: Function:		
[0] *	Off	
[1]	On	

10-34 DeviceNet Product Code		
Range: Function:		
Size related*	[0 - 65535]	

16-90 Alarm Word		
Range: Function:		
0*	[0 - 4294967295]	View the alarm word sent via the serial communication port in hex code.

16-91 Alarm Word 2		
Range: Function:		
0*	[0 - 4294967295]	View the alarm word sent via the serial communication port in hex code.

16-92 Warning Word		
Range: Function:		
0*	[0 - 4294967295]	View the warning word sent via the serial communication port in hex code.

16-93 Warning Word 2		
Range: Function:		
0*	[0 - 4294967295]	View the warning word sent via the serial communication port in hex code.

16-94 Ext. Status Word		
Range: Function:		
0*	[0 - 4294967295]	Returns the extended warning word sent via the serial communication port in hex code.

6.2 Parameter List

Parameter	Default value	Range	Conversion index	Data type
Parameter 8-01 Control Site	[0] Dig. & ctrl. word	[0–2]	–	5
Parameter 8-02 Control Word Source	[0] FC RS485	[0–4]	–	5
Parameter 8-03 Control Word Timeout Time	1 s	0.1–18000	-1	7
Parameter 8-04 Control Word Timeout Function	[0] Off	[0–10]	-1	5
Parameter 8-05 End-of-Timeout Function	[0] Hold set-up	[0–1]	–	5
Parameter 8-06 Reset Control Word Timeout	[0] Do not reset	[0–1]	–	5
Parameter 8-07 Diagnosis Trigger	[0] Disable	[0–3]	–	5
Parameter 8-10 Control Word Profile	[0] FC profile	[0–x]	–	5
Parameter 8-50 Coasting Select	[3] Logic OR	[0–3]	–	5
Parameter 8-51 Quick Stop Select	[3] Logic OR	[0–3]	–	5
Parameter 8-52 DC Brake Select	[3] Logic OR	[0–3]	–	5
Parameter 8-53 Start Select	[3] Logic OR	[0–3]	–	5
Parameter 8-54 Reversing Select	[3] Logic OR	[0–3]	–	5
Parameter 8-55 Set-up Select	[3] Logic OR	[0–3]	–	5
Parameter 8-56 Preset Reference Select	[3] Logic OR	[0–3]	–	5
Parameter 8-90 Bus Jog 1 Speed	100 RPM	0–parameter 4-13 Motor Speed High Limit [RPM]	67	6
Parameter 8-91 Bus Jog 2 Speed	200 RPM	0–parameter 4-13 Motor Speed High Limit [RPM]	67	6
Parameter 10-00 CAN Protocol	[1] DeviceNet	[0–1]	–	5
Parameter 10-01 Baud Rate Select	[20] 125 Kbps	[20–22]	–	5
Parameter 10-02 MAC ID	63	0–63	0	5
Parameter 10-05 Readout Transmit Error Counter	0	0–255	0	5
Parameter 10-06 Readout Receive Error Counter	0	0–255	0	6
Parameter 10-07 Readout Bus Off Counter	0	0–1000	0	
Parameter 10-10 Process Data Type Selection	[0]/[2]	[0–3]	0	5
Parameter 10-11 Process Data Config Write	0	list	0	5
Parameter 10-12 Process Data Config Read	0	list	0	5
Parameter 10-13 Warning Parameter	0	0–FFFF	0	5
Parameter 10-14 Net Reference	[0] Off	[0–1]	–	5
Parameter 10-15 Net Control	[0] Off	[0–1]	–	5
Parameter 10-20 COS Filter 1	0	0–FFFF	0	6
Parameter 10-21 COS Filter 2	0	0–FFFF	0	6
Parameter 10-22 COS Filter 3	0	0–FFFF	0	6
Parameter 10-23 COS Filter 4	0	0–FFFF	0	6
Parameter 10-31 Store Data Values	[0] Off	[0–2]	–	5
Parameter 10-32 Devicenet Revision	–	–	–	6
Parameter 10-33 Store Always	[0] Off	[0–1]	–	5
Parameter 16-90 Alarm Word	0	0–FFFF	0	7
Parameter 16-92 Warning Word	0	0–FFFF	0	7

Table 6.2 Parameter List

6.3 Data Types Supported

6.3.1 Object and Data Types Supported

Data type	Description
3	Integer 16
4	Integer 32
5	Unsigned 8
6	Unsigned 16
7	Unsigned 32
9	Visible string
10	Byte string
33	Standardized value (16 bit)
35	Bit sequence
41	Byte
42	Word

Table 6.3 Data Types Supported

6.3.2 Conversion Index

Conversion index refers to a conversion figure used when writing or reading to parameters.

Conversion index	Conversion factor
100	1
67	1/60
6	1000000
5	100000
4	10000
3	1000
2	100
1	10
0	1
-1	0.1
-2	0.01
-3	0.001
-4	0.0001
-5	0.00001
-6	0.000001

Table 6.4 Conversion Index

7 Application Examples

7.1 Example: Working with Instance 101/151 Process

This example shows how to work with I/O instance 101/151, which consists of control word/status word and reference/main actual value. The instance 101/151 also has 2 extra words, which can be programmed to monitor process signals, as shown in *Illustration 7.1*.

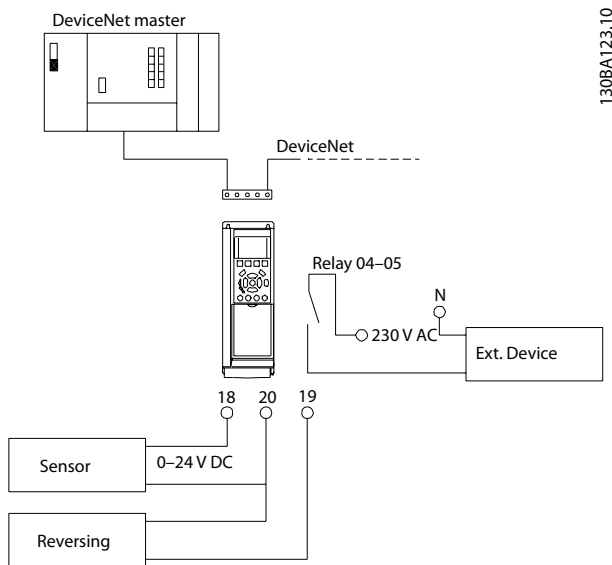

Illustration 7.1 Instance 101/151 Process

The application requires monitoring of the motor torque and digital input, so PCD 3 is set up to read the actual motor torque. PCD 4 is set up to monitor the state of an external sensor via the process signal digital input. The sensor is connected to digital input 18.

An external device is also controlled via control word bit 11 and the built-in relay of the frequency converter.

Reversing is permitted only when the reversing bit 15 in the control word and the digital input 19 are set to high.

For safety reasons the frequency converter stops the motor when:

- The DeviceNet cable is broken.
- The master has a system failure.
- The PLC is in stop mode.

Parameter	Function	Setting
Parameter 4-10 Motor Speed Direction	Motor speed range/direction	[2] Both directions
Parameter 5-10 Terminal 18 Digital Input	Digital input 18	[0] No operation
Parameter 5-11 Terminal 19 Digital Input	Digital input 19	[10] Reversing
Parameter 5-40 Function Relay	Function relay	[36] Control word bit 11 [37] Control word bit 12
Parameter 8-03 Control Word Timeout Time	Control word timeout time	1.0 s
Parameter 8-04 Control Word Timeout Function	Control word timeout function	[2] Stop
Parameter 8-10 Control Word Profile	Control word profile	FC Profile
Parameter 8-50 Coasting Select	Coasting select	[1] Bus
Parameter 8-51 Quick Stop Select	Quick-stop select	[1] Bus
Parameter 8-52 DC Brake Select	DC-brake select	[1] Bus
Parameter 8-53 Start Select	Start select	[1] Bus
Parameter 8-54 Reversing Select	Reversing select	[2] Logic AND
Parameter 8-55 Set-up Select	Set-up select	[1] Bus
Parameter 8-56 Preset Reference Select	Preset reference select	[1] Bus
Parameter 10-01 Baud Rate Select	Baud rate select	Set to match other DeviceNet stations
Parameter 10-02 MAC ID	MAC ID	Set desired station address
Parameter 10-10 Process Data Type Selection	Process data type selection	[1] Instance 101/151
Parameter 10-12 Process Data Config Read	Process Data Config Read	PCD 3: Torque PCD 4: Digital input

Table 7.1 Function and Setting of the Parameters

7.1.1 Example of PLC Programming

In this example, instance 101/151 is placed in the following input/output address, see Table 7.2 and Table 7.3.

Input address	0.0–0.15	0.16–0.31	1.0–1.15	1.16–1.31
Set-up	Status word	MAV	Motor torque	Digital input

Table 7.2 Input Address

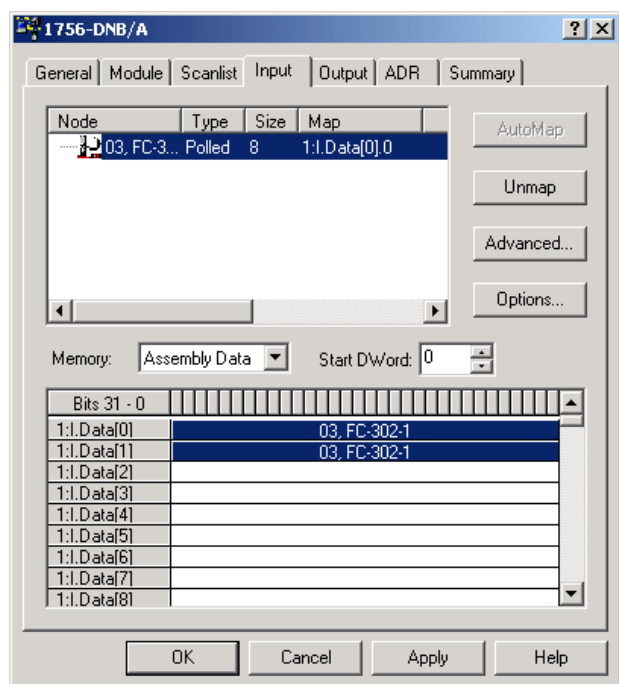

Illustration 7.2 Input

Output address	0.0–0.15	0.16–0.31	1.0–1.15	1.16–1.31
Set-up	Control word	Reference	Not used	Not used

Table 7.3 Output Address

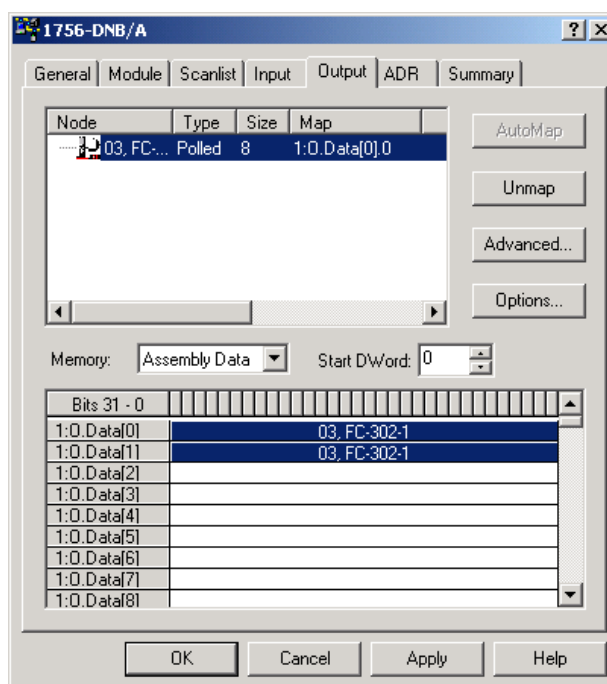

Illustration 7.3 Output

7

8 Troubleshooting

8.1 LED Status

The 2 bicolor LEDs on the DeviceNet card indicate the status of DeviceNet communication:

- The lower LED (NS) indicates the net status.
- The upper LED (MS) indicates the module status.

130BA122.10

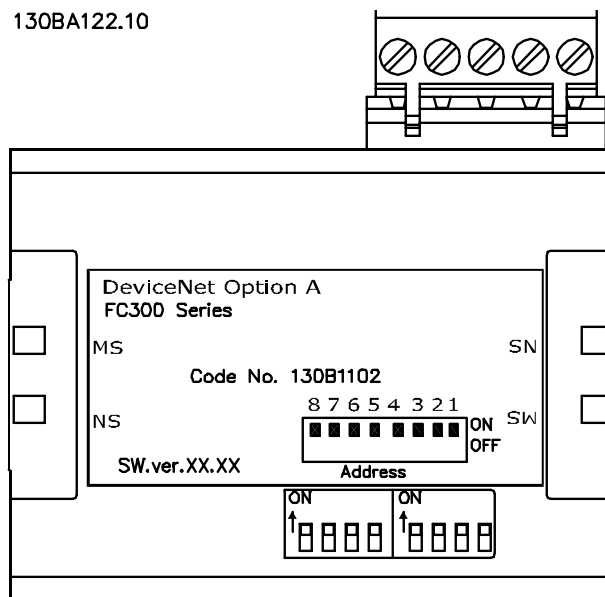

MS	Upper left LED
NS	Lower left LED

Illustration 8.1 LED Panel DeviceNet MCA 104

State	Bicolor LED	Status	
No Power	Off	-	There is no power applied to the option.
Device operational	Green		The DeviceNet option operates in normal condition.
Standby	Green		The DeviceNet option needs commissioning due to configuration missing, incomplete, or incorrect.
Minor fault	Red		Recoverable fault.
Unrecoverable fault	Red		Unrecoverable fault, may need replacing.
Self-test	Green		The DeviceNet option is in self-test mode.
	Red		

Table 8.1 LED: Module Status (MS)

State	Bicolor LED	Status
No Power/Not on-line	Off	The option has not completed "Duplicate MAC ID" test yet or may not be powered.
On-line, not connected	Green	The option is on-line, but not allocated to a master.
On-line and connected	Green	The DeviceNet option is on-line and connected to a master.
Connection timeout	Red	One or more I/O connections are in timeout state.
Critical link failure	Red	-

Table 8.2 LED: Network Status (NS)

8.2 No Communication with the Frequency Converter

When there is no communication with the frequency converter, proceed with the following checks:

1. Check that cabling is correct. Check that the cables are connected to the correct terminals as shown in *Illustration 8.2*.

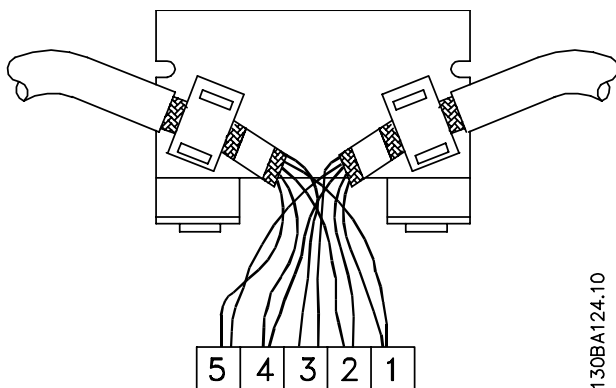

Pin number	Terminal	Color	Name
1	V-	Black	GND
2	CAN_L	Blue	CAN LOW
3	Drain	(bare)	Screen
4	CAN_H	White	CAN HIGH
5	V+	Red	+24 V

Illustration 8.2 Correct Cabling

2. The 24 V network voltage is applied.
3. The correct EDS file is installed. Download the correct EDS file from www.danfoss.com/drives.
4. Check that the bus connection is terminated at both ends. If not, terminate the bus connection with termination resistors at the initial and final nodes. Refer to *Illustration 8.3*. Termination is performed between terminal 2 (CAN_L) and 4 (CAN_H) with a resistor: 121 Ω, 1% metal film, ¼ W.

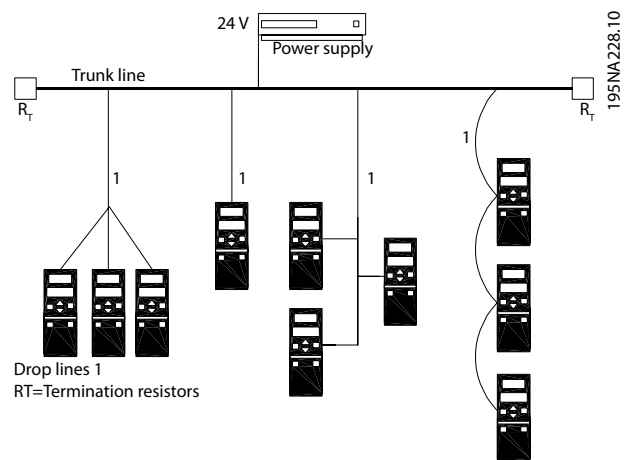

Illustration 8.3 Topology

8.3 Frequency Converter Does Not Respond to Control Signals

For Danfoss control word profile (instances 100/150 and 101/151), check that:

1. The control word is valid. When bit 10=0 in the control word, the frequency converter does not accept the control word, because the default setting is bit 10=1. Set bit 10=1 via the PLC.
2. The relationship between bits in the control word and the terminal I/O is correct. Check the logical relationship in the frequency converter. Set the logic to bit 3=1 and digital input=1 to achieve a successful start.

Define the logical relationship in *parameter 8-50 Coasting Select* to *parameter 8-56 Preset Reference Select* according to the following range of options. Select the FC control mode, digital input and/or bus communication, using

parameter 8-50 Coasting Select to parameter 8-56 Preset Reference Select.

The effect of control mode after the function of parameter 8-50 Coasting Select, parameter 8-51 Quick Stop Select, and parameter 8-52 DC Brake Select are shown in Table 8.3, Table 8.4, Table 8.5, and Table 8.6:

If [0] Digital input is selected, terminals control the coast and DC brake functions.

Terminal	Bit 02/03/04	Function
0	0	Coast/DC brake/Q-Stop
0	1	Coast/DC brake/Q-Stop
1	0	No Coast/DC brake/Q-Stop
1	1	No Coast/DC brake/Q-Stop

Table 8.3 Parameter 8-50/51/52 Setting: [0] Digital Input

If [1] Bus is selected, commands are activated only when given via the control word.

Terminal	Bit 02/03/04	Function
0	0	Coast/DC brake/Q-Stop
0	1	No Coast/DC brake/Q-Stop
1	0	Coast/DC brake/Q-Stop
1	1	No Coast/DC brake/Q-Stop

Table 8.4 Parameter 8-50/51/52 Setting: [1] Bus

If [2] Logic AND is selected, activate both signals to perform the function.

Terminal	Bit 02/03/04	Function
0	0	Coast/DC brake/Q-Stop
0	1	No Coast/DC brake/Q-Stop
1	0	No Coast/DC brake/Q-Stop
1	1	No Coast/DC brake/Q-Stop

Table 8.5 Parameter 8-50/51/52 Setting: [2] Logic AND

If [3] Logic OR is selected, activation of 1 signal activates the function.

Terminal	Bit 02/03/04	Function
0	0	Coast/DC brake/Q-Stop
0	1	Coast/DC brake/Q-Stop
1	0	Coast/DC brake/Q-Stop
1	1	No Coast/DC brake/Q-Stop

Table 8.6 Parameter 8-50/51/52 Setting: [3] Logic OR

NOTICE

Coasting, Quick Stop, and DC brake functions are active for logic 0'.

The effect of control mode after the function of parameter 8-53 Start Select and parameter 8-54 Reversing Select are shown in Table 8.7, Table 8.8, Table 8.9, and Table 8.10:

If [0] Digital Input is selected, terminals control the start and reversing functions.

Terminal	Bit 06/15	Function
0	0	Stop/Counter-clockwise
0	1	Stop/Counter-clockwise
1	0	Start/Clockwise
1	1	Start/Clockwise

Table 8.7 Parameter 8-53/54 Setting: [0] Digital input

If [1] Bus is selected, commands are activated only when given via the control word.

Terminal	Bit 02/03/04	Function
0	0	Stop/Counter-clockwise
0	1	Start/Clockwise
1	0	Stop/Counter-clockwise
1	1	Start/Clockwise

Table 8.8 Parameter 8-53/54 Setting: [1] Bus

If [2] Logic AND is selected, activate both signals to perform the function.

Terminal	Bit 02/03/04	Function
0	0	Stop/Counter-clockwise
0	1	Stop/Counter-clockwise
1	0	Stop/Counter-clockwise
1	1	Start/Clockwise

Table 8.9 Parameter 8-53/54 Setting: [2] Logic AND

If [3] Logic OR is selected, activation of 1 signal activates the function.

Terminal	Bit 02/03/04	Function
0	0	Stop/Counter-clockwise
0	1	Start/Clockwise
1	0	Start/Clockwise
1	1	Start/Clockwise

Table 8.10 Parameter 8-53/54 Setting: [3] Logic OR

The effect of control mode after the function of parameter 8-55 Set-up Select and parameter 8-56 Preset Reference Select are shown in Table 8.11, Table 8.12, Table 8.13, and Table 8.14:

If [0] Digital input is selected, the terminals control the set-up and preset reference functions.

Terminal		Bit 00/01, 13/14		Function
Msb	Lsb	Msb	Lsb	Preset reference, set-up number
0	0	0	0	1
0	0	0	1	1
0	0	1	0	1
0	0	1	1	1
0	1	0	0	2
0	1	0	1	2
0	1	1	0	2
0	1	1	1	2
1	0	0	0	3
1	0	0	1	3
1	0	1	0	3
1	0	1	1	3
1	1	0	0	4
1	1	0	1	4
1	1	1	0	4
1	1	1	1	4

Table 8.11 Parameter 8-55/56 Setting: [0] Digital input

If [1] Bus is selected, commands are activated only when given via the control word.

Terminal		Bit 00/01, 13/14		Function
Msb	Lsb	Msb	Lsb	Preset reference, set-up number
0	0	0	0	1
0	0	0	1	2
0	0	1	0	3
0	0	1	1	4
0	1	0	0	1
0	1	0	1	2
0	1	1	0	3
0	1	1	1	4
1	0	0	0	1
1	0	0	1	2
1	0	1	0	3
1	0	1	1	4
1	1	0	0	1
1	1	0	1	2
1	1	1	0	3
1	1	1	1	4

Table 8.12 Parameter 8-55/56 Setting: [1] Bus

If [2] Logic AND is selected, activate both signals to perform the function.

Terminal		Bit 00/01, 13/14		Function
Msb	Lsb	Msb	Lsb	Preset reference, Set-up number
0	0	0	0	1
0	0	0	1	1
0	0	1	0	1
0	0	1	1	1
0	1	0	0	1
0	1	0	1	2
0	1	1	0	1
0	1	1	1	2
1	0	0	0	1
1	0	0	1	1
1	0	1	0	3
1	0	1	1	3
1	1	0	0	1
1	1	0	1	2
1	1	1	0	3
1	1	1	1	4

Table 8.13 Parameter 8-55/56: [2] Logic AND

If [3] Logic OR is selected, activation of 1 signal activates the function.

Terminal		Bit 00/01, 13/14		Function
Msb	Lsb	Msb	Lsb	Preset reference, set-up number
0	0	0	0	1
0	0	0	1	2
0	0	1	0	3
0	0	1	1	4
0	1	0	0	2
0	1	0	1	2
0	1	1	0	4
0	1	1	1	4
1	0	0	0	3
1	0	0	1	4
1	0	1	0	3
1	0	1	1	4
1	1	0	0	4
1	1	0	1	4
1	1	1	0	4

Table 8.14 Parameter 8-55/56 Setting: [3] Logic OR

8.4 Warnings and Alarms

NOTICE

Refer to the relevant *operating instructions* for an overview of warning and alarm types and for the full list of warnings and alarms.

Alarm word, warning word, and DeviceNet warning word are shown on the frequency converter display in hex format. When there is more than 1 warning or alarm, the sum of all warnings or alarms is shown. Alarm word, warning word, and DeviceNet warning word can also be shown using the serial bus in *parameter 16-90 Alarm Word*, *parameter 16-92 Warning Word*, and *parameter 16-05 Main Actual Value [%]*.

Bit (Hex)	Alarm word (parameter 16-90 Alarm Word)	Alarm number	Major/ minor alarm	Recoverable/ unrecoverable alarm
00000001	Unused	–	–	–
00000002	Drive overtemperature	29	Major	Recoverable
00000004	Ground fault	14	Major	Unrecoverable
00000008	Unused	–	–	–
00000010	Control word timeout	18	Minor	Recoverable
00000020	Overcurrent	13	Major	Unrecoverable
00000040	Torque limit	12	Major	Recoverable
00000080	Motor thermistor over temp.	11	Major	Recoverable
00000100	Motor ETR overtemperature	10	Major	Recoverable
00000200	Inverter overloaded	9	Major	Recoverable
00000400	DC link undervoltage	8	Major	Recoverable
00000800	DC link overvoltage	7	Major	Recoverable
00001000	Short circuit	16	Major	Unrecoverable
00002000	Inrush fault	33	Major	Recoverable
00004000	Mains phase loss	4	Major	Unrecoverable
00008000	AMA not OK	50	Major	Recoverable
00010000	Live zero error	2	Major	Recoverable
00020000	Internal fault	38	Major	Unrecoverable
00040000	Brake resistor power limit	26	Major	Unrecoverable
00080000	Motor phase U is missing	30	Major	Unrecoverable
00100000	Motor phase V is missing	31	Major	Unrecoverable
00200000	Motor phase W is missing	32	Major	Unrecoverable
00400000	Fieldbus comm. fault	34	Major	Recoverable
00800000	24 V supply fault	47	Major	Unrecoverable
01000000	Mains failure	36	Major	Recoverable
02000000	1.8 V supply fault	48	Major	Unrecoverable
04000000	Brake resistor short circuit	25	Major	Recoverable
08000000	Brake chopper fault	27	Major	Recoverable
10000000	Unused	–	–	–
20000000	Unused	–	–	–
40000000	Unused	–	–	–
80000000	Unused	–	–	–

Table 8.15 Alarm Word

Bit (Hex)	Warning word (parameter 16-92 Warning Word)	Warning number
00000001	Unused	–
00000002	Drive over temperature	29
00000004	Ground fault	14
00000008	Unused	–
00000010	Control word timeout	18
00000020	Overcurrent	13
00000040	Torque limit	12
00000080	Motor thermistor over temp.	11
00000100	Motor ETR overtemperature	10
00000200	Inverter overloaded	9
00000400	DC link undervoltage	8
00000800	DC link overvoltage	7
00001000	DC-link voltage low	6
00002000	DC-link voltage high	5
00004000	Mains phase loss	4
00008000	No motor	3
00010000	Live zero error	2
00020000	10 V low	1
00040000	Brake resistor power limit	26
00080000	Brake resistor short circuit	25
00100000	Brake chopper fault	27
00200000	Speed limit	49
00400000	Fieldbus comm. fault	34
00800000	24 V supply fault	47
01000000	Mains failure	36
02000000	Current limit	59
04000000	Unused	–
08000000	Unused	–
10000000	Unused	–
20000000	Unused	–
40000000	Unused	–
80000000	Warning word 2 (ext. stat. word)	–

Table 8.16 Warning Word

Index

A

Abbreviation..... 4
 Additional resources..... 3
 Address switch..... 7
 Alarm word..... 44
 Alarms..... 44
 Approvals..... 4

B

Baud rate..... 7

C

Certifications..... 4
 Configuration..... 28
 Control signals, no response..... 41
 Convention..... 4
 Conversion index..... 37

D

Danfoss object classes..... 27
 Data types supported..... 37
 Discharge time..... 5

E

EDS file..... 8

H

High voltage..... 5

I

I/O assembly instance..... 10

L

Leakage current..... 5
 LED..... 4
 LED panel..... 40
 LED status..... 40
 Load sharing..... 5

N

No communication with the frequency converter..... 41

P

Polling..... 9
 Process data..... 10

Product overview..... 3

Q

Qualified personnel..... 5

S

Safety..... 6
 Symbol..... 4

T

Topology..... 3

U

Unintended start..... 5

W

Warning word..... 44
 Warnings..... 44



.....
Danfoss can accept no responsibility for possible errors in catalogues, brochures and other printed material. Danfoss reserves the right to alter its products without notice. This also applies to products already on order provided that such alterations can be made without subsequential changes being necessary in specifications already agreed. All trademarks in this material are property of the respective companies. Danfoss and the Danfoss logotype are trademarks of Danfoss A/S. All rights reserved.
.....

Danfoss A/S
Ulsnaes 1
DK-6300 Graasten
vlt-drives.danfoss.com

