

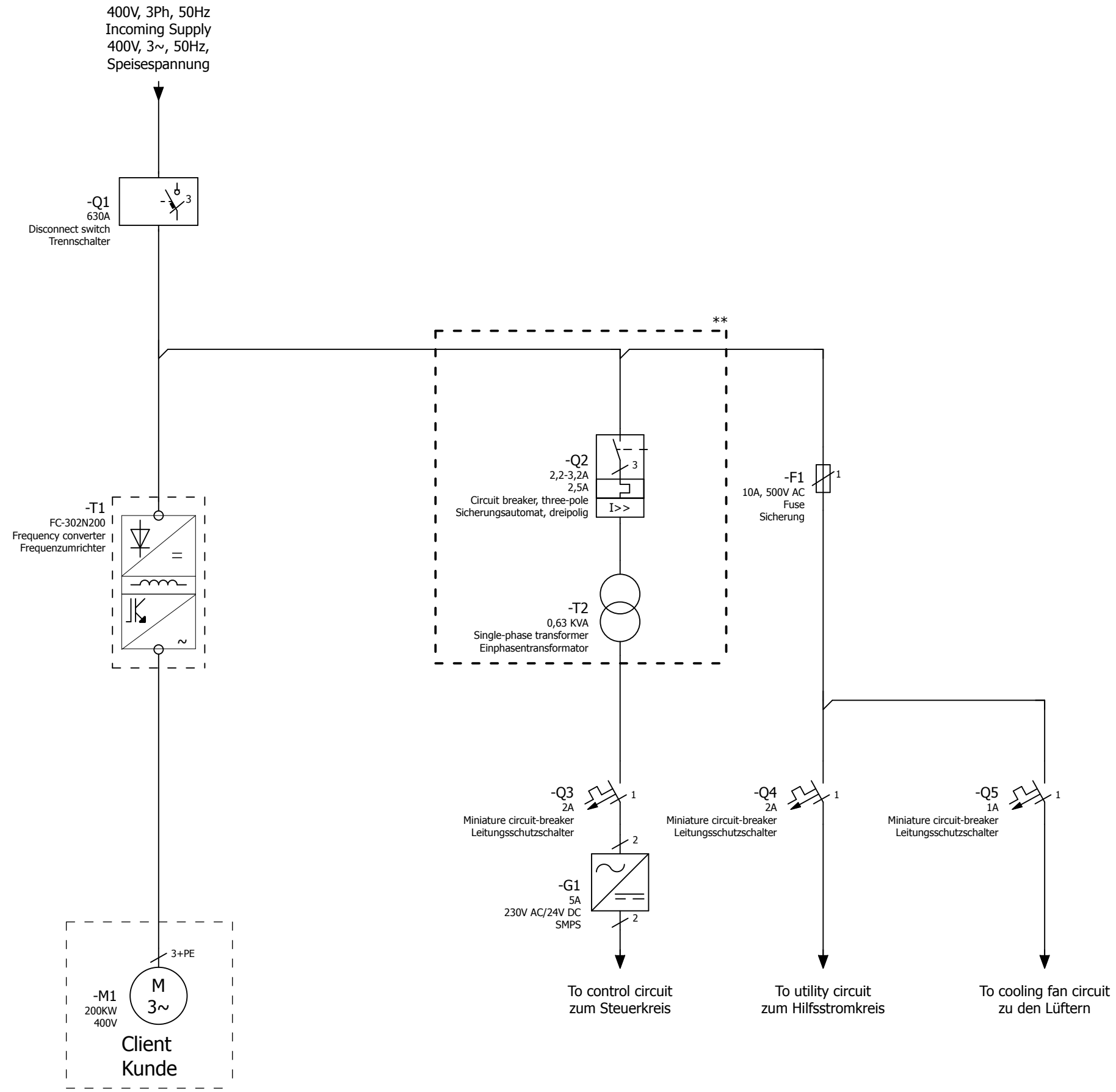

** - Circuit will be removed if external power supply considered
 Verbindung wird entfernt, wenn externe Spannungsversorgung angelegt wird



=REPORT+CONNECTION LIST/2

Date		9/30/2013	Commission		Danfoss GmbH		FILE-NAME: LOGOB300.jpg Size 300px x 116px	Project Number		= FC302	Page
Ed.		----	Project description		VLT Drives EMA, Carl-Legien Strasse 8			Page description		-----	+ N200KW 24V
Appr.		----	Disconnect switch		63073 Offenbach, Germany	SAP NO		Manufacturer no		Page	
Modification	Date	Name	Contr.	----	Trennschalter					33	