

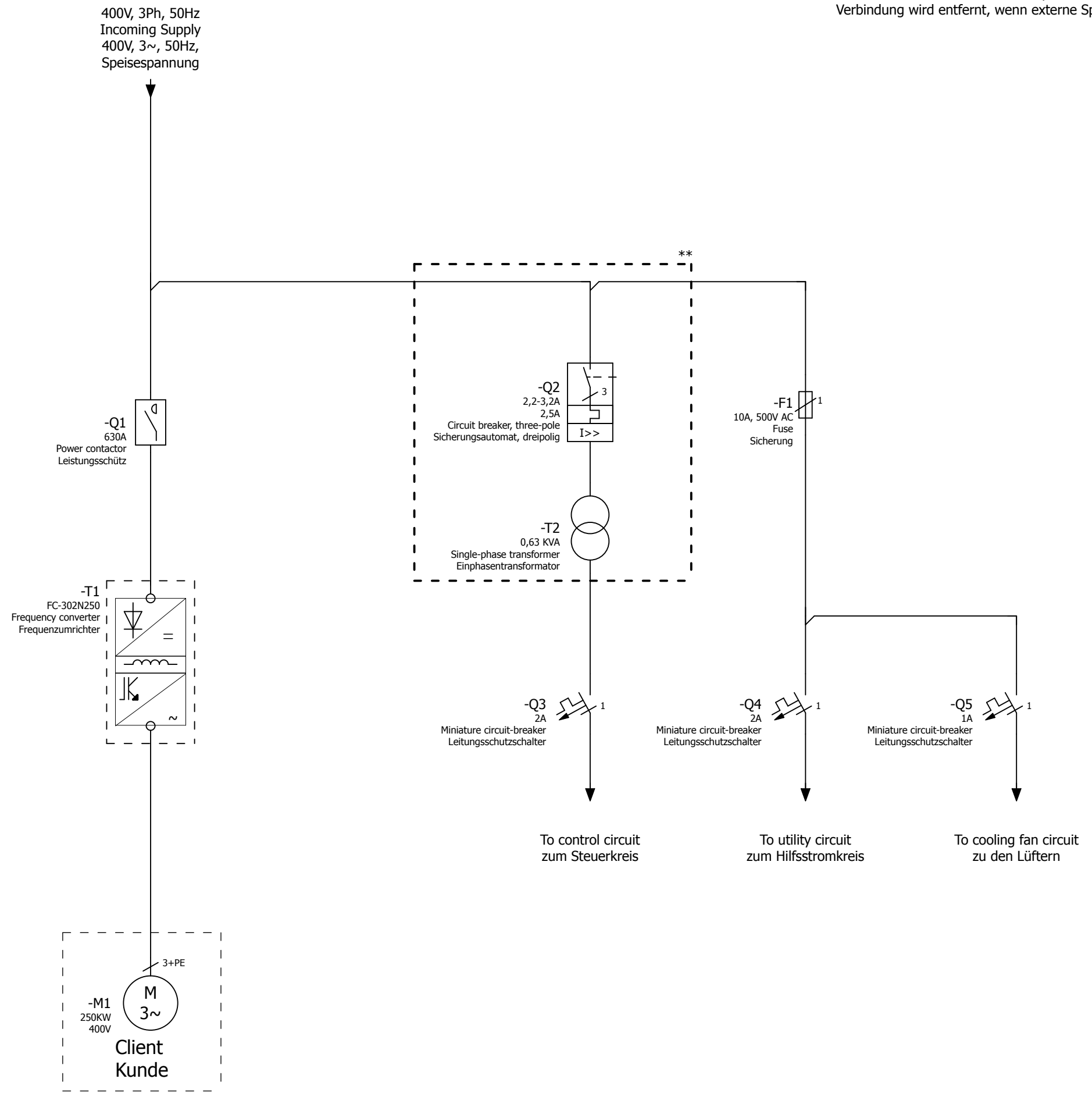

** - Circuit will be removed if external power supply considered
 Verbindung wird entfernt, wenn externe Spannungsversorgung angelegt wird



=REPORT+CONNECTION LIST/2

Date		9/30/2013	Commission		Danfoss GmbH		FILE-NAME: LOGOB300.jpg Size 300px x 116px	Page description		Project Number		= FC302		Page
Ed.		----	Project description		VLT Drives EMA, Carl-Legien Strasse 8			Schematic single-line Schaltplan einpolig		-----		+ N250KW 230V		1
Appr.		----	Contactor		63073 Offenbach, Germany			SAP NO		Manufacturer no		Page		
Modification	Date	Name	Contr.	----	Schütz							32		