

** - Circuit will be removed if external power supply considered
Verbindung wird entfernt, wenn externe Spannungsversorgung angelegt wird

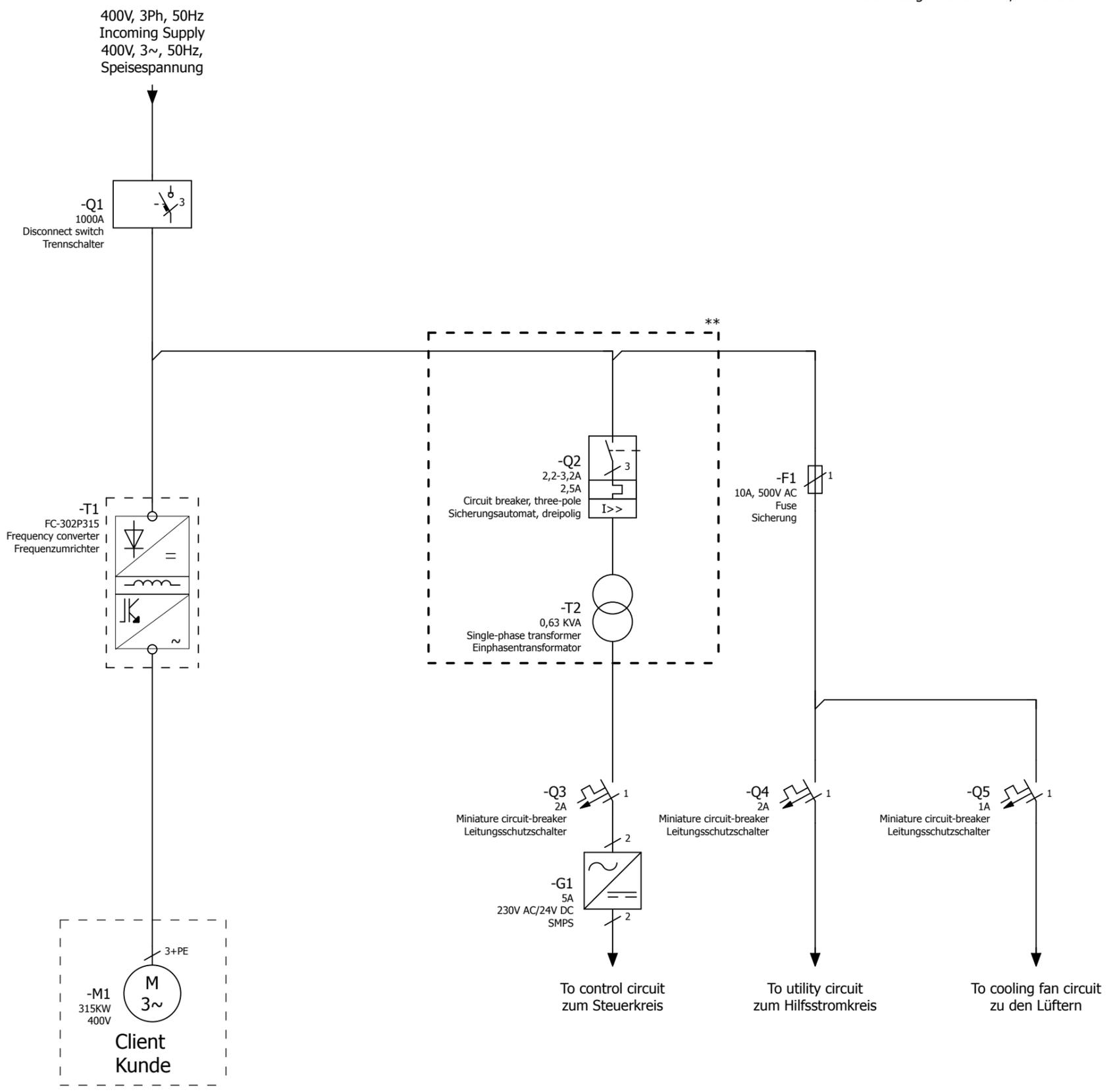

=REPORT+CONNECTION LIST/2

Date		9/30/2013	Commission		Danfoss GmbH			FILE-NAME: LOGOB300.jpg Size 300px x 116px	Page description		Project Number		= FC302		Page
Ed.		----	315KW VFD Panel		VLT Drives EMA, Carl-Legien Strasse 8				Schematic single-line		-----		+ P315KW 24V		1
Appr.		----	Disconnect switch		63073 Offenbach, Germany		Schaltplan einpolig		SAP NO		Manufacturer no		Page		
Modification	Date	Name	Contr.	----	Trennschalter								33		