

Installation Guide

Pumping Smart Card VLT® Soft Starter MCD 600



Contents

1	Safety	5
1.1	Disclaimer	5
1.2	Warnings	5
2	Overview	6
2.1	Features of the Pumping Smart Card	6
2.1.1	Monitoring	6
2.1.2	Protection	6
2.1.3	Control	6
3	Setting up the Smart Card	7
3.1	Set-up Procedure	7
4	Installation	8
4.1	Installing the Expansion Card	8
4.2	Compatible Input Devices	8
4.3	Active and Passive 4–20 mA Input Devices	8
4.4	Minimizing Noise	9
4.5	Inputs	9
5	Operation	11
5.1	Monitoring	11
5.2	Protection and Monitoring	11
5.3	Protecting, Monitoring, and Controlling the Soft Starter	11
6	Configuration	12
6.1	Parameter Configuration	12
6.2	Off-line Configuration	12
6.3	Flow Protection	12
6.3.1	Operation	12
6.3.1.1	Using an Analog 4–20 mA Sensor	13
6.3.1.2	Using a Switch Sensor	13
6.3.1.3	Using a Pulse Sensor	13
6.3.2	Parameter Group 30-** Pump Input Configuration	14
6.3.3	Parameter Group 31-** Flow Protection	15
6.3.4	Parameter Group 36-** Pump Trip Action	15
6.4	Pressure Protection	16
6.4.1	Operation	17
6.4.1.1	Using an Analog 4–20 mA Sensor	17
6.4.1.2	Using a Switch Sensor	17

6.4.1.3	Parameter Group 30-** Pump Input Configuration	18
6.4.1.4	Parameter Group 32-** Pressure Protection	18
6.4.1.5	Parameter Group 36-** Pump Trip Action	19
6.5	Pressure Control	20
6.5.1	Configuring Pressure Control	20
6.5.2	Operation	20
6.5.2.1	Level Control Operation	21
6.5.2.2	Pressure-based Operation	22
6.5.2.3	Parameter Group 30-** Pump Input Configuration	23
6.5.2.4	Parameter Group 33-** Pressure Control	23
6.5.2.5	Parameter Group 36-** Pump Trip Action	24
6.6	Depth Protection	24
6.6.1	Operation	25
6.6.1.1	Using an Analog 4–20 mA Sensor	25
6.6.1.2	Using a Switch Sensor	25
6.6.1.3	Parameter Group 30-** Pump Input Configuration	26
6.6.1.4	Parameter Group 34-** Depth Protection	26
6.6.1.5	Parameter Group 36-** Pump Trip Action	27
6.7	Thermal Protection	27
6.7.1	Parameter Group 35-** Thermal Protection	28
6.7.2	Parameter Group 36-** Pump Trip Action	28
7	Trip Messages	29
7.9	Pressure Sensor	31
8	Specifications	33
8.1	Connections	33
8.2	Certification	33

1 Safety

1.1 Disclaimer

The examples and diagrams in this manual are included solely for illustrative purposes. The information contained in this manual is subject to change at any time and without prior notice. Responsibility or liability is never accepted for direct, indirect, or consequential damage resulting from the use or application of this equipment.

1.2 Warnings

⚠ WARNING ⚠

UNEXPECTED BEHAVIOR

When the soft starter is connected to mains voltage, the Pumping Smart Card can start or stop the motor without warning. Unexpected behavior can lead to personal injury.

- To ensure personnel safety, isolate the soft starter from mains voltage before installing the smart card.

⚠ WARNING ⚠

RISK OF PERSONAL INJURY AND EQUIPMENT DAMAGE

Inserting foreign objects or touching the inside of the soft starter while the expansion port cover is open may endanger personnel and can damage the soft starter.

- Do not insert foreign objects in the soft starter with the port cover open.
- Do not touch the inside of the soft starter with the port cover open.

⚠ NOTICE ⚠

The hydraulic characteristics of pump systems vary considerably. The default parameter settings may not be suitable for every application and care should be taken to configure the soft starter appropriately.

2 Overview

2.1 Features of the Pumping Smart Card

The Pumping Smart Card provides dedicated inputs for pressure, depth, temperature, and flow sensors to allow protection, control, and monitoring integration in a range of pumping applications.

2.1.1 Monitoring

Data from analog or pulse sensors can be shown directly on the display of the soft starter.

A real-time graph is also available if the optional remote LCP is installed.

2.1.2 Protection

The smart card can trip the soft starter based on user-selected levels for high or low pressure, depth, temperature, or flow.

2.1.3 Control

The smart card can automatically start and stop the soft starter in response to rising or falling pressure, or rising or falling depth.

Smart card control can be used with the VLT® Soft Starter MCD 600 scheduling function to restrict starting or stopping to specified days and times.

3 Setting up the Smart Card

3.1 Set-up Procedure

Context:

⚠ WARNING ⚠

SHOCK HAZARD

Attaching or removing accessories while the soft starter is connected to mains voltage may cause personal injury.

- Before attaching or removing accessories, isolate the soft starter from mains voltage.

Procedure

1. Insert the smart card into the soft starter.
2. Connect sensors to the inputs:
 - A Depth protection: B13, B14 or C13, C14
 - B Pressure protection: B23, B24 or C33, C34, C43, C44.
 - C Flow protection: B33, B34 or C23, C24.
 - D Motor temperature protection: R1, R2, R3.
 - E Pressure or depth-based control: B23, B24.
3. Configure the soft starter's auto-reset as required (*parameter 6-1 Auto-Reset Count* and *parameter 6-2 Auto-Reset Delay*).
4. Configure flow protection operation if required.
5. Configure pressure protection operation if required.
6. Configure pressure or depth-based control if required.

⚠ NOTICE ⚠

Protection features still operate even if control is set to Off.

7. Configure depth protection if required.
8. Configure temperature protection if required.
9. Select the command source (*parameter 1-1 Command Source*).
 - For protection and monitoring, use Digital input, Remote LCP, or Clock.
 - For control, use Smart card or Smart card+Clock.

4 Installation

4.1 Installing the Expansion Card

Procedure

1. Push a small flat-bladed screwdriver into the slot in the center of the expansion port cover and ease the cover away from the soft starter.
2. Line up the card with the expansion port.
3. Gently push the card along the guide rails until it clicks into the soft starter.

Example:

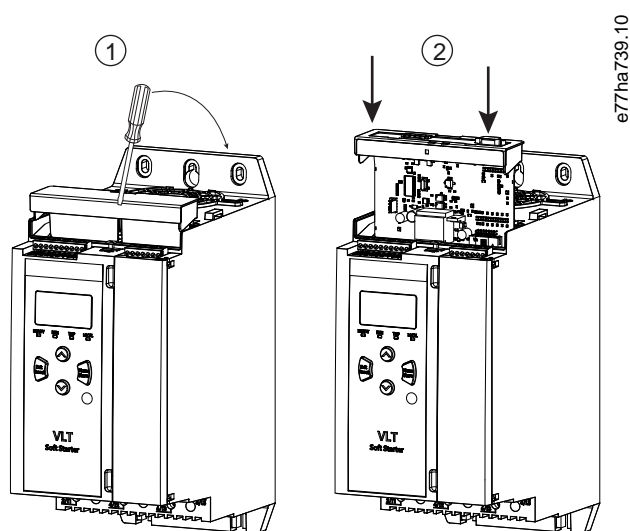

Illustration 1: Installation of the Expansion Cards

4.2 Compatible Input Devices

The smart card supports the following types of input devices:

- Analog 4–20 mA active (self-powered) and passive (loop-powered)
- Pulse
- Digital switch

4.3 Active and Passive 4–20 mA Input Devices

The wiring connections for 4–20 mA sensors vary depending on how the sensor is powered. This manual describes the wiring connections for passive (loop-powered) sensors, but active (self-powered) sensors can also be used by changing the wiring connections.

- Passive (loop-powered) sensors are powered from the 4–20 mA terminals of the smart card. For these sensors, use B13-B14, B23-B24, B33-B34.
- Active (self-powered) sensors have either an internal or external power supply. The sensor is not powered from the smart card terminals. For these sensors, connect the 0 V to terminal R1 and connect the active input to B13, B23, or B33 as required.

Active and passive sensors can be used in the same installation.

4.4 Minimizing Noise

To minimize noise when using the analog 4–20 mA inputs, use twisted pair wiring.

4.5 Inputs

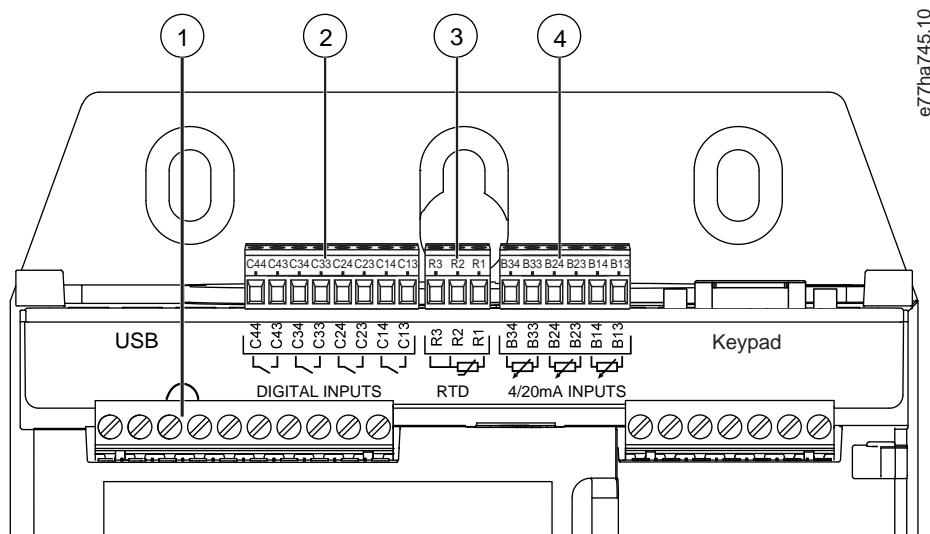

Illustration 2: Location of Inputs

Table 1: Legend to Location of Inputs

Number	Function	Terminals	Description
1	Reset input	RESET, COM+	If the reset input is active, the soft starter does not operate. If a reset switch is not required, fit a link across terminals RESET, COM+ on the soft starter. The reset input is normally closed by default.
2	Digital inputs (normally open)	C13, C14	Depth protection
		C23, C24	Flow protection and monitoring
		C33, C34	Low-pressure protection
		C43, C44	High-pressure protection
3	RTD/PT100 input	R1, R2, R3	Motor temperature protection
4	4–20 mA inputs	B13, B14 [+]	Depth protection and monitoring
		B23, B24 [+]	Pressure protection and monitoring/pressure or depth-based control
		B33, B34 [+]	Flow protection and monitoring

⚠ NOTICE ⚠

The reset input can be configured for normally open or normally closed operation. Use *parameter 7-9 Reset/ Enable Logic* to select the configuration.

⚠ NOTICE ⚠**FLOW PROTECTION AND MONITORING**

When used with a switch sensor, C23, C24 provide flow protection only. When used with a pulse sensor, C23, C24 provide flow protection and monitoring.

5 Operation

5.1 Monitoring

Data from analog or pulse sensors can be shown directly on the soft starter display.

A real-time graph is also available if the optional remote LCP is installed.

- To scroll to the graph screen, press [▲] and [▼].
- To change which data is shown on the graph, press [GRAPH] on the remote LCP.

5.2 Protection and Monitoring

The smart card can stop or trip the soft starter based on user-selected levels for high or low pressure, depth, temperature, or flow.

Smart card protection features are always active while the soft starter is operating. Protection levels are set via *parameter groups 31 to 35*.

5.3 Protecting, Monitoring, and Controlling the Soft Starter

Context:

The smart card can automatically start and stop the soft starter in response to rising or falling pressure, or rising and falling depth.

⚠ NOTICE ⚠

Smart card protection features are always active while the soft starter is operating. Smart card protection is not affected by the command source.

⚠ NOTICE ⚠

To use the smart card to control the soft starter, use sensors connected to B23, B24.

⚠ NOTICE ⚠

If the reset input is active, the soft starter does not operate. If a reset switch is not required, fit a link across terminals RESET, COM+ on the soft starter.

Procedure

1. Set *parameter 1-1 Command Source* to *Smart Card* or *Smart Card+Clock*.
2. Set *parameter 33-1 Pressure Control Mode* as required.
3. Set *parameter 4-1 Auto-Start/Stop Mode* to *Enable* to use clock-based scheduling.

6 Configuration

6.1 Parameter Configuration

Operating parameters for the Pumping Smart Card are set and stored in the soft starter. Parameters can be configured via the main menu or uploaded using the USB Save & Load function.

For details on how to configure the soft starter, see the VLT® Soft Starter MCD 600 Operating Guide.

In the parameter descriptions, an asterisk (*) indicates the default setting.

6.2 Off-line Configuration

⚠ NOTICE ⚠

Parameters for smart card functions are only visible in the parameter list if the smart card is installed.

To configure smart card settings in the soft starter before the card is installed, generate a parameter file in the MCD PC Software and load it into the soft starter using USB Save & Load.

6.3 Flow Protection

Flow protection uses terminals B33, B34 or C23, C24 on the smart card.

- B33, B34: Use an analog 4–20 mA sensor.
- C23, C24: Use a normally open digital switch sensor for protection only, or use a pulse sensor for protection and monitoring.

Flow protection is active when the soft starter is in start, stop, or run mode.

The smart card trips the soft starter when the flow rate passes through the programmed trip level. If the flow rate is still outside the expected operating range when the trip is reset (including auto-reset), the soft starter does not trip again.

6.3.1 Operation

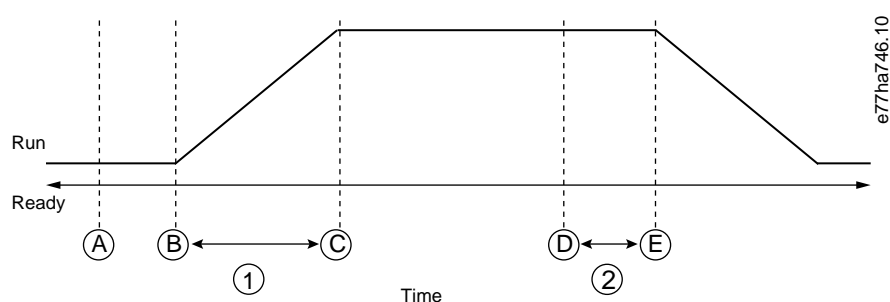

A Off (Ready)	B Start signal
C Flow protection active	D Protection event (<i>parameter 31-1 High Flow Trip Level and parameter 31-2 Low Flow Trip Level</i>)
	1 Flow protection start delay (<i>parameter 31-3 Flow Start Delay</i>)

- | | |
|---|--|
| E | Protection response (<i>parameter 36-2 Flow Sensor, parameter 36-6 High Flow, parameter 36-7 Low Flow, parameter 36-8 Flow Switch</i>) |
| 2 | Flow protection response delay (<i>parameter 31-4 Flow Response Delay</i>) |

Illustration 3: Operation - Flow Protection

6.3.1.1 Using an Analog 4–20 mA Sensor

Context:

An analog 4–20 mA sensor provides protection and monitoring.

Procedure

1. Connect the sensor to B33, B34.
2. Set *parameter 30-5 Flow Sensor Type* to *Analog*.
3. Set *parameters 30-6* to *30-8* according to the sensor specifications.
4. Set *parameters 31-1* to *31-4*, *parameter 36-2 Flow Sensor*, and *parameter 36-7 Low Flow* as required.

6.3.1.2 Using a Switch Sensor

Context:

A switch sensor provides protection only.

Procedure

1. Connect the sensor to C23, C24.
2. Set *parameter 30-5 Flow Sensor Type* to *Switch*.
3. Set *parameters 31-3* to *31-4*, *parameter 36-2 Flow Sensor*, and *parameter 36-8 Flow Switch* as required.

Parameters 31-1 to 31-2 are not used with a switch sensor.

6.3.1.3 Using a Pulse Sensor

Context:

A pulse sensor provides protection and monitoring.

Procedure

1. Connect the sensor to C23, C24.
2. Set *parameter 30-5 Flow Sensor Type* to *Pulses per Minute* or *Pulses per Unit*.
3. Set *parameter 30-6 Flow Units*, *30-11 Units per Pulse*, and either *parameter 30-9 Units per Minute at Max Flow* or *parameter 30-10 Pulses per Minute at Max Flow* according to the sensor specifications.
4. Set *parameters 31-1* to *31-4*, and *parameter 36-2 Flow Sensor*, *parameter 36-6 High Flow*, and *parameter 36-7 Low Flow* as required.

6.3.2 Parameter Group 30-** Pump Input Configuration

Table 2: 30-5 - Flow Sensor Type

Option		Function
		Selects which type of sensor is associated with the flow sensor input on the smart card.
*	None	
	Switch	
	Analog	
	Pulses per minute	
	Pulses per unit	

Table 3: 30-6 - Flow Units

Option		Function
		Selects which units the sensor uses to report the measured flow.
*	liters/second	
	liters/minute	
	gallons/second	
	gallons/minute	

Table 4: 30-7 - Flow at 4 mA

Range		Function
*0	0-5000	Calibrates the soft starter to the 4 mA (0%) level of the flow sensor input.

Table 5: 30-8 - Flow at 20 mA

Range		Function
*0	0-5000	Calibrates the soft starter to the 20 mA (100%) level of the flow sensor input.

Table 6: 30-9 - Units per Minute at Max Flow

Range		Function
*0	0-5000	Calibrates the soft starter to the maximum flow volume of the flow sensor.

Table 7: 30-10 - Pulses per Minute at Max Flow

Range		Function
*0	0-20000	Calibrates the soft starter to the maximum flow volume of the flow sensor.

Table 8: 30-11 - Units per Pulse

Range		Function
*0	0-1000	Set to match how many units the flow sensor measures for each pulse.

6.3.3 Parameter Group 31-** Flow Protection

Flow protection uses terminals B33, B34 or C23, C24 on the smart card.

Table 9: 31-1 - High Flow Trip Level

Range		Function
*10	0–5000	Sets the trip point for high flow protection.

Table 10: 31-2 - Low Flow Trip Level

Range		Function
* 5	1–5000	Sets the trip point for low flow protection.

Table 11: 31-3 - Flow Start Delay

Range		Function
*00:00:500 ms	00:00:100– 30:00:000 mm:ss:ms	Sets a delay before a flow protection trip can occur. The delay is counted from the time a start signal is received. The flow level is ignored until the start delay has elapsed.

Table 12: 31-4 - Flow Response Delay

Range		Function
* 00:00:500 ms	00:00:100–30:00:000 mm:ss:ms	Sets a delay between the flow passing the high or low flow trip levels, and the soft starter tripping.

6.3.4 Parameter Group 36-** Pump Trip Action

Table 13: 36-2 - Flow Sensor

	Option	Function
		Selects the soft starter's response if it detects a fault with the flow sensor.
*	Soft Trip and Log	
	Soft Trip and Reset	
	Trip Starter	
	Trip and Reset	
	Warn and Log	
	Log Only	

Table 14: 36-6 - High Flow

	Option	Function
		Selects the soft starter's response if the flow exceeds the high flow trip level (<i>parameter 31-1 High Flow Trip Level</i>).
*	Soft Trip and Log	

	Option	Function
	Soft Trip and Reset	
	Trip Starter	
	Trip and Reset	
	Warn and Log	
	Log Only	

Table 15: 36-7 - Low Flow

	Option	Function
		Selects the soft starter's response if the flow drops below the low flow trip level (set in <i>parameter 31-2 Low Flow Trip Level</i>).
*	Soft Trip and Log	
	Soft Trip and Reset	
	Trip Starter	
	Trip and Reset	
	Warn and Log	
	Log Only	

Table 16: 36-8 - Flow Switch

	Option	Function
		Selects the soft starter's response if the flow sensor closes (switch type sensors only).
*	Soft Trip and Log	
	Soft Trip and Reset	
	Trip Starter	
	Trip and Reset	
	Warn and Log	
	Log Only	

6.4 Pressure Protection

Pressure protection uses terminals B23, B24 or C33, C34, C43, C44 on the smart card.

- B23, B24: Use an analog 4–20 mA sensor.
- C33, C34 (low-pressure protection): Use a normally open digital switch sensor.
- C43, C44 (high-pressure protection): Use a normally open digital switch sensor.

Pressure protection is active when the soft starter is in the start, run, or stop mode.

The smart card trips the soft starter when the pressure level passes through the programmed trip level. If the pressure is still outside the expected operating range when the trip is reset (including auto-reset), the soft starter does not trip again.

6.4.1 Operation

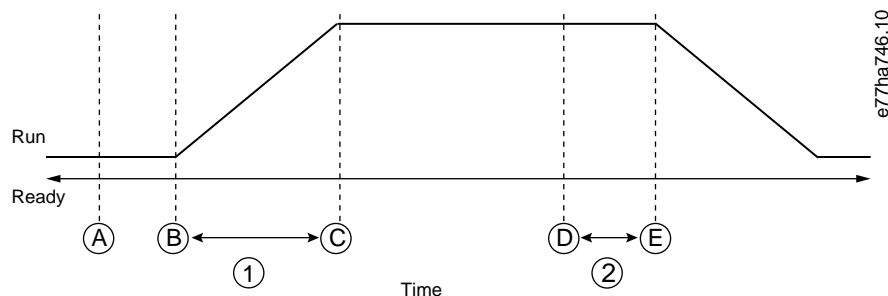

A Off (Ready)	B Start signal
C Pressure protection active	D Protection event (<i>parameter 32-1 High Pressure Trip Level and parameter 32-4 Low Pressure Trip Level</i>)
E Protection response (<i>parameter 36-1 Pressure Sensor, parameter 36-4 High Pressure, parameter 36-5 Low Pressure</i>)	1 Pressure protection start delay (<i>parameter 32-2 High Pressure Start Delay and parameter 32-5 Low Pressure Start Delay</i>)
2 Pressure protection response delay (<i>parameter 32-3 High Pressure Response Delay and parameter 32-6 Low Pressure Response Delay</i>)	

Illustration 4: Operation - Pressure Protection

6.4.1.1 Using an Analog 4–20 mA Sensor

Context:

An analog 4–20 mA sensor provides protection and monitoring.

Procedure

1. Connect the sensor to B23, B24.
2. Set *parameter 30-1 Pressure Sensor Type* to *Analog*.
3. Set *parameters 30-2 to 30-4* according to the sensor specifications.
4. Set *parameters 32-1 to 32-6, parameter 36-1 Pressure Sensor, and parameters 36-4 to 36-5* as required.

6.4.1.2 Using a Switch Sensor

Context:

A switch sensor provides protection only.

Procedure

1. Connect the low-pressure sensor to C33, C34 and the high-pressure sensor to C43, C44.
2. Set *parameter 30-1 Pressure Sensor Type* to *Switch*.
3. High-pressure protection: Set *parameters 32-2 to 32-3, parameter 36-1 Pressure Sensor, and parameter 36-4 High Pressure* as required.
4. Low-pressure protection: Set *parameters 32-5 to 32-6, parameter 36-1 Pressure Sensor, and parameter 36-5 Low Pressure* as required.

Parameter 32-1 High Pressure Trip Level and parameter 32-4 Low Pressure Trip Level are not used with a switch sensor.

6.4.1.3 Parameter Group 30-** Pump Input Configuration

Table 17: 30-1 - Pressure Sensor Type

Option		Function
		Selects which type of sensor is associated with the pressure sensor input on the smart card.
*	None	
	Switch	
	Analog	

Table 18: 30-2 - Pressure Units

Option		Function
		Selects which units the sensor uses to report the measured pressure.
	Bar	
*	kPa	
	Psi	

Table 19: 30-3 - Pressure at 4 mA

Range		Function
*0	0-5000	Calibrates the soft starter to the 4 mA (0%) level of the pressure sensor input.

Table 20: 30-4 - Pressure at 20 mA

Range		Function
*0	0-5000	Calibrates the soft starter to the 20 mA (100%) level of the pressure sensor input.

6.4.1.4 Parameter Group 32-** Pressure Protection

Pressure protection uses terminals B23, B24 or C33, C34, C44 on the smart card.

Table 21: 32-1 - High Pressure Trip Level

Range		Function
*10	0-5000	Sets the trip point for high-pressure protection.

Table 22: 32-2 - High Pressure Start Delay

Range		Function
* 0.5 s	00:00:100- 30:00:000 mm:ss:ms	Sets a delay before a high-pressure protection trip can occur. The delay is counted from the time a start signal is received. The pressure is ignored until the start delay has elapsed.

Table 23: 32-3 - High Pressure Response Delay

Range		Function
* 0.5 s	00:00:100–30:00:000 mm:ss:ms	Sets a delay between the pressure passing the high-pressure trip level and the soft starter tripping.

Table 24: 32-4 - Low Pressure Trip Level

Range		Function
* 5	0–5000	Sets the trip point for low-pressure protection.

Table 25: 32-5 - Low Pressure Start Delay

Range		Function
* 0.5 s	00:00:100–30:00:000 mm:ss:ms	Sets a delay before a low-pressure protection trip can occur. The delay is counted from the time a start signal is received. The pressure is ignored until the start delay has elapsed.

Table 26: 32-6 - Low Pressure Response Delay

Range		Function
* 0.5 s	00:00:100–30:00:000 mm:ss:ms	Sets a delay between the pressure passing the low-pressure trip level and the soft starter tripping.

6.4.1.5 Parameter Group 36-** Pump Trip Action

Table 27: 36-1 - Pressure Sensor

	Option	Function
		Selects the soft starter's response if it detects a fault with the pressure sensor.
*	Soft and Trip Log	
	Soft Trip and Reset	
	Trip Starter	
	Trip and Reset	
	Warn and Log	
	Log Only	

Table 28: 36-4 - High Pressure

	Option	Function
		Selects the soft starter's response if the pressure exceeds the high-pressure trip level (<i>parameter 32-1 High Pressure Trip Level</i>) or the high-pressure switch sensor closes.
*	Soft Trip and Log	
	Soft Trip and Reset	
	Trip Starter	

	Option	Function
	Trip and Reset	
	Warn and Log	
	Log Only	

Table 29: 36-5 - Low Pressure

	Option	Function
		Selects the soft starter's response if the pressure drops below the low-pressure trip level (<i>parameter 32-4 Low Pressure Trip Level</i>) or the low-pressure sensor switch closes.
*	Soft Trip and Log	
	Soft Trip and Reset	
	Trip Starter	
	Trip and Reset	
	Warn and Log	
	Log Only	

6.5 Pressure Control

The smart card can start or stop the soft starter (wake or sleep the pump) according to the measured pressure. This can be used for direct pressure-based control, or the pressure measurement can be used to indicate water depth.

Other sensors can also be used to provide protection and monitoring.

Pressure control uses terminals B23, B24 on the smart card. Use an analog 4–20 mA sensor.

6.5.1 Configuring Pressure Control

Procedure

1. Connect the sensor to B23, B24.
2. Set *parameter 30-1 Pressure Sensor Type* to *Analog*.
3. Set *parameters 30-2 to 30-4* according to the sensor specifications.
4. Set *parameters 33-1 to 33-5* as required.
5. Set *parameter 1-1 Command Source* to *Smart Card* or *Smart Card+Clock*.

6.5.2 Operation

There are 2 different operating modes when using pressure control:

- Level control operation.
- Pressure-based operation.

6.5.2.1 Level Control Operation

A pressure sensor can be used to control the pump based on fluid level in a storage tank on the principle that deeper water exerts higher pressure on the sensor.

Set *parameter 33-1 Pressure Control Mode* to *Falling Pressure Start* to fill the tank or *Rising Pressure Start* to empty the tank.

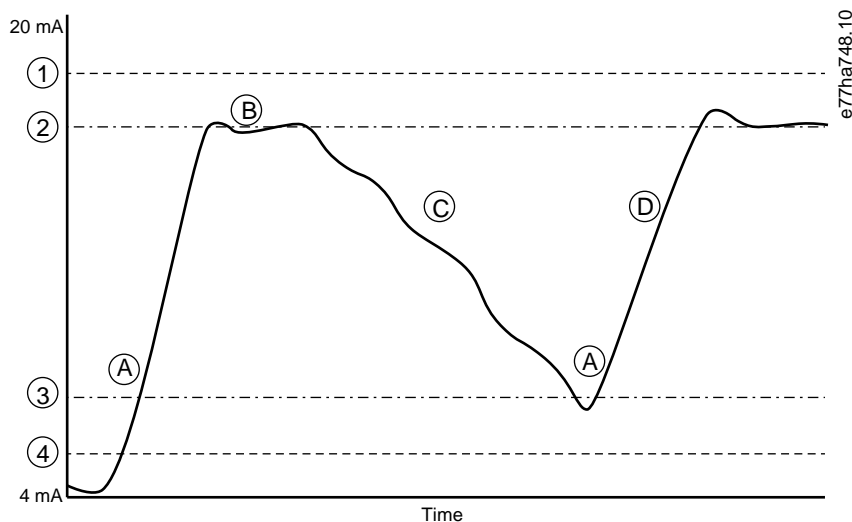

1 <i>Parameter 32-1 High Pressure Trip Level</i>	2 Pump sleep (<i>parameter 33-4 Stop Pressure Level</i>)
3 Pump wake (<i>parameter 33-2 Start Pressure Level</i>)	4 <i>Parameter 32-4 Low Pressure Trip Level</i>
A Pump on (wake)	B Pump off (sleep)
C Falling fluid level	D Rising fluid level

Illustration 5: Falling Pressure (Fill Tank)

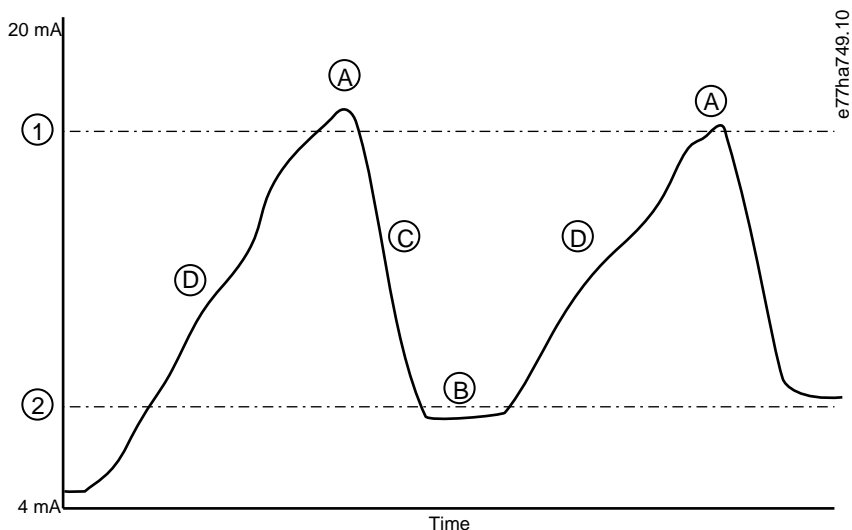

1 Pump wake (<i>parameter 33-2 Start Pressure Level</i>)	2 Pump sleep (<i>parameter 33-4 Stop Pressure Level</i>)
--	--

A Pump on (wake)	B Pump off (sleep)
C Falling fluid level	D Rising fluid level

Illustration 6: Rising Pressure (Tank Empty)

6.5.2.2 Pressure-based Operation

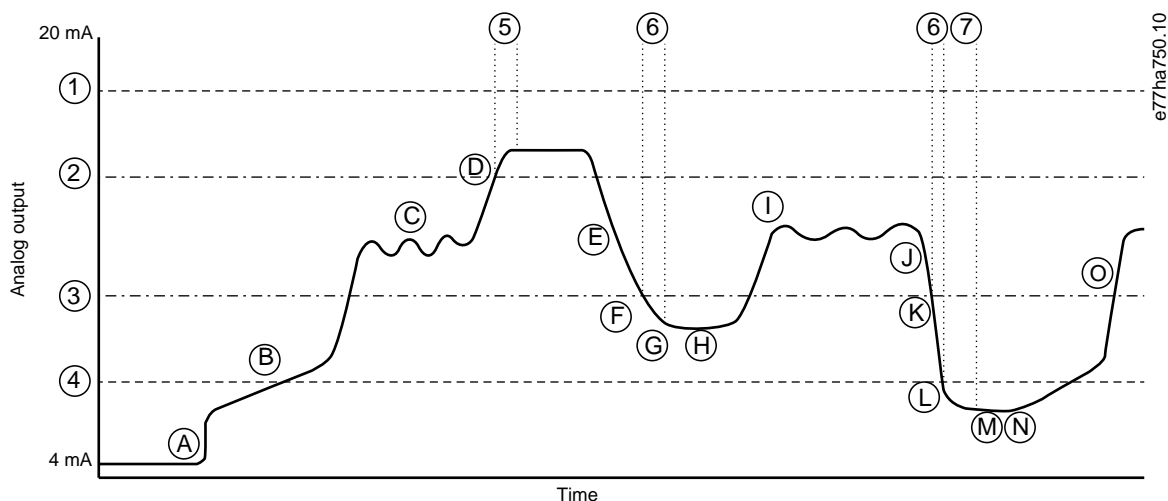

1 Parameter 32-1 High Pressure Trip Level	2 Pump sleep (parameter 33-4 Stop Pressure Level)
3 Pump wake (parameter 33-2 Start Pressure Level)	4 Parameter 32-4 Low Pressure Trip Level
5 Parameter 33-5 Stop Response Delay	6 Parameter 33-3 Start Response Delay
7 Parameter 6-2 Auto-Reset Delay	A Smart card control enabled, pump starts
B Pipe filling	C Normal pressure variation
D Pressure at stop threshold, pump stops (sleep)	E Falling system pressure
F Pressure below start threshold, start response delay	G Pump wakes
H Pump running	I Normal pressure variation
J Falling system pressure	K Pressure below start threshold, start response delay
L Low-pressure trip level	M Soft starter auto-reset
N Pump wakes	O Normal operation

Illustration 7: Example of Pressure-based Operation

6.5.2.3 Parameter Group 30-** Pump Input Configuration

Table 30: 30-1 - Pressure Sensor Type

Option	Function
	Selects which type of sensor is associated with the pressure sensor input on the smart card.
* None	
Switch	
Analog	

Table 31: 30-2 - Pressure Units

Option	Function
	Selects which units the sensor uses to report the measured pressure.
Bar	
* kPa	
Psi	

Table 32: 30-3 - Pressure at 4 mA

Range	Function
*0 0-5000	Calibrates the soft starter to the 4 mA (0%) level of the pressure sensor input.

Table 33: 30-4 - Pressure at 20 mA

Range	Function
*0 0-5000	Calibrates the soft starter to the 20 mA (100%) level of the pressure sensor input.

6.5.2.4 Parameter Group 33-** Pressure Control

Pressure control uses terminals B23, B24 on the smart card. Use an analog 4–20 mA sensor.

Table 34: 33-1 - Pressure Control Mode

Option	Function
	Selects how the soft starter uses data from the pressure sensor to control the motor.
* Off	The soft starter does not use the pressure sensor to control soft starting.
Falling Pressure Start	The soft starter starts when the pressure drops below the level selected in <i>parameter 33-2 Start Pressure Level</i> .
Rising Pressure Start	The soft starter starts when the pressure rises above the level selected in <i>parameter 33-2 Start Pressure Level</i> .

Table 35: 33-2 - Start Pressure Level

Range		Function
* 5	1–5000	Sets the pressure level to trigger the soft starter to perform a soft start.

Table 36: 33-3 - Start Response Delay

Range		Function
* 0.5 s	00:00:100–30:00:000 mm:ss:ms	Sets a delay between the pressure passing the pressure control start level and the soft starter performing a soft start.

Table 37: 33-4 - Stop Pressure Level

Range		Function
* 10	0–5000	Sets the pressure level to trigger the soft starter to stop the motor.

Table 38: 33-5 - Stop Response Delay

Range		Function
* 0.5 s	00:00:100–30:00:000 mm:ss:ms	Sets a delay between the pressure passing the pressure control stop level and the soft starter stopping the motor.

6.5.2.5 Parameter Group 36-** Pump Trip Action

Table 39: 36-1 - Pressure Sensor

	Option	Function
		Selects the soft starter's response if it detects a fault with the pressure sensor.
*	Soft and Trip Log	
	Soft Trip and Reset	
	Trip Starter	
	Trip and Reset	
	Warn and Log	
	Log Only	

6.6 Depth Protection

Depth protection uses terminals B13, B14 or C13, C14 on the smart card.

- B13, B14: Use an analog 4–20 mA sensor.
- C13, C14: Use a normally open digital switch sensor.

Depth protection is always active (ready, start, run, and stop modes).

The smart card trips the soft starter when the depth level passes through the programmed trip level. The trip cannot be reset until the depth has returned above the reset level (*parameter 34-2 Depth Reset Level*).

⚠ NOTICE ⚠

If the depth has not returned above the reset level when the soft starter auto-resets, the smart card trips the soft starter again.

6.6.1 Operation

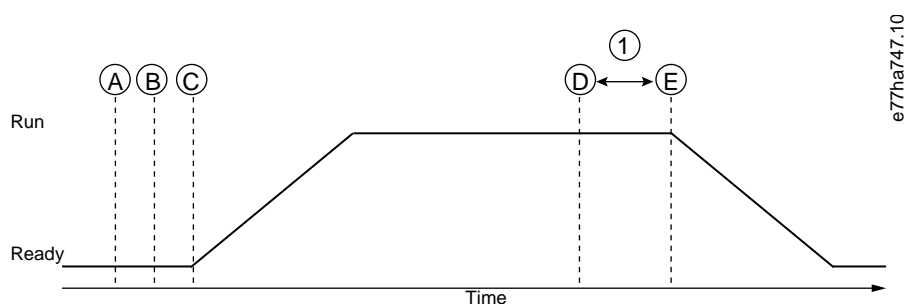

A Off (ready)	B Depth protection active
C Start signal	D Protection event (<i>parameter 34-1 Depth Trip Level</i>)
E Protection response (<i>parameter 36-3 Depth Sensor and parameter 36-9 Well Depth</i>)	1 Depth protection response delay (<i>parameter 34-4 Depth Response Delay</i>)

Illustration 8: Operation - Depth Protection

6.6.1.1 Using an Analog 4–20 mA Sensor

Context:

An analog 4–20 mA sensor provides protection and monitoring.

Procedure

1. Connect the sensor to B13, B14.
2. Set *parameter 30-12 Depth Sensor Type* to Analog.
3. Set *parameters 30-13 to 30-15* according to the sensor specifications.
4. Set *parameters 34-1 to 34-4, parameter 36-3 Depth Sensor, and parameter 36-9 Well Depth* as required.

6.6.1.2 Using a Switch Sensor

Context:

A switch sensor provides protection only.

Procedure

1. Connect the sensor to C13, C14.
2. Set *parameter 30-12 Depth Sensor Type* to Switch.
3. Set *parameters 34-3 to 34-4, parameter 36-3 Depth Sensor, and parameter 36-9 Well Depth* as required.

Parameters 34-1 to 34-2 are not used with a switch sensor.

6.6.1.3 Parameter Group 30-** Pump Input Configuration

Table 40: 30-12 - Depth Sensor Type

Option		Function
		Selects which type of sensor is associated with the depth sensor input on the smart card.
*	None	
	Switch	
	Analog	

Table 41: 30-13 - Depth Units

Option		Function
		Selects which units the sensor uses to report the measured depth.
*	meters	
	feet	

Table 42: 30-14 - Depth at 4 mA

Range		Function
*0	0-1000	Calibrates the soft starter to the 4 mA (0%) level of the depth sensor input.

Table 43: 30-15 - Depth at 20 mA

Range		Function
*0	0-1000	Calibrates the soft starter to the 20 mA (100%) level of the depth sensor input.

6.6.1.4 Parameter Group 34-** Depth Protection

Depth protection uses terminals B13, B14 or C13, C14 on the smart card.

Table 44: 34-1 - Depth Trip Level

Range		Function
* 5	0-1000	Sets the trip point for depth protection.

Table 45: 34-2 - Depth Reset Level

Range		Function
* 10	0-1000	Sets the level for the soft starter to allow a depth trip to be reset.

Table 46: 34-3 - Depth Start Delay

Range		Function
* 0.5 s	00:00:100- 30:00:000 mm:ss:ms	Sets a delay before a depth protection trip can occur. The delay is counted from the time a start signal is received. The depth input is ignored until the start delay has elapsed.

Table 47: 34-4 - Depth Response Delay

Range		Function
* 0.5 s	00:00:100–30:00:000 mm:ss:ms	Sets a delay between the depth passing the depth protection trip level and the soft starter tripping.

6.6.1.5 Parameter Group 36-** Pump Trip Action

Table 48: 36-3 - Depth Sensor

	Option	Function
		Selects the soft starter's response if it detects a fault with the depth sensor.
*	Soft Trip and Log	
	Soft Trip and Reset	
	Trip Starter	
	Trip and Reset	
	Warn and Log	
	Log Only	

Table 49: 36-9 - Well Depth

	Option	Function
		Selects the soft starter's response if the depth drops below the depth trip level (<i>parameter 34-1 Depth Trip Level</i>) or the depth switch sensor closes.
*	Soft Trip and Log	
	Soft Trip and Reset	
	Trip Starter	
	Trip and Reset	
	Warn and Log	
	Log Only	

6.7 Thermal Protection

Thermal protection uses terminals R1, R2, R3 on the smart card.

Thermal protection is active only when the soft starter is in run mode.

6.7.1 Parameter Group 35-** Thermal Protection

Table 50: 35-1 - Temperature Sensor Type

Option		Function
		Selects which type of sensor is associated with the temperature sensor input on the smart card.
*	None	
	PT100	

Table 51: 35-2 - Temperature Trip Level

Range	Function
* 40 ° 0–240 °	Sets the trip point for temperature protection. Use <i>parameter 10-2 Temperature Scale</i> to configure the temperature scale.

6.7.2 Parameter Group 36-** Pump Trip Action

Table 52: 36-10 - RTD/PT100 B

Option	Function
	Selects the soft starter's response to the protection event.
*	Soft Trip and Log
	Soft Trip and Reset
	Trip Starter
	Trip and Reset
	Warn and Log
	Log Only

7 Trip Messages

7.1 Depth Sensor

Cause

The smart card has detected a fault with the depth sensor.

Troubleshooting

- Check the following parameters:
 - *Parameter 30-12 Depth Sensor Type.*
 - *Parameter 36-3 Depth Sensor.*

7.2 Flow Sensor

Cause

The smart card has detected a fault with the flow sensor.

Troubleshooting

- Check the following parameters:
 - *Parameter 30-5 Flow Sensor Type.*
 - *Parameter 36-2 Flow Sensor.*

7.3 Flow Switch

Cause

The flow switch sensor (smart card terminals C23, C24) has closed.

Troubleshooting

- Check the following parameters:
 - *Parameter 30-5 Flow Sensor Type.*
 - *Parameter 36-8 Flow Switch.*

7.4 High Flow

Cause

The flow sensor connected to the smart card has activated high-flow protection.

Troubleshooting

- Check the following parameters:
 - *Parameter 30-5 Flow Sensor Type.*
 - *Parameter 30-7 Flow at 4 mA.*
 - *Parameter 30-8 Flow at 20 mA.*
 - *Parameter 31-1 High Flow Trip Level.*
 - *Parameter 31-3 Flow Start Delay.*
 - *Parameter 31-4 Flow Response Delay.*
 - *Parameter 36-6 High Flow.*

7.5 High Pressure

Cause

The pressure sensor connected to the smart card has activated high-pressure protection.

Troubleshooting

- Check the following parameters:
 - *Parameter 30-1 Pressure Sensor Type.*
 - *Parameter 30-3 Pressure at 4 mA.*
 - *Parameter 30-4 Pressure at 20 mA.*
 - *Parameter 32-1 High Pressure Trip Level.*
 - *Parameter 32-2 High Pressure Start Delay.*
 - *Parameter 32-3 High Pressure Response Delay.*
 - *Parameter 36-4 High Pressure.*

7.6 Low Flow

Cause

The flow sensor connected to the smart card has activated low-flow protection. Related parameters:

Troubleshooting

- Check the following parameters:
 - *Parameter 30-5 Flow Sensor Type.*
 - *Parameter 30-7 Flow at 4 mA.*
 - *Parameter 30-8 Flow at 20 mA.*
 - *Parameter 31-2 Low Flow Trip Level.*
 - *Parameter 31-3 Flow Start Delay.*
 - *Parameter 31-4 Flow Response Delay.*
 - *Parameter 36-7 Low Flow.*

7.7 Low Pressure

Cause

The pressure sensor connected to the smart card has activated low-pressure protection.

Troubleshooting

- Check the following parameters:
 - *Parameter 30-1 Pressure Sensor Type.*
 - *Parameter 30-3 Pressure at 4 mA.*
 - *Parameter 30-4 Pressure at 20 mA.*
 - *Parameter 32-4 Low Pressure Trip Level.*
 - *Parameter 32-5 Low Pressure Start Delay.*
 - *Parameter 32-6 Low Pressure Response Delay.*
 - *Parameter 36-5 Low Pressure.*

7.8 Low Water

Cause

The depth sensor connected to the smart card has activated depth protection.

Troubleshooting

- Check the following parameters:
 - *Parameter 30-12 Depth Sensor Type.*
 - *Parameter 30-14 Depth at 4 mA.*
 - *Parameter 30-15 Depth at 20 mA.*
 - *Parameter 34-1 Depth Trip Level.*
 - *Parameter 34-2 Depth Reset Level.*
 - *Parameter 34-3 Depth Start Relay.*
 - *Parameter 36-9 Well Depth.*

7.9 Pressure Sensor

Cause

The smart card has detected a fault with the pressure sensor.

Troubleshooting

- Check the following parameters:
 - *Parameter 30-1 Pressure Sensor Type.*
 - *Parameter 36-1 Pressure Sensor.*

7.10 RTD Circuit

Cause

The smart card has detected a fault with the RTD sensor, or the RTD has activated temperature protection.

Troubleshooting

- Check the following parameters:
 - *Parameter 35-2 Temperature Trip Level.*
 - *Parameter 36-10 RTD/PT100 B.*

8 Specifications

8.1 Connections

External equipment	Unpluggable connectors (supplied)
Maximum cable size	2.5 mm ² (14 AWG)

8.2 Certification

RCM	IEC 60947-4-2
CE	EN 60947-4-2
RoHS	Compliant with EU Directive 2011/65/EU

Index

C

Cable size	33
Certification	
CE	33
RCM	33
RoHS	33
Compatibility	8

E

Expansion port cover	8
----------------------------	---

F

Features	6
----------------	---

I

Inputs, location of	9
---------------------------	---

L

Low flow	30
Low pressure	31

P

Programmable input	29
--------------------------	----

R

Real-time graph	6, 11
-----------------------	-------

S

Sensors	
Active	8
Analog 4–20 mA	8, 13, 17, 25
Passive	8
Pulse sensor	13
Switch sensor	13, 17, 25

T

Thermal protection	27
Tools	
Flat-bladed screwdriver	8

W

Wiring	8
--------------	---

ENGINEERING
TOMORROW

Danfoss

.....
Danfoss can accept no responsibility for possible errors in catalogues, brochures and other printed material. Danfoss reserves the right to alter its products without notice. This also applies to products already on order provided that such alterations can be made without subsequential changes being necessary in specifications already agreed. All trademarks in this material are property of the respective companies. Danfoss and the Danfoss logotype are trademarks of Danfoss A/S. All rights reserved.
.....

Danfoss A/S
Ulsnaes 1
DK-6300 Graasten
vlt-drives.danfoss.com

