

Service

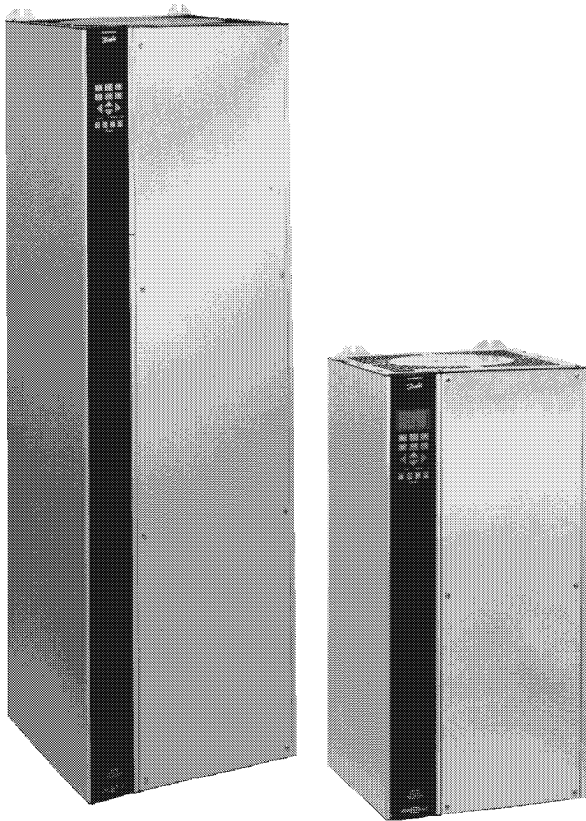

VLT® 5060-5250 Series Service Instructions

Table of Contents

Introduction	1
Product Overview	1
Warnings and Cautions	1
Section I	Drive Build Up	
	Description of Operation	2
	Logic Section	2
	Logic to Power Interface	3
	Power Section	3
	Sequence of Operation	4
	Soft Charge Section	4
	Intermediate Section	5
	Inverter Section	6
	Brake Option	7
	Cooling Fans	8
	Fan Control	8
	Specific Power Card Connectors	8
	Load Sharing	8
Section II	Diagnostics	
	Warnings and Alarms	9
	Fault Flow Chart	15
	Symptom and Cause Chart	18
	Applications	20
Section III	Static Checks	
	Rectifier (Input) Section	25
	Inverter (Output) Section	27
	Intermediate (DC Bus) Section	28
	Brake Circuit	28
	Motor	28
	Heatsink Temperature Sensor	29
	Inductor Temperature Sensor	29
Section IV	Dynamic Checks	
	Output Voltage and Current Balance	35
	Input SCR/Diode Module	36
	IGBT Gate Drive Signals	36
	Current Feedback	37

VLT® 5000 Series Service Instructions

Section V Disassembly

5060-5100 Nema 12 / IP54

Control Card	39
Capacitor Bank	39
Power Card	40
Current Sensor	40
IGBT	41
Brake IGBT	41
Testing Brake Snubber Board	41
SCR/Diode Module	42

5060-5100 Chassis / Nema 1 / IP20

Control Card	43
Capacitor Bank	44
Power Card	44
Current Sensor	44
IGBT	45
Brake IGBT	45
Testing Brake Snubber Board	45
SCR/Diode Module	46

5125-5150 Nema 12 / IP54

Control Card	47
Capacitor Bank	47
Power Card	48
Current Sensor	48
IGBT	49
Brake IGBT	49
Testing Brake Snubber Board	49
SCR/Diode Module	50

5125-5150 Chassis / Nema 1/ IP20

Control Card	51
Capacitor Bank	52
Power Card	52
Current Sensor	52
IGBT	53
Brake IGBT	53
Testing Brake Snubber Board	53
SCR/Diode Module	54

5200-5250 Nema 12/ IP54

Control Card	55
Capacitor Bank	56
Power Card	57
IGBT	57
Brake IGBT	58
Testing Brake Snubber Board	58
SCR/Diode Module	59
Current Sensor	59

5200-5250 Chassis / Nema 1/ IP20

Control Card	60
Capacitor Bank	61
Power Card	62
IGBT	62
Brake IGBT	63
Testing Brake Snubber Board	63
SCR/Diode Module	64
Current Sensor	64

Block Diagrams

VLT 5060 Process	65
VLT 6075/5075 Aqua	66
VLT 5075 Process	67
VLT 6100/5100 Aqua	68
VLT 5100 Process	69
VLT 6125/5125 Aqua	70
VLT 5125 Process	71
VLT 6150/5150 Aqua	72
VLT 5151 Process	73
VLT 6175/5200 Aqua	74
VLT 5200 Process	75
VLT 6225/5250 Aqua	76
VLT 5250 Process	77
VLT 6275/5300 Aqua	78

Torque Specifications

SCR/Diode Module	79
IGBT	80

Test Equipment

Signal Test Board	81
SCR Gate Drive Test Cable	92
Power Card DC Supply Source	94
Spare Parts List	98

INTRODUCTION

The purpose of this manual is to provide technical information and instructions that will enable the user to identify faults and perform repairs on the VLT 5000, VLT 5000 AQUA and the VLT 6000 series Adjustable Frequency Drives models VLT 5060-5250, VLT 5075-5300 AQUA and VLT 6075-6275.

This manual has been divided into five sections. The first section covers the description and sequence of operations. Section two covers fault messages, troubleshooting charts, and application specific information. Section and four describe the various tests and methods used to evaluate the drives condition. Section five covers the removal and replacement of the various components.

VLT® PRODUCT OVERVIEW

The VLT 5000, 5000 AQUA and the 6000 Series inverters are available in power sizes from 1Hp - 600Hp in the 380 - 460V range and 1 - 60Hp in the 200V range. This manual covers the VLT 5000 60-250Hp, VLT 5000 AQUA 75-300Hp and VLT 6000 75-300Hp all in the 380-460V range.

These models are available in Chassis, NEMA 1 or NEMA 12 enclosures.

The VLT 5000 series units are programmable for either constant or variable torque operation. There are three hardware configurations available for all sizes of drives, they are: Standard (ST), Standard with Brake (SB), and Extended with Brake (EB).

The SB and EB units contain all logic and hardware necessary to connect an external resistor to provide dynamic braking.

The EB configuration offers connection terminals for load sharing capabilities between multiple VLT 5000 Series units, plus input terminals for a remote 24 VDC power supply to maintain control logic during removal of the AC input power.

The VLT 5000 AQUA is designed primarily for the water industry for control of variable torque pumping applications. It is available with the same enclosure possibilities as its 5000 series counterpart but without the choice of hardware configurations. The VLT 5000 AQUA has specific advantages over the VLT 5000 series in variable torque applications and can only be used for such loads.

The VLT 6000 series is designed primarily for the HVAC industry for control of variable torque fan and pump applications. It is available with the same enclosure possibilities as its 5000 series counterparts but has specific advantages over the VLT 5000 series in HVAC applications and can only be used on variable torque loads.

WARNING:

The VFD contains dangerous voltages when connected to the line voltage. Only a competent technician should carry out the service.

FOR YOUR SAFETY:

- 1) **DO NOT** touch the electrical parts of the AFD when the AC line is connected. After the AC line is disconnected wait at least 15 minutes before touching any of the components.
- 2) When repair or inspection is made the AC line must be disconnected.
- 3) The STOP key on the control panel does not disconnect the AC line.
- 4) During operation and programming of the parameters **the motor may start without warning**. Activate the STOP key when changing data.

CAUTION:

Electrostatic discharge (ESD)- Many electronic components are sensitive to static electricity. Voltages so low that they cannot be felt, seen or heard can reduce the life, affect performance, or completely destroy sensitive electronic components.



When performing service, proper ESD equipment should be used to prevent possible damage from occurring.

SECTION ONE

DESCRIPTION OF OPERATION

It is not the intention of this manual to enter into a detailed description of the unit's operation. Moreover, it is intended to provide the reader with a general view of the unit's main assemblies. With this information, the repair technician should have a better understanding of the unit's operation and therefore aid in the troubleshooting process.

The VLT 5060-5250, VLT 5075-5300 AQUA and the VLT 6075-6275 series units are very similar in construction and design. For the purpose of troubleshooting two main differences exist: First, the control card and LCP for the 5060-5250 differ from that of the VLT 5000 AQUA and 6000 series. Second, the rating of the power section is sized differently in a constant torque drive versus a variable torque drive. For example the power section of a VLT 5075 AQUA and VLT 6075 would be similar to that of a VLT 5000 series 60HP (VLT5060). To simplify the discussion we will always refer to the constant torque drives (VLT 5060-5250).

The VLT is divided primarily into three sections commonly referred to as: logic, power, and interface.

LOGIC SECTION

The control card, Figure 1, contains the majority of the logic section. The heart of the control card is a microprocessor which controls and supervises all functions of the unit's operation. In addition, separate PROM's contain parameter sets which characterize the unit and provide the user with the definable data enabling the unit to be adjusted to meet the customers specific application requirements. This data is then stored in an EEPROM which provides security during power-down and also allows flexibility for future changes as needed. A custom integrated circuit generates the PWM waveform which is then sent on to the interface circuitry located on the Power Card.

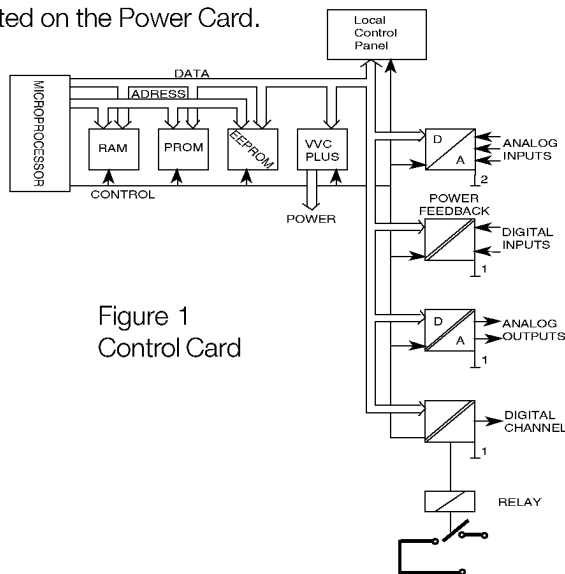

Figure 1
Control Card

The PWM waveform is created using an improved control scheme called VVC^{plus}, which is a further development of the VVC (Voltage Vector Control) system used in the VLT 3000 Series. VVC^{plus} provides a variable frequency and voltage to the motor in such a way that it matches the requirements of the motor. The dynamic response of the system is such that it changes to meet the changing requirements of the load.

Also, part of the logic section is the LCP (Local Control Panel). This is a removable keypad/display mounted on the front of the unit. The keypad or the MMI (Man/Machine Interface) provides the interface between the digital logic and the human programmer.

In addition, The LCP can be removed during operation to prevent undesired program changes. The final shared program of the drive can be also uploaded into the EEPROM at the LCP. This function can be helpful in programming multiple drives or if needed to restore a program to a repaired unit. With the addition of a remote mounting kit, the LCP can be mounted in a remote location of up to three meters away.

A series of customer accessible terminals are provided for the input of such commands as: Run, Stop, Forward, Reverse and Speed reference. Terminals are also provided to supply output signals to peripheral devices for the purpose of monitoring and control.

In addition, the control card is capable of communicating via serial link with outside devices such as personal computers or programmable logic controllers.

The control card provides two voltage supplies for use from the customer terminal strip. The 24VDC is used for switching functions such as: Start, Stop and Forward/Reverse. The 24VDC supply is capable of supplying 200ma of power, part of which may be used to power external devices such as encoders. A 10VDC supply rated at 17ma is also available for use with speed reference circuitry.

The analog and digital output signals are powered through a third non customer accessible supply.

All three power supplies are isolated from one another to eliminate ground loop problems in the control input circuitry.

A single pole low voltage relay is provided on the control card for the purpose of activating external devices based on the status of the drive. The contacts of the control card relay are rated for 50VAC at 1Amp. However, in UL applications the rating is limited to 30VDC at 1Amp.

Provisions have been made on the control card assembly for the addition of option modules such as: synchronizing control, serial communication options, additional relays, cascade controller option or custom operating software.

LOGIC TO POWER INTERFACE

The Logic to Power Interface isolates the high voltage components of the power section from the low voltage signals of the Logic Section. This is accomplished on the Power Card. All communication between the control logic and the rest of the unit passes through the Power Card. This communication includes: DC bus voltage monitoring, line voltage monitoring, output current monitoring, temperature sensing, inrush control and the gate drive firing signals.

The Power Card also contains a Switch Mode Power Supply (SMPS) which provides the unit with 24VDC, +14VDC, -14VDC and 5VDC operating supplies. All logic and interface circuitry is powered by the SMPS. Normally the SMPS is fed by the DC bus voltage, however, in the Extended version of the drive, it is possible to power it with an external 24VDC power supply. This enables operation of the logic circuitry without the power section being energized. Circuitry for controlling the cooling fan power auto transformer is also provided on the Power Card.

In units with Dynamic Brake options, the logic and firing circuitry for the brake operation are also contained on the Power Card.

In addition to passing the communication pertaining to output current to the control logic, much of the fault processing of output short circuit and ground fault conditions is done on the Power Card. A custom IC called an Application Specific Integrated Circuit (ASIC) continually monitors output current conditions with respect to: peak amplitude, rate of rise (di/dt) and leakage current (ground fault). At the point that any of these conditions are considered critical, the gate drive signals are immediately shut-off and an alarm signal is sent to the control logic for displaying the fault information.

Also located on the Power Card is a second relay for monitoring the status of the VLT 5000. The relay is Form C, meaning it has one normally open contact and one normally closed contact on a single throw. The contacts of the relay are rated for a maximum load of 240VAC at 2Amps.

POWER SECTION

The Power Section, Figure 2, contains the Soft Charge Circuitry, SCR/Diode modules (rectifier), the DC Bus Filter Circuitry, often referred to as the Intermediate Circuit, Motor Coils, and the Output IGBT (Isolated Gate Bipolar Transistor) modules which make up the Inverter Section.

In conjunction with the SCR/Diode modules the soft charge circuit limits the inrush current when power is first applied and the DC bus capacitors are charging. This is accomplished by the SCR's in the modules being held off while charging current passes through the soft charge resistors, thereby limiting the current. The DC bus circuitry smooths the pulsating DC voltage created by the conversion from the AC supply. The number of DC bus capacitors will vary depending on the drive size with the VLT 5250 having the most at 20. The DC coil is a single unit with two coils wound on a common core. One coil is placed in the positive side of the bus and the other in the negative. The DC coil serves to aid in the reduction of line harmonics.

The inverter section is made up of six IGBT's commonly referred to as switches. It is necessary to have one switch for each half phase or a total of six. These six IGBT's may be found incorporated into various packages. In very small units, typically under 10Hp, all six IGBT's will be in a single module called six-packs. In the VLT 5060 - 5100 two switches are contained in a single module, called a dual pack, for a total of three and in VLT 5125 - 5250 each switch is in a single module for a total of six modules in all.

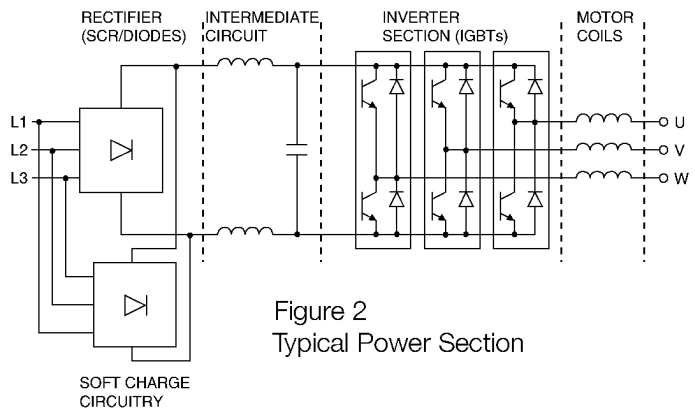

Figure 2
Typical Power Section

The Motor Coils serve to provide a limit to the rate of current rise (di/dt) during peak demands of the output. They serve their greatest purpose during the high and fast rising currents experienced during ground faults or short circuits on the output. The Motor Coil is a single assembly with three coils wound on a common core.

SEQUENCE OF OPERATION

Soft Charge Section

When input power is first applied, Figure 3, it enters the VLT through the RFI option if the unit is so equipped. The SCR's in the combined SCR/Diode modules are not gated so current travels down and through the soft charge fuses to the soft charge rectifier, BR1. Three phase power is also branched off and sent to the Power Card. It only serves the power card a reference of the main supply voltage.

During the charging process the top diodes of the soft charge rectifier conduct and rectify during the positive half cycle. The diodes in the main rectifier conduct during the negative half cycle. The DC voltage is applied to the bus capacitors through F4, the soft charge resistor fuse, and R1, the soft charge resistor. In units of 150Hp and up, two soft charge resistors and fuses are placed in parallel.

The purpose of charging the DC bus through these resistors is to limit the high inrush current that would otherwise be present.

A thermal switch, SW1, is mounted on each soft charge resistor. Should the resistor overheat due to repeated power cycling or a problem in the DC bus circuit the thermal switch will close causing F4, the soft charge resistor fuse, to blow thereby opening the charging circuit.

The Metal Oxide Varistor (MOV), MOV1, serves to protect the soft charge rectifier from transients. R2 and C1 in conjunction with the lower diodes in the soft charge rectifier serve as a snubber network for the SCR/Diode modules. The additional resistor, R13, provides a return path for current flow should the thermal switch, SW1, close.

Once the charging process is completed and the DC bus reaches an acceptable level the Power Card will begin sending gate signals to the SCR/Diode modules, these gate signals will fire at every zero crossing of the input voltage waveform. The SCR/Diode module will then act as a typical uncontrolled rectifier. Phase angle firing of the SCR's is not used in this configuration. The SCR's are on full at each firing.

At this point the DC bus capacitors are fully charged. The DC bus voltage will be approximately 650VDC when the VLT is connected to a nominal 460VAC supply line. This voltage is now present in the inverter section. This same DC voltage is also delivered to the Power Card to operate the Switch Mode Power Supply (SMPS) which in turn provides all the low voltage supplies used by the Power and Control Cards.

(Also refer to the full block diagrams in the appendix)

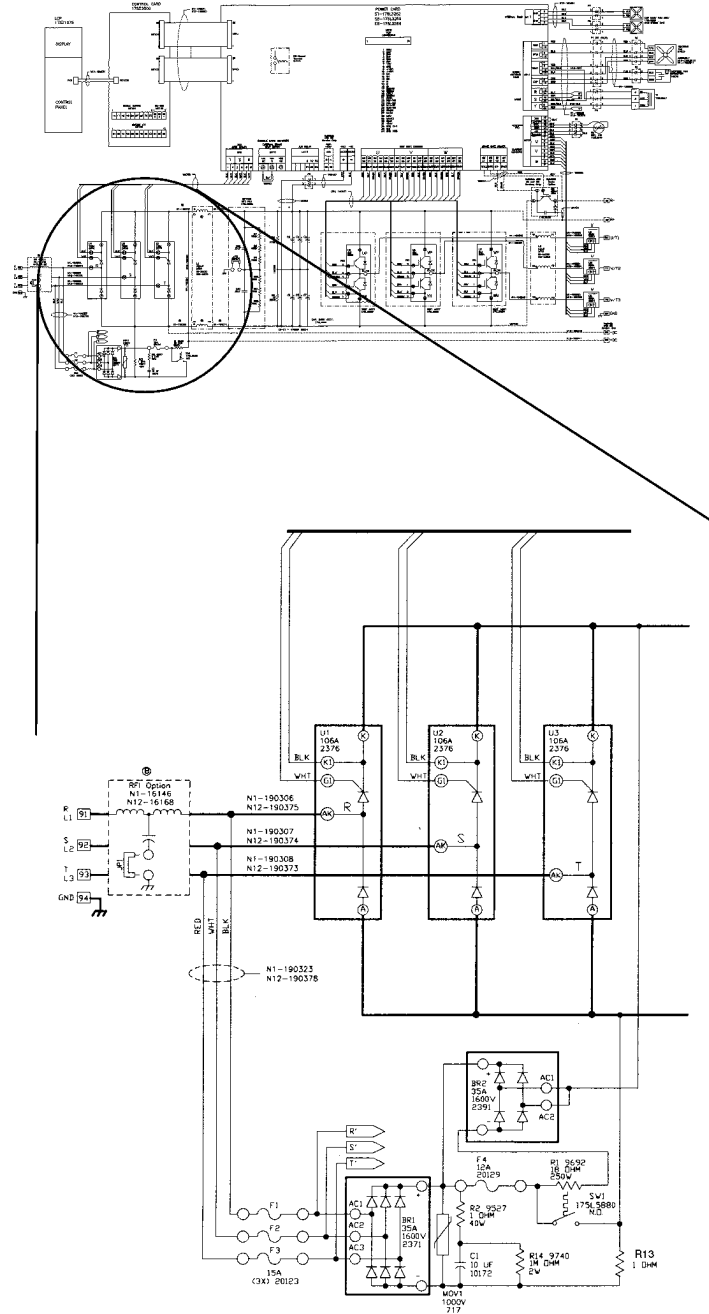

Figure 3
Soft Charge Circuit

Intermediate Section

Moving left to right in the drawing we come to the Intermediate Section, Figure 4. Shown first is the DC Bus Inductor, next is the RFI DC Bus Filter if the unit is equipped with the RFI Option. Notice the jumper to earth ground, this jumper is attached to the Printed Circuit Card which is physically placed at the bottom of the DC Capacitor Bank. This drawing represents a VLT 5075. So, six DC bus capacitors are present, connected in a series parallel configuration. Resistors R4 and R5 are balance resistors for the capacitor bank and also serve to bleed off the bus voltage after input power is removed. Due to the size of the capacitor bank in relation to the resistors it can take up to 15 minutes before the voltage on the capacitors is fully discharged.

(Also refer to the full block diagrams in the appendix Pages 65-78)

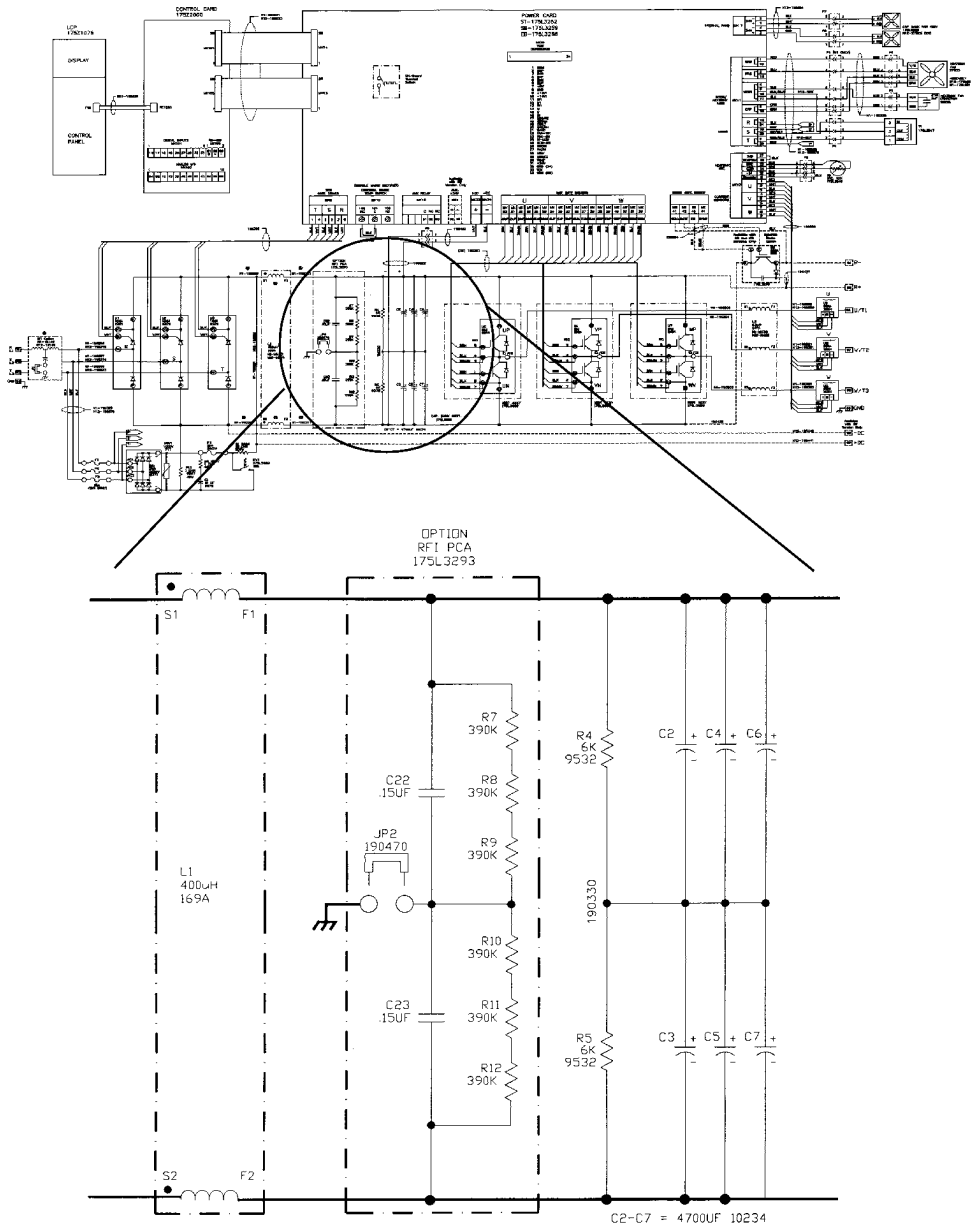

Figure 4
Intermediate Section

Inverter Section

As we reach the Inverter Section, Figure 5. Six IGBT's are packaged in three modules. Gate signals are delivered from the Control Card, through the Power Card and to the gates of the IGBT's. The series connection of each set of IGBT's is delivered to the output, first passing through the output motor coil and the current sensors.

The current sensors are hall effect devices which monitor the output current and deliver a proportional signal to the Power Card. These current signals are used by the Control card to determine proper waveform compensations based on load conditions. They further serve to detect over current conditions including ground faults and phase to phase shorts on the output.

(Also refer to the full block diagrams in the appendix Pages 65-78)

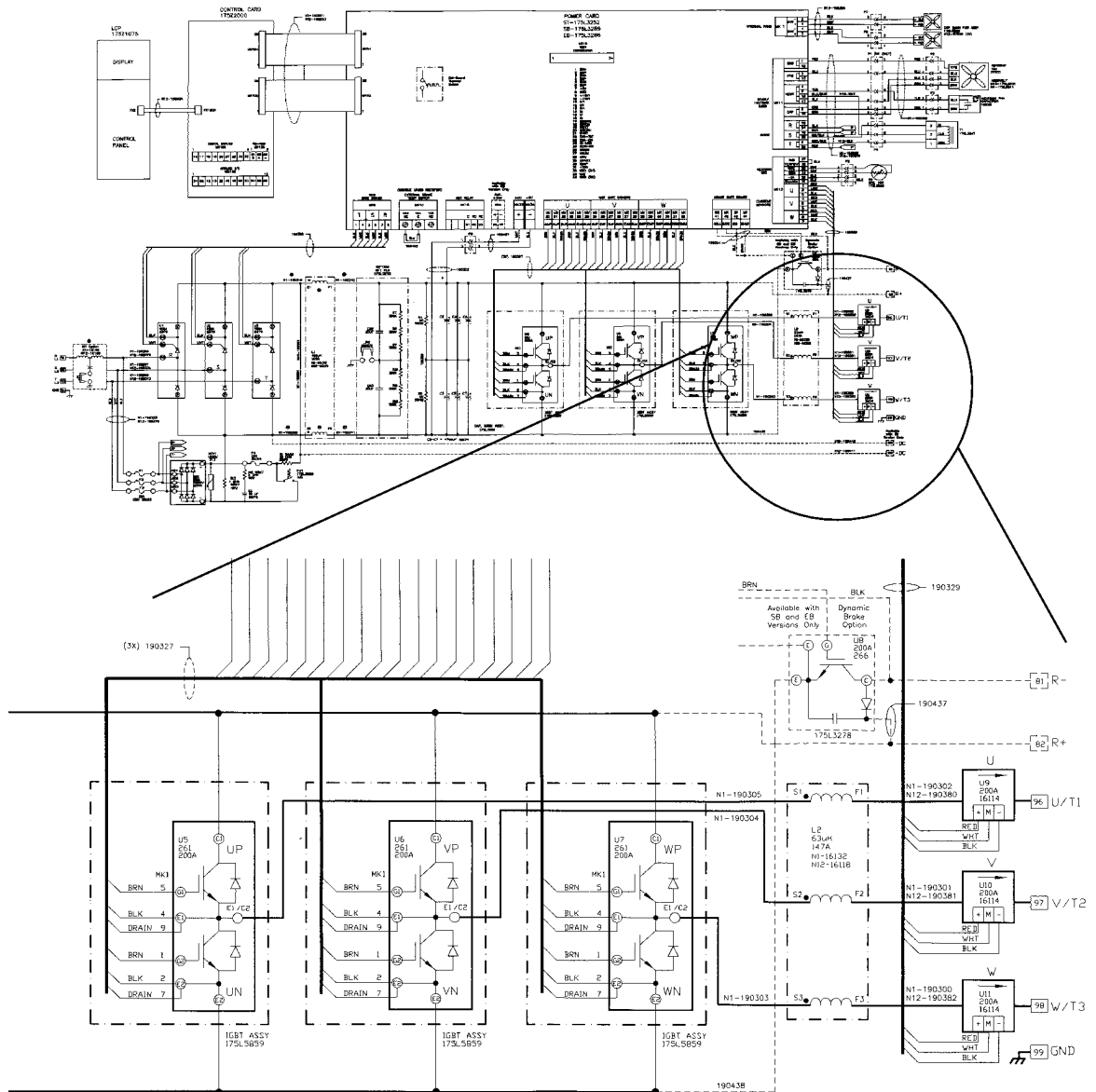

Figure 5
Inverter Section

Once a run command and speed reference are present the IGBT's begin switching to create the output waveform, Figure 6. Looking at the phase to phase voltage waveform with an oscilloscope. It can be seen that the Pulse Width Modulation (PWM) principal creates a series of pulses which vary in width. Basically the pulses are narrower as zero crossing is neared and wider the farther you move away from zero crossing. The resultant current waveform, as shown, replicates a true AC sine wave.

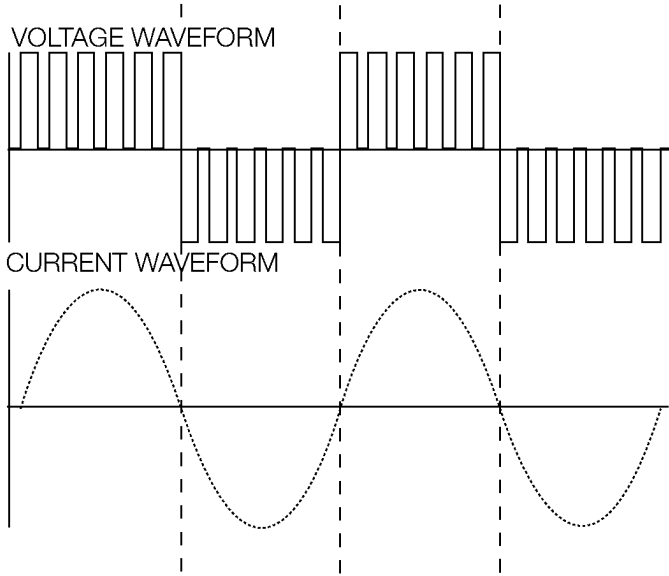

Figure 6

Output voltage & current waveforms

This waveform as generated by the Danfoss VVC^{plus} PWM principle provides optimal performance and minimal losses in the motor.

During normal operation the Power Card and Control Card are monitoring various functions within the VLT. The current sensors are providing current feedback information, the DC bus voltage and AC line voltage are monitored as well as the voltage delivered to the motor. A thermal sensor mounted on the heatsink, Power Card and cap bank (N12 only-5125-5250) provide temperature feedback.

BRAKE OPTION

The optional Brake is available only on SB and EB models. The function of the Brake IGBT, Figure 7, is to switch an externally mounted resistor bank across the DC bus to remove excess DC voltage present on the bus capacitors. Excess DC bus voltage is generally a result of an overhauling

load causing regenerative energy to be returned to the DC bus.

The Brake IGBT gate signal originates on the Control Card and is delivered to the Brake IGBT via the Power Card. Additionally the Power and Control Card monitor the Brake IGBT and brake resistor connection for short circuits and overloads.

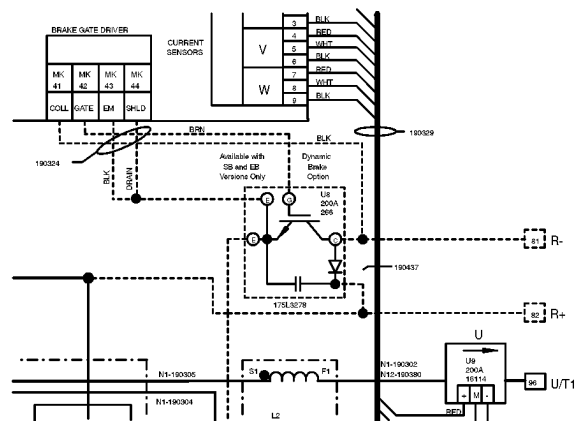
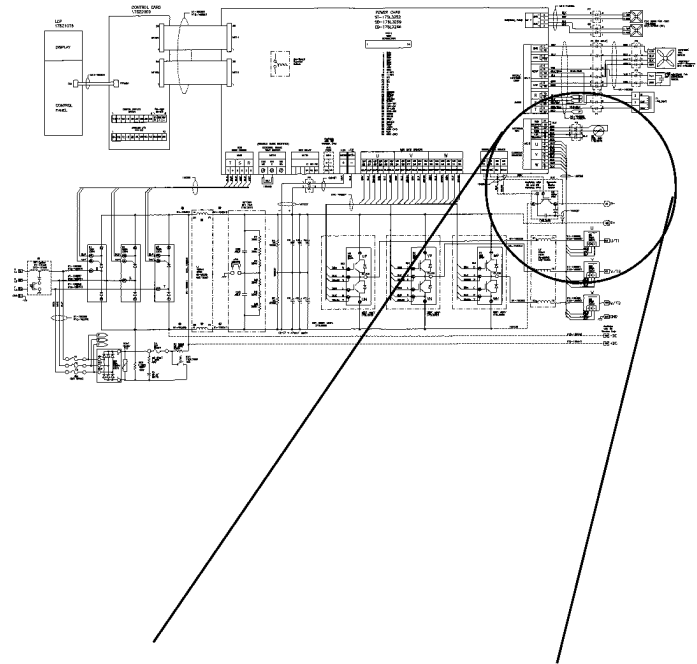

Figure 7
Brake IGBT

COOLING FANS

Various fans are incorporated in the unit. All VLT 's in this size range are equipped with a heatsink fan. In Chassis and NEMA 1 units this fan is mounted on the top of the unit. In NEMA 12 units the fan is mounted below the heatsink in the bottom of the unit. The VLT 5125 - 5250 NEMA 12 units are also equipped with door fans. As the VLT 5060 - 5100 NEMA 12 units are built without door fans they further incorporate capacitor bank fans mounted internally to the DC capacitor bank.

All fans, except the capacitor bank fans which are 24VDC, are powered from an auto transformer that provides 230VAC. On/Off and High/Low speed control of the 230VAC fans is provided in an effort to reduce overall acoustical noise and extend the life of the fans.

FAN CONTROL

Regardless of heatsink temperature, the fans are started shortly after main input power is applied to the VLT. If the heatsink temperature is below 30°C the fans will turn off after a short interval. At a heatsink temperature of >45°C, the fans will be switched on at low speed. This will equate to approximately 165VAC applied to the fans. At a heatsink temperature of >60°C, full voltage is applied to the fans to obtain full speed. When the heatsink temperature returns to <55°C the fans return to low speed and if the heatsink temperature should drop below 30°C, the fans will be switched off.

Since the internal ambient temperature is maintained by one or more 230VAC fans, the transition between low and high speeds can also be made if the internal ambient rises, regardless of heatsink temperature. The internal ambient temperature sensor is located on the power card. If the temperature detected rises to >65°C, the fans will switch to high speed regardless of heatsink temperature. If the internal ambient temperature returns to <50°C and the heatsink temperature remains below 60°C, the fans will return to low speed.

The fans will be switched to high speed should a heatsink over temperature trip occur. Any other temperature trip; internal ambient, output inductor or external disable will result in the fans running at low speed. For further tests, Reference Fan Test on page 29 or the Signal Board in Appendix III.

SPECIFIC POWER CARD CONNECTORS

Connector MK10 on the Power Card provides for the connection of an external temperature switch. It is assumed that such a switch could be used to monitor the temperature of an external brake resistor. Should the switch change states the VLT would trip on a thermal overload and the SCR's as part of the SCR/Diode modules would be disabled.

Connector MK15 provides access to Relay 01 which is mounted on the Power Card. This relay provides a status of the VLT based on the programming of Parameter 323.

A Signal Board is provided for accessing various signals which could be useful in troubleshooting the VLT. An adapter card with test points is available for ease of connection. For a further description of the Signal Board outputs see Appendix III.

Only available on EB type units is connector MK4. This connection allows for the input of an external 24VDC power supply. When connected, a secondary SMPS is powered which enables the Control Card functions to remain active even after the removal of the main supply. The VLT can be run from this power supply however, the IGBT's will not be switched on during this mode.

LOAD SHARING

NOTE: By using the load sharing option of the drive the function of the soft charge circuit is bypassed.

Only available on EB, VLT 5000 AQUA and VLT 6000 type units are terminals +DC and -DC. These terminals provide access to the DC bus and are used for load sharing applications. Should these terminals be used as the main supply input to the VLT, provisions would be required for powering the 230VAC cooling fans.

The built in load sharing in the VLT gives the possibility to connect more frequency converters over the DC-bus.

The number of VLT's which can be connected together is in principal infinite, but the VLT's which are connected must be of the same voltage (200-240V or 380-500V).

SECTION TWO

FAULT MESSAGES, WARNINGS, ALARMS

A variety of warning and alarm messages may be displayed. During the warning phase the VLT is operational. The VLT may however be taking action at that time to reduce the condition causing the warning. For example, if the warning displayed were Torque Limit, the VLT would be reducing speed to compensate for the over current condition. If the condition is not corrected before the allotted time expires an alarm condition would be activated. As listed below not all warnings are associated with an alarm and not all alarms are preceded by a warning. With some faults it will not be automatic to move from a warning to an alarm, instead the choice of a warning or alarm trip is determined by programming the specific parameter associated with that fault condition.

In an Alarm State two reset conditions exist. If the display shows TRIP (RESET), the alarm can be manually reset or automatically reset if the Auto Restart Function is enabled.

If the display indicates TRIPLOCK (DISC> MAINS) then main input power must be removed long enough for the display to go blank and then reapplied. Following power up the Triplock will change to TRIP (RESET) and allow for a manual reset.

Also note that the Local Stop key and Reset key are one in the same. By pressing the Stop/Rest key the fault is reset and Local Stop is initiated. To run either local or remote the Local Start key must be pressed.

WARNINGS

Warning and alarm messages vary depending on the particular VLT model. The parameters that effect the warnings and alarms also vary and are noted in the fault descriptions.

The display flashes between normal state and warning. A warning comes up on the first and second line of the display. See examples below:

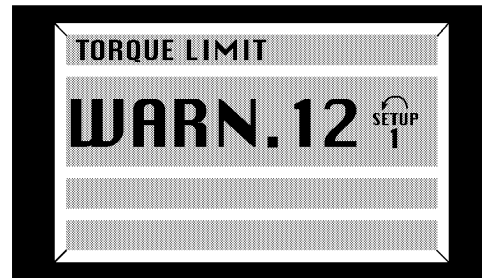

ALARM MESSAGES

The alarm comes up in lines 2 and 3 of the display, see the example below:

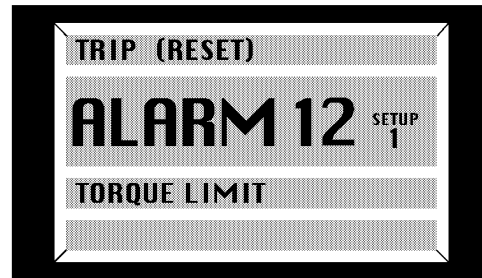

WARNING 1

Under 10 Volts (10 VOLT LOW):

The 10VDC supply on terminal 50 of the control card is too low. This condition may be caused by overloading terminal 50 or a short circuit in the Speed Potentiometer or related wiring. Max capacity of terminal 50 is 17 mA. The 10V DC supply on terminal 50 is supplied from a 13 volt regulator that supplies option boards and the LCP. If the 10V DC is missing or low the most common link would be the control card as the faulty part (after the external wiring was removed and verified).

WARNING/ALARM 2

Live zero fault (LIVE ZERO ERROR):

The current signal on terminal 60 is less than 50% of the value programmed in parameter 315, and parameters 317 and 318 have been programmed for the time out function to be active. It is possible to choose between a warning only or a warning and trip based on the selection of parameter 318. Manual reset is possible once the fault is corrected.

WARNING/ALARM 3**No motor (NO MOTOR):**

The motor check function has been activated in parameter 122. During stop conditions the motor check is performed. This warning will appear if the VLT fails to detect a motor. (Not applicable for the VLT 5000 AQUA/6000 series.)

WARNING/ALARM 4**Phase fault (AC LINE PHASE LOSS):**

One phase of the input AC line is missing or extremely low, or severe waveform distortion is present on the input line. An alarm condition will automatically follow the warning. Trip lock will require power to be cycled before reset. This alarm is derived from reading the AC ripple on the DC Bus. Measuring the input voltage and verifying the wave form may be the first step to restoring proper operation of the drive. Refer to the application section in section II for more Information.

WARNING 5**Voltage warning high (DC LINK VOLTAGE HIGH):**

The intermediate circuit voltage (DC) is above the upper warning limit of 825VDC. The VLT is still operational. Refer to the application section in section II for more Information.

WARNING 6**Voltage warning low (DC LINK VOLTAGE LOW):**

The intermediate circuit voltage (DC) is below the lower warning limit of 435VDC. The VLT is still operational.

WARNING/ALARM 7**Overvoltage (DC LINK OVERVOLT):**

The intermediate circuit voltage (DC) is above the overvoltage limit of 850VDC. The voltage detected will be displayed. It may be necessary to use dynamic braking. As an alternative in the VLT 5000 the Over Voltage Control (OVC) scheme can be activated in parameter 400. For the VLT 5000 AQUA/6000 the OVC function is always active. The setting of parameters 400 and 410 have no effect on this alarm. Manual reset is possible. Warns for 5 sec's trips after 25 sec. Refer to the application section in section II for more Information.

WARNING/ALARM 8**Under voltage (DC LINK UNDERVOLT):**

The intermediate circuit voltage (DC) is below the Under voltage limit of 400VDC. The unit will trip after a set period of time. On the VLT 5000 extended units with an external 24VDC supply, this message will be displayed as long as input power is removed, however, the unit will not trip. The voltage level detected will be displayed. Manual reset is possible.

WARNING/ALARM 9**Inverter overload (INVERTER TIME):**

The unit has been operating with the output current having been in the intermittent range (between 100% and 150%) for too long. A warning will be displayed when the ETR counter reaches 98%. When the counter reaches 100%, the drive will trip. The unit can be programmed to display the ETR counter. Using a clamp on amp meter verify current going to the motor. Manual reset is only possible after the counter has gone below 90%.

WARNING /ALARM 10**Motor over temperature (MOTOR TIME):**

The unit's ETR function has calculated an over temperature condition in the motor. This calculation is based on motor current, speed and the length of time these conditions exist, based on the settings of parameters 102 through 106. Based on the selection in parameter 128 the unit will display a warning or an alarm when the counter reaches 100%. Verify parameters 102 - 106 are set correctly. Also use a clamp on amp meter to check motor amperage. Manual reset is possible after the ETR counter has counted to zero.

WARNING/ALARM 11**Motor thermistor (MOTOR THERMISTOR):**

The motor thermistor function has been activated in parameter 128 and a thermistor is connected to either terminal 53 or 54 and programmed as such in parameter 308 or 311. Parameter 128 provides a choice of warning or alarm. This warning or trip indicates the input to terminal 53 or 54 is more than 3K Ohms impedance between that terminal and terminal 50. It is also possible that the connection has been broken. Manual reset is possible.

WARNING/ALARM 12**Torque limit (TORQUE LIMIT/CURRENT LIMIT):**

The torque requirement of the motor is higher than the value set in parameter 221 for the VLT 5000 or 215 for the VLT 5000 AQUA/6000(in motor operation) or parameter 222 (regenerative operation). The warning will be present until the time programmed in parameter 409 for VLT 5000 or 412 for the VLT 5000 AQUA/6000 expires. If the current exceeds the VLT continuous rating or motor rating and parameter 128 is set for ETR trip/thermistor, the drive will trip on either alarm 9 or 10. Manual reset is possible.

WARNING/ALARM 13**Over current (OVERCURRENT):**

The peak output current limit of the unit has exceeded 165% of the unit's rating. After 1.5 seconds the unit will trip. This fault may be caused by shock loading or fast accel ramps with high inertia loads. Incorrect settings of various group 1 parameters may also be the cause. This fault results in a Trip Locked condition. Refer to the application section in section II for more Information.

ALARM 14**Earth fault (EARTH FAULT):**

The unit has sensed output leakage current sufficient enough to determine that there is a ground fault in the motor or motor wiring. This fault results in a Trip Locked condition. Refer to the application section in section II for more Information.

ALARM 15**Switch mode fault (SWITCH MODE FAULT):**

The internal plus and/or minus 14VDC power supply voltage is not within the specified range. This fault results in a Trip Locked condition.

ALARM 16

Short-circuiting (CURR.SHORT CIRCUIT):

This indicates the existence of a phase to phase short circuit condition in the motor wiring. This fault results in a Trip Locked condition. Refer to over current section in the application section.

WARNING/ALARM 17

Standard bus time out (STD BUS TIMEOUT):

Indicates the serial communication with the VLT has failed and the time out function has been activated. The delay time programmed determines how long the warning will be present before a trip, provided "stop and trip" has been selected. Manual reset is possible.

WARNING/ALARM 18

HPFB bus timeout (HPFB BUS TIMEOUT):

Indicates the communication between a field bus option (such as DeviceNet) and the VLT has failed and the time out function has been activated in parameter 804. The delay time programmed in parameter 803 determines how long the warning will be present before a trip, provided "stop and trip" has been selected in parameter 804. Manual reset is possible.

WARNING 19

Fault in the EEprom on the power card (EE ERROR POWER CARD):

A fault exists in the ability of the VLT to read and write information to the power card EEPROM. The drive will operate normal and in most cases once power is cycled the warning clears. If the problem halts operation replacement of power card may be needed.

WARNING 20

Fault in the EEprom on the control card (EE ERROR CTRL CARD):

A fault exists in the ability of the VLT to read and write information to the control card EEPROM. The drive will operate normally and in most cases once the power is cycled the warning clears. If the problem halts operation replacement of control card may be needed.

ALARM 21

Auto-optimization OK (AUTO MOTOR ADAPT OK):

The automatic motor tuning function has been completed successfully. It is necessary to manually reset to resume normal operation. (Not applicable for the VLT 5000 AQUA/6000.)

ALARM: 22

Auto-optimization not OK (AUTO MOT ADAPT FAIL):

The automatic motor tuning function failed. The possible causes as shown in the display are listed below. The numbers in brackets will be logged as the value in parameter 617.

CHECK P.103, 105

[0]

Parameter 102, 103 or 105 have incorrect settings. Correct the setting and start AMA all over.

LOW P. 105

[1]

The value entered in parameter 105 is too small for the VLT 5000. Correct the value. Note: the motor nameplate current, and that value entered in parameter 105, must be greater than 35% of the nominal rating of the VLT in order to carry out AMA.

ASYMMETRICAL IMPEDANCE

[2]

AMA has detected asymmetrical impedance in the windings of the motor connected. The motor may be defective.

MOTOR TOO BIG

[3]

The motor is too large for AMA to be carried out or the setting in parameter 102 is incorrect.

MOTOR TOO SMALL

[4]

The motor is too small for AMA to be carried out or the setting in parameter 102 is incorrect.

TIME OUT

[5]

AMA has failed after attempting to tune for a period in excess of what should be normal. It is possible that the signal data being returned is noisy. It is possible to make several attempts under these conditions and eventually get the unit to pass.

INTERRUPTED BY USER

[6]

The AMA function has been interrupted by the user.

INTERNAL FAULT

[7]

A fault has occurred internal to the VLT. Contact the factory.

LIMIT VALUE FAULT

[8]

The parameter values programmed for the motor are outside the typical characteristics of the VLT's internal motor table. AMA cannot be performed on this particular motor.

MOTOR ROTATES

[9]

The motor shaft rotated during the tuning process. Ensure the load is not capable of rotating the shaft. AMA may be started over.

WARNING/ALARM 23

Fault during brake test (BRAKE TEST FAILED):

When a unit with braking is powered-up and a stop command is present, a brake test is performed automatically by the unit. If the result of this test indicates a fault condition in the brake circuit and parameter 404 is set to warning, a warning will be displayed. If *Trip* has been set in 404 an alarm will occur. Possible causes for this are: No brake resistor connected, faulty connection to the brake resistor, defective brake resistor or a defective brake IGBT. The unit will be able to operate in this condition, however, the brake function will be inoperative. Manual reset is possible. (Not applicable for the VLT 5000 AQUA/6000.)

WARNING 25**Brake resistor fault (BRAKE RESISTOR FAULT):**

The brake resistor or the connection is short circuited. The unit will be able to operate in this condition, however, the brake function will be inoperative. Manual reset is possible. (Not applicable for the VLT 5000 AQUA/6000.)

WARNING 26**Brake resistor power 100% (BRK PWR WRN 100%):**

The monitoring function has been activated in parameter 403. The power transmitted to the brake resistor is monitored over a 120 second period. The power is based on the values entered in parameters 401 and 402. If the calculated power being dissipated exceeds 100% a warning will occur based on the choice in parameter 403. If warning is selected the warning will disappear when the dissipated power drops below 80%. Manual reset is possible. (Not applicable for the VLT 5000 AQUA/6000.)

WARNING 27**Brake transistor fault (BRAKE IGBT FAULT):**

The brake transistor is shorted. As a result of the shorted transistor substantial power may be transmitted to the brake resistor. Disconnect main input power to the VLT. It may be possible to run with the brake resistor disconnected but the braking function will be inoperative. (Not applicable for the VLT 5000 AQUA/6000.)

ALARM 29**Heat sink temperature too high (HEAT SINK OVER TEMP.):**

The heatsink temperature has exceeded 95°C. The possible causes are: defective cooling fan, blocked heat sink or air flow path, defective thermal sensor or possibly incorrect mounting to a flush surface to ensure proper airflow across the heatsink. This fault results in a Trip Locked condition. Additionally there are four LED's on the Power Card that are associated with an Over Temperature alarm. Reference application section.

LED 1:

This LED will be lit when the power card temperature sensor has determined the VLT's internal ambient temperature to be above 85°C. The sensor will automatically reset when the temperature drops below 70°C.

LED 2:

This LED will be lit when the power card temperature sensor has determined the VLT's internal ambient temperature to be below minus 20°C. The sensor will automatically reset when the temperature rises above minus 5°C.

LED 3:

This LED will be lit when the thermal switch on the output inductor or mounted on the left side of capacitor bank, depending on age of drive, detects a temperature in excess of 135°C. The sensor will automatically reset. As this sensor is a switch, the temperature displayed will typically be the default value of 139°C. This is not the actual temperature that has been sensed.

LED 4:

This LED will be lit when the connection at MK15 (external disable) has been activated. Based on the way MK15 is wired this could mean the external input has closed or become open. As this input is closed or open, the temperature displayed will typically be the default value of 139°C. This is not the actual temperature that has been sensed.

ALARM 30**Motor phase U missing (MISSING MOT. PHASE U):**

The unit has detected an open circuit in the U phase. This fault may be manually reset. Parameter 234 (VLT 5000 only) can disable the tripping or missing motor phase.

ALARM 31**Motor phase V missing (MISSING MOT. PHASE V):**

The unit has detected an open circuit in the V phase. This fault may be manually reset. Parameter 234 (VLT 5000 only) can disable the tripping or missing motor phase.

ALARM 32**Motor phase W missing (MISSING MOT. PHASE W):**

The unit has detected an open circuit in the W phase. This fault may be manually reset. Parameter 234 (VLT 5000 only) can disable the tripping or missing motor phase.

ALARM 33**Quick discharge not failure (QUICK DISCHARGE NOT OK):**

This indicates that the Quick Discharge feature is not functioning. Possible causes are: No 24V external power supply, brake resistors not connected properly. Sequence of operation not correct. This fault results in a Trip locked condition. This feature is available only with the VLT 5000 EB version.

WARNING/ALARM 34**Profibus communication fault (PROFIBUS COMMUNICATION FAULT):**

The Profibus option is no longer communicating. In a warning state this may indicate the cable has been disconnected or the master has stopped. In an alarm state it may indicate the option card is disturbed by noise or possibly defective. A trip can be manually reset.

WARNING 35**Out of frequency range (OUT OF FREQ. RANGE):**

This warning will only be displayed when operating in Process Closed Loop and the output frequency of the VLT is above or below the limits programmed in parameters 201 and 202. Parameter 455 (VLT 5000 only) can be disabled to eliminate this warning.

WARNING/ALARM 36**Mains failure (MAINS FAILURE):**

The mains failure function has been activated in parameter 407. A choice of actions are available including whether or not to trip. A trip can be manually reset. (Not applicable for the VLT 5000 AQUA/6000.)

ALARM 37

Inverter fault (INVERTER FAULT):

Indicates an IGBT or the power card is defective. This fault results in a Trip Locked condition. Verify signals coming from the power card, also verify the gate to emitter resistance on the IGBT for problems.

WARNING 39

CHECK Parameter 104, 106:

The settings in parameter 102, 104 or 106 are possibly incorrect. Check the setting and choose "Continue" or "Stop". If stop is selected AMA will have to be started over.

WARNING: 40

CHECK Parameter 103, 105:

The settings in parameter 102, 103 or 105 are possibly wrong. Check the setting and choose "Continue" or "Stop". If stop is selected AMA will have to be started over.

WARNING 41

MOTOR TOO BIG:

The motor is too large for the VLT or the setting of parameter 102 is incorrect. Check the motor and setting and choose "Continue" or "Stop". If stop is selected AMA will have to be started over.

WARNING 42

MOTOR TOO SMALL:

The motor is too small for the VLT or the setting of parameter 102 is incorrect. Check the motor and setting and choose "Continue" or "Stop". If stop is selected AMA will have to be started over.

ALARM 43

Brake fault (BRAKE FAULT):

A test of the brake function has failed. The possible causes as shown in the display are listed below. The numbers in brackets will be logged as the value in parameter 617. These failures result in a Trip Locked condition. (Not applicable for the VLT 5000 AQUA/6000.)

Brake check failed

(BRAKE CHECK FAILED) [0]

During power up the brake test failed to find a resistor connected. Verify proper connections have been made to the VLT 5000.

Brake resistor short-circuited

(BRAKE RESISTOR FAULT) [1]

During the brake test the VLT 5000 has found a short circuit at the brake terminals. Verify no shorts exist at the terminals and the brake resistor is the proper value for the VLT 5000.

Brake Transistor short-circuited

(BRAKE IGBT FAULT) [2]

The brake transistor is shorted. As a result of the shorted transistor substantial power may be transmitted to the brake resistor. Disconnect main input power to the VLT 5000. It may be possible to run with the brake resistor disconnected but the braking function will be inoperative.

WARNING/ALARM 44

ENCODER LOSS (ENCODER FAULT)

The encoder signal is interrupted from terminal 32 or 33. Check the connections of encoder device.

The following warning/Alarms are only applicable to the VLT 5000 AQUA/6000.

WARNING: 62

Output frequency high (FOUT>FHIGH)

The output frequency is higher than parameter 224
Warning: High frequency, f_{HIGH}

WARNING?ALARM: 63

Output current low(I MOTOR<I HIGH)

The output current is lower than parameter 221
Warning: Low current, I_{LOW} . Select the required function in parameter 409 function in case of no load.

WARNING: 64

Output current high (I MOTOR>I HIGH)

The output current is higher than parameter 222
Warning: High current, I_{High} .

WARNING: 65

Feedback low (FEEDBACK<FDB LOW)

The resulting feedback value is lower than parameter 227
Warning: Low feedback, FB_{LOW}

WARNING: 66

Feedback high (FEEDBACK>FDB HIGH)

The resulting feedback value is higher than parameter 228
Warning: High feedback, FB_{HIGH}

WARNING: 67

Remote reference low (REF.<REF LOW)

The remote reference is lower than parameter 225
Warning: Low reference, REF_{LOW}

WARNING: 68

Remote reference high (REF.>REF HIGH)

The remote reference is higher than parameter 226
Warning: High reference, REF_{HIGH}

WARNING: 69

Temperature auto derate (TEMP.AUTO DERATE)

The heatsink temperature has exceeded the max value and the auto derating function (par. 411) is active.
Warning: Temp. auto derate.

WARNING: 99

Unknown fault (UNKNOWN ALARM)

An unknown fault has occurred which the software is not able to handle. Cycle power and or reinitialize the VLT to clear the fault. Possible replacement of control card is needed.

GENERAL TROUBLESHOOTING TIPS

Prior to diving into a repair here a few tips if followed will make the job easier and may prevent unnecessary damage to good components.

1. First and foremost respect the voltages produced by the drive. Always verify the presence of line voltage and bus voltage before working on the unit. Also remember that some points in the drive are referenced to the negative bus and are at bus potential even though you may not expect it.
2. Never power up a unit which has had power removed and is suspected of being faulty. If a short circuit exists within the unit applying power is likely to result in further damage. The safe approach is to conduct the Static Test Procedures starting in section three. The static tests check all high voltage components for short circuits. The tests are relatively simple to make and can save money and downtime in the long run.
3. The safest method of conducting tests on the drive is with the motor disconnected. In this way a faulty component that was overlooked or the unfortunate slip of a test probe will generally result in a unit trip instead of a component failure.
4. Following the replacement of parts test run the unit with the motor disconnected. Start the unit at zero speed and slowly ramp the speed up until the speed is at least above 40 Hz. Monitor the phase to phase output voltage on all three motor terminals to check for balance. If balanced the unit is ready to be tested on a motor. If not, further investigation is necessary.
5. Never attempt to defeat fault protection devices within the drive. This will only result in unwanted component damage and may result in personal injury as well.
6. Always use factory approved replacement parts. The unit has been designed to operate within certain specifications. Incorrect parts may effect the tolerance and result in further damage to the unit.
7. Read the instruction and service manuals. A thorough understanding of the unit is the best approach. If ever in doubt consult the factory or an authorized repair center for assistance.

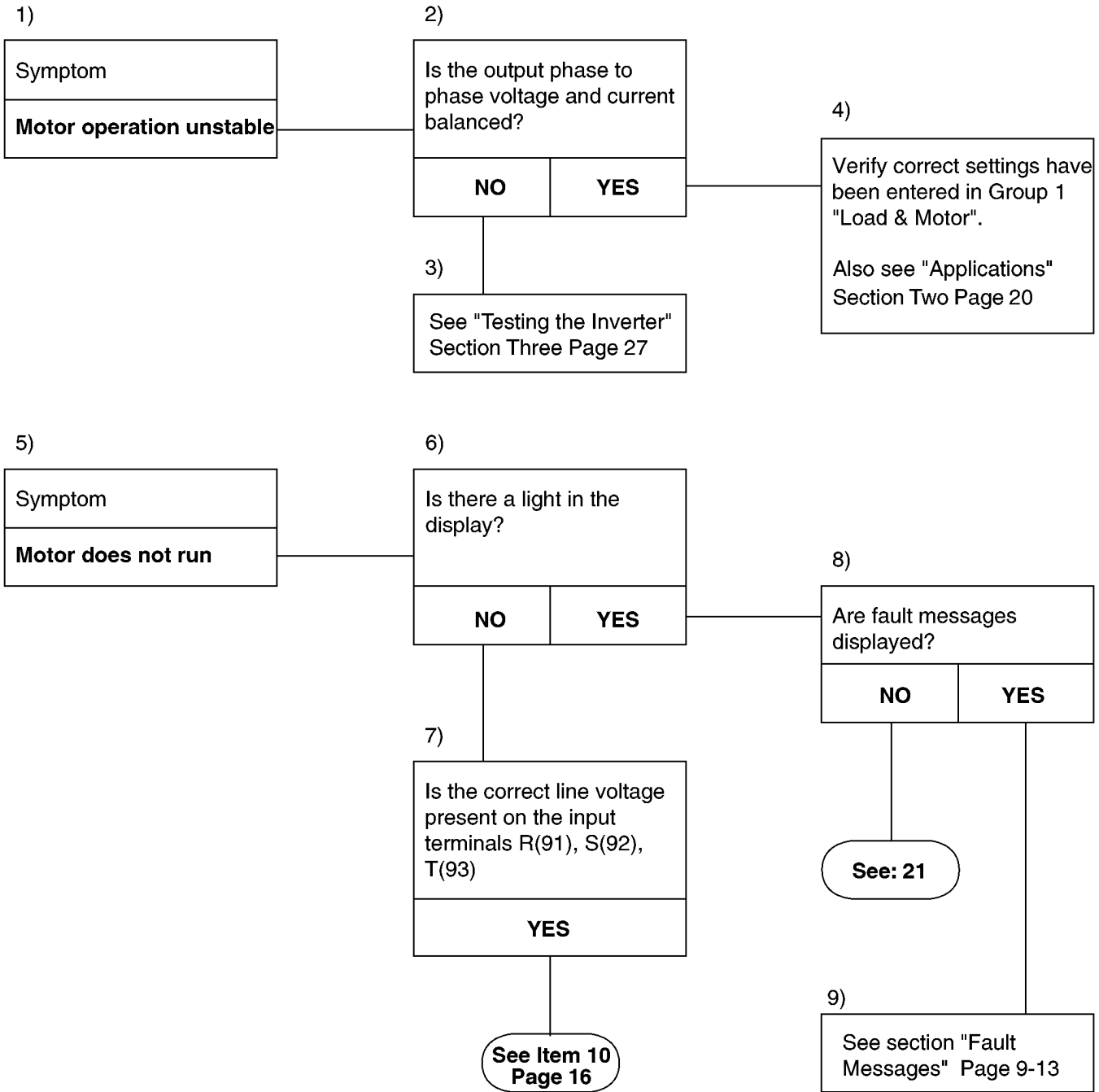

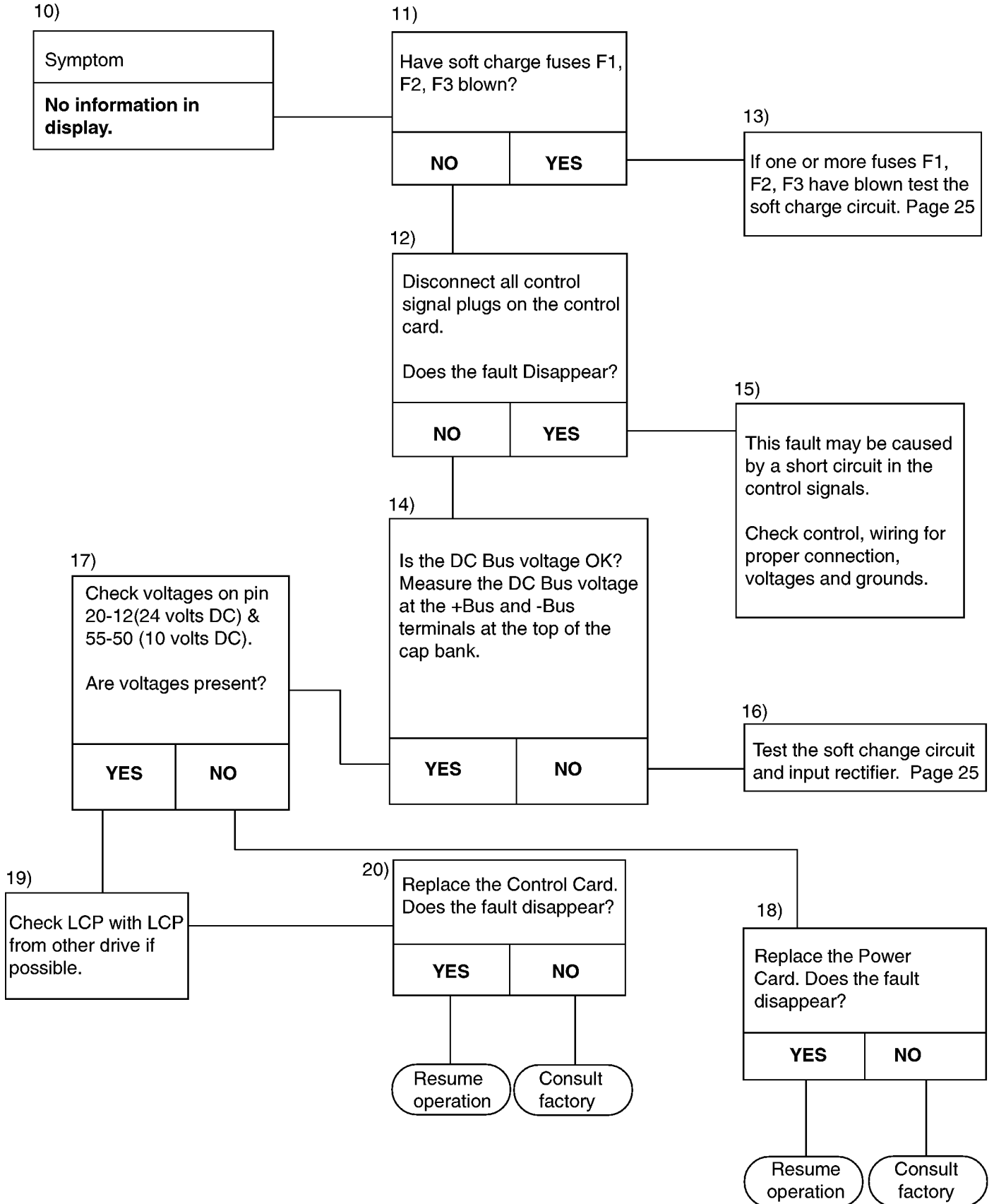

SYMPTOM/CAUSE CHARTS

SYMPTOM/CAUSE charts are generally directed towards the more experienced technician. The intent of these charts is to provide a range of possible causes for a specific symptom. In doing so, these charts provide a direction, but with limited instruction.

SYMPTOM	POSSIBLE CAUSES
1. Control Card Display Is Not Lit.	<ul style="list-style-type: none"> Incorrect or missing input voltage Incorrect or missing DC bus voltage Remote control wiring loading the power supply Defective Control/Power Card Defective LCP Defective or disconnected ribbon cables
2. Blown Input Line Fuses	<ul style="list-style-type: none"> Shorted SCR/Diode module Shorted IGBT
3. Blown Soft Charge Fuses	<ul style="list-style-type: none"> Shorted soft charge rectifier Shorted DC bus Shorted brake IGBT Open/ shorted softcharge resistor Shorted fan transformer
4. Motor Operation Unstable (Speed Fluctuating)	<ul style="list-style-type: none"> Incorrect settings of motor parameters Load compensations set incorrectly Slip Compensation set too high Improper current feedback PID Regulator or Auxiliary Reference mis-adjusted Possible single phase motor
5. Motor Draws High Current But Cannot Start. (May appear to rock back and forth.)	<ul style="list-style-type: none"> Open winding in motor Open connection to motor One inverter phase missing. Test output phase balance. Ramp up time to short
6. Motor Runs Unloaded But Stalls When Loaded. (Motor may run rough and VLT may trip.)	<ul style="list-style-type: none"> One half of one inverter phase missing. Test output phase balance. Over magnetizing motor check motor parameters.

SYMPTOM/CAUSE CHARTS

SYMPTOM/CAUSE charts are generally directed towards the more experienced technician. The intent of these charts is to provide a range of possible causes for a specific symptom. In doing so, these charts provide a direction, but with limited instruction.

SYMPTOM	POSSIBLE CAUSES
7. Unbalanced Input Phase Currents <i>Note: Slight variations in phase currents is normal. Variations greater than 5% require investigation.</i>	Input line voltage unbalanced Faulty connection on input wiring Fault in plant power transformer Input SCR/Diode module faulty or not being gated.
8. Unbalanced Motor Phase Currents <i>Note: Slight variations in phase currents is normal. Variations greater than 5% require investigation.</i>	Open motor winding Faulty motor connection Fault in inverter section (see Symptom No. 6.) Motor parameters

APPLICATIONS

TORQUE LIMIT, CURRENT LIMIT, OR UNSTABLE MOTOR OPERATION

Excessive loading of the VLT may result in the unit displaying Torque Limit, Over current or possibly tripping on Torque Limit, Over current, or Inverter Time. This is not a concern if the VLT has been properly sized for the application and intermittent load conditions cause anticipated operation in Torque Limit or an occasional trip. Nuisance unexplained occurrences may be the result of improperly setting specific parameters. The following parameters are critical to the VLT/Motor relationship:

Parameters 100 through 109 and the setting of parameters 221 and 409.

Parameters 100 and 101 configure the VLT for a specific mode of operation.

Parameter 100 sets the VLT for open or closed loop operation or torque mode operation. In a closed loop configuration it is necessary that a feedback signal is received by the unit. In turn the settings for the PID controller play a key role in the stable operation of the VLT.

Parameter 101 sets the VLT for constant or variable torque operation. Based on the application it is imperative that the correct torque characteristic is selected. If for example the load type was such that it was constant torque, such as a conveyor, and variable torque was selected, the VLT may have great difficulty starting the load if not at all. Consult the factory if you are unsure of the torque characteristics of your application.

Parameters 102 through 106 configure the VLT for the motor connected. With the VLT Series the accuracy of these parameters are of great importance. For the VLT to be effective and efficient in controlling the load the unit relies on this information for making calculations that result in corrections to the output waveform based on the changing demands of the application.

Parameter 107 activates the Automatic Motor Adaptation function. As the VLT queries the motor it sets various parameters based on the findings. Two key parameter values which are set by this function are Stator Resistance and Stator Reactance, Parameters 108 and 109. If you are experiencing unstable motor operation and have not performed AMA, it should be done. Remember however, that AMA can only be performed on a single motor application, and then only within the programming range of the VLT. Consult the instruction manual for more on this function.

Parameters 108 and 109 as stated earlier are set by the AMA function or should be left at their factory default value. Never adjust these parameters to any random values even though it may seem to improve the operation. Such adjustments may appear to improve operation under a single set of circumstances but should the conditions change the result may be unpredictable.

Parameter 221 sets the level at which the VLT limits torque. The factory setting is 160% and 110% for 5000 Aqua/6000 and will vary up and down with the setting of motor power. For example, a VLT 5150 programmed to operate a smaller motor will yield a higher torque limit value than the same unit programmed to operate an equivalent or larger size motor. It is important that this value not be set too low for the requirements of the application. In some cases it is desirable to have a torque limit set at a lesser value, lets say for example 120%. This offers protection for the application in that the VLT will limit the torque to that value. It may however be the case that during initial start up the load requires 130% torque. Under these circumstances nuisance tripping may be the result.

Parameter 409 works in conjunction with parameter 221. This parameter allows you to select a time that the VLT will operate in torque limit and then trip. The factory default value is set to off. A setting of Off does indeed mean that the VLT will not trip on torque limit but doesn't mean it will never trip from an overload condition. Built into the VLT is the internal Inverter Thermal Protection circuit. This circuit monitors the output load on the inverter. If the load exceeds 100% of the VLT continuous rating the counter begins counting. If the load remains there long enough the counter will count to 100% and the VLT will trip on Inverter Time. No adjustments can be made to alter this circuit however, the settings of the parameters listed above can effect load current and result in premature trips of this type. You can view the counter in the display.

EARTH FAULT TRIPS

Trips occurring from ground faults are usually the result of short circuits to earth ground either in the motor or the wiring to the motor. The VLT detects ground faults by monitoring all three phases of output current and looking for severe imbalances in those currents. When a "Ground Fault" trip occurs it is necessary to measure the resistance of the motor windings and wiring with respect to earth ground. The instrument normally used for this purpose is a Megohmmeter or commonly referred to as a "Megger". Many times these resistance readings are taken with a common Ohmmeter, which is actually incapable of detecting any shorts other than those that are virtually direct. A Megger has the capability of supplying higher voltages, typically 500 volts or more, which enables the Megger to detect breakdowns in insulation or higher resistance shorts which cannot be picked up through the use of an Ohmmeter. When making resistance measurements to ground, it is necessary to disconnect the motor leads from the output of the VLT. The measurements should then be taken at the point of connection to the VLT so the motor and all associated wiring and connections are captured in the test. When reading the results of the Megger test, the rule of thumb is any reading less than 500 Megohms should be suspect. Solid, dry wiring connections normally result in a reading of infinity.

As stated the VLT detects ground fault conditions by monitoring the current through the hall effect current sensors on the output of the unit. The three signals from these sensors is sent to power card and then summed together. When no earth current is flowing the sum of these three currents will be zero. A defective current sensor could then be the cause of an Earth Fault. If for example the signal from one sensor is missing the sum of the three currents would not equal zero and an earth fault would occur. This is normally only seen when the load current is significant since the current imbalance must be in excess of the maximum continuous rating of the VLT. It could further be the case that the signal from the current sensor is present but offset from zero. The signals midpoint must be zero with the maximum peaks reaching the level of the + and - 14 volt sensor power supply. This offset and or the lack of a signal can be observed on the signal board. See the section on testing current feedback.

It is also possible that if an earth fault occurs when the motor is under power the result may actually be an Overvoltage Trip. This is due to the fact that when the earth fault occurs the DC bus can increase rapidly to as much as 200 volts over its nominal value. Also see the explanation on Overvoltage Trips later in this section.

OVER CURRENT TRIPS

The VLT detects over current conditions by monitoring the current output of all three phases. An over current condition exists when the current in an individual phase exceeds 165% of the units maximum overload rating. At that point the IGBT's in that phase are turned off. Shortly after turning off, the IGBT's will once again be gated on as the current in that phase will have dropped. This turning on and off of the IGBT's will continue for up to 1.5 seconds after which time the VLT will trip on Over current.

Over current trips may occur as a result of attempting to start a jammed load, energizing an output conductor while the VLT is already running at a given speed, attempting to start a high inertia load with short acceleration ramps, attempting to start windmilling load, or a phase to phase short on the output of the VLT. It may also be the case that the over current trip is a phantom occurrence caused by incorrect settings of motor parameters as was discussed earlier. Except for the latter all of these conditions are relatively simple to diagnose.

The VLT incorporates some features that can be used to overcome some of the conditions mentioned. One such feature is Flying Start. This feature is helpful in starting windmilling loads. An example of such a load is a fan that while it is not powered it is being driven by airflow through the duct work. As the VLT is started it begins ramping from zero frequency. Since the load is not at zero the VLT must first brake the load to zero and then begin ramping from there. This consumes large amounts of current, almost as what could be seen in applying a plug reverse to a motor to bring it to a stop. By enabling the Flying Start function, when a run command is given, the VLT searches the frequency range looking for the actual speed of the motor. Once found the VLT starts its ramp from that frequency and then carries the load up or down to the commanded speed.

Solving over current trips due to fast acceleration ramps or closing a conductor on the output can be solved easily by adapting the ramp time and sequence of operation to within the limits of the VLT. This is not always possible as the methods used to control the application are required to function in such a way. It may be the case that given the circumstances the VLT is undersized for the application requirements. It may also be possible to adjust the VLT to perform under these circumstances. Running the AMA function should be the first step in optimizing the VLT to the motor. Following that, an adjustment of the load compensations may give favorable results. If all else fails consult the Application Engineering group at Danfoss for further assistance.

OVERVOLTAGE TRIPS

This trip occurs when the DC bus voltage reaches a level of approximately 840VDC. Prior to the trip the VLT will display warnings of high voltage. Most times an over voltage condition is due to fast deceleration ramps with respect to the inertia of the load. As an attempt is made to decelerate the load the inertia of the system will act to sustain the running speed. Once the frequency of the motor drops below the running speed the load begins overhauling the motor. At this point the motor becomes a generator and starts returning energy to the VLT. This is called regenerative energy. This return voltage is rectified by the diodes in the IGBT modules and raises the DC bus. If the amount of returned voltage is more than the unit can consume the VLT will trip.

There are a few ways to overcome this situation. One method is to increase the deceleration rate so it takes longer for the VLT to decelerate to a new speed or come to a stop. A general rule of thumb is that the drive can only decelerate the load slightly faster than it would take for the load to naturally coast to a stop. A second method is to allow the Overvoltage control circuit to take care of the deceleration ramp. When enabled in parameter 400 the over voltage control circuit will regulate the deceleration ramp at a rate that maintains the DC bus at an acceptable level. One caution with over voltage control, it is set up in such a way that it will not make corrections to unrealistic ramp rates. For example if the deceleration ramp needs to be 100 seconds due to the inertia, and you set the ramp rate for 3 seconds, over voltage control will initially engage and then disengage and allow the VLT 5000 to trip. This is purposely done so the units operation is not misinterpreted. The third method in controlling regenerated energy is with a dynamic brake. With this system the optional brake electronics are built into the VLT and an external resistor bank is mounted outside of the VLT. The drive monitors the level of the DC bus. Should the level become too high the electronics will switch the resistor across the DC bus and dissipate the unwanted energy into the resistor bank. This is the only means available to actually increase the rate of deceleration.

Less often is the case that the over voltage condition is caused by the load while it is running at speed. In this case the dynamic brake option can be used but you may also choose to activate the over voltage control circuit. It works with the load in this way. As stated earlier regeneration occurs when the speed of the load is greater than the commanded speed. If the load should become regenerative while the unit is running at a steady state speed, the over voltage circuit will increase the frequency to match the speed of the load.

Remember for the load to become regenerative it must be running faster than the commanded speed. The same restriction on the amount of influence applies. The VLT will only add 10% to the base speed before a trip occurs. Otherwise, in theory, the speed could continue to rise to levels that may be unsafe.

MAINS PHASE LOSS TRIPS

The VLT actually monitors phase loss by monitoring the amount of ripple voltage on the DC bus. The VLT uses this method because although ripple voltage on the DC bus is a product of a phase loss, the main concern is ripple voltage causes overheating in the DC bus capacitors and the DC coil. Left unchecked the lifetime of the capacitors and the DC coil would be drastically reduced.

As the voltage becomes unbalanced or a phase should disappear completely the ripple voltage will increase and the VLT will trip. Other than the obvious missing phase voltage increased bus ripple can be the result of line disturbances or line imbalances. Imbalances or oscillations on the output voltages or current will also simulate the Alarm 4 symptoms. Line disturbances may be caused by line notching, defective transformers or other loads that may be effecting the form factor of the AC waveform. Line imbalances which exceed 3% will cause sufficient DC bus ripple to initiate a Mains Phase Loss Trip.

Severe phase imbalances, or phase losses can easily be detected with a volt meter. Line disturbances will most likely have to be viewed on an oscilloscope.

OVER TEMPERATURE TRIPS

The VLT 5060-5250 monitors the temperature of the heatsink, the internal ambient, and provides for monitoring the temperature of an external device. In addition, VLT 5125-5250 NEMA 12/IP54 type units have a sensor monitoring the surface temperature of the motor coil. In newer units the AC indicator thermal sensor was moved to the left side of the capacitor bank. This was done because of a change to the inductor. The purpose of this sensor was to protect drives internal ambient temperature if door fan filters are clogged or dirty.

For each of the above trip will result in an alarm condition with the display indicating HEAT SINK OVER TEMP. It is then necessary to view the 4 LED's mounted on the power card to further identify the source of the fault. If the display indicates over temp and none of the power card LED's are lit than the source of the fault is the heatsink thermal sensor. This sensor is a Negative Temperature Coefficient (NTC) device. The sensor delivers a resistance value based on temperature and operates within a range of 787 ohms to 105 Kohms, with 787 ohms equal to 95°C. As the temperature rises the resistance decreases and as the temperature falls the resistance increases. A trip caused by the heatsink thermal sensor can be due to the ambient temperature around the unit is too high, the path of the air flow for the heatsink fan is obstructed, the heatsink fan is not operating, or the thermal sensor is defective. Since the fans and the sensor have a relatively long life expectancy, most failures are due to restricted air flow or incorrect installation practices causing poor air circulation. It is important for all chassis drives to be mounted flush on a flat surface to provide a proper air channel. If this is not done the drives fan can only supply air to the upper portion of the heatsink, instead of drawing it across the whole heatsink. Consult the instruction manual for proper installation instructions to ensure spacing and air flow space is provided.

Following is a description of the 4 LED's associated with an over temperature fault.

LED 1:

This led will be lit when the power card temperature sensor has determined the VLT internal ambient temperature to be above 85°C. The sensor will automatically reset when the temperature drops below 70°C.

LED 2:

This LED will be lit when the power card temperature sensor has determined the VLT's internal ambient temperature to be below minus 20°C. The sensor will automatically reset when the temperature rises above minus 5°C.

LED 3:

This LED will be lit when the thermal switch on the output inductor detects a temperature in excess of 135°C. The sensor will automatically reset. As this sensor is a switch, the temperature displayed will typically be the default value of 139°C. This is not the actual temperature that has been sensed.

LED 4:

This LED will be lit when the connection at MK15 (external disable) has been activated. Based on the way MK15 is wired this could mean the external input has closed or become open. As this input is closed or open, the temperature displayed will typically be the default value of 139°C. This is not the actual temperature that has been sensed.

SECTION THREE

NOTE: Remember from discussion in the description of operation section the variations between variable and constant torque units was described. The same will hold true throughout the remainder of this manual. All references will be made to the constant torque versions, VLT 5060-5250. The actual frame of the VLT 5000 AQUA or 6000 series drive will be one size smaller in comparison. For example, if servicing a VLT 5075 AQUA or 6075 refer to the VLT 5060 sections.

STATIC TEST PROCEDURES

The purpose of performing static tests is to rule out the possibility of any shorted power components. These tests should be performed on any unit that is suspected faulty, prior to applying power. Should any component be found defective or suspect, it must be replaced before power can be reapplied to the VLT.

The following static tests are covered in this section:

- Soft Charge and Rectifier Circuit
- Inverter Section
- Intermediate Section or DC Bus
- Miscellaneous

All tests will be made with a meter capable of testing diodes. Use a digital VOM set on the Diode scale or an analog ohmmeter set on R x 100 scale. Before making any checks disconnect all input, motor and brake resistor connections.

CAUTION:

Following the removal of input power, it can take up to 15 minutes for the DC bus capacitors to discharge. Allow sufficient time for the DC bus capacitors to fully discharge before beginning any testing. The presence of DC bus voltage can be tested by connecting a voltmeter set to read up to 1000VDC to the +DC Bus and –DC Bus terminals, Photo 1, located at the top of the capacitor bank.

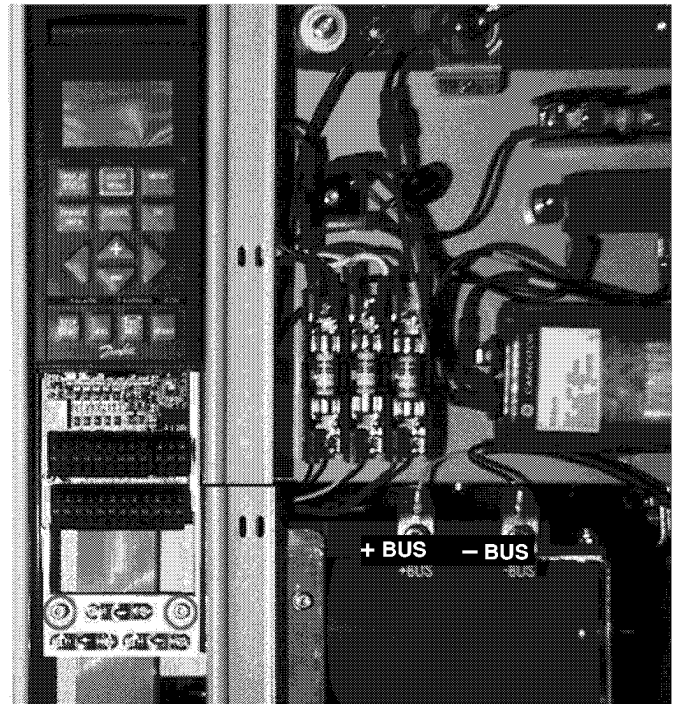

Photo 1

NOTE:

Photo is typical of a VLT 5060-5100 Chassis, others will be similar however, polarity of + and - bus connection is opposite on VLT 5125-5250.

TESTING THE SOFT CHARGE AND RECTIFIER CIRCUIT:

Refer to Photos 2 through 6 starting on page 30 for location of components and test points.

In the "Sequence of Operation" section the function of the soft charge and rectifier circuits were discussed. The soft charge circuit is made up of the soft charge rectifier, resistor fuses and the soft charge resistor. The rectifier circuit is made up of the SCR/Diode modules and included are the lower diodes of the soft charge rectifier which serve as snubber diodes for the SCR portion of the module.

As the tests are carried out both the rectifier and soft charge circuits will be tested simultaneously. It is important to pay close attention to the polarity of the meter leads to ensure you can identify a faulty component should an incorrect reading appear.

Step 1

Prior to making the test it is necessary to ensure the soft charge rectifier fuses, F1, F2, F3 and resistor fuses F4, and F5 if applicable, are good. If not, replace them before proceeding.

Step 2

Connect the positive (+) meter lead to the positive DC bus connection. Connect the negative (-) meter lead to terminals L1, L2, and L3 in turn. Each reading should show infinity. In actuality the meter will start at a low value and slowly climb towards infinity due to capacitance within the drive being charged by the meter.

Incorrect Reading:

With the "Step 2" test connection the SCR's in the SCR/Diode modules are reverse biased so they are blocking current flow. The upper diodes in the soft charge rectifier are also reverse biased so they too are blocking current flow. The upper diodes in the rectifier are blocked from this measurement by capacitor C1. However, if a diode drop was read, this would indicate that one or both of the soft charge resistor thermal sensors were closed. If a short circuit exists it would be possible that either the SCR's or the diodes in the soft charge rectifier are shorted. In this case it would be necessary to remove the soft charge fuses in order to isolate the two devices. Once the fuses are removed make the same measurement to confirm the SCR's. To check the soft charge rectifier make the negative (-) lead connection at the side of the soft charge rectifier fuse block that has the wires which connect to the rectifier.

Step 3

Reverse the meter leads. Connect the negative (-) meter lead to the positive DC bus connection. Connect the positive (+) meter lead to L1, L2, and L3 in turn. Each reading should show a diode drop. Note in some new drives BR2 causes a double diode drop reading .900. Due to the SCR/Snubber Diode assembly (BR2). Reference Section I soft charge circuit.

Incorrect Reading:

With the "Step 3" test connection, even though the SCR's in the SCR/Diode modules are forward biased by the meter, current will not flow through the SCR's without providing a signal to their gates, so they are still blocking current flow. The upper diodes in the soft charge rectifier are forward biased so the meter reads the voltage drop across those diodes. If an open reading were present it would indicate the upper diodes in the soft charge rectifier are open. It could also indicate that one or more of the soft charge rectifier or resistor fuses are open. It could further be the case that the soft charge resistor(s) are open. To check the soft charge resistors place an ohmmeter across the +DC Bus terminal and the resistor fuses. If the unit has a single resistor installed it will read 18 ohms. Two resistors in parallel will read 9 ohms.

A short circuit reading indicates either the upper soft charge rectifier diodes are shorted or the SCR's are shorted in the SCR/Diode module. In this case it would be necessary to remove the soft charge fuses in order to isolate the two devices. Once the fuses are removed make the same measurement to confirm the SCR's. To check the soft charge rectifier make the positive (+) lead connection at the side of the soft charge rectifier fuse block that has the wires which connect to the rectifier.

Step 4

Connect the positive (+) meter lead to the negative DC bus connection. Connect the negative (-) meter lead to terminals L1, L2 and L3 in turn. Each reading should show a diode drop.

Incorrect Reading:

With the "Step 4" test connection the diodes in the SCR/Diode modules are forward biased as well as the lower diodes in the soft charge rectifier so the meter reads the diode drops. If a short circuit exists it would be possible that either the diodes in the SCR/Diode modules or the lower diodes in the soft charge rectifier are shorted. In this case it would be necessary to remove the soft charge fuses in order to isolate the two devices. Once the fuses are removed make the same measurement to confirm the diodes in the SCR/Diode modules. To check the soft charge rectifier make the negative (-) lead connection at the side of the Soft Charge Rectifier fuse block that has the wires which connect to the rectifier.

Step 5

Reverse the meter leads. Connect the negative (-) meter lead to the negative DC bus connection. Connect the positive (+) meter lead to L1, L2 and L3 in turn. Each reading should show infinity. Remember the same is true as before. The meter will move slowly towards infinity as it charges the capacitance within the drive.

Incorrect Reading:

With the "Step 5" test connection, the diodes in the SCR/Diode modules are reversed biased as well as the lower diodes in the soft charge rectifier. If a short circuit exists it would be possible that either the diodes in the SCR/Diode modules or the lower diodes in the soft charge rectifier are shorted. In this case it would be necessary to remove the soft charge fuses in order to isolate the two devices. Once the fuses are removed make the same measurement to confirm the diodes in the SCR/Diode modules. To check the soft charge rectifier make the positive (+) lead connection at the side of the soft charge rectifier fuse block that has the wires which connect to the rectifier.

Step 6

To complete the testing of the soft charge circuit, measure the soft charge resistors to ensure they are the correct value. Make this reading by placing the meter across the negative connection of BR2 and the resistor fuses. Remember to reset your meter to read ohms on its lowest scale. One soft charge resistor will read 18 ohms. If two resistors are used, they are connected in parallel so they will read 9 ohms. If a short were to be present it could indicate the resistors are shorted or the thermostats mounted to the resistors have closed. An open reading of course indicates the resistor is open. An 18 ohm reading on two parallel resistors would indicate one of the resistors is open. In any case the faulty components must be replaced.

Indications of a failure in this circuit:

In rare instances a failure of a component in this circuitry may be just that, a component failure. That is however not likely. It would be expected that other components in the drive failed first causing this failure or the conditions of operating the unit lead to such a failure.

CONDITION:**Blown Soft Charge Resistor Fuses:****Cause 1: Excessive input power cycling:**

The DC bus capacitors are charged by current flowing through the soft charge resistors. Due to the fact that current flowing through the soft charge resistors generates heat, excessive power cycling can overheat the resistors, cause the thermal switches to activate (close) and blow the resistor fuses. For this reason, input power cycling is limited to once every two minutes. Under normal circumstances the thermal switch will reset (open) once it cools down. The fuses can then be replaced and operation resumed.

Cause 2: SCR/Diode modules not conducting:

In this case all the power required by the inverter section must pass through the soft charge circuitry. The SCR's are controlled by the power card. A failure in the power card circuitry may be the cause or the cable connections from the power card to the gates of the SCR's. It could be possible

that one or more of the SCR/Diode modules could be open but this type of failure is extremely rare. See the section on dynamic tests for more on testing the SCR/Diode modules.

Refer to the SCR gate driver test cable instruction for further testing of SCR gate signals. (This is a service tool that can be used to ease the testing of SCR by breaking out the SCR wire harness that connects to the power card. This cable can be ordered separate 176F1430.)

Cause 3: Short circuit in the intermediate or inverter section:

In this case, as the DC bus is attempting to charge all the energy is being drawn away by the fault. For example: a shorted brake IGBT would be dumping the DC bus voltage into the external brake resistor as the DC bus is attempting to charge. Since the soft charge resistors can not sustain the amount of current flow that would be present in this situation, The resistors would overheat, the thermals would close and the fuses would blow. Other such faults could be that the DC bus is being taken to ground through defective DC bus capacitors or inverter IGBT's. See more on this fault in the procedure for statically testing the intermediate circuit.

CONDITION:**Blown Soft Charge Rectifier Fuses:****Cause 1: Shorted Soft Charge Rectifier:**

This component failure, is most likely the result of a failure elsewhere in the soft charge circuitry. Possibly due to shorted soft charge resistors. It would be expected that the resistor fuses would blow following the failure of the resistor. See the section above for more details on the possible causes of failure.

CONDITION:**Shorted SCR/Diode Modules:****Cause 1: Shorted IGBT:**

An IGBT failure, under short circuit conditions, draws extensive current across the input of the drive. If slow acting interrupting devices (circuit breaker or improper fusing) are installed external to the drive it is likely for an SCR/Diode module to short circuit following an IGBT failure.

Cause 2: Shorted Brake IGBT:

In this case the shorted brake IGBT is dumping the DC bus voltage into the external brake resistors. This will cause extensive current to be drawn across the input of the unit as the SCR/Diode modules attempt to resupply the DC bus. This should also result in an overheated brake resistor. The resistor overload device should open and remove power from the drive or open the circuit to the DB resistors themselves.

Testing the Inverter Section

Refer to Photos 2 through 6 for location of components and test points.

The inverter section is primarily made up of the six IGBT's used for switching the DC bus voltage to create the output to the motor. Depending on the size of the VLT 5000 the six IGBT's will be installed as two per module for a total of three modules or one per module for a total of six IGBT modules. The VLT 5200 and 5250 also have snubber boards with snubber diodes mounted on each set of two modules.

When testing the inverter section it is important to disconnect the motor leads. With them connected a short circuit in one phase will be read in the other phases making the diagnosis more difficult.

Step 1

Connect the positive (+) meter lead to the positive DC bus connection. Connect the negative (-) meter lead to terminals U, V and W in turn. Each reading should show infinity. In actuality the meter will start at a low value and slowly climb towards infinity due to capacitance within the drive being charged by the meter.

Incorrect Reading:

With the "Step 1" test connection the diodes in the positive IGBT's and negative snubber diodes are reverse biased so they are blocking current flow. If a short circuit exists, it would indicate the positive IGBT in the phase being tested is defective. In VLT 5200 and 5250 it could further indicate that the negative snubber diode in that same phase is shorted. To verify the faulty component it will be necessary to disassemble the unit and isolate the components. See the section on replacing IGBT's and snubber boards.

Step 2

Reverse the meter leads. Connect the negative (-) meter lead to the positive DC bus connection. Connect the positive (+) meter lead to U, V and W in turn. Each reading should show a diode drop.

Incorrect Reading:

With the "Step 2" test connection the diodes in the positive IGBT's and negative snubber diodes are forward biased so the meter reads the diode drop. If a short circuit exists, it would indicate the positive IGBT in the phase being tested is shorted. In VLT 5200 and 5250 it could further indicate that the negative snubber diode in the same phase is shorted. To verify the faulty component it will be necessary to disassemble the unit and isolate the components. See the section on replacing IGBT's and snubber boards.

Step 3

Connect the positive (+) meter lead to the negative DC bus connection. Connect the negative (-) meter lead to terminals U, V and W in turn. Each reading should show a diode drop.

Incorrect Reading:

With the "Step 3" test connection the diodes in the negative IGBT's and positive snubber diodes are forward biased so the meter reads the diode drop. If a short circuit exists it would indicate the negative IGBT in the phase being tested is defective. In VLT 5200 and 5250 it could further indicate that the positive snubber in that same phase is shorted. To verify the faulty component it will be necessary to disassemble the unit and isolate the components. See the section on replacing IGBT's and snubber boards.

Step 4

Reverse the meter leads. Connect the negative (-) meter lead to the negative DC bus connection. Connect the positive (+) meter lead to U, V and W in turn. Each reading should show infinity. The meter will move slowly towards infinity as it charges the capacitance within the drive.

Incorrect Reading:

With the "Step 4" test connection the diodes in the negative IGBT's and positive snubber diodes are reverse biased so they are blocking current flow. If a short circuit exists, it would indicate the negative IGBT in the phase being tested is defective. In VLT 5200 and 5250 it could further indicate that the positive snubber diode in the same phase is shorted. To verify the faulty component it will be necessary to disassemble the unit and isolate the components. See the section on replacing IGBT's and snubber boards.

Indications of a failure in this circuit:

An IGBT failure by itself is generally difficult to explain. In most cases the IGBT erupts, making it nearly impossible to conduct an analysis on the damaged device. IGBT failures may be caused by the drive being exposed to repeated short circuits or ground faults or operation of the unit outside of its normal operating parameters for extended periods of time. Following an IGBT failure it is important to verify the gate drive signals are present and of the correct waveshape. See the dynamic test section on checking IGBT gate signals.

Additional notes when troubleshooting the Inverter Section:

For VLT 5060-5100 a small gate board is soldered to the gate terminals of each IGBT. For VLT 5125-5150 the gate board is attached by screws to the gate terminals. The spare part IGBT is supplied with this board attached. Never replace just the IGBT without including a new gate board. For VLT 5200-5250 the gate board is part of the snubber card which mounts to one phase (two modules) via screws. The snubber board is not provided with spare part IGBT's but must always be tested if an IGBT is replaced. See the section on replacing IGBT's and snubber boards.

TESTING THE INTERMEDIATE SECTION

Refer to Photos 2 through 6 starting on page 30 for location of components and test points.

The Intermediate section is made up of the DC bus capacitors, the DC coils and the balance resistors across the capacitors. Also included in our tests of this section will be the Brake IGBT and Brake Snubber board if the unit is so equipped.

Step 1

Test for short circuits by setting an ohmmeter on the RX100 scale and read across the +DC and –DC terminals at the top of the capacitor bank. With the meter leads in one direction the meter will start out with low ohms and then move towards infinity as the meter charges the capacitors. Reversing the meter leads will then peg the meter at zero while the charge in the capacitors is discharged by the meter and then begin moving slowly towards infinity as the meter charges the capacitors in the reverse direction.

Although this test does not ensure the capacitors are fully functional it is a good test to ensure no short circuits exist in the intermediate circuit. A visual check can also be conducted. Check for vented capacitors, loose connections or damage to exterior of the capacitors.

Incorrect Reading:

If a short circuit were present and the unit is equipped with a brake perform the test of that circuit next.

A short circuit could further be caused by a short circuit in the soft charge, rectifier, or inverter section. Perform those tests as outlined in this chapter to isolate the cause of the short circuit. The only other likely cause would be a defective capacitor within the capacitor bank. The capacitor bank would then have to be removed and individual tests made to identify the defective component.

TESTING THE BRAKE IGBT

Step 2

Connect the positive (+) meter lead to the R– terminal and the negative (–) meter lead to the R+ terminal. The meter should read a diode drop.

Step 3

Reverse the meter leads, connecting the negative (–) meter lead to the R– terminal and the positive (+) meter lead to the R+ terminal. As with previous tests the meter will climb towards infinity as the meter charges the units internal capacitance.

Step 4

Connect the positive (+) meter lead to the R– terminal and the negative (–) meter lead to the DC– connection at the top of the capacitor bank. The meter will climb towards infinity as the units internal capacitance is charged by the meter.

Step 5

Reverse the meter leads, connecting the negative (–) meter lead to the R– terminal and the positive (+) meter lead to the DC– connection at the top of the capacitor bank. The meter should read a diode drop.

Incorrect Reading:

An incorrect reading from the previous 4 steps indicates a fault in the Brake IGBT. Be sure however that the previous tests of the Inverter, Rectifier, Soft Charge and Intermediate circuit have been performed. A failure in one of these sections could be read at this test since the brake IGBT is across the DC bus. See the section on replacing the Brake IGBT.

MISCELLANEOUS TESTS

Testing The Motor:

While making the various other static checks it is logical to make a resistance reading of the motor windings. Set the ohmmeter on the highest resistance scale. Read each of the motor leads, T1 (U), T2 (V), T3 (W) to ground. The reading should be infinity. Any reading at all indicates a breakdown in the motors insulation system or the wiring to the motor.

Test the phase to phase resistance of the motor. Set the ohmmeter on the lowest resistance scale. Read the phase to phase resistance on all three motor leads. Typical resistance readings on small motors such as 1 horsepower will only be in the range of 3 to 8 ohms. As the motors get larger the resistance decreases to a point that only precision measuring instruments can be used to make such a test. The main objective is to check for short circuits and not to verify a correct resistance reading for a particular motor. If that is your objective, please consult the motor manufacturer for the correct values.

A high voltage breakdown test should be conducted. This is normally done with a Megohmmeter, commonly referred to as a megger. This device is capable of supplying up to 500Volts as the resistance measurement is made. In contrast to a typical ohmmeter using a 1.5 or 9 VDC battery, a megger can detect insulation breakdowns far more accurately. When making such a test the motor leads must be disconnected from the VLT. Make the measurement at the wire nearest to the VLT. In this way all wiring, connections, and the motor windings will be captured by the test. Keep in mind all connections between drive and motor need to be closed or the testing will need to be done from each point in the circuit. Further isolation of components may be needed to determine which component is faulty. (Example motor verse wiring between drive and motor). Although the readings from motor leads to ground may vary based on the motor design, the amount of moisture in the windings, and the temperature of the motor it would be expected to see a reading of at least 500 Megohms or more.

Testing The Heatsink Temperature Sensor:

The temperature sensor is an NTC (Negative Temperature Coefficient) device. This means that when the temperature is low the resistance is high. As the temperature rises the resistance decreases. The power card reads the resistance of the device and makes decisions on fan speed and whether or not an over temperature condition exists. See the section on fan control for more on that subject.

The temperature sensor is rated as 10K ohms equals 25°C. The range of the sensors ohmic value is 787 ohms to 105K ohms with 787 ohms equal to 95°C. The easiest method to test the sensor is to separate the wire harness connector located just to the right of the capacitor bank. Read the resistance at the connector that is attached to the wires traveling under the capacitor bank. The resistance reading must correspond to the values described above. You can also test the signal from the heatsink thermal sensor while the drive is powered up. Refer to the signal board instruction manual on how to calculate heatsink temp. from the voltage feedback signal on the power card. (This service tool can be used to breakout different signals located on the power card to verify operation of the drive. This board can be ordered separate 176F1429.)

FAN TEST

Continuity test

NOTE: All continuity checks are made using an ohmmeter set to Rx1 scale. Digital or analog ohmmeters can be used.

1. Measure the connections from the autotransformer by measuring from L3 (T) to terminal 1 of the autotransformer. A reading of <1ohm should be indicated.
2. measure from L2 (S) to terminal 3 of the autotransformer. <1 ohm should be read.
3. measure from terminal 2 of the autotransformer to the black lead of the fan motor. <1 ohm should be read.
4. Measure between terminals 1 and 3 of the autotransformer. Approximately 60 ohms should be read.
5. Measure between terminals 1 and 2 of the autotransformer. Approximately 25 ohms should be read.
- 6 Measure between terminals 2 and 3 of the autotransformer. Approximately 35 ohms should be read.
7. Measure the black lead of the fan motor to the blue lead of the capacitor. <1 oh should be read.
8. Measure the brown lead of the fan motor to the brown lead of the capacitor. <1 ohm should be read.
9. Measure between the two leads of the capacitor (blue & brown). A capacitor charging effect should be seen.

Voltage Checks

To ensure that the autotransformer and control circuitry is operating correctly, the voltage supplied by the transformer to the fan should be measured. To perform this check a voltmeter capable of measuring up to 250 VAC and the signal test board(176F1429) should be used.

Connect the voltmeter to the black and blue leads of the fan motor. Install the signal test board into the test connector socket in the VLT according to the instructions.

Voltage checks should be taken at high and low speeds. High-speed operation can be controlled by the fan test switch on the signal test board. The fan will run at the low speed for a few seconds when the VLT is powered up.

Voltage at high speed - 230 VAC

Voltage at low speed - 165 VAC

Testing The Inductor Temperature Sensor:

Only VLT 5125-5250 NEMA 12/IP54 units are equipped with this sensor. The sensor is physically mounted on the lamination surface of the output inductor or on the left side of the cap bank depending on age of drive. It is a simple normally closed switch that opens when the surface of the inductor reaches 135°C. The sensor itself is an enclosed device but a measurement can be taken by separating the cable connector located just inches from the sensor.

With an ohmmeter probe the two pins in the connector checking for a short circuit. This would indicate the switch is closed as it is normally suppose to be. If the switch were open it has either reached its trip temperature and has not yet reset, or it is defective.

Photo 2: Actual photo of VLT 5150 Chassis/NEMA 1, VLT 5060-5250 Chassis/NEMA 1 Units are similar.

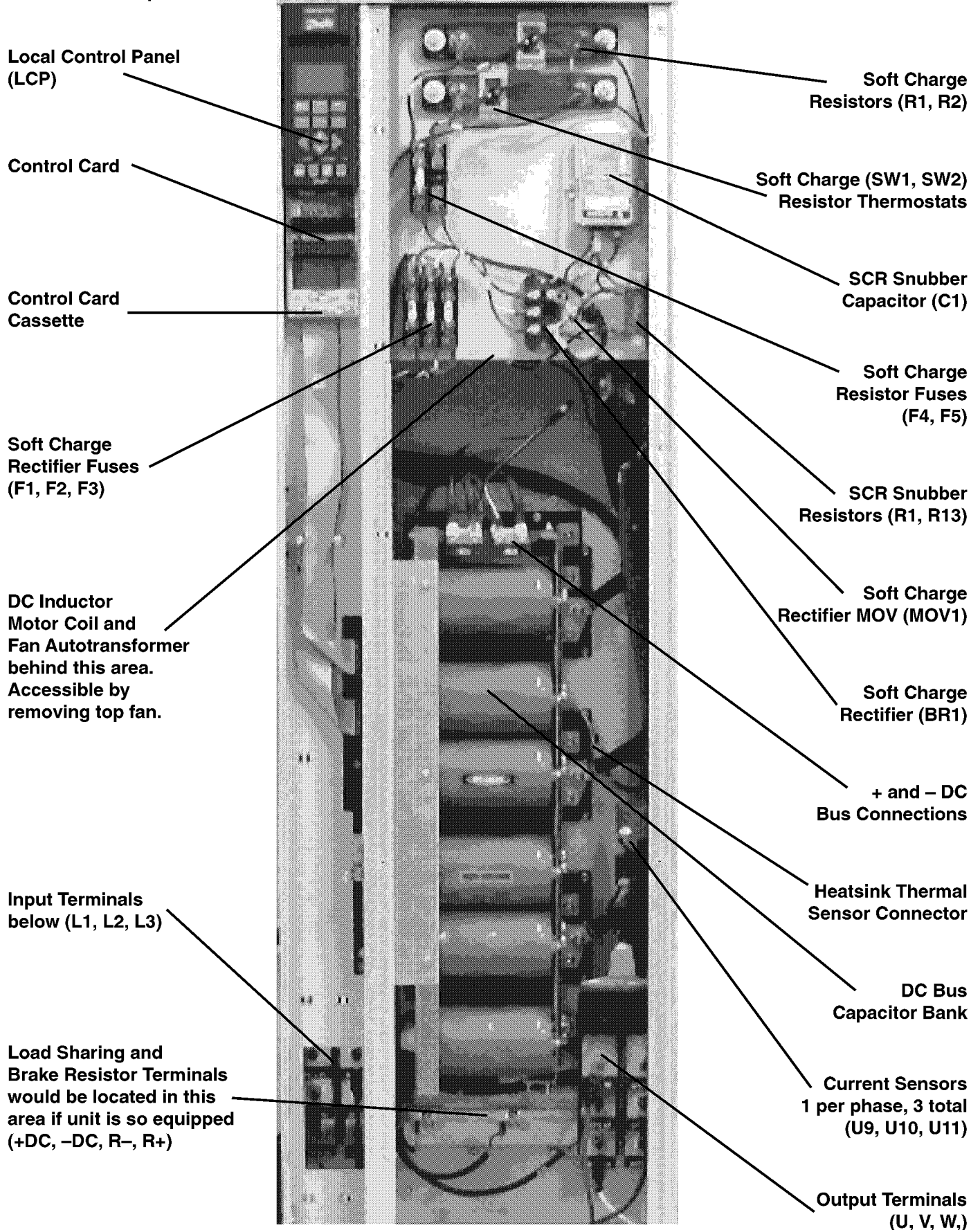

Photo 3: Actual photo of VLT 5100 NEMA 12, VLT 5060 and 5075 NEMA 12 units are similar.

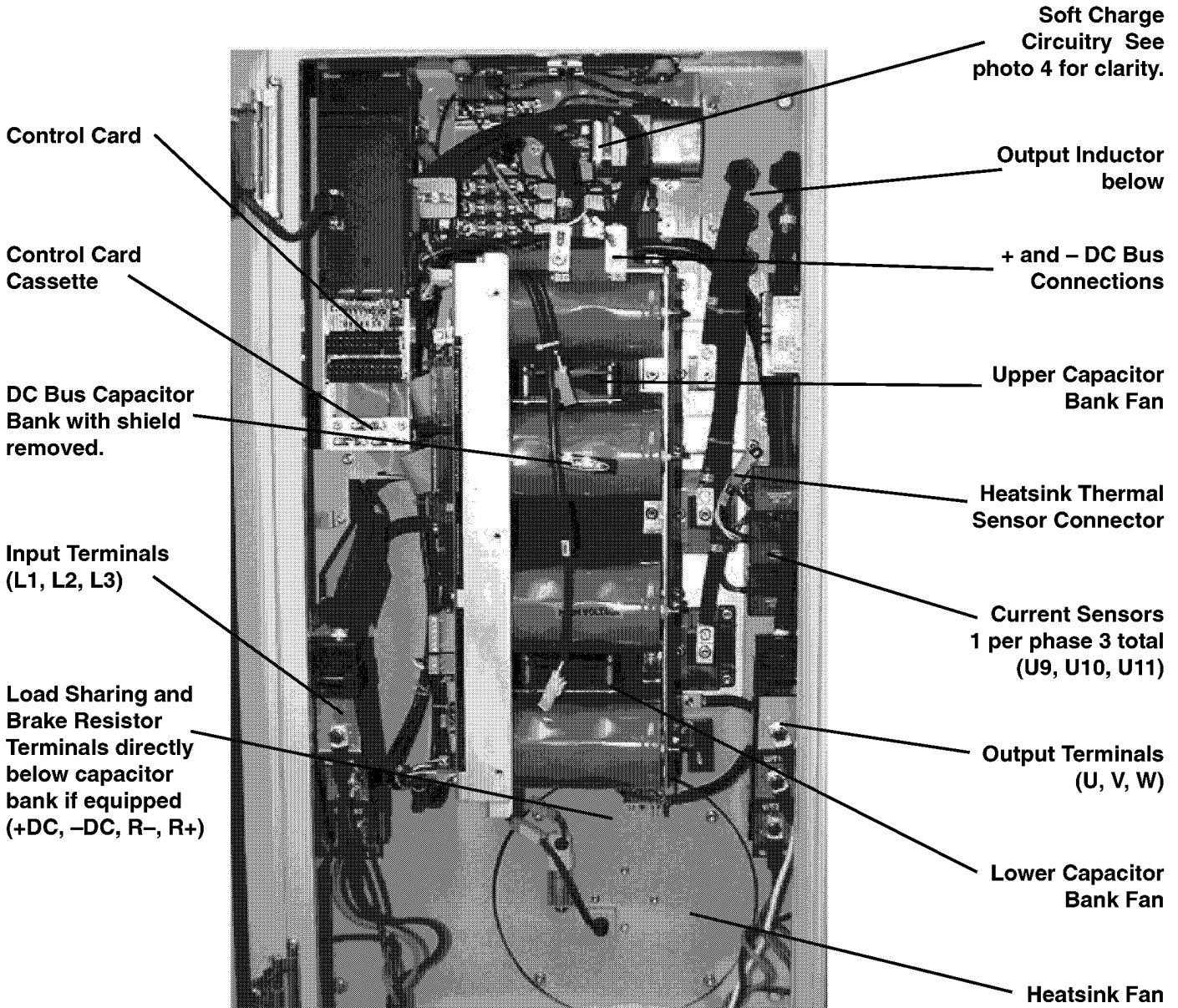

Photo 4: Actual photo of VLT 5100 NEMA 12 with + and – DC Bus wires removed for clarity. VLT 5060 and 5075 NEMA 12 units are similar.

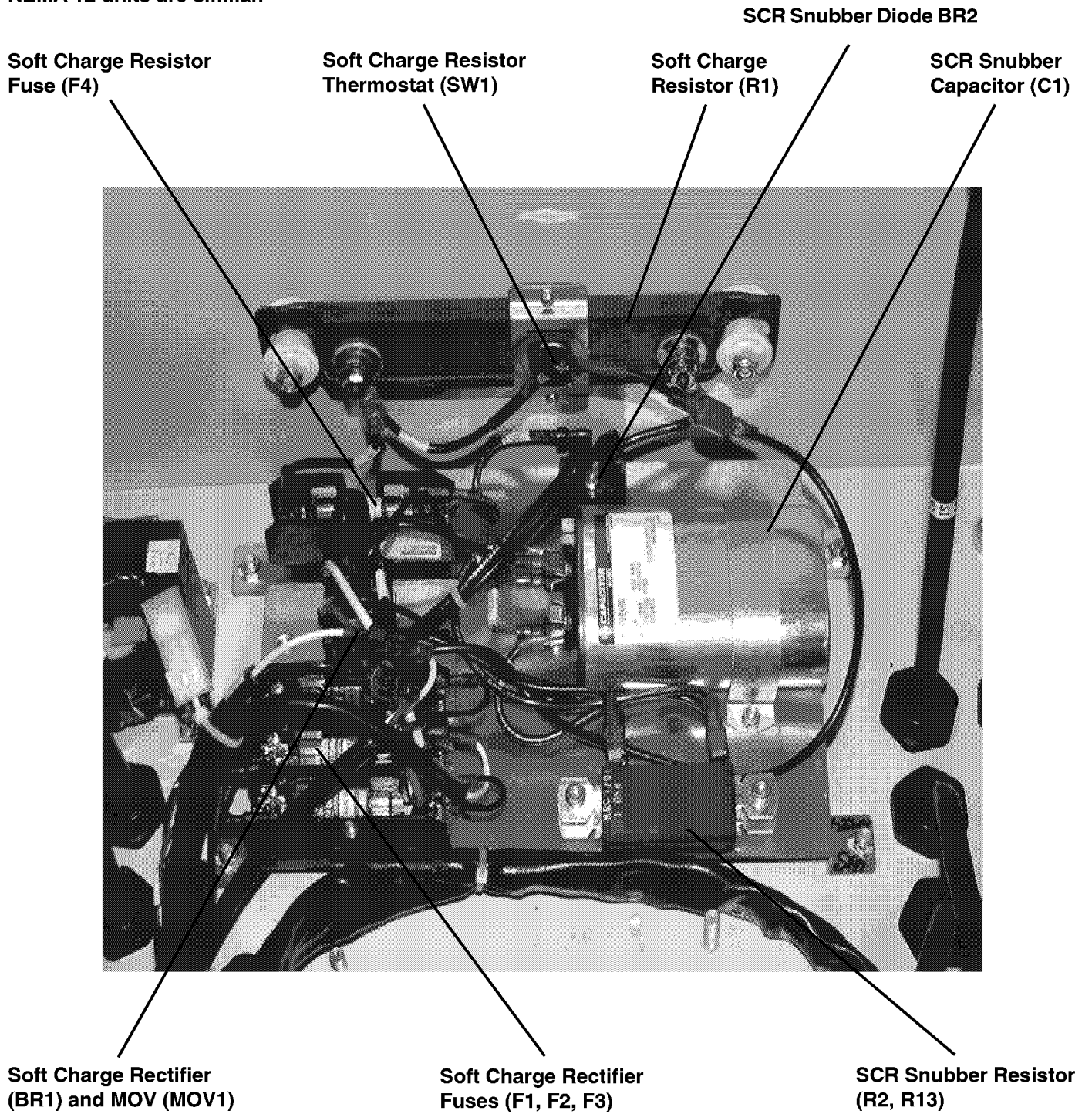

Photo 5: Actual photo of VLT 5200 NEMA 12, VLT 5125-5250 NEMA 12 units are similar.

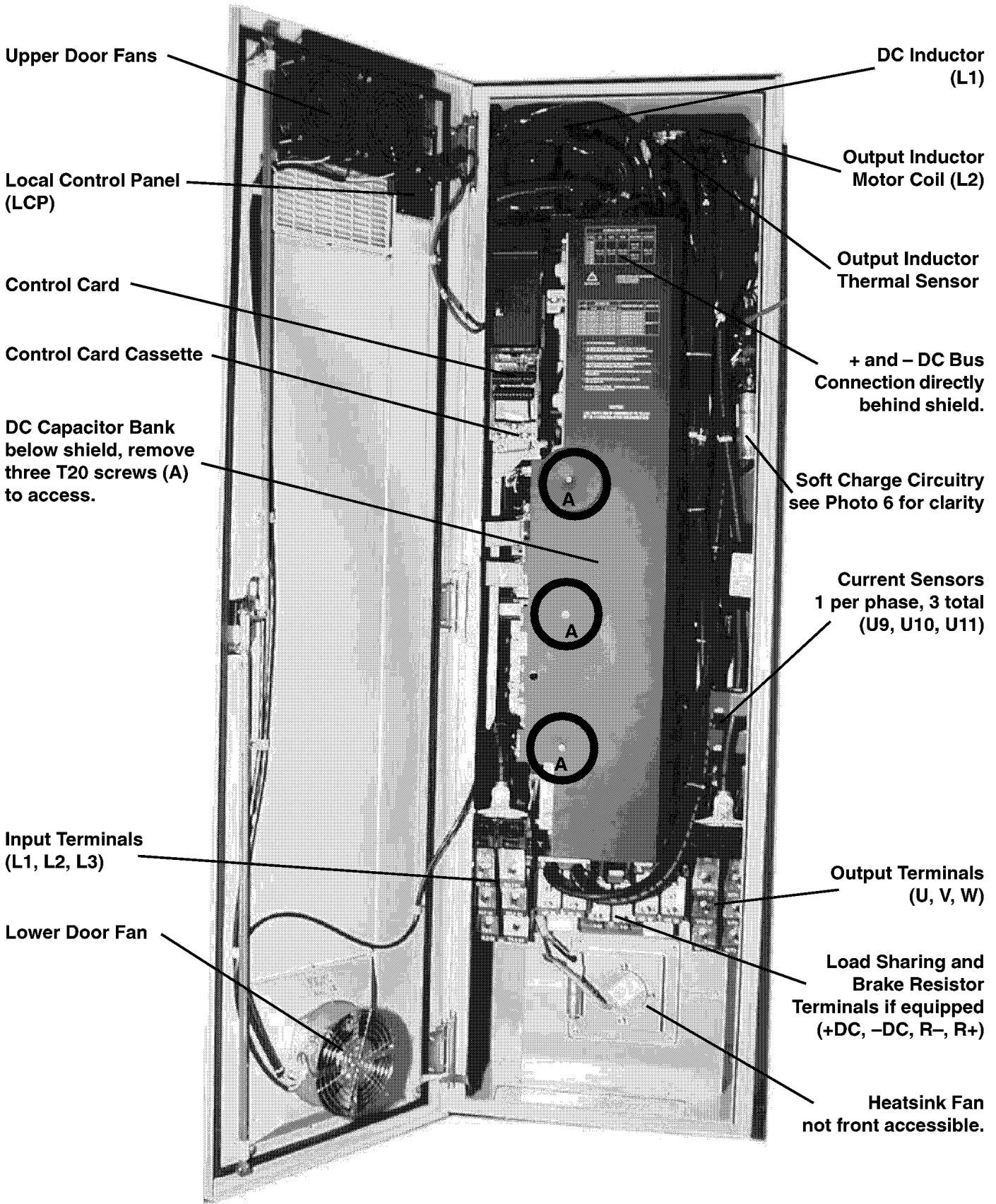
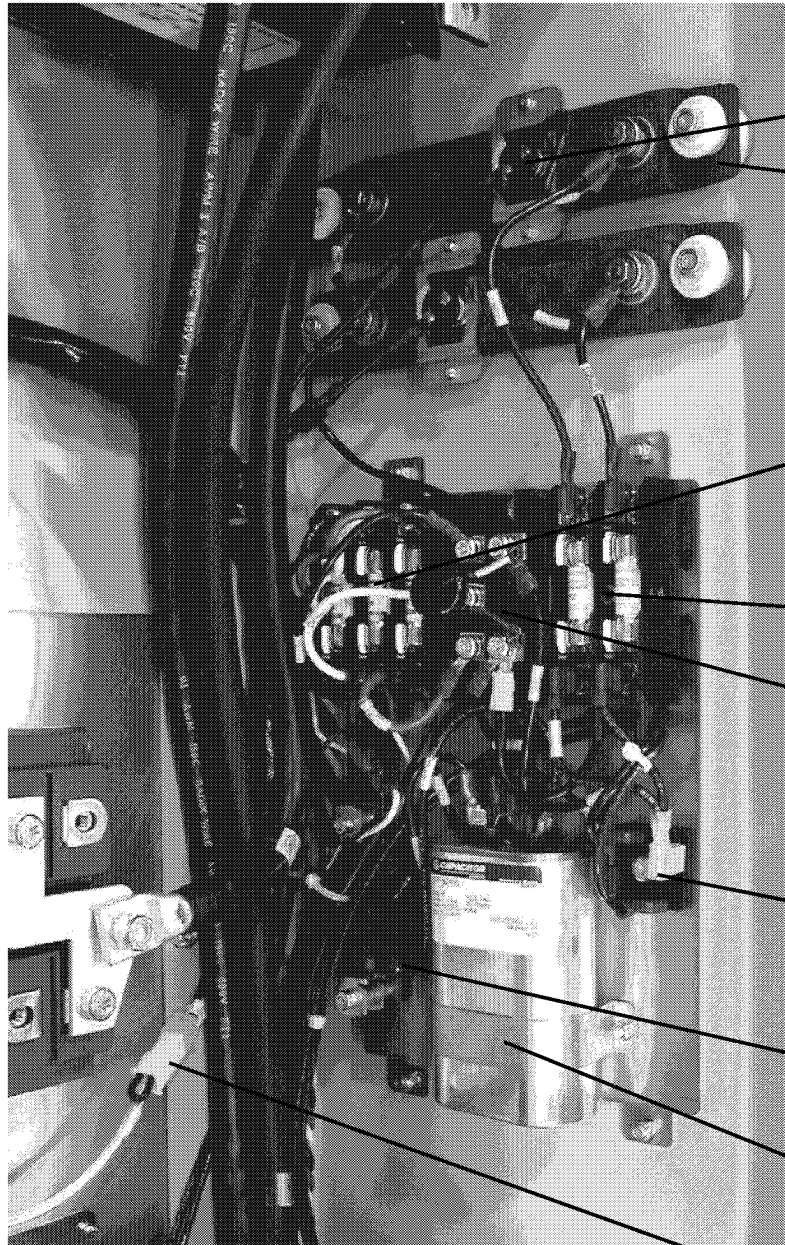

Photo 6: Actual photo of VLT 5200 NEMA 12 with Capacitor Bank removed. VLT 5125-2550 NEMA 12 units are similar.



Soft Charge Resistor
Thermostats (SW1, SW2)

Soft Charge Resistors
(R1, R2)

Soft Charge Rectifier
Fuses (F1, F2, F3)

Soft Charge Resistor
Fuses (F4, F5)

Soft Charge Rectifier,
BR1 and
MOV (MOV1)

SCR Snubber Diode BR2

SCR Snubber Resistors
(R2, R13)

SCR Snubber Capacitor
(C1)

Heatsink Thermal
Sensor Connector

DYNAMIC TEST PROCEDURES

Testing For Output Phase Imbalance

Checking the balance of the output voltage and current can give you an indication of whether or not the VLT is functioning correctly. When testing the output, both voltage and current are monitored. If the voltage is balanced but the current is not, it indicates the motor is drawing an uneven load. This could be the result of a defective motor, defective contacts in an overload conductor, or a poor connection in the wires feeding the motor. If the output current is unbalanced as well as the voltage, then the indication is the VLT is not gating the output properly. This could be the result of a defective power card, the connections from the power card to the IGBT's, or a poor connection within the VLT.

The voltage tests can be made with the motor connected however this is a good test to make following a repair, prior to connecting the motor wires. Further more it would be typical that if both output voltage and current were unbalanced the VLT would most likely be tripping on an over current fault when attempting to run the load. The voltage test could then only be made with the motor leads disconnected.

NOTE: When monitoring output voltage use an analog voltmeter. Digital voltmeters are sensitive to the waveform and switching frequency and commonly return erroneous readings.

Step 1
Remove AC input power to the VLT.

CAUTION: The DC bus capacitors remain charged for approximately 15 minutes following the removal of the main supply. Allow sufficient time for the capacitors to discharge before entering the unit. Test for the presence of bus voltage by connecting a voltmeter set to read 1000VDC to the terminals at the top of the capacitor bank, labeled +BUS and -BUS.

Step 2
Disconnect the motor leads from the output terminals of the VLT.

Step 3
If you have not yet run the static tests on the inverter section perform that procedure now.

Step 4
If the inverter section test is successful, apply main power to the VLT, initiate a run command with a speed greater than 40Hz.

Note: the speed of 40 Hz is only significant with regards to the clamp on device being used to read current. Some test equipment of this type is only specified to be accurate above a frequency of 40Hz.



Photo 1

NOTE:

Photo is typical of a VLT 5060-5100 Chassis, others will be similar however, polarity of + and - bus connection is opposite on VLT 5125-5250.

Step 5
Read the phase to phase output voltage of all three phases. The actual value is less of a concern than the balance of all three phases. All three phases should be within 8VAC of each other. If a greater imbalance exists proceed to the Testing IGBT Gate Drive Signal section and check for loose connections within the drive.

Step 6
If the voltage is balanced, remove power, allow the DC bus to discharge, reconnect the motor, return to running at a speed close to or above 40Hz and monitor the output current of all three phases. The output current should be balanced within 2 to 3% of each other. If an imbalance exists, check for poor connections to the motor or the quality of the motor itself.

TESTING THE INPUT SCR/DIODE MODULES:

Theoretically the current drawn on each of the three input phases of the VLT should be equal. Some imbalance may be seen however due to variations in phase to phase input voltage and some single phase loads within the unit. Reference figure 8

A simple test of monitoring input current can be made to rule out any suspicion of a problem in this area but a more thorough test may be warranted if the SCR/Diode module or the gate signals are thought to be at fault.

Given that the input voltage is balanced, monitor the three input phases with a clamp on ampmeter. The current readings should be within 5% of each other. An imbalance of greater than 5% may indicate that either the input voltage is not balanced or the SCR/Diode modules are not conducting properly. If the latter is true this may be due to a defective power card, wiring connection from the power card to the devices or the SCR/Diode modules themselves.

One step would be to swap two of the input leads to verify if the imbalance follows or stays in the same phase of the drive. If the problem follows it is possible the input voltage supply should be in question. If the problem stays in the same phase proceed to verify proper SCR/Diode operation by monitoring the SCR/Diode gate signal.

Monitoring the actual SCR gate signals can be difficult depending on the specific model of VLT. In order to view the gate signal an oscilloscope and a current probe are required. The VLT must be running at some minimum load, at least above magnetizing current by 10 to 20%. An unloaded motor may not draw sufficient current to generate gate signals with adequate amplitude so they can be easily identified.

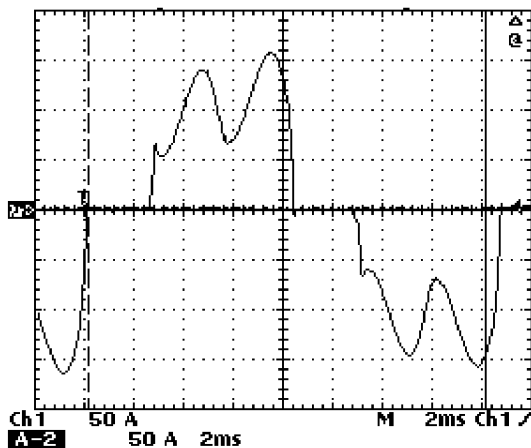

Figure 8

Typical input current wave form 5075 at 100 amp load

In most units the gate wiring and SCR/Diode modules are physically located below the capacitor bank. The only means to access the gate leads is through the use of the SCR gate lead break out wiring assembly. This assembly, available from Danfoss, inserts between the power card and the cable assembly from the SCR/Diode modules. On some units the SCR/Diode modules are located at the bottom of the unit and are easily accessed (see photo 7). For those units place the current probe around the white gate wire. With the unit running the SCR gate current should appear as in Figure 9:

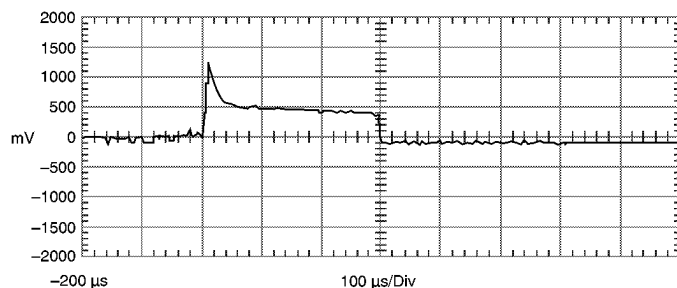

Figure 9
SCR Gate Signal

TESTING IGBT GATE DRIVE SIGNALS:

The gate drive signals, one for each IGBT for a total of six, originate on the control card. They are delivered to the power card, isolated, and then sent to each IGBT. A defective gate drive signal can cause an IGBT failure, over current trips, or an imbalance in the output of the VLT. Tripping caused by imbalances will most likely be the result of a gate drive signal missing completely. Any other form of distortion in one of the gating signals will normally result in a shorted IGBT. The signal board can be used to monitor these signals. As seen on the signal board, these signals are on the isolated side of the power card. A good signal here does not rule out a defective signal on the IGBT side of the power card. To test that portion of the signal it would be necessary to carry out the following procedure. The gate drive signals can be tested in two ways. One method is with the signal board allowing you to view the signal as it is distributed to the individual gate drivers on the power card. This is explained later in this section. However, following a repair it would be beneficial to monitor the gate drive signals directly at the gates of the IGBT's. This can only be carried out with the capacitor bank removed and the VLT powered by means of an external DC bus supply. Danfoss makes available such a power supply for making these measurements. Reference Appendix V Pages 94-97.

CAUTION: The gate drive signals are referenced to the negative DC bus. Line powered test equipment such as an oscilloscope must be isolated from ground when making measurements. Failure to do so will cause damage to the VLT. Also, depending on the method used to isolate the test equipment, the chassis of the test equipment may be at DC bus potential when connected to the VLT.

With the VLT powered by the external bus supply use an oscilloscope to monitor the gate drive signals. Place the unit in run with a speed reference of 0Hz. Connect the ground of the scope to the emitter (E) terminal of the IGBT. Place the probe on the gate (G) terminal of the IGBT (see photos 8,9,10). The signal should appear as in Figure 10:

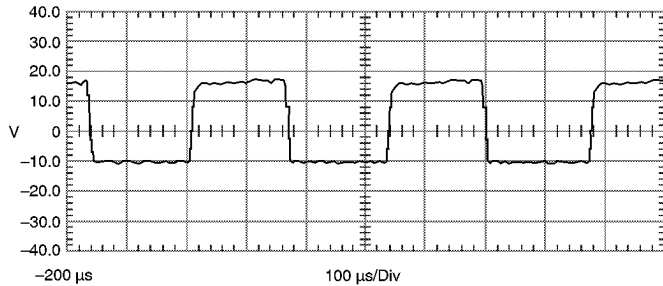

Figure 10
IGBT Gate Signal

Note: The waveform above was taken with the VLT 5000 carrier frequency set to 3.0Khz. Higher carrier frequencies will result in a waveform with a higher frequency.

Although an oscilloscope is the test instrument of choice in the absence of such equipment a volt meter can be used to obtain a reading that will give you a reasonable indication that the gate signals are functioning correctly. Set the volt meter to read 10VDC. Connect the positive (+) meter lead to the gate (G) terminal of the IGBT. Connect the negative (-) meter lead to the emitter (E) terminal of the IGBT. Place the VLT in run at 0Hz. The meter should read approximately 2 VDC. Compare all six gates to one another. If the readings are not similar further investigation is required.

NOTE:

The following signals will be monitored by use of the signal board. Danfoss makes available a signal board for ease of monitoring these signals.

TESTING FOR CURRENT FEEDBACK:

In each phase of the output resides a hall effect current sensor. These devices provide a current signal that is scaled down but proportional to the current being drawn by the output. The power card and the control card use this current feedback to make corrections to the waveform and protect the VLT from output short circuits and severe overload conditions. A defect in this circuit may also cause the VLT to erroneously trip on over current and ground fault alarms.

If you have verified that the application is not overloading the unit and the motor is not shorted phase to phase or to ground and the VLT still trips, you may want to conduct a test on current feedback. The signal from the current sensors are available on the signal board. Reference Appendix III Pages 81-91.

OTHER SIGNALS:

Many other signals can be monitored via the signal board. Among the signals that can be observed:

Low voltage power supplies; Fan speed control; Over voltage limits; Temperature trip signal; Brake control signal; Inrush control signal. See Appendix III for more on using the signal board.

PHOTO 7
SCR Gate Connections
VLT 5125-5150

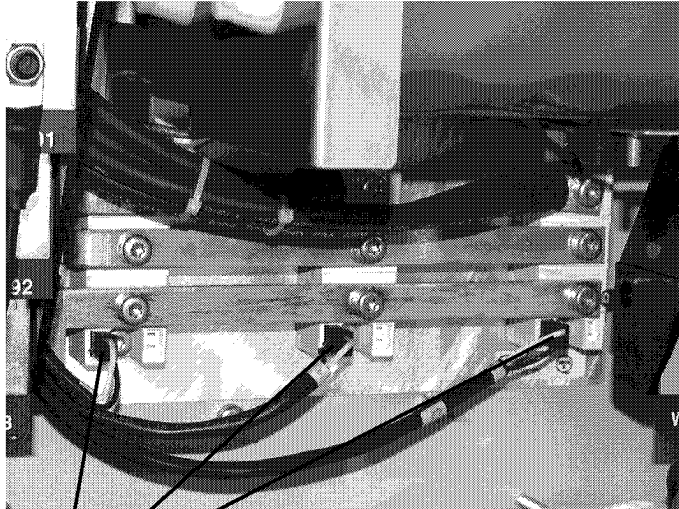

Gate signals

PHOTO 9
IGBT VLT 5125-5150

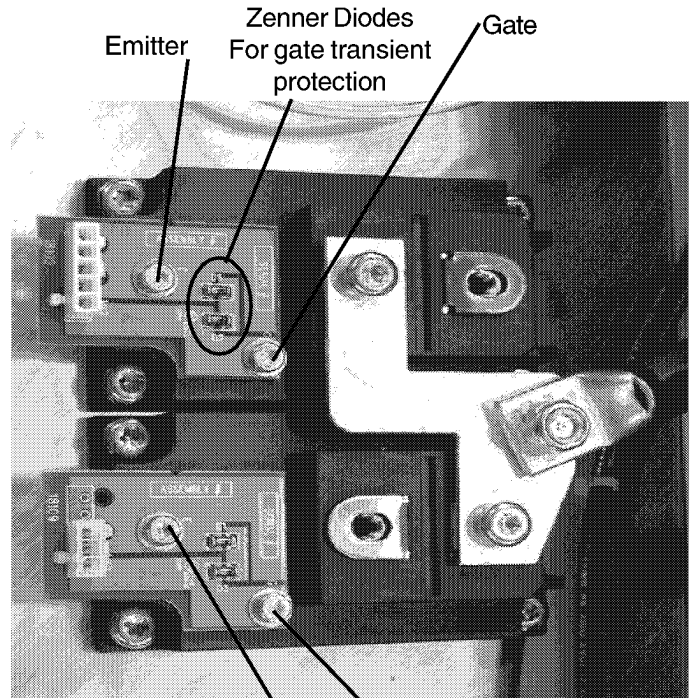

Emitter Gate
Emitter Gate

PHOTO 8
IGBT VLT 5060-5100

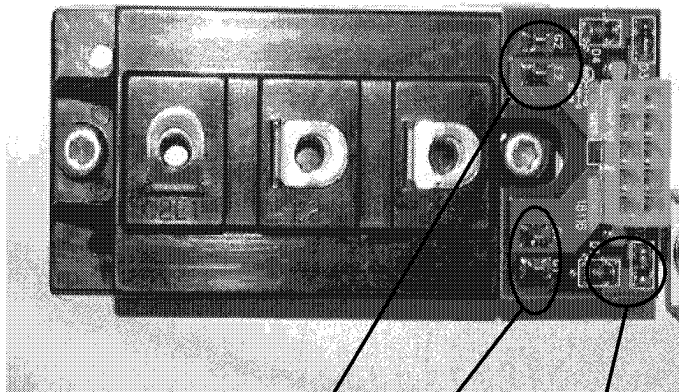

Emitter/Gate
Zener Diodes
For Gate Transient Protection

PHOTO 10
IGBT With Snubber Board
VLT 5200-5250

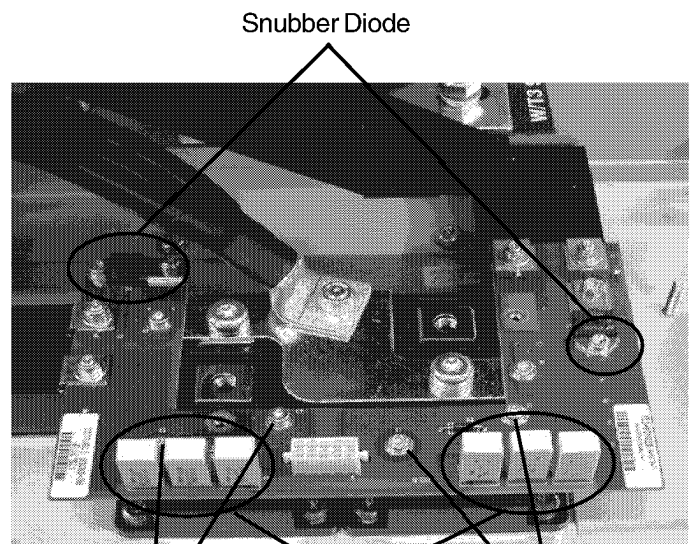

Snubber Diode
Emitter/Gate Snubber Resistors Emitter/Gate

SECTION FOUR

DISASSEMBLY INSTRUCTIONS

VLT 5060-5100

NEMA 12/IP54

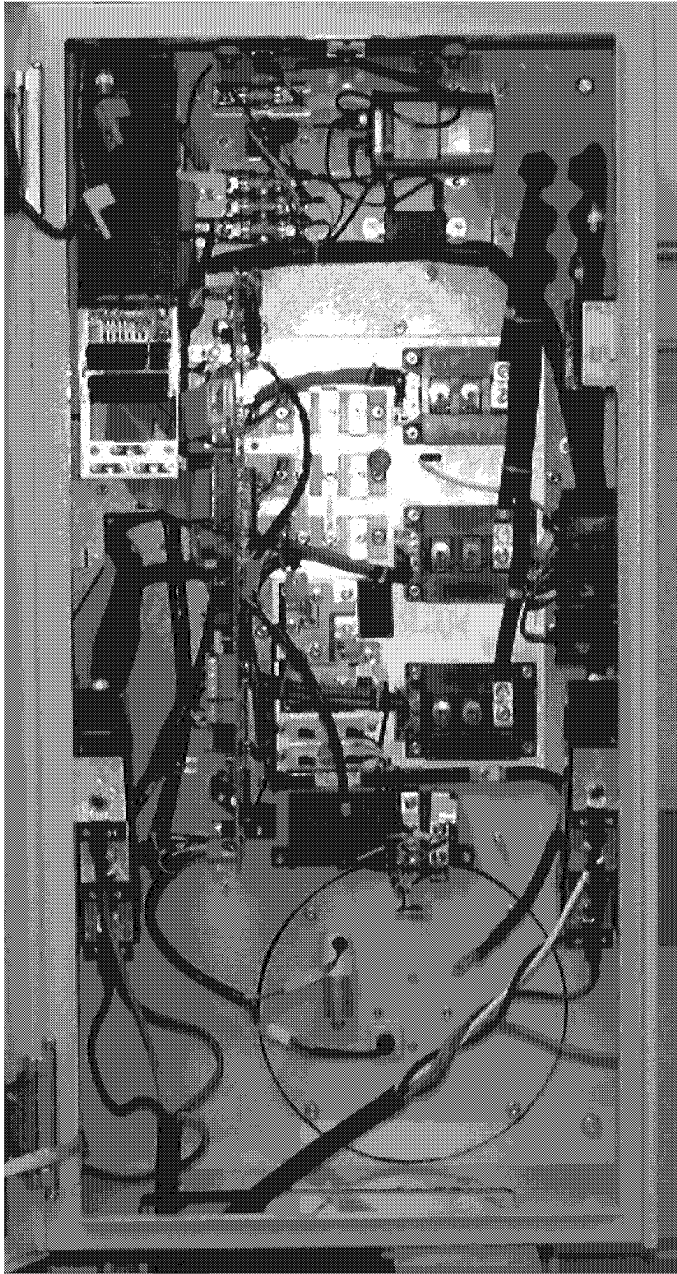

Photo 11

VLT 5060 - 5100 NEMA 12/IP54

Removing the control card:

Note: In Appendix II a quick reference to all Torque Specifications for the IGBT and SCR modules, throughout the disassembly section the torque specifications are referenced.

1. Disconnect the cable going to the local control panel.
2. Loosen the two T20 torx captive screws to free the cassette.
3. Lift the cassette from the bottom until its approximately at a 45° angle.
4. Unplug the two ribbon cables from the control card.
5. Push the cassette upwards to free it from the top hooks.
6. To replace the control card follow the instructions included with the spare part.

To reinstall the control card reverse the procedure.

Torque specifications: T20 screws to 8 Lb-In (1 NM).

Cable placement: The ribbon cables are made such that when laid flat the correct cable will be aligned to the proper connector or as installed the top power card connector mates to the lower control card connector.

Removing the capacitor bank:

1. Remove the black shield covering the capacitor bank by removing the three T20 torx screws.
2. Remove the three T20 torx screws securing the grounding bracket to the power card.
3. Remove the two T30 torx screws from the +Bus and -Bus connections.
4. Unplug the capacitor bank fan cable from the power card.
5. Remove the six T30 torx screws from the cap bank to IGBT connections.
6. Remove the wires from the three M8 studs at the bottom of the capacitor bank.
7. While supporting the capacitor bank, remove the three M10 locknuts.
8. Carefully remove the capacitor bank from the VLT and set upright.

To reinstall the capacitor bank reverse the procedure.

Torque specifications:

T20 screws to 8 Lb-In (1 NM)

T30 screws for IGBT's 35 Lb-In (4 NM)

T30 screws for + and -Bus 27 lb-In (3 NM)

M8 locknuts to 16 Lb-In (2 NM)

M10 locknuts to 27 Lb-In (3 NM)

Cable placement: Reconnect the wires to the studs at the bottom of the capacitor bank. First connect the white wire to the center stud. The shorter black wire from that same cable assembly connects to the inner most stud and the longer black wire to the outer most stud. If a brake is installed in the VLT then there will also be a 10 gauge wire attached to the inner most stud and a 4 gauge wire attached to the outer most stud. Reconnect the capacitor bank fan cable to connector MK 7 on the power card.

Removing the power card:

1. Unplug the three cable assemblies that attach to the IGBT's. If a brake is installed there will be 4.
2. Unplug the DC bus supply cable.
3. Remove the M10 locknut from the top of the power card mounting bracket to the heatsink.
4. Tilt the power card towards the middle of the unit and remove the connectors.
5. Lift the power card from the VLT.

Note: If the power card is being replaced you must remove the power card mounting bracket from the power card. A new bracket is not supplied with the spare part. The bracket is secured to the power card by means of two T20 screws and 2 nylon swags.

To reinstall the power card reverse the procedure.

Torque specifications: M10 locknuts to 27 Lb-In (3 NM).

Cable placement: As the power card is installed the gate cable assemblies align to the IGBT's from top to bottom. If a brake is installed the bottom cable attaches to the brake IGBT. Connect MK6, MK11 and MK12. The style and arrangement of the cables makes it impossible to make an incorrect connection. Connect the two ribbon cables from the control card. The top power card connector mates to the lower control card connector. Connect the DC bus supply cable to the mating connector. MK7 will be connected after the capacitor bank is reinstalled.

Removing the current sensors:

The spare current sensor assembly is provided as a complete unit with the three sensors, output terminals, splicer block, and wires all mounted on a common base plate. It is done in this way since the three current sensors have integrated leads that all combine into a common cable assembly within the VLT. It is also of prime importance that the correct sensor is placed in the right output phase. Providing the assembly in this way ensures correct placement of the sensors and makes installation easier.

1. Remove the motor leads from the output terminals.
2. Loosen the 3/16 hex screws in the splicer block to free the motor cables.
3. Unplug the heatsink thermal sensor connector from the cable harness.
4. Unplug the other end of the cable assembly at MK12 on the power card.
5. Cut any tie wraps securing the cable assembly.
6. Remove the four 7mm lock nuts securing the base plate to the VLT enclosure.
7. Remove the entire assembly

Note: For installing the wire into splicer block refer to photo below.

To reinstall the current sensor assembly reverse the procedure. Replace the tie wraps to secure the cable in place. Remember to reconnect the heatsink thermal sensor to the new cable harness and plug the cable harness into MK12 of the power card.

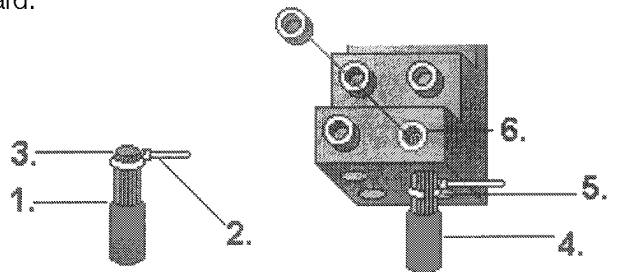

Torque the 7mm lock nuts to 16 Lb-In (2 NM).

Torque the 3/16 hex screws to 120 Lb-In (14 NM).

Removing the IGBT's:

1. Remove the T30 torx screw that secures the output cable to the IGBT.
2. Remove the four T30 torx screws that secure the IGBT to the heatsink.
3. Do not remove the small circuit board mounted to the gate connections of the IGBT. The new spare part will be supplied with this circuit board attached.

Reinstalling the IGBT's:

1. Remove the old thermal pad and insure the heatsink is free of dirt and remaining thermal compound.
2. Align the new thermal pad over the mounting holes in the heatsink.
3. Align the IGBT so the gate connections point towards the middle of the unit.
4. Insert the four T30 torx mounting screws, finger tight.
5. Torque the four T30 torx mounting screws following the pattern shown.

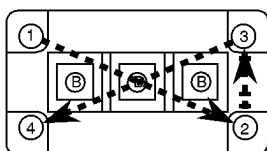

Tighten screws flush with the IGBT and torque initially to 9 Lb-In (1 NM)

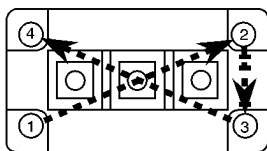

Final torque to 22-30 Lb-In (2.5-3.5 NM)

6. Mount the output lead to the furthest terminal to the right on the IGBT.
7. Torque the T30 torx screw to 31-39 Lb-In (3.5-4.5 NM).

Removing the Brake IGBT:

1. Remove the two T30 torx screw that make the bus connection from the snubber card to the IGBT.
2. Remove the two T20 torx screws that make the gate connection from the snubber card to the IGBT..
3. Remove the T20 torx screw at the K1 position, remove the bus wire.
4. Remove the snubber card.
5. Remove the four T30 torx screws that secure the IGBT to the heatsink.
6. Remove the IGBT. Also remove the two M4 standoffs from the gate connections of the IGBT. The new spare part does not include these standoffs.

Now that the snubber board is removed this is a good time to check the components on the board to ensure they are functional.

Testing the Brake Snubber Board:

1. The two diodes, D1 and D2, provide transient suppression for the gate of the IGBT. With a VOM set to read diodes, measure the two diodes and look for a voltage drop in one direction, infinity in the other.
2. Resistors R1 - R6 are 1ohm resistors in parallel. Place an ohmmeter across terminal K1 and Cap 2. The resistance value will be equal to .16ohm. Most meters will not read this low resistance accurately so the important thing is to insure the resistance value is close without a short circuit or open being present.
3. The large diode on the board is the snubber diode. With a VOM set to read diodes measure the diode and look for a voltage drop in one direction, infinity in the other.

Reinstalling the Brake IGBT:

1. Remove the old thermal pad and insure the heatsink is free of dirt and remaining thermal compound.
2. Align the new thermal pad on the heatsink.
3. Align the IGBT so the gate connections point towards the upper left hand side of the unit.
4. Insert the four T30 torx mounting screws, finger tight.
5. Torque the four T30 torx mounting screws following the pattern shown.

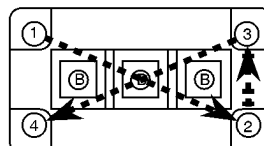

Tighten screws flush with the IGBT and torque initially to 9 Lb-In (1 NM)

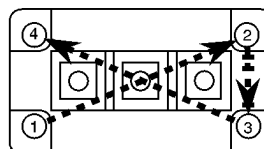

Final torque to 22-30 Lb-In (2.5-3.5 NM)

6. Insert the M4 standoffs in the IGBT gate connections and torque to 13 Lb-In (1.5 NM).
7. Align the bus bars over the IGBT connections and place the snubber board on the IGBT.
8. Insert the two T30 screws in the power connections making sure the bus bar and IGBT connections are made. Torque to 35 Lb-In (4 NM).
9. Insert the two T20 screws, with washers, in the gate connections and torque to 13 Lb-In (1.5 NM).
10. Reconnect the bus wire to K1 with one T20 screw and torque to 13 Lb-In (1.5 NM).

Removing the SCR/Diode modules:

1. Remove or loosen the six T30 torx screws that secure the bus bars to the top of the modules. Remove the input line connection to the failed or defective SCR.
2. Remove the two T30 torx screws that secure the module to the heatsink.
3. Unplug the gate connector from the module.

Reinstalling the SCR/Diode modules:

1. Remove the old thermal pad and insure the heatsink is free of dirt and remaining thermal compound.
2. Align the new thermal pad over the mounting holes in the heatsink.
3. Align the module so the gate connections point towards the outside of the unit.
4. Insert the two T30 torx mounting screws, finger tight.
5. Torque the two T30 torx mounting screws following the pattern shown.
6. Insert the six bus bar screws and secure finger tight.
7. Torque each module following the patterns shown:
8. Plug the gate connector on to the module.

For VLT 5060 - 5075

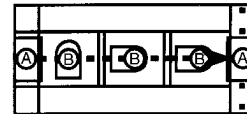

Tighten screws flush with the IGBT and torque initially to:
Torque A; 15 Lb-In (1.5 NM) Torque B; 9 Lb-In (1 NM)

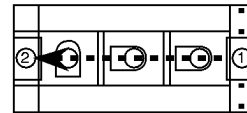

Final torque to:
Torque A; 44 Lb-In (5 NM) Torque B; 26 Lb-In (3 NM)

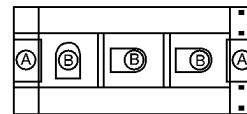

For VLT 5100

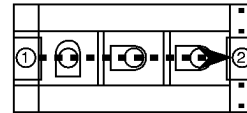

Tighten screws flush with the IGBT and torque initially to:
Torque A; 15 Lb-In (1.5 NM) Torque B; 9 Lb-In (1 NM)

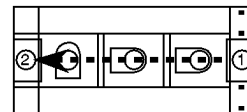

Final torque to:
Torque A; 44 Lb-In (5 NM) Torque B; 44 Lb-In (5 NM)

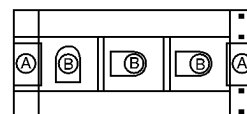

DISASSEMBLY INSTRUCTIONS

VLT 5060 - 5100 CHASSIS/NEMA1/IP20

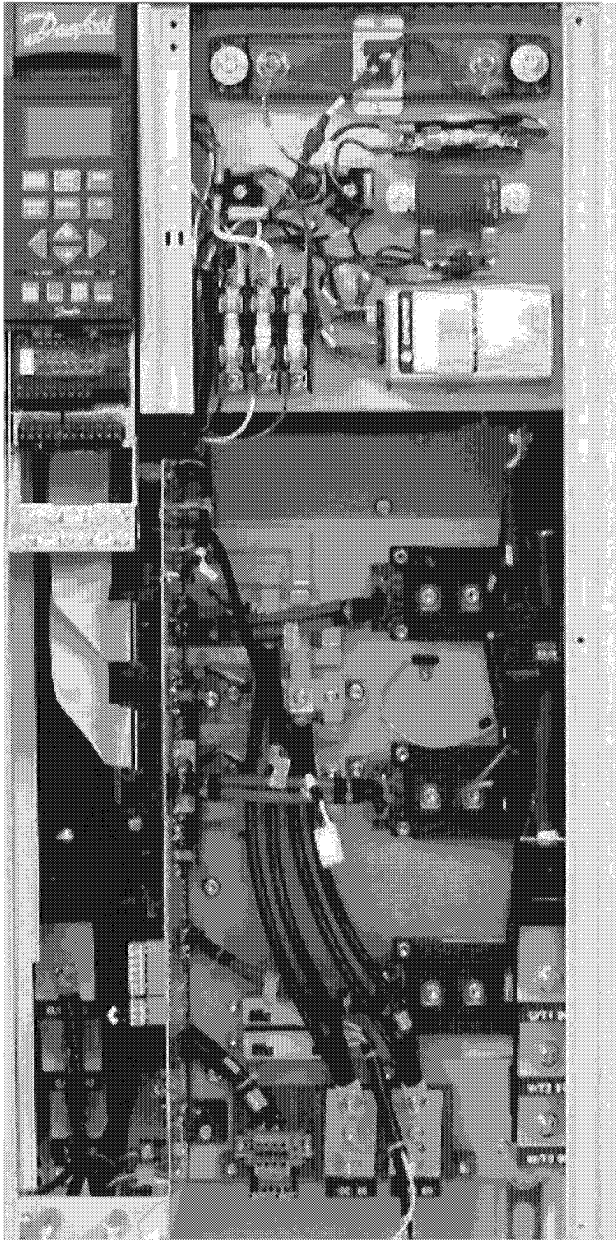

Photo 12

VLT 5060 - 5100 CHASSIS/NEMA 1/IP20

Removing the control card:

1. Disconnect the cable going to the local control panel.
2. Loosen the two T20 torx captive screws to free the cassette.
3. Lift the cassette from the bottom until its approximately at a 45° angle.
4. Unplug the two ribbon cables from the control card.
5. Push the cassette upwards to free it from the top hooks.
6. To replace the control card follow the instructions included with the spare part.

To reinstall the control card reverse the procedure.

Torque specifications: T20 screws to 8 Lb-In (1 NM).

Cable placement: The ribbon cables are made such that when laid flat the correct cable will be aligned to the proper connector or as installed the top power card connector mates to the lower control card connector.

Removing the cable tray:

On these units the removal of the capacitor bank and power card will be much easier if the control wiring cable tray is removed first.

1. Remove the black front plastic cover.
2. Remove the plexi-glass cover from the tray by removing the four T20 torx screws.
3. Remove the two bottom M10 standoffs.
4. Remove the T20 screw that secures the stiffener to the cable tray at the bottom of the unit.
5. Unplug the ribbon cables from the power card.
6. Remove the two T20 screws at the top of the cable tray.
7. The cable tray is now free. Rotate the right edge of the tray to the left and lift out the tray.

To reinstall the cable tray reverse the procedure. Torque the T20 and M10 hardware to 16 Lb-in or 1.8 NM.

Removing the capacitor bank:

1. Remove the three T28 torx screws securing the power card bracket to the capacitor bank.
2. Remove the three T20 torx screws securing the grounding bracket to the power card.
3. Remove the two T30 torx screws from the +Bus and -Bus connections.
4. Remove the six T30 torx screws from the cap bank to IGBT connections.
5. Remove the wires from the three M8 studs at the bottom of the capacitor bank.
6. While supporting the capacitor bank, remove the three M10 locknuts.
7. Carefully remove the capacitor bank from the VLT.

To reinstall the capacitor bank reverse the procedure.

Torque specifications:

- T20 screws to 8 Lb-In (1 NM)
- T30 screws for IGBT's 35 Lb-In (4 NM)
- T30 screws for + and -Bus 27 lb-In (3 NM)
- M8 locknuts to 16 Lb-In (2 NM)
- M10 locknuts to 27 Lb-In (3 NM)

Cable placement: Reconnect the wires to the studs at the bottom of the capacitor bank. First connect the white wire to the center stud. The shorter black wire from that same cable assembly connects to the inner most stud and the longer black wire to the outer most stud. If a brake is installed in the VLT then there will also be a 10 gauge wire attached to the inner most stud and a 4 gauge wire attached to the outer most stud.

Removing the power card:

1. Unplug the three cable assemblies that attach to the IGBT's. If a brake is installed there will be 4.
2. Unplug the DC bus supply cable.
3. Remove the M10 locknut from the top of the power cord mounting bracket to the heat sink.
4. Tilt the power card towards the middle of the unit and remove the connectors.
5. Lift the power card from the VLT.

Note: If the power card is being replaced you must remove the lower mounting bracket from the power card. A new bracket is not supplied with the spare part. The bracket is secured to the power card by means of two T20 screws and 2 nylon swags.

To reinstall the power card reverse the procedure.

Torque specifications: M10 locknuts to 27 Lb-In (3 NM).

Cable placement: As the power card is installed the gate cable assemblies align to the IGBT's from top to bottom. If a brake is installed the bottom cable attaches to the brake IGBT. Connect MK6, MK11 and MK12. The style and arrangement of the cables makes it impossible to make an incorrect connection. Connect the two ribbon cables from the control card. The top power card connector mates to the lower control card connector. Connect the DC bus supply cable to the mating connector.

Removing the current sensors:

The spare current sensor assembly is provided as a complete unit with the three sensors, output terminals, and wires all mounted on a common base plate. It is done in this way since the three current sensors have integrated leads that all combine into a common cable assembly within the VLT. It is also of prime importance that the correct sensor is placed in the right output phase. Providing the assembly in this way ensures correct placement of the sensors and makes installation easier.

1. Remove the motor leads from the output terminals.
2. Remove the T30 torx screws securing the 3 internal motor cables to the output inductor.
3. Unplug the heatsink thermal sensor connector from the cable harness.
4. Unplug the other end of the cable assembly at MK12 on the power card.
5. Cut any tie wraps securing the cable assembly.
6. Remove the four 7mm lock nuts securing the base plate to the VLT enclosure.
7. Remove the entire assembly

To reinstall the current sensor assembly reverse the procedure. Replace the tie wraps to secure the cable in place. Remember to reconnect the heatsink thermal sensor to the new cable harness and plug the cable harness into MK12 of the power card.

Torque the 7mm lock nuts to 16 Lb-In (2 NM).

Torque the T30 Torx screws to 27 Lb-In (3 NM).

Removing the IGBT's:

1. Remove the T30 torx screw that secures the output cable to the IGBT.
2. Remove the four T30 torx screws that secure the IGBT to the heatsink.
3. Do not remove the small circuit board mounted to the gate connections of the IGBT. The new spare part will be supplied with this circuit board attached.

Reinstalling the IGBT's:

1. Remove the old thermal pad and insure the heatsink is free of dirt and remaining thermal compound.
2. Align the new thermal pad over the mounting holes in the heatsink.
3. Align the IGBT so the gate connections point towards the middle of the unit.
4. Insert the four T30 torx mounting screws, finger tight.
5. Torque the four T30 torx mounting screws following the pattern shown.

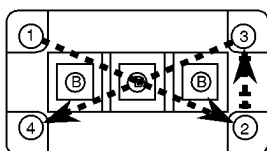

Tighten screws flush with the IGBT and torque initially to 9 Lb-In (1 NM)

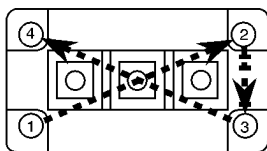

Final torque to 22-30 Lb-In (2.5-3.5 NM)

6. Mount the output lead to the furthest terminal to the right on the IGBT.
7. Torque the T30 torx screw to 31-39 Lb-In (3.5-4.5 NM).

Removing the Brake IGBT:

1. Remove the two T30 torx screw that make the bus connection from the snubber card to the IGBT.
2. Remove the two T20 torx screws that make the gate connection from the snubber card to the IGBT..
3. Remove the T20 torx screw at the K1 position, remove the bus wire.
4. Remove the snubber card.
5. Remove the four T30 torx screws that secure the IGBT to the heatsink.
6. Remove the IGBT. Also remove the two M4 standoffs from the gate connections of the IGBT. The new spare part does not include these standoffs.

Now that the snubber board is removed this is a good time to check the components on the board to ensure they are functional.

Testing the Brake Snubber Board:

1. The two diodes, D1 and D2, provide transient suppression for the gate of the IGBT. With a VOM set to read diodes, measure the two diodes and look for a voltage drop in one direction, infinity in the other.
2. Resistors R1 - R6 are 1ohm resistors in parallel. Place an ohmmeter across terminal K1 and Cap 2. The resistance value will be equal to .16ohm. Most meters will not read this low resistance accurately so the important thing is to insure the resistance value is close without a short circuit or open being present.
3. The large diode on the board is the snubber diode. With a VOM set to read diodes measure the diode and look for a voltage drop in one direction, infinity in the other.

Reinstalling the Brake IGBT:

1. Remove the old thermal pad and insure the heatsink is free of dirt and remaining thermal compound.
2. Align the new thermal pad on the heatsink.
3. Align the IGBT so the gate connections point towards the upper left hand side of the unit.
4. Insert the four T30 torx mounting screws, finger tight.
5. Torque the four T30 torx mounting screws following the pattern shown.

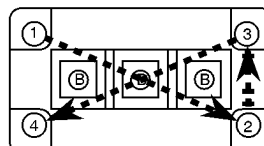

Tighten screws flush with the IGBT and torque initially to 9 Lb-In (1 NM)

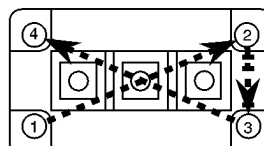

Final torque to 22-30 Lb-In (2.5-3.5 NM)

6. Insert the M4 standoffs in the IGBT gate connections and torque to 13 Lb-In (1.5 NM).
7. Align the bus bars over the IGBT connections and place the snubber board on the IGBT.
8. Insert the two T30 screws in the power connections making sure the bus bar and IGBT connections are made. Torque to 35 Lb-In (4 NM).
9. Insert the two T20 screws, with washers, in the gate connections and torque to 13 Lb-In (1.5 NM).
10. Reconnect the bus wire to K1 with one T20 screw and torque to 13 Lb-In (1.5 NM).

Removing the SCR/Diode modules:

1. Remove or loosen the six T30 torx screws that secure the bus bars to the top of the modules. Remove the input line connection to the failed or defective SCR.
2. Remove the two T30 torx screws that secure the module to the heatsink.
3. Unplug the gate connector from the module.

Reinstalling the SCR/Diode modules:

1. Remove the old thermal pad and insure the heatsink is free of dirt and remaining thermal compound.
2. Align the new thermal pad over the mounting holes in the heatsink.
3. Align the module so the gate connections point towards the outside of the unit.
4. Insert the two T30 torx mounting screws, finger tight.
5. Torque the two T30 torx mounting screws following the pattern shown.
6. Insert the six bus bar screws and secure finger tight.
7. Torque each module following the patterns shown:
8. Plug the gate connector on to the module.

For VLT 5060 - 5075

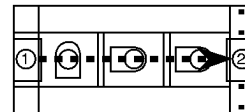

Tighten screws flush with the IGBT and torque initially to:
Torque A; 15 Lb-In (1.5 NM) Torque B; 9 Lb-In (1 NM)

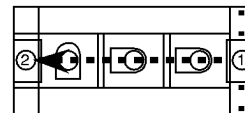

Final torque to:
Torque A; 44 Lb-In (5 NM) Torque B; 26 Lb-In (3 NM)

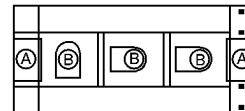

For VLT 5100

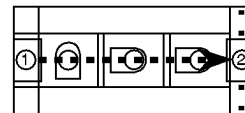

Tighten screws flush with the IGBT and torque initially to:
Torque A; 15 Lb-In (1.5 NM) Torque B; 9 Lb-In (1 NM)

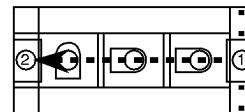

Final torque to:
Torque A; 44 Lb-In (5 NM) Torque B; 44 Lb-In (5 NM)

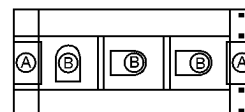

DISASSEMBLY INSTRUCTIONS

VLT 5125 - 5150

NEMA 12/IP54

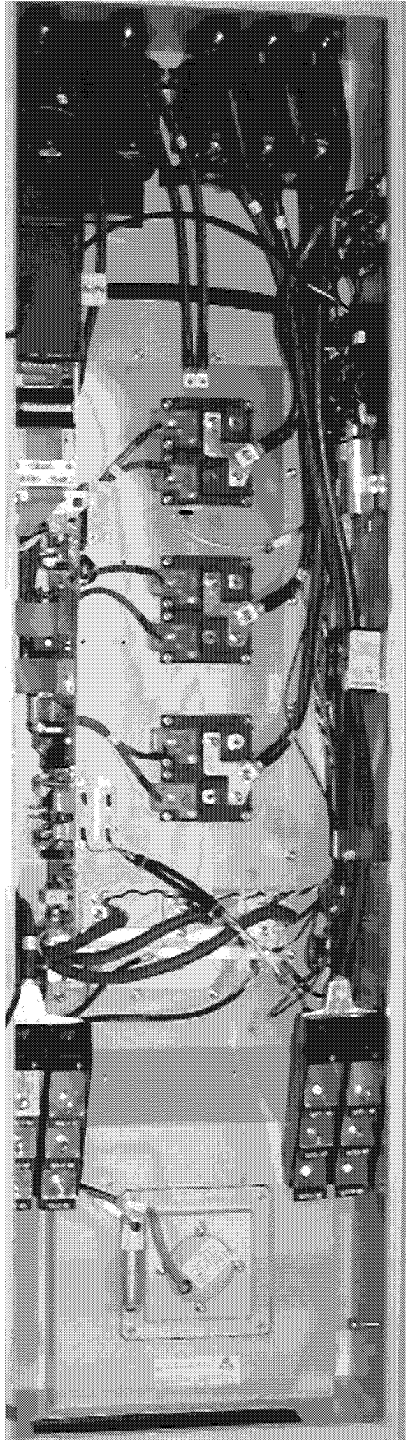

Photo 13

VLT 5125 - 5150 NEMA 12/IP54

Removing the control card:

1. Disconnect the cable going to the local control panel.
2. Loosen the two T20 torx captive screws to free the cassette.
3. Lift the cassette from the bottom until its approximately at a 45° angle.
4. Unplug the two ribbon cables from the control card.
5. Push the cassette upwards to free it from the top hooks.
6. To replace the control card follow the instructions included with the spare part.

To reinstall the control card reverse the procedure.

Torque specifications: T20 screws to 8 Lb-In (1 NM).

Cable placement: The ribbon cables are made such that when laid flat the correct cable will be aligned to the proper connector or as installed the top power card connector mates to the lower control card connector.

Removing the capacitor bank:

1. Remove the black shield covering the capacitor bank by removing the three T20 torx screws.
2. Remove the three T20 torx screws securing the grounding bracket to the power card.
3. Remove the four T30 torx screws from the +Bus and -Bus connections.
4. Remove the six T30 torx screws from the cap bank to IGBT connections.
5. Remove the wires from the three M8 studs at the bottom of the capacitor bank.
6. While supporting the capacitor bank, remove the four M10 locknuts.
7. Carefully remove the capacitor bank from the VLT and set upright.

To reinstall the capacitor bank reverse the procedure.

Torque specifications:

T20 screws to 8 Lb-In (1 NM)

T30 screws for IGBT's 35 Lb-In (4 NM)

T30 screws for + and -Bus 27 lb-In (3 NM)

M8 locknuts to 16 Lb-In (2 NM)

M10 locknuts to 27 Lb-In (3 NM)

Cable placement: Reconnect the wires to the studs at the bottom of the capacitor bank. First connect the white wire to the center stud. The shorter black wire from that same cable assembly connects to the inner most stud and the longer black wire to the outer most stud. If a brake is installed in the VLT then there will also be a 10 gauge wire attached to the inner most stud and a 4 gauge wire attached to the outer most stud.

Removing the power card:

1. Unplug the three cable assemblies that attach to the IGBT's. If a brake is installed there will be 4.
2. Unplug the DC bus supply cable.
3. Remove the M10 locknuts from the top and bottom of the power cord to the heat sink mounting bracket.
4. Tilt the power card towards the middle of the unit and remove the connectors.
5. Lift the power card from the VLT 5000.

Note: If the power card is being replaced you must remove the power cord mounting bracket from the power card. A new bracket is not supplied with the spare part. The bracket is secured to the power card by means of two T20 screws and 2 nylon swags.

To reinstall the power card reverse the procedure.
 Torque specifications: M10 locknuts to 27 Lb-In (3 NM).
 Cable placement: As the power card is installed the gate cable assemblies align to the IGBT's from top to bottom. If a brake is installed the bottom cable attaches to the brake IGBT. Connect MK6, MK11 and MK12. The style and arrangement of the cables makes it impossible to make an incorrect connection. Connect the two ribbon cables from the control card. The top power card connector mates to the lower control card connector. Connect the DC bus supply cable to the mating connector.

Removing the current sensors:

Each of the three current sensors is provided with a plug in connector so they can be replaced individually. It is of prime importance that if more than one sensor is removed, when installing the sensors ensure the correct cable is associated with the correct output phase.

1. Loosen the 3/16 hex screw securing the internal motor cable to the splicer block.
2. Unplug the wire connector at the current sensor.
3. Remove the two 8mm lock nuts securing the sensor to the base plate.
4. Slide the sensor off the end of the cable.

Note: For installing the wire into splicer block refer to photo below.

To reinstall the sensor reverse the procedure. Be sure the arrow on the top of the current sensor points towards the output of the VLT.

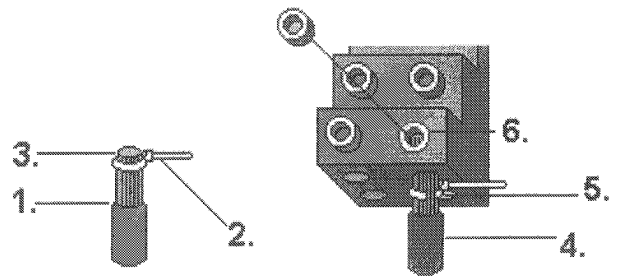

Torque the 8mm lock nuts to 16 Lb-In (2 NM)
 Torque the 3/16 hex screws to 120 Lb-In (14 NM)

Removing the IGBT's:

1. Remove the two T30 torx screw that secures the output cable to both upper and lower IGBT.
2. Remove the four T30 torx screws that secure the IGBT to the heatsink.
3. Do not remove the small circuit board mounted to the gate connections of the IGBT. The new spare part will be supplied with this circuit board attached.

Reinstalling the IGBT's:

1. Remove the old thermal pad and insure the heatsink is free of dirt and remaining thermal compound.
2. Align the new thermal pad over the mounting holes in the heatsink.
3. Align the IGBT so the gate connections point towards the middle of the unit.
4. Insert the four T30 torx mounting screws, finger tight.
5. Torque the four T30 torx mounting screws following the pattern shown.

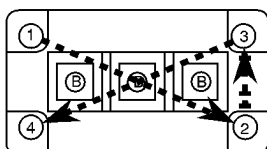

Tighten screws flush with the IGBT and torque initially to 9 Lb-In (1 NM)

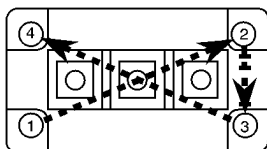

Final torque to 22-30 Lb-In (2.5-3.5 NM)

6. Mount the output lead to the furthest terminal to the right on the IGBT. The lower IGBT will be mounted on the left terminal refer to photo 9.
7. Torque the T30 torx screw to 31-39 Lb-In (3.5-4.5 NM).

Removing the Brake IGBT:

1. Remove the two T30 torx screw that make the bus connection from the snubber card to the IGBT.
2. Remove the two T20 torx screws that make the gate connection from the snubber card to the IGBT..
3. Remove the two T20 torx screw at the K1 and K2 positions, remove the bus wire.
4. Remove the snubber card.
5. Remove the four T30 torx screws that secure the IGBT to the heatsink.
6. Remove the IGBT. Also remove the two M4 standoffs from the gate connections of the IGBT. The new spare part does not include these standoffs.

Now that the snubber board is removed this is a good time to check the components on the board to ensure they are functional.

Testing the Brake Snubber Board:

1. The two diodes, D1 and D2, provide transient suppression for the gate of the IGBT. With a VOM set to read diodes, measure the two diodes and look for a voltage drop in one direction, infinity in the other.
2. Resistors R1 - R9 are 1ohm resistors in parallel. Place an ohmmeter across terminal K1 and Cap 2. The resistance value will be equal to .11ohm. Most meters will not read this low resistance accurately so the important thing is to insure the resistance value is close without a short circuit or open being present.
3. The two large diodes on the board is the snubber diode. With a VOM set to read diodes measure the diode and look for a voltage drop in one direction, infinity in the other.

Reinstalling the Brake IGBT:

1. Remove the old thermal pad and insure the heatsink is free of dirt and remaining thermal compound.
2. Align the new thermal pad on the heatsink.
3. Align the IGBT so the gate connections point towards the upper left hand side of the unit.
4. Insert the four T30 torx mounting screws, finger tight.
5. Torque the four T30 torx mounting screws following the pattern shown.

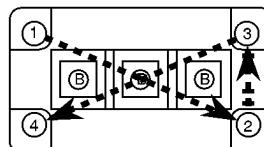

Tighten screws flush with the IGBT and torque initially to 9 Lb-In (1 NM)

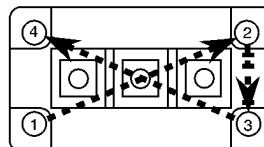

Final torque to 22-30 Lb-In (2.5-3.5 NM)

6. Insert the M4 standoffs in the IGBT gate connections and torque to 13 Lb-In (1.5 NM).
7. Align the bus bars over the IGBT connections and place the snubber board on the IGBT.
8. Insert the two T30 screws in the power connections making sure the bus bar and IGBT connections are made. Torque to 35 Lb-In (4 NM).
9. Insert the two T20 screws, with washers, in the gate connections and torque to 13 Lb-In (1.5 NM).
10. Reconnect the bus wire to K1 and K2 with two T20 screws and torque to 13 Lb-In (1.5 NM).

Removing the SCR/Diode modules:

1. Remove or loosen the six T30 torx screws that secure the bus bars to the top of the modules. Remove the input line connection to the failed or defective SCR.
2. remove the two T30 torx screws that secure the module to the heatsink.
3. Unplug the gate connector from the module.

Reinstalling the SCR/Diode modules:

1. Remove the old thermal pad and insure the heatsink is free of dirt and remaining thermal compound.
2. Align the new thermal pad over the mounting holes in the heatsink.
3. Align the module so the gate connections point towards the outside of the unit.
4. Insert the two T30 torx mounting screws, finger tight.
5. Torque the two T30 torx mounting screws following the pattern shown.
6. Insert the six bus bar screws and secure finger tight.
7. Torque each module following the patterns shown:
8. Plug the gate connector on to the module.

For VLT 5125-5150

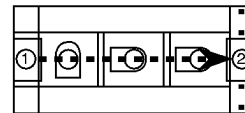

Tighten screws flush with the IGBT and torque initially to:
Torque A; 15 Lb-In (1.5 NM) Torque B; 9 Lb-In (1 NM)

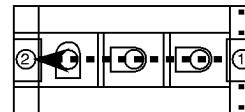

Final torque to:
Torque A; 44 Lb-In (5 NM) Torque B; 44 Lb-In (5 NM)

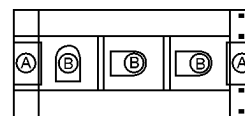

DISASSEMBLY INSTRUCTIONS

VLT 5125 - 5150 CHASSIS/NEMA1/IP20

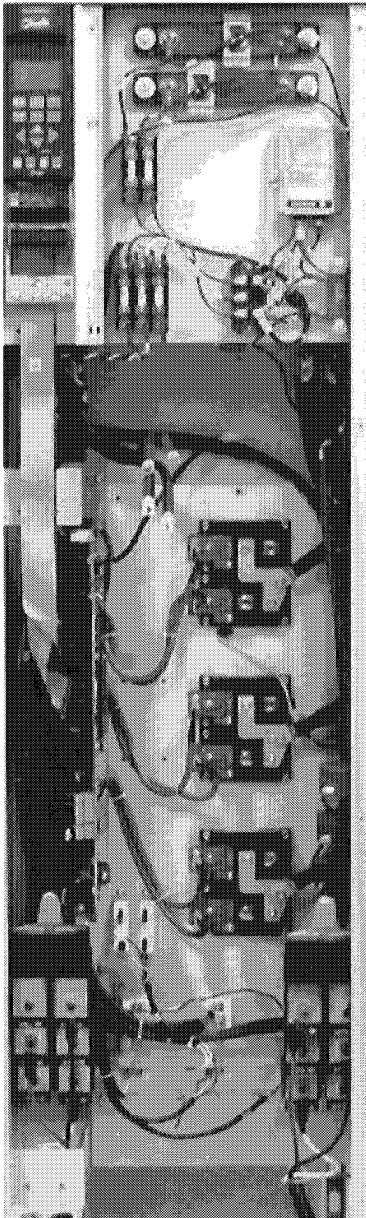

Photo 14

VLT 5125 - 5150 CHASSIS/NEMA 1/IP20

Removing the control card:

1. Remove the black front plastic piece.
2. Loosen the two T20 torx captive screws to free the cassette.
3. Lift the cassette from the bottom until its approximately at a 45° angle.
4. Unplug the two ribbon cables from the control card.
5. Push the cassette upwards to free it from the top hooks.
6. To replace the control card follow the instructions included with the spare part.

To reinstall the control card reverse the procedure.

Torque specifications: T20 screws to 8 Lb-In (1 NM).

Cable placement: The ribbon cables are made such that when laid flat the correct cable will be aligned to the proper connector or as installed the top power card connector mates to the lower control card connector.

Removing the cable tray:

On these units the removal of the capacitor bank and power card will be much easier if the control wiring cable tray is removed first.

1. Remove the black front plastic cover.
2. Remove the plexi-glass cover from the tray by removing the four T20 torx screws.
3. Remove the four M10 standoffs.
4. Remove the T20 screw that secures the stiffener to the cable tray at the bottom of the unit.
5. Unplug the ribbon cables from the power card.
6. Remove the two T20 screws at the top of the cable tray.
7. The cable tray is now free. Rotate the right edge of the tray to the left and lift out the tray.

To reinstall the cable tray reverse the procedure. Torque the T20 and M10 hardware to 16 Lb-in or 1.8 NM.

Removing the capacitor bank:

1. Remove the three T20 torx screws securing the power card bracket to the capacitor bank .
2. Remove the three T20 torx screws securing the grounding bracket to the power card.
3. Remove the four T30 torx screws from the +Bus and –Bus connections.
4. Remove the six T30 torx screws from the cap bank to IGBT connections.
5. Remove the wires from the three M8 studs at the bottom of the capacitor bank.
6. While supporting the capacitor bank, remove the four M10 locknuts.
7. Carefully remove the capacitor bank from the VLT.

To reinstall the capacitor bank reverse the procedure.

Torque specifications:

- T20 screws to 8 Lb-In (1 NM)
- T30 screws for IGBT's 35 Lb-In (4 NM)
- T30 screws for + and –Bus 27 lb-In (3 NM)
- M8 locknuts to 16 Lb-In (2 NM)
- M10 locknuts to 27 Lb-In (3 NM)

Cable placement: Reconnect the wires to the studs at the bottom of the capacitor bank. First connect the white wire to the center stud. The shorter black wire from that same cable assembly connects to the inner most stud and the longer black wire to the outer most stud. If a brake is installed in the VLT then there will also be a 10 gauge wire attached to the inner most stud and a 4 gauge wire attached to the outer most stud.

Removing the power card:

1. Unplug the three cable assemblies that attach to the IGBT's. If a brake is installed there will be 4.
2. Unplug the DC bus supply cable.
3. Remove the M10 locknuts from the top and bottom of the power cord to the heat sink mounting bracket.
4. Tilt the power card towards the middle of the unit and remove the connectors.
5. Lift the power card from the VLT.

Note: If the power card is being replaced you must remove the lower mounting bracket from the power card. A new bracket is not supplied with the spare part. The bracket is secured to the power card by means of two T20 screws and 2 nylon swags.

To reinstall the power card reverse the procedure.

Torque specifications: M10 locknuts to 27 Lb-In (3 NM).

Cable placement: As the power card is installed the gate cable assemblies align to the IGBT's from top to bottom. If a brake is installed the bottom cable attaches to the brake IGBT. Connect MK6, MK11 and MK12. The style and arrangement of the cables makes it impossible to make an incorrect connection. Connect the two ribbon cables from the control card. The top power card connector mates to the lower control card connector. Connect the DC bus supply cable to the mating connector.

Removing the current sensors:

Each of the three current sensors is provided with a plug in connector so they can be replaced individually. It is of prime importance that if more than one sensor is removed, when installing the sensors ensure the correct cable is associated with the correct output phase.

1. Remove the T40 torx screw securing the internal motor to the output inductor.
2. Unplug the wire connector at the current sensor.
3. Remove the two 8mm lock nuts securing the sensor to the base plate.
4. Slide the sensor off the end of the cable.

To reinstall the sensor reverse the procedure. Be sure the arrow on the top of the current sensor points towards the output of the VLT.

- Torque the 8mm lock nuts to 16 Lb-In (2 NM)
- Torque the T40 torx screw to 64 Lb-In (7.2 NM)

Removing the IGBT's:

1. Remove the two T30 torx screw that secures the output cable to both upper and lower IGBT.
2. Remove the four T30 torx screws that secure the IGBT to the heatsink.
3. Do not remove the small circuit board mounted to the gate connections of the IGBT. The new spare part will be supplied with this circuit board attached.

Reinstalling the IGBT's:

1. Remove the old thermal pad and insure the heatsink is free of dirt and remaining thermal compound.
2. Align the new thermal pad over the mounting holes in the heatsink.
3. Align the IGBT so the gate connections point towards the middle of the unit.
4. Insert the four T30 torx mounting screws, finger tight.
5. Torque the four T30 torx mounting screws following the pattern shown.

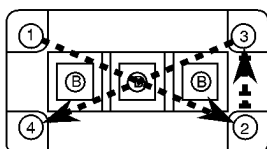

Tighten screws flush with the IGBT and torque initially to 9 Lb-In (1 NM)

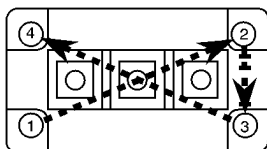

Final torque to 22-30 Lb-In (2.5-3.5 NM)

6. Mount the output lead to the furthest terminal to the right on the IGBT. The lower IGBT will be anchored on the left terminal. Refer to photo 9.
7. Torque the T30 torx screw to 31-39 Lb-In (3.5-4.5 NM).

Removing the Brake IGBT:

1. Remove the two T30 torx screw that make the bus connection from the snubber card to the IGBT.
2. Remove the two T20 torx screws that make the gate connection from the snubber card to the IGBT..
3. Remove the two T20 torx screw at the K1 and K2 positions, remove the bus wire.
4. Remove the snubber card.
5. Remove the four T30 torx screws that secure the IGBT to the heatsink.
6. Remove the IGBT. Also remove the two M4 standoffs from the gate connections of the IGBT. The new spare part does not include these standoffs.

Now that the snubber board is removed this is a good time to check the components on the board to ensure they are functional.

Testing the Brake Snubber Board:

1. The two diodes, D1 and D2, provide transient suppression for the gate of the IGBT. With a VOM set to read diodes, measure the two diodes and look for a voltage drop in one direction, infinity in the other.
2. Resistors R1 - R9 are 1ohm resistors in parallel. Place an ohmmeter across terminal K1 and Cap 2. The resistance value will be equal to .11ohm. Most meters will not read this low resistance accurately so the important thing is to insure the resistance value is close without a short circuit or open being present.
3. The two large diodes on the board is the snubber diode. With a VOM set to read diodes measure the diode and look for a voltage drop in one direction, infinity in the other.

Reinstalling the Brake IGBT:

1. Remove the old thermal pad and insure the heatsink is free of dirt and remaining thermal compound.
2. Align the new thermal pad on the heatsink.
3. Align the IGBT so the gate connections point towards the upper left hand side of the unit.
4. Insert the four T30 torx mounting screws, finger tight.
5. Torque the four T30 torx mounting screws following the pattern shown.

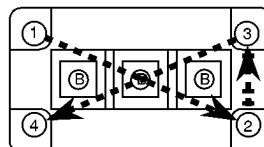

Tighten screws flush with the IGBT and torque initially to 9 Lb-In (1 NM)

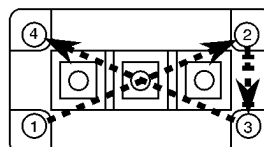

Final torque to 22-30 Lb-In (2.5-3.5 NM)

6. Insert the M4 standoffs in the IGBT gate connections and torque to 13 Lb-In (1.5 NM).
7. Align the bus bars over the IGBT connections and place the snubber board on the IGBT.
8. Insert the two T30 screws in the power connections making sure the bus bar and IGBT connections are made. Torque to 35 Lb-In (4 NM).
9. Insert the two T20 screws, with washers, in the gate connections and torque to 13 Lb-In (1.5 NM).
10. Reconnect the bus wire to K1 and K2 with two T20 screws and torque to 13 Lb-In (1.5 NM).

Removing the SCR/Diode modules:

1. Remove or loosen the six T30 torx screws that secure the bus bars to the top of the modules.
Remove the input line connection to the failed or defective SCR.
2. Remove the two T30 torx screws that secure the module to the heatsink.
3. Unplug the gate connector from the module.

Reinstalling the SCR/Diode modules:

1. Remove the old thermal pad and insure the heatsink is free of dirt and remaining thermal compound.
2. Align the new thermal pad over the mounting holes in the heatsink.
3. Align the module so the gate connections point towards the outside of the unit.
4. Insert the two T30 torx mounting screws, finger tight.
5. Torque the two T30 torx mounting screws following the pattern shown.
6. Insert the six bus bar screws and secure finger tight.
7. Torque each module following the patterns shown:
8. Plug the gate connector on to the module.

For VLT 5125-5150

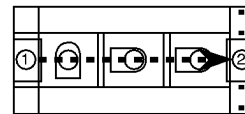

Tighten screws flush with the IGBT and torque initially to:
Torque A; 15 Lb-In (1.5 NM) Torque B; 9 Lb-In (1 NM)

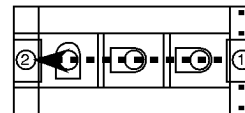

Final torque to:
Torque A; 44 Lb-In (5 NM) Torque B; 44 Lb-In (5 NM)

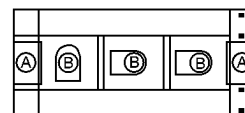

DISASSEMBLY INSTRUCTIONS

**VLT 5200 - 5250
NEMA 12/IP54**

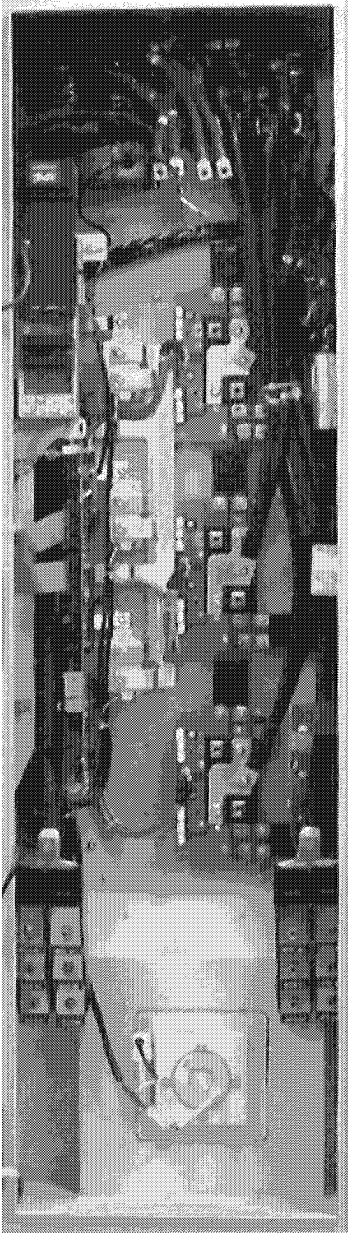

Photo 15

VLT 5200 - 5250 NEMA 12/IP54

Removing the control card:

1. Disconnect the cable going to the local control panel.
2. Loosen the two T20 torx captive screws to free the cassette.
3. Lift the cassette from the bottom until its approximately at a 45° angle.
4. Unplug the two ribbon cables from the control card.
5. Push the cassette upwards to free it from the top hooks.
6. To replace the control card follow the instructions included with the spare part.

To reinstall the control card reverse the procedure.

Torque specifications: T20 screws to 8 Lb-In (1 NM).

Cable placement: The ribbon cables are made such that when laid flat the correct cable will be aligned to the proper connector or as installed the top power card connector mates to the lower control card connector.

Removing the capacitor bank:

1. Remove the black shield covering the capacitor bank by removing the three T20 torx screws.
2. Remove the three T20 torx screws securing the grounding bracket to the power card.
3. Remove the four T30 torx screws from the +Bus and -Bus connections.
4. Remove the six T30 torx screws from the cap bank to IGBT connections.
5. Remove the six T20 torx screws from the cap bank to IGBT snubber board connections.
6. If a brake is installed, remove the wires from the three M8 studs at the bottom of the capacitor bank.
7. While supporting the capacitor bank, remove the four M10 locknuts.
8. Carefully remove the capacitor bank from the VLT.

NOTE: Now that the capacitor bank has been removed this is a good time to test the condition of the snubber boards.

Testing snubber boards:

Only in the VLT 5200 and 5250 is the snubber board a removable spare part. Part of this board are the snubber diodes, capacitors and resistors. Also found on the board are two smaller devices which appear to be diodes but are actually transorbs, transient suppression devices. These two transorbs are marked D3 and D4 and are placed across the gate of the IGBT to suppress transient energy. For this reason as soon as the snubber card is removed from the IGBT's the gates of the IGBT's should be shorted together to protect them from transient static electricity. Refer to photo 16.



Photo 16

IGBT with Snubber Board VLT 5200 - 5250

Use a digital ohmmeter set on diode scale or an analog meter set on RX100.

Checking the snubber diodes, D1 and D2:

1. Connect the positive (+) meter lead to the large tab and the negative (-) meter lead to the small tab. The result should be a diode drop.
2. Reverse the meter leads, the reading should be infinity.
3. Repeat the same procedure on all the snubber diodes.

Should the diodes read incorrectly the entire snubber board is to be replaced. If a snubber diode is found shorted, the IGBT in that phase should also be replaced even if they have tested good. See "Removing the IGBT's".

Checking the transorbs, D3 and D4:

1. Set your ohmmeter to read on the highest scale. Check each device with the meter leads in one direction and then in the other. Both readings should be infinity.
2. Repeat this same procedure on all transorbs.

Should a transorb read incorrectly the entire snubber board is to be replaced. If a transorb is shorted it is likely that its corresponding IGBT is also defective. It too should be replaced. See "Removing the IGBT's".

To reinstall the capacitor bank reverse the procedure.

Torque specifications:

T20 screws for the IGBT's snubber board 14 Lb-In (2 NM)

Other T20 screws to 8 Lb-In (1 NM)

T30 screws for IGBT's 84 Lb-In (9.5 NM)

T30 screws for + and -Bus 27 lb-In (3 NM)

M8 locknuts to 16 Lb-In (2 NM)

M10 locknuts to 27 Lb-In (3 NM)

Cable placement: Reconnect the wires to the studs at the bottom of the capacitor bank. First connect the white wire to the center stud. The shorter black wire from that same cable assembly connects to the inner most stud and the longer black wire to the outer most stud. If a brake is installed in the VLT then there will also be a 10 gauge wire attached to the inner most stud and a 4 gauge wire attached to the outer most stud.

Removing the power card:

1. Unplug the three cable assemblies that attach to the IGBT's. If a brake is installed there will be 4.
2. Unplug the DC bus supply cable.
3. Remove the M10 locknuts from the top and bottom of the lower mounting bracket.
4. Tilt the power card towards the middle of the unit and remove the connectors.
5. Lift the power card from the VLT.

Note: If the power card is being replaced you must remove the power card mounting bracket from the power card. A new bracket is not supplied with the spare part. The bracket is secured to the power card by means of two T20 screws and 2 nylon swags.

To reinstall the power card reverse the procedure.

Torque specifications: M10 locknuts to 27 Lb-In (3 NM).

Cable placement: As the power card is installed the gate cable assemblies align to the IGBT's from top to bottom. If a brake is installed the bottom cable attaches to the brake IGBT. Connect MK6, MK11 and MK12. The style and arrangement of the cables makes it impossible to make an incorrect connection. Connect the two ribbon cables from the control card. The top power card connector mates to the lower control card connector. Connect the DC bus supply cable to the mating connector.

Removing the IGBT's:

Caution: IGBT's are sensitive to static electricity. Once the snubber board is removed a jumper must be placed across the gate leads of the IGBT.

Note: If an IGBT is found defective ensure the snubber board has been tested as described above. Always replace both IGBT's in the damaged phase even if the other IGBT tested good.

1. Remove the snubber board by removing the four T20 screws from the gate connections and the two T20 screws securing the board to the jumper bus bar.
2. Remove the two T30 torx screw that secure the bus bar jumper to the two IGBT's.
3. Remove the four T30 torx screws that secure the IGBT to the heatsink.

Reinstalling the IGBT's:

1. Remove the thermal pad and insure the heatsink is free of dirt and remaining thermal compound.
2. Align the new thermal pad over the mounting holes in the heatsink.
3. Align the IGBT so the gate connections point towards the middle of the unit.
4. Insert the four T30 torx mounting screws, finger tight.
5. Torque the four T30 torx mounting screws following the pattern shown.

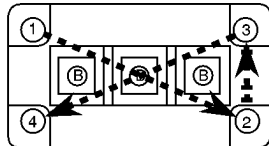

Tighten screws flush with the IGBT and torque initially to 10 Lb-In (1.5 NM)

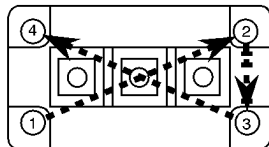

Final torque to 31-39 Lb-In (3.5-4.5 NM)

6. Mount the bus bar jumper to the two IGBT's. Reference photo 10.
7. Torque the T30 torx screws to 66-84 Lb-In (7.5-9.5 NM).
8. Install the snubber board aligning the wholes with the IGBT's.
9. Torque the 6 T20 screws to 12-15 Lb-In (1.3-1.7 NM).

Removing the Brake IGBT:

1. Remove the two T30 torx screw that make the bus connection from the snubber card to the IGBT.
2. Remove the two T20 torx screws that make the gate connection from the snubber card to the IGBT..
3. Remove the T20 torx screws at the K1, K2 and K3 positions, remove the bus wire.
4. Remove the snubber card.
5. Remove the four T30 torx screws that secure the IGBT to the heatsink.
6. Remove the IGBT. Also remove the two M4 standoffs from the gate connections of the IGBT. The new spare part does not include these standoffs.

Now that the snubber board is removed this is a good time to check the components on the board to ensure they are functional.

Testing the Brake Snubber Board:

1. The two diodes, D1 and D2, provide transient suppression for the gate of the IGBT. With a VOM set to read diodes, measure the two diodes and look for a voltage drop in one direction, infinity in the other.
2. Resistors R1 - R12 are 1ohm resistors in parallel. Place an ohmmeter across terminal K1 and Cap 2. The resistance value will be equal to .08ohm. Most meters will not read this low resistance accurately so the important thing is to insure the resistance value is close without a short circuit or open being present.
3. The two large diodes on the board is the snubber diode. With a VOM set to read diodes measure the diode and look for a voltage drop in one direction, infinity in the other.

Reinstalling the Brake IGBT:

1. Remove the old thermal pad and insure the heatsink is free of dirt and remaining thermal compound.
2. Align the new thermal pad on the heatsink.
3. Align the IGBT so the gate connections point towards the upper left hand side of the unit.
4. Insert the four T30 torx mounting screws, finger tight.
5. Torque the four T30 torx mounting screws following the pattern shown.

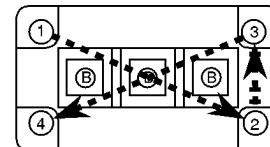

Tighten screws flush with the IGBT and torque initially to 9 Lb-In (1 NM)

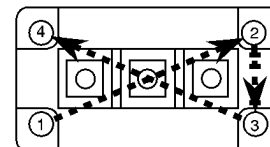

Final torque to 22-30 Lb-In (2.5-3.5 NM)

6. Insert the M4 standoffs in the IGBT gate connections and torque to 13 Lb-In (1.5 NM).
7. Align the bus bars over the IGBT connections and place the snubber board on the IGBT.
8. Insert the two T30 screws in the power connections making sure the bus bar and IGBT connections are made. Torque to 35 Lb-In (4 NM).
9. Insert the two T20 screws, with washers, in the gate connections and torque to 13 Lb-In (1.5 NM).
10. Reconnect the bus wire to K1 and K2 with two T20 screws and torque to 13 Lb-In (1.5 NM).

Removing the SCR/Diode modules:

1. Remove or loosen the six T30 Drive Dependent torx screws that secure the bus bars to the top of the modules. Remove the input line connection to the failed or defective SCR.
2. Remove the additional T30 torx screws from the module being replaced.
3. Remove the four T30 torx screws that secure the module to the heatsink.
4. Unplug the gate connector from the module.
5. Slide the module out from under the bus bars.

Reinstalling the SCR/Diode modules:

1. Remove the thermal pad and insure the heatsink is free of dirt and remaining thermal compound.
2. Align the new thermal pad over the mounting holes in the heatsink.
3. Align the module so the gate connections point towards the bottom of the unit.
4. Insert the four T30 torx mounting screws, finger tight.
5. Torque the mounting screws following the pattern shown.
6. Insert the six bus bar screws and secure finger tight.
7. Torque each module following the pattern below:

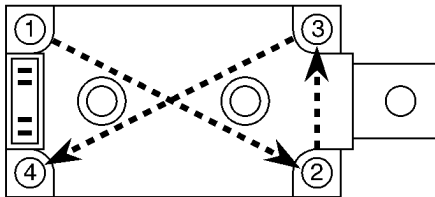

Tighten screws flush with the IGBT and torque initially to:
Torque A; 15 Lb-In (1.5 NM) Torque B; 26 Lb-In (3 NM)

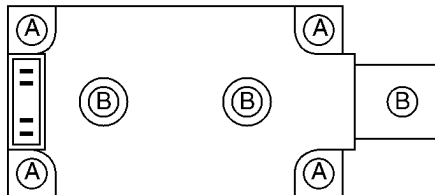

Final torque to:
Torque A; 44 Lb-In (5 NM) Torque B; 80 Lb-In (9 NM)

8. Plug the gate connector on to the module.

Removing the current sensors:

Each of the three current sensors is provided with a plug in connector so they can be replaced individually. It is of prime importance that if more than one sensor is removed, when installing the sensors ensure the correct cable is associated with the correct output phase.

1. Loosen the 5/16 (8mm) hex screw securing the internal motor cable to the splicer block.
2. Unplug the wire connector at the current sensor.
3. Remove the two 8mm lock nuts securing the sensor to the base plate.
4. Slide the sensor off the end of the cable.

Note: For installing the wire into splicer block refer to photo below.

To reinstall the sensor reverse the procedure. Be sure the arrow on the top of the current sensor points towards the output of the VLT.

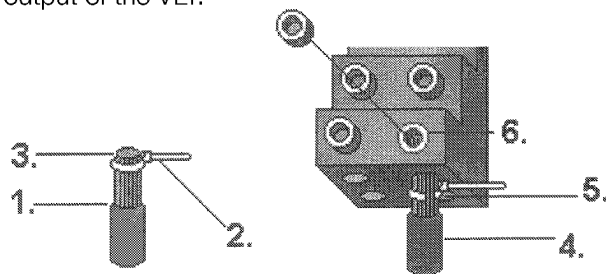

Torque the 8mm lock nuts to 16 Lb-In (2 NM)
Torque the 5/16 (8mm) hex screws to 120 Lb-In (14 NM)

DISASSEMBLY INSTRUCTIONS

VLT 5200 - 5250 CHASSIS/NEMA1/IP20

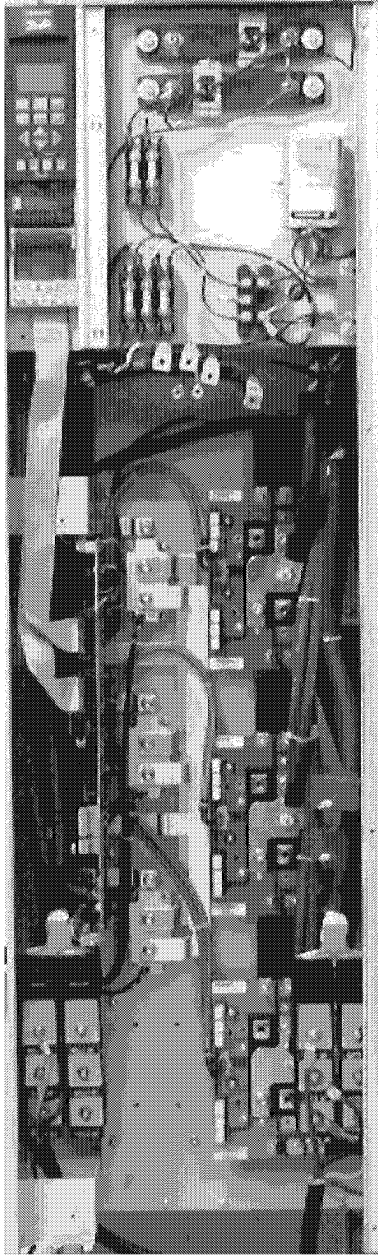

Photo 17

VLT 5200 - 5250 CHASSIS/NEMA 1/IP20

Removing the control card:

1. Remove the black front plastic piece.
2. Loosen the two T20 torx captive screws to free the cassette.
3. Lift the cassette from the bottom until its approximately at a 45° angle.
4. Unplug the two ribbon cables from the control card.
5. Push the cassette upwards to free it from the top hooks.
6. To replace the control card follow the instructions included with the spare part.

To reinstall the control card reverse the procedure.
Torque specifications: T20 screws to 8 Lb-In (1 NM).
Cable placement: The ribbon cables are made such that when laid flat the correct cable will be aligned to the proper connector or as installed the top power card connector mates to the lower control card connector.

Removing the cable tray:

On these units the removal of the capacitor bank and power card will be much easier if the control wiring cable tray is removed first.

1. Remove the black front plastic cover.
2. Remove the plexi-glass cover from the tray by removing the four T20 torx screws.
3. Remove the four M10 standoffs.
4. Remove the T20 screw that secures the stiffener to the cable tray at the bottom of the unit.
5. Unplug the ribbon cables from the power card.
6. Remove the two T20 screws at the top of the cable tray.
7. The cable tray is now free. Rotate the right edge of the tray to the left and lift out the tray.

To reinstall the cable tray reverse the procedure. Torque the T20 and M10 hardware to 16 Lb-in or 1.8 NM.

Removing the capacitor bank:

1. Remove the three T20 torx screws securing the power card to the capacitor bank.
2. Remove the three T20 torx screws securing the grounding bracket to the power card.
3. Remove the four T30 torx screws from the +Bus and -Bus connections.
4. Remove the six T30 torx screws from the cap bank to IGBT connections.
5. Remove the six T20 torx screws from the cap bank to the IGBT snubber board connections.
6. If a brake is installed, remove the wires from the three M8 studs at the bottom of the capacitor bank.
7. While supporting the capacitor bank, remove the four M10 locknuts.
8. Carefully remove the capacitor bank from the VLT and set upright.

NOTE: Now that the capacitor bank has been removed this is a good time to test the condition of the snubber boards.

Testing snubber boards:

Only in the VLT 5200 and 5250 is the snubber board a removable spare part. Part of this board are the snubber diodes, capacitors and resistors. Also found on the board are two smaller devices which appear to be diodes but are actually transorbs, transient suppression devices. These two transorbs are marked D3 and D4 and are placed across the gate of the IGBT to suppress transient energy. For this reason as soon as the snubber card is removed from the IGBT's the gates of the IGBT's should be shorted together to protect them from transient static electricity. Reference photo 18.

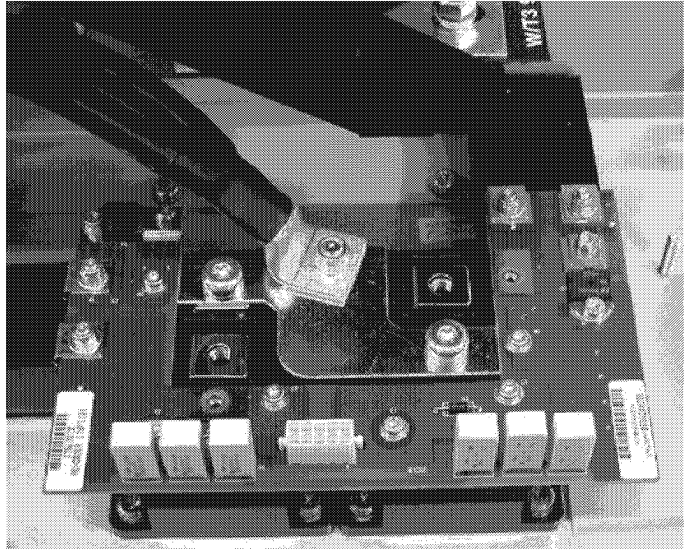

IGBT with Snubber Board VLT 5200 - 5250

Photo 18

Use a digital ohmmeter set on diode scale or an analog meter set on RX100.

Checking the snubber diodes, D1 and D2:

1. Connect the positive (+) meter lead to the large tab and the negative (-) meter lead to the small tab. The result should be a diode drop.
2. Reverse the meter leads, the reading should be infinity.
3. Repeat the same procedure on all the snubber diodes.

Should the diodes read incorrectly the entire snubber board is to be replaced. If a snubber diode is found shorted, the IGBT in that phase should also be replaced even if they have tested good. See "Removing the IGBT's".

Checking the transorbs, D3 and D4:

1. Set your ohmmeter to read on the highest scale. Check each device with the meter leads in one direction and then in the other. Both readings should be infinity.
2. Repeat this same procedure on all transorbs.

Should a transorb read incorrectly the entire snubber board is to be replaced. If a transorb is shorted it is likely that its corresponding IGBT is also defective. It too should be replaced. See "Removing the IGBT's".

To reinstall the capacitor bank reverse the procedure.

Torque specifications:

- T20 screws for the IGBT's snubber board 14 Lb-In (2 NM)
- Other T20 screws to 8 Lb-In (1 NM)
- T30 screws for IGBT's 84 Lb-In (9.5 NM)
- T30 screws for + and -Bus 27 lb-In (3 NM)
- M8 locknuts to 16 Lb-In (2 NM)
- M10 locknuts to 27 Lb-In (3 NM)

Cable placement: Reconnect the wires to the studs at the bottom of the capacitor bank. First connect the white wire to the center stud. The shorter black wire from that same cable assembly connects to the inner most stud and the longer black wire to the outer most stud. If a brake is installed in the VLT then there will also be a 10 gauge wire attached to the inner most stud and a 4 gauge wire attached to the outer most stud.

Removing the power card:

1. Unplug the three cable assemblies that attach to the IGBT's. If a brake is installed there will be 4.
2. Unplug the DC bus supply cable.
3. Remove the M10 locknuts from the top and bottom of the lower mounting bracket.
4. Tilt the power card towards the middle of the unit and remove the connectors.
5. Lift the power card from the VLT.

Note: If the power card is being replaced you must remove the lower mounting bracket from the power card. A new bracket is not supplied with the spare part. The bracket is secured to the power card by means of two T20 screws and 2 nylon swags.

To reinstall the power card reverse the procedure.

Torque specifications: M10 locknuts to 27 Lb-In (3 NM).

Cable placement: As the power card is installed the gate cable assemblies align to the IGBT's from top to bottom. If a brake is installed the bottom cable attaches to the brake IGBT. Connect MK6, MK11 and MK12. The style and arrangement of the cables makes it impossible to make an incorrect connection. Connect the two ribbon cables from the control card. The top power card connector mates to the lower control card connector. Connect the DC bus supply cable to the mating connector.

Removing the IGBT's:

Caution: IGBT's are sensitive to static electricity. Once the snubber board is removed a jumper must be placed across the gate leads of the IGBT.

Note: If an IGBT is found defective ensure the snubber board has been tested as described above. Always replace both IGBT's in the damaged phase even if the other IGBT tested good.

1. Remove the snubber board by removing the four T20 screws from the gate connections and the two T20 screws securing the board to the jumper bus bar.
2. Remove the two T30 torx screw that secure the bus bar jumper to the two IGBT's.
3. Remove the four T30 torx screws that secure the IGBT to the heatsink.

Reinstalling the IGBT's:

1. Remove the thermal pad and insure the heatsink is free of dirt and remaining thermal compound.
2. Align the new thermal pad over the mounting holes in the heatsink.
3. Align the IGBT so the gate connections point towards the middle of the unit.
4. Insert the four T30 torx mounting screws, finger tight.
5. Torque the four T30 torx mounting screws following the pattern shown.

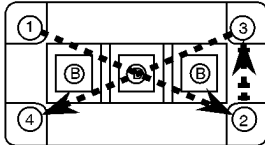

Tighten screws flush with the IGBT and torque initially to 10 Lb-In (1.5 NM)

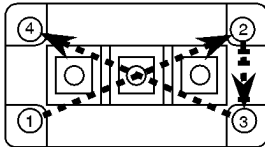

Final torque to 31-39 Lb-In (3.5-4.5 NM)

6. Mount the bus bar jumper to the two IGBT's. Reference photo 10.
7. Torque the T30 torx screws to 66-84 Lb-In (7.5-9.5 NM).
8. Install the snubber board aligning the wholes with the IGBT's.
9. Torque the 6 T20 screws to 12-15 Lb-In (1.3-1.7 NM).

Removing the Brake IGBT:

1. Remove the two T30 torx screw that make the bus connection from the snubber card to the IGBT.
2. Remove the two T20 torx screws that make the gate connection from the snubber card to the IGBT.
3. Remove the T20 torx screws at the K1, K2 and K3 positions, remove the bus wire.
4. Remove the snubber card.
5. Remove the four T30 torx screws that secure the IGBT to the heatsink.
6. Remove the IGBT. Also remove the two M4 standoffs from the gate connections of the IGBT. The new spare part does not include these standoffs.

Now that the snubber board is removed this is a good time to check the components on the board to ensure they are functional.

Testing the Brake Snubber Board:

1. The two diodes, D1 and D2, provide transient suppression for the gate of the IGBT. With a VOM set to read diodes, measure the two diodes and look for a voltage drop in one direction, infinity in the other.
2. Resistors R1 - R12 are 1ohm resistors in parallel. Place an ohmmeter across terminal K1 and Cap 2. The resistance value will be equal to .08ohm. Most meters will not read this low resistance accurately so the important thing is to insure the resistance value is close without a short circuit or open being present.
3. The two large diodes on the board is the snubber diode. With a VOM set to read diodes measure the diode and look for a voltage drop in one direction, infinity in the other.

Reinstalling the Brake IGBT:

1. Remove the old thermal pad and insure the heatsink is free of dirt and remaining thermal compound.
2. Align the new thermal pad on the heatsink.
3. Align the IGBT so the gate connections point towards the upper left hand side of the unit.
4. Insert the four T30 torx mounting screws, finger tight.
5. Torque the four T30 torx mounting screws following the pattern shown.

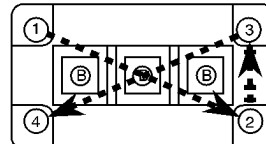

Tighten screws flush with the IGBT and torque initially to 9 Lb-In (1 NM)

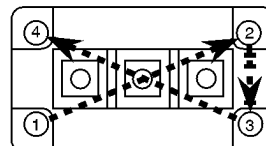

Final torque to 22-30 Lb-In (2.5-3.5 NM)

6. Insert the M4 standoffs in the IGBT gate connections and torque to 13 Lb-In (1.5 NM).
7. Align the bus bars over the IGBT connections and place the snubber board on the IGBT.
8. Insert the two T30 screws in the power connections making sure the bus bar and IGBT connections are made. Torque to 35 Lb-In (4 NM).
9. Insert the two T20 screws, with washers, in the gate connections and torque to 13 Lb-In (1.5 NM).
10. Reconnect the bus wire to K1 and K2 with two T20 screws and torque to 13 Lb-In (1.5 NM).

Removing the SCR/Diode modules:

1. Remove or loosen the six T30 Drive Dependent torx screws that secure the bus bars to the top of the modules. Remove the input line connection to the failed or defective SCR.
2. Remove the additional T30 torx screws from the module being replaced.
3. Remove the four T30 torx screws that secure the module to the heatsink.
4. Unplug the gate connector from the module.
5. Slide the module out from under the bus bars.

Reinstalling the SCR/Diode modules:

1. Remove the thermal pad and insure the heatsink is free of dirt and remaining thermal compound.
2. Align the new thermal pad over the mounting holes in the heatsink.
3. Align the module so the gate connections point towards the bottom of the unit.
4. Insert the four T30 torx mounting screws, finger tight.
5. Torque the mounting screws following the pattern shown.
6. Insert the six bus bar screws and secure finger tight.
7. Torque each module following the pattern below:

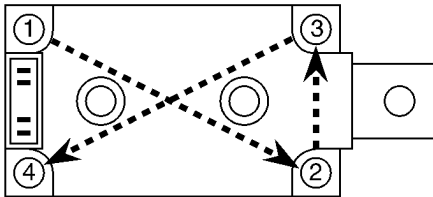

Tighten screws flush with the IGBT and torque initially to:
Torque A; 15 Lb-In (1.5 NM) Torque B; 26 Lb-In (3 NM)

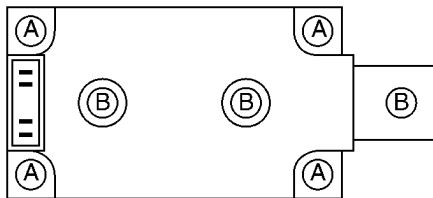

Final torque to:
Torque A; 44 Lb-In (5 NM) Torque B; 80 Lb-In (9 NM)

8. Plug the gate connector on to the module.

Removing the current sensors:

Each of the three current sensors is provided with a plug in connector so they can be replaced individually. It is of prime importance that if more than one sensor is removed, when installing the sensors ensure the correct cable is associated with the correct output phase.

1. Loosen the 5/16 (8mm) hex screw securing the internal motor cable to the splicer block.
2. Unplug the wire connector at the current sensor.
3. Remove the two 8mm lock nuts securing the sensor to the base plate.
4. Slide the sensor off the end of the cable.

Note: For installing the wire into splicer block refer to photo below.

To reinstall the sensor reverse the procedure. Be sure the arrow on the top of the current sensor points towards the output of the VLT 5000.

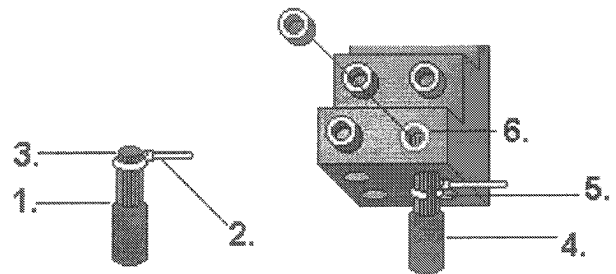

Torque the 8mm lock nuts to 16 Lb-In (2 NM)
Torque the 5/16 (8mm) hex screws to 120 Lb-In (14 NM)

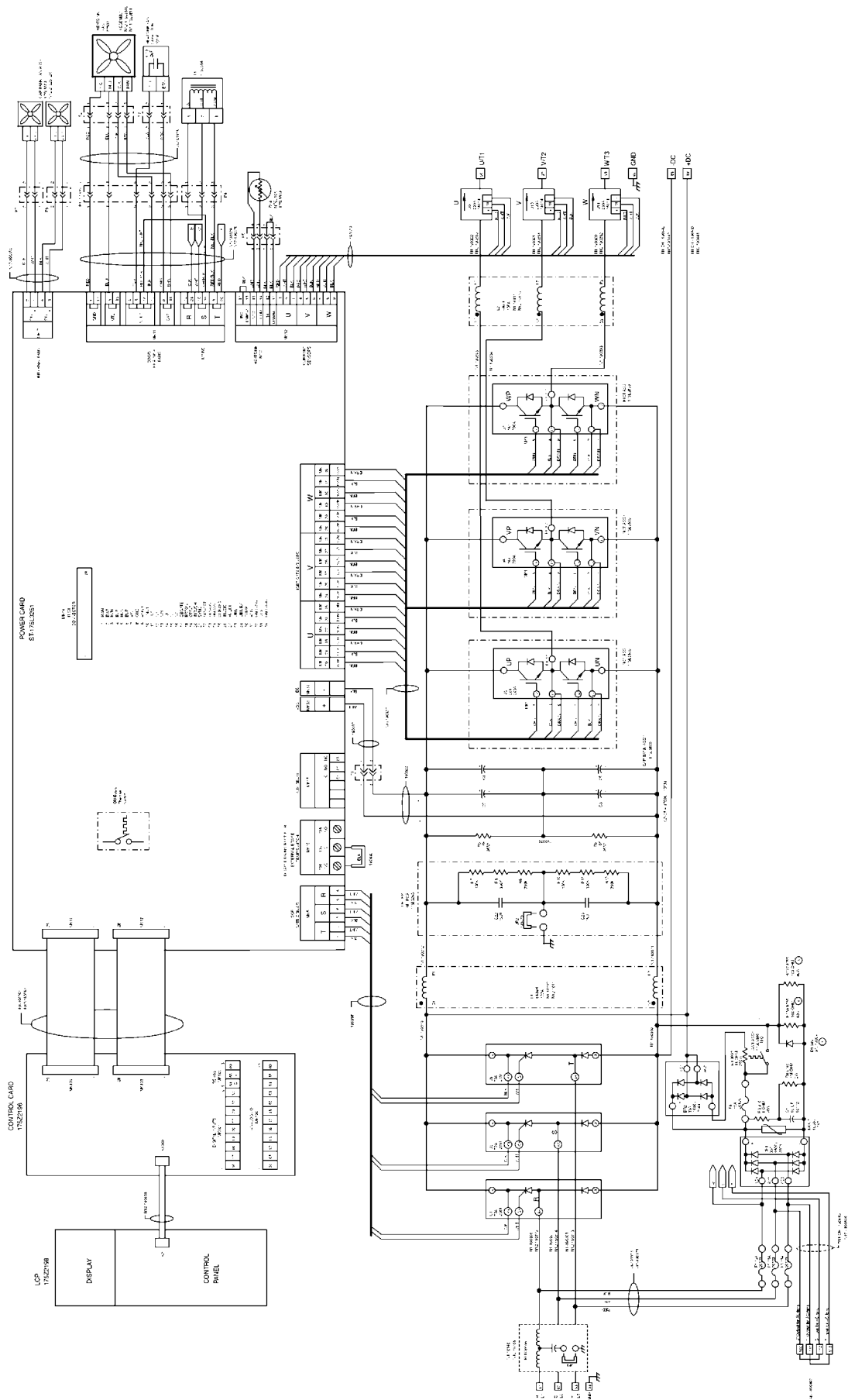

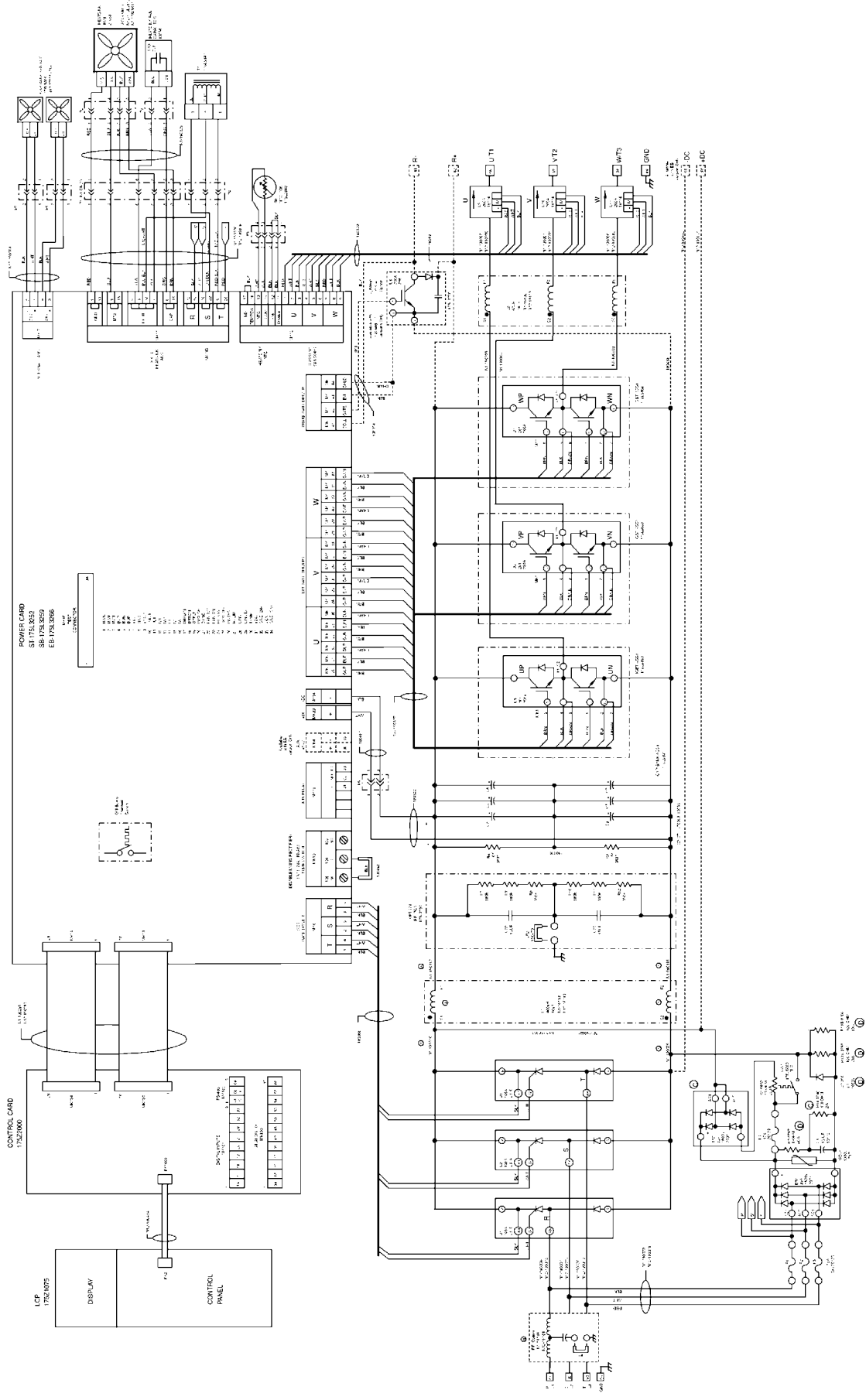

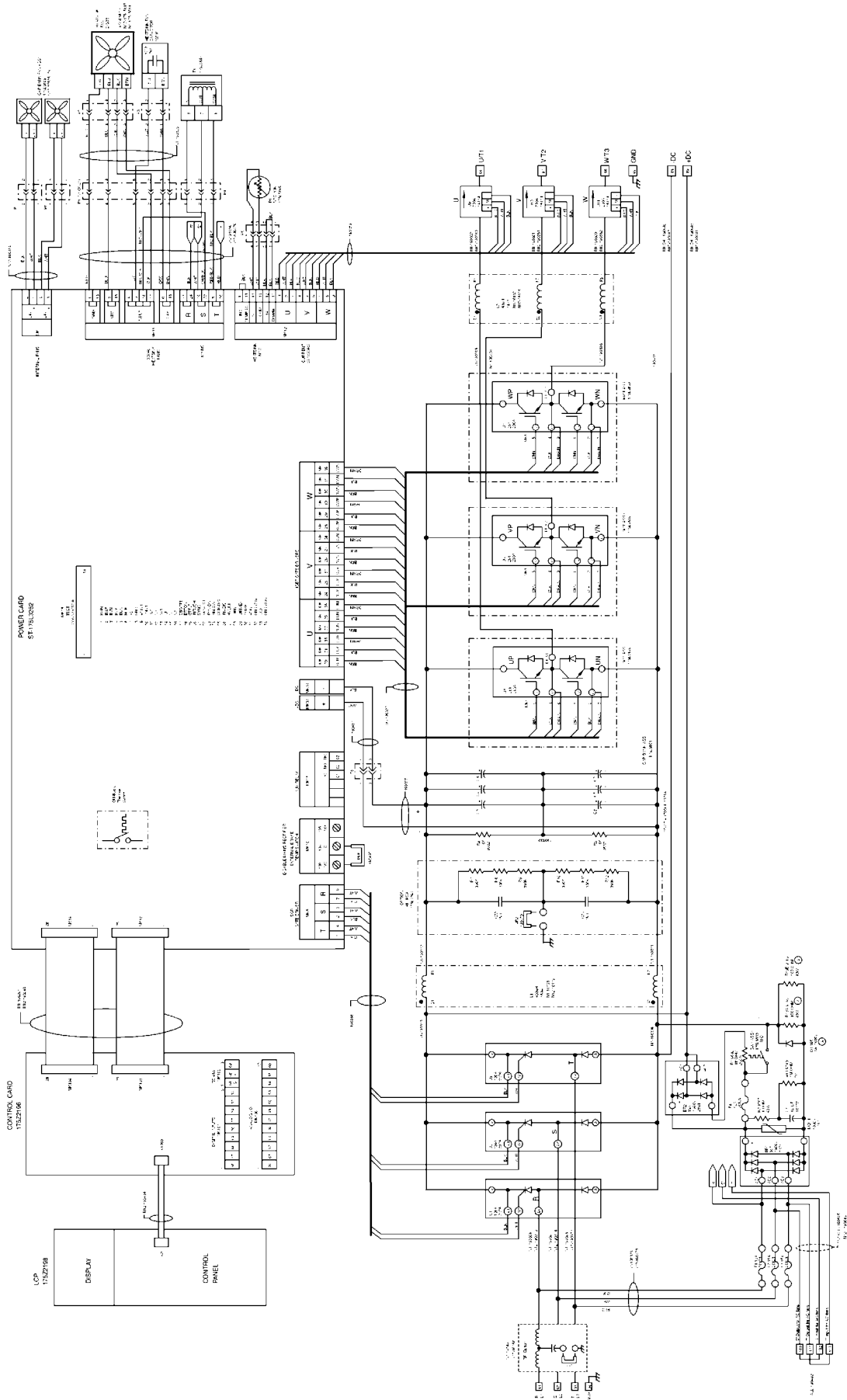

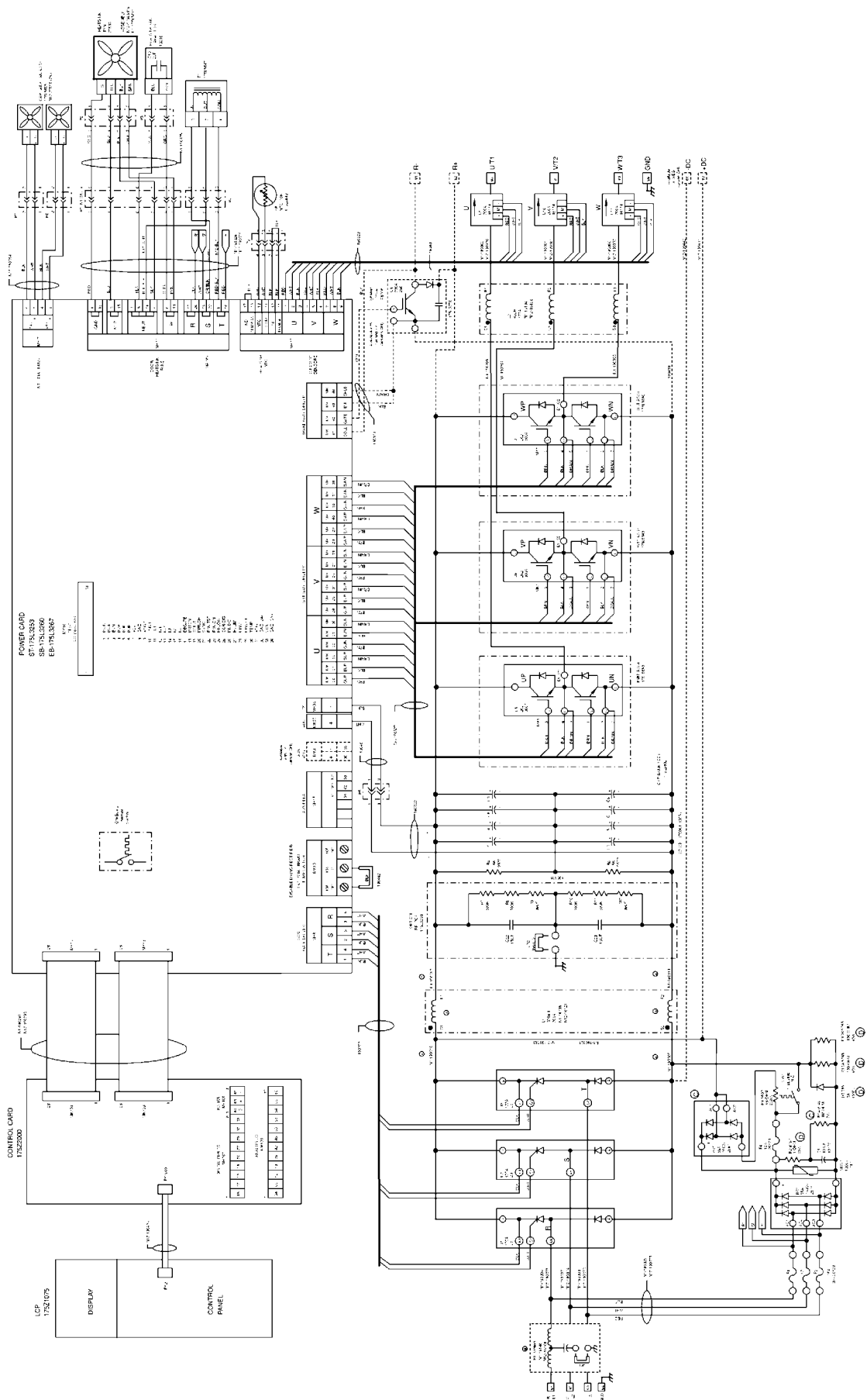

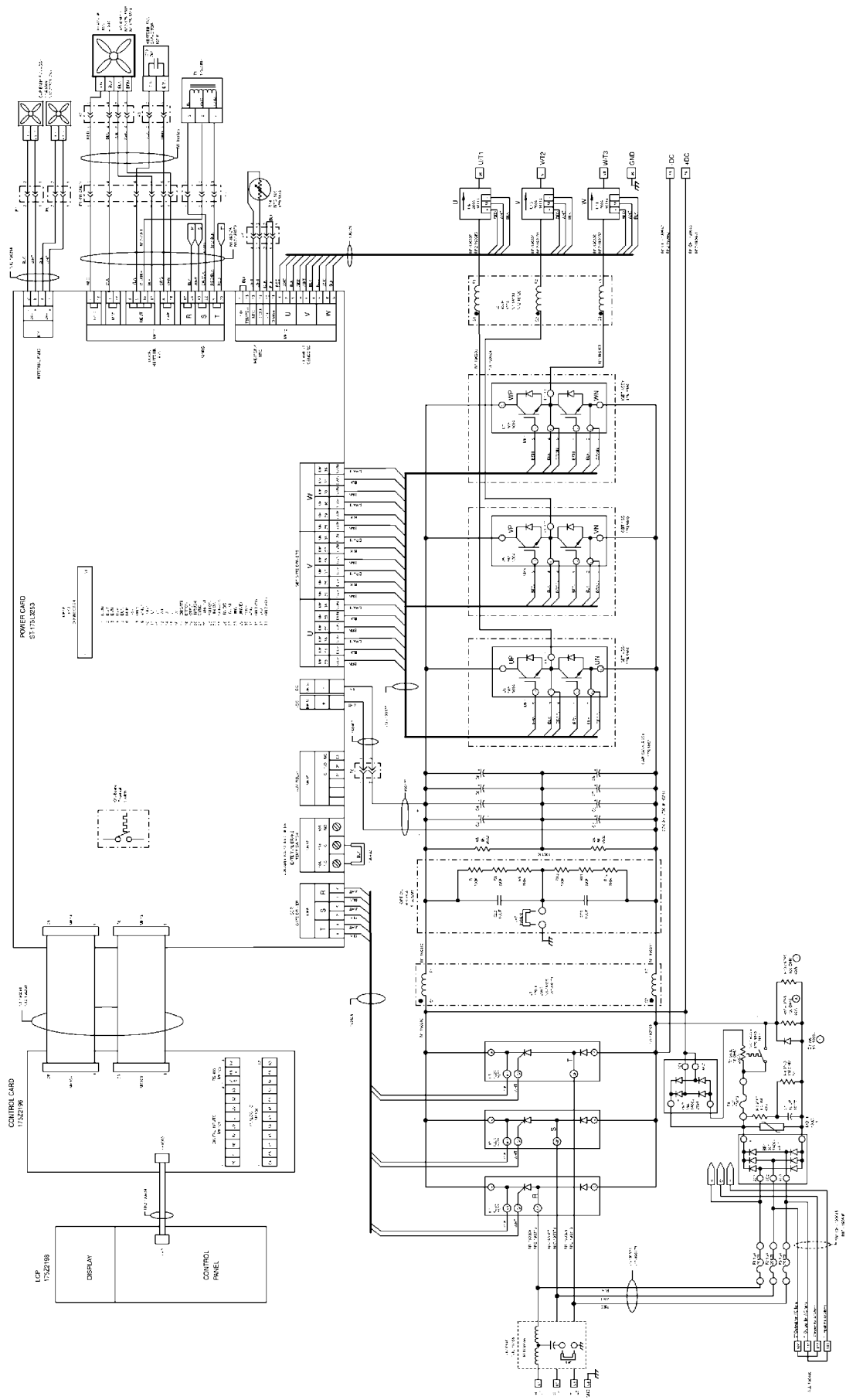

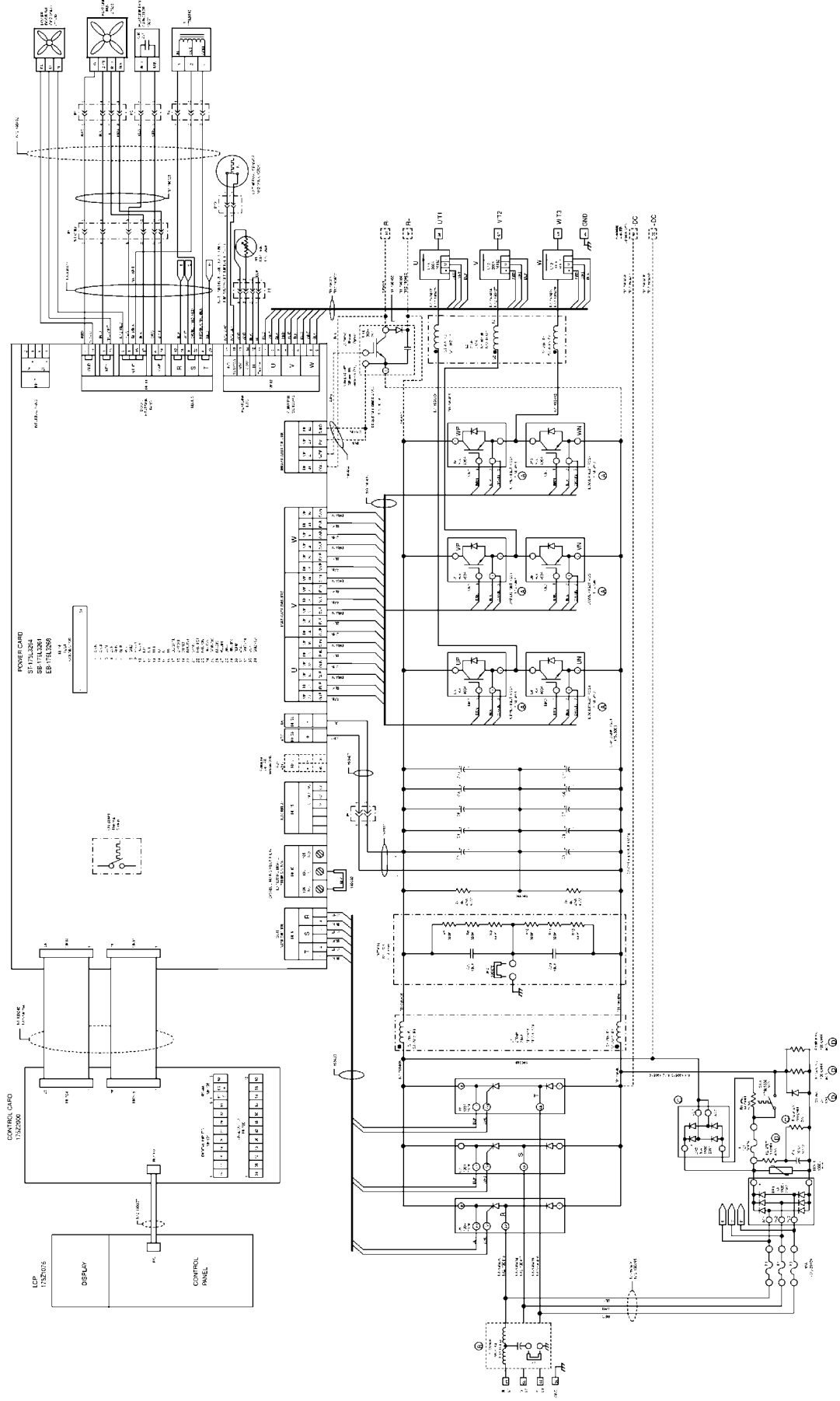

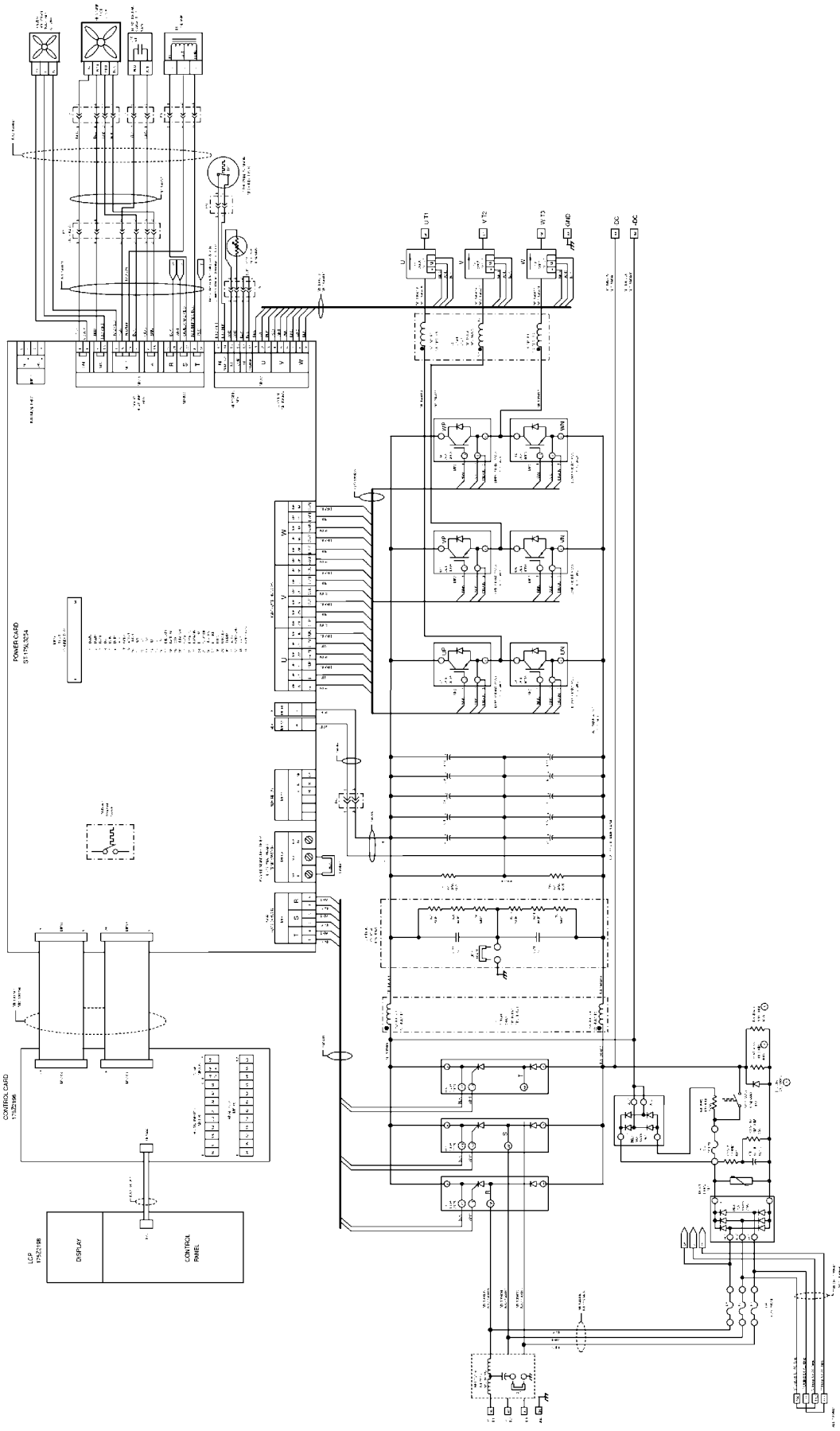

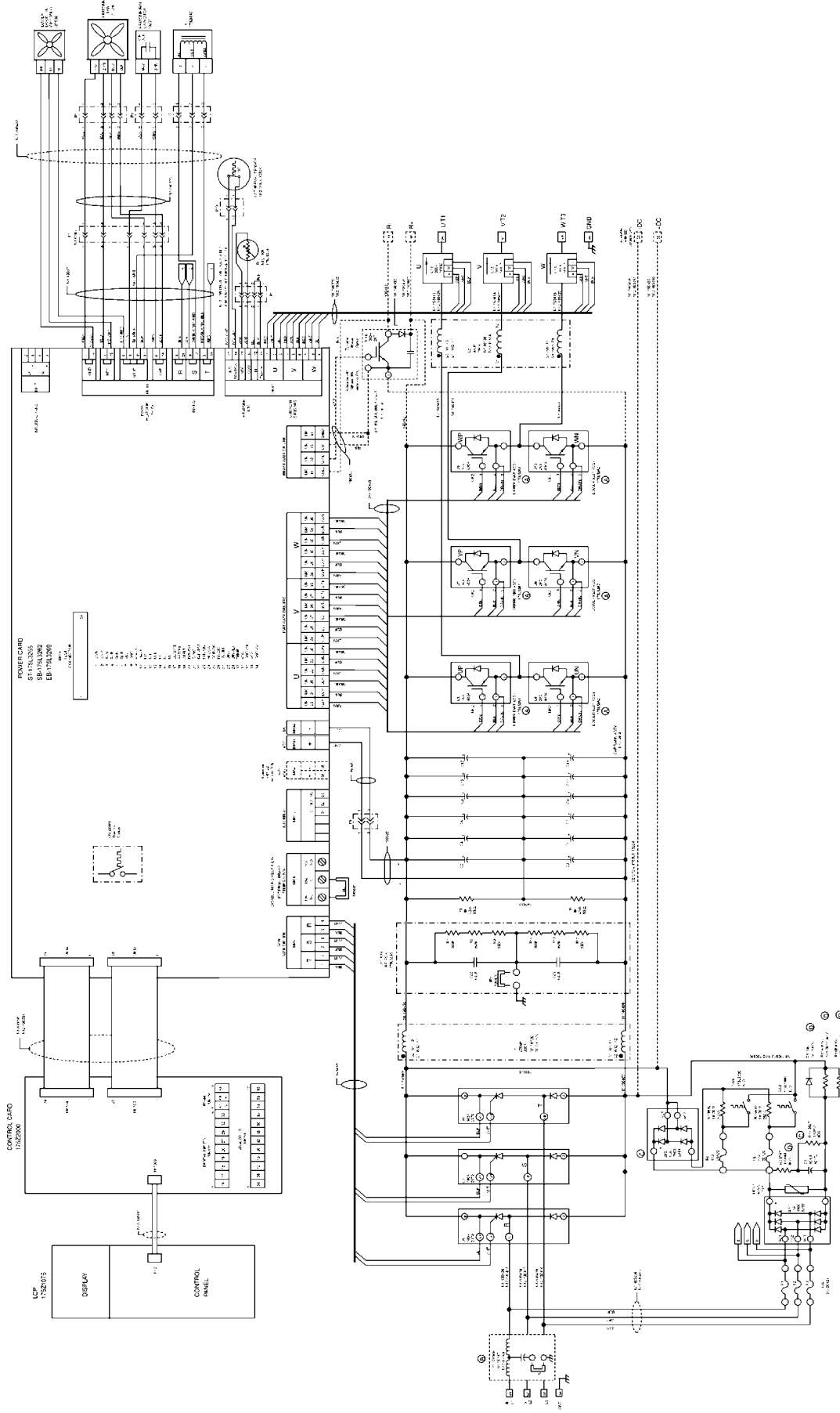

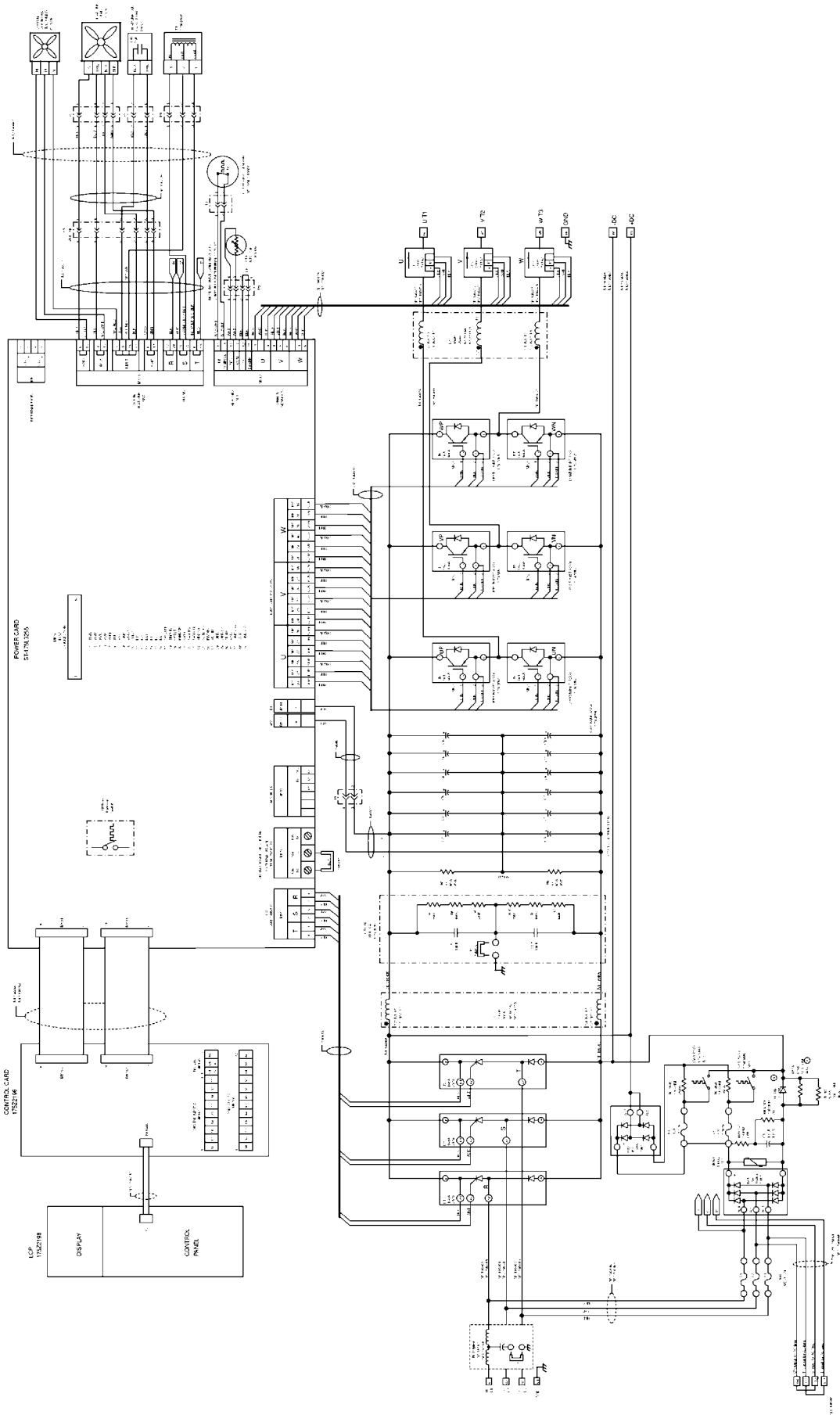

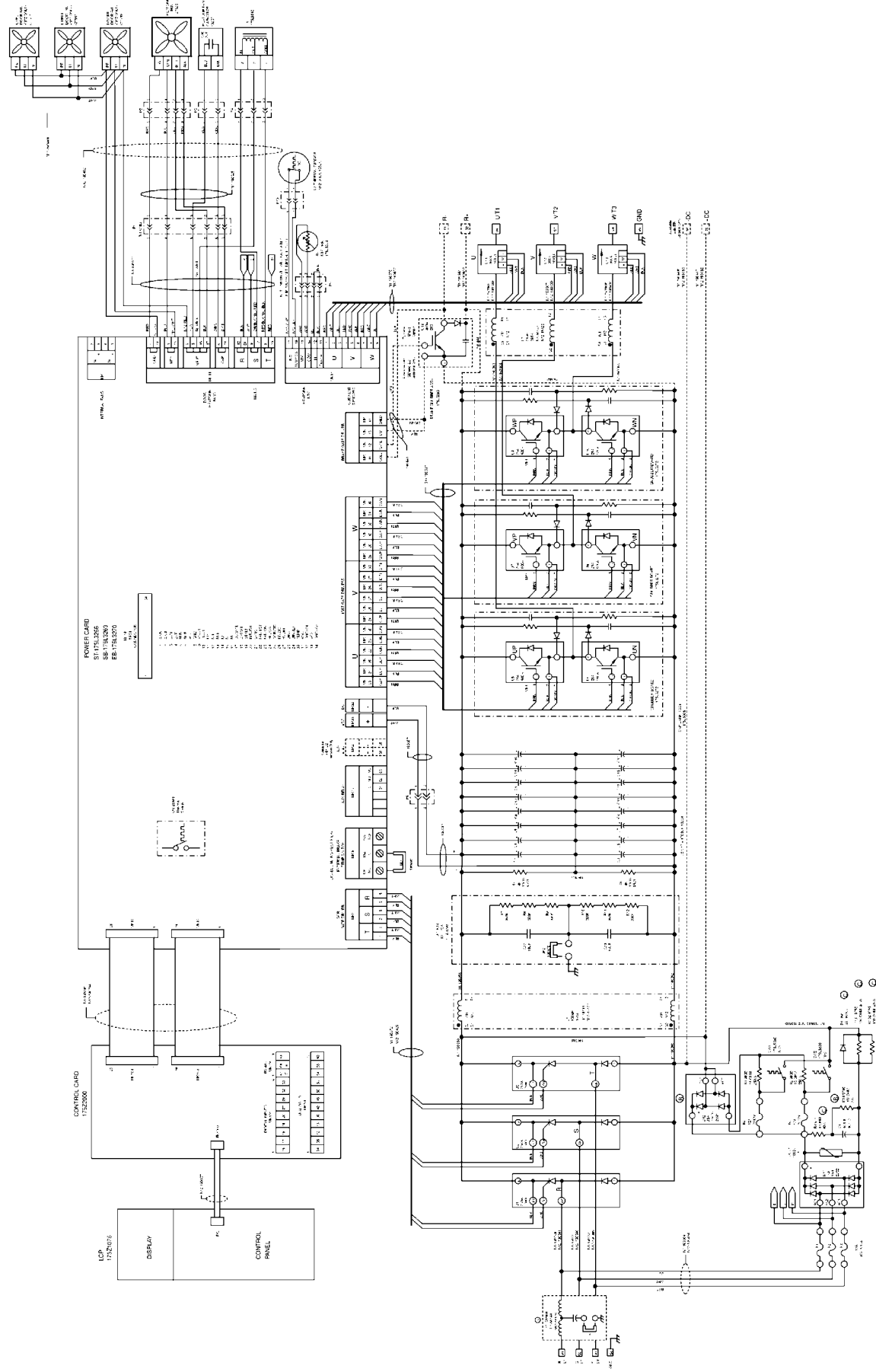

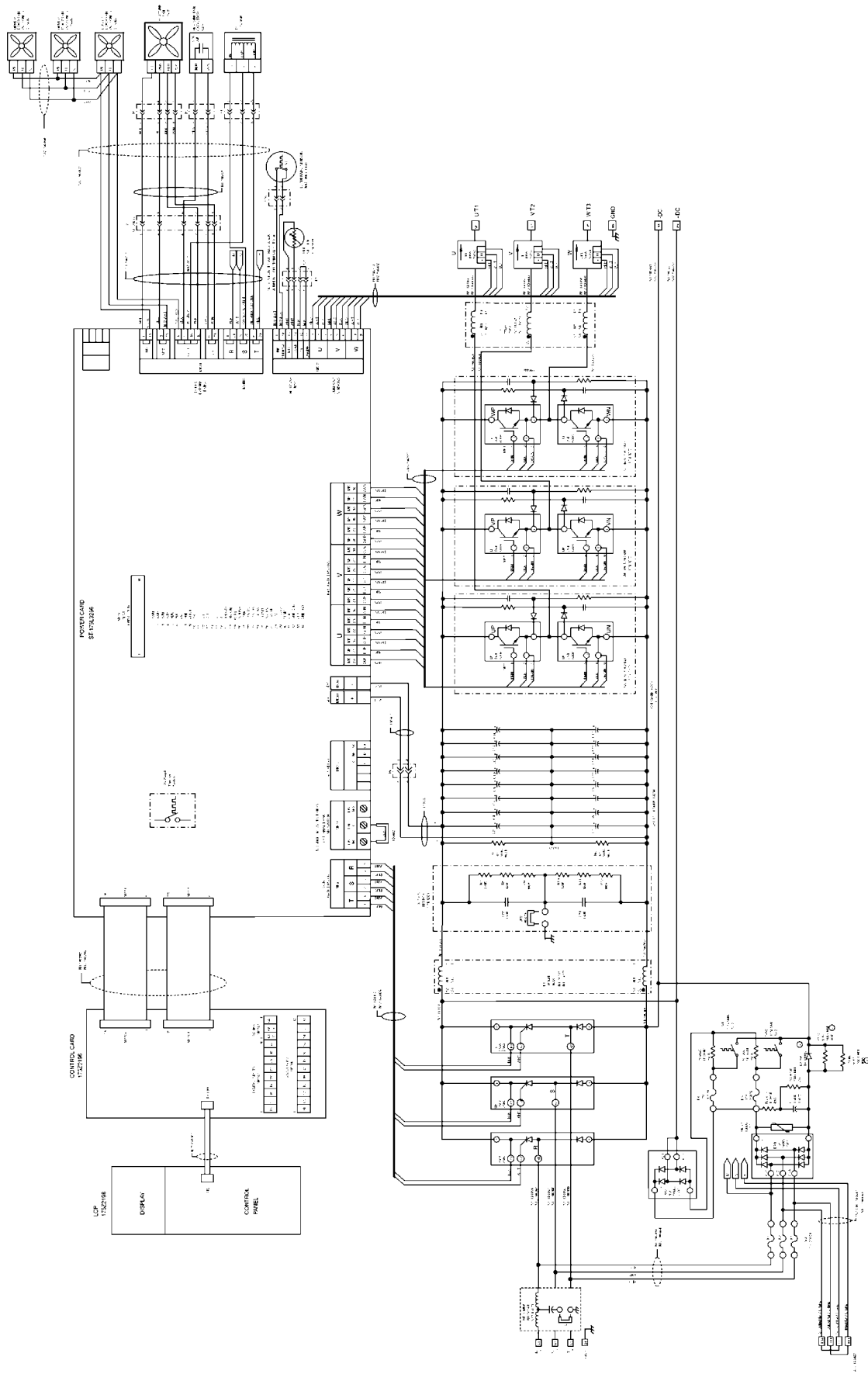

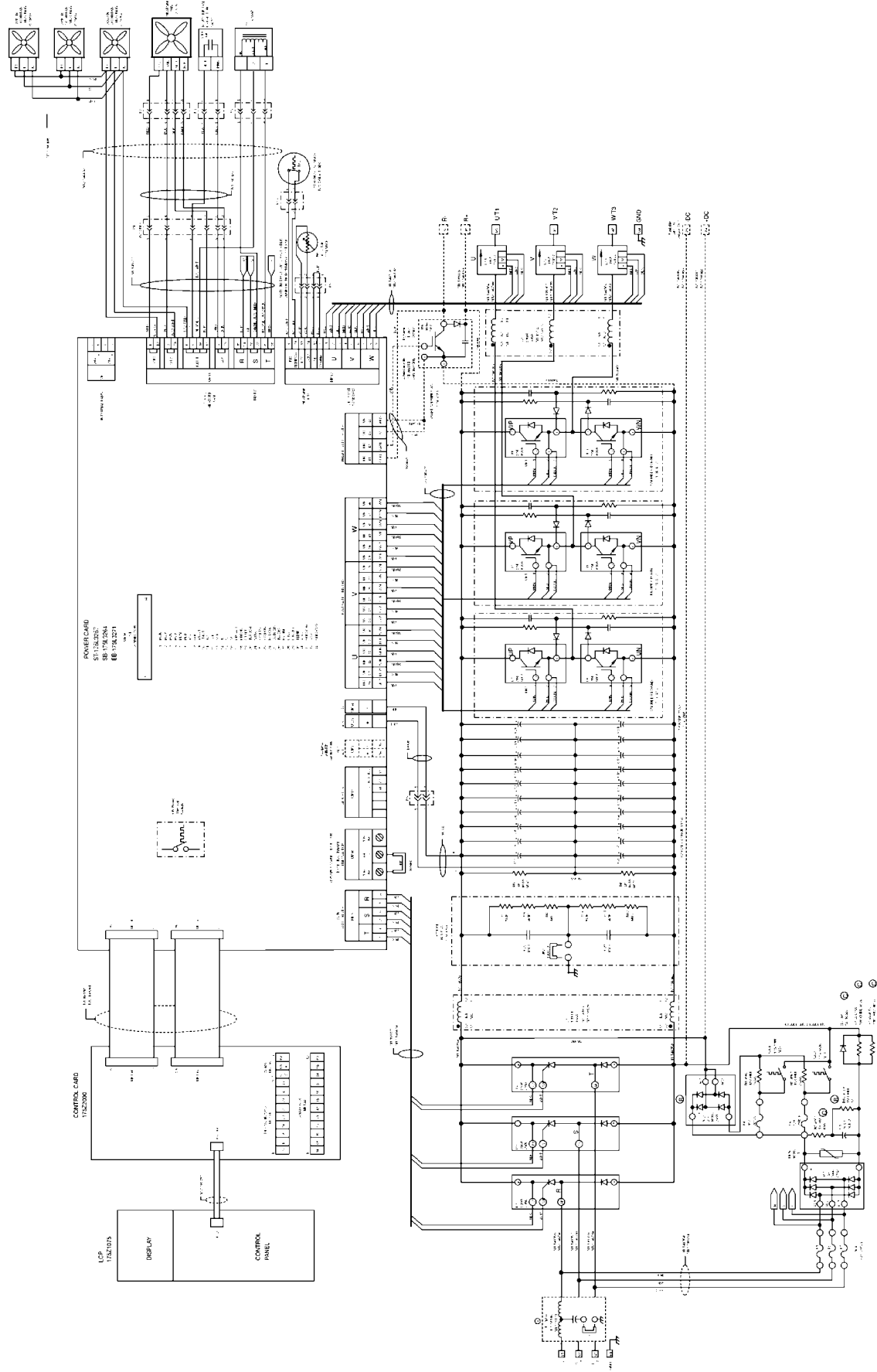

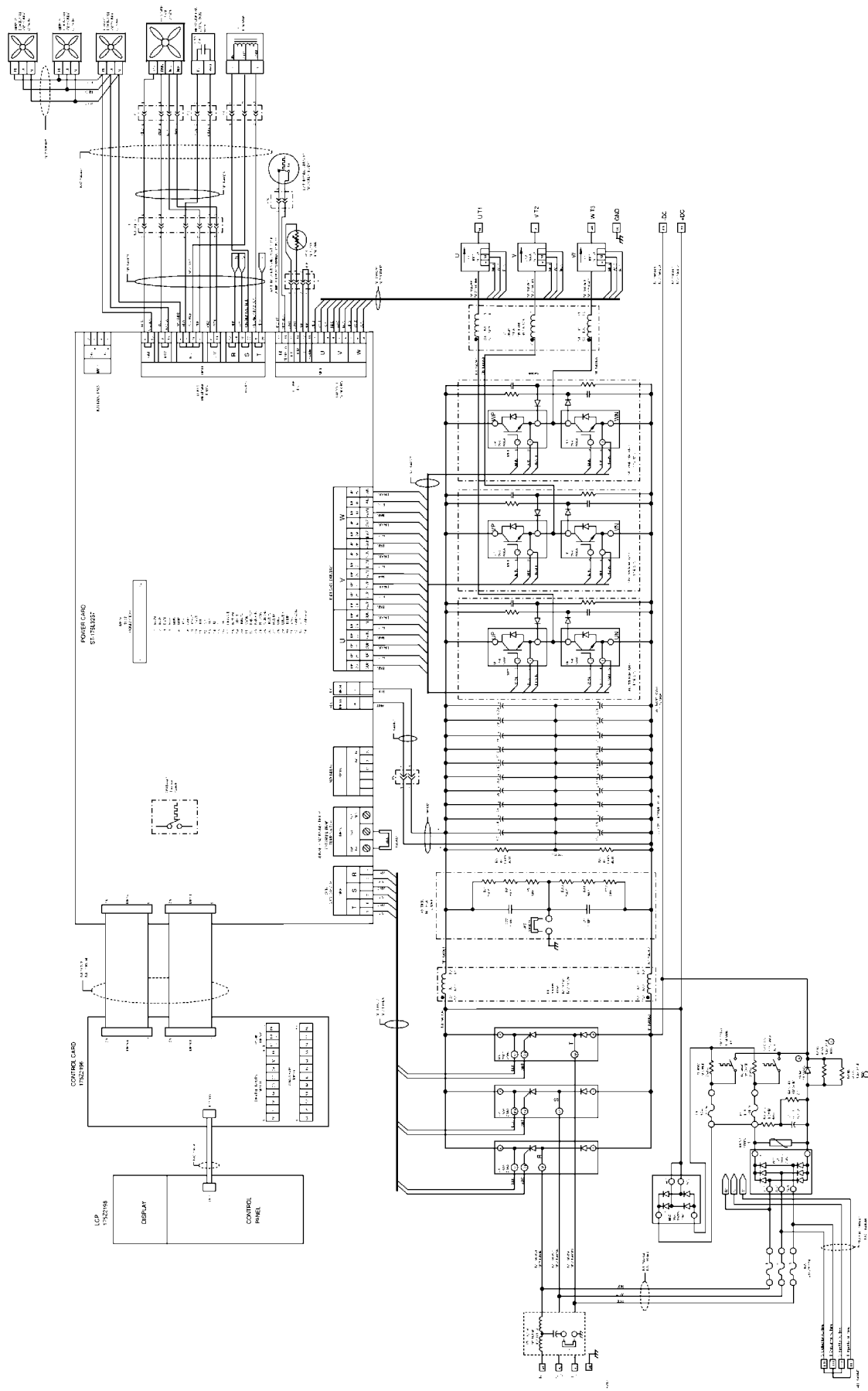

VLT® 5060 - 5250 SCR/Diode Installation and Torque Specifications

Installation

Note: For the VLT 5060 - 5250, the SCR/Diode module is a single package that contains both devices.

1. Prior to installing the SCR/Diode module ensure the surface area of the heatsink is clean of dirt and excess thermal compound.
2. Before installing the SCR/Diode module, place the thermal pad provided on the surface of the heatsink, aligning it with the SCR/Diode mounting holes.
3. Place the SCR/Diode module in position. Install the mounting screws and tighten by hand until the head is flush with the surface of the module.
4. Identify the SCR/Diode module style and adhere to the following tightening patterns and torque specifications as each connection to the module is made.

VLT	Torque A	Torque B
VLT 5060	44 LB•IN (5 NM)	27 LB•IN (3 NM)
VLT 5075	44 LB•IN (5 NM)	27 LB•IN (3 NM)
VLT 5100	44 LB•IN (5 NM)	44 LB•IN (5 NM)
VLT 5125	44 LB•IN (5 NM)	44 LB•IN (5 NM)
VLT 5150	44 LB•IN (5 NM)	44 LB•IN (5 NM)
VLT 5200-5250	44 LB•IN (5 NM)	80 LB•IN (9 NM)

The following figures indicate torque designation, A and B:

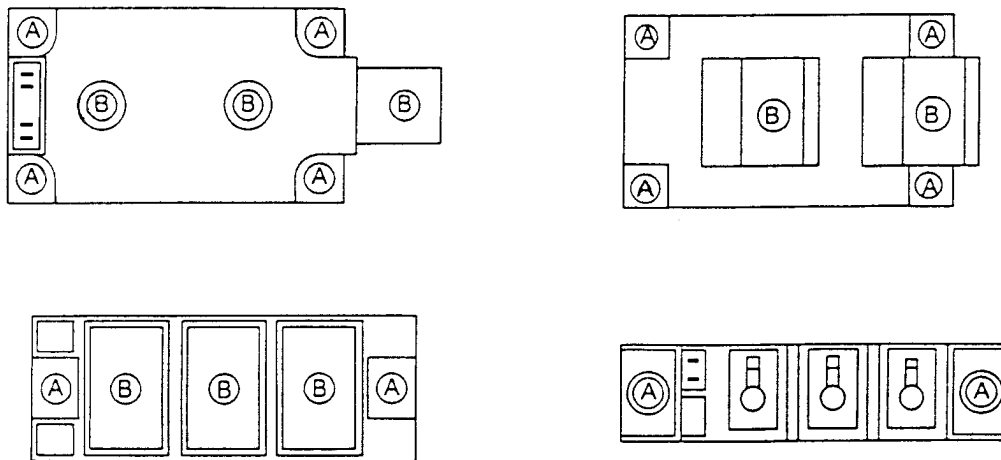

The following figures show tightening patterns. First, hand tighten until the screw head is flush. Second, torque to one-third of the value listed above in the pattern shown. Final torque in the same pattern to the values listed above.

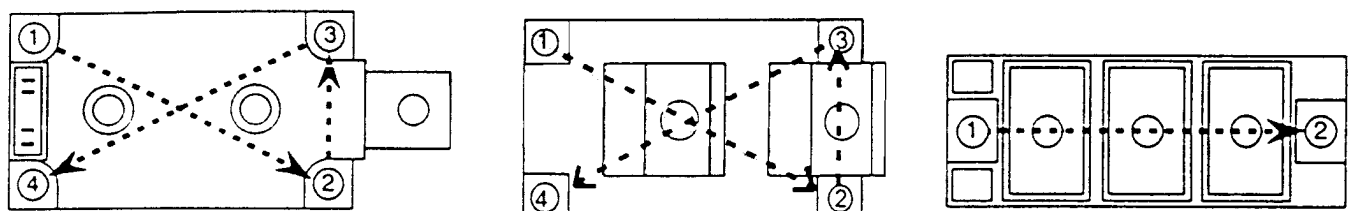

VLT® 5060 - 5250 IGBT Installation and Torque Specifications

Caution: The gate of the IGBT is static sensitive. The Inverter IGBT's used in the VLT 5060-5150 have gate drive boards mounted to the gate terminals. These are not to be removed. Gate drive boards are provided with the replacement spare part IGBT.

The Inverter IGBT's used in the VLT 5200 and 5250 and all brake IGBT's will have the gate connections exposed when the snubber board is removed. Immediately after removing the snubber board a jumper must be placed across the gate leads to prevent the IGBT from being damaged by static electricity.

Installation

1. Prior to installing the IGBT ensure the surface area of the heatsink is clean of dirt and excess thermal compound.
2. Before installing the IGBT, place the thermal pad provided on the surface of the heatsink aligning it with the IGBT mounting holes.
3. Place the IGBT in position. Install the mounting screws and tighten by hand until the head is flush with the surface of the IGBT.
4. Identify the IGBT style and adhere to the following tightening patterns and torque specifications as each connection to the IGBT is made.

IGBT Position and VLT	Torque A	Torque B	Torque C
Inverter VLT 5060-5075	22-30 LB•IN (2.5-3.5 NM)	31-39 LB•IN (3.5-4.5 NM)	N/A
Inverter VLT 5100	22-30 LB•IN (2.5-3.5 NM)	31-39 LB•IN (3.5-4.5 NM)	N/A
Inverter VLT 5125-5150	22-30 LB•IN (2.5-3.5 NM)	31-39 LB•IN (3.5-4.5 NM)	12-15 LB•IN (1.3-1.7 NM)
Inverter VLT 5200-5250	31-39 LB•IN (3.5-4.5 NM)	66-84 LB•IN (7.5-9.5 NM)	12-15 LB•IN (1.3-1.7 NM)
Brake VLT 5060-5100	22-30 LB•IN (2.5-3.5 NM)	31-39 LB•IN (3.5-4.5 NM)	12-15 LB•IN (1.3-1.7 NM)
Brake VLT 5125-5150	22-30 LB•IN (2.5-3.5 NM)	31-39 LB•IN (3.5-4.5 NM)	12-15 LB•IN (1.3-1.7 NM)
Brake VLT 5200-5250	22-30 LB•IN (2.5-3.5 NM)	31-39 LB•IN (3.5-4.5 NM)	12-15 LB•IN (1.3-1.7 NM)

The following figures indicate torque designation, A,B or C:

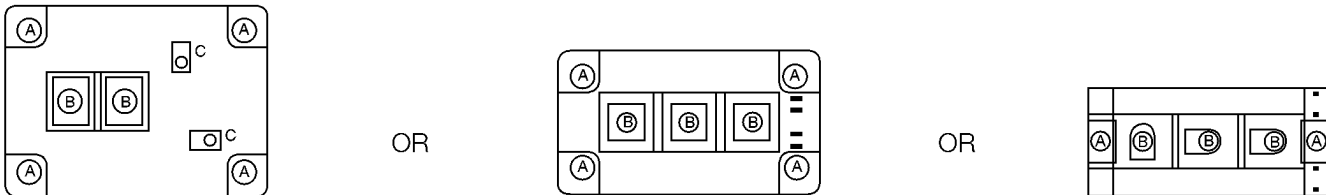

The following figures show tightening patterns. First hand tighten until the screw head is flush. Second torque to one-third of the value listed above in the pattern shown:

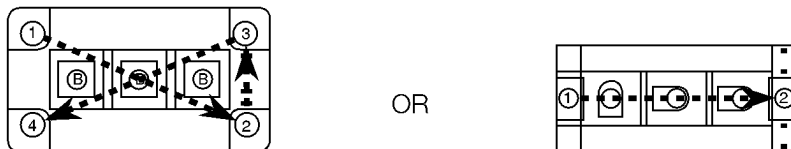

The following figures show final tightening patterns. Final torque to the value listed above in the pattern shown:



The Signal Test Board can be used to monitor a variety of signals that are available from the power card. Refer to the following pages for test point and signal information. Order the Signal Test Board using part number 176F1429.

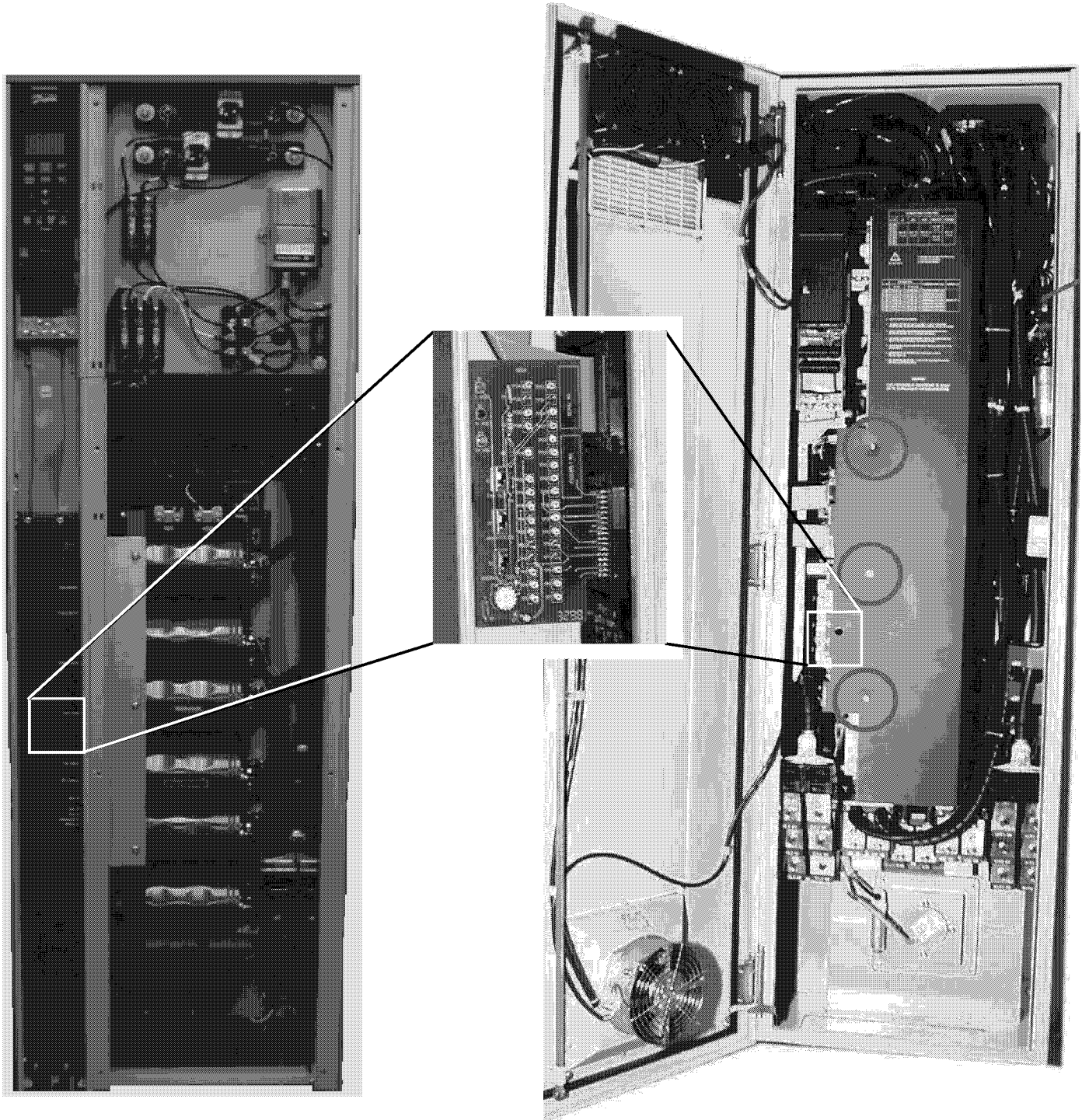

TYPICAL CHASSIS

TYPICAL NEMA 12

Signal Description and Voltage Levels:

Other than power supply measurements most of the signals being measured are made up by a waveform. Though in some cases a digital voltmeter can be used to verify the presence of such signals, it cannot be relied upon to verify the waveform is correct. An oscilloscope is the instrument of choice, however when similar signals are being measured at multiple points a digital voltmeter can be used with some degree of confidence. By comparing several signals to each other, such as gate drive signals, and obtaining similar readings it can be concluded each of the waveforms match one another and therefore are correct.

Power Supplies:

Four separate power supplies are available using the Signal Board.

+5 volt DC	Green LED indicates voltage present
±14 volt DC	Red LED indicates voltage present
+24 volt DC	Yellow LED indicates voltage present
+5 volt DC (RS485)	No LED present

Test Point No.	Color	Schematic Acronym	Function	Comments	Reading from Digital Volt Meter
7	Red	+5V	+5.0 VDC regulated supply. +4.75-5.25 VDC	Green LED indicates voltage is present.	+5.0 VDC regulated supply +4.75 to 5.25 VDC
9	Red	+14V1	+14 VDC supply. +12 VDC to +15 VDC	Red LED indicates voltage is present between +14 and -14v terminals.	+14 VDC supply. +12 to +15 VDC
10	Red	-14V1	-14 VDC supply -12 to -15 VDC	See +14v comment.	-14 VDC supply. -12 to -15 VDC
8	Black	COMMON	Logic common	This common is for all signals except TP31 and TP33.	
31	Yellow	+24V	+24 VDC power supply	+21 to +27 VDC Yellow LED indicates voltage is present +21 to +27 VDC between pins 31 and 32.	+21 to +27VDC
32	Black	COMMON	+24 VDC common	Use only for TP31	
33	White	VCX	+5.0 VDC regulated supply for RS 485. +4.75 to 5.25VDC	5.0 VDC regulated supply is reserved for the RS 485 communications link on the control card.	5 VDC between TP33 and and TP34.
34	White	GX	5v common for RS 485	Use only for TP33	

Gate Signals:

The gate signals available on the Signal Board are monitored at the low voltage side of the opto-isolator on the Power Card. The presence of the gate signal on the Signal Board does not ensure the signal is making it through the opto and to the gate of the IGBT. Reference figures 1 and 2.

Test Point No.	Color	Schematic Acronym	Function	Comments	Average Waveform Reading when using a Digital Volt Meter
1	White	BWN	IGBT gate signal, buffered, W phase, negative. Signal originates on Control Card.	Compare each Gate signal, looking for consistency between each phase.	2.3 - 2.4 VDC Equal on all phases TP1-TP6
2	White	BWP	IGBT gate signal buffered, W phase, positive. Signal originates on Control Card.	Compare each Gate signal, looking for consistency between each phase.	2.3-2.4 VDC Equal on all phases TP1-TP6
3	White	BVN	IGBT gate signal, buffered, V phase, negative. Signal originates on Control Card.	Compare each Gate signal, looking for consistency between each phase.	2.3-2.4 VDC Equal on all phases TP1-TP6
4	White	BVP	IGBT gate signal, buffered, V phase, positive. Signal originates on Control Card.	Compare each Gate signal, looking for consistency between each phase.	2.3-2.4 VDC Equal on all phases TP1-TP6
5	White	BUN	IGBT gate signal, buffered, U phase, negative. Signal originates on Control Card.	Compare each Gate signal, looking for consistency between each phase.	2.3-2.4 VDC Equal on all phases TP1-TP6
6	White	BUP	IGBT gate signal, buffered, U phase, positive. Signal originates on Control Card.	Compare each Gate signal, looking for consistency between each phase.	2.3-2.4 VDC Equal on all phases TP1-TP6
8	Black	COMMON	Logic common	This common is for all signals except TP31, TP33 & TP34.	

BWN Gate Signal

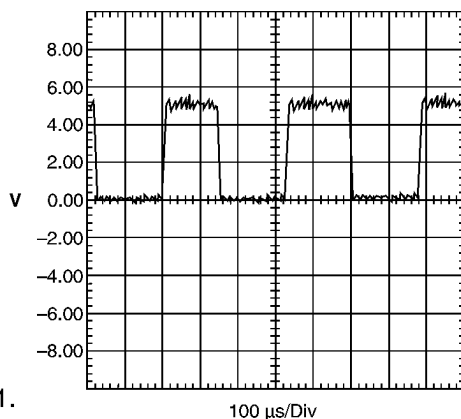

Figure 1.

BWN Gate Signal

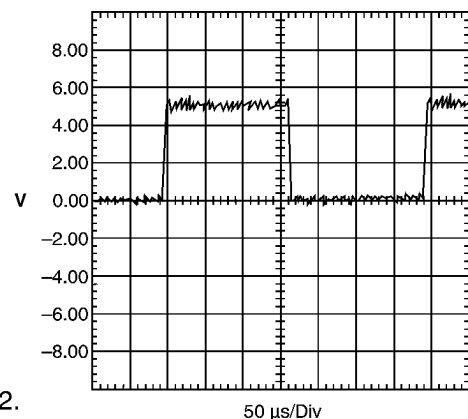

Figure 2.

Typical gate drive signal when using an oscilloscope. VLT 5000 in run mode, running at zero speed.

Current Feedback Signals

Current feedback signals consist of both non-conditioned and conditioned signals. Non-conditioned (IU1, IV1, IW1) are the non-buffered signals that come straight from the current sensor to the power card. Conditioned (IU, IV, IW) are the buffered non-conditioned signals that are sent from the Power Card to the Control Card. Reference figures 3 and 4.

Test Point No.	Color	Schematic Acronym	Function	Comments	Reading from Digital Volt Meter
11	White	IU1	Current sensed, U phase, not conditioned.	All current feedback signals should be compared to each other. All measurements will be within mV's from each other in normal operation.	Less than 15mV at zero current 890mV AC (VLT 5100 at 87A)
12	White	IV1	Current sensed, V phase, not conditioned.	All current feedback signals should be compared to each other. All measurements will be within mV's from each other in normal operation.	Less than 15mV at zero current 890mV AC (VLT 5100 at 87A)
13	White	IW1	Current sensed, W phase, not conditioned.	All current feedback signals should be compared to each other. All measurements will be within mV's from each other in normal operation.	Less than 15mV at zero current 890mV AC (VLT 5100 at 87A)
14	White	IU	Current sensed, U phase, conditioned.	All current feedback signals should be compared to each other. All measurements will be within mV's from each other in normal operation.	Less than 15mV at zero current 890mV AC (VLT 5100 at 87A)
15	White	IV	Current sensed, V phase, conditioned.	All current feedback signals should be compared to each other. All measurements will be within mV's from each other in normal operation.	Less than 15mV at zero current 890mV AC (VLT 5100 at 87A)
16	White	IW	Current sensed, W phase, conditioned.	All current feedback signals should be compared to each other. All measurements will be within mV's from each other in normal operation.	Less than 15mV at zero current 890mV AC (VLT 5100 at 87A)
8	Black	COMMON	Logic common	This common is for all signals except TP31 and TP33.	

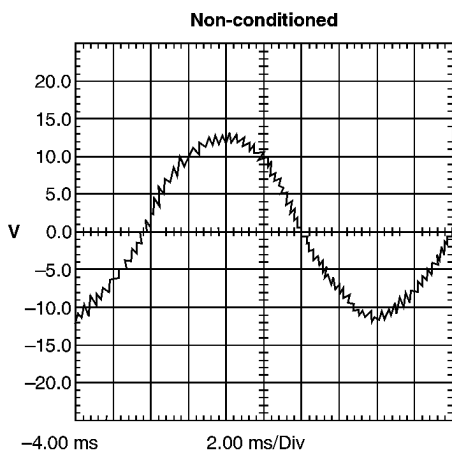

Figure 3.

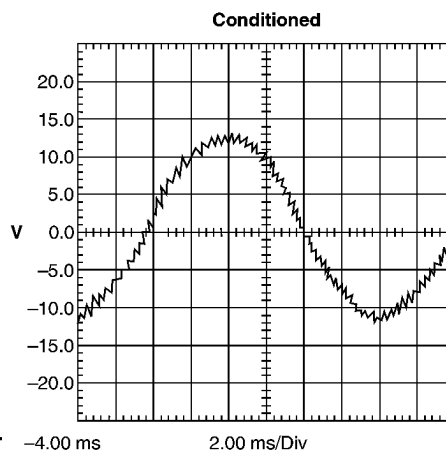

Figure 4.

Typical current feedback waveform when using an oscilloscope. VLT 5100 at 84 amps.

Brake Signals

The DBGATE signal is enabled by signal (BRPWM) originating from the Control Card. The DBGATE signal is monitored at the low voltage side of the opto-isolator on the Power Card. The presence of the gate signal on the Signal Board does not ensure the signal is making it through the opto and to the gate of the IGBT. The DBRTON signal is the low voltage feedback indicating the brake IGBT is conducting by a flow of current through the collector to the emitter. Reference figures 5 and 6.

Test

- 1) Insure drive is running at zero speed.
- 2) For SB and EB drives only, change parameter 400 to Resistor.
A resistor must be hooked up to the drives R+ and R- terminals.
- 3) Display DC Link Voltage in the LCP. (Parameter 009-012 can be changed to customize display).
- 4) Close Over Volt Test switch (down position).
- 5) Monitoring voltage in display, increase the DC Link Voltage by turning the potentiometer counter clockwise.
 - a) check brake operation message in LCP and verify signal (DBGATE DBRTON)
 - ~795vDC Brake turn on voltage (380-500 volt units)
 - ~390vDC Brake turn on voltage (200-240 volt units)
- 6) Upon completion of the tests turn potentiometer fully clockwise and open switch (up position).
- 7) Return all changed parameters to original settings.

Test Point No.	Color	Schematic Acronym	Function	Comments	Reading from Digital Volt Meter
17	White	DBGATE	Brake IGBT gate pulse train.	Pulse wave form. May use OVERVOLTAGE TEST switch and potentiometer to force braking.	4.04 volt DC level with brake turned off. Voltage drops to zero when brake is turned on.
18	White	DBRTON	Brake IGBT 5V logic level signal.	Pulse wave form. May use OVERVOLTAGE TEST switch and potentiometer to force braking.	5.10 volt DC level with brake turned off. Voltage drops to zero when brake is turned on.
8	Black	COMMON	Logic common	This common is for all signals except TP31 and TP33.	

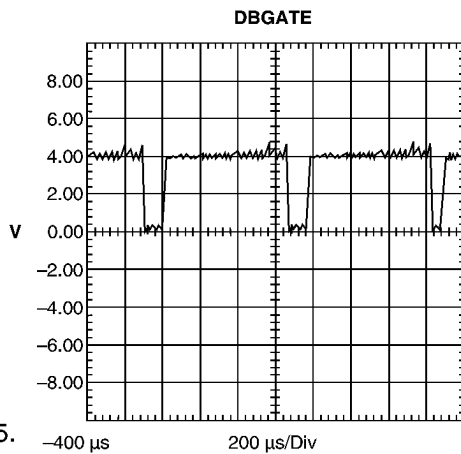

Figure 5.

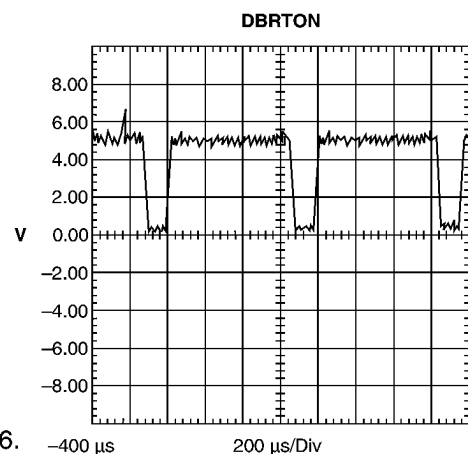

Figure 6.

Typical waveform when using an oscilloscope. VLT 5060 at zero speed using the Overvolt Test switch to force braking.

Fan Signals

FAN-ON - Is active anytime the fan is running, either high or low speed. The waveforms falling edge is synchronized with AC line (S & T). If the fan is off, this signal is pulled to -14 volt DC.

- 45°C the fan is turned on low speed
- 60°C the fan is turned on high speed
- 55°C the fan is turned from high to low speed
- <30°C the fan is turned off

HI-LOW - This signal changes the fans speed to high speed.

Reference figures 7 and 8.

Test

- 1) Power must be applied to drive, but RUN command is not necessary.
- 2) Display Heatsink Temp in LCP. (Parameter 009-012 can be changed to customize display).
- 3) Monitor FAN-ON and/or Monitor HI-LOW
- 4) Close Fan Test switch (down position).
 - a) Verify FAN-ON signal (high speed only)
 - b) Verify HI-LOW voltage
- 5) Open Fan Test switch (up position), view heatsink temperature in LCP if <55°C verify if fan is running in low speed by the FAN-ON signal. If fan is off start and run drive if possible, to heat up the heatsink. Once the heatsink temperature is >45°C fan will be on low speed, verify FAN-ON signal.
- 6) Upon completion of tests insure Fan Test switch is open (up position).

Test Point No.	Color	Schematic Acronym	Function	Comments	Reading from Digital Volt Meter
23	White	FAN-ON	Fan speed control TRIAC gate pulse train.	Rectangular pulses Is turned off by FANO signal (heat sink temperature < 45°C) from control card at which time FAN-ON is forced to -14v.	
24	White	HI-LOW	Commands the fan speed control circuit to run the fans fast .	Commands the fan speed control circuit to run the fans fast when the hear sink is over 60°C or other conditions warrant or when the POWER CARD TESTER FAN TEST switch is closed. Fast ~230VAC, slow ~165VAC at the fan terminals.	0 vDC with fan off. 14 vDC with fan on high.
8	Black	COMMON	Logic common	This common is for all signals except TP31 and TP33.	

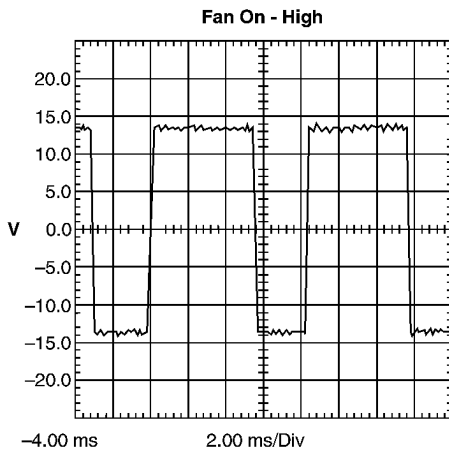

Figure 7.

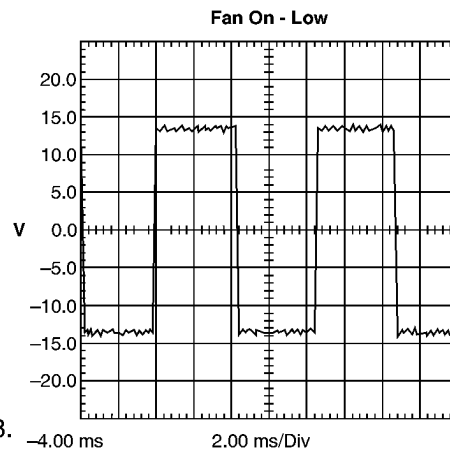

Figure 8.

Typical waveform when using an oscilloscope. Fan On - High was forced by using the Fan Test Switch. Fan On - Low was with the drive running at 60Hz and the heatsink above 45°C.

DC Bus Signals

Use the following signal to verify actual DC Bus voltage (UINV) or determine if the upper limit of the DC bus has been reached (HVLIM).

UINV - A scaled low voltage representation of the DC bus voltage.

Use the formula $[256 \cdot (\text{meter voltage}) = \text{DC Bus voltage}]$ to determine if the power card is relaying the correct information to the processor.

HVLIM - This signal is high when an upper limit is reached.

HVLIM set points in the drive.

380-500 volt units 815 volts DC

200-240 volt units 400 volts DC

Test

- 1) Insure drive is running at zero speed.
- 2) Display DC Link Voltage in the LCP. (Parameter 009-012 can be changed to customize display).
- 3) Disconnect brake resistors R+ and R- if applicable, turn Parameter 400 off (SB and EB units only).
- 4) Close Over Volt Test switch (down position).
- 5) Monitor voltage in display, increase the DC Link Voltage by turning the potentiometer counter clockwise.
 - a) Record Warning and Alarm voltage set points, verify signal voltage once high voltage limit is reached (HVLIM)

Warnings: 200-240 volt units 384 w/o brake — 405 w/brake $\pm 5\%$
 380-500 volt units 801 w/o brake — 840 w/brake $\pm 5\%$

Alarms: 200-240 volt units 425 volts DC $\pm 5\%$
 380-500 volt units 855 volts DC $\pm 5\%$
 - b) Verify DC Link voltage (UINV)
 $[256 \cdot (\text{meter voltage}) = \text{DC Bus voltage}]$
- 6) Upon completion of tests turn potentiometer fully clockwise and open switch (up position).
- 7) Return all changed parameters to original settings.

Test Point No.	Color	Schematic Acronym	Function	Comments	Reading from Digital Volt Meter
27	White	HVLIM	High bus voltage limit has been exceeded. ~+6v indicates over threshold, ~-6v indicates under.	Nominal bus voltage threshold is ~815v (790-840v).	-6 VDC no high voltage fault 6 VDC with active high voltage fault
28	White	UINV	Bus voltage scaled down to $1/256 \pm 3\%$	@ 500v bus, 1.953v, (1.924v to 1.98v) @ 800v bus, 3.125v, (3.078v to 3.172v)	Formula for determining DC bus voltage $[256 \cdot (\text{meter voltage}) = \text{DC bus level}]$
8	Black	COMMON	Logic common	This common is for all signals except TP31 and TP33.	

Auxiliary Signals

OTFLT - PCB-OT (Power Card Over Temp Signal), PCB-UT (Power Card Under Temp Signal), IND-OT (Inductor Over Temp Signal), and EXTDIS (MK10 jumper terminals 106 & 104) are inputs to a four input Nor Gate that gives an Over Temperature fault on the Power Card. The OTFLT is also sent to disable the input SCR's.

INRUSH - This signal is sent from the Control Card to a 4 input NOR gate that is then sent to the low voltage side of the opto-isolator for the SCR's gate. It is also used for gating the internal 24 volt fans. Reference figure 9.

SYNC - This is the carrier frequency signal. This could be used as an external trigger function for an Oscilloscope. Reference figures 10 and 11.

SCR-DIS - This signal is on the low voltage side of the input SCR's and internal fan Gate signals, which forces the signal low turning the input SCR's off.

TEMP - This signal is the analog voltage from the NTC. It can be used to determine correct feedback from heatsink thermal sensor through the acquired voltage on test point 30, using this formula $[2.82 - (\Delta T \cdot .035) = V_{TEMP}] \Delta T = \text{heatsink temperature } -30^{\circ}\text{C}$

Test

- 1) Power must be applied to the drive, but a RUN command is not necessary.
- 2) Display Heatsink Temp in LCP. (Parameter 009-012 can be changed to customize display).
 - a) Measure and verify TEMP with displayed temperature.
 $[2.82 - (\Delta T \cdot .035) = V_{TEMP}] \Delta T = \text{heatsink temperature } -30^{\circ}\text{C}$
- 3) Close Fan Test switch, view heatsink temperature in LCP and compare temperature with voltage from signal using the formula above.
- 4) Upon completion of tests insure Fan Test switch is open (up position).

Test Point No.	Color	Schematic Acronym	Function	Comments	Reading from Digital Volt Meter
19	White	OTFLT	Combined inductor (LED3), brake resistor (LED4), and power card over temperature (LED1) faults plus power card under temperature (LED2) fault. (LED1) faults plus power under temperature (LED2) fault. OTFLT will turn off front end SCRs and inverter IGBTs.	Verify jumper is present in terminal block of MK10 of the Power Card. Terminals 106 to 104.	Fault = 0v, no fault = 5v
20	White	INRUSH	Signal from BCC enabling turning on the front end SCRs.		Use oscilloscope
21	White	SYNC	The carrier frequency of the drive.	This is the carrier frequency signal. This could be used as an external trigger function for an oscilloscope.	
25	White	SCR-DIS	0v indicates SCRs and internal fans (24vdc) disabled. Enabled signal level is 0.6 to 0.8 volts.	SCRs and internal fans are turned on by INRUSH signal from the control card	
30	White	TEMP	Provides a low voltage analog signal proportional to heat sink temperature.	Will read ~3.267 volts if the circuit to the NTC on the heat sink is open. As heatsink temperature increases the TEMP signal decreases.	Formula for determining heatsink temp $[2.82 - (\Delta T \cdot .035) = V_{TEMP}]$ $(\Delta T = \text{heatsink Temp. } -30^{\circ}\text{C})$
8	Black	COMMON	Logic common	This common is for all signals except TP31 and TP33.	

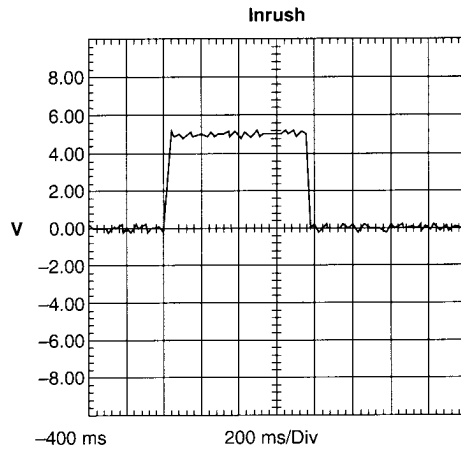

Figure 9

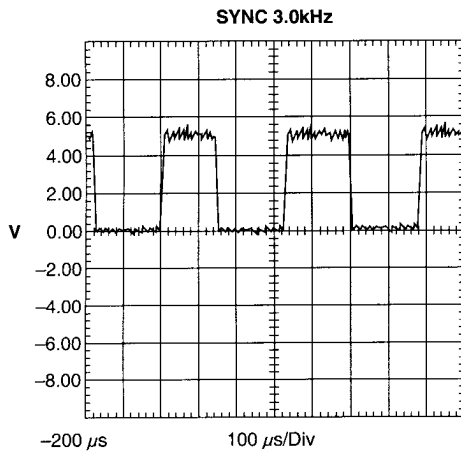

Figure 10

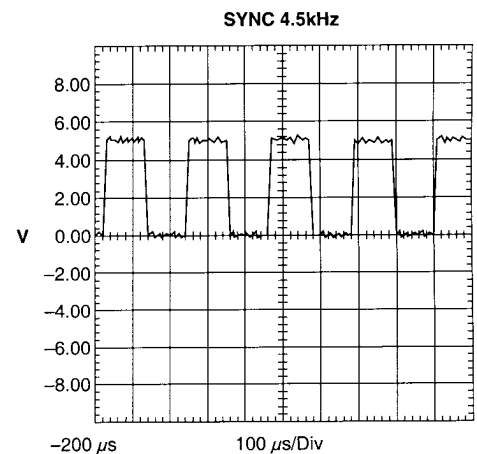

Figure 11

Switches / Potentiometer

Three switches on the Signal Board are used in conjunction with select signals to either force conditions or verify signals are operational.

Fan Test - This switch will force the fan on high speed. This enables you to check the FAN-ON, HI-LOW signals. Also use the TEMP signal to verify the change in heatsink temperature.

- 1) Power must be applied to the drive, but a RUN command is not necessary.
- 2) Display Heatsink Temp in LCP. (Parameter 009-012 may be changed to customize display).
- 3) Monitor FAN-ON and/or Monitor HI-LOW
- 4) Close Fan Test switch (down position).
 - a) Verify FAN-ON signal (high speed only)
 - b) Verify HI-LOW voltage
 - c) Measure and verify TEMP signal is changing with displayed temperature.
[$2.82 - (\Delta T \cdot .035) = V_{TEMP}$] $\Delta T =$ heatsink temperature -30°C
- 5) Open the Fan Test switch (up position), view heatsink temperature in LCP if $\leq 55^{\circ}\text{C}$ verify if fan is running in low speed by the FAN-ON signal. If fan is off, start and run drive if possible, to heat up the heatsink. Once the heatsink temperature is $> 45^{\circ}\text{C}$ fan will be on low speed, verify FAN-ON signal.
- 6) Upon completion of tests insure Fan Test switch is open (up position).

Inverter Dis - This switch will cause the drives output section to be disabled. This is only functional in Rev E power cards.

OverVolt Test - This switch can be used to check the DBGATE, DBRTON, HVLIM< and UINV are in working order.

- 1) Insure the drive is running at zero speed.
- 2) Display DC Link Voltage in the LCP. (Parameter 009-012 may be changed to customize display).
- 3) Disconnect brake resistors R+ and R- if applicable, turn Parameter 400 off (SB and EB units only).
- 4) Close the Over Voltage Test switch (down position).
- 5) Monitoring voltage in display, increase the DC Link Voltage by turning the potentiometer counter clockwise.
 - a) Record warning and Alarm voltage set points, verify signal voltage once high voltage limit is reached (HVLIM)
Warnings:
200-240 volt units 384 w/o brake — 405 w/brake $\pm 5\%$
380-500 volt units 801 w/o brake — 840 w/brake $\pm 5\%$
Alarms:
200-240 volt units 425 volts DC $\pm 5\%$
380-500 volt units 855 volts DC $\pm 5\%$
 - b) Verify the DC Link Voltage (UNIV)
[$256 \cdot (\text{meter voltage}) = \text{DC Bus voltage}$]
- 6) Turn the potentiometer full clockwise and open the switch (up position).
- 7) For SB and EB drives only, change parameter 400 to Resistor. A resistor must be hooked up to the drives R+ and R- terminals.
- 8) Close the Over Volt Test switch (down position).
- 9) Monitoring the voltage in the display, increase the DC Link Voltage by turning the potentiometer counter clockwise.
 - a) Check Brake operation and verify signal (DBGATE DBRTON)
~795vDC Brake turn on voltage (380-500 volt units)
~390vDC Brake turn on voltage (200-240 volt units)
- 10) Upon completion of tests turn the potentiometer fully clockwise and open the switch (up position).
- 11) Return all parameters to original settings.

Test Points

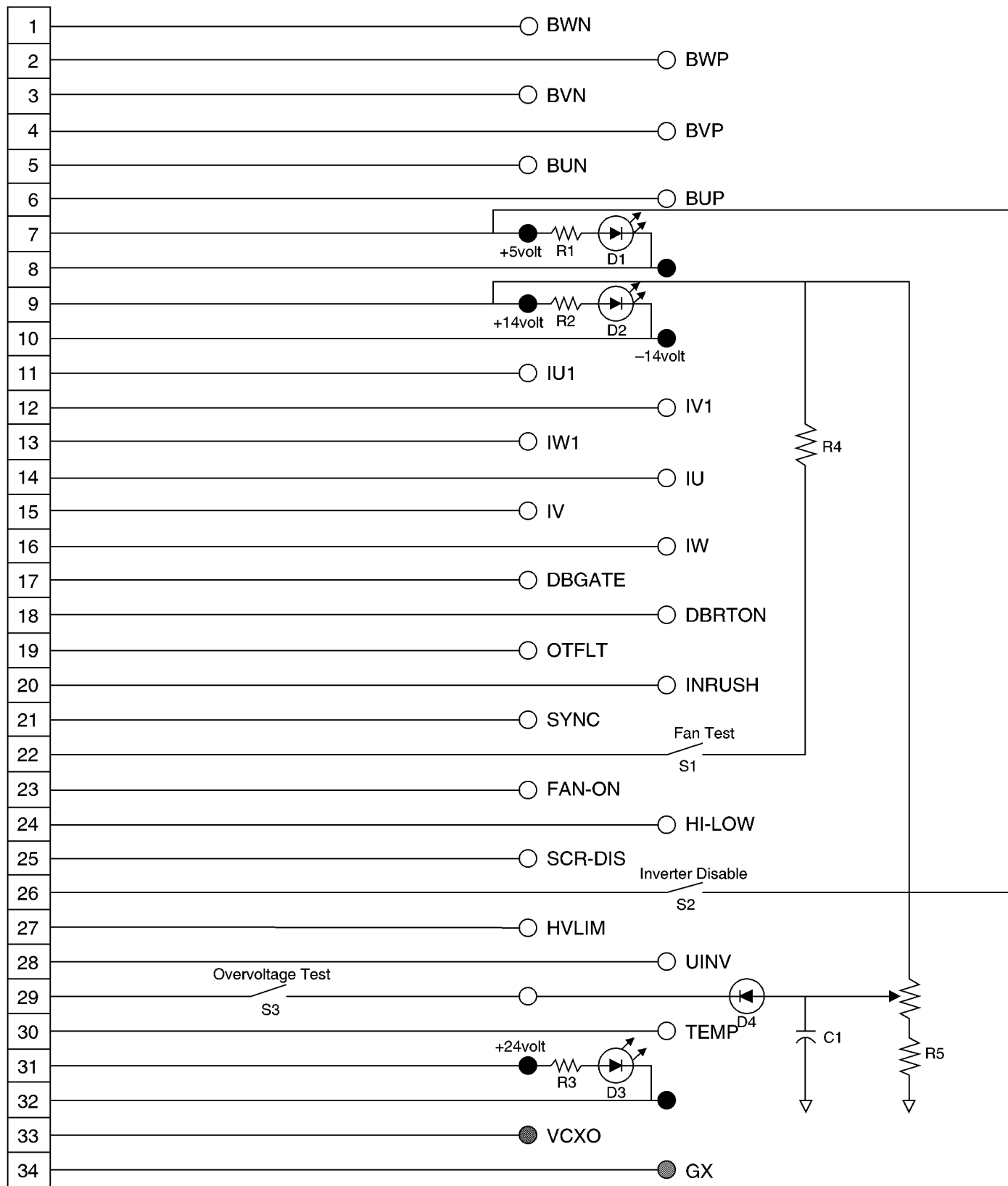

SCR Gate Driver Test Cable

The SCR Gate Driver Test Cable gives the technician the ability to breakout and extend the length of the cable supplying the gate signals from the power/IF cards to the SCR's. The breakout enables the technician access to the gate signal wires away from high voltages (both AC input and DC bus) and a 2 inch gap in the shield enables proper placement of test equipment . By using a clamp-on current probe, attached to an oscilloscope, the proper firing signals of SCR can be both verified and measured. With out this cable the ability to verify the proper firing of the SCR's is next to impossible due to the close proximity of components in the drives.

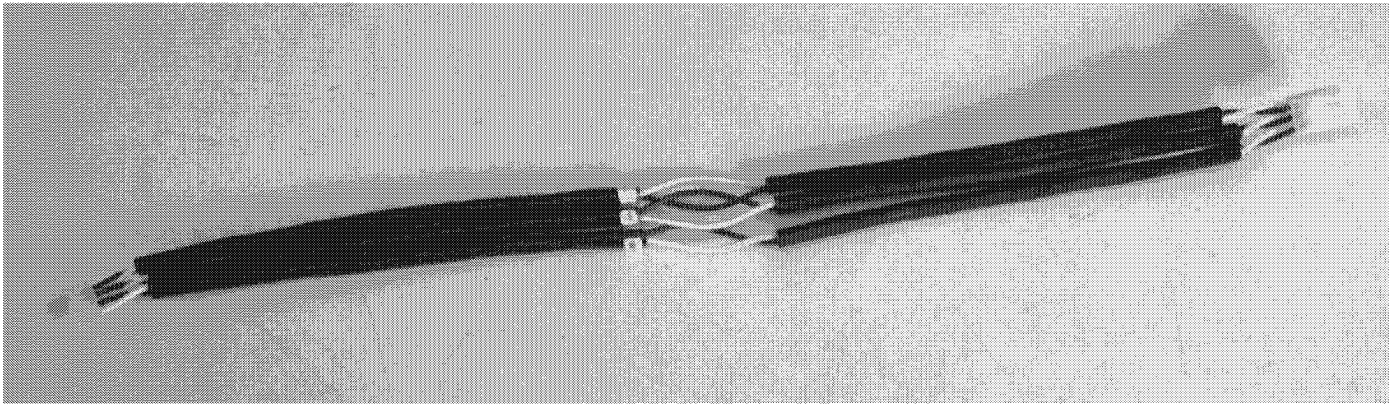

Installation

Once the voltages are removed the SCR gate lead connection needs to be removed. This is done by removing:

- MK14 -VLT 3060-3250 500 Volt, VLT 3032-3052 200 Volt
- MK6 -VLT 5060-5250 500 Volt, VLT 5032-5052 200 Volt, VLT 5075-5300 Aqua 460 Volt, VLT 5042-5062 Aqua 200 Volt, VLT 6075-6275 460 Volt VLT 6042-6062 200 Volt
- MK5 - VLT 5300-5500 500 Volt, VLT 5350-5600 Aqua 460 Volt, VLT 6350-6550 460 Volt

Now, proceed by plugging the SCR Gate Driver Test Cable into the applicable MK connector on the power/IF card. The other end is then plugged into the original SCR gate lead closing the loop from the SCR's to the power/IF card. Once the cable is hooked up use a current probe and an oscilloscope connecting the probe around the white wire of the SCR Gate Driver Test Cable. Now it is time AC power can be reconnected and the proper gate signal wave form can be verified.

The current pulse should have a waveform as shown at left with:

A1 > 1.1 A

A2 > 0.40 A

T1 > 300 μ s

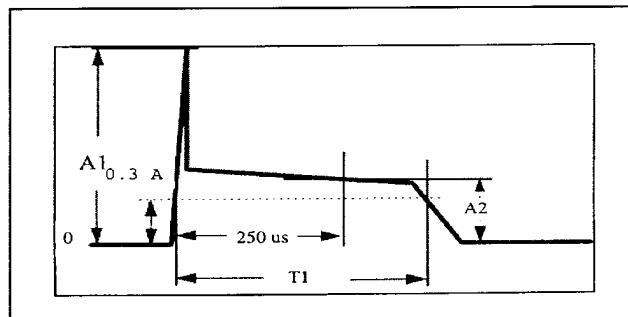

Figure 1: SCR Gate Current Pulse Waveform

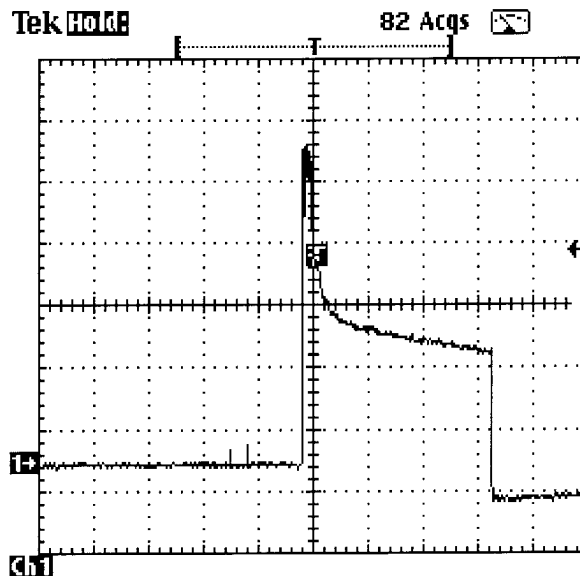

Figure 2: SCR Gate Current Pulse Waveform with a 112 Amp load.

Power Card DC Supply Source

The Power Card DC Supply Source is an alternate means of powering up the inverter section of the VLT without applying DC bus voltage to the remainder of the unit. In VLT 5000, 6000 and 5000 AQUA Series units, it also makes it possible to power the inverter section while the capacitor bank is removed. This can be helpful in troubleshooting, enabling the technician to make a variety of tests without the risk of damage or injury due to a fully charged DC bus. One such example is the ability to test IGBT gate drive signals right at the IGBT connection. Such a test can only be made with the capacitor bank removed and the power card powered from an alternative source. The Power Card DC Supply Source does not in itself perform any diagnostic tests.

Safety Notice

Keep in mind the voltage levels in the drive are still maintained through the Power Card DC Supply Source. Both AC and DC voltage are present in the drive while servicing, so close attention is required to prevent either personnel injury and/or equipment damage. The use of the Power Card DC Supply Source should be done by a qualified technician familiar with the voltage levels inside the VLT.

VLT 5000, 6000 and 5000 AQUA Installation

For Power Card DC Supply Source installation in the following drives:

- VLT 5060-5250
- VLT 5032-5052 (230 VAC)
- VLT 5075-5300 AQUA
- VLT 5042-5062 (230 VAC) AQUA
- VLT 6075-6275
- VLT 6042-6062 (230 VAC)

Note: After the AC voltage is removed and prior to servicing, all voltages (AC and DC) should be verified with a meter.

1. Disconnect power to the drive. Wait at least 15 minutes after AC voltage is disconnected before servicing to ensure the DC bus capacitors are fully discharged.
2. Remove DC capacitor bank, if necessary, to perform test on drive. When removing DC capacitor bank, follow these instructions dependent on enclosure type:
 - **NEMA 12** - Remove the DC+ and DC- leads coming from the DC link inductor to the top of the capacitor bank (See Figure 5). Ensure these leads are taped off and adequately insulated to protect personnel and equipment.
 - **Chassis and NEMA 1** - Remove the two Torx head screws from the DC link inductors while keeping the wire assemblies attached to the DC bus assembly (See Figure 5). It may be easier to first remove these wires from the DC capacitor bank, then remove the two Torx head screws.

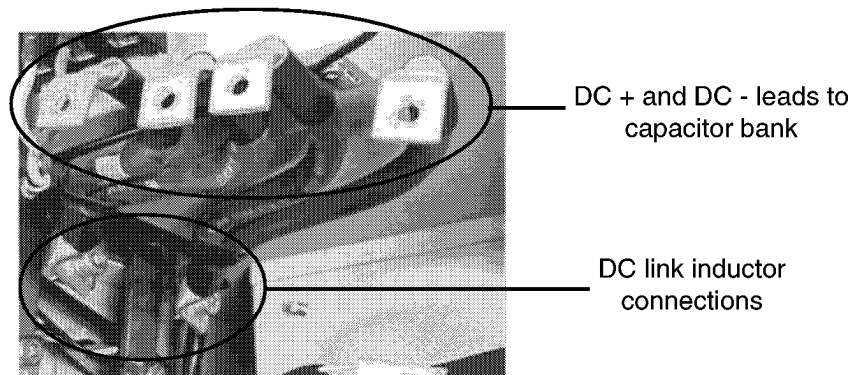

Figure 5. DC capacitor bank connections

3. Remove the three soft charge fuses from the soft charge fuse block (See Figures 6 and 7).

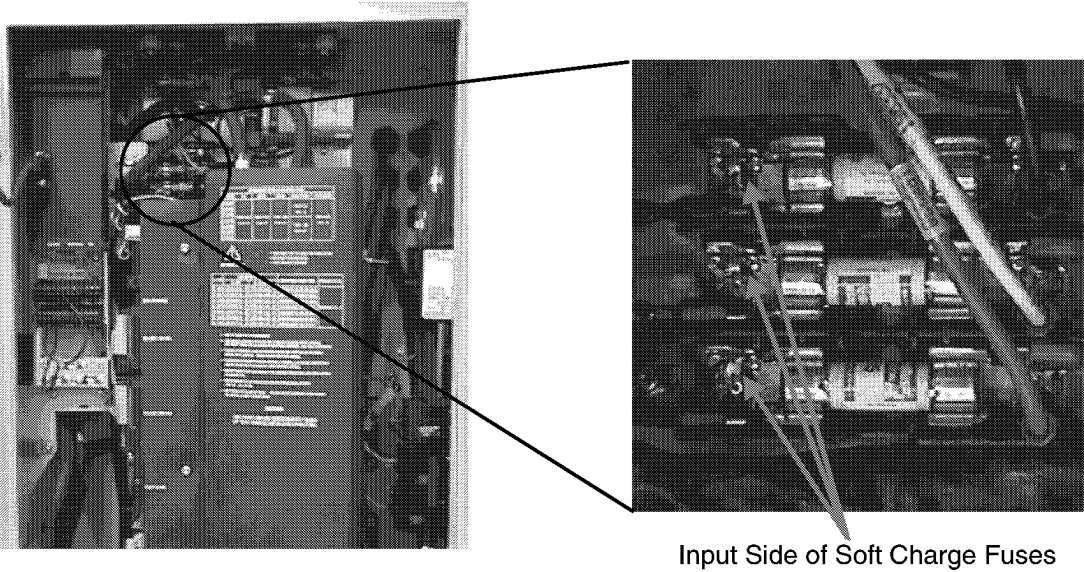

Figure 6. Soft charge fuses - Horizontal Mount

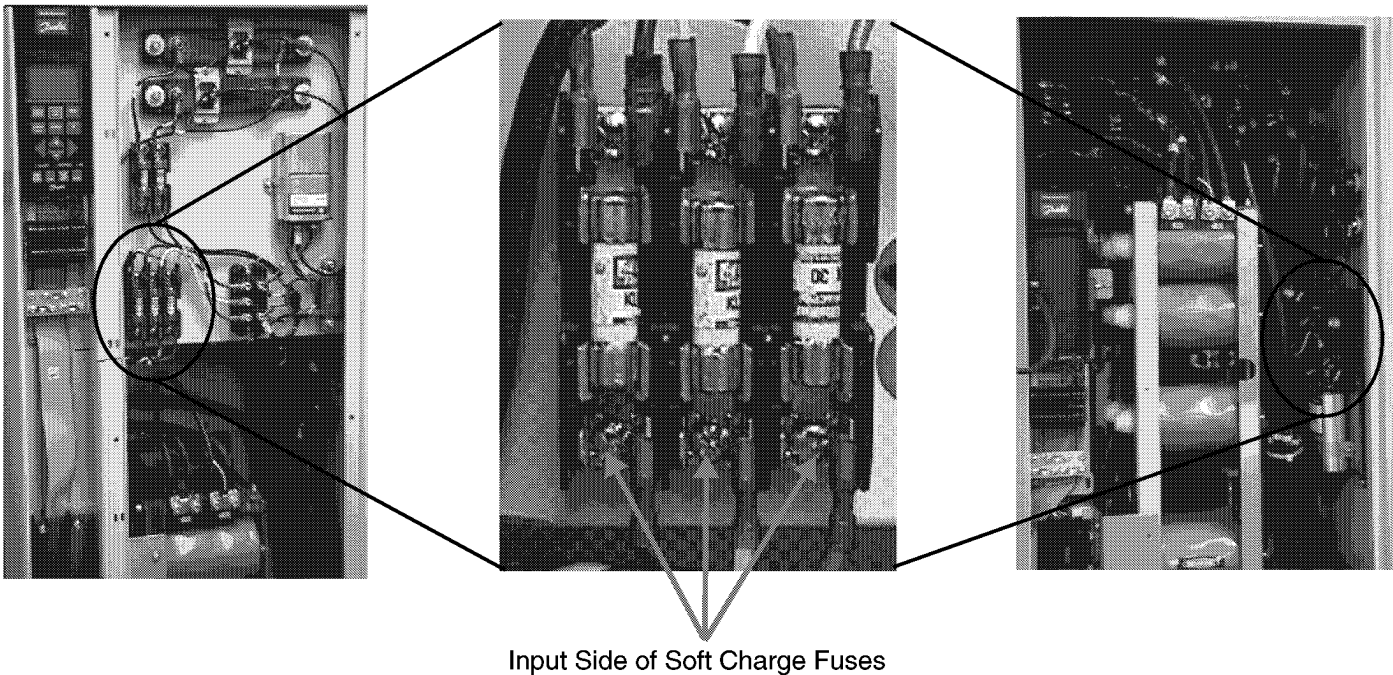
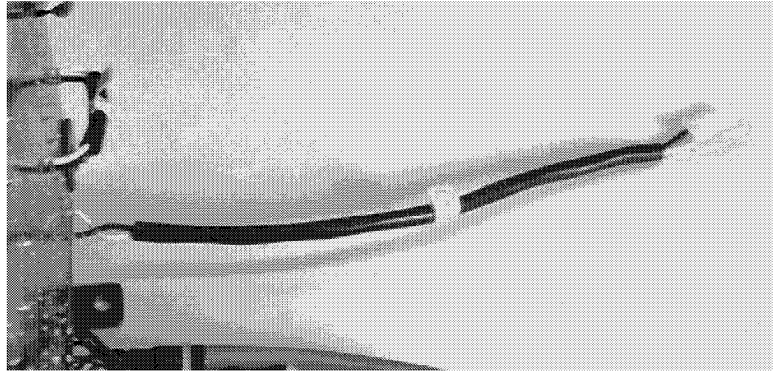

Figure 7. Soft charge fuses - Vertical Mount

4. Connect the VLT 5000/6000 wire harness assembly, supplied with the Power Card DC Supply Source, to the common connector at the bottom of the Power Card DC Supply Source box.
5. Connect the three fast-on connectors to the input side (left side or bottom end) of the soft charge fuse block (See Figures 6 and 7).

6. Connect the DC bus connections of the Power Card DC Supply Source to the 3-pin Molex connector attached to the Power Card.



7. Remove the SCR cable assembly from MK6 of the Power Card.
8. Short the SCR Gate-Cathode connections by inserting the SCR Jumper Plug into the end of the MK6 cable (See Figure 9).

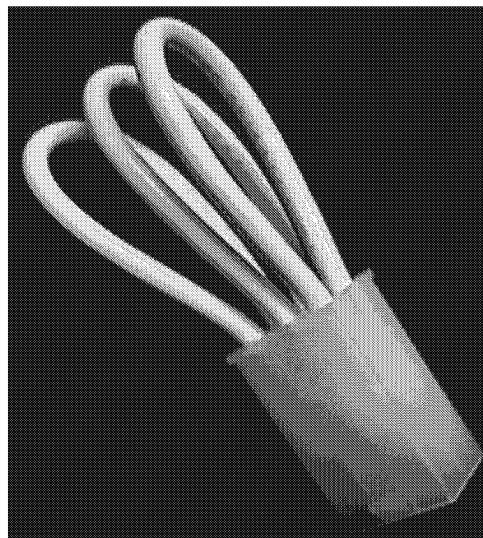

9. Reapply power and perform necessary tests.



VLT® 5000 Series Service Instructions

SPARE PARTS LIST

VLT 5060 - 5250 380/500V, 5075 - 5300 Aqua, 6075 - 6275 380/460V

DESCRIPTION	5060	5075	5100	5125	5150	5200	5250
	Aqua 5075	Aqua 5100	Aqua 50125	Aqua 5150	Aqua 5200	Aqua 5250	Aqua 5300
	6075	6100	6125	6150	6175	6225	6275
Control Card, Process, includes software	176F1400	176F1400	176F1400	176F1400	176F1400	176F1400	176F1400
Control Card, Process (conformal coated)	176F1452	176F1452	176F1452	176F1452	176F1452	176F1452	176F1452
Control Card, HVAC/Aqua, includes software	176F1405	176F1405	176F1405	176F1405	176F1405	176F1405	176F1405
Control Card, AQUA/HVAC (conformal)	176F1453	176F1453	176F1453	176F1453	176F1453	176F1453	176F1453
Local Control Panel Process	175Z0401	175Z0401	175Z0401	175Z0401	175Z0401	175Z0401	175Z0401
Local Control Panel HVAC/Aqua	175Z7804	175Z7804	175Z7804	175Z7804	175Z7804	175Z7804	175Z7804
Power Card ST/HVAC/Aqua Revised	176F1466	176F1467	176F1468	176F1469	176F1470	176F1471	176F1472
Power Card ST/HVAC/Aqua Rev CONF	176F2349	176F2350	176F2351	176F2352	176F2353	176F2354	176F2355
Power Card EB Revised	176F1473	176F1474	176F1475	176F1476	176F1477	176F1478	176F1479
Power Card EB Revised Conformal	176F2356	176F2357	176F2358	176F2359	176F2360	176F2361	176F2362
Brake Snubber Card	176F1122	176F1122	176F1122	176F1123	176F1123	176F1124	176F1124
Brake Snubber Card Conformal	176F2446	176F2446	176F2446	176F2447	176F2447	176F2448	176F2448
IGBT Snubber Card						176F1121	176F1121
IGBT Snubber Card Conformal						176F2460	176F2460
DC Bus RFI Filter Card	176F1187	176F1187	176F1187	176F1187	176F1187	176F1187	176F1187
DC Bus RFI Filter Card Conformal	176F2458	176F2458	176F2458	176F2458	176F2458	176F2458	176F2458
IGBT Assembly	176F1125	176F1125	176F1126			176F1129	176F1129
IGBT Assembly, Conformal	176F2402	176F2402	176F2403				
IGBT Assembly, Lower				176F1127	176F1127		
IGBT Assembly, Lower Conformal				176F2405	176F2405		
IGBT Assembly, Upper				176F1128	176F1128		
IGBT Assembly, Upper Conformal				176F2404	176F2404		
Brake IGBT	176F1130	176F1130	176F1130	176F1131	176F1131	176F1132	176F1132
SCR/Diode Input Rectifier	176F1133	176F1134	176F1135	176F1136	176F1137	176F1138	176F1139
DC Bus Capacitor	176F1139	176F1139	176F1139	176F1139	176F1139	176F1139	176F1139
Mylar Insulator, DC Capacitor Bank	176F1321	176F1321	176F1321	176F1323	176F1323	176F1325	176F1325
Bus Plate +, DC Capacitor Bank	176F1290	176F1290	176F1290	176F1293	176F1293	176F1296	176F1296
Bus Plate -, DC Capacitor Bank	176F1291	176F1291	176F1291	176F1294	176F1294	176F1297	176F1297
Bus Plate +/-, DC Capacitor Bank	176F1292	176F1292	176F1292	176F1295	176F1295	176F1298	176F1298
Bottom Insulator, DC Capacitor Bank	176F1322	176F1322	176F1322	176F1324	176F1324	176F1326	176F1326
Front Shield, DC Cap Bank, IP54/N12	176F1287	176F1287	176F1287	176F1288	176F1288	176F1289	175F1289
Front Shield, DC Cap Bank, IP20/N1	176F1357	176F1357	176F1357	176F1358	176F1358	176F1359	176F1359
Front Shield, Soft Charge, IP20/N1	176F1360	176F1360	176F1360	176F1361	176F1361	176F1361	176F1361
DC Bus Capacitor Bank Assembly	176F1275	176F1276	176F1277	176F1278	176F1279	176F1280	176F1281
Current Sensor Assy IP20/CHM/N1	176F1140	176F1140	176F1140				
I Sensor Assy IP20/CHM/N1 CONF	176F2400	176F2400	176F2400				
Current Sensor Assy IP54/N12, Pkg of 3	176F1143	176F1143	176F1143				
I Sensor Assy IP54/N12, Pkg of 3 CONF	176F2401	176F2401	176F2401				
Current Sensor				176F1141	176F1141		
Current Sensor Conformal				176F2461	176F2461		
Current Sensor IP54						176F1142	176F1142
Current Sensor IP54 Conformal						176F2462	176F2462
Current Sensor w/Output Wire (U) IP20						176F1488	176F1488
I Sensor w/Output Wire (U) IP20 Conformal						176F2463	176F2463
Current Sensor w/Output Wire (V) IP20						176F1489	176F1489
I Sensor w/Output Wire (V) IP20 Conformal						176F2464	176F2464
Current Sensor w/Output Wire (W) IP20						176F1490	176F1490
I Sensor w/Output Wire (W) IP20 Conformal						176F2465	176F2465
DC Bus Balance Resistor	176L3423	175L3423	175L3423	175L3423	175L3423	175L3550	175L3550
SCR Snubber Capacitor	175L3424	175L3424	175L3424	175L3424	175L3424	175L3424	175L3424
SCR Snubber Resistor	176F1145	176F1145	176F1145	176F1145	176F1145	176F1145	176F1145
Heatsink Thermal Sensor Assembly	176F1273	176F1273	176F1273	176F1273	176F1273	176F1273	176F1273
Soft Charge Rectifier	175L3421	175L3421	175L3421	176F1146	176F1146	176F1146	176F1146
Soft Charge Resistor, include thermostat	176F1144	176F1144	176F1144	176F1144	176F1144	176F1144	176F1144
Soft Charge Rectifier Fuse, Pkg of 3	176F1147	176F1147	176F1147	176F1148	176F1148	176F1148	176F1148
Soft Charge Rectifier Fuse Block	175L3418	175L3418	175L3418	175L3418	175L3418	175L3418	175L3418
SCR Snubber Diode	176F1343	176F1343	176F1343	176F1343	176F1343	176F1343	176F1343
Soft Charge Resistor Fuse	176F1192	176F1192	176F1192	176F1192	176F1192	176F1192	176F1192



VLT® 5000 Series Service Instructions

SPARE PARTS LIST

VLT 5060 - 5250 380/500V, 5075 - 5300 Aqua, 6075 - 6275 380/460V Continued

DESCRIPTION	5060	5075	5100	5125	5150	5200	5250
	Aqua 5075	Aqua 5100	Aqua 50125	Aqua 5150	Aqua 5200	Aqua 5250	Aqua 5300
	6075	6100	6125	6150	6175	6225	6275
Soft Charge Resistor Fuse Block	176F1193	176F1193	176F1193	176F1193	176F1194	176F1194	176F1194
DC Link Inductor IP20/CHM/N1	176F2324	176F2328	176F2332	176F2336	176F2340	176F2343	176F2345
DC Link Inductor IP54/N12	176F2326	176F2330	176F2334	176F2338	176F2342	176F2346	176F2348
Output Inductor IP20/CHM/N1	176F2323	176F2327	176F2331	176F2335	176F2339	176F2344	176F2344
Output Inductor IP54/N12	176F2325	176F2329	176F2333	176F2337	176F2341	176F2347	176F2347
Fan, Heatsink IP20/CHM/N1	176F1177	176F1177	176F1177	176F1178	176F1178	176F1178	176F1178
Cap, Fan Heatsink IP20/CHM/N1/IP54/N1	176F1179	176F1179	176F1179	176F1180	176F1180	1876F1180	176F1180
Inlet Ring, Heatsink Fan, IP20/N1/CHM				176F2397	176F2397	176F2397	176F2397
Fan Assy, Heatsink IP54/N12	176F1181	176F1181	176F1181	176F1182	176F1182	176F1182	176F1182
Fan, Cap Bank IP54/N12	176F1245	176F1245	176F1245				
Fan, Cap Bank IP54/N12 Conformal	176F2457	176F2457	176F2457				
Fan, Door, Lower IP54/N12				176F1184	176F1184	176F1184	176F1184
Fan, Door, Upper IP54/N12				176F1223	176F1223	176F1223	176F1223
Fan Guard, Upper IP54/N12				176F1224	176F1224	176F1224	176F1224
Autotransformer, Fan Supply	176F1243	176F1243	176F1243	176F1244	176F1244	176F1244	176F1244
Filter, Door Fan IP54/N12				176F1185	176F1185	176F1185	176F1185
Grill, Door Fan IP54/N12, includes filter				176F1186	176F1186	176F1186	176F1186
SMPS Fuse	175L3437	175L3437	175L3437	175L3437	175L3437	175L3437	175L3437
Terminals, Line	176F1188	176F1188	176F1188	176F1189	176F1189	176F1189	176F1189
Terminals, Motor	176F1190	176F1190	176F1190	176F1191	176F1191	176F1191	176F1191
Terminals, Brake (SB/EB Only)	176F1212	176F1212	176F1212	176F1213	176F1213	176F1213	176F1213
Terminals, DC (EB Only)	176F1214	176F1214	176F1214	176F1215	176F1215	176F1215	176F1215
Terminal Kit, Control Card	176F1210	176F1210	176F1210	176F1210	176F1210	176F1210	176F1210
Terminal Kit, Power Card	176F1211	176F1211	176F1211	176F1211	176F1211	176F1211	176F1211
Terminals, Aux Fan Supply, HVAC/Aqua	176F1338	176F1338	176F1338	176F1338	176F1338	176F1338	176F1338
DC Terminal Repair Kit, Cap Bank	176F2381	176F2381	176F2381	176F2382	176F2382	176F2382	176F2382
Top Cover IP20/CHM/N1	176F1263	176F1263	176F1263	176F1264	176F1264	176F1264	176F1264
Front Door w/Screws IP20/CHM/N1	176F1266	176F1266	176F1266	176F1267	176F1267	176F1267	176F1267
Front Cover (Plas) Process IP20/CHM/N1	176F1268	176F1268	176F1268	176F1265	176F1265	176F1265	176F1265
Front Cover (Plas) HVAC IP20/CHM/N1	175Z3010	175Z3010	175Z3010	176F1339	176F1339	176F1339	176F1339
Front Cover (Plas) Aqua IP20/CHM/N1	176F1348	176F1348	176F1348	176F1349	176F1349	176F1349	176F1349
Front Logo (Plastic) IP20/CHM/N1	175Z3001	175Z3001	175Z3001	175Z3001	175Z3001	175Z3001	175Z3001
Front Door w/Hardware Process IP54/N12	176F1269	176F1269	176F1269	176F1328	176F1328	176F1270	176F1270
Front Door w/Hardware HVAC IP54/N12	176F1340	176F1340	176F1340	176F1341	176F1341	176F1342	176F1342
Front Door w/Hardware Aqua IP54/N12	176F1353	176F1353	176F1353	176F1354	176F1354	176F1355	176F1355
Hinge Kit, Front Door IP54/N12	176F1216	176F1216	176F1216	176F1216	176F1216	176F1216	176F1216
Latch Kit, Front Door IP54/N12	176F1217	176F1217	176F1217	176F1218	176F1218	176F1218	176F1218
Bottom Access Plate Assy. IP20/IP54	175L3592	175L3592	175L3592	175L3592	175L3592	175L3592	175L3592
Conduit Bracket IP20/CHM/N1	176F1246	176F1246	176F1246	176F1247	176F1247	176F1247	176F1247
Display Cradle IP20/CHM/N1	175Z1158	175Z1158	175Z1158	175Z1158	175Z1158	175Z1158	175Z1158
Control Card Cassette	176F1240	176F1240	176F1240	176F1240	176F1240	176F1240	176F1240
Control Card Mtg. Bracket IP55/N12	176F1299	176F1299	176F1299	176F1299	176F1299	176F1299	176F1299
Power Card Bracket Top	176F1259	176F1259	176F1259	176F1261	176F1261	176F1261	176F1261
Power Card Bracket Bottom	176F1260	176F1260	176F1260	176F1262	176F1262	176F1262	176F1262
Ribbon Cable Set, IP20/CHM/N1	176F1225	176F1225	176F1225	176F1226	176F1226	176F1226	176F1226
Ribbon Cable Set, IP54/N12	176F1227	176F1227	176F1227	176F1228	176F1228	176F1228	176F1228
RFI Assembly, IP20/CHM/N1	176F1201	176F1201	176F1201	176F1202	176F1202	176F1203	176F1203
RFI Assembly, IP20/CHM/N1 Conformal	176F2451	176F2451	176F2451	176F2452	176F2452	176F2453	176F2453
RFI Assembly, IP54/N12	176F1282	176F1282	176F1282	176F1283	176F1283	176F1284	176F1284
RFI Assembly, IP54/N12 Conformal	176F2454	176F2454	176F2454	176F2455	176F2455	176F2456	176F2456
Soft Change Thermostat	176F1274	175F1274	176F1274	176F1274	176F1274	176F1274	176F1274
Bus Bar SCR +	176F1285	176F1285	176F1256	176F1253	176F1253	176F1251	176F1251
Bus Bar SCR -	176F1286	176F1286	176F1255	176F1254	176F1254	176F1252	176F1252
Bus Bar SCR AC	176F1257	176F1257	176F1257			176F1248	176F1248
Kit, SCR Bus Bar Insulator	176F1494	176F1494	176F1494	176F1494	176F1494	176F1494	176F1494
Bus Bar IGBT E-1-C2				176F1249	176F1249	176F1250	176F1250
Barrel Lug, Screw terminal, IP54/N12	176F2386	176F2386	176F2386				
Lifting Hook	176F1258	176F1258	176F1258	176F1258	176F1258	176F1258	176F1258



VLT® 5000 Series Service Instructions

SPARE PARTS LIST

VLT 5060 - 5250 380/500V, 5075 - 5300 Aqua, 6075 - 6275 380/460V Continued

DESCRIPTION	5060	5075	5100	5125	5150	5200	5250
	Aqua 5075	Aqua 5100	Aqua 50125	Aqua 5150	Aqua 5200	Aqua 5250	Aqua 5300
	6075	6100	6125	6150	6175	6225	6275
Cable Assy. Control to LCP IP54/N12	176F1220	176F1220	176F1220	176F1221	176F1221	176F1221	176F1221
Wire Assy. Pwr Card to SCR	176F1229	176F1229	176F1230	176F1231	176F1231		
Wire Assy. Pwr to SCR IP20/CHM/N1						176F1232	176F1232
Wire Assy. Pwr Card to SCR IP54/N12						176F1233	176F1233
Wire Assy. Pwr to I Sense IP54/N12				176F1234	176F1234	176F1234	176F1234
Wire Kit, Input to SCR, incl 3 Phases IP20	176F2372	176F2372	176F2372	176F1486	176F1486	176F2374	176F2374
Wire Kit, Input to SCR, incl 3 Phases IP54	176F2373	176F2373	176F2373	176F1487	176F1487	176F2375	176F2375
Wire Kit, Motor Coil to Output Terminals, incl. 3 Phases IP20	Use 176F1140	Use 176F1140	Use 176F1140	176F2370	176F2370	Use 176F1488 176F1489 176F1490	Use 176F1488 176F1489 176F1490
Wire Kit, Splicer Block to Output Terminals, incl 3 Phases IP54	176F2385	176F2385	176F2385	176F2371	176F2371	176F2369	176F2369
Splicer Block for Output Wires IP54	176F2383	176F2383	176F2383	176F2383	176F2383	176F2384	176F2384
Wire Assy, MK7-Cap Bank Fans IP54/N12	176F1493	176F1493	176F1493				
Wire Assembly, MOV1	176F1464	176F1464	176F1464	176F1465	176F1465	176F1465	176F1465
Wire Assy, Pwr to I Sense IP20/CHM/N1				176F1235	165F1235	176F1235	176F1235
SPARE, WIRE Assy SFT CH							176F2387
SPARE, WIRE Assy R13 Soft Charge							176F2388
SPARE, WIRE Assy L1-Cap							176F2389
SPARE, WIRE Assy L1-Cap							176F2390
SPARE, WIRE Assy DC Bus							176F2391
SPARE, WIRE Assy +Bus to R							176F2392
SPARE, WIRE Assy -Bus to R							176F2393
SPARE, BUS Bar 400A Brake option							176F2394
SPARE, WIRE Assy BR2 to F4							176F2395
SPARE, WIRE Assy BR2 to R1							176F2396
EMC Ground Plate Chassis	176F5453	176F5453	176F5453	176F5454	187F5454	176F5454	176F5454

Danfoss can accept no responsibility for possible errors in catalogs, brochures and other printed material. Danfoss reserves the right to alter its products without notice, provided that alterations to products already on order shall not require material changes in specifications previously agreed upon by Danfoss and the purchaser. All trademarks in this material are property of the respective companies. Danfoss and the Danfoss logotype are trademarks of Danfoss A/S. All rights are reserved.



Danfoss Drives

4401 N. Bell School Road
Loves Park, IL. 61111
Phone TollFree: 800/432-6367
Phone: 815/639-8600
Fax: 815/639-8000