

VACON[®] 20
AC DRIVES

PFC APPLICATION MANUAL

A decorative graphic consisting of numerous thin, light blue lines that curve and flow across the lower half of the page, creating a sense of motion and depth.

VACON[®]
DRIVEN BY DRIVES

TABLE OF CONTENTS

1.Safety	1
1.1Warnings	1
1.2Safety instructions	3
1.3Earthing and earth fault protection	3
1.4Before running the motor	5
2.Receipt of delivery	6
2.1Type designation code	6
2.2Storage	6
2.3Maintenance	7
2.3.1Capacitor recharge	7
2.4Warranty	8
2.5Manufacturer's declaration of conformity	9
3.Installation	10
3.1Mechanical installation	10
3.1.1Vacon 20 dimensions	14
3.1.2Cooling	18
3.1.3Power losses	19
3.1.4EMC levels	26
3.1.5Changing the EMC protection class from C2 or C3 to C4	27
3.2Cabling and connections	29
3.2.1Power cabling	29
3.2.2Control cabling	31
3.2.3Allowed option boards in Vacon20	35
3.2.4Screw of cables	37
3.2.5Cable and fuse specifications	39
3.2.6General cabling rules	42
3.2.7Stripping lengths of motor and mains cables	43
3.2.8Cable installation and the UL standards	43
3.2.9Cable and motor insulation checks	43
4.Commissioning	45
4.1Commissioning steps of Vacon 20	45
5.Fault tracing	47
6.PFC SYSTEM Interface	51
6.1I/O signals	51
7.Control panel	56
7.1General	56
7.2Display	56
7.3Keypad	57
7.4Navigation on the Vacon 20 control panel	59

7.4.1	Main menu	59
7.4.2	Reference menu	60
7.4.3	Monitoring menu	61
7.4.4	Parameter menu	62
7.4.5	System menu	64
8.	PFC application parameters	66
8.1	Startup wizard	67
8.2	Monitor	67
8.2.1	Basic	67
8.2.2	I/O	68
8.2.3	Extras/advanced	69
8.2.4	PID control	69
8.3	Main parameters lists (Menu PAR)	70
8.3.1	Motor settings	70
8.3.2	Start/stop setup	72
8.3.3	References	73
8.3.4	Ramps and brakes	73
8.3.5	Digital inputs	75
8.3.6	Analog inputs	76
8.3.7	Digital outputs	77
8.3.8	Analog outputs	78
8.3.9	Fieldbus data-Mapping	79
8.3.10	Prohibited frequencies	79
8.3.11	Protections	80
8.3.12	Automatic reset	82
8.3.13	PID controller	82
8.3.14	PFC	84
8.3.15	Application settings	85
8.4	System parameters	85
9.	Parameter descriptions	89
9.1	Motor settings	89
9.2	Start/stop setup	93
9.3	References	95
9.4	Ramps and brakes	96
9.5	Digital inputs	98
9.6	Analog inputs	99
9.7	Digital outputs	100
9.8	Analog outputs	101
9.9	Fieldbus data-mapping	102
9.10	Prohibited frequencies	103
9.11	Protections	104

9.12Automatic reset	107
9.13PID controller	108
9.14PFC	110
9.15Application setting	113
10.Technical data	114
10.1Vacon 20 technical data	114
10.2Power ratings	117
10.2.1Vacon 20 – Mains voltage 208-240 V	117
10.2.2Vacon 20 – Mains voltage 115 V	118
10.2.3Vacon 20 – Mains voltage 380-480 V	118
10.2.4Vacon 20 – Mains voltage 600 V	119
10.3Brake resistors	119

1. SAFETY



ONLY A COMPETENT ELECTRICIAN IS ALLOWED TO CARRY OUT THE ELECTRICAL INSTALLATION!

This manual contains clearly marked cautions and warnings which are intended for your personal safety and to avoid any unintentional damage to the product or connected appliances.

Please read the information included in cautions and warnings carefully:

	<p>=Dangerous voltage Risk of death or severe injury</p>
	<p>=General warning Risk of damage to the product or connected appliances</p>

1.1 Warnings



The components of the power unit of the frequency converter are live when Vacon 20 is connected to mains. Coming into contact with this voltage is extremely dangerous and may cause death or severe injury. The control unit is isolated from the mains potential.



The motor terminals U, V, W (T1, T2, T3) and the possible brake resistor terminals - / + are live when Vacon 20 is connected to mains, even if the motor is not running.



The control I / O-terminals are isolated from the mains potential. However, the relay output terminals may have a dangerous control voltage present even when Vacon 20 is disconnected from mains.



The earth leakage current of Vacon 20 frequency converters exceeds 3.5 mA AC. According to standard EN61800-5-1, a reinforced protective ground connection must be ensured.



If the frequency converter is used as a part of a machine, the machine manufacturer is responsible for providing the machine with a main switch [EN 60204-1].



If Vacon 20 is disconnected from mains while running the motor, it remains live if the motor is energized by the process. In this case the motor functions as a generator feeding energy to the frequency converter.







After disconnecting the frequency converter from the mains, wait until the fan stops and the indicators on the display go out. Wait 5 more minutes before doing any work on Vacon 20 connections.



The motor can start automatically after a fault situation, if the autoreset function has been activated.

1.2 Safety instructions

-  The Vacon 20 frequency converter has been designed for fixed installations only.
-  Do not perform any measurements when the frequency converter is connected to the mains.
-  Do not perform any voltage withstand tests on any part of Vacon 20. The product safety is fully tested at factory.
-  Prior to measurements on the motor or the motor cable, disconnect the motor cable from the frequency converter.
-  Do not open the cover of Vacon 20. Static voltage discharge from your fingers may damage the components. Opening the cover may also damage the device. If the cover of Vacon 20 is opened, warranty becomes void.

1.3 Earthing and earth fault protection

The Vacon 20 frequency converter **must always** be earthed with an earthing conductor connected to the earthing terminal. See figure below:

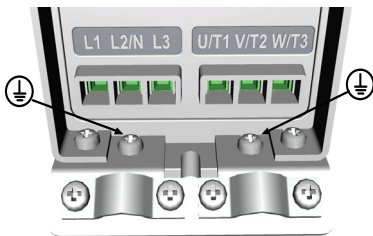

MI1 - MI3



MI4

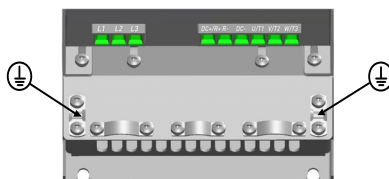

MI5

- The earth fault protection inside the frequency converter protects only the converter itself against earth faults.
- If fault current protective switches are used they must be tested with the drive with earth fault currents that are possible to arise in fault situations.

1.4 Before running the motor

Checklist:



Before starting the motor, check that the motor is mounted properly and ensure that the machine connected to the motor allows the motor to be started.



Set the maximum motor speed (frequency) according to the motor and the machine connected to it.



Before reversing the motor shaft rotation direction make sure that this can be done safely.



Make sure that no power correction capacitors are connected to the motor cable.

NOTE! You can download the English and French product manuals with applicable safety, warning and caution information from www.vacon.com/downloads.

REMARQUE Vous pouvez télécharger les versions anglaise et française des manuels produit contenant l'ensemble des informations de sécurité, avertissements et mises en garde applicables sur le site www.vacon.com/downloads.

2. RECEIPT OF DELIVERY

After unpacking the product, check that no signs of transport damages are to be found on the product and that the delivery is complete (compare the type designation of the product to the code below).

Should the drive have been damaged during the shipping, please contact primarily the cargo insurance company or the carrier.

If the delivery does not correspond to your order, contact the supplier immediately.

2.1 Type designation code

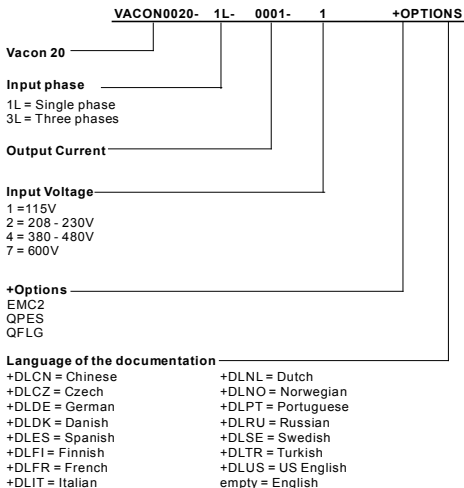

Figure 2.1: Vacon 20 type designation code

2.2 Storage

If the frequency converter is to be kept in store before use make sure that the ambient conditions are acceptable:

Storing temperature -40...+70 °C

Relative humidity < 95%, no condensation

2.3 Maintenance

In normal operating conditions, Vacon 20 frequency converters are maintenance-free. However, regular maintenance is recommended to ensure a trouble-free operating and a long lifetime of the drive. We recommended to follow the table below for maintenance intervals.

Maintenance interval	Maintenance action
Whenever necessary	<ul style="list-style-type: none"> Clean headsink*
Regular	<ul style="list-style-type: none"> Check tightening torques of terminals
12 months (If stored)	<ul style="list-style-type: none"> Check input and output terminals and control I / O terminals. Clean cooling tunnel.* Check operation of cooling fan, check for corrosion on terminals, busbars and other surfaces.*
6 - 24 months (depending on environment)	<ul style="list-style-type: none"> Check and clean and clean cooling fans: Main fan* Interminal fan*

* Only for frame 4 and frame 5

2.3.1 Capacitor recharge

After a longer storage time the capacitors need to be recharge in order to avoid capacitor damage. Possible high leakage current through the capacitors must be limited. The best way to achieve this is to use a DC-power supply with adjustable current limit.

- 1) Set the current limit to 300...800 mA according to the size of the drive.
- 2) Then connect the DC-power supply to the input phase L1 and L2.
- 3) Then set the DC-voltage to the nominal DC-voltage level of the (1.35*Un AC) and supply the converter for at least 1 h.

If DC-voltage is not available and the unit has been stored much longer than 12 months deenergized, consult the factory before connecting power.

2.4 Warranty

Only manufacturing defects are covered by the warranty. The manufacturer assumes no responsibility for damages caused during or resulting from transport, receipt of the delivery, installation, commissioning or use.

The manufacturer shall in no event and under no circumstances be held responsible for damages and failures resulting from misuse, wrong installation, unacceptable ambient temperature, dust, corrosive substances or operation outside the rated specifications. Neither can the manufacturer be held responsible for consequential damages.

The Manufacturer's time of warranty is 18 months from the delivery or 12 months from the commissioning whichever expires first (Vacon Warranty Terms).

The local distributor may grant a warranty time different from the above. This warranty time shall be specified in the distributor's sales and warranty terms. Vacon assumes no responsibility for any other warranties than that granted by Vacon itself.

In all matters concerning the warranty, please contact first your distributor.

2.5 Manufacturer's declaration of conformity

**EC DECLARATION OF CONFORMITY**

We

Manufacturer's name: Vacon Oyj
Manufacturer's address: P.O.Box 25
Runsorintie 7
FIN-65381 Vaasa
Finland

hereby declare that the product

Product name: Vacon 20 Frequency Converter
Model designation: Vacon 20 1L 0001 2...to 0009 2
Vacon 20 3L 0001 2...to 0038 2
Vacon 20 3L 0001 4...to 0038 4

has been designed and manufactured in accordance with the following standards:

Safety: EN 60204 -1:2009 (as relevant),
EN 61800-5-1:2007
EMC: EN 61800-3:2004+A1:2012

and conforms to the relevant safety provisions of the Low Voltage Directive 2006/95/EC and EMC Directive 2004/108/EC.

It is ensured through internal measures and quality control that the product conforms at all times to the requirements of the current Directive and the relevant standards.

In Vaasa, 16th of April, 2014

Vesa Laisi
President

The year the CE marking was affixed: 2011

3. INSTALLATION

3.1 Mechanical installation

There are two possible ways to mount Vacon 20 in the wall. For MI1-MI3, either screw or DIN-rail mounting; For MI4-MI5, screw or flange mounting.

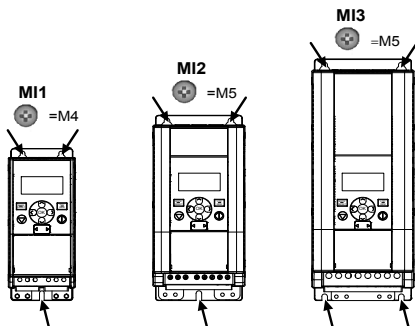

Figure 3.1: Screw mounting, MI1 - MI3

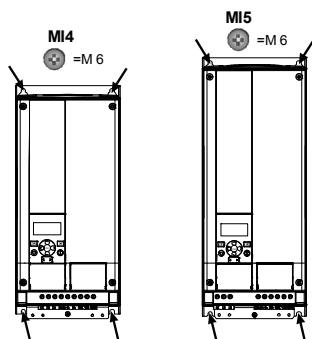

Figure 3.2: Screw mounting, MI4 - MI5

Note! See the mounting dimensions on the back of the drive. More details in Chapter 3.1.1.

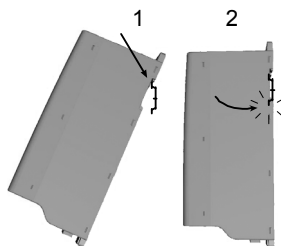

Figure 3.3: DIN-rail mounting, MI1 - MI3

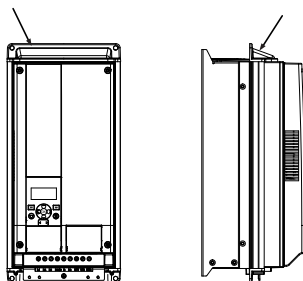

Figure 3.4: Flange mounting, MI4 - MI5

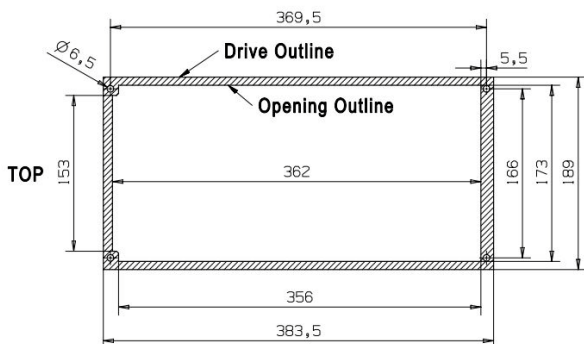

Figure 3.5: Flange mounting cutout dimensions for MI4 (Unit: mm)

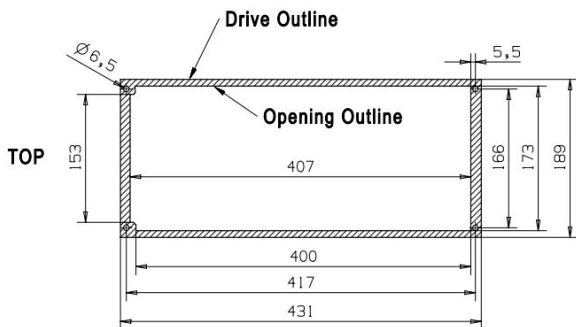

Figure 3.6: Flange mounting cutout dimensions for MI5 (Unit: mm)

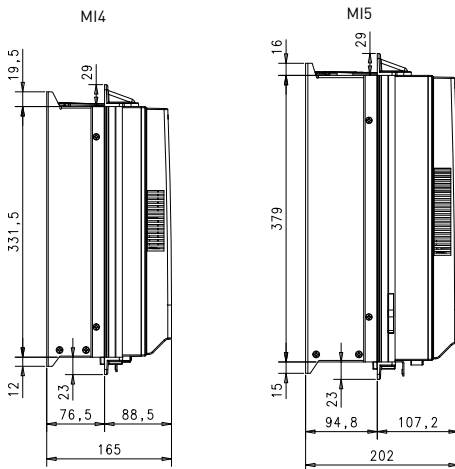

Figure 3.7: Flange mounting depth dimensions for MI4 and MI5 (Unit: mm)

3.1.1 Vacon 20 dimensions

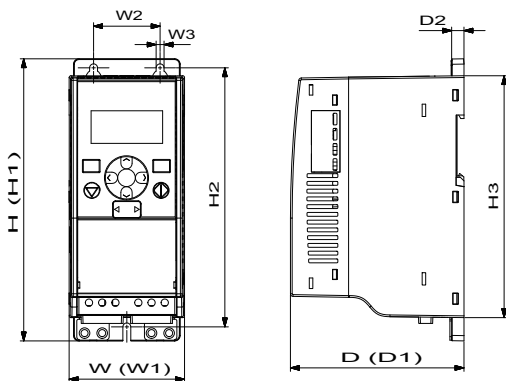

Figure 3.8: Vacon 20 dimensions, MI1 - MI3

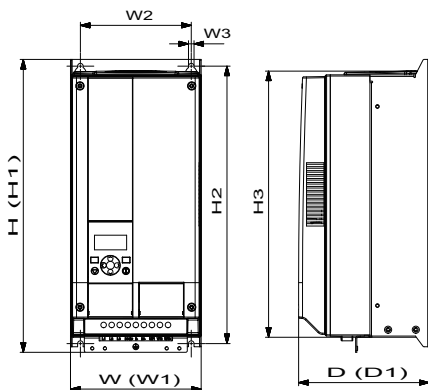

Figure 3.9: Vacon 20 dimensions, MI4 - MI5

Type	H1	H2	H3	W1	W2	W3	D1	D2
MI1	160.1	147	137.3	65.5	37.8	4.5	98.5	7
MI2	195	183	170	90	62.5	5.5	101.5	7
MI3	254.3	244	229.3	100	75	5.5	108.5	7
MI4	370	350.5	336.5	165	140	7	165	-
MI5	414	398	383	165	140	7	202	-

Table 3.1: Vacon 20 dimensions in millimetres

Frame	Dimensions(mm)			Weight*
	W	H	D	(kg.)
MI1	66	160	98	0.5
MI2	90	195	102	0.7
MI3	100	254.3	109	1
MI4	165	370	165	8
MI5	165	414	202	10
				*without shipping package

Table 3.2: Vacon 20 frame dimensions (mm) and weights (kg)

Frame	Dimensions(Inches)			Weight*
	W	H	D	(lbs.)
MI1	2.6	6.3	3.9	1.2
MI2	3.5	9.9	4	1.5
MI3	3.9	10	4.3	2.2
MI4	6.5	14.6	6.5	18
MI5	6.5	16.3	8	22
				*without shipping package

Table 3.3: Vacon 20 frame dimensions (Inch) and weights (lbs)

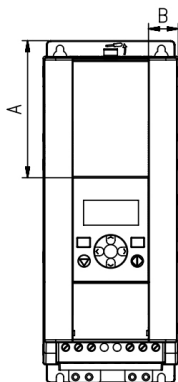

Figure 3.10: Vacon20 dimensions, MI2 - 3 Display Location

Dimensions (mm)	Frame	
	MI2	MI3
A	17	22.3
B	44	102

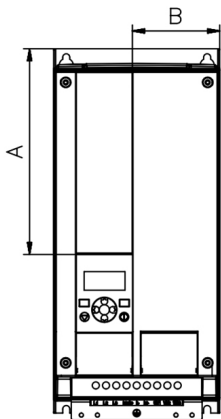

Figure 3.11: Vacon20 dimensions, MI4 - 5 Display Location

Dimensions (mm)	Frame	
	MI2	MI3
A	205	248.5
B	87	87

3.1.2 Cooling

Enough free space shall be left above and below the frequency converter to ensure sufficient air circulation and cooling. You will find the required dimensions for free space in the table below.

If several units are mounted above each other the required free space equals C + D (see figure below). Moreover, the outlet air used for cooling by the lower unit must be directed away from the air intake of the upper unit.

The amount of cooling air required is indicated below. Also make sure that the temperature of the cooling air does not exceed the maximum ambient temperature of the converter.

Min clearance (mm)				
Type	A*	B*	C	D
MI1	20	20	100	50
MI2	20	20	100	50
MI3	20	20	100	50
MI4	20	20	100	100
MI5	20	20	120	100

Table 3.4: Min. clearances around AC drive

*. Min clearance A and B for drives for MI1 - MI3 can be 0 mm if the ambient temperature is below 40 degrees.

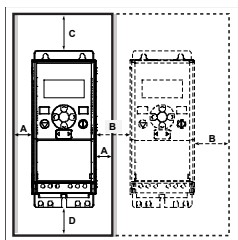

Figure 3.12: Installation space

A = clearance around the freq. converter (see also B)

B = distance from one frequency converter to another or distance to cabinet wall

C = free space above the frequency converter

D = free space underneath the frequency converter

NOTE! See the mounting dimensions on the back of the drive.

Leave **free space** for cooling above (**100 mm**), below (**50 mm**), and on the sides (**20 mm**) of Vacon 20! [For MI1 - MI3, side-to-side installation allowed only if the ambient temperature is below 40 °C; For MI4-MI5, side-to-side installation is not allowed.]

Type	Cooling air required (m ³ /h)
MI1	10
MI2	10
MI3	30
MI4	45
MI5	75

Table 3.5: Required cooling air

3.1.3 Power losses

If the operator wants to raise the switching frequency of the drive for some reason (typically e.g. in order to reduce the motor noise), this inevitably affects the power losses and cooling requirements, for different motor shaft power, operator can select the switching frequency according to the graphs below.

MI1 - MI5 3P 380 V POWER LOSS

MI1 400V, 2.4A, Eff., 400V, 50C

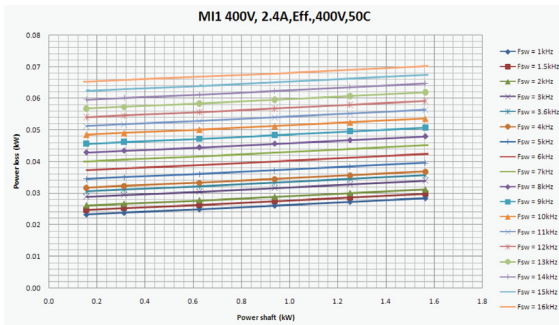

MI2 400V, 5.6A, Eff., 400V, 50C

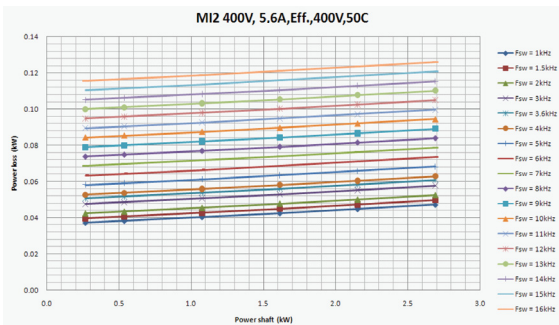

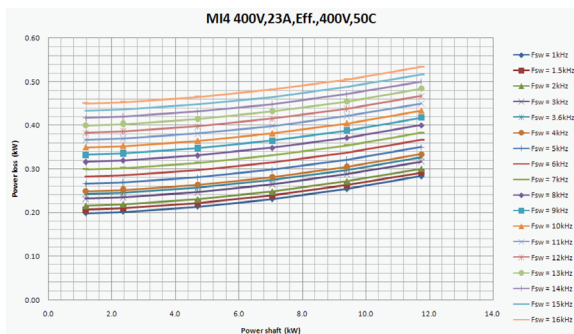
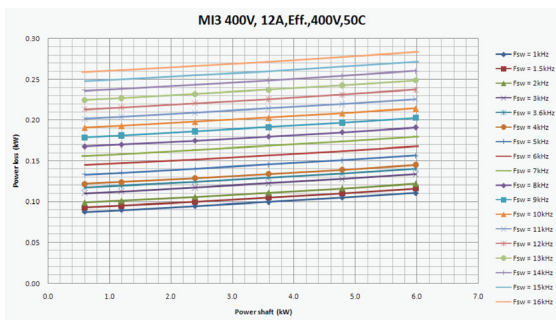

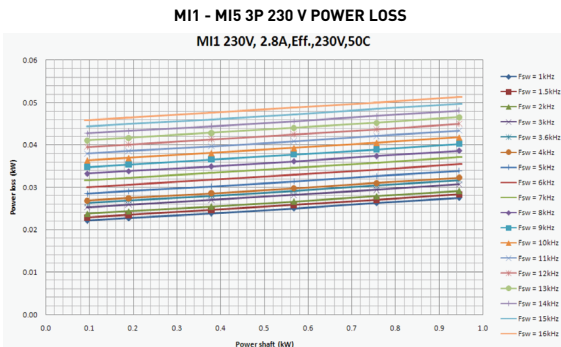
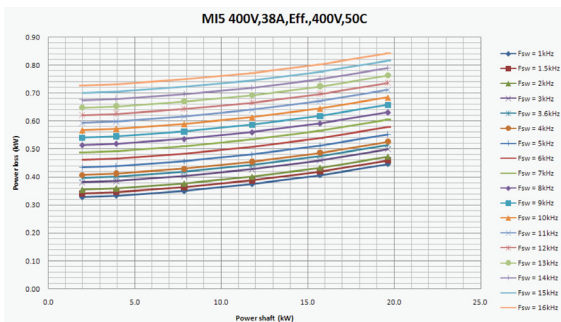

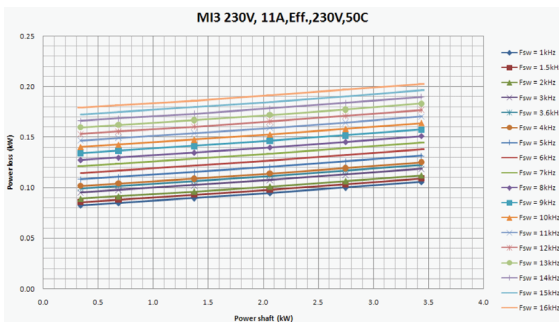
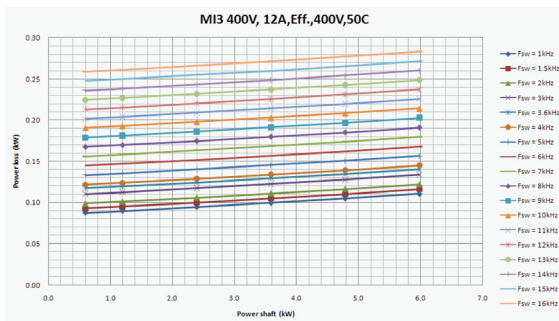

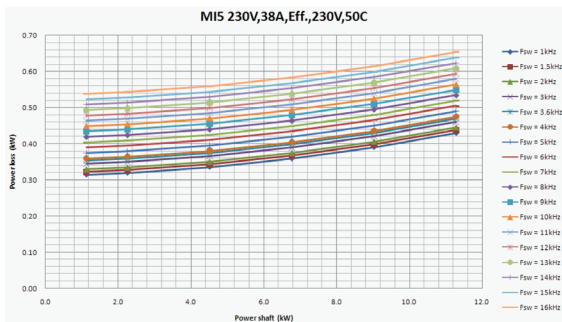
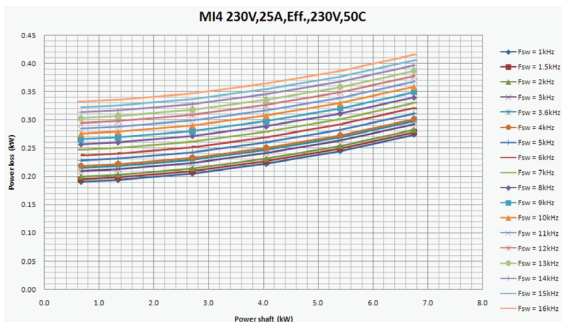

MI1 - MI3 1P 230 V POWER LOSS

MI1 230V, 2.8A, Eff., 230V, 50C

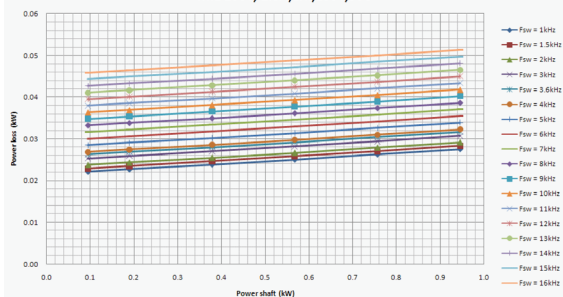

MI2 230V, 7A, Eff., 230V, 50C

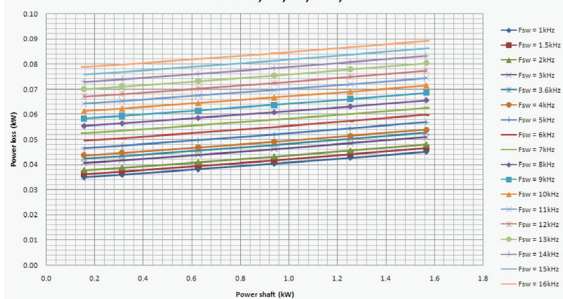

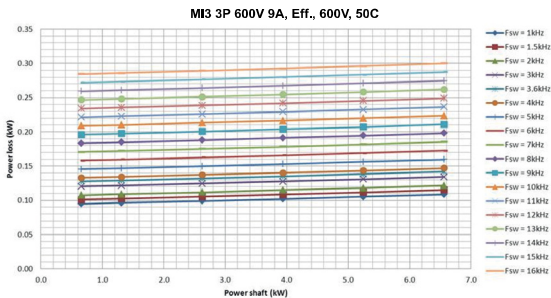
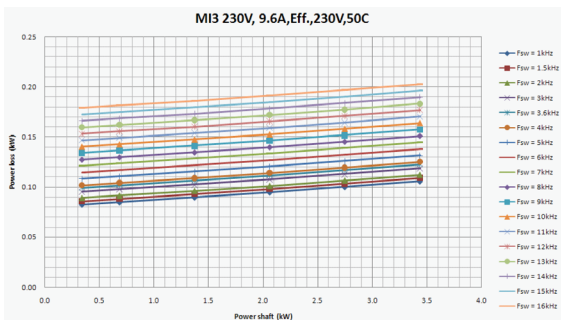

3.1.4 EMC levels

EN61800-3 defines the division of frequency converters into four classes according to the level of electromagnetic disturbances emitted, the requirements of a power system network and the installation environment (see below). The EMC class of each product is defined in the type designation code.

Category C1: Frequency converters of this class comply with the requirements of category C1 of the product standard EN 61800-3 (2004). Category C1 ensures the best EMC characteristics and it includes converters the rated voltage of which is less than 1000 V and which are intended for use in the 1st environment.

NOTE: The requirements of class C are fulfilled only as far as the conducted emissions are concerned.

Category C2: Frequency converters of this class comply with the requirements of category C2 of the product standard EN 61800-3 (2004). Category C2 includes converters in fixed installations and the rated voltage of which is less than 1000 V. The class C2 frequency converters can be used both in the 1st and the 2nd environment.

Category C3: Frequency converters of this class comply with the requirements of category C3 of the product standard EN 61800-3 (2004). Category C3 includes converters the rated voltage of which is less than 1000 V and which are intended for use in the second environment only.

Category C4: The drives of this class do not provide EMC emission protection. These kinds of drives are mounted in enclosures.

Environments in product standard EN 61800-3 (2004)

First environment: Environment that includes domestic premises. It also includes establishments directly connected without intermediate transformers to a low-voltage power supply network which supplies buildings used for domestic purposes.

NOTE: houses, apartments, commercial premises or offices in a residential building are examples of first environment locations.

Second environment: Environment that includes all establishments other than those directly connected to a low-voltage power supply network which supplies buildings used for domestic purposes.

NOTE: industrial areas, technical areas of any building fed from a dedicated transformer are examples of second environment locations.

3.1.5 Changing the EMC protection class from C2 or C3 to C4

The EMC protection class of MI1-3 frequency converters can be changed from class C2 or C3 to class C4 by **removing the EMC-capacitor disconnecting screw**, see figure below. MI4 & 5 can also be changed by removing the EMC jumpers.

Note! Do not attempt to change the EMC level back to class C2 or C3. Even if the procedure above is reversed, the frequency converter will no longer fulfil the EMC requirements of class C2 / C3!

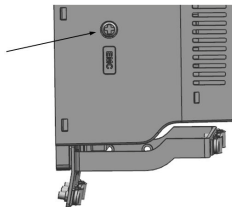

Figure 3.13: EMC protection class, MI1 - MI3

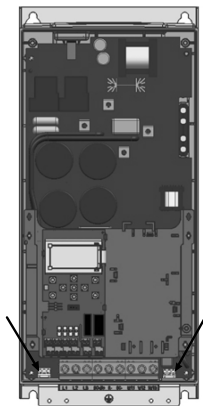

Figure 3.14: EMC protection class, MI4

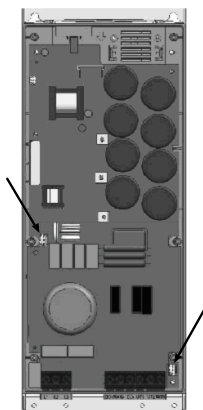

Figure 3.15: EMC protection class, M15



Figure 3.16: Jumpers

- Remove the main cover and locate the two jumpers.
- Disconnect the RFI-filters from ground by lifting the jumpers up from their default positions. See Figure 3.16

3.2 Cabling and connections

3.2.1 Power cabling

Note! Tightening torque for power cables is 0.5 - 0.6 Nm (4-5 in.lbs).

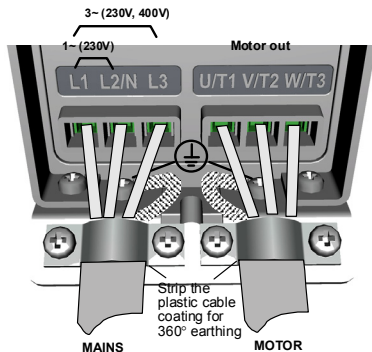

Figure 3.17: Vacon 20 power connections, MI1

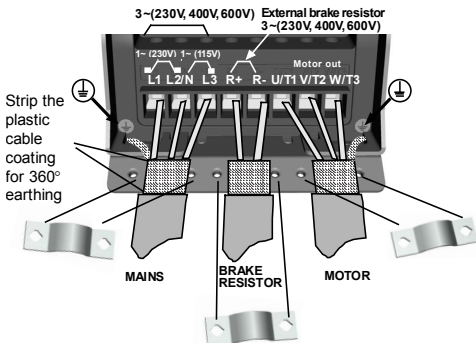

Figure 3.18: Vacon 20 power connections, MI2 - MI3

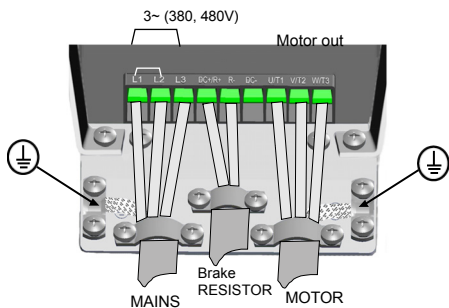

Figure 3.19: Vacon 20 power connections, MI4

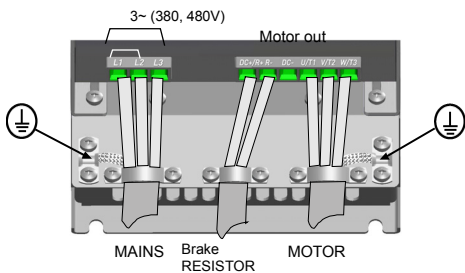

Figure 3.20: Vacon 20 power connections, MI5

3.2.2 Control cabling

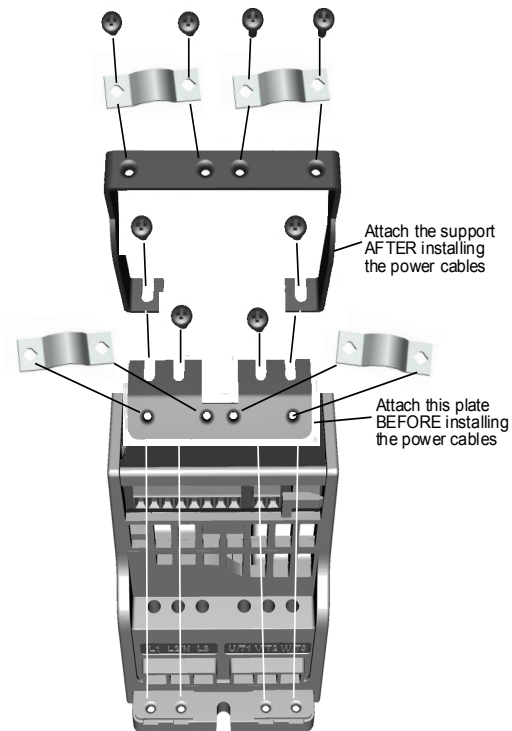

Figure 3.21: Mount the PE-plate and API cable support, MI1 - MI3

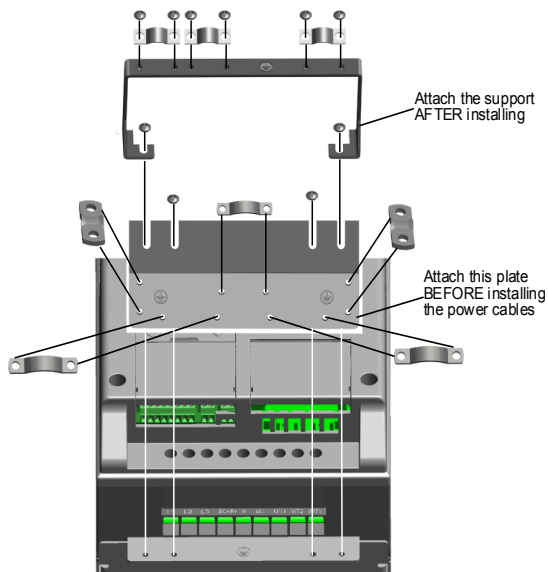

Figure 3.22: Mount the PE-plate and API cable support, MI4 - MI5

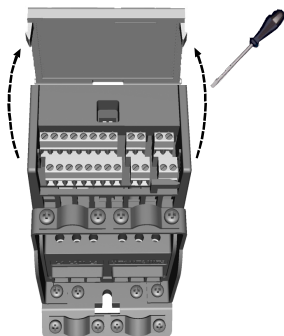

Figure 3.23: Open the lid, M11 - M13

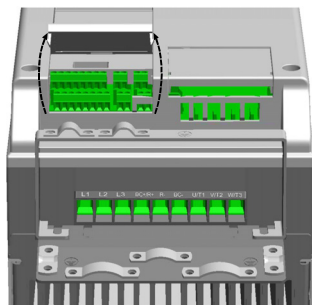

Figure 3.24: Open the lid, M14 - M15

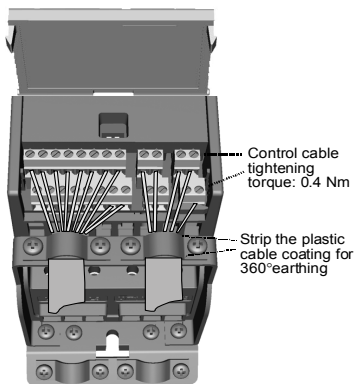

Figure 3.25: Install the control cables. MI1 - MI3. See Chapter 6.1

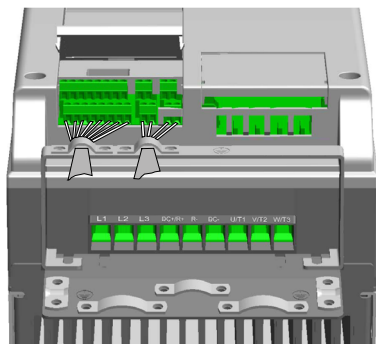

Figure 3.26: Install the control cables. MI4 - MI5. See Chapter 6.1

3.2.3 Allowed option boards in Vacon20

See below for the allowed option boards in the slot:

SLOT	E3	E5	E6	E7	B1	B2	B4	B5	B9	BH	BF
------	----	----	----	----	----	----	----	----	----	----	----

Note! OPT-B1 and OPT-B4 only support external power supply.

Option board assembly structure:

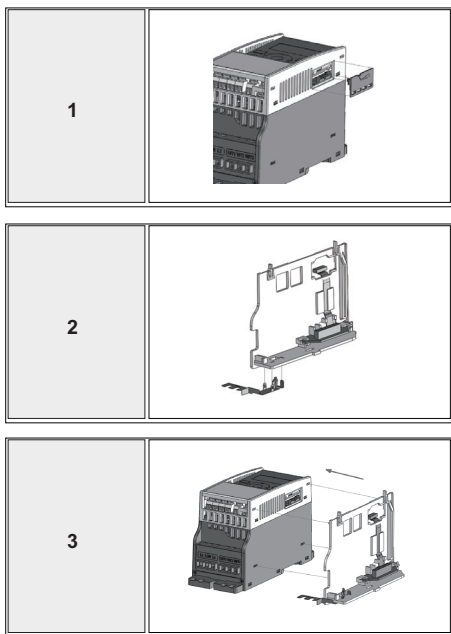

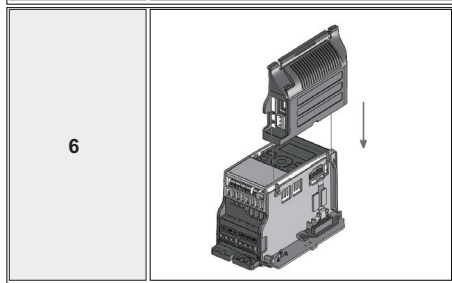
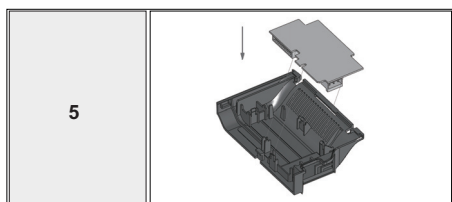
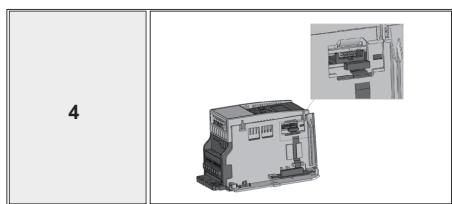

3.2.4 Screw of cables

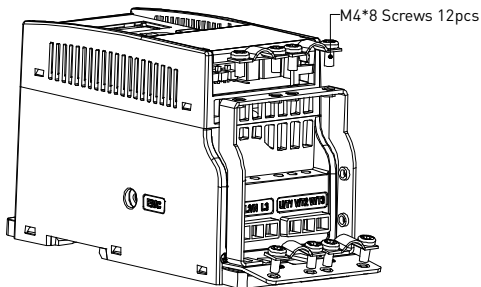

Figure 3.27: M11 screws

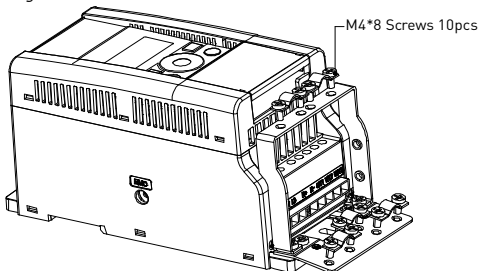

Figure 3.28: M12 screws

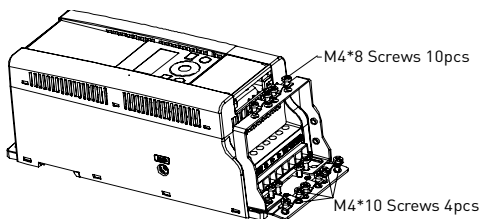

Figure 3.29: M13 screws

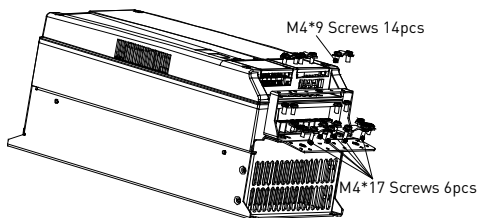

Figure 3.30: M14 - M15 screw

3.2.5 Cable and fuse specifications

Use cables with heat resistance of at least +70 °C. The cables and the fuses must be dimensioned according to the tables below. Installation of cables according to UL regulations is presented in Chapter 3.2.8.

The fuses function also as cable overload protection.

These instructions apply only to cases with one motor and one cable connection from the frequency converter to the motor. In any other case, ask the factory for more information.

EMC category	cat. C2	cat. C3	cat. C4
Mains cable types	1	1	1
Motor cable types	3	2	1
Control cable types	4	4	4

Table 3.6: Cable types required to meet standards. EMC categories are described in Chapter 3.1.4

Cable type	Description
1	Power cable intended for fixed installation and the specific mains voltage. Shielded cable not required. (NKCABLES / MCMK or similar recommended)
2	Power cable equipped with concentric protection wire and intended for the specific mains voltage. (NKCABLES / MCMK or similar recommended).
3	Power cable equipped with compact low-impedance shield and intended for the specific mains voltage. (NKCABLES / MCCMK, SAB / ÖZCUY-J or similar recommended). *360° earthing of both motor and FC connection required to meet the standard
4	Screened cable equipped with compact low-impedance shield (NKCABLES / Jamak, SAB / ÖZCuY-0 or similar).

Table 3.7: Cable type descriptions

Frame	Type	Fuse [A]	Mains cable Cu [mm ²]	Motor cable Cu [mm ²]	Terminal cable size (min/max)			
					Main terminal [mm ²]	Earth terminal [mm ²]	Control terminal [mm ²]	Relay terminal [mm ²]
MI2	0001-0004	20	2*2.5+2.5	3*1.5+1.5	1.5-4	1.5-4	0.5-1.5	0.5-1.5
MI3	0005	32	2*6+6	3*1.5+1.5	1.5-4	1.5-4	0.5-1.5	0.5-1.5

Table 3.8: Cable and fuse sizes for Vacon 20, 115 V, 1~

Frame	Type	Fuse [A]	Mains cable Cu [mm ²]	Motor cable Cu [mm ²]	Terminal cable size (min/max)			
					Main terminal [mm ²]	Earth terminal [mm ²]	Control terminal [mm ²]	Relay terminal [mm ²]
MI1	0001-0003	10	2*1.5+1.5	3*1.5+1.5	1.5-4	1.5-4	0.5-1.5	0.5-1.5
MI2	0004-0007	20	2*2.5+2.5	3*1.5+1.5	1.5-4	1.5-4	0.5-1.5	0.5-1.5
MI3	0009	32	2*6+6	3*1.5+1.5	1.5-6	1.5-6	0.5-1.5	0.5-1.5

Table 3.9: Cable and fuse sizes for Vacon 20, 208 - 240 V, 1~

Frame	Type	Fuse [A]	Mains cable Cu [mm ²]	Motor cable Cu [mm ²]	Terminal cable size (min/max)			
					Main terminal [mm ²]	Earth terminal [mm ²]	Control terminal [mm ²]	Relay terminal [mm ²]
MI1	0001-0003	6	3*1.5+1.5	3*1.5+1.5	1.5-4	1.5-4	0.5-1.5	0.5-1.5
MI2	0004-0007	10	3*1.5+1.5	3*1.5+1.5	1.5-4	1.5-4	0.5-1.5	0.5-1.5
MI3	0011	20	3*2.5+2.5	3*2.5+2.5	1.5-6	1.5-6	0.5-1.5	0.5-1.5
MI4	0012-0025	20 25 40	3*6+6	3*6+6	1-10Cu	1-10	0.5-1.5	0.5-1.5
MI5	0031-0038	40	3*10+10	3*10+10	2.5-50 Cu / Al	2.5-35	0.5-1.5	0.5-1.5

Table 3.10: Cable and fuse sizes for Vacon 20, 208 - 240 V, 3~

Frame	Type	Fuse [A]	Mains cable Cu [mm ²]	Motor cable Cu [mm ²]	Terminal cable size (min/max)			
					Main terminal [mm ²]	Earth terminal [mm ²]	Control terminal [mm ²]	Relay terminal [mm ²]
MI1	0001-0003	6	3*1.5+1.5	3*1.5+1.5	1.5-4	1.5-4	0.5-1.5	0.5-1.5
MI2	0004-0006	10	3*1.5+1.5	3*1.5+1.5	1.5-4	1.5-4	0.5-1.5	0.5-1.5
MI3	0008-0012	20	3*2.5+2.5	3*2.5+2.5	1.5-6	1.5-6	0.5-1.5	0.5-1.5
MI4	0016-0023	25	3*6+6	3*6+6	1-10Cu	1-10	0.5-1.5	0.5-1.5
MI5	0031-0038	40	3*10+10	3*10+10	2.5-50 Cu / Al	2.5-35	0.5-1.5	0.5-1.5

Table 3.11: Cable and fuse sizes for Vacon 20, 380 - 480 V, 3~

Frame	Type	Fuse [A]	Mains cable Cu [mm ²]	Motor cable Cu [mm ²]	Terminal cable size (min/max)			
					Main terminal [mm ²]	Earth terminal [mm ²]	Control terminal [mm ²]	Relay terminal [mm ²]
MI3	0002-0004	6	3*1.5+1.5	3*1.5+1.5	1.5-4	1.5-4	0.5-1.5	0.5-1.5
MI3	0005-0006	10	3*1.5+1.5	3*1.5+1.5	1.5-4	1.5-4	0.5-1.5	0.5-1.5
MI3	0009	20	3*2.5+2.5	3*2.5+2.5	1.5-6	1.5-6	0.5-1.5	0.5-1.5

Table 3.12: Cable and fuse sizes for Vacon 20, 600 V, 3~

Note! To fulfil standard EN61800-5-1, the protective conductor should be **at least 10 mm² Cu or 16 mm² Al**. Another possibility is to use an additional protective conductor of at least the same size as the original one.

3.2.6 General cabling rules

1	Before starting the installation, check that none of the components of the frequency converter is live.
2	Place the motor cables sufficiently far from other cables: <ul style="list-style-type: none"> • Avoid placing the motor cables in long parallel lines with other cables. • If the motor cable runs in parallel with other cables, the minimum distance between the motor cable and other cables is 0.3 m. • The given distance also applies between the motor cables and signal cables of other systems. • The maximum length of the motor cables for M11-3 is 30 m. For M14 & 5, maximum length is 50 m, if use longer cable, current accuracy will be decreased. • The motor cables should cross other cables at an angle of 90 degrees.
3	If cable insulation checks are needed, see Chapter 3.2.9.
4	Connecting the cables: <ul style="list-style-type: none"> • Strip the motor and mains cables as advised in Figure 3.31. • Connect the mains, motor and control cables into their respective terminals, see Figures 3.17 - 3.26. • Note the tightening torques of power cables and control cables given in chapter 3.2.1 and 3.2.2. • For information on cable installation according to UL regulations see Chapter 3.2.8. • Make sure that the control cable wires do not come in contact with the electronic components of the unit. • If an external brake resistor (option) is used, connect its cable to the appropriate terminal. • Check the connection of the earth cable to the motor and the frequency converter terminals marked with <div style="text-align: center; margin: 5px 0;">  </div> • Connect the separate shield of the motor cable to the earth plate of the frequency converter, motor and the supply centre.

3.2.7 Stripping lengths of motor and mains cables

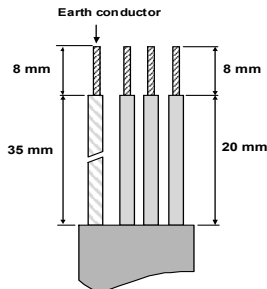

Figure 3.31: Stripping of cables

Note! Strip also the plastic cover of the cables for 360 degree earthing. See Figures 3.17, 3.18 and 3.25.

3.2.8 Cable installation and the UL standards

To meet the UL (Underwriters Laboratories) regulations, a UL-approved copper cable with a minimum heat-resistance of +60 / 75 °C must be used.

Use Class 1 wire only.

The units are suitable for use on a circuit capable of delivering not more than 50,000 rms symmetrical amperes, 600V maximum, when protected by T and J Class fuses. For MI4 without DC-choke, maximum short circuit current has to be not more than 2.3 kA, for MI5 without DC-choke, maximum short circuit current has to be not more than 3.8 kA.

Integral solid state short circuit protection does not provide branch circuit protection. Branch circuit protection must be provided in accordance with the National Electric Code and any additional local codes. Branch circuit protection provided by fuses only.

Motor overload protection provided at 110% of full load current.

3.2.9 Cable and motor insulation checks

These checks can be performed as follows if motor or cable insulations are suspected to be faulty.

1. Motor cable insulation checks

Disconnect the motor cable from terminals U / T1, V / T2 and W / T3 of the frequency converter and from the motor. Measure the insulation resistance of the motor cable

between each phase conductor as well as between each phase conductor and the protective ground conductor.

The insulation resistance must be >1 M Ω m.

2. Mains cable insulation checks

Disconnect the mains cable from terminals L1, L2 / N and L3 of the frequency converter and from the mains. Measure the insulation resistance of the mains cable between each phase conductor as well as between each phase conductor and the protective ground conductor. The insulation resistance must be >1 M Ω m.

3. Motor insulation checks

Disconnect the motor cable from the motor and open the bridging connections in the motor connection box. Measure the insulation resistance of each motor winding. The measurement voltage must equal at least the motor nominal voltage but not exceed 1000 V. The insulation resistance must be >1 M Ω m.

4. COMMISSIONING

Before commissioning, read the warnings and instructions listed in Chapter 1!

4.1 Commissioning steps of Vacon 20

1	Read carefully the safety instructions in Chapter 1 and follow them.
2	<p>After the installation, make sure that:</p> <ul style="list-style-type: none"> • both the frequency converter and the motor are grounded. • the mains and motor cables comply with the requirements given in Chapter 3.2.5. • the control cables are located as far as possible from the power cables (see Chapter 3.2.6, step 2) and the shields of the shielded cables are connected to protective earth. <div style="text-align: center;">  </div>
3	Check the quality and quantity of cooling air (Chapter 3.1.2).
4	Check that all Start / Stop switches connected to the I / O terminals are in Stop position.
5	Connect the frequency converter to mains.
6	<p>Set the parameters of group 1 according to the requirements of your application. At least the following parameters should be set:</p> <ul style="list-style-type: none"> • motor nominal speed (par. 1.3) • motor nominal current (par. 1.4) <p>You will find the values needed for the parameters on the motor rating plate.</p>

7	<p>Perform test run without motor. Perform either Test A or Test B:</p> <p>A) Control from the I / O terminals:</p> <ul style="list-style-type: none"> • Turn the Start/Stop switch to ON position. • Change the frequency reference (potentiometer). • Check the Monitoring Menu and make sure that the value of Output frequency changes according to the change of frequency reference. • Turn the Start / Stop switch to OFF position. <p>B) Control from the keypad:</p> <ul style="list-style-type: none"> • Select the keypad as the control place with par 2.1. You can also move to keypad control by pressing Loc / Rem button or select Local control with par 2.5. • Push the Start button on the keypad. • Check the Monitoring Menu and make sure that the value of Output frequency changes according to the change of frequency reference. • Push the Stop button on the keypad.
8	<p>Run the no-load tests without the motor being connected to the process, if possible. If this is impossible, secure the safety of each test prior to running it. Inform your co-workers of the tests.</p> <ul style="list-style-type: none"> • Switch off the supply voltage and wait up until the drive has stopped. • Connect the motor cable to the motor and to the motor cable terminals of the frequency converter. • See to that all Start / Stop switches are in Stop positions. • Switch the mains ON. • Repeat test 7A or 7B.
9	<p>Perform an identification run (see par. 1.19), especially if the application requires a high startup torque or a high torque with low speed.</p>
10	<p>Connect the motor to the process (if the no-load test was running without the motor being connected).</p> <ul style="list-style-type: none"> • Before running the tests, make sure that this can be done safely. • Inform your co-workers of the tests. • Repeat test 7A or 7B.

5. FAULT TRACING

When a fatal fault is detected by the frequency converter control electronics, the drive will stop and the symbol FT and the fault code blinked on the display are in the following format, e.g.:

FT 2

Fault code (02 = overvoltage)

The active fault can be reset by pressing BACK / RESET button when the API is in active fault menu level (FT XX), or pressing BACK / RESET button with long time (> 2 s) when the API is in active fault submenu level (F5.x), or via the I / O terminal or field bus. Reset fault history (long push > 5 s), when the API is in fault history submenu level (F6.x). The faults with subcode and time labels are stored in the Fault history submenu which can be browsed. The different fault codes, their causes and correct-ing actions are presented in the table below.

Fault code	Fault name	Possible cause	Correcting actions
1	Overcurrent	Frequency converter has detected too high a current ($>4 \cdot I_N$) in the motor cable: <ul style="list-style-type: none"> • sudden heavy load increase • short circuit in motor cables • unsuitable motor 	Check loading. Check motor size. Check cables.
2	Overvoltage	The DC-link voltage has exceeded the internal safety limit: <ul style="list-style-type: none"> • deceleration time is too short • high overvoltage peaks in mains 	Increase the deceleration time (Par.4.3 or Par.4.6)
3	Earth fault	Current measurement has detected extra leakage current at start: <ul style="list-style-type: none"> • insulation failure in cables or motor 	Check motor cables and motor

Table 5.1: Fault codes

Fault code	Fault name	Possible cause	Correcting actions
8	System fault	<ul style="list-style-type: none"> • component failure • faulty operation 	Reset the fault and restart. If the fault re-occurs, contact the distributor near to you. NOTE! If fault F8 occurs, find out the subcode of the fault from the Fault History menu under Id xxx!
9	Under voltage	The DC-link voltage has gone below the internal safety limit: <ul style="list-style-type: none"> • most probable cause: supply voltage is too low • frequency converter internal fault • Power outages 	In case of temporary supply voltage break reset the fault and restart the frequency converter. Check the supply voltage. If it is adequate, an internal failure has occurred. Contact the distributor near to you.
11	Output phase fault	Current measurement has detected that there is no current in one motor phase.	Check motor cable and motor.
13	Frequency converter under temperature	Heat sink temperature is under -10°C	Check the ambient temperature.
14	Frequency converter over temperature	Heat sink is overheated.	Check that the cooling air flow is not blocked. Check the ambient temperature. Clean the heatsink dust. Make sure that the switching frequency is not too high in relation to ambient temperature and motor load.
15	Motor stalled	Motor stall protection has tripped.	Check that the motor is able to rotate freely.
16	Motor over temperature	Motor overheating has been detected by frequency converter motor temperature model. Motor is overloaded.	Decrease the motor load. If no motor overload exists, check the temperature model parameters.
17	Motor underload	Motor underload protection has tripped.	Check motor and load, e.g. for broken belts or dry pumps.

Table 5.1: Fault codes

Fault code	Fault name	Possible cause	Correcting actions
22	EEPROM checksum fault	Parameter save fault <ul style="list-style-type: none"> • faulty operation • component failure 	Contact the distributor near to you.
25	Microcontroller watchdog fault	<ul style="list-style-type: none"> • faulty operation • component failure 	Reset the fault and restart. If the fault re-occur, contact the distributor near to you.
27	Back EMF protection	Drive has detected that the magnetized motor is running in start situation. <ul style="list-style-type: none"> • A rotating PM-motor 	Make sure that there is no rotating PM-motor when the start command is given.
29	Thermistor fault	The thermistor input of option board has detected increase of the motor temperature.	Check motor cooling and loading. Check thermistor connection (If thermistor input of the option board is not in use it has to be short circuited).
34	Internal bus communication	Ambient interference or defective hardware.	If the fault re-occur, contact the distributor near to you.
35	Application fault	Application is not working properly.	Contact the distributor near to you.
41	IGBT Overtemperature	Overtemperature alarm is issued when the IGBT switch temperature exceeds 110 °C.	Check loading. Check motor size. Make identification run.
50	Analog input select 20% - 100% (selected signal range 4 to 20 mA or 2 to 10 V)	Current at the analogue input is < 4mA; Voltage at the analogue input is < 2 V. <ul style="list-style-type: none"> • control cable is broken or loose. • signal source has failed. 	Check the current loop circuitry.
51	External fault	Digital input fault. Digital input has been programmed as external fault input and this input is active.	Remove the external device fault.

Table 5.1: Fault codes

Fault code	Fault name	Possible cause	Correcting actions
52	Door Panel fault	Control place is keypad, but door panel has been disconnected.	Check the connection between optional board and API. If connection is correct, contact the nearest Vacon distributor.
53	Fieldbus fault	The data connection between the fieldbus Master and the fieldbus of the drive has broken.	Check installation. If installation is correct, contact the nearest Vacon distributor.
54	Slot fault	The connection between optional board and API has been broken.	Check board and slot. Contact the nearest Vacon distributor.
55	Wrong run fault	Run forward and backward are high at the same time.	Check I/O control signal 1 and I/O control signal 2.
57	Identification fault	Identification run has failed.	Run command was removed before completion of identification run. Motor is not connected to frequency converter. There is load on motor shaft.
60	Regulated pump loss	Pump is not connected	Check the connection of the pump
80	Interlock start fault		Check DIN input signal.
81	Auto turning done fault		Check transducer or man force stop when auto turning.
82	Under min. frequency fault		Check motor or load.
84	Over pressure		Check transducer or parameter limit.

Table 5.1: Fault codes

6. PFC SYSTEM INTERFACE

6.1 I/O signals

API I/O signals

Terminal	Signal	Function	Description
A	A	RS 485 A	Communication Modbus RTU
B	B	RS 485 B	Communication Modbus RTU
1	+10V _{ref}	Reference output	Voltage for potentiometer Max 10 mA
2	AI1+	Analogue signal input 1	Frequency reference ^(P) 0 - +10 V Ri ≥ 200 k Resolution: 11-bit, accuracy: ±1%
3	GND	I/O signals ground	-
6	+24 V	Output control voltage	Voltage for digital inputs Max 50 mA
7	DI_COM	Digital Input Common for DI1-DI6	-
8	DIN1	Digital input 1	Run forward ^(P) 18-30 V, Ri > 5 K Ohm
9	DIN2	Digital input 2	PID set point 2 ^(P) 18-30 V, Ri > 5 K Ohm
10	DIN3	Digital input 3	Remote control place 2 and reference 2 selected ^(P) 18-30 V, Ri > 5 K Ohm
4	AI2+	Analogue signal input 2	PID feed back Default: 0(4) - 20 mA, Ri ≤ 250 Other: 0 - +10 V Ri ≥ 200 k Resolution: 11-bit, Accuracy: ±1% Selection V/mA with switches
5	GND	I/O signals ground	-
13	DO-	Digital Output Common	-
14	DIN4	Digital input 4	Inter lock 1 ^(P) 18-30 V, Ri > 5 K Ohm
15	DIN5	Digital input 5	Inter lock 2 ^(P) As DI, Other: Encoder Input A (frequency up to 10 kHz)
16	DIN6	Digital input 6	Inter lock 3 ^(P) As DI, Other: Encoder Input B (frequency up to 10 kHz) Pulse Train Input (frequency up to 5 kHz)
18	AO1+	Analogue output	Ready ^(P) 0-10 V, load > 1 K Ohm 0(4)-20 mA, load < 500 Ohm Selection V/mA with switches

Table 6.1: I/O signals

(P): function is programmable

Terminal	Signal	Function	Description
20	DO+	Digital output	Control pump 3 ^(P) Open collector Max 48 VDC, max 50 mA
22	R13	Relay 1, no contact	Control pump 1 ^(P)
23	R14	Relay 1, common contact	-
24	R22	Relay 2, no contact	No Fault ^(P)
25	R21	Relay 2, common contact	-
26	R24	Relay 2, no contact	Control pump 2 ^(P) Max. switching load: 250 Vac/ 2A or 250 Vdc/0,4A

Table 6.1: I/O signals

(P): function is programmable

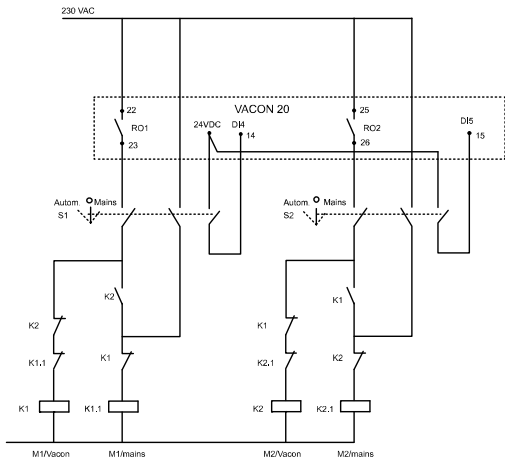

Figure 6.1: 2-pump auto-change systems, sample control diagram

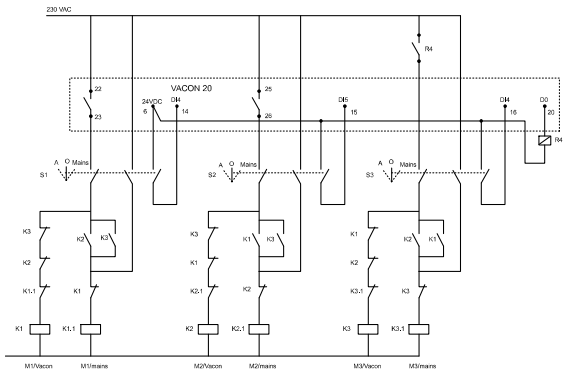

Figure 6.2: 3-pump auto-change systems, sample control diagram

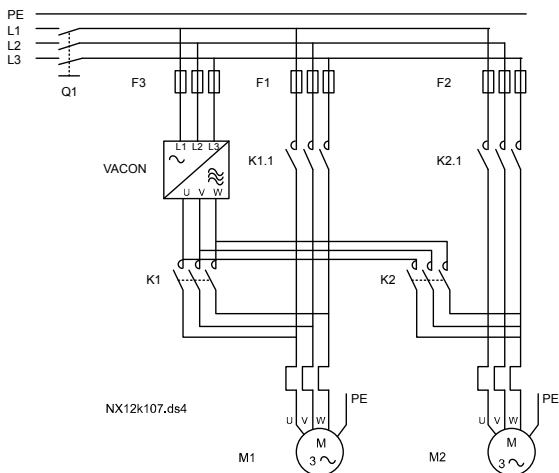

Figure 6.3: Example of 2-pumps auto-change, power diagram

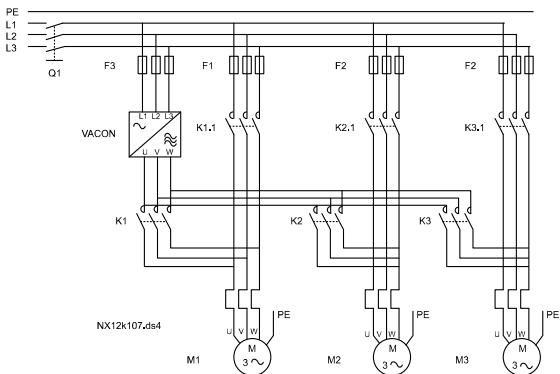

Figure 6.4: Example of 3-pumps auto-change, power diagram

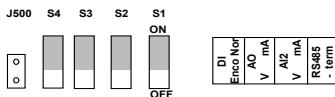
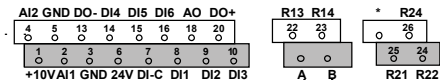

Figure 6.5: Microswitches

Vacon 20 I / O terminals:



7. CONTROL PANEL

7.1 General

The panel is an irremovable part of the drive consisting of corresponding control board; The overlay with display status on the cover and the button are in clarifications in the user language.

The User Panel consists of an alphanumeric LCD display with backlight and a keypad with the 9 push buttons (see Figure 7.1).

7.2 Display

The display includes 14-segment and 7-segment blocks, arrowheads and clear text unit symbols. The arrowheads, when visible, indicate some information about the drive, which is printed in clear text in user language on the overlay (numbers 1...14 in the figure below). The arrowheads are grouped in 3 groups with the following meanings and English overlay texts (see Figure 7.1):

Group 1 - 5; Drive status

- 1= Drive is ready to start (READY)
- 2= Drive is running (RUN)
- 3= Drive has stopped (STOP)
- 4= Alarm condition is active (ALARM)
- 5= Drive has stopped due to a fault (FAULT)

Group 6 - 10; Control selections

When API is operated by PC control, there are no arrowhead at I / O, KEYPAD and BUS.

- 6= Motor is rotating forward (FWD)
- 7= Motor is rotating reverse (REV)
- 8= I/O terminal block is the selected control place (I / O)
- 9= Keypad is the selected control place (KEYPAD)
- 10= Fieldbus is the selected control place (BUS)

Group 11 - 14; Navigation main menu

- 11= Reference main menu (REF)
- 12= Monitoring main menu (MON)
- 13= Parameter main menu (PAR)
- 14= System main menu (SYS)

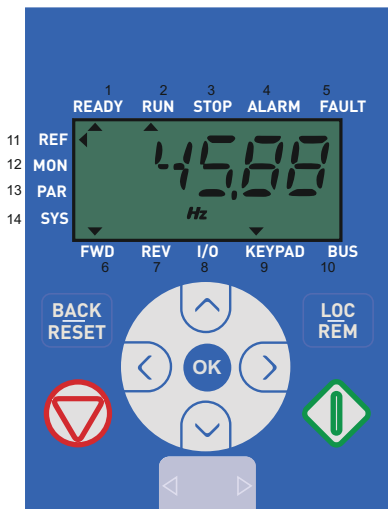

Figure 7.1: Vacon 20 Control panel

7.3 Keypad

The keypad section of the control panel consists of 9 buttons (see Figure 7.1). The buttons and their functions are described as Table 7.1.

The drive stops by pressing the keypad STOP button, regardless of the selected control place when Par. 2.7 (Keypad stop button) is 1. If Par. 2.7 is 0, the drive stops by keypad STOP button only when control place is keypad. The drive starts by pressing the keypad START button when the selected control place is KEYPAD or LOCAL control.









Symbol	Button Name	Function Description
	Start	Motor START from the panel
	STOP	Motor STOP from the panel
	OK	Used for confirmation. Enter edit mode for parameter. Alternate in display between the parameter value and parameter code. Reference frequency value adjusting no need to press OK-button to confirm.
	Back / Reset	Cancels edited parameter Move backwards in menu levels Reset fault indication
 	Up and Down	Select root parameter number on root-parameter list, Up decrease / Down increase parameter number, Up increase / Down decrease parameter value change.
 	Left and Right	Available in REF, PAR and SYS menu parameter digit setting when changing value. MON, PAR and SYS can also use left and right button to navigate the parameter group, like e.g., in MON menu use right button from V1.x to V2.x to V3.x. Can be used to change direction in REF menu in local mode: -Right arrow would mean reverse (REV) -Left arrow would mean forward (FWD)
	Loc / Rem	Change control place

Table 7.1: Keypad Function

NOTE! The status of all the 9 buttons are available for application program!

7.4 Navigation on the Vacon 20 control panel

This chapter provides you with information on navigating the menus on Vacon 20 and editing the values of the parameters.

7.4.1 Main menu

The menu structure of Vacon 20 control software consists of a main menu and several submenus. Navigation in the main menu is shown below:

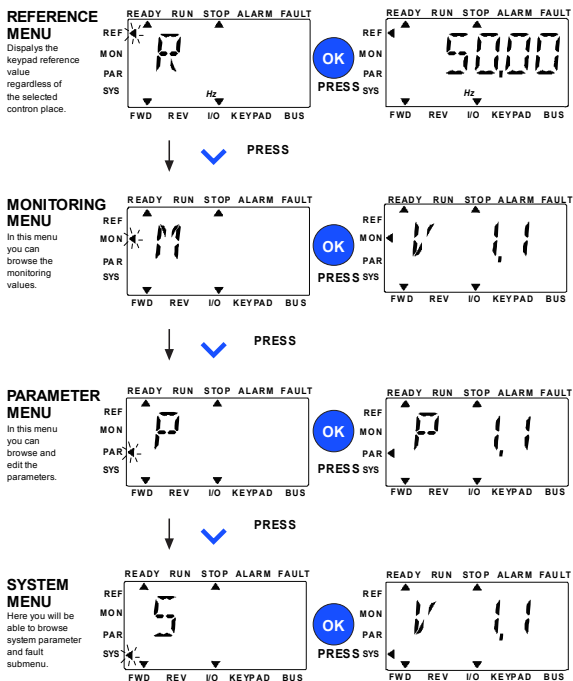

Figure 7.2: The main menu of Vacon 20

7.4.2 Reference menu

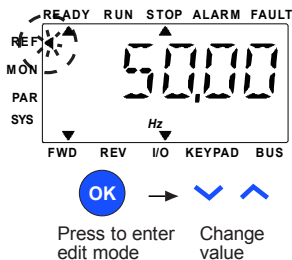

Figure 7.3: Reference menu display

Move to the reference menu with the UP / DOWN button (see Figure 7.2). The reference value can be changed with UP / DOWN button as shown in Figure 7.3.

If the value has big change, first press Left and Right buttons to select the digit which has to be changed, then press Up button to increase and Down button to decreases the value in the selected digit. The changing reference frequency will be taken into use immediately without pressing OK.

Note! LEFT and RIGHT buttons can be used to change the direction in Ref menu in local control mode.

7.4.3 Monitoring menu

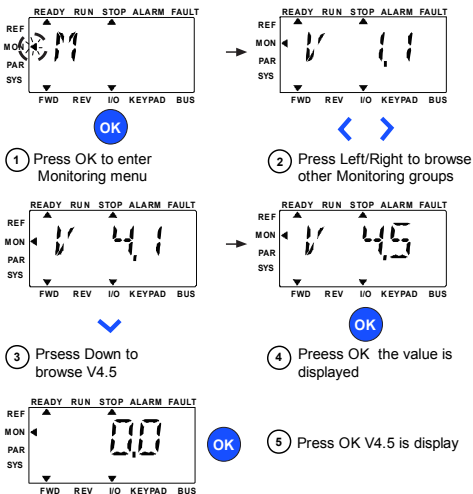

Figure 7.4: Monitoring menu display

Monitoring values are actual values of measured signals as well as status of some control settings. It is visible in Vacon 20 display, but it can not be edited. See Chapter 8.2.

Pressing Left/Right button to change the actual parameter to the first parameter of the next group, to browse monitor menu from V1.x to V2.1 to V3.1 to V4.1. After entering the desired group, the monitoring values can be browsed by pressing UP / DOWN button, as shown in Figure 7.4.

In MON menu the selected signal and its value are alternating in the display by pressing OK button.

Note! Turn on drive power, arrowhead of main menu is at MON, V x.x or monitor parameter value of Vx.x is displayed in Panel.

Display Vx.x or monitor parameter value of Vx.x is determined by the last show status before power shut down. E.g., it was V4.5, and it is also V4.5 when restart.

7.4.4 Parameter menu

In Parameter menu only the Quick setup parameter list is shown as default. By giving the value 0 to the parameter 15.2, it is possible to open other advanced parameter groups. The parameter lists and descriptions can be found in chapters 8 and 9.

The following figure shows the parameter menu view:

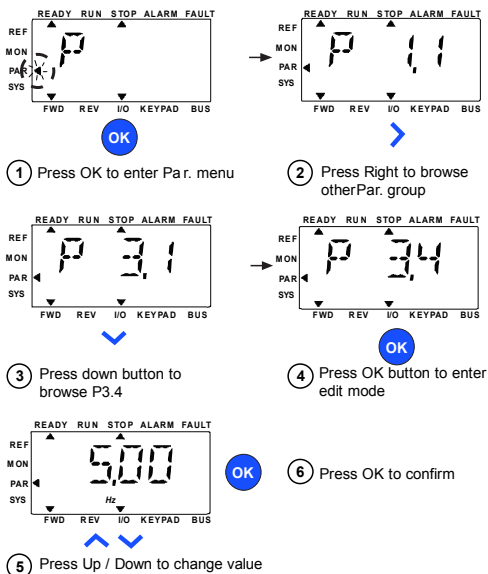

Figure 7.5: Parameter menu

The parameter can be changed as the Figure 7.5.

Left / Right button is available inside Parameter menu. Pressing Left / Right button to change the actual parameter to the first parameter of the next group [Example: any parameter of P1... is displayed -> RIGHT button -> P2.1 is displayed -> RIGHT button -> P3.1 is displayed ...]. After entering the desired group, pressing UP / DOWN button to select root parameter number, and then press OK button to display the value of the parameter and also enter edit mode.

In edit mode, Left and Right buttons are used to select the digit which has to be changed, and Up increases / Down decreases parameter value.

In edit mode, the value of Px.x is displayed blinkingly in the panel. After about 10 s, Px.x is displayed in the panel again if you don't press any button.

Note! In edit mode, if you edit the value and don't press OK button, the value isn't changed successfully.

In edit mode, if you don't edit the value, you can press Reset / Back button to display Px.x again.

7.4.5 System menu

SYS menu including fault submenu, field bus submenu and system parameter submenu, and the display and operation of the system parameter submenu is similar to PAR menu or MON menu. In system parameter submenu, there are some editable parameter (P) and some uneditable parameter (V).

The Fault submenu of SYS menu includes active fault submenu and fault history submenu.

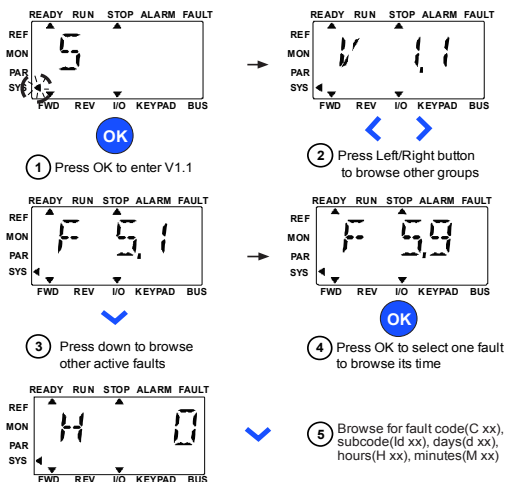

Figure 7.6: Fault menu

In active fault situation, FAULT arrow is blinking and the display is blinking active fault menu item with fault code. If there are several active faults, you can check it by entering the active fault submenu F5.x. F5.1 is always the latest active fault code. The active faults can be reset by pressing BACK / RESET button with long time (>2 s), when the API is in active fault submenu level (F5.x). If the fault cannot be reset, the blinking continues. It is possible to select other display menus during active fault, but in this case the display returns automatically to the fault menu if no button is pressed in 10 seconds. The fault code, subcode and the operating day, hour and minute values at the fault instant are shown in the value menu [operating hours = displayed reading].

Note! Fault History can be reset by long pressing the BACK / RESET button for 5 second time,when the API is in fault history sub-menu level (F6.x), it will also clear all active faults.

See Chapter 5 for fault descriptions.

8. PFC APPLICATION PARAMETERS

On the next pages you can find the lists of parameters within the respective parameter groups. The parameter descriptions are given in Chapter 9 .

Explanations:

Code: Location indication on the keypad; Shows the operator the present Monitoring value number or Parameter number

Parameter: Name of monitoring value or parameter

Min: Minimum value of parameter

Max: Maximum value of parameter

Unit: Unit of parameter value; given if available

Default: Factory preset value

ID: ID number of the parameter (used with fieldbus control)



Modifiable only in stop state

NOTE: This manual is for Vacon 20 standard application only. If you need more application information, please download the appropriate user manual on <http://www.vacon.com> -> Downloads.

8.1 Startup wizard

The startup wizard ask the following questions.

1. Motor Nominal Speed
2. Motor Nominal Current
3. Auto-change Mode
4. Number of Auxiliary Pumps

And configure parameters as in the table below.

Code	Parameter	ID	Description
P1.1	Normal voltage of the motor	110	From motor name plate
P1.2	Normal frequency of the motor	111	From motor name plate
P1.3	Motor nominal speed	112	From motor name plate
P1.4	Motor nominal current	113	From motor name plate
P1.5	Motor cos fi	120	From motor name plate
P3.1	Minimum frequency	101	Minimum allowed frequency reference.
P14.1	Auto-change Mode	1623	0 = No Auto-change 1 = Aux. auto-change without interlocks 2 = Auto-change all without interlocks 3 = Aux. auto-change with interlocks 4 = Auto-change all with interlocks
P14.2	Number of Auxiliary Pumps	1600	Auxiliary pumps in the system
P14.3	Desired work pressure	1670	Desired work pressure in kg

8.2 Monitor

Read only variables that report of signals and drive/motor measurements.

8.2.1 Basic

Code	Monitor	Unit	ID	Description
V1.1	Output Frequency	Hz	1	Output frequency to motor
V1.2	Frequency Reference	Hz	25	Frequency reference to motor control
V1.3	Motor speed	rpm	2	Estimated motor speed
V1.4	Motor current	A	3	
V1.5	Motor torque	%	4	As % of motor nominal torque
V1.6	Motor shaft power	%	5	As % of motor nominal power

Code	Monitor	Unit	ID	Description
V1.7	Motor voltage	V	6	Output voltage to motor.
V1.8	DC link voltage	V	7	Voltage on the DC-Link
V1.9	Drive temperature	°C	8	Heat sink temperature
V1.10	Motor temperature	%	9	Estimated motor temperature
V1.11	Output Power	kW	79	Output power from drive to motor

8.2.2 I/O

Code	Monitor	Unit	ID	Description
V2.1	Analogue input 1	%	59	Analogue input AI1
V2.2	Analogue input 2	%	60	Analogue input AI2
V2.3	Analogue output	%	81	Analogue output
V2.4	DIN1, DIN2, DIN3		15	Digital inputs state
V2.5	DIN4, DIN5, DIN6		16	Digital inputs state
V2.6	RO1, RO2, DO		17	Digital outputs state
V2.14	DIE1, DIE2, DIE3		33	This monitor value shows status of the digital inputs 1-3 from option board, hidden until an option board is connected.
V2.15	DIE4, DIE5, DIE6		34	This monitor value shows status of the digital inputs 4-6 from option board, hidden until an option board is connected.
V2.16	DOE1, DOE2, DOE3		35	This monitor value shows status of the relay outputs 1-3 from option board, hidden until an option board is connected.
V2.17	DOE4, DOE5, DOE6		36	This monitor value shows status of the relay outputs 4-6 from option board, hidden until an option board is connected.

8.2.3 Extras/advanced

Code	Monitor	Unit	ID	Description
V3.1	Drive Status Word		43	Bit coded status of drive. B0 = Ready, B1 = Run, B2 = Reverse B3 = Fault, B6 = RunEnable, B7 = AlarmActive, B10 = B11 = B12 = RunRequest, B13 = MotorRegulatorActive
V3.2	Application Status Word		89	Bit coded status of application. B0 = B1 = B2 = B3 = Ramp 2 Active B4 = B5 = Remote CTRL Place 1active B6 = Remote CTRL Place 2active B7 = Fieldbus Control Active B8 = Local Control Active B9 = PC Control Active B10 = Preset Frequencies Active B11 = B12 = B13 = B14 =
V3.3	DIN Status Word		56	16 bit word where each bit is the status of one digital input in. Word 1 starts from input 1 in slot A (bit0) and goes to input 6 in slot A (bit5).

8.2.4 PID control

Code	Monitor	Unit	ID	Description
V4.1	PID setpoint	%	20	Regulator setpoint
V4.2	PID feedback value	%	21	Regulator actual value
V4.3	PID error	%	22	Regulator error
V4.4	PID output	%	23	Regulator output
V4.5	Process		29	Scaled process variable See parameter P13.18
V4.6	Current pressure value	Kg	1616	Current pressure in Kg

8.3 Main parameters lists (Menu PAR)

8.3.1 Motor settings

Code	Parameter	Min	Max	Unit	Default	ID	Description
P1.1	Motor nominal voltage	180	690	V	varies	110	From motor name plate
P1.2	Motor nominal frequency	30,00	320,00	Hz	50,00/ 60,00	111	From motor name plate
P1.3	Motor nominal speed	30	20000	rpm	1440/ 1720	112	From motor name plate
P1.4	Motor nominal current	$0,2 \times I_n$	$2 \times I_n$	A	I_n	113	From motor name plate
P1.5	Motor cos phi	0,30	1,00		0,85	120	From motor name plate
P1.6	Motor type	0	1		0	650	0 = Induction 1 = Permanent magnet
P1.7	Current limit	$0,2 \times I_n$	$2 \times I_n$	A	$1,5 \times I_n$	107	Maximum motor current
P1.8	Motor control mode	0	1		0	600	0 : Frequency control 1 : Open loop speed control
P1.9	U/f ratio *	0	2		0	108	0 : Linear 1 : Quadratic 2 : Programmable
P1.10	Field weakening point *	8,00	320,00	Hz	50,00/ 60,00	602	Field weakening point frequency
P1.11	Field weakening point voltage *	10,00	200,00	%	100,00	603	Voltage at field weakening point as % of $U_{n\text{mot}}$
P1.12	U/f mid point frequency *	0,00	P1.10	Hz	50,00/ 60,00	604	Mid point frequency for programmable U/f
P1.13	U/f mid point voltage *	0,00	P1.11	%	100,00	605	Mid point voltage for programmable U/f as % of $U_{n\text{mot}}$
P1.14	Zero freq voltage *	0,00	40,00	%	varies	606	Voltage at 0 Hz as % of $U_{n\text{mot}}$
P1.15	Torque Boost	0	1		0	109	0 : Disabled 1 : Enabled
P1.16	Switching frequency	1,5	16,0	kHz	4,0/2,0	601	PWM frequency. Values higher than default reduce the current capacity.

Code	Parameter	Min	Max	Unit	Default	ID	Description
P1.17	BrakeChopper	0	2		0	504	0: Disabled 1: Enabled: Always 2: Enabled: Run state
P1.18	Brake chopper level	0	Varies	V	911	1267	Brake chopper control activation level in volt. For 240V Supply: 240*1.35*1.18 = 382V For 400V Supply: 400*1.35*1.18 = 638V Please note that when brake chopper is used the overvoltage controller can be switched off or the overvoltage reference level can be set above the brake chopper level.
P1.19	Motor identification	0	1		0	631	0: not active 1: standstill identification (needs run command within 20s to activate)
P1.20	Rs voltage drop *	0.00	100.00	%	0,00	662	Voltage drop over motor windings as % of $U_{n\text{mot}}$ at nominal current.
P1.21	Overvoltage controller	0	2		1	607	0 = Disabled 1 = Enabled, Standard Mode 2 = Enabled, Shock Load Mode
P1.22	Undervoltage controller	0	1		1	608	0 = Disabled 1 = Enabled
P1.23	Sine filter	0	1		0	522	0 = Not in use 1 = In use
P1.24	Modulator type	0	65535		28928	648	Bit 1 = Discontinuous modulation Bit 2 = Pulse dropping in overmodulation Bit 6 = Under modulation Bit 8 = Instantaneous DC voltage compensation Bit 11 = Low noise Bit 12 = Dead time compensation Bit 13 = Flex error compensation

* parameter is automatically set by motor identification

8.3.2 Start/stop setup

Code	Parameter	Min	Max	Unit	Default	ID	Description
P2.1	Remote Control Place 1 Selection	0	2		0	172	Run and direction control 0: I/O terminals 1: Fieldbus 2: Keypad
P2.2	Start function	0	1		0	505	0: Ramping 1: Flying start
P2.3	Stop function	0	1		1	506	0: Coasting 1: Ramping
P2.4	I/O Start stop logic	0	4		0	300	Logic = 0 I/O Ctrl Signal 1 = Forward I/O Ctrl Signal 2 = Backward Logic = 1 I/O Ctrl Signal 1 = Forward (edge) I/O Ctrl Signal 2 = Inverted Stop Logic = 2 I/O Ctrl Signal 1 = Forward (edge) I/O Ctrl Signal 2 = Backward (edge) Logic = 3 I/O Ctrl Signal 1 = Start I/O Ctrl Signal 2 = Reverse Logic = 4 I/O Ctrl Signal 1 = Start (edge) I/O Ctrl Signal 2 = Reverse
P2.5	Local/Remote	0	1		0	211	Parameter for switching between local and remote. Same parameter is accessed from loc/rem button. Local is always keypad. 0 = Remote Ctrl 1 = Local Ctrl
P2.6	Keypad control direction	0	1		0	123	Only valid if control place is keypad. 0: Forward 1: Reverse
P2.7	Keypad stop button	0	1		1	114	Defines when keypad stop button is enabled. 0: Keypad control only 1: Always

Code	Parameter	Min	Max	Unit	Default	ID	Description
P2.8	Remote Control place 2 selection	0	2		0	173	Alternative run and direction control place. Forced from digital input. 0: I/O terminals 1: Fieldbus 2: Keypad
P2.9	Keypad button lock	0	1		0	1552 0	0 = Unlock all the keypad button 1 = Loc/Rem button locked

8.3.3 References

Code	Parameter	Min	Max	Unit	Default	ID	Description
P3.1	Min frequency	0,00	P3.2	Hz	30,00	101	Minimum freq reference
P3.2	Max frequency	P3.1	320,00	Hz	51,00/ 61,00	102	Maximum freq reference
P3.3	Remote control place1 frequency reference selection	1	Varies		6	117	Freq reference control 1: Preset Speed 0 2: Keypad 3: Fieldbus 4: AI1 5: AI2 6: PID 7: AI1+AI2
P3.4	Preset Speed 0	P3.1	P3.2	Hz	10,00	180	Base speed when frequency reference selection is = Preset Speed 0.
P3.5	Remote control place2 frequency reference selection	1	Varies		1	131	Same as Remote Control Place1.

8.3.4 Ramps and brakes

Code	Parameter	Min	Max	Unit	Default	ID	Description
P4.1	Ramp S-shape	0.0	10.0	s	0.0	500	S-curve time ramp
P4.2	Acceleration time1	0,1	3000,0	s	5,0	103	Time from 0 to max frequency

Code	Parameter	Min	Max	Unit	Default	ID	Description
P4.3	Deceleration time 1	0,1	3000,0	s	5,0	104	Time from max frequency to 0
P4.4	Ramp S-shape 2	0.0	10.0	s	0.0	501	S-curve time ramp
P4.5	Acceleration time 2	0,1	3000,0	s	60,0	502	Time from 0 to max frequency
P4.6	Deceleration time 2	0,1	3000,0	s	10,0	503	Time from max frequency to 0
P4.7	Flux Braking	0	3		0	520	0 = Off 1 = Deceleration 2 = Chopper 3 = Full Mode
P4.8	Flux Braking Current	$0,5 \times I_n$	$2 \times I_n$	A	varies	519	Defines the current level for fluxbraking
P4.9	DC braking current	$0,3 \times I_n$	$2 \times I_n$	A	I_n	507	DC current for braking
P4.10	Stop DC current time	0,00	600,00	s	0,00	508	DC current time at stop 0: not active
P4.11	Stop DC current frequency	0,10	10,00	Hz	1,50	515	Frequency under which DC current starts
P4.12	Start DC current time	0,00	600,00	s	0,00	516	DC current time at start 0: not active
P4.13	Accel2 Freq Threshold	0,00	P3.2	Hz	0,00	527	Threshold for auto change from acceleration time1 to 2 0,00 = disabled
P4.14	Decel2 Freq Threshold	0,00	P3.2	Hz	0,00	528	Threshold for auto change from deceleration time 2 to 1 0,00 = disabled

8.3.5 Digital inputs

Code	Parameter	Min	Max	Unit	Default	ID	Description
P5.1	I/O Ctrl Signal 1	0	Varies		1	403	See P2.4 for function 0: not used 1: DIN1 2: DIN2 3: DIN3 4: DIN4 5: DIN5 6: DIN6 7: DIE1 8: DIE2 9: DIE3 10: DIE4 11: DIE5 12: DIE6
P5.2	I/O Ctrl signal 2	0	Varies		0	404	See P2.6 for functions See P5.1 for selections
P5.3	Reverse	0	Varies		0	412	Independent from P2.4 See P5.1 for selections
P5.4	Ext fault closed	0	Varies		0	405	Fault if signal high See P5.1 for selections
P5.5	Ext fault open	0	Varies		0	406	Fault is signal low See P5.1 for selections
P5.6	Fault reset	0	Varies		0	414	Fault reset (on edge) See P5.1 for selections
P5.7	Run enable	0	Varies		0	407	Enables motor control See P5.1 for selections
P5.8	Ramp time 2 selection	0	Varies		0	408	Activates ramp 2 See P5.1 for selections
P5.9	Remote control place 2	0	Varies		3	425	Activates control place 2 See P5.1 for selections
P5.10	Remote control place freq reference 2	0	Varies		3	343	Activates reference 2 See P5.1 for selections
P5.11	PID setpoint 2	0	Varies		2	1047	Activates setpoint 2 See P5.1 for selections
P5.12	Inter lock 1	0	6		4	1621	
P5.13	Inter lock 2	0	6		5	1622	
P5.14	Inter lock 3	0	6		6	1623	

8.3.6 Analog inputs

Code	Parameter	Min	Max	Unit	Default	ID	Description
P6.1	AI1 range	0	1		0	379	0 = 0—100% 1 = 20%—100% 20% is the same as 2V minimum signal level.
P6.2	AI1 custom min	-100,00	100,00	%	0,00	380	Custom min signal level
P6.3	AI1 custom max	-100,00	300,00	%	100,00	381	Custom max signal level
P6.4	AI1 filter time	0,0	10,0	s	0,1	378	Filter time constant
P6.5	AI2 range	0	1		1	390	0 = 0—100% 1 = 20%—100% 20% is the same as 2V or 4mA minimum signal level.
P6.6	AI2 custom min	-100,00	100,00	%	0,00	391	Custom min signal level
P6.7	AI2 custom max	-100,00	300,00	%	100,00	392	Custom min signal level
P6.8	AI2 filter time	0,0	10,0	s	0,1	389	Filter time constant

8.3.7 Digital outputs

Code	Parameter	Min	Max	Unit	Default	ID	Description
P7.1	RO1 signal selection	0	23		9	313	0: Not used 1: Ready 2: Run 3: Fault 4: Fault inverted 5: Warning 6: Reverse 7: At speed 8: Motor regulator active 9: Ctr.Pump 1 10: Ctr.Pump 2 11: Ctr.Pump 3
P7.2	RO2 signal selection	0	Varies		10	314	See P7.1
P7.3	DO1 signal selection	0	Varies		11	312	See P7.1
P7.4	RO1 inversion	0	1		0	1587	0: no inversion 1: inverted
P7.5	RO2 inversion	0	1		0	1588	0: no inversion 1: inverted
P7.6	DOE1 signal selection	0	Varies		0	317	As parameter 8.1, hidden until an option board is connected.
P7.7	DOE2 signal selection	0	Varies		0	318	As parameter 8.1, hidden until an option board is connected.
P7.8	DOE3 signal selection	0	Varies		0	1386	As parameter 8.1, hidden until an option board is connected.
P7.9	DOE4 signal selection	0	Varies		0	1390	As parameter 8.1, hidden until an option board is connected.
P7.10	DOE5 signal selection	0	Varies		0	1391	As parameter 8.1, hidden until an option board is connected.
P7.11	DOE6 signal selection	0	Varies		0	1395	As parameter 8.1, hidden until an option board is connected.

Code	Parameter	Min	Max	Unit	Default	ID	Description
P7.12	AO as Digital Output enable	0	1		0	1621	enable AO as DO function
P7.13	Digital Output (AO)	0	3		0	1624	0 = ready 1 = run 2 = Fault 3 = Fault inverted Note! Must active AO as Digitaloutput by parameter

8.3.8 Analog outputs

Code	Parameter	Min	Max	Unit	Default	ID	Description
P8.1	Analog output signal selection	0	14		1	307	0: Test 0% (Not used) 1: Output freq [0– f_{max}] 2: Output current [0– I_{nMotor}] 3: Motor torque [0– T_{nMotor}] 4: PID output (0-100%) 5: Freq refer [0– f_{max}] 6: Motor speed [0 – n_{max}] 7: Motor power [0– P_{nMotor}] 8: Motor Voltage [0– U_{nMotor}] 9: DC-link Voltage (0-1000V) 10: Process Data In1 (0-10000) 11: Process Data In2 (0-10000) 12: Process Data In3 (0-10000) 13: Process Data In4 (0-10000) 14: Test 100%
P8.2	Analog output minimum	0	1		0	310	0 = 0 mA 1 = 4 mA
P8.3	Analog output scaling	0,0	1000,0	%	100,0	311	Scaling factor
P8.4	Analog output filter time	0,00	10,00	s	0,10	308	Filter time

8.3.9 Fieldbus data-Mapping

Code	Parameter	Min	Max	Unit	Default	ID	Description
P9.1	FB Data Out1 Sel	0	Varies		0	852	Variable mapped on PD1 0: Frequency reference 1: Output frequency 2: Motor speed 3: Motor current 4: Motor voltage 5: Motor torque 6: Motor power 7: DC link voltage 8: Active fault code 9: Analogue AI1 10: Analogue AI2 11: Digital inputs state 12: PID feedback value 13: PID setpoint
P9.2	FB Data Out2 Sel	0	Varies		1	853	Variable mapped on PD2
P9.3	FB Data Out3 Sel	0	Varies		2	854	Variable mapped on PD3
P9.4	FB Data Out4 Sel	0	Varies		4	855	Variable mapped on PD4
P9.5	FB Data Out5 Sel	0	Varies		5	856	Variable mapped on PD5
P9.6	FB Data Out6 Sel	0	Varies		3	857	Variable mapped on PD6
P9.7	FB Data Out7 Sel	0	Varies		6	858	Variable mapped on PD7
P9.8	FB Data Out8 Sel	0	Varies		7	859	Variable mapped on PD8
P9.9	Aux CW Data In Sel	0	5		0	1167	PDI for Aux CW 0: Not used 1: PDI1 2: PDI2 3: PDI3 4: PDI4 5: PDI5

8.3.10 Prohibited frequencies

Code	Parameter	Min	Max	Unit	Default	ID	Description
P10.1	Prohibit Frequency Range 1 Low Limit	0,00	P3.2	Hz	0,00	509	Low limit
P10.2	Prohibit Frequency Range 1 High Limit	0,00	P3.2	Hz	0,00	510	High limit

Code	Parameter	Min	Max	Unit	Default	ID	Description
P10.3	Prohibit Frequency Range 2 Low Limit	0,00	P3.2	Hz	0,00	511	Low limit
P10.4	Prohibit Frequency Range 2 High Limit	0,00	P3.2	Hz	0,00	512	High limit

8.3.11 Protections

Code	Parameter	Min	Max	Unit	Default	ID	Description
P11.1	Analog Input low fault	0	4		4	700	0: No action 1: Alarm 2: Alarm, preset alarm frequency 3: Fault: Stop function 4: Fault: Coast
P11.2	Under voltage fault	1	2		2	727	1: No response(no fault generated but drive still stopsmodulation) 2: Fault: Coast
P11.3	Earth fault	0	3		2	703	0: No action 1: Alarm 2: Fault: Stop function 3: Fault: Coast
P11.4	Output Phase Fault	0	3		2	702	0: No Action 1: Alarm 2: Fault: Stop function 3: Fault: Coast
P11.5	Stall protection	0	3		0	709	0: No action 1: Alarm 2: Fault: Stop function 3: Fault: Coast
P11.6	Under load protection	0	3		0	713	0: No action 1: Alarm 2: Fault: Stop function 3: Fault: Coast
P11.7	Motor thermal protection	0	3		2	704	0: No action 1: Alarm 2: Fault: Stop function 3: Fault: Coast
P11.8	Mtp: Ambient temperature	-20	100	°C	40	705	Environment temperature

Code	Parameter	Min	Max	Unit	Default	ID	Description
P11.9	Mtp: Zero speed cooling	0,0	150,0	%	40,0	706	Cooling as % at 0 speed
P11.10	Mtp: Thermal time constant	1	200	min	varies	707	Motor thermal time constant.
P11.11	Stall Current	0.00	2xI _N	A	I _N	710	
P11.12	Stall time	0,00	300,00	s	15,00	711	Stall time limit
P11.13	Stall frequency	0,10	320,00	Hz	25,00	712	Stall min frequency
P11.14	UL: Field weakening load	10,0	150,0	%	50,0	714	Minimum torque at field weakening
P11.15	UL: Zero freq load	5,0	150,0	%	10,0	715	Minimum torque at F0
P11.16	UL: Time limit	1,0	300,0	s	20,0	716	Underload time limit
P11.17	Analog Input low fault delay	0,0	10,0	s	0,5	1430	Time limit
P11.18	External fault	0	3		2	701	0: No action 1: Alarm 2: Fault: Stop function 3: Fault: Coast
P11.19	Fieldbus fault	0	4		3	733	0: No action 1: Alarm 2: Alarm, preset alarm frequency 3: Fault: Stop function 4: Fault: Coast
P11.20	Preset alarm frequency	P3.1	P3.2	Hz	25.00	183	Frequency used when fault response is Alarm+preset Frequency
P11.21	Parameters edit lock	0	1		0	819	0: Edit enabled 1: Edit disabled
P11.22	FWD/REV conflict supervision	0	3		1	1463	As parameter P13.3
P11.23	Low frequency protection time	0	99.99		10.00	1621	
P11.24	Over pressure limit	0	200	%	150	1901	Over pressure limit

8.3.12 Automatic reset

Code	Parameter	Min	Max	Unit	Default	ID	Description
P12.1	Automatic Reset	0	1		0	731	0: Disabled 1: Enabled
P12.2	Wait time	0,10	10,00	s	0,50	717	Waiting time after fault
P12.3	Trial time	0,00	60,00	s	30,00	718	Maximum time for trials
P12.4	Trials number	1	10		3	759	Maximum trials
P12.5	Restart Function	0	2		2	719	0: Ramping 1: Flying 2: From Start Function

8.3.13 PID controller

Code	Parameter	Min	Max	Unit	Default	ID	Description
P13.1	Setpoint source selection	0	11		0	332	0: Fixed setpoint % 1: AI1 2: AI2 3: ProcessDataIn1 (0-100%) 4: ProcessDataIn2 (0-100%) 5: ProcessDataIn3 (0-100%) 6: ProcessDataIn4 (0-100%) Notice! ProcessDataIns are handled as integers having two decimals and range 0 (0.00%) to 10000 (100.00%).
P13.2	Fixed setpoint 1	0,0	100,0	%	50,0	167	Fixed setpoint
P13.3	Fixed setpoint 2	0,0	100,0	%	50,0	168	Alternative fixed setpoint. Selectable with DI.

Code	Parameter	Min	Max	Unit	Default	ID	Description
P13.4	Feedback source selection	0	7		1	334	0: AI1 1: AI2 2: ProcessDataIn1 (0-100%) 3: ProcessDataIn2 (0-100%) 4: ProcessDataIn3 (0-100%) 5: ProcessDataIn4 (0-100%) 6: AI2-AI1 Notice! ProcessDataIns are handled as integers having two decimals and range 0 (0.00%) to 10000 (100.00%).
P13.5	Feedback value min	0,0	50,0	%	0,0	336	Value at minimum signal
P13.6	Feedback value max	10,0	300,0	%	100,0	337	Value at maximum signal
P13.7	P gain	0,0	1000,0	%	125,0	118	Proportional gain
P13.8	I time	0,00	320,00	s	1,00	119	Integrative time
P13.9	D time	0,00	10,00	s	0,00	132	Derivative time
P13.10	PID error inversion	0	1		0	340	0: Direct 1: Inverted
P13.11	Process unit source select	0	6		0	1513	Selection of variable proportional to process 0: PID feedback value 1: Output frequency 2: Motor speed 3: Motor torque 4: Motor power 5: Motor current
P13.12	Process unit decimal digits	0	3		1	1035	Decimals on display
P13.13	Process unit min value	0.0	P15.21		0	1033	Process min value
P13.14	Process unit max value	P15.20	3200.0		100.0	1034	Process max value
P13.15	Increase Ref. PI to run	0	162.75	s	5	1614	Increase Ref. PI to run

8.3.14 PFC

Code	Parameter	Min	Max	Unit	Default	ID	Description
P14.1	Auto-change Mode	0	4	-	4	1603	0 = No Auto-change 1 = Aux. auto-change without interlocks 2 = Auto-change all without interlocks 3 = Aux. auto-change with interlocks 4 = Auto-change all with interlocks
P14.2	Number of Auxiliary Pumps	0	3	-	1	1600	Auxiliary pumps in the system
P14.3	Desired work pressure I	0	P14.13	kg	4.0	1670	Desired work pressure I in Kg
P14.4	Desired work pressure II	0	P14.13	kg	5.0	1617	Second pressure reference. Activated using DI
P14.5	Auto-change Interval	0	3000.0	h	48.0	1604	0,0 = Test 16 s. Auto-change time elapsed
P14.6	Auto-change: Max No. of Auxiliaries	0	3	-	0	1605	Auto-change level for auxiliary pump connection
P14.7	Auto-change: frequency limit	0	Max Frequency	hz	0.00	1606	Controller output frequency level for auto-change
P14.8	Auxiliary start frequency	min frequency	320.00	hz	51.00	1607	ON threshold AI superv
P14.9	Auxiliary connection delay	0	200.0	S	4.0	1601	OFF threshold AI superv
P14.10	Auxiliary stop frequency	Min frequency	Max Frequency	hz	31.00	1608	
P14.11	Auxiliary stop delay	0	200.0	S	2.0	1602	
P14.12	PI Hysteresis	0	50.0	%	0.5	1613	
P14.13	Sleep min frequency	0,00	P3.2	Hz	35,00	1016	Threshold for enter sleep
P14.14	Sleep delay	0	3600	s	15,0	1017	Delay for enter sleep
P14.15	Sleep setpoint boost	0,0	50,0	%	0,0	1071	Referred to setpoint

Code	Parameter	Min	Max	Unit	Default	ID	Description
P14.16	Setpoint boost time	0	60	s	0,0	1072	Boost time after P8.13
P14.17	Sleep max loss	0,0	50,0	%	0,0	1509	Referred to feedback value after boost
P14.18	Sleep loss check time	1	300	s	0,0	1510	After boost time P8.16
P14.19	Wake up level	0,0	100,0	%	92,0	1611	Wake up level [%] of PID reference
P14.20	Interlock updating	0	1	-	0	1620	0 = Always 1 = Only in Stop mode
P14.21	Pressure Transducer scale	0	100,0	kg	10,0	1615	
P14.22	Pressure unit select	0	1		1	1618	0 = % 1 = Kg
P14.23	Smart interlockless	0	1		1	1612	0 = Disabled 1 = Enabled (When P14.1 = 2, the regulated pump is changed if is not connected)

8.3.15 Application settings

Code	Parameter	Min	Max	Unit	Default	ID	Description
P15.2	Parameter conceal	0	1		1	115	0 = All parameters visible 1 = Only quick setup parameter group visible

8.4 System parameters

Code	Parameter	Min	Max	Default	ID	Note
Software information (MENU PAR -> V1)						
V1.1	API SW ID				2314	
V1.2	API SW version				835	
V1.3	Power SW ID				2315	
V1.4	Power SW version				834	
V1.5	Application ID				837	
V1.6	Application revision				838	
V1.7	System load				839	

Code	Parameter	Min	Max	Default	ID	Note
When no field bus Option Board or no OPT-BH Board has been installed, the Modbus comm. Parameters are as follows						
V2.1	Communication status				808	Status of Modbus communication. Format: xx.yyy where xx = 0 - 64 (Number of error messages) yyy = 0 - 999 (Number of good messages)
P2.2	Fieldbus protocol	0	1	0	809	0 = Not used 1 = Modbus used
P2.3	Slave address	1	255	1	810	
P2.4	Baud rate	0	8	5	811	0 = 300 1 = 600 2 = 1200 3 = 2400 4 = 4800 5 = 9600 6 = 19200 7 = 38400 8 = 57600
P2.6	Parity type	0	2	0	813	0 = None 1 = Even 2 = Odd The Stop Bit is 2-bit When Parity type is 0 = None; The Stop Bit is 1-bit When Parity type is 1 = Even or 2 = Odd
P2.7	Communication time out	0	255	10	814	0 = Not used 1 = 1 sec 2 = 2 secs, etc
P2.8	Reset communication status	0	1	0	815	
When Canopen E6 board has been installed, the comm. Parameters are as follows						
V2.1	Canopen communication status				14004	0 = Initialising 4 = Stopped 5 = Operational 6 = Pre_Operational 7 = Reset_Application 8 = Reset_Comm 9 = Unknow
P2.2	Canopen operation mode	1	2	1	14003	1 = Driver Profile 2 = Bypass

Code	Parameter	Min	Max	Default	ID	Note
P2.3	Canopen Node ID	1	127	1	14001	
P2.4	Canopen baud rate	1	8	6	14002	1 = 10 kBaud 2 = 20 kBaud 3 = 50 kBaud 4 = 100 kBaud 5 = 125 kBaud 6 = 250 kBaud 7 = 500 kBaud 8 = 1000 kBaud
When DeviceNet E7 board has been installed, the comm. Parameters are as follows						
V2.1	Communication status				14014	Status of Modbus communication. Format: XXXX.Y, X = DeviceNet msg counter, Y = DeviceNet status. 0 = Non-existent or no bus power. 1 = Configuring state 2 = Established 3 = Timeout
P2.2	Output assembly type	20	111	21	14012	20, 21, 23, 25, 101, 111
P2.3	MAC ID	0	63	63	14010	
P2.4	Baud rate	1	3	1	14011	1 = 125 kbit/s 2 = 250 kbit/s 3 = 500 kbit/s
P2.5	Input assembly type	70	117	71	14013	70, 71, 73, 75, 107, 117
When ProfidBus E3/E5 board has been installed, the comm. Parameters are as follows						
V2.1	Communication status				14022	
V2.2	Fieldbus protocol status				14023	
V2.3	Active protocol				14024	
V2.4	Active baud rate				14025	
V2.5	Telegram type				14027	
P2.6	Operate mode	1	3	1	14021	1 = Profidrive 2 = Bypass 3 = Echo
P2.7	Slave address	2	126	126	14020	
When OPT-BH board has been installed, the comm. Parameters are as follows						

Code	Parameter	Min	Max	Default	ID	Note
P2.1	Sensor 1 type	0	6	0	14072	0 = No Sensor 1 = PT100 2 = PT1000 3 = Ni1000 4 = KTY84 5 = 2 x PT100 6 = 3 x PT100
P2.2	Sensor 2 type	0	6	0	14073	0 = No Sensor 1 = PT100 2 = PT1000 3 = Ni1000 4 = KTY84 5 = 2 x PT100 6 = 3 x PT100
P2.3	Sensor 3 type	0	6	0	14074	0 = No Sensor 1 = PT100 2 = PT1000 3 = Ni1000 4 = KTY84 5 = 2 x PT100 6 = 3 x PT100
Other information						
V3.1	MWh counter				827	Million Watt Hour
V3.2	Power on days				828	
V3.3	Power on hours				829	
V3.4	Run counter: Days				840	
V3.5	Run counter: Hours				841	
V3.6	Fault counter				842	
V3.7	Panel parameter set status monitor					Hidden when connect with PC.
P4.2	Restore factory defaults	0	1	0	831	1 = Restores factory defaults for all parameters
P4.3	Password	0000	9999	0000	832	
P4.4	Time for panel and lcd backlight active	0	99	5	833	
P4.5	Save parameter set to panel	0	1	0		Hidden when connect with PC.
P4.6	Restore parameter set from panel	0	1	0		Hidden when connect with PC.
F5.x	Active Fault menu					
F6.x	Fault History menu					

9. PARAMETER DESCRIPTIONS

On the next pages you can find the descriptions of certain parameters. The descriptions have been arranged according to parameter group and number.

9.1 Motor settings

P1.1 **MOTOR NOMINAL VOLTAGE**

Value must be read on motor nameplate. Changing of the value will set the voltage at field weakening point (P1.11) to value 100%.

P1.2 **MOTOR NOMINAL FREQUENCY**

Value must be read on motor nameplate. Changing of the value will set the field weakening point (P1.10) to same value.

P1.3 **MOTOR NOMINAL SPEED**

Value must be read on motor nameplate. Speed must be referred to nominal frequency and nominal load condition (not synchronous speed).

P1.4 **MOTOR NOMINAL CURRENT**

Value must be read on motor nameplate.

P1.5 **MOTOR COS PHI**

Value must be read on motor nameplate.

P1.6 **MOTOR TYPE**

Configures the motor control for an induction motor or permanent motor.

P1.7 **CURRENT LIMIT**

Maximum motor current delivered from the drive.

P1.8 **MOTOR CONTROL MODE**

0: Frequency control

1: Speed control (sensorless control)

In speed control, the motor slip is compensated and torque boost is always automatically enabled.

P1.9 **U/F RATIO**

0: linear

(from voltage P1.14 at 0Hz, to voltage P1.11 at P1.10 frequency)

1: quadratic

(from voltage P1.14 at 0Hz, to voltage P1.11 at P1.10 frequency)

2: programmable

(linear from voltage P1.14 at 0Hz, to voltage P1.13 at P1.12 frequency + linear from voltage P1.13 at P1.12 frequency, to voltage P1.11 at P1.10 frequency)

Note: motor identification automatically sets this parameters value to 2 = programmable.

P1.10 **FIELD WEAKENING POINT**

Output frequency corresponding to max voltage.

Note: if P1.2 Motor nominal frequency is changed, this parameter will be set at same value.

P1.11 **FIELD WEAKENING POINT VOLTAGE**

Motor voltage when frequency is above FWP, defined as % of nominal voltage.

Note: if P1.1 Motor nominal voltage is changed, this parameter will be set at 100%.

P1.12 **U/F MID POINT FREQUENCY**

Enabled if P1.9 = 2.

Note: motor identification automatically sets this parameter.

P1.13 **U/F MID POINT VOLTAGE**

Enabled if P1.9 = 2.

Note: motor identification automatically sets this parameter.

P1.14 **ZERO FREQUENCY VOLTAGE**

Motor voltage at frequency zero.

Note: motor identification automatically sets this parameter.

P1.15 **TORQUE BOOST**

0: Disabled

1: Enabled

Automatic voltage boost (improves motor torque).

P1.16 **SWITCHING FREQUENCY**

PWM frequency. Values above default can cause drive thermic overload.

P1.17 BRAKE CHOPPER

- 0: Chopper disabled
- 1: Chopper enabled: in Run state
- 2: Chopper enabled: Always

P1.18 BRAKE CONTROL LEVEL

Brake chopper control activation level in volt.

For 240 V Supply: $240 * 1.35 * 1.18 = 382 \text{ V}$

For 400 V Supply: $400 * 1.35 * 1.18 = 638 \text{ V}$

Please note that when brake chopper is used the overvoltage controller can be switched off or the overvoltage reference level can be set above the brake chopper level.

P1.19 MOTOR IDENTIFICATION

This procedure measures motor stator resistance and automatically sets U/f characteristic, to obtain good torque also at low speed.

- 0: not active
- 1: standstill identification

Run command must be given and hold high within 20s after programming the value 1. The motor does not rotate and the drive will automatically exit run state at the end of the measurements.

Procedure sets the following parameters: P1.9, P1.12, P1.13, P1.14, P1.15, P1.17.

In case of P1.6 Motor type = Permanent magnet, then also P1.10 and P1.11 will be set in addition to the previously mentioned according to the equations below.

$$P1.11 = U_{FWP, Voltage} [\%] = \text{MIN}\{U_{UnitNom}, 2 * U_{MotNom}\} / * U_{MotNom}$$

$$P1.10 = f_{FWP} [\text{Hz}] = U_{FWP, Voltage} * f_{MotNom}$$

Note: Torque boost settings will cause motor current values comparable to nominal one, also at very low speed. External cooling of the motor is needed if the motor works in this condition.

P1.20 RS VOLTAGE DROP

Voltage drop on stator windings, at motor nominal current, defined as % of nominal voltage. Value affects motor torque estimation, slip compensation and voltage boost.

Note: it is suggested not to program manually the value, but to perform motor identification procedure that automatically sets the value.

P1.21 OVERVOLTAGE CONTROLLER**P1.22 UNDERVOLTAGE CONTROLLER**

These parameters allow the under-/overvoltage controllers to be switched out of operation. This may be useful, for example, if the mains supply voltage varies more than -15% to +10% and the application will not tolerate this over-/undervoltage. In this case, the regulator controls the output frequency taking the supply fluctuations into account.

P1.23 SINE FILTER

A sine filter is usually rated for a certain switching frequency. Activating this parameter disabled automatic switching frequency fold back, which could otherwise lower the switching frequency under some circumstances e.g. to avoid overheating.

P1.24 MODULATOR TYPE

Modulator configuration word:

- B1** = Discontinuous modulation (DPWMMIN)
- B2** = Pulse dropping in overmodulation
- B6** = Under modulation
- B8** = Instantaneous DC voltage compensation *
- B11** = Low noise
- B12** = Dead time compensation *
- B13** = Flux error compensation *

* Enabled by default

9.2 Start/stop setup

P2.1 **REMOTE CONTROL PLACE 1 SELECTION**

Run and direction control. A second control place is programmable in P2.3.

- 0: I/O terminals
- 1: Keypad
- 2: Fieldbus

P2.2 **START FUNCTION**

- 0: Ramping
- 1: Flying start

P2.3 **STOP FUNCTION**

- 0: Coasting
- 1: Ramping

Note: fall of Enable signal, when configured, always determines stop by coasting.

P2.4 **I/O START STOP LOGIC**

These logics are based on I/O Ctrl Signal 1 and I/O Ctrl Signal 2 (defined with P5.1 and P5.2). Usually they are coupled to inputs DIN1 and DIN2.

- 0: I/O Ctrl Signal 1 = Forward
I/O Ctrl Signal 2 = Backward
First signal has priority.
- 1: I/O Ctrl Signal 1 = Forward (edge)
I/O Ctrl Signal 2 = Inverted Stop
Direction must come from a 3rd input (Reverse).
- 2: I/O Ctrl Signal 1 = Forward (edge)
I/O Ctrl Signal 2 = Backward (edge)
- 3: I/O Ctrl Signal 1 = Start
I/O Ctrl Signal 2 = Reverse
- 4: I/O Ctrl Signal 1 = Start (edge)
I/O Ctrl Signal 2 = Reverse

Note: in mode 1,2 & 3, run pulse is acquired only if the drive is Ready and actual control place is I/O terminals.

P2.5 LOCAL/REMOTE

Parameter for switching between local and remote control. Same parameter is also accessed by pressing the loc/rem button.

Local is always keypad control, and remote is programmable with P2.2 Remote Control Place 1 Selection. There is also a second remote control place which can be activated by digital input.

0 = Remote Control

1 = Local Control

P2.6 KEYPAD CONTROL DIRECTION

Effective when control is from panel

0: Forward

1: Backward

P2.7 KEYPAD STOP BUTTON

0: Keypad control active

1: Always

P2.8 REMOTE CONTROL PLACE 2 SELECTION

Run and direction control. Activated by digital input, which is configurable with P5.14.

0: I/O terminals

1: Fieldbus

2: Keypad

P2.9 KEYPAD BUTTON LOCK

When set this parameter, it will affect the button actions under the panel

0: Unlock all the keypad button

1: Loc/Rem button locked

9.3 References

P3.1 **MIN FREQUENCY**

Minimum frequency reference.

Note: if motor current limit is reached, actual output frequency might be lower than parameter. If this is not acceptable, stall protection should be activated.

P3.2 **MAX FREQUENCY**

Maximum frequency reference.

P3.3 **REMOTE CONTROL PLACE 1 FREQUENCY REFERENCE SELECTION**

Defines the source of frequency reference. A second reference source is programmable in P3.4.

1: Preset Speed 0

2: Keypad

3: Fieldbus

4: AI1

5: AI2

6: PID

7: AI1+AI2

P3.4 **PRESET SPEED 0**

Speed when P3.3 or P3.12 is set to Preset Speed 0.

P3.5 **REMOTE CONTROL PLACE 2 FREQUENCY REFERENCE SELECTION**

Alternative source of frequency reference. Activated by digital input defined in P5.15 or fieldbus.

1: Preset Speed 0

2: Keypad

3: Fieldbus

4: AI1

5: AI2

6: PID

7: AI1+AI2

9.4 Ramps and brakes

P4.1 RAMP 1 S-SHAPE

When value is greater than zero, acceleration and deceleration ramps have a S shape.

The parameter is the time needed to reach full acc/dec.

P4.2 ACCELERATION TIME 1

The time it takes to change speed from zero frequency to max frequency.

A second acceleration time is available in P4.5.

P4.3 DECELERATION TIME 1

The time it takes to change speed from max frequency to zero.

A second deceleration time is available in P4.6.

P4.4 RAMP 2 S-SHAPE

When value is greater than zero, acceleration and deceleration ramps have a S shape.

The parameter is the time needed to reach full acc/dec.

P4.5 ACCELERATION TIME 2

P4.6 DECELERATION TIME 2

Ramp 2 is activated through digital input defined in P5.11 or through fieldbus. Automatic selection based on output frequency by parameters P4.13 and P4.14 is also available.

P4.7 FLUX BRAKING

Like other brakes, flux braking tries to stop the motor as quickly as possible. This is done by over magnetizing the motor, which leads to increased losses. Kinetic energy is turned into heat in the motor and a quicker deceleration can be used.

An important difference compared to DC-brake is that flux brake can be used while running in U/f control. This means that the motor is still controlled and braking can be aborted, where as with DC-brake is the control of motor is lost.

Mode	Description
0 = Off	Not Used
1 = Deceleration	Normal mode. Activates flux braking during deceleration regardless of load
2 = Chopper	Emulates the behavior of a brake chopper by activating flux braking based on DC-link voltage Minimizes the heating up of the motor in applications with frequent speed changes.
3 = Full mode	Activates flux braking both during deceleration and on generative shock loads at constant speed. Offers the highest performance in demanding applications.

P4.8 FLUX BRAKING CURRENT

Flux brake current reference. Voltage is raised to reach the reference.

P4.9 DC BRAKING CURRENT

DC current injected at start or stop.

P4.10 STOP DC CURRENT TIME

Time for DC current injection at stop.

P4.11 STOP DC CURRENT FREQUENCY

DC current injection starts below this frequency.

P4.12 START DC CURRENT TIME

Time for DC current injection at start. This works as a start magnetization of the motor, ensuring there is torque when starting to rotate.

P4.13 THRESHOLD FOR ACCELERATION TIME 2

Acceleration time 2 is activated when output frequency is higher than the value.

If this parameter is set to 0Hz the functionality will be disabled.

Note: Acceleration time 2 can also at any time be forced active by digital input.

P4.14 THRESHOLD FOR DECELERATION TIME 2.

Deceleration time 2 is activated when output frequency is higher than the value.

If this parameter is set to 0Hz the functionality will be disabled.

Note: Deceleration time 2 can also at any time be forced active by digital input.

9.5 Digital inputs

P5.1 **I/O CTRL SIGNAL 1**

P5.2 **I/O CTRL SIGNAL 2**

Signals for start and direction in I/O control. Logic is selected with P2.4.

P5.3 **REVERSE DIRECTION**

Can be used when Ctrl signal 2 does not have the meaning of reverse.

P5.4 **EXTERNAL FAULT, CLOSE**

Fault is triggered by high digital input.

P5.5 **EXTERNAL FAULT, OPEN**

Fault is triggered by low digital input.

P5.6 **FAULT RESET**

Fault reset command is given on rising edge.

P5.7 **RUN ENABLE**

Motor stops by coasting if the signal is missing.

Note: The drive is not in Ready state when Enable is low.

P5.8 **RAMP TIME 2 SELECTION**

Ramp 2 is selected by digital input high. Meaning that Acceleration time 2, Deceleration time 2 is taken into use.

P5.9 **REMOTE CONTROL PLACE 2**

Digital input high activates Remote control place 2 (P2.8).

P5.10 **REMOTE CONTROL PLACE FREQ REFERENCE 2**

Digital input high activates Remote control place 2 frequency reference selection (P3.6).

P5.11 **PID SETPOINT 2**

Digital input high activates setpoint 2 (P13.3), when P13.1 = 0.

P5.12 **INTER LOCK 1**

P5.13 **INTER LOCK 2**

P5.13 **INTER LOCK 3**

External input confirm if PFC function is active.

9.6 Analog inputs

P6.1 **AI1 RANGE**

P6.5 **AI2 RANGE**

Range of the electrical signal.

0: 0-100%: 0 ...10 V or 0 ... 20 mA

1: 20-100%: 2 ...10 V or 4 ... 20 mA

P6.2 **AI1 CUSTOM MIN**

P6.6 **AI2 CUSTOM MIN**

Customized value for minimum signal. Effective when different than 0%.

P6.3 **AI1 CUSTOM MAX**

P6.7 **AI2 CUSTOM MAX**

Customized value for maximum signal. Effective when different than 100%.

P6.4 **AI1 FILTER TIME**

P6.8 **AI2 FILTER TIME**

Low pass filter time constant, to reduce noise. A too high value can delay the response to reference variations.

9.7 Digital outputs

P7.1 RO1 SIGNAL SELECTION

P7.2 RO2 SIGNAL SELECTION

P7.3 DO1 SIGNAL SELECTION

Function for relays and digital output.

Value	Output active condition
0 = Not used	Output not used
1 = Ready	Drive is ready to run
2 = Run	Drive is running
3 = Fault	Drive is in fault state
4 = Fault inverted	Drive is not in fault state
5 = Warning	A warning is active
6 = Reverse	Reverse running
7 = At speed	Motor speed has reached the reference
8 = Motor regular active	Output frequency is over/under the limit set with parameters P12.1 and P12.2
9 = Control pump 1	Pump 1 is active
10 = Control pump 2	Pump 2 is active
11 = Control pump 3	Pump 3 is active

Functions for digital outputs

P7.4 RO1 INVERSION

Inversion of relay state.

P7.5 RO2 INVERSION

Inversion of relay state.

P7.12 AO AS DIGITAL OUTPUT ENABLE

Enable A0 as DO function

P7.13 DIGITAL OUT (AO)

0 = ready

1 = run

2 = fault

3 = fault inverted

Note: Must active A0 as digital output by parameter

9.8 Analog outputs

P8.1 ANALOG OUTPUT FUNCTION

Signal coupled to analog output.

Signal	Value corresponding to max output
0 = Test 0% (Not Used)	Output always 0%
3 = Output frequency	Max frequency (P3.2)
5 = Motor current	Motor nominal current
6 = Motor torque	Motor nominal torque (absolute value)
10 = PID Output	100%
2 = Frequency reference	Max frequency (P3.2)
4 = Motor speed	Motor speed at maximum frequency.
7 = Motor power	Motor nominal power (absolute value)
8 = Motor Voltage	Motor nominal voltage
9 = DC-Link voltage	1000 V
11 = Process Data In1	10000
12 = Process Data In2	10000
13 = Process Data In3	10000
14 = Process Data In4	10000
1 = Test 100%	Output always 100%, can be used for testing purposes

Analog output signals

P8.2 ANALOGUE OUTPUT MINIMUM SIGNAL

0: 0 mA

1: 4 mA

P8.3 ANALOGUE OUTPUT SCALING

Scaling factor added to the analog output.

E.g. 200% would mean that when Output frequency is the selected signal, the output would reach 20 mA already at half the maximum frequency.

P8.4 ANALOGUE OUTPUT FILTER TIME

Time constant of low pass filter.

9.9 Fieldbus data-mapping

P9.1 *OUTPUT PROCESS DATA 1 SELECTION*

P9.2 *OUTPUT PROCESS DATA 2 SELECTION*

P9.3 *OUTPUT PROCESS DATA 3 SELECTION*

P9.4 *OUTPUT PROCESS DATA 4 SELECTION*

P9.5 *OUTPUT PROCESS DATA 5 SELECTION*

P9.6 *OUTPUT PROCESS DATA 6 SELECTION*

P9.7 *OUTPUT PROCESS DATA 7 SELECTION*

P9.8 *OUTPUT PROCESS DATA 8 SELECTION*

Parameter couples read only variables to output process data 1.

0: Frequency reference

1: Output frequency

2: Motor speed

3: Motor current

4: Motor voltage

5: Motor torque

6: Motor power

7: DC link voltage

8: Active fault code

9: Analogue AI1

10: Analogue AI2

11: Digital inputs state

12: PID feedback value

13: PID setpoint

P9.9 *AUX CW SELECTION*

Parameter defines the input process data coupled to Aux Control Word (see chapter 8.3.9 Fieldbus mapping).

0: not used

1: PDI1

2: PDI2

3: PDI3

4: PDI4

5: PDI5

9.10 Prohibited frequencies

P10.1 *PROHIBIT FREQUENCY RANGE 1: LOW LIMIT*

P10.2 *PROHIBIT FREQUENCY RANGE 1: HIGH LIMIT*

P10.3 *PROHIBIT FREQUENCY RANGE 2: LOW LIMIT*

P10.4 *PROHIBIT FREQUENCY RANGE 2: HIGH LIMIT*

Two skip frequency regions are available if there is a need to avoid certain frequencies because of e.g. mechanical resonance. In this case the actual frequency reference sent to the motor control will be kept out of these ranges according to the example below, where one range is in use.

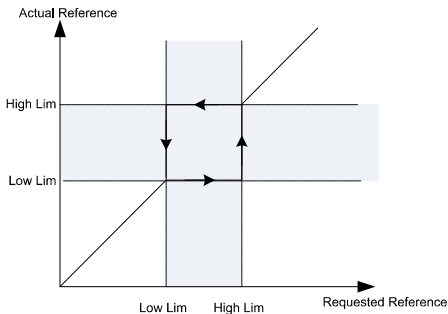

9.11 Protections

P11.1 ANALOG INPUT LOW FAULT

- 0: No action
- 1: Alarm
- 2: Alarm, preset alarm frequency
- 3: Fault: Stop function
- 4: Fault: Coast

Analogue reference below min range.

P11.2 UNDER VOLTAGE FAULT

- 0: No response (no fault generated but drive still stops modulation)
- 1: Fault: Coast

Analogue reference below min range.

P11.3 EARTH FAULT

- 0: No action
- 1: Alarm
- 2: Fault: Stop function
- 3: Fault: Coast

Output currents sum not zero.

P11.4 OUTPUT PHASE SUPERVISION

- 0: No action
- 1: Alarm
- 2: Fault: Stop function
- 3: Fault: Coast

An output phase is missing.

P11.5 STALL PROTECTION

- 0: No action
- 1: Alarm
- 2: Fault: Stop function
- 3: Fault: Coast

This is an overload protection. Stall is recognized by maximum motor current and low output frequency.

P11.6 UNDERLOAD PROTECTION

- 0: No action
- 1: Alarm
- 2: Fault: Stop function
- 3: Fault: Coast

Underload is recognized when torque is above the minimum curve defined by P13.11 and P13.12, for the programmed time P13.13.

P11.7 MOTOR THERMAL PROTECTION

- 0: No action
- 1: Alarm
- 2: Fault: Stop function
- 3: Fault: Coast

This is a software protection, based on time integral of current.

NOTE! To comply with UL 508C requirements Motor over-temperature sensing is required at installation if the parameter is set to 0.

P11.8 MOTOR THERMAL PROTECTION: AMBIENT TEMPERATURE

Change if environment is not standard.

P11.9 MOTOR THERMAL PROTECTION: ZERO SPEED COOLING

Set 100% if the motor has independent fan or cooling. Set 30-40% if the fan is on motor shaft.

P11.10 MOTOR THERMAL PROTECTION: THERMAL TIME CONSTANT

Time at nominal current, to reach nominal temperature.

P11.11 STALL CURRENT**P11.12 STALL TIME****P11.13 STALL FREQUENCY**

Stall is recognized when the current is over the stall current and the output frequency below P13.9, for the time in P13.8.

P11.14 UNDERLOAD: FIELD WEAKENING LOAD**P11.15 UNDERLOAD: ZERO FREQ LOAD****P11.16 UNDERLOAD: TIME LIMIT**

Definition of minimum torque at nominal and zero speed zero. Fault condition delay.

P11.17 ANALOG INPUT LOW FAULT DELAY

Delay as filter on fault generation

P11.18 EXTERNAL FAULT

- 0: No action
- 1: Alarm
- 2: Fault: Stop function
- 3: Fault: Coast

A fault or alarm can be triggered as response to the state of a digital input. The digital input is set with P5.4 or P5.5.

P11.19 FIELD BUS FAULT

- 0: No action
- 1: Alarm
- 2: Alarm, preset alarm frequency
- 3: Fault: Stop function
- 4: Fault: Coast

P11.20 PRESET ALARM FREQUENCY

This frequency is used as frequency reference when fault response is Alarm+preset Frequency.

P11.21 PARAMETERS EDIT LOCK

- 0: Edit enabled
- 1: Edit disabled

P11.22 FWD/REV CONFLICT SUPERVISION

If Forward and reverse input at the same time, there will be alarm 55 as the parameter default.

P11.23 LOW FREQUENCY PROTECTION TIME

When the time elapse, and frequency output is less than the frequency Min, then give the fault NO.82

9.12 Automatic reset

P12.1 **AUTOMATIC RESET**

0: Disabled

1: Enabled

The automatic reset function deletes fault state when the fault cause has been eliminated and the wait time P14.2 has elapsed. Parameter P14.4 determines the maximum number of automatic resets that can be effected during the trial time set by parameter P14.3. The time count starts from the first automatic reset. If the number of faults detected during the trial time exceeds the values of trials, the fault status becomes permanent and a reset command is needed.

P12.2 **WAIT TIME**

Time after which the converter attempts to restart the motor automatically after the fault has been eliminated.

P12.3 **TRIAL TIME**

Total time for reset attempts.

P12.4 **TRIALS NUMBER**

Trials attempted during time P14.3.

P12.5 **RESTART FUNCTION**

0: Start with ramp

1: Flying start

2: According to start function

Start function after an automatic fault reset.

9.13 PID controller

P13.1 SETPOINT SELECTION

- 0: Fixed setpoint 1-2
- 1: Analog input 1 (0-100%)
- 2: Analog input 2 (0-100%)
- 3: ProcessDataIn1 (0-100%)
- 4: ProcessDataIn2 (0-100%)
- 5: ProcessDataIn3 (0-100%)
- 6: ProcessDataIn4 (0-100%)

Note: ProcessDataIns are handled as integers having two decimals and range 0 (0.00%) to 10000 (100.00%).

P13.2 FIXED SETPOINT 1

P13.3 FIXED SETPOINT 2

Programmable setpoints. Setpoint 2 is activated with digital input defined in P5.16.

P13.4 FEEDBACK VALUE SELECTION

- 0: Analog input 1 (0-100%)
- 1: Analog input 2 (0-100%)
- 2: ProcessDataIn1 (0-100%)
- 3: ProcessDataIn2 (0-100%)
- 4: ProcessDataIn3 (0-100%)
- 5: ProcessDataIn4 (0-100%)
- 6: AI2-AI1 (differential)
- 7: Pulse train/encoder (0-100%)

Note: Process DataIns are handled as integers having two decimals and range 0 (0.00%) to 10000 (100.00%).

P13.5 FEEDBACK VALUE MIN

P13.6 FEEDBACK VALUE MAX

Minimum and maximum feedback values, corresponding to minimum and maximum of the signal.

P13.7 PROPORTIONAL GAIN

Proportional gain. If set to 100%, a variation of 10% on error causes a variation of 10% on regulator output.

P13.8 INTEGRAL TIME

Integral time constant. If set to 1s, a variation of 10% on error will cause a variation of 10% on regulator output after 1s.

P13.9 DERIVATIVE TIME

Derivative time. If set to 1s, a variation of 10% in 1s on error causes a variation of 10% on regulator output.

P13.10 ERROR INVERSION

0: direct control.

Frequency increased if setpoint > feedback

1: inverted control.

Frequency increased if setpoint < feedback

P13.11 PROCESS DISPLAY SOURCE

Monitor V4.5 can show a process value, proportional to a variable measured by the drive. Source variables are:

0: PID feedback value (max: 100%)

1: output frequency (max: f_{max})

2: motor speed (max: n_{max})

3: motor torque (max: T_{nom})

4: motor power (max: P_{nom})

5: motor current (max: I_{nom})

P13.12 PROCESS DISPLAY DECIMAL DIGITS

Number of decimals shown on monitor V4.5 and also on parameter P15.20.

P13.13 PROCESS DISPLAY MIN VALUE**P13.14 PROCESS DISPLAY MAX VALUE**

Value shown on V4.5 when source variable is at between minimum maximum. Proportionality is kept if source overtakes between minimum and maximum.

9.14 PFC

The Auto-change function allows the starting and stopping order of drives controlled by the pump and fan automatics to be changed at desired intervals. The drive controlled by frequency converter can also be included in the automatic changing and locking sequence. The Auto-change function makes it possible to equalize the run times of the motors and to prevent e.g. pump stalls due to too long running breaks.

- Apply the Auto-change function with parameter 14.1, Auto-change Mode.
- The auto-change takes place when the time set with parameter 14.5, Auto-change interval, has expired and the capacity used is below the level defined with parameter 14.7, Auto-change frequency limit.
- The running drives are stopped and re-started according to the new order.
- External contactors controlled through the relay outputs of the frequency converter connect the drives to the frequency converter or to the mains. If the motor controlled by the frequency converter is included in the auto-change sequence, it is always controlled through the relay output activated first. The other relays activated later control the auxiliary drives.

P14.1 AUTO-CHANGE MODE

Auto-change is used to make pump wear more uniform.

0 = No auto-change.

Connection/disconnection order of pumps will always remain the same and the controller will regulate the speed of the first pump.

1 = Auxiliary auto-change without interlocks.

Controller regulates the speed of the first pump and auxiliary pumps alternate (connecting and disconnecting).

2 = Total auto-change without interlocks.

Controller alternates the regulation of all pump speeds in the system.

3 = Auxiliary auto-change with interlocks.

Controller regulates the speed of the first pump and auxiliary pumps alternate (connecting and disconnecting). Interlocks are required to connect pumps.

4 = Total auto-change with interlocks.

Controller alternates regulation of the speed of all the pumps in the system. Interlocks are required to connect pumps.

The automatic change of starting and stopping order is activated and applied to either the auxiliary drives only or the auxiliary drives and the drive controlled by the frequency converter.

P14.2 NUMBER OF AUXILIARY PUMPS

Auxiliary pumps assist the main pump.

For example, a pressure unit with a total of 3 pumps has 2 auxiliary pumps. Number of Auxiliary Pumps = No of pumps - 1.

P14.5 AUTO-CHANGE INTERVAL

After the time set by this parameter has elapsed, auto-change takes place if the load used is less than the level set in parameters 14.7 (Auto-change frequency limit) and 14.6 (Maximum number of auxiliary drives). If the load exceeds the value in parameter 14.7, auto-change will not occur until the load is below this limit.

- Timing is enabled only if Start/Stop request is activated.
- Timing is reset after auto-change takes place or when the Start request is removed.

P14.6 MAXIMUM NUMBER OF AUXILIARY DRIVES AND P14.7 AUTO-CHANGE FREQUENCY LIMIT

These parameters define the level below which the capacity used must remain so that the auto-change can take place.

This level is defined as follows:

- If the number of running auxiliary drives is smaller than the value of parameter 14.6 the auto-change function can take place.
- If the number of running auxiliary drives is equal to the value of parameter 14.6 and the frequency of the controlled drive is below the value of parameter 14.7 the auto-change can take place.
- If the value of parameter 14.7 is 0.0 Hz, the auto-change can take place only in rest position (Stop and Sleep) regardless of the value of parameter 14.6.

P14.8 AUXILIARY PUMP START FREQUENCY

When the pump controlled at this output frequency, or higher, and the time set in P14.9 has elapsed, an auxiliary pump will be connected.

P14.9 AUXILIARY PUMP CONNECTION DELAY

The time that must elapse before an auxiliary pump is connected when the main pump is at its maximum level of output, if required by the system.

P14.10 AUXILIARY PUMP STOP FREQUENCY

When the controlled pump runs at this output frequency, or a lower value, and the time set in P14.11 has elapsed, an auxiliary pump will be disconnected.

P14.11 AUXILIARY PUMP STOP DELAY

Time that must elapse before an auxiliary pump is disconnected, when the controlled pump is at its minimum level of output.

P14.13 SLEEP MIN FREQUENCY

The drive can automatically stop if setpoint is reached and output frequency is lower than this value, for the time programmed in P14.14.

P14.14 SLEEP DELAY

Time of working at minimum frequency, before entering sleep condition.

P14.15 SLEEP SETPOINT BOOST**P14.16 SETPOINT BOOST TIME****P14.17 SLEEP MAX LOSS****P14.18 SLEEP LOSS CHECK TIME**

These parameters manage a more complex sleep sequence. After the time in P14.14, the setpoint is increased of the term in P14.15, for the time in P14.16. This will cause a higher output frequency. Frequency reference is then forced at minimum frequency and the feedback value is sampled.

If the variation on the feedback value stays then lower than P14.17 for the time in P14.18, the drive will enter sleep condition.

If this sequence is not needed, then program P14.15 = 0%, P14.16 = 0s, P14.17 = 50%, P14.18 = 1s.

P14.19 WAKE UP LEVEL

Wake up level [%] of PID reference

P14.20 INTERLOCK SELECTION:

0: Not used

1: Update in stop

P14.21 PRESSURE TRANSDUCER SCALE

Maximum pressure permitted by pressure transducer.

9.15 Application setting

P15.2 **PARAMETER CONCEAL**

0: All parameters visible

1: Only quick setup parameter group visible

10. TECHNICAL DATA

10.1 Vacon 20 technical data

Mains connection	Input voltage U_{in}	115 V, -15%...+10% 1-208...240 V, -15%...+10% 1-208...240 V, -15%...+10% 3-380 - 480 V, -15%...+10% 3-600 V, -15%...+10% 3-
	Input frequency	45...66 Hz
	Connection to mains	Once per minute or less (normal case)
Supply network	Networks	Vacon 20 (400 V) cannot be used with corner grounded networks
	Short circuit current	Maximum short circuit current has to be < 50 kA, For M14 without DC-choke, maximum short circuit current has to be < 2.3 kA, for M15 without DC-choke, maximum short circuit current has to be < 3.8 kA
Motor connection	Output voltage	0 - U_{in}
	Output current	Continuous rated current I_N at ambient temperature max. +50 °C (depends on the unit size), overload 1.5 x I_N max 1 min / 10 min
	Starting current / torque	Current 2 x I_N for 2 sec in every 20 sec period. Torque depends on motor
	Output frequency	0...320 Hz
	Frequency resolution	0,01 Hz
Control connection	Digital input	Positive, Logic1: 18...+30V, Logic0: 0...5V; Negative, Logic1: 0...10V, Logic0: 18...30V; $R_i = 10K\Omega$ (floating)
	Analogue input voltage	0...+10V, $R_i = 250K\Omega$
	Analogue input current	0(4)...20mA, $R_i \leq 250\Omega$
	Analogue output	0...10V, $R_L \geq 1K\Omega$; 0(4)...20mA, $R_L \leq 500\Omega$, Selectable through microswitch
	Digital output	Open collector, max. load 35V/50mA (floating)
	Relay output	Switching load: 250Vac/3A
	Auxiliary voltage	$\pm 20\%$, max. load 50mA

Table 10.1: Vacon 20 technical data

Control characteristics	Control method	Frequency Control U / f Open Loop Sensorless Vector Control
	Switching frequency	1...16 kHz; Factory default 4 kHz
	Frequency reference	Resolution 0.01 Hz
	Field weakening point	30...320 Hz
	Acceleration time	0.1...3000 sec
	Deceleration time	0.1...3000 sec
	Braking torque	100%* T_N with brake option (only in 3- drives sizes MI2-5) 30%* T_N without brake option
Ambient conditions	Ambient operating temperature	-10 °C (no frost)...+40 / 50 °C (depends on the unit size): rated loadability I_N Side by side installation for MI1-3 it is always 40 °C; For IP21/ Nema1 option in MI1-3 the maximum temperature is also 40 °C
	Storage temperature	-40 °C...+70 °C
	Relative humidity	0...95% RH, non-condensing, non-corrosive, no dripping water
	Air quality: - chemical vapours - mech. particles	IEC 721-3-3, unit in operation, class 3C2 IEC 721-3-3, unit in operation, class 3S2
	Altitude	100% load capacity (no derating) up to 1000 m. 1% derating for each 100 m above 1000 m; max. 2000 m
	Vibration: EN60068-2-6	3...150 Hz Displacement amplitude 1(peak) mm at 3...15.8 Hz Max acceleration amplitude 1 G at 15.8...150 Hz
	Shock IEC 68-2-27	UPS Drop Test (for applicable UPS weights) Storage and shipping: max 15 G, 11 ms (in package)
	Enclosure class	IP20 / IP21 / Nema1 for MI1-3, IP21/Nema 1 for MI4-5
	Pollution degree	PD2

Table 10.1: Vacon 20 technical data

EMC	Immunity	Complies with EN50082-1, -2, EN61800-3
	Emissions	230V : Complies with EMC category C2; With an internal RFI filter M14&5 complies C2 with an optional DC choke and CM choke 400V: Complies with EMC category C2; With an internal RFI filter M14&5 complies C2 with an optional DC choke and CM choke Both: No EMC emission protection (Vacon level N); Without RFI filter
Standards		For EMC: EN61800-3, For safety: UL508C, EN61800-5
Certificates and manufacturer's declarations of conformity		For safety: CE, UL, cUL, For EMC: CE (see unit nameplate for more detailed approvals)

Table 10.1: Vacon 20 technical data

10.2 Power ratings

10.2.1 Vacon 20 – Mains voltage 208-240 V

Mains voltage 208-240 V, 50/60 Hz, 1~ series							
Freq. converter type	Rated loadability		Motor shaft power		Nominal input current [A]	Mechanical size	Weight (kg)
	100% contin. current I_N [A]	150% over-load current [A]	P [HP]	P [KW]			
0001	1.7	2.6	0.33	0.25	4.2	M11	0.55
0002	2.4	3.6	0.5	0.37	5.7	M11	0.55
0003	2.8	4.2	0.75	0.55	6.6	M11	0.55
0004	3.7	5.6	1	0.75	8.3	M12	0.7
0005	4.8	7.2	1.5	1.1	11.2	M12	0.7
0007	7	10.5	2	1.5	14.1	M12	0.7
0009*	9.6	14.4	3	2.2	22.1	M13	0.99

Table 10.2: Vacon 20 power ratings, 208-240 V

* The maximum ambient operating temperature of this drive is 40 °C!

Mains voltage 208 - 240 V, 50/60 Hz, 3~ series							
Freq. converter type	Rated loadability		Motor shaft power		Nominal input current [A]	Mechanical size	Weight (kg)
	100% contin. current I_N [A]	150% over-load current [A]	P [HP]	P [KW]			
0001	1.7	2.6	0.33	0.25	2.7	M11	0.55
0002	2.4	3.6	0.5	0.37	3.5	M11	0.55
0003	2.8	4.2	0.75	0.55	3.8	M11	0.55
0004	3.7	5.6	1	0.75	4.3	M12	0.7
0005	4.8	7.2	1.5	1.1	6.8	M12	0.7
0007*	7	10.5	2	1.5	8.4	M12	0.7
0011*	11	16.5	3	2.2	13.4	M13	0.99
0012	12.5	18.8	4	3	14.2	M14	9
0017	17.5	26.3	5	4	20.6	M14	9
0025	25	37.5	7.5	5.5	30.3	M14	9
0031	31	46.5	10	7.5	36.6	M15	11
0038	38	57	15	11	44.6	M15	11

Table 10.3: Vacon 20 power ratings, 208-240 V, 3~

* The maximum ambient operating temperature of these drives is +40 °C.

10.2.2 Vacon 20 – Mains voltage 115 V

Mains voltage 115 V, 50/60 Hz, 1~ series							
Freq. converter type	Rated loadability		Motor shaft power		Nominal input current [A]	Mechanical size	Weight [Kg]
	100% contin. current I _N [A]	150% over-load current [A]	P [HP]	P [KW]			
0001	1.7	2.6	0.33	0.25	9.2	MI2	0.7
0002	2.4	3.6	0.5	0.37	11.6	MI2	0.7
0003	2.8	4.2	0.75	0.55	12.4	MI2	0.7
0004	3.7	5.6	1	0.75	15	MI2	0.7
0005	4.8	7.2	1.5	1.1	16.5	MI3	0.99

Table 10.4: Vacon 20 power ratings, 115 V, 1~

10.2.3 Vacon 20 – Mains voltage 380-480 V

Mains voltage 380-480 V, 50/60 Hz, 3~ series							
Freq. converter type	Rated loadability		Motor shaft power		Nominal input current [A]	Mechanical size	Weight (kg)
	100% contin. current I _N [A]	150% over-load current [A]	P [HP]	P [KW]			
0001	1.3	2	0.5	0.37	2.2	MI1	0.55
0002	1.9	2.9	0.75	0.55	2.8	MI1	0.55
0003	2.4	3.6	1	0.75	3.2	MI1	0.55
0004	3.3	5	1.5	1.1	4	MI2	0.7
0005	4.3	6.5	2	1.5	5.6	MI2	0.7
0006	5.6	8.4	3	2.2	7.3	MI2	0.7
0008	7.6	11.4	4	3	9.6	MI3	0.99
0009	9	13.5	5	4	11.5	MI3	0.99
0012	12	18	7.5	5.5	14.9	MI3	0.99
0016	16	24	10	7.5	17.1	MI4	9
0023	23	34.5	15	11	25.5	MI4	9
0031	31	46.5	20	15	33	MI5	11
0038	38	57	25	18.5	41.7	MI5	11

Table 10.5: Vacon 20 power ratings, 380-480 V

10.2.4 Vacon 20 – Mains voltage 600 V

Mains voltage 600 V, 50/60 Hz, 3~ series							
Fre- quency converter type	Rated loadability		Motor shaft power		Nominal input current [A]	Mechanical size	Weight (kg)
	100% contin. current I _N [A]	150% over- load current [A]	P [HP]	P [KW]			
0002	1,7	2,6	1	0,75	2	MI3	0,99
0003	2,7	4,2	2	1,5	3,6	MI3	0,99
0004	3,9	5,9	3	2,2	5	MI3	0,99
0006	6,1	9,2	5	3,7	7,6	MI3	0,99
0009	9	13,5	7,5	5,5	10,4	MI3	0,99

Table 10.6: Vacon 20 power ratings, 600 V

Note 1: The input currents are calculated values with 100 kVA line transformer supply.

Note 2: The mechanical dimensions of the units are given in Chapter 3.1.1.

10.3 Brake resistors

Vacon 20 type	Minimum brak- ing resistance	Resistor type code (from Vacon NX family)		
		Light duty	Heavy duty	Resistance
MI2 204-240V,3~	50 Ohm	-	-	-
MI2 380-480V,3~	118 Ohm	-	-	-
MI3 204-240V, 3~	31 Ohm	-	-	-
MI3 380-480V, 3~	55 Ohm	BRR-0022-LD-5	BRR-0022-HD-5	63 Ohm
MI3 600V, 3~	100 Ohm	BRR-0013-LD-6	BRR-0013-HD-6	100 Ohm
MI4 204-240V, 3~	14 Ohm	BRR-0025-LD-2	BRR-0025-HD-2	30 Ohm
MI4 380-480V, 3~	28 Ohm	BRR-0031-LD-5	BRR-0031-HD-5	42 Ohm
MI5 204-240V, 3~	9 Ohm	BRR-0031-LD-2	BRR-0031-HD-2	20 Ohm
MI5 380-480V, 3~	17 Ohm	BRR-0045-LD-5	BRR-0045-HD-5	21 Ohm

Note! For MI2 and MI3, only 3-phase units are equipped with brake chopper.

For further information on brake resistors, please download Vacon NX Brake Resistor Manual (UD00971C) on [http://www.vacon.com/Support & Downloads](http://www.vacon.com/Support%20&%20Downloads)

VACON[®]

DRIVEN BY DRIVES

Find your nearest Vacon office
on the Internet at:

www.vacon.com

Manual authoring:
documentation@vacon.com

Vacon Suzhou Drives Co. Ltd.
No. 71 Xinqing Road
Suzhou Industrial Park
Suzhou, Jiangsu Province,
P.R. China, 215123

Subject to change without prior notice
© 2013 Vacon Plc.

Document ID:



Rev. B