

VACON 50X
AC DRIVES

USER'S MANUAL

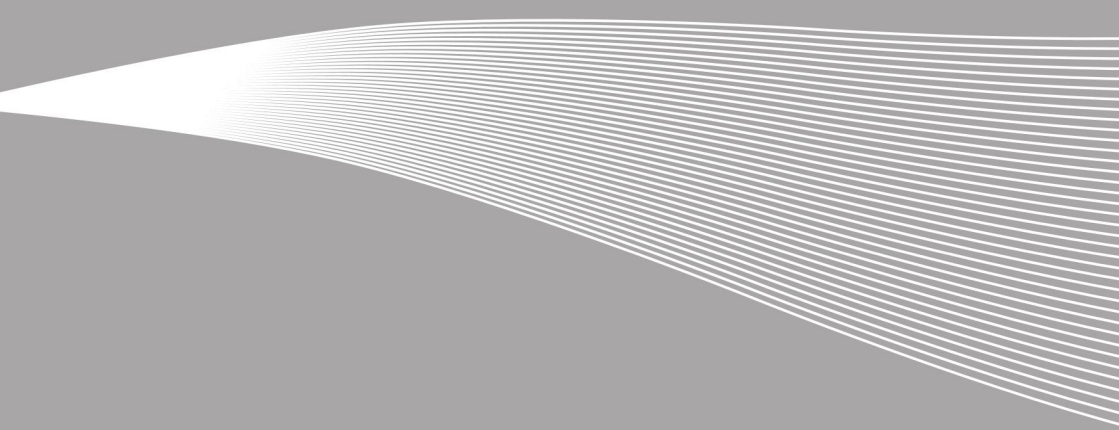

1. INTRODUCTION	3
1.1 Product Overview	3
1.2 Overview of This Manual	3
1.3 User's Manual Publication History	3
2. TECHNICAL CHARACTERISTICS	5
2.1 Interpreting Model Numbers	5
2.2 Power and Current Ratings	6
2.2.1 230-volt drives	6
2.2.2 380-480-volt drives	7
2.2.3 575-volt drives	8
2.3 Environmental Specifications	9
2.4 Electrical Specifications	9
2.5 Control Features Specifications	9
2.6 Dimensions and Weights	11
3. RECEIVING AND INSTALLATION	19
3.1 Preliminary Inspection	19
3.2 Installation Precautions	19
3.3 Dissipation Requirements	20
3.4 Cover Assembly and Torque Specifications	21
3.5 Serial Number Label	21
3.6 Conduit Usage	21
3.7 Condensation	21
4. CONNECTIONS	23
4.1 General Wiring Information	23
4.1.1 Wiring Practices	23
4.1.2 Considerations for Power Wiring	23
4.1.3 Considerations for Control Wiring	24
4.2 Input Line Requirements	25
4.2.1 Line Voltage	25
4.2.2 Use of Isolation Transformers and Line Reactors	25
4.2.3 Line Capacity	25
4.2.4 Phase Imbalance	25
4.2.5 Single-phase Operation	26
4.2.6 Ground Fault Circuit Interrupters	26
4.2.7 Motor Lead Length	26
4.2.8 Using Output Contactors	26
4.3 Terminals Found on the Vacon 50X Power Board	27
4.3.1 Description of the Terminals	27
4.3.2 Typical Power Connections	30
4.4 Dynamic Braking	31
4.5 Terminals Found on the Vacon 50X Control Board	33
4.5.1 Description of the Control Terminals	33
4.5.2 Typical Connection Diagrams for Digital Inputs	35
4.5.3 Typical Connection Diagrams for Analog Inputs	36
4.5.4 Typical Connection Diagrams for Analog Outputs	36
4.6 Reducing Current Surges and Voltage Transients	37
5. KEYPAD OPERATION AND PROGRAMMING	39
5.1 Introduction	39
5.2 Keypad Operation	40
5.3 LCD Displays	42
5.3.1 Control	42
5.3.2 Vacon 50X Keypad Status and Warning Messages	42

5.3.3	Rights	44
5.3.4	Other Data	44
5.4	Keypad Display Window	44
5.5	Programming	45
5.5.1	Accessing Parameters	45
5.5.2	Changing the Display Scroll Rate	45
5.5.3	Programming Procedure	45
5.5.4	Restoring Factory Settings	46
5.5.5	Viewing Parameters That Have Changed	46
5.5.6	Using Macro Mode	46
5.6	Measuring Stator Resistance (RS Measurement)	46
5.6.1	Activating Automatic RS Measurement via Keypad	46
5.6.2	Activating Automatic RS Measurement via Serial Link (Modbus)	47
6.	USING MACRO MODE AND GETTING A QUICK START	49
6.1	Entering Macro Mode	49
6.2	Description of Parameters Used in Macro Mode	49
6.3	Macro Mode Applications and Included Parameters	53
6.4	Quick Start	57
7.	VACON 50X PARAMETERS	59
7.1	Introduction	59
7.2	Level 1 Parameters	59
7.3	Description of Parameters	60
7.4	Using the Vacon 50X Program Sequencer	92
7.4.1	Enabling the Vacon 50X Program Sequencer	92
7.4.2	Controlling the Vacon 50X Program Sequencer	92
7.4.3	Sequencer State Configuration Overview	93
7.4.4	Sequencer Status Indicators	96
7.4.5	Sample Sequencer Program	97
8.	TROUBLESHOOTING	101
8.1	Vacon 50X Fault Codes	101
9.	HEXADECIMAL TO BINARY CONVERSION	105
10.	FUNDAMENTALS OF PI CONTROL	107
10.1	Introduction	107
10.2	Configuration of PI Control Parameters	107
10.2.1	Parameter 490 (Appl Macro)	107
10.2.2	Parameter 857 (PI High Corr) and 858 (PI Low Corr)	107
10.2.3	Parameter 852 (PI Prop Gain)	109
10.2.4	Parameter 853 (PI Int Gain)	109
10.2.5	Parameter 854 (PI Feed Gain)	109
10.2.6	Parameter 850 (PI Configure)	109
10.3	Tuning the PI Control Loop	110
11.	EU DECLARATION OF CONFORMITY	111
12.	SUMMARY OF VACON 50X PARAMETERS	113
12.1	Default Settings	113
12.2	Parameter Names in 5 Languages	117
12.3	Settings and Messages in 5 Languages	121

1. Introduction

1.1 Product Overview

Although the Vacon 50X AC drive is small in size, it is big on performance. It is an economical yet powerful solution for many industrial applications. It features remote communications capability (using Modbus® protocol), a keypad for easy configuration, and standard NEMA 4X / IP66 and NEMA 12 / IP55 enclosures that eliminate the need for mounting in a separate enclosure.

The Vacon 50X product family includes a wide variety of models to suit almost any input voltage requirement. An 'x' in the following table indicates what models are currently available. Refer to Chapter 2 on page 5 for help in interpreting model numbers.

Power (kW)	Power (hp)	Input Voltage		
		230 Vac 3 Phase	460 Vac 3 Phase	575 Vac 3 Phase
0.75	1	x	x	x
1.5	2	x	x	x
2.2	3	x	x	x
4.0	5	x	x	x
5.5	7.5	x	x	x
7.5	10	x	x	x
11	15	x	x	x
15	20	x	x	x
18.5	25	x	x	x
22	30		x	x
30	40		x	x
37	50		x	x
45	60		x	x
55	75		x	x
75	100		x	x
90	125		x	x
110	150		x	x
150	200		x	x

1.2 Overview of This Manual

This manual contains specifications, receiving and installation instructions, configuration, description of operation, and procedures for Vacon 50X AC drive devices.

For experienced users, a "Quick Start" section begins on page 57.

1.3 User's Manual Publication History

Date	Form Number	Nature of Change
16.7.2008	DPD00080A	Original version
10.12.2008	DPD00080B	Changed installation diagrams to reflect changes in product; changed photographs of product; added information to Chapter 2 on current surges and voltage transients; deleted mention of Model 0002 5; other minor changes and corrections.

2. Technical Characteristics

2.1 Interpreting Model Numbers

The model number of the Vacon 50X AC drive appears on the shipping carton label and on the technical data label affixed to the model. The information provided by the model number is shown below:

VACON

This segment is common for all products.

0050

Product range:

0050=Vacon 50X

3L

Input/Function:

3L=Three-phase input

0023

Drive rating in ampere; e.g. 0023 = 23 A

5

Supply voltage:

2=230 V

5=400 V

6=575 V

X

Information for factory

2.2 Power and Current Ratings

2.2.1 230-volt drives

Mains voltage 230V, IP66, EMC N, 50-60 Hz, 3~							
Converter type	Motor shaft power and current						
	High overload		Low overload				
	50% overload 50°C [kW]	50% overload current [A]	10% overload 40°C [kW]	20% overload current [A]	Dimensions W x H x D [mm]	Weight [kg]	
S0	0004	0,37	2,2	0,75	4,2	165x241x155	3,9
	0007	0,75	4,2	1,5	6,8	165x241x155	3,9
	0010	1,5	6,8	2,2	9,6	165x241x155	3,9
S1	0015	2,2	9,6	4,0	15,2	221x306x166	6,35
	0022	4,0	15,2	5,5	22,0	221x306x166	6,35
	0028	5,5	22,0	7,5	28,0	221x306x166	6,35
S2	0042	7,5	28,0	11	42,0	273x442x201	13,38
	0054	11,0	42,0	15	54,0	273x442x201	13,38
S3	0068	15,0	54,0	18,5	68,0	286x513x314	22,68

2.2.2 380-480-volt drives

Mains voltage 380-480V, IP66, EMC N, 50-60 Hz, 3~							
	Converter type	Motor shaft power and current					
		High overload		Low overload		Dimensions W x H x D [mm]	Weight [kg]
		50% overload 50°C [kW]	50% overload current [A]	10% overload 40°C [kW]	20% overload current [A]		
S0	0002	0,55	1,8	0,75	2,4	165x241x155	3,9
	0004	0,75	2,4	1,5	3,8	165x241x155	3,9
	0005	1,5	3,8	2,2	5,1	165x241x155	3,9
S1	0009	2,2	5,1	4,0	8,9	221x306x166	6,35
	0012	4,0	8,9	5,5	12,0	221x306x166	6,35
	0016	5,5	12,0	7,5	15,6	221x306x166	6,35
S2	0023	7,5	15,6	11,0	23,0	273x442x201	13,38
	0031	11,0	23,0	15,0	31,0	273x442x201	13,38
	0037	15,0	31,0	18,5	37,0	273x442x201	13,38
	0043	18,5	37,0	22,0	43,0	273x442x201	13,38
S3	0061	22,0	43,0	30,0	61,0	286x513x314	22,68
	0071	30,0	61,0	37,0	71,0	286x513x314	22,68
S4	0086	37,0	71,0	45,0	86,0	326x745x351	43,1
	0105	45,0	86,0	55,0	105,0	326x745x351	43,1
	0140	55,0	105,0	75,0	140,0	326x745x351	43,1
S5^a	0168	75,0	140,0	90,0	168,0	414x1296x429	138,35
	0205	90,0	168,0	110,0	205,0	414x1296x429	138,35
	0240	110,0	205,0	132,0	240,0	414x1296x429	138,35

a. Enclosure class IP54

2.2.3 575-volt drives

Mains voltage 575V, IP66, EMC N, 50-60 Hz, 3~							
	Converter type	Motor shaft power and current					
		High overload		Low overload		Dimensions W x H x D [mm]	Weight [kg]
		50% overload 50°C [kW]	50% overload current [A]	10% overload 40°C [kW]	20% overload current [A]		
S1	0002	0,5	1	1,1	1,7	221x306x166	6,35
	0003	1,1	1,7	1,5	2,7	221x306x166	6,35
	0004	1,5	2,7	2,2	3,9	221x306x166	6,35
	0006	2,2	3,9	3,0	6,1	221x306x166	6,35
	0009	3,0	6,1	5,0	9,0	221x306x166	6,35
	0011	5,0	9,0	7,5	11,0	221x306x166	6,35
S2	0017	7,5	11,0	11,0	17,0	273x442x201	13,38
	0022	11,0	17,0	15,0	22,0	273x442x201	13,38
	0027	15,0	22,0	18,5	27,0	273x442x201	13,38
	0032	18,5	27,0	22,0	32,0	273x442x201	13,38
S3	0041	22,0	32,0	30,0	41,0	286x513x314	22,68
	0052	30,0	41,0	37,0	52,0	286x513x314	22,68
S4	0062	37,0	52,0	45,0	62,0	326x745x351	43,1
	0077	45,0	62,0	55,0	77,0	326x745x351	43,1
	0099	55,0	77,0	75,0	99,0	326x745x351	43,1
S5^a	0125	75,0	99,0	90,0	125,0	414x1296x429	138,35
	0144	90,0	125,0	110,0	144,0	414x1296x429	138,35
	0192	110,0	144,0	132,0	192,0	414x1296x429	138,35

a. Enclosure class IP55

2.3 Environmental Specifications

Operating temperature	For 0010 2, 0015 2, and 0040 5 models: -10 °C to +35 °C For all other models: -10 °C to +40 °C
Storage temperature	-20 °C to +65 °C [-4 °F to 149 °F]
Humidity	0% to 95% non-condensing
Altitude	1000 m (3300 ft) without derating
Maximum vibration	per EN50178 (1g @ 57-150 Hz)
Acoustic noise	80 dba sound power at 1 m (3 ft), maximum
Cooling	0,75–4,0 kW models: Natural convection. 5,5–150 kW models: Forced air.

2.4 Electrical Specifications

Input voltage	230 Vac, 3 phase, ±15% 380–460 Vac, 3 phase, ±15%		
Line frequency	50 / 60 Hz ±2 Hz		
Source kVA (maximum)	10 times the unit rated kVA (see note below)		
DC bus voltage for:	230 Vac models	460 Vac models	575 Vac models
Overvoltage trip	406 Vdc	814 Vdc	1017 Vdc
Dynamic brake activation	388 Vdc	776 Vdc	970 Vdc
Nominal undervoltage (UV) trip	199 Vdc	397 Vdc	497 Vdc
Control system	V/Hz or SVC Carrier frequency = 1–16 kHz, programmable; 8 kHz max. for 90–150 kW models		
Output voltage	0–100% of line voltage, three-phase		
Overload capacity	120% of rated normal duty rms current for 60 seconds. 150% of rated heavy duty rms current for 60 seconds.		
Frequency range	0,1–400 Hz		
Frequency stability	0.1 Hz (digital), 0.1% (analog) over 24 hours ±10 °C		
Frequency setting	By keypad or by external signal (Speed Pot 0–5 Vdc; 0–10 Vdc; 0–20 mA, or 4–20 mA) OR by pulse train up to 100 kHz		

NOTE: Unit Rated kVA = rate Voltage × rated Current × 1.732

2.5 Control Features Specifications

Vin1 reference input	0–5/10 Vdc, 0/4–20 mAdc (250 Ω load) Pulse train input, 0–1/10/100 kHz pulse input, inverted function, 0–5–10 bipolar input, broken wire detection. Span and offset adjustment.
Vin2 reference input	0–5/10 Vdc, 0–5–10 bipolar input, inverted function, broken wire detection, span and offset adjustment. Programmable for frequency reference or current limit input.
Cin reference input	0/4–20 mAdc (50 Ω load), inverted function, span and offset adjustment. Programmable for frequency reference or current limit input.
Reference voltage	10 Vdc (10 mAdc maximum)
Digital inputs – 10	Off = 0 to 3 Vdc; On = 10 to 32 Vdc (pullup logic), selectable between pullup and pulldown logic
Digital supply voltage	24 Vdc (150 mAdc maximum)
Preset frequencies	3 inputs for seven preset frequencies (selectable)
Digital outputs	2 SPDT relay output – 130 Vac, 1 A/250 Vac, 0.5 A. 2 open collector outputs 50 mA per device

Digital pulse train output	Open collector output pulse train proportional to output frequency
Vmet analog output	0 to 10 Vdc (5 mAdc maximum)
Imet analog output	0–20 mAdc output into a 500 Ω load (maximum)
DC holding / injection braking	At start, stop, by frequency with adjustable current level and time or continuous DC injection by digital input
Current limit	Four quadrant adjustable from 5 to 150%
Speed ramps	Primary and alternate adjustable from 0.1 to 3200.0 seconds
Voltage boost	Fixed boost adjustable from 0 to 50% or auto boost
Voltage characteristic (V/Hz)	Linear, pump, fan or 2-piece linear
Timed overload	Adjustable inverse time trip (shear pin, 30 sec, 60 sec, 5 min), standard or inverterduty motors
Protective features	Overcurrent, overvoltage fault, ground fault, short circuit, dynamic brake overload, drive temperature, power wiring fault, drive timed overload, input voltage quality, overvoltage ride-through
Program Sequence Logic Controller (PSLC)	9-step PLC type functionality that can control speed, direction, and ramps based on time, analog input, digital input, or pulse input
Serial communications	Modbus Standard: RTU

2.6 Dimensions and Weights

Table 1 lists dimensions and weights for the Vacon 50X frame size 0, 1, 2, and 3 models. Dimensions and weights for the Vacon 50X frame size 4 and 5 models are shown in Table 2 on page 12.

See Figures on pages 13–18 for locations of dimensions. Dimensions A through Q are in millimeters (mm). Weight is in kilograms (kg).

Frame	0		1			2			3		
Voltage [V]	230	460	230	460	575	230	460	575	230	460	575
KW	0.75–2.2		4–5.5	4–7.5	1.1–7.5	7.5–11	11–22	11–22	15–22	30–37	30–37
hp	1–3		5–7.5	5–10	1–10	10–15	15–30	15–30	20–30	40–50	40–50
Dimensions in mm	A	241	306			442			513		
	B	165	221			274			289		
	C (with- out Filter)	156	167			202			314		
	C1 (with Filter)		217			252			303		
	D	215	280			419			489		
	E	144	198			248			200		
	F	7.1	7.1			9.0			7.1		
	G	95	104			119			199		
	H	69	–			–			–		
	J	49	56			72			63		
	K	71	98			123			58		
	L	95	100			172			100		
	M	22	25.5			32			44		
N	–	–			25.5			25.5			
P	–	–			–			142			
Q	–	–			–			184			
Weight (kg) without Filter (C)	3.9		6.7			12.7			23.7		
Weight (kg) with Fil- ter (C1)			7.8			15.6					

Table 1: Dimensions and Weights for Frame Sizes 0–3

Frame		4		5	
Voltage (V)		460	575	460	575
KW		45-75	45-75	90-132	90-132
hp		60-100	60-100	125-200	125-200
Dimensions in mm	A	745		1296	
	B	326		414	
	C (without Filter)	351		429	
	D	711		1163	
	E	200		194	
	F	11		11	
	G	219		319	
	H	210		282	
	J	13		5	
	K	68		59	
	L	100		97	
	M	62		75	
	N	22		22	
	P	132		135	
	Q	187		189	
R	260		-		
S	49		47		
Weight (kg) without Filter (C)		43.1		138.4	

Table 2:Dimensions and Weights for Frame Sizes 4-5

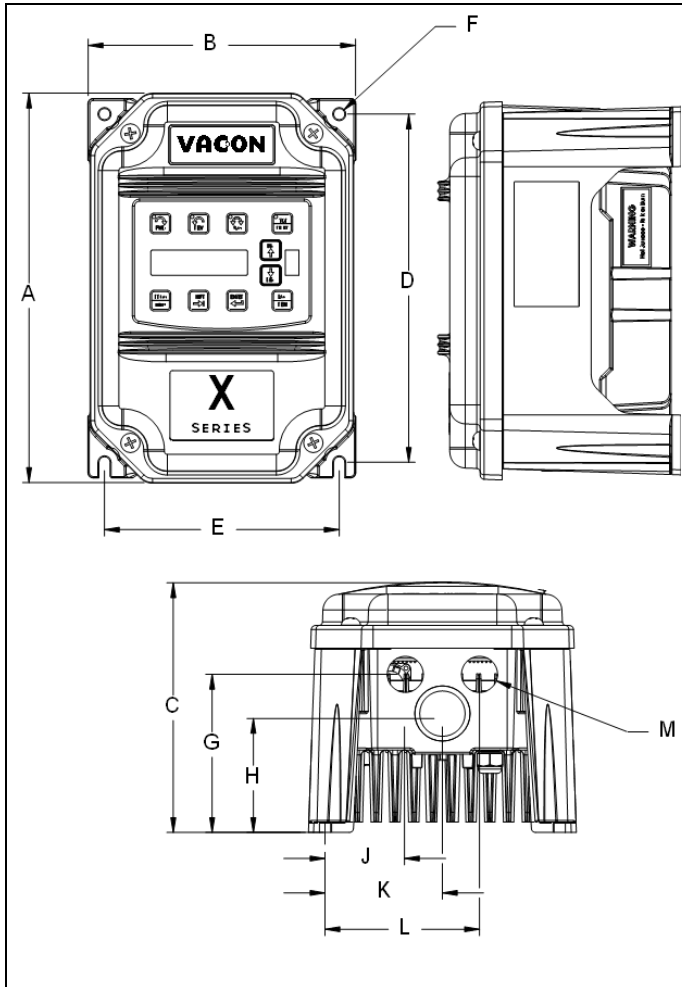

Figure 1: Vacon 50X Frame Size 0 Models

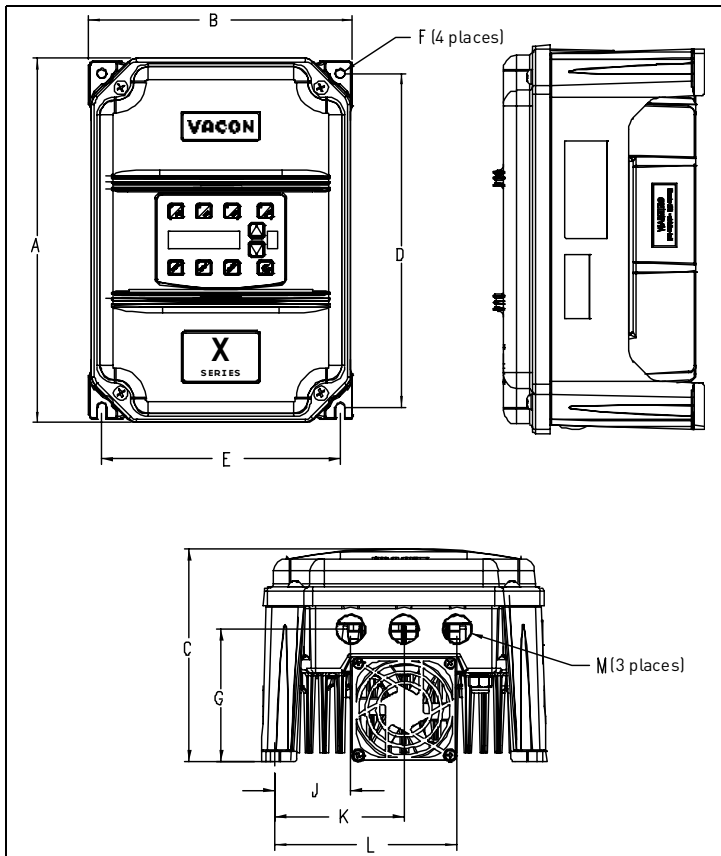

Figure 2: Vacon 50X Frame Size 1 Models

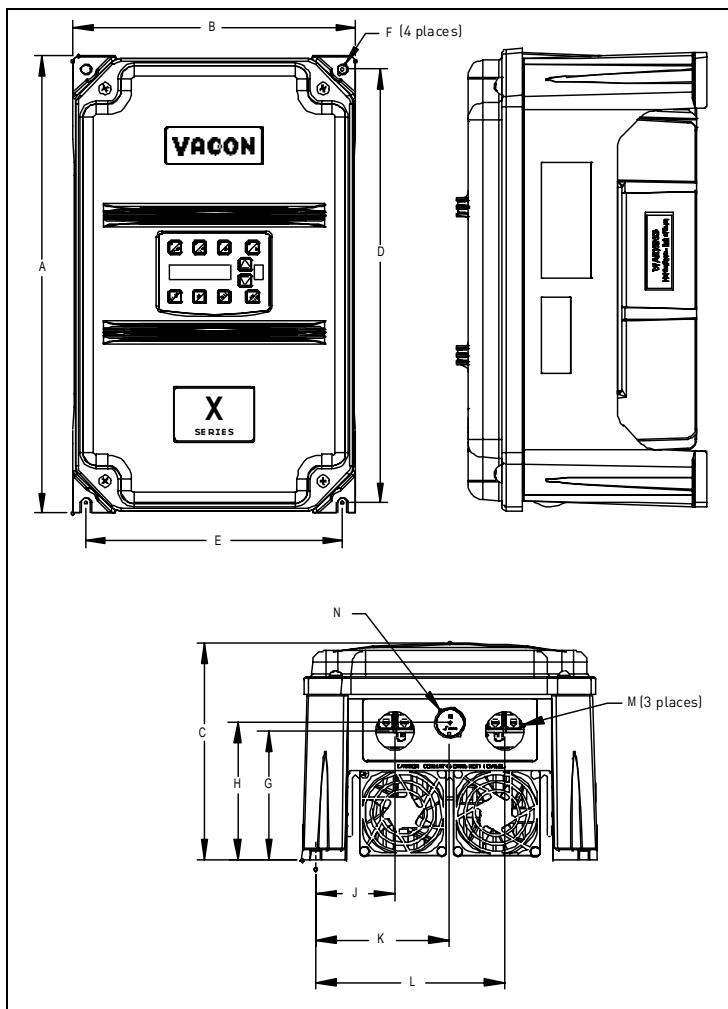

Figure 3: Vacon 50X Frame Size 2 Models

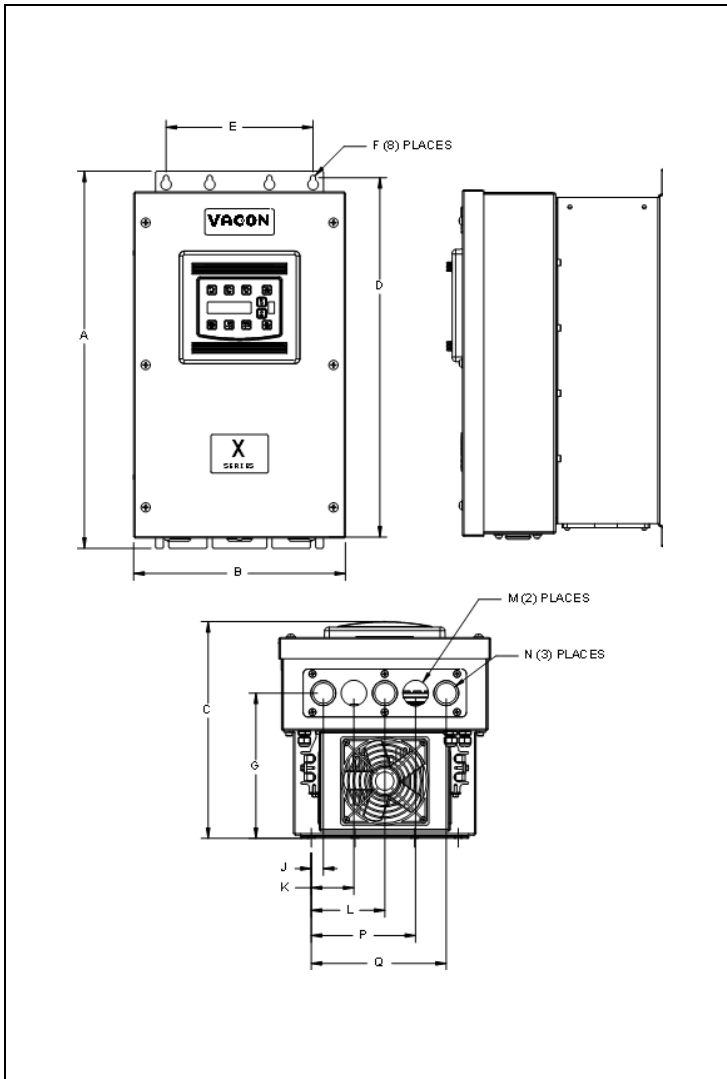

Figure 4: Vacon 50X Frame Size 3 Models

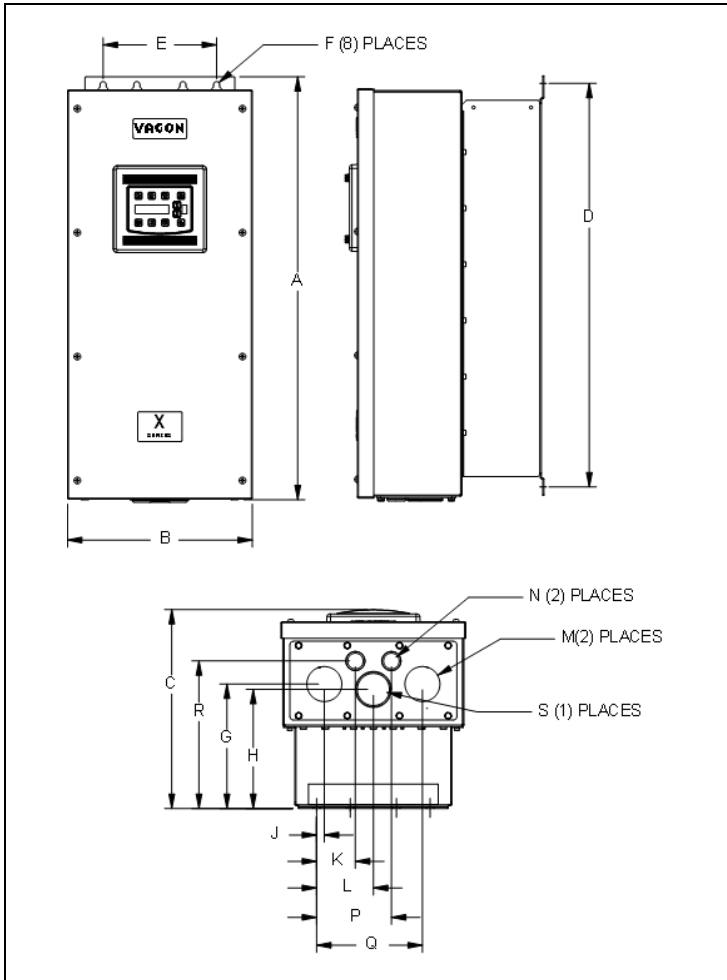

Figure 5: Vacon 50X Frame Size 4 Models

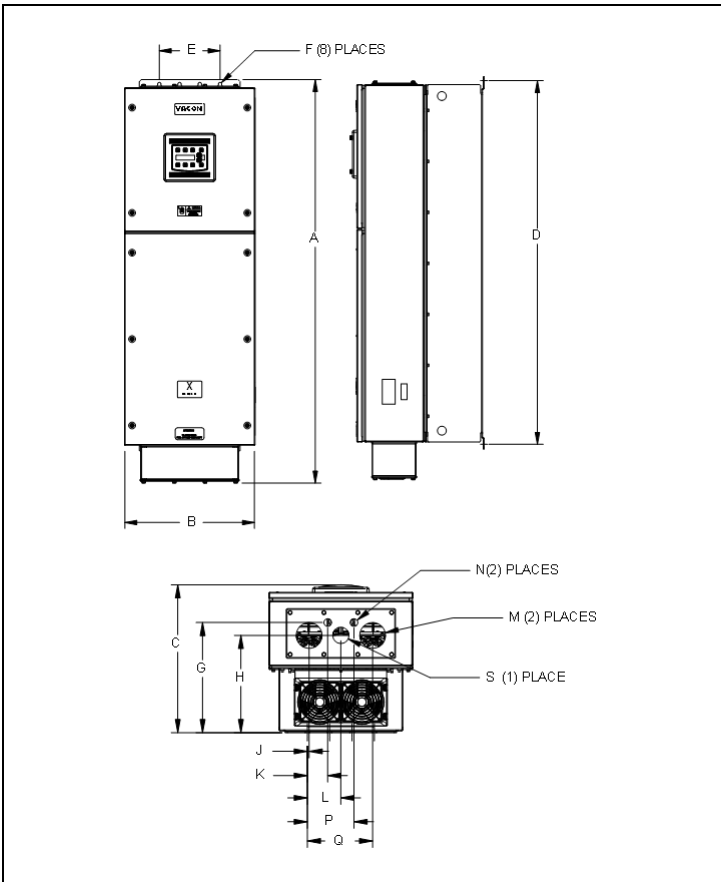



Figure 6: Vacon 50X Frame Size 5 Models

3. Receiving and Installation

3.1 Preliminary Inspection

Before storing or installing the Vacon 50X AC drive, thoroughly inspect the device for possible shipping damage. Upon receipt:

1. Remove the drive from its package and inspect exterior for shipping damage. If damage is apparent, notify the shipping agent and your sales representative.
2. Remove the cover and inspect the drive for any apparent damage or foreign objects. (See Figure 7 on page 21 for locations of cover screws.) Ensure that all mounting hardware and terminal connection hardware is properly seated, securely fastened, and undamaged.
3. Read the technical data label affixed to the drive and ensure that the correct horsepower and input voltage for the application has been purchased.
4. If you will be storing the drive after receipt, place it in its original packaging and store it in a clean, dry place free from direct sunlight or corrosive fumes, where the ambient temperature is not less than -20°C (-4°F) or greater than $+65^{\circ}\text{C}$ ($+149^{\circ}\text{F}$).

 <p>CAUTION</p>	<p>EQUIPMENT DAMAGE HAZARD Do not operate or install any drive that appears damaged. Failure to follow this instruction can result in injury or equipment damage.</p>
--	--

3.2 Installation Precautions

Improper installation of the Vacon 50X AC drive will greatly reduce its life. Be sure to observe the following precautions when selecting a mounting location. Failure to observe these precautions may void the warranty!

- Do not install the drive in a place subjected to high temperature, high humidity, excessive vibration, corrosive gases or liquids, or airborne dust or metallic particles. See Chapter 2 for temperature, humidity, and maximum vibration limits.
- Do not mount the drive near heat-radiating elements or in direct sunlight.
- Mount the drive vertically and do not restrict the air flow to the heat sink fins.
- The drive generates heat. Allow sufficient space around the unit for heat dissipation. See "Dissipation Requirements" on page 20.

3.3 Dissipation Requirements

Model	Required Dissipation for Models Entirely Inside an Enclosure at Rated Current, 3 kHz Carrier Frequency (Watts)	Required Dissipation When Fins are External to the Enclosure (Watts)
0004 2	47	13
0007 2	48	14
0010 2	71	17
0015 2	92	16
0022 2	132	20
0028 2	177	23
0042 2	263	67
0054 2	362	68
0068 2	550	97
0004 5	46	16
0005 5	71	20
0009 5	91	21
0012 5	114	28
0016 5	155	30
0023 5	304	77
0031 5	393	76
0037 5	459	78
0043 5	458	77
0061 5	695	95
0071 5	834	100
0086 5	776	130
0105 5	988	135
0140 5	1638	155
0168 5	1656	353
0205 5	1891	372
0240 5	2302	382

Table 3:Dissipation Requirement for Vacon 50X Models

3.4 Cover Assembly and Torque Specifications

Figure 7 shows the locations of the Vacon 50X cover screws. The torque range for the Size 0 and 1 covers is 2–3 Nm (18–26 in/lbs).



Figure 7: Vacon 50X Cover Assembly and Screw Locations

Torque specifications for control terminals and power terminals are listed in "General Wiring Information" on page 23.

3.5 Serial Number Label

To determine if your drive is within the warranty time frame, find the bar code label or look in the lower left of the technical nameplate. The serial number can be broken down as follows:

- yywwxxxx = yy ... year of manufacture
- ww ... week of manufacture
- xxxx....sequential number drive during that week.

3.6 Conduit Usage

The Vacon 50X drive in the IP66 enclosure is rated for 70 bar washdown from 15 cm. To keep this rating, the use of a sealed conduit is required. The use of a Romex-type conduit will not prevent water entry into the enclosure. If the approved conduit is not used, all warranty claims against water damage will be void.

3.7 Condensation

The washdown process of an Vacon 50X drive may create a temperature and humidity change in and around the drive. If the unit is mounted in a cool environment and washed down with higher-temperature water, as the drive cools to room temperature, condensation can form inside the drive, especially around the display. To prevent this from happening, avoid using sealed connectors around rubbercoated cables to seal the drive. These do not allow any air transfer and hence create a level of condensation and humidity that exceeds the drive's rating.

4. Connections

This chapter provides information on connecting power and control wiring to the Vacon 50X AC drive.

 Danger	<p>HAZARDOUS VOLTAGE</p> <ul style="list-style-type: none"> • Read and understand this manual in its entirety before installing or operating the Vacon 50X AC drive. Installation, adjustment, repair, and maintenance of these drives must be performed by qualified personnel. • Disconnect all power before servicing the drive. WAIT 5 MINUTES until the DC bus capacitors discharge. • DO NOT short across DC bus capacitors or touch unshielded components or terminal strip screw connections with voltage present. • Install all covers before applying power or starting and stopping the drive. • The user is responsible for conforming to all applicable code requirements with respect to grounding all equipment. • Many parts in this drive, including printed circuit boards, operate at line voltage. DO NOT TOUCH. Use only electrically-insulated tools. <p>Before servicing the drive:</p> <ul style="list-style-type: none"> • Disconnect all power. • Place a "DO NOT TURN ON" label on the drive disconnect. • Lock the disconnect in the open position. <p>Failure to observe these precautions will cause shock or burn, resulting in severe personal injury or death.</p>
---	---

4.1 General Wiring Information

Pay conscientious attention to ensuring that the installation wiring is installed in conformity with local standards. Where local codes exceed these requirements, they must be followed.

4.1.1 Wiring Practices

When making power and control connections, observe these precautions:

- Never connect input AC power to the motor output terminals T1/U, T2/V, or T3/W. Damage to the drive will result.
- Power wiring to the motor must have the maximum possible separation from all other power wiring. Do not run in the same conduit; this separation reduces the possibility of coupling electrical noise between circuits.
- Cross conduits at right angles whenever power and control wiring cross.
- Good wiring practice also requires separation of control circuit wiring from all power wiring. Since power delivered from the drive contains high frequencies which may cause interference with other equipment, do not run control wires in the same conduit or raceway with power or motor wiring.

4.1.2 Considerations for Power Wiring

Power wiring refers to the line and load connections made to terminals L1/R, L2/S, L3/T, and T1/U, T2/V, T3/W respectively. Select power wiring as follows:

1. Use only VDE, UL or CUL recognized wire.
2. Wire voltage rating must be a minimum of 300 V for 230 Vac systems and 600 V (Class 1 wire) for 400 Vac systems.

3. Wire gauge must be selected based on 125% of the continuous input current rating of the drive. Wire gauge must be selected from wire tables for 75 °C insulation rating, and must be of copper construction. The 230 V 5.5 and 11 kW models, and the 460 V 22 kW models require 90 °C wire to meet UL requirements. See Chapter 2 for the continuous output ratings for the drive.
4. Grounding must be in accordance with VDE, NEC and CEC. If multiple Vacon 50X drives are installed near each other, each must be connected to ground. A central earthing point should be used for interference suppression (e.g. equipotential bonding strip or centrally at an interference suppression filter). The earthing lines are routed to the respective terminals radially from this point. Conductor loops of the earthing lines are impermissible and can lead to unnecessary interference.

See Table 4 below for a summary of power terminal wiring specifications.

Vacon 50X Size / Models	Specifications
Size 0	1.36 Nm [12 in-lbs] nominal torque or 1.47 Nm [13 in-lbs] maximum torque 1.5–4 mm ² [11–15 awg wire]
Size 1	1.8 Nm [16 in-lbs] nominal torque or 2.0 Nm [18 in-lbs] maximum torque 1.5–10 mm ² [7–15 awg wire]
Size 2	3.4 Nm [30 in-lbs] nominal torque 10–16 mm ² [5–7 awg wire]
Size 3	4.0 Nm [35 in-lbs] nominal torque 25 mm ² [3 awg wire]
Size 4	7.3 Nm [64 in-lbs] nominal torque 25 mm ² [3 awg wire max]
Size 5	14.9 Nm [131 in-lbs] nominal torque 120 mm ² [250MCM wire max]

Table 4:Vacon 50X Power Terminal Wiring Specifications

NOTE: Wire type not specified by the manufacturer. Some types of wire may not fit within the constraints of the conduit entry and bend radius inside the drive.

4.1.3 Considerations for Control Wiring

Control wiring refers to the wires connected to the control terminal strip. Select control wiring as follows:

1. Shielded wire is recommended to prevent electrical noise interference from causing improper operation or nuisance tripping.
2. Use only VDE, UL or CUL recognized wire.
3. Wire voltage rating must be at least 300 V for 230 Vac systems. It must be at least 600 V for 460 Vac systems.

See Table 5 below for a summary of power terminal control wiring specifications.

Vacon 50X Size / Models	Specifications
All Sizes / Models	0.5 Nm [4.4 in-lbs] maximum torque 0.2–4 mm ² [12–24 awg wire]

Table 5:Vacon 50X Control Wiring Specifications

4.2 Input Line Requirements

4.2.1 Line Voltage

See "Power and Current Ratings" on chapter 2.2 for the allowable fluctuation of AC line voltage for your particular Vacon 50X model. A supply voltage above or below the limits given in the table will cause the drive to trip with either an overvoltage or undervoltage fault.

Exercise caution when applying the Vacon 50X AC drive on low-line conditions.

For example, an Vacon 50X 2-series unit will operate properly on a 208 Vac line, but the maximum output voltage will be limited to 208 Vac. If a motor rated for 230 Vac line voltage is controlled by this drive, higher motor currents and increased heating will result.

Therefore, ensure that the voltage rating of the motor matches the applied line voltage.

4.2.2 Use of Isolation Transformers and Line Reactors

In nearly all cases, the Vacon 50X drive may be connected directly to a power source. However, in the following cases, a properly-sized isolation transformer or line reactor should be utilized to minimize the risk of drive malfunction or damage:

- When the line capacity exceeds the requirements of the drive (see Section 4.2.3).
- When power factor correction capacitors are used on the drive's power source.
- When the power source experiences transient power interruptions or voltage spikes.
- When the power source supplying the drive also supplies large devices (such as DC drives) that contain controlled rectifiers.

Drive kW	0.75	1.5	2.2	4.0	5.5	7.5	11	15	18.5	30	37	45	55	75	90	110	150
Drive hp	1	2	3	5	7.5	10	15	20	25	40	50	60	75	100	125	150	200
Transformer kVA	2	4	5	9	13	18	23	28	36	57	70	90	112	150	180	220	250

Table 6:Transformer Sizing for the Vacon 50X Drive

4.2.3 Line Capacity

If the source of AC power to the Vacon 50X drive is greater than 10 times the kVA rating shown in Table 6, an isolation transformer or line reactor is recommended. Consult VACON for assistance in sizing the reactor.

NOTE: Vacon 50X AC drive devices are suitable for use on a circuit capable of delivering not more than 65,000 rms symmetrical amperes at 10% above the maximum rated voltage.

4.2.4 Phase Imbalance

Phase voltage imbalance of the input AC source can cause unbalanced currents and excessive heat in the drive's input rectifier diodes and DC bus capacitors. Phase imbalance can also damage motors running directly across the line. The phase imbalance should not exceed 2% of the voltage rating.

 <p>CAUTION</p>	<p>EQUIPMENT DAMAGE HAZARD</p> <p>Never use power-factor correction capacitors on motor terminals T1/U, T2/V, or T3/W of the Vacon 50X AC drive. Doing so will damage the semiconductors.</p> <p>Failure to follow this instruction can result in injury or equipment damage.</p>
--	--

4.2.5 Single-phase Operation

Vacon 50X AC drive 230 Vac models are designed for both three-phase and singlephase input power. If one of these models is operated with single-phase power, use any two line input terminals. The output of the device will always be three-phase.

The safe derating of the Vacon 50X series of drives is 50% of the nominal current (hp) rating. Consult the factory with the particular application details for exact derating by model.

4.2.6 Ground Fault Circuit Interrupters

Vacon 50X drives rated for 230 Vac are not designed to operate with ground fault circuit interrupters (GFCI). The GFCI breakers are designed for residential use to protect personnel from stray currents to ground. Most GFCI breakers will shut off at 5 mA of leakage. It is not uncommon for an AC drive to have 30 to 60 mA of leakage.

4.2.7 Motor Lead Length

The distance from the Vacon 50X drive to the motor should not exceed 300 meters. If the leads for motor connections exceed 30 meters, the motor windings may be subjected to voltage stresses two to three times nominal values unless an output filter is utilized. Consult with the motor manufacturer to ensure compatibility. Line disturbance and noise can be present in motor wiring of any distance. The carrier frequency for the drive should also be reduced using parameter 803 (PWM Frequency).

Nuisance trips can occur due to capacitive current flow to ground.

Some applications can have a restricted lead length because of type of wire, motor type, or wiring placement. Consult VACON and the motor manufacturer for additional information.

4.2.8 Using Output Contactors

Contactors in the output wiring of an AC drive may be needed as part of the approved safety circuit. Problems can arise if these contactors are opened for the safety circuit and the drive is left in run mode of operation. When the contactor is open, the drive is in a no-load, no-resistance state, but is still trying to supply current to the motor. However, when the contactor closes, the drive sees the motor resistance and instantly demands current. This inrush of current when the contactor closes can fault or cause failure to the drive.

To prevent problems, interlock an auxiliary contact to the drive's Run or Enable circuit to stop the drive when the contactor opens. In this way, the drive will be disabled and no inrush will occur when the contactor is closed again.

4.3 Terminals Found on the Vacon 50X Power Board

4.3.1 Description of the Terminals

Table 7 describes the Vacon 50X power terminals.

Terminal	Description
L1/R (L) L2/S L3/T (N)	These terminals are the line connections for input power. [Single-phase 230 Vac, 0,75 to 4,0 kW models connect to any two of these terminals.] See Figure 8 on page 27.
T1/U T2/V T3/W	These terminals are for motor connections.

Table 7:Description of Vacon 50X Power Terminals

Note that earth ground is on the terminal strip (see Figure 8 below). See page 31 for specific information about dynamic braking.

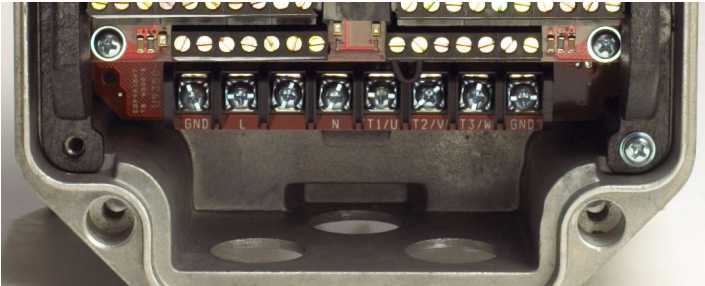
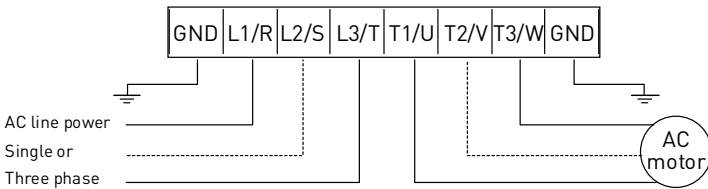

Figure 8: Power Terminals Size 0

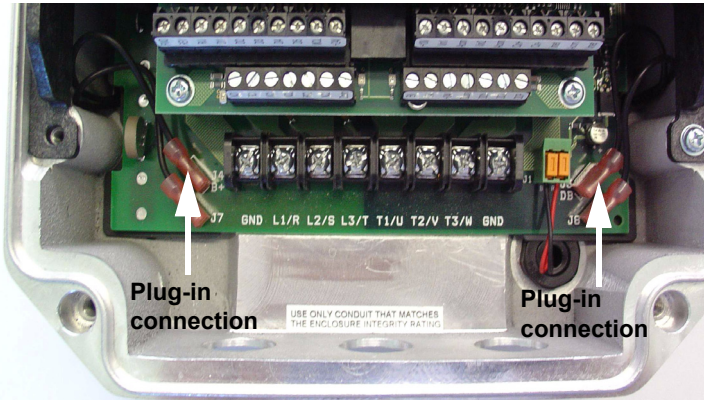

Figure 9: Power Terminals Size 1

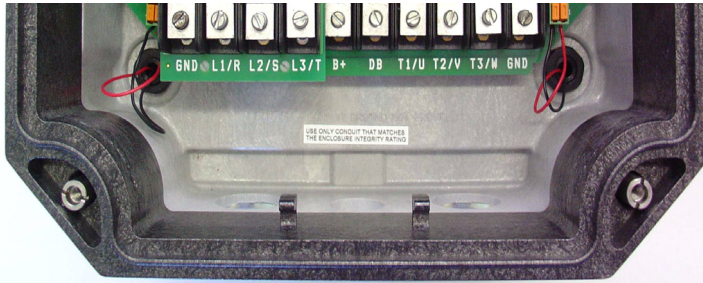

Figure 10: Power Terminals Size 2 and 3

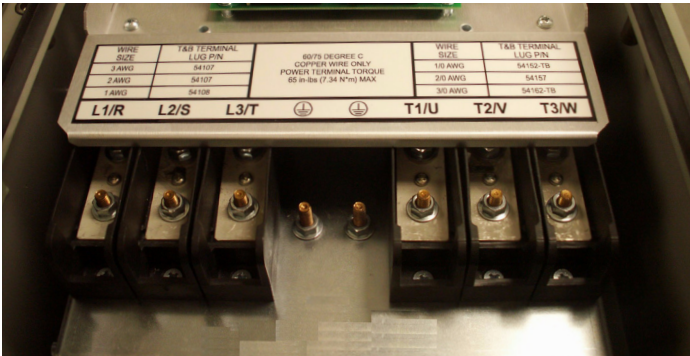

Figure 11: Power Terminals Size 4 and 5

4.3.2 Typical Power Connections

See Section 4.2 starting on page 25 for input line requirements. Note that when testing for a ground fault, do not short any motor lead (T1/U, T2/V, or T3/W) back to an input phase (L1/R, L2/S, or L3/T).

It is necessary to provide fuses and a disconnect switch for the input AC line in accordance with all applicable electrical codes. The Vacon 50X AC drive is able to withstand a 150% overload for 60 seconds for heavy duty rating, and 120% overload for normal duty rating.

The fusing and input protection of the drive must always meet UL, NEC (National Electric Code), CEC (Canadian Electric Code) and local requirements. All fuse ratings included in Table 8 below are for reference only and do not supersede code requirements. For 230/400 V mains supplies we recommend time-lag type NEOZED-fuses. The recommended supplier is Bussman.

	Model Number	Fuse Size 208 Vac JJS/JJN	Fuse Size 230 Vac JJS/JJN	Fuse Size 380 Vac	Fuse Size 460 Vac
230 V drives	0004	10	6	—	—
	0007	15	10	—	—
	0010	20	15	—	—
	0015	30	25	—	—
	0022	40	35	—	—
	0028	50	40	—	—
	0042	70	60	—	—
	0054	90	80	—	—
380-480 V drives	0068	100	90	—	—
	0002	—	—	6	6
	0004	—	—	10	6
	0005	—	—	10	10
	0009	—	—	16	16
	0012	—	—	20	20
	0016	—	—	25	20
	0023	—	—	40	35
	0031	—	—	50	40
	0037	—	—	63	50
	0043	—	—	80	63
	0061	—	—	100	80
	0071	—	—	100	100
	0086	—	—	125	100
	0105	—	—	160	125
	0140	—	—	200	160
	0168	—	—	250	200
0205	—	—	250	250	
0240	—	—	315	315	

Table 8:Fuse Ratings

4.4 Dynamic Braking

The Vacon 50X AC drive is supplied with an integrated dynamic braking (DB) resistor, and is designed to have adequate dynamic braking for most applications. In cases where short stopping times or high inertia loads require additional braking capacity, install an external resistor.

NOTE: External braking cannot be added to Size 0 models. For Size 4 (45–75 kW) and Size 5 (90–150 kW) models, additional external dynamic braking requires a kit that provides the connections to the braking transistors. The XDBKITS4 and XDBKITS5 kits can be purchased through VACON.

- Starting from size 1 the internal DB resistor can be replaced by an external DB resistor.
- The terminal identifications of the DB resistor are "B+" and "DB".
- On the size 1 the DB resistor is connected by fast-on terminals 6.35 mm (see Figure 9 on page 28).
- Starting from size 2 the DB resistor is connected by 2 separate terminals (see Figure 3 on page 29). The internal DB resistor is connected by fast-on terminals "J3/DB" and "J4/B+", which are placed on the power board (right and left side of the display).

To install an external resistor, first disconnect the internal DB resistor and properly terminate the wires leading to it. Connect now the external resistance over the connections planned for it.

Changes to Parameter 410 must be made when using external DB resistors.

Verify with the manufacturer of the selected resistor that the resistor is appropriate for your application. Contact VACON Application Engineering for further assistance with other possible sizing limitations.

Refer to Table 9 below for information about dynamic braking capacity for each Vacon 50X model.

Model	kW	Standard Resistance (Ω)	Standard DB % of Drive	Min. Allowed Res. (Ω)	Max. Peak Watts	Max. Ext. DB % of Drive
0004 2	0,75	125	164%	125	1,223	164%
0007 2	1,5	125	82%	125	1,223	82%
0010 2	2,2	125	55%	125	1,223	55%
0015 2	4,0	60	68%	43	3,555	95%
0022 2	5,5	60	45%	30	5,096	91%
0028 2	7,5	60	34%	27	5,662	76%
0042 2	11	60	23%	20	7,644	68%
0054 2	15	30	34%	10	15,288	102%
0068 2	18,5	30	27%	10	15,288	82%
0002 5	0,75	500	163%	270	2253	302%
0004 5	1,5	500	82%	270	2253	151%
0005 5	2,2	500	54%	270	2253	101%
0009 5	4,0	120	136%	100	6084	163%
0012 5	5,5	120	91%	75	8112	145%
0016 5	7,5	120	68%	75	8112	109%
0023 5	11	120	45%	57	12944	116%
0031 5	15	120	34%	47	12944	87%
0037 5	18,5	120	27%	47	12944	69%
0043	22	120	23%	39	15600	70%

Table 9:Vacon 50X Dynamic Braking Capacity

Model	kW	Standard Resistance (Ω)	Standard DB % of Drive	Min. Allowed Res. (Ω)	Max. Peak Watts	Max. Ext. DB % of Drive
0061	30	60	34%	20	30420	102%
0071	37	60	27%	20	30420	82%
0086	45	60	23%	15	40560	91%
0105	55	60	18%	10	60840	109%
0140	75	60	14%	10	60840	82%
0168	90	60	11%	10	60840	65%
0205	110	60	9%	10	60840	54%
0240	132	60	7%	10	60840	41%

Table 9:Vacon 50X Dynamic Braking Capacity

*Note that the asterisked Vacon 50X model numbers cannot have external braking added.

Terminal	Description
Cin+ / Cin-	Current Input. The default input signal is 4–20 mA, although this range may be adjusted by using parameters 209 (Cin Offset) (which configures an offset for the range) and 210 (Cin Span) (to reduce or enlarge the range – for example, setting this parameter to 50% results in a range of 4–12 mA). See page 65 for more information on these parameters. The burden for this terminal is 50 Ω.
Vin2	Voltage Input 2, which is used to provide speed references. The default input signal is 0 to 10 Vdc (the type of input signal is selected with parameter 211 (Vin2 Config); see page 65). Parameters 212 (Vin2 Offset) and 213 (Vin2 Span) may be used to offset the starting value of the range and the size of the range, respectively; see page 65 for more information. If a 0 to 20 mAdc input signal is configured, the burden is 250 Ω. If a 0 to 10 Vdc input signal is configured, the input impedance is 475 kΩ. A potentiometer with a range of 1 to 2 kΩ is suggested for this input.
Acom	Common for the Analog Inputs and Outputs. Note that while there are three Acom (common) terminals, they connect to the same electrical point.
+24	A source for positive nominal 24 Vdc voltage, and has a source capacity of 150 mA.
FWD	Forward Direction Selection terminal. This may be connected for two-wire maintained or three wire momentary operation.
REV	Reverse Direction Selection Terminal. This may be connected for two-wire maintained or three wire momentary operation.
R/J	Run/Jog Selector. When this terminal is connected to +24 or common (depending upon Active Logic setting), momentarily connecting either FWD or REV to +24 results in a latched run mode (3-wire operation).
MOL	Motor Overload input terminal. This requires a N/O or N/C contact for operation, referenced to +24 or COM, depending on Active Logic setting.
EN	Enable terminal. A jumper is placed between this terminal and the +24 terminal at the factory. You may replace this with a contact, if desired. The circuit from EN to +24 must be closed for the drive to operate. Note that unlike all other terminals, this terminal cannot be configured for “pull-down logic.” That is, a high input to this terminal is always regarded as true, and must be present for the drive to operate.
Dcom	Digital Common for use with digital inputs and +24 internal power.
DI1–DI5	Digital inputs. The function of a digital input is configured by the parameter with the same name as the digital input (for example, DI2 is configured by parameter 722 [DI2 Configure]; see page 81).
NC1 NO1 RC1	The first auxiliary relay. The function of the relay is set by parameter 705 (Relay 1 Select) (see page 80); the default setting is for the relay to activate when a fault occurs (Drv Fault). Terminal NO1 is the normally-open contact, which closes when the relay is activated. Terminal NC1 is the normally-closed contact, which opens when the relay is activated. Terminal RC1 is the common terminal.
NC2 NO2 RC2	The second auxiliary relay. The function of the relay is set by parameter 706 (Relay 2 Select) (see page 80); the default setting is for the relay to activate when the drive is running (Drv Run). Terminal NO2 is the normally-open contact; it will close when the relay is activated. RC2 is the common terminal.
DO1 DO2	Digital Outputs 1 and 2. The function of the outputs is set by parameters 707 (DO1 Select) and 708 (DO2 Select). The default setting for DO1 is Drive Ready; for DO2 it is At Speed. See page 80. Note that if you are using a high-impedance meter to this terminal, the pull-up resistor value may need to change. Please consult the factory for more information.
DOP	Open collector transistor output that supplies a pulse train proportional to speed. The frequency of the output is set by parameter 812 (Freq Ref Output) to either 6x or 48x the running frequency. The output has a maximum rating of 28 Vdc and requires a pull-up resistor (4.7 kOhms) if using the drive’s internal supply. Note that if you are using a high-impedance meter to this terminal, the pull-up resistor value may need to change. Please consult the factory for more information.

Table 10:Description of Vacon 50X Control Terminals

4.5.2 Typical Connection Diagrams for Digital Inputs

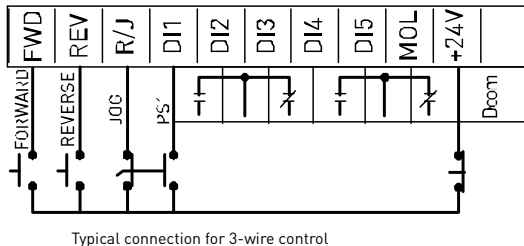
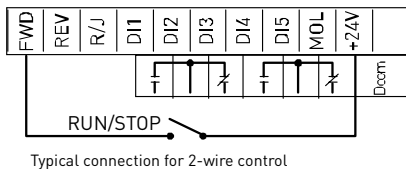

Figure 13: Connections for 2-wire and 3-wire Control

PS3 (Bit 3)	PS2 (Bit 2)	PS1 (Bit 1)	Speed Selected
0	0	0	Normal reference speed as defined by parameters 201 (Input Mode) and 204 (Ref Select)
0	0	1	Preset frequency F1 (303-F1).
0	1	0	Preset frequency F2 (304-F2).
0	1	1	Preset frequency F3 (305-F3).
1	0	0	Preset frequency F4 (306-F4).
1	0	1	Preset frequency F5 (307-F5).
1	1	0	Preset frequency F6 (308-F6).
1	1	1	Maximum frequency (302, Max Frequency).

Table 11: Selection of Preset Speeds

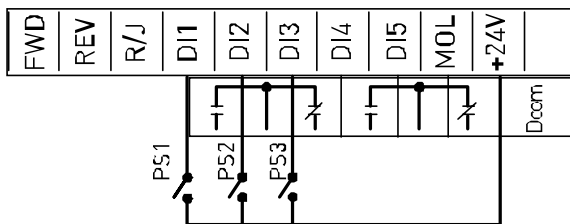

Figure 14: Connections for Preset Speeds

4.5.3 Typical Connection Diagrams for Analog Inputs

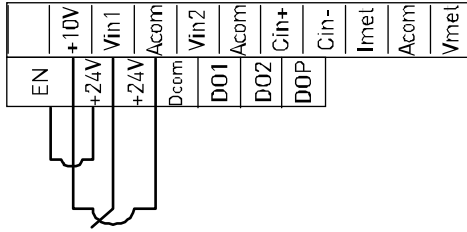

Figure 15: Connections for Speed Potentiometer

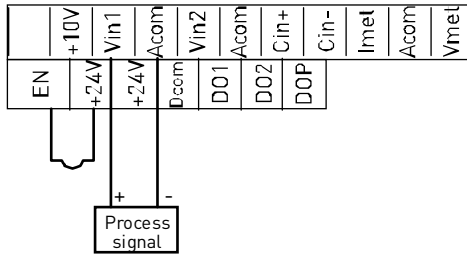

Figure 16: Connections for Process Signal

4.5.4 Typical Connection Diagrams for Analog Outputs

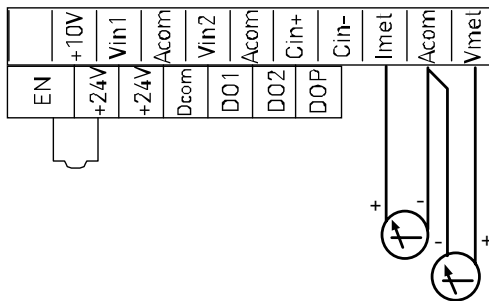

Figure 17: Connections for Process Meters

4.6 Reducing Current Surges and Voltage Transients

Inrush currents to coils of magnetic contactors, relays, and solenoids associated with or near the drive can induce high current spikes in the power and control wiring, causing faulty operation. If this occurs, a snubber network consisting of a series resistor and capacitor for AC loads, or a freewheeling or flyback diode for DC loads, can be placed across the relay coil to prevent this condition. The following component values should be used for 115 VAC or 230 VAC relays or solenoids.

For Main Circuit Contactors and Solenoids
C = 0.2 MFD, 500 VDC R = 500 5 Watts

For Auxiliary Control Circuit Relays
C = 0.1 MFD, 500 VDC R = 200 2 Watts

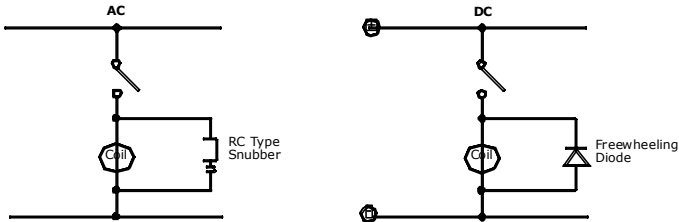

Figure 18: Connection Diagram for AC and DC Relay Coils and Solenoids

For magnetic contactors, relays, and solenoids energized from a DC source, use a free-wheeling diode of the high-speed, fast-recovery type. Connect the diode across the coil as shown above in Figure 18. The diode current and voltage should be selected using the following formulae:

$$\text{Diode Current Rating (A)} = \frac{\text{Coil Capacity (VA)}}{\text{Rated Voltage of Coil (V)}}$$

$$\text{Diode Voltage Rating} = \text{Rated Voltage of Coil (V)} \times 2$$

5. Keypad Operation and Programming

5.1 Introduction

The Vacon 50X AC drive is pre-programmed to run a standard, 4-pole AC induction motor. For many applications, the drive is ready for use right out of the box with no additional programming needed. The digital keypad controls all operations of the unit. The ten input keys allow “press and run” operation of the motor (Operation mode) and straightforward programming of the parameters (Program mode).



Figure 19: The Vacon 50X Keypad

To simplify programming, the parameters are grouped into three levels:

1. Enter Level 1 by pressing the Program (PROG) key at any time. Level 1 allows you to access the most commonly used parameters.
2. Enter Level 2 by holding down the SHIFT key while pressing the PROG key. Level 2 allows access to all Vacon 50X parameters, including those in Level 1, for applications which require more advanced features.
3. Enter Macro mode by holding the Program (PROG) key down for more than 3 seconds. The display then shows “Hold PROG for Macro Mode.” See Chapter 6, “Using Macro Mode and Getting a Quick Start”, starting on page 49, for more information.

The parameter table on page 113 shows the standard settings, the table on page 117 the parameter names in 5 languages and on page 121 the settings and messages in 5 languages. “Vacon 50X Parameter” describes the individual parameters starting from page 59.

If you want to get started quickly, see the “Quick Start” section on page 57.

5.2 Keypad Operation

Parameter 201, Input Mode [see page 62], determines whether the Vacon 50X AC drive accepts its Run/Stop and speed commands from the digital keypad or from the input terminals. Table 12 describes the function of the keys in Operation mode.





	<p>Initiates forward run when pressed momentarily. If the drive is running in reverse when FWD is pressed, it will decelerate to zero speed, change direction, and accelerate to the set speed.</p> <p>The green FWD designation in the key illuminates whenever a FWD command has been given.</p> <p>When both the FWD and REV lights are on, the DC braking function is active.</p>
	<p>Initiates reverse run when pressed momentarily. If the drive is running in forward when REV is pressed, it will decelerate to zero speed, change direction, and accelerate to the set speed. The green REV in the key illuminates whenever a REV command has been issued. When both the FWD and REV lights are on, the DC braking function is active.</p>
	<p>Causes a Ramp-to-Stop when pressed. Programmable to Coast-to-Stop by parameter 401, Ramp Select [page 67]. The red STOP indicator in the key illuminates whenever a STOP command has been given. If the drive has stopped because of a fault, this indicator flashes to call attention to the display.</p>
	<p>Press the Jog key to enter Jog mode. The green JOG indicator in the key illuminates when the drive is in the JOG mode of operation. To jog the motor in either direction, press either the FWD or REV (if REV is enabled in parameter 202). The motor will operate at the speed programmed in parameter 303. To exit Jog mode, press the JOG key again.</p>
	<p>When the drive is stopped, pressing this key increases the desired running speed. When the drive is running, pressing this key increases the actual running speed in 0.1 Hz increments. Holding the SHIFT key while pressing the INC (UP arrow) key moves the decimal place to the left with each press (0.1 Hz, 1.0 Hz, 10.0 Hz increments).</p>
	<p>When the drive is stopped, pressing this key decreases the desired running speed. When the drive is running, pressing the DEC (down arrow) key decreases the actual running speed in 0.1 Hz increments. Holding the SHIFT key while pressing the DEC key moves the decimal place to the right with each press (10.0 Hz, 1.0 Hz, 0.1 Hz increments).</p>
<p>NOTE: The operating speed for the drive is stored on Power Down.</p>	
	<p>Pressing this key while a parameter is displayed allows that parameter to have its value changed by use of the INC and DEC (up and down arrow) keys. The P indicator flashes to show that the parameter can be programmed. See also the descriptions for the INC and DEC keys above to see how they work with the SHIFT key.</p>
	<p>The ENTER key has no function when the drive is running or stopped. ENTER can be used to store the speed command so that it is saved through a power-down. To enable this function, see the description for parameter 802 (Start Options) on page 83.</p>

Table 12: Function of Keys in Operation Mode (Vacon 50X Running or Stopped)



	<p>Whether the drive is running or stopped, pressing this key places the drive in Program mode. See Table 13 on page 41 for more information on how this key functions.</p>
	<p>Pressing this key toggles drive control between the LOCAL and REMote control modes, as selected by parameter 201 (Input mode). It can be configured to shift:</p> <ul style="list-style-type: none"> • the Run/Stop command (either FWD or REV) • the speed reference signal • both of the above <p>It can also be set to "disabled," which is the factory setting. It will operate either in Stop mode or while the drive is running. If power is removed and reapplied, the memory will retain the last selected function.</p>

Table 12:Function of Keys in Operation Mode (Vacon 50X Running or Stopped)

You can access Program mode by stopping the Vacon 50X drive and pressing the Program (PROG) key for Level 1 access; or holding down SHIFT while pressing PROG for Level 2 access. Pressing and holding the Enter key and then pressing the Program key will show only those parameters that have been changed from the factory defaults. Table 13 describes the function of the keys in Program mode.





	<p>Press this key to have the drive enter Program mode and have Level 1 parameters available. (To access Level 2 parameters, hold down SHIFT while pressing this key; to access Macro mode, hold down the PROG key for more than 3 seconds.) Once Program mode is active, pressing this key at any time returns the drive to the Operation mode. If an Access Code has been programmed, it must be entered to proceed with programming. See Parameter 811 (Access Code) (page 85).</p>
	<p>NOTE: To see what parameters have changed from the factory default, press ENTER + PROG. If the display flashes "Factory Defaults," no parameters have changed.</p>
	<p>In the Program mode, pressing this key scrolls forward through the parameters. If the P indicator is flashing, it increases the value of the parameter. To change the scroll rate, hold the SHIFT key at the same time to increase the scroll rate; release the SHIFT key to return to the normal scroll rate. Press the ENTER key to store the new value.</p>
	<p>In the Program mode, pressing this key scrolls backward through the parameters. If the P indicator is flashing, it decreases the value of the parameter. To change the scroll rate, hold the SHIFT key at the same time to increase the scroll rate; release the SHIFT key to return to the normal scroll rate. Press the ENTER key to store the new value.</p>
	<p>NOTE: If the P indicator on the keypad display is flashing, momentarily pressing and releasing both the INC and DEC keys at the same time restores the parameter to the factory default value. Press ENTER to store the new value.</p>
	<p>Pressing this key while a parameter is displayed allows that parameter to have its value changed by use of INC and DEC (up and down arrow) keys. The P indicator flashes to show that the parameter can be programmed. See also the descriptions for INC and DEC (up and down arrow) keys above to see how they work with the SHIFT key.</p>

Table 13:Function of Keys in Program Mode

	<p>This key must be pressed after the value of a parameter has been changed to store the new value. The display will show "stored" for one second indicating that the new value has been entered into memory.</p>
	<p>NOTE: The Vacon 50X unit allows you to view only those parameters that have changed. If you press keypad keys ENTER and PROGram simultaneously, only those parameters that have been changed from the factory defaults will be shown.</p>

Table 13:Function of Keys in Program Mode



	<p>In Fault mode, pressing the INC (up arrow) and DEC (down arrow) keys allows the operator to view the drive's status immediately before the fault occurred. Use the INC or DEC keys to scroll through the status parameters. Press the STOP (Reset) key to return to normal operation.</p>
	<p>See "Troubleshooting" on page 101 for information about viewing Advanced Fault Codes and understanding error codes.</p>
	<p>The red STOP key functions as a reset button when in Fault mode. If the drive has stopped because of a fault, this light flashes to call attention to the display.</p>

Table 14:Function of Keys in Fault Mode

5.3 LCD Displays

The Vacon 50X drive's digital keypad display provides information such as source of drive control, status, mode, and access rights.

5.3.1 Control

The first 3 characters of the display show the source of control for the drive:

Display Values	Meaning
LOC	Local control via the keypad
REM	Remote control from the terminal strip
SIO	Remote control via the RS485 Serial SIO Link
SQx	Control via the Program Sequencer
MEA	The Stator Resistance Measurement is armed

5.3.2 Vacon 50X Keypad Status and Warning Messages

Table 4 shows Vacon 50X keypad status messages that may appear during operation:

Message	Meaning
Stopped	The drive is not spinning the motor or injecting DC voltage. The drive is ready to run when given the proper signal.
FWD Accel	The drive is spinning the motor in the forward direction and the speed of the motor is increasing.
REV Accel	The drive is spinning the motor in the reverse direction and the speed of the motor is increasing.

Table 15:Keypad Status States

FWD Decel	The drive is spinning the motor in the forward direction and the speed of the motor is decreasing.
REV Decel	The drive is spinning the motor in the reverse direction and the speed of the motor is decreasing.
Jog FWD	The drive is jogging in the forward direction.
Jog REV	The drive is jogging in the reverse direction.
FWD At Spd	The drive is spinning the motor in the forward direction and the speed of the motor is at the reference frequency.
REV At Spd	The drive is spinning the motor in the reverse direction and the speed of the motor is at the reference frequency.
Zero Speed	The drive has an active run signal but the motor is not spinning because the reference speed to the drive must be 0.0 Hz.
DC Inject	The drive is injecting DC voltage into the motor.
Faulted	The drive is faulted.
Reset-Flt	The drive is faulted, but has the possibility of being automatically reset.
LS Lockout	Line-Start Lockout functionality has become active. This means there was an active run signal during power-up or when a fault was reset. This run signal must be removed before the Line-Start Lockout functionality will be removed.
Catch Fly	The Catch on the Fly functionality is actively searching for the motor frequency.
Forward	The drive is running forward without accelerating, decelerating or residing at the reference frequency. This means that something is keeping the drive from the reference frequency (for example, Current Limit).
Reverse	The drive is running in reverse without accelerating, decelerating or residing at the reference frequency. This means that something is keeping the drive from the reference frequency (for example, Current Limit).
Not Enabled	The drive is not allowed to run either because the digital input enable is not active or because ARCTIC mode has shut down the run operation.
Volt Range	The drive has not met the input voltage requirements that it needs to be able to run. In other words, the Bus Voltage of the drive is either too low or too high.
Low Voltage	The drive has reached an undervoltage state.
Kpd Stop	A stop command was given from the keypad when the keypad was not the active control source. To remove this condition, the run signal to the drive must be removed.

Table 15:Keypad Status States

Table 16 shows Vacon 50X keypad warning messages that may appear during operation:

Message	Meaning
DB Active	The DB Resistor is being actively pulsed.
Curr Limit	The drive is operating in current limit.
HS Fan Err	Either the heatsink fan should be on and is off, or vice-versa.
Addr XXX	This is the node address of the drive when it receives a valid message through the IR port address to another node. The XXX will be replaced with the node address.
High Temp	The temperature of either the heatsink or the control board is nearing a high temperature limit that will fault the drive.
Low Temp	The temperature of either the heatsink or the control board is nearing a low temperature limit that will fault the drive.
Vac Imblnce	Either the drive has lost an input phase or the input voltage is unbalanced more than 2%.
Power Supp	A power supply short occurred.

Table 16:Keypad Warnings

Seq Dwell	The sequencer is active, but the transition to the next step is halted.
Int Fan Err	Either the internal fan is on and should be off, or vice-versa.
DB OverTemp	The temperature of the DB Resistor is nearing a high temperature and will fault the drive.
ARCTIC Mode	The ARCTIC DB Resistor mode is actively pulsing the DB Resistor.
CPU Warning	A system error occurred in the software of the Vacon 50X.
Mtr Measure	An RS Measurement is armed or active.
IR Active	Valid IR communications are occurring.
Seq Running	The program sequencer functionality is active.

Table 16:Keypad Warnings

5.3.3 Rights

After Program mode is entered, the operator's access rights are displayed:

Display Values		
ACCESS RIGHTS	P	This indicates that while in Programming mode, parameter data can be changed.
	V	If the drive is in Run mode (FWD or REV) when the PROG key was pressed, parameters can be viewed, but not changed.
	The first character of the second line indicates if the particular parameter can be changed (P) or only examined (V). If an attempt is made to change data while in the View (V) mode, the message **NO ACCESS** will appear for one second.	

5.3.4 Other Data

The top line gives 16-character description of the parameter being accessed. The parameter number will flash when data is being changed. Up to 10 characters are used to display the information stored in the parameter. Some parameters have a unit designator such as:

s	Seconds
h	Hours
C	Degrees centigrade
Hz	Hertz
%	Percent
A	Amperes

When the drive stops because of a fault trip, a unique error message will be displayed, along with the flashing STOP indicator. "Pages," or screens of information are available concerning the actual fault and drive status.

"Troubleshooting" on page 101 gives information about fault codes and troubleshooting.

5.4 Keypad Display Window

The keypad display provides information on drive operation and programming. Special symbols provide further information about drive operation (see the following section). Figure 20 shows an example of the Vacon 50X keypad display.

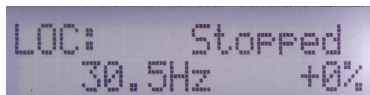

Figure 20: Vacon 50X Keypad Display

5.5 Programming

5.5.1 Accessing Parameters

When PROG (or SHIFT+PROG) is pressed after application of power or a fault reset, parameter 201, Input Mode, is always the first parameter displayed. Figure 21 shows a typical programming display.

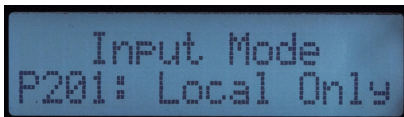

Figure 21: Typical Programming Display

If a different parameter is accessed and Program mode is exited, that parameter is the first one displayed the next time Program mode is entered. The drive remembers a different "last parameter accessed" for Levels 1 and 2.

5.5.2 Changing the Display Scroll Rate

Pressing the INC or DEC keys (up or down arrows) causes the display to scroll at a slow rate. To increase the scroll rate, hold the SHIFT key at the same time that you press the INC key. Release the SHIFT key to return to the slow scroll rate. This procedure works in all programming and operation modes.

5.5.3 Programming Procedure

To program the value of a parameter, follow these steps:

1. Press the Program (PROG) key to enter Level 1 Program mode. To enter Level 2, press SHIFT+PROG. The P indicator will appear on the display. You must enter one level of programming or the other; you cannot switch between levels without exiting Program mode.

Note that some parameters cannot be changed in Run mode. For example, if you wish to program parameter 201, Input Mode, you must stop the drive before beginning programming. Refer to the Parameter Summary Table at the front of this manual to see which parameters cannot be changed in Run mode (they appear as shaded entries in the table).

2. Press the INC/DEC keys to access the desired parameter.
3. Press the SHIFT key to allow the value to be changed. The P indicator starts to blink.
4. Press the INC/DEC keys to select the new value.
5. Press the ENTER key to store the new value. The display shows "Stored" for one second.
6. Press the PROG key to exit the Program mode, or the INC/DEC keys to select a new parameter.

To program a text parameter, follow these steps:

1. Like other parameters, text parameters use the INC/DEC (up/down arrow) and SHIFT keys for editing. A line appears under the character that you are changing.
2. Press SHIFT to advance to the next character that you want to change.
3. Use the INC or DEC keys to change the character value.
4. Press ENTER to store the edited text.

5.5.4 Restoring Factory Settings

Whenever a parameter's value is being changed (noted by the P indicator flashing), the original factory setting for that parameter may be restored by pressing and releasing both the INC and DEC keys simultaneously and then pressing the ENTER key.

To restore ALL parameters to factory settings, or to recall a previously stored parameter set, see parameter 801, Program Number (page 83).

5.5.5 Viewing Parameters That Have Changed

The Vacon 50X unit allows you to view only those parameters that have changed. If you press the ENTER and PROG keys simultaneously, only those parameters that have been changed from the factory defaults will be shown. Note that all parameters, regardless of Level 1 or 2 default location, will be shown. If other parameters need to be changed, press the PROG key to exit this mode in either Level 1 or 2, as needed.

5.5.6 Using Macro Mode

A special Macro programming mode is available with the Vacon 50X series of AC drives. The Macro programming mode allows you to customize the most common parameters for your application in the Level 1 group. Macro mode provides special parameters for activating modes of operation by macros, program sequencer, or serial communications.

Parameters that are important to the drive's operation are also included in the Macro mode. Although these parameters are also available with standard programming, the Macro mode allows you to quickly and easily configure the drive with essential parameters.

See "Using Macro Mode and Getting a Quick Start" on page 49, for detailed information about using macros to program the Vacon 50X drive.

5.6 Measuring Stator Resistance (RS Measurement)

5.6.1 Activating Automatic RS Measurement via Keypad

1. Make sure there is no load applied to the motor and that the motor shaft is free to spin without damage or injury.
2. Enter the Macro programming mode of the Vacon 50X keypad by pressing and holding the PROG key until the parameter "Appl Macro" appears on the keypad. This takes about two seconds.
3. Scroll through the parameters of the Vacon 50X Macro programming mode and configure the following parameters to the data provided on the nameplate of the motor:
 - Rated Mtr Volt (509)
 - Rated Mtr FLA (510)
 - Rated Mtr RPM (511)
 - Power Factor (515)
4. Change parameter "Find Mtr Data" (519) to a value of "Motor RS." At this point, the RS Measurement will be armed.
5. Exit the Macro programming mode by pressing the PROG key.
6. The Operate screen shows in two ways that an RS Measurement is ready to be made. First, the Control path status field displays "MEA." Second, a "Mtr Measure" warning flashes, both of these signifying that a measurement is about to be taken.
7. Start the RS Measurement by pressing the FWD key. The measurement can only be made with the FWD key. The FWD/REV terminals and the REV key will not work.
8. The measurement will begin as the drive injects voltage to the motor at zero frequency. The test lasts about two seconds.

9. If the test was successful, the drive will stop and return to the configured control path. The "Motor RS" parameter will contain a new value that is the calculated resistance of the motor.
10. If the test was not successful, the drive will fault with a "RS Meas. Fail" message [Fault 34]. If the test fails, you may want to try the test again with a different "Rated Mtr FLA" or different Current Limit percentage.
11. If the measurement process fails for any reason, it is possible to physically measure motor resistance by using an ohmmeter and dividing the result by 2. Then enter this value manually into parameter 514 (Motor RS).

5.6.2 Activating Automatic RS Measurement via Serial Link (Modbus)

1. Make sure there is no load applied to the motor and that the motor shaft is free to spin without damage or injury.
2. Configure the following parameters to the data provided on the nameplate of the motor:
 - Rated Mtr Volt [509]
 - Rated Mtr FLA [510]
 - Rated Mtr RPM [511]
 - Power Factor [515]
3. Change parameter "Find Mtr Data" [519] to a value of "Motor RS." At this point, the RS Measurement will be armed.
4. Start the RS Measurement by writing a value of 0x0007 to parameter "SIO Cntl Word" [904].
5. The measurement begins as the drive injects voltage to the motor at zero frequency. The test lasts about two seconds.
6. If the test was successful, the drive will stop and return to the configured control path. The "Motor RS" parameter will contain a new value that is the calculated resistance of the motor.
7. If the test was not successful, the drive will fault with a "RS Meas. Fail" message [Fault 34]. If the test fails, you may want to try the test again with a different "Rated Mtr FLA" or different Current Limit percentage.
8. If the measurement process fails for any reason, it is possible to physically measure motor resistance by using an ohmmeter and dividing the result by 2. Then enter this value manually into parameter 514 (Motor RS).

6. Using Macro Mode and Getting a Quick Start

A special Macro programming mode is available with the Vacon 50X series of AC drives. The Macro programming mode allows you to customize quickly the most common parameters for your application in the Level 1 group. Macro mode provides special parameters for activating modes of operation by macros, program sequencer, or serial communications.

Parameters important to the drive's operation are also included in Macro mode. Although these parameters are also available with standard programming, the Macro mode allows you to easily configure the drive with essential parameters.

Macros configure what advanced functions will be active in the drive. A macro can also change the default or visibility of a parameter within the programming levels. Parameter 490 (Appl Macro) configures what macro will be active in the drive. Parameter 491 (Seq Appl) configures the visibility of sequencer parameters and the time base of the sequencer. Parameter 492 (SIO Visible) configures whether or not SIO parameters are visible. (See page 50.)

6.1 Entering Macro Mode

To enter the Macro mode, press and hold the PROGram key for more than three seconds. The drive then enters Macro mode and displays "Hold PROG for Macro Mode." Following is a list of the different macros available and their features. A description of parameters used in Macro mode begins on page 49.

Factory	The Factory macro provides a simple way to restore the factory default parameter listings.
Fan	The Fan macro provides a basic set-up for Fan applications. Parameters such as the V/Hz curve and terminal strip operation are available in Level 1 programming.
Fan w/ PI	The Fan w/ PI macro allows for a simple set-up for Fan applications requiring process control. Parameters such as the V/Hz curve, terminal strip operation, and PI configuration parameters are available in Level 1 programming.
Pump	The Pump macro provides a basic set-up for Pump applications. Parameters such as the V/Hz curve and terminal strip operation are available in Level 1 programming.
Pump w/ PI	The Pump w/ PI macro allows for a simple set-up for Pump applications requiring process control. Parameters such as the V/Hz curve, terminal strip operation, and PI configuration parameters are available in Level 1 programming.
Vector	The Vector macro activates the sensorless vector control algorithm. When an operation requires low speed and high torque, this macro should be activated.

6.2 Description of Parameters Used in Macro Mode

Parameters 490, 491, and 492 are used only in the Macro mode. Parameters 509, 510, 511, 801, and 810 are used in both Macro and Level 2 programming. Vacon 50X parameters are described in "Vacon 50X Parameters" on page 59 of this manual.

490 Appl Macro	Default: Factory	Range: Text string Macro
-----------------------	------------------	-----------------------------

This parameter configures what macro will be active in the drive. A macro will change a default or visibility of a parameter.

The following data values may be assigned to this parameter:

<u>Macro</u>	<u>Description</u>
Factory	Provides a simple way to restore factory default parameter listings.
Fan	Provides a basic set-up for Fan applications, including V/Hz curve and terminal strip operation in Level 1 programming.
Fan w/PI	Provides a simple set-up for Fan applications that require process control. Parameters such as V/Hz curve, terminal strip operation, and PI configuration are available in Level 1 programming.
Pump	Provides a basic set-up for Pump applications, including V/Hz curve and terminal strip operation in Level 1 programming.
Pump w/PI	Provides a simple set-up for Pump applications requiring process control. Parameters such as V/Hz curve, terminal strip operation, and PI configuration are available in Level 1 programming.
Vector	Activates the sensorless vector control algorithm. When an operation requires low speed and high torque, this macro should be activated. Note that in Vector control, the drive automatically runs the the Motor Rs measurements when leaving PROGram mode.

491 Seq Appl	Default: Disabled	Range: Text string Macro
---------------------	-------------------	-----------------------------

This parameter configures sequencer parameters are visible and the time base of the sequencer. The time base may change depending on the timing loops used.

The following data values may be assigned to this parameter:

<u>Macro Value</u>	<u>Description</u>
Disabled	Sequencer disabled and parameters hidden.
1sec Base	Sequencer enabled and 1 second time base.
.1sec Base	Sequencer enabled and 0.1 second time base.
.01sec Base	Sequencer enabled and 0.01 second time base.

492 SIO Visible	Default: No	Range: Text string Macro
------------------------	-------------	-----------------------------

This parameter configures whether SIO parameters are visible.

The following data values may be assigned to this parameter:

<u>Macro Value</u>	<u>Description</u>
No	SIO parameters hidden
Yes	SIO parameters visible

509 Rated Mtr Volt	Default: Model dependent	Range: 100–690 V Level 2, Macro
---------------------------	--------------------------	------------------------------------

The Rated Motor Voltage parameter configures the rated motor voltage, and allows a user to enter the rated voltage from the motor nameplate to provide optimal control and protection. This is usually the amount of voltage delivered to the motor terminals at the setting of 503 [V/Hz Knee Freq].

510 Rated Mtr FLA	Default: ND Rating	Range: 50% of ND rating–200% of ND rating Level 2, Macro
--------------------------	--------------------	---

The Rated Motor FLA parameter allows a user to enter the rated FLA from the motor nameplate to provide optimal control and protection. This parameter should be configured to the value on the nameplate of the motor, as that value is used in calculating the percentage of current at which the drive is operating.

For information on motor timed overload operation, and how Parameter 610 works with it, see page 78.

511 Rated Mtr RPM	Default: 1750 rpm	Range: 0–24000 rpm Level 2, Macro
--------------------------	-------------------	--------------------------------------

This parameter replaces the slip compensation parameter setting of the drive so the user does not need to calculate it.

514 Motor RS	Default: Model-dependent	Range: 0.00–655.35 Ω Level 2
---------------------	--------------------------	--

This parameter allows direct entry of the Stator Resistance (Rs) of the motor for better vector performance. The motor manufacturer can provide this information, or you can physically measure this value with an ohmmeter. From the line-to-line measurement of motor resistance, enter half the measured value. See "Measuring Stator Resistance (RS Measurement)" on page 46.

515 Power Factor	Default: 0.80	Range: 0.50–1.00 Level 2
-------------------------	---------------	-----------------------------

This parameter allows direct entry of the motor's power factor for better vector performance. The motor manufacturer can provide this information.

519 Find Mtr Data	Default: Not active	Range: Text string Macro
--------------------------	---------------------	-----------------------------

This parameter activates the drive's ability to measure the stator resistance of the attached motor. The automatic stator resistance measurement can be performed either through the keypad or through the serial link. See "Measuring Stator Resistance (RS Measurement)" on page 46 for more information about this parameter. The following data values may be assigned:

<u>Parameter Value</u>	<u>Description</u>
Not Active	No stator RS measurement.
Motor RS	Automatic RS measurement using macro procedure.

801 Program Number	Default: 0	Range: 0–9999 Level 2, Macro
---------------------------	------------	---------------------------------

This parameter (Special Program Number) provides a method of enabling hidden functions in the drive and storing parameters to the customer set.

<u>Data Value</u>	<u>Special Function Configured</u>
0	Standard program
1	Reset all parameters to factory default values (display = SETP).
2	Store customer parameter values (display = STOC).
3	Load customer parameter values (display = SETC).
4	Swap active parameters with customer stored settings.

810 Language	Default: English	Range: Text string Level 2, Macro
---------------------	------------------	--------------------------------------

This parameter configures the language in which text strings will be displayed.

The following data values may be assigned to this parameter:

Parameter Value

- English
- Spanish
- German
- Italian
- French

6.3 Macro Mode Applications and Included Parameters

The tables below list the different applications and the Level 1 parameters included in the macro for that application. The Factory Application macro is the core package (listed in Table 17); the other macros include the Factory Application macro parameters as well as the ones listed in their respective tables (Tables 18, 19, 20, 21, and 22). The macro mode applications are as follows:

- Factory Application (Table 17)
- Fan Application (Table 18)
- Fan with PI Application (Table 19)
- Pump Application (Table 20)
- Pump with PI Application (Table 21)
- Vector Application (Table 22)

Para. #	Parameter Name	Default	See Page
001	Model Number	Read-only	60
010	Last Fault	Read-only	60
102	Output Freq	Read-only	61
103	Output Voltage	Read-only	61
104	Output Current	Read-only	61
105	Drive Load	Read-only	61
106	Load Torque	Read-only	61
107	Drive Temp	Read-only	61
111	DC Bus Voltage	Read-only	62
201	Input Mode	Local Only	62
202	Rev Enable	Forward	63
301	Min Frequency	0.0 Hz	67
302	Max Frequency	60.0 Hz	67
303	Preset Freq 1	50 Hz	67
402	Accel Time 1	5.0 sec	68
403	Decel Time 1	5.0 sec	68
502	Voltage Boost	0.0%	72
610	Timed OL Select	In Duty 60sec	78
700	Vmet Config	Freq Out	79
705	Relay 1 Select	Drv Fault	80
706	Relay 2 Select	Drive Rdy	80

Table 17:Factory Application Macro

Para. #	Parameter Name	Default	See Page
203	Stop Key Remote	Coast	63
204	Ref Select	Vin1	63
205	Vin1 Config	0-10 V	64
206	Vin1 Offset	0.00%	64
207	Vin1 Span	100.00%	64
406	DC Inject Config	DC at Start	69
501	V/Hz Select	Fan Fixed	71
504	Skip Freq Band	0.2 Hz	72
505	Skip Freq 1	0.0 Hz	72

Table 18:Fan Application Macro
(Core Factory Application from Table 17, plus the following parameters)

Para. #	Parameter Name	Default	See Page
608	Restart Number	0	78
609	Restart Delay	60 sec	78
702	Imet Config	Current Out	80
703	Imet Span	100.0%	80
704	Imet Offset	0.0%	80
721	DI1 Configure	Preset 1	81
722	DI2 Configure	Preset 2	81
723	DI3 Configure	Preset 3	81
724	DI4 Configure	Ref Switch	81
725	DI5 Configure	Fault Reset	81
803	PWM Frequency	16.0 kHz	83
804	Display Mode	Output Freq	84

Table 18: Fan Application Macro
(Core Factory Application from Table 17, plus the following parameters)

Para. #	Parameter Name	Default	See Page
203	Stop Key Remote	Coast	63
204	Ref Select	Vin1	63
205	Vin1 Config	0-10 V	64
206	Vin1 Offset	0.00%	64
207	Vin1 Span	100.00%	64
208	Cin Config	0-20 mA 50	64
209	Cin Offset	0.0%	65
210	Cin Span	100.0%	65
211	Vin2 Config	0-10 V	65
212	Vin2 Offset	0.00%	65
213	Vin2 Span	100.00%	65
401	Ramp Select	ART-DI	67
406	DC Inject Config	DC at Start	69
501	V/Hz Select	Fan Fixed	71
504	Skip Freq Band	0.2 Hz	72
505	Skip Freq 1	0.0 Hz	72
608	Restart Number	0	78
609	Restart Delay	60 sec	78
702	Imet Config	Current Out	80
703	Imet Span	100.0%	80
704	Imet Offset	0.0%	80
721	DI1 Configure	Preset 1	81
722	DI2 Configure	Preset 2	81
723	DI3 Configure	Preset 3	81
724	DI4 Configure	Ref Switch	81
725	DI5 Configure	PI Enable	81
803	PWM Frequency	16.0 kHz	83
804	Display Mode	Output Freq	84

Table 19: Fan with PI Application Macro
(Core Factory Application from Table 17, plus the following parameters)

Para. #	Parameter Name	Default	See Page
850	PI Configure	No PI	86
851	PI Feedback	Vin1	87
852	PI Prop Gain	0	87
853	PI Int Gain	0	87
854	PI Feed Gain	1000	87
857	PI High Corr	100.00	87
858	PI Low Corr	0.00%	87

Table 19:Fan with PI Application Macro
[Core Factory Application from Table 17, plus the following parameters]

Para. #	Parameter Name	Default	See Page
203	Stop Key Remote	Coast	63
204	Ref Select	Vin1	63
205	Vin1 Config	0-10 V	64
206	Vin1 Offset	0.00%	64
207	Vin1 Span	100.00%	64
401	Ramp Select	ART-DI	67
501	V/Hz Select	Pump Fxd	71
608	Restart Number	0	78
609	Restart Delay	60 sec	78
702	Imet Config	Current Out	80
703	Imet Span	100.0%	80
704	Imet Offset	0.0%	80
721	DI1 Configure	Preset 1	81
722	DI2 Configure	Preset 2	81
723	DI3 Configure	Preset 3	81
724	DI4 Configure	Ref Switch	81
725	DI5 Configure	Fault Reset	81
803	PWM Frequency	16.0 kHz	83
804	Display Mode	Output Freq	84

Table 20: Pump Application Macro
[Core Factory Application from Table 17, plus the following parameters]

Para. #	Parameter Name	Default	See Page
203	Stop Key Remote	Coast	63
204	Ref Select	Vin1	63
205	Vin1 Config	0-10 V	64
206	Vin1 Offset	0.00%	64
207	Vin1 Span	100.00%	64
208	Cin Config	0-20 mA 50	64
209	Cin Offset	0.0%	65
210	Cin Span	100.0%	65
211	Vin2 Config	0-10 V	65
212	Vin2 Offset	0.00%	65
213	Vin2 Span	100.00%	65

Table 21: Pump with PI Application Macro
[Core Factory Application from Table 17, plus the following parameters]

Para. #	Parameter Name	Default	See Page
401	Ramp Select	ART-DI	67
406	DC Inject Config	DC at Stop	69
501	V/Hz Select	Pump Fxd	71
504	Skip Freq Band	0.2 Hz	72
505	Skip Freq 1	0.0 Hz	72
608	Restart Number	0	78
609	Restart Delay	60 sec	78
702	Imet Config	Current Out	80
703	Imet Span	100.0%	80
704	Imet Offset	0.0%	80
721	DI1 Configure	Preset 1	81
722	DI2 Configure	Preset 2	81
723	DI3 Configure	Preset 3	81
724	DI4 Configure	Ref Switch	81
725	DI5 Configure	PI Enable	81
803	PWM Frequency	16.0 kHz	83
804	Display Mode	Output Freq	84
850	PI Configure	No PI	86
851	PI Feedback	Vin1	87
852	PI Prop Gain	0	87
853	PI Int Gain	0	87
854	PI Feed Gain	1000	87
857	PI High Corr	100.00	87
858	PI Low Corr	0.00%	87

Table 21: Pump with PI Application Macro
(Core Factory Application from Table 17, plus the following parameters)

Para. #	Parameter Name	Default	See Page
501	V/Hz Select	Vector	71
509	Rated Mtr Volt	Model dependent	73
510	Rated Mtr FLA	ND rating	73
511	Rated Mtr RPM	1750 rpm	73
514	Motor RS	Model dependent	73
515	Power Factor	0.8	73
516	Slip Comp Enable	No	74
519	Find Mtr Data	Not Active	74
520	Filter FStator	8 mS	74
521	Start Field En	No	74
522	Filter Time Slip	100 mS	75
523	Id Percent	Read-only	75
524	Iq Percent	Read-only	75
803	PWM Frequency	3.0 kHz	83
804	Display Mode	Std Display	84

Table 22: Vector Application Macro
(Core Factory Application from Table 17, plus the following parameters)

6.4 Quick Start

The following procedure is for operators using simple applications, who would like to get started quickly. Be sure to read and understand all the sections in this chapter before proceeding with these instructions. If you are using remote operators, substitute the speed potentiometer for the INC and DEC keys (up and down arrows), and the remote Run/Stop switch for the FWD key in the following instructions.

 <p>CAUTION</p>	<p>IMPROPER EQUIPMENT COORDINATION</p> <p>Verify that proper voltage is connected to the drive before applying power.</p> <p>Failure to observe this instruction can result in injury or equipment damage.</p>
--	---

1. Follow all precautions and procedures in "Receiving and Installation" on page 19.
2. Find the motor nameplate, and using parameters 509 (Rated Mtr Volt), 510 (Rated Mtr FLA), 511 (Rated Mtr RPM), and 515 (Power Factor), set up the motor parameters appropriately. Parameter 514 (Motor RS) should also be set up accurately so the drive can run its routine to measure motor stator resistance. (See "Measuring Stator Resistance (RS Measurement)" on page 46.
3. Apply AC power to the input terminals. For about 2 seconds the display will show all segments active. The display then changes to zeros.
4. The factory settings are for keypad-only operation in the forward direction – that is, the REV key is disabled. Press the FWD key, which causes the FWD indicator to illuminate.
5. Press the INC key to increase the desired running frequency. When the display gets to 0.1 Hz, the drive starts to produce an output.
6. When the motor starts to turn, check the rotation. If the motor is turning in the wrong direction, press STOP, remove AC power, and wait for all indicators to go out. After the STATUS indicator has gone out, reverse any two of the motor leads at T1/U, T2/V, or T3/W.
7. The Vacon 50X drive is preset to run a typical NEMA B 4-pole induction motor to a maximum speed of 60.0 Hz with both acceleration and deceleration times set to 5.0 seconds.
8. Use the INC and DEC keys to set the proper running speed of the motor and the FWD and STOP keys to control its operation.

7. Vacon 50X Parameters

7.1 Introduction

The Vacon 50X AC drive incorporates a comprehensive set of parameters that allow you to configure the device to meet the special requirements of your particular application.

Note that pressing the PROG key enters Level 1 programming. Press SHIFT+PROG to enter Level 2 programming. Press ENTER+PROG to show only those parameters that have changed from the factory default values.

This chapter describes the available parameters and the values that may be assigned to them. The parameter summary table on page 113 provides a summary of all parameters including their ranges and default values.

7.2 Level 1 Parameters

The most commonly configured Vacon 50X parameters are stored in a group named Level 1. This group is easily accessed by pressing the PROG key as described in "Keypad Operation and Programming" on page 39. The following table lists the parameters in this group; for further information on the parameter, please turn to the indicated page.

Para. #	Parameter Name	See Page	Para. #	Parameter Name	See Page
001	Model Number	60	301	Min Frequency	67
010	Last Fault	60	302	Max Frequency	67
102	Output Freq	61	303	Preset Freq 1	67
103	Output Voltage	61	402	Accel Time 1	68
104	Output Current	61	403	Decel Time 1	68
105	Drive Load	61	502	Voltage Boost	72
106	Load Torque	61	610	Timed OL Select	78
107	Drive Temp	61	700	Vmet Config	79
111	DC Bus Voltage	62	705	Relay 1 Select	80
201	Input Mode	62	706	Relay 2 Select	80
202	Rev Enable	63			

Table 23: Parameters Available in Level 1 Programming (Factory Macro)

7.3 Description of Parameters

This chapter lists the Vacon 50X parameters in the order in which they appear in the keypad display. For each parameter, the table lists the default value and range as well as describes the use of the parameter.

001 Model Number	Read-Only	Range: Text string Levels 1, 2
-------------------------	-----------	-----------------------------------

Parameter 001, the Model Number parameter, contains the portion of the Vacon 50X model number related to voltage and horsepower. The number format is vvhhf, where vv is the code for the input voltage (20 = 230 Vac, three-phase; 40 = 460 Vac, three-phase; 50 = 575 Vac, three-phase); hh is horsepower; and f is the fractional part of the horsepower. Example: 20020 = 230 Vac, three-phase, 2.0 hp model.

002 Software Rev	Read-Only	Range: 0.00–99.99 Level 2
-------------------------	-----------	------------------------------

Parameter 002, the Software Revision parameter, displays the software revision that is installed in the drive.
Options: 0.00–99.99

003 Rated Current	Read-Only	Range: 0.0–200.0 A Level 2
--------------------------	-----------	-------------------------------

Parameter 003, the Rated Current parameter, displays the normal duty current rating of the model of drive.

005 Serial No 1	Read-Only	Range: 0–65535 Level 2
------------------------	-----------	---------------------------

Parameter 005, Serial No 1, contains a number that corresponds to the year and week in which the drive was manufactured.

006 Serial No 2	Read-Only	Range: 0–65535 Level 2
------------------------	-----------	---------------------------

Parameter 006, Serial No 2, contains a number that determines the number of the drive that was manufactured during the week of Serial No 1.
Options: 0.00–99.99

010 Last Fault	Read-Only	Range: Text string Levels 1, 2
-----------------------	-----------	-----------------------------------

Parameter 010, Last Fault, lists the fault that occurred most recently.
For more information, refer to Chapter 8, “Troubleshooting”, beginning on page 101.

025 4th Fault	Read-Only	Range: Text string Level 2
----------------------	-----------	-------------------------------

Parameter 025, 4th Fault, lists the fault that occurred 1 before the last fault.
For more information, refer to Chapter 8, “Troubleshooting”, beginning on page 101.

040 3rd Fault	Read-Only	Range: Text string Level 2
----------------------	-----------	-------------------------------

Parameter 040, 3rd Fault, lists the fault that occurred 2 before the last.
For more information, refer to Chapter 8, “Troubleshooting”, beginning on page 101.

055 2nd Fault	Read-Only	Range: Text string Level 2
----------------------	-----------	-------------------------------

Parameter 055, 2nd Fault, lists the fault that occurred 3 before the last. For more information, refer to Chapter 8, "Troubleshooting", beginning on page 101.

070 1st Fault	Read-Only	Range: 0-65535 Level 2
----------------------	-----------	---------------------------

Parameter 070, 1st Fault, lists the fault that occurred 4 before the last. For more information, refer to Chapter 8, "Troubleshooting", beginning on page 101.

102 Output Freq	Read-Only	Range: 0.0-400.0 Hz Levels 1, 2
------------------------	-----------	------------------------------------

Parameter 102, the Output Frequency parameter, shows the frequency being applied to the motor connected to the drive (ramp).

103 Output Voltage	Read-Only	Range: 0-600 V Levels 1, 2
---------------------------	-----------	-------------------------------

Parameter 103, the Output Voltage parameter, displays the output voltage of the drive.

104 Output Current	Read-Only	Range: 0.0-200.0 A Levels 1, 2
---------------------------	-----------	-----------------------------------

Parameter 104, the Output Current parameter, displays the output current of the drive.

105 Drive Load	Read-Only	Range: -200.0 to 200.0% Levels 1, 2
-----------------------	-----------	--

Parameter 105, the Drive Load parameter, shows the percentage torque of the drive when operating below the knee frequency. It displays Load Torque if the frequency is below FKNEE, and displays Power if above FKNEE.

The output current is measured with the motor power factor applied to an accuracy of $\pm 20\%$. The parameter value is positive when the motor is pulling a load ("motoring mode") and negative when being pulled by a load ("regenerative mode").

106 Load Torque	Read-Only	Range: -200.0...200.0% Levels 1, 2
------------------------	-----------	---------------------------------------

Parameter 106, the Load Torque parameter, displays the load torque of the drive.

107 Drive Temp	Read-Only	Range: -20.0...200.0 °C Levels 1, 2
-----------------------	-----------	--

Parameter 107, the Drive Temp parameter, shows the actual temperature of the drive's heatsink. The drive will fault when the internal temperature reaches 85 °C.

108 Total Run Time	Read-Only	Range: 0.0-6553.5 h Level 2
---------------------------	-----------	--------------------------------

Parameter 108, Total Run Time, is a resettable timer for drive operation. To reset the timer, enter 10 in parameter 801, Program Number.

109 Power On Hours	Read-Only	Range: 0–65535 h Level 2
---------------------------	-----------	-----------------------------

Parameter 109, Power On Hours, displays how long the drive has been powered up.

110 Stator Freq	Read-Only	Range: 0.0–400.0 Hz Level 2
------------------------	-----------	--------------------------------

Parameter 110, Stator Frequency, displays the frequency the drive is applying to the motor stator.

111 DC Bus Voltage	Read-Only	Range: 0–1000 Vdc Levels 1, 2
---------------------------	-----------	----------------------------------

Parameter 111, DC Bus Voltage, displays the voltage on the DC bus.

115 Drive Power Out	Read-Only	Range: 0.0–200.0% Level 2
----------------------------	-----------	------------------------------

This parameter displays the power being output by the drive in terms of drive rating. The measurement is calculated by scaling the Load Torque value by the ratio of Volt-Amps to Rated Volt-Amps, and adjusted by Output Frequency.

201 Input Mode	Default = Local only	Range: Text string Levels 1, 2
-----------------------	----------------------	-----------------------------------

Parameter 201, the Input Mode parameter, configures local and remote control of the Start/Stop source and the reference source.

The following data values may be assigned to this parameter:

<u>Parameter Value</u>	<u>Run/Stop Control</u>
Local only	Local keypad operation only
Remote only	Terminal strip operation only
L/R Rem Ref	LOCAl Keypad Start/Stop and Speed REMote Keypad Start/Stop, Terminal Strip Speed Reference
L/R Rem Ctl	LOCAl Keypad Start/Stop and Speed REMote Keypad Speed Reference, Terminal Strip Start/Stop
L/R Rem Bth	LOCAl Keypad Start/Stop and Speed REMote Terminal Strip Start/Stop and Speed Reference
EMOP ^{1} {2} {4}	Terminal strip operation using Increase/Decrease buttons
EMOP ₂ ^{1} {3} {4}	Terminal strip operation using Increase/Decrease buttons
LOC/EMOP ^{1} {2} {4}	LOCAl Keypad Start/Stop and Speed REMote Terminal strip operation using Increase/Decrease
LOC/EMOP ₂ ^{1} {3} {4}	LOCAl Keypad Start/Stop and Speed REMote Terminal strip operation using Increase/Decrease

NOTES:

1. Electronic Motor Operated Potentiometer (EMOP): simulates the INC/DEC keys on keypad using external remote N/O pushbuttons
2. Commanded output frequency returns to the value of parameter 301 (Min Frequency) when the drive is stopped.
3. Commanded output frequency remains at the previous setpoint when the drive is stopped.
4. The parameters that set the functions of the designated digital inputs for EMOP must be configured as "EMOP+" and "EMOP-" to complete the implementation.

202 Rev Enable	Default = Forward	Range: Text string Levels 1, 2
-----------------------	-------------------	-----------------------------------

Parameter 202, the Rev Enable parameter, configures whether the REV key on the keypad is functional. If this parameter is configured to "Forward," then pressing the REV key on the keypad will have no effect. Note that this parameter does not affect terminal strip operation.

The following data values may be assigned to this parameter:

<u>Parameter Value</u>	<u>Description</u>
Forward	Forward Only, REV key disabled
FWD/REV	FWD and REV keys enabled

203 Stop Key Remote	Default = Coast	Range: Text string Level 2
----------------------------	-----------------	-------------------------------

Parameter 203, the Stop Key Remote parameter, configures how the Stop key on the keypad will operate when the keypad is not the drive's control source (terminals, S10, or SEQ). The following data values may be assigned to this parameter:

<u>Parameter Value</u>	<u>Description</u>
Coast	Drive will coast to a stop
Ramp	Drive will ramp to a stop using Decel #1
Disabled	Stop key will have no function

204 Ref Select	Default = Vin1	Range: Text string Level 2
-----------------------	----------------	-------------------------------

Parameter 204, the Ref Select parameter, configures how the reference is determined when the reference source is configured to terminals. The following data values may be assigned to this parameter:

<u>Parameter Value</u>	<u>Description</u>
Vin1	Vin1 terminal (configured by parameter 205)
Cin	Cin terminal (configured by parameter 208)
Vin2	Vin2 terminal (configured by parameter 211)
Vin1 6FS	Vin1 terminal with 6x pulse train from an Vacon 50X, WFC, WF2 drive
Vin1 48FS	Vin1 terminal with 48x pulse train from an Vacon 50X, WFC, WF2 drive
Vin1+Cin	Sum of signal at Vin1 and the signal at Cin
Vin1+Vin2	Sum of signal at Vin1 and the signal at Vin2
Vin1-Cin	Difference between the signal at Vin and the signal at Cin
Vin1-Vin2	Difference between the signal at Vin and the signal at Vin2
Max Input ^{2}	Greatest signal between Vin, Vin2 and Cin
Vin1/Cin DI ^{1}	Switch between Vin and Cin using a Digital Input
Vin1/2 DI ^{1}	Switch between Vin and Vin2 using a Digital Input
Vin1/KYP DI ^{1}	Switch between Vin and Keypad reference using Digital Input
Cin/KYP DI ^{1}	Switch between Cin and Keypad reference using Digital Input

NOTES:

1. The parameter that sets the function of the designated digital input must be configured as "Ref Switch" to complete the implementation.
2. The "Max Input" option will compare the inputs of all three analog inputs (Vin1, Vin2, Cin) and take the analog input with the highest percentage input after span, offset, and inversion is applied.
3. When using a 6FS or 48FS signal, parameter 205 should be set to 0-10V.

205 Vin1 Config	Default = 0-10V	Range: Text string Level 2
------------------------	-----------------	-------------------------------

Parameter 205, Vin1 Config, selects the type of signal for analog input Vin1. Vin1 can be voltage, current, or pulse train input. This parameter also determines input range, impedance, and characteristics. Use Parameters 206 (Vin1 Offset) and 207 (Vin1 Span) to customize the selected range. The following data values may be assigned to this parameter:

<u>Parameter Value</u>	<u>Description</u>
0-10V	0-10 Vdc signal
0-10V Brk W	0-10 Vdc signal with broken wire detection for speed pot operation
0-10V I	0-10 Vdc signal Inverted
0-10V Bipol	0-10 Vdc signal [5 Vdc is stop with 0 Vdc Full Rev and 10 Vdc Full FWD]
0-5V	0-5 Vdc signal
0-5V I	0-5 Vdc signal Inverted
0-20mA 250	0 to 20 mA current signal with 250 Ohm load
0-20mA 250I	0 to 20 mA current signal with 250 Ohm load Inverted
4-20mA 250	4 to 20 mA current signal with 250 Ohm load
4-20mA 250I	4 to 20 mA current signal with 250 Ohm load Inverted
PT 0-1kHz	0 to 1 kHz pulse train
PT 0-10kHz	0 to 10 kHz pulse train
PT 0-100kHz	0 to 100 kHz pulse train

When the signal range is inverted [that is, the minimum input corresponds to the maximum output, while the maximum input corresponds to the minimum output].

206 Vin1 Offset	Default = 0.00%	Range: 0.0-100.0% Level 2
------------------------	-----------------	------------------------------

Parameter 206, Vin1 Offset, configures the input range (offset) for analog input Vin1 that will affect speed or torque limit functions. It is expressed as a percentage of the maximum value of the input signal.

Note that if the input signal drops below the offset value or if the input signal is lost (if no offset is configured), fault 22 will be generated. See parameter 222 for options related to the drive's response to loss of input signal.

207 Vin1 Span	Default = 100%	Range: 10.0-200.0% Level 2
----------------------	----------------	-------------------------------

Parameter 207, the Vin1 Span parameter, is used to alter the input range (span) of the input signal for analog input Vin1 that will affect speed or torque limit functions. For example, if parameter 205, Vin1 Config, selects the 0 to 10 Vdc input signal, setting this parameter to 50% reduces it to 0 to 5 Vdc.

208 Cin Config	Default = 0-20 mA 50	Range: Text string Level 2
-----------------------	----------------------	-------------------------------

Parameter 208, Cin Config, selects the type of signal for analog input Cin. Parameters 209 (Cin Offset) and 210 (Cin Span) may be used to customize the selected range. The following data values may be assigned to this parameter:

<u>Parameter Value</u>	<u>Description</u>
4-20mA 50	4 to 20 mA current signal with 50 Ohm load
4-20mA 50I	4 to 20 mA current signal with 50 Ohm load Inverted

0-20mA 50 0 to 20 mA current signal with 50 Ohm load
 0-20mA 50I 0 to 20 mA current signal with 50 Ohm load Inverted
 When the signal range is inverted (that is, the minimum input corresponds to the maximum output, while the maximum input corresponds to the minimum output).

209 Cin Offset	Default = 0.0%	Range: 0.0-100.0% Level 2
-----------------------	----------------	------------------------------

Parameter 209, Cin Offset, configures the offset for analog input Cin expressed as a percentage of the maximum value of the input signal. Note that if the input signal drops below the offset value or if the input signal is lost (if no offset is configured), a fault will be generated.

210 Cin Span	Default = 100.0%	Range: 10.0-200.0% Level 2
---------------------	------------------	-------------------------------

Parameter 210, Cin Span, is used to alter the range of the input signal for analog input Cin. For example, if parameter 208 (Cin Config) selects the 0 to 20 mA input signal, setting this parameter to 50% reduces it to 0 to 10 mA.

211 Vin2 Config	Default = 0-10 V	Range: Text string Level 2
------------------------	------------------	-------------------------------

Parameter 211, Vin2 Config, selects the type of signal for analog input Vin2. Parameters 212 (Vin2 Offset) and 213 (Vin2 Span) may be used to customize the selected range. The following data values may be assigned to this parameter:

<u>Parameter Value</u>	<u>Description</u>
0-10V	0-10 Vdc signal
0-10V Brk W	0-10 Vdc signal with broken wire detection for speed pot operation
0-10V I	0-10 Vdc signal inverted
0-10V Bipol	0-10 Vdc signal (5 Vdc is stop with 0 Vdc Full REV and 10 Vdc Full FWD)
0-5V	0-5 Vdc signal
0-5V I	0-5 Vdc signal inverted

212 Vin2 Offset	Default = 0.0%	Range: 0.0-100.0% Level 2
------------------------	----------------	------------------------------

Parameter 212, Vin2 Offset, configures the offset for analog input Vin2 expressed as a percentage of the maximum value of the input signal. Note that if the input signal drops below the offset value or if the input signal is lost (if no offset is configured), a fault will be generated.

213 Vin2 Span	Default = 100%	Range: 10.0-200.0% Level 2
----------------------	----------------	-------------------------------

Parameter 213, Vin2 Span, is used to alter the range of the input signal for analog input Vin2. For example, if parameter 211 (Vin2 Config) selects the 0 to 10 Vdc input signal, setting this parameter to 50% reduces it to 0 to 5 Vdc.

214 Vin1 Filter Time	Default = 20 ms	Range: 0–1000 ms Level 2
-----------------------------	-----------------	-----------------------------

This parameter configures the time constant of a first-order filter of the Vin1 analog input. When this parameter is a value of 0 ms there is no software filtering of the analog input. Note that long filter times will create a delay in the drive response to signal changes.

215 Cin Filter Time	Default = 20 ms	Range: 0–1000 ms Level 2
----------------------------	-----------------	-----------------------------

This parameter configures the time constant of a first-order filter of the Cin analog input. When this parameter is a value of 0 ms there is no software filtering of the analog input. Note that long filter times will create a delay in the drive response to signal changes.

216 Vin2 Filter Time	Default = 20 ms	Range: 0–1000 ms Level 2
-----------------------------	-----------------	-----------------------------

This parameter configures the time constant of a first-order filter of the Vin2 analog input. When this parameter is a value of 0 ms there is no software filtering of the analog input. Note that long filter times will create a delay in the drive response to signal changes.

217 Trim Ref Enable	Default = Disabled	Range: Text string Level 2
----------------------------	--------------------	-------------------------------

This parameter enables or disables trimming of the drive reference by an analog input and selects which analog input will perform the trimming function.
 $\text{Speed Ref.} = \text{Main ref.} + (\text{Trim \% Factor}) \times \text{value of parameter 217} \times \frac{\text{Max Frequency}}{100\%}$

<u>Parameter Value</u>	<u>Description</u>
Disabled	No trimming of drive reference
Vin1	Value of Vin1 will be used in the calculation above
Vin2	Value of Vin2 will be used in the calculation above
Cin	Value of Cin will be used in the calculation above
Fxd Trim %	Value of Fxd Trim % will be used
	$\text{Drive Ref.} = \text{Drive ref.} + (\text{Trim \% Factor}) \times \frac{\text{Max Frequency}}{100\%}$

Note that setting a parameter for a Bipolar input value allows trimming both positive and negative around the reference value.

218 Trim % Factor	Default = 0.0%	Range: –100.0 to 100.0% Level 2
--------------------------	----------------	------------------------------------

This parameter determines the percentage of the analog input signal selected in Parameter 217, Trim Ref Enable, that will affect the reference signal.

222 Ref Loss Fault	Default = Disabled	Range: Text string Level 2
---------------------------	--------------------	-------------------------------

This parameter allows for the control of the drive's response to a 4–20mA input on either the Vin1 or Cin input terminals when the input drops below approximately 3mA. The default value is No Fault. The options for this parameter are:

- Retain Spd** Hold the last operating speed
- Preset Spd2** Go to the speed programmed at address 304
- Fault** Drive faults with an F22 Reference Loss indication
- No Fault** Drive does NOT fault; operating frequency drops to the limit set at Parameter 301, Min Frequency

301 Min Frequency	Default = 0.0%	Range: 0.0–Max Freq Level 1
--------------------------	----------------	--------------------------------

Parameter 301, Minimum Frequency, configures the minimum frequency output of the drive. This parameter governs the minimum frequency when operating from the keypad or from an analog input. The preset speeds can be set lower than the minimum frequency in parameter 301.

302 Max Frequency	Default: 50 Hz	Range: 0.0–400.0 Hz Level 1
--------------------------	----------------	--------------------------------

Parameter 302, the Maximum Frequency parameter, configures the maximum frequency output of the drive.

303 Preset Freq 1 (Jog Ref)	Default: 5 Hz	Range: Min–Max Freq Levels 1, 2 for 303 Level 2 for 304–308
304 Preset Freq 2	Default: 10 Hz	
305 Preset Freq 3	Default: 20 Hz	
306 Preset Freq 4	Default: 30 Hz	
307 Preset Freq 5	Default: 40 Hz	
308 Preset Freq 6	Default: 50 Hz	

These parameters configure six preset speeds in addition to the normal reference speed of the drive (as defined by parameters 201 (Input Mode) and 204 (Ref Select) and the maximum frequency of the drive (as set with parameter 302, Max Frequency). Thus, in effect, you may choose to operate the drive at up to eight different speeds.

The eight speeds are selected by a combination of three digital inputs (PS1, PS2, PS3). A wiring scheme for utilizing preset speeds is provided on page 24 along with a truth table showing what combination of inputs results in the selection of which speeds.

Note that parameter Parameter 303 (Preset Freq1) also serves as the reference frequency for jogging.

309 Cut-Off Freq	Default = 0.0 Hz	Range: 0.0–5.0 Hz Level 2
-------------------------	------------------	------------------------------

This parameter sets the point where the drive no longer attempts to spin the motor. The range of this parameter is 0.0–5.0 Hz. When the parameter is configured to a value of 0.0 Hz, the drive will operate with no Cut-off Frequency. If the function is enabled, the drive will be able to ramp up through the cut-off frequency range, as in normal operation. If the speed command falls below the cut-off frequency, the drive stops “gating” the outputs and coasts down to zero speed. The keypad display will indicate Zero Speed, and the Forward or Reverse LED will be lit depending on the command. When the reference returns to a value greater than the cut-off frequency, the drive will ramp from 0.0 Hz to the reference frequency.

401 Ramp Select	Default: ART-DI	Range: Text string Level 2
------------------------	-----------------	-------------------------------

The Ramp Select parameter configures when the alternate ramps of the drive will be active and whether the drive ramps to stop, or coasts to stop. The following data values may be assigned to this parameter:

<u>Parameter Value</u>	<u>Type of Ramp</u>	<u>Ramp Configured by:</u>
ART-DI	Ramp-to-Stop	402 (Accel Time 1) and 403 (Decel Time 1)

ART-F/R	Ramp-to-Stop	Running forward: 402 (Accel Time 1) and 403 (Decel Time 1). Running reverse: 404 (Accel Time 2) and 405 (Decel Time 2)
ART-Frq	Ramp-to-Stop	If the output frequency is less than preset frequency parameter 308 (Preset Freq 6), the active ramp is set by 402 Accel Time 1 and 403 Decel Time 1. If the output frequency is equal to or greater than 308 (Preset Freq 6), the active ramp is set by 404 (Accel Time 2) and 405 (Decel Time 2).
ART-Strt/RS	Ramp-to-Stop	This setting uses the Alternate Ramp for Acceleration (parameter 404) to the set speed, then uses the Main ramps (parameters 402 and 403) when the speeds are adjusted. The drive will revert to the Alternate Decel ramp (parameter 405) when a Stop command is given.
S-Curve	Ramp-to-Stop	The drive uses 402 (Accel Time 1) and 403 (Decel Time 1) for total time and 414 as the S Ramp Rounding value. The amount of rounding is the same for that start and stop of the ramp time.
ART-DI CTS	Coast-to-Stop	Same as ART-DI but with Coast-to-Stop
ART-F/R CTS	Coast-to-Stop	Same as ART-F/R but with Coast-to-Stop
ART-Frq CTS	Coast-to-Stop	Same as ART-Frq but with Coast-to-Stop
ART-Str/CS	Coast-to-Stop	Same as ART-Strt but with Coast-to-Stop
ART-STR/CTS	Coast-to-Stop	Same as S-Curve but with Coast-to-Stop

402 Accel Time 1	Default: 5.0 s	Range: 0.1–3200.0 s Levels 1, 2
-------------------------	----------------	------------------------------------

This parameter configures the default length of time to accelerate from 0 Hz to the value of parameter 302 (Max Frequency). This acceleration ramp is selected by parameter 401 (Ramp Select).
Note that extremely short acceleration times may result in nuisance fault trips.

403 Decel Time 1	Default: 5.0 s	Range: 0.1–3200.0 s Levels 1, 2
-------------------------	----------------	------------------------------------

This parameter configures the default length of time to decelerate from the value of parameter 302 (Max Frequency) to 0 Hz. The deceleration ramp is selected by Parameter 401 (Ramp Select).
Note that extremely short deceleration times may result in nuisance fault trips or may require an external dynamic brake or regen current limit.

404 Accel Time 2	Default: 3.0 s	Range: 0.1–3200.0 s Level 2
-------------------------	----------------	--------------------------------

This parameter provides an alternate ramping time for the drive when accelerating, configuring the length of time to accelerate from 0 Hz to the value of parameter 302 (Max Frequency). This acceleration ramp is selected by parameter 401 (Ramp Select) or Sequencer Configuration.
Note that extremely short acceleration times may result in nuisance fault trips.

405 Decel Time 2	Default: 3.0 s	Range: 0.1–3200.0 s Level 2
-------------------------	----------------	--------------------------------

This parameter provides an alternate ramping time for the drive when decelerating, configuring the length of time to decelerate from the value of parameter 302 (Max Frequency) to 0 Hz. This deceleration ramp is selected by parameter 401 (Ramp Select) or Sequencer Configuration.

Note that extremely short deceleration times may result in nuisance fault trips or may require an external dynamic brake or regen current limit.

406 DC Inject Config	Default: DC at Stop	Range: Text string Level 2
-----------------------------	---------------------	-------------------------------

DC injection braking may be used to stop the motor more quickly than is possible by either a ramp-to-stop or a coast to-stop. The Vacon 50X drive allows DC braking to be initiated either when a digital input assigned to DC braking becomes true, when a specified frequency is reached, or when either of these events occurs.

When using a digital input for DC braking, you must use one of the DI parameters to configure the selected digital input for DC braking. The amount of braking force is set by parameter 408 (DC Inject Level). The length of time that the braking force is applied is determined by the time that the selected digital input is active. The second type of DC injection braking supported by the Vacon 50X drive is where DC braking occurs at a specified frequency. The duration of the braking is adjusted by parameter 407 (DC Inject Time). With this type of braking, as the drive slows down after a Stop command, DC braking begins when the frequency reaches the value set in parameter 409 (DC Inj Freq). If the frequency at the time of a Stop command is less than that of DC Inj Freq, DC braking begins immediately. The braking continues for the time period specified by parameter DC Inj Time. Once the time period elapses, the drive may be restarted.

<u>Parameter Value</u>	<u>Description</u>
DC at Stop	DC inject only on Stop
DC at Start	DC inject only on Start
DC at Both	DC inject only on both Start and Stop
DC on Freq	DC inject only on Stop below the set frequency

407 DC Inject Time	Default: 0.2 sec	Range: 0.0 to 5.0 sec Level 2
---------------------------	------------------	----------------------------------

If parameter 406 is set to DC at Stop (see page 69), direct current is applied to the motor. This parameter, DC Inject Time, determines how long the direct current will be applied, and how long DC is applied at Start if programmed accordingly.

This parameter works in tandem with parameter 410 (DC Inject Config) and the other parameters associated with DC Inject Config. That is, the time period configured by this parameter, DC Inject Time, determines how long DC injection braking will be active. When DC injection braking is controlled by a digital input, the braking continues for as long as the digital input is true, plus the time set by parameter 407 (DC Inject Time). When it is controlled by frequency, however, it continues for the length of time once the drive reaches the frequency set by parameter 409 (DC Inj Freq).

408 DC Inject Level	Default: 50.0%	Range: 0.0% to 100.0% Level 2
----------------------------	----------------	----------------------------------

Configures the amount of DC injection that will occur when direct current is injected into the motor windings, which acts as a braking force. The amount of current is expressed as a percentage of nominal motor current. The braking force may be applied when starting or stopping. If this parameter is set to 0.0%, the DC injection is disabled.

409 DC Inj Freq	Default: 0 Hz	Range: 0.0 to 20.0 Hz Level 2
------------------------	---------------	----------------------------------

Configures the frequency under which direct current will be applied to the drive when DC Inject Config is set to "DC on Freq." If this parameter is set to 0.0, the parameter operates in the same way as "DC at Stop."

410 DB Config	Default: DB Internal	Range: 0-2 Level 2
----------------------	----------------------	-----------------------

Determines whether an external or internal dynamic brake is utilized or disabled. The drive provides an internal dynamic brake (DB) to assist in stopping. If desired, an external resistor can be connected to DB and B+ for additional capacity. (Note: Size 0 models cannot have an external brake added.)

The following data values may be assigned to this parameter:

<u>Parameter Value</u>	<u>Description</u>
DB Internal	Internal dynamic braking active
DB External	External dynamic braking active
No Dyn Brk	Dynamic braking circuit disabled
Int-ARCTIC	When DB Config is configured to "Int-ARCTIC," dynamic braking becomes active if the drive temperature drops below -7 degrees C. When the DB becomes active, an "ARCTIC Mode" warning flashes on the keypad. If the drive drops below -10 degrees C, the drive will be disabled and not allowed to run. The keypad will indicate a "Not enabled" state at this point. If the drive heats up after being below -10 degrees C, the drive must meet the following criteria before operating again: a) Drive temperature must be above -9 degrees C, and b) Drive temperature must stay above -9 degrees C until a time period has elapsed. The time period is dependent on how far below -10 degrees C the drive was. Each degree below -10 degrees C adds another 4 minutes before restart.

 CAUTION	<p>MOTOR OVERHEATING Do not use DC injection braking as a holding brake or excessive motor heating may result. Failure to observe this instruction can result in equipment damage.</p>
--	---

414 S Ramp Rounding	Default: 25%	Range: 1-100% Level 2
----------------------------	--------------	--------------------------

This parameter is used to define the amount of rounding or S-curve to the Accel and Decel ramp. The amount of rounding is split evenly between the beginning and the end of the ramp. A value of 1% would mean that the rounding of the ramp is near linear. A value of 50% would have 25% rounding at the start of the ramp and 25% at the end of the ramp.

501 V/Hz Select	Default: Linear Fxd	Range: n/a Level 2
------------------------	---------------------	-----------------------

The V/Hz Characteristic Selection parameter determines the characteristic of the V/Hz curve and whether any boost will be applied at starting. (The amount of boost may be automatically determined or set with parameter 502 (Voltage Boost).) The following data values may be assigned:

The following data values may be assigned to this parameter:

<u>Parameter Value</u>	<u>Description</u>
Linear Auto	The Linear Auto selection operates the Vector algorithm and activates current limiting functionality.
Linear Fxd	V/Hz curve with the amount of boost fixed at the value set in parameter 502 (Voltage Boost).
Pump Fxd	V/Hz curve with the amount of boost fixed at the value set in parameter 502 (Voltage Boost).
Fan Fxd	V/Hz curve with the amount of boost fixed at the value set in parameter 502 (Voltage Boost).
Linear 2pc	Activates parameters 512 (Midpoint Frq) and 513 (Midpoint Volt). These parameters are used to define a midpoint through which the V/Hz curve passes so a custom curve may be created for special motor applications.
Vector	Activates the sensorless vector algorithm for high torque / low speed operation. A vector-duty motor should be used for this mode of operation. Vector mode does not use of the parameter (parameter 502).

	501 = Linear Auto	501 = Linear Fxd	501 = Pump Fxd	501 = Fan Fxd	501 = Linear 2pc	501 = Vector
Limiting Feature	4-Quad Current Limit	4-Quad Current Limit	4-Quad Current Limit	4-Quad Current Limit	4-Quad Current Limit	4-Quad Trq Limit
Parameter Value Changes						
Slip Comp Enable	0 = No	0 = No	0 = No	0 = No	0 = No	1 = Yes
Start Field En	0 = No	0 = No	0 = No	0 = No	0 = No	1 = Yes
Find Mtr Data	0 = No	0 = No	0 = No	0 = No	0 = No	1 = Motor RS
Parameter Lock Status Changes						
Slip Comp Enable	Unlocked	Locked	Locked	Locked	Locked	Unlocked
Start Field En	Unlocked	Locked	Locked	Locked	Locked	Unlocked
Filter Fstator	Unlocked	Locked	Locked	Locked	Locked	Unlocked
Filter Time Slip	Unlocked	Locked	Locked	Locked	Locked	Unlocked
Power Fail Config	Unlocked	Locked	Locked	Locked	Locked	Unlocked
Voltage Boost	Locked	Unlocked	Unlocked	Unlocked	Unlocked	Locked
Parameter Visibility Changes						
Slip Comp Enable	Level 2	Invisible	Invisible	Invisible	Invisible	Level 1/Level 2
Start Field En	Level 2	Invisible	Invisible	Invisible	Invisible	Level 1/Level 2
Filter Fstator	Level 2	Invisible	Invisible	Invisible	Invisible	Level 2
Filter Time Slip	Level 2	Invisible	Invisible	Invisible	Invisible	Level 2
Power Fail Config	Level 2	Invisible	Invisible	Invisible	Invisible	Level 2
ID Percent	Level 2	Invisible	Invisible	Invisible	Invisible	Level 2
IQ Percent	Level 2	Invisible	Invisible	Invisible	Invisible	Level 2
Voltage Boost	Invisible	Level 2	Level 2	Level 2	Level 2	Invisible

502 Voltage Boost	Default: 1.0%	Range: 0.0–50.0% Levels 1, 2
--------------------------	---------------	---------------------------------

Parameter 502, Voltage Boost, increases the motor voltage at low speed to increase the starting torque of the motor. The parameter sets the amount of boost (expressed as a percentage of the default boost) to be applied at zero frequency. The amount of boost decreases linearly with increasing speed.

This parameter is used when parameter 501 is set with fixed boost options. For vector mode this parameter is inactive.

 CAUTION	<p>MOTOR OVERHEATING</p> <p>Too much boost may cause excessive motor currents and motor overheating.</p> <p>Use only as much boost as is necessary to start the motor. Auto-boost may be selected at parameter 501 (V/Hz Select) to provide optimum value of boost to suit the load automatically.</p> <p>Failure to observe this instruction can result in equipment damage.</p>
---	--

503 V/Hz Knee Freq	Default: 50	Range: 25–400 Hz Level 2
---------------------------	-------------	-----------------------------

This parameter sets the point on the frequency scale of the V/Hz curve at which the output is at full line voltage. Normally, this is set at the base frequency of the motor, but it may be increased to enlarge the constant torque range on special motors. Setting this parameter to a higher value can reduce motor losses at low frequencies.

504 Skip Freq Band	Default: 0.2 Hz	Range: 0.2–20.0 Hz Level 2
---------------------------	-----------------	-------------------------------

To reduce mechanical resonances in a drive system, the drive may be configured to “skip” certain frequencies. Once configured, the drive will accelerate or decelerate through the prohibited frequency band without settling on any frequency in the band.

The Vacon 50X AC drive provides the capability to configure four prohibited frequency bands. Parameter 504 (Skip Freq Band), the Skip Frequency Band parameter, sets the width of the band above and below each of the prohibited frequencies set in parameters 505, 506, 507, and 508 (Skip Freq 1, 2, 3, 4).

For example, if this parameter is set to its default value of 1 Hz and parameter 505 (Skip Freq 1) is set to 20 Hz, a skip band from 19 to 21 Hz is established.

505 Skip Freq 1 506 Skip Freq 2 507 Skip Freq 3 508 Skip Freq 4	Default: 0.0 Hz	Range: Min Freq–Max Freq Level 2
--	-----------------	-------------------------------------

As discussed in the description of parameter 504 (Skip Freq Band), the drive may be configured to skip certain frequencies. These three parameters set the center of the three skip frequency bands (with the width of each band being twice the value of parameter 504 – an equal amount above and below the skip frequency).

For example, if parameter 504 is set to 2.5 Hz and parameter 508 [Skip Freq 4] is set to 55 Hz, a skip band from 52.5 to 57.5 Hz is established.

509 Rated Mtr Volt	Default: Model dependent	Range: 100–690 V Level 2, Macro
---------------------------	--------------------------	------------------------------------

The Rated Motor Voltage parameter configures the rated motor voltage, and allows a user to enter the rated voltage from the motor nameplate to provide optimal control and protection. This is usually the amount of voltage delivered to the motor terminals at the setting of 503 [V/Hz Knee Freq].

510 Rated Mtr FLA	Default: ND Rating	Range: 50–200% of ND rating Level 2, Macro
--------------------------	--------------------	---

The Rated Motor FLA parameter allows a user to enter the rated FLA from the motor nameplate to provide optimal control and protection. This parameter should be configured to the value on the nameplate of the motor, as that value is used in calculating the percentage of current at which the drive is operating.

For information on motor timed overload operation, and how Parameter 610 works with it, see page 78.

511 Rated Mtr RPM	Default: 1450 rpm	Range: 0–24000 rpm Level 2, Macro
--------------------------	-------------------	--------------------------------------

This parameter replaces the slip compensation parameter setting of the drive so the user does not need to calculate it.

512 Midpoint Freq	Default: 50.0 Hz	Range: 0.0 Hz–V/Hz Knee Freq Level 2
--------------------------	------------------	---

When parameter 501, V/Hz Select, is configured to "Linear 2pc," this parameter, together with parameter 513, Midpoint Volt, defines an additional point in the V/Hz characteristic.

513 Midpoint Volt	Default: 100.0%	Range: 0.0–100.0% Level 2
--------------------------	-----------------	------------------------------

When parameter 501, V/Hz Select, is configured to "Linear 2pc," this parameter, along with parameter 512, Midpoint Freq, defines an additional point in the V/Hz characteristic.

514 Motor RS	Default: Model dependent	Range: 0.00–655.35 Ohms Level 2, Macro
---------------------	--------------------------	---

This parameter allows direct entry of the Stator Resistance (Rs) of the motor for better vector performance. The motor manufacturer can provide this information, or you can physically measure this value with an ohmmeter. From the line-to-line measurement of motor resistance, enter half the measured value. (See page 46 for more information.)

515 Power Factor	Default: 0.80	Range: 0.50–1.00 (0.5 times the measured line to line resistance of motor) Level 2, Macro
-------------------------	---------------	---

This parameter allows direct entry of the motor's power factor for better vector performance. The motor manufacturer can provide this information.

516 Slip Comp Enable	Default: No	Range: Text string Levels 1, 2
-----------------------------	-------------	-----------------------------------

The following data values may be assigned to this parameter:

<u>Parameter Value</u>	<u>Description</u>
No	No Slip Compensation enabled
Yes	Slip Compensation enabled

Parameter 516 permits activation of slip compensation for better speed regulation. The motor rated speed must be entered into parameter 511 (Rated Mtr RPM) for best results.

517 Single Phase	Default: Model dependent	Range: Text string Level 2
-------------------------	--------------------------	-------------------------------

The following data values may be assigned to this parameter:

<u>Parameter Value</u>	<u>Description</u>
No	No single phase input operation. Phase loss engaged.
Yes	Single phase operation. No phase loss.

519 Find Mtr Data	Default: Not active	Range: Text string Macro
--------------------------	---------------------	-----------------------------

This parameter activates the drive's ability to measure the stator resistance of the attached motor. The automatic stator resistance measurement can be performed either through the keypad or through the serial link. See "Measuring Stator Resistance (RS Measurement)" on page 46 for more information about this parameter. The following data values may be assigned:

<u>Parameter Value</u>	<u>Description</u>
Not Active	No stator RS measurement.
Motor RS	Automatic RS measurement using macro procedure.

520 Filter FStator	Default: 8 ms	Range: 1-100 ms Level 2
---------------------------	---------------	----------------------------

This parameter filters the stator frequency applied to the motor, which can help tune the acceleration behavior of the motor. This is particularly helpful when using short ramps and operating the motor at a frequency above the "V/Hz Knee Freq" (parameter 503) value (field weakening area). Lower values allow dynamic currents to be produced, but with greater peaks. This could produce unstable states in the field weakening area. Low values for this parameter can cause overcurrent faults while accelerating to frequencies over the Knee Frequency. Higher values allow the drive to run more smoothly at frequencies over the Knee Frequency and protect the drive against overcurrents – often the case when using special motors or spindle drives.

521 Start Field En	Default: No	Range: Text string Level 2
---------------------------	-------------	-------------------------------

<u>Parameter Value</u>	<u>Description</u>
No	The shaft will begin rotating after receiving a Start command, without delay. If the application has heavy load conditions or short ramp times, this setting can produce very large starting currents, to overcome the inertia of the system. This may produce nuisance trips when starting.

Yes The shaft will begin rotating after receiving a Start command, with delay. During this delay, the drive is building up the magnetic field in the motor. This allows the drive to start in vector mode with less starting current.

523 Filter Time Slip	Default: 100 ms	Range: 10–1000 ms Level 2
-----------------------------	-----------------	------------------------------

This parameter filters the slip frequency applied to the motor, which can help improve the dynamic response of the drive. This parameter produces the following results based on the parameter value:

If the parameter is configured to 100 ms, the drive will produce stable conditions to a change in load, in most cases.

If the parameter is configured to less than 100 ms, the drive will be able to react quickly to a change in load, but may over-compensate its reaction to the load.

If the parameter is configured to greater than 100 ms, the drive will react very slowly to a change in load and will need a longer time to compensate for the difference between the setpoint and the actual frequency.

523 Id Percent	Default: Read-only	Range: 0–200% Level 2
-----------------------	--------------------	--------------------------

This parameter shows the Flux producing current (as a percentage of motor rated current) that is being applied to the drive.

524 Iq Percent	Default: Read-only	Range: 0–200% Level 2
-----------------------	--------------------	--------------------------

This parameter shows the Torque producing current (as a percentage of motor rated current) that is being applied to the drive.

525 Power Fail Cfg	Default = CTS No Msg	Range: Text string Level 2
---------------------------	----------------------	-------------------------------

This parameter can be used to define how the drive responds to an undervoltage operation when parameter 501 is set for Vector or Linear Auto mode. The following data values may be assigned to this parameter:

<u>Parameter Value</u>	<u>Description</u>
CTS No Msg	The drive will coast to a stop when an undervoltage condition (power-down) is detected.
Coast Stop	The drive will coast to a stop when an undervoltage condition (power-down) is detected. In this mode, however, the drive will generate an undervoltage fault, which will be registered in the fault log.
Ramp Down	With this setting, if power is lost, the drive ramps the motor down at a decel rate of Decel 1. When the drive is fully ramped down, the drive will generate an undervoltage fault. If power is restored, the drive will continue to ramp to a stop and will fault.
Quick Ramp	Same as Ramp Down, except the shorter ramp time (Decel 1 or Decel 2) will be used.
Controlled	With this setting, if power is lost, the drive decelerates the motor, trying to regulate the bus voltage to the undervoltage level. If power is restored, the drive accelerates to the command frequency without faulting. If the drive reaches the stopped condition, it will generate an undervoltage fault.
ContrNoMsg	Same as Controlled, but without generating an undervoltage fault.

NOTE: Current limit is only available when Parameter 501 is set to Linear Auto. If Parameter 501 is set to Vector, then the Current Limiting values will actually be Torque Limiting values.

526 UV Ride-Thru En	Default = w/ LVT	Range: Text string Level 2
----------------------------	------------------	-------------------------------

This parameter allows the function to disable either (a) undervoltage ride-through or (b) continuous Line Voltage Tracking (LVT) that produces dynamic Undervoltage Ride-Thru Thresholds. The following data values may be assigned to this parameter:

<u>Parameter Value</u>	<u>Description</u>
Disabled	This turns off the Undervoltage Ride-Thru function.
w/ LVT	This enables the standard Ride-Thru algorithm in the V/Hz modes and allows the choice of algorithm in the Linear Auto and Vector modes.
w/o LVT	This option operates in the same way as "w/ LVT" except that the Line Voltage Tracker function of the Undervoltage Ride-Thru is not active. The Line Voltage will be estimated on powering up the drive.
No UV Fault	This mode is the same as "w/o LVT" except if the bus recover from the ride-thru timeout state the under voltage fault is not generated. The bus voltage system will reset and goes back thru the startup sequence.

Summary of UV Ride-Thru Enable Parameter (Parameter 526)			
Parameter Setting	Tracking	Ride-thru mode	UV Fault
Disabled	Disabled	Disabled	Disabled
w/ LVT	Enabled	Enabled	Enabled
w/o LVT	Disabled	Enabled	Enabled
No UV Fault	Disabled	Enabled	Disabled

600 Current Lim Sel	Default: Fixed LvlS	Range: Text string Level 2
----------------------------	---------------------	-------------------------------

The Vacon 50X drive provides a Current Limit feature. With this feature enabled, the drive's frequency is automatically reduced when operating in motoring mode to keep the measured torque within limits. When operating in regenerative mode, the output frequency can be automatically increased for the same reason. In addition to the current limit parameters that activate the Current Limit mode, more current limit parameters are available to adjust the drive's response to the load demands. The following data values may be assigned to this parameter:

The following data values may be assigned to this parameter:

<u>Parameter Value</u>	<u>Description</u>
Fixed LvlS	The fixed levels set in parameters 601, 602, 603 and 604 determine the current limit in each of the four quadrants of operation.
Vin2	Vin2 analog input sets the current limit value, range 0–200%
Cin	Cin analog input sets the current limit value, range 0–200%
Vin2 Motor	Vin2 analog input sets the motoring current limit value, range 0–200%
Cin Motor	Cin analog input sets the motoring current limit value, range 0–200%
Vin2 F-Mtr	Vin2 analog input sets the FWD motoring current limit value, range 0–200%

Cin F-Motor Cin analog input sets the FWD motoring current limit value, range 0–200%

NOTE: Current limit is only available when Parameter 501 is set to Linear Auto. If Parameter 501 is set to Vector, then the Current Limiting values will actually be Torque Limiting values.

601 Cur Lim Mtr Fwd	Default: 120%	Range: 5–150% Level 2
----------------------------	---------------	--------------------------

This parameter sets the current limiting point when the drive is in motoring mode in the forward direction. The limit is expressed as a percentage of the current capacity of the drive.

602 Cur Lim Mtr Rev	Default: 120%	Range: 5–150% Level 2
----------------------------	---------------	--------------------------

This parameter sets the current limiting point when the drive is in motoring mode in the reverse direction. The limit is expressed as a percentage of the current capacity of the drive.

603 Cur Lim Reg Fwd	Default: 80%	Range: 5–150% Level 2
----------------------------	--------------	--------------------------

This parameter sets the current limiting point when the drive is in regenerative mode in the forward direction. The limit is expressed as a percentage of the current capacity of the drive.

604 Cur Lim Reg Rev	Default: 80%	Range: 5–150% Level 2
----------------------------	--------------	--------------------------

This parameter sets the current limiting point when the drive is in regenerative mode in the reverse direction. The limit is expressed as a percentage of the current capacity of the drive.

605 Cur Lim Freq	Default: 3.0 Hz	Range: 0.0–400.0 Hz Level 2
-------------------------	-----------------	--------------------------------

This parameter sets the frequency where current limit becomes active. This value will also be the frequency point the drive will decelerate the motor to during Motoring Current Limit.

606 Ramp Time CL	Default: 1.0 sec	Range: 0.1–3200.0 sec Level 2
-------------------------	------------------	----------------------------------

This parameter determines the ramp rate when the drive enters Current Limit, and defines the ramping rate of the drive when in a current limiting mode. If the drive is in regenerative current limit, it is an acceleration time. If the drive is in motoring current limit, it is a deceleration time.

607 Cur Lim Minimum	Default: 10%	Range: 0–50% Level 2
----------------------------	--------------	-------------------------

This parameter limits the lowest amount of current (or Torque) limiting that can occur when the limit threshold is determined by an analog input.

608 Restart Number	Default: 0	P608 Range: 0-8
609 Restart Delay	Default: 60 sec	P609 Range: 0-60 sec Level 2

You may configure the drive to attempt to re-start a specified number of times after certain faults occur. Chapter 8 lists all faults and notes which ones may be reset automatically.

The number of attempts at re-starting is set with parameter 608 (Restart Number). A value of 0 prevents the drive from attempting a re-start. The time duration that must elapse between re-start attempts is set with parameter 609 (Restart Delay). The type of start to be attempted is set with parameter 802 (Start Options); see page 83.

If the number of attempted re-starts is exceeded, the drive will trip with a fault and will stop operating. Resetting the fault can result in instant starting. (See page 101 for more information on faults and troubleshooting.)

Note that for 2-wire operation, the FWD or REV terminal must still be active for the drive to attempt a re-start.

Also note that the counter for attempted re-starts will not reset to zero until ten minutes after a successful re-start.

 WARNING	<p>UNINTENDED EQUIPMENT ACTION</p> <p>Ensure that automatic re-starting will not cause injury to personnel or damage to equipment.</p> <p>Failure to observe this instruction can result in serious injury or equipment damage.</p>
---	--

610 Timed OL Select	Default: In Duty 60sec	Range: Text string Level 2
----------------------------	------------------------	-------------------------------

Two parameters in the Vacon 50X work together to configure how the motor timed overload operates: Parameter 510 (Rated Mtr FLA) and Parameter 610 (Timed OL Select). Parameter 510 (Rated Mtr FLA) should be configured to the value on the nameplate of the motor. This value is used in calculating the percentage of current at which the drive is operating.

Set parameter 610 to one of the following data values to configure the desired overload characteristic:

<u>Options</u>	<u>Trip Time</u>	<u>Motor Type</u>
Std Ind Shp	0 sec	Standard Induction
Std Ind 30s	30 sec	Standard Induction
Std Ind 60s	60 sec	Standard Induction
Std Ind 5mn	300 sec	Standard Induction
In Duty Shp	0 sec	Inverter Duty
In Duty 30s	30 sec	Inverter Duty
In Duty 60s	60 sec	Inverter Duty
In Duty 5mn	300 sec	Inverter Duty

Parameter 610 (Timed OL Select) determines the graph of Trip (Fault) Time vs. Percent Current that is used by the Motor TOL functionality. This protective feature is speed-de-

pendent to handle standard induction motors whose cooling is limited by the shaft-mounted fan. Blower-cooled motors and most inverter-duty motors do not have this limitation.

613 Max Regen Ramp	Default: 300%	Range: 100-1000% Level 2
---------------------------	---------------	-----------------------------

This parameter operates as a percentage of the longest ramp time. This time then defines the amount of time a deceleration to stop can take without causing a "Regen Timeout" fault. For example, if "Decel Time 1" is 5.0 seconds, "Decel Time 2" is 10.0 seconds, and "Max Regen Ramp" is 300%, a deceleration to stop that takes more than 30 seconds will cause a "Regen Timeout" fault in the drive.

614 Stability Gain	Default: Model dependent	Range: 0-10 Level 2
---------------------------	--------------------------	------------------------

615 Stability Rate	Default: Model dependent	Range: 0-1000 Level 2
---------------------------	--------------------------	--------------------------

Both of these parameters can be used to resolve stability problems if they occur. Use Parameter 615 if the load has significant inertia with respect to the motor itself.

700 Vmet Config	Default: Freq Out	Range: Text string Levels 1, 2
------------------------	-------------------	-----------------------------------

This parameter configures the analog signal that will be applied to the Vmet output pin. The following data values may be assigned to this parameter:

<u>Parameter Value</u>	<u>Description</u>	<u>Range Limit</u>
Freq Out	Output frequency of the drive	Parameter max freq.
Voltage Out	Voltage being supplied to the motor	Rated motor voltage
Current Out	Current being supplied to the motor	200% of drive rating
Drive Load	Calculated percentage of drive rating	200% of drive rating
Drive Temp	Calculation of total drive temp rating	100% of unit temp rating
Stator Freq	Commanded frequency	100% of input config
Power Out	Calculated power output of drive	250% of drive rating
PI Fback	Allows the analog output to produce a signal in proportion to the PI feedback received	100% of feedback signal

701 Vmet Span	Default: 100%	Range: 0.0-200.0% Level 2
----------------------	---------------	------------------------------

This parameter sets the span of the Vmet analog output.

702 Imet Config	Default: Drive Load	Range: Text string Level 2
------------------------	---------------------	-------------------------------

This parameter configures the analog signal that will be applied to the Imet output pin. The following data values may be assigned to this parameter:

<u>Parameter Value</u>	<u>Description</u>	<u>Range Limit</u>
Freq Out	Output frequency of the drive	Parameter max freq.
Voltage Out	Voltage being supplied to the motor	Rated motor voltage
Current Out	Current being supplied to the motor	200% of drive rating
Drive Load	Calculated percentage of drive rating	200% of drive rating
Drive Temp	Calculation of total drive temp rating	100% of unit temp rating
Stator Freq	Commanded frequency	100% of input config
Power Out	Calculated power output of drive	250% of drive rating
PI Fback	Allows the analog output to produce a signal in proportion to the PI feedback received	

703 Imet Span	Default: 100%	Range: 0.0-200.0% Level 2
----------------------	---------------	------------------------------

This parameter sets the span of the Imet analog output.

704 Imet Offset	Default: 0.0%	Range: 0.0-90.0% Level 2
------------------------	---------------	-----------------------------

This parameter sets the offset of the Imet analog output.

705 Relay 1 Select 706 Relay 2 Select 707 D01 Select 708 D02 Select	Default: Drv Fault Default: Drive Run Default: Drive Ready Default: At Speed	Range for Parameters 705-708: Text string Levels 1, 2 for Parameters 705-706 Level 2 for Parameters 707-708
--	---	---

This parameter configures what condition will cause relays R1 and R2 to activate. The following values may be assigned:

<u>Parameter Value</u>	<u>Description</u>
Drv Ready	The drive is ready. (The relay will be open in Fault and Low Voltage conditions.)
Drv Fault	A fault occurs. (If automatic fault reset and re-start is enabled, only faults that cannot be reset will activate the relay. The relay will also activate for faults that can be reset when the number of restart attempts exceeds the value set in parameter 608 (Restart Number).)
Drive Run	The drive has received a direction command.
Running FWD	The motor is running Forward and the output frequency is above 0.5 Hz.

Running REV	The motor is running in Reverse and the output frequency is above 0.5 Hz.
Zero Speed	The drive is in Run mode, but the speed reference is 0 Hz.
At Speed	The drive has reached reference speed.
Freq Limit	The drive limit is active when the speed commanded exceeds the value of parameter 306, Preset Freq 4.
Freq Hyst	This is active when the speed exceeds parameter 306 (Preset Freq 4) but is less than parameter 307 (Preset Freq 5).
Current Lim	Current Limit mode is active.
High Temp	The temperature limit of the drive has been exceeded.
Local Mode	The keypad is the control path for reference speed and control functions.
SeqOut-00 SeqOut-01 SeqOut-10 SeqOut-11	Programmed sequence step active. SeqOut-00, SeqOut-01, SeqOut-10, SeqOut-11 are all status outputs linked to a step in the program sequencer.
Sequencer ¹ on page 92	See "Using the Vacon 50X Program Sequencer" on page 92 for more information.
ARCTIC	When a digital output is configured to use this option, the output will be active when the Arctic Mode is turning on the DB resistor. This option will turn on when the temperature drops below the Arctic mode entry point, which is -7 degrees C. This will work even if Arctic Mode is not enabled.
Ref Loss	Independent of the status of parameter 222 (Ref Loss Config), this selection activates the digital output when a 4-20mA input to either the VIN1 or CIN inputs drop to approximately 3mA.

720 Active Logic	Default: Active High	Range: Text string Level 2
-------------------------	----------------------	-------------------------------

This parameter configures the input state of all the digital inputs except the EN digital input. The EN digital input is always active high. The following data values may be assigned to this parameter:

<u>Parameter Value</u>	<u>Description</u>
Active Low	Low input is true ("pull-down logic")
Active High	High input is true ("pull-up logic")

721 DI1 Configure	Default: Preset 1	Range: Text string Level 2
722 DI2 Configure	Default: Preset 2	
723 DI3 Configure	Default: Preset 3	
724 DI4 Configure	Default: Alt Ramp	
725 DI5 Configure	Default: Fault Reset	

These parameters configure the function that the digital inputs DI1-5 will perform when active. The following data values may be assigned:

<u>Parameter Value</u>	<u>Description</u>
Preset 1	Preset Speed Input 1 (PS1).
Preset 2	Preset Speed Input 2 (PS2).
Preset 3	Preset Speed Input 3 (PS3).
Coast Stop	Activates a Coast-to-Stop condition.
DC Inject	Begins DC injection braking.
Loc/Rem	Switches from Local to Remote mode.
Alt Ramp	Activates Alternate Ramp.
Fault Reset	Resets a fault.

EMOP+	EMOP increases speed.
EMOP-	EMOP decreases speed.
PI Enable	Enables PI control.
Ref Switch	Switches speed reference signals.
Cur Lim Dis	Disables Current Limit mode.
CurLimIMax	Set the current limit to I _{max}
SL Override	Takes control away from the serial link.
Seq 1	Sequencer input 1.
Seq 2	Sequencer input 2.
Seq 3	Sequencer input 3.
Seq Dwell	Sequencer dwell mode (pause).
Seq Advance	Sequencer advance (skip).
FLY Dis	Disable Catch-on-fly operation.

726 MOL Polarity	Default: NO Operate	Range: Text string Level 2
-------------------------	---------------------	-------------------------------

This parameter sets the Motor Overload input polarity. The following data values may be assigned to this parameter:

<u>Parameter Value</u>	<u>Description</u>
NC Operate	A normally closed (NC) connection allows the unit to operate; the drive faults when the connection opens.
NO Operate	A normally open (NO) connection allows the unit to operate; the drive faults when the connection closes.

727 MOL Configure	Default = MOL	Range: n/a Level 2
--------------------------	---------------	-----------------------

This allow the MOL digital input to be programmable.

<u>Parameter Value</u>	<u>Description</u>
Preset 1	Preset Speed Input 1 (PS1).
Preset 2	Preset Speed Input 2 (PS2).
Preset 3	Preset Speed Input 3 (PS3).
Coast Stop	Activates a Coast-to-Stop condition.
DC Inject	Begins DC injection braking.
Loc/Rem	Switches from Local to Remote mode.
Alt Ramp	Activates Alternate Ramp.
Fault Reset	Resets a fault.
EMOP+	EMOP increases speed.
EMOP-	EMOP decreases speed.
PI Enable	Enables PI control.
Ref Switch	Switches speed reference signals.
Cur Lim Dis	Disables Current Limit mode.
CurLimIMax	Set the current limit to I _{max}
SL Override	Takes control away from the serial link.
Seq 1	Sequencer input 1.
Seq 2	Sequencer input 2.
Seq 3	Sequencer input 3.
Seq Dwell	Sequencer dwell mode (pause).
Seq Advance	Sequencer advance (skip).
FLY Dis	Disable Catch-on-fly operation.

801 Program Number	Default: 0	Range: 0–9999 Level 2, Macro
---------------------------	------------	---------------------------------

This parameter [Special Program Number] provides a way of enabling hidden functions in the drive and storing parameters to the customer set.

<u>Data Value</u>	<u>Special Function Configured</u>
0	Standard program
1	Reset all parameters to factory default values (display = SETP).
2	Store customer parameter values (display = STOC).
3	Load customer parameter values (display = SETC).
4	Swap active parameters with customer stored settings.
10	Reset Total Run Time, parameter 108.

802 Start Options	Default: LS Lockout	Range: Text string Level 2
--------------------------	---------------------	-------------------------------

The Start Options parameter configures the Line Start Lockout functionality of the drive. All data values ending with "2" allow the user to press the Enter key to store the customer speed reference value on the keypad. You must press and hold the Enter key for two seconds to save the speed command. The following data values may be assigned to this parameter:

<u>Data Value</u>	<u>Description</u>
LS Lockout	[Line Start Lockout]. If maintained contact run operators are used, they must be opened and then re-closed for the drive to start after AC power is applied.
AutoStart	When AC power is applied, if a Run command is present through the terminal strip, the drive will start.
LSL w/FLY	This setting has both LS Lockout and Catch on the Fly enabled at the same time.
Auto w/FLY	This setting has both Auto-Start and Catch on the Fly enabled at the same time.
LS Lockout2	[Line Start Lockout]. If maintained contact run operators are used, they must be opened and then re-closed for the drive to start after AC power is applied.
AutoStart2	When AC power is applied, if a Run command is present through the terminal strip, the drive will start.
LSL w/FLY 2	This setting has both LS Lockout and Catch on the Fly enabled at the same time.
Auto w/FLY2	This setting has both Auto-Start and Catch on the Fly enabled at the same time.

803 PWM Frequency	Default: 3.0 kHz	Range: 0.6–16.0 kHz Level 2
--------------------------	------------------	--------------------------------

The PWM Carrier Frequency parameter sets the carrier frequency of the Pulse-Width Modulation (PWM) waveform supplied to the motor. Low carrier frequencies provide better low-end torque, but produce some audible noise from the motor. Higher carrier frequencies produce less audible noise, but cause more heating in the drive and motor.

804 Display Mode	Default: Std Disply	Range: Text string Level 2
-------------------------	---------------------	-------------------------------

The Display Mode parameter determines how the reference or output of the drive will be displayed to the user. If User Units is selected, parameter 805 allows you to customize the 3 unit values on the display. The following data values may be assigned to this parameter:

<u>Parameter Value</u>	<u>Description</u>
Std Disply	Standard commanded frequency
Out Freq	Output frequency actually sent to the motor
Stator Freq	Frequency of the stator
User Units	Custom units display based on values in parameter 805
RPM Units	Custom speed display with RPM as units
GPM Units	Custom speed display with GPM as units
FPM Units	Custom speed display with FPM as units
MPM Units	Custom speed display with MPM as units
PSI Units	Custom speed display with PSI as units
Degrees C	Custom display with degrees C
Degrees F	Custom display with degrees F
Time hrs	Custom display time in hours of operation
Time min	Custom display time in minutes of operation
Time sec	Custom display time in seconds of operation
Fbk RPM	Display is scaled to read in RPM based on the PI feedback input to an analog input
Fbk PSI	Display is scaled to read in PSI based on the PI feedback input to an analog input
Fbk GPM	Display is scaled to read in GPM based on the PI feedback input to an analog input
Fbk User	Display is scaled to read in User units (parameter 805) based on PI feedback input to an analog input

When using any of the Time functions, these refer to "Retention Time." Retention time is an inverse function: as speed goes up, time goes down, and vice versa. It is typically used in oven-type applications. The value set in parameter 809 (Display Scale) references the time of operation when running at Max. Frequency. For instance, if parameter 302 (Max. Frequency) is set for 60 Hz, 804 (Display Mode) is set for Time min, and 809 (Display Scale) is set for 600, the scales of the display will read 60.0 min at maximum speed and increase in time (in minutes) up to the maximum scale of 6553.5 at minimum frequency.

805 Display Units(1)	Default: RPM: 1	Range: Text string Level 2
-----------------------------	-----------------	-------------------------------

This parameter determines the three-character customer display units used when parameter 804 is set to User Units. The last digit indicates the number of decimal places to be shown on the display. Up to three decimal places are possible.

809 Display Scale	Default: 1	Range: 1-65535 Level 2
--------------------------	------------	---------------------------

This parameter determines how the reference or output of the drive will be displayed to the user. It selects the maximum scaling of the display when running at maximum frequency.

810 Language	Default: English	Range: Text string Level 2, Macro
---------------------	------------------	--------------------------------------

This parameter configures the language text strings will be displayed in. The following data values may be assigned:

Parameter Value

English
Spanish
German
Italian
French

811 Access Code	Default: 0	Range: 0-9999 Level 2
------------------------	------------	--------------------------

The security Access Code allows the user to control access to the programmable functions of the inverter. The initial value of this parameter is 000, which signifies that no access code is necessary. Any number between 001 and 999 may be used for an access code, but is not necessary. If an access code is entered, you will not be able to view the values while scrolling through parameters. Only after the Shift key is pressed will the actual value appear.

To enter an access code, re-program parameter 811 as you would any other parameter. After the new value is stored, you have 10 minutes of free access. If you remove power and then restore it, you will need to enter the access code to change any program parameter. If you enter an incorrect access code, the drive displays ****WRONG CODE**** and allows only viewing rights to the various parameters. Once the correct code is entered, you again have 10 minutes of free access unless power is removed and restored. To disable the access code requirement, set parameter 811 back to 000.

812 Freq Ref Output	Default: 6FS	Range: Text string Level 2
----------------------------	--------------	-------------------------------

The Frequency Reference Output parameter determines the frequency pulse-train output from the DOP terminal. This digital output is a pulse train that can be linked to another drive or to a field meter for speed indication. The pulse train is a 50% duty cycle signal and requires a pull-up resistor of approximately 4.7 kOhms.

The following data values may be assigned to this parameter:

Parameter Value

6FS
48FS

813 Speed Ratio	Default: 100.0%	Range: 0.0-200.0% Level 2
------------------------	-----------------	------------------------------

The Master / Follower Speed Ratio parameter allows the pulse train output of one Vacon 50X series drive (master) to be used to control the speed of up to 8 other follower drives. The output of each follower can be individually programmed, or trimmed "ON-THE-FLY" with A2-RATIO. The range of adjustment is 0-200% of the master. This function only works when using the 6FS or 48FS functions in parameter 204.

814 Display Status	Default: Drive Load	Range: Text string Level 2
---------------------------	---------------------	-------------------------------

This parameter allows configuration of the additional parameter status field on the operate screen. The following fields can be configured:

<u>Parameter Value</u>	<u>Description</u>	<u>Range Limit</u>
Voltage Out	Voltage being supplied to the motor	Rated motor voltage
Current Out	Current being supplied to the motor	200% of drive rating
Drive Load	Calculated percentage of drive rating	200% of drive rating
Drive Temp	Calculation of total drive temp rating	100% of unit temp rating
Power Out	Calculated power output of drive	250% of drive rating
% of FLA	Calculated percentage of drive rating	Percent of motor FLA

816 Fly Catch Mode	Default: Sweep Fwd	Range: Text string Level 2
---------------------------	--------------------	-------------------------------

This parameter configures how the "catch on the fly" operates.

<u>Parameter Value</u>	<u>Description</u>
Sweep Fwd	Catch on the fly algorithm sweeps through frequencies only in the forward direction while searching for the operating frequency.
Sweep Rev	Catch on the fly algorithm sweeps through frequencies only in the reverse direction while searching for the operating frequency.
Sweep F/R	Catch on the fly algorithm sweeps through frequencies in both directions while searching for the operating frequency. The direction that is chosen first depends on the direction of the command given to the drive. Note that this option is slower than the other two modes of operation.

850 PI Configure	Default: No PI	Range: Text string Level 2
-------------------------	----------------	-------------------------------

The PI Configure parameter determines what type of PI control is active in the drive. PI can be active at all times, or activated using a digital input. If you select a digital input or function key as the means to enable PI control, remember to configure the parameter that sets the function of the digital input or function key to enable PI control to complete the implementation.

The following data values may be assigned to this parameter:

<u>Parameter Value</u>	<u>Description</u>
No PI	PI control is always inactive.
Dir F-FWD	Direct action with feed-forward.
Rev F-FWD	Reverse action with feed-forward.
Dir F-FWD E	Direct action with feed-forward, with PI enabled by DI.
Rev F-FWD E	Reverse action with feed-forward, with PI enabled by DI.
Dir Full	Direct action with full range.
Rev Full	Reverse action with full range.
Dir Full E	Direct action with full range, with PI enabled by DI.
Rev Full E	Reverse action with full range, with PI enabled by DI.

851 PI Feedback	Default: Vin1	Range: Text string Level 2
------------------------	---------------	-------------------------------

The PI Feedback parameter configures the feedback signal to be used in PI control. The following data values may be assigned to this parameter:

<u>Parameter Value</u>	<u>Description</u>
Vin1	Vin1 is the PI feedback.
Cin	Cin is the PI feedback.
Vin2	Vin2 is the PI feedback.

852 PI Prop Gain	Default: 0	Range: 0-2000 Level 2
-------------------------	------------	--------------------------

The PI Proportional Gain parameter configures the proportional gain that is applied to the PI control.

NOTE: Value must be greater than 0 for this to be active.

853 PI Int Gain	Default: 0	Range: 0-10000 Level 2
------------------------	------------	---------------------------

The PI Integral Gain parameter configures the integral gain that is applied to the PI control.

NOTE: Value must be greater than 0 for this to be active.

854 PI Feed Gain	Default: 1000	Range: 0-2000 Level 2
-------------------------	---------------	--------------------------

The PI Feed Gain parameter allows the feedback signal to be scaled. A setting of 1000 indicates 100.0%.

855 PI Error 1 856 PI Error 2	Default: Read-Only	Range: 0.00-100.00% Level 2
--	--------------------	--------------------------------

Both the PI Error 1 and PI Error 2 parameters are read-only; they provide feedback on how the PI control is operating.

857 PI High Corr	Default: 100.00%	Range: 0.00-100.00% Level 2
-------------------------	------------------	--------------------------------

This parameter sets the high limit of the PI output.

858 PI Low Corr	Default: 0.00%	Range: 0.00-100.00% Level 2
------------------------	----------------	--------------------------------

This parameter sets the low limit of the PI output.

900 SIO Protocol	Default: RTU N81	Range: Text string Level 2 (SIO)
-------------------------	------------------	-------------------------------------

This parameter defines the protocol and the parity of the SIO port.

The following data values may be assigned to this parameter:

<u>Parameter Value</u>	<u>Description</u>
RTU N81	No parity, 8 data bits, 1 stop bit
RTU N82	No parity, 8 data bits, 2 stop bits
RTU E81	Even parity, 8 data bits, 1 stop bit
RTU O81	Odd parity, 8 data bits, 1 stop bit

901 SIO Baud Rate	Default: 9600	Range: Text string Level 2 (SIO)
--------------------------	---------------	-------------------------------------

This parameter defines the baud rate of the SIO port.

The following data values may be assigned to this parameter:

<u>Parameter Value</u>
4800
9600
19200
38400
57600

902 Comm Drop #	Default: 1	Range: 1-247 Level 2 (SIO)
------------------------	------------	-------------------------------

This parameter defines the network drop number for both SIO and IRDA communications.

903 SIO Timer	Default: 1.0 sec	Range: 0.0-60.0 sec Level 2 (SIO)
----------------------	------------------	--------------------------------------

This parameter defines a watchdog timer that will require a valid communication in the specified time period while in SIO control. If the requirement is not met, a fault occurs.

904 SIO Cntl Word	Default: 0x0000	Range: Text string Level 2 (SIO)
--------------------------	-----------------	-------------------------------------

The SIO Control Word parameter allows control of the drive through Modbus communications.

The following bits are used with this parameter:

15	14	13	12	11	10	9	8	7	6	5	4	3	2	1	0
Bit	When Set to 1 Signifies							Bit	When Set to 1 Signifies						
8	Alt Ramp							0	SLC (Run)						
9	PI Enable							1	SLF (Ref)						
10	Not Used							2	FWD						
11	Cur Lim							3	REV						
12	DCI							4	FEXT2						
13	CTS							5	Preset Input 1 (PS1)						
14	Ref Switch							6	Preset Input 2 (PS2)						
15	Fault Reset							7	Preset Input 3 (PS3)						

905 Ext Ref Freq 1	Default: 0.0 Hz	Range: Min. Freq.–Max. Freq. Level 2 (SIO)
906 Ext Ref Freq 2		

These parameters provide access for changing the frequency reference over the serial link.

908 Status Word	Default: Read-Only	Range: Text string Level 2 (SIO)
------------------------	--------------------	-------------------------------------

The Status Word parameter provides status of the drive operation to a serial link user.

The following bits are used with this parameter:

15	14	13	12	11	10	9	8	7	6	5	4	3	2	1	0
Bit	When Set to 1 Signifies							Bit	When Set to 1 Signifies						
8	Alt Ramp							0	SLC (Run)						
9	SL Override							1	SLF (Ref)						
10	Remote							2	FWD run						
11	Curr Lim							3	REV run						
12	DCI							4	FEXT2						
13	Jogging							5	Accel						
14	Zero Spd							6	Decel						
15	Drive Flt							7	At Speed						

909 DI Status	Default: Read-Only	Range: Text string Level 2
----------------------	--------------------	-------------------------------

This parameter provides a 10-bit status display.

The following bits are used with this parameter:

9	8	7	6	5	4	3	2	1	0
---	---	---	---	---	---	---	---	---	---

Bit	When Set to 1 Signifies	Bit	When Set to 1 Signifies
5	DI3 Input	0	FWD Input
6	DI4 Input	1	REV Input
7	DI5 Input	2	R/J Input
8	MOL Input	3	DI1 Input
9	EN Input	4	DI2 Input

910 Vin1 Status 911 Cin Status 912 Vin2 Status	Default: Read-Only	Range: 0.00–100.00% Level 2
---	--------------------	--------------------------------

Parameter 910 provides the input percentage applied to the Vin1 terminal; parameter 911 provides the input percentage applied to the Cin terminal; and parameter 912 provides the input percentage applied to the Vin2 terminal.

913 Output Status	Default: Read-Only	Range: n/a Level 2
--------------------------	--------------------	-----------------------

This parameter provides a 10-bit binary status display. A “1” in the status word indicates that the output is active.

The following bits are used with this parameter:

9	8	7	6	5	4	3	2	1	0
---	---	---	---	---	---	---	---	---	---

Bit	When Set to 1 Signifies	Bit	When Set to 1 Signifies
5	N/A	0	R1 Output
6	N/A	1	R2 Output
7	N/A	2	DO1 Output
8	N/A	3	DO2 Output
9	N/A	4	N/A

914 Vmet Status 915 Imet Status	Default: Read-Only	Range: 0.00–100.00% Level 2
--	--------------------	--------------------------------

Parameter 914 provides the output percentage applied to the Vmet terminal; parameter 915 provides the output percentage applied to the Imet terminal.

916 Infrared Baud	Default: 9600	Range: Text string Level 2 (SIO)
--------------------------	---------------	-------------------------------------

This parameter defines the baud rate of the IRDA port.

The following data values may be assigned to this parameter:

Parameter Value

9600
19200
38400
57600

931 Seq Cntl 1 932 Seq Cntl 2 933 Seq Cntl 3 934 Seq Cntl 4 935 Seq Cntl 5 936 Seq Cntl 6 937 Seq Cntl 7 938 Seq Cntl 8 939 Seq Cntl 9	Default: 000000000000	Range: Text string Level 2 (SEQ)
---	-----------------------	-------------------------------------

These parameters each provide a 10-bit binary status display. See “Using the Vacon 50X Program Sequencer” on page 92.

The following bits are used with this parameter:

Bit 0-2 = Speed Sel
Bit 3 = Accl Sel
Bit 4-6 = Event Length
Bit 7-8 = Dir Sel
Bit 9-10 = Output Sel

951 Seq Count 1 952 Seq Count 2 953 Seq Count 3 954 Seq Count 4 955 Seq Count 5 956 Seq Count 6 957 Seq Count 7 958 Seq Count 8 959 Seq Count 9	Default: 0	Range: 0-65535 Level 2 (SEQ)
--	------------	---------------------------------

These parameters configure the time, number of pulses, or analog level of sequencer steps 1 through 9, respectively. See “Using the Vacon 50X Program Sequencer” on page 92.

7.4 Using the Vacon 50X Program Sequencer

The Vacon 50X AC drive offers functionality that allows users to program up to nine independent operation states of the drive. This functionality is called the “program sequencer” because it allows the drive to sequence through the operation states programmed by the user. The Vacon 50X Program Sequencer can be used in applications that would normally require external intelligence, such as a simple programmable logic controller.

7.4.1 Enabling the Vacon 50X Program Sequencer

The Vacon 50X Program Sequencer can be enabled with parameter 491 (Seq Appl), found in the Application Macro programming mode of the Vacon 50X keypad. This parameter configures:

- Whether the sequencer is enabled,
- The time base used for all timing of the sequencer,
- Whether other sequencer parameters are visible in Level 2 programming.

Table 2 shows the options for this parameter:

Options	Value	Meaning
Disabled	0	The Sequencer mode of the Vacon 50X is not active and the sequencer parameters are not visible in Level 2 programming.
1 sec base	1	The Sequencer mode of the Vacon 50X is active, sequencer parameters are visible in Level 2, and all timing for the sequencer will be on a 1-second base.
0.1 sec base	2	The Sequencer mode of the Vacon 50X is active, sequencer parameters are visible in Level 2, and all timing for the sequencer will be on a .1-second base.
0.01 sec base	3	The Sequencer mode of the Vacon 50X is active, sequencer parameters are visible in Level 2, and all timing for the sequencer will be on a .01-second base.

Table 24:Seq Appl Parameter Options

7.4.2 Controlling the Vacon 50X Program Sequencer

The Program Sequencer can be activated and controlled from either the keypad or the terminal strip. It is not possible to control the sequencer through the serial link. The control method of the program sequencer is determined by parameter 201, Input Mode. Setting the Input Mode parameter also allows switching from Sequencer mode to normal keypad operation by way of the Local/Remote switch. Table 3 illustrates possible program sequencer control configurations.

Input Mode Setting	Input Mode Value	Local Operation	Remote Operation
Local Only	0	Sequencer control via keypad (FWD/Stop). Default Seq Ref is keypad	N/A
Remote Only	1	N/A	Seq control via FWD terminal. Default Seq Ref is “Ref Select”
L/R Rem Ref	2	Normal Vacon 50X keypad operation (Sequencer disabled)	Seq control via keypad (FWD/ Stop). Default Seq Ref is “Ref Select”
L/R Rem Ctl	3	Normal Vacon 50X keypad operation (Sequencer disabled)	Seq control via FWD terminal. Default Seq Ref is keypad
L/R Rem Bth	4	Normal Vacon 50X keypad operation (Sequencer disabled)	Seq control via FWD terminal. Default Seq Ref is “Ref Select”
EMOP	5	Sequencer not enabled	Sequencer not enabled
EMOP2	6	Sequencer not enabled	Sequencer not enabled
LOC/EMOP	7	Sequencer not enabled	Sequencer not enabled
LOC/EMOP2	8	Sequencer not enabled	Sequencer not enabled

Table 25:Program Sequencer Control Configuration

NOTE: If Input Mode is configured to any of the EMOP options, the sequencer is not available.

Keypad Control (Activation) of the Vacon 50X Program Sequencer

When activating or controlling the Vacon 50X Program Sequencer from the keypad, pressing the FWD key commands the drive to cycle through the programmed states of the sequencer one time only (oneshot operation). One-shot operation will run the sequencer until state 9 is reached, or until any state that is not changed from the default is reached.

Pressing the SHIFT and FWD keys simultaneously causes the programmed sequence to repeat until the Stop key is pressed (continuous operation). In continuous mode, the sequencer runs until state 9 or any state that is not changed from the default is reached; it then jumps back to state 1.

Note that the REV key has no function in the sequencer mode.

Terminal Control of the Vacon 50X Program Sequencer

When activating or controlling the Vacon 50X Program Sequencer from terminals, continuous and one-shot operation is determined by whether the drive is wired for 2-wire or 3-wire control. If the terminal is set up for 2-wire control, the sequencer operates in continuous mode (R/J terminal inactive). This will run the sequencer until the Forward command is removed. If the terminal is set up for 3-wire control, the sequencer runs one cycle when the FWD terminal is activated.

Note that the REV terminal has no function in sequencer mode.

Vacon 50X Sequencer Dwell Functionality

The Vacon 50X sequencer has the capability to dwell, or pause, in a state and disregard any command to advance to the next state. This can be done in two different ways, and both methods can be used at the same time.

If the sequencer is actively running and the Enter key is pressed from the Operate screen of the Vacon 50X keypad, the sequencer will dwell in the current state (it will never advance to the next state). While the sequencer is dwelling, a warning of "Seq Dwell" will flash on the Operate screen. To leave the dwell state, press the Enter key again from the Operate screen.

The sequencer Dwell mode can also be entered by programming a digital input to "Seq Dwell." The sequencer will then dwell in the current state, for as long as the digital input is active.

Vacon 50X Sequencer Advance Functionality

The sequencer has the ability to allow the user to advance to the next state without satisfying the conditions programmed to advance. To do this, program a digital input to "Seq Advance." When a digital input program to this option changes from inactive to active, a running sequencer will advance one state. This feature is useful when debugging a sequence with long time intervals.

7.4.3 Sequencer State Configuration Overview

Each state of the program sequencer is defined by five characteristics:

- Direction in which the drive will operate
- Speed at which the drive will operate
- Ramp selection of the drive
- Output configuration (relays and digital outputs) of the drive
- How the sequencer advances to the next state.

These five characteristics are configured by two parameters for each state. These parameters are named "Seq Cntl X" and "Seq Count X," where X represents the state number of the sequencer. The "Seq Cntl X" parameter is a binary parameter that sets each of the five characteristics listed above. "Seq Count X" configures the threshold that the sequencer will use in determining when to advance by the

method programmed in the control parameter. The bit patterns of the Seq Cntl X” parameters are shown in Table 4:

Table 26:Seq Cntl Parameter, Bit Definition

10	9	8	7	6	5	4	3	2	1	0		Bit number
0	0	0	0	0	0	0	0	0	0	0		Program data
Bit	Description											
10 9	Output Configuration: 00 - SeqOut-00 01 - SeqOut-01						10 - SeqOut-10 11 - SeqOut-11					
8 7	Direction Selection: 00 - Stopped 01 - Forward						10 - Reverse 11 - DC Inject					
6 5 4	State Duration: 000 - Time Base 001 - Pulse Count (Vin1) 010 - Low Volt Thres (Vin2) 011 - High Volt Thres (Vin2)						100 - Low Curr Thres (Cin) 101 - High Curr Thres (Cin) 110 - DI Compare 111 - Never Advance					
3	Ramp Selection: 0 - Accel/Decel Time 1						1 - Accel/Decel Time 2					
2 1 0	Speed Selection: 000 - Default Setpoint 001 - Preset Speed 1 010 - Preset Speed 2 011 - Preset Speed 3						100 - Preset Speed 4 101 - Preset Speed 5 110 - Preset Speed 6 111 - Max Frequency					

Vacon 50X Sequencer Speed Selection

Table 5 gives more information on the speed selection options available in the Vacon 50X sequencer by programming bits 0, 1, and 2 of each state’s control parameter. The options include any Preset Speed, MaxFrequency, or allowing the reference to be determined in the normal Vacon 50X control path.

Binary Value	Definition (Resulting Speed)
000	Speed selection as in normal Vacon 50X operation, as defined by parameters 204 (Ref Select) and 201 (Input Mode).
001	Value of parameter Preset Speed 1 {303}.
010	Value of parameter Preset Speed 2 {304}.
011	Value of parameter Preset Speed 3 {305}.
100	Value of parameter Preset Speed 4 {306}.
101	Value of parameter Preset Speed 5 {307}.
110	Value of parameter Preset Speed 6 {308}.
111	Value of parameter Max Frequency {302}

Table 27:Speed Selection Options

Vacon 50X Sequencer Ramping Selection

When the sequencer is active, the active ramp is no longer determined by parameter “Ramp Select.” The user, however, does have the choice of using the main ramps (Accel Time 1/Decel Time1), or the alternate ramps (Accel Time 2/Decel Time 2) for each independent state. This is determined by bit 3 of the control parameter. If bit 3 is set to 1, then the alternate ramps are used (Accel Time 2/Decel Time 2).

Sequencer Output Configuration

The Vacon 50X Program Sequencer allows digital outputs to be activated during states of the sequencer. This function could be used to activate other devices in a system or to signal to an operator when a part of the sequence is active. The user sets the digital output by setting bits 9 and 10 of the control parameter with a binary value, and then sets a digital output parameter with the option for that same binary value. For example, if a control state was output configured for a binary value of 11, then any digital output configured to "SeqOut-11" would be activated during that time.

Sequencer Direction Selection

The sequencer allows each state to be configured as running Forward, Reverse, Stopped, or DC Injected by setting bits 7 and 8 of the control parameters.

Sequencer State Duration

Bits 4, 5, and 6 of each sequencer control parameter specify how that step will allow advancement to the next step. The options for advancement are time, pulse input, voltage threshold, current threshold, or digital input comparison. After the advancement method is selected with these bits, the threshold of advancement is determined by the state's count parameter (see the next paragraph).

Sequencer State Advance Threshold (via Count Parameter)

The sequencer count parameters work in conjunction with the state duration configuration in the control parameter to determine when to advance to the next state. The function of this parameter is dependent on the state duration configuration as defined in Table 6 on page 96. The range of data programmed into this parameter can be from 0 to 65,535, and can represent time, pulse counts, analog voltage thresholds, analog current thresholds, or digital comparison values.

Bits 4, 5, 6 of Seq Cntl	Description of Seq Count Function				
000	Time Base – The current sequencer state will last for a time interval equal to the number "Seq Count X" multiplied by the time base configured in the Seq Appl parameter.				
	Seq Appl Setting	Time to Advance		Maximum Sequence Time	
	1 sec Base	(1 sec) * [Seq Count X]		18.2 hours	
	.1 sec Base	[0.1 sec] * [Seq Count X]		1.82 hours	
	0.01 sec Base	[0.01 sec] * [Seq Count X]		10.92 minutes	
001	Pulse Count – The current sequencer state will last until the number of pulses programmed into "Seq Count X" is detected on terminal Vin1.				
010	Low Analog Voltage Threshold – The active sequencer state lasts until the voltage signal applied to terminal Vin2 is < a value programmed into "Seq Count X." The value programmed into "Seq Count X" should be the percentage of input after span and offset are applied (where 100.00% = 10000). Note: The % of analog input after span and offset can be read in parameter 912, Vin2 Status.				
011	High Analog Voltage Threshold – The active sequencer state lasts until the voltage signal applied to terminal Vin2 is > a value programmed into "Seq Count X." The value programmed into "Seq Count X" should be the percentage of input after span and offset are applied (where 100.00% = 10000). Note: The % of analog input after span and offset can be read in parameter 912, Vin2 Status.				
100	Low Analog Current Threshold – The active sequencer state lasts until the current signal applied to Cin terminals is < a value programmed into "Seq Count X." The value programmed into "Seq Count X" should be the percentage of input after span and offset are applied (where 100.00% = 10000). Note: The % of analog input after span and offset can be read in parameter 911, Cin Status.				
101	High Analog Current Threshold – The active sequencer state lasts until the current signal applied to Cin terminals is > a value programmed into "Seq Count X." The value programmed into "Seq Count X" should be the percentage of input after span and offset are applied (where 100.00% = 10000). Note: The % of analog input after span and offset can be read in parameter 911, Cin Status.				
110	Digital Comparison – The active sequencer state lasts until the binary value of digital inputs configured to Seq1, Seq2, and Seq3 is equal to the value programmed into "Seq Count X." Note: For this option to work, "Dlx Configure" parameters must be set to "Seq1," "Seq2," and "Seq3."				
	Seq Count	Digital Input Terminals			Description
		Seq1	Seq2	Seq3	
	0	0	0	0	No input active
	1	1	0	0	Seq1 active
	2	0	1	0	Seq2 active
	3	1	1	0	Seq1 & Seq2 active
	4	0	0	1	Seq3 active
	5	1	0	1	Seq1 & Seq3 active
6	0	1	1	Seq2 & Seq3 active	
7	1	1	1	Seq1, Seq2, Seq3 active	
111	The sequencer will never advance if this option is selected.				

Table 28:Seq Count Definition Based on Cntl Parameter Configuration

7.4.4 Sequencer Status Indicators

When the sequencer is enabled, the control path indication field on the keypad will indicate SQx, where x represents the active state of the sequencer. A sample operate screen (where the sequencer is in state 1) is shown below:

S	Q	1	:					S	t	o	p	e	d	
				0	.	0	H	z				+	0	%

When the sequencer is running, a warning, "Seq Running," will flash on the screen to indicate that the drive control state may change without user input. For example:

S	Q	1	:					S	t	o	p	p	e	d		S	Q	1	:	S	e	q		R	u	n	n	i	n	g		
				0	.	0	H	z						+	0	%					0	.	0	H	z					+	0	%

When the sequencer is dwelling (pausing) in a state, a warning, "Seq Dwell," will flash on the screen to indicate that the sequencer will not advance. For example:

S	Q	1	:					S	t	o	p	p	e	d		S	Q	1	:			S	e	q		D	w	e	l	l		
				0	.	0	H	z						+	0	%					0	.	0	H	z					+	0	%

7.4.5 Sample Sequencer Program

A machine is required to run in the forward direction at 50 Hz for one hour, then quickly decelerate to a stop. While stopped, a digital output must be enabled to sound an alarm to an operator. After two minutes, the machine must accelerate in the reverse direction to 5 Hz until a limit switch is activated, causing the drive to decelerate to a stop. The following three sequential states can be programmed using only the drive:

	State 1	State 2	State 3
Direction Selection	Forward	Stop	Reverse
Speed Selection	50 Hz	Zero speed	5 Hz
Ramp Selection	Primary	Alternate	Primary
Output Configuration	SeqOut-00	SeqOut-01	SeqOut-10
State Duration	1 hour	2 minutes	Until DI active

Table 29: Sample Sequencer Program Requirements

First, since two of the sequential states are time-based, the proper setting of the "Seq Appl" parameter must be determined. Since there is not time required that has resolution needed of less than one second, the "1 sec Base" option is the easiest to use. If greater resolution is needed (for example, if a state needed to last for 2.5 seconds), another option should be chosen.

Since the sequence requires use of a digital input and a digital output, two non-sequencer parameters need to be used. Set the parameter "DI1 Configure" to "Seq1" and the parameter "DO1 Configure" to "SeqOut-01."

Since control of the sequencer is only needed from the keypad, the configuration of the "Input Mode" parameter should be "Local Only."

Required parameter modifications for this program are provided in Table 30, with explanations.

Parameter	Value	Explanation
Seq Appl	1 sec Base	Sets 1 second time increments
DI1 Configure	Seq1	Allows DI1 to end state 3
DO1 Configure	SeqOut-01	Allows DO1 to be active in state 2
Preset Speed 1	5 Hz	Speed for state 3
Preset Speed 6	50 Hz	Speed for state 1
Seq Cntl1	00010000110	No outputs/FWD/Timed/Primary Ramp/Preset Speed 6
Seq Count 1	3600	1 hour = 3600 seconds
Seq Cntl 2	01000001000	Enable Output/Stop/Timed/Alt Ramp/Speed Ignored
Seq Count 2	120	2 minutes = 120 seconds
Seq Cntl 3	00101100001	No outputs/REV/DI Value/Primary Ramp/Preset Speed 1
Seq Count 3	1	Seq1 active

Table 30: Required Parameter Settings for Sample Sequencer Program

Worksheet for Sequencer Program Setup

Step	Output Configuration		Direction Selection		State Duration		Ramp Selection	Speed Selection	
1									
2									
3									
4									
5									
6									
7									
8									
9									
10									

8. Troubleshooting

8.1 Vacon 50X Fault Codes

Table 1 shows the fault codes that may be displayed during Vacon 50X AC drive operation, along with suggestions for recovering from the fault condition.

When faults occur, you can access the status parameters that are saved along with the fault (Advanced Fault history). To view these parameters, which store the drive's status at the time of the fault, view Fault History, and select Last Fault. Press the Shift key while viewing the last fault, and then use the UP and DOWN arrow keys to scroll through the stored drive status parameters. Press the Shift key again to return to the programming mode fault parameter.

Code	Fault Display	Description	Adv. Fault Code	Explanation	Suggestions for Recovery
1	System	System fault	0, 1, 2	Internal microprocessor problem	Consult factory for repair or replacement.
			3	Thermistor profile incorrect	Consult factory for repair or replacement.
2	EE Checksum	Checksum error	0	Memory problem when re-flashing the drive's memory	Reset drive to factory settings. Consult VACON.
			1, 2, 3	Conflict in drive's memory	Reset drive to factory settings. Consult VACON.
			4	Unable to write an EE parameter after a parameter has been changed through the keypad or SIO	Reset drive to factory settings. Consult VACON.
			5	The drive is receiving EE write requests faster than they can be processed. This would typically be caused by writing parameters too frequently through Modbus.	Slow down the frequency of Modbus writes.
3	Curr Calibr	Current calibration fault	0	Current calibration fault on phase T1/U	Check the motor connections to the terminal strip of the drive and at the motor. Have motor checked. Consult VACON for repair or replacement of drive.
			1	Current calibration fault on phase T2/V	
			2	Current calibration fault on phase T3/W	
4	Power Supp	Power supply fault	0	5 V supply is below 4 Vdc for more than 100 ms	Increase resistance between REF and analog inputs. Check wiring to REF terminals. Consult VACON.
6	IOC Trip	Instantaneous overcurrent trip	0	Short circuit was detected on power-up	Remove the short from the power wiring. Check for shorted motor. Consult VACON.
			1	Short circuit was detected during operation	
7	MOL	MOL contact fault	0	The MOL digital input was activated, depending on pull-up or pull-down logic configuration	Reset MOL contact or remove condition causing the MOL contact activation.
8	Model ID	ID # out of range	0, 1, 2	Control board is not reading the drive ID properly	Consult VACON for repair or replacement.
10	Res Lock-out	Restart lockout	0	The number of fault restarts is greater than the limit defined in the customer parameter.	Check the actual fault in the fault log and use the appropriate remedy.
11	Ground	Ground fault	0	The drive has detected current imbalance between output phases. Imbalance determined to be current flow to ground.	Check for unbalanced currents. Check for grounded motor leads or motor. Consult VACON.

Note: Shaded faults are auto-resettable, except where noted.

Table 31:Vacon 50X Fault Codes

Code	Fault Display	Description	Adv. Fault Code	Explanation	Suggestions for Recovery
12	Vac Im-balance	Input voltage imbalance	0	The drive has detected a singlephase condition or a voltage imbalance outside the drive's rating while running a load that could be damaging to the drive.	Check input voltage and current for imbalance, and correct.
13	OverVoltage	Overvoltage condition	0	The drive has detected an overvoltage condition during power-up (not auto-resettable).	Verify incoming line power is within specification. Add reactor or transformer to correct.
			1, 3	The drive has detected an overvoltage condition during a running condition.	Verify incoming line power and check for regenerative load. Reduce Regen load or add dynamic braking resistors. Regen Current Limit may help; consult VACON.
			2	The drive has detected an overvoltage condition on power-up on the load side.	Verify incoming line power is within specification. Add reactor or transformer to correct.
15	Dyn Brake	Dynamic brake overload	0	The DB circuit is active on power-up (not auto-resettable)	Check for failed braking transistor. Consult VACON.
			1	The DB circuit is being activated for too long, possibly causing the resistor to overheat or fail.	Reduce braking cycle or increase capacity. Activate current limit; consult VACON.
			2	The DB circuit is overloaded because of too large a regenerative load.	Reduce braking cycle or increase capacity. Activate current limit; consult VACON.
			3, 4, 5	The DB circuit is faulty on power-up (not auto-resettable).	
18	OverCurrent	Overcurrent condition	0	The drive sensed an overcurrent condition on power-up (not auto-resettable).	Check for failed output power device or shorted motor.
			1	The drive sensed an overcurrent condition during operation. The current has exceeded the safe operation point of power devices.	Reduce load on motor. Verify that Motor FLA is programmed correctly. Check for mechanical binding and shock loading.
19	OverTemp	Over-temperature condition	0	The temperature of the heatsink exceeded a temperature limit.	Check that ambient temperature does not exceed drive's rating. Check for fan operation (assuming drive has fans installed).
			1	The temperature of the control board exceeded a temperature limit.	Check that ambient temperature does not exceed drive's rating. Check for fan operation (assuming drive has fans installed).
			2	The drive sensed the heatsink thermistor sensor is faulty or not connected properly.	Check thermistor connections or replace. Consult VACON.
			3	The drive sensed the control board thermistor sensor is faulty or not connected properly.	Check thermistor connections or replace. Consult VACON.
20	Motor TOL	Motor timed overload trip	0	The drive detected an overload that exceeds the customer's defined overload setting.	Check load current demand. Verify Motor FLA is programmed to the correct value. Verify TOL characteristic is correct for the application.
21	Low Temp	Low temperature	0	This fault occurs if the temperature of the heatsink falls below -10.0 degrees C.	Verify that ambient temperature is within the drive's specifications; increase the ambient temperature if necessary.

Note: Shaded faults are auto-resettable, except where noted.

Table 31:Vacon 50X Fault Codes

Code	Fault Display	Description	Adv. Fault Code	Explanation	Suggestions for Recovery
22	Ref Loss	Speed reference loss	0	The drive detected the analog input was configured to fault if the input current went below the level specified by customer parameters.	Check physical connections for reference signal. Check that programming for 4–20 mA signal is correct. Verify that signal to the drive is correct.
23	Brk Wire	Broken wire detection	0	The drive detected that the potentiometer circuit wiring opened and generated a fault.	Check wiring for loss of connection to control terminals. Check that a proper-value potentiometer is installed.
24	Keypad Loss	Keypad loss	0	This fault occurs because of a problem with the keypad or a keypad connection. It occurs if the drive detects that it cannot read any key presses.	Check the connection from keypad to control board. Note that the keypad is not designed for remote mounting.
			1	This fault occurs because of a problem with the keypad, a keypad connection, or the wrong keypad is being used. It occurs if the keypad ID for an Vacon 50X cannot be read.	
			2	This fault occurs because of a problem with the keypad or a keypad connection. It occurs if the drive detects that it cannot write to the LCD.	
25	Comm Loss	Communication loss	0	This fault occurs when the drive is in a serial link control path and the amount of time since the last Modbus comm. exceeds the time set in parameter 903 [SIO Timer].	Check connections to the Modbus port. Adjust value of parameter 903 [SIO Timer] as needed.
26	Regen Time	Regen timeout	0	This fault occurs if the drive takes more time to decelerate to a stop than is allowed. The timeout is determined by the longest deceleration ramp time [Decel1 or Decel2] plus the Regen Timeout parameter.	Reduce the amount of regenerative energy or increase the Regen timeout parameter.
27	Pwr Bridge	Power bridge fault	0, 1, 2	The drive detected a failure in the output power devices.	Check for failed input power device.
28	Drive TOL	Drive timed overload	0	The drive sensed an overload that exceeded the drive rating.	Check that load conditions do not exceed the drive's rating (120% for 60 seconds from nameplate current rating for normal duty and 150% or rated current for 60 seconds heavy duty).
29	Stuck Key	Stuck key error	0	This fault occurs if a key press is detected upon power-up. This would occur because of a defective keypad or because someone was holding down a key when powering-up the drive.	Check for stuck keypad and repair or replace. Consult VACON.
30	Param Range	Parameter out of range	0	One of the customer parameters is out of range.	Check for a parameter value saved out of the standard range. Reset parameters to factory default. Consult VACON.
Note: Shaded faults are auto-resettable, except where noted.					

Table 31:Vacon 50X Fault Codes

Code	Fault Display	Description	Adv. Fault Code	Explanation	Suggestions for Recovery
31	Pwr Wiring	Power wiring error	0	This fault flags a problem with the drive wiring.	Check that input power wiring is not connected to load power terminals. Consult VACON.
			1	This fault can occur if an IOC fault is detected during the power wiring test.	
32	Low Voltage	Low voltage trip	0	This fault occurs if a power dip occurs when the drive is operating, and the drive is not able to ride through the power dip before shutting off outputs.	Verify that input line power is within the drive's specifications. Add a transformer or reduce demands to power feed. Consult VACON.
33	1Ph Overload	1Ph overload	0	If the user configures parameter 517 (Single Phase) for singlephase operation, this fault occurs if the bus voltage ripple is outside the limit of the drive.	Check that input power demand does not exceed the drive's capacity for single-phase operation. Consult VACON.
34	RS Meas. Fail	Stator resistance measurement failed	0	If the drive cannot measure the stator resistance properly, this fault occurs.	Try the routine again and if the fault occurs twice, consult VACON.
35	Fan Loss	Loss of fan control or operation	0	There is a problem with the heat sink fan.	Consult VACON.
			1	There is a problem with the internal fan. This occurs only on Size 4 and 5 models. All other models display a fan error warning. Note that this is lack of fan control, so the fan can be spinning and this fault will still occur. This can happen if the fan is on and should not be, or if the fan feedback signals are obstructed from getting to the control board.	
Note: Shaded faults are auto-resettable, except where noted.					

Table 31:Vacon 50X Fault Codes

9. Hexadecimal to Binary Conversion

The Vacon 50X AC drive utilizes hexadecimal numbers to display and store the binary values of some parameters. These parameters are read and written as four-digit hexadecimal values. The hexadecimal values are then translated to binary values, with the binary values being compared to the "key" provided for each parameter to determine what status is shown or what action is commanded.

The following table shows the sixteen hexadecimal values and the corresponding binary values. The binary values are divided into four columns so you may more readily see which bits of the status or control words are affected by the binary values.

Hexadecimal Value	Binary Value			
0	0	0	0	0
1	0	0	0	1
2	0	0	1	0
3	0	0	1	1
4	0	1	0	0
5	0	1	0	1
6	0	1	1	0
7	0	1	1	1
8	1	0	0	0
9	1	0	0	1
A	1	0	1	0
B	1	0	1	1
C	1	1	0	0
D	1	1	0	1
E	1	1	1	0
F	1	1	1	1
	15	14	13	12
	11	10	9	8
	7	6	5	4
	3	2	1	0
Corresponding Bit Positions of Parameter Words				

10. Fundamentals of PI Control

10.1 Introduction

The Vacon 50X AC drive has a built-in PI (Proportional-Integral) Controller that makes it possible to control a process by adjusting motor speed using a reference input and a feedback input. When the drive is configured to operate with feedback from a transducer, the Vacon 50X AC drive essentially ceases to be a frequency controller and instead becomes a process controller.

Several Vacon 50X parameters are specifically designed for PI control. These include:

- 490 (Appl Macro)
- 850 (PI Configure)
- 851 (PI Feedback)
- 852 (PI Prop Gain)
- 853 (PI Int Gain)
- 854 (PI Feed Gain)
- 855 (PI Error 1)
- 856 (PI Error 2)
- 857 (PI High Corr)
- 858 (PI Low Corr)

The function performed by each of these parameters is described in the following section. Figure 22 on page 108 provides a flowchart of PI control and shows the interaction of these parameters.

10.2 Configuration of PI Control Parameters

This section discusses the parameters used for PI control and provides advice on how best to configure these parameters for your particular application.

10.2.1 Parameter 490 (Appl Macro)

Parameter 490 (Appl Macro) is used to activate the PI mode for either a Fan with PI or Pump with PI application.

10.2.2 Parameter 857 (PI High Corr) and 858 (PI Low Corr)

These two parameters define the correction limits for the drive's response to a change in, or loss of, the feedback signal.

10.2.3 Parameter 852 (PI Prop Gain)

Parameter 852 (PI Prop Gain) is the proportional feedback gain for the process control loop. It determines the overall effect on the process for an incremental change in the feedback signal.

Generally, when configuring this parameter, you must observe the drive's response to an incremental change in the feedback input, and then decide if this response is sufficient.

For example, if the feedback input changes 1 V (or 1 mA), what is the drive's response? Is it enough or too much?

10.2.4 Parameter 853 (PI Int Gain)

Parameter 853 (PI Int Gain) is the integral feedback gain for the process control loop. This parameter determines the short-term effects of a change in the feedback signal.

Generally, when configuring this parameter, you must observe the drive's response to an incremental change in the feedback input over a certain length of time, and then decide if this response is acceptable.

For example, if the feedback input changed 1 V (or 1 mA) for 5 seconds, what is the drive's response? Is it acceptable? Would you prefer to have the drive ignore a change over such a short time period, but still react to longer time durations (say, 8 to 10 seconds)? (If so, decreasing the integral gain by reducing the value for parameter 853 would have that effect.)

10.2.5 Parameter 854 (PI Feed Gain)

Parameter 854 (PI Feed Gain) is the feedback scaling factor. It is used to scale the signal supplied by the transducer — thereby optimizing the effect of the signal on the drive.

10.2.6 Parameter 850 (PI Configure)

Parameter 850 (PI Configure) determines the characteristics of the process control loop – direct-acting or inverse-acting (also known as reverse-acting), the rate of response (fast or slow), whether feed-forward is enabled, and whether the loop is operated via digital inputs. The following paragraphs discuss each of these characteristics in more detail:

- Direct- or inverse-acting loop

In a direct-acting loop, as the process speed increases, the feedback signal will decrease and cause a corresponding decrease in the process speed as it approaches the regulation point. This type is typically employed in pump applications where the level control is the process variable.

Conversely, in an inverse-acting loop, as the process speed increases, the feedback signal increases but causes a corresponding decrease in the process speed as it approaches the regulation point. This type is typically employed in supply pump applications where the pressure is the process variable.

- Slow or fast rate of response

A slow rate of response (over 10 s, usually) is most often selected for processes with long time constraints (for example, thermal and fluid level controls). On the other hand, a fast response rate is utilized for processes with short time constraints (such as mechanical systems and pressure loops). Most industrial systems require a slow rate of response.

- Whether feed-forward is enabled

Feed-forward is usually enabled when there is very little difference between the process speed and the feedback signal.

For example, feed-forward is useful in "speed regulation" situations, such as controlling motor speed in a closed loop. Note that feed-forward should be enabled when attempting to close a speed loop.

Feed-forward is not suited to applications such as pressure regulation systems because generally the process speed and the process variable are vastly different.

- Whether PI control is enabled via a digital input

A digital input, when properly configured via the corresponding parameter, may be used to toggle PI control.

Generally, a digital input is used when the process will be operated as both a closed and an open loop and/or when circumstances may arise where you would want to override the process speed as determined by the process variable and reference.

Remember: to complete the implementation, you must configure a digital input separately to invoke PI control.

10.3 Tuning the PI Control Loop

Once the parameters are initially configured, you should tune them so the process control loop operates as optimally as possible. To make tuning easier, the following recommendations should be observed:

- If your application does not require enabling by digital input, for the duration of tuning you should select a value for parameter 850 (PI Configure) which does allow a digital input to enable PI control. Once tuning is finished, you can restore the parameter to its original value.
- Install a switch to select closed loop and open loop performance.
- Connect a calibration signal to the drive to simulate the effects of the transducer's signal. While this is not absolutely required, it can be very helpful.

Once the preparations for tuning are complete, enable PI control via the digital input and set the switch to open loop. Then operate the drive, utilizing any necessary instrumentation (for example, pressure gauges, meters, etc.) to characterize the range of the signal supplied from the transducer (for example, at 3 PSI, the transducer provides 1 V). This will aid in better understanding the operation of the system and make calibration easier.

Select a mid-range operating point for the system and inject a signal close to that which the transducer would provide at that point. Vary the signal by the value determined by the set-up technician and determine whether the proportional response of the system is appropriate. If the questions posed in the previous section are answered correctly and your initial assumptions prove correct, a combination of input scaling and proportional gain should make the performance match the system.

Next, examine the transient or short-term effects that are common on all realworld systems. Use the calibrator to change the feedback signal by some value for a measured interval, with the value and duration approximating the real system.

For example, say 1 V for 5 seconds was selected. By monitoring parameter 856 (PI Error 2), the effect of the feedback signal may be observed. The value of this parameter should increase and then settle back to zero, or perhaps go below zero (negative). The value of the parameter may go positive and negative a number of times as a response to repeated 5 second transients. Tune parameter 853 (PI Int Gain) to optimize this effect to suit the circumstances.

Finally, put the transducer into the circuit and review the results. The results will likely show that the value of parameter 853 (PI Int Gain) needs to be modified to complete the implementation. Minor adjustment of the other PI control parameters may also be necessary.

Once the process control loop is optimally functioning, if you changed the value of parameter 850 (PI Configure) for tuning, restore it to its original value.

If you need further assistance or advice, please contact VACON. [See the inside front cover of this manual for information on how to contact technical support.]

11. EU Declaration of Conformity

Vacon, Inc.
440 North Fifth Avenue
Chambersburg, PA 17201 USA

hereby declare that the products:

Product Name: Vacon 50X Series

Model Numbers:

0004 2, 0007 2, 0010 2, 0015 2, 0022 2, 0028 2, 0042 2, 0054 2, 0068 2, 0002 5, 0004 5, 0005 5,
0009 5, 0012 5, 0016 5, 0023 5, 0031 5, 0037 5, 0043 5, 0061 5, 0071 5, 0086 5, 0105 5, 0140 5, 0168 5,
0205 5, 0240 5, 0002 6, 0003 6, 0004 6, 0006 6, 0009 6, 0011 6, 0017 6, 0022 6, 0027 6, 0032 6, 0041 6, 0052
6, 0062 6, 0077 6, 0099 6, 0125 6, 0144 6, 0192 6

have been designed and manufactured in accordance with standards:

Low Voltage Directive: EN50178

Electronic equipment for use in power installations

Electromagnetic compatibility: EN61800-3

Adjustable speed electrical power drive systems – Part 3:

EMC product standard including specific test methods

The products referenced above are for the use of control of the speed of AC motors.

The use in residential and commercial premises (Class B) requires an optional WLF series filter.

Via internal mechanisms and Quality Control, it is verified that these products conform to the requirements of the Directive and applicable standards.

Chambersburg, PA, USA – 31. May 2007



Frank H. Custis
Marketing Manager
Electronics Division

12. Summary of Vacon 50X Parameters

12.1 Default Settings

No.	Parameter Name	Options	Default	User Setting	See Page
001	Model Number	Model Dependent	Read-only		60
002	Software Rev	0.00-99.99	Read-only		60
003	Rated Current	0.0-200.0 A	Read-only		60
005	Serial No. 1	0-65535	Read-only		60
006	Serial No. 2	0-65535	Read-only		60
010	Last Fault	text string	Read-only		60
025	4th Fault	text string	Read-only		60
040	3rd Fault	text string	Read-only		60
055	2nd Fault	text string	Read-only		61
070	1st Fault	text string	Read-only		61
102	Output Freq	0.0-400.0 Hz	Read-only		61
103	Output Voltage	0-600 V	Read-only		61
104	Output Current	0.0-200.0 A	Read-only		61
105	Drive Load	-200.0-200.0%	Read-only		61
106	Load Torque	-200.0-200.0%	Read-only		61
107	Drive Temp	-20.0-200.0 °C	Read-only		61
108	Total Run Time	0.0-6553.5 h	Read-only		61
109	Power On Hours	0-65535 h	Read-only		62
110	Stator Freq	0.0-400.0 Hz	Read-only		62
111	DC Bus Voltage	0-1000 Vdc	Read-only		62
115	Drive Power Out	0.0-200.0%	Read-only		62
201	Input Mode	text string	Local Only		62
202	Rev Enable	text string	Forward		63
203	Stop Key Remote	text string	Coast		63
204	Ref Select	text string	Vin1		63
205	Vin1 Config	text string	0-10V		64
206	Vin1 Offset	0.0-100.0%	0.00%		64
207	Vin1 Span	10.0-200.0%	100.00%		64
208	Cin Config	text string	0-20mA 50		64
209	Cin Offset	0.0-100.0%	0.0%		65
210	Cin Span	10.0-200.0%	100.0%		65
211	Vin2 Config	text string	0-10V		65
212	Vin2 Offset	0.0-100.0%	0.00%		65
213	Vin2 Span	10.0-200.0%	100.00%		65
214	Vin1 Filter Time	0-1000 ms	20 ms		66
215	Cin Filter Time	0-1000 ms	20 ms		66
216	Vin2 Filter Time	0-1000 ms	20 ms		66
217	Trim Ref Enable	text string	Disabled		66
218	Trim % Factor	-100.0 to 100.0%	0.0%		66
222	Ref Loss Fault	text string	Disabled		66
301	Min Frequency	0.0-Max Freq.	0.0 Hz		67
302	Max Frequency	20.0-400.0 Hz	60.0 Hz		67
303	Preset Freq 1	Min Freq-Max Freq	5.0 Hz		67

No.	Parameter Name	Options	Default	User Setting	See Page
304	Preset Freq 2	Min Freq–Max Freq	10.0 Hz		67
305	Preset Freq 3	Min Freq–Max Freq	20.0 Hz		67
306	Preset Freq 4	Min Freq–Max Freq	30.0 Hz		67
307	Preset Freq 5	Min Freq–Max Freq	40.0 Hz		67
308	Preset Freq 6	Min Freq–Max Freq	50.0 Hz		67
309	Cut-Off Freq	0.0–5.0 Hz	0.0 Hz		67
401	Ramp Select	text string	(Size 0–4): ART-D (Size 5): S-Curve		67
402	Accel Time 1	0.1–3200.0 sec	5.0 sec		68
403	Decel Time 1	0.1–3200.0 sec	5.0 sec		68
404	Accel Time 2	0.1–3200.0 sec	3.0 sec		68
405	Decel Time 2	0.1–3200.0 sec	3.0 sec		69
406	DC Inject Config	text string	DC at Stop		69
407	DC Inject Time	0.0–5.0 sec	0.2 sec		69
408	DC Inject Level	0.0–100.0%	50.0%		69
409	DC Inj Freq	0.0–20.0 Hz	0.0 Hz		70
410	DB Config	text string	Internal		70
414	S Ramp Rounding	1–100%	25%		70
490	App Macro	text string	Factory		50
491	Seq Appl	text string	Disabled		50
492	SIO Visible	text string	No		50
501	V/Hz Select	text string	Linear Fxd		71
502	Voltage Boost	0.0–50%	1.0%		72
503	V/Hz Knee Freq	25.0–400.0 Hz	60.0 Hz		72
504	Skip Freq Band	0.2–20.0 Hz	0.2 Hz		72
505	Skip Freq 1	Min Freq–Max Freq	0.0 Hz		72
506	Skip Freq 2	Min Freq–Max Freq	0.0 Hz		72
507	Skip Freq 3	Min Freq–Max Freq	0.0 Hz		72
508	Skip Freq 4	Min Freq–Max Freq	0.0 Hz		72
509	Rated Mtr Volt	100V–690V	Model Dependent		73
510	Rated Mtr FLA	50%–200% of ND Rating	ND Rating		73
511	Rated Mtr RPM	0–24000 rpm	1750 rpm		73
512	Midpoint Freq	0.0 Hz–V/Hz Knee Freq	60.0 Hz		73
513	Midpoint Volt	0.0–100.0%	100.0%		73
514	Motor RS	0.0–655.35 Ohm	Model Dependent		73
515	Power Factor	0.50–1.00	0.80		73
516	Slip Comp Enable	text string	No		74
517	Single Phase	text string	No		74
519	Find Mtr Data	Not Active/Motor RS	Not Active		74
520	Filter FStator	1–100 ms	8 ms		74
521	Start Field En	Yes/No	No		74
522	Filter Time Slip	10–1000 ms	100 ms		75
523	Id Percent	0–200%	Read-only		75
524	Iq Percent	0–200%	Read-only		75

No.	Parameter Name	Options	Default	User Setting	See Page
525	Power Fail Cfg	text string	CTS No Msg		75
526	UV Ride-Thru En	text string	w/ LVT		76
600	Current Lim Sel	0-6	Fixed Lvl		76
601	Cur Lim Mtr Fwd	5%-150%	120%		77
602	Cur Lim Mtr Rev	5%-150%	120%		77
603	Cur Lim Reg Fwd	5%-150%	80%		77
604	Cur Lim Reg Rev	5%-150%	80%		77
605	Cur Lim Freq	0.0-400.0 Hz	3.0 Hz		77
606	Ramp Time CL	0.1-3200.0 sec	1.0 sec		77
607	Cur Lim Minimum	0-50%	10%		77
608	Restart Number	text string	0		78
609	Restart Delay	0-60 sec	60 sec		78
610	Timed OL Select	text string	In Duty 60sec		78
613	Max Regen Ramp	100-1000%	300%		79
700	Vmet Config	text string	Freq Out		79
701	Vmet Span	0.0-200.0%	100.0%		79
702	Imet Config	text string	Drive Load		80
703	Imet Span	0.0-200.0%	100.0%		80
704	Imet Offset	0.0-90.0%	0.0%		80
705	Relay 1 Select	text string	Drv Fault		80
706	Relay 2 Select	text string	Drv Run		80
707	D01 Select	text string	Drv Ready		80
708	D02 Select	text string	At Speed		80
720	Active Logic	text string	Active High		81
721	DI1 Configure	text string	Preset 1		81
722	DI2 Configure	text string	Preset 2		81
723	DI3 Configure	text string	Preset 3		81
724	DI4 Configure	text string	Alt Ramp		81
725	DI5 Configure	text string	Fault Reset		81
726	MOL Polarity	text string	NO Operate		82
727	MOL Configure	text string	MOL		82
801	Program Number	0-9999	0		83
802	Start Options	text string	LS Lockout		83
803	PWM Frequency	0.6-16.0 kHz	3.0 kHz		83
804	Display Mode	text string	Std Disply		84
805	Display Units(1)	alphanumeric	RPM:1		84
809	Display Scale	1-65535	1		84
810	Language	text string	English		85
811	Access Code	0-9999	0		85
812	Freq Ref Output	text string	6FS		85
813	Speed Ratio	0.0-200.0%	100.0%		85
814	Display Status	text string	Drive load		85
816	Fly Catch Mode	Sweep Fwd / Rev / F / R	Sweep Fwd		86
850	PI Configure	text string	No PI		86
851	PI Feedback	text string	Vin1		87

No.	Parameter Name	Options	Default	User Setting	See Page
852	PI Prop Gain	0-2000	0		87
853	PI Int Gain	0-10000	0		87
854	PI Feed Gain	0-2000	1000		87
855	PI Error 1	0.00-100.00%	Read-only		87
856	PI Error 2	0.00-100.00%	Read-only		87
857	PI High Corr	0.00-100.00%	100.00%		87
858	PI Low Corr	0.00-100.00%	0.00%		87
900	SIO Protocol	text string	RTU N81		88
901	SIO Baud Rate	text string	9600		88
902	Comm Drop #	1-247	1		88
903	SIO Timer	0.0-60.0 sec	1.0 sec		88
904	SIO Cntl Word	text string	0x0000		89
905	Ext Ref Freq1	Min-Max Freq	0.0 Hz		89
906	Ext Ref Freq2	Min-Max Freq	0.0 Hz		89
908	Status Word	text string	Read-only		89
909	DI Status	text string	Read-only		90
910	Vin1 Status	0.00-100.00%	Read-only		90
911	Cin Status	0.00-100.00%	Read-only		90
912	Vin2 Status	0.00-100.00%	Read-only		90
913	Output Status	text string	Read-only		90
914	Vmet Status	0.00-100.00%	Read-only		90
915	Imet Status	0.00-100.00%	Read-only		90
916	Infrared Baud	n/a	9600		91
931	Seq Cntl 1	n/a	0000000000		91
932	Seq Cntl 2	n/a	0000000000		91
933	Seq Cntl 3	n/a	0000000000		91
934	Seq Cntl 4	n/a	0000000000		91
935	Seq Cntl 5	n/a	0000000000		91
936	Seq Cntl 6	n/a	0000000000		91
937	Seq Cntl 7	n/a	0000000000		91
938	Seq Cntl 8	n/a	0000000000		91
939	Seq Cntl 9	n/a	0000000000		91
951	Seq Count 1	0-65535	0		91
952	Seq Count 2	0-65535	0		91
953	Seq Count 3	0-65535	0		91
954	Seq Count 4	0-65535	0		91
955	Seq Count 5	0-65535	0		91
956	Seq Count 6	0-65535	0		91
957	Seq Count 7	0-65535	0		91
958	Seq Count 8	0-65535	0		91
959	Seq Count 9	0-65535	0		91

12.2 Parameter Names in 5 Languages

Nr.	English	German	Italian	French	Spanish
001	Model Number	Modelnummer	Numero Modello	Numero Modelo	Numero de modelo
002	Software Rev	Softwareversion	Vers Software	Rev del Softwar	Rev du Logiciel
003	Rated Current	Gera- etenennstrom	Corrente Nom	Corrien Clasif	Courant Nominal
005	Serial No 1	Serien Nr. 1	Nr Seriele 1	Num de Serie 1	Numero Serie 1
006	Serial No 2	Serien Nr. 2	Nr Seriele 2	Num de Serie 2	Numero Serie 2
010	Last Fault	Letzter Fehler	Ultimo Errore	Ultima Fallo	Derniere Faute
025	4th Fault	Vierter Fehler	Quarto Errore	4to Fallo	4ieme Faute
040	3rd Fault	Dritter Fehler	Terzo Errore	3ro Fallo	3ieme Faute
055	2nd Fault	Zweiter Fehler	Secondo Errore	2do Fallo	2ieme Faute
070	1st Fault	Erster Fehler	Primo Errore	1r Fallo	1iere Faute
102	Output Freq	Ausg. Freq.	Freq Uscita	Frec Salida	Freq Sortie
103	Output Voltage	Ausg. Spannung	Tens di Uscita	Tension Salida	Tension Sortie
104	Output Current	Ausg. Strom	Corr di Uscita	Corrien Salida	Courant Sortie
105	Drive Load	Ausg. Last	Caric Inver	Invert Carga	Charge Sort
106	Load Torque	Ausg. Moment	Mom di Uscita	Torque de Carga	Couple Charge
107	Drive Temp	Kk. Temp.	Temp Invert	Temp Invert	Temp Cntl
108	Total Run Time	Motor Laufzeit	Tempo Funz Mot	Tiemp Pasad Tot	Duree Fonction
109	Power On Hours	Betriebszeit	Ore funzionam	Hrs Tot Prend	Duree D'Aliment
110	Stator Freq	Statorfreq.	FreqStatore	Frc Estator	Freq Stator
111	DC Bus Voltage	Zwischenk. Spa.	Tensione Bus DC	Tens Bus CC	Tension Bus-DC
115	Drive Power Out	Ausgangsleist.	Pot Usc Inv	Pot Sal Drive	Puis Sort Cntl
201	Input Mode	Steuermodus	Modo Comando	Modo Entrada	Mode Entree
202	Rev Enable	Rev. Auswahl	Rev Abilitato	Rev Permits	Activer Renverse
203	Stop Key Remote	Stoptaste Rem	Tast Stop Rem	Boton Parat Tel	Rem Cle Arret
204	Ref Select	Ref. Auswahl	Selezione Rif	Ref Selec	Ref Select
205	Vin1 Config	Vin1 Auswahl	Vin1 Config	Vin1 Config	Vin1 Config
206	Vin1 Offset	Vin1 Offset	Vin1 Offset	Vin1 Comp	Vin1 Decalage
207	Vin1 Span	Vin1 Bereich	Vin1 Campo	Vin1 Extension	Vin1 Span
208	Cin Config	Cin Auswahl	Cin Config	Cin Config	Cin Config
209	Cin Offset	Cin Offset	Cin Offset	Cin Comp	Cin Decalage
210	Cin Span	Cin Bereich	Cin Campo	Cin Extension	Cin Span
211	Vin2 Config	Vin2 Auswahl	Vin2 Config	Vin2 Config	Vin2 Config
212	Vin2 Offset	Vin2 Offset	Vin2 Offset	Vin2 Comp	Vin2 Decalage
213	Vin2 Span	Vin2 Bereich	Vin2 Campo	Vin2 Extension	Vin2 Span
301	Min Frequency	Min. Frequenz	Frequenza Min	Frecuencia Min	Frequence Min
302	Max Frequency	Max. Frequenz	Frequenza Max	Frecuencia Max	Frequence Max
303	Preset Freq 1	Fixfrequenz 1	Freq Fissa 1	Frec Predet 1	Freq 1 Prereglee
304	Preset Freq 2	Fixfrequenz 2	Freq Fissa 2	Frec Predet 2	Freq 2 Prereglee
305	Preset Freq 3	Fixfrequenz 3	Freq Fissa 3	Frec Predet 3	Freq 3 Prereglee
306	Preset Freq 4	Fixfrequenz 4	Freq Fissa 4	Frec Predet 4	Freq 4 Prereglee
307	Preset Freq 5	Fixfrequenz 5	Freq Fissa 5	Frec Predet 5	Freq 5 Prereglee
308	Preset Freq 6	Fixfrequenz 6	Freq Fissa 6	Frec Predet 6	Freq 6 Prereglee
401	Ramp Select	Rampen Auswahl	Selezione Rampa	Rampa Selec	Select Rampe
402	Accel Time 1	Hochlaufz. 1	Tempo Accel 1	Tiempo Acel 1	Temps Accel 1

Nr.	English	German	Italian	French	Spanish
403	Decel Time 1	Tieflaufz. 1	Tempo Decel 1	Tiemp Desacel 1	Temps Decel 1
404	Accel Time 2	Hochlaufz. 2	Tempo Accel 2	Tiempo Accl 2	Temps Accel 2
405	Decel Time 2	Tieflaufz. 2	Tempo Decel 2	Tiemp Desacel 2	Temps Decel 2
406	DC Inject Config	DC-Bremsauswahl	Config Freno DC	Config CC Inyect	Config Inject DC
407	DC Inject Time	DC-Bremszeit	Tempo Freno DC	Tiemp CC Inyect	Temps DC Inject
408	DC Inject Level	DC-Bremspegel	Livello Freno DC	Nivel CC Inyec	Niveau DC Inject
409	DC Inject Freq	DC-Bremsfreq.	Freq Freno DC	Frec CC Inyec	Freq DC Inject
410	DB Config	DB Auswahl	DB Config	DB Config	DB Config
414	S Ramp Rounding	S-Rampenverschl.	Andamento Curvas	Redondeo S-Rampa	Arrond. Rampe S
490	Appl Macro	Makro Auswahl	Scelta Macro	Macro de apl	Appl Macro
491	Seq Appl	Sequenz Auswahl	Scelta Sequenza	Secuen Aplic	Seq Appl
492	SIO Visible	SIO Sichtbar	SIO Visibile	SIO Visible	SIO Visible
501	V/Hz Select	V/Hz Auswahl	Selezione V/Hz	V/Hz Selec	V/Hz Select
502	Voltage Boost	Boost Spannung	Tensione Boost	Refuerzo Tens	Boost Tension
503	V/Hz Knee Freq	V/Hz Knickfreq.	V/Hz Knee Freq	V/Hz Frec Rodil	V/Hz Knee Freq
504	Skip Freq Band	Sperrfreq. Band	Banda Escl Freq	Banda Frec Salto	Bande Extraite
505	Skip Freq 1	Sperrbereich 1	Escl Freq 1	Frec Salto 1	Freq Extraite 1
506	Skip Freq 2	Sperrbereich 2	Escl Freq 2	Frec Salto 2	Freq Extraite 2
507	Skip Freq 3	Sperrbereich 3	Escl Freq 3	Frec Salto 3	Freq Extraite 3
508	Skip Freq 4	Sperrbereich 4	Escl Freq 4	Frec Salto 4	Freq Extraite 4
509	Rated Mtr Volt	Motornennspan.	Tens Nom Motore	Tens Salida Nom	Tens Mtr Nominal
510	Rated Mtr FLA	Motornennstrom	Corr Nom Motore	Corr Nom Mtr	Mtr FLA Nominal
511	Rated Mtr RPM	Motornendrehz.	RPM Nom Motore	RPM Nom Mtr	Mtr RPM Nominal
512	Midpoint Freq	Freq. Stuetzst.	Punto Medio Freq	Punto Med Frec	Point Centr Freq
513	Midpoint Volt	Span. Stuetzst.	Punto Medio Tens	Punto Med Tens	Point Centr Tens
514	Motor RS	Motor RS	Motore RS	Motor RS	Moteur RS
515	Power Factor	Leistungsfaktor	Fattore Pot	Factor Pot	Fact. Puiss
516	Slip Comp Enable	Schlupfkomp.	Comp Scorrimento	Perm Comp Dslz	Activ Comp Gliss
517	Single Phase	1 Phasen	Singola Fase	Solo Fase	Simple Phase
519	Find Mtr Data	Find Mtr Daten	Cerc dati Mtr	Consig Datos Mtr	Find Mtr Data
520	Filter Fstator	Fstator Filterz.	Filtro Fstatore	Filt Fstator	Filter Fstator
521	Start Field En	Feldaufbau	Campo Start Abil	Campo Arr Perm	Start Field En
522	Filter Time Slip	Schlupf Filterz.	Filter Temp Scor	Tiemp Filt Sliz	Filter Time Slip
523	ID Percent	ID Prozent	ID Percento	ID Por Ciento	ID Pourcent
524	IQ Percent	IQ Prozent	IQ Percento	IQ Por Ciento	IQ Pourcent
600	Current Lim Sel	Strombegr. Ausw.	Sel Limite Corr	Sel Lim Corrien	Sel Lim Courant
601	Cur Lim Mtr Fwd	Strombegr.Mtr.Fw	Lim Corr Mtr Fwd	Lim Cor Mtr FWD	Lim Cour Mtr Avt
602	Cur Lim Mtr Rev	Strombegr.Mtr.Rw	Lim Corr Mtr Rev	Lim Cor Mtr REV	Lim Cour Mtr Inv
603	Cur Lim Reg Fwd	Strombegr.Gen.Fw	Lim Corr Reg Fwd	Lim Cor Reg FWD	Lim Cour Reg Avt
604	Cur Lim Reg Rev	Strombegr.Gen.Rw	Lim Corr Reg Rev	Lim Cor Reg REV	Lim Cour Reg Inv
605	Cur Lim Freq	Freq. Strombegr.	Lim Corr Freq	Lim Cor Frec	Lim Cour Freq
606	Ramp Time CL	Rampe Strombegr.	Tempo Rampa LC	Tiempo Rampa LC	Temps Rampe LC

Nr.	English	German	Italian	French	Spanish
607	Cur Lim Minimum	Min. Strombegr.	Lim cor minimo	Min Lim Cor	Cur Lim Minimum
608	Restart Number	Fehlerrestart	Numero Restart	Numero Arranque	Nbr Redemarrage
609	Restart Delay	Verzoeg.Fehlerr.	Ritardo Restart	Retardo Arranque	Delai Redemar
610	Timed OL Select	Ueberlast Ausw.	Selez Tempo OL	Tiemp Sobrec Sel	Temps Surch Sel
613	Max Regen Ramp	Max Regen Ramp	Max Regen Ramp	Max Regen Ramp	Max Regen Ramp
700	Vmet Config	Vmet Auswahl	Vmet Config	Vmet Config	Vmet Config
701	Vmet Span	Vmet Bereich	Vmet Campo	Vmet Extension	Vmet Span
702	Imet Config	Imet Auswahl	Imet Config	Imet Config	Imet Config
703	Imet Span	Imet Bereich	Imet Campo	Imet Extension	Imet Span
704	Imet Offset	Imet Offset	Imet Offset	Imet Comp	Imet Decalage
705	Relay 1 Select	Relais 1 Auswahl	Rele 1 Selez	Relais 1 Selec	Relais 1 Select
706	Relay 2 Select	Relais 2 Auswahl	Rele 2 Selez	Relais 2 Selec	Relais 2 Select
707	D01 Select	D01 Auswahl	D01 Selez	D01 Selec	D01 Select
708	D02 Select	D02 Auswahl	D02 Selez	D02 Selec	D02 Select
720	Active Logic	DI Logik	Logica Attiva	Logica Activa	Logique Active
721	DI1 Configure	DI1 Auswahl	DI1 Configuraz	DI1 Configure	DI1 Configure
722	DI2 Configure	DI2 Auswahl	DI2 Configuraz	DI2 Configure	DI2 Configure
723	DI3 Configure	DI3 Auswahl	DI3 Configuraz	DI3 Configure	DI3 Configure
724	DI4 Configure	DI4 Auswahl	DI4 Configuraz	DI4 Configure	DI4 Configure
725	DI5 Configure	DI5 Auswahl	DI5 Configuraz	DI5 Configure	DI5 Configure
726	MOL Polarity	MOL Polaritaet	Polarita MOL	Polaridad MOL	Polaritee MOL
801	Program Number	Programm Nummer	Num Programma	Numero Del Prog	Numero Program
802	Start Options	Startoption	Opzioni di Avvio	Opciones Arranq	Options Demarr
803	PWM Frequency	PWM Frequenz	Frequenza PWM	Frecuencia Mod	Frequence PWM
804	Display Mode	Anzeigeinheit	Modo Visualiz	Opzione en Pant	Mode Affichage
805	Display Units	Anzeigeformat	Unit Visualiz	Unidad en Pant	Unites Affichage
809	Display Scale	Anzeigefaktor	Scala Visualiz	Escala en Pant	Echelle Affichee
810	Language	Sprache	Lingua	Idioma	Language
811	Access Code	Zugangscode	Codice Accesso	Codigo Aceso	Code Acces
812	Freq Ref Output	Frequenzausgang	Freq Rif Uscita	Frec Ref Salida	Ref Freq Sortie
813	Speed Ratio	Skal.Freq.Eing.	Cal Rif Dig	Relacion de Frec	Ratio Vitesse
814	Display Status	Anzeigeoption	Opzione Display	Estado en Pant	Etat Affichage
816	Fly Catch Mode	Fangmodus	Modo agg al volo	Modo de Reten	Fly Catch Mode
850	PI Config	PI Auswahl	PI Config	PI Config	PI Config
851	PI Feedback	PI Rueckfuehrung	PI Retroazione	PI Regeneracion	PI Feedback
852	PI Prop Gain	PI Proportional	PI Quad Prop	PI Aumento Prop	PI Prop Gain
853	PI Int Gain	PI Integral	PI Quad Int	PI Aumento Int	PI Int Gain
854	PI Feed Gain	PI Verst.Rueckf.	PI Quad Deriv	PI Aumento Reg	PI Feed Gain
855	PI Error 1	PI Fehler 1	PI Errore 1	PI Error 1	PI Erreur 1
856	PI Error 2	PI Fehler 2	PI Errore 2	PI Error 2	PI Erreur 2
857	PI High Corr	PI Obergrenze	PI Lim Superiore	PI Alto Corr	PI Haute Corr
858	PI Low Corr	PI Untergrenze	PI Lim Inferiore	PI Bajo Corr	PI Basse Corr
900	SIO Protocol	SIO Protokoll	Protocollo SIO	SIO Protocol	SIO Protocol
901	SIO Baud Rate	SIO Baudrate	Baud Rate SIO	SIO Baud Rate	SIO Baud Rate
902	Comm Drop #	SIO Adresse	Indirizzo SIO	Direccion SIO	Comm Drop #

Nr.	English	German	Italian	French	Spanish
903	SIO Timer	SIO Timeout	Timer SIO	SIO Temporizador	SIO Timer
904	SIO Cntl Word	SIO Steuerwort	Cntl Word SIO	SIO Palab Cntl	SIO Cntl Word
905	Ext Ref Freq 1	Ext Freq. Ref. 1	Rif Est Freq 1	Frec Ref Ext 1	Freq Ref Ext 1
906	Ext Ref Freq 2	Ext Freq. Ref. 2	Rif Est Freq 2	Frec Ref Ext 2	Freq Ref Ext 2
908	Status Word	Statuswort	Status Word	Palabra Estado	Status Word
909	DI Status	Status DI	Stato DI	DI Estado	DI Status
910	Vin1 Status	Status Vin1	Stato Vin1	Vin1 Estado	Vin1 Status
911	Cin Status	Status Cin	Stato Cin	Cin Estado	Cin Status
912	Vin2 Status	Status Vin2	Stato Vin2	Vin2 Estado	Vin2 Status
913	Output Status	Status Ausgang	Stato Usci	Salida Estado	Output Status
914	Vmet Status	Status Vmet	Stato Vmet	Vmet Estado	Vmet Status
915	Imet Status	Status Imet	Stato Imet	Imet Estado	Imet Status
916	Infrared Baud	Infrarot Baudr.	Baud Infrarosso	Baudio Infrared	Infrared Baud
931	Seq Cntl 1	Seq. Strg 1	Seq Cntl 1	Secuen Cntl 1	Seq Cntl 1
932	Seq Cntl 2	Seq. Strg 2	Seq Cntl 2	Secuen Cntl 2	Seq Cntl 2
933	Seq Cntl 3	Seq. Strg 3	Seq Cntl 3	Secuen Cntl 3	Seq Cntl 3
934	Seq Cntl 4	Seq. Strg 4	Seq Cntl 4	Secuen Cntl 4	Seq Cntl 4
935	Seq Cntl 5	Seq. Strg 5	Seq Cntl 5	Secuen Cntl 5	Seq Cntl 5
936	Seq Cntl 6	Seq. Strg 6	Seq Cntl 6	Secuen Cntl 6	Seq Cntl 6
937	Seq Cntl 7	Seq. Strg 7	Seq Cntl 7	Secuen Cntl 7	Seq Cntl 7
938	Seq Cntl 8	Seq. Strg 8	Seq Cntl 8	Secuen Cntl 8	Seq Cntl 8
939	Seq Cntl 9	Seq. Strg 9	Seq Cntl 9	Secuen Cntl 9	Seq Cntl 9
951	Seq Count 1	Seq. Zaehler 1	Seq Cont 1	Sec Cuenta 1	Seq Compte 1
952	Seq Count 2	Seq. Zaehler 2	Seq Cont 2	Sec Cuenta 2	Seq Compte 2
953	Seq Count 3	Seq. Zaehler 3	Seq Cont 3	Sec Cuenta 3	Seq Compte 3
954	Seq Count 4	Seq. Zaehler 4	Seq Cont 4	Sec Cuenta 4	Seq Compte 4
955	Seq Count 5	Seq. Zaehler 5	Seq Cont 5	Sec Cuenta 5	Seq Compte 5
956	Seq Count 6	Seq. Zaehler 6	Seq Cont 6	Sec Cuenta 6	Seq Compte 6
957	Seq Count 7	Seq. Zaehler 7	Seq Cont 7	Sec Cuenta 7	Seq Compte 7
958	Seq Count 8	Seq. Zaehler 8	Seq Cont 8	Sec Cuenta 8	Seq Compte 8
959	Seq Count 9	Seq. Zaehler 9	Seq Cont 9	Sec Cuenta 9	Seq Compte 9

12.3 Settings and Messages in 5 Languages

English	German	Italian	French	Spanish
%	%	%	%	%
1200	1200	1200	1200	1200
4800	4800	4800	4800	4800
9600	9600	9600	9600	9600
19200	19200	19200	19200	19200
38400	38400	38400	38400	38400
57600	57600	57600	57600	57600
% of FLA	% Motorstr.	% of FLA	% of FLA	% of FLA
%/s	%/s	%/s	%/s	%/s
.01sec Base	.01sekBasis	.01sec Base	.01seg Base	.01sec Base
.1sec Base	.1 sekBasis	.1sec Base	.1seg Base	.1sec Base
°C	°C	°C	°C	°C
0-10V	0-10V	0-10V	0-10V	0-10V
0-10V Bipol	0-10V Bipol	0-10V Bipol	0-10V Bipol	0-10V Bipol
0-10V Brk W	0-10V K.Br.	0-10V Brk W	0-10V Brk W	0-10V Brk W
0-10V I	0-10V I	0-10V I	0-10V I	0-10V I
0-20mA 250	0-20mA 250	0-20mA 250	0-20mA 250	0-20mA 250
0-20mA 250I	0-20mA 250I	0-20mA 250I	0-20mA 250I	0-20mA 250I
0-20mA 50	0-20mA 50	0-20mA 50	0-20mA 50	0-20mA 50
0-20mA 50I	0-20mA 50I	0-20mA 50I	0-20mA 50I	0-20mA 50I
0-5V	0-5V	0-5V	0-5V	0-5V
0-5V I	0-5V I	0-5V I	0-5V I	0-5V I
1Ph Ovrload	1Ph Ueberl.	1Ph Sovvrac	1Fase SCrga	1Ph Surchar
1sec Base	1 sekBasis	1sec Base	1seg Base	1sec Base
4-20mA 250	4-20mA 250	4-20mA 250	4-20mA 250	4-20mA 250
4-20mA 250I	4-20mA 250I	4-20mA 250I	4-20mA 250I	4-20mA 250I
4-20mA 50	4-20mA 50	4-20mA 50	4-20mA 50	4-20mA 50
4-20mA 50I	4-20mA 50I	4-20mA 50I	4-20mA 50I	4-20mA 50I
48FS	48FS	48FS	48FS	48FS
6FS	6FS	6FS	6FS	6FS
A	A	A	A	A
Active High	Highaktiv	Attivo High	Alto Activo	Actif Haut
Active Low	Lowaktiv	Attivo Low	Bajo Activo	Actif Bas
Actual Carrier	Akt. PWM-Freq.	Freq PWM Att	Frc Mod Actual	Freq PWM Actuel
Addr XXX	Adr. XXX	Ind XXX	Direcc XXX	Addr XXX
Adv Fault Code	Zus. Fehl. Code	Cod Err Aggiunt	Codig Fallo Adv	Adv Fault Code
Alt Ramp	Alt. Rampe	Rampa Alt	Rampa Alt	Alt Ramp
ARCTIC Mode	ARCTIC Mode	Modo ARCTIC	Modo ARCTIC	ARCTIC Mode
ART-DI	ART-DI	ART-DI	ART-DI	ART-DI
ART-DI CTS	ART-DI CTS	ART-DI CTS	ART-DI CTS	ART-DI CTS
ART-F/R	ART-F/R	ART-F/R	ART-F/R	ART-F/R
ART-F/R CTS	ART-F/R CTS	ART-F/R CTS	ART-F/R CTS	ART-F/R CTS
ART-Frq	ART-Frq	ART-Frq	ART-Frec	ART-Frq
ART-Frq CTS	ART-Frq CTS	ART-Frq CTS	ART-FrecCTS	ART-Frq CTS

English	German	Italian	French	Spanish
ART-Strt/CS	ART-Strt/CS	ART-Strt/CS	ART-And CTS	ART-Strt/CS
ART-Strt/RS	ART-Strt/RS	ART-Strt/RS	ART-Andar	ART-Strt/RS
At Speed	F. soll Er.	A Regime	a Velocidad	Vit. Attein
Auto w/FLY	A-S m.Fang.	Auto c agga	Auto conRet	Auto w/FLY
Auto w/FLY2	A-S m.Fang2	Auto c agg2	Auto Ret2	Auto w/FLY2
AutoSelect	AutoSelekt	AutoSelez	AutoSelec	AutoSelect
AutoStart	Auto-Start	AutoStart	AutoEmpez	AutoStart
AutoStart2	Auto-Start2	AutoStart 2	AutoEmpez2	AutoStart2
Brk Wire	Unterb.Ref.	Interuz Rif	Alamb Roto	Brk Wire
Catch Fly	Freq. Suche	RicercaFreq	Reten March	Attrape Vol
Catch Vlt Ramp	Fang.Spann.Rampe	Rampa tens agg	Catch Vlt Ramp	Catch Vlt Ramp
Cin	Cin	Cin	Cin	Cin
CIN Counts	CIN Counts	CIN Counts	CIN Counts	CIN Counts
Cin Filter Time	Cin Filter Time	Cin Filter Time	Cin Filter Time	Cin Filter Time
Cin F-Motor	Cin F-Mtr.	Cin F-Mtr	Cin F-Motor	Cin F-Mtr
Cin Motor	Cin Motor.	Cin Motori	Cin Motor	Cin Moteur
Cin/KYP DI	Cin/KYP DI	Cin/KYP DI	Cin/KYP DI	Cin/KYP DI
Cntl Board Temp	Steuerk. Temp.	Temp Sched Cont	Temp Tab Cont	Cntl Board Temp
Coast	Auslauf	In Folle	Rodar	Coast
Coast Stop	FreierAusl.	Rotaz Stop	Rodar Parar	Arret Libre
Comm Loss	Ausf. SIO	Perdita Com	Perdid Com	Perte Comm
ContrNoMsg	ContrNoMsg	ContrNoMsg	ContrNoMsg	ContrNoMsg
Control Group	Gruppe Steuerung	Gruppo Controllo	Grupo Control	Groupe Controle
Controlled	ZK-Gefuehrt	ContrBus-DC	Controlled	Controlled
CPU Load	CPU Auslastung	Carico CPU	Carga CPU	Charge CPU
CPU Warning	CPU Warnung	CPU Avvert	Aviso CPU	Avert. CPU
CTS No Msg	CTS No Msg	CTS No Msg	CTS No Msg	CTS No Msg
Cur Lim Dis	Str.Begr.A.	DisLim Corr	Lim Cor Dis	Cur Lim Dis
CurLimlMax	CurLimlMax	CurLimlMax	CurLimlMax	CurLimlMax
Curr Calibr	Stromkalib.	Corr Calibr	Corr Calibr	Calibr Cour
Curr Limit	Strombegr.	Limite Corr	Limit Corr	Lim. Cour.
Curr Stability	Stromstabilit.	StabilitaCorr	Estabilidad Cor	Stabilite Courant
Current Fault	AktuellerFehler	Errore Attuale	Fallo Actual	Faute Actuelle
Current Group	Gruppe Strom	Gruppo Corrente	Grupo Corriente	Groupe Courant
Current Lim	Strombegr.	Lim Corr	Lim Corr	Lim Courant
Current Out	Ausg. Strom	CorrenteUsc	Corrien Sal	Cour Sortie
Cut-off Freq	Cut-off Freq	Cut-off Freq	Cut-off Freq	Cut-off Freq
DAC 1 Address	DAC 1 Adresse	DAC 1 Indiriz	DAC 1 Direccion	DAC 1 Adresse
DAC 1 Divide	DAC 1 Divisor	DAC 1 Divis	DAC 1 Divide	DAC 1 Divide
DAC 1 Mask	DAC 1 Maske	DAC 1 Masc	DAC 1 Mascara	DAC 1 Mask
DAC 1 Multiply	DAC 1 Multiplik.	DAC 1 Multipl	DAC 1 Multiplic	DAC 1 Multiply
DAC 1 Offset	DAC 1 Offset	DAC 1 Offset	DAC 1 Comp	DAC 1 Offset
DAC 1 Output	DAC1 Ausgang	DAC 1 Uscita	DAC 1 Salida	DAC 1 Output
DAC 2 Address	DAC 2 Adresse	DAC 2 Indiriz	DAC 2 Direccion	DAC 2 Address
DAC 2 Divide	DAC 2 Divisor	DAC 2 Divis	DAC 2 Divide	DAC 2 Divide
DAC 2 Mask	DAC 2 Maske	DAC 2 Masc	DAC 2 Mascara	DAC 2 Mask

English	German	Italian	French	Spanish
DAC 2 Multiply	DAC 2 Multiplik.	DAC 2 Multipl	DAC 2 Multiplic	DAC 2 Multipli
DAC 2 Offset	DAC 2 Offset	DAC 2 Offset	DAC 2 Comp	DAC 2 Offset
DAC 2 Output	DAC2 Ausgang	DAC 2 Uscita	DAC 2 Salida	DAC 2 Output
DAC 3 Address	DAC 3 Adresse	DAC 3 Indiriz	DAC 3 Direccion	DAC 3 Address
DAC 3 Divide	DAC 3 Divisor	DAC 3 Divis	DAC 3 Divide	DAC 3 Divide
DAC 3 Mask	DAC 3 Maske	DAC 3 Masc	DAC 3 Mascara	DAC 3 Mask
DAC 3 Multiply	DAC 3 Multiplik.	DAC 3 Multipl	DAC 3 Multiplic	DAC 3 Multipli
DAC 3 Offset	DAC 3 Offset	DAC 3 Offset	DAC 3 Comp	DAC 3 Offset
DAC 3 Output	DAC3 Ausgang	DAC 3 Uscita	DAC 3 Salida	DAC 3 Output
DB Active	DB Aktiv	DB Attivo	DB Activo	DB Actif
DB Duty Cycle	DB Impulsdauer	DB Duty Cycle	DB Ciclo Deber	DB Duty Cycle
DB External	DB Extern	DB Esterno	DB External	DB Externe
DB Internal	DB Intern	DB Interno	DB Internal	DB Interne
DB OverLoad	DB Ueberla.	DB SovraCar	DB Carga	DB Surchauf
DB OverTemp	DB Uebert.	DB SovraTem	DB SobreTem	DB Surcharg
DB Res Cth	DB Res Cth	DB Res Cth	DB Res Cth	DB Res Cth
DB Res Rth	DB Res Rth	DB Res Rth	DB Res Rth	DB Res Rth
DB Res Value	DB Wid. Wert	DB Res Value	DB Res Cant	DB Res Valeur
DC at Both	DC b. St/St	DC in St/St	CC en Ambos	DC au deux
DC at Start	DC v. Start	DC in Start	CC Comienzo	DC Demarrag
DC at Stop	DC n. Stop	DC in Stop	CC en Parar	DC a Arret
DC Bus Volt	Zwischenkr.	DC Bus Volt	CC Bus Tens	Tens DC Bus
DC Bus Voltage	Zwischenk. Spa.	Tensione Bus-DC	CC Bus Tens	Tension Bus-DC
DC Inject	DC Stop	Stop DC	CC Inyect	DC Inject
DC Inject	DC Bremse	IniezioneDC	CC Inyect	DC Inject
DC on Freq	DC bei Freq	DC in Freq	CC en Frec	DC a Freq
Degrees C	Grad C	Gradi C	Grados C	Degres C
Degrees F	Grad F	Gradi F	Grados F	Degres F
Dir F-FWD	Dir. F-FWD	Dir F-FWD	Dir F-FWD	Dir F-FWD
Dir F-FWD E	Dir.F-FWD E	Dir F-FWD E	Dir F-FWD E	Dir F-FWD E
Dir Full	Dir. Optim.	Dir Ottim	Dir Full	Dir Full
Dir Full E	Dir. Opt. E	Dir Ottim E	Dir Full E	Dir Full E
Disabled	Deaktiviert	Disabilit	Incapacidad	Desactive
Drive Info Group	Gruppe Umrichter Info	Info Gruppo Drive	Grupo Info Inv	Drive Info Group
Drive Load	Ausg. Last	Caric Inver	Carga Invert	Charge Ctrl
Drive Run	Gestartet	In Movim	Drive Andar	Ctrl Fonct
Drive Status	UmrichterStatus	Stato Inverter	Estado Invert	Statut Controle
Drive Temp	Kuehlk.Temp.	Invert Temp	Temp Invert	Temp Ctrl
Drive TOL	Umrich. TOL	Invert TOL	Invert TOL	Drive TOL
Drive Warning	Umrich.Warnung	InvertAvvertenza	Adv Inverter	Ctrl Avert.
Drv Fault	Fehler	In Errore	Drv Fallo	Ctrl Erreur
Drv Ready	Bereit	Pronto	Listo	Ctrl Pret
DT_Comp Gain	Totzeitkomp.	Guad DT_Comp	Aum DT_Comp	DT_Comp Gain
Dyn Brake	Dyn. Bremse	Freno Din	Freno Din	Frein Dyn
EE Checksum	EE Checksum	EE Checksum	EE Checksum	EE Checksum
EMOP	EMOP	EMOP	EMOP	EMOP

English	German	Italian	French	Spanish
EMOP-	EMOP-	EMOP-	EMOP-	EMOP-
EMOP+	EMOP+	EMOP+	EMOP+	EMOP+
EMOP2	EMOP2	EMOP2	EMOP2	EMOP2
English	Englisch	Inglese	Ingles	Anglais
Factory	Werkseinst.	Fabbrica	Fabrica	Usine
Factory Group	Gruppe Werkseintellung	Gruppo Fabbrica	Grupo Fabrica	Groupe Factory
Family Code	Geraetecode	Codice Inverter	Codigo Inverter	Code Famil.
Fan	Ventilator	Ventilatore	Ventilador	Ventilateur
Fan Fxd	Vent. Fix	Vent Fisso	Vent Est	Vent. Fixe
Fan w/PI	Vent. m. PI	Vent con PI	Vent con PI	Vent. PI
Fast Stop	Schnellstop	Stop Rapido	Parar Rapid	Arret Rapid
Fault Enable	Fehler Aktiv	Errori Abilitati	Fallo Permit	Faute Permi
Fault History Group	Gruppe Fehler Historie	Gruppo Storia Fault	Grupo Hist Falla	Groupe Hist Faut
Fault Reset	Fehlerreset	Reset Err	Recom Fallo	Fault Reset
Faulted	Fehler	Errore	Fallada	Erreur
Fbk GPM	Istw. GPM	GPM retro	Fbk GPM	Fbk GPM
Fbk PSI	Istw. PSI	PSI retro	Fbk PSI	Fbk PSI
Fbk RPM	Istw. RPM	RPM retro	Fbk RPM	Fbk RPM
Fbk User	Istw.Benuz.	Retro Opera	Fbk Usador	Fbk User
Fixed Lvl's	FixeSchwel.	Livel Fisso	Nvl's. Estac	Niveau Fixe
FLY Dis	Fangen Aus	Agganc Dis	Ret Incap	FLY Dis
Forward	Vorw.	Avanti	Delantero	Avant
FPM Units	FPM Einheit	Unit FPM	Unidad FPM	Unites FPM
French	Franzoes.	Francese	Frances	Francais
Freq Hyst	Freq. Hyst	Ister Freq	Hyst Frec	Freq Hyst
Freq Limit	Freq. Schw.	Limite Freq	Limit Frec	Freq Limite
Freq Out	Ausg. Freq.	Freq Usc	Frec Sal	Freq Sortie
Frequency Group	Gruppe Frequenz	Gruppo Frequenza	Grupo Frecuen	Groupe Frequenc
Future Use	Reserviert	Usi Futuri	Usa Futura	Usage Futur
FWD Accel	FWD Hochl.	FWD Accel	FWD Accl	Accel AVT
FWD At Spd	FWD Endfre.	FWD Vel Fin	FWD a Veloc	V-Att. AVT
FWD Decel	FWD Tief.	FWD Decel	FWD Desacel	Decel AVT
FWD/REV	Vorw.+Rev.	FWD/REV	FWD/REV	AVT/ARR
Fxd Trim %	Fxd Trim %	Fxd Trim %	Fxd Trim %	Fxd Trim %
German	Deutsch	Tedesco	Aleman	Alemand
GPM Units	GPM Einheit	Unit GPM	Unidad GPM	Unites GPM
Ground	Kurzschl.	Terra	Tierra	Terre
h	h	h	h	h
High Temp	Hohe Temp.	Temp Elev	Temp Alta	Haute Temp
HS Fan Err	Kk.Ven.Feh.	Err HS Vent	Err HS Vent	HS Fan Err
HSTemp Counts	HSTemp Counts	HSTemp Counts	HSTemp Counts	HTemp Counts
Hz	Hz	Hz	Hz	Hz
I/O Group	Gruppe I/O	Gruppo I/O	Grupo I/O	Groupe I/O
ID 1 Counts	ID 1 Counts	ID 1 Counts	ID 1 Counts	ID 1 Counts
ID 2 Counts	ID 2 Counts	ID 2 Counts	ID 2 Counts	ID 2 Counts

English	German	Italian	French	Spanish
IMET Percent	IMET Prozent	IMET Percent	IMET Percent	IMET Percent
In Duty 30s	Um.Motor30s	In Duty 30s	In Duty 30s	In Duty 30s
In Duty 5mn	Um.Motor5mn	In Duty 5mn	In Duty 5mn	In Duty 5mn
In Duty 60s	Um.Motor60s	In Duty 60s	In Duty 60s	In Duty 60s
In Duty ShP	Um.MotorShP	In Duty ShP	In Duty ShP	In Duty ShP
Int Fan Err	I.Vent.Feh.	ErrVent Int	ErrVent Int	ErrVent Int
Int-ARCTIC	Int-ARCTIC	Int-ARCTIC	Int-ARCTIC	Int-ARCTIC
IOC Trip	IOC Ausl.	IOC Trip	Alarma IOC	IOC Trip
IR Active	IR Aktiv	IR Attivo	IR Activo	IR Actif
Italian	Italienisch	Italiano	Italiano	Italien
IUFB Counts	IUFB Counts	IUFB Counts	IUFB Counts	IUFB Counts
IVFB Counts	IVFB Counts	IVFB Counts	IVFB Counts	IVFB Counts
IWFB Counts	IWFB Counts	IWFB Counts	IWFB Counts	IWFB Counts
Jog FWD	Tipp FWD	Jog FWD	JOG FWD	Jog AVT
Jog REV	Tipp REV	Jog REV	JOG REV	Jog ARR
Keypad Loss	Ausf.Tasta.	PerditaTast	Perdid Tecl	Perte Clav
kHz		kHz	kHz	kHz
Kpd Stop	Tast. Stop	Stop Kpd	Stop Tec	Clav. Arret
kW	kW	kW	kW	kW
L/R Rem Bth	L/R Rem R/S	L/R Rem Bth	L/R Rem Bth	L/R Rem Bth
L/R Rem Ctl	L/R RemStrg	L/R Rem Ctl	L/R Rem Ctl	L/R Rem Ctl
L/R Rem Ref	L/R Rem Ref	L/R Rem Ref	L/R Rem Ref	L/R Rem Ref
Linear 2pc	Linear 2p.	Linear 2pc	Linear 2pc	Linear 2pc
Linear Auto	Linear Auto	Linear Auto	Linear Auto	Linear Auto
Linear Fxd	Linear Fix	LinearFisso	Lin Estac	Linear Fixe
LOC	LOC	LOC	LOC	LOC
LOC/EMOP	LOK/EMOP	LOC/EMOP	LOC/EMOP	LOC/EMOP
LOC/EMOP2	LOK/EMOP2	LOC/EMOP2	LOC/EMOP2	LOC/EMOP2
Loc/Rem	Loc/Rem	Loc/Rem	Loc/Rem	Loc/Rem
Local Mode	Lokal Modus	Modo Locale	Modo Local	Mode Locale
Local Only	Nur Lokat	Solo Locale	Solo Local	Local Seul
Low Temp	Untertemp.	SottoTemp	Temp Bajo	Basse Temp
Low Voltage	Unterspann.	SottoTens	Tens Baja	Basse Tens
LS Lockout	Anlaufsperr.	No A-Start	LS Lockout	LS Lockout
LS Lockout	Anlaufsperr.	No A-Start	Bloq Arranq	LS Lockout
LS Lockout2	Anlaufspe.2	Blocc LS 2	Bloq Arranq2	LS Lockout2
LSL w/FLY	Als.m.Fang	LSL c aggan	LSL con Ret	LSL w/FLY
LSL w/FLY2	Als.m.Fang2	LSL c agg2	LSL con Ret2	LSL w/FLY2
Macro Group	Gruppe Makro	Gruppo Macro	Grupo Macro	Groupe Macro
Mag Amps	Magnet. Strom	Corr Mag	Corr Mag	Amp Magnet
Max Input	Max.Eingang	IngressoMax	Entrada Max	Max Input
MEA	MEA	MEA	MEA	MEA
Meas. Fail	Messfehler	Err Misura	Medida fallo	Meas. Fail
Model ID	Modul ID	Modulo ID	ID Modelo	Model ID
MOL	MOL	MOL	MOL	MOL
MOL Configure	MOL Configure	MOL Configure	MOL Configure	MOL Configure

English	German	Italian	French	Spanish
Motor	Motor	Motore	Motor	Moteur
Motor Group	Gruppe Motor	Gruppo Motore	Grupo Motor	Groupe Moteur
Motor TOL	Motor TOL	Motor TOL	Motor TOL	Motor TOL
MPM Units	MPM Einheit	Unit MPM	Unidad MPM	Unites MPM
ms	ms	ms	ms	ms
Mtr Measure	Motor mess.	Misuraz Mtr	Medida Motor	Mtr Measure
NC Operate	NC Betrieb	Funz NC	NC Func	NC Fonction
NetID_996	NetID_996	NetID_996	NetID_996	NetID_996
NetID_997	NetID_997	NetID_997	NetID_997	NetID_997
NetID_998	NetID_998	NetID_998	NetID_998	NetID_998
NetID_999	NetID_999	NetID_999	NetID_999	NetID_999
No	Nein	No	No	Non
No Dyn Brk	DB Inaktiv	No FrenoDin	No Fren Din	No Dyn Brk
No Fault	Kein Fehler	No Errore	No Fallo	Pas D'erreur
NO Operate	NO Betrieb	Funz NA	NO Func	NO Fonction
No PI	PI Inaktiv	No PI	No PI	No PI
Not Active	Nicht Aktiv	Non attivo	No es activo	Not Active
Not Enabled	EN offen	EN Aperto	NoPermitada	Non Permis
Out Ph Loss	Ausf. M.Ph.	Perd F Usc	Perd F Sal	Pert Ph Sor
Out Power (kW)	Out Power (kW)	Out Power (kW)	Out Power (kW)	Out Power (kW)
Output	Ausgang	Uscita	Salida	Sorite
Output Freq	Ausg. Freq.	Freq Uscita	Frec Salida	Freq Sortie
Over Temp	Uebertemp.	SovraTemp	SobreTemp	Surchauffe
Over Temp	Uebertemp.	SovraTemp	SobreTemp	Surchauffe
OverCurrent	Ueberstrom	SovraCorr	SobreCorr	OverCurrent
OverVoltage	Ueberspann.	SovraTens	Sobre Tens	Surtension
Param Range	Par.Bereich	Gamma Param	Gama Param	Plage Param
PI Enable	PI Aktiv.	PI Abilito	PI Permita	PI Activer
PI Fback	PI Fback	PI Fback	PI Fback	PI Fback
PI Group	Gruppe PI	Gruppo PI	Grupo PI	Groupe PI
PID Deriv Gain	PID Deriv Gain	PID Deriv Gain	PID Deriv Gain	PID Deriv Gain
PID Feedback	PID Feedback	PID Feedback	PID Feedback	PID Feedback
PID Reference	PID Reference	PID Reference	PID Reference	PID Reference
Ping Mode	Ping Mode	Ping Mode	Modo Ping	Ping Mode
Power Fail Cfg	Netzausf.Vektor	Cad Rete Vector	Power Fail Cfg	Power Fail Cfg
Power Out	Ausg.Leist.	Potenza Usc	Poten Sal	Puiss Sorti
Power Supp	Referenzsp.	Fonte Alim	Fuente Alim	Alim. Puiss
Preset 1	Fixfreq. 1	Freq Fiss 1	Preset 1	Preregle 1
Preset 2	Fixfreq. 2	Freq Fiss 2	Preset 2	Preregle 2
Preset 3	Fixfreq. 3	Freq Fiss 3	Preset 3	Preregle 3
PSI Units	PSI Einheit	Unit PSI	Unidad PSI	Unites PSI
PT 0-100kHz	PT 0-100kHz	PT 0-100kHz	PT 0-100kHz	PT 0-100kHz
PT 0-10kHz	PT 0-10kHz	PT 0-10kHz	PT 0-10kHz	PT 0-10kHz
PT 0-1kHz	PT 0-1kHz	PT 0-1kHz	PT 0-1kHz	PT 0-1kHz
Pump	Pumpe	Pompa	Bomba	Pompe
Pump Fxd	Pumpe Fix	Pompa Fissa	Bomba Estac	Pompe Fixe

English	German	Italian	French	Spanish
Pump w/PI	Pumpe m. PI	Pompa conPI	Bomba c/PI	Pompe PI
Pwr Bridge	Gleichrich.	Ponte Rad	Puente Pot	Pwr Bridge
Pwr Wiring	Netzverkab.	Cabl Pot	CableadoPot	Cable Puiss
Quick Ramp	Schnellstop	Rampa veloc	Quick Ramp	Quick Ramp
Ramp	Rampe	Rampa	Rampa	Rampe
Ramp Down	Tiefl.Rampe	Decel Rampa	Ramp Down	Ramp Down
Ramp Group	Gruppe Rampen	Gruppo Rampa	Grupo Rampa	Groupe Rampe
Ref Loss	Ausf.Refer.	Perdita Rif	Perdido Ref	Ref Loss
Ref Switch	Ref. Umsch.	Ref Switch	Interup Ref	Ref Switch
Regen Time	Stop Gener.	Tempo Gener	Tiemp Regen	Temps Regen
REM	REM	REM	REM	REM
Remote Only	Nur Remote	Solo Remoto	SoloAlejdo	Rem Seul
Res Lockout	Max.Restart	Res Blocc	Rec Bloq	Res Lockout
Reset-Flt	Fehlerreset	Reset-Err	Recom-Fall	Reset-Flt
REV Accel	REV Hochl.	REV Accel	REV Acel	Accel ARR
REV At Spd	REV Endfre.	REV Vel Fin	REV a Veloc	V-Att. ARR
REV Decel	REV Tiefl.	REV Decel	REV Desaccel	Decel ARR
Rev F-FWD	Inv. F-FWD	Rev F-FWD	Rev F-FWD	Rev F-FWD
Rev F-FWD E	Inv.F-FWD E	Rev F-FWD E	Rev F-FWD E	Rev F-FWD E
Rev Full	Inv. Optim.	Rev Ottim	Rev Full	Rev Full
Rev Full E	Inv. Opt. E	Rev Ottim E	Rev Full E	Rev Full E
Reverse	Rueckw.	Indietro	Atraz	Arriere
rpm	rpm	rpm	rpm	rpm
RPM Units	RPM Einheit	Unit RPM	Unidad RPM	Unites RPM
RTU E81	RTU E81	RTU E81	RTU E81	RTU E81
RTU N81	RTU N81	RTU N81	RTU N81	RTU N81
RTU N82	RTU N82	RTU N82	RTU N82	RTU N82
RTU O81	RTU O81	RTU O81	RTU O81	RTU O81
Running FWD	FWD Lauf	Movim FWD	Andando FWD	Mouv. AVT
Running REV	REV Lauf	Movim REV	Andando REV	Mouv. ARR
S-Curve	S-Kurve	Curva ad S	S-Curva	Courbe-S
S-Curve CTS	S-Kurve CTS	Curva-S CTS	S-Curva CTS	Courb-S CTS
sec	sek	sec	seg	sec
Seq 1	Sequenz 1	Seq 1	Sec 1	Seq 1
Seq 2	Sequenz 2	Seq 2	Sec 2	Seq 2
Seq 3	Sequenz 3	Seq 3	Sec 3	Seq 3
Seq Advance	Seq. Vorw.	Seq Avanz	Sec Avance	Seq Avance
Seq Dwell	Seq. Halten	Arresto Seq	Sec Deten	Seq Dwell
Seq Running	Seq. Aktiv	Seq Attiva	Sec Func	Seq Fonct.
Seq Thres Input	SeqAna.Eing.Aus.	Selez IngrAn Seq	Seq Thres Input	Seq Thres Input
SeqOut-00	SeqAusg-00	SeqOut-00	SeqOut-00	SeqOut-00
SeqOut-01	SeqAusg-01	SeqOut-01	SeqOut-01	SeqOut-01
SeqOut-10	SeqAusg-10	SeqOut-10	SeqOut-10	SeqOut-10
SeqOut-11	SeqAusg-11	SeqOut-11	SeqOut-11	SeqOut-11
Sequencer Group	Gruppe Sequenzer	Gruppo Sequencer	Grupo Secuen	Groupe Sequence
SIO	SIO	SIO	SIO	SIO

English	German	Italian	French	Spanish
SIO Group	Gruppe SIO	Gruppo SIO	Grupo SIO	Grupo SIO
SL Override	SL Aufheben	Sovrapp SL	Anular SL	SL Override
Spanish	Spanisch	Spagnolo	Espanol	Espagnol
Special Mode	Special Mode	Special Mode	Special Mode	Special Mode
SPI Read 1	SPI Read 1	SPI Read 1	SPI Read 1	SPI Read 1
SPI Read 2	SPI Read 2	SPI Read 2	SPI Read 2	SPI Read 2
SPI Read 3	SPI Read 3	SPI Read 3	SPI Read 3	SPI Read 3
SQ1	SQ1	SQ1	SQ1	SQ1
SQ2	SQ2	SQ2	SQ2	SQ2
SQ3	SQ3	SQ3	SQ3	SQ3
SQ4	SQ4	SQ4	SQ4	SQ4
SQ5	SQ5	SQ5	SQ5	SQ5
SQ6	SQ6	SQ6	SQ6	SQ6
SQ7	SQ7	SQ7	SQ7	SQ7
SQ8	SQ8	SQ8	SQ8	SQ8
SQ9	SQ9	SQ9	SQ9	SQ9
Start Group	Gruppe Start	Gruppo Start	Grupo Arranq	Grupo Demarrag
Std Display	Std.Anzeige	Display Std	Pant Estand	Affich Std
Std Ind 30s	Std Ind 30s	Std Ind 30s	Std Ind 30s	Std Ind 30s
Std Ind 5mn	Std Ind 5mn	Std Ind 5mn	Std Ind 5mn	Std Ind 5mn
Std Ind 60s	Std Ind 60s	Std Ind 60s	Std Ind 60s	Std Ind 60s
Std Ind ShP	Std Ind ShP	Std Ind ShP	Std Ind ShP	Std Ind ShP
Stopped	Stop	Stop	Parada	Arrete
Stuck Key	Tast.steckt	Tast Attacc	Boton Peg	Cle Bloquee
Sweep F/R	Fangen F/R	Agganc F/R	Buscar Ambos	Sweep F/R
Sweep FWD	Fangen FWD	Agganc FWD	Buscar FWD	Sweep FWD
Sweep REV	Fangen REV	Agganc REV	Buscar REV	Sweep REV
System	System	Sistema	Sistema	Systeme
Test Inputs	Test Eing.	Test Ingressi	Test Inputs	Test Inputs
Test Outputs	Test Ausg.	Test Uscite	Test Outputs	Test Outputs
Test Vin1 Freq	Test Vin1 Freq.	Test Vin1 Freq	Test Vin1 Frec	Test Vin1 Freq
Time hrs	Zeit Std.	Tempo ore	Tiemp horas	Temps hrs
Time min	Zeit Min.	Tempo min	Tiemp min	Temps min
Time sec	Zeit Sek.	Tempo sec	Tiemp sec	Temps sec
Timed Overload	Ueberlastschutz	Tempo Overload	Tiempo Sobrecar	Temps Surcharge
Trim % Factor	Trim % Factor	Trim % Factor	Trim % Factor	Trim % Factor
Trim Ref Enable	Trim Ref Enable	Trim Ref Enable	Trim Ref Enable	Trim Ref Enable
User Units	Benutz.Ein.	Unit Oper	Unidad Oper	Unites Oper
UV Clamp Ramp	UV Rampengeb.	UV Clamp Ramp	Ramp UV Abraz	UV Clamp Ramp
UV Ride-Thru En	UV Ride-Thru En	UV Ride-Thru En	UV Ride-Thru En	UV Ride-Thru En
V	V	V	V	V
Vac Imblnce	DC Unausgeg	Vac Imbilan	Vac Imblnce	Vac Imblnce
VBUS Counts	VBUS Counts	VBUS Counts	VBUS Counts	VBUS Counts
Vdc	Vdc	Vdc	Vdc	Vdc
Vector	Vektor	Vector	Vector	Vectoriel
Vector	Vektor	Vector	Vector	Vectoriel

English	German	Italian	French	Spanish
VIN 1 Counts	VIN 1 Counts	VIN 1 Counts	VIN 1 Counts	VIN 1 Counts
VIN 2 Counts	VIN 2 Counts	VIN 2 Counts	VIN 2 Counts	VIN 2 Counts
Vin1	Vin1	Vin1	Vin1	Vin1
Vin1 48FS	Vin1 48FS	Vin1 48FS	Vin1 48FS	Vin1 48FS
Vin1 6FS	Vin1 6FS	Vin1 6FS	Vin1 6FS	Vin1 6FS
Vin1 Filter Time	Vin1 Filter Time	Vin1 Filter Time	Vin1 Filter Time	Vin1 Filter Time
Vin1/2 DI	Vin1/2 DI	Vin1/2 DI	Vin1/2 DI	Vin1/2 DI
Vin1/Cin DI	Vin1/Cin DI	Vin1/Cin DI	Vin1/CIN DI	Vin1/Cin DI
Vin1/KYP DI	Vin1/KYP DI	Vin1/KYP DI	Vin1/KYP DI	Vin1/KYP DI
Vin1+Cin	Vin1+Cin	Vin1+Cin	Vin1+Cin	Vin1+Cin
Vin1+Vin2	Vin1+Vin2	Vin1+Vin2	Vin1+Vin2	Vin1+Vin2
Vin1-Cin	Vin1-Cin	Vin1-Cin	Vin1-Cin	Vin1-Cin
Vin1-Vin2	Vin1-Vin2	Vin1-Vin2	Vin1-Vin2	Vin1-Vin2
Vin2	Vin2	Vin2	Vin2	Vin2
Vin2 Filter Time	Vin2 Filter Time	Vin2 Filter Time	Vin2 Filter Time	Vin2 Filter Time
Vin2 F-Mtr	Vin2 F-Mtr.	Vin2 F-Mtr	Vin2 F-Mtr	Vin2 F-Mtr
Vin2 Motor	Vin2 Motor.	Vin2 Motori	Vin2 Motor	Vin2 Moteur
VMET Percent	VMET Prozent	VMET Percent	VMET Percent	VMET Percent
Volt Range	VoltBereich	Gamma Volt	Gama Tens	Volt Range
Voltage Out	Ausg. Span.	Volt Usc	Tension Sal	Tens Sortie
w/ LVT	w/ LVT	w/ LVT	w/ LVT	w/ LVT
w/o LVT	w/o LVT	w/o LVT	w/o LVT	w/o LVT
Warning	Warnung	Avvertenza	Advertencia	Avertissem.
Wfx Appl ID	Wfx Appl ID	Wfx Appl ID	Wfx ID Aplic	Wfx Appl ID
Wfx Network ID	Wfx Netzwerk ID	Wfx Network ID	Wfx ID Red	Wfx ID Reseau
Wfx Revision ID	Wfx Version ID	Wfx Versione ID	Wfx ID Rev	Wfx Revision ID
Vacon 50C	Vacon 50C	Vacon 50C	Vacon 50C	Vacon 50C
Vacon 50C(B)	Vacon 50C(B)	Vacon 50C(B)	Vacon 50C(B)	Vacon 50C(B)
Vacon 50K	Vacon 50K	Vacon 50K	Vacon 50K	Vacon 50K
Vacon 50K(B)	Vacon 50K(B)	Vacon 50K(B)	Vacon 50K(B)	Vacon 50K(B)
Yes	Ja	Si	Si	Oui
Zero Speed	Stillstand	Vel Zero	Cero Veloc	V-Zero

VACON

DRIVEN BY DRIVES

Find your nearest Vacon office
on the Internet at:
www.vacon.com

