

VACON CX/CXL/CXS FREQUENCY CONVERTERS



Brake choppers and resistors

Subject to changes without notice

FOR SMOOTH CONTROL



vacon

TABLE OF CONTENTS**1 GENERAL**

1.1	Requirement for braking	2
1.2	Brake components	2
1.3	Brake classifications	3

2 TECHNICAL DATA 3

2.1	Standard resistors for partial use	3
2.2	Power rating of standard resistors	4
2.3	Environment	4
2.4	Dimensioning of brake resistors	4

3 CHOICE OF BRAKE RESISTOR 5

3.1	General	5
3.2	Sizing principle	5
3.3	Choice of standard resistor	6

4 CONNECTIONS 9

4.1	General	9
4.2	Thermal protection	9
4.3	Resistor package connections	10

5 DIMENSIONS 11

1 GENERAL

1.1 Requirement for braking

When you want to slow down a running squirrel-cage motor it turns into a generator, feeding energy back into the frequency converter. The energy increases the voltage in the DC-link. The frequency converter compensates for this increase by increasing the output frequency, decreasing the slip and increasing the motor load.

The deceleration is, in this case, dependent on the power losses in the converter and in the motor.

This is usually sufficient in most cases, for pumps, fans, conveyors etc. where the kinetic energy in the load is small or the braking time is not critical.

When you have to brake the motor faster than the losses allow, you have to use an

external brake resistor for energy dissipation together with an internal, factory mounted brake chopper. The extra energy from the load is turned into heat in the brake resistor.

Applications where dynamic braking is usually needed include centrifuges, cranes, some conveyors and drives requiring very fast reversing.

1.2 Brake components

The brake chopper is an extra IGBT mounted into the Vacon CX frequency converters by the manufacturer. The CXS range contains it as standard. It controls the DC-link voltage by connecting the brake resistor across it and thus dissipates the energy. The brake chopper in the Vacon CX frequency converter is rated for continuous drive rated power.

The brake resistor is an external, low impedance resistor. In order to achieve the correct power handling capacity for a specific application, resistors can be connected in series and parallel, keeping within the limits in Table 2.1.1

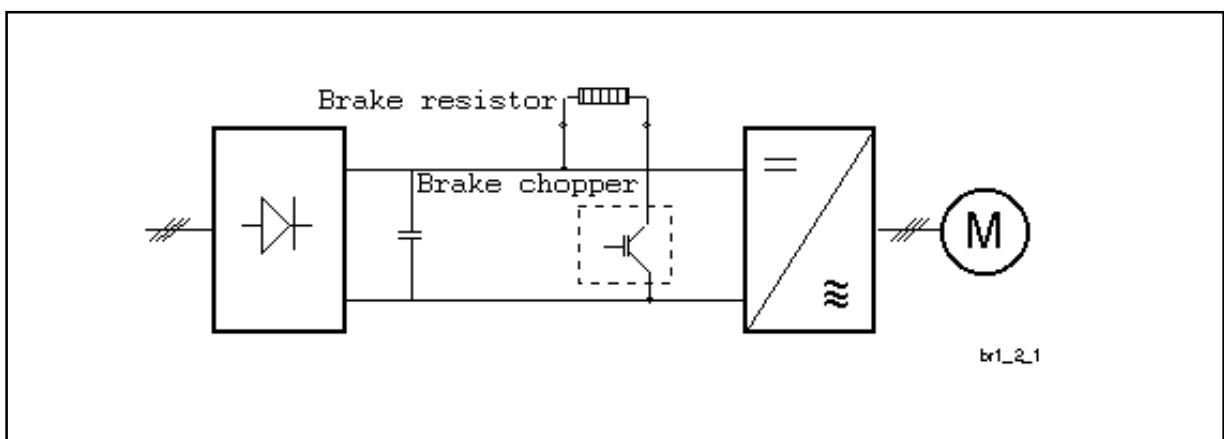

Figure 1.2-1. The brake components and their basic connection

1.3 Classes of use

a) Partial use (most common)

The process requires regular or irregular rapid decelerations, stops or reversings.

b) Continuous use

The motor continuously brakes with constant torque

c) Combination use

The motor continuously brakes with variable torque

d) DC-link voltage smoothing

The brake resistor smooths overvoltage spikes from the supply

2 TECHNICAL DATA

2.1 Standard resistors for partial use

Brake resistors for partial use for Vacon CX_4, Vacon CX_5 and Vacon CX_6¹⁾ – frequency converters can be chosen from the tables below.

When other resistors are used, make sure that the resistance is higher than the minimum resistance defined. The power handling capacity must be sufficient for the application.

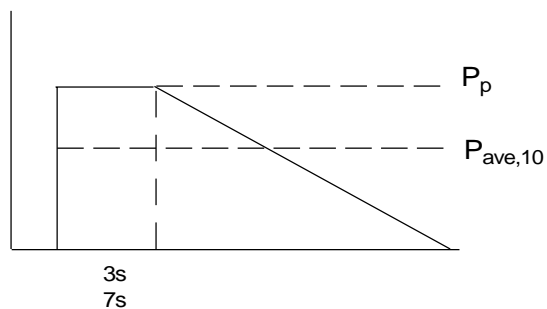

P_p = peak power
 $P_{ave,10}$ = 10 s average power
 P_{ave} = continuous power

Figure 2.1-1 Shape of the power pulse

Vacon type kW	Brake resistor type	Energy handling kJ	P_p	$P_{ave,10}$	P_p	$P_{ave,10}$	P_{ave} kW	Min. cable mm ²
			kW	kW	kW	kW		
			500 V		400 V			
M3: ≤3	BR100R0,4	41	6,4	4,1	4,1	2,7	0,17	1,5
M4B:4-7,5	BR75R1,0	55	8,5	5,5	5,4	3,5	0,25	1,5
M4B: 11	BR36R1,0	114	17,6	11,4	11,2	7,3	0,75	1,5
M4:2,2-5,5	BR36R1,0	114	17,6	11,4	11,2	7,3	0,75	1,5
M5B:15-18,5	BR18R2	230	35	22	22,3	15	0,95	6
M5:7,5-15	BR12R2,6	340	53	34	34	22	1,4	6
M5B:22	BR12R2,6	340	53	34	34	22	1,4	6
M6:18,5-45	BR6R5,1	690	106	69	68	44	2,9	16
M7:55-90	BR3R10,2	1380	212	138	135	88	5,8	185
M8:110-160	2 x BR3R10,2 ⁴⁾	2760	424	276	270	196	18	2 x 185
M9:200-250	3 x BR3R10,2 ⁴⁾	4140	636	414	406	264	27	3 x 185
M10:315-400	4 x BR3R10,2 ⁴⁾	5520	848	552	541	352	36	4 x 185

Table 2.1-1 Vacon BR_ standard resistors for partial use, CX_4 and CX_5 ranges.

¹⁾Marking CX_, etc. refers to all Vacon series; CX, CXL and CXS.

Vacon type CX_6 kW	Brake resistor type kW	Energy handling kJ	P _p kW	P _{ave,10} kW	P _{ave} kW	Min. cable mm ²
M5:7,5-22	BR18R2	436	67	43	2,9	6
M6:30-75	BR9R3,2	934	143	93	6,1	16
M8:90-132	2 x BR9R3,2 ⁴⁾	1868	286	187	12	2 x 185
M9:160-200	3 x BR9R3,2 ⁴⁾	2802	429	280	18	3 x 185
M10:250-315	4 x BR9R3,2 ⁴⁾	3740	590	370	24	4 x 185

Vacon type CX2 kW	Brake resistor type, kW	Energy handling, kJ	P _p , kW	P _{ave, 10} kW	P _{ave} kW	Min. cable mm ²
M3: 0.55...0.75	BR100R0.4	10	1.5	1	0.33	1.5
M3: 1.1...1.5	BR75R1.0	13	2.0	1.3	1.0	1.5
M4B: 2.2...3	BR75R1.0	13	2.0	1.3	1.0	2.5
M4: 1.5...3	BR36R1.0	26	4.0	2.6	1.0	2.5
M4B: 4...5.5	BR36R1.0	26	4.0	2.6	1.0	4kW:6/5.5kW:10
M5B: 7.5...11	BR12R2.6	78	12.0	7.8	3	7.5kW:10 / 11 kW:16
M5: 4...7.5	BR9R3.2	104	16.0	10.4	3.2	10
M5B: 15	BR9R3.2	104	16.0	10.4	3.2	16
M6: 11...22	BR6R5.1	156	24.0	15.6	5	16
M7: 30...45	BR3R10.2	312	48.0	31.2	10	30kW:70 / 37kW:95 / 45kW:95
M8: 55...90	2xBR3R10.2	624	96.0	62.4	20	95

Table 2.1-2 Vacon BR_ standard resistors for partial use, CX_6 and CX_2 ranges.

3) Maximum resistor temperature. +280°C

4) Includes separate connector box

2.2 Power rating of standard resistors.

The power handling capacity of the standard resistors as a function of the duty cycle is shown in Figure 2.2-1. The figure

shows the relative power handling capacity at various duty cycles, i.e. compared to continuous 150 s. braking.

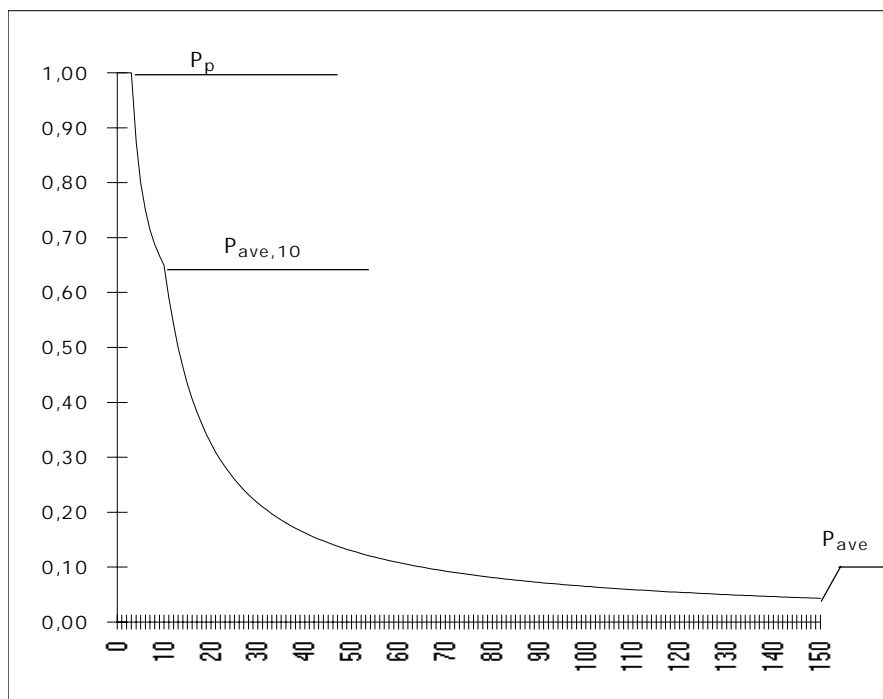

Figure 2.2-1. The power handling capacity of standard resistors as a function of the duty cycle.

2.3 Environment

Surface temperature of the resistor box:
<80°C

Maximum ambient temperature: 30°C

Protection class: IP20

NOTE: When you mount the resistor package, note the high surface temperature. The mounting surface must be non-flammable and there must be sufficient free space around the box. Ensure sufficient ventilation of the area.

2.4 Dimensioning of brake resistors

You can connect an external brake resistance to Vacon CX frequency converters equipped with a brake chopper. The minimum resistance values as well as the maximum current allowed per power rating are shown in the table below. These values must be kept at all times. The re-

sistor has to be protected also against overtemperature. The overtemperature protection has to be connected as shown in Chapter 4.2. As for frames M11, M12 and M13, read Chapter 4, Connections.

Vacon CX_4 and CX_5 rated power [kW]	DC-current I_{max} (80°C) [A]	Brake resistor	
		CX_4 [Ω]	CX_5 [Ω]
M3: 0,75 - 3,0	12,0	63,0	75,9
M4B: 4,0 - 7,5	12,0	63,0	75,9
M4B: 11	22	30,6	38,4
M4: 2,2 - 5,5	25	30,2	36,4
M5B:15-18,5	45	16,7	20,2
M5B:22	65	11,6	14
M5: 7,5 - 15	75	10,1	12,2
M6: 18,5 - 45	150	5,0	6,1
M7: 55 - 90	300	2,5	3,0
M8: 110 - 160	600	1,3	1,5
M9: 200 - 250	900	0,84	1,0
M10: 315 - 400	1200	0,63	0,76

Table 2.4-1 Vacon CX_4 and CX_5 brake chopper ratings

Vacon CX_2 rated power (kW)	DC-current, I_{max} (80 dgr C) [A]	Brake resistor CX2 Ω
M3: 0.55 - 1.5	15	30
M4B: 2.2 - 3.0	15	30
M4B: 4.0 - 5.5	22	20
M4: 1.5 - 3.0	25	18
M5B: 7.5 - 11.0	45	10
M5B: 15	65	7
M5: 4.0 - 7.5	75	6
M6: 11.0 - 22.0	150	3
M7: 30.0 - 45.0	300	1.5
M8: 55-90	600	0.75

Vacon CX_6 rated power [kW]	DC-current I_{max} (80°C) [A]	Brake resistor [Ω]
M5:7,5 - 22	75,0	16,8
M6:30 - 75	150	8,4
M8:90 - 132	300	4,2
M9: 160 - 200	450	2,8
M10:250 - 315	600	2,1

Table 2.4-2 Vacon CX_6 brake chopper ratings.

Table 2.4-3 Vacon CX_2 brake chopper ratings

3 CHOICE OF BRAKE RESISTOR

3.1 General

When you choose the brake resistor, start from the requirements of the process/drive.

The choice of brake resistor is influenced by the maximum power dissipation required and the average power dissipation during one braking cycle. The maximum power defines the required cable sizes and resistor size, the average power the required cooling capacity. You also have to keep within the limits set by the

brake chopper as specified in Tables 2.1-1 and 2.1-2. The standard resistors supplied by Vacon Plc, are designed for partial use according to the limits presented in the preceding chapter. In all other cases the required resistors have to be sized according to your needs.

Table 2.1-1 also defines the minimum resistances that may be used.

Our technical support will assist you in all matters concerning braking.

3.2. Sizing principles

When you have to brake a load, you have to know its moment of inertia in order to define the power handling capacity required of your resistor. Figure 3.2-1. shows some typical examples for the calculation of the torque, moment of inertia and power and their reduction to the shaft of the motor. The moment of inertia is often available from the machine supplier. Other factors influencing the choice

are:

- rated power of the motor
- maximum speed of the motor
- minimum speed of the motor
- the start/stop times during one work cycle
- the required deceleration time

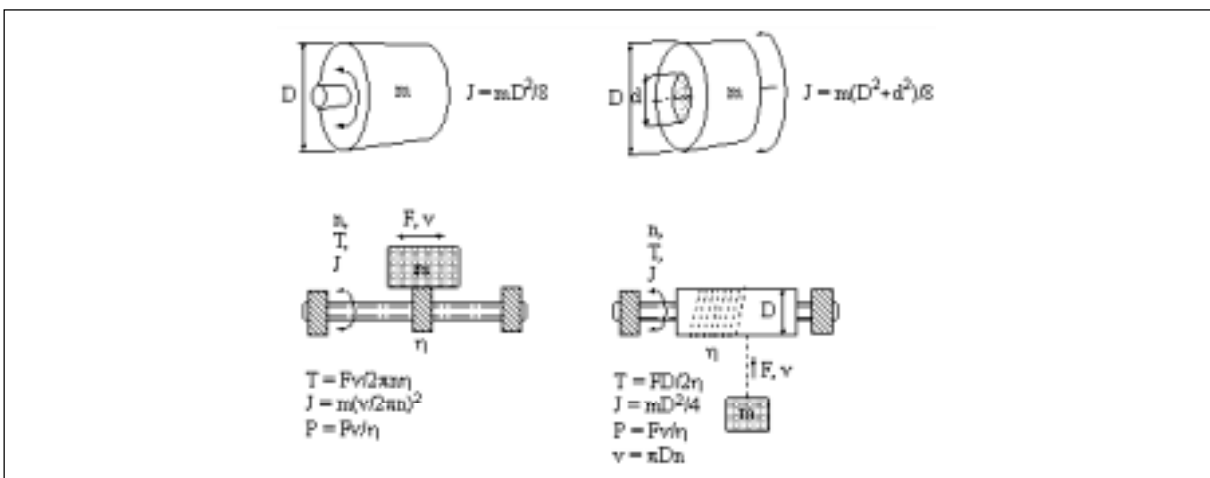

Figure 3.2-1. Formulae for torque, moment of inertia and power

3.3. Choice of a standard resistor

The sizing of Vacon standard resistors can be checked following the procedure below. For the calculation you need:

- motor rated power (kW)
- motor rated speed (1/min)
- motor maximum speed (1/min)
- motor minimum speed (1/min)
- running time of one cycle (s)
- stop time of one cycle (s)
- desired acceleration/deceleration time (s)
- moment of inertia of motor and drive (kgm²)
- gear ratio of any gear

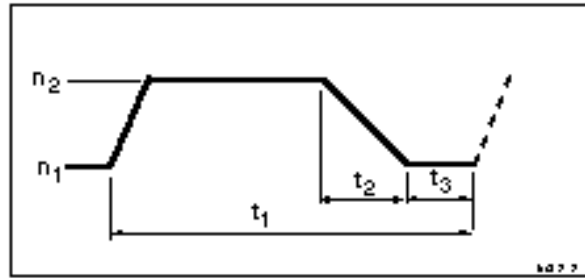

Figure 3.3-2 Speed profile of one drive cycle.

- t_1 = length of cycle
- t_2 = deceleration time
- t_3 = stop time
- n_1 = minimum speed of motor
- n_2 = maximum speed of motor

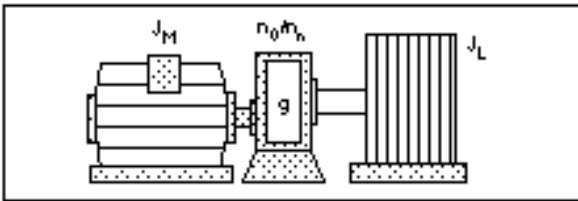

Figure 3.3-1 Moments of inertia of motor and drive

Phase 1. Brake requirement

a) Calculate the rated torque of the motor T_M :

$$T_M = 9550 \times P_M / n_0 \text{ [Nm]}, \text{ where}$$

P_M = rated power of the motor [kW]
 n_0 = rated speed of the motor [1/min]

$$T_M = 9550 \times \text{___} / \text{___} = \text{___} \text{ Nm}$$

b) Calculate the total moment of inertia J :

$$J = J_M + J_L \times g^2 \text{ [kgm}^2\text{]}, \text{ where}$$

J_M = Moment of inertia of the motor
 J_L = Moment of inertia of the drive
 g = gear ratio (if any)
 $g = (n_L / n_0)$, where
 n_0 = rated speed of motor
 n_L = rated speed of drive

$$J = \text{___} + \text{___} \times (\text{___} / \text{___})^2 = \text{___} \text{ kgm}^2$$

c) Calculate the required braking T_B :

$$T_B = 2\pi \times J \times (n_2 - n_1) / 60 / t_2, \text{ where}$$

J = Moment of inertia (kgm²)
 n_2 = speed at start of braking [1/min]
 n_1 = speed at end of braking [1/min]
 t_2 = braking time [s]

$$T_B = 2\pi \times \text{___} \times \text{___} / 60 / \text{___} \text{ Nm}$$

$$= \text{___} \text{ Nm}$$

d) Calculate the required braking need percentage:

$$T_{\%} = T_B / T_M \times 100\%$$

$$T_{\%} = \text{___} / \text{___} \times 100\% = \text{___}\%$$

If $T_{\%}$ is smaller than 20%, you do not need any additional braking capability. The losses in the converter and motor are sufficient to brake the drive as required.

If $T_{\%}$ is greater than 20%, an external brake resistor and chopper is needed. Continue from phase 2.

Phase 2: Choice of brake resistor

The choice of brake resistor is influenced by:

- maximum power handling capacity
- average power handling capacity/ cycle
- number of cycles/time

You can also use the method below to check if the brake is sufficient when conditions change.

a) Calculate the maximum power during braking

$$P_{max} = T_B \times n_2 / 9550 \text{ [kW]}$$

$$P_{max} = \text{___} \times \text{___} / 9550 = \text{___} \text{ kW}$$

P_{max} must be smaller than or equal to the maximum power handling capacity of the resistor in Table 2.1-1 and -2. If P_{max} is greater than P_p , the frequency converter and its brake resistor cannot handle the power required. Increase the braking time, decrease the moment of inertia of the load or use a larger frequency converter.

b) Calculate the average power during one

working cycle P_{avg} :

$$P_{avg} = T_B \times (n_1 + n_2) / 2 / 9550 \text{ [kW]}$$

$$P_{avg} = \text{___} \times \text{___} / 19100 = \text{___} \text{ kW}$$

c) Calculate the average relative braking power: $P\%$:

$$P\% = P_{avg} / P_p \times 100\%$$

$$P\% = \text{___} / \text{___} \times 100\% = \text{___}\%$$

Locate the $P\%$ -result in the diagram below. If your $P\%$ value is below the curve, the brake resistor can handle the power required. If your value is above the curve, your resistor is insufficient for the power required. Increase the resistor power handling capacity or increase the braking time, decrease the moment of inertia or increase your frequency converter size.

Figure 3.3-3 Relation between braking time

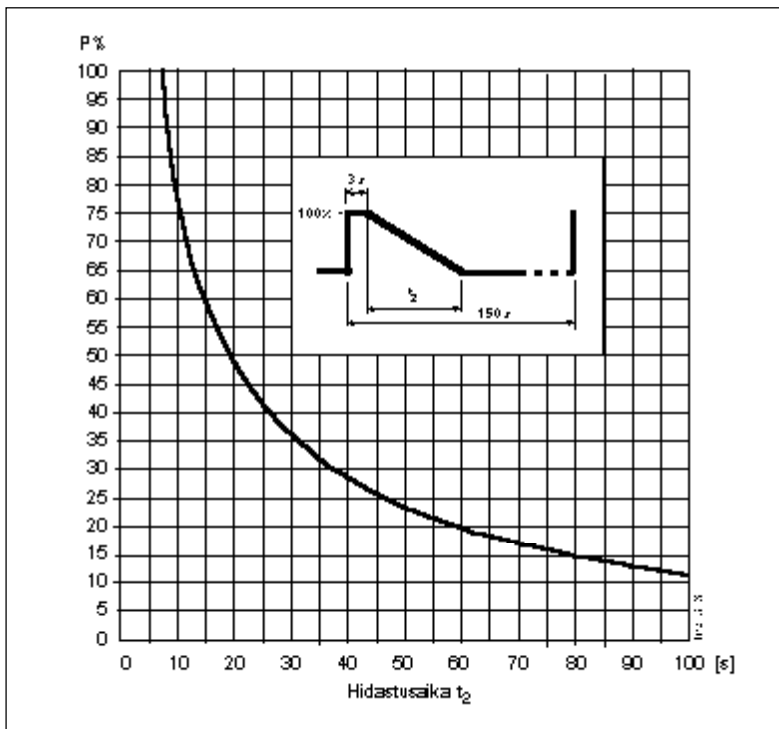

and average power handling capacity.

d) Check that the duty cycle is sufficient for your needs

$$\eta_t = t_2 / t_1 \times 100\%$$

$$\eta_t = \text{___} / \text{___} \times 100\% = \text{___}\%$$

Place η_t and $P_{\%}$ into the diagram in Figure 3.3-4. If you end up below the line, you're OK. If you end up above the line, increase the resistor power handling capacity or increase the braking time, decrease the moment of inertia or increase your frequency converter size.

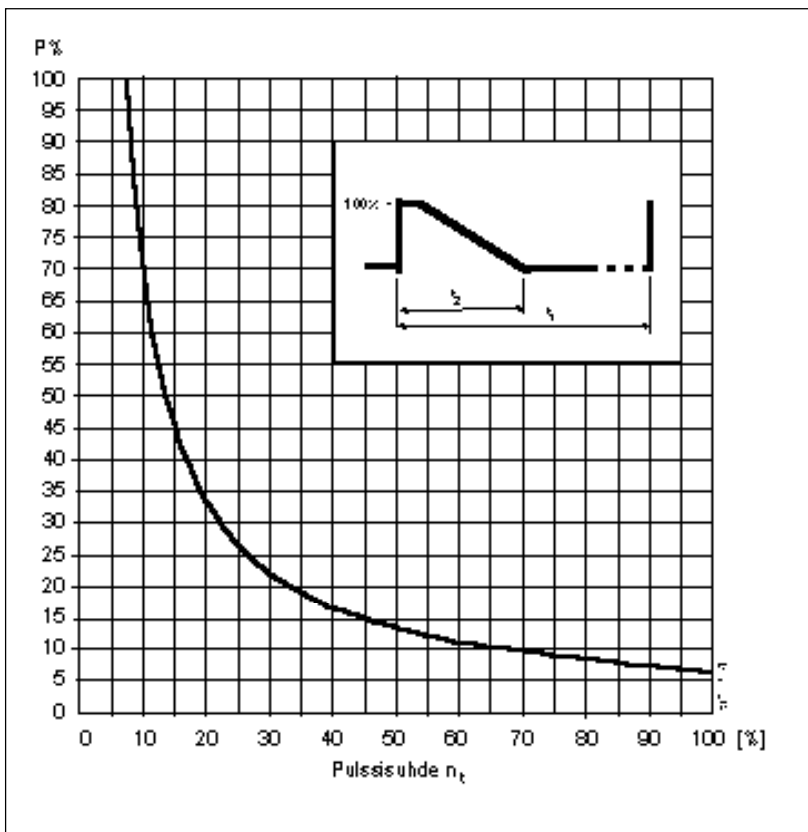

Figure 3.3-4 Relation between duty cycle and average braking power.

4 CONNECTIONS

4.1 General

Note: Make sure that your frequency converter is equipped with a brake chopper. This is a factory installed option!!

The brake resistor is connected to the DC+ and R-connectors on the frequency converter.

In sizes M8, M9 and M10, each power block with internal connection in parallel has a brake connector of its own. The number of brake connectors equals to the number of blocks with parallel connection (M8: 2, M9: 3 and M10: 4). The numbering of the connectors follows the numbering of the blocks, R1, R2 etc. If separate brake resistors for each block are used in these sizes, the connection must be made between the DC+ connector and one of the R-connectors. The minimum ratings of separate brake resistors equal two times (M8), three times (M9) or four times (M10) the values given in tables 2.3-1,2,3. **NOTE: All R-connectors must have a resistor connected.** If you use brake resistors belonging to the same package the connectors R1, R2 etc. shall be interconnected. (The same can also be done with separate resistors.)

4.2 Sizes M11, M12 and M13

Units of these sizes are composed of a 'master' unit and one or two 'slave' units.

Vacon type	Minimum resistor value per resistor	
	Separate resistors used	One resistor used
M11; CX_4	0.84	0.42
M11; CX_5	1.0	0.5
M11; CX_6	2.8	1.4
M12; CX_4	0.63	0.315
M12; CX_5	0.76	0.38
M12; CX_6	2.1	1.05
M13; CX_4	0.63	0.21
M13; CX_5	0.76	0.25
M13; CX_6	2.1	0.7

Table 4.2-1 Minimum resistor values

Each unit embodies a D+ connector and a brake connector (R). If effective braking is not necessary, only one brake resistor connected to the DC+ and R connectors on the master unit is sufficient. If greater braking effect is needed or several brake resistors used, a separate resistor package can be connected to each unit. Alternatively, the R-connectors of each unit can be interconnected and the connection to the resistor established. In the latter case, the other end of the package is coupled with the interconnected DC+ connectors.

The minimum resistor value for size M11 is the value for M9 given in tables 2.4-1 and 2 divided by two. If separate resistors are used for both master and slave, the minimum resistor value for size M11 equals that for M9. Correspondingly, the minimum resistor value for size M12 is the value for M10 divided by two. If separate resistors are used for both master and slave, the minimum resistor value for size M12 equals that for M10.

The size M13 is composed of three M10's, which means that the minimum resistor values for separately used resistors correspond that for M10 and in case of only one resistor, this value must be divided by 3. See table 4.2-1 below.

The minimum cable sizes are shown in Table 2.1-1 and -2. When you size the cables, note that the input fuses of the converter also protect this cable.

4.2 Thermal protection

The Vacon BR –brake resistors are equipped with a thermal supervision, which opens on overtemperature. We recommend that you use this contact to stop the drive, either by removing power as in Figure 4.2-1, by linking it to the Start/stop circuit or to the emergency stop circuit.

The contact can be multiplied for use in annunciator systems or for controlling the frequency converter.

Note: If you use other resistors than Vacon BR they must be equipped with thermal supervision.

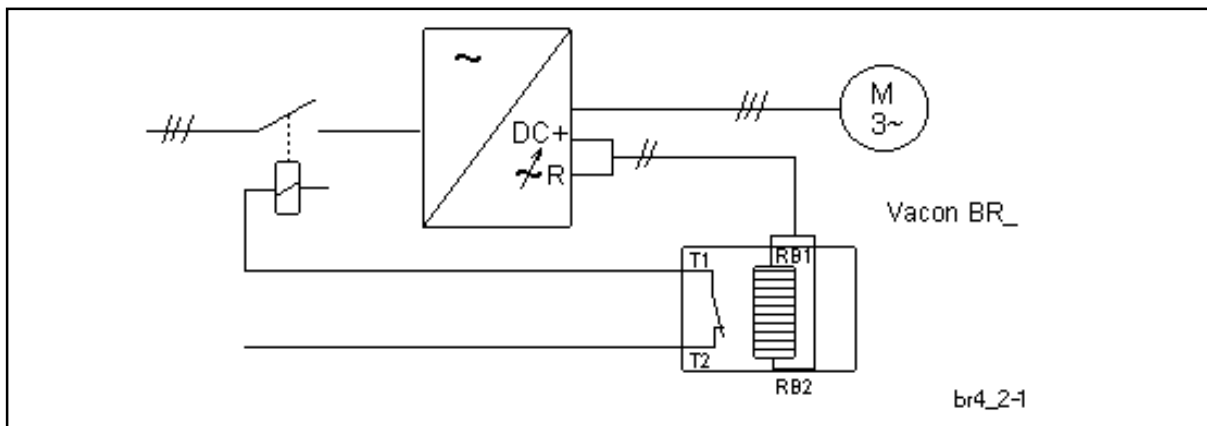

Figure 4.2-1 Thermal supervision of the resistor element

Do not place the brake resistor cables close to any other cables. The recommended minimum distance to the control cables is 0.5 m.

Note: When making the connections, make sure that the converter is not connected to the mains. After disconnecting it, you have to wait at least 5 minutes before opening the converter cover. Make sure by measuring at connectors DC+ and R- that the drive is not powered. Also read Chapter 1. SAFETY in the converter manual.

4.3 Connecting the brake resistors

The cable from the converter is connected to terminals RB1 and RB2 on the end of the resistor package. The cable for the thermal supervision is connected to terminals T1 and T2. Connect earth to the earthing terminal, see Figure 4.3-1

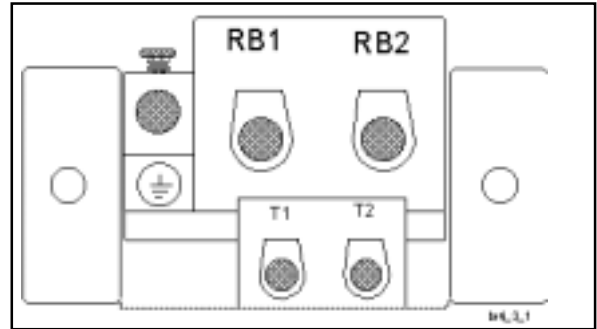

Figure 4.3-1 Connecting the brake resistor.

On Vacon BR3R10.2 and bigger units containing two or more parallelly connected resistors a separate, included, terminal box is used, see Figure 4.3-2

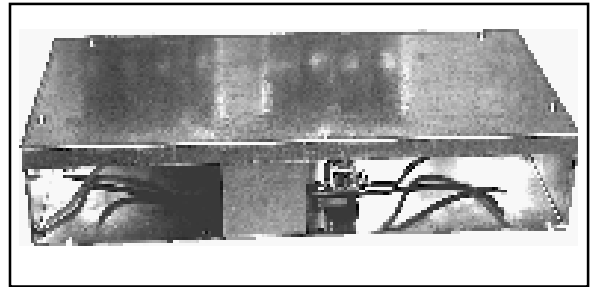

Figure 4.3-2 Brake terminal box

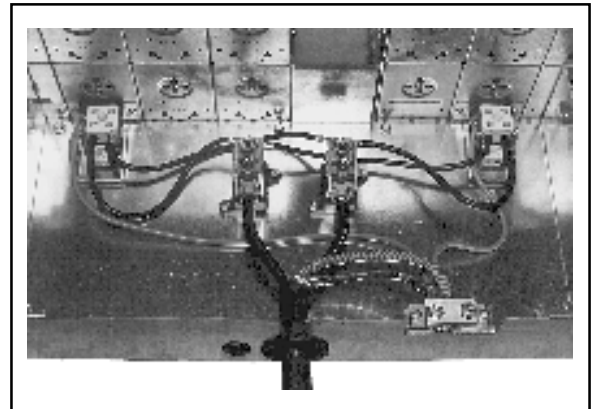

Figure 4.3-3 Connection of the resistors at the terminal box.

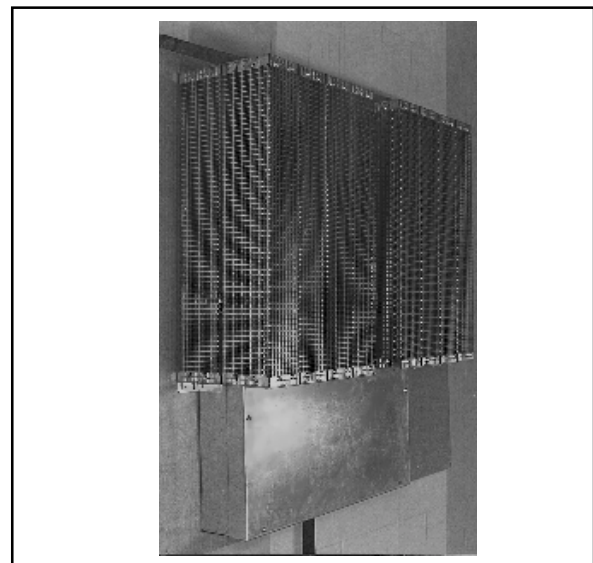
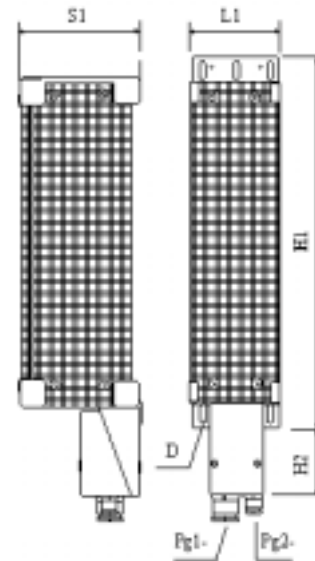

Figure 4.3-4 Mounted brake resistor package

5. Dimensions

BR100R0.4

H1	H2	L1	S1	D	Pg1-	Pg2-
270	66.5	97	119	6,5x15.5	13	7



BR36R1.0 / BR75R1.0

H1	H2	L1	S1	D	Pg1-	Pg2-
650	66	89	115	6,5x15	13	7

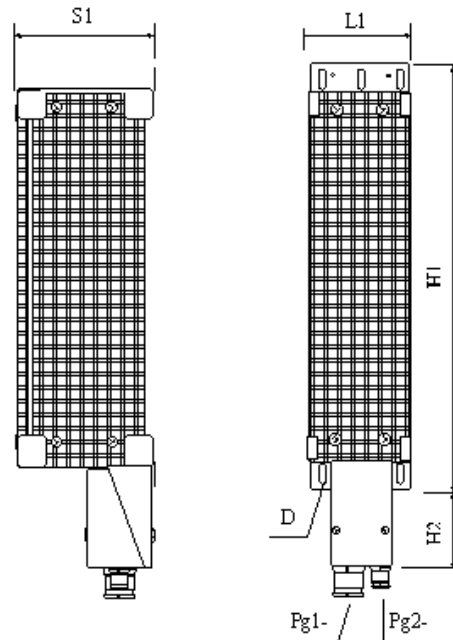

BR18R2.0

H1	H2	L1	S1	D	Pg1-	Pg2-
650	66	176	115	6,5x15	13	7

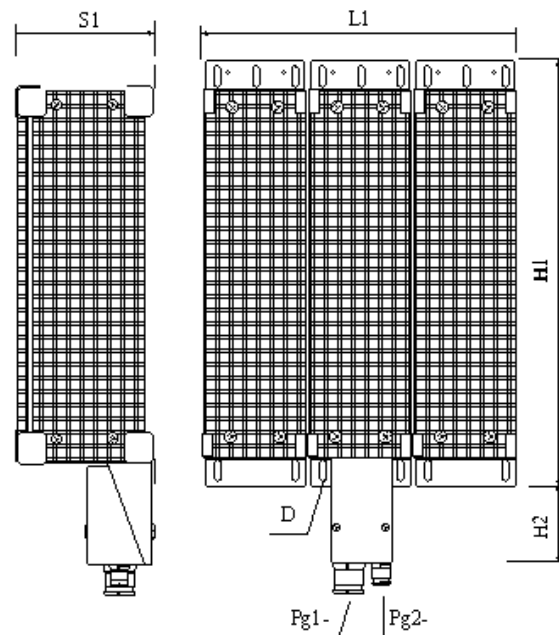

BR12R2.6

H1	H2	L1	S1	D	Pg1-	Pg2-
650	66	265	115	6,5x15	13	7

BR6R5.1

H1	H2	L1	S1	D	Pg1-	Pg2-
650	66	265	230	6,5x15	13	7

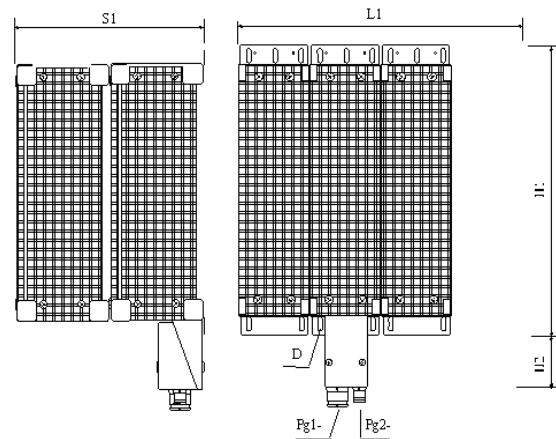

BR3R10.2

2 BR6R5.1 connected in parallel

The resistor package contains a separate terminal box for connecting the BR6R5.1 packages, see Figure 5.1-1.

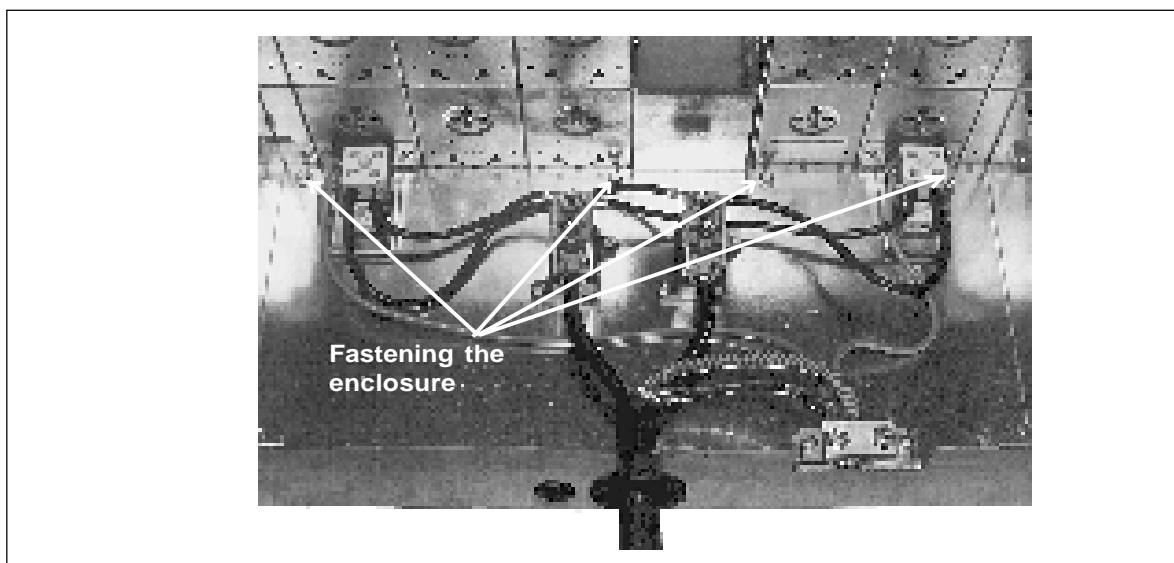

Figure 5.1-1. Connecting the resistors to the terminal box.

Ud219c.doc
9.10.2000



VACON PLC
PL 25
Runsorintie 7
65381 VAASA
Tel: +358-201-2121
Fax: +358-201-212 205
Service: +358-40-8371 150
E-mail: vacon@vacon.com
<http://www.vacon.com>