

**V A C O N**  
**C X / C X L / C X S**  
**F R E Q U E N C Y   C O N V E R T E R S**

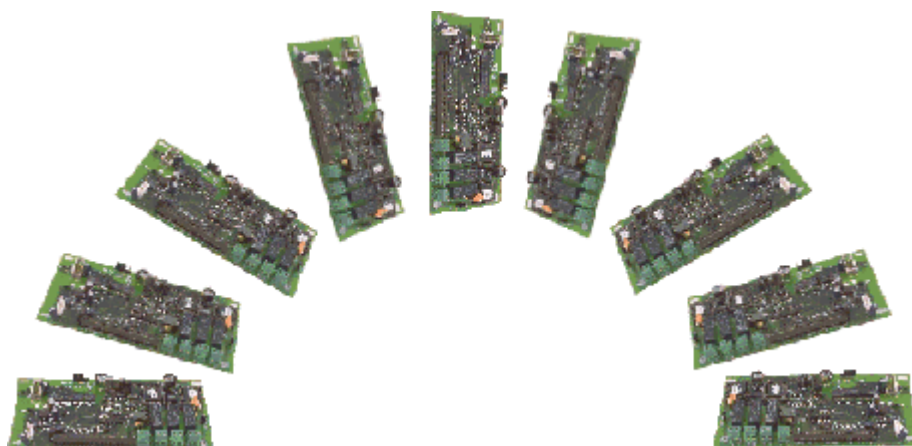

***I/O-expander board  
installation manual  
(Vacon CXS-range)***

*Subject to changes without notice.*

**F O R S M O O T H C O N T R O L**



**vacon**

---

## CONTENTS

<b>1 GENERAL .....</b>	<b>2</b>
1.1 Vacon CX100OPT .....	2
1.2 Vacon CX101OPT .....	2
1.3 Vacon CX102OPT .....	2
1.4 Vacon CX103OPT .....	2
1.5 Vacon CX104OPT .....	3
1.6 Vacon fieldbus boards .....	3
<b>2 SPECIFICATIONS .....</b>	<b>4</b>
<b>3 INSTALLATION .....</b>	<b>5</b>
3.1 General .....	5
3.2 Installation .....	6
<b>4 CONTROL CONNECTIONS .....</b>	<b>11</b>
4.1 Vacon CX100OPT .....	11
4.2 Vacon CX101OPT .....	12
4.3 Vacon CX102OPT .....	13
4.4 Vacon CX103OPT .....	14
4.5 Vacon CX104OPT .....	15

## 1 GENERAL

Due to the compact frame size of the Vacon CXS series all I/O-expander boards need to be installed in a separate box (Vacon CXSOPTBKIT), except the smaller, specifically for Vacon CXS designed boards (Vacon CX104OPT, CX105OPT, CX107OPT, CX108OPT). If ordered together with the option board these will be preinstalled.

### 1.1 Vacon CX100OPT

The available I/O can be increased by using the Vacon CX100OPT I/O-expander board:

- 5 digital inputs (standard signals)
- 2 analogue inputs (standard signals)
- 3 relay outputs (standard signals)
- analogue output (programmable)
- thermistor input (can be directly connected to the motor thermistors to monitor the motor temperature)
- encoder input

Typical use: Closed Loop Vector Control

### 1.2 Vacon CX101OPT

The available I/O can be increased by using the Vacon CX101OPT I/O-expander board:

- 5 digital inputs (standard signals)
- relay output (standard signal)
- thermistor input (can be directly connected to the motor thermistors to monitor the motor temperature)

Typical use: thermistor input required

### 1.3 Vacon CX102OPT

The available I/O can be increased by using the Vacon CX102OPT I/O-expander board:

- 5 digital inputs (standard signals)
- 2 analogue inputs (standard signals)
- 3 relay outputs (standard signals)
- analogue output (programmable)
- thermistor input (can be directly connected to the motor thermistors to monitor the motor temperature)
- encoder input

Typical use: Closed Loop Vector Control

### 1.4 Vacon CX103OPT

The available I/O can be increased by using the Vacon CX103OPT I/O-expander board:

- 5 digital inputs (standard signals)
- 3 relay outputs (standard signals)
- analogue output (programmable)
- thermistor input (can be directly connected to the motor thermistors to monitor the motor temperature)

Typical use: thermistor input and additional analogue output required

**1.5 Vacon CX104OPT**

The available I/O can be increased by using the Vacon CX104OPT I/O-expander board:

- encoder input

Typical use: Closed Loop Vector Control

**1.6 Fieldbus boards**

Vacon fieldbus boards can be installed in the Vacon CXS range frequency converters as I/O-expander boards. The needed information to install/commission fieldbus boards can be found in the respective Vacon fieldbus manual.

- Vacon CX 200OPT (Interbus-S)
- Vacon CX 201OPT (Modbus)
- Vacon CX 202OPT (Profibus-DP)
- Vacon CX 203OPT (LonWorks)
- Vacon CX 204OPT (C-bus)
- Vacon CX 205OPT (SDS-bus)

## 2 SPECIFICATIONS

<b>Safety</b>		Fulfills EN50178, C-UL and EN60204-1 standards
<b>Control connections</b>	Analogue voltage, input	0—± 10 V, $R_i \geq 200 \text{ k}\Omega$
	Analogue current, input	0(4)—20 mA, $R_i = 250 \Omega$
	Digital input	24 V: "0" $\leq 10 \text{ V}$ , "1" $\geq 18 \text{ V}$ , $R_i > 5 \text{ k}\Omega$
	Aux. voltage	24 V ( $\pm 20\%$ ), max. 50 mA
	Reference voltage	10 V $\pm 3 \%$ , max. 10 mA
	Analogue current, output	0(4)—20 mA, $R_L = 500 \Omega$ , resolution 10 bit, accuracy $\leq \pm 2\%$
	Analogue voltage, output	0(2)—10 V, $R_L \geq 1 \text{ k}\Omega$ , resolution 10 bit, accuracy $\leq \pm 2\%$
	Relay output	Max. switching voltage: 300 V DC, 250 V AC Max. switching load: 8A / 24 V DC 0,4 A / 300 V DC 2 kVA / 250 V AC Max. continuous load: 2 A rms
	Thermistor input	$R_{\text{trip}} = 4.7 \text{ k}\Omega$
Encoder input	24 V: "0" $\leq 10 \text{ V}$ , "1" $\geq 18 \text{ V}$ , $R_i = 2.2 \text{ k}\Omega$	
	5 V: "0" $\leq 2 \text{ V}$ , "1" $\geq 3 \text{ V}$ , $R_i = 330 \Omega$	

Table 2-1 Specifications. (All the control connections are not found on every I/O-expander board, for specific information see Chapters 1 and 4.)

The control connections are isolated from the mains potential and the I/O ground is connected to the frame of the inverter via a 1-M $\Omega$  resistor and 4,7-nF capacitor\*). The control I/O ground can be connected directly to the frame by changing the position of the jumper X4 (GND ON/OFF) to the ON-position. Digital inputs and relay outputs are also isolated from the I/O ground.

\*) Default value (X4 is GND OFF- position).

<p><b>NOTE!</b></p> 	<p>Internal components and circuit boards (except the isolated I/O terminals) are at mains potential when the frequency converter is connected to the mains. This voltage is extremely dangerous and may cause death or severe injury if you come into contact with it.</p>
	<p>The control I/O terminals are isolated from the mains potential, but the relay outputs and other I/O's may have a dangerous voltage connected even if the power is disconnected from the frequency converter.</p>

### 3 INSTALLATION

#### 3.1. General

Check that you have received all the required parts (Figure 3-1):

- I/O-repeater board (1) and I/O-pole shielded data cable (2)
- check that you have also received the jumper for I/O-repeater board terminal X5 (3)
- 4-pole power cable (4)
- protection foil below (5) and above (6) the I/O-repeater board
- stand sleeve (7)
- screw for fixing I/O-repeater board (8)
- 12-pole communication cable (9)
- option box (10)
- I/O-expander board (11) (check that the typecode is corresponds to your order)
- I/O-interface board (12)
- 10-pole data cable (13)
- 4-pole power cable (14)
- screws for I/O-expander board (15)
- screws for I/O-interface board (16)

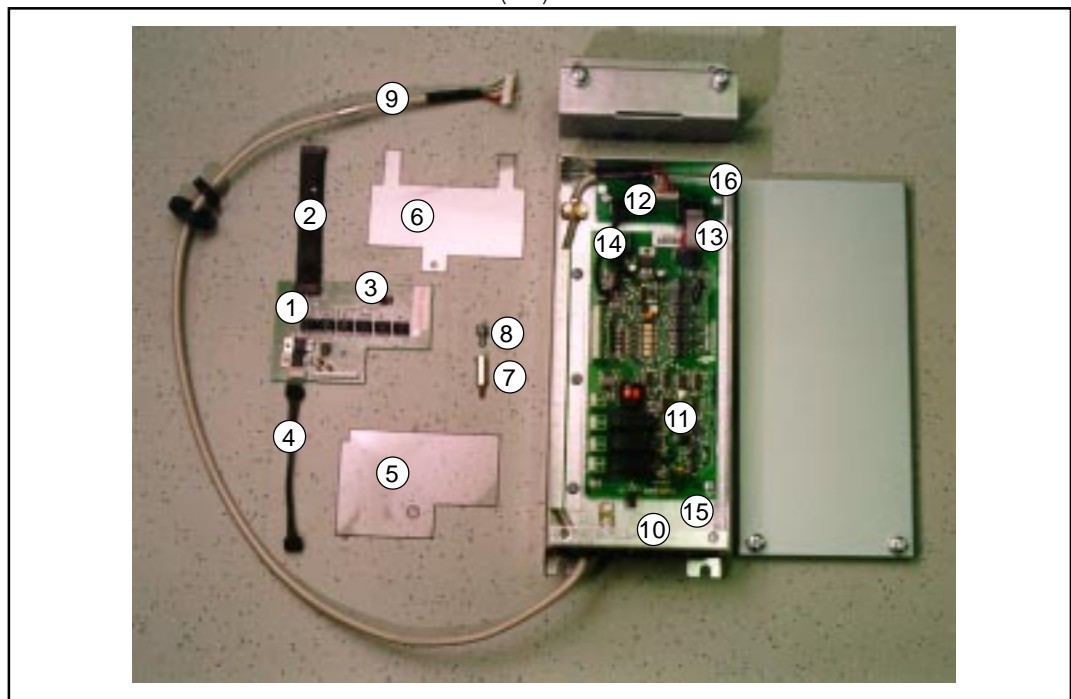

Figure 3-1. I/O-expander board parts.



If the delivery does not match your order, please contact the supplier immediately. Only a competent electrician should carry out the electrical installation.

Before doing any commissioning, carefully read the safety instructions in the "USER'S MANUAL, VACON CX/CXL/CXS", Chapter 1, SAFETY.

Disconnect the frequency converter from the mains. NOTE: Also the control circuits! Wait further 5 minutes before opening the cover of the frequency converter. Verify by measuring that the frequency converter is safe to touch.

### 3.2 INSTALLATION

I/O-repeater board (1) should be installed above the control board inside the frequency converter. The I/O-expander board (10) and I/O-interface board (11) should be installed in the option box. Follow the instructions below (see Table 3-2).



<p><b>1</b></p>	<p>Check that the jumper for I/O-repeater board (1) is in the right position in terminal X5 (3). The position of the jumper must be chosen according to the I/O-expander board (11) :</p>  <ul style="list-style-type: none"> <li>- If I/O-expander board CX101OPT or 103OPT is in use, jumper must be in position A.</li> <li>- If I/O-expander board CX100OPT or 102OPT is in use, jumper must be in position B.</li> <li>- If one of the following fieldbus boards is in use: CX200OPT, CX201OPT, CX202OPT or CX203OPT, jumper must be in position C. (Position D is not in use).</li> </ul>
<p><b>2</b></p>	<p>Remove the control panel, control panel base (4 screws) and the jumper X4 from the control board.</p>   
<p><b>3</b></p>	<p>Remove the fixing screw from the control board and replace it with the stand sleeve (7).</p> 
<p><b>4</b></p>	<p>Make sure that the cable of the control panel cover is connected to the control board X1 terminal. Connect the 4-pole power cable (4) to the control board X5 terminal (The power cable can also be connected to the X6-terminal, if the power cable from the power board is connected to the X5-terminal.)</p> <p>Set the protection foil (5) above the control board as shown in the picture. Make sure that the protection foil is correctly located, the hole in the foil will must be located above the stand sleeve.</p> 

Table 3-2. I/O-expander board installation (continues ...).





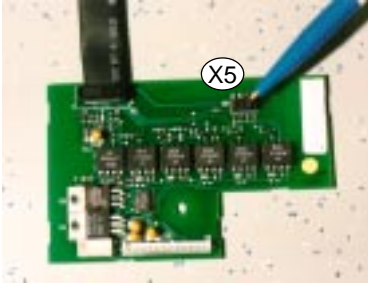

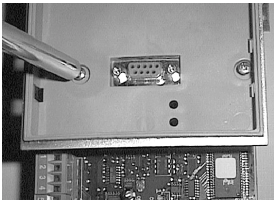
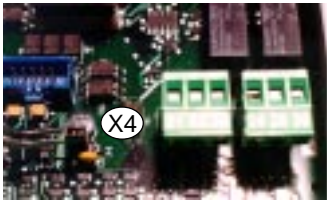
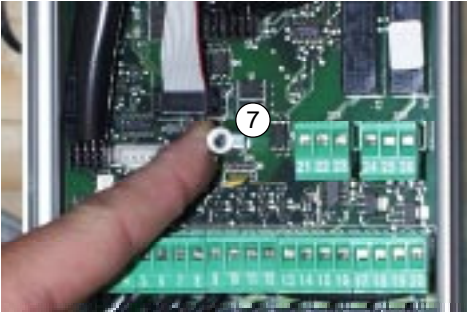
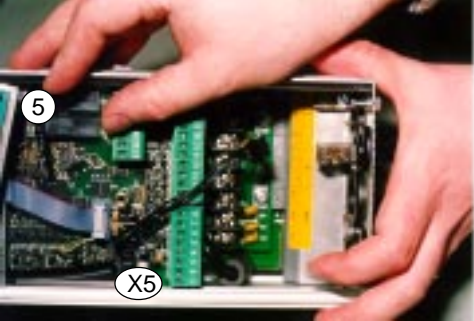
<p>5</p>	<p>Connect the shielded data cable for I/O-repeater board (2) to the control board terminal X14.</p>	
<p>6</p>	<p>Install the control panel cover with 4 screws.</p>	
<p>7</p>	<p>Set the protection foil (6) above the I/O-repeater board as shown in the picture. Make sure that the protection foil is correctly located, push the "arms" of the protection foil under the control panel cover. Fasten the I/O-repeater board and protection foil to the stand sleeve (7) with the screw.</p>	
<p>8</p>	<p>Connect the power cable (4) to the I/O-repeater terminal X1 and communication cable (9) to the I/O-repeater terminal X3. Uncover carefully the shield of the communication cable (max. 1,5 cm), tighten up to the metal clamp (of the cable) and earth the cable to the frequency converter ground as shown in the picture.</p>	

Table 3-2. I/O-expander board installation (continues ...).



9	<p>Check the connections and make sure that there are no foreign objects inside the frequency converter.</p> <p>Close the cover of the frequency converter.</p>
10	<p>Install the jumper removed from the control board X4 terminal into the I/O-expander board terminal X9. Note: the jumper can be connected in ON or OFF position, see Vacon CX/CXL/CXS User's manual, Chapter 6.2.2.</p> 
11	<p>If you have the option box with the I/O-expander (11) and I/O-interface boards (12) pre-installed, jump to section 17.</p> <p>Mount the I/O-expander board (11) and I/O-interface board (12) in the option box (10) with the screws.</p> 
12	<p>Connect data cable (13) between terminal X14 in the I/O-interface board (12) and terminal X14 in the I/O-expander board (11).</p> 
13	<p>Connect power cable (14) between terminal X6 in the I/O-interface board (12) and terminal X6 in the I/O-expander board (11).</p> 

Table 3-2. I/O-expander board installation (continues ...).

<p>14</p>	<p>Connect the communication cable (9) to the I/O-expander board X15 terminal (12). Earth the communication cable to the option box ground.</p>	
<p>15</p>	<p>Connect the necessary control signals. If a fieldbus board is in use, see separate manual for more specific information.</p>	
<p>16</p>	<p>If an encoder input (closed loop control) is to be used and the encoder works at a 5V level, move three jumpers from terminal X5 to terminal X8. If the encoder works at 24V, then terminal X8 should be left free.</p>	
<p>17</p>	<p>Check the connections and make sure that there are no foreign objects inside the option box. Before connecting the mains make sure that the cover of the option box and frequency converter are closed.</p>	
<p>18</p>	<p>Set the parameters of I/O-expander board according to the Vacon "Five in One+" -application manual (parameter group 3).</p>	

Table 3-2. I/O-expander board installation.

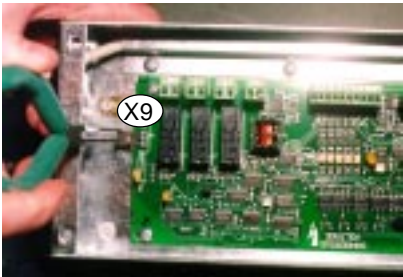
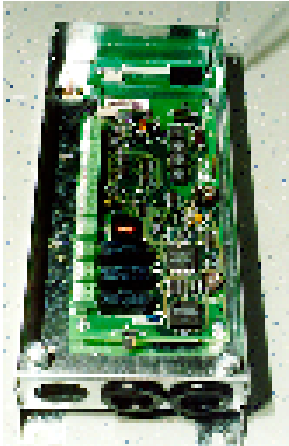
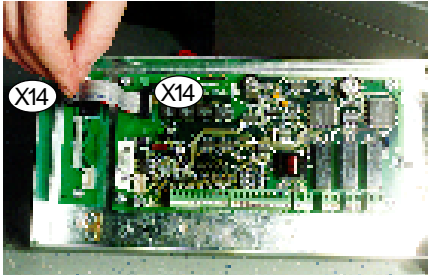
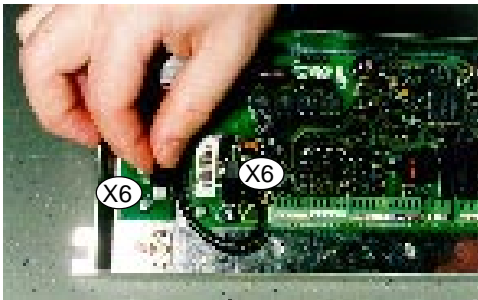

Figure 3-2. Frequency converter and external I/O-expander box installation (unit sizes M3 and M4B).  
I/O-expander box can also be installed beside the frequency converter (unit sizes M3, M4B and M5B).

4 CONTROL CONNECTIONS

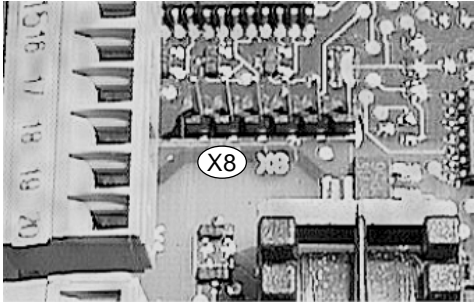
4.1 Vacon CX100OPT

Terminal	Signal	Description
201	+10V <sub>ref</sub>	Reference output Voltage for a potentiometer, etc.
202	U <sub>in</sub> +	Analogue input, voltage range 0—10 V DC Not in use
203	GND	I/O ground Ground for reference and controls
204	I <sub>in</sub> +	Analogue input, current range 0—20 mA Not in use
205	I <sub>in</sub> -	
206	+24V	Control voltage output Voltage for switches, etc. max. 50 mA
207	GND	I/O ground Ground for reference and controls
208	CMC	Common for DIC1-DIC5 Connect to GND or + 24 V
209	DIC1	External fault (closing contact) Contact open = no fault Contact closed = fault
210	DIC2	Run disable Cont. open = start of motor enabled Cont. closed = start of motor disabled
211	DIC3	Acceler. / Decel. time selection Contact open = time 1 selected Contact closed = time 2 selected
212	DIC4	Jogging speed selection Contact open = no action Contact closed = jogging speed
213	DIC5	Fault reset Contact open = no action Contact closed = fault reset
214	DI6A+	Pulse input A (differential input)
215	DI6A-	
216	DI7B+	Pulse input B (differential input) 90 degrees phase shift compared to pulse input A
217	DI7B-	
218	DI8Z+	Pulse input C (differential input) one pulse per one revolution
219	DI8Z-	
220	I <sub>out</sub> +	Analogue output 0—20 mA/R <sub>L</sub> max. 500 Ω Programmable (Motor current as default value)
221	TI+	Thermistor input Signal from motor thermistors *)
222	TI-	
223	RO3/1	Relay output 3 READY
224	RO3/2	
225	RO4/1	Relay output 4 RUN
226	RO4/2	
227	RO5/1	Relay output 5 FAULT
228	RO5/2	

Figure 4-1 Control connections of Vacon CX100OPT.

\*) **NOTE!** Thermistor input (terminals 221 and 222) must be shorted if not used.

## 4.2 Vacon CX101OPT

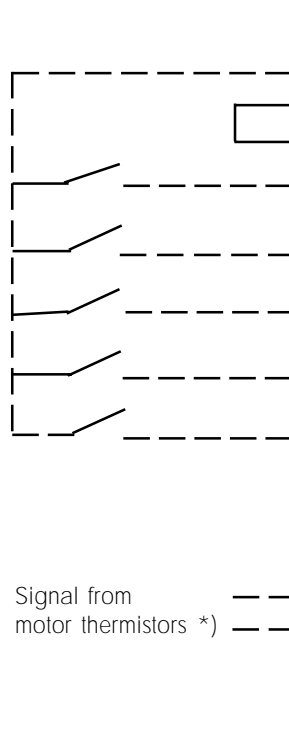

Terminal	Signal	Description
206	+24V	Control voltage output
207	GND	I/O ground
208	CMC	Common for DIC1-DIC5
209	DIC1	External fault (closing contact)
210	DIC2	Run disable
211	DIC3	Acceler. / Decel. time selection
212	DIC4	logging speed selection
213	DIC5	Fault reset
214	N.C.	Not connected
215	N.C.	Not connected
221	TI +	Thermistor input
222	TI +	
225	RO4/1	Relay output 4
226	RO4/2	

Figure 4-2 Control connections of Vacon CX101OPT.

**\*) NOTE!** Thermistor input (terminals 221 and 222) must be shorted if not used.

4.3 Vacon CX102OPT

Terminal	Signal	Description
201	+10V <sub>ref</sub>	Reference output Voltage for a potentiometer, etc.
202	U <sub>in</sub> +	Analogue input, voltage range 0—10 V DC Not in use
203	GND	I/O ground Ground for reference and controls
204	U <sub>in</sub> +	Analogue input, voltage range 0—10 V DC Not in use
205	U <sub>in</sub> -	
206	+24V	Control voltage output Voltage for switches, etc. max. 50 mA
207	GND	I/O ground Ground for reference and controls
208	CMC	Common for DIC1-DIC5 Connect to GND or + 24 V
209	DIC1	External fault (closing contact) Contact open = no fault Contact closed = fault
210	DIC2	Run disable Cont. open = start of motor enabled Cont. closed= start of motor disabled
211	DIC3	Acceler. / Decel. time selection Contact open = time 1 selected Contact closed = time 2 selected
212	DIC4	Jogging speed selection Contact open = no action Contact closed = jogging speed
213	DIC5	Fault reset Contact open = no action Contact closed = fault reset
214	DI6A+	Pulse input A (differential input)
215	DI6A-	
216	DI7B+	Pulse input B (differential input) 90 degrees phase shift compared to pulse input A
217	DI7B-	
218	DO1	Encoder direction output
219	DO2	Encoder divider 1/64 output
220	U <sub>out</sub> +	Analogue output 0—10 V DC/R <sub>L</sub> ≥ 1 kΩ Programmable (Motor voltage as default value)
221	TI+	Thermistor input
222	TI-	
223	RO3/1	Relay output 3 READY
224	RO3/2	
225	RO4/1	Relay output 4 RUN
226	RO4/2	
227	RO5/1	Relay output 5 FAULT
228	RO5/2	

Figure 4-3 Control connections of Vacon CX102OPT.

\*) **NOTE!** Thermistor input (terminals 221 and 222) must be shorted if not used.

4.4 Vacon CX103OPT

Terminal	Signal	Description
206	+24V	Control voltage output Voltage for switches, etc. max. 50 mA
207	GND	I/O ground Ground for reference and controls
208	CMC	Common for DIC1-DIC5 Connect to GND or + 24 V
209	DIC1	External fault (closing contact) Contact open = no fault Contact closed = fault
210	DIC2	Run disable Cont. open = start of motor enabled Cont. closed= start of motor disabled
211	DIC3	Acceler. / Decel. time selection Contact open = time 1 selected Contact closed = time 2 selected
212	DIC4	jogging speed selection Contact open = no action Contact closed = jogging speed
213	DIC5	Fault reset Contact open = no action Contact closed = fault reset
214	GND	I/O ground
215	I <sub>out</sub> +	Analogue output 0—20 mA/R <sub>L</sub> max. 500 Ω Programable (Motor current as default value)
221	TI+	Thermistor input
222	TI-	
223	RO3/1	Relay output 3 READY
224	RO3/2	
225	RO4/1	Relay output 4 RUN
226	RO4/2	
227	RO5/1	Relay output 5 FAULT
228	RO5/2	

Figure 4-4 Control connections of Vacon CX103OPT.

**\*) NOTE!** Thermistor input (terminals 221 and 222) must be shorted if not used.



4.5 Vacon CX104OPT

More information on the Vacon CX104OPT encoder option board you will find in a separate manual (ud318). Ask your distributor for more information.

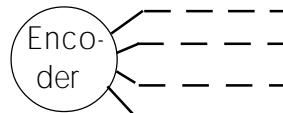

Terminal	Signal	Description
201	+5V	Control voltage output Voltage for switches, max load 100-150 mA
203	GND	I/O ground Ground for controls
206	+24V	Control voltage output
207	GND	I/O ground Ground for controls
214	D16A+	Pulse input A (differential input)
215	D16A-	
216	D17B+	Pulse input B (differential input)
217	D17B-	
218	DIR	Encoder direction
219	DIV	Encoder divider 1/1024

Figure 4-5 Control connections of Vacon CX104OPT.



VACONPLC

P.O. Box 25

Runsorintie 7

FIN-65381 VAASA

FINLAND

Phone: +358-201 2121

Fax: +358-201 212 205

Service: +358-40-8371 150

E-mail: [vacon@vacon.com](mailto:vacon@vacon.com)

<http://www.vacon.com>

Distributor: