

**VACON<sup>®</sup> NX**  
AC DRIVES

**BRAKE RESISTORS**  
**USER MANUAL**

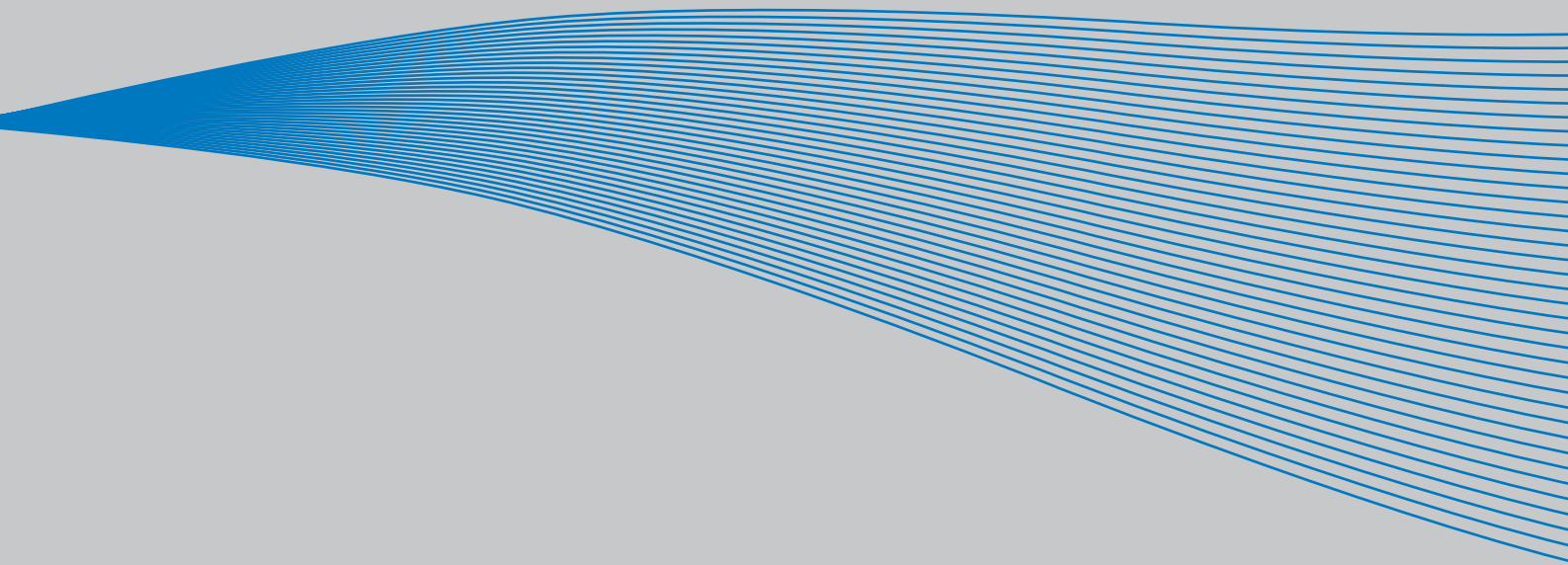

**VACON<sup>®</sup>**  
DRIVEN BY DRIVES



## INDEX

Document code: DPD01573A

Date edited: 15.4.2014

1.	GENERAL .....	2
1.1	Requirement for braking.....	2
1.2	Brake components.....	2
1.3	Classes of use.....	2
2.	TECHNICAL DATA .....	3
2.1	Standard resistors for partial use.....	3
2.1.1	380...500V range .....	4
2.1.2	208...240V range .....	5
2.1.3	525...690V range .....	6
2.2	Other resistors.....	8
2.3	Power rating of standard resistors .....	9
2.4	Environment.....	11
2.5	Thermal protection for the LD resistors .....	12
2.5.1	Thermal protection:.....	13
3.	CHOICE OF BRAKE RESISTOR .....	14
3.1	General .....	14
3.2	Sizing principles.....	14
3.2.1	Calculating braking time .....	15
3.2.2	Calculating the moment of inertia .....	15
3.2.3	Internal resistors.....	19
4.	CONNECTIONS.....	20
4.1	General .....	20

## 1. GENERAL

### 1.1 Requirement for braking

When you want to slow down a running asynchronous motor fed by a frequency converter it turns into a generator, feeding energy back into the frequency converter. The energy increases the voltage in the DC-link. The frequency converter compensates for this increase by increasing the output frequency, decreasing the instantaneous slip and increasing the motor load.

The deceleration is, in this case, dependent on the power losses in the converter and in the motor. This is usually sufficient in most cases, for pumps, fans, conveyors etc. where the kinetic energy in the load is small or the braking time is not critical.

When you have to brake the motor faster than the losses allow, you have to use an external brake resistor for energy dissipation together with an internal, factory-mounted brake chopper. The extra energy from the load is turned into heat in the brake resistor.

Applications where dynamic braking is usually needed include centrifuges, cranes, some conveyors and drives requiring very fast reversing.

### 1.2 Brake components

The **brake chopper** is an extra IGBT mounted into the NX frequency converters at the time of manufacturing. Smaller drives (FR4 to FR6 and MF4 to MF6) contain it as standard. If the DC link voltage increases too much, the brake IGBT turns on and discharges the capacitors through the brake resistor. The brake chopper in the NX frequency converter ranges is rated for continuous drive rated power.

The **brake resistor** is an external, low impedance resistor. In order to achieve the correct power handling capacity for a specific application, resistors can be connected in series and parallel, keeping within the limits in Table 7.

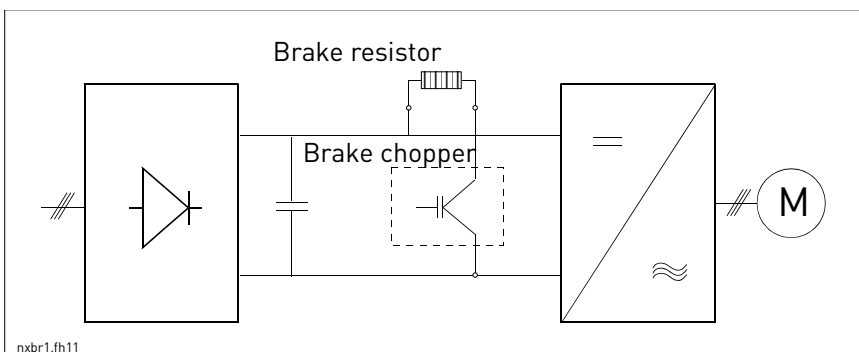

Figure 1. The brake components and their basic connection

### 1.3 Classes of use

#### a) Partial use (most typical)

The process requires regular or irregular rapid decelerations, stops or reversings.

#### b) Continuous use

The motor continuously brakes with constant torque.

#### c) Combination use

The motor continuously brakes with variable torque.

#### d) DC-link voltage smoothing

The brake resistor smooths overvoltage spikes from the supply.

## 2. TECHNICAL DATA

### 2.1 Standard resistors for partial use

Brake resistors for partial use for the NX ranges for 208...240V, 380...500V and 525...690V supply voltages can be chosen from the tables below.

For the NX\_5 range we have predefined two ranges of brake resistors, one for heavy duty and one for light duty. The heavy duty resistor is sized for a 3-second full power braking with a 7-second ramp to zero. The light duty resistor is rated for a 5-second ramp from full power to zero. See Figure 2.

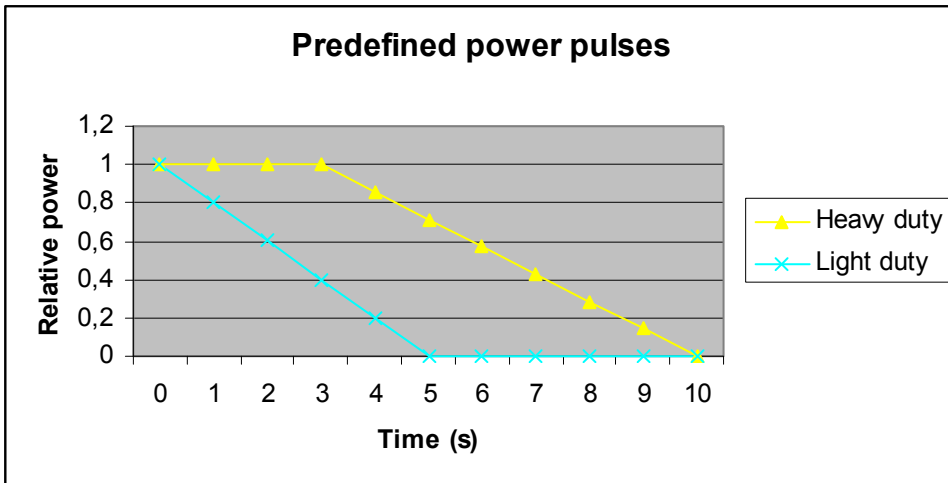

Figure 2. Heavy and light duty braking definitions.

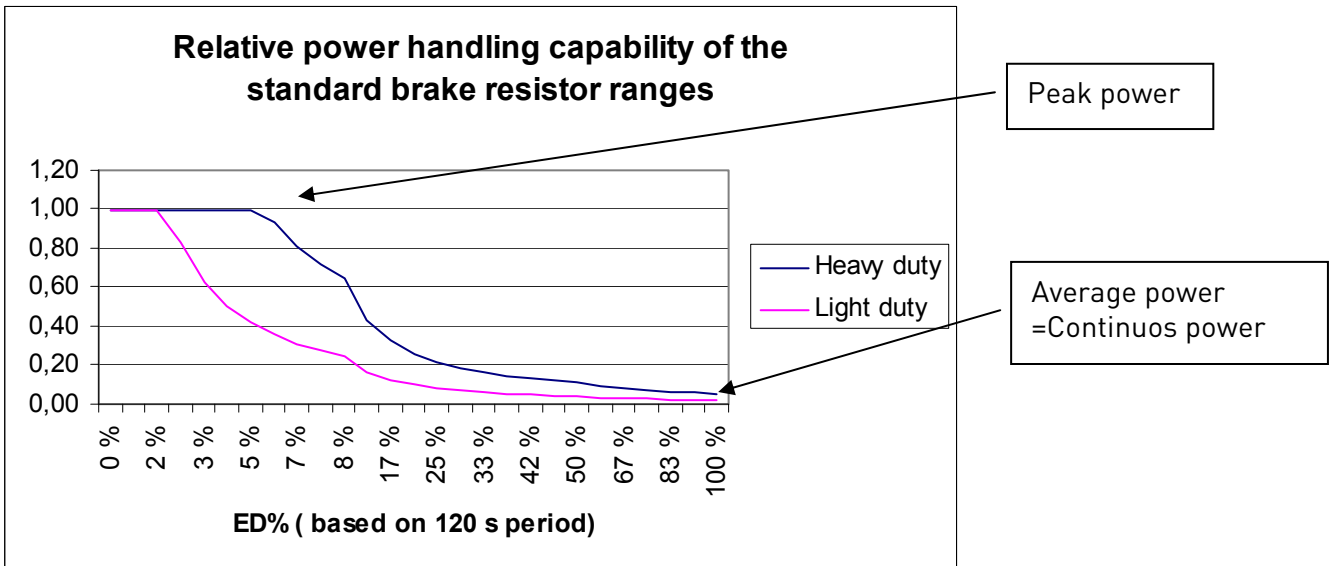

Figure 3. Peak and average power definitions.

## 2.1.1 380...500V range

Light duty			
		Energy [kJ]	Average power [kW]
Type code	Resistance	5 sec full torque braking	1 pulse/2 min
BRR 0022 LD 5	63	28	0.24
BRR 0031 LD 5	42	42	0.35
BRR 0045 LD 5	21	84	0.71
BRR 0061 LD 5	14	127	1.06
BRR 0105 LD 5	6,5	273	2.28
BRR 0300 LD 5	3.3	547	4.56
BRR 0520 LD 5	1,4	1270	10,6
BRR 0730 LD 5	0,9	1975	16,5
Heavy duty			
		Energy [kJ]	Average power [kW]
Type code	Resistance	3 sec full torque decreasing to zero in 7s	1 pulse / 2min
BRR 0022 HD 5	63	73	0.61
BRR 0031 HD 5	42	110	0,91
BRR 0045 HD 5	21	220	1.83
BRR 0061 HD 5	14	330	2,74
BRR 0105 HD 5	6,5	710	5,9
BRR 0300 HD 5	3.3	1421	11,8
BRR 0520 HD 5	1,4	3300	27,4
BRR 0730 HD 5	0,9	5132	43

Table 1. Brake resistors for the voltage range 380...500V

Choose the resistor for all types of frequency converters ( NXL, NXS and NXP) according to the table below:

Unit	Frame	Light duty resistor	Heavy duty resistor
NX_0003 5 NX_0004 5 NX_0005 5 NX_0007 5 NX_0009 5 NX_0012 5	FR4	BRR 0022 LD 5	BRR 0022 HD 5
NX_0016 5 NX_0022 5	FR5	BRR 0022 LD 5	BRR 0022 HD 5
NX_0031 5	FR5	BRR 0031 LD 5	BRR 0031 HD 5
NX_0038 5 NX_0045 5	FR6	BRR 0045 LD 5	BRR 0045 HD 5
NX_0061 5	FR6	BRR 0061 LD 5	BRR 0061 HD 5
NX_0072 5 NX_0087 5	FR7	BRR 0105 LD 5	BRR 0105 HD 5
NX_0105 5 NX_0140 5	FR7 FR8	BRR 0105 LD 5 BRR 0300 LD 5	BRR 0105 HD 5 BRR 0300 HD 5

NX_0168 5			
NX_0205 5	FR8	BRR 0300 LD 5	BRR 0300 HD 5
NX_0261 5	FR9	BRR 0300 LD 5	BRR 0300 HD 5
NX_0300 5			
NX_0385 5	FR10	BRR 0520 LD 5	BRR 0520 HD 5
NX_0460 5			
NX_0520 5			
NX_0590 5	FR11	BRR 0730 LD 5	BRR 0730 HD 5
NX_0650 5			
NX_0730 5			
NX_0820 5	FR12	2 x BRR 0520 LD 5	2 x BRR 0520 HD 5
NX_0920 5			
NX_1030 5			

Table 2. Brake resistors used with drives

Light duty resistor: IP50 with direct wire connection, BRR0022 LD5 has a thermal protection as option.  
 Heavy duty resistor: IP20/21, connecting box, thermal protection as standard.

### 2.1.2 208...240V range

Light duty			
		Energy [kJ]	Average power [kW]
Type code	Resistance	<i>5 sec full torque braking</i>	<i>1 pulse/2 min</i>
BRR 0025 LD2	30	12,55	0,10
BRR 0031 LD2	20	18,8	0,16
BRR 0061 LD2	10	38	0,31
BRR 0114 LD2	3,3	114	0,95
BRR 0205 LD2	1,4	269	2,24
Heavy duty			
		Energy [kJ]	Average power [kW]
Type code	Resistance	<i>3 sec full torque decreasing to zero in 7 sec</i>	<i>1 pulse / 2min</i>
BRR 0025 HD2	30	32,6	0,27
BRR 0031 HD2	20	49	0,41
BRR 0061 HD2	10	98	0,81
BRR 0114 HD2	3,3	297	2,47
BRR 0205 HD2	1,4	699	5,81

Table 3. Brake resistors for the voltage range 208...240V

Choose the resistor for the frequency converter (voltage range 208...240V) according to the table below:

Unit	Frame	Light duty resistor	Heavy duty resistor
NX_0003 2 NX_0004 2 NX_0007 2 NX_0008 2 NX_0011 2 NX_0012 2	FR4	BRR 0025 LD 2	BRR 0025 HD 2
NX_0017 2 NX_0025 2	FR5	BRR 0025 LD 2	BRR 0025 HD 2
NX_0031 2	FR5	BRR 0031 LD 2	BRR 0031 HD 2
NX_0048 2 NX_0061 2	FR6	BRR 0061 LD 2	BRR 0061 HD 2
NX_0075 2 NX_0088 2 NX_0114 2	FR7	BRR 0114 LD 2	BRR 0114 HD 2
NX_0140 2 NX_0170 2 NX_0205 2	FR8	BRR 0205 LD2	BRR 0205 HD2
NX_0261 2 NX_0300 2	FR9	BRR 0205 LD2	BRR 0205 HD2

Table 4. Brake resistors used with drives

Light duty resistor: IP50 with direct wire connection,

Heavy duty resistor: IP20/21, connecting box, thermal protection as standard.

### 2.1.3 525...690V range

Light duty			
		Energy [kJ]	Average power [kW]
Type code	Resistance	5 sec full torque braking	1 pulse/2 min
BRR 0013 LD 6	100	34	0,28
BRR 0034 LD 6	30	113	0,94
BRR 0052 LD 6	18	188	1,6
BRR 0100 LD 6	9	376	3,1
BRR 0208 LD 6	7	484	4,0
BRR 0416 LD 6	2,5	1355	11
BRR 0590 LD 6	1,7	1993	17
Heavy duty			
		Energy [kJ]	Average power [kW]
Type code	Resistance	3 sec full torque decreasing to zero in 7 sec	1 pulse / 2min
BRR 0013 HD 6	100	88	0,73
BRR 0034 HD 6	30	294	2,4
BRR 0052 HD 6	18	489	4,1



BRR 0100 HD 6	9	978	8,1
BRR 0208 HD 6	7	1258	10
BRR 0416 HD 6	2,5	3523	29
BRR 0590 HD 6	1,7	5181	43

Table 5. Brake resistors for the voltage range 525...690V

Choose the resistor for the frequency converter (voltage range 208...240V) according to the table below:

Unit	Frame	Light duty resistor	Heavy duty resistor
NX_0003 6 NX_0004 6 NX_0005 6 NX_0007 6 NX_0010 6 NX_0013 6	FR6	BRR 0013 LD 6	BRR 0013 HD 6
NX_0018 6 NX_0022 6 NX_0027 6 NX_0034 6	FR6	BRR 0034 LD 6	BRR 0034 HD 6
NX_0041 6 NX_0052 6	FR7	BRR 0052 LD 6	BRR 0052 HD 6
NX_0062 6 NX_0080 6 NX_0100 6	FR8	BRR 0100 LD 6	BRR 0100 HD 6
NX_0144 6 NX_0170 6 NX_0208 6	FR9	BRR 0208 LD 6	BRR 0208 HD 6
NX_0261 6 NX_0325 6 NX_0385 6 NX_0416 6	FR10	BRR 0416 LD 6	BRR 0416 HD 6
NX_0460 6 NX_0502 6 NX_0590 6	FR11	BRR 0590 LD 6	BRR 0590 HD 6
NX_0650 6 NX_0750 6 NX_0820 6	FR12	BRR 0416 LD 6	BRR 0416 HD 6

Table 6. Brake resistors used with drives

Light duty resistor: IP50 with direct wire connection.

Heavy duty resistor: IP20/21, connecting box, thermal protection as standard.

## 2.2 Other resistors

Should other types of resistors be used, make sure that the resistance is higher than the minimum resistance defined. The power handling capacity must be sufficient for the application.

The minimum resistances calculated at the trip level (NX\_5: 911VDC, NX\_2: 437VDC and NX\_6: 1200VDC) can be found in the following tables.

380...500V range			208...240V range		
Frame	Brake chopper $I_{nom}$ @80°C	$R_{min}$ [ Ω ]	Frame	Brake chopper $I_{nom}$ @80°C	$R_{min}$ [ Ω ]
NX_0003 5... NX_0022 5	12	63	NX_0003 2... NX_0025 2	15	30
NX_0031 5	17	42	NX_0031 2	23	20
NX_0038 5... NX_0045 5	35	21	NX_0048 2... NX_0061 2	46	10
NX_0061 5	65	14	NX_0075 2... NX_0114 2	148	3,3
NX_0072 5... NX_0105 5	111	6.5	NX_0140 2... NX_0300 2	296	1,4
NX_0140 5... NX_0300 5	222	3.3			
NX_0385 5... NX_0520 5	570	1.4			
NX_0590 5... NX_0730 5	855	0,9			
NX_0820 5 NX_1030 5	2 x 570	2 x 1,4			

575...690V range		
Frame	Brake chopper $I_{nom}$ @80°C	$R_{min}$ [ Ω ]
NX_0004 6... NX_0013 6	11	100
NX_0018 6... NX_0034 6	37	30
NX_0041 6... NX_0052 6	61	18
NX_0061 6... NX_0100 6	122	9
NX_0125 6... NX_0208 6	157	7
NX_0261 6... NX_0416 6	440	2,5
NX_0460 6... NX_0590 6	647	1.7
NX_0650 6... NX_0820 6	2x 440	2 x 2.5

Table 7. Specification for other types of resistors

### 2.3 Power rating of standard resistors

The power handling capacity of the standard resistors as a function of the duty cycle is shown in Figure 4. The figure shows the relative power handling capacity at various duty cycles, i.e. compared to continuous 120 s braking.

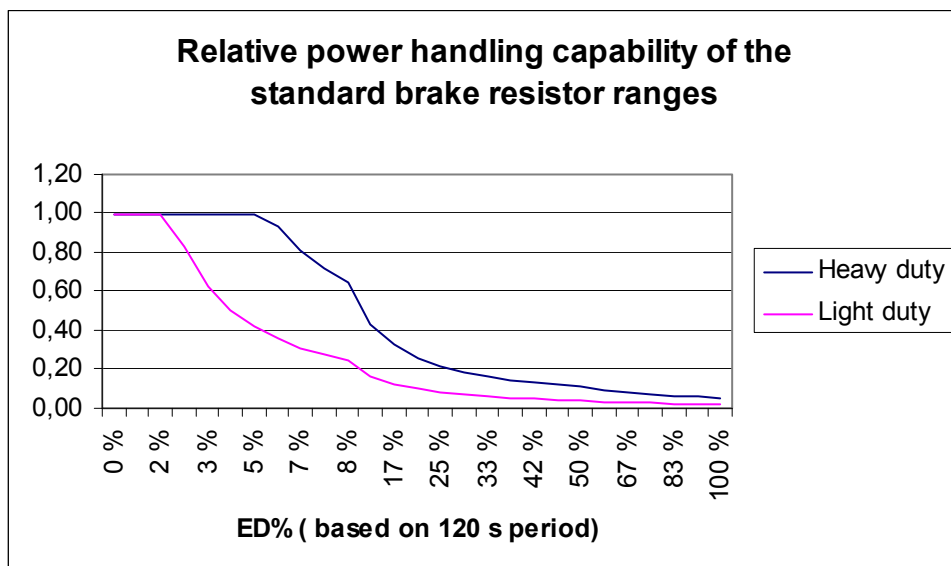

Figure 4. Relative power rating of standard resistors

	Power at different duty cycles based on a 120 sec cycle					
	100% ED	60% ED	40 % ED	25 % ED	10 % ED	5 % ED
	kW					
BRR 0025 LD 2	0,10	0,17	0,26	0,42	1,0	2,1
BRR 0031 LD 2	0,16	0,26	0,39	0,63	1,6	3,1
BRR 0061 LD 2	0,31	0,52	0,78	1,3	3,1	6,3
BRR 0114 LD 2	0,95	1,6	2,4	3,8	9,5	19,0
BRR 0205 LD 2	2,2	3,7	5,6	9,0	22	45
BRR 0022 LD 5	0,24	0,39	0,59	0,94	2,4	4,7
BRR 0031 LD 5	0,35	0,59	0,88	1,41	3,5	7,1
BRR 0045 LD 5	0,71	1,2	1,8	2,8	7,1	14,1
BRR 0061 LD 5	1,1	1,8	2,6	4,2	10,6	21
BRR 0105 LD 5	2,3	3,8	5,7	9,1	23	46
BRR 0300 LD 5	4,6	7,6	11,4	18,2	46	91
BRR 0520 LD 5	11	17,6	26	42	106	212
BRR 0730 LD 5	16	27	41	66	165	329
BRR 0013 LD 6	0,28	0,47	0,71	1,13	2,8	5,6
BRR 0034 LD 6	0,94	1,6	2,4	3,8	9,4	18,8
BRR 0052 LD 6	1,6	2,6	3,9	6,3	15,7	31
BRR 0100 LD 6	3,1	5,2	7,8	12,5	31	63
BRR 0208 LD 6	4,0	6,7	10,1	16,1	40	81
BRR 0416 LD 6	11	19	28	45	113	226
BRR 0590 LD 6	17	28	42	66	166	332
BRR 0025 HD 2	0,27	0,45	0,68	1,1	2,7	5,4
BRR 0031 HD 2	0,41	0,68	1,0	1,6	4,1	8,1

BRR 0061 HD 2	0,81	1,4	2,0	3,3	8,1	16,3
BRR 0114 HD 2	2,5	4,1	6,2	9,9	25	49
BRR 0205 HD 2	5,8	9,7	14,5	23	58	116
BRR 0022 HD 5	0,61	1,02	1,52	2,44	6,1	12,2
BRR 0031 HD 5	0,91	1,5	2,3	3,7	9,1	18,3
BRR 0045 HD 5	1,8	3,0	4,6	7,3	18,3	37
BRR 0061 HD 5	2,7	4,6	6,9	11,0	27	55
BRR 0105 HD 5	5,9	9,8	14,8	24	59	118
BRR 0300 HD 5	11,8	19,7	30	47	118	236
BRR 0520 HD 5	27	46	69	110	274	549
BRR 0730 HD 5	43	71	107	171	427	854
BRR 0013 HD 6	0,73	1,2	1,8	2,9	7,3	14,6
BRR 0034 HD 6	2,4	4,1	6,1	9,8	24	49
BRR 0052 HD 6	4,1	6,8	10,2	16,3	41	81
BRR 0100 HD 6	8,1	13,6	20	33	81	163
BRR 0208 HD 6	10	17,4	26	42	105	209
BRR 0416 HD 6	29	49	73	117	293	586
BRR 0590 HD 6	43	72	108	172	431	862

## 2.4 Environment

Surface temperature of the resistor box	<80°C
Maximum ambient temperature	30°C
Protection class	IP20, IP21, IP50

**NOTE:** On mounting the resistor package, note the high surface temperature ( up to 200 °C). The mounting surface must be non-flammable and there must be sufficient free space around the resistor (100 mm).

The resistors are designed for natural convection cooling in a free space; ensure sufficient ventilation of the area.

## 2.5 Thermal protection for the LD resistors

There are two different overtemperature sensors in use – one for the resistors with a smooth surface and the other for the ones with cooling fins. The larger steel plate resistors have a thermal supervision built in as standard.

OT1 – for brake resistors with cooling fins.



Thermal supervision OT1

This is intended to be mounted on the lower (connector) end when the resistor is mounted vertically. It is screwed onto the fins.

Types:

BRR 0114 LD 2	BRR 0031 LD 5	BRR 0034 LD 6
BRR 0205 LD 2	BRR 0045 LD 5	BRR 0052 LD 6
	BRR 0061 LD 5	BRR 0100 LD 6
BRR 0025 HD 2	BRR 0105 LD 5	BRR 0206 LD 6
BRR 0031 HD 2	BRR 0300 LD 5	
BRR 0061 HD 2		BRR 0013 HD 6
BRR 0114 HD 2	BRR 0022 HD 5	BRR 0034 HD 6
BRR 0205 HD 2	BRR 0031 HD 5	
	BRR 0045 HD 5	
	BRR 0061 HD 5	

OT2

This thermal supervision is designed for the resistors with a smooth surface. The thermistor is placed beneath the clip and the clip clipped onto the resistor surface.

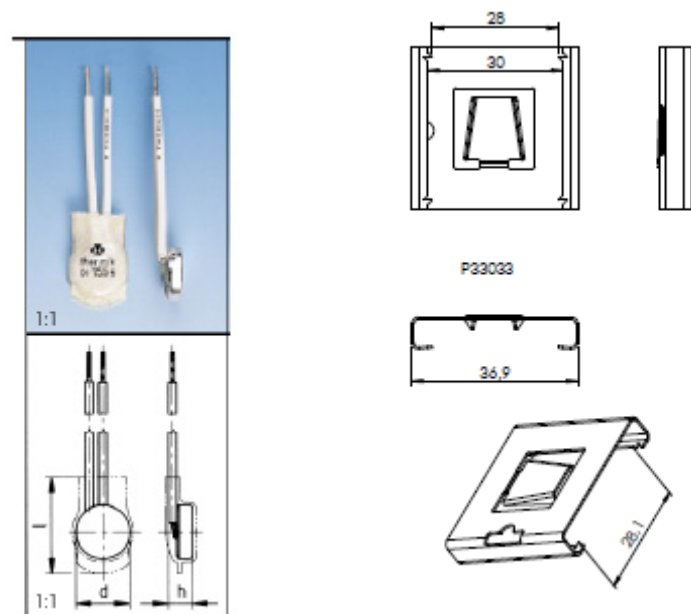

Thermal protection and the holder for it

**2.5.1 Thermal protection:**

The thermal protection in the resistors should be connected to the external Fault input on the drive.

### 3. CHOICE OF BRAKE RESISTOR

#### 3.1 General

When you choose the brake resistor for your drive, start from the requirements of the process/drive. The choice of brake resistor is influenced by

- a) *the average braking power during one cycle*; this defines the power dissipation required of the brake resistor
- b) *the maximum power dissipation*; this defines the instantaneous power handling capacity of the brake resistor and
- c) *the maximum current of the brake IGBT*; this defines the minimum resistance for the brake resistor.

Vacon Technical Support will assist you in all matters concerning braking.

#### 3.2 Sizing principles

All rotating parts contain kinetic energy. When the load is braked, the energy difference between the higher speed and the lower speed must be dissipated somewhere. Some of the energy is used in the losses of the motor and the frequency converter, but the majority must be dissipated in the brake resistor.

The energy of a load at speed  $n$  is given by the formula:

$$E = \frac{1}{2} J \omega^2$$

where

$J$  is the moment of inertia of the load (in  $\text{kgm}^2$ ) and  
 $\omega$  is the rotating speed of the load (in radians/s)

In engineering units

$$E = \frac{1}{182,3} J n^2$$

where  $n$  is the rotating speed (in 1/min)

The difference between the energy at two speeds is thus

$$\Delta E = E_1 - E_2 = \frac{1}{182,3} J (n_1^2 - n_2^2) = \frac{1}{2} J (\omega_1^2 - \omega_2^2)$$

The average power required is

$$P = \frac{\Delta E}{t}$$

where  $t$  is the braking time.



If the load has a cycle with a total cycle time  $t_c$ , the average power of the cycle is

$$P = \frac{\Delta E}{t_c}$$

The chosen resistor must be able to handle this power. If the braking time is longer than 1 minute, the resistor must be sized for the continuous braking power.

### 3.2.1 Calculating braking time

The time required to accelerate or brake a load can be calculated as follows:

The basic equation is:

$$T = J \frac{d\omega}{dt}$$

where  $T$  is the required torque.

The time required to change the speed of a load is

$$\Delta t = J \frac{\omega_1 - \omega_2}{T}$$

or the torque required to change the speed in time  $t$  is

$$T = J \frac{\omega_1 - \omega_2}{t}$$

The available torque consists of the torque generated by the motor  $T_{\text{motor}}$  and the braking torque generated by the load and friction in it  $T_{\text{load}}$ .

$$T_{\text{total}} = T_{\text{motor}} + T_{\text{load}}$$

In many cases the frictional torque is sufficient to brake the load, it might even be too high, so the motor must drive the load even if the speed is slowing down.

This torque required from the motor should be compared to the rated torque of the motor:

$$T = 9550 \frac{P}{n}$$

If the rated torque is higher, the motor can perform the required acceleration/deceleration.

### 3.2.2 Calculating the moment of inertia

The moment of inertia as 'seen' by the motor consists of the motor inertia plus the load inertia, changed by the gear ratio as follows:

$$J_{\text{tot}} = J_{\text{motor}} + g^2 J_{\text{load}}$$

where  $g$  is the gear ratio,  $J_{\text{motor}}$  is the motor inertia and  $J_{\text{load}}$  is the load inertia. The ratio  $g$  is  $> 1$  if the load speed is higher than the motor speed and  $< 1$  if the load speed is lower than the motor speed.

In many cases the moment of inertia of the motor is very small compared to the moment of inertia of the load. Only in cases where the load turns very slowly (i.e. the gear ratio is low) the motor inertia is significant.

The moment of inertia of typical shapes is shown in Figure 5

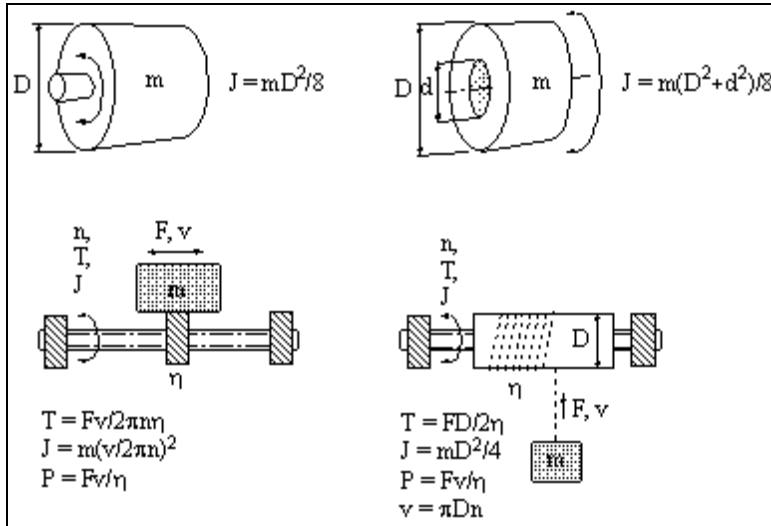

Figure 5.

The moment of inertia of a specific machine is often specified on the rating plate. Otherwise the manufacturer is responsible to give this information.

Sizing procedure:

1. Maximum speed	$n_1$		rpm
2 Minimum speed	$n_2$		rpm
3 Moment of inertia = $J_{tot} = J_{motor} + g^2 J_{load}$ g = gear ratio	J		kgm <sup>2</sup>
4 Energy to be dissipated	$\Delta E = E_1 - E_2 = \frac{1}{182,3} \frac{J(n_1^2 - n_2^2)}{1000}$		kJ
5 Braking time	t		s
6 Braking power	$P = \frac{\Delta E}{t}$		kW
7 Determine duty cycle for braking t <sub>1</sub> = duration of cycle – assumption 120 s.	$f = \frac{t}{t_1}$		

8 Determine average power for the resistor	$P_{ave} = fP$		kW
9 Calculate the relative power required.  $P_{res}$ = peak power of chosen resistor	$P_{rel} = \frac{P_{ave}}{P_{res}}$		%
10 Verify that the pair of values in 7 and 9 are within limits for the chosen resistor – see Figure 5			
7 Calculate the braking torque required	$T = J \times 0,105 \times \frac{n_1 - n_2}{t}$		Nm
8 Verify motor rated torque > required torque  $P_M$ in kW  $n_M$ in rpm	$T_M = 9550 \times \frac{P_M}{n_M}$		Nm

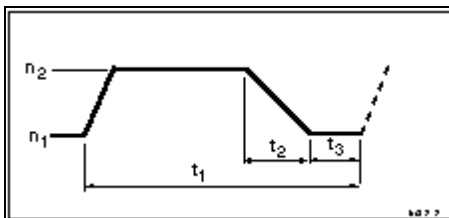

Figure 6. Speed profile of one drive cycle.

$t_1$  = length of cycle

$t_2$  = deceleration time

$t_3$  = stop time

$n_1$  = minimum speed of motor

$n_2$  = maximum speed of motor

The relative power handling capability of the standard resistor ranges is shown in the figure below:

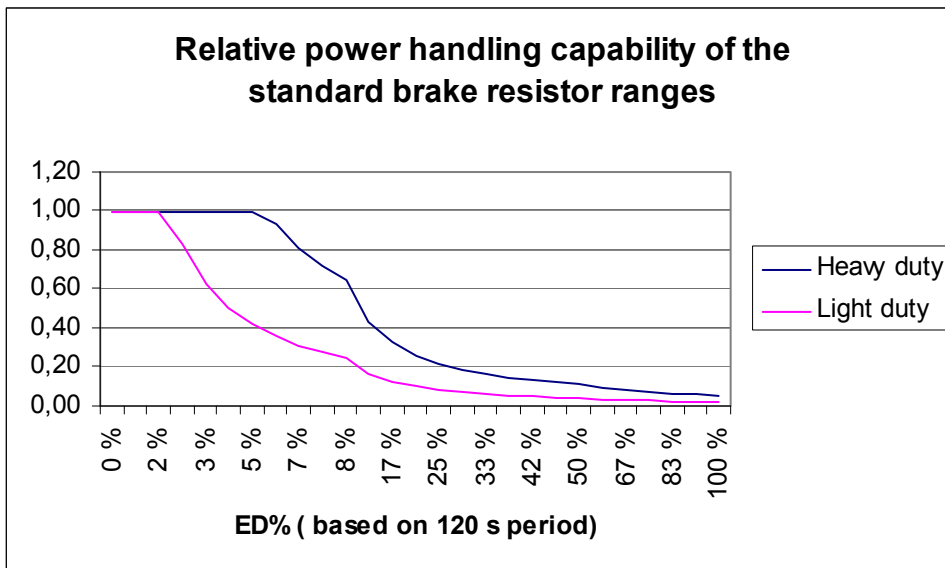

Figure 7.

Verify the following:

- a) The chosen resistor type can handle the required power (NOTE: As the brake IGBT current is limited by the device, a resistance with a smaller impedance than the minimum specified for the drive cannot be used).
- b) If this is not the case, the resistor has to be sized specifically for the application. In many cases a suitable combination of series and parallel connection of standard resistances may be the solution, in others a special resistor must be defined and manufactured.

### 3.2.3 Internal resistors

Frame sizes FR4, FR5 and FR6 (380...500V) drives can be equipped with an internal brake resistor as a factory option. The resistors are designed for a 2s full torque braking from nominal motor speed to zero or a 1 second full power braking every minute.

Type code	Resistance [ Ω ]	Energy 2s full torque braking [kJ]	Average power 1 pulse/min [W]
NX_5 FR4	120	4	45
NX_5 FR5	55	8.9	100
NX_5 FR6	30	16	175

Table 8.

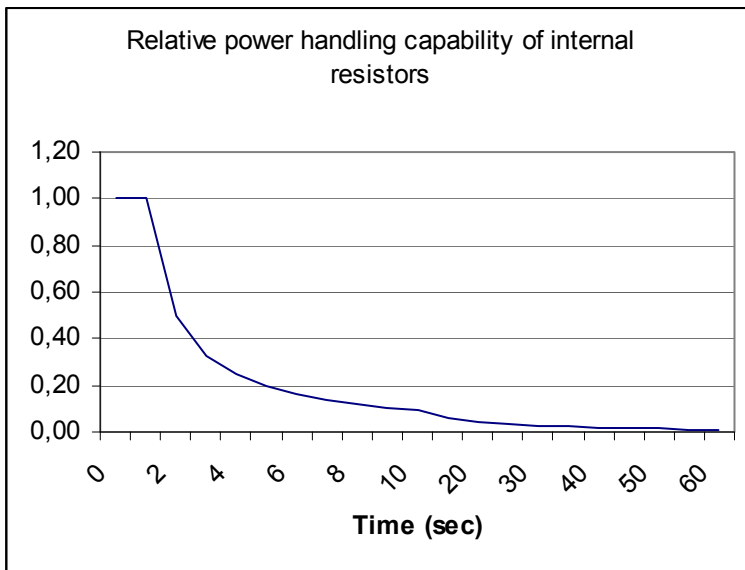

Figure 8.

## 4. CONNECTIONS

### 4.1 General

**Make sure that your frequency converter is equipped with a brake chopper. This is a factory installed option!**

The brake resistor is connected to the DC+ and R- connectors on the frequency converter.

The minimum cable sizes are shown in Table 1 and Table 2. When you size the cables, note that the input fuses of the converter also protect this cable.

Avoid running the brake resistor cable too near other cables. The recommended minimum distance to e.g. the control cables is 0.5 meters.

**Note:** Disconnect the frequency converter from the mains when connecting the brake resistor. Wait a further 5 minutes before opening the frequency converter cover. Perform measurements to ensure that no voltage is present on the DC and R- connectors.

Read Chapter 1, SAFETY, in Vacon NX User's Manual.

#### Cable sizing

Resistor	Cable and terminal	Resistor	Cable and terminal
BRR 0025 LD 2	Integral AWG16	BRR 0025 HD 2	6
BRR 0031 LD 2	Integral AWG16	BRR 0031 HD 2	6
BRR 0061 LD 2	Integral AWG16	BRR 0061 HD 2	6
BRR 0114 LD 2	Integral AWG10	BRR 0114 HD 2	16
BRR 0205 LD 2	16-50	BRR 0205 HD 2	16-50
BRR 0022 LD 5	Integral AWG16	BRR 0022 HD 5	6
BRR 0031 LD 5	Integral AWG16	BRR 0031 HD 5	6
BRR 0045 LD 5	Integral AWG16	BRR 0045 HD 5	6
BRR 0061 LD 5	Integral AWG14	BRR 0061 HD 5	16
BRR 0105 LD 5	16	BRR 0105 HD 5	M8 / 3X16+16
BRR 0300 LD 5	16-50	BRR 0300 HD 5	M8 / 3X70+35
BRR 0520 LD 5	M8 / 3X95+50	BRR 0520 HD 5	M8 / 3X95+50
BRR 0730 LD 5	M8 / 3X95+50	BRR 0730 HD 5	M8 / 3X95+50
BRR 0013 LD 6	Integral AWG16	BRR 0013 HD 6	6
BRR 0034 LD 6	Integral AWG16	BRR 0034 HD 6	6
BRR 0052 LD 6	Integral AWG14	BRR 0052 HD 6	6
BRR 0100 LD 6	16-50	BRR 0100 HD 6	M8/3X16+16
BRR 0208 LD 6	16-50	BRR 0208 HD 6	M8/3X50+25
BRR 0416 LD 6	M8/ 3X70+35	BRR 0416 HD 6	M8/ 3X70+35
BRR 0590 LD 6	M8/ 3X70+35	BRR 0590 HD 6	M8/ 3X70+35

M8 = M8 bolt on the resistor

Only two conductors of a normal three phase cable are needed. The shield of the cable should be connected at each end. The third, unused connector should also be grounded by connecting it to ground at one end.

Cable sizes:

<b>AWG Number</b>	<b>Ø [Inch]</b>	<b>Ø [mm]</b>	<b>Ø [mm<sup>2</sup>]</b>
6/0 = 000000	0.580	14.73	170.30
5/0 = 00000	0.517	13.12	135.10
4/0 = 0000	0.460	11.7	107
3/0 = 000	0.410	10.4	85.0
2/0 = 00	0.365	9.26	67.4
1/0 = 0	0.325	8.25	53.5
2	0.258	6.54	33.6
4	0.204	5.19	21.1
6	0.162	4.11	13.3
8	0.128	3.26	8.36
10	0.102	2.59	5.26
12	0.0808	2.05	3.31
14	0.0641	1.63	2.08
16	0.0508	1.29	1.31
18	0.0403	1.02	0.823
20	0.0320	0.812	0.518

**MOUNTING:**  
Vertical with cables down  
or  
Horizontal  
Protection class  
IP50

VACON TYPE	R OHM	FRAME SIZE	CABLE mm <sup>2</sup>	LINE VOLTAGE V	NOMINEL POWER Kw	L mm	L1 mm	Weight kg	ID
BRR 0025 LD 2	30	F4/F5	AWG16	230	0.11	165	146	0.39	CBV 165 C 30R
BRR 0031 LD 2	20	F5	AWG16	230	0.2	265	246	0.88	CBV 265 C 20
BRR 0061 LD 2	10	F6	AWG16	230	0.53	405	386	1.45	CBV 405 CH 10R
BRR 0022 LD 5	63	F4/F5	AWG16	500	0.27	335	316	1.2	CBV 335 C 63R
BRR 0013 LD 6	100	F6	AWG16	690	0.33	405	386	1.45	CBV 405 C 100R
BRR 0022 FP 5	63	AWG16	AWG16	690	0.27	335	316	1.2	CBV 335 C 800 63R

**VACON OYj**  
 Runsonrinte 7 Tel: + 358 (0) 201 2121  
 P.O. Box 25 Fax: + 358 (0) 201 212207  
 65381 VAASA  
 FINLAND

DRAWN: **P. Mandel**  
 APPROVED:  
 SCALE: **1:2**

NOTE:  
 NAME: **BRR 0025 LD 2**

FILE:  
 DRAWING NO: **430CBVXXXC**  
 SHEET: **A3**  
 REVISION:



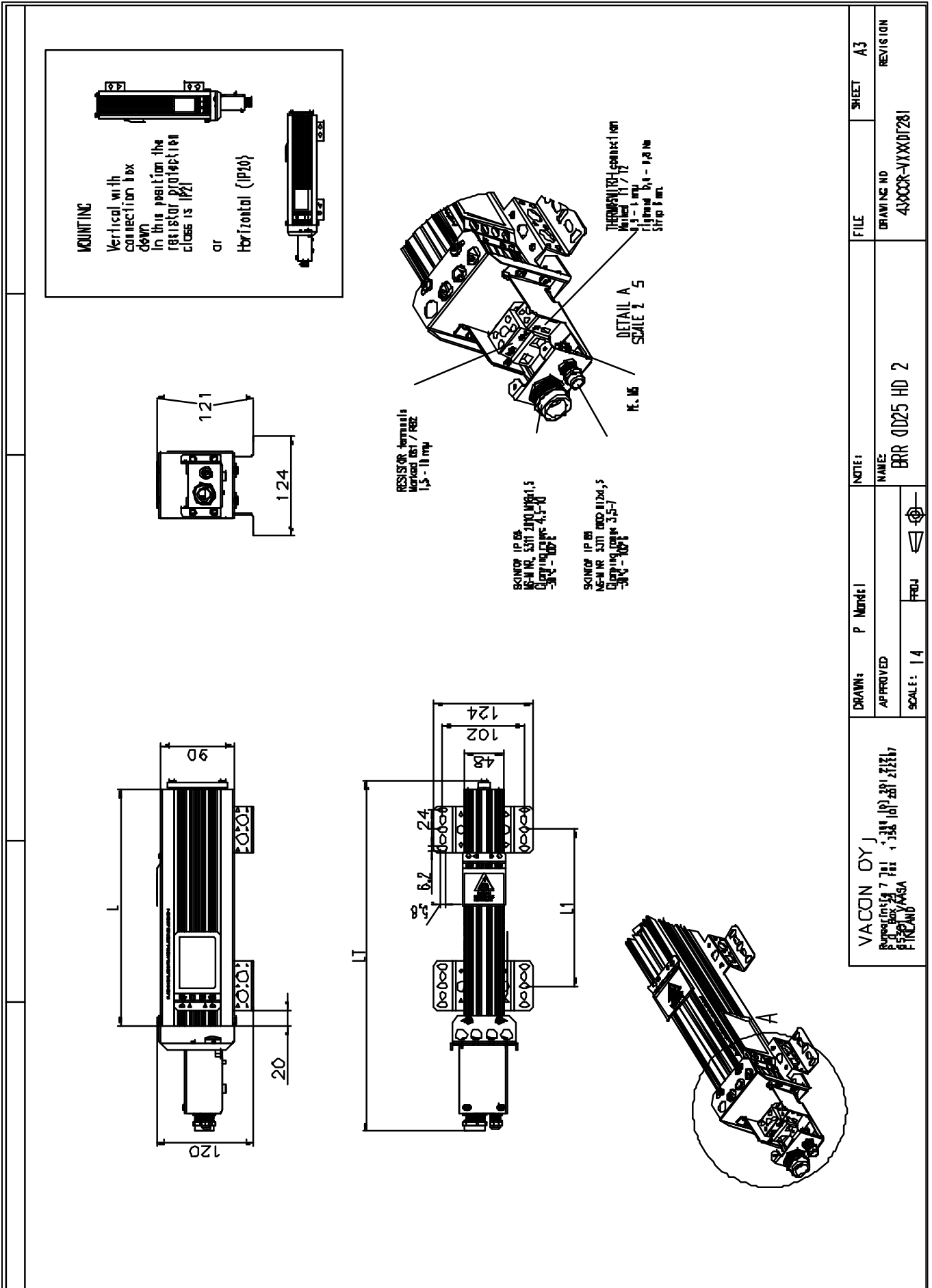

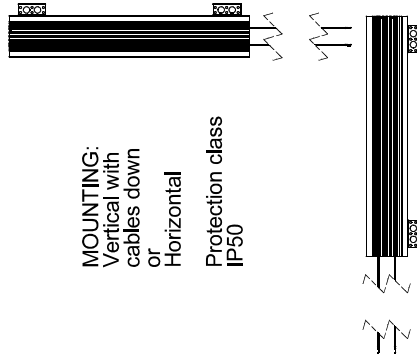
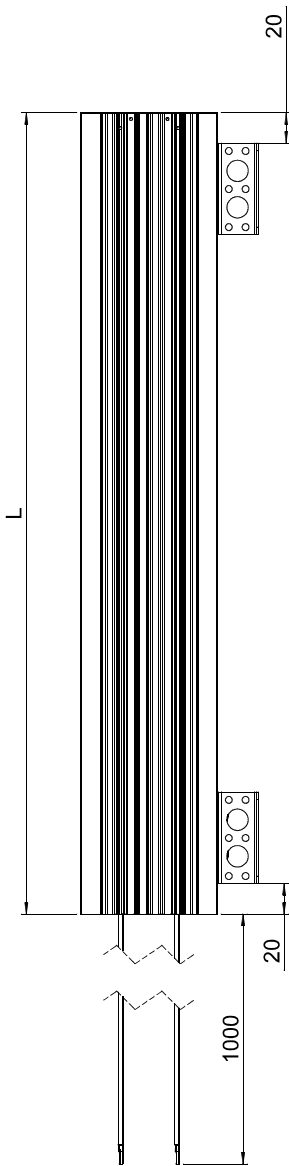
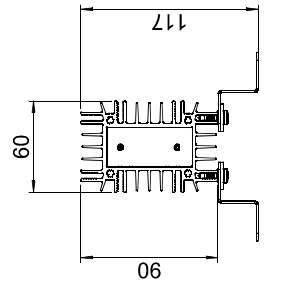

**MOUNTING:**  
Vertical with  
cables down  
or  
Horizontal  
Protection class  
IP50

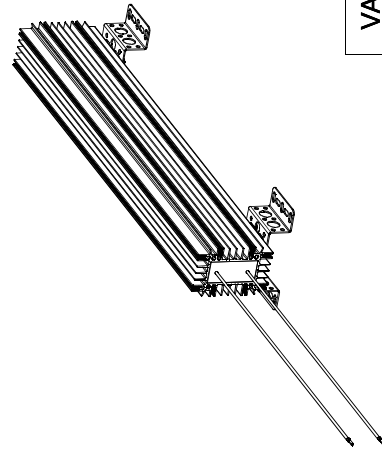
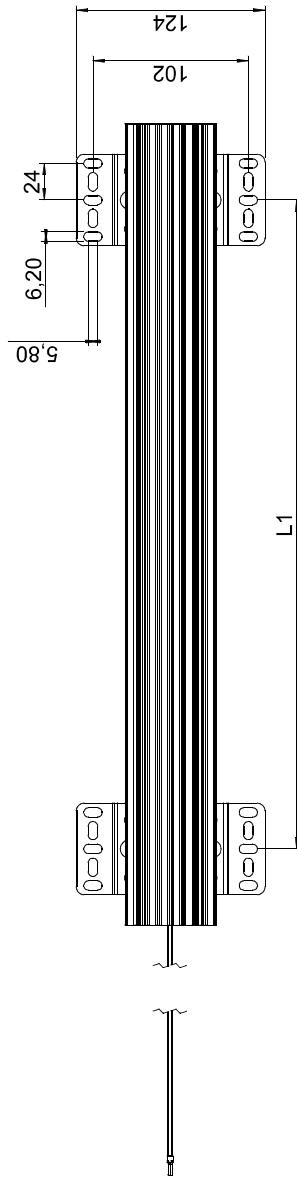

VACON TYPE	R OHM	FRAME SIZE	CABLE mm <sup>2</sup>	LINE VOLTAGE V	NOMINEL POWER Kw	L mm	L1 mm	Weight kg	ID
BRR 0114 LD 2	3,3	F17	AWG10	230	0,95	426	326	3,3	CBR-V 426 CH 3R3
BRR 0031 LD 5	42	F15	AWG16	500	0,35	225	125	1,8	CBR-V 225 C 800 42R
BRR 0045 LD 5	21	F16	AWG16	500	0,71	426	326	3,3	CBR-V 426 CH 800 21R
BRR 0061 LD 5	14	F16	AWG14	500	1,06	526	426	4	CBR-V 526 CH 800 14R
BRR 0034 LD 6	30	F16	AWG16	690	0,94	426	326	3,3	CBR-VM 426 CH 30R
BRR 0052 LD 6	18	F17	AWG14	690	1,57	725	626	5,6	CBR-VM 725 CH 18R

**VACON OYI**  
Ruusuranta, 7 Tel. +358 (0)201 2121  
P.O. Box 25 Fax: +358 (0)201 212207  
65381 VAAASA  
FINLAND

DRAWN: P.Mandel  
APPROVED:  
SCALE: 1:3  
PROJ:

NOTE:  
NAME: BRR 0114 LD2

FILE:  
DRAWING NO: 430CBR-VxxxC  
SHEET: A3  
REVISION:

**MOUNTING:**  
Vertical with connection box down.  
In this position the resistor protection class is IP21  
or  
Horizontal (IP20)

**Resistor terminals**  
Marked RB1 / RB2  
Type: Ensto KE61:  
IEC: 2,6 - 50 mm<sup>2</sup> / 750V  
2,5 - 16 mm<sup>2</sup>: Use Ferrules  
UL: AWG 1/0 - 6 / 600V  
Wire Stripping: 23mm (7/8 in)  
Terminal torque tightening: 10Nm (90 in.lb)

**Thermo Switch Connection**  
Marked: T1/T2  
Type: PHOENIX GS/2 with Screw Connection.  
IEC: 0, 2-4 mm<sup>2</sup> / 500V  
UL: AWG 24 -12 / 300V  
Wire Stripping: 8 mm  
Terminal torque tightening: 0,6 - 0,8 Nm

**DETAIL B SCALE 1 : 3**

**Cable Gland with Screen Connection**  
For resistor cable  
MS-SC-M  
Clamping Range: 19-28 mm  
Minimum Braid Diam.: 15 mm

**Cable gland for Thermo switch Connection**  
MS-M  
Clamping Range: 3,5 - 7,0 mm

VACON TYPE	R	OHM	FRAME	CABLE	VOLTAGE	NOMINEL	L	L1	WT	WEIGHT	Thermostat
				mm <sup>2</sup>	VAC	POWER	L	L1	kg		ID
BRR 0205 LD 2	1.4	F8/ F9	16-50	230	2,5	545	454	745	11	N	CBT-H 545 GH 181 1R4
BRR 0114 HD 2	3.3	F7	16	230	2,8	660	560	860	12,8	Y	CBT-H 660 GH 281 3R3
BRR 0105 LD 5	6.5	F7	16	500	2,8	660	560	860	12,8	N	CBT-H 660 GH 281 6R5
BRR 0061 HD 3	14	F6	16	690	2,8	660	560	860	12,8	Y	CBT-H 660 GH 281 7R8
BRR 0100 LD 6	9	F8	16-50	690	3,2	760	660	960	14,6	N	CBT-H 760 GH 281 9R0

**VACON OY**  
Runsonitie 7 Tel. + 358 (0) 201 2121  
P.O. Box 25 Fax: + 358 (0) 201 212207  
FINLAND

**DRAWN:** PM  
**APPROVED:**  
**SCALE:** 1:5  
**PROJ.:**

**NOTE:**  
**NAME:** BRR 0205 LD 2  
**FILE:**  
**DRAWING NO:** 430CBT-HxxxGT281  
**REVISION:**

**SHEET:** A3

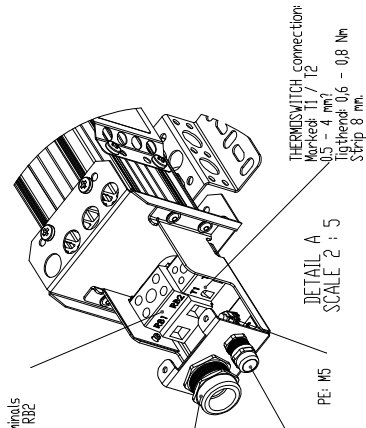
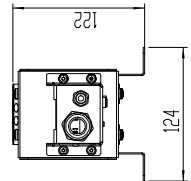
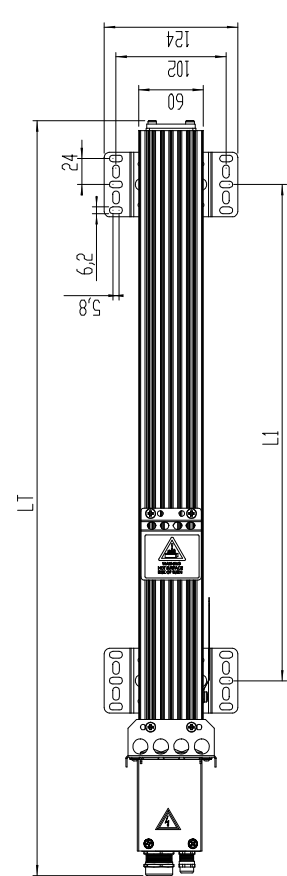
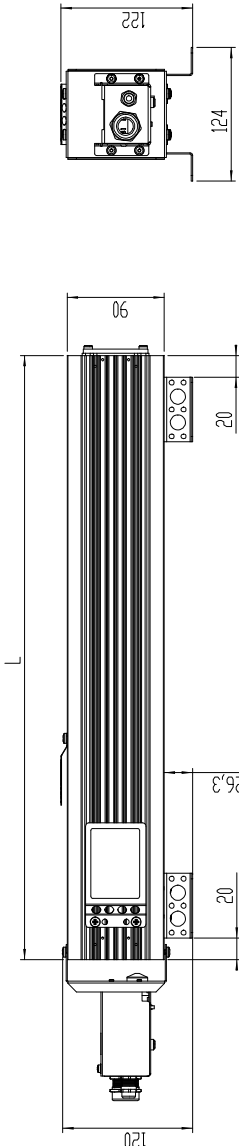
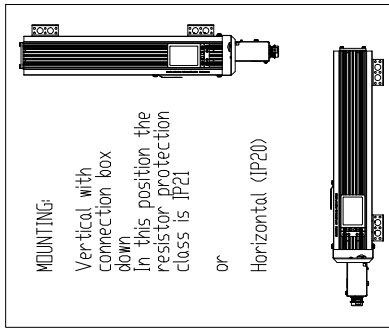

SKINTIP IP 65  
 MS-M NR. 5311 200 M16x15  
 Clamping range 4,5-10  
 -30°C - 100°C

SKINTIP IP 65  
 MS-M NR. 5311 200 M12x15  
 Clamping range 3,5-7  
 -30°C - 100°C

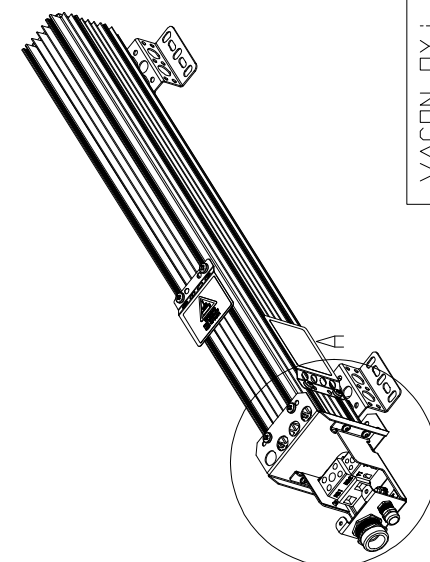

VACON TYPE	R OHM	FRAME SIZE	CABLE mm <sup>2</sup>	LINE VOLTAGE V	NOMINEL POWER Kw	L mm ±2	L1 mm ±2	LT mm ±5	Weight kg	ID
BRR 0031 HD 2	20	F15	6	230	0.45	260	160	400	2.4	CBR-V260 DT 281 20R
BRR 0061 HD 2	10	F16	6	230	0.96	560	460	700	4.6	CBR-V560 DHT 281 10R
BRR 0022 HD 5	63	F14/F15	6	500	0.68	400	300	540	3.5	CBR-V 400 DT 281 63R
BRR 0031 HD 5	42	F15	6	500	0.96	560	460	700	4.6	CBR-V 560 DHT 281 42R
BRR 0013 HD 6	100	F16	6	690	0.79	460	360	600	3.9	CBR-V 460 DT 100R

**VACON OY J**  
 Runspringtie 7  
 P.O. Box 413  
 FIN-00030 HELSINKI  
 FINLAND

Teli + 358 (0) 201 2121  
 Fax: + 358 (0) 201 212207

DRAWN: P. Mandel  
 APPROVED:

SCALE: 1:4

NOTE:  
 NAME: BRR 0031 HD 2  
 DRAWING NO: 430CBR-VXXXDT281

FILE: SHEET: A3

REVISION:

**MOUNTING:**  
Vertical with connection box down.  
In this position the resistor protection class is IP21  
or  
Horizontal (IP20)

**Resistor terminals**  
Marked RB1 / RB2  
Type: Ensto KE61  
IEC: 2.6 - 50 mm<sup>2</sup> / 750V  
2.5 - 16 mm<sup>2</sup> Use Ferrules  
UL: AWG 1/0 - 6 / 600V  
Wire Stripping: 23mm. (7/8 in)  
Terminal torque tightening: 10Nm (90 in.lb)

**Thermo Switch Connection**  
Market: T1/T2  
Type: PHOENIX G5/2 with Screw Connection.  
IEC: 0, 2-4 mm<sup>2</sup> / 500V  
UL: AWG 24-12 / 300V  
Wire Stripping: 8 mm  
Terminal torque tightening: 0.6 - 0.8 Nm

**DETAIL A**  
SCALE 1 : 3

VACON TYPE	R OHM	FRAME	CABLE mm <sup>2</sup>	LINE VOLTAGE VAC	NOMINEL POWER KW	L	L1	LT	Weight kg	Thermostat	ID
BRR 0205 HD 2	1.4	F8/F9	16-50	230	5.5	760	660	960	29	Y	CBTLV 760 GH 282 1R4
BRR 0300 LD 5	3.25	F8/F9	16-50	500	5.5	760	660	960	29	N	CBTLV 760 GH 282 3R3
BRR 0208 LD 6	7	F9	16-50	690	4.2	660	560	860	26	N	CBTLV 660 GH 282 7R

**VACON OYJ**  
Runkonitie 7 Tel. + 358 (0) 201 2121  
P.O. Box 25 Fax. + 358 (0) 201 212207  
FIN-00010 VASA  
FINLAND

**DRAWN:** PM  
**APPROVED:**  
**SCALE:** 1:5

**NOTE:**  
**NAME:** BRR 0205 HD2  
**PROJ.:**

**FILE:** A3  
**DRAWING NO.:** 430CBT-VxxxGTT282  
**REVISION:**

**MOUNTING:**  
Vertical with connection box down.  
In this position the resistor protection class is IP21  
or  
Horizontal (IP20)

**Resistor terminals**  
Marked RCT1/RCT2  
Type: PHOENIX C 10/2  
UL: AWG 20 / 1800V  
UL: AWG 20 / 6 / 600V  
Wire Stripping: 12 mm  
Terminal torque tightening: 1,5-1,8 Nm

**Thermo Switch Connection**  
Marked: T1/T2  
Type: PHOENIX GS/2 with Screw Connection.  
IEC: 0 - 2,4 mm<sup>2</sup> / 500V  
UL: AWG 24 -12 / 300V  
Wire Stripping: 8 mm  
Terminal torque tightening: 0,6 - 0,8 Nm

**DETAIL B**  
SCALE 1 : 3

**Cable Gland with Screen Connection**  
For resistor cable  
MS-SC-M  
Clamping Range: 9-16,6 mm  
Minimum Braided Diam: 7,5 mm

**Cable gland for Thermo switch Connection**  
MS-M  
Clamping Range: 3,5 - 7,0 mm

VACON TYPE	R	FRAME SIZE	CABLE mm <sup>2</sup>	LINE VOLTAGE VAC	NOMINEL LOAD Kw	L	L1	LT	Weight kg	Thermostat	ID
BRR 0045 HD 5	21	F6	6	500	2,2	560	460	700	11,3	Y	CBT-H 560 DHT 281 21R
BRR 0034 HD 6	30	F7	6	690	2,8	660	560	800	13	Y	CBT-H 660 DHT 281 30R

**VACON OY**  
Runsonitie 7 Tel. + 358 (0) 201 2121  
P.O. Box 25 Fax. + 358 (0) 201 21207  
FIN-00010 VASA  
FINLAND

DRAWN: **PM**      NOTE:      FILE:      SHEET: **A3**

APPROVED:      NAME: **BRR 0045 HD 5**      DRAWING NO: **430CBT-HXXXDT281**

SCALE: **1:5**      PROJ:

Vacon code	Ohm	FRAME	Connection	Cable mm	Vac	Pn kW	Weight Kg
BRR 0052 HD6	18	Fr7 / 16mm <sup>2</sup>	M8 / 3X10+10	20	690V	4,0 kW	15

**Connection:**

<b>A</b>	Terminals for cable M8 Torque moment 4,5 [Nm]	
<b>B</b>	Terminals for cable M8 Torque moment 4,5 [Nm]	
<b>C</b>	Cable gland SH21, Clamping range 18 – 23,5 mm	
<b>D</b>	Connection Earth (PE)	

<b>1</b>	Cable	
<b>2</b>	Screen braiding	
<b>3</b>	Cable gland	
<b>4</b>	Core	

The connection cable to the brake resistor is to be screened/armoured.  
Always connect the screen/armouring in both ends.

**Mounting:**

**Note:** for proper performance the resistor sheets have to be vertical

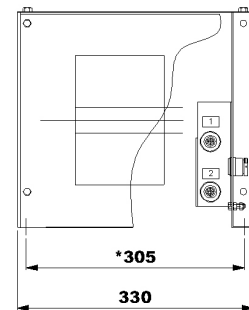
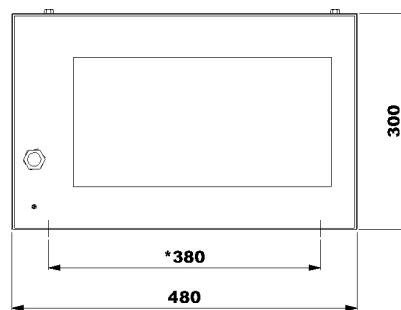
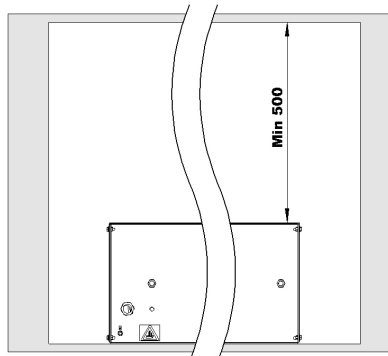
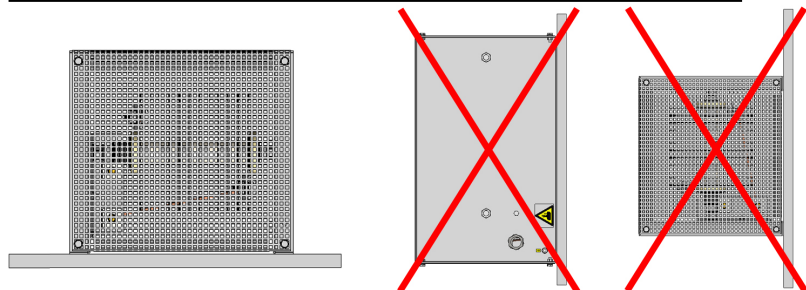
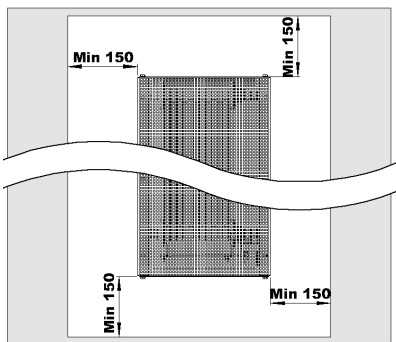

\* Mounting holes

Vacon code	Ohm	FRAME	Connection	Cable mm	Vac	Pn kW	Weight Kg
BRR 0105 HD 5	6,5	Fr7 / 16mm <sup>2</sup>	M8 / 3X10+10	20	500V	6,92 kW	17
BRR 0100 HD 6	9,0	Fr10/ 16 mm <sup>2</sup>	M8 / 3X16+16	23	690V	9,4 kW	20

**Connection:**

<b>A</b>	Terminals for cable M8 Torque moment 4,5 [Nm]	
<b>B</b>	Terminals for cable M8 Torque moment 4,5 [Nm]	
<b>C</b>	Cable gland M25, Clamping range 18 – 23,5 mm	
<b>D</b>	Connection Earth (PE)	

<b>1</b>	Cable	
<b>2</b>	Screen braiding	
<b>3</b>	Cable gland	
<b>4</b>	Core	

The connection cable to the brake resistor is to be screened/armoured.  
Always connect the screen/armouring in both ends.

**Note:** for proper performance the resistor sheets have to be vertical

**Mounting:**

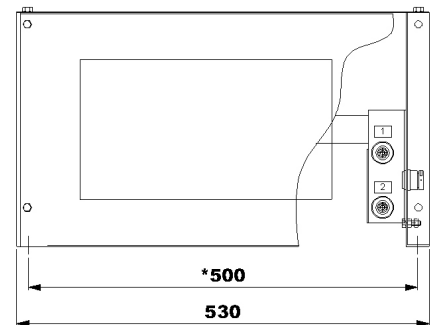
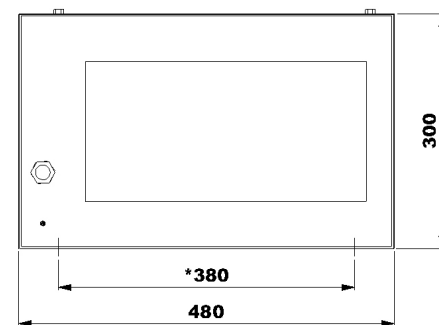
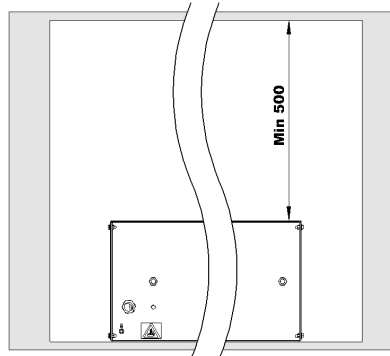
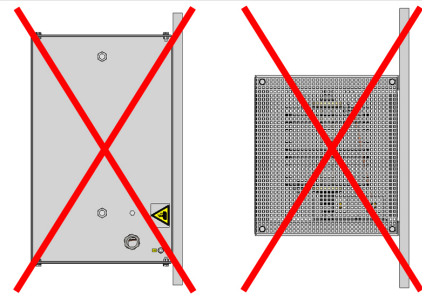
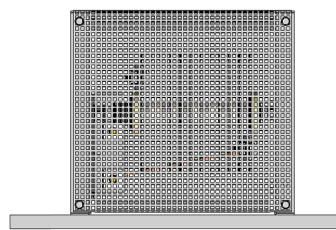
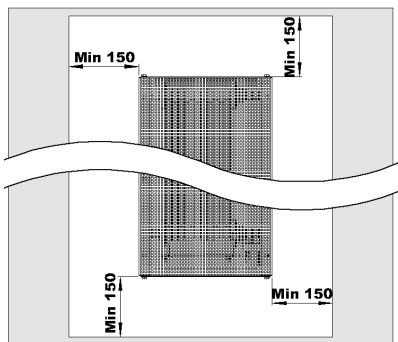

\* Mounting holes Ø9



Vacon code	Ohm	Danotherm code	FRAME	Connection	Cable mm	Vac	Pn kW	Weight kg
BRR 0300 HD5	3,25	BRC 17 AT20 3R25 E726	Fr8/Fr9	M8/3x70+35	32	500 V	12,84 kW	30
BRR 0520 LD5	1,4	BRC 17 AT20 1R4 E725	Fr10	M8/3x95+50	37	500 V	12,3 kW	30
BRR 0208 HD6	7	BRC 17 AT20 7R E724	Fr11	M8/3x50+25	28	690 V	12 kW	30
BRR 0416 LD6	2,5	BRC 17 AT20 2R5 E726	Fr10	M8/3x70+35	32	690 V	13 kW	30

**Connection:**

<b>A</b>	Terminals for cable M8 Torque moment 4,5 [Nm]	
<b>B</b>	Terminals for cable M8 Torque moment 4,5 [Nm]	
<b>C</b>	Cable gland M25, Clamping range 18 – 23,5 mm	
<b>D</b>	Connection Earth (PE)	

<b>1</b>	Cable	
<b>2</b>	Screen braiding	
<b>3</b>	Cable gland	
<b>4</b>	Core	

**The connection cable to the brake resistor is to be screened/armoured. Always connect the screen/armouring in both ends.**

**Mounting:**

**Note:** for proper performance the resistor sheets have to be vertical

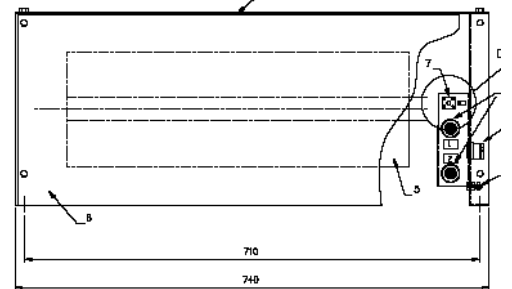
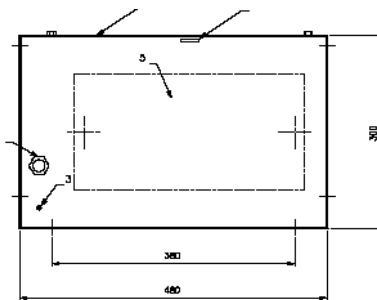
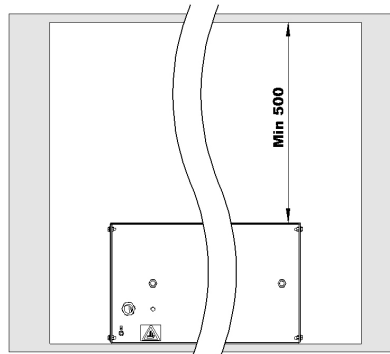
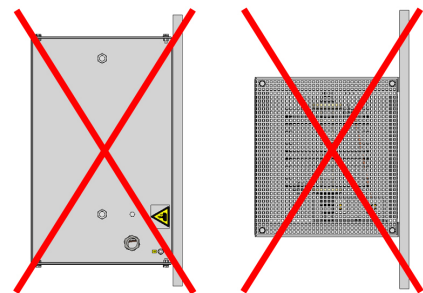
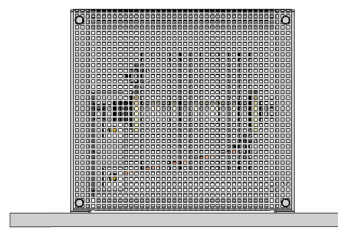
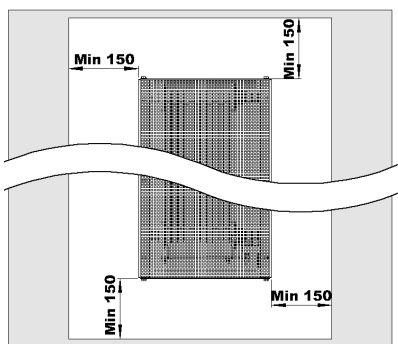

\* Mounting holes Ø9

Vacon code	Ohm	FRAME	Connection	Cable mm	Vac	Pn kW	Weight Kg
BRR 0730 LD 5	0,9	Fr11	M8 / 3X95+50	37	500V	19,2 kW	35
BRR 0590 LD 6	1,7	Fr11/ 50 mm2	M8 / 3X70+35	32	690V	19,0 kW	35

**Connection:**

<b>A</b>	Terminals for cable M8 Torque moment 4,5 [Nm]	
<b>B</b>	Terminals for cable M8 Torque moment 4,5 [Nm]	
<b>C</b>	Cable gland SH40, Clamping range 29 - 40,5 mm	
<b>D</b>	Connection Earth (PE)	

<b>1</b>	Cable	
<b>2</b>	Screen braiding	
<b>3</b>	Cable gland	
<b>4</b>	Core	

The connection cable to the brake resistor is to be screened/armoured. Always connect the screen/armouring in both ends.

**Note:** for proper performance the resistor sheets have to be vertical

**Mounting:**

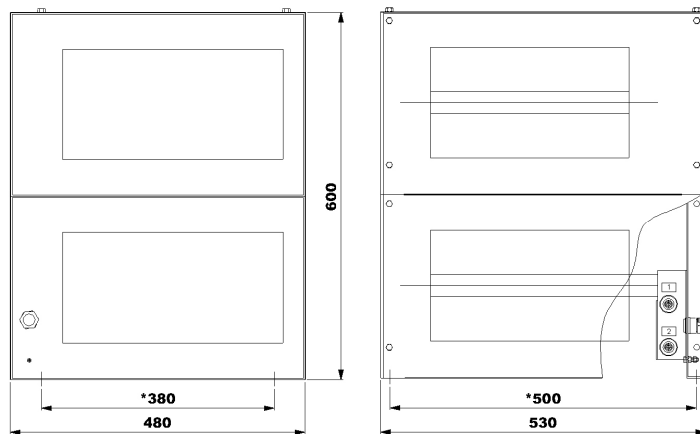
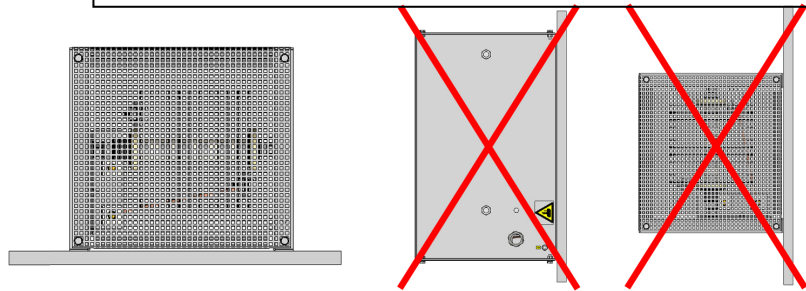
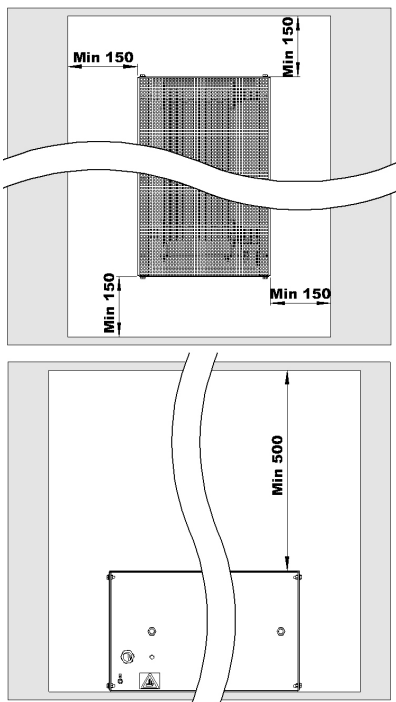

\* Mounting holes Ø9

Vacon code	Ohm	FRAME	Connection	Cable mm	Vac	Pn kW	Weight Kg
BRR 0520 HD 5	1,4	Fr10	M8 / 3X95+50	37	500V	32 kW	90
BRR 0416 HD 6	2,5	Fr10	M8 / 3X70+35	32	690V	33,8 kW	90

**Connection:**

<b>A</b>	Cable gland SH40, Clamping range 29 – 40,5 mm	
<b>B</b>	Terminals for cable M 8 Torque moment 4,5 [Nm]	
<b>C</b>	Connection Earth (PE)	

<b>1</b>	Cable	
<b>2</b>	Screen braiding	
<b>3</b>	Cable gland	
<b>4</b>	Core	

The connection cable to the brake resistor is to be screened/armoured.  
Always connect the screen/armouring in both ends.

**Note:** for proper performance the resistor sheets have to be vertical

**Mounting:**

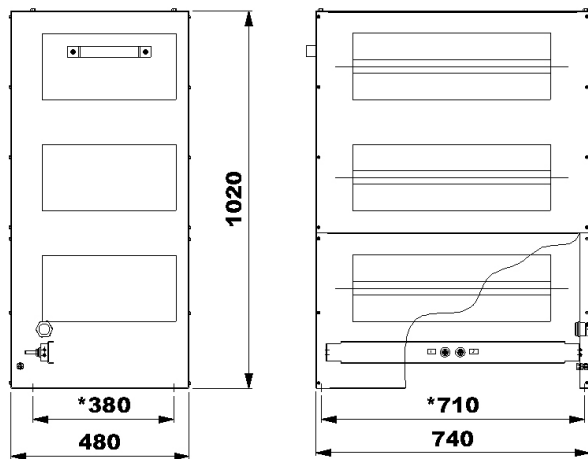
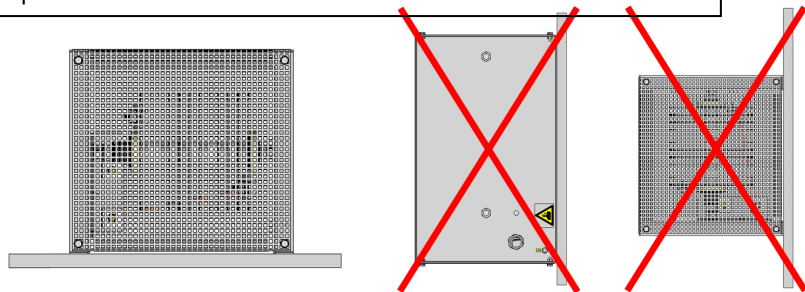
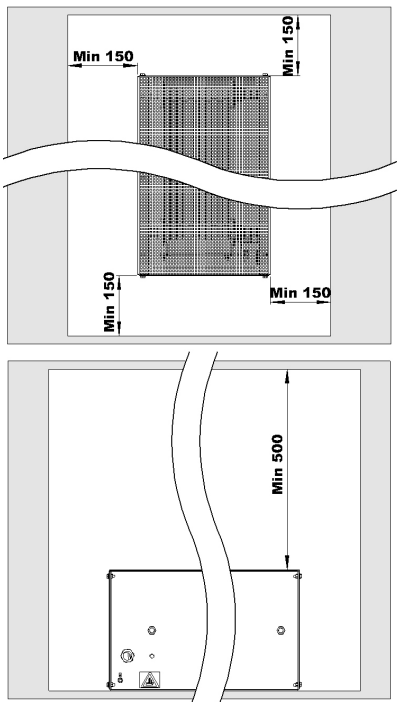

\* Mounting holes Ø9

Vacon code	Ohm	FRAME	Connection	Cable mm	Vac	Pn kW	Weight Kg
BRR 0730 HD 5	0,9	Fr11	M8 / 3X95+50	37	500V	49,9 kW	120
BRR 0590 HD 6	1,7	Fr12	M8 / 3X70+35	32	690V	49,7 kW	120

**Connection:**

<b>A</b>	Cable gland SH40, Clamping range 29,0 – 40,5 mm	
<b>B</b>	Terminals for cable M 8 Torque moment 4,5 [Nm]	
<b>C</b>	Connection Earth (PE)	

1	Cable	
2	Screen braiding	
3	Cable gland	
4	Core	

The connection cable to the brake resistor is to be screened/armoured.  
Always connect the screen/armouring in both ends.

**Note:** for proper performance the resistor sheets have to be vertical

**Mounting:**

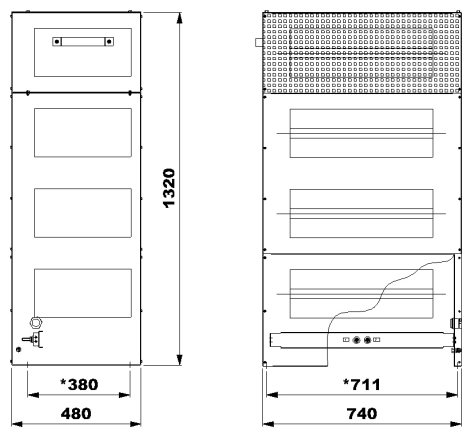
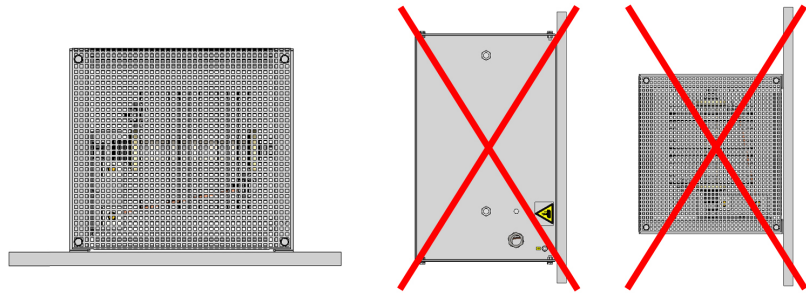
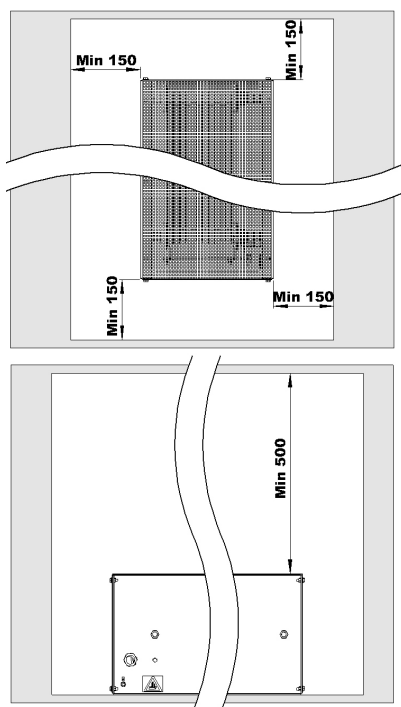

\* Mounting holes Ø9



# VACON<sup>®</sup>

DRIVEN BY DRIVES

Find your nearest Vacon office  
on the Internet at:

[www.vacon.com](http://www.vacon.com)

Manual authoring:  
[documentation@vacon.com](mailto:documentation@vacon.com)

Vacon Plc.  
Runsorintie 7  
65380 Vaasa  
Finland

Subject to change without prior notice  
© 2014 Vacon Plc.

Document ID:



Rev. A