

VACON[®] NX
AC DRIVES

OPT-AF
SAFE TORQUE OFF &
ATEX OPTION BOARD
USER MANUAL

VACON[®]

TABLE OF CONTENTS

Document ID:DPD00891D

Revision release date: 24.08.2017

1.	GENERAL	3
2.	INSTALLATION OF THE OPT-AF BOARD	11
2.1.	OPT-AF Board layout.....	13
3.	STO AND SS1 SAFETY FUNCTIONS.....	14
3.1.	Safe Torque Off (STO) principle.....	15
3.2.	Safe Stop 1 (SS1) principle	16
3.3.	Technical details	18
3.3.1.	Response times.....	18
3.3.2.	Connections.....	18
3.3.3.	Safety-related data according to the standard	19
3.3.4.	Technical data	21
3.4.	Wiring examples.....	22
3.4.1.	Example 1: OPT-AF board without reset for Safe Torque Off (STO)	22
3.4.2.	Example 2: OPT-AF board with reset for Safe Torque Off (STO) or EN 60204-1 stop category 0	23
3.4.3.	Example 3: OPT-AF board with external safety relay module with or without reset for Safe Torque Off (STO) or EN 60204-1 stop category 0	24
3.4.4.	Example 4: OPT-AF board with external time delayed safety relay for Safe Stop 1 (SS1) or EN 60204-1 stop category 1.....	25
3.5.	Commissioning.....	26
3.5.1.	General wiring instructions	26
3.5.2.	Examples of cable sealing grommets or glands.....	26
3.5.3.	Checklist for commissioning the OPT-AF board.....	28
3.5.4.	Parametrizing the drive for the Safe Torque Off (STO) safety functions	29
3.5.5.	3.5.5Parametrizing the drive and the external time delayed safety relay for Safe Stop (SS1) safety function	30
3.5.6.	Testing the Safe Torque Off (STO) or Safe Stop 1 (SS1) safety functions.....	30
3.6.	Maintenance	31
3.6.1.	Faults related to the Safe Torque Off (STO) or Safe Stop 1 (SS1) safety functions	31
4.	THERMISTOR FUNCTION (ATEX)	33
4.1.	Technical data	36
4.1.1.	Functional description	36
4.1.2.	Hardware and connections	37
4.2.	Commissioning.....	39
4.2.1.	General wiring instructions	39
4.2.2.	Parameter setting for ATEX function.....	39
4.2.3.	Short circuit monitoring.....	40
4.2.4.	Exceptional use of thermistor function on OPT-AF board (similar to OPT-A3, not in compliance with ATEX directive 94/9/EC)	40
4.2.5.	OPT-AF board parameter	41

4.2.6. Fault diagnosis of thermistor function42

NOTE! You can download the English and French product manuals with applicable safety, warning and caution information from

<http://drives.danfoss.com/knowledge-center/technical-documentation/>.

REMARQUE Vous pouvez télécharger les versions anglaise et française des manuels produit contenant l'ensemble des informations de sécurité, avertissements et mises en garde applicables sur le site <http://drives.danfoss.com/knowledge-center/technical-documentation/>.

.

1. GENERAL

This document covers OPT-AF option board VB00328H (or newer) and VACON® NXP Control board VB00761B (or newer).

Table 1. Version history of the manual

Date	Revision	Updates
10/2012	B	<ul style="list-style-type: none"> • ATEX certificate added. • Figures updated throughout the manual. • Other minor updates and layout changes throughout the manual.
1/2016	C	<ul style="list-style-type: none"> • STO & SS1 standard info corrected • EC type examination (STO & SS1) certificate updated • STO safety related data updated • ATEX declaration of conformity added • Other minor updates. Throughout the manual.
8/2017	D	<ul style="list-style-type: none"> • Updated ATEX certificate • Updated EC declaration • Changed information related to IP54 requirement in Chapters 1 and 2. • Changed information related to programmable relays in Figure 1 and Figure 17 • Removed notes related to edge sensitive start command in chapters 3.4.1, 3.4.2, 3.4.3 and 3.4.4 • Other minor updates. Throughout the manual.

The OPT-AF option board together with VACON® NXP control board provides the following safety functions with VACON® NX family products.

Safe Torque Off (STO)

Hardware based 'Safe Torque Off' safety function to prevent the drive from generating torque on the motor shaft. STO safety function has been designed for use in accordance with the following standards:

- EN 61800-5-2 Safe Torque Off (STO) SIL2
- EN ISO 13849-1 PL "d" Category 3
- EN 62061 SILCL2
- IEC 61508 SIL2
- The function also corresponds to an uncontrolled stop in accordance with stop category 0, EN 60204-1.
- EN 954-1, Category 3

The STO safety function has been certified by IFA*

NOTE! IP54 cabinet or IP54 enclosure must be used. Lower IP rating can be used if the AC drive is used in environment that does not contain conductive contamination and if the AC drive is equipped with coated PCBs.

Safe Stop 1 (SS1)

SS1 safety function is realized in compliance with type C of the drives safety standard EN 61800-5-2 (Type C: “The PDS(SR) initiates the motor deceleration and initiates the STO function after an application specific time delay”). SS1 safety function has been designed for use in accordance with the following standards:

- EN 61800-5-2 Safe Stop 1 (SS1) SIL2
- EN ISO 13849-1 PL“d” Category 3
- EN 62061 SILCL2
- IEC 61508 SIL2
- The function also corresponds to a controlled stop in accordance with stop category 1, EN 60204-1.

The SS1 safety function has been certified by IFA *

NOTE! IP54 cabinet or IP54 enclosure must be used. Lower IP rating can be used if the AC drive is used in environment that does not contain conductive contamination and if the AC drive is equipped with coated PCBs.

Motor Thermistor Over temperature protection (according to ATEX)

Overtemperature detection using thermistor. It can be used as a tripping device for ATEX certified motors.

The thermistor tripping function is certified by VTT** according to ATEX directive 94/9/EC.

All safety functions of the OPT-AF board are described in this user's manual. The OPT-AF option board contains also two programmable output relays. (**Note!** Not part of any safety function.)

NOTE! The STO function is not the same as a prevention of unexpected start-up function. For fulfilling those requirements, additional external components are required according to appropriate standards and application requirements. Required external components may be for example:

- Appropriate lockable switch
- A safety relay providing a reset function

NOTE! The safety functions of the OPT-AF board do not comply with Emergency Switching Off according to EN 60204-1.

* IFA = Institut für Arbeitsschutz der Deutsche Gesetzlichen Unfallversicherung, Germany

** VTT = Technical Research Centre of Finland

**Danfoss A/S**

DK-6430 Nordborg
Denmark
CVR nr.: 20 16 57 15

Telephone: +45 7488 2222
Fax: +45 7449 0949

EU DECLARATION OF CONFORMITY**Danfoss A/S**

Vacon Ltd

declares under our sole responsibility that the

Product name	Vacon OPT-AF option board to be used with Vacon NXP control board in NX family products
Product identification	OPT-AF option board, VB00328H (or newer revision) NXP control board, VB00761B (or newer revision)
Product Safety Functions	Safe Torque Off, Safe Stop 1 (Specified in EN 61800-5-2:2007)



fulfils all of the relevant safety component requirements of EC Machinery Directive 2006/42/EC.

Notified body that carried out the EC type examination:

IFA – Institute for Occupational Safety and Health of the German Social Accident Insurance
Testing and Certification Body in BG-PRÜFZERT
Alte Heerstraße 111
D-53757 Sankt Augustin, Germany
European notified body, Identification number 0121 IFA Certificate No: IFA 1001221

The following standards and/or technical specifications referenced below were used:

- EN ISO 13849-1:2006
Safety of machinery – Safety-related parts of the control systems. Part 1: General principles for design
- EN ISO 13849-2:2006
Safety of machinery – Safety-related parts of the control systems. Part 2: Validation
- EN 60204-1:2006
Safety of machinery – Electrical equipment of machines – Part 1: General requirements
- EN 61800-5-2:2007
Adjustable speed electrical power drive systems – Part 5-2: Safety requirements – Functional
- IEC 61508:2000
Functional safety of electrical/electronic/programmable electronic safety-related systems – Parts 1-7
- EN 62061:2005
Safety of machinery – Functional safety of safety-related electrical, electronic and programmable electronic control systems

Date 15-04-2016	Issued by Signature  Name: Kimmo Syvänen Title: Director, Premium Drives	Date 15-04-2016	Approved by Signature  Name: Timo Kasi Title: VP, Design Center Finland and Italy
---------------------------	---	---------------------------	--

Danfoss only vouches for the correctness of the English version of this declaration. In the event of the declaration being translated into any other language, the translator concerned shall be liable for the correctness of the translation

ID No: DPD01854 Revision No: A

Page 1 of 1

certificate
no. **IFA 1501228**
dated 2015-11-03

 **IFA**
Institut für Arbeitsschutz der
Deutschen Gesetzlichen Unfallversicherung
Prüf- und Zertifizierungsstelle im DGUV Test

Translation In any case, the German original shall prevail.

European notified body
Identification number: 0121

EC Type-Examination Certificate

Name and address of the holder of the certificate (customer): **Vacon Plc
Runsorintie 7
65380 Vaasa
FINLAND**

Product designation: **Frequency converter with integrated safety function**

Type: **Type series NX (see attachment)**

Testing based on: **- DIN EN 61800-5-1:2008-04 - DIN EN 61800-5-2:2008-04
- DIN EN ISO 13849-1:2008-12 - DIN EN ISO 13849-2:2013-02**

Test Report: **No. 2015 21579 of 2015-10-28**

Further details: **Intended purpose:
Implementation of the Safety Functions
"Safe Torque Off" (STO) and "Safe Stop 1" (SS1)**

Remarks:
The frequency converters of the type series NX meet the requirements of the test regulations.
The integrated safety function „Safe Torque Off" (STO) fulfills the requirements on SIL 2 according to DIN EN 61800-5-2, as well as category 3 and PL d according to DIN EN ISO 13849-1.
With correct wiring according to the user manual, in connection with a suitable external safety relay, this also applies to "SS1".

This EC Type-Examination Certificate replaces the EC-Type Test Certificate with the number IFA 1001221 of 2010-08-27

The type tested complies with the provisions laid down in the directive 2006/42/EC (**Machinery**).
The present certificate is valid until: **2020-11-02**
Further provisions concerning the validity, the extension of the validity and other conditions are laid down in the Rules of Procedure for Testing and Certification.

n/ae

Dipl.-rer. nat. Peter Paszkiewicz
Head of testing and certification body

Dipl.-Ing. Ralf Apfeld
Certification officer

PZB02E Deutsche Gesetzliche Unfallversicherung (DGUV) e.V.
11.14 Spitzenverband der gewerblichen Berufsgenossenschaften
und der Unfallversicherungsträger der öffentlichen Hand
Vereinsregister-Nr. VR 751 B, Amtsgericht Charlottenburg

Institut für Arbeitsschutz der DGUV (IFA)
Prüf- und Zertifizierungsstelle im DGUV Test
Alte Heerstraße 111 • 53754 Sankt Augustin • Deutschland
Telefon: +49 (0) 22 41 2 31-2751 • Fax: +49 (0) 22 41 2 31-22 34

 **DAKKS**
Deutsche
Akkreditierungsstelle
D-ZE-17009-33-00



1. **EU-TYPE EXAMINATION CERTIFICATE**
2. **Equipment or Protective System Intended for use in
Potentially explosive atmospheres
Directive 2014/34/EU**
3. Reference: **VTT 06 ATEX 048X Issue 4**
4. Equipment: **Thermal motor protection system for inverter drives**
Certified types: **OPT-AF and OPT-BJ**
5. Manufactured by: **Vacon Ltd**
6. Address: **Runsorintie 7
FI-65380 VAASA
Finland**
7. This equipment or protective system and any acceptable variations thereto are specified in the schedule and possible supplement(s) to this Certificate and the documents therein referred to.
8. VTT Expert Services Ltd, notified body number 0537, in accordance with Article 21 of the Directive 2014/34/EU of February 2014, certifies that this equipment or protective system has been found to comply with the Essential Health and Safety Requirements relating to the design and construction of equipment and protective system intended for use in potentially explosive atmospheres given in Annex II to the Directive.

The examination and test results are recorded in confidential report no. VTT-S-05774-06.
9. Compliance with the Essential Health and Safety Requirements has been assured by using standards:

EN ISO 13849-1 (2008) + AC:2009
EN ISO 13849-2 (2013)
EN 60079-14 (2014)
EN 61508-1 (2010)
EN 50495 (2010)



10. If the sign "X" is placed after the certificate number, it indicates that the equipment or protective system is subject to special conditions for safe use specified in the schedule to this certificate.
11. This EC-Type examination certificate relates only to the design, examination and tests of the specified equipment or protective system in accordance to the directive 2014/34/EU. Further requirements of the Directive apply to the manufacturing process and supply of this equipment or protective system. These are not covered by this certificate.
12. The marking of the equipment or protective system shall include the following:



II (2) GD

Espoo 28.4.2017
VTT Expert Services Ltd



Juho Pörhönen
Expert



Risto Sulonen
Product Manager

Certificate without signatures shall not be valid.
This certificate, including the schedule, may only be reproduced in its entirety and without any change.



SCHEDULE TO EU-TYPE
EXAMINATION CERTIFICATE
VTT 06 ATEX 048X Issue 4

1 (2)

13.

Schedule

14.

EU-TYPE EXAMINATION CERTIFICATE VTT 06 ATEX 048X Issue 4

15.

Description of Equipment

Thermal motor protection system consist one safe disable & ATEX option board with possibility to connect to temperature sensor (PTC). The temperature sensor is not included in this certificate. The ATEX safety function may be used with all Vacon 100 and NX drives.

Documents specifying the equipment:

OPT-AF: Prevention of Unexpected Start Up ; SC00328 J
EC Type-Examination Certificate IFA1501228 (dated 2015-11-03) by IFA

OPT-BJ: STO option board; SC01380, rev C.01
EC Type-Examination Certificate 01/205/5216.02/15 (dated 2015-09-22) by TÜV Rheinland

16.

Report No. VTT-S-05774-06

17.

Special conditions for safe use

The allowed ambient temperature range is -10°C...+50°C.

18.

Essential Health and Safety Requirements

Assessment using standards referred in point 9 have confirmed compliance with the Directive 2014/34/EU, Annex II and in particular point 1.5. The device themselves are to be installed outside potentially explosive atmospheres (article 1, section (b) of the Directive).

Certificate without signatures shall not be valid.
This certificate, including the schedule, may only be reproduced in its entirety and without any change.



SCHEDULE TO EU-TYPE
EXAMINATION CERTIFICATE
VTT 06 ATEX 048X Issue 4

2 (2)

Certificate history

Issue	Date	Report No.	Comment
-	19.6.2006	VTT-S-05774-06	Prime certificate
Supplement 1 and 2	26.6.2008 and 6.4.2010		The introduction of new revisions and STO function
1	26.4.2012	968/M 350.00/12	The introduction of M-Platform STO-function and changing equipment name and type designation. Updating the certificate with the latest edition of relevant standards
2	9.7.2012	-	The introduction the old type OPT-AF in the scope of the certificate.
3	8.1.2016	-	Constraining the references only to ATEX-relevant documents
4	28.4.2017	-	Updating the certificate to refer the new directive 2014/34/EU and latest version of relevant standards. Special conditions for safe use changed

Espoo 28.4.2017
VTT Expert Services Ltd

Juho Pörhönen
Expert



Risto Sulonen
Product Manager



Certificate without signatures shall not be valid.

This certificate, including the schedule, may only be reproduced in its entirety and without any change.

2. INSTALLATION OF THE OPT-AF BOARD

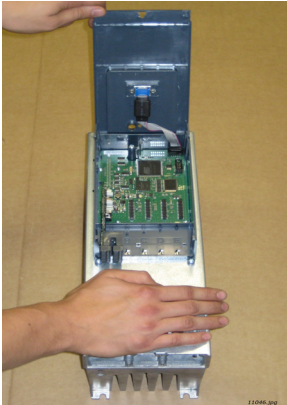
 NOTE	<p>MAKE SURE THAT THE AC DRIVE IS SWITCHED OFF BEFORE AN OPTION OR FIELDBUS BOARD IS CHANGED OR ADDED!</p>
--	---

A	<p>VACON® NXP AC drive with IP54 enclosure.</p>	
B	<p>Remove the main cover.</p>	
C	<p>Open the cover of the control unit.</p>	

<p>D</p>	<p>Install OPT-AF option board in slot B on the control board of the AC drive. Make sure that the grounding plate fits tightly in the clamp.</p>	
<p>E</p>	<p>Cable installation:</p> <p>STO and SS1 safety functions require the use of cable sealing grommets or glands for all cables in the drive. The grommets or glands must be suitable for the type and amount of cables used and they shall fulfil IP54 requirements.</p> <p>See the User Manual for hole sizes for the Power cables. The hole size is PG21 (28.3 mm) for the control cables.</p> <p>See Chapter 3.5.2 for examples of cable sealing grommets or glands that can be used.</p>	
<p>F</p>	<p>Close the cover of the control unit and attach the main cover. Before attaching the main cover, check that the gasket of the cover is not damaged for IP54 units. Use a tightening torque of 0.9...1.1 Nm for the main cover screws.</p>	

2.1 OPT-AF BOARD LAYOUT

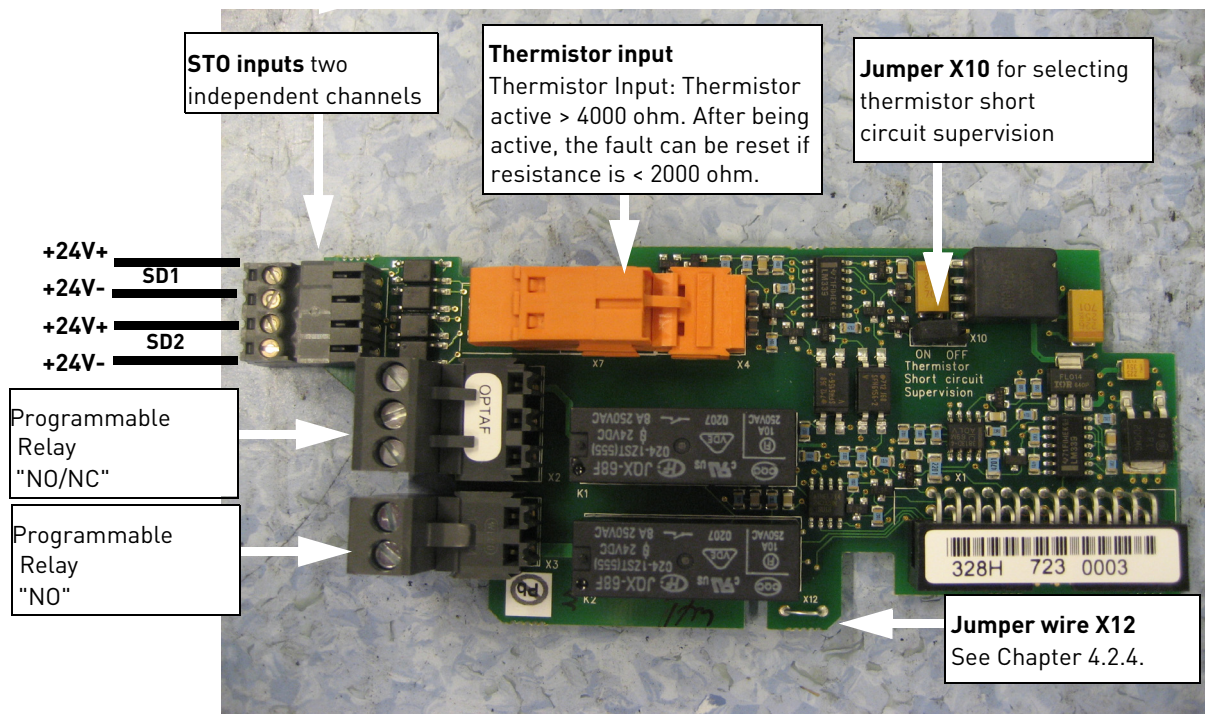

11052.emf

Figure 1. The layout of the OPT-AF board

3. STO AND SS1 SAFETY FUNCTIONS

The safety functions of the OPT-AF board, such as the technical principle and data, wiring examples and commissioning, will be described in this chapter.

NOTE! Designing of safety-related systems requires special knowledge and skills. Only qualified persons are permitted to install and set up the OPT-AF board.

The use of STO, SS1 or other safety functions does not itself ensure safety. An overall risk evaluation is required in order to make sure that the commissioned system is safe. Safety devices like the OPT-AF board must be correctly incorporated into the entire system. The entire system must be designed in compliance with all relevant standards within the field of industry.

Standards such as EN 12100 Part 1, Part 2, & ISO 14121-1 provide methods for designing safe machinery and for carrying out a risk assessment.

CAUTION! The information in this manual provides guidance on the use of the safety functions that OPT-AF option board provides together with VACON® NXP control board. This information is in compliance with accepted practice and regulations at the time of writing. However, the end product/system designer is responsible for ensuring that the system is safe and in compliance with relevant regulations.

CAUTION! The OPT-AF board and its safety functions do not electrically isolate the drive output from the mains supply. If electrical work is to be carried out on the drive, the motor or the motor cabling, the drive has to be completely isolated from the mains supply e.g. using an external supply disconnecting switch. See for e.g. EN 60204-1 section 5.3.

CAUTION! If STO or SS1 safety function is required in DriveSynch installation, please contact your nearest distributor for more information.

CAUTION! In LineSynch application the use of OPT-AF board will not fulfill STO or SS1 -safety functions while the drive is in by-pass mode.

3.1 SAFE TORQUE OFF (STO) PRINCIPLE

The STO safety function of the OPT-AF board allows the drive output to be disabled so that the drive cannot generate torque in the motor shaft. For STO, the OPT-AF board has two separate, galvanically isolated inputs $\overline{SD1}$ and $\overline{SD2}$.

Note! Both $\overline{SD1}$ and $\overline{SD2}$ inputs are normally closed for the drive to be in enable state.

The STO safety function is achieved by disabling the drive modulation. The drive modulation is disabled through two independent paths controlled by $\overline{SD1}$ and $\overline{SD2}$ so that a single fault in any of the safety related parts will not lead to the loss of the safety function. This is done by disabling the gate driver signal outputs to the driver electronics. The gate drive output signals control the IGBT module. When gate drive output signals are disabled, the drive will not generate torque in the motor shaft. See Figure 2.

If either of the STO inputs is not connected to a +24 V signal, the drive will not go to the RUN state.

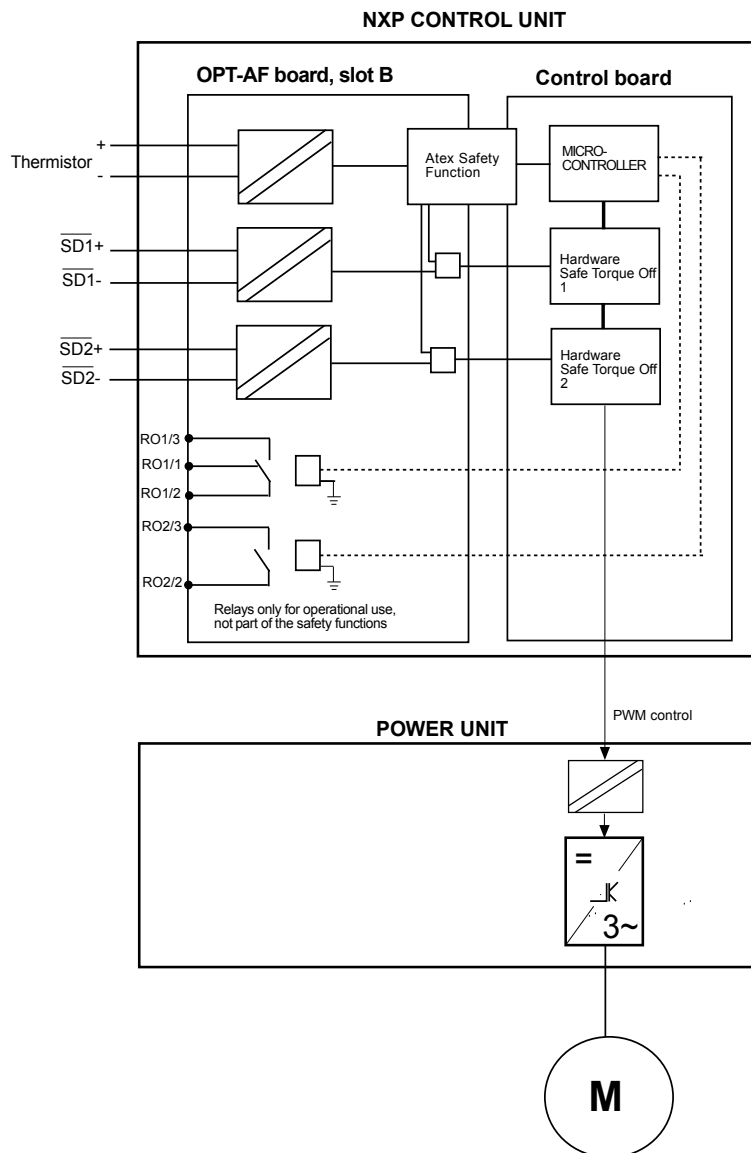

11053.emf

Figure 2. STO safety function principle in VACON® NXP AC drive with the OPT-AF board

3.2 SAFE STOP 1 (SS1) PRINCIPLE

The Safe Stop 1 (SS1) safety function initiates the motor deceleration and initiates the STO after a (user set) time delay.

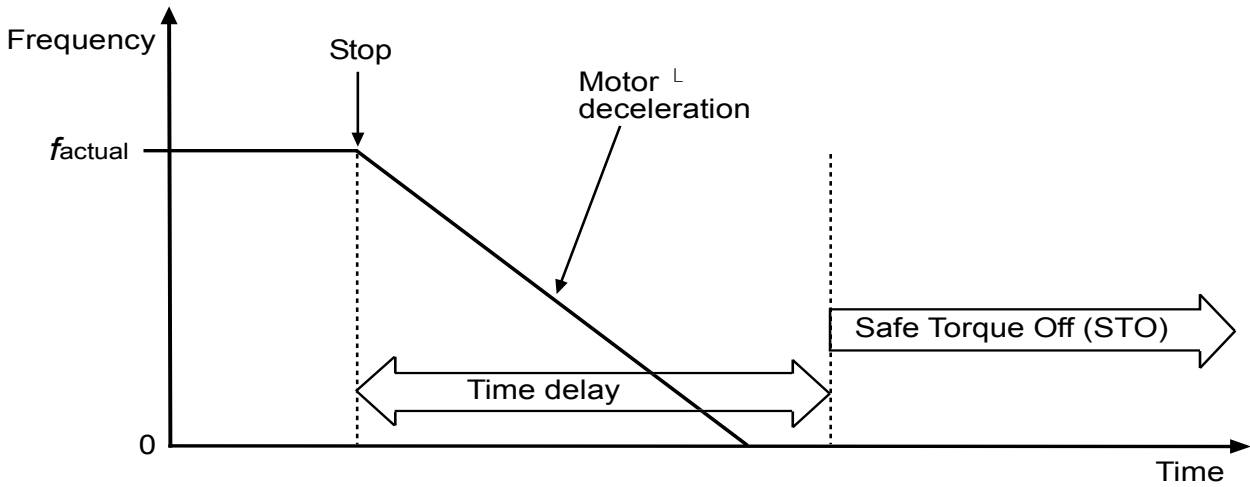

11054.emf

Figure 3. The principle of Safe Stop 1 (EN 61800-5-2, SS1 type c)

The Safe Stop 1 (SS1) safety function consists of two safety related subsystems, an external time delayed safety relay and the STO safety function. These two subsystems combined compose the Safe Stop 1 safety function as shown in Figure 4.

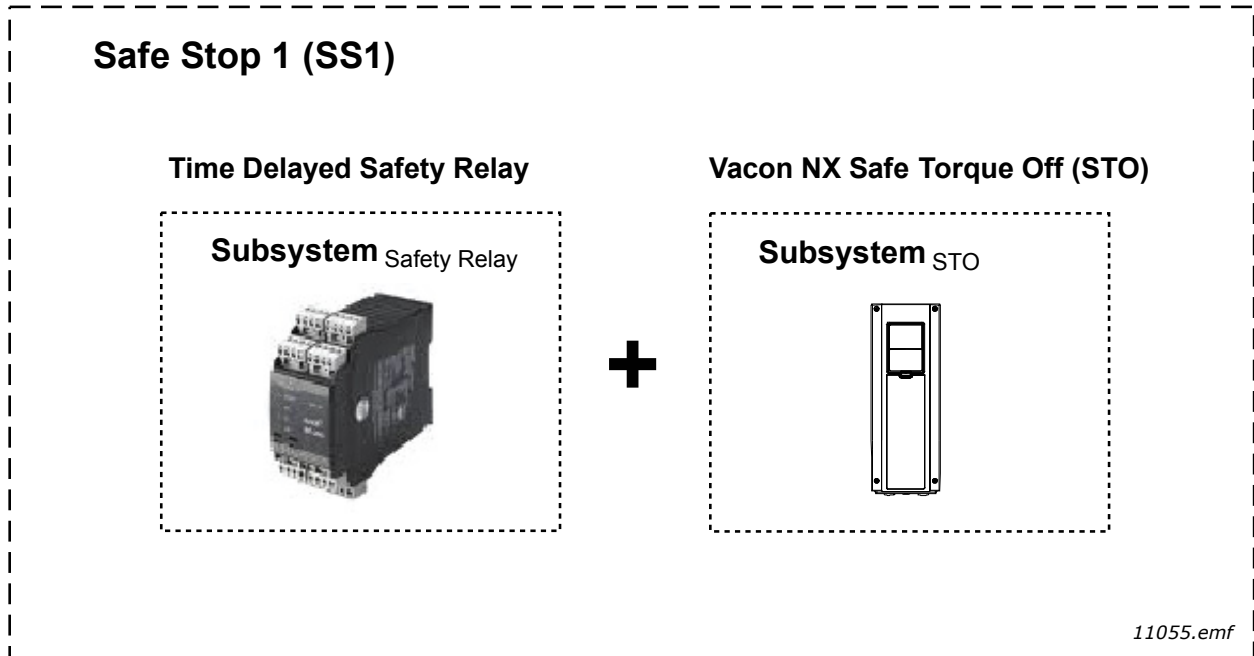

11055.emf

Figure 4. Safe Stop 1 (SS1) safety function

Figure 5 shows the connection principle of Safe Stop 1 safety function.

- The time delayed safety relay outputs are connected to the STO inputs.
- A separate digital output from the safety relay is connected to a general digital input of the VACON® NX drive. The general digital input must be programmed to detect the drive stop command and initiates without time delay the drive stop function (must be set to "stop by ramp") and causes motor deceleration.

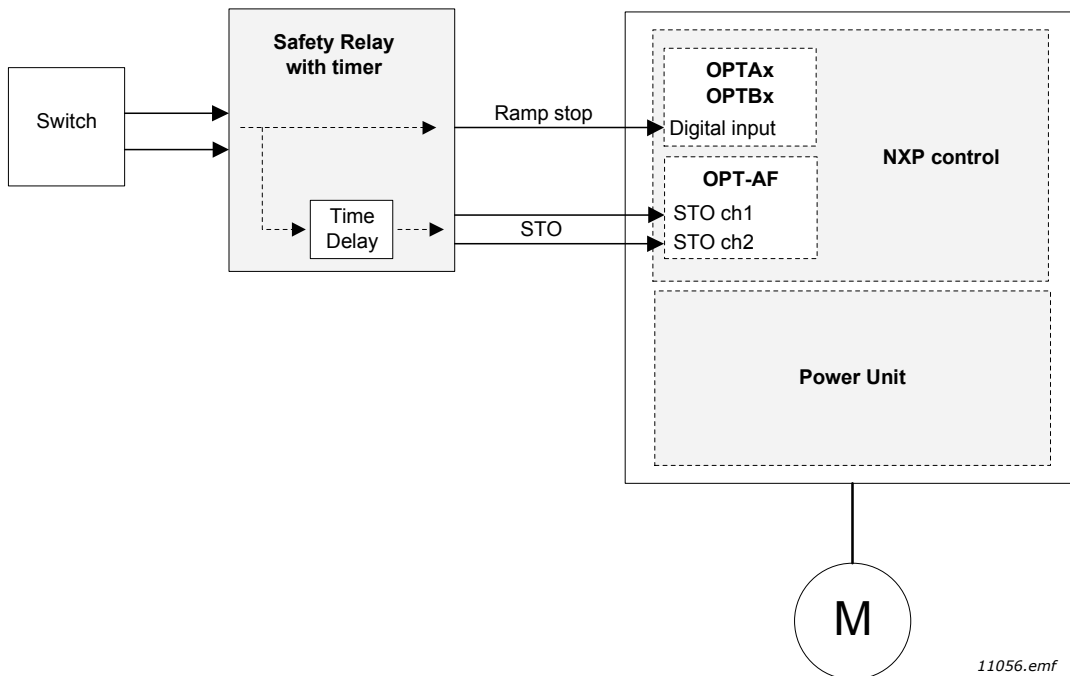

Figure 5. The connection principle of Safe Stop 1 (SS1)

CAUTION! The system designer/user is responsible of understanding and setting the time delay of the safety relay, due to the fact it is process/machine dependent.

- The time delay must be set to a greater value than the deceleration time of the drive. The motor deceleration time is process/machine dependent.
- The stop function of the drive needs to be correctly set for the process/machine.

See Chapter 3.5.5 concerning the parametrizing of Safe Stop 1 and Chapter 3.4.4 "Example 4" for the wiring of Safe Stop 1.

3.3 TECHNICAL DETAILS

3.3.1 RESPONSE TIMES

Safety function	Activation time	De-activation time
Safe Torque Off	< 20 ms	1000 ms

Safety Function	Delay from stop signal at safety relay input until activation of ramp stop	Time delay for Safe Torque Off (STO) activation
Safe Stop 1 (SS1)	Safety relay delay + typ. 20 ms (drive) NOTE! Drive application software dependent. Refer to the user manual of the application in use.	System process dependent. User settable through the safety relay timer.

3.3.2 CONNECTIONS

In addition to the STO inputs, the board contains also a thermistor input. If the thermistor input is not used it must be disabled. The thermistor input is disabled by making a short circuit to the terminals and setting the jumper X10 in "OFF" state. The termistor input operation and instructions are presented in Chapter 4.

I/O terminals on OPT-AF

Table 2. OPT-AF I/O terminals

Terminal		Parameter reference on keypad and NCDrive	Technical information
1	SD1+	DigIN:B.2	Isolated STO input 1 +24 V +-20% 10... 15 mA
2	SD1-		Virtual GND 1
3	SD2+	DigIN:B.3	Isolated STO input 2 +24 V +-20% 10... 15 mA
4	SD2-		Virtual GND 2
21	R01/normal closed	DigOUT:B.1	Relay output 1 (NO/NC) *
22	R01/common		Switching capacity 24 VDC/8 A
23	R01/normal open		250 VAC/8 A 125 VDC/0.4 A Min. switching load 5 V/10 mA
25	R02/common	DigOUT:B.2	Relay output 2 (NO) *
26	R02/normal open		Switching capacity 24 VDC/8 A 250 VAC/8 A 25 VDC/0.4 A Min. switching load 5 V/10 mA
28	T11+	DigIN:B.1	Thermistor input; R _{trip} > 4.0 kΩ (PTC)
29	T11-		

* If 230 VAC is used as control voltage from the output relays, the control circuitry must be powered with a separate isolation transformer to limit short circuit current and overvoltage spikes. This is to prevent the welding on the relay contacts. Refer to standard EN 60204-1, section 7.2.9.

3.3.3 SAFETY-RELATED DATA ACCORDING TO THE STANDARD

Safe Torque Off (STO) safety-related data

EN 61800-5-2:2007	SIL 2 PFH = 2.98×10^{-9} /hour Dual Channel Structure
EN 62061:2005	SIL CL 2 PFH = 2.98×10^{-9} /hour Dual Channel Structure
EN/ISO 13849-1:2006	PL d MTTF _d = 828 years DC _{avg} = low PFH = 2.8×10^{-9} /hour Category 3
IEC 61508:2000 High Demand Mode	SIL 2 PFH = 2.98×10^{-9} /hour Dual Channel Structure
IEC 61508:2000 Low Demand Mode	SIL 2 PFD _{AVG} = 2.61×10^{-4} T _M = 20 years Dual Channel Structure

Safe Stop (SS1) safety-related data

The SS1 safety function consists of two subsystems with different safety-related data. The subsystem consisting of the time delayed safety relay is manufactured by PHOENIX CONTACT and of type:

- PSR-SCP-24DC/ESD/5X1/1X2/300 or
- PSR-SPP-24DC/ESD/5X1/1X2/300

See manufacturer user manual (by ID "2981428 or "2981431") for more information regarding the time delayed safety relay.

PSR-SC/PP-24DC/ESD/5X1/1X2 300 safety-related data from user manual and certificate:

IEC 61 508	SIL 2
EN 62061	SIL CL 2
DIN EN/ISO 13849-1	PL d Category 3
PFH	1.89×10^{-9} /hour

Subsystem_{Safety Relay}

VACON® NX STO safety-related data:

EN 61800-5-2:2007	SIL 2
EN 62061:2005	SIL CL 2
IEC 61508:2000	SIL 2
DIN EN/ISO 13849-1:2006	PL d Category 3
PFH	2.98×10^{-9} /hour

Subsystem_{NX STO}

+

Safe Stop 1 (SS1) safety-related data:

→

EN 61800-5-2:2007	SIL 2
EN 62061:2005	SIL CL 2
IEC 61508:2000	SIL 2
DIN EN/ISO 13849-1:2006	PL d Category 3
PFH	4.87×10^{-9} /hour

- For combining the two subsystems, the maximum safety integrity level or performance level reached is the lowest of a subsystem.
→ SIL 2 or PL d
- The PFH value for a safety function of combined subsystems is the sum of all subsystems PFH values.
 $PFH_{SS1} = PFH_{\text{Safety Relay}} + PFH_{\text{NX STO}} = 1.89 \times 10^{-9} \text{ /hour} + 2.98 \times 10^{-9} \text{ /hour} = 4.87 \times 10^{-9} \text{ /hour}$
→ The result is within the requirements for SIL 2 or PL d (PFH is even within the requirements for up to SIL 3/PL e).

Abbreviations or safety parameters definitions

SIL	Safety Integrity Level
PL	Performance Level
PFH	Probability of a dangerous random hardware Failure per Hour
Category	Designated architecture for a safety function (from EN ISO 13849-1:2006)
PFD_{AVG}	The average probability of (random hardware) failure on demand
T_M	Mission time

3.3.4 TECHNICAL DATA

For more information, see the chapter "Technical data" in the product-specific user manual.

3.4 WIRING EXAMPLES

The examples in this chapter show the basic principles for wiring OPT-AF board. Local norms and regulations should be always followed in the final design.

3.4.1 EXAMPLE 1: OPT-AF BOARD WITHOUT RESET FOR SAFE TORQUE OFF (STO)

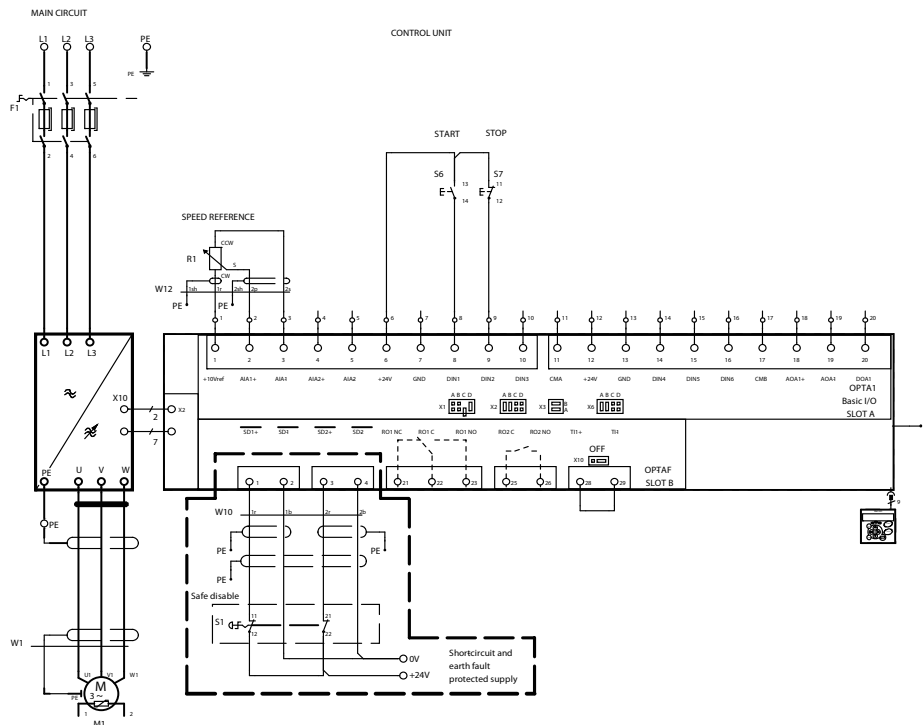

11057.emf

Figure 6. Example 1.

Figure 6 shows a connection example of OPT-AF board for Safe Torque Off safety function without reset. The switch S1 is connected with 4 wires to the OPT-AF board as shown above.

The power supply to S1 may come from OPT-A1 board (connector pins 6 & 7 in Figure 6) or it may also be external.

When the switch S1 is activated (contacts open), the drive will go to STO state and motor (if running) will stop by coasting. The drive will indicate: "A30 SafeTorqueOff".

When switch S1 is released (contacts closed), the drive returns to the ready state. The motor can then be run with a valid start command.

3.4.2 EXAMPLE 2: OPT-AF BOARD WITH RESET FOR SAFE TORQUE OFF (STO) OR EN 60204-1 STOP CATEGORY 0

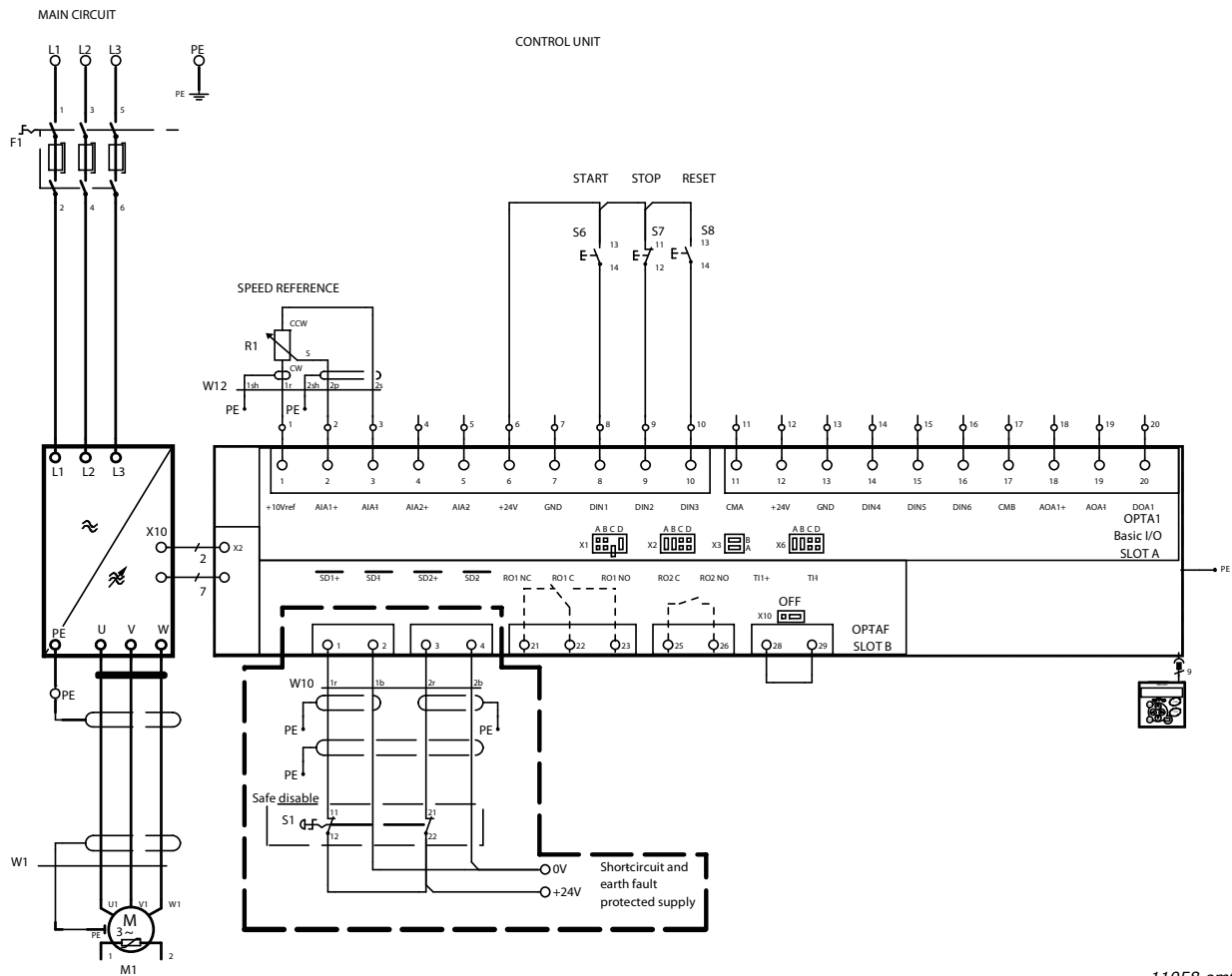

Figure 7. Example 2.

Figure 7 presents a connection example of OPT-AF board for STO safety function with reset. The switch S1 is connected with 4 wires to the OPT-AF board as shown above. The digital input 3 (DIN3), for example, is wired for the fault reset function. The reset function can be programmed to any of the available digital inputs. The drive must be programmed to generate a fault in STO state.

The power supply to S1 may come from OPT-A1 board (connector pins 6 & 7 in Figure 6) or it may also be external.

When the switch S1 is activated (contacts open), the drive will go to STO state and motor (if running) will stop by coasting. The drive will indicate: "F30 SafeTorqueOff".

To start the motor operation again, following sequence is performed.

- Release switch S1 (contacts closed). The hardware is now enabled but the drive continues to display the fault "F30 SafeTorqueOff".
- Acknowledge the releasing of switch by edge sensitive reset function. The drive returns to the ready state.
- Giving a valid start command will start running the motor.

Note: For EN 60204-1 emergency stop according to stop category 0, use emergency stop button.

3.4.3 EXAMPLE 3: OPT-AF BOARD WITH EXTERNAL SAFETY RELAY MODULE WITH OR WITHOUT RESET FOR SAFE TORQUE OFF (STO) OR EN 60204-1 STOP CATEGORY 0

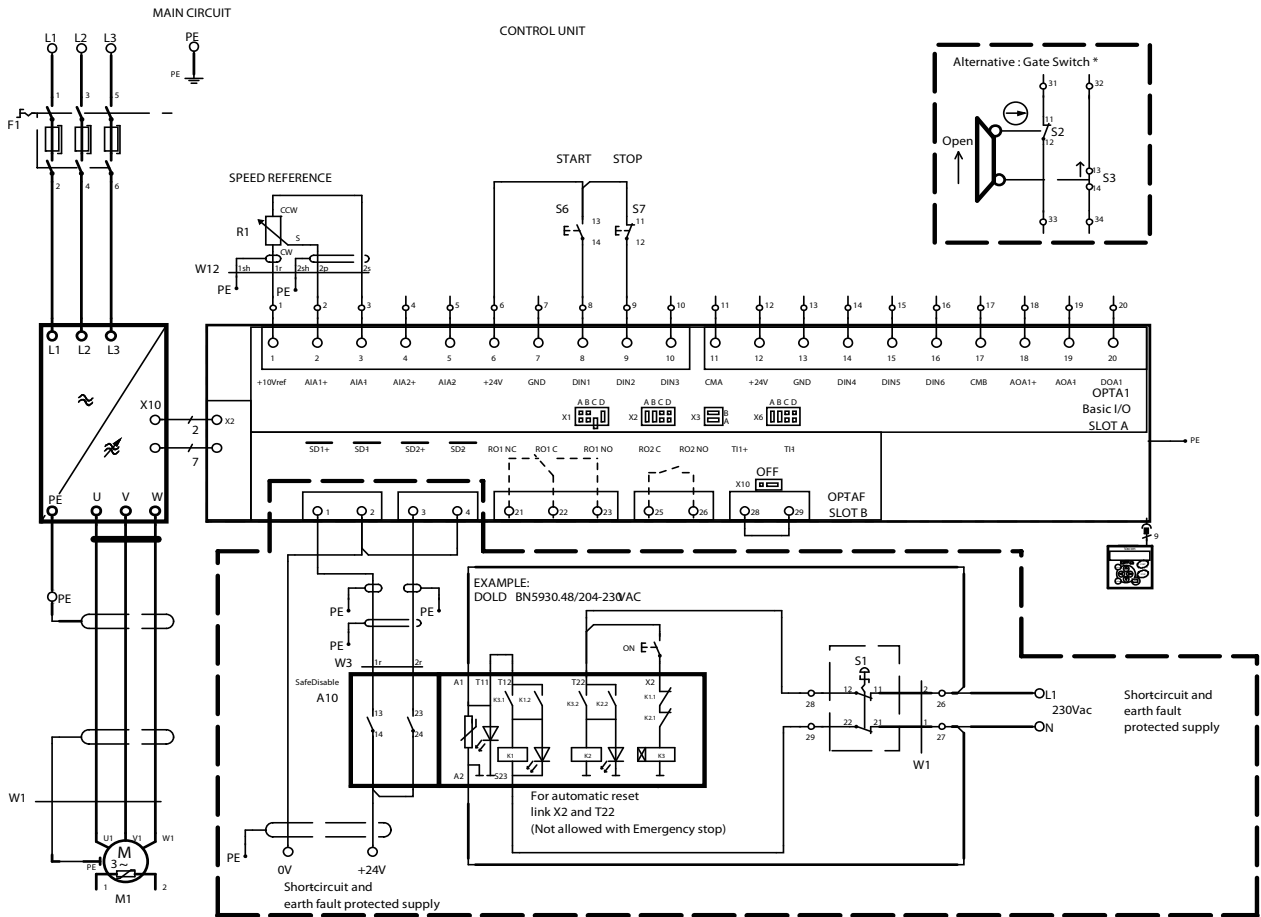

11059.emf

Figure 8. Example 3.

Figure 8 presents a connection example of OPT-AF board for STO safety function with external safety relay module and without reset.

External safety relay module is connected to the switch S1. The used power supply to switch S1 is 230 VAC as an example. The safety relay module is connected to OPT-AF board with 4 wires as shown in Figure 8.

When the switch S1 is activated (contacts open), the drive will go to STO state and motor (if running) will stop by coasting. The drive will indicate: "A30 SafeTorqueOff".

When switch S1 is released (contacts closed), the drive returns to the ready state. The motor can then be run with a valid start command.

The external relay can be wired so that manual reset is required to reset the STO safety function.

More information regarding the safety relay module may be found from the safety relay documentation.

Note: For EN 60204-1 emergency stop according to stop category 0, use emergency stop button.

* Switch S1 in the figure can be replaced with the gate switch, then only Safe torque off mode is required. In normal operation, both contacts are closed.

3.4.4 EXAMPLE 4: OPT-AF BOARD WITH EXTERNAL TIME DELAYED SAFETY RELAY FOR SAFE STOP 1 (SS1) OR EN 60204-1 STOP CATEGORY 1

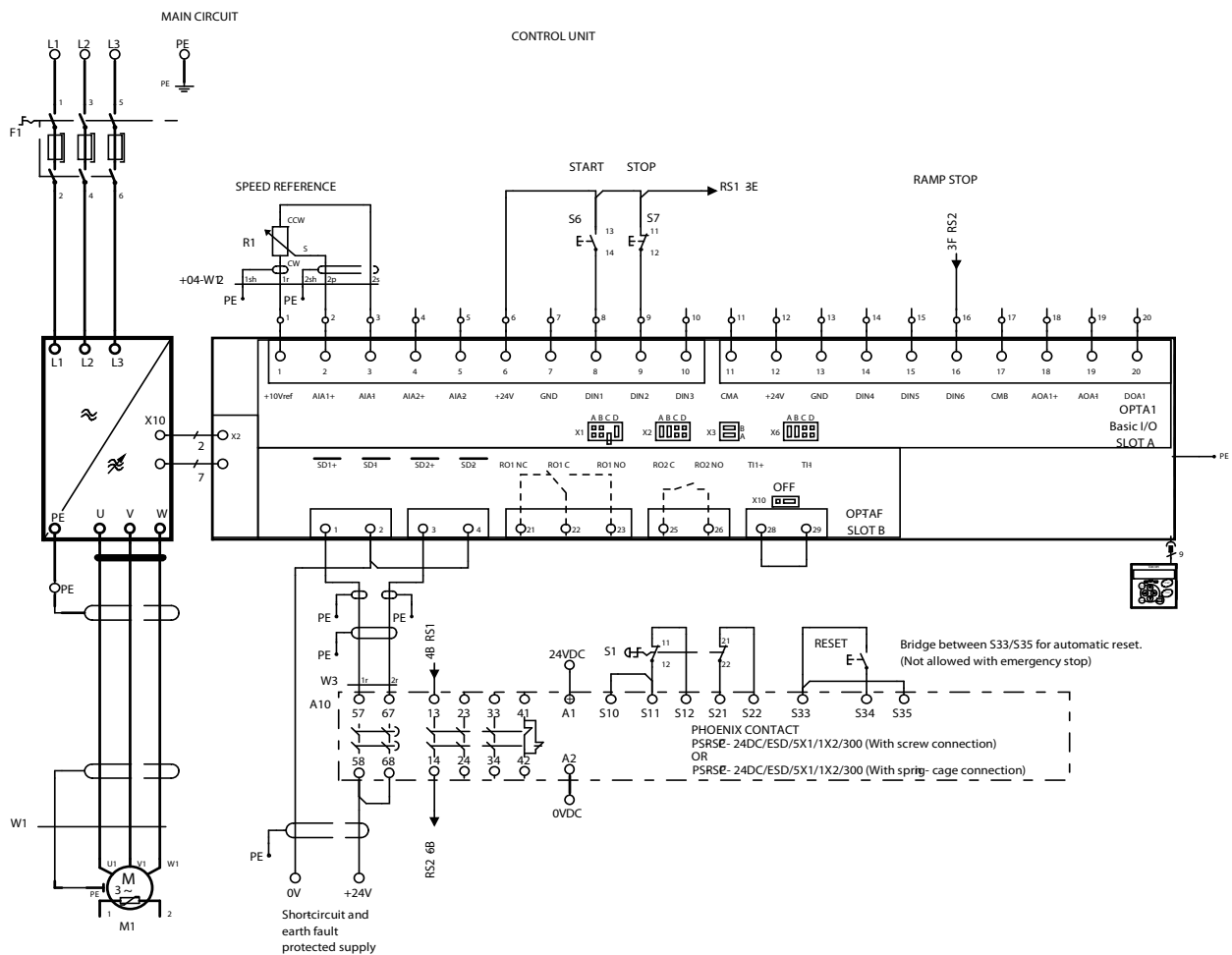

11060.emf

Figure 9. Example 4.

Figure 9 presents a connection example of OPT-AF board for STO safety function with external time delayed safety relay module for realizing the Safe Stop 1 or EN 60204-1 Stop Category 1.

External safety relay module is connected to the switch S1. The safety relay module is connected to OPT-AF board with 4 wires as shown in Figure 9. The time delay settings of the safety relay must correspond to the application requirements.

When the switch S1 is activated, the safety relay module will immediately activate DIN6, which in turn activates the STOP command to the drive. The STOP function is programmed to "Stop by Ramp". The safety relay activates the Safe Torque Off state after the time delay has expired. The time delay is set more than the deceleration time set in the drive to stop by ramp from maximum speed. The drive will indicate: "A30 SafeTorqueOff".

When the switch S1 is released (contacts closed), the drive returns to ready state. The motor can then be run with a valid start command.

The external relay can be wired so that manual reset is required to reset the STO safety function. More information regarding the safety relay module may be found from the safety relay datasheet.

3.5 COMMISSIONING

NOTE! The use of STO, SS1 or other safety functions does not itself ensure safety. Always make sure that the safety of the entire system is confirmed. See also the warnings on page 14.

3.5.1 GENERAL WIRING INSTRUCTIONS

- The wiring should be done according to the general wiring instructions for the specific product where OPT-AF is installed.
- Shielded cable is required for connecting the OPT-AF board.
- EN 60204-1 part 13.5: The voltage drop from supply point to load should not exceed 5%.
- In practice, due to electromagnetic disturbances, the cable length should be limited to 200 m max. In a noisy environment, the length of the cable could still be less than 200 m.

Table 3. Example of cable types

Example of cable types		
Name	Conductors	Manufacturer
KJAAM	2x(2+1)x0.5 mm ²	Reka
JAMAK	2x(2+1)x0.5 mm ²	Draka NK Cables Oy
RFA-HF(i)	2x(2+1)x0.5 mm ²	Helkama
LiYDY-CY TP	2x(2+1)x0.5 mm ²	SAB Bröckskes

3.5.2 EXAMPLES OF CABLE SEALING GROMMETS OR GLANDS

Below you can see examples of cable sealing grommets or glands. Refer to the listed manufacturers or corresponding manufacturers for more information on correct types that are suitable for the hole and cable diameter:



11061.emf

Figure 10. VET membrane glands from Oy Mar-Con Polymers Ltd



11062.emf

Figure 11. Cable gland, polystyrene from WISKA Hoppmann & Mulsow GmbH, CABLE ACCESSORY SYSTEMS



Figure 12. QUIXX membrane for several cables from WISKA Hoppmann & Mulsow GmbH, CABLE ACCESSORY SYSTEMS. Note! A metric to PG adapter is needed.



11064.emf

Figure 13. SNAP -PG cable grommet from A. Vogt GmbH & Co. KG (gummivogt)



11065.emf

Figure 14. UNI Dicht cable glands for multiple cables from PFLITSCH GmbH



11066.emf

Figure 15. Cable gland model "PERFECT" with multiple sealing insert from Jacob GmbH.

3.5.3 CHECKLIST FOR COMMISSIONING THE OPT-AF BOARD

The minimum steps required during connecting the Safe Torque Off (STO) or Safe Stop 1 (SS1) safety functions of the OPT-AF board are shown in the checklist below. To comply with the functional safety standards, each point of the checklist must be answered yes. For ATEX related issues see the ATEX section.

Table 4. Checklist for commissioning the STO or SS1 safety functions.

Nr	Step	No	Yes
1	Has a risk assessment of the system been carried out to ensure that using the OPT-AF board Safe Torque Off (STO) or Safe Stop 1 (SS1) safety function is safe and according to local regulations?		
2	Does the assessment include an examination of whether using external devices such as a mechanical brake is required?		
3	Switch S1 <ul style="list-style-type: none"> - Has the switch S1 been chosen according to the required safety performance target (SIL or PL) set during the risk evaluation? - Is the switch S1 required to be lockable or otherwise secured in the isolating position? - Is it ensured that color coding and marking is in accordance with the intended use? - Is the external power supply earth fault and short circuit protected (EN 60204-1)? 		
4	Is the reset function edge sensitive? If a reset function is used with Safe Torque Off (STO) or Safe Stop 1 (SS1) it must be edge sensitive.		
5	The shaft of a permanent magnet motor might in an IGBT fault situation rotate up to 360 degrees / pole of the motor. Has it been ensured that the system designed in such a way that the this can be accepted?		
6	Have process requirements (including deceleration time) been considered for correct execution of Safe Stop 1 (SS1) safety function and are the corresponding settings done according to Chapter ?		
7	Is the enclosure class or the cabinet class of the drive where the OPT-AF board is installed either: <ul style="list-style-type: none"> a) at least IP54? b) used in environment that does not contain conductive contamination and are coated PCBs used in the drive? 		
8	Have the User's Manual instructions for the specific product, on EMC compliant cabling been followed?		
9	Has the system been designed in such a way that activating (enabling) the drive through STO inputs will not lead to an unexpected start of the drive?		
10	Have only approved units and parts been used?		
11	Is the VACON [®] NXP control board VB00761 revision B or newer? (See the sticker on the VACON [®] NXP control board).		
12	Is the VACON [®] NXP system software version NXP00002V179, or newer?		
13	Has a routine been set up to ensure that the functionality of the safety function is being checked at regular intervals?		
14	Has this manual been read, understood and followed carefully?		

3.5.4 PARAMETRIZING THE DRIVE FOR THE SAFE TORQUE OFF (STO) SAFETY FUNCTIONS

There are no parameters for the STO function itself.

In applications, there is a possibility to change the warning A30 "SafeTorqueOff" to a fault. For example in VACON® NXP Multi Purpose application through parameters → protections → SafeDisable mode, the STO state may be changed to generate a fault. As default, it is always set to generate a warning.

NOTE! When STO state is changed to indicate a fault, the drive will display the fault "F30 Safe-TorqueOff" even after the switch S1 have been released (contacts closed) and the hardware is enabled. The fault must be acknowledged.

In application, there is also a possibility to indicate the STO state. This can be done through a digital output.

For example the VACON® NXP multi purpose application provides the user with this possibility. The indication of STO state could be parametrized to one of the relays on OPT-AF board (B1 or B2). The parameter for providing this feedback can be found in: parameters → output signals → dig out signals → SafeDisableactiv.

NOTE! The feedback or indication of the STO state is NOT part of the Safety functions.

OPT-AF board parameter:

Code	Parameter	Default	Note
P7.2.1.2	Start-Up Prev	"Fault"	<p>To start the motor operation, after a thermistor fault, an edge sensitive start command is required after the drive returns to ready state.</p> <p>a) When OPT-AF board parameter "Start-Up Prev" is "Fault", the drive will generate a "F26 Start-Up Prev" fault if start command is on, when returning to ready state after a thermistor fault has been active. The drive can be started with an edge sensitive start command after fault reset.</p> <p>b) When OPT-AF board parameter "Start-Up Prev" is "Warning", the drive will generate a "A26 Start-Up Prev" warning if start command is on, when returning to ready state after a thermistor fault has been active. The drive can be started with an edge sensitive start command. No fault reset is required in this case.</p> <p>c) When OPT-AF board parameter "Start-Up Prev" is "No action", the drive will not generate any indication. The drive can be started with an edge sensitive start command. No fault reset is required in this case.</p>

3.5.5 PARAMETRIZING THE DRIVE AND THE EXTERNAL TIME DELAYED SAFETY RELAY FOR SAFE STOP (SS1) SAFETY FUNCTION

Safe Stop 1 requires setting of time delay on the external safety relay component:

- Requirement: The time delay setting needs to be greater than the deceleration time set in the drive

NOTE! See manufacturer user manual for more information regarding the setting of the time delay.

Safe Stop 1 safety function requires that the drive is configured according to the following guidelines:

- Deceleration time must be set according to the machine or process requirement
- The drive stop function must be programmed to "stop by ramp"
- A dedicated digital stop input must be used (not combined with start command) for the drive stop command

See the previous chapter for parametrizing the drive for Safe Torque Off (STO) safety function.

NOTE! The drive will indicate Safe Torque Off (STO) state when Safe Stop 1 time delay has expired

NOTE! If the time delay (of the external safety relay component) is NOT set correctly (time delay set shorter than the required deceleration time of the process/machine), the motor will stop by coasting when the time delay expires.

3.5.6 TESTING THE SAFE TORQUE OFF (STO) OR SAFE STOP 1 (SS1) SAFETY FUNCTIONS

NOTE! After connecting the board ALWAYS make sure that the STO or SS1 safety functions are working properly by testing them before operating the system.

NOTE! Before testing the STO or SS1 safety functions, make sure that the checklist (Table 3) is inspected and completed.

NOTE! Concerning the SS1 safety function, **make sure by testing** that the drive's **stop by ramp function** is working **in accordance with the process requirements**.

When the STO safety function is activated, a code: A30 "SafeTorqueOff " appears on the control keypad display. This indicates that the STO safety function is active. After STO has been deactivated, the warning remains active for 10 seconds.

3.6 MAINTENANCE

CAUTION! If any service or repair is to be conducted on the drive installed with OPT-AF board please follow the check list given in Chapter 3.5.3.

CAUTION! During maintenance breaks, or in case of service/repair, the OPT-AF board might have to be removed from its slot. After reconnecting the board, ALWAYS make sure that the STO or SS1 safety functions are active and fully functional by testing them. See Chapter 3.5.6.

3.6.1 FAULTS RELATED TO THE SAFE TORQUE OFF (STO) OR SAFE STOP 1 (SS1) SAFETY FUNCTIONS

Table 5 shows the normal warning / alarm, generated when STO safety function is active.

Table 5. Warning/alarm indicating that STO safety function is active

Fault code	Warning	Subcode	Possible cause	Correcting measures
30	SafeTorque-Off	1	STO inputs SD1 & SD2 are activated through the OPT-AF option board.	

Table 6 shows faults that may be generated from the software part that monitors the hardware related to the STO safety function. If some of the faults listed below occur, the fault may NOT be reset.

Table 6. Single hardware problems detected in the STO safety function

Fault code	Fault	Subcode	Possible cause	Correcting measures
8	System Fault	30	STO inputs are in different state. This fault occurs when the SD inputs are in different state more than 5 seconds.	<ul style="list-style-type: none"> - Check the S1 switch. - Check the cabling to the OPT-AF board - Single hardware problem possible in either OPT-AF board or VACON® NXP control board.
8	System Fault	31	Thermistor short circuit detected.	<ul style="list-style-type: none"> - Correct the cabling - Check the jumper for the thermistor short circuit supervision, if thermistor function is not used, and the thermistor input is short circuited.

Table 6. Single hardware problems detected in the STO safety function

Fault code	Fault	Subcode	Possible cause	Correcting measures
8	System Fault	32	OPT-AF board has been removed.	- It is not allowed to remove the OPT-AF board once it has been recognized by the software. NOTE! There is only one method to clear this fault. By writing "OPT-AF Removed" to "1" and then back to "0" again. This variable is found from the "System Menu" "Security" (6.5.5).
8	System Fault	33	OPT-AF board EEPROM error (checksum, not answering...).	- Change the OPT-AF board.
8	System Fault	34...36	OPT-AF supply voltage hardware problem detected.	- Change the OPT-AF board.
8	System Fault	37...40	Single hardware problem detected in STO inputs.	- Change the OPT-AF board <i>or the VACON[®] NXP control board.</i>
8	System Fault	41...43	Single hardware problem detected in the thermistor input.	- Change the OPT-AF board.
8	System Fault	44...46	Single hardware problem detected in STO inputs or in the thermistor input.	- Change the OPT-AF board <i>or the VACON[®] NXP control board.</i>
8	System Fault	47	OPT-AF board mounted in old VACON [®] NXP control board.	- Change the VACON [®] NXP control board to VB00561, rev. H or newer.

4. THERMISTOR FUNCTION (ATEX)

The thermistor overtemperature supervision is designed in accordance with ATEX directive 94/9/EC. It is approved by VTT Finland for group II (certificate nr. VTT 06 ATEX 048X), category (2) in the 'G' area (area in which potentially explosive gas, vapor, mist or air mixtures are present) and D area (area with combustible dust). The "X" in the certificate number refers to special conditions for safe use. See the conditions in the last note in this page.

CE 0537  II (2) GD

11070.emf

It can be used as an overtemperature tripping device for motors in explosive area (EX motors).

Note: The OPT-AF board also contains the Safe Torque Off (STO) safety function. When STO is not intended to be used, inputs SD1+(OPT-AF: 1), SD2+(OPT-AF:3) are to be connected to +24 V (e.g. OPT-A1:6) & SD1-(OPT-AF:2), SD2- (OPT-AF:4) are to be connected to GND(for e.g. OPT-A1:7).

NOTE!

Safety devices like the OPT-AF board must be correctly incorporated into the entire system. The functionality of the OPT-AF board is not necessarily suitable for all systems. The entire system must be designed in compliance with all relevant standards within the field of industry. Maximum SIL capability of this function in the drive is SIL1.

CAUTION! The information in this manual provides guidance on the use of thermistor function for protecting overheating of motors in explosive atmosphere. This information is ensured to be correct and in compliance with accepted practice and regulations at the time of writing. However, the end product/system designer is responsible for ensuring that the system is safe and in compliance with relevant regulations.

CAUTION! During maintenance breaks, or in case of service/repair the OPT-AF board might have to be removed from its slot. After reconnecting the board ALWAYS make sure that the thermistor function is working correctly by testing it.

CAUTION! The thermistor function on OPT-AF board with VACON[®] NXP control is used to protect the overheating of motors in explosive atmosphere. The drive itself including OPT-AF board can not be installed in explosive atmosphere.

NOTE! Special conditions required for safe use (X in the certificate number): This function can be used with Exe-, Exd-, and ExnA- type of motors. In case of Exe-, and ExnA- motors, the end user has to confirm that the installation of the measurement circuit is done according to area classification. E.g. in Exe- and ExnA- motors PTC sensors shall be certified together with the motor according to the requirements of the type of protection. The allowed ambient temperature range for the drive is -10 °C...+50 °C.

Note: Changes in this chapter are only allowed with the permission of certification body.



Danfoss A/S

DK-6430 Nordborg
Denmark
CVR nr.: 20 16 57 15

Telephone: +45 7488 2222
Fax: +45 7449 0949

EU DECLARATION OF CONFORMITY

Danfoss A/S

Vacon Ltd

declares under our sole responsibility that the

Product name Vacon OPT-AF option board to be used with Vacon NXP control board in NX family products
Product identification OPT-AF option board, VB00328H (or newer revision)
NXP control board, VB00761B (or newer revision)



Marking of the equipment  II (2) GD

has been designed in conformity with the requirements of the Council directive for explosive atmospheres, 94/9/EC of March 1994 (until April 19th, 2016), 2014/34/EU (from April 20th, 2016) according to following standards.

- EN ISO 13849-1 (2006)
Safety of machinery – safety-related parts of the control systems. Part 1: General principles for design
- EN ISO 13849-2 (2003)
Safety of machinery – safety-related parts of the control systems. Part 2: Validation
- EN 60079-14 (2007)
Electrical apparatus for explosive gas atmospheres.
Part 14: Electrical installations in hazardous area (other than mines).
- EN 61508-3(2010)
Functional safety of electrical/electronic/programmable electronic safety- related systems – Part3: Software requirements
- EN ISO/IEC 80079-34 (2011)
Explosive atmospheres – Part 34: Application of quality systems for equipment manufacture.
- EN 50495 (2010)
Safety devices for ignition prevention.

VTT Industrial Systems, Electrical Ex apparatus, the Notified Body having identification number 0537, has assessed the conformity of thermal motor protection system and has issued the certificate VTT 06 ATEX 048X.

It is ensured through internal measures and quality control that the product conforms at all times to the requirements of the current Directive and the relevant standards.

Date 15-04-2016	Issued by Signature  Name: Kimmo Syvänen Title: Director, Premium Drives	Date 15-04-2016	Approved by Signature  Name: Timo Kasi Title: VP, Design Center Finland and Italy
---------------------------	---	---------------------------	--

Danfoss only vouches for the correctness of the English version of this declaration. In the event of the declaration being translated into any other language, the translator concerned shall be liable for the correctness of the translation

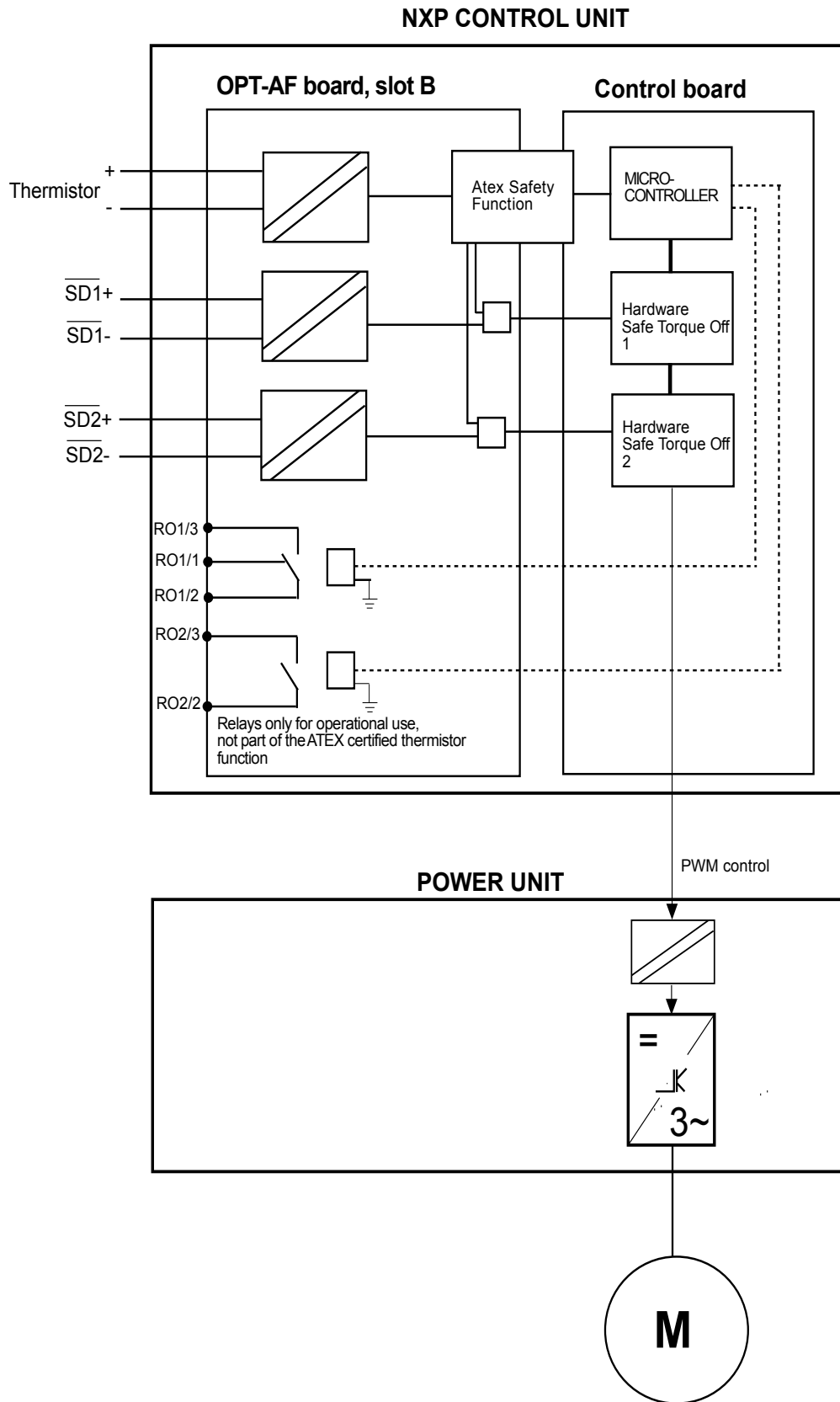

11068.emf

Figure 16. Thermistor function principle in VACON[®] NXP AC drive with the OPT-AF board

4.1 TECHNICAL DATA

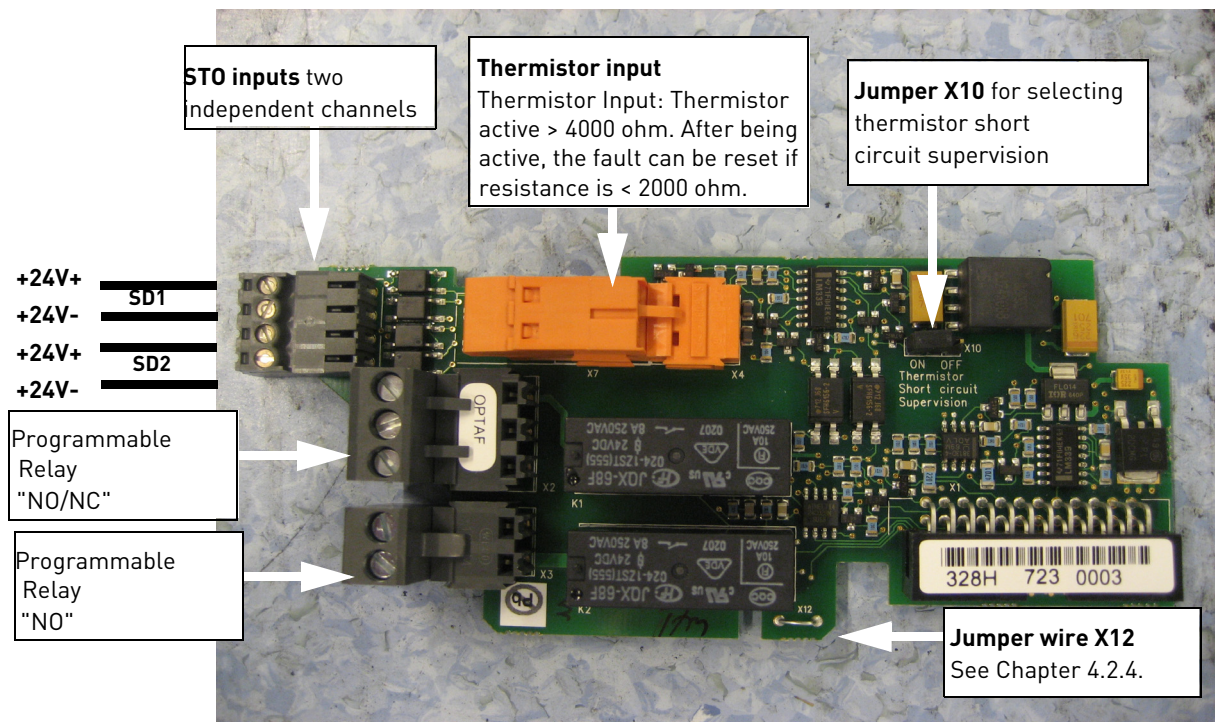

11052.emf

Figure 17. The layout of the OPT-AF board

4.1.1 FUNCTIONAL DESCRIPTION

The thermistor supervision circuit of the OPT-AF board is designed to provide a reliable way of disabling the drive modulation in case there is an overtemperature at the motor thermistor(s).

By disabling the drive modulation the feeding of the energy to the motor is prevented and a further heating up of the motor due to this is avoided.

The thermistor supervision circuit meets the requirements in the ATEX directive by acting directly on the "STO" safety function of the VACON® NXP (See Figure 16) and is thus providing a reliable, software and parameter independent way of preventing the energy supply to the motor.

4.1.2 HARDWARE AND CONNECTIONS

Table 7. OPT-AF I/O terminals

Terminal		Parameter reference on keypad and NCDrive	Technical information
1	SD1+	DigIN: B.2	Isolated STO input 1 +24 V +-20% 10... 15 mA
2	SD1-		Virtual GND 1
3	SD2+	DigIN: B.3	Isolated STO input 2 +24 V +-20% 10... 15 mA
4	SD2-		Virtual GND 2
21	R01/normal closed	DigOUT: B.1	Relay output 1 (NO/NC) *
22	R01/common		Switching capacity 24 VDC/8 A
23	R01/normal open		250 VAC/8 A 125 VDC/0.4 A Min. switching load 5 V/10 mA
25	R02/common	DigOUT: B.2	Relay output 2 (NO) *
26	R02/normal open		Switching capacity 24 VDC/8 A 250 VAC/8 A 125 VDC/0.4 A Min. switching load 5 V/10 mA
28	T11+	DigIN: B.1	Thermistor input; $R_{trip} > 4.0 \text{ k}\Omega$ (PTC)
29	T11-		max voltage = 10 V max current = 6.7 mA

The thermistor (PTC) is connected between the terminals 28(T11+) and 29(T11-) of the OPT-AF board. The optocoupler isolates the thermistor inputs from the control board potential.

* If 230 VAC is used as control voltage from the output relays, the control circuitry must be powered with a separate isolation transformer to limit short circuit current and overvoltage spikes. This is to prevent the welding on the relay contacts. Refer to standard EN 60204-1, section 7.2.9.

The overtemperature is detected by hardware on OPT-AF board. See temperature versus resistance curve as in the figure below.

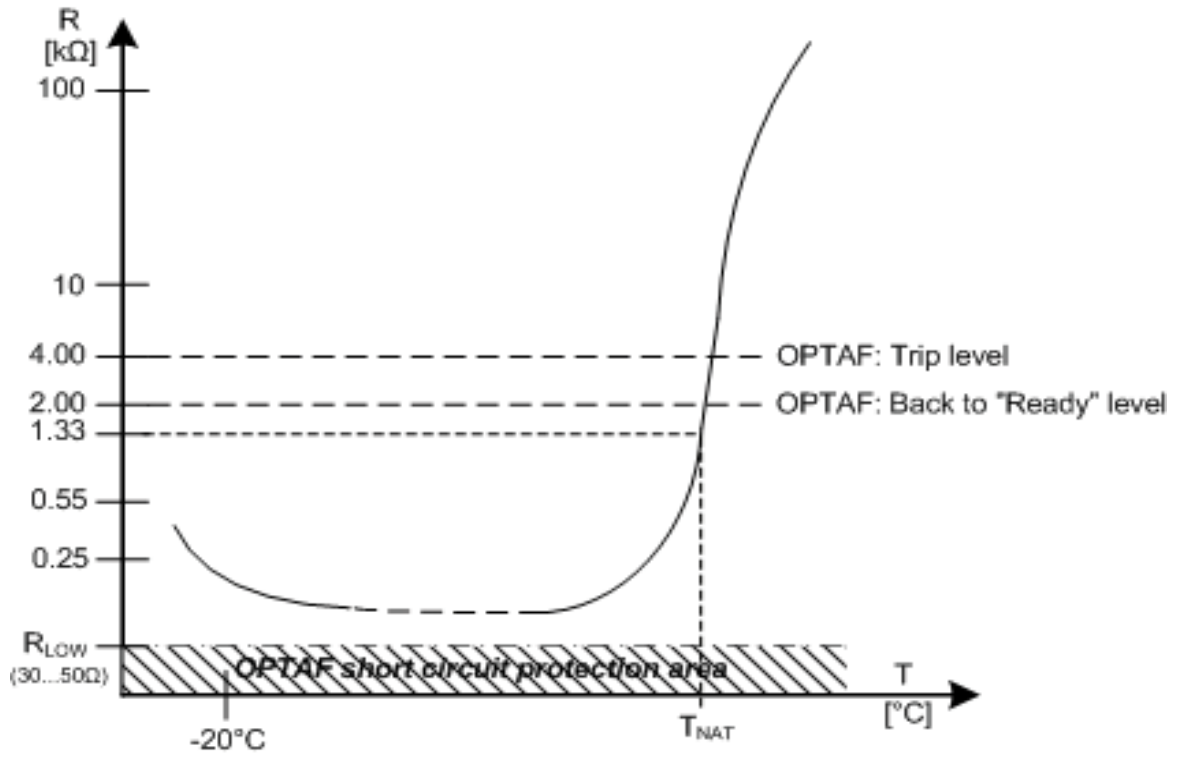

11069.emf

Figure 18. Typical characteristics of a motor-protection sensor as specified in DIN 44081/DIN 440

4.2 COMMISSIONING

Note: Installation, testing and service work on the OPT-AF board can be performed only by professional persons.

Note: It is not allowed to perform any repair work on the OPT-AF board.

4.2.1 GENERAL WIRING INSTRUCTIONS

The thermistor connection must be done using a separate control cable. It is not allowed to use wires belonging to the motor supply cables or any other main circuit cables. It is recommended to use a shielded control cable.

	Maximum cable length without short circuit monitoring X10: OFF	Maximum cable length with short circuit monitoring X10: ON
>= 1.5 sq mm	1500 meters	250 meters

Note: It is recommended to test the ATEX functionality using thermistor input on OPT-AF board periodically (typically once a year). For testing, the thermistor connection to the OPT-AF board is disconnected. The drive ready signal goes low (green LED on the keypad goes OFF). Check for the corresponding warning or fault indication in the drive according to the parameter setting explained in Chapter 4.2.2.

4.2.2 PARAMETER SETTING FOR ATEX FUNCTION

In case of overtemperature, the drive modulation is disabled. The drive will not anymore feed energy to the motor thus preventing further overheating of the motor. See Figure 16.

When drive is connected to the main power and if the motor temperature is below overtemperature limits (see Figure 18), the drive goes to ready state. The motor may start in presence of start command from a selected control place.

If the motor temperature is above the overtemperature limits (see Figure 18), fault /warning (F29) thermistor is activated depending on the programming in the application.

The application programming for the thermistor fault is as follows e.g. in factory applications.

Code	Parameter	Default	ID	Note
P2.7.21	Response to Thermistor Fault	2	732	0= No Response 1= Warning 2= Fault according to Stop Mode. * 3= Fault, stop by coasting.

* With OPT-AF board according to ATEX directive 94/9/EC (i.e jumper wire X12 not cut) , response to thermistor fault = 2 is always same as response to thermistor fault =3, i.e. stop by coasting.

When the resistance of the thermistor(s) mounted in the motor goes above 4 k Ω due to motor overheating, the drive modulation is disabled within 20 ms. Fault F29 or warning A29 is generated in the drive according to the above-mentioned programming.

According to the curve, when the temperature falls below 2 k Ω (see Figure 18), the thermistor function allows the drive to be enabled again.

The thermistor fault configuration cause following reactions:

- Response to thermistor fault = No action. No warning/ fault is generated in case of overtemperature . The drive goes to run disable mode. The drive can be restarted when temperature is normalized, by giving a valid start command.
- Response to thermistor fault = Warning. A29 is generated in case of overtemperature. The drive goes to run disable mode. The drive can be restarted when temperature is normalized by giving a valid start command when the drive has returned to Ready state.
- Response to thermistor fault = Fault. F29 is generated in case of overtemperature and the drive goes to run disable mode. When the temperature is normalized, a reset command is needed before the drive can be restarted. The drive returns to Ready state. The valid start command is then needed to restart the drive.

Note: With OPT-AF board according to ATEX directive 94/9/EC (i.e jumper wire X12 not cut) all VACON[®] NXP drives are programmed to accept only an edge sensitive start command for a valid start after a thermistor fault . To start the motor operation, a new start command is required after the drive returns to ready state.

4.2.3 SHORT CIRCUIT MONITORING

The thermistor inputs TI1+ and TI1- are monitored for short circuit. If a short circuit is detected, the drive modulation is disabled within 20ms, F8 system fault (subcode 31) is generated. When the short circuit has been removed, the drive can be reset only after power recycle to the VACON[®] NXP control board.

The short circuit monitoring can be enabled or disabled using the jumper X10 in ON or OFF position respectively. The jumper is set in ON position by factory default.

Important: For the functionality of OPT-AF board according to ATEX directive 94/9/EC, it **must be checked that the jumper wire X12 is not damaged or cut**. Also set the parameter Expander Boards/Slot B/ "Therm Trip (HW)" to "ON" (P.7.2.1.1).

4.2.4 EXCEPTIONAL USE OF THERMISTOR FUNCTION ON OPT-AF BOARD (SIMILAR TO OPT-A3, NOT IN COMPLIANCE WITH ATEX DIRECTIVE 94/9/EC)

In systems where the drive detects the overtemperature of the motor through a thermistor input, there might be a need of running down the whole system in a controlled way or continue running the motor. In these cases the thermistor input must not cause an immediate stop of the drive. To achieve this functionality, the following actions must be carried out:

- Cut the jumper wire X12 on OPT-AF board.
- Set the jumper X10 to OFF position (short circuit monitoring disabled).
- Set the parameter Expander Boards/Slot B/ "Therm Trip (HW)" to "Off".



WARNING: When the jumper wire X12 is cut, the OPT-AF board is not more valid for using in an environment that requires a certified overheating protection device according to the ATEX directive 94/9/EC.

4.2.5 OPT-AF BOARD PARAMETER

Code	Parameter	Default	Note
P7.2.1.1	Therm Trip (HW) Refer 4.2.4	"On"	<p><u>Correct settings:</u></p> <ul style="list-style-type: none"> "Jumper wire X12 not cut and this board parameter "On" (for ATEX) "Jumper wire X12 cut and this board parameter "Off" (for no ATEX and similar to OPT-A3) <p><u>Wrong settings:</u></p> <ul style="list-style-type: none"> "If jumper wire X12 is cut and this board parameter is "On", thermistor trip will cause unresettable System Fault 8, subcode 41. "If jumper wire X12 is not cut and this board parameter is "Off", thermistor trip will cause unresettable System Fault 8, subcode 48.
P7.2.1.2	Start-Up Prev	"Fault"	<p>To start the motor operation, after a thermistor fault, an edge sensitive start command is required after the drive returns to ready state.</p> <p>a) When OPT-AF board parameter "Start-Up Prev" is "Fault", the drive will generate a "F26 Start-Up Prev" fault if start command is on, when returning to ready state after a thermistor fault has been active. The drive can be started with an edge sensitive start command after fault reset.</p> <p>b) When OPT-AF board parameter "Start-Up Prev" is "Warning", the drive will generate a "A26 Start-Up Prev" warning if start command is on, when returning to ready state after a thermistor fault has been active. The drive can be started with an edge sensitive start command. No fault reset is required in this case.</p> <p>c) When OPT-AF board parameter "Start-Up Prev" is "No action", the drive will not generate any indication. The drive can be started with an edge sensitive start command. No fault reset is required in this case.</p>

4.2.6 FAULT DIAGNOSIS OF THERMISTOR FUNCTION

The table below shows the normal fault / warning, generated when thermistor input is active.

Table 8. Fault/ Warning indicating that the thermistor is active.

Fault code	Fault/Warning	Subcode	Possible cause	Correcting measures
29	Thermistor	1	Thermistor input is activated (> 4 k Ω) on the OPT-AF option board.	The resistance of thermistor input must go below 2 k Ω to be able to restart the drive.

The table below shows faults that may be generated from the software part that monitors the hardware related to the STO and thermistor function. If some of the faults mentioned in this table occur, the fault may NOT be reset.

Table 9. Faults related to the STO & thermistor function

Fault code	Fault	Subcode	Possible cause	Correcting measures
8	System Fault	30	STO inputs are in different state. This fault occurs when the STO inputs are in different state more than 5 seconds.	-Check the S1 switch. -Check the cabling to the OPT-AF board. -Single hardware problem possible in either OPT-AF board or VACON [®] NXP control board.
8	System Fault	31	Thermistor short circuit detected.	-Correct the cabling. -Check the jumper for the thermistor short circuit supervision, if thermistor function is not used, and the thermistor input is short circuited.
8	System Fault	32	OPT-AF board has been removed.	-It is not allowed to remove the OPT-AF board once it has been recognized by the software. NOTE! There is only one method to clear this fault. By writing "OPT-AF Removed" to "1" and then back to "0" again. This variable is found from the "System Menu" "Security" (6.5.5).
8	System Fault	33	OPT-AF board EEPROM error (checksum, not answering...).	-Change the OPT-AF board.
8	System Fault	34...36	OPT-AF supply voltage hardware problem detected.	-Change the OPT-AF board.

Table 9. Faults related to the STO & thermistor function

Fault code	Fault	Subcode	Possible cause	Correcting measures
8	System Fault	37...40	Single hardware problem detected in STO inputs.	-Change the OPT-AF board or the VACON® NXP control board.
8	System Fault	41...43	Single hardware problem detected in the thermistor input.	-Change the OPT-AF board.
8	System Fault	44...46	Single hardware problem detected in STO inputs or in the thermistor input.	-Change the OPT-AF board or the VACON® NXP control board.
8	System Fault	47	OPT-AF board mounted in old VACON® NXP control board.	-Change the VACON® NXP control board to VB00561, rev. H or newer.
8	System Fault	48	Parameter Expander boards/SlotB/Therm Trip(HW) is set to OFF even if the jumper wire X12 is not cut.	Correct the parameter according to the jumper settings.

VACON®

www.danfoss.com

Vacon Ltd
Member of the Danfoss Group
Runsorintie 7
65380 Vaasa
Finland

Document ID:



DPD00891D

Rev. D

Sales code: DOC-OPTAF+DLUK