

VACON[®] NX
AC DRIVES

OPTBC
RESOLVER OPTION BOARD
USER MANUAL

VACON[®]

TABLE OF CONTENTS

Document code: DPD01362B

Date: 05.06.2017

1.	Resolver option board OPT-BC.....	4
1.1	Resolver basics	4
1.2	Resolver to digital conversion basics.....	5
1.3	Compatible resolver types.....	5
1.4	Resolver board features.....	6
2.	Configuration	7
2.1	Board parameters and monitoring values.....	7
2.2	Connectors and jumpers.....	8
3.	Installation.....	14
3.1	Installing the option board	14
3.2	Installing the resolver	16
3.3	Additional cabling instructions.....	16
4.	Diagnostics and troubleshooting.....	17
4.1	Fault handling.....	17
4.2	LED indicators	18

NOTE! You can download the English and French product manuals with applicable safety, warning and caution information from <http://drives.danfoss.com/knowledge-center/technical-documentation/>.

REMARQUE Vous pouvez télécharger les versions anglaise et française des manuels produit contenant l'ensemble des informations de sécurité, avertissements et mises en garde applicables sur le site <http://drives.danfoss.com/knowledge-center/technical-documentation/>.

1. RESOLVER OPTION BOARD OPT-BC

This manual is valid for board versions VB00339i or later. The Resolver option board OPT-BC provides the user with an interface to use resolvers as feedback device to VACON® NXP Drive. The interface provides speed and position data. The OPT-BC includes also encoder simulation output (HTL –level) and secondary encoder input (HTL-level).

1.1 Resolver basics

A resolver is a rotary transformer where the magnitude of the energy through the resolver windings varies sinusoidal as the shaft rotates. A resolver contains one primary winding and two secondary windings, the SIN and COS windings.

Primary winding is in the rotor of the resolver and secondary windings are in the stator. Secondary windings are mechanically displaced 90 degrees from each other.

The primary winding is excited by an AC voltage called the reference voltage (V_r). The induced voltages in the SIN and COS Windings are equal to the value of the Reference Voltage multiplied by the SIN or COS of the angle of the input shaft from a fixed zero point.

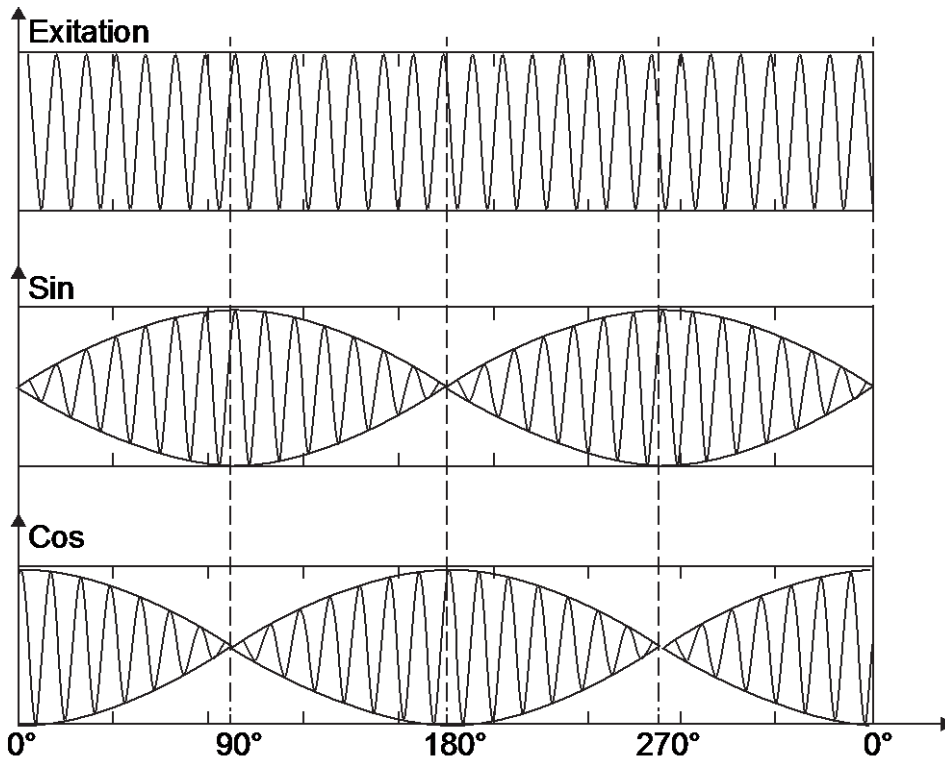
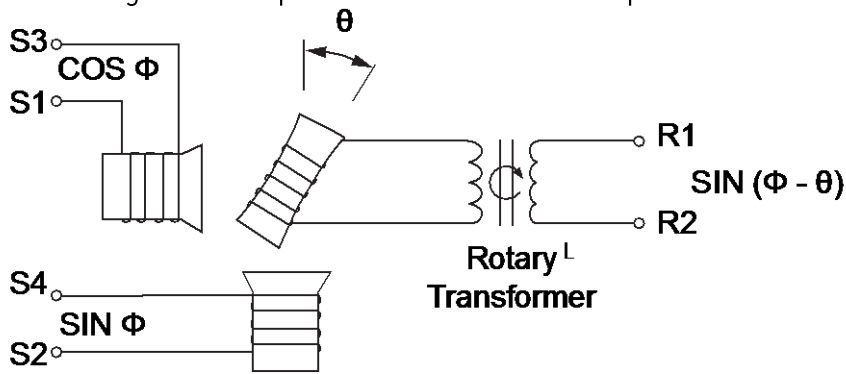

Resolver signals

Why resolvers?

When a Motion control application exists in a hot, humid, dusty, oily, or mechanically demanding environment, a resolver-based system is the preferred choice.

1.2 Resolver to digital conversion basics

The OPT-BC board sends the Excitation signal to the resolver, and resolver sends sin and cos signals back to the board. In the OPT-BC board, sin and cos signals are converted to incremental encoder pulses by the ASIC circuitry (see picture 1).

The incremental pulses are used for calculating rotation speed in the VACON® NXP control card. The conversion from resolver sin/cos signals to digital pulses is called RTD (Resolver To Digital conversion).

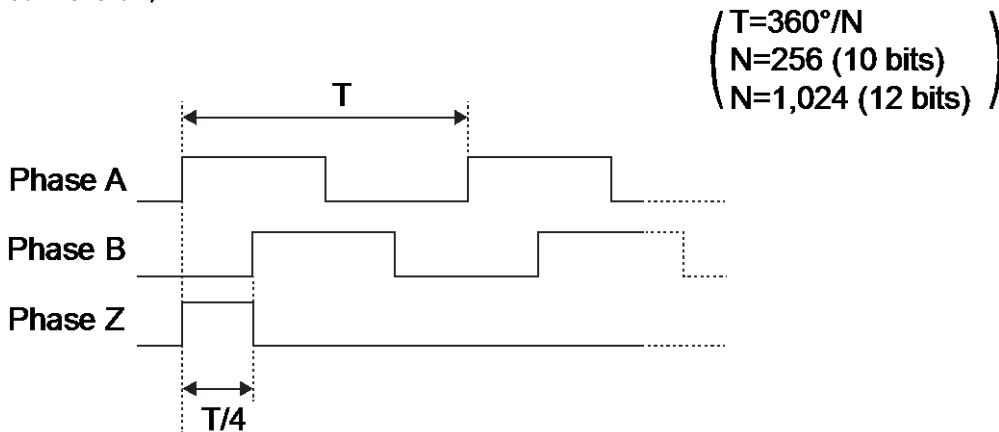

Picture 1 Simulated encoder signals from RTD ASIC

1.3 Compatible resolver types

- Resolver Output voltage: 1.8V_{rms} – 4.0V_{rms}
- Resolver Input voltage: 1.3V_{rms} – 7.5V_{rms}
- Number of poles: 2, 4, 6 ... 20 (System software version V182 or later)

Note

If the number of poles of the resolver is not 2, then the resolver can only work with a motor that has the same number of poles (e.g. a 6 pole resolver with a 6 pole motor). Maximum tracking rates assume that resolver has 2 poles.

1.4 Resolver board features

Converter's internal resolution	14bit	14bit	14bit	16bit
Encoder Simulation Output Resolution	10bit	12bit	14bit	14bit
Encoder Simulation Pulses / rev	256	1024	4096	4096
Converter's position accuracy*	+/- 4 LSB	+/- 4 LSB	+/- 4 LSB	+/- 16 LSB
Converter's velocity accuracy*	+/- 4 LSB	+/- 4 LSB	+/- 4 LSB	+/- 4 LSB
Excitation frequency	1-20kHz (adjustable with 1kHz steps)			
Transformation Ratio	The output voltage of the resolver has to be between $1.8V_{rms}$ and $4V_{rms}$. Input voltage can be adjusted between $1.3V_{rms}$ and $7.5V_{rms}$.			
Slots	C			
Encoder Simulation Output	A,B, Z (max. pulse frequency 150kHz)			

*tested in zero acceleration

Note: by selecting 16bit mode, you can improve only position accuracy. Velocity accuracy remains the same (14bit).

Encoder Simulation Pulses per Revolution and Maximum tracking rate depend on the number of resolver poles.

$$\text{Simulated Pulses / rev} = 2^R \cdot \text{Resolver_Poles} / 8$$

R = Encoder simulation output resolution

2. CONFIGURATION

2.1 Board parameters and monitoring values

Monitor Menu

Number	Monitor	Unit	Description
7.3.2.1	Resolver Freq	Hz	Resolver Frequency
7.3.2.2	Resolver Speed	RPM	Resolver Speed
7.3.2.3	Sim. Pulses/rev	-	Simulated pulsed / revolution
7.3.2.4	Encoder 2 Freq	Hz	Encoder Frequency from secondary encoder
7.3.2.5	Encoder 2 Speed	RPM	Encoder Speed from secondary encoder
7.3.2.6	AnIN:C.5		Error register bits. Please see chapter 4.3 OPTBC Resolver error register bits
7.3.2.7	AnIN:C.6		Cumulative error register bits. Please see chapter 4.3 OPTBC Resolver error register bits

Parameters menu

Number	Parameter	Min	Max	Default	Description
7.3.1.1	Invert Direction	0	1	0	0 = No 1 = Yes
7.3.1.2	Reading Rate	0	4	1	0 = No 1 = 1 ms 2 = 5 ms 3 = 10 ms 4 = 50 ms
7.3.1.3	Exciting freq	0	19	0	0 = 10 kHz 1 = 20 kHz 2 = 1 kHz 3 = 2 kHz 4 = 3 kHz 5 = 4 kHz 6 = 5 kHz 7 = 6 kHz 8 = 7 kHz 9 = 8 kHz 10 = 9 kHz 11 = 11 kHz 12 = 12 kHz 13 = 13 kHz 14 = 14 kHz 15 = 15 kHz 16 = 16 kHz 17 = 17 kHz 18 = 18 kHz 19 = 19 kHz
7.3.1.4	Resolution	0	3	1	0 = 10 bit 1 = 12 bit 2 = 14 bit 3 = 16 bit
7.3.1.5	Resolver poles	0	9	0	0 = 2 pole 1 = 4 pole 2 = 6 pole 3 = 8 pole 4 = 10 pole

					5 = 12 pole 6 = 14 pole 7 = 16 pole 8 = 18 pole 9 = 20 pole
7.3.1.6	Enc 2 Pulse/Rev	0	65535	1024	
7.3.1.7	Encoder 2 Type	1	3	1	1 = A,B=Speed 2 = A=Ref,B=Dir 3 = A=Forw,B=Rev

7.3.2.3 Simulated pulses / rev is calculated on the basis of resolution bits(R) and resolver poles. The formula used is:

$$\text{Simulated Pulses/rev} = 2^R * \text{Resolver poles} / 8$$

Example:

Resolution bits = 12

Resolver poles = 2

$$\text{Simulated Pulses/rev} = 2^{12} * 2 / 8$$

$$\text{Simulated Pulses/rev} = 2^{12} * 2 / 8 = 1024$$

The absolute position value is from 0 to 4095 ($2^{12}=4096$).

2.2 Connectors and jumpers

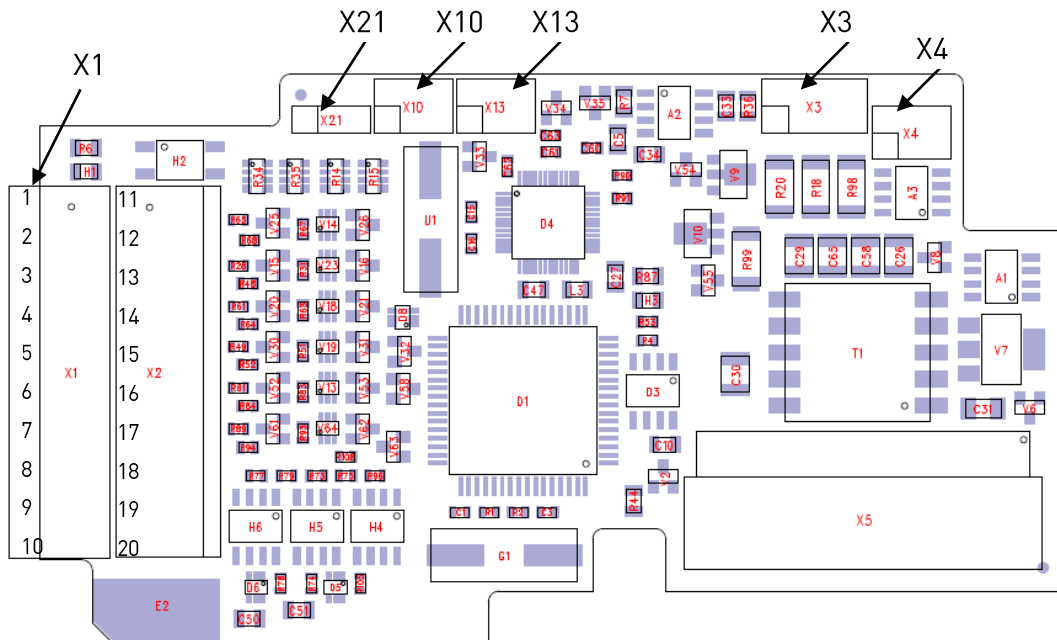

Picture 2 Connector and pin header placement in OPT Board. Pin number 1 is marked with a small square on the X3, X4, X10, X13 and X21.

2.2.1 Terminal data for X1 and X2 connectors

PIN	Name	Description
1	S4	SIN
2	S2	SIN\
3	S1	COS
4	S3	COS\
5	R1	Excitation HI
6	R2	Excitation LO
7	Frz+	Freeze signal HTL+
8	Frz-	Freeze signal HTL-
9	ENC2_C+	Encoder input channel C
10	ENC2_C-	Encoder input channel C\
11	A	Encoder Simulation Output A
12	A\	Encoder Simulation Output A\
13	B	Encoder Simulation Output B
14	B\	Encoder Simulation Output B\
15	C	Encoder Simulation Output C
16	C\	Encoder Simulation Output C\
17	ENC2_A+	Encoder input channel A
18	ENC2_A-	Encoder input channel A\
19	ENC2_B+	Encoder input channel B
20	ENC2_B-	Encoder input channel B\

2.2.2 X21 (C-Pulse source selection)



Incremental C-pulse (Zero pulse) to control board is read from the resolver attached to the option board (Default).



C-pulse is External. Read from FRZ input. This feature can be used with special applications for marking position data. Not supported in Standard VACON® NXP applications.

2.2.3 X10 and X13 (Gain selection)

SIN and COS feedback signals from the resolver should be in the range of 1.8 – 4V_{rms} (between SINHI - SINLO and COSHI - COSLO). To scale the input signals to an acceptable level we can select 1/3, 1/2 or 1/4 attenuation for the input lines. Following equation can be used to calculate output signal level. Transformation for the corresponding resolver is told in resolver datasheets.

EXC_OUT = excitation output voltage
 SIN Feedback voltage = EXC_OUT * Transformation ratio



1/4 gain for SIN / COS feedback signals from 3.25 V_{rms} to 4V_{rms}



1/3 gain for SIN / COS feedback signals from
2.4 V_{rms} to 3.24V_{rms}



1/2 gain for SIN / COS feedback signals from
1.8 V_{rms} to 2.39V_{rms}

X13 sets SIN attenuation and X10 sets COS attenuation. SIN and COS input pairs should all have the same attenuation to keep signals symmetrical.

For example, a resolver that is rated for 5.6V_{rms} excitation and has a transformation ratio of 0.485 gives output voltage of 2.72V_{rms}. Excitation voltage and corresponding settings are selected from the table 1 in chapter 2.2.4. In this case exact match is found. Resolver output voltage of 2.72V V_{rms} fits to the signal range of 1/3 attenuation.

2.2.4 X3 and X4 Excitation Voltage Control

Resolver option board has an amplifier for adjusting excitation voltage. Jumpers X3-1-4 and X4-1-3 set the amplifier gain and consequently the excitation voltage. Excitation voltage can be set in the range of 1.3V_{rms} to 7.5V_{rms}. To get the best possible accuracy, excitation voltage should be selected to be as high as the used resolver allows AND so that the output voltage fits to the given range.

Excitation frequency is set from the control panel and it should be set prior to connecting the resolver to the option board.

To set the excitation voltage accurately, measure the excitation voltage when resolver is connected. Notice that measurement device must be capable of measuring high frequency RMS voltage.

Typical excitation voltage for each jumper setting can be checked from the table, usable values are highlighted.

EXC_OUT = target excitation output voltage. This is specified in resolver datasheets (Excitation Voltage)

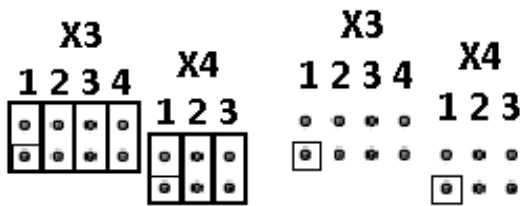

Now, set the calculated gain with X3 and X4 jumpers. Jumper settings for the desired gain can be found from table. All jumpers attached gives minimum gain and all jumpers open gives maximum gain. Maximum output voltage is limited to the boards internal voltages and is approximately 7.5V_{rms}. Recommended voltage range is highlighted with blue.

X = Jumper installed

X3-1	X3-2	X3-3	X3-4	X4-1	X4-2	X4-3	EXC_OUT [Vrms] Typical
X	X	X	X	X	X	X	1.27
	X	X	X	X	X	X	1.34

X		X	X	X	X	X	1.43
		X	X	X	X	X	1.50
X	X		X	X	X	X	1.55
	X		X	X	X	X	1.62
X			X	X	X	X	1.71
			X	X	X	X	1.78
X	X	X		X	X	X	1.87
	X	X		X	X	X	1.94
X		X		X	X	X	2.02
		X		X	X	X	2.10
X	X			X	X	X	2.15
	X			X	X	X	2.22
X				X	X	X	2.30
				X	X	X	2.38
X	X	X	X		X	X	2.43
	X	X	X		x	X	2.50
X		X	X		X	X	2.58
		X	X		X	X	2.66
X	X		X		x	X	2.71
	X		X		X	X	2.78
X			X		X	X	2.86
			X		X	X	2.94
X	X	X			X	X	3.03
	X	X			X	X	3.10
X		X			X	X	3.18
		X			X	X	3.25
X	X				X	X	3.31
	X				X	X	3.38
X					X	X	3.46
					X	X	3.53
X	X	X	X	X		X	3.56
	X	X	X	X		X	3.64
X		X	X	X		X	3.72
		X	X	X		X	3.79
X	X		X	X		X	3.84
	X		X	X		X	3.92
X			X	X		X	4.00
			X	X		X	4.07
X	X	X		X		X	4.16
	X	X		X		X	4.23
X		X		X		X	4.31
		X		X		X	4.39
X	X			X		X	4.44
	X			X		X	4.51
X				X		X	4.59
				X		X	4.67
X	X	X	X			X	4.72
	X	X	X			X	4.79
X		X	X			X	4.87
		X	X			X	4.95
X	X		X			X	5.00
	X		X			X	5.07
X			X			X	5.15
			X			X	5.23
X	X	X				X	5.32
	X	X				X	5.39
X		X				X	5.47
		X				X	5.54

X	X					X	5.60
	X					X	5.67
X						X	5.75
						X	5.82
X	X	X	X	X	X		5.85
	X	X	X	X	X		5.93
X		X	X	X	X		6.01
		X	X	X	X		6.08
X	X		X	X	X		6.13
	X		X	X	X		6.21
X			X	X	X		6.29
			X	X	X		6.36
X	X	X		X	X		6.45
	X	X		X	X		6.52
X		X		X	X		6.61
		X		X	X		6.68
X	X			X	X		6.73
	X			X	X		6.80
X				X	X		6.89
				X	X		6.96
X	X	X	X		X		7.01
	X	X	X		X		7.08
X		X	X		X		7.17
		X	X		X		7.24
X	X		X		X		7.29
	X		X		X		7.36
X			X		X		7.45
			X		X		7.52

Table 1 Excitation voltage selection

2.2.5 Configuration example

Example Resolver Datasheet

Input Voltage (rms)	6.1 V @ 10 kHz
Transformation Ratio (+-5%)	0.485
Output Voltage	2.96V

Step 1:

Check resolver's input voltage and select corresponding configuration for jumpers X3 and X4 from the table 1.

->6.1 V (Use smaller Voltage from the table if exact match is not found = 6.08V)

X3-1	X3-2	X3-3	X3-4	X4-1	X4-2	X4-3	EXC_OUT [Vrms] Typical
		X	X	X	X		6.08
X	X		X	X	X		6.3

Set jumpers to X3-3, X3-4, X4-1 and X4-2:

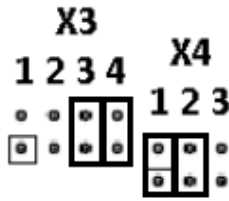

Step 2:

Find resolver output voltage from the datasheet or calculate it.

Output voltage = input voltage · transformation ratio.

Output Voltage = 6.08 · 0.485

Output Voltage = 2.95 V_{rms}



1/4 gain for SIN / COS feedback signals from
3.25 V_{rms} to 4V_{rms}



1/3 gain for SIN / COS feedback signals from
2.4 V_{rms} to 3.24V_{rms}



1/2 gain for SIN / COS feedback signals from
1.8 V_{rms} to 2.39V_{rms}

If Output voltage is higher than 4V_{rms} -> Lower the excitation voltage.

->Use 1/3 gain

Step 3:

Configure board using the control panel. (Software configuration)

7.3.1.1 Invert Direction ->This parameter can be used for inverting rotation direction

7.3.1.2 Reading Rate -> Default 1ms. In noisy environments this parameter can be used to filter disturbances. Set first to 5ms if the shaft is not running smoothly.

7.3.1.3 Exciting freq -> Select the Exciting frequency as told in specification
->In this example 10kHz

7.3.1.4 Resolution ->Default 12bit ->In slow Speed applications high Resolution can be used.

Planned Max Speed in Example is 1500rpm

Select highest possible accuracy ->16 bit

(16bit) = 7500rpm · 2 / Resolver_Poles

7.3.1.5 Resolver poles = 2 poles

3. INSTALLATION

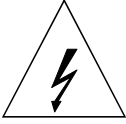
 WARNING!	<p><i>Internal components and circuit boards are at high potential when the AC drive is connected to the power source. This voltage is extremely dangerous and may cause death or severe injury if you come into contact with it.</i></p>
--	---



3.1 Installing the option board



Following installation guidelines should be followed carefully to get the best performance of the system. Improper installation of the system might cause to disturbances which may in RTD conversion generate extra encoder pulses or jitter to the pulse lengths.

Since the board supports large variation of resolvers, the used resolver should always be verified before installation.

The option board OPT-BC can only be used with VACON® NXP drives.

The option board OPT-BC can be connected to **slot C**.
 Disconnect the drive from the mains before starting the installation.

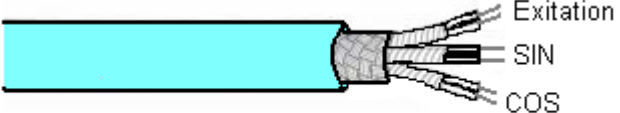
A	VACON® NXP AC drive	
B	Remove the cable cover.	

<p>C</p>	<p>Open the cover of the control unit.</p>	
<p>D</p>	<p>Install the option board in slot C on the control board of the AC drive. Make sure that the grounding plate fits tightly in the clamp. Strip the cable at such distance from the terminal that you can fix it to the enclosure with the grounding clamp.</p> <p>Note! We recommend to use always shielded twisted pair cables with resolvers. Use cables that are recommended for encoder and resolver feedback. Do not mix signals in twisted pairs.</p>  <p>Always make grounding contact throughout the full circumference of the cable (360°) Only remove the resolver cable's outer insulation where required. The cable is weakened where the shield is removed</p>	
<p>E</p>	<p>Make a sufficiently wide opening for your cable by cutting the grid as wide as necessary.</p>	

F	Close the cover of the control unit and the cable cover.	
---	--	---

3.2 Installing the resolver

Connect the resolver after setting the jumpers. Use cable clamp in the lower part of the VACON® NXP drive to connect cable shield. Strip the cable so that the shield is exposed only from the part that is fitted to the clamp.

3.3 Additional cabling instructions

The resolver and other control cables should not be in parallel with power cables (supply and motor cable).

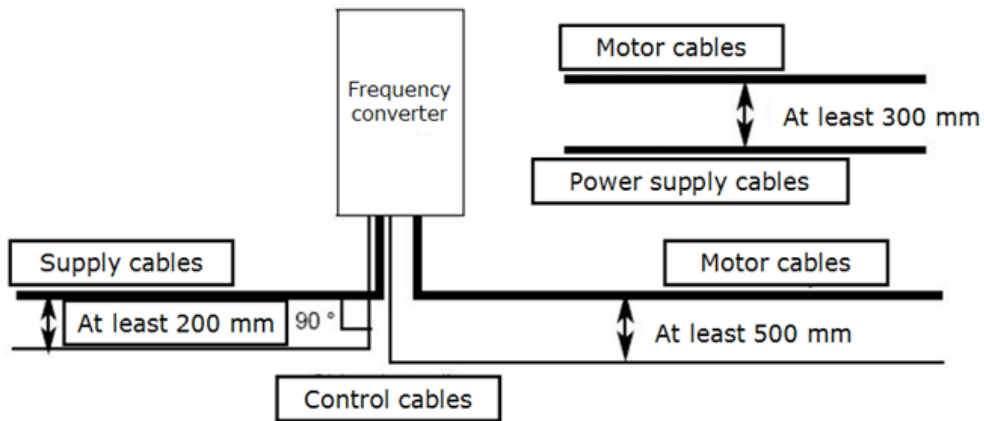

The feedback signals might also suffer from the noise coming from motor and supply cables. Use shielded symmetrical motor cables. It is recommended to connect the motor cable shield with 360° emc bushing. The motor and supply cables should not be in parallel with resolver signal cable.

4. DIAGNOSTICS AND TROUBLESHOOTING

The panel shows in the G7.3 that board is OPT-BC. Monitor values from 7.3.2 shows:

7.3.2.1	Resolver Freq (Hz)
7.3.2.2	Resolver Speed (Rpm)
7.3.2.3	Sim. Pulses/rev
7.3.2.4	Encoder 2 Freq
7.3.2.5	Encoder 2 Speed
7.3.2.6	AnIN:C.5*
7.3.2.7	AnIN:C.6*

*Error register bits. Please see [chapter 4.3 OPTBC Resolver error register bits](#)

Parameter values from panel index 7.3.1

7.3.1.1	Invert direction
7.3.1.2	Reading rate
7.3.1.3	Exciting freq (10 / 20 kHz)
7.3.1.4	Resolution bits(10 / 12 bits)
7.3.1.5	Resolver Poles
7.3.1.6	Enc 2 Pulse / Rev
7.3.1.7	Encoder 2 type

7.3.2.3 Simulated pulses / rev is calculated on the basis of resolution bits(R) and resolver poles. The formula used is $Simulated\ Pulses/rev = 2^R * Resolver\ poles / 8$.

Example:

$$\begin{aligned} \text{Resolution bits} &= 12 \\ \text{Resolver poles} &= 2 \\ \text{Simulated Pulses/rev} &= 2^{12} * 2 / 8 \\ \text{Simulated Pulses/rev} &= 2^{12} * 2 / 8 = 1024 \end{aligned}$$

Lower resolution is used in high speed applications. In 10bit mode the resolver sends 256 pulses / revolution and in 12 bit mode 1024 pulses / revolution, if resolver's poles = 2 .

The absolute position value is from 0 to 4095 ($2^{12}=4096$).

4.1 Fault handling

OPTBC Resolver option board reports fault to the application in case where LOS (loss of signal) or LOT (loss of traction) situation is detected. Actions after the fault depends from the application configuration.

The option board informs the application when the situation comes back to normal.

4.2 LED indicators

There are two LED indicators in the option board:

Yellow – Board status LED

LED is:	Meaning:
OFF	Option board not activated
Fast Blinking	Normal operation (cycle 1s)
Slow Blinking	Fault state (cycle 2s)

Red – Error LED (Loss of traction)

LED is:	Meaning:
OFF	OK
ON	Loss of traction. Error LED is set to OFF when the problem disappears

Fault conditions:

- Incorrect settings for resolver
- Resolver failure
- Cabling failure

In case of failure, check the jumper settings, cabling and resolver assembling.

4.3 OPTBC Resolver error register bits

Analog input variables ANIN5 and ANIN6 shows error registers of OPTBC Resolver option board. These variables can be seen as 7.3.2.6 AnIN:C.5 and 7.3.2.7 AnIN:C.6 monitor values. Application developers can also use this information in application if needed.

ANIN5 shows currently active error register bits.

ANIN6 shows cumulative error register bits after AC drive boot.

Bit	Description
D7	Sine/cosine inputs clipped
D6	Sine/cosine inputs below LOS threshold
D5	Sine/cosine inputs exceed DOS overrange threshold
D4	Sine/cosine inputs exceed DOS mismatch threshold
D3	Tracking error exceeds LOS threshold
D2	Velocity exceeds maximum tracking rate
D1	Phase error exceeds phase lock range
D0	Configuration parity error

VACON®

www.danfoss.com

Vacon Ltd
Member of the Danfoss Group
Runsorintie 7
65380 Vaasa
Finland

Document ID:



DPD01362B

Rev. B

Sales code: DOC-OPTBC+DLUK