



**USER'S MANUAL**  
**NXL FREQUENCY CONVERTERS**

**ALCNF127**  
**LIFT DOOR APPLICATION**  
**APPLICATION MANUAL**

Vacon Lift Door Application (Software alcnf127) Ver. 1.03

## INDEX

<b>1.</b>	<b>INTRODUCTION .....</b>	<b>3</b>
<b>2.</b>	<b>CONTROL I/O.....</b>	<b>4</b>
<b>3.</b>	<b>PARAMETER LISTS .....</b>	<b>5</b>
3.1	MONITORING VALUES (CONTROL KEYPAD: MENU M1) .....	5
3.2	BASIC PARAMETERS (CONTROL KEYPAD: MENU P2 → P2.1).....	6
3.3	INPUT SIGNALS (CONTROL KEYPAD: MENU P2 → P2.2) .....	8
3.4	OUTPUT SIGNALS (CONTROL KEYPAD: MENU P2 → P2.3).....	10
3.5	DRIVE CONTROL PARAMETERS (CONTROL KEYPAD: MENU P2 → P2.4) .....	11
3.6	MOTOR CONTROL PARAMETERS (CONTROL KEYPAD: MENU P2 → P2.5) .....	12
3.7	PROTECTIONS (CONTROL KEYPAD: MENU P2 → P2.6) .....	13
3.8	AUTORESTART PARAMETERS (CONTROL KEYPAD: MENU P2 → P2.7) .....	14
3.9	LIFT DOOR PARAMETERS (CONTROL KEYPAD: MENU P2 → P2.8).....	15
3.10	KEYPAD CONTROL (CONTROL KEYPAD: MENU K3) .....	16
3.11	SYSTEM MENU (CONTROL KEYPAD: MENU S6) .....	16
3.12	EXPANDER BOARDS (CONTROL KEYPAD: MENU E7) .....	16
<b>4.</b>	<b>DESCRIPTION OF PARAMETERS .....</b>	<b>17</b>
4.1	BASIC PARAMETERS.....	17
4.2	INPUT SIGNALS .....	22
4.3	OUTPUT SIGNALS.....	26
4.4	DRIVE CONTROL .....	30
4.5	MOTOR CONTROL .....	34
4.6	PROTECTIONS.....	37
4.7	AUTO RESTART PARAMETERS .....	44
4.8	LIFT DOOR PARAMETERS .....	45
4.9	KEYPAD CONTROL PARAMETERS .....	46
<b>5.</b>	<b>CONTROL SIGNAL LOGIC .....</b>	<b>47</b>
<b>6.</b>	<b>FAULT TRACING.....</b>	<b>48</b>

## Lift Door Application

### 1. INTRODUCTION

The Lift Door Application for Vacon NXL uses direct frequency reference from the preset speed as a default. The direct frequency reference can be selected from the analogue inputs, fieldbus, keypad, preset speeds or motor potentiometer.

Special parameters for Lift Door Control (**Group P2.8**) can be browsed and edited.

The preset speed can be defined by door position switch, including door open low speed, door open hold, door close low speed and door close hold switches. Please find more parameter about preset speed setting in M2.8.

Also more accelerate time and decelerate time parameters can be set at different position defined by position switch.

The input type can be select by parameter from P2.2.22 to P2.2.28, which has normal, inversion, rise edge and fall edge choices.

The Lift Door Application defines forward to close the door and reverse to open the door as default. Four warning and fault codes have been added to supervise position switch. The motor will run at safe speed once happens warning or fault.

There're three drive run mode, demo, central system and tuning can be selected by P2.8.1. Demo mode usually is used as demonstrate, central system mode is a standard run mode, and tuning is used to install and test as purpose.

- Digital inputs DIN2, DIN3, (DIN4) and optional dig. Inputs DIE1, DIE2, DIE3 are freely programmable.
- Internal and optional digital/relay and analogue outputs are freely programmable.
- Analogue input 1 can be programmed as current input, voltage input or **digital input DIN4**.

**NOTE!** If the analogue input 1 has been programmed as DIN4 with [parameter 2.2.6](#) (AI1 Signal Range), check that the jumper selections (Figure 1- 1) are correct.

Additional functions:

- Fire mode and safe input
- Switch status and door cycle times
- Identification
- Programming wizard
- Actual value supervision function: fully programmable; off, warning, fault
- Programmable Start/Stop and Reverse signal logic
- RS485 communication as standard
- Analogue input range selection, signal scaling, inversion and filtering
- Frequency limit supervision
- Programmable start and stop functions
- DC-brake at start and stop
- Prohibit frequency area
- Programmable U/f curve and U/f optimisation
- Adjustable switching frequency
- Autorestart function after fault
- Protections and supervisions (all fully programmable; off, warning, fault):
  - Current input fault
  - External fault
  - Output phase
  - Under voltage
  - Earth fault
  - Motor thermal, stall and underload protection
  - Thermistor
  - Fieldbus communication
  - Option board
  - Position switch

2. CONTROL I/O

Reference  
Potentiometer

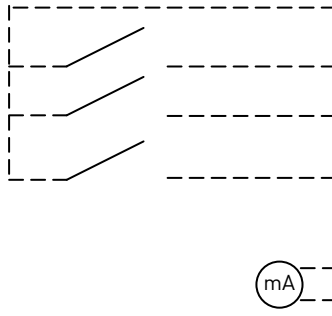

Terminal	Signal	Description
1	+10V <sub>ref</sub>	Reference output Voltage for potentiometer, etc.
2	AI1+	Analogue input, voltage range 0—10V DC. Voltage input frequency reference Can be programmed as DIN4
3	AI1-	I/O Ground Ground for reference and controls
4	AI2+	Analogue input, voltage range 0—10V DC, or current range 0/4—20mA Current input frequency reference
5	AI2- /GND	
6	+24V	Control voltage output Voltage for switches, etc. max 0.1 A
7	GND	I/O ground Ground for reference and controls
8	DIN1	Start forward Contact closed = start forward
9	DIN2	Start reverse (programmable) Contact closed = start reverse
10	DIN3	Open low speed (programmable) Contact closed = open low speed
11	GND	I/O ground Ground for reference and controls
18	A01+	Output frequency Analogue output Programmable Range 0—20 mA/R <sub>L</sub> , max. 500Ω
19	A01-	
A	RS 485	Serial bus Differential receiver/transmitter
B	RS 485	Serial bus Differential receiver/transmitter
30	+24V	24V aux. input voltage Control power supply backup
21	R01	Relay output 1 FAULT
22	R01	
23	R01	

Table 1- 1. Lift Door application default I/O configuration.

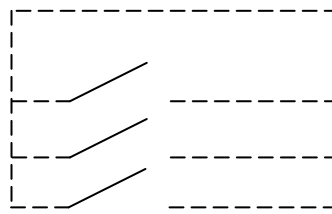

Terminal	Signal	Description
1	+24V	Control voltage output Control voltage output; voltage for witches etc, max. 150 mA
2	GND	I/O ground Ground for controls, e.g. for +24 V and D0
3	DIN1	Open hold Digital input 1 (DIN4)
4	DIN2	Close low speed Digital input 2 (DIN5)
5	DIN3	Close hold Digital input 3 (DIN6)
6	D01	Digital output Digital output 1
24	R02	Relay output 2 RUN
25	R02	
26	R02	

Table 1- 2. OPTAA configuration.

### 3. PARAMETER LISTS

On the next pages you will find the lists of parameters within the respective parameter groups. The parameter descriptions are given on pages 17 to 44.

#### Column explanations:

Code	=	Location indication on the keypad; Shows the operator the present param. Number
Parameter	=	Name of parameter
Min	=	Minimum value of parameter
Max	=	Maximum value of parameter
Unit	=	Unit of parameter value; given if available
Default	=	Value preset by factory
Cust	=	Customer's own setting
ID	=	ID number of the parameter (used with PC tools)
	=	On the parameter code: parameter value can only be changed after the FC has been stopped.

#### 3.1 Monitoring values (Control keypad: menu M1)

The monitoring values are the actual values of parameters and signals as well as statuses and measurements. Monitoring values cannot be edited.

See Vacon NXL User's Manual, Chapter 7.4.1 for more information.

Code	Parameter	Unit	ID	Description
V1.1	Output frequency	Hz	1	Frequency to the motor
V1.2	Frequency reference	Hz	25	
V1.3	Motor speed	rpm	2	Calculated motor speed
V1.4	Motor current	A	3	Measured motor current
V1.5	Motor torque	%	4	Calculated actual torque/nom. torque of the motor
V1.6	Motor power	%	5	Calculated actual power/nom. power of the motor
V1.7	Motor voltage	V	6	Calculated motor voltage
V1.8	DC-link voltage	V	7	Measured DC-link voltage
V1.9	Unit temperature	°C	8	Heat sink temperature
V1.10	Analogue input 1		13	AI1
V1.11	Analogue input 2		14	AI2
V1.12	Analogue output current	mA	26	AO1
V1.13	Analogue output current 1, expander board	mA	31	
V1.14	Analogue output current 2, expander board	mA	32	
V1.15	DIN1, DIN2, DIN3		15	Digital input statuses
V1.16	DIE1, DIE2, DIE3		33	I/O expander board: Digital input statuses
V1.17	RO1		34	Relay output 1 status
V1.18	ROE1, ROE2, ROE3		35	I/O exp. board: Relay output statuses
V1.19	DOE 1		36	I/O exp. board: Digital output 1 status
V1.20	Operate counter	%	67	Door operate time, 0-65535
V1.21	Door DIN status	%	68	The status of position switch (DIN)

Table 1- 3. Monitoring values

## 3.2 Basic parameters (Control keypad: Menu P2 → P2.1)

Code	Parameter	Min	Max	Unit	Default	Cust	ID	Note
P2.1.1	Min frequency	0,00	Par. 2.1.2	Hz	0,00		101	
P2.1.2	Max frequency	Par. 2.1.1	320,00	Hz	50,00		102	<b>NOTE:</b> If $f_{max}$ > than the motor synchronous speed, check suitability for motor and drive system
P2.1.3	Current limit	$0,1 \times I_L$	$1,5 \times I_L$	A	$I_L$		107	<b>NOTE:</b> Formulas apply approximately for frequency converters up to
P2.1.4	Nominal voltage of the motor	180	690	V	2:230v		110	
P2.1.5	Nominal frequency of the motor	30,00	320,00	Hz	50,00		111	Check the rating plate of the motor
P2.1.6	Nominal speed of the motor	300	20 000	rpm	1440		112	The default applies for a 4-pole motor and a nominal size frequency converter.
P2.1.7	Nominal current of the motor	$0,3 \times I_L$	$1,5 \times I_L$	A	$I_H$		113	Check the rating plate of the motor
P2.1.8	Motor cosφ	0,30	1,00		0,85		120	Check the rating plate of the motor
P2.1.9	Start function	0	2		0		505	0=Ramp 1=Flying start 2=Conditional flying start
P2.1.10	Stop function	0	1		0		506	0=Coasting 1=Ramp
P2.1.11	U/f optimisation	0	1		1		109	0=Not used 1=Automatic torque boost
P2.1.12	I/O reference	0	5		6		117	0=A11 1=A12 2=Keypad reference 3=Fieldbus reference (FBSpeedReference) 4=Motor potentiometer 5=A11/A12 selection 6=Preset speed
P2.1.13	DIN2 function	0	8		1		319	0=Not used 1=Start Reverse (DIN1=Start forward) 2=Reverse (DIN1=Start) 3=Stop pulse (DIN1=Start pulse) 4=External fault, cc 5=External fault, oc 6=Run enable 7=Door open low 8= Door open hold

P2.1.14	DIN3 function	0	18		6		301	0=Not used 1=Reverse 2=External fault, cc 3=External fault, oc 4=Fault reset 5=Run enable 6=Door open low 7=Door open hold 8=DC-braking command 9=Motor pot. UP (cc) 10=Motor pot. DOWN (cc) 11=ThermFlt/Wrn 12=I/O Terminal 13=Fieldbus 14=AI1/AI2 Sel 15= Door close low 16= Door close hold 17=Fire mode 18=Safe enable
P2.1.15	Automatic restart	0	1		0		731	0=Not used 1=Used
P2.1.16	Parameter conceal	0	1		0		854	0=All visual 1=Basic
P2.1.17	Password	0	65535		0		852	0-65535 0-1=disable password when access; and password status, 0 is disable, 1 is active 2-65535= password data

Table 1- 4. Basic parameters P2.1

CP= control place

## 3.3 Input signals (Control keypad: Menu P2 → P2.2)

Code	Parameter	Min	Max	Unit	Default	Cust	ID	Note
P2.2.1	Expander board DIE1 function	0	18		7		368	0=Not used 1=Reverse 2=External fault, cc 3=External fault, oc 4=Fault reset 5=Run enable 6=Door open low 7=Door open hold 8=DC-braking command 9=Motor pot. UP (cc) 10=Motor pot. DOWN (cc) 11=ThermFlt/Wrn 12=I/O Terminal 13=Fieldbus 14=AI1/AI2 Select 15= Door close low 16= Door close hold 17=Fire mode 18=Safe enable
P2.2.2	Expander board DIE2 function	0	18		15		330	As par. 2.2.1, except: 13=Interlock 2
P2.2.3	Expander board DIE3 function	0	18		16		369	As par. 2.2.1, except: 13=Interlock 3
P2.2.4	DIN4 function (AI1)	0	18		18		499	Used if P2.2.6 = 0 Selections as in par.2.2.3
P2.2.5	AI1 signal selection	0			10		377	10=AI1 (1=Local, 0=input 1) 11=AI2 (1=Local, 1= input 2) 20=Exp. AI1 (2=exp.board 0=input 1) 21=Exp AI2 (2=exp.board 1=input 2)
P2.2.6	AI1 signal range	1	4		3		379	0=Digital input 4 1=0mA – 20mA (MF4-->) 2=4mA – 20mA (MF4-->) 3=0V – 10V 4=2V – 10V Not used if AI1 Custom min > 0% or AI1 custom max. < 100% <b>Note!</b> See NXL User's manual, chapter 7.4.6: AI1 <b>mode</b>
P2.2.7	AI1 custom minimum setting	0,00	100,00	%	0,00		380	
P2.2.8	AI1 custom maximum setting	0,00	100,00	%	100,00		381	
P2.2.9	AI1 inversion	0	1		0		387	0=Not inverted 1=Inverted
P2.2.10	AI1 filter time	0,00	10,00	s	0,10		378	0=No filtering



P2.2.11	AI2 signal selection	0			11		388	As par. 2.2.5
P2.2.12	AI2 signal range	1	4		2		390	Not used if AI2 Custom min <> 0% or AI2 custom max. <> 100% 1=0—20 mA 2=4—20 mA 3=0V – 10V 4=2V – 10V
P2.2.13	AI2 custom minimum setting	0,00	100,00	%	0,00		391	
P2.2.14	AI2 custom maximum setting	0,00	100,00	%	100,00		392	
P2.2.15	AI2 inversion	0	1		0		398	0=Not inverted 1=Inverted
P2.2.16	AI2 filter time	0,00	10,00	s	0,10		389	0=No filtering
P2.2.17	Motor potentiometer frequency reference memory reset	0	2		1		367	0=No reset 1=Reset if stopped or powered down 2=Reset if powered down
P2.2.18	Reference scaling minimum value	0,00	P2.2.19		0,00		344	Does not affect the fieldbus reference (Scaled between par. 2.1.1 and par. 2.1.2)
P2.2.19	Reference scaling maximum value	P2.2.18	320,00		0,00		345	Does not affect the fieldbus reference (Scaled between par. 2.1.1 and par. 2.1.2)
P2.2.20	Keypad control reference selection	0	5		2		121	0=AI1 1=AI2 2=Keypad reference 3=Fieldbus reference (FBSpeedreference) 4=Motor potentiometer 5=AI1/AI2 Select 6=Preset speed
P2.2.21	Fieldbus control reference selection	0	5		3		122	See above
P2.2.22	DIN 1 Type	0	3		0		740	0=Normal 1=Inversion 2=Rise edge 3=Fall edge
P2.2.23	DIN 2 Type	0	3		0		741	See P2.2.22
P2.2.24	DIN 3 Type	0	3		0		742	See P2.2.22
P2.2.25	Exp DIN 1 Type	0	3		0		743	See P2.2.22
P2.2.26	Exp DIN 2 Type	0	3		0		744	See P2.2.22
P2.2.27	Exp DIN 3 Type	0	3		0		745	See P2.2.22
P2.2.28	DIN4(AI1) Type	0	3		0		746	See P2.2.22

Table 1- 5. Input signals, P2.2

CP=control place  
cc=closing contact  
oc=opening contact

## 3.4 Output signals (Control keypad: Menu P2 → P2.3)

Code	Parameter	Min	Max	Unit	Default	Cust	ID	Note
P2.3.1	Relay output 1 function	0	17		16		313	0=Not used 1=Ready 2=Run 3=Fault 4=Fault inverted 5=FC overheat warning 6=Ext. fault or warning 7=Ref. fault or warning 8=Warning 9=Reversed 10=Preset speed 11=At speed 12=Mot. regulator active 13=OP freq. limit superv.1 14=Control place: IO 15=Thermistor fault/ warning 16=Open end 17=Close end
P2.3.2	Expander board relay output 1 function	0	17		17		314	As parameter 2.3.1
P2.3.3	Expander board relay output 2 function	0	17		3		317	As parameter 2.3.1
P2.3.4	Expander board digital output 1 function	0	17		1		312	As parameter 2.3.1
P2.3.5	Analogue output function	0	12		1		307	See par. 2.1.14
P2.3.6	Analogue output filter time	0,00	10,00	s	1,00		308	0=No filtering
P2.3.7	Analogue output inversion	0	1		0		309	0=Not inverted 1=Inverted
P2.3.8	Analogue output minimum	0	1		0		310	0=0 mA 1=4 mA
P2.3.9	Analogue output scale	10	1000	%	100		311	
P2.3.10	Expander board analogue output 1 function	0	12		0		472	As parameter 2.1.14
P2.3.11	Expander board analogue output 2 function	0	12		0		479	As parameter 2.1.14
P2.3.12	Output frequency limit 1 supervision	0	2		0		315	0=No limit 1=Low limit supervision 2=High limit supervision
P2.3.13	Output frequency limit 1; Supervised value	0,00	Par. 2.1.2	Hz	0,00		316	
P2.3.14	Analogue input supervision	0	2		0		356	0=Not used 1=A11 2=A12
P2.3.15	AI supervision OFF limit	0,00	100,00	%	10,00		357	
P2.3.16	AI supervision ON limit	0,00	100,00	%	90,00		358	
P2.3.17	Relay output 1 ON delay	0,00	320,00	s	0,00		487	ON delay for RO1
P2.3.18	Relay output 1 OFF delay	0,00	320,00	s	0,00		488	OFF delay for RO1

Table 1- 6. Output signals, G2.3

## 3.5 Drive control parameters (Control keypad: Menu P2 → P2.4)

Code	Parameter	Min	Max	Unit	Default	Cust	ID	Note
P2.4.1	Ramp 1 shape	0,0	10,0	s	0,0		500	0=Linear >0=S-curve ramp time
P2.4.2	Brake chopper	0	3		0		504	0=Disabled 1=Used in Run state 3=Used in Run and Stop state
P2.4.3	DC braking current	$0,15 \times I_n$	$1,5 \times I_n$	A	Varies		507	
P2.4.4	DC braking time at stop	0,00	600,00	s	0,00		508	0=DC brake is off at stop
P2.4.5	Frequency to start DC braking during ramp stop	0,10	10,00	Hz	1,50		515	
P2.4.6	DC braking time at start	0,00	600,00	s	0,00		516	0=DC brake is off at start
P2.4.7	Flux brake	0	1		0		520	0=Off 1=On
P2.4.8	Flux braking current	0,0	Varies	A	0,0		519	

Table 1- 7. Drive control parameters, P2.4

## 3.6 Motor control parameters (Control keypad: Menu P2 → P2.5)

Code	Parameter	Min	Max	Unit	Default	Cust	ID	Note
P2.5.1	Motor control mode	0	1		0		600	0=Frequency control 1=Speed control
P2.5.2	U/f ratio selection	0	3		0		108	0=Linear 1=Squared 2=Programmable 3=Linear with flux optim.
P2.5.3	Field weakening point	30,00	320,00	Hz	50,00		602	
P2.5.4	Voltage at field weakening point	10,00	200,00	%	100,00		603	$n\% \times U_{nmot}$
P2.5.5	U/f curve midpoint frequency	0,00	par. P2.5.3	Hz	50,00		604	
P2.5.6	U/f curve midpoint voltage	0,00	100,00	%	100,00		605	$n\% \times U_{nmot}$ Parameter max. value = par. 2.5.4
P2.5.7	Output voltage at zero frequency	0,00	40,00	%	0,00		606	$n\% \times U_{nmot}$
P2.5.8	Switching frequency	1,0	16,0	kHz	6,0		601	Depends on kW
P2.5.9	Overvoltage controller	0	1		1		607	0=Not used 1=Used
P2.5.10	Undervoltage controller	0	1		1		608	0=Not used 1=Used
P2.5.11	Identification	0	1		0		631	0=No action 1=ID no run
P2.5.12	MeasRsVoltDrop	0	2000	%	0		866	Measured Voltage drop at stator resistance between two phases with nom current of motor. Unit: 256=10%

Table 1- 8. Motor control parameters, P2.6

## 3.7 Protections (Control keypad: Menu P2 → P2.6)

Code	Parameter	Min	Max	Unit	Default	Cust	ID	Note
P2.6.1	Response to 4mA reference fault	0	3		0		700	0=No response 1=Warning 2=Fault,stop acc. to 2.1.10 3=Fault,stop by coasting
P2.6.2	Response to external fault	0	3		2		701	0=No response 1=Warning 2=Fault,stop acc. to 2.1.10 3=Fault,stop by coasting
P2.6.3	Response to undervoltage fault	1	3		2		727	
P2.6.4	Output phase supervision	0	3		2		702	
P2.6.5	Earth fault protection	0	3		2		703	
P2.6.6	Thermal protection of the motor	0	3		0		704	
P2.6.7	Motor ambient temperature factor	-100,0	100,0	%	0,0		705	
P2.6.8	Motor cooling factor at zero speed	0,0	150,0	%	40,0		706	
P2.6.9	Motor thermal time constant	1	200	min	45		707	
P2.6.10	Motor duty cycle	0	100	%	100		708	
P2.6.11	Stall protection	0	3		1		709	As par. 2.6.1
P2.6.12	Stall current limit	0,1	$I_{n\text{motor}} \times 2$	A	$I_{n\text{motor}} \times 1.3$		710	
P2.6.13	Stall time limit	1,00	120,00	s	15,00		711	
P2.6.14	Stall frequency limit	1,0	P 2.1.2	Hz	25,0		712	
P2.6.15	Underload protection	0	3		0		713	As par. 2.6.1
P2.6.16	Underload curve at nominal frequency	10,0	150,0	%	50,0		714	
P2.6.17	Underload curve at zero frequency	5,0	150,0	%	10,0		715	
P2.6.18	Underload protection time limit	2,00	600,00	s	20,00		716	
P2.6.19	Response to thermistor fault	0	3		2		732	As par. 2.6.1
P2.6.20	Response to fieldbus fault	0	3		2		733	As par. 2.6.1
P2.6.21	Response to slot fault	0	3		2		734	As par. 2.6.1

Table 1- 9. Protections, P2.6

### 3.8 Autorestart parameters (Control keypad: Menu P2 → P2.7)

Code	Parameter	Min	Max	Unit	Default	Cust	ID	Note
P2.7.1	Wait time	0,10	10,00	s	0,50		717	
P2.7.2	Trial time	0,00	60,00	s	30,00		718	
P2.7.3	Start function	0	2		0		719	0=Ramp 1=Flying start 2=According to par. 2.1.9

Table 1- 10. Autorestart parameters, P2.7

## 3.9 Lift door parameters (Control keypad: Menu P2 → P2.8)

Code	Parameter	Min	Max	Unit	Default	Cust	ID	Note
P2.8.1	Door Run Mode	0	2		2		851	0=Demo mode 1=Central system 2=Tuning Note, demo and tuning mode, the start request is from <b>start</b> button, reverse request is from <b>left</b> button. Demo mode is used to demonstrate, and tuning is used to identify motor direction
P2.8.2	Open Start Acc.T	0.1	10.0	s	2.0		747	Open start acc. time
P2.8.3	Open Start Time	0.01	10.00	s	1.00		748	Open start time
P2.8.4	Open Start Speed	0.00	P2.1.2	Hz	5.00		749	Open start speed
P2.8.5	Open Norm Acc.T	0.1	10.0	s	2.0		750	Open normal acc. time
P2.8.6	Open Norm Speed	0.00	P2.1.2	Hz	20.00		751	Open normal speed
P2.8.7	Open Low Dec.T	0.1	10.0	s	2.0		752	Open low dec. time
P2.8.8	Open Low Speed	0.00	P2.1.2	Hz	8.00		753	Open low speed
P2.8.9	Open Hold Dec.T	0.1	10.0	s	2.0		754	Open hold dec. time
P2.8.10	Open Hold Time	0.01	10.00	s	2.00		755	Open hold time
P2.8.11	Open Hold Low	0.00	P2.1.2	Hz	3.00		756	Open hold low speed
P2.8.12	Open Hold Time1	0.01	10.00	s	0.20		757	Open hold time 1
P2.8.13	Open Hold Acc.T	0.1	10.0	s	2.0		758	Open hold acc. time
P2.8.14	Open Hold High	0.00	P2.1.2	Hz	8.00		759	Open hold high speed
P2.8.15	Open Hold Time2	0.01	10.00	s	1.00		760	Open hold time 2
P2.8.16	OpenHoldHighDecT	0.1	10.0	s	2.0		761	Open hold high dec. time
P2.8.17	Open Force Freq	0.00	P2.1.2	Hz	5.00		781	Open force frequency, Hz
P2.8.18	Open Force Torq	0.01	10.00	%	50.0		762	Open force torque limit
P2.8.19	Open Force Time	0.01	10.00	s	0.30		763	Open force keep time
P2.8.20	Open Superv Time	0.01	10.00	s	10.00		779	Open switch sup. time
P2.8.21	Open Safe Speed	5.00	P2.1.2	Hz	5.00		785	Open safe speed
P2.8.22	Close Start Acc.T	0.1	10.0	s	2.0		764	Close start acc. time
P2.8.23	Close Start Time	0.01	10.00	s	1.00		765	Close start time
P2.8.24	Close Start Speed	0.00	P2.1.2	Hz	5.00		766	Close start speed
P2.8.25	Close Norm Acc.T	0.1	10.0	s	2.0		767	Close normal acc. time
P2.8.26	Close Norm Speed	0.00	P2.1.2	Hz	20.00		768	Close normal speed
P2.8.27	Close Low Dec.T	0.1	10.0	s	2.0		769	Close low dec. time
P2.8.28	Close Low Speed	0.00	P2.1.2	Hz	8.00		770	Close low speed
P2.8.29	Close Hold Dec.T	0.1	10.0	s	2.0		771	Close hold dec. time
P2.8.30	Close Hold Time	0.01	10.00	s	2.00		772	Close hold time
P2.8.31	Close Hold Low	0.00	P2.1.2	Hz	3.00		773	Close hold low speed
P2.8.32	Close Hold Time1	0.01	10.00	s	0.2		774	Close hold time 1
P2.8.33	Close Hold Acc.T	0.1	10.0	s	2.0		775	Close hold acc. time
P2.8.34	Close Hold High	0.00	P2.1.2	Hz	8.00		776	Close hold high speed
P2.8.35	Close Hold Time2	0.01	10.00	s	1.00		777	Close hold time 2
P2.8.36	ClosHoldHighDecT	0.1	10.0	s	0.2		778	Close hold high dec. time
P2.8.37	Close Superv Time	0.01	10.00	s	10.00		780	Close switch sup. time
P2.8.38	Close Safe Speed	0	P2.1.2	Hz	5.00		784	Close safe speed
P2.8.39	Hold Freq Ref	0	P2.1.2	Hz	2.00		783	Open/close hold speed
P2.8.40	Tuning Freq Ref	0	P2.1.2	Hz	5.00		782	Tuning frequency ref.
P2.8.41	Op. Counter clear	0	1		0		853	0=Not used 1=Clear, 0->1 trigger

Table 1- 11. Lift door parameters, P2.8

### 3.10 Keypad control (Control keypad: Menu K3)

The parameters for the selection of control place and direction on the keypad are listed below. See the Keypad control menu in the Vacon NXL User's Manual.

Code	Parameter	Min	Max	Unit	Default	Cust	ID	Note
P3.1	Control place	1	3		1		125	1 = I/O terminal 2 = Keypad 3 = Fieldbus
R3.2	Keypad reference	Par. 2.1.1	Par. 2.1.2	Hz				
P3.3	Direction (on keypad)	0	1		0		123	0 = Forward 1 = Reverse
R3.4	Stop button	0	1		1		114	0=Limited function of Stop button 1=Stop button always enabled

Table 1- 12. Keypad control parameters, M3

### 3.11 System menu (Control keypad: Menu S6)

For parameters and functions related to the general use of the frequency converter, such as customised parameter sets or information about the hardware and software, see Chapter 7.4.6 in the Vacon NXL User's Manual.

### 3.12 Expander boards (Control keypad: Menu E7)

The E7 menu shows the expander boards attached to the control board and board-related information. For more information, see Chapter 7.4.7 in the Vacon NXL User's Manual.



## 4. DESCRIPTION OF PARAMETERS

### 4.1 BASIC PARAMETERS

#### 2.1.1, 2.1.2 *Minimum/maximum frequency*

Defines the frequency limits of the frequency converter.

The maximum value for parameters 2.1.1 and 2.1.2 is 320 Hz.

The software will automatically check the values of parameters, [2.3.13](#), [2.5.3](#), [2.5.5](#).

#### 2.1.3 *Current limit*

This parameter determines the maximum motor current from the frequency converter. To avoid motor overload, set this parameter according to the rated current of the motor. The current limit is equal to the rated converter current ( $I_L$ ) by default.

#### 2.1.4 *Nominal voltage of the motor*

Find this value  $U_n$  on the rating plate of the motor. This parameter sets the voltage at the field weakening point ([parameter 2.5.4](#)) to  $100\% \times U_{n\text{motor}}$ .

#### 2.1.5 *Nominal frequency of the motor*

Find this value  $f_n$  on the rating plate of the motor. This parameter sets the field weakening point ([parameter 2.5.3](#)) to the same value.

#### 2.1.6 *Nominal speed of the motor*

Find this value  $n_n$  on the rating plate of the motor.

#### 2.1.7 *Nominal current of the motor*

Find this value  $I_n$  on the rating plate of the motor.

#### 2.1.8 *Motor cos phi*

Find this value "cos phi" on the rating plate of the motor.

### 2.1.9 *Start function*

Ramp:

- 0 The frequency converter starts from 0 Hz and accelerates to maximum frequency within the set P2.8. (Load inertia or starting friction may cause prolonged acceleration times).

Flying start:

- 1 The frequency converter is able to start into a running motor by applying a small torque to motor and searching for the frequency corresponding to the speed the motor is running at. The searching starts from the maximum frequency towards the actual frequency until the correct value is detected. Thereafter, the output frequency will be increased / decreased to the set reference value according to the set acceleration/deceleration parameter

Use this mode if the motor is coasting when the start command is given. With the flying start, it is possible to ride through short mains voltage interruptions.

Conditional flying start

- 2 With this mode it is possible to disconnect and connect the motor from the frequency converter even when the Start command is active. On re-connecting the motor, the drive will operate as described in selection 1

### 2.1.10 *Stop function*

Coasting:

- 0 The motor coasts to a halt without control from the frequency converter after the Stop command.

Ramp:

- 1 After the Stop command, the speed of the motor is decelerated according to the set deceleration parameters.

If the regenerated energy is high it may be necessary to use an external braking resistor for faster deceleration.

### 2.1.11 *U/f optimisation*

0 Not used

1 **Automatic torque boost**

The voltage to the motor changes automatically which makes the motor produce sufficient torque to start and run at low frequencies. The voltage increase depends on the motor type and power. Automatic torque boost can be used in applications where starting torque due to starting friction is high, e.g. in conveyors.

*NOTE!* *In high torque – low speed applications – it is likely that the motor will overheat. If the motor has to run a prolonged time under these conditions, special attention must be paid to cooling the motor. Use external cooling for the motor if the temperature tends to rise too high.*

### 2.1.12 *I/O Reference selection*

Defines the selected frequency reference source when the drive is controlled from the I/O terminal.

0 AI1 reference (terminals 2 and 3, e.g. potentiometer)

1 AI2 reference (terminals 4 and 5, e.g. transducer)

2 Keypad reference (parameter 3.2)

3 Reference from Fieldbus (FBspeedReference)

4 Motor potentiometer reference

5 AI1/AI2 selection. Selection of AI2 is made programmable by DIN3 Function ([P2.1.16](#))

### 2.1.13 *DIN2 function*

This parameter has 9 selections. If digital input DIN2 need not be used, set the parameter value to 0.

1 Start reverse

2 Reverse

3 Stop pulse

4 External fault

Contact closed: Fault is displayed and motor stopped when the input is active

5 External fault

Contact open: Fault is displayed and motor stopped when the input is not active

6 Run enable

Contact open: Start of motor disabled

Contact closed: Start of motor enabled

Coast stop if dropped during RUN

7 Door open low

8 Door open hold

Contact closed: door open hold switch on.

### 2.1.14 *DIN3 function*

The parameter has 19 selections. If digital input DIN3 need not be used, set the param. Value to 0.

- 1 Reverse  
Contact open: Forward  
Contact closed: Reverse
- 2 External fault  
Contact closed: Fault is displayed and motor stopped when the input is active
- 3 External fault  
Contact open: Fault is displayed and motor stopped when the input is not active
- 4 Fault reset  
Contact closed: All faults reset
- 5 Run enable  
Contact open: Start of motor disabled  
Contact closed: Start of motor enabled  
Coast stop if dropped during RUN
- 6 Door open low
- 7 Door open hold
- 8 DC braking command  
Contact closed: In Stop mode, the DC braking operates until the contact is opened.  
DC-braking current is about 10% of the value selected with [par. 2.4.3](#).
- 9 Motor potentiometer UP  
Contact closed: Reference increases until the contact is opened.
- 10 Motor potentiometer DOWN.  
Contact closed: Reference decreases until the contact is opened
- 11 Thermistor fault/warning input, **NOTE!** See [NXL User's Manual, Chapter 6.2.4](#)  
Contact open: thermal fault/warning is active
- 12 I/O terminal
- 13 Fieldbus
- 14 AI1/AI2 select
- 15 Door close low
- 16 Door close hold
- 17 Fire mode
- 18 Safe enable

### 2.1.15 *Automatic restart function*

The automatic restart is taken into use with this parameter

0 = Disabled

1 = Enabled (3 automatic restarts, see [par. 2.7.1 – 2.7.3](#))

**2.1.16**    *Parameter conceal*

Define parameter visual or conceal

.

**0** = All visual

All parameter set can be visual

**1** = Basic

Only lift door and basic parameter can be visual

**2.1.17**    *Password*

Define password protection

.

**0-1**

0 = Reactive, 1 = active (password status when active and not access)

0 or 1 = disable password (protection operate when active and access)

**2-65535**

Password data

## 4.2 INPUT SIGNALS

### 2.2.1 Expander board DIE1 function

This parameter has 19 selections. If the expander board digital input DIN1 need not be used, set the parameter value to 0.

Selections are as in [parameter 2.2.1](#),

### 2.2.2 Expander board DIE2 function

The selections are the same as in parameter 2.2.1,

### 2.2.3 Expander board DIE3 function

The selections are the same as in parameter 2.2.1.

### 2.2.4 DIN4 Function

If the value of [par. 2.2.6](#) is set to 0, All functions as digital input 4.

The selections are the same as in parameter 2.2.3.

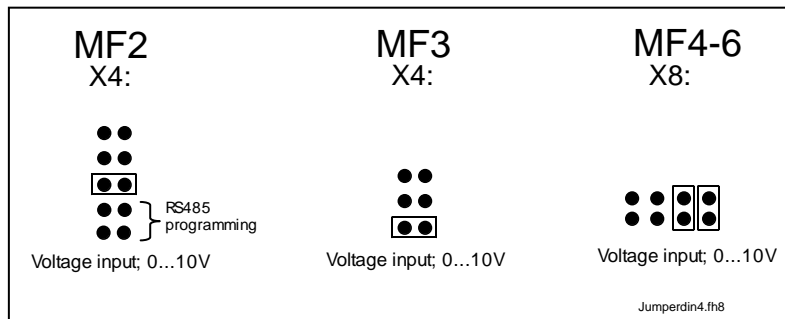

**NOTE!** If you program the analogue input as DIN4 check that the jumper selections are correct (see figure below).

Figure 1- 1. Jumper selections of X4/X8 when All functions as DIN4

### 2.2.5 AI1 signal selection

Connect the AI1 signal to the analogue input of your choice with this parameter.

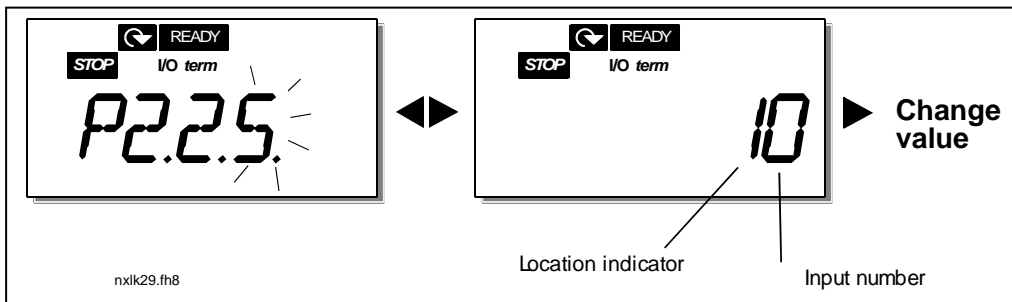

Figure 1- 2. AI1 signal selection

The value of this parameter is formed of the *board indicator* and the *respective input terminal number*. See Figure 1- 2 above.

Board indicator 1	= Local inputs
Board indicator 2	= Expander board inputs
Input number 0	= Input 1
Input number 1	= Input 2
Input number 2	= Input 3
⋮	
Input number 9	= Input 10

Example:

If you set the value of this parameter to **10**, you have selected the local input **1** for the AI1 signal. Again, if the value is set to **21**, the expander board input **2** has been selected for the AI1 signal.

If you want to use the values of analogue input signal for e.g. testing purposes only, you can set the parameter value to **0 - 9**. In this case, value **0** corresponds to **0%**, value **1** corresponds to **20%** and any value between **2** and **9** corresponds to **100%**.

### 2.2.6 AI1 signal range

With this parameter you can select the AI1 signal range.

- 0 = DIN 4
- 1 = Signal range 0...20mA (only for sizes MF4 and bigger)
- 2 = Signal range 4...20mA (only for sizes MF4 and bigger)
- 3 = Signal range 0...10V
- 4 = Signal range 2...10V

**Note!** The selections have no effect if par. 2.2.7 > 0%, or par. 2.2.8 < 100%.

If the value of par. 2.2.6 is set to **0**, AI1 functions as digital input 4. See par. 2.2.4

**2.2.7** *AI1 custom setting minimum***2.2.8** *AI1 custom setting maximum*

Set the custom minimum and maximum levels for the AI1 signal within 0...10V.

**2.2.9** *AI1 signal inversion*

By setting the parameter value to 1 the AI1 signal inversion takes place.

**2.2.10** *AI1 signal filter time*

This parameter, given a value greater than 0, activates the function that filters out disturbances from the incoming analogue  $U_{in}$  signal.

Long filtering time makes the regulation response slower. See Figure 1- 3

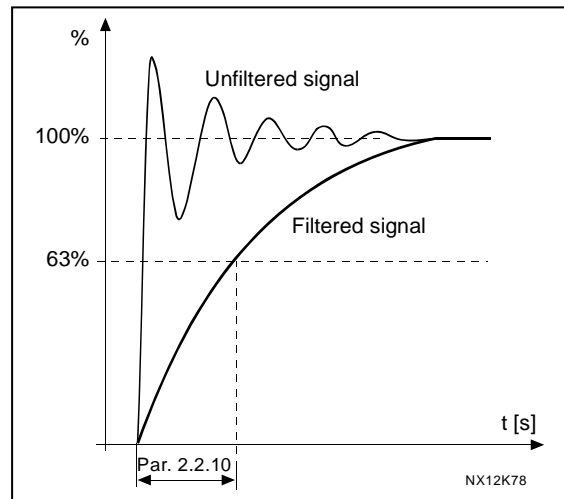

Figure 1- 3. AI1 signal filtering

**2.2.11** *AI2 signal selection*

Connect the AI2 signal to the analogue input of your choice with this parameter. See [par. 2.2.5](#) for the value setting procedure.

**2.2.12** *AI2 signal range*

- 1 = Signal range 0...20mA
- 2 = Signal range 4...20mA
- 3 = Signal range 0...10V
- 4 = Signal range 2...10V

**Note!** The selections have no effect if [par. 2.2.13](#) > 0%, or [par. 2.2.14](#) < 100%.

**2.2.13** *AI2 custom minimum***2.2.14** *AI2 custom maximum*

These parameters allow you to scale the input current signal between 0 and 20 mA.

Cf. parameters [2.2.7](#) and [2.2.8](#).

**2.2.15** *Analogue input AI2 signal inversion*

See corresponding parameter [2.2.9](#).



**2.2.16** *Analogue input AI2 signal filter time*

See corresponding parameter [2.2.10](#).

**2.2.17** *Motor potentiometer memory reset (Frequency reference)*

- 0 = No reset
- 1 = Memory reset in stop and power down
- 2 = Memory reset in power down

**2.2.18** *Reference scaling minimum value***2.2.19** *Reference scaling maximum value*

You can choose a scaling range for the frequency reference between the Minimum and Maximum frequency. If no scaling is desired set the parameter value to 0.

In the figures below, voltage input AI1 with signal range 0...10V is selected for reference.

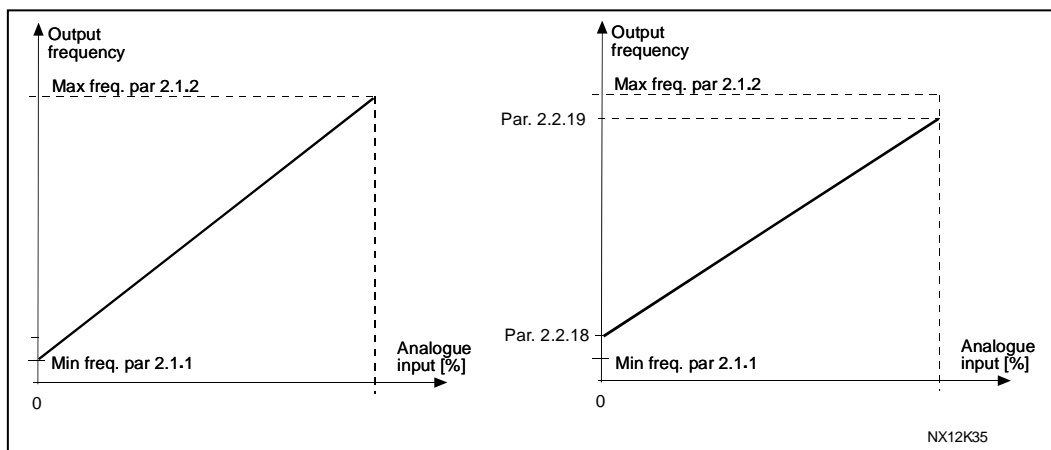

Figure 1- 4. Left: Par. 2.1.18=0 (No reference scaling) Right: Reference scaling

**2.2.20** *Keypad frequency reference selection*

Defines the selected reference source when the drive is controlled from the keypad

- 0 AI1 reference (by default AI1, terminals 2 and 3, e.g. potentiometer)
- 1 AI2 reference (by default AI2, terminals 4 and 5, e.g. transducer)
- 2 Keypad reference (parameter 3.2)
- 3 Reference from Fieldbus (FBSpeedReference)
- 4 Motor potentiometer reference
- 5 AI1/AI2 select
- 6 Preset speed

**2.2.21** *Fieldbus frequency reference selection*

Defines the selected reference source when the drive is controlled from the fieldbus.  
For the parameter values, see [par. 2.2.20](#).

## 4.3 OUTPUT SIGNALS

**2.3.1**     *Relay output 1 function*

**2.3.2**     *Expander board relay output 1 function*

**2.3.3**     *Expander board relay output 2 function*

**2.3.4**     *Expander board digital output 1 function*

Setting value	Signal content
0 = Not used	Out of operation
	<u>Relay output R01 and expander board programmable relays (R01, R02) are activated when:</u>
1 = Ready	The frequency converter is ready to operate
2 = Run	The frequency converter operates (motor is running)
3 = Fault	A fault trip has occurred
4 = Fault inverted	A fault trip <u>not</u> occurred
5 = Frequency converter overheat warning	The heat-sink temperature exceeds +70°C
6 = External fault or warning	Fault or warning depending on par. 2.6.2
7 = Reference fault or warning	Fault or warning depending on par. 2.6.1 - if analogue reference is 4–20 mA and signal is <4mA
8 = Warning	Always if a warning exists
9 = Reversed	The reverse command has been selected
10 = Preset speed	A preset speed has been selected
11 = At speed	The output frequency has reached the set reference
12 = Motor regulator activated	Overvoltage or overcurrent regulator was activated
13 = Output frequency limit 1 supervision	The output frequency goes outside the set supervision low limit/high limit ( <a href="#">see parameters 2.3.12 and 2.3.13 below</a> )
14 = Control from I/O terminals	Selected control place (Menu <b>K3</b> ; par. 3.1) is "I/O terminal"
15 = Thermistor fault or warning	The thermistor input of option board indicates overtemperature. Fault or warning depending on parameter <a href="#">2.6.19</a> .
16 = Open end	Door open at the end switch
17 = Close end	Door close at the end switch

Table 1- 13. Output signals via R01 and expander board R01, R02 and D01.

**2.3.5**     *Analogue output function*

This parameter selects the desired function for the analogue output signal.

See the table on page 6 for the parameter values.

### 2.3.6 Analogue output filter time

Defines the filtering time of the analogue output signal.

If you set value **0** for this parameter, no filtering takes place.

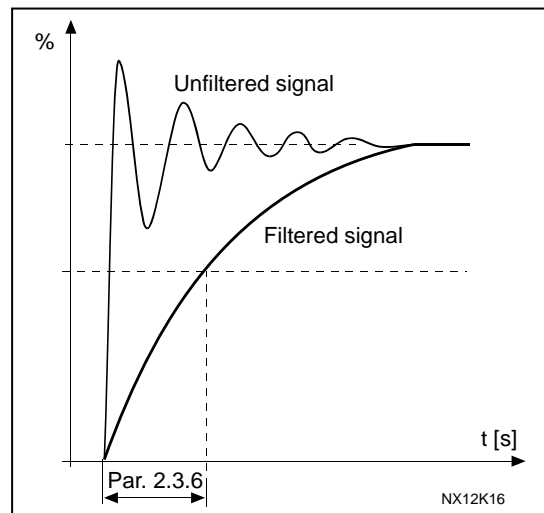

Figure 1- 5. Analogue output filtering

### 2.3.7 Analogue output invert

Inverts the analogue output signal:

Maximum output signal = 0 %

Minimum output signal = Maximum set value (parameter [2.3.9](#))

- 0 Not inverted
- 1 Inverted

See [parameter 2.3.9](#) below.

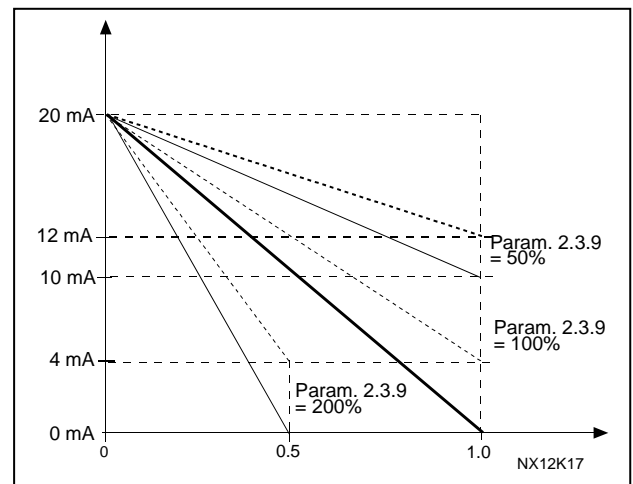

Figure 1- 6. Analogue output invert

### 2.3.8 Analogue output minimum

Sets the signal minimum to either 0 mA or 4 mA (living zero). Note the difference in the analogue output scaling in [parameter 2.3.9](#).

**2.3.9 Analogue output scale**

Scaling factor for the analogue output.

Signal	Max. value of the signal
Output frequency	100% x $f_{max}$
Motor speed	100% x Motor nom. speed
Output current	100% x $I_{nMotor}$
Motor torque	100% x $T_{nMotor}$
Motor power	100% x $P_{nMotor}$
Motor voltage	100% x $U_{nMotor}$
DC-link voltage	1000 V
PI-ref. value	100% x ref. value max.
PI act. value 1	100% x actual value max.
PI error value	100% x error value max.
PI output	100% x output max.

Table 1- 14. Analogue output scaling

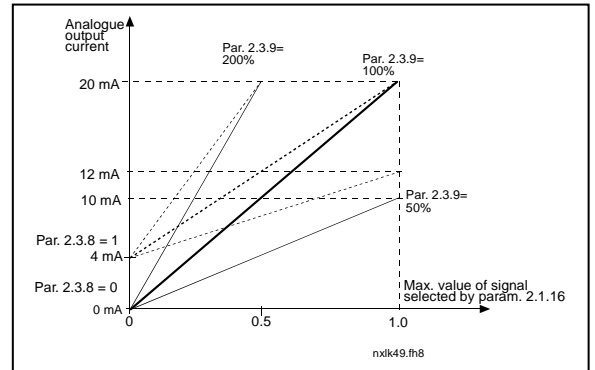

Figure 1- 7. Analogue output scaling

**2.3.10 Expander board analogue output 1 function**

**2.3.11 Expander board analogue output 2 function**

These parameters select the desired functions for the expander board analogue output signals. See [par. 2.1.14](#) for the parameter values.

**2.3.12 Output frequency limit 1 supervision function**

- 0 No supervision
- 1 Low limit supervision
- 2 High limit supervision

If the output frequency goes under/over the set limit ([par. 2.3.13](#)) this function generates a warning message via the relay outputs depending on the settings of parameters [2.3.1](#) – [2.3.4](#).

**2.3.13 Output frequency limit 1 supervised value**

Selects the frequency value supervised by parameter 2.3.12.

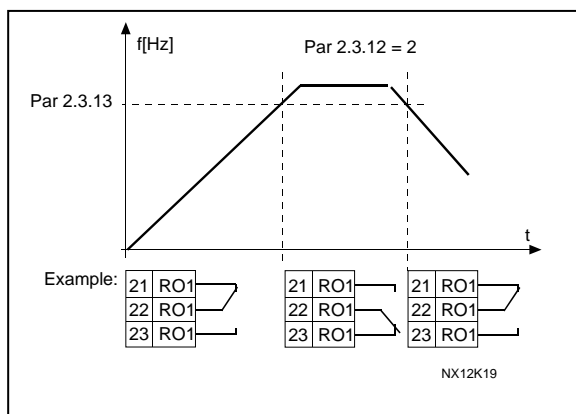

Figure 1- 8. Output frequency supervision

### 2.3.14 *Analogue input supervision*

With this parameter you can select the analogue input to be supervised.

0 = Not used

1 = AI1

2 = AI2

### 2.3.15 *Analogue input supervision OFF limit*

When the signal of analogue input selected with par. 2.3.14 falls under the limit set with this parameter, the relay output goes off.

### 2.3.16 *Analogue input supervision ON limit*

When the signal of analogue input selected with par. 2.3.14 goes over the limit set with this parameter, the relay output goes on.

This means that if for example ON limit is 60% and OFF limit is 40%, the relay goes on when signal goes over 60% and remains on until it falls under 40%.

### 2.3.17 *Relay output 1 ON delay*

### 2.3.18 *Relay output 1 OFF delay*

With these parameters you can set on- and off-delays to relay output 1 ([par 2.3.1](#)).

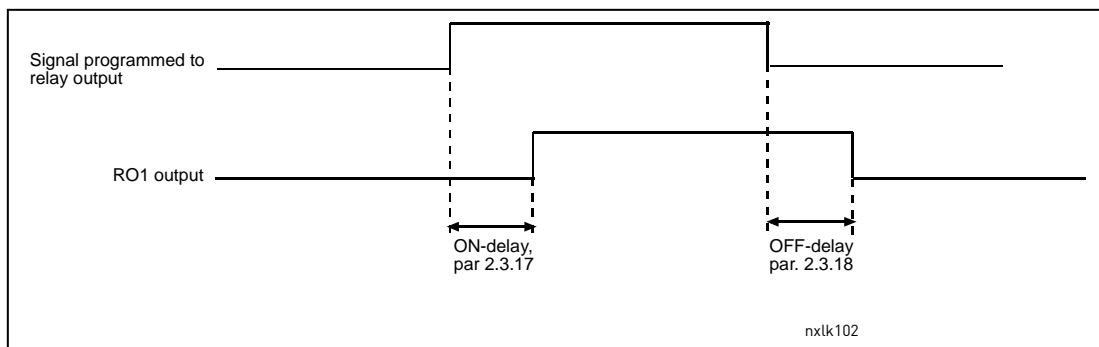

Figure 1- 9. Relay output 1 on- and off-delays

## 4.4 DRIVE CONTROL

### 2.4.1 Acceleration/Deceleration ramp 1 shape

The start and end of the acceleration and deceleration ramp can be smoothed with this parameter. Setting value 0 gives a linear ramp shape which causes acceleration and deceleration to act immediately to the changes in the reference signal.

Setting value 0.1...10 seconds for this parameter produces an S-shaped acceleration/deceleration. The acceleration time is determined with parameters [P2.8](#).

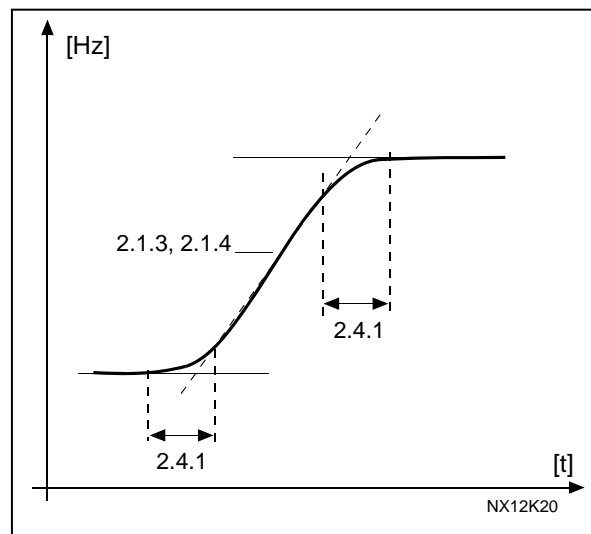

Figure 1-10. Acceleration/Deceleration (S-shaped)

### 2.4.2 Brake chopper

**Note!** An internal brake chopper is installed in all other sizes but MF2

- 0 No brake chopper used
- 1 Brake chopper used in Run state
- 3 Used in Run and Stop state

When the frequency converter is decelerating the motor, the inertia of the motor and the load are fed into an external brake resistor. This enables the frequency converter to decelerate the load with a torque equal to that of acceleration (provided that the correct brake resistor has been selected). See separate Brake resistor installation manual.

### 2.4.3 DC-braking current

Defines the current injected into the motor during DC-braking.

### 2.4.4 DC-braking time at stop

Determines if braking is ON or OFF and the braking time of the DC-brake when the motor is stopping. The function of the DC-brake depends on the stop function, [parameter 2.1.10](#).

- 0 DC-brake is not used
- >0 DC-brake is in use and its function depends on the Stop function, ([par. 2.1.10](#)). The DC-braking time is determined with this parameter

#### **Par. 2.1.10 = 0 (Stop function = Coasting):**

After the stop command, the motor coasts to a stop without control from the frequency converter.

With the DC injection, the motor can be electrically stopped in the shortest possible time, without using an optional external braking resistor.

The braking time is scaled by the frequency when the DC-braking starts. If the frequency is greater than the nominal frequency of the motor, the set value of parameter 2.4.4 determines the braking time. When the frequency is  $\leq 10\%$  of the nominal, the braking time is 10% of the set value of parameter 2.4.4.

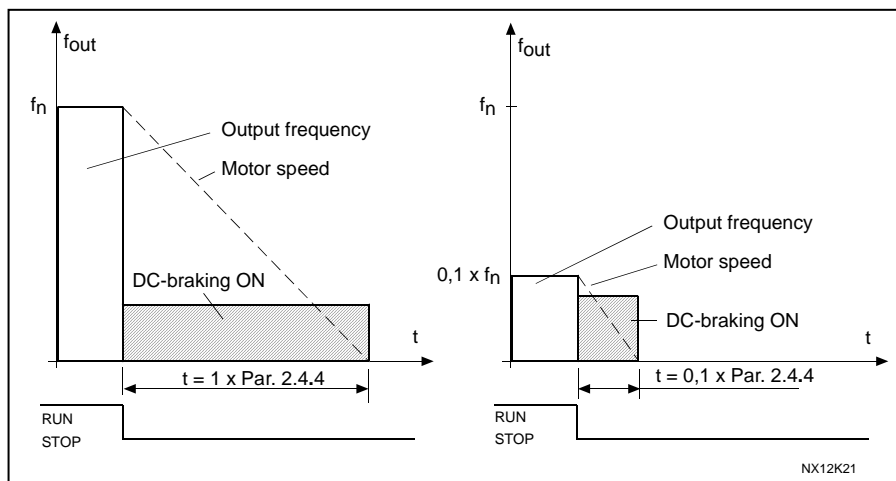

Figure 1- 11. DC-braking time when Stop mode = Coasting.

**Par. 2.1.10 = 1 (Stop function = Ramp):**

After the Stop command, the speed of the motor is reduced according to the set deceleration parameters, as fast as possible, to the speed defined with parameter 2.4.5, where the DC-braking starts.

The braking time is defined with parameter 2.4.4. If high inertia exists, it is recommended to use an external braking resistor for faster deceleration. See Figure 1- 12.

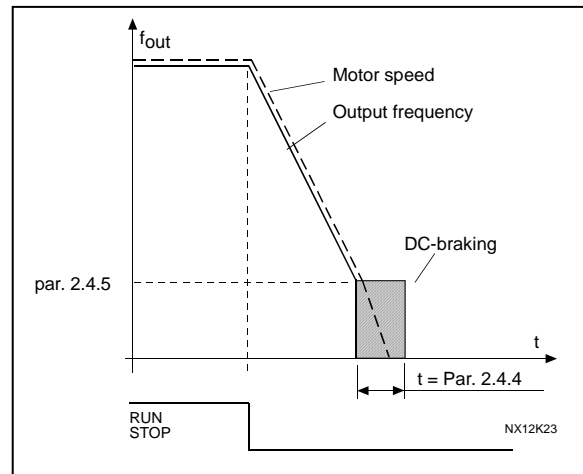

Figure 1- 12. DC-braking time when Stop mode = Ramp

**2.4.5 DC-braking frequency in ramp stop**

The output frequency at which the DC-braking is applied. See Figure 1- 12.

**2.4.6 DC-braking time at start**

DC-brake is activated when the start command is given. This parameter defines the time before the brake is released. After the brake is released, the output frequency increases according to the set start function by parameter 2.1.9. See Figure 1- 13.

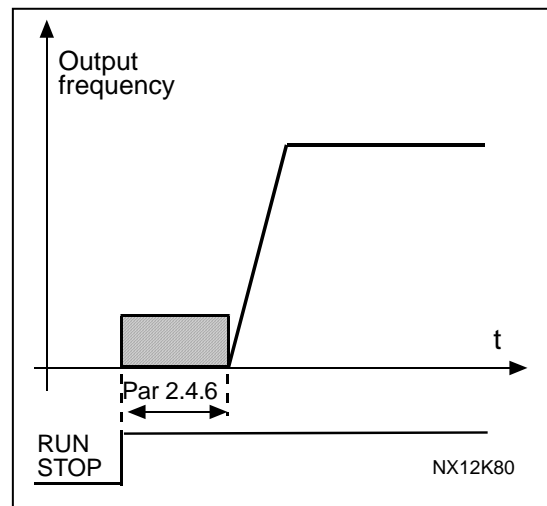

Figure 1- 13. DC braking time at start

**2.4.7 Flux brake**

Instead of DC braking, flux braking is a useful form of braking with motors  $\leq 15\text{kW}$ .

When braking is needed, the frequency is reduced and the flux in the motor is increased, which in turn increases the motor's capability to brake. Unlike DC braking, the motor speed remains controlled during braking



The flux braking can be set ON or OFF.

0 = Flux braking OFF

1 = Flux braking ON

**Note:** Flux braking converts the energy into heat at the motor, and should be used intermittently to avoid motor damage

#### 2.4.8 *Flux braking current*

Defines the flux braking current value. It can be set between  $0.3 \times I_H$  (approximately) and the [Current limit](#).

## 4.5 MOTOR CONTROL

### 2.5.1 Motor control mode

- 0 Frequency control: The I/O terminal and keypad references are frequency references and the frequency converter controls the output frequency (output frequency resolution = 0.01 Hz)
- 1 Speed control: The I/O terminal and keypad references are speed references and the frequency converter controls the motor speed (accuracy  $\pm 0, 5\%$ ).

### 2.5.2 U/f ratio selection

Linear: The voltage of the motor changes linearly with the frequency in the constant flux area from 0 Hz to the field weakening point where the nominal voltage is supplied to the motor. Linear U/f ratio should be used in constant torque applications. See Figure 1- 14.

0

**This default setting should be used if there is no special need for another setting.**

Squared: The voltage of the motor changes following a squared curve form with the frequency in the area from 0 Hz to the field weakening point where the nominal voltage is also supplied to the motor. The motor runs under magnetised below the field weakening point and produces less torque and electromechanical noise. Squared U/f ratio can be used in applications where torque demand of the load is proportional to the square of the speed, e.g. in centrifugal fans and pumps.

1

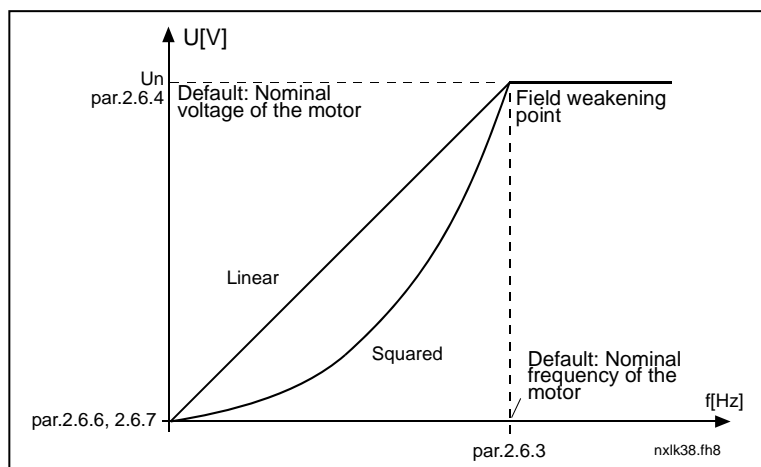

Figure 1- 14. Linear and squared change of motor voltage

Programmable U/f curve:

- 2 The U/f curve can be programmed with three different points. Programmable U/f curve can be used if the other settings do not satisfy the needs of the application.

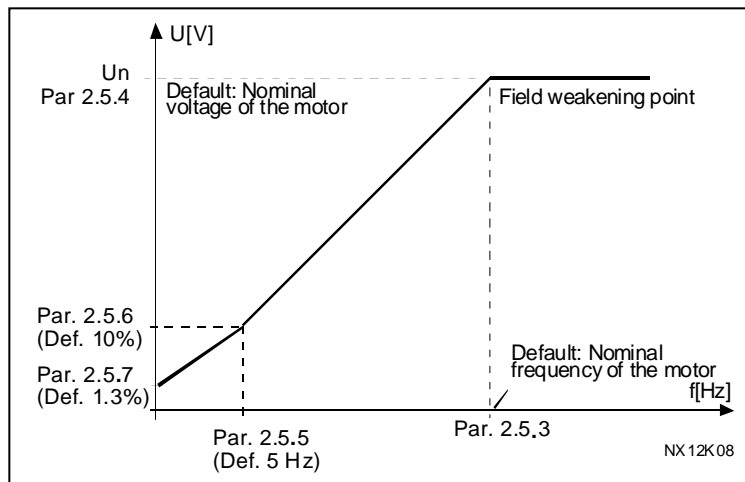

Figure 1- 15. Programmable U/f curve

Linear with flux optimisation:

- 3 The frequency converter starts to search for the minimum motor current and in order to save energy, lower the disturbance level and the noise. Can be used in applications with constant motor load, such as fans, pumps etc.

### 2.5.3 *Field weakening point*

The field weakening point is the output frequency at which the output voltage reaches the value set with par. 2.5.4.

### 2.5.4 *Voltage at field weakening point*

Above the frequency at the field weakening point, the output voltage remains at the value set with this parameter. Below the frequency at the field weakening point, the output voltage depends on the setting of the U/f curve parameters. See parameters [2.1.11](#), [2.5.2](#), [2.5.5](#), [2.5.6](#) and [2.5.7](#) and Figure 1- 15.

When the parameters [2.1.4](#) and [2.1.5](#) (nominal voltage and nominal frequency of the motor) are set, the parameters 2.5.3 and 2.5.4 are automatically given the corresponding values. If you need different values for the field weakening point and the voltage, change these parameters **after** setting the parameters 2.1.4 and 2.1.5.

### 2.5.5 *U/f curve, middle point frequency*

If the programmable U/f curve has been selected with parameter [2.5.2](#) this parameter defines the middle point frequency of the curve. See Figure 1- 15.

### 2.5.6 *U/f curve, middle point voltage*

If the programmable U/f curve has been selected with the parameter 2.5.2 this parameter defines the middle point voltage of the curve. See Figure 1- 15.

### 2.5.7 *Output voltage at zero frequency*

This parameter defines the zero frequency voltage of the curve. See Figure 1- 15.

### 2.5.8 *Switching frequency*

Motor noise can be minimised using a high switching frequency. Increasing the switching frequency reduces the capacity of the frequency converter unit.

Switching frequency for Vacon NXL: 1...16 kHz

### 2.5.9 *Overvoltage controller*

### 2.5.10 *Undervoltage controller*

These parameters allow the under-/overvoltage controllers to be switched out of operation. This may be useful, for example, if the mains supply voltage varies more than -15% to +10% and the application will not tolerate this over-/undervoltage. This regulator controls the output frequency taking the supply fluctuations into account.

**Note:** Over-/undervoltage trips may occur when controllers are switched out of operation.

0 Controller switched off

1 Controller switched on

### 2.5.11 *Identification*

0 No action

1 ID no run

When ID no run is selected, the drive will perform an ID-run when it is started from selected control place. Drive has to be started within 20 seconds, otherwise identification is aborted.

The drive does not rotate the motor during ID no run. When ID run is ready the drive is stopped. Drive will start normally, when the next start command is given.

**The ID run improves the torque calculations and the automatic torque boost function. It will also result in a better slip compensation in speed control (more accurate RPM)**

## 4.6 PROTECTIONS

### 2. 6.1 *Response to 4mA reference fault*

0 = No response

1 = Warning

2 = Fault, stop mode after fault according to [parameter 2.1.10](#)

3 = Fault, stop mode after fault always by coasting

A warning or a fault action and message is generated if the 4...20 mA reference signal is used and the signal falls below 3.5 mA for 5 seconds or below 0.5 mA for 0.5 seconds. The information can also be programmed into relay outputs.

### 2. 6.2 *Response to external fault*

0 = No response

1 = Warning

2 = Fault, stop mode after fault according to [parameter 2.1.10](#)

3 = Fault, stop mode after fault always by coasting

A warning or a fault action and message is generated from the external fault signal in the programmable digital inputs. The information can also be programmed into relay outputs.

### 2. 6.3 *Response to undervoltage fault*

1 = Warning

2 = Fault, stop mode after fault according to [parameter 2.1.10](#)

3 = Fault, stop mode after fault always by coasting

For the undervoltage limits see Vacon NXL, User's Manual, and Table 4-3.

**Note:** This protection cannot be inactivated.

### 2. 6.4 *Output phase supervision*

0 = No response

1 = Warning

2 = Fault, stop mode after fault according to [parameter 2.1.10](#)

3 = Fault, stop mode after fault always by coasting

Output phase supervision of the motor ensures that the motor phases have an approximately equal current.

### 2. 6.5 *Earth fault protection*

0 = No response

1 = Warning

2 = Fault, stop mode after fault according to [parameter 2.1.10](#)

3 = Fault, stop mode after fault always by coasting

Earth fault protection ensures that the sum of the motor phase currents is zero. The overcurrent protection is always working and protects the frequency converter from earth faults with high currents.

### Parameters 2.6.6—2.6.10, Motor thermal protection:

#### General

The motor thermal protection is to protect the motor from overheating. The Vacon drive is capable of supplying higher than nominal current to the motor. If the load requires this high current there is a risk that the motor will be thermally overloaded. This is the case especially at low frequencies. At low frequencies the cooling effect of the motor is reduced as well as its capacity. If the motor is equipped with an external fan the load reduction at low speeds is small.

The motor thermal protection is based on a calculated model and it uses the output current of the drive to determine the load on the motor.

The motor thermal protection can be adjusted with parameters. The thermal current  $I_T$  specifies the load current above which the motor is overloaded. This current limit is a function of the output frequency.



**CAUTION!** *The calculated model does not protect the motor if the airflow to the motor is reduced by blocked air intake grill.*

### 2. 6.6 *Motor thermal protection*

0 = No response

1 = Warning

2 = Fault, stop mode after fault according to [parameter 2.1.10](#)

3 = Fault, stop mode after fault always by coasting

If tripping is selected the drive will stop and activate the fault stage.

Deactivating the protection, i.e. setting parameter to 0, will reset the thermal model of the motor to 0%.

### 2. 6.7 Motor thermal protection: Motor ambient temperature factor

When the motor ambient temperature must be taken into consideration, it is recommended to set a value for this parameter. The value of the factor can be set between  $-100.0\%$  and  $100.0\%$  where  $-100.0\%$  corresponds to  $0^{\circ}\text{C}$  and  $100.0\%$  to the maximum running ambient temperature of the motor. Setting this parameter value to  $0\%$  assumes that the ambient temperature is the same as the temperature of the heat sink at power-on.

### 2. 6.8 Motor thermal protection: Cooling factor at zero speed

The cooling power can be set between  $0-150.0\%$  x cooling power at nominal frequency. See Figure 1- 16.

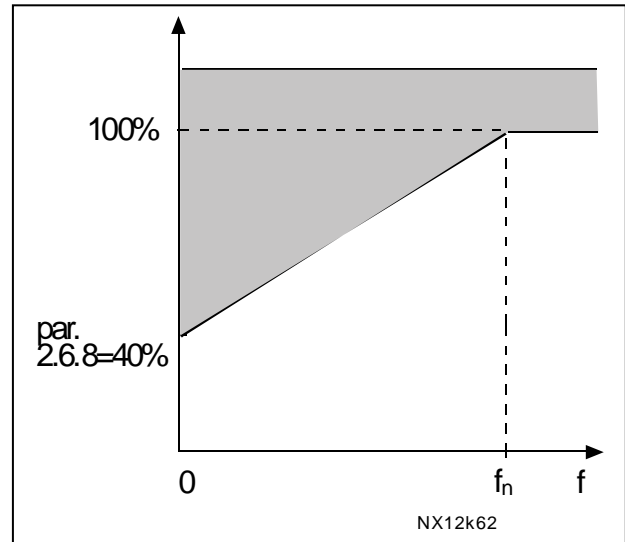

Figure 1- 16. Motor cooling power

### 2. 6.9 Motor thermal protection: Time constant

This time can be set between 1 and 200 minutes.

This is the thermal time constant of the motor. The bigger the motor, the bigger the time constant. The time constant is the time within which the calculated thermal model has reached 63% of its final value.

The motor thermal time is specific to the motor design and it varies between different motor manufacturers.

If the motor's  $t_6$ -time ( $t_6$  is the time in seconds the motor can safely operate at six times the rated current) is known (given by the motor manufacturer) the time constant parameter can be set basing on it. As a rule of thumb, the motor thermal time constant in minutes equals to  $2 \times t_6$ . If the drive is in stop state the time constant is internally increased to three times the set parameter value. The cooling in the stop state is based on convection and the time constant is increased. See also Figure 1- 17.

**Note:** If the nominal speed (par. 2.1.4) or the nominal current (par. 2.1.7) of the motor are changed this parameter is automatically set to the default value (45).

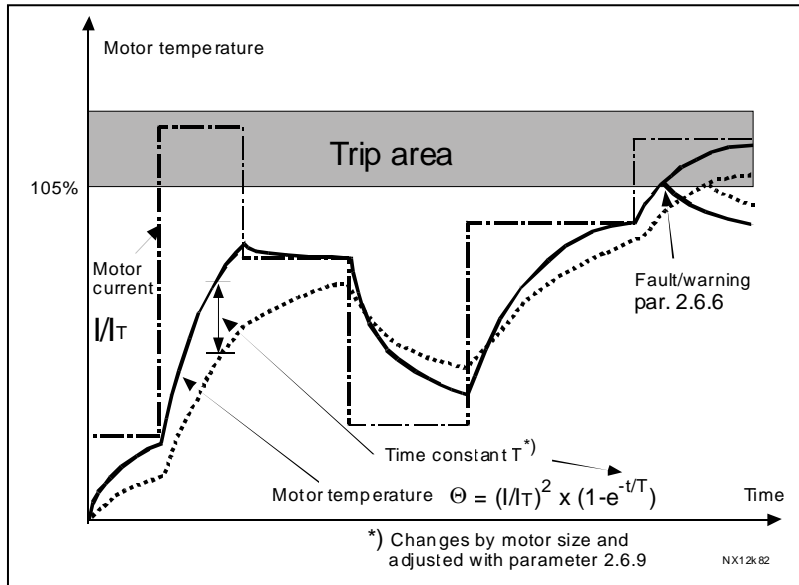

Figure 1- 17. Motor temperature calculation

### 2. 6.10 Motor thermal protection: Motor duty cycle

Defines how much of the nominal motor load is applied.  
The value can be set to 0%...100%.

### Parameter 2.6.11, Stall protection:

#### General

The motor stall protection protects the motor from short time overload situations such as one caused by a stalled shaft. The reaction time of the stall protection can be set shorter than that of motor thermal protection. The stall state is defined with two parameters, 2.6.12 (Stall current) and 2.6.13 (Stall frequency). If the current is higher than the set limit and output frequency is lower than the set limit, the stall state is true. There is actually no real indication of the shaft rotation. Stall protection is a type of overcurrent protection.

### 2. 6.11 Stall protection

- 0 = No response
- 1 = Warning
- 2 = Fault, stop mode after fault according to [parameter 2.1.10](#)
- 3 = Fault, stop mode after fault always by coasting

Setting the parameter to 0 will deactivate the protection and reset the stall time counter.



### 2. 6.12 Stall current limit

The current can be set to  $0.0 \dots I_{nMotor} * 2$ . For a stall stage to occur, the current must have exceeded this limit. See Figure 1- 18. The software does not allow entering a greater value than  $I_{nMotor} * 2$ . If the [parameter 2.1.7](#) Nominal current of motor is changed, this parameter is automatically restored to the default value ( $I_{nMotor} * 1.3$ ).

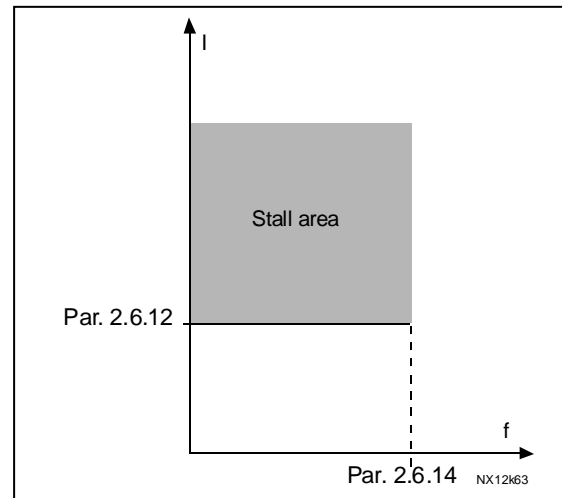

Figure 1- 18. Stall characteristics settings

### 2. 6.13 Stall time

This time can be set between 1.0 and 120.0s.

This is the maximum time allowed for a stall event detection. The stall time is counted by an internal up/down counter. If the stall time counter value goes above this limit the protection will cause a trip (see Figure 1- 19)

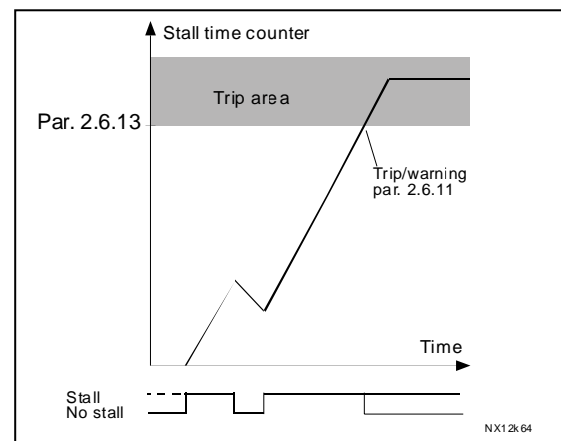

Figure 1- 19. Stall time count

### 2. 6.14 Maximum stall frequency

The frequency can be set between  $1-f_{max}$  ([par. 2.1.2](#)).

For a stall event to occur, the output frequency must have remained below this limit.

## Parameters 2.6.15—2.6.18, Underload protection:

### General

The purpose of the motor underload protection is to ensure that there is load on the motor when the drive is running. If the motor loses its load there might be a problem in the process, e.g. a broken belt or a dry pump.

Motor underload protection can be adjusted by setting the underload curve with parameters 2.6.16 (Field weakening area load) and 2.6.17 (Zero frequency load), see below. The underload curve is a squared curve set between the zero frequency and the field weakening point. The protection is not active below 5 Hz (the underload time counter is stopped).

The torque values for setting the underload curve are set in percentage which refers to the nominal torque of the motor. The motor's name plate data, the parameter Motor nominal current and the drive's nominal current  $I_L$  are used to find the scaling ratio for the internal torque value. If other than nominal motor is used with the drive, the accuracy of the torque calculation decreases.

### 2.6.15 Underload protection

0 = No response

1 = Warning

2 = Fault, stop mode after fault according to [parameter 2.1.10](#)

3 = Fault, stop mode after fault always by coasting

If tripping is set active the drive will stop and activate the fault stage.

Deactivating the protection by setting the parameter to 0 will reset the underload time counter.

### 2.6.16 Underload protection, field weakening area load

The torque limit can be set between 10.0—150.0 % x  $T_{nMotor}$ .

This parameter gives the value for the minimum torque allowed when the output frequency is above the field weakening point. See Figure 1- 20.

If you change the [parameter 2.1.7](#) (Motor nominal current) this parameter is automatically restored to the default value.

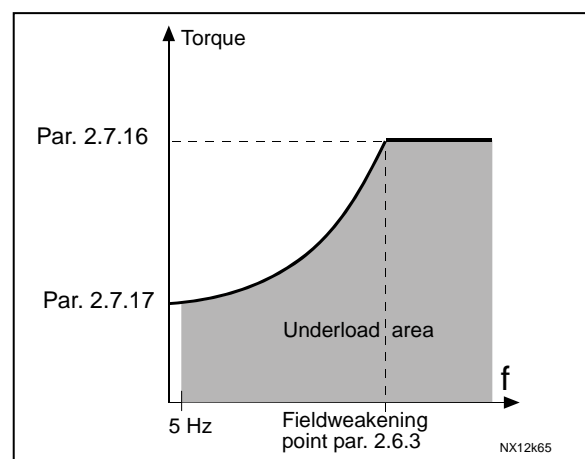

Figure 1- 20. Setting of minimum load

### 2.6.17 Underload protection, zero frequency load

The torque limit can be set between 5.0—150.0 % x  $T_{nMotor}$ .

This parameter gives value for the minimum torque allowed with zero frequency. See Figure 1- 20.

If you change the value of [parameter 2.1.7](#) (Motor nominal current) this parameter is automatically restored to the default value.

### 2.6.18 Underload time

This time can be set between 2.0 and 600.0 s.

This is the maximum time allowed for an underload state to exist. An internal up/down counter counts the accumulated underload time. If the underload counters value goes above this limit the protection will cause a trip according to [parameter 2.6.15](#). If the drive is stopped the underload counter is reset to zero. See Figure 1- 21.

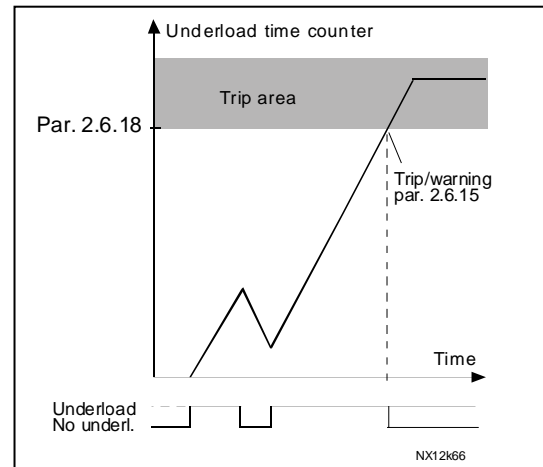

Figure 1- 21. Underload time counter function

### 2.6.19 Response to thermistor fault

0 = No response

1 = Warning

2 = Fault, stop mode after fault according to [parameter 2.1.10](#)

3 = Fault, stop mode after fault always by coasting

Setting the parameter to 0 will deactivate the protection.

### 2.6.20 Response to fieldbus fault

Set here the response mode for the fieldbus fault if a fieldbus board is used. For more information, see the respective Fieldbus Board Manual.

See [parameter 2.6.19](#).

### 2.6.21 Response to slot fault

Set here the response mode for a board slot fault due to missing or broken board.

See [parameter 2.6.19](#).

## 4.7 AUTO RESTART PARAMETERS

The automatic restart function is active if the value of [par. 2.1.17](#) = 1. There are always three restart trials

### 2.7.1 Automatic restart: Wait time

Defines the time before the frequency converter tries to automatically restart the motor after the fault has disappeared.

### 2.7.2 Automatic restart: Trial time

The Automatic restart function restarts the frequency converter when the faults have disappeared and the waiting time has elapsed.

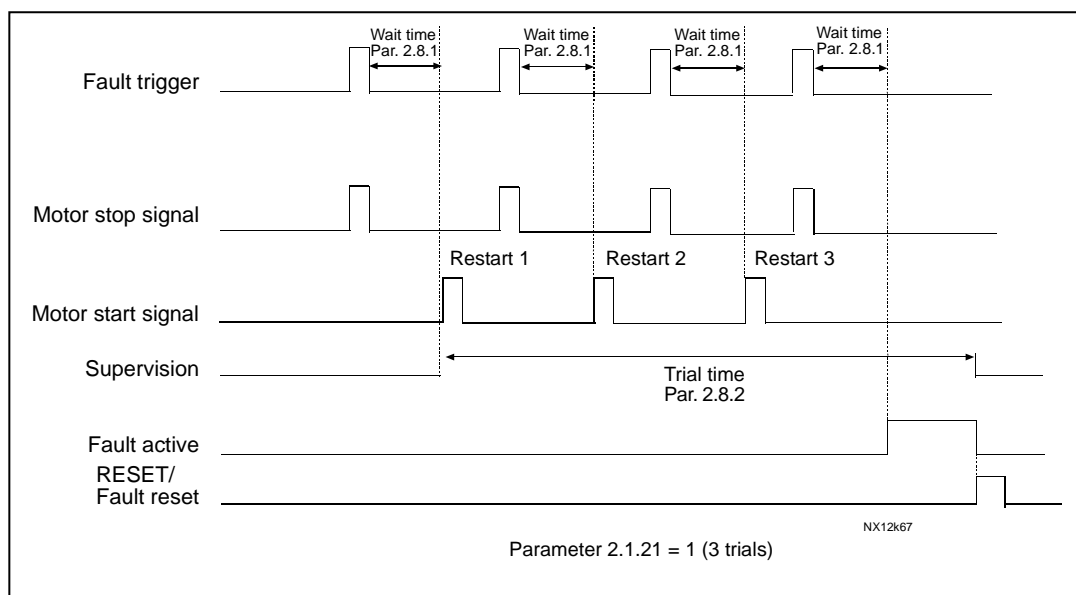

Figure 1- 22. Automatic restart.

The time count starts from the first autorestart. If the number of faults occurring during the trial time exceeds three, the fault state becomes active. Otherwise the fault is cleared after the trial time has elapsed and the next fault starts the trial time count again.

If a single fault remains during the trial time, a fault state is true.

### 2.7.3 Automatic restart, start function

The Start function for Automatic restart is selected with this parameter. The parameter defines the start mode:

- 0 = Start with ramp
- 1 = Flying start
- 2 = Start according to [par. 2.1.9](#)

4.8 LIFT DOOR PARAMETERS

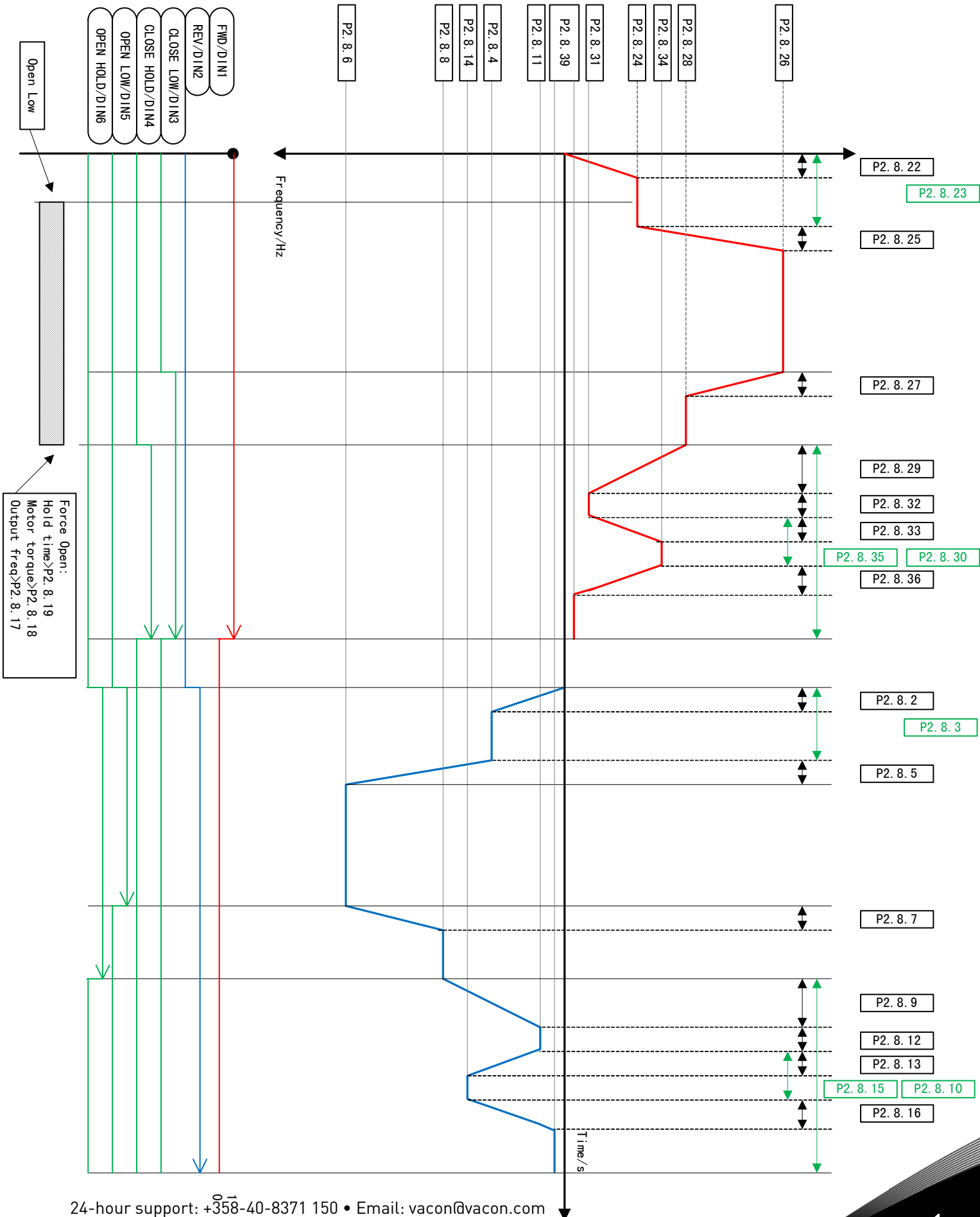

## 4.9 KEYPAD CONTROL PARAMETERS

### 3.1 *Control place*

The active control place can be changed with this parameter. For more information, see Vacon NXL User's Manual, Chapter 7.4.3.

### 3.2 *Keypad reference*

The frequency reference can be adjusted from the keypad with this parameter. For more information, see Vacon NXL User's Manual, Chapter 7.4.3.2.

### 3.3 *Keypad direction*

- 0 Forward: The rotation of the motor is forward, when the keypad is the active control place.
- 1 Reverse: The rotation of the motor is reversed, when the keypad is the active control place.

For more information, see Vacon NXL User's Manual, Chapter 7.4.3.3.

### 3.4 *Stop button activated*

If you wish to make the Stop button a "hotspot" which always stops the drive regardless of the selected control place, give this parameter the value 1 (default). See Vacon NXL User's Manual, Chapter 7.4.3.

See also parameter 3.1.

5. CONTROL SIGNAL LOGIC

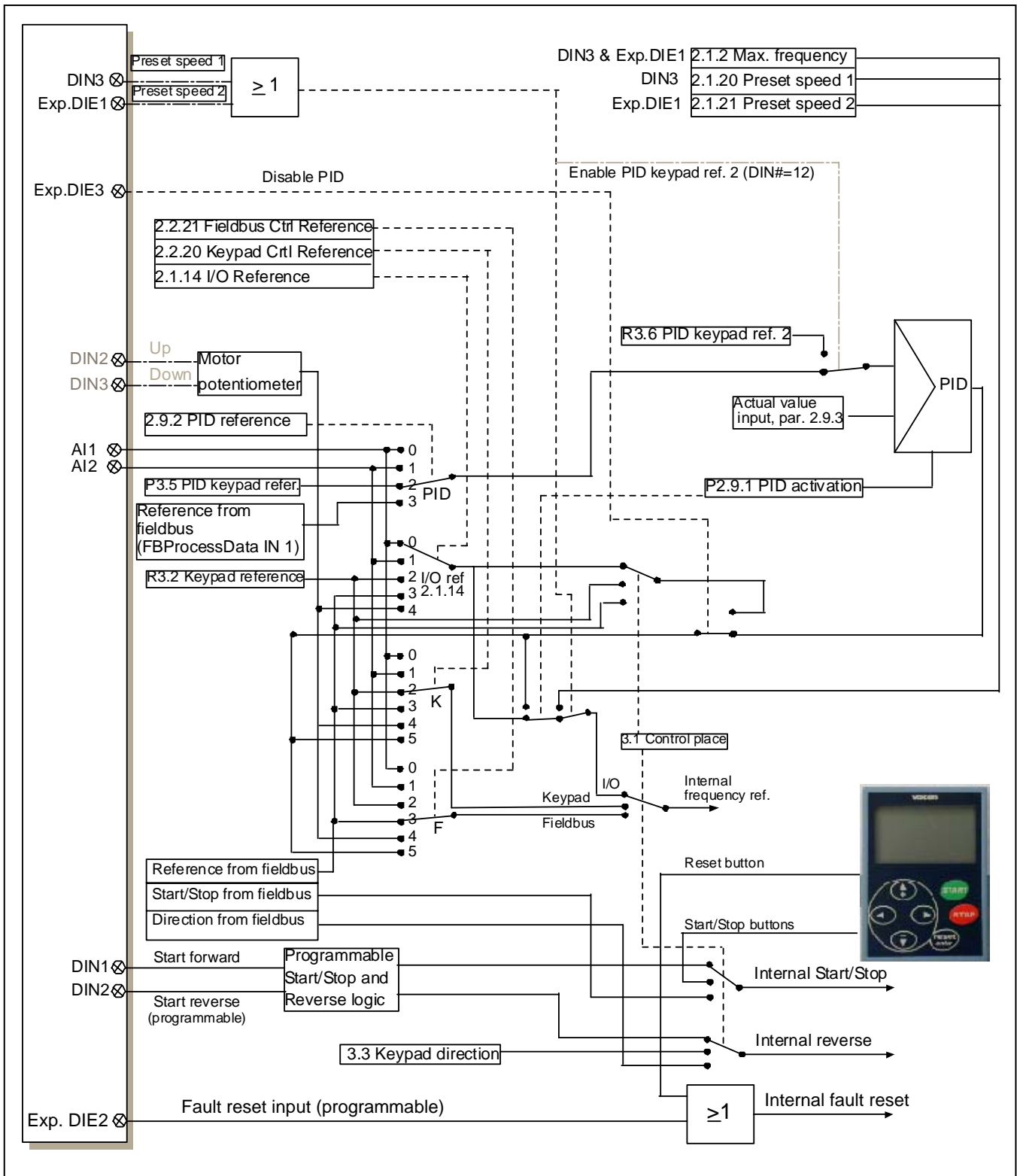

Figure 1- 23. Control signal logic of the Lift Door Application

## 6. FAULT TRACING

When a fault is detected by the frequency converter control electronics, the drive is stopped and the symbol **F** together with the ordinal number of the fault and the fault code appear on the display. The fault can be reset with the *Reset button* on the control keypad or via the I/O terminal. The faults are stored in the Fault history menu (H5) which can be browsed. The different fault codes you will find in the table below.

The fault codes, their causes and correcting actions are presented in the table below. The shadowed faults are A faults only. The items written in white on black background present faults for which you can program different responses in the application. See parameter group Protections.

Fault code	Fault	Possible cause	Correcting measures
1	Overcurrent	Frequency converter has detected too high a current ( $>4 \cdot I_n$ ) in the motor cable: <ul style="list-style-type: none"> <li>– sudden heavy load increase</li> <li>– short circuit in motor cables</li> <li>– unsuitable motor</li> </ul>	Check loading. Check motor size. Check cables.
2	Overvoltage	The DC-link voltage has exceeded the limits defined in. <ul style="list-style-type: none"> <li>– too short a deceleration time</li> <li>– high overvoltage spikes in utility</li> </ul>	Make the deceleration time longer.
3	Earth fault	Current measurement has detected that the sum of motor phase current is not zero. <ul style="list-style-type: none"> <li>– insulation failure in cables or motor</li> </ul>	Check motor cables and motor.
8	System fault	<ul style="list-style-type: none"> <li>- component failure</li> <li>- faulty operation</li> </ul>	Reset the fault and restart. Should the fault re-occur, contact the distributor near to you.
9	Undervoltage	DC-link voltage is under the voltage limits defined in. <ul style="list-style-type: none"> <li>– most probable cause: too low a supply voltage</li> <li>– frequency converter internal fault</li> </ul>	In case of temporary supply voltage break reset the fault and restart the frequency converter. Check the supply voltage. If it is adequate, an internal failure has occurred. Contact the distributor near to you.
11	Output phase supervision	Current measurement has detected that there is no current in one motor phase.	Check motor cable and motor.
13	Frequency converter under-temperature	Heatsink temperature is under $-10^{\circ}\text{C}$	
14	Frequency converter overtemperature	Heatsink temperature is over $90^{\circ}\text{C}$ .  Overtemperature warning is issued when the heatsink temperature exceeds $85^{\circ}\text{C}$ .	Check the correct amount and flow of cooling air. Check the heatsink for dust. Check the ambient temperature. Make sure that the switching frequency is not too high in relation to ambient temperature and motor load.
15	Motor stalled	Motor stall protection has tripped.	Check motor.



Fault code	Fault	Possible cause	Correcting measures
16	Motor overtemperature	Motor overheating has been detected by frequency converter motor temperature model. Motor is overloaded.	Decrease the motor load. If no motor overload exists, check the temperature model parameters.
17	Motor underload	Motor underload protection has tripped.	
22	EEPROM checksum fault	Parameter save fault – faulty operation – component failure	Contact the distributor near to you
24	Counter fault	Values displayed on counters are incorrect	
25	Microprocessor watchdog fault	– faulty operation – component failure	Reset the fault and restart. Should the fault re-occur, contact the distributor near to you.
29	Thermistor fault	The thermistor input of option board has detected increase of the motor temperature	Check motor cooling and loading Check thermistor connection (If thermistor input of the option board is not in use it has to be short circuited)
34	Internal bus communication	Ambient interference or defective hardware	Should the fault re-occur, contact the distributor near to you.
35	Application fault	Selected application does not function.	Contact the distributor near to you.
39	Device removed	Option board removed. Drive removed.	Reset
40	Device unknown	Unknown option board or drive.	Contact the distributor near to you.
41	IGBT temperature	IGBT Inverter Bridge overtemperature protection has detected too high a motor current.	Check loading. Check motor size.
44	Device change	Option board changed. Option board has default settings.	Reset
45	Device added	Option board added.	Reset
50	Analogue input $I_{in}$ < 4mA (selected signal range 4 to 20 mA)	Current at the analogue input is < 4mA. – control cable is broken or loose – signal source has failed	Check the current loop circuitry.
51	External fault	Digital input fault. Digital input has been programmed as external fault input and this input is active.	Check the programming and the device indicated by the external fault information. Check also the cabling of this device.
52	Keypad communication fault	The connection between the control keypad and the frequency converter is broken.	Check keypad connection and possible keypad cable.
53	Fieldbus fault	The data connection between the fieldbus Master and the fieldbus board is broken	Check installation. If installation is correct contact the nearest Vacon distributor.
54	Slot fault	Defective option board or slot	Check board and slot. Contact the nearest Vacon distributor.

Fault code	Fault	Possible cause	Correcting measures
55	Actual value supervision	Actual value has exceeded or fallen below (depending on par. 2.7.22) the actual value supervision limit (par. 2.7.23)	
60	Open low DIN	Open low DIN or switch broken	Check open low DIN or motor
61	Open hold DIN	Open hold DIN or switch broken	Check open hold DIN or motor
62	Close low DIN	Close low DIN or switch broken	Check close low DIN or motor
63	Close hold DIN	Close hold DIN or switch broken	Check close hold DIN or motor

Table 1- 15. Fault code