

**VACON<sup>®</sup> NX**

**AC DRIVES**

**APF1FF08 ADVANCED  
APPLICATION MANUAL**

**VACON<sup>®</sup>**



# VACON ADVANCED APPLICATION MANUAL

## INDEX

Document code: DPD01973  
 Software code: APFIFF08V235  
 Date: 3.9.2019

<b>1. Advanced Application - introduction .....</b>	<b>7</b>
1.1 General .....	7
1.2 Basic Features.....	8
1.3 Fast response .....	8
<b>2. Version parameter compatibility issues .....</b>	<b>9</b>
<b>3. Commissioning notes .....</b>	<b>10</b>
3.1 Frequency scale.....	10
3.2 Parameter download .....	10
<b>4. Control I/O .....</b>	<b>11</b>
<b>5. "Terminal To Function" (TTF) programming principle.....</b>	<b>12</b>
5.1 Defining an input/output for a certain function on keypad .....	12
5.2 Defining a terminal for a certain function with NCDrive programming tool .....	13
5.3 Defining unused inputs/outputs.....	14
<b>6. Advance Application – Monitoring values .....</b>	<b>15</b>
6.1 Monitoring values (Control keypad: menu M1) .....	16
6.1.1 Monitoring values 2 (Control keypad: menu M1.23).....	17
6.1.2 FieldBus Monitoring values (Control keypad: menu M1.24) .....	18
6.2 Monitoring values description.....	19
6.2.1 Monitoring values 2.....	22
6.2.2 FieldBus Monitoring values.....	26
<b>7. Advanced Application – Parameter List .....</b>	<b>31</b>
7.1 Basic parameters (Control keypad: Menu M2 → G2.1).....	31
7.2 Reference Handling .....	32
7.2.1 Basic Settings .....	32
7.2.2 Constant Reference .....	32
7.2.3 Torque Reference.....	33
7.2.4 Prohibit frequency parameters (Control keypad: Menu M2 → G2.5).....	34
7.2.5 Motor Potentiometer (Control keypad: Menu M2 → G2.5).....	34
7.2.6 Adjust Reference .....	34
7.3 Ramp Control .....	35
7.3.1 Basic Settings .....	35
7.3.2 Ramp Control Options .....	35
7.4 Input Signals .....	36
7.4.1 Basic Settings .....	36
7.4.2 Digital inputs (Control keypad: Menu M2 → G2.2.4) .....	37
7.4.3 Analogue input 1 (Control keypad: Menu M2 → G2.2.2) .....	38
7.4.4 Analogue input 2 (Control keypad: Menu M2 → G2.2.3) .....	38
7.4.5 Analogue input 3 (Control keypad: Menu M2 → G2.2.4) .....	39
7.4.6 Analogue input 4 (Control keypad: Menu M2 → G2.2.5) .....	39
7.4.7 Options .....	39

7.5	Output Signals .....	40
7.5.1	Digital output signals (Control keypad: Menu M2 → G2.3.3) .....	40
7.5.2	Analogue output 1 (Control keypad: Menu M2 → G2.3.5) .....	41
7.5.3	Analogue output 2 (Control keypad: Menu M2 → G2.3.6) .....	41
7.5.4	Analogue output 3 (Control keypad: Menu M2 → G2.3.7) .....	42
7.5.5	Delayed digital output 1 (Keypad: Menu M2 → G2.3.1) .....	42
7.5.6	Delayed digital output 2 (Keypad: Menu M2 → G2.3.2) .....	43
7.5.7	Supervision Limits .....	43
7.6	Limit Settings .....	44
7.6.1	Current handling .....	44
7.6.2	Power Handling .....	44
7.6.3	Torque Handling .....	45
7.6.4	Frequency Handling .....	45
7.6.5	DC-Link Handling .....	46
7.7	Flux and DC Current handling .....	47
7.7.1	Flux and DC Current handling OL Settings .....	47
7.7.2	Flux and DC Current handling CL Settings .....	47
7.8	Motor Control .....	48
7.8.1	Motor Control Basic Settings .....	48
7.8.2	U/f Settings .....	48
7.8.3	Closed Loop Control Settings .....	48
7.8.4	PMSM Control settings .....	49
7.8.5	Stabilators .....	49
7.8.6	Tuning parameters .....	50
7.8.7	Identification parameters (Control keypad: Menu M2 → G2.6.6) .....	51
7.8.8	Fine tuning parameters .....	51
7.9	Speed Control .....	52
7.9.1	Speed Control Basic settings .....	52
7.9.2	Speed Control OL Settings .....	52
7.9.3	Speed Control CL Settings .....	52
7.10	Drive Control .....	53
7.11	Master Follower Control Parameters (Control keypad: Menu M2 → G2.5) .....	54
7.12	Protections (Control keypad: Menu M2 → G2.7) .....	55
7.12.1	Common settings .....	55
7.12.2	Temperature sensor protections .....	55
7.12.3	Stall Protection .....	56
7.12.4	Speed error monitoring .....	56
7.12.5	Motor thermal protections .....	56
7.12.6	Living Zero monitoring .....	56
7.12.7	Underload protection .....	57
7.12.8	Earth Fault protection .....	57
7.12.9	Fieldbus protection .....	57
7.13	Fieldbus parameters (Control Keypad: Menu M2 → G2.9) .....	58
7.14	ID Control Functions .....	59
7.14.1	Value Control (Keypad: Menu M2 → G2.2.9) .....	59
7.14.2	DIN ID Control 1 .....	59
7.14.3	DIN ID Control 2 .....	59
7.14.4	DIN ID Control 3 .....	60
7.15	Brake Control (Control keypad: Menu M2 → G2.15) .....	60
7.15.1	Brake Control Start up torque for CL .....	60
7.16	Autorestart parameters (Control keypad: Menu M2 → G2.8) .....	61
7.17	Keypad control (Control keypad: Menu M3) .....	62
7.18	System menu (Control keypad: Menu M6) .....	62
7.19	Expander boards (Control keypad: Menu M7) .....	62
<b>8.</b>	<b>Description of parameters .....</b>	<b>63</b>
8.1	Basic Parameters .....	63

8.2	Reference Handling – “Ref Handling” .....	73
8.2.1	Basic Parameters .....	74
8.2.2	Constant Reference .....	78
8.2.3	Torque Reference .....	79
8.2.4	Prohibited frequencies .....	85
8.2.5	Motor potentiometer .....	86
8.2.6	Adjust Reference .....	87
8.3	Ramp control .....	89
8.3.1	Ramp Options .....	93
8.4	Input signals .....	94
8.4.1	Basic Settings .....	94
8.4.2	Digital inputs .....	96
8.4.3	Analogue Input 1 & 2 .....	101
8.4.4	Analogue input 3 & 4 .....	106
8.4.5	Inversion control .....	109
8.5	Output signals .....	110
8.5.1	Digital output signals .....	110
8.5.2	Analogue outputs 1 & 2 & 3 .....	115
8.5.3	Delayed Digital Output 1 & 2 .....	119
8.5.4	Supervision limits .....	122
8.6	Limit settings .....	124
8.6.1	Current limit handling .....	124
8.6.2	Power limit handling .....	125
8.6.3	Torque limit handling .....	127
8.6.4	Frequency limit handling .....	129
8.6.5	DC Link handling .....	131
8.7	DC current and magnetization handling .....	135
8.7.1	Open loop settings .....	135
8.7.2	Closed loop settings .....	139
8.8	Motor Control .....	141
8.8.1	U/f Settings .....	144
8.8.2	Close Loop Settings .....	148
8.8.3	Permanent magnet synchronous motor settings .....	151
8.8.4	Stabilator settings .....	156
8.8.5	Tuning settings .....	157
8.8.6	Identification settings .....	158
8.9	Speed Control settings .....	160
8.10	Drive Control .....	165
8.11	Master Follower .....	168
8.11.1	Master Follower: Standard system .....	168
8.11.2	Master follower configuration .....	169
8.12	Protections .....	173
8.12.1	General settings .....	173
8.12.2	Temperature sensor protections .....	175
8.12.3	Stall protection .....	176
8.12.4	Speed Error .....	178
8.12.5	Motor Protection .....	179
8.12.6	4mA Protection .....	181
8.12.7	Underload protection .....	182
8.12.8	Earth Fault .....	184
8.12.9	Fieldbus communication .....	185
8.13	Fieldbus settings .....	187
8.13.1	General settings .....	187
8.14	ID Functions .....	192
8.14.1	Value Control .....	192
8.14.2	DIN ID Control .....	194
8.14.3	DIN ID Control 2 .....	195

---

8.14.4	DIN ID Control 3 .....	196
8.15	Brake Control.....	197
8.15.1	Brake monitoring function.....	201
8.15.2	Closed Loop settings.....	202
8.16	Auto Fault Reset .....	203
8.17	Keypad control parameters.....	206
<b>9.</b>	<b>Identification function for permanent magnet synchronous motor.....</b>	<b>207</b>
9.1	Identification with absolute encoder.....	207
9.2	Identification with incremental encoder without Z-pulse input.....	207
9.3	Identification with incremental encoder with Z-pulse input.....	208
<b>10.</b>	<b>Problem solving .....</b>	<b>209</b>
<b>11.</b>	<b>Fault codes.....</b>	<b>210</b>

# 1. ADVANCED APPLICATION - INTRODUCTION

Software APFIFF08, Advanced application

## 1.1 General

This application is not backwards compatible. Please read the application change note or chapter 2 Version parameter compatibility issues in this application manual to see what needs to be noted when updating the application. See also the updated parameter description in NCDrive when commissioning.

Help is available in NCDrive through selecting “Variable Text” and pressing “F1”. Below an example from Identification parameter help text from the NCDrive.

Index	Variable Text	Value	Unit	Min	Max	ID
P 2.1.1	Supply Voltage	690	V	0	1000	1201
P 2.1.2	Motor Nom Voltg	550	V	20	690	110
P 2.1.3	Motor Nom Freq	80,00	Hz	6,00	320,00	111
P 2.1.4	Motor Nom Speed	4800	rpm	24	20000	112
P 2.1.5	Motor Nom Currnt	2060	A	0	4120	113
P 2.1.6	Motor Cos Phi	0,85		0,30	1,00	120
P 2.1.7	Motor Nom Power	1890	kW	0	32700	116
P 2.1.8	MagnCurrent	0	A	0	4120	612
P 2.1.9	Identification	0 / No Action		0	5	631
P 2.1.10	Motor Type	1 / PMSM		0	1	650

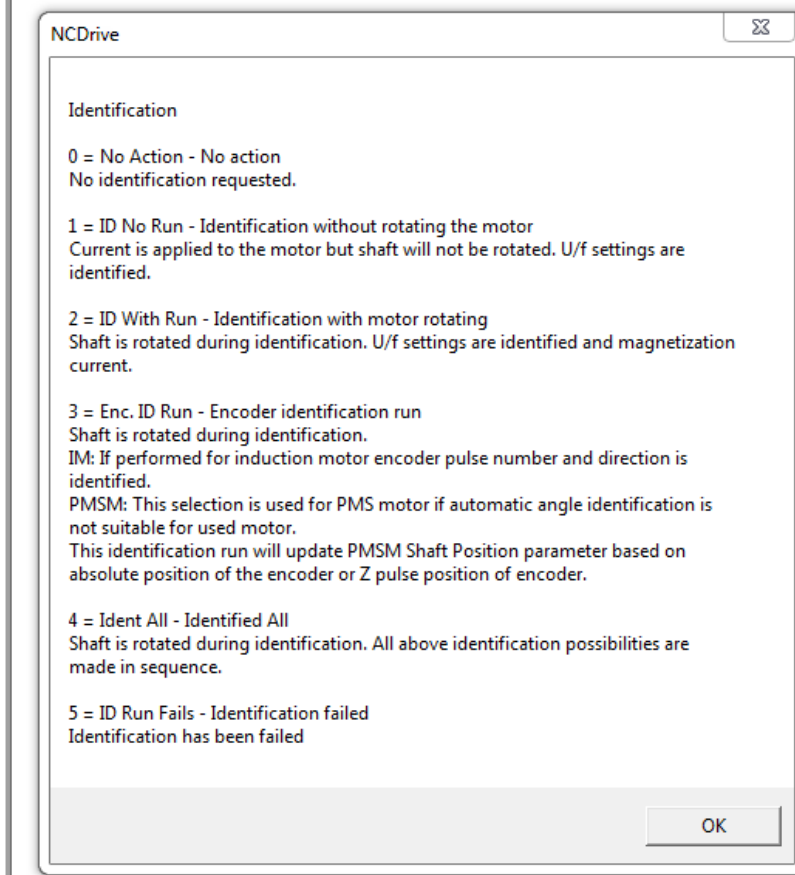

## 1.2 Basic Features

Advanced application provides a wide range of parameters for controlling motors. It can be used for various kinds of different processes, where wide flexibility of I/O signals is needed and PID-control is not necessary (if you need PID-control functions, use the PID Control Application or Pump and Fan Control Application).

The frequency reference can be selected e.g. from the analogue inputs, joystick control, motor potentiometer and from a mathematical function of the analogue inputs. There are parameters also for Fieldbus communication. Multi-step speeds and jogging speed can also be selected if digital inputs are programmed for these functions.

## 1.3 Fast response

This application digital inputs and analogue inputs are handled in 1 ms time level.

- A type option boards.
- By using hardware bypassing filtering function to OPT-A1 option board
  - o See ID1084 Control Options

Support for Fast Profibus profile

- When fast mode is activated it's not possible to use B-type boards.
- Only bypass mode can be used when fast Profibus mode is activated.
- Service data is not supported by fast Profibus

Additional functions:

- Power limit functions
- Different power limits for motoring and generating side
- Master Follower function
- Different torque limits for motoring and generating side
- Cooling monitor input from heat exchange unit
- Brake monitoring input and actual current monitor for immediate brake close.
- Separate speed control tuning for different speeds and loads
- Inching function two different references
- Possibility to connect the FB Process data to any parameter and some monitoring values
- Analogue input 3 and 4 can control any parameter by ID number.
- Possibility to control single parameters with digital inputs.
- Redundant Profibus; possibility to connect two PB masters to control same drive, freezing of control values and changing control slot in case of FBFault.



## 2. VERSION PARAMETER COMPATIBILITY ISSUES

- **V200 Major compatibility issue:**

- **ID numbers has been changed to be more compatible with APFIFF09 (Marine) and APFIFF40 (SIA-II) applications:**

○ FreqRefInterp. TC:	ID1780 -> ID1184
○ Torque Scale:	ID1601 -> ID1247
○ DeadTimeComp.	ID1580 -> ID1751
○ DeadTimeContCurL	ID1581 -> ID1752
○ DeadTHWComp.Disa	ID1704 -> ID1750
○ ContrInSignal ID	ID1582 -> ID1580
○ Contrl Off Limit	ID1583 -> ID1581
○ Contrl On Limit	ID1584 -> ID1582
○ Contrl Off Value	ID1585 -> ID1583
○ Contrl On Value	ID1586 -> ID1584
○ ControlOutSignID	ID1587 -> ID1585
○ Control Mode	ID1588 -> ID1586
○ Control Filt TC	ID1589 -> ID1721
○ I/f Control Lim	ID1608 -> ID1790
○ I/f Current	ID1609 -> ID1693
○ FBFaultDelay	ID1500 -> ID1850
○ ID Control DI B1	ID1574 -> ID1277
○ B10 Value	ID1578 -> ID1193
○ B11 Value	ID1575 -> ID1182
○ Ramp Rate	ID1579 -> DI1112

### 3. COMMISSIONING NOTES

#### 3.1 Frequency scale

This application support output frequency up to 599 Hz. if higher output frequencies are needed ask APFIFFO8 Advanced HS application from Vacon technical support and guidance to how to obtain license key for high speed operations.

#### 3.2 Parameter download

Before downloading parameters to drive it is recommended to select first frequency range and after that download parameters to drive. Parameter to select frequency range is P2.1.12 Frequency Scale.

4. CONTROL I/O

NXOPTA1		Terminal	Signal	Description
		1	+10V <sub>ref</sub>	Reference voltage output Voltage for potentiometer, etc.
		2	AI1+	Analogue input 1. Range 0-10V, R <sub>i</sub> = 200Ω Range 0-20 mA R <sub>i</sub> = 250Ω Analogue input 1 frequency reference. Input range selected by jumpers. Default range: Voltage 0 – 10 V
		3	AI1-	I/O Ground Ground for reference and controls
		4	AI2+	Analogue input 2. Range 0-10V, R <sub>i</sub> = 200Ω Range 0-20 mA R <sub>i</sub> = 250Ω Analogue input 2 frequency reference Input range selected by jumpers. Default range: Current 0 – 20 mA
		5	AI2-	
		6	+24V	Control voltage output Voltage for switches, etc. max 0.1 A
		7	GND	I/O ground Ground for reference and controls
		8	DIN1	Start forward Programmable G2.2.7 Contact closed = start forward Programmable start logic P2.2.1
		9	DIN2	Start reverse Programmable G2.2.7 Contact closed = start reverse Programmable logic P2.2.1
		10	DIN3	Fault reset Programmable G2.2.7 Contact open = no fault Contact closed = fault
		11	CMA	Common for DIN 1–DIN 3 Connect to GND or +24V
		12	+24V	Control voltage output Voltage for switches (see #6)
		13	GND	I/O ground Ground for reference and controls
		14	DIN4	Programmable G2.2.7 No function defined at default
		15	DIN5	Programmable G2.2.7 No function defined at default
		16	DIN6	Programmable G2.2.7 No function defined at default
		17	CMB	Common for DIN4–DIN6 Connect to GND or +24V
		18	AOA1+	Analogue output 1 Programmable P2.3.1.2 Output range selected by jumpers. Range 0–20 mA. R <sub>L</sub> , max. 500Ω Range 0–10 V. R <sub>L</sub> > 1kΩ
		19	AOA1-	
		20	DOA1	Digital output Programmable Open collector, I <sub>s</sub> ≤50mA, U <sub>s</sub> ≤48 VDC
NXOPTA2				
		21	RO1	Relay output 1 Programmable G2.3.3 Switching capacity 24 VDC / 8 A 250 VAC / 8 A 125 VDC / 0.4 A
		22	RO1	
		23	RO1	
		24	RO2	RELAY OUTPUT 2 Programmable G2.3.3 Programmable No function defined at default
		25	RO2	
		26	RO2	

Table 4-1. Advance application default I/O configuration and connection example.

Note: See Users Manual, chapter Control Connections, for hardware specification and configuration.

Note: See jumper selections below. More information in Vacon NX User's Manual, Chapter 6.2.2.2.

Jumper block X3: CMA and CMB grounding

- CMB connected to GND  
CMA connected to GND
- CMB isolated from GND  
CMA isolated from GND
- CMB and CMA internally connected together, isolated from GND

= Factory default

### 5. “TERMINAL TO FUNCTION” (TTF) PROGRAMMING PRINCIPLE

The programming principle of the input and output signals in the **Multipurpose Control Application NXP** as well as in the **Pump and Fan Control Application** (and partly in the other applications) is different compared to the conventional method used in other Vacon NX applications.

In the conventional programming method, *Function to Terminal Programming Method (FTT)*, you have a fixed input or output that you define a certain function for. The applications mentioned above, however, use the *Terminal to Function Programming method (TTF)* in which the programming process is carried out the other way round: Functions appear as parameters which the operator defines a certain input/output for. See *Warning* on page 13.

#### 5.1 Defining an input/output for a certain function on keypad

Connecting a certain input or output with a certain function (parameter) is done by giving the parameter an appropriate value. The value is formed of the *Board slot* on the Vacon NX control board (see Vacon NX User’s Manual, Chapter 6.2) and the *respective signal number*, see below.

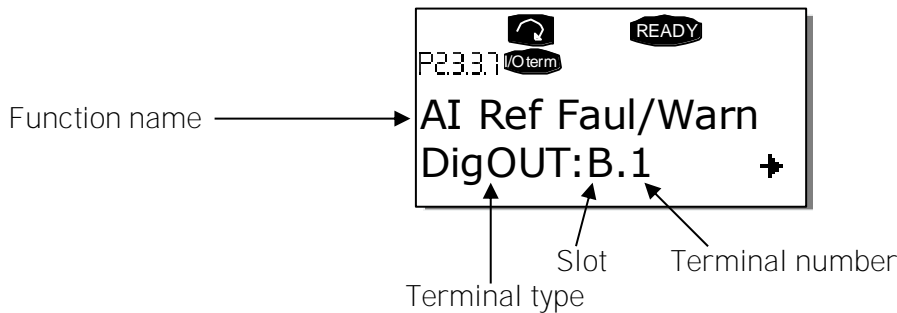

**Example:** You want to connect the digital output function *Reference fault/warning* (parameter 2.3.3.7) to the digital output DO1 on the basic board NXOPTA1 (see Vacon NX User’s Manual, Chapter 6.2).

First find the parameter 2.3.3.7 on the keypad. Press the *Menu button right* once to enter the edit mode. On the *value line*, you will see the terminal type on the left (DigIN, DigOUT, An.IN, An.OUT) and on the right, the present input/output the function is connected to (B.3, A.2 etc.), or if not connected, a value (0.#).

When the value is blinking, hold down the *Browser button up* or *down* to find the desired board slot and signal number. The program will scroll the board slots starting from 0 and proceeding from A to E and the I/O selection from 1 to 10.

Once you have set the desired value, press the *Enter button* once to confirm the change.

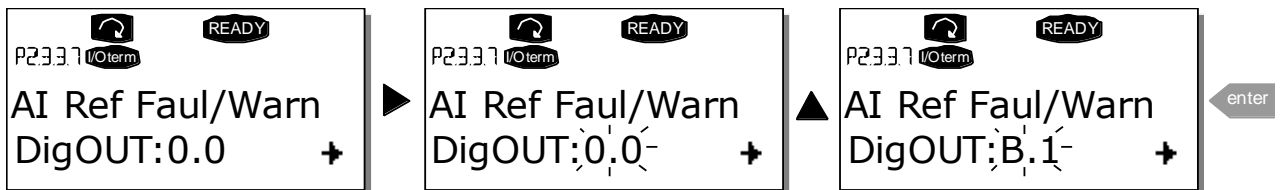

5.2 Defining a terminal for a certain function with NCDrive programming tool

If you use the NCDrive Programming Tool for parametrizing you will have to establish the connection between the function and input/output in the same way as with the control panel. Just pick the address code from the drop-down menu in the *Value* column (see the Figure below).

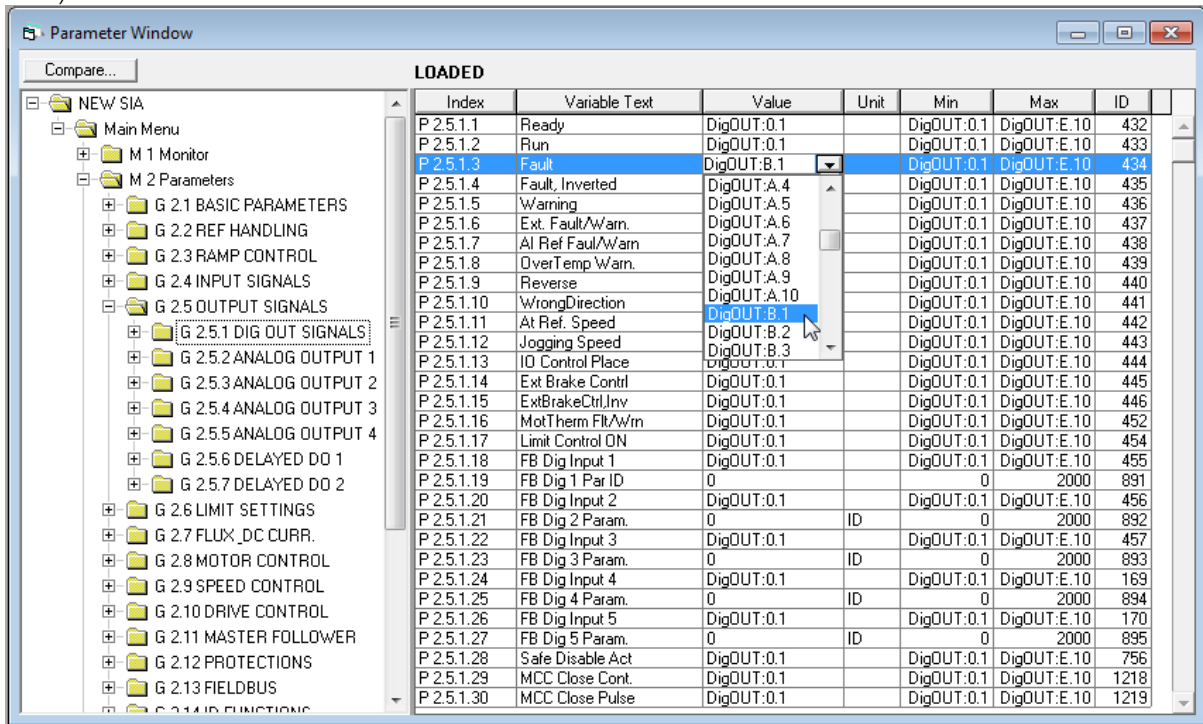



Figure 5-1. Screenshot of NCDrive programming tool; Entering the address code

 <b>WARNING</b>	Be <b>ABSOLUTELY</b> sure not to connect two functions to one and same <u>output</u> in order to avoid function overruns and to ensure flawless operation.
---	--

Note: The *inputs*, unlike the *outputs*, cannot be changed in RUN state.

### 5.3 Defining unused inputs/outputs

All unused inputs and outputs must be given the board slot value **0** and the value **1** also for the terminal number. The value **0.1** is also the default value for most of the functions.



However, if you want to use the **values of a digital input signal** for e.g. testing purposes only, you can set the board slot value to **0** and the terminal number to any number between **2...10** to place the input to a TRUE state. In other words, the value **1** corresponds to 'open contact' and values **2** to **10** to 'closed contact'.

In case of analogue inputs, giving the value **1** for the terminal number corresponds to 0% signal level, value **2** corresponds to 20%, value **3** to 30% and so on. Giving value **10** for the terminal number corresponds to 100% signal level.

## 6. ADVANCE APPLICATION – MONITORING VALUES

On the next pages you will find the lists of parameters within the respective parameter groups. The parameter descriptions are given on pages 63 to 202. Parameter description includes more than is available in this application see parameter list what is available.

### Column explanations:

Code	= Location indication on the keypad; Shows the operator the present parameter number
Parameter	= Name of parameter
Min	= Minimum value of parameter
Max	= Maximum value of parameter
Unit	= Unit of parameter value; Given if available
Default	= Value preset by factory
Cust	= <b>Customer's own setting</b>
ID	= ID number of the parameter
	= On parameter code: Parameter value can only be changed after the FC has been stopped.
	= Apply the Terminal to Function method (TTF) to these parameters (see chapter 5)
	= Monitoring value is possible to control from fieldbus by ID number

The manual presents signals that are not normally visible for monitoring, i.e. is not a parameter or standard monitoring signal. These signals are presented with [Letter]. e.g. [FW]MotorRegulatorStatus

[V]	Normal monitoring signal
[P]	Normal parameter in application.
[FW]	Firmware signal, Can be monitored with NCDrive when signal type is selected Firmware
[A]	Application signal, can be monitored with NCDrive when signal type is selected Application.
[R]	Reference type parameter on keypad.
[F]	Function. Signal is received as a output of function.
[DI]	Digital input signal.

## 6.1 Monitoring values (Control keypad: menu M1)

The monitoring values are the actual values of parameters and signals as well as statuses and measurements.

Code	Parameter	Unit	Form.	ID	Description
V1.1	Output frequency	Hz	#,##	1	Output frequency to motor
V1.2	Frequency reference	Hz	#,##	25	Frequency reference to motor control
V1.3	Motor speed	rpm	#	2	Motor speed in rpm
V1.4	Motor current	A	Varies	3	1 s linear filtering
V1.5	Motor torque	%	#,.	4	In % of Motor nominal torque
V1.6	Motor Power	%	#,.	5	
V1.7	Motor voltage	V	#,.	6	Calculated motor voltage
V1.8	DC link voltage	V	#	7	Measured DC voltage, filtered.
V1.9	Unit temperature	°C	#	8	Heatsink temperature
V1.10	Motor temperature	%	#	9	Calculated motor temperature
V1.11	Analogue input 1	%	#,##	13	AI1, unfiltered.
V1.12	Analogue input 2	%	#,##	14	AI2, unfiltered.
V1.13	Analogue input 3	%	#,##	27	AI3, unfiltered.
V1.14	Analogue input 4	%	#,##	28	AI4, unfiltered.
V1.15	Analogue Out 1	%	#,##	26	A01
V1.16	Analogue Out 2	%	#,##	31	A02
V1.17	Analogue Out 3	%	#,##	32	A03
V1.18	DIN1, DIN2, DIN3			15	Digital input statuses
V1.19	DIN4, DIN5, DIN6			16	Digital input statuses
V1.20	Torque reference	%	#,.	18	Used Torque Reference
V1.21	Sensor max Temp	C°	#,.	42	Highest temperature of OPTB8 board. 4 s filtering.
G1.22	Multimonitoring items				Displays three selectable monitoring values

Table 6-1. Monitoring values



## 6.1.1 Monitoring values 2 (Control keypad: menu M1.23)

Code	Parameter	Unit	Form.	ID	Description
V1.23.1	Current	A	Varies	1113	Unfiltered motor current
V1.23.2	Torque	%	#, #	1125	Unfiltered motor torque
V1.23.3	DC Voltage	V	#	44	Unfiltered DC link voltage
V1.23.4	Application Status Word			43	
V1.23.5	Encoder 1 Frequency	Hz	#, ##	1124	Unfiltered
V1.23.6	Output Power	kw	Varies	1508	Unfiltered electrical power
V1.23.7	Sensor 1 Temp	C°	#, #	50	4 s filtering.
V1.23.8	Sensor 2 Temp	C°	#, #	51	4 s filtering.
V1.23.9	Sensor 3 Temp	C°	#, #	52	4 s filtering.
V1.23.10	Sensor 4 Temp	C°	#, #	69	4 s filtering.
V1.23.11	Sensor 5 Temp	C°	#, #	70	4 s filtering.
V1.23.12	Sensor 6 Temp	C°	#, #	71	4 s filtering.
V1.23.13	ABS Encoder Revolutions	r	#	55	
V1.23.14	ABS Encoder Position		#	54	
V1.23.15	Actual Torque Reference	%	#, #		Final torque reference from speed control and/or torque control
V1.23.16	Final Frequency Reference	Hz	#, ##	1131	Final reference to speed controller.
V1.23.17	Step response	Hz	#, ##	1132	
V1.23.18	Encoder 2 Frequency	Hz	#, ##	53	
V1.23.19	ID Run Status			49	
V1.23.20	Pole Pair Number			58	
V1.23.21	Encoder 1 Frequency	Hz	#, ##	1164	
V1.23.22	ABS FreqOut	Hz	#, ##	1704	
V1.23.23	Identfail			98	
V1.23.24	Non Ready Cause		#	1608	
V1.23.25	Prevent MC Ready		#	1609	

Table 6-2. Monitoring values 2

## 6.1.2 FieldBus Monitoring values (Control keypad: menu M1.24)

Code	Parameter	Unit	Form.	ID	Description
V1.24.1	FB Control Word			1160	
V1.24.2	FB Speed Ref			875	
V1.24.3	FB Status Word			65	
V1.24.4	FB Actual Speed			865	
V1.24.5	FB Torque Reference	%	#, #	1140	Default Control of FB PD 1
V1.24.6	FB Limit Scaling	%	#, #, #	46	Default Control of FB PD 2
V1.24.7	FB Adjust Reference	%	#, #, #	47	Default Control of FB PD 3
V1.24.8	FB Analog Output	%	#, #, #	48	Default Control of FB PD 4
V1.24.9	FB Motor Current	A	#, #	45	Motor current (drive independent) given with one decimal point
V1.24.10	Fault Word 1			1172	
V1.24.11	Fault Word 2			1173	
V1.24.12	Warning Word 1			1174	
V1.24.13	Last Active Fault			37	
V1.24.14	Din Status Word			56	
V1.24.15	Din Status Word 2			57	
V1.24.16	MC Status			64	
V1.24.17	Last Active Warning			74	
V1.24.18	Shaft Rounds			1170	
V1.24.19	Shaft Angle			1169	
V1.24.20	FB Scale Speed			1703	

Table 6-3. FieldBus Monitoring values

## 6.2 Monitoring values description

**V1.1**      *Output frequency*      [#,## Hz]      ID1

Output frequency to motor, updated at 10 ms time level.

**V1.2**      *Frequency reference*      [#,## Hz]      ID 25

Frequency reference to motor control, after speed share function. updates at 1 ms time level.

**V1.3**      *Motor speed*                      [ # rpm]      ID 2

Motor speed in rpm

**V1.4**      *Motor current*                      [A]              ID 3

**Open loop:**

1 s linear filtering.

**Closed Loop:**

32 ms filtering

#### Current scaling in different size of units

Note: ID45, usually in Process data OUT 3 is scaled to be with one decimal always.

Voltage	Size	Scale
208 – 240 Vac	NX0001 – NX0011	100 – 0,01A
208 – 240 Vac	NX0012 – NX0420	10 – 0,1A
208 – 240 Vac	NX0530	1 – 1A
380 – 500 Vac	NX0003 – NX0007	100 – 0,01A
380 – 500 Vac	NX0009 – NX0300	10 – 0,1A
380 – 500 Vac	NX0385 – NX2643	1 – 1A
525 – 690 Vac	NX0004 – NX0013	100 – 0,01A
525 – 690 Vac	NX0018 – NX0261	10 – 0,1A
525 – 690 Vac	NX0325 – NX1500	1 – 1A

**V1.5**      *Motor torque*      %      ID 4

In % of Motor nominal torque

**Open loop**

1 s linear filtering

**Closed Loop**

32 ms filtering

*V1.6 Motor Power % ID 5*

Calculated motor power

*V1.7 Motor voltage V ID 6*

Calculated motor voltage

*V1.8 DC link voltage V ID 7*

Measured DC voltage, filtered.

*V1.9 Unit temperature •C ID 8*

Heatsink temperature

*V1.10 Motor temperature % ID 9*

Calculated motor temperature  
105 % is tripping limit if response is fault.

*V1.11 Analogue input 1% ID 13*

*V1.12 Analogue input 2% ID 14*

Unfiltered analogue input level.  
0 % = 0 mA / 0 V, -100 % = -10 V, 100 % = 20 mA / 10 V.  
Monitoring scaling is determined by the option board parameter.

*V1.13 Analogue input 3% ID 27*

*V1.14 Analogue input 4% ID 28*

It is possible to adjust this input value from fieldbus when the input terminal selection is 0.1. This way it is possible to adjust the free analogue input from fieldbus and have all analogue input functions available for fieldbus process data.

*V1.15 Analogue Out 1 % ID 26*

*V1.16 Analogue Out 2 % ID 50*

*V1.17 Analogue Out 3 % ID 51*

*V1.18 DIN1, DIN2, DIN3 ID 15*

*V1.19 DIN4, DIN5, DIN6 ID 16*

	DIN1/DIN2/DIN3 status	DIN4/DIN5/DIN6 status
<b>b0</b>	DIN3	DIN6
<b>b1</b>	DIN2	DIN5
<b>b2</b>	DIN1	DIN4

*V1.20 Torque reference % ID 18*

Torque reference value before load share.

V1.21 *PT-100 Temperature C° ID 42*

Highest temperature of OPTB8 board. 4 s filtering.

## 6.2.1 Monitoring values 2

**V1.23.1** *Current A* ID 1113

Unfiltered motor current, recommended signal for NCDrive monitoring.

**V1.23.2** *Torque %* ID 1125

Unfiltered motor torque, recommended signal for NCDrive monitoring.

**V1.23.3** *DC Voltage V* ID 44

Unfiltered DC link voltage, recommended signal for NCDrive monitoring.

**V1.23.4** *Application Status Word* ID 43

Application Status Word combines different drive statuses to one data word.  
Recommended signal for NCDrive monitoring.

Application Status Word ID43		
	FALSE	TRUE
b0	Flux not ready	Flux ready (>90 %)
b1	Not in Ready state	Ready
b2	Not Running	Running
b3	No Fault	Fault
b4	Direction Forward	Direction Reverse
b5	Emergency Stop Active	Emergency Stop NOT Active
b6	Run Disabled	Run Enable
b7	No Warning	Warning
b8		
b9		
b10		
b11	No DC Brake	DC Brake is active
b12	No Run Request	Run Request
b13	No Limit Controls Active	Limit control Active
b14	External Brake Control OFF	External Brake Control ON
b15		

**V1.23.5** *Encoder 1 Frequency Hz* ID 1124

Encoder frequency after filter. P2.8.4.6 Encoder1FiltTime.

**V1.23.6** *Output Power kw* ID 1508

Unfiltered electrical drive output power.

**V1.23.7** *Sensor 1 temperature C°* ID 50**V1.23.8** *Sensor 2 temperature C°* ID 51**V1.23.9** *Sensor 3 temperature C°* ID 52**V1.23.10** *Sensor 4 temperature C°* ID 69**V1.23.11** *Sensor 5 temperature C°* ID 70**V1.23.12** *Sensor 6 temperature C°* ID 71

Separate measurement from two temperature measurement boards. The signal has 4 s filtering time.

- V1.23.13 ABS Encoder Revolutions** *ID55*  
Absolute encoder revolution information.
- V1.23.14 ABS Encoder Position** *ID54*  
Absolute encoder position within one rotation. See encoder manual for scaling.
- V1.23.15 Actual Torque Reference** % *ID1180*  
Final torque reference from speed control and torque control. Also includes torque step and acceleration compensation factors.
- V1.23.16 Final Frequency Reference** Hz *ID 1131*  
Final reference to speed controller. After ramp generator and after Speed Step function, used for closed loop speed tuning when used together with Encoder 1 frequency.
- V1.23.17 Step response** Hz *ID 1132*  
Frequency error. Compares ramp output to actual encoder frequency with 0,001 Hz accuracy. Can be used for speed control tuning in closed loop control.
- V1.23.18 Encoder 2 freq** Hz *ID 53*
- V1.23.19 ID Run Status** *ID 49*  
Status of identification run. Bits are set if items are done successfully.
- V1.23.20 PolePairNumber** *ID 58*  
Pole pair number of the motor.
- V1.23.21 Encoder 1 freq** Hz *ID 1164*  
Unfiltered encoder frequency, directly from encoder.
- V1.23.22 ABS FreqOut** Hz *ID 1704*  
Absolute value from output frequency to motor.

**V1.23.23 Identfail****ID 98**

Failure code for failed identification:

- 1 = Current measurement offset
- 2 = Identification current level
- 3 = Acceleration time too long
- 4 = Identification frequency reference not reached
- 5 = Too low or high magnetization current
- 6 = Flux curve outside expected levels
- 7 = PMSM, Encoder zero position
- 8 = Too low maximum frequency limit
- 9 = PMSM, encoder zero pulse not found.
- 10 = Ls Identification timeout
- 11 = Ls Identification current

**V1.23.24 Non Ready Cause****ID 1608**

Non Ready Cause ID1608	
	Signal
b0	Fault is Active
b1	PreventMCReady is set
b2	Charge switch is open
b3	DC Voltage not OK
b4	Power unit state not OK
b5	StartUp Wizard is active
b6	Run Enable is not set
b7	Ready state prevented by STO
b8	
b9	
b10	
b11	
b12	
b13	
b14	
b15	



## V1.23.25 Prevent MC Ready

## ID 1609

Prevent MC Ready ID1609	
Signal	
b0	Endat option board (OPTBB, OPTBE) communication is not initialized after power-up.
b1	Drive sync master has wrong modulator or 1000ms task parameters are not initialized
b2	Drive sync follower delay is active
b3	Drive sync failure in sw modulator double period mode
b4	Charge switch delay is active
b5	AFE fast run disable through ENC C1 is active
b6	100ms task not executed
b7	
b8	
b9	
b10	
b11	
b12	
b13	
b14	
b15	

## 6.2.2 FieldBus Monitoring values

V1.24.1 *FB Control Word*

ID1160

Control word used in bypass mode. See P2.13.22 and option board ByPass.

Bit	Description	
	Value = 0	Value = 1
0	OFF	ON, Reset after Fault or b1 and b2
1	Emergency stop by coast	ON, On normal operation: Keep TRUE
2	Emergency stop by ramp	ON, On normal operation: Keep TRUE
3	STOP REQUEST	RUN REQUEST
4	Force ramp to Zero	Enable Ramp,
5	Freeze Ramp	Enable Ramp,
6	Force Ref to Zero	Enable Ramp,
7	No Action	FAULT RESET (0 -> 1)
8	No Action	Inching 1
9	No Action	Inching 2
10	Disable Profibus control	Enable Profibus control
11	Fieldbus DIN1=OFF	Fieldbus DIN1=ON (Watchdog pulse)
12	Fieldbus DIN2=OFF	Fieldbus DIN2=ON
13	Fieldbus DIN3=OFF	Fieldbus DIN3=ON
14	Fieldbus DIN4=OFF	Fieldbus DIN4=ON
15	No Action	No Action

V1.24.2 *FB Speed Reference*

ID 875

Speed reference value from fieldbus.

V1.24.3 *FB Status Word*

ID65

Profibus type status word. Generated in the application level.

Needs to be selected with P2.13.19 GSW to be used. When needed with profibus board, operation mode needs to be set to ByPass in option board and with P2.14.22 ProfiBus Mode select: 2 / ProfiDrive.

Bit	Description	
	Value = 0	Value = 1
0	Not ready to switch on	Ready to switch on
1	Not ready to operate	Ready to operate
2	Not Running	Running
3	No Fault	Fault
4	Coast stop Active	Coast stop not active
5	Quick stop active	Quick stop not active
6	Switch not inhibited	Switch on inhibit
7	No Warning	Warning
8	Speed error	Speed At Reference
9	No FB Control request	FB Control Active
10	Fout < Fmax	Fout > Fmax
11	not used	not used
12	not used	not used
13	not used	not used
14	not used	not used
15	Fieldbus DIN1=OFF	Fieldbus DIN1=ON (Watchdog pulse)

**V1.24.4** *FB Actual Speed* **ID 865**

Actual speed 0-100% from fieldbus.

**V1.24.5** *FB Torque Reference* **% ID 1140**

Torque reference value from fieldbus  
Default Control of FB PD 1

**V1.24.6** *FB Limit Scaling* **% ID 46**

Limit scaling input value from fieldbus.  
Default Control of FB PD 2.

**V1.24.7** *FB Adjust Reference* **% ID 47**

Reference adjustment value from fieldbus.  
Default Control of FB PD 3.

**V1.24.8** *FB Analog Output* **% ID 48**

Fieldbus value to control analogue output.  
Default Control of FB PD 4.

**V1.24.9** *FB Motor Current* **A ID 45**

Motor current (drive independent) given with one decimal point.

**V1.24.10** *Fault Word 1* **ID 1172**

Different faults are collected to two words that can be read from fieldbus or with NCDrive PC software.

Fault Word 1 ID1172		
	Fault	Comment
b0	Over Current or IGBT	F1, F31, F41
b1	Over Voltage	F2
b2	Under Voltage	F9
b3	Motor Stalled	F15
b4	Earth Fault	F3
b5	Motor Under Load	F17
b6	Drive over temperature	F14
b7	Over Temperature	F16, F56, F29
b8	Input Phase	F10
b9	Brake resistor over temperature	F42 (Not implemented)
b10	Device Changed	F37, F38, F39, F40, F44, F45 (Not implemented)
b11	Keypad or PCControl	F52
b12	FielBus	F53
b13	SystemBus	F59
b14	Slot	F54
b15	4 mA	F50

**V1.24.11 Fault Word 2 ID 1173**

Fault Word 2 ID1173		
	Fault	Comment
b0	Output phase	F11
b1	Charge Switch	F5 (Not implemented)
b2	Encoder	F43
b3	Inverter	F4, F7 (Not implemented)
b4		
b5	EEPROM	F22 (Not implemented)
b6	External	F51
b7	Brake Chopper	F12 (Not implemented)
b8	Watch Dog	F25 (Not implemented)
b9	IGBT	F31, F41
b10	Brake	F58
b11	Fan Cooling	F32
b12	Application	F35 (Not implemented)
b13	Control fault	F33, F36, F8 (Not implemented)
b14	Main Switch Open	F64 (Not implemented)
b15		

**V1.24.12 Warning Word 1 ID 1174**

Warning Word 1 ID1174		
	Fault	Comment
b0	Motor stalled	W15
b1	Motor over temperature	W16
b2	Motor under load	W17
b3	Input phase loss	W10
b4	Output phase loss	W11
b5	Safe disable	W30 (Not implemented)
b6	FieldBus communication fault in slot D	W53 (Not implemented)
b7	FieldBus communication fault in slot E	W67 (Not implemented)
b8	Drive over temperature	W14
b9	Analogue input < 4mA	W50
b10	Not used	
b11	Emergency stop	W63 (Not implemented)
b12	Run disabled	W62 (Not implemented)
b13	Not used	
b14	Mechanical Brake	W58
b15	Not used	

**V1.24.13 Fault History ID 37**

Fault number of the last active fault.

**V1.24.14 Din Status Word ID 56**

V1.24.15 *Din Status Word 2*

ID 57

	DIN StatusWord 1	DIN StatusWord 2
b0	DIN: A.1	DIN: C.5
b1	DIN: A.2	DIN: C.6
b2	DIN: A.3	DIN: D.1
b3	DIN: A.4	DIN: D.2
b4	DIN: A.5	DIN: D.3
b5	DIN: A.6	DIN: D.4
b6	DIN: B.1	DIN: D.5
b7	DIN: B.2	DIN: D.6
b8	DIN: B.3	DIN: E.1
b9	DIN: B.4	DIN: E.2
b10	DIN: B.5	DIN: E.3
b11	DIN: B.6	DIN: E.4
b12	DIN: C.1	DIN: E.5
b13	DIN: C.2	DIN: E.6
b14	DIN: C.3	
b15	DIN: C.4	

V1.24.16 *MC Status*

ID 64

This is the value that is also send to fieldbus on those fieldbus that do not use own state machine.

Motor Control Status Word		
	FALSE	TRUE
b0	Not in Ready state	Ready
b1	Not Running	Running
b2	Direction Clockwise	Counterclockwise
b3	No Fault	Fault
b4	No Warning	Warning
b5		At reference speed
b6		At Zero Speed
b7		Flux Ready
b8		TC Speed Limiter Active
b9	Encoder Direction	Counterclockwise
b10		Under Voltage Fast stop
b11	No DC brake	DC Brake is active
b12		
b13		Restart delay active
b14		
b15		

V1.24.17 *Warning*

ID 74

Last active warning.

**V1.24.18** *Shaft Rounds* **ID 1170**

Rounds information from incremental encoder. The value is reset when 24 Vdc is removed from the drive.

**V1.24.19** *Shaft Angle* **ID 1169**

Angle information from incremental encoder. The value is reset when 24 Vdc is removed from the drive.

**V1.24.20** *FB Scale Speed* **ID 1703**

## 7. ADVANCED APPLICATION – PARAMETER LIST

## 7.1 Basic parameters (Control keypad: Menu M2 → G2.1)

Code	Parameter	Min	Max	Unit	Default	Cust	ID	Note
P2.1.1	Frequency Scale	0	2		1		523	0 = 0,000 – 32,000 Hz 1 = 0,00 – 320,00 Hz 2 = 0,0 – 599,0 Hz
P2.1.2	RPM Format	0	4		0		1852	0 = Default 1 = #,# rpm 2 = # rpm 3 = #,## krpm 4 = #,# krpm
P2.1.3	Minimum frequency	0,00	P2.1.2	Hz	0,00		101	
P2.1.4	Maximum frequency	P2.1.1	320,00	Hz	50,00		102	<b>NOTE:</b> If $f_{max}$ > than the motor synchronous speed, check suitability for motor and drive system
P2.1.5	Motor nominal voltage	180	690	V	NX2: 230V NX5: 400V NX6: 690V		110	Check the rating plate of the motor. Note also used connection Delta/Star
P2.1.6	Motor nominal frequency	8,00	320,00	Hz	50,00		111	Check the rating plate of the motor
P2.1.7	Motor nominal speed	24	20 000	rpm	1440		112	The default applies for a 4-pole motor and a nominal size frequency converter.
P2.1.8	Motor nominal current	0,1 x I <sub>H</sub>	2 x I <sub>H</sub>	A	I <sub>H</sub>		113	Check the rating plate of the motor.
P2.1.9	Motor cosφ	0,30	1,00		0,85		120	Check the rating plate of the motor
P2.1.10	Motor Nominal Power	0,0	3200,0	kW	0,0		116	Check the rating plate of the motor
P2.1.11	Magnetizing current	0,00	100,00	A	0,00		612	0,00 A = Drive uses estimated value from motor name plate values
P2.1.12	Identification	0	5		0		631	0=No action 1=Identification w/o run 2=Identification with run 3=Encoder ID Run 4=Ident All 5=Absolute encoder, locked rotor <b>NOTE:</b> Set motor control mode to Freq Control before identification!
P2.1.13	Motor type	0	1		0		650	0=Induction Motor 1=PMS Motor
P2.1.14	Supply Voltage	0	1000		0		1201	

Table 7-1. Basic parameters G2.1

## 7.2 Reference Handling

## 7.2.1 Basic Settings

Code	Parameter	Min	Max	Unit	Default	Cust	ID	Note
P2.2.1	Torque Scale	0	1		0		1207	0 = 1000 = 100,0 % 1 = 10000 = 100,00 %
P2.2.2	I/O Reference	0	16		0		117	0=AI1 1=AI2 2=AI1+AI2 3=AI1-AI2 4=AI2-AI1 5=AI1xAI2 6=AI1 Joystick 7=AI2 Joystick 8=Keypad 9=Fieldbus 10=Motor potentiometer 11=AI1 , AI2 minimum 12=AI1 , AI2 maximum 13=Max frequency 14=AI1/AI2 selection 15=Encoder 1 16=Encoder 2
P2.2.3	Keypad reference selector	0	9		8		121	0=AI1 1=AI2 2=AI1+AI2 3=AI1-AI2 4=AI2-AI1 5=AI1xAI2 6=AI1 Joystick 7=AI2 Joystick 8=Keypad 9=Fieldbus
P2.2.4	Fieldbus control reference	0	9		9		122	See par. 2.2.2
P2.2.5	I/O Reference 2	0	16		1		131	See ID117 & ID422
P2.2.6	Speed Share	-300,00	300,00	%	100,00		1241	
P2.2.7	Load Share	0,0	500,0	%	100,0		1248	

## 7.2.2 Constant Reference

Code	Parameter	Min	Max	Unit	Default	Cust	ID	Note
P2.2.8.1	Jogging speed reference	0,00	320,00	Hz	5,00		124	
P2.2.8.2	Preset speed 1	0,00	320,00	Hz	10,00		105	Multi-step speed 1
P2.2.8.3	Preset speed 2	0,00	320,00	Hz	15,00		106	Multi-step speed 2
P2.2.8.4	Preset speed 3	0,00	320,00	Hz	20,00		126	Multi-step speed 3
P2.2.8.5	Preset speed 4	0,00	320,00	Hz	25,00		127	Multi-step speed 4
P2.2.8.6	Preset speed 5	0,00	320,00	Hz	30,00		128	Multi-step speed 5
P2.2.8.7	Preset speed 6	0,00	320,00	Hz	40,00		129	Multi-step speed 6
P2.2.8.8	Preset speed 7	0,00	320,00	Hz	50,00		130	Multi-step speed 7
P2.2.8.9	Inching reference 1	-320,00	320,00	Hz	2,00		1239	
P2.2.8.10	Inching reference 2	-320,00	320,00	Hz	-2,00		1240	



## 7.2.3 Torque Reference

Code	Parameter	Min	Max	Unit	Default	Cust	ID	Note
P2.2.9.1	Torque reference selection	0	8		0		641	0=Not used 1=A11 2=A12 3=A13 4=A14 5=A11 joystick (-10 – 10 V) 6=A12 joystick (-10 – 10 V) 7=Torque reference from keypad, R3.5 8=FB Torque Reference 9=Master Torque 10=Power Reference
P2.2.9.2	Torque reference max.	-300,0	300,0	%	100		642	
P2.2.9.3	Torque reference min.	-300,0	300,0	%	0,0		643	
P2.2.9.4	Torque reference filtering time	0	32000	ms	0		1244	
P2.2.9.5	Torque Reference Dead Zone	0,0	300,0	%	0,00		1246	
P2.2.9.6	Torque Select	0	5		2		1278	0 = Speed control 1 = Pos/neg freq limits 2 = RampOut (-/+) 3 = NegFreqLimit-RampOut 4 = RampOut-PosFreqLimit 5 = RampOut Window 6 = 0-RampOut 7 = RampOut Window On/Off
P2.2.9.7	Window negative	0,00	50,00	Hz	2,00		1305	
P2.2.9.8	Window positive	0,00	50,00	Hz	2,00		1304	
P2.2.9.9	Window negative off	0,00	P2.10.11	Hz	0,00		1307	
P2.2.9.10	Window positive off	0,00	P2.10.12	Hz	0,00		1306	

## 7.2.3.1 Torque Reference OL Settings

Code	Parameter	Min	Max	Unit	Default	Cust	ID	Note
P2.2.9.11.1	Open loop torque control minimum frequency	0,00	50,00	Hz	3,00		636	
P2.2.9.11.2	Open loop torque controller P gain	0	32000		150		639	
P2.2.9.11.3	Open loop torque controller I gain	0	32000		10		640	
P2.2.9.11.4	Torque speed limit for Open Loop	0	2		1		644	0=Max. frequency 1=Selected frequency ref. 2=Preset speed 7

7.2.3.2 *Torque Reference CL Settings*

Code	Parameter	Min	Max	Unit	Default	Cust	ID	Note
P2.2.9.12.1	Torque Step	-300,0	300,0	%	0,0		1253	

7.2.4 *Prohibit frequency parameters (Control keypad: Menu M2 → G2.5)*

Code	Parameter	Min	Max	Unit	Default	Cust	ID	Note
P2.2.10.1	Prohibit frequency range 1 low limit	-1,00	320,00	Hz	0,00		509	0=Not used
P2.2.10.2	Prohibit frequency range 1 high limit	0,00	320,00	Hz	0,00		510	0=Not used
P2.2.10.3	Ramp time factor	0,1	10,0	x	1,0		518	Multiplier of the currently Selected ramp time between prohibit frequency limits.

Table 7-2. Prohibit frequencies (G2.5)

7.2.5 *Motor Potentiometer (Control keypad: Menu M2 → G2.5)*

Code	Parameter	Min	Max	Unit	Default	Cust	ID	Note
P2.2.11.1	Motor potentiometer ramp rate	0,10	2000,00	Hz/s	1,00		331	Ramp rate for motor potentiometer
P2.2.11.2	Motor potentiometer frequency reference memory reset	0	2		1		367	0=No reset 1=Reset in stop state 2=Reset in powered down

Table 7-3. Motor potentiometer (G2.5)

7.2.6 *Adjust Reference*

Code	Parameter	Min	Max	Unit	Default	Cust	ID	Note
P2.2.12.1	Adjust input	0	5		0		493	0=Not used 1=AI1 2=AI2 3=AI3 4=AI4 5=Fieldbus
P2.2.12.2	Adjust minimum	0,0	100,0	%	0,0		494	Adjust limit to decrease ref.
P2.2.12.3	Adjust maximum	0,0	100,0	%	0,0		495	Adjust limit to increase ref.
P2.2.12.4	Speed step	-200,0	200,0	%	0		1252	

## 7.3 Ramp Control

## 7.3.1 Basic Settings

Code	Parameter	Min	Max	Unit	Default	Cust	ID	Note
P2.3.1	Start function	0	2		0		505	0=Ramp 1=Flying start 2=Conditional flying start
P2.3.2	Stop function	0	1		0		506	0=Coasting 1=Ramp
P2.3.3	Acceleration time 1	0,2	3270,0	s	3,0		103	0 Hz to Max frequency
P2.3.4	Deceleration time 1	0,2	3270,0	s	3,0		104	Max frequency to 0 Hz
P2.3.5	Ramp 1 shape	0	100	%	2		500	0=Linear >0=S-curve ramp time
P2.3.6	Acceleration time 2	0,2	3270,0	s	10,0		502	
P2.3.7	Deceleration time 2	0,2	3270,0	s	10,0		503	
P2.3.8	Ramp 2 shape	0	100	%	4		501	0=Linear >0=S-curve ramp time
P2.3.9	Inching Ramp	0,01	320,00	s	1,00		1257	
P2.3.10	Reducing of acc./dec. times	0	5		0		401	Scales active ramp from 100 % to 10 %. 0=Not used 1=AI1 2=AI2 3=AI3 4=AI4 5=Fieldbus
P2.3.11	IO Quick Stop Mode	0	1		0		1276	0=Coasting 1= Ramp

## 7.3.2 Ramp Control Options

Code	Parameter	Min	Max	Unit	Default	Cust	ID	Note
P2.3.12.1	Ramp Input Interpolator TC	0	200	ms	10		1184	

## 7.4 Input Signals

## 7.4.1 Basic Settings

Code	Parameter	Min	Max	Unit	Default	Cust	ID	Note		
P2.4.1.1	Start/Stop logic selection	0	7		0		300		Start signal 1 (Default: DIN1)	Start signal 2 (Default: DIN2)
								0	Start fwd	Start rvs
								1	Start/Stop	Reverse
								2	Start/Stop	Run enable
								3	Start pulse	Stop pulse
								4	Start	Mot.Pot UP
								5	Start fwd*	Start rvs*
								6	Start*/Stop	Reverse
7	Start*/Stop	Run Enable								

Table 7-4. Input signals: basic settings, G2.2.1

\* = Rising edge required to start

## 7.4.2 Digital inputs (Control keypad: Menu M2 → G2.2.4)

Code	Parameter	Min	Default	Cust	ID	Note
P2.4.2.1	Start signal 1	0.1	A.1		403	Forward, See ID300
P2.4.2.2	Start signal 2	0.1	A.2		404	Reverse. See ID300
P2.4.2.3	Run enable	0.1	0.2		407	Motor start enabled (cc)
P2.4.2.4	Reverse	0.1	0.1		412	Direction forward (oc) Direction reverse (cc)
P2.4.2.5	Preset speed 1	0.1	0.1		419	See preset speeds in basing parameter group G2.1
P2.4.2.6	Preset speed 2	0.1	0.1		420	
P2.4.2.7	Preset speed 3	0.1	0.1		421	
P2.4.2.8	Motor potentiometer reference DOWN	0.1	0.1		417	Mot.pot. reference decreases (cc)
P2.4.2.9	Motor potentiometer reference UP	0.1	0.1		418	Mot.pot. reference increases (cc)
P2.4.2.10	Fault reset	0.1	0.1		414	All faults reset (cc)
P2.4.2.11	External fault (close)	0.1	0.1		405	Ext. fault displayed (cc)
P2.4.2.12	External fault (open)	0.1	0.2		406	Ext. fault displayed (oc)
P2.4.2.13	Acc/Dec time selection	0.1	0.1		408	Acc/Dec time 1 (oc) Acc/Dec time 2 (cc)
P2.4.2.14	Acc/Dec prohibit	0.1	0.1		415	Acc/Dec prohibited (cc)
P2.4.2.15	DC braking	0.1	0.1		416	DC braking active (cc)
P2.4.2.16	Jogging speed	0.1	0.1		413	Jogging speed selected for frequency reference (cc)
P2.4.2.17	IO reference 1 / 2 selection	0.1	0.1		422	IO reference selection:14 ID117
P2.4.2.18	Control from I/O terminal	0.1	0.1		409	Force control place to I/O terminal (cc)
P2.4.2.19	Control from keypad	0.1	0.1		410	Force control place to keypad (cc)
P2.4.2.20	Control from fieldbus	0.1	0.1		411	Force control place to fieldbus (cc)
P2.4.2.21	Parameter set 1/set 2 selection	0.1	0.1		496	Closed cont.=Set 2 is used Open cont.=Set 1 is used
P2.4.2.22	Motor control mode 1/2	0.1	0.1		164	Closed cont.=Mode 2 is used Open cont.=Mode 1 is used See par 2.6.1, 2.6.12
P2.4.2.23	External Brake Acknowledge	0.1	0.2		1210	Monitoring signal from mechanical brake
P2.4.2.24	Cooling Monitor	0.1	0.2		750	Used when water cooled unit
P2.4.2.25	Enable Inching	0.1	0.1		532	Enables Inching function
P2.4.2.26	Inching 1	0.1	0.1		531	Inching reference 1 (Default Forward 2 Hz. See P2.4.16). <b>This will start the drive.</b>
P2.4.2.27	Inching 2	0.1	0.1		532	Inching reference 2 (Default Reverse -2 Hz. See P2.4.17). <b>This will start the drive.</b>
P2.4.2.28	Reset Position	0.1	0.1		1090	
P2.4.2.29	MF Mode 2	0.1	0.1		1092	
P2.4.2.30	Emergency Stop	0.1	0.2		1213	
P2.4.2.31	Input Switch Ack	0.1	0.1		1209	

Table 7-5. Digital input signals, G2.2.4

cc = closing contact  
oc = opening contact

## 7.4.3 Analogue input 1 (Control keypad: Menu M2 → G2.2.2)

Code	Parameter	Min	Max	Unit	Default	Cust	ID	Note
P2.4.3.1	A11 signal selection	0.1	E.10		A.1		377	Slot . Board input No.
P2.4.3.2	A11 filter time	0,000	32,000	s	0,000		324	0=No filtering
P2.4.3.3	A11 signal range	0	3		0		320	0=0...100%* 1=20...100%* 4 mA Fault 2= -10V...+10V* 3= Custom range*
P2.4.3.4	A11 custom minimum setting	-160,00	160,00	%	0,00		321	Custom Range: Minimum input
P2.4.3.5	A11 custom maximum setting	-160,00	160,00	%	100,00		322	Custom Range: Maximum input
P2.4.3.6	A11 reference scaling, minimum value	0,00	320,00	Hz	0,00		303	Selects the frequency that corresponds to the min. reference signal
P2.4.3.7	A11 reference scaling, maximum value	0,00	320,00	Hz	0,00		304	Selects the frequency that corresponds to the max. reference signal
P2.4.3.8	A11 joystick Dead Zone	0,00	20,00	%	0,00		384	Dead Zone for joystick input
P2.4.3.9	A11 sleep limit	0,00	100,00	%	0,00		385	Drive goes to stop if input is below this limit for this time.
P2.4.3.10	A11 sleep delay	0,00	320,00	s	0,00		386	
P2.4.3.11	A11 joystick offset	-100,00	100,00	%	0,00		165	Press enter for 1s to set offset

Table 7-6. Analogue input 1 parameters, G2.2.2

\*Remember to place jumpers of block X2 accordingly. See NX User's Manual, chapter 6.2.2.2

## 7.4.4 Analogue input 2 (Control keypad: Menu M2 → G2.2.3)

Code	Parameter	Min	Max	Unit	Default	Cust	ID	Note
P2.4.4.1	A12 signal selection	0.1	E.10		A.2		388	Slot . Board input No.
P2.4.4.2	A12 filter time	0,000	32,000	s	0,000		329	0=No filtering
P2.4.4.3	A12 signal range	0	3		1		325	0=0...100%* 1=20...100%* 4 mA Fault 2= -10V...+10V* 3= Custom range*
P2.4.4.4	A12 custom minimum setting	-160,00	160,00	%	0,00		326	Custom Range: Minimum input
P2.4.4.5	A12 custom maximum setting	-160,00	160,00	%	100,00		327	Custom Range: Maximum input
P2.4.4.6	A12 reference scaling, minimum value	0,00	320,00	Hz	0,00		393	Selects the frequency that corresponds to the min. reference signal
P2.4.4.7	A12 reference scaling, maximum value	0,00	320,00	Hz	0,00		394	Selects the frequency that corresponds to the max. reference signal
P2.4.4.8	A12 joystick Dead Zone	0,00	20,00	%	0,00		395	Dead Zone for joystick input
P2.4.4.9	A12 sleep limit	0,00	100,00	%	0,00		396	Drive goes to stop if input is below this limit for this time.
P2.4.4.10	A12 sleep delay	0,00	320,00	s	0,00		397	
P2.4.4.11	A12 joystick offset	-100,00	100,00	%	0,00		166	Press enter for 1s to set offset

Table 7-7. Analogue input 2 parameters, G2.2.3

## 7.4.5 Analogue input 3 (Control keypad: Menu M2 → G2.2.4)

Code	Parameter	Min	Max	Unit	Default	Cust	ID	Note
P2.4.5.1	AI3 signal selection	0.1	E.10		0.1		141	Slot . Board input No. If 0.1 ID27 can be controlled from FB
P2.4.5.2	AI3 filter time	0,000	32,000	s	0,000		142	0=No filtering
P2.4.5.3	AI3 custom minimum setting	-160,00	160,00	%	0,00		144	Custom range always active. See ID326
P2.4.5.4	AI3 custom maximum setting	-160,00	160,00	%	100,00		145	Custom range always active. See ID327
P2.4.5.5	AI3 signal inversion	0	1		0		151	0=Not inverted 1=Inverted
P2.4.5.6	AI3 reference scaling, minimum value	-32000	32000		0		1037	Selects the value that corresponds to the min. reference signal
P2.4.5.7	AI3 reference scaling, maximum value	-32000	32000		0		1038	Selects the value that corresponds to the max. reference signal
P2.4.5.8	AI3 Controlled ID	0	10000		0		1509	Select parameter that you want to control by ID number.

Table 7-8. Analogue input 3 parameters, G2.2.4

\*\*Remember to place jumpers of block X2 accordingly.  
See NX User's Manual, chapter 6.2.2.2

## 7.4.6 Analogue input 4 (Control keypad: Menu M2 → G2.2.5)

Code	Parameter	Min	Max	Unit	Default	Cust	ID	Note
P2.4.6.1	AI4 signal selection	0.1	E.10		0.1		152	Slot . Board input No. If 0.1 ID28 can be controlled from FB
P2.4.6.2	AI4 filter time	0,000	32,000	s	0,000		153	0=No filtering
P2.4.6.3	AI4 custom minimum setting	-160,00	160,00	%	0,00		155	Custom range always active. See ID326
P2.4.6.4	AI4 custom maximum setting	-160,00	160,00	%	100,00		156	Custom range always active. See ID327
P2.4.6.5	AI4 signal inversion	0	1		0		162	0=Not inverted 1=Inverted
P2.4.6.6	AI3 reference scaling, minimum value	-32000	-32000		0		1039	Selects the value that corresponds to the min. reference signal
P2.4.6.7	AI3 reference scaling, maximum value	-32000	32000		0		1040	Selects the value that corresponds to the max. reference signal
P2.4.6.8	AI4 Controlled ID	0	10000		0		1510	Select parameter that you want to control by ID number.

Table 7-9. Analogue input 4 parameters, G2.2.5

## 7.4.7 Options

Code	Parameter	Min	Max	Unit	Default	Cust	ID	Note
P2.4.22	Input signal inversion Control	0	65535		0		1091	

## 7.5 Output Signals

## 7.5.1 Digital output signals (Control keypad: Menu M2 → G2.3.3)

Code	Parameter	Min	Default	Cust	ID	Note
P2.5.1.1	Ready	0.1	0.1		432	Ready to Run
P2.5.1.2	Run	0.1	0.1		433	Running
P2.5.1.3	Fault	0.1	0.1		434	Drive in fault state
P2.5.1.4	Inverted fault	0.1	0.1		435	Drive not in fault state
P2.5.1.5	Warning	0.1	0.1		436	Warning active
P2.5.1.6	External fault	0.1	0.1		437	External fault active
P2.5.1.7	Reference fault/warning	0.1	0.1		438	4 mA fault active
P2.5.1.8	Over temperature warning	0.1	0.1		439	Drive over temperature active
P2.5.1.9	Reverse	0.1	0.1		440	Output frequency < 0 Hz
P2.5.1.10	Unrequested direction	0.1	0.1		441	Reference <> Output frequency
P2.5.1.11	At speed	0.1	0.1		442	Reference = Output frequency
P2.5.1.12	Jogging speed	0.1	0.1		443	Jogging or preset speed command active
P2.5.1.13	External control place	0.1	0.1		444	IO control active
P2.5.1.14	External brake control	0.1	0.1		445	See explanations on chapter Brake Control
P2.5.1.15	External brake control, inverted	0.1	0.1		446	
P2.5.1.16	Output frequency limit 1 supervision	0.1	0.1		447	See ID315
P2.5.1.17	Output frequency limit 2 supervision	0.1	0.1		448	See ID346
P2.5.1.18	Reference limit supervision	0.1	0.1		449	See ID350
P2.5.1.19	Temperature limit supervision	0.1	0.1		450	Drive temperature supervision. See ID354
P2.5.1.20	Torque limit supervision	0.1	0.1		451	See ID348
P2.5.1.21	Motor thermal protection	0.1	0.1		452	Thermistor fault or warning
P2.5.1.22	Analogue input supervision limit	0.1	0.1		463	See ID356
P2.5.1.23	Motor regulator activation	0.1	0.1		454	One of limit controller is active
P2.5.1.24	Fieldbus digital input 1	0.1	0.1		455	FB CW B11
P2.5.1.25	FB Dig 1 Parameter	ID0	ID0		891	Select parameter to control
P2.5.1.26	Fieldbus digital input 2	0.1	0.1		456	FB CW B12
P2.5.1.27	FB Dig 2 Parameter	ID0	ID0		892	Select parameter to control
P2.5.1.28	Fieldbus digital input 3	0.1	0.1		457	FB CW B13
P2.5.1.29	FB Dig 3 Parameter	ID0	ID0		893	Select parameter to control
P2.5.1.30	Fieldbus digital input 4	0.1	0.1		169	FB CW B14
P2.5.1.31	FB Dig 4 Parameter	ID0	ID0		894	Select parameter to control
P2.5.1.32	Fieldbus digital input 5	0.1	0.1		170	FB CW B15
P2.5.1.33	FB Dig 5 Parameter	ID0	ID0		895	Select parameter to control
P2.5.1.34	Safe Disable Active	0.1	0.1		756	
P2.5.1.35	MCC Close Continuous	0.1	0.1		1218	
P2.5.1.36	MCC Close Pulse	0.1	0.1		1219	



## 7.5.2 Analogue output 1 (Control keypad: Menu M2 → G2.3.5)

Code	Parameter	Min	Max	Unit	Default	Cust	ID	Note
P2.5.2.1	Analogue output 1 signal selection	0.1	E.10		A.1		464	TTF programming See chapter 3.1 and 3.2
P2.5.2.2	Analogue output 1 function	0	20		1		307	0=Not used (4 mA / 2 V) 1=Output freq. (0– $f_{max}$ ) 2=Freq. reference (0– $f_{max}$ ) 3=Motor speed (0–Motor nominal speed) 4=Motor current (0– $I_{nMotor}$ ) 5=Motor torque (0– $T_{nMotor}$ ) 6=Motor power (0– $P_{nMotor}$ ) 7=Motor voltage (0– $U_{nMotor}$ ) 8=DC-link volt (0–1000V) 9=AI1 10=AI2 11=Output freq. ( $f_{min}$ - $f_{max}$ ) 12=-2xTorque...+2xTorque 13=-2xPower...+2xPower 14=PT100 temperature 15=FB Analog Output 16=-2xSpeed...+2xSpeed 17= Encoder speed (0–Motor nominal speed) 18=Final Freq.Ref 19= Value Control Out 20=Drive Output Power
P2.5.2.3	Analogue output 1 filter time	0,00	10,00	s	1,00		308	0=No filtering
P2.5.2.4	Analogue output 1 inversion	0	1		0		309	0=Not inverted 1=Inverted
P2.5.2.5	Analogue output 1 minimum	0	1		0		310	0=0 mA (0 %) 1=4 mA (20 %)
P2.5.2.6	Analogue output 1 scale	10	1000	%	100		311	
P2.5.2.7	Analogue output 1 offset	-100,00	100,00	%	0,00		375	

Table 7-10. Analogue output 1 parameters, G2.3.5

## 7.5.3 Analogue output 2 (Control keypad: Menu M2 → G2.3.6)

Code	Parameter	Min	Max	Unit	Default	Cust	ID	Note
P2.5.3.1	Analogue output 2 signal selection	0.1	E.10		0.1		471	TTF programming See chapter 3.1 and 3.2
P2.5.3.2	Analogue output 2 function	0	20		4		472	See P2.5.2.2
P2.5.3.3	Analogue output 2 filter time	0,00	10,00	s	1,00		473	0=No filtering
P2.5.3.4	Analogue output 2 inversion	0	1		0		474	0=Not inverted 1=Inverted
P2.5.3.5	Analogue output 2 minimum	0	1		0		475	0=0 mA (0 %) 1=4 mA (20 %)
P2.5.3.6	Analogue output 2 scale	10	1000	%	100		476	
P2.5.3.7	Analogue output 2 offset	-100,00	100,00	%	0,00		477	

Table 7-11. Analogue output 2 parameters, G2.3.6

## 7.5.4 Analogue output 3 (Control keypad: Menu M2 → G2.3.7)

Code	Parameter	Min	Max	Unit	Default	Cust	ID	Note
P2.5.4.1	Analogue output 3 signal selection	0.1	E.10		0.1		478	TTF programming See chapter 3.1 and 3.2
P2.5.4.2	Analogue output 3 function	0	20		5		479	See P2.5.2.2
P2.5.4.3	Analogue output 3 filter time	0,00	10,00	s	1,00		480	0=No filtering
P2.5.4.4	Analogue output 3 inversion	0	1		0		481	0=Not inverted 1=Inverted
P2.5.4.5	Analogue output 3 minimum	0	1		0		482	0=0 mA (0 %) 1=4 mA (20 %)
P2.5.4.6	Analogue output 3 scale	10	1000	%	100		483	
P2.5.4.7	Analogue output 3 offset	-100,00	100,00	%	0,00		484	

Table 7-12. Analogue output 3 parameters, G2.3.7

## 7.5.5 Delayed digital output 1 (Keypad: Menu M2 → G2.3.1)

Code	Parameter	Min	Max	Unit	Default	Cust	ID	Note
P2.5.5.1	Digital output 1 signal selection	0.1	E.10		0.1		486	Possibility to invert by ID1091 INV Commands
P2.5.5.2	Digital output 1 function	0	26		1		312	0=Not used 1=Ready 2=Run 3=Fault 4=Fault inverted 5=FC overheat warning 6=Ext. fault or warning 7=Ref. fault or warning 8=Warning 9=Reverse 10=Jogging spd selected 11=At speed 12=Mot. regulator active 13=Freq. limit 1 superv. 14=Freq. limit 2 superv. 15=Torque limit superv. 16=Ref. limit supervision 17=External brake control 18=I/O control place act. 19=FC temp. limit superv. 20=Reference inverted 21=Ext. brake control inverted 22=Therm. fault or warn. 23=On/Off control 24=Fieldbus input data 1 25=Fieldbus input data 2 26=Fieldbus input data 3
P2.5.5.3	Digital output 1 on delay	0,00	320,00	s	0,00		487	0,00 = On delay not in use
P2.5.5.4	Digital output 1 off delay	0,00	320,00	s	0,00		488	0,00 = Off delay not in use
P2.5.5.5	Invert delayed DO1	0	1		0		1587	0=Not inverted 1=Inverted

Table 7-13. Delayed digital output 1 parameters, G2.3.1

## 7.5.6 Delayed digital output 2 (Keypad: Menu M2 → G2.3.2)

Code	Parameter	Min	Max	Unit	Default	Cust	ID	Note
P2.5.6.1	Digital output 2 signal selection	0.1	E.10		0.1		489	Possibility to invert by ID1091 INV Commands
P2.5.6.2	Digital output 2 function	0	28		0		490	See P2.5.6.2
P2.5.6.3	Digital output 2 on delay	0,00	320,00	s	0,00		491	0,00 = On delay not in use
P2.5.6.4	Digital output 2 off delay	0,00	320,00	s	0,00		492	0,00 = Off delay not in use
P2.5.6.5	Invert delayed DO2	0	1		0		1588	0=Not inverted 1=Inverted

Table 7-14. Delayed digital output 2 parameters, G2.3.2

## 7.5.7 Supervision Limits

Code	Parameter	Min	Max	Unit	Default	Cust	ID	Note
P2.5.7.1	Output frequency limit 1 supervision	0	2		0		315	0=No limit 1=Low limit supervision 2=High limit supervision
P2.5.7.2	Output frequency limit 1; Supervised value	0,00	320,00	Hz	0,00		316	
P2.5.7.3	Output frequency limit 2 supervision	0	2		0		346	0=No limit 1=Low limit supervision 2=High limit supervision
P2.5.7.4	Output frequency limit 2; Supervised value	0,00	320,00	Hz	0,00		347	
P2.5.7.5	Torque limit supervision	0	2		0		348	0=Not used 1=Low limit supervision 2=High limit supervision
P2.5.7.6	Torque limit supervision value	-300,0	300,0	%	100,0		349	
P2.5.7.7	Reducing of torque supervision limit	0	5		0		402	
P2.5.7.8	Reference limit supervision	0	2		0		350	0=Not used 1=Low limit 2=High limit
P2.5.7.9	Reference limit supervision value	0,00	100,0	%	0,00		351	
P2.5.7.10	FC temperature supervision	0	2		0		354	0=Not used 1=Low limit 2=High limit
P2.5.7.11	FC temperature supervised value	-10	100	°C	40		355	
P2.5.7.12	Analogue supervision signal	0	4		0		356	0=Not used 1=A11 2=A12 3=A13 4=A14
P2.5.7.13	Analogue supervision low limit	0,00	100,00	%	10,00		357	Reset limit
P2.5.7.14	Analogue supervision high limit	0,00	100,00	%	90,00		358	Set limit

Table 7-15. Supervision Limit settings, G2.3.4

## 7.6 Limit Settings

## 7.6.1 Current handling

Code	Parameter	Min	Max	Unit	Default	Cust	ID	Note
P2.6.1	Current limit	0	$2 \times I_H$	A	$I_L$		107	Reaching the limit will lower output frequency
P2.6.2	Scaling of current limit	0	5		0		399	Scaling from 0 to ID107 0=Not used 1=A11 2=A12 3=A13 4=A14 5=FB Limit Scaling ID46

## 7.6.2 Power Handling

Code	Parameter	Min	Max	Unit	Default	Cust	ID	Note
P2.6.2.1	Generator Power Limit	0,0	300,0	%	300,0		1290	
P2.6.2.2	Motoring Power Limit	0,0	300,0	%	300,0		1289	
P2.6.2.3	Scaling Motoring Power Limit	0	5		0		179	As parameter P2.6.2 Scaling from 0 to ID1289
P2.6.2.4	Scaling Generator Power Limit	0	5		0		1088	As parameter P2.6.2 Scaling from 0 to ID1290

## 7.6.3 Torque Handling

Code	Parameter	Min	Max	Unit	Default	Cust	ID	Note
P2.6.3.1	Motoring Torque Limit	0,0	300,0	%	300,0		1287	Motoring side torque limit
P2.6.3.2	Generator Torque Limit	0,0	300,0	%	300,0		1288	Generator side torque limit
P2.6.3.3	Scaling Motoring Torque limit	0	5		0		485	Scaling from 0 to ID1287 0=Not used 1=AI1 2=AI2 3=AI3 4=AI4 5=FB Limit Scaling ID46
P2.6.3.4	Scaling Generator Torque limit	0	5		0		1087	Scaling from 0 to ID1288 As parameter P2.6.3.9

## 7.6.3.1 Torque Handling OL Settings

Code	Parameter	Min	Max	Unit	Default	Cust	ID	Note
P2.6.3.5.1	Torque limit control P-gain	0,0	32000		3000		610	
P2.6.3.5.2	Torque limit control I-gain	0,0	32000		200		611	

## 7.6.3.2 Torque Handling CL Settings

Code	Parameter	Min	Max	Unit	Default	Cust	ID	Note
P2.6.3.6.1	SPC Out Limit	0,0	300,0	%	300,0		1382	
P2.6.3.6.2	SPC Pos Limit	0,0	300,0	%	300,0		646	
P2.6.3.6.3	SPC Neg Limit	0,0	300,0	%	300,0		645	

## 7.6.4 Frequency Handling

Code	Parameter	Min	Max	Unit	Default	Cust	ID	Note
P2.6.4.1	Negative frequency limit	-320,00	320,00	Hz	-320,00		1286	Alternative limit for negative direction
P2.6.4.2	Positive frequency limit	-320,00	320,00	Hz	320,00		1285	Alternative limit for positive direction
P2.6.4.3	Zero Frequency limit	0,00	320,00	Hz	1,00		1283	

## 7.6.5 DC-Link Handling

Code	Parameter	Min	Max	Unit	Default	Cust	ID	Note
P2.6.5.1	Overvoltage controller	0	2		1		607	0=Not used 1=Used (no ramping) 2=Used (ramping)
P2.6.5.2	Over Voltage Reference selector	0	2		1		1262	0=High Voltage 1=Normal Voltage 2=BrakeChopperLevel
P2.6.5.3	Brake chopper	0	4		0		504	0=Disabled 1=Used when running 2=External brake chopper 3=Used when stopped/running 4=Used when running (no testing)
P2.6.5.4	Brake Chopper Level	0	1267	V	Varies		1267	500 V unit: 567 Vdc 6690 V unit: 836 Vdc
P2.6.5.5	Undervoltage controller	0	2		1		608	0=Not used 1=Used (no ramping) 2=Used (ramping to zero)
P2.6.5.6	Under Voltage Kp						1415	
P2.6.5.7	Under Voltage Ki						1416	
P2.6.5.8	Under Voltage Kd						1265	

7.6.5.1 CL Settings

Code	Parameter	Min	Max	Unit	Default	Cust	ID	Note
P2.6.5.9.1	Over Voltage Reference	83	130	%	118,00		1528	
P2.6.5.9.2	CL OV Motoring Torque Limit	0	100	%	10,0		1634	
P2.6.5.9.3	CL Under Voltage Reference	50	100	%	65,00		1567	

## 7.7 Flux and DC Current handling

## 7.7.1 Flux and DC Current handling OL Settings

Code	Parameter	Min	Max	Unit	Default	Cust	ID	Note
P2.7.1.1	DC braking current	0,00	I <sub>L</sub>	A	0,00		507	
P2.7.1.2	DC braking time at start	0,00	600,00	s	0,00		516	0=DC brake is off at start
P2.7.1.3	DC braking time at stop	0,00	600,00	s	0,00		508	0=DC brake is off at stop
P2.7.1.4	Frequency to start DC braking during ramp stop	0,10	10,00	Hz	1,50		515	
P2.7.1.5	Scaling of DC-braking current	0	5		0		400	ID46Scaling from 0 to ID507 0=Not used 1=AI1 2=AI2 3=AI3 4=AI4 5=FB Limit Scaling
P2.7.1.6	DC-Brake Current in Stop	0,00	I <sub>L</sub>	A	Varies		1080	
P2.7.1.7	Flux brake	0	1		0		520	0=Off 1=On
P2.7.1.8	Flux braking current	0,00	I <sub>L</sub>	A	I <sub>H</sub>		519	

## 7.7.2 Flux and DC Current handling CL Settings

Code	Parameter	Min	Max	Unit	Default	Cust	ID	Note
P2.7.2.1	Magnetizing current at start	0	I <sub>L</sub>	A	0,00		627	
P2.7.2.2	Magnetizing time at start	0,0	600,0	s	0,0		628	
P2.7.2.3	Flux Reference	0,0	500,0	%	100,0		1250	
P2.7.2.4	Flux Off Delay	-1	32000	s	0		1402	-1=forever
P2.7.2.5	Stop State Flux	0,0	150,0	%	100,0		1401	

## 7.8 Motor Control

## 7.8.1 Motor Control Basic Settings

Code	Parameter	Min	Max	Unit	Default	Cust	ID	Note
P2.8.1	Motor control mode	0	5		0		600	0=Frequency control 1= OL Speed control 2= Open Loop 3=Closed loop speed ctrl 4=Closed Loop 5=Sensorless
P2.8.2	Motor control mode 2	0	5		2		521	See P2.8.1

## 7.8.2 U/f Settings

Code	Parameter	Min	Max	Unit	Default	Cust	ID	Note
P2.8.3.1	U/f optimisation	0	1		0		109	0=Not used 1=Automatic torque boost
P2.8.3.2	U/f ratio selection	0	3		0		108	0=Linear 1=Squared 2=Programmable 3=Linear with flux optim.
P2.8.3.3	Field weakening point	6,00	320,00	Hz	50,00		602	
P2.8.3.4	Voltage at field weakening point	10,00	200,00	%	100,00		603	n% x U <sub>nmot</sub>
P2.8.3.5	U/f curve midpoint frequency	0,00	P2.8.3.3	Hz	50,00		604	
P2.8.3.6	U/f curve midpoint voltage	0,00	100,00	%	100,00		605	n% x U <sub>nmot</sub> Parameter max. value = P2.6.5
P2.8.3.7	Output voltage at zero frequency	0,00	40,00	%	0,00		606	n% x U <sub>nmot</sub>
P2.8.3.8	OL Mode	0	3		0		1600	

## 7.8.3 Closed Loop Control Settings

Code	Parameter	Min	Max	Unit	Default	Cust	ID	Note
P2.8.4.1	Current control P gain	0,00	100,00	%	40,00		617	
P2.8.4.2	Current control I Time	0,0	3200,0	ms	1,5		657	
P2.8.4.3	Slip adjust	0	500	%	75		619	
P2.8.4.4	Acceleration compensation	0,00	300,00	s	0,00		626	
P2.8.4.5	Speed Error Filter TC	0	1000	ms	0		1311	
P2.8.4.6	Encoder filter time	0	1000	ms	0		618	
P2.8.4.7	SC Torque Chain Select	0	65535		0		1557	Default 96 after identification.



## 7.8.4 PMSM Control settings

Code	Parameter	Min	Max	Unit	Default	Cust	ID	Note
P2.8.5.1	PMSM Shaft Position	0	65535		0		649	
P2.8.5.2	Start Angle Identification mode	0	10		0		1691	0=Automatic 1=Forced 2=After Power Up 3=Disabled
P2.8.5.3	Start Angle Identification DC Current	0,0	150,0	%	0,0		1756	
P2.8.5.4	Polarity Pulse Current	-10,0	200,0	%	0,0		1566	
P2.8.5.5	Start Angle ID Time	0	32000	ms	0		1755	
P2.8.5.6	I/f Current	0,0	150,0	%	50,0		1693	
P2.8.5.7	I/f Control Limit	0,0	300,0	%	10,0		1790	
P2.8.5.8	Flux Current Kp	0	32000		5000		651	
P2.8.5.9	Flux Current Ti	0	1000		25		652	
P2.8.5.10	Ext Id Ref	-150	150	%	0		1730	
P2.8.5.11	Enable Rs Identification	0	1		1		654	0=No 1=Yes
P2.8.5.12	Lsd Voltage Drop	-32000	32000		0		1757	
P2.8.5.13	Lsq Voltage Drop	-32000	32000		0		1758	
P2.8.5.14	Current Control Kp d	0	320,00	%			1761	
P2.8.5.15	Start Angle Offset	-360	360	Dec	0		1291	

## 7.8.5 Stabilators

Code	Parameter	Min	Max	Unit	Default	Cust	ID	Note
P2.8.6.1	Torque Stabilator Gain	0	1000		100		1412	
P2.8.6.2	Torque Stabilator Damping	0	1000		800		1413	With PMSM use 980
P2.8.6.3	Torque Stabilator Gain in FWP	0	1000		50		1414	
P2.8.6.4	Torque Stabilator Limit	0	1500		150		1720	
P2.8.6.5	Flux Circle Stabilator Gain	0	32767		10000		1550	
P2.8.6.6	Flux Circle Stabilator TC	0	32700		900		1551	
P2.8.6.7	Flux Stabilator Gain	0	32000		500		1797	
P2.8.6.8	Flux Stab Coeff	-30000	30000				1796	
P2.8.6.9	Voltage Stabilator Gain	0	100,0	%	10,0		1738	
P2.8.6.10	Voltage Stabilator TC	0	1000		900		1552	
P2.8.6.11	Voltage Stabilator Limit	0	320,00	Hz	1,50		1553	

## 7.8.6 Tuning parameters

Code	Parameter	Min	Max	Unit	Default	Cust	ID	Note
P2.8.7.1	<a href="#">Fly Start Options</a>	0	65535		0		1610	
P2.8.7.2	Resonance Damping Select	0	200		0,00		1760	
P2.8.7.3	Damping Frequency	0	320,00	Hz	0		1763	
P2.8.7.4	Damping Gain	0	32000		0		1764	
P2.8.7.5	Damping Phase	0	360		0,00		1765	
P2.8.8.6	Damping Activation Frequency	0	320,00	%	0		1770	
P2.8.7.7	Damping Filter Time Constant	0	32700		105		1771	
P2.8.7.8	<a href="#">Over Modulation Limit</a>	50	120	%	105		1515	If you have sini filter in use set this to 101 %
P2.8.7.9	<a href="#">Modulator Index Limit</a>	0	200	%	100		655	

## 7.8.7 Identification parameters (Control keypad: Menu M2 → G2.6.6)

Code	Parameter	Min	Max	Unit	Default	Cust	ID	Note
P2.8.8.1	Flux 10 %	0	2500	%	10		1355	
P2.8.8.2	Flux 20 %	0	2500	%	20		1356	
P2.8.8.3	Flux 30 %	0	2500	%	30		1357	
P2.8.8.4	Flux 40 %	0	2500	%	40		1358	
P2.8.8.5	Flux 50 %	0	2500	%	50		1359	
P2.8.8.6	Flux 60 %	0	2500	%	60		1360	
P2.8.8.7	Flux 70 %	0	2500	%	70		1361	
P2.8.8.8	Flux 80 %	0	2500	%	80		1362	
P2.8.8.9	Flux 90 %	0	2500	%	90		1363	
P2.8.8.10	Flux 100 %	0	2500	%	100		1364	
P2.8.8.11	Flux 110 %	0	2500	%	110		1365	
P2.8.8.12	Flux 120 %	0	2500	%	120		1366	
P2.8.8.13	Flux 130 %	0	2500	%	130		1367	
P2.8.8.14	Flux 140 %	0	2500	%	140		1368	
P2.8.8.15	Flux 150 %	0	2500	%	150		1369	
P2.8.8.16	Rs voltage drop	0	30000		Varies		662	Used for torque calculation in open loop
P2.8.8.17	Ir add zero point voltage	0	30000		Varies		664	
P2.8.8.18	Ir add generator scale	0	30000		Varies		665	
P2.8.8.19	Ir add motoring scale	0	30000		Varies		667	
P2.8.8.20	Ls Voltage Dropp	0	3000		0		673	
P2.8.8.21	Motor BEM Voltage	0,00	320,00	%	0		674	
P2.8.8.22	Iu Offset	-32000	32000		0		668	
P2.8.8.23	Iv Offset	-32000	32000		0		669	
P2.8.8.24	Iw Offset	-32000	32000		0		670	
P2.8.8.25	Estimator Kp	0	32000				1781	
P2.8.8.26	No Load Torque	0	300,0		0		676	
P2.8.8.27	ID Run Curr. Kp	0	32000				1611	

Table 7-16. Identification parameters, G2.6.4

## 7.8.8 Fine tuning parameters

Code	Parameter	Min	Max	Unit	Default	Cust	ID	Note
P 2.8.9.1	DeadTimeComp.						1751	
P 2.8.9.2	DeadTieContCurL						1752	
P 2.8.9.3	DeadTHWCompDisab						1750	
P 2.8.9.4	MakeFluxTime						660	
P 2.8.9.5	CurrMeasFCompTC						1554	
P 2.8.9.6	TCDunDampGain						1576	
P 2.8.9.7	TCDynDampTC						1577	
P 2.8.9.8	CurrLimOptions						1702	
P 2.8.9.9	AdConvStartShift						1701	
P 2.8.9.10	VoltageCorr. Kp						1783	
P 2.8.9.11	VoltageCorr. Ki						1784	
P 2.8.9.12	GearRatioMultipl						1558	
P 2.8.9.13	GearRatioDivider						1559	

Table 7-17. Fine tuning parameters

## 7.9 Speed Control

## 7.9.1 Speed Control Basic settings

Code	Parameter	Min	Max	Unit	Default	Cust	ID	Note
P2.9.1	Load drooping	0,00	100,00	%	0,00		620	
P2.9.2	Load Drooping Time	0	32000	ms	0		656	For dynamic changes

Table 7-18. Speed control basic settings

## 7.9.2 Speed Control OL Settings

Code	Parameter	Min	Max	Unit	Default	Cust	ID	Note
P2.9.3.1	Speed controller P gain (open loop)	0	32767		3000		637	
P2.9.3.2	Speed controller I gain (open loop)	0	32767		300		638	

Table 7-19. Speed control OL settings

## 7.9.3 Speed Control CL Settings

Code	Parameter	Min	Max	Unit	Default	Cust	ID	Note
P2.9.4.1	Speed control P gain	0	1000		30		613	
P2.9.4.2	Speed control I time	-32000	32000	ms	100		614	Negative value uses 0,1 ms format instead of 1 ms
P2.9.4.3	0-speed time at start	0	32000	ms	100		615	
P2.9.4.4	0-speed time at stop	0	32000	ms	100		616	
P2.9.4.5	SPC f1 Point	0,00	320,00	Hz	0,00		1301	
P2.9.4.6	SPC f0 Point	0,00	320,00	Hz	0,00		1300	
P2.9.4.7	SPC Kp f0	0	1000	%	100		1299	
P2.9.4.8	SPC Kp FWP	0	1000	%	100		1298	
P2.9.4.9	SPC Torque minimum	0	400,0	%	0,0		1296	
P2.9.4.10	SPC Torque minimum Kp	0	1000	%	100		1295	
P2.9.4.11	SPC Kp TC Torque	0	1000	ms	0		1297	

Table 7-20. Speed control CL settings

## 7.10 Drive Control

Code	Parameter	Min	Max	Unit	Default	Cust	ID	Note
P2.10.1	Switching frequency	1,0	Varies	kHz	Varies		601	
P2.10.2	Modulator Type	0	3		0		1516	
P2.10.3	Control Options	0	65535		64		1084	
P2.10.4	Advanced Options 1	0	65535		0		1560	
P2.10.5	Advanced Options 2	0	65535		0		1561	
P2.10.6	Advanced Options 4	0	65535		0		1563	
P2.10.7	Advanced Options 5	0	65535		0		1564	
P2.10.8	Advanced Options 6	0	65535		0		1565	
P2.10.9	Advanced Options 7	0	65535		0		1562	
P2.10.10	Restart Delay	0	65535	s	Varies		1424	
P2.10.11	Restart Delay CL	0	60,000	s	Varies		672	CL and Flying Start
P2.10.12	Sine Filter Capacitor Size						1460	
P2.10.13	Sine Filter Inductor Size						1461	

Table 7-21. Drive control

## 7.11 Master Follower Control Parameters (Control keypad: Menu M2 → G2.5)

Code	Parameter	Min	Max	Unit	Default	Cust	ID	Note
P2.11.1	Master Follower Mode	0	2		0		1324	0=Not Used 1=Master 2=Follower
P2.11.2	Follower Speed Reference Select	0	18		17		1081	0=AI1 1=AI2 2=AI1+AI2 3=AI1-AI2 4=AI2-AI1 5=AI1xAI2 6=AI1 Joystick 7=AI2 Joystick 8=Keypad 9=Fieldbus 10=Motor potentiometer 11=AI1, AI2 minimum 12=AI1, AI2 maximum 13=Max frequency 14=AI1/AI2 selection 15=Encoder 1 16=Encoder 2 17=Master Reference 18=Master Ramp Out
P2.11.3	Follower Torque Reference Select	0	10		10		1083	0=Not used 1=AI1 2=AI2 3=AI3 4=AI4 5=AI1 joystick 6=AI2 joystick 7=Torque reference from keypad, R3.5 8=FB Torque Reference 9=Master Torque OL 10=Master Torque CL
P2.11.4	Follower Stop Function	0	2		2		1089	0=Coasting 1=Ramping 2=As Master
P2.11.5	MF Mode 2	0	4		0		1093	P2.11.1
P2.11.6	System Bus Fault	0	3		1		1082	0=No response 1=Warning 2=Fault, stop acc. to 2.3.2 3=Fault, stop by coasting
P2.11.7	System Bus Fault Delay	0,00	320,00	s	3,00		1352	

Table 7-22. Master Follower Control parameters, G2.5

## 7.12 Protections (Control keypad: Menu M2 → G2.7)

## 7.12.1 Common settings

Code	Parameter	Min	Max	Unit	Default	Cust	ID	Note
P2.12.1.1	Response to external fault	0	3		2		701	0=No response 1=Warning 2=Fault,stop acc. to 2.4.7 3=Fault,stop by coasting
P2.12.1.2	Input phase supervision	0	3		0		730	0=No response 1=Warning 2=Fault,stop acc. to 2.3.2 3=Fault,stop by coasting
P2.12.1.3	Response to undervoltage fault	0	1		0		727	0=Fault stored in history 1=Fault not stored
P2.12.1.4	Output phase supervision	0	3		2		702	See P2.12.1.1
P2.12.1.5	Response to slot fault	0	3		2		734	See P2.12.1.1
P2.12.1.6	Safe Disable Response	0	2		1		755	See P2.12.1.1
P2.12.1.7	Cooling Fault delay	0,00	7,00	s	2,00		751	
P2.12.1.8	Encoder fault mode	0	3		2		1353	0=No response 1=Warning 2=Fault,stop by coasting 3=Warning; To OL

Table 7-23. Common settings

## 7.12.2 Temperature sensor protections

Code	Parameter	Min	Max	Unit	Default	Cust	ID	Note
P2.12.2.1	TBoard 1 Numbers	0	5		0		739	0=Not used (ID Write) 1 = Sensor 1 in use 2 = Sensor 1 & 2 in use 3 = Sensor 1 & 2 & 3 in use 4 = Sensor 2 & 3 in use 5 = Sensor 3 in use
P2.12.2.2	TBoard Flt.Resp	0	3		2		740	0=No response 1=Warning 2=Fault,stop acc. to 2.3.2 3=Fault,stop by coasting
P2.12.2.3	TBoard 1 Warn.Lim	-30,0	200,0	C°	120,0		741	Alarm triggering limit
P2.12.2.4	TBoard1 Flt.Lim	-30,0	200,0	C°	130,0		742	Fault triggering limit
P2.12.2.5	TBoard 2 Numbers	0	5		0		743	0=Not used (ID Write) 1 = Sensor 1 in use 2 = Sensor 1 & 2 in use 3 = Sensor 1 & 2 & 3 in use 4 = Sensor 2 & 3 in use 5 = Sensor 3 in use
P2.12.2.6	TBoard 2 Warn.Lim	-30,0	200,0	C°	120,0		745	
P2.12.2.7	TBoard 2 Flt.Lim	-30,0	200,0	C°	130,0		746	

Table 7-24. PT-100 protections

## 7.12.3 Stall Protection

Code	Parameter	Min	Max	Unit	Default	Cust	ID	Note
P2.12.3.1	Stall protection	0	3		0		709	0=No response 1=Warning 2=Fault, stop acc. to 2.3.2 3=Fault, stop by coasting
P2.12.3.2	Stall current	0,1	2 x I <sub>H</sub>	A	I <sub>H</sub>		710	
P2.12.3.3	Stall time limit	1,00	120,00	s	15,00		711	
P2.12.3.4	Stall frequency limit	1,0	P2.1.2	Hz	25,0		712	

Table 7-25. Stall protection

## 7.12.4 Speed error monitoring

Code	Parameter	Min	Max	Unit	Default	Cust	ID	Note
P2.12.4.1	Speed Error Mode	0	3		0		752	0=No response 1=Warning 2=Fault, stop acc. to 2.3.2 3=Fault, stop by coasting
P2.12.4.2	Speed Error Limit	0,0	100,0	%	5,0		753	
P2.12.4.3	Speed Fault Delay	0,00	100,00	S	0,1		754	

Table 7-26. Speed error monitoring

## 7.12.5 Motor thermal protections

Code	Parameter	Min	Max	Unit	Default	Cust	ID	Note
P2.12.5.1	Thermal protection of the motor	0	3		2		704	0=No response 1=Warning 2=Fault, stop acc. to 2.3.2 3=Fault, stop by coasting
P2.12.5.2	Motor ambient temperature factor	-100,0	100,0	%	0,0		705	
P2.12.5.3	Motor cooling factor at zero speed	0,0	150,0	%	40,0		706	
P2.12.5.4	Motor thermal time constant	1	200	min	45		707	
P2.12.5.5	Motor duty cycle	0	100	%	100		708	
P2.12.5.6	Response to thermistor fault	0	3		2		732	See P2.12.5.1

Table 7-27. Motor thermal protections

## 7.12.6 Living Zero monitoring

Code	Parameter	Min	Max	Unit	Default	Cust	ID	Note
P2.12.6.1	Response to 4mA reference fault	0	5		0		700	0=No response 1=Warning 2=Warning+Previous Freq. 3=Wring+PresetFreq 2.12.6.2 4=Fault, stop acc. to 2.3.2 5=Fault, stop by coasting
P2.12.6.2	4mA reference fault frequency	0,00	P2.1.2	Hz	0,00		728	

Table 7-28. Living zero monitoring



## 7.12.7 Underload protection

Code	Parameter	Min	Max	Unit	Default	Cust	ID	Note
P2.12.7.1	Underload protection	0	3		0		713	0=No response 1=Warning 2=Fault,stop acc. to 2.3.2 3=Fault,stop by coasting
P2.12.7.2	Field weakening area load	10,0	150,0	%	50,0		714	
P2.12.7.3	Zero frequency load	5,0	150,0	%	10,0		715	
P2.12.7.4	Underload protection time limit	2,00	600,00	s	20,00		716	

Table 7-29. Underload protection

## 7.12.8 Earth Fault protection

Code	Parameter	Min	Max	Unit	Default	Cust	ID	Note
P2.12.8.1	Earth fault protection	0	3		2		703	0=No response 1=Warning 2=Fault,stop acc. to 2.3.2 3=Fault,stop by coasting
P2.12.8.2	Eart fault current limit	0,0	100,0	%	50,0		1333	

Table 7-30. Earth fault protection

## 7.12.9 Fieldbus protection

Code	Parameter	Min	Max	Unit	Default	Cust	ID	Note
P2.12.9.1	Fieldbus Communication response Slot D	0	3		2		733	0=No Action 1=Warning 2= Fault 3= Fault,stop by coasting 4=Warning; Prev Freq 5=Warning; 4 mA Freq 6=Warning; Change Slot
P2.12.9.2	Fieldbus Communication response Slot E	0	3		2		761	0=No Action 1=Warning 2= Fault 3= Fault,stop by coasting 4=Warning; Prev Freq 5=Warning; 4 mA Freq 6=Warning; Change Slot
P2.12.9.3	FB Fault Delay	0,00	60,00	s	0,50		1850	Delay to fault when FB Response is 4
P2.12.9.4	FB Watchdog Delay	0,00	30,00	s	0,00		1354	Delay when WD pulse is missing. 0,00 s = Disabled

Table 7-31. Fieldbus protection

## 7.13 Fieldbus parameters (Control Keypad: Menu M2 →G2.9)

Code	Parameter	Min	Max	Unit	Default	Cust	ID	Note
P2.13.1	Fieldbus min scale	0,00	320,00	Hz	0,00		850	
P2.13.2	Fieldbus max scale	0,00	320,00	Hz	0,00		851	
P2.13.3	Fieldbus actual speed selection	0	10000				1851	
P2.13.4	Fieldbus process data out 1 selection	0	10000		1		852	Choose monitoring data with parameter ID Def: Output Frequency
P2.13.5	Fieldbus process data out 2 selection	0	10000		2		853	Choose monitoring data with parameter ID Def: Motor Speed
P2.13.6	Fieldbus process data out 3 selection	0	10000		3		854	Choose monitoring data with parameter ID Def: Motor Current to FB
P2.13.7	Fieldbus process data out 4 selection	0	10000		4		855	Choose monitoring data with parameter ID Def: Motor Torque
P2.13.8	Fieldbus process data out 5 selection	0	10000		5		856	Choose monitoring data with parameter ID Def: Motor Power
P2.13.9	Fieldbus process data out 6 selection	0	10000		6		857	Choose monitoring data with parameter ID Def: Motor Voltage
P2.13.10	Fieldbus process data out 7 selection	0	10000		7		858	Choose monitoring data with parameter ID Def: DC-Link Voltage
P2.13.11	Fieldbus process data out 8 selection	0	10000		37		859	Choose monitoring data with parameter ID Def: Last Active Fault
P2.13.12	Fieldbus process data in 1 selection	0	10000		1140		876	Choose controlled data with parameter ID. Def: FB Torque Reference
P2.13.13	Fieldbus process data in 2 selection	0	10000		46		877	Choose controlled data with parameter ID. Def: FB Limit Scaling
P2.13.14	Fieldbus process data in 3 selection	0	10000		47		878	Choose controlled data with parameter ID. Def: FB Adjust Reference
P2.13.15	Fieldbus process data in 4 selection	0	10000		48		879	Choose controlled data with parameter ID. Def: FB Analogue Output.
P2.13.16	Fieldbus process data in 5 selection	0	10000		0		880	Choose controlled data with parameter ID
P2.13.17	Fieldbus process data in 6 selection	0	10000		0		881	Choose controlled data with parameter ID
P2.13.18	Fieldbus process data in 7 selection	0	10000		0		882	Choose controlled data with parameter ID
P2.13.19	Fieldbus process data in 8 selection	0	10000		0		883	Choose controlled data with parameter ID
P2.13.20	General Status Word ID	0	10000		67		897	Choose monitoring data in General Status Word
P2.13.21	Control Slot Selector	0	8		0		1440	0=All 4=Slot D 5=Slot E
P2.13.22	ProfiBus Mode	1	2		1		896	1 = Standard 2 = ProfiDrive
P2.13.23	FB Custom Minimum	-32000	+32000		0		898	FB Speed Reference Minimum scaling
P2.13.24	FB Custom Maximum	-32000	+32000		+10000		899	FB Speed Reference Maximum Scaling

Table 7-32. Fieldbus parameters

## 7.14 ID Control Functions

## 7.14.1 Value Control (Keypad: Menu M2 → G2.2.9)

Code	Parameter	Min	Max	Unit	Default	Cust	ID	Note
P2.14.1.1	Control Input Signal ID	0	10000	ID	0		1580	
P2.14.1.2	Control Input Off Limit	-32000	32000		0		1581	
P2.14.1.3	Control Input On Limit	-32000	32000		0		1582	
P2.14.1.4	Control Output Off Value	-32000	32000		0		1583	
P2.14.1.5	Control Output On Value	-32000	32000		0		1584	
P2.14.1.6	Control Output Signal ID	0	10000	ID	0		1585	
P2.14.1.7	Control Mode	0	5		0		1586	0=SR ABS 1=Scale ABS 2=Scale INV ABS 3=SR 4=Scale 5=Scale INV
P2.14.1.8	Control Output Filtering time	0,000	32,000	s	0,000		1721	

Table 7-33. Power reference input signal selection, G2.2.8

## 7.14.2 DIN ID Control 1

Code	Parameter	Min	Max	Unit	Default	Cust	ID	Note
P2.14.2.1	ID Control DI B0	0.1	E.10		0.1		1570	Slot . Board input No.
P2.14.2.2	ID Control DI B1	0.1	E.10		0.1		1277	Slot . Board input No.
P2.14.2.3	Controlled ID	0	10000	ID	0		1571	Select ID that is controlled by digital input
P2.14.2.4	B00 value	-32000	32000		0		1572	
P2.14.2.5	B01 value	-32000	32000		0		1573	
P2.14.2.6	B10 value	-32000	32000		0		1193	
P2.14.2.7	B11 value	-32000	32000		0		1182	
P2.14.2.8	Ramp Rate	0	32000		0		1112	

Table 7-34. DIN ID Control parameters

## 7.14.3 DIN ID Control 2

Code	Parameter	Min	Max	Unit	Default	Cust	ID	Note
P2.14.3.1	ID Control DIN	0.1	E.10		0.1		1578	Slot . Board input No.
P2.14.3.2	Controlled ID	0	10000	ID	0		1579	Select ID that is controlled by digital input
P2.14.3.3	False Value	-32000	32000		0		1594	
P2.14.3.4	True Value	-32000	32000		0		1596	

Table 7-38. DIN ID Control 2 parameters

## 7.14.4 DIN ID Control 3

Code	Parameter	Min	Max	Unit	Default	Cust	ID	Note
P2.14.4.1	ID Control DIN	0.1	E.10		0.1		1620	Slot . Board input No.
P2.14.4.2	Controlled ID	0	10000	ID	0		1621	Select ID that is controlled by digital input
P2.14.4.3	False Value	-32000	32000		0		1622	
P2.14.4.4	True Value	-32000	32000		0		1623	

Table 7-39. DIN ID Control 3 parameters

## 7.15 Brake Control (Control keypad: Menu M2 → G2.15)

Code	Parameter	Min	Max	Unit	Default	Cust	ID	Note
P2.15.1	Brake Logic	0	1		0		1546	0=Multi-Purpose 2=Marine
P2.15.2	BrakeMechDelay	0,00	320,00	s	0,00		1544	Time that is required to open the brake
P2.15.3	Brake OFF FreqLim Open Loop	0,00	320,00	Hz	1,50		1535	Opening limit and maximum reference limit when brake is closed.
P2.15.4	Brake OFF FreqLim Closed Loop	0,00	320,00	Hz	0,00		1555	Opening limit and maximum reference limit when brake is closed.
P2.15.5	Brake ON FreqLim +	0,00	320,00	Hz	1,00		1539	Close frequency from positive direction
P2.15.6	Brake ON FreqLim -	0,00	320,00	Hz	1,50		1540	Close frequency from negative direction
P2.15.7	Brake On/Off Current Limit	0,00	320,00	A	0,00		1085	Brake is closed immediately id current goes below this value.
P2.15.8	External brake-off delay	0,00	100,00	s	0,10		352	From brake off limits
P2.15.9	External brake-on delay	0,00	100,00	s	2,90		353	From Run Request. Use longer time than ID104
P2.15.10	Brake Fault Action	1	3		1		1316	1=Warning 2=Fault, stop acc. to 2.3.2 3=Fault, stop by coasting
P2.15.11	Brake Fault Delay	0,00	320,00	s	0,20		1317	

Table 7-35. Brake control parameters, G2.3.9

## 7.15.1 Brake Control Start up torque for CL

Code	Parameter	Min	Max	Unit	Default	Cust	ID	Note
P2.15.12.1	Start-up torque	0	3		0		621	0=Not used 1=Torque memory 2=Torque reference 3=Start-up torque fwd/rev
P2.15.12.2	Start-up torque FWD	-300,0	300,0	s	0,0		633	
P2.15.12.3	Start-up torque REV	-300,0	300,0	s	0,0		634	
P2.15.12.4	Start Up Torque Time	-1	10000	ms	-1		1371	-1 = Automatic

## 7.16 Autorestart parameters (Control keypad: Menu M2 → G2.8)

Code	Parameter	Min	Max	Unit	Default	Cust	ID	Note
P2.16.1	Wait time	0,10	10,00	s	0,50		717	
P2.16.2	Trial time	0,00	60,00	s	0,10		718	
P2.16.3	Start function	0	2		2		719	0=Ramp 1=Flying start 2=According to Stop Function
P2.16.4	Number of tries after undervoltage trip	0	10		0		720	
P2.16.5	Number of tries after overvoltage trip	0	10		0		721	
P2.16.6	Number of tries after overcurrent trip	0	3		0		722	
P2.16.7	Number of tries after reference trip	0	10		0		723	
P2.16.8	Number of tries after motor temperature fault trip	0	10		0		726	
P2.16.9	Number of tries after external fault trip	0	10		0		725	
P2.16.10	Number of tries after underload fault trip	0	10		0		738	

Table 7-36. Autorestart parameters, G2.16

### 7.17 Keypad control (Control keypad: Menu M3)

The parameters for the selection of control place and direction on the keypad are listed below. See the Keypad control menu in the Vacon NX User's Manual.

Code	Parameter	Min	Max	Unit	Default	Cust	ID	Note
P3.1	Control place	1	3		2		125	0=PC Control 1=I/O terminal 2=Keypad 3=Fieldbus
R3.2	Keypad reference	P2.1.1	P2.1.2	Hz	0,00			
P3.3	Direction (on keypad)	0	1		0		123	0=Forward 1=Reverse
P3.4	Stop button	0	1		1		114	0=Limited function of Stop button 1=Stop button always enabled
R3.5	Torque reference	0,0	100,0	%	0,0			
P3.6	License	0	65535		0			

Table 7-37. Keypad control parameters, M3

### 7.18 System menu (Control keypad: Menu M6)

For parameters and functions related to the general use of the frequency converter, such as application and language selection, customised parameter sets or information about the hardware and software, see Chapter 7.3.6 in the Vacon NX User's Manual.

### 7.19 Expander boards (Control keypad: Menu M7)

The **M7** menu shows the expander and option boards attached to the control board and board-related information. For more information, see Chapter 7.3.7 in the Vacon NX User's Manual.

## 8. DESCRIPTION OF PARAMETERS

### 8.1 Basic Parameters

#### ***P2.1.1 Frequency Scale ID523***

This parameter defines speed area where frequency converter can operate. Changing this parameter affect to all Hz and rpm monitoring values and parameters.

- 0 : 0,000 - 32,000 Hz for low speed motors, 0,0 – 1 920,0 rpm
- 1 : 0,00 - 320,00 Hz standard, 0 – 19 200 rpm
- 2 : 0,0 - 599,0 Hz for high speed motors, 0 – 35 940 rpm.

#### ***P2.1.12 RPM Format ID1852***

- 0 = Default
- 1 = #,# rpm
- 2 = # rpm
- 3 = #,## krpm
- 4 = #,# krpm

#### ***P2.1.3 Minimum frequency ID101 "Min Frequency"***

Defines minimum frequency of any adjustable reference input (i.e. reference is not a parameter). Minimum frequency is bypassed when jogging speed, preset speed or inching reference is used.

#### ***P2.1.4 Maximum frequency ID102 "Max Frequency"***

Defines maximum frequency limit both negative and positive directions. Direction dependent frequency limits can be given in "G: Limit Settings \ Frequency Handling".

Note: Do not change this parameter to lower value that current output frequency. If changed while running, change will be executed without ramp.

#### ***P2.1.5 Motor Nominal Voltage ID110 "Motor Nom Voltg"***

Find this value  $U_n$  on the rating plate of the motor.

#### ***P2.1.6 Motor Nominal Frequency ID111 "Motor Nom Freq"***

Find this value  $f_n$  on the rating plate of the motor. This parameter sets the field weakening point to the same value in "G: Motor Control \ U/f Settings".

#### ***P2.1.7 Motor nominal speed ID112 "Motor Nom Speed"***

Find this value  $n_n$  on the rating plate of the motor. Note also nominal frequency.

Some cases motor nominal speed is shown with one decimal. In this case the practice is to give nearest integer number and adjust motor nominal frequency so that drive will calculate correct [FW]PolePairNumber.

#### ***P2.1.8 Motor nominal current ID113 "Motor Nom Currnt"***

Find this value  $I_n$  on the rating plate of the motor. If magnetization current is provided set also Magnetization current P2.1.9 before identification run.

*P2.1.9 Motor cos phi* *ID120 "Motor Cos Phi"*

Find this value "cos phi" on the rating plate of the motor.

*P2.1.10 Motor Nominal Power* *ID116 "Motor Nom Power"*

Find this value on the rating plate of the motor.



### P2.1.11 Magnetizing current ID612 "MagnCurrent"

Set here the motor magnetizing current (no-load current).  
Can be measured by running motor without load at 2/3 of nominal speed.

When value is zero the magnetization current is calculated from motor nominal parameters

$$\text{Motor Magnetization Current} = \frac{5 * \sin \varphi - 1}{5 - \sin \varphi} * \text{Motor Nominal Current}$$

$$[FW]\text{RotorFlux} = \left( \frac{f(\text{MotorNomFreq})}{f(\text{Out})} \right)^2, \text{ when } f(\text{Out}) > f(\text{MotorNomFreq})$$

If given before identification run this is used as reference for U/f tuning when making identification without rotating the motor.

### P2.1.12 Identification ID631 "Identification"

Identification Run is a part of tuning the motor and the drive specific parameters. It is a tool for commissioning and service of the drive with the aim to find as good parameter values as possible for most drives. The automatic motor identification calculates or measures the motor parameters that are needed for optimum motor and speed control.

**NOTE:** Set motor control mode to Frequency Control before identification!

**NOTE:** During identification drive will not open mechanical brake for safety reasons. If motor rotation requires that brake is opened this needs to be achieved externally.

**NOTE:** During identification run torque and power limits should be above 100 %. Also current limit should be above motor nominal current.

**NOTE:** During identification run acceleration time should be below 20 second.

**NOTE:** If switching frequency is changed after identification it's recommended to do identification run again.

**NOTE:** Small motor with long motor cabled may require reduction of switching frequency if identification is not successful.

**0 = "No Action" No action**

No identification requested.

## 1 = "ID No Run" - Identification without rotating the motor

Current is applied to the motor but shaft will not be rotated. U/f settings are identified. This identification is minimum requirement if motor is only to be used in open loop control. It is however recommended to make always identification with rotating motor if need for closed loop control comes after mechanics are connected to shaft.

Example of behaviour

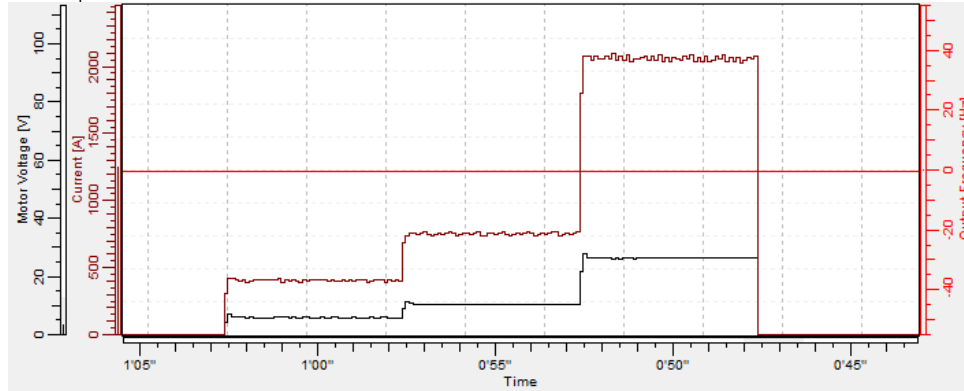

Parameters updated during this identification

AM:

- P2.1.9 MagnCurrent
- P2.8.3.2 U/f Ratio Select
- P2.8.3.5 U/f Mid Freq
- P2.8.3.6 U/f Mid Voltg
- P2.8.3.7 Zero Freq Voltg
- P2.8.8.16 RsVoltageDrop
- P2.8.8.17 IrAddZeroPVoltg
- P2.8.8.22-24 Ix Offset

PM:

- P2.8.3.2 U/f Ratio Select
- P2.8.3.5 U/f Mid Freq
- P2.8.3.6 U/f Mid Voltg
- P2.8.3.7 Zero Freq Voltg
- P2.8.4.1 CurrentControlKp
- P2.8.5.11 LsdVoltageDrop
- P2.8.5.12 LsqVoltageDrop
- P2.8.8.16 RsVoltageDrop
- P2.8.8.17 IrAddZeroPVoltg
- P2.8.8.20 LsVoltageDrop
- P2.8.8.22-24 Ix Offset
- P2.8.8.25 Estimator Kp

## 2 = "ID With Run" - Identification with motor rotating

Shaft is rotated during identification.

This identification must be run without load on motor shaft. U/f settings and magnetization current are identified. This identification should be run regardless of the final operation mode (closed loop or open loop) to get the best performance from the motor. When identification with motor rotation is successfully finished the drive starts to use internal slip estimator to compensate the motor temperature changed. SCTorqueChainSelect B5 & B6.

Example of behaviour

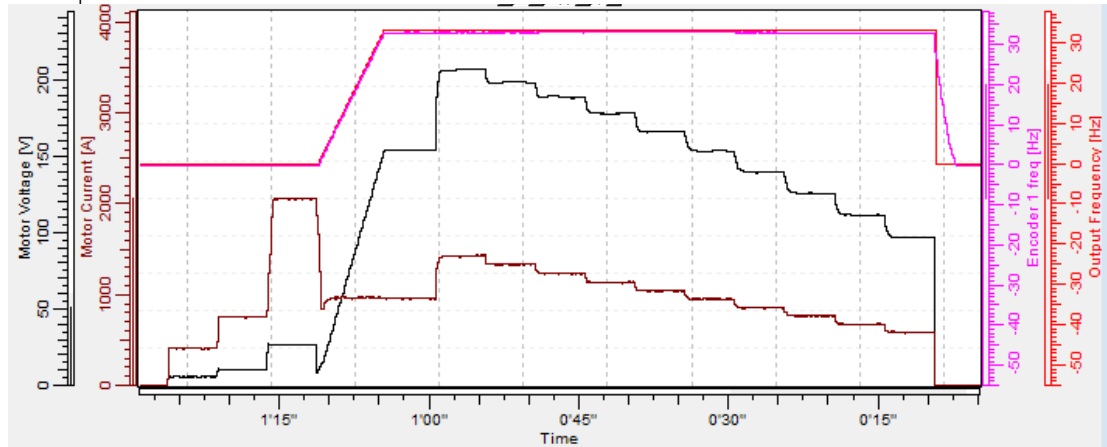

Parameters updated during this identification

AM:

- P2.1.9 MagnCurrent
- P2.8.3.2 U/f Ratio Select
- P2.8.3.5 U/f Mid Freq
- P2.8.3.6 U/f Mid Voltg
- P2.8.3.7 Zero Freq Voltg
- P2.8.8.16 RsVoltageDrop
- P2.8.8.17 IrAddZeroPVoltg
- P2.8.8.22-24 Ix Offset
- P2.8.8.1-15 Flux X %

PM:

- P2.8.3.2 U/f Ratio Select
- P2.8.3.3 Field WeakngPnt
- P2.8.3.5 U/f Mid Freq
- P2.8.3.6 U/f Mid Voltg
- P2.8.3.7 Zero Freq Voltg
- P2.8.4.1 CurrentControlKp
- P2.8.5.11 LsdVoltageDrop
- P2.8.5.12 LsqVoltageDrop
- P2.8.8.16 RsVoltageDrop
- P2.8.8.17 IrAddZeroPVoltg
- P2.8.8.20 LsVoltageDrop
- P2.8.8.21 MotorBEMVoltage
- P2.8.8.22-24 Ix Offset
- P2.8.8.25 Estimator Kp

### 3 = "Enc. ID Run" - Encoder identification run

The motor shaft is rotated during identification.

**IM:** If performed for induction motor encoder pulse number and direction are identified. Can be used if there is no encoder information available, correct result can be achieved only when motor is unloaded.

**PMSM:** This selection is used for PMS motor if automatic angle identification is not suitable for used motor (angle is identified automatically in every start if PMSM Shaft Position parameter is zero).

This identification run will update PMSM Shaft Position parameter based on absolute position of the encoder or Z pulse position of incremental type encoder.

**Note:** Identification needs to be remade if encoder position related to motor is changed e.g. due to maintenance.

Parameters updated during this identification

AM:

P2.1.8 MagnCurrent  
 P2.8.4.2 U/f Ratio Select  
 P2.8.4.5 U/f Mid Freq  
 P2.8.4.6 U/f Mid Voltg  
 P2.8.4.7 Zero Freq Voltg  
 P2.8.9.16 RsVoltageDrop  
 P2.8.9.17 IrAddZeroPVoltg  
 P2.8.9.22-24 Ix Offset  
 P2.8.9.29 Org UF ZeroPVolt  
 P2.8.5.8 Temp.Compen.Mode  
 P2.8.9.1-15 Flux X %  
 P7.3.1.2 Pulse revolution  
 P7.3.1.3 Invert direction

PM:

P2.8.6.1 PMSMShaftPositio  
 P2.8.9.22-24 Ix Offset  
 P2.8.9.25 Estimator Kp

**4 = "Ident All" - Identified All**

Shaft is rotated during identification.

All the above identification selections are made in sequence.

Parameters updated during this identification

AM:

P2.1.8 MagnCurrent  
 P2.8.4.2 U/f Ratio Select  
 P2.8.4.5 U/f Mid Freq  
 P2.8.4.6 U/f Mid Voltg  
 P2.8.4.7 Zero Freq Voltg  
 P2.8.9.16 RsVoltageDrop  
 P2.8.9.17 IrAddZeroPVoltg  
 P2.8.9.22-24 Ix Offset  
 P2.8.9.29 Org UF ZeroPVolt  
 P2.8.5.8 Temp.Compen.Mode  
 P2.8.9.1-15 Flux X %

PM:

P2.8.4.2 U/f Ratio Select  
 P2.8.4.3 Field WeakngPnt  
 P2.8.4.5 U/f Mid Freq  
 P2.8.4.6 U/f Mid Voltg  
 P2.8.4.7 Zero Freq Voltg  
 P2.8.5.1 CurrentControlKp  
 P2.8.6.12 LsdVoltageDrop  
 P2.8.6.13 LsqVoltageDrop  
 P2.8.6.19 Curr. Contr. Kp d  
 P2.8.9.16 RsVoltageDrop  
 P2.8.9.17 IrAddZeroPVoltg  
 P2.8.9.20 LsVoltageDrop  
 P2.8.9.21 MotorBEMVoltage  
 P2.8.9.22-24 Ix Offset  
 P2.8.9.25 Estimator Kp  
 P2.8.9.29 Org UF ZeroPVolt  
 P2.8.5.8 Temp.Compen.Mode  
 P2.8.6.1 PMSMShaftPositio

**5 = "Enc.ABS.Lock" – Absolute encoder when locked rotor**

Absolute encoder zero position identification when rotor is locked while using permanent magnet motor.

It's recommended to have shaft locked during this identification mode.

Parameters updated during this identification

PM:

P2.8.6.1 PMSMShaftPositio  
 P2.8.9.22-24 Ix Offset  
 P2.8.9.25 Estimator Kp

## 6 = "U/f + Magn.Curr" – U/f Curve and magnetization current

Shaft is rotated during identification.

This identification selection will not make a saturation curve identification and will open the brake when the start rotation begins.

Because saturation curve run is not made, the running time is shorter and gives possibility to make even if lifting hook is connected.

Example of behaviour

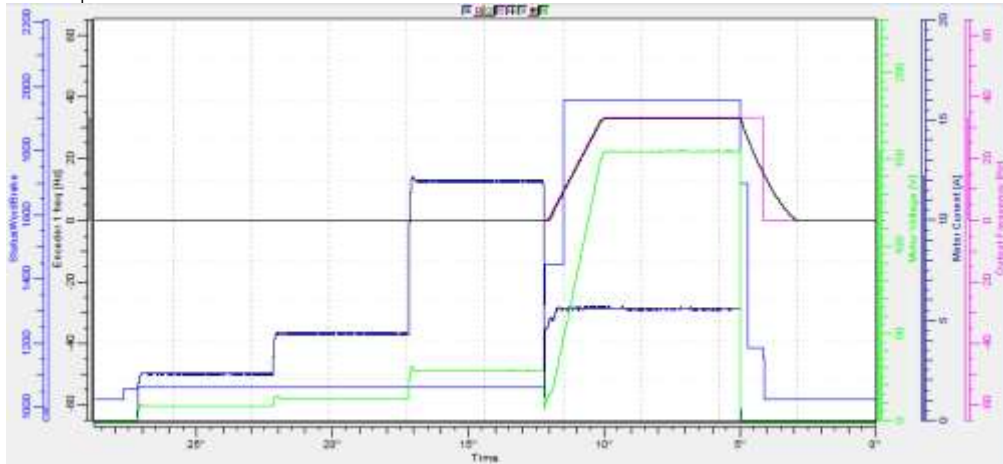

Parameters updated during this identification

- P2.1.9 MagnCurrent
- P2.8.4.2 U/f Ratio Select
- P2.8.4.5 U/f Mid Freq
- P2.8.4.6 U/f Mid Voltg
- P2.8.4.7 Zero Freq Voltg
- P2.8.9.16 RsVoltageDrop
- P2.8.9.17 IrAddZeroPVoltg
- P2.8.9.22-24 Ix Offset

## 7 = "DTC Ident" – Dead Time Compensation Identification

Current is applied to the motor but shaft will not be rotated.

This identification mode is needed for Sensorless control, Ident All can be used instead of this.

**10 = "ID Run Fails" - Identification failed**

Identification failed in last attempt.

The basic motor name plate data has to be set correctly before performing the identification run:

- P2.1.3 – P2.1.8. Motor basic data.
- P2.1.9 Magnetization current can also be given if available if given before identification without rotating motor; U/f curve will be tuned according to given magnetization current.
- P2.1.11 Motor Type.

When in closed loop and with an encoder installed, also the parameter for pulses / revolutions (in Menu M7) has to be set.

The automatic identification is activated by setting this parameter to the appropriate value followed by a start command in the requested direction. The start command to the drive has to be given within 20 s. If no start command is given within 20 s the identification run is cancelled and the parameter will be reset to its default setting. The identification run can be stopped any time with normal stop command and the parameter is reset to its default setting. In case identification run detects fault or other problems, the identification run is completed if possible. After the identification is finished, warning will be given is not all requested identification types has been completed successfully. During Identification Run, the brake control is disabled.

**Note:** After identification is made drive requires rising edge of start command.

**Note:** Advance application has all identified values stored to parameters, no need to redo identification if previous parameters are loaded back to the drive if e.g. control board is changed.

**P2.1.13 Motor Type ID650 "Motor Type"**

Select used motor type with this parameter

**0 "Induction" - Induction motor**

-Asynchronous motor

**1 "PMSM" - Permanent magnet synchronous motor**

- Contact factory before using with externally magnetized motor.

See related parameter in "G2.8.6: Motor Control \ PMSM Control".

*P2.1.14 Supply Voltage ID1201*

This parameter can be used when license key P3.6 License has been give.  
This enables use of 690 Vac unit in voltage range of 500 Vac unit. Contact factory for warranty and license issues.



## 8.2 Reference Handling – “Ref Handling”

Priority order of Advance application speed reference chain.

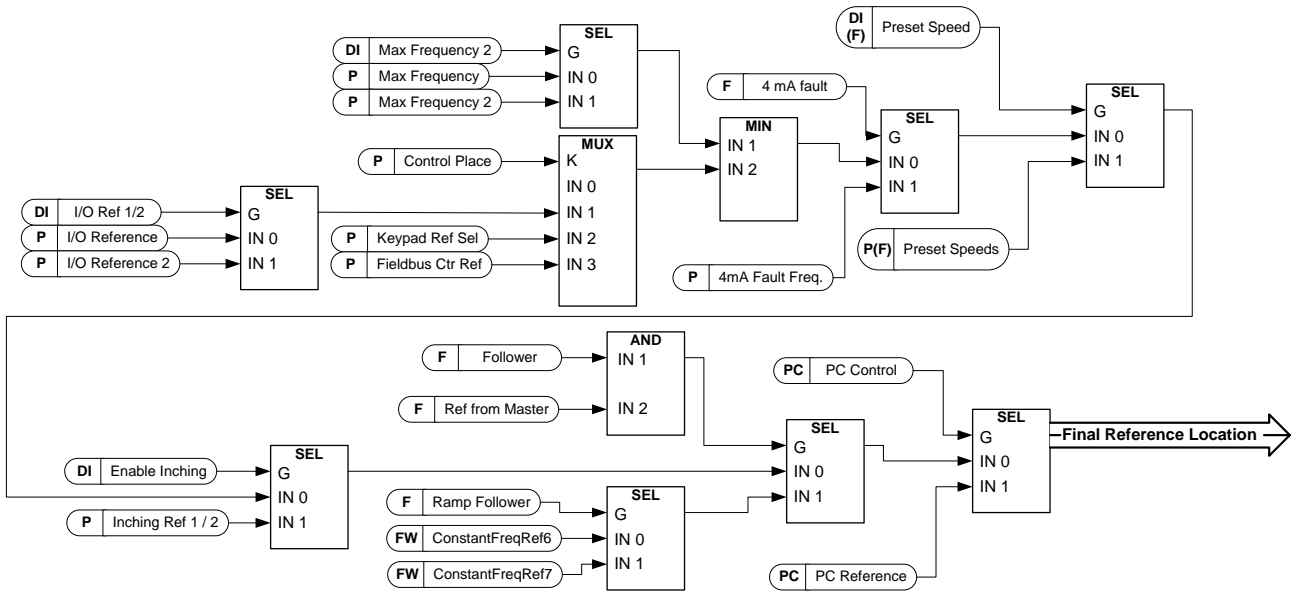

Speed reference chain before ramp control

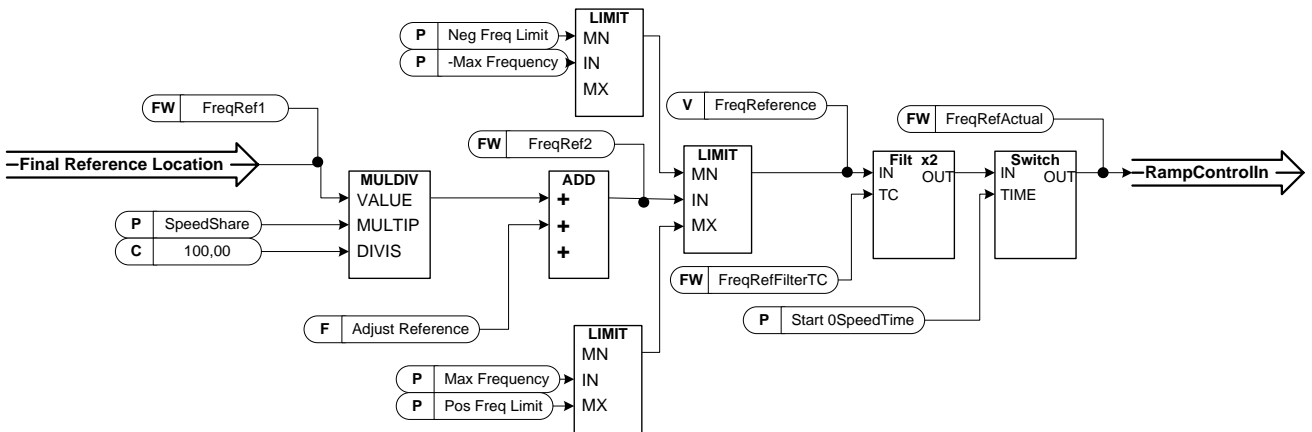

## 8.2.1 Basic Parameters

**P2.2.1 Torque reference scale ID1247 "Torque Scale"**

With this parameter the default resolution of torque reference 1000 = motor nominal torque can be changed to 10000 = motor nominal torque. This function is available for closed loop control only.

- 0 1000: (100,0 %)
- 1 10000: (100,00 %)

All the torque related signals and parameters are changed and displayed automatically in the same scale.

Parameters affected by this:

- P2.2.9.2 Torque Ref Max
- P2.2.9.3 Torque Ref Min
- P2.2.9.5 TorqueRefDeadZone
- (P2.2.9.6 Torque Ref. Hyst)
- P2.2.9.12.1 Torque Step
- (P2.2.12.13 Torque Ref. Add)
- (P2.3.13.4 Quick Stop T Lim)
- P2.2.9.6 Torque Limit
- P2.6.3.1 MotorTorqueLimit
- P2.6.3.2 GenerTorqueLimit
- P2.6.3.6.1 SPC Out Limit
- P2.6.3.6.2 SPC Neg Limit
- P2.6.3.6.3 SPC Pos Limit
- (P2.6.5.12.2 CL OV ConMotTLim)
- P2.9.4.9 SPC Torq Min
- P2.12.7.3 UP F0 Torque
- P2.12.7.2 UP Fnom Torque
- (P2.15.9 MaxTorqLim)

**P2.2.2 I/O frequency reference selection 1 ID117 "I/O Reference"**

Defines which frequency reference source is used when control place is I/O terminal  
P3.1 Control Place

**0="AI1" - Analogue Input 1.**

Signal scaling in "G2.4.2: Input Signals \ Analogue Input 1"

**1="AI2" - Analogue Input 2.**

Signal scaling in "G2.4.3: Input Signals \ Analogue Input 2"

**2="AI1+AI2" - Analogue Input 1 + Analogue Input 2.**

With alternative reference scaling in Analogue Input group 100 % input values can be set to correspond 25 Hz thus when both are at 100 % final reference will be 50 Hz.

**3="AI1-AI2"**

Analogue Input 1 - Analogue Input 2.

**4="AI2-AI1"**

Analogue Input 2 - Analogue Input 1.

**5="AI1xAI2"**

Analogue Input 1 x Analogue Input 2

**6="AI1 Joystick"**

Analogue input 1, -10 Vdc... +10 Vdc

**7="AI2 Joystick"**

Analogue input 2, -10 Vdc... +10 Vdc

**8="Keypad Ref"**

Reference from keypad R3.2

**9="Fieldbus"**

Reference is taken from Fieldbus, alternative scaling can be selected in "G: Fieldbus"

**10="Motor Pot" - Motor potentiometer.**

Reference handled with two digital input "G: Input Signals \ Digital Inputs" (increase and decrease). Behaviour adjusted in "G: Ref Handling \ Motor Poten.mete".

**11="AI1, AI2 min"**

The minimum of Analogue Input 1 and Analogue Input 2 is used as reference.

**12="AI1, AI2 max"**

The maximum from Analogue Input 1 and Analogue Input 2 is used as reference.

**13="Max Freq" – Maximum Frequency**

P2.1.2 Max Frequency is used as reference.

**14="AI1/AI2 Sel" – AI1/AI2 Selection**

Digital Input "I/O Ref 1/2" is used to select between Analogue Input 1 and Analogue Input 2 reference. "I/O Ref 1/2" is used to select between "I/O Reference" and "I/O Reference 2" if selection is different than 14 (this one).

**15="Encoder 1"**

Reference is read from encoder input 1.

**16="Encoder 2"**

Reference is read from encoder input 2. This selection is usable with double encoder boards. Could be used e.g. for speed synchronization where two motor needs to run at same speed but not necessarily same angle.

**P2.2.3 Keypad frequency reference selection ID121 "Keypad Ref Sel"**

Defines which frequency reference source is used when control place is keypad P3.1 Control Place

**0="AI1" - Analogue Input 1.**

Signal scaling in "G2.4.3: Input Signals \ Analogue Input 1"

**1="AI2" - Analogue Input 2.**

Signal scaling in "G2.4.4: Input Signals \ Analogue Input 2"

**2="AI1+AI2" - Analogue Input 1 + Analogue Input 2.**

With alternative reference scaling in Analogue Input group 100 % input values can be set to correspond 25 Hz. That is, when both are at 100 % final reference will be 50 Hz.

**3="AI1-AI2"**

Analogue Input 1 - Analogue Input 2.

**4="AI2-AI1"**

Analogue Input 2 - Analogue Input 1.

**5="AI1xAI2"**

Analogue Input 1 x Analogue Input 2

**6="AI1 Joystick"**

Analogue input 1, -10 Vdc... +10 Vdc

**7="AI2 Joystick"**

Analogue input 2, -10 Vdc... +10 Vdc

**8="Keypad Ref"**

Reference from keypad R3.2

**9="Fieldbus"**

Reference is taken from Fieldbus, alternative scaling can select in "G: Fieldbus"

**P2.2.4 Fieldbus frequency reference selection ID122 "Fieldbus Ctr Ref"**

Defines which frequency reference source is selected when control place is Fieldbus P3.1. Control Place

**0="AI1" - Analogue Input 1.**

Signal scaling in "G2.4.3: Input Signals \ Analogue Input 1"

**1="AI2" - Analogue Input 2.**

Signal scaling in "G2.4.4: Input Signals \ Analogue Input 2"

**2="AI1+AI2" - Analogue Input 1 + Analogue Input 2.**

With alternative reference scaling in Analogue Input group 100 % input values can be set to correspond 25 Hz thus when both are at 100 % final reference will be 50 Hz.

**3="AI1-AI2"**

Analogue Input 1 - Analogue Input 2.

**4="AI2-AI1"**

Analogue Input 2 - Analogue Input 1.

**5="AI1xAI2"**

Analogue Input 1 x Analogue Input 2

**6="AI1 Joystick"**

Analogue input 1, -10 Vdc... +10 Vdc

**7="AI2 Joystick"**

Analogue input 2, -10 Vdc... +10 Vdc

**8="Keypad Ref"**

Reference from keypad R3.2

**9="Fieldbus"**

Reference is taken from Fieldbus, alternative scaling can select in "G: Fieldbus"

*P2.2.5 I/O frequency reference selection 2 ID131 "I/O Reference 2"*

This parameter is used to select different reference input location with digital input P2.4.2.17 I/O Ref. 2. Selections for this are the same as for the I/O frequency reference selection 1.

Other parameters related to function  
- Digital input P2.4.2.17 I/O Ref. 1/2

*P2.2.6 Speed share ID1241 "Speed Share"*

Defines the speed reference percentage ratio after final reference location but before ramp control. Monitoring value "FreqReference" shows the reference after speed share function. Used to adjust reference ration e.g. in line drive that PLC can give same reference to all drives while speed share compensate gear ratio affect to the line speed.

*P2.2.7 Load Share ID1248 "Load Share"*

Defines the percentage for final torque reference after final torque reference location selection but before the torque reference step function, torque reference dead zone and reference filtering.

### 8.2.2 Constant Reference

#### P2.2.8.1 Jogging speed reference ID124 "Jog Speed Ref"

Defines the jogging speed reference when activated by a digital input. This reference will follow the reverse command if given. Jogging speed has a higher priority than preset speed references.

Related parameters

- DigitalInput P2.4.2.16 Jogging Speed

P2.2.8.2	Preset speed 1	ID105	"Preset Speed 1"
P2.2.8.3	Preset speed 2	ID106	"Preset Speed 2"
P2.2.8.4	Preset speed 3	ID126	"Preset Speed 3"
P2.2.8.5	Preset speed 4	ID127	"Preset Speed 4"
P2.2.8.6	Preset speed 5	ID128	"Preset Speed 5"
P2.2.8.7	Preset speed 6	ID129	"Preset Speed 6"
P2.2.8.8	Preset speed 7	ID130	"Preset Speed 7"

Parameter values define the Preset speeds references activated by digital inputs. These references will follow reverse command if given.

Speed	Digital Input Preset speed 1	Digital Input Preset speed 2	Digital Input Preset speed 3
Basic speed	0	0	0
Preset Speed 1	1	0	0
Preset Speed 2	0	1	0
Preset Speed 3	1	1	0
Preset Speed 4	0	0	1
Preset Speed 5	1	0	1
Preset Speed 6	0	1	1
Preset Speed 7	1	1	1

Table 8-1. Preset speeds 1 to 7

Related parameters

Digital inputs P2.4.2.5-7 Preset Speed 1-3

#### 8.2.2.1 Inching function

Inching function will start the drive to reference without additional start command regardless of control place. Inching function requires enabling from digital input before command is accepted. Inching is also disabled if there is start command active from active control place.

P2.2.8.9	Inching reference 1	ID1239	"Inching Ref 1"
P2.2.8.10	Inching reference 2	ID1240	"Inching Ref 2"

These parameters define the reference for the inching function. The references are bidirectional and the reverse command does not affect the direction of the inching reference.

Other parameters for inching function

- Digital input selection: Enable Inching
- Digital input selection: Inching 1
- Digital input selection: Inching 2
- Parameter: Inching Ramp

### 8.2.3 Torque Reference

Motor torque is controlled which allows the motor speed to change depending on the actual load on the motor shaft. Speed limit behaviour is controlled by P2.2.9.6 TorqSpeedLimit parameter.

For joystick inputs maximum negative reference is negated "Torq Ref Max". The minimum is used only for analogue input selections 1 to 4. Also the maximum negative torque reference maximum is negated "Torq Ref Max".

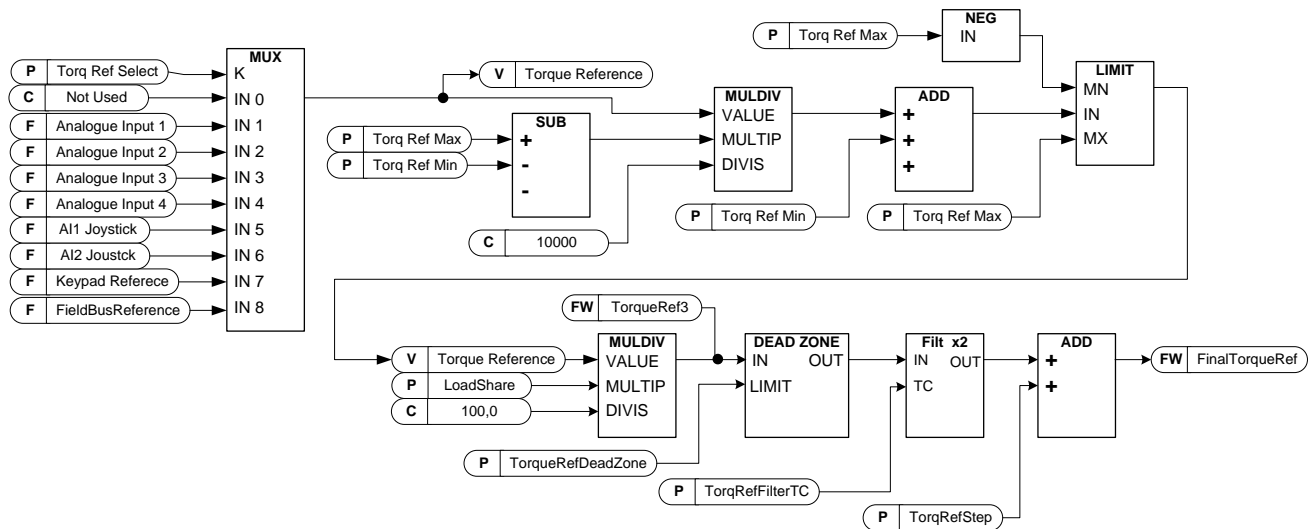

#### P2.2.9.1 Torque reference selection

#### ID641 "Torq Ref Select"

0="Not Used"

1="AI1" - Analogue Input 1.

Signal scaling in "G: Input Signals \ Analogue Input 1"

2="AI2" - Analogue Input 2.

Signal scaling in "G: Input Signals \ Analogue Input 2"

3="AI3"

4="AI4"

5="AI1 Joystick"

Analogue input 1, -10 Vdc... +10 Vdc. For joystick inputs the maximum negative reference is negated "Torq Ref Max".

6="AI2 Joystick"

Analogue input 2, -10 Vdc... +10 Vdc For joystick inputs the maximum negative reference is negated "Torq Ref Max".

7="Keypad Ref"

Torque reference from keypad R3.5.

8="Fieldbus"

Reference is taken from Fieldbus. Alternative scaling can be selected in "G: Fieldbus"

**P2.2.9.2 Torque reference scaling, maximum value ID641 "Torq Ref Max"**

Maximum allowed torque reference for positive and negative values. This is also used for joystick input for negative maximum limit.

**P2.2.9.3 Torque reference scaling, minimum value ID642 "Torq Ref Min"**

Minimum torque reference for analogue input reference selections 1-4.

**P2.2.9.4 Torque reference filtering time ID1244 "TorqRefFilterTC"**

Defines the filtering time for torque reference. Filtering is after load share function and before torque step function.

**P2.2.9.5 Torque reference dead zone ID1246 "TorqRefDeadZone"**

The small values of the torque reference around zero can be ignored by setting this value greater than zero. When reference is between zero to plus/minus this parameter, the reference is forced to zero.

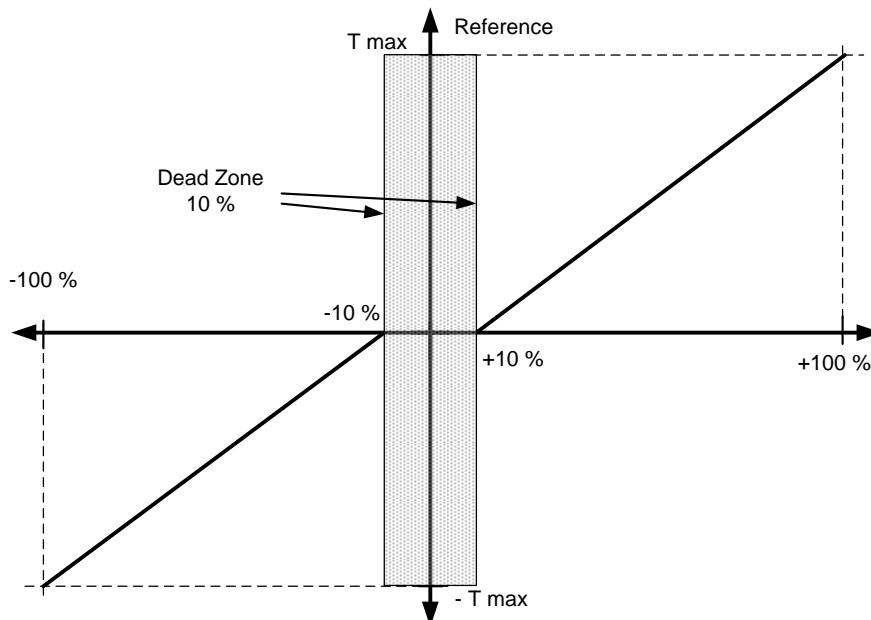



P2.2.9.6 Torque Select ID1278 "Torque Select"

This parameter defines the speed limiting mode in torque control mode. This parameter can be used as single motor control mode selection when no change is made between open loop and closed loop controls.

0 = Speed Control Mode	SpeedControl
1 = Positive - Negative Frequency limits	MaxFreqLimit
2 = RampOut (-/+)	RampOutPut
3 = Negative frequency limit -- RampOut	MIN
4 = RampOut - Positive frequency limit	MAX
5 = RampOut in Window	
6 = 0 -- RampOut	
7 = RampOut in Window with On Off limits	Window

**0= "SpeedControl" - Speed control mode**

The drive is forced to operate in speed control mode while the motor control mode parameter is set to torque control mode thus allowing selection of speed control and torque control mode with single parameter e.g. from Fieldbus.

**1="MaxFreqLimit" - Positive and negative frequency limits**

Speed is not limited by speed reference, only maximum frequency or Positive and Negative frequency limit if set lower than maximum frequency parameter.

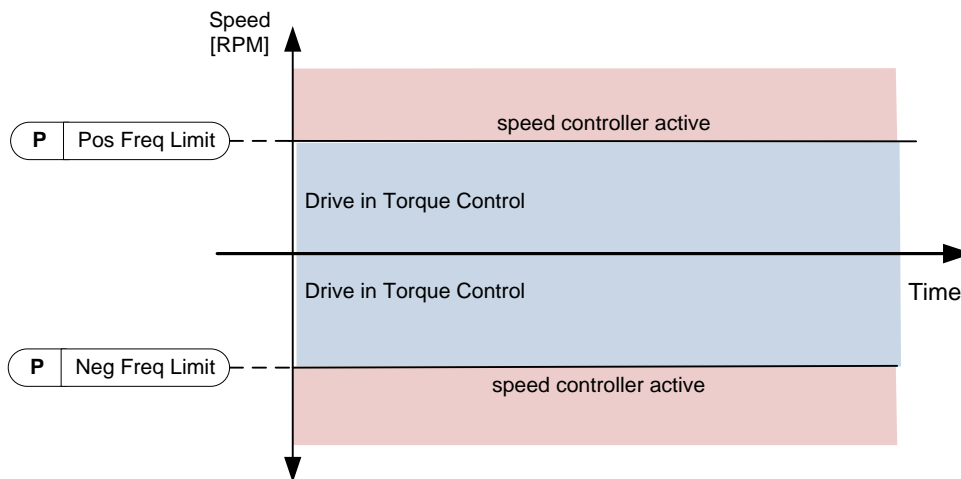

**2="RampOutput" – Ramp output for both directions**

Speed is limited by reference after ramp generator, thus speed will increase with set ramp time until actual torque is equal to reference torque. If speed is below reference when load is removed from the shaft the speed will increase without ramp.

This is the default selection. For master follower system it is recommended to use selection that allows a little higher reference for torque follower that load will be balanced equally e.g. window control.

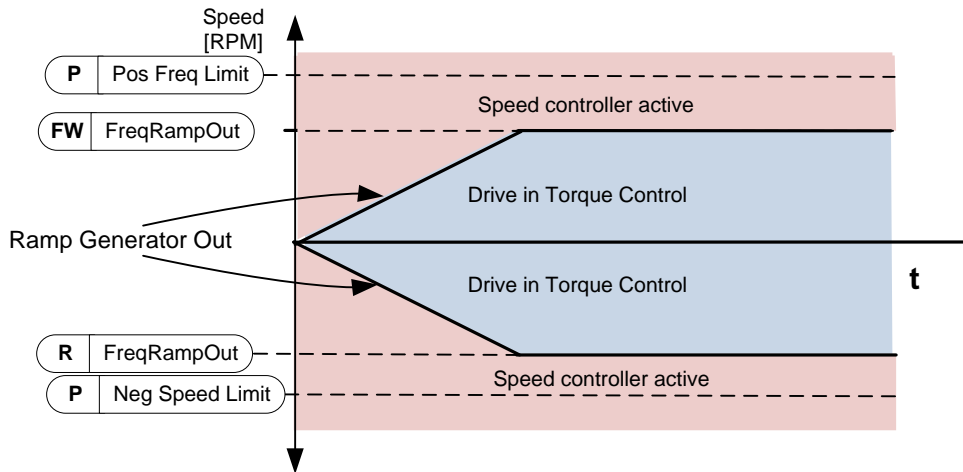

**3="Min" – Minimum from speed reference and torque reference.**

The minimum of the speed controller output and the torque reference is selected as final torque reference.

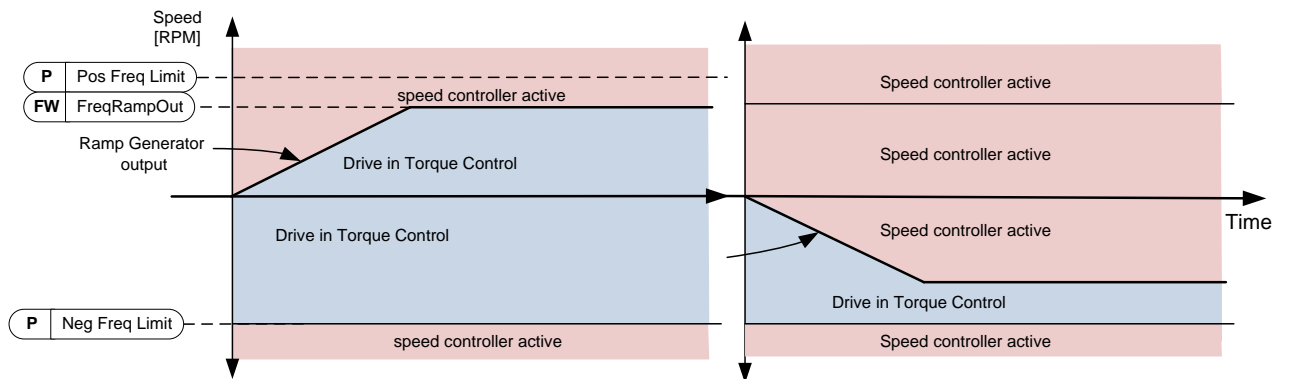

**4="Max"** – Maximum from speed reference and torque reference

The maximum of the speed controller output and the torque reference is selected as final torque reference.

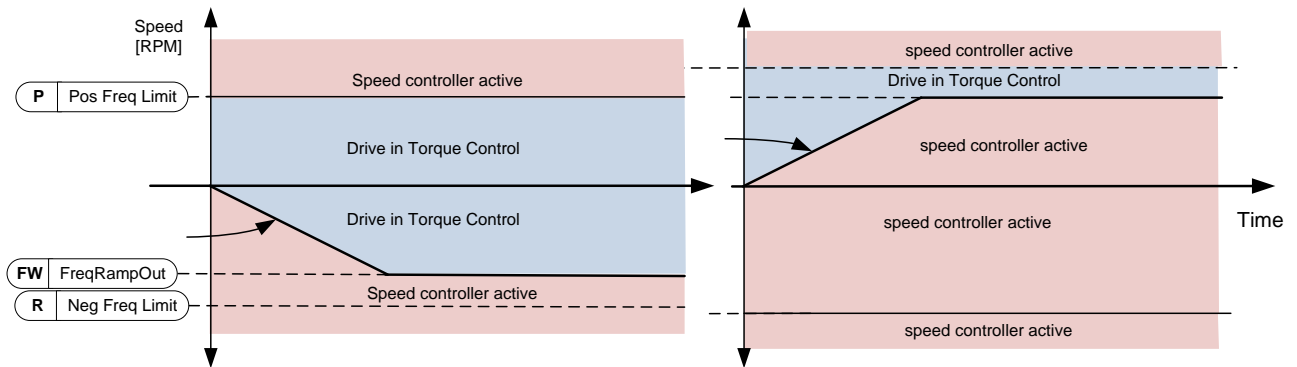

**7="Window"** – Window control

Speed is limited within window from speed reference.

Speed control activation limit is different from the speed limit. Speed needs, therefore, to go first to "Window Pos" or "Window Neg" limit before the speed controller activates, when speed controller is active speed will be restricted to limit defined by "Window Pos Off" and "Windows Neg Off" from the "FinalFreqRef"

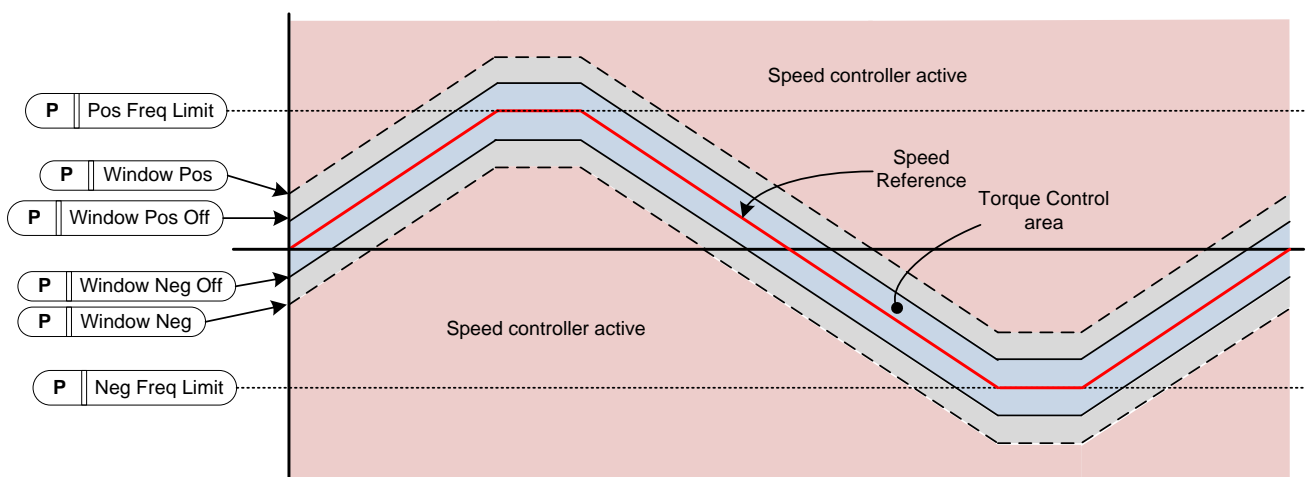

**P2.2.9.7 Window negative ID1305 "Window Neg"**

Defines the size of window to negative direction from the final speed reference. If both windows off limits are zero this parameter is also the speed limit from the "FinalFreqRef". Otherwise this is the speed control activation limit.

**P2.2.9.8 Window positive ID1304 "Window Pos"**

Defines the size of window to positive direction from the final speed reference. If both windows off limits are zero this parameter is also the speed limit from the "FinalFreqRef". Otherwise this is the speed control activation limit.

**P2.2.9.9 Window negative Off limit ID1307 "Window Neg Off"**

Defines the speed controller negative off limit when the speed controller brings the speed back to window.

**P2.2.9.10 Window positive Off limit ID1306 "Window Pos Off"**

Defines speed controller positive off limit when speed controller brings speed back to window.

**8.2.3.1 Torque reference OL settings****P2.2.9.11.1 Open loop torque control minimum frequency ID636 "OL TC Min Freq"**

Defines the frequency limit below which the frequency converter operates in *frequency control mode*.

**P2.2.9.11.2 Open loop torque controller P gain ID639 "OL TorqCtrl P"**

Defines the gain for open loop torque control.

**P2.2.9.11.3 Open loop torque controller I gain ID640 "OL TorqCtrl I"**

Defines the integration gain for open loop torque control.

NOTE: This is a gain for integration part.

**P2.2.9.11.4 Torque speed limit in Open Loop Control (2.10.7)**

With this parameter the maximum frequency for the torque control can be selected.

- 0 Maximum frequency, par. [ID102](#)
- 1 Selected frequency reference
- 2 Preset speed 7, par. [ID130](#)

NXP drives have more selections for this parameter in Closed Loop control.

**2.2.9.12.1 Torque step ID1253 "Torque Step"**

Step torque reference in percentage of motor nominal torque. Added after the filtering function and ramp function.

This step reference is normally used for the inertia/friction compensation of the drive system through fieldbus in fieldbus control. E.g. the inertia compensation for winder or unwinder roll can be written from fieldbus to this parameter.

8.2.4 Prohibited frequencies

In some systems it may be necessary to avoid certain frequencies because of mechanical resonance problems. With these parameters it is possible to set limits for the prohibited frequency region and ramp rate factor to use when frequency is going above this area. When the input reference is increased the internal reference is kept at the low limit until the input reference is above the high limit.

- P2.2.10.1 Prohibit frequency area 1; Low limit
- P2.2.10.2 Prohibit frequency area 1; High limit

- ID509 "Range 1 Low Lim"
- ID510 "Range 1 High Lim"

Range definition where a different ramp time defined by "RampTimeFactor" is used.

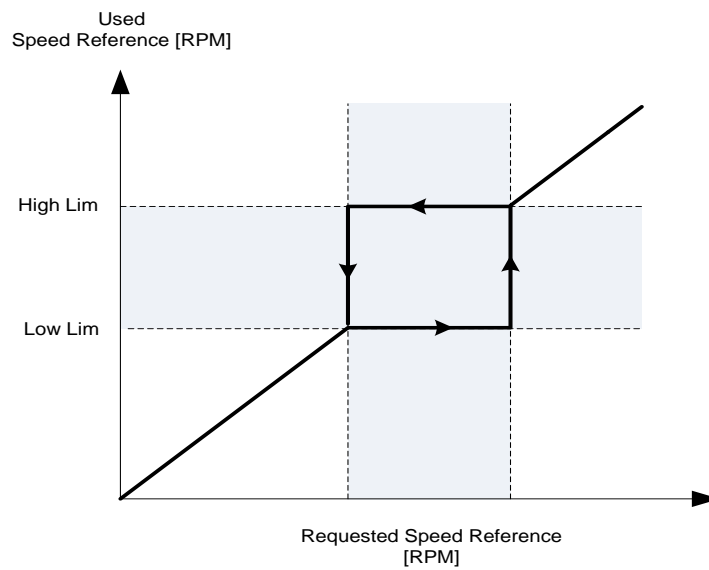

- P2.2.10.3 Ramp time factor for prohibited range

- ID518 "RampTimeFactor"

Multiplier of the currently selected ramp time between prohibit frequency limits.

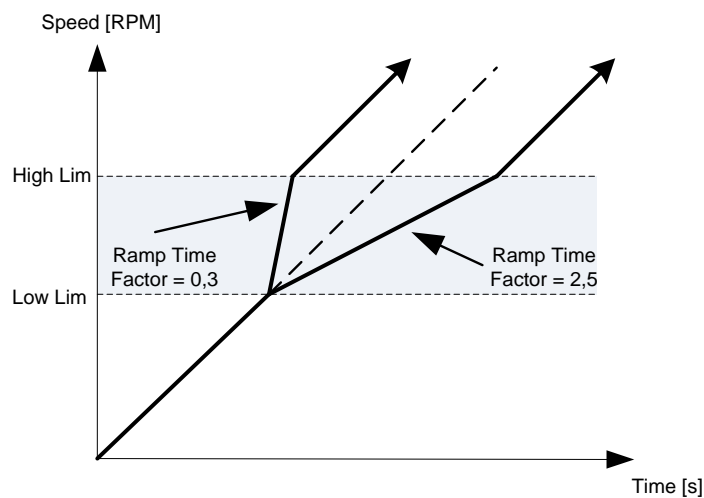
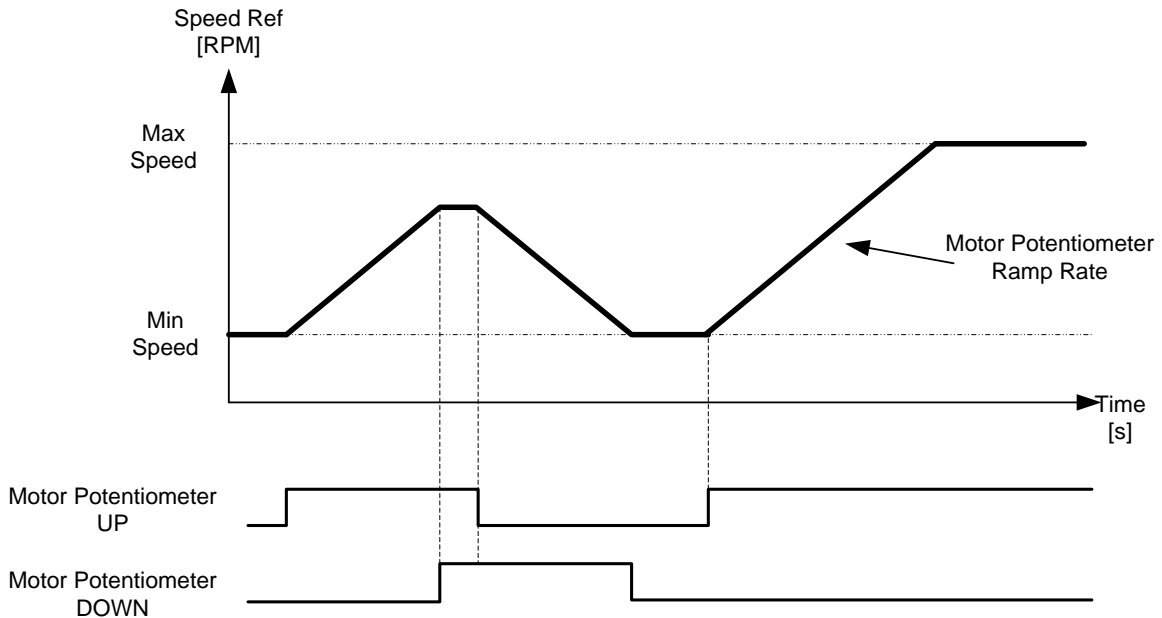

Figure 8-1. Ramp rate scaling between prohibit frequencies

### 8.2.5 Motor potentiometer

Motor potentiometer is used to control the reference with two digital inputs, one increasing the reference and the other decreasing the reference. The reference change rate can be set by parameter [Hz/s]. Motor potentiometer reference is available in I/O control only. It can be changed only when the drive is in running state.



#### P2.2.11.1 Motor potentiometer ramp rate ID331 "MotPot Ramp Rate"

Defines the rate of change of the motor potentiometer reference value in Hz/s. Normal ramp times are still active and determine how fast the actual output frequency increases.

#### P2.2.11.2 Motor potentiometer reference reset ID367 "MotPotRef Reset"

##### 0 "No reset"

Reference is kept past the stop state and stored to memory in case of a powerdown.

##### 1 "Stop State"

Reference is set to zero when the drive is in stop state. This selection includes powerdown situations.

##### 2 "Power Down"

Reference is reset only in a powerdown situation.

Other parameters related to function

- P2.4.2.8 Motor potentiometer DOWN ID417 "Mot Pot Ref Down"
- P2.4.2.9 Motor potentiometer UP ID418 "Mot Pot Ref Up"

8.2.6 Adjust Reference

Adjust reference function is used to fine tune the main reference. Adjust reference is added to main reference after "SpeedShare" function.

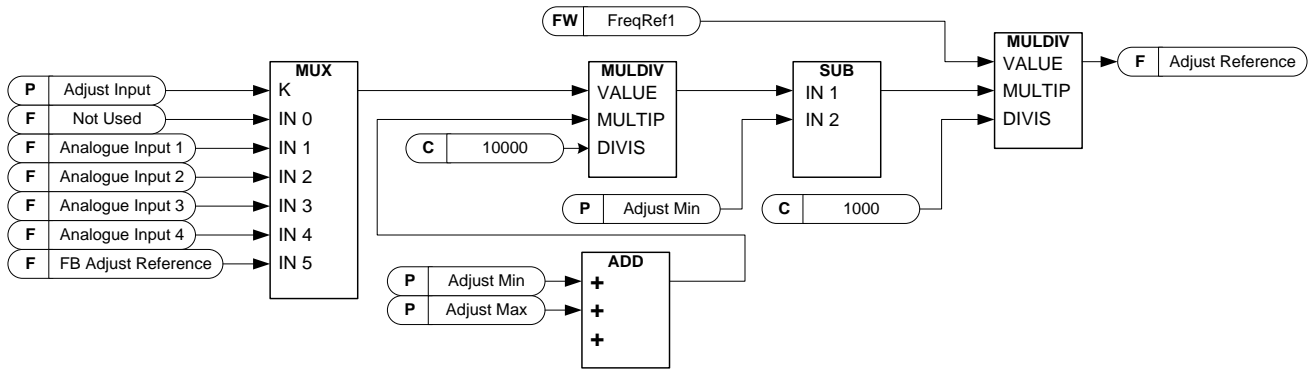

P2.2.12.1 Adjust input ID493 "Adjust Input"

With this parameter you can select the signal according to which the frequency reference to the motor is fine adjusted.

- 0 Not used
- 1 Analogue input 1
- 2 Analogue input 2
- 3 Analogue input 3
- 4 Analogue input 4
- 5 FB Adjust Reference ID47 Monitoring Signal

P2.2.12.2 Adjust minimum ID494 "Adjust minimum"

Percentage that is subtracted from the main reference when adjust input is at minimum.

P2.2.12.3 Adjust maximum ID495 "Adjust Maximum"

These parameters define the minimum and maximum of adjusted signals.

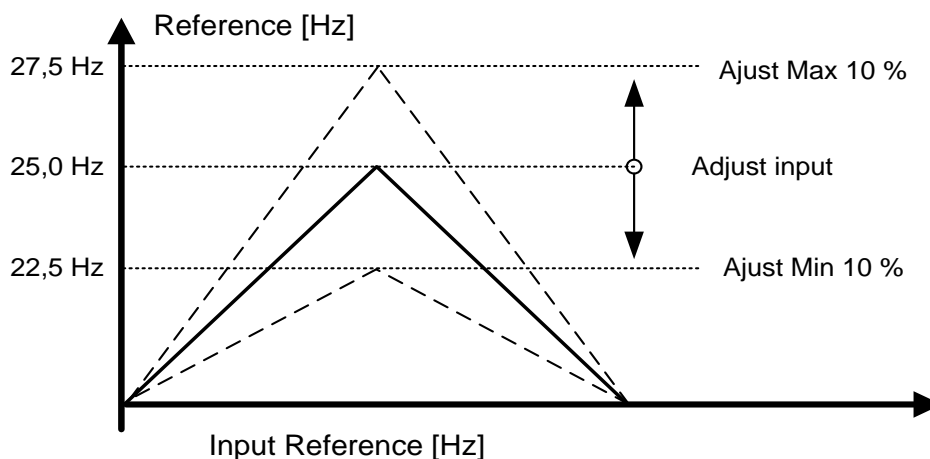

If minimum and maximum are not equal to zero adjustment is not at the midpoint of analogue input or at zero point if -10...+10 Vdc input is used. Below picture minimum is 20 % and maximum 10 %.

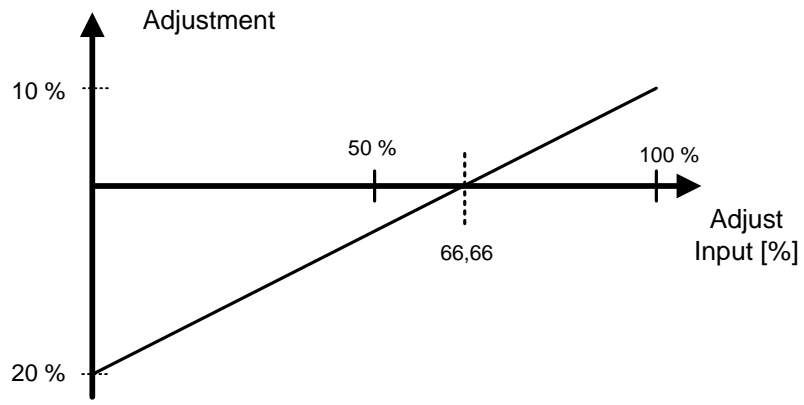



8.3 Ramp control

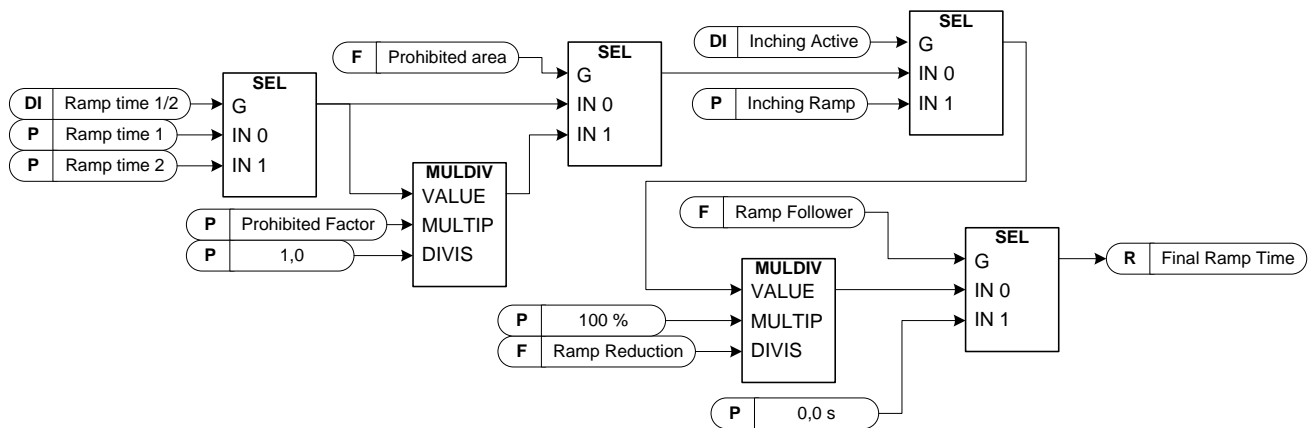

P2.3.1 Start function ID505 "Start Function"

Ramp:

0 The frequency converter starts from 0 Hz and accelerates to the set reference frequency within the set acceleration time.

Flying start:

1 The frequency converter is able to start with motor running by applying current to motor and searching for the frequency corresponding to the speed the motor is running at. Searching starts from the maximum frequency towards the zero frequency until the correct value is detected.

Use this mode if the motor is coasting when the start command is given. With the flying start it is possible to start motor from actual speed without forcing the speed to zero before ramping to reference.

Conditional Flying start:

2 With this mode it is possible to disconnect and connect the motor from the frequency converter even when the Start command is active. On re-connecting the motor, the drive will operate as described in selection 1.

Closed loop control will always start like flying start because exact speed of the motor is known from encoder feedback.

P2.3.2 Stop function ID506 "Stop Function"

Coasting:

0 Drive stops controlling the motor immediately and let's motor rotate freely.

Ramp:

2 After the Stop command, the speed of the motor is decelerated according to the set deceleration parameters to zero speed. DI "Run Enable" will make coasting stop regardless of selected stop function.

**P2.3.3 Acceleration time 1 ID103 "Accel Time 1"**

This parameter defines the time required for the output frequency to increase from the zero frequency to maximum frequency.

**P2.3.4 Deceleration time 1 ID104 "Decel Time 1"**

This parameter defines the time required for the output frequency to decrease from the maximum frequency to zero frequency.

**P2.3.5 Acceleration/Deceleration ramp 1 shape ID500 "Ramp 1 Shape"**

The start and end of acceleration and deceleration ramps can be smoothed with these parameters. Setting value 0 gives a linear ramp shape which causes acceleration and deceleration to act immediately to the changes in the reference signal. Setting value 1...100 % for this parameter produces an S-shaped acceleration/deceleration.

Used to reduce mechanical erosion and current spikes when reference is changed.

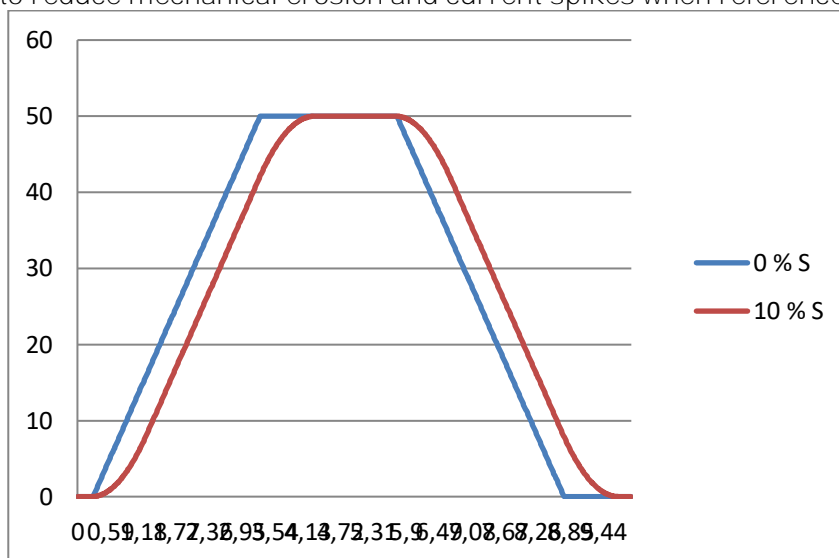

Figure 8-2. 10 % S ramp with 3 s ramp time compared to without S ramp

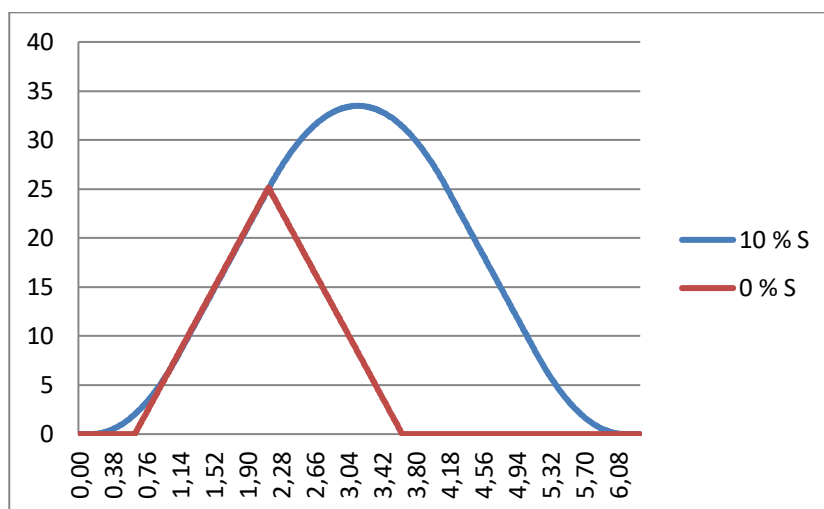

Figure 8-3. 10 % S ramp with 3 s ramp time when reference set to zero at 25 Hz

---

<i>P2.3.6</i>	<i>Acceleration time 2</i>	<i>ID502 "Accel Time 2"</i>
<i>P2.3.7</i>	<i>Deceleration time 2</i>	<i>ID503 "Decel"</i>
<i>P2.3.8</i>	<i>Acceleration/Deceleration ramp 2 shape</i>	<i>ID501 "Ramp 2 Shape"</i>

These ramp times and ramp shapes are used when the second ramp time is activated by digital input "Acc/Dec Time Sel"

### P2.3.9 Inching ramp ID1257 "Inching Ramp"

This parameter defines acceleration and deceleration times when inching is active. Inching function will start the drive to reference without additional start command regardless of control place. Inching function requires enabling from digital input before command is accepted. Inching is also disabled if there is a start command active on the active control place.

Other parameters for inching:

- Parameter: Inching Reference 1
- Parameter: Inching Reference 2
- Digital input selection: Enable Inching
- Digital input selection: Inching 1
- Digital input selection: Inching 2

### P2.3.10 Reduction of acceleration and deceleration times ID401

Acceleration and deceleration times can be reduced with the input signal. Input signal level zero means ramp times set by parameters. Maximum level equals one tenth of the value set by parameter.

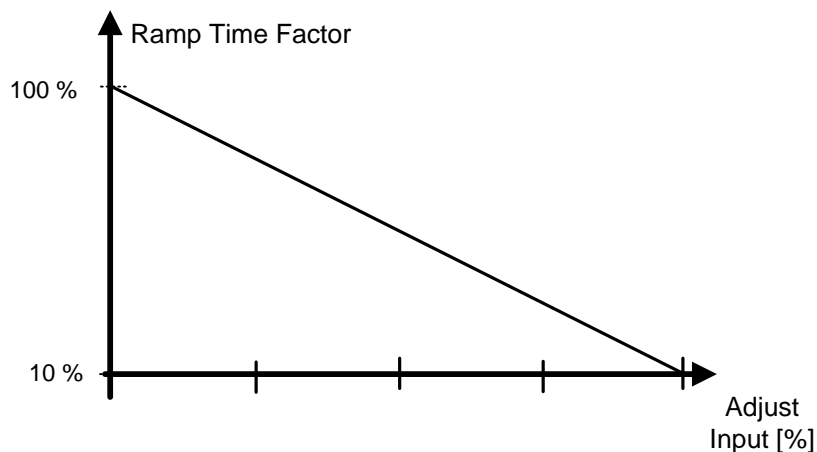

Figure 8-4. Reducing acceleration and deceleration times

### P2.3.11 Quick stop mode ID1276 "Quick Stop Mode"

Selects the mode of stopping the drive when quick stop is active.

- It is recommended to use same stop function in follower drives.
- It is recommended to use same ramp time in both drives

- 0 Coast stop.
- 1 Ramp stop.

### 8.3.1 Ramp Options

#### P2.3.12.1 Speed Reference Interpolator TC ID1184 "Ramp In Inter. TC"

Set here time on what interval speed reference is updated. This function ramps the reference between updated values.

Function is used when PLC is updating reference e.g. 100 ms time level but drive own ramp is set much shorter to have fast response. When reference (Green) is used without interpolator also output frequency would behave same way causing torque and current spikes every time reference changes. When interpolator time is set to 100 ms output frequency behaves as blue line.

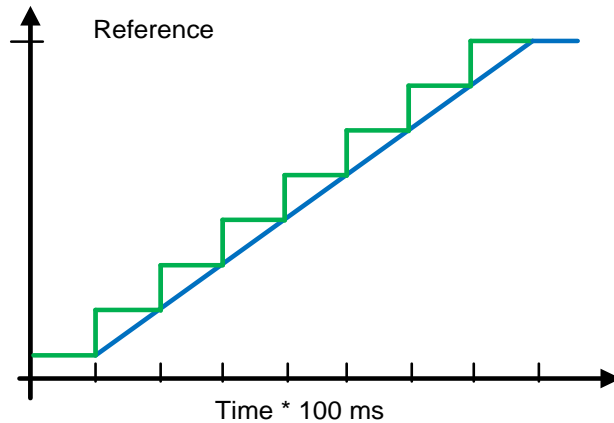

## 8.4 Input signals

## 8.4.1 Basic Settings

## P2.4.1.1 Start/Stop logic selection ID300 "Start/Stop Logic"

This parameter defines start stop logic when using I/O control. Some of these selections do not include the 'Reverse' command. Reverse command can be activated by a separate digital input "Reverse".

## 0 "Forw – Rev" – Forward Start – Reverse Start

Start 1: closed contact = start forward DI "Start 1"

Start 2: closed contact = start reverse DI "Start 2"

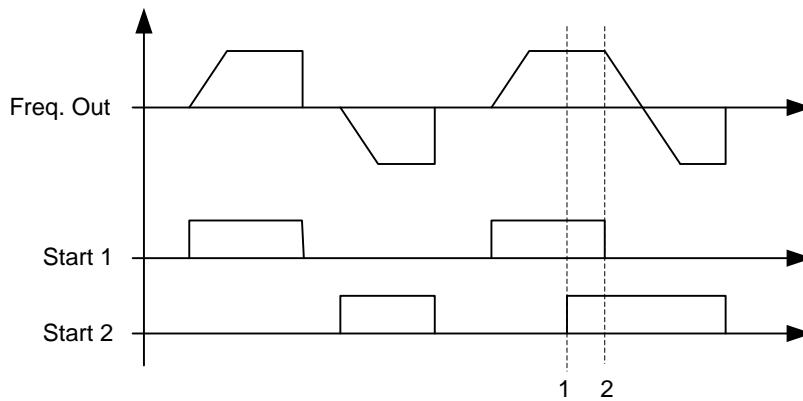

Figure 8-5. Start forward/Start reverse

- ① The first selected direction has the highest priority.
- ② When the DIN1 contact opens the direction of rotation starts the change.

## 1 "Start – Rev" - Start command – Direction command

Start 1: closed contact = start      open contact = stop

Start 2: closed contact = reverse      open contact = forward

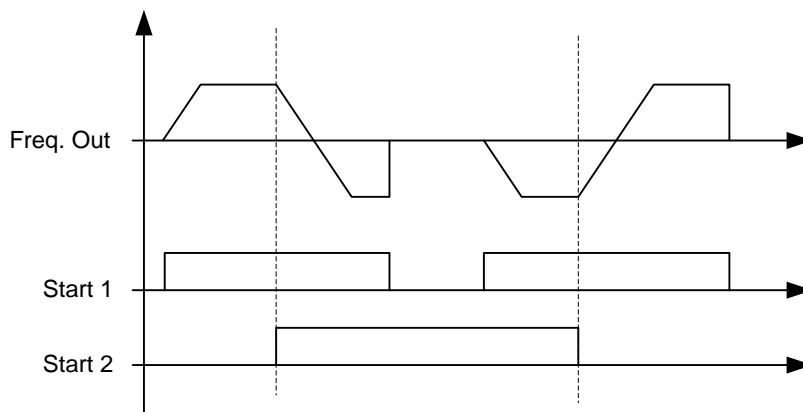

Figure 8-6. Start, Stop, Reverse

## 2 "Start – Enable" – Start command – Run Enable

DIN1: closed contact = start      open contact = stop

DIN2: closed contact = start enabled      open contact = start disabled and drive stopped if running

### 3 “StartP-StopP” – Start Pulse – Stop Pulse

3-wire connection (pulse control):

DIN1: closed contact = start pulse

DIN2: open contact = stop pulse, falling edge.

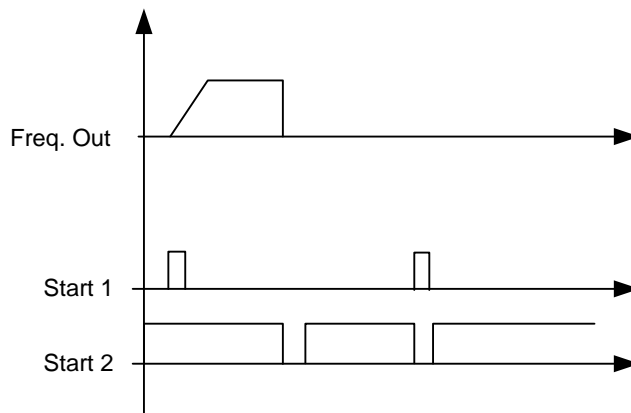

Figure 8-7. Start pulse/ Stop pulse.

The selections including the text '**Rising edge required to start**' shall be used to exclude the possibility of an unintentional start when, for example, power is connected, re-connected after a power failure, after a fault reset, after the drive is stopped by Run Enable (Run Enable = False) or when the control place is changed. The Start/Stop contact must be opened before the motor can be started.

### 4 “Strt-MotP UP” – Start – Motor potentiometer UP

DIN1: closed contact = start forward

DIN2: closed contact = Increases motor potentiometer reference, see Motor potentiometer function for more details.

### 5 “ForwR – RevR” – Forward start rising edge – Reverse start rising edge

DIN1: closed contact = start forward (**Rising edge required to start**)

DIN2: closed contact = start reverse (**Rising edge required to start**)

### 6 “StartR-Rev” - Start command rising edge – Direction command

DIN1: closed contact = start (**Rising edge required to start**)  
open contact = stop

DIN2: closed contact = reverse  
open contact = forward

### 7 “StrtR-Enable” – Start command rising edge – Run Enable

DIN1: closed contact = start (**Rising edge required to start**)  
open contact = stop

DIN2: closed contact = start enabled  
open contact = start disabled and drive stopped if running

### 8.4.2 Digital inputs

#### P2.4.2.1 Start signal 1 ID403 "Start Signal 1"

Signal selection 1 for the start/stop logic.  
Default programming A.1.Default Forward start.

#### P2.4.2.2 Start signal 2 ID404 "Start Signal 2"

Signal selection 2 for the start/stop logic.  
Default programming A.2. Default Reverse start.

#### P2.4.2.3 Run enable ID407 "Run Enable"

When run enable is removed from the drive coasting stop is made always.  
Drive will also show warning indication when run is disabled.

Contact open: Start of motor disabled  
Contact closed: Start of motor enabled

#### P2.4.2.4 Reverse ID412 "Reverse"

This reverse command is active when Start signal 2 is not used for reverse command because setting of "Start/Stop logic selection" parameter.

Contact open: Direction forward  
Contact closed: Direction reverse

#### P2.4.2.5 Preset speed 1 ID419 "Preset Speed 1"

#### P2.4.2.6 Preset speed 2 ID419 "Preset Speed 2"

#### P2.4.2.7 Preset speed 3 ID419 "Preset Speed 3"

Digital input selections for activating preset speeds.  
References are set in the "Constant Reference" parameter group.

Speed	Digital Input Preset speed 1	Digital Input Preset speed 2	Digital Input Preset speed 3
Basic speed	0	0	0
Preset Speed 1	1	0	0
Preset Speed 2	0	1	0
Preset Speed 3	1	1	0
Preset Speed 4	0	0	1
Preset Speed 5	1	0	1
Preset Speed 6	0	1	1
Preset Speed 7	1	1	1

Related parameters

- G2.2.7 Constant Ref

#### P2.4.2.8 Motor potentiometer DOWN ID417 "Mot Pot Ref Down"

Contact closed: Motor potentiometer reference DECREASES until the contact is opened. See details in G2.2.11 Motor Pot.



**P2.4.2.9 Motor potentiometer UP ID418 "Mot Pot Ref Up"**

Contact closed: Motor potentiometer reference DECREASES until the contact is opened. See details in G2.2.11 Motor Pot.

**P2.4.2.10 Fault reset ID414 "Fault Reset"**

Rising edge required to reset fault.

**P2.4.2.11 External fault closing contactor ID405 "Ext Fault Close"**

External fault input closing contactor, response selected in protection parameter group G2.11.1 Protections / General. Gives fault "51 Ext Fault"

**P2.4.2.12 External fault opening contactor ID406 "Ext Fault Open"**

External fault input opening contactor, response selected in protection parameter group. Gives fault "51 Ext Fault"

**P2.4.2.13 Acceleration/Deceleration time selection ID408 "Acc/Dec Time Sel"**

Digital input to select between ramp time 1 and 2, times are set in "Ramp Control" parameter group.

Contact open: Acceleration/Deceleration time 1 selected

Contact closed: Acceleration/Deceleration time 2 selected

**P2.4.2.14 Acceleration/Deceleration prohibited ID415 "Acc/Dec Prohibit"**

Contact closed: No acceleration or deceleration possible until the contact is opened.

With P2.9.3 Control Options B13 is possible to select that deceleration direction is allowed thus speed is reduced if reference is smaller than drive speed at the time.

**P2.4.2.15 DC-braking command ID416 "DC Brake Command"**

Contact closed: In STOP mode, the DC braking operates until the contact is opened. Current level is set with P2.7.1.16 DCBrakeCurInStop parameter.

**P2.4.2.16 Jogging speed ID413 "Jogging Speed"**

Contact closed: Jogging speed selected for frequency reference  
Reference for jogging speed is set in G2.2.7 Constant Reference group.

**P2.4.2.16 I/O Reference 1/2 selection ID422 "I/O Ref. 1/2"**

With this parameter you can select either AI1 or AI2 signal for frequency reference if I/O reference selection is "14 / AI1/AI2 Sel".

If selection for P2.2.1 I/O Reference is other than "14 / AI1/AI2 Sel" this digital input will change reference between P2.2.1 I/O Reference and P2.2.4 I/O Reference 2.

### 8.4.2.1 Forced control place

Digital inputs can be used to bypass parameter P3.1 Control Place, for example, in an emergency situation when PLC is not able to send command to the drive.

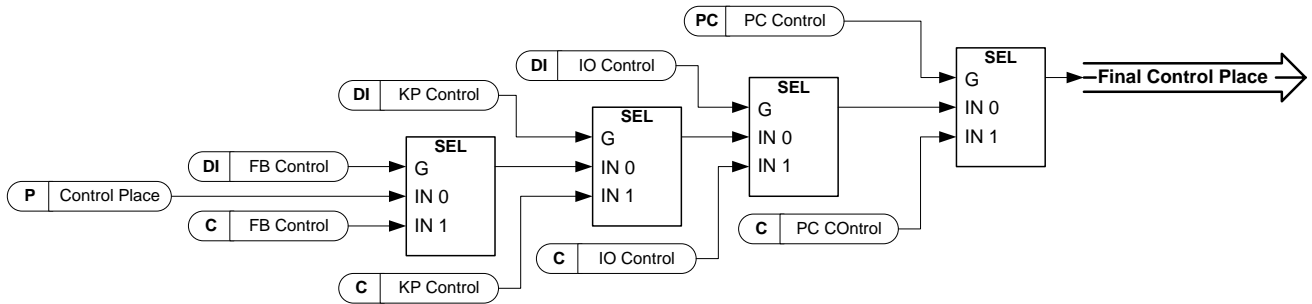

Figure 8-8. Control place selection priority order

#### P2.4.2.18 Control from I/O terminal ID409 "I/O Term Control"

Contact closed: Force control place to I/O terminal

#### P2.4.2.19 Control from keypad ID410 "Keypad Control"

Contact closed: Force control place to keypad

#### P2.4.2.20 Control from Fieldbus ID411 "Keypad Control"

Contact closed: Force control place to fieldbus

**NOTE:** When the control place is forced to change the values of Start/Stop, Direction and Reference valid in the respective control place are used. The value of parameter ID125 (Keypad Control Place) does not change. When the input opens the control place is selected according to keypad control parameter P3.1 Control Place

#### P2.4.2.21 Parameter Set 1/Set 2 selection ID496 "Param Set1/Set2"

With this parameter you can select between Parameter Set 1 and Set 2.

Remember to put same input for both parameter set. Parameter sets cannot be changed while drive is in run state.

Digital input = FALSE:

- Set 1 is loaded as the active set

Digital input = TRUE:

- The active set is saved to set 1
- 

When making two parameter sets from the keypad

1. Set all parameters as needed for SET1
2. In "P6.3.1 Parameter Set" select "Store Set1"
3. Set all parameters as needed for SET 1
4. In "P6.3.1 Parameter Set" select "Store Set2"

**Note:** The parameter values are stored only when selecting parameter P6.3.1 Parameter sets Store Set 1 or Store Set 2 or from NCDrive: Drive > Parameter Sets.

**P2.4.2.22 Motor control mode 1/2 ID164 "Mot Ctrl Mode1/2"**

This digital input is used to change between to motor control mode selection parameters:

- P2.8.1 Motor Ctrl Mode ID600
- P2.8.2 Motor Ctrl Mode2 ID521

Contact is open = Motor control mode 1 is selected

Contact is closed = Motor control mode 2 is selected

When changing between open loop and closed loop control modes, make this change in stop state.

**P2.4.2.23 External brake acknowledgment. ID1210 "Ext. Brake ACK"**

Connect this input signal to auxiliary contact of mechanical brake. If contact is not closed within given time when brake is controlled open the drive will generate a brake fault F58, response can be selected in G2.14 Brake Control parameter group.

**P2.4.2.24 Cooling monitor ID750 "Cooling Monitor"**

When using a liquid-cooled drive, connect this input to the *Cooling OK* signal from Vacon flow control application or any input that shows state of used cooling unit. Fault is generated if input is low when drive is in run state, while drive is in stop state only warning is generated. See product user manual of liquid-cooled drive. Delay and response can be selected in G2.11.9 Cooling parameters group.

**8.4.2.2 Inching function**

Inching function will start the drive to reference without additional start command regardless of control place. Inching requires enabling from digital input before the command is accepted. Inching is also disabled if there is a start command active on the active control place.

**P2.4.2.25 Enable Inching ID532 "Enable Inching"**

If you are using inching function the given input must be set TRUE by either digital signal or by setting the parameter value to 0.2.

**P2.4.2.26 Inching reference 1 ID530 "Inching 1"****P2.4.2.27 Inching reference 2 ID531 "Inching 2"**

These inputs activate inching reference if inching is enabled. These inputs also start the drive if activated and if there is no Run Request command from anywhere else.

Other parameter for inching function

- P2.3.9 Inching Ramp ID1257 "Inching Ramp"
- P2.2.7.9 Inching reference 1 ID1239 "Inching Ref 1"
- P2.2.7.10 Inching reference 2 ID1240 "Inching Ref 2"

**P2.4.2.28 Reset encoder counter ID1090 "Reset Position"**

When using encoder, the drive monitors the encoder rotations and angle (V: Shaft Rounds and V:Shaft Angle).

When this input has a rising edge monitoring values V:Shaft Angle (ID1169) and Shaft Rounds (ID1170) are set to zero. Reset command is also included in V: Aux Control Word.

**P2.4.2.29 Master Follower mode 2 ID1092 "MF Mode 2"**

Master Follower mode can be changed with digital input between P2.10.1 MF Mode and P2.10.5: MF Mode 2 in the Master Follower parameter group. This can be used for redundancy purposes e.g. when using a Drive Synch system.

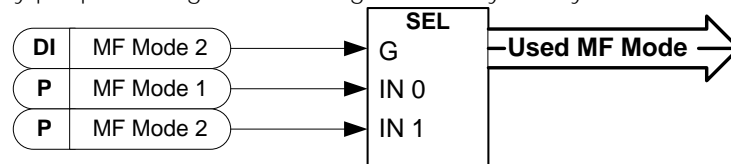
**P2.4.2.30 Quick Stop ID1213 "Quick Stop"**

Digital input for Quick Stop function

**P2.4.2.31 Input Switch Acknowledge ID1209**

Selects the digital input to acknowledge the status of input switch. The input switch is normally switch fuse unit or main contactor with which the power is fed to the drive. If the input switch acknowledgement is missing, the drive trips on "F64 Input Switch open" fault.

8.4.3 Analogue Input 1 & 2

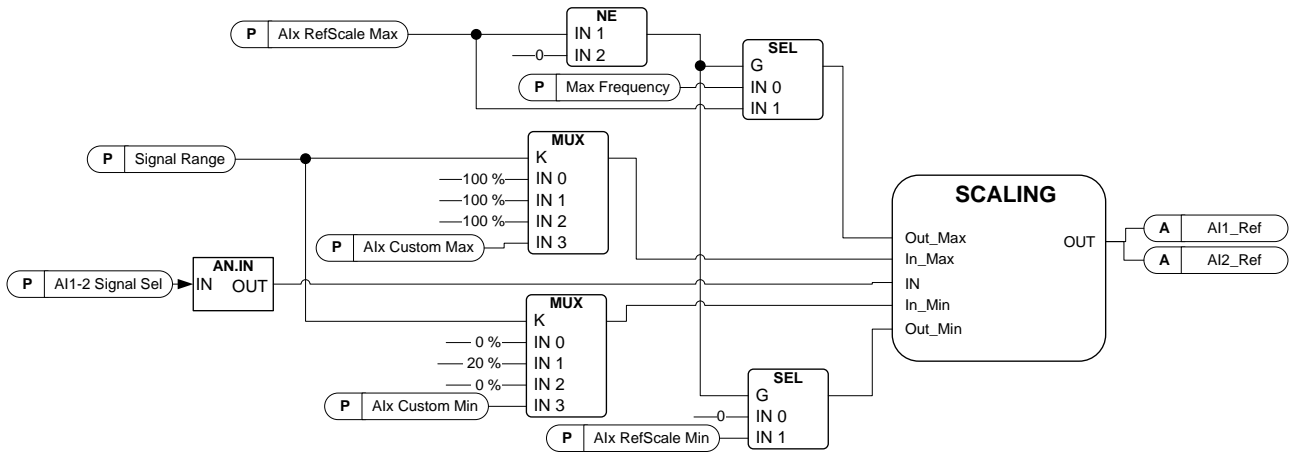

- P2.4.3.1 AI1 signal selection ID377 "AI1 Signal Sel"
- P2.4.4.1 AI2 signal selection ID388 "AI2 Signal Sel"

Connect the AI1/AI2 signal to the analogue input of your choice with this parameter. For more information about the TTF programming method, see chapter 5.

- P2.4.3.2 Analogue input 1 signal filter time ID324 "AI1 Filter Time"
- P2.4.4.2 Analogue input 2 signal filter time ID329 "AI2 Filter Time"

First order filtering is used for analogue signals that are used to control e.g. the power limit. Second order filtering is used for frequency reference filtering.

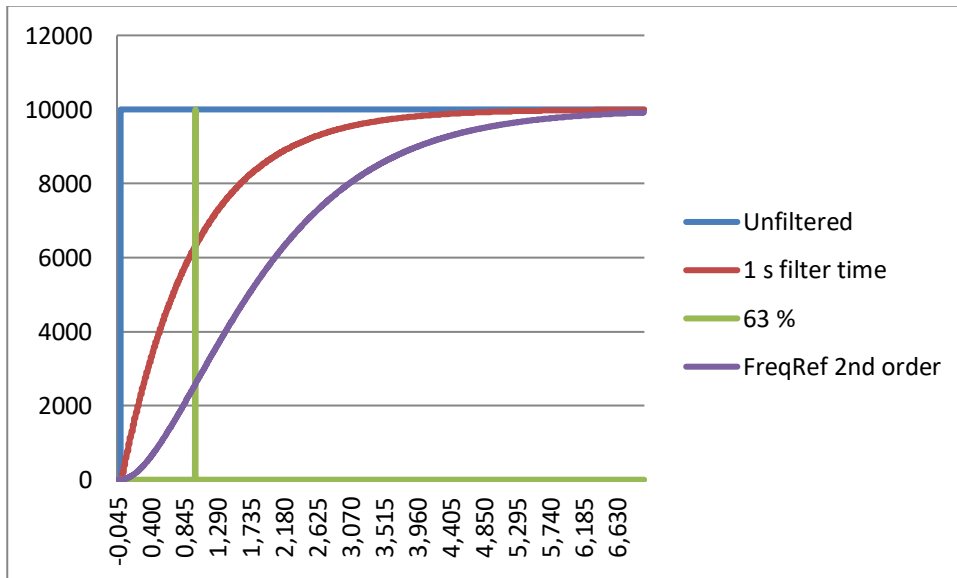

Figure 8-9. AI1 signal filtering

P2.4.3.3 Analogue input signal 1 signal range ID320 "AI1 Signal Range"

P2.4.4.3 Analogue input signal 2 signal range ID325 "AI2 Signal Range"

### 0 "0-20mA/10V"

Signal input ranges: 0...10 V and 0...20 mA.  
Input signal is used from 0% to 100%.

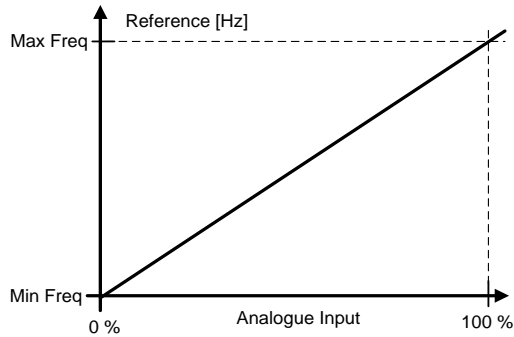

### 1 "4-20 mA"

Signal input ranges: 4 – 20 mA and 2 – 10 V  
Input signal is used from 20 % to 100 %

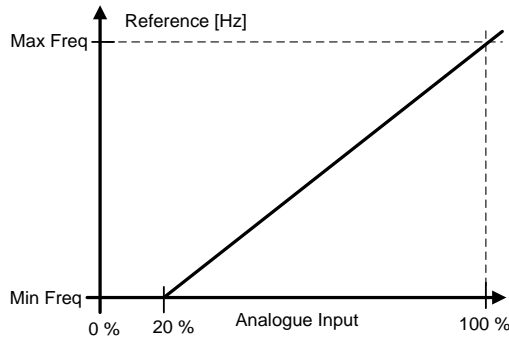

### 2 "-10 - + 10 V"

Signal input range: -10 V - + 10 V.  
Input signal is used from -100 % to +100 %.

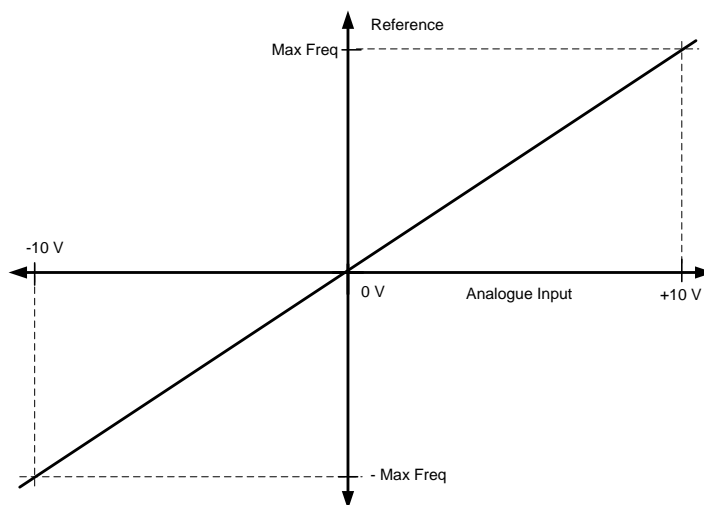

### 3 “Custom Range”

With custom range it is possible to freely adjust what input level corresponds to the minimum and maximum frequencies.

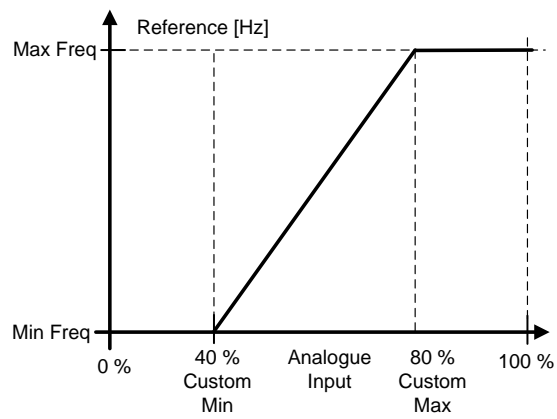

- P2.4.3.4 AI1 custom minimum setting ID321 "AI1 Custom Min"
- P2.4.3.5 AI1 custom maximum setting ID322 "AI1 Custom Max"
- P2.4.4.4 AI2 custom minimum setting ID326 "AI2 Custom Min"
- P2.4.4.5 AI2 custom maximum setting ID327 "AI2 Custom Max"

These parameters set the analogue input signal for any input signal span within -160...160%. E.g. if the signal input scaling is set to 40 %...80 % the reference can be changed from 8 mA (for Minimum Frequency) to 16 mA (for Maximum Frequency).

- P2.4.3.6 AI1 Reference scaling, minimum value ID303 "AI1 RefScale Min"
- P2.4.3.7 AI1 Reference scaling, maximum value ID304 "AI1 RefScale Max"
- P2.4.4.6 AI2 reference scaling, minimum value ID393 "AI2 RefScale Min"
- P2.4.4.7 AI2 reference scaling, maximum value ID394 "AI2 RefScale Max"

Additional reference scaling. Analogue input reference scaling can be set to a different value than the minimum and maximum frequency.

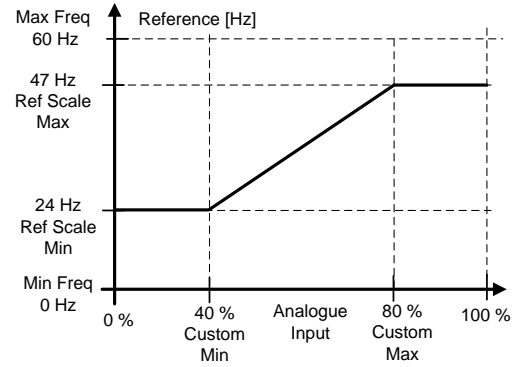
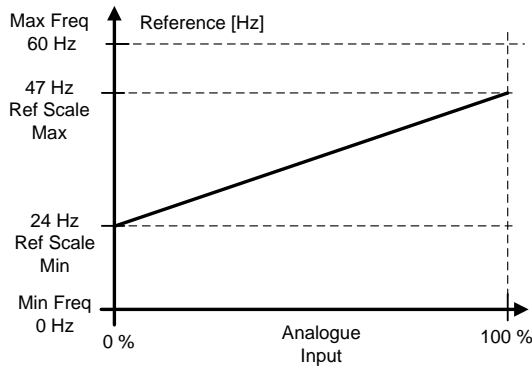

- P2.4.3.8 Analogue Input 1 joystick input dead zone ID382 "AI1 JoysDeadZone"
- P2.4.4.8 Analogue Input 2 joystick input dead zone ID395 "AI2 JoysDeadZone"

The small values of the reference around zero can be ignored by setting this value greater than zero. When the reference lies between zero and ± this parameter, it is forced to zero.

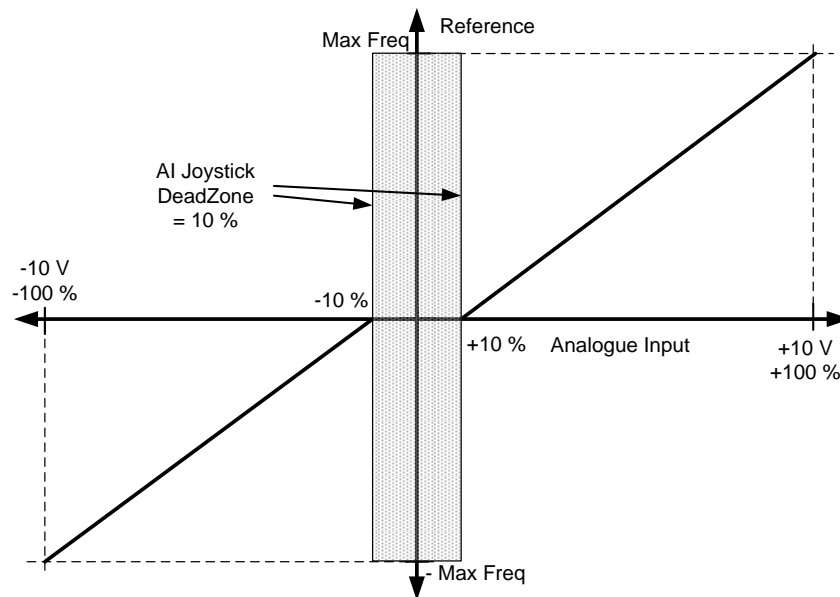



### 8.4.3.1 Sleep function

The drive can be stopped by sleep function when the analogue input falls below a certain value for a certain time and speed functions become active.

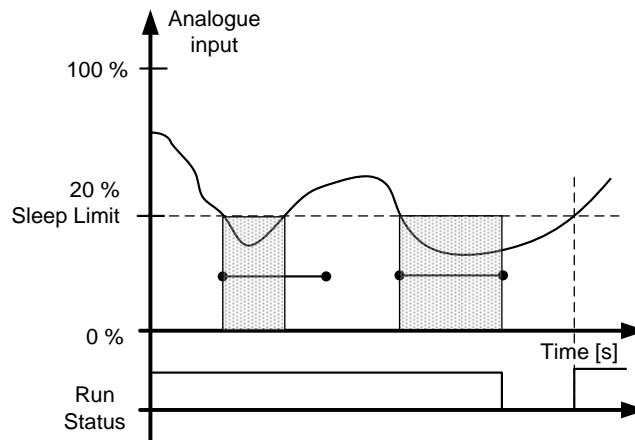

**P2.4.3.9 AI1 sleep limit ID385 "AI1 Sleep Limit"**

**P2.4.4.9 AI2 sleep limit ID396 "AI2 Sleep Limit"**

The drive is stopped automatically if the AI signal level falls below the Sleep limit defined with this parameter. In joystick function, when input is between zero and  $\pm$  this parameter the drive will go to sleep state.

**P2.4.3.10 AI1 sleep delay ID386 "AI1 Sleep Delay"**

**P2.4.4.10 AI2 sleep delay ID397 "AI2 Sleep Delay"**

This parameter defines the time the analogue input signal has to stay under the sleep limit in order to stop the drive.

**P2.4.3.11 AI1 joystick offset ID165 "AI1 Joyst. Offset"**

**P2.4.4.11 AI2 joystick offset ID166 "AI2 Joyst. Offset"**

Defines the frequency zero point as follows:

With this parameter on display, place the potentiometer in the assumed zero point and press *Enter* on keypad.

**Note:** This will not, however, change the reference scaling.  
Press *Reset* button to change the parameter value back to 0,00%.

8.4.4 Analogue input 3 & 4

Analogue Inputs 3 and 4 can be written from fieldbus. This allows signal scaling and inversion. useful e.g. in case when PLC is not operational (value zero received) signal will be automatically at maximum.

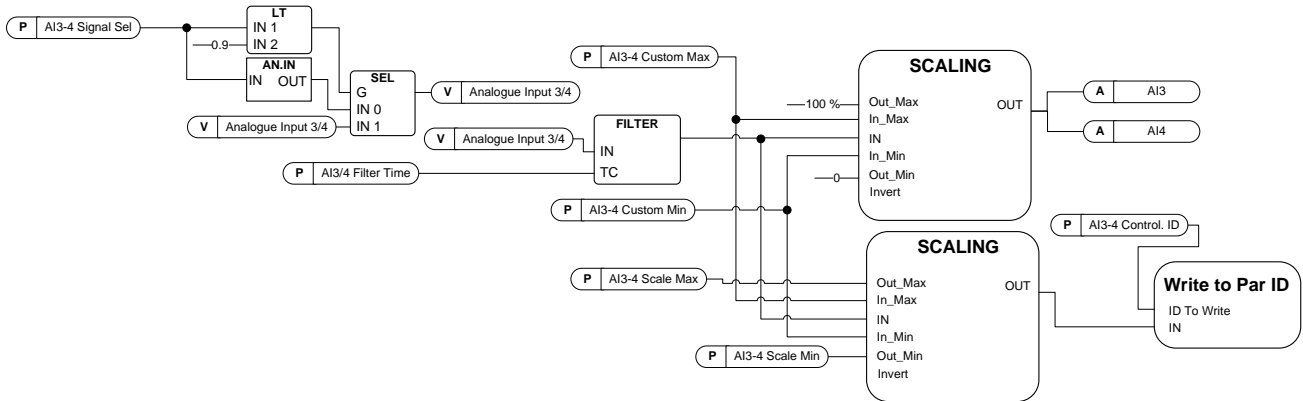

P2.4.5.1 AI3 signal selection ID141 "AI3 Signal Sel"

P2.4.6.1 AI4 signal selection ID152 "AI4 Signal Sel"

Connect the AI3/AI4 signal to the analogue input of your choice with this parameter. For more information, see Chapter 5 "Terminal To Function" (TTF) programming principle.

When the parameter for Analogue input signal selection is set to 0.1 you can control the analogue input monitoring variable from Fieldbus by assigning the Process Data Input ID number to the analogue input monitoring signal thus allowing the PLC input signals to be scaled with analogue input scaling functions.

P2.4.5.2 Analogue input 3 signal filtering time ID142 "AI3 Filter Time"

P2.4.6.2 Analogue input 4 signal filtering time ID153 "AI3 Filter Time"

First order filtering is used for analogue inputs signals 3 and 4.

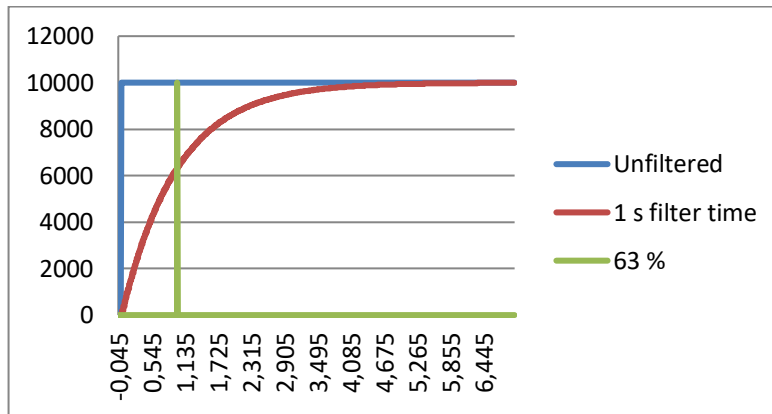

- P2.4.5.3 AI3 custom setting minimum ID144 "AI3 Custom Min"
- P2.4.5.4 AI3 custom setting maximum ID145 "AI3 Custom Max"
- P2.4.6.3 AI4 custom setting minimum ID155 "AI4 Custom Min"
- P2.4.6.4 AI4 custom setting maximum ID156 "AI4 Custom Max"

Set the custom minimum and maximum input levels for the AI3 signal within -160...160%.

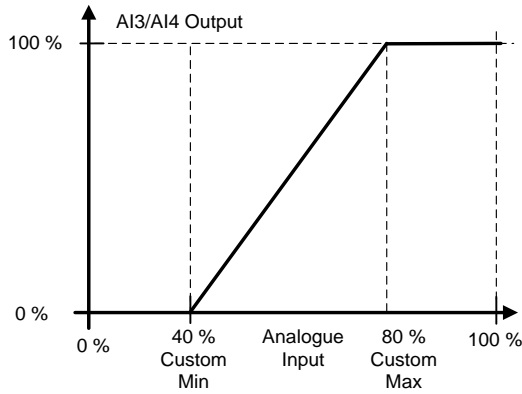

- P2.4.5.5 AI3 signal inversion ID151 "AI3 Signal Inv"
- P2.4.6.5 AI4 signal inversion ID162 "AI3 Signal Inv"

The signal inversion function is useful in a situation when e.g. the PLC is sending power limit to the drive using fieldbus. If the PLC is unable to communicate with the drive the power limit from fieldbus to the drive would be zero. Using an inverted signal logic zero value from PLC would mean maximum power limit. When inversion is needed for the process data signal fieldbus values need to be written to Analogue input monitoring signals. See parameter P2.4.5.1 AI3 Signal selection for details.

- 0 = No inversion
- 1 = Signal inverted

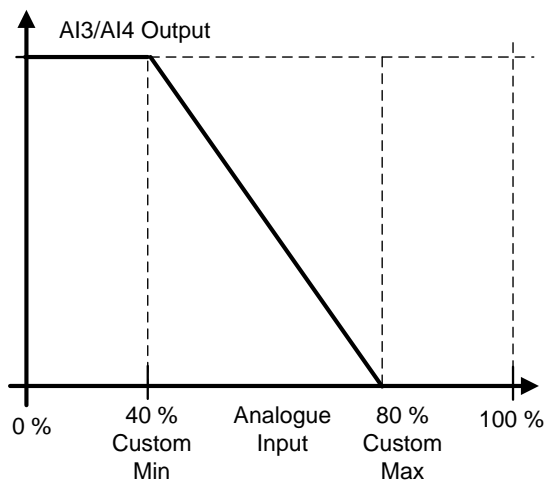

#### 8.4.4.1 *Analogue input to any parameter.*

This function allows control of any parameter by using an analogue input. The parameter selects what the range of control area and the ID number for the parameter that is controlled.

<i>P2.4.5.6</i>	<i>Analogue input 3, minimum value</i>	<i>ID1037</i>	<i>"AI3 Scale Min"</i>
<i>P2.4.5.7</i>	<i>Analogue input 3, maximum value</i>	<i>ID1038</i>	<i>"AI3 Scale Max"</i>
<i>P2.4.6.6</i>	<i>Analogue input 4, minimum value</i>	<i>ID1039</i>	<i>"AI4 Scale Min"</i>
<i>P2.4.6.7</i>	<i>Analogue input 4, maximum value</i>	<i>ID1040</i>	<i>"AI4 Scale Max"</i>

These parameters define the range for the controlled parameters. All the values are considered to be integers i.e. when controlling the Field Weakening Point (as in example) you also need to set numbers for decimals. e.g. FWP 100,00 needs to be set as 10000.

<i>P2.4.5.8</i>	<i>AI3 Controlled ID</i>	<i>ID1509</i>	<i>"AI3 Control. ID"</i>
<i>P2.4.6.8</i>	<i>AI4 Controlled ID</i>	<i>ID1510</i>	<i>"AI4 Control. ID"</i>

These parameters define the controlled parameter.

#### Example:

You want to control motor field weakening point voltage through an analogue input from 70,00 % to 130,00 %.

Set Scale min to 7000 = 70,00 %

Set Scale max to 13000 = 130,00 %

Set Controlled ID to 603 (Voltage at field weakening point)

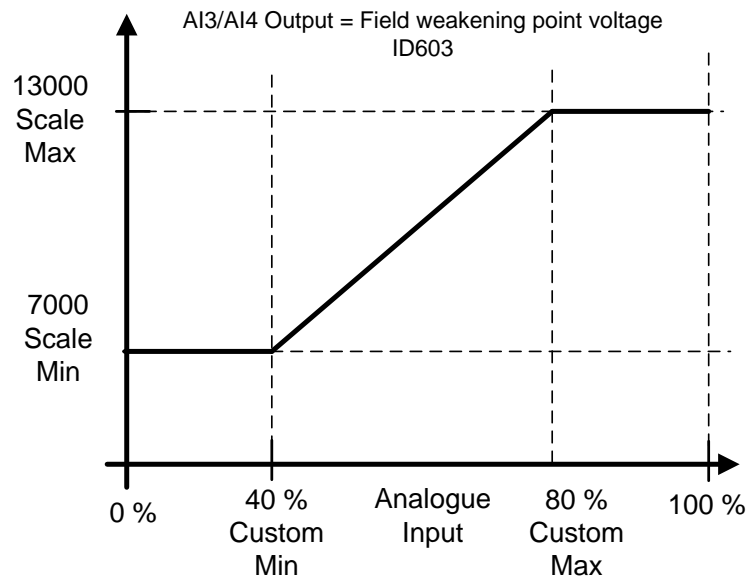

Now analogue input 3 signal 0 V to 10 V (0 mA to 20 mA) will control the field weakening point voltage between 70,00 % - 130,00 %. When setting the value remember that decimals are handled as integers.

### 8.4.5 Inversion control

#### P2.4.7.1 Inversion Control ID1091 "INV Control"

Inversion control allows you to select which input signal operation will be inverted.

B00 = +1 = Reserved

B01 = +2 = Reserved

B02 = +4 = Inverted Run Enable digital input

B03 = +8 = Inverted Brake acknowledge digital input

## 8.5 Output signals

### 8.5.1 Digital output signals

In the Advance application, all output signals are not used by default.

#### **P2.5.1.1 Ready ID432 "Ready"**

The frequency converter is ready to operate.

Common reasons when ready signals are missing:

- Run enable signal is low
- DC Voltage is too low
- DC Voltage is too high

#### **P2.5.1.2 Run ID433 "Run"**

The frequency converter is modulating.

#### **P2.5.1.3 Fault ID434 "Fault"**

A fault trip has occurred.

#### **P2.5.1.4 Inverted fault ID435 "Fault, Inverted"**

No active faults in the drive.

#### **P2.5.1.5 Warning ID436 "Warning"**

General warning signal.

#### **P2.5.1.6 External fault or warning ID437 "Ext. Fault/Warn."**

Fault or warning depending on parameter Response to external fault. P2.4.2.11 Ext Fault Close and P2.4.2.12 Ext Fault Open are used to trigger a fault. P2.12.1 External fault is used to select response.

#### **P2.5.1.7 Reference fault or warning (4mA) ID438 "AI Ref Faul/Warn"**

Fault or warning depending on parameter Response to the 4mA reference fault. Response is selected in G2.11.6.

#### **P2.5.1.8 Drive overtemperature warning ID439 "OverTemp Warn"**

Drive temperature has exceeded normal operation conditions. Temperature limit may vary depending on drive type on size.

#### **P2.5.1.9 Reverse ID440 "Reverse"**

Drive output frequency is negative

#### **P2.5.1.10 Wrong direction ID441 "WrongDirection"**

Motor rotation direction is different from the requested one. This happens in situation when external force makes the motor rotate in different direction or when the direction change command has been given and the drive is still ramping down to change direction.

#### **P2.5.1.11 At reference speed ID442 "At Ref. Speed"**

**Induction motor:** Speed is within nominal slip of the reference.

**PMS motor:** Output frequency is within 1 Hz of the reference frequency.

**P2.5.1.12 Jogging speed ID413 “Jogging Speed”**

Jogging speed command has been given.

**P2.5.1.13 IO Control Place ID444 “IO Control Place”**

Active control place is I/O terminal defined by the parameter for Control place (P3.1) or forced with digital input function.

**8.5.1.1 Brake Control**

The mechanical brake control has two parts that need to be synchronically controlled. The first part is the *mechanical brake release* and the second is the *speed reference release*. Whole brake control logic is explained in chapter 6.15 Brake Control on page 207.

Conditions to open the brake:

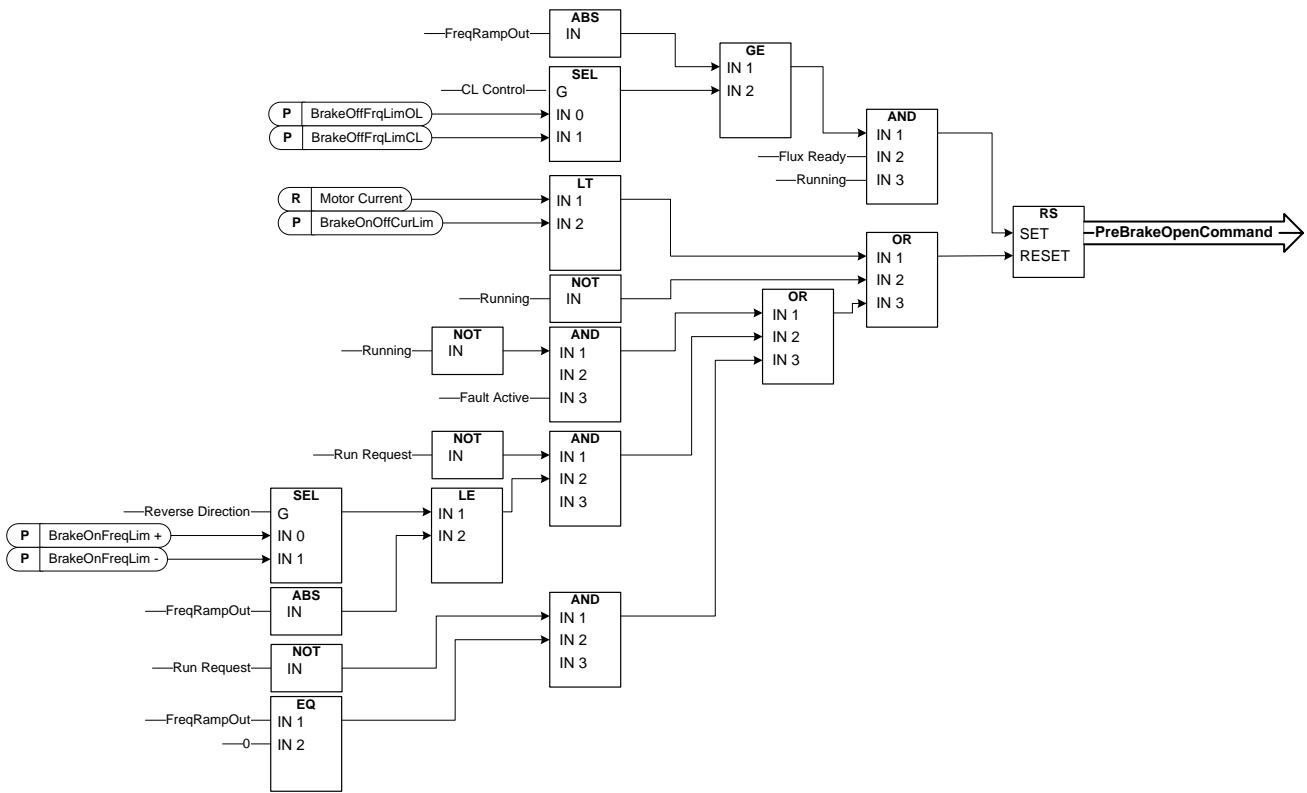

**The final brake open command:** It is possible that in a Master/Follower system the master drive opens the brake. Also an overriding system may do this without any control from the drive using AucControlWord1.B7. During identification run the brake will not open.

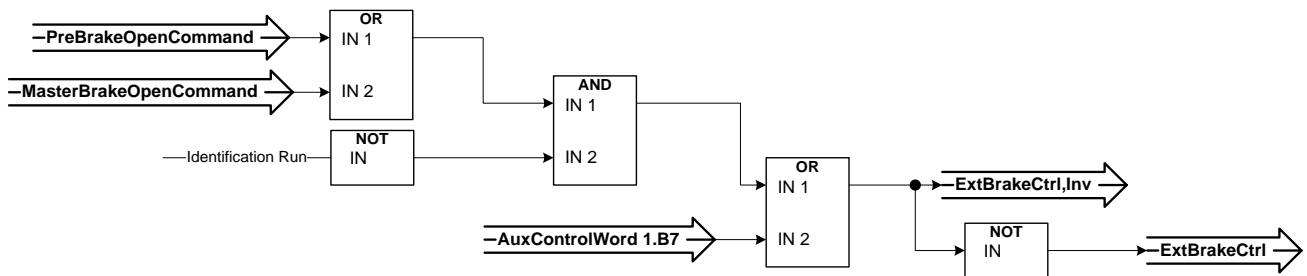

Relay state when control unit is not powered

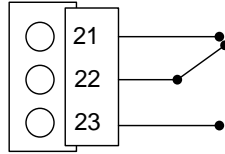

**P2.5.1.14 External brake control ID445 “Ext Brake Contrl”**

See detailed description about brake operation in G2.15 Brake Control.

External brake ON/OFF control

Example: OPTA2 board RO1 :

Brake function ON: Terminals 22-23 are connected (Relay is energized).

Brake function OFF: Terminals 22-23 are open (Relay not energized).

Brake Open Command  
Brake function OFF

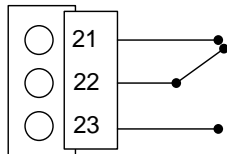

Brake Close Command  
Brake function ON

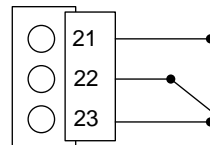

**Note:** When power from control board is removed terminals 22-23 are open.

When using the Master Follower function, the follower drive will open the brake at the same time as the Master even if the Follower's conditions for brake opening have not been met.

**P2.5.1.15 External brake control, inverted ID446 “ExtBrakeCtrl,Inv”**

See detail description about brake operation in G2.15 Brake Control

Example: OPTA2 board RO1 :

Brake function ON: Terminals 22-23 are open. (Relay not energized)

Brake function OFF: Terminals 22-23 are connected. (Relay is energized).

Brake Open Command  
Brake function OFF

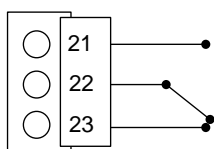

Brake Close Command  
Brake function ON

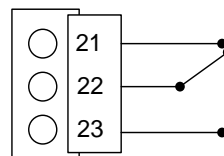

When using the Master Follower function, the follower drive will open the brake at the same time as the Master does even if the Follower's conditions for brake opening have not been met.



***P2.5.1.16 Output frequency limit 1 supervision ID447 "FreqOut SupvLim1"***

The output frequency goes outside the set supervision limits defined in Supervision Lim parameter group. The function can be set to monitor either the high or the low limit. Limit and functions are selected in G2.5.8 Supervision Limits.

***P2.5.1.17 Output frequency limit 2 supervision ID448 "FreqOut SupvLim2"***

The output frequency goes outside the set supervision limits 2 defined in Supervision Lim parameter group. The function can be set to monitor either the high or the low limit. Limit and functions are selected in G2.5.8 Supervision Limits.

***P2.5.1.18 Reference limit supervision ID449 "Ref Lim Superv."***

Active reference goes beyond the set supervision low limit/high limit defined in Supervision Lim parameter group. The function can be set to monitor either the high or the low limit Limit. The functions are selected in G2.5.8 Supervision Limits.

***P2.5.1.19 Temperature limit supervision ID450 "Temp Lim Superv."***

The drive temperature goes beyond the set supervision limits defined in Supervision Lim parameter group. The function can be set to monitor either the high or the low limit. Limit and functions are selected in G2.5.8 Supervision Limits.

***P2.5.1.20 Torque limit supervision ID451 "Torq Lim Superv."***

The motor torque goes beyond the set supervision limits defined in Supervision Lim parameter group. The function can be set to monitor either the high or the low limit. Limit and functions are selected in G2.5.8 Supervision Limits.

***P2.5.1.21 Motor thermal protection ID452 "MotTherm Flt/Wrn"***

Motor thermistor initiates an overtemperature signal which can be led to a digital output. The response is selected with P2.12.5.6 ThermistorF.Resp.

***P2.5.1.22 Analogue input supervision limit ID453 "Ain Supv Lim"***

The selected analogue input signal goes beyond the set supervision limits defined in G2.5.8 Supervision Lim parameter group. The function can be set to monitor either the high or the low limit.

***P2.5.1.23 Limit Control active ID454 "Limit Control ON"***

One or more of the drive limit controllers is active.

***8.5.1.2 Fieldbus digital inputs connection******P2.5.1.24 Fieldbus input data 1 ID455 "FB Dig Input 1"******P2.5.1.26 Fieldbus input data 2 ID456 "FB Dig Input 2"******P2.5.1.28 Fieldbus input data 3 ID457 "FB Dig Input 3"******P2.5.1.30 Fieldbus input data 4 ID169 "FB Dig Input 4"******P2.5.1.32 Fieldbus input data 5 ID170 "FB Dig Input 5"***

The data from the Fieldbus main control word can be led to the drive's digital outputs. See used fieldbus board manual for location of these bits.

<i>P2.5.1.25</i>	<i>Fieldbus digital input 1 parameter</i>	<i>ID891</i>	<i>"FB Dig 1 Par ID"</i>
<i>P2.5.1.27</i>	<i>Fieldbus digital input 2 parameter</i>	<i>ID892</i>	<i>"FB Dig 2 Par ID"</i>
<i>P2.5.1.29</i>	<i>Fieldbus digital input 3 parameter</i>	<i>ID893</i>	<i>"FB Dig 3 Par ID"</i>
<i>P2.5.1.31</i>	<i>Fieldbus digital input 4 parameter</i>	<i>ID894</i>	<i>"FB Dig 4 Par ID"</i>
<i>P2.5.1.33</i>	<i>Fieldbus digital input 5 parameter</i>	<i>ID895</i>	<i>"FB Dig 5 Par ID"</i>

With these parameters you can define the parameter to be controlled by using FB Digital input.

**Example:**

All option board inputs are in use and you still want to give DI: DC Brake Command (ID416). You also have a fieldbus board in the drive.

Set parameter ID891 (Fieldbus digital input 1) to 416.

Now you are able to control DC Braking command from the fieldbus by Profibus control word (bit 11).

It is possible to control any parameter in the same way if values 0=FALSE and 1=TRUE are significant for that parameter. For example, P2.6.5.3 Brake Chopper (ID504) can be controlled on and off using this function (Brake Chopper; 0 = Not Used, 1 = On, Run).

<i>P2.5.1.34</i>	<i>Safe disable active</i>	<i>ID756</i>	<i>"Safe Disable Act"</i>
------------------	----------------------------	--------------	---------------------------

Select the digital output to show the status of the Safe Disable.

<i>P2.5.1.35</i>	<i>MCC Close Continues</i>	<i>ID1218</i>	<i>"MCC Close Cont."</i>
------------------	----------------------------	---------------	--------------------------

<i>P2.5.1.36</i>	<i>MCC Close Pulse</i>	<i>ID1219</i>	<i>"MCC Close Pulse"</i>
------------------	------------------------	---------------	--------------------------

Used to close OEVA type of input switch. When the DC link voltage is above the charging level a 2-second pulse train is generated to close the input switch. The pulse train is OFF when the input switch acknowledgement goes high.

## 8.5.2 Analogue outputs 1 &amp; 2 &amp; 3

P2.5.2.1	Analogue output 1 signal selection	ID464	"Iout 1 Signal"
P2.5.3.1	Analogue output 2 signal selection	ID471	"Iout 2 Signal"
P2.5.4.1	Analogue output 3, signal selection	ID478	"Iout 3 Signal"

Connect the AO1 signal to the analogue output of your choice with this parameter.

P2.5.2.2	Analogue output function	ID307	"Iout Content"
P2.5.3.2	Analogue output 2 function	ID472	"Iout 2 Content"
P2.5.3.2	Analogue output 3, function	ID479	"Iout 3 Content"

This parameter selects the desired function for the analogue output signal.

- 0 "Not used"  
Analogue output is forced to 20 % (= 2 V/4 mA)
- 1 "O/P Freq"  
Output frequency from zero to maximum frequency.
- 2 "Freq Ref"  
Freq. reference from zero to maximum frequency
- 3 "Motor speed "  
Motor speed from zero speed to motor synchronous speed
- 4 "O/P Current"  
Drive output current from zero to motor nominal current
- 5 "Motor Torque "  
Motor torque from zero to motor nominal torque (100 %)
- 6 "Motor Power"  
Motor power from zero to motor nominal power (100 %)
- 7 "Mot Voltage"  
Drive output voltage from zero to motor nominal voltage
- 8 "DC-link volt"  
500 V unit: DC voltage from zero to 1000 Vdc  
690 V unit: DC voltage from zero to 1317 Vdc
- 9 "AI1"  
Unfiltered Analogue input 1 signal
- 10 "AI2"  
Unfiltered Analogue input 2 signal
- 11 "Fout,min-max  
Output frequency from minimum frequency to maximum frequency
- 12 "[-2Tn)-{2Tn]"  
Motor torque from negative two times motor nominal to positive two times motor nominal torque
- 13 "[-2Pn)-{2Pn]"  
Motor power from negative two times motor nominal to positive two times motor nominal power
- 14 "PT100 Temp."  
Maximum PT100 temperature value from used input scaling from -30 C to +200 C
- 15 "FB Data In4"  
FB analogue output fieldbus process data value can be connected to analogue output by using monitoring signal ID48 .

- P2.5.2.3 Analogue output filter time ID308 "Iout Filter Time"
- P2.5.3.3 Analogue output 2 filter time ID473 "Iout 2 Filter T"
- P2.5.4.3 Analogue output 3, filter time ID480 "Iout 3 Filter T"

First order filtering is used for analogue output signals.

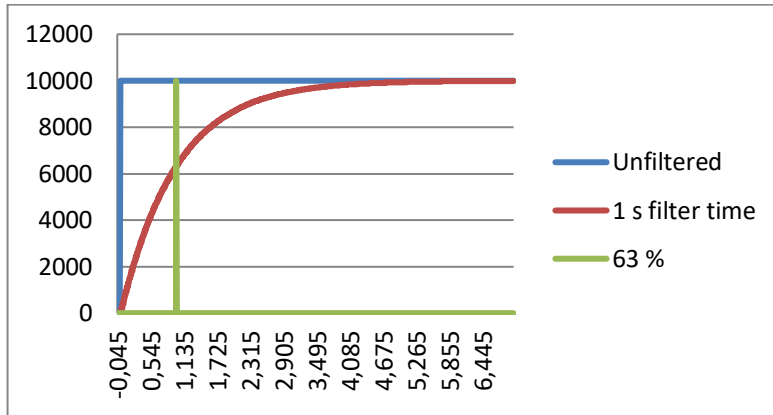

- P2.5.2.4 Analogue output inversion ID309 "Iout Invert"
- P2.5.3.4 Analogue output 2 inversion ID474 "Iout 2 Invert"
- P2.5.4.4 Analogue output 3 inversion ID481 "Iout 3 Invert"

Inverts the analogue output signal:

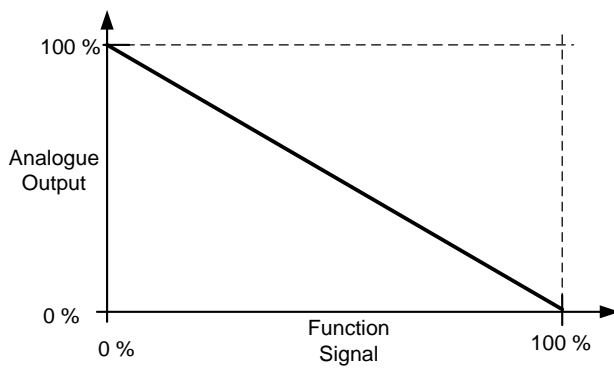

- P2.5.2.5 Analogue output minimum ID310
- P2.5.3.5 Analogue output 2 minimum ID475
- P2.5.4.5 Analogue output 3 minimum ID482

Defines the signal minimum to either 0 mA or 4 mA (living zero).

- 0 Set minimum value to 0 mA (0 %)
- 1 Set minimum value to 4 mA (20 %)

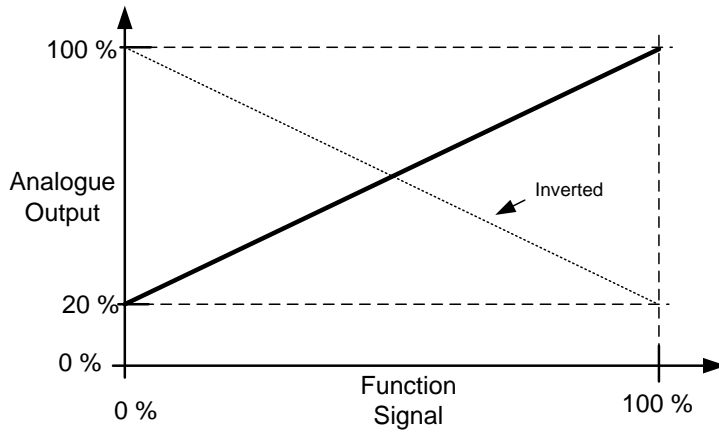

- P2.5.2.6 Analogue output scale ID311 "Iout Scale"
- P2.5.3.6 Analogue output 2 scaling ID476 "Iout 2 Scale"
- P2.5.4.6 Analogue output 3 scaling ID483 "Iout 3 Scale"

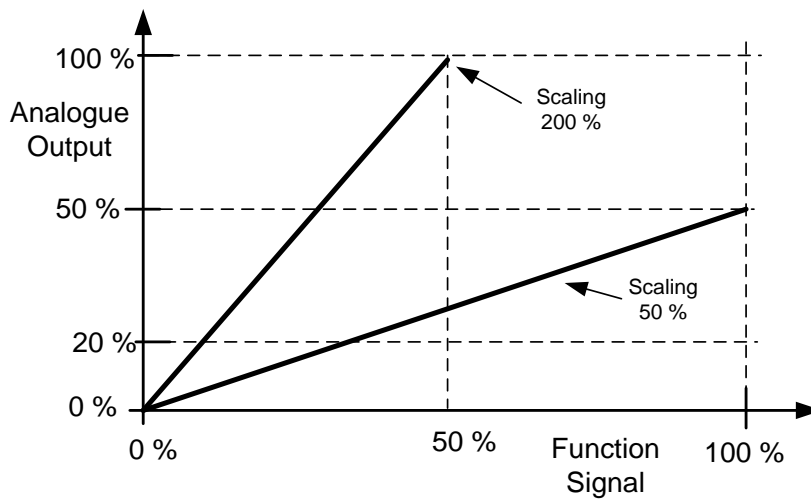

P2.5.2.7	Analogue output offset	ID375	"Iout Offset"
P2.5.3.7	Analogue output 2 offset	ID477	"Iout 2 Offset"
P2.5.4.7	Analogue output 3 offset	ID484	"Iout 3 Offset"

Define the offset for the analogue output signal.

In picture below 50 % scaling signal has been given 20 % offset and for 200 % scaling 50 % offset.

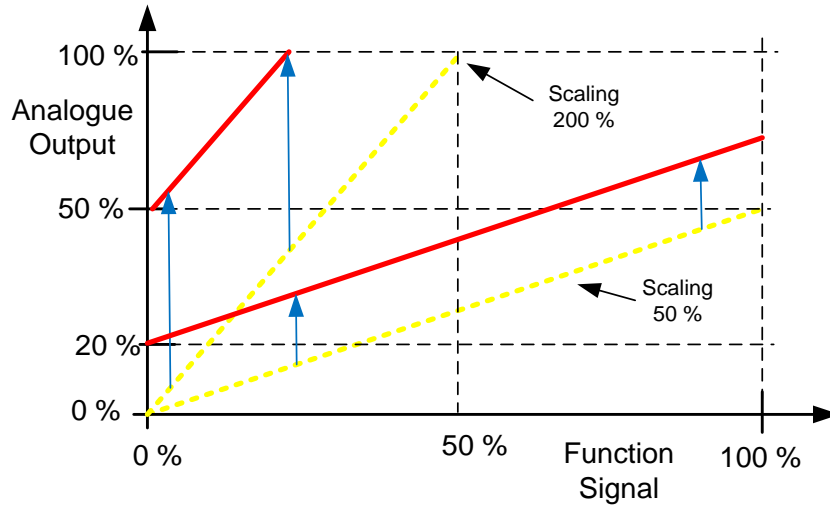

### 8.5.3 Delayed Digital Output 1 & 2

**P2.5.5.1** *Digital output 1 signal selection*      **ID486** *“Dig.Out 1 Signal”*

**P2.5.6.1** *Digital output 2 signal selection*      **ID489** *“Dig.Out 2 Signal”*

Connect the delayed digital output signal to the digital output of your choice with this parameter. For more information about the TTF programming method, see chapter 5.

**P2.5.5.2** *Digital output function*      **ID312** *“D01 Content”*

**P2.5.6.2** *Digital output 2 function*      **ID490** *“D02 Content”*

**0 = “Not used”**

**1 = “Ready”**

The AC drive is ready to operate.

Common reasons when ‘Ready’ signals are missing:

- Run enable signal is low
- DC Voltage is too low
- DC Voltage is too high

**2 = “Run”**

The frequency converter is modulating.

**3 = “Fault”**

A fault trip has occurred

**4 = “FaultInvert”**

No active faults in the drive.

**5 = “OverheatWarn”**

Drive temperature has exceeded normal operation conditions. Temperature limit may vary depending on drive type and size.

**6 = “ExtFaul/Warn”**

External fault or warning depending on parameter response to external fault

**7 = “RefFaul/Warn”**

Fault or warning depending on parameter Response to the 4mA reference fault - occurs if analogue reference is 4—20 mA and signal is <4mA

**8 = “Warning”**

Always if a warning is on

**9 = “Reversed”**

Drive output frequency is negative

**10 = “JogSpeedSel”**

The jogging, preset or inching speed has been activated with digital input.

**11 = “At speed”**

Induction motor: speed is within nominal slip of the reference.

PMS motor: output frequency is within 1 Hz of the reference.

**12 = “MotorRegAct”**

One of the limit regulators is active.

**13 = “FreqLim1Sup”**

Output frequency limit 1 supervision

The output frequency goes outside the set supervision low limit/high limit.

**14 = “FreqLim2up”**

Output frequency limit 2 supervision

The output frequency goes outside the set supervision low limit/high limit.

**15 = “TorqLimSprv”**

Torque limit supervision

The motor torque goes beyond the set supervision low limit/high .

- 16 = "RefLimSprv"**  
Reference limit supervision  
Active reference goes beyond the set supervision low limit/high limit.
- 17 = "ExtBrakeCont"**  
External brake control  
External brake ON/OFF control with programmable delay
- 18 = "I/O ContAct"**  
Control from I/O terminals  
IO control place is active.
- 19 = "TempLimSprv"**  
Drive temperature limit supervision.  
Drive temperature goes beyond the set supervision limits (par. ID354)
- 20 = "WrongDirecti"**  
Motor rotation direction is different from the requested one. This happens in situation when an external force makes the motor to rotate into different direction or when a command for direction change has been given and the drive is still ramping down to change direction.
- 21 = "ExtBrakeInv"**  
External brake control inverted  
External brake ON/OFF control; Output active when brake control is OFF.
- 22 = "ThermFlt/Wrn"**  
Thermistor fault or warning  
The thermistor input of option board indicates overtemperature. Fault or warning depending on the response parameter.
- 23 = "AI Supervis"**  
Analogue input supervision  
Analogue input supervision function, Set Reset type output function.
- 24 = "FB DigInput1"**  
Fieldbus digital input data 1
- 25 = "FB DigInput2"**  
Fieldbus digital input data 2
- 26 = "FB DigInput3"**  
Fieldbus digital input data 3



- P2.5.5.3 Digital output 1 on-delay ID487 "D01 ON Delay"
- P2.5.5.4 Digital output 1 off-delay ID488 "D01 OFF Delay"
- P2.5.6.3 Digital output 2 on-delay ID491 "D02 ON Delay"
- P2.5.6.4 Digital output 2 off-delay ID492 "D02 OFF Delay"

With these parameters you can set on- and off-delays to digital outputs.

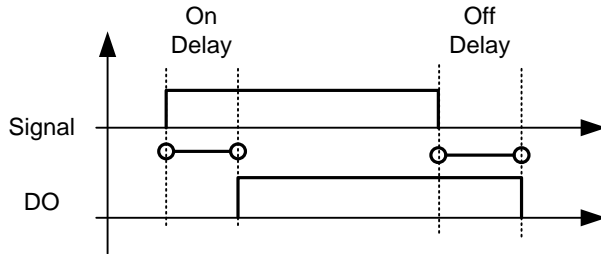
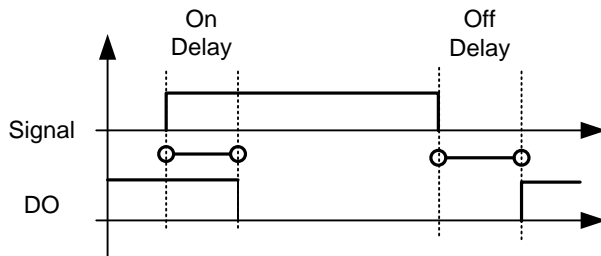

Figure 8-10. Digital outputs 1 and 2, on- and off-delays

- P2.5.5.5 Invert digital output 1 ID1587 "INV Delayed D01"
- P2.5.6.5 Invert digital output 2 ID1588 "INV Delayed D02"



### 8.5.4 Supervision limits

Supervision function gives you the possibility to monitor certain values with the limit setting. When the actual value exceeds or goes below the set value a message through a digital output can be given. The torque limit supervision is scalable.

<i>P2.5.7.1</i>	<i>Output frequency limit supervision function</i>	<i>ID315</i>	<i>"Freq Supv Lim 1"</i>
<i>P2.5.7.3</i>	<i>Output frequency limit 2 supervision function</i>	<i>ID346</i>	<i>"Freq Supv Lim 2"</i>
<i>P2.5.7.5</i>	<i>Torque limit, supervision function</i>	<i>ID348</i>	<i>"Torque Supv Lim"</i>
<i>P2.5.7.8</i>	<i>Reference limit, supervision function</i>	<i>ID350</i>	<i>"Ref Superv Lim"</i>
<i>P2.5.7.10</i>	<i>Drive temperature limit supervision function</i>	<i>ID354</i>	<i>"Temp Lim Superv."</i>

- 0 No supervision
- 1 Low limit supervision
- 2 High limit supervision

The following five parameters are used to set a limit value to be monitored with the corresponding parameter above.

<i>P2.5.7.2</i>	<i>Output frequency limit supervision value</i>	<i>ID316</i>	<i>"Freq Dupv Val 1"</i>
<i>P2.5.7.4</i>	<i>Output frequency limit 2 supervision value</i>	<i>ID347</i>	<i>"Freq Supv Val 2"</i>
<i>P2.5.7.6</i>	<i>Torque limit, supervision value</i>	<i>ID349</i>	<i>"Torque Supv Val"</i>
<i>P2.5.7.9</i>	<i>Reference limit, supervision value</i>	<i>ID351</i>	<i>"Ref Superv Value"</i>
<i>P2.5.7.11</i>	<i>Drive temperature limit value</i>	<i>ID355</i>	<i>"Temp Supv Value"</i>

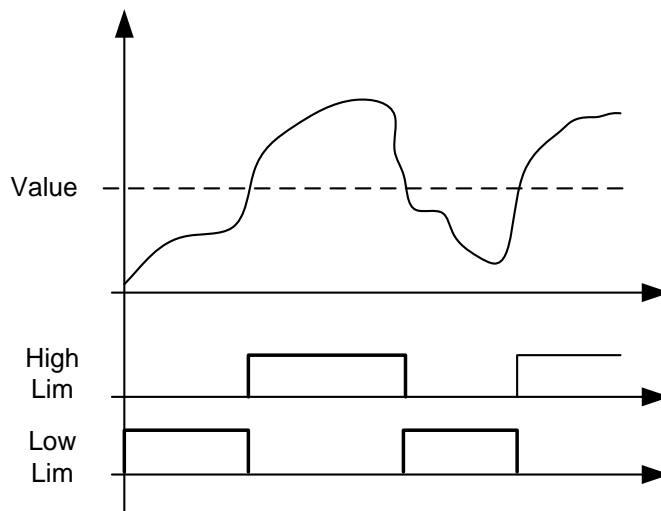

Figure 8-11. Supervision function

<i>P2.5.7.7</i>	<i>Torque Supervision value scaling input</i>	<i>ID402</i>	<i>"Torque Superv Scl"</i>
-----------------	---	--------------	----------------------------

This parameter is used to change the torque limit supervision level between zero and P2.5.8.6 Torque Supv Val

- 0 = Not used
- 1 = AI1
- 2 = AI2
- 3 = AI3
- 4 = AI4
- 5 = FBLimScaling

### 8.5.4.1 Analogue input supervision function

The analogue input supervision function will control the selected digital output to close when the analogue input signal has exceeded the high limit and open when the signal goes below the low limit.

#### P2.5.7.12 Analogue input supervision signal ID356 "Ain Supv Input"

With this parameter you can select the analogue input to be monitored.

- 0 = Not used
- 1 = AI1
- 2 = AI2
- 3 = AI3
- 4 = AI4
- 5 = FBLimScaling

#### P2.5.7.13 Analogue Low supervision control limit ID357 "Ain Supv Llim"

#### P2.5.7.14 Analogue High supervision control limit ID358 "Ain Supv Hlim"

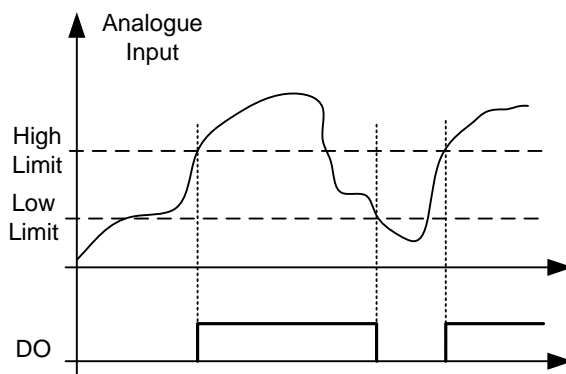

Figure 8-12. An example of On/Off-control

## 8.6 Limit settings

### 8.6.1 Current limit handling

#### P2.6.1.1 Current limit ID107 "Current Limit"

This parameter determines the maximum motor current from the AC drive. The parameter's value range differs from size to size.

When the Current limit is changed the Stall current limit is internally calculated to 90% of the current limit (if the Stall current limit is greater than the Current limit). When the current limit is active the drive output frequency is reduced until current is below the set limit.

In closed loop control, the current limit affects the torque producing current limit, not total current. This can be changed in options group with the "LimitTotalCurrent" parameter.

In drive synch operation limiting is for average current of units.

#### P2.6.1.2 Scaling of current limit ID399 "Currnt Lim Sclng"

0 = Not used

1 = AI1

2 = AI2

3 = AI3

4 = AI4

5 = FB Limit Scaling ID46 Monitoring value

This signal will adjust the maximum motor current between 0 and the parameter Motor Current Limit.

8.6.2 Power limit handling

Power limit function is meant to limit the drive output power to the motor. The general way to do this is to give a limiting signal from a primary system that gives information about how much power is available for drive operations.

NOTE: Power limit is not operational in open loop control in Advanced application. If power limit is needed in open loop control use Marine application (APFIFF09).

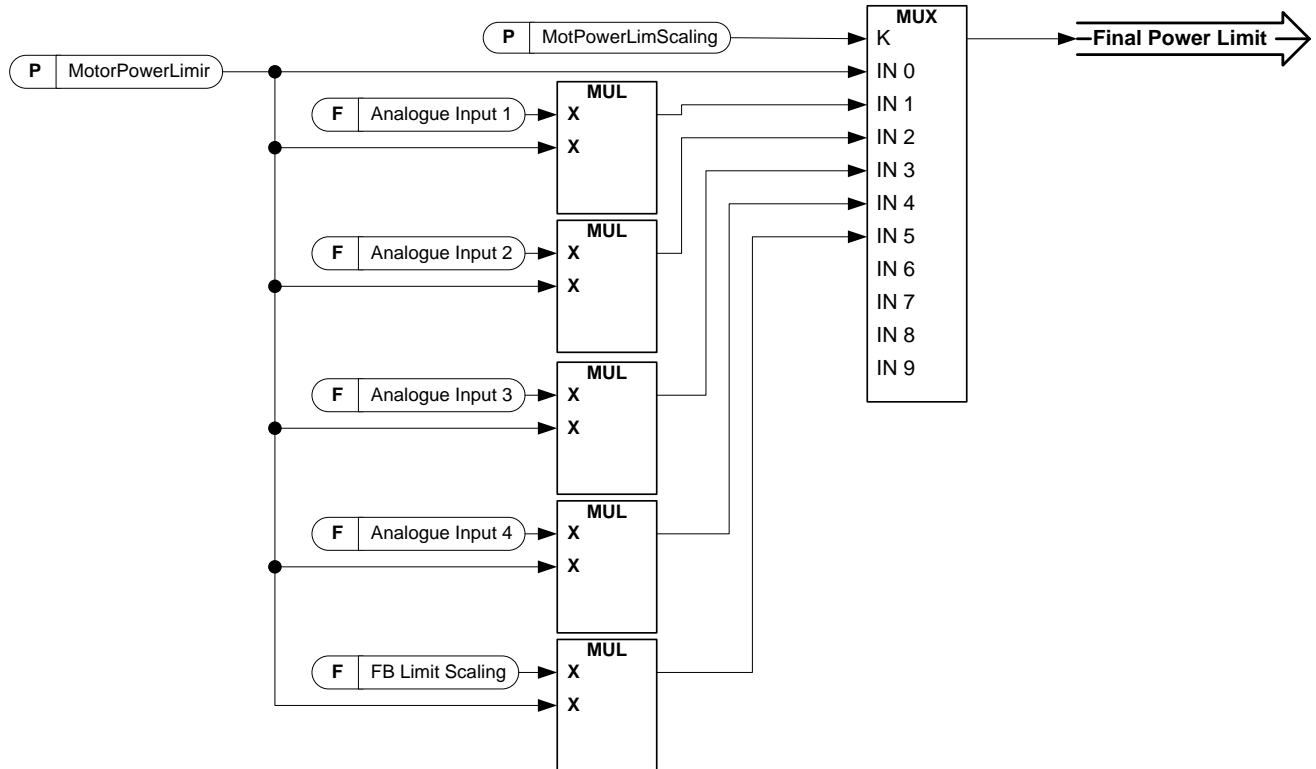

P2.6.2.1 Motoring power limit ID1289 “MotorPowerLimit”

Motoring side power limit. This limit value is used for all scaling functions and power limit ramp rate functions.

P2.6.2.2 Generator power limit ID1290 “GenerPower Limit”

Generator side power limit. This limit value is used for all scaling functions and power limit ramp rate functions.

P2.6.2.3 Scaling of Motoring Power Limit ID179 “MotPowerLimScng”

The motoring power limit is equal to parameter Motoring Power Limit if value 'Not Used' is selected. If any of the inputs is selected the motoring power limit is scaled between zero and parameter P2.6.2.3 Motoring Power Lim.

- 0 = Parameter
- 1 = AI1
- 2 = AI2
- 3 = AI3
- 4 = AI4
- 5 = FieldBus Scaling ID46 (Monitoring Value)

*P2.6.2.4 Scaling of Generating power limit ID1088 "GenPowerLimScIng"*

The generator power limit is equal to parameter Generator Power Limit if value 'Not Used' is selected. If any of the inputs is selected the generator power limit is scaled between zero and parameter P2.6.2.2 Generator Power Lim.

0 = Parameter

1 = AI1

2 = AI2

3 = AI3

4 = AI4

5 = FieldBus Scaling ID46 (Monitoring Value)

8.6.3 Torque limit handling

8.6.3.1 Motoring torque limit function

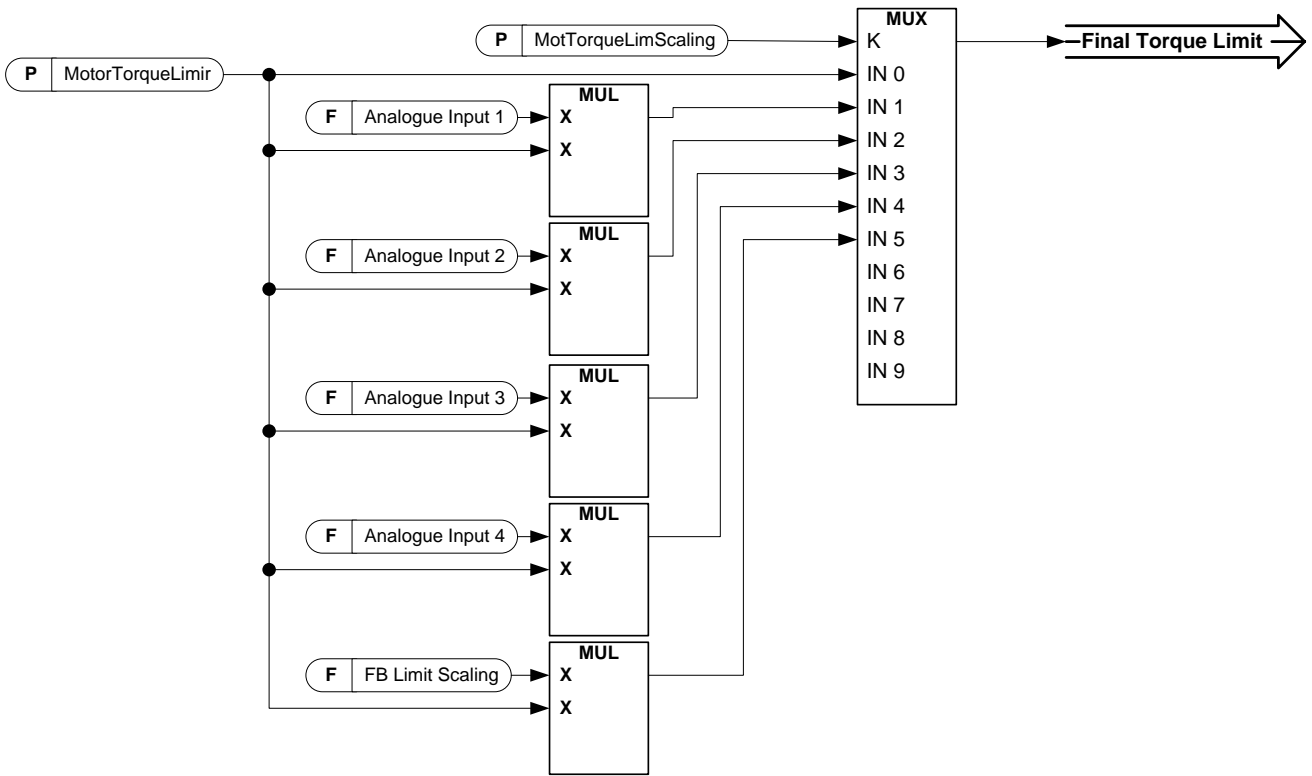

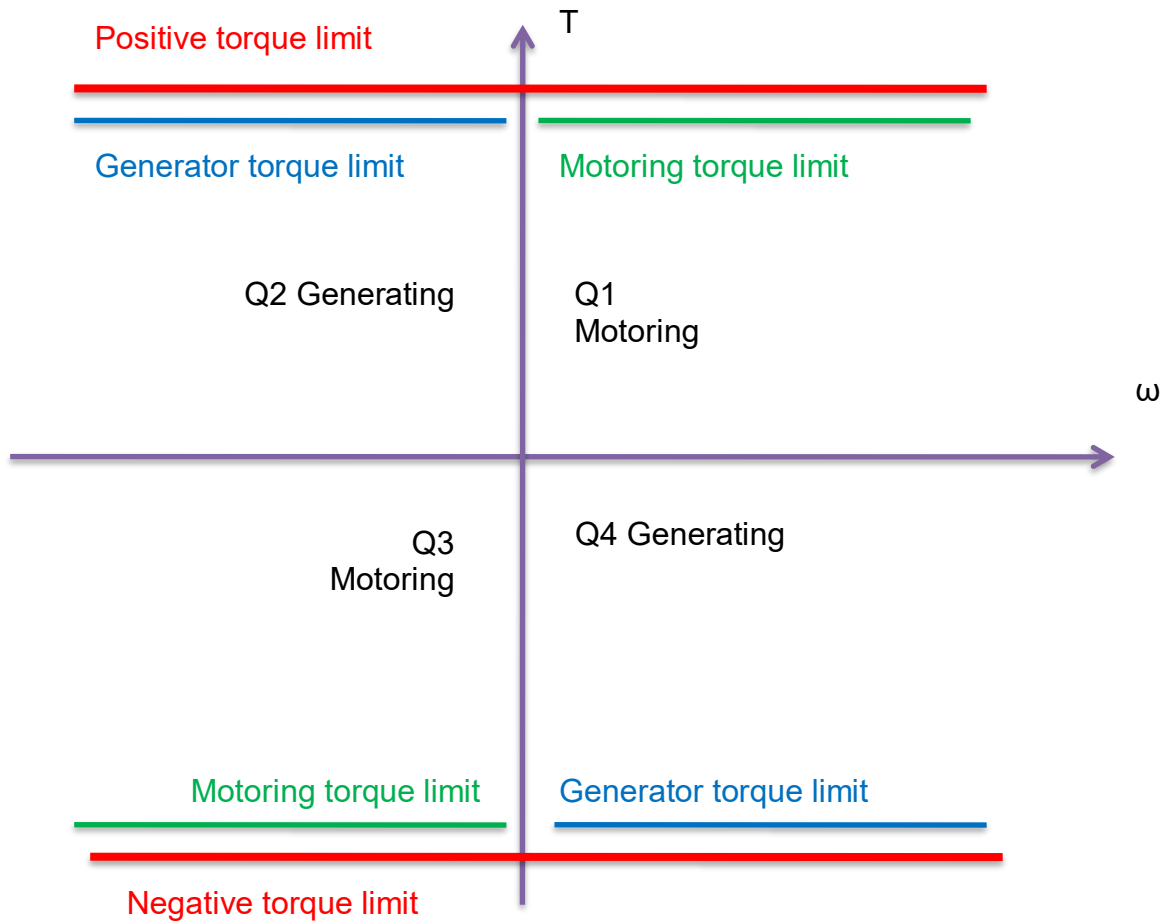

**P2.6.3.1 Motoring Torque limit ID1287 "MotorTorqueLimit"**

Motoring side torque limit. This limit value is used for all scaling functions and torque limit ramp rate functions if activated.

**P2.6.3.2 Generator Torque limit ID1288 "GenerTorqueLimit"**

Generator side torque limit. This limit is used for all scaling functions generator side torque limit is not included in ramp up rate function.

**P2.6.3.3 Motoring Torque limit scaling ID485 "MotTorqLimScIng"**

The motoring torque limit is equal to parameter Motoring Torque Limit if value 'Not Used' is selected. If any of the inputs is selected the motoring torque limit is scaled between zero and parameter Motorin Torque Limit.

0 = Not used

1 = AI1

2 = AI2

3 = AI3

4 = AI4

5 = FB Limit Scaling ID46 Monitoring value



**P2.6.3.4** *Generating torque limit scaling*      **ID1087**      **“GenTorqLimScIng”**

The generator torque limit is equal to parameter Generator Torque Limit if value ‘Not Used’ is selected. If any of the inputs is selected the generator torque limit is scaled between zero and parameter generator torque limit.

0 = Not used

1 = AI1

2 = AI2

3 = AI3

4 = AI4

5 = FB Limit Scaling ID46 Monitoring value

**8.6.3.2** *Open Loop settings only*

**P2.6.3.5.1** *Torque limit control P-gain*      **ID610**      **“TorqLimCtrl P”**

This parameter defines the gain of the torque limit controller. It is used in Open Loop control mode only.

**P2.6.3.5.2** *Torque limit control I-gain*      **ID611**      **“TorqLimCtrl I”**

This parameter determines the I-gain of the torque limit controller. It is used in Open Loop control mode only.

**8.6.3.3** *Closed Loop settings only*

**P2.6.3.6.1**      *Speed Control output limit*      **ID1382**      **“SPC Out Limit”**

Torque limit for the speed controller. It affects both the positive and negative direction torques.

**P2.6.3.6.2**      *Speed Control negative limit*      **ID645**      **“SPC Neg Limit”**

Negative torque limit for speed controller output.

**P2.6.3.6.3**      *Speed Control positive limit*      **ID646**      **“SPC Pos Limit”**

Positive torque limit for speed controller output.

**8.6.4** *Frequency limit handling*

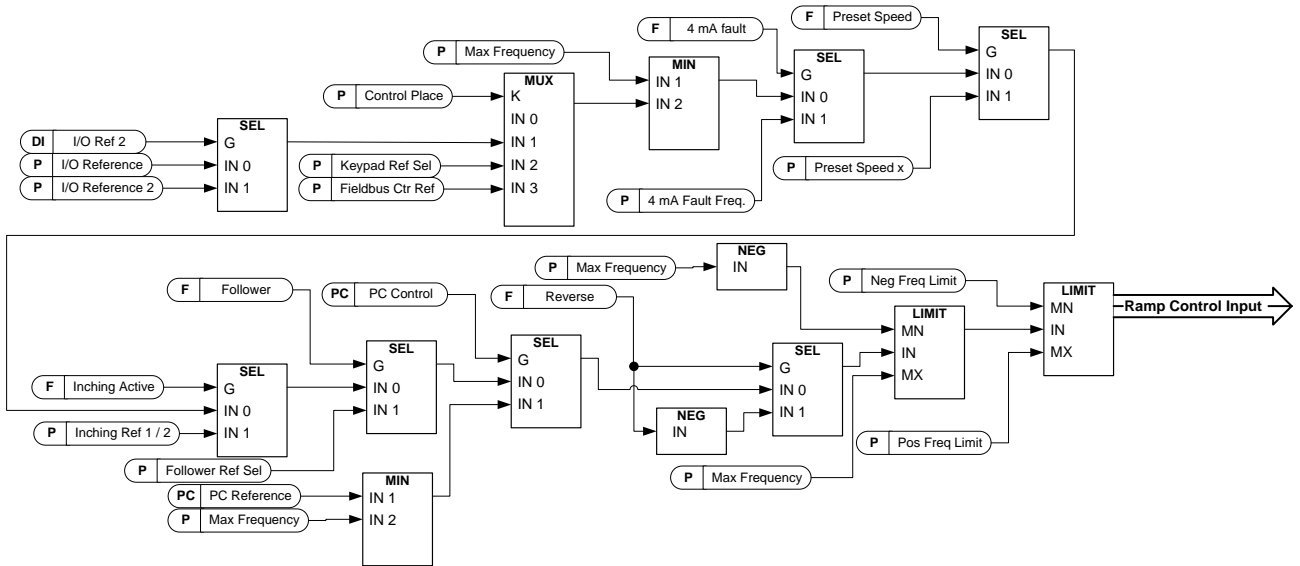

**P2.6.4.1 Negative frequency limit ID1286 "Neg Freq Limit"**

Positive direction frequency limit. When changed in closed loop control mode change is made without ramp.

**P2.6.4.2 Positive frequency limit ID1285 "Pos Freq Limit"**

Negative direction frequency limit. When changed in closed loop control mode change is made without ramp.

**P2.6.4.3 Zero Frequency limit ID1283 "Zero Freq. Limit"**

Defines the zero frequency limit.  
Used to determine when load drooping is set to zero if load drooping removal function 1 is selected

8.6.5 DC Link handling

**P2.6.5.1 Overvoltage controller ID607 “Overvolt Contr”**

The parameter selects the behaviour of the overvoltage controller in open loop control. It also activates the closed loop overvoltage controller but the operation is always of type ‘PI’ in closed loop control modes.

**0 “Off” - Controller switched off**

Both open and closed loop overvoltage controllers are off.

**1 “On:NoRamping” – Activated P-Controller type operation**

Both open and closed loop controllers are activated.

Open loop controller is a P-type controller.

Closed loop controller is a PI-type controller.

**2 “On: Ramping” – Activated PI-Type controller**

Both open and closed loop controllers are activated.

Open loop controller is a PI-type controller.

Closed loop controller is PI-type controller (as in selection 1).

**P2.6.5.2 Overvoltage Reference Select ID1262 “OverVolt.Ref.Sel”**

Overvoltage reference level depending on the status of the brake chopper.

In closed loop control, the overvoltage controller level is adjusted by “OverVoltageRef.”

The parameter can be found in the CL setting parameter group.

ID1262	Brake chopper in use	Brake chopper not in use
0 / High Voltage	500 V Unit: 844 V 690 V Unit: 1164 V	500 V Unit: 797 V 690 V Unit: 1099 V
1 / Norm.Voltage	1.25*Estimated DC nominal voltage	1.18*Estimated DC nominal voltage
2 / BrakeChLevel	1.07*brake chopper level	Brake chopper level

### P2.6.5.3 Brake chopper ID504 "Brake Chopper"

When the AC drive is decelerating the motor, the inertia of the motor and the load are fed into an external brake resistor. This enables the drive to decelerate the load with a torque equal to that of acceleration (provided that the correct brake resistor has been selected). See separate Brake resistor installation manual. Brake chopper test mode generates pulse to resistor every second. If the pulse feedback is wrong (resistor or chopper is missing) fault F12 is generated.

Over Voltage Reference Select	Brake chopper level
0 / High voltage	500 V Unit: 797 V 690 V Unit: 1099 V
1 / Norm.Voltage	1.18* Estimated DC nominal voltage
2 / BrakeChLevel	Brake chopper level

#### 0 = "Not Used" - No brake chopper used

Brake chopper not active or present in the DC link. **NOTE:** The overvoltage controller level is set to a little lower, see parameter P2.6.5.2.

#### 1 = "On, Run" - Brake chopper in use and tested when running.

The drive's own brake chopper is activated and operational when the drive is in Run state. The drive also sends test pulses for feedback from the brake resistor.

#### 2 = "External" - External brake chopper (no testing)

The system has an item that handles the DC link voltage. This could be a system with AFE or there is an external BCU unit. When this option is selected the drive overvoltage level is set a little higher so that its operation does not conflict with AFE or BCU units.

#### 3 = "On, Run+Stop" - Used and tested in READY state and when running

Brake chopper is also active when the drive is not in Run state. This option can be use e.g. when other drives are generating but energy levels are low enough to be handled with only one drive.

#### 4 = "On, No test" - Used when running (no testing)

Brake chopper is active in Run state but no test pulse to resistor is generated.

**Note:** In the system menu there is a parameter "InternBrakeRes". This parameter is used for brake resistor overheating calculations. If an external brake resistor is connected to the drive the parameter should be set to 'Not connected' to disable temperature calculation for the brake resistor.

### P2.6.5.4 Brake Chopper Level ID1267 "BrakeChopperLeve"

Brake chopper control activation level in volt. This parameter is active when "OverVolt.Ref.Sel" is 2 / "BrakeChLevel"

For 400V Supply:  $400 * 1.35 * 1.18 = 638V$

For 500V Supply:  $500 * 1.35 * 1.18 = 808V$

For 690V Supply:  $690 * 1.35 * 1.18 = 1100V$

### *P2.6.5.5 Undervoltage controller ID608 "Undervolt Contr"*

Undervoltage controller will decrease the output frequency in order to get energy from the motor when the DC voltage has dropped to a limit where the undervoltage controller activates trying to keep DC voltage at the minimum level.

#### **0 "Off" - Controller switched off**

Both open and closed loop overvoltage controllers are off.

#### **1 "On:NoRamping" – Activated PI-Controller type operation**

Both open and closed loop controllers are activated.

Both open and closed loop controllers are PI-type controllers.

If power comes back while drive is at undervoltage the controller output frequency will regain the reference value.

#### **2 "On: Ramping" – PI controller type and ramping down.**

Both open and closed loop controllers are activated.

Both open and closed loop controllers are PI-type controllers.

If power comes back while drive is at undervoltage the controller drive will ramp to zero speed and generate an undervoltage fault.

**Note:** In closed loop control, also parameter "CLrmpFollEncFreq" needs to be activated to achieve identical operation.

### *P2.6.5.6 Undervoltage Kp*

### *P2.6.5.7 Undervoltage Ki*

### *P2.6.5.8 Undervoltage Kd*

### *8.6.5.1 CL Settigns*

### *P2.6.5.9.1 Overvoltage reference ID1528 "OverVoltageRef."*

Defines the overvoltage reference level in Closed Loop control mode. Percentage value related to unit nominal voltage DC voltage. Default 118%.

$$690 \text{ Vac} * 1.35 * 118\% = 1099 \text{ Vdc}$$

$$500 \text{ Vac} * 1.35 * 118\% = 796 \text{ Vdc}$$

### *P2.6.5.9.2 Overvoltage controller motoring torque limit ID1634*

Defines motoring torque limit, when drive is operating under over voltage controller.

### *P2.6.5.9.3 CL Under Voltage Reference ID1637*

Defines the under voltage reference level in Closed Loop control mode. Percentage value related to unit nominal voltage DC voltage. Default 65%.

$$690 \text{ Vac} * 1.35 * 65\% = 605 \text{ Vdc}$$

$$500 \text{ Vac} * 1.35 * 65\% = 438 \text{ Vdc}$$

### 8.7 DC current and magnetization handling

The DC brake can be used to hold the motor in place (nominal torque at nominal slip). It can be also used to keep the motor warm in places with high humidity and to speed up the generation of rotor flux. Rotor flux is needed in the induction motor to generate torque. The current that is needed to make the nominal flux is defined by the magnetization current parameter but, depending on motor size, nominal flux takes a different time to produce after start command.

Giving a higher current on start to the motor will decrease the time when the motor is able to generate nominal torque.

Blue: Motor Current. Red: Rotor Flux.

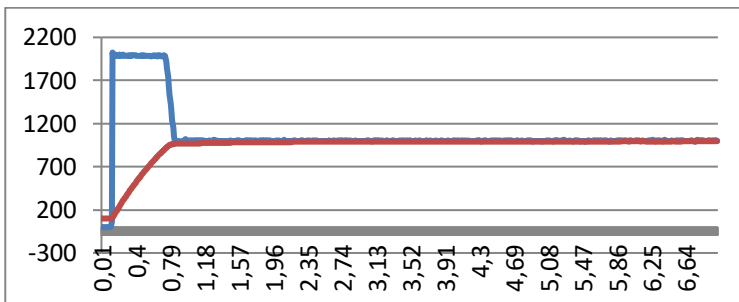
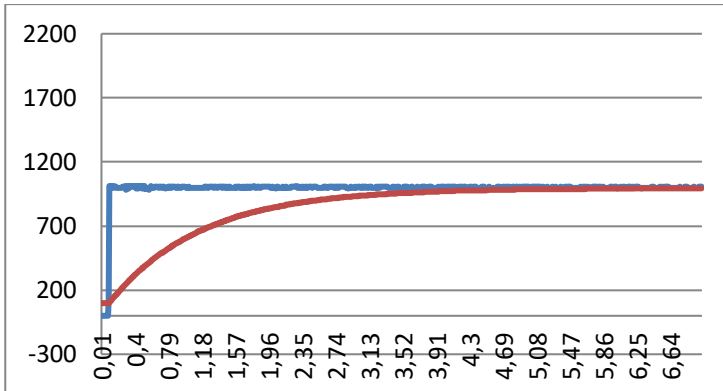

#### 8.7.1 Open loop settings

##### P2.7.1.1 DC-braking current ID627 "DC-Brake Current"

Defines the current injected into the motor during DC-braking. On start this parameter is used together with DC Brake time to decrease the time when motor is able to produce nominal torque. When DC brake current is applied to the motor the output frequency is zero.

##### P2.7.1.2 DC-braking time at start ID507 "Start DC-BrakeTm"

DC-brake is activated when the start command is given. This parameter defines for how long DC current is given to the motor before acceleration starts. DC brake current at start is used in order to magnetize the motor before running which will improve torque performance at start. Needed time depends on motor size, value varying between 100 ms to 3 second. The bigger the motor the more time is needed.

The default setting 0,00 s means that 200 ms is spent to magnetize motor. This 200 ms can be set to zero with parameter "MakeFluxTime".

Activating flying start will disable the DC brake functions at start.

### P2.7.1.3 DC-braking time at stop ID508 "Stop D-BrakeTm"

Defines the time to use DC brake at stop. The operation is different depending on the selected stop mode (coasting or ramping).

#### Stop function = 0 / Coasting:

After the stop command, the motor coasts to a stop without control of the drive.

With DC injection, the motor can be electrically stopped in the shortest possible time, without using an optional external braking resistor.

The braking time is scaled according to the frequency at the moment of stop command. If the frequency is the nominal frequency of the motor or higher, the set value of DC braking time at stop is used as the braking time. When the frequency is below the nominal frequency, the relation between the nominal frequency and the output frequency at the time of stop command will determine the DC braking time. For example, 50-hertz motor is running at 25 Hz when the stop command is given. The DC brake time will be 50 % of the DC braking time at stop. If the frequency is below 5 Hz the minimum DC braking time is 10 % of the DC braking time at stop.

DC braking is started after a short restart delay following the stop command if stop function is coasting.

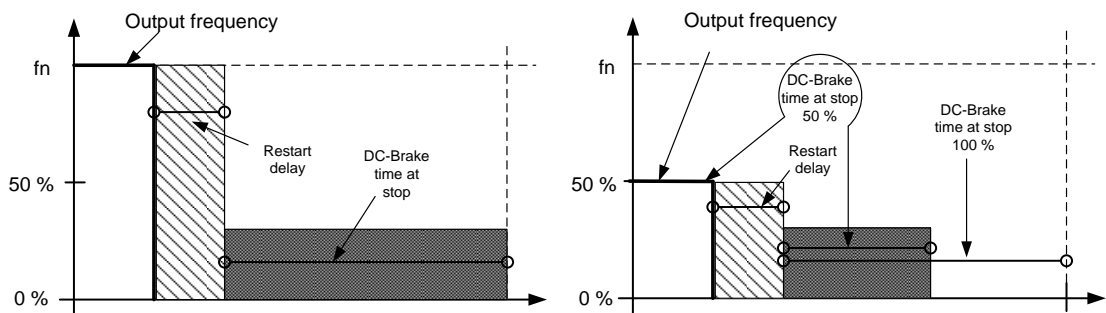

Figure 8-13. DC-braking time when Stop mode = Coasting, from nominal speed and 50 % of nominal speed.

#### Stop function = Ramp:

After the Stop command, the speed of the motor is reduced according to the set deceleration parameters, to the speed defined with parameter DC braking frequency at stop, where the DC braking starts.

The braking time is defined with parameter *DC braking time at stop*. If high inertia exists, it is recommended to use an external braking resistor for faster deceleration. See Figure 8-14.



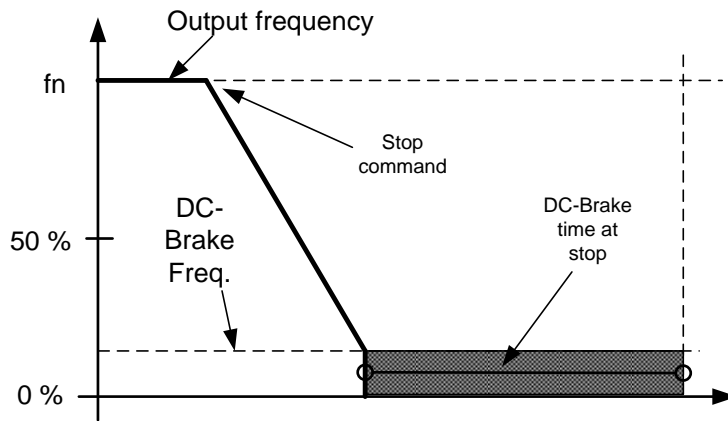

Figure 8-14. DC-braking time when Stop mode = Ramp

#### P2.7.1.4 DC braking frequency at stop ID515 "Stop D-BrakeFr"

The output frequency at which the DC braking is applied when making ramping stop.

#### P2.7.1.5 Scaling of DC-braking current ID400 "DC-currnt Sclng"

The DC braking current can be reduced with the free analogue input signal between zero current and the current set with parameter *DC Braking Current*.

0 = Not used

1 = AI1

2 = AI2

3 = AI3

4 = AI4

5 = FB Limit Scaling ID46 Monitoring value

#### P2.7.1.6 DC brake current in stop ID1080 "DCBrakeCurlnStop"

Defines the current injected to the motor in stop state when the digital input signal "DC Brake Command" is used to activate the DC brake when no run request is active. When the DC brake is activated the drive will indicate being in Run state.

8.7.1.1 *Flux braking*P2.7.1.7 *Flux brake* ID520 "Flux Brake"

Instead of DC braking, flux braking is a useful way to raise the braking capacity in cases where additional brake resistors are not needed.

When braking is needed, the frequency is reduced and the flux in the motor is increased. This increases losses on motor, which in turn increases the motor's capability to brake. Unlike in DC braking, the motor speed remains controlled during braking.

The flux braking can be set ON or OFF.

0 = Flux braking OFF

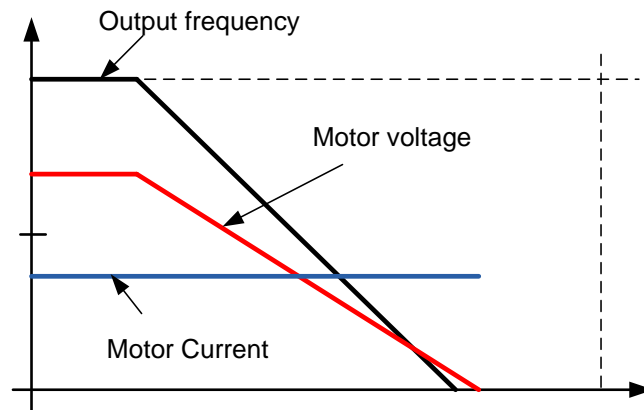

1 = Flux braking ON

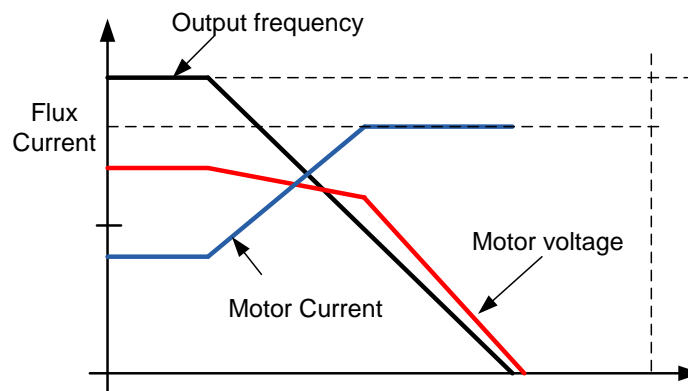
P2.7.1.8 *Flux braking current* ID519 "FluxBrakeCurrent"

Defines the flux braking current value. The value setting range depends on the used unit size.

### 8.7.2 Closed loop settings

#### P2.7.2.1 Magnetizing current at start ID627 "Start Magn Curr"

Defines the current that is applied to the motor when the start command is given in closed loop control. At start this parameter is used together with *Magnetizing time at start* to decrease the time when the motor is able to produce nominal torque. In closed loop control output frequency is not forced to zero while magnetization current is applied to motor.

#### P2.7.2.2 Magnetizing time at start ID628 "Start Magn Time"

Defines the time for how long magnetization current is applied to motor at start. *Magnetizing current at start* is used to shorten the time when flux is at nominal level. This will improve the torque performance at start. The time needed depends on the motor size, value varying between 100 ms to 3 second. The bigger the motor the more time it needs. Set this time so that the rotor flux is more than 90 % before speed is released (Start Zero Speed Time ID615) or mechanical brake is released.

#### P2.7.2.3 Flux reference ID1250 "FluxReference"

Reference value for rotor flux. Rotor flux can be reduced by changing the magnetization current. This, however, also affects the motor model making the torque calculations a little less accurate. When using this parameter the motor model can compensate the effect of the different magnetization current in torque calculations.

$$[FW]RotorFlux = \left( \frac{f(MotorNomFreq)}{f(Out)} \right)^2 \quad \text{when } f(Out) > f(MotorNomFreq)$$

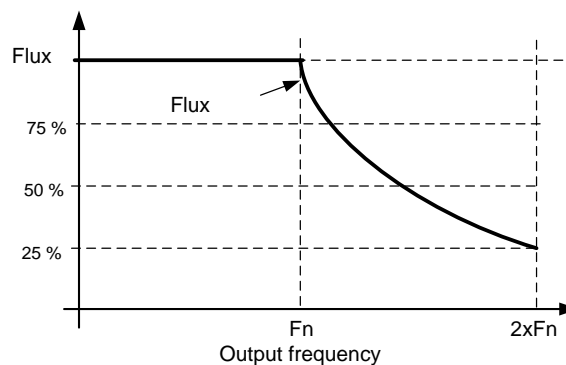

#### P2.7.2.4 Flux Off Delay ID1402 "Flux Off Delay"

The Flux off delay function will keep the motor magnetized after a stop command thus making the next start faster because flux is already available in the motor. The function is used e.g. in a system where several repeated starts are made in short cycles. The flux level can be adjusted by parameter *Stop State Flux*.

0 = Flux is not maintained in the motor

>0 = Flux off delay in seconds.

-1 = Flux is maintained indefinitely in the motor

### *P2.7.2.5 Stop State Flux ID1401 "Stop State Flux"*

The amount of flux in percentage of the motor nominal flux maintained in the motor after the drive is stopped. The flux is maintained for the time set by parameter ID1402 *Flux Off Delay*. This parameter can only be used in closed loop motor control.

8.8 Motor Control

Open Loop control

Open loop control controls the motor without encoder feedback from the motor shaft. Control mode selections 0, 1 and 2 are open loop control modes.

Slip

Induction motor torque is based on slip. When load increases also slip will increase. Slip is the speed that rotor is behind of stator electrical frequency.

Below picture presents torque that is produced by induction motor when connected directly on line.

1. Motor Synchronous speed. Motor is taking only magnetization current.
2. Motor nominal operation point. Motor is producing 100 % of rated torque and power. Actual shaft speed is motor nominal speed and motor takes nominal current.
3. Pullout torque. This is point where motor produced torque start to decrease when slip increases. After this point motor will stop if load is not reduced.

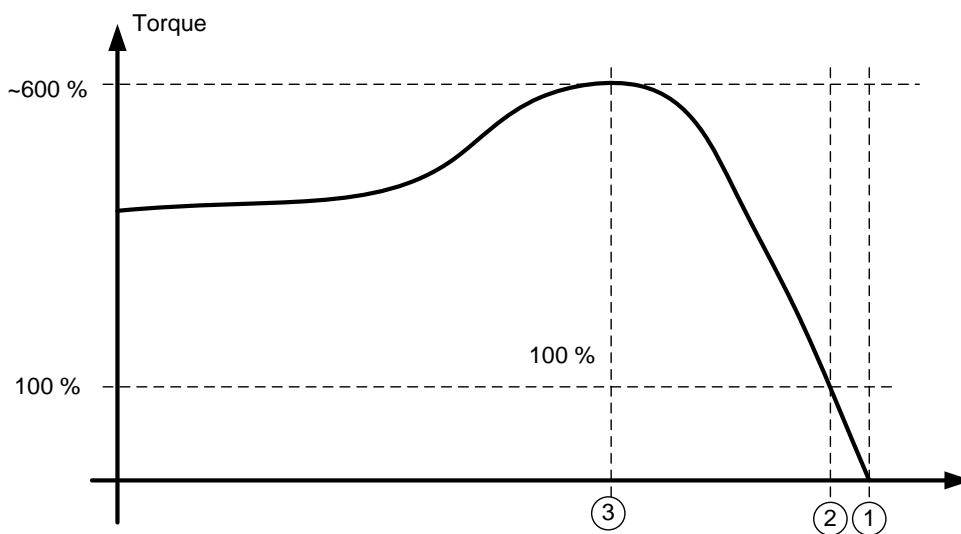

In frequency control, the load will determine the actual shaft speed

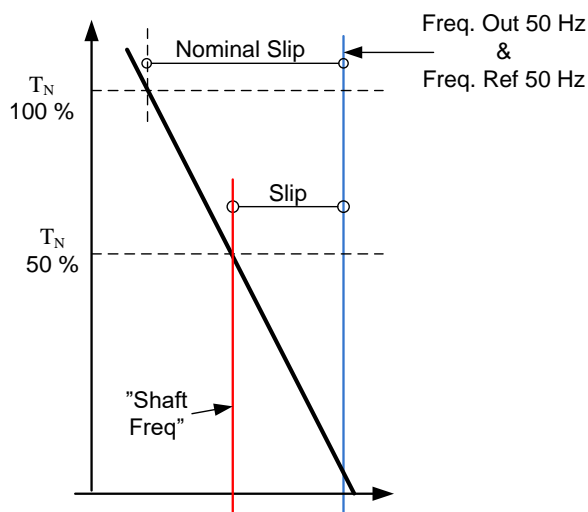

*Slip compensation in open loop control*

The drive uses motor torque and motor nominal rpm to compensate slip. If the motor nominal rpm is 1440 -> the nominal slip is 60 rpm. And when the motor torque is 50 % the slip is 30 rpm. To keep the reference speed the drive must increase the output frequency by 1 Hz.

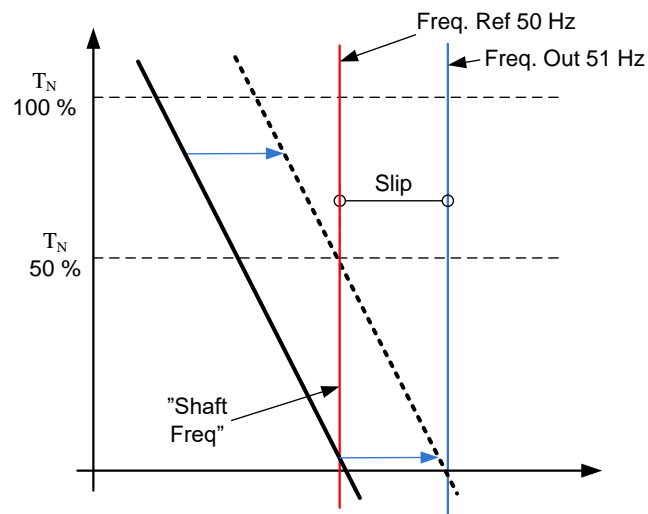
**Closed Loop control**

Closed loop control controls the motor using the exact information of the motor speed from the encoder. Control mode selections 3 and 4 are closed loop control modes. Using these modes without encoder board (and encoder) will result in encoder fault.

### P2.8.1 Motor control mode ID600 "Motor Ctrl Mode"

#### 0 "Freq Control"

Open loop frequency control:

Drive frequency reference is set to output frequency without slip compensation. Motor speed is defined by motor load.

#### 1 "OL SpeedCont"

Open loop speed control:

Drive frequency reference is set to motor speed reference. Motor speed stays the same regardless of motor load.

#### 2 "Open Loop"

Open loop Speed or Torque control

In this control mode the drive can be selected to run in torque control mode. The operation is selected by parameter *TorqueSpeedLimit* in the Torque Reference parameter group. The default selection is torque control mode speed limited by ramp generator output.

#### 3 "CL SpeedCtrl"

Close loop speed control

Drive frequency reference is set to motor speed reference. Motor speed stays the same regardless of motor load.

#### 4 "Closed Loop"

Closed loop speed or torque control

In this control mode the drive can be selected to run in torque control mode. The operation is selected by parameter *TorqueSpeedLimit* in the Torque Reference parameter group. The default selection is torque control mode speed limited by ramp generator output.

#### 5 "Sensorless"

Sensorless speed or torque control.

To use this control mode DTC Identification or Ident All is needed to perform.

### P2.8.2 Motor control mode 2 ID521 "Motor Ctrl Mode2"

With this parameter you can set another motor control mode which is activated with parameter *Mot Ctrl Mode1/2*.

**Note:** The Motor control mode cannot be changed between open loop and closed loop while the drive is in Run state.

### 8.8.1 U/f Settings

U/f settings are mainly used in open loop control modes with the exception of the *Field weakening point voltage* that is also used in closed loop control mode as a limit for voltage. U/f settings are used to control the voltage level that are applied to the motor at different frequencies and different load situations.

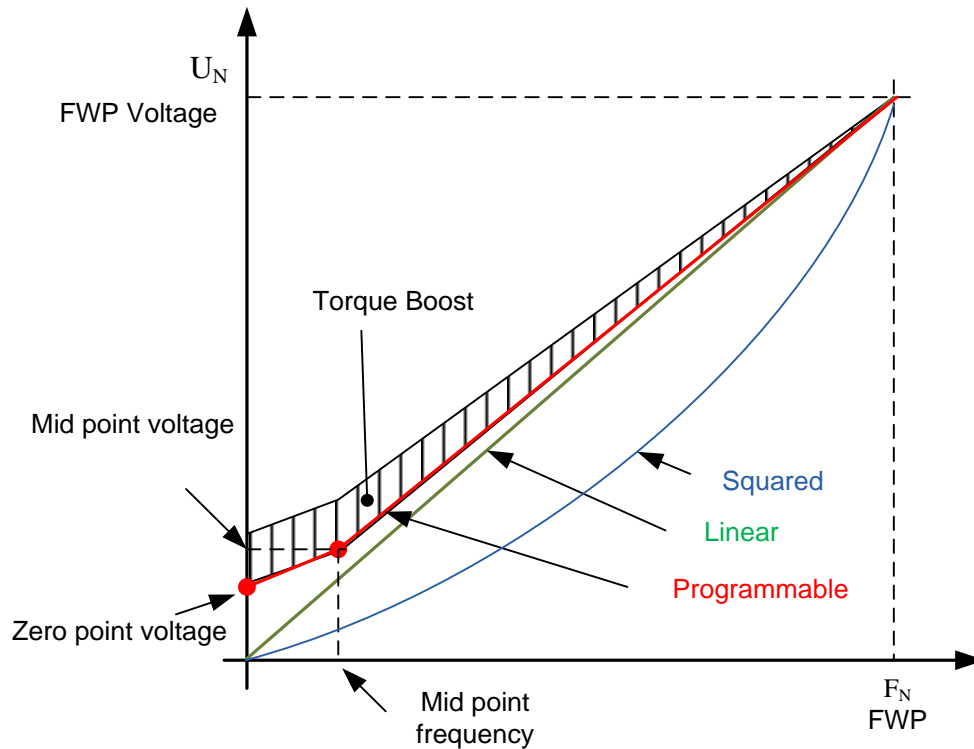

What changes are required to start with load from 0 Hz?

- ◆ First set the motor nominal values (Parameter group 2.1).

Option 1: Automatic functions

Step 1: Make identification with rotating motor

Step 2 (If needed): Activate speed control or U/f optimization (Torque boost).

Step 3 (If needed): Activate both speed control and U/f optimization.

Option 2: Manual tuning

Step 1:

Run the motor using 2/3 of motor nominal frequency as the frequency reference. Read the motor current in the monitoring menu or use NCDrive for monitoring. This current shall be set as the motor magnetization current.

Change the U/f curve ratio selection to programmable (= 2).

Run the motor with zero frequency reference and increase the motor zero point voltage until the motor current is approximately same as the motor magnetising current. (If the



motor is in a low frequency area for only short periods, it is possible to use up to 65 % of the motor nominal current).

Set then the midpoint voltage to  $\sqrt{2} * \text{Zero Point Voltage}$   
and

the midpoint frequency to  $(\text{Zero Point Voltage}/100\%)*\text{Nominal frequency of motor}$

Step 2 (If needed): Activate speed control or U/f optimization (Torque boost).

Step 3 (If needed): Activate both speed control and U/f optimization.

*NOTE! In high torque – low speed applications – it is likely that the motor will overheat. If the motor has to run long times under these conditions, special attention must be paid to cooling of the motor. Use external cooling for the motor if the temperature tends to rise too high.*

### P2.8.3.1 U/f optimisation ID109 “U/f Optimization”

**Automatic torque boost** The voltage to the motor changes proportionally to required torque which makes the motor produce more torque at start and when running at low frequencies. Automatic torque boost can be used in applications where starting torque due to starting friction is high, e.g. in conveyors. Even with linear U/f curve, the torque boost has an affect but the best result will be achieved after the identification run when programmable U/f curve is activated.

### P2.8.3.2 U/f ration selection ID108 “U/f Ratio Select”

**Linear:**

**0** The voltage of the motor changes linearly from zero point voltage to the field weakening point where the voltage at FWP is supplied to the motor.

**Squared:**

**1** The voltage of the motor changes from zero point voltage following the squared curve form zero frequency to the field weakening point. The motor runs undermagnetised below the field weakening point and produces less torque. Squared U/f ratio can be used in applications where torque demand is proportional to the square of the speed, e.g. in centrifugal fans and pumps.

**Programmable U/f curve:**

**2** The U/f curve can be programmed with three different points.

1. Zero point voltage
2. Midpoint frequency and Midpoint voltage.
3. Field weakening point and field weakening point voltage.

Programmable U/f curve can be used if more torque is needed at low frequencies. Make the Identification run for optimal setting (ID631).

**Linear with flux optimisation:**

**3** The frequency converter starts to search for the minimum motor current in order to save energy. This function can be used in applications with constant motor load, such as fans, pumps etc.

**P2.8.3.3 Field weakening point ID602 "Field WeakngPnt"**

The field weakening point is the output frequency at which the output voltage reaches the field weakening point voltage.

**P2.8.3.4 Voltage at field weakening point ID603 "Voltage at FWP"**

Above the frequency at the field weakening point, the output voltage remains at the set maximum value. Below the frequency at the field weakening point, the output voltage depends on the setting of the U/f curve parameters.

When the parameter *Motor nominal frequency* is set, the parameter *Field weakening point* is automatically given the corresponding value. If you need different values for the field weakening point and the maximum output voltage, change these parameters **after** setting the *Nominal frequency*.

In closed loop control this defines maximum voltage to the motor, can be increases if sufficient DC voltage is available.

**P2.8.3.5 U/f curve, middle point frequency ID604 "U/f Mid Freq"**

If the programmable U/f curve has been selected with parameter U/f ratio this parameter defines the middle point frequency of the curve. See also parameter *Middle point voltage*.

When the programmable U/f curve is selected this value is set to 10 % of motor nominal frequency.

**P2.8.3.6 U/f curve, middle point voltage ID605 "U/f mid Voltg"**

If the programmable U/f curve has been selected with the parameter U/f ratio this parameter defines the middle point voltage of the curve. See also parameter *Middle point frequency*.

When the programmable U/f curve is selected this value is set to 10 % (of motor nominal voltage).

**P2.8.3.7 Output voltage at zero frequency ID606 "Zero Freq Voltg"**

This parameter defines the zero frequency voltage of the U/f curve. The default value is unit size dependent.

**NOTE:** If the value of parameter *U/f Ratio Select* is changed this parameter is set to zero.

**P2.8.3.8 Open Loop mode ID1600**

0 = Normal

1 = Mode 2

2 = CL Speed Limits

3 = Mode 2 + CL Speed Limits

### 8.8.1.1 I/f Control

I/f-control can be used to start the motor using a constant current control. This is useful especially, if the motor stator resistance is low, which makes the motor current sensitive for u/f-curve tuning at low speed area.

#### P2.8.3.9 *I/f Start* ID534

Activates I/f control

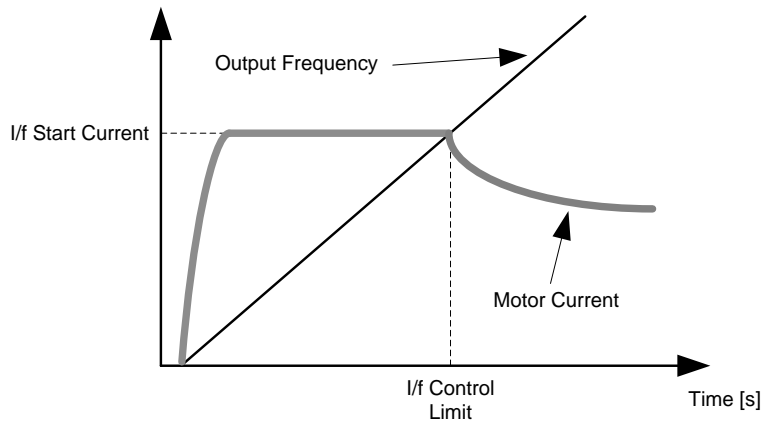

#### P2.8.3.10 *I/f Current* ID1693 "I/f Current"

NOTE: I/f Current parameter is used for several different purposes.

##### I/f Control

This parameter defines the current level during I/f control, in percent of the motor nominal current

##### Zero position with incremental encoder and Z-Pulse

In closed loop control utilizing the encoder z-pulse, defines also the current level used in starting before the z-pulse is received to synchronize with.

##### DC Start Angle identification

This parameter defined DC Current level when Start Angle Identification Time is set greater than zero. See P2.8.5.5 Start Angle Identification Time.

#### P2.8.3.11 *I/f Control Limit* ID1790 "I/f Control Lim"

This parameter sets the frequency limit for I/f-control in per cent of the motor nominal frequency. I/f-control is used if the frequency is below this limit. The operation changes back to normal when the frequency is above this limit with 1 Hz hysteresis.

### 8.8.2 Close Loop Settings

#### P2.8.4.1 Current control P gain ID617 "CurrentControlKp"

Sets the gain for the current controller. The controller generates the voltage vector reference to the modulator. The gain is also used in open loop flying start. When the Sine filter parameter (parameter P6.7.5 in the System menu) has been set to *Connected* the value of this parameter is changed to 20.00 %.

The value is also identified when using a PMS motor and making identification run with rotating motor. At low speed the motor values may increase up to 300 %. At high speed motor gain and motor with sine filter may have gain values of 10...40 %.

#### P2.8.4.3 Current control Ti ID657 "CurrentControlTi"

Current controller integrator time constant.

#### P2.8.4.3 Slip adjust ID619 "Slip Adjust"

The motor name plate speed is used to calculate the nominal slip. This value is used to adjust the voltage of motor when loaded. The name plate speed is sometimes inaccurate and this parameter can therefore be used to trim the slip. Reducing the slip adjust value increases the motor voltage when the motor is loaded.

#### P2.8.4.4 Acceleration compensation ID626 "Accel.Compens."

Sets the inertia compensation to improve the speed response during acceleration and deceleration. The time is defined as acceleration time to nominal speed with nominal torque. This function is used when the inertia of the system is known to achieve the best speed accuracy when reference is changed.

Acceleration compensation is added to *TorqueReferenceActual* i.e. torque is added after speed controller. The speed controller can, therefore, be tuned only for speed error and the acceleration compensation makes sure that the system inertia does not affect the speed controller.

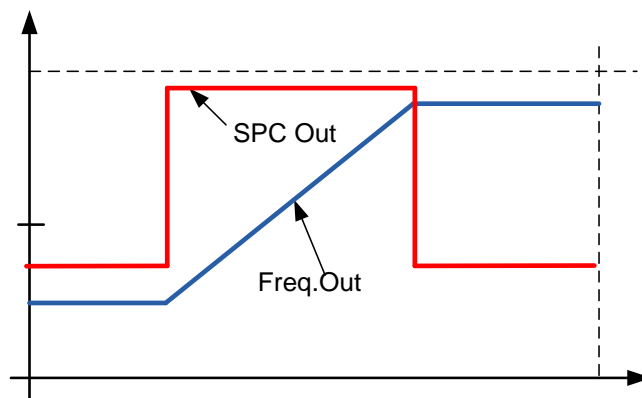

Acceleration compensation not in use

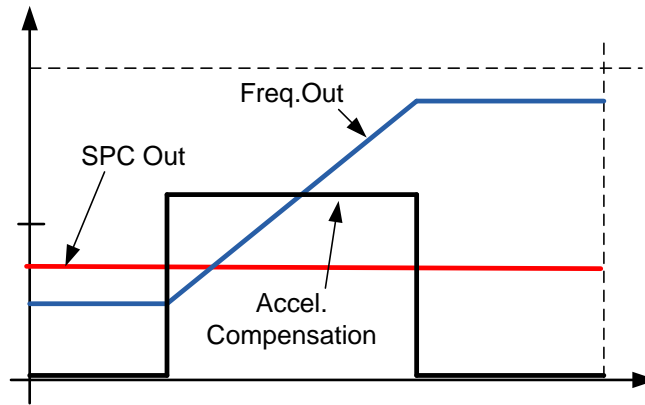

Acceleration compensation in use

$$AccelCompensationTC = J \cdot \frac{2\pi \cdot f_{nom}}{T_{nom}} = J \cdot \frac{(2\pi \cdot f_{nom})^2}{P_{nom}}$$

J = System inertia (kg\*m<sup>2</sup>)

f<sub>nom</sub> = Motor nominal frequency (Hz)

T<sub>nom</sub> = Motor nominal torque

P<sub>nom</sub> = Motor nominal power (kW).

**P2.8.4.5 Speed Error filtering time constant ID1311 "SpeedErrorFiltTC"**

Filter time constant for speed reference and actual speed error. May be used to remove small disturbances from encoder signal.

**P2.8.4.6 Encoder filter time ID618 "Encoder1FiltTime"**

Sets the filter time constant for speed measurement.

The parameter can be used to eliminate encoder signal noise. Too high a filter time reduces speed control stability. Values over 10 ms are not recommended in normal cases.

**P2.8.4.7 Speed Control Torque Chain Select ID1557 "SCTorqueChainSel"**

Values are bit coded. For example, after identification run with rotating motor the value will be 96. If you want to activate an external acceleration compensation you need to add +2 to the existing value.

**B0 +1 = Additional torque limit**

The torque reference chain can be used as an additional torque limit. This option is available in closed loop control mode only.

**B1 +2 = External acceleration compensation**

The torque reference is added to the speed control output, allowing the external controller to give inertia compensation for the drive in speed control mode. This option is available in closed loop control mode only.

**B5&B6, +96 = Internal motor temperature compensation**

When the motor cools down or warms up the slip of the motor will change. When this function is activated in closed loop control mode the drive will estimate changes in motor resistance and correct the changes of motor slip automatically to achieve the best torque estimation.

This function is automatically activated when identification run with rotating motor is successfully finished. This option is available in closed loop control mode only.

### 8.8.3 Permanent magnet synchronous motor settings

There are three ways to know the magnet positions when using the closed loop control. The first one will identify the motor magnet position during every start when using incremental encoder without Z-pulse. Second one uses incremental encoder Z-pulse and the third one uses absolute encoder information. See details of selecting correct mode from chapter "Identification function for permanent magnet synchronous motor".

#### P2.8.5.1 PMSM Shaft Position ID649 "PMSMShaftPositio"

Absolute encoder position value corresponding to the shaft position where rotor magnet axis is aligned with the stator U-phase magnet axis will be stored here as a result of the encoder identification run. If incremental encoder with a z-pulse is used, z-pulse position will be stored instead. Depending on the motor shaft mechanical position, this parameter can have different values, as there is one right value for each pole-pair of the motor. If incremental encoder and the z-pulse is utilized, the first start after power up is less optimal and i/f-control (see 6.8.3.2) will be used until the drive finds the z-pulse and is able to synchronize in that.

#### P2.8.5.2 Start Angle Identification Mode ID1691 "StartAngleIdMode"

Start angle, i.e. rotor magnet axis position in respect to the stator U-phase magnet axis, identification is needed if there are no absolute encoder or incremental encoder with z-pulse used. This function defines how the start angle identification is made in those cases. Identification time depends on the motor electrical characteristics but takes typically 50ms...200ms.

In case of absolute encoders, start angle will read directly from the encoder absolute angle value. On the other hand, incremental encoder z-pulse will be used automatically for synchronization if it's position is defined different from zero in P2.8.5.1. Also for absolute encoders, P2.8.5.1 must be different from zero, otherwise it is interpreted that the encoder identification run has not been done and the running will be prohibited except if the absolute channel is bypassed by the start angle identification.

#### NOTE!

ModulatorType (P2.10.2) need to be > 0 to be able to use this function.

#### 0 = Automatic

Decision to use start angle identification is made automatically based on the encoder type connected to the drive. This will serve common cases.

#### 1 = Forced

Bypasses the drive automatic logic and forces the start angle identification to be active. Can be used, for example, with absolute encoders to bypass absolute channel information and to use start angle identification instead.

#### 2 = On Power UP

As a default, start angle identification will be repeated in every start if the identification is active. This setting will enable identification only in a first start after drive is powered up. In consecutive starts, angle will be updated based on the encoder pulse count.

#### 10 = Disabled

Used when Z- pulse from encoder is used for start angle identification.

*P2.8.5.3 Start Angle Identification Current*      *ID1759*      *“StartAngleIdCurr”*

This parameter defines the current level that is used in start angle identification. The correct level depends of the motor type used. In general, 50% of motor nominal current seems to sufficient, but depending for example on the motor saturation level, higher current might be needed.

*P2.8.5.4 Polarity Pulse Current*      *ID1566*      *“PolarityPulseCur”*

This parameters defines the current level for the magnet axis polarity direction check during the start angle identification (P2.8.5.2). Value 0 means that the internal current level is used, which is typically slightly higher than the normal identification current defined by P2.8.5.3. Polarity direction check is seldom needed because the identification itself gives already the right direction. Hence in most cases, this function can disabled by setting any negative parameter value, which is recommended especially if there occurs F1 faults during the identification.

*P2.8.5.5 Start Angle Identification Time*      *ID1755*      *“StartAngleIdTime”*

Start angle can be determined also by feeding dc-current into the motor. Then dc-current will align the rotor magnet axis with the stator magnet axis. This function is activated by determining the time duration dc-current is injected to the motor. Motor must be free to move during the alingment and the time need to be long enough for shaft oscillations to damp out. Hence, this method is not so pracatical and is intednded to be used mainly for testing purposes or to improve starting in together with i/f-control. Dc-current level is determined by P2.8.5.6. Also P2.8.5.2 need to disabled otherwise overriding this function.



### 8.8.3.1 I/f Control

I/f-control can be used to start the motor using a constant current control. This is useful especially, if the motor stator resistance is low, which makes the motor current sensitive for u/f-curve tuning at low speed area. I/f-control is activated by setting AdvancedOptions2.B9 = 1 (P2.10.6) for PM-motors.

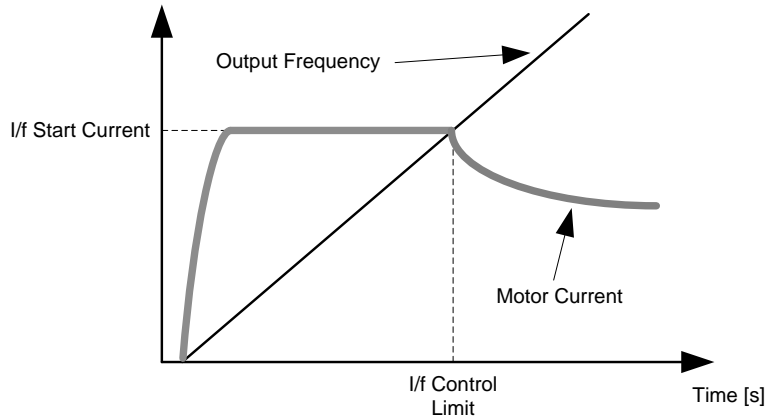

### P2.8.5.6 I/f Current ID1693 "I/f Current"

NOTE: I/f Current parameter is used for several different purposes.

#### I/f Control

This parameter defines the current level during I/f control, in percent of the motor nominal current

#### Zero position with incremental encoder and Z-Pulse

In closed loop control utilizing the encoder z-pulse, defines also the current level used in starting before the z-pulse is received to synchronize with.

#### DC Start Angle identification

This parameter defined DC Current level when Start Angle Identification Time is set greater than zero. See P2.8.5.5 Start Angle Identification Time.

### P2.8.5.7 I/f Control Limit ID1790 "I/f Control Lim"

This parameter sets the speed limit for I/f-control in percent of the motor nominal speed (1000 = 100.0%). I/f-control is used if the speed is below this limit. The operation changes back to normal when the speed is above this limit with 60 rpm hysteresis.

### 8.8.3.2 *Flux current controller*

The flux current controller is used with a PMS motor when running in closed loop control in the field weakening area. This function controls negative Id current to PM motor in the field weakening area that motor terminal voltage do not increase above maximum level (set by field weakening point voltage, maximum drive output voltage) . Field weakening area operation depends on motor construction and motor construction may prohibit operation above field weakening area.

If there is instability in the field weakening area, gain can be decreased and/or time constant increased.

#### **P2.8.5.8 Flux Current Kp ID551 "FluxCurrent Kp"**

Defines gain for the flux current controller when using a PMS motor. Depending on motor construction and the ramp rate that is used to go to field weakening area high may be needed that output voltage do not reach maximum limit and prevent proper motor control. Too high gain may also lead to unstable control. Integration time is more significant in this case for control.

#### **P2.8.5.9 Flux Current Ti ID652 "FluxCurrent Ti"**

Defines the integration time for the flux current controller when using a PMS motor. Depending on motor construction and the ramp rate that is used to go to field weakening area, short integration times may be needed that output voltage do not reach maximum limit and prevent proper motor control. Too fast integration time may also lead to unstable control.

#### **P2.8.6.10 ExtIdRef ID1730 "ExtIdRef"**

This reference value can be used for the external control of the motor id-current i.e. reactive current. Normally there is no need for that as the control uses already the optimal value. This reference value is additive to the drive internal values but, for example, field-weakening controller can override the given reference in field-weakening operation.

#### **P2.8.5.11 EnableRsIdentifi ID654 "EnableRsIdentifi"**

This parameter enables the Rs identification during DC brake current operations and in closed loop control for every start. If the identification run was made successfully it is recommended to keep this parameter disabled.

8.8.3.3 *D and Q axis voltage drops*

If d-axis and q-axis reactances (voltage drops) are defined, drive calculates the optimal d-axis current reference based on the reactance values and the motor torque in order to account motor reluctance torque part. In this way, motor Torque/Current ratio can be increased.

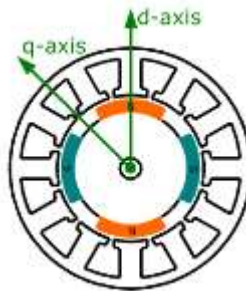

**P2.8.5.12 Lsd Voltage Drop ID1757 "Lsd Voltage Drop"**

D-axis reactance voltage drop 2560 = 100%.  
 Gives the % voltage drop across the stator inductance at nominal current and frequency.

$$X_d[\text{Drive scale}] = \frac{X_d[\Omega] * I_n[A] * \sqrt{3} * 2560}{U_n[V]}$$

**P2.8.5.13 Lsq Voltage Drop ID1758 "Lsq Voltage Drop"**

Q-axis reactance voltage drop 2560 = 100%.  
 Gives the % voltage drop across the stator inductance at nominal current and frequency.

$$X_q[\text{Drive scale}] = \frac{X_q[\Omega] * I_n[A] * \sqrt{3} * 2560}{U_n[V]}$$

**P2.8.5.14 Current Control Kp d ID1761**

**P2.8.5.15 Start Angle Offset ID1291**

### 8.8.4 Stabilator settings

#### 8.8.4.1 Torque stabilator

Torque stabilator is used if there are oscillations in motor speed and torque (current).

##### **P2.8.6.1 Torque Stabilator Gain ID1412 “TorqStabGain”**

Gain for the torque stabilator in open loop motor control operation.

##### **P2.8.6.2 Torque Stabilator Damping ID1413 “TorqStabDamp”**

If a PMS motor is used in open loop control mode it is recommended to use value 980 in this parameter instead of 800. The value '980' is set automatically when PMS motor is selected.

##### **P2.8.6.3 Torque Stabilator Gain in FWP area ID1414 “TorqStabGainFWP”**

Gain of the torque stabilator at field weakening point in open loop motor control operation.

##### **P2.8.6.4 Torque Stabilator Limit ID1720 “TorqStabLimit”**

This defines how much torque stabilator can affect output frequency.

##### **P2.8.6.5 Flux Circle Stabilator Gain ID1550 “FluxCircleStabG”**

Gain for flux circle stabilizer.

##### **P2.8.6.6 Flux Stabilators TC ID1551 “FluxStab TC”**

Filter coefficient of id-current stabilizer.

##### **P2.8.6.7 Flux Stabilator Gain ID1797 “Flux Stab G”**

Gain of flux stabilizer.

##### **P2.8.6.8 Flux Stabilator coefficient ID1796 “Flux Stab Coeff”**

##### **P2.8.6.9 Voltage Stabilator Gain ID1738 “VoltStabGain”**

Gain of voltage stabilizer.

##### **P2.8.6.10 Voltage Stabilator TC ID1552 “VoltageStab TC”**

Damping rate of voltage stabilizer

##### **P2.8.6.11 Voltage Stabilator Limit ID1553 “VoltStabLimit”**

Limit of voltage stabilator output as Hz.

### 8.8.5 Tuning settings

#### **P2.8.7.1 Flying Start Options ID1610**

- b0 = +1= Disable movement to reverse direction
- b1 = +2=Disable AC Scanning
- b2 = +4=Disable Fly Brake phase
- b3 = +8=Use encoder information for frequency estimate
- b4 = +16=Use frequency reference for initial guess
- b5 = +32=Disable DC scanning for step-up application

#### **P2.8.7.2 Resonance Damping Select ID1760**

feature can be used to dampen the constant frequency torque oscillations in the drive system.

- 0 Not in use
- 1 Band pass. Oscillation damping with band pass filter.
- 2 BandStop+BandPass. Oscillation damping with band stop and band pass filter.

#### **P2.8.7.3 Resonance Damping Frequency ID1763**

Frequency of torque oscillations to be damped in Hz.

#### **P2.8.7.4 Resonance Damping Gain ID1764**

The gain for the oscillation damping. This changes amplitude of the compensating signal used for oscillation damping.

#### **P2.8.7.5 Resonance Damping Phase ID1765**

The compensating signal used for oscillation damping can be phase shifted 0 to 360 degrees using this parameter.

#### **P2.8.7.6 Resonance Damping Activation frequency ID1770**

Defines the frequency limit when resonance damping is started.

#### **P2.8.7.7 Resonance Damping Filtering TC ID1771**

Filter TC for external feedback (Iq) signal .

#### **P2.8.7.8 Over modulation limit ID1515**

Output Voltage Limit for partial modulation in 1%. 100% means maximum sinusoidal modulation. 113% is full six step.  
If you have sini filter in use set this to 96 %.

#### **P2.8.7.9 Modulation Index Limit ID655**

Modulation index in % for closed loop operation. Higher value of motor terminal voltage can be achieved by increasing this value.

### 8.8.6 Identification settings

#### P2.8.8.1 to

#### P2.8.8.15 Flux 10...150% ID1355 – ID1369

Motor voltage corresponding to 10%...150% of flux as a percentage of Nominal Flux voltage. Measured during identification.

#### P2.8.8.16 Measured Rs voltage drop ID662 "RsVoltageDrop"

The measured voltage drop at stator resistance between two phases with the nominal current of the motor. This parameter is identified during identification run.

This parameter defines the motor stator resistance as a voltage drop at nominal current. The parameter value is defined according to motor nominal voltage and the current and the actual stator resistance as

$$RsVoltageDrop = 2560 \frac{I_n}{U_n} R_s$$

#### P2.8.8.17 Ir: Add zero point voltage ID664 "IrAddZeroPVoltag"

Defines how much voltage is applied to motor in zero speed when torque boost is used.

#### P2.8.8.18 Ir: Add generator scale ID665 "IrAddGeneScale"

Defines the scaling factor for generator side IR-compensation when torque boost is used.

#### P2.8.8.19 Ir: Add motoring scale ID667 "IrAddMotorScale"

Defines the scaling factor for motoring side IR-compensation when torque boost is used.

#### P2.8.8.20 Measured Ls voltage drop ID673 "LsVoltageDrop"

Leakage inductance voltage drop with nominal current and frequency of the motor. This parameter defines the Ls voltage drop between two phases. Use identification run to determine the optimum setting.

#### P2.8.8.21 Motor BEM Voltage ID674 "Motor BEM Voltage"

Motor-induced back voltage.

#### P2.8.8.22 IU Offset ID668 "IU Offset"

#### P2.8.8.23 IV Offset ID669 "IV Offset"

#### P2.8.9.24 IW Offset ID670 "IW Offset"

Offsets the value for phase current measurement. Identified during identification run.

#### P2.8.8.25 Estimator Kp ID1782 "Estimator Kp"

Estimator gain for PMS motor. Identified during identification run.

*P2.8.8.26 No Load Torque ID676*

*P2.8.8.27 ID Run Current Kp ID1611*

## 8.9 Speed Control settings

**P2.9.1 Load drooping ID620 "LoadDrooping"**

The drooping function enables speed drop as a function of load. This parameter sets the value corresponding to the nominal torque of the motor.

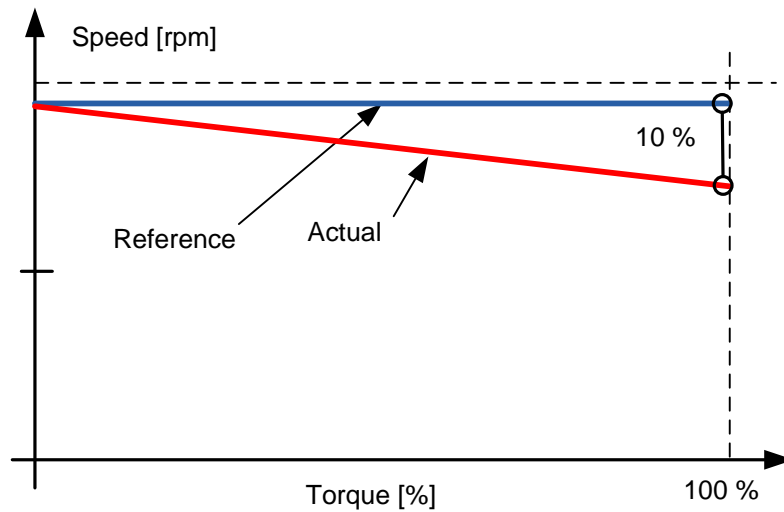

**Example:** If load drooping is set to 10 % for a motor that has a nominal frequency of 50 Hz and is nominally loaded (100 % of torque) the output frequency is allowed to decrease 5 Hz from the frequency reference. The function is used for e.g. when balanced load is needed for mechanically connected motors.

**P2.9.2 Load Drooping Time ID656 "LoadDroopingTime"**

This function is used in order to achieve a dynamic speed drooping because of changing load. The parameter defines the time during which the speed is restored to the level it was before the load increase.

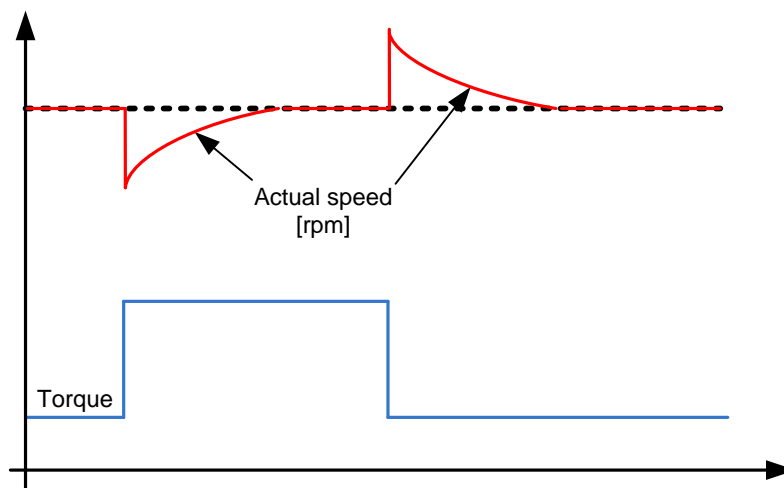



### 8.9.1.1 Open Loop Settings

#### P2.9.3.1 *Speed controller P gain, Open Loop ID637 "OL Speed Reg P"*

Defines the P gain for the speed controlled in Open Loop control mode.

#### P2.9.3.2 *Speed controller I gain, Open Loop ID638 "OL Speed Reg I"*

Defines the I gain for the speed controlled in Open Loop control mode.

### 8.9.1.2 Closed Loop Speed Control Settings

#### P2.9.4.1 *Speed control P gain ID613 "Speed Control Kp"*

Gain for the speed controller in closed loop motor control operation. Gain value 100 means that the nominal torque reference is produced at the speed controller output for the frequency error of 1Hz.

#### P2.9.4.2 *Speed control I time ID614 "Speed Control Ti"*

Sets the integral time constant for the speed controller. Increasing the I-time increases stability but lengthens the speed response time.

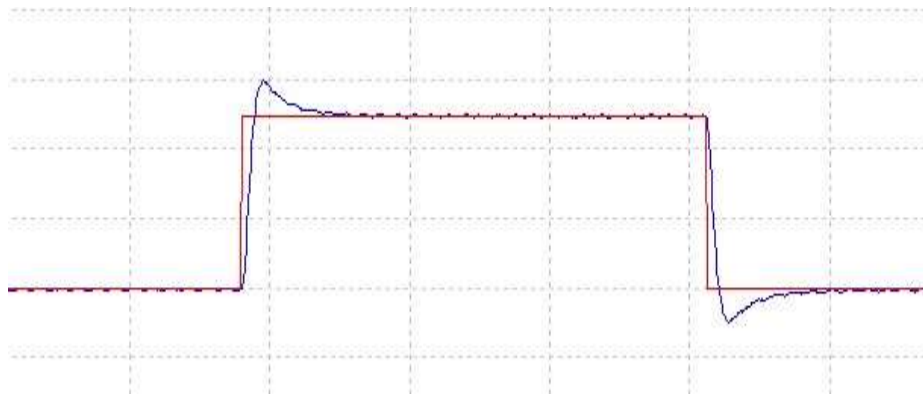

Kp 30, Ti 100

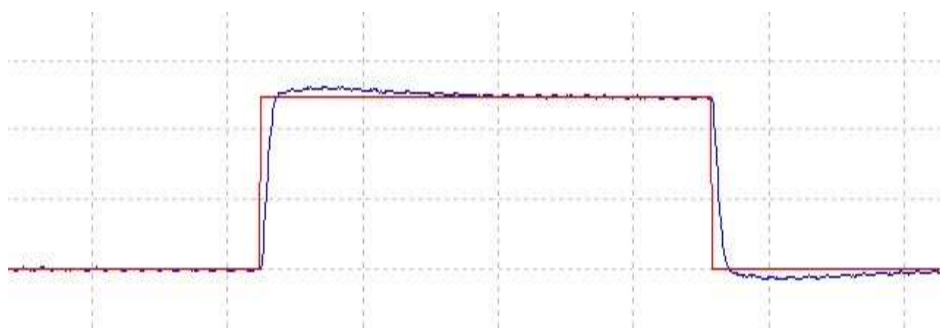

Kp 30, Ti 300

### P2.9.4.3 Zero speed time at start ID615 "Start 0SpeedTime"

After giving the start command the drive will remain at zero speed for the time defined by this parameter. The ramp will be released to follow the set frequency/speed reference after this time has elapsed counted from the instant when the command was given.

### P2.9.4.4 Zero speed time at stop ID616 "Stop 0 SpeedTime"

The drive will remain at zero speed with controllers active for the time defined by this parameter after reaching the zero speed when a stop command is given. This parameter has no effect if the selected stop function is *Coasting*. Note that the zero speed time starts when the ramp time is expected to reach the zero speed, not when the actual speed reaches zero. Such situation can happen when the generator power limit is small or the overvoltage controller is active while decelerating.

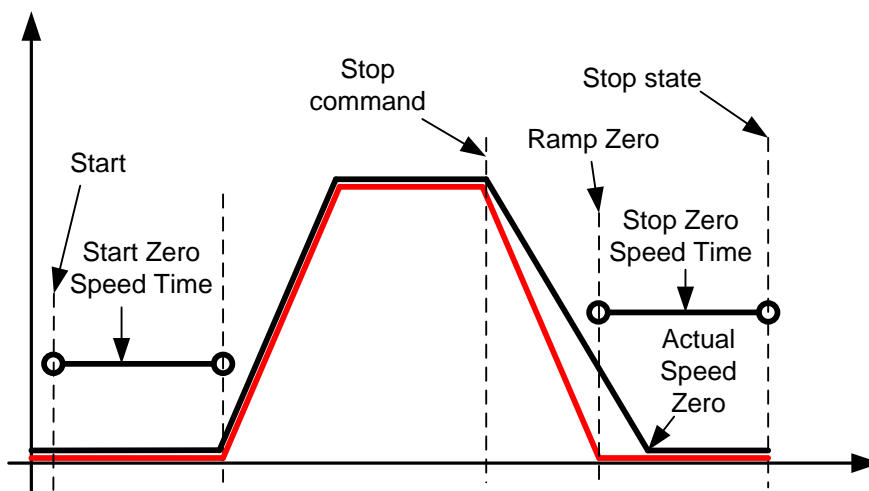

### 8.9.1.3 Speed controller tuning for different speed areas

The speed controller can be tuned for different gains in different speed areas, for slow speed and above the parameter *Field weakening point*. Gains for different speed areas are percentages of the original Speed Controller Gain value.

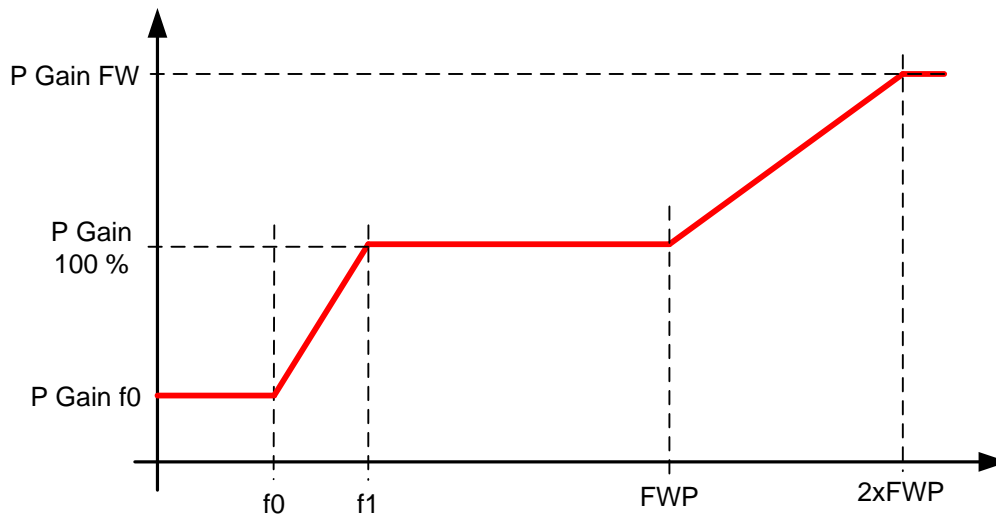

#### P2.9.4.5 Speed Controller f0 point ID1300 "SPC f0 Point"

The speed level in Hz below which the speed controller gain is *Speed Controller gain f0*.

#### P2.9.4.6 Speed Controller f1 point ID1301 "SPC f1 Point"

The speed level in Hz above which the speed controller gain is *Speed Controller P gain*. Gain changes linearly between f0 and f1 points.

#### P2.9.4.7 Speed Controller gain f0 ID1299 "SPC Kp f0"

The relative gain of the speed controller as a percentage of the *Speed Controller P Gain* when the speed is below the level defined by *Speed Controller f0 point*.

#### P2.9.4.8 Speed controller gain in field weakening area ID1298 "SPC Kp FWP"

Relative gain of the speed controller in field weakening area as a percentage of *Speed Controller P Gain* values. The set value is reached at two times the *Field weakening point*.

#### 8.9.1.4 *Speed controller gain with different loads*

The speed controller can also be tuned for different loads. Speed controller gain is first manipulated by the speed area gain function and this result is then further adjusted by torque related relative gain.

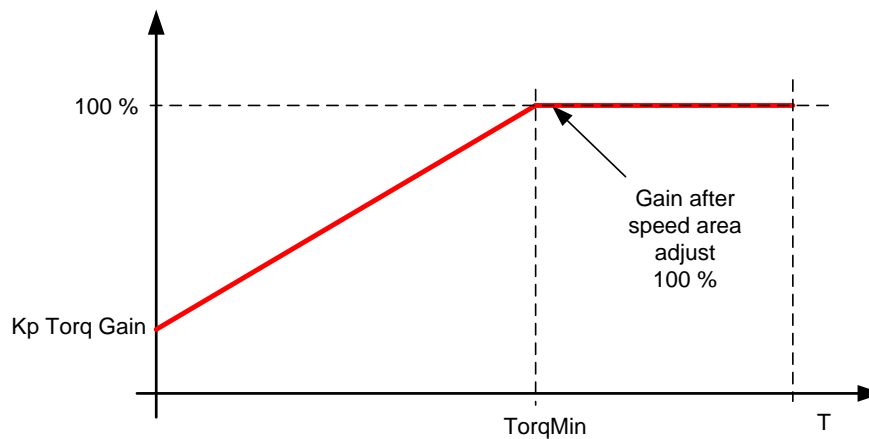

#### P2.9.4.9 *Speed Controller torque minimum* ID1296 **"SPC Torq Min"**

The level of speed controller output which the speed controller gain is changed to with parameter P2.8.5.4.10 "Speed Controller torque minimum gain" using a filter set by parameter P2.8.5.4.11 "Speed Controller torque minimum filtering time". This is in percent of the motor nominal torque.

#### P2.9.4.10 *Speed Controller torque minimum gain* ID1295 **"SPC Kp Torq Min"**

Relative gain as a percentage of the speed controller gain after speed area adjustment when the speed control output is less than the "Speed Controller torque minimum". This parameter is normally used to stabilise the speed controller for a drive system with gear backlash.

#### P2.9.4.11 *Speed Controller torque minimum filtering time* ID1297 **"SPC Kp TC Torq"**

Filtering time for torque. When the speed controller gain is changed below the Speed Controller torque minimum.

## 8.10 Drive Control

**P2.10.1 Switching frequency ID601 "Switching Freq"**

Motor noise can be minimised using a high switching frequency. Note, however, that increasing the switching frequency increases losses of the frequency converter. Lower frequencies are used when the motor cable is long and the motor is small.

The range of this parameter depends on the size of the frequency converter:

Type	Min. [kHz]	Max. [kHz]	Default [kHz]
0003—0061 NX_5 0003—0061 NX_2	1.0	16,0	10.0
0072—0520 NX_5	1.0	10.0	3.6
0041—0062 NX_6 0144—0208 NX_6	1.0	6.0	1.5

Table 8-2. Size-dependent switching frequencies

**Note!**

The actual switching frequency might be reduced down to 1,5kHz by thermal management functions. This has to be considered when using sine wave filters or other output filters with a low resonance frequency.

**Note!**

If the switching frequency is changed it is necessary to redo the identification run.

**DriveSynch operation**

When using DriveSynch the maximum switching frequency is limited to 3,6 kHz.

**P2.10.2 Modulator Type ID1516 "Modulator type"**

Select modulator type. Some operations require use of a software modulator.

**0 = ASIC modulator**

A classical third harmonic injection. The spectrum is slightly better compared to the Software 1 modulator.

**NOTE:** An ASIC modulator cannot be used when using PMS motor with an incremental type encoder.

**1 = Software Modulator 1**

Symmetric vector modulator with symmetrical zero vectors.

Current distortion is less than with software modulator 2 if boosting is used.

**2 = Software modulator 2**

One phase at a time in IGBT switches is not modulated during a 60-degree period of the frequency cycle. The unmodulated phase is connected to either positive or negative DC-bus.

This modulator type reduces switching losses up to two-thirds and all switches become evenly loaded.

BusClamp modulation is useful if the voltage is >80% of the maximum voltage, in other words, when the drive is operating near full speed. Then again, the motor ripple at low speeds is the double compared to selection 1.

**3 = Software modulator 3**

Unsymmetrical BusClamb in which one switch always conducts 120 degrees to negative DC-rail to reduce switching losses. However, upper and lower switches are unevenly loaded and the spectrum is wide.

**4 = Software modulator 4:**

Pure sinewave, sinusoidal modulator without harmonic injection. Dedicated to be used in back to back test benches etc. to avoid circulating third harmonic current. Drawback is that required DC voltage is 15% higher compared to other modulator types.

**P2.10.3 Control Options ID1084 "Control Options"**

These parameter functions are dependent of Vacon Advance application version.

B02 = Reserved

B03 = Use also Control Word B10 for Profibus fault detection.

B07 = Disables switching frequency decrease due to drive temperature rise

B08 = Disable Encoder fault when brake is closed

B11 = Force Load Drooping to Zero when reference is below Zero freq. Limit

B12 = Disable Slot A filtering, DI and AI will work in 1 ms time level..

**P2.10.4 Advanced Options 1 ID1560 "AdvancedOptions1"**

B00 = Disable Synchronous modulation

B01 = Use encoder information to slip compensation in Open Loop Speed control

B02 = Disable encoder fault

B03 = Disable slip compensation for reverse direction

B06 = Enable synchronous symmetrical modulation

B07 = Automatically handled by application logic.

B15 = Cosphi = 1 control. This controls the motor reactive power to zero. Possible to use only with PMS motors in closed loop control.

**P2.10.5 Advanced Options 2 ID1561 "AdvancedOptions1"**

B00 = Sensorless control for PMS motors. This is an open loop control but uses the same control system than the normal closed loop control. Calculations try to estimate the encoder speed instead of using the encoder signal. This mode has speed and torque range limitations and therefore application limitations. A lower speed controller gain may be required to gain stability. Useful for generator applications.

B04 = Enable Start Positioning damping active if PMSM

B08 = Current optimization for PMS motor. This function activates the current optimization for PMSM motor based on torque calculation and motor parameters. When activated, the optimization starts after 13 % of the motor nominal speed and below this a normal U/f curve is used. The activation of this selection requires a performed identification with run.

B09 = I/f control for PMS motors. PMS motor can be started with I/f control. Used with high power motor when there is low resistance in motor and U/f is difficult to tune to be stable.

B13 = Changes automatically depending on Drive Synch operation

- P2.10.6 Advanced Options 4 ID1563 "AdvancedOptions4"*  
Reserved for future use. Some bits are controlled by application software so value may not be always zero.
- P2.10.7 Advanced Options 5 ID 1564*
- P2.10.8 Advanced Options 6 ID1565*
- P2.10.9 Advanced Options 7 ID1562*
- P2.10.10 Restart Delay ID1424 "Restart Delay OL"*  
The time delay within which the drive cannot be restarted after a coast stop and flying start is not in use. Closed Loop control mode and the flying start use a different delay see P2.9.11.
- P2.10.11 Restart Delay Closed Loop & Flying Start ID672 "Restart Delay CL"*  
The time delay within which the drive cannot be restarted if flying start is used or the control mode is closed loop.
- P2.10.12 Sine Filter Capacitor Size ID1460*
- P2.10.13 Sine Filter Inductor Size ID1461*

8.11 Master Follower

8.11.1 Master Follower: Standard system

The Master/Follower function is designed for applications in which the system is run by several NXP drives and the motor shafts are coupled to each other via gearing, chain, belt etc. The NXP drives are in closed loop control mode.

The external control signals are connected to the Master NXP only. The Master controls the Follower(s) via a System bus. The Master station is typically speed-controlled and the other drives follow its torque or speed reference.

Torque control of the Follower should be used when the motor shafts of the Master and Follower drives are coupled solidly to each other by gearing, a chain etc., so that no speed difference between the drives is possible.

Speed control of the Follower should be used when the motor shafts of the Master and the Follower drives are coupled flexibly to each other so that a slight speed difference between the drives is possible. When both the Master and Followers are speed-controlled, drooping is typically also used.

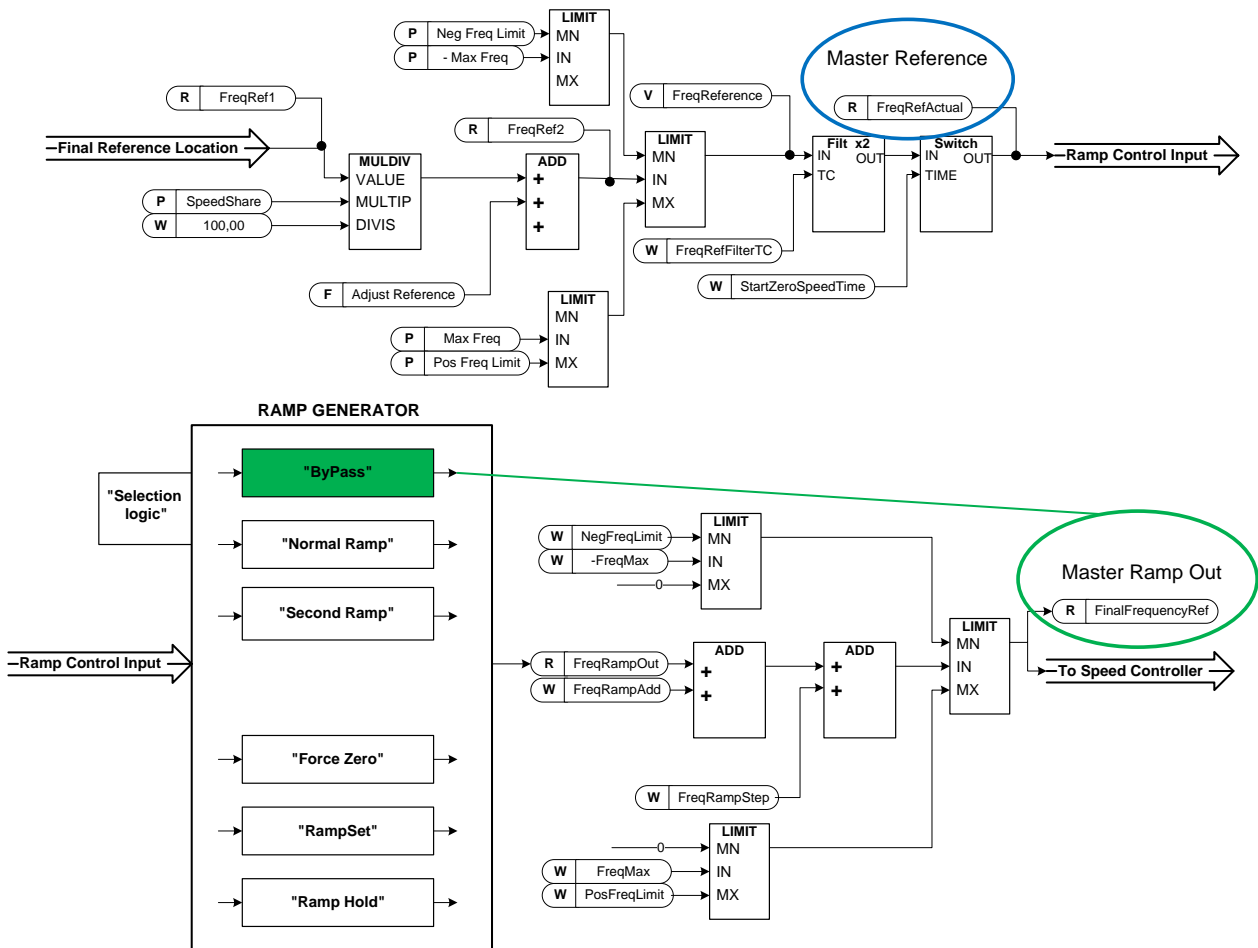



8.11.2 Master follower configuration

The OPTD2 board in the Master has default jumper selection, X5:1-2. For the followers, the jumper positions have to be changed: X5:2-3. This board also has a CAN communication option that is useful for multiple drive monitoring with NCDrive PC software when commissioning Master Follower functions or line systems. Older boards has X6, leave this to ON (X6:1-2).

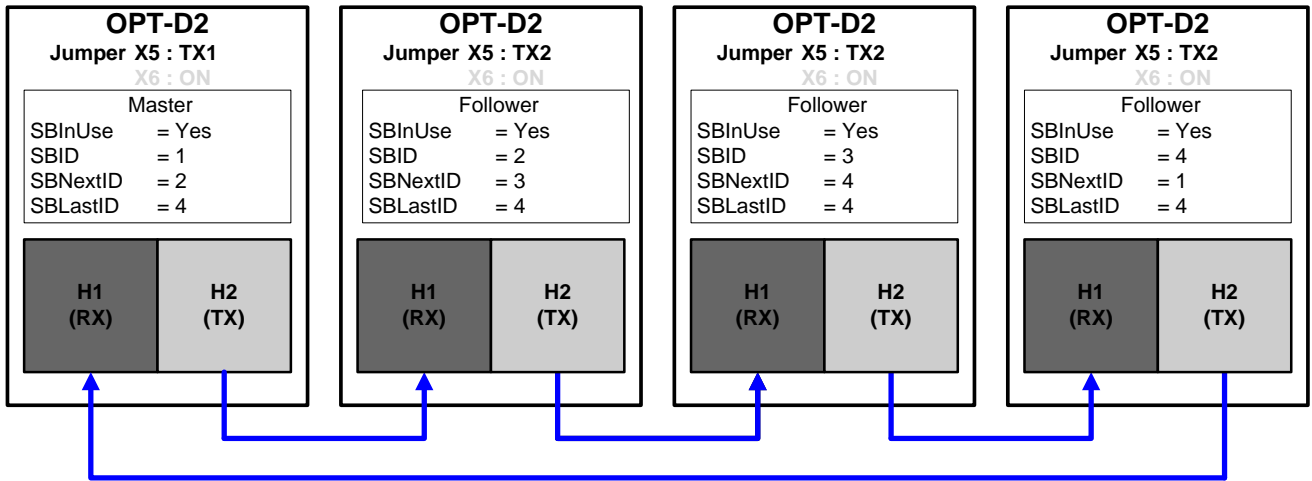

Figure 8-15. System bus physical connections with the OPT-D2 board

P2.11.1 Master/Follower selection ID1324 "MF Mode"

Select the Master Follower mode. When the drive is a follower, the Run Request command is monitored from Master but all references are selectable by parameters.

- 0 = Single drive  
System bus is deactivated
- 1 = Master  
Drive sends control word to follower drive.
- 2 = Follower  
Drive receives control word from Master and sends some diagnostic information to the Master drive.

### P2.11.2 Follower reference selection ID1081 "Follower Ref Sel"

Select where the follower drive receives its speed reference from.

**0="AI1" - Analogue Input 1.**

Signal scaling in "G: Input Signals \ Analogue Input 1"

**1="AI2" - Analogue Input 2.**

Signal scaling in "G: Input Signals \ Analogue Input 2"

**2="AI1+AI2" - Analogue Input 1 + Analogue Input 2.**

With alternative reference scaling in Analogue Input group, 100 % input values can be set to correspond 25 Hz. In other words, when both are 100% the final reference will be 50 Hz.

**3="AI1-AI2"**

Analogue Input 1 minus Analogue Input 2.

**4="AI2-AI1"**

Analogue Input 2 minus Analogue Input 1.

**5="AI1xAI2"**

Analogue Input 1 x Analogue Input 2

**6="AI1 Joystick"**

Analogue Input 1, -10 Vdc... +10 Vdc

**7="AI2 Joystick"**

Analogue input 2, -10 Vdc... +10 Vdc

**8="Keypad Ref"**

Reference from keypad R3.2

**9="Fieldbus"**

Reference is taken from fieldbus. Alternative scaling can be selected in "G: Fieldbus"

**10="Motor Pot" - Motor potentiometer**

Reference handled with two digital inputs "G: Input Signals \ Digital Inputs" (increase and decrease). Behaviour adjusted in "G: Ref Handling \ Motor Potente".

**11="AI1, AI2 min"**

The smaller of Analogue Input 1 and Analogue Input 2 is used as reference.

**12="AI1, AI2 max"**

The greater of Analogue Input 1 and Analogue Input 2 is used as reference.

**13="Max Freq" - Maximum Frequency**

P2.1.2 Max Frequency is used as reference.

**14="AI1/AI2 Sel" - AI1/AI2 Selection**

The digital input "I/O Ref 1/2" is used to select between Analogue Input 1 and Analogue Input 2 reference. "I/O Ref 1/2" is used to elect between "I/O Reference" and "I/O Reference 2" if selection of this parameter is different from 14 (this one).

**15="Encoder 1"**

Reference is read from encoder input 1.

**16="Encoder 2"**

Reference is read from encoder input 2. This selection is usable with double encoder boards. Could be utilized e.g. for speed synchronization.

**17 Master Reference**

Master reference before ramp generator. When this is selected the follower drive's own ramp times are active and used.

**18 Master Ramp Out**

Master reference after ramp generator, before speed controller. When this is selected the follower drive will use the ramp times defined by the Master drive.

**P2.11.3 Follower torque reference selection ID1083 "FollowerTorq Sel"**

Select the source of torque reference for the follower drive.

**0="Not Used"**

**1="AI1" - Analogue Input 1.**

Signal scaling in "G: Input Signals \ Analogue Input 1"

**2="AI2" - Analogue Input 2.**

Signal scaling in "G: Input Signals \ Analogue Input 2"

**3="AI3"**

**4="AI4"**

**5="AI1 Joystick"**

Analogue input 1, -10 Vdc... +10 Vdc. For joystick inputs, the maximum negative reference is the negative of "Torq Ref Max".

**6="AI2 Joystick"**

Analogue input 2, -10 Vdc... +10 Vdc For joystick inputs maximum negative reference is the negative of "Torq Ref Max".

**7="Keypad Ref"**

Torque reference from keypad R3.5

**8="Fieldbus"**

Reference is taken from fieldbus. Alternative scaling can be selected in "G: Fieldbus"

**9="Master Torque"**

Reference is taken from Master drive when using the Master Follower function.

**P2.11.4 Follower stop function ID1089 "FollowerStopFunction"**

When the follower drive does not use the Master Drive Ramp Output as reference this parameter defines how the follower drive will stop as Run request is removed from the Master drive.

**0=Coasting;** the follower remains in control even if master has stopped to fault.

**1=Ramping;** the follower remains in control even if master has stopped to fault.

**2=As master;** the follower behaves as master.

**P2.11.5 Master Follower mode 2 selection ID1093 "MF Mode 2"**

Selects the Master Follower mode 2 that is used when the DI is activated. When *Follower* is selected the Run Request command is monitored from Master and all other references are selectable by parameters. This parameter can be used for redundancy purposes. If drive number one is unable to be operated through a digital input drive number 2 can be selected as master.

**0 = Single Drive**

System bus is deactivated.

**1 = Master**

Drive sends control word to follower drive.

**2 = Follower**

Drive received control word from Master and sends some diagnostic information to the Master drive.

*P2.11.6 SystemBus communication fault response ID1082 "SB Comm Fault"*

Defines the action when the System Bus heartbeat is missing.  
The master drive sends a heartbeat signal to all follower drives and this heartbeat is sent back to the master drive.

0 = No response

1 = Warning

2 = Fault, stop mode after fault according to Stop function

3 = Fault, stop mode after fault always by coasting

*P2.11.7 Systembus fault delay ID1352 "SB fault Delay"*

Defines the delay before fault generation when heartbeat is missing.

## 8.12 Protections

### 8.12.1 General settings

#### **P2.12.1.1 Response to external fault ID701 "External Fault"**

Defines the response to a digital input signal informing about an external condition where the drive needs to react to. The external warning/fault indication can be connected to a digital output.

- 0 = No response
- 1 = Warning
- 2 = Fault, stop mode after fault according to Stop Function
- 3 = Fault, stop mode after fault always by coasting

#### **P2.12.1.2 Input phase supervision ID730 "Input Ph. Superv"**

Defines the response when the drive notices that one of the input phases is missing.

- 0 = No response
- 1 = Warning
- 2 = Fault, stop mode after fault according to Stop Function
- 3 = Fault, stop mode after fault always by coasting

#### **P2.12.1.3 Response to undervoltage fault ID727 "UVolt Fault Resp"**

In some applications it is normal that the drive will be powered down when in run state. With this parameter it is possible to choose whether undervoltage faults are stored to the fault history of the drive.

- 0 = Fault stored in fault history
- 1 = Fault not stored in fault history

Undervoltage fault limits:

- 500 V units: 333 Vdc
- 690 V units: 460 Vdc

#### **P2.12.1.4 Output phase supervision ID702 "OutputPh. Superv"**

Output phase supervision of the motor ensures that the motor phases have an approximately equal current.

- 0 = No response
- 1 = Warning
- 2 = Fault, stop mode after fault according to Stop Function
- 3 = Fault, stop mode after fault always by coasting

#### **P2.12.1.5 Response to slot fault ID734 "SlotComFaultResp"**

Set here the response mode for a board slot fault due to a missing or broken board.

- 0 = No response
- 1 = Warning
- 2 = Fault, stop mode after fault according to Stop Function
- 3 = Fault, stop mode after fault always by coasting

*P2.12.1.6 Safe Torque Off (STO) mode ID755 "SafeDisableResp."*

With this parameter it is possible to choose whether the STO signal is handled as fault or warning. The STO input will stop the drive from modulating regardless of this parameter value.

*P2.12.1.7 Cooling fault delay ID751*

This parameter defines delay after the drive goes to fault state when cooling OK signal is missing. If drive is in Stop state this is only warning, In Run state drive will make fault with coast stop.

*P2.12.1.8 Encoder fault mode ID1353*

Defines function when encoder signal is missing in closed loop control mode.

Do not select 3 while drive is in run state.

1 = Warning

2 = Fault

3 = Warning; Change to Open Loop

This selection changes operation mode to Open Loop Sensorless when encoder fault is detected.

**Note:** It's recommended to activate I/f start when this is selection is used and speed remains long period of times in zero speed area.

### 8.12.2 Temperature sensor protections

The temperature protection function is used to measure temperatures and issue warnings and/or faults when the set limits are exceeded. The Advance application supports two OPT-BH and OPT-B8 board simultaneously. One can be used for the motor winding and one for the motor bearings.

#### P2.12.2.1 Temperature board 1 numbers ID739 "TBoard1 Numbers"

Select used temperature sensor combination with this parameter. See also the Vacon I/O boards manual.

- 0 = Not used (ID Write, value of maximum temperature can be written from fieldbus)
- 1 = Sensor 1 in use
- 2 = Sensor 1 & 2 in use
- 3 = Sensor 1 & 2 & 3 in use
- 4 = Sensor 2 & 3 in use
- 5 = Sensor 3 in use

**Note:** If the selected value is greater than the actual number of used sensor inputs, the display will read 200°C. If the input is short-circuited the displayed value is -30°C.

#### P2.12.2.2 Temperature board fault response ID740 "TBoard Flt.Resp"

- 0 = No response
- 1 = Warning
- 2 = Fault, stop mode after fault according to Stop Function
- 3 = Fault, stop mode after fault always by coasting

#### P2.12.2.3 Temperature board 1 warning limit ID741 "TBoard1 Warn.Lim"

Set here the limit at which the PT100 warning will be activated.

#### P2.12.2.4 Temperature board 1 fault limit ID742 "TBoard1 Flt.Lim"

Set here the limit at which the temperature fault (F56) will be activated.

#### P2.12.2.5 Temperature board 2 numbers ID743 "TBoard2 Numbers"

If you have two temperature sensor boards installed in your frequency converter you can choose here the combination inputs in use in the second board. See also the Vacon I/O boards manual.

- 0 = Not used (ID Write, value of maximum temperature can be written from fieldbus)
- 1 = Sensor 1 in use
- 2 = Sensor 1 & 2 in use
- 3 = Sensor 1 & 2 & 3 in use
- 4 = Sensor 2 & 3 in use
- 5 = Sensor 3 in use

#### P2.12.2.6 Temperature board 2 warning limit ID745 "TBoard2 Warn.Lim"

Set here the limit at which the second temperature sensor board warning will be activated.

### P2.12.2.7 Temperature board 2 fault limit ID746 "TBoard2 Flt.Lim"

Set here the limit at which the second temperature sensor board fault (F61) will be activated.

### 8.12.3 Stall protection

The motor stall protection protects the motor from short time overload situations such as one caused by a stalled shaft. The reaction time of the stall protection can be set shorter than that of the motor thermal protection. The stall state is defined with two parameters, Stall current and Stall frequency limit. If the current is higher than the set limit and the output frequency is lower than the set limit, the stall state is true. There is actually no real indication of the shaft rotation. Stall protection is a kind of overcurrent protection.

#### P2.12.3.1 Stall protection ID709 "Stall Protection"

- 0 = No response
- 1 = Warning
- 2 = Fault, stop mode after fault according to Stop Function
- 3 = Fault, stop mode after fault always by coasting

#### P2.12.3.2 Stall current limit ID710 "Stall Current"

The current can be set to  $0 \dots 2 \cdot I_H$ . For a stall stage to occur, the current must have exceeded this limit. The software does not allow entering a greater value than  $2 \cdot I_H$ . If the motor current limit is changed this parameter is automatically recalculated to the value 90 % of motor current limit.

**Note:** This limit must be set below the current limit in order for this function to operate.

#### P2.12.3.3 Stall frequency limit ID712 "Stall Freq Lim"

The frequency can be set between  $1 - f_{\max}$  (Max Frequency).

For a stall state to occur, the output frequency must have remained below this limit for a certain time. This function requires that the output frequency is 1 Hz below the frequency reference before the stall time count is started.

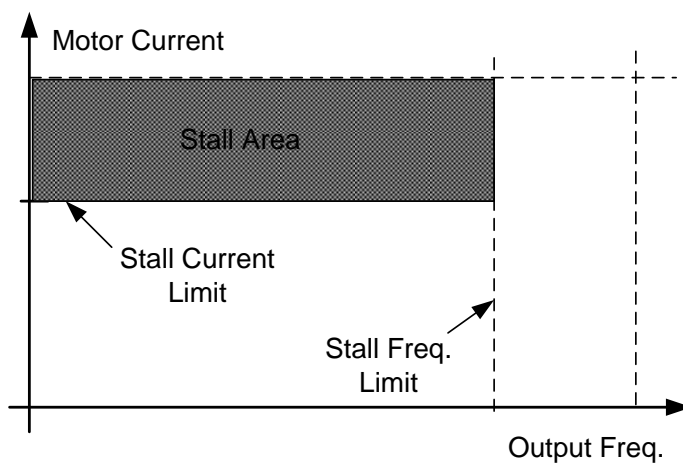



### P2.12.3.4 Stall time ID711 "Stall Time Lim"

This is the maximum time allowed for a stall stage. The stall time is counted by an internal up/down counter. If the stall time counter value goes above this limit the protection will cause a trip.

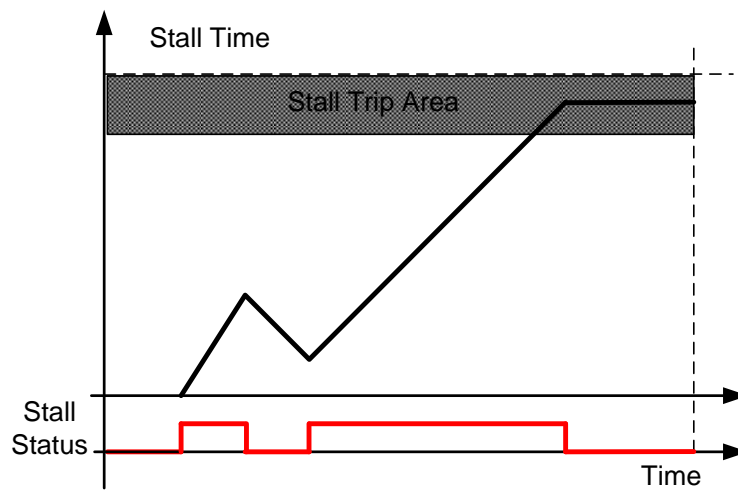

### 8.12.4 Speed Error

The Speed error monitoring function compares the encoder frequency and the ramp generator output. The function is used with a PMS motor to detect if the motor is off synchronization or to disable the open loop function using the encoder speed for slip compensation. The slip compensation is disabled regardless of the response and needs to be re-activated once a speed error is detected (set parameter again or power down the drive).

#### P2.12.4.1 Speed error fault function ID752 "Speed Error Mode"

Defines the fault function when the speed reference and the encoder speed are above the set limits.

0 = No response

1 = Warning

2 = Fault, stop mode after fault always by coasting

#### P2.12.4.2 Speed error maximum difference ID753 "SpeedErrorLimit"

Defines the limit when fault situation is noted. The difference between the speed reference and the encoder speed. Percentage value is in relation to motor nominal frequency.

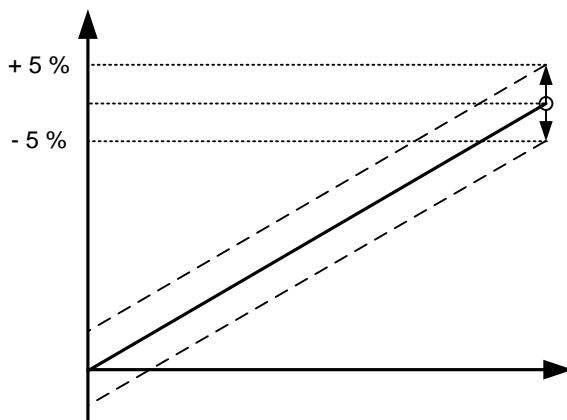

#### P2.12.4.3 Speed error delay ID754 "Speed Fault Delay"

Defines the delay after which a speed error is considered as a fault.

When used to disable open loop slip compensation based on encoder frequency it is recommended to set this time to zero to avoid a speed jump at the time of encoder malfunction.

## 8.12.5 Motor Protection



CAUTION! *The calculated model does not protect the motor if the airflow to the motor is reduced by blocked air intake grill.*

The motor thermal protection is to protect the motor from overheating. The drive is capable of supplying higher than nominal current to the motor. If the load requires this high current there is a risk that the motor will be thermally overloaded. This is the case especially at low frequencies. At low frequencies the cooling effect of the motor is reduced as well as its capacity. If the motor is equipped with an external fan the load reduction at low speeds is small.

The motor thermal protection is based on a calculated model and it uses the output current of the drive to determine the load on the motor.

The motor thermal protection can be adjusted with parameters. The thermal current  $I_T$  specifies the load current above which the motor is overloaded. This current limit is a function of the output frequency.

#### P2.12.5.1 Motor thermal protection response ID704 "Motor Therm Prot"

Defines the response when the calculated temperature of the motor has reached 105 % (monitoring signal).

0 = No response

1 = Warning

2 = Fault, stop mode after fault according to Stop Function

3 = Fault, stop mode after fault always by coasting

#### P2.12.5.2 Motor ambient temp. factor ID705 "MotAmbTempFactor"

Defines the temperature factor for conditions where the motor is located. The factor can be set between -100.0%—100.0%.

-100.0 % = 0°C,

0.0 % = 40°C,

100.0 % = 80°C

#### P2.12.5.3 Motor cooling factor at zero speed ID706 "MTP f0 Current"

Defines the cooling factor at zero speed in relation to the point where the motor is running at nominal speed without external cooling.

The default value is set assuming that there is no external fan cooling the motor. If an external fan is used this parameter can be set to 90% (or even higher).

**Note:** The value is set as a percentage of the motor name plate data, (Nominal current of motor), not the drive's nominal output current. The motor's nominal current is the current that the motor can withstand in direct on-line use without being overheated.

Setting this parameter does not affect the maximum output current of the drive which is determined by parameter Motor Current Limit alone.

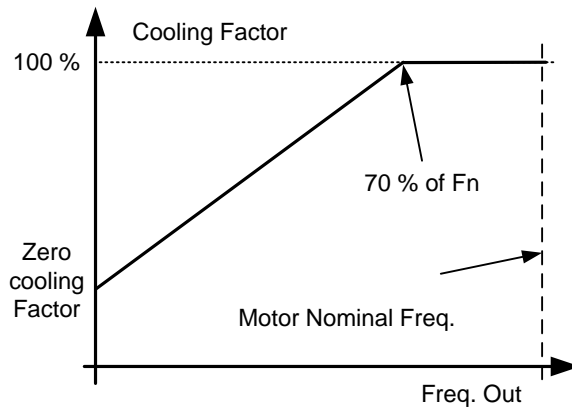

#### P2.12.5.4 Motor thermal protection: Time constant ID707 "MTP Motor T"

This time can be set between 1 and 200 minutes.

This is the thermal time constant of the motor. The bigger the motor, the bigger the time constant. The time constant is the time within which the calculated thermal stage has reached 63% of its final value.

The motor thermal time is specific to motor design and it varies between different motor manufacturers. The default value changes between unit sizes.

If the motor's  $t_6$ -time ( $t_6$  is the time in seconds the motor can safely operate at six times the rated current) is known (given by the motor manufacturer) the time constant parameter can be set basing on it. As a rule of thumb, the motor thermal time constant in minutes equals to  $2 \times t_6$ . If the drive is in stop stage the time constant is internally increased to three times the set parameter value. The cooling in the stop stage is based on convection and the time constant is increased.

#### P2.12.5.5 Motor thermal protection: Motor duty cycle ID708 "Motor Duty Cycle"

The value can be set to 0%...150%.

Setting value to 130 % motor calculated temperature will reach nominal temperature with 130 % of motor nominal current.

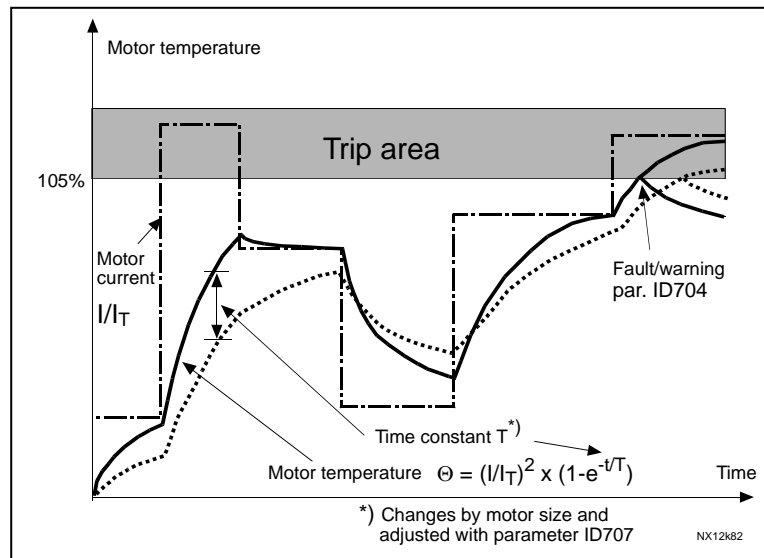

Figure 8-16. Motor temperature calculation

#### P2.12.5.6 Response to thermistor fault ID732 "ThermistF.Resp"

- 0 = No response
- 1 = Warning
- 2 = Fault, stop mode after fault according to ID506
- 3 = Fault, stop mode after fault always by coasting

Setting the parameter to 0 will deactivate the protection.

#### 8.12.6 4mA Protection

The 4 mA protection monitors the analogue input signal level from Analogue input 1 and Analogue input 2.

The monitoring function is active when signal range 4 mA – 20 mA is selected. A fault or warning is generated when the signal falls below 3.5 mA for 5 seconds or below 0.5 mA for 0.5 seconds.

#### P2.12.6.1 Response to the 4mA reference fault ID700 "4mA Input Fault"

- 0 = No response
- 1 = Warning
- 2 = Warning, the frequency from 10 seconds back is set as reference
- 3 = Warning, the Preset Frequency is set as reference
- 4 = Fault, stop mode after fault according to Stop Function
- 5 = Fault, stop mode after fault always by coasting

#### P2.12.6.2 4mA reference fault: preset frequency reference ID728 "4mA Fault Freq."

If value 3 in parameter P2.12.6.1 is selected and a fault occurs the frequency reference to the motor is the value of this parameter.

### 8.12.7 Underload protection

The purpose of the motor underload protection is to ensure that there is load on the motor when the drive is running. If the motor loses its load there might be a problem in the process, e.g. a broken belt or a dry pump.

The underload curve is a squared curve set between the zero frequency and the field weakening point. The protection is not active below 5Hz (the underload time counter is stopped).

The torque values for setting the underload curve are set in percent which refers to the nominal torque of the motor. The motor's name plate data, parameter motor nominal current and the drive's nominal current  $I_H$  are used to find the scaling ratio for the internal torque value.

#### P2.12.7.1 Underload protection ID713 "Underload Protec"

- 0 = No response
- 1 = Warning
- 2 = Fault, stop mode after fault according to Stop Function
- 3 = Fault, stop mode after fault always by coasting

If tripping is set active the drive will stop and activate the fault stage.

Deactivating the protection by setting the parameter to 0 will reset the underload time counter to zero.

#### P2.12.7.2 Underload protection, zero frequency load ID715 "UP F0 Torque"

The torque limit can be set between 5.0—150.0 % x  $T_{nMotor}$ .

This parameter gives the value for the minimum torque allowed with zero frequency.

#### P2.12.7.3 Underload protection, field weakening area load ID714 "UP fnom Torque"

The torque limit can be set between 10.0—150.0 % x  $T_{nMotor}$ .

This parameter gives the value for the minimum torque allowed when the output frequency is above the field weakening point.

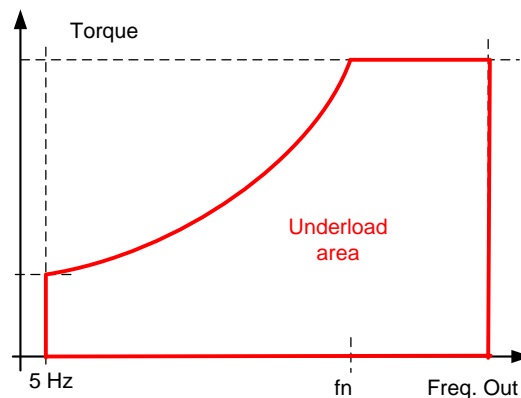

*P2.12.7.4 Underload time ID716 "UP Time Limit"*

This time can be set between 2.0 and 600.0 s.

This is the maximum time allowed for an underload state to exist. An internal up/down counter counts the accumulated underload time. If the underload counter value goes above this limit the protection will cause a trip according to parameter Underload Protection.

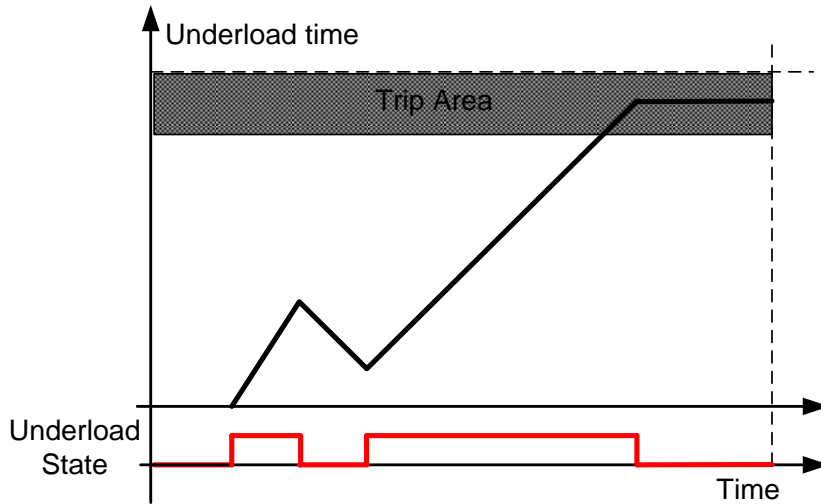

### 8.12.8 Earth Fault

The earth fault protection ensures that the sum of the motor phase currents is zero. The overcurrent protection is always working and protects the frequency converter from earth faults with high currents.

#### P2.12.8.1 Earth fault protection ID703 "Earth fault"

0 = No response

1 = Warning

2 = Fault, stop mode after fault according to Stop Function

3 = Fault, stop mode after fault always by coasting

#### P2.12.8.2 Earth fault current limit ID1333 "EarthFaultCurLim"

Maximum level for Earth current in % of the unit nominal current.



8.12.9 Fieldbus communication

8.12.9.1 Redundant profibus

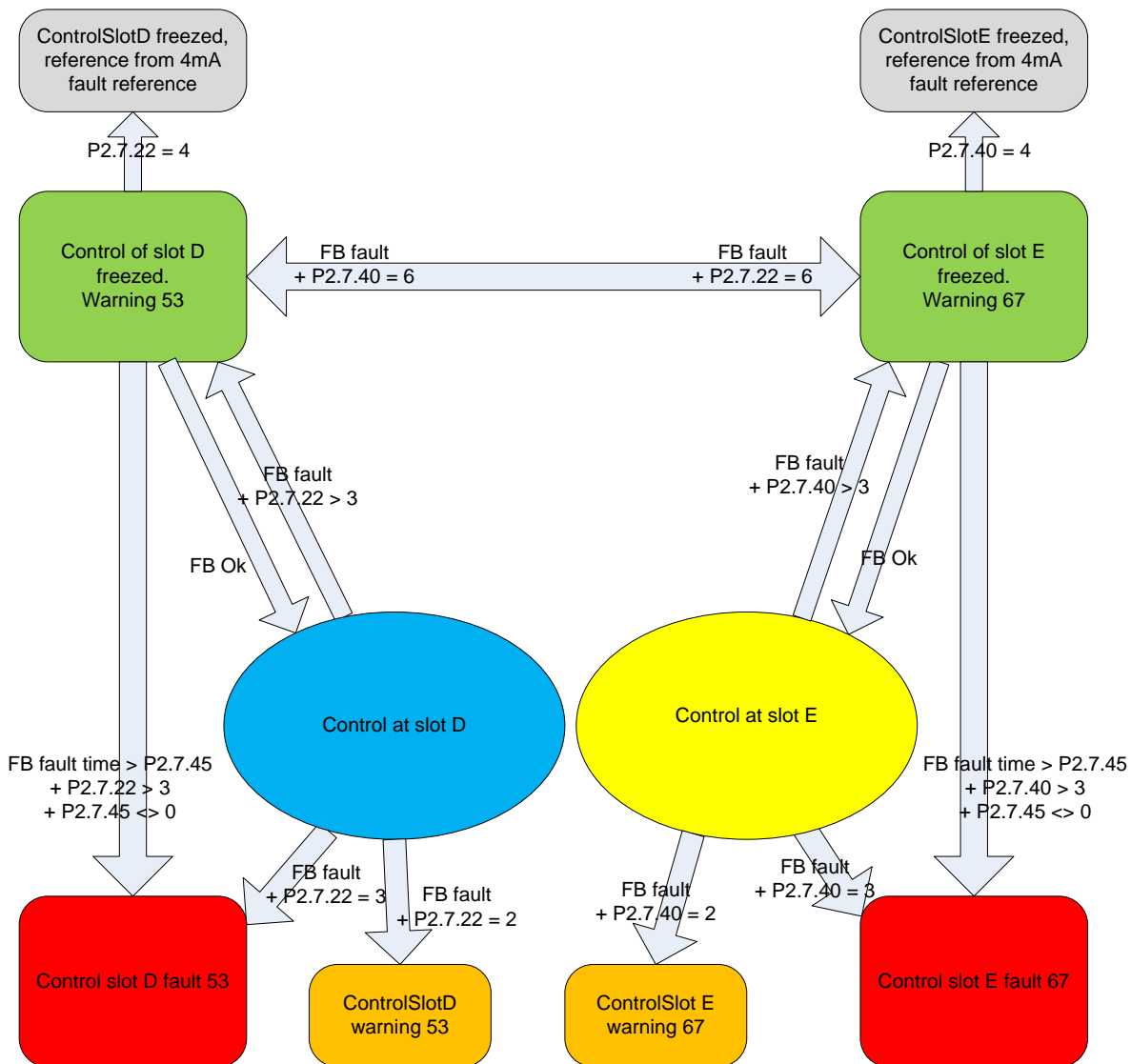

Figure: Redundant PB

Redundant PB is based on ControlSlot Selector (P2.9.21) that is used for selecting option board slot where the fieldbus control commands are coming. Figure above describes selection possibilities.

Working of FB-communication is monitored by supervising the state of FBFixedControlWord bit 15 that signals is the communication working or not. Bit 15 is controlled by Profibus board.

Function can be used only in Profibus ByPass mode, thus profibus state machine needs to be inside application level. Bypass function is activated by selecting ByPass in profibus board parameters and application parameter P2.9.19 PB Profile.

**P2.12.9.1 Response to fieldbus fault Slot D ID733 "FBFaultSlotEResp"**

Set here the response mode for the fieldbus fault if active control place is fieldbus. For more information, see the respective Fieldbus Board Manual.

This response is only for Slot D.

0 = No response

1 = Warning

2 = Fault, stop mode after fault according to Stop Function

3 = Fault, stop mode after fault always by coasting

4 = Warning, Previous frequency. Forced fault after delay. Only for profibus communication. See also Control Options B3.

5=Warning; 4 mA Freq

6=Warning; Change Slot

**P2.12.9.2 Response to fieldbus fault Slot E ID761 "FBFaultSlotEResp"**

Set here the response mode for the fieldbus fault if active control place is fieldbus. For more information, see the respective Fieldbus Board Manual.

This response is only for Slot E.

0 = No response

1 = Warning

2 = Fault, stop mode after fault according to Stop Function

3 = Fault, stop mode after fault always by coasting

4 = Warning, Previous frequency. Forced fault after delay. Only for profibus communication. See also Control Options B3.

5=Warning; 4 mA Freq

6=Warning; Change Slot

**P2.12.9.3 Fieldbus fault delay ID1850 "FB Fault Delay"**

This how long drive will stay in run state after the communication has been lost if fault response is set to 4 / Warning, previous frequency. If time is set to zero drive will remain running until communication is established and stop command is given.

**P2.12.9.4 Fieldbus Watch Dog delay ID1354 "FB WD Delay"**

Defines delay when fault is generated when watch dog pulse is missing from fieldbus. Set the time to zero to disable watchdog monitoring.

8.13 Fieldbus settings

8.13.1 General settings

P2.13.1 Fieldbus reference minimum scaling ID850 "FB Min Scale"

P2.13.2 Fieldbus reference maximum scaling ID851 "FB Max Scale"

Use these two parameters to scale the fieldbus reference signal. If both parameters have the same value the minimum and maximum frequency limits are used for scaling.

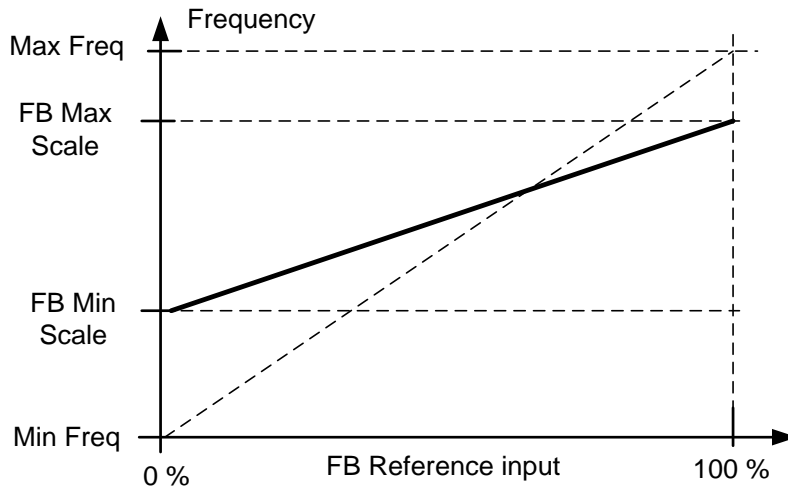

Using this custom scaling function also affects the scaling of the actual value.

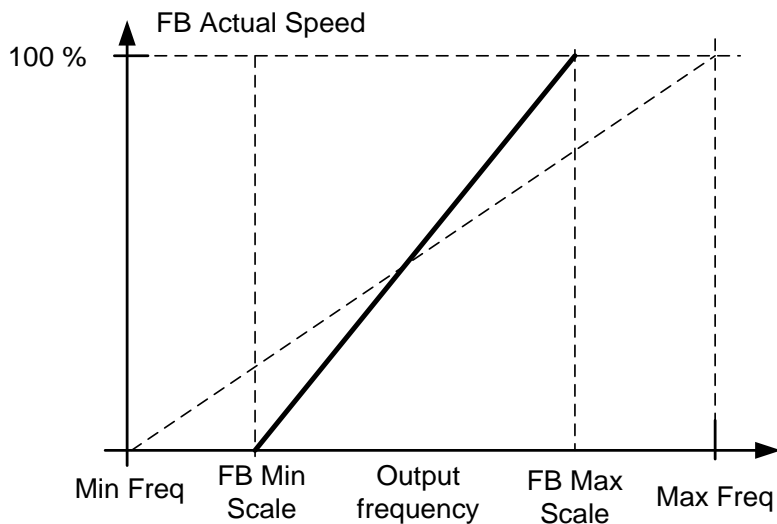

P2.13.3 FB Act. Speed Sel ID1851

*P2.13.4 to**P2.13.11 Fieldbus data out selections 1 to 8 ID852-ID859 "FB Data OutX Sel"*

Using these parameters, you can monitor any monitoring or parameter value from the fieldbus. Enter the ID number of the item you wish to monitor for the value of these parameters. See monitoring signals for full details of ID numbers.

Default settings:

Data	Value	Unit	Scale	ID
Status Word	Main Status Word			
FB General Status Word	MCStatus			64
FB Actual Speed	Actual Speed	%	0,01 %	
Process data OUT 1	Output Frequency	Hz	0,01 Hz	1
Process data OUT 2	Motor Speed	rpm	1 rpm	2
Process data OUT 3	Motor Current	A	0,1 A	45
Process data OUT 4	Motor Torque	%	0,1 %	4
Process data OUT 5	Motor Power	%	0,1 %	5
Process data OUT 6	Motor Voltage	V	0,1 V	6
Process data OUT 7	DC link voltage	V	1 V	7
Process data OUT 8	Active Fault Code	-	-	37

*P2.13.12 to**P2.13.19 Fieldbus data IN selections 1 to 8 ID876-833 "FB Data In X Sel"*

Using these parameters, you can control any monitoring or parameter value from the fieldbus. Enter the ID number of the item you wish to control for the value of these parameters. Monitoring signals that can be controlled from fieldbus are shadowed.

Default settings:

Data	Value	Unit	Scale	ID
Reference	Speed Reference	%	0.01%	-
Control Word	Main Control Word	-	-	-
Control Word 2	General Control Word			
Process Data IN1	Torque Reference	%	0.1%	1140
Process Data IN2	Free Analogue INPUT	%	0.01%	46
Process Data IN3	Adjust Input	%	0.01%	47
Process Data IN4	FB Analogue Output	%	0.01%	48
PD4 – PD8	Not Used	-	-	-

*P2.13.20 Fieldbus General Status Word ID ID897 "GSW ID"*

With this parameter it is possible to select which data are sent in FBGeneralStatusWord (see for details and availability in used fieldbus manual).

*P2.13.21 Control Slot selector ID1440 "ControlSlotSel."*

This parameter defines which slot is used as the main control place when two fieldbus boards have been installed in the drive. When values 6 or 7 are selected, the drive uses the Fast Profibus profile. When the Fast Profibus profile is used type 'B' boards or other C type boards cannot be used.

**Note:** Set first the Slave Address and the PPO type before selecting the Fast Profibus mode.

0 = All slots

4 = Slot D

5 = Slot E

6 = Slot D, Fast Profibus support

7 = Slot E, Fast Profibus support

**P2.13.22 ProfiBus Mode**

Defines if standard profile (Explained in fieldbus manual that is used) or if application level profibus profile is used.

**1 = Standard**

Profile that is explained in used filedbus manual.

**2 = ProfiDirve**

Drive uses application level ProfiDrive profile, used fieldbus board needs to be in "ByPass" type or communication needs to be set to ByPass mode to be able to use this.

FB Control Word		
	Signal	Comment
b0	ON	0>1 will reset the Switch On Inhibit state and bring the drive to Ready Run. Should be reset after fault, Coast Stop (b1) and Emergency Stop (b2) .
b1	EM Stop Coasting	0=Coast stop Active 1=Coast stop NOT active
b2	EM Stop	0=Emergency stop Active 1=Emergency stop NOT active
b3	Start	Normal start command 0=Stop the drive 1=Start the drive
b4	Ramp Output to Zero	0=Force speed ramp output to zero 1=Release speed ramp output
b5	Ramp Hold	0=Hold speed ramp output 1=Release speed ramp
b6	Ramp Input to Zero	0=Force speed ramp input to zero 1=Release speed ramp input
b7	Fault Reset	0=No Action 1=Reset active faults
b8	Inching 1	Run the drive with defined constant speed 0=No Action 1=Run with constant speed
b9	Inching 2	Run the drive with defined constant speed 0=No Action 1=Run with constant speed
b10	Fieldbus Control Enable	Activate Fieldbus control when P3.1 =3/Fieldbus 0=Fieldbus Control NOT active 1=Activate Fieldbus Control
b11	Watch Dog	0>1>0>1...1 sec square wave clock. This is used to check data communication between Profibus master and the drive. Used to generate FB Communication -Fault.
b12		
b13		
b14		
b15		

FB Status Word		
	Signal	Comment
b0	Ready to switch On	0=The drive NOT ready to switch ON 1=The drive is ready to switch ON
b1	Ready to Operate	0=The drive is NOT ready to run 1=The drive is ready to run
b2	Running	0=The drive is NOT running 1=The drive is running and ready to release the reference
b3	Fault Active	0=No fault active 1=Fault IS active
b4	Cost Stop NOT active	0=Coast stop active 1=Coast stop NOT active
b5	EM Stop not Active	0=Emergency stop active 1=Emergency stop NOT active
b6	Switch On Inhibit	0=No Inhibit 1=The drive is out of fault and coast / emergency stop state.
b7	Warning	0=NO alarm 1=Alarm IS active
b8	Speed At Ref	0=Speed actual is NOT equal to speed reference 1=Speed actual is equal to speed reference
b9	FB Control Active	0=Fieldbus Control NOT active 1=Fieldbus Control active
b10	Above Limit	Indicate if speed actual is below the limit P2.4.16 0=Speed actual is below the speed limit 1=Speed actual is above the speed limit
b11		
b12		
b13		
b14		
b15	Watch Dog Feedback	

*P2.13.23* *Fieldbus Custom Minimum* *ID898* *"FB Custom Min"*

*P2.13.24* *Fieldbus Custom Maximum* *ID899* *"FB Custom Max"*

With these parameters its possible to define fieldbus reference input values scaling. default is 0...10000 (0...100%)

## 8.14 ID Functions

Listed here are the functions that use the parameter ID number to control and monitor the signal.

## 8.14.1 Value Control

The value control parameters are used to control an input signal parameter.

**P2.14.1.1 Control Input Signal ID ID1580 "ContrInSignal ID"**

With this parameter you can select what signal is used to control selected parameter.

**P2.14.1.2 Control Off Limit ID1581 "Contrl Off Limit"**

This parameter defines the limit when the selected parameter value is forced to Off value.

**P2.14.1.3 Control On Limit ID1582 "Contrl On Limit"**

This parameter defines the limit when the selected parameter value is forced to On value.

**P2.14.1.4 Control Off Value ID1583 "Contrl Off Value"**

This parameter defines the value that is used when the used input signal is below Off limit.

**P2.14.1.5 Control On Value ID1584 "Contrl On Value"**

This parameter defines the value that is used when the used input signal is above On limit.

**P2.14.1.6 Control Output Signal ID ID1585 "ContrlOutSignID"**

This parameter defines which parameter is forced to On and Off values when selected input signal exceeds the set limits.

**P2.14.1.7 Control Mode ID1586 "Control Mode"**

This parameter defines how the value control output behaves.

0 = SR ABS

Absolute input value is used to make a step change in the output between On and Off values.

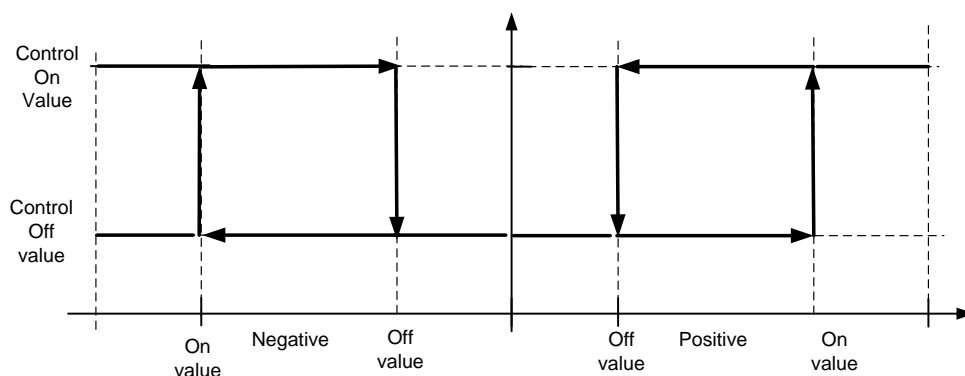



1 = Scale ABS

Absolute input value is scaled linearly between On and Off values.

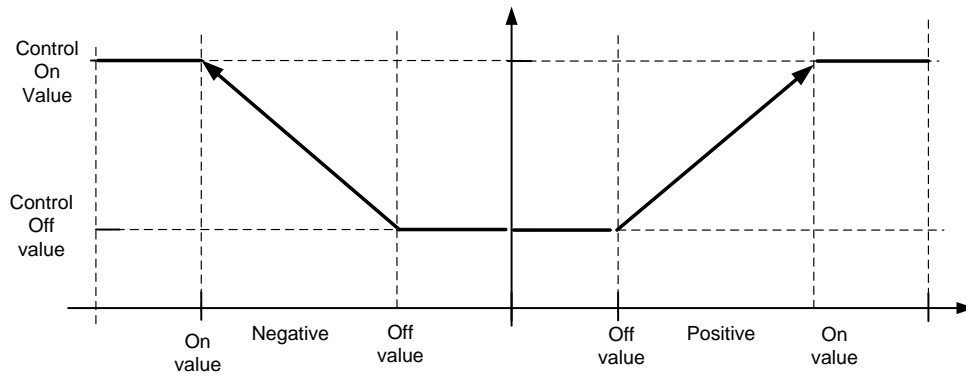

2 = Scale ABS Inverted

Inverted absolute value is scaled linearly between On and Off values.

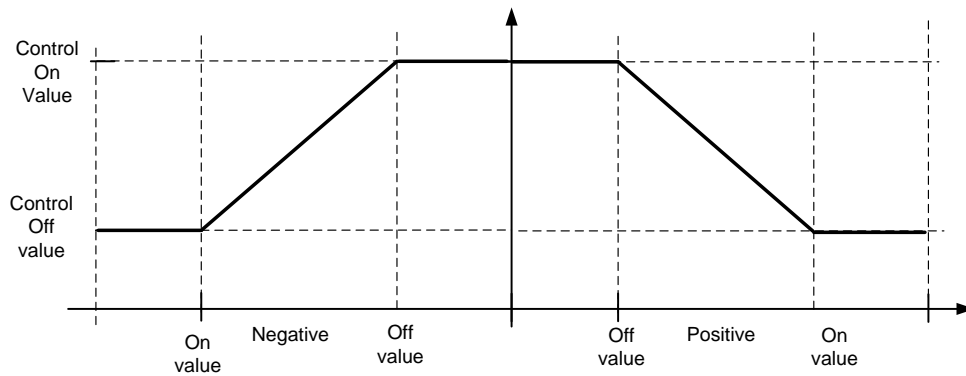

3 = SR

Input value is used to make a step change in the output between On and Off values.

4 = Scale ABS

Input values is scaled linearly between On and Off values.

5 = Scale Inverted

Inverted value is scaled linearly between On and Off values

**P2.14.1.8 Control Signal Filtering TC ID1586 "Control Filt TC"**

This parameter is used to filter the scaling function output. Used e.g. when unfiltered torque is used to control a parameter that needs stabilization.

### 8.14.2 DIN ID Control

This function is used to control any parameter between two different values with a digital input. Different values are given for DI 'low' and DI 'high'.

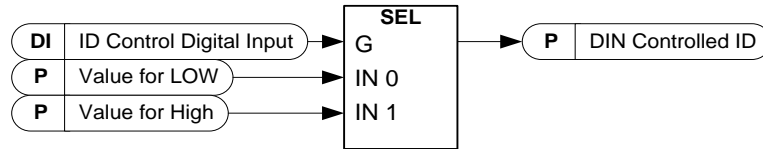

#### P2.14.2.1 ID Control Digital Input B0 ID1570 "ID Control DI B0"

Select digital input to be used for controlling the parameter selected by ID1571.

#### P2.14.2.2 ID Control Digital Input B1 ID1277 "ID Control DI B1"

Select digital input to be used for controlling the parameter selected by ID1571.

#### P2.14.2.3 DIN Controlled ID ID1571 "Controlled ID"

Select parameter ID controlled by ID1570.

#### P2.14.2.4 B00 Value ID1572 "B00 Value"

#### P2.14.2.5 B01 Value ID1573 "B01 Value"

#### P2.14.2.6 B10 Value ID1193 "B10 Value"

#### P2.14.2.7 B11 Value ID1182 "B11 Value"

Set here the controlled parameter value when the digital input (ID1570) is LOW for the parameter selected by ID1571. The function does not recognize decimals. Give, therefore, e.g. 10.00 Hz as '1000'.

Set here the controlled parameter value when the digital input (ID1570) is HIGH for the parameter selected by ID1571. The function does not recognize decimals. Give, therefore, e.g. 10.00 Hz as '1000'.

#### P2.14.2.8 Ramp Rate ID1112 "Ramp Rate"

## 8.14.3 DIN ID Control 2

This function is used to control any parameter between two different values with a digital input. Different values are given for DI 'low' and DI 'high'.

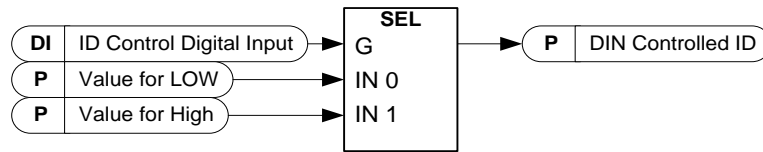

**P2.14.3.1**                    *ID Control Digital Input*    **ID 1578**                    **"ID Control DIN"**

Select digital input to be used for controlling the parameter selected by ID1579.

**P2.14.3.2**                    *DIN Controlled ID*    **ID 1579**                    **"Controlled ID"**

Select parameter ID controlled by ID 1578.

**P2.14.3.3**                    *False Value*    **ID 1594**                    **"False Value"**

Set here the controlled parameter value when the digital input (ID1578) is LOW for the parameter selected by ID1579. The function does not recognize decimals. Give, therefore, e.g. 10.00 Hz as '1000'.

**P2.14.3.4**                    *True Value*    **ID 1596**                    **"True Value"**

Set here the controlled parameter value when the digital input (ID1578) is HIGH for the parameter selected by ID1579. The function does not recognize decimals. Give, therefore, e.g. 10.00 Hz as '1000'.

## 8.14.4 DIN ID Control 3

This function is used to control any parameter between two different values with a digital input. Different values are given for DI 'low' and DI 'high'.

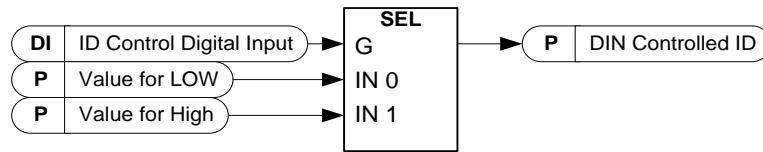

**P2.14.4.1** *ID Control Digital Input* ID 1620 "ID Control DIN"

Select digital input to be used for controlling the parameter selected by ID1621.

**P2.14.4.2** *DIN Controlled ID* ID 1621 "Controlled ID"

Select parameter ID controlled by ID 1620.

**P2.14.4.3** *False Value* ID 1622 "False Value"

Set here the controlled parameter value when the digital input (ID1620) is LOW for the parameter selected by ID1621. The function does not recognize decimals. Give, therefore, e.g. 10.00 Hz as '1000'.

**P2.14.4.4** *True Value* ID 1623 "True Value"

Set here the controlled parameter value when the digital input (ID1620) is HIGH for the parameter selected by ID1621. The function does not recognize decimals. Give, therefore, e.g. 10.00 Hz as '1000'.

### 8.15 Brake Control

The mechanical brake control has two parts that need to be synchronically controlled. The first part is the *mechanical brake release* and the second is the *speed reference release*.

#### P2.15.1 Brake Logic ID1546

Use this parameter to select brake control logic  
 0 = Multi-Purpose brake control logic

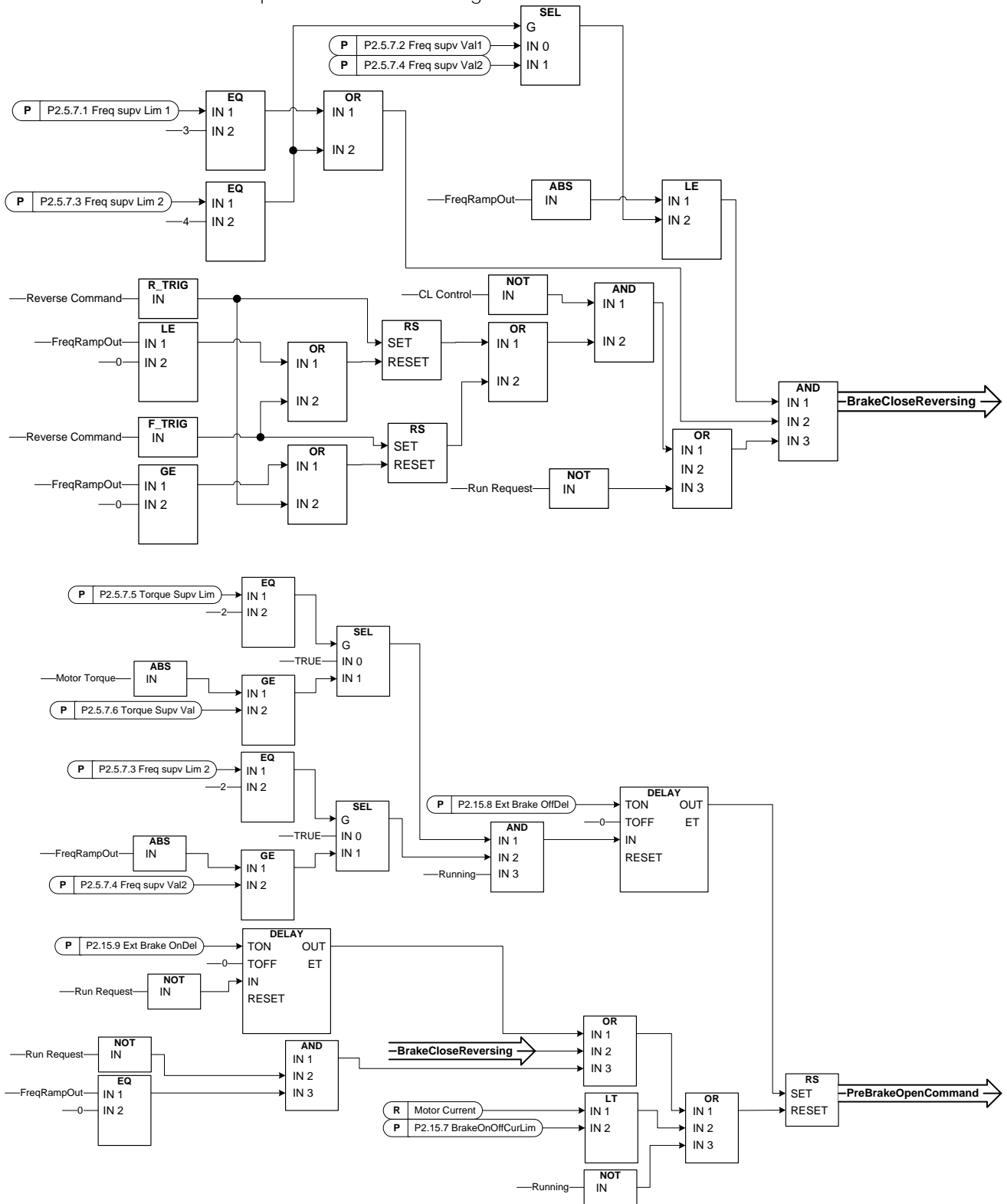

1 = Smooth brake control logic

Conditions to open the brake:

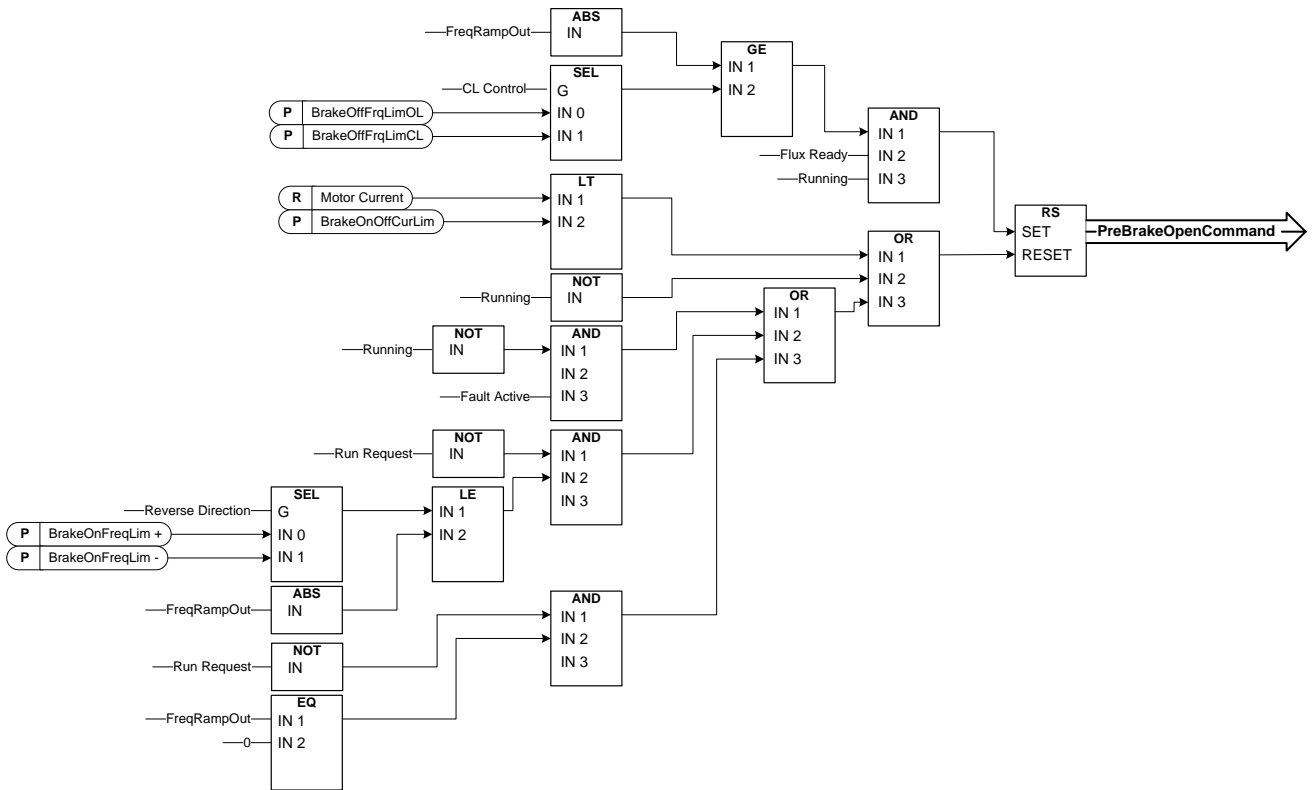

**The final brake open command:** It is possible that in a Master/Follower system the master drive opens the brake. Also an overriding system may do this without any control from the drive using AucControlWord1.B7. During identification run the brake will not open.

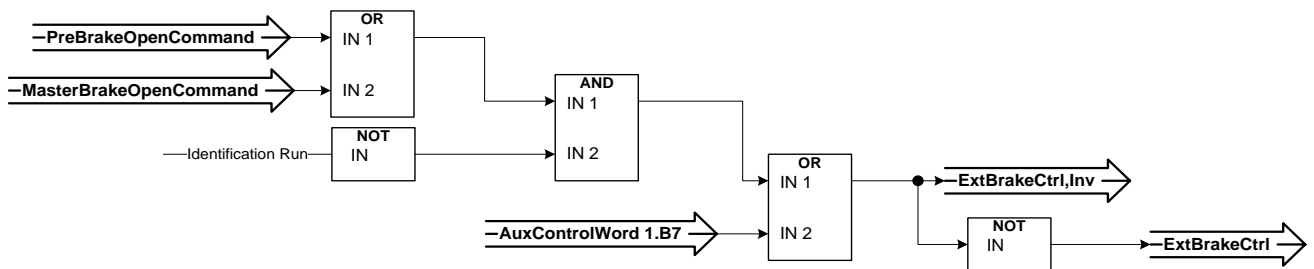

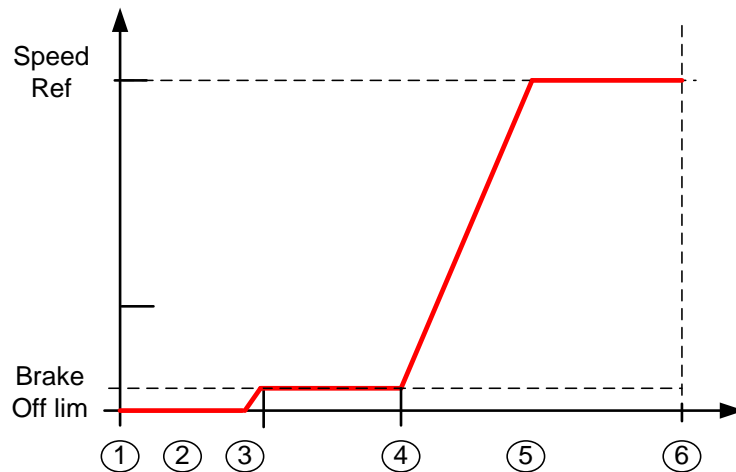

1. Start command
2. Start magnetization is used to build rotor flux fast. The drive *Zero speed time* is used during this.
3. When the rotor flux is > 90 % and the start zero time has expired the speed reference is released to BrakeOpenFreq limit.
4. Speed is kept at this speed until feedback is received from the brake acknowledge or when brake mechanical delay time has passed.
5. Speed follows normal reference signal.

Speed reference release function:

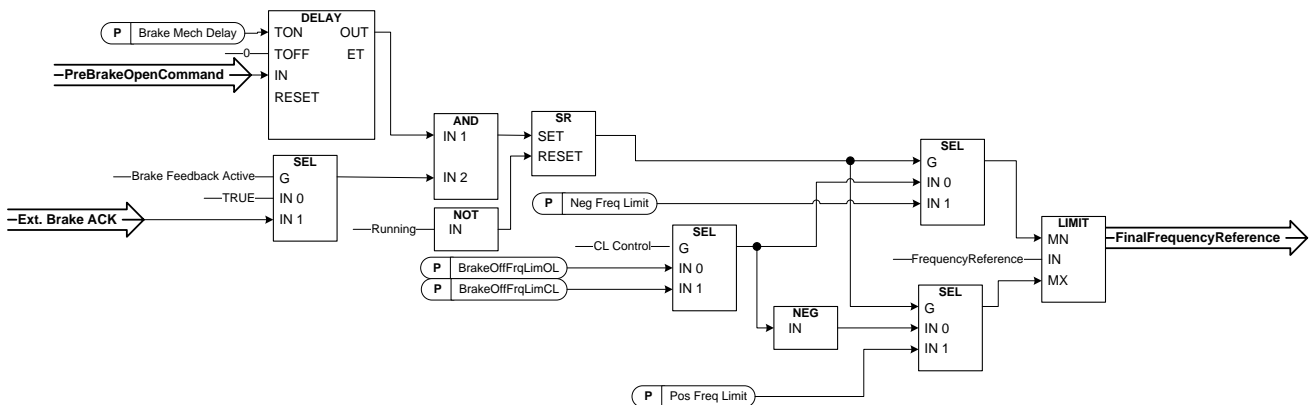

**P2.15.2 Mechanical brake reaction time ID1544 “Brake Mech Delay”**

After the brake open command has been given, speed is kept at the Brake Open limit until the reaction time has passed. This hold time should be set corresponding to the mechanical brake reaction time. This function is used to avoid current and/or torque spikes eliminating a situation where the motor is run at full speed against the brake. If this parameter is used when simultaneously with the brake acknowledge input both time and brake acknowledgements are needed before the speed reference is released.

- P2.15.3 Brake Frequency limit Open Loop ID1535 "BrakeOFFFrqLimOL"**  
This parameter defines the frequency limit to release the brake.  
This value also applies as the maximum frequency reference limit while the brake is closed. In open loop control it is recommended to use a value that is equal to the motor's nominal slip.
- P2.15.4 Brake Frequency limit Closed Loop ID1555 "BrakeOFFFrqLimCL"**  
This parameter defines the frequency limit to release the brake.  
This value also applies as the maximum frequency reference limit while the brake is closed. In closed loop control it is recommended to use zero value so that the brake is released while the drive has zero speed at start. If torque is needed to avoid position change at the moment the brake mechanically opens use the start-up torque function.
- P2.15.5 Closing frequency from forward direction ID1539 "BrakeOnFrqLim +"**  
Output frequency limit to close the brake when the speed approaches zero speed from positive direction. Lifting direction must be given as positive frequency.
- P2.15.6 Closing frequency from reverse direction ID1540 "BrakeInFrqLim -"**  
Output frequency limit to close the brake when the speed approaches zero speed from positive direction. Lowering direction must be given as negative frequency.
- P2.15.7 Brake On/Off Current limit ID1085 "BrakeOnOffCurLim"**  
If motor current is below this value the brake is closed immediately.  
It is recommended to set this value to approximately 25 % of the magnetization current from the maximum used frequency.



**P2.15.8** External brake-off delay (2.3.4.9)

**P2.15.9** External brake-on delay (2.3.4.10)

The function of the external brake can be timed to the start and stop control signals with these parameters.

The brake control signal can be programmed via the digital outputs. See parameters External brake control (ID445), inverted (ID446) and Delayed outputs (G2.3.1 and G2.3.2)

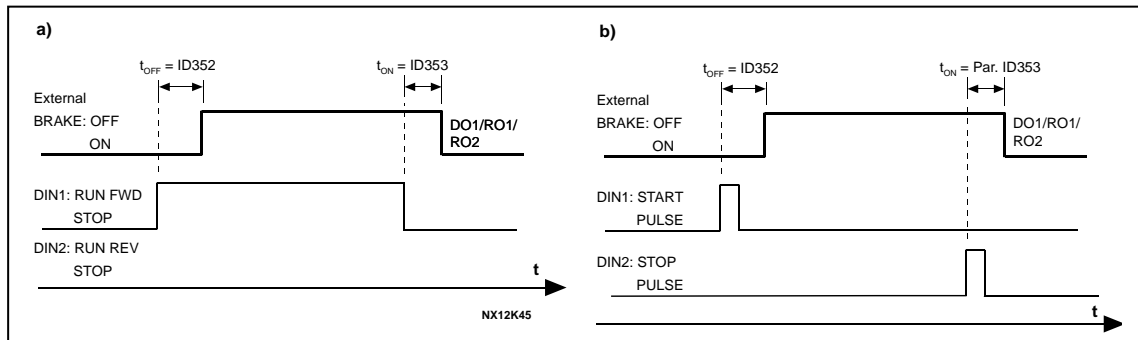

Figure 8-17. External brake control:  
 a) Start/Stop logic selection, ID300 = 0, 1 or 2  
 b) Start/Stop logic selection, ID300 = 3

### 8.15.1 Brake monitoring function

The brake monitoring function is activated when the function Brake acknowledge is used. The brake monitoring function compares the brake feedback to the control signal. In other words, a fault will be issued if the feedback is missing when drive is in Run state and the output frequency is above the opening limit and the fault delay has expired. A fault is also triggered if the brake feedback indicates that the brake is open while the drive is in stop state.

In some cases it is possible that an encoder fault appears when the drive is run against closed brake. The encoder fault can be disabled with Control Options B8 when the drive is controlling the brake to be closed.

### P2.15.10 Brake fault response ID1316 "Brake Fault"

Defines the action after detection of a brake fault.

- 0 = No response
- 1 = Warning
- 2 = Fault, stop mode after fault according to Stop Function
- 3 = Fault, stop mode after fault always by coasting

### P2.15.11 Brake fault delay ID1317 "BrakeFaultDelay"

The delay before the brake fault (F58) is activated. Used when there is a mechanical delay in the brake. See digital input signal *External brake acknowledge*.

## 8.15.2 Closed Loop settings

### 8.15.2.1 Start Up torque

The start-up torque is used to generate torque against the brake so that when the brake is mechanically opened there will be no position change because the drive is already generating the torque needed to keep the load in place.

Settings the start-up torque time is set to -1 means that the start-up torque is removed when the drive notices encoder movement. Setting the time greater than 0 will denote the actual time for how long the start-up torque is applied to the motor even if the motor shaft is already rotating thus making the motor accelerate without control until time has expired.

#### **P2.15.12.1 CL: Startup torque ID621 "StartUp Torque!"**

0 = Not Used

1 = Torque Memory

Torque memory uses the torque that was used by the speed controller last time the drive was in running state. Normally, this is the torque generated when the zero speed time at stop has expired and the drive has stopped modulation or started the flux off delay function.

2 = Torque Reference

The normal torque reference chain is used (expect TorqueStep) for the start-up torque level. This can be used when the external system knows the load on the shaft when brake is released.

3 = Torque Forward/Reverse

Drive uses torque values defined by the start-up torque forward and reverse.

#### **P2.15.12.2 Start-up torque, forward ID633 "StartupTorq FWD"**

Sets the start-up torque for forward direction if selected with parameter Startup Torque.

#### **P2.15.12.3 Start-up torque, reverse ID634 "StartupTorq REV"**

Sets the start-up torque for reverse direction if selected with parameter Startup Torque.

#### **P2.15.12.4 Start-Up Torque Time ID1371 "StartupTorq Time"**

This parameter defines for how long the start-up torque will be used instead of the speed controller output. If the time is set to -1 the drive will automatically start to use the speed controller when speed change is read from encoder. When the setting is >0 the drive will use this defined torque even if speed changes are read from encoder.

## 8.16 Auto Fault Reset

The Auto reset function tries to reset the fault automatically during the trial time. An individual fault can be defined to be reset certain number of times before the actual fault indication is given. The function will operate as Automatic Restart function if the start command is received as a static signal. In I/O control of the Advance application, the default start function requires a rising edge command after fault trigger.

### P2.16.1 Automatic reset: Wait time ID717 "Wait Time"

Defines the time for the attempted fault reset after the fault trigger has passed.

Note: In case of external fault, remove the cause of fault on the external device. The wait time count starts only when the cause of fault has been removed.

### P2.16.2 Automatic reset: Trial time ID718 "Trial Time"

The Automatic reset function keeps trying to reset the faults appearing during the time set with this parameter. If the number of faults during the trial time exceed the value of the respective parameter set with ID720 to ID725 a permanent fault is generated.

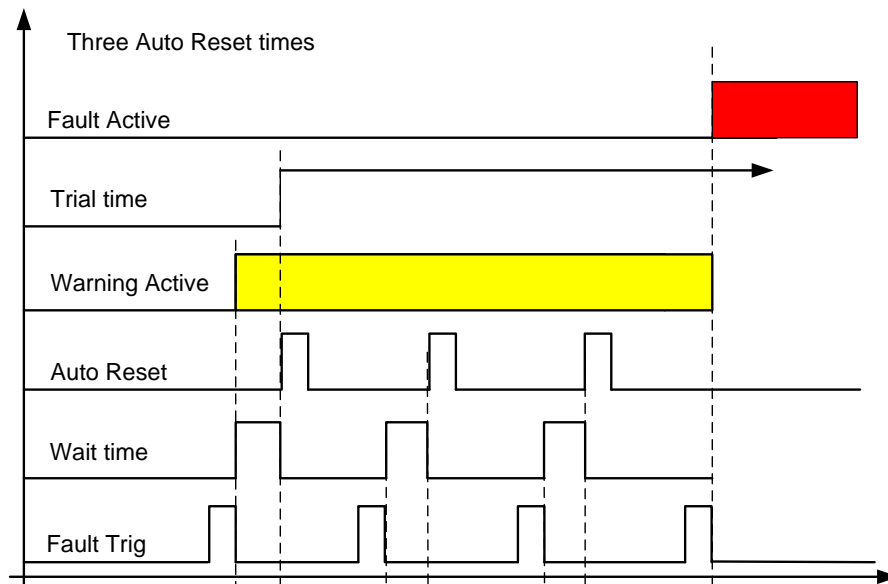

Figure 8-18. Example of Automatic restarts with three restarts

### P2.16.3 Automatic restart: Start function ID719 "Start Function"

The Start function for restart is selected with this parameter; restart will take place if there is a static Start command active when an automatic fault reset is made.

- 0 = Start with ramp
- 1 = Flying start
- 2 = Start according to Start Function parameter (Default)

The following 'Number of tries' parameters determine the maximum number of automatic restarts during the trial time. The time count starts from the first autoreset. If the number of faults occurring during the trial time exceeds the values set by number of tries the fault state becomes active.

**P2.16.4** *Number of tries after undervoltage fault trip* **ID720** *“Undervolt. Tries”*

This parameter determines how many automatic fault resets can be made during the trial time after undervoltage trip.

- 0 = No automatic reset
- >0 = Number of automatic fault resets after undervoltage fault.

**P2.16.5** *Number of tries after overvoltage trip* **ID721** *“Overvolt. Tries”*

This parameter determines how many automatic fault resets can be made during the trial time after overvoltage trip.

- 0 = No automatic fault reset after overvoltage fault trip
- >0 = Number of automatic fault resets after overvoltage fault trip.

**P2.16.6** *Number of tries after overcurrent trip* **ID722** *“Overcurr. Tries”*

(NOTE! IGBT temp faults also included)

This parameter determines how many automatic fault resets can be made during the trial time after overcurrent trip.

- 0 = No automatic fault reset after overcurrent fault trip
- >0 = Number of automatic fault resets after overcurrent trip, saturation trip and IGBT temperature faults.

**P2.16.7** *Number of tries after reference trip* **ID723** *“4mA Fault Tries”*

This parameter determines how many automatic fault resets can be made during the trial time after 4 mA reference fault.

- 0 = No automatic fault reset after reference fault trip
- >0 = Number of automatic fault resets after the analogue current signal (4...20mA) has returned to the normal level ( $\geq 4$ mA)

**P2.16.8** *Number of tries after motor temperature fault trip* **ID726** *“MotTempF Tries”*

This parameter determines how many automatic fault resets can be made during the trial time after calculated motor temperature fault trip.

- 0 = No automatic fault reset after Motor temperature fault trip
- >0 = Number of automatic fault resets after the motor temperature has returned to its normal level

**P2.16.9** *Number of tries after external fault trip* **ID725** *“Ext.Fault Tries”*

This parameter determines how many automatic fault resets can be made during the trial time after external fault trip.

- 0 = No automatic fault reset after External fault trip
- >0 = Number of automatic fault resets after External fault trip

*P2.16.10 Number of tries after underload fault trip ID738 "Underload tries"*

This parameter determines how many automatic fault resets can be made during the trial time after underload trip.

- 0 = No automatic fault reset after Underload fault trip
- >0 = Number of automatic fault resets after Underload fault trip

### 8.17 Keypad control parameters

Unlike the parameters listed above, these parameters are located in the **M3** menu of the control keypad. The reference parameters do not have an ID number.

#### **P3.1**      *Control Place*      **ID125**      **"Control Place"**

The active control place can be changed with this parameter.

Pushing the Start button for 3 seconds selects the control keypad as the active control place and copies the Run status information (Run/Stop, direction and reference).

0 = PC Control, Activeted by NCDrive

1 = I/O terminal

2 = Keypad

3 = Fieldbus

#### **R3.2**      *Keypad Reference*      **No ID**      **"Keypad Reference"**

The frequency reference can be adjusted from the keypad with this parameter.

The output frequency can be copied as the keypad reference by pushing the Stop button for 3 seconds when you are on any of the pages of menu **M3**.

#### **P3.3**      *Keypad Direction*      **ID123**      **"Keypad Direction"**

0      Forward: The rotation of the motor is forward, when the keypad is the active control place.

1      Reverse: The rotation of the motor is reversed, when the keypad is the active control place.

#### **P3.4**      *Stop button activated*      **ID114**      **"StopButtonActive"**

If you wish to make the Stop button a "hotspot" which always stops the drive regardless of the selected control place, give this parameter the value 1.

#### **R3.5**      *Torque reference*      **No ID**      **"Torque Reference"**

Define here the torque reference within 0.0...100.0%.

#### **P3.6**      *License*      **No ID**      **"License"**

## 9. IDENTIFICATION FUNCTION FOR PERMANENT MAGNET SYNCHRONOUS MOTOR

PM Motor has several zero positioning identification modes. This chapter explains what kind of identification mode is needed to select when using different kind of hardware configuration.

This chapter is addition to P2.1.9 Identification parameter description and P2.8.5.2 Start Angle Identification mode description.

### 9.1 Identification with absolute encoder.

When using absolute encoder identification is made only once. Remade is needed if encoder and rotor position changes related to each other.

Motor needs to be able to rotate freely that magnet positions can be identified.

Identification mode in this case is selected by "P2.1.9 Identification" selection "3 / Enc.ID Run".

During identification drive feeds DC current to motor (~90 % of motor nominal), this causes motor to move zero position, there may be oscillatory movement on the shaft. When identification is successful "P2.8.5.1 PMSM Shaft Position" is updated, if not successful value is set to zero and identification warning is displayed for 10 seconds (W57). If identification is made several times, result may be different; there are as many positions as there are pole pairs in the motor.

Benefit to use absolute encoder is that magnet position is always known thus motor can be fully loaded from the start.

Related parameters:

P2.1.9	Identification	ID631
P2.8.5.1	PMSM Shaft Position	ID649

### 9.2 Identification with incremental encoder without Z-pulse input.

When using incremental encoder without Z-pulse, identification is made in every start. Identification mode can be selected by "P2.8.5.2 Start Angle Identification Mode" In this case encoder identification cannot be done because zero position cannot be identified without Z-pulse. But identification P2.1.9 Identification selection "2 / ID With Run" is needed to make. Identification at every start will be automatically active if "P2.8.5.1 PMSM Shaft Position" parameter value is zero.

Best result is get when motor has a mechanical brake that prevents shaft movements. Acceptable result can be achieved also when motor has high load and/or inertia that prevent shaft movements during identification.

Angle identification is done in every start by feeding motor with a DC pulses that identifies magnet position. DC pulses are in two different groups. First one identifies zero position and second one makes polarity check. These DC current levels are adjusted by "P2.8.5.3 Start Angle Identification Current" and "P2.8.5.4 Polarity Pulse current", respectively.

**NOTE:** Not all motors are suitable for this identification mode.

Benefit of this mode is that motor can be fully loaded from the start.

Related parameters:

P2.8.5.2	Start Angle Identification Mode	ID1691
P2.8.5.1	PMSM Shaft Position	ID649
P2.8.5.3	Start Angle Identification Current	ID1759
P2.8.5.4	Polarity Pulse current	ID1566

### 9.3 Identification with incremental encoder with Z-pulse input.

When using incremental encoder with Z-pulse, identification is made only once. Remade is needed if encoder and rotor position changes related to each other.

Motor needs to be able to rotate freely that magnet positions can be identified. Identification mode in this case is selected by “P2.1.10 Identification” selection “3 / Enc.ID Run”.

During identification drive feeds DC current to motor (~90 % of motor nominal), this causes motor to move to zero position, there may be oscillatory movement on the shaft. When motor oscillatory movement has stopped motor is rotated until Z-pulse is received from the encoder. When identification is successful “P2.8.5.1 PMSM Shaft Position” is updated, if not successful value is set to zero and identification warning is displayed for 10 seconds (W57). If identification is made several times result may be different, there are as many positions as there are pole pairs in the motor.

When motor is started and zero position is not “remembered”: Drive will start to feed DC current to motor (Defined by “P2.8.5.6 I/f Current”) till Z-pulse is received from the encoder. During this DC injection motor may not be able to produce 100 % torque. When running without load Z-pulse position can be seen in the motor current when current goes nearly to zero.

Related parameters:

P2.1.10 Identification

P2.8.5.1 PMSM Shaft Position

P2.8.5.6 I/f Current



### 10. PROBLEM SOLVING

In problem situations it is important to have proper information about the problem.

However, it is recommended first to try with latest application- and system software versions available. Software is continuously developed and default settings are improved.

If the problem persists, contact your local contacts. Before you contact the local contacts, follow the guidelines below so that you give the information they need for problem solving.

Type	Signal Name	Actual	Unit	Min	
Value	Status Word 1	20583			6!
Value	Torque	3,5			1!
Value	Current	4,5			4!
Value	FreqReference	37,29			6!
Value	DC Voltage	550	V		1!
Value	Output Frequency	37,35	Hz	-65,00	6!
Value	Shaft Frequency	37,27	Hz	-65,00	6!
Value	Motor Voltage	293,4	V	0,0	7!

Figure 1. Recommended signals for VACON® NCDrive.

Use the fastest communication speed (Baudrate: 57 600) and a 50 ms update interval for signals for the RS232 communication.

For the CAN communication, use a 1 Mbit communication speed and 7 ms update interval for signals.

When you contact the support, send the \*.trn, \*.par and Service info (\*.txt) files with a description of the situation. If the situation is caused by a fault, take also the Datalogger data from the drive.

Note that Datalogger settings can be changed to catch correct situation and it's also to possible make manual force trig for Datalogger.

Before storing the parameter file, upload the parameters from the drive and save when VACON® NCDrive is in the ON-LINE state. If it is possible, do this while the problem is active.

It is also helpful to have single line diagram from the system where the problem occurs.

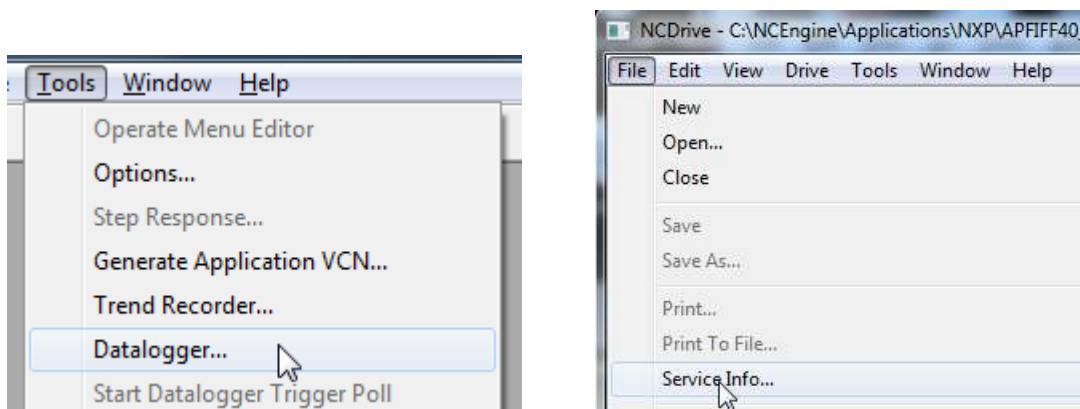

## 11. FAULT CODES

### F1 *Overcurrent fault*

Drive has detected a high current in the output phase.

#### S1 = Hardware trip:

- Current above  $4 \cdot I_h$

#### S3 = Current controller supervision.

- Current limit too low or current peak value too high.

#### S4 = Software trip:

- User configured software over current limit exceeded.
  - Check Motor Protection for software over current trip limit settings

#### Possible cause and solutions

- Sudden increase in load
  - Check motor load.
- Short circuit in motor cables
  - Check motor and cables.
- Motor is under magnetized at start.
  - Check motor name plate data.
  - Make identification run
- Sine filter is used but drive settings are not correct
  - Activate Sine filter parameter (P6.7.5) in system menu.

### F2 *Overvoltage fault*

DC-link voltage has exceeded the drive protection limits.

#### S1 = Hardware trip.

500 Vac unit DC voltage above 911 Vdc

690 Vac unit DC voltage above 1200 Vdc

#### S2 = Overvoltage control supervision (only 690 Vac unit).

DC voltage has been above 1100 Vdc for too long.

#### Possible cause and solutions

1. Too short a deceleration time
  - Increase deceleration time.
  - Use brake chopper and brake resistor.
  - Use Brake chopper unit.
  - Use active front end unit (AFE ARFIFF02).
  - Activate overvoltage controller.
2. High overvoltage spikes in supply
  - Activate overvoltage controller.
3. 690 V unit operating too long above 1100 Vdc
  - Check input voltage.

### F3 *Earth fault*

Earth fault protection ensures that the sum of the motor phase currents is zero. The overcurrent protection is always working and protects the frequency converter from earth faults with high currents.

#### S1 = Sum of motor current is not zero

**Possible cause and solutions**

1. Insulation failure in cables or motor
  - Check motor cables and motor.

*F5 Charge switch*

Charge switch status is not correct when start command is given.

**S1 = Charge switch was open when START command was given.**

**Possible cause and solutions**

1. Charge switch was open when the START command was given.
  - Check connection of the feedback from charging relay
  - Reset the fault and restart.

Should the fault re-occur, contact your local distributor.

*F6 Emergency stop*

Emergency stop command has been given by using a special option board.

*F7 Saturation fault*

**S1 = Hardware failure**

**Possible cause and solutions**

1. If there is a brake chopper in use
  - Check the isolation resistance and the resistance on the brake resistor.
2. FR4-FR8: Power module
  - Measure the power module directly from its terminals.
3. Hardware
  - Check the capacitors.

*F8 System Fault*

A system fault indicates several different fault situations in drive operation.

**S1 = Reserved**

- Disturbance.
  - Reset the unit and try again.
- If there is star coupler in the unit.
  - Check the fibre connections and phase order.
- Driver board or IGBT broken.
- FR9 and the bigger size drives, which includes not star coupler, ASIC board (VB00451) is broken.
  - Change ASIC board
- FR8 and smaller size drives: control board broken.
  - Change control board
- FR8 and smaller size drives: if there is boards VB00449 / VB00450 in use, failure might be in there.
  - Check the boards

**S7 = Charge switch**

**S8 = No power to driver card**

**S9 = Power unit communication (TX)**

**S10 = Power unit communication (Trip)**

**S11 = Power unit comm. (Measurement)**

**S12 = SystemBus synchronization has failed in DriveSynch operation**

**S30 = Safe disable inputs are in different state (OPT-AF)**

**S31 = Thermistor short circuit detected (OPT-AF)**

**S32 = OPT-AF board has been removed**

**S33 = OPT-AF board EEPROM error**

**S34-36 = OPT-AF supply voltage hardware problem detected.**

**S37-40 = Single hardware problem detected in STO inputs.**

**S41-43 = Single hardware problem detected in the thermistor input.**

**S44-46 = Single hardware problem detected in STO inputs or in the thermistor input.**

**S47 = OPT-AF board mounted in old NXP control board.**

**S48 = Parameter Expander boards/SlotB/Therm Trip(HW) is set to OFF even if the jumper wire X12 is not cut.**

**S49 = OPT-AF board mounted in NXS control board.**

**F9** *Undervoltage fault*

DC-link voltage is below the fault voltage limit of the drive.

S1 = DC-link too low during run

S2 = No data from power unit

S3 = Undervoltage control supervision

**Possible cause**

1. Too low a supply voltage
2. Frequency converter internal fault
3. One of the input fuses is broken.
4. External charge switch has not been closed.

**Correcting measures**

- In case of temporary supply voltage break, reset the fault and restart the frequency converter.
- Check supply voltage.
- Check function of DC charge.
- Contact your local distributor.

**F10** *Input line supervision*

S1 = Phase supervision diode supply

S2 = Phase supervision active front end

**Possible cause:**

1. Input line phase is missing.

**Correcting measures**

- Check supply voltage, fuses and cable.

**F11** *Output phase supervision*

Current measurement has detected that there is no current in one phase or one phase current is considerably different from other phases.

**Correcting measures**

- Check motor cable and motor.

**F12** *Brake chopper supervision*

Brake chopper supervision generates pulses to the brake resistor for response. If no response is received within set limits a fault is generated.

**Possible cause:**

1. No brake resistor installed.
2. Brake resistor is broken.
3. Brake chopper failure.

**Correcting measures:**

- Check brake resistor and cabling.
- If these are ok the chopper is faulty. Contact your local distributor.

*F13 Drive undertemperature fault*

Possible cause:

1. Heatsink temperature is under  $-10^{\circ}\text{C}$

*F14 Drive overtemperature fault*

Possible cause:

1. Heatsink temperature is over acceptable limits. See user's manual for the temperature limit. Overtemperature warning is issued before actual trip limit is reached.

Correcting measures

- Check correct amount and flow of cooling air.
- Check the heatsink for dust.
- Check ambient temperature.
- Make sure that switching frequency is not too high in relation to ambient temperature and motor load.

*F15 Motor Stalled*

The motor stall protection protects the motor from short time overload situations such as one caused by a stalled shaft. The reaction time of the stall protection can be set shorter than that of motor thermal protection. The stall state is defined with two parameters, Stall current and Stall frequency limit. If the current is higher than the set limit and output frequency is lower than the set limit the stall state is true. There is actually no real indication of the shaft rotation. Stall protection is a type of over current protection.

- Check motor and load.

*F16 Motor over temperature*

Motor overheating has been detected by frequency converter motor temperature model. Motor is overloaded.

Possible cause:

1. Motor load is too high.
2. Motor values are set incorrectly.

Correcting measures:

- Decrease motor load.
- If no motor overload exists, check the temperature model parameters.

*F17 Motor underload fault*

The purpose of the motor underload protection is to ensure that there is load on the motor when the drive is running. If the motor loses its load there might be a problem in the process, e.g. a broken belt or a dry pump.

The underload curve is a squared curve set between the zero frequency and the field weakening point. The protection is not active below 5Hz (the underload time counter is stopped).

The torque values for setting the underload curve are set in percentage which refers to the nominal torque of the motor. The motor's name plate data, parameter motor nominal current and the drive's nominal current  $I_H$  are used to find the scaling ratio for the internal torque value..

Correcting measures:

- Check load.

*F22 EEPROM checksum fault*

Possible cause:

1. Parameter save fault
2. Faulty operation
3. Component failure

Correcting measures:

- Should the fault re-occur, contact your local distributor.

*F24 Counter fault*

Possible cause:

1. Values displayed on counters are incorrect

Correcting measures:

- Have a critical attitude towards values shown on counters.

*F25 Microprocessor watchdog fault*

Possible cause:

1. Start-up of the drive has been prevented.
2. Run request is ON when a new application is loaded to the drive.

Correcting measures:

- Reset the fault and restart.
- Should the fault re-occur, contact your local distributor.

*F26 Start-Up prevention*

Possible cause:

1. Start-up of the drive has been prevented.
2. Run request is ON when a new application is loaded to drive

Correcting measures:

- Cancel prevention of start-up if this can be done safely.
- Remove Run Request.

*F29 Thermistor fault*

The thermistor input of the option board has detected too high a motor temperature.

Possible cause:

1. Motor is overheated.
2. Thermistor cable is broken.

Correcting measures:

- Check motor cooling and load
- Check thermistor connection (If thermistor input of the option board is not in use it has to be short circuited).

*F31 IGBT temperature*

IGBT Inverter Bridge overtemperature protection has detected too high a short term overload current.

Possible cause:

1. Too high load
2. Identification run has not been made which causes the motor to start undermagnetized.

Correcting measures:

- Check load.
- Check motor size.
- Make identification Run.

*F32 Fan cooling*

Possible cause:

1. Cooling fan of the frequency converter does not start when ON command is given.

Correcting measures:

- Contact your local distributor.

*F37 Device change*

Option board or power unit changed.

Possible cause:

1. New device of same type and rating.

Correcting measures:

- Reset. Device is ready for use.

*F38 Device added*

Option board added.

Correcting measures:

- Reset. Device is ready for use. Old board settings will be used.

*F39 Device removed*

Option board removed.

Correcting measures:

- Reset. Device no longer available.

*F40 Device unknown*

Unknown option board or drive.

**S1 = Unknown device**

**S2 = Power1 not same type as Power2**

Correcting measures:

- Contact the distributor near to you.



*F41 IGBT temperature*

IGBT inverter bridge overtemperature protection has detected too high a short term overload current.

- Check load.
- Check motor size.
- Make Identification run.

*F42 Brake resistor overtemperature***S1: Brake resistor high temperature**

Calculation for internal brake resistor has exceeded the tripping limit. If the internal brake resistor is not in use set the brake chopper parameter in System menu to 'Not connected'.

**S2: Brake resistor resistance is too high****S3: Brake resistor resistance is too low****S4: No brake resistor detected***F43 Encoder fault*

Encoder fault is issued when the drive is not able to operate in closed loop control mode (encoder is used). See subcodes for details for the reason of the fault:

S1 = Encoder 1 channel A is missing

S2 = Encoder 1 channel B is missing

S3 = Both encoder 1 channels are missing

S4 = Encoder reversed

S5 = Encoder board missing

S6 = Serial communication fault

S7 = Ch A / Ch B Mismatch

S8 = Resolver/Motor pole pair mismatch

S9 = Missed Start Angle

S10 = Sin/Cos encoder feedback is missing.

S11 = Encoder angle is drifting fault.

S12 = Dual speed supervision fault

S13 = Encoder angle supervision fault

S14 = Encoder estimated missing pulse fault, switch from the CL ctrl to the OL sensorless ctrl.

1. Modulation type is ASIC while incremental encoder is used.
  - Change modulator type to Software 1
2. Start identification does not work due low identification current
  - Increase identification current
3. Start angle identification is not working at all because there is no saturation based saliency in the motor
  - Use absolute encoder
4. There are too much noise pick-ups in encoder cable
  - check encoder cable shield and grounding in drive

*F44 Device changed (Default param.)*

Possible cause:

1. Option board or power unit changed.
2. New device of different type or different rating from the previous one.

Correcting measures:

- Reset
- Set the option board parameters again if option board was changed. Set converter parameters again if power unit was changed.

*F45 Device added (default param.)*

Possible cause:

1. Option board of different type added.

Correcting measures:

- Reset
- Set the option board parameters again.

*F50 4mA supervision*

Possible cause:

1. Current at the analogue input is below 4mA.
2. Signal source has failed
3. Control cable is broken or loose

Correcting measures:

- Check the current loop circuitry.

*F51 External fault*

Possible cause:

1. Digital input fault.

Correcting measures:

- Remove fault situation from external device.

*F52 Keypad communication*

Possible cause:

1. The connection between the control keypad or NCDrive and the AC drive is broken.

Correcting measures:

- Check keypad connection and possible keypad cable.

*F53 Fieldbus communication*

Possible cause:

1. The data connection between the fieldbus Master and the fieldbus board is broken.

Correcting measures:

- Check installation.
- If installation is correct contact the nearest Vacon distributor.

*F54 Slot fault*

Possible cause:

1. Defective option board or slot

Correcting measures:

- Check board and slot.
- Contact the nearest Vacon distributor.

*F56 Temperature sensor board 1 fault*

Temperature protection function is used to measure temperature and give warning and/or fault when set limits are exceeded. Advance application supports two temperature sensor boards simultaneously. One can be used for the motor winding and the other for the motor bearings.

**A1 – Temperature limit has been exceeded.**

**A2 – Sensor not wired or not working.**

**A3 – Short circuit.**

Possible cause:

1. Temperature limit values set for the temperature board parameters have been exceeded

Correcting measures:

- Find the cause of temperature rise
- Check sensor wiring

*F57 Identification*

Identification run has failed.

**A1 = Current measurement offset**

**A2 = Identification current level**

**A3 = Acceleration time too long**

**A4 = Identification frequency reference not reached**

**A5 = Too low or high magnetization current**

**A6 = Flux curve outside expected levels**

**A7 = PMSM, Encoder zero position**

**A8 = Too low maximum frequency limit**

**A9 = PMSM, encoder zero pulse not found.**

**A10 = Ls Identification timeout**

**A11 = Ls Identification current**

Possible cause:

1. There was load on the motor shaft when making the identification run with rotating motor.
2. Motoring or generator side torque/power limits are too low to achieve a stable run.

Correcting measures:

- Run command was removed before identification was ready
- Motor is not connected to the AC drive.
- There is load on the motor shaft.
- In some cases, levering the DC-Link voltage may help, for example, by stopping AFE boosting.

### F58 *Mechanical brake*

This fault is generated when the acknowledge signal from the brake is used. If the status of the signal is opposite from the control signal for a longer period of time than the delay defined with P2.15.11 *Brake Fault Delay* a fault is generated.

Correcting measures:

- Check the condition and connections of mechanical brake.

### F59 *SystemBus communication*

The master drive sends pulses to all follower drives. If the pulses are missing a system bus communication fault is generated. The master drive also receives pulses back from the follower drives (max. four drives) and generates warnings if pulses are missing.

SystemBus communication is broken between master and follower.

Correcting measures:

- Check expander board parameters.
- Check optical fibre.
- Check option board jumpers.

### F60 *Cooling*

Protection for the liquid-cooled units. An external sensor is connected to the drive (DI: Cooling Monitor) to indicate if cooling liquid is circulating. If the drive is in Stop state only a warning is issued. In Run state a fault is issued and the drive makes a coast stop.

Possible cause:

1. Liquid cooled drive cooling circulation have been failed

Correcting measures:

- Check reason for cooling failure from external system.

### F61 *Speed Error*

Speed error monitoring function compares the encoder frequency and the ramp generator output. This function is used with PMS motors to detect if the motor is out of synchronization or to disable open loop function that uses encoder speed for slip compensation. The slip compensation is disabled regardless of the response and needs to be re-activated once speed error is detected (set parameter again or power down the drive).

Possible cause:

1. Motor speed is not the same as the reference. For example, motor speed is limited by torque limit.
2. PMS motor has gone off synchronization.
3. Encoder cable is broken.

*F62 Run Disabled*

Run Disable warning signal is issued when Run Enable signal has been removed from the IO.

*F63 Emergency stop (Not implemented)*

Possible cause:

1. A command has been given from a digital input or the fieldbus to make an emergency stop.

Correcting measures:

- New run command is accepted after the emergency stop is reset.

*F64 Input switch open (Not implemented)*

Possible cause:

1. Drive input switch is opened

Correcting measures:

- Check the main power switch of the drive.

*F65 Temperature sensor board 2 fault*

Temperature protection function is used to measure temperature and give warning and/or fault when set limits are exceeded. Advance application supports two temperature sensor boards simultaneously. One can be used for the motor winding and the other for the motor bearings.

**A1 – Temperature limit has been exceeded.**

**A2 – Sensor not wired or not working.**

**A3 – Short circuit.**

Possible cause:

2. Temperature limit values set for the temperature board parameters have been exceeded

Correcting measures:

- Find the cause of temperature rise
- Check sensor wiring

*F74 Follower fault*

When using the normal master follower function this fault code is given if one or more follower drives trip to fault.

# VAGON<sup>®</sup>

[www.danfoss.com](http://www.danfoss.com)

Vacon Ltd  
Member of the Danfoss Group

Runsorintie 7  
65380 Vaasa  
Finland

Document ID:



Rev. A