

VACON[®] NX

AC DRIVES

APF1FF20

CRANE CONTROL

APPLICATION MANUAL

VACON[®]

VACON CRANE CONTROL APPLICATION MANUAL

INDEX

Document code: DPD01974B
 Software code: APFIFF20V099
 Date: 31.7.2020

1. Crane Control Application - introduction	8
1.1 General	8
1.2 Basic Features	9
1.3 Crane Control Application Compatibility issues	9
2. Quick Commissioning for crane features	10
2.1 Mechanical Brake Control and Monitoring	10
2.2 Catch Dropping load	13
2.3 Tandem Operation for Cranes	13
2.4 Speed limit switch for Horizontal Movement	14
2.5 Anti-Sway	14
2.6 Speed Optimization (Power dependant speed control)	15
2.7 Bumpless transfer from closed loop to sensorless control	15
2.8 Shock Load Prevention	15
2.9 Slack Rope Prevention	16
2.10 Integrated functional safety	16
2.11 Load Estimation	16
3. Control I/O	17
4. "Terminal To Function" (TTF) programming principle	18
4.1 Defining an input/output for a certain function on keypad	18
4.2 Defining a terminal for a certain function with NCDrive programming tool	19
4.3 Defining unused inputs/outputs	20
5. Crane Control Application – monitoring values	21
5.1 Monitoring values	22
5.1.1 Monitoring values 1	22
5.1.2 Monitoring values 2	23
5.1.3 Fieldbus Monitoring values	24
5.1.4 Master/Follower Monitoring values	24
5.1.5 PI Control Monitoring values	24
5.1.6 Frequency Chain	25
5.1.7 Torque Chain	25
5.1.8 Brake Control	25
5.1.9 Motion	25
5.1.10 Shaft Synch	25
5.1.11 Functional Safety Monitoring	26
5.2 Monitoring Values description	27
5.2.1 Monitoring values	27
5.2.2 Monitoring values 2	29
5.2.3 FieldBus Monitoring values	33
5.2.4 Master / Follower	39
5.2.5 PI Control monitoring	42
5.2.6 Frequency Chain	42
5.2.7 Torque Chain	43
5.2.8 Brake Control	43
5.2.9 Motion	44

5.2.10	Tandem Operation (Shaft Synch).....	44
5.2.11	Functional Safety Monitoring.....	45
5.2.12	Counters.....	51
6.	Crane Control Application – Parameter lists.....	53
6.1	Basic parameters.....	53
6.2	Reference Handling.....	54
6.2.1	Basic Settings.....	54
6.2.2	Constant Reference.....	54
6.2.3	Torque Reference.....	55
6.2.4	Prohibit frequency parameters.....	56
6.2.5	Motor Potentiometer.....	56
6.2.6	Adjust Reference.....	56
6.2.7	End limits reference handling.....	57
6.3	Ramp Control.....	58
6.3.1	Basic Settings.....	58
6.3.2	Quick Stop.....	58
6.3.3	Ramp Control Options.....	58
6.3.4	Slack Rope and Shock Load functions.....	59
6.4	Input Signals.....	60
6.4.1	Basic Settings.....	60
6.4.2	Digital inputs.....	61
6.4.3	Analogue input 1.....	62
6.4.4	Analogue input 2.....	62
6.4.5	Analogue input 3.....	63
6.4.6	Analogue input 4.....	63
6.4.7	Options.....	63
6.5	Output Signals.....	64
6.5.1	Digital output signals.....	64
6.5.2	Analogue output 1.....	65
6.5.3	Analogue output 2.....	65
6.5.4	Analogue output 3.....	66
6.5.5	Analogue output 4.....	66
6.5.6	Delayed digital output 1.....	67
6.5.7	Delayed digital output 2.....	67
6.5.8	Supervision Limits.....	68
6.6	Limit Settings.....	69
6.6.1	Current handling.....	69
6.6.2	Torque Handling.....	69
6.6.3	Frequency Handling.....	70
6.6.4	DC-Link Handling.....	71
6.6.5	Limit Settings Options.....	71
6.7	Flux and DC Current handling.....	72
6.7.1	Flux and DC Current handling OL Settings.....	72
6.7.2	Flux and DC Current handling CL Settings.....	72
6.8	Motor Control.....	73
6.8.1	Motor Control Basic Settings.....	73
6.8.2	Open Loop Settings.....	73
6.8.3	Closed Loop Control Settings.....	74
6.8.4	PMSM Control settings.....	75
6.8.5	Stabilators.....	76
6.8.6	Tuning parameters.....	76
6.8.7	Identification parameters.....	77
6.8.8	Fine tuning parameters.....	78
6.8.9	AOL Control Tuning parameters.....	78
6.9	Speed Control.....	79
6.9.1	Speed Control Basic settings.....	79

6.9.2	Speed Control OL Settings	79
6.9.3	Speed Control CL Settings.....	79
6.10	Drive Control.....	79
6.11	Master Follower Control Parameters.....	80
6.12	Protections.....	82
6.12.1	General settings.....	82
6.12.2	Temperature sensor protections	82
6.12.3	Stall Protection	83
6.12.4	Speed error monitoring.....	83
6.12.5	Motor thermal protections.....	83
6.12.6	Living Zero monitoring	84
6.12.7	Underload protection.....	84
6.12.8	Earth Fault protection	84
6.12.9	Cooling protection	84
6.12.10	Fieldbus protection	85
6.12.11	External Fault.....	85
6.12.12	Encoder Fault.....	85
6.12.1	Options.....	85
6.13	Fieldbus parameters.....	85
6.13.1	Value Control.....	88
6.13.2	DIN ID Control 1	88
6.13.3	DIN ID Control 2.....	88
6.13.4	DIN ID Control 3.....	88
6.13.5	ID Controlled Digital Output 1	89
6.13.6	ID Controlled Digital Output 2	89
6.13.7	Free DIN Delay.....	89
6.14	Brake Control Parameters.....	90
6.14.1	Brake Control Start up torque for CL.....	90
6.14.2	Roll Back Control for CL.....	90
6.14.3	Brake Fault handling	91
6.14.4	Functions.....	91
6.14.5	Brake Test Function	91
6.15	Auto Reset parameters.....	92
6.16	PI Control Parameters	92
6.17	Shaft Synchronization.....	93
6.18	Load Estimation.....	93
6.19	Functional Safety.....	93
6.20	Anti-Swing Function	94
6.21	Keypad control (Control keypad: Menu M3)	95
6.22	System menu (Control keypad: Menu M6).....	95
6.23	Expander boards (Control keypad: Menu M7).....	95
7.	Description of parameters	96
7.1	Basic Parameters.....	96
7.2	Reference Handling – “Ref Handling”.....	106
7.2.1	Basic Parameters.....	107
7.2.2	Constant Reference.....	110
7.2.3	Torque Reference.....	112
7.2.4	Prohibited frequencies.....	118
7.2.5	Motor potentiometer.....	119
7.2.6	Adjust Reference.....	121
7.2.1	Speed limits reference handling for horizontal movement	123
7.3	Ramp control	125
7.3.1	Ramp Options	129
7.3.2	Slack Rope and Shock Load.....	131
7.4	Input signals.....	132
7.4.1	Basic Settings	132

7.4.2	Digital inputs	134
7.4.3	Analogue Input 1 & 2	140
7.4.4	Analogue input 3 & 4	145
7.4.5	Inversion control	148
7.5	Output signals	149
7.5.1	Digital output signals	149
7.5.2	Analogue outputs 1 & 2 & 3 & 4	154
7.5.3	Delayed Digital Output 1 & 2	158
7.5.4	Supervision limits	161
7.6	Limit settings	163
7.6.1	Current limit handling	163
7.6.2	Torque limit handling	164
7.6.3	Frequency limit handling	167
7.6.4	DC Link handling	169
7.6.5	Limit options	172
7.7	DC current and magnetization handling	173
7.7.1	Open loop settings	174
7.7.2	Closed loop settings	177
7.8	Motor Control	179
7.8.1	Open Loop Settings	184
7.8.2	Close Loop Settings	188
7.8.3	Permanent magnet synchronous motor settings	191
7.8.4	Stabilization settings	197
7.8.5	Tuning settings	200
7.8.6	Identification settings	202
7.8.7	AOL control for IM	204
7.9	Speed Control settings	205
7.10	Drive Control	211
7.11	Master-Follower	214
7.11.1	Master-Follower: Standard system	214
7.11.2	Master Follower: DriveSynch system	215
7.11.3	Master-Follower configuration	218
7.12	Protections	223
7.12.1	General settings	223
7.12.2	Temperature sensor protections	224
7.12.3	Stall protection	226
7.12.4	Speed Error	228
7.12.5	Motor Protection	229
7.12.6	Over Load Protection	232
7.12.7	4mA Protection	233
7.12.8	Underload protection	234
7.12.9	Earth Fault	236
7.12.10	Cooling protection	236
7.12.11	Fieldbus communication	237
7.12.12	External Fault function	237
7.12.13	Encoder Fault function	238
7.13	Fieldbus settings	240
7.13.1	General settings	240
7.14	ID Functions	244
7.14.1	Value Control	244
7.14.2	DIN ID Control	246
7.14.3	ID-controlled DO	247
7.14.4	Free DIN Delay	248
7.15	Brake Control	249
7.15.1	Brake time control timing in closed loop	250
7.15.2	Brake control timing in open loop	251
7.15.3	Start Up torque	254

7.15.4	Roll Back Control for Closed Loop	255
7.15.5	Brake monitoring function	256
7.15.6	Functions	258
7.15.7	Brake Test Function	258
7.16	Auto Fault Reset.....	259
7.17	PI Control.....	262
7.18	Tandem operation.....	264
7.19	Load Estimation.....	265
7.20	Functional Safety.....	266
7.21	Anti-Swing Function	267
7.22	Keypad control parameters	270
8.	Identification function for permanent magnet synchronous motor	271
8.1	Identification with absolute encoder.	271
8.2	Identification with incremental encoder without Z-pulse input	271
8.3	Identification with incremental encoder with Z-pulse input.....	272
9.	Status and control word in detail	273
9.1	Fieldbus	273
9.1.1	Combination 1, ProfiDrive – Standard with Profibus option board.....	274
9.1.2	Combination 2, ByPass – ProfiDrive	275
9.1.3	Combination 3, ByPass – Standard.....	282
9.2	Application Status Word	283
9.3	Regulator Status.....	283
9.4	Data Logger Trigger Word.....	284
9.5	MC Status Word	284
9.6	Brake Control Status.....	285
10.	Problem solving	287
11.	Fault codes.....	288

1. CRANE CONTROL APPLICATION - INTRODUCTION

Software APFIFF20, Crane Control application

Crane Control application is designed for use in crane systems.

1.1 General

This application is not backwards compatible. Please read the application change note or chapter 2: Brake Control versions compatibility issues in this manual to see what needs to be noted when updating the application. See also the updated parameter description in NCDrive when commissioning.

Help is available in NCDrive through selecting “Variable Text” and pressing “F1”. See below an example from the Identification parameter help text from the NCDrive.

Index	Variable Text	Value	Unit	Min	Max	ID
P 2.1.1	Supply Voltage	690	V	0	1000	1201
P 2.1.2	Motor Nom Voltg	550	V	20	690	110
P 2.1.3	Motor Nom Freq	80.00	Hz	6.00	320.00	111
P 2.1.4	Motor Nom Speed	4800	rpm	24	20000	112
P 2.1.5	Motor Nom Currnt	2060	A	0	4120	113
P 2.1.6	Motor Cos Phi	0.85		0.30	1.00	120
P 2.1.7	Motor Nom Power	1890	kW	0	32700	116
P 2.1.8	MagnCurrent	0	A	0	4120	612
P 2.1.9	Identification	0 / No Action		0	5	631
P 2.1.10	Motor T.type	1 / PMSM		0	1	650

NCDrive ☒

Identification

0 = No Action - No action
No identification requested.

1 = ID No Run - Identification without rotating the motor
Current is applied to the motor but shaft will not be rotated. U/f settings are identified.

2 = ID With Run - Identification with motor rotating
Shaft is rotated during identification. U/f settings are identified and magnetization current.

3 = Enc. ID Run - Encoder identification run
Shaft is rotated during identification.
IM: If performed for induction motor encoder pulse number and direction is identified.
PMSM: This selection is used for PMS motor if automatic angle identification is not suitable for used motor.
This identification run will update PMSM Shaft Position parameter based on absolute position of the encoder or Z pulse position of encoder.

4 = Ident All - Identified All
Shaft is rotated during identification. All above identification possibilities are made in sequence.

5 = ID Run Fails - Identification failed
Identification has been failed

OK

1.2 Basic Features

The Crane Control application provides a wide range of parameters for controlling induction motors and permanent magnet motors. It can be used for various kinds of different processes where wide flexibility of I/O signals is needed and only simple PI control logic.

Flexible ID control possibilities takes the application suitability to different processes to a new level, allowing any input or actual value to be connected to any parameter with a scaling factor.

Additional functions:

- Joystick input dead zone
- Master-Follower function
- Cooling monitor input from heat exchange unit with selectable response
- Brake monitoring input and actual current monitor for immediate brake close
- Separate speed control tuning for different speeds and loads
- Inching function with two different references
- Possibility to connect FB Process data to any parameter and some monitoring values
- Analogue input 3 and 4 can control any parameter by ID number
- Support for four analogue outputs
- Support for two PT100 boards
- Roll-Back control and Torque memory
- Brake slipping monitor (Start to falling load)

1.3 Crane Control Application Compatibility issues

2. QUICK COMMISSIONING FOR CRANE FEATURES

2.1 Mechanical Brake Control and Monitoring

The Mechanical Brake Control function in drive supports to build-up torque smoothly against the closed brake before releasing the mechanical brake for smooth startup, and drive will continue to deliver torque until mechanical brake control takes over the command.

Mechanical brake control parameters are in the group **G 2.15.x**.

See chapter 8.15 Brake Control for more details on parameters and their behaviour.

Easy commissioning tips for Mechanical Brake Control:

The application software makes calculations for parameter setting during the identification run based on motor nominal parameters, brake mechanical opening delay (P2.15.3) and brake mechanical closing delay (P2.15.4).

1. Enter motor name plate value G2.1 Basic Parameters.
 - a. Enter motor magnetization current P2.1.8 if known (calculated from Cos Phi if not given).
2. Make identification run in standstill with P2.1.9 Identification: selection 1 - ID No Run.
 - a. If magnetization current is not known, arrange so that Identification selection 6 - U/f + magn ID run can be made.
3. After identification, upload the parameters from the drive.
4. Brake related parameters are gathered to G2.15.
 - a. Select output for controlling the brake P2.15.1 BrakeOpen, Direct.
 - b. Select feedback input if used: P2.15.2 Brake Feedback.
 - c. Enter brake mechanical time delay for opening the brake: P2.15.3.
 - d. Enter brake mechanical time delay for closing the brake: P2.15.4.
 - e. Depending on system, Brake Timing identification run can be made.
5. Make necessary parameter changes to control place and control signal.
6. Make Crane ID Run for hoisting P2.1.11 Crane Identification modes.
 - a. If mode accurate timings for brake are found during commissioning, it is recommended to make Crane Identification again. See detailed list of modified parameters from P2.1.11 explanation.
7. Make Open Loop run without load with monitoring signals below.
 - a. Use ~7 ms monitoring interval if possible (see chapter 10 Problem Solving).
 - Value: BrakeStatusWord
 - Value: Motor Torque
 - Value: Motor Current
 - Value: Freq.Ramp Out
 - Value: Output Frequency
 - Value: Shaft Frequency
 - Value: Motor Voltage
 - Value: DC Voltage
 - b. Monitor that Shaft Frequency from encoder is correct.
In some cases, filtering a few ms may be needed: P2.8.5.6.
 - c. See that current and torque do not show abnormal behaviour.
8. Change to Closed Loop Control P2.8.1 Motor Control Mode: 3 / CL Speed Control.

Easy commissioning tips for Mechanical Brake Control:

The application software makes calculations for parameter setting during the identification run based on motor nominal parameters, brake mechanical opening delay (P2.15.3) and brake mechanical closing delay (P2.15.4).

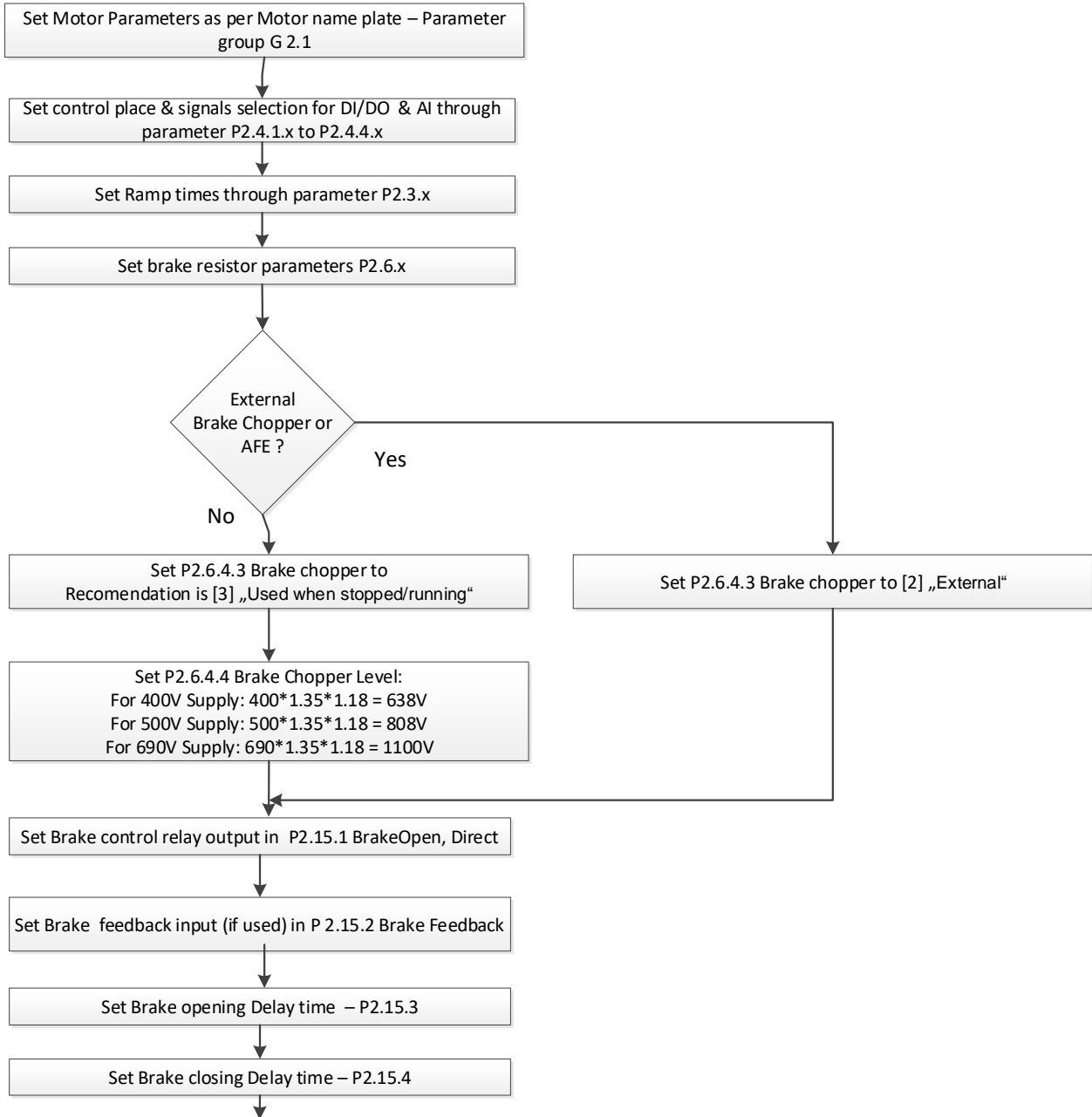

Continue....

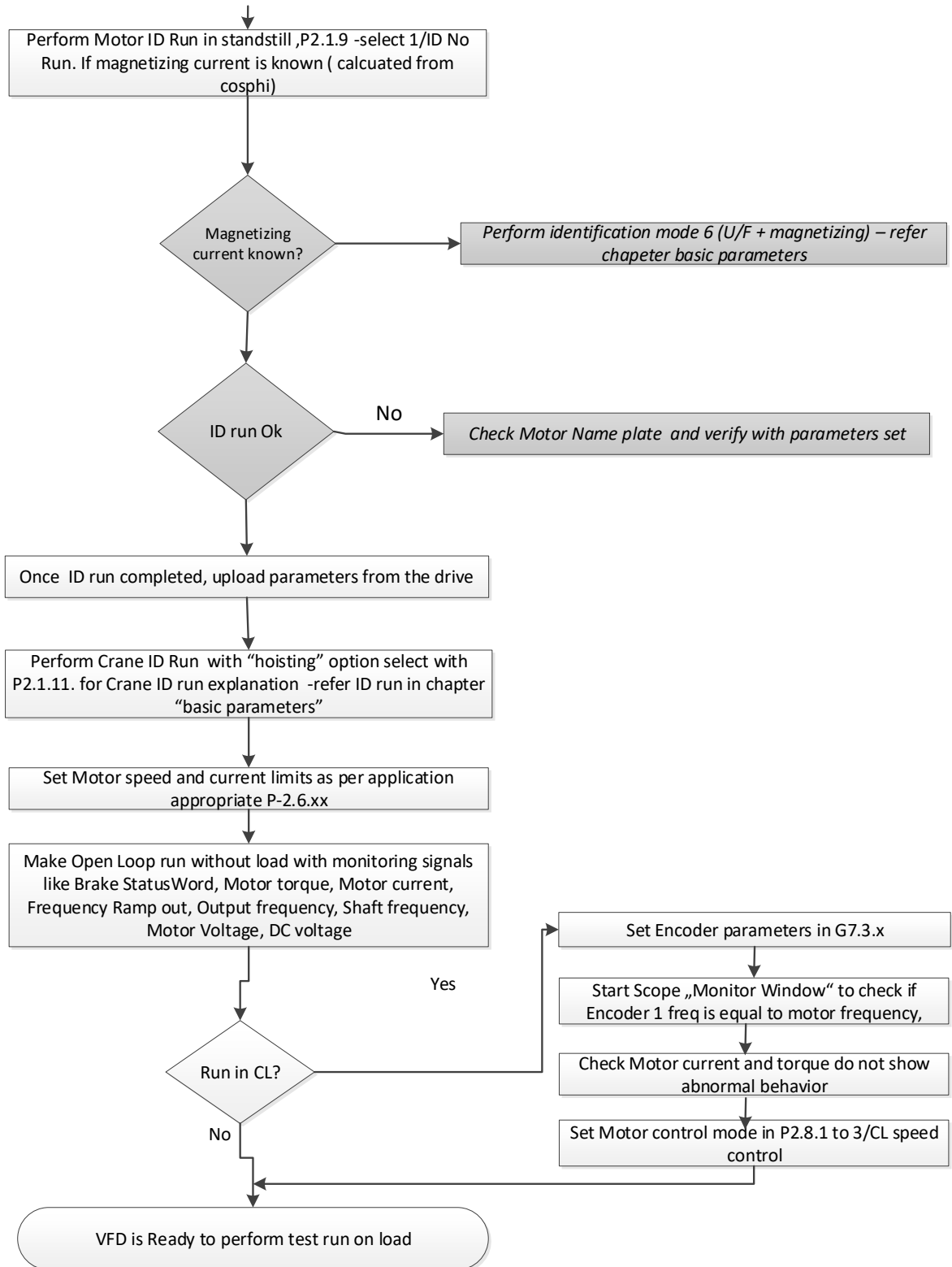

➤ Roll Back Control for CL

Roll Back function prevents downwards movement of the load when brake is opening and giving smooth lifting at start. Parameters available in group **G2.15.12.x**

2.2 Catch Dropping load

When Drive is in standby mode (No start command given) and if Mech. Brake failed, VFD will detect and take over automatically, takes over (starts) and bring the load down to the ground in controlled way. (Operator can only give down command, forced

lowering, no hoist will be allowed.

This function required closed loop operation.

This function can activate in parameter **P2.15.13.5**

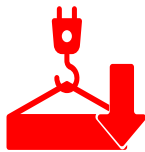

2.3 Tandem Operation for Cranes

➤ Master-Follower (Speed-Torque sharing)

Master-Follower (Speed-Torque sharing) function is mainly used when motor shafts are coupled to each other for running a common load. In this case, the master will be in speed control mode and the follower will be in torque control mode.

The external control signals are connected to the master NXP only. The master controls the follower(s) via a system bus. The master station is typically speed-controlled, and the other drives follow its torque reference.

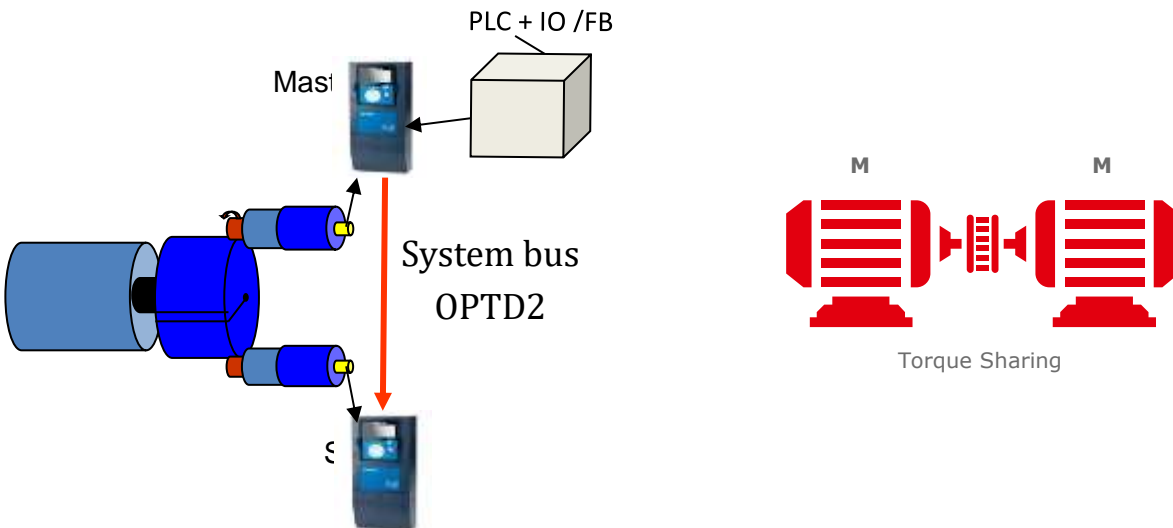

Master-Follower parameters are in group **G 2.11.x** in **chapter 6.11**

➤ Tandem Hoist (Shaft Sync)

Tandem Hoist function is used to lift higher capacity load with synchronizing of two axes at the same time OR more than 01 lifting gear to be connected.

Tandem operation helps to monitor and control the position difference of the hooks and synchronize the movement of each axes.

Shaft synchronization works between master-slave axes through system bus with crane application software.

Maximum **four** axes can be synchronized.

Tandem operation communication is enabled with Master-Follower mode P2.11.1 (selection 3 and 4). See chapter 7.11 Master-Follower.

Tandem operation (Shaft Sync) parameters are in group **G 2.11.x** and **G2.18.x** in chapter 7.11 and chapter 8.18.

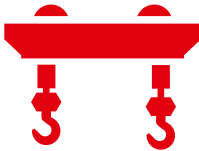

2.4 Speed limit switch for Horizontal Movement

Speed limit switch function help to limit speed for horizontal movement when trolley or travel motion moving towards end direction. External sensors for forward and reverse direction will connect to Digital inputs of VFD. Forward and reverse speed can be set independently. Parameters are in group **G 2.2.12.x**

2.5 Anti-Sway

Typically, overhead cranes are used in manufacturing or maintenance processes where productivity and safety are considered the most important requirements. Swinging of the load during the crane's movement is a natural phenomenon as load is suspended from a gripping device by cables and acts as a pendulum device.

NXP offers an integrated sensorless Anti-Sway control, where there is no need for encoders or communication with a hoist drive. The Anti-Sway feature is to be used in trolley and travel motion only.

The Anti-Sway function is license protected. Users need to buy a license key from a Danfoss supplier to make the Anti-Sway function effective. License key status can be checked and verified in monitoring parameter **V1.31.2**.

To eliminate sway, two different methods are available in Crane application software. User needs to set either Average Swinging Period or Maximum Rope length.

How to calculate swinging period

- Lower the hook to the lowest practical position. There is no need to connect load on the hook.
- Run the crane with full speed and give stop command.
- Measure the duration of 5–10 swings (back and forth) and calculate the swinging period.
- Enter the swinging period into parameters.

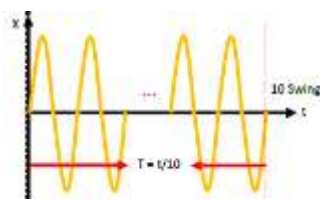

Anti-Sway parameters are in group 2.21.x. Refer to group 2.21.x for different modes for Anti-Sway with swinging period method.

Rope Length

Maximum rope length (in cm), to be entered in P 2.21.4. From drum to hook touch down to the ground or just above.



NOTE: If swinging period method is to be used, then Rope Length parameter is to be kept “ZERO”. If the value for Rope Length is other than zero, then the swinging period method will not work. With Rope Length method, only “Mode 1” will work effectively.

Anti-Sway parameters are in group **P2.21.x**. See chapter 6.20 and chapter 7.21 for more details.

2.6 Speed Optimization (Power dependant speed control)

Speed optimizing function limits speed directly to requested power(kW) level. There are different settings for forward limit speed and reverse limit speed. This function can activate in parameters **G2.6.3.7** and **G2.6.3.8**.

2.7 Bumpless transfer from closed loop to sensorless control

For closed loop operation, in case of encoder failure, VFD will switch to sensorless mode with last speed recorded before encoder failure and display “Encoder loss warning”. It will be Bump less transfer because customer will not see any jerk, speed variation during changeover from closed loop to sensorless mode and allow them to run in sensorless mode without any interruption in process. It is Customer responsibility to take safety of crane movement in account while running in sensorless mode.

This function can activate in parameter **P2.12.12.1**.

2.8 Shock Load Prevention

Shock Load function enables smooth load pick-up until the load is lifted to air. This protects the crane from extra stress caused by sudden load change detected by hoist drum and rope at higher speed.

With Shock Load Prevention, the hoist drive monitors the load. If it is lifted too fast, the hoisting speed will reduce with predefined “*Shock load ref*” until “*Shock load time*” has elapsed.

Shock Load and Slack Rope parameters are in group **P2.13.14.x**. See chapter 6.3.4 and chapter 7.3.2 for more details.

2.9 Slack Rope Prevention

When the load or hook is approaching the ground, it will generate slack at the rope, which could damage the rope. The rope could also jump out of the rope guides when the load or hook touches the ground at high speed.

Slack Rope protection mode can be activated through parameter **P2.3.14.1**. While lowering the hook load, drive will activate “*Zero speed Reference*” when actual torque drops below the “*Load off the hook*”.

2.10 Integrated functional safety

To activate integrated functional safety features in compliance with SIL3/“Ple”, an advanced safety option board is required to be installed in C or D slot. There are three types of safety option boards available (OPTBL, OPTBM and OPTBN), and they can be selected according to application requirements. See VACON® Advanced Functional Safety Operating Guide for more details.

Crane application supports Stop Function (STO, SQS, SS1 and SS2) and Speed Limit Function (SLS, SSR and SDI). Functional safety parameters can be activated in parameter group **P2.20.x**. See chapter 6.19 and chapter 7.20 for more details.

2.11 Load Estimation

Hoist drive will estimate load on the hook to protect the crane against overload mode. This means that when the drive detects overload it gives an alarm and stops the crane.

To calculate actual load, hoist mechanical parameters are required to be set in group **P2.19.x**.

It is important to know that actual load measurement is based on hoist mechanical parameters. Therefore if the values have not been correctly entered, the drive will not show an accurate value.

See chapter 6.18 and chapter 7.19 for more details.

3. CONTROL I/O

NXOPTA1			
Terminal	Signal	Description	
1	+10V _{ref}	Reference voltage output	Voltage for potentiometer, etc.
2	AI1+	Analogue input 1. Range 0-10V, R _i = 200Ω Range 0-20 mA R _i = 250Ω	Analogue input 1 frequency reference. Input range selected by jumpers. Default range: Voltage 0 – 10 V
3	AI1-	I/O Ground	Ground for reference and controls
4	AI2+	Analogue input 2. Range 0-10V, R _i = 200Ω Range 0-20 mA R _i = 250Ω	Analogue input 2 frequency reference Input range selected by jumpers. Default range: Current 0 – 20 mA
5	AI2-		
6	+24V	Control voltage output	Voltage for switches, etc. max 0.1 A
7	GND	I/O ground	Ground for reference and controls
8	DIN1	Programmable G2.2.7	No function defined at default
9	DIN2	Programmable G2.2.7	No function defined at default
10	DIN3	Programmable G2.2.7	No function defined at default
11	CMA	Common for DIN 1—DIN 3	Connect to GND or +24V
12	+24V	Control voltage output	Voltage for switches (see #6)
13	GND	I/O ground	Ground for reference and controls
14	DIN4	Programmable G2.2.7	No function defined at default
15	DIN5	Programmable G2.2.7	No function defined at default
16	DIN6	Programmable G2.2.7	No function defined at default
17	CMB	Common for DIN4—DIN6	Connect to GND or +24V
18	AOA1+	Analogue output 1 Programmable P2.3.1.2	Output range selected by jumpers. Range 0—20 mA. R _L , max. 500Ω Range 0—10 V. R _L > 1kΩ
19	AOA1-		
20	DOA1	Digital output	Programmable Open collector, I _s ≤50mA, U _s ≤48 VDC
NXOPTA2			
21	RO1	Relay output 1 Programmable G2.3.3	Switching capacity 24 VCD / 8 A 250 VAC / 8 A 125 VDC / 0.4 A
22	RO1		
23	RO1		
24	RO2	RELAY OUTPUT 2 Programmable G2.3.3	Programmable No function defined at default
25	RO2		
26	RO2		

Table 3-1. Brake Control application default I/O configuration and connection example.

Note: See User Manual, chapter Control Connections, for hardware specification and configuration.

Note: See jumper selections below. More information in VACON® NX User Manual.

Jumper block X3: CMA and CMB grounding

- CMB connected to GND
CMA connected to GND
- CMB isolated from GND
CMA isolated from GND
- CMB and CMA internally connected together, isolated from GND

= Factory default

4. “TERMINAL TO FUNCTION” (TTF) PROGRAMMING PRINCIPLE

The programming principle of the input and output signals in the **Multipurpose Control Application NXP** as well as in the **Pump and Fan Control Application** (and partly in the other applications) is different compared to the conventional method used in other VACON® NX applications.

In the conventional programming method, *Function to Terminal Programming Method (FTT)*, you have a fixed input or output that you define a certain function for. The applications mentioned above, however, use the *Terminal to Function Programming method (TTF)* in which the programming process is carried out the other way round: Functions appear as parameters which the operator defines a certain input/output for. See *Warning* on page 19.

4.1 Defining an input/output for a certain function on keypad

Connecting a certain input or output with a certain function (parameter) is done by giving the parameter an appropriate value. The value is formed of the *Board slot* on the VACON® NX control board (see VACON® NX User Manual) and the *respective signal number*, see below.

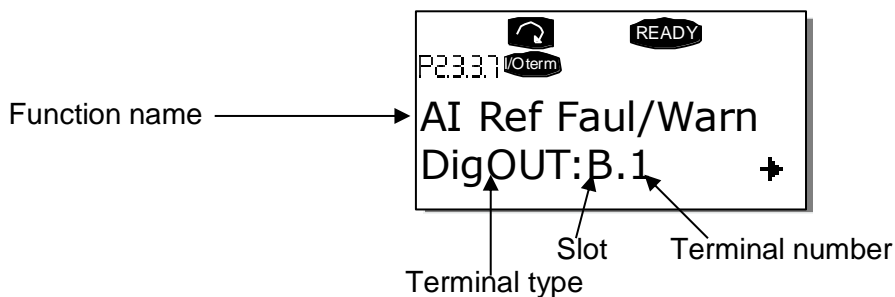

Example: You want to connect the digital output function *Reference fault/warning* (parameter 2.3.3.7) to the digital output DO1 on the basic board NXOPTA1 (see VACON® NX User Manual).

First find the parameter 2.3.3.7 on the keypad. Press the *Menu button right* once to enter the edit mode. On the *value line*, you will see the terminal type on the left (DigIN, DigOUT, An.IN, An.OUT) and on the right, the present input/output the function is connected to (B.3, A.2 etc.), or if not connected, a value (0.#).

When the value is blinking, hold down the *Browser button up* or *down* to find the desired board slot and signal number. The program will scroll the board slots starting from **0** and proceeding from **A** to **E** and the I/O selection from **1** to **10**.

Once you have set the desired value, press the *Enter button* once to confirm the change.

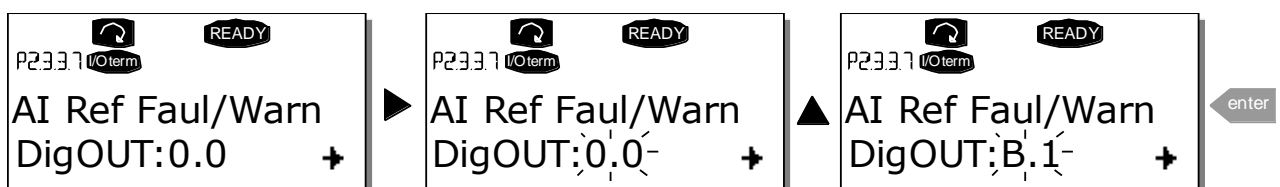

4.2 Defining a terminal for a certain function with NCDrive programming tool

If you use the NCDrive Programming Tool for parametrizing you will have to establish the connection between the function and input/output in the same way as with the control panel. Just pick the address code from the drop-down menu in the *Value* column (see the Figure below).

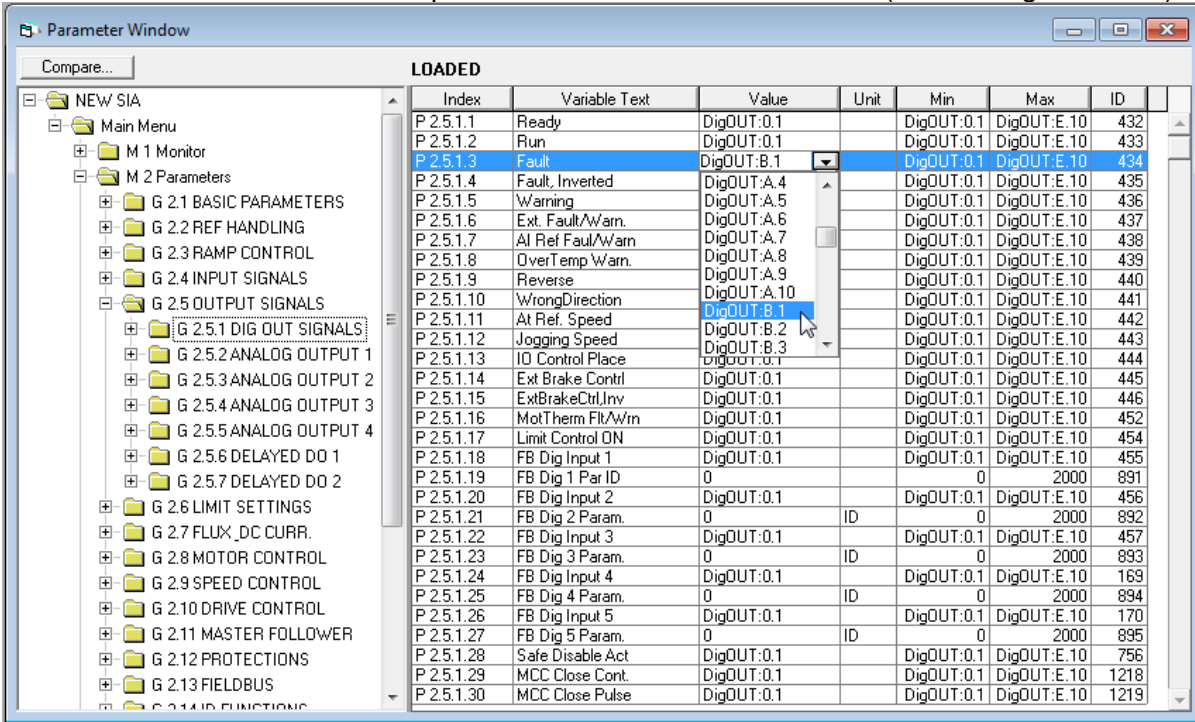

Figure 4-1. Screenshot of NCDrive programming tool; Entering the address code



Be ABSOLUTELY sure not to connect two functions to one and same output in order to avoid function overruns and to ensure flawless operation.

Note: The *inputs*, unlike the *outputs*, cannot be changed in RUN state.

4.3 Defining unused inputs/outputs



All unused inputs and outputs must be given the board slot value **0** and the terminal number value **1**. The value **0.1** is also the default value for most of the functions. However, if you want to use the **values of a digital input signal** for e.g. testing purposes only, you can set the board slot value to **0** and the terminal number to any number between 2...10 to place the input to a TRUE state. In other words, the value 1 corresponds to 'open contact' and values 2 to 10 to 'closed contact'.

In case of analogue inputs, giving the value **1** for the terminal number corresponds to 0% signal level, value **2** corresponds to 20%, value **3** to 30% and so on. Giving value **10** for the terminal number corresponds to 100% signal level.

5. CRANE CONTROL APPLICATION – MONITORING VALUES

On the next pages you will find the lists of parameters within the respective parameter groups. The parameter descriptions are given on pages 96 to 259. The parameter description includes more than is available in this application, see parameter list for parameters that are available in this application.

Column explanations:

Code	= Location indication on the keypad; Shows the operator the present parameter number
Parameter	= Name of parameter
Min	= Minimum value of parameter
Max	= Maximum value of parameter
Unit	= Unit of parameter value; given if available
Default	= Value preset by factory
Cust	= Customer's own setting
ID	= ID number of the parameter
	= On parameter code: Parameter value can only be changed after the FC has been stopped.
	= Apply the Terminal to Function method (TTF) to these parameters (see chapter 4)
	= Monitoring value is possible to control from fieldbus by ID number

The manual presents signals that are not normally visible for monitoring. i.e. is not a parameter or standard monitoring signal. These signals are presented with [Letter]. e.g. [FW]MotorRegulatorStatus

[V]	Normal monitoring signal
[P]	Normal parameter in application
[FW]	Firmware signal, Can be monitored with NCDrive when signal type is selected Firmware
[A]	Application signal, can be monitored with NCDrive when signal type is selected Application
[R]	Reference type parameter on keypad
[F]	Function. Signal is received as a output of function.
[DI]	Digital input signal

5.1 Monitoring values

The monitoring values are the actual values of parameters and signals as well as statuses and measurements.

5.1.1 Monitoring values 1

Code	Parameter	Unit	Form.	ID	Description
V1.1	Output frequency	Hz	###	1	Output frequency to motor
V1.2	Frequency reference	Hz	###	25	Frequency reference to motor control
V1.3	Motor speed	rpm	#	2	Motor speed in rpm
V1.4	Motor current	A	Varies	3	1 s linear filtering
V1.5	Motor torque	%	#, #	4	In % of Motor nominal torque
V1.6	Motor Power	%	#, #	5	
V1.7	Motor voltage	V	#, #	6	Calculated motor voltage
V1.8	DC link voltage	V	#	7	Measured DC voltage, filtered.
V1.9	Unit temperature	°C	#	8	Heatsink temperature
V1.10	Motor temperature	%	#	9	Calculated motor temperature
V1.11	Analogue input 1	%	###	13	AI1, unfiltered.
V1.12	Analogue input 2	%	###	14	AI2, unfiltered.
V1.13	Analogue input 3	%	###	27	AI3, unfiltered.
V1.14	Analogue input 4	%	###	28	AI4, unfiltered.
V1.15	Analogue Out 1	%	###	26	AO1
V1.16	Analogue Out 2	%	###	50	AO2
V1.17	Analogue Out 3	%	###	51	AO3
V1.18	Analogue Out 4	%	###	1526	
V1.19	DIN1, DIN2, DIN3			15	Digital input statuses
V1.20	DIN4, DIN5, DIN6			16	Digital input statuses
V1.21	Torque reference	%	#, #	18	Used Torque Reference
V1.22	PT-100 Temperature	C°	#, #	42	Highest temperature of OPTB8 board. 4 s filtering.
G1.23	Multimonitoring items				Displays three selectable monitoring values

Table 5-1. Monitoring values

5.1.2 Monitoring values 2

Code	Parameter	Unit	Form.	ID	Description
V1.24.1	Current	A	Varies	1113	Unfiltered motor current
V1.24.2	Torque	%	#, #	1125	Unfiltered motor torque
V1.24.3	DC Voltage	V	#	44	Unfiltered DC link voltage
V1.24.4	Status Word 1 (Application)			43	
V1.24.5	Encoder 1 Frequency	Hz	#, ##	1124	Unfiltered
V1.24.6	Output Power	kw	Varies	1508	Unfiltered electrical power
V1.24.7	Measured temperature 1	C°	#, #	50	4 s filtering.
V1.24.8	Measured temperature 2	C°	#, #	51	4 s filtering.
V1.24.9	Measured temperature 3	C°	#, #	52	4 s filtering.
V1.24.10	Measured temperature 4	C°	#, #	69	4 s filtering.
V1.24.11	Measured temperature 5	C°	#, #	70	4 s filtering.
V1.24.12	Measured temperature 6	C°	#, #	71	4 s filtering.
V1.24.13	ABS Encoder Revolutions	r	#	55	
V1.24.14	ABS Encoder Position		#	54	
V1.24.15	Step response	Hz	#, ##	1132	
V1.24.16	CosPhiActual		#, ###	68	
V1.24.17	Flux Current	%	#, #	72	
V1.24.18	Regulator Status			77	
V1.24.19	Frequency Delta			1847	
V1.24.20	Rotor Flux	%	#, #	1158	
V1.24.21	DataLogger Trigger Word			97	
V1.24.22	Ident Failure Code			98	
V1.24.23	Non Ready Causes			1608	
V1.24.24	Prevent MC Ready			1609	

Table 5-2. Monitoring values 2

5.1.3 Fieldbus Monitoring values

Code	Parameter	Unit	Form.	ID	Description
V1.25.1	FB Control Word			1160	
V1.25.2	FB Speed Reference			875	
V1.25.3	FB Status Word			65	
V1.25.4	FB Actual Speed			865	
V1.25.5	FB Torque Reference	%	#, #	1140	Default Control of FB PD 1
V1.25.6	FB Limit Scaling	%	#, #, #	46	Default Control of FB PD 2
V1.25.7	FB Adjust Reference	%	#, #, #	47	Default Control of FB PD 3
V1.25.8	FB Analog Output	%	#, #, #	48	Default Control of FB PD 4
V1.25.9	FB Motor Current	A	#, #	45	Motor current (drive independent) given with one decimal point
V1.25.10	Fault Word 1			1172	
V1.25.11	Fault Word 2			1173	
V1.25.12	Warning Word 1			1174	
V1.25.13	AuxStatusWord			1163	
V1.25.14	Last Active Fault			37	
V1.25.15	AuxControlWord			1161	
V1.25.16	Din Status Word			56	
V1.25.17	Din Status Word 2			57	
V1.25.18	MC Status			64	
V1.25.19	Last Active Warning			74	
V1.25.20	Encoder Rounds			1170	
V1.25.21	Encoder Angle			1169	
V1.25.22	Fault Word 10			1202	
V1.25.23	Warning Word 10			1269	

Table 5-3. Fieldbus Monitoring values

5.1.4 Master/Follower Monitoring values

Code	Parameter	Unit	Form.	ID	Description
V1.26.1	SB System Status			1601	
V1.26.2	Total Current	A	#, #	80	Sum current of all drives (DS)
V1.26.3	Master Control Word			93	
Code	Parameter	Unit	ID	Description	
V1.26.4.1	Motor Current D1	A		1616	
V1.26.4.2	Motor Current D2	A		1605	
V1.26.4.3	Motor Current D3	A		1606	
V1.26.4.4	Motor Current D4	A		1607	
Code	Parameter	Unit	ID	Description	
V1.26.4.1	Status Word D1			1615	
V1.26.4.2	Status Word D2			1602	
V1.26.4.3	Status Word D3			1603	
V1.26.4.4	Status Word D4			1604	

Table 5-4. Master/Follower Monitoring values

5.1.5 PI Control Monitoring values

Code	Parameter	Unit	Form.	ID	Description
V1.27.1	PI Reference			20	Used PI Reference
V1.27.2	PI Actual Value			21	PI Actual value
V1.27.3	PI Output			23	PI Output before scaling
V1.27.4	PI Output Scaled			1807	Scaled PI Output This is used for ID connection

5.1.6 Frequency Chain

Code	Parameter	Unit	Form.	ID	Description
V1.28.1	Frequency Reference 1	Hz		1126	
V1.28.2	Frequency Reference 2	Hz		1127	
V1.28.3	Frequency reference	Hz	###	25	Frequency reference to motor control
V1.28.4	Frequency Reference Actual	Hz		1128	
V1.28.5	Frequency Ramp Out	Hz		1129	
V1.28.6	Frequency Reference Final	Hz		1131	
V1.28.7	Encoder Frequency	Hz		1164	

5.1.7 Torque Chain

Code	Parameter	Unit	Form.	ID	Description
V1.29.1	Torque Reference	%		18	
V1.29.2	Torque Reference 3	%		1144	
V1.29.3	Torque Ref Final	%		1145	
V1.29.4	Speed Control Out	%		1134	
V1.29.5	Torque Reference Actual	%		1180	Final torque reference from speed control and/or torque control

5.1.8 Brake Control

Code	Parameter	Unit	Form.	ID	Description
V1.30.1	Brake Status Word			89	
V1.30.2	Load Estimation	kg	#	1914	
V1.30.3	Load Estimation 100	kg	###	1913	
V1.30.4	RopeLengthInUse	cm	#	1915	

5.1.9 Motion

Code	Parameter	Unit	Form.	ID	Description
V1.31.1	Serial Number Key				
V1.31.2	License Status				

5.1.10 Shaft Synch

Code	Parameter	Unit	Form.	ID	Description
V1.32.1	Master Rotations			1820	
V1.32.2	Own Rotations			1821	
V1.32.3	Control Out			1822	
V1.32.4	Rotation Error			1823	
V1.32.5	Position Ref			1825	

5.1.11 *Functional Safety Monitoring*

Code	Signal	Unit	ID	Description
V1.33.1	Safety App Status		1653	
V1.33.2	Integrity Level		1640	
V1.33.3	Acknowledge Mode		1641	
V1.33.4	Safety Encoder Speed	rpm	1642	
V1.33.5	Ramp Selection		1643	
V1.33.6	Function Reached		1644	
V1.33.7	Request DIN		1645	
V1.33.8	Request PLC		1646	
V1.33.9	Function In Use		1647	
V1.33.10	Safety Status Word		1648	
V1.33.11	Safety General Status Word		1649	
V1.33.12	Safety Status		1650	
V1.33.13	Safety Zero Speed		1651	
V1.33.14	SBC Speed	rpm	1652	

5.2 Monitoring Values description

5.2.1 Monitoring values

V1.1 Output frequency [# ,## Hz] **ID1**
Output frequency to motor, updated at 10 ms time level.

V1.2 Frequency reference [# ,## Hz] **ID 25**
Frequency reference to motor control, after speed share function, updated at 1 ms time level.

V1.3 Motor speed [# rpm] **ID 2**
Motor speed in rpm

V1.4 Motor current [A] **ID 3**
Measured motor RMS current

Current scaling in different size of units

Note: ID45, usually in Process data OUT 3 is scaled to be with one decimal always.

Voltage	Size	Scale
208 – 240 Vac	NX0001 – NX0011	100 – 0.01A
208 – 240 Vac	NX0012 – NX0420	10 – 0.1A
208 – 240 Vac	NX0530	1 – 1A
380 – 500 Vac	NX0003 – NX0007	100 – 0.01A
380 – 500 Vac	NX0009 – NX0300	10 – 0.1A
380 – 500 Vac	NX0385 – NX2643	1 – 1A
525 – 690 Vac	NX0004 – NX0013	100 – 0.01A
525 – 690 Vac	NX0018 – NX0261	10 – 0.1A
525 – 690 Vac	NX0325 – NX1500	1 – 1A

V1.5 Motor torque % **ID 4**
In % of Motor nominal torque

V1.6 Motor Power % **ID 5**
Calculated motor power

V1.7 Motor voltage V **ID 6**
Calculated motor voltage

V1.8 DC link voltage V **ID 7**
Measured DC voltage, filtered.

V1.9 Unit temperature C **ID 8**
Heatsink temperature

V1.10 Motor temperature % **ID 9**
Calculated motor temperature
105 % is tripping limit if response is fault.

V1.11 **Analogue input 1** % **ID 13**

V1.12 **Analogue input 2** % **ID 14**

Unfiltered analogue input level.

0% = 0 mA / 0 V, -100% = -10 V, 100% = 20 mA / 10 V.

Monitoring scaling is determined by the option board parameter.

V1.13 **Analogue input 3** % **ID 27**

V1.14 **Analogue input 4** % **ID 28**

It is possible to adjust this input value from fieldbus when the input terminal selection is 0.1. This way it is possible to adjust the free analogue input from fieldbus and have all analogue input functions available for fieldbus process data.

V1.15 **Analogue Out 1** % **ID 26**

V1.16 **Analogue Out 2** % **ID 50**

V1.17 **Analogue Out 3** % **ID 51**

V1.18 **Analogue Out 4** % **ID 1526**

Analogue Output value 0% = 0 mA / 0 V, 100% = 20 mA / 10 V

V1.19 **DIN1, DIN2, DIN3** **ID 15**

V1.20 **DIN4, DIN5, DIN6** **ID 16**

	DIN1/DIN2/DIN3 status	DIN4/DIN5/DIN6 status
b0	DIN3	DIN6
b1	DIN2	DIN5
b2	DIN1	DIN4

V1.21 **Torque reference** % **ID 18**

Torque reference value before load share.

V1.22 **PT-100 Temperature** C° **ID 42**

Highest temperature of OPTB8 board. 4 s filtering.

5.2.2 Monitoring values 2

V1.24.1 Current A ID 1113

Unfiltered motor current, recommended signal for NCDrive monitoring.

V1.24.2 Torque % ID 1125

Unfiltered motor torque, recommended signal for NCDrive monitoring.

V1.24.3 DC Voltage V ID 44

Unfiltered DC link voltage, recommended signal for NCDrive monitoring.

V1.24.4 Application Status Word ID 43

Application Status Word combines different drive statuses to one data word. Recommended signal for NCDrive monitoring.

Application Status Word ID43		
	FALSE	TRUE
b0	Flux not ready	Flux ready (>90 %)
b1	Not in Ready state	Ready
b2	Not Running	Running
b3	No Fault	Fault
b4	Direction Forward	Direction Reverse
b5	Emergency Stop Active	Emergency Stop NOT Active
b6	Run Disabled	Run Enable
b7	No Warning	Warning
b8	Power positive	Power negative or Gen torque or current limit active
b9		
b10		
b11	No DC Brake	DC Brake is active
b12	No Run Request	Run Request
b13	No Limit Controls Active	Limit control Active
b14	External Brake Control OFF	External Brake Control ON
b15		

V1.24.5 Shaft Frequency Hz ID 1124

Encoder frequency after filter. P2.8.4.6 Encoder1FiltTime.

V1.24.6 Output Power [kw] ID1508

Unfiltered electrical drive output power.

V1.24.7	Measured temperature 1	C°	ID 50
V1.24.8	Measured temperature 2	C°	ID 51
V1.24.9	Measured temperature 3	C°	ID 52
V1.24.10	Measured temperature 4	C°	ID 69
V1.24.11	Measured temperature 5	C°	ID 70
V1.24.12	Measured temperature 6	C°	ID 71

Separate measurement from two PT100 boards. The signal has 4 s filtering time.

V1.24.13	ABS Encoder Revolutions		ID55
-----------------	--------------------------------	--	-------------

Absolute encoder revolution information.

V1.24.14	ABS Encoder Position		ID54
-----------------	-----------------------------	--	-------------

Absolute encoder position within one rotation. See encoder manual for scaling.

V1.24.15	Step response	Hz	ID 1132
-----------------	----------------------	-----------	----------------

Frequency error. Compares ramp output to actual encoder frequency with 0.001 Hz accuracy. Can be used for speed control tuning in closed loop control.

V1.24.16	CosPhiiActual		ID 68
-----------------	----------------------	--	--------------

Estimated Cos Phii.

V1.24.17	Flux Current	%	ID 72
-----------------	---------------------	----------	--------------

Flux current part or the total current. 100% = Motor Nominal Current.

V1.24.18	Regulator Status		ID 77
-----------------	-------------------------	--	--------------

Regulator status ID77		
b0	Motoring Current Regulator Status	
b1	Generator Current Regulator Status	
b2	Motoring Torque Regulator Status	For CL monitor B0
b3	Generator Torque Regulator Status	For CL monitor B1
b4	Over Voltage Regulator Status	DC Voltage
b5	Under Voltage Regulator Status	DC Voltage
b6		
b7		
b8		
b9		
b10		
b11		
b12		
b13		
b14		
b15		

V1.24.19 Frequency Delta ID 1847

Change of Final Frequency Reference in Hz/s.

V1.24.20 Rotor Flux ID1158 "Rotor Flux"

Calculated Rotor flux.

V1.24.21 Data Logger Trigger Word ID 97

Data Logger Trig Word ID97		
	Function	Comment
b0	Fault Status	Logger is triggered when there is a fault
b1	Warning Status	Logger is triggered when there is a warning
b2	Auto Reset Warning	Logger is triggered when there is a fault that has been defined to be automatically reset. This bit can be used to get the first fault situation.
b3	Fault Status OR Warning Status	B0 OR B1 triggering situation has occurred
b4	Fault Status OR Auto Reset Warning	B0 OR B2 triggering situation has occurred
b5		
b6		
b7		
b8		
b9		
b10		
b11		
b12		
b13		
b14		
b15		

V1.24.22 Ident Failure Code [Ident Fail. Code] ID 98

Failure code for failed identification:

- 1 = Current measurement offset
- 2 = Identification current level
- 3 = Acceleration time too long
- 4 = Identification frequency reference not reached
- 5 = Too low or high magnetization current
- 6 = Flux curve outside expected levels
- 7 = PMSM, Encoder zero position
- 8 = Too low maximum frequency limit
- 9 = PMSM, encoder zero pulse not found
- 10 = Ls Identification timeout
- 11 = Ls Identification current

V1.24.23 Non Ready Cause

ID 1608

Non Ready Cause ID1608	
	Signal
b0	Fault is Active
b1	PreventMCReady is set
b2	Charge switch is open
b3	DC Voltage not OK
b4	Power unit state not OK
b5	StartUp Wizard is active
b6	Run Enable is not set
b7	Ready state prevented by STO
b8	
b9	
b10	
b11	
b12	
b13	
b14	
b15	

V1.24.24 Prevent MC Ready

ID 1609

Prevent MC Ready ID1609	
	Signal
b0	Endat option board (OPTBB, OPTBE) communication is not initialized after power-up.
b1	Drive sync master has wrong modulator or 1000ms task parameters are not initialized
b2	Drive sync follower delay is active
b3	Drive sync failure in sw modulator double period mode
b4	Charge switch delay is active
b5	AFE fast run disable through ENC C1 is active
b6	100ms task not executed
b7	
b8	
b9	
b10	
b11	
b12	
b13	
b14	
b15	

5.2.3 FieldBus Monitoring values

V1.25.1 FB Control Word**ID1160**

Control word used in bypass mode. See P2.13.22 and option board ByPass.

Bit	Description	
	Value = 0	Value = 1
0	OFF	ON, Reset after Fault or b1 and b2
1	Emergency stop by coast	ON, On normal operation: Keep TRUE
2	Emergency stop by ramp	ON, On normal operation: Keep TRUE
3	STOP REQUEST	RUN REQUEST
4	Force ramp to Zero	Enable Ramp,
5	Freeze Ramp	Enable Ramp,
6	Force Ref to Zero	Enable Ramp,
7	No Action	FAULT RESET (0 -> 1)
8	No Action	Inching 1
9	No Action	Inching 2
10	Disable Profibus control	Enable Profibus control
11	Fieldbus DIN1=OFF	Fieldbus DIN1=ON (Watchdog pulse)
12	Fieldbus DIN2=OFF	Fieldbus DIN2=ON
13	Fieldbus DIN3=OFF	Fieldbus DIN3=ON
14	Fieldbus DIN4=OFF	Fieldbus DIN4=ON
15	No Action	No Action

V1.25.2 FB Speed Reference ID875

FB Speed Reference from the fieldbus

V1.25.3 FB Status Word ID65

Profibus type status word. Generated in the application level.

Needs to be selected with P2.14.19 GSW to be used. When needed with profibus board, operation mode needs to be set to ByPass in option board and with P2.14.22 ProfiBus Mode select: 2 / ProfiDrive.

Bit	Description	
	Value = 0	Value = 1
0	Not ready to switch on	Ready to switch on
1	Not ready to operate	Ready to operate
2	Not Running	Running
3	No Fault	Fault
4	Coast stop Active	Coast stop not active
5	Quick stop active	Quick stop not active
6	Switch not inhibited	Switch on inhibit
7	No Warning	Warning
8	Speed error	Speed At Reference
9	No FB Control request	FB Control Active
10	Fout < Fmax	Fout > Fmax
11	not used	not used
12	not used	not used
13	not used	not used
14	not used	not used
15	Fieldbus DIN1=OFF	Fieldbus DIN1=ON (Watchdog pulse)

V1.25.4 FB Speed Actual ID865

Actual speed value send to fieldbus.

V1.25.5 FB Torque Reference % ID 1140

Torque reference value from fieldbus
Default Control of FB PD 1

V1.25.6 FB Limit Scaling% ID 46

Limit scaling input value from fieldbus.
Default Control of FB PD 2.

V1.25.7 FB Adjust Reference % ID 47

Reference adjustment value from fieldbus.
Default Control of FB PD 3.

V1.25.8 FB Analog Output % ID 48

Fieldbus value to control analogue output.
Default Control of FB PD 4.

V1.25.9 FB Motor Current A ID 45

Motor current (drive independent) given with one decimal point.

V1.25.10 Fault Word 1 ID 1172

Different faults are collected to two words that can be read from fieldbus or with NCDrive PC software.

Fault Word 1 ID1172		
	Fault	Comment
b0	Over Current or IGBT	F1, F31, F41
b1	Over Voltage	F2
b2	Under Voltage	F9
b3	Motor Stalled	F15
b4	Earth Fault	F3
b5	Motor Under Load	F17
b6	Drive over temperature	F14
b7	Over Temperature	F16, F56, F29
b8	Input Phase	F10
b9	Brake resistor over temperature	F42 (Not implemented)
b10	Device Changed	F37, F38, F39, F40, F44, F45 (Not implemented)
b11	Keypad or PCControl	F52
b12	FielBus	F53
b13	SystemBus	F59
b14	Slot	F54
b15	4 mA	F50

V1.25.11 Fault Word 2**ID 1173**

Fault Word 2 ID1173		
	Fault	Comment
b0	Output phase	F11
b1	Charge Switch	F5 (Not implemented)
b2	Encoder	F43
b3	Inverter	F4, F7 (Not implemented)
b4		
b5	EEPROM	F22 (Not implemented)
b6	External	F51
b7	Brake Chopper	F12 (Not implemented)
b8	Watch Dog	F25 (Not implemented)
b9	IGBT	F31, F41
b10	Brake	F58
b11	Fan Cooling	F32
b12	Application	F35 (Not implemented)
b13	Control fault	F33, F36, F8 (Not implemented)
b14	Main Switch Open	F64 (Not implemented)
b15		

V1.25.12 Warning Word 1**ID 1174**

Warning Word 1 ID1174		
	Fault	Comment
b0	Motor stalled	W15
b1	Motor over temperature	W16
b2	Motor under load	W17
b3	Input phase loss	W10
b4	Output phase loss	W11
b5	Safe disable	W30 (Not implemented)
b6	FieldBus communication fault in slot D	W53 (Not implemented)
b7	FieldBus communication fault in slot E	W67 (Not implemented)
b8	Drive over temperature	W14
b9	Analogue input < 4mA	W50
b10	Not used	
b11	Emergency stop	W63 (Not implemented)
b12	Run disabled	W62 (Not implemented)
b13	Not used	
b14	Mechanical Brake	W58
b15	Not used	

V1.25.13 AuxStatusWord ID 1163

Aux Status Word ID1163		
	Fault	Comment
b0	Reserved	Reserved
b1		Window control active and speed outside of widow
b2	Reserved	Reserved
b3	Reserved	Reserved
b4	Reserved	Reserved
b5	Reserved	Reserved
b6	Reserved	Reserved
b7	No Action	Ext brake is forced open
b8	Reserved	Reserved
b9	Reserved	Reserved
b10	Reserved	Drive in torque control mode
b11	Reserved	Reserved
b12	Reserved	Reserved
b13	Reserved	Reserved
b14	Reserved	Reserved
b15	Reserved	Reserved

V1.25.14 Fault History ID 37

Fault number of the last active fault.

V1.25.15 AuxControlWord ID 1161

Aux Control Word ID1161		
	FALSE	TRUE
b0	Reserved	Reserved
b1	Reserved	Reserved
b2	Reserved	Reserved
b3	Reserved	Reserved
b4	Reserved	Reserved
b5	Reserved	Reserved
b6	Reserved	Reserved
b7	No Action	Ext brake is forced open
b8	Reserved	Reserved
b9	No Action	Reset encoder position
b10	Reserved	Reserved
b11	Reserved	Reserved
b12	Reserved	Reserved
b13	Reserved	Reserved
b14	Reserved	Reserved
b15	Reserved	Reserved

V1.25.16 Din Status Word ID 56

V1.25.17 Din Status Word 2 ID 57

	DIN StatusWord 1	DIN StatusWord 2
b0	DIN: A.1	DIN: C.5
b1	DIN: A.2	DIN: C.6
b2	DIN: A.3	DIN: D.1
b3	DIN: A.4	DIN: D.2
b4	DIN: A.5	DIN: D.3
b5	DIN: A.6	DIN: D.4
b6	DIN: B.1	DIN: D.5
b7	DIN: B.2	DIN: D.6
b8	DIN: B.3	DIN: E.1
b9	DIN: B.4	DIN: E.2
b10	DIN: B.5	DIN: E.3
b11	DIN: B.6	DIN: E.4
b12	DIN: C.1	DIN: E.5
b13	DIN: C.2	DIN: E.6
b14	DIN: C.3	
b15	DIN: C.4	

V1.25.18 MC Status ID 64

Value sent to the fieldbus when the fieldbus does not use its own state machine.

Motor Control Status Word		
	FALSE	TRUE
b0	Not in Ready state	Ready
b1	Not Running	Running
b2	Direction Clockwise	Counterclockwise
b3	No Fault	Fault
b4	No Warning	Warning
b5		At reference speed
b6		At Zero Speed
b7		Flux Ready
b8		TC Speed Limiter Active
b9	Encoder Direction	Counterclockwise
b10		Under Voltage Fast stop
b11	No DC brake	DC Brake is active
b12		
b13		Restart delay active
b14		
b15		

V1.23.19 Warning ID 74

Last active warning.

V1.25.20 EncoderRounds ID 1170

Rounds information from incremental encoder. The value is reset when 24 Vdc is removed from the drive.

V1.25.21 Encoder Angle ID 1169

Angle information from incremental encoder. The value is reset when 24 Vdc is removed from the drive.

V1.25.22 Fault Word 10 ID 1202

Fault Word 10 ID1202		
	Fault	Comment
b0	Speed Error	F61
b1		
b2	Over Load Fault Active	F82
b3	No Motor Fault	F83
b4	PT100 Fault	F56 & F65
b5	Brake Slipping	F83
b6		
b7		
b8		
b9		
b10		
b11		
b12		
b13		
b14		
b15		

V1.25.23 Warning Word 10 ID 1269

Warning Word 1 ID1269		
	Fault	Comment
b0	Speed Error	W61
b1	Earth fault Warning	W3
b2	Over Load Warning Active	W82
b3	No Motor Warning	W83
b4	PT100 Warning	W56 & W65
b5	Brake Slipping	W83
b6	CL Changed to Sensorless	F43 S14
b7		
b8		
b9		
b10		
b11		
b12		
b13		
b14		
b15		

5.2.4 Master / Follower

V1.26.1 SB SystemStatus ID 1601

System Bus Status Word ID1601		
	Signal	Comment
b0		
b1	Drive 1 Ready	
b2	Drive 1 Running	
b3	Drive 1 Fault	
b4		
b5	Drive 2 Ready	
b6	Drive 2 Running	
b7	Drive 2 Fault	
b8		
b9	Drive 3 Ready	
b10	Drive 3 Running	
b11	Drive 3 Fault	
b12		
b13	Drive 4 Ready	
b14	Drive 4 Running	
b15	Drive 4 Fault	

V1.26.2 Total Current A ID 80**Drive Synch Operation Master drive**

This value is the current of whole drive synch system.

Drive Synch Operation Follower drive

D1 and D2: This value is the current of whole drive synch system.

D2 and D4: This value is the sum current of the drive's own power unit and that of the drives with smaller system bus identification number starting from master drive.

V1.26.3 Master CW ID93

Master Drive Control Word. Master Sending, Follower receiving.

Master Control Word ID93		
	Master-Follower	DriveSynch Master-Follower
b0	Ready Status	
b1	Run Enable	
b2	Final Run Request	
b3	Fault Reset	Fault Reset
b4	Running	Running
b5	Fault	
b6	Brake Control	Brake Control
b7	WD Pulse	
b8	Brake Control Reference Release	
b9	Data Logger Trigger	Data Logger Trigger
b10	Ramp Stop Active	
b11	Start Delay Active	
b12		
b13		
b14	Disable SB Diagnostic	Disable SB Diagnostic
b15		

V1.26.4.1 Motor Current D1 A ID 1616

D1: This value is the current of drive number one power unit.

D2,D3 and D4: Master drive power unit current.

V1.26.4.2 Motor Current D2 A ID 1605

D1: This value is the current of drive number two power unit.

D2,D3 and D4: Not updated.

V1.26.4.3 Motor Current D3 A ID 1606

D1: This value is the current of drive number three power unit.

D2,D3 and D4: Not updated.

V1.26.4.4 Motor Current D4 A ID 1607

D1: This value is the current of drive number four power unit.

D2,D3 and D4: Not updated.

V1.26.5.1 Status Word D1 ID 1615

V1.26.5.2 Status Word D2 ID 1602

V1.26.5.3 Status Word D3 ID 1603

V1.26.5.4 Status Word D4 ID 1604

Follower Drive status word		
	FALSE	TRUE
b0	Flux not ready	Flux ready (>90 %)
b1	Not in Ready state	Ready
b2	Not Running	Running
b3	No Fault	Fault
b4	Charge Switch Closed	Charge Switch Open
b5	Brake Closed	Brake Open
b6	Run Disabled	Run Enable
b7	No Warning	Warning
b8	Not at Reverse end limit	End Limit Reverse Reached
b9	Not at Forward end limit	End Limit Forward Reached
b10	SB Communication Failed	SB Communication OK
b11	No DC Brake	DC Brake is active
b12	No Run Request	Run Request
b13	No Limit Controls Active	Limit control Active
b14	External Brake Control OFF	External Brake Control ON
b15	Heard Beat Pulse	Heard Beat Pulse

5.2.5 PI Control monitoring

This PI control uses ID numbers for input and output signal. See details in PI Control chapter.

- V1.27.1 PI Reference ID20**
Used PI Reference, reference is selected by ID number.
- V1.27.2 PI Actual Value ID21**
PI Actual value. Actual input is selected by ID number.
- V1.27.3 PI Output ID23**
PI Output before scaling. This value uses PI Out High and Low for limiting.
- V1.27.3 PI Output Scaled ID1807**
Scaled PI Output.
This is used for ID connection. Scaling function is used to scale value more suitable for connected signal. For example, when the output is connected to torque limit, the actual value needs to be -1000 ...+1000 (-100.0%..+100.0%), but PI Out High and Low can be from -30000...+30000 to have more accurate PI control.

5.2.6 Frequency Chain

- V1.28.1 Frequency Reference 1 Hz 1126**
Frequency reference before speed share. Speed Share is used also for reference direction control.
- V1.28.2 Frequency Reference 2 Hz 1126**
Frequency reference after speed share and reference adjust but before interpolator.
- V1.28.3 Frequency Reference Hz 25**
Frequency reference after interpolator but before second order filtering.
- V1.28.4 Frequency Reference Actual Hz 1128**
Frequency reference for ramp control.
- V1.28.5 Frequency Ramp Out Hz 1129**
Ramp control output.
- V1.28.6 Frequency Reference Final Hz 1131**
Final reference to speed controller. After ramp generator and after Speed Step function, used for closed loop speed tuning when used together with Encoder 1 frequency.
- V1.28.7 Encoder 1 Frequency Hz 1164**
Encoder frequency, monitored directly from encoder.

5.2.7 Torque Chain

V1.29.1 Torque reference % ID 18

Torque reference value before load share.

V1.29.2 Torque Reference 3 % 1144

Torque reference after load share and before torque step.

V1.29.3 Torque Ref Final % 1145

Final torque reference in torque reference chain, before acceleration compensation and speed controller output.

V1.29.4 Speed Control Out % 1134

Closed Loop speed controller output.

V1.29.5 Torque Reference Actual % 1180

Final torque reference from speed control and torque control. Also includes torque step and acceleration compensation factors.

5.2.8 Brake Control

V1.30.1 Brake Status Word

Brake Status Word ID89		
	FALSE	TRUE
b0	Flux not ready	Flux ready (>90 %)
b1	Not in Ready state	Ready
b2	Not Running	Running
b3	No Fault	Fault
b4	No Warning	Warning
b5	No Run Request	Run Request
b6	No DC Brake	DC Brake is active
b7	Zero Speed	Not Zero Speed
b8	Brake Control Close	Brake Control Open
b9	Brake Closed (Mech.Delays)	Brake Open (Mech.Delays)
b10	Brake feedback LOW	Brake feedback HIGH
b11	No Limit Controls Active	Limit control Active
b12	Brake Not Slipping	Brake Slipping
b13	Quick Stop NOT active	Quick Stop Active
b14		
b15		

V1.30.2 Load Estimation [kg] # ID1914

Load estimation in kg 16bit value

V1.30.3 Load Estimation 100[kg] #,## ID1913

Load estimation in kg 32bit value

V1.30.4 RopeLengthInUse [cm] # ID1915

Used rope length for anti-swing function.

5.2.9 Motion

V1.31.1 Serial Number Key ID1997

1.31.2 License Status ID1996

This value indicates the status of the licence key activation.

0 / No Function

If PLC receives this number from this ID, it is likely that there is no license function in the application that is loaded on the drive.

1 / No Code

Correct application in the drive, but the licence key has not been given.

2 / Code Given, not possible to verify, no connection to power unit

The licence key has been given, but there is no connection to power unit to verify it. Charge the DC at least for 20 s.

NOTE! It is possible that the drive gives a licence fault in this state. Power up the power unit, so that the control board can read the drive serial number.

3 / Code Wrong

The code that was entered is wrong.

4 / Licence Key entered too many times

A wrong licence key has been entered three times. Power down the drive before trying to enter a new code.

5 / Code Accepted

The correct key has been entered, and functions behind license are available.

6 / Unknown Error

The licence key calculation has detected an internal error. Take the service information and the parameter file from the drive when the power unit is powered. Send these files to the technical support of the manufacture.

5.2.10 Tandem Operation (Shaft Synch)

V1.32.1 Master Rotations ID1820

Master position information received trough system bus.
1,000 equals one master shaft rotation.

V1.32.2 Own Rotations ID1821

Drive own position information received from encoder
1,000 equals one master shaft rotation.

V1.32.3 Control Out ID1822

Position controller output in Hz.

V1.32.4 Rotation Error ID1823

Follower drive position error, 1,000 equals one master shaft rotation.

V1.32.5 Position Ref ID1825

Master position that is used for position control.

5.2.11 *Functional Safety Monitoring*

V1.33.1 Safety App Status ID1653

	FALSE	TRUE
b0	Drive ack not accepted	Advanced safety option board will accept ack from drive
b1	Drive reset not accepted	Advanced safety option board will accept reset from drive
b2		
b3		
b4		
b5		
b6		
b7		
b8		
b9		
b10		
b11		
b12		
b13		
b14		
b15		

V1.33.2 Integrity Level ID1640

Safety integrity level (SIL) of drive. Considers presence of OPTAF, control board version and power unit topology.

Possible values: 0 (no safety), 2 (SIL2), 3 (SIL3). *)

V1.33.3 Acknowledge Mode ID1641

Bits indicate whether specific safety functions are acknowledged automatically by advanced safety option board or require acknowledge from outside.

0 = automatic, 1 = manual

	FALSE	TRUE
b0	B0 = Start up (STO active) [ACK-STO-Boot]	
b1	B1 = STO [ACK-STO]	
b2	B2 = SS1 [ACK-SS1]	
b3	B3 = SS2 [ACK-SS2]	
b4	B4 = SQS [ACK-SQS]	
b5	B5 = SLS [ACK-SLS]	
b6	B6 = SSR [ACK-SSR]	
b7	B7 = SMS [ACK-SMS]	
b8	B8 = SSM [ACK-SSM]	
b9	B9 = SAR [ACK-SAR]	
b10	B10 = SDI [ACK-SDI]	
b11		
b12		
b13		
b14		
b15		

V1.33.4 Safety Encoder Speed ID1642

Encoder speed in RPM reported by advanced safety option board.

V1.33.5 Ramp Selection ID1643

B1,B0 = SLS ramp

B3,B2 = SSR ramp

00 = none, 01 = ramp 1, 10 = ramp 2. *)

V1.33.6 Function Reached ID1644

Advanced safety option board -> Control board safety function status word. For active functions, indicates if a safety function is reached

		FALSE	TRUE
b0	STO		
b1	SS1		
b2	SS2		
b3	SQS		
b4	SSR		
b5	SLS1		
b6	SLS2		
b7	SLS3		
b8	SDI+		
b9	SDI-		
b10	SSM		
b11	SMS		
b12	SAR		
b13	SOS		
b14	SBC		
b15			

V1.33.7 Request DIN ID1645

Advanced safety option board -> Control board safety function request word. Indicates if a function is requested by Digital input of the advanced safety option board.

		FALSE	TRUE
b0	STO		
b1	SS1		
b2	SS2		
b3	SQS		
b4	SSR		
b5	SLS1		
b6	SLS2		
b7	SLS3		
b8	SDI+		
b9	SDI-		
b10	SSM		
b11	SMS		
b12	SAR		
b13			
b14			
b15			

V1.33.8 Request PLC ID1646

Advanced safety option board -> Control board safety function request word.
Indicates if a function is requested by safe PLC.

	FALSE	TRUE
b0	STO	
b1	SS1	
b2	SS2	
b3	SQS	
b4	SSR	
b5	SLS1	
b6	SLS2	
b7	SLS3	
b8	SDI+	
b9	SDI-	
b10	SSM	
b11	SMS	
b12	SAR	
b13		
b14		
b15		

V1.33.9 Function In Use ID1647

Indicates which safety functions have been enabled by configuration

	FALSE	TRUE
b0	STO	
b1	SS1	
b2	SS2	
b3	SQS	
b4	SOS	
b5	SBC	
b6	SLS	
b7	SSR	
b8	SMS	
b9	SSM	
b10	SAR	
b11	SDI	
b12		
b13		
b14		
b15		

V1.33.10 Safety Status Word ID1648

Advanced safety option board -> Control board safety function status word. Indicates if a safety function is active (being executed). 1 = active, 0 = not active

	FALSE	TRUE
b0	STO	
b1	SS1	
b2	SS2	
b3	SQS	
b4	SSR	
b5	SLS1	
b6	SLS2	
b7	SLS3	
b8	SDI+	
b9	SDI-	
b10	SSM	
b11	SMS	
b12	SAR	
b13		
b14		
b15		

V1.33.11 Safety General Status Word ID1649

Indicates states of the advanced safety option board input & outputs.

	FALSE	TRUE
b0	DIN1	
b1	DIN2	
b2	SIN3	
b3	SIN4	
b4	DOUT1	
b5	DOUT2	
b6	SSM_Above_Max_Limit	
b7	SSM_Below_Max_Limit	
b8	Acknowledge_Requested_DIN	
b9	Acknowledge_Requested_PLC	
b10	Acknowledge_Requested_Drive	
b11	SS1_Ramp_Select	
b12	SS2_Ramp_Select	
b13	Reset_Requested_DIN	
b14	Reset_Requested_PLC	
b15	Reset_Requested_Drive	

V1.33.12 Safety Status**ID1650**

	FALSE	TRUE
b0	StoAtexBoardDetected	
b1	StoLinesActivated	
b2	StoFault	
b3	StoConfigureError	
b4	StoDiagnosticFault	
b5	StoThermistorActivated	
b6	StoThermistorFaultActive	
b7	StoThermistorDiagnosticFault	
b8	StoThermistorShortCircuitFault	
b9	StoChannel1State	
b10	StoChannel2State	
b11	StartUpPreventActivated	
b12		
b13		
b14		
b15		

V1.33.13 Safety Zero Speed**ID1651**

Speed value the advanced safety option board uses for determining motor stoppage.

V1.33.14 SBC Speed rpm ID1652

Indicates the speed the brake is intended to be activated.

If SBC Order = 1 (SBC activated after STO/SOS), SBC will be activated at SBC Speed or after SBC t1.

If SBC Order = 0 (SBC activated before STO/SOS), SBC Speed is neglected.

5.2.12 Counters

Below counter values are not visible as a standard monitoring signal but are accessible with ID numbers from fieldbus.

5.2.12.1 Power On Time counter

This timer is counting when control board is powered (i.e. counting when only 24 Vdc is given to control board).

ID10 PowerOnTimeTripCounter

Resettable power on time counter.
 UINT value. READ only access.
 Use ID1050 to define format.
 Use ID1051 to reset value

ID1050 PowerOnTripCounterUnit

Read or select power on counter format.
 USINT value. WRITE access.
 1 = 1 ms
 2 = 10 ms
 3 = 100 ms
 4 = 1 s
 5 = 1 min
 6 = 1 h (Default)
 7 = 1 d

ID1051 ResetOnTimeTripCounter

Reset Power on trip counter, rising edge will reset counter.
 BOOL value. WRITE access.
 Write INT value 1 to reset if Process Data is used.

5.2.12.2 Energy Meter counter monitoring

ID11 EnergyMeter

Read ID80 and ID81 to see used format.
 UINT value. READ only access.

ID82 EnergyMeterFormat

Decimal point place in the value
 60 = 6 max number of digits, 0 fractional digits
 61 = 6 max number of digits, 1 fractional digits
 62 = 6 max number of digits, 2 fractional digits
 UINT value. READ only access.

NOTE: Most of the other application use ID number ID80 for this variable.

ID81 ***EnergyMeterUnit***

Unit for the energy meter
USINT value. READ only access.
1 = kWh
2 = MWh
3 = GWh
4 = TWh

5.2.12.3 *Energy Trip counter monitoring***ID12** ***EnergytripCounter***

Energy trip counter, use ID1052 define format.
UINT value. READ only access.
Max. value is 65 535 and after that value is reset to zero and counting is restarted.

ID1052 ***EnergyTripCounterUnit***

WRITE access. Unit value can be changed via fieldbus .USINT value.
1 = 0.01 kWh
2 = 0.1 kWh
3 = 1 kWh
4 = 10 kWh
5 = 100 kWh
6 = 1 MWh
7 = 10 MWh
8 = 100 MWh
9 = 1 GWh
10 = 10 GWh

ID1053 ***ResetMWhTripCounter***

Reset energy trip counter, rising edge will reset counter.
BOOL value. Write INT value 1 to reset if Process Data is used.

6. CRANE CONTROL APPLICATION – PARAMETER LISTS

6.1 Basic parameters

Code	Parameter	Min	Max	Unit	Default	Cust	ID	Note
P2.1.1	Maximum frequency	P2.1.1	320.00	Hz	50.00		102	NOTE: If f_{max} > than the motor synchronous speed, check suitability for motor and drive system
P2.1.2	Motor nominal voltage	180	690	V	NX2: 230V NX5: 400V NX6: 690V		110	Check the rating plate of the motor. Note also used connection Delta/Star
P2.1.3	Motor nominal frequency	8.00	320.00	Hz	50.00		111	Check the rating plate of the motor
P2.1.4	Motor nominal speed	24	20 000	rpm	1440		112	The default applies for a 4-pole motor and a nominal size AC drive.
P2.1.5	Motor nominal current	$0.1 \times I_H$	$2 \times I_H$	A	I_H		113	Check the rating plate of the motor.
P2.1.6	Motor $\cos\phi$	0.30	1.00		0.85		120	Check the rating plate of the motor
P2.1.7	Motor Nominal Power	0.0	3200.0	kW	0.0		116	Check the rating plate of the motor
P2.1.8	Magnetizing current	0.00	100.00	A	0.00		612	0.00 A = Drive uses estimated value from motor name plate values
P2.1.9	Identification	0	11		0		631	0=No action 1=Identification w/o run 2=Identification with run 3=Encoder ID Run 4=Ident All 5=Absolute encoder, locked rotor 6=U/f and Magn.Current 7=DTC Identification
P2.1.10	Motor type	0	1		0		650	0=Induction Motor 1=PMS Motor
P2.1.11	Crane ID Run	0	3		0		1683	0=No Function 1=Hoisting 2=Horizontal 3=Brake Timing
P2.1.12	Movement Type	0	2		0		1685	0=Not Selected 1=Hoisting 2=Horizontal

Table 6-1. Basic parameters G2.1

6.2 Reference Handling

6.2.1 Basic Settings

Code	Parameter	Min	Max	Unit	Default	Cust	ID	Note
P2.2.1	I/O Reference	0	19		0		117	0=AI1 1=AI2 2=AI1+AI2 3=AI1-AI2 4=AI2-AI1 5=AI1xAI2 6=AI1 Joystick 7=AI2 Joystick 8=Keypad 9=Fieldbus 10=Motor potentiometer 11=AI1, AI2 minimum 12=AI1, AI2 maximum 13=Max frequency 14=AI1/AI2 selection 15=Encoder 1 16=Encoder 2 17=Preset Speeds 18=Master Reference 19=Master Ramp Out
P2.2.2	Keypad reference selector	0	19		8		121	See par 2.2.1
P2.2.3	Fieldbus control reference	0	19		9		122	See par. 2.2.1
P2.2.4	I/O Reference 2	0	19		1		131	See ID117 & ID422
P2.2.5	Speed Share	-300.00	300.00	%	100.00		1241	
P2.2.6	Load Share	0.0	500.0	%	100.0		1248	

6.2.2 Constant Reference

Code	Parameter	Min	Max	Unit	Default	Cust	ID	Note
P2.2.7.1	Jogging speed reference	0.00	320.00	Hz	5.00		124	
P2.2.7.2	Preset speed 0	0.00	320.00	Hz	0.00		1810	
P2.2.7.3	Preset speed 1	0.00	320.00	Hz	10.00		105	Multi-step speed 1
P2.2.7.4	Preset speed 2	0.00	320.00	Hz	15.00		106	Multi-step speed 2
P2.2.7.5	Preset speed 3	0.00	320.00	Hz	20.00		126	Multi-step speed 3
P2.2.7.6	Preset speed 4	0.00	320.00	Hz	25.00		127	Multi-step speed 4
P2.2.7.7	Preset speed 5	0.00	320.00	Hz	30.00		128	Multi-step speed 5
P2.2.7.8	Preset speed 6	0.00	320.00	Hz	40.00		129	Multi-step speed 6
P2.2.7.9	Preset speed 7	0.00	320.00	Hz	50.00		130	Multi-step speed 7
P2.2.7.10	Inching reference 1	-320.00	320.00	Hz	2.00		1239	
P2.2.7.11	Inching reference 2	-320.00	320.00	Hz	-2.00		1240	

6.2.3 Torque Reference

Code	Parameter	Min	Max	Unit	Default	Cust	ID	Note
P2.2.9.1	Torque reference selection	0	9		0		641	0=Not used 1=A11 2=A12 3=A13 4=A14 5=A11 joystick (-10-10 V) 6=A12 joystick (-10-10 V) 7=Torque reference from keypad, R3.5 8=FB Torque Reference 9=Master Torque
P2.2.8.2	Torque reference max.	-300.0	300.0	%	100		642	
P2.2.8.3	Torque reference min.	-300.0	300.0	%	0.0		643	
P2.2.8.4	Torque reference filtering time	0	32000	ms	0		1244	
P2.2.8.5	Torque Reference Dead Zone	0.0	300.0	%	0.00		1246	
P2.2.8.6	Torque Select	0	5		2		1278	0=Speed Control 1=Maximum freq. limit 2=Ramp Output 3=Min 4=Max 5=Window
P2.2.8.7	Window negative	0.00	50.00	Hz	2.00		1305	
P2.2.8.8	Window positive	0.00	50.00	Hz	2.00		1304	
P2.2.8.9	Window negative off	0.00	P2.10.11	Hz	0.00		1307	
P2.2.8.10	Window positive off	0.00	P2.10.12	Hz	0.00		1306	

6.2.3.1 Torque Reference OL Settings

Code	Parameter	Min	Max	Unit	Default	Cust	ID	Note
P2.2.8.11.1	Open loop torque control minimum frequency	0.00	50.00	Hz	3.00		636	
P2.2.8.11.2	Open loop torque controller P gain	0	32000		150		639	
P2.2.8.11.3	Open loop torque controller I gain	0	32000		10		640	

6.2.4 Prohibit frequency parameters

Code	Parameter	Min	Max	Unit	Default	Cust	ID	Note
P2.2.9.1	Prohibit frequency range 1 low limit	-1.00	320.00	Hz	0.00		509	0=Not used
P2.2.9.2	Prohibit frequency range 1 high limit	0.00	320.00	Hz	0.00		510	0=Not used
P2.2.9.3	Ramp time factor	0.1	10.0	x	1.0		518	Multiplier of the currently Selected ramp time between prohibit frequency limits.

Table 6-2. Prohibit frequencies (G2.5)

6.2.5 Motor Potentiometer

Code	Parameter	Min	Max	Unit	Default	Cust	ID	Note
P2.2.10.1	Motor potentiometer ramp rate	0.10	2000.00	Hz/s	1.00		331	Ramp rate for motor potentiometer
P2.2.10.2	Motor potentiometer frequency reference memory reset	0	3		1		367	0=No reset 1=Reset in stop state 2=Reset in powered down 3=StopReq;Fout
P2.2.10.3	Motor potentiometer reference copy	0	2		0		366	0=No copy 1=Copy Reference 2=Copy output frequency

Table 6-3. Motor potentiometer (G2.5)

6.2.6 Adjust Reference

Code	Parameter	Min	Max	Unit	Default	Cust	ID	Note
P2.2.11.1	Adjust input	0	5		0		493	0=Not used 1=AI1 2=AI2 3=AI3 4=AI4 5=Fieldbus
P2.2.11.2	Adjust minimum	0.0	100.0	%	0.0		494	Adjust limit to decrease ref.
P2.2.11.3	Adjust maximum	0.0	100.0	%	0.0		495	Adjust limit to increase ref.

6.2.7 End limits reference handling

Code	Parameter	Min	Max	Unit	Default	Cust	ID	Note
P2.2.12.1	Disable Negative Direction	0.1	E.10	DigIn	0.2		1814	
P2.2.12.2	Disable Positive Direction	0.1	E.10	DigIn	0.2		1813	
P2.2.12.3	Limit Negative Reference DI	0.1	E.10	DigIn	0.2		1827	
P2.2.12.4	Limit Positive Reference DI	0.1	E.10	DigIn	0.2		1828	
P2.2.12.5	Limited Negative Reference Hz	-320.00	0.00	Hz	-10.00		1829	
P2.2.12.6	Limited Positive Reference Hz	0.00	320.00	Hz	10.00		1830	
P2.2.12.7	Limit Negative Reference DI 2	0.1	E.10	DigIn	0.2		1831	
P2.2.12.8	Limit Positive Reference DI 2	0.1	E.10	DigIn	0.2		1842	
P2.2.12.9	Limited Negative Reference Hz 2	-320.00	0.00	Hz	-2.00		1845	
P2.2.12.10	Limited Positive Reference Hz 2	0.00	320.00	Hz	2.00		1848	
P2.2.12.11	End Limit Ramp Time	0.1	320.0	s	1.0		1815	
P2.2.12.12	Anti-Swing at End Limits	0	3		0		1856	0 =Anti-Swing Active 1 =Off at Disabled 2 =Off at Disabled and 2 nd limit 3 =Off at all limits

6.3 Ramp Control

6.3.1 Basic Settings

Code	Parameter	Min	Max	Unit	Default	Cust	ID	Note
P2.3.1	Start function	0	1		0		505	0=Ramp 1=Flying start
P2.3.2	Stop function	0	1		1		506	0=Coasting 1=Ramp
P2.3.3	Acceleration time 1	0.2	3270.0	s	3.0		103	0 Hz to Max frequency
P2.3.4	Deceleration time 1	0.2	3270.0	s	3.0		104	Max frequency to 0 Hz
P2.3.5	Ramp 1 shape	0	100	%	2		500	0=Linear >0=S-curve ramp time
P2.3.6	Acceleration time 2	0.2	3270.0	s	10.0		502	
P2.3.7	Deceleration time 2	0.2	3270.0	s	10.0		503	
P2.3.8	Ramp 2 shape	0	100	%	4		501	0=Linear >0=S-curve ramp time
P2.3.9	Inching Ramp	0.01	320.00	s	1.00		1257	
P2.3.10	Reducing of acc./dec. times	0	5		0		401	Scales active ramp from 100 % to 10 %. 0=Not used 1=AI1 2=AI2 3=AI3 4=AI4 5=Fieldbus
P2.3.11	Disabled direction ramp	0	3270.0	s	1.0		1815	

6.3.2 Quick Stop

Code	Parameter	Min	Max	Unit	Default	Cust	ID	Note
P2.3.12.1	Quick Stop Mode	0	1		1		1276	0=Coasting 1= Ramp
P2.3.13.2	Quick Stop Ramp time	0.1	3200.0	s	10.0		1256	

6.3.3 Ramp Control Options

Code	Parameter	Min	Max	Unit	Default	Cust	ID	Note
P2.3.13.1	Ramp: Skip S2	0	1		1		1900	
P2.3.13.2	CL Ramp Follower Encoder Frequency	0	1		0		1902	
P2.3.13.3	Ramp Input Interpolator TC	0	200	ms	1		1184	

6.3.4 Slack Rope and Shock Load functions

Code	Parameter	Min	Max	Unit	Default	Cust	ID	Note
P 2.3.14.1	Slack Rope Mode	1	0		0 / Not in use		1930	
P 2.3.14.2	ShockLoadMode	1	0		0 / Not in use		1933	
P 2.3.14.3	LoadOnHookTorq	300	0	%	20		1931	
P 2.3.14.4	LoadOfHookTorq	300	0	%	10		1932	
P 2.3.14.5	ShockLoadTorq	300	-300	%	30		1934	
P 2.3.14.6	ShockLoadTime	10000	0	ms	500		1935	
P 2.3.14.7	ShockTorqRiseTime	10000	0	ms	50		1936	
P 2.3.14.8	ShockLoadRef	50	0	Hz	1		1937	

6.4 Input Signals

6.4.1 Basic Settings

Code	Parameter	Min	Max	Unit	Default	Cust	ID	Note		
P2.4.1.1	Start/Stop logic selection	0	8		5		300		Start signal 1 (Default: DIN1)	Start signal 2 (Default: DIN2)
								0	Start fwd	Start rvs
								1	Start/Stop	Reverse
								2	Start/Stop	Run enable
								3	Start pulse	Stop pulse
								4	Start	Mot.Pot UP
								5	Start fwd*	Start rvs*
								6	Start*/Stop	Reverse
								7	Start*/Stop	Run Enable
8	Start pulse	Stop pulse								

Table 6-4. Input signals: basic settings, G2.2.1

* = Rising edge required to start

6.4.2 Digital inputs

Code	Parameter	Default	Cust	ID	Note
P2.4.2.1	Start signal 1	0.1		403	Forward, See ID300
P2.4.2.2	Start signal 2	0.1		404	Reverse. See ID300
P2.4.2.3	Run enable	0.2		407	Motor start enabled (cc)
P2.4.2.4	Reverse	0.1		412	Direction forward (oc) Direction reverse (cc)
P2.4.2.5	Preset speed 1	0.1		419	See preset speeds in basing parameter group G2.1
P2.4.2.6	Preset speed 2	0.1		420	
P2.4.2.7	Preset speed 3	0.1		421	
P2.4.2.8	Motor potentiometer reference DOWN	0.1		417	Mot.pot. reference decreases (cc)
P2.4.2.9	Motor potentiometer reference UP	0.1		418	Mot.pot. reference increases (cc)
P2.4.2.10	Fault reset	0.1		414	All faults reset (cc)
P2.4.2.11	External fault (close)	0.1		405	Ext. fault displayed (cc)
P2.4.2.12	External fault (open)	0.2		406	Ext. fault displayed (oc)
P2.4.2.13	Acc/Dec time selection	0.1		408	Acc/Dec time 1 (oc) Acc/Dec time 2 (cc)
P2.4.2.14	Acc/Dec prohibit	0.1		415	Acc/Dec prohibited (cc)
P2.4.2.15	DC braking	0.1		416	DC braking active (cc)
P2.4.2.16	Jogging speed	0.1		413	Jogging speed selected for frequency reference (cc)
P2.4.2.17	IO reference 1 / 2 selection	0.1		422	IO reference selection:14 ID117
P2.4.2.18	Control from I/O terminal	0.1		409	Force control place to I/O terminal (cc)
P2.4.2.19	Control from keypad	0.1		410	Force control place to keypad (cc)
P2.4.2.20	Control from fieldbus	0.1		411	Force control place to fieldbus (cc)
P2.4.2.21	Parameter set 1/set 2 selection	0.1		496	Closed cont.=Set 2 is used Open cont.=Set 1 is used
P2.4.2.22	Motor control mode 1/2	0.1		164	Closed cont.=Mode 2 is used Open cont.=Mode 1 is used See par 2.6.1, 2.6.12
P2.4.2.23	External Brake Acknowledge	0.2		1210	Monitoring signal from mechanical brake. Logic activate when 0.3 or greater
P2.4.2.24	Cooling Monitor	0.2		750	Used when water cooled unit
P2.4.2.25	Enable Inching	0.1		532	Enables Inching function
P2.4.2.26	Inching 1	0.1		531	Inching reference 1 (Default Forward 2 Hz. See P2.4.16). This will start the drive.
P2.4.2.27	Inching 2	0.1		532	Inching reference 2 (Default Reverse - 2 Hz. See P2.4.17). This will start the drive.
P2.4.2.28	2 nd frequency Limit	0.1		1511	Activates second freq. Limit P2.2.7.31 2 nd Freq Limit
P2.4.2.29	Reset Position	0.1		1090	
P2.4.2.30	MF Mode 2	0.1		1092	
P2.4.2.31	Quick Stop	0.2		1213	
P2.4.2.32	Motoring Torque Limit 1	0.1		1624	
P2.4.2.33	Generator Torque Limit 1	0.1		1626	
P2.4.2.34	PID Activation	0.1		1804	
P2.4.2.35	Store Parameter Set	0.1		1753	Stores active parameter set to selected parameter set
P2.4.2.36	Start Place A/B	0.1		425	Changes start signals between A and B places.
P2.4.2.37	Start signal 1B	0.1		403	Forward, See ID300
P2.4.2.38	Start signal 2B	0.1		404	Reverse. See ID300
P2.4.2.39	Disable Negative Direction	0.2		1814	
P2.4.2.40	Disable Positive Direction	0.2		1813	
P2.4.2.41	SB Control	0.1		1952	
P2.4.2.42	Set Rope Length	0.1		1916	
P2.4.2.43	Set Rope Zero Length	0.1		1917	

Table 6-5. Digital input signals, G2.2.4

6.4.3 Analogue input 1

Code	Parameter	Min	Max	Unit	Default	Cust	ID	Note
P2.4.3.1	AI1 signal selection	0.1	E.10		A.1		377	Slot . Board input No.
P2.4.3.2	AI1 filter time	0.000	32.000	s	0.000		324	0=No filtering
P2.4.3.3	AI1 signal range	0	3		0		320	0=0...100%* 1=20...100%* 4 mA Fault 2= -10V...+10V* 3= Custom range*
P2.4.3.4	AI1 custom minimum setting	-160.00	160.00	%	0.00		321	Custom Range: Minimum input
P2.4.3.5	AI1 custom maximum setting	-160.00	160.00	%	100.00		322	Custom Range: Maximum input
P2.4.3.6	AI1 reference scaling, minimum value	0.00	320.00	Hz	0.00		303	Selects the frequency that corresponds to the min. reference signal
P2.4.3.7	AI1 reference scaling, maximum value	0.00	320.00	Hz	0.00		304	Selects the frequency that corresponds to the max. reference signal
P2.4.3.8	AI1 joystick Dead Zone	0.00	20.00	%	2.00		384	Dead Zone for joystick input
P2.4.3.9	AI1 sleep limit	0.00	100.00	%	0.00		385	Drive goes to stop if input is below this limit for this time.
P2.4.3.10	AI1 sleep delay	0.00	320.00	s	0.00		386	
P2.4.3.11	AI1 joystick offset	-100.00	100.00	%	0.00		165	Press enter for 1s to set offset

Table 6-6. Analogue input 1 parameters, G2.2.2

*Remember to place jumpers of block X2 accordingly.
See NX User Manual, chapter 6.2.2.2

6.4.4 Analogue input 2

Code	Parameter	Min	Max	Unit	Default	Cust	ID	Note
P2.4.4.1	AI2 signal selection	0.1	E.10		A.2		388	Slot . Board input No.
P2.4.4.2	AI2 filter time	0.000	32.000	s	0.000		329	0=No filtering
P2.4.4.3	AI2 signal range	0	3		1		325	0=0...100%* 1=20...100%* 4 mA Fault 2= -10V...+10V* 3=Custom range*
P2.4.4.4	AI2 custom minimum setting	-160.00	160.00	%	0.00		326	Custom Range: Minimum input
P2.4.4.5	AI2 custom maximum setting	-160.00	160.00	%	100.00		327	Custom Range: Maximum input
P2.4.4.6	AI2 reference scaling, minimum value	0.00	320.00	Hz	0.00		393	Selects the frequency that corresponds to the min. reference signal
P2.4.4.7	AI2 reference scaling, maximum value	0.00	320.00	Hz	0.00		394	Selects the frequency that corresponds to the max. reference signal
P2.4.4.8	AI2 joystick Dead Zone	0.00	20.00	%	2.00		395	Dead Zone for joystick input
P2.4.4.9	AI2 sleep limit	0.00	100.00	%	0.00		396	Drive goes to stop if input is below this limit for this time.
P2.4.4.10	AI2 sleep delay	0.00	320.00	s	0.00		397	
P2.4.4.11	AI2 joystick offset	-100.00	100.00	%	0.00		166	Press enter for 1s to set offset

Table 6-7. Analogue input 2 parameters, G2.2.3

6.4.5 Analogue input 3

Code	Parameter	Min	Max	Unit	Default	Cust	ID	Note
P2.4.5.1	AI3 signal selection	0.1	E.10		0.1		141	Slot . Board input No. If 0.1 ID27 can be controlled from FB
P2.4.5.2	AI3 filter time	0.000	32.000	s	0.000		142	0=No filtering
P2.4.5.3	AI3 custom minimum setting	-160.00	160.00	%	0.00		144	Custom range always active. See ID326
P2.4.5.4	AI3 custom maximum setting	-160.00	160.00	%	100.00		145	Custom range always active. See ID327
P2.4.5.5	AI3 signal inversion	0	1		0		151	0=Not inverted 1=Inverted
P2.4.5.6	AI3 reference scaling, minimum value	-32000	32000		0		1037	Selects the value that corresponds to the min. reference signal
P2.4.5.7	AI3 reference scaling, maximum value	-32000	32000		0		1038	Selects the value that corresponds to the max. reference signal
P2.4.5.8	AI3 Controlled ID	0	10000		0		1509	Select parameter that you want to control by ID number.

Table 6-8. Analogue input 3 parameters, G2.2.4

**Remember to place jumpers of block X2 accordingly.
See NX User Manual, chapter 6.2.2.2

6.4.6 Analogue input 4

Code	Parameter	Min	Max	Unit	Default	Cust	ID	Note
P2.4.6.1	AI4 signal selection	0.1	E.10		0.1		152	Slot . Board input No. If 0.1 ID28 can be controlled from FB
P2.4.6.2	AI4 filter time	0.000	32.000	s	0.000		153	0=No filtering
P2.4.6.3	AI4 custom minimum setting	-160.00	160.00	%	0.00		155	Custom range always active. See ID326
P2.4.6.4	AI4 custom maximum setting	-160.00	160.00	%	100.00		156	Custom range always active. See ID327
P2.4.6.5	AI4 signal inversion	0	1		0		162	0=Not inverted 1=Inverted
P2.4.6.6	AI3 reference scaling, minimum value	-32000	-32000		0		1039	Selects the value that corresponds to the min. reference signal
P2.4.6.7	AI3 reference scaling, maximum value	-32000	32000		0		1040	Selects the value that corresponds to the max. reference signal
P2.4.6.8	AI4 Controlled ID	0	10000		0		1510	Select parameter that you want to control by ID number.

Table 6-9. Analogue input 4 parameters, G2.2.5

6.4.7 Options

Code	Parameter	Min	Max	Unit	Default	Cust	ID	Note
P2.4.7.1	Input signal inversion Control	0	6553 5		2		1091	

6.5 Output Signals

6.5.1 Digital output signals

Code	Parameter	Min	Default	Cust	ID	Note
P2.5.1.1	Ready	0.1	0.1		432	Ready to Run
P2.5.1.2	Run	0.1	0.1		433	Running
P2.5.1.3	Fault	0.1	0.1		434	Drive in fault state
P2.5.1.4	Inverted fault	0.1	0.1		435	Drive not in fault state
P2.5.1.5	Warning	0.1	0.1		436	Warning active
P2.5.1.6	External fault	0.1	0.1		437	External fault active
P2.5.1.7	Reference fault/warning	0.1	0.1		438	4 mA fault active
P2.5.1.8	Over temperature warning	0.1	0.1		439	Drive over temperature active
P2.5.1.9	Reverse	0.1	0.1		440	Output frequency < 0 Hz
P2.5.1.10	Unrequested direction	0.1	0.1		441	Reference <> Output frequency
P2.5.1.11	At speed	0.1	0.1		442	Reference = Output frequency
P2.5.1.12	Jogging speed	0.1	0.1		443	Jogging or preset speed command active
P2.5.1.13	External control place	0.1	0.1		444	IO control active
P2.5.1.14	External brake control, Direct	0.1	0.1		446	See explanations on chapter Brake Control
P2.5.1.15	External brake control, Invert	0.1	0.1		445	
P2.5.1.16	Output frequency limit 1 supervision	0.1	0.1		447	See ID315
P2.5.1.17	Output frequency limit 2 supervision	0.1	0.1		448	See ID346
P2.5.1.18	Reference limit supervision	0.1	0.1		449	See ID350
P2.5.1.19	Temperature limit supervision	0.1	0.1		450	Drive temperature supervision. See ID354
P2.5.1.20	Torque limit supervision	0.1	0.1		451	See ID348
P2.5.1.21	Motor thermal protection	0.1	0.1		452	Thermistor fault or warning
P2.5.1.22	Analogue input supervision limit	0.1	0.1		463	See ID356
P2.5.1.23	Motor regulator activation	0.1	0.1		454	One of limit controller is active
P2.5.1.24	Fieldbus digital input 1	0.1	0.1		455	FB CW B11
P2.5.1.25	FB Dig 1 Parameter	ID0	ID0		891	Select parameter to control
P2.5.1.26	Fieldbus digital input 2	0.1	0.1		456	FB CW B12
P2.5.1.27	FB Dig 2 Parameter	ID0	ID0		892	Select parameter to control
P2.5.1.28	Fieldbus digital input 3	0.1	0.1		457	FB CW B13
P2.5.1.29	FB Dig 3 Parameter	ID0	ID0		893	Select parameter to control
P2.5.1.30	Fieldbus digital input 4	0.1	0.1		169	FB CW B14
P2.5.1.31	FB Dig 4 Parameter	ID0	ID0		894	Select parameter to control
P2.5.1.32	Fieldbus digital input 5	0.1	0.1		170	FB CW B15
P2.5.1.33	FB Dig 5 Parameter	ID0	ID0		895	Select parameter to control
P2.5.1.34	Safe Disable Active	0.1	0.1		756	
P2.5.1.35	Brake Slipping	0.1	0.1		1786	

6.5.2 Analogue output 1

Code	Parameter	Min	Max	Unit	Default	Cust	ID	Note
P2.5.2.1	Analogue output 1 signal selection	0.1	E.10		A.1		464	TTF programming See chapter 3.1 and 3.2
P2.5.2.2	Analogue output 1 function	0	20		0		307	0 =Not used (4 mA / 2 V) 1 =Output freq. (0— f_{max}) 2 =Freq. reference (0— f_{max}) 3 =Motor speed (0—Motor nominal speed) 4 =Motor current (0— I_{nMotor}) 5 =Motor torque (0— T_{nMotor}) 6 =Motor power (0— P_{nMotor}) 7 =Motor voltage (0— U_{nMotor}) 8 =DC-link volt (0—1000V) 9 =AI1 10 =AI2 11 =Output freq. (f_{min} - f_{max}) 12 =- 2xTorque...+2xTorque 13 =-2xPower...+2xPower 14 =PT100 temperature 15 =FB Analog Output 16 = -2xSpeed...+2xSpeed 17 = Encoder speed (0—Motor nominal speed) 18 =Final Freq.Ref 19 = Value Control Out 20 =Drive Output Power
P2.5.2.3	Analogue output 1 filter time	0.00	10.00	s	1.00		308	0 =No filtering
P2.5.2.4	Analogue output 1 inversion	0	1		0		309	0 =Not inverted 1 =Inverted
P2.5.2.5	Analogue output 1 minimum	0	1		0		310	0 =0 mA (0 %) 1 =4 mA (20 %)
P2.5.2.6	Analogue output 1 scale	10	1000	%	100		311	
P2.5.2.7	Analogue output 1 offset	-100.00	100.00	%	0.00		375	

Table 6-10. Analogue output 1 parameters, G2.3.5

6.5.3 Analogue output 2

Code	Parameter	Min	Max	Unit	Default	Cust	ID	Note
P2.5.3.1	Analogue output 2 signal selection	0.1	E.10		0.1		471	TTF programming See chapter 3.1 and 3.2
P2.5.3.2	Analogue output 2 function	0	20		4		472	See P2.5.2.2
P2.5.3.3	Analogue output 2 filter time	0.00	10.00	s	1.00		473	0 =No filtering
P2.5.3.4	Analogue output 2 inversion	0	1		0		474	0 =Not inverted 1 =Inverted
P2.5.3.5	Analogue output 2 minimum	0	1		0		475	0 =0 mA (0 %) 1 =4 mA (20 %)
P2.5.3.6	Analogue output 2 scale	10	1000	%	100		476	
P2.5.3.7	Analogue output 2 offset	-100.00	100.00	%	0.00		477	

Table 6-11. Analogue output 2 parameters, G2.3.6

6.5.4 Analogue output 3

Code	Parameter	Min	Max	Unit	Default	Cust	ID	Note
P2.5.4.1	Analogue output 3 signal selection	0.1	E.10		0.1		478	TTF programming See chapter 3.1 and 3.2
P2.5.4.2	Analogue output 3 function	0	20		5		479	See P2.5.2.2
P2.5.4.3	Analogue output 3 filter time	0.00	10.00	s	1.00		480	0=No filtering
P2.5.4.4	Analogue output 3 inversion	0	1		0		481	0=Not inverted 1=Inverted
P2.5.4.5	Analogue output 3 minimum	0	1		0		482	0=0 mA (0 %) 1=4 mA (20 %)
P2.5.4.6	Analogue output 3 scale	10	1000	%	100		483	
P2.5.4.7	Analogue output 3 offset	-100.00	100.00	%	0.00		484	

Table 6-12. Analogue output 3 parameters, G2.3.7

6.5.5 Analogue output 4

Code	Parameter	Min	Max	Unit	Default	Cust	ID	Note
P2.5.5.1	Analogue output 4 signal selection	0.1	E.10		0.1		1527	TTF programming See chapter 3.1 and 3.2
P2.5.5.2	Analogue output 4 function	0	20		5		1520	See P2.5.2.2
P2.5.5.3	Analogue output 4 filter time	0.00	10.00	s	1.00		1521	0=No filtering
P2.5.5.4	Analogue output 4 inversion	0	1		0		1522	0=Not inverted 1=Inverted
P2.5.5.5	Analogue output 4 minimum	0	1		0		1523	0=0 mA (0 %) 1=4 mA (20 %)
P2.5.5.6	Analogue output 4 scale	10	1000	%	100		1525	
P2.5.5.7	Analogue output 4 offset	-100.00	100.00	%	0.00		1524	

Table 6-13. Analogue output 4 parameters, G2.3.8

6.5.6 Delayed digital output 1

Code	Parameter	Min	Max	Unit	Default	Cust	ID	Note
P2.5.6.1	Digital output 1 signal selection	0.1	E.10		0.1		486	Possibility to invert by ID1091 INV Commands
P2.5.6.2	Digital output 1 function	0	28		1		312	0=Not used 1=Ready 2=Run 3=Fault 4=Fault inverted 5=FC overheat warning 6=Ext. fault or warning 7=Ref. fault or warning 8=Warning 9=Reverse 10=Jogging spd selected 11=At speed 12=Mot. regulator active 13=Freq. limit 1 superv. 14=Freq. limit 2 superv. 15=Torque limit superv. 16=Ref. limit supervision 17= Brake Open, Invert. 18=l/O control place act. 19=FC temp. limit superv. 20=Reference inverted 21=Brake Open, Direct. 22=Therm. fault or warn. 23=On/Off control 24=Fieldbus input data 1 25=Fieldbus input data 2 26=Fieldbus input data 3 27=Warning Set Reset 28=ID.Bit Select
P2.5.6.3	Digital output 1 on delay	0.00	320.00	s	0.00		487	0.00 = On delay not in use
P2.5.6.4	Digital output 1 off delay	0.00	320.00	s	0.00		488	0.00 = Off delay not in use
P2.5.6.5	Invert delayed DO1	0	1		0		1587	0=Not inverted 1=Inverted
P2.5.6.6	ID.Bit Free DO	0.00	2000.15		0.00		1217	
P2.5.6.7	DO1 Time Scale	0	2		0		1060	0 = s 1 = min 2 = h

Table 6-14. Delayed digital output 1 parameters, G2.3.1

6.5.7 Delayed digital output 2

Code	Parameter	Min	Max	Unit	Default	Cust	ID	Note
P2.5.7.1	Digital output 2 signal selection	0.1	E.10		0.1		489	Possibility to invert by ID1091 INV Commands
P2.5.7.2	Digital output 2 function	0	28		0		490	See P2.5.6.2
P2.5.7.3	Digital output 2 on delay	0.00	320.00	s	0.00		491	0.00 = On delay not in use
P2.5.7.4	Digital output 2 off delay	0.00	320.00	s	0.00		492	0.00 = Off delay not in use
P2.5.7.5	Invert delayed DO2	0	1		0		1588	0=Not inverted 1=Inverted
P2.5.7.6	ID.Bit Free DO	0.00	2000.15		0.00		1385	
P2.5.7.7	DO2 Time Scale	0	2		0		1061	0 = s 1 = min 2 = h

Table 6-15. Delayed digital output 2 parameters, G2.3.2

6.5.8 Supervision Limits

Code	Parameter	Min	Max	Unit	Default	Cust	ID	Note
P2.5.8.1	Output frequency limit 1 supervision	0	2		0		315	0=No limit 1=Low limit supervision 2=High limit supervision
P2.5.8.2	Output frequency limit 1; Supervised value	0.00	320.00	Hz	0.00		316	
P2.5.8.3	Output frequency limit 2 supervision	0	2		0		346	0=No limit 1=Low limit supervision 2=High limit supervision
P2.5.8.4	Output frequency limit 2; Supervised value	0.00	320.00	Hz	0.00		347	
P2.5.8.5	Torque limit supervision	0	2		0		348	0=Not used 1=Low limit supervision 2=High limit supervision
P2.5.8.6	Torque limit supervision value	-300.0	300.0	%	100.0		349	
P2.5.8.7	Reducing of torque supervision limit	0	5		0		402	
P2.5.8.8	Reference limit supervision	0	2		0		350	0=Not used 1=Low limit 2=High limit
P2.5.8.9	Reference limit supervision value	0.00	100.0	%	0.00		351	
P2.5.8.10	FC temperature supervision	0	2		0		354	0=Not used 1=Low limit 2=High limit
P2.5.8.11	FC temperature supervised value	-10	100	°C	40		355	
P2.5.8.12	Analogue supervision signal	0	4		0		356	0=Not used 1=A11 2=A12 3=A13 4=A14
P2.5.8.13	Analogue supervision low limit	0.00	100.00	%	10.00		357	Reset limit
P2.5.8.14	Analogue supervision high limit	0.00	100.00	%	90.00		358	Set limit

Table 6-16. Supervision Limit settings, G2.3.4

6.6 Limit Settings

6.6.1 Current handling

Code	Parameter	Min	Max	Unit	Default	Cust	ID	Note
P2.6.1	Current limit	0	2 x I _H	A	Unit Max		107	Reaching the limit will lower the output frequency
P2.6.2	Scaling of current limit	0	5		0		399	Scaling from 0 to ID107 0=Not used 1=A11 2=A12 3=A13 4=A14 5=FB Limit Scaling ID46
P2.6.3	Current Limit Kp	1	32000		Varies		1451	
P2.6.4	Current Limit Ki	1	32000		Varies		1452	

6.6.2 Torque Handling

Code	Parameter	Min	Max	Unit	Default	Cust	ID	Note
P2.6.2.1	Torque Limit	0.0	300.0	%	300.0		609	General maximum limit
P2.6.2.2	Motoring Torque Limit	0.0	300.0	%	300.0		1287	Motoring side torque limit
P2.6.2.3	Generator Torque Limit	0.0	300.0	%	300.0		1288	Generator side torque limit
P2.6.2.4	Motoring Torque Limit 1	0.0	300.0	%	300.0		1625	
P2.6.2.5	Generator Torque limit 1	0.0	300.0	%	300.0		1627	
P2.6.2.6	Scaling Motoring Torque limit	0	5		0		485	Scaling from 0 to ID1287 0=Not used 1=A11 2=A12 3=A13 4=A14 5=FB Limit Scaling ID46
P2.6.2.7	Scaling Generator Torque limit	0	5		0		1087	Scaling from 0 to ID1288 As parameter P2.6.3.9

6.6.2.1 Torque Handling OL Settings

Code	Parameter	Min	Max	Unit	Default	Cust	ID	Note
P2.6.2.8.1	Torque limit control P-gain	0.0	32000		3000		610	
P2.6.2.8.2	Torque limit control I-gain	0.0	32000		200		611	

6.6.2.2 Torque Handling CL Settings

Code	Parameter	Min	Max	Unit	Default	Cust	ID	Note
P2.6.2.9.1	SPC Out Limit	0.0	300.0	%	300.0		1382	
P2.6.2.9.2	SPC Pos Limit	0.0	300.0	%	300.0		646	
P2.6.2.9.3	SPC Neg Limit	0.0	300.0	%	300.0		645	
P2.6.2.9.4	Pull Out Torque	0.0	600.0	%	500.0		1291	

6.6.2.3 *Run a way load catch for CL*

Code	Parameter	Min	Max	Unit	Default	Cust	ID	Note
P2.6.2.10.1	Generator Torque limit increase speed level	0.00	320.0 0	Hz	0.00		1547	Function disabled when zero. Point where Generator torque limit starts to increase.
P2.6.2.10.2	Generator Torque limit increase maximum speed limit	0.00	320.0 0	Hz	100.00		1548	Point where torque value of ID1549 is added to base generator torque limit.
P2.6.2.10.3	Generator Torque limit increase maximum addition	0.0	300.0	%	300.0		1549	

6.6.3 *Frequency Handling*

Code	Parameter	Min	Max	Unit	Default	Cust	ID	Note
P2.6.3.1	Max Frequency 2	0.00	320.00	Hz	35.00		1512	Maximum frequency limit that is activated by digital input.
P2.6.3.2	Negative frequency limit	-320.00	320.00	Hz	-320.00		1286	Alternative limit for negative direction
P2.6.3.3	Positive frequency limit	-320.00	320.00	Hz	320.00		1285	Alternative limit for positive direction
P2.6.3.4	Zero Frequency limit	0.00	320.00	Hz	1.00		1283	
P2.6.3.5	Minimum Frequency Open Loop	0.00	50.00	Hz	Varies		101	Calculated during Brake ID Run
P2.6.3.6	Minimum Frequency Closed Loop	0.00	50.00	Hz	0.00		215	Calculated during Brake ID Run
P2.6.3.7	Acceleration Power Limit Forward	0.00	600.0	%	300.0		1903	
P2.6.3.8	Acceleration Power Limit Reverse	0.00	600.0	%	300.0		1904	

6.6.4 DC-Link Handling

Code	Parameter	Min	Max	Unit	Default	Cust	ID	Note
P2.6.4.1	Overvoltage controller	0	2		0		607	0=Not used 1=Used (no ramping) 2=Used (ramping)
P2.6.4.2	Over Voltage Reference selector	0	2		1		1262	0=High Voltage 1=Normal Voltage 2=BrakeChopperLevel
P2.6.4.3	Brake chopper	0	4		0		504	0=Disabled 1=Used when running 2=External brake chopper 3=Used when stopped/running 4=Used when running (no testing)
P2.6.4.4	Brake Chopper Level	5: 605 6: 836	5: 797 6: 1099	V			1267	
P2.6.4.5	Undervoltage controller	0	2		0		608	0=Not used 1=Used (no ramping) 2=Used (ramping to zero)
P2.6.4.6	Under Voltage Ref Selector	0	1		1		1537	0=Under Voltage Ref 1= 0.8 * Estimated DC Volt.
P2.6.4.6	Under Voltage Reference	5: 410 6: 567	5: 540 6: 745	V	Varies		1538	

6.6.4.1 DC-Link Handling CL Settings

Code	Parameter	Min	Max	Unit	Default	Cust	ID	Note
P2.6.4.8.1	Over voltage reference	94.00	130.00	%	118.00		1528	
P2.6.4.8.2	Over voltage motoring side torque limit	0.0	300.0	%	10.0		1623	Maximum motoring torque when over voltage controller is active.
P2.6.4.8.3	CL Under Voltage Reference	60.00	80.00	%	65.00		1567	

6.6.5 Limit Settings Options

Code	Parameter	Min	Max	Unit	Default	Cust	ID	Note
P2.6.6.1	Limit Total Current In Closed Loop	0	1		0		1901	0=No 1=Yes

6.7 Flux and DC Current handling

6.7.1 Flux and DC Current handling OL Settings

Code	Parameter	Min	Max	Unit	Default	Cust	ID	Note
P2.7.1.1	DC braking current	0.00	I _L	A	0.00		507	Calculated during Brake ID
P2.7.1.2	DC braking time at start	0.00	600.00	s	0.00		516	Calculated during Brake ID
P2.7.1.3	DC braking time at stop	0.00	600.00	s	0.00		508	Calculated during Brake ID
P2.7.1.4	Frequency to start DC braking during ramp stop	0.10	10.00	Hz	1.50		515	
P2.7.1.5	DC-Brake Current in Stop	0.00	I _L	A	Varies		1080	
P2.7.1.6	Flux brake	0	1		0		520	0=Off 1=On
P2.7.1.7	Flux braking current	0.00	I _L	A	I _H		519	

6.7.2 Flux and DC Current handling CL Settings

Code	Parameter	Min	Max	Unit	Default	Cust	ID	Note
P2.7.2.1	Magnetizing current at start	0	I _L	A	0.00		627	Calculated during Brake ID
P2.7.2.2	Magnetizing time at start	0.0	600.0	s	0.0		628	Calculated during Brake ID
P2.7.2.3	Flux Reference	0.0	500.0	%	100.0		1250	
P2.7.2.4	Flux Off Delay	-1	32000	s	0		1402	-1=forever
P2.7.2.5	Stop State Flux	0.0	150.0	%	100.0		1401	
P2.7.2.6	Reduced Flux Level	0.0	500.0	%	100.0		1613	
P2.7.2.7	Reduced Flux Frequency	0.00	32.00	Hz	0.00		1614	

6.8 Motor Control

6.8.1 Motor Control Basic Settings

Code	Parameter	Min	Max	Unit	Default	Cust	ID	Note
P2.8.1	MC mode	0	3		0		694	0= Open Loop 1= Closed Loop 2= Sensorless 3= AOL Control
P2.8.3	Torque Select	0	6		1		1278	0=Frequency Control 1=Speed Control 2=Torque 3=Torque; Ramp Output 4=Torque; Min 5=Torque; Max 6=Torque; Window

6.8.2 Open Loop Settings

Code	Parameter	Min	Max	Unit	Default	Cust	ID	Note
P2.8.3.1	U/f optimisation	0	1		0		109	0=Not used 1=Automatic torque boost
P2.8.3.2	U/f ratio selection	0	3		0		108	0=Linear 1=Squared 2=Programmable 3=Linear with flux optim.
P2.8.3.3	Field weakening point	6.00	320.00	Hz	50.00		602	
P2.8.3.4	Voltage at field weakening point	10.0 0	200.00	%	100.00		603	n% x U _{nmot}
P2.8.3.5	U/f curve midpoint frequency	0.00	P2.8.3.3	Hz	50.00		604	
P2.8.3.6	U/f curve midpoint voltage	0.00	100.00	%	100.00		605	n% x U _{nmot} Parameter max. value = P2.6.5
P2.8.3.7	Output voltage at zero frequency	0.00	40.00	%	0.00		606	n% x U _{nmot}
P2.8.3.8	Freq. Dir. Change	0	32000		25000		1682	
P2.8.3.9	Hoisting ID UF Strength	33	200	%	90		1905	
P2.8.3.10	I/f Start	0	1		0		1809	
P2.8.3.11	I/f Current	0.0	150.0		120.0		1693	
P2.8.3.12	I/f Control Limit	0.0	300.0		10.0		1790	Calculated during Crane ID
P2.8.3.13	MakeFluxTime	0	32000	ms	200		660	

6.8.3 Closed Loop Control Settings

Code	Parameter	Min	Max	Unit	Default	Cust	ID	Note
P2.8.4.1	Current control P gain	0.00	100.00	%	40.00		617	
P2.8.4.2	Current control I Time	0.0	3200.0	ms	1.5		657	
P2.8.4.3	Slip adjust	0	500	%	75		619	
P2.8.4.4	Acceleration compensation	0.00	300.00	s	0.00		626	
P2.8.4.5	Speed Error Filter TC	0	1000	ms	0		1311	
P2.8.4.6	Encoder filter time	0	1000	ms	0		618	
P2.8.4.7	Encoder Selection	0	1		0		1595	0=Encoder Input 1 1=Encoder Input 2
P2.8.4.8	Motor Temperature Compensation mode	0	2		0		1426	0=Not used 1=Internal 2=Measured Temperature
P2.8.4.9	SC Torque Chain Select	0	65535		0		1557	Default 96 after identification.
P2.8.4.10	CL MC Mode	0	1		1		691	0=Flux Model 1 1=Flux Model 2
P2.8.4.11	TCDunDampGain	0,00	100,00	%			1576	
P2.8.4.12	TCDynDampTC	0	32000	ms	0		1577	

6.8.4 PMSM Control settings

Code	Parameter	Min	Max	Unit	Default	Cust	ID	Note
P2.8.5.1	PMSM Shaft Position	0	65535		0		649	
P2.8.5.2	Start Angle Identification mode	0	10		0		169 1	0=Automatic 1=Forced 2=After Power Up 3=Disabled
P2.8.5.3	Start Angle Identification DC Current	0.0	150.0	%	0.0		175 6	
P2.8.5.4	Polarity Pulse Current	-10.0	200.0	%	0.0		156 6	
P2.8.5.5	Start Angle ID Time	0	32000	ms	0		175 5	
P2.8.5.6	I/f Current	0.0	150.0	%	50.0		169 3	
P2.8.5.7	I/f Control Limit	0.0	300.0	%	10.0		179 0	
P2.8.5.8	Flux Current Kp	0	32000		5000		651	
P2.8.5.9	Flux Current Ti	0	1000		25		652	
P2.8.5.10	External Id Reference	-150.0	150.0	%	0.0		173 0	
P2.8.5.11	Enable Rs Identification	0	1		1		654	0=No 1=Yes
P2.8.5.12	Lsd Voltage Drop	-32000	32000		0		175 7	
P2.8.5.13	Lsq Voltage Drop	-32000	32000		0		175 8	
P2.8.5.14	EnclDCCurrent	0.0	150.0	%	90.0		173 4	
P2.8.5.15	Polarity ID Mode	0	1				173 7	
P2.8.5.16	Polarity Pulse Length	0	1000	ms	200		174 2	
P2.8.5.17	Polarity Detection Angle	0.0	360.0	Deg	1.5		174 8	
P2.8.5.18	Angle Identification Mode	0	2				174 9	
P2.8.5.19	Current Control Kp d	0	32000	%			176 1	
P2.8.5.20	Voltage Margin	0.0	120.0	%			175 9	
P2.8.5.21	Encoder ID Run Mode	0	2		0		680	
P2.8.5.22	VoltageCorr. Kp	0,000	32,000		0,100		178 3	
P2.8.5.23	VoltageCorr. Ki	0	32000		5000		178 4	

6.8.5 Stabilators

Code	Parameter	Min	Max	Unit	Default	Cust	ID	Note
P2.8.6.1	Torque Stabilator Gain	0	1000		100		1412	
P2.8.6.2	Torque Stabilator Damping	0	1000		800		1413	With PMSM use 980
P2.8.6.3	Torque Stabilator Gain in FWP	0	1000		50		1414	
P2.8.6.4	Torque Stabilator Limit	0	1500		150		1720	
P2.8.6.5	Flux Circle Stabilator Gain	0	32767		10000		1550	
P2.8.6.6	Flux Circle Stabilator TC	0	32700		900		1551	
P2.8.6.7	Flux Stabilator Gain	0	32000		500		1797	
P2.8.6.8	Flux Stab Coeff	-30000	30000				1796	
P2.8.6.9	Voltage Stabilator Gain	0	100.0	%	10.0		1738	
P2.8.6.10	Voltage Stabilator TC	0	1000		900		1552	
P2.8.6.11	Voltage Stabilator Limit	0	320.00	Hz	1.50		1553	

6.8.6 Tuning parameters

Code	Parameter	Min	Max	Unit	Default	Cust	ID	Note
P2.8.7.1	Fly Start Options	0	65535		0		1610	
P2.8.7.2	MC Options	0	65535		0		1740	
P2.8.7.3	Resonance Damping Select	0	200		0.00		1760	
P2.8.7.4	Damping Frequency	0	320.00	Hz	0		1763	
P2.8.7.5	Damping Gain	0	32000		0		1764	
P2.8.7.6	Damping Phase	0	360		0.00		1765	
P2.8.7.7	Damping Activation Frequency	0	320.00	%	0		1770	
P2.8.7.8	Damping Filter Time Constant	0	32700		105		1771	
P2.8.7.9	Over Modulation Limit	50	120	%	105		1515	If you have sine filter in use set this to 101 %
P2.8.7.10	Modulator Index Limit	0	200	%	100		655	
P2.8.7.11	DC Voltage Filter	0.0	500.0		0.0		1591	
P2.8.7.12	GearRatioMultipl	0	32000		1		1558	
P2.8.7.13	GearRatioDivider	0	32000		1		1559	

6.8.7 Identification parameters

Code	Parameter	Min	Max	Unit	Default	Cust	ID	Note
P2.8.8.1	Flux 10 %	0	2500	%	10		135 5	
P2.8.8.2	Flux 20 %	0	2500	%	20		135 6	
P2.8.8.3	Flux 30 %	0	2500	%	30		135 7	
P2.8.8.4	Flux 40 %	0	2500	%	40		135 8	
P2.8.8.5	Flux 50 %	0	2500	%	50		135 9	
P2.8.8.6	Flux 60 %	0	2500	%	60		136 0	
P2.8.8.7	Flux 70 %	0	2500	%	70		136 1	
P2.8.8.8	Flux 80 %	0	2500	%	80		136 2	
P2.8.8.9	Flux 90 %	0	2500	%	90		136 3	
P2.8.8.10	Flux 100 %	0	2500	%	100		136 4	
P2.8.8.11	Flux 110 %	0	2500	%	110		136 5	
P2.8.8.12	Flux 120 %	0	2500	%	120		136 6	
P2.8.8.13	Flux 130 %	0	2500	%	130		136 7	
P2.8.8.14	Flux 140 %	0	2500	%	140		136 8	
P2.8.8.15	Flux 150 %	0	2500	%	150		136 9	
P2.8.8.16	Rs voltage drop	0	30000		Varies		662	Used for torque calculation in open loop
P2.8.8.17	Ir add zero point voltage	0	30000		Varies		664	
P2.8.8.18	Ir add generator scale	0	30000		Varies		665	
P2.8.8.19	Ir add motoring scale	0	30000		Varies		667	
P2.8.8.20	Ls Voltage Dropp	0	3000		0		673	
P2.8.8.21	Motor BEM Voltage	0.00	320.00	%	0		674	
P2.8.8.22	Iu Offset	-32000	32000		0		668	
P2.8.8.23	Iv Offset	-32000	32000		0		669	
P2.8.8.24	Iw Offset	-32000	32000		0		670	
P2.8.8.25	Estimator Kp	0	32000		400		178 1	
P2.8.8.26	Estimator Ki	0	3200		2000		178 2	
P2.8.8.27	Speed step	-50.0	50.0	0.0	0.0		125 2	NCDrive speed tuning
P2.8.8.28	Torque step	-100.0	100.0	0.0	0.0		125 3	NCDrive torque tuning
P2.8.8.29	Original UF Zero Point Voltage	0.00	20.00	%	0.00		681	
P2.8.8.30	Voltage Drop	0.00	20.00	%	0.00		671	
P2.8.8.31	ID Run Current Kp						695	
P2.8.8.32	Flux Saturation Ratio	0,0	100,0		0,0		682	
P2.8.8.33	DeadTimeComp	-10	32000		2000		175 1	

P2.8.8.34	DeadTieContCu rL	-3200	32000		100		175 2	
-----------	---------------------	-------	-------	--	-----	--	----------	--

Table 6-17. Identification parameters, G2.6.4

6.8.8 Fine tuning parameters

Code	Parameter	Min	Max	Unit	Default	Cust	ID	Note
P 2.8.9.1	DeadTHWCompDisab						1750	
P 2.8.9.2	CurrMeasFCompTC						1554	
P 2.8.9.3	CurrLimOptions						1702	
P 2.8.9.4	AdConvStartShift						1701	

Table 6-18. Fine tuning parameters

6.8.9 AOL Control Tuning parameters

Code	Parameter	Min	Max	Unit	Default	Cust	ID	Note
P 2.8.10.1	Freq. 0	0	3200	%	10		1684	
P 2.8.10.2	Freq. 1	0	3200	%	20		1707	
P 2.8.10.3	Freq. 2	0	300	%	20		1791	
P 2.8.10.4	Freq. 3	0	100	%	30		635	
P 2.8.10.5	MinCurrentRef	0	100	%	70		622	
P 2.8.10.6	NoLoadFluxCurr	0	100	%	70		623	
P 2.8.10.7	M5 StrayFluxCurr	0	100	%	55		624	
P 2.8.10.8	0 Speed Current	0	250	%	125		625	
P 2.8.10.9	DeltaAngleFWD	0	2500		560		692	
P 2.8.10.10	DeltaAngleREV	0	2500		1536		693	
P 2.8.10.11	Flux Current Kp	0	32000		5000		1708	
P 2.8.10.12	Flux Current Ti	0	3200		4		1709	
P 2.8.10.13	FluxStabGain1	0	32000		100		1541	
P 2.8.10.14	FluxStabGainFWP	0	32000		300		1542	
P 2.8.10.15	FluxStabLimit	0	32000		300		1543	
P 2.8.10.16	FluxCurrentDamp	0	32000		50		1546	

Table 6-19. AOL Control tuning parameters

6.9 Speed Control

6.9.1 Speed Control Basic settings

Code	Parameter	Min	Max	Unit	Default	Cust	ID	Note
P2.9.1	Load drooping	0.00	100.00	%	0.00		620	
P2.9.2	Load Drooping Time	0	32000	ms	0		656	For dynamic changes
P2.9.3	Load Drooping Removal	0	2		0		1534	0=Normal 1= At zero Freq Lim 2=Linear zero to Fnom

Table 6-20. Speed control basic settings

6.9.2 Speed Control OL Settings

Code	Parameter	Min	Max	Unit	Default	Cust	ID	Note
P2.9.4.1	Speed controller P gain (open loop)	0	32767		3000		637	
P2.9.4.2	Speed controller I gain (open loop)	0	32767		300		638	

Table 6-21 Speed control OL settings

6.9.3 Speed Control CL Settings

Code	Parameter	Min	Max	Unit	Default	Cust	ID	Note
P2.9.5.1	Speed control P gain	0	1000		30		613	
P2.9.5.2	Speed control I time	-32000	32000	ms	100		614	Negative value uses 0.1 ms format instead of 1 ms
P2.9.5.3	0-speed time at start	0	32000	ms	100		615	
P2.9.5.4	0-speed time at stop	0	32000	ms	100		616	
P2.9.5.5	SPC f1 Point	0.00	320.00	Hz	0.00		1301	
P2.9.5.6	SPC f0 Point	0.00	320.00	Hz	0.00		1300	
P2.9.5.7	SPC Kp f0	0	1000	%	100		1299	
P2.9.5.8	SPC Kp FWP	0	1000	%	100		1298	
P2.9.5.9	SPC Torque minimum	0	400.0	%	0.0		1296	
P2.9.5.10	SPC Torque minimum Kp	0	1000	%	100		1295	
P2.9.5.11	SPC Kp TC Torque	0	1000	ms	0		1297	

Table 6-212. Speed control CL settings

6.10 Drive Control

Code	Parameter	Min	Max	Unit	Default	Cust	ID	Note
P2.10.1	Switching frequency	1.0	Varies	kHz	Varies		601	
P2.10.2	Modulator Type	0	3		0		1516	
P2.10.3	Control Options	0	65535		64		1084	
P2.10.4	Control Options 2	0	65535		0		1798	
P2.10.5	Advanced Options 1	0	65535		0		1560	
P2.10.6	Advanced Options 2	0	65535		0		1561	
P2.10.7	Advanced Options 4	0	65535		0		1563	
P2.10.8	Advanced Options 5	0	65535		0		1564	
P2.10.9	Advanced Options 6	0	65535		0		1565	
P2.10.10	Restart Delay	0	65535	s	Varies		1424	
P2.10.11	Restart Delay CL	0	60.000	s	Varies		672	CL and Flying Start

Table 6-22. Drive control

6.11 Master Follower Control Parameters

Code	Parameter	Min	Max	Unit	Default	Cust	ID	Note
P2.11.1	Master Follower Mode	0	6		0		1324	0=Not Used 1=Master 2=Follower 3=ShaftSynch Master 4=ShaftSynch Follower 5=DriveSynch Master 6=DriveSynch Follower
P2.11.2	Follower Speed Reference Select	0	18		17		1081	0=A11 1=A12 2=A11+A12 3=A11-A12 4=A12-A11 5=A11x12 6=A11 Joystick 7=A12 Joystick 8=Keypad 9=Fieldbus 10=Motor potentiometer 11=A11, A12 minimum 12=A11, A12 maximum 13=Max frequency 14=A11/A12 selection 15=Encoder 1 16=Encoder 2 17=MSS Reference 18=Master Reference 19=Master Ramp Out
P2.11.3	Follower Torque Reference Select	0	10		10		1083	0=Not used 1=A11 2=A12 3=A13 4=A14 5=A11 joystick 6=A12 joystick 7=Torque reference from keypad, R3.5 8=FB Torque Reference 9=Master Torque OL 10=Master Torque CL
P2.11.4	Follower Stop Function	0	2		2		1089	0=Coasting 1=Ramping 2=As Master
P2.11.5	MF Brake Logic	0	3		2		1326	Not used when Ramp follower or in drive sync mode 0=Master or Own 1=Own 2=Master & Own, Master monitors also follower brake status. 3=Master
P2.11.6	MF Mode 2	0	4		0		1093	P2.11.1
P2.11.7	System Bus Fault	0	3		1		1082	0=No response 1=Warning 2=Fault, stop acc. to 2.3.2 3=Fault, stop by coasting
P2.11.8	System Bus Fault Delay	0.00	320.00	s	3.00		1352	
P2.11.9	Follower Fault	0	3		1		1536	0=No response 1=Warning 2=Fault, stop acc. to 2.3.2 3=Fault, stop by coasting
P2.11.10	Force SB Control	0	1		0		1851	

Table 6-234. Master Follower Control parameters, G2.11

6.11.1.1 Drive Synch specific parameters

Code	Parameter	Min	Max	Unit	Default	Cust	ID	Note
2.11.11.1	Drive Synch Follower fault	0	2				1531	
2.11.11.2	Follower phase shift	0.0	360.0	Dec	0.0		1518	
2.11.11.3	DC Voltage Balance Gain	0	1000		100		1519	

Table 6-24. Drive Synch specific parameters, G2.11.10

6.12 Protections

6.12.1 General settings

Code	Parameter	Min	Max	Unit	Default	Cust	ID	Note
P2.12.1.1	Input phase supervision	0	3		0		730	0=No response 1=Warning 2=Fault,stop acc. to 2.3.2 3=Fault,stop by coasting
P2.12.1.2	Response to undervoltage fault	0	1		0		727	0=Fault stored in history 1=Fault not stored
P2.12.1.3	Output phase supervision	0	3		2		702	See P2.12.1.1
P2.12.1.4	Response to slot fault	0	3		2		734	See P2.12.1.1
P2.12.1.5	Safe Disable Response	0	2		1		755	See P2.12.1.1

Table 6-255. Common settings

6.12.2 Temperature sensor protections

Code	Parameter	Min	Max	Unit	Default	Cust	ID	Note
P2.12.2.1	No. of used inputs on board 1	0	5		0		739	0=Not used (ID Write) 1 = Sensor 1 in use 2 = Sensor 1 & 2 in use 3 = Sensor 1 & 2 & 3 in use 4 = Sensor 2 & 3 in use 5 = Sensor 3 in use
P2.12.2.2	Response to temperature fault	0	3		2		740	0=No response 1=Warning 2=Fault,stop acc. to 2.3.2 3=Fault,stop by coasting
P2.12.2.3	Board 1 warning limit	-30.0	200.0	C°	120.0		741	
P2.12.2.4	Board 1 fault limit	-30.0	200.0	C°	130.0		742	
P2.12.2.5	No. of uses inputs on board 2	0	5		0		743	0=Not used (ID Write) 1 = Sensor 1 in use 2 = Sensor 1 & 2 in use 3 = Sensor 1 & 2 & 3 in use 4 = Sensor 2 & 3 in use 5 = Sensor 3 in use
P2.12.2.6	Response to temperature fault	0	3		2		766	0=No response 1=Warning 2=Fault,stop acc. to 2.3.2 3=Fault,stop by coasting
P2.12.2.7	Board 2 warning limit	-30.0	200.0	C°	120.0		745	
P2.12.2.8	Board 2 fault limit	-30.0	200.0	C°	130.0		746	
P2.12.2.9.1	Channel 1B Warn	-30.0	200.0	C°	0.0		764	
P2.12.2.9.2	Channel 1B Fault	-30.0	200.0	C°	0.0		765	
P2.12.2.9.3	Channel 1C Warn	-30.0	200.0	C°	0.0		768	
P2.12.2.9.4	Channel 1C Fault	-30.0	200.0	C°	0.0		769	
P2.12.2.9.5	Channel 2B Warn	-30.0	200.0	C°	0.0		770	
P2.12.2.9.6	Channel 2B Fault	-30.0	200.0	C°	0.0		771	
P2.12.2.9.7	Channel 2C Warn	-30.0	200.0	C°	0.0		772	
P2.12.2.9.8	Channel 2C Fault	-30.0	200.0	C°	0.0		773	

Table 6-26. PT-100 protections

6.12.3 Stall Protection

Code	Parameter	Min	Max	Unit	Default	Cust	ID	Note
P2.12.3.1	Stall protection	0	3		0		709	0=No response 1=Warning 2=Fault,stop acc. to 2.3.2 3=Fault,stop by coasting
P2.12.3.2	Stall current	0.1	2 x I _H	A	I _H		710	
P2.12.3.3	Stall time limit	1.00	120.00	s	15.00		711	
P2.12.3.4	Stall frequency limit	1.0	P2.1.2	Hz	25.0		712	

Table 6-27. Stall protection

6.12.4 Speed error monitoring

Code	Parameter	Min	Max	Unit	Default	Cust	ID	Note
P2.12.4.1	Speed Error Mode	0	3		0		752	0=No response 1=Warning 2=Fault,stop acc. to 2.3.2 3=Fault,stop by coasting
P2.12.4.2	Speed Error Limit	0.0	100.0	%	5.0		753	
P2.12.4.3	Speed Fault Delay	0.00	100.00	S	0.1		754	
P2.12.4.4	Over Sped Limit	0.00	50.00	Hz	5.00		1812	Hysteresis for over speed, when exceeding Pos/Neg Frequency limits

Table 6-28. Speed error monitoring

6.12.5 Motor thermal protections

Code	Parameter	Min	Max	Unit	Default	Cust	ID	Note
P2.12.5.1	Thermal protection of the motor	0	3		2		704	0=No response 1=Warning 2=Fault,stop acc. to 2.3.2 3=Fault,stop by coasting
P2.12.5.2	Motor ambient temperature factor	-100.0	100.0	%	0.0		705	
P2.12.5.3	Motor cooling factor at zero speed	0.0	150.0	%	40.0		706	
P2.12.5.4	Motor thermal time constant	1	200	min	45		707	
P2.12.5.5	Motor duty cycle	0	100	%	100		708	
P2.12.5.6	Response to thermistor fault	0	3		2		732	See P2.12.5.1
P2.12.5.7	Over Load Response	0	2		1		1838	0=No response 1=Warning 2=Fault
P2.12.5.8	Over Load Signal	0	2		0		1837	0=Not Used 1=Current 2=Torque 3=Power
P2.12.5.9	Over Load Maximum Input	0.0	300.0	%	150.0		1839	
P2.12.5.10	Over Load maximum Step	0	10000		200		1840	

Table 6-29. Motor thermal protections

6.12.6 Living Zero monitoring

Code	Parameter	Min	Max	Unit	Default	Cust	ID	Note
P2.12.6.1	Response to 4mA reference fault	0	5		0		700	0=No response 1=Warning 2=Warning+Previous Freq. 3=Wrng+PresetFreq 2.12.6.2 4=Fault,stop acc. to 2.3.2 5=Fault,stop by coasting
P2.12.6.2	4mA reference fault frequency	0.00	P2.1.2	Hz	0.00		728	

Table 6-300. Living zero monitoring

6.12.7 Underload protection

Code	Parameter	Min	Max	Unit	Default	Cust	ID	Note
P2.12.7.1	Underload protection	0	3		0		713	0=No response 1=Warning 2=Fault,stop acc. to 2.3.2 3=Fault,stop by coasting
P2.12.7.2	Field weakening area load	10.0	150.0	%	50.0		714	
P2.12.7.3	Zero frequency load	5.0	150.0	%	10.0		715	
P2.12.7.4	Underload protection time limit	2.00	600.00	s	20.00		716	

Table 6-31. Underload protection

6.12.8 Earth Fault protection

Code	Parameter	Min	Max	Unit	Default	Cust	ID	Note
P2.12.8.1	Earth fault protection	0	3		2		703	0=No response 1=Warning 2=Fault,stop acc. to 2.3.2 3=Fault,stop by coasting
P2.12.8.2	Eart fault current limit	0.0	100.0	%	50.0		1333	

Table 6-32. Earth fault protection

6.12.9 Cooling protection

Code	Parameter	Min	Max	Unit	Default	Cust	ID	Note
P2.12.9.1	Cooling Fault Response	1	2		2		762	0= No Action, Warning 1= Warning, Warning 2= Warning, Fault 3= No Action, Fault
P2.12.9.2	Cooling Fault delay	0.00	7.00	s	2.00		751	

Table 6-33. Cooling protection

6.12.10 Fieldbus protection

Code	Parameter	Min	Max	Unit	Default	Cust	ID	Note
P2.12.10.1	Fieldbus Communication response	0	3		2		733	0=No Action 1=Warning 2= Fault 3= Fault, stop by coasting 4=Warning; Prev Freq 5= Quick Stop
P2.12.10.2	FB Fault Delay	0.00	60.00	s	0.50		1850	Delay to fault when FB Response is 4
P2.12.10.3	FB Watchdog Delay	0.00	30.00	s	0.00		1354	Delay when WD pulse is missing. 0.00 s = Disabled

Table 6-34. Fieldbus protection

6.12.11 External Fault

Code	Parameter	Min	Max	Unit	Default	Cust	ID	Note
P2.12.11.1	Response to external fault 1	0	3		2		701	0=No response 1=Warning 2=Fault, stop acc. to 2.3.2 3=Fault, stop by coasting
P2.12.11.2	Response to external fault 2	0	3		2		747	0=No response 1=Warning 2=Fault, stop acc. to 2.3.2 3=Fault, stop by coasting

6.12.12 Encoder Fault

Code	Parameter	Min	Max	Unit	Default	Cust	ID	Note
P2.12.12.1	Encoder Supervision	1	3		2		1353	1=Warning 2=Fault 3=Warning, To Open Loop
P2.12.12.2	Encoder Fast Hz Limit	0.00	320.00	Hz			1801	
P2.12.12.3	Fast Time Limit	0.00	32.00	s			1805	
P2.12.12.4	Iq Fault Limit	0	300	%			1800	

6.12.1 Options

Code	Parameter	Min	Max	Unit	Default	Cust	ID	Note
P2.12.13	Disable Stop Lock	0	1		0		1086	
P2.12.14	Reset Datalogger	0	4		0		1857	0 = Auto 1 = Reset to Auto 2 = SW Default 3 = Auto Fast 4 = No Change
P2.12.15	LDL License	0	65535		0		1993	

6.13 Fieldbus parameters

Code	Parameter	Min	Max	Unit	Default	Cust	ID	Note
P2.13.1	Fieldbus min scale	0.00	320.00	Hz	0.00		850	
P2.13.2	Fieldbus max scale	0.00	320.00	Hz	0.00		851	
P2.13.3	Fieldbus process data out 1 selection	0	10000		1		852	Choose monitoring data with parameter ID Def: Output Frequency
P2.13.4	Fieldbus process data out 2 selection	0	10000		2		853	Choose monitoring data with parameter ID Def: Motor Speed
P2.13.5	Fieldbus process data out 3 selection	0	10000		45		854	Choose monitoring data with parameter ID Def: Motor Current to FB
P2.13.6	Fieldbus process data out 4 selection	0	10000		4		855	Choose monitoring data with parameter ID Def: Motor Torque
P2.13.7	Fieldbus process data out 5 selection	0	10000		5		856	Choose monitoring data with parameter ID Def: Motor Power
P2.13.8	Fieldbus process data out 6 selection	0	10000		6		857	Choose monitoring data with parameter ID Def: Motor Voltage
P2.13.9	Fieldbus process data out 7 selection	0	10000		7		858	Choose monitoring data with parameter ID Def: DC-Link Voltage
P2.13.10	Fieldbus process data out 8 selection	0	10000		37		859	Choose monitoring data with parameter ID Def: Last Active Fault
P2.13.11	Fieldbus process data in 1 selection	0	10000		1140		876	Choose controlled data with parameter ID. Def: FB Torque Reference
P2.13.12	Fieldbus process data in 2 selection	0	10000		46		877	Choose controlled data with parameter ID. Def: FB Limit Scaling
P2.13.13	Fieldbus process data in 3 selection	0	10000		47		878	Choose controlled data with parameter ID. Def: FB Adjust Reference
P2.13.14	Fieldbus process data in 4 selection	0	10000		48		879	Choose controlled data with parameter ID. Def: FB Analogue Output.
P2.13.15	Fieldbus process data in 5 selection	0	10000		0		880	Choose controlled data with parameter ID
P2.13.16	Fieldbus process data in 6 selection	0	10000		0		881	Choose controlled data with parameter ID
P2.13.17	Fieldbus process data in 7 selection	0	10000		0		882	Choose controlled data with parameter ID
P2.13.18	Fieldbus process data in 8 selection	0	10000		0		883	Choose controlled data with parameter ID
P2.13.19	General Status Word ID	0	10000		64		897	Choose monitoring data in General Status Word Def: MC Status
P2.13.20	FB Actual Speed Mode	0	1		0		1741	0 =Calculated 1 =Actual
P2.13.21	Control Slot Selector	0	Varies		0		1440	0 =All 4 =Slot D 5 =Slot E 6 =Slot D Fast 7 =Slot E Fast 8 =Slot D 16 9 =Slot E 16 Note: 6-9 visible with correct hardware and software

P2.13.22	State Machine	1	2		1		896	1 = Standard 2 = ProfiDrive
P2.13.23	FB Custom Minimum	-32000	+32000		0		898	FB Speed Reference Minimum scaling
P2.13.24	FB Custom Maximum	-32000	+32000		+10000		899	FB Speed Reference Maximum Scaling
P2.13.25	Fieldbus process data out 9 selection	0	10000		0		558	Visible with correct hardware and software
P2.13.26	Fieldbus process data out 10 selection	0	10000		0		559	Visible with correct hardware and software
P2.13.27	Fieldbus process data out 11 selection	0	10000		0		560	Visible with correct hardware and software
P2.13.28	Fieldbus process data out 12 selection	0	10000		0		561	Visible with correct hardware and software
P2.13.29	Fieldbus process data out 13 selection	0	10000		0		562	Visible with correct hardware and software
P2.13.30	Fieldbus process data out 14 selection	0	10000		0		563	Visible with correct hardware and software
P2.13.31	Fieldbus process data out 15 selection	0	10000		0		564	Visible with correct hardware and software
P2.13.32	Fieldbus process data out 16 selection	0	10000		0		565	Visible with correct hardware and software
P2.13.33	Fieldbus process data in 9 selection	0	10000		0		550	Visible with correct hardware and software
P2.13.34	Fieldbus process data in 10 selection	0	10000		0		551	Visible with correct hardware and software
P2.13.35	Fieldbus process data in 11 selection	0	10000		0		552	Visible with correct hardware and software
P2.13.36	Fieldbus process data in 12 selection	0	10000		0		553	Visible with correct hardware and software
P2.13.37	Fieldbus process data in 13 selection	0	10000		0		554	Visible with correct hardware and software
P2.13.38	Fieldbus process data in 14 selection	0	10000		0		555	Visible with correct hardware and software
P2.13.39	Fieldbus process data in 15 selection	0	10000		0		556	Visible with correct hardware and software
P2.13.40	Fieldbus process data in 16 selection	0	10000		0		557	Visible with correct hardware and software

Table 6-35. Fieldbus parameters

6.13.1 Value Control

Code	Parameter	Min	Max	Unit	Default	Cust	ID	Note
P2.14.1.1	Control Input Signal ID	0	10000	ID	0		1580	
P2.14.1.2	Control Input Off Limit	-32000	32000		0		1581	
P2.14.1.3	Control Input On Limit	-32000	32000		0		1582	
P2.14.1.4	Control Output Off Value	-32000	32000		0		1583	
P2.14.1.5	Control Output On Value	-32000	32000		0		1584	
P2.14.1.6	Control Output Signal ID	0	10000	ID	0		1585	
P2.14.1.7	Control Mode	0	5		0		1586	0=SR ABS 1=Scale ABS 2=Scale INV ABS 3=SR 4=Scale 5=Scale INV
P2.14.1.8	Control Output Filtering time	0.000	32.000	s	0.000		1721	

Table 6-36. Power reference input signal selection, G2.2.8

6.13.2 DIN ID Control 1

Code	Parameter	Min	Max	Unit	Default	Cust	ID	Note
P2.14.2.1	ID Control DIN	0.1	E.10		0.1		1570	Slot . Board input No.
P2.14.2.2	Controlled ID	0	10000	ID	0		1571	Select ID that is controlled by digital input
P2.14.2.3	False value	-32000	32000		0		1572	Value when DI is low
P2.14.2.4	True value	-32000	32000		0		1573	Value when DI is high

Table 6-37. DIN ID Control parameters

6.13.3 DIN ID Control 2

Code	Parameter	Min	Max	Unit	Default	Cust	ID	Note
P2.14.3.1	ID Control DIN	0.1	E.10		0.1		1590	Slot . Board input No.
P2.14.3.2	Controlled ID	0	10000	ID	0		1575	Select ID that is controlled by digital input
P2.14.3.3	False value	-32000	32000		0		1592	Value when DI is low
P2.14.3.4	True value	-32000	32000		0		1593	Value when DI is high

Table 6-38. DIN ID Control parameters

6.13.4 DIN ID Control 3

Code	Parameter	Min	Max	Unit	Default	Cust	ID	Note
P2.14.4.1	ID Control DIN	0.1	E.10		0.1		1578	Slot . Board input No.
P2.14.4.2	Controlled ID	0	10000	ID	0		1579	Select ID that is controlled by digital input
P2.14.4.3	False value	-32000	32000		0		1594	Value when DI is low
P2.14.4.4	True value	-32000	32000		0		1596	Value when DI is high

Table 6-39. DIN ID Control parameters

6.13.5 ID Controlled Digital Output 1

Code	Parameter	Min	Max	Unit	Default	Cust	ID	Note
P2.14.5.1	ID.Bit Free DO	0.00	2000.15	ID.Bit	0.00		1216	
P2.14.5.2	Free DO Sel	0.1	E.10		0.1		1574	

Table 6-40. ID Controlled Digital Output parameters, G2.3.10

6.13.6 ID Controlled Digital Output 2

Code	Parameter	Min	Max	Unit	Default	Cust	ID	Note
P2.14.6.1	ID.Bit Free DO	0.00	2000.15	ID.Bit	0.00		1386	
P2.14.6.2	Free DO Sel	0.1	E.10		0.1		1574	

Table 6-41. ID Controlled Digital Output parameters, G2.3.10

6.13.7 Free DIN Delay

Code	Parameter	Min	Max	Unit	Default	Cust	ID	Note
P2.14.7.1	ID.Bit Free DIN	0.00	2000.15	ID.Bit	0.00		1832	
P2.14.7.2	On Delay	0.00	320.00	s	0.00		1833	
P2.14.7.3	Off Delay	0.00	320.00	s	0.00		1834	
P2.14.7.4	Mono Time	0.00	320.00	s	0.00		1836	
P2.14.7.5	Control Out ID	0	10000		0		1835	

Table 6-42. ID Controlled Digital Output parameters, G2.3.10

6.14 Brake Control Parameters

Code	Parameter	Min	Max	Unit	Default	Cust	ID	Note
P2.15.1	Brake Open, Direct	0.1	E.10	DigOUT	0.1		446	
P2.15.2	Brake FeedBack	0.1	E.10	DigIN	0.2		1210	Logic activate when 0.3 or greater
P2.15.3	Brake Open Delay	0.00	320.00	s	0.50		1544	Time that is required to open the brake
P2.15.4	Brake Close Delay	0.00	320.00	s	0.50		1545	
P2.15.5	Brake Open FreqLim Open Loop	0.00	320.00	Hz	0.00		1535	Brake opening limit and maximum reference limit when brake is closed in open loop.
P2.15.6	Brake Open FreqLim Closed Loop	0.00	320.00	Hz	0.00		1555	Brake opening limit and maximum reference limit when brake is closed in closed loop.
P2.15.7	Brake Close FreqLim Open Loop	0.00	320.00	Hz	0.00		1539	0.00 = Calculated internally
P2.15.8	Brake Close FreqLim Closed Loop	0.00	320.00	Hz	0.00		1540	0.00 = Calculated internally
P2.15.9	Brake Close/Open Current Limit	0.00	320.00	A	0.00		1085	Brake is closed immediately id current goes below this value.
P2.15.10	Brake Options 1	0	65535		0		1600	

Table 6-43. Brake control parameters, G2.3.9

6.14.1 Brake Control Start up torque for CL

Code	Parameter	Min	Max	Unit	Default	Cust	ID	Note
P2.15.11.1	Start-up torque	0	3		0		621	0=Not used 1=Torque memory 2=Torque reference 3=Start-up torque fwd/rev
P2.15.11.2	Start-up torque FWD	-300.0	300.0	s	0.0		633	
P2.15.11.3	Start-up torque REV	-300.0	300.0	s	0.0		634	
P2.15.11.4	Start Up Torque Time	-1	10000	ms	-1		1371	-1 = Automatic

6.14.2 Roll Back Control for CL

Code	Parameter	Min	Max	Unit	Default	Cust	ID	Note
P2.15.12.1	Roll Back Kp	-32000	32000		0		1787	
P2.15.12.2	Roll Back Torque	-3200	3200		0.0		1788	
P2.15.12.3	Roll Back Level	-32000	32000		3		1789	
P2.15.12.4	Roll Back Kp 2	-32000	32000		0		1792	

6.14.3 Brake Fault handling

Code	Parameter	Min	Max	Unit	Default	Cust	ID	Note
P2.15.13.1	Brake Closed Fault	1	3		1		1316	1=Warning 2=Fault,stop acc. to 2.3.2 3=Fault,stop by coasting
P2.15.13.2	Brake Open Fault	1	4		1		777	1=Warning 2=Fault,stop acc. to 2.3.2 3=Fault,stop by coasting 4=Warning; Start holding
P2.15.13.3	Feed Back Open Delay	0.00	320.00	s	0.00		1317	
P2.15.13.4	Feed Back Close Delay	0.00	320.00	s	0.00		1733	
P2.15.13.5	Brake Slip Response	0	4		1		1785	0=No response 1=Warning 2=Fault,stop acc. to 2.3.2 3=Fault,stop by coasting 4=Warning, Start Drive

6.14.4 Functions

Code	Parameter	Min	Max	Unit	Default	Cust	ID	Note
P2.15.14.1	Load Floating Time	0.00	32.00	s	0.00		1282	
P2.15.14.2	StopTorqueReleTime	0	500	ms	0		1858	

6.14.5 Brake Test Function

Code	Parameter	Min	Max	Unit	Default	Cust	ID	Note
P2.15.15.1	Brake Test	0	1		0		1843	
P2.15.15.2	Testing Torque	-300	300	%	50.0		1844	
P2.15.15.3	Brake Timing Torque Reference	-300	300	%	40.0		1849	

6.15 Auto Reset parameters

Code	Parameter	Min	Max	Unit	Default	Cust	ID	Note
P2.16.1	Wait time	0.10	10.00	s	0.50		717	
P2.16.2	Trial time	0.00	60.00	s	0.10		718	
P2.16.3	Start function	0	2		2		719	0=Ramp 1=Flying start 2=According to Stop Function
P2.16.4	Number of tries after undervoltage trip	0	10		0		720	
P2.16.5	Number of tries after overvoltage trip	0	10		0		721	
P2.16.6	Number of tries after overcurrent trip	0	3		0		722	
P2.16.7	Number of tries after reference trip	0	10		0		723	
P2.16.8	Number of tries after motor temperature fault trip	0	10		0		726	
P2.16.9	Number of tries after external fault trip	0	10		0		725	
P2.16.10	Number of tries after underload fault trip	0	10		0		738	
P2.16.11	Fault Simulation	0	65535		0		1569	

Table 6-44. Autorestart parameters, G2.16

6.16 PI Control Parameters

Code	Parameter	Min	Max	Unit	Step	Default	ID	Note
P2.17.1	PI controller gain	0.0	1000.0	%		100.0	118	
P2.17.2	PI controller I-time	0.00	320.00	s		1.00	119	
P2.17.3	PI Reference	-32000	32000			0	167	
P2.17.4	PI controller reference signal ID	0	10000			167	332	Default P2.17.3
P2.17.5	PI Actual value ID	0	10000			0	333	
P2.17.6	PI Controller output ID	0	10000			0	1802	
P2.17.7	PI Controller Scale	-32000	32000			1	340	>= 1 = No inversion <=-1 = Inverted 0 = Illegal value
P2.17.8	PI Low limit	-32000	32000				359	
P2.17.9	PI High limit	-32000	32000			10000	360	
P2.17.10	PI Controller Output scale	-3200.0	3200.0	%		100.0	1803	
P2.17.11	PI Stop state value	-32000	32000			0	1806	

Table 6.45. PI Controller parameters, G2.15

6.17 Shaft Synchronization

Code	Parameter	Min	Max	Unit	Default	Cust	ID	Note
P2.18.1	Enable Synch	0.1	E.10	DigIn	0.1		1816	
P2.18.2	Synch Kp	0	1000		100		1817	
P2.18.3	Synch Ti	0	20000	ms	500		1818	
P2.18.4	MaxRefCorrection	0.00	20.00	Hz	2.00		1819	
P2.18.5	ZeroErrorLimit	0	1000		10		1824	
P2.18.6	Fault Limit	0	100		1		1826	0 = Disabled
P2.18.7	Reset Position	0.1	E.10		0.1		1090	

6.18 Load Estimation

Code	Parameter	Min	Max	Unit	Default	Cust	ID	Note
P2.19.1	Motor Nominal Torque	0,0	3200,0	Nm	0,0		1906	
P2.19.2	Rotor Inertia	0,0	10,0	kgm2	0,0		1907	
P2.19.3	Gear Box Inertia	0,0	1000	kgm2	0,0		1908	
P2.19.4	Drum Inertia	0,0	1000	kgm2	0,0		1909	
P2.19.5	Gear Ratio	0,0	1000	1/x	1		1910	
P2.19.6	Drum Radius	0,0	1000	m	1		1911	
P2.19.7	Rope Multiply	0	100	x	1		1912	

6.19 Functional Safety

Code	Parameter	Min	Max	Unit	Default	Cust	ID	Note
P2.20.1	SQS Reaction	0	1		1		545	0=No Action 1=Quick Stop
P2.20.2	SS1 Reaction	0	1		1		542	0=No Action 1=Stop
P2.20.3	SS2 Reaction	0	1		1		546	0=No Action 1=Zero Speed
P2.20.4	SDI Reaction	0	1		1		544	0=No Action 1=Disable Dir
P2.20.5	SLS Reaction	0	1		1		543	0=No Action 1=End Limit Ref
P2.20.6	SSR Reaction	0	1		1		547	0=No Action 1=Limit Speed

6.20 Anti-Swing Function

Code	Parameter	Min	Max	Unit	Default	Cust	ID	Note
P 2.21.1	License Key	0	65535		0		1995	
P 2.21.2	Anti-Swing Mode	0	4		0		1846	0=Not used 1=Mode 1 2=Mode 2 3=Mode 3 4=Mode 4
P 2.21.3	Swinging Period	0.0	100.0	s	0.0		1743	
P 2.21.4	Rope Length	0	32000	cm	0.0		1686	
P 2.21.5	Smoothing TC	0	32000	ms	0		1186	
P2.21.6	Disable Anti-Swing	0.1	E.10	DigIN	0.1		1853	
P2.21.7	Low Speed Positioning Run	0	5		0		1854	0=Not used 1=Mode 1 2=Mode 2 3=Mode 3 4=Mode 4 5=Mode 5
P2.21.8	Low Speed Positioning Maximum Frequency	0.00	320.00	Hz	0.00		1855	
P2.21.9	Rope Length Selection	0	2		0		1918	0=Parameter 1=From Hoist 2=Own Calculation

6.21 Keypad control (Control keypad: Menu M3)

The parameters for the selection of control place and direction on the keypad are listed below. See the Keypad control menu in the VACON® NX User Manual.

Code	Parameter	Min	Max	Unit	Default	Cust	ID	Note
P3.1	Control place	1	4		2		125	0=PC Control 1=I/O terminal 2=Keypad 3=Fieldbus 4=SB Control
R3.2	Keypad reference	P2.1.1	P2.1.2	Hz	0.00			
P3.3	Direction (on keypad)	0	1		0		123	0=Forward 1=Reverse
P3.4	Stop button	0	1		1		114	0=Limited function of Stop button 1=Stop button always enabled
R3.5	Torque reference	0.0	100.0	%	0.0			

Table 6-46. Keypad control parameters, M3

6.22 System menu (Control keypad: Menu M6)

For parameters and functions related to the general use of the AC drive, such as application and language selection, customised parameter sets or information about the hardware and software, see VACON® NX User Manual.

6.23 Expander boards (Control keypad: Menu M7)

The **M7** menu shows the expander and option boards attached to the control board and board-related information. For more information, see VACON® NX User Manual.

7. DESCRIPTION OF PARAMETERS

7.1 Basic Parameters

P2.1.1 Maximum frequency ID102 "Max Frequency"

Defines maximum frequency limit both negative and positive directions. Direction dependent frequency limits can be given in "G: Limit Settings \ Frequency Handling".

Note: When the AC drive is in run state, do not change this parameter to a value lower than the current output frequency. The change will be executed without ramp.

P2.1.2 Motor Nominal Voltage ID110 "Motor Nom Voltg"

Find this value U_n on the rating plate of the motor.

P2.1.3 Motor Nominal Frequency ID111 "Motor Nom Freq"

Find this value f_n on the rating plate of the motor. This parameter sets the field weakening point to the same value in "G: Motor Control \ U/f Settings".

P2.1.4 Motor nominal speed ID112 "Motor Nom Speed"

Find this value n_n on the rating plate of the motor. Note also nominal frequency.

In some cases, the motor nominal speed is shown with one decimal. In this case the practice is to give nearest integer number and adjust motor nominal frequency so that drive will calculate correct [FW]PolePairNumber.

P2.1.5 Motor nominal current ID113 "Motor Nom Currnt"

Find this value I_n on the rating plate of the motor. If magnetization current is provided set also Magnetization current P2.1.9 before identification run.

DriveSynch Operation

Motor Nominal current from the motor name plate / Number of drives in parallel using VACON® Drive Synch.

P2.1.6 Motor cos phi ID120 "Motor Cos Phi"

Find this value "cos phi" on the rating plate of the motor.

P2.1.7 Motor Nominal Power ID116 "Motor Nom Power"

Find this value on the rating plate of the motor.

P2.1.8 Magnetizing current ID612 “MagnCurrent”

Set here the motor magnetizing current (no-load current).
Can be measured by running motor without load at 2/3 of nominal speed.

When value is zero the magnetization current is calculated from motor nominal parameters, formulas below:

$$\text{Motor Magnetization Current} = \frac{5 * \sqrt{1 - (\text{Cos } \varphi)^2} - 1}{5 - \sqrt{1 - (\text{Cos } \varphi)^2}} * \text{Motor Nominal Current}$$

If given before identification run this is used as reference for U/f tuning when making identification without rotating the motor.

P2.1.9 Identification ID631 “Identification”

Identification Run is a part of tuning the motor and the drive specific parameters. It is a tool for commissioning and service of the drive with the aim to find as good parameter values as possible for most drives. The automatic motor identification calculates or measures the motor parameters that are needed for optimum motor and speed control.

NOTE: Set motor control mode to Frequency Control before identification!

NOTE: During the identification, the AC drive will not open mechanical brake for safety reasons. If motor rotation requires that brake is opened this needs to be achieved externally.

NOTE: During the identification run, the torque and power limits should be above 100%. Also current limit should be above motor nominal current.

NOTE: During the identification run, the acceleration time should be below 20 seconds.

NOTE: If switching frequency is changed after the identification, we recommend you to do the identification run again.

NOTE: A small motor with a long motor cable may require a reduction of switching frequency if identification is not successful.

0 = “No Action” No action

No identification requested.

1 = “ID No Run” - Identification without rotating the motor

Current is applied to the motor but shaft will not be rotated. U/f settings are identified. This identification is minimum requirement if motor is only to be used in open loop control. It is however recommended to make the identification always with rotating motor in case the closed loop control is needed after the mechanics are connected to shaft.

Example of behaviour

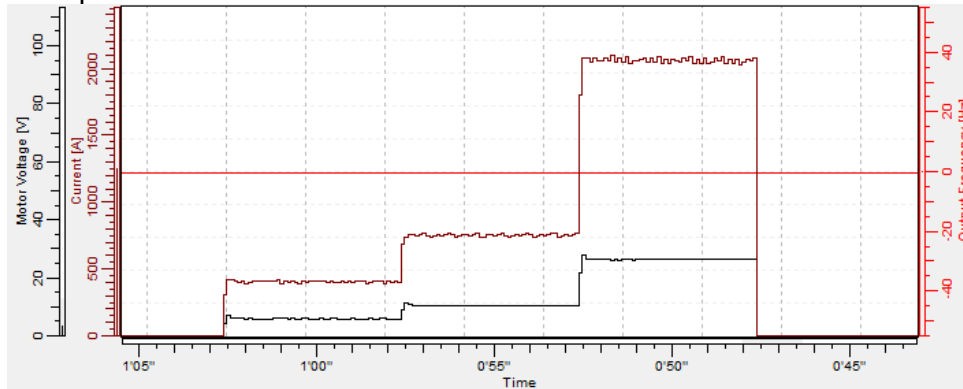

Parameters updated during this identification

AM:

- P2.1.8 MagnCurrent
- P2.8.4.2 U/f Ratio Select
- P2.8.4.5 U/f Mid Freq
- P2.8.4.6 U/f Mid Voltg
- P2.8.4.7 Zero Freq Voltg
- P2.8.9.16 RsVoltageDrop
- P2.8.9.17 IrAddZeroPVoltg
- P2.8.9.22-24 Ix Offset
- P2.8.9.29 Org UF ZeroPVolt

PM:

- P2.8.4.2 U/f Ratio Select
- P2.8.4.5 U/f Mid Freq
- P2.8.4.6 U/f Mid Voltg
- P2.8.4.7 Zero Freq Voltg
- P2.8.5.1 CurrentControlKp
- P2.8.6.12 LsdVoltageDrop
- P2.8.6.13 LsqVoltageDrop
- P2.8.6.19 Curr. Contr. Kp d
- P2.8.9.16 RsVoltageDrop
- P2.8.9.17 IrAddZeroPVoltg
- P2.8.9.20 LsVoltageDrop
- P2.8.9.22-24 Ix Offset
- P2.8.9.25 Estimator Kp
- P2.8.9.29 Org UF ZeroPVolt

2 = "ID With Run" - Identification with motor rotating

Shaft is rotated during identification.

This identification must be run without load on motor shaft. U/f settings and magnetization current are identified. This identification should be run regardless of the final operation mode (closed loop or open loop) to get the best performance from the motor. When identification with motor rotation is successfully finished the drive starts to use internal slip estimator to compensate the motor temperature changed. SCTorqueChainSelect B5 & B6.

Example of behaviour

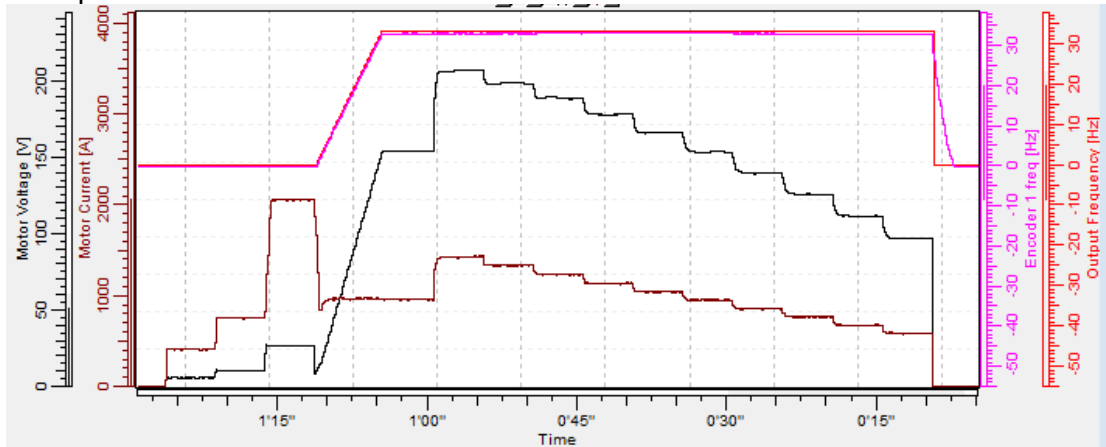

Parameters updated during this identification

AM:

- P2.1.8 MagnCurrent
- P2.8.4.2 U/f Ratio Select
- P2.8.4.5 U/f Mid Freq
- P2.8.4.6 U/f Mid Voltg
- P2.8.4.7 Zero Freq Voltg
- P2.8.9.16 RsVoltageDrop
- P2.8.9.17 IrAddZeroPVoltg
- P2.8.9.22-24 Ix Offset
- P2.8.9.29 Org UF ZeroPVolt
- P2.8.5.8 Temp.Compen.Mode
- RsVoltageDrop
- P2.8.9.1-15 Flux X %

Temp.Compen.Mode

PM:

- P2.8.4.2 U/f Ratio Select
- P2.8.4.3 Field WeakngPnt
- P2.8.4.5 U/f Mid Freq
- P2.8.4.6 U/f Mid Voltg
- P2.8.4.7 Zero Freq Voltg
- P2.8.5.1 CurrentControlKp
- P2.8.6.12 LsdVoltageDrop
- P2.8.6.13 LsqVoltageDrop
- P2.8.6.19 Curr. Contr. Kp d
- P2.8.9.16
- P2.8.9.17 IrAddZeroPVoltg
- P2.8.9.20 LsVoltageDrop
- P2.8.9.21 MotorBEMVoltage
- P2.8.9.22-24 Ix Offset
- P2.8.9.25 Estimator Kp
- P2.8.9.29 Org UF ZeroPVolt
- P2.8.5.8

3 = “Enc. ID Run” - Encoder identification run

The motor shaft is rotated during identification.

IM: If performed for induction motor encoder pulse number and direction are identified. Can be used if there is no encoder information available, correct result can be achieved only when motor is unloaded.

PMSM: This selection is used for PMSM motor if automatic angle identification is not suitable for used motor (angle is identified automatically in every start if PMSM Shaft Position parameter is zero).

This identification run will update PMSM Shaft Position parameter based on absolute position of the encoder or Z pulse position of incremental type encoder.

Note: Identification needs to be remade if encoder position related to motor is changed e.g. due to maintenance.

Parameters updated during this identification

AM:

P2.1.8 MagnCurrent
 P2.8.4.2 U/f Ratio Select
 P2.8.4.5 U/f Mid Freq
 P2.8.4.6 U/f Mid Voltg
 P2.8.4.7 Zero Freq Voltg
 P2.8.9.16 RsVoltageDrop
 P2.8.9.17 IrAddZeroPVoltg
 P2.8.9.22-24 Ix Offset
 P2.8.9.29 Org UF ZeroPVolt
 P2.8.5.8 Temp.Compen.Mode
 P2.8.9.1-15 Flux X %
 P7.3.1.2 Pulse revolution
 P7.3.1.3 Invert direction

PM:

P2.8.6.1 PMSMShaftPositio
 P2.8.9.22-24 Ix Offset
 P2.8.9.25 Estimator Kp

4 = “Ident All” - Identified All

Shaft is rotated during identification.

All the above identification selections are made in sequence.

Parameters updated during this identification

AM:

P2.1.8 MagnCurrent
 P2.8.4.2 U/f Ratio Select
 P2.8.4.5 U/f Mid Freq
 P2.8.4.6 U/f Mid Voltg
 P2.8.4.7 Zero Freq Voltg
 P2.8.9.16 RsVoltageDrop
 P2.8.9.17 IrAddZeroPVoltg
 P2.8.9.22-24 Ix Offset
 P2.8.9.29 Org UF ZeroPVolt
 P2.8.5.8 Temp.Compen.Mode
 RsVoltageDrop
 P2.8.9.1-15 Flux X %

Temp.Compen.Mode

PM:

P2.8.4.2 U/f Ratio Select
 P2.8.4.3 Field WeakngPnt
 P2.8.4.5 U/f Mid Freq
 P2.8.4.6 U/f Mid Voltg
 P2.8.4.7 Zero Freq Voltg
 P2.8.5.1 CurrentControlKp
 P2.8.6.12 LsdVoltageDrop
 P2.8.6.13 LsqVoltageDrop
 P2.8.6.19 Curr. Contr. Kp d
 P2.8.9.16

P2.8.9.17 IrAddZeroPVoltg
 P2.8.9.20 LsVoltageDrop
 P2.8.9.21 MotorBEMVoltage
 P2.8.9.22-24 Ix Offset
 P2.8.9.25 Estimator Kp
 P2.8.9.29 Org UF ZeroPVolt
 P2.8.5.8

P2.8.6.1 PMSMShaftPositio

5 = “Enc.ABS.Lock” – Absolute encoder when locked rotor

Absolute encoder zero position identification when rotor is locked while using permanent magnet motor.

It is recommended to have shaft locked during this identification mode.

Parameters updated during this identification

PM:

P2.8.6.1 PMSMShaftPositio
 P2.8.9.22-24 Ix Offset
 P2.8.9.25 Estimator Kp

6 = “U/f + Magn.Curr” – U/f Curve and magnetization current

Shaft is rotated during identification.

This identification selection will not make a saturation curve identification and will open the brake when start rotation starts.

Because saturation curve run is not made running time is shorter and gives possibility to make even if lifting hook is connected.

Example of behaviour

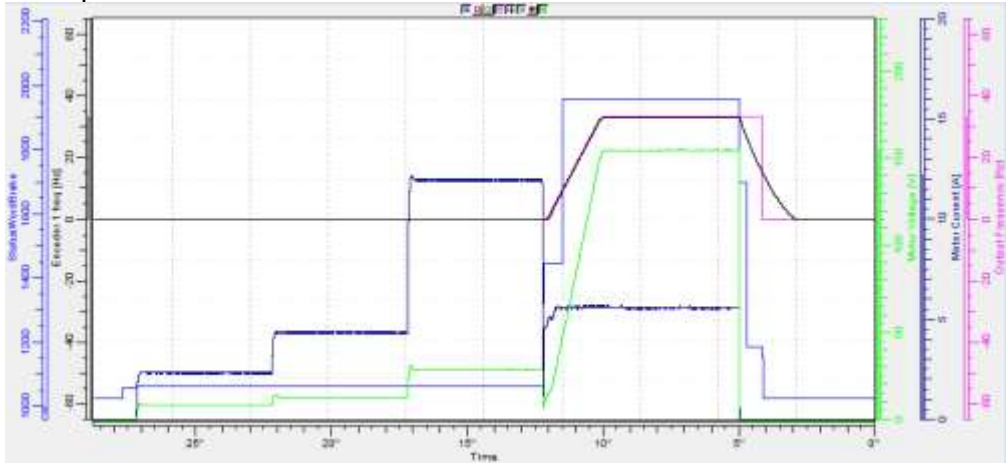

Parameters updated during this identification

- P2.1.8 MagnCurrent
- P2.8.4.2 U/f Ratio Select
- P2.8.4.5 U/f Mid Freq
- P2.8.4.6 U/f Mid Voltg
- P2.8.4.7 Zero Freq Voltg
- P2.8.5.8 Temp.Compen.Mode
- P2.8.9.16 RsVoltageDrop
- P2.8.9.17 IrAddZeroPVoltg
- P2.8.9.22-24 Ix Offset
- P2.8.9.29 Org UF ZeroPVolt

7 = “DTC Ident” – Dead Time Compensation identification

Current is applied to the motor but shaft will not be rotated.

This identification mode is needed for Sensorless control, Ident All can be used instead of this.

10 = “ID Run Fails” - Identification failed

Identification failed in last attempt.

The basic motor name plate data has to be set correctly before performing the identification run:

- P2.1.3 – P2.1.8. Motor basic data.
- P2.1.9 Magnetization current can also be given if available if given before identification without rotating motor; U/f curve will be tuned according to given magnetization current.
- P2.1.11 Motor Type.

When in closed loop and with an encoder installed, also the parameter for pulses / revolutions (in Menu M7) has to be set.

The automatic identification is activated by setting this parameter to the appropriate value followed by a start command in the requested direction. The start command to the drive has to be given within 20 s. If no start command is given within 20 s the identification run is cancelled and the parameter will be reset to its default setting. The identification run can be stopped any time with normal stop command and the parameter is reset to its default setting. In case identification run detects fault or other problems, the identification run is completed if possible. After the identification is finished, warning will be given is not all requested identification types has been completed successfully.

During Identification Run, the brake control is disabled.

Note: After identification is made drive requires rising edge of start command.

Note: Brake Control application has all identified values stored to parameters. There is no need to redo identification if previous parameters are loaded back to the drive for example in case the control board is changed.

DriveSynch operation: Activate identification only from the master drive:

P2.1.10 Motor Type ID650 “Motor Type”

Select used motor type with this parameter

0 “Induction” - Induction motor

-Asynchronous motor

1 “PMSM” - Permanent magnet synchronous motor

- Contact factory before using with externally magnetized motor.

See related parameter in “G2.8.6: Motor Control \ PMSM Control”.

P2.1.11 Crane Identification modes ID1683

Select identification settings for Brake Control Operations.

Before making Crane identification make at least identification at standstill (P2.1.9) where basic U/f curve is tuned.

These identification modes use brake mechanical delays and brake feedback delays to calculate proper brake related parameters (G2.15 Brake Control). Therefore set these delay times before identification if known or give good estimation values.

When/If more accurate values are found, it is recommended to make crane identification again.

0 “No Function”**1 “Hoisting”**

This selection will calculate proper drive settings for hoisting purposes. This is pure calculation, no need to give start command.

This identification will calculate values for:

- P2.7.1.1 DC-Brake Current
- P2.7.2.1 Start Magnetization Current
- P2.7.1.2 Start DC-Brake Time
- P2.7.2.2 Start Magnetization Time
- P2.15.5 Brake Open Frequency Limit Open Loop
- P2.6.3.5 Minimum Frequency Open Loop
- P2.7.1.4 Stop DC-Brake Frequency
- P2.8.3.7 Zero Frequency Voltage
- P2.8.3.6 U/f Middle Voltage
- P2.8.3.5 U/f Middle Frequency
- P2.8.3.12 I/f Control Lim
- P2.7.1.3 Stop DC-Brake Time
- P2.9.5.4 Stop 0 Speed Time
- P2.1.12 Movement Type.
- P2.15.7 Brake Close Frequency Limit OL calculated internally if kept Zero.
- P2.15.8 Brake Close Frequency Limit CL calculated internally if kept Zero.

This is pure calculation, no need to give start command.

2 “Horizontal”

This selection will calculate proper drive settings for horizontal movement. This is pure calculation, no need to give start command. Basically, these settings are for holding brake.

This identification will calculate values for:

- P2.7.1.1 DC-Brake Current
- P2.7.2.1 Start Magnetization Current
- P2.7.1.2 Start DC-Brake Time
- P2.7.2.2 Start Magnetization Time
- P2.15.5 Brake OpenFrequency Limit Open Loop
- P2.7.1.4 Stop DC-Brake Frequency
- P2.7.1.3 Stop DC-Brake Time
- P2.9.5.4 Stop 0 Speed Time
- P2.1.12 Movement Type.
- P2.15.7 Brake Close Frequency Limit OL calculated internally if kept Zero.
- P2.15.8 Brake Close Frequency Limit CL calculated internally if kept Zero.

This is pure calculation, no need to give start command.

3 “Brake Timing”

This identification mode measures brake timing in closed loop control, start command is needed to give.

Set drive in closed loop control.

Brake control DO needs to be activated.

Drive will run for 7 seconds in Window Torque control with zero speed reference. Using two Hz window. Brake is considered to be open when encoder frequency is more than a 0.5 Hz. In the middle of the ID run brake is closed again and brake is considered to be closed when frequency is below 0.5 Hz. After identification run, the drive will stop.

Used torque reference during the identification run can be adjusted in G2.15.15 Brake Test group.

P2.1.12 Movement Type

Select what type of movement this drive is used.

0 “Not Selected”

Drive operates like a standard drive, no Crane related functionality is activated.

1 “Hoisting”

Drive functions are activated for hoisting purposes.

- For open loop control dynamic minimum frequency control is activated.

2 “Horizontal”

Drive functions are activated for horizontal movement purposes.

- Dynamic minimum frequency is disabled.

7.2 Reference Handling – “Ref Handling”

Priority order of Brake Control application speed reference chain.

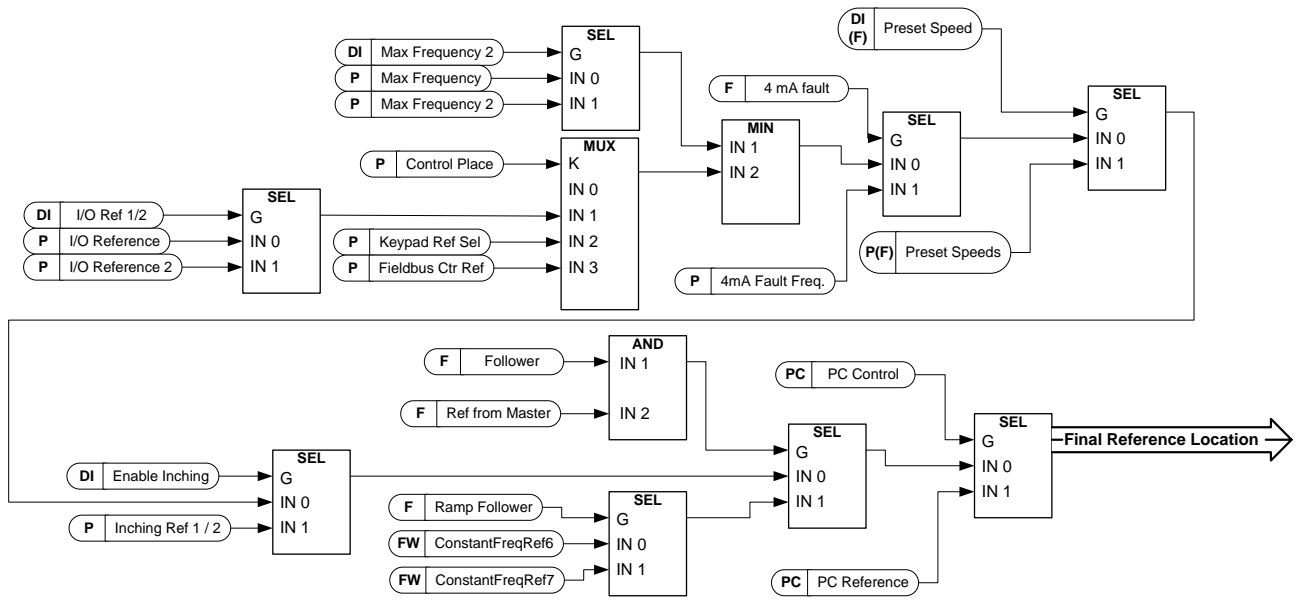

Speed reference chain before ramp control

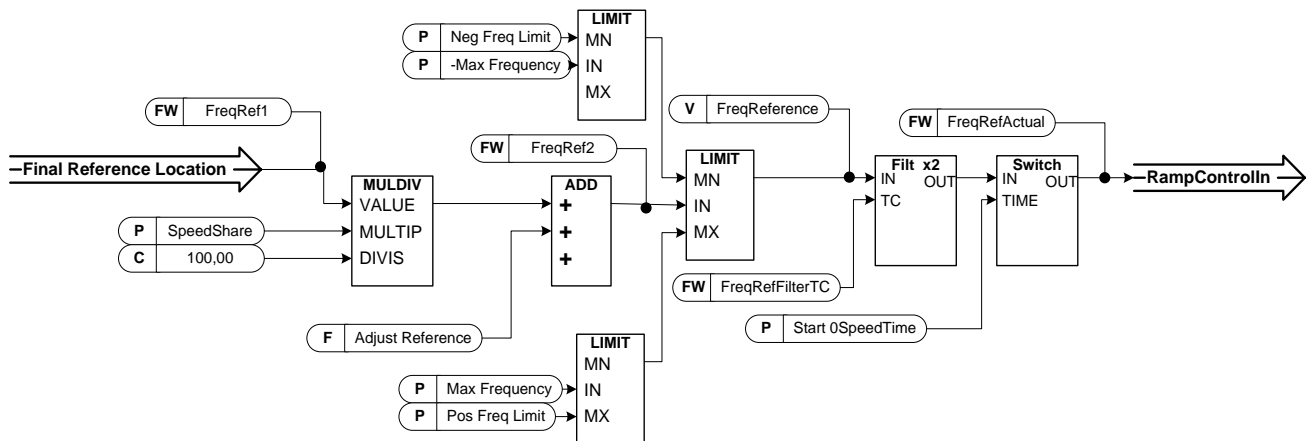

7.2.1 Basic Parameters

P2.2.1 I/O frequency reference selection 1 ID117 "I/O Reference"

Defines which frequency reference source is used when control place is I/O terminal
P3.1 Control Place

0="AI1" - Analogue Input 1.

Signal scaling in "G2.4.2: Input Signals \ Analogue Input 1"

1="AI2" - Analogue Input 2.

Signal scaling in "G2.4.3: Input Signals \ Analogue Input 2"

2="AI1+AI2" - Analogue Input 1 + Analogue Input 2.

With alternative reference scaling in Analogue Input group 100 % input values can be set to correspond 25 Hz thus when both are at 100% final reference will be 50 Hz.

3="AI1-AI2"

Analogue Input 1 - Analogue Input 2.

4="AI2-AI1"

Analogue Input 2 - Analogue Input 1.

5="AI1xAI2"

Analogue Input 1 x Analogue Input 2

6="AI1 Joystick"

Analogue input 1, -10 Vdc... +10 Vdc

7="AI2 Joystick"

Analogue input 2, -10 Vdc... +10 Vdc

8="Keypad Ref"

Reference from keypad R3.2

9="Fieldbus"

Reference is taken from Fieldbus, alternative scaling can be selected in "G: Fieldbus"

10="Motor Pot" - Motor potentiometer.

Reference handled with two digital input "G: Input Signals \ Digital Inputs" (increase and decrease). Behaviour adjusted in "G: Ref Handling \ Motor Potentiometer".

11="AI1, AI2 min"

The minimum of Analogue Input 1 and Analogue Input 2 is used as reference.

12="AI1, AI2 max"

The maximum from Analogue Input 1 and Analogue Input 2 is used as reference.

13="Max Freq" - Maximum Frequency

P2.1.2 Max Frequency is used as reference.

14="AI1/AI2 Sel" - AI1/AI2 Selection

Digital Input "I/O Ref 1/2" is used to select between Analogue Input 1 and Analogue Input 2 reference. "I/O Ref 1/2" is used to elect between "I/O Reference" and "I/O Reference 2" if selection is different than 14 (this one).

15="Encoder 1"

Reference is read from encoder input 1.

16="Encoder 2"

Reference is read from encoder input 2. This selection is usable with double encoder boards. Could be used e.g. for speed synchronization where two motor needs to run at same speed but not necessarily same angle.

P2.2.2 Keypad frequency reference selection**ID121 “Keypad Ref Sel”**

Defines which frequency reference source is used when control place is keypad P3.1 Control Place

0=“AI1” - Analogue Input 1.

Signal scaling in “G2.4.3: Input Signals \ Analogue Input 1”

1=“AI2” - Analogue Input 2.

Signal scaling in “G2.4.4: Input Signals \ Analogue Input 2”

2=“AI1+AI2” - Analogue Input 1 + Analogue Input 2.

With alternative reference scaling in Analogue Input group 100 % input values can be set to correspond 25 Hz. That is, when both are at 100% final reference will be 50 Hz.

3=“AI1-AI2”

Analogue Input 1 - Analogue Input 2.

4=“AI2-AI1”

Analogue Input 2 - Analogue Input 1.

5=“AI1xAI2”

Analogue Input 1 x Analogue Input 2

6=“AI1 Joystick”

Analogue input 1, -10 Vdc... +10 Vdc

7=“AI2 Joystick”

Analogue input 2, -10 Vdc... +10 Vdc

8=“Keypad Ref”

Reference from keypad R3.2

9=“Fieldbus”

Reference is taken from Fieldbus, alternative scaling can select in “G: Fieldbus”

P2.2.3 Fieldbus frequency reference selection**ID122 “Fieldbus Ctr Ref”**

Defines which frequency reference source is selected when control place is Fieldbus P3.1. Control Place

0=“AI1” - Analogue Input 1.

Signal scaling in “G2.4.3: Input Signals \ Analogue Input 1”

1=“AI2” - Analogue Input 2.

Signal scaling in “G2.4.4: Input Signals \ Analogue Input 2”

2=“AI1+AI2” - Analogue Input 1 + Analogue Input 2.

With alternative reference scaling in Analogue Input group 100% input values can be set to correspond 25 Hz thus when both are at 100% final reference will be 50 Hz.

3=“AI1-AI2”

Analogue Input 1 - Analogue Input 2.

4=“AI2-AI1”

Analogue Input 2 - Analogue Input 1.

5=“AI1xAI2”

Analogue Input 1 x Analogue Input 2

6=“AI1 Joystick”

Analogue input 1, -10 Vdc... +10 Vdc

7=“AI2 Joystick”

Analogue input 2, -10 Vdc... +10 Vdc

8=“Keypad Ref”

Reference from keypad R3.2

9=“Fieldbus”

Reference is taken from Fieldbus, alternative scaling can select in “G: Fieldbus”

P2.2.4 I/O frequency reference selection 2 ID131 “I/O Reference 2”

This parameter is used to select different reference input location with digital input P2.4.2.17 I/O Ref. 2. Selections for this are the same as for the I/O frequency reference selection 1.

Other parameters related to function

- Digital input P2.4.2.17 I/O Ref. 1/2

P2.2.5 Speed share ID1241 “Speed Share”

Defines the speed reference percentage ratio after final reference location but before ramp control. Monitoring value “FreqReference” shows the reference after speed share function. Used to adjust reference ration e.g. in line drive that PLC can give same reference to all drives while speed share compensate gear ratio affect to the line speed.

P2.2.6 Load Share ID1248 “Load Share”

Defines the percentage for final torque reference after final torque reference location selection but before the torque reference step function, torque reference dead zone and reference filtering.

7.2.2 Constant Reference

P2.2.7.1 Jogging speed reference ID124 “Jog Speed Ref”

Defines the jogging speed reference when activated by a digital input. This reference will follow the reverse command if given. Jogging speed has a higher priority than preset speed references.

Related parameters

- Digital Input P2.4.2.16 Jogging Speed

P2.2.7.2 Preset speed 0	ID1810 “Preset Speed 0”
P2.2.7.3 Preset speed 1	ID105 “Preset Speed 1”
P2.2.7.4 Preset speed 2	ID106 “Preset Speed 2”
P2.2.7.5 Preset speed 3	ID126 “Preset Speed 3”
P2.2.7.6 Preset speed 4	ID127 “Preset Speed 4”
P2.2.7.7 Preset speed 5	ID128 “Preset Speed 5”
P2.2.7.8 Preset speed 6	ID129 “Preset Speed 6”
P2.2.7.9 Preset speed 7	ID130 “Preset Speed 7”

Parameter values define the Preset speeds references activated by digital inputs. These references will follow reverse command if given.

When preset speeds are selected as main reference no selection will use Preset Speed 0.

Speed	Digital Input Preset speed 1	Digital Input Preset speed 2	Digital Input Preset speed 3
Basic speed / Preset Speed 0	0	0	0
Preset Speed 1	1	0	0
Preset Speed 2	0	1	0
Preset Speed 3	1	1	0
Preset Speed 4	0	0	1
Preset Speed 5	1	0	1
Preset Speed 6	0	1	1
Preset Speed 7	1	1	1

Table 7-1. Preset speeds 1 to 7

Related parameters

Digital inputs P2.4.2.5-7 Preset Speed 1-3

7.2.2.1 *Inching function*

Inching function will start the drive to reference without additional start command regardless of control place. Inching function requires enabling from digital input before command is accepted. Inching is also disabled if there is start command active from active control place.

P2.2.7.10 Inching reference 1 ID1239 “Inching Ref 1”

P2.2.7.11 Inching reference 2 ID1240 “Inching Ref 2”

These parameters define the reference for the inching function. The references are bidirectional and the reverse command does not affect the direction of the inching reference.

Other parameters for inching function

- Digital input selection: Enable Inching
- Digital input selection: Inching 1
- Digital input selection: Inching 2
- Parameter: Inching Ramp

7.2.3 Torque Reference

Motor torque is controlled which allows the motor speed to change depending on the actual load on the motor shaft. Speed limit behaviour is controlled by P2.2.9.6 TorqSpeedLimit parameter.

For joystick inputs maximum negative reference is negated “Torq Ref Max”. The minimum is used only for analogue input selections 1 to 4. Also the maximum negative torque reference maximum is negated “Torq Ref Max”.

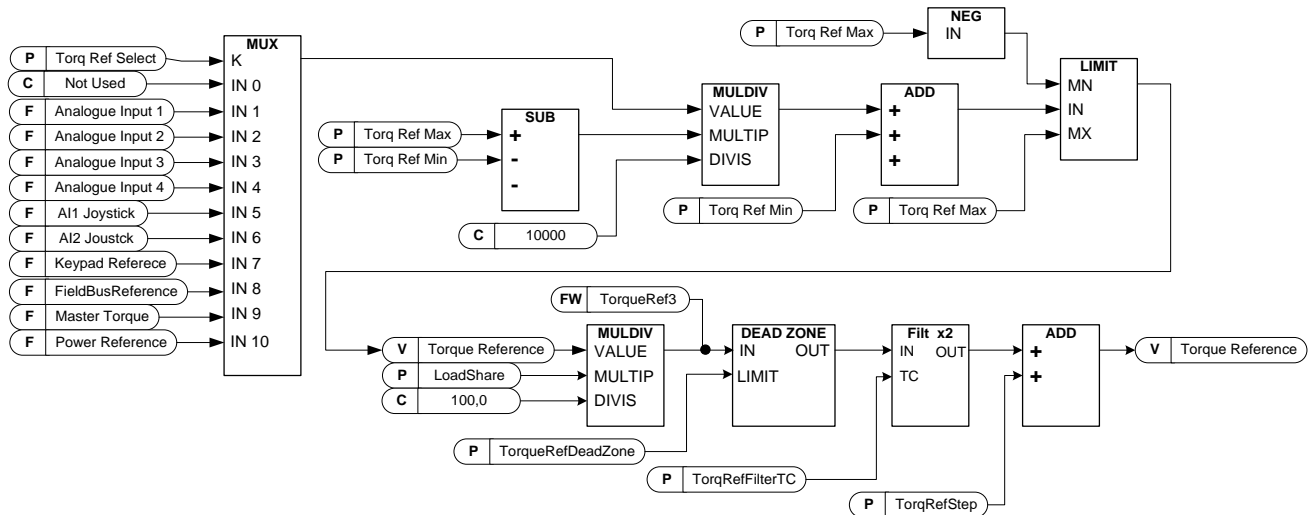

P2.2.8.1 Torque reference selection

ID641 “Torq Ref Select”

0=“Not Used”

1=“AI1” - Analogue Input 1.

Signal scaling in “G: Input Signals \ Analogue Input 1”

2=“AI2” - Analogue Input 2.

Signal scaling in “G: Input Signals \ Analogue Input 2”

3=“AI3”

4=“AI4”

5=“AI1 Joystick”

Analogue input 1, -10 Vdc... +10 Vdc. For joystick inputs the maximum negative reference is negated “Torq Ref Max”.

6=“AI2 Joystick”

Analogue input 2, -10 Vdc... +10 Vdc For joystick inputs the maximum negative reference is negated “Torq Ref Max”.

7=“Keypad Ref”

Torque reference from keypad R3.5.

8=“Fieldbus”

Reference is taken from Fieldbus. Alternative scaling can be selected in “G: Fieldbus”

9=“Master Torque”

Reference is taken from Master drive when using Master Follower function.

P2.2.8.2 Torque reference scaling, maximum value ID641 “Torq Ref Max”

Maximum allowed torque reference for positive and negative values. This is also used for joystick input for negative maximum limit.

P2.2.8.3 Torque reference scaling, minimum value ID642 “Torq Ref Min”

Minimum torque reference for analogue input reference selections 1-4.

P2.2.8.4 Torque reference filtering time ID1244 “TorqRefFilterTC”

Defines the filtering time for torque reference. Filtering is after load share function and before torque step function.

P2.2.8.5 Torque reference dead zone ID1246 “TorqRefDeadZone”

The small values of the torque reference around zero can be ignored by setting this value greater than zero. When reference is between zero to plus/minus this parameter, the reference is forced to zero.

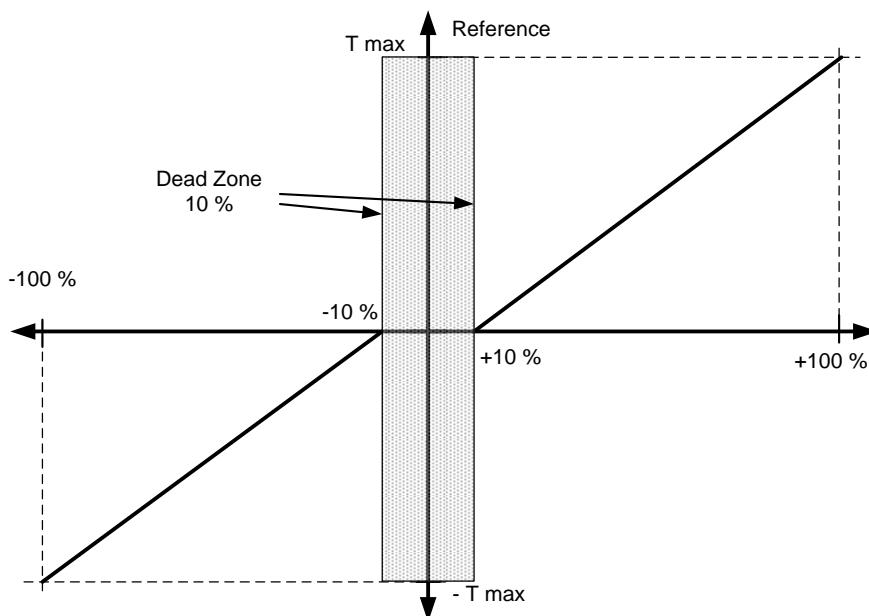

P2.2.8.6 Torque Select ID1278 “Torque Select”

This parameter defines the speed limiting mode in torque control mode. This parameter can be used as single motor control mode selection when no change is made between open loop and closed loop controls.

0= “SpeedControl” - Speed control mode

The drive is forced to operate in speed control mode while the motor control mode parameter is set to torque control mode thus allowing selection of speed control and torque control mode with single parameter e.g. from Fieldbus.

1=“MaxFreqLimit” - Positive and negative frequency limits

Speed is not limited by speed reference, only maximum frequency or Positive and Negative frequency limit if set lower than maximum frequency parameter.

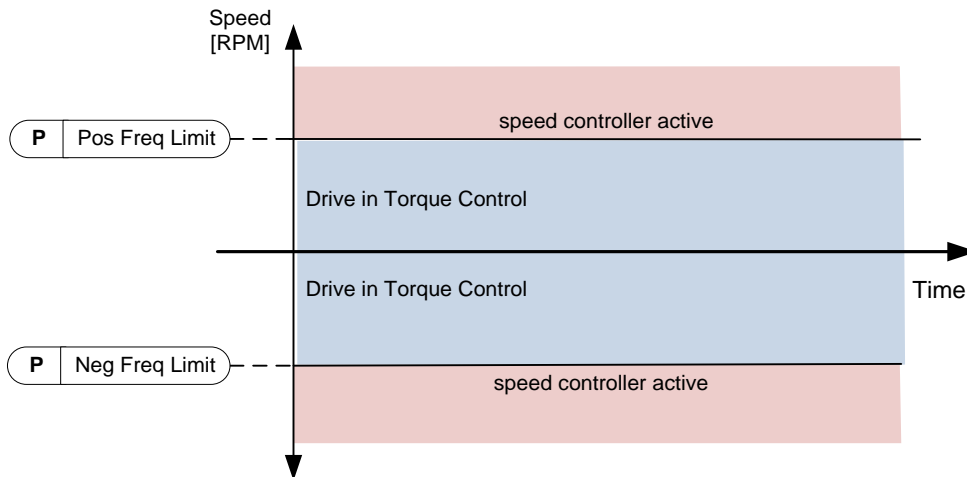

2=“RampOutput” – Ramp output for both directions

Speed is limited by reference after ramp generator, thus speed will increase with set ramp time until actual torque is equal to reference torque. If speed is below reference when load is removed from the shaft the speed will increase without ramp.

This is the default selection. For master follower system it is recommended to use selection that allows a little higher reference for torque follower that load will be balanced equally e.g. window control.

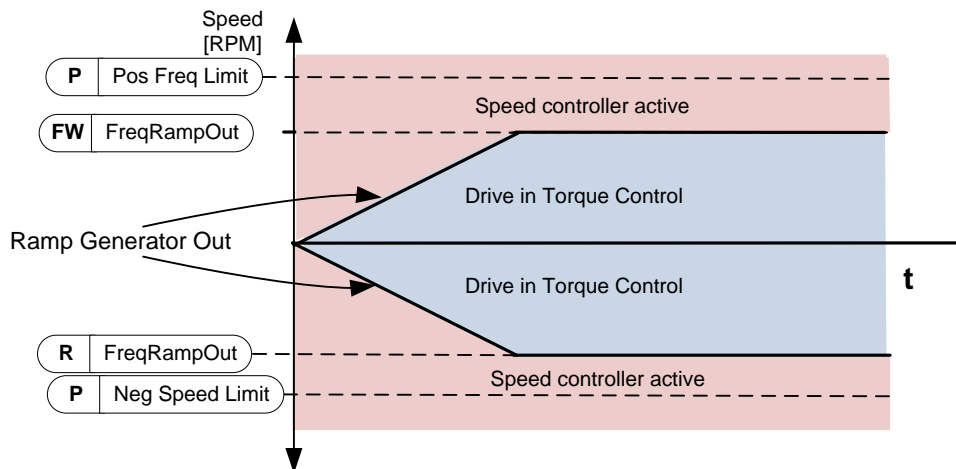

3="Min" – Minimum from speed reference and torque reference.

The minimum of the speed controller output and the torque reference is selected as final torque reference.

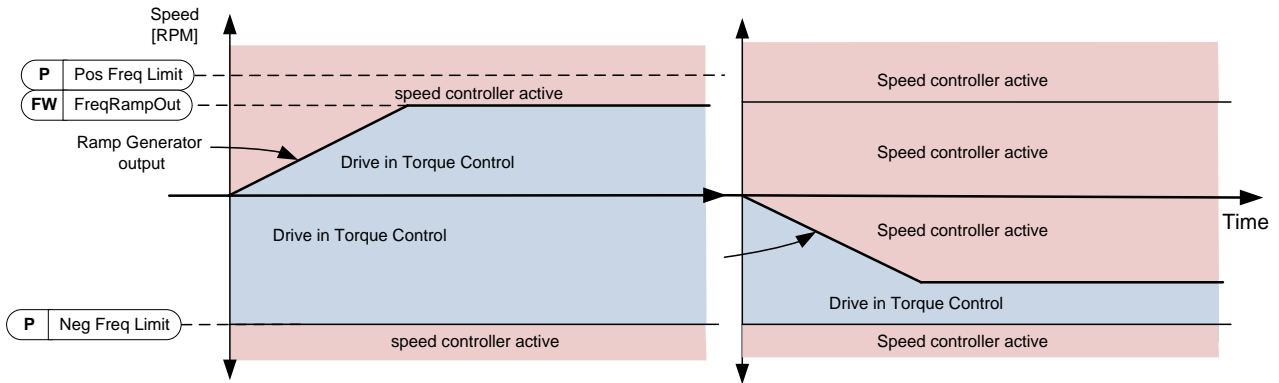

4="Max" – Maximum from speed reference and torque reference

The maximum of the speed controller output and the torque reference is selected as final torque reference.

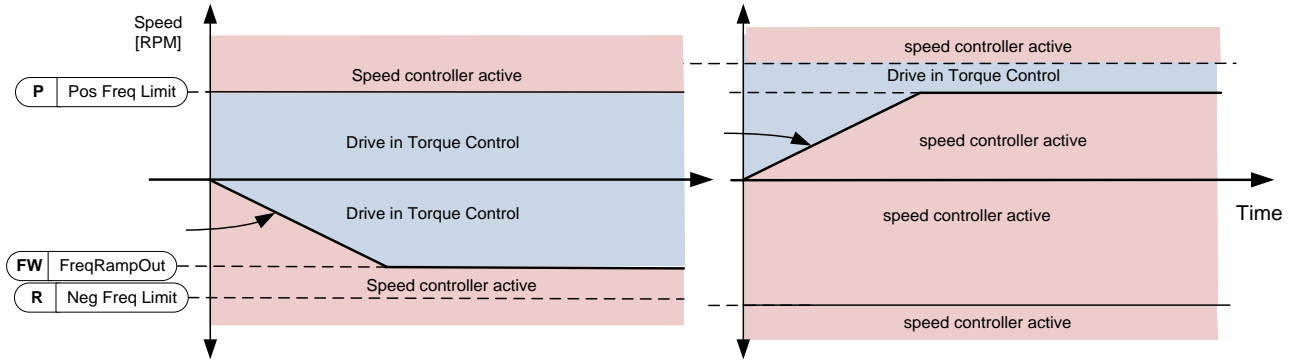

5="Window" – Window control

Speed is limited within window from speed reference.

Speed control activation limit is different from the speed limit. Speed needs, therefore, to go first to "Window Pos" or "Window Neg" limit before the speed controller activates, when speed controller is active speed will be restricted to limit defined by "Window Pos Off" and "Windows Neg Off" from the "FinalFreqRef"

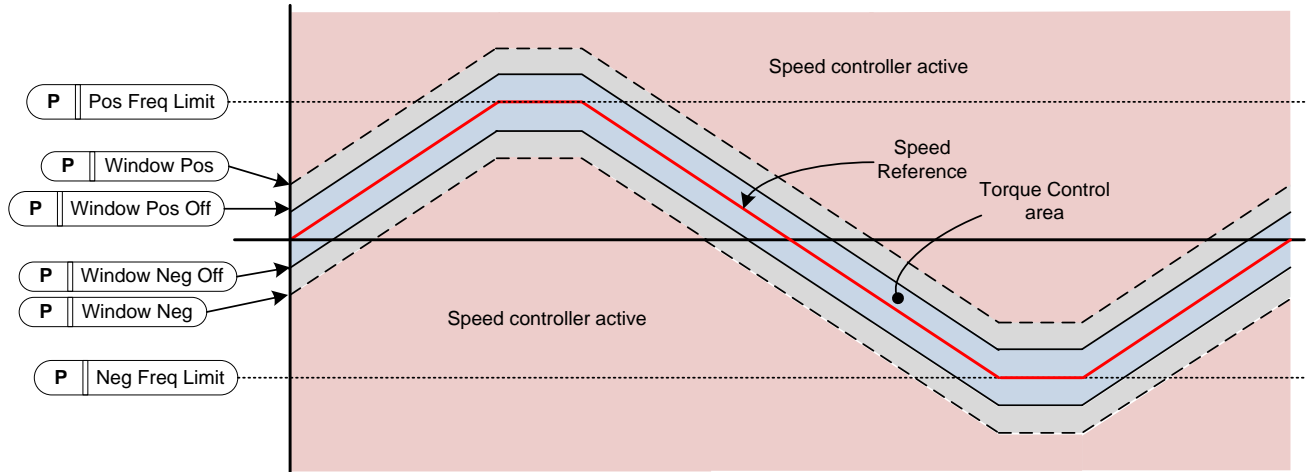

P2.2.8.7 Window negative ID1305 "Window Neg"

Defines the size of window to negative direction from the final speed reference. If both windows off limits are zero this parameter is also the speed limit from the "FinalFreqRef". Otherwise this is the speed control activation limit.

P2.2.8.8 Window positive ID1304 "Window Pos"

Defines the size of window to positive direction from the final speed reference. If both windows off limits are zero this parameter is also the speed limit from the "FinalFreqRef". Otherwise this is the speed control activation limit.

P2.2.8.9 Window negative Off limit ID1307 "Window Neg Off"

Defines the speed controller negative off limit when the speed controller brings the speed back to window.

P2.2.8.10 Window positive Off limit ID1306 "Window Pos Off"

Defines speed controller positive off limit when speed controller brings speed back to window.

7.2.3.1 Torque reference OL settings

P2.2.8.11.1 Open loop torque control minimum frequency ID636 “OL TC Min Freq”

Defines the frequency limit below which the AC drive operates in *frequency control mode*.

P2.2.8.11.2 Open loop torque controller P gain ID639 “OL TorqCtrl P”

Defines the gain for open loop torque control.

P2.2.8.11.3 Open loop torque controller I gain ID640 “OL TorqCtrl I”

Defines the integration gain for open loop torque control.

7.2.4 Prohibited frequencies

In some systems it may be necessary to avoid certain frequencies because of mechanical resonance problems. With these parameters it is possible to set limits for the prohibited frequency region and ramp rate factor to use when frequency is going above this area. When the input reference is increased the internal reference is kept at the low limit until the input reference is above the high limit.

P2.2.9.1 Prohibit frequency area 1; Low limit **ID509 “Range 1 Low Lim”**

P2.2.9.2 Prohibit frequency area 1; High limit **ID510 “Range 1 High Lim”**

Range definition where a different ramp time defined by “RampTimeFactor” is used.

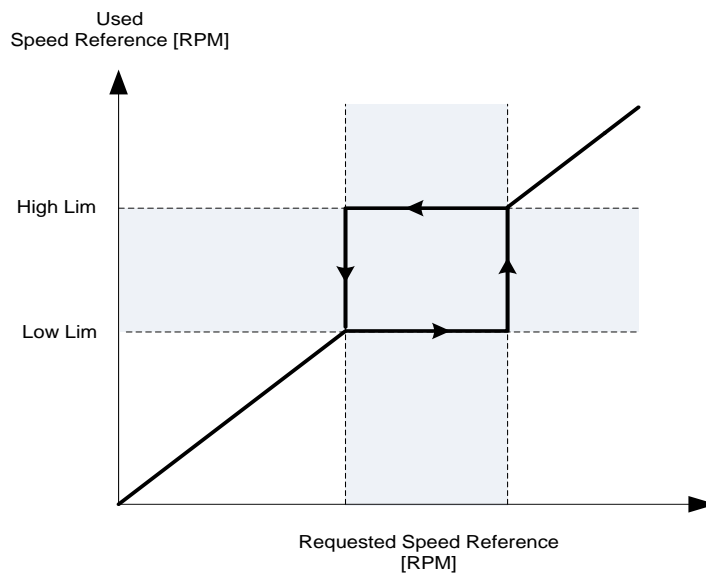

P2.2.9.3 Ramp time factor for prohibited range **ID518 “RampTimeFactor”**

Multiplier of the currently selected ramp time between prohibit frequency limits.

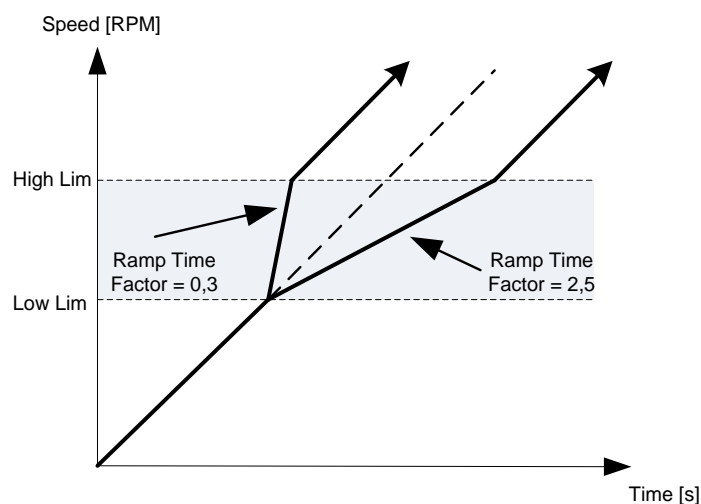
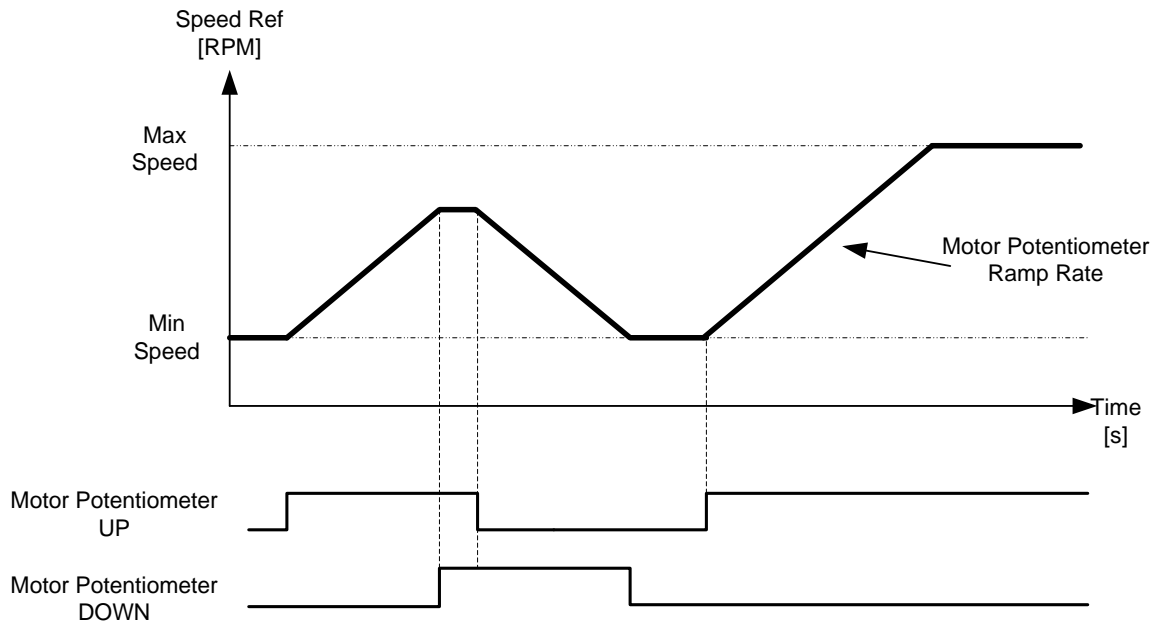

Figure 7-1. Ramp rate scaling between prohibit frequencies

7.2.5 Motor potentiometer

Motor potentiometer is used to control the reference with two digital inputs, one increasing the reference and the other decreasing the reference. The reference change rate can be set by parameter [Hz/s]. Motor potentiometer reference is available in I/O control only. It can be changed only when the drive is in running state.



P2.2.10.1 Motor potentiometer ramp rate ID331 "MotPot Ramp Rate"

Defines the rate of change of the motor potentiometer reference value in Hz/s. Normal ramp times are still active and determine how fast the actual output frequency increases.

P2.2.10.2 Motor potentiometer reference reset ID367 "MotPotRef Reset"

0 "No reset"

Reference is kept past the stop state and stored to memory in case of a power down.

1 "Stop State"

Reference is set to zero when the drive is in stop state. This selection includes power down situations.

2 "Power Down"

Reference is reset only in a power down situation.

3 "StopReq; Fout"

When stop command is given and drive is ramping down; motor potentiometer reference follows actual output frequency. If new start command is given while ramping down, the drive will stay at the frequency of the moment when start command was given.

Other parameters related to function

- P2.4.2.8 Motor potentiometer DOWN ID417 "Mot Pot Ref Down"
- P2.4.2.9 Motor potentiometer UP ID418 "Mot Pot Ref Up"

P2.2.10.3 Motor potentiometer reference copy ID366 “MotPotRefCopy”

This parameter defines how reference is handled when reference input is changed to motor potentiometer in I/O control.

0 “No copy”

Reference is not copied. Depending on “MotPot Reset” function, the drive may start from minimum frequency or from reference that was last used when the drive was run with motor potentiometer.

1 “Reference”

The drive’s active reference is copied. If the drive is ramping when the value of motor potentiometer is changed, the drive will continue ramping after the change. This allows the reference copy in stop state unless the “MotPot Reset” function overruns it (e.g. reset in stop state is not selected).

2 “Freq. Output”

Speed at the time of change is copied to reference. If the drive is ramping when the change is made, the drive will stop ramping and keep the present speed.

7.2.6 Adjust Reference

Adjust reference function is used to fine tune the main reference. Adjust reference is added to main reference after “SpeedShare” function.

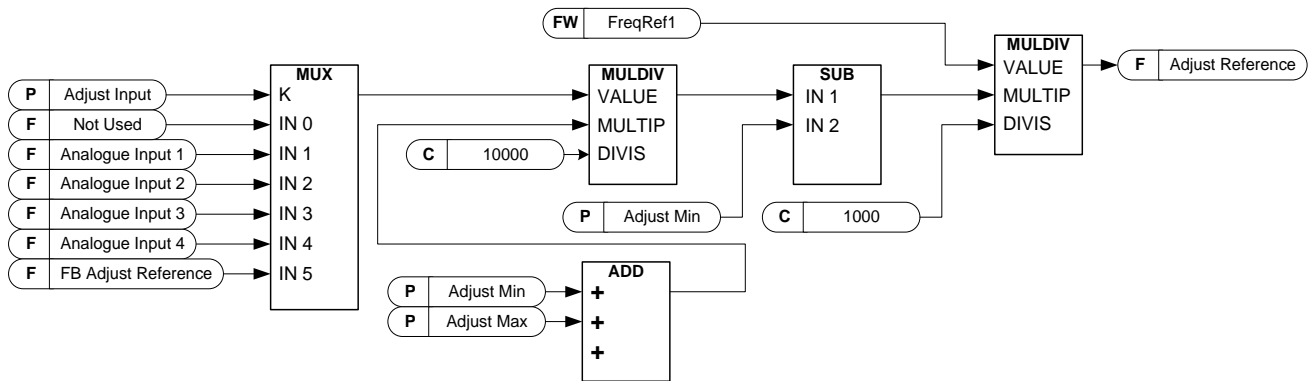

P2.2.11.1 Adjust input ID493 “Adjust Input”

With this parameter you can select the signal according to which the frequency reference to the motor is fine adjusted.

- 0 Not used
- 1 Analogue input 1
- 2 Analogue input 2
- 3 Analogue input 3
- 4 Analogue input 4
- 5 FB Adjust Reference ID47 Monitoring Signal

P2.2.11.2 Adjust minimum ID494 “Adjust minimum”

Percentage that is subtracted from the main reference when adjust input is at minimum.

P2.2.11.3 Adjust maximum ID495 “Adjust Maximum”

These parameters define the minimum and maximum of adjusted signals.

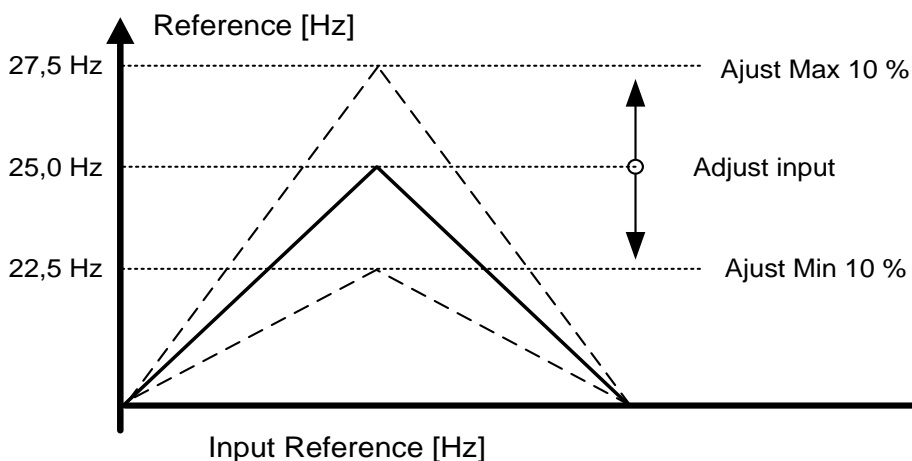

If minimum and maximum are not equal to zero, the adjustment is not at the middle point of analogue input or at zero point in case -10...+10 Vdc input is used. In the below picture, the minimum is 20% and the maximum 10%.

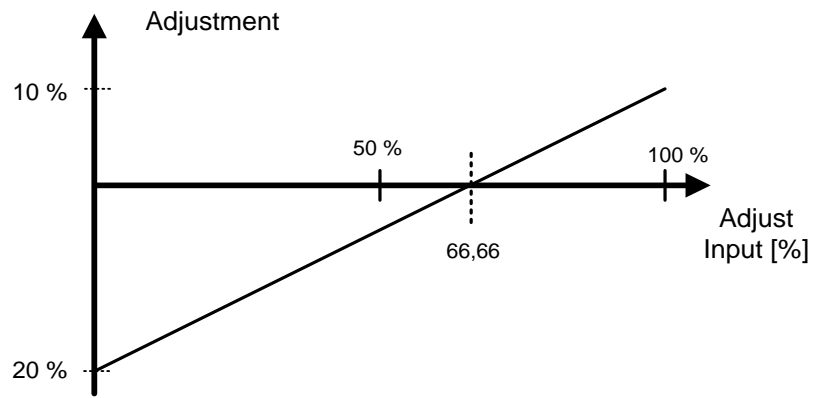

7.2.1 Speed limits reference handling for horizontal movement

P2.2.12.1 Disable Negative Direction ID1814

Select digital input for opening contact to disable negative/reverse direction. Positive/Forward direction is possible while negative/reverse direction is disabled.

P2.2.12.2 Disable Positive Direction ID1813

Select digital input for opening contact to disable positive/forward direction. Negative/Reverse direction is possible while positive/forward direction is disabled.

P2.2.12.3 Limit Negative Reference DI ID1827

Select digital input for opening contact to limit negative/reverse direction reference.

P2.2.12.4 Limit Positive Reference ID1828

Select digital input for opening contact to limit positive/forward direction reference.

P2.2.12.5 Limited Negative Reference Hz ID1829

Maximum negative/reverse reference limit used when ID1827 is active.

P2.2.12.6 Limited Positive Reference Hz ID1830

Maximum positive/forward reference limit used when ID1828 is active.

P2.2.12.7 Limit Negative Reference DI 2 ID1831

Select digital input for opening contact to limit negative/reverse direction reference.

P2.2.12.8 Limit Positive Reference DI 2 ID1842

Select digital input for opening contact to limit positive/forward direction reference.

P2.2.12.9 Limited Negative Reference Hz 2 ID1845

Maximum negative/reverse reference limit used when ID1831 is active.

P2.2.12.10 Limited Positive Reference Hz 2 ID1848

Maximum positive/forward reference limit used when ID1842 is active.

P2.2.12.11 End Limit Ramp Time ID1815

Ramp rate used when ramping to limited or zero speed when end limits speed reference limitation is active.

P2.2.12.12 Anti-Swing at end limits ID1856

Select with this parameter if Anti-Swing is active when end limits are activated.

0 / Anti-Swing stays active at all limits

1 / Anti-Swing is disabled at Disabled Direction inputs (ID1814 & ID1813)

2 / Anti-Swing is disabled at Disabled Direction and 2nd limit reference (ID1814, ID1813, ID1842 & 1831)

3 / Anti-Swing is disabled if any of the end limit switches is activated.

7.3 Ramp control

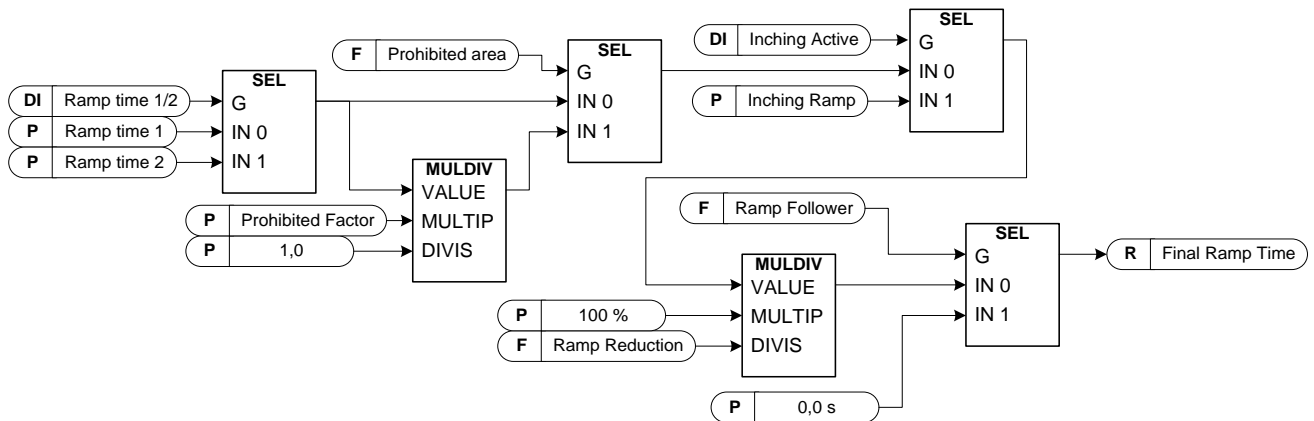

P2.3.1 Start function ID505 “Start Function”

Ramp:

0 The AC drive starts from 0 Hz and accelerates to the set reference frequency within the set acceleration time.

Flying start:

1 The AC drive is able to start with motor running by applying current to motor and searching for the frequency corresponding to the speed the motor is running at. Searching starts from the maximum frequency towards the zero frequency until the correct value is detected.

Use this mode if the motor is coasting when the start command is given. With the flying start it is possible to start motor from actual speed without forcing the speed to zero before ramping to reference.

Closed loop control will always start like flying start because exact speed of the motor is known from encoder feedback.

P2.3.2 Stop function ID506 “Stop Function”

Coasting:

0 Drive stops controlling the motor immediately and allows the motor rotate freely.

Ramp:

1 After the Stop command, the speed of the motor is decelerated according to the set deceleration parameters to zero speed. DI “Run Enable” will make coasting stop regardless of selected stop function.

P2.3.3 Acceleration time 1 ID103 “Accel Time 1”

This parameter defines the time required for the output frequency to increase from the zero frequency to maximum frequency.

P2.3.4 Deceleration time 1 ID104 “Decel Time 1”

This parameter defines the time required for the output frequency to decrease from the maximum frequency to zero frequency.

P2.3.5 Acceleration/Deceleration ramp 1 shape ID500 “Ramp 1 Shape”

The start and end of acceleration and deceleration ramps can be smoothed with these parameters. Setting value 0 gives a linear ramp shape which causes acceleration and deceleration to act immediately to the changes in the reference signal. Setting value 1...100% for this parameter produces an S-shaped acceleration/deceleration.

Used to reduce mechanical erosion and current spikes when reference is changed.

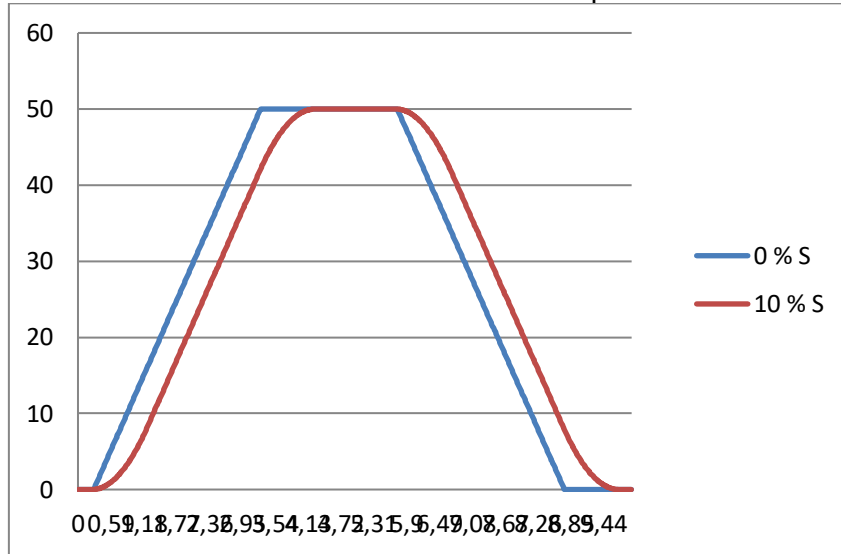

Figure 7-2. 10 % S ramp with 3 s ramp time compared to without S ramp

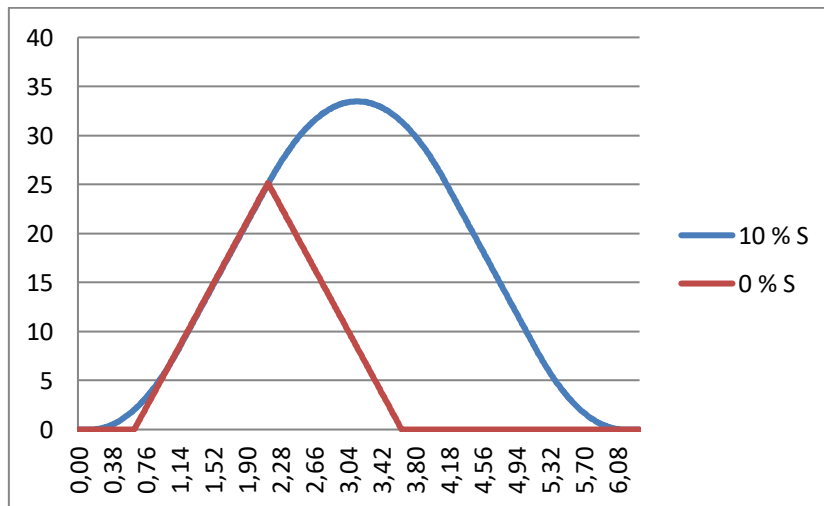

Figure 7-3. 10 % S ramp with 3 s ramp time when reference set to zero at 25 Hz

P2.3.6 Acceleration time 2

ID502 “Accel Time 2”

P2.3.7 Deceleration time 2

ID503 “Decel Time 2”

P2.3.8 Acceleration/Deceleration ramp 2 shape ID501 “Ramp 2 Shape”

These ramp times and ramp shapes are used when the second ramp time is activated by digital input “Acc/Dec Time Sel”

P2.3.9 Inching ramp ID1257 “Inching Ramp”

This parameter defines acceleration and deceleration times when inching is active. Inching function will start the drive to reference without additional start command regardless of control place. Inching function requires enabling from digital input before command is accepted. Inching is also disabled if there is a start command active on the active control place.

Other parameters for inching:

- Parameter: Inching Reference 1
- Parameter: Inching Reference 2
- Digital input selection: Enable Inching
- Digital input selection: Inching 1
- Digital input selection: Inching 2

P2.3.10 Reduction of acceleration and deceleration times ID401

Acceleration and deceleration times can be reduced with the input signal. Input signal level zero means ramp times set by parameters. Maximum level equals one tenth of the value set by parameter.

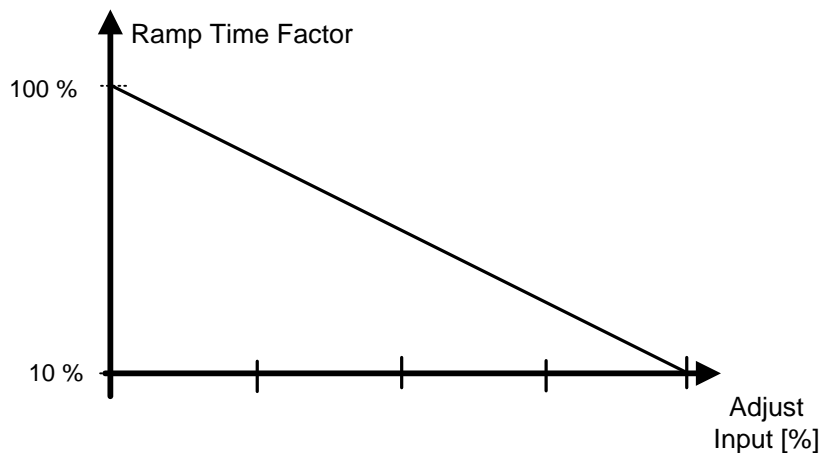

Figure 7-4. Reducing acceleration and deceleration times

P2.3.11 Disabled direction ramp

This parameter defines the ramp time used when the digital input for disabled direction changes to active

Other parameters fro disabled direction

- DI: Disable Neg Dir
- DI: Disable Pos Dir

P2.3.12.1 Quick stop mode ID1276 “Quick Stop Mode”

Selects the mode of stopping the drive when quick stop is active.

- It is recommended to use the same stop function in follower drives.
- It is recommended to use the same ramp time in both drives

0 Coast stop.

1 Ramp stop.

P2.3.12.2 Quick Stop Ramp time ID1256

Ramp time used during Quick Stop if ramping option is selected.

7.3.1 Ramp Options

P2.3.13.1 Ramp: Skip S2/S4

ID1900

This function is used to bypass the second corner S ramp (i.e. to avoid the unnecessary speed increase, the blue line in Figure 7-5) when the reference is changed before the final speed is reached. Also S4 is bypassed when reference is increased while speed is ramping down.

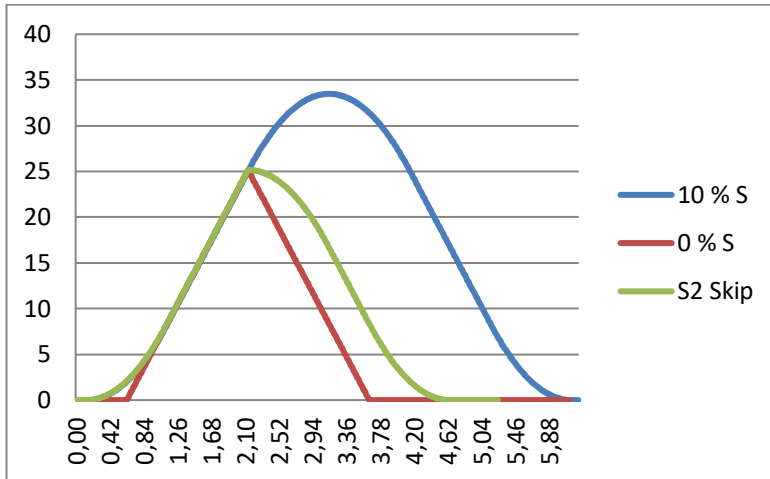

Figure 7-5. Second S curve is bypassed when reference changes at 25 Hz

P2.3.13.2 CL Ramp generator follows encoder ID1902

“CLRmpFollEncFreq”

In a normal situation, the ramp generator is not updated with the actual speed from the encoder (like in open loop control). So when the limiting situation has passed (with a step) speed is accelerated against the limit controller to the reference speed (if speed control is used). In case this parameter is active, the speed will increase with set ramp times.

This parameter also sets the Ramp Frequency to actual frequency when change from torque control to speed control is made.

Note: When using the under voltage controller function 2 (Ramping to zero speed), this parameter needs to be activated to have similar operation than in open loop control.

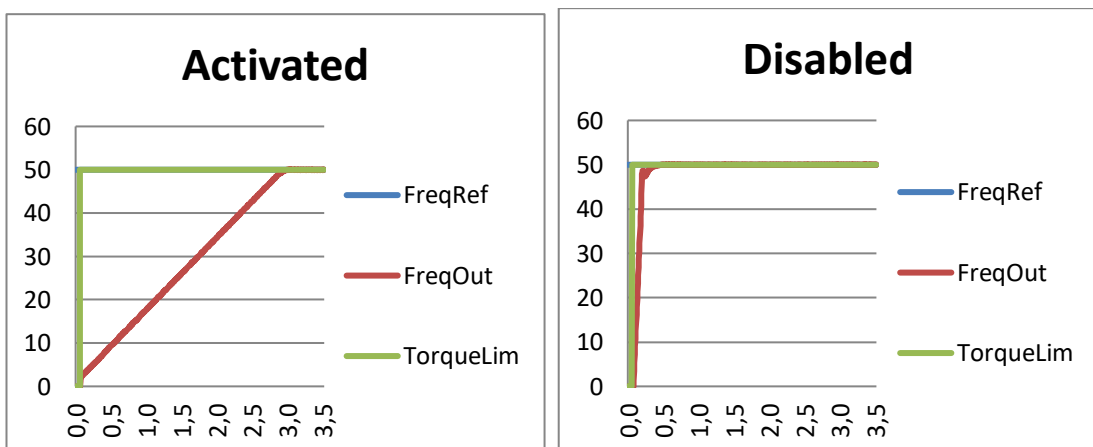

P2.3.13.3 Speed Reference Interpolator TC

ID1184

“Ramp In Inter. TC”

Use this parameter to set the time during which the interval speed reference is updated. This function ramps the reference between updated values. Function is used when the PLC is updating the reference to, for example, 100 ms time level but the drive's own ramp is set much shorter to have fast response. When the reference (Green) is used without interpolator, also the output frequency would behave in the same way causing torque and current spikes every time reference changes. When the interpolator time is set to 100 ms, the output frequency behaves as blue line.

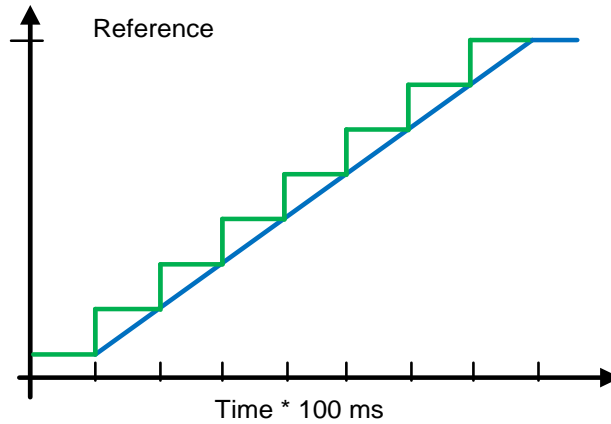

7.3.2 Slack Rope and Shock Load

P 2.3.14.1 Slack Rope Mode ID1930 "Slack Rope Mode"

Activate slack rope protection function. When lowering the load and motor torque drops below parameter P2.3.14.2 "Load Off the Hook", zero reference is activated. Speed reference is reset to normal operation when user reference has dropped to zero. Minimum output frequency required is 5Hz. Meaning if output frequency is <5Hz then this function will not activate.

P 2.3.14.2 Shock Load Mode ID1933 "ShockLoadMode"

Activate shock load protection. When lifting the load and motor torque increases rapidly from below "Load On the Hook" to above "Shock Load Torque" speed reference is reduced to "Shock Load Reference" level for at least for "Shock Load Time", speed reference is released when torque is stable above "Load On the Hook". Function is not active when speed is greater than half of the motor nominal speed.

P 2.3.14.3 Load On the Hook Torque ID1931 "LoadOnHookTorq"

When torque is above this level, it will assume that, there is load connected on hook

P 2.3.14.4 Load Off the Hook Torque ID1932 "LoadOfHookTorq"

When torque is below this level, it will assume empty hook or load touch down the ground. This parameter applicable only for "slack rope mode".

P 2.3.14.5 Shock Load Torque ID1934 "ShockLoadTorq"

During lifting the load, if torque increases rapidly above this level, then shock load function is activated and output frequency limit to "shock load reference" for "shock load time" or load stabilize above "load on the hook torque".

P 2.3.14.6 Shock Load Time ID1935 "ShockLoadTime"

Time to keep low reference during "Shock load prevention mode"..

P 2.3.14.7 Shock Torque Rise Time ID1936 "ShockTorqRiseTim"

If torque increases from Load On the Hook level to above Shock Load Torque level below this time Shock Load Prevention reference is activated.

P 2.3.14.8 Shock Load Ref ID1937 "ShockLoadRef"

Reference at which output frequency limits during for Shock Load Prevention.

7.4 Input signals

7.4.1 Basic Settings

P2.4.1.1 Start/Stop logic selection ID300 “Start/Stop Logic”

This parameter defines the start stop logic when using I/O control. Some of these selections do not include the 'Reverse' command. Reverse command can be activated by a separate digital input “Reverse”.

0 “Forw – Rev” – Forward Start – Reverse Start

Start 1: closed contact = start forward DI “Start 1”

Start 2: closed contact = start reverse DI “Start 2”

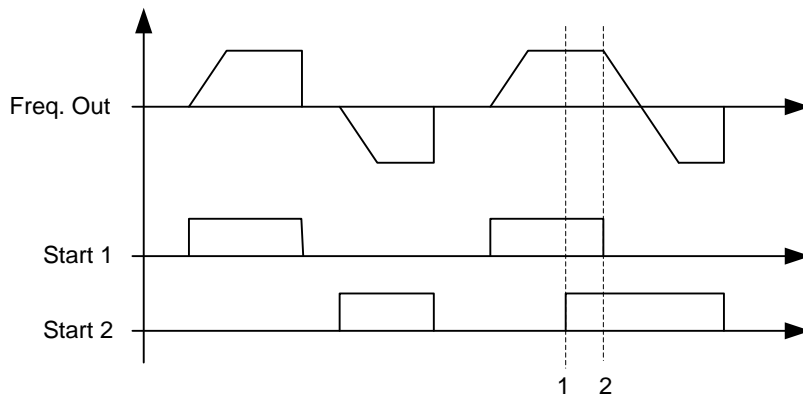

Figure 7-6. Start forward/Start reverse

- ① The first selected direction has the highest priority.
- ② When the DIN1 contact opens the direction of rotation starts the change.

1 “Start – Rev” - Start command – Direction command

Start 1: closed contact = start open contact = stop

Start 2: closed contact = reverse open contact = forward

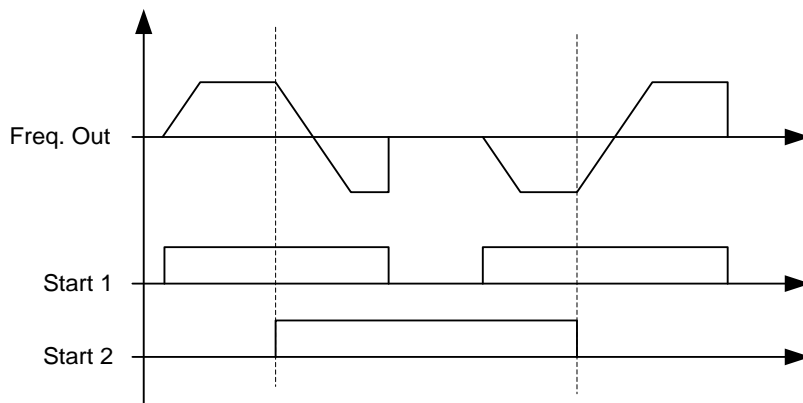

Figure 7-7. Start, Stop, Reverse

2 “Start – Enable” – Start command – Run Enable

DIN1: closed contact = start open contact = stop

DIN2: closed contact = start enabled open contact = start disabled and drive stopped if running

3 “StartP-StopP” – Start Pulse – Stop Pulse

3-wire connection (pulse control):

DIN1: closed contact = start pulse

DIN2: open contact = stop pulse, falling edge.

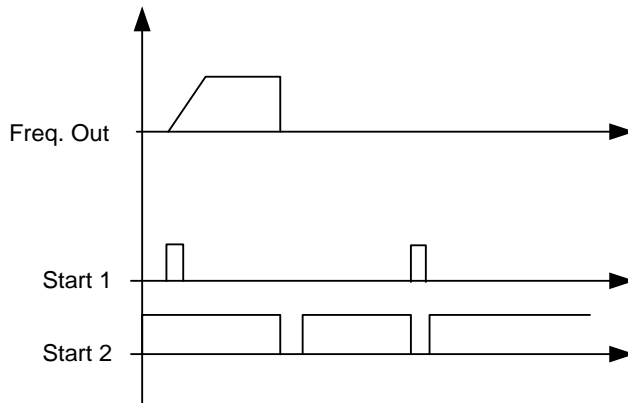

Figure 7-8. Start pulse/ Stop pulse.

The selections including the text '**Rising edge required to start**' must be used to exclude the possibility of an unintentional start when, for example, power is connected, re-connected after a power failure, after a fault reset, after the drive is stopped by Run Enable (Run Enable = False) or when the control place is changed. The Start/Stop contact must be opened before the motor can be started.

4 “Strt-MotP UP” – Start – Motor potentiometer UP

DIN1: closed contact = start forward

DIN2: closed contact = Increases motor potentiometer reference, see Motor potentiometer function for more details.

5 “ForwR – RevR” – Forward start rising edge – Reverse start rising edge

DIN1: closed contact = start forward (**Rising edge required to start**)

DIN2: closed contact = start reverse (**Rising edge required to start**)

6 “StartR-Rev” - Start command rising edge – Direction command

DIN1: closed contact = start (**Rising edge required to start**)

open contact = stop

DIN2: closed contact = reverse

open contact = forward

7 “StrtR-Enable” – Start command rising edge – Run Enable

DIN1: closed contact = start (**Rising edge required to start**)

open contact = stop

DIN2: closed contact = start enabled

open contact = start disabled and drive stopped if running

7.4.2 Digital inputs

P2.4.2.1 Start signal 1 ID403 “Start Signal 1”

Signal selection 1 for the start/stop logic.
This is for Start Place A, selected with P2.4.2.39
Default programming A.1. Default Forward start.

P2.4.2.2 Start signal 2 ID404 “Start Signal 2”

Signal selection 2 for the start/stop logic.
This is for Start Place A, selected with P2.4.2.39
Default programming A.2. Default Reverse start.

P2.4.2.3 Run enable ID407 “Run Enable”

When run enable is removed from the drive coasting stop is made always.
Drive will also show warning indication when run is disabled.

Contact open: Start of motor disabled
Contact closed: Start of motor enabled

P2.4.2.4 Reverse ID412 “Reverse”

This reverse command is active when Start signal 2 is not used for reverse command because setting of “Start/Stop logic selection” parameter.

Contact open: Direction forward
Contact closed: Direction reverse

P2.4.2.5 Preset speed 1 ID419 “Preset Speed 1”**P2.4.2.6 Preset speed 2 ID419 “Preset Speed 2”****P2.4.2.7 Preset speed 3 ID419 “Preset Speed 3”**

Digital input selections for activating preset speeds.
References are set in the “Constant Reference” parameter group.

Speed	Digital Input Preset speed 1	Digital Input Preset speed 2	Digital Input Preset speed 3
Basic speed / Preset Speed 0	0	0	0
Preset Speed 1	1	0	0
Preset Speed 2	0	1	0
Preset Speed 3	1	1	0
Preset Speed 4	0	0	1
Preset Speed 5	1	0	1
Preset Speed 6	0	1	1
Preset Speed 7	1	1	1

Related parameters

- G2.2.7 Constant Ref

P2.4.2.8 Motor potentiometer DOWN ID417 “Mot Pot Ref Down”

Contact closed: Motor potentiometer reference DECREASES until the contact is opened. See details in G2.2.11 Motor Pot.

P2.4.2.9 Motor potentiometer UP ID418 “Mot Pot Ref Up”

Contact closed: Motor potentiometer reference DECREASES until the contact is opened. See details in G2.2.11 Motor Pot.

P2.4.2.10 Fault reset ID414 “Fault Reset”

Rising edge required to reset fault.

P2.4.2.11 External fault closing contactor ID405 “Ext Fault Close”

External fault input closing contactor, response selected in protection parameter group G2.11.1 Protections / General. Gives fault “51 Ext Fault”

P2.4.2.12 External fault opening contactor ID406 “Ext Fault Open”

External fault input opening contactor, response selected in protection parameter group. Gives fault “51 Ext Fault”

P2.4.2.13 Acceleration/Deceleration time selection ID408 “Acc/Dec Time Sel”

Digital input to select between ramp time 1 and 2, times are set in “Ramp Control” parameter group.

Contact open: Acceleration/Deceleration time 1 selected

Contact closed: Acceleration/Deceleration time 2 selected

P2.4.2.14 Acceleration/Deceleration prohibited ID415 “Acc/Dec Prohibit”

Contact closed: No acceleration or deceleration possible until the contact is opened.

With P2.9.3 Control Options B13 it is possible to select if the deceleration direction is allowed so that the speed is reduced when the reference is smaller than the drive speed at the time.

P2.4.2.15 DC-braking command ID416 “DC Brake Command”

Contact closed: In STOP mode, the DC braking operates until the contact is opened.

Current level is set with P2.7.1.16 DCBrakeCurlnStop parameter.

P2.4.2.16 Jogging speed ID413 “Jogging Speed”

Contact closed: Jogging speed selected for frequency reference

Reference for jogging speed is set in G2.2.7 Constant Reference group.

P2.4.2.16 I/O Reference 1/2 selection ID422 “I/O Ref. 1/2”

With this parameter you can select either AI1 or AI2 signal for frequency reference if I/O reference selection is “14 / AI1/AI2 Sel”.

If selection for P2.2.1 I/O Reference is other than “14 / AI1/AI2 Sel” this digital input will change reference between P2.2.1 I/O Reference and P2.2.4 I/O Reference 2.

7.4.2.1 Forced control place

Digital inputs can be used to bypass parameter P3.1 Control Place, for example, in an emergency situation when PLC is not able to send command to the drive.

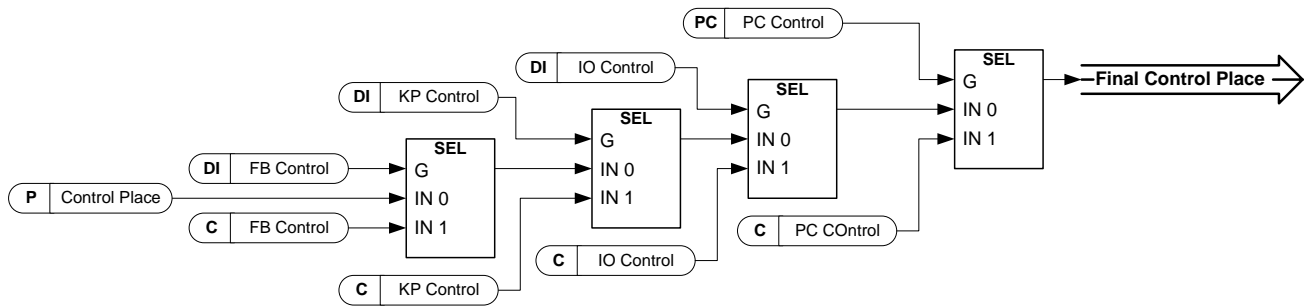

Figure 7-9. Control place selection priority order

P2.4.2.18 Control from I/O terminal ID409 “I/O Term Control”

Contact closed: Force control place to I/O terminal

P2.4.2.19 Control from keypad ID410 “Keypad Control”

Contact closed: Force control place to keypad

P2.4.2.20 Control from Fieldbus ID411 “Keypad Control”

Contact closed: Force control place to fieldbus

NOTE: When the control place is forced to change the values of Start/Stop, Direction and Reference valid in the respective control place are used. The value of parameter [ID125](#) (Keypad Control Place) does not change. When the input opens the control place is selected according to keypad control parameter [P3.1](#) Control Place

P2.4.2.21 Parameter Set 1/Set 2 selection ID496 “Param Set1/Set2”

With this parameter you can select between Parameter Set 1 and Set 2. Remember to put same input for both parameter sets. Parameter sets cannot be changed while the drive is in run state.

Digital input = FALSE:

- Set 1 is loaded as the active set

Digital input = TRUE:

- The active set is saved to set 1
-

When making two parameter sets from the keypad

1. Set all parameters as needed for SET1
2. In “P6.3.1 Parameter Set” select “Store Set1”
3. Set all parameters as needed for SET 1
4. In “P6.3.1 Parameter Set” select “Store Set2”

Note: The parameter values are stored only when selecting parameter P6.3.1 Parameter sets Store Set 1 or Store Set 2 or from NCDrive: Drive > Parameter Sets.

P2.4.2.22 Motor control mode 1/2 ID164 “Mot Ctrl Mode1/2”

This digital input is used to change between two motor control mode selection parameters:

- P2.8.1 Motor Ctrl Mode ID600
- P2.8.2 Motor Ctrl Mode2 ID521

Contact is open = Motor control mode 1 is selected
 Contact is closed = Motor control mode 2 is selected

When changing between open loop and closed loop control modes, make this change in stop state.

P2.4.2.23 External brake acknowledgment. ID1210 “Ext. Brake ACK”

Connect this input signal to auxiliary contact of mechanical brake. If contact is not closed within the given time when brake is opened, the drive will generate a brake fault F58. The response can be selected in G2.14 Brake Control parameter group. Logic will activate when input is 0.3 or greater. If using FB Digital inputs for brake feedback use DIN ID control function between 0.3 (TRUE) and A.9 (FALSE).

P2.4.2.24 Cooling monitor ID750 “Cooling Monitor”

When using a liquid-cooled drive, connect this input to the *Cooling OK* signal from VACON® flow control application or any input that shows state of used cooling unit. See details of operation from G2.11.9 cooling parameters group.

7.4.2.2 Inching function

Inching function will start the drive to reference without additional start command regardless of control place. Inching requires enabling from digital input before the command is accepted. Inching is also disabled if there is a start command active on the active control place.

P2.4.2.25 Enable inching ID532 “Enable Inching”

If you are using inching function the given input must be set TRUE by either digital signal or by setting the parameter value to 0.2.

P2.4.2.26 Inching reference 1 ID530 “Inching 1”**P2.4.2.27 Inching reference 2 ID531 “Inching 2”**

These inputs activate inching reference if inching is enabled. These inputs also start the drive if activated and if there is no Run Request command from anywhere else.

Other parameter for inching function

- | | | | | |
|---|-----------|---------------------|--------|-----------------|
| - | P2.3.9 | Inching Ramp | ID1257 | “Inching Ramp” |
| - | P2.2.7.9 | Inching reference 1 | ID1239 | “Inching Ref 1” |
| - | P2.2.7.10 | Inching reference 2 | ID1240 | “Inching Ref 2” |

P2.4.2.28 Digital input 2nd Frequency Limit ID1511 “Max frequency 2”

With this parameter you can select the digital input that will limit the maximum frequency to a lower value than what is defined by Maximum Frequency. This limit does not affect any constant references. The limit is set in G2.6.4 Freq. Limit Handling.

P2.4.2.29 Reset encoder counter ID1090 “Reset Position”

When using encoder, the drive monitors the encoder rotations and angle (V: Shaft Rounds and V:Shaft Angle).

When this input has a rising edge monitoring values V:Shaft Angle (ID1169) and Shaft Rounds (ID1170) are set to zero. Reset command is also included in V: Aux Control Word.

P2.4.2.30 Master Follower mode 2 ID1092 “MF Mode 2”

Master Follower mode can be changed with digital input between P2.10.1 MF Mode and P2.10.5: MF Mode 2 in the Master Follower parameter group. This can be used for redundancy purposes e.g. when using a Drive Synch system.

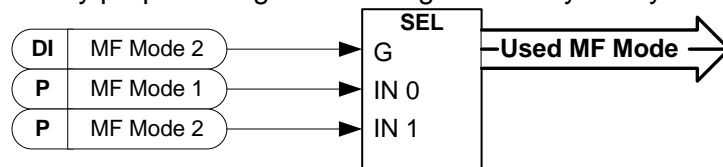
**P2.4.2.31 Quick Stop ID1213 “Quick Stop”**

Digital input for Quick Stop function

P2.4.2.32 Motoring Torque Limit 1 ID1624 “Mot. Torq. Limit 1”

Digital input for activating motoring torque limit 1

P2.4.2.33 Generator Torque Limit 1 ID1626 “Gen. Torq. Limit 1”

Digital input for activation generator torque limit 1

P2.4.2.34 PIC Function Activation ID1804 “PI Activation”

Select the digital input that will activate PI controller. Set selection to 0.2 and PI-controller is activated without external wiring.

P2.4.2.35 Store Parameters ID1753 “Store Param. Set”

Stores active set to currently selected parameters set. Selection is done by “Param. Set1/Set2” digital input that is also used to load parameter set to active set.

P2.4.2.35 Start Place A/B ID425 “Start PlaceA/B”

This parameter is used to select if start signal in IO control is monitored from P2.4.2.1 and P2.4.2.2

P2.4.2.37 Start signal 1B ID403 “Start Signal 1B”

Signal selection 1B for the start/stop logic.

This is for Start Place B, selected with P2.4.2.39

Default programming 0.1.Default Forward start, selected with P2.4.1.1.

P2.4.2.38 Start signal 2B ID404 “Start Signal 2B”

Signal selection 2B for the start/stop logic.
This is for Start Place B, selected with P2.4.2.39
Default programming 0.1. Default Reverse start, selected with P2.4.1.1.

P2.4.2.39 Disable Negative Direction ID1814 “DisableNegDir”

Digital input to disable running to negative direction. Possible to define own ramp time for decelerating.

P2.4.2.40 Disable Positive Direction ID1814 “DisablePosDir”

Digital input to disable running to positive direction. Possible to define own ramp time for decelerating.

P2.4.2.41 SB Control ID1952

Forces control place to System Bus Master.

P2.4.2.42 Set Rope Length ID1916

In hoisting drive rope length calculation this input can be used to set rope length to maximum ID1686 Anti-Swing rope length. The rope length can be read by PLC and send to trolley and bridge drives. It's also possible to use system bus communication to send rope length to the drives.

P2.4.2.43 Set Rope Zero Length ID1917

In hoisting drive rope length calculation this input can be used to set rope length to zero. e.g. rope is its highest position.

7.4.3 Analogue Input 1 & 2

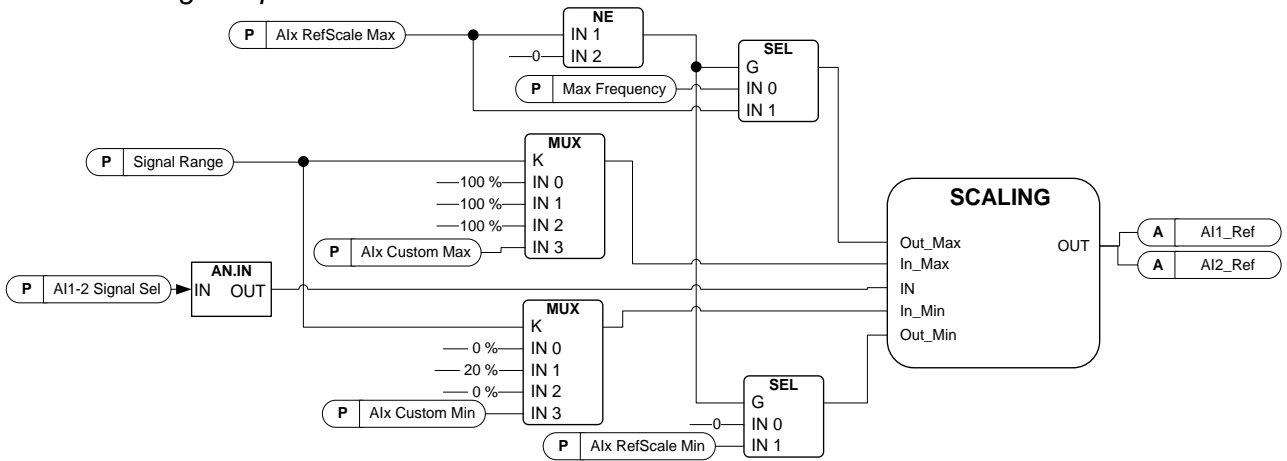

- P2.4.3.1 AI1 signal selection ID377 "AI1 Signal Sel"**
- P2.4.4.1 AI2 signal selection ID388 "AI2 Signal Sel"**

Connect the AI1/AI2 signal to the analogue input of your choice with this parameter. For more information about the TTF programming method, see chapter 4.

- P2.4.3.2 Analogue input 1 signal filter time ID324 "AI1 Filter Time"**
- P2.4.4.2 Analogue input 2 signal filter time ID329 "AI2 Filter Time"**

First order filtering is used for analogue signals that are used to control e.g. the power limit. Second order filtering is used for frequency reference filtering.

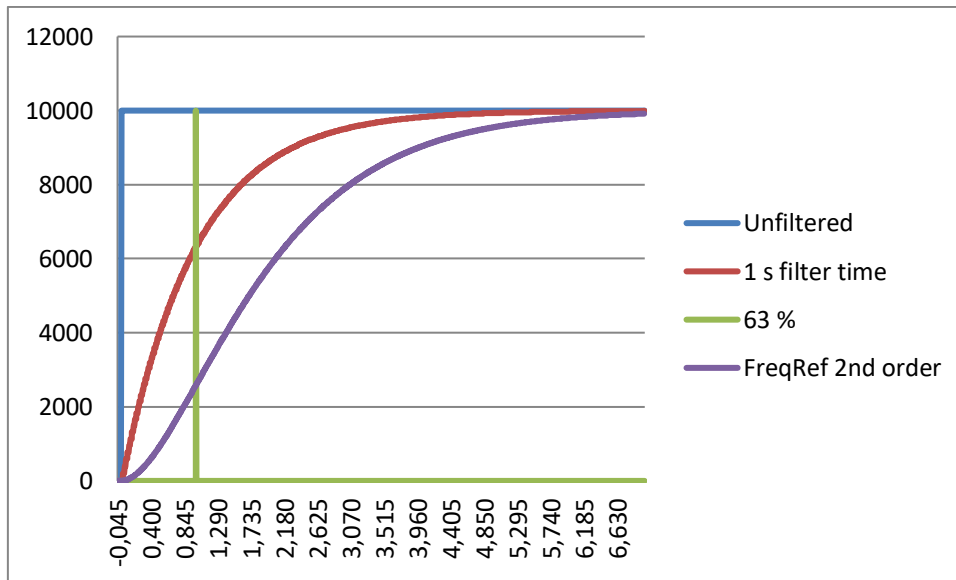

Figure 7-10. AI1 signal filtering

P2.4.3.3 Analogue input signal 1 signal range ID320 “AI1 Signal Range”

P2.4.4.3 Analogue input signal 2 signal range ID325 “AI2 Signal Range”

0 “0-20mA/10V

Signal input ranges: 0...10 V and 0...20 mA.
Input signal is used from 0% to 100%.

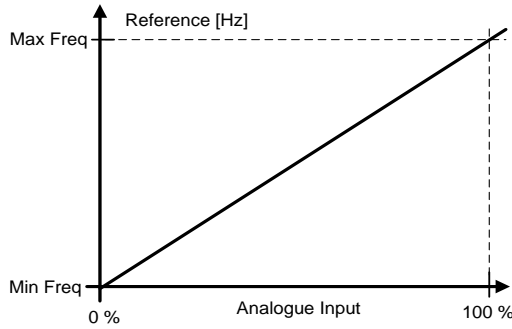

1 “4-20 mA

Signal input ranges: 4–20 mA and 2–10 V
Input signal is used from 20% to 100%

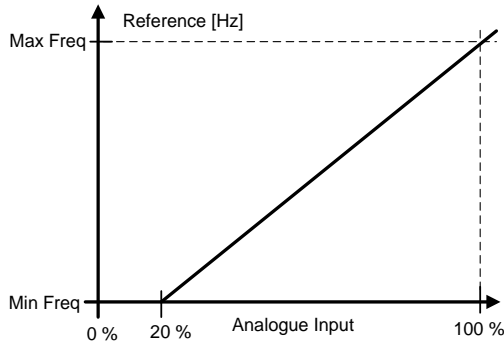

2 “-10 - + 10 V

Signal input range: -10 V – + 10 V.
Input signal is used from -100% to +100%.

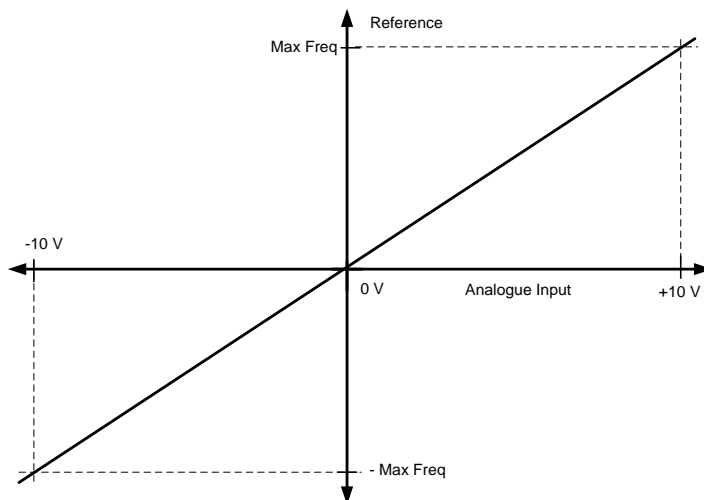

3 “Custom Range”

With custom range it is possible to freely adjust what input level corresponds to the minimum and maximum frequencies.

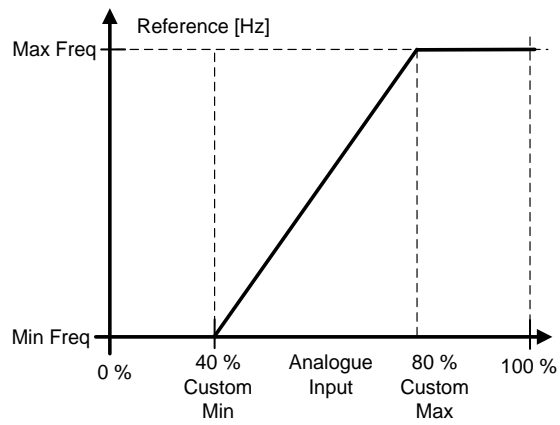

- P2.4.3.4** AI1 custom minimum setting ID321 "AI1 Custom Min"
- P2.4.3.5** AI1 custom maximum setting ID322 "AI1 Custom Max"
- P2.4.4.4** AI2 custom minimum setting ID326 "AI2 Custom Min"
- P2.4.4.5** AI2 custom maximum setting ID327 "AI2 Custom Max"

These parameters set the analogue input signal for any input signal span within -160...160%. E.g. if the signal input scaling is set to 40%...80%, the reference can be changed from 8 mA (for Minimum Frequency) to 16 mA (for Maximum Frequency).

- P2.4.3.6** AI1 Reference scaling, minimum value ID303 "AI2 RefScale Min"
- P2.4.3.7** AI1 Reference scaling, maximum value ID304 "AI2 RefScale Max"
- P2.4.4.6** AI2 reference scaling, minimum value ID393 "AI2 RefScale Min"
- P2.4.4.7** AI2 reference scaling, maximum value ID394 "AI2 RefScale Max"

Additional reference scaling. Analogue input reference scaling can be set to a different value than the minimum and maximum frequency.

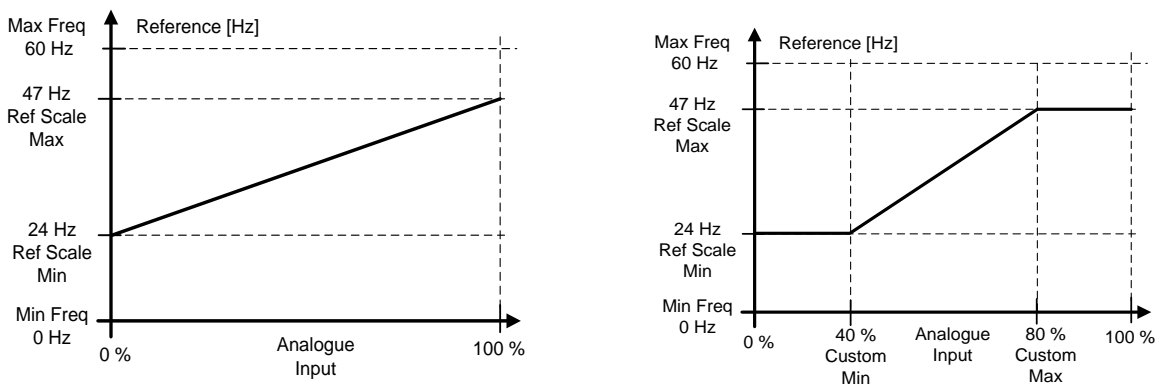

- P2.4.3.8** Analogue Input 1 joystick input dead zone ID382 "AI1 JoysDeadZone"
- P2.4.4.8** Analogue Input 2 joystick input dead zone ID395 "AI2 JoysDeadZone"

The small values of the reference around zero can be ignored by setting this value to greater than zero. When the reference lies between zero and ± this parameter, it is forced to zero.

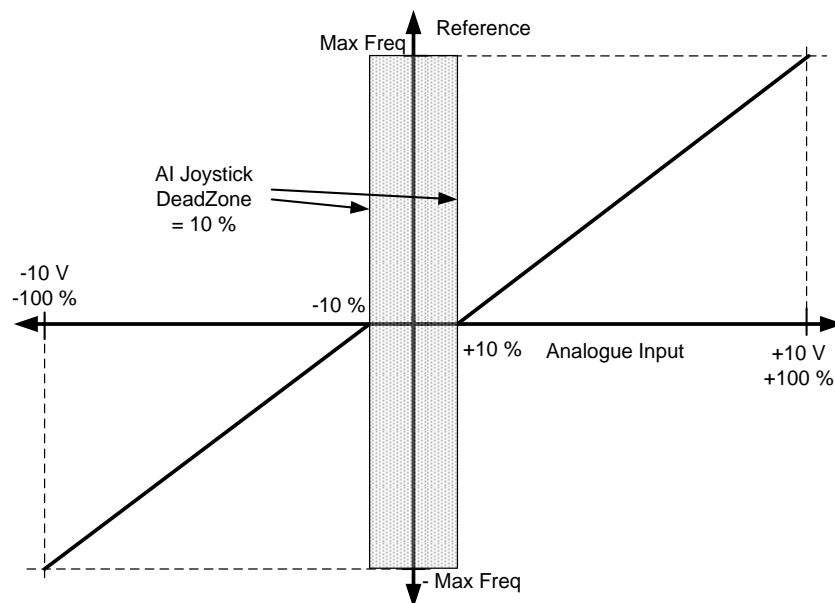

7.4.3.1 Sleep function

The drive can be stopped by sleep function when the analogue input falls below a certain value for a certain time and speed functions become active.

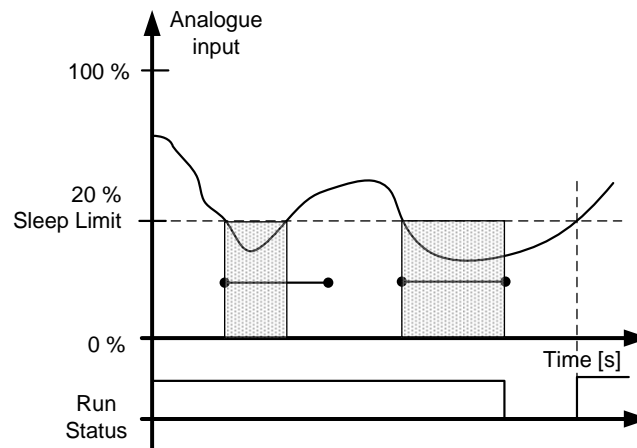

P2.4.3.9 AI1 sleep limit ID385 "AI1 Sleep Limit"

P2.4.4.9 AI2 sleep limit ID396 "AI2 Sleep Limit"

The drive is stopped automatically if the AI signal level falls below the Sleep limit defined with this parameter. In joystick function, when input is between zero and \pm this parameter the drive will go to sleep state.

P2.4.3.10 AI1 sleep delay ID386 "AI1 Sleep Delay"

P2.4.4.10 AI2 sleep delay ID397 "AI2 Sleep Delay"

This parameter defines the time the analogue input signal has to stay under the sleep limit in order to stop the drive.

P2.4.3.11 AI1 joystick offset ID165 "AI1 Joyst.Offset"

P2.4.4.11 AI2 joystick offset ID166 "AI2 Joyst.Offset"

Defines the frequency zero point as follows:

With this parameter on display, place the potentiometer in the assumed zero point and press *Enter* on keypad.

Note: This will not, however, change the reference scaling.
Press *Reset* button to change the parameter value back to 0.00%.

7.4.4 Analogue input 3 & 4

Analogue Inputs 3 and 4 can be written form fieldbus. This allows signal scaling and inversion. useful e.g. in case when PLC is not operational (value zero received) signal will be automatically at maximum.

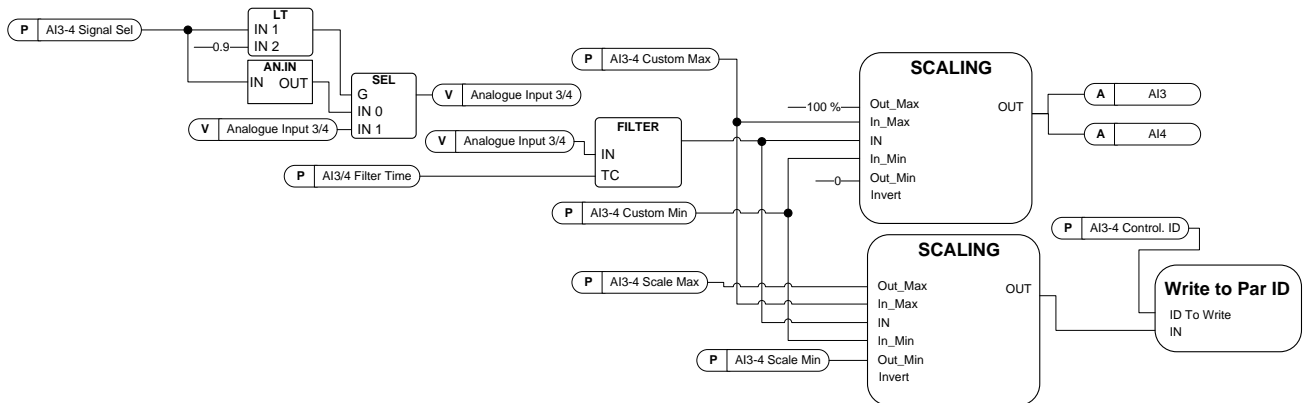

P2.4.5.1 AI3 signal selection ID141 “AI3 Signal Sel”

P2.4.6.1 AI4 signal selection ID152 “AI4 Signal Sel”

Connect the AI3/AI4 signal to the analogue input of your choice with this parameter. For more information, see Chapter 4 “Terminal To Function” (TTF) programming principle.

When the parameter for Analogue input signal selection is set to 0.1, you can control the analogue input monitoring variable from Fieldbus by assigning the Process Data Input ID number to the analogue input monitoring signal thus allowing the PLC input signals to be scaled with analogue input scaling functions.

P2.4.5.2 Analogue input 3 signal filtering time ID142 “AI3 Filter Time”

P2.4.6.2 Analogue input 4 signal filtering time ID153 “AI3 Filter Time”

First order filtering is used for analogue inputs signals 3 and 4.

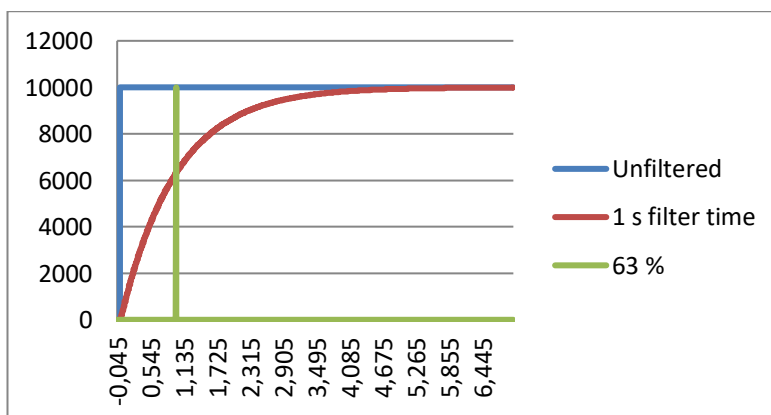

P2.4.5.3 AI3 custom setting minimum ID144 “AI3 Custom Min”

P2.4.5.4 AI3 custom setting maximum ID145 “AI3 Custom Max”

P2.4.6.3 AI4 custom setting minimum ID155 “AI4 Custom Min”

P2.4.6.4 AI4 custom setting maximum ID156 “AI4 Custom Max”

Set the custom minimum and maximum input levels for the AI3 signal within -160...160%.

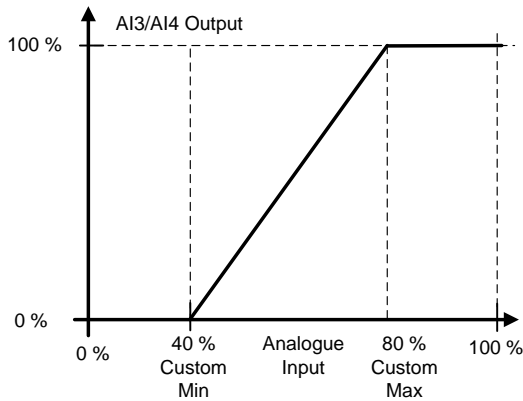

P2.4.5.5 AI3 signal inversion ID151 “AI3 Signal Inv”

P2.4.6.5 AI4 signal inversion ID162 “AI3 Signal Inv”

The signal inversion function is useful in a situation when, for example, the PLC is sending power limit to the drive using fieldbus. If the PLC is unable to communicate with the drive, the power limit from fieldbus to the drive would be zero. Using an inverted signal logic zero value from PLC would mean maximum power limit. When inversion is needed for the process data signal fieldbus values need to be written to Analogue input monitoring signals. See parameter P2.4.5.1 AI3 Signal selection for details.

0 = No inversion

1 = Signal inverted

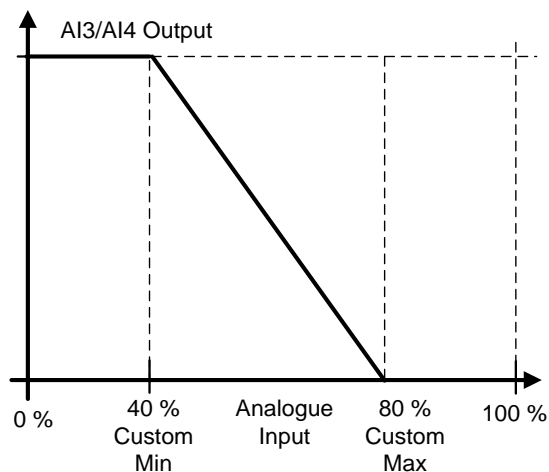

7.4.4.1 *Analogue input to any parameter*

This function allows control of any parameter by using an analogue input. The parameter selects what the range of control area and the ID number for the parameter that is controlled.

- P2.4.5.6** Analogue input 3, minimum value **ID1037** "AI3 Scale Min"
- P2.4.5.7** Analogue input 3, maximum value **ID1038** "AI3 Scale Max"
- P2.4.6.6** Analogue input 4, minimum value **ID1039** "AI4 Scale Min"
- P2.4.6.7** Analogue input 4, maximum value **ID1040** "AI4 Scale Max"

These parameters define the range for the controlled parameters. All the values are considered to be integers i.e. when controlling the Field Weakening Point (as in example) you also need to set numbers for decimals, for example, FWP 100.00 needs to be set as 10000.

- P2.4.5.8** AI3 Controlled ID **ID1509** "AI3 Control. ID"
- P2.4.6.8** AI4 Controlled ID **ID1510** "AI4 Control. ID"

These parameters define the controlled parameter.

Example:

You want to control motor field weakening point voltage through an analogue input from 70.00% to 130.00%.

- Set Scale min to 7000 = 70.00%
- Set Scale max to 13000 = 130.00%
- Set Controlled ID to 603 (Voltage at field weakening point)

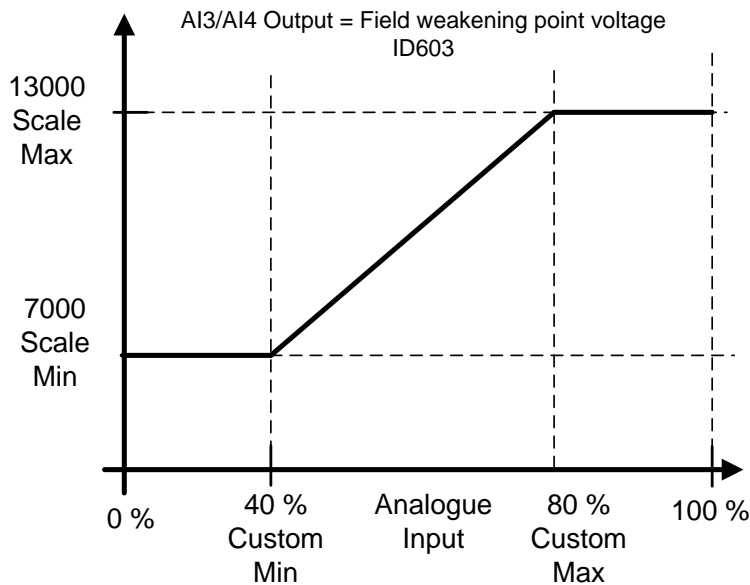

Now analogue input 3 signal 0 V to 10 V (0 mA to 20 mA) will control the field weakening point voltage between 70.00%–130.00%. When setting the value remember that decimals are handled as integers.

*7.4.5 Inversion control***P2.4.7.1 Inversion Control ID1091 “INV Control”**

Inversion control allows you to select which input signal operation will be inverted.

B00 = +1 = Invert external fault 1

B01 = +2 = Invert external fault 2

B02 = +4 = Inverted Run Enable digital input

B03 = +8 = Inverted Brake acknowledge digital input

B04 = +16 = Motoring Torque limit digital input inverted

B05 = +32 = Maxim Frequency 2 digital input inverted

B06 = +64 = Quick Stop digital input inverted

7.5 Output signals

7.5.1 Digital output signals

In the Brake Control application, all output signals are not used by default.

P2.5.1.1 Ready ID432 “Ready”

The AC drive is ready to operate.

Common reasons when ready signals are missing:

- Run enable signal is low
- DC Voltage is too low
- DC Voltage is too high

P2.5.1.2 Run ID433 “Run”

The AC drive is modulating.

P2.5.1.3 Fault ID434 “Fault”

A fault trip has occurred.

P2.5.1.4 Inverted fault ID435 “Fault, Inverted”

No active faults in the drive.

P2.5.1.5 Warning ID436 “Warning”

General warning signal.

P2.5.1.6 External fault or warning ID437 “Ext. Fault/Warn.”

Fault or warning depending on parameter Response to external fault. P2.4.2.11 Ext Fault Close and P2.4.2.12 Ext Fault Open are used to trigger a fault. P2.12.1 External fault is used to select response.

P2.5.1.7 Reference fault or warning (4mA) ID438 “AI Ref Faul/Warn”

Fault or warning depending on parameter Response to the 4mA reference fault. Response is selected in G2.11.6.

P2.5.1.8 Drive overtemperature warning ID439 “OverTemp Warn”

Drive temperature has exceeded normal operation conditions. Temperature limit may vary depending on drive type on size.

P2.5.1.9 Reverse ID440 “Reverse”

Drive output frequency is negative

P2.5.1.10 Wrong direction ID441 “WrongDirection”

Motor rotation direction is different from the requested one. This happens in situation when external force makes the motor rotate in different direction or when the direction change command has been given and the drive is still ramping down to change direction.

P2.5.1.11 At reference speed ID442 “At Ref. Speed”

Induction motor: Speed is within nominal slip of the reference.

PMS motor: Output frequency is within 1 Hz of the reference frequency.

P2.5.1.12 Jogging speed ID413 “Jogging Speed”

Jogging speed command has been given.

P2.5.1.13 IO Control Place ID444 “IO Control Place”

Active control place is I/O terminal defined by the parameter for Control place (P3.1) or forced with digital input function.

P2.5.1.14 Brake Open Control, Direct ID446 “BrakeOpen,Direct”

See detailed description about the brake operation in G2.15 Brake Control Chapter 7.15

Example: OPTA2 board RO1 :

Brake function ON: Terminals 22-23 are open (Relay not energized).

Brake function OFF: Terminals 22-23 are connected (Relay is energized).

Brake Close Command
Brake function ON

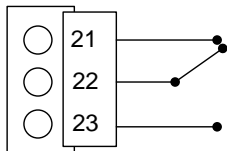

Brake Open Command
Brake function OFF

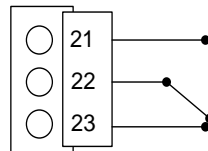

When using the Master-Follower function, the follower drive will open the brake at the same time as the master does even if the follower's conditions for brake opening have not been met.

P2.5.1.15 Brake Open Control, Inverted ID445 “BrakeOpen, Invert”

See detailed description about the brake operation in G2.15 Brake Control Chapter 7.15

External brake Close /Open control

Example: OPTA2 board RO1 :

Brake Closed: Terminals 22-23 are connected (Relay is energized).

Brake Open: Terminals 22-23 are open (Relay not energized).

Brake Close Command
Brake function ON

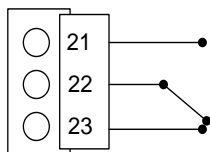

Brake Open Command
Brake function OFF

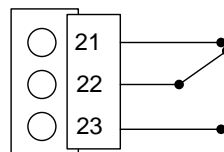

Note: When power from the control board is removed, the terminals 22-23 are open.

When using the Master-Follower function, the follower drive will open the brake at the same time as the master even if the follower's conditions for brake opening have not been met.

P2.5.1.16 Output frequency limit 1 supervision ID447 “FreqOut SupvLim1”

The output frequency goes outside the set supervision limits defined in Supervision Lim parameter group. The function can be set to monitor either the high or the low limit. Limit and functions are selected in G2.5.8 Supervision Limits.

P2.5.1.17 Output frequency limit 2 supervision ID448 “FreqOut SupvLim2”

The output frequency goes outside the set supervision limits 2 defined in Supervision Lim parameter group. The function can be set to monitor either the high or the low limit. Limit and functions are selected in G2.5.8 Supervision Limits.

P2.5.1.18 Reference limit supervision ID449 “Ref Lim Superv.”

Active reference goes beyond the set supervision low limit/high limit defined in Supervision Lim parameter group. The function can be set to monitor either the high or the low limit Limit. The functions are selected in G2.5.8 Supervision Limits.

P2.5.1.19 Temperature limit supervision ID450 “Temp Lim Superv.”

The drive temperature goes beyond the set supervision limits defined in Supervision Lim parameter group. The function can be set to monitor either the high or the low limit. Limit and functions are selected in G2.5.8 Supervision Limits.

P2.5.1.20 Torque limit supervision ID451 “Torq Lim Superv.”

The motor torque goes beyond the set supervision limits defined in Supervision Lim parameter group. The function can be set to monitor either the high or the low limit. Limit and functions are selected in G2.5.8 Supervision Limits.

P2.5.1.21 Motor thermal protection ID452 “MotTherm Flt/Wrn”

Motor thermistor initiates an overtemperature signal which can be led to a digital output. The response is selected with P2.12.5.6 ThermistorF.Resp.

P2.5.1.22 Analogue input supervision limit ID453 “Ain Supv Lim”

The selected analogue input signal goes beyond the set supervision limits defined in G2.5.8 Supervision Lim parameter group. The function can be set to monitor either the high or the low limit.

P2.5.1.23 Limit Control active ID454 “Limit Control ON”

One or more of the drive limit controllers is active.

7.5.1.1 Fieldbus digital inputs connection

- P2.5.1.24** *Fieldbus input data 1* **ID455** “**FB Dig Input 1**”
P2.5.1.26 *Fieldbus input data 2* **ID456** “**FB Dig Input 2**”
P2.5.1.28 *Fieldbus input data 3* **ID457** “**FB Dig Input 3**”
P2.5.1.30 *Fieldbus input data 4* **ID169** “**FB Dig Input 4**”
P2.5.1.32 *Fieldbus input data 5* **ID170** “**FB Dig Input 5**”

The data from the Fieldbus main control word can be led to the drive's digital outputs. See used fieldbus board manual for location of these bits.

- P2.5.1.25** *Fieldbus digital input 1 parameter* **ID891** “**FB Dig 1 Par ID**”
P2.5.1.27 *Fieldbus digital input 2 parameter* **ID892** “**FB Dig 2 Par ID**”
P2.5.1.29 *Fieldbus digital input 3 parameter* **ID893** “**FB Dig 3 Par ID**”
P2.5.1.31 *Fieldbus digital input 4 parameter* **ID894** “**FB Dig 4 Par ID**”
P2.5.1.33 *Fieldbus digital input 5 parameter* **ID895** “**FB Dig 5 Par ID**”

With these parameters you can define the parameter to be controlled by using FB Digital input.

Example:

All option board inputs are in use and you still want to give DI: DC Brake Command (ID416). You also have a fieldbus board in the drive.

Set parameter ID891 (Fieldbus digital input 1) to 416.

Now you are able to control DC Braking command from the fieldbus by Profibus control word (bit 11).

It is possible to control any parameter in the same way if values 0=FALSE and 1=TRUE are significant for that parameter. For example, P2.6.5.3 Brake Chopper (ID504) can be controlled on and off using this function (Brake Chopper; 0 = Not Used, 1 = On, Run).

P2.5.1.34 *Safe disable active* **ID756** “**Safe Disable Act**”

Select the digital output to show the status of the Safe Torque Off.

P2.5.1.35 *Brake Slipping* **ID1786**

Digital output indication that brake is slipping.

7.5.2 Analogue outputs 1 & 2 & 3 & 4

P2.5.2.1	Analogue output 1 signal selection	ID464	"Iout 1 Signal"
P2.5.3.1	Analogue output 2 signal selection	ID471	"Iout 2 Signal"
P2.5.4.1	Analogue output 3, signal selection	ID478	"Iout 3 Signal"
P2.5.5.1	Analogue output 4, signal selection	ID1527	"Iout 4 Signal"

Connect the AO1 signal to the analogue output of your choice with this parameter.

P2.5.2.2	Analogue output function	ID307	"Iout Content"
P2.5.3.2	Analogue output 2 function	ID472	"Iout 2 Content"
P2.5.4.2	Analogue output 3, function	ID479	"Iout 3 Content"
P2.5.5.2	Analogue output 4, function	ID1520	"Iout 4 Content"

This parameter selects the desired function for the analogue output signal.

- 0 "Not used"**
Analogue output is forced to 20% (= 2 V/4 mA)
- 1 "O/P Freq"**
Output frequency from zero to maximum frequency.
- 2 "Freq Ref"**
Freq. reference from zero to maximum frequency
- 3 "Motor speed "**
Motor speed from zero speed to motor synchronous speed
- 4 "O/P Current"**
Drive output current from zero to motor nominal current
- 5 "Motor Torque "**
Motor torque from zero to motor nominal torque (100%)
- 6 "Motor Power"**
Motor power from zero to motor nominal power (100%)
- 7 "Mot Voltage"**
Drive output voltage from zero to motor nominal voltage
- 8 "DC-link volt"**
500 V unit: DC voltage from zero to 1000 Vdc
690 V unit: DC voltage from zero to 1317 Vdc
- 9 "AI1"**
Unfiltered Analogue input 1 signal
- 10 "AI2"**
Unfiltered Analogue input 2 signal
- 11 "Fout,min-max"**
Output frequency from minimum frequency to maximum frequency
- 12 "(-2Tn)-(2Tn)"**
Motor torque from negative two times motor nominal to positive two times motor nominal torque
- 13 "(-2Pn)-(2Pn)"**
Motor power from negative two times motor nominal to positive two times motor nominal power
- 14 "PT100 Temp."**
Maximum PT100 temperature value from used input scaling from -30°C to +200°C
- 15 "FB Data In4"**
FB analogue output fieldbus process data value can be connected to analogue output by using monitoring signal ID48.
- 16 "(-2nN)-(2nN)"**
Motor speed from negative two times nominal to positive two times nominal speed

17 “Enc 1 Speed”

Encoder 1 speed from zero speed to motor synchronous speed

- P2.5.2.3** *Analogue output filter time* **ID308** **“Iout Filter Time”**
- P2.5.3.3** *Analogue output 2 filter time* **ID473** **“Iout 2 Filter T”**
- P2.5.4.3** *Analogue output 3, filter time* **ID480** **“Iout 3 Filter T”**
- P2.5.5.3** *Analogue output 4, filter time* **ID1521** **“Iout 4 Filter T”**

First order filtering is used for analogue output signals.

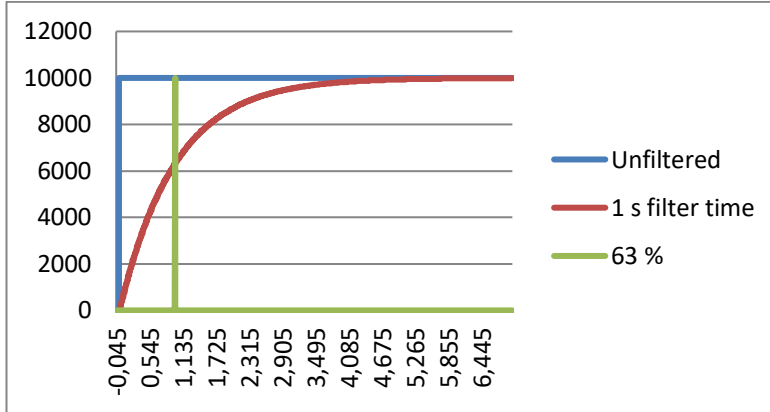

- P2.5.2.4** *Analogue output inversion* **ID309** **“Iout Invert”**
- P2.5.3.4** *Analogue output 2 inversion* **ID474** **“Iout 2 Invert”**
- P2.5.4.4** *Analogue output 3 inversion* **ID481** **“Iout 3 Invert”**
- P2.5.5.4** *Analogue output 4 inversion* **ID1522** **“Iout 4 Invert”**

Inverts the analogue output signal:

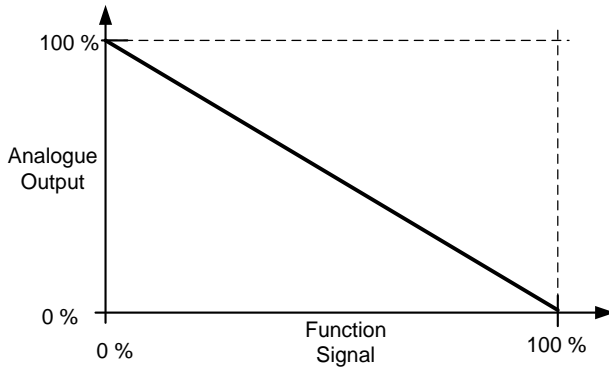

- P2.5.2.5** *Analogue output minimum* **ID310**
- P2.5.3.5** *Analogue output 2 minimum* **ID475**
- P2.5.4.5** *Analogue output 3 minimum* **ID482**
- P2.5.5.5** *Analogue output 4 minimum* **ID1523**

Defines the signal minimum to either 0 mA or 4 mA (living zero).

- 0** Set minimum value to 0 mA (0%)
- 1** Set minimum value to 4 mA (20%)

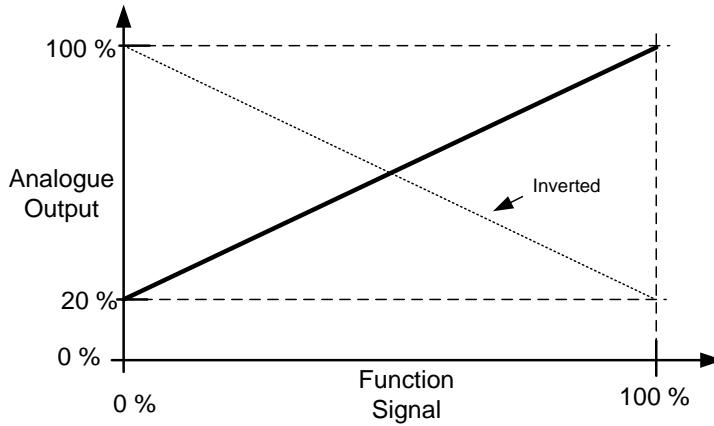

- P2.5.2.6** *Analogue output scale* **ID311** **"Iout Scale"**
- P2.5.3.6** *Analogue output 2 scaling* **ID476** **"Iout 2 Scale"**
- P2.5.4.6** *Analogue output 3 scaling* **ID483** **"Iout 3 Scale"**
- P2.5.5.6** *Analogue output 4 scaling* **ID1525** **"Iout 4 Scale"**

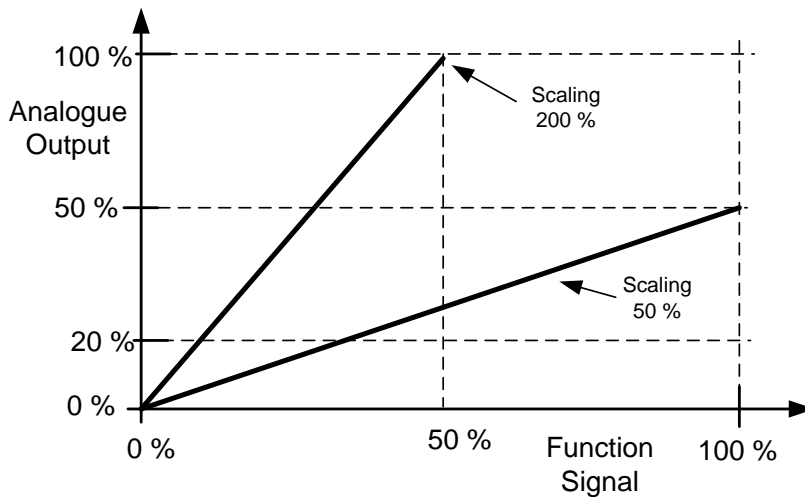

P2.5.2.7	Analogue output offset	ID375	"Iout Offset"
P2.5.3.7	Analogue output 2 offset	ID477	"Iout 2 Offset"
P2.5.4.7	Analogue output 3 offset	ID484	"Iout 3 Offset"
P2.5.5.7	Analogue output 4 offset	ID1524	"Iout 4 Offset"

Define the offset for the analogue output signal.

In the picture below, the 50% scaling signal has been given 20% offset and the 200% scaling has been given 50% offset.

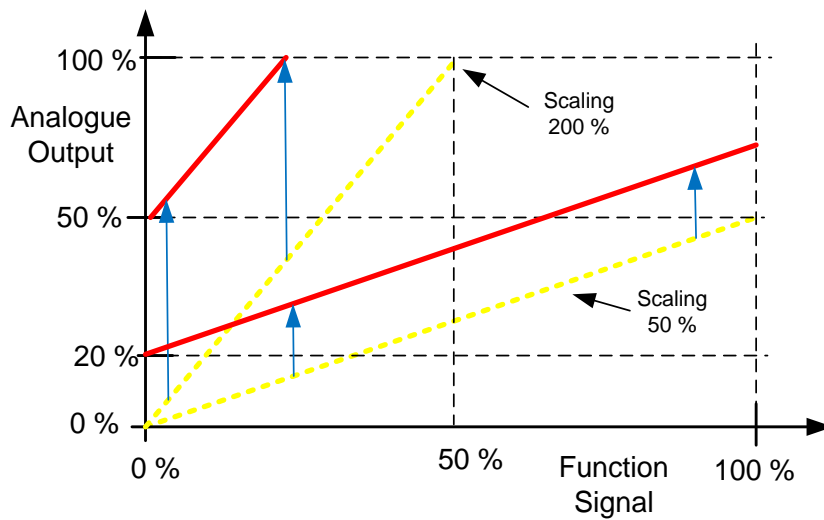

7.5.3 Delayed Digital Output 1 & 2

P2.5.6.1 Digital output 1 signal selection **ID486 “Dig.Out 1 Signal”**

P2.5.7.1 Digital output 2 signal selection **ID489 “Dig.Out 2 Signal”**

Connect the delayed digital output signal to the digital output of your choice with this parameter. For more information about the TTF programming method, see chapter 4.

P2.5.6.2 Digital output function **ID312 “DO1 Content”**

P2.5.7.2 Digital output 2 function **ID490 “DO2 Content”**

0 = “Not used”

1 = “Ready”

The AC drive is ready to operate.

Common reasons when ‘Ready’ signals are missing:

- Run enable signal is low
- DC Voltage is too low
- DC Voltage is too high

2 = “Run”

The AC drive is modulating.

3 = “Fault”

A fault trip has occurred.

4 = “FaultInvert”

No active faults in the drive.

5 = “OverheatWarn”

Drive temperature has exceeded normal operation conditions. Temperature limit may vary depending on drive type and size.

6 = “ExtFaul/Warn”

External fault or warning depending on parameter response to external fault.

7 = “RefFaul/Warn”

Fault or warning depending on parameter Response to the 4mA reference fault - occurs if analogue reference is 4–20 mA and signal is <4mA.

8 = “Warning”

Always if a warning is on.

9 = “Reversed”

Drive output frequency is negative.

10 = “JogSpeedSel”

The jogging, preset or inching speed has been activated with digital input.

11 = “At speed”

Induction motor: speed is within nominal slip of the reference.

PMS motor: output frequency is within 1 Hz of the reference.

12 = “MotorRegAct”

One of the limit regulators is active.

13 = “FreqLim1Sup”

Output frequency limit 1 supervision

The output frequency goes outside the set supervision low limit/high limit.

14 = “FreqLim2up”

Output frequency limit 2 supervision

The output frequency goes outside the set supervision low limit/high limit.

15 = “TorqLimSprv”

Torque limit supervision

The motor torque goes beyond the set supervision low limit/high.

- 16 = "RefLimSprv"**
Reference limit supervision
Active reference goes beyond the set supervision low limit/high limit.
- 17 = "BrkOpnInvert"**
Brake Open Control Inverted
External brake close/open control; Output active when brake is controlled closed.
- 18 = "I/O ContAct"**
Control from I/O terminals
IO control place is active.
- 19 = "TempLimSprv"**
Drive temperature limit supervision
Drive temperature goes beyond the set supervision limits (par. ID354)
- 20 = "WrongDirecti"**
Motor rotation direction is different from the requested one. This happens in situation when an external force makes the motor to rotate into different direction or when a command for direction change has been given and the drive is still ramping down to change direction.
- 21 = "BrkOpnDirect"**
Brake Open Control Direct
External brake close/open control; Output active when brake is controlled open.
- 22 = "ThermFlt/Wrn"**
Thermistor fault or warning
The thermistor input of option board indicates overtemperature. Fault or warning depending on the response parameter.
- 23 = "AI Supervis"**
Analogue input supervision
Analogue input supervision function, Set Reset type output function.
- 24 = "FB DigInput1"**
Fieldbus digital input data 1
- 25 = "FB DigInput2"**
Fieldbus digital input data 2
- 26 = "FB DigInput3"**
Fieldbus digital input data 3
- 27 = "Warning SR"**
Warning indication that requires pressing of Reset button. Normally the drive will remove warning indication when the fault situation has passed. This output requires that reset button is pressed before signal goes low after there has been a warning trigger.
- 28 = "ID.Bit"**
Select the signal for controlling the DO. The parameter has to be set in format xxxx.yy where xxxx is the ID number of a signal and yy is the bit number. For example, the value for DO control is 1174.02. 1174 is the ID number of Warning Word 1. So the digital output is ON when bit number 02 of the warning word (ID no. 1174) i.e. Motor underload is high.

P2.5.6.3	Digital output 1 on-delay	ID487	“DO1 ON Delay”
P2.5.6.4	Digital output 1 off-delay	ID488	“DO1 OFF Delay”
P2.5.7.3	Digital output 2 on-delay	ID491	“DO2 ON Delay”
P2.5.7.4	Digital output 2 off-delay	ID492	“DO2 OFF Delay”

With these parameters you can set on- and off-delays to digital outputs.

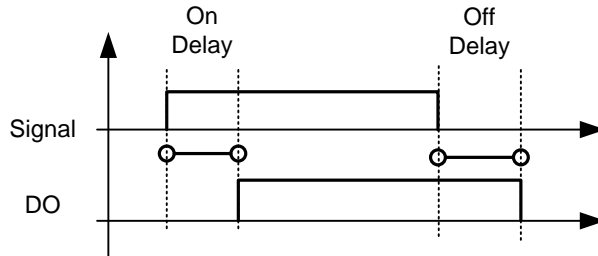
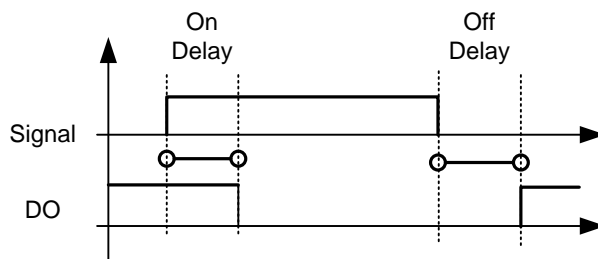

Figure 7-11. Digital outputs 1 and 2, on- and off-delays

P2.5.6.5	Invert digital output 1	ID1587	“INV Delayed DO1”
P2.5.7.5	Invert digital output 2	ID1588	“INV Delayed DO2”

Inverts delayed digital output operation.



P2.5.6.6	ID.Bit Free DO 1	ID1217
P2.5.7.6	ID.Bit Free DO 2	ID1385

Select the signal for controlling the DO. The parameter has to be set in format xxx.yy where xxx is the ID number of a signal and yy is the bit number. For example, the value for DO control is 1174.02. 1174 is the ID number of Warning Word 1. So the digital output is ON when bit number 02 of the warning word (ID no. 1174) i.e. *Motor underload* is high.

P2.5.6.7 **DO1 Time Scale ID1060**

P2.5.7.7 **DO2 Time Scale ID1061**

Select the time scale of delayed output time

- 0 = s
- 1 = min
- 2 = h

7.5.4 Supervision limits

Supervision function gives you the possibility to monitor certain values with the limit setting. When the actual value exceeds or goes below the set value a message through a digital output can be given. The torque limit supervision is scalable.

P2.5.8.1	Output frequency limit supervision function	ID315	“Freq Supv Lim 1”
P2.5.8.3	Output frequency limit 2 supervision function	ID346	“Freq Supv Lim 2”
P2.5.8.5	Torque limit, supervision function	ID348	“Torque Supv Lim”
P2.5.8.8	Reference limit, supervision function	ID350	“Ref Superv Lim”
P3.6.8.10	Drive temperature limit supervision function	ID354	“Temp Lim Superv.”

- 0 No supervision
- 1 Low limit supervision
- 2 High limit supervision

The following five parameters are used to set a limit value to be monitored with the corresponding parameter above.

P2.5.8.2	Output frequency limit supervision value	ID316	“Freq Dupv Val 1”
P2.5.8.4	Output frequency limit 2 supervision value	ID347	“Freq Supv Val 2”
P2.5.8.6	Torque limit, supervision value	ID349	“Torque Supv Val”
P2.5.8.9	Reference limit, supervision value	ID351	“Ref Superv Value”
P2.5.8.11	Drive temperature limit value	ID355	“Temp Supv Value”

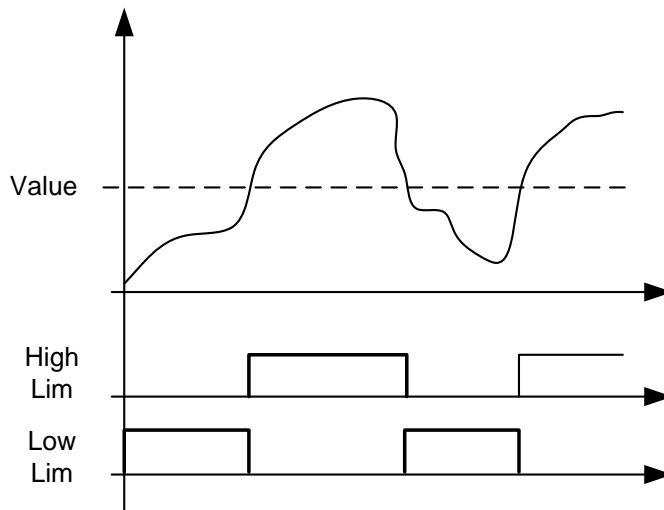

Figure 7-12. Supervision function

P2.5.8.7	Torque Supervision value scaling input	ID402	“Torque Superv Scl”
-----------------	---	--------------	----------------------------

This parameter is used to change the torque limit supervision level between zero and P2.5.8.6 Torque Supv Val

- 0 = Not used
- 1 = AI1
- 2 = AI2
- 3 = AI3
- 4 = AI4
- 5 = FBLimScaling

7.5.4.1 *Analogue input supervision function*

The analogue input supervision function will control the selected digital output to close when the analogue input signal has exceeded the high limit and open when the signal goes below the low limit.

P2.5.8.12 Analogue input supervision signal ID356 “Ain Supv Input”

With this parameter you can select the analogue input to be monitored.

- 0 = Not used
- 1 = AI1
- 2 = AI2
- 3 = AI3
- 4 = AI4
- 5 = FBLimScaling

P2.5.8.13 Analogue Low supervision control limit ID357 “Ain Supv Llim”

P2.5.8.14 Analogue High supervision control limit ID358 “Ain Supv Hlim”

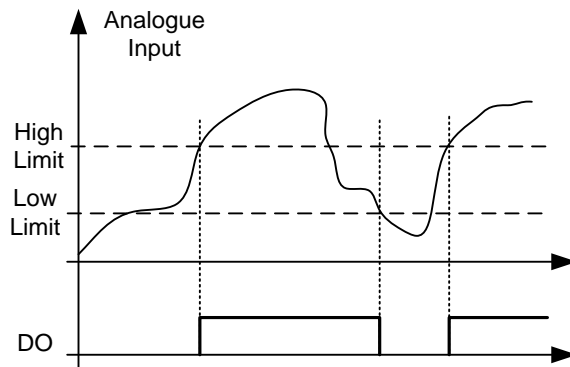

Figure 7-13. An example of On/Off-control

7.6 Limit settings

7.6.1 Current limit handling

P2.6.1.1 Current limit ID107 “Current Limit”

This parameter determines the maximum motor current from the AC drive. The parameter's value range differs from size to size.

When the Current limit is changed the Stall current limit is internally calculated to 90% of the current limit (if the Stall current limit is greater than the Current limit).

When the current limit is active the drive output frequency is reduced until current is below the set limit.

In closed loop control, the current limit affects the torque producing current limit, not total current. This can be changed in options group with the “LimitTotalCurrent” parameter.

In drive synch operation limiting is for average current of units.

P2.6.1.2 Scaling of current limit ID399 “Currnt Lim ScIng”

0 = Not used

1 = AI1

2 = AI2

3 = AI3

4 = AI4

5 = FB Limit Scaling ID46 Monitoring value

This signal will adjust the maximum motor current between 0 and the parameter Motor Current Limit.

P2.6.1.3 Current Limit Kp 1451

Current limit K gain for open loop control

P2.6.1.4 Current Limit Ki 1452

Current limit I gain for open loop control.

7.6.2 Torque limit handling

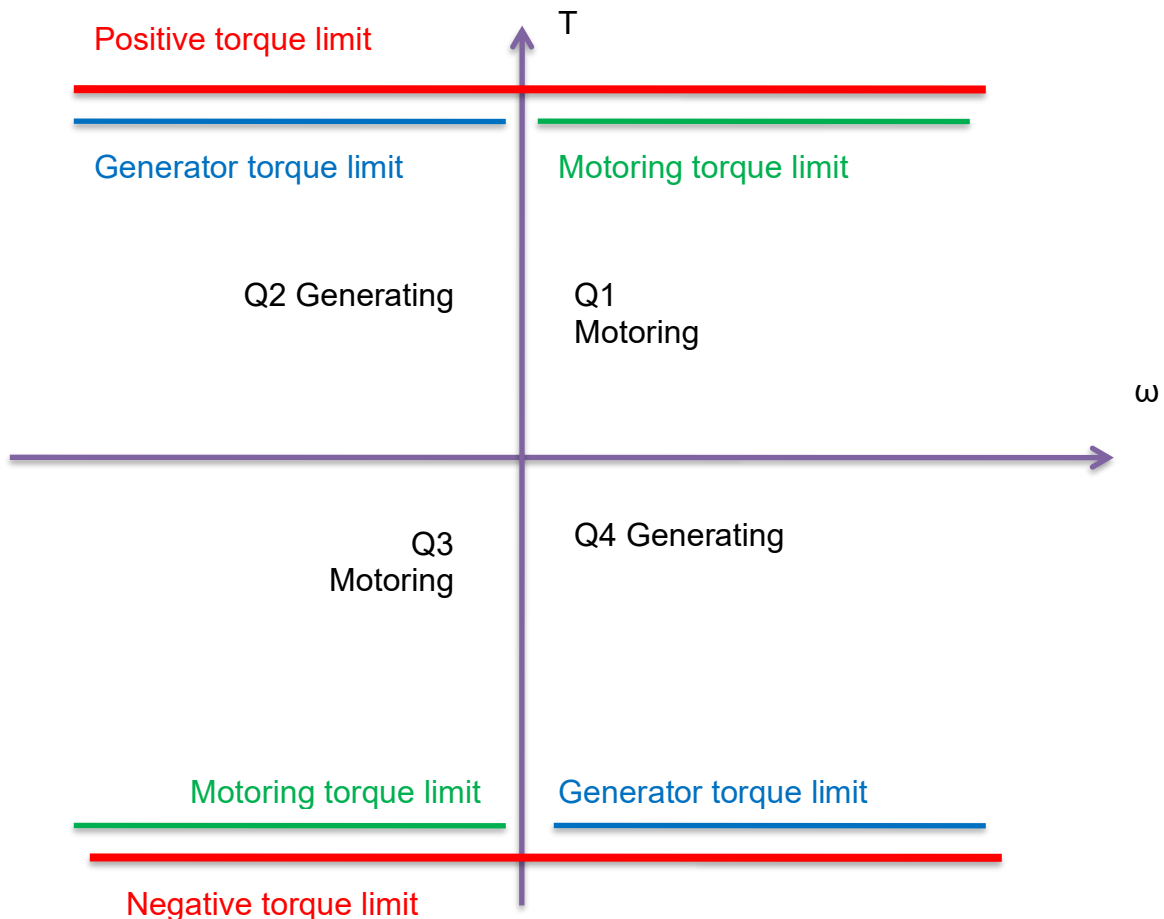
**P2.6.2.1 Torque Limit ID609 “Torque Limit”**

The general torque limit for both motoring and generator sides. This value is the final limit for all scaling functions. This value should not be used for scaling but for maximum safety limit because the ramp up rate function is ineffective when this parameter is changed. Only the motoring side torque limit has a ramp up limiting function.

P2.6.2.2 Motoring Torque limit ID1287 “MotorTorqueLimit”

Motoring side torque limit. This limit value is used for all scaling functions and torque limit ramp rate functions if activated.

P2.6.2.3 Generator Torque limit ID1288 “GenerTorqueLimit”

Generator side torque limit. This limit is used for all scaling functions generator side torque limit is not included in ramp up rate function.

P2.6.2.4 Motoring Torque limit 1 ID1625 “Mot.TorqueLim 1”

Motoring side torque limit that is activated by digital input.

P2.6.2.5 Generator Torque limit 1 ID1627 “Gen. Torque Lim 1”

Generator side torque limit that is activated by digital input.

P2.6.2.6 Motoring Torque limit scaling ID485 “MotTorqLimScIng”

The motoring torque limit is equal to parameter Motoring Torque Limit if value ‘Not Used’ is selected. If any of the inputs is selected, the motoring torque limit is scaled between zero and parameter Motoring Torque Limit.

- 0 = Not used
- 1 = AI1
- 2 = AI2
- 3 = AI3
- 4 = AI4
- 5 = FB Limit Scaling ID46 Monitoring value

P2.6.2.7 Generating torque limit scaling ID1087 “GenTorqLimScIng”

The generator torque limit is equal to parameter Generator Torque Limit if value ‘Not Used’ is selected. If any of the inputs is selected, the generator torque limit is scaled between zero and parameter generator torque limit.

- 0 = Not used
- 1 = AI1
- 2 = AI2
- 3 = AI3
- 4 = AI4
- 5 = FB Limit Scaling ID46 Monitoring value

7.6.2.1 Open Loop settings only**P2.6.2.8.1 Torque limit control P-gain ID610 “TorqLimCtrl P”**

This parameter defines the gain of the torque limit controller. It is used in Open Loop control mode only.

P2.6.2.8.2 Torque limit control I-gain ID611 “TorqLimCtrl I”

This parameter determines the I-gain of the torque limit controller. It is used in Open Loop control mode only.

7.6.2.2 Closed Loop settings only**P2.6.2.9.1 Speed Control output limit ID1382 “SPC Out Limit”**

Torque limit for the speed controller. It affects both the positive and negative direction torques.

P2.6.2.9.2 Speed Control positive limit ID646 “SPC Pos Limit”

Positive torque limit for speed controller output.

P2.6.2.9.3 Speed Control negative limit ID645 “SPC Neg Limit”

Negative torque limit for speed controller output.

P2.6.2.9.4 Pull Out Torque Limit ID1291

Pull out torque limit

7.6.2.3 *Runaway load protection*

Runaway load protection is used to increase the generator torque limit in case when the speed of the load is increasing above the defined frequency limit. Used in cases when upper system is controlling generator torque limit and its needed to drive itself control situation when speed increases too high.

Note! The maximum generator side torque limit is still limited by the General torque limit parameter.

P2.6.2.10.1 Generator Torque limit increase speed level ID1547 “TorqLimInc Hz”

The frequency limit at which the generator side torque limit is started to increased when speed of the motor increases (over speed).

P2.6.2.10.2 Generator Torque limit increase high speed limit ID1548 “MaxTorqLim Hz”

The frequency level at which point the torque defined by the “Generator Torque Limit increase maximum addition” is added entirely to the final torque limit.

P2.6.2.10.3 Generator Torque limit increase added torque ID1549 “MaxTorqLim”

When this parameter is set greater than zero the generator torque limit increases at high speed is activated. This parameter defines the torque that is added to generator torque limit, linearly starting from ID1547 to ID1548.

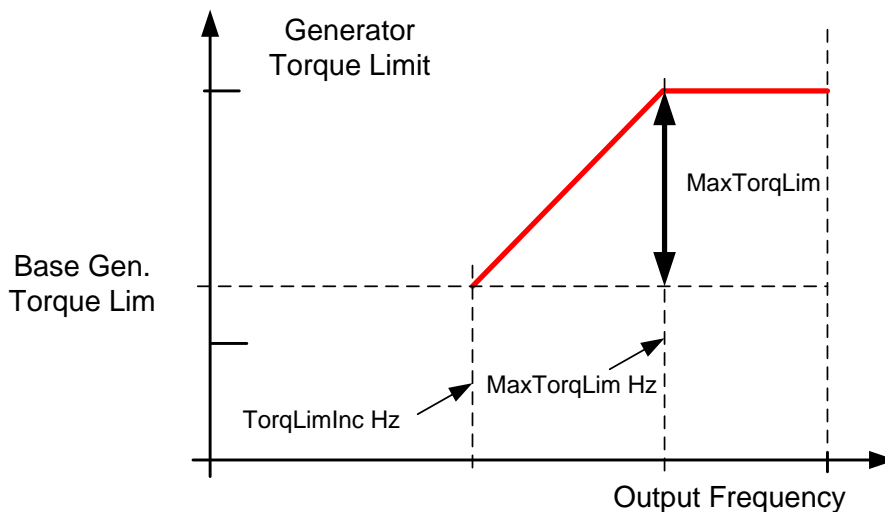
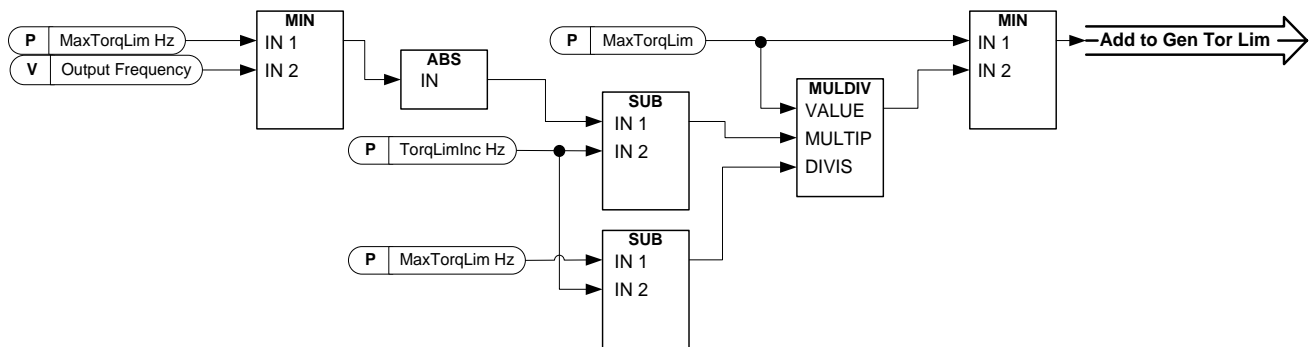

7.6.3 Frequency limit handling

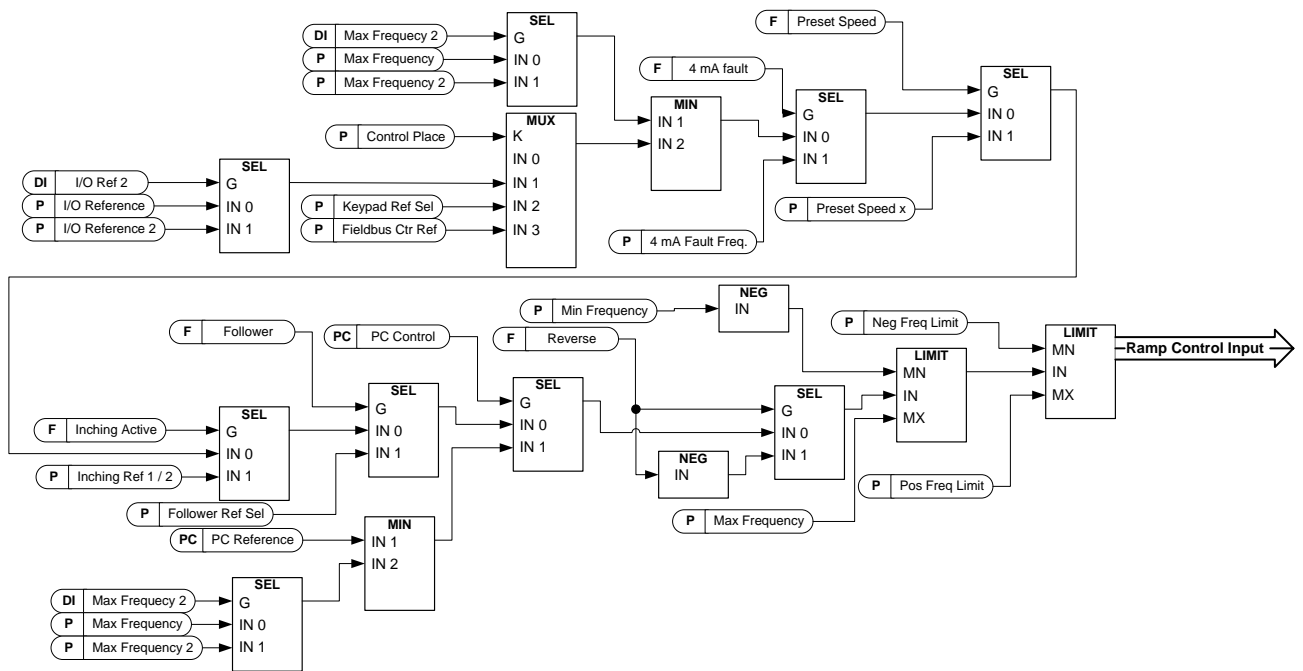

P2.6.3.1 Maximum Frequency Limit 2 ID1512 “Max Frequency 2”

This parameter defines the maximum frequency when the digital input “Max Frequency 2” is activated. This limit does not affect the reference values that are of constant type, e.g. preset speed references. If actual speed is higher than Max Frequency 2, limited reference is activated by ramp.

P2.6.3.2 Negative frequency limit ID1286 “Neg Freq Limit”

Positive direction frequency limit. When changed in closed loop control mode change is made without ramp. If calculated speed exceed by ID1812 F61 Speed Error response is activated.

P2.6.3.3 Positive frequency limit ID1285 “Pos Freq Limit”

Negative direction frequency limit. When changed in closed loop control mode change is made without ramp. If calculated speed exceed by ID1812 F61 Speed Error response is activated.

P2.6.3.4 Zero Frequency limit ID1283 “Zero Freq. Limit”

Defines the zero frequency limit. Used to determine when load drooping is set to zero if load drooping removal function 1 is selected

P2.6.3.5 Minimum frequency Open Loop ID101 “Min Frequency OL”

Defines minimum frequency of any adjustable reference input (i.e. reference is not a parameter). Minimum frequency is bypassed when jogging speed, preset speed or inching reference is used.

P2.6.3.6 Minimum frequency Closed Loop ID101 “Min Frequency CL”

Defines minimum frequency of any adjustable reference input (i.e. reference is not a parameter). Minimum frequency is bypassed when jogging speed, preset speed or inching reference is used

P2.6.3.7 Acceleration Power Limit Forward ID1903

This parameter will limit speed so that certain power level is not exceeded.

P2.6.3.8 Acceleration Power Limit Reverse ID1904

This parameter will limit speed so that certain power level is not exceeded.

7.6.4 DC Link handling

P2.6.4.1 Overvoltage controller ID607 “Overvolt Contr”

The parameter selects the behaviour of the overvoltage controller in open loop control. It also activates the closed loop overvoltage controller but the operation is always of type ‘PI’ in closed loop control modes.

0 “Off” - Controller switched off

Both open and closed loop overvoltage controllers are off.

1 “On:NoRamping” – Activated P-Controller type operation

Both open and closed loop controllers are activated.

Open loop controller is a P-type controller.

Closed loop controller is a PI-type controller.

2 “On: Ramping” – Activated PI-Type controller

Both open and closed loop controllers are activated.

Open loop controller is a PI-type controller.

Closed loop controller is PI-type controller (as in selection 1).

P2.6.4.2 Overvoltage Reference Select ID1262 “OverVolt.Ref.Sel”

Overvoltage reference level depending on the status of the brake chopper. In closed loop control, the overvoltage controller level is adjusted by “OverVoltageRef.” The parameter can be found in the CL setting parameter group.

ID1262	Brake chopper in use	Brake chopper not in use
0 / High Voltage	500 V Unit: 844 V 690 V Unit: 1164 V	500 V Unit: 797 V 690 V Unit: 1099 V
1 / Norm.Voltage	1.25*Estimated DC nominal voltage	1.18*Estimated DC nominal voltage
2 / BrakeChLevel	1.07*brake chopper level	Brake chopper level

P2.6.4.3 Brake chopper ID504 “Brake Chopper”

When the AC drive is decelerating the motor, the inertia of the motor and the load are fed into an external brake resistor. This enables the drive to decelerate the load with a torque equal to that of acceleration (provided that the correct brake resistor has been selected). See separate Brake resistor installation manual. Brake chopper test mode generates pulse to resistor every second. If the pulse feedback is wrong (resistor or chopper is missing) fault F12 is generated.

Over Voltage Reference Select	Brake chopper level
0 / High voltage	500 V Unit: 797 V 690 V Unit: 1099 V
1 / Norm.Voltage	1.18* Estimated DC nominal voltage
2 / BrakeChLevel	Brake chopper level

0 = “Not Used” - No brake chopper used

Brake chopper not active or present in the DC link. **NOTE:** The overvoltage controller level is set to a little lower, see parameter P2.6.5.2.

1 = “On, Run” - Brake chopper in use and tested when running

The drive’s own brake chopper is activated and operational when the drive is in Run state. The drive also sends test pulses for feedback from the brake resistor.

2 = “External” - External brake chopper (no testing)

The system has an item that handles the DC link voltage. This could be a system with AFE or there is an external BCU unit. When this option is selected the drive overvoltage level is set a little higher so that its operation does not conflict with AFE or BCU units.

3 = “On, Run+Stop” - Used and tested in READY state and when running

Brake chopper is also active when the drive is not in Run state. This option can be use e.g. when other drives are generating but energy levels are low enough to be handled with only one drive.

4 = “On, No test” - Used when running (no testing)

Brake chopper is active in Run state but no test pulse to resistor is generated.

Note: In the system menu there is a parameter “InternBrakeRes”. This parameter is used for brake resistor overheating calculations. If an external brake resistor is connected to the drive the parameter should be set to ‘Not connected’ to disable temperature calculation for the brake resistor.

P2.6.4.4 Brake Chopper Level ID1267 “BrakeChopperLeve”

Brake chopper control activation level in volt. This parameter is active when “OverVolt.Ref.Sel” is 2 / “BrakeChLevel”

For 400V Supply: $400 * 1.35 * 1.18 = 638V$

For 500V Supply: $500 * 1.35 * 1.18 = 808V$

For 690V Supply: $690 * 1.35 * 1.18 = 1100V$

P2.6.4.5 Undervoltage controller ID608 "Undervolt Contr"

Undervoltage controller will decrease the output frequency in order to get energy from the motor when the DC voltage has dropped to a limit where the undervoltage controller activates trying to keep DC voltage at the minimum level.

0 "Off" - Controller switched off

Both open and closed loop overvoltage controllers are off.

1 "On:NoRamping" – Activated PI-Controller type operation

Both open and closed loop controllers are activated.

Both open and closed loop controllers are PI-type controllers.

If power comes back while drive is at undervoltage the controller output frequency will regain the reference value.

2 "On: Ramping" – PI controller type and ramping down

Both open and closed loop controllers are activated.

Both open and closed loop controllers are PI-type controllers.

If power comes back while drive is at undervoltage the controller drive will ramp to zero speed and generate an undervoltage fault.

Note: In closed loop control, also parameter "CLmpFollEncFreq" needs to be activated to achieve identical operation.

P2.6.4.6 Under Voltage Reference Select ID1537 "UnderVoltRef.Sel"

Select the operation level for open loop under voltage controller.

0 "UnderVoltRef"

Under voltage operation level is selecte with P2.6.5.7

1 "0.8 * Estimated DC Voltage"

Automatic DC voltage level

P2.6.4.7 Under Voltage Reference OL ID1538 "UnderVoltage Ref"

Set the operation level for open loop under voltage controller when P2.6.5.6 is 0 / UnderVoltageRef.

7.6.4.1 CL Settigns**P2.6.4.8.1 Overvoltage reference ID1528 "OverVoltageRef."**

Defines the overvoltage reference level in Closed Loop control mode. Percentage value related to unit nominal voltage DC voltage. Default 118%.

$$690 \text{ Vac} * 1.35 * 118 \% = 1099 \text{ Vdc}$$

$$500 \text{ Vac} * 1.35 * 118 \% = 796 \text{ Vdc}$$

P2.6.4.8.2 Overvoltage controller motoring torque limit

Defines motoring torque limit, when drive is operating under over voltage controller.

P2.6.4.8.3 CL Under Voltage Reference

Defines the under voltage reference level in Closed Loop control mode. Percentage value related to unit nominal voltage DC voltage. Default 65%.

$$690 \text{ Vac} * 1.35 * 65\% = 605 \text{ Vdc}$$

$$500 \text{ Vac} * 1.35 * 65\% = 438 \text{ Vdc}$$

7.6.5 Limit options

P2.6.5.1 Limit total current ID1901 "LimitTotalCurren"

This function activates the total current limit function in close loop control. Normally in closed loop the current limit only affects the torque producing current.

7.7 DC current and magnetization handling

The DC brake can be used to hold the motor in place (nominal torque at nominal slip). It can be also used to keep the motor warm in places with high humidity and to speed up the generation of rotor flux. Rotor flux is needed in the induction motor to generate torque. The current that is needed to make the nominal flux is defined by the magnetization current parameter but, depending on motor size, nominal flux takes a different time to produce after start command.

Giving a higher current on start to the motor will decrease the time when the motor is able to generate nominal torque.

Blue: Motor Current. Red: Rotor Flux.

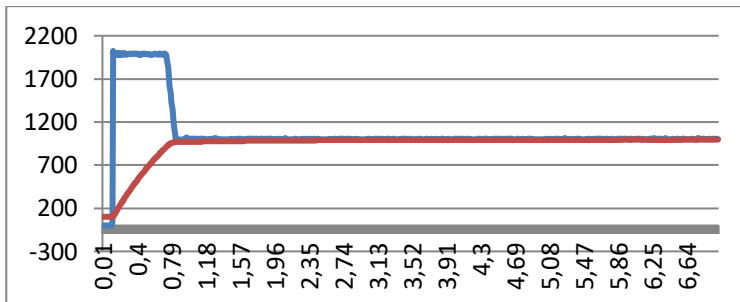
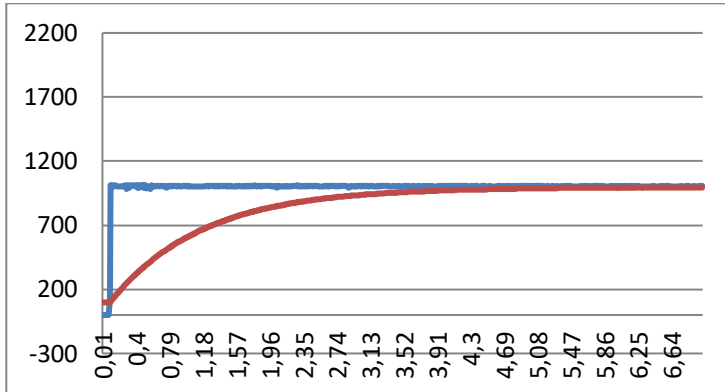

7.7.1 Open loop settings

P2.7.1.1 DC-braking current ID627 “DC-Brake Current”

Defines the current injected into the motor during DC-braking. On start this parameter is used together with DC Brake time to decrease the time when motor is able to produce nominal torque. When DC brake current is applied to the motor the output frequency is zero.

P2.7.1.2 DC-braking time at start ID507 “Start DC-BrakeTm”

DC-brake is activated when the start command is given. This parameter defines for how long DC current is given to the motor before acceleration starts. DC brake current at start is used in order to magnetize the motor before running which will improve torque performance at start. Needed time depends on motor size, value varying between 100 ms to 3 second. The bigger the motor the more time is needed. The default setting 0.00 s means that 200 ms is spent to magnetize motor. This 200 ms can be set to zero with parameter “MakeFluxTime”. Activating flying start will disable the DC brake functions at start.

P2.7.1.3 DC-braking time at stop ID508 “Stop D-BrakeTm”

Defines the time to use DC brake at stop. The operation is different depending on the selected stop mode (coasting or ramping).

Stop function = 0 / Coasting:

After the stop command, the motor coasts to a stop without control of the drive.

With DC injection, the motor can be electrically stopped in the shortest possible time, without using an optional external braking resistor.

The braking time is scaled according to the frequency at the moment of stop command. If the frequency is the nominal frequency of the motor or higher, the set value of DC braking time at stop is used as the braking time. When the frequency is below the nominal frequency, the relation between the nominal frequency and the output frequency at the time of stop command will determine the DC braking time. For example, 50-hertz motor is running at 25 Hz when the stop command is given. The DC brake time will be 50% of the DC braking time at stop. If the frequency is below 5 Hz the minimum DC braking time is 10% of the DC braking time at stop.

DC braking is started after a short restart delay following the stop command if stop function is coasting.

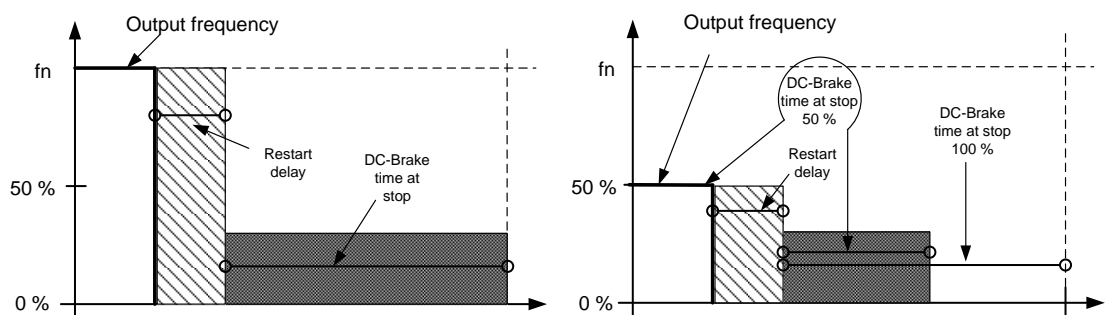

Figure 7-14. DC-braking time when Stop mode = Coasting, from nominal speed and 50% of nominal speed.

Stop function = Ramp:

After the Stop command, the speed of the motor is reduced according to the set deceleration parameters, to the speed defined with parameter DC braking frequency at stop, where the DC braking starts.

The braking time is defined with parameter *DC braking time at stop*. If high inertia exists, it is recommended to use an external braking resistor for faster deceleration. See Figure 7-15.

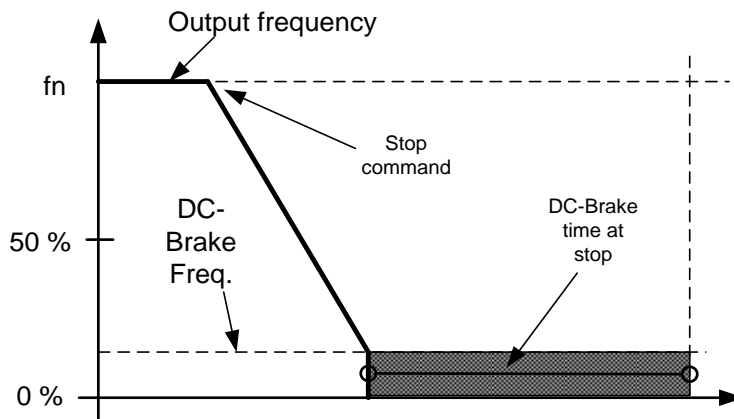

Figure 7-15. DC-braking time when Stop mode = Ramp

P2.7.1.4 DC braking frequency at stop ID515 “Stop D-BrakeFr”

The output frequency at which the DC braking is applied when making ramping stop.

P2.7.1.5 DC brake current in stop ID1080 “DCBrakeCurlnStop”

Defines the current injected to the motor in stop state when the digital input signal “DC Brake Command” is used to activate the DC brake when no run request is active. When the DC brake is activated the drive will indicate being in Run state.

7.7.1.1 *Flux braking***P2.7.1.6 Flux brake ID520 “Flux Brake”**

Instead of DC braking, flux braking is a useful way to raise the braking capacity in cases where additional brake resistors are not needed.

When braking is needed, the frequency is reduced and the flux in the motor is increased. This increases losses on motor, which in turn increases the motor's capability to brake. Unlike in DC braking, the motor speed remains controlled during braking.

The flux braking can be set ON or OFF.

0 = Flux braking OFF

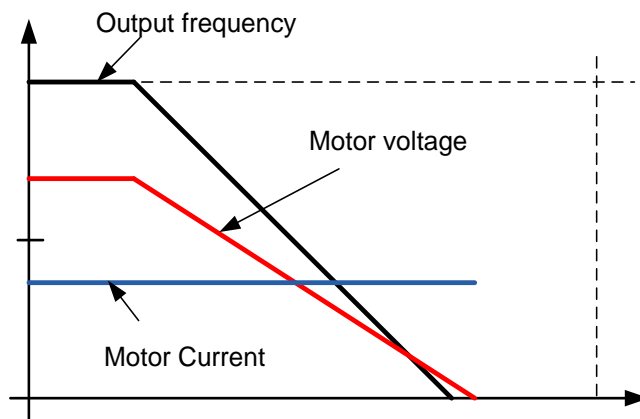

1 = Flux braking ON

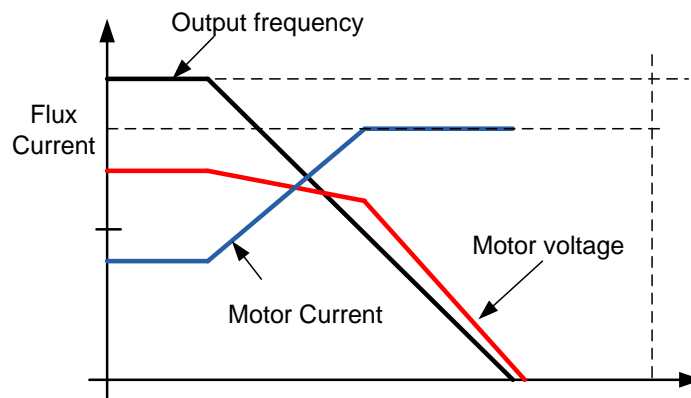
**P2.7.1.7 Flux braking current ID519 “FluxBrakeCurrent”**

Defines the flux braking current value. The value setting range depends on the used unit size.

7.7.2 Closed loop settings

P2.7.2.1 Magnetizing current at start ID627 “Start Magn Curr”

Defines the current that is applied to the motor when the start command is given in closed loop control. At start this parameter is used together with *Magnetizing time at start* to decrease the time when the motor is able to produce nominal torque. In closed loop control output frequency is not forced to zero while magnetization current is applied to motor.

P2.7.2.2 Magnetizing time at start ID628 “Start Magn Time”

Defines the time for how long magnetization current is applied to motor at start. *Magnetizing current at start* is used to shorten the time when flux is at nominal level. This will improve the torque performance at start. The time needed depends on the motor size, value varying between 100 ms to 3 second. The bigger the motor the more time it needs. Set this time so that the rotor flux is more than 90% before speed is released (Start Zero Speed Time ID615) or mechanical brake is released.

P2.7.2.3 Flux reference ID1250 “FluxReference”

Reference value for rotor flux. Rotor flux can be reduced by changing the magnetization current. This, however, also affects the motor model making the torque calculations a little less accurate. When using this parameter the motor model can compensate the effect of the different magnetization current in torque calculations.

$$= \left(\frac{f(\text{MotorNomFreq})}{f(\text{Out})} \right)^2 \quad \text{when } f(\text{Out}) > f(\text{MotorNomFreq})$$

[FW]RotorFlux

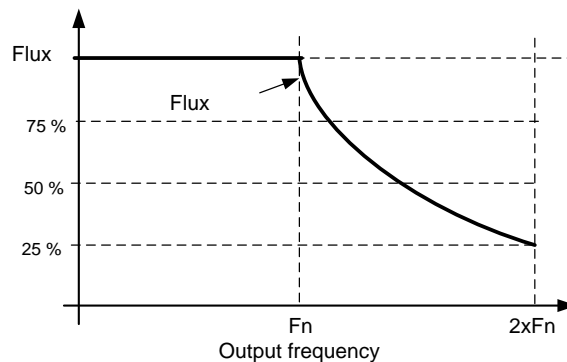

P2.7.2.4 Flux Off Delay ID1402 “Flux Off Delay”

The Flux off delay function will keep the motor magnetized after a stop command thus making the next start faster because flux is already available in the motor. The function is used e.g. in a system where several repeated starts are made in short cycles. The flux level can be adjusted by parameter *Stop State Flux*.

- 0 = Flux is not maintained in the motor
- >0 = Flux off delay in seconds.
- 1 = Flux is maintained indefinitely in the motor

P2.7.2.5 Stop State Flux ID1401 “Stop State Flux”

The amount of flux in percentage of the motor nominal flux maintained in the motor after the drive is stopped. The flux is maintained for the time set by parameter ID1402 *Flux Off Delay*. This parameter can only be used in closed loop motor control.

7.7.2.1 *Reduced flux function*

Reduced flux function is used to decrease the magnetization current below a certain frequency limit. This function is used in systems where high starting torque is not needed. This function CAN NOT be used in any situation where motor nominal torque from zero speed is required.

P2.7.2.6 Reduced Flux frequency

A frequency point where flux starts to reduce to a level defined by *Reduced Flux Level* toward the zero speed.

P2.7.2.7 Reduced Flux level

This parameter defines the flux level when the output frequency is zero. The flux is reduced linearly from ID1614 to zero frequency.

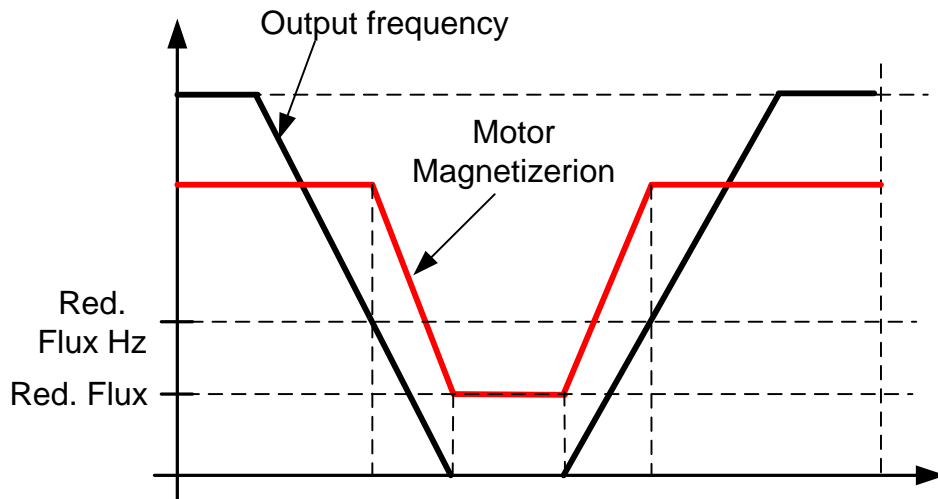

7.8 Motor Control

Open Loop control

Open loop control controls the motor without encoder feedback from the motor shaft. Control mode selections 0, 1 and 2 are open loop control modes.

Slip

Induction motor torque is based on slip. When load increases also slip will increase. Slip is the speed that rotor is behind of stator electrical frequency.

Below picture presents torque that is produced by induction motor when connected directly on line.

1. Motor Synchronous speed. Motor is taking only magnetization current.
2. Motor nominal operation point. Motor is producing 100% of rated torque and power. Actual shaft speed is motor nominal speed and motor takes nominal current.
3. Pullout torque. This is point where motor produced torque start to decrease when slip increases. After this point motor will stop if load is not reduced.

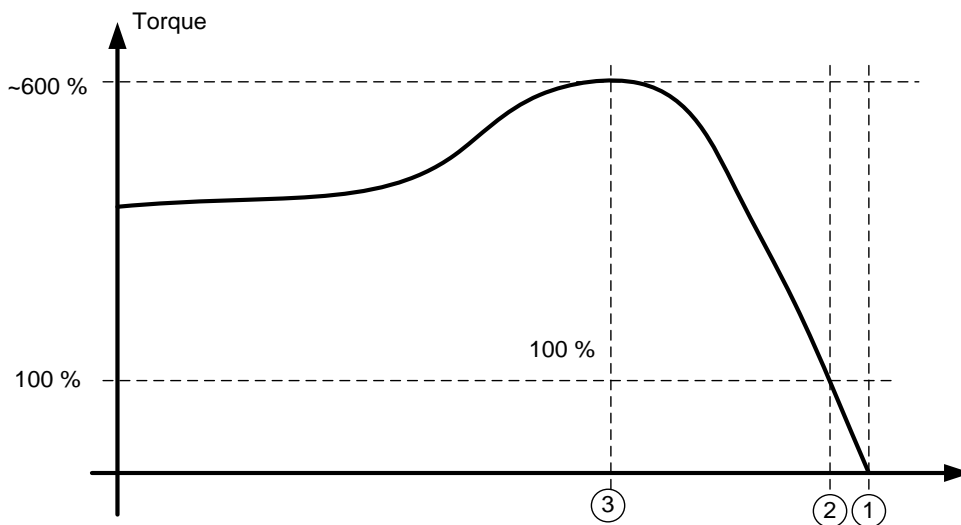

In frequency control, the load will determine the actual shaft speed.

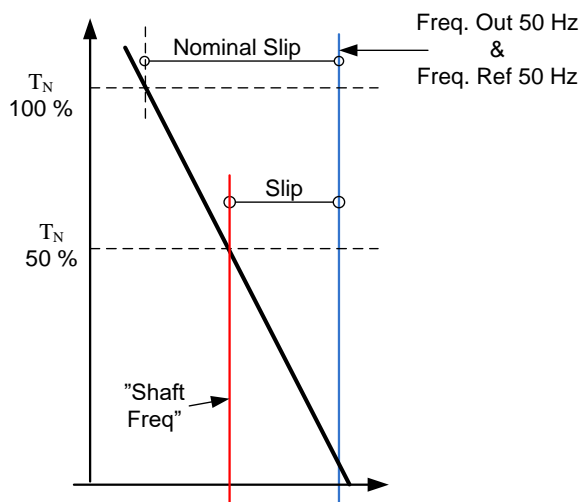

Slip compensation in open loop control

The drive uses motor torque and motor nominal rpm to compensate slip. If the motor nominal rpm is 1440 -> the nominal slip is 60 rpm. And when the motor torque is 50% the slip is 30 rpm. To keep the reference speed the drive must increase the output frequency by 1 Hz.

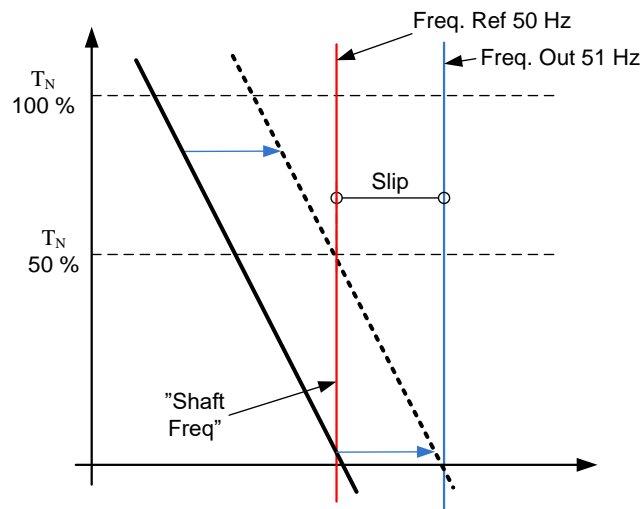

Closed Loop control

Closed loop control controls the motor using the exact information of the motor speed from the encoder. Control mode selections 3 and 4 are closed loop control modes. Using these modes without encoder board (and encoder) will result in encoder fault.

P2.8.1 Motor control mode ID694 “MC Mode” (2.6.1)

- 0 “Open Loop”**
Open loop control controls the motor without encoder feedback from the motor shaft using U/f curve to control the voltage.
- 1 “Closed Loop”**
Closed loop control controls the motor using the exact information of the motor speed from the encoder.
- 2 “Sensorless”**
Sensorless control is same as Closed Loop control but the motor speed is estimated.
- 3 “AOL Control”**

P2.8.3 Torque Select ID1278 “Torque Select”

This parameter defines the speed limiting mode in torque control mode.

0= “Frequency Control”

1= “SpeedControl” - Speed control mode

The drive is forced to operate in speed control mode while the motor control mode parameter is set to torque control mode thus allowing selection of speed control and torque control mode with single parameter e.g. from Fieldbus.

2=“Torque” - Positive and negative frequency limits

Speed is not limited by speed reference, only maximum frequency or Positive and Negative frequency limit if set lower than maximum frequency parameter.

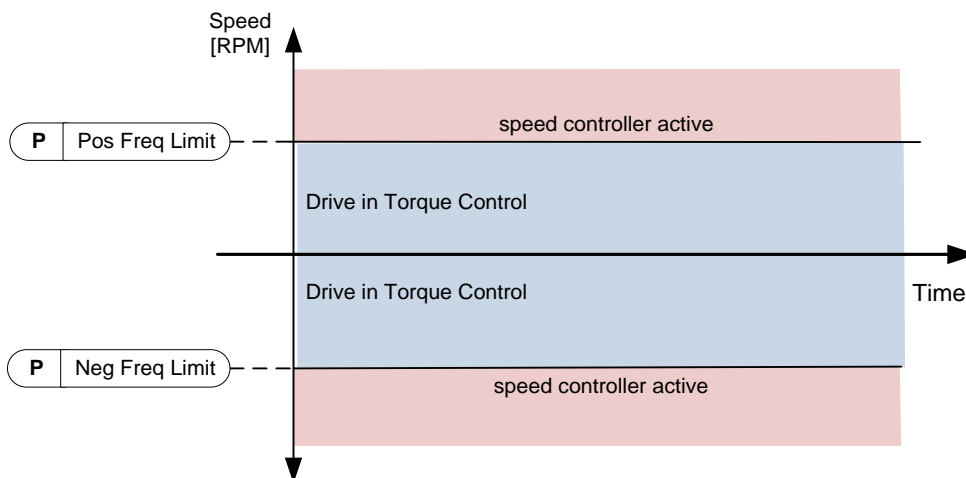

3="RampOutput" – Ramp output for both directions

Speed is limited by reference after ramp generator, thus speed will increase with set ramp time until actual torque is equal to reference torque. If speed is below reference when load is removed from the shaft the speed will increase without ramp.

This is the default selection. For master follower system it is recommended to use selection that allows a little higher reference for torque follower that load will be balanced equally e.g. window control.

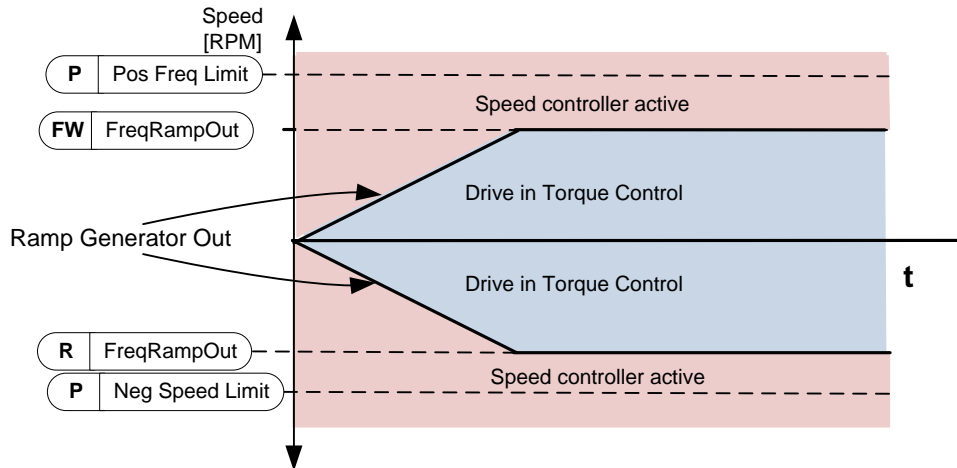

4="Min" – Minimum from speed reference and torque reference.

The minimum of the speed controller output and the torque reference is selected as final torque reference.

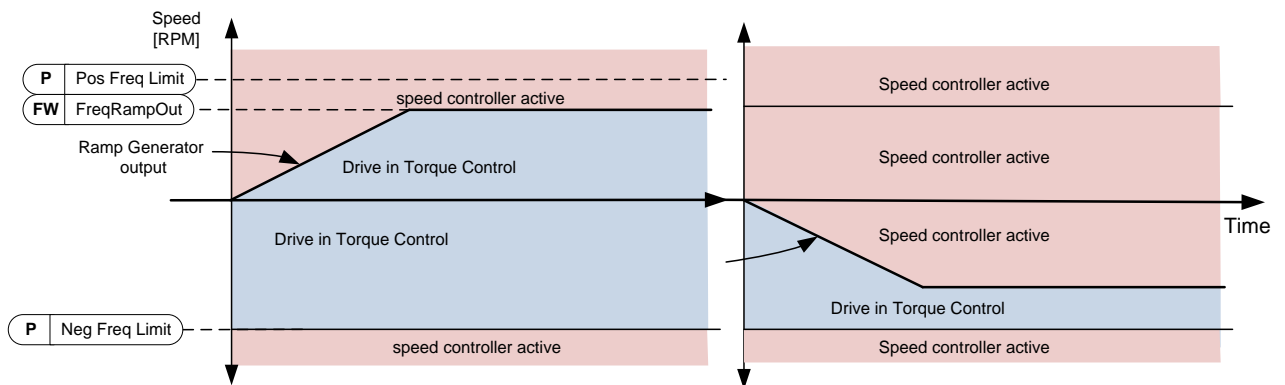

5="Max" – Maximum from speed reference and torque reference

The maximum of the speed controller output and the torque reference is selected as final torque reference.

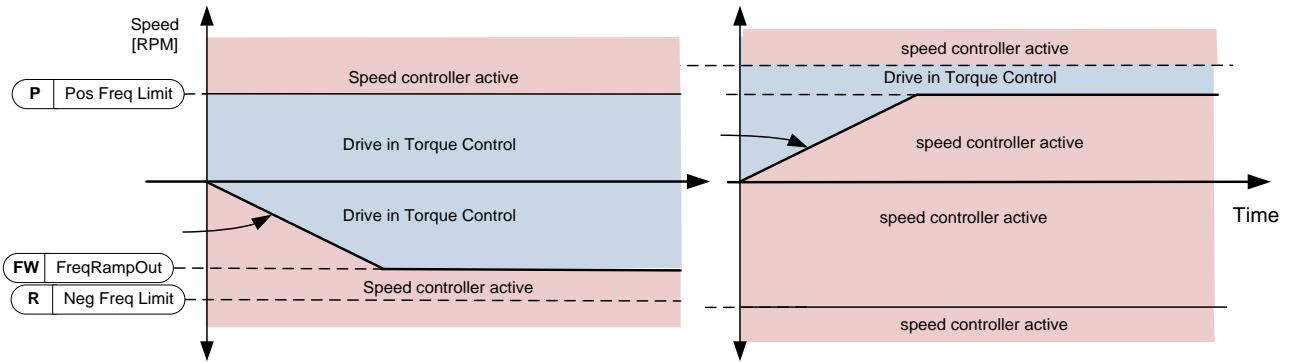

6="Window" – Window control

Speed is limited within window from speed reference. Speed control activation limit is different from the speed limit. Speed needs, therefore, to go first to "Window Pos" or "Window Neg" limit before the speed controller activates, when speed controller is active speed will be restricted to limit defined by "Window Pos Off" and "Windows Neg Off" from the "FinalFreqRef"

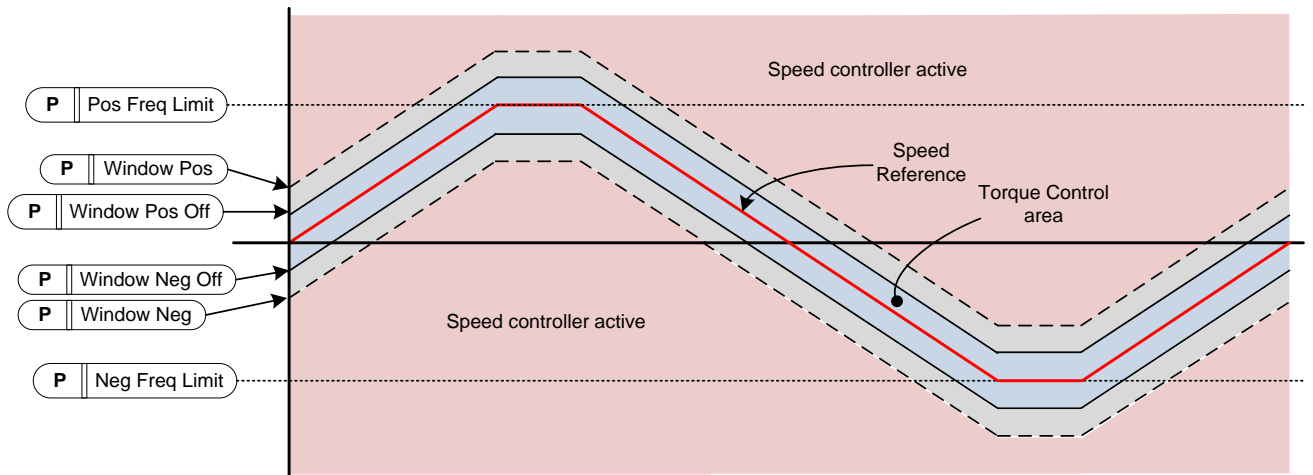

7.8.1 Open Loop Settings

Open Loop settings are mainly used in open loop control modes with the exception of the *Field weakening point voltage* that is also used in closed loop control mode as a limit for voltage. U/f settings are used to control the voltage level that are applied to the motor at different frequencies and different load situations.

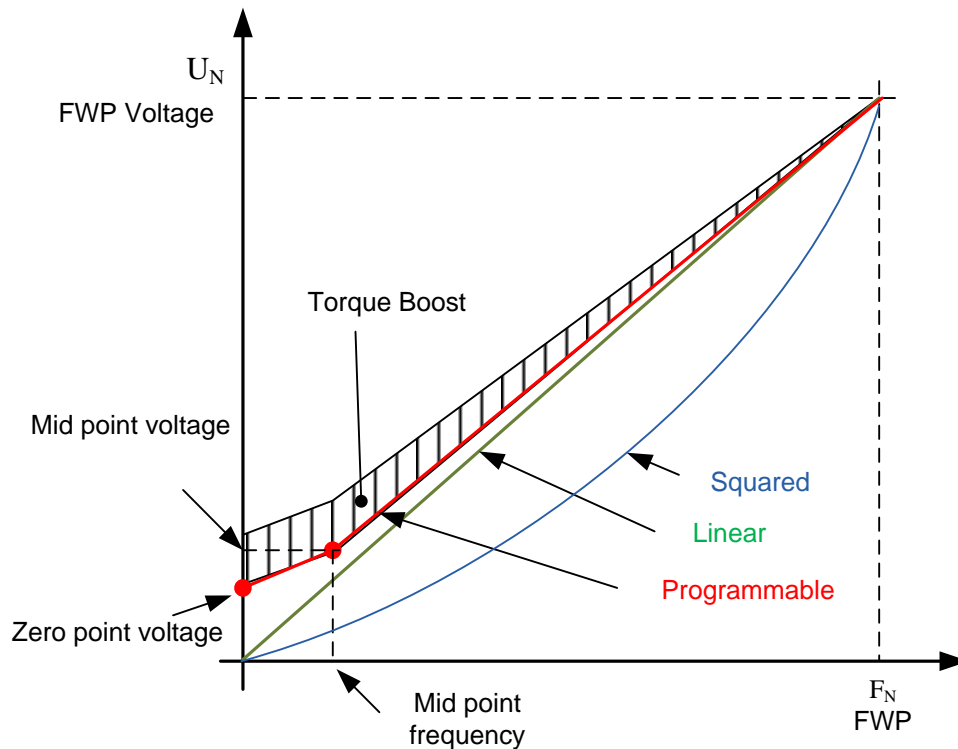

What changes are required to start with load from 0 Hz?

- ◆ First set the motor nominal values (Parameter group 2.1).

Option 1: Automatic functions

Step 1: Make identification with rotating motor

Step 2 (If needed): Activate speed control or U/f optimization (Torque boost).

Step 3 (If needed): Activate both speed control and U/f optimization.

Option 2: Manual tuning

Step 1:

Run the motor using 2/3 of motor nominal frequency as the frequency reference. Read the motor current in the monitoring menu or use NCDrive for monitoring. This current must be set as the motor magnetization current.

Change the U/f curve ratio selection to programmable (= 2).

Run the motor with zero frequency reference and increase the motor zero point voltage until the motor current is approximately same as the motor magnetising current. (If the motor is in a low frequency area for only short periods, it is possible to use up to 65% of the motor nominal current).

Set then the midpoint voltage to $\sqrt{2} * \text{Zero Point Voltage}$ and the midpoint frequency to $(\text{Zero Point Voltage}/100\%)*\text{Nominal frequency of motor}$

Step 2 (If needed): Activate speed control or U/f optimization (Torque boost).

Step 3 (If needed): Activate both speed control and U/f optimization.

NOTE! *In high torque – low speed applications – it is likely that the motor will overheat. If the motor has to run long times under these conditions, special attention must be paid to cooling of the motor. Use external cooling for the motor if the temperature tends to rise too high.*

P2.8.3.1 U/f optimisation ID109 “U/f Optimization”

Automatic torque boost The voltage to the motor changes proportionally to required torque which makes the motor produce more torque at start and when running at low frequencies. Automatic torque boost can be used in applications where starting torque due to starting friction is high, e.g. in conveyors. Even with linear U/f curve, the torque boost has an affect but the best result will be achieved after the identification run when programmable U/f curve is activated.

P2.8.3.2 U/f ration selection ID108 “U/f Ratio Select”

Linear:

0 The voltage of the motor changes linearly from zero point voltage to the field weakening point where the voltage at FWP is supplied to the motor.

Squared:

1 The voltage of the motor changes from zero point voltage following the squared curve form zero frequency to the field weakening point. The motor runs undermagnetised below the field weakening point and produces less torque. Squared U/f ratio can be used in applications where torque demand is proportional to the square of the speed, e.g. in centrifugal fans and pumps.

Programmable U/f curve:

2 The U/f curve can be programmed with three different points.

1. Zero point voltage.
2. Midpoint frequency and Midpoint voltage.
3. Field weakening point and field weakening point voltage.

Programmable U/f curve can be used if more torque is needed at low frequencies. Make the Identification run for optimal setting (ID631).

Linear with flux optimisation:

3 The AC drive starts to search for the minimum motor current in order to save energy. This function can be used in applications with constant motor load, such as fans, pumps etc.

P2.8.3.3 Field weakening point ID602 “Field WeakngPnt”

The field weakening point is the output frequency at which the output voltage reaches the field weakening point voltage.

P2.8.3.4 Voltage at field weakening point ID603 “Voltage at FWP”

Above the frequency at the field weakening point, the output voltage remains at the set maximum value. Below the frequency at the field weakening point, the output voltage depends on the setting of the U/f curve parameters.

When the parameter *Motor nominal frequency* is set, the parameter *Field weakening point* is automatically given the corresponding value. If you need different values for the field weakening point and the maximum output voltage, change these parameters **after** setting the *Nominal frequency*.

In closed loop control this defines maximum voltage to the motor, can be increases if sufficient DC voltage is available.

P2.8.3.5 U/f curve, middle point frequency ID604 “U/f Mid Freq”

If the programmable U/f curve has been selected with parameter U/f ratio this parameter defines the middle point frequency of the curve. See also parameter *Middle point voltage*.

When the programmable U/f curve is selected this value is set to 10% of motor nominal frequency.

P2.8.3.6 U/f curve, middle point voltage ID605 “U/f mid Voltg”

If the programmable U/f curve has been selected with the parameter U/f ratio this parameter defines the middle point voltage of the curve. See also parameter *Middle point frequency*.

When the programmable U/f curve is selected this value is set to 10% (of motor nominal voltage).

P2.8.3.7 Output voltage at zero frequency ID606 “Zero Freq Voltg”

This parameter defines the zero frequency voltage of the U/f curve. The default value is unit size dependent.

NOTE: If the value of parameter *U/f Ratio Select* is changed this parameter is set to zero.

P2.8.3.8 FreqDirChange ID1682**P2.8.3.9 Brake identification U/f Strength ID1905**

This parameter defines how strong will be the U/f curve for open loop control when Crane Identification “Hoisting” is made.

7.8.1.1 I/f Control

I/f-control can be used to start the motor using a constant current control. This is useful especially, if the motor stator resistance is low, which makes the motor current sensitive for u/f-curve tuning at low speed area. Also software modulator is required.

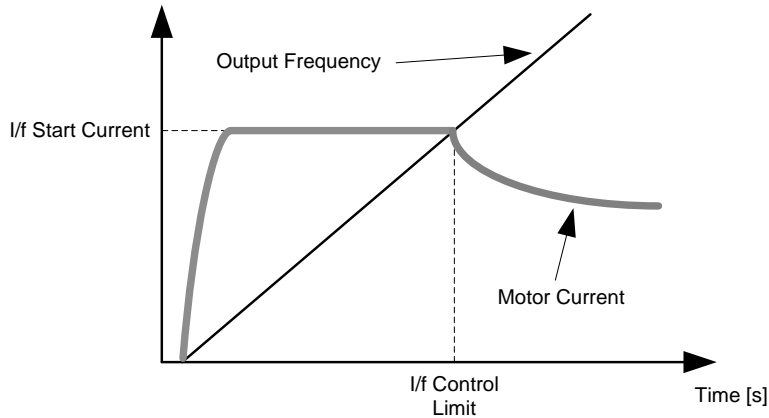

P2.8.3.10 I/f Start ID1809

Activates I/f control

P2.8.3.11 I/f Current ID1693 "I/f Current"

NOTE: I/f Current parameter is used for several different purposes.

I/f Control

This parameter defines the current level during I/f control, in percent of the motor nominal current

Zero position with incremental encoder and Z-Pulse

In closed loop control utilizing the encoder z-pulse, defines also the current level used in starting before the z-pulse is received to synchronize with.

DC Start Angle identification

This parameter defined DC Current level when Start Angle Identification Time is set greater than zero. See P2.8.5.5 Start Angle Identification Time.

P2.8.3.12 I/f Control Limit ID1790 "I/f Control Lim"

This parameter sets the speed limit for I/f-control in percent of the motor nominal speed (1000 = 100.0%). I/f-control is used if the speed is below this limit. The operation changes back to normal when the speed is above this limit with 60 rpm hysteresis.

P2.8.4.13 MakeFluxTime ID660

Time for magnetize the motor in ms. In Open Loop control drive will remain in zero speed during this time. Using DC Brake in start will bypass Make Flux Time. During the Make Flux Time voltage reference can be set separately, in Marine application Make Flux Voltage is same as Zero Freq Voltage.

7.8.2 Close Loop Settings

P2.8.4.1 Current control P gain ID617 “CurrentControlKp”

Sets the gain for the current controller. The controller generates the voltage vector reference to the modulator. The gain is also used in open loop flying start. When the Sine filter parameter (parameter P6.7.5 in the System menu) has been set to *Connected* the value of this parameter is changed to 20.00%.

The value is also identified when using a PMS motor and making identification run with rotating motor. At low speed the motor values may increase up to 300%. At high speed motor gain and motor with sine filter may have gain values of 10...40%.

P2.8.4.2 Current control Ti ID657 “CurrentControlTi”

Current controller integrator time constant.

P2.8.4.3 Slip adjust ID619 “Slip Adjust”

The motor name plate speed is used to calculate the nominal slip. This value is used to adjust the voltage of motor when loaded. The name plate speed is sometimes inaccurate and this parameter can therefore be used to trim the slip. Reducing the slip adjust value increases the motor voltage when the motor is loaded.

P2.8.4.4 Acceleration compensation ID626 “Accel.Compens.”

Sets the inertia compensation to improve the speed response during acceleration and deceleration. The time is defined as acceleration time to nominal speed with nominal torque. This function is used when the inertia of the system is known to achieve the best speed accuracy when reference is changed.

Acceleration compensation is added to *TorqueReferenceActual* i.e. torque is added after speed controller. The speed controller can, therefore, be tuned only for speed error and the acceleration compensation makes sure that the system inertia does not affect the speed controller.

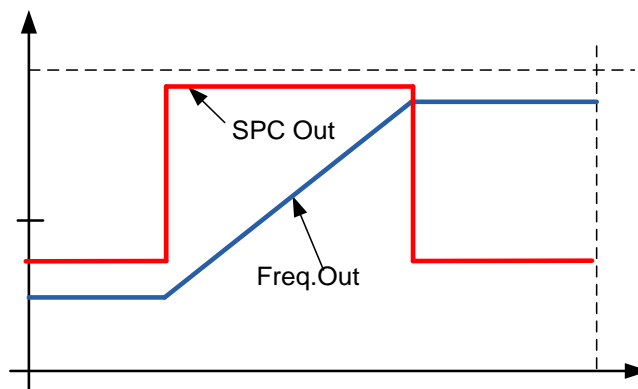

Acceleration compensation not in use

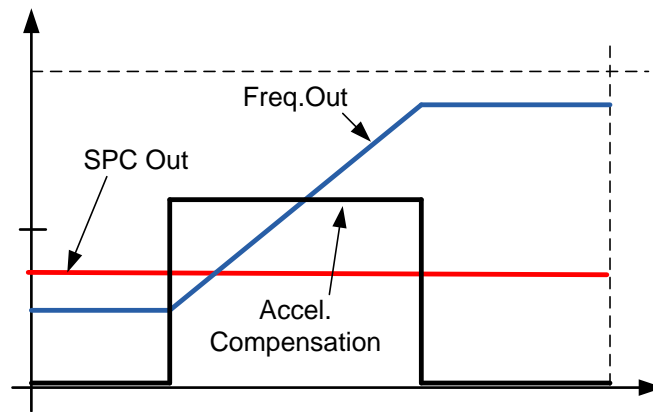

Acceleration compensation in use

$$AccelCompensationTC = J \cdot \frac{2\pi \cdot f_{nom}}{T_{nom}} = J \cdot \frac{(2\pi \cdot f_{nom})^2}{P_{nom}},$$

J = System inertia (kg*m²)

f_{nom} = Motor nominal frequency (Hz)

T_{nom} = Motor nominal torque

P_{nom} = Motor nominal power (kW).

P2.8.4.5 Speed Error filtering time constant ID1311 “SpeedErrorFiltTC”

Filter time constant for speed reference and actual speed error. May be used to remove small disturbances from encoder signal.

P2.8.4.6 Encoder filter time ID618 “Encoder1FiltTime”

Sets the filter time constant for speed measurement.

The parameter can be used to eliminate encoder signal noise. Too high a filter time reduces speed control stability. Values over 10 ms are not recommended in normal cases.

P2.8.4.7 Encoder Selection ID1595 “Encoder Selector”

With this parameter it is possible to select which encoder input is used for closed loop control. Encoder board OPTA7 is needed because of the possibility to connect two encoders.

P2.8.4.8 Motor Temperature Compensation ID1426 “MotorTempComMode”

This parameter is used to select how motor temperature compensation is made.

0 / Not Used

Slip adjust value is a constant value set by parameter P2.8.4.5 Slip Adjust.

1 / Internal

When the motor cools down or warms up the slip of the motor will change. When this function is activated in closed loop control mode the drive will estimate changes in motor resistance and correct the changes of motor slip automatically to achieve the best torque estimation.

This function is automatically activated when identification run with rotating motor is successfully finished. This option is available in closed loop control mode only.

P2.8.4.9 Speed Control Torque Chain Select ID1557 "SCTorqueChainSel"

Values are bit coded. For example, after identification run with rotating motor the value will be 96. If you want to activate an external acceleration compensation you need to add +2 to the existing value.

B0 +1 = Additional torque limit

The torque reference chain can be used as an additional torque limit. This option is available in closed loop control mode only.

B1 +2 = External acceleration compensation

The torque reference is added to the speed control output, allowing the external controller to give inertia compensation for the drive in speed control mode. This option is available in closed loop control mode only.

P2.8.4.10 Closed Loop MC Mode

Select Flux model.

0 = Flux Mode 1

Current Flux Model, robust when flux curve and slip adjust are correct.

1 = Flux Mode 2

Voltage flux model. Robust in higher frequencies, requires that DTC identification run has been made successfully with correct motor name plate data.

P2.8.4.11 TCDynDampGain ID1576

Dynamic damping gain in closed loop torque control mode.

P2.8.4.12 TCDynDampTC ID1577

Bandpass time constant in ms for dynamic damping

7.8.3 Permanent magnet synchronous motor settings

There are three ways to know the magnet positions when using the closed loop control. The first one will identify the motor magnet position during every start when using incremental encoder without Z-pulse. Second one uses incremental encoder Z-pulse and the third one uses absolute encoder information. See details of selecting correct mode from chapter "Identification function for permanent magnet synchronous motor".

P2.8.5.1 PMSM Shaft Position ID649 "PMSMShaftPositio"

Absolute encoder position value corresponding to the shaft position where rotor magnet axis is aligned with the stator U-phase magnet axis will be stored here as a result of the encoder identification run. If incremental encoder with a z-pulse is used, z-pulse position will be stored instead. Depending on the motor shaft mechanical position, this parameter can have different values, as there is one right value for each pole-pair of the motor. If incremental encoder and the z-pulse is utilized, the first start after power up is less optimal and i/f-control (see 6.8.3.2) will be used until the drive finds the z-pulse and is able to synchronize in that.

P2.8.5.2 Start Angle Identification Mode ID1691 "StartAngleIdMode"

Start angle, i.e. rotor magnet axis position in respect to the stator U-phase magnet axis, identification is needed if there are no absolute encoder or incremental encoder with z-pulse used. This function defines how the start angle identification is made in those cases. Identification time depends on the motor electrical characteristics but takes typically 50ms...200ms.

In case of absolute encoders, start angle will read directly from the encoder absolute angle value. On the other hand, incremental encoder z-pulse will be used automatically for synchronization if it's position is defined different from zero in P2.8.5.1. Also for absolute encoders, P2.8.5.1 must be different from zero, otherwise it is interpreted that the encoder identification run has not been done and the running will be prohibited except if the absolute channel is bypassed by the start angle identification.

NOTE!

ModulatorType (P2.10.2) need to be > 0 to be able to use this function.

0 = Automatic

Decision to use start angle identification is made automatically based on the encoder type connected to the drive. This will serve common cases.
Supports: OPT-A4, OPT-A5, OPT-A7 and OPT-AE boards.

1 = Forced

Bypasses the drive automatic logic and forces the start angle identification to be active. Can be used, for example, with absolute encoders to bypass absolute channel information and to use start angle identification instead.

2 = On Power UP

As a default, start angle identification will be repeated in every start if the identification is active. This setting will enable identification only in a first start after drive is powered up. In consecutive starts, angle will be updated based on the encoder pulse count.

10 = Disabled

Used when Z- pulse from encoder is used for start angle identification.

P2.8.5.3 Start Angle Identification Current ID1759 “StartAngleIdCurr”

This parameter defines the current level that is used in start angle identification. The correct level depends of the motor type used. In general, 50% of motor nominal current seems to sufficient, but depending for example on the motor saturation level, higher current might be needed.

P2.8.5.4 Polarity Pulse Current ID1566 “PolarityPulseCur”

This parameter defines the current level for the magnet axis polarity direction check during the start angle identification (P2.8.5.2). Value 0 means that the internal current level is used, which is typically slightly higher than the normal identification current defined by P2.8.5.3. Polarity direction check is seldom needed because the identification itself gives already the right direction. Hence in most cases, this function can be disabled by setting any negative parameter value, which is recommended especially if F1 faults occur during the identification.

P2.8.5.5 Start Angle Identification Time ID1755 “StartAngleIdTime”

Start angle can be determined also by feeding dc-current into the motor. Then dc-current will align the rotor magnet axis with the stator magnet axis. This function is activated by determining how long the dc-current is injected to the motor. Motor must be free to move during the alignment and the time needs to be long enough for shaft oscillations to damp out. Hence, this method is not so practical and is intended to be used mainly for testing purposes or to improve starting in together with i/f-control. Dc-current level is determined by P2.8.5.6. Also P2.8.5.2 need to disabled otherwise overriding this function.

7.8.3.1 I/f Control

I/f-control can be used to start the motor using a constant current control. This is useful especially, if the motor stator resistance is low, which makes the motor current sensitive for u/f-curve tuning at low speed area. I/f-control is activated by setting P2.8.3.10 I/f Start to Enabled.

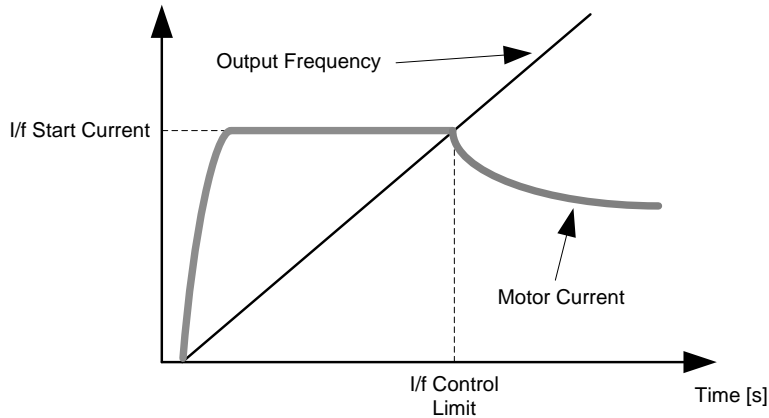

P2.8.5.6 I/f Current ID1693 "I/f Current"

NOTE: I/f Current parameter is used for several different purposes.

I/f Control

This parameter defines the current level during I/f control, in percent of the motor nominal current.

Zero position with incremental encoder and Z-Pulse

In closed loop control utilizing the encoder z-pulse, this parameter defines also the current level used in starting before the z-pulse is received to synchronize with.

DC Start Angle identification

This parameter defines DC Current level when Start Angle Identification Time is set greater than zero. See P2.8.5.5 Start Angle Identification Time.

P2.8.5.7 I/f Control Limit ID1790 "I/f Control Lim"

This parameter sets the speed limit for I/f-control in percent of the motor nominal speed (1000 = 100.0%). I/f-control is used if the speed is below this limit. The operation changes back to normal when the speed is above this limit with 60 rpm hysteresis.

7.8.3.2 *Flux current controller*

The flux current controller is used with a PMS motor when running in closed loop control in the field weakening area. This function controls negative Id current to PM motor in the field weakening area that motor terminal voltage do not increase above maximum level (set by field weakening point voltage, maximum drive output voltage) . Field weakening area operation depends on motor construction and motor construction may prohibit operation above field weakening area.

If there is instability in the field weakening area, gain can be decreased and/or time constant increased.

P2.8.5.8 Flux Current Kp ID551 “FluxCurrent Kp”

Defines gain for the flux current controller when using a PMS motor. Depending on motor construction and the ramp rate that is used to go to field weakening area, high integration times may be needed so that output voltage do not reach maximum limit and prevent proper motor control. Too high gain may also lead to unstable control. Integration time is more significant in this case for control.

P2.8.5.9 Flux Current Ti ID652 “FluxCurrent Ti”

Defines the integration time for the flux current controller when using a PMS motor. Depending on motor construction and the ramp rate that is used to go to field weakening area, short integration times may be needed so that output voltage do not reach maximum limit and prevent proper motor control. Too fast integration time may also lead to unstable control.

P2.8.5.10 ExtIdRef ID1730 “ExtIdRef”

This reference value can be used for the external control of the motor id-current i.e. reactive current. Normally there is no need for that as the control uses already the optimal value. This reference value is additive to drive internal values but, for example, field-weakening controller can override the given reference in field-weakening operation.

P2.8.5.11 EnableRsIdentifi ID654 “EnableRsIdentifi”

This parameter enables the Rs identification during DC brake current operations and in closed loop control for every start. If the identification run was made successfully it is recommended to keep this parameter disabled.

7.8.3.3 D and Q axis voltage drops

If d-axis and q-axis reactances (voltage drops) are defined, drive calculates the optimal d-axis current reference based on the reactance values and the motor torque in order to account motor reluctance torque part. In this way, motor Torque/Current ratio can be increased.

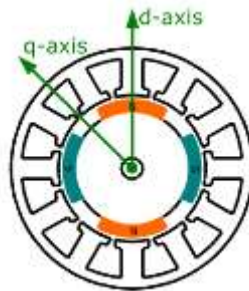

P2.8.5.12 Lsd Voltage Drop ID1757 “Lsd Voltage Drop”

D-axis reactance voltage drop 2560 = 100%.

Gives the % voltage drop across the stator inductance at nominal current and frequency.

$$X_d[\text{Drive scale}] = \frac{X_d[\Omega] * I_n[A] * \sqrt{3}}{U_n[V] * 2560}$$

P2.8.5.13 Lsq Voltage Drop ID1758 “Lsq Voltage Drop”

Q-axis reactance voltage drop 2560 = 100%.

Gives the % voltage drop across the stator inductance at nominal current and frequency.

$$X_q[\text{Drive scale}] = \frac{X_q[\Omega] * I_n[A] * \sqrt{3}}{U_n[V] * 2560}$$

P2.8.5.14 Encoder ID Current % ID1734

Current reference for encoder identification run

P2.8.5.15 Polarity ID Mode ID1737

0 = Current Pulse

1 = Torque Pulse

P2.8.5.16 Polarity Pulse Length ms ID1742

Pulse length for Polarity ID Run.

P2.8.5.17 Polarity Detection Angle Deg ID1748

Detection angle for Polarity ID Run.

P2.8.5.18 Angle Identification Mode**ID1749**

- 0 = Current Pulse
- 1 = High Frequency Sine
- 2 = Low Frequency Sine

P2.8.5.19 Current Control Kp d %**ID1761**

Current controller gain for d-axis

P2.8.5.20 Voltage Margin %**ID1759**

Voltage margin to prevent current controller from saturating.

P2.8.5.21 Encoder ID Run Mode "EnclIDRunMode"**ID680**

This parameter defines how the start angle identification is made for absolute encoder with the identification mode selections 3 / "Enc. ID Run" or 4 / "Ident All".

0 = Default

This mode feeds the DC current to the motor and aligns the rotor to find the zero position. The rotor needs to be able to rotate freely to align correctly.

1 = Current Pulses

This mode sends current pulses to the motor, and the rotor can be locked to a position, for example with a mechanical brake. This mode should be tested to the motor in use, since all PMSM are not suitable for this identification mode.

2 = ID with Run

This method is the most reliable to find the zero position but requires that the motor can be accelerated to 2/3 of motor nominal speed to find the absolute encoder zero position. After 2/3 of nominal speed is reached, the motor is coasted to determine the encoder zero position after the DC brake is applied to make the rotor to stop to stand still. This method can be used also when step-up transforms are used.

P2.8.5.22 VoltageCorr. Kp**ID1783**

Flux integrator drift compensator proportional part

P2.8.5.23 VoltageCorr. Ki**ID1784**

Flux integrator drift compensator integral part

7.8.4 Stabilization settings

7.8.4.1 Torque stabiliser

The torque stabiliser is basically a first order high-pass filter for the estimated torque $[T]$. The output of the filter is a frequency correction term df added to the output frequency reference. The purpose of the torque stabiliser is to stabilise the possible oscillations in the estimated torque. The controller gain is changing linearly between the zero and field weakening point frequencies. The zero and field weakening point gains can be controlled independently with gains. The stabiliser operates at frequencies above 3 Hz.

The discrete implementation of the filter is:

$$\frac{1000}{TorqStabDamp} df_k = \frac{1000}{TorqStabDamp} G(T_k - T_{k-1}) + df_{k-1} = G_f(T_k - T_{k-1}) + df_{k-1}$$

Where G_f is the total gain of the filter. The gain and the corner frequency of the filter is controlled by the following parameters

P2.8.6.1 Torque stabiliser damping ID1413 “TorqStabDamp”

If a PMS motor is used in open loop control mode it is recommended to use value 980 instead of 800. The value ‘980’ is set automatically when PMS motor is selected.

This parameter defines the corner frequency of the high-pass filter. The time constant of the filter is calculated as

$$T_c = T_s \frac{TorqStabDamp}{1000 - TorqStabDamp} = 1ms \frac{TorqStabDamp}{1000 - TorqStabDamp}$$

It follows that the corner frequency of the filter is obtained from

$$\omega_c = \frac{1}{T_c} \text{ rad/s}$$

For example, if Torque stabilizer damping = 600, it follows that $T_c = 1.5$ ms and $\omega_c = 667$ rad/s.

P2.8.6.2 Torque stabiliser Gain ID1412 “TorqStabGain”

These parameters define together with the Torque Stabiliser Damping the actual gain of the filter. Torque Stabiliser Gain is the gain at the zero frequency. Torque stabiliser Gain in FWP is the gain at the field-weakening frequency. The gain changes linearly with the frequency between these two points so that the gain is

$$G = TorqStabGainFWP + TorqStabGain - \frac{f}{f_{FWP}} TorqStabGain, \quad \text{if } f < f_{FWP}$$

$$G = TorqStabGainFWP, \quad \text{if } f \geq f_{FWP}$$

The final gain is obtained by considering the value of Torque Stabiliser Damping and the scaling in which 256 means the gain 1. So, the final and the actual gain of the filter is obtained from

$$G_f = \frac{1000 * G}{256 * TorqStabDamp}$$

P2.8.6.3 Torque stabiliser Gain in FWP area ID1414 “TorqStabGainFWP”

Gain of the torque stabiliser at field weakening point in open loop motor control operation. See details from Torque Stabiliser Gain.

P2.8.6.4 Torque stabiliser Limit ID1720 “TorqStabLimit

This defines how much torque stabiliser can affect output frequency.

7.8.4.2 Flux Circle stabiliser**P2.8.6.5 Flux Circle stabiliser Gain ID1550 “FluxCircleStabG”**

Gain for flux circle stabiliser. This will control the flux to origin when error is detected. Controller output is added to output frequency. Affect decreases at low frequencies where flux stabiliser has more affect. This parameter is used at frequencies where output voltage is at maximum limit (set by field weakening point voltage or maximum drive output voltage).

7.8.4.3 Flux stabiliser

Flux stabilizer is a first order high-pass filter for the estimated flux producing current I_d . The output of the filter is correcting term dU added to the output voltage reference. The gain and the corner frequency of the filter is controlled by the following parameters.

P2.8.6.6 Flux stabiliser TC ID1551 “FluxStab TC”

Flux Stabiliser TC defines the corner frequency of the high-pass filter. The time constant of the filter is calculated from:

$$T_c = T_s \frac{65536 - 2 * \text{FluxStab TC}}{2 * \text{FluxStab TC}} = 1ms \left(\frac{65536}{2 * \text{FluxStab TC}} - 1 \right)$$

For example, if Flux Stabiliser TC = 64, it follows that $T_c = 511$ ms and $\omega_c = 1.96$ rad/s.

P2.8.6.7 Flux Stabiliser Gain ID1797 “Flux Stab Gain”

Flux stabilizer gain is 0 at the zero speed and is increased linearly with the frequency to value defined by the Flux Stab Gain which is reached at the 1 Hz. So, the gain is obtained from

$$G = \text{Flux Stab Gain} * f, \quad \text{if } f < 1 \text{ Hz}$$

$$G = \text{Flux Stab Gain}, \quad \text{if } f \geq 1 \text{ Hz}$$

The gain is scaled by 1000 and the actual gain of the filter is obtained from

$$G_f = \frac{G}{1000} = \frac{\text{Flux Stab Gain}}{1000}$$

P2.8.6.8 Flux Stabiliser Coeff ID1796

7.8.4.4 Voltage stabiliser

The voltage stabilizer is similar to the torque stabilizer controlling the change in DC-link voltage at frequencies above 3 Hz. It is a first order high-pass filter for the measured DC-link voltage U_{dc} . The output of the filter is a frequency correction term df added to the output frequency reference. Gain is adjusted relative to the estimated torque. As the torque increases from 10% to 50% of the motor nominal torque, the controller gain decreases from the voltage stabiliser Gain down to zero. The gain and the corner frequency of the filter are controlled by the following parameters:

P2.8.6.9 Voltage stabiliser Gain ID1738 “VoltStabGain”

Voltage Stabilizer Gain is a function of a torque. If the torque is below 15%, the gain is the value defined by the Voltage Stabilizer Gain. If the torque is above 50% the gain is 0. Between 15-50% the gain decreases linearly with the torque from Voltage Stabilizer Gain to 0. In other words,

$$G = \text{VoltStabGain}, \quad \text{if } T < 15 \%$$

$$G = \frac{\text{VoltStabGain}}{35\%} (50\% - T(\%)), \quad \text{if } 15\% \leq T < 50 \%$$

$$G = 0, \quad \text{if } T > 50 \%$$

The final gain is obtained by considering the value of Voltage stabiliser TC and the scaling in which 256 means the gain 1. So, the final and the actual gain of the filter is obtained from

$$G_f = \frac{1000 * G}{256 * \text{VoltStab TC}}$$

P2.8.6.10 Voltage stabiliser TC ID1552 “VoltageStab TC”

This parameter defines the corner frequency of the high-pass filter. The time constant of the filter is calculated as

$$T_c = T_s \frac{\text{VoltageStab TC}}{1000 - \text{VoltageStab TC}} = 1\text{ms} \frac{\text{VoltageStab TC}}{1000 - \text{VoltageStab TC}} \text{ms}$$

P2.8.6.11 Voltage stabiliser Limit ID1553 “VoltStabLimit”

This parameter sets the limits for the voltage stabilizer output. The maximum and the minimum value for the correction term df in FreqScale.

7.8.5 Tuning settings

P2.8.7.1 Flying Start Options ID1610

- b0** = +1= Disable movement to reverse direction
- b1** = +2=Disable AC Scanning
- b2** = +4=Disable Fly Brake phase
- b3** = +8=Use encoder information for frequency estimate
- b4** = +16=Use frequency reference for initial guess
- b5** = +32=Disable DC scanning for step-up application

P2.8.7.2 Motor Control Options ID1740

- B02** = +4= Enable angle identification in open loop control for PM Motor

P2.8.7.3 Resonance Damping Select ID1760

This feature can be used to dampen the constant frequency torque oscillations in the drive system.

- 0** Not in use
- 1** Band pass. Oscillation damping with band pass filter.
- 2** BandStop+BandPass. Oscillation damping with band stop and band pass filter.

P2.8.7.4 Resonance Damping Frequency ID1763

Frequency of torque oscillations to be damped in Hz.

P2.8.7.5 Resonance Damping Gain ID1764

The gain for the oscillation damping. This changes amplitude of the compensating signal used for oscillation damping.

P2.8.7.6 Resonance Damping Phase ID1765

The compensating signal used for oscillation damping can be phase shifted 0 to 360 degrees using this parameter.

P2.8.7.7 Resonance Damping Activation frequency ID1770

Defines the frequency limit when resonance damping is started.

P2.8.7.8 Resonance Damping Filtering TC ID1771

Filter TC for external feedback (Iq) signal .

P2.8.7.9 Over modulation limit ID1515

Output Voltage Limit for partial modulation in 1%. 100% means maximum sinusoidal modulation. 113% is full six step.
If you have a sine filter in use, set this to 96%.

P2.8.7.10 Modulation Index Limit ID655

Modulation index in % for closed loop operation. Higher value of motor terminal voltage can be achieved by increasing this value.

P2.8.7.11 DC Voltage Filtering Time ID1591

Cut off frequency in 0.1 Hz for 2nd order butterwort filter used in DCV-compensation.

P2.8.7.12 GearRatioMultipl ID1558

Gear ratio multiplier

P2.8.7.13 GearRatioDivider ID1559

Gear ratio divider

7.8.6 Identification settings

P2.8.8.1 to

P2.8.8.15 Flux 10...150% ID1355 – ID1369

Motor voltage corresponding to 10%...150% of flux as a percentage of Nominal Flux voltage. Measured during identification.

P2.8.8.16 Measured Rs voltage drop ID662 “RsVoltageDrop”

The measured voltage drop at stator resistance between two phases with the nominal current of the motor. This parameter is identified during identification run.

This parameter defines the motor stator resistance as a voltage drop at nominal current. The parameter value is defined according to motor nominal voltage and the current and the actual stator resistance as

$$RsVoltageDrop = 2560 \frac{I_n}{U_n} R_s$$

P2.8.8.17 Ir: Add zero point voltage ID664 “IrAddZeroPVoltag”

Defines how much voltage is applied to motor in zero speed when torque boost is used.

P2.8.8.18 Ir: Add generator scale ID665 “IrAddGeneScale”

Defines the scaling factor for generator side IR-compensation when torque boost is used.

P2.8.8.19 Ir: Add motoring scale ID667 “IrAddMotorScale”

Defines the scaling factor for motoring side IR-compensation when torque boost is used.

P2.8.8.20 Measured Ls voltage drop ID673 “LsVoltageDrop”

Leakage inductance voltage drop with nominal current and frequency of the motor. This parameter defines the Ls voltage drop between two phases. Use identification run to determine the optimum setting.

P2.8.8.21 Motor BEM Voltage ID674 “Motor BEM Voltage”

Motor-induced back voltage.

P2.8.8.22 IU Offset ID668 “IU Offset”

P2.8.8.23 IV Offset ID669 “IV Offset”

P2.8.9.24 IW Offset ID670 “IW Offset”

Offsets the value for phase current measurement. Identified during identification run.

P2.8.8.25 Estimator Kp ID1782 “Estimator Kp”

Estimator gain for PMS motor. Identified during identification run.

P2.8.9.26 Estimator Ki ID1782 “Estimator Ki”

Estimator gain and Ti for PMS motor. Identified during identification run.

P2.8.8.27 Speed step ID1252 "Speed Step"

NCDrive parameter to help adjusting the speed controller (see NCDrive Tools: Step Response). With this tool you can give step to speed reference after ramp control.

P2.8.8.28 Torque step ID1253 "Torque Step"

NCDrive parameter to help adjusting the torque controller (see NCDrive Tools: Step Response). With this tool you can give step to torque reference.

P2.8.9.29 Original UF Zero Point Voltage

Zero point voltage that is identified during normal identification. Used as a base point for brake control U/f curves.

P2.8.9.30 Voltage Drop ID671 "Voltage Drop"

Measured residual voltage error.

P2.8.9.31 ID Run Current Kp ID695 "ID Run Curr.Kp"

Current controller gain during identification fun.

P2.8.9.32 Flux Saturation Ratio ID682

Relative nominal magnetizing current compared to non-saturated value

P2.8.9.33 DeadTimeComp. ID1751

Dead Time Compensation in ns. Identified during 7 / DTC Identification run.

P2.8.9.34 DeadTieContCurl ID1752

Continuous/discontinuous current limit for Dead Time Compensation. Identified during 7 / DTC Identification run.

7.8.7 AOL control for IM

<i>P2.8.10.1 Freq. 0</i>	1684
<i>P2.8.10.2 Freq. 1</i>	1707
<i>P2.8.10.3 Freq. 2</i>	1791
<i>P2.8.10.4 Freq. 3</i>	635
<i>P2.8.10.5 MinCurrentRef</i>	622
<i>P2.8.10.6 NoLoadFluxCurr</i>	623
<i>P2.8.10.7 M5 StrayFluxCurr</i>	624
<i>P2.8.10.8 0 Speed Current</i>	625
<i>P2.8.10.9 DeltaAngleFWD</i>	692
<i>P2.8.10.10 DeltaAngleREV</i>	693
<i>P2.8.10.11 Flux Current Kp</i>	1708
<i>P2.8.10.12 Flux Current Ti</i>	1709
<i>P2.8.10.13 FluxStabGain1</i>	1541
<i>P2.8.10.14 FluxStabGainFWP</i>	1542
<i>P2.8.10.15 FluxStabLimit</i>	1543
<i>P2.8.10.16 FluxCurrentDamp</i>	1546

7.9 Speed Control settings

P2.9.1 Load drooping ID620 “LoadDrooping”

The drooping function enables speed drop as a function of load. This parameter sets the value corresponding to the nominal torque of the motor.

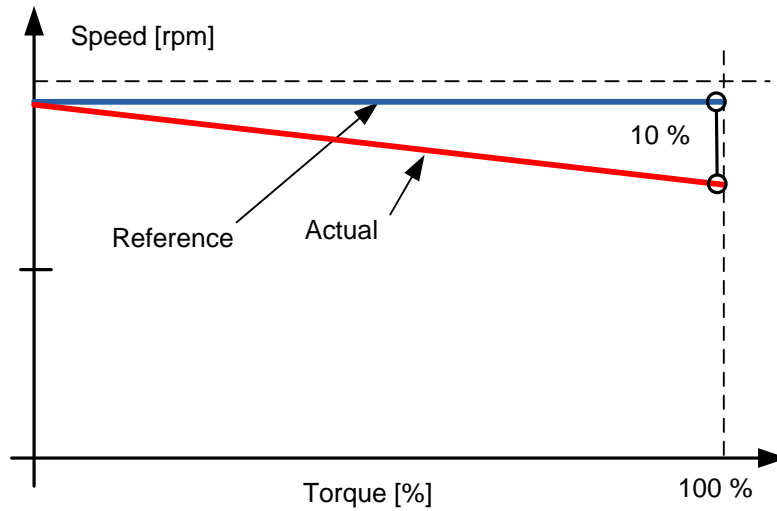

Example: If load drooping is set to 10% for a motor that has a nominal frequency of 50 Hz and is nominally loaded (100% of torque), the output frequency is allowed to decrease 5 Hz from the frequency reference. The function is used for e.g. when balanced load is needed for mechanically connected motors.

P2.9.2 Load Drooping Time ID656 “LoadDroopingTime”

This function is used in order to achieve a dynamic speed drooping because of changing load. The parameter defines the time during which the speed is restored to the level it was before the load increase.

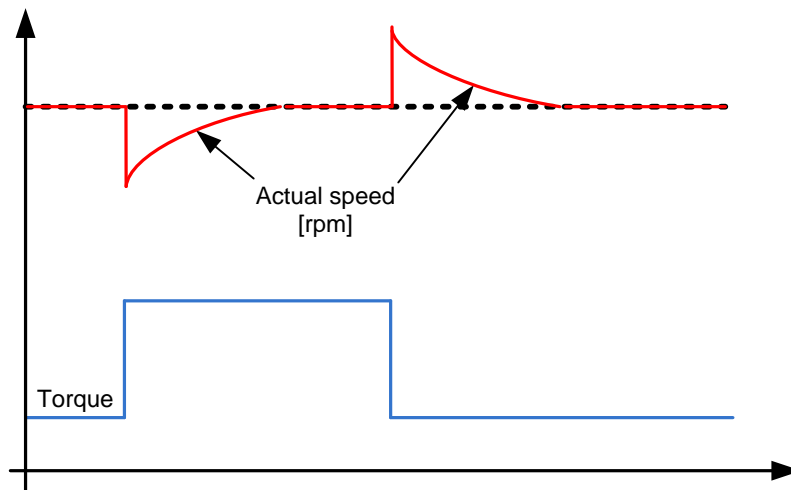

P2.9.3 Load Drooping Removal ID1534 “LoadDroopRemoval”

This function defines how load drooping is removed with reference to speed. It is used in lifting situations when it is necessary to keep the load at the same position without closing the brake. When using option ‘Normal’ the load will slowly come down depending on load and the drooping factor.

Normal

0 Load Drooping factor is constant through the whole speed range.

Removed below zero frequency limit

1 Load drooping is removed linearly below the zero frequency limit (defined in G2.6.4 Freq. Handling).

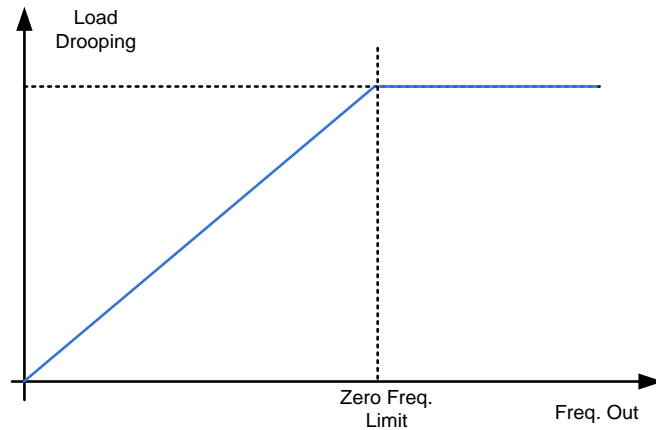

Linearly increased to nominal frequency

2 Load drooping is removed linearly from nominal frequency to zero frequency.

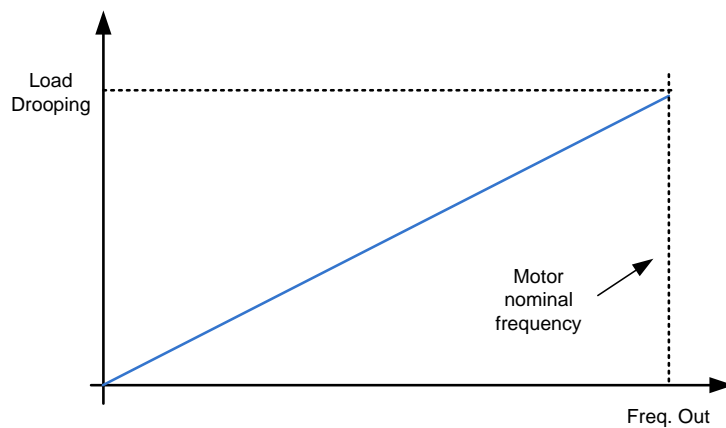

7.9.1.1 Open Loop Settings

P2.9.4.1 Speed controller P gain, Open Loop ID637 “OL Speed Reg P”

Defines the P gain for the speed controlled in Open Loop control mode.

P2.9.4.2 Speed controller I gain, Open Loop ID638 “OL Speed Reg I”

Defines the I gain for the speed controlled in Open Loop control mode.

7.9.1.2 Closed Loop Speed Control Settings

Speed control formula:

$$y = Kp \left[1 + \frac{1}{Ti s} \right] e$$

$$u(k) = y(k - 1) + Kp[e(k) - e(k - 1) + \frac{Ts}{Ti} e(k)]$$

P2.9.5.1 Speed control P gain ID613 “Speed Control Kp”

Gain for the speed controller in closed loop motor control operation. Gain value 100 means that the nominal torque reference is produced at the speed controller output for the frequency error of 1 Hz.

P2.9.5.2 Speed control I time ID614 “Speed Control Ti”

Sets the integral time constant for the speed controller. Increasing the I-time increases stability but lengthens the speed response time.

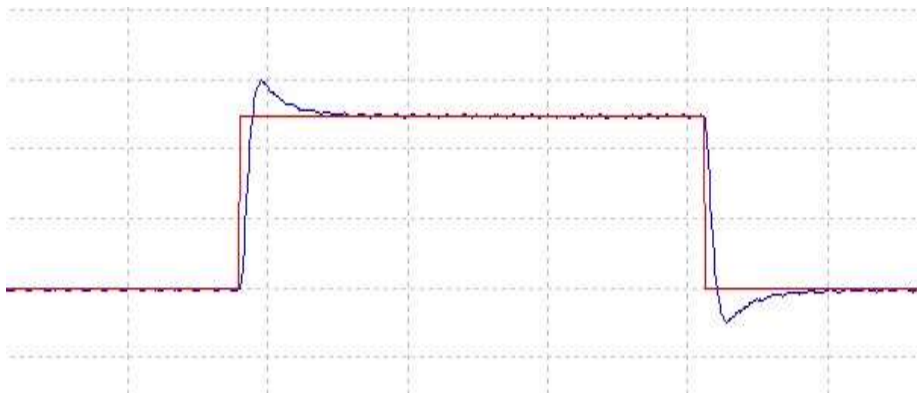

Kp 30, Ti 100

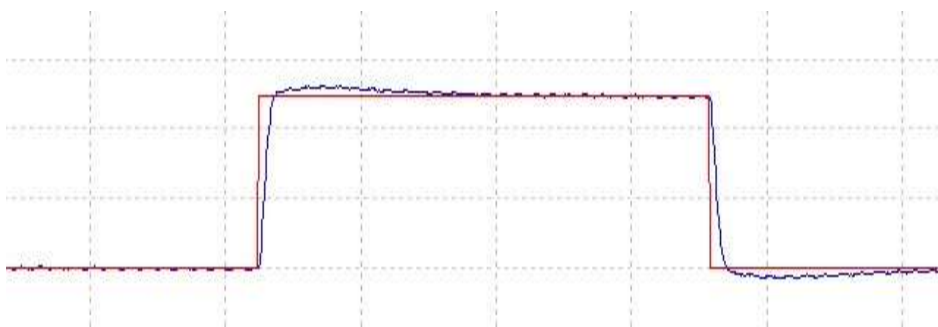

Kp 30, Ti 300

P2.9.5.3 Zero speed time at start **ID615 “Start 0SpeedTime”**

After giving the start command the drive will remain at zero speed for the time defined by this parameter. The ramp will be released to follow the set frequency/speed reference after this time has elapsed counted from the instant when the command was given.

P2.9.5.4 Zero speed time at stop **ID616 “Stop 0 SpeedTime”**

The drive will remain at zero speed with controllers active for the time defined by this parameter after reaching the zero speed when a stop command is given. This parameter has no effect if the selected stop function is *Coasting*. Note that the zero speed time starts when the ramp time is expected to reach the zero speed, not when the actual speed reaches zero. Such situation can happen when the generator power limit is small or the overvoltage controller is active while decelerating.

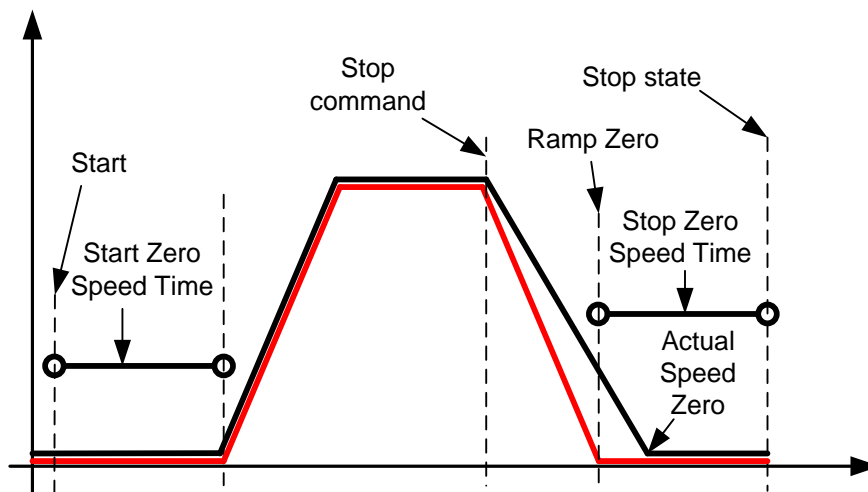

7.9.1.3 Speed controller tuning for different speed areas

The speed controller can be tuned for different gains in different speed areas, for slow speed and above the parameter *Field weakening point*. Gains for different speed areas are percentages of the original Speed Controller Gain value.

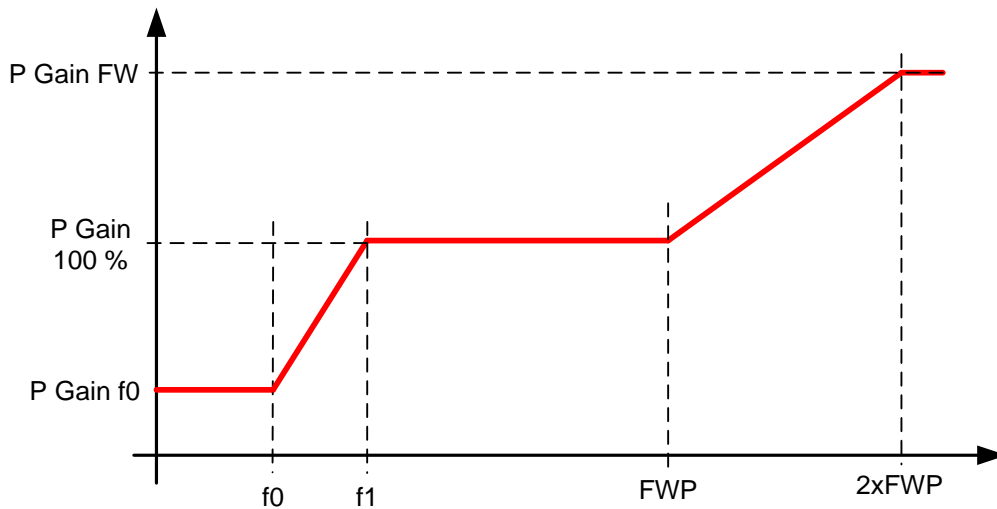

P2.9.5.5 Speed Controller f0 point ID1300 “SPC f0 Point”

The speed level in Hz below which the speed controller gain is *Speed Controller gain f0*.

P2.9.5.6 Speed Controller f1 point ID1301 “SPC f1 Point”

The speed level in Hz above which the speed controller gain is *Speed Controller P gain*.
Gain changes linearly between f0 and f1 points.

P2.9.5.7 Speed Controller gain f0 ID1299 “SPC Kp f0”

The relative gain of the speed controller as a percentage of the *Speed Controller P Gain* when the speed is below the level defined by *Speed Controller f0 point*.

P2.9.5.8 Speed controller gain in field weakening area ID1298 “SPC Kp FWP”

Relative gain of the speed controller in field weakening area as a percentage of *Speed Controller P Gain* values. The set value is reached at two times the *Field weakening point*.

7.9.1.4 Speed controller gain with different loads

The speed controller can also be tuned for different loads. Speed controller gain is first manipulated by the speed area gain function and this result is then further adjusted by torque related relative gain.

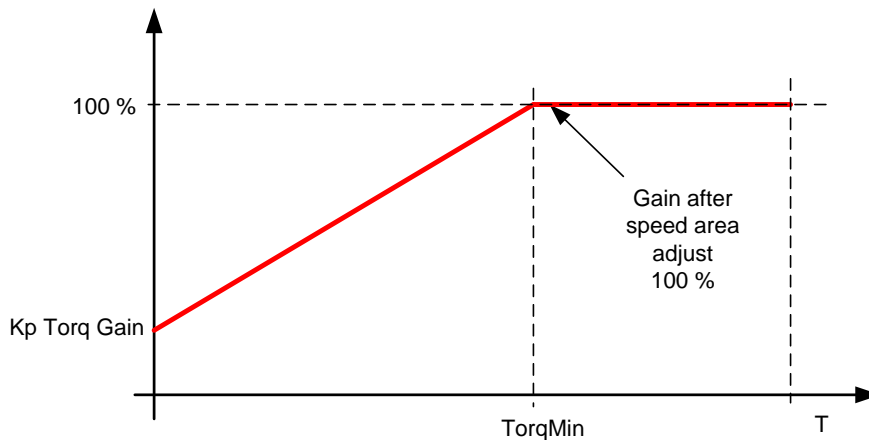

P2.9.5.9 Speed Controller torque minimum ID1296 “SPC Torq Min”

The level of speed controller output which the speed controller gain is changed to with parameter P2.8.5.4.10 “Speed Controller torque minimum gain” using a filter set by parameter P2.8.5.4.11 “Speed Controller torque minimum filtering time”. This is in percent of the motor nominal torque.

P2.9.5.10 Speed Controller torque minimum gain ID1295 “SPC Kp Torq Min”

Relative gain as a percentage of the speed controller gain after speed area adjustment when the speed control output is less than the “Speed Controller torque minimum”. This parameter is normally used to stabilise the speed controller for a drive system with gear backlash.

P2.9.5.11 Speed Controller torque minimum filtering time ID1297 “SPC Kp TC Torq”

Filtering time for torque. When the speed controller gain is changed below the Speed Controller torque minimum.

7.10 Drive Control

P2.10.1 Switching frequency ID601 “Switching Freq”

Motor noise can be minimised using a high switching frequency. Note, however, that increasing the switching frequency increases losses of the AC drive. Lower frequencies are used when the motor cable is long and the motor is small.

The range of this parameter depends on the size of the AC drive:

Type	Min. [kHz]	Max. [kHz]	Default [kHz]
0003—0061 NX_5 0003—0061 NX_2	1.0	16.0	10.0
0072—0520 NX_5	1.0	10.0	3.6
0041—0062 NX_6 0144—0208 NX_6	1.0	6.0	1.5

Table 7-2. Size-dependent switching frequencies

Note!

The actual switching frequency might be reduced down to 1.5 kHz by thermal management functions. This has to be considered when using sine wave filters or other output filters with a low resonance frequency.

Note!

If the switching frequency is changed it is necessary to redo the identification run.

DriveSynch operation

When using DriveSynch the maximum switching frequency is limited to 3.6 kHz.

P2.10.2 Modulator Type ID1516 “Modulator type”

Select modulator type. Some operations require use of a software modulator.

0 = ASIC modulator

A classical third harmonic injection. The spectrum is slightly better compared to the Software 1 modulator.

NOTE: An ASIC modulator cannot be used when using DriveSynch or PMS motor with an incremental type encoder.

1 = Software Modulator 1

Symmetric vector modulator with symmetrical zero vectors.

Current distortion is less than with software modulator 2 if boosting is used.

NOTE: Recommended for DriveSynch (Set by default when DS activated) and needed when using PMS motor with an incremental encoder.

2 = Software modulator 2

One phase at a time in IGBT switches is not modulated during a 60-degree period of the frequency cycle. The unmodulated phase is connected to either positive or negative DC-bus.

This modulator type reduces switching losses up to two-thirds and all switches become evenly loaded.

BusClamp modulation is useful if the voltage is >80% of the maximum voltage, in other words, when the drive is operating near full speed. Then again, the motor ripple at low speeds is the double compared to selection 1.

3 = Software modulator 3

Unsymmetrical BusClamb in which one switch always conducts 120 degrees to negative DC-rail to reduce switching losses. However, upper and lower switches are unevenly loaded and the spectrum is wide.

4 = Software modulator 4:

Pure sinewave, sinusoidal modulator without harmonic injection. Dedicated to be used in back to back test benches etc. to avoid circulating third harmonic current. Drawback is that required DC voltage is 15% higher compared to other modulator types.

P2.10.3 Control Options ID1084 "Control Options"

These parameter functions are dependent of VACON® Brake Control application version.

B01 = Reserved

B06 = Disable Closed Loop type speed limit function in Open Loop

B07 = Disables switching frequency decrease due to drive temperature rise

B08 = Disable Encoder fault when brake is closed

B12 = Disable Process Data locking function when Profibus communication fails.

When using Profibus, an occurring communication fault will lock the process data to previous values. This bit will disable the locking of process data forcing the values to zero. NOTE: This bit can only be used with Profibus.

B13 = Disable only acceleration when using DI Acc/Dec prohibit function

P2.10.4 Control Options 2 ID1798 "ControlOptions2"

Reserved for future use.

P2.10.5 Advanced Options 1 ID1560 "AdvancedOptions1"

B00 = Disable Synchronous modulation

B01 = Use encoder information to slip compensation in Open Loop Speed control

B02 = Disable encoder fault

B03 = Disable slip compensation for reverse direction

B06 = Enable synchronous symmetrical modulation

B07 = Automatically handled by application logic.

B15 = Cosphi = 1 control. This controls the motor reactive power to zero. Possible to use only with PMS motors in closed loop control.

P2.10.6 Advanced Options 2 ID1561 “AdvancedOptions1”

B00 = Sensorless control for PMS motors. This is an open loop control but uses the same control system than the normal closed loop control. Calculations try to estimate the encoder speed instead of using the encoder signal. This mode has speed and torque range limitations and therefore application limitations. A lower speed controller gain may be required to gain stability. Useful for generator applications.

B04 = Enable Start Positioning damping active if PMSM

B08 = Current optimization for PMS motor. This function activates the current optimization for PMSM motor based on torque calculation and motor parameters. When activated, the optimization starts after 13% of the motor nominal speed and below this a normal U/f curve is used. The activation of this selection requires a performed identification with run.

B09 = I/f control for PMS motors. PMS motor can be started with I/f control. Used with high power motor when there is low resistance in motor and U/f is difficult to tune to be stable.

B13 = Changes automatically depending on Drive Synch operation.

P2.10.7 Advanced Options 4 ID1563 “AdvancedOptions4”

Reserved for future use. Some bits are controlled by application software so value may not be always zero.

P2.10.8 Advanced Options 5 ID1564 “AdvancedOptions5”

Reserved for future use. Some bits are controlled by application software so value may not be always zero.

P2.10.9 Advanced Options 6 ID1565 “AdvancedOptions6”

B05 = To reduce aliasing effects in current measurement, it is possible to take an average from all internal samples taken at fast time level. It must be noted, that this mode does not affect the motor control, only monitoring.

P2.10.10 Restart Delay ID1424 “Restart Delay OL”

The time delay within which the drive cannot be restarted after a coast stop and flying start is not in use. Closed Loop control mode and the flying start use a different delay see P2.9.11.

P2.10.11 Restart Delay Closed Loop & Flying Start ID672 “Restart Delay CL”

The time delay within which the drive cannot be restarted if flying start is used or the control mode is closed loop.

7.11 Master-Follower

7.11.1 Master-Follower: Standard system

The Master-Follower function is designed for applications in which the system is run by several NXP drives and the motor shafts are coupled to each other via gearing, chain, belt etc. The NXP drives are in closed loop control mode.

The external control signals are connected to the master NXP only. The master controls the follower(s) via a system bus. The master station is typically speed-controlled and the other drives follow its torque or speed reference.

Torque control of the follower should be used when the motor shafts of the master and follower drives are coupled solidly to each other by gearing, a chain etc., so that no speed difference between the drives is possible.

Speed control of the follower should be used when the motor shafts of the master and the follower drives are coupled flexibly to each other so that a slight speed difference between the drives is possible. When both the master and the followers are speed-controlled, drooping is typically also used.

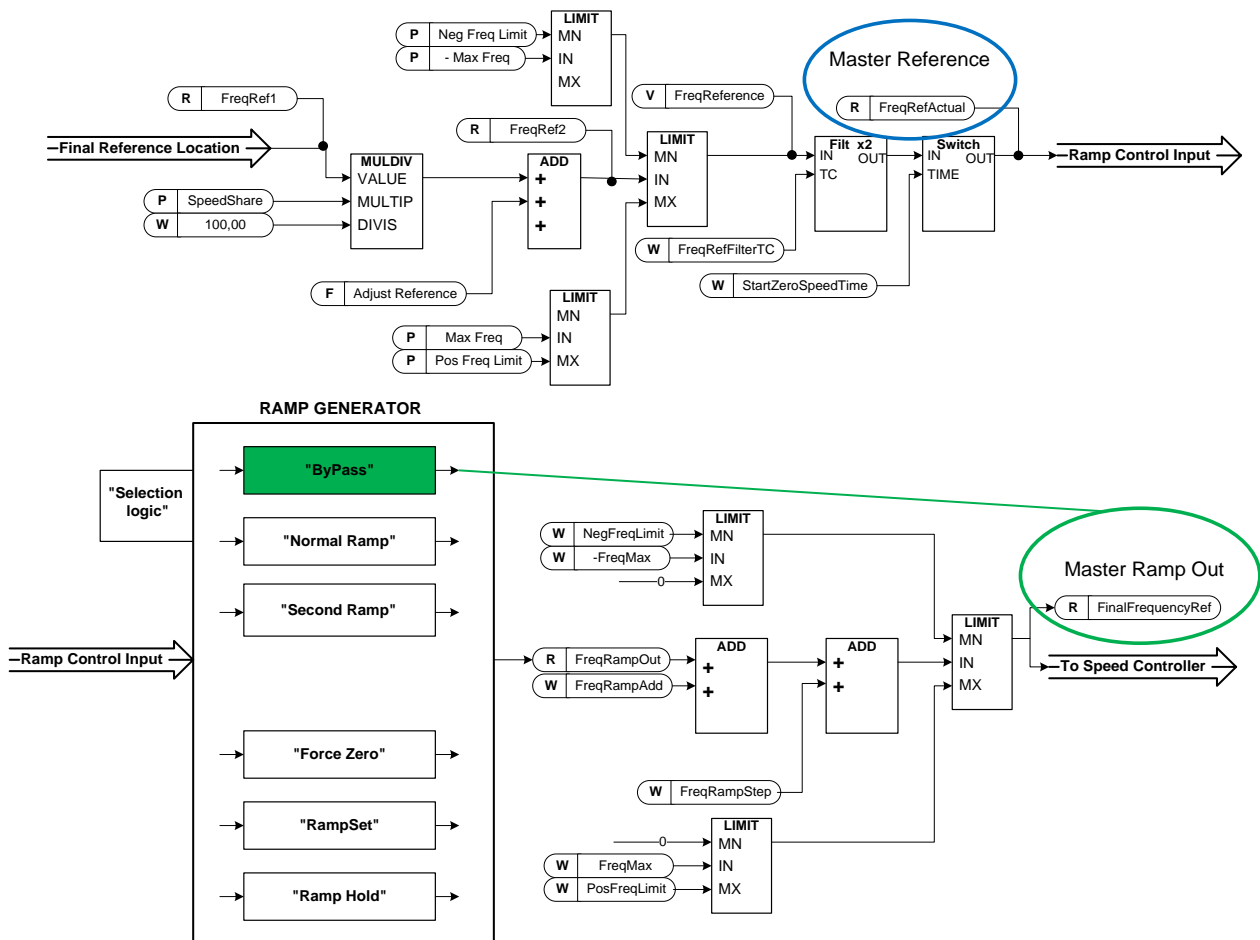

7.11.2 Master Follower: DriveSynch system

DriveSynch is used to control parallel drives. Up to four drives can be connected parallelly. The motor can be a single winding motor or there can be several winding motors.

VACON® DriveSynch works in open loop and closed loop motor control modes. With closed loop motor control, the encoder feedback needs to be wired only to the master drive. If redundancy is required, it may be necessary to wire the encoder feedback also to follower drives using the double encoder option board OPTA7.

Note:

In a DriveSynch system, only Master drive monitoring signals are reliable.

Only directly measured values are reliable in follower units. Even the Output Frequency of DriveSynch follower is not directly observed and thus may not show actual output frequency that is controlled by DriveSynch Master Drive.

Note!

The maximum switching frequency for the drives using VACON® DriveSynch is 3.6 kHz.

Minimum recommended switching frequency in Open Loop control is 1.7 kHz.

Minimum recommended switching frequency in Closed Loop control is 2.5 kHz.

Note!

The VACON® NXP control board must be VB00761 (NXP3) or newer.

OPT-D2 boards needs to VB276J or newer.

Master needs to be #1 and cannot be changed.

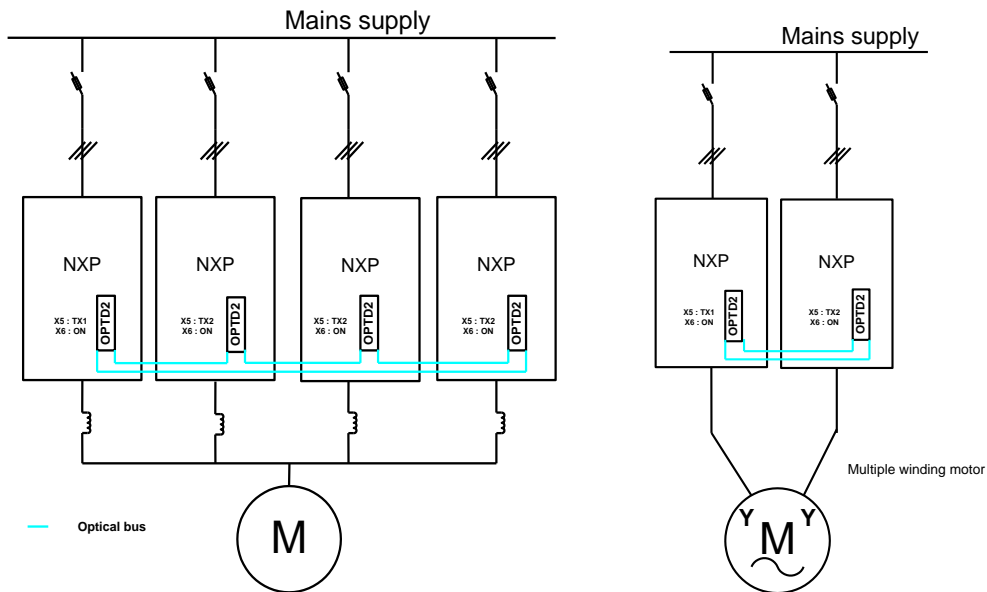

7.11.2.1 Redundancy

The units working in parallel with VACON® DriveSynch have a high level of redundancy. The system keeps running without interruption even if any of the follower units is non-functional. In case of a hardware failure, the failed unit need be isolated before the system can be restarted. The actual level of redundancy, however, needs to be carefully defined considering the motor, load and the requirements of the process.

The master drive unit and the fast drive to drive optical communication has to be functional for the VACON® DriveSynch functionality. The auxiliary power (+24V) must be continuously provided for all the control units including the non-functional drive units in VACON® drive synch system.

It is also a common practice to use (n+1) units, where n is the number of required units for full functionality of the system. In this case, the system is fully operational even if any follower is non-functional.

	Master (D1)	Follower (D2)	Follower (D3)	Follower (D4)
Parameter settings				
Motor Nominal Voltage	Motor Nominal voltage from the motor name plate	Motor Nominal voltage from the motor name plate	Motor Nominal voltage from the motor name plate	Motor Nominal voltage from the motor name plate
Motor nominal Frequency	Motor Nominal frequency from the motor name plate	Motor Nominal frequency from the motor name plate	Motor Nominal frequency from the motor name plate	Motor Nominal frequency from the motor name plate
Motor Nominal Current	Motor Nominal current from the motor name plate / Number of drives in parallel using VACON® Drive Synch	Motor Nominal current from the motor name plate / Number of drives in parallel using VACON® Drive Synch	Motor Nominal current from the motor name plate / Number of drives in parallel using VACON® Drive Synch	Motor Nominal current from the motor name plate / Number of drives in parallel using VACON® Drive Synch
Motor COS PHI (Motor nominal power factor)	Motor COS PHI from the motor name plate	Motor COS PHI from the motor name plate	Motor COS PHI from the motor name plate	Motor COS PHI from the motor name plate
Motor Nominal Power	Motor Nominal power from the motor name plate / Number of drives in parallel using VACON® Drive Synch	Motor Nominal power from the motor name plate / Number of drives in parallel using VACON® Drive Synch	Motor Nominal power from the motor name plate / Number of drives in parallel using VACON® Drive Synch	Motor Nominal power from the motor name plate / Number of drives in parallel using VACON® Drive Synch
Master Follower Mode	Master, DriveSynch	Follower, DriveSynch	Follower, DriveSynch	Follower, DriveSynch
Motor Control Mode (Open Loop)	Open Loop Frequency	If used as Secondary Master: Open Loop Frequency. When used as Follower: no meaning.	No meaning, internally handled. Recommended to have same setting as in master.	No meaning, internally handled. Recommended to have same setting as in master.
Motor Control Mode (Closed Loop)	Closed Loop Speed /Torque	If used as Secondary Master: Closed Loop Speed/Torque. When used as Follower: no meaning.	No meaning, internally handled Recommended to have same setting as in master.	No meaning, internally handled Recommended to have same setting as in master.
Magnetizing current (needed only for closed loop motor control)	Motor nominal magnetizing current / Number of drives in parallel using VACON® Drive Synch	Motor nominal magnetizing current / Number of drives in parallel using VACON® Drive Synch	Motor nominal magnetizing current / Number of drives in parallel using VACON® Drive Synch	Motor nominal magnetizing current / Number of drives in parallel using VACON® Drive Synch
Switching Frequency	Max 3.6 KHz	Same as in Master	Same as in Master	Same as in Master
Modulator Type	1, Software	Same as in Master	Same as in Master	Same as in Master
Follower Phase shift (single winding motor)	0 degrees	0	0	0
Follower Phase shift (multiple winding motor)	0 degrees	As per motor name plate	As per motor name plate	As per motor name plate

7.11.3 Master-Follower configuration

The OPTD2 board in the master has default jumper selections, i.e. X6:1-2, X5:1-2. For the followers, the jumper positions have to be changed: X6:1-2, **X5:2-3**. This board also has a CAN communication option that is useful for multiple drive monitoring with NCDrive PC software when commissioning Master-Follower functions or line systems.

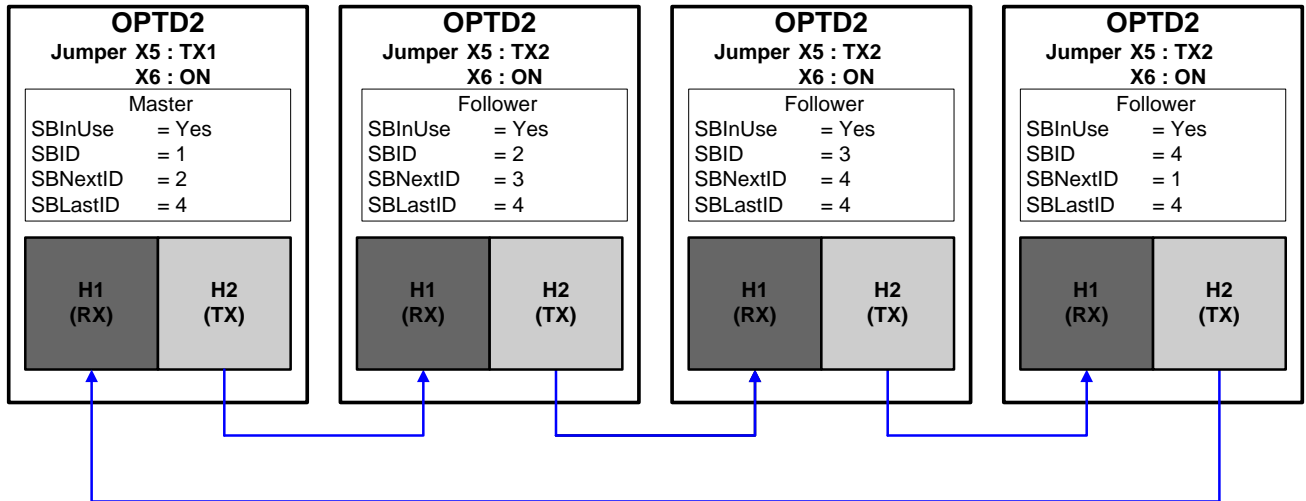

Figure 7-16. System bus physical connections with the OPT-D2 board

P2.11.1 Master/Follower selection ID1324 “MF Mode”

Select the Master-Follower mode. When the drive is a follower, drive will receive communication from master but to receive Run Request command from master drive control place needs to be set to SC Control. Speed and Torque references are still selectable by parameter.

0 = Single drive

System bus is deactivated.

1 = Master

Drive sends control word to follower drive. In this mode hoisting drive can send rope length to other drives.

2 = Follower

Drive receives control word from Master and sends some diagnostic information to the master drive. In this mode other drives can receive rope length from hoisting drives.

3 = Tandem Operation Master

Drive sends shaft position to follower drives to use in tandem operation.

4 = Tandem Operation Follower

Drive receives shaft position from master to be used in tandem operation.

5 = Drive Synch Master

6 = Drive Synch Follower

P2.11.2 Follower reference selection ID1081 "Follower Ref Sel"

Select where the follower drive receives its speed reference from.

0="AI1" - Analogue Input 1.

Signal scaling in "G: Input Signals \ Analogue Input 1"

1="AI2" - Analogue Input 2.

Signal scaling in "G: Input Signals \ Analogue Input 2"

2="AI1+AI2" - Analogue Input 1 + Analogue Input 2.

With alternative reference scaling in Analogue Input group, 100% input values can be set to correspond 25 Hz. In other words, when both are 100% the final reference will be 50 Hz.

3="AI1-AI2"

Analogue Input 1 minus Analogue Input 2.

4="AI2-AI1"

Analogue Input 2 minus Analogue Input 1.

5="AI1xAI2"

Analogue Input 1 x Analogue Input 2

6="AI1 Joystick"

Analogue input 1, -10 Vdc... +10 Vdc

7="AI2 Joystick"

Analogue input 2, -10 Vdc... +10 Vdc

8="Keypad Ref"

Reference from keypad R3.2

9="Fieldbus"

Reference is taken from fieldbus. Alternative scaling can be selected in "G: Fieldbus"

10="Motor Pot" - Motor potentiometer

Reference handled with two digital inputs "G: Input Signals \ Digital Inputs" (increase and decrease). Behaviour adjusted in "G: Ref Handling \ Motor Poten.mete".

11="AI1, AI2 min"

The smaller of Analogue Input 1 and Analogue Input 2 is used as reference.

12="AI1, AI2 max"

The greater of Analogue Input 1 and Analogue Input 2 is used as reference.

13="Max Freq" – Maximum Frequency

P2.1.2 Max Frequency is used as reference.

14="AI1/AI2 Sel" – AI1/AI2 Selection

The digital input "I/O Ref 1/2" is used to select between Analogue Input 1 and Analogue Input 2 reference. "I/O Ref 1/2" is used to select between "I/O Reference" and "I/O Reference 2" if selection of this parameter is different from 14 (this one).

15="Encoder 1"

Reference is read from encoder input 1.

16="Encoder 2"

Reference is read from encoder input 2. This selection is usable with double encoder boards. Could be utilized e.g. for speed synchronization.

17="Master Reference"

Master reference before ramp generator. When this is selected the follower drive's own ramp times are active and used.

18="Master Ramp Out"

Master reference after ramp generator, before speed controller. When this is selected the follower drive will use the ramp times defined by the master drive.

P2.11.3 Follower torque reference selection ID1083“FollowerTorq Sel”

Select the source of torque reference for the follower drive.

0=“Not Used”

1=“AI1” - Analogue Input 1.

Signal scaling in “G: Input Signals \ Analogue Input 1”

2=“AI2” - Analogue Input 2.

Signal scaling in “G: Input Signals \ Analogue Input 2”

3=“AI3”

4=“AI4”

5=“AI1 Joystick”

Analogue input 1, -10 Vdc... +10 Vdc. For joystick inputs, the maximum negative reference is the negative of “Torq Ref Max”.

6=“AI2 Joystick”

Analogue input 2, -10 Vdc... +10 Vdc For joystick inputs maximum negative reference is the negative of “Torq Ref Max”.

7=“Keypad Ref”

Torque reference from keypad R3.5

8=“Fieldbus”

Reference is taken from fieldbus. Alternative scaling can be selected in “G: Fieldbus”

9=“Master Torque”

Reference is taken from the master drive when using the Master-Follower function.

P2.11.4 Follower stop function ID1089“FollowerStopFunction”

When the follower drive does not use the Master Drive Ramp Output as reference, this parameter defines how the follower drive will stop as Run request is removed from the master drive.

0=Coasting; the follower remains in control even if master has stopped to fault.

1=Ramping; the follower remains in control even if master has stopped to fault.

2=As master; the follower behaves as master.

P2.11.5 Master Follower Brake Logic ID1326 “MF Brake Logic”

This parameter defines brake functionality when operating Master-Follower mode. This parameter is not active when follower is operating in Ramp Follower mode (i.e. Follower reference selection is “18 = Master Ramp”) or follower is a DriveSynch follower. In these cases follower brake is controlled by master drive.

Note: When follower reference selection is 17 = “Master Ref”, speed limitation function from brake control are bypassed on follower side.

0 = Master or Own

Brake is opened when master or follower brake opening conditions are met in follower drive.

1 = Own

Brake is opened when follower drive own brake opening conditions are met. Also brake is close if follower drive own conditions are met regardless of master status.

2 = Own & Master Speed Release (Default)

Brake is opened when follower drive own brake opening conditions are met. Also brake is close if follower drive own conditions are met regardless of master status.

However, Speed is not released until the drive has the feedback from the brake, actual or defined by Mechanical Brake Delay parameter and master has released speed.

When this selection is made also in Master drive, Speed is not released until master drive has the feedback from the brake actual or defined by Mechanical Brake Delay parameter also from followers.

3 = Master

Master drive is controlling follower drive brake and speed release.

P2.11.6 Master Follower mode 2 selection ID1093 “MF Mode 2”

Selects the Master-Follower mode 2 that is used when the DI is activated. When *Follower* is selected the Run Request command is monitored from the master and all other references are selectable by parameters. This parameter can be used for redundancy purposes. If drive number one is unable to be operated through a digital input drive number 2 can be selected as master.

0 = Single Drive

System bus is deactivated.

1 = Master

Drive sends control word to follower drive.

2 = Follower

Drive received control word from the master and sends some diagnostic information to the master drive.

P2.11.7 SystemBus communication fault response ID1082 “SB Comm Fault”

Defines the action when the System Bus heartbeat is missing.
The master drive sends a heartbeat signal to all follower drives and this heartbeat is sent back to the master drive.

- 0 = No response
- 1 = Warning
- 2 = Fault, stop mode after fault according to Stop function
- 3 = Fault, stop mode after fault always by coasting

P2.11.8 Systembus fault delay ID1352 “SB fault Delay”

Defines the delay before fault generation when heartbeat is missing.

P2.11.9 Follower Fault ID1536 “Follower Fault”

Defines the response in the master drive when a fault occurs in any of the follower drives. When one of the drives trips to fault the master drive will send a command to trigger the Data Logger in all the drives for diagnostic purposes.

- 0 = No response
- 1 = Warning
- 2 = Fault, stop mode after fault according to Stop function

P2.11.10 Force SB Control ID1851

When drive is set as follower this parameter can be used to force the control place to SB Master.

7.11.3.1 Drive Synch Control parameters**P2.11.11.1 DriveSynch Follower Fault ID1531 “DS Follower Fault”**

Defines the response in the Master drive when a fault occurs in any of the follower drives. When one of the drives trips to fault, the master drive will send a command to trigger the Data Logger in all the drives for diagnostic purposes.

- 0 = No response
- 1 = Warning
- 2 = Fault, stop mode after fault according to Stop function

P2.11.11.2 Follower drive winding phase shift ID1518 “FollPhaseShift”

Windings phase shift between the master and follower drive. Used with drive synch operation when the motor has multiple windings.

P2.11.11.3 DC Voltage balancing gain ID519 “DCVoltageBalGain”

Multiple wind motor option. Contact the factory before changing this value.

7.12 Protections

7.12.1 General settings

P2.12.1.1 Input phase supervision**ID730 "Input Ph. Superv"**

Defines the response when the drive notices that one of the input phases is missing.

0 = No response

1 = Warning

2 = Fault, stop mode after fault according to Stop Function

3 = Fault, stop mode after fault always by coasting

P2.12.1.2 Response to undervoltage fault**ID727 "UVolt Fault Resp"**

In some applications it is normal that the drive will be powered down when in run state. With this parameter it is possible to choose whether undervoltage faults are stored to the fault history of the drive.

0 = Fault stored in fault history

1 = Fault not stored in fault history

Undervoltage fault limits:

500 V units: 333 Vdc

690 V units: 460 Vdc

P2.12.1.3 Output phase supervision**ID702 "OutputPh. Superv"**

Output phase supervision of the motor ensures that the motor phases have an approximately equal current.

0 = No response

1 = Warning

2 = Fault, stop mode after fault according to Stop Function

3 = Fault, stop mode after fault always by coasting

P2.12.1.4 Response to slot fault ID734 "SlotComFaultResp"

Set here the response mode for a board slot fault due to a missing or broken board.

0 = No response

1 = Warning

2 = Fault, stop mode after fault according to Stop Function

3 = Fault, stop mode after fault always by coasting

P2.12.1.5 Safe Torque Off (STO) mode ID755 "SafeDisableResp."

With this parameter it is possible to choose whether the STO signal is handled as fault or warning. The STO input will stop the drive from modulating regardless of this parameter value.

7.12.2 Temperature sensor protections

The temperature protection function is used to measure temperatures and issue warnings and/or faults when the set limits are exceeded. The Brake Control application supports two OPTBH and OPTB8 board simultaneously. One can be used for the motor winding and one for the motor bearings.

P2.12.2.1 Number of used inputs in board 1 **ID739 “Board1 Channels”**

Select used temperature sensor combination with this parameter. See also the VACON® I/O boards manual.

- 0** = Not used (ID Write, value of maximum temperature can be written from fieldbus)
- 1** = Sensor 1 in use
- 2** = Sensor 1 & 2 in use
- 3** = Sensor 1 & 2 & 3 in use
- 4** = Sensor 2 & 3 in use
- 5** = Sensor 3 in use

Note: If the selected value is greater than the actual number of used sensor inputs, the display will read 200°C. If the input is short-circuited the displayed value is -30°C.

P2.12.2.2 Board 1 Temperature response **ID740 “Board1 Response”**

- 0** = No response
- 1** = Warning
- 2** = Fault, stop mode after fault according to Stop Function
- 3** = Fault, stop mode after fault always by coasting

P2.12.2.3 Board 1 warning limit **ID741 “Board1Warn.Limit”**

Set here the limit at which the PT100 warning will be activated. When individual warning and fault limits are activated this is first board first channel (1A).

P2.12.2.5 Board fault limit **ID742 “Board1 Fault Lim.”**

Set here the limit at which the PT100 fault (F56) will be activated. When individual warning and fault limits are activated this is first board first channel (1A).

P2.12.2.5 Number of used inputs in board 2 **ID743 “Board2 Channels”**

If you have two temperature sensor boards installed in your AC drive you can choose here the combination inputs in use in the second board. See also the VACON® I/O boards manual.

- 0** = Not used (ID Write, value of maximum temperature can be written from fieldbus)
- 1** = Sensor 1 in use
- 2** = Sensor 1 & 2 in use
- 3** = Sensor 1 & 2 & 3 in use
- 4** = Sensor 2 & 3 in use
- 5** = Sensor 3 in use

P2.12.2.6 Board 2 Temperature response ID766 "Board2 Response"

- 0 = No response
- 1 = Warning
- 2 = Fault, stop mode after fault according to Stop Function
- 3 = Fault, stop mode after fault always by coasting

P2.12.2.7 Board 2 warning limit ID745 "Board2 Warn. Lim"

Set here the limit at which the second temperature sensor board warning will be activated. When individual warning and fault limits are activated this is second board first channel (2A).

P2.12.2.8 Board2 fault limit ID746 "Board2 FaultLim"

Set here the limit at which the second temperature sensor board fault (F61) will be activated. When individual warning and fault limits are activated this is second board first channel (2A).

7.12.2.1 Individual channel monitoring

Individual channel monitoring is activated by setting one of the warning limits (per board) different than zero. Common limits in above parameters will be channel A warning and fault limits. Channel B and C limits are set with below parameters.

P2.12.2.9.1 Channel 1B Warn ID764**P2.12.2.9.2 Channel 1B Fault ID765**

First board second (1B) channel warning and fault limits.

P2.12.2.9.3 Channel 1C Warn ID768**P2.12.2.9.4 Channel 1C Fault ID769**

First board third (1C) channel warning and fault limits.

P2.12.2.9.5 Channel 2B Warn ID770**P2.12.2.9.6 Channel 2B Fault ID771**

Second board second (2B) channel warning and fault limits.

P2.12.2.9.7 Channel 2C Warn ID772**P2.12.2.9.8 Channel 2C Fault ID773**

Second board third (2C) channel warning and fault limits.

7.12.3 Stall protection

The motor stall protection protects the motor from short time overload situations such as one caused by a stalled shaft. The reaction time of the stall protection can be set shorter than that of the motor thermal protection. The stall state is defined with two parameters, Stall current and Stall frequency limit. If the current is higher than the set limit and the output frequency is lower than the set limit, the stall state is true. There is actually no real indication of the shaft rotation. Stall protection is a kind of overcurrent protection.

P2.12.3.1 Stall protection ID709 “Stall Protection”

- 0 = No response
- 1 = Warning
- 2 = Fault, stop mode after fault according to Stop Function
- 3 = Fault, stop mode after fault always by coasting

P2.12.3.2 Stall current limit ID710 “Stall Current”

The current can be set to $0 \dots 2 \cdot I_H$. For a stall stage to occur, the current must have exceeded this limit. The software does not allow entering a greater value than $2 \cdot I_H$. If the motor current limit is changed this parameter is automatically recalculated to the value 90% of motor current limit.

Note: This limit must be set below the current limit in order for this function to operate.

P2.12.3.3 Stall frequency limit ID712 “Stall Freq Lim”

The frequency can be set between $1 - f_{\max}$ (Max Frequency).

For a stall state to occur, the output frequency must have remained below this limit for a certain time. This function requires that the output frequency is 1 Hz below the frequency reference before the stall time count is started.

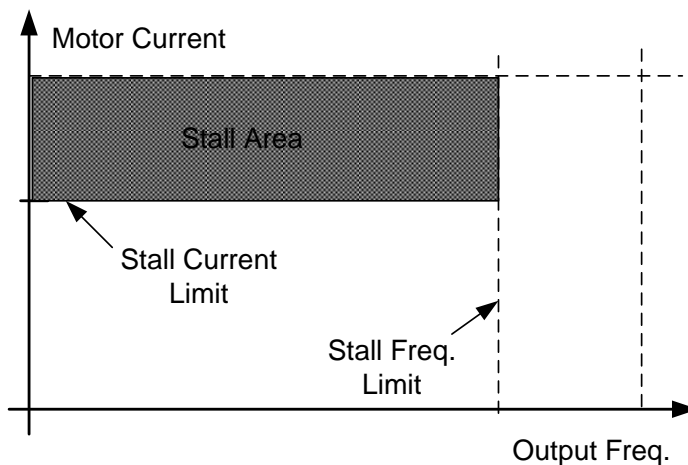

P2.12.3.4 Stall time **ID711 “Stall Time Lim”**

This is the maximum time allowed for a stall stage. The stall time is counted by an internal up/down counter. If the stall time counter value goes above this limit the protection will cause a trip.

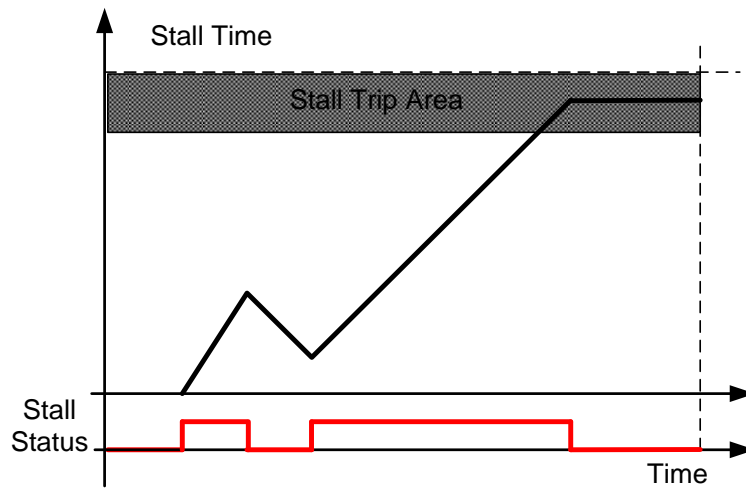

7.12.4 Speed Error

The Speed error monitoring function compares the encoder frequency and the ramp generator output. The function is used with a PMS motor to detect if the motor is off synchronization or to disable the open loop function using the encoder speed for slip compensation. The slip compensation is disabled regardless of the response and needs to be re-activated once a speed error is detected (set parameter again or power down the drive).

P2.12.4.1 Speed error fault function ID752 “Speed Error Mode”

Defines the fault function when the speed reference and the encoder speed are above the set limits.

0 = No response

1 = Warning

2 = Fault, stop mode after fault always by coasting

P2.12.4.2 Speed error maximum difference ID753 “SpeedErrorLimit”

Defines the limit when fault situation is noted. The difference between the speed reference and the encoder speed. Percentage value is in relation to motor nominal frequency.

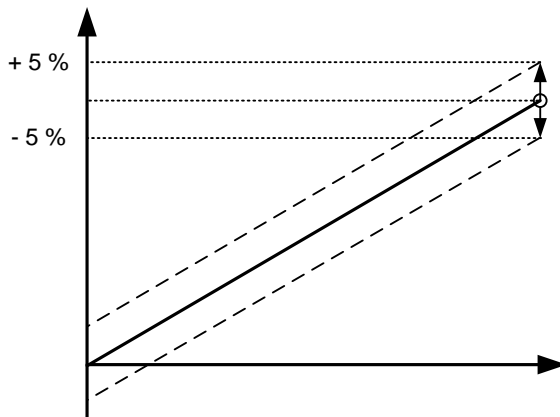

P2.12.4.3 Speed error delay ID754 “Speed Fault Delay”

Defines the delay after which a speed error is considered as a fault.

When used to disable open loop slip compensation based on encoder frequency it is recommended to set this time to zero to avoid a speed jump at the time of encoder malfunction.

P2.12.4.4 Over Speed Limit ID1812 “Over Speed Limit”

Defines hysteresis for ID1286 and ID1285 Positive and Negative Frequency limits when Speed Error response is activated. Setting value to zero disables over speed protection.

7.12.5 Motor Protection

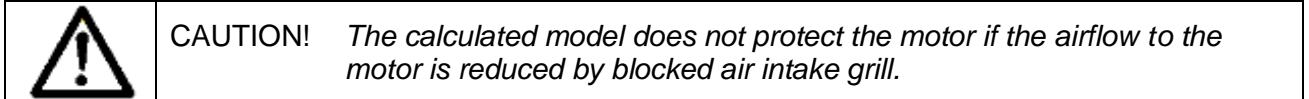

The motor thermal protection is to protect the motor from overheating. The drive is capable of supplying higher than nominal current to the motor. If the load requires this high current there is a risk that the motor will be thermally overloaded. This is the case especially at low frequencies. At low frequencies the cooling effect of the motor is reduced as well as its capacity. If the motor is equipped with an external fan the load reduction at low speeds is small.

The motor thermal protection is based on a calculated model and it uses the output current of the drive to determine the load on the motor.

The motor thermal protection can be adjusted with parameters. The thermal current I_T specifies the load current above which the motor is overloaded. This current limit is a function of the output frequency.

P2.12.5.1 Motor thermal protection response ID704 "Motor Therm Prot"

Defines the response when the calculated temperature of the motor has reached 105% (monitoring signal).

0 = No response

1 = Warning

2 = Fault, stop mode after fault according to Stop Function

3 = Fault, stop mode after fault always by coasting

P2.12.5.2 Motor ambient temp. factor ID705 "MotAmbTempFactor"

Defines the temperature factor for conditions where the motor is located. The factor can be set between -100.0%–100.0%.

-100.0% = 0°C

0.0% = 40°C

100.0% = 80°C

P2.12.5.3 Motor cooling factor at zero speed ID706 "MTP f0 Current"

Defines the cooling factor at zero speed in relation to the point where the motor is running at nominal speed without external cooling.

The default value is set assuming that there is no external fan cooling the motor. If an external fan is used this parameter can be set to 90% (or even higher).

Note: The value is set as a percentage of the motor name plate data, (Nominal current of motor), not the drive's nominal output current. The motor's nominal current is the current that the motor can withstand in direct on-line use without being overheated.

Setting this parameter does not affect the maximum output current of the drive which is determined by parameter Motor Current Limit alone.

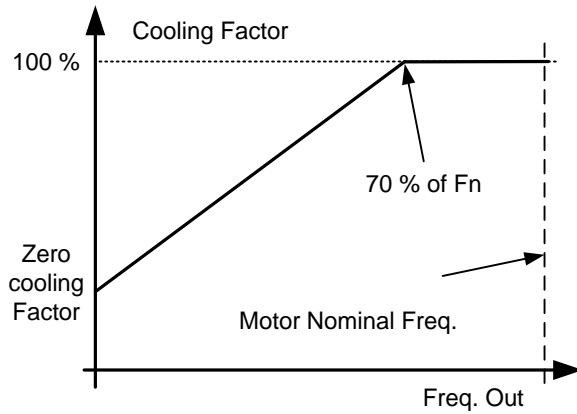

P2.12.5.5 Motor thermal protection: Time constant ID707 “MTP Motor T”

This time can be set between 1 and 200 minutes.

This is the thermal time constant of the motor. The bigger the motor, the bigger the time constant. The time constant is the time within which the calculated thermal stage has reached 63% of its final value.

The motor thermal time is specific to motor design and it varies between different motor manufacturers. The default value changes between unit sizes.

If the motor's t6–time (t6 is the time in seconds the motor can safely operate at six times the rated current) is known (given by the motor manufacturer) the time constant parameter can be set basing on it. As a rule of thumb, the motor thermal time constant in minutes equals to 2xt6. If the drive is in stop stage the time constant is internally increased to three times the set parameter value. The cooling in the stop stage is based on convection and the time constant is increased.

P2.12.5.5 Motor thermal protection: Motor duty cycle ID708 “Motor Duty Cycle”

The value can be set to 0%...150%.

When you set the value to 130%, the motor calculated temperature will reach nominal temperature with 130% of motor nominal current.

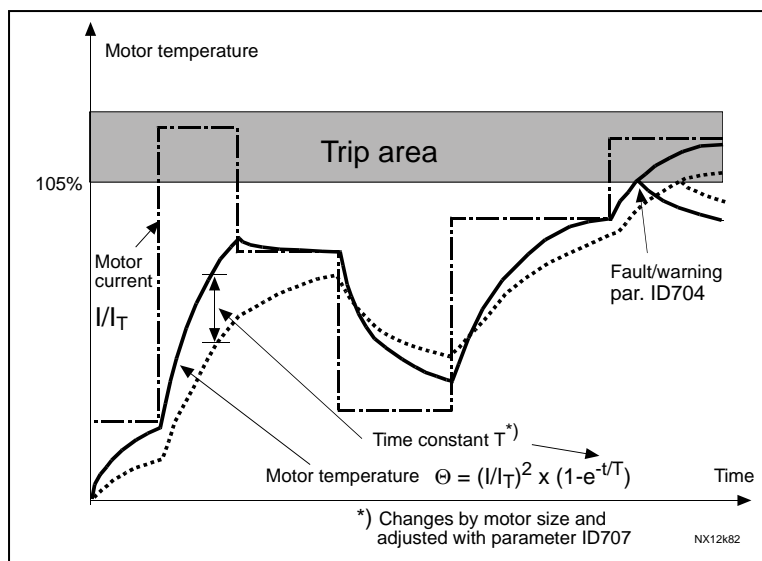

Figure 7-17. Motor temperature calculation

P2.12.5.6 Response to thermistor fault ID732 “ThermistF.Resp”

0 = No response

1 = Warning

2 = Fault, stop mode after fault according to [ID506](#)

3 = Fault, stop mode after fault always by coasting

Setting the parameter to **0** will deactivate the protection.

7.12.6 Over Load Protection

With this function it is possible to select if Current, Torque or Power is used for overload protection.

Overload is based on internal counter that is increased when the input value is above 105% level and decreased when below 105% level. The increase and decrease occurs every 100 ms. Tripping occurs when overload counter value is over 10,000.

With parameters, you can be define the amount of increase (Overload maximum step) at maximum defined input level (Overload Maximum Input). These points define the slope for the function. For example, if the input value is in the middle of 105% and Overload Maximum Input values, the counter is increased by half of the Over Load Maximum step.

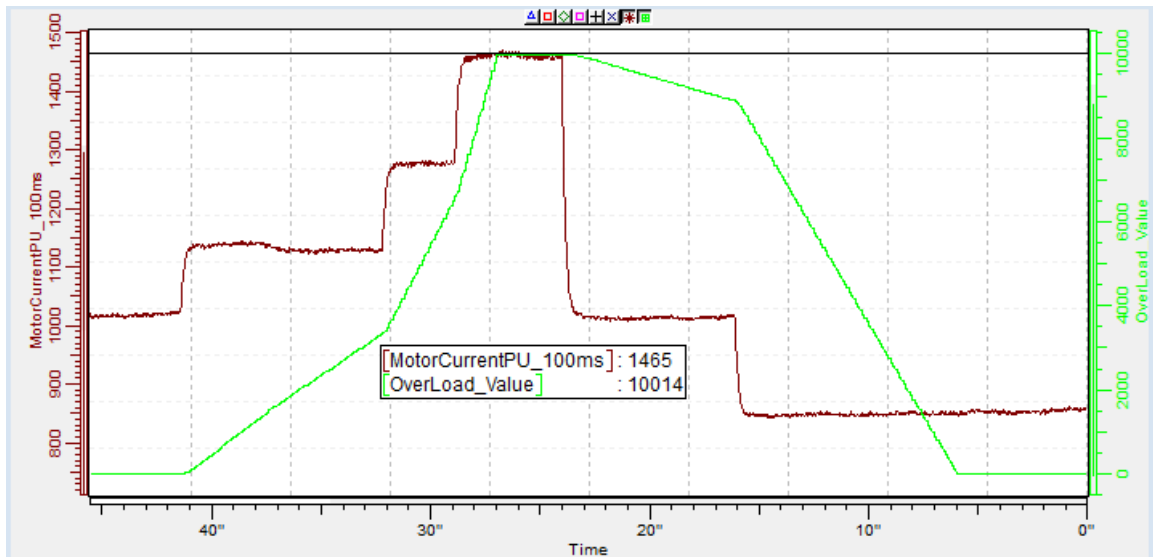

2.12.5.7 Response to over load ID1838 “OverLoadResponse”

- 0 = No response
- 1 = Warning
- 2 = Fault

2.12.5.8 Over Load Signal ID1837 “OverLoadSignal”

- 0 = Not Used
- 1 = Output Current (FW: MotorCurrentPU_100ms)
- 2 = Motor Torque
- 3 = Motor Power

2.12.5.9 Over Load Maximum Input ID1839 “OverLoadMaxIN”

Input value level where over load counter is increased with maximum step defined by P2.12.5.10.

2.12.5.10 Over Load Maximum Step ID1840 “OverLoadMaxStep”

Step in the over load counter when input value is at maximum input level defined by P2.12.5.9.

7.12.7 4mA Protection

The 4 mA protection monitors the analogue input signal level from Analogue input 1 and Analogue input 2.

The monitoring function is active when signal range 4 mA–20 mA is selected. A fault or warning is generated when the signal falls below 3.5 mA for 5 seconds or below 0.5 mA for 0.5 seconds.

P2.12.6.1 Response to the 4mA reference fault ID700 “4mA Input Fault”

0 = No response

1 = Warning

2 = Warning, the frequency from 10 seconds back is set as reference

3 = Warning, the Preset Frequency is set as reference

4 = Fault, stop mode after fault according to Stop Function

5 = Fault, stop mode after fault always by coasting

P2.12.6.2 4mA reference fault: preset frequency reference ID728 “4mA Fault Freq.”

If value 3 in parameter P2.12.6.1 is selected and a fault occurs the frequency reference to the motor is the value of this parameter.

7.12.8 Underload protection

The purpose of the motor underload protection is to ensure that there is load on the motor when the drive is running. If the motor loses its load there might be a problem in the process, e.g. a broken belt or a dry pump.

The underload curve is a squared curve set between the zero frequency and the field weakening point. The protection is not active below 5 Hz (the underload time counter is stopped).

The torque values for setting the underload curve are set in percent which refers to the nominal torque of the motor. The motor's name plate data, parameter motor nominal current and the drive's nominal current I_H are used to find the scaling ratio for the internal torque value.

P2.12.7.1 Underload protection ID713 "Underload Protec"

- 0 = No response
- 1 = Warning
- 2 = Fault, stop mode after fault according to Stop Function
- 3 = Fault, stop mode after fault always by coasting

If tripping is set active the drive will stop and activate the fault stage.

Deactivating the protection by setting the parameter to 0 will reset the underload time counter to zero.

P2.12.7.2 Underload protection, zero frequency load ID715 "UP F0 Torque"

The torque limit can be set between 5.0–150.0% x T_{nMotor} .

This parameter gives the value for the minimum torque allowed with zero frequency.

P2.12.7.3 Underload protection, field weakening area load ID714 "UP fnom Torque"

The torque limit can be set between 10.0–150.0% x T_{nMotor} .

This parameter gives the value for the minimum torque allowed when the output frequency is above the field weakening point.

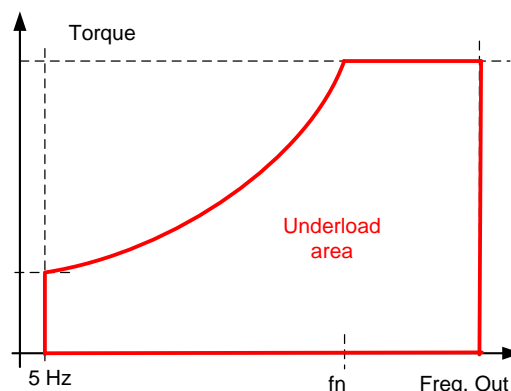

P2.12.7.4 Underload time ID716 "UP Time Limit"

This time can be set between 2.0 and 600.0 s.

This is the maximum time allowed for an underload state to exist. An internal up/down counter counts the accumulated underload time. If the underload counter value goes above this limit the protection will cause a trip according to parameter Underload Protection.

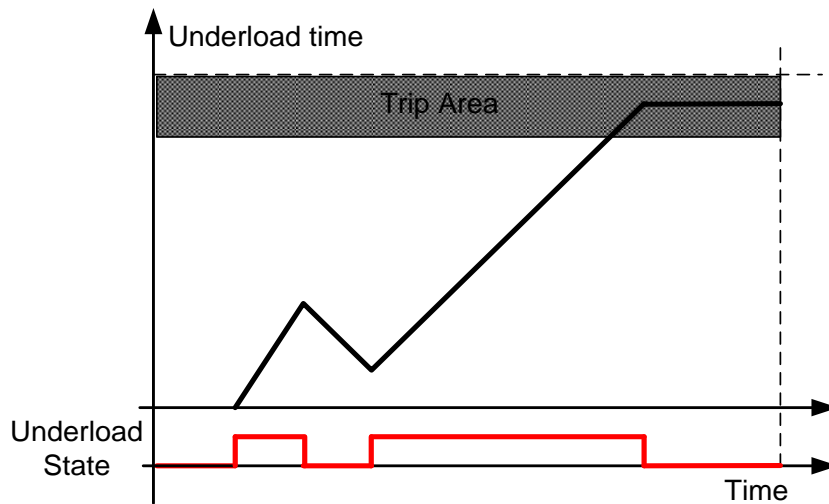

7.12.9 Earth Fault

The earth fault protection ensures that the sum of the motor phase currents is zero. The overcurrent protection is always working and protects the AC drive from earth faults with high currents.

P2.12.8.1 Earth fault protection ID703 “Earth fault”

- 0** = No response
- 1** = Warning
- 2** = Fault, stop mode after fault according to Stop Function
- 3** = Fault, stop mode after fault always by coasting

P2.12.8.2 Earth fault current limit ID1333 “EarthFaultCurLim”

Maximum level for Earth current in % of the unit nominal current.

7.12.10 Cooling protection

Protection for liquid cooled units. An external sensor is connected to the drive (DI: Cooling Monitor) to indicate if cooling liquid is circulating.

P2.12.9.1 Cooling fault delay ID751 “Cooling F Delay”

This parameter defines the delay after which the drive goes to fault state when ‘Cooling OK’ signal is missing.

P2.12.9.2 Cooling fault response ID762 “CoolingFaultREsp”

In some cases it is more important to allow the drive to run even if the cooling liquid is not circulating. Then it is possible to select warning as the response. The drive will then continue running until its internal protection will stop it. If cooling signal loss happens on stop state indication is not stored to fault history if previous fault is already Cooling Fault. In Run State indication is always stored to fault history.

- 0** = Stop State: No Action, Run State: Warning
- 1** = Stop State: Warning, Run State: Warning
- 2** = Stop State: Warning, Run State: Fault
- 3** = Stop State: No Action, Run State: Fault

7.12.11 Fieldbus communication

P2.12.10.1 Response to fieldbus fault ID733 "FBComm.FaultResp"

Set here the response for a fieldbus fault if the active control place is fieldbus. For more information, see the respective fieldbus board manual.

0 = No response

1 = Warning

2 = Fault, stop mode after fault according to Stop Function

3 = Fault, stop mode after fault always by coasting

4 = Warning, Previous frequency. Forced fault after delay. Only for Profibus communication.

5 = Quick Stop, Action defined by P2.3.12.1 Quick Stop Mode is taken.

P2.12.10.2 Fieldbus fault delay ID1850 "FB Fault Delay"

This parameter defines for how long the drive will stay in run state after the communication has been lost if fault response is set to 4 / Warning, previous frequency. If time is set to zero drive will remain running until communication is established and stop command is given.

P2.12.10.3 Fieldbus Watch Dog delay ID1354 "FB WD Delay"

Defines delay when fault is generated when watch dog pulse is missing from fieldbus. Set the time to zero to disable watchdog monitoring.

7.12.12 External Fault function

P2.12.11.1 Response to external fault ID701 "External Fault 1"

P2.12.11.2 Response to external fault ID747 "External Fault 2"

Defines the response to a digital input signal informing about an external condition where the drive needs to react to. The external warning/fault indication can be connected to a digital output.

0 = No response

1 = Warning

2 = Fault, stop mode after fault according to Stop Function

3 = Fault, stop mode after fault always by coasting

7.12.13 Encoder Fault function

Encoder supervision gives fault in case there are no pulses from encoder. Requirement is that reference is above 1 Hz and torque can reach 100% level. This torque level can be adjusted by Iq Fault limit parameter. This limit may need adjustment when torque limit is below 100%. Alternative method to detect encoder fault is Speed Error detection.

P2.12.12.1 Encoder Supervision fault response

Do not select 3 while drive is in run state.

1 = Warning

2 = Fault

3 = Warning; Change to Open Loop

This selection changes operation mode to Open Loop Sensorless when encoder fault is detected.

Note: It's recommended to activate I/f start when this is selection is used and speed remains long period of times in zero speed area.

P2.12.12.1 Encoder Fast Hz Limit ID1801

Frequency limit where detection is made using fast detection.

P2.12.12.2 Fast Time Limit ID1805

Delay to encoder fault when fault happens above Encoder Fast Hz Limit.

P2.12.12.3 Iq Fault Limit ID1800

This defined Iq current limit what must be exceeded before situation is determine to be encoder fault is pulses are missing from encoder at the same time.

P2.12.13 Disable Stop Lock ID1086

Some parameters are locked during the Run state, with this parameter it's possible to bypass this Run State parameter lock. Be careful what you change and how big change you make to those parameters.

P2.12.14 Reset Datalogger ID1857

0 = Auto

Datalogger signals will changed based on motor control mode automatically.

Setting datalogger from NCDrive will disable signal change automatically, to reactivate automatic change set this parameter to 1.

1 = Reset to Auto

When datalogger signals has been changed in NCDrive use this to set datalogger back to Auto mode.

2 = SW Default

System software default are activated and mode changes automatically to 4.

3 = Auto Fast

Same as selection 0 but signals are recorded at fast time level. This selection will increase system load.

4 = No Change

Application will not make changes to signal.

P2.12.15 LDL License ID1993

Enter license to activate Long DataLogger.

7.13 Fieldbus settings

7.13.1 General settings

P2.13.1 Fieldbus reference minimum scaling ID850 "FB Min Scale"

P2.13.2 Fieldbus reference maximum scaling ID851 "FB Max Scale"

Use these two parameters to scale the fieldbus reference signal.

If both parameters have the same value the minimum and maximum frequency limits are used for scaling.

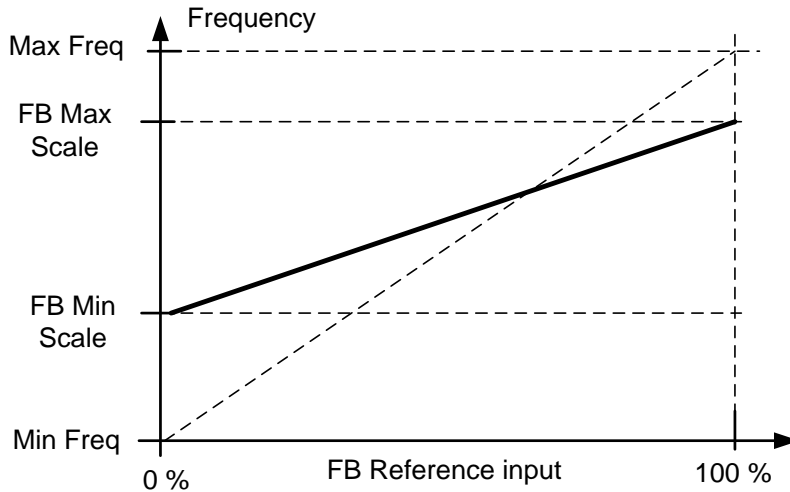

Using this custom scaling function also affects the scaling of the actual value.

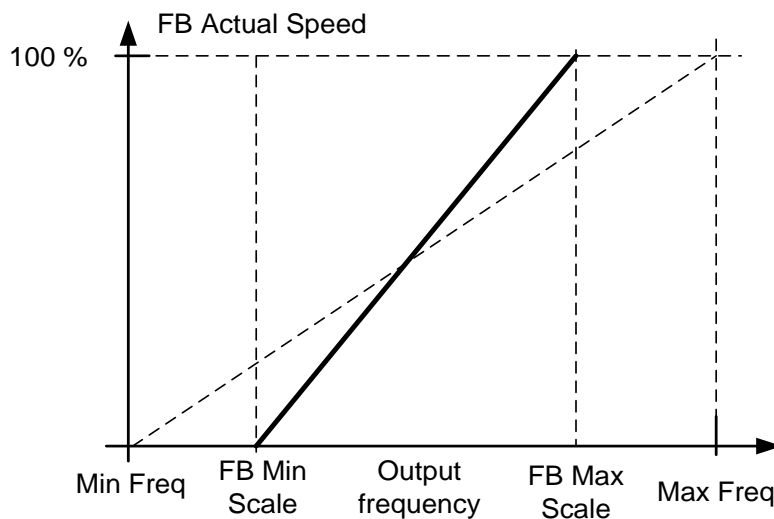

P2.13.3 to**P2.13.10 Fieldbus data out selections 1 to 8 ID852-ID859 “FB Data OutX Sel”**

Using these parameters, you can monitor any monitoring or parameter value from the fieldbus. Enter the ID number of the item you wish to monitor for the value of these parameters. See monitoring signals for full details of ID numbers.

Default settings:

Data	Value	Unit	Scale	ID
Status Word	Main Status Word			
FB General Status Word	MCStatus			64
FB Actual Speed	Actual Speed	%	0.01 %	
Process data OUT 1	Output Frequency	Hz	0.01 Hz	1
Process data OUT 2	Motor Speed	rpm	1 rpm	2
Process data OUT 3	Motor Current	A	0.1 A	45
Process data OUT 4	Motor Torque	%	0.1 %	4
Process data OUT 5	Motor Power	%	0.1 %	5
Process data OUT 6	Motor Voltage	V	0.1 V	6
Process data OUT 7	DC link voltage	V	1 V	7
Process data OUT 8	Active Fault Code	-	-	37

P2.13.11 to**P2.13.18 Fieldbus data IN selections 1 to 8 ID876-833 “FB Data In X Sel”**

Using these parameters, you can control any monitoring or parameter value from the fieldbus. Enter the ID number of the item you wish to control for the value of these parameters. Monitoring signals that can be controlled from fieldbus are shadowed.

Default settings:

Data	Value	Unit	Scale	ID
Reference	Speed Reference	%	0.01%	-
Control Word	Main Control Word	-	-	-
Control Word 2	General Control Word			
Process Data IN1	Torque Reference	%	0.1%	1140
Process Data IN2	Free Analogue INPUT	%	0.01%	46
Process Data IN3	Adjust Input	%	0.01%	47
Process Data IN4	FB Analogue Output	%	0.01%	48
PD4 – PD8	Not Used	-	-	-

P2.13.19 Fieldbus General Status Word ID ID897 “GSW ID”

With this parameter it is possible to select which data are sent in FBGeneralStatusWord (see for details and availability in used fieldbus manual).

P2.13.20 FB Actual Speed ID1741 "FBActualsSpeed"

With this it is possible to select which Actual speed is shown on the fieldbus.

0 = Calculated

This selection shows what the ramp generator output is.

Open Loop

In frequency control mode when only the ramp output is shown on the fieldbus and, therefore, the motor slip or any other changes of speed due to load changes are not visible in the actual speed value. However, limiting functions are visible in the ramp output.

Closed Loop

In closed loop control, the limiting functions take place after ramp generator. When speed is limited by e.g. motoring torque limit the actual shaft speed may be lower even if FB Actual Speed shows that speed is at reference.

1 = Actual

Open Loop

Motor speed is a calculated value (Monitoring variable Motor Speed) showing the load effect on the speed and slip compensation.

Closed Loop

Motor speed is taken from the actual encoder signal showing the real speed all the time.

P2.13.21 Control Slot selector ID1440 "ControlSlotSel."

This parameter defines which slot is used as the main control place when two fieldbus boards have been installed in the drive. When values 6 or 7 are selected, the drive uses the Fast Profibus profile. When the Fast Profibus profile is used type 'B' boards or other C type boards cannot be used. When values 8 or 9 are selected the drive can use 16 process data variables if the used Fieldbus-board hardware and firmware support it. See the Fieldbus-board manual for further details.

Note: Set first the Slave Address and the PPO type before selecting the Fast Profibus mode.

0 = All slots

4 = Slot D, Normal (8 process data variables)

5 = Slot E, Normal (8 process data variables)

6 = Slot D, Fast Profibus support

7 = Slot E, Fast Profibus support

8 = Slot D, Extended (16 process data variables)

9 = Slot E, Extended (16 process data variables)

P2.13.22 State Machine

Application has possibility to select what kind of state machine is used.

1: Standard

This mode makes fieldbus control behave as in explained in used fieldbus board manual.

2: ProfiDrive

This mode uses ProfiDrive type state machine in application level. This mode is possible to use on fieldbus boards that does not have state machine itself or has possibility to bypass state machine functionality in option board.

See chapter 9: Status and Control Word in detail

P2.13.23 Fieldbus Custom Minimum ID898 “FB Custom Min”

P2.13.24 Fieldbus Custom Maximum ID899 “FB Custom Max”

With these parameters it is possible to define fieldbus reference input values scaling. default is 0...10000 (0...100%)

P2.13.25 to

P2.13.32 Fieldbus data OUT selections 9 to 16 ID558-565 “FB Data OutXSel”

With these parameters, you can monitor any monitoring or parameter value from the fieldbus. Enter the ID number of the item you wish to monitor for the value of these parameters. See monitoring signals for full details of ID numbers.

Note that these parameters are visible only if a Fieldbus board with support for 16 process data variables is inserted in slots D or E. By default, these parameters are not used.

P2.13.33 to

P2.13.40 Fieldbus data IN selections 9 to 16 ID550-557 “FB Data InX Sel”

With these parameters, you can control any monitoring or parameter value from the fieldbus. Enter the ID number of the item you wish to control for the value of these parameters. Monitoring signals that can be controlled from fieldbus are shadowed.

Note that these parameters are visible only if a Fieldbus board with support for 16 process data variables is inserted in slots D or E. By default, these parameters are not used.

7.14 ID Functions

Listed here are the functions that use the parameter ID number to control and monitor the signal.

7.14.1 Value Control

The value control parameters are used to control an input signal parameter.

P2.14.1.1 Control Input Signal ID ID1580 “ContrInSignal ID”

With this parameter you can select what signal is used to control selected parameter.

P2.14.1.2 Control Off Limit ID1581 “Contrl Off Limit”

This parameter defines the limit when the selected parameter value is forced to Off value.

P2.14.1.3 Control On Limit ID1582 “Contrl On Limit”

This parameter defines the limit when the selected parameter value is forced to On value.

P2.14.1.4 Control Off Value ID1583 “Contrl Off Value”

This parameter defines the value that is used when the used input signal is below Off limit.

P2.14.1.5 Control On Value ID1584 “Contrl On Value”

This parameter defines the value that is used when the used input signal is above On limit.

P2.14.1.6 Control Output Signal ID ID1585 “ContrlOutSignID”

This parameter defines which parameter is forced to On and Off values when selected input signal exceeds the set limits.

P2.14.1.7 Control Mode ID1586 “Control Mode”

This parameter defines how the value control output behaves.

0 = SR ABS

Absolute input value is used to make a step change in the output between On and Off values.

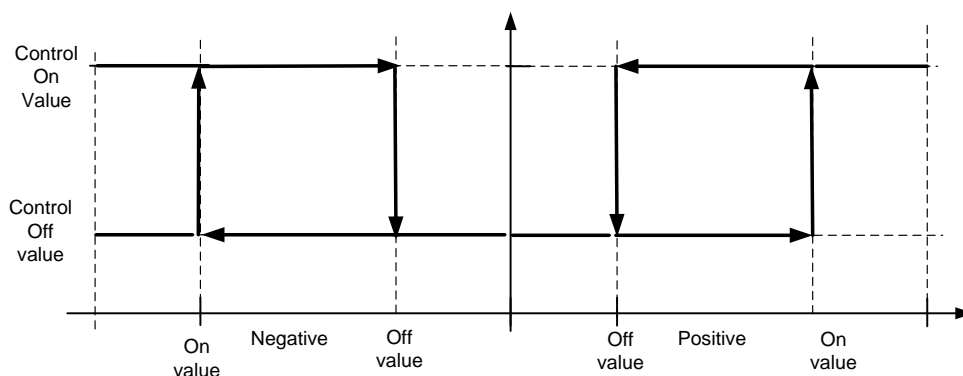

1 = Scale ABS

Absolute input value is scaled linearly between On and Off values.

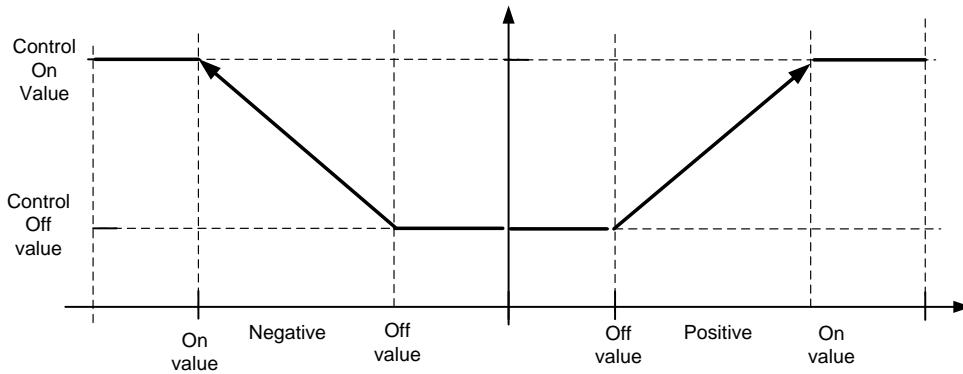

2 = Scale ABS Inverted

Inverted absolute value is scaled linearly between On and Off values.

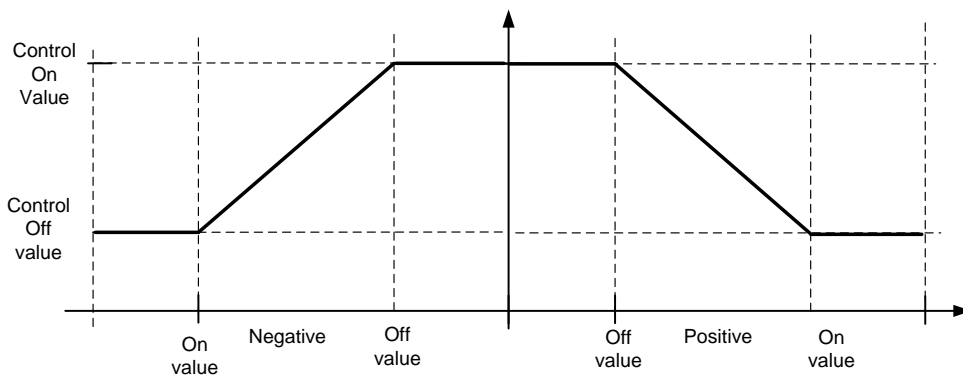

3 = SR

Input value is used to make a step change in the output between On and Off values.

4 = Scale

Input value is scaled linearly between On and Off values.

5 = Scale Inverted

Inverted value is scaled linearly between On and Off values.

P2.14.1.8 Control Signal Filtering TC ID1586 "Control Filt TC"

This parameter is used to filter the scaling function output. Used e.g. when unfiltered torque is used to control a parameter that needs stabilization.

7.14.2 DIN ID Control

This function is used to control any parameter between two different values with a digital input. Different values are given for DI 'low' and DI 'high'.

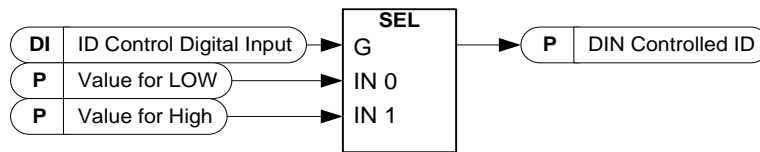

P2.14.2.1 ID Control Digital Input ID1570 **“ID Control DIN”**

P2.14.3.1 ID Control Digital Input ID1590 **“ID Control DIN”**

P2.14.4.1 ID Control Digital Input ID1578 **“ID Control DIN”**

Select digital input to be used for controlling the parameter selected by ID1571, ID1575 and 1579.

P2.14.2.2 DIN Controlled ID ID1571 **“Controlled ID”**

P2.14.3.2 DIN Controlled ID ID1575 **“Controlled ID”**

P2.14.4.2 DIN Controlled ID ID1579 **“Controlled ID”**

Select parameter ID controlled by ID1570.

P2.14.2.3 Value for Low digital input (FALSE) ID1572 **“FALSE Value”**

P2.14.3.3 Value for Low digital input (FALSE) ID1592 **“FALSE Value”**

P2.14.4.3 Value for Low digital input (FALSE) ID1594 **“FALSE Value”**

Set here the controlled parameter value when the digital input (ID1570) is LOW for the parameter selected by ID1571. The function does not recognize decimals. Give, therefore, e.g. 10.00 Hz as ‘1000’.

P2.14.2.4 Value for High digital input (TRUE) ID1573 **“TRUE Value”**

P2.14.3.4 Value for High digital input (TRUE) ID1593 **“TRUE Value”**

P2.14.4.4 Value for High digital input (TRUE) ID1596 **“TRUE Value”**

Set here the controlled parameter value when the digital input (ID1570) is HIGH for the parameter selected by ID1571. The function does not recognize decimals. Give, therefore, e.g. 10.00 Hz as ‘1000’.

7.14.3 ID-controlled DO

This function is used to control any Digital output by any status that can be presented as bit. The input signal is selected with the ID number and bit number.

Example: Most of the faults and warnings are normally presented in the common digital output. With the ID-controlled DO function, it is possible to select a specific fault to be connected to the digital output.

Warning Word 1 ID1174		
	Fault	Comment
b0	Motor stalled	W15
b1	Motor over temperature	W16
b2	Motor under load	W17
b3	Input phase loss	W10
b4	Output phase loss	W11
b5	Safe disable	W30 (Not implemented)
b6	FieldBus communication fault in slot D	W53 (Not implemented)
b7	FieldBus communication fault in slot E	W67 (Not implemented)
b8	Drive over temperature	W14
b9	Analogue input < 4mA	W50
b10	Not used	
b11	Emergency stop	W63 (Not implemented)
b12	Run disabled	W62 (Not implemented)
b13	Not used	
b14	Mechanical Brake	W58
b15	Not used	

P2.14.5.1 ID.Bit Free Digital output control 1 ID1216 “ID.Bit Free DO1”

P2.14.6.1 ID.Bit Free Digital output control 2 ID1386 “ID.Bit Free DO2”

Select the signal for controlling the DO. The parameter has to be set in format xxxx.yy where xxxx is the ID number of a signal and yy is the bit number. For example, the value for DO control is 1174.02. 1174 is the ID number of Warning Word 1. So the digital output is ON when bit number 02 of the warning word (ID no. 1174) i.e. *Motor underload* is high.

P2.14.5.2 Free Digital Output selector ID1574 “Free DO1 Sel.”

P2.14.6.2 Free Digital Output selector ID1325 “Free DO2 Sel.”

Select the output terminal to be controlled with the parameter ID.bit Free Digital output control.

7.14.4 Free DIN Delay

This function is used when certain DIN signal needs On or Off delay before actual command is given. For example, Reading from DIN Status Word: DIN1 status giving it a 1.00 s delay and then writing it by ID number to ID403 Start 1, thus giving 1 second delay to start on drive side.

P2.14.7.1 ID.Bit Free Digital input delay ID1832 “ID.Bit Free DIN”

Select digital input from DIN Status Word to be delayed.

P2.14.7.2 On Delay ID1833 “On Delay”

This defines ON delay for the input signal.

P2.14.7.3 Off Delay ID1834 “Off Delay”

This defines OFF delay for the input signal.

P2.14.7.4 Mono Time ID1836 “Mono Time”

This timer makes a pulse that last defined time. Pulse will start after On Delay time.

P2.14.7.5 Control Out ID ID1835 “Control Out ID”

Select the signal ID to be controlled by input signal. If inversion or parameter value other than zero and one is needed this can be connected to DIN ID Control function ID1570, ID1590 or 1578 where desired values can be set and connected to correct parameter.

7.15 Brake Control

The mechanical brake control has two parts that need to be synchronically controlled. The first part is the *mechanical brake release* and the second is the *speed reference release*.

Conditions to open the brake:

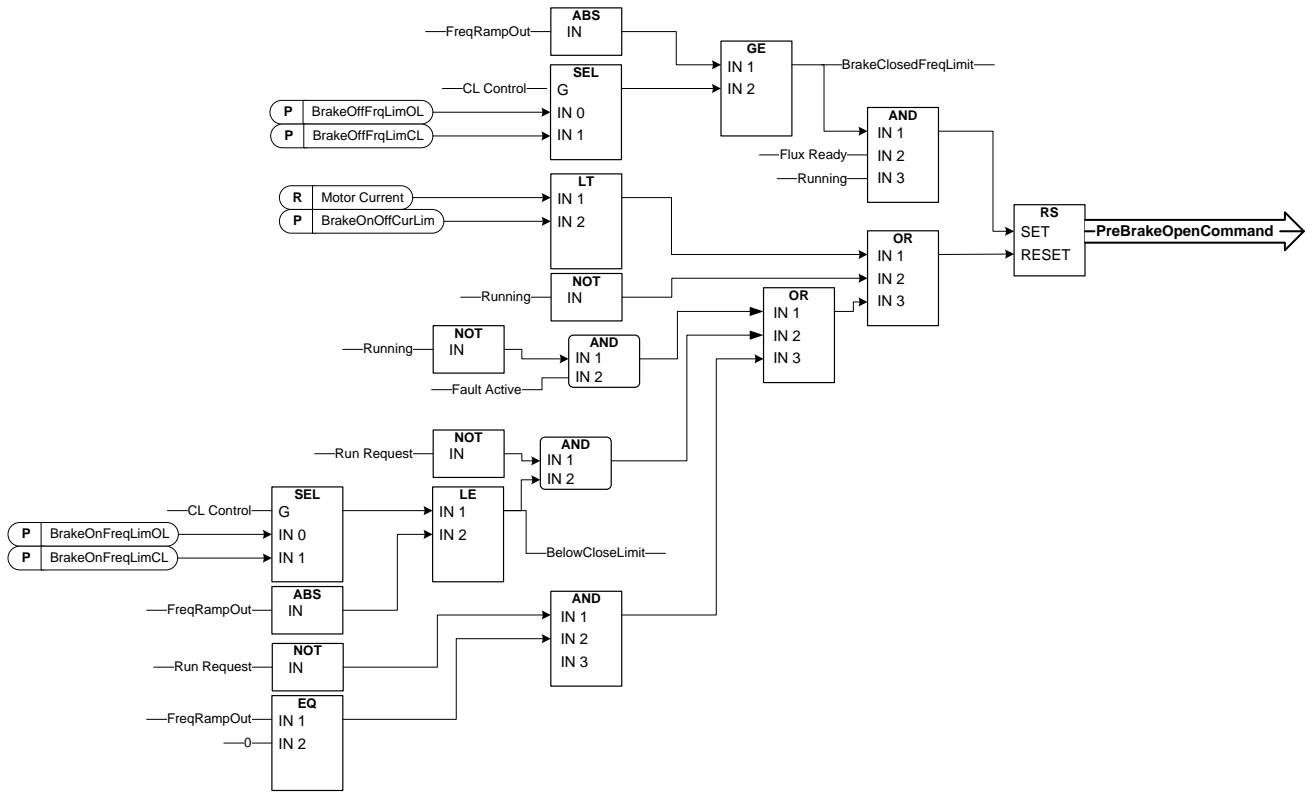

The final brake open command: It is possible that in a Master-Follower system the master drive opens the brake. Also an overriding system may do this without any control from the drive using AucControlWord1.B7. During identification run the brake will not open.

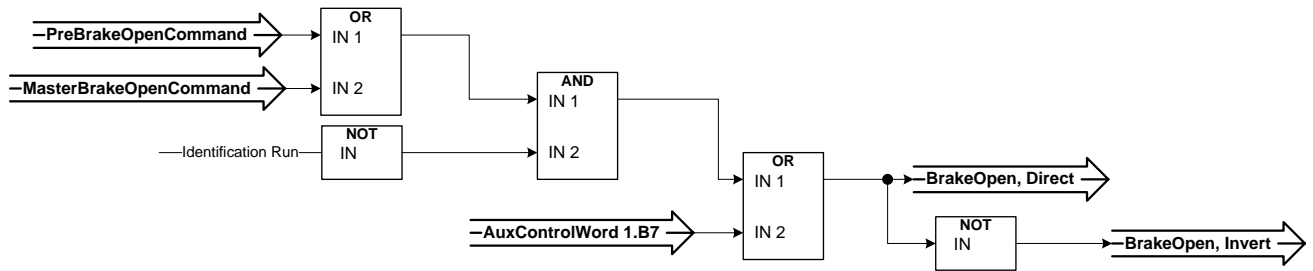

Speed reference release function:

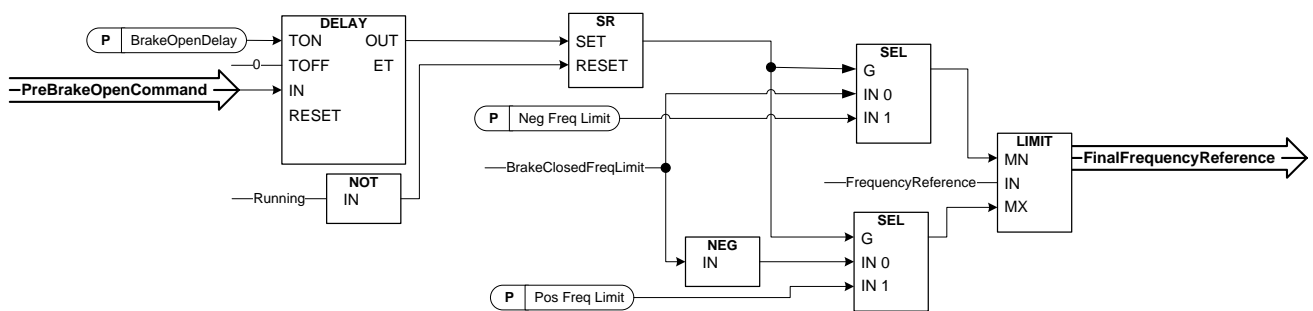

7.15.1 Brake time control timing in closed loop

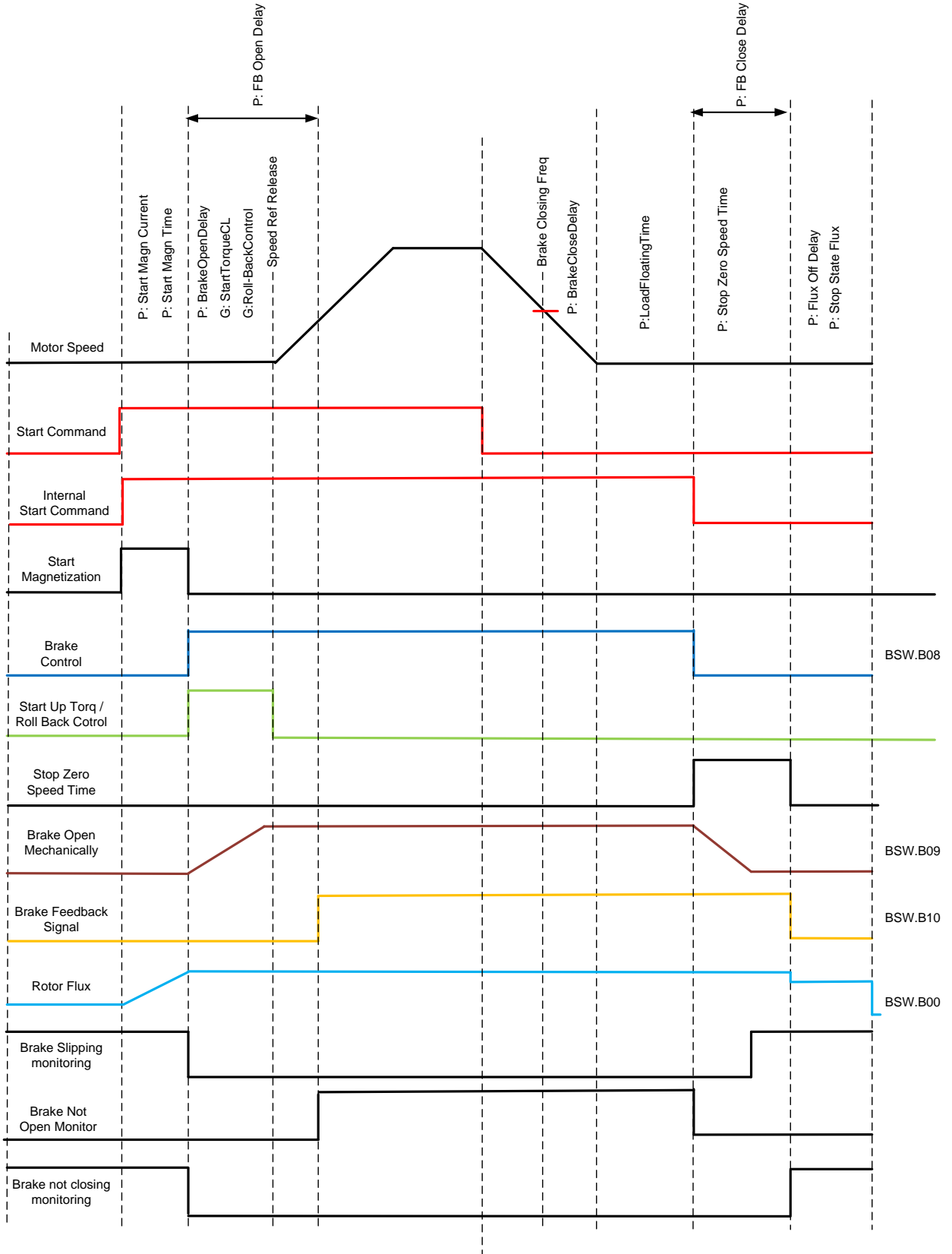

*BSW = Brake Status Word

7.15.2 Brake control timing in open loop

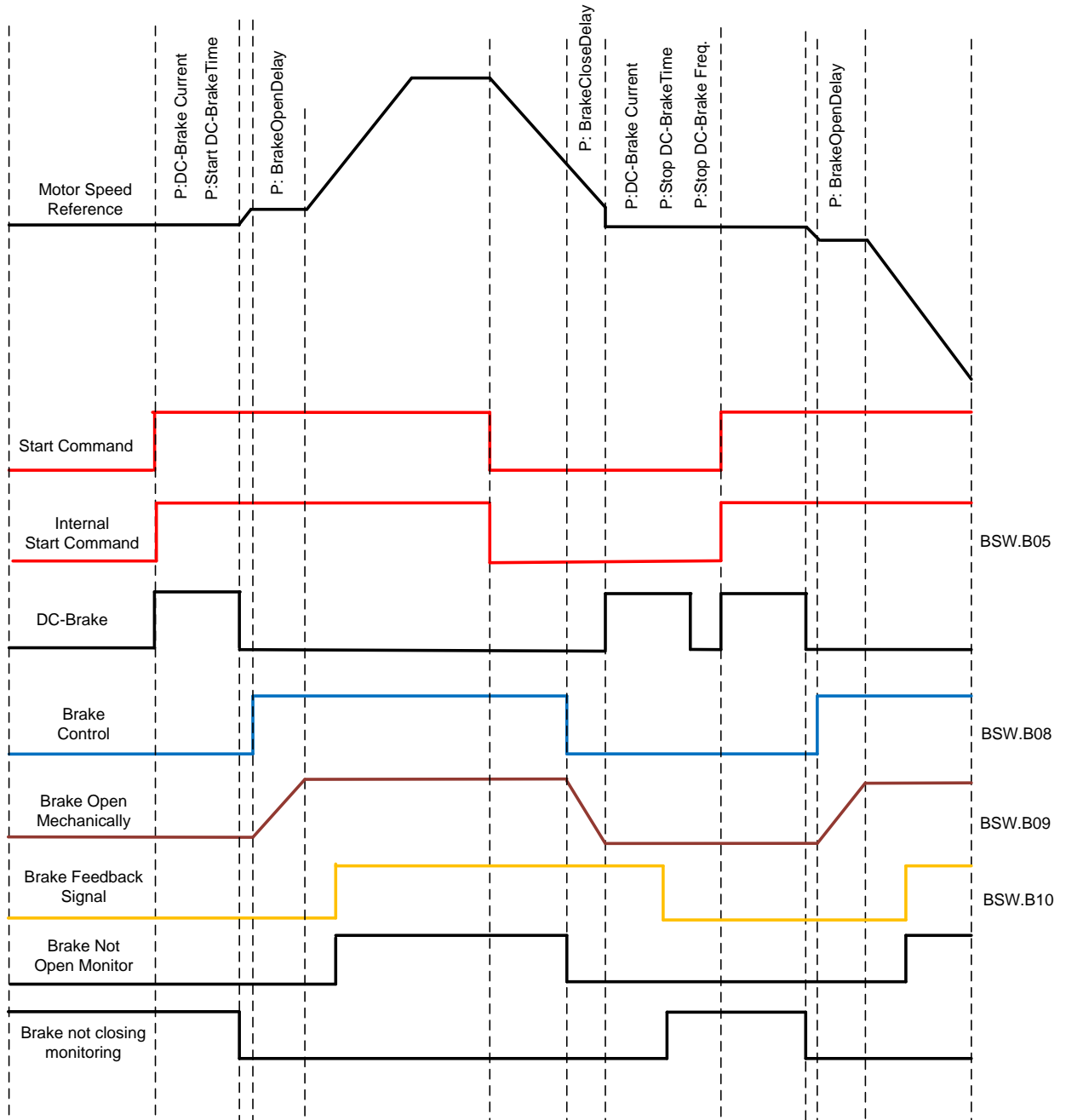

*BSW = Brake Status Word

P2.15.1 Brake Open Control, Direct ID446 “BrakeOpen,Direct”

Select the digital output that will control brake to open.

Example: OPTA2 board RO1 :

Brake Control Closed: Terminals 22-23 are open (Relay not energized).

Brake Control Open: Terminals 22-23 are connected (Relay is energized).

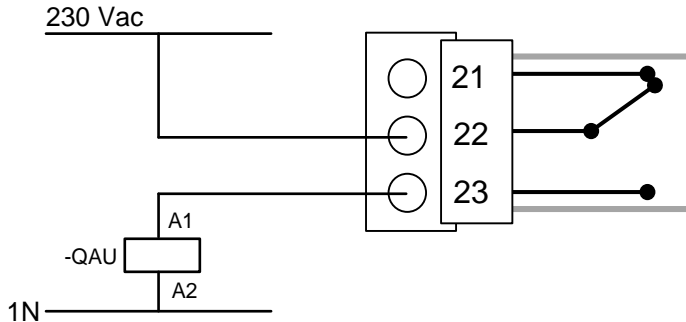

When using the Master-Follower function, the follower drive will open the brake at the same time as the master does even if the follower's conditions for brake opening have not been met.

P2.15.2 Brake Feedback ID1210 “Brake FeedBack”

Select the input for mechanical brake feedback. If contact is not closed within given time when brake is controlled open, the drive will generate a brake fault F58, response can be selected in G2.15 Brake Control parameter group. By default if contact is not open when brake should be closed, warning F84 is give. Feedback signal delays are parametrizable separately from brake mechanical delays. Logic will activate when input is 0.3 or greater. If using FB Digital inputs for brake feedback use DIN ID control function between 2 [0.3] (TRUE) and 19 [A.10] (FALSE).

P2.15.3 Brake Mechanical Open Delay ID1544 “Brake Open Delay”

After the brake open command has been given, speed is kept at the Brake Open Frequency limit until the Brake Mechanical Open Delay has passed. This hold time should be set corresponding to the mechanical brake reaction time. This function is used to avoid current and/or torque spikes eliminating a situation where the motor is run at full speed against the brake.

P2.15.4 Brake Mechanical Close Delay ID1545 “Brake Close Delay”

Mechanical Brake closing delay is used to time the brake closing correctly with drive ramping to zero speed after the stop command.

P2.15.5 Brake Open Frequency limit Open Loop ID1535 “BrakeOpnFrqLimOL”

This parameter defines the frequency limit to release the brake.

This value also applies as the maximum frequency reference limit while the brake is closed. This value is automatically calculated when Crane ID Run is made.

P2.15.6 Brake Open Frequency limit Closed Loop ID1555
“BrakeOpnFreqLimCL”

This parameter defines the frequency limit to release the brake. This value also applies as the maximum frequency reference limit while the brake is closed. In closed loop control it is recommended to use zero value, so that the brake is released while the drive has zero speed at start. If torque is needed to avoid position change at the moment the brake mechanically opens, use Roll-Back control function or the start-up torque function.

P2.15.7 Brake Close Frequency limit Open Loop ID1539
“BrakeClFreqLimOL”

Output frequency limit to close the brake when the speed approaches zero speed in open loop control. When this parameter is zero, drive will calculate best suitable closing frequency limit considering deceleration time, brake closing delay, motor nominal slip. When value different than zero is given, internal closing limit calculation is bypassed and set parameter value is used.

P2.15.8 Brake Close Frequency Limit Closed Loop ID1540
“BrakeCLFreqLimCL”

Output frequency limit to close the brake when the speed approaches zero speed in closed loop control. When this parameter is zero, drive will calculate best suitable closing frequency limit considering deceleration time, brake closing delay, motor nominal slip. When value different than zero is given, internal closing limit calculation is bypassed and set parameter value is used.

P2.15.9 Brake Close/Open Current limit ID1085 “BrakeOpnClCurLim”

If motor current is below this value the brake is closed immediately.

P2.15.10 Brake Options 1 ID1600 “Brake Options 1”

B00 = Keep speed control active when brake is closed (Open Loop)
B01 = Disable higher minimum frequency when brake state estimate shows Open
B02 = Enable speed error monitoring in open loop
B03 =

7.15.3 Start Up torque

The start-up torque is used to generate torque against the brake so that when the brake is mechanically opened there will be no position change because the drive is already generating the torque needed to keep the load in place.

Settings the start-up torque time is set to -1 means that the start-up torque is removed when the drive notices encoder movement. Setting the time greater than 0 will denote the actual time for how long the start-up torque is applied to the motor even if the motor shaft is already rotating, thus making the motor accelerate without control until time has expired.

P2.15.11.1 CL: Startup torque ID621 “StartUp Torque”

0 = Not Used

1 = Torque Memory

Torque memory uses the torque that was used by the speed controller last time the drive was in running state. Normally, this is the torque generated when the zero speed time at stop has expired and the drive has stopped modulation or started the flux off delay function.

2 = Torque Reference

The normal torque reference chain is used (expect TorqueStep) for the start-up torque level. This can be used when the external system knows the load on the shaft when brake is released.

3 = Torque Forwad/Reverse

Drive uses torque values defined by the start-up torque forward and reverse.

P2.15.11.2 Start-up torque, forward ID633 “StartupTorq FWD”

Sets the start-up torque for forward direction if selected with parameter Startup Torque.

P2.15.11.3 Start-up torque, reverse ID634 “StartupTorq REV”

Sets the start-up torque for reverse direction if selected with parameter Startup Torque.

P2.15.11.4 Start-Up Torque Time ID1371 “StartupTorq Time”

This parameter defines for how long the start-up torque will be used instead of the speed controller output. If the time is set to -1 the drive will automatically start to use the speed controller when speed change is read from encoder. When the setting is >0 the drive will use this defined torque even if speed changes are read from encoder.

7.15.4 Roll Back Control for Closed Loop

Roll Back controller will control speed to zero when after start the speed reference is zero and e.g. the brake is opening.

P2.15.12.1 Roll Back Kp ID1787

Gain for Roll Back controller. When zero function is disabled. First starting value 2500.

P2.15.12.2 Roll Back Torque ID1788

Initial torque level, which is stepwise fed to the motor after the RB is active (in the direction which tends to oppose the RB movement). Recommended minimum value is torque needed to keep empty hook in zero speed.

P2.15.12.3 Roll Back Level ID1789

Encoder pulses threshold level when roll back controller is active. Higher value means that shaft will move more before Roll-Back controller is activated. Typical encoder has 1024 ppr default is 3 pulses.

P2.15.12.4 Roll Back Kp 2 ID1792

7.15.5 Brake monitoring function

The brake monitoring function is activated when the digital input P2.15.2 Brake Feedback is used. The brake monitoring function compares the brake feedback to the control signal. In other words, a fault will be issued if the feedback is missing when drive is in Run state and the output frequency is above the opening limit and the fault delay has expired. A fault is also triggered if the brake feedback indicates that the brake is open while the drive is in stop state.

In some cases, it is possible that an encoder fault appears when the drive is run against closed brake. The encoder fault can be disabled with Control Options B8 when the drive is controlling the brake to be closed.

2.15.13.1 Brake Closed Fault ID1316 “Brake Closed Fault”

Defines action after detecting that brake do not open. Feedback is needed to this fault to function.

- 0 = No response
- 1 = Warning
- 2 = Fault, stop mode after fault according to Stop Function
- 3 = Fault, stop mode after fault always by coasting

2.15.13.2 Brake Open Fault ID777 “Brake Open Fault”

Defines the action after detecting that brake do not close.

- 0 = No response
- 1 = Warning
- 2 = Fault, stop mode after fault according to Stop Function
- 3 = Fault, stop mode after fault always by coasting
- 4 = Warning; Start the drive to keep the load

2.15.13.3 Feed Back Open Delay ID1317 “FB Open Delay”

The delay before the brake fault (F58) is activated. Used when there is a mechanical delay in the brake. See digital input signal *External brake acknowledge*.

2.15.13.4 Feed Back Close Delay ID1733 “FB Close Delay”

The delay before the brake fault (F58) is activated. Used when there is a mechanical delay in the brake. See digital input signal *External brake acknowledge*.

2.15.13.5 *Brake Slipping Response* ID1785

Works only in closed loop operation, this function monitors encoder speed when brake is controlled to be closed.

Digital output “Brake Slip” will be activated when this situation happens and will not reset until situation has been acknowledged by giving reset command to the drive.

0 = No response

1 = Warning

2 = Fault, stop mode after fault according to Stop Function

3 = Fault, stop mode after fault always by coasting

4 = Warning; Start the drive to keep the load

“Catch dropping load” functionality. When slipping is detected drive will start and prevents load dropping even when drive is in stop state and no start command has been given, but drive needs to be in ready state.

7.15.6 Functions

P2.15.14.1 Load Floating Time

After drive has received stop request drive will keep in zero speed with mechanical brake open until this time has passed. Used to keep drive and motor fast available when needed to make restarts e.g. on positioning hoist to certain height. Motor cooling should be considered when this function is used for longer periods.

P2.15.14.2 Stop Torque Release Time ID1858

This parameter defines how fast torque is released against closed brake when drive is stopped.

7.15.7 Brake Test Function

P2.15.15.1 Brake Test ID1843

Use this parameter to activate brake testing function. This will run against the brake with torque control and checks that brake is not slipping. ID1844 is used as a torque reference to both direction during this test.

P2.15.15.2 Testing Torque ID1844

Torque reference used in Brake Test activated by ID1843.

P2.15.15.3 Brake Timing Torque Reference ID1849

Torque reference used during Brake Timing identification run. Activated by Crane ID Run selection 3 / Brake Timing.

7.16 Auto Fault Reset

The Auto reset function tries to reset the fault automatically during the trial time. An individual fault can be defined to be reset certain number of times before the actual fault indication is given. The function will operate as Automatic Restart function if the start command is received as a static signal. In I/O control of the Brake Control application, the default start function requires a rising edge command after fault trigger.

P2.16.1 Automatic reset: Wait time ID717 “Wait Time”

Defines the time for the attempted fault reset after the fault trigger has passed. Note: In case of external fault, remove the cause of fault on the external device. The wait time count starts only when the cause of fault has been removed.

P2.16.2 Automatic reset: Trial time ID718 “Trial Time”

The Automatic reset function keeps trying to reset the faults appearing during the time set with this parameter. If the number of faults during the trial time exceed the value of the respective parameter set with ID720 to ID725 a permanent fault is generated.

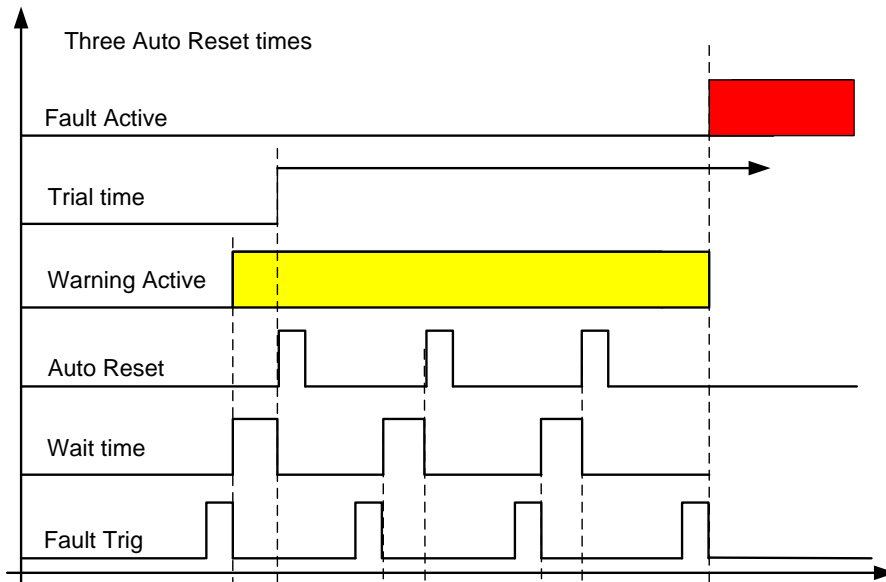

Figure 7-18. Example of Automatic restarts with three restarts

P2.16.3 Automatic restart: Start function ID719 “Start Function”

The Start function for restart is selected with this parameter; restart will take place if there is a static Start command active when an automatic fault reset is made.

- 0 = Start with ramp
- 1 = Flying start
- 2 = Start according to Start Function parameter (Default)

The following ‘Number of tries’ parameters determine the maximum number of automatic restarts during the trial time. The time count starts from the first autoreset. If the number of faults occurring during the trial time exceeds the values set by number of tries the fault state becomes active.

P2.16.4 Number of tries after undervoltage fault trip ID720 “Undervolt. Tries”

This parameter determines how many automatic fault resets can be made during the trial time after undervoltage trip.

- 0 = No automatic reset
- >0 = Number of automatic fault resets after undervoltage fault

P2.16.5 Number of tries after overvoltage trip ID721 “Overvolt. Tries”

This parameter determines how many automatic fault resets can be made during the trial time after overvoltage trip.

- 0 = No automatic fault reset after overvoltage fault trip
- >0 = Number of automatic fault resets after overvoltage fault trip

P2.16.6 Number of tries after overcurrent trip ID722 “Overcurr. Tries”

(NOTE! IGBT temp faults also included)

This parameter determines how many automatic fault resets can be made during the trial time after overcurrent trip.

- 0 = No automatic fault reset after overcurrent fault trip
- >0 = Number of automatic fault resets after overcurrent trip, saturation trip and IGBT temperature faults

P2.16.7 Number of tries after reference trip ID723 “4mA Fault Tries”

This parameter determines how many automatic fault resets can be made during the trial time after 4 mA reference fault.

- 0 = No automatic fault reset after reference fault trip
- >0 = Number of automatic fault resets after the analogue current signal (4...20 mA) has returned to the normal level (≥ 4 mA)

P2.16.8 Number of tries after motor temperature fault trip ID726 “MotTempF Tries”

This parameter determines how many automatic fault resets can be made during the trial time after calculated motor temperature fault trip.

- 0 = No automatic fault reset after Motor temperature fault trip
- >0 = Number of automatic fault resets after the motor temperature has returned to its normal level

P2.16.9 Number of tries after external fault trip ID725 “Ext.Fault Tries”

This parameter determines how many automatic fault resets can be made during the trial time after external fault trip.

- 0 = No automatic fault reset after External fault trip
- >0 = Number of automatic fault resets after External fault trip

P2.16.10 Number of tries after underload fault trip ID738 "Underload tries"

This parameter determines how many automatic fault resets can be made during the trial time after underload trip.

- 0** = No automatic fault reset after Underload fault trip
- >0** = Number of automatic fault resets after Underload fault trip

P2.16.11 Fault Simulation ID1569 "Fault Simulation"

With this parameter it is possible to simulate different faults without actually making e.g. overcurrent situation. In drive interface point of view behaviour is identical to actual fault situation.

- B00** = +1 = Simulates over current fault (F1)
- B01** = +2 = Simulates over voltage fault (F2)
- B02** = +4 = Simulates under voltage fault (F9)
- B03** = +8 = Simulates output phase supervision fault (F11)
- B04** = +16 = Simulates earth fault (F3)
- B05** = +32 = Simulates system fault (F8)

This fault simulation cover wide range of different faults in drive, see fault description for details.

- B06** = +64 = Simulates encoder fault (F43)
- B07** = +128 = Simulates over temperature warning (W14)
- B08** = +256 = Simulates over temperature fault (F14)

Warning bit needs to be active that fault will come in simulation. If fault bit is left active drive will go fault state at warning limit when drive temperature will rise to warning level.

- B09** = +512 = Reserved

7.17 PI Control

PI Control in system interface application uses ID number to make connection between reference, actual value and output. PIC function will be active when PIC Controller Output ID is higher than zero.

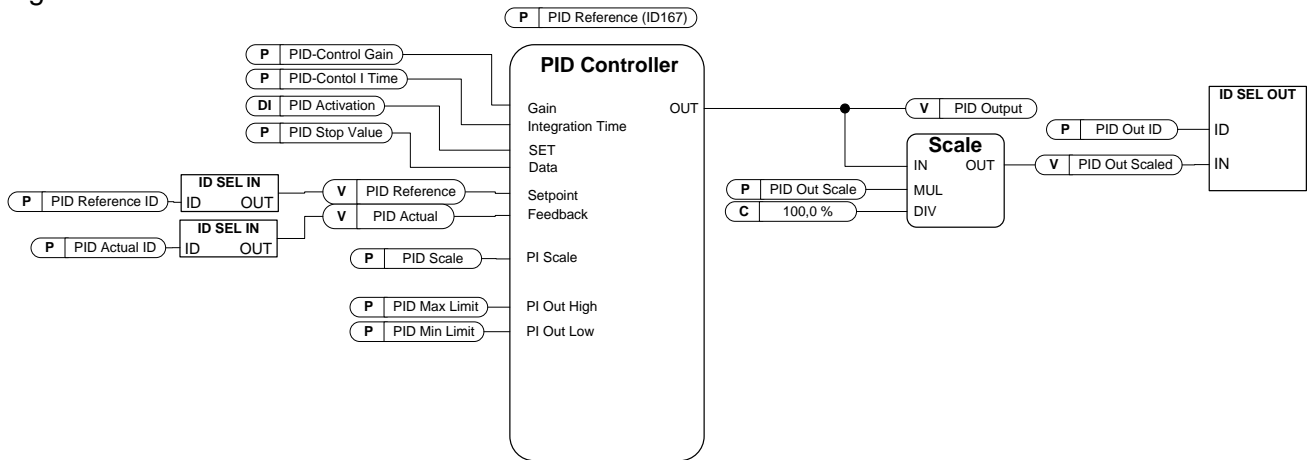

P2.17.1 PI Controller Gain ID118 “PID-Contr Gain”

This parameter defines the gain of the PID controller. If the value of the parameter is set to 100% a change of 10% in the error value causes the controller output to change by 10%. If the parameter value is set to 0 the PID controller operates as I-controller.

P2.17.2 PI Controller I time ID119 “PID-Contr I Time”

The parameter ID119 defines the integration time of the PID controller. If this parameter is set to 1.00 second, a change of 10% in the error value causes the controller output to change by 10.00%/s. If the parameter value is set to 0.00 s the PID controller will operate as P controller.

P2.17.3 PI Controller reference ID167 “PID Reference”

PI controller reference from keypad, used also when reference is controlled from Fieldbus.

P2.17.4 PI Controller reference value ID number ID332 “PID Ref ID”

Select ID number of the signal that is used as reference valued for PI controller. Default value is the ID of P2.17.3

P2.17.5 PI Controller actual value ID number ID333 “PID Actual ID”

Select ID number of the signal that is used as actual value for PI controller. PI Actual value can be written from Fieldbus directly to monitoring variable ID21 when this parameters is set to zero.

P2.17.6 PI Controller output ID ID1802 "PID Out ID"

Select ID number of parameter of signal that is controlled by PI controller. When this value is greater than zero, the PI function is operational. This is scaled value by PI Controller Output Scale. Scaling function is used to scale value more suitable for connected signal. For example, when the output is connected to torque limit, the actual value needs to be -1000 ...+1000.

(-100.0%..+100.0%). But PI Out High and Low can be from -30000...+30000 to have more accurate PI control.

P2.17.7 PI Controller Scale ID340 "PID Scale"

This parameter allows you to invert the error value of the PID controller (and thus the operation of the PID controller).

1 No inversion

-1 Inverted

This value is a multiplier for P and I part of the control thus working as additional gain.

NOTE! Zero is illegal value for PI controller.

P2.17.8 PI Controller minimum output ID359 "PID Min Limit"**P2.17.9 PI Controller maximum output ID360 "PID Max Limit"**

With these parameters you can set the minimum and maximum limits for the PID controller output.

These limits are of importance for example when you define the gain and I-time for the PID controller.

P2.17.10 PI Controller output scale ID1803 "PID Out Scale"

This parameter is used to scale PI output to have more controlling are for the PI controller. For example, the PI controller maximum limit can be set to 10000, and by setting scaling to 10%, the PI output can be used directly to motoring torque limit, for instance.

PI Output * Scaling [%] = P2.18.5 -> 10000 * 10% = 1000, (1000 = 100.0% of Tn).

P2.17.11 PI Stop state value ID1806 "PID Stop Value"

This value is forced to PI controller out when controller is not activated by digital input P2.2.1.15.

7.18 Tandem operation

Tandem operation communication is enabled with Master-Follower mode (See chapter 7.11 Master-Follower) selection 3 and 4. Three for the master (P2.11.1), the drive that will send its position to follower drives. And four for follower drive(s), drive(s) that will receive master position and are in active shaft angle control when shaft synchronization is enabled. Encoder is required on motor shafts. See monitoring signals in chapter 6.1.19.

Besides receiving master position information, follower drives also receive encoder frequency information from the master drive. This frequency is used as a reference, and position information is used to correct this frequency reference in follower drives so that same shaft angle is maintained.

Follower drives are not directly using the master position but are monitoring change of the master position. This change is incremented to own position counter when follower position controller is enabled and follower drive is in run state.

When master synchronization command is not enabled, its own counter is also frozen. Thus even if follower drives remain in position control, they will not see change in the master position and remain in same position. Enables to change the master position in relation to the follower(s).

P2.18.1 *Enable Synch* *ID1816*

Select digital input for enabling shaft synchronization positioning. Remember to enable also Master-Follower communication for positioning. Disabling and enabling tandem operation is only possible when drives are in stop state.

P2.18.2 *Synch Kp* *ID1817*

Gain for position controller.

P2.18.3 *Synch Ti* *ID1818*

Integration time for position controller.

P2.18.4 *MaxRefCorrection* *ID1819*

Maximum frequency that positioning controller can give.

P2.18.5 *ZeroErrorLimit* *ID1824*

When position error is below this level PI controller is disabled.

P2.18.6 *Fault Limit* *ID1826*

When position error exceeds this level fault is generated. 1,000 equals to one shaft rotation. Setting 0 (zero) fault is disabled.

P2.18.7 *Reset Position* *ID1090*

Reset all encoder information and position integrators. When given in master drive also follower drives counters are reset. When given in follower drive only that drive positions are reset.

7.19 Load Estimation

Given enough accurate information about the system to below parameter drive can estimate load from motor torque.

Load estimation parameters are used also for rope length calculations

P2.19.1 Motor Nominal Torque ID1906

Motor nominal torque in Nm.

$$T_N = \frac{P_N}{2\pi \frac{n_N}{60}}$$

P2.19.2 Rotor Inertia ID1907

Rotor inertia kgm²

P2.19.3 Gear Box Inertia ID1908

Gearbox inertia kgm²

P2.19.4 Drum Inertia ID1909

Drum inertia kgm²

P2.19.5 Gear Ratio ID1910

Gear Ratio 1/x. Used also in rope length calculations.

P2.19.6 Drum Radius ID1911

Drum radius in m. Used also in rope length calculations.

$$r = \frac{\text{Circumference}}{2\pi}$$

P2.19.7 Rope Multiply ID1912

Defines how much rope needs to be pulled to drum to lift the load. e.g. when pulling four meters of rope and load rises one meter the rope multiply is four. Used also in rope length calculations.

7.20 Functional Safety

P2.20.1 SQS Reaction ID545**0=No Action****1=Quick Stop**

Activates same function as Digital Input Quick Stop P2.4.2.31.

P2.20.2 SS1 Reaction ID542**0=No Action****1=Stop**

Makes a normal stop command.

P2.20.3 SS2 Reaction ID546**0=No Action****1=Zero Speed**

Reference is forced to zero and brake is closed.

P2.20.4 SDI Reaction ID544**0=No Action****1=Disable Dir**

Activated same function as Disable Neg Dir and Disable Pos Dir P2.2.12.1/2.

P2.20.5 SLS Reaction ID543**0=No Action****1=End Limit Ref**

Safe Limited Speed 1 activates Limit Neg/Pos Ref DI2 P2.2.12.7/8.

Safe Limited Speed 2 activates Limit Neg/Pos Ref DI1 P2.2.12.3/4.

P2.20.6 SSR Reaction ID547**0=No Action****1=Limit Speed**

Speed Reference is limited to Safe Board limit – Motor Nominal Slip.

7.21 Anti-Swing Function

P2.21.1 License Key ID1995

Enter here the license key for Anti Swing functionality.

P2.21.2 Anti-Swing Mode ID1846

Select mode of anti-swing function.

0 = Not used

Anti-Swing function is disabled.

1 = Mode 1

General purpose mode with slightly reduced damping with half rope length.

2 = Mode 2

Slightly slower mode but good damping for all rope lengths less than defined maximum.

3 = Mode 3

Mode almost independent of rope length but faster reaction for human control.

4 = Mode 4

Most aggressive mode, response is good but sensitive to rope length information and higher peak power demand.

P2.21.3 Swinging Period ID1743

Enter here the swinging period in seconds. If swinging period has been given, the drive will not use rope length for anti-swing. For faster operation time, the value can be slightly smaller than the measured value.

P2.21.4 Rope Length ID1686

Enter here the maximum practical rope length in centimeters. If swinging period time has been given rope length parameters is not used. Rope length can be calculated also in hoisting drive and by using SystemBus length can be used in other drives see ID1918.

P2.21.5 Smoothing TC ID1186

Use this parameter to give additional smoothness to frequency reference.

P2.21.6 Disable Anti-Swing ID1853

Digital input to disable Anti-Swing function.

P2.21.7 Low Speed Positioning Run ID1854

Select how low speed positioning run is made. This function is used to disable Anti-Swing in low speed in certain selectable situations. Use ID1855 to set frequency level where Anti-Swing is disabled.

With the anti-swing continuously on at low speed, the positioning is different than with the anti-swing off. If the anti-swing is on also at low speed, the user needs to learn how to control the final 10 cm with the run command. The hook will travel as long as the run command is given. After the user has learned the principle, it is easy to get 1 cm accuracy without any swinging. If the user prefers to control last 10 cm movement with normal ramps, it is possible to disable the anti-swing for positioning for low speeds.

0 / Not Used

Anti-Swing will not be disabled on low speeds.

1 / Mode 1

Anti-Swing is disabled if reference is not increased above ID1855.

2 / Mode 2

Anti-Swing is disabled if reference is not increased above ID1855. Anti-Swing is also disabled when actual speed goes below ID1855 when returning from higher speed to zero speed.

3 / Mode 3

Anti-Swing is disabled if reference is not increased above ID1855. Anti-Swing is also disabled when returning from higher speeds and remaining shortly in frequency defined by ID1855 but not when going to zero speed directly from higher speeds.

4 / Mode 4

Anti-Swing is disabled if ramp output is not increased above ID1855. Anti-Swing is also disabled when returning from higher speeds and remaining shortly in frequency defined by ID1855 but not when going to zero speed directly from higher speeds.

5 / Mode 5

Anti-Swing is disabled if Ramp Output is below ID1855 when start command is removed.

P2.21.8 Low Speed Maximum Frequency ID1855

Set here the maximum frequency limit used in Low Speed Positioning Run function selected by ID1854.

P2.21.9 Rope length selection ID1918

Select how the drive will handle Rope length source.

0 = Parameter

Drive own rope length parameter is used for final rope length for anti-swing.

1 = Hoist

Rope length is calculated in Master Hoisting drive, rope length calculation is activated in hoisting drive by setting this parameter to 3 / Calculate.

2 = Calculate

In hoisting drive use this selection that drive will calculate rope length for other drives to be used in anti-sway. Calculation used gear-ratio, drum radius and rope multiplier from load estimation. Rope length can be set to maximum (ID1686) or to zero by using digital inputs ID1916 & ID1917

7.22 Keypad control parameters

Unlike the parameters listed above, these parameters are located in the **M3** menu of the control keypad. The reference parameters do not have an ID number.

P3.1 Control Place ID125 “Control Place”

The active control place can be changed with this parameter.

Pushing the Start button for 3 seconds selects the control keypad as the active control place and copies the Run status information (Run/Stop, direction and reference).

0 = PC Control, Activated by NCDrive

1 = I/O terminal

2 = Keypad

3 = Fieldbus

4 = SC Control

System Bus communication can be active between drives for data communication while control place it self can be e.g. Fieldbus.

R3.2 Keypad Reference No ID “Keypad Reference”

The frequency reference can be adjusted from the keypad with this parameter.

The output frequency can be copied as the keypad reference by pushing the Stop button for 3 seconds when you are on any of the pages of menu **M3**.

P3.3 Keypad Direction ID123 “Keypad Direction”

0 Forward: The rotation of the motor is forward, when the keypad is the active control place.

1 Reverse: The rotation of the motor is reversed, when the keypad is the active control place.

P3.4 Stop button activated ID114 “StopButtonActive”

If you wish to make the Stop button a "hotspot" which always stops the drive regardless of the selected control place, give this parameter the value **1**.

R3.5 Torque reference No ID “Torque Reference”

Define here the torque reference within 0.0...100.0%.

8. IDENTIFICATION FUNCTION FOR PERMANENT MAGNET SYNCHRONOUS MOTOR

PM Motor has several zero positioning identification modes. This chapter explains what kind of identification mode is needed to select when using different kind of hardware configuration.

This chapter is addition to P2.1.9 Identification parameter description and P2.8.5.2 Start Angle Identification mode description.

8.1 Identification with absolute encoder.

When using absolute encoder identification is made only once. A new identification is needed if encoder and rotor position changes related to each other.

Motor needs to be able to rotate freely that magnet positions can be identified.

Identification mode in this case is selected by "P2.1.9 Identification" selection "3 / Enc.ID Run".

During identification drive feeds DC current to motor (~90% of motor nominal), this causes motor to move zero position, there may be oscillatory movement on the shaft. When identification is successful "P2.8.5.1 PMSM Shaft Position" is updated, if not successful value is set to zero and identification warning is displayed for 10 seconds (W57). If identification is made several times, result may be different; there are as many positions as there are pole pairs in the motor.

Benefit to use absolute encoder is that magnet position is always known thus motor can be fully loaded from the start.

Related parameters:

P2.1.9	Identification	ID631
P2.8.5.1	PMSM Shaft Position	ID649

8.2 Identification with incremental encoder without Z-pulse input

When using incremental encoder without Z-pulse, identification is made in every start.

Identification mode can be selected by "P2.8.5.2 Start Angle Identification Mode". In this case the encoder identification cannot be done because zero position cannot be identified without Z-pulse, but identification P2.1.9 with Identification selection "2 / ID With Run" needs to be made. Identification at every start will be automatically active if "P2.8.5.1 PMSM Shaft Position" parameter value is zero.

Best result is achieved when the motor has a mechanical brake that prevents shaft movements. Acceptable result can be achieved also when motor has high load and/or inertia that prevent shaft movements during identification.

Angle identification is done in every start by feeding motor with a DC pulses that identifies magnet position. DC pulses are in two different groups. First one identifies zero position and second one makes polarity check. These DC current levels are adjusted by "P2.8.5.3 Start Angle Identification Current" and "P2.8.5.4 Polarity Pulse current", respectively.

NOTE: Not all motors are suitable for this identification mode. Functionality needs to be tested before production use.

Benefit of this mode is that motor can be fully loaded from the start.

Related parameters:

P2.8.5.2	Start Angle Identification Mode	ID1691
P2.8.5.1	PMSM Shaft Position	ID649
P2.8.5.3	Start Angle Identification Current	ID1759
P2.8.5.4	Polarity Pulse current	ID1566

8.3 Identification with incremental encoder with Z-pulse input

When using incremental encoder with Z-pulse, identification is made only once. A new identification is needed if encoder and rotor position changes related to each other.

Motor needs to be able to rotate freely that magnet positions can be identified. Identification mode in this case is selected by “P2.1.9 Identification” selection “3 / Enc.ID Run”.

During identification, the drive feeds DC current to motor (~90% of motor nominal). This causes the motor to move to zero position. There may be oscillatory movement on the shaft. When motor oscillatory movement has stopped, the motor rotates until Z-pulse is received from the encoder. When identification is successful, “P2.8.5.1 PMSM Shaft Position” is updated. If the identification is not successful, the value of this parameter is set to zero and an identification warning is displayed for 10 seconds (W57). If identification is made several times, the result may be different, because there are as many positions as there are pole pairs in the motor.

When motor is started and zero position is not “remembered”: Drive will start to feed DC current to motor (Defined by “P2.8.5.6 I/f Current”) until the Z-pulse is received from the encoder. During this DC injection, the motor may not be able to produce 100% torque. When running without load, the Z-pulse position can be seen in the motor current when current goes nearly to zero.

Related parameters:

P2.1.9 Identification

P2.8.5.1 PMSM Shaft Position

P2.8.5.6 I/f Current

9. STATUS AND CONTROL WORD IN DETAIL

9.1 Fieldbus

Combination	P7.x.1.4 Operate Mode	P2.13.22 State machine	
1	1 / ProfiDrive	1 / Basic	FB Control and FB Status Word are explained in fieldbus option board manual
2	2 / ByPass Some fieldbus board operate by default in "ByPass" mode	2 / ProfiDrive	<u>Control word</u> is ProfiDrive type and explained in this manual. <u>Status Word</u> is can be selected by ID number, default is ProfiDrive type ID65 V1.26.2 FB Status Word
3	2 / ByPass	1 / Basic	<u>Control word</u> is "Three Bit" control. <u>Status Word</u> is can be selected by ID number, default is ProfiDrive type ID65 V1.26.2 FB Status Word
4	1 / ProfiDrive	2 / ProfiDrive	Drive cannot be operated in this combination from fieldbus

9.1.1 Combination 1, ProfiDrive – Standard with Profibus option board

9.1.1.1 Control Word Combination 1, ProfiDrive – Standard with Profibus option board

Main Control Word for Profibus in Combination 1			
	FALSE	TRUE	Comment
b0	STOP 1 (by ramp)	ON 1	Keep this TRUE
b1	STOP 2 (by cost)	ON 2	Keep this TRUE
b2	STOP 3 (by ramp)	ON 3	Keep this TRUE
b3	RUN DISABLE	ENABLE	Use this for start and stop command
b4	No Action	START	Keep this TRUE
b5	No Action	START	Keep this TRUE
b6	No Action	START	Keep this TRUE
b7	No Action	Fault Reset 0 > 1	Use this for fault reset
b8	No Action	No Action	Not used
b9	No Action	No Action	Not used
b10	Disable Profibus control	Enable fieldbus control	See Profibus manual
b11	Fieldbus DIN1=OFF	Fieldbus DIN1=ON	See P2.5.1.17 -18
b12	Fieldbus DIN2=OFF	Fieldbus DIN2=ON	See P2.5.1.19 -20
b13	Fieldbus DIN3=OFF	Fieldbus DIN3=ON	See P2.5.1.21 -22
b14	Fieldbus DIN4=OFF	Fieldbus DIN4=ON	See P2.5.1.23 -24
b15	Fieldbus DIN5=OFF	Fieldbus DIN5=ON	Not used

9.1.1.2 Status Word Combination 1, ProfiDrive – Standard with Profibus option board

Main Status Word for Profibus in Combination 1			
	FALSE	TRUE	Comment
b0	Not Ready (initial)	READY 1 (SM)	See Profibus manual
b1	Not Ready	READY 2 (SM)	See Profibus manual
b2	DISABLE	ENABLE (SM)	See Profibus manual
b3	NO FAULT	FAULT ACTIVE	Directly from the drive
b4	STOP 2	NO STOP 2 (SM)	See Profibus manual
b5	STOP 3	NO STOP 3 (SM)	See Profibus manual
b6	START ENABLE	START DISABLE (SM)	See Profibus manual
b7	No Warning	Warning	Directly from the drive
b8	Reference ≠ Actual value	Reference = Actual value	
b9	Fielbus control OFF	Fielbus control ON	See Profibus manual
b10	Not used	Not used	
b11	Not used	Not used	
b12	FC Stopped	Running	Directly from the drive
b13	FC not ready	Ready	Directly from the drive
b14	Not used	Not used	
b15	Not used	Not used	

SM = Profibus board State Machine

9.1.2 Combination 2, ByPass – ProfiDrive

9.1.2.1 State Diagram

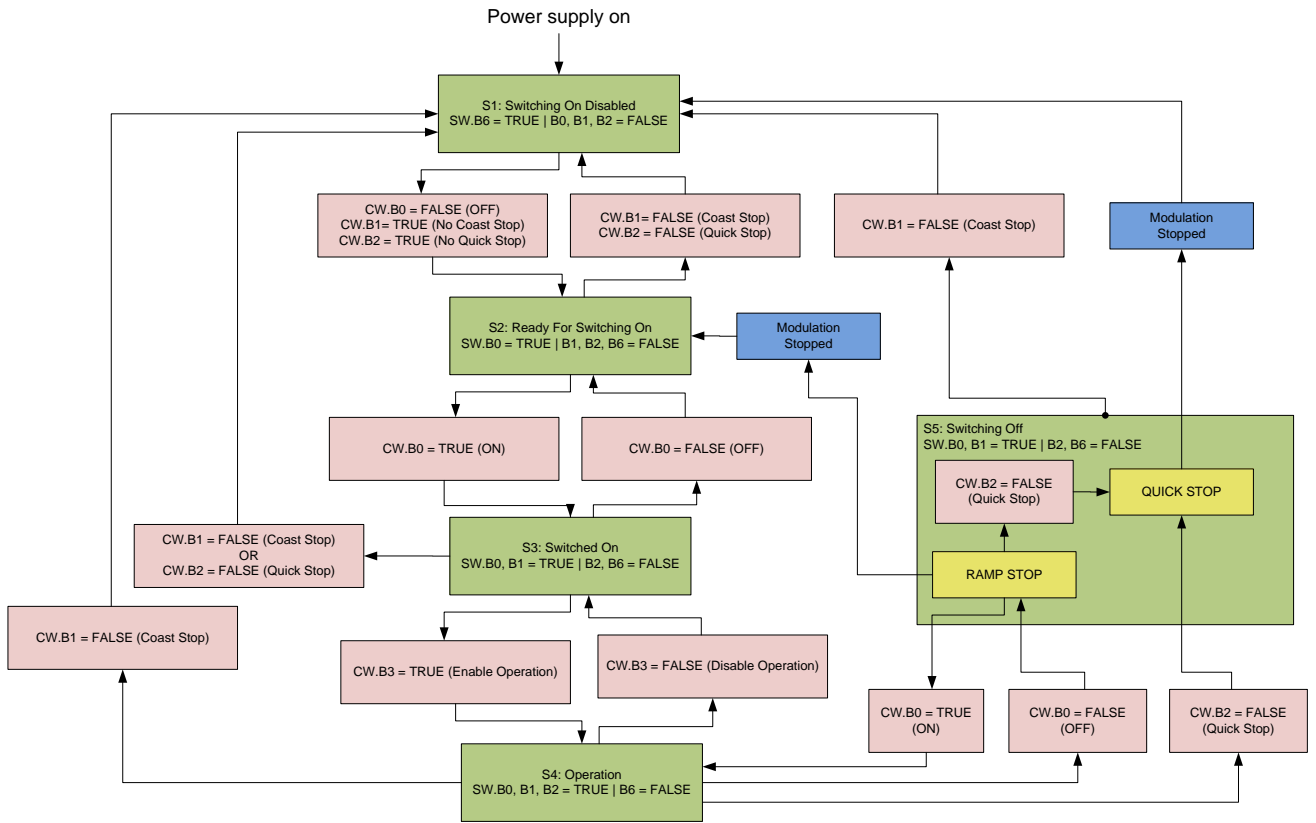

9.1.2.2 State Machine

Coasting Stop

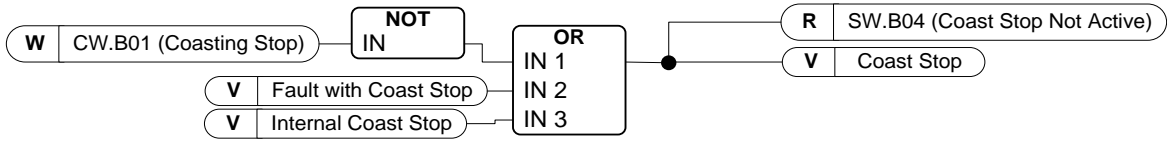

Quick stop

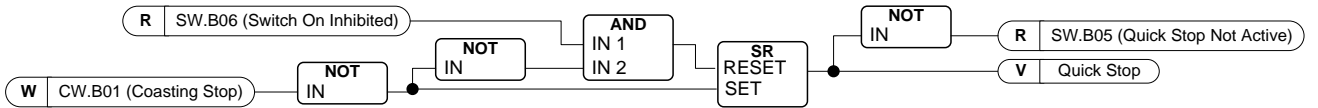

Ready to Switch-On, Operate and Running

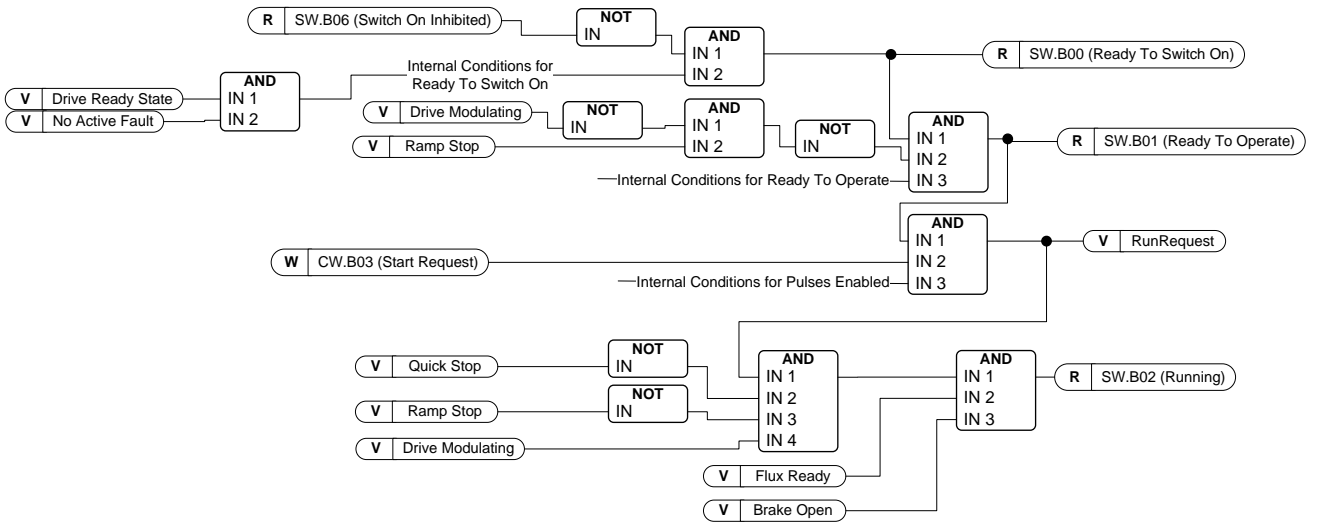

9.1.2.3 FB Control Word

FB Control Word		
	Signal	Comment
b0	ON	0>1 will reset the Switch On Inhibit state and bring the drive to Ready Run. Should be reset after fault, Coast Stop (b1) and Emergency Stop (b2) .
b1	Coasting Stop	0=Coast stop Active 1=Coast stop NOT active
b2	Quick Stop	0=Quick stop Active 1=Quick stop NOT active
b3	Start	Normal start command 0=Stop the drive 1=Start the drive
b4	Ramp Output to Zero	0=Force speed ramp output to zero 1=Release speed ramp output
b5	Ramp Hold	0=Hold speed ramp output 1=Release speed ramp
b6	Ramp Input to Zero	0=Force speed ramp input to zero 1=Release speed ramp input
b7	Fault Reset	0=No Action 1=Reset active faults
b8	Inching 1	Run the drive with defined constant speed 0=No Action 1=Run with constant speed
b9	Inching 2	Run the drive with defined constant speed 0=No Action 1=Run with constant speed
b10	Fieldbus Control Enable	Activate Fieldbus control when P3.1 =3/Fieldbus 0=Fieldbus Control NOT active 1=Activate Fieldbus Control
b11	Watch Dog	0>1>0>1...1 sec square wave clock. This is used to check data communication between Profibus master and the drive. Used to generate FB Communication -Fault.
b12		
b13		
b14		
b15		

B00: FALSE = OFF 1, TRUE = ON 1

OFF 1: Drive will make ramping stop and goes to “Ready to switch-on”. If drive is in “Switch on Inhibit” state this bit is used to reset this status.

ON: Voltage connected to drive and/or DC link charged if drive has the control.

B01: FALSE = Coast stop (OFF 2), TRUE = ON 2

Coast Stop: Drive will make coasting stop and goes to “Switch-on Inhibit” state.

ON 2: No Coast Stop command

B02: FALSE = Quick Stop (OFF 3), TRUE = ON 3

Quick Stop: Drive will make stop function defined by Quick Stop function parameter.

ON 3: No Quick stop command.

B03: FALSE = Stop Request, TRUE = Start Request

Stop Request: Drive will make stop defined by stop function.

Start Request: Start Command to the drive.

B04: FALSE = Reset Ramp Generator, TRUE = Enable Ramp Generator

This bit has priority over B05 and B06 in Control Word.

Reset Ramp Generator: Closed Loop: Ramp generator is forced to zero, drive will make stop as fast as possible running against set torque limits or e.g. over voltage controller.

Enable Ramp Generator: Ramp Generator function is enabled.

To activate Jogging function from fieldbus B04, B05 and B06 needs to be zero.

B05: FALSE = Freeze Ramp Generator, TRUE = Unfreeze Ramp Generator

This bit has priority over B06 but not over B05.

Freeze Ramp Generator: Drive will not accept new reference from Fieldbus, drive remain in same speed.

Unfreeze Ramp Generator: Drive will follow reference from Fieldbus.

To activate Jogging function from fieldbus B04, B05 and B06 needs to be zero.

B06: FALSE = Disable Set point, TRUE = Enable Set point

This bit has lowers priority compared to B04 and B05.

Disable Set point: Reference (FW:FreqRef1) is forced to zero, drive will ramp to zero speed.

Enable Set point: Drive will follow reference.

To activate Jogging function from fieldbus B04, B05 and B06 needs to be zero.

B07: FALSE = No significance, TRUE = Fault Acknowledge

Fault Acknowledge: The group signal is acknowledged with a positive edge; the drive reaction to a fault depends on the type of fault (refer to "alarm handling in Appendix A.8).If the fault reaction has isolated the voltage, the drive then goes into the "Switching On Inhibited" condition.

9.1.2.4 Jogging function

I/O Jogging Command: Jogging function will start the drive to reference without additional start command regardless of control place when given from IO. Jogging function requires enabling from digital input before command is accepted. Inching is also disabled if there is start command active from active control place. If both inching references are active at the same time drive will stop.

Fieldbus Jogging Command: Jogging command is activated by giving normal start command but the ramp control bits CW.B4, B5 & B6 needs to be zero. Drive needs to be at zero speed before command is accepted and CW.B4, B5 & B6 are active after drive is at zero speed when jogging function is stopped.

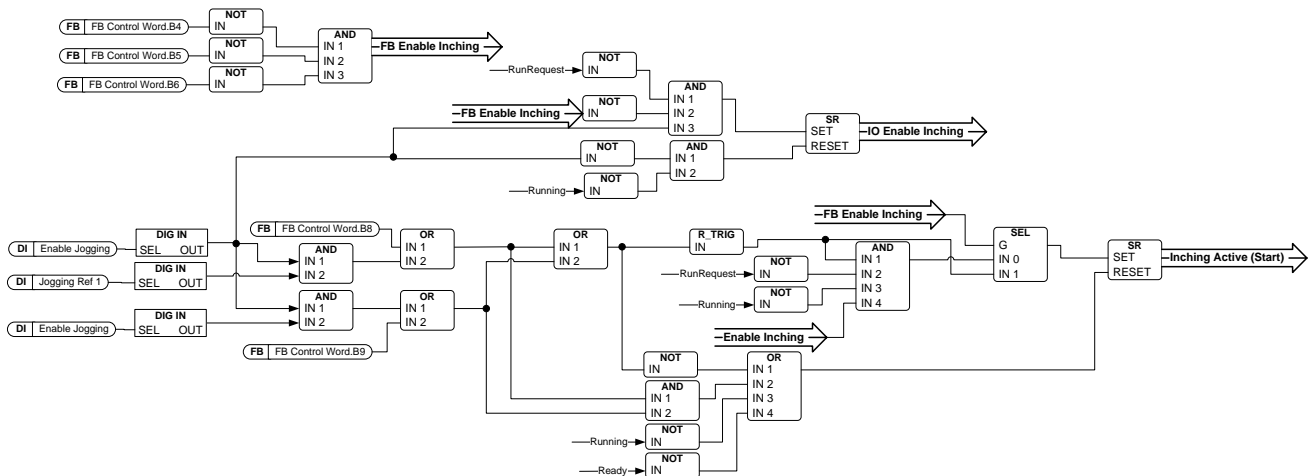

B08: FALSE = No Function, TRUE = Jogging 1

Inching 1: Drive follows reference set by Jogging Ref 1. Function needs to separately activated by Aux Control Word or by digital input Enable Jogging when IO control used for Jogging.

B09: FALSE = No Function, TRUE = Inching 2

Inching 2: Drive follows reference set by Jogging Ref 2. Function needs to separately activated by Aux Control Word or by digital input Enable Jogging when IO control used for Jogging.

B10: FALSE = FB Control disabled TRUE = FB Control Enabled

FB Control Disabled: Drive will not follow main control word from Fieldbus. If removed while running drive will make coasting stop.

FB Control Enabled: Drive follows control word from fieldbus

B11: FALSE = FB WD Pulse Low, TRUE = FB WD Pulse High

Watch dog pulse: This pulse is used to monitor that PLC is alive. If pulse is missing drive will go to fault state. This function is activated by P2.12.10.3 FB WD Delay. When value is zero pulse is not monitored.

9.1.2.5 FB Status Word

FB Status Word		
	Signal	Comment
b0	Ready to switch On	0=The drive NOT ready to switch ON 1=The drive is ready to switch ON
b1	Ready to Operate	0=The drive is NOT ready to run 1=The drive is ready to run
b2	Running	0=The drive is NOT running 1=The drive is running and ready to release the reference
b3	Fault Active	0=No fault active 1=Fault IS active
b4	Coast Stop NOT active	0=Coast stop active 1=Coast stop NOT active
b5	Quick Stop not Active	0=Quick stop active 1=Quick stop NOT active
b6	Switch On Inhibit	0=No Inhibit 1=The drive is out of fault and coast / emergency stop state.
b7	Warning	0=NO alarm 1=Alarm IS active
b8	Speed At Ref	0=Speed actual is NOT equal to speed reference 1=Speed actual is equal to speed reference
b9	FB Control Active	0=Fieldbus Control NOT active 1=Fieldbus Control active
b10	Above Limit	Indicate if speed actual is below the limit P2.4.16 0=Speed actual is below the speed limit 1=Speed actual is above the speed limit
b11		
b12		
b13		
b14		
b15	Watch Dog Feedback	

B00: FALSE = Not Ready to Switch On, TRUE = Ready to Switch On

Not Ready to Switch On:

Ready to Switch On: Power supply is switched on, electronics initialized, main contactor, if available, has dropped out, pulses are inhibited.

B01: FALSE = Not Ready To Operate, TRUE = Ready To Operate

Not Ready To Operate:

Ready To Operate:

B02: FALSE = Drive is not operating, TRUE = Drive is operational

Drive is not operating: Drive is not run state (modulating)

Drive is operational: Drive is in run state and modulating. Also rotor flux is ready and brake is opened if feedback signal is used.

B03: FALSE = No Fault, TRUE = Fault Present

No Fault: Drive is not on fault state.

Fault Present: Drive is in fault state.

B04: FALSE = Coast Stop Activated, TRUE = Coast Stop Not Activated

Coast Stop Activated: "Coast Stop (OFF 2)" command is present.

Coast Stop Not Activated: Coast stop command is not active.

B05: FALSE = Quick Stop Activated, TRUE = Quick Stop Not Activated

Quick Stop Activated: " Quick Stop (OFF 3)" command is present.

Quick Stop Not Activated: Quick stop command is not active.

B06: FALSE = Switching On Not Inhibit, TRUE = Switching On Inhibited

Switching On Not Inhibit:

Switching On Inhibited: The drive goes only again in the "Switched On" condition with "No Coast Stop AND No Quick Stop" followed by "ON". This means that the "Switching On Inhibited" bit is only set back to zero if the OFF command is set after "No Coast Stop AND No Quick Stop".

B07: FALSE = No Warning, TRUE = Warning Present

No Warning: There is no warning or the warning has disappeared again.

Warning Present: Drive still works; warning in the service/maintenance parameter; no acknowledgement.

B08: FALSE = Speed Error Out Of Tolerance Range, TRUE = Speed Error Within Tolerance Range

Speed Error Out Of Tolerance Range:

Speed Error Within Tolerance Range:

B09: FALSE = No Control Requested, TRUE = Control Requested

No Control Requested: Control by the automation system is not possible, only possible at the device or by another interface.

Control Requested: The automation system is requested to assume control.

B10: FALSE = f Or n Not Reached, TRUE = f Or n Reached Or Exceeded

f Or n Not Reached: Speed is below P2.6.4.5 Above Speed Limit.

f Or n Reached Or Exceeded: Speed is above P2.6.4.5 Above Speed Limit.

B15: FALSE = FB DW Feedback Low, TRUE = FB DW Feedback High

FB DW Feedback: FB Control Word B11 is echoed back to the Fieldbus. Can be used to monitor communication status from the drive.

9.1.3 Combination 3, ByPass – Standard

9.1.3.1 Control Word Combination 3, ByPass – Standard

Main Control Word for Profibus in Combination 3			
	FALSE	TRUE	Comment
b0	STOP	START	
b1	Clockwise	Counter clockwise	
b2	No action	FAULT RESET (0 -> 1)	
b3	Not used	Not used	
b4	Not used	Not used	
b5	Not used	Not used	
b6	Not used	Not used	
b7	Not used	Not used	
b8	Not used	Not used	
b9	Not used	Not used	
b10	Not used	Not used	
b11	Not used	Not used	
b12	Not used	Not used	
b13	Not used	Not used	
b14	Not used	Not used	
b15	Not used	Not used	

9.1.3.2 Status Word Combination 3, ByPass – Standard

Most of the field busses use “MCStatus” as Status word that is shown below. For Profibus, the status word can be selected. The default is Combination 2 Status Word, ProfiDrive type ID68 V1.3.2 MainStatusWord. The below Status Word can be selected with P2.10.17 GSW Data by setting it to ID64.

Main Status Word for Profibus in Combination 3			
	FALSE	TRUE	Comment
b0	Not Ready	READY	
b1	STOP	RUN	
b2	Clockwise	Counter clockwise	
b3	NO FAULT	FAULT ACTIVE	
b4	No Warning	Warning	
b5	Reference ≠ Actual value	Reference = Actual value	
b6	Speed > Zero	At Zero Speed	
b7	Flux Not Ready	Flux Ready	
b8	TC Speed Limit Active	TC Speed Limit Not Active	
b9	Detected Encoder Direction Clockwise	Encoder Direction Counter clockwise	
b10	UV Fast Stop Active	UV Fast Stop Not Active	
b11	Not used	Not used	
b12	Not used	Not used	
b13	Not used	Not used	
b14	Not used	Not used	
b15	Not used	Not used	

SM = Profibus board State Machine

9.2 Application Status Word

Application Status Word ID43		
	FALSE	TRUE
b0	Flux not ready	Flux ready (>90%)
b1	Not in Ready state	Ready
b2	Not Running	Running
b3	No Fault	Fault
b4	Direction Forward	Direction Reverse
b5	Emergency Stop Active	Emergency Stop NOT Active
b6	Run Disabled	Run Enable
b7	No Warning	Warning
b8	Power positive	Power negative or Gen torque or current limit active
b9		
b10		
b11	No DC Brake	DC Brake is active
b12	No Run Request	Run Request
b13	No Limit Controls Active	Limit control Active
b14	External Brake Control OFF	External Brake Control ON
b15		

B00: FALSE = Flux not Ready, TRUE = Flux Ready

Not Ready to Switch On:

Ready to Switch On: Power supply is switched on, electronics initialized, main contactor, if available, has dropped out, pulses are inhibited.

9.3 Regulator Status

Regulator status ID77		
b0	Motoring Current Regulator Status	
b1	Generator Current Regulator Status	
b2	Motoring Torque Regulator Status	For CL monitor B0
b3	Generator Torque Regulator Status	For CL monitor B1
b4	Over Voltage Regulator Status	DC Voltage
b5	Under Voltage Regulator Status	DC Voltage
b6		
b7		
b8		
b9		
b10		
b11		
b12		
b13		
b14		
b15		

9.4 Data Logger Trigger Word

There is a special trigger word in application level that can be used to trigger data logger. This word can be used for triggering when source is selected from Application and original VACON® Marine application vcn is used. Variable is called "DataLoggerTrigWord"

DataLoggerTrigWord		
	Function	Comment
b0	Fault Status	Logger is triggered when there is a fault
b1	Warning Status	Logger is triggered when there is a warning
b2	Auto Reset Warning	Logger is triggered when there is a fault that has been defined to be automatically reset. This bit can be used to get the first fault situation.
b3	Fault Status OR Warning Status	B0 OR B1 triggering situation has happened
b4	Fault Status OR Auto Reset Warning	B0 OR B2 triggering situation has happened
b5		
b6		
b7		
b8		
b9		
b10		
b11		
b12		
b13		
b14		
b15		

9.5 MC Status Word

Motor Control Status Word		
	FALSE	TRUE
b0	Not in Ready state	Ready
b1	Not Running	Running
b2	Direction Clockwise	Counterclockwise
b3	No Fault	Fault
b4	No Warning	Warning
b5		At reference speed
b6		At Zero Speed
b7		Flux Ready
b8		TC Speed Limiter Active
b9	Encoder Direction	Counterclockwise
b10		Under Voltage Fast stop
b11	No DC brake	DC Brake is active
b12		
b13		Restart delay active
b14		
b15		

9.6 Brake Control Status

Brake Status Word ID89		
	FALSE	TRUE
b0	Flux not ready	Flux ready (>90%)
b1	Not in Ready state	Ready
b2	Not Running	Running
b3	No Fault	Fault
b4	No Warning	Warning
b5	No Run Request	Run Request
b6	No DC Brake	DC Brake is active
b7	Zero Speed	Not Zero Speed
b8	Brake Control Close	Brake Control Open
b9	Brake Closed (Mech. Delays)	Brake Open (Mech. Delays)
b10	Brake feedback LOW	Brake feedback HIGH
b11	No Limit Controls Active	Limit control Active
b12		
b13		
b14		
b15		

BrakeStatusWord.B00; Flux State:

FALSE: Rotor flux is below 90%.

TRUE: Rotor flux is above 90%.

BrakeStatusWord.B01; Ready State:

FALSE: Drive is not in Ready state.

TRUE: Drive is in Ready state.

BrakeStatusWord.B02; Run state:

FALSE: Drive is not modulating.

TRUE: Drive is modulating.

BrakeStatusWord.B03; Fault State:

FALSE: Drive does not have fault.

TRUE: Drive is in fault state, depending on fault type drive may be still modulating. E.g. when fault is defined as a ramp stop.

BrakeStatusWord.B04; Warning state:

FALSE: No active warnings is drive.

TRUE: Drive has one or more active warnings.

BrakeStatusWrod.B05; Run Request state:

FALSE: No start command to motor control.

TRUE: Start request to motor control.

BrakeStatusWord.B06; DC Brake state:

FALSE: DC current is not injected to motor.

TRUE: DC Current is injected to motor.

BrakeStatusWord.B07; Zero Speed State:**FALSE:** Ramp Output is above 1 Hz.**TRUE:** Ramp Output is below 1 Hz.BrakeStatusWord.B08; Brake Control State:**FALSE:** Drive is requesting brake to be closed.**TRUE:** Drive is requesting brake to be opened.BrakeStatusWord.B09; Brake Estimated state:**FALSE:** Brake is estimated to be closed, this signal considers brake mechanical delays.**TRUE:** Brake is estimated to be open, this signal considers brake mechanical delays.BrakeStatusWord.B10; Brake Feedback state:**FALSE:** Brake feedback digital input state indicates brake to be closed.**TRUE:** Brake feedback digital input state indicates brake to be open.BrakeStatusWord.B11; Limit controller state:**FALSE:** No active limit controllers.**TRUE:** One or more limit controller is active (Current, torque, power, DC voltage).

10. PROBLEM SOLVING

In problem situations it is important to have proper information about the problem.

However, it is recommended first to try with latest application and system software versions available. Software is continuously developed and default settings are improved.

If the problem persists, contact your local contacts. Before you contact the local contacts, follow the guidelines below so that you give the information they need for problem solving.

Type	Signal Name	Actual	Unit	Min	Max
Value	BrakeStatusWord	1959	n		5535
Value	Motor Torque	2,4			10,0
Value	Motor Current	3,9			10,0
Value	FreqReference	15			100,0
Value	DC Voltage	558	V	0	1000
Value	Output Frequency	15,13	Hz	-65,00	65,00
Value	Shaft Frequency	14,95	Hz	-65,00	65,00
Value	Motor Voltage	71,4	V	0,0	1000,0

Figure 1. Recommended signals for NCDrive.

Use the fastest communication speed (Baudrate: 57 600) and a 50 ms update interval for signals for the RS232 communication.

For the CAN communication, use a 1 Mbit communication speed and 7 ms update interval for signals.

When you contact the support, send the *.trn, *.par and Service info (*.txt) files with a description of the situation. If the situation is caused by a fault, take also the Datalogger data from the drive.

Note that Datalogger settings can be changed to catch correct situation and it is also possible to make manual force trig for Datalogger.

Before storing the parameter file, upload the parameters from the drive and save when NCDrive is in the ON-LINE state. If it is possible, do this while the problem is active.

It is also helpful to have single line diagram from the system to show where the problem occurs.

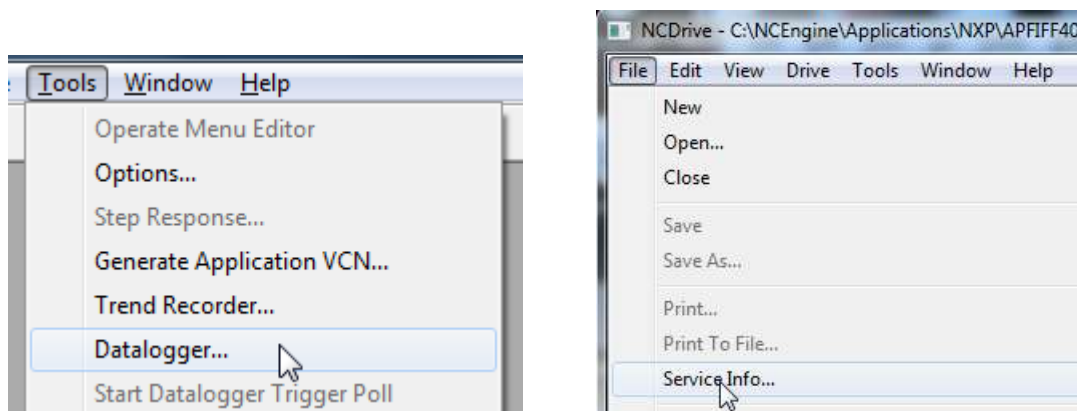

Figure 2. Datalogger window opening and Service Info upload.

11. FAULT CODES

F1 *Overcurrent fault*

Drive has detected a high current in the output phase.

S1 = Hardware trip: Current above $4 \cdot I_h$

S2 = Only in NXS unit

S3 = Current controller supervision. Current limit too low or current peak value too high.

Possible cause and solutions

1. Sudden increase in load
 - Check motor load.
2. Short circuit in motor cables
 - Check motor and cables.
3. Motor is undermagnetized at start.
 - Make identification run
4. Unsuitable motor
5. Sine filter is used but drive settings are not correct
 - Activate Sine filter parameter (P6.7.5) in system menu

F2 *Overvoltage fault*

DC-link voltage has exceeded the drive protection limits.

S1 = Hardware trip.

500 Vac unit DC voltage above 911 Vdc

690 Vac unit DC voltage above 1200 Vdc

S2 = Overvoltage control supervision (only 690 Vac unit).

DC voltage has been above 1100 Vdc for too long.

Possible cause and solutions

1. Too short a deceleration time
 - Increase deceleration time.
 - Use brake chopper and brake resistor.
 - Use Brake chopper unit.
 - Use active front end unit (AFE ARFIFF02).
 - Activate overvoltage controller.
2. High overvoltage spikes in supply
 - Activate overvoltage controller.
3. 690 V unit operating too long above 1100 Vdc
 - Check input voltage.

F3 *Earth fault*

Earth fault protection ensures that the sum of the motor phase currents is zero. The overcurrent protection is always working and protects the AC drive from earth faults with high currents.

S1 = Sum of motor current is not zero

Possible cause and solutions

1. Insulation failure in cables or motor
 - Check motor cables and motor.

F5 *Charge switch*

Charge switch status is not correct when start command is given.

S1 = Charge switch was open when START command was given.

Possible cause and solutions

1. Charge switch was open when the START command was given
 - Check connection of the feedback from charging relay.
 - Reset the fault and restart.

Should the fault re-occur, contact your local distributor.

F6 *Emergency stop*

Emergency stop command has been given by using a special option board.

F7 *Saturation fault*

S1 = Hardware failure

Possible cause and solutions

1. If there is a brake chopper in use
 - Check the isolation resistance and the resistance on the brake resistor.
2. FR4-FR8: Power module
 - Measure the power module directly from its terminals.
3. Hardware
 - Check the capacitors.

F8 *System Fault*

A system fault indicates several different fault situations in drive operation.

S1 = Reserved

- Disturbance. Reset the unit and try again.
- If there is star coupler in the unit, check the fibre connections and phase order.
- Driver board or IGBT broken.
- FR9 and the bigger size drives , which includes not star coupler, ASIC board (VB00451) is broken.
- FR8 and smaller size drives: control board broken.
- FR8 and smaller size drives: if there is boards VB00449 / VB00450 in use, failure might be in there.

S2 = Reserved

S3 = Reserved

S4 = Reserved

S5 = Reserved

S6 = Reserved

S7 = Charge switch

S8 = No power to driver card

S9 = Power unit communication (TX)

S10 = Power unit communication (Trip)

S11 = Power unit comm. (Measurement)

S12 = SystemBus synchronization has failed in DriveSynch operation

S30 = Safe disable inputs are in different state (OPT-AF)

S31 = Thermistor short circuit detected (OPT-AF)

S32 = OPT-AF board has been removed

S33 = OPT-AF board EEPROM error

F9 *Undervoltage fault*

DC-link voltage is below the fault voltage limit of the drive.

S1 = DC-link too low during run

S2 = No data from power unit

S3 = Undervoltage control supervision

Possible cause

1. Too low a supply voltage.
2. AC drive internal fault.
3. One of the input fuses is broken.
4. External charge switch has not been closed.

Correcting measures

- In case of temporary supply voltage break, reset the fault and restart the AC drive.
- Check supply voltage.
- Check function of DC charge.
- Contact your local distributor.

F10 *Input line supervision*

S1 = Phase supervision diode supply

S2 = Phase supervision active front end

Possible cause:

1. Input line phase is missing.

Correcting measures

- Check supply voltage, fuses and cable.

F11 *Output phase supervision*

Current measurement has detected that there is no current in one phase or one phase current is considerably different from other phases.

Correcting measures

- Check motor cable and motor.

F12 *Brake chopper supervision*

Brake chopper supervision generates pulses to the brake resistor for response. If no response is received within set limits a fault is generated.

Possible cause:

1. No brake resistor installed.
2. Brake resistor is broken.
3. Brake chopper failure.

Correcting measures:

- Check brake resistor and cabling.
- If these are ok the chopper is faulty. Contact your local distributor.

F13 *Drive undertemperature fault*

Possible cause:

1. Heatsink temperature is under -10°C

F14 *Drive overtemperature fault*

Possible cause:

1. Heatsink temperature is over acceptable limits. See user manual for the temperature limit. Overtemperature warning is issued before actual trip limit is reached.

Correcting measures

- Check correct amount and flow of cooling air.
- Check the heatsink for dust.
- Check ambient temperature.
- Make sure that switching frequency is not too high in relation to ambient temperature and motor load.

F15 *Motor Stalled*

The motor stall protection protects the motor from short time overload situations such as one caused by a stalled shaft. The reaction time of the stall protection can be set shorter than that of motor thermal protection. The stall state is defined with two parameters, Stall current and Stall frequency limit. If the current is higher than the set limit and output frequency is lower than the set limit the stall state is true. There is actually no real indication of the shaft rotation. Stall protection is a type of over current protection.

- Check motor and load.

F16 *Motor over temperature*

Motor overheating has been detected by AC drive motor temperature model. Motor is overloaded.

Possible cause:

1. Motor load is too high.
2. Motor values are set incorrectly.

Correcting measures:

- Decrease motor load.
- If no motor overload exists, check the temperature model parameters.

F17 *Motor underload fault*

The purpose of the motor underload protection is to ensure that there is load on the motor when the drive is running. If the motor loses its load there might be a problem in the process, e.g. a broken belt or a dry pump.

The underload curve is a squared curve set between the zero frequency and the field weakening point. The protection is not active below 5Hz (the underload time counter is stopped).

The torque values for setting the underload curve are set in percentage which refers to the nominal torque of the motor. The motor's name plate data, parameter motor nominal current and the drive's nominal current I_H are used to find the scaling ratio for the internal torque value.

Correcting measures:

- Check load.

F22 *EEPROM checksum fault*

Possible cause:

1. Parameter save fault.
2. Faulty operation.
3. Component failure.

Correcting measures:

- Should the fault re-occur, contact your local distributor.

F24 *Counter fault*

Possible cause:

1. Values displayed on counters are incorrect.

Correcting measures:

- Have a critical attitude towards values shown on counters.

F25 *Microprocessor watchdog fault*

Possible cause:

1. Start-up of the drive has been prevented.
2. Run request is ON when a new application is loaded to the drive.

Correcting measures:

- Reset the fault and restart.
- Should the fault re-occur, contact your local distributor.

F26 *Start-Up prevention*

Possible cause:

1. Start-up of the drive has been prevented.
2. Run request is ON when a new application is loaded to drive.

Correcting measures:

- Cancel prevention of start-up if this can be done safely.
- Remove Run request.

F29 *Thermistor fault*

The thermistor input of the option board has detected too high a motor temperature.

Possible cause:

1. Motor is overheated.
2. Thermistor cable is broken.

Correcting measures:

- Check motor cooling and load.
- Check thermistor connection (if thermistor input of the option board is not in use, it has to be short circuited).

F31 *IGBT temperature*

IGBT Inverter Bridge overtemperature protection has detected too high a short term overload current.

Possible cause:

1. Too high load.
2. Identification run has not been made which causes the motor to start undermagnetized.

Correcting measures:

- Check load.
- Check motor size.
- Make identification Run.

F32 *Fan cooling*

Possible cause:

1. Cooling fan of the AC drive does not start when ON command is given.

Correcting measures:

- Contact your local distributor.

F37 *Device change*

Option board or power unit changed.

Possible cause:

1. New device of same type and rating.

Correcting measures:

- Reset. Device is ready for use.

F38 *Device added*

Option board added.

Correcting measures:

- Reset. Device is ready for use. Old board settings will be used.

F39 *Device removed*

Option board removed.

Correcting measures:

- Reset. Device no longer available.

F40 *Device unknown*

Unknown option board or drive.

S1 = Unknown device

S2 = Power1 not same type as Power2

Correcting measures:

- Contact the distributor near to you.

F41 IGBT temperature

IGBT inverter bridge overtemperature protection has detected too high a short term overload current.

- Check load.
- Check motor size.
- Make Identification run.

F42 Brake resistor overtemperature**S1: Brake resistor high temperature**

Calculation for internal brake resistor has exceeded the tripping limit. If the internal brake resistor is not in use set the brake chopper parameter in System menu to 'Not connected'.

S2: Brake resistor resistance is too high**S3: Brake resistor resistance is too low****S4: No brake resistor detected****F43** Encoder fault

Encoder fault is issued when the drive is not able to operate in closed loop control mode (encoder is used). See subcodes for details on the reason of the fault:

S1 = Encoder 1 channel A is missing

S2 = Encoder 1 channel B is missing

S3 = Both encoder 1 channels are missing

S4 = Encoder reversed

S5 = Encoder board missing

S6 = Serial communication fault

S7 = Ch A / Ch B Mismatch

S8 = Resolver/Motor pole pair mismatch

S9 = Missed Start Angle

S10 = Sin/Cos encoder feedback is missing.

S11 = Encoder angle is drifting fault.

S12 = Dual speed supervision fault

S13 = Encoder angle supervision fault

S14 = Encoder estimated missing pulse fault, switch from the CL ctrl to the OL sensorless ctrl.

1. Modulation type is ASIC while incremental encoder is used.
 - Change modulator type to Software 1.
2. Start identification do not work due low identification current.
 - Increase identification current.
3. Start angle identification is not working at all because there is no saturation based saliency in the motor.
 - Use absolute encoder.
4. There are too much noise pick-ups in encoder cable.
 - Check encoder cable shield and grounding in drive.

F44 *Device changed (Default param.)*

Possible cause:

1. Option board or power unit changed.
2. New device of different type or different rating from the previous one.

Correcting measures:

- Reset.
- Set the option board parameters again if option board was changed. Set converter parameters again if power unit was changed.

F45 *Device added (default param.)*

Possible cause:

1. Option board of different type added.

Correcting measures:

- Reset.
- Set the option board parameters again.

F50 *4mA supervision*

Possible cause:

1. Current at the analogue input is below 4mA.
2. Signal source has failed.
3. Control cable is broken or loose.

Correcting measures:

- Check the current loop circuitry.

F51 *External fault*

Possible cause:

1. Digital input fault.

Correcting measures:

- Remove fault situation from external device.

F52 *Keypad communication*

Possible cause:

1. The connection between the control keypad or NCDrive and the AC drive is broken.

Correcting measures:

- Check keypad connection and possible keypad cable.

F53 *Fieldbus communication*

Possible cause:

1. The data connection between the fieldbus Master and the fieldbus board is broken.

Correcting measures:

- Check installation.
- If installation is correct, contact the nearest VACON® distributor.

F54 Slot fault

Possible cause:

1. Defective option board or slot.

Correcting measures:

- Check board and slot.
- Contact the nearest VACON® distributor.

F56 Temperature sensor board 1 fault

Temperature protection function is used to measure temperature and give warning and/or fault when set limits are exceeded. Brake Control application supports two temperature sensor boards simultaneously. One can be used for the motor winding and the other for the motor bearings.

A1 – Temperature limit has been exceeded.

A2 – Sensor not wired or not working.

A3 – Short circuit.

Possible cause:

1. Temperature limit values set for the temperature board parameters have been exceeded.

Correcting measures:

- Find the cause of temperature rise.
- Check sensor wiring.

F57 Identification

Identification run has failed.

A1 = Current measurement offset

A2 = Identification current level

A3 = Acceleration time too long

A4 = Identification frequency reference not reached

A5 = Too low or high magnetization current

A6 = Flux curve outside expected levels

A7 = PMSM, Encoder zero position

A8 = Too low maximum frequency limit

A9 = PMSM, encoder zero pulse not found.

A10 = Ls Identification timeout

A11 = Ls Identification current

Possible cause:

1. There was load on the motor shaft when making the identification run with rotating motor.
2. Motoring or generator side torque/power limits are too low to achieve a stable run.

Correcting measures:

- Run command was removed before identification was ready.
- Motor is not connected to the AC drive.
- There is load on the motor shaft.
- In some cases, levering the DC-Link voltage may help, for example, by stopping AFE boosting.

F58 *Mechanical brake*

This fault is generated when the acknowledge signal from the brake is used. If the status of the signal is opposite from the control signal for a longer period of time than the delay defined with P2.15.11 *Brake Fault Delay*, a fault is generated.

Correcting measures:

- Check the condition and connections of mechanical brake.

F59 *SystemBus communication*

The master drive sends pulses to all follower drives. If the pulses are missing, a system bus communication fault is generated. The master drive also receives pulses back from the follower drives (max. four drives) and generates warnings if pulses are missing.

System bus communication is broken between the master and the follower.

Correcting measures:

- Check expander board parameters.
- Check optical fibre.
- Check option board jumpers.

F60 *Cooling*

Protection for the liquid-cooled units. An external sensor is connected to the drive (DI: Cooling Monitor) to indicate if cooling liquid is circulating. If the drive is in Stop state, only a warning is issued. In Run state a fault is issued and the drive makes a coast stop.

Possible cause:

1. Liquid cooled drive cooling circulation have been failed.

Correcting measures:

- Check reason for cooling failure from external system.

F61 *Speed Error*

Speed error monitoring function compares the encoder frequency and the ramp generator output.

This function is used with PMS motors to detect if the motor is out of synchronization or to disable open loop function that uses encoder speed for slip compensation. The slip compensation is disabled regardless of the response and needs to be re-activated once speed error is detected (set parameter again or power down the drive).

Possible cause:

1. Motor speed is not the same as the reference. For example, motor speed is limited by torque limit.
2. PMS motor has gone off synchronization.
3. Encoder cable is broken.

F62 *Run Disabled*

Run Disable warning signal is issued when Run Enable signal has been removed from the IO.

F63 *Emergency stop (Not implemented)*

Possible cause:

1. A command has been given from a digital input or the fieldbus to make an emergency stop.

Correcting measures:

- New run command is accepted after the emergency stop is reset.

F64 *Input switch open (Not implemented)*

Possible cause:

1. Drive input switch is opened.

Correcting measures:

- Check the main power switch of the drive.

F65 *Temperature sensor board 2 fault*

Temperature protection function is used to measure temperature and give warning and/or fault when set limits are exceeded. Brake Control application supports two temperature sensor boards simultaneously. One can be used for the motor winding and the other for the motor bearings.

A1 – Temperature limit has been exceeded.

A2 – Sensor not wired or not working.

A3 – Short circuit.

Possible cause:

2. Temperature limit values set for the temperature board parameters have been exceeded.

Correcting measures:

- Find the cause of temperature rise.
- Check sensor wiring.

F74 *Follower fault*

When using the normal Master-Follower function, this fault code is given if one or more follower drives trip to fault.

F75 *Drive Synch follower*

In DriveSynch mode the master drive has detected a fault in one or more follower drives. When this fault occurs, the master drive sends a command to all drives to trig the data logger.

F81 *External fault 2*

Possible cause:

1. Digital input fault.

Correcting measures:

- Remove fault situation from external device.

F82 *Over Load*

User defined overload limits has been exceeded. See functional description from Motor Protection chapter.

F83 Brake Slipping

Drive sees movement on encoder while brake is supposed to be closed.

Possible cause:

1. Brake has opened without drive control.
2. Brake is slipping and can keep load.

F84 Brake Open Fault

Brake closed feedback has not come in set feedback delay time.

Possible cause:

1. Brake has not closed.

VAGON®

www.danfoss.com

Vacon Ltd
Member of the Danfoss Group

Runsorintie 7
65380 Vaasa
Finland

Document ID:



Rev. B