

VACON[®] NXP
AC DRIVES

ARFIFF30
GENERATOR APPLICATION
USER MANUAL

VACON[®]

VACON® GENERATOR APPLICATION MANUAL

INDEX

Document code: DPD01916B
Software code: ARFIFF30V100
Date: 14.4.2019

1. GENERATOR APPLICATION - INTRODUCTION	7
2. Generator Versions compatibility issues	8
3. Power Take Modes.....	9
3.1 Power Take Out modes.....	9
3.1.1 Induction motor	9
3.1.2 Permanent Magnet Synchronous Motor	10
3.2 Synchronous machine	10
3.3 Power Take In modes	11
3.3.1 Induction Motor – Boosting.....	11
3.3.2 Induction Motor- Take Me Harbour.....	11
3.3.3 Permanent Magnet Synchronous Motor - Boosting.....	11
3.3.4 Permanent Magnet Synchronous Motor – Take Me Harbour	12
3.3.5 Synchronous machine - Boosting.....	12
3.3.6 Synchronous machine – Take Me Harbor	12
4. Main contactor control	14
5. Control I/O.....	15
6. Monitoring signals.....	16
6.1 Monitoring	16
6.1.1 Monitoring 1 Values.....	16
6.1.2 Monitoring 2 Values.....	17
6.1.3 Fieldbus Monitoring values.....	18
6.1.4 IO Monitoring values.....	18
6.1.5 Master Follower values.....	18
6.1.6 License code activation	19
6.1.7 Line synch	19
6.2 Monitoring Signal Descriptions	20
6.2.1 Monitoring 1 values	20
6.2.2 Monitoring 2 values	23
6.2.3 Fieldbus monitoring values.....	25
6.2.4 IO Monitoring values.....	30
6.2.5 Master Follower monitoring values	32
7. ARFIFF30– Parameter list.....	33
7.1 Basic Parameters (G2.1).....	33
7.2 Reference Handling (G2.2).....	33
7.2.1 PTM handling.....	33
7.2.2 PTO handling.....	34
7.2.3 PTI-Boost handling.....	34

7.2.4	PTI 0-Speed.....	35
7.2.5	Regen Motor Mode	35
7.2.6	Commissioning	35
7.2.7	DC Voltage Reference Handling	36
7.2.8	Speed / Frequency Ref handling.....	36
7.2.9	Torque Control.....	36
7.2.10	Motor Potentiometer reference.....	37
7.3	Ramp Control (G2.3)	37
7.3.1	Ramp Control.....	37
7.4	Input Signals (G2.4).....	37
7.4.1	Basic settings.....	37
7.4.2	Digital Inputs.....	38
7.4.3	Analogue Input 1.....	39
7.4.4	Analogue Input 2.....	39
7.4.5	Analogue Input 3.....	40
7.4.6	Analogue Input 4.....	40
7.5	Output Signals (G2.5)	41
7.5.1	Dig Out Signals	41
7.5.2	Delayed DO 1.....	42
7.5.3	Delayed DO 2.....	42
7.5.4	Analog Output 1	43
7.5.5	Analog Output 2	43
7.5.6	Analog Output 3	44
7.5.7	Options	44
7.6	Limit Settings (G2.6)	45
7.6.1	Current Limit	45
7.6.2	Power Limit.....	45
7.6.3	Frequency Limit.....	45
7.6.4	Voltage.....	45
7.6.5	DC Voltage.....	46
7.6.6	Torque.....	46
7.6.7	Active Current.....	46
7.7	Flux and DC Current handling CL Settings (G2.7).....	47
7.8	Motor Control (G2.8)	47
7.8.1	Motor Control Basic Settings.....	47
7.8.2	U/f Settings	47
7.8.3	PMSM Control settings	48
7.8.4	Stabilators.....	48
7.8.5	Identification parameters.....	49
7.8.6	Tuning parameters.....	49
7.8.7	Flying Start Tuning parameters.....	50
7.9	Speed Control (G2.9)	50
7.10	Drive Control (G2.10).....	51
7.11	Master Follower (G2.11)	51
7.12	Protection (G 2.12)	52
7.12.1	General.....	52
7.12.2	PT-100.....	52
7.12.3	Earth fault	52
7.12.4	External Fault	53
7.12.5	Generator Voltage.....	53
7.12.6	Generator Frequency	53

7.12.7	Motor thermal protections.....	54
7.12.8	Fieldbus protection.....	54
7.12.9	Options	54
7.13	Fieldbus (G 2.13)	55
7.14	ID Control Functions (G2.14)	56
7.14.1	Value Control	56
7.14.2	DIN ID Control 1.....	56
7.14.3	DIN ID Control 2.....	56
7.14.4	DIN ID Control 3.....	57
7.15	Curve 1 definition (G2.15)	57
7.16	Curve 2 definition (G2.16)	58
7.17	Curve 3 definition (G2.17)	59
7.18	Line Synch (G2.18).....	60
7.19	Keypad control (Control keypad: Menu M3)	60
7.20	System menu (Control keypad: Menu M6).....	60
7.21	Expander boards (Control keypad: Menu M7).....	60
8.	Parameter Descriptions	61
8.1	Basic parameters.....	61
8.2	Reference Handling	68
8.2.1	PTM Handling.....	68
8.2.2	PTO Handling	68
8.2.3	PTI-Boost	72
8.2.4	PTI 0-Speed.....	74
8.2.5	Regen Motor.....	75
8.2.6	Commissioning	76
8.2.7	DC Voltage Reference	78
8.2.8	Speed and Frequency	79
8.2.9	Torque Control.....	80
8.2.10	Ramp Control.....	81
8.3	Input Signals.....	82
8.3.1	Basic Settings	82
8.3.2	Digital input signals.....	83
8.3.3	Analogue Inputs 1-4	87
8.4	Output Signals.....	90
8.4.1	Digital output signals	90
8.4.2	Delayed digital output 1 & 2.....	92
8.4.3	Analogue output 1 & 2 & 3	93
8.4.4	Options	96
8.5	Limit settings	98
8.5.1	Current Limits	98
8.5.2	Power Limits.....	98
8.5.3	Frequency limits.....	100
8.5.4	Voltage.....	101
8.5.5	DC Voltage limit regulators.....	102
8.5.6	Torque.....	103
8.5.7	Active Current.....	103
8.6	Flux Control.....	104
8.7	Motor Control	105
8.7.1	U/f Settings	107
8.7.2	Close Loop Settings.....	112

8.7.3	Permanent magnet synchronous motor settings.....	113
8.7.4	Stabilization settings	119
8.7.5	Identification settings.....	123
8.7.6	Flying Start.....	124
8.8	Speed Control settings	125
8.9	Drive Control	127
8.10	Master Follower	132
8.11	Protections.....	133
8.11.1	General settings	133
8.11.2	PT-100.....	136
8.11.3	Earth Fault	137
8.11.4	External Fault	137
8.11.5	Generator Voltage OPT-D7.....	138
8.11.6	Generator Frequency OPT- D7	138
8.12	Motor Protection.....	140
8.12.1	Over Load Protection.....	142
8.12.2	Fieldbus communication.....	143
8.13	Fieldbus.....	145
8.13.1	Signals from drive to Fieldbus.....	145
8.13.2	Signals from fieldbus to drive.....	145
8.14	ID Functions	147
8.14.1	Value Control	147
8.14.2	DIN ID Control.....	149
8.15	Curve 1 Definition.....	151
8.16	Curve 2 Definition.....	151
8.17	Curve 3 Definition.....	151
8.18	Line synch.....	152
9.	Keypad control parameters	153
10.	Status and control words in detail.....	154
10.1	Basic In ByPass (0).....	154
10.2	FB Control Word	155
10.2.1	Standard (1).....	155
10.2.2	Vacon Generator 1 profile (2).....	156
10.2.3	Vacon AFE 2 Profile (Not Implemented as of 1.7.2014).....	158
10.3	FB Status Word	160
10.4	Status Word (Application) ID 43.....	162
11.	Problem solving.....	164
12.	FAULT CODES	165

1. GENERATOR APPLICATION - INTRODUCTION

Software ARFIF30, Generator application

The VACON® Generator application is an application that can be used to keep constant DC Voltage regardless of input power source. The application supports Synchronous Generator (LCL Needed), Permanent Magnet Synchronous Motor (Absolute Encoder needed) and asynchronous motor (Incremental Encoder needed).

VACON® Generator application also support PTI operations. However, this manual does include details on related hardware selections. We recommend you to read the Grid Converter technical documentation and contact VACON® technical support for more details.

The basic I/O-configuration of the AC drive consists of OPT-A1, OPT-A2 and if needed OPT-D7 or OPT-A5 option cards depending of what type of generator is used. Also for commissioning purposes it is recommended to use OPT-D2 board. The basic I/O configuration has been described in table 2-1.

As a default the control place (P3.1) of the Generator drive is Keypad.

This application requires NXP3 control board 761 or newer.

2. GENERATOR VERSIONS COMPATIBILITY ISSUES

V095

- Frequency Reference monitoring signal ID number changed from 1752 to 25
 - o 1752 is reserved for P 2.8.7.4 DeadTieContCurL

Note 1: When updating application it is not recommended to use VACON® NCDrive parameter download function. Instead, upload the parameters from the unit and make comparison to the old parameter file. Application is constantly developed, this includes changing parameter default values. If parameters are directly downloaded to drive, the improved default values will be lost.

3. POWER TAKE MODES

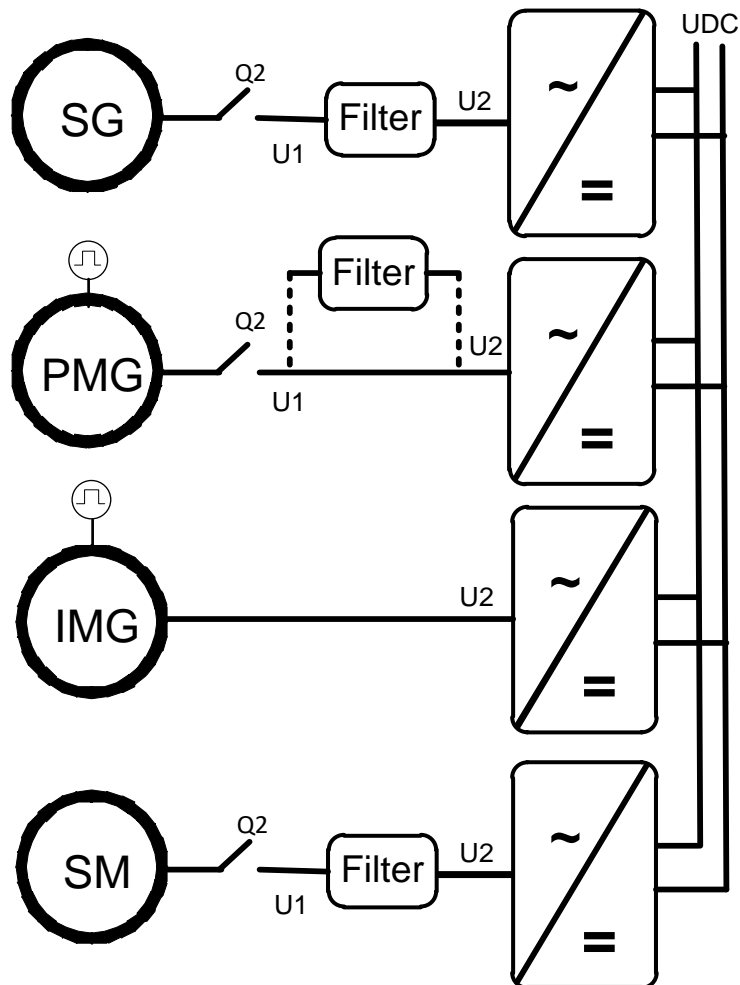

Figure 3-1.

3.1 Power Take Out modes

3.1.1 Induction motor

AC drive is operated in closed loop control. Closed Loop is needed to have good response to power demand changes. AC drive will be set to operate in DC Reference mode with negative torque reference, which can be handled in G2.2.1.6 PTO group, when Power Take mode is PTO. Torque reference can be handled by using curve reference mode or with direct control from upper system.

3.1.1.1 Induction motor in open loop control.

Pure open loop control can be used on cases where generator drive is not required to keep the DC stable, e.g. when grid side drive can be kept in AFE mode.

3.1.1.2 Regenerative Motor Mode

This mode can be used in open loop mode but involve limits for frequency range: 30 Hz... 85 Hz and for voltage range: 150 Vac...Unit Nominal voltage. When starting this operation mode, the

recommended generator speed is in range of 40 Hz...70 Hz. **This mode requires licence code.** To get the licence, provide the technical details beforehand to VACON® Finland for approval.

3.1.2 Permanent Magnet Synchronous Motor

Depending on the system requirements, the PMSM can be controlled in normal motor control modes or AFE mode. If PTI – TMH is also needed, we recommend the normal motor control mode. If only PTI – Boosting is needed, the system may be possible to operate in AFE mode.

PMSM in normal motor control modes needs to be operated in closed loop control to have a good response time to the changes in power demand.

AFE mode can be used without filter if motor can be run with unity power factor. AFE can compensate if inductor size is programmed according to stray inductance of PM motor and stray inductance voltage is over half of BEM voltage, if not, LC filter is enough. When paralleling, LCL is needed

3.2 Synchronous machine

This is normal AFE operation.

3.3 Power Take In modes

PTI needs to be separated to two different modes. In all modes the DC Voltage needs to be kept constant with the Grid side drive (or otherwise have suitable DC Voltage available). When using the Grid Converter application on grid side, change the operation mode to AFE operation mode. Constant DC Voltage can be also kept with the uGrid operation mode when special care of references and limit values in PMS has been take care of.

PTI - Boosting.

In this mode the generator (motor) is already rotating when more power is started to be fed to the generator (motor). When the PTI is started, we recommend a minimum frequency limit of ~20 Hz for the drive is. Above this limit, the operation is considered to be boosting.

PTI – TMH (Take Me Harbour)

In this mode, the generator (motor) needs to be started from zero speed. You can do this for example so that the main engine is not running and the propeller power is taken from the diesel generator using existing shaft generator system.

3.3.1 Induction Motor – Boosting

3.3.1.1 In DC Voltage Reference mode

While in PTO mode, the AC drive is operated in the torque reference mode. When you change the operation mode to boosting, you can simply put the AC drive torque reference to positive direction.

3.3.1.2 In Speed Reference Mode

In this mode, the AC drive will follow the speed reference of the PMS. Usually the power capacity of the Shaft Generator system is only a fraction of the main engine power capacity. Therefore, you need to check the power, torque and current limitations.

3.3.2 Induction Motor- Take Me Harbour.

In this mode, the AC drive will follow the speed reference of the PMS. Usually the power capacity of the Shaft Generator system is only a fraction of the main engine power capacity. Therefore, you need to check the power, torque and current limitations.

3.3.3 Permanent Magnet Synchronous Motor - Boosting

Depending on the system requirements, the PMSM can be controlled in normal motor control modes or AFE mode. If PTI – TMH is also needed, we recommend the normal motor control mode. If only PTI – Boosting is needed and there is space for sine filter, the system can be operated in AFE mode.

3.3.3.1 Operating in AFE Mode, DC Voltage Reference Mode

Change is made only between PTO and PTI – Boosting mode.

When the AC drive is operating in PTO mode, the constant DC Voltage is maintained. When you change to the Boosting mode, the constant DC Voltage needs to be kept with grid side drive. When the grid side drive keeps the constant DC Voltage, the DC Voltage Reference can be set lower on the generator side drive thus changing the power flow direction. To be able to control the power flow, the PMS needs to control the Output Power.

3.3.3.2 Operating in AFE Mode, Speed Reference Mode

This operation mode is not possible.

3.3.3.3 Operating in normal motor control mode. DC Voltage Reference Mode

While in PTO mode, the AC drive is operated in the torque reference mode. When you change the operation mode to boosting, you can simply put the AC drive torque reference to positive direction. With this selection, the PMS will control the positive torque reference thus defining boosting torque.

3.3.3.4 Operating in normal motor control mode. Speed Reference Mode

In this mode, the AC drive will follow the speed reference of the PMS. Usually the power capacity of the Shaft Generator system is only a fraction of the main engine power capacity. Therefore, you need to check the power, torque and current limitations.

3.3.4 Permanent Magnet Synchronous Motor – Take Me Harbour

This control can be made only by using the normal motor control modes. AFE mode cannot start from below 25 Hz.

3.3.4.1 Operating in normal motor control mode. DC Voltage Reference Mode

While in PTO mode, the AC drive is operated in the torque reference mode by using selection 1 / Curve in P2.2.9.1 Torque Ref Select. When you change the operation mode to boosting, you need to set the reference to positive direction. With this selection, the PMS will control the positive torque reference thus defining torque to be used for propulsion.

3.3.4.2 Operating in normal motor control mode. Speed Reference Mode

In this mode, the AC drive will follow the speed reference of the PMS. Usually the power capacity of the Shaft Generator system is only a fraction of the main engine power capacity. Therefore, you need to check the power, torque and current limitations.

3.3.5 Synchronous machine - Boosting

3.3.5.1 Operating in AFE Mode. DC Voltage Reference Mode

Change is made only between PTO and PTI – Boosting mode. While the AC drive is operating in the PTO mode, the constant DC Voltage is maintained. When you change to the Boosting mode, the constant DC Voltage needs to be kept with grid side drive. When the grid side drive keeps the constant DC Voltage, the DC Voltage Reference can be set lower in the generator side thus changing power flow direction. To be able to control power flow, the PMS needs to control the Output Power limit P2.6.2.1 OutputPowerLim.

3.3.5.2 Operating in AFE Mode. Speed Reference Mode

This operation mode is not possible.

3.3.5.3 Operating in normal motor control mode. DC Voltage Reference Mode

Not supported nor recommended.

3.3.5.4 Operating in normal motor control mode. Speed Reference Mode

Not supported nor recommended.

3.3.6 Synchronous machine – Take Me Harbor

This operation mode is only possible in the normal motor control modes.

3.3.6.1 Operating in normal motor control mode, DC Voltage Reference Mode

Not supported nor recommended

3.3.6.2 Operating in normal motor control mode, Speed Reference Mode

Change is made only between PTO and PTI – TMH.

While the AC drive is operating in PTO mode, the constant DC Voltage is maintained. When you change to PTI - TMH mode, the constant DC Voltage needs to be kept with grid side drive.

In this mode the AC drive will follow the speed reference of the PMS Usually the power capacity of the Shaft Generator system is only a fraction of the main engine power capacity. Therefore, you need to check the power, torque and current limitations.

4. MAIN CONTACTOR CONTROL

The Generator application controls the MCB (Main Circuit Breaker) of the system with selectable Relay Output. When charging of the DC bus is ready, the MCB will be closed. The status of the MCB is monitored via digital input. Digital input used for monitoring is chosen with parameter P2.4.2.4.

Faults can be set to open the main contactor by choosing a response to fault to be “3=Fault, DC OFF”. When a fault occurs, the MCB will be opened after one second so the drive will go to stop state first. In case of F1 Over Current, F2 Over Voltage or F31 and F41 IGBT faults, the breaker is opened immediately. If the charging is on when the fault is acknowledged the MCB will be closed.

An external charging circuit is needed to charge the DC bus.

5. CONTROL I/O

Reference

OPT-A1			
Terminal		Signal	Description
1	+10V _{ref}	Reference voltage output	Voltage for potentiometer, etc.
2	AI1+	Analogue input 1. Range 0-10V, R _i = 200Ω Range 0-20 mA R _i = 250Ω	Input range selected by jumpers. Default range: Voltage 0 – 10 V
3	AI1-	I/O Ground	Ground for reference and controls
4	AI2+	Analogue input 2. Range 0-10V, R _i = 200Ω Range 0-20 mA R _i = 250Ω	Input range selected by jumpers. Default range: Current 0 – 20 mA
5	AI2-		
6	+24V	Control voltage output	Voltage for switches, etc. max 0.1 A
7	GND	I/O ground	Ground for reference and controls
8	DIN1	Start Programmable G2.2.1	0=Stop, 1=Run
9	DIN2	Programmable G2.2.1	No function defined at default
10	DIN3	Programmable G2.2.1	
11	CMA	Common for DIN 1—DIN 3	Connect to GND or +24V
12	+24V	Control voltage output	Voltage for switches (see #6)
13	GND	I/O ground	Ground for reference and controls
14	DIN4	Main contactor supervision Programmable G2.2.1	0 = contactor open 1 = contactor closed
15	DIN5	Programmable G2.2.1	No function defined at default
16	DIN6	Fault reset Programmable G2.2.1	Rising edge will reset active faults
17	CMB	Common for DIN4—DIN6	Connect to GND or +24V
18	AO1+	Analogue output 1	Programmable Range 0—20 mA/R _L , max. 500Ω
19	AO1-		
20	DO1	Digital output READY	Programmable P2.3.1.1 Open collector, I _s ≤50mA, U _s ≤48 VDC
OPT-A2			
21	RO1	Relay output 1 Programmable P2.3.1.2	Switching capacity 24 VDC / 8 A 250 VAC / 8 A 125 VDC / 0.4 A
22	RO1		
23	RO1		
24	RO2	Relay output 2 Main contactor control	This RO is not programmable. Fixed for Main Contactor Control
25	RO2		
26	RO2		

Table 5-1 Default I/O configuration.

6. MONITORING SIGNALS

Menu M1 (Monitoring) holds all the monitoring values. Values are only for monitoring, and cannot be altered by the panel.

6.1 Monitoring

6.1.1 Monitoring 1 Values

Code	Parameter	Unit	Form.	ID	Description
V1.1.1	DC-Link Voltage	V	#	1108	DC Voltage filtered
V1.1.2	DC Voltage Ref.	%	#,##	1200	Used DC voltage reference by the regenerative unit in % of Nominal DC Voltage. Nominal DC voltage = 1.35 * Supply voltage
V1.1.3	DC Voltage Actual	%	#,##	7	Same scaling as DC Voltage Ref.
V1.1.4	Total Current	A	Varies	1104	Filtered current
V1.1.5	Active Current	%	#, #	1125	
V1.1.6	Reactive Current	%	#, #	1157	
V1.1.7	Power kW	kW	Varies	1508	
V1.1.8	Power %	%	#, #	5	
V1.1.9	Status Word		#	43	
V1.1.10	Supply Frequency	Hz	#,##	1	Drive output frequency
V1.1.11	Supply Voltage	V	#, #	1107	Drive output voltage
V1.1.12	LineFrequency D7	Hz	#,##	1654	Measured line frequency
V1.1.13	Line Voltage D7	V	#	1650	Measured line voltage
V1.1.14	AC Voltage Reference	V	#	1556	
V1.1.15	DC Ref Max Lim	%	#,##	1606	
V1.1.16	Encoder 1 Freq.	Hz	#,##	1164	
V1.1.17	Torque Reference	%	#, #	18	
V1.1.18	Final Torque Reference	%	#, #	1145	
V1.1.19	Actual Torque Reference	%	#, #	1180	
V1.1.20	Motor Torque	%	#, #	4	Filtered

Table 6-1, Monitoring 1

6.1.2 Monitoring 2 Values

Code	Parameter	Unit	Form.	ID	Description
V1.2.1	DC Voltage	V	#	44	Measured DC Link voltage in Volts, unfiltered.
V1.2.2	Cos Phii Actual		#,###	1706	
V1.2.3	Unit Temperature	°C	#	1109	
V1.2.4	Freq Reference	Hz	#,##	25	Used line frequency reference
V1.2.5	Current	A	Varies	1113	Unfiltered current
V1.2.6	Operation Hours	h	#, #	1856	
V1.2.7	Reactive Current Reference	%	#, #	1389	
V1.2.8	Power Take Mode		#	1925	
V1.2.9	Torque	%	#, #	1134	Unfiltered
V1.2.10	Limit & Regulators		#	77	
V1.2.11	Shaft Frequency	Hz	#,##	1124	
V1.2.12	U Phase Current	A	Varies	39	
V1.2.13	V Phase Current	A	Varies	40	
V1.2.14	W Phase Current	A	Varies	41	

Table 6-2, Monitoring 2

6.1.3 Fieldbus Monitoring values

Code	Parameter	Unit	Form.	ID	Description
V1.3.1	FB Control Word		#	1160	Control word from fieldbus
V1.3.2	FB Status Word		#	68	Status word to fieldbus
V1.3.3	FB Actual Value		#	865	
V1.3.4	FB Speed Ref		#	875	
V1.3.5	FB Torque Ref		#, #	1140	
V1.3.6	Generator CW		#	1700	
V1.3.7	Generator SW		#	1701	
V1.3.8	Fault Word 1		#	1172	
V1.3.9	Fault Word 2		#	1173	
V1.3.10	Warning Word 1		#	1174	
V1.3.11	Last Active Warning		#	74	
V1.3.12	Last Active Fault		#	37	
V1.3.13	Speed FB Scaled		#, #, #	1907	
V1.3.14	FB Analog Out	%	#, #, #	48	

Table 6-3, Fieldbus

6.1.4 IO Monitoring values

Code	Parameter	Unit	Form.	ID	Description
V1.4.1	DIN1, DIN2, DIN3		#	15	
V1.4.2	DIN4, DIN5, DIN6		#	16	
V1.4.3	DIN Status 1		#	56	
V1.4.4	DIN Status 2		#	57	
V1.4.5	Analogue Input 1	%	#, #, #	13	
V1.4.6	Analogue Input 2	%	#, #, #	14	
V1.4.7	Analogue input 3	%	#, #, #	27	AI3, unfiltered.
V1.4.8	Analogue input 4	%	#, #, #	28	AI4, unfiltered.
V1.4.9	Analogue Out 1	%	#, #, #	26	
V1.4.10	Analogue Out 2	%	#, #, #	50	AO2
V1.4.11	Analogue Out 3	%	#, #, #	51	AO3
V1.4.12	PT100 Temp. 1	°C	#, #	50	
V1.4.13	PT100 Temp. 2	°C	#, #	51	
V1.4.14	PT100 Temp. 3	°C	#, #	52	
V1.4.15	PT100 Temp. 4	°C	#, #	69	
V1.4.16	PT100 Temp. 5	°C	#, #	70	
V1.4.17	PT100 Temp. 6	°C	#, #	71	

Table 6-4, IO monitoring

6.1.5 Master Follower values

Code	Parameter	Unit	Form.	ID	Description
V1.5.1	SB System Status		#	1800	
V1.5.2	D1 Status		#	1801	
V1.5.3	D2 Status		#	1802	

Table 6-5, Master follower

6.1.6 License code activation

Code	Parameter	Unit	Form.	ID	Description
V1.6.1	License Status		#	1996	
V1.6.2	Serial Number Key		#	1997	Give this number to VACON® technical support in case of License Key problems.

*Table 6-6, Activation**6.1.7 Line synch*

Code	Parameter	Unit	Form.	ID	Description
V1.7.1	Line Synch Error		#, #	1659	

Table 6-7, Line synch

6.2 Monitoring Signal Descriptions

6.2.1 Monitoring 1 values

V1.1.1 DC Voltage V ID1108

Measured DC voltage, filtered.

V1.1.2 DC Voltage Ref. % ID1200

DC voltage reference. Compared to given supply voltage.

$1.35 * \text{Supply Voltage} * \text{DC Voltage Ref} = \text{DC Voltage}$

$\text{DC Voltage} = \text{Supply Voltage} * 1.35 * \text{Boost}$

$621 \text{ Vdc} = 400 \text{ Vac} * 1.35 * 1.15$

V1.1.3 DC Voltage Actual % ID7

DC voltage actual in same scale as V1.1.2 DC Voltage Reference.

V1.1.4 Total Current A ID 1113

Filtered current of the drive.

V1.1.5 Active Current % ID 1125

Active current in % of System Rated Current.

V1.1.6 Reactive Current% ID 1157

Reactive current of the regenerative drive in % of System Rated Current.

V1.1.7 Power kW kW ID 1508

Drive output power in kW.

Negative value means that current is flowing to AC side from DC side.

V1.1.8 Power % % ID 5

Drive output power in %.

Negative value means that current is flowing to AC side from DC side.

V1.1.9 Status Word (Application) ID 43

Application Status Word combines different drive statuses to one data word.

Application Status Word ID43		
	FALSE	TRUE
b0	No Charge Command	Charge Command Active
b1	Not in Ready state	Ready
b2	Not Running	Running
b3	No Fault	Fault
b4	No Start Request	Start Request Active
b5	Quick stop active	Quick stop not active
b6	Run Disabled	Run Enable
b7	No Warning	Warning
b8		Charging Switch closed (internal)
b9		Main Contactor Control (DO Final)
b10		Main Contactor Feedback
b11		
b12	No Run Request	Run Request
b13		PTO
b14		PTI
b15		Regen

Table 6-8, Application status word

V1.1.10 Supply Frequency Hz ID 1

Drive output frequency. Updated in stop state when Regen Options B9 is activated.

V1.1.11 Supply Voltage V ID 1107

Drive output voltage.

V1.1.12 Line Frequency D7 Hz ID 1654

Measured Line Voltage Frequency when using OPT-D7 option board in slot C.

V1.1.13 Line Voltage D7 [V] ID 1650

Measured line voltage rms value when using OPT-D7 option board in slot C.

V1.1.14 AC Voltage Reference [V] ID1556

AC side voltage reference.

V1.1.15 DC Voltage max limit ID1606

Drive will limit DC Reference to inside drive specification but allows higher reference if lower supply voltage. This shows the final limit of DC reference.

V1.1.16 Encoder 1 Frequency Hz ID 1164

Encoder frequency directly from encoder

V1.1.17 Torque reference % ID 18

Torque reference value before load share.

V1.1.18 Final Torque Ref % ID1145

Final torque reference in torque reference chain, before acceleration compensation and speed controller output.

V1.1.19 Actual Torque Reference % ID1180

Final torque reference from speed control and torque control. Also includes torque step and acceleration compensation factors.

V1.1.20 Motor torque % ID 4

In % of Motor nominal torque

Open loop

1 s linear filtering

Closed Loop

32 ms filtering

6.2.2 Monitoring 2 values

V1.2.1 DC Voltage V ID44

The measured DC voltage, unfiltered.

V1.2.2 CosPhiActual ID 1706

The calculated Cos Phi.

V1.2.3 Unit Temperature °C ID 1109

The heatsink temperature of the drive.

V1.2.4 Freq Reference Hz ID25

Used frequency reference. In AFE mode frequency reference is determined internally when synchronization is made.

V1.2.5 Current A ID 1113

Unfiltered current of the drive.

V1.2.6 Operation Hours h ID1856

This shows operation hours of the drive. P2.7.19 is used to enter old value if software is updated.

V1.2.7 Reactive Current Reference % ID1389

Final reactive current reference.

V1.2.8 Power Take Mode Used ID1925

0 = Commissioning.

1 = Power Take Out.

2 = Power Take In, Boost.

3 Power Take In, From Zero Speed.

V1.2.9 Torque % ID 1125

Unfiltered motor torque, recommended signal for NCDrive monitoring.

V1.2.10 *Limits and Regulators* ID77

Limit & Regulators ID77	
Bit	
B0	Motoring Current Limit
B1	Generator Current Limit
B2	Motoring Torque Limit
B3	Generator Torque Limit
B4	Over Voltage Regulator
B5	Under Voltage Regulator
B6	Positive Speed Controller Limit
B7	Negative Speed Controller Limit
B8	Positive Iq Limit
B9	Negative Iq Limit
B10	Motoring Power Limit Active
B11	Generator Power Limit Active
B12	
B13	
B14	
B15	

Table 6-10, Limits and regulators

V1.2.11 *Shaft Frequency* ID1124

Shaft Frequency used by motor control

V1.2.12 *U Phase Current* A ID39

V1.2.13 *V Phase Current* A ID40

V1.2.14 *W Phase Current* A ID41

Phase current in rpm, 1 second linear filtering.

6.2.3 Fieldbus monitoring values

V1.3.1 FB Control Word ID 1160

Control word from fieldbus. The table below shows the bypass operation for such fieldbus boards that natively support the bypass operation or can be parameterized to bypass mode.

FB Control Word ID1160		
	Signal	Comment
B00	DC Charge	0= Open MCB. 1= Close DC charge contactor, CB closed automatically.
B01		
B02		
B03	Run	0= AFE is stopped 1= AFE is started
B04		
B05		
B06		
B07	Reset	0>1 Reset fault.
B08		
B09		
B10	Fieldbus Control	0= No control from fieldbus 1=Control from fieldbus
B11	Watchdog	0>1>0>1...0,5 sec square wave clock. This is used to check data communication between fieldbus master and the drive.
B12	FB DIN2	Can be used to control RO or directly parameter by ID number. G2.4.1
B13	FB DIN3	Can be used to control RO or directly parameter by ID number. G2.4.1
B14	FB DIN4	Can be used to control RO or directly parameter by ID number. G2.4.1
B15		Reserved for future use.

Table 6-10, Fieldbus control word

V1.3.2 FB Status Word ID 68

Status word to fieldbus. The table below shows the bypass operation for such fieldbus boards that natively support the bypass operation or can be parameterized to bypass mode.

	Signal	Comment
b0	Ready On	0=Drive not ready to switch on 1=Drive ready to start charging
b1	Ready Run	0=Drive not ready to run 1=Drive ready and MCB is ON
b2	Running	0=Drive not running 1=Drive in Run state (Modulating)
b3	Fault	0=No active fault 1=Fault is active
b4	Run Enable Status	0= Run Disabled. Drive in stop state 1= Run Enabled. Drive can be started.
b5	Quick Stop Active	0=Quick Stop Active 1=Quick Stop not Active
b6	CB Control OK	0= Status opposite of control 1= Status and control OK
b7	Warning	0= No active warnings 1= Warning active
b8	At Reference	0= DC Voltage Ref and Act DC Voltage are not same.
b9	Fieldbus Control Active	0=Fieldbus control not active 1=Fieldbus control active
b10	Above Limit	0= DC Voltage is below P2.5.5.2 level 1=The DC Voltage is above the P2.5.5.2 level
b11		Reserved for future use.
b12		Reserved for future use.
b13		Reserved for future use.
b14	DC Charge DO Control	0= DC not charged 1= DC Charging Active
b15	Watchdog	Same as received on bit 11 of the main control word.

Table 6-11, Fieldbus status word

V1.3.3 FB Actual Value ID865

Use Process data ID to drive this value.

V1.3.4 FB Speed Reference ID875

Use Process data ID to drive this value.

V1.3.5 FB Torque Reference ID1140

Use Process data ID to drive this value.

V1.3.6 Generator Control Word

ID1700

	FALSE	TRUE
b0		
b1		
b2		
b3		
b4		
b5		
b6		
b7		
b8		
b9		
b10		
b11		
b12		
b13		
b14		
b15		

Table 6-12, Generator control word

V1.3.7 Generator Status Word

ID1701

	FALSE	TRUE
b0		Generation Operation Selected
b1		DC Control Active
b2		
b3		
b4		
b5		
b6		
b7		
b8		
b9		
b10		
b11		
b12		
b13		
b14		
b15		

Table 6-13, Generator status word

V1.3.8 *Fault Word 1*

ID 1172

Fault Word 1	
Bit	Fault(s)
B0	F1 Over current, F31 IGBT, F41 IGBT
B1	F2 Over Voltage
B2	F9 Under Voltage
B3	
B4	F3 Earth Fault
B5	
B6	F14 Unit Over Temperature
B7	F16 Motor Temperature, F29 Thermistor, F56 PT100
B8	F10 Line Synch fault (AFE), F10 Input line fault (INU)
B9	
B10	
B11	F52 Keypad or F52 PC communication fault
B12	F53 FieldBus fault
B13	F59 System Bus fault
B14	F54 Slot Communication fault
B15	F50 4mA fault

Table 6-14, Fault word 1

V1.3.9 *Fault Word 2*

ID 1173

Fault Word 2	
Bit	Fault(s)
B0	
B1	
B2	F43 Encoder Fault
B3	
B4	
B5	
B6	F51 External fault
B7	
B8	
B9	F31 IGBT, F41 IGBT
B10	
B11	
B12	
B13	
B14	F64 Main Switch State fault
B15	

Table 6-15, Fault word 2

V1.3.10 Warning Word 1 ID 1174

Warning Word 1 ID1174	
Bit	Warning(s)
B0	
B1	
B2	
B3	
B4	
B5	
B6	F53 FB Warning Slot D
B7	F67 FB Warning Slot E
B8	
B9	
B10	
B11	
B12	
B13	
B14	
B15	

*Table 6-16, Warning word***V1.3.11 Warning ID74**

Last active warning number.

V1.3.12 Last Active Fault ID37

Last active fault. number.

V1.3.13 Speed, FB Scaled ID1907**V1.3.14 FB Analog Out % ID48**

Fieldbus value to control analogue output.

6.2.4 IO Monitoring values

V1.4.1 *DIN1, DIN2, DIN3* *ID 15*

V1.4.2 *DIN4, DIN5, DIN6* *ID 16*

	DIN1/DIN2/DIN3 status	DIN4/DIN5/DIN6 status
b0	DIN3	DIN6
b1	DIN2	DIN5
b2	DIN1	DIN4

Table 6-17, Digital input status word 1

V1.4.3 *DIN Status 1* *ID 56*

V1.4.4 *DIN Status 2* *ID 57*

	DIN StatusWord 1	DIN StatusWord 2
b0	DIN: A.1	DIN: C.5
b1	DIN: A.2	DIN: C.6
b2	DIN: A.3	DIN: D.1
b3	DIN: A.4	DIN: D.2
b4	DIN: A.5	DIN: D.3
b5	DIN: A.6	DIN: D.4
b6	DIN: B.1	DIN: D.5
b7	DIN: B.2	DIN: D.6
b8	DIN: B.3	DIN: E.1
b9	DIN: B.4	DIN: E.2
b10	DIN: B.5	DIN: E.3
b11	DIN: B.6	DIN: E.4
b12	DIN: C.1	DIN: E.5
b13	DIN: C.2	DIN: E.6
b14	DIN: C.3	
b15	DIN: C.4	

Table 6-18, Digital input status word 2

V1.4.5 *Analogue Input 1* % *ID13*

V1.4.6 *Analogue Input 2* % *ID14*

V1.4.7 *Analogue input 3* % *ID 27*

V1.4.8 *Analogue input 4* % *ID 28*

Unfiltered analogue input level.

0% = 0 mA / 0 V, -100% = -10 V, 100% = 20 mA / 10 V.

Monitoring scaling is determined by the option board parameter.

It is possible to adjust this input value from fieldbus when the input terminal selection is 0.1. This way it is possible to adjust the free analogue input from fieldbus and have all analogue input functions available for fieldbus process data.

V1.4.9 *Analogue Out 1* % *ID 26*

V1.4.10 Analogue Out 2 % ID 50

V1.4.11 Analogue Out 3 % ID 51

Analogue Output value 0% = 0 mA / 0 V, 100% = 20 mA / 10 V

V1.4.12 PT100 Temp. 1 °C ID 50

V1.4.13 PT100 Temp. 2 °C ID 51

V1.4.14 PT100 Temp. 3 °C ID 52

V1.4.15 PT100 Temp. 4 °C ID 69

V1.4.16 PT100 Temp. 5 °C ID 70

V1.4.17 PT100 Temp. 6 °C ID 71

Separate measurement from two PT100 board. The signal has 4 s filtering time.

6.2.5 Master Follower monitoring values

V1.5.1 SB System Status ID1800

System Bus Status Word ID1800		
	FALSE	TRUE
b0		
b1		Drive 1 Ready
b2		Drive 1 Running
b3		Drive 1 Fault
b4		
b5		Drive 2 Ready
b6		Drive 2 Running
b7		Drive 2 Fault
b8		
b9		Drive 3 Ready
b10		Drive 3 Running
b11		Drive 3 Fault
b12		
b13		Drive 4 Ready
b14		Drive 4 Running
b15		Drive 4 Fault

Table 6-19, System bus status word

V1.5.2 Drive 1 Status Word ID1801

V1.5.3 Drive 2 Status Word ID1802

Follower Drive Status Word		
	FALSE	TRUE
b0		
b1	Not in Ready state	Ready
b2	Not Running	Running
b3	No Fault	Fault
b4		ChargeSwState
b5		
b6	Run Disabled	Run Enable
b7	No Warning	Warning
b8		
b9		
b10		
b11		
b12	No Run Request	Run Request
b13		
b14		
b15		Heard Beat

Table 6-20, Follower drive status word

7. ARFIFF30– PARAMETER LIST

In this document you will find the lists of parameters and monitoring values which are available in this application.

7.1 Basic Parameters (G2.1)

Code	Parameter	Min	Max	Unit	Default	ID	Note
P2.1.1	Mot/Gen Type	0	2		0	650	0 = Synchronous Machine 1 = PM Motor 2 = Asynchronous Motor
P2.1.2	Nominal Voltage	400V: 323V 690V: 446V	400V: 550V 690V: 758V	V	400	110	Set here the nominal voltage of the generator.
P2.1.3	Nominal Frequency	0	125	Hz	50	1532	
P2.1.4	Nominal Current	0.0		A		113	
P2.1.5	Nominal Speed	24	20000	rpm	1440	112	
P2.1.6	Nominal Cos Phi	0.30	1.00		0.85	120	
P2.1.7	Nominal Power	0	32700	kW	0	116	
P2..1.8	Magnetization Current					612	
P2.1.9	Parallel Generator	0	1		0	1501	0 = Single Generator 1 = Parallel Generator Activation will set DC Drooping to 4%.
P2.1.10	Identification	0	7		0	631	

Table 7-1, Basic parameters

7.2 Reference Handling (G2.2)

7.2.1 PTM handling

Code	Parameter	Min	Max	Unit	Default	ID	Note
P2.2.1.1	Power Take Mode 00	0	4		0	1910	0 = Commissioning 1 = PTO 2 = PTI-BOOST 3 = PTI- 0-Speed 4 = Regen Motor
P2.2.1.2	Power Take Mode 01	0	4		0	1902	0 = Commissioning 1 = PTO 2 = PTI-BOOST 3 = PTI- 0-Speed 4 = Regen Motor
P2.2.1.3	Power Take Mode 10	0	4		0	1903	0 = Commissioning 1 = PTO 2 = PTI-BOOST 3 = PTI- 0-Speed 4 = Regen Motor
P2.2.1.4	Power Take Mode 11	0	4		0	1904	0 = Commissioning 1 = PTO 2 = PTI-BOOST 3 = PTI- 0-Speed 4 = Regen Motor
P2.2.1.5	PTM Stop Time	0.00	30.00	s	3.00	1915	

Table 7-2, Power take mode handling

7.2.2 PTO handling

Code	Parameter	Min	Max	Unit	Default	ID	Note
2.2.1.6.1	Torque Select	0	5		0	1931	0 = Speed 1 = Torque 2 = Ramp Out 3 = Min 4 = Max 5 = Window
2.2.1.6.2	Torque Reference Select	0	6		0	1929	0 = Torque Ref Max 1 = Curve 1 2 = Analogue Input 1 3 = Analogue Input 2 4 = AI1 Joystick 5 = AI2 Joystick 6 = Fieldbus 7 = Curve 2 8 = Curve 3
2.2.1.6.3	Load Share	0.0	400.0	%	100.0	1248	

Table 7-3, Power take out handling

7.2.3 PTI-Boost handling

Code	Parameter	Min	Max	Unit	Default	ID	Note
2.2.1.7.1	Torque Select	0	5		0	1930	0 = Speed 1 = Torque 2 = Ramp Out 3 = Min 4 = Max 5 = Window
2.2.1.7.2	Torque Reference Select	0	6		0	1928	0 = Torque Ref Max 1 = Curve 1 2 = Analogue Input 1 3 = Analogue Input 2 4 = AI1 Joystick 5 = AI2 Joystick 6 = Fieldbus 7 = Curve 2 8 = Curve 3

Table 7-4, Power Take in boost handling

7.2.4 PTI 0-Speed

Code	Parameter	Min	Max	Unit	Default	ID	Note
2.2.1.8.1	Torque Select	0	5		0	1933	0 = Speed 1 = Torque 2 = Ramp Out 3 = Min 4 = Max 5 = Window
2.2.1.8.2	Torque Reference Select	0	6		0	1932	0 = Torque Ref Max 1 = Curve 1 2 = Analogue Input 1 3 = Analogue Input 2 4 = AI1 Joystick 5 = AI2 Joystick 6 = Fieldbus 7 = Curve 2 8 = Curve 3

Table 7-5, Power take in zero speed parameters

7.2.5 Regen Motor Mode

Code	Parameter	Min	Max	Unit	Default	ID	Note
2.2.1.9.1	License Key	0	65535		0	1995	
2.2.1.9.2	Reserved						

Table 7-6, Regenerative motor mode parameters

7.2.6 Commissioning

Code	Parameter	Min	Max	Unit	Default	ID	Note
2.2.1.10.1	MC Mode	0	4		0	1913	0 = AFE 1 = Freq. Control 2 = OL Torque Control 3 = CL Speed Control 4 = CL Torque Control
2.2.1.10.2	DC Control	0	1		0	1914	0 = No 1 = Yes
2.2.1.10.3	Torque Select	0	5		0	1278	0 = Speed 1 = Torque 2 = Ramp Out 3 = Min 4 = Max 5 = Window
2.2.1.10.4	Torque Reference Select	0	6		1	641	0 = Torque Ref Max 1 = Curve 1 2 = Analogue Input 1 3 = Analogue Input 2 4 = AI1 Joystick 5 = AI2 Joystick 6 = Fieldbus 7 = Curve 2 8 = Curve 3

Table 7-7, Commissioning parameters

7.2.7 DC Voltage Reference Handling

Code	Parameter	Min	Max	Unit	Default	ID	Note
P2.2.2.1	System Nominal AC	400V: 323V	400V: 550V	V	0	1201	Keep zero if motor or generator voltage is same as grid voltage.
P2.2.2.2	System Nominal DC	0	1500	V	0	1809	
P2.2.2.3	DC Voltage Ref.	500V: 105%	500V: 130%	%	110.00	1462	DC Voltage reference as % of Nominal DC Voltage Nominal DC voltage = 1.35 * Supply voltage
P2.2.2.4	DC Voltage Drooping	0	100	%	0	620	AFE drooping DC-voltage. Parallel 3.00%
P2.2.2.5	Reactive Current Reference	-100	100	%	0	1459	Regenerative reactive current reference 100,0 = nominal current. Positive = Inductive Negative = Capacitive
P2.2.2.6	DC Voltage Filtering time	0	15.00	s	0,00	1760	

Table 7-8, DC voltage reference handling

7.2.8 Speed / Frequency Ref handling

Code	Parameter	Min	Max	Unit	Default	ID	Note
P2.2.3.1	Speed Ref Select	0	5		0	117	0 = Keypad Reference 1 = Analogue Input 1 2 = Analogue Input 2 3 = AI1 Joystick 4 = AI2 Joystick 5 = Fieldbus
P2.2.3.2	Min Frequency	0	125		0	101	
P2.2.3.3	Max Frequency	0	125		50	102	

Table 7-9, Speed / frequency reference handling

7.2.9 Torque Control

Code	Parameter	Min	Max	Unit	Default	ID	Note
P2.2.4.1	PTI Torq Ref Min	-300.0	300.0	%	0.0	643	
P2.2.4.2	PTI Torq Ref Max	-300.0	300.0	%	100.0	642	
P2.2.4.3	PTO Torq Ref Min	-300.0	300.0	%	0.0	1926	
P2.2.4.4	PTO Torq Ref Max	-300.0	300.0	%	-100.0	1927	
P2.2.4.5	Torque Reference Ramp time	0	32000	ms	1000	1249	

Table 7-10, Torque control

7.2.10 Motor Potentiometer reference

Code	Parameter	Min	Max	Unit	Default	ID	Note
P2.2.5.1	Frequency Adjust Rate	0.001	20.000	Hz/s	0.100	331	
P2.2.5.2	Frequency Down	0.1	E.10	DigIN	0.1	417	
P2.2.5.3	Frequency Up	0.1	E.10	DigIN	0.1	418	
P2.2.5.4	Frequency Max Adjust	0.00	25.00	Hz	5.00	1558	

Table 7-11, Motor potentiometer reference parameters

7.3 Ramp Control (G2.3)

7.3.1 Ramp Control

Code	Parameter	Min	Max	Unit	Default	ID	Note
P2.3.1	Start Function	0	1		1	1274	0 = Ramp Start 1 = Flying Start
P2.3.2	Ramp Time	0.1	3200.0	s	10.0	103	
P2.3.3	Ramp Shape	0	100	%	2	500	

Table 7-12, Ramp control parameters

7.4 Input Signals (G2.4)

7.4.1 Basic settings

Code	Parameter	Min	Max	Unit	Default	ID	Note
P2.4.1.1	Start/Stop Logic	0	2		0	300	0=Start-No Act 1=RPuls-FPuls 2=RPuls-RPuls
P2.4.1.2	Input Inversion	0	65535		4	1091	Inversion control of the input IO signals. B0= INV Open Contactor B1=INV Ext. Fault 1 B2=INV Ext. Fault 2

Table 7-13, Input signal basic parameters

7.4.2 Digital Inputs

Code	Parameter	Min	Max	Unit	Default	ID	Note
P2.4.2.1	Start Signal 1	0.1	E.10		A.1	403	This parameter is used to choose the input for Run Request signal. When controlling the AFE from I/O this signal must be connected.
P2.4.2.2	Start Signal 2	0.1	E.10		0.1	404	This parameter is used to choose the input for Stop Request signal.
P2.4.2.3	Open Contactor	0.1	E.10		0.1	1600	This parameter is used to choose the input for Contactor Open signal. The signal is used to force the main contactor open and stop modulating.
P2.4.2.4	MainContFeedBack	0.1	E.10		0.1	1453	AFE contactor feedback (MCC 1)
P2.4.2.5	Fault Reset	0.1	E.10		A.3	414	Contact closed: All faults are reset
P2.4.2.6	Ext Fault 1	0.1	E.10		0.1	405	Can be inverted by Input inversion control.
P2.4.2.7	Ext Fault 2	0.1	E.10		0.2	406	Can be inverted by Input inversion control.
P2.4.2.8	Run Enable	0.1	E.10		0.2	407	Contact open: Start of motor disabled Contact closed: Start of motor enabled
P2.4.2.9	Cooling Monitor	0.1	E.10		0.2	750	OK input from the cooling unit
P2.4.2.10	Quick Stop	0.1	E.10		0.2	1213	
P2.4.2.11	LCL Temperature	0.1	E.10		0.2	1179	
P2.4.2.12	RR Enable	0.1	E.10		0.2	1896	Disables final Run Command
P2.4.2.13	I/O Control	0.1	E.10		0.1	409	
P2.4.2.14	Keypad Control	0.1	E.10		0.1	410	
P2.4.2.15	Fieldbus Control	0.1	E.10		0.1	411	
P2.4.2.16	Power Take Mode 01	0.1	E.10		0.1	1905	
P2.4.2.17	Power Take Mode 10	0.1	E.10		0.1	1906	
P2.4.2.18	In Power Lim 1	0.1	E.10		0.1	1917	
P2.4.2.19	In Power Lim 2	0.1	E.10		0.1	1918	
P2.4.2.20	Out Power Lim 1	0.1	E.10		0.1	1919	
P2.4.2.21	Out Power Lim 2	0.1	E.10		0.1	1920	
P2.4.2.22	Active synchro	0.1	E.10		0.1	1610	
P2.4.2.23	Active Direct	0.1	E.10		0.1	1601	
P2.4.2.24	Reset Direct	0.1	E.10		0.1	1612	
P2.4.2.25	Parameter set 1/set 2 selection	0.1	E.10		0.1	496	Closed cont.=Set 2 is used Open cont.=Set 1 is used

Table 7-14, Digital input parameters

7.4.3 Analogue Input 1

Code	Parameter	Min	Max	Unit	Default	ID	Note
P2.4.3.1	AI1 signal selection	0.1	E.10		A.1	377	
P2.4.3.2	AI1 filter time	0.000	32.000	s	0.000	324	
P2.4.3.3	AI1 custom minimum setting	-160.00	160.00	%	0.00	321	4 mA protection active is > 16.00%
P2.4.3.4	AI1 custom maximum setting	-160.00	160.00	%	100.00	322	
P2.4.3.5	AI1 reference scaling, minimum value	0	320,00	Hz	0,00	1722	
P2.4.3.6	AI1 reference scaling, maximum value	0	320,00	Hz	0,00	1723	
P2.4.3.7	AI1 signal inversion	0	1		0	387	
P2.4.3.8	AI1 scaling, minimum value	-32000	32000		0	303	
P2.4.3.9	AI1 scaling, maximum value	-32000	32000		0	304	
P2.4.3.10	AI1 Controlled ID	0	10000		0	1507	

Table 7-15, Analog input 1 parameters

7.4.4 Analogue Input 2

Code	Parameter	Min	Max	Unit	Default	ID	Note
P2.4.4.1	AI2 signal selection	0.1	E.10		A.2	388	
P2.4.4.2	AI2 filter time	0.000	32.000	s	0.000	329	
P2.4.4.3	AI2 custom minimum setting	-160.00	160.00	%	20.00	326	4 mA protection active is > 16.00%
P2.4.4.4	AI2 custom maximum setting	-160.00	160.00	%	100.00	327	
P2.4.4.5	AI2 reference scaling, minimum value	0	320,00	Hz	0,00	1724	
P2.4.4.6	AI2 reference scaling, maximum value	0	320,00	Hz	0,00	1725	
P2.4.4.7	AI2 signal inversion	0	1		0	398	
P2.4.4.8	AI2 reference scaling, minimum value	-32000	32000		0	393	
P2.4.3.9	AI2 reference scaling, maximum value	-32000	32000		0	394	
P2.4.4.10	AI2 Controlled ID	0	10000		0	1511	

Table 7-16, Analog input 2 parameters

7.4.5 Analogue Input 3

Code	Parameter	Min	Max	Unit	Default	ID	Note
P2.4.5.1	AI3 signal selection	0.1	E.10		0.1	141	
P2.4.5.2	AI3 filter time	0.000	32.000	s	0.000	142	
P2.4.5.3	AI3 custom minimum setting	-160.00	160.00	%	0.00	144	
P2.4.5.4	AI3 custom maximum setting	-160.00	160.00	%	100.00	145	
P2.4.5.5	AI3 signal inversion	0	1		0	151	
P2.4.5.6	AI3 reference scaling, minimum value	-32000	32000		0	1037	
P2.4.5.7	AI3 reference scaling, maximum value	-32000	32000		0	1038	
P2.4.5.8	AI3 Controlled ID	0	10000		0	1509	

Table 7-17, Analog input 3 parameters

7.4.6 Analogue Input 4

Code	Parameter	Min	Max	Unit	Default	ID	Note
P2.4.6.1	AI4 signal selection	0.1	E.10		0.1	152	
P2.4.6.2	AI4 filter time	0.000	32.000	s	0.000	153	
P2.4.6.3	AI4 custom minimum setting	-160.00	160.00	%	20.00	155	
P2.4.6.4	AI4 custom maximum setting	-160.00	160.00	%	100.00	156	
P2.4.6.5	AI4 signal inversion	0	1		0	162	
P2.4.6.6	AI4 reference scaling, minimum value	-32000	32000		0	1039	
P2.4.6.7	AI4 reference scaling, maximum value	-32000	32000		0	1040	
P2.4.6.8	AI4 Controlled ID	0	10000		0	1510	

Table 7-18, Analog input 4 parameters

7.5 Output Signals (G2.5)

7.5.1 Dig Out Signals

Code	Parameter	Min	Max	Unit	Default	ID	Note
P2.5.1.1	Main Contactor Close	0.1	E.10		0.1	1218	AFE contactor, fixed to Relay output B.2
P2.5.1.2	Main Contactor Open	0.1	E.10		0.1	1219	Used if pulse control is need for main breaker.
P2.5.1.3	Ready	0.1	E.10		0.1	432	The AC drive is ready to operate.
P2.5.1.4	Run	0.1	E.10		0.1	433	The AC drive operates (the motor is running).
P2.5.1.5	Common Fault	0.1	E.10		0.1	434	A fault trip has occurred.
P2.5.1.6	Fault, Inverted	0.1	E.10		0.1	435	No fault trip has occurred.
P2.5.1.7	At reference	0.1	E.10		0.1	442	The output frequency has reached the set reference In AFE when DC-Voltage level is on setpoint.
P2.5.1.8	OverTemp Warn.	0.1	E.10		0.1	439	The heatsink temperature exceeds +70 C
P2.5.1.9	Warning	0.1	E.10		0.1	436	General warning signal.
P2.5.1.10	Charge Control	0.1	E.10		0.1	1568	Charge control from start command
P2.5.1.11	Common Alarm	0.1	E.10		0.1	1684	
P2.5.1.12	Ready For Start	0.1	E.10		0.1	1686	No conditions that could disable starting active
P2.5.1.13	Quick Stop Active	0.1	E.10		0.1	1687	
P2.5.1.14	Fieldbus digital input 1	0.1	0.1		0.1	455	FB CW B11
P2.5.1.15	FB Dig 1 Parameter	ID0	ID0		0	891	Select parameter to control
P2.5.1.16	Fieldbus digital input 2	0.1	0.1		0.1	456	FB CW B12
P2.5.1.17	FB Dig 2 Parameter	ID0	ID0		0	892	Select parameter to control
P2.5.1.18	Fieldbus digital input 3	0.1	0.1		0.1	457	FB CW B13
P2.5.1.19	FB Dig 3 Parameter	ID0	ID0		0	893	Select parameter to control
P2.5.1.20	Fieldbus digital input 4	0.1	0.1		0.1	169	FB CW B14
P2.5.1.21	FB Dig 4 Parameter	ID0	ID0		0	894	Select parameter to control
P2.5.1.22	Generator Operation	0.1	E.10		0.1	1916	
P2.5.1.23	Bypass CB	0.1	E.10		0.1	1603	

Table 7-19, Digital output parameters

7.5.2 Delayed DO 1

Code	Parameter	Min	Max	Unit	Default	ID	Note
P2.5.2.1	Dig.Out 1 Signal	0.1	E.10		0.1	486	Connect the delayed DO1 signal to the digital output of your choice with this parameter.
P2.5.2.2	DO1 Content	0	15		0	312	0=Not used 1=Ready 2=Run 3=Fault 4=Fault inverted 5=FC overheat warning 6=Ext. fault or warning 7=Ref. fault or warning 8=Warning 9=Reverse 10= 11= Start Command given 12= FB DIN2 13= FB DIN3 14=ID.Bit DO
P2.5.2.3	DO1 ON Delay	0.00	320.00	s	0.00	487	0.00 = On delay not in use
P2.5.2.4	DO1 OFF Delay	0.00	320.00	s	0.00	488	0.00 = On delay not in use
P2.5.2.5	ID.Bit Free DO	0.00	2000.00	ID.Bit	0.00	1216	

Table 7-20, Delayed digital output 1 parameters

7.5.3 Delayed DO 2

Code	Parameter	Min	Max	Unit	Default	ID	Note
P2.5.3.1	Dig.Out 2 Signal	0.1	E.10		0.1	489	Connect the delayed DO2 signal to the digital output of your choice with this parameter.
P2.5.3.2	DO2 Content	0	15		0	490	0=Not used 1=Ready 2=Run 3=Fault 4=Fault inverted 5=FC overheat warning 6=Ext. fault or warning 7=Ref. fault or warning 8=Warning 9=Reverse 10= 11=Start Command given 12= FB DIN2 13=FB DIN3 14=ID.Bit DO
P2.5.3.3	DO2 ON Delay	0.00	320.00	S	0.00	491	0.00 = On delay not in use
P2.5.3.4	DO2 OFF Delay	0.00	320.00	S	0.00	492	0.00 = On delay not in use
P2.5.2.5	ID.Bit Free DO	0.00	2000.00	ID.Bit	0.00	1217	

Table 7-21, Delayd digital output 2 parameters

7.5.4 Analog Output 1

Code	Parameter	Min	Max	Unit	Default	ID	Note
P2.5.4.1	lout 1 signal	AnOUT:0.1	AnOUT:E.10		AnOUT:A.1	464	Connect the AO1 signal to the analogue output of your choice with this parameter.
P2.5.4.2	lout Content	0	13		1 / O/P Freq	307	
P2.5.4.3	lout Filter Time	0	10	s	1	308	0=No filtering
P2.5.4.4	lout Invert	0	1		0 / No Inversion	309	0=Not inverted 1=Inverted
P2.5.4.5	lout Minimum	0	1		0 / 0 mA	310	0=0 mA 1=4 mA
P2.5.4.6	lout Scale	10	1000	%	100	311	Percentage multiplier. Defines output when content is it maximum value
P2.5.4.7	lout Offset	-100	100	%	0	375	Add -1000 to 1000% to the analogue output.

Table 7-22, Analog output 1 parameters

7.5.5 Analog Output 2

Code	Parameter	Min	Max	Unit	Default	ID	Note
P2.5.5.1	lout 2 signal	AnOUT:0.1	AnOUT:E.10		AnOUT:0.1	471	Connect the AO1 signal to the analogue output of your choice with this parameter.
P2.5.5.2	lout Content	0	13		0 / Not used	472	
P2.5.5.3	lout Filter Time	0	10	s	0.02	473	0=No filtering
P2.5.5.4	lout Invert	0	1		0 / No Inversion	474	0=Not inverted 1=Inverted
P2.5.5.5	lout Minimum	0	1		0 / 0 mA	475	0=0 mA 1=4 mA
P2.5.5.6	lout Scale	10	1000	%	100	476	Percentage multiplier. Defines output when content is it maximum value
P2.5.5.7	lout Offset	-100	100	%	0	477	Add -1000 to 1000% to the analogue output.

Table 7-23, Analog output 2 parameters

7.5.6 Analog Output 3

Code	Parameter	Min	Max	Unit	Default	ID	Note
P2.5.6.1	lout 3 signal	AnOUT:0.1	AnOUT:E.10		AnOUT:0.1	478	Connect the AO1 signal to the analogue output of your choice with this parameter.
P2.5.6.2	lout Content	0	13		0	479	
P2.5.6.3	lout Filter Time	0	10	s	0,02	480	0=No filtering
P2.5.6.4	lout Invert	0	1		0 / No Inversion	481	0=Not inverted 1=Inverted
P2.5.6.5	lout Minimum	0	1		0 / 0 mA	482	0=0 mA 1=4 mA
P2.5.6.6	lout Scale	10	1000	%	100	483	Percentage multiplier. Defines output when content is it maximum value
P2.5.6.7	lout Offset	-100	100	%	0	484	Add -1000 to 1000% to the analogue output.

Table 7-24, Analog output 3 parameters

7.5.7 Options

Code	Parameter	Min	Max	Unit	Default	ID	Note
P2.5.7.1	Output Inversion	0	65535		0	1806	
P2.5.7.2	DC Supervision Limit	0	1500	V		1454	
P2.5.7.3	MCB At Stop Command	0	1		0	1685	0=Keep MCB Closed 1=Open MCB
P2.5.7.4	MCB Close Delay	0.00	3.00		0.00	1513	Delay to MCB RO
P2.5.7.5	MCB Close Mode	0	3		0/DC Voltage	1607	0 = DC Voltage 1 = DC or Start command 2 = Start Command. 3 = DC, Start or Pre-Charge

Table 7-25, Output signal options

7.6 Limit Settings (G2.6)

7.6.1 Current Limit

Code	Parameter	Min	Max	Unit	Default	ID	Note
P2.6.1.1	Current Limit	0	Varies	A	Varies	107	Total current limit
P2.6.1.2	Output Active Current Limit	0	300,0	%	150,0	1621	Regen Active Current
P2.6.1.3	Input Active Current Limit	0	300,0	%	150,0	1622	Regen Active Current

Table 7-26, Current limit parameters

7.6.2 Power Limit

Code	Parameter	Min	Max	Unit	Default	ID	Note
P2.6.2.1	OutputPowerLim	0	300	%	150,0	1290	Generating power
P2.6.2.2	InputPowerLim	0	300	%	150,0	1289	Motoring power limit
P2.6.2.3	PowerLimIncRate	0	10000	%/s	10	1502	
P2.6.2.4	Input power limit scaling	0	3		0	179	0 = Parameter 1 = Curve 1 2 = Curve 2 3 = Curve 3
P2.6.2.5	Output power limit scaling	0	3		0	1088	0 = Parameter 1 = Curve 1 2 = Curve 2 3 = Curve 3
P2.6.2.6	In Power Lim 1	0	300	%	50	1921	
P2.6.2.7	In Power Lim 2	0	300	%	25	1922	
P2.6.2.8	Out Power Lim 1	0	300	%	50	1923	
P2.6.2.9	Out Power Lim 2	0	300	%	25	1924	

Table 7-27, Power limit parameters

7.6.3 Frequency Limit

Code	Parameter	Min	Max	Unit	Default	ID	Note
P2.6.3.1	AFE Line Low Trip Limit	0.00	120.00	Hz	25.00	1717	
P2.6.3.2	AFE Line High Trip Limit	0.00	120.00	Hz	75.00	1716	
P2.6.3.3	Neg Freq Limit	-120	0.00	Hz	-0.10	1286	
P2.6.3.4	Pos Freq Limit	0	120	Hz	100.00	1285	

Table 7-28, Frequency limit parameters

7.6.4 Voltage

Code	Parameter	Min	Max	Unit	Default	ID	Note
P2.6.4.1	Voltage Low Trip Limit	0.00	320.00	%	0.00	1891	
P2.6.4.2	Voltage High Trip Limit	0.00	320.00	%	150.00	1892	

Table 7-29, Voltage parameters

7.6.5 DC Voltage

7.6.5.1 Open Loop

Code	Parameter	Min	Max	Unit	Default	ID	Note
P2.6.5.1.1	Over Voltage Kp	0	32767		2000	1468	
P2.6.5.1.2	Over Voltage Ki	0	32767		500	1409	
P2.6.5.1.3	OverVoltageKpAdd	0	32767		2000	1425	
P2.6.5.1.4	Brake chopper	0	3		0	504	
P2.6.5.1.5	Brake Chopper Level	5: 605 6: 836	5: 797 6: 1099	V	5: 797 6: 1099	1267	

Table 7-30, DC voltage control open loop parameters

7.6.5.2 Closed Loop

Code	Parameter	Min	Max	Unit	Default	ID	Note
P2.6.5.2.1	Over Voltage Kp	0	32000		50	699	
P2.6.5.2.2	Over Voltage Ki	0	32000		15	698	
P2.6.5.2.3	OverVoltageKpAdd	0	32000		50	697	
P2.6.5.2.4	Over Voltage Control Motoring Torque Limit	0.0	300.0	%	10.0	1623	

Table 7-31, DC voltage control closed loop parameters

7.6.6 Torque

Code	Parameter	Min	Max	Unit	Default	ID	Note
P2.6.6.1	Generator Torque Limit	0.0	300.0	%	120.0	1288	
P2.6.6.2	Motoring Torque Limit	0.0	300.0	%	300.0	1287	
P2.6.6.3	TorqLimIncRate	0	10000	%/s	10	1819	
P2.6.6.4	Generator Torque Limit Scaling	0	3		0	1087	0 = Parameter 1 = Curve 1 2 = Curve 2 3 = Curve 3
P2.6.6.5	Motoring Torque Limit Scaling	0	3		0	485	0 = Parameter 1 = Curve 1 2 = Curve 2 3 = Curve 3

Table 7-32, DC voltage control torque parameters

7.6.7 Active Current

Code	Parameter	Min	Max	Unit	Default	ID	Note
P2.6.7.1	Active Current Min Lim	-320,0	320.0	%	0,0	1704	
P2.6.7.2	Active Current Max Lim	-320,0	320.0	%	120,0	1705	

Table 7-33, DC voltage control active current parameters

7.7 Flux and DC Current handling CL Settings (G2.7)

Code	Parameter	Min	Max	Unit	Default	Cust	ID	Note
P2.7.1	Magnetizing current at start	0	I _L	A	0.00		627	
P2.7.2	Magnetizing time at start	0.0	600.0	s	0.0		628	
P2.7.3	Flux Reference	0.0	500.0	%	100.0		1250	

Table 7-34, DC voltage control flux and dc current handling

7.8 Motor Control (G2.8)

7.8.1 Motor Control Basic Settings

Code	Parameter	Min	Max	Unit	Default	Cust	ID	Note
P2.8.1	Motor control mode	0	2		0		600	0=Open Loop 1=Closed Loop 2=PM Sensorless

Table 7-35, Motor control basic parameters

7.8.2 U/f Settings

Code	Parameter	Min	Max	Unit	Default	Cust	ID	Note
P2.8.2.1	U/f optimisation	0	1		0		109	0=Not used 1=Automatic torque boost
P2.8.2.2	U/f ratio selection	0	3		0		108	0=Linear 1=Squared 2=Programmable 3=Linear with flux optim.
P2.8.2.3	Field weakening point	6.00	320.00	Hz	50.00		602	
P2.8.2.4	Voltage at field weakening point	10.00	200.00	%	100.00		603	$n\% \times U_{n\text{mot}}$
P2.8.2.5	U/f curve midpoint frequency	0.00	P2.8.3.3	Hz	50.00		604	
P2.8.2.6	U/f curve midpoint voltage	0.00	100.00	%	100.00		605	
P2.8.2.7	Output voltage at zero frequency	0.00	40.00	%	0.00		606	$n\% \times U_{n\text{mot}}$
P2.8.2.8	U/f curve midpoint frequency 2	0.00	P2.8.3.3	Hz	50.00		1592	
P2.8.2.9	U/f curve midpoint voltage 2	0.00	100.00	%	100.00		1593	
P2.8.2.10	U/f curve midpoint frequency 3	0.00	P2.8.3.3	Hz	50.00		1589	
P2.8.2.11	U/f curve midpoint voltage 3	0.00	100.00	%	100.00		1591	
P2.8.2.12	Field weakening point 2	6.00	320.00	Hz	50.00		1596	
P2.8.2.13	Voltage at field weakening point 2	10.00	200.00	%	100.00		1597	

Table 7-36, U/f settings

7.8.2.1 Closed Loop Control Settings

Code	Parameter	Min	Max	Unit	Default	Cust	ID	Note
P2.8.3.1	Current control P gain	0.00	100.00	%	40,00		617	
P2.8.3.2	Current control I Time	0.0	3200.0	ms	1.5		657	
P2.8.3.3	Slip adjust	0	500	%	75		619	
P2.8.3.4	Speed Error Filter TC	0	1000	ms	0		1311	
P2.8.3.5	Encoder filter time	0	1000	ms	0		618	
P2.8.3.6	SC Torque Chain Select	0	65535		0		1557	
P2.8.3.7	Encoder Selection	0	2		0		1595	0,1=Encoder Input 1 2=Encoder Input 2

Table 7-37, Motor control closed loop settings

7.8.3 PMSM Control settings

Code	Parameter	Min	Max	Unit	Default	Cust	ID	Note
P2.8.4.1	PMSM Shaft Position	0	65535		0		649	
P2.8.4.2	Start Angle Identification mode	0	10		0		1691	0=Automatic 1=Forced 2=After Power Up 3=Disabled
P2.8.4.3	Start Angle Identification DC Current	0.0	150.0	%	0.0		1756	
P2.8.4.4	Polarity Pulse Current	-10.0	200.0	%	0.0		1566	
P2.8.4.5	Start Angle ID Time	0	32000	ms	0		1755	
P2.8.4.6	I/f Current	0.0	150.0	%	50.0		1693	
P2.8.4.7	I/f Control Limit	0.0	300.0	%	10.0		1790	
P2.8.4.8	Flux Current Kp	0	32000		500		651	
P2.8.4.9	Flux Current Ti	0	1000	ms	5		652	
P2.8.4.10	External Id Ref	-100.0	100.0		0.0		1730	
P2.8.4.11	Lsd Voltage Drop	-32000	32000		0		1757	
P2.8.4.12	Lsq Voltage Drop	-32000	32000		0		1758	
P2.8.4.13	I/f Current 2	0,0	150,0	%	0,0		1694	
P2.8.4.14	I/f Control Limit 2	0,0	300,0	%	0,0		1791	
P2.8.4.15	Current Control Kp D	0,00	320,00	%	0,00		1761	
P2.8.4.16	Voltage Margin	0,0	120,0	%	100,0		1762	

Table 7-38, PMSM control settings

7.8.4 Stabilizers

Code	Parameter	Min	Max	Unit	Default	Cust	ID	Note
P2.8.5.1	Torque Stabilator Damping	0	1000		800		1413	With PMSM use 980
P2.8.5.2	Torque Stabilator Gain	0	1000		100		1412	

Code	Parameter	Min	Max	Unit	Default	Cust	ID	Note
P2.8.5.3	Torque Stabilator Gain in FWP	0	1000		50		1414	
P2.8.5.4	Torque Stabilator Limit	0	1500		150		1720	
P2.8.5.5	Flux Circle Stabilator Gain	0	32767		10000		1550	
P2.8.5.6	Flux Stabilator Gain	0	32000		500		1797	
P2.8.5.6	Flux Circle Stabilator TC	0	32700		900		1551	
P2.8.5.8	Flux Stab Coeff	-30000	30000				1796	
P2.8.5.9	Voltage Stabilator Gain	0	100.0	%	10.0		1738	
P2.8.5.10	Voltage Stabilator TC	0	1000		900		1552	
P2.8.5.11	Voltage Stabilator Limit	0	320.00	Hz	1.50		1553	

Table 7-39, Stabilator parameters

7.8.5 Identification parameters

Code	Parameter	Min	Max	Unit	Default	Cust	ID	Note
P2.8.6.1	Flux 10%	0	2500	%	10		1355	
P2.8.6.2	Flux 20%	0	2500	%	20		1356	
P2.8.6.3	Flux 30%	0	2500	%	30		1357	
P2.8.6.4	Flux 40%	0	2500	%	40		1358	
P2.8.6.5	Flux 50%	0	2500	%	50		1359	
P2.8.6.6	Flux 60%	0	2500	%	60		1360	
P2.8.6.7	Flux 70%	0	2500	%	70		1361	
P2.8.6.8	Flux 80%	0	2500	%	80		1362	
P2.8.6.9	Flux 90%	0	2500	%	90		1363	
P2.8.6.10	Flux 100%	0	2500	%	100		1364	
P2.8.6.11	Flux 110%	0	2500	%	110		1365	
P2.8.6.12	Flux 120%	0	2500	%	120		1366	
P2.8.6.13	Flux 130%	0	2500	%	130		1367	
P2.8.6.14	Flux 140%	0	2500	%	140		1368	
P2.8.6.15	Flux 150%	0	2500	%	150		1369	
P2.8.6.16	Rs voltage drop	0	30000		Varies		662	Used for torque calculation in open loop
P2.8.6.17	Ir add zero point voltage	0	30000		Varies		664	
P2.8.6.18	Ir add motoring scale	0	30000		Varies		667	
P2.8.6.19	Ir add generator scale	0	30000		Varies		665	
P2.8.6.20	Ls Voltage Dropp	0	3000		0		673	
P2.8.6.21	Motor BEM Voltage	0.00	320.00	%	0		674	
P2.8.6.22	Iu Offset	-32000	32000		0		668	
P2.8.6.23	Iv Offset	-32000	32000		0		669	
P2.8.6.24	Iw Offset	-32000	32000		0		670	
P2.8.6.25	Estimator Kp	0	32000				1781	
P2.8.6.26	Voltage Dropp	0	2000	%			671	

Table 7-40, Identification parameters

7.8.6 Tuning parameters

Code	Parameter	Min	Max	Unit	Default	Cust	ID	Note
------	-----------	-----	-----	------	---------	------	----	------

P2.8.7.1	Voltage Corr. Kp	0.000	32.000		0.100		1783	
P2.8.7.2	Voltage Corr. Ki	0	32000		5000		1784	

Table 7-41, Tuning parameters

7.8.7 Flying Start Tuning parameters

Code	Parameter	Min	Max	Unit	Default	Cust	ID	Note
P2.8.8.1	Flying Start Options	0	65535		33		1770	
P2.8.8.2	AC magnetization Current	0.0	150.0	%	70.0		1810	
P2.8.8.3	AC Scanning Time	0	32000	ms	900		1811	
P2.8.8.4	DC magnetization Current	0.0	150.0	%	100.0		1812	
P2.8.8.5	Flux Build Torque	0.0	300.0		10.0		1814	
P2.8.8.6	Flux Build Time	0	10000		300		1813	
P2.8.8.7	Magnetization Phases	0	20		10		1815	

Table 7-42, Flying start parameters

7.9 Speed Control (G2.9)

Code	Parameter	Min	Max	Unit	Default	Cust	ID	Note
P2.9.1	Speed controller P gain (open loop)	0	32767		3000		637	
P2.9.2	Speed controller I gain (open loop)	0	32767		300		638	
P2.9.3	Speed control P gain (Closed Loop)	0	1000		5		613	
P2.9.4	Speed control I time (Closed Loop)	- 32000	32000	ms	100		614	Negative value uses 0.1 ms format instead of 1 ms
P2.9.5	Load Drooping	0	100	%	0,00		647	

Table 7-43. Speed control open loop settings

7.10 Drive Control (G2.10)

Code	Parameter	Min	Max	Unit	Default	ID	Note
P 2.10.1	Switching Freq	3.6	6	kHz	3.6	601	
P 2.10.2	AFE Options 1	0	65535		544	1463	
P 2.10.3	AFE Options 2	0	65535		0	1464	Reserved for future use
P 2.10.4	Start Delay	0.00	3200	s	1.0	1500	
P 2.10.5	AdvancedOptions1	0	65535		0	1560	
P 2.10.6	AdvancedOptions2	0	65535		0	1561	
P 2.10.7	AdvancedOptions3	0	65535		0	1562	
P 2.10.8	AdvancedOptions4	0	65535		0	1563	
P 2.10.9	AdvancedOptions5	0	65535		0	1564	
P 2.10.10	AdvancedOptions6	0	65535		0	1565	
P 2.10.11	Modulator Type	0	4		1	1516	
P 2.10.12	Control Options 1	0	65535		1024	1707	
P 2.10.13	Control Options 2	0	65535		0	1798	
P2.10.14	Synch Kp Start	0	32000		4000	1698	
P2.10.15	Capacitor Size	0.0	100.0		6.3	1460	
P2.10.16	Inductor Size	0.0	100.0		15.5	1461	
P2.10.17	Operation Time	0				1855	
P2.10.18	Active Current Kp				400	1455	
P2.10.19	Active Current Ti				15	1456	
P2.10.20	Restart Delay	0	32000		1000	672	
P2.10.21	DC Voltage Kp					1451	
P2.10.22	DC Voltage Ti					1452	
P2.10.23	Synch Kp					1457	
P2.10.24	Synch Ti					1458	

Table 7-45, Drive control parameters

7.11 Master Follower (G2.11)

Code	Parameter	Min	Max	Unit	Default	ID	Note
P2.11.1	MF Mode	0	4		0	1324	
P2.11.2	SB Comm Fault	0	3		2	1082	
P2.11.3	SB Fault Delay	0.00	10.00	s	3.00	1352	

Table 7-46, Master follower parameters

7.12 Protection (G 2.12)

7.12.1 General

Code	Parameter	Min	Max	Unit	Default	ID	Note
P2.12.1.1	Thermistor Fault Response	0	3		2 / Fault	732	0=No response 1=Warning 2=Fault,stop acc. StopMode 3=Fault,stop by coasting
P2.12.1.2	Cooling Flt. Delay	0	7	s	2	751	
P2.12.1.3	LCL Over Temperature	0	3		2	1505	
P2.12.1.4	Max Charge Time	0.00	30.00	s	5.00	1522	Charging time limit when drive charging options are used.
P2.12.1.5	MCC At Fault	0	1		0	1699	0= No Action 1=Open MCC
P2.12.1.6	Start Fault Delay	0.00	320.00	s	3.00	1512	
P2.12.1.7	Quick Stop Response				1 / Warning	1543	1=Warning 2=Fault
P2.12.1.8	Reac Error Trip Limit			%	7.5	1759	
P2.12.1.9	MCC Fault Delay			s	3.50	1521	
P2.12.1.10	Line Phase Supervision				0 / No Action	702	0=No Action 1=Warning 2=Fault
P2.12.1.11	4 mA Fault Response	0	2		0 / No Action	700	0=No Action 1=Warning 2=Fault
P2.12.1.12	Response to encoder fault	1	3		2	1353	1=Warning 2=Fault 3=Warning: To Open Loop
P2.12.1.13	FaultWarnIndicat	0	2		1	1940	0=Static 1=Toggle 2=Marine

Table 7-47, Protections parameters

7.12.2 PT-100

Code	Parameter	Min	Max	Unit	Default	ID	Note
P2.12.2.1	PT100 Numbers	0	5		0	739	0= Not used (ID Write) 1= PT100 input 1 2= PT100 input 1 & 2 3= PT100 input 1 & 2 & 3 2= PT100 input 2 & 3 3= PT100 input 3
P2.12.2.2	PT100 FaultResponse	0	3		2 / Fault	740	0= No response 1= Warning 2= Fault,stop acc. to 2.4.7 3= Fault,stop by coasting
P2.12.2.3	PT100 Warn.Limit	-30	200	°C	120	741	
P2.12.2.4	PT100 Fault Lim.	-30	200	°C	130	742	
P2.12.2.5	PT100 2 Inputs	0	5		0	743	See ID739
P2.12.2.6	PT100 2 WarnLim	-30	200	°C	120	745	
P2.12.2.7	PT100 2 FaultLim	-30	200	°C	130	746	

Table 7-48, PT-100 parameters

7.12.3 Earth fault

Code	Parameter	Min	Max	Unit	Default	ID	Note
P2.12.3.1	EarthFlt Response	2	5		2 / Fault	1544	

P2.12.3.2	EarthFaultLevel	0	100	%	50	1333	
-----------	-----------------	---	-----	---	----	------	--

Table 7-49, Earth fault parameters

7.12.4 External Fault

Code	Parameter	Min	Max	Unit	Default	ID	Note
P2.12.4.1	External Fault 1	0	3		2 / Fault	701	
P2.12.4.2	External Fault 2	0	3		1 / Warning	1504	
P2.12.4.3	External Fault Delay	0.00	320.00	s	0.00	1506	

Table 7-50, External fault parameters

7.12.5 Generator Voltage

Code	Parameter	Min	Max	Unit	Default	ID	Note
P2.12.5.1	Voltage Error Response	0	2		0	1880	
P2.12.5.2	Voltage Low Warning Limit	0.00	320.00	%	90.00	1893	
P2.12.5.3	Voltage Low Trip Limit	0.00	320.00	%	80.00	1899	
P2.12.5.4	Voltage High Warning Limit	0.00	320.00	%	110.00	1895	
P2.12.5.5	Voltage High Trip Limit	0.00	320.00	%	120.00	1799	
P2.12.5.6	Voltage Trip Delay	0.00	320.00	s	0.50	1898	

Table 7-51, Generator voltage parameters

7.12.6 Generator Frequency

Code	Parameter	Min	Max	Unit	Default	ID	Note
P2.12.6.1	Frequency Error Response	0	2		0	1981	
P2.12.6.2	Freq. low Warning Limit	0.00	320.00	%	95.00	1780	
P2.12.6.3	Freq. Low Trip Limit	0.00	320.00	%	90.00	1788	
P2.12.6.4	Freq. High Warning Limit	0.00	320.00	%	105.00	1786	
P2.12.6.5	Freq. High Trip Limit	0.00	320.00	%	110.00	1787	
P2.12.6.6	Freq. Trip Delay	0.00	320.00	s	0.50	1785	

Table 7-52, Generator frequency parameters

7.12.7 Motor thermal protections

Code	Parameter	Min	Max	Unit	Default	Cust	ID	Note
2.12.7.1	Thermal protection of the motor	0	3		2		704	0=No response 1=Warning 2=Fault, stop acc. to 2.3.2 3=Fault, stop by coasting
2.12.7.2	Motor ambient temperature factor	-100.0	100.0	%	0.0		705	
2.12.7.3	Motor cooling factor at zero speed	0.0	150.0	%	40.0		706	
2.12.7.4	Motor thermal time constant	1	200	min	45		707	
2.12.7.5	Motor duty cycle	0	100	%	100		708	
2.12.7.6	Over Load Response	0	2		1		1838	0=No response 1=Warning 2=Fault
2.12.7.7	Over Load Signal	0	2		0		1837	0=Not Used 1=Current 2=Torque 3=Power
2.12.7.8	Over Load Maximum Input	0.0	300.0	%	150.0		1839	
2.12.7.9	Over Load maximum Step	0	10000		200		1840	

Table 7-53. Motor thermal protection parameters

7.12.8 Fieldbus protection

Code	Parameter	Min	Max	Unit	Default	Cust	ID	Note
P2.12.8.1	FB Fault response Slot D	0	2		2		733	0=No Action 1=Warning 2= Fault
P2.12.8.2	FB Fault response Slot E	0	2		2		761	0=No Action 1=Warning 2= Fault
P2.12.8.3	FB Watchdog Delay	0.00	30.00	s	0.00		1354	Delay when WD pulse is missing. 0.00 s = Disabled

Table 7-54. Fieldbus protection parameters

7.12.9 Options

Code	Parameter	Min	Max	Unit	Default	ID	Note
P2.12.9	Disable Stoplock	0	1		0/No	1086	
P2.12.10	Fault Simulation	0	65535		0	1569	

Table 7-55. Protection options

7.13 Fieldbus (G 2.13)

Code	Parameter	Min	Max	Unit	Default	ID	Note
P2.13.1	FB Actual ID	0	10000		7	1851	
P2.13.2	FB Data Out1 Sel	0	10000		1104	852	
P2.13.3	FB Data Out2 Sel	0	10000		1508	853	
P2.13.4	FB Data Out3 Sel	0	10000		1172	854	
P2.13.5	FB Data Out4 Sel	0	10000		1173	855	
P2.13.6	FB Data Out5 Sel	0	10000		56	856	
P2.13.7	FB Data Out6 Sel	0	10000		1174	857	
P2.13.8	FB Data Out7 Sel	0	10000		1125	858	
P2.13.9	FB Data Out8 Sel	0	10000		1157	859	
P2.13.10	FB Data Out9 Sel	0	10000		0	558	Visible with correct hw and sw
P2.13.11	FB Data Out10 Sel	0	10000		0	559	Visible with correct hw and sw
P2.13.12	FB Data Out11 Sel	0	10000		0	560	Visible with correct hw and sw
P2.13.13	FB Data Out12 Sel	0	10000		0	561	Visible with correct hw and sw
P2.13.14	FB Data Out13 Sel	0	10000		0	562	Visible with correct hw and sw
P2.13.15	FB Data Out14 Sel	0	10000		0	563	Visible with correct hw and sw
P2.13.16	FB Data Out15 Sel	0	10000		0	564	Visible with correct hw and sw
P2.13.17	FB Data Out16 Sel	0	10000		0	565	Visible with correct hw and sw
P2.13.18	FB Reference Sel	0	10000		0	1850	
P2.13.19	FB Data In 1 Sel	0	10000		0	876	
P2.13.20	FB Data In 2 Sel	0	10000		0	877	
P2.13.21	FB Data In 3 Sel	0	10000		0	878	
P2.13.22	FB Data In 4 Sel	0	10000		0	879	
P2.13.23	FB Data In 5 Sel	0	10000		0	880	
P2.13.24	FB Data In 6 Sel	0	10000		0	881	
P2.13.25	FB Data In 7 Sel	0	10000		0	882	
P2.13.26	FB Data In 8 Sel	0	10000		0	883	
P2.13.27	FB Data In 9 Sel	0	10000		0	550	Visible with correct hw and sw
P2.13.28	FB Data In 10 Sel	0	10000		0	551	Visible with correct hw and sw
P2.13.29	FB Data In 11 Sel	0	10000		0	552	Visible with correct hw and sw
P2.13.30	FB Data In 12 Sel	0	10000		0	553	Visible with correct hw and sw
P2.13.31	FB Data In 13 Sel	0	10000		0	554	Visible with correct hw and sw
P2.13.32	FB Data In 14 Sel	0	10000		0	555	Visible with correct hw and sw
P2.13.33	FB Data In 15 Sel	0	10000		0	556	Visible with correct hw and sw
P2.13.34	FB Data In 16 Sel	0	10000		0	557	Visible with correct hw and sw
P2.13.35	GSW Data	0	10000		0	897	
P2.13.36	Control Slot Selector	0	Varies		0	1440	0=Not Sel., 4=Slot D 5=Slot E, 6=Slot D Fast 7=Slot E Fast, 8=Slot D 16, 9=Slot E 16 Note: 6-9 visible with correct hw and sw.
P2.13.37	State Machine	1	2		2	896	0=Basic 1=Standard 2=Generator
P2.13.38	SW B11 ID.Bit	0.00	2000.00		0.00	1912	
P2.13.39	SW B12 ID.Bit	0.00	2000.00		0.00	1908	
P2.13.40	SW B13 ID.Bit	0.00	2000.00		0.00	1909	
P2.13.41	SW B14 ID.Bit	0.00	2000.00		0.00	1911	

Table 7-56, Fieldbus parameters

7.14 ID Control Functions (G2.14)

7.14.1 Value Control

Code	Parameter	Min	Max	Unit	Default	Cust	ID	Note
P2.14.1.1	Control Input Signal ID	0	10000	ID	0		1580	
P2.14.1.2	Control Input Off Limit	-32000	32000		0		1581	
P2.14.1.3	Control Input On Limit	-32000	32000		0		1582	
P2.14.1.4	Control Output Off Value	-32000	32000		0		1583	
P2.14.1.5	Control Output On Value	-32000	32000		0		1584	
P2.14.1.6	Control Output Signal ID	0	10000	ID	0		1585	
P2.14.1.7	Control Mode	0	5		0		1590	0=SR ABS 1=Scale ABS 2=Scale INV ABS 3=SR 4=Scale 5=Scale INV
P2.14.1.8	Control Output Filtering rime	0.000	32.000	s	0.000		1721	

Table 7-57, Power reference input signal selection

7.14.2 DIN ID Control 1

Code	Parameter	Min	Max	Unit	Default	Cust	ID	Note
P2.14.2.1	ID Control DIN	0.1	E.10		0.1		1570	Slot . Board input No. If 0.1 ID61 can be controlled from FB
P2.14.2.2	Controlled ID	0	10000	ID	0		1571	Select ID that is controlled by digital input
P2.14.2.3	False value	-32000	32000		0		1572	Value when DI is low
P2.14.2.4	True value	-32000	32000		0		1573	Value when DI is high

Table 7-58, Digital input ID control 1 parameters

7.14.3 DIN ID Control 2

Code	Parameter	Min	Max	Unit	Default	Cust	ID	Note
P2.14.3.1	ID Control DIN	0.1	E.10		0.1		1574	Slot . Board input No. If 0.1 ID61 can be controlled from FB
P2.14.3.2	Controlled ID	0	10000	ID	0		1575	Select ID that is controlled by digital input
P2.14.3.3	False value	-32000	32000		0		1576	Value when DI is low
P2.14.3.4	True value	-32000	32000		0		1577	Value when DI is high

Table 7-59, Digital input ID Control 2 parameters

7.14.4 DIN ID Control 3

Code	Parameter	Min	Max	Unit	Default	Cust	ID	Note
P2.14.4.1	ID Control DIN	0.1	E.10		0.1		1578	Slot . Board input No. If 0.1 ID61 can be controlled from FB
P2.14.4.2	Controlled ID	0	10000	ID	0		1579	Select ID that is controlled by digital input
P2.14.4.3	False value	-32000	32000		0		1587	Value when DI is low
P2.14.4.4	True value	-32000	32000		0		1588	Value when DI is high

Table 7-60, Digital input ID Control 3 parameters

7.15 Curve 1 definition (G2.15)

Code	Parameter	Min	Max	Unit	Default	Cust	ID	Note
P2.15.1	0% Speed	-320	320	%			1626	
P2.15.2	5% Speed	-320	320	%			1627	
P2.15.3	10% Speed	-320	320	%			1628	
P2.15.4	15% Speed	-320	320	%			1629	
P2.15.5	20% Speed	-320	320	%			1630	
P2.15.6	25% Speed	-320	320	%			1631	
P2.15.7	30% Speed	-320	320	%			1632	
P2.15.8	35% Speed	-320	320	%			1633	
P2.15.9	40% Speed	-320	320	%			1634	
P2.15.10	45% Speed	-320	320	%			1635	
P2.15.11	50% Speed	-320	320	%			1636	
P2.15.12	55% Speed	-320	320	%			1637	
P2.15.13	60% Speed	-320	320	%			1638	
P2.15.14	65% Speed	-320	320	%			1639	
P2.15.15	70% Speed	-320	320	%			1640	
P2.15.16	75% Speed	-320	320	%			1641	
P2.15.17	80% Speed	-320	320	%			1642	
P2.15.18	85% Speed	-320	320	%			1643	
P2.15.19	90% Speed	-320	320	%			1644	
P2.15.20	95% Speed	-320	320	%			1645	
P2.15.21	100% Speed	-320	320	%			1646	
P2.15.22	105% Speed	-320	320	%			1647	
P2.15.23	110% Speed	-320	320	%			1648	
P2.15.24	115% Speed	-320	320	%			1649	
P2.15.25	120% Speed	-320	320	%			1651	

Table 7-61, Curve 1 definition parameters

7.16 Curve 2 definition (G2.16)

Code	Parameter	Min	Max	Unit	Default	Cust	ID	Note
P2.16.1	0% Speed	-320	320	%			2001	
P2.16.2	5% Speed	-320	320	%			2002	
P2.16.3	10% Speed	-320	320	%			2003	
P2.16.4	15% Speed	-320	320	%			2004	
P2.16.5	20% Speed	-320	320	%			2005	
P2.16.6	25% Speed	-320	320	%			2006	
P2.16.7	30% Speed	-320	320	%			2007	
P2.16.8	35% Speed	-320	320	%			2008	
P2.16.9	40% Speed	-320	320	%			2009	
P2.16.10	45% Speed	-320	320	%			2010	
P2.16.11	50% Speed	-320	320	%			2011	
P2.16.12	55% Speed	-320	320	%			2012	
P2.16.13	60% Speed	-320	320	%			2013	
P2.16.14	65% Speed	-320	320	%			2014	
P2.16.15	70% Speed	-320	320	%			2015	
P2.16.16	75% Speed	-320	320	%			2016	
P2.16.17	80% Speed	-320	320	%			2017	
P2.16.18	85% Speed	-320	320	%			2018	
P2.16.19	90% Speed	-320	320	%			2019	
P2.16.20	95% Speed	-320	320	%			2020	
P2.16.21	100% Speed	-320	320	%			2021	
P2.16.22	105% Speed	-320	320	%			2022	
P2.16.23	110% Speed	-320	320	%			2023	
P2.16.24	115% Speed	-320	320	%			2024	
P2.16.25	120% Speed	-320	320	%			2025	

Table 7-62, Curve 2 definition parameters

7.17 Curve 3 definition (G2.17)

Code	Parameter	Min	Max	Unit	Default	Cust	ID	Note
P2.17.1	0% Speed	-320	320	%			2030	
P2.17.2	5% Speed	-320	320	%			2031	
P2.17.3	10% Speed	-320	320	%			2032	
P2.17.4	15% Speed	-320	320	%			2033	
P2.17.5	20% Speed	-320	320	%			2034	
P2.17.6	25% Speed	-320	320	%			2035	
P2.17.7	30% Speed	-320	320	%			2036	
P2.17.8	35% Speed	-320	320	%			2037	
P2.17.9	40% Speed	-320	320	%			2038	
P2.17.10	45% Speed	-320	320	%			2039	
P2.17.11	50% Speed	-320	320	%			2040	
P2.17.12	55% Speed	-320	320	%			2041	
P2.17.13	60% Speed	-320	320	%			2042	
P2.17.14	65% Speed	-320	320	%			2043	
P2.17.15	70% Speed	-320	320	%			2044	
P2.17.16	75% Speed	-320	320	%			2045	
P2.17.17	80% Speed	-320	320	%			2046	
P2.17.18	85% Speed	-320	320	%			2047	
P2.17.19	90% Speed	-320	320	%			2048	
P2.17.20	95% Speed	-320	320	%			2049	
P2.17.21	100% Speed	-320	320	%			2050	
P2.17.22	105% Speed	-320	320	%			2051	
P2.17.23	110% Speed	-320	320	%			2052	
P2.17.24	115% Speed	-320	320	%			2053	
P2.17.25	120% Speed	-320	320	%			2054	

Table 7-63, Curve 3 definition parameters

7.18 Line Synch (G2.18)

Code	Parameter	Min	Max	Unit	Default	Cust	ID	Note
P2.18.1	Delay To Coast	0	30000	ms	25		1621	
P2.18.2	Delay To Open	0	60000	ms	10		1611	
P2.18.3	Delay To Close	0	60000	ms	15		1624	
P2.18.4	Phase Offset	-179.0	179.0	Dec	-15.0		1608	
P2.18.5	Freq Hyst For Synch	0.00	50.00	Hz	0.60		1613	
P2.18.6	Phase Hyst	0	10000	Deg	10.0		1620	
P2.18.7	Freq Hyst For Chang	0.00	50.00	Hz	0.20		1614	

Table 7-64, Line synch parameters

7.19 Keypad control (Control keypad: Menu M3)

Code	Parameter	Default	Min	Max	Unit	ID	Description
P3.1	Control place	2	0	2		1403	0=Fieldbus 1=I/O terminal 2=Keypad (Default)
P3.2	Keypad reference	0.00	0.00	320.00	Hz	105	
P3.3	PC ref	2/Freq ref	0	3		1805	0=Not used 1=DC-link voltage 2=Freq ref 3=Power ref

Table 7-64, Keypad control parameters

7.20 System menu (Control keypad: Menu M6)

For parameters and functions related to the general use of the AC drive, such as application and language selection, customised parameter sets or information about the hardware and software, see the VACON® NXS/P User Manual.

7.21 Expander boards (Control keypad: Menu M7)

The **M7** menu shows the expander and option boards attached to the control board and board-related information. For more information, see the VACON® NXS/P User Manual and VACON® I/O Option Board manual.

8. PARAMETER DESCRIPTIONS

8.1 Basic parameters

2.1.1 *Motor / Generator Type* ID650

Select the generator type that is used.

0 = Synchronous generator

Separate excited motor/generator

1 = PM Motor

Permanent magnet synchronous motor.

2 = Asynchronous motor

Induction motor

2.1.2 *Nominal Voltage* V ID110

Nominal voltage of connected generator.

2.1.3 *Nominal Frequency* Hz ID1532

Nominal frequency of connected generator.

2.1.4 *Nominal Current* A ID113

For induction motor and PMSM, set here the motor nominal current. If the synchronous generator is considerably bigger than the AC drive, use the I_h current of the AC drive.

Active Current and reactive current are scaled to this parameter.

2.1.5 *Motor nominal speed* ID112 "Motor Nom Speed"

Find this value n_n on the rating plate of the motor. Note also nominal frequency.

In some cases, the motor nominal speed is shown with one decimal. In these cases, give the nearest integer number and adjust the motor nominal frequency so that the drive will calculate the correct [FW]PolePairNumber.

2.1.6 *Motor cos phi* ID120 "Motor Cos Phi"

Find this value "cos phi" on the rating plate of the motor.

2.1.7 *Nominal Power kW* ID116

Set here the rated active power of the system.

2.1.8 Magnetizing current ID612 "MagnCurrent"

Set here the motor magnetizing current (no-load current).

Can be measured by running motor without load at 2/3 of nominal speed.

When value is zero the magnetization current is calculated from motor nominal parameters

$$\text{Motor Magnetization Current} = \frac{5 * \sin \varphi - 1}{5 - \sin \varphi} * \text{Motor Nominal Current}$$

$$[FW]\text{RotorFlux} = \left(\frac{f(\text{MotorNomFreq})}{f(\text{Out})} \right)^2, \text{ when } f(\text{Out}) > f(\text{MotorNomFreq})$$

If given before the identification run, this is used as reference for U/f tuning when making identification without rotating the motor.

2.1.9 Parallel Generators ID1501

0 = Single

1 = Parallel

When you select Parallel, the DC Drooping is set to 3.00% and the modulation is synchronized to reduce circulating current when the drives are in common DC bus.

2.1.11 Identification ID631 "Identification"

Identification Run is a part of tuning the motor and the drive specific parameters. It is a tool for commissioning and service of the drive with the aim to find as good parameter values as possible for most drives. The automatic motor identification calculates or measures the motor parameters that are needed for optimum motor and speed control.

NOTE: Set motor control mode to Frequency Control before identification!

NOTE: During identification, the drive will not open mechanical brake for safety reasons. If motor rotation requires that brake is opened this needs to be achieved externally.

NOTE: During identification run, the torque and power limits should be above 100%. Also the current limit should be above the motor nominal current.

NOTE: During the identification run, the acceleration time should be below 20 second.

NOTE: If the switching frequency is changed after the identification, we recommend you to do the identification run again.

NOTE: A small motor with long motor cables may require reduction of the switching frequency if the identification is not successful.

0 = "No Action" No action

No identification requested.

1 = "ID No Run" - Identification without rotating the motor

Current is applied to the motor but shaft will not be rotated. U/f settings are identified.

This identification is a minimum requirement if motor is only to be used in open loop control. However, we recommend you to always make the identification with rotating motor in case the need for closed loop control arises after the mechanics are connected to the shaft.

Example of behaviour:

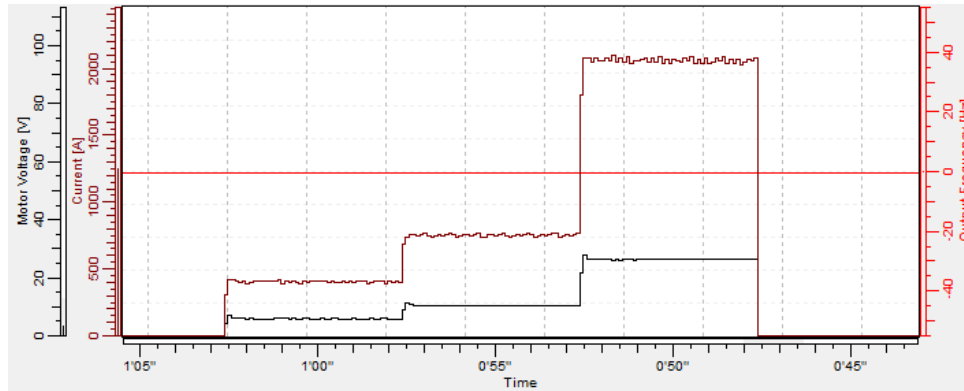

Figure 8-1

2 = "ID With Run" - Identification with motor rotating

Shaft is rotated during identification.

This identification must be run without load on motor shaft. U/f settings and magnetization current are identified. This identification should be run regardless of the final operation mode (closed loop or open loop) to get the best performance from the motor. When identification with motor rotation is successfully finished, the drive starts to use internal slip estimator to compensate the motor temperature changed. SCTorqueChainSelect B5 & B6.

Example of behaviour

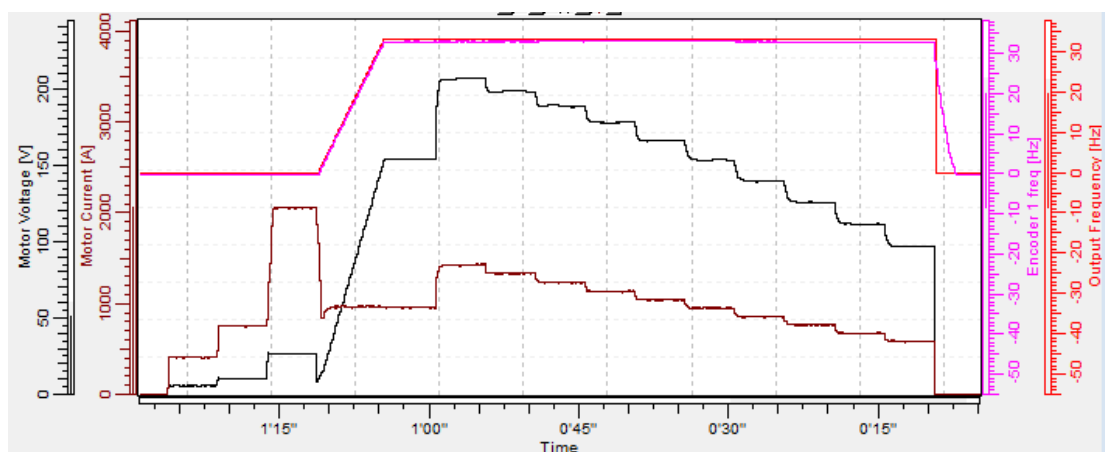

Figure 8-2

3 = "Enc. ID Run" - Encoder identification run

The motor shaft is rotated during identification.

IM: If performed for induction motor, the encoder pulse number and direction are identified. Can be used if there is no encoder information available. The correct result can be achieved only when the motor is unloaded.

PMSM: This selection is used for PMS motor if automatic angle identification is not suitable for the motor in use (angle is identified automatically in every start if PMSM Shaft Position parameter is zero).

This identification run will update the PMSM Shaft Position parameter based on absolute position of the encoder or Z pulse position of incremental type encoder.

Note: Make the identification again if the encoder position related to the motor is changed e.g. due maintenance.

4 = "Ident All" - Identified All

Shaft is rotated during identification.

All the above identification selections are made in sequence.

5 = "Enc.ABS.Lock" – Absolute encoder when locked rotor

Absolute encoder zero position identification when rotor is locked while using permanent magnet motor.

Shaft needs to be locked during this identification mode.

6 = "U/f + Magn.Curr" – U/f Curve and magnetization current

Shaft is rotated during identification.

This identification selection will not make a saturation curve identification and will open the brake when the start rotation begins.

Because saturation curve run is not made, the running time is shorter and gives possibility to make even if lifting hook is connected.

Example of behaviour

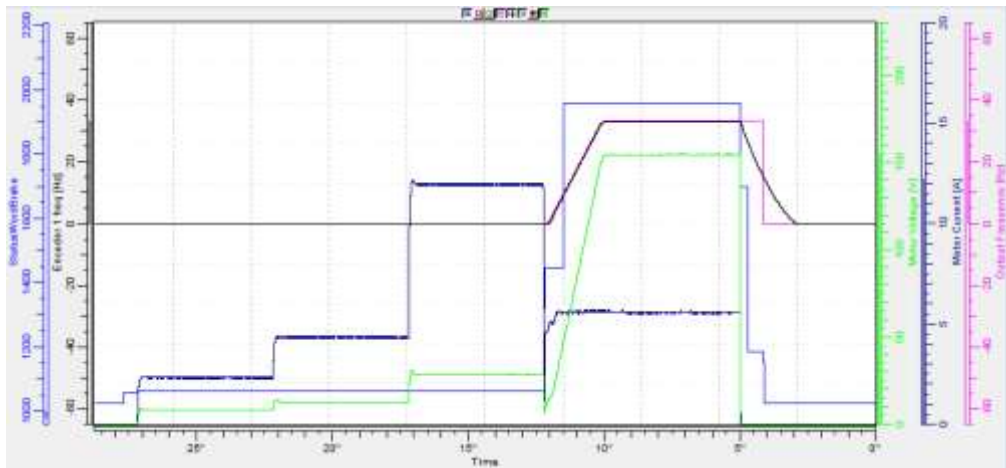

Parameters updated during this identification

- P2.1.8 MagnCurrent
- P2.8.2.2 U/f Ratio Select
- P2.8.2.5 U/f Mid Freq
- P2.8.2.6 U/f Mid Voltg
- P2.8.2.7 Zero Freq Voltg
- P2.8.6.16 RsVoltageDrop
- P2.8.6.17 IrAddZeroPVoltg
- P2.8.6.22-24 Ix Offset

7 = "DTC Ident" – Dead Time Compensation Identification

Current is applied to the motor but shaft will not be rotated.

This identification mode is needed for Sensorless control, Ident All can be used instead of this.

Parameters updated during this identification

- P2.8.2.2 U/f Ratio Select
- P2.8.2.5 U/f Mid Freq
- P2.8.2.6 U/f Mid Voltg
- P2.8.2.7 Zero Freq Voltg
- P2.8.6.16 RsVoltageDrop
- P2.8.6.17 IrAddZeroPVoltg
- P 2.8.6.20 LsVoltageDrop
- P 2.8.6.22 IU Offset
- P 2.8.6.23 IV Offset
- P 2.8.6.24 IW Offset
- P 2.8.6.25 Estimator Kp
- P 2.8.6.26 VoltageDrop
- P 2.8.7.3 DeadTimeComp.
- P 2.8.7.4 DeadTieContCurL

10 = "ID Run Fails" - Identification failed

Identification failed in the last attempt.

The basic motor name plate data has to be set correctly before performing the identification run:

- P2.1.1 – P2.1.8. Motor basic data.
- P2.1.8 Give also the magnetization current. It is available if it has been given before the identification without rotating motor. The U/f curve will be tuned according to the given magnetization current.
- P2.1.1 Motor Type.

When in closed loop and with an encoder installed, also the parameter for pulses / revolutions (in Menu M7) has to be set.

The automatic identification is activated by setting this parameter to the appropriate value followed by a start command in the requested direction. The start command to the drive has to be given within 20 s. If no start command is given within 20 s, the identification run is cancelled and the parameter will be reset to its default setting. The identification run can be stopped any time with normal stop command and the parameter is reset to its default setting. If the identification run detects a fault or other problems, the identification run is completed if possible. After the identification is finished, a warning will be given if not all requested identification types have been completed successfully.

During Identification Run, the brake control is disabled.

Note: After identification is made, the AC drive requires a rising edge of start command.

8.2 Reference Handling

8.2.1 PTM Handling

P2.2.1.1 Power Take Mode 00 ID1910

P2.2.1.2 Power Take Mode 01 ID 1902

P2.2.1.3 Power Take Mode 10 ID 1903

P2.2.1.4 Power Take Mode 11 ID 1904

0 = Commissioning

This mode is for commissioning purposes. Operation mode can be freely selected in G2.2.1.10 Commissioning.

1 = PTO

Power Take Out Mode.

2 = PTI-BOOST

PTI – Boost Mode

3 = PTI- 0-Speed

PTI Mode from zero speed.

4 = Regen Motor

Requires license key if used with induction motor.

P2.2.1.5 PTM Stop Time ID1915

Time when the AC drive is in stop state during the PTM mode change.

8.2.2 PTO Handling

2.2.1.6.1 Torque Select ID1931 "Torque Select"

This parameter defines the speed limiting mode in torque control mode. This parameter can be used as single motor control mode selection when no change is made between open loop and closed loop controls.

0= "SpeedControl" - Speed control mode

The drive is forced to operate in speed control mode while the motor control mode parameter is set to torque control mode thus allowing selection of speed control and torque control mode with single parameter e.g. from Fieldbus.

1="Torque" - Positive and negative frequency limits

The speed is not limited by the speed reference, only by the maximum frequency or Positive and Negative frequency limit if set lower than maximum frequency parameter.

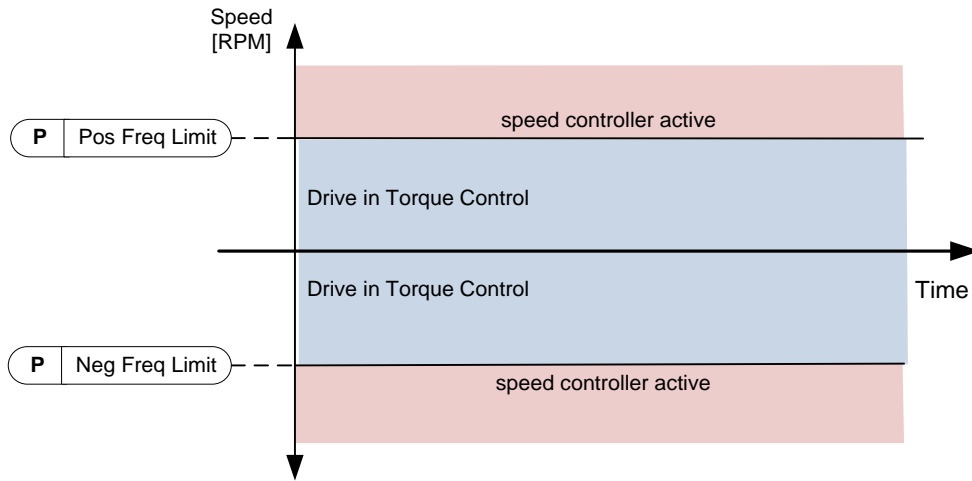

Figure 8-3

2="RampOutput" – Ramp output for both directions

The speed is limited by the reference after the ramp generator, thus the speed will increase with the set ramp time until the actual torque is equal to the reference torque. If the speed is below the reference when the load is removed from the shaft, the speed will increase without ramp.

This is the default selection. For master-follower system, we recommend that you use a selection that allows a little higher reference for torque follower, so that the load will be balanced equally, e.g. window control.

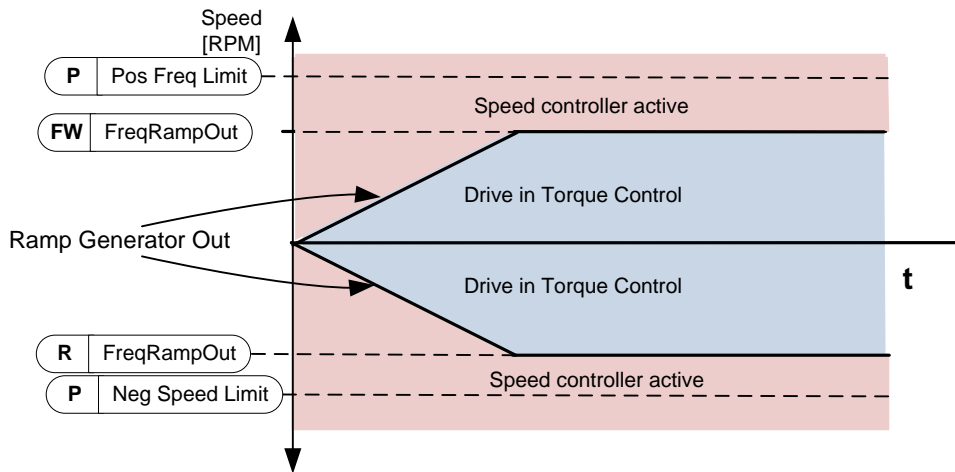

Figure 8-4

3="Min" – Minimum from speed reference and torque reference.

The minimum of the speed controller output and the torque reference is selected as final torque reference.

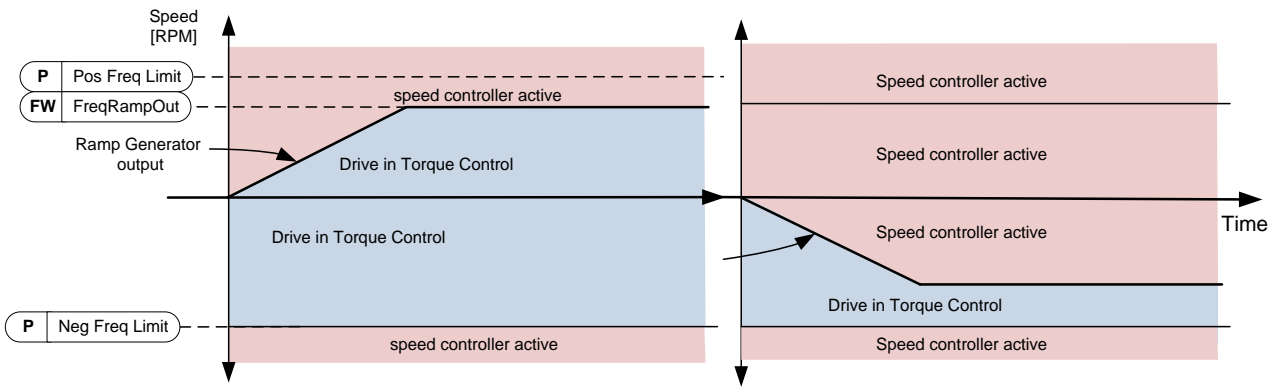

Figure 8-5

4="Max" – Maximum from speed reference and torque reference

The maximum of the speed controller output and the torque reference is selected as final torque reference.

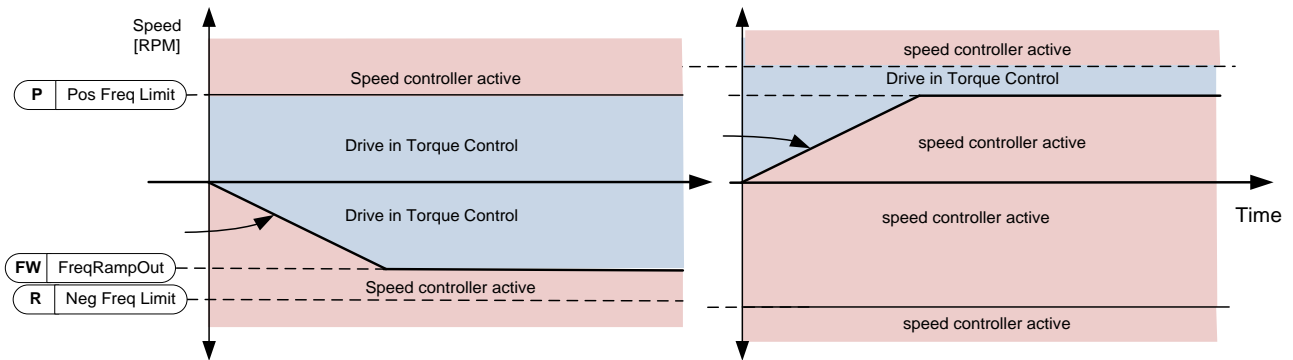

Figure 8-6

5="Window" – Window control

Speed is limited within window from speed reference.

The speed control activation limit is different from the speed limit. The speed needs, therefore, to go first to "Window Pos" or "Window Neg" limit before the speed controller activates. When the speed controller is active, the speed will be restricted to the limit defined by "Window Pos Off" and "Windows Neg Off" from the "FinalFreqRef".

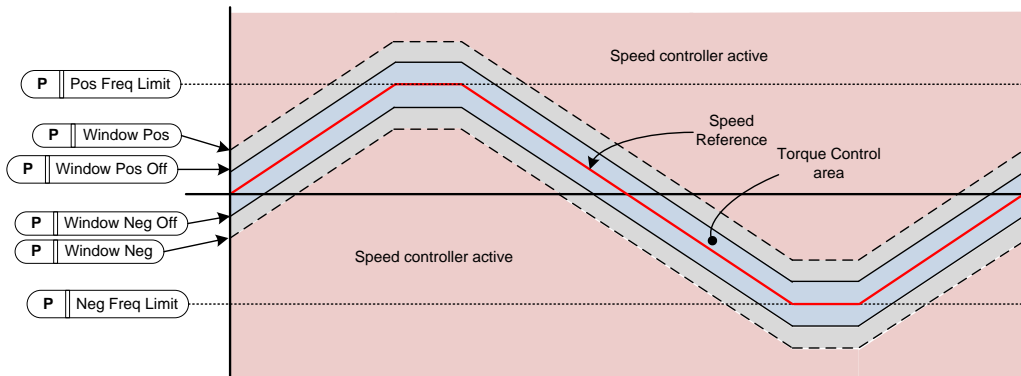

Figure 8-7

2.2.1.6.2 Torque reference selection ID1929 "Torq Ref Select"

0="Torque Ref Max"

P2.2.9.3 Torque Ref Max is used as a torque reference. When the drive is in stop state, the reference is internally forced to zero.

1="Curve 1"

P2.2.9.3 Torque Ref Max is scaled with G2.15 Curve parameters thus creating actual speed dependent torque reference.

2="AI1" - Analogue Input 1.

P2.2.9.3 Torque Ref Max is scaled with Analogue Input 1 signal.

3="AI2" - Analogue Input 2.

P2.2.9.3 Torque Ref Max is scaled with Analogue Input 2 signal.

4="AI1 Joystick"

Analogue input 1, -10 Vdc... +10 Vdc. For joystick inputs, the maximum negative reference is negated "Torq Ref Max".

5="AI2 Joystick"

Analogue input 2, -10 Vdc... +10 Vdc For joystick inputs, the maximum negative reference is negated "Torq Ref Max".

6="Fieldbus"

Reference is taken from Fieldbus. V1.1.17 Torque Reference ID18.

7="Curve 2"

P2.2.9.3 Torque Ref Max is scaled with G2.15 Curve parameters thus creating actual speed dependent torque reference.

8="Curve 3"

P2.2.9.3 Torque Ref Max is scaled with G2.15 Curve parameters thus creating actual speed dependent torque reference.

2.2.1.6.3 Load Share ID1931 "Load Share"

Load Share for PTO operation. This parameter is used to adjust the load share between different generators using this Generator application.

8.2.3 PTI-Boost

2.2.1.7.1 Torque Select ID1931 "Torque Select"

This parameter defines the speed limiting mode in torque control mode. This parameter can be used as single motor control mode selection when no change is made between open loop and closed loop controls.

See P2.2.1.6.1

0= "SpeedControl" - Speed control mode

The drive is forced to operate in speed control mode while the motor control mode parameter is set to torque control mode thus allowing selection of speed control and torque control mode with single parameter e.g. from Fieldbus.

1="MaxFreqLimit" - Positive and negative frequency limits

The speed is not limited by the speed reference, only by maximum frequency or Positive and Negative frequency limit if set lower than maximum frequency parameter.

2="RampOutput" – Ramp output for both directions

The speed is limited by reference after the ramp generator, thus speed will increase with the set ramp time until the actual torque is equal to the reference torque. If the speed is below the reference when the load is removed from the shaft, the speed will increase without ramp.

This is the default selection. For the master-follower system we recommend you to use a selection that allows a little higher reference for the torque follower so that the load will be balanced equally, e.g. window control.

3="Min" – Minimum from speed reference and torque reference.

The minimum of the speed controller output and the torque reference is selected as final torque reference.

4="Max" – Maximum from speed reference and torque reference

The maximum of the speed controller output and the torque reference is selected as final torque reference.

5="Window" – Window control

The speed is limited within a window from the speed reference.

The speed control activation limit is different from the speed limit. The speed needs, therefore, to go first to the "Window Pos" or "Window Neg" limit before the speed controller activates. When the speed controller is active, the speed will be restricted to the limit defined by "Window Pos Off" and "Windows Neg Off" from the "FinalFreqRef".

2.2.1.7.2 Torque reference selection ID1929 "Torq Ref Select"

0="Torque Ref Max"

P2.2.9.3 Torque Ref Max is used as torque reference. When the AC drive is in stop state, the reference is internally forced to zero.

1="Curve 1"

P2.2.9.3 Torque Ref Max is scaled with G2.15 Curve parameters thus creating actual speed dependent torque reference.

2="AI1" - Analogue Input 1.

P2.2.9.3 Torque Ref Max is scaled with Analogue Input 1 signal.

3="AI2" - Analogue Input 2.

P2.2.9.3 Torque Ref Max is scaled with Analogue Input 2 signal.

4="AI1 Joystick"

Analogue input 1, -10 Vdc... +10 Vdc. For joystick inputs, the maximum negative reference is negated "Torq Ref Max".

5="AI2 Joystick"

Analogue input 2, -10 Vdc... +10 Vdc For joystick inputs, the maximum negative reference is negated "Torq Ref Max".

6="Fieldbus"

Reference is taken from Fieldbus. V1.1.17 Torque Reference ID18.

7="Curve 2"

P2.2.9.3 Torque Ref Max is scaled with G2.15 Curve parameters thus creating actual speed dependent torque reference.

8="Curve 3"

P2.2.9.3 Torque Ref Max is scaled with G2.15 Curve parameters thus creating actual speed dependent torque reference.

8.2.4 PTI 0-Speed

2.2.1.8.1 Torque Select ID1933 "Torque Select"

This parameter defines the speed limiting mode in torque control mode. This parameter can be used as single motor control mode selection when no change is made between open loop and closed loop controls.

See P2.2.1.6.1

0= "SpeedControl" - Speed control mode

The drive is forced to operate in speed control mode while the motor control mode parameter is set to torque control mode thus allowing selection of speed control and torque control mode with single parameter e.g. from Fieldbus.

1="MaxFreqLimit" - Positive and negative frequency limits

The speed is not limited by the speed reference, only by the maximum frequency or Positive and Negative frequency limit if set lower than the maximum frequency parameter.

2="RampOutput" – Ramp output for both directions

The speed is limited by reference after the ramp generator, thus the speed will increase with the set ramp time until the actual torque is equal to the reference torque. If the speed is below the reference when the load is removed from the shaft, the speed will increase without ramp.

This is the default selection. For the master-follower system we recommend you to use a selection that allows a little higher reference for the torque follower so that the load will be balanced equally, e.g. window control.

3="Min" – Minimum from speed reference and torque reference.

The minimum of the speed controller output and the torque reference is selected as final torque reference.

4="Max" – Maximum from speed reference and torque reference

The maximum of the speed controller output and the torque reference is selected as final torque reference.

5="Window" – Window control

The speed is limited within a window from the speed reference.

The speed control activation limit is different from the speed limit. The speed needs, therefore, to go first to the "Window Pos" or "Window Neg" limit before the speed controller activates. When the speed controller is active, the speed will be restricted to the limit defined by "Window Pos Off" and "Windows Neg Off" from the "FinalFreqRef".

2.2.1.8.2 Torque reference selection ID1932 "Torq Ref Select"

0="Torque Ref Max"

P2.2.9.3 Torque Ref Max is used as torque reference. When the drive is in stop state, the reference is internally forced to zero.

1="Curve 1"

P2.2.9.3 Torque Ref Max is scaled with G2.15 Curve parameters thus creating actual speed dependent torque reference.

2="AI1" - Analogue Input 1.

P2.2.9.3 Torque Ref Max is scaled with Analogue Input 1 signal.

3="AI2" - Analogue Input 2.

P2.2.9.3 Torque Ref Max is scaled with Analogue Input 2 signal.

4="AI1 Joystick"

Analogue input 1, -10 Vdc... +10 Vdc. For joystick inputs the maximum negative reference is negated "Torq Ref Max".

5="AI2 Joystick"

Analogue input 2, -10 Vdc... +10 Vdc For joystick inputs the maximum negative reference is negated "Torq Ref Max".

6="Fieldbus"

Reference is taken from Fieldbus. V1.1.17 Torque Reference ID18.

7="Curve 2"

P2.2.9.3 Torque Ref Max is scaled with G2.15 Curve parameters thus creating actual speed dependent torque reference.

8="Curve 3"

P2.2.9.3 Torque Ref Max is scaled with G2.15 Curve parameters thus creating actual speed dependent torque reference.

8.2.5 Regen Motor

2.2.1.9.1 License key ID1995 "License Key"

Enter here license code to activate Regen Motor operation for induction motor without encoder.

Frequency range is from 30 Hz to 110 Hz. Starting in range of 40 Hz to 80 Hz with an induction motor that has nominal voltage from 380 Vac to 690 Vac.

8.2.6 Commissioning

2.2.1.10.1 MC Mode

Possibility to freely select the drive operation mode for commissioning purposes. By default, the AC drive will not try to control the DC Link voltage in commissioning mode.

0 = AFE Operation

1 = Frequency control operation

2 = Open Loop Torque Control

3 = Closed Loop Speed Control

4 = Closed Loop Torque Control.

2.2.1.10.2 DC Control

Possibility to activate the DC-Link Voltage Controller in commissioning operation.

2.2.1.10.3 Torque Select ID1278 "Torque Select"

This parameter defines the speed limiting mode in torque control mode. This parameter can be used as single motor control mode selection when no change is made between open loop and closed loop controls.

See P2.2.1.6.1

0= "SpeedControl" - Speed control mode

The drive is forced to operate in speed control mode while the motor control mode parameter is set to torque control mode thus allowing selection of speed control and torque control mode with single parameter e.g. from Fieldbus.

1="MaxFreqLimit" - Positive and negative frequency limits

The speed is not limited by the speed reference, but only by the maximum frequency or Positive and Negative frequency limit if set lower than the maximum frequency parameter.

2="RampOutput" – Ramp output for both directions

The speed is limited by reference after the ramp generator, thus the speed will increase with the set ramp time until the actual torque is equal to the reference torque. If the speed is below the reference when the load is removed from the shaft, the speed will increase without ramp.

This is the default selection. For master-follower system we recommend you to use a selection that allows a little higher reference for the torque follower, so that the load will be balanced equally, e.g. window control.

3="Min" – Minimum from speed reference and torque reference.

The minimum of the speed controller output and the torque reference is selected as final torque reference.

4="Max" – Maximum from speed reference and torque reference

The maximum of the speed controller output and the torque reference is selected as final torque reference.

5="Window" – Window control

The speed is limited within a window from the speed reference.

The speed control activation limit is different from the speed limit. The speed needs, therefore, to go first to the "Window Pos" or "Window Neg" limit before the speed controller activates. When the speed controller is active, the speed will be restricted to the limit defined by "Window Pos Off" and "Windows Neg Off" from the "FinalFreqRef"

2.2.1.10.4 Torque reference selection ID641 "Torq Ref Select"

0="Torque Ref Max"

P2.2.9.3 Torque Ref Max is used as torque reference. When the drive is in the stop state, the reference is internally forced to zero.

1="Curve 1"

P2.2.9.3 Torque Ref Max is scaled with G2.15 Curve parameters thus creating actual speed dependent torque reference.

2="AI1" - Analogue Input 1.

P2.2.9.3 Torque Ref Max is scaled with Analogue Input 1 signal.

3="AI2" - Analogue Input 2.

P2.2.9.3 Torque Ref Max is scaled with Analogue Input 2 signal.

4="AI1 Joystick"

Analogue input 1, -10 Vdc... +10 Vdc. For joystick inputs the maximum negative reference is negated "Torq Ref Max".

5="AI2 Joystick"

Analogue input 2, -10 Vdc... +10 Vdc For joystick inputs the maximum negative reference is negated "Torq Ref Max".

6="Fieldbus"

Reference is taken from Fieldbus. V1.1.17 Torque Reference ID18.

7="Curve 2"

P2.2.9.3 Torque Ref Max is scaled with G2.15 Curve parameters thus creating actual speed dependent torque reference.

8="Curve 3"

P2.2.9.3 Torque Ref Max is scaled with G2.15 Curve parameters thus creating actual speed dependent torque reference.

8.2.7 DC Voltage Reference

2.2.2.1 System Nom. AC ID1201

Set this parameter if the DC voltage reference needs to be different than the nominal voltage of the generator.

2.2.2.2 System Nom. DC ID1809

When the nominal DC is given, this value is used as a reference point for the DC Voltage reference instead of the Grid Nominal Voltage. We recommend you to use this for any DC voltage control operation. This parameter is also available in the Grid Converter application and DC-DC Converter application.

2.2.2.3 DC Voltage Reference ID1462

This parameter sets the DC Voltage reference in % of Nominal DC voltage.

If P2.2.3.3 Nominal DC is zero then

Nominal DC voltage = 1.35 * Nominal Voltage (P2.1.2).

Final DC Voltage Ref (V1.1.2) = Nominal DC Voltage * DC Voltage Reference

The DC Voltage will be maintained at this level when running in generator mode.

There is internal limitation to reference: For 500V units the maximum limit is 797 Vdc and for 690V units the maximum limit 1099 Vdc.

Maximum limit can be monitored from V1.1.15 DC Ref Max Lim.

NOTE! If the DC Voltage exceeds below values in stop state, the AC drive will lose ready state:

- 797 Vdc for 500V unit, trip limit 911 Vdc
- 1099 Vdc for 690V unit, immediate trip limit 1200 Vdc, U2t protection above 1100 Vdc.
- 1136 Vdc for LC 690V voltage class 8 (Order code example: NXA15008_ _ _ _ _W)

By default, the internal DC Voltage reference is kept same as the actual DC voltage when the AC drive is in stop state.

2.2.2.4 DC Droop ID620

When PTO modes are used in parallel, drooping can be used for current balancing. The DC Voltage reference drooping is set as % of active current reference.

For example, if drooping is 3.00% and the active current is 50%, the DC voltage reference is reduced to 1.5%. With drooping, the paralleled units can be balanced by adjusting the DCVoltReference to slightly different values.

2.2.2.5 *Reactive Current Reference* ID1459

This parameter sets the reference for the reactive current in % of the nominal current.

This parameter can be used for power factor correction of the AFE system or reactive power compensation. A positive value gives inductive compensation whereas a negative value gives capacitive compensation.

2.2.2.6 *DC voltage filter time* ID1760

This parameter is used to filter the DC voltage reference from the actual value to a set reference value when the control mode is changed to AFE from uGrid and Island operation mode.

This will prevent overcurrent and current spikes when the control mode is changed.

8.2.8 *Speed and Frequency*

2.2.3.1 *Speed Reference Select* ID117

0 = Keypad Reference

Reference from keypad E3.2

1 = Analogue Input 1

2 = Analogue Input 2

3 = AI1 Joystick

4 = AI2 Joystick

5 = Fieldbus

Reference taken from V1.3.4 FB Torq Ref ID1140

2.2.3.2 *Minimum Frequency* ID101

Defines the minimum frequency of any adjustable reference input (i.e. reference is not a parameter). The minimum frequency is bypassed when jogging speed, preset speed or inching reference is used.

2.2.3.3 *Maximum frequency* ID102 *"Max Frequency"*

Defines the maximum frequency limit for both negative and positive directions. Direction dependent frequency limits can be given in "G: Limit Settings \ Frequency Handling".

Note: Do not change this parameter to a lower value than the current output frequency if you change it during running. The change will be executed without ramp.

8.2.9 Torque Control

P2.2.4.1 PTI Torque reference scaling, minimum value ID643 "Torq Ref Min"

The minimum torque reference for analogue input reference selections. Use negative values to make the AC drive to operate on the generator side, and positive values for motoring side operation.

P2.2.4.2 PTI Torque reference scaling, maximum value ID642 "Torq Ref Max"

The maximum allowed torque reference for positive and negative values. Use negative values to make the AC drive to operate on the generator side, and positive values for motoring side operation.

This is also used for joystick input for negative maximum limit.

P2.2.4.2 PTO Torque reference scaling, minimum value ID1926 "Torq Ref Min"

The minimum torque reference for analogue input reference selections. Use negative values to make the AC drive to operate on the generator side, and positive values for motoring side operation.

P2.2.4.4 PTO Torque reference scaling, maximum value ID1927 "Torq Ref Max"

The maximum allowed torque reference for positive and negative values. Use negative values to make the AC drive to operate on the generator side, and positive values for motoring side operation.

This is also used for joystick input for negative maximum limit.

P2.2.5.4 Torque Reference Ramp time ID1249 "Torq.RefRampTime"

Defines the time when the reference from 0% to 100% is completed.

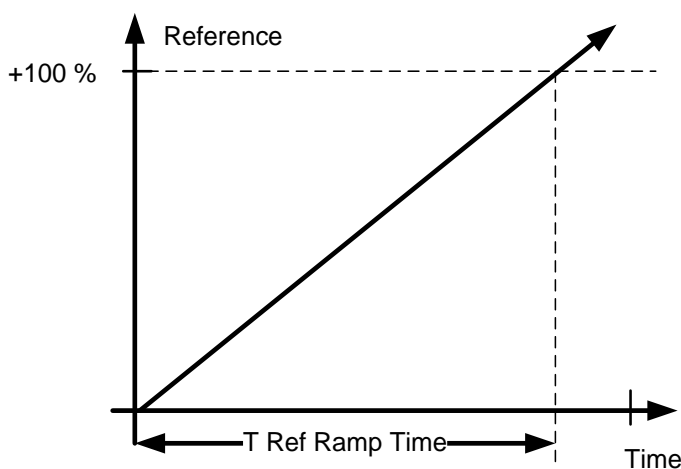

Figure 8-8

*8.2.10 Ramp Control**P2.3.1 Start Function ID1274*

0 = Ramp Start

1 = Flying Start

P2.3.2 Ramp Time ID103

Used ramp time for frequency reference while synchronization functions are not used.

P2.3.3 Acceleration/Deceleration ramp 1 shape ID500

The start and end of acceleration and deceleration ramps can be smoothed with these parameters. Setting value to 0 gives a linear ramp shape which causes acceleration and deceleration to act immediately to the changes in the reference signal. Setting other value for this parameter produces an S-shaped acceleration/deceleration.

8.3 Input Signals

8.3.1 Basic Settings

P2.4.1.1 Start/Stop logic selection ID300 "Start/Stop Logic"

This parameter defines the start stop logic when using I/O control.

0 "Start – No Act" – Start Drive – No Action

Start 1: closed contact = start command DI "Start 1"

1 "StartP-StopP" – Start Pulse – Stop Pulse

3-wire connection (pulse control):

DIN1: closed contact = start pulse

DIN2: open contact = stop pulse, falling edge.

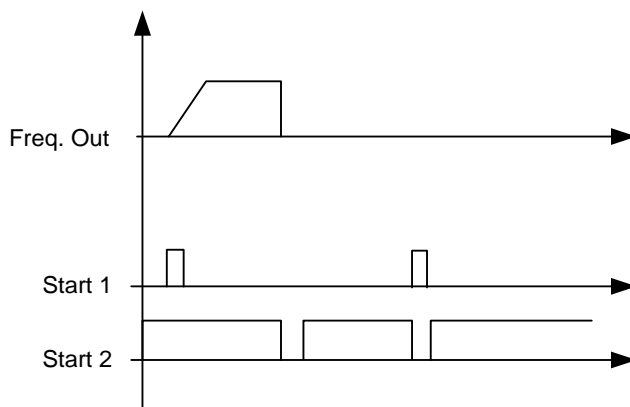

Figure 8-9. Start pulse/ Stop pulse.

The selections including the text '**Rising edge required to start**' must be used to exclude the possibility of an unintentional start when, for example, power is connected or re-connected after a power failure, after a fault reset, after the drive is stopped by Run Enable (Run Enable = False) or when the control place is changed. The Start/Stop contact must be opened before the motor can be started.

2 "RPuls – RPuls" – Rising pulse start – Rising pulse stop

Start 1: closed contact = Start command DI "Start 1"

Start 2: closed contact = Stop command DI "Start 1"

2.4.1.2 *Input Inversion ID1091*

Bit selection to invert input signal logic.

B00 = INV Open Contactor

B01 = INV Ext. Fault 1

B02 = INV Ext. Fault 2

8.3.2 *Digital input signals*

2.4.2.1 *Start Signal 1 ID403*

Signal selection 1 for the start/stop logic.

2.4.2.2 *Start Signal 2 ID404*

Signal selection 1 for the start/stop logic.

2.4.2.3 *Open Contactor ID1600*

This parameter is used to choose the input for Contactor Open signal. The signal is used to force the main contactor open (MCC or MCC2) and stop modulating.

When this input is used to stop AFE and to open a main contactor, the DC-link must be discharged and recharged to close the main contactor again and continue modulation

If Force Main Contactor Open signal is not used the option "0.1" = FALSE must be chosen.

2.4.2.4 *MainContFeedBack ID1453*

This parameter defines if the drive monitors the status of the main contactor (MCC 1) of the unit. If the monitoring function is used, the unit monitors the status and will not start if the state of the contactor does not correspond to the required status, i.e. is open when it should be closed.

If status of the main contactor is not monitored in the system the option "0.1" = FALSE, must be chosen.

2.4.2.5 *Fault Reset ID414*

Contact closed: All faults are reset.

Rising edge.

2.4.2.6 *Ext Fault 1 ID405*

Contact closed: Fault is displayed and motor stopped. Fault 51

2.4.2.7 *Ext Fault 2 ID406*

Contact open: Fault is displayed and motor stopped. Fault 51

2.4.2.8 *Run Enable* ID407

When signal is low drive will lose Ready status.

Contact open: Start of drive disabled.

Contact closed: Start of drive enabled.

2.4.2.9 *Cooling Monitor* ID750

OK input from the cooling unit.

If status is not monitored in the system the option "0.2" = TRUE must be chosen.

2.4.2.10 *Quick stop* ID1213

Drive stops modulation immediately and opens main contactor

2.4.2.11 *LCL Temperature* ID1179

Digital input from LCL temperature monitoring

2.4.2.12 *RR Enable*

Enables the final run request command. Used for testing purposes when the precharge control is started directly from start command and system must not go to run state.

8.3.2.1 Forced control place

Digital inputs can be used to bypass parameter P3.1 Control Place, for example, in an emergency situation when the PLC is not able to send command to the drive.

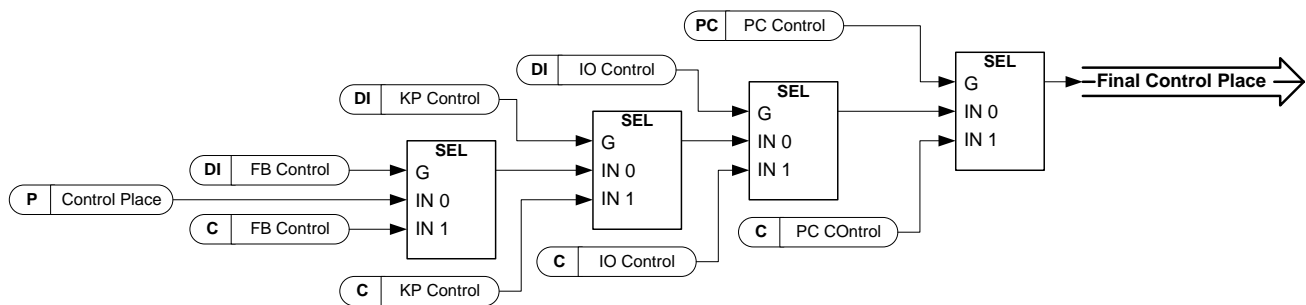

Figure 8-10. Control place selection priority order

P2.4.2.13 Control from I/O terminal ID409 "I/O Term Control"

Contact closed: Force control place to I/O terminal

P2.4.2.14 Control from keypad ID410 "Keypad Control"

Contact closed: Force control place to keypad

P2.4.2.15 Control from Fieldbus ID411 "Keypad Control"

Contact closed: Force control place to fieldbus

NOTE: When the control place is changed by force, the values of Start/Stop, Direction and Reference valid in the respective control place are used. The value of parameter ID125 (Keypad Control Place) does not change. When the input opens, the control place is selected according to the keypad control parameter P3.1 Control Place

P2.4.2.16 Power Take Mode 01

P2.4.2.17 Power Take Mode 10

Bit selection to change the Power Take mode. Set modes in G2.15

P2.4.2.18 *Input Power limit Digital input 1* **ID1917** **"In. PowerLimit 1"**

P2.4.2.19 *Input Power limit Digital input 2* **ID1918** **"In. PowerLimit 2"**

With these parameters you can select the desired digital input for controlling the generator power limit. "Gen.PowerLimit 1" and "Gen.PowerLimit 2" activate the respective power limits defined in G2.6.2 Power Handling parameter group. If both inputs are activated, the power limit is zero.

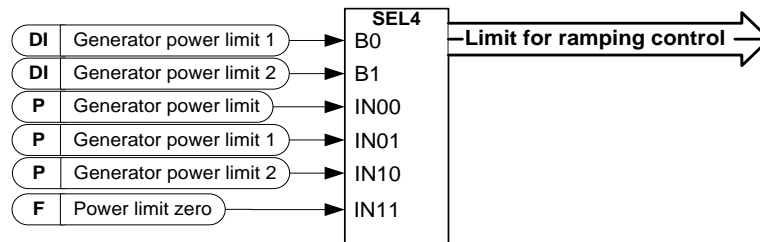

Figure 8-11

P2.4.2.20 *Output Power limit Digital input 1* **ID1919** **"Out PowerLimit 1"**

P2.4.2.21 *Output Power limit Digital input 2* **ID1920** **"Out PowerLimit 2"**

With this parameter you can select the desired digital input for controlling the motoring power limit. "Mot.PowerLimit 1" and "Mot.PowerLimit 2" activate the respective power limits defined in parameter group G2.6.2 Power Handling. If both inputs are activated, the power limit is zero.

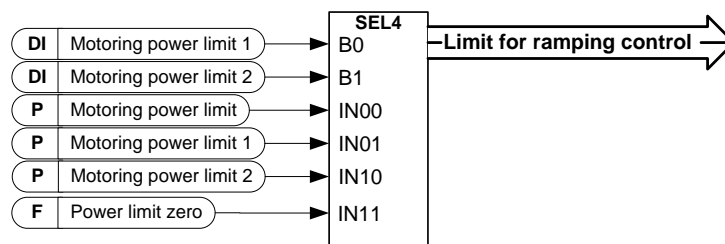

Figure 8-12

P2.4.2.25 *Parameter Set 1/Set 2 selection* **ID496** **"Param Set1/Set2"**

With this parameter you can select between Parameter Set 1 and Set 2.

Remember to put the same input for both parameter sets. The parameter sets cannot be changed when the AC drive is in run state.

Digital input = FALSE:

- Set 1 is loaded as the active set

Digital input = TRUE:

- Set 2 is loaded as the active set

When making two parameter sets from the keypad

1. Set all parameters as needed for SET1
2. In "P6.3.1 Parameter Set" select "Store Set1"
3. Set all parameters as needed for SET 1
4. In "P6.3.1 Parameter Set" select "Store Set2"

Note: The parameter values are stored only when selecting parameter P6.3.1 Parameter sets Store Set 1 or Store Set 2 or from NCDrive: Drive > Parameter Sets.

8.3.3 Analogue Inputs 1-4

2.4.3.1 AI1 signal selection ID377 "AI1 Signal Sel"

2.4.4.1 AI2 signal selection ID388 "AI2 Signal Sel"

2.4.5.1 AI3 signal selection ID141 "AI3 Signal Sel"

2.4.6.1 AI4 signal selection ID152 "AI4 Signal Sel"

Connect the AI3/AI4 signal to the analogue input of your choice with this parameter.

When the analogue input selection parameter is set to 0.1, you can control the analogue input monitoring variable from Fieldbus by assigning process data input ID number to the monitoring signal. This allows the making of the scaling function in AC drive side to the PLC input signals.

2.4.3.2 Analogue input 1 signal filtering time ID324 "AI1 Filter Time"

2.4.4.2 Analogue input 2 signal filtering time ID329 "AI2 Filter Time"

2.4.5.2 Analogue input 3 signal filtering time ID142 "AI3 Filter Time"

2.4.6.2 Analogue input 4 signal filtering time ID153 "AI3 Filter Time"

First order filtering is used for analogue inputs signals 3 and 4.

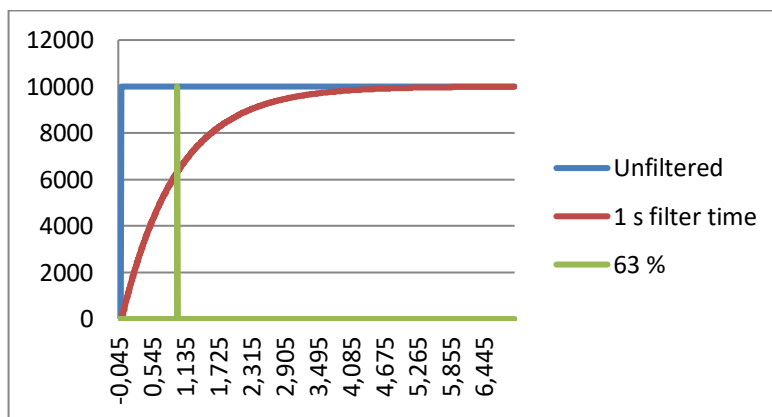

Figure 8-13

2.4.3.3 AI1 custom setting minimum ID321 "AI1 Custom Min"

2.4.3.4 AI1 custom setting maximum ID322 "AI1 Custom Max"

2.4.4.3 AI2 custom setting minimum ID326 "AI2 Custom Min"

2.4.4.4 AI2 custom setting maximum ID327 "AI2 Custom Max"

2.4.5.3 AI3 custom setting minimum ID144 "AI3 Custom Min"

2.4.5.4 AI3 custom setting maximum ID145 "AI3 Custom Max"

- 2.4.6.3 *AI4 custom setting minimum* ID155 "AI4 Custom Min"
 2.4.6.4 *AI4 custom setting maximum* ID156 "AI4 Custom Max"

Set the custom minimum and maximum input levels for the AI3 signal within - 160...160%.

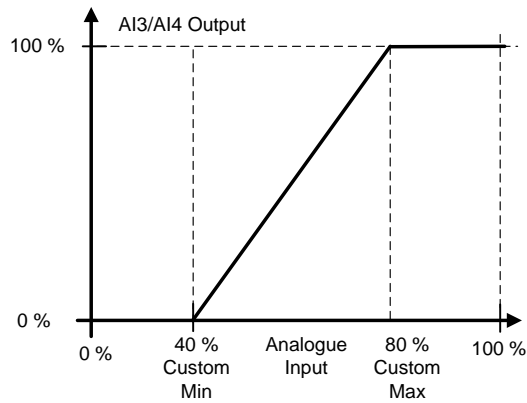

Figure 8-14

- 2.4.3.7 *AI1 signal inversion* ID387 "AI1 Signal Inv"
 2.4.4.7 *AI2 signal inversion* ID398 "AI2 Signal Inv"
 2.4.5.5 *AI3 signal inversion* ID151 "AI3 Signal Inv"
 2.4.6.5 *AI4 signal inversion* ID162 "AI3 Signal Inv"

The signal inversion function is useful when, for example, the PLC is sending power limit to the drive by using analogue inputs. If the PLC is unable to communicate to the drive, the power limit would normally be zero, but by using the inverted signal logic the zero value from the PLC would mean maximum power limit thus allowing to run the drive for example from the keypad without changing the power limit function parameters.

0 = No inversion

1 = Signal inverted

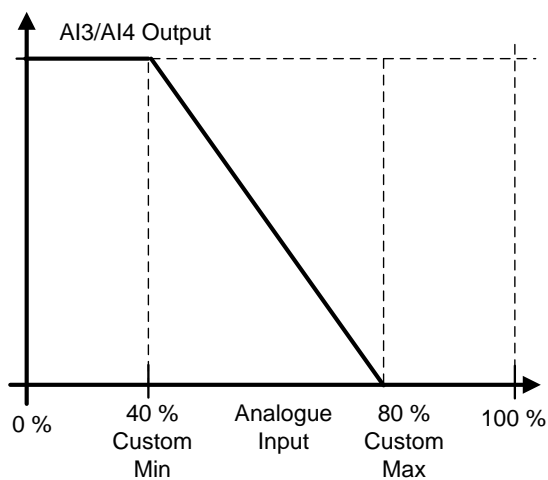

Figure 8-15

8.3.3.1 *Analogue input to any parameter*

This function allows control of any parameter by using analogue input. Use these parameters to select the range of control area and the ID number for parameter that is controlled.

2.4.3.8	<i>Analogue input 1, minimum value</i>	ID303 "AI1 Scale Min"
2.4.3.9	<i>Analogue input 1, maximum value</i>	ID304 "AI1 Scale Max"
2.4.4.8	<i>Analogue input 2, minimum value</i>	ID393 "AI2 Scale Min"
2.4.4.9	<i>Analogue input 2, maximum value</i>	ID394 "AI2 Scale Max"
2.4.5.6	<i>Analogue input 3, minimum value</i>	ID1037 "AI3 Scale Min"
2.4.5.7	<i>Analogue input 3, maximum value</i>	ID1038 "AI3 Scale Max"
2.4.6.6	<i>Analogue input 4, minimum value</i>	ID1039 "AI4 Scale Min"
2.4.6.7	<i>Analogue input 4, maximum value</i>	ID1040 "AI4 Scale Max"

These parameters define the range for controlled parameter. All the values are considered to be integers thus when controlling the FWP, you need to set also the digits for decimals, for example, FWP 100.00 needs to be set as 10000.

2.4.3.10	<i>AI1 Controlled ID</i>	ID1507	"AI1 Control. ID"
2.4.4.10	<i>AI2 Controlled ID</i>	ID1511	"AI2 Control. ID"
2.4.5.8	<i>AI3 Controlled ID</i>	ID1509	"AI3 Control. ID"
2.4.6.8	<i>AI4 Controlled ID</i>	ID1510	"AI4 Control. ID"

These parameters define what the controller parameter is.

Example:

You want to control the motor field weakening point voltage by an analogue input from 70.00% to 130.00%.

Set Scale min to 7000 = 70.00%

Set Scale max to 13000 = 130.00%

Set Controlled ID to 603 Voltage at field weakening point

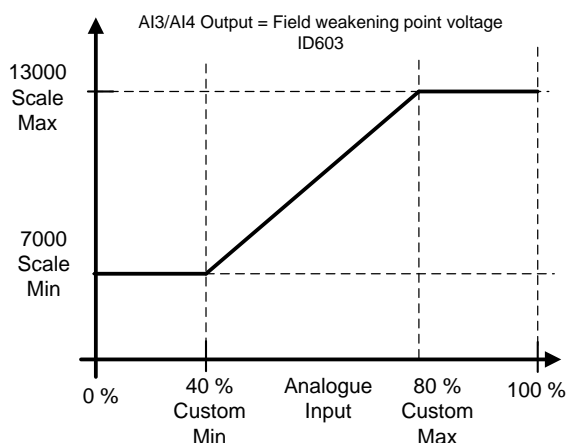

Figure 8-16

Now the analogue input 3 signal 0 V to 10 V (0 mA to 20 mA) will control the field weakening point voltage between 70.00% - 130.00%. When setting the value, the decimals are handled as integer.

8.4 Output Signals

8.4.1 Digital output signals

2.5.1.1 *Main Contactor Contr Close*

When P2.5.1.2 is not activated, this output will stay high as long as the MCC needs to be closed. When the signal goes low, the MCC should be opened.

When P2.5.1.2 is activated, this will give only a closing command with two second pulse.

2.5.1.2 *Main Contactor Contr Open*

When this output is selected above 0.9. The AC drive will use the pulse control for the MCC breaker.

P2.5.1.1 is used to close the breaker with a two second pulse.

Opening command is given by P2.5.1.2 with two second pulse.

2.5.1.3 *Ready*

The AC drive is ready to operate.

2.5.1.4 *Run*

The AC drive operates (the drive is modulating).

2.5.1.5 *Fault*

A fault trip has occurred.

2.5.1.6 *Fault, Inverted*

No fault trip has occurred.

2.5.1.7 *At Ref. Speed*

The voltage has reached the set reference.

2.5.1.8 *OverTemp Warn.*

The heatsink temperature exceeds +70°C.

2.5.1.9 *Warning*

General warning signal. Will go low when situation has passed.

If it must remain high, use the Common Alarm signals.

2.5.1.10 *Charge control*

When this is activated, the AC drive will start charging the DC from the start command and go directly to run state. Charge is started from the start command.

2.5.1.11 *Common alarm*

The AC drive has a warning active. This indication needs to be reset separately even if the situation has passed

2.5.1.12 *Ready For Start*

The AC drive has no interlock for starting the charging and going to run state.

2.5.1.13 *Quick Stop Active*

The AC Drive has received an quick stop command.

Fieldbus digital inputs connection

<i>P2.5.1.14</i>	<i>Fieldbus input data 1</i>	<i>ID455</i>	<i>"FB Dig Input 1"</i>
<i>P2.5.1.16</i>	<i>Fieldbus input data 2</i>	<i>ID456</i>	<i>"FB Dig Input 2"</i>
<i>P2.5.1.18</i>	<i>Fieldbus input data 3</i>	<i>ID457</i>	<i>"FB Dig Input 3"</i>
<i>P2.5.1.20</i>	<i>Fieldbus input data 4</i>	<i>ID169</i>	<i>"FB Dig Input 4"</i>

The data from the Fieldbus main control word can be led to the digital outputs of the AC drive. See the applicable fieldbus board manual for location of these bits.

<i>P2.5.1.15</i>	<i>Fieldbus digital input 1 parameter</i>	<i>ID891</i>	<i>"FB Dig 1 Par ID"</i>
<i>P2.5.1.17</i>	<i>Fieldbus digital input 2 parameter</i>	<i>ID892</i>	<i>"FB Dig 2 Par ID"</i>
<i>P2.5.1.19</i>	<i>Fieldbus digital input 3 parameter</i>	<i>ID893</i>	<i>"FB Dig 3 Par ID"</i>
<i>P2.5.1.21</i>	<i>Fieldbus digital input 4 parameter</i>	<i>ID894</i>	<i>"FB Dig 4 Par ID"</i>

With these parameters you can define the parameter to be controlled by using FB Digital input.

Example:

All option board inputs are in use and you still want to give DI: DC Brake Command (ID416). You also have a fieldbus board in the drive.

Set parameter ID891 (Fieldbus digital input 1) to 416.

Now you are able to control the DC Braking command from the fieldbus by Profibus control word (bit 11).

It is possible to control any parameter in the same way if values 0=FALSE and 1=TRUE are significant for that parameter. For example, P2.6.5.3 Brake Chopper (ID504) can be controlled on and off using this function (Brake Chopper; 0 = Not Used, 1 = On, Run).

2.5.1.22 Generator Operation Active

The AC drive is in generator operation.

8.4.2 Delayed digital output 1 & 2

2.5.2.1 Dig.Out 1 Signal

2.4.3.1 Dig.Out 2 Signal

Connect the delayed DO1 signal to the digital output of your choice with this parameter.

2.4.2.2 DO1 Content

2.4.3.2 DO2 Content

0=Not used

1=Ready

2=Run

3=Fault

4=Fault inverted

5=FC overheat warning

6=Ext. fault or warning

7=Ref. fault or warning

8=Warning

9=Reverse

10=SynchronizedToD7

11=Start Command given

12= FB DIN2

13=FB DIN3

14=ID.Bit DO, See P2.4.x.5

2.4.2.3 DO1 ON Delay

2.4.3.3 DO2 ON Delay

2.4.2.4 DO1 OFF Delay

2.4.3.4 DO2 OFF Delay

With these parameters you can set on- and off-delays to digital outputs.

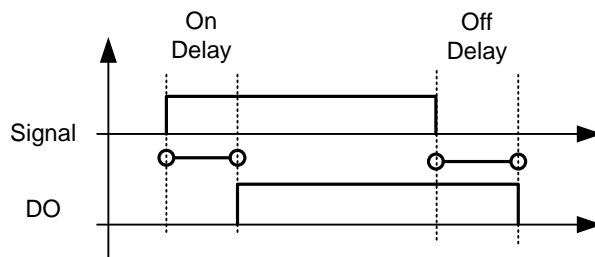

Figure 8-17. Digital outputs 1 and 2, on- and off-delays

2.4.2.5 *ID.Bit Free DO***2.4.3.5** *ID.Bit Free DO*

Select the signal for controlling the DO. The parameter has to be set in format xxxx.yy where xxxx is the ID number of a signal and yy is the bit number. For example, the value for DO control is *1174.02*. 1174 is the ID number of Warning Word 1. So the digital output is ON when bit number 02 of the warning word (ID no. 1174) i.e. *Motor underload* is high.

8.4.3 *Analogue output 1 & 2 & 3***2.4.4.1** *lout 1 signal***2.4.5.1** *lout 2 signal***2.4.6.1** *lout 3 signal*

Connect the AO signal to the analogue output of your choice with this parameter. For more information about the TTF programming method, see VACON® the NXS/P User manual.

2.4.4.2 *lout 1 Content***2.4.5.2** *lout 2 Content***2.4.6.2** *lout 3 Content*

0=Not used

1=DC Voltage

Scaling: 500 Vac Unit 0-1000 Vac, 690 Vac Unit 0-1317 Vdc

2= Current

Scaled to Nominal Current

3= AC Voltage

Scaled to Nominal Voltage

4=Active Current / Motor Torque

AFE mode: Active Current, Motoring Modes: Motor Torque.

Scaled to 100%.

5= Power

Scaled to 100%

6= Active Current / Motor Torque, bidirectional

AFE mode: Active Current, Motoring Modes: Motor Torque

Scaled to -200% to 200%

7=Power, Bidirectional

Scaled to -200% to 200%

8= AI1

9=AI2

10=FB Analogue Output

11= Line Voltage from OPT-D7

Scaled to Nominal Voltage.

12= Speed

Scaled to Synchronous Speed

13= Control Value output

14= Speed, Bidirectional.

Scaled from -2*Synchronous speed to +2*Synchronous Speed.

2.4.4.3 *lout 1 Filter Time*

2.4.5.3 *lout 2 Filter Time*

2.4.6.3 *lout 3 Filter Time*

Defines the filtering time of the analogue output signal. Setting this parameter value 0 will deactivate filtering.

First order filtering is used for analogue output signals.

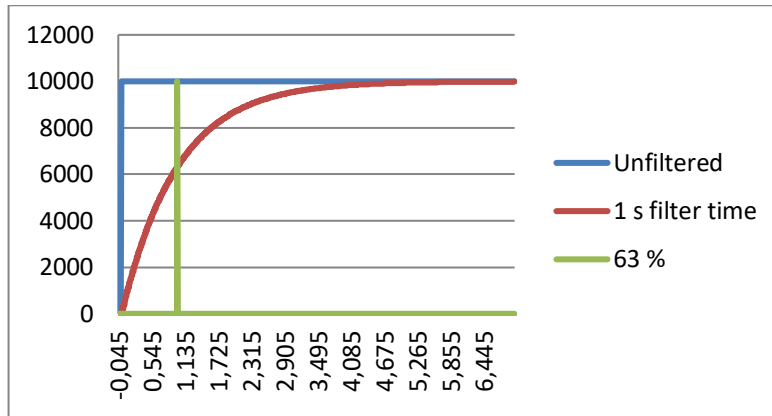

Figure 8-18

2.4.4.4 *lout 1 Invert*

2.4.5.4 *lout 2 Invert*

2.4.6.4 *lout 3 Invert*

Inverts the analogue output signal:

Maximum output signal = Minimum set value

Minimum output signal = Maximum set value

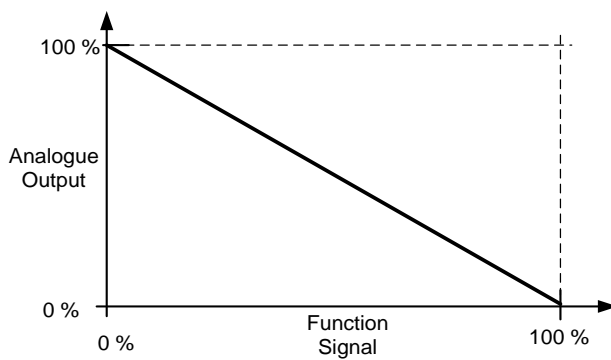

Figure 8-19

2.4.4.5 *lout 1 Minimum*2.4.5.5 *lout 2 Minimum*2.4.6.5 *lout 3 Minimum*

0 Set minimum value to 0 mA (0%)

1 Set minimum value to 4 mA (20%)

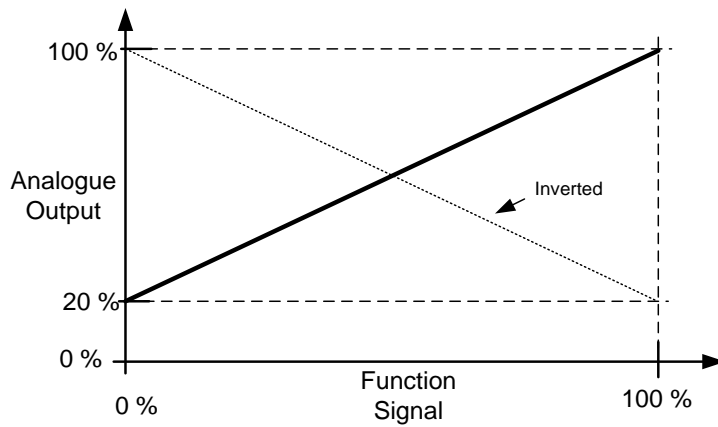

Figure 8-20

2.4.4.6 *lout 1 Scale*2.4.5.6 *lout 2 Scale*2.4.6.6 *lout 3 Scale*

Scaling factor for analogue output.

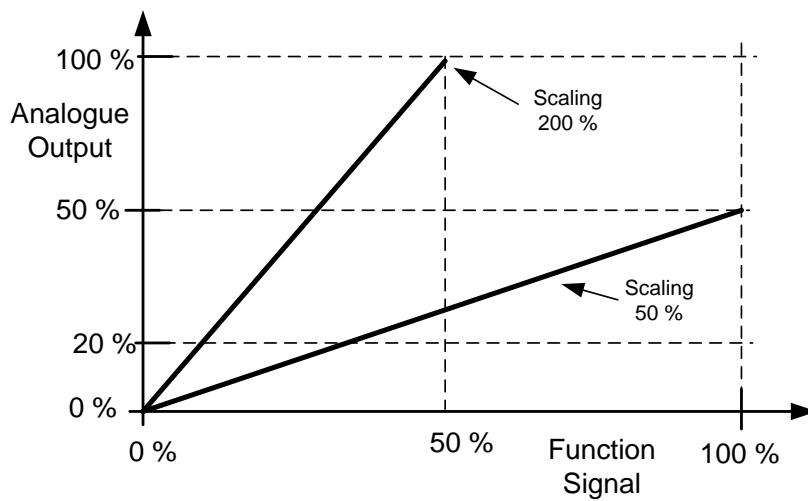

Figure 8-21

2.4.4.7 *lout 1 Offset***2.4.5.7** *lout 2 Offset***2.4.6.7** *lout 3 Offset*

Add -100.0 to 100.0% to the analogue output.

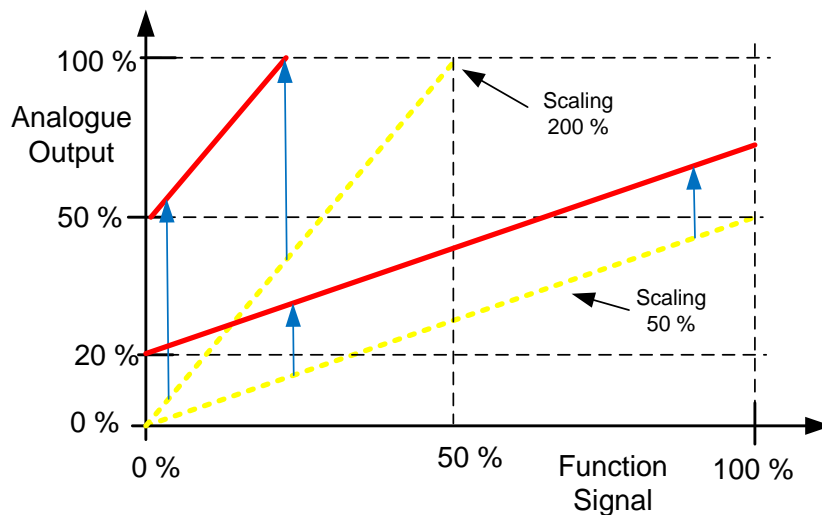

Figure 8-22

8.4.4 Options**P2.5.7.1** *Output Inversion* **ID1806**

With this parameter it is possible to select which output signals are inverted.

B00 = +1 = Inver Common Alarm

B01 = +2 = Invert Common Warning

B02 = +4 = Invert delayed output 1

B03 = +8 = Invert delayed output 2

P2.5.7.2 *DC Supervision Limit* **ID1454**

This parameter defines when the Status Word B10 is high. The bit is high when the DC voltage is above the limit set by this parameter.

2.5.7.3 *MCC At Stop Command*

Defines action for the MCC when the stop command has been given.

0 = Keep closed

1 = Open MCC when drive has stopped

2.5.7.4 *MCC close delay*

Defines the delay when R02 is closed after the AC drive has determined that MCC can be closed.

2.5.7.5 *CB Close Mode*

This parameter defines how the closing of circuit breaker is handled.

0 = DC Voltage

Normal AFE operation type circuit breaker control. The circuit breaker is closed when DC voltage is at a required level.

1 = DC Voltage or Start Command

The circuit breaker is closed when DC voltage is at the required level, or from a start command if DC is at a required level. This can be used when the breaker is opened, for example, by a stop command but DC remains high. It is useful when used in a battery system.

2 = Start Command

The circuit breaker is closed from a start command if DC is at a required level.

3 = DC Voltage, Start Command or Pre-Charge Command from FB

The circuit breaker is closed when DC voltage is at the required level, or from a start command if DC is at a required level. This can be used when the breaker is opened, for example, by a stop command but DC remains high. It is useful when used in a battery system. This mode will also close MCB from FB Control Word B0 if DC-Link voltage is at required level.

8.5 Limit settings

8.5.1 Current Limits

2.6.1.1 Current Limit ID107

Sets the current limit for the regenerative supply unit. Set this to correspond to the maximum required load or peak overload for the unit, bearing in mind that the load might consist of several motor drive units.

Maximum value $2 * I_H$ depends on the unit size.

2.6.1.2 Output Active Current Limit ID1621

Output active current limit. Limits current flow from DC-Link to AC side in Regen modes.

2.6.1.3 Input Active Current Limit ID1622

Input active current limit. Limits current flow from AC side to DC-Link in Regen modes.

8.5.2 Power Limits

2.6.2.1 Output Power Lim ID1290

Drive output power limit.

2.6.2.2 Input Power Lim ID1289

Drive input power limit.

2.6.2.3 Power limit increase rate ID1502 "PowerLimInc.rate"

Defines the power limit increase rate. Decreasing power limit will be in effect immediately.

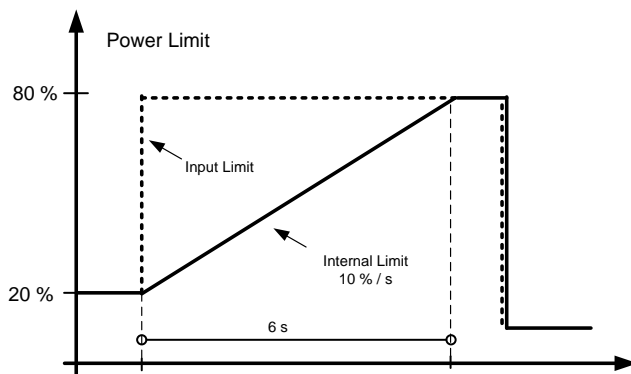

Figure 8-23

2.6.2.4 *Input Power Limit Scaling* ID179

This parameter selects if the power limit will be a constant value or changing based on a defined curve1, 2 or 3.

2.6.2.5 *Output Power Limit Scaling* ID1088

This parameter selects if the power limit will be a constant value or changing based on defined curve1, 2 or 3.

P2.6.2.6 Generator Power limit 1 ID1513 "Gen.PowerLimit 1"

P2.6.2.7 Generator Power limit 2 ID1514 "Gen.PowerLimit 2"

Generator side power limit values when limits are activated by digital inputs. When both digital inputs are activated the power limit is forced to zero.

P2.6.2.8 Motoring Power limit 1 ID1503 "Mot.PowerLimit 1"

P2.6.2.9 Motoring Power limit 2 ID1504 "Mot.PowerLimit 2"

Motoring side power limit values when limits are activated by digital inputs. When both digital inputs are activated the power limit is forced to zero.

8.5.3 Frequency limits

2.6.3.1 Regen line high frequency limit

If the AC drive output frequency exceeds this level, the AC drive will trip to line synch fault.

Use this limit as a final protection function for the grid or generator. The protection group has protection functions that will use OPT-D7 information.

2.6.3.2 Regen line low frequency limit

If the AC drive output frequency goes below this level, the AC drive will trip to line synch fault.

Use this limit as a final protection function for the grid or generator. The protection group has protection functions that will use OPT-D7 information.

2.6.3.3 Negative frequency limit *ID1286* "Neg Freq Limit"

Positive direction frequency limit. When changed in closed loop control mode, the change is made without ramp. Used in Motor Control operation modes.

2.6.3.4 Positive frequency limit *ID1285* "Pos Freq Limit"

Negative direction frequency limit. When changed in closed loop control mode, the change is made without ramp. Used in Motor Control operation modes.

8.5.4 Voltage

P2.6.4.1 Voltage Low Trip Limit *ID1891*

When supply voltage drops below this limit, the AC drive will trip to “Line Synch” fault.

NOTE: OPT-D7 is not used for detection.

Use this function for final protection function for grid or generator. The protection group has functions that use OPT-D7 for voltage level protection.

P2.6.4.2 Voltage High Trip Limit *D1892*

When supply voltage increases above this limit, the AC drive will trip to “Line Synch” fault.

NOTE: OPT-D7 is not used for detection.

Use this function for final protection function for grid or generator. The protection group has functions that use OPT-D7 for voltage level protection.

8.5.5 DC Voltage limit regulators

Parameters to adjust over voltage controllers, no need to adjust unless requested from factory.

8.5.5.1 Open Loop DC voltage regulators

<i>P2.6.5.1.1 Over Voltage Kp</i>	<i>ID1468</i>	
<i>P2.6.5.1.2 Over Voltage Ki</i>	<i>ID1406</i>	
<i>P2.6.5.1.3 Over Voltage Kp Add</i>	<i>ID1425</i>	
<i>P2.6.5.3 Brake chopper</i>	<i>ID504</i>	<i>"Brake Chopper"</i>

When the AC drive is decelerating the motor, the inertia of the motor and the load are fed into an external brake resistor. This enables the drive to decelerate the load with a torque equal to that of acceleration (provided that the correct brake resistor has been selected). See separate VACON® Brake resistor installation manual. Brake chopper test mode generates pulse to resistor every second. If the pulse feedback is wrong (resistor or chopper is missing) fault F12 is generated.

0 = "Not Used" - No brake chopper used

Brake chopper not active or present in the DC link. **NOTE:** The overvoltage controller level is set to a little lower, see parameter P2.6.5.2.

1 = "On, Run" - Brake chopper in use and tested when running.

The drive's own brake chopper is activated and operational when the drive is in Run state. The drive also sends test pulses for feedback from the brake resistor.

2 = "On, Run+Stop" - Used and tested in READY state and when running

Brake chopper is also active when the drive is not in Run state. This option can be use e.g. when other drives are generating but energy levels are low enough to be handled with only one drive.

3 = "On, No test" - Used when running (no testing)

Brake chopper is active in Run state but no test pulse to resistor is generated.

Note: In the system menu, there is a parameter "InternBrakeRes". This parameter is used for brake resistor overheating calculations. If an external brake resistor is connected to the drive the parameter should be set to 'Not connected' to disable temperature calculation for the brake resistor.

<i>P2.6.5.4 Brake Chopper Level</i>	<i>ID1267</i>	<i>"BrakeChopperLeve"</i>
-------------------------------------	---------------	---------------------------

Brake chopper control activation level in volt.

For 400V Supply: $400 \cdot 1.35 \cdot 1.18 = 638V$

For 500V Supply: $500 \cdot 1.35 \cdot 1.18 = 808V$

For 690V Supply: $690 \cdot 1.35 \cdot 1.18 = 1100V$

8.5.5.2 Closed Loop DC voltage regulators

P2.6.5.2.1 Over Voltage Kp ID699

P2.6.5.2.2 Over Voltage Ti ID698

P2.6.5.2.3 Over Voltage Kp Add ID697

P2.6.5.2.4 Over Voltage Control Motoring Torque Limit

This parameter limits how much motoring torque the AC drive can use to keep the DC-Link Voltage at overvoltage limit.

8.5.6 Torque

P2.6.6.1 Motoring Torque Limit ID1287 "MotorTorqueLimit"

Motoring side torque limit. This limit value is used for all scaling functions and torque limit ramp rate functions if activated.

P2.6.6.2 Generator Torque limit ID1288 "GenerTorqueLimit"

Generator side torque limit. This limit is used for all scaling functions generator side torque limit is not included in ramp up rate function.

P2.6.6.3 Torque limit increase rate ID1819 "TorqueLimInc.rate"

Defines the torque limit increase rate. Decreasing power limit will be in effect immediately.

P2.6.6.4 Generator Torque Limit Scaling ID1087

This parameter selects if torque limit will be a constant value or changing based on a defined curve1, 2 or 3.

P2.6.6.5 Motoring Torque Limit Scaling ID485

This parameter selects if torque limit will be a constant value or changing based on a defined curve1, 2 or 3.

8.5.7 Active Current

P2.6.7.1 Active current min limit ID1704

P2.6.7.2 Active current max limit ID1705

These parameters set the active current minimum and maximum limits for the motoring side operation of the regenerative unit and for the generator side operation of the inverter control. 100.0% is equal to nominal power, defined by System Rated Current.

8.6 Flux Control

P2.7.1 Magnetizing current at start ID627 "Start Magn Curr"

Defines the current that is applied to the motor when the start command is given in closed loop control. At start, this parameter is used together with *Magnetizing time at start* to decrease the time when the motor is able to produce nominal torque. In closed loop, the control output frequency is not forced to zero while magnetization current is applied to the motor.

P2.7.2 Magnetizing time at start ID628 "Start Magn Time"

Defines the time for how long the magnetization current is applied to the motor at start. *Magnetizing current at start* is used to shorten the time when flux is at nominal level. This will improve the torque performance at start. The time needed depends on the motor size. The value varies between 100 ms and 3 s. The bigger the motor the more time it needs. Set this time so that the rotor flux is more than 90% before the speed is released (Start Zero Speed Time ID615) or mechanical brake is released.

P2.7.3 Flux reference ID1250 "FluxReference"

Reference value for rotor flux. Rotor flux can be reduced by changing the magnetization current. This, however, also affects the motor model making the torque calculations a little less accurate. When using this parameter the motor model can compensate the effect of the different magnetization current in torque calculations.

$$[FW]RotorFlux = \left(\frac{f(MotorNomFreq)}{f(Out)} \right)^2 \quad \text{when } f(Out) > f(MotorNomFreq)$$

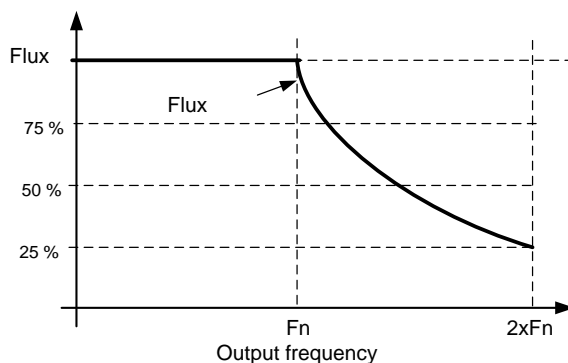

Figure 8-24

8.7 Motor Control

Open Loop control

The Open loop control controls the motor without encoder feedback from the motor shaft. The control mode selections 0, 1 and 2 are open loop control modes.

Slip

Induction motor torque is based on slip. When the load increases, also the slip will increase. The slip is the speed that rotor is behind of stator electrical frequency.

The picture below presents the torque that is produced by an induction motor when connected directly online.

1. Motor Synchronous speed. Motor is taking only magnetization current.
2. Motor nominal operation point. Motor is producing 100% of rated torque and power. Actual shaft speed is motor nominal speed and motor takes nominal current.
3. Pullout torque. This is the point where the motor-produced torque starts to decrease when the slip increases. After this point, the motor will stop if the load is not reduced.

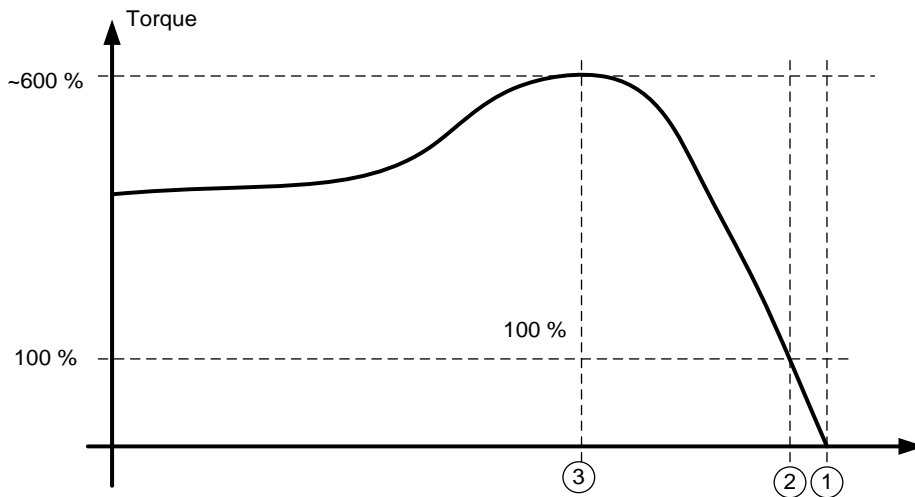

Figure 8-25

In the frequency control, the load will determine the actual shaft speed

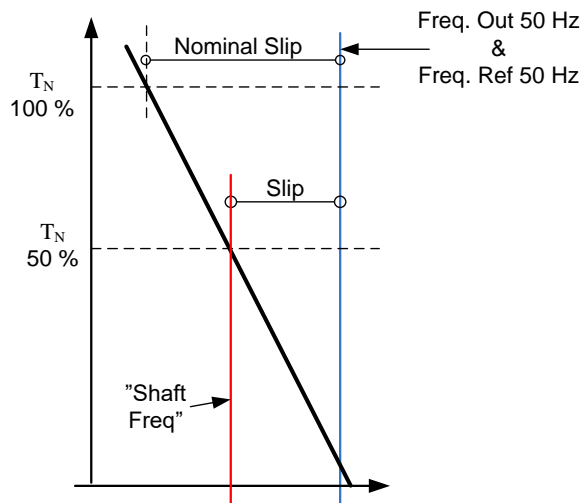

Figure 8-26

Slip compensation in open loop control

The drive uses motor torque and motor nominal rpm to compensate slip. If the motor nominal rpm is 1440 -> the nominal slip is 60 rpm. And when the motor torque is 50% the slip is 30 rpm. To keep the reference speed the drive must increase the output frequency by 1 Hz.

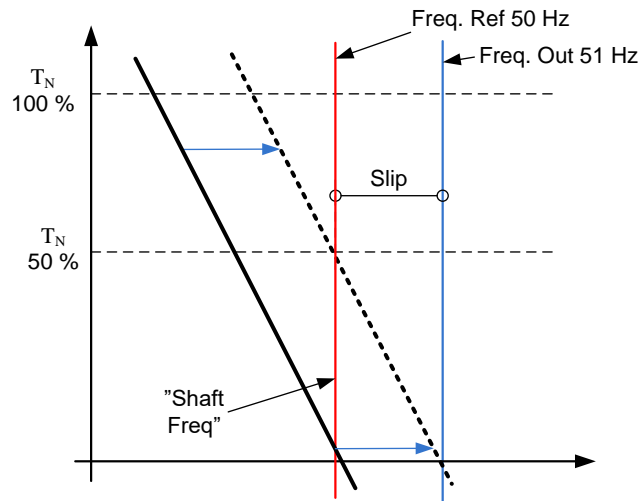

Figure 8-27

Closed Loop control

Closed loop control controls the motor using the exact information of the motor speed from the encoder. Control mode selections 3 and 4 are closed loop control modes. Using these modes without encoder board (and encoder) will result in encoder fault.

P2.8.1 Motor control mode ID600 "Motor Ctrl Mode"

(2.6.1)

0 "Open Loop"

Open loop Speed or Torque control

In this control mode the drive can be selected to run in torque control mode. The operation is selected by parameter *TorqueSpeedLimit* in the Torque Reference parameter group. The default selection is torque control mode speed limited by ramp generator output.

1 "Closed Loop"

Closed loop speed or torque control

In this control mode the drive can be selected to run in torque control mode. The operation is selected by parameter *TorqueSpeedLimit* in the Torque Reference parameter group. The default selection is torque control mode speed limited by ramp generator output.

8.7.1 U/f Settings

U/f settings are mainly used in open loop control modes with the exception of the *Field weakening point voltage* that is also used in closed loop control mode as a limit for voltage. U/f settings are used to control the voltage level that are applied to the motor at different frequencies and different load situations.

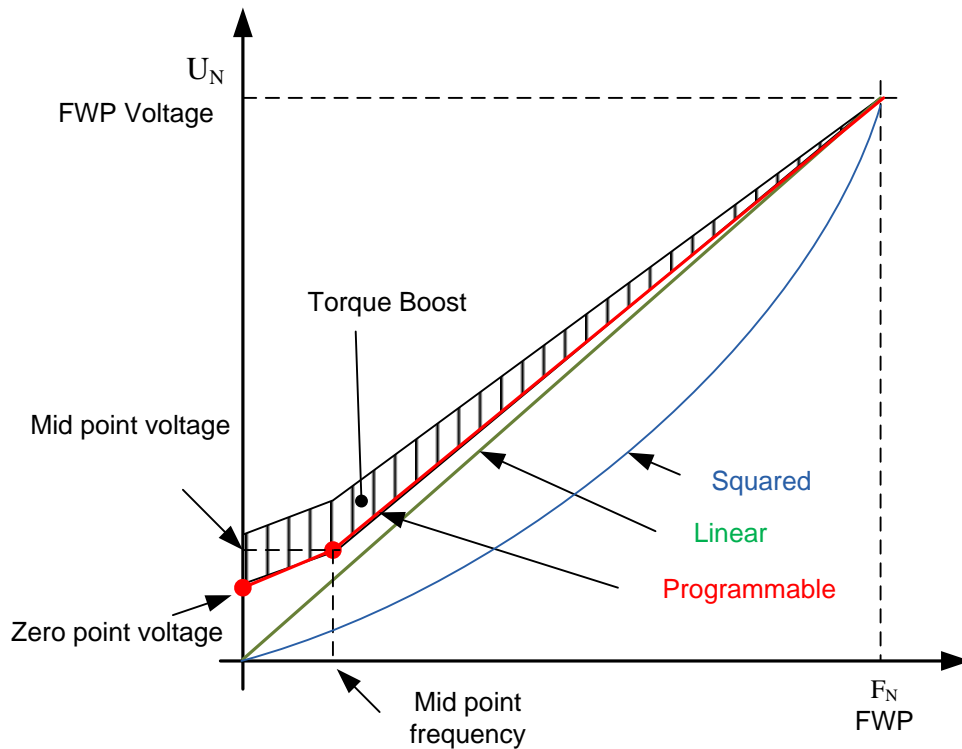

Figure 8-28

What changes are required to start with load from 0 Hz?

- ◆ First set the motor nominal values (Parameter group 2.1).

Option 1: Automatic functions

Step 1: Make identification with rotating motor

Step 2 (If needed): Activate speed control or U/f optimization (Torque boost).

Step 3 (If needed): Activate both speed control and U/f optimization.

Option 2: Manual tuning

Step 1:

Run the motor using 2/3 of motor nominal frequency as the frequency reference. Read the motor current in the monitoring menu or use NCDrive for monitoring. This current must be set as the motor magnetization current.

Change the U/f curve ratio selection to programmable (= 2).

Run the motor with zero frequency reference and increase the motor zero point voltage until the motor current is approximately same as the motor magnetising current. (If the motor is in a low frequency area for only short periods, it is possible to use up to 65% of the motor nominal current).

Set then the midpoint voltage to $\sqrt{2} * \text{Zero Point Voltage}$
and

the midpoint frequency to $(\text{Zero Point Voltage}/100\%)*\text{Nominal frequency of motor}$

Step 2 (If needed): Activate speed control or U/f optimization (Torque boost).

Step 3 (If needed): Activate both speed control and U/f optimization.

NOTE! In high torque – low speed applications – it is likely that the motor will overheat. If the motor has to run long times under these conditions, special attention must be paid to cooling of the motor. Use external cooling for the motor if the temperature tends to rise too high.

P2.8.2.1 U/f optimisation ID109 “U/f Optimization”

Automatic torque boost The voltage to the motor changes proportionally to required torque which makes the motor produce more torque at start and when running at low frequencies. Automatic torque boost can be used in applications where starting torque due to starting friction is high, e.g. in conveyors. Even with linear U/f curve, the torque boost has an affect but the best result will be achieved after the identification run when programmable U/f curve is activated.

P2.8.2.2 U/f ration selection ID108 “U/f Ratio Select”

Linear:

0 The voltage of the motor changes linearly from zero point voltage to the field weakening point where the voltage at FWP is supplied to the motor.

Squared

:
1 The voltage of the motor changes from zero point voltage following the squared curve form zero frequency to the field weakening point. The motor runs undermagnetised below the field weakening point and produces less torque. Squared U/f ratio can be used in applications where torque demand is proportional to the square of the speed, e.g. in centrifugal fans and pumps.

Programmable U/f curve:

2 The U/f curve can be programmed with three different points.

1. Zero point voltage
2. Midpoint frequency and Midpoint voltage.
3. Field weakening point and field weakening point voltage.

Programmable U/f curve can be used if more torque is needed at low frequencies. Make the Identification run for optimal setting (ID631).

Linear with flux optimisation:

- 3 The AC drive starts to search for the minimum motor current in order to save energy. This function can be used in applications with constant motor load, such as fans, pumps etc.

Programmable multi U/f points

- 4 The U/f curve can be programmed with six different points.
 1. Zero point voltage
 2. Midpoint frequency and Midpoint voltage.
 3. Midpoint frequency 2 and Midpoint voltage 2.
 4. Midpoint frequency 3 and Midpoint voltage 3.
 5. Field weakening point and field weakening point voltage.
 6. Field weakening point 2 and field weakening point voltage 2.

Multi programmable U/f points can be used to compensate motor/generator behaviours.

P2.8.2.3 Field weakening point ID602 "Field WeakngPnt"

The field weakening point is the output frequency at which the output voltage reaches the field weakening point voltage.

P2.8.2.4 Voltage at field weakening point ID603 "Voltage at FWP"

Above the frequency at the field weakening point, the output voltage remains at the set maximum value. Below the frequency at the field weakening point, the output voltage depends on the setting of the U/f curve parameters.

When the parameter *Motor nominal frequency* is set, the parameter *Field weakening point* is automatically given the corresponding value. If you need different values for the field weakening point and the maximum output voltage, change these parameters **after** setting the *Nominal frequency*.

In closed loop control this defines the maximum voltage to the motor. It can be increased if sufficient DC voltage is available.

P2.8.2.5 *U/f curve, middle point frequency* **ID604** “U/f Mid Freq”

If the programmable U/f curve has been selected with parameter U/f ratio this parameter defines the middle point frequency of the curve. See also parameter *Middle point voltage*.

When the programmable U/f curve is selected this value is set to 10% of motor nominal frequency.

P2.8.2.6 *U/f curve, middle point voltage* **ID605** “U/f mid Voltg”

If the programmable U/f curve has been selected with the parameter U/f ratio this parameter defines the middle point voltage of the curve. See also parameter *Middle point frequency*.

When the programmable U/f curve is selected this value is set to 10% (of motor nominal voltage).

P2.8.2.7 *Output voltage at zero frequency* **ID606** “Zero Freq Voltg”

This parameter defines the zero frequency voltage of the U/f curve. The default value is unit size dependent.

NOTE: If the value of parameter *U/f Ratio Select* is changed this parameter is set to zero.

P2.8.2.8 *U/f curve, middle point frequency 2* **ID1592** “U/f Mid Freq 2”

If the programmable U/f curve has been selected with parameter U/f ratio this parameter defines the middle point frequency of the curve. See also parameter *Middle point voltage*.

When the programmable U/f curve is selected this value is set to 10% of motor nominal frequency.

P2.8.2.9 *U/f curve, middle point voltage 2* **ID1593** “U/f mid Voltg 2”

If the programmable U/f curve has been selected with the parameter U/f ratio this parameter defines the middle point voltage of the curve. See also parameter *Middle point frequency*.

When the programmable U/f curve is selected this value is set to 10% (of motor nominal voltage).

P2.8.2.10 *U/f curve, middle point frequency 3* **ID1589** “U/f Mid Freq 3”

If the programmable U/f curve has been selected with parameter U/f ratio this parameter defines the middle point frequency of the curve. See also parameter *Middle point voltage*.

When the programmable U/f curve is selected this value is set to 10% of motor nominal frequency.

P2.8.2.11 U/f curve, middle point voltage 3 ID1591 "U/f mid Voltg 3"

If the programmable U/f curve has been selected with the parameter U/f ratio this parameter defines the middle point voltage of the curve. See also parameter *Middle point frequency*.

When the programmable U/f curve is selected this value is set to 10% (of motor nominal voltage).

P2.8.2.12 Field weakening point 2 ID1596 "Field WeakngPnt 2"

The field weakening point is the output frequency at which the output voltage reaches the field weakening point voltage.

P2.8.2.13 Voltage at field weakening point 2 ID1597 "Voltage at FWP 2"

Above the frequency at the field weakening point, the output voltage remains at the set maximum value. Below the frequency at the field weakening point, the output voltage depends on the setting of the U/f curve parameters.

When the parameter *Motor nominal frequency* is set, the parameter *Field weakening point* is automatically given the corresponding value. If you need different values for the field weakening point and the maximum output voltage, change these parameters **after** setting the *Nominal frequency*.

In closed loop control this defines the maximum voltage to the motor. It can be increased if sufficient DC voltage is available.

8.7.2 Close Loop Settings

P2.8.3.1 Current control P gain ID617 "CurrentControlKp"

Sets the gain for the current controller. The controller generates the voltage vector reference to the modulator. The gain is also used in open loop flying start. When the Sine filter parameter (parameter P6.7.5 in the System menu) has been set to *Connected* the value of this parameter is changed to 20.00%.

The value is also identified when using a PMS motor and making identification run with rotating motor. At low speed, the motor values may increase up to 300%. At high speed, the motor gain and motor with sine filter may have gain values of 10...40%.

P2.8.3.3 Current control Ti ID657 "CurrentControlTi"

Current controller integrator time constant.

P2.8.3.3 Slip adjust ID619 "Slip Adjust"

The motor name plate speed is used to calculate the nominal slip. This value is used to adjust the voltage of motor when loaded. The name plate speed is sometimes inaccurate and this parameter can therefore be used to trim the slip. Reducing the slip adjust value increases the motor voltage when the motor is loaded.

P2.8.3.4 Speed Error filtering time constant ID1311 "SpeedErrorFiltTC"

Filter time constant for speed reference and actual speed error. Can be used to remove small disturbances from encoder signal.

P2.8.3.5 Encoder filter time ID618 "Encoder1FiltTime"

Sets the filter time constant for speed measurement.

The parameter can be used to eliminate encoder signal noise. Too high a filter time reduces speed control stability. Values over 10 ms are not recommended in normal cases.

P2.8.3.6 Speed Control Torque Chain Select ID1557 "SCTorqueChainSel"

Values are bit coded. For example, after identification run with rotating motor the value will be 96. If you want to activate an external acceleration compensation you need to add +2 to the existing value.

B0 +1 = Additional torque limit

The torque reference chain can be used as an additional torque limit. This option is available in closed loop control mode only.

B1 +2 = External acceleration compensation

The torque reference is added to the speed control output, allowing the external controller to give inertia compensation for the drive in speed control mode. This option is available in closed loop control mode only.

B5&B6, +96 = Internal motor temperature compensation

When the motor cools down or warms up, the slip of the motor will change. When this function is activated in closed loop control mode, the AC drive will estimate changes in motor resistance and correct the changes of motor slip automatically to achieve the best torque estimation.

This function is automatically activated when identification run with rotating motor is successfully finished. This option is available in closed loop control mode only.

B11 +2048 = Disable CL Over Voltage Iq reference setting to zero

This function stabilizes operation when needed to operate continuously against over voltage limit.

P2.8.3.7 Encoder Selection ID1595 "Encoder Selector"

With this parameter it is possible to select which encoder input is used for closed loop control. Encoder board OPT-A7 is needed because of the possibility to connect two encoders.

0,1 = Encoder input 1

2 = Encoder input 2

8.7.3 Permanent magnet synchronous motor settings

There are three ways to know the magnet positions when using the closed loop control. The first one will identify the motor magnet position during every stage when the incremental encoder is used without a Z-pulse. Second one uses the incremental encoder Z-pulse and the third one uses absolute encoder information. See details of selecting correct mode from chapter "Identification function for permanent magnet synchronous motor".

P2.8.4.1 PMSM Shaft Position ID649 "PMSMShaftPositio"

Absolute encoder position value corresponding to the shaft position where rotor magnet axis is aligned with the stator U-phase magnet axis will be stored here as a result of the encoder identification run. If incremental encoder with a z-pulse is used, the z-pulse position will be stored instead. Depending on the motor shaft mechanical position, this parameter can have different values, as there is one correct value for each pole-pair of the motor. If the incremental encoder and the z-pulse is used, the first start after a power up is less optimal and the i/f-control (see 6.8.3.2) will be used until the drive finds the z-pulse and is able to synchronize in that.

P2.8.4.2 Start Angle Identification Mode ID1691 "StartAngleIdMode"

Start angle, i.e. rotor magnet axis position in respect to the stator U-phase magnet axis. Identification is needed if no absolute encoder or incremental encoder with z-pulse is used. This function defines how the start angle identification is made in those cases. Identification time depends on the motor electrical characteristics but takes typically 50ms...200ms.

In case of absolute encoders, the start angle will read directly from the encoder absolute angle value. On the other hand, incremental encoder z-pulse will be used automatically for synchronization if its position is defined different from zero in P2.8.5.1. Also for absolute encoders, P2.8.5.1 must be different from zero, otherwise it is interpreted that the encoder identification run has not been done and the running will be prohibited except if the absolute channel is bypassed by the start angle identification.

NOTE!

ModulatorType (P2.10.2) need to be > 0 to be able to use this function.

0 = Automatic

Decision to use start angle identification is made automatically based on the encoder type connected to the AC drive. This will serve common cases.

1 = Forced

Bypasses the drive automatic logic and forces the start angle identification to be active. Can be used, for example, with absolute encoders to bypass absolute channel information and to use start angle identification instead.

2 = On Power UP

As a default, the start angle identification will be repeated in every start if the identification is active. This setting will enable identification only in a first start after drive is powered up. In consecutive starts, angle will be updated based on the encoder pulse count.

10 = Disabled

Used when the Z- pulse from the encoder is used for start angle identification.

P2.8.4.3 Start Angle Identification Current ID1759 "StartAngleIdCurr"

This parameter defines the current level that is used in start angle identification. The correct level depends of the motor type used. In general, 50% of the motor nominal current seems to be sufficient, but depending for example on the motor saturation level, higher current might be needed.

P2.8.4.4 Polarity Pulse Current ID1566 "PolarityPulseCur"

This parameter defines the current level for the magnet axis polarity direction check during the start angle identification (P2.8.5.2). Value 0 means that the internal current level is used, which is typically slightly higher than the normal identification current defined by P2.8.5.3. The polarity direction check is seldom needed because the identification itself gives already the right direction. Hence in most cases, this function can be disabled by setting any negative parameter value, which is recommended especially if F1 faults occur during the identification.

P2.8.4.5 Start Angle Identification Time ID1755 "StartAngleIdTime"

The start angle can be determined also by feeding DC current into the motor. The DC current will align the rotor magnet axis with the stator magnet axis. This function is activated by determining the time duration DC current is injected to the motor. Motor must be free to move during the alignment and the time needs to be long enough for shaft oscillations to damp out. Hence, this method is not so practical and is intended to be used mainly for testing purposes or to improve starting in together with i/f-control. DC current level is determined by P2.8.5.6. Also P2.8.5.2 needs to be disabled, otherwise it will override this function.

8.7.3.1 I/f Control

I/f-control can be used to start the motor using a constant current control. This is useful especially, if the motor stator resistance is low, which makes the motor current sensitive for u/f-curve tuning at low speed area. I/f-control is activated by setting AdvancedOptions2.B9 = 1 (P2.10.6).

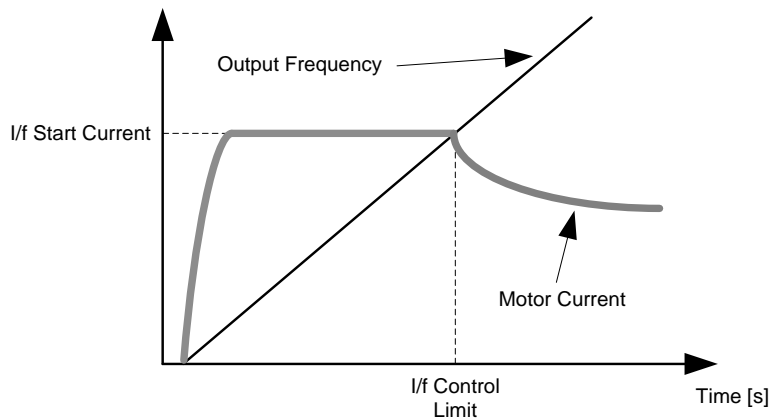

Figure 8-29

P2.8.4.6 I/f Current ID1693 "I/f Current"

NOTE: I/f Current parameter is used for several different purposes.

I/f Control

This parameter defines the current level during I/f control, in percent of the motor nominal current

Zero position with incremental encoder and Z-Pulse

In closed loop control utilizing the encoder z-pulse, this parameter defines also the current level used in the start before the z-pulse is received to synchronize with.

DC Start Angle identification

This parameter defines the DC Current level when the Start Angle Identification Time is set greater than zero. See P2.8.5.5 Start Angle Identification Time.

P2.8.4.7 I/f Control Limit ID1790 "I/f Control Lim"

This parameter sets the speed limit for I/f-control in percent of the motor nominal speed (1000 = 100.0%). I/f-control is used if the speed is below this limit. The operation changes back to normal when the speed is above this limit with 60 rpm hysteresis.

8.7.3.2 *Flux current controller*

The flux current controller is used with a PMS motor when running in closed loop control in the field weakening area. This function controls the negative Id current to the PM motor in the field weakening area so that the motor terminal voltage does not increase above the maximum level (set by field weakening point voltage, maximum drive output voltage). The field weakening area operation depends on the motor construction. The motor construction may prohibit operation above the field weakening area.

If there is instability in the field weakening area, gain can be decreased and/or time constant increased.

P2.8.4.8 Flux Current Kp ID551 "FluxCurrent Kp"

Defines gain for the flux current controller when using a PMS motor. Depending on the motor construction and the ramp rate that is used to go to the field weakening area, high gain may be needed so that the output voltage does not reach the maximum limit and prevent proper motor control. Too high gain may lead to unstable control. The integration time is more significant in this case for control.

P2.8.4.9 Flux Current Ti ID652 "FluxCurrent Ti"

Defines the integration time for the flux current controller when using a PMS motor.

Depending on the motor construction and the ramp rate that is used to go to field weakening area, short integration times may be needed so that the output voltage does not reach the maximum limit and prevent proper motor control. Too fast integration time may also lead to unstable control.

P2.8.4.10 ExtIdRef ID1730 "ExtIdRef"

This reference value can be used for the external control of the motor id-current i.e. reactive current. Normally there is no need for that as the control uses already the optimal value. This reference value is additive to the internal values of the AC drive but, for example, the field-weakening controller can override the given reference in field-weakening.

8.7.3.3 *D and Q axis voltage drops*

If d-axis and q-axis reactances (voltage drops) are defined, the AC drive calculates the optimal d-axis current reference based on the reactance values and the motor torque in order to account the motor reluctance torque part. In this way, the motor Torque/Current ratio can be increased.

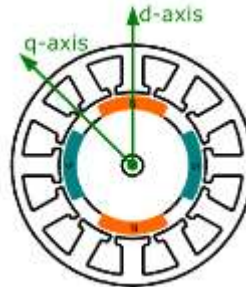

Figure 8-30

P2.8.5.11 Lsd Voltage Drop ID1757 "Lsd Voltage Drop"

D-axis reactance voltage drop 2560 = 100%.

Gives the % voltage drop across the stator inductance at nominal current and frequency.

$$X_d[\text{Drive scale}] = \frac{X_d[\Omega] * I_n[\text{A}] * \sqrt{3} * 2560}{U_n[\text{V}]}$$

P2.8.5.12 Lsq Voltage Drop ID1758 "Lsq Voltage Drop"

Q-axis reactance voltage drop 2560 = 100%.

Gives the % voltage drop across the stator inductance at nominal current and frequency.

$$X_q[\text{Drive scale}] = \frac{X_q[\Omega] * I_n[\text{A}] * \sqrt{3} * 2560}{U_n[\text{V}]}$$

P2.8.4.13 I/f Current 2 ID1694

If current level can be adjusted together with ID1791 to different level based on output frequency. This parameter adjusts the current level of the second point

P2.8.4.14 I/f Control Limit 2 ID1791

If current level can be adjusted together with ID1694 to different level based on output frequency. This parameter adjusts the frequency level of the second point

P2.8.4.15 Current Control Kp D ID1761

P2.8.4.16 Voltage Margin ID1762

8.7.4 Stabilization settings

Torque stabiliser

The torque stabiliser is basically a first order high-pass filter for the estimated torque [T]. The output of the filter is a frequency correction term df added to the output frequency reference. The purpose of the torque stabiliser is to stabilise the possible oscillations in the estimated torque. The controller gain is changing linearly between the zero and field weakening point frequencies. The zero and field weakening point gains can be controlled independently with gains. The stabiliser operates at frequencies above 3 Hz.

The discrete implementation of the filter is:

$$\frac{1000}{TorqStabDamp} df_k = \frac{1000}{TorqStabDamp} G(T_k - T_{k-1}) + df_{k-1} = G_f(T_k - T_{k-1}) + df_{k-1}$$

Where G_f is the total gain of the filter. The gain and the corner frequency of the filter is controlled by the following parameters

P2.8.5.1 Torque stabiliser damping ID1413 "TorqStabDamp"

If a PMS motor is used in open loop control mode it is recommended to use value 980 instead of 800. The value '980' is set automatically when PMS motor is selected.

This parameter defines the corner frequency of the high-pass filter. The time constant of the filter is calculated as:

$$T_c = T_s \frac{TorqStabDamp}{1000 - TorqStabDamp} = 1ms \frac{TorqStabDamp}{1000 - TorqStabDamp}$$

This means that the corner frequency of the filter is obtained from:

$$\omega_c = \frac{1}{T_c} \text{ rad/s}$$

For example, if Torque stabilizer damping = 600, this means that $T_c = 1.5$ ms and $\omega_c = 667$ rad/s.

P2.8.5.2 Torque stabiliser Gain ID1412 "TorqStabGain"

These parameters define together with the Torque Stabiliser Damping the actual gain of the filter. Torque Stabiliser Gain is the gain at the zero frequency. Torque stabiliser Gain in FWP is the gain at the field-weakening frequency. The gain changes linearly with the frequency between these two points so that the gain is

$$G = TorqStabGainFWP + TorqStabGain - \frac{f}{f_{FWP}} TorqStabGain, \quad \text{if } f < f_{FWP}$$

$$G = \text{TorqStabGainFWP}, \quad \text{if } f \geq f_{\text{FWP}}$$

The final gain is obtained by considering the value of Torque Stabiliser Damping and the scaling in which 256 means the gain 1. So, the final and the actual gain of the filter is obtained from

$$G_f = \frac{1000 * G}{256 * \text{TorqStabDamp}}$$

P2.8.5.3 Torque stabiliser Gain in FWP area ID1414 "TorqStabGainFWP"

Gain of the torque stabiliser at field weakening point in open loop motor control operation. See details from Torque Stabiliser Gain.

P2.8.5.4 Torque stabiliser Limit ID1720 "TorqStabLimit"

This defines how much the torque stabiliser can affect the output frequency.

Flux Circle stabiliser

P2.8.5.5 Flux Circle stabiliser Gain ID1550 "FluxCircleStabG"

Gain for flux circle stabiliser. This will control the flux to origin when error is detected. The controller output is added to the output frequency. The effect decreases at low frequencies where flux stabiliser has more effect. The parameter is used at frequencies where output voltage is at the maximum limit (set by field weakening point voltage or maximum drive output voltage).

Flux stabiliser

Flux stabilizer is a first order high-pass filter for the estimated flux producing current I_d . The output of the filter is correcting term dU added to the output voltage reference. The gain and the corner frequency of the filter is controlled by the following parameters.

P2.8.5.6 Flux Stabiliser Gain ID1797 "Flux Stab Gain"

Flux stabilizer gain is 0 at the zero speed and is increased linearly with the frequency to value defined by the Flux Stab Gain which is reached at the 1 Hz.

So, the gain is obtained from

$$G = \text{Flux Stab Gain} * f, \quad \text{if } f < 1 \text{ Hz}$$

$$G = \text{Flux Stab Gain}, \quad \text{if } f \geq 1 \text{ Hz}$$

The gain is scaled by 1000 and the actual gain of the filter is obtained from

$$G_f = \frac{G}{1000} = \frac{\text{Flux Stab Gain}}{1000}$$

P2.8.5.7 Flux stabiliser TC *ID1551* *"FluxStab TC"*

Flux Stabiliser TC defines the corner frequency of the high-pass filter. The time constant of the filter is calculated from:

$$T_c = T_s \frac{65536 - 2 * \text{FluxStab TC}}{2 * \text{FluxStab TC}} = 1ms \left(\frac{65536}{2 * \text{FluxStab TC}} - 1 \right)$$

For example, if Flux Stabiliser TC = 64, this means that $T_c = 511$ ms and $\omega_c = 1.96$ rad/s.

Voltage stabiliser

The voltage stabilizer is similar to the torque stabilizer controlling the change in DC-link voltage at frequencies above 3 Hz. It is a first order high-pass filter for the measured DC-link voltage U_{dc} . The output of the filter is a frequency correction term df added to the output frequency reference. Gain is adjusted relative to the estimated torque. As the torque increases from 10% to 50% of the motor nominal torque, the controller gain decreases from the voltage stabiliser Gain down to zero. The gain and the corner frequency of the filter are controlled by the following parameters:

P2.8.5.9 Voltage stabiliser Gain ID1738 "VoltStabGain"

Voltage Stabilizer Gain is a function of a torque. If the torque is below 15%, the gain is the value defined by the Voltage Stabilizer Gain. If the torque is above 50% the gain is 0. Between 15-50% the gain decreases linearly with the torque from Voltage Stabilizer Gain to 0. In other words,

$$G = \text{VoltStabGain}, \quad \text{if } T < 15\%$$

$$G = \frac{\text{VoltStabGain}}{35\%} (50\% - T(\%)), \quad \text{if } 15\% \leq T < 50\%$$

$$G = 0, \quad \text{if } T > 50\%$$

The final gain is obtained by considering the value of Voltage stabiliser TC and the scaling in which 256 means the gain 1. So, the final and the actual gain of the filter is obtained from

$$G_f = \frac{1000 * G}{256 * \text{VoltStab TC}}$$

P2.8.5.10 Voltage stabiliser TC ID1552 "VoltageStab TC"

This parameter defines the corner frequency of the high-pass filter. The time constant of the filter is calculated as

$$T_c = T_s \frac{\text{VoltageStab TC}}{1000 - \text{VoltageStab TC}} = 1\text{ms} \frac{\text{VoltageStab TC}}{1000 - \text{VoltageStab TC}} \text{ms}$$

P2.8.5.11 Voltage stabiliser Limit ID1553 "VoltStabLimit"

This parameter sets the limits for the voltage stabilizer output. The maximum and the minimum value for the correction term df in FreqScale.

8.7.5 Identification settings

P2.8.6.1 to

P2.8.6.15 Flux 10...150% ID1355 – ID1369

Motor voltage corresponding to 10%...150% of flux as a percentage of Nominal Flux voltage. Measured during identification.

P2.8.6.16 Measured Rs voltage drop ID662 "RsVoltageDrop"

The measured voltage drop at stator resistance between two phases with the nominal current of the motor. This parameter is identified during identification run.

This parameter defines the motor stator resistance as a voltage drop at nominal current. The parameter value is defined according to the motor nominal voltage and the current and the actual stator resistance as

$$Rs\ VoltageDrop = 2560 \frac{I_n}{U_n} R_s$$

P2.8.6.17 Ir: Add zero point voltage ID664 "IrAddZeroPVoltag"

Defines how much voltage is applied to the motor in zero speed when the torque boost is used.

P2.8.6.18 Ir: Add motoring scale ID667 "IrAddMotorScale"

Defines the scaling factor for the motoring side IR-compensation when the torque boost is used.

P2.8.6.19 Ir: Add generator scale ID665 "IrAddGeneScale"

Defines the scaling factor for the generator side IR-compensation when the torque boost is used.

P2.8.6.20 Measured Ls voltage drop ID673 "LsVoltageDrop"

Leakage inductance voltage drop with nominal current and frequency of the motor. This parameter defines the Ls voltage drop between two phases. Use identification run to determine the optimum setting.

P2.8.6.21 Motor BEM Voltage ID674 "Motor BEM Voltage"

Motor-induced back voltage.

P2.8.6.22 IU Offset ID668 "IU Offset"

P2.8.6.23 IV Offset ID669 "IV Offset"

P2.8.6.24 IW Offset ID670 "IW Offset"

Offsets the value for the phase current measurement. Identified during identification run.

P2.8.6.25 Estimator Kp ID1782 "Estimator Kp"

Estimator gain for PMS motor. Identified during identification run.

P2.8.6.26 Voltage Drop ID671 "Voltage Drop"

Measured residual voltage error.

8.7.6 Flying Start

P2.8.8.1 Flying Start Options ID1770

- b0 = +1= Disable movement to reverse direction
- b1 = +2=Disable AC Scanning
- b2 = +4=Disable Fly Brake phase
- b3 = +8=Use encoder information for frequency estimate
- b4 = +16=Use frequency reference for initial guess
- b5 = +32=Disable DC scanning for step-up application

P2.8.8.2 AC magnetization Current ID1810

Current reference during AC scanning phase.

P2.8.8.3 AC Scanning Time ID1811

Reference time for the AC scanning when the motor slip is 1 Hz. If slip is 0.50 Hz, the actual scanning time is double.

P2.8.8.4 DC magnetization Current ID1812

Current reference during the DC scanning phase.

P2.8.8.5 Flux Build Torque DI1814

Torque reference during the Flux built time.

P2.8.8.6 Flux Build Time ID1813

Time when the rotor flux is increased to nominal after the flying start has found the motor actual speed. If zero speed is found, this function is not used.

P2.8.8.7 Magnetization Phases ID1815

8.8 Speed Control settings

8.8.1.1 Open Loop Settings

P2.9.1 *Speed controller P gain, Open Loop ID637 "OL Speed Reg P"*

Defines the P gain for the speed controlled in Open Loop control mode.

P2.9.2 *Speed controller I gain, Open Loop ID638 "OL Speed Reg I"*

Defines the I gain for the speed controlled in Open Loop control mode.

8.8.1.2 Closed Loop Speed Control Settings

Speed control formula:

$$y = Kp \left[1 + \frac{1}{Ti s} \right] e$$

$$u(k) = y(k - 1) + Kp[e(k) - e(k - 1) + \frac{Ts}{Ti} e(k)]$$

P2.9.3 *Speed control P gain ID613 "Speed Control Kp"*

Gain for the speed controller in closed loop motor control operation. Gain value 100 means that the nominal torque reference is produced at the speed controller output for the frequency error of 1Hz.

P2.9.4 *Speed control I time ID614 "Speed Control Ti"*

Sets the integral time constant for the speed controller. Increasing the I-time increases stability but lengthens the speed response time.

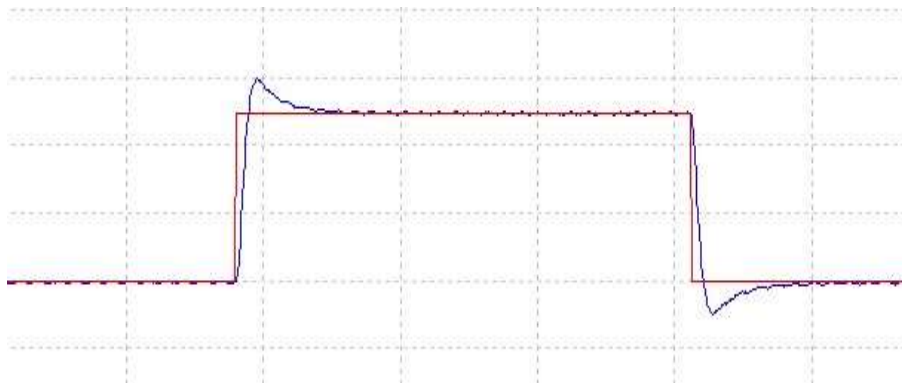

Figure 8-31, Kp 30, Ti 100

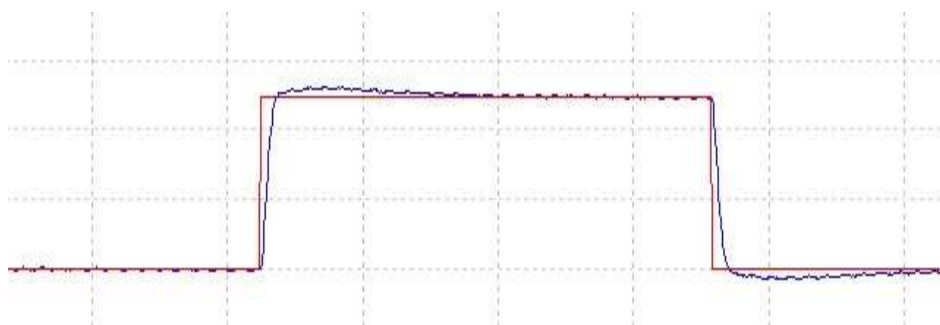
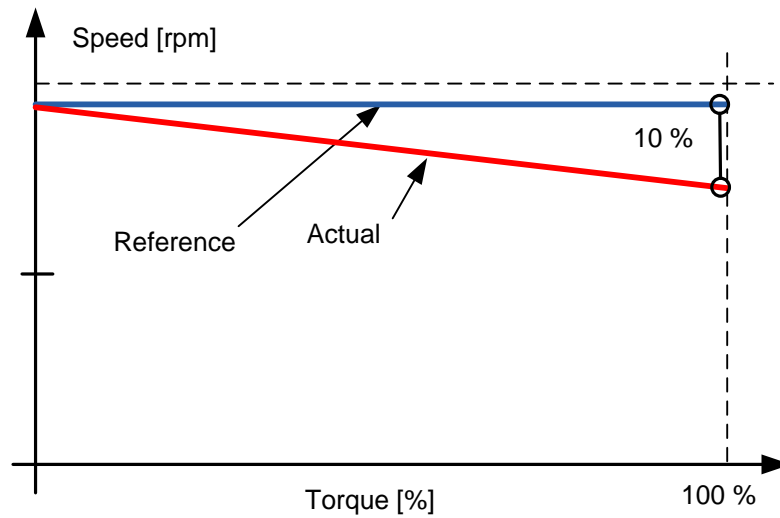

Figure 8-32, Kp 30, Ti 300

P2.9.5 Load drooping ID647 "LoadDrooping"

The drooping function enables speed drop as a function of load. This parameter sets the value corresponding to the nominal torque of the motor.



Example: If load drooping is set to 10% for a motor that has a nominal frequency of 50 Hz and is nominally loaded (100% of torque) the output frequency is allowed to decrease 5 Hz from the frequency reference. The function is used for, for example, when the balanced load is needed for mechanically connected motors.

8.9 Drive Control

2.10.1 *Switching Freq*

The switching frequency of the IGBT Bridge in kHz. Changing the default value may impact on the LCL filter operation.

2.10.2 *AFE Options 1*

This packed bit word is made for enabling/disabling different control options for regeneration control.

B0 = Disable DCV reduction with reactive reference generation with high line voltage.

B1 = Disable LCL reactive power compensation.

B5 = Disable all harmonic elimination compensation

This is active by default. When activated, this function will reduce the 5th and 7th harmonics a bit. This will not reduce harmonics of the grid, only the harmonics of the AFE Unit.

B8 = Enable double pulse synchronization

This option will generate two synchronization pulses instead of one. It may help synchronization on a weak grid.

B9 = Enable soft synchronization (\geq FI9)

This function enables zero crossing detection on FI9 and bigger units. When it is active and there is a connection to the grid with the AC drive in stop state, the Supply Frequency is updated by the detected frequency.

B12 = Enable floating DC reference. DC-link voltage will follow line voltage.

If the run state AC drive can detect the Supply Voltage, the internal DC Reference is changed when the supply voltage changes, so that the DC Voltage is:

$$DC\ Voltage = Measured\ Supply\ Voltage * 1.35 * DC\ Reference$$

B13 = Enable use of D7 board for start synchronization.

When the OPT-D7 board is installed, this bit will activate the synchronization by using the voltage angle and frequency information from the D7 board. Note that the phase order needs to be the same in both OPT-D7 and input phases. We also recommend to keep the frequency on the positive side. Note that the Frequency of the D7 board can be the same as the Supply Frequency but the phase order can be still wrong,

2.10.3 *AFE Options 2*

This packed bit word is made for enabling/disabling different control options for regeneration control.

B0 = Use encoder fast input for fast Run Enable

2.10.4 *Start Delay*

This parameter defines a starting delay when the run command is given. When programming different delays to the paralleled units, the units will start in sequence. This is needed in parallel units so that the synchronization does not happen simultaneously with all the drives. Simultaneous starting may lead to failed synchronization. Recommended value between the drives is 500 ms.

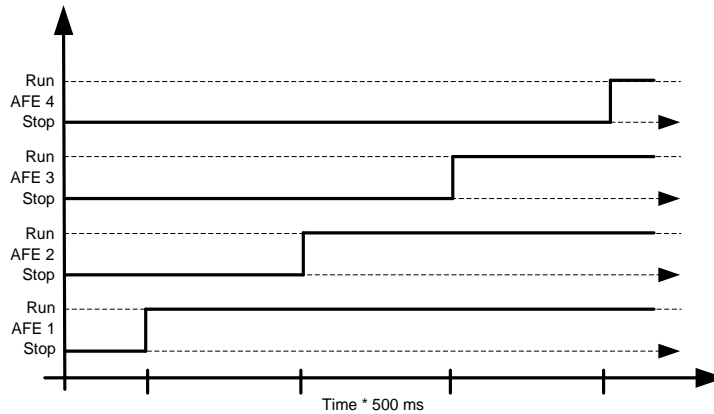

Figure 8-33

2.10.5 *AdvancedOptions1*

This packed bit word is made for enabling/disabling different control options for regeneration control.

2.10.6 *AdvancedOptions2*

This packed bit word is made for enabling/disabling different control options for regeneration control.

2.10.7 *AdvancedOptions3*

This packed bit word is made for enabling/disabling different control options for regeneration control.

2.10.8 *AdvancedOptions4*

This packed bit word is made for enabling/disabling different control options for regeneration control.

2.10.9 *AdvancedOptions5*

This packed bit word is made for enabling/disabling different control options for regeneration control.

2.10.10 *AdvancedOptions6*

This packed bit word is made for enabling/disabling different control options for regeneration control.

2.10.11 Modulator type (ID1516)

This parameter is for changing the modulator type. With ASIC (HW) modulator, the current distortion is lower, but losses are higher compared to a software modulator. We recommend to use Software modulator 1 as a default option.

0 = Hardware modulator: ASIC modulator, which is classical third harmonic injection. Spectrum is slightly better compared to Software 1 modulator.

1 = Software modulator 1: Symmetric vector modulator with symmetrical zero vectors. Current distortion is less than with software modulator 2 if boosting is used.

2 = Software modulator 2: Symmetric BusClamb, in which one switch always conducts 60 degrees either to negative or positive DC-rail. Switching losses are reduced without different heating of upper and lower switches. Spectrum is narrow.

3 = Software modulator 3: Unsymmetric BusClamb, in which one switch always conducts 120 degrees to negative DC-rail to reduce switching losses. Drawback is that upper and lower switches are unevenly loaded and spectrum is wide.

4 = Software modulator 4: Pure sinewave, sinusoidal modulator without harmonic injection. Dedicated to be used in back to back test benches etc. to avoid circulating third harmonic current. Drawback is that required DC voltage is 15% higher compared to other modulator types.

2.10.12 Control Options

B00 = +1 = Reserved

B01 = +2 = Reserved

B02 = +4 = Reserved

B03 = +8 = Disable D7 frequency monitoring for diagnostic. Used for testing purposes.

B04 = +16 = Disable D7 voltage monitoring for diagnostic. Used for testing purposes.

B05 = +32 = Keep frequency drooping while synchronization to external grid.

B06 = +64 = Enable External grid contactor closing on stop state

B07 = +128 = Enable changing (temporarily) MCC Control output, used to disable MCC close for testing purposes.

B08 = +256 = Disable floating DC reference, Island and uGrid modes will follow actual DC

B09 = +512 = Reserved

B10 = +1024 = Activate Closed Loop type speed limit function in Open Loop

B11 = + = Rem

B12 = + = Reserved

B13 = + = Use Drive own angle information for SG synchronization.

B14 = + = Reserved.

B15 = + = Reserved.

2.10.13 Control Options 2

B01 = +2 = No longer available, use P2.12.1.13 FaultWarnIndicat

2.10.14 Synch Kp Start

[Description needed]

2.10.15 Capacitor size [%] (ID1460)

AFE: This parameter defines the reactive current going to the LCL filter capacitor. Compensates the LCL effect to reactive current by adjusting reactive current reference internally. Inductor size is also added to compensation. If set correctly, power factor on the grid side will be one.

$$I_{CAP} = \left(\frac{V_{Grid}}{\sqrt{3}} \right) (2\pi f C_Y)$$

Where C_Y = Filter capacitance

$$\text{Capacitor size [\%]} = \frac{I_{CAP} * [CurrenScale]}{\text{System Rated Current}} * 100$$

CurrentScale; if no decimals in current value then current scale is 1. If one decimal in current value then current scale is 10. If two decimals in current value, then current scale is 100.

2.10.16 Inductor size [%] (ID1461)

AFE:

This parameter defines voltage losses in percentage from nominal voltage at 100% active current. This value is internally added to the reactive current reference thus giving power factor one on the grid side if set correctly together with the Capacitor size. Transformer and feeding cables can be compensated by increasing this value.

$$\text{Inductor size [\%]} = \frac{2\pi f L * 100}{\left(\frac{\frac{V_{Grid}}{\sqrt{3}} * [CurrenScale]}{\text{System Rated Current}} \right)}$$

P2.10.17 Operation Time ID1855

The parameter that stores the operation time. When application is reloaded, the operation hours will go to zero if this parameter is not updated.

Monitoring signal is in hours with two decimal.

Parameter is in format of:

xx (Years) XX (Monts) XX (Days) XX (Hours) XX Minutes

1211292359 -> 12 years, 11 months, 29 days, 23 hours and 59 minutes.

P2.10.18 Active Current Kp ID1455

P2.10.19 Active Current Ti ID1456

P2.10.20 Restart Delay ID672

P2.10.21 DC Volt. Kp ID1451

<i>P2.10.22</i>	<i>DC Volt. Ti</i>	<i>ID1452</i>
<i>P2.10.23</i>	<i>Synch Kp</i>	<i>ID1457</i>
<i>P2.10.24</i>	<i>Synch Ti</i>	<i>ID1458</i>

8.10 Master Follower

In the system where there are two back to back AFE units, the system can be controlled by using the system bus communication. This will reduce needed IO because e.g. the start command needs to be given only on the drive. Also in fault situations, the AC drives can behave logically because both drives know the status of the other drive.

2.11.1 MF Mode

This parameter is used when using two drives in Shaft Generator operation and drives need to operate towards the upper system as a single unit.

0 = Single drive

System bus is deactivated. For example, in the Shaft Generator system both drives are controlled separately.

1 = Master

Drive sends control word to follower drive. For example, in the Shaft Generator system both drives need to operate as a single drive.

2 = Follower

Drive receives control word from Master and sends some diagnostic information to the Master drive.

3 = "Synchronization Master Mode 1"

Operation mode for special cases.

4 = "Synchronization Follower Mode 1"

Operation mode for special cases.

2.11.2 SB Comm. Fault

Defines the response when the System Bus heartbeat is missing.

The master drive sends a heartbeat signal to all follower drives and this heartbeat is sent back to the master drive.

2.11.3 SB Fault Delay

Defines the delay before the fault generation when heartbeat is missing.

8.11 Protections

8.11.1 *General settings*

2.12.1.1 *Thermistor fault response*

0 = No response

1 = Warning

2 = Fault, stop mode after fault according to ID506

3 = Fault, stop mode after fault always by coasting

Setting the parameter to **0** will deactivate the protection.

2.12.1.2 *CoolingFlt.Delay*

Protection for liquid cooled units. An external sensor is connected to the drive (DI: Cooling Monitor) to indicate if cooling liquid is circulating. If the drive is in Stop state this is only a warning. In Run state, the drive will issue a fault with a coast stop.

This parameter defines the delay after which the drive goes to fault state when 'Cooling OK' signal is missing.

2.12.1.3 *LCL Temperature input monitor*

This parameter defines a response to Input filter overtemperature fault. The fault is monitored through digital input.

2.12.1.4 *Max Charge Time*

When drive charging options are used, this parameter defines the maximum time limit for charging.

2.12.1.5 *MCC At Fault*

Defines action for main contactor when drive has a fault.

0 = Keep closed

1 = Open at fault situation.

2.12.1.6 *Start Fault Delay*

When using the master-follower system, for example, the shaft generator, this parameter defines the fault delay if both drives are not started.

2.12.1.7 *Quick Stop Response* *ID1543*

This will stop the drive at any case. This parameter is used to select what action is shown on keypad.

1 = Warning

2 = Fault,

2.12.1.8 *Reactive Error Trip Limit* ID1759

Limit for reactive current for line fault detection, when reactive current is less than this parameter Line Synch fault is given.

2.12.1.9 *MCC Fault Delay* ID1521

Delay for Main contactor open fault. Delay between main contactor control relay close command and main contactor acknowledge signal. If acknowledge signal is not received within this time, a fault F64 will be triggered.

2.12.1.10 *Line Phase Supervision* ID702

Defines the response when the drive notices that one of the input phases is missing.

0 = No response

1 = Warning

2 = Fault, stop mode after fault according to Stop Function

3 = Fault, stop mode after fault always by coasting

2.12.1.11 *Response to the 4mA reference fault* ID700

The 4 mA protection monitors the analogue input signal level from Analogue input 1 and Analogue input 2. The monitoring function is active when signal Custom minimum is greater than 16.00%. A fault or warning is generated when the signal falls below 3.5 mA for 5 seconds or below 0.5 mA for 0.5 seconds.

0 = No response

1 = Warning

2 = Fault,

P2.12.1.12 *Encoder Supervision* ID1353

Encoder supervision gives fault in case there are no pulses from encoder. It is required that the reference is above 1 Hz and that the torque can reach 100% level.

1 = Warning

2 = Fault

3 = Warning; Change to Open Loop

P2.12.1.13 FaultWarnIndicat ID1940

With this parameter its possible to select how warning and fault indication as handled to digital outputs and to fieldbus

0 = Static

Static signal, as long as warning or fault is active

1 = Toggle

New fault or warning toggles signal for one second.

2 = Marine

Signal toggles in new fault or warning and status needs to be reset to get signal down.

8.11.2 PT-100

PT100 protection function is used to measure temperature and give warning and/or fault when set limits are exceeded. Marine application supports two PT100 boards thus one can be used to motor winding and one for motor bearings.

2.12.2.1 *Number of PT100 inputs In use* ID739 "PT100 Numbers"

If you have a PT100 input board installed in your AC drive you can choose here the number of PT100 inputs in use. See also the VACON® I/O boards manual.

0 = Not used (ID Write, value of maximum temperature can be written from fieldbus)

1 = PT100 input 1

2 = PT100 input 1 & 2

3 = PT100 input 1 & 2 & 3

4 = PT100 input 2 & 3

5 = PT100 input 3

Note: If the selected value is greater than the actual number of used PT100 inputs, the display will read 200°C. If the input is short-circuited the displayed value is -30°C.

2.12.2.2 *Response to PT100 fault* ID740 "PT100 FaultRespo"

0 = No response

1 = Warning

2 = Fault, stop mode after fault according to Stop Function

3 = Fault, stop mode after fault always by coasting

2.12.2.3 *PT100 warning limit* ID741 "PT100 Warn.Limit"

Set here the limit at which the PT100 warning will be activated.

2.12.2.4 *PT100 fault limit* ID742 "PT100 Fault Lim."

Set here the limit at which the PT100 fault (F56) will be activated.

2.12.2.5 *Number of PT100 2 inputs in use* ID743 "PT100 2 Numbers"

If you have a two PT100 input board installed in your AC drive you can choose here the number of PT100 inputs in use in second board. See also the VACON® I/O boards manual.

0 = Not used (ID Write, value of maximum temperature can be written from fieldbus)

1 = PT100 input 1

2 = PT100 input 1 & 2

3 = PT100 input 1 & 2 & 3

4 = PT100 input 2 & 3

5 = PT100 input 3

2.12.2.6 *PT100 2 warning limit ID745 "PT100 2 Warn. Lim"*

Set here the limit at which the second PT100 warning will be activated.

2.12.2.7 *PT100 2 fault limit ID746 "PT100 2 FaultLim"*

Set here the limit at which the second PT100 fault (F61) will be activated.

8.11.3 *Earth Fault*

2.12.3.1 *EarthFlt Response*

2= Fault

3= Fault, Open MAIN contactor

4= Fault, Open NET contactor

5 = Fault, Open Main en NET contactor

2.12.3.2 *EarthFaultLevel*

This parameter defines the maximum level of earth current in% of unit current.

8.11.4 *External Fault*

2.12.4.1 *Response to external fault 1 ID701 "External Fault 1"*

2.12.4.2 *Response to external fault 2 ID1504 "External Fault 1"*

Defines response when the digital input signal is used to give signal about external condition where the AC drive needs to react. External warning/fault indication can be connected to digital output.

0 = No response

1 = Warning

2 = Fault, stop mode after fault according to Stop Function

3 = Fault, stop mode after fault always by coasting

2.12.4.3 *External fault delay*

Defines the delay for the external fault, affects both external fault inputs.

8.11.5 Generator Voltage OPT-D7

This function monitors the grid voltage by using measurement from the OPT-D7 board.

P2.12.5.1 Voltage Response ID1880

0 = No response

1 = Warning

2 = Fault

P2.12.5.2 Voltage Low Warning Limit ID1893

Low limit for warning indication. Percentage value from the set supply voltage parameter.

P2.12.5.3 Voltage Low Trip Limit ID1899

Low limit for fault indication. Percentage value from the set supply voltage parameter.

P2.12.5.4 Voltage High Warning Limit ID1895

High limit for warning indication. Percentage value from the set supply voltage parameter.

P2.12.5.5 Voltage High Trip Limit ID1799

High limit for fault indication. Percentage value from set the supply voltage parameter.

P2.12.5.6 Voltage Trip Delay ID1898

Delay to fault when the voltage has exceeded fault levels.

8.11.6 Generator Frequency OPT- D7

P2.12.6.1 Frequency Error Response

0 = No response

1 = Warning

2 = Fault

P2.12.6.2 Freq. low Warning Limit ID1780

Low limit for warning indication. Percentage value from the set supply frequency parameter.

P2.12.6.3 Freq. Low Trip Limit ID1788

Low limit for fault indication. Percentage value from the set supply frequency parameter.

P2.12.6.4 Freq. High Warning Limit *ID1786*

High limit for warning indication. Percentage value from the set supply frequency parameter.

P2.12.6.5 Freq. High Trip Limit *ID1787*

High limit for fault indication. Percentage value from the set supply frequency parameter.

P2.12.6.6 Freq. Trip Delay *ID1785*

Delay to fault when the frequency has exceeded fault levels.

8.12 Motor Protection



CAUTION! *The calculated model does not protect the motor if the airflow to the motor is reduced by a blocked air intake grill.*

The motor thermal protection is to protect the motor from overheating. The drive is capable of supplying higher than nominal current to the motor. If the load requires this high current there is a risk that the motor will be thermally overloaded. This is the case especially at low frequencies. At low frequencies the cooling effect of the motor is reduced as well as its capacity. If the motor is equipped with an external fan the load reduction at low speeds is small.

The motor thermal protection is based on a calculated model and it uses the output current of the drive to determine the load on the motor.

The motor thermal protection can be adjusted with parameters. The thermal current I_T specifies the load current above which the motor is overloaded. This current limit is a function of the output frequency.

P2.12.71 Motor thermal protection response ID704 "Motor Therm Prot"

Defines the response when the calculated temperature of the motor has reached 105% (monitoring signal).

0 = No response

1 = Warning

2 = Fault, stop mode after fault according to Stop Function

3 = Fault, stop mode after fault always by coasting

P2.12.7.2 Motor ambient temp. factor ID705 "MotAmbTempFactor"

Defines the temperature factor for conditions where the motor is located. The factor can be set between -100.0%—100.0%.

-100.0% = 0°C,

0.0% = 40°C,

100.0% = 80°C

P2.12.7.3 Motor cooling factor at zero speed ID706 "MTP f0 Current"

Defines the cooling factor at zero speed in relation to the point where the motor is running at nominal speed without external cooling.

The default value is set assuming that there is no external fan cooling the motor. If an external fan is used, this parameter can be set to 90% (or even higher).

Note: The value is set as a percentage of the motor name plate data, (Nominal current of motor), not the AC drive's nominal output current. The motor's nominal current is the current that the motor can withstand in direct on-line use without being overheated.

Setting this parameter does not affect the maximum output current of the drive which is determined by parameter Motor Current Limit alone.

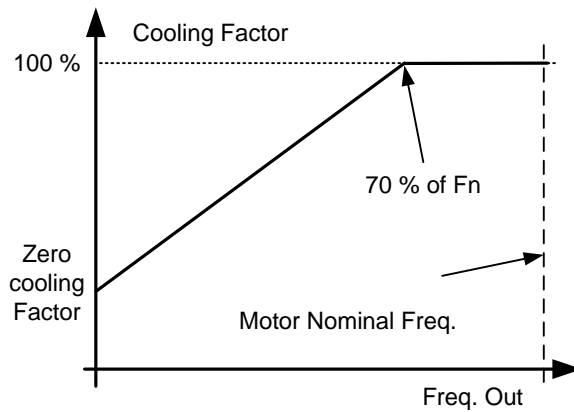

Figure 8-34

P2.12.7.5 Motor thermal protection: Time constant ID707 "MTP Motor T"

This time can be set between 1 and 200 minutes.

This is the thermal time constant of the motor. The bigger the motor, the bigger the time constant. The time constant is the time within which the calculated thermal stage has reached 63% of its final value.

The motor thermal time is specific to motor design and it varies between different motor manufacturers. The default value changes between unit sizes.

If the motor's t_6 -time (t_6 is the time in seconds the motor can safely operate at six times the rated current) is known (given by the motor manufacturer), the time constant parameter can be set basing on it. As a rule of thumb, the motor thermal time constant in minutes equals to $2 \times t_6$. If the drive is in stop stage, the time constant is internally increased to three times the set parameter value. The cooling in the stop stage is based on convection and the time constant is increased.

P2.12.7.5 Motor thermal protection: Motor duty cycle ID708 "Motor Duty Cycle"

The value can be set to 0%...150%.

Setting value to 130% motor calculated temperature will reach nominal temperature with 130% of motor nominal current.

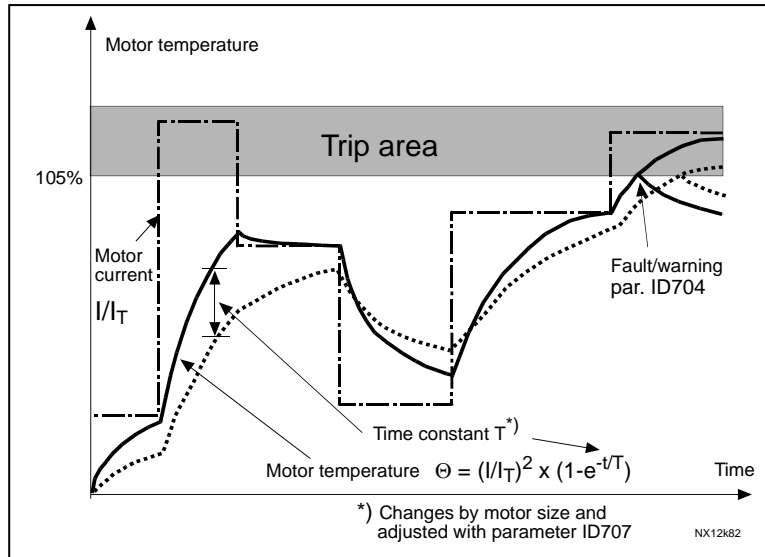

Figure 8-35. Motor temperature calculation

8.12.1 Over Load Protection

With this function it is possible to select between Current, Torque and Power which one is used for overload protection.

Overload is based on internal counter that is increased when input value is above 105% level and decreased when below 105% level. The increase and decrease happens every 100 ms.

Tripping is made when overload counter value is over 10 000.

Use the parameters to define what is increased (Overload maximum step) at the maximum defined input level (Overload Maximum Input). These points define the slope for the function. For example, the input value is in the middle of 105% and the Overload Maximum Input values counter is increased by a half of the Overload Maximum step.

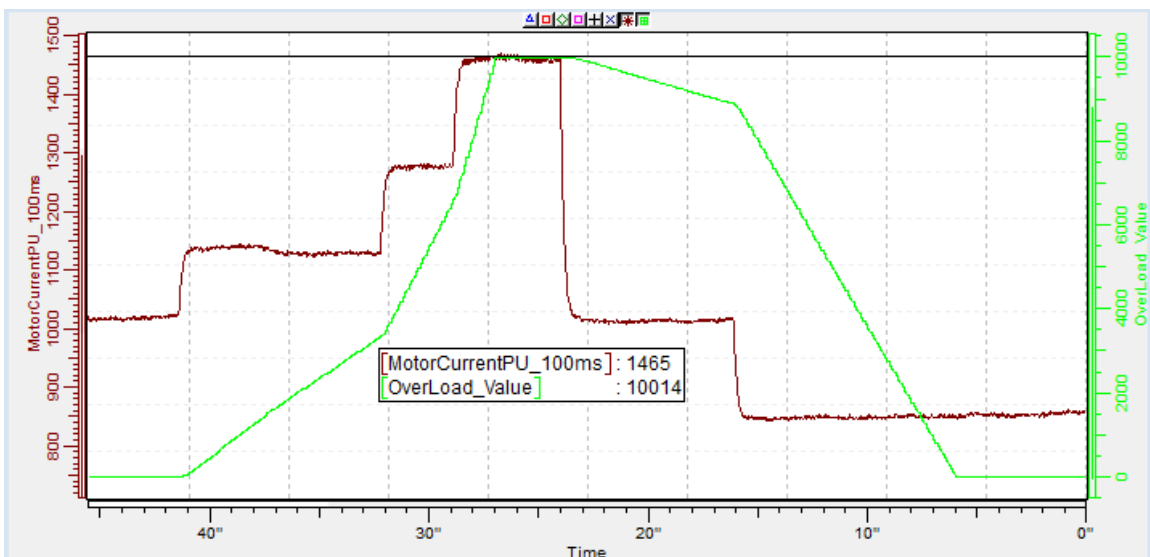

Figure 8-36

2.12.7.6 *Response to over load* **ID1838** **"OverLoadResponse"**

0 = No response

1 = Warning

2 = Fault

2.12.7.7 *Over Load Signal* **ID1837** **"OverLoadSignal"**

0 = Not Used

1 = Output Current (FW: MotorCurrentPU_100ms)

2 = Motor Torque

3 = Motor Power

2.12.7.8 *Over Load Maximum Input* **ID1839** **"OverLoadMaxIN"**

Input value level where the overload counter is increased with maximum step defined by P2.12.5.10

2.12.7.9 *Over Load Maximum Step* **ID1840** **"OverLoadMaxStep"**

Step in the overload counter when the input value is at the maximum input level defined by P2.12.5.9.

8.12.2 *Fieldbus communication*

P2.12.8.1 *Fieldbus fault Slot D response* **ID733**

P2.12.8.2 *Fieldbus fault Slot E response* **ID761**

Set here the response for a fieldbus fault if the active control place is fieldbus. For more information, see the respective Fieldbus Board Manual.

0 = No response

1 = Warning

2 = Fault, stop mode after fault according to Stop Function

P2.12.8.3 *Fieldbus Watch Dog delay* **ID1354** **"FB WD Delay"**

Defines the delay when a fault is generated when the watch dog pulse is missing from fieldbus. Set the time to zero to disable watchdog monitoring.

2.12.9	<i>Disable stop lock</i>	<i>ID1086</i>	<i>“Disable StopLock”</i>
2.12.10	<i>Fault Simulation</i>	<i>ID1569</i>	<i>“Fault Simulation”</i>

With this parameter it is possible to simulate different faults without actually making, for example, an over current situation. In the point of view of the drive interface, the operation is identical to actual fault situation.

B00 = +1 = Simulates an over current fault (F1)

B01 = +2 = Simulates an over voltage fault (F2)

B02 = +4 = Simulates an under voltage fault (F9)

B03 = +8 = Simulates an output phase supervision fault (F11)

B04 = +16 = Simulates an earth fault (F3)

B05 = +32 = Simulates a system fault (F8)

This fault simulation covers a wide range of different faults in drive. See the fault description for details.

B06 = +64 = Simulates an encoder fault (F43)

B07 = +128 = Simulates an over temperature warning (W14)

B08 = +256 = Simulates an over temperature fault (F14)

The warning bit must be active for a fault to appear in simulation. If the fault bit is left active, the drive will go FAULT state at warning limit when the drive temperature rises to the warning level.

B09 = +512 = Reserved

8.13 Fieldbus

8.13.1 Signals from drive to Fieldbus

2.13.1 FB Actual Speed ID ID1851 "FB Actual ID"

Enter the ID number of the item you wish to use as the Fieldbus Actual Speed -variable.

2.13.2 to

2.13.9 FB Data Out Selections 1 to 8 ID852-ID859 "FB Data OutX Sel"

With these parameters, you can monitor any monitoring or parameter value from the fieldbus. Enter the ID number of the item you wish to monitor for the value of these parameters.

2.13.10 to

2.13.17 FB Data Out Selections 9 to 16 ID558-565 "FB Data OutXSel"

These parameters are the same as *P2.13.1-.9*, but they are only available if a fieldbus board with hardware and software support for 16 process data variables is inserted in option board slot D or E.

8.13.2 Signals from fieldbus to drive

2.13.18 FB Reference Selection ID1850 "FB Reference Sel"

Enter the ID number of the item you wish to use as the Fieldbus Reference -variable

2.13.19 to

2.13.26 FB Data In Selection 1 to 8 ID876-ID833 "FB Data In X sel"

With these parameters, you can control any parameter value from the fieldbus. Enter the ID number of the item you wish to control for the value of these parameters.

2.13.27 to

2.13.34 FB Data In Selection 9 to 16 ID550-557 "FB Data InX Sel"

These parameters are the same as *P2.13.18-.26*, but they are only available if a fieldbus option board with hardware and software support for 16 process data variables is inserted in option board slot D or E.

2.13.35 FB General Status Word Data ID897 "GSW Data"

Enter the ID number of the item you wish to send in the Fieldbus General Status Word.

2.13.36 Control Slot Selector **ID1440** **"ControlSlotSel."**

This parameter defines which slot is used as the main control place when two fieldbus boards have been installed in the drive. When values 6 or 7 are selected, the drive can use a Fast Fieldbus Mode. When values 8 or 9 are selected the drive can use an Extended Fieldbus mode with 16 process data variables if the used Fieldbus-board hardware and firmware support it. For further details about Fast and Extended modes refer to an appropriate Fieldbus-board manual.

0 = Not Sel.

4 = Slot D, Normal (8 process data variables)

5 = Slot E, Normal (8 process data variables)

6 = Slot D, Fast fieldbus support

7 = slot E, Fast Fieldbus support

8 = Slot D, Extended (16 process data variables)

9 = Slot E, Extended (16 process data variables)

2.13.37 State Machine **ID896** **"State Machine"**

With this parameter it is possible to select what FB profile is used in application.

0 = Basic

Control as explained in fieldbus manual.

1 = Standard

2 = Generator 1

2.13.38 SW B11 ID.Bit **ID1912** **"SW B11 ID.Bit"**

2.13.39 SW B12 ID.Bit **ID1908** **"SW B12 ID.Bit"**

2.13.40 SW B13 ID.Bit **ID1909** **"SW B13 ID.Bit"**

2.13.41 SW B14 ID.Bit **ID1911** **"SW B14 ID.Bit"**

Parameters *P2.13.38-.41* are used for selecting items for the Fieldbus Status Word bits 11, 12, 13 and 14. Enter the ID number of the item you wish to select.

8.14 ID Functions

The functions that use the parameter ID number to control and monitor the signal are listed below.

8.14.1 Value Control

The value control parameters are used to control an input signal parameter.

P2.14.1.1 Control Input Signal ID ***ID1580*** ***“ContrInSignal ID”***

With this parameter you can select what signal is used to control selected parameter.

P2.14.1.2 Control Off Limit ***ID1581*** ***“Contrl Off Limit”***

This parameter defines the limit when the selected parameter value is forced to Off value.

P2.14.1.3 Control On Limit ***ID1582*** ***“Contrl On Limit”***

This parameter defines the limit when the selected parameter value is forced to On value.

P2.14.1.4 Control Off Value ***ID1583*** ***“Contrl Off Value”***

This parameter defines the value that is used when the used input signal is below Off limit.

P2.14.1.5 Control On Value ***ID1584*** ***“Contrl On Value”***

This parameter defines the value that is used when the used input signal is above On limit.

P2.14.1.6 Control Output Signal ID ***ID1585*** ***“ContrlOutSignalID”***

This parameter defines which parameter is forced to On and Off values when the selected input signal exceeds the set limits.

P2.14.1.7 Control Mode ID1590 "Control Mode"

This parameter defines how the value control output behaves.

0 = SR ABS

Absolute input value is used to make a step change in the output between On and Off values.

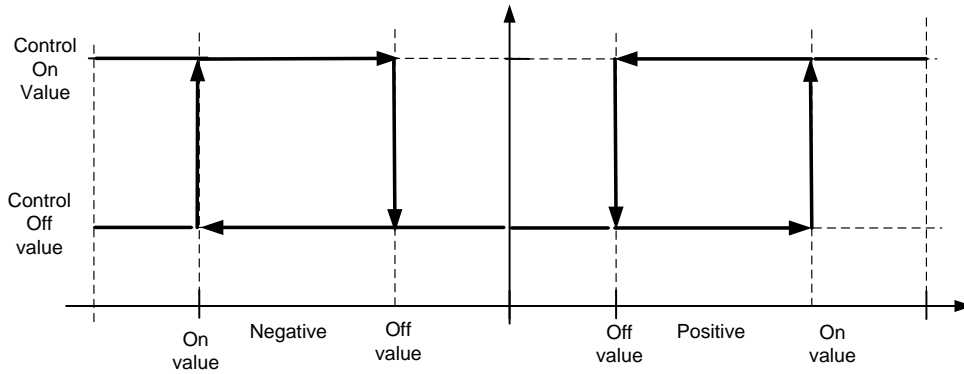

Figure 8-37

1 = Scale ABS

Absolute input value is scaled linearly between On and Off values.

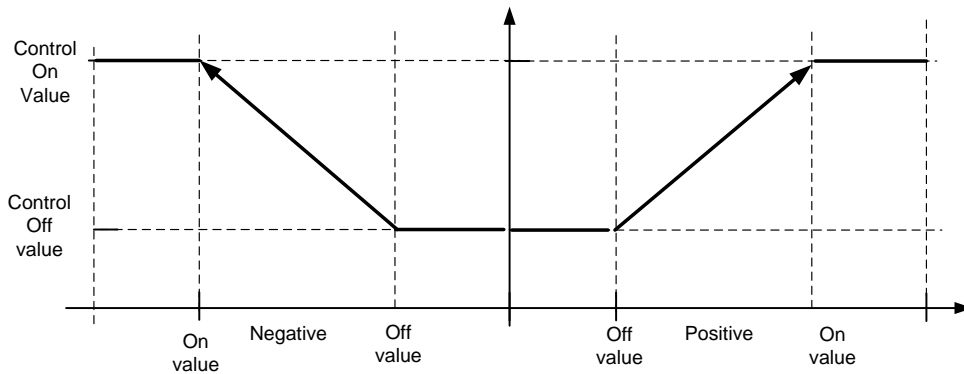

Figure 8-38

2 = Scale ABS Inverted

Inverted absolute value is scaled linearly between On and Off values.

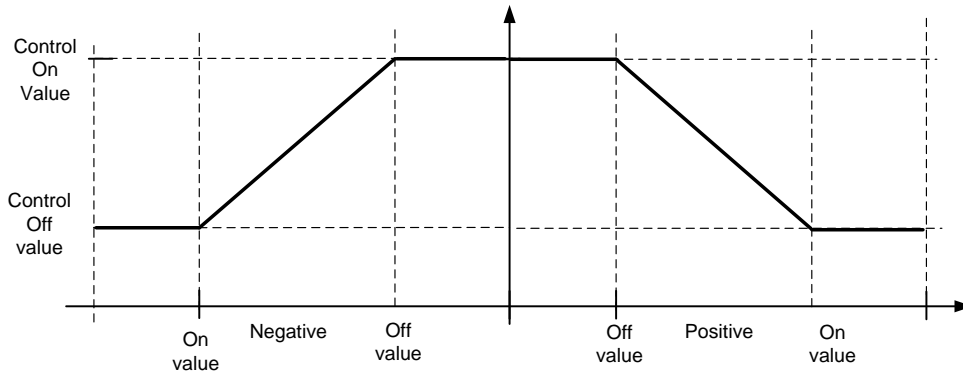

Figure 8-39

3 = SR

Input value is used to make a step change in the output between On and Off values.

4 = Scale ABS

Input values is scaled linearly between On and Off values.

5 = Scale Inverted

Inverted value is scaled linearly between On and Off values

P2.14.1.8 Control Signal Filtering TC ID1586 "Control Filt TC"

This parameter is used to filter the scaling function output. Used, for example, when unfiltered torque is used to control a parameter that needs stabilization.

8.14.2 DIN ID Control

This function is used to control any parameter between two different values with a digital input. Different values are given for DI 'low' and DI 'high'.

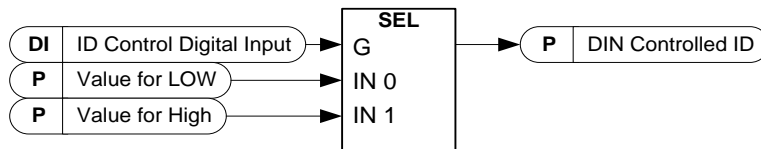

Figure 8-40

P2.14.2.1 ID Control Digital Input ID1570 "ID Control DIN"

P2.14.3.1 ID Control Digital Input ID1574 "ID Control DIN"

P2.14.4.1 ID Control Digital Input ID1578 "ID Control DIN"

Select the digital input to be used for controlling the parameter selected by ID1571.

P2.14.2.2 DIN Controlled ID ID1571 "Controlled ID"

<i>P2.14.3.2</i>	<i>DIN Controlled ID</i>	<i>ID1575</i>	<i>"Controlled ID"</i>
<i>P2.14.4.2</i>	<i>DIN Controlled ID</i>	<i>ID1579</i>	<i>"Controlled ID"</i>

Select parameter ID controlled by ID1570.

<i>P2.14.2.3</i>	<i>Value for Low digital input (FALSE)</i>	<i>ID1572</i>	<i>"FALSE Value"</i>
<i>P2.14.3.3</i>	<i>Value for Low digital input (FALSE)</i>	<i>ID1576</i>	<i>"FALSE Value"</i>
<i>P2.14.4.3</i>	<i>Value for Low digital input (FALSE)</i>	<i>ID1587</i>	<i>"FALSE Value"</i>

Set here the controlled parameter value when the digital input (ID1570) is LOW for the parameter selected by ID1571. The function does not recognize decimals. Give, therefore, e.g. 10.00 Hz as '1000'.

<i>P2.14.2.4</i>	<i>Value for High digital input (TRUE)</i>	<i>ID1573</i>	<i>"TRUE Value"</i>
<i>P2.14.3.4</i>	<i>Value for High digital input (TRUE)</i>	<i>ID1577</i>	<i>"TRUE Value"</i>
<i>P2.14.4.4</i>	<i>Value for High digital input (TRUE)</i>	<i>ID1588</i>	<i>"TRUE Value"</i>

Set the controlled parameter value when the digital input (ID1570) is HIGH for the parameter selected by ID1571. The function does not recognise decimals. For example, give the value 10.00 Hz as *1000*.

8.15 Curve 1 Definition

P2.15.1 0 % Speed

-

P2.15.25 120 % Speed

These parameters define a curve that is related to the motor nominal frequency.

The value is a percentage value from the function maximum or the used reference.

For example, if 100% Speed point definition is 90%, the AC drive input power limit is 120% and P2.6.2.4 is set to 2 / Curve1, the drive power limit at nominal speed is 108% (90% from 120%).

8.16 Curve 2 Definition

P2.16.1 0 % Speed

-

P2.16.25 120 % Speed

These parameters define a curve that is related to the motor nominal frequency.

The value is a percentage value from the function maximum or the used reference.

For example, if 100% Speed point definition is 90%, the AC drive input power limit is 120% and P2.6.2.4 is set to 2 / Curve1, the drive power limit at nominal speed is 108% (90% from 120%).

8.17 Curve 3 Definition

P2.17.1 0 % Speed

-

P2.17.25 120 % Speed

These parameters define a curve that is related to the motor nominal frequency.

The value is a percentage value from the function maximum or the used reference.

For example, if 100% Speed point definition is 90%, the AC drive input power limit is 120% and P2.6.2.4 is set to 2 / Curve1, the drive power limit at nominal speed is 108% (90% from 120%).

8.18 Line synch

2.18.1 *Delay to coast* ID 1621

This parameter defines delay when modulation will be stopped from internal decision to make the change.

2.18.2 *Delay to open* ID 1611

This parameter defines delay when FC contactor will be opened from internal decision to make the change.

2.18.3 *Delay to close* ID 1624

This parameter defines delay when NET contactor will be closed from internal decision to make the change net.

2.18.4 *Phase offset* ID 1608

This parameter defined FC voltage angle advance to net voltage angle when synchronization command is on. This parameter is adjusted depending on motor load and delay when motor do not have current.

2.18.5 *Frequency hysteresis for synch* ID 1613

Hysteresis for frequency when synchronization function is started.

2.18.6 *Phase hysteresis* ID 1620

2.18.7 *Frequency hysteresis for change* ID 1614

Hysteresis when changed DOL can be made for frequency. Frequency can be out of hysteresis while angle is within hysteresis.

9. KEYPAD CONTROL PARAMETERS

Unlike the parameters listed above, these parameters are located in the **M3** menu of the control keypad. The reference parameters do not have an ID number.

P3.1 Control Place ID125 "Control Place"

The active control place can be changed with this parameter.

Push the Start button for 3 seconds to select the control keypad as the active control place and to copy the Run status information (Run/Stop, direction and reference).

0 = PC Control, Activated by NCDrive

1 = I/O terminal

2 = Keypad

3 = Fieldbus

10. STATUS AND CONTROL WORDS IN DETAIL

P2.13.20 State machine	
0 / Basic	This mode makes the fieldbus control to behave as explained in the relevant fieldbus board manual.
1 / Standard	Simple control word that is used in modes where control word from the fieldbus is used as such. For some fieldbus boards this requires bypass operation.
2 / Generator 1	This mode uses ProfiDrive type state machine in application level. This mode can be used on fieldbus boards that do not have state machine itself or have the possibility to bypass state machine functionality in option board.
3 / Vacon AFE 2	This mode uses ProfiDrive type state machine in application level. This mode can be used on fieldbus boards that do not have state machine itself or have the possibility to bypass state machine functionality in option board.

Table 10-1

10.1 Basic In ByPass (0)

FB Control Word ID1160		
	Signal	Comment
B00	Run	0= Stop request 1= Start Request
B01		
B02	Fault Reset	0>1 Reset fault.
B03	FB DIN1	Can be used to control RO or directly parameter by ID number. G2.4.1
B04	FB DIN2	Can be used to control RO or directly parameter by ID number. G2.4.1
B05	FB DIN3	Can be used to control RO or directly parameter by ID number. G2.4.1
B06	FB DIN4	Can be used to control RO or directly parameter by ID number. G2.4.1
B07	FB DIN5	Can be used to control RO or directly parameter by ID number. G2.4.1
B08		
B09		
B10		
B11		
B12		
B13		
B14		
B15		

Table 10-2

10.2 FB Control Word

10.2.1 Standard (1)

FB Control Word ID1160		
	Signal	Comment
B00	DC Charge	0= Open MCB. 1= Close DC charge. CB closed automatically.
B01		
B02		
B03	Run	0= AFE is stopped 1= AFE is started
B04		
B05		
B06		
B07	Reset	0>1 Reset fault.
B08		
B09		
B10		
B11	FB DIN1	Can be used to control RO or directly parameter by ID number. G2.4.1
B12	FB DIN2	Can be used to control RO or directly parameter by ID number. G2.4.1
B13	FB DIN3	Can be used to control RO or directly parameter by ID number. G2.4.1
B14	FB DIN4	Can be used to control RO or directly parameter by ID number. G2.4.1
B15		

Table 10-3

B00: FALSE = Open MCB, TRUE = PreCharge DC

Open MCB: Opens MCB if closed, stops precharging if not closed.

PreCharge DC: Drive will start precharge if function activated by digital output and control place is fieldbus. When control place is not fieldbus precharging is started from normal start command.

B03: FALSE = Stop Request, TRUE = Start Request

Stop Request: Drive will stop .

Start Request: Start Command to the drive. Rising edge needed for start.

B07: FALSE = No significance, TRUE = Fault Acknowledge

Fault Acknowledge: The group signal is acknowledged with a positive edge.

10.2.2 Vacon Generator 1 profile (2)

FB Control Word ID1160		
	Signal	Comment
B00	DC Charge	0= Open MCB. 1= Close DC charge contactor, CB closed automatically.
B01		
B02		
B03	Run	0= AFE is stopped 1= AFE is started
B04		
B05		
B06		
B07	Reset	0>1 Reset fault.
B08	DC Voltage Ref B00	B00 B01 0 0 = FB Reference. P2.2.1, if not FB Control & FB Ref > 50.00% 0 1 = 110%
B09	DC Voltage Ref B01	1 0 = 115% 1 1 = 120%
B10	Fieldbus Control	0= No control from fieldbus 1=Control from fieldbus
B11	Watchdog	0>1>0>1...0.5 sec square wave clock. This is used to check data communication between fieldbus master and the drive.
B12	FB DIN2	Can be used to control RO or directly parameter by ID number. G2.4.1
B13	FB DIN3	Can be used to control RO or directly parameter by ID number. G2.4.1
B14	FB DIN4	Can be used to control RO or directly parameter by ID number. G2.4.1
B15		Reserved for future use.

Table 10-4

B00: FALSE = Open MCB, TRUE = PreCharge DC

Open MCB: Opens MCB if closed, stops precharging if not closed.

PreCharge DC: Drive will start precharge if function activated by digital output and control place is fieldbus. When control place is not fieldbus precharging is started from normal start command.

B03: FALSE = Stop Request, TRUE = Start Request

Stop Request: The AC drive will stop .

Start Request: Start Command to the drive. Rising edge needed for start.

B07: FALSE = No significance, TRUE = Fault Acknowledge

Fault Acknowledge: The group signal is acknowledged with a positive edge.

B08: FALSE = No Function, TRUE = DC Ref 1

B09: FALSE = No Function, TRUE = DC Ref 2

Table 10-5

DC Ref	FB Reference	110.00%	115.00%	120.00%
B08	FALSE	TRUE	FALSE	TRUE
B09	FALSE	FALSE	TRUE	TRUE

B10: FALSE = FB Control disabled TRUE = FB Control Enabled

FB Control Disabled: The AC drive will not follow the main control word from the Fieldbus. If removed while running, the AC drive will stop.

FB Control Enabled: The AC drive follows control word from fieldbus

B11: FALSE = FB WD Pulse Low, TRUE = FB WD Pulse High

Watch Dog pulse: This pulse is used to monitor that PLC is alive. If pulse is missing, the AC drive will go to fault state. This function is activated by the P2.7.6 FB WD Delay. When the value is zero, the pulse is not monitored.

10.2.3 Vacon AFE 2 Profile (Not Implemented as of 1.7.2014)

FB Control Word ID1160		
	Signal	Comment
B00	DC Charge	0= Open MCB. 1= Close DC charge contactor, CB closed automatically, see B01.
B01	CB Close Enable	0= Disable Closing of CB 1= Enable Closing if CB
B02	Forced Restart	0= Forced Restart, DC need to go zero before new DC charge. 1= Enable Operation
B03	Run	0= AFE is stopped 1= AFE is started
B04	Floating DC Ref	0= Enable floating DC Reference 1= Disable floating DC Reference
B05	DC Drooping	0= Disable DC Drooping (DC Droop 2) 1= Enable DC Drooping (DC Droop 1)
B06	Power Limit	0= Power Limited (5%) 1= Power Limit set by parameters
B07	Reset	0>1 Reset fault.
B08	DC Voltage Ref B00	B00 B01 0 0 = FB Reference. P2.2.1, if not FB Control & FB Ref > 50.00% 0 1 = 110%
B09	DC Voltage Ref B01	1 0 = 115% 1 1 = 120%
B10	Fieldbus Control	0= No control from fieldbus 1=Control from fieldbus
B11	Watchdog	0>1>0>1...0.5 sec square wave clock. This is used to check data communication between fieldbus master and the drive.
B12	FB DIN2	Can be used to control RO or directly parameter by ID number. G2.4.1
B13	FB DIN3	Can be used to control RO or directly parameter by ID number. G2.4.1
B14	FB DIN4	Can be used to control RO or directly parameter by ID number. G2.4.1
B15		Reserved for future use.

Table 10-6

B00: FALSE = Open MCB, TRUE = PreCharge DC

Open MCB: Opens MCB if closed, stops precharging if not closed.

PreCharge DC: The AC drive will start precharge if the function is activated by the digital output and the control place is fieldbus. When the control place is not fieldbus, precharging is started from the normal start command.

B01: FALSE = (OFF 2), TRUE =

Coast Stop:

ON 2:

B03: FALSE = Stop Request, TRUE = Start Request

Stop Request: The AC drive will stop .

Start Request: Start Command to the AC drive. Rising edge needed for start.

B07: FALSE = No significance, TRUE = Fault Acknowledge

Fault Acknowledge: The group signal is acknowledged with a positive edge.

B08: FALSE = No Function, TRUE = DC Ref 1

B09: FALSE = No Function, TRUE = DC Ref 2

Table 10-7

DC Ref	FB Reference	110.00%	115.00%	120.00%
B08	FALSE	TRUE	FALSE	TRUE
B09	FALSE	FALSE	TRUE	TRUE

B10: FALSE = FB Control disabled TRUE = FB Control Enabled

FB Control Disabled: The AC drive will not follow the main control word from the Fieldbus. If removed while running, the AC drive will make coasting stop.

FB Control Enabled: The AC drive follows the control word from the fieldbus

B11: FALSE = FB WD Pulse Low, TRUE = FB WD Pulse High

Watch dog pulse: This pulse is used to monitor that PLC is alive. If pulse is missing, the AC drive will go to fault state. This function is activated by P2.7.6 FB WD Delay. When value is zero, the pulse is not monitored.

10.3 FB Status Word

	Signal	Comment
b0	Ready On	0=Drive not ready to switch on 1=Drive ready to start charging
b1	Ready Run	0=Drive not ready to run 1=Drive ready and MCB is ON
b2	Running	0=Drive not running 1=Drive in Run state (Modulating)
b3	Fault	0=No active fault 1=Fault is active
b4	Run Enable Status	0= Run Disabled. Drive in stop state 1= Run Enabled. Drive can be started.
b5	Quick Stop Active	0=Quick Stop Active 1=Quick Stop not Active
b6	CB Control OK	0= Status opposite of control 1= Status and control OK
b7	Warning	0= No active warnings 1= Warning active
b8	At Reference	0= DC Voltage Ref and Act DC Voltage are not same.
b9	Fieldbus Control Active	0=Fieldbus control not active 1=Fieldbus control active
b10	Above Limit	0= DC Voltage is below P2.5.5.2 level 1=The DC Voltage is above the P2.5.5.2 level
b11		Reserved for future use.
b12		Reserved for future use.
b13		Reserved for future use.
b14	DC Charge DO Control	0= DC not charged 1= DC Charging Active
b15	Watchdog	Same as received on bit 11 of the main control word.

Table 10-8

B00: FALSE = Not Ready to Switch On, TRUE = Ready to Switch On

Not Ready to Switch On: Fault active, DI: Run Enable low, MCB Forced open command active, Quick Stop Active.

Ready to Switch On: No Faults, DI: Run Enabled, DI: MCB not forced open, Quick Stop not active.

B01: FALSE = Not Ready To Operate, TRUE = Ready To Operate

Not Ready To Operate: CW.B0 = FALSE, DC Not Ready, MCB Control Open, MCB Status Low.

Ready To Operate: CW.B0 = TRUE, DC Ready, MCB Control closed, MCB Status High.

B02: FALSE = Drive is not operating, TRUE = Drive is operational

Drive is not operating: Drive is not run state (modulating)

Drive is operational: Drive is in run state and modulating.

B03: FALSE = No Fault, TRUE = Fault Present

No Fault: Drive is not on fault state.

Fault Present: Drive is in fault state.

B04: FALSE = Coast Stop Activated, TRUE = Coast Stop Not Activated

Coast Stop Activated: DI: Run Enable False, Quick Stop Active, MCB Status Open, MCB Control Open, Enable CB Close, MCB Forced Open.

Coast Stop Not Activated: Running Enabled

B05: FALSE = Quick Stop Activated, TRUE = Quick Stop Not Activated

Quick Stop Activated: Quick Stop command is active.

Quick Stop Not Activated: Quick stop command is not active.

B06: FALSE = CB Control OK, TRUE = CB Control Not OK

CB Control OK: CB Control and Drive internal status are the same.

CB Control Not OK: Drive internal status to close the MCB is high but application logic request MCB open. This can be case when CB has been opened but DC is connected to battery system. DC needs to be discharged or CB is needed to close.

B07: FALSE = No Warning, TRUE = Warning Present

No Warning: There is no warning or the warning has disappeared again.

Warning Present: Drive still works; warning in the service/maintenance parameter; no acknowledgement.

B08: FALSE = DC Voltage out of tolerance TRUE = DC Voltage within tolerance

DC Error Out Of Tolerance Range:

DC Error Within Tolerance Range:

B09: FALSE = No Control Requested, TRUE = Control Requested

No Control Requested: Control by the automation system is not possible.

Control Requested: The automation system is controlling.

B10: FALSE = DC Not Reached, TRUE = DC Reached Or Exceeded

DC Not Reached: DC Voltage is below P2.5.5.1 level

DC Reached Or Exceeded: DC Voltage is above the P2.5.5.1 level

B14: FALSE = Charge DO Open, TRUE = Charge DO Closed

Charge DO Open: Charging Command not active

Charge DO Closed: Charging Command Active

B15: FALSE = FB DW Feedback Low, TRUE = FB DW Feedback High

FB DW Feedback: FB Control Word B11 is echoed back to the Fieldbus. Can be used to monitor communication status from the drive.

10.4 Status Word (Application) ID 43

Application Status Word combines different drive statuses to one data word.

Application Status Word ID43		
	FALSE	TRUE
b0		
b1	Not in Ready state	Ready
b2	Not Running	Running
b3	No Fault	Fault
b4		
b5		
b6	Run Disabled	Run Enable
b7	No Warning	Warning
b8		Charging Switch closed (internal)
b9		MCB Control (DO Final)
b10		MCB Feedback
b11		DO Charging Active
b12	No Run Request	Run Request
b13		
b14		
b15		

Table 10-9

B01: FALSE = Not Ready, TRUE = Ready

Not Ready: DC Voltage low, Fault active

Ready: Drive in ready state, start command can be given.

B02: FALSE = Not Running, TRUE = Running

Not Running: Drive is not modulating

Running: Drive is modulating.

B03: FALSE = No Fault, TRUE = Fault Active

No Faults: Drive do not have active faults.

Fault: Drive has an active faults.

B06: FALSE = Run Enable Low, TRUE = Run Enable High

Run Enable Low: Run Enable command to motor control is low

Run Enable High: Run Enable command to motor control is high.

B07: FALSE = No Warning, TRUE = Warning Active

No Warning: No warning signals active in the drive

Warning: Drive has active warning signal. Warning signal not stop the operation.

B08: FALSE = Charging Switch Open, TRUE = Charging Switch closed

Charging Switch Open: DC voltage level is nor reached closing level or has drop below the opening level. This information is from drive motor control.

Charging switch Closed: DC voltage level is above closing limit and no interlock active internally.

B09: FALSE = MCB Open command, TRUE = MCB closed command

MCB Open Command: Final command to open the MCB from application logic.

MCB Close Command: Final close command to MCB from application logic.

B10: FALSE = Main contactor Open, TRUE = Main contactor closed

MCB Open: Feedback from MCB, open.

MCB Closed: Feedback from MCB, closed.

B11: FALSE = Charge Control Open, TRUE = Charge Control Closed

Charge Control Open: Charging Contactor is not controlled.

Charge Control Closed: Charging contactor controlled closed.

B12: FALSE = No Run Request, TRUE = Run Request

No Run Request: Final Run Request command has not been given to motor control.

Run Request: Final Run Request command has been given to motor control.

11. PROBLEM SOLVING

While proper information is needed from the problem, we also recommend you to try with the latest application and system software versions available. The software is continuously developed and default settings are improved.

Type	Signal Name	Actual	Unit
Value	Status Word	22374	
Value	DC Voltage	575	V
Value	Active Current	-9,8	%
Value	Reactive Current	-49,6	%
Value	Current	351	A
Value	Supply Frequency	50	Hz
Value	Supply Voltage	248,3	V
Value	DIN Status 1	56	

Figure 11-1, The recommended signals for NCDrive

Use the fastest communication speed (Baudrate: 57 600) and a 50 ms update interval for signals for the RS232 communication.

For the CAN communication, use a 1 Mbit communication speed and 7 ms update interval for signals.

When you contact the support, send the *.trn, *.par and Service info (*.txt) files with a description of the situation. If the situation is caused by a fault, take also the Datalogger data from the drive.

Note that Datalogger settings can be changed to catch correct situation and it is also possible to make manual force trig for Datalogger.

Before storing the parameter file, upload the parameters from the drive and save when NCDrive is in the ON-LINE state. If it is possible, do this while the problem is active. You must use original vcn file placed in NCDrive\Applications folder.

It is also helpful to have a single line diagram from the system where problem is faced.

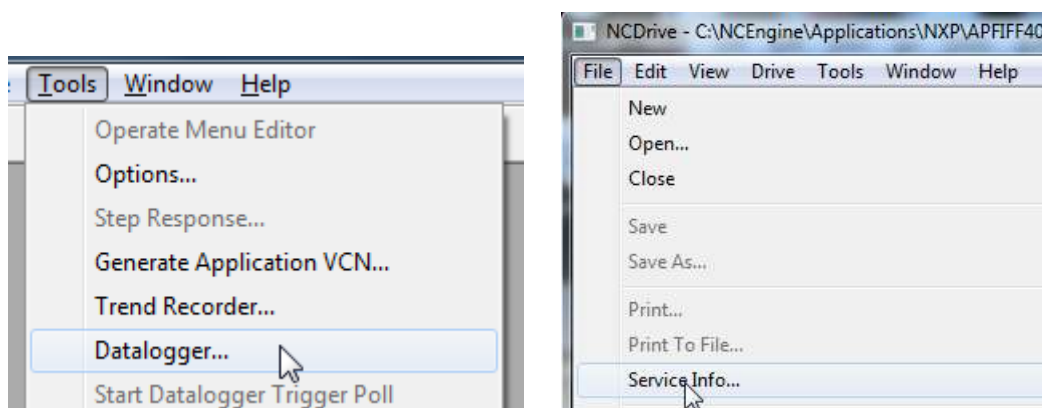

Figure 11-2, Datalogger window opening and Service Info upload.

12. FAULT CODES

This chapter includes all fault codes that are possible. However some faults are not possible in the AFE application. In addition, some fault descriptions may be different when compared to a standard AC drive.

F1 Over current fault

The AC drive has detected a high current in the output phase.

S1 = Hardware trip:

Current above $4 \cdot I_h$

S3 = Current controller supervision.

Current limit too low or current peak value too high.

Possible cause

- Sudden change in grid frequency
- Sudden change in grid voltage
- Short circuit in in grid while Short Circuit function is not active

Correcting measures

- Check grid conditions load.
- Activate Short Circuit function

F2 Overvoltage fault

The DC-link voltage has exceeded the AC drive protection limits.

S1 = Hardware trip.

500 Vac unit DC voltage above 911 Vdc

690 Vac unit DC voltage above 1200 Vdc

S2 = Overvoltage control supervision (only 690 Vac unit).

DC voltage has been above 1100 Vdc for too long.

Possible cause and solutions

- Sudden change in supply voltage or frequency.
- Unstable DC power source in uGrid mode.
- Wrong Grid frequency

Correcting measures

- Check supply voltage.
- Check DC source.
- Check grid conditions

F3 Earth fault

Earth fault protection ensures that the sum of the motor phase currents is zero. The overcurrent protection is always working and protects the AC drive from earth faults with high currents.

S1 = Sum of output phase current is not zero

Possible cause

- No transformer on the input/output side.
- Insulation failure

Correcting measures

- Contact factory

F5 Charge switch

Charge switch status is not correct when the start command is given.

S1 = Charge switch was open when the START command was given.

Possible cause

- Charge switch was open when the START command was given.
- Reset the fault and restart.

Correcting measures

- Check connection of the feedback from the charging relay.
- Should the fault re-occur, contact your local distributor.

F6 Emergency stop

Emergency stop command has been given by using a special option board.

F7 Saturation fault

S1 = Hardware failure

Possible cause and solutions

-

Correcting measures

- Check the isolation resistance and the resistance on the brake resistor.
- Check the capacitors.

F8 System Fault

A system fault indicates several different fault situations in the drive operation.

S1 = Reserved

- Disturbance. Reset the unit and try again.
- If there is a star coupler in the unit, check the fibre connections and phase order.
- Driver board or IGBT broken.
- FR9 and the bigger size drives that do not include a star coupler: the ASIC board (VB00451) is broken.
- FR8 and smaller size drives: control board broken.
- FR8 and smaller size drives: if boards VB00449 / VB00450 are used, the failure might be in there.

S2 = Reserved

S3 = Reserved

S4 = Reserved

S5 = Reserved

S6 = Reserved

S7 = Charge switch

S8 = No power to driver card

S9 = Power unit communication (TX)

S10 = Power unit communication (Trip)

S11 = Power unit comm. (Measurement)

S12 = SystemBus synchronization has failed in DriveSynch operation

S30 = Safe disable inputs are in different state (OPT-AF)

S31 = Thermistor short circuit detected (OPT-AF)

S32 = OPT-AF board has been removed

S33 = OPT-AF board EEPROM error

Possible cause and solutions

- **Correcting measures**
-

F9 Undervoltage fault

DC-link voltage is below the fault voltage limit of the drive.

S1 = DC-link too low during run

S2 = No data from power unit

S3 = Undervoltage control supervision

Possible cause

- Too low a supply voltage
- AC drive internal fault
- One of the input fuses is broken.
- External charge switch has not been closed.

Correcting measures

- In case of temporary supply voltage break, reset the fault and restart the AC drive.
- Check supply voltage.
- Check function of DC charge.
- Contact your local distributor.

F10 Line Synchronization Fault

S1 = Phase supervision diode supply

S2 = Phase supervision active front end

Possible cause:

- Input line phase is missing.

Correcting measures

- Check supply voltage, fuses and cable.

F11 Line phase supervision**Possible cause:**

- Current measurement has detected that there is no current in one phase or one phase current is considerably different from other phases.

Correcting measures

- Check motor cable and motor.

F12 Brake chopper supervision

Brake chopper supervision generates pulses to the brake resistor for response. If no response is received within set limits a fault is generated.

Possible cause:

- No brake resistor installed.
- Brake resistor is broken.
- Brake chopper failure.

Correcting measures:

- Check brake resistor and cabling.
- If these are ok the chopper is faulty. Contact your local distributor.

F13 Drive under temperature fault**Possible cause:**

- Heatsink temperature is under -10°C

Correcting measures:

-

F14 Drive over temperature fault**Possible cause:**

- Heatsink temperature is over acceptable limits. See the user manual for the temperature limit. Overtemperature warning is issued before the actual trip limit is reached.

Correcting measures

- Check the correct amount and flow of cooling air.
- Check the heatsink for dust.
- Check ambient temperature.
- Make sure that the switching frequency is not too high in relation to ambient temperature and motor load.

F22 EEPROM checksum fault**Possible cause:**

- Parameter save fault
- Faulty operation
- Component failure

Correcting measures:

- Should the fault re-occur, contact your local distributor.

F24 Counter fault**Possible cause:**

- Values displayed on the counters are incorrect
-

Correcting measures:

- Have a critical attitude towards values shown on counters.

F25 Microprocessor watchdog fault**Possible cause:**

- Start-up of the drive has been prevented.
- Run request is ON when a new application is loaded to the drive.

Correcting measures:

- Reset the fault and restart.
- Should the fault re-occur, contact your local distributor.

F26 Start-Up prevention**Possible cause:**

- Start-up of the drive has been prevented.
- Run request is ON when a new application is loaded to the AC drive

Correcting measures:

- Cancel prevention of start-up if this can be done safely.
- Remove Run Request.

F29 Thermistor fault

The thermistor input of the option board has detected too high a motor temperature.

Possible cause:

- LCL is overheated.
- Thermistor cable is broken.

Correcting measures:

- Check LCL cooling and load
- Check thermistor connection (If thermistor input of the option board is not in use it has to be short circuited).

F31 IGBT temperature

IGBT Inverter Bridge over temperature protection has detected too high a short term overload current.

Possible cause:

- Too high load
- Identification run has not been made, and this causes the motor to start under magnetized.

Correcting measures:

- Check load.
- Check motor size.
- Make identification Run.

F32 Fan cooling**Possible cause:**

- Cooling fan of the AC drive does not start when ON command is given.

Correcting measures:

- Contact your local distributor.

F37 Device change

Option board or power unit changed.

Possible cause:

- New device of the same type and rating.

Correcting measures:

- Reset. Device is ready for use.

F38 Device added

Option board added.

Correcting measures:

- Reset. Device is ready for use. Old board settings will be used.

F39 Device removed**Possible cause:**

- Option board removed.

Correcting measures:

- Reset. Device no longer available.

F40 *Device unknown*

Unknown option board or drive.

S1 = Unknown device

S2 = Power1 not same type as Power2

Correcting measures:

- Contact the distributor near to you.

F41 *IGBT temperature*

IGBT inverter bridge overtemperature protection has detected too high a short term overload current.

Correcting measures:

- Check load.
- Check motor size.
- Make Identification run.

F42 *Brake resistor over temperature*

S1: Brake resistor high temperature

Calculation for internal brake resistor has exceeded the tripping limit. If the internal brake resistor is not in use set the brake chopper parameter in System menu to 'Not connected'.

S2: Brake resistor resistance is too high

S3: Brake resistor resistance is too low

S4: No brake resistor detected

F43 Encoder fault

Encoder fault is issued when the drive is not able to operate in closed loop control mode (encoder is used). See subcodes for details for the reason of the fault:

- S1 =Encoder 1 channel A is missing
- S2 =Encoder 1 channel B is missing
- S3 =Both encoder 1 channels are missing
- S4 =Encoder reversed
- S5 =Encoder board missing
- S6= Serial communication fault
- S7=Ch A / Ch B Mismatch
- S8=Resolver/Motor polepair mismatch
- S9=Missed Start Angle

This fault comes when using PMS motor.

1. Modulation type is ASIC while incremental encoder is used.
 - Change modulator type to Software 1
2. Start identification do not work due low identification current
 - Increase identification current
3. Start angle identification is not working at all because there is no saturation based saliency in the motor
 - Use absolute encoder
4. There are too much noise pick-ups in encoder cable
 - check encoder cable shield and grounding in drive

F44 *Device changed (Default param.)***Possible cause:**

- Option board or power unit changed.
- New device of different type or different rating from the previous one.

Correcting measures:

- Reset
- Set the option board parameters again if option board was changed. Set AC drive parameters again if power unit was changed.

F45 *Device added (default param.)***Possible cause:**

- Option board of different type added.

Correcting measures:

- Reset
- Set the option board parameters again.

F50 *4mA supervision***Possible cause:**

- Current at the analogue input is below 4mA.
- Signal source has failed
- Control cable is broken or loose

Correcting measures:

- Check the current loop circuitry.

F51 *External fault***Possible cause:**

- Digital input fault.

Correcting measures:

- Remove fault situation from external device.

F52 *Keypad communication***Possible cause:**

- The connection between the control keypad or NCDrive and the AC drive is broken.

Correcting measures:

- Check keypad connection and possible keypad cable.

F53 Fieldbus communication fault on slot D**Possible cause:**

- The data connection between the fieldbus Master and the fieldbus board is broken.
- Watch Dig pulse is missing from PLC, if Control Slot selector is zero or set for slot D.

Correcting measures:

- Check installation.
- If installation is correct contact the nearest VACON® distributor.

F54 Slot fault**Possible cause:**

- Defective option board or slot

Correcting measures:

- Check board and slot.
- Contact the nearest VACON® distributor.

F56 PT100 temperature fault

PT100 protection function is used to measure temperature and give warning and/or fault when set limits are exceeded. Marine application supports two PT100 boards. One can be used for the motor winding and the other for the motor bearings.

Possible cause:

- Temperature limit values set for the PT100 board parameters have been exceeded.

Correcting measures:

- Find the cause of temperature rise

F57 Identification

Identification run has failed.

- A1 = Current measurement offset
- A2 = Identification current level
- A3 = Acceleration time too long
- A4 = Identification frequency reference not reached
- A5 = Too low or high magnetization current
- A6 = Flux curve outside expected levels
- A7 = PMSM, Encoder zero position
- A8 = Too low maximum frequency limit
- A9 = PMSM, encoder zero pulse not found.
- A10 = Ls Identification timeout
- A11 = Ls Identification current

Possible cause:

1. There was load on the motor shaft when making the identification run with rotating motor.
2. Motoring or generator side torque/power limits are too low to achieve a stable run.

Correcting measures:

- Run command was removed before identification was ready
- Motor is not connected to the AC drive.
- There is load on the motor shaft.
- In some cases, levering the DC-Link voltage may help, for example, by stopping AFE boosting.

F58 Mechanical brake

This fault is generated when the acknowledge signal from the brake is used. If the status of the signal is opposite from the control signal for a longer period of time than the delay defined with P2.15.11 *Brake Fault Delay* a fault is generated.

Correcting measures:

- Check the condition and connections of mechanical brake.

F59 SystemBus communication

The master drive sends pulses to all follower drives. If the pulses are missing, a system bus communication fault is generated. The master drive also receives pulses back from the follower drives (max. four drives) and generates warnings if pulses are missing.

SystemBus communication is broken between master and follower.

Correcting measures:

- Check expander board parameters.
- Check optical fibre.
- Check option board jumpers.

F60 Cooling

Protection for the liquid-cooled units. An external sensor is connected to the drive (DI: Cooling Monitor) to indicate if cooling liquid is circulating. If the drive is in Stop state, only a warning is issued. In Run state a fault is issued and the drive makes a coast stop.

Possible cause:

- Liquid cooled drive cooling circulation has failed

Correcting measures:

- Check reason for cooling failure from external system.

F62 Run Disabled

Run Disable warning signal is issued when Run Enable signal has been removed from the IO.

F63 Quick stop

Possible cause:

- A command has been given from a digital input or the fieldbus to make an quick stop.

Correcting measures:

- New run command is accepted after the quick stop is reset.

F64 MCB State Fault

This function monitors MCB status. Feedback status should correspond to the control signal. Delay to fault is defined by P2.9.1.13 MCB Fault Delay.

- F64 A1: Code given by V064 and older versions.
- F64 A2: MCB open while requested closed
- F64 A3: MCB closed while requested open.
- F64 A4: MCB opened externally while unit was in run state.

Possible cause:

1. Main circuit breaker has opened while drive controls it to close.
2. Main circuit breaker has closed while drive control it to be open.

Correcting measures:

1. Check the main contactor functionality

F65 PT100 board 2

PT100 protection function is used to measure temperature and give a warning and/or a fault when the set limits are exceeded. Marine application supports two PT100 boards. One can be used for the motor winding and the other for the motor bearings.

Possible cause:

Temperature limit values set for the PT100 board parameters have been exceeded.

The number of inputs selected is higher than what is actually connected.
PT100 cable is broken

F67 Fieldbus communication fault on slot E

Possible cause:

- The data connection between the fieldbus Master and the fieldbus board is broken.
- Watch Dog pulse is missing from PLC, if Control Slot Selector is for slot E.

Correcting measures:

- Check installation.
- If installation is correct contact the nearest VACON® distributor.

F68 D7 Voltage or frequency fault

This monitors Grid frequency and voltage.

Possible cause:

- OPT-D7 measurements are not within limits.

F69 OPT-D7 Missing

OPT-D7 board is not present for the function that is requested.

Possible cause:

Correcting measures:

F70 Line Voltage

Supply voltage is not inside of set hysteresis. Not to be confused with OPT-D7 protections.

F71 LCL Temperatuer

LCL Temperature has reached warning limit.

Possible cause:

Correcting measures:

F72 License

License has not been given or license code is wrong

Possible cause:

Correcting measures:

F73 Supply Frequency

Supply frequency is not inside of set hysteresis. Not to be confused with OPT-D7 protections.

F80 Charging Fault

Drive has not reached need voltage at set time

Possible cause:

Correcting measures:

F81 External Fault 2

Digital input fault

Possible cause:

Correcting measures:

- Remove fault situation from external device.

F82 Over Load

User defined over load limits has been exceeded. See functional description from Motor Protection chapter.

Possible cause:

Correcting measures:

F89 Grid Side Fault

In MF Mode Grid side AFE has a active fault

Possible cause:

Correcting measures:

F91 Short Circuit

Drive is operating against current limit

Possible cause:

- There is a short circuit in the grid.

Correcting measures:

F92 D7 Voltage

Measured voltage is not within limits set in protection group Grid Voltage D7

Possible cause:

- Voltage reference is below set limit.
- Supply Voltage is below set limit
- There is a short circuit in the grid
- OPT-D7 is installed but not connected
 - o Monitoring can be disabled with Control Options

F93 D7 Frequency

Measured frequency is not within limits set in protection group Grid Frequency .

- OPT-D7 is installed but not connected
 - o Monitoring can be disabled with Control Options

VACON®

www.danfoss.com

Vacon Ltd
Member of the Danfoss Group
Runsorintie 7
65380 Vaasa
Finland

Document ID:



DPD01916A

Rev. A