

**VACON<sup>®</sup> NXP**  
AC DRIVES

**ARFIFF30**  
**GENERATOR APPLICATION**  
**USER MANUAL**

**VACON<sup>®</sup>**



# VACON® GENERATOR APPLICATION MANUAL

## INDEX

Document code: DPD01916B  
 Software code: ARFIFF30V122  
 Date: 2.6.2021

|  |           |
|--|-----------|
| <b>1. Generator Application.....</b>                             | <b>7</b>  |
| <b>2. Generator Versions compatibility issues .....</b>          | <b>8</b>  |
| <b>3. Power Take Modes.....</b>                                  | <b>9</b>  |
| 3.1 Power Take Out modes.....                                    | 9         |
| 3.1.1 Induction motor .....                                      | 9         |
| 3.1.2 Permanent Magnet Synchronous Motor .....                   | 9         |
| 3.2 Synchronous machine.....                                     | 10        |
| 3.3 Power Take In modes .....                                    | 11        |
| 3.3.1 Induction Motor – Boosting.....                            | 11        |
| 3.3.2 Induction Motor- Take Me Harbour .....                     | 11        |
| 3.3.3 Permanent Magnet Synchronous Motor - Boosting.....         | 11        |
| 3.3.4 Permanent Magnet Synchronous Motor – Take Me Harbour ..... | 12        |
| 3.3.5 Synchronous machine - Boosting .....                       | 12        |
| 3.3.6 Synchronous machine – Take Me Harbor .....                 | 13        |
| <b>4. Main contactor control .....</b>                           | <b>14</b> |
| <b>5. Control I/O .....</b>                                      | <b>15</b> |
| <b>6. Monitoring signals.....</b>                                | <b>16</b> |
| 6.1 Monitoring .....   | 16        |
| 6.1.1 Monitoring 1 Values .....                                  | 16        |
| 6.1.2 Monitoring 2 Values .....                                  | 17        |
| 6.1.3 Fieldbus Monitoring values.....                            | 18        |
| 6.1.4 IO Monitoring values .....                                 | 18        |
| 6.1.5 Master Follower values .....                               | 19        |
| 6.1.6 License code activation.....                               | 19        |
| 6.1.7 Line synch .....   | 19        |
| 6.2 Monitoring Signal Descriptions .....                         | 20        |
| 6.2.1 Monitoring 1 values.....                                   | 20        |
| 6.2.2 Monitoring 2 values.....                                   | 23        |
| 6.2.3 Fieldbus monitoring values.....                            | 26        |
| 6.2.4 IO Monitoring values .....                                 | 31        |
| 6.2.5 Master Follower monitoring values .....                    | 33        |
| <b>7. ARFIFF30– Parameter list .....</b>                         | <b>35</b> |
| 7.1 Basic Parameters (G2.1).....                                 | 35        |
| 7.2 Reference Handling (G2.2).....                               | 36        |
| 7.2.1 PTM handling .....   | 36        |
| 7.2.2 PTO handling.....  | 36        |
| 7.2.3 PTI-Boost handling .....                                   | 37        |
| 7.2.4 PTI 0-Speed .....  | 37        |
| 7.2.5 Regen Motor Mode .....                                     | 37        |
| 7.2.6 Commissioning.....   | 38        |

|         |   |    |
|---------|---|----|
| 7.2.7   | DC Voltage Reference Handling .....                   | 38 |
| 7.2.8   | Speed / Frequency Ref handling .....                  | 39 |
| 7.2.9   | Torque Control .....                                  | 39 |
| 7.2.10  | Motor Potentiometer reference .....                   | 39 |
| 7.3     | Ramp Control (G2.3) .....                             | 39 |
| 7.3.1   | Ramp Control .....                                    | 39 |
| 7.4     | Input Signals (G2.4) .....                            | 40 |
| 7.4.1   | Basic settings .....                                  | 40 |
| 7.4.2   | Digital Inputs .....                                  | 41 |
| 7.4.3   | Analogue Input 1 .....                                | 42 |
| 7.4.4   | Analogue Input 2 .....                                | 42 |
| 7.4.5   | Analogue Input 3 .....                                | 43 |
| 7.4.6   | Analogue Input 4 .....                                | 43 |
| 7.5     | Output Signals (G2.5) .....                           | 44 |
| 7.5.1   | Dig Out Signals .....                                 | 44 |
| 7.5.2   | Delayed DO 1 .....                                    | 45 |
| 7.5.3   | Delayed DO 2 .....                                    | 45 |
| 7.5.4   | Analog Output 1 .....                                 | 47 |
| 7.5.5   | Analog Output 2 .....                                 | 47 |
| 7.5.6   | Analog Output 3 .....                                 | 48 |
| 7.5.7   | Options .....   | 48 |
| 7.5.8   | Supervision limits .....                              | 48 |
| 7.6     | Limit Settings (G2.6) .....                           | 49 |
| 7.6.1   | Current Limit .....                                   | 49 |
| 7.6.2   | Power Limit .....                                     | 49 |
| 7.6.3   | Frequency Limit .....                                 | 49 |
| 7.6.4   | Voltage .....   | 49 |
| 7.6.5   | DC Voltage .....                                      | 50 |
| 7.6.6   | Torque .....  | 50 |
| 7.6.7   | Active Current .....                                  | 51 |
| 7.7     | Flux and DC Current handling CL Settings (G2.7) ..... | 51 |
| 7.8     | Motor Control (G2.8) .....                            | 52 |
| 7.8.1   | Motor Control Basic Settings .....                    | 52 |
| 7.8.2   | U/f Settings .....                                    | 52 |
| 7.8.3   | PMSM Control settings .....                           | 53 |
| 7.8.4   | Stabilators .....                                     | 54 |
| 7.8.5   | Identification parameters .....                       | 55 |
| 7.8.6   | Tuning parameters .....                               | 55 |
| 7.8.7   | Flying Start Tuning parameters .....                  | 56 |
| 7.9     | Speed Control (G2.9) .....                            | 56 |
| 7.10    | Drive Control (G2.10) .....                           | 57 |
| 7.11    | Master Follower (G2.11) .....                         | 57 |
| 7.12    | Protection (G 2.12) .....                             | 58 |
| 7.12.1  | General .....   | 58 |
| 7.12.2  | Temperature Board parameters .....                    | 59 |
| 7.12.3  | Earth fault .....                                     | 59 |
| 7.12.4  | External Fault .....                                  | 59 |
| 7.12.5  | Generator Voltage .....                               | 60 |
| 7.12.6  | Generator Frequency .....                             | 60 |
| 7.12.7  | Motor thermal protections .....                       | 60 |
| 7.12.8  | Fieldbus protection .....                             | 61 |
| 7.12.9  | Cooling Monitoring .....                              | 61 |
| 7.12.10 | Options .....   | 61 |
| 7.13    | Fieldbus (G 2.13) .....                               | 62 |

|           |  |           |
|-----------|--|-----------|
| 7.14      | ID Control Functions (G2.14).....                | 63        |
| 7.14.1    | Value Control .....                              | 63        |
| 7.14.2    | DIN ID Control 1 .....                           | 63        |
| 7.14.3    | DIN ID Control 2 .....                           | 63        |
| 7.14.4    | DIN ID Control 3 .....                           | 64        |
| 7.15      | Curve 1 definition (G2.15).....                  | 64        |
| 7.16      | Curve 2 definition (G2.16).....                  | 65        |
| 7.17      | Curve 3 definition (G2.17).....                  | 66        |
| 7.18      | Line Synch (G2.18).....                          | 67        |
| 7.19      | Keypad control (Control keypad: Menu M3).....    | 67        |
| 7.20      | System menu (Control keypad: Menu M6).....       | 67        |
| 7.21      | Expander boards (Control keypad: Menu M7).....   | 67        |
| <b>8.</b> | <b>Parameter Descriptions.....</b>               | <b>68</b> |
| 8.1       | Basic parameters.....                            | 68        |
| 8.2       | Reference Handling .....                         | 74        |
| 8.2.1     | PTM Handling.....                                | 74        |
| 8.2.2     | PTO Handling .....                               | 74        |
| 8.2.3     | PTI-Boost.....                                   | 79        |
| 8.2.4     | PTI 0-Speed .....                                | 81        |
| 8.2.5     | Regen Motor .....                                | 82        |
| 8.2.6     | Commissioning.....                               | 83        |
| 8.2.7     | DC Voltage Reference.....                        | 85        |
| 8.2.8     | Speed and Frequency .....                        | 86        |
| 8.2.9     | Torque Control.....                              | 87        |
| 8.2.10    | Ramp Control.....                                | 88        |
| 8.3       | Input Signals.....                               | 89        |
| 8.3.1     | Basic Settings .....                             | 89        |
| 8.3.2     | Digital input signals .....                      | 90        |
| 8.3.3     | Analogue Inputs 1-4 .....                        | 95        |
| 8.4       | Output Signals .....                             | 98        |
| 8.4.1     | Digital output signals .....                     | 98        |
| 8.4.2     | Delayed digital output 1 & 2 .....               | 100       |
| 8.4.3     | Analogue output 1 & 2 & 3 .....                  | 101       |
| 8.4.4     | Options .....                                    | 105       |
| 8.4.5     | Supervision limits .....                         | 107       |
| 8.5       | Limit settings.....                              | 108       |
| 8.5.1     | Current Limits.....                              | 108       |
| 8.5.2     | Power Limits .....                               | 108       |
| 8.5.3     | Frequency limits.....                            | 110       |
| 8.5.4     | Voltage.....                                     | 111       |
| 8.5.5     | DC Voltage limit regulators .....                | 112       |
| 8.5.6     | Torque .....                                     | 114       |
| 8.5.7     | Active Current .....                             | 114       |
| 8.6       | Flux Control.....                                | 115       |
| 8.7       | Motor Control .....                              | 116       |
| 8.7.1     | U/f Settings.....                                | 117       |
| 8.7.2     | Close Loop Settings .....                        | 124       |
| 8.7.3     | Permanent magnet synchronous motor settings..... | 126       |
| 8.7.4     | Stabilization settings.....                      | 132       |
| 8.7.5     | Identification settings.....                     | 136       |
| 8.7.6     | Flying Start.....                                | 138       |
| 8.8       | Speed Control settings.....                      | 139       |
| 8.9       | Drive Control .....                              | 141       |

|            |  |            |
|------------|--|------------|
| 8.10       | Master Follower .....                                      | 148        |
| 8.10.1     | Master Follower: DriveSynch system .....                   | 148        |
| 8.10.2     | Master follower configuration .....                        | 151        |
| 8.11       | Protections.....   | 153        |
| 8.11.1     | General settings .....                                     | 153        |
| 8.11.2     | Temperature Board.....                                     | 156        |
| 8.11.3     | Earth Fault .....  | 158        |
| 8.11.4     | External Fault.....  | 158        |
| 8.11.5     | Generator Voltage OPT-D7.....                              | 159        |
| 8.11.6     | Generator Frequency OPT- D7.....                           | 160        |
| 8.11.7     | Motor Protection .....                                     | 161        |
| 8.11.8     | Over Load Protection .....                                 | 163        |
| 8.11.9     | Fieldbus communication .....                               | 165        |
| 8.11.10    | Cooling protection.....                                    | 165        |
| 8.11.11    | Protection Options.....                                    | 166        |
| 8.12       | Fieldbus.....  | 167        |
| 8.12.1     | Signals from drive to Fieldbus.....                        | 167        |
| 8.12.2     | Signals from fieldbus to drive .....                       | 167        |
| 8.13       | ID Functions .....   | 169        |
| 8.13.1     | Value Control .....  | 169        |
| 8.13.2     | DIN ID Control.....  | 172        |
| 8.14       | Curve 1 Definition.....                                    | 173        |
| 8.15       | Curve 2 Definition.....                                    | 173        |
| 8.16       | Curve 3 Definition.....                                    | 173        |
| 8.17       | Line synch .....   | 174        |
| <b>9.</b>  | <b>Keypad control parameters.....</b>                      | <b>175</b> |
| <b>10.</b> | <b>Status and control words in detail.....</b>             | <b>176</b> |
| 10.1       | Basic In ByPass (0) .....                                  | 176        |
| 10.2       | FB Control Word.....                                       | 177        |
| 10.2.1     | Standard (1).....  | 177        |
| 10.2.2     | Vacon Generator 1 profile (2) .....                        | 178        |
| 10.2.3     | Vacon AFE 2 Profile (Not Implemented as of 1.7.2014) ..... | 180        |
| 10.3       | FB Status Word.....  | 182        |
| 10.4       | Status Word (Application) ID 43.....                       | 184        |
| <b>11.</b> | <b>Problem solving .....</b>                               | <b>186</b> |
| <b>12.</b> | <b>FAULT CODES .....</b>                                   | <b>187</b> |

# 1. GENERATOR APPLICATION

## Software ARFIFF30, Generator application

The VACON® Generator application is an application that can be used to keep constant DC Voltage regardless of input power source. The application supports Synchronous Generator (LCL Needed), Permanent Magnet Synchronous Motor (Absolute Encoder needed) and asynchronous motor (Incremental Encoder needed).

VACON® Generator application also support PTI operations. However, this manual does include details on related hardware selections. We recommend you read the Grid Converter technical documentation and contact VACON® technical support for more details.

The basic I/O-configuration of the AC drive consists of OPT-A1, OPT-A2 and if needed OPT-D7 or OPT-A5 option cards depending of what type of generator is used. Also, for commissioning purposes it is recommended to use OPT-D2 board. The basic I/O configuration has been described in table 2-1.

As a default the control place (P3.1) of the Generator drive is Keypad.

This application requires NXP3 control board 761 or newer.

## 2. GENERATOR VERSIONS COMPATIBILITY ISSUES

### V095

- Frequency Reference monitoring signal ID number changed from ID1752 to ID25
  - 1752 is reserved for P 2.8.7.4 DeadTieContCurl

### V101

- P2.2.4.5 TorqueRefRampTime is removed and internally forced to zero.
- New parameter for new ramp handling
  - P2.2.4.5 TRefRampUpRate ID1934
  - P2.2.4.6 TRefRampDownRate ID1935
- P2.2.4.5 TorqueRefRampTime was ramping regardless of Run state. With long ramp time torque reference did not ramp to new reference fast enough e.g. when changing between PTO and PTI-Boost modes.
- TRefRampUpRate is ramp rate when absolute value is increasing.
- TRefRampDownRate is ramp rate when negative or positive value is going toward zero.

**Note 1:** When updating application, it is not recommended to use VACON® NCDrive parameter download function. Instead, upload the parameters from the unit and make comparison to the old parameter file. Application is constantly developed; this includes changing parameter default values. If parameters are directly downloaded to drive, the improved default values will be lost.



### 3. POWER TAKE MODES

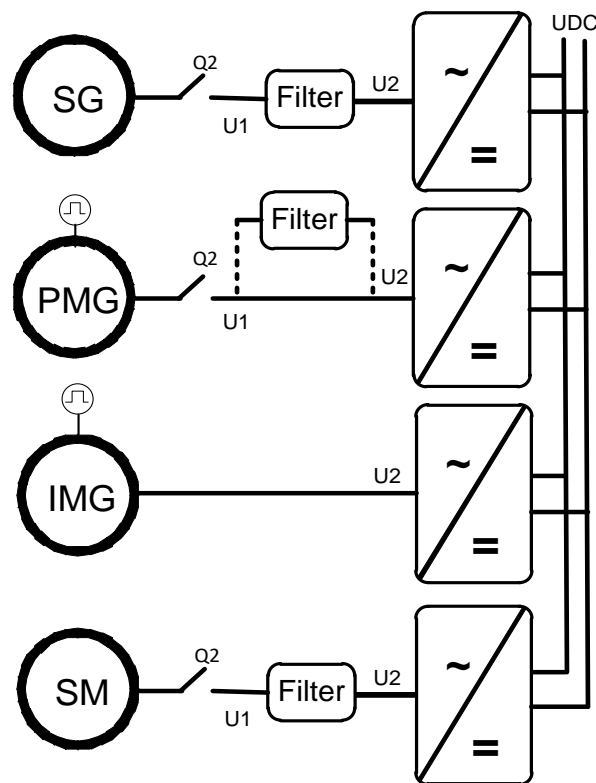

Figure 3-1.

#### 3.1 POWER TAKE OUT MODES

##### 3.1.1 INDUCTION MOTOR

AC drive is operated in closed loop control. Closed Loop is needed to have good response to power demand changes. AC drive will be set to operate in DC Reference mode with negative torque reference, which can be handled in G2.2.1.6 PTO group, when Power Take mode is PTO. Torque reference can be handled by using curve reference mode or with direct control from upper system.

##### 3.1.1.1 *Induction motor in open loop control.*

Pure open loop control can be used on cases where generator drive is not required to keep the DC stable, e.g. when grid side drive can be kept in AFE mode.

##### 3.1.1.2 *Regenerative Motor Mode*

This mode can be used in open loop mode but involve limits for frequency range: 30 Hz... 85 Hz and for voltage range: 150 Vac...Unit Nominal voltage. When starting this operation mode, the recommended generator speed is in range of 40 Hz...70 Hz. **This mode requires licence code.** To get the licence, provide the technical details beforehand to VACON® Finland for approval.

##### 3.1.2 PERMANENT MAGNET SYNCHRONOUS MOTOR

Depending on the system requirements, the PMSM can be controlled in normal motor control modes or AFE mode. If PTI – TMH is also needed, we recommend the normal motor control mode. If only PTI – Boosting is needed, the system may be possible to operate in AFE mode.

PMSM in normal motor control modes needs to be operated in closed loop control to have a good response time to the changes in power demand.

AFE mode can be used without filter if motor can be run with unity power factor. AFE can compensate if inductor size is programmed according to stray inductance of PM motor and stray inductance voltage is over half of BEM voltage, if not, LC filter is enough. When paralleling, LCL is needed

### **3.2 SYNCHRONOUS MACHINE**

This is normal AFE operation.

### 3.3 POWER TAKE IN MODES

PTI needs to be separated to two different modes. In all modes the DC Voltage needs to be kept constant with the Grid side drive (or otherwise have suitable DC Voltage available). When using the Grid Converter application on grid side, change the operation mode to AFE operation mode. Constant DC Voltage can be also kept with the uGrid operation mode when special care of references and limit values in PMS has been take care of.

#### PTI - Boosting.

In this mode the generator (motor) is already rotating when more power is started to be fed to the generator (motor). When the PTI is started, we recommend a minimum frequency limit of ~20 Hz for the drive is. Above this limit, the operation is considered to be boosting.

#### PTI – TMH (Take Me Harbour)

In this mode, the generator (motor) needs to be started from zero speed. You can do this for example so that the main engine is not running and the propeller power is taken from the diesel generator using existing shaft generator system.

#### **3.3.1 INDUCTION MOTOR – BOOSTING**

##### *3.3.1.1 In DC Voltage Reference mode*

While in PTO mode, the AC drive is operated in the torque reference mode. When you change the operation mode to boosting, you can simply put the AC drive torque reference to positive direction.

##### *3.3.1.2 In Speed Reference Mode*

In this mode, the AC drive will follow the speed reference of the PMS. Usually the power capacity of the Shaft Generator system is only a fraction of the main engine power capacity. Therefore, you need to check the power, torque and current limitations.

#### **3.3.2 INDUCTION MOTOR- TAKE ME HARBOUR.**

In this mode, the AC drive will follow the speed reference of the PMS. Usually the power capacity of the Shaft Generator system is only a fraction of the main engine power capacity. Therefore, you need to check the power, torque and current limitations.

#### **3.3.3 PERMANENT MAGNET SYNCHRONOUS MOTOR - BOOSTING**

Depending on the system requirements, the PMSM can be controlled in normal motor control modes or AFE mode. If PTI – TMH is also needed, we recommend the normal motor control mode. If only PTI – Boosting is needed and there is space for sine filter, the system can be operated in AFE mode.

##### *3.3.3.1 Operating in AFE Mode, DC Voltage Reference Mode*

Change is made only between PTO and PTI – Boosting mode.

When the AC drive is operating in PTO mode, the constant DC Voltage is maintained. When you change to the Boosting mode, the constant DC Voltage needs to be kept with grid side drive. When the grid side drive keeps the constant DC Voltage, the DC Voltage Reference can be set lower on the generator side drive thus changing the power flow direction. To be able to control the power flow, the PMS needs to control the Output Power.

### 3.3.3.2 Operating in AFE Mode, Speed Reference Mode

This operation mode is not possible.

### 3.3.3.3 Operating in normal motor control mode, DC Voltage Reference Mode

While in PTO mode, the AC drive is operated in the torque reference mode. When you change the operation mode to boosting, you can simply put the AC drive torque reference to positive direction. With this selection, the PMS will control the positive torque reference thus defining boosting torque.

### 3.3.3.4 Operating in normal motor control mode, Speed Reference Mode

In this mode, the AC drive will follow the speed reference of the PMS. Usually the power capacity of the Shaft Generator system is only a fraction of the main engine power capacity. Therefore, you need to check the power, torque and current limitations.

## 3.3.4 PERMANENT MAGNET SYNCHRONOUS MOTOR – TAKE ME HARBOUR

This control can be made only by using the normal motor control modes. AFE mode cannot start from below 25 Hz.

### 3.3.4.1 Operating in normal motor control mode, DC Voltage Reference Mode

While in PTO mode, the AC drive is operated in the torque reference mode by using selection 1 / Curve in P2.2.9.1 Torque Ref Select. When you change the operation mode to boosting, you need to set the reference to positive direction. With this selection, the PMS will control the positive torque reference thus defining torque to be used for propulsion.

### 3.3.4.2 Operating in normal motor control mode, Speed Reference Mode

In this mode, the AC drive will follow the speed reference of the PMS. Usually the power capacity of the Shaft Generator system is only a fraction of the main engine power capacity. Therefore, you need to check the power, torque and current limitations.

## 3.3.5 SYNCHRONOUS MACHINE - BOOSTING

### 3.3.5.1 Operating in AFE Mode, DC Voltage Reference Mode

Change is made only between PTO and PTI – Boosting mode.

While the AC drive is operating in the PTO mode, the constant DC Voltage is maintained. When you change to the Boosting mode, the constant DC Voltage needs to be kept with grid side drive. When the grid side drive keeps the constant DC Voltage, the DC Voltage Reference can be set lower in the generator side thus changing power flow direction. To be able to control power flow, the PMS needs to control the Output Power limit P2.6.2.1 OutputPowerLim.

### 3.3.5.2 Operating in AFE Mode, Speed Reference Mode

This operation mode is not possible.

### 3.3.5.3 Operating in normal motor control mode, DC Voltage Reference Mode

Not supported nor recommended.

### 3.3.5.4 Operating in normal motor control mode, Speed Reference Mode

Not supported nor recommended.

### 3.3.6 SYNCHRONOUS MACHINE – TAKE ME HARBOR

This operation mode is only possible in the normal motor control modes.

#### 3.3.6.1 *Operating in normal motor control mode, DC Voltage Reference Mode*

Not supported nor recommended

#### 3.3.6.2 *Operating in normal motor control mode, Speed Reference Mode*

Change is made only between PTO and PTI – TMH.

While the AC drive is operating in PTO mode, the constant DC Voltage is maintained. When you change to PTI - TMH mode, the constant DC Voltage needs to be kept with grid side drive.

In this mode the AC drive will follow the speed reference of the PMS Usually the power capacity of the Shaft Generator system is only a fraction of the main engine power capacity. Therefore, you need to check the power, torque and current limitations.

## 4. MAIN CONTACTOR CONTROL

The Generator application controls the MCB (Main Circuit Breaker) of the system with selectable Relay Output. When charging of the DC bus is ready, the MCB will be closed. The status of the MCB is monitored via digital input. Digital input used for monitoring is chosen with parameter P2.4.2.4.

Faults can be set to open the main contactor by choosing a response to fault to be “3=Fault, DC OFF”. When a fault occurs, the MCB will be opened after one second so the drive will go to stop state first. In case of F1 Over Current, F2 Over Voltage or F31 and F41 IGBT faults, the breaker is opened immediately. If the charging is on when the fault is acknowledged the MCB will be closed.

An external charging circuit is needed to charge the DC bus.

## 5. CONTROL I/O

### Reference

| OPT-A1   |                     |  |   |
|----------|---------------------|--|---|
| Terminal |                     | Signal   | Description   |
| 1        | +10V <sub>ref</sub> | Reference voltage output   | Voltage for potentiometer, etc.   |
| 2        | AI1+                | Analogue input 1.<br>Range 0-10V, R <sub>i</sub> = 200Ω<br>Range 0-20 mA R <sub>i</sub> = 250Ω | Input range selected by jumpers.<br>Default range: Voltage 0 – 10 V                   |
| 3        | AI1-                | I/O Ground   | Ground for reference and controls   |
| 4        | AI2+                | Analogue input 2.<br>Range 0-10V, R <sub>i</sub> = 200Ω<br>Range 0-20 mA R <sub>i</sub> = 250Ω | Input range selected by jumpers.<br>Default range: Current 0 – 20 mA                  |
| 5        | AI2-                |  |   |
| 6        | +24V                | Control voltage output   | Voltage for switches, etc. max 0.1 A  |
| 7        | GND                 | I/O ground   | Ground for reference and controls   |
| 8        | DIN1                | Start<br>Programmable G2.2.1   | 0=Stop,<br>1=Run  |
| 9        | DIN2                | Programmable G2.2.1  | No function defined at default  |
| 10       | DIN3                | Programmable G2.2.1  | No function defined at default  |
| 11       | CMA                 | Common for DIN 1—DIN 3   | Connect to GND or +24V  |
| 12       | +24V                | Control voltage output   | Voltage for switches (see #6)   |
| 13       | GND                 | I/O ground   | Ground for reference and controls   |
| 14       | DIN4                | Main contactor supervision<br>Programmable G2.2.1  | 0 = contactor open<br>1 = contactor closed  |
| 15       | DIN5                | Programmable G2.2.1  | No function defined at default  |
| 16       | DIN6                | Fault reset<br>Programmable G2.2.1   | Rising edge will reset active faults  |
| 17       | CMB                 | Common for DIN4—DIN6   | Connect to GND or +24V  |
| 18       | AO1+                | Analogue output 1  | Programmable<br>Range 0—20 mA/R <sub>L</sub> , max. 500Ω                              |
| 19       | AO1-                |  |   |
| 20       | DO1                 | Digital output<br>READY  | Programmable P2.3.1.1<br>Open collector, I <sub>s</sub> ≤50mA, U <sub>s</sub> ≤48 VDC |
| OPT-A2   |                     |  |   |
| 21       | RO1                 | Relay output 1<br>Programmable P2.3.1.2  | Switching capacity<br>24 VDC / 8 A<br>250 VAC / 8 A<br>125 VDC / 0.4 A                |
| 22       | RO1                 |  |   |
| 23       | RO1                 |  |   |
| 24       | RO2                 | Relay output 2<br>Main contactor control   | This RO is not programmable.<br>Fixed for Main Contactor Control                      |
| 25       | RO2                 |  |   |
| 26       | RO2                 |  |   |

Table 5-1 Default I/O configuration.

## 6. MONITORING SIGNALS

Menu M1 (Monitoring) holds all the monitoring values. Values are only for monitoring, and cannot be altered by the panel.

### 6.1 MONITORING

#### 6.1.1 MONITORING 1 VALUES

| Code    | Parameter               | Unit | Form.  | ID   | Description  |
|---------|-------------------------|------|--------|------|--|
| V1.1.1  | DC-Link Voltage         | V    | #      | 1108 | DC Voltage filtered  |
| V1.1.2  | DC Voltage Ref.         | %    | #,##   | 1200 | Used DC voltage reference by the regenerative unit in % of Nominal DC Voltage.<br>Nominal DC voltage = 1.35 * Supply voltage |
| V1.1.3  | DC Voltage Actual       | %    | #,##   | 7    | Same scaling as DC Voltage Ref.  |
| V1.1.4  | Total Current           | A    | Varies | 1104 | Filtered current   |
| V1.1.5  | Active Current          | %    | #,#    | 1125 |  |
| V1.1.6  | Reactive Current        | %    | #,#    | 1157 |  |
| V1.1.7  | Power kW                | kW   | Varies | 1508 |  |
| V1.1.8  | Power %                 | %    | #,#    | 5    |  |
| V1.1.9  | Status Word             |      | #      | 43   |  |
| V1.1.10 | Supply Frequency        | Hz   | #,##   | 1    | Drive output frequency   |
| V1.1.11 | Supply Voltage          | V    | #,#    | 1107 | Drive output voltage   |
| V1.1.12 | LineFrequency D7        | Hz   | #,##   | 1654 | Measured line frequency  |
| V1.1.13 | Line Voltage D7         | V    | #      | 1650 | Measured line voltage  |
| V1.1.14 | AC Voltage Reference    | V    | #      | 1556 |  |
| V1.1.15 | DC Ref Max Lim          | %    | #,##   | 1606 |  |
| V1.1.16 | Encoder 1 Freq.         | Hz   | #,##   | 1164 |  |
| V1.1.17 | Torque Reference        | %    | #,#    | 18   |  |
| V1.1.18 | Final Torque Reference  | %    | #,#    | 1145 |  |
| V1.1.19 | Actual Torque Reference | %    | #,#    | 1180 |  |
| V1.1.20 | Motor Torque            | %    | #,#    | 4    | Filtered   |
| V1.1.21 | Motor Speed             | rpm  | #      | 2    |  |

Table 6-1, Monitoring 1



## 6.1.2 MONITORING 2 VALUES

| Code    | Parameter                  | Unit | Form.  | ID   | Description                                    |
|---------|----------------------------|------|--------|------|--|
| V1.2.1  | DC Voltage                 | V    | #      | 44   | Measured DC Link voltage in Volts, unfiltered. |
| V1.2.2  | Cos Phi Actual             |      | #,###  | 1706 |  |
| V1.2.3  | Unit Temperature           | °C   | #      | 1109 |  |
| V1.2.4  | Freq Reference             | Hz   | #,##   | 25   | Used line frequency reference                  |
| V1.2.5  | Current                    | A    | Varies | 1113 | Unfiltered current                             |
| V1.2.6  | Operation Hours            | h    | #, #   | 1856 |  |
| V1.2.7  | Reactive Current Reference | %    | #, #   | 1389 |  |
| V1.2.8  | Power Take Mode            |      | #      | 1925 |  |
| V1.2.9  | Torque                     | %    | #, #   | 1134 | Unfiltered                                     |
| V1.2.10 | Limit & Regulators         |      | #      | 77   |  |
| V1.2.11 | Shaft Frequency            | Hz   | #,###  | 1124 |  |
| V1.2.12 | U Phase Current            | A    | Varies | 39   |  |
| V1.2.13 | V Phase Current            | A    | Varies | 40   |  |
| V1.2.14 | W Phase Current            | A    | Varies | 41   |  |
| V1.2.15 | Fault Word 10              |      |        | 1202 |  |
| V1.2.16 | Warning Word 10            |      |        | 1269 |  |

Table 6-2, Monitoring 2

### 6.1.3 FIELDBUS MONITORING VALUES

| Code    | Parameter           | Unit | Form.   | ID   | Description                |
|---------|---------------------|------|---------|------|----------------------------|
| V1.3.1  | FB Control Word     |      | #       | 1160 | Control word from fieldbus |
| V1.3.2  | FB Status Word      |      | #       | 68   | Status word to fieldbus    |
| V1.3.3  | FB Actual Value     |      | #       | 865  |                            |
| V1.3.4  | FB Speed Ref        |      | #       | 875  |                            |
| V1.3.5  | FB Torque Ref       |      | #, #    | 1140 |                            |
| V1.3.6  | Generator CW        |      | #       | 1700 |                            |
| V1.3.7  | Generator SW        |      | #       | 1701 |                            |
| V1.3.8  | Fault Word 1        |      | #       | 1172 |                            |
| V1.3.9  | Fault Word 2        |      | #       | 1173 |                            |
| V1.3.10 | Warning Word 1      |      | #       | 1174 |                            |
| V1.3.11 | Last Active Warning |      | #       | 74   |                            |
| V1.3.12 | Last Active Fault   |      | #       | 37   |                            |
| V1.3.13 | Speed FB Scaled     |      | #, #, # | 1907 |                            |
| V1.3.14 | FB Analog Out       | %    | #, #, # | 48   |                            |

Table 6-3, Fieldbus

### 6.1.4 IO MONITORING VALUES

| Code    | Parameter             | Unit | Form.   | ID | Description      |
|---------|-----------------------|------|---------|----|------------------|
| V1.4.1  | DIN1, DIN2, DIN3      |      | #       | 15 |                  |
| V1.4.2  | DIN4, DIN5, DIN6      |      | #       | 16 |                  |
| V1.4.3  | DIN Status 1          |      | #       | 56 |                  |
| V1.4.4  | DIN Status 2          |      | #       | 57 |                  |
| V1.4.5  | Analogue Input 1      | %    | #, #, # | 13 |                  |
| V1.4.6  | Analogue Input 2      | %    | #, #, # | 14 |                  |
| V1.4.7  | Analogue input 3      | %    | #, #, # | 27 | AI3, unfiltered. |
| V1.4.8  | Analogue input 4      | %    | #, #, # | 28 | AI4, unfiltered. |
| V1.4.9  | Analogue Out 1        | %    | #, #, # | 26 |                  |
| V1.4.10 | Analogue Out 2        | %    | #, #, # | 50 | AO2              |
| V1.4.11 | Analogue Out 3        | %    | #, #, # | 51 | AO3              |
| V1.4.12 | PT100 Temp. 1         | °C   | #, #    | 50 |                  |
| V1.4.13 | PT100 Temp. 2         | °C   | #, #    | 51 |                  |
| V1.4.14 | PT100 Temp. 3         | °C   | #, #    | 52 |                  |
| V1.4.15 | PT100 Temp. 4         | °C   | #, #    | 69 |                  |
| V1.4.16 | PT100 Temp. 5         | °C   | #, #    | 70 |                  |
| V1.4.17 | PT100 Temp. 6         | °C   | #, #    | 71 |                  |
| V1.4.18 | PT100 Max Temperature | °C   | #, #    | 42 |                  |

Table 6-4, IO monitoring

**6.1.5 MASTER FOLLOWER VALUES**

| Code     | Parameter        | Unit | Form.  | ID   | Description |
|----------|------------------|------|--------|------|-------------|
| V1.5.1   | SB System Status |      | #      | 1800 |             |
| V1.5.2   | System Current   | A    | Varies | 80   |             |
| V1.5.3.1 | Current D1       |      | Varies | 1820 |             |
| V1.5.3.2 | Current D2       |      | Varies | 1821 |             |
| V1.5.3.3 | Current D3       |      | Varies | 1822 |             |
| V1.5.3.4 | Current D1       |      | Varies | 1823 |             |
| V1.5.4.1 | Status Word D1   |      | #      | 1828 |             |
| V1.5.4.2 | Status Word D2   |      | #      | 1829 |             |
| V1.5.4.3 | Status Word D3   |      | #      | 1830 |             |
| V1.5.4.4 | Status Word D4   |      | #      | 1831 |             |

*Table 6-5, Master follower***6.1.6 LICENSE CODE ACTIVATION**

| Code   | Parameter         | Unit | Form. | ID   | Description   |
|--------|-------------------|------|-------|------|---|
| V1.6.1 | License Status    |      | #     | 1996 |   |
| V1.6.2 | Serial Number Key |      | #     | 1997 | Give this number to VACON® technical support in case of License Key problems. |

*Table 6-6, Activation***6.1.7 LINE SYNCH**

| Code   | Parameter        | Unit | Form. | ID   | Description |
|--------|------------------|------|-------|------|-------------|
| V1.7.1 | Line Synch Error |      | #, #  | 1659 |             |

*Table 6-7, Line synch*

## 6.2 MONITORING SIGNAL DESCRIPTIONS

### 6.2.1 MONITORING 1 VALUES

*V1.1.1 DC Voltage V ID1108*

Measured DC voltage, filtered.

*V1.1.2 DC Voltage Ref. % ID1200*

DC voltage reference. Compared to given supply voltage.

$1.35 * \text{Supply Voltage} * \text{DC Voltage Ref} = \text{DC Voltage}$

$\text{DC Voltage} = \text{Supply Voltage} * 1.35 * \text{Boost}$

$621 \text{ Vdc} = 400 \text{ Vac} * 1.35 * 1.15$

*V1.1.3 DC Voltage Actual % ID7*

DC voltage actual in same scale as V1.1.2 DC Voltage Reference.

*V1.1.4 Total Current A ID 1113*

Filtered current of the drive.

*V1.1.5 Active Current % ID 1125*

Active current in % of System Rated Current.

Active Current > 0: Current flow from Drive DC-Link to AC-Side.

Active Current < 0: Current flow from AC-Side to Drive DC-Link.

*V1.1.6 Reactive Current % ID 1157*

Reactive current of the regenerative drive in % of System Rated Current.

*V1.1.7 Power kW [kW] ID 1508*

Drive output power in kW.

#### AFE control modes:

Power kW > 0: Current flow from AC-Side to Drive DC-Link.

Power kW < 0: Current flow from Drive DC-Link to AC-Side.

#### Motor control modes:

Power kW > 0: Current flow from Drive DC-Link to AC-Side.

Power kW < 0: Current flow from AC-Side to Drive DC-Link.

*V1.1.8 Power % % ID 5*

Drive output power in %.

Negative value means that current is flowing to AC side from DC side.

**V1.1.9 Status Word (Application) ID 43**

Application Status Word combines different drive statuses to one data word.

| Application Status Word ID43 |                    |                                   |
|------------------------------|--------------------|-----------------------------------|
|                              | FALSE              | TRUE                              |
| b0                           | No Charge Command  | Charge Command Active             |
| b1                           | Not in Ready state | Ready                             |
| b2                           | Not Running        | Running                           |
| b3                           | No Fault           | Fault                             |
| b4                           | No Start Request   | Start Request Active              |
| b5                           | Quick stop active  | Quick stop not active             |
| b6                           | Run Disabled       | Run Enable                        |
| b7                           | No Warning         | Warning                           |
| b8                           |                    | Charging Switch closed (internal) |
| b9                           |                    | Main Contactor Control (DO Final) |
| b10                          |                    | Main Contactor Feedback           |
| b11                          |                    |                                   |
| b12                          | No Run Request     | Run Request                       |
| b13                          |                    | PTO                               |
| b14                          |                    | PTI                               |
| b15                          |                    | Regen                             |

*Table 6-8, Application status word*

**V1.1.10 Supply Frequency Hz ID 1**

Drive output frequency. Updated in stop state when Regen Options B9 is activated.

**V1.1.11 Supply Voltage V ID 1107**

Drive output voltage.

**V1.1.12 Line Frequency D7 Hz ID 1654**

Measured Line Voltage Frequency when using OPT-D7 option board in slot C.

**V1.1.13 Line Voltage D7 [V] ID 1650**

Measured line voltage rms value when using OPT-D7 option board in slot C.

**V1.1.14 AC Voltage Reference [V] ID1556**

AC side voltage reference.

**V1.1.15 DC Voltage max limit ID1606**

Drive will limit DC Reference to inside drive specification but allows higher reference if lover supply voltage. This shows the final limit of DC reference.

- V1.1.16**    *Encoder 1 Frequency*    *Hz*    *ID 1164*  
Encoder frequency directly from encoder
- V1.1.17**    *Torque reference*    *%*    *ID 18*  
Torque reference value before load share.
- V1.1.18**    *Final Torque Ref*    *%*    *ID1145*  
*Final torque reference in torque reference chain, before acceleration compensation and speed controller output.*
- V1.1.19**    *Actual Torque Reference*    *%*    *ID1180*  
Final torque reference from speed control and torque control. Also includes torque step and acceleration compensation factors.
- V1.1.20**    *Motor torque*    *%*    *ID 4*  
In % of Motor nominal torque
- Open loop**  
1 s linear filtering
- Closed Loop**  
32 ms filtering
- V1.1.21**    *Motor Speed*    *rpm*    *#*    *ID2*  
Estimated motor speed.

**6.2.2 MONITORING 2 VALUES****V1.2.1 DC Voltage V ID44**

The measured DC voltage, unfiltered.

**V1.2.2 CosPhiActual ID 1706**

The calculated Cos Phi.

**V1.2.3 Unit Temperature °C ID 1109**

The heatsink temperature of the drive.

**V1.2.4 Freq Reference Hz ID25**

Used frequency reference. In AFE mode frequency reference is determined internally when synchronization is made.

**V1.2.5 Current A ID 1113**

Unfiltered current of the drive.

**V1.2.6 Operation Hours h ID1856**

This shows operation hours of the drive. P2.7.19 is used to enter old value if software is updated.

**V1.2.7 Reactive Current Reference % ID1389**

Final reactive current reference.

**V1.2.8 Power Take Mode Used ID1925**

0 = Commissioning.

1 = Power Take Out.

2 = Power Take In, Boost.

3 Power Take In, From Zero Speed.

**V1.2.9 Torque % ID 1125**

Unfiltered motor torque, recommended signal for NCDrive monitoring.

**V1.2.10 Limits and Regulators ID77**

| Limit & Regulators ID77 |                                 |
|-------------------------|---------------------------------|
| Bit                     |                                 |
| B0                      | Motoring Current Limit          |
| B1                      | Generator Current Limit         |
| B2                      | Motoring Torque Limit           |
| B3                      | Generator Torque Limit          |
| B4                      | Over Voltage Regulator          |
| B5                      | Under Voltage Regulator         |
| B6                      | Positive Speed Controller Limit |
| B7                      | Negative Speed Controller Limit |
| B8                      | Positive Iq Limit               |
| B9                      | Negative Iq Limit               |
| B10                     | Motoring Power Limit Active     |
| B11                     | Generator Power Limit Active    |
| B12                     |                                 |
| B13                     |                                 |
| B14                     |                                 |
| B15                     |                                 |

Table 6-10, Limits and regulators

**V1.2.11 Shaft Frequency ID1124**  
Shaft Frequency used by motor control

**V1.2.12 U Phase Current A ID39**

**V1.2.13 V Phase Current A ID40**

**V1.2.14 W Phase Current A ID41**

Phase current in rpm, 1 second linear filtering.



**V1.2.15 Fault Word 10 ID1202**

|     | Fault Word 10               |
|-----|-----------------------------|
| Bit | Fault(s)                    |
| B0  |                             |
| B1  |                             |
| B2  | F82 Overload Fault          |
| B3  |                             |
| B4  | F56 & F65 PT100 Temperature |
| B5  |                             |
| B6  |                             |
| B7  |                             |
| B8  |                             |
| B9  |                             |
| B10 |                             |
| B11 |                             |
| B12 |                             |
| B13 |                             |
| B14 |                             |
| B15 |                             |

**V1.2.15 Warning Word 10 ID1269**

|     | Warning Word 10             |
|-----|-----------------------------|
| Bit | Fault(s)                    |
| B0  |                             |
| B1  | W3 Earth Fault              |
| B2  | W82 Overload fault          |
| B3  |                             |
| B4  | W56 & W65 PT100 Temperature |
| B5  |                             |
| B6  |                             |
| B7  |                             |
| B8  |                             |
| B9  |                             |
| B10 |                             |
| B11 |                             |
| B12 |                             |
| B13 |                             |
| B14 |                             |
| B15 |                             |

### 6.2.3 FIELDBUS MONITORING VALUES

#### V1.3.1 FB Control Word ID 1160

Control word from fieldbus. The table below shows the bypass operation for such fieldbus boards that natively support the bypass operation or can be parameterized to bypass mode.

| FB Control Word ID1160 |                  |  |
|------------------------|------------------|--|
|                        | Signal           | Comment  |
| B00                    | DC Charge        | 0= Open MCB.<br>1= Close DC charge contactor, CB closed automatically.   |
| B01                    |                  |  |
| B02                    |                  |  |
| B03                    | Run              | 0= AFE is stopped<br>1= AFE is started   |
| B04                    |                  |  |
| B05                    |                  |  |
| B06                    |                  |  |
| B07                    | Reset            | 0>1 Reset fault.   |
| B08                    |                  |  |
| B09                    |                  |  |
| B10                    | Fieldbus Control | 0= No control from fieldbus<br>1=Control from fieldbus   |
| B11                    | Watchdog         | 0>1>0>1...0,5 sec square wave clock. This is used to check data communication between fieldbus master and the drive. |
| B12                    | FB DIN2          | Can be used to control RO or directly parameter by ID number. G2.4.1   |
| B13                    | FB DIN3          | Can be used to control RO or directly parameter by ID number. G2.4.1   |
| B14                    | FB DIN4          | Can be used to control RO or directly parameter by ID number. G2.4.1   |
| B15                    |                  | Reserved for future use.   |

Table 6-10, Fieldbus control word

**V1.3.2 FB Status Word ID 68**

Status word to fieldbus. The table below shows the bypass operation for such fieldbus boards that natively support the bypass operation or can be parameterized to bypass mode.

|     | Signal                  | Comment   |
|-----|-------------------------|---|
| b0  | Ready On                | 0=Drive not ready to switch on<br>1=Drive ready to start charging                     |
| b1  | Ready Run               | 0=Drive not ready to run<br>1=Drive ready and MCB is ON                               |
| b2  | Running                 | 0=Drive not running<br>1=Drive in Run state (Modulating)                              |
| b3  | Fault                   | 0=No active fault<br>1=Fault is active  |
| b4  | Run Enable Status       | 0= Run Disabled. Drive in stop state<br>1= Run Enabled. Drive can be started.         |
| b5  | Quick Stop Active       | 0=Quick Stop Active<br>1=Quick Stop not Active  |
| b6  | CB Control OK           | 0= Status opposite of control<br>1= Status and control OK                             |
| b7  | Warning                 | 0= No active warnings<br>1= Warning active  |
| b8  | At Reference            | 0= DC Voltage Ref and Act DC Voltage are not same.                                    |
| b9  | Fieldbus Control Active | 0=Fieldbus control not active<br>1=Fieldbus control active                            |
| b10 | Above Limit             | 0= DC Voltage is below P2.5.5.2 level<br>1=The DC Voltage is above the P2.5.5.2 level |
| b11 |                         | Reserved for future use.  |
| b12 |                         | Reserved for future use.  |
| b13 |                         | Reserved for future use.  |
| b14 | DC Charge DO Control    | 0= DC not charged<br>1= DC Charging Active  |
| b15 | Watchdog                | Same as received on bit 11 of the main control word.                                  |

*Table 6-11, Fieldbus status word*

**V1.3.3 FB Actual Value ID865**

Use Process data ID to drive this value.

**V1.3.4 FB Speed Reference ID875**

Use Process data ID to drive this value.

**V1.3.5 FB Torque Reference ID1140**

Use Process data ID to drive this value.

V1.3.6 Generator Control Word ID1700

|     | FALSE | TRUE |
|-----|-------|------|
| b0  |       |      |
| b1  |       |      |
| b2  |       |      |
| b3  |       |      |
| b4  |       |      |
| b5  |       |      |
| b6  |       |      |
| b7  |       |      |
| b8  |       |      |
| b9  |       |      |
| b10 |       |      |
| b11 |       |      |
| b12 |       |      |
| b13 |       |      |
| b14 |       |      |
| b15 |       |      |

Table 6-12, Generator control word

V1.3.7 Generator Status Word ID1701

|     | FALSE | TRUE                          |
|-----|-------|-------------------------------|
| b0  |       | Generation Operation Selected |
| b1  |       | DC Control Active             |
| b2  |       |                               |
| b3  |       |                               |
| b4  |       |                               |
| b5  |       |                               |
| b6  |       |                               |
| b7  |       |                               |
| b8  |       |                               |
| b9  |       |                               |
| b10 |       |                               |
| b11 |       |                               |
| b12 |       |                               |
| b13 |       |                               |
| b14 |       |                               |
| b15 |       |                               |

Table 6-13, Generator status word

V1.3.8 *Fault Word 1* ID 1172

| Fault Word 1 |   |
|--------------|---|
| Bit          | Fault(s)  |
| B0           | F1 Over current, F31 IGBT, F41 IGBT                         |
| B1           | F2 Over Voltage   |
| B2           | F9 Under Voltage  |
| B3           |   |
| B4           | F3 Earth Fault  |
| B5           |   |
| B6           | F14 Unit Over Temperature                                   |
| B7           | F16 Motor Temperature, F29 Thermistor, F56 PT100, F65 PT100 |
| B8           | F10 Line Synch fault (AFE), F10 Input line fault (INU)      |
| B9           |   |
| B10          |   |
| B11          | F52 Keypad or F52 PC communication fault                    |
| B12          | F53 FieldBus fault  |
| B13          | F59 System Bus fault  |
| B14          | F54 Slot Communication fault                                |
| B15          | F50 4mA fault   |

Table 6-14, Fault word 1

V1.3.9 *Fault Word 2* ID 1173

| Fault Word 2 |                             |
|--------------|-----------------------------|
| Bit          | Fault(s)                    |
| B0           |                             |
| B1           |                             |
| B2           | F43 Encoder Fault           |
| B3           |                             |
| B4           |                             |
| B5           |                             |
| B6           | F51 External fault          |
| B7           |                             |
| B8           |                             |
| B9           | F31 IGBT, F41 IGBT          |
| B10          |                             |
| B11          |                             |
| B12          |                             |
| B13          |                             |
| B14          | F64 Main Switch State fault |
| B15          |                             |

Table 6-15, Fault word 2

**V1.3.10 Warning Word 1 ID 1174**

| Warning Word 1 ID1174 |                       |
|-----------------------|-----------------------|
| Bit                   | Warning(s)            |
| B0                    |                       |
| B1                    |                       |
| B2                    |                       |
| B3                    |                       |
| B4                    |                       |
| B5                    |                       |
| B6                    | F53 FB Warning Slot D |
| B7                    | F67 FB Warning Slot E |
| B8                    | W14 Over Temperature  |
| B9                    |                       |
| B10                   |                       |
| B11                   |                       |
| B12                   |                       |
| B13                   |                       |
| B14                   |                       |
| B15                   |                       |

*Table 6-16, Warning word***V1.3.11 Warning ID74**

Last active warning number.

**V1.3.12 Last Active Fault ID37**

Last active fault. number.

**V1.3.13 Speed, FB Scaled ID1907****V1.3.14 FB Analog Out % ID48**

Fieldbus value to control analogue output.

#### 6.2.4 I/O MONITORING VALUES

V1.4.1 *DIN1, DIN2, DIN3* *ID 15*

V1.4.2 *DIN4, DIN5, DIN6* *ID 16*

|    | DIN1/DIN2/DIN3 status | DIN4/DIN5/DIN6 status |
|----|-----------------------|-----------------------|
| b0 | DIN3                  | DIN6                  |
| b1 | DIN2                  | DIN5                  |
| b2 | DIN1                  | DIN4                  |

Table 6-17, Digital input status word 1

V1.4.3 *DIN Status 1* *ID 56*

V1.4.4 *DIN Status 2* *ID 57*

|     | DIN StatusWord 1 | DIN StatusWord 2 |
|-----|------------------|------------------|
| b0  | DIN: A.1         | DIN: C.5         |
| b1  | DIN: A.2         | DIN: C.6         |
| b2  | DIN: A.3         | DIN: D.1         |
| b3  | DIN: A.4         | DIN: D.2         |
| b4  | DIN: A.5         | DIN: D.3         |
| b5  | DIN: A.6         | DIN: D.4         |
| b6  | DIN: B.1         | DIN: D.5         |
| b7  | DIN: B.2         | DIN: D.6         |
| b8  | DIN: B.3         | DIN: E.1         |
| b9  | DIN: B.4         | DIN: E.2         |
| b10 | DIN: B.5         | DIN: E.3         |
| b11 | DIN: B.6         | DIN: E.4         |
| b12 | DIN: C.1         | DIN: E.5         |
| b13 | DIN: C.2         | DIN: E.6         |
| b14 | DIN: C.3         |                  |
| b15 | DIN: C.4         |                  |

Table 6-18, Digital input status word 2

V1.4.5 *Analogue Input 1* % *ID13*

V1.4.6 *Analogue Input 2* % *ID14*

V1.4.7 *Analogue Input 3* % *ID 27*

V1.4.8 *Analogue input 4* % *ID 28*

Unfiltered analogue input level.

0% = 0 mA / 0 V, -100% = -10 V, 100% = 20 mA / 10 V.

Monitoring scaling is determined by the option board parameter.

It is possible to adjust this input value from fieldbus when the input terminal selection is 0.1. This way it is possible to adjust the free analogue input from fieldbus and have all analogue input functions available for fieldbus process data.

V1.4.9 *Analogue Out 1* % ID 26

V1.4.10 *Analogue Out 2* % ID 50

V1.4.11 *Analogue Out 3* % ID 51

Analogue Output value 0% = 0 mA / 0 V, 100% = 20 mA / 10 V

V1.4.12 *PT100 Temp. 1* °C ID 50

V1.4.13 *PT100 Temp. 2* °C ID 51

V1.4.14 *PT100 Temp. 3* °C ID 52

V1.4.15 *PT100 Temp. 4* °C ID 69

V1.4.16 *PT100 Temp. 5* °C ID 70

V1.4.17 *PT100 Temp. 6* °C ID 71

Separate measurement from two PT100 board. The signal has 4 s filtering time.

V1.4.18 *PT-100 Temperature* C° ID 42

Highest temperature of OPTB8 board. 4 s filtering.



**6.2.5 MASTER FOLLOWER MONITORING VALUES***V1.5.1 SB System Status ID1800*

| System Bus Status Word ID1800 |                             |
|-------------------------------|-----------------------------|
|                               | FALSE TRUE                  |
| b0                            | Drive 1 System Bus in Synch |
| b1                            | Drive 1 Ready               |
| b2                            | Drive 1 Running             |
| b3                            | Drive 1 Fault               |
| b4                            | Drive 2 System Bus in Synch |
| b5                            | Drive 2 Ready               |
| b6                            | Drive 2 Running             |
| b7                            | Drive 2 Fault               |
| b8                            | Drive 3 System Bus in Synch |
| b9                            | Drive 3 Ready               |
| b10                           | Drive 3 Running             |
| b11                           | Drive 3 Fault               |
| b12                           | Drive 4 System Bus in Synch |
| b13                           | Drive 4 Ready               |
| b14                           | Drive 4 Running             |
| b15                           | Drive 4 Fault               |

*Table 6-19, System bus status word**V1.5.2 System Current ID80*

Sum current of all drives in system bus

*V1.5.3.1 Current D1 ID1820**V1.5.3.2 Current D2 ID1821**V1.5.3.3 Current D3 ID1822**V1.5.3.4 Current D4 ID1823*

|          |                |   |        |
|----------|----------------|---|--------|
| V1.5.4.1 | Status Word D1 | # | ID1828 |
| V1.5.4.2 | Status Word D2 | # | ID1829 |
| V1.5.4.3 | Status Word D3 | # | ID1830 |
| V1.5.4.4 | Status Word D4 | # | ID1831 |

| Follower Drive Status Word |                    |                  |
|----------------------------|--------------------|------------------|
|                            | FALSE              | TRUE             |
| b0                         |                    |                  |
| b1                         | Not in Ready state | Ready            |
| b2                         | Not Running        | Running          |
| b3                         | No Fault           | Fault            |
| b4                         |                    |                  |
| b5                         |                    |                  |
| b6                         |                    |                  |
| b7                         |                    |                  |
| b8                         |                    |                  |
| b9                         |                    |                  |
| b10                        | SB Not In Synch    | SB In Synch      |
| b11                        |                    |                  |
| b12                        |                    |                  |
| b13                        |                    |                  |
| b14                        |                    |                  |
| b15                        | Heard Beat Pulse   | Heard Beat Pulse |

*Table 6-20, Follower drive status word*

## 7. ARFIFF30– PARAMETER LIST

In this document you will find the lists of parameters and monitoring values which are available in this application.

### 7.1 BASIC PARAMETERS (G2.1)

| Code    | Parameter             | Min                            | Max                            | Unit | Default | ID   | Note  |
|---------|-----------------------|--------------------------------|--------------------------------|------|---------|------|---|
| P2.1.1  | Mot/Gen Type          | 0                              | 2                              |      | 0       | 650  | 0 = Synchronous Machine<br>1 = PM Motor<br>2 = Asynchronous Motor   |
| P2.1.2  | Nominal Voltage       | 400V:<br>323V<br>690V:<br>446V | 400V:<br>550V<br>690V:<br>758V | V    | 400     | 110  | Set here the nominal voltage of the generator.  |
| P2.1.3  | Nominal Frequency     | 0                              | 125                            | Hz   | 50      | 1532 |   |
| P2.1.4  | Nominal Current       | 0.0                            |                                | A    |         | 113  |   |
| P2.1.5  | Nominal Speed         | 24                             | 20000                          | rpm  | 1440    | 112  |   |
| P2.1.6  | Nominal Cos Phi       | 0.30                           | 1.00                           |      | 0.85    | 120  |   |
| P2.1.7  | Nominal Power         | 0                              | 32700                          | kW   | 0       | 116  |   |
| P2..1.8 | Magnetization Current |                                |                                |      |         | 612  |   |
| P2.1.9  | Parallel Generator    | 0                              | 1                              |      | 0       | 1501 | 0 = Single Generator<br>1 = Parallel Generator<br>Activation will set DC Drooping to 4%.  |
| P2.1.10 | Identification        | 0                              | 8                              |      | 0       | 631  | <b>0=No action</b><br><b>1=Identification w/o run</b><br><b>2=Identification with run</b><br><b>3=Encoder ID Run</b><br><b>4=Ident All</b><br><b>5=Absolute encoder, locked rotor</b><br><b>6=U/f and Magn.Current</b><br><b>7=DTC ident.</b><br><b>8=Current Meas. Offset AFE.</b><br><b>NOTE: Set motor control mode to Freq Control before identification!</b> |

Table 7-1, Basic parameters

## 7.2 REFERENCE HANDLING (G2.2)

### 7.2.1 PTM HANDLING

| Code     | Parameter          | Min  | Max   | Unit | Default | ID   | Note   |
|----------|--------------------|------|-------|------|---------|------|--|
| P2.2.1.1 | Power Take Mode 00 | 0    | 4     |      | 0       | 1910 | 0 = Commissioning<br>1 = PTO<br>2 = PTI-BOOST<br>3 = PTI- 0-Speed<br>4 = Regen Motor |
| P2.2.1.2 | Power Take Mode 01 | 0    | 4     |      | 0       | 1902 | 0 = Commissioning<br>1 = PTO<br>2 = PTI-BOOST<br>3 = PTI- 0-Speed<br>4 = Regen Motor |
| P2.2.1.3 | Power Take Mode 10 | 0    | 4     |      | 0       | 1903 | 0 = Commissioning<br>1 = PTO<br>2 = PTI-BOOST<br>3 = PTI- 0-Speed<br>4 = Regen Motor |
| P2.2.1.4 | Power Take Mode 11 | 0    | 4     |      | 0       | 1904 | 0 = Commissioning<br>1 = PTO<br>2 = PTI-BOOST<br>3 = PTI- 0-Speed<br>4 = Regen Motor |
| P2.2.1.5 | PTM Stop Time      | 0.00 | 30.00 | s    | 3.00    | 1915 |  |

Table 7-2, Power take mode handling

### 7.2.2 PTO HANDLING

| Code      | Parameter               | Min | Max   | Unit | Default | ID   | Note  |
|-----------|-------------------------|-----|-------|------|---------|------|---|
| 2.2.1.6.1 | Torque Select           | 0   | 5     |      | 0       | 1931 | 0 = Speed<br>1 = Torque<br>2 = Ramp Out<br>3 = Min<br>4 = Max<br>5 = Window   |
| 2.2.1.6.2 | Torque Reference Select | 0   | 6     |      | 0       | 1929 | 0 = Torque Ref Max<br>1 = Curve 1<br>2 = Analogue Input 1<br>3 = Analogue Input 2<br>4 = AI1 Joystick<br>5 = AI2 Joystick<br>6 = Fieldbus<br>7 = Curve 2<br>8 = Curve 3 |
| 2.2.1.6.3 | Load Share              | 0.0 | 400.0 | %    | 100.0   | 1248 |   |

Table 7-3, Power take out handling

**7.2.3 PTI-BOOST HANDLING**

| Code      | Parameter               | Min | Max | Unit | Default | ID   | Note  |
|-----------|-------------------------|-----|-----|------|---------|------|---|
| 2.2.1.7.1 | Torque Select           | 0   | 5   |      | 0       | 1930 | 0 = Speed<br>1 = Torque<br>2 = Ramp Out<br>3 = Min<br>4 = Max<br>5 = Window   |
| 2.2.1.7.2 | Torque Reference Select | 0   | 6   |      | 0       | 1928 | 0 = Torque Ref Max<br>1 = Curve 1<br>2 = Analogue Input 1<br>3 = Analogue Input 2<br>4 = AI1 Joystick<br>5 = AI2 Joystick<br>6 = Fieldbus<br>7 = Curve 2<br>8 = Curve 3 |

Table 7-4, Power Take in boost handling

**7.2.4 PTI 0-SPEED**

| Code      | Parameter               | Min | Max | Unit | Default | ID   | Note  |
|-----------|-------------------------|-----|-----|------|---------|------|---|
| 2.2.1.8.1 | Torque Select           | 0   | 5   |      | 0       | 1933 | 0 = Speed<br>1 = Torque<br>2 = Ramp Out<br>3 = Min<br>4 = Max<br>5 = Window   |
| 2.2.1.8.2 | Torque Reference Select | 0   | 6   |      | 0       | 1932 | 0 = Torque Ref Max<br>1 = Curve 1<br>2 = Analogue Input 1<br>3 = Analogue Input 2<br>4 = AI1 Joystick<br>5 = AI2 Joystick<br>6 = Fieldbus<br>7 = Curve 2<br>8 = Curve 3 |

Table 7-5, Power take in zero speed parameters

**7.2.5 REGEN MOTOR MODE**

| Code      | Parameter   | Min | Max   | Unit | Default | ID   | Note |
|-----------|-------------|-----|-------|------|---------|------|------|
| 2.2.1.9.1 | License Key | 0   | 65535 |      | 0       | 1995 |      |
| 2.2.1.9.2 | Reserved    |     |       |      |         |      |      |

Table 7-6, Regenerative motor mode parameters

## 7.2.6 COMMISSIONING

| Code       | Parameter               | Min | Max | Unit | Default | ID   | Note  |
|------------|-------------------------|-----|-----|------|---------|------|---|
| 2.2.1.10.1 | MC Mode                 | 0   | 4   |      | 0       | 1913 | 0 = AFE<br>1 = Freq. Control<br>2 = OL Torque Control<br>3 = CL Speed Control<br>4 = CL Torque Control  |
| 2.2.1.10.2 | DC Control              | 0   | 1   |      | 0       | 1914 | 0 = No<br>1 = Yes   |
| 2.2.1.10.3 | Torque Select           | 0   | 5   |      | 0       | 1278 | 0 = Speed<br>1 = Torque<br>2 = Ramp Out<br>3 = Min<br>4 = Max<br>5 = Window   |
| 2.2.1.10.4 | Torque Reference Select | 0   | 6   |      | 1       | 641  | 0 = Torque Ref Max<br>1 = Curve 1<br>2 = Analogue Input 1<br>3 = Analogue Input 2<br>4 = AI1 Joystick<br>5 = AI2 Joystick<br>6 = Fieldbus<br>7 = Curve 2<br>8 = Curve 3 |

Table 7-7, Commissioning parameters

## 7.2.7 DC VOLTAGE REFERENCE HANDLING

| Code     | Parameter                  | Min           | Max           | Unit | Default | ID   | Note  |
|----------|----------------------------|---------------|---------------|------|---------|------|---|
| P2.2.2.1 | System Nominal AC          | 400V:<br>323V | 400V:<br>550V | V    | 0       | 1201 | Keep zero if motor or generator voltage is same as grid voltage.  |
| P2.2.2.2 | System Nominal DC          | 690V:<br>446V | 690V:<br>758V | V    | 0       | 1809 |   |
| P2.2.2.3 | DC Voltage Ref.            | 0             | 1500          | V    | 0       | 1462 | DC Voltage reference as % of Nominal DC Voltage<br><br>Nominal DC voltage = 1.35 * Supply voltage                 |
| P2.2.2.4 | DC Voltage Drooping        | 500V:<br>105% | 500V:<br>130% | %    | 110.00  | 1462 | AFE drooping DC-voltage. Parallel 3.00%   |
| P2.2.2.5 | Reactive Current Reference | 0             | 100           | %    | 0       | 620  | Regenerative reactive current reference 100,0 = nominal current.<br>Positive = Inductive<br>Negative = Capacitive |
| P2.2.2.6 | DC Voltage Filtering time  | -100          | 100           | %    | 0       | 1459 |   |
| P2.2.2.6 | DC Voltage Filtering time  | 0             | 15.00         | s    | 0,03    | 1760 |   |

Table 7-8, DC voltage reference handling

**7.2.8 SPEED / FREQUENCY REF HANDLING**

| Code     | Parameter        | Min | Max | Unit | Default | ID  | Note   |
|----------|------------------|-----|-----|------|---------|-----|--|
| P2.2.3.1 | Speed Ref Select | 0   | 5   |      | 0       | 117 | 0 = Keypad Reference<br>1 = Analogue Input 1<br>2 = Analogue Input 2<br>3 = AI1 Joystick<br>4 = AI2 Joystick<br>5 = Fieldbus |
| P2.2.3.2 | Min Frequency    | 0   | 125 |      | 0       | 101 |  |
| P2.2.3.3 | Max Frequency    | 0   | 125 |      | 50      | 102 |  |

Table 7-9, Speed / frequency reference handling

**7.2.9 TORQUE CONTROL**

| Code     | Parameter        | Min    | Max   | Unit | Default | ID   | Note |
|----------|------------------|--------|-------|------|---------|------|------|
| P2.2.4.1 | PTI Torq Ref Min | -300.0 | 300.0 | %    | 0.0     | 643  |      |
| P2.2.4.2 | PTI Torq Ref Max | -300.0 | 300.0 | %    | 100.0   | 642  |      |
| P2.2.4.3 | PTO Torq Ref Min | -300.0 | 300.0 | %    | 0.0     | 1926 |      |
| P2.2.4.4 | PTO Torq Ref Max | -300.0 | 300.0 | %    | -100.0  | 1927 |      |
| P2.2.4.5 | TRefRampUpRate   | -10    | 32000 | %/s  | 50,0    | 1934 |      |
| P2.2.4.6 | TRefRampDownRate | -10    | 32000 | %/s  | 200,0   | 1935 |      |

Table 7-10, Torque control

**7.2.10 MOTOR POTENTIOMETER REFERENCE**

| Code     | Parameter             | Min   | Max    | Unit  | Default | ID   | Note |
|----------|-----------------------|-------|--------|-------|---------|------|------|
| P2.2.5.1 | Frequency Adjust Rate | 0.001 | 20.000 | Hz/s  | 0.100   | 331  |      |
| P2.2.5.2 | Frequency Down        | 0.1   | E.10   | DigIN | 0.1     | 417  |      |
| P2.2.5.3 | Frequency Up          | 0.1   | E.10   | DigIN | 0.1     | 418  |      |
| P2.2.5.4 | Frequency Max Adjust  | 0.00  | 25.00  | Hz    | 5.00    | 1558 |      |

Table 7-11, Motor potentiometer reference parameters

**7.3 RAMP CONTROL (G2.3)****7.3.1 RAMP CONTROL**

| Code   | Parameter      | Min | Max    | Unit | Default | ID   | Note                               |
|--------|----------------|-----|--------|------|---------|------|------------------------------------|
| P2.3.1 | Start Function | 0   | 1      |      | 1       | 1274 | 0 = Ramp Start<br>1 = Flying Start |
| P2.3.2 | Ramp Time      | 0.1 | 3200.0 | s    | 10.0    | 103  |                                    |
| P2.3.3 | Ramp Shape     | 0   | 100    | %    | 2       | 500  |                                    |

Table 7-12, Ramp control parameters

## 7.4 INPUT SIGNALS (G2.4)

### 7.4.1 BASIC SETTINGS

| Code     | Parameter        | Min | Max   | Unit | Default | ID   | Note   |
|----------|------------------|-----|-------|------|---------|------|--|
| P2.4.1.1 | Start/Stop Logic | 0   | 2     |      | 0       | 300  | 0=Start-No Act<br>1=RPuls-FPuls<br>2=RPuls-RPuls   |
| P2.4.1.2 | Input Inversion  | 0   | 65535 |      | 4       | 1091 | Inversion control of the input IO signals.<br>B0= INV Open Contactor<br>B1=INV Ext. Fault 1<br>B2=INV Ext. Fault 2 |

Table 7-13, Input signal basic parameters



## 7.4.2 DIGITAL INPUTS

| Code      | Parameter                       | Min | Max  | Unit | Default | ID   | Note   |
|-----------|---------------------------------|-----|------|------|---------|------|--|
| P2.4.2.1  | Start Signal 1                  | 0.1 | E.10 |      | A.1     | 403  | This parameter is used to choose the input for Run Request signal. When controlling the AFE from I/O this signal must be connected.            |
| P2.4.2.2  | Start Signal 2                  | 0.1 | E.10 |      | 0.1     | 404  | This parameter is used to choose the input for Stop Request signal.  |
| P2.4.2.3  | Open Contactor                  | 0.1 | E.10 |      | 0.1     | 1600 | This parameter is used to choose the input for Contactor Open signal. The signal is used to force the main contactor open and stop modulating. |
| P2.4.2.4  | MainContFeedBack                | 0.1 | E.10 |      | 0.1     | 1453 | AFE contactor feedback (MCC 1)   |
| P2.4.2.5  | Fault Reset                     | 0.1 | E.10 |      | A.3     | 414  | Contact closed: All faults are reset   |
| P2.4.2.6  | Ext Fault 1                     | 0.1 | E.10 |      | 0.1     | 405  | Can be inverted by Input inversion control.  |
| P2.4.2.7  | Ext Fault 2                     | 0.1 | E.10 |      | 0.2     | 406  | Can be inverted by Input inversion control.  |
| P2.4.2.8  | Run Enable                      | 0.1 | E.10 |      | 0.2     | 407  | Contact open: Start of motor disabled<br>Contact closed: Start of motor enabled  |
| P2.4.2.9  | Cooling Monitor                 | 0.1 | E.10 |      | 0.2     | 750  | OK input from the cooling unit   |
| P2.4.2.10 | Quick Stop                      | 0.1 | E.10 |      | 0.2     | 1213 |  |
| P2.4.2.11 | LCL Temperature                 | 0.1 | E.10 |      | 0.2     | 1179 |  |
| P2.4.2.12 | RR Enable                       | 0.1 | E.10 |      | 0.2     | 1896 | Disables final Run Command   |
| P2.4.2.13 | I/O Control                     | 0.1 | E.10 |      | 0.1     | 409  |  |
| P2.4.2.14 | Keypad Control                  | 0.1 | E.10 |      | 0.1     | 410  |  |
| P2.4.2.15 | Fieldbus Control                | 0.1 | E.10 |      | 0.1     | 411  |  |
| P2.4.2.16 | Power Take Mode 01              | 0.1 | E.10 |      | 0.1     | 1905 |  |
| P2.4.2.17 | Power Take Mode 10              | 0.1 | E.10 |      | 0.1     | 1906 |  |
| P2.4.2.18 | In Power Lim 1                  | 0.1 | E.10 |      | 0.1     | 1917 |  |
| P2.4.2.19 | In Power Lim 2                  | 0.1 | E.10 |      | 0.1     | 1918 |  |
| P2.4.2.20 | Out Power Lim 1                 | 0.1 | E.10 |      | 0.1     | 1919 |  |
| P2.4.2.21 | Out Power Lim 2                 | 0.1 | E.10 |      | 0.1     | 1920 |  |
| P2.4.2.22 | Active synchro                  | 0.1 | E.10 |      | 0.1     | 1610 |  |
| P2.4.2.23 | Active Direct                   | 0.1 | E.10 |      | 0.1     | 1601 |  |
| P2.4.2.24 | Reset Direct                    | 0.1 | E.10 |      | 0.1     | 1612 |  |
| P2.4.2.25 | Parameter set 1/set 2 selection | 0.1 | E.10 |      | 0.1     | 496  | Closed cont.=Set 2 is used<br>Open cont.=Set 1 is used   |
| P2.4.2.26 | Klixon In 1                     | 0.1 | E.10 |      | 0.2     | 780  |  |
| P2.4.2.27 | Klixon In 2                     | 0.1 | E.10 |      | 0.2     | 781  |  |
| P2.4.2.28 | Input Switch                    | 0.1 | E.10 |      | 0.2     | 1209 |  |
| P2.4.2.29 | Ambient Temp                    | 0.1 | E.10 |      | 0.2     | 783  |  |

Table 7-14, Digital input parameters

### 7.4.3 ANALOGUE INPUT 1

| Code      | Parameter                            | Min     | Max    | Unit | Default | ID   | Note                               |
|-----------|--------------------------------------|---------|--------|------|---------|------|------------------------------------|
| P2.4.3.1  | AI1 signal selection                 | 0.1     | E.10   |      | A.1     | 377  |                                    |
| P2.4.3.2  | AI1 filter time                      | 0.000   | 32.000 | s    | 0.000   | 324  |                                    |
| P2.4.3.3  | AI1 custom minimum setting           | -160.00 | 160.00 | %    | 0.00    | 321  | 4 mA protection active is > 16.00% |
| P2.4.3.4  | AI1 custom maximum setting           | -160.00 | 160.00 | %    | 100.00  | 322  |                                    |
| P2.4.3.5  | AI1 reference scaling, minimum value | 0       | 320,00 | Hz   | 0,00    | 1722 |                                    |
| P2.4.3.6  | AI1 reference scaling, maximum value | 0       | 320,00 | Hz   | 0,00    | 1723 |                                    |
| P2.4.3.7  | AI1 signal inversion                 | 0       | 1      |      | 0       | 387  |                                    |
| P2.4.3.8  | AI1 scaling, minimum value           | -32000  | 32000  |      | 0       | 303  |                                    |
| P2.4.3.9  | AI1 scaling, maximum value           | -32000  | 32000  |      | 0       | 304  |                                    |
| P2.4.3.10 | AI1 Controlled ID                    | 0       | 10000  |      | 0       | 1507 |                                    |

Table 7-15, Analog input 1 parameters

### 7.4.4 ANALOGUE INPUT 2

| Code      | Parameter                            | Min     | Max    | Unit | Default | ID   | Note                               |
|-----------|--------------------------------------|---------|--------|------|---------|------|------------------------------------|
| P2.4.4.1  | AI2 signal selection                 | 0.1     | E.10   |      | A.2     | 388  |                                    |
| P2.4.4.2  | AI2 filter time                      | 0.000   | 32.000 | s    | 0.000   | 329  |                                    |
| P2.4.4.3  | AI2 custom minimum setting           | -160.00 | 160.00 | %    | 20.00   | 326  | 4 mA protection active is > 16.00% |
| P2.4.4.4  | AI2 custom maximum setting           | -160.00 | 160.00 | %    | 100.00  | 327  |                                    |
| P2.4.4.5  | AI2 reference scaling, minimum value | 0       | 320,00 | Hz   | 0,00    | 1724 |                                    |
| P2.4.4.6  | AI2 reference scaling, maximum value | 0       | 320,00 | Hz   | 0,00    | 1725 |                                    |
| P2.4.4.7  | AI2 signal inversion                 | 0       | 1      |      | 0       | 398  |                                    |
| P2.4.4.8  | AI2 reference scaling, minimum value | -32000  | 32000  |      | 0       | 393  |                                    |
| P2.4.3.9  | AI2 reference scaling, maximum value | -32000  | 32000  |      | 0       | 394  |                                    |
| P2.4.4.10 | AI2 Controlled ID                    | 0       | 10000  |      | 0       | 1511 |                                    |

Table 7-16, Analog input 2 parameters

**7.4.5 ANALOGUE INPUT 3**

| Code     | Parameter                            | Min     | Max    | Unit | Default | ID   | Note |
|----------|--------------------------------------|---------|--------|------|---------|------|------|
| P2.4.5.1 | AI3 signal selection                 | 0.1     | E.10   |      | 0.1     | 141  |      |
| P2.4.5.2 | AI3 filter time                      | 0.000   | 32.000 | s    | 0.000   | 142  |      |
| P2.4.5.3 | AI3 custom minimum setting           | -160.00 | 160.00 | %    | 0.00    | 144  |      |
| P2.4.5.4 | AI3 custom maximum setting           | -160.00 | 160.00 | %    | 100.00  | 145  |      |
| P2.4.5.5 | AI3 signal inversion                 | 0       | 1      |      | 0       | 151  |      |
| P2.4.5.6 | AI3 reference scaling, minimum value | -32000  | 32000  |      | 0       | 1037 |      |
| P2.4.5.7 | AI3 reference scaling, maximum value | -32000  | 32000  |      | 0       | 1038 |      |
| P2.4.5.8 | AI3 Controlled ID                    | 0       | 10000  |      | 0       | 1509 |      |

*Table 7-17, Analog input 3 parameters***7.4.6 ANALOGUE INPUT 4**

| Code     | Parameter                            | Min     | Max    | Unit | Default | ID   | Note |
|----------|--------------------------------------|---------|--------|------|---------|------|------|
| P2.4.6.1 | AI4 signal selection                 | 0.1     | E.10   |      | 0.1     | 152  |      |
| P2.4.6.2 | AI4 filter time                      | 0.000   | 32.000 | s    | 0.000   | 153  |      |
| P2.4.6.3 | AI4 custom minimum setting           | -160.00 | 160.00 | %    | 20.00   | 155  |      |
| P2.4.6.4 | AI4 custom maximum setting           | -160.00 | 160.00 | %    | 100.00  | 156  |      |
| P2.4.6.5 | AI4 signal inversion                 | 0       | 1      |      | 0       | 162  |      |
| P2.4.6.6 | AI4 reference scaling, minimum value | -32000  | 32000  |      | 0       | 1039 |      |
| P2.4.6.7 | AI4 reference scaling, maximum value | -32000  | 32000  |      | 0       | 1040 |      |
| P2.4.6.8 | AI4 Controlled ID                    | 0       | 10000  |      | 0       | 1510 |      |

*Table 7-18, Analog input 4 parameters*

## 7.5 OUTPUT SIGNALS (G2.5)

### 7.5.1 DIG OUT SIGNALS

| Code      | Parameter                        | Min | Max  | Unit | Default | ID   | Note   |
|-----------|----------------------------------|-----|------|------|---------|------|--|
| P2.5.1.1  | Main Contactor Close             | 0.1 | E.10 |      | 0.1     | 1218 | AFE contactor, fixed to Relay output B.2   |
| P2.5.1.2  | Main Contactor Open              | 0.1 | E.10 |      | 0.1     | 1219 | Used if pulse control is need for main breaker.  |
| P2.5.1.3  | Ready                            | 0.1 | E.10 |      | 0.1     | 432  | The AC drive is ready to operate.  |
| P2.5.1.4  | Run                              | 0.1 | E.10 |      | 0.1     | 433  | The AC drive operates (the motor is running).  |
| P2.5.1.5  | Common Fault                     | 0.1 | E.10 |      | 0.1     | 434  | A fault trip has occurred.   |
| P2.5.1.6  | Fault, Inverted                  | 0.1 | E.10 |      | 0.1     | 435  | No fault trip has occurred.  |
| P2.5.1.7  | At reference                     | 0.1 | E.10 |      | 0.1     | 442  | The output frequency has reached the set reference<br><br>In AFE when DC-Voltage level is on setpoint. |
| P2.5.1.8  | OverTemp Warn.                   | 0.1 | E.10 |      | 0.1     | 439  | The heatsink temperature exceeds +70 C   |
| P2.5.1.9  | Warning                          | 0.1 | E.10 |      | 0.1     | 436  | General warning signal.  |
| P2.5.1.10 | Charge Control                   | 0.1 | E.10 |      | 0.1     | 1568 | Charge control from start command  |
| P2.5.1.11 | Common Alarm                     | 0.1 | E.10 |      | 0.1     | 1684 |  |
| P2.5.1.12 | Ready For Start                  | 0.1 | E.10 |      | 0.1     | 1686 | No conditions that could disable starting active   |
| P2.5.1.13 | Quick Stop Active                | 0.1 | E.10 |      | 0.1     | 1687 |  |
| P2.5.1.14 | Fieldbus digital input 1         | 0.1 | E.10 |      | 0.1     | 455  | FB CW B11  |
| P2.5.1.15 | FB Dig 1 Parameter               | ID0 | ID0  |      | 0       | 891  | Select parameter to control  |
| P2.5.1.16 | Fieldbus digital input 2         | 0.1 | E.10 |      | 0.1     | 456  | FB CW B12  |
| P2.5.1.17 | FB Dig 2 Parameter               | ID0 | ID0  |      | 0       | 892  | Select parameter to control  |
| P2.5.1.18 | Fieldbus digital input 3         | 0.1 | E.10 |      | 0.1     | 457  | FB CW B13  |
| P2.5.1.19 | FB Dig 3 Parameter               | ID0 | ID0  |      | 0       | 893  | Select parameter to control  |
| P2.5.1.20 | Fieldbus digital input 4         | 0.1 | E.10 |      | 0.1     | 169  | FB CW B14  |
| P2.5.1.21 | FB Dig 4 Parameter               | ID0 | ID0  |      | 0       | 894  | Select parameter to control  |
| P2.5.1.22 | Generator Operation              | 0.1 | E.10 |      | 0.1     | 1916 |  |
| P2.5.1.23 | Bypass CB                        | 0.1 | E.10 |      | 0.1     | 1603 |  |
| P2.5.1.24 | Temperature limit supervision    | 0.1 | E.10 |      | 0.1     | 450  | Drive temperature supervision. See ID354   |
| P2.5.1.25 | Encoder 1 supervision function 1 | 0.1 | E.10 |      | 0.1     | 3505 |  |
| P2.5.1.25 | Encoder 1 supervision function 1 | 0.1 | E.10 |      | 0.1     | 3506 |  |

Table 7-19, Digital output parameters

**7.5.2 DELAYED DO 1**

| Code     | Parameter        | Min  | Max     | Unit   | Default | ID   | Note   |
|----------|------------------|------|---------|--------|---------|------|--|
| P2.5.2.1 | Dig.Out 1 Signal | 0.1  | E.10    |        | 0.1     | 486  | Connect the delayed DO1 signal to the digital output of your choice with this parameter.   |
| P2.5.2.2 | DO1 Content      | 0    | 15      |        | 0       | 312  | 0=Not used<br>1=Ready<br>2=Run<br>3=Fault<br>4=Fault inverted<br>5=FC overheat warning<br>6=Ext. fault or warning<br>7=Ref. fault or warning<br>8=Warning<br>9=Reverse<br>10=<br>11= Start Command given<br>12= FB DIN2<br>13= FB DIN3<br>14=ID.Bit DO |
| P2.5.2.3 | DO1 ON Delay     | 0.00 | 320.00  | s      | 0.00    | 487  | 0.00 = On delay not in use   |
| P2.5.2.4 | DO1 OFF Delay    | 0.00 | 320.00  | s      | 0.00    | 488  | 0.00 = On delay not in use   |
| P2.5.2.5 | ID.Bit Free DO   | 0.00 | 2000.00 | ID.Bit | 0.00    | 1216 |  |

Table 7-20, Delayed digital output 1 parameters

**7.5.3 DELAYED DO 2**

| Code     | Parameter        | Min  | Max     | Unit   | Default | ID   | Note   |
|----------|------------------|------|---------|--------|---------|------|--|
| P2.5.3.1 | Dig.Out 2 Signal | 0.1  | E.10    |        | 0.1     | 489  | Connect the delayed DO2 signal to the digital output of your choice with this parameter.   |
| P2.5.3.2 | DO2 Content      | 0    | 15      |        | 0       | 490  | 0=Not used<br>1=Ready<br>2=Run<br>3=Fault<br>4=Fault inverted<br>5=FC overheat warning<br>6=Ext. fault or warning<br>7=Ref. fault or warning<br>8=Warning<br>9=Reverse<br>10=<br>11=Start Command given<br>12= FB DIN2<br>13=FB DIN3<br>14=ID.Bit DO |
| P2.5.3.3 | DO2 ON Delay     | 0.00 | 320.00  | S      | 0.00    | 491  | 0.00 = On delay not in use   |
| P2.5.3.4 | DO2 OFF Delay    | 0.00 | 320.00  | S      | 0.00    | 492  | 0.00 = On delay not in use   |
| P2.5.2.5 | ID.Bit Free DO   | 0.00 | 2000.00 | ID.Bit | 0.00    | 1217 |  |

*Table 7-21, Delayd digital output 2 parameters*

**7.5.4 ANALOG OUTPUT 1**

| Code     | Parameter           | Min       | Max        | Unit | Default             | ID  | Note  |
|----------|---------------------|-----------|------------|------|---------------------|-----|---|
| P2.5.4.1 | lout 1 signal       | AnOUT:0.1 | AnOUT:E.10 |      | AnOUT:A.1           | 464 | Connect the AO1 signal to the analogue output of your choice with this parameter. |
| P2.5.4.2 | lout Content        | 0         | 13         |      | 1 / 0/P<br>Freq     | 307 |   |
| P2.5.4.3 | lout Filter<br>Time | 0         | 10         | s    | 1                   | 308 | 0=No filtering  |
| P2.5.4.4 | lout Invert         | 0         | 1          |      | 0 / No<br>Inversion | 309 | 0=Not inverted<br>1=Inverted  |
| P2.5.4.5 | lout<br>Minimum     | 0         | 1          |      | 0 / 0 mA            | 310 | 0=0 mA<br>1=4 mA  |
| P2.5.4.6 | lout Scale          | 10        | 1000       | %    | 100                 | 311 | Percentage multiplier.<br>Defines output when<br>content is it maximum value      |
| P2.5.4.7 | lout Offset         | -100      | 100        | %    | 0                   | 375 | Add -1000 to 1000% to the<br>analogue output.                                     |

Table 7-22, Analog output 1 parameters

**7.5.5 ANALOG OUTPUT 2**

| Code     | Parameter           | Min       | Max        | Unit | Default             | ID  | Note  |
|----------|---------------------|-----------|------------|------|---------------------|-----|---|
| P2.5.5.1 | lout 2 signal       | AnOUT:0.1 | AnOUT:E.10 |      | AnOUT:0.1           | 471 | Connect the AO1 signal to the analogue output of your choice with this parameter. |
| P2.5.5.2 | lout Content        | 0         | 13         |      | 0 / Not<br>used     | 472 |   |
| P2.5.5.3 | lout Filter<br>Time | 0         | 10         | s    | 0.02                | 473 | 0=No filtering  |
| P2.5.5.4 | lout Invert         | 0         | 1          |      | 0 / No<br>Inversion | 474 | 0=Not inverted<br>1=Inverted  |
| P2.5.5.5 | lout<br>Minimum     | 0         | 1          |      | 0 / 0 mA            | 475 | 0=0 mA<br>1=4 mA  |
| P2.5.5.6 | lout Scale          | 10        | 1000       | %    | 100                 | 476 | Percentage multiplier.<br>Defines output when<br>content is it maximum value      |
| P2.5.5.7 | lout Offset         | -100      | 100        | %    | 0                   | 477 | Add -1000 to 1000% to the<br>analogue output.                                     |

Table 7-23, Analog output 2 parameters

### 7.5.6 ANALOG OUTPUT 3

| Code     | Parameter        | Min       | Max        | Unit | Default          | ID  | Note  |
|----------|------------------|-----------|------------|------|------------------|-----|---|
| P2.5.6.1 | lout 3 signal    | AnOUT:0.1 | AnOUT:E.10 |      | AnOUT:0.1        | 478 | Connect the AO1 signal to the analogue output of your choice with this parameter. |
| P2.5.6.2 | lout Content     | 0         | 13         |      | 0                | 479 |   |
| P2.5.6.3 | lout Filter Time | 0         | 10         | s    | 0,02             | 480 | 0=No filtering  |
| P2.5.6.4 | lout Invert      | 0         | 1          |      | 0 / No Inversion | 481 | 0=Not inverted<br>1=Inverted  |
| P2.5.6.5 | lout Minimum     | 0         | 1          |      | 0 / 0 mA         | 482 | 0=0 mA<br>1=4 mA  |
| P2.5.6.6 | lout Scale       | 10        | 1000       | %    | 100              | 483 | Percentage multiplier. Defines output when content is it maximum value            |
| P2.5.6.7 | lout Offset      | -100      | 100        | %    | 0                | 484 | Add -1000 to 1000% to the analogue output.  |

Table 7-24, Analog output 3 parameters

### 7.5.7 OPTIONS

| Code     | Parameter            | Min  | Max   | Unit | Default      | ID   | Note   |
|----------|----------------------|------|-------|------|--------------|------|--|
| P2.5.7.1 | Output Inversion     | 0    | 65535 |      | 0            | 1806 |  |
| P2.5.7.2 | DC Supervision Limit | 0    | 1500  | V    |              | 1454 |  |
| P2.5.7.3 | MCB At Stop Command  | 0    | 1     |      | 0            | 1685 | 0=Keep MCB Closed<br>1=Open MCB  |
| P2.5.7.4 | MCB Close Delay      | 0.00 | 3.00  |      | 0.00         | 1513 | Delay to MCB RO  |
| P2.5.7.5 | MCB Close Mode       | 0    | 3     |      | 0/DC Voltage | 1607 | 0 = DC Voltage<br>1 = DC or Start command<br>2 = Start Command.<br>3 = DC, Start or Pre-Charge |

Table 7-25, Output signal options

### 7.5.8 SUPERVISION LIMITS

| Code     | Parameter                                  | Min  | Max    | Unit | Default | ID   | Note   |
|----------|--|------|--------|------|---------|------|--|
| P2.5.8.1 | Temperature limit supervision function     | 0    | 2      |      | 0       | 354  | 0 = Not Used<br>1 = Low limit<br>2 = High limit. |
| P2.5.8.2 | Temperature supervision limit              | -10  | 75     | C    | 0       | 355  |  |
| P2.5.8.3 | Encoder 1 frequency supervision function 1 | 0    | 2      |      | 0       | 3503 | 0 = Not Used<br>1 = Low limit<br>2 = High limit. |
| P2.5.8.4 | Encoder 1 supervision frequency 1          | 0,00 | 320,00 | Hz   | 0       | 3507 |  |
| P2.5.8.5 | Encoder 1 frequency supervision function 2 | 0    | 2      |      | 0       | 3504 | 0 = Not Used<br>1 = Low limit<br>2 = High limit. |
| P2.5.8.6 | Encoder 1 supervision frequency 2          | 0,00 | 320,00 | Hz   | 0       | 3508 |  |

Table 7-26, Supervision limits



## 7.6 LIMIT SETTINGS (G2.6)

### 7.6.1 CURRENT LIMIT

| Code     | Parameter                   | Min | Max    | Unit | Default | ID   | Note                 |
|----------|-----------------------------|-----|--------|------|---------|------|----------------------|
| P2.6.1.1 | Current Limit               | 0   | Varies | A    | Varies  | 107  | Total current limit  |
| P2.6.1.2 | Output Active Current Limit | 0   | 300,0  | %    | 150,0   | 1621 | Regen Active Current |
| P2.6.1.3 | Input Active Current Limit  | 0   | 300,0  | %    | 150,0   | 1622 | Regen Active Current |

Table 7-27, Current limit parameters

### 7.6.2 POWER LIMIT

| Code      | Parameter                    | Min    | Max   | Unit | Default | ID   | Note   |
|-----------|------------------------------|--------|-------|------|---------|------|--|
| P2.6.2.1  | OutputPowerLim               | 0      | 300   | %    | 150,0   | 1290 |  |
| P2.6.2.2  | InputPowerLim                | 0      | 300   | %    | 150,0   | 1289 |  |
| P2.6.2.3  | PowerLimIncRate              | 0      | 10000 | %/s  | 10      | 1502 |  |
| P2.6.2.4  | Input power limit scaling    | 0      | 3     |      | 0       | 179  | 0 = Parameter<br>1 = Curve 1<br>2 = Curve 2<br>3 = Curve 3 |
| P2.6.2.5  | Output power limit scaling   | 0      | 3     |      | 0       | 1088 | 0 = Parameter<br>1 = Curve 1<br>2 = Curve 2<br>3 = Curve 3 |
| P2.6.2.6  | In Power Lim 1               | 0      | 300   | %    | 50      | 1921 |  |
| P2.6.2.7  | In Power Lim 2               | 0      | 300   | %    | 25      | 1922 |  |
| P2.6.2.8  | Out Power Lim 1              | 0      | 300   | %    | 50      | 1923 |  |
| P2.6.2.9  | Out Power Lim 2              | 0      | 300   | %    | 25      | 1924 |  |
| P2.6.2.10 | Under Voltage Power DC Level | 0      | 1200  | V    | 0       | 1611 |  |
| P2.6.2.11 | Under Voltage Power Limit    | -300,0 | 300,0 | %    | 0       | 1613 |  |

Table 7-28, Power limit parameters

### 7.6.3 FREQUENCY LIMIT

| Code     | Parameter                | Min  | Max    | Unit | Default | ID   | Note |
|----------|--------------------------|------|--------|------|---------|------|------|
| P2.6.3.1 | AFE Line Low Trip Limit  | 0,00 | 120,00 | Hz   | 25,00   | 1717 |      |
| P2.6.3.2 | AFE Line High Trip Limit | 0,00 | 120,00 | Hz   | 75,00   | 1716 |      |
| P2.6.3.3 | Neg Freq Limit           | -120 | 0,00   | Hz   | -0,10   | 1286 |      |
| P2.6.3.4 | Pos Freq Limit           | 0    | 120    | Hz   | 100,00  | 1285 |      |

Table 7-29, Frequency limit parameters

### 7.6.4 VOLTAGE

| Code     | Parameter               | Min  | Max    | Unit | Default | ID   | Note |
|----------|-------------------------|------|--------|------|---------|------|------|
| P2.6.4.1 | Voltage Low Trip Limit  | 0,00 | 320,00 | %    | 0,00    | 1891 |      |
| P2.6.4.2 | Voltage High Trip Limit | 0,00 | 320,00 | %    | 150,00  | 1892 |      |

Table 7-30, Voltage parameters

## 7.6.5 DC VOLTAGE

### 7.6.5.1 Open Loop

| Code       | Parameter           | Min              | Max               | Unit | Default           | ID   | Note |
|------------|---------------------|------------------|-------------------|------|-------------------|------|------|
| P2.6.5.1.1 | Over Voltage Kp     | 0                | 32767             |      | 2000              | 1468 |      |
| P2.6.5.1.2 | Over Voltage Ki     | 0                | 32767             |      | 500               | 1409 |      |
| P2.6.5.1.3 | OverVoltageKpAdd    | 0                | 32767             |      | 2000              | 1425 |      |
| P2.6.5.1.4 | Brake chopper       | 0                | 3                 |      | 0                 | 504  |      |
| P2.6.5.1.5 | Brake Chopper Level | 5: 605<br>6: 836 | 5: 797<br>6: 1099 | V    | 5: 797<br>6: 1099 | 1267 |      |

Table 7-31, DC voltage control open loop parameters

### 7.6.5.2 Closed Loop

| Code       | Parameter                                  | Min | Max   | Unit | Default | ID   | Note  |
|------------|--|-----|-------|------|---------|------|---|
| P2.6.5.2.1 | Over Voltage Kp                            | 0   | 32000 |      | 50      | 699  |   |
| P2.6.5.2.2 | Over Voltage Ki                            | 0   | 32000 |      | 15      | 698  |   |
| P2.6.5.2.3 | OverVoltageKpAdd                           | 0   | 32000 |      | 50      | 697  |   |
| P2.6.5.2.4 | Over Voltage Control Motoring Torque Limit | 0.0 | 300.0 | %    | 10.0    | 1623 |   |
| P2.6.5.2.5 | CL OV On PTI                               | 0   | 1     |      | 1       | 607  | OV Controller on PTI Operation<br>0 = Disabled<br>1 = Enabled |
| P2.6.5.2.6 | CL OV Ref On PTI                           | 83  | 118   | %    | 118     | 1528 | CL Over Voltage reference on PTI operation                    |
| P2.6.5.2.7 | Disable Iq Reset on Over Voltage Control   | 0   | 1     |      | 1       | 3501 |   |
| P2.6.5.2.8 | Under Voltage Controller                   | 0   | 1     |      | 0       | 608  | 0 = Off<br>1 = CL: On, OL: Off                                |
| P2.6.5.2.9 | CL Under Voltage Reference                 | 0   | 130   | %    | 65      | 1567 |   |

Table 7-32, DC voltage control closed loop parameters

## 7.6.6 TORQUE

| Code     | Parameter                      | Min | Max   | Unit | Default | ID   | Note   |
|----------|--------------------------------|-----|-------|------|---------|------|--|
| P2.6.6.1 | Generator Torque Limit         | 0.0 | 300.0 | %    | 120.0   | 1288 |  |
| P2.6.6.2 | Motoring Torque Limit          | 0.0 | 300.0 | %    | 300.0   | 1287 |  |
| P2.6.6.3 | TorqLimIncRate                 | 0   | 10000 | %/s  | 10      | 1819 |  |
| P2.6.6.4 | Generator Torque Limit Scaling | 0   | 3     |      | 0       | 1087 | 0 = Parameter<br>1 = Curve 1<br>2 = Curve 2<br>3 = Curve 3 |
| P2.6.6.5 | Motoring Torque Limit Scaling  | 0   | 3     |      | 0       | 485  | 0 = Parameter<br>1 = Curve 1<br>2 = Curve 2<br>3 = Curve 3 |
| P2.6.6.6 | Vdc TorqLimZero                | 0   | 1100  | Vdc  | 0       | 1992 |  |
| P2.6.6.7 | VdcZeroTRampUp                 | -10 | 3200  | %/s  | 100.0   | 1993 |  |

Table 7-33, DC voltage control torque parameters

**7.6.7 ACTIVE CURRENT**

| Code     | Parameter              | Min    | Max   | Unit | Default | ID   | Note |
|----------|------------------------|--------|-------|------|---------|------|------|
| P2.6.7.1 | Active Current Min Lim | -320,0 | 320.0 | %    | 0,0     | 1704 |      |
| P2.6.7.2 | Active Current Max Lim | -320,0 | 320.0 | %    | 120,0   | 1705 |      |

*Table 7-33, DC voltage control active current parameters*

**7.7 FLUX AND DC CURRENT HANDLING CL SETTINGS (G2.7)**

| Code   | Parameter                    | Min | Max            | Unit | Default | Cust | ID   | Note |
|--------|------------------------------|-----|----------------|------|---------|------|------|------|
| P2.7.1 | Magnetizing current at start | 0   | I <sub>L</sub> | A    | 0.00    |      | 627  |      |
| P2.7.2 | Magnetizing time at start    | 0.0 | 600.0          | s    | 0.0     |      | 628  |      |
| P2.7.3 | Flux Reference               | 0.0 | 500.0          | %    | 100.0   |      | 1250 |      |

*Table 7-34, DC voltage control flux and dc current handling*

## 7.8 MOTOR CONTROL (G2.8)

### 7.8.1 MOTOR CONTROL BASIC SETTINGS

| Code   | Parameter          | Min | Max | Unit | Default | Cust | ID  | Note  |
|--------|--------------------|-----|-----|------|---------|------|-----|---|
| P2.8.1 | Motor control mode | 0   | 2   |      | 0       |      | 600 | 0=Open Loop<br>1=Closed Loop<br>2=PM Sensorless |

Table 7-35, Motor control basic parameters

### 7.8.2 U/F SETTINGS

| Code      | Parameter                          | Min   | Max      | Unit | Default | Cust | ID   | Note   |
|-----------|------------------------------------|-------|----------|------|---------|------|------|--|
| P2.8.2.1  | U/f optimisation                   | 0     | 1        |      | 0       |      | 109  | 0=Not used<br>1=Automatic torque boost                               |
| P2.8.2.2  | U/f ratio selection                | 0     | 3        |      | 0       |      | 108  | 0=Linear<br>1=Squared<br>2=Programmable<br>3=Linear with flux optim. |
| P2.8.2.3  | Field weakening point              | 6.00  | 320.00   | Hz   | 50.00   |      | 602  |  |
| P2.8.2.4  | Voltage at field weakening point   | 10.00 | 200.00   | %    | 100.00  |      | 603  | $n\% \times U_{nmot}$  |
| P2.8.2.5  | U/f curve midpoint frequency       | 0.00  | P2.8.3.3 | Hz   | 50.00   |      | 604  |  |
| P2.8.2.6  | U/f curve midpoint voltage         | 0.00  | 100.00   | %    | 100.00  |      | 605  |  |
| P2.8.2.7  | Output voltage at zero frequency   | 0.00  | 40.00    | %    | 0.00    |      | 606  | $n\% \times U_{nmot}$  |
| P2.8.2.8  | U/f curve midpoint frequency 2     | 0.00  | P2.8.3.3 | Hz   | 50.00   |      | 1592 |  |
| P2.8.2.9  | U/f curve midpoint voltage 2       | 0.00  | 100.00   | %    | 100.00  |      | 1593 |  |
| P2.8.2.10 | U/f curve midpoint frequency 3     | 0.00  | P2.8.3.3 | Hz   | 50.00   |      | 1589 |  |
| P2.8.2.11 | U/f curve midpoint voltage 3       | 0.00  | 100.00   | %    | 100.00  |      | 1591 |  |
| P2.8.2.12 | Field weakening point 2            | 6.00  | 320.00   | Hz   | 50.00   |      | 1596 |  |
| P2.8.2.13 | Voltage at field weakening point 2 | 10.00 | 200.00   | %    | 100.00  |      | 1597 |  |

Table 7-36, U/f settings

### 7.8.2.1 Closed Loop Control Settings

| Code     | Parameter                 | Min  | Max    | Unit | Default | Cust | ID   | Note                                     |
|----------|---------------------------|------|--------|------|---------|------|------|--|
| P2.8.3.1 | Current control<br>P gain | 0.00 | 100.00 | %    | 40,00   |      | 617  |  |
| P2.8.3.2 | Current control<br>I Time | 0.0  | 3200.0 | ms   | 1.5     |      | 657  |  |
| P2.8.3.3 | Slip adjust               | 0    | 500    | %    | 75      |      | 619  |  |
| P2.8.3.4 | Speed Error Filter TC     | 0    | 1000   | ms   | 0       |      | 1311 |  |
| P2.8.3.5 | Encoder filter time       | 0    | 1000   | ms   | 0       |      | 618  |  |
| P2.8.3.6 | SC Torque Chain<br>Select | 0    | 65535  |      | 0       |      | 1557 |  |
| P2.8.3.7 | Encoder Selection         | 0    | 2      |      | 0       |      | 1595 | 0,1=Encoder Input 1<br>2=Encoder Input 2 |

Table 7-37, Motor control closed loop settings

### 7.8.3 PMSM CONTROL SETTINGS

| Code      | Parameter                                   | Min    | Max    | Unit | Default | Cust | ID   | Note  |
|-----------|---|--------|--------|------|---------|------|------|---|
| P2.8.4.1  | PMSM Shaft<br>Position                      | 0      | 65535  |      | 0       |      | 649  |   |
| P2.8.4.2  | Start Angle<br>Identification mode          | 0      | 10     |      | 0       |      | 1691 | 0=Automatic<br>1=Forced<br>2=After Power Up<br>3=Disabled |
| P2.8.4.3  | Start Angle<br>Identification DC<br>Current | 0.0    | 150.0  | %    | 0.0     |      | 1756 |   |
| P2.8.4.4  | Polarity Pulse<br>Current                   | -10.0  | 200.0  | %    | 0.0     |      | 1566 |   |
| P2.8.4.5  | Start Angle ID Time                         | 0      | 32000  | ms   | 0       |      | 1755 |   |
| P2.8.4.6  | I/f Current                                 | 0.0    | 150.0  | %    | 50.0    |      | 1693 |   |
| P2.8.4.7  | I/f Control Limit                           | 0.0    | 300.0  | %    | 10.0    |      | 1790 |   |
| P2.8.4.8  | Flux Current Kp                             | 0      | 32000  |      | 500     |      | 651  |   |
| P2.8.4.9  | Flux Current Ti                             | 0      | 1000   | ms   | 5       |      | 652  |   |
| P2.8.4.10 | External Id Ref                             | -100.0 | 100.0  |      | 0.0     |      | 1730 |   |
| P2.8.4.11 | Lsd Voltage Drop                            | -32000 | 32000  |      | 0       |      | 1757 |   |
| P2.8.4.12 | Lsq Voltage Drop                            | -32000 | 32000  |      | 0       |      | 1758 |   |
| P2.8.4.13 | I/f Current 2                               | 0,0    | 150,0  | %    | 0,0     |      | 1694 |   |
| P2.8.4.14 | I/f Control Limit 2                         | 0,0    | 300,0  | %    | 0,0     |      | 1791 |   |
| P2.8.4.15 | Current Control Kp<br>D                     | 0,00   | 320,00 | %    | 0,00    |      | 1761 |   |
| P2.8.4.16 | Voltage Margin                              | 0,0    | 120,0  | %    | 100,0   |      | 1762 |   |
| P2.8.4.17 | Enc ID Run Mode                             | 0      | 2      |      | 0       |      | 680  |   |

Table 7-38, PMSM control settings

**7.8.4 STABILATORS**

| Code      | Parameter                     | Min    | Max    | Unit | Default | Cust | ID   | Note              |
|-----------|-------------------------------|--------|--------|------|---------|------|------|-------------------|
| P2.8.5.1  | Torque Stabilator Damping     | 0      | 1000   |      | 800     |      | 1413 | With PMSM use 980 |
| P2.8.5.2  | Torque Stabilator Gain        | 0      | 1000   |      | 100     |      | 1412 |                   |
| P2.8.5.3  | Torque Stabilator Gain in FWP | 0      | 1000   |      | 50      |      | 1414 |                   |
| P2.8.5.4  | Torque Stabilator Limit       | 0      | 1500   |      | 150     |      | 1720 |                   |
| P2.8.5.5  | Flux Circle Stabilator Gain   | 0      | 32767  |      | 10000   |      | 1550 |                   |
| P2.8.5.6  | Flux Stabilator Gain          | 0      | 32000  |      | 500     |      | 1797 |                   |
| P2.8.5.6  | Flux Circle Stabilator TC     | 0      | 32700  |      | 900     |      | 1551 |                   |
| P2.8.5.8  | Flux Stab Coeff               | -30000 | 30000  |      |         |      | 1796 |                   |
| P2.8.5.9  | Voltage Stabilator Gain       | 0      | 100.0  | %    | 10.0    |      | 1738 |                   |
| P2.8.5.10 | Voltage Stabilator TC         | 0      | 1000   |      | 900     |      | 1552 |                   |
| P2.8.5.11 | Voltage Stabilator Limit      | 0      | 320.00 | Hz   | 1.50    |      | 1553 |                   |

*Table 7-39, Stabilator parameters*

## 7.8.5 IDENTIFICATION PARAMETERS

| Code      | Parameter                 | Min    | Max    | Unit | Default | Cust | ID   | Note |
|-----------|---------------------------|--------|--------|------|---------|------|------|------|
| P2.8.6.1  | Flux 10%                  | 0      | 2500   | %    | 10      |      | 1355 |      |
| P2.8.6.2  | Flux 20%                  | 0      | 2500   | %    | 20      |      | 1356 |      |
| P2.8.6.3  | Flux 30%                  | 0      | 2500   | %    | 30      |      | 1357 |      |
| P2.8.6.4  | Flux 40%                  | 0      | 2500   | %    | 40      |      | 1358 |      |
| P2.8.6.5  | Flux 50%                  | 0      | 2500   | %    | 50      |      | 1359 |      |
| P2.8.6.6  | Flux 60%                  | 0      | 2500   | %    | 60      |      | 1360 |      |
| P2.8.6.7  | Flux 70%                  | 0      | 2500   | %    | 70      |      | 1361 |      |
| P2.8.6.8  | Flux 80%                  | 0      | 2500   | %    | 80      |      | 1362 |      |
| P2.8.6.9  | Flux 90%                  | 0      | 2500   | %    | 90      |      | 1363 |      |
| P2.8.6.10 | Flux 100%                 | 0      | 2500   | %    | 100     |      | 1364 |      |
| P2.8.6.11 | Flux 110%                 | 0      | 2500   | %    | 110     |      | 1365 |      |
| P2.8.6.12 | Flux 120%                 | 0      | 2500   | %    | 120     |      | 1366 |      |
| P2.8.6.13 | Flux 130%                 | 0      | 2500   | %    | 130     |      | 1367 |      |
| P2.8.6.14 | Flux 140%                 | 0      | 2500   | %    | 140     |      | 1368 |      |
| P2.8.6.15 | Flux 150%                 | 0      | 2500   | %    | 150     |      | 1369 |      |
| P2.8.6.16 | Rs voltage drop           | 0      | 30000  |      | Varies  |      | 662  |      |
| P2.8.6.17 | Ir add zero point voltage | 0      | 30000  |      | Varies  |      | 664  |      |
| P2.8.6.18 | Ir add motoring scale     | 0      | 30000  |      | Varies  |      | 667  |      |
| P2.8.6.19 | Ir add generator scale    | 0      | 30000  |      | Varies  |      | 665  |      |
| P2.8.6.20 | Ls Voltage Dropp          | 0      | 3000   |      | 0       |      | 673  |      |
| P2.8.6.21 | Motor BEM Voltage         | 0.00   | 320.00 | %    | 0       |      | 674  |      |
| P2.8.6.22 | Iu Offset                 | -32000 | 32000  |      | 0       |      | 668  |      |
| P2.8.6.23 | Iv Offset                 | -32000 | 32000  |      | 0       |      | 669  |      |
| P2.8.6.24 | Iw Offset                 | -32000 | 32000  |      | 0       |      | 670  |      |
| P2.8.6.25 | Estimator Kp              | 0      | 32000  |      |         |      | 1781 |      |
| P2.8.6.26 | Estimator Ki              |        |        |      | 400     |      | 1782 |      |
| P2.8.6.27 | Voltage Dropp             | 0      | 2000   | %    |         |      | 671  |      |
| P2.8.6.28 | ID Run Curr. Kp           |        |        |      |         |      | 695  |      |
| P2.8.6.29 | FluxSaturatRatio          |        |        |      |         |      | 682  |      |
| P2.8.6.30 | T:Identification          | 0      | 65535  |      | 1       |      | 3520 |      |
| P2.8.6.31 | T:IdentOptions            | 0      | 65535  |      | 3       |      | 3521 |      |

Table 7-40. Identification parameters

## 7.8.6 TUNING PARAMETERS

| Code     | Parameter        | Min   | Max    | Unit | Default | Cust | ID   | Note |
|----------|------------------|-------|--------|------|---------|------|------|------|
| P2.8.7.1 | Voltage Corr. Kp | 0.000 | 32.000 |      | 0.100   |      | 1783 |      |
| P2.8.7.2 | Voltage Corr. Ki | 0     | 32000  |      | 5000    |      | 1784 |      |

Table 7-41, Tuning parameters

### 7.8.7 FLYING START TUNING PARAMETERS

| Code     | Parameter                | Min | Max   | Unit | Default | Cust | ID   | Note |
|----------|--------------------------|-----|-------|------|---------|------|------|------|
| P2.8.8.1 | Flying Start Options     | 0   | 65535 |      | 33      |      | 1770 |      |
| P2.8.8.2 | AC magnetization Current | 0.0 | 150.0 | %    | 70.0    |      | 1810 |      |
| P2.8.8.3 | AC Scanning Time         | 0   | 32000 | ms   | 900     |      | 1811 |      |
| P2.8.8.4 | DC magnetization Current | 0.0 | 150.0 | %    | 100.0   |      | 1812 |      |
| P2.8.8.5 | Flux Build Torque        | 0.0 | 300.0 |      | 10.0    |      | 1814 |      |
| P2.8.8.6 | Flux Build Time          | 0   | 10000 |      | 300     |      | 1813 |      |
| P2.8.8.7 | Magnetization Phases     | 0   | 20    |      | 10      |      | 1815 |      |
| P2.8.8.8 | FlyStartPhs1Time         | 0   | 1000  | ms   |         |      | 1718 |      |

Table 7-42, Flying start parameters

### 7.9 SPEED CONTROL (G2.9)

| Code   | Parameter                           | Min    | Max   | Unit | Default | Cust | ID  | Note  |
|--------|-------------------------------------|--------|-------|------|---------|------|-----|---|
| P2.9.1 | Speed controller P gain (open loop) | 0      | 32767 |      | 3000    |      | 637 |   |
| P2.9.2 | Speed controller I gain (open loop) | 0      | 32767 |      | 300     |      | 638 |   |
| P2.9.3 | Speed control P gain (Closed Loop)  | 0      | 1000  |      | 5       |      | 613 |   |
| P2.9.4 | Speed control I time (Closed Loop)  | -32000 | 32000 | ms   | 100     |      | 614 | Negative value uses 0.1 ms format instead of 1 ms |
| P2.9.5 | Load Drooping                       | 0      | 100   | %    | 0,00    |      | 647 |   |

Table 7-43. Speed control open loop settings



**7.10 DRIVE CONTROL (G2.10)**

| Code      | Parameter         | Min   | Max   | Unit | Default | ID   | Note                    |
|-----------|-------------------|-------|-------|------|---------|------|-------------------------|
| P 2.10.1  | Switching Freq    | 3.6   | 6     | kHz  | 3.6     | 601  |                         |
| P 2.10.2  | AFE Options 1     | 0     | 65535 |      | 544     | 1463 |                         |
| P 2.10.3  | AFE Options 2     | 0     | 65535 |      | 0       | 1464 | Reserved for future use |
| P 2.10.4  | Start Delay       | 0.00  | 3200  | s    | 1.0     | 1500 |                         |
| P 2.10.5  | AdvancedOptions1  | 0     | 65535 |      | 0       | 1560 |                         |
| P 2.10.6  | AdvancedOptions2  | 0     | 65535 |      | 0       | 1561 |                         |
| P 2.10.7  | AdvancedOptions3  | 0     | 65535 |      | 0       | 1562 |                         |
| P 2.10.8  | AdvancedOptions4  | 0     | 65535 |      | 0       | 1563 |                         |
| P 2.10.9  | AdvancedOptions5  | 0     | 65535 |      | 0       | 1564 |                         |
| P 2. 0.10 | AdvancedOptions6  | 0     | 65535 |      | 0       | 1565 |                         |
| P 2.10.11 | AdvancedOptions7  | 0     | 65535 |      | 0       | 1594 |                         |
| P 2.10.12 | Modulator Type    | 0     | 4     |      | 1       | 1516 |                         |
| P 2.10.13 | Control Options 1 | 0     | 65535 |      | 1024    | 1707 |                         |
| P2.10.14  | Control Options 2 | 0     | 65535 |      | 0       | 1798 |                         |
| P2.10.15  | Synch Kp Start    | 0     | 32000 |      | 4000    | 1698 |                         |
| P2.10.16  | Capacitor Size    | 0.0   | 100.0 |      | 6.3     | 1460 |                         |
| P2.10.17  | Inductor Size     | 0.0   | 100.0 |      | 15.5    | 1461 |                         |
| P2.10.18  | Operation Time    | 0     |       |      |         | 1855 |                         |
| P2.10.19  | Active Current Kp |       |       |      | 400     | 1455 |                         |
| P2.10.20  | Active Current Ti |       |       |      | 15      | 1456 |                         |
| P2.10.21  | Restart Delay     | 0     | 32000 |      | 1000    | 672  |                         |
| P2.10.22  | DC Voltage Kp     |       |       |      |         | 1451 |                         |
| P2.10.23  | DC Voltage Ti     |       |       |      |         | 1452 |                         |
| P2.10.24  | Synch Kp          |       |       |      |         | 1457 |                         |
| P2.10.25  | Synch Ti          |       |       |      |         | 1458 |                         |
| P2.10.26  | ModIndexLimit     | 0     | 150   | %    |         | 1936 |                         |
| P2.10.27  | DCLinkMeasCalib   | -2,00 | 2,00  | %    |         | 549  |                         |

Table 7-45, Drive control parameters

**7.11 MASTER FOLLOWER (G2.11)**

| Code    | Parameter               | Min  | Max  | Unit | Default | ID   | Note |
|---------|-------------------------|------|------|------|---------|------|------|
| P2.11.1 | MF Mode                 | 0    | 6    |      | 0       | 1324 |      |
| P2.11.2 | Follower Phase Shift    | -360 | 360  | Dec  | 0       | 1518 |      |
| P2.11.3 | DC Voltage Balance Gain | 0    | 1000 |      |         | 1519 |      |
| P2.11.4 | Reserved                |      |      |      |         |      |      |

Table 7-46, Master follower parameters

## 7.12 PROTECTION (G 2.12)

### 7.12.1 GENERAL

| Code       | Parameter                 | Min  | Max   | Unit | Default       | ID   | Note   |
|------------|---------------------------|------|-------|------|---------------|------|--|
| P2.12.1.1  | Thermistor Faul Response  | 0    | 3     |      | 2 / Fault     | 732  | 0=No response<br>1=Warning<br>2=Fault,stop acc. StopMode<br>3=Fault,stop by coasting |
| P2.12.1.2  | LCL Over Temperature      | 0    | 3     |      | 2             | 1505 |  |
| P2.12.1.3  | Max Charge Time           | 0.00 | 30.00 | s    | 5.00          | 1522 | Charging time limit when drive charging options are used.                            |
| P2.12.1.4  | MCC At Fault              | 0    | 1     |      | 0             | 1699 | 0= No Action<br>1=Open MCC   |
| P2.12.1.5  | Quick Stop Responce       | 0    | 2     |      | 1 / Warning   | 1543 | 0=No indication<br>1=Warning<br>2=Fault  |
| P2.12.1.6  | Reac Error Trip Limit     |      |       | %    | 7.5           | 1759 |  |
| P2.12.1.7  | MCC Fault Delay           |      |       | s    | 3.50          | 1521 |  |
| P2.12.1.8  | Line Phase Supervision    |      |       |      | 0 / No Action | 702  | 0=No Action<br>1=Warning<br>2=Fault  |
| P2.12.1.9  | 4 mA Fault Response       | 0    | 2     |      | 0 / No Action | 700  | 0=No Action<br>1=Warning<br>2=Fault  |
| P2.12.1.10 | Response to encoder fault | 1    | 3     |      | 2             | 1353 | <b>1=Warning</b><br><b>2=Fault</b><br><b>3=Warning: To Open Loop</b>                 |
| P2.12.1.11 | FaultWarnIndicat          | 0    | 2     |      | 1             | 1940 | <b>0=Static</b><br><b>1=Toggle</b><br><b>2=Marine</b>                                |
| P2.12.1.12 | Run Enable Indication     | 0    | 2     |      | 1             | 1177 | 0=No Action<br>1=Warning<br>2=Fault  |

Table 7-47, Protections parameters

**7.12.2 TEMPERATURE BOARD PARAMETERS**

| Code        | Parameter           | Min   | Max   | Unit | Default   | ID  | Note   |
|-------------|---------------------|-------|-------|------|-----------|-----|--|
| P2.12.2.1   | PT100 Channels      | 0     | 5     |      | 0         | 739 | 0= Not used (ID Write)<br>1= PT100 input 1<br>2= PT100 input 1 & 2<br>3= PT100 input 1 & 2 & 3<br>2= PT100 input 2 & 3<br>3= PT100 input 3 |
| P2.12.2.2   | PT100 FaultResponse | 0     | 3     |      | 2 / Fault | 740 | 0= No response<br>1= Warning<br>2= Fault,stop acc. to 2.4.7<br>3= Fault,stop by coasting   |
| P2.12.2.3   | PT100 Warn.Limit    | -30   | 200   | °C   | 120       | 741 |  |
| P2.12.2.4   | PT100 Fault Lim.    | -30   | 200   | °C   | 130       | 742 |  |
| P2.12.2.5   | PT100 2 Response    | 0     | 3     |      | 2 / Fault | 766 | 0= No response<br>1= Warning<br>2= Fault,stop acc. to 2.4.7<br>3= Fault,stop by coasting   |
| P2.12.2.6   | PT100 2 Channels    | 0     | 5     |      | 0         | 743 |  |
| P2.12.2.7   | PT100 2 WarnLim     | -30   | 200   | °C   | 120       | 745 |  |
| P2.12.2.8   | PT100 2 FaultLim    | -30   | 200   | °C   | 130       | 746 |  |
| P2.12.2.9.1 | Channel 1B Warn     | -30,0 | 200,0 | C°   | 0,0       | 764 |  |
| P2.12.2.9.2 | Channel 1B Fault    | -30,0 | 200,0 | C°   | 0,0       | 765 |  |
| P2.12.2.9.3 | Channel 1C Warn     | -30,0 | 200,0 | C°   | 0,0       | 768 |  |
| P2.12.2.9.4 | Channel 1C Fault    | -30,0 | 200,0 | C°   | 0,0       | 769 |  |
| P2.12.2.9.5 | Channel 2B Warn     | -30,0 | 200,0 | C°   | 0,0       | 770 |  |
| P2.12.2.9.6 | Channel 2B Fault    | -30,0 | 200,0 | C°   | 0,0       | 771 |  |
| P2.12.2.9.7 | Channel 2C Warn     | -30,0 | 200,0 | C°   | 0,0       | 772 |  |
| P2.12.2.9.8 | Channel 2C Fault    | -30,0 | 200,0 | C°   | 0,0       | 773 |  |

Table 7-48, PT-100 parameters

**7.12.3 EARTH FAULT**

| Code      | Parameter         | Min | Max | Unit | Default   | ID   | Note |
|-----------|-------------------|-----|-----|------|-----------|------|------|
| P2.12.3.1 | EarthFlt Response | 2   | 5   |      | 2 / Fault | 1544 |      |
| P2.12.3.2 | EarthFaultLevel   | 0   | 100 | %    | 50        | 1333 |      |

Table 7-49, Earth fault parameters

**7.12.4 EXTERNAL FAULT**

| Code      | Parameter            | Min  | Max    | Unit | Default     | ID   | Note |
|-----------|----------------------|------|--------|------|-------------|------|------|
| P2.12.4.1 | External Fault 1     | 0    | 3      |      | 2 / Fault   | 701  |      |
| P2.12.4.2 | External Fault 2     | 0    | 3      |      | 1 / Warning | 1504 |      |
| P2.12.4.3 | External Fault Delay | 0.00 | 320.00 | s    | 0.00        | 1506 |      |

Table 7-50, External fault parameters

**7.12.5 GENERATOR VOLTAGE**

| Code      | Parameter                  | Min  | Max    | Unit | Default | ID   | Note |
|-----------|----------------------------|------|--------|------|---------|------|------|
| P2.12.5.1 | Voltage Error Response     | 0    | 2      |      | 0       | 1880 |      |
| P2.12.5.2 | Voltage Low Warning Limit  | 0.00 | 320.00 | %    | 90.00   | 1893 |      |
| P2.12.5.3 | Voltage Low Trip Limit     | 0.00 | 320.00 | %    | 80.00   | 1899 |      |
| P2.12.5.4 | Voltage High Warning Limit | 0.00 | 320.00 | %    | 110.00  | 1895 |      |
| P2.12.5.5 | Voltage High Trip Limit    | 0.00 | 320.00 | %    | 120.00  | 1799 |      |
| P2.12.5.6 | Voltage Trip Delay         | 0.00 | 320.00 | s    | 0.50    | 1898 |      |

Table 7-51, Generator voltage parameters

**7.12.6 GENERATOR FREQUENCY**

| Code      | Parameter                | Min  | Max    | Unit | Default | ID   | Note |
|-----------|--------------------------|------|--------|------|---------|------|------|
| P2.12.6.1 | Frequency Error Response | 0    | 2      |      | 0       | 1981 |      |
| P2.12.6.2 | Freq. low Warning Limit  | 0.00 | 320.00 | %    | 95.00   | 1780 |      |
| P2.12.6.3 | Freq. Low Trip Limit     | 0.00 | 320.00 | %    | 90.00   | 1788 |      |
| P2.12.6.4 | Freq. High Warning Limit | 0.00 | 320.00 | %    | 105.00  | 1786 |      |
| P2.12.6.5 | Freq. High Trip Limit    | 0.00 | 320.00 | %    | 110.00  | 1787 |      |
| P2.12.6.6 | Freq. Trip Delay         | 0.00 | 320.00 | s    | 0.50    | 1785 |      |

Table 7-52, Generator frequency parameters

**7.12.7 MOTOR THERMAL PROTECTIONS**

| Code     | Parameter                          | Min    | Max   | Unit | Default | Cust | ID   | Note   |
|----------|------------------------------------|--------|-------|------|---------|------|------|--|
| 2.12.7.1 | Thermal protection of the motor    | 0      | 3     |      | 2       |      | 704  | 0=No response<br>1=Warning<br>2=Fault, stop acc. to 2.3.2<br>3=Fault, stop by coasting |
| 2.12.7.2 | Motor ambient temperature factor   | -100.0 | 100.0 | %    | 0.0     |      | 705  |  |
| 2.12.7.3 | Motor cooling factor at zero speed | 0.0    | 150.0 | %    | 40.0    |      | 706  |  |
| 2.12.7.4 | Motor thermal time constant        | 1      | 200   | min  | 45      |      | 707  |  |
| 2.12.7.5 | Motor duty cycle                   | 0      | 100   | %    | 100     |      | 708  |  |
| 2.12.7.6 | Over Load Response                 | 0      | 2     |      | 1       |      | 1838 | 0=No response<br>1=Warning<br>2=Fault  |
| 2.12.7.7 | Over Load Signal                   | 0      | 2     |      | 0       |      | 1837 | 0=Not Used<br>1=Current<br>2=Torque<br>3=Power   |
| 2.12.7.8 | Over Load Maximum Input            | 0.0    | 300.0 | %    | 150.0   |      | 1839 |  |
| 2.12.7.9 | Over Load maximum Step             | 0      | 10000 |      | 200     |      | 1840 |  |

Table 7-53, Motor thermal protection parameters

**7.12.8 FIELDBUS PROTECTION**

| Code      | Parameter                | Min  | Max   | Unit | Default | Cust | ID   | Note  |
|-----------|--------------------------|------|-------|------|---------|------|------|---|
| P2.12.8.1 | FB Fault response Slot D | 0    | 2     |      | 2       |      | 733  | 0=No Action<br>1=Warning<br>2= Fault              |
| P2.12.8.2 | FB Fault response Slot E | 0    | 2     |      | 2       |      | 761  | 0=No Action<br>1=Warning<br>2= Fault              |
| P2.12.8.3 | FB Watchdog Delay        | 0.00 | 30.00 | s    | 0.00    |      | 1354 | Delay when WD pulse is missing. 0.00 s = Disabled |

Table 7-54. Fieldbus protection parameters

**7.12.9 COOLING MONITORING**

| Code      | Parameter              | Min | Max | Unit | Default | ID  | Note   |
|-----------|------------------------|-----|-----|------|---------|-----|--|
| P2.12.9.1 | Cooling Flt. Delay     | 0   | 7   | s    | 2       | 751 |  |
| P2.12.9.1 | Cooling Fault Response | 0   | 3   |      | 2       | 762 | 0= No Action, Warning<br>1= Warning, Warning<br>2= Warning, Fault<br>3= No Action, Fault |

Table 7-55, Cooling monitoring

**7.12.10 OPTIONS**

| Code     | Parameter        | Min | Max   | Unit | Default | ID   | Note                              |
|----------|------------------|-----|-------|------|---------|------|-----------------------------------|
| P2.12.9  | Disable Stoplock | 0   | 1     |      | 0/No    | 1086 |                                   |
| P2.12.10 | Fault Simulation | 0   | 65535 |      | 0       | 1569 |                                   |
| P2.12.11 | Reset Datalogger | -1  | 1     |      | 0       | 1857 | -1 = Blocked<br>0 = No<br>1 = Yes |

Table 7-55, Protection options

## 7.13 FIELDBUS (G 2.13)

| Code     | Parameter             | Min  | Max     | Unit | Default | ID   | Note   |
|----------|-----------------------|------|---------|------|---------|------|--|
| P2.13.1  | FB Actual ID          | 0    | 10000   |      | 7       | 1851 |  |
| P2.13.2  | FB Data Out1 Sel      | 0    | 10000   |      | 1104    | 852  |  |
| P2.13.3  | FB Data Out2 Sel      | 0    | 10000   |      | 1508    | 853  |  |
| P2.13.4  | FB Data Out3 Sel      | 0    | 10000   |      | 1172    | 854  |  |
| P2.13.5  | FB Data Out4 Sel      | 0    | 10000   |      | 1173    | 855  |  |
| P2.13.6  | FB Data Out5 Sel      | 0    | 10000   |      | 56      | 856  |  |
| P2.13.7  | FB Data Out6 Sel      | 0    | 10000   |      | 1174    | 857  |  |
| P2.13.8  | FB Data Out7 Sel      | 0    | 10000   |      | 1125    | 858  |  |
| P2.13.9  | FB Data Out8 Sel      | 0    | 10000   |      | 1157    | 859  |  |
| P2.13.10 | FB Data Out9 Sel      | 0    | 10000   |      | 0       | 558  | Visible with correct hw and sw   |
| P2.13.11 | FB Data Out10 Sel     | 0    | 10000   |      | 0       | 559  | Visible with correct hw and sw   |
| P2.13.12 | FB Data Out11 Sel     | 0    | 10000   |      | 0       | 560  | Visible with correct hw and sw   |
| P2.13.13 | FB Data Out12 Sel     | 0    | 10000   |      | 0       | 561  | Visible with correct hw and sw   |
| P2.13.14 | FB Data Out13 Sel     | 0    | 10000   |      | 0       | 562  | Visible with correct hw and sw   |
| P2.13.15 | FB Data Out14 Sel     | 0    | 10000   |      | 0       | 563  | Visible with correct hw and sw   |
| P2.13.16 | FB Data Out15 Sel     | 0    | 10000   |      | 0       | 564  | Visible with correct hw and sw   |
| P2.13.17 | FB Data Out16 Sel     | 0    | 10000   |      | 0       | 565  | Visible with correct hw and sw   |
| P2.13.18 | FB Reference Sel      | 0    | 10000   |      | 0       | 1850 |  |
| P2.13.19 | FB Data In 1 Sel      | 0    | 10000   |      | 0       | 876  |  |
| P2.13.20 | FB Data In 2 Sel      | 0    | 10000   |      | 0       | 877  |  |
| P2.13.21 | FB Data In 3 Sel      | 0    | 10000   |      | 0       | 878  |  |
| P2.13.22 | FB Data In 4 Sel      | 0    | 10000   |      | 0       | 879  |  |
| P2.13.23 | FB Data In 5 Sel      | 0    | 10000   |      | 0       | 880  |  |
| P2.13.24 | FB Data In 6 Sel      | 0    | 10000   |      | 0       | 881  |  |
| P2.13.25 | FB Data In 7 Sel      | 0    | 10000   |      | 0       | 882  |  |
| P2.13.26 | FB Data In 8 Sel      | 0    | 10000   |      | 0       | 883  |  |
| P2.13.27 | FB Data In 9 Sel      | 0    | 10000   |      | 0       | 550  | Visible with correct hw and sw   |
| P2.13.28 | FB Data In 10 Sel     | 0    | 10000   |      | 0       | 551  | Visible with correct hw and sw   |
| P2.13.29 | FB Data In 11 Sel     | 0    | 10000   |      | 0       | 552  | Visible with correct hw and sw   |
| P2.13.30 | FB Data In 12 Sel     | 0    | 10000   |      | 0       | 553  | Visible with correct hw and sw   |
| P2.13.31 | FB Data In 13 Sel     | 0    | 10000   |      | 0       | 554  | Visible with correct hw and sw   |
| P2.13.32 | FB Data In 14 Sel     | 0    | 10000   |      | 0       | 555  | Visible with correct hw and sw   |
| P2.13.33 | FB Data In 15 Sel     | 0    | 10000   |      | 0       | 556  | Visible with correct hw and sw   |
| P2.13.34 | FB Data In 16 Sel     | 0    | 10000   |      | 0       | 557  | Visible with correct hw and sw   |
| P2.13.35 | GSW Data              | 0    | 10000   |      | 0       | 897  |  |
| P2.13.36 | Control Slot Selector | 0    | Varies  |      | 0       | 1440 | 0=Not Sel., 4=Slot D<br>5=Slot E, 6=Slot D Fast<br>7=Slot E Fast, 8=Slot D 16,<br>9=Slot E 16<br><br>Note: 6-9 visible with correct hw and sw. |
| P2.13.37 | State Machine         | 1    | 2       |      | 2       | 896  | 0=Basic<br>1=Standard<br>2=Generator   |
| P2.13.38 | SW B11 ID.Bit         | 0.00 | 2000.00 |      | 0.00    | 1912 |  |
| P2.13.39 | SW B12 ID.Bit         | 0.00 | 2000.00 |      | 0.00    | 1908 |  |
| P2.13.40 | SW B13 ID.Bit         | 0.00 | 2000.00 |      | 0.00    | 1909 |  |
| P2.13.41 | SW B14 ID.Bit         | 0.00 | 2000.00 |      | 0.00    | 1911 |  |

Table 7-56, Fieldbus parameters

## 7.14 ID CONTROL FUNCTIONS (G2.14)

### 7.14.1 VALUE CONTROL

| Code      | Parameter                     | Min    | Max    | Unit | Default | Cust | ID   | Note   |
|-----------|-------------------------------|--------|--------|------|---------|------|------|--|
| P2.14.1.1 | Control Input Signal ID       | 0      | 10000  | ID   | 0       |      | 1580 |  |
| P2.14.1.2 | Control Input Off Limit       | -32000 | 32000  |      | 0       |      | 1581 |  |
| P2.14.1.3 | Control Input On Limit        | -32000 | 32000  |      | 0       |      | 1582 |  |
| P2.14.1.4 | Control Output Off Value      | -32000 | 32000  |      | 0       |      | 1583 |  |
| P2.14.1.5 | Control Output On Value       | -32000 | 32000  |      | 0       |      | 1584 |  |
| P2.14.1.6 | Control Output Signal ID      | 0      | 10000  | ID   | 0       |      | 1585 |  |
| P2.14.1.7 | Control Mode                  | 0      | 5      |      | 0       |      | 1590 | 0=SR ABS<br>1=Scale ABS<br>2=Scale INV ABS<br>3=SR<br>4=Scale<br>5=Scale INV |
| P2.14.1.8 | Control Output Filtering rime | 0.000  | 32.000 | s    | 0.000   |      | 1721 |  |

Table 7-57, Power reference input signal selection

### 7.14.2 DIN ID CONTROL 1

| Code      | Parameter      | Min    | Max   | Unit | Default | Cust | ID   | Note  |
|-----------|----------------|--------|-------|------|---------|------|------|---|
| P2.14.2.1 | ID Control DIN | 0.1    | E.10  |      | 0.1     |      | 1570 | Slot . Board input No.<br>If 0.1 ID61 can be controlled from FB |
| P2.14.2.2 | Controlled ID  | 0      | 10000 | ID   | 0       |      | 1571 | Select ID that is controlled by digital input                   |
| P2.14.2.3 | False value    | -32000 | 32000 |      | 0       |      | 1572 | Value when DI is low  |
| P2.14.2.4 | True value     | -32000 | 32000 |      | 0       |      | 1573 | Value when DI is high   |

Table 7-58, Digital input ID control 1 parameters

### 7.14.3 DIN ID CONTROL 2

| Code      | Parameter      | Min    | Max   | Unit | Default | Cust | ID   | Note  |
|-----------|----------------|--------|-------|------|---------|------|------|---|
| P2.14.3.1 | ID Control DIN | 0.1    | E.10  |      | 0.1     |      | 1574 | Slot . Board input No.<br>If 0.1 ID61 can be controlled from FB |
| P2.14.3.2 | Controlled ID  | 0      | 10000 | ID   | 0       |      | 1575 | Select ID that is controlled by digital input                   |
| P2.14.3.3 | False value    | -32000 | 32000 |      | 0       |      | 1576 | Value when DI is low  |
| P2.14.3.4 | True value     | -32000 | 32000 |      | 0       |      | 1577 | Value when DI is high   |

Table 7-59, Digital input ID Control 2 parameters

**7.14.4 DIN ID CONTROL 3**

| Code      | Parameter      | Min    | Max   | Unit | Default | Cust | ID   | Note   |
|-----------|----------------|--------|-------|------|---------|------|------|--|
| P2.14.4.1 | ID Control DIN | 0.1    | E.10  |      | 0.1     |      | 1578 | Slot . Board input No.<br>If 0.1 ID61 can be<br>controlled from FB |
| P2.14.4.2 | Controlled ID  | 0      | 10000 | ID   | 0       |      | 1579 | Select ID that is<br>controlled by digital input                   |
| P2.14.4.3 | False value    | -32000 | 32000 |      | 0       |      | 1587 | Value when DI is low   |
| P2.14.4.4 | True value     | -32000 | 32000 |      | 0       |      | 1588 | Value when DI is high  |

Table 7-60, Digital input ID Control 3 parameters

**7.15 CURVE 1 DEFINITION (G2.15)**

| Code     | Parameter  | Min  | Max | Unit | Default | Cust | ID   | Note |
|----------|------------|------|-----|------|---------|------|------|------|
| P2.15.1  | 0% Speed   | -320 | 320 | %    |         |      | 1626 |      |
| P2.15.2  | 5% Speed   | -320 | 320 | %    |         |      | 1627 |      |
| P2.15.3  | 10% Speed  | -320 | 320 | %    |         |      | 1628 |      |
| P2.15.4  | 15% Speed  | -320 | 320 | %    |         |      | 1629 |      |
| P2.15.5  | 20% Speed  | -320 | 320 | %    |         |      | 1630 |      |
| P2.15.6  | 25% Speed  | -320 | 320 | %    |         |      | 1631 |      |
| P2.15.7  | 30% Speed  | -320 | 320 | %    |         |      | 1632 |      |
| P2.15.8  | 35% Speed  | -320 | 320 | %    |         |      | 1633 |      |
| P2.15.9  | 40% Speed  | -320 | 320 | %    |         |      | 1634 |      |
| P2.15.10 | 45% Speed  | -320 | 320 | %    |         |      | 1635 |      |
| P2.15.11 | 50% Speed  | -320 | 320 | %    |         |      | 1636 |      |
| P2.15.12 | 55% Speed  | -320 | 320 | %    |         |      | 1637 |      |
| P2.15.13 | 60% Speed  | -320 | 320 | %    |         |      | 1638 |      |
| P2.15.14 | 65% Speed  | -320 | 320 | %    |         |      | 1639 |      |
| P2.15.15 | 70% Speed  | -320 | 320 | %    |         |      | 1640 |      |
| P2.15.16 | 75% Speed  | -320 | 320 | %    |         |      | 1641 |      |
| P2.15.17 | 80% Speed  | -320 | 320 | %    |         |      | 1642 |      |
| P2.15.18 | 85% Speed  | -320 | 320 | %    |         |      | 1643 |      |
| P2.15.19 | 90% Speed  | -320 | 320 | %    |         |      | 1644 |      |
| P2.15.20 | 95% Speed  | -320 | 320 | %    |         |      | 1645 |      |
| P2.15.21 | 100% Speed | -320 | 320 | %    |         |      | 1646 |      |
| P2.15.22 | 105% Speed | -320 | 320 | %    |         |      | 1647 |      |
| P2.15.23 | 110% Speed | -320 | 320 | %    |         |      | 1648 |      |
| P2.15.24 | 115% Speed | -320 | 320 | %    |         |      | 1649 |      |
| P2.15.25 | 120% Speed | -320 | 320 | %    |         |      | 1651 |      |

Table 7-61, Curve 1 definition parameters



**7.16 CURVE 2 DEFINITION (G2.16)**

| Code     | Parameter  | Min  | Max | Unit | Default | Cust | ID   | Note |
|----------|------------|------|-----|------|---------|------|------|------|
| P2.16.1  | 0% Speed   | -320 | 320 | %    |         |      | 2001 |      |
| P2.16.2  | 5% Speed   | -320 | 320 | %    |         |      | 2002 |      |
| P2.16.3  | 10% Speed  | -320 | 320 | %    |         |      | 2003 |      |
| P2.16.4  | 15% Speed  | -320 | 320 | %    |         |      | 2004 |      |
| P2.16.5  | 20% Speed  | -320 | 320 | %    |         |      | 2005 |      |
| P2.16.6  | 25% Speed  | -320 | 320 | %    |         |      | 2006 |      |
| P2.16.7  | 30% Speed  | -320 | 320 | %    |         |      | 2007 |      |
| P2.16.8  | 35% Speed  | -320 | 320 | %    |         |      | 2008 |      |
| P2.16.9  | 40% Speed  | -320 | 320 | %    |         |      | 2009 |      |
| P2.16.10 | 45% Speed  | -320 | 320 | %    |         |      | 2010 |      |
| P2.16.11 | 50% Speed  | -320 | 320 | %    |         |      | 2011 |      |
| P2.16.12 | 55% Speed  | -320 | 320 | %    |         |      | 2012 |      |
| P2.16.13 | 60% Speed  | -320 | 320 | %    |         |      | 2013 |      |
| P2.16.14 | 65% Speed  | -320 | 320 | %    |         |      | 2014 |      |
| P2.16.15 | 70% Speed  | -320 | 320 | %    |         |      | 2015 |      |
| P2.16.16 | 75% Speed  | -320 | 320 | %    |         |      | 2016 |      |
| P2.16.17 | 80% Speed  | -320 | 320 | %    |         |      | 2017 |      |
| P2.16.18 | 85% Speed  | -320 | 320 | %    |         |      | 2018 |      |
| P2.16.19 | 90% Speed  | -320 | 320 | %    |         |      | 2019 |      |
| P2.16.20 | 95% Speed  | -320 | 320 | %    |         |      | 2020 |      |
| P2.16.21 | 100% Speed | -320 | 320 | %    |         |      | 2021 |      |
| P2.16.22 | 105% Speed | -320 | 320 | %    |         |      | 2022 |      |
| P2.16.23 | 110% Speed | -320 | 320 | %    |         |      | 2023 |      |
| P2.16.24 | 115% Speed | -320 | 320 | %    |         |      | 2024 |      |
| P2.16.25 | 120% Speed | -320 | 320 | %    |         |      | 2025 |      |

Table 7-62, Curve 2 definition parameters

**7.17 CURVE 3 DEFINITION (G2.17)**

| Code     | Parameter  | Min  | Max | Unit | Default | Cust | ID   | Note |
|----------|------------|------|-----|------|---------|------|------|------|
| P2.17.1  | 0% Speed   | -320 | 320 | %    |         |      | 2030 |      |
| P2.17.2  | 5% Speed   | -320 | 320 | %    |         |      | 2031 |      |
| P2.17.3  | 10% Speed  | -320 | 320 | %    |         |      | 2032 |      |
| P2.17.4  | 15% Speed  | -320 | 320 | %    |         |      | 2033 |      |
| P2.17.5  | 20% Speed  | -320 | 320 | %    |         |      | 2034 |      |
| P2.17.6  | 25% Speed  | -320 | 320 | %    |         |      | 2035 |      |
| P2.17.7  | 30% Speed  | -320 | 320 | %    |         |      | 2036 |      |
| P2.17.8  | 35% Speed  | -320 | 320 | %    |         |      | 2037 |      |
| P2.17.9  | 40% Speed  | -320 | 320 | %    |         |      | 2038 |      |
| P2.17.10 | 45% Speed  | -320 | 320 | %    |         |      | 2039 |      |
| P2.17.11 | 50% Speed  | -320 | 320 | %    |         |      | 2040 |      |
| P2.17.12 | 55% Speed  | -320 | 320 | %    |         |      | 2041 |      |
| P2.17.13 | 60% Speed  | -320 | 320 | %    |         |      | 2042 |      |
| P2.17.14 | 65% Speed  | -320 | 320 | %    |         |      | 2043 |      |
| P2.17.15 | 70% Speed  | -320 | 320 | %    |         |      | 2044 |      |
| P2.17.16 | 75% Speed  | -320 | 320 | %    |         |      | 2045 |      |
| P2.17.17 | 80% Speed  | -320 | 320 | %    |         |      | 2046 |      |
| P2.17.18 | 85% Speed  | -320 | 320 | %    |         |      | 2047 |      |
| P2.17.19 | 90% Speed  | -320 | 320 | %    |         |      | 2048 |      |
| P2.17.20 | 95% Speed  | -320 | 320 | %    |         |      | 2049 |      |
| P2.17.21 | 100% Speed | -320 | 320 | %    |         |      | 2050 |      |
| P2.17.22 | 105% Speed | -320 | 320 | %    |         |      | 2051 |      |
| P2.17.23 | 110% Speed | -320 | 320 | %    |         |      | 2052 |      |
| P2.17.24 | 115% Speed | -320 | 320 | %    |         |      | 2053 |      |
| P2.17.25 | 120% Speed | -320 | 320 | %    |         |      | 2054 |      |

*Table 7-63, Curve 3 definition parameters*

**7.18 LINE SYNCH (G2.18)**

| Code    | Parameter           | Min    | Max   | Unit | Default | Cust | ID   | Note |
|---------|---------------------|--------|-------|------|---------|------|------|------|
| P2.18.1 | Delay To Coast      | 0      | 30000 | ms   | 25      |      | 3001 |      |
| P2.18.2 | Delay To Open       | 0      | 60000 | ms   | 10      |      | 3002 |      |
| P2.18.3 | Delay To Close      | 0      | 60000 | ms   | 15      |      | 3003 |      |
| P2.18.4 | Phase Offset        | -179.0 | 179.0 | Dec  | -15.0   |      | 3006 |      |
| P2.18.5 | Freq Hyst For Synch | 0.00   | 50.00 | Hz   | 0.60    |      | 3004 |      |
| P2.18.6 | Phase Hyst          | 0      | 10000 | Deg  | 10.0    |      | 3007 |      |
| P2.18.7 | Freq Hyst For Chang | 0.00   | 50.00 | Hz   | 0.20    |      | 3005 |      |

Table 7-64, Line synch parameters

**7.19 KEYPAD CONTROL (CONTROL KEYPAD: MENU M3)**

| Code | Parameter        | Default    | Min  | Max    | Unit | ID   | Description  |
|------|------------------|------------|------|--------|------|------|--|
| P3.1 | Control place    | 2          | 0    | 2      |      | 1403 | 0=Fieldbus<br>1=I/O terminal<br>2=Keypad (Default)           |
| P3.2 | Keypad reference | 0.00       | 0.00 | 320.00 | Hz   | 105  |  |
| P3.3 | PC ref           | 2/Freq ref | 0    | 3      |      | 1805 | 0=Not used<br>1=DC-link voltage<br>2=Freq ref<br>3=Power ref |

Table 7-64, Keypad control parameters

**7.20 SYSTEM MENU (CONTROL KEYPAD: MENU M6)**

For parameters and functions related to the general use of the AC drive, such as application and language selection, customised parameter sets or information about the hardware and software, see the VACON® NXS/P User Manual.

**7.21 EXPANDER BOARDS (CONTROL KEYPAD: MENU M7)**

The M7 menu shows the expander and option boards attached to the control board and board-related information. For more information, see the VACON® NXS/P User Manual and VACON® I/O Option Board manual.

## 8. PARAMETER DESCRIPTIONS

### 8.1 BASIC PARAMETERS

#### 2.1.1 *Motor / Generator Type* *ID650*

Select the generator type that is used.

0 = Synchronous generator

Separate excited motor/generator

1 = PM Motor

Permanent magnet synchronous motor.

2 = Asynchronous motor

Induction motor

#### 2.1.2 *Nominal Voltage* *V* *ID110*

Nominal voltage of connected generator.

#### 2.1.3 *Nominal Frequency* *Hz* *ID1532*

Nominal frequency of connected generator.

#### 2.1.4 *Nominal Current* *A* *ID113*

For induction motor and PMSM, set here the motor nominal current. If the synchronous generator is considerably bigger than the AC drive, use the  $I_h$  current of the AC drive.

Active Current and reactive current are scaled to this parameter.

#### 2.1.5 *Motor nominal speed* *ID112 "Motor Nom Speed"*

Find this value  $n_n$  on the rating plate of the motor. Note also nominal frequency.

In some cases, the motor nominal speed is shown with one decimal. In these cases, give the nearest integer number and adjust the motor nominal frequency so that the drive will calculate the correct  $[FW]PolePairNumber$ .

#### 2.1.6 *Motor cos phi* *ID120 "Motor Cos Phi"*

Find this value "cos phi" on the rating plate of the motor.

#### 2.1.7 *Nominal Power kW* *ID116*

Set here the rated active power of the system.

### 2.1.8 Magnetizing current ID612 "MagnCurrent"

Set here the motor magnetizing current (no-load current).

Can be measured by running motor without load at 2/3 of nominal speed.

When value is zero the magnetization current is calculated from motor nominal parameters

$$\text{Motor Magnetization Current} = \frac{5 * \sin \varphi - 1}{5 - \sin \varphi} * \text{Motor Nominal Current}$$

$$[FW]\text{RotorFlux} = \left( \frac{f(\text{MotorNomFreq})}{f(\text{Out})} \right)^2, \text{ when } f(\text{Out}) > f(\text{MotorNomFreq})$$

If given before the identification run, this is used as reference for U/f tuning when making identification without rotating the motor.

### 2.1.9 Parallel Generators ID1501

0 = Single

1 = Parallel

When you select Parallel, the DC Drooping is set to 3.00% and the modulation is synchronized to reduce circulating current when the drives are in common DC bus.

### 2.1.11 Identification ID631 "Identification"

Identification Run is a part of tuning the motor and the drive specific parameters. It is a tool for commissioning and service of the drive with the aim to find as good parameter values as possible for most drives. The automatic motor identification calculates or measures the motor parameters that are needed for optimum motor and speed control.

**NOTE:** Set motor control mode to Frequency Control before identification!

**NOTE:** During identification, the drive will not open mechanical brake for safety reasons. If motor rotation requires that brake is opened this needs to be achieved externally.

**NOTE:** During identification run, the torque and power limits should be above 100%. Also the current limit should be above the motor nominal current.

**NOTE:** During the identification run, the acceleration time should be below 20 second.

**NOTE:** If the switching frequency is changed after the identification, we recommend you to do the identification run again.

**NOTE:** A small motor with long motor cables may require reduction of the switching frequency if the identification is not successful.

**0 = "No Action" No action**

No identification requested.

## 1 = "ID No Run" - Identification without rotating the motor

Current is applied to the motor but shaft will not be rotated. U/f settings are identified.

This identification is a minimum requirement if motor is only to be used in open loop control. However, we recommend you to always make the identification with rotating motor in case the need for closed loop control arises after the mechanics are connected to the shaft.

Example of behaviour:

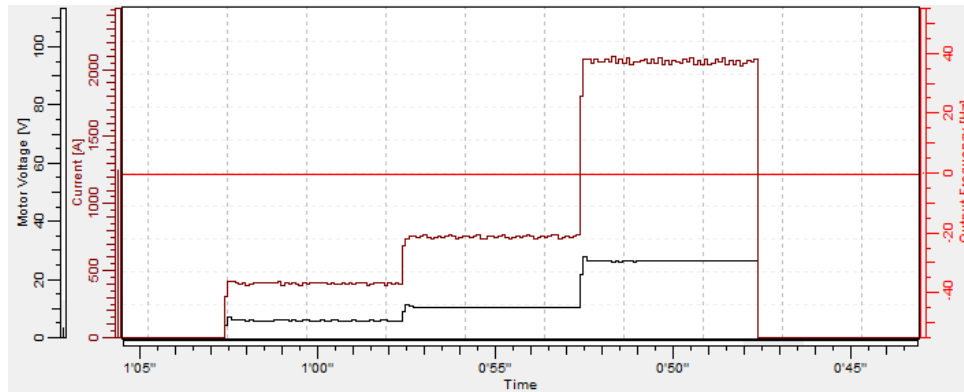

Figure 8-1

## 2 = "ID With Run" - Identification with motor rotating

Shaft is rotated during identification.

This identification must be run without load on motor shaft. U/f settings and magnetization current are identified. This identification should be run regardless of the final operation mode (closed loop or open loop) to get the best performance from the motor. When identification with motor rotation is successfully finished, the drive starts to use internal slip estimator to compensate the motor temperature changed. SCTorqueChainSelect B5 & B6.

Example of behaviour

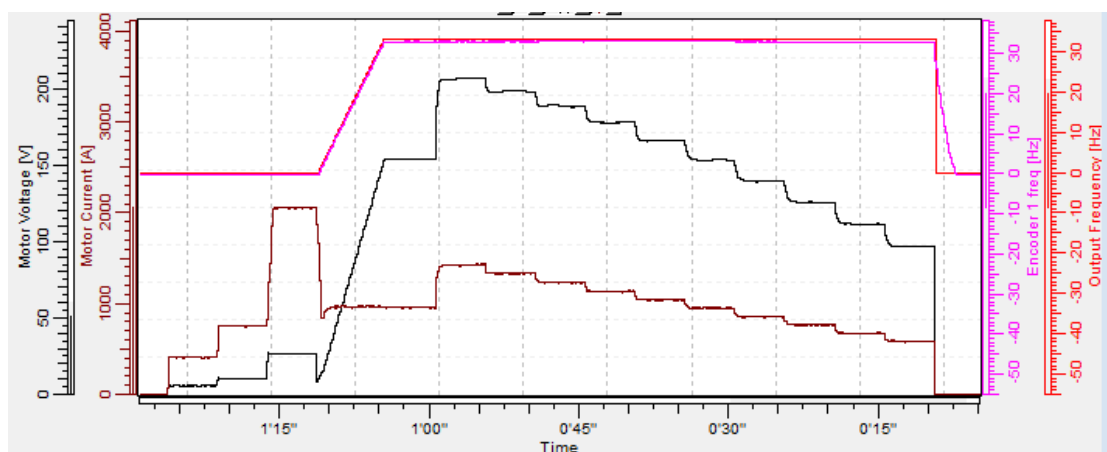

Figure 8-2

### 3 = "Enc. ID Run" - Encoder identification run

The motor shaft is rotated during identification.

**IM:** If performed for induction motor, the encoder pulse number and direction are identified. Can be used if there is no encoder information available. The correct result can be achieved only when the motor is unloaded.

**PMSM:** This selection is used for PMS motor if automatic angle identification is not suitable for the motor in use (angle is identified automatically in every start if PMSM Shaft Position parameter is zero).

This identification run will update the PMSM Shaft Position parameter based on absolute position of the encoder or Z pulse position of incremental type encoder.

**Note:** Make the identification again if the encoder position related to the motor is changed e.g. due maintenance.

### 4 = "Ident All" - Identified All

Shaft is rotated during identification.

All the above identification selections are made in sequence.

### 5 = "Enc.ABS.Lock" – Absolute encoder when locked rotor

Absolute encoder zero position identification when rotor is locked while using permanent magnet motor.

Shaft needs to be locked during this identification mode.

## 6 = “U/f + Magn.Curr” – U/f Curve and magnetization current

Shaft is rotated during identification.

This identification selection will not make a saturation curve identification and will open the brake when the start rotation begins.

Because saturation curve run is not made, the running time is shorter and gives possibility to make even if lifting hook is connected.

Example of behaviour

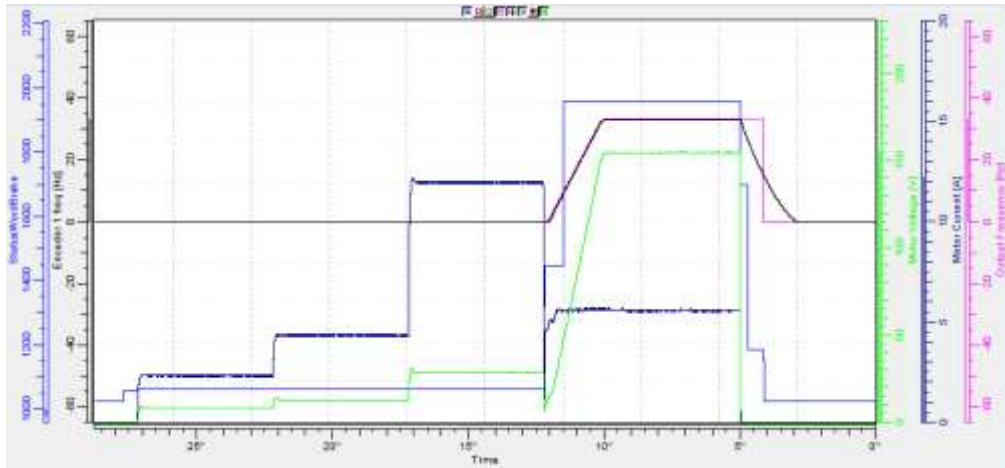

Parameters updated during this identification

- P2.1.8 MagnCurrent
- P2.8.2.2 U/f Ratio Select
- P2.8.2.5 U/f Mid Freq
- P2.8.2.6 U/f Mid Voltg
- P2.8.2.7 Zero Freq Voltg
- P2.8.6.16 RsVoltageDrop
- P2.8.6.17 IrAddZeroPVoltg
- P2.8.6.22-24 Ix Offset



## 7 = “DTC Ident” – Dead Time Compensation identification

Current is applied to the motor, but shaft will not be rotated. This identification mode is needed for Sensorless control, Ident All can be used instead of this.

Parameters updated during this identification

- P2.8.2.2 U/f Ratio Select
- P2.8.2.5 U/f Mid Freq
- P2.8.2.6 U/f Mid Voltg
- P2.8.2.7 Zero Freq Voltg
- P2.8.6.16 RsVoltageDrop
- P2.8.6.17 IrAddZeroPVoltg
- P 2.8.6.20 LsVoltageDrop
- P 2.8.6.22 IU Offset
- P 2.8.6.23 IV Offset
- P 2.8.6.24 IW Offset
- P 2.8.6.25 Estimator Kp
- P 2.8.6.26 VoltageDrop
- P 2.8.7.3 DeadTimeComp.
- P 2.8.7.4 DeadTieContCurl

## 8 = “Current Meas. Offset AFE”.

Current measurement offset identification for AFE mode.

## 10 = “ID Run Fails” - Identification failed

Identification failed in the last attempt.

The basic motor name plate data has to be set correctly before performing the identification run:

- P2.1.1 – P2.1.8. Motor basic data.
- P2.1.8 Give also the magnetization current. It is available if it has been given before the identification without rotating motor. The U/f curve will be tuned according to the given magnetization current.
- P2.1.1 Motor Type.

When in closed loop and with an encoder installed, also the parameter for pulses / revolutions (in Menu M7) has to be set.

The automatic identification is activated by setting this parameter to the appropriate value followed by a start command in the requested direction. The start command to the drive has to be given within 20 s. If no start command is given within 20 s, the identification run is cancelled and the parameter will be reset to its default setting. The identification run can be stopped any time with normal stop command and the parameter is reset to its default setting. If the identification run detects a fault or other problems, the identification run is completed if possible. After the identification is finished, a warning will be given if not all requested identification types have been completed successfully.

During Identification Run, the brake control is disabled.

**Note:** After identification is made, the AC drive requires a rising edge of start command.

## 8.2 REFERENCE HANDLING

### 8.2.1 PTM HANDLING

|                 |                           |                |
|-----------------|---------------------------|----------------|
| <i>P2.2.1.1</i> | <i>Power Take Mode 00</i> | <i>ID1910</i>  |
| <i>P2.2.1.2</i> | <i>Power Take Mode 01</i> | <i>ID 1902</i> |
| <i>P2.2.1.3</i> | <i>Power Take Mode 10</i> | <i>ID 1903</i> |
| <i>P2.2.1.4</i> | <i>Power Take Mode 11</i> | <i>ID 1904</i> |

#### 0 = Commissioning

This mode is for commissioning purposes. Operation mode can be freely selected in G2.2.1.10 Commissioning.

#### 1 = PTO

Power Take Out Mode.

#### 2 = PTI-BOOST

PTI – Boost Mode

#### 3 = PTI- 0-Speed

PTI Mode from zero speed.

#### 4 = Regen Motor

Requires license key if used with induction motor.

### *P2.2.1.5 PTM Stop Time ID1915*

Time when the AC drive is in stop state during the PTM mode change.

### 8.2.2 PT0 HANDLING

#### *2.2.1.6.1 Torque Select ID1931 "Torque Select"*

This parameter defines the speed limiting mode in torque control mode. This parameter can be used as single motor control mode selection when no change is made between open loop and closed loop controls.

#### 0= "SpeedControl" - Speed control mode

The drive is forced to operate in speed control mode while the motor control mode parameter is set to torque control mode thus allowing selection of speed control and torque control mode with single parameter e.g. from Fieldbus.

**1="Torque" - Positive and negative frequency limits**

The speed is not limited by the speed reference, only by the maximum frequency or Positive and Negative frequency limit if set lower than maximum frequency parameter.

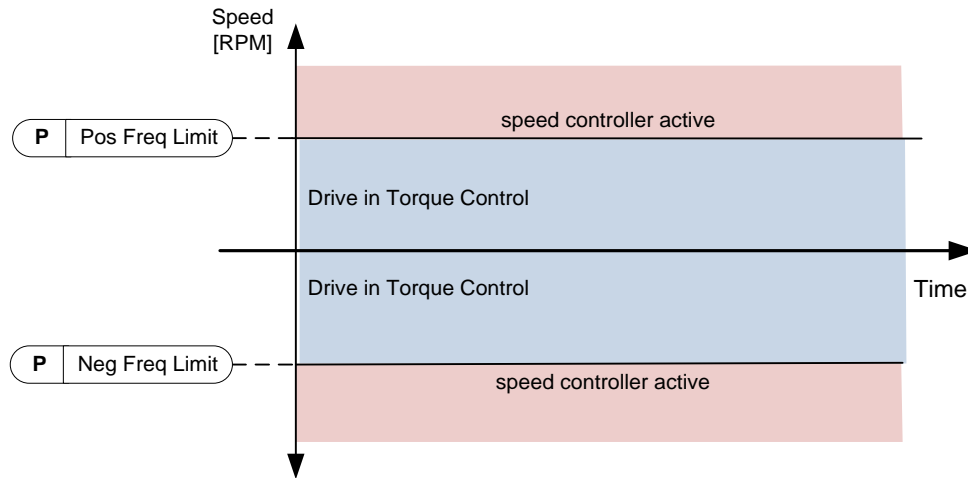

Figure 8-3

**2="RampOutput" – Ramp output for both directions**

The speed is limited by the reference after the ramp generator, thus the speed will increase with the set ramp time until the actual torque is equal to the reference torque. If the speed is below the reference when the load is removed from the shaft, the speed will increase without ramp.

This is the default selection. For master-follower system, we recommend that you use a selection that allows a little higher reference for torque follower, so that the load will be balanced equally, e.g. window control.

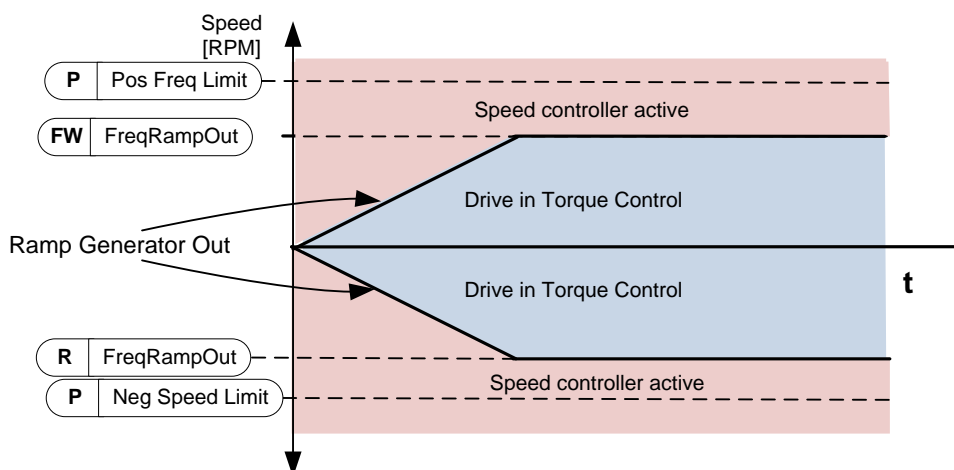

Figure 8-4

**3="Min"** – Minimum from speed reference and torque reference.

The minimum of the speed controller output and the torque reference is selected as final torque reference.

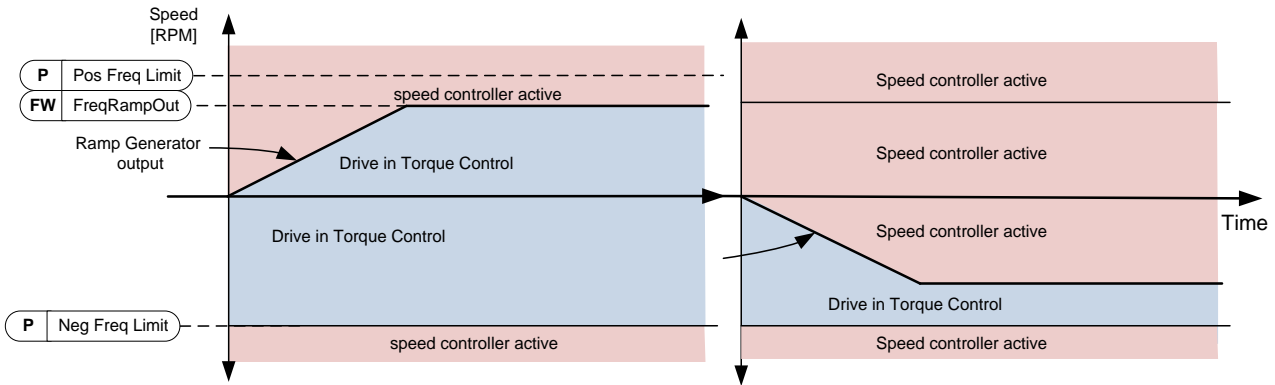

Figure 8-5

**4="Max"** – Maximum from speed reference and torque reference

The maximum of the speed controller output and the torque reference is selected as final torque reference.

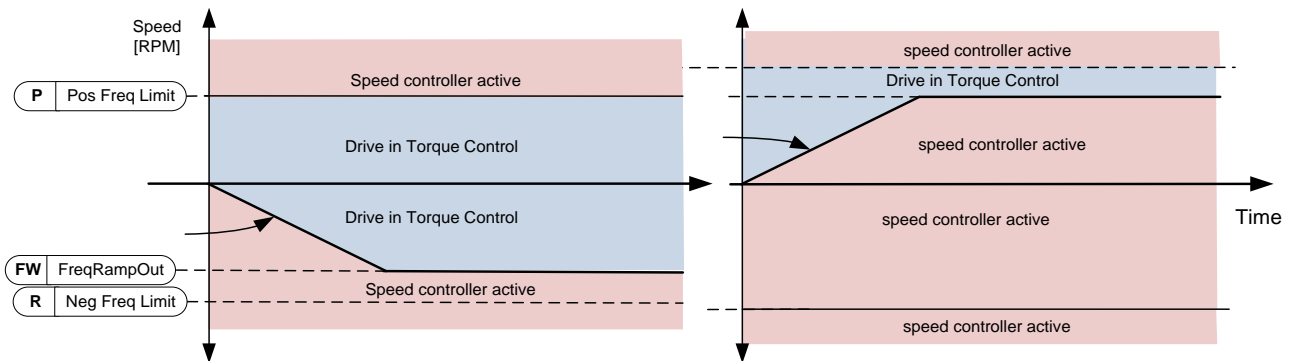

Figure 8-6

## 5="Window" – Window control

Speed is limited within window from speed reference.

The speed control activation limit is different from the speed limit. The speed needs, therefore, to go first to "Window Pos" or "Window Neg" limit before the speed controller activates. When the speed controller is active, the speed will be restricted to the limit defined by "Window Pos Off" and "Windows Neg Off" from the "FinalFreqRef".

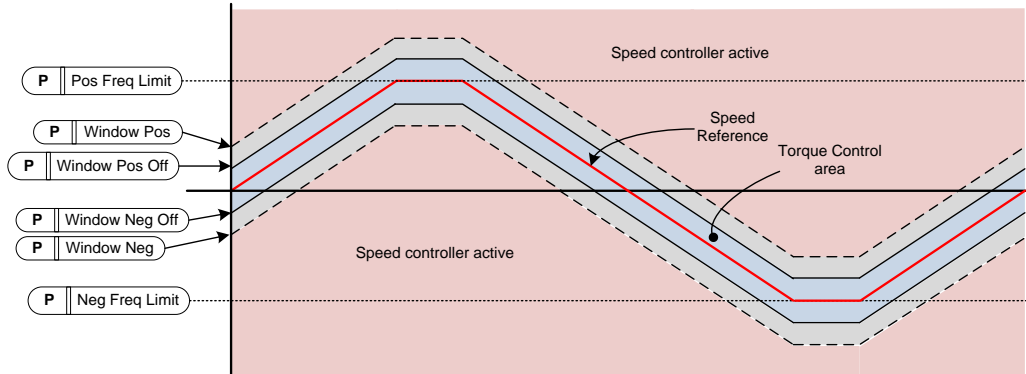

Figure 8-7

### 2.2.1.6.2 Torque reference selection ID1929 "Torq Ref Select"

#### 0="Torque Ref Max"

P2.2.9.3 Torque Ref Max is used as a torque reference. When the drive is in stop state, the reference is internally forced to zero.

#### 1="Curve 1"

P2.2.9.3 Torque Ref Max is scaled with G2.15 Curve parameters thus creating actual speed dependent torque reference.

#### 2="AI1" - Analogue Input 1.

P2.2.9.3 Torque Ref Max is scaled with Analogue Input 1 signal.

#### 3="AI2" - Analogue Input 2.

P2.2.9.3 Torque Ref Max is scaled with Analogue Input 2 signal.

#### 4="AI1 Joystick"

Analogue input 1, -10 Vdc... +10 Vdc. For joystick inputs, the maximum negative reference is negated "Torq Ref Max".

#### 5="AI2 Joystick"

Analogue input 2, -10 Vdc... +10 Vdc For joystick inputs, the maximum negative reference is negated "Torq Ref Max".

#### 6="Fieldbus"

Reference is taken from Fieldbus. V1.1.17 Torque Reference ID18.

#### 7="Curve 2"

P2.2.9.3 Torque Ref Max is scaled with G2.15 Curve parameters thus creating actual speed dependent torque reference.

#### 8="Curve 3"

P2.2.9.3 Torque Ref Max is scaled with G2.15 Curve parameters thus creating actual speed dependent torque reference.

### 2.2.1.6.3 Load Share ID1931 "Load Share"

Load Share for PTO operation. This parameter is used to adjust the load share between different generators using this Generator application.

### 8.2.3 PTI-BOOST

#### 2.2.1.7.1 Torque Select ID1931 "Torque Select"

This parameter defines the speed limiting mode in torque control mode. This parameter can be used as single motor control mode selection when no change is made between open loop and closed loop controls.

See P2.2.1.6.1

##### 0= "SpeedControl" - Speed control mode

The drive is forced to operate in speed control mode while the motor control mode parameter is set to torque control mode thus allowing selection of speed control and torque control mode with single parameter e.g. from Fieldbus.

##### 1="MaxFreqLimit" - Positive and negative frequency limits

The speed is not limited by the speed reference, only by maximum frequency or Positive and Negative frequency limit if set lower than maximum frequency parameter.

##### 2="RampOutput" – Ramp output for both directions

The speed is limited by reference after the ramp generator, thus speed will increase with the set ramp time until the actual torque is equal to the reference torque. If the speed is below the reference when the load is removed from the shaft, the speed will increase without ramp.

This is the default selection. For the master-follower system we recommend you to use a selection that allows a little higher reference for the torque follower so that the load will be balanced equally, e.g. window control.

##### 3="Min" – Minimum from speed reference and torque reference.

The minimum of the speed controller output and the torque reference is selected as final torque reference.

##### 4="Max" – Maximum from speed reference and torque reference

The maximum of the speed controller output and the torque reference is selected as final torque reference.

##### 5="Window" – Window control

The speed is limited within a window from the speed reference.

The speed control activation limit is different from the speed limit. The speed needs, therefore, to go first to the "Window Pos" or "Window Neg" limit before the speed controller activates. When the speed controller is active, the speed will be restricted to the limit defined by "Window Pos Off" and "Windows Neg Off" from the "FinalFreqRef".

### 2.2.1.7.2 Torque reference selection ID1929 "Torq Ref Select"

#### 0="Torque Ref Max"

P2.2.9.3 Torque Ref Max is used as torque reference. When the AC drive is in stop state, the reference is internally forced to zero.

#### 1="Curve 1"

P2.2.9.3 Torque Ref Max is scaled with G2.15 Curve parameters thus creating actual speed dependent torque reference.

#### 2="AI1" - Analogue Input 1.

P2.2.9.3 Torque Ref Max is scaled with Analogue Input 1 signal.

#### 3="AI2" - Analogue Input 2.

P2.2.9.3 Torque Ref Max is scaled with Analogue Input 2 signal.

#### 4="AI1 Joystick"

Analogue input 1, -10 Vdc... +10 Vdc. For joystick inputs, the maximum negative reference is negated "Torq Ref Max".

#### 5="AI2 Joystick"

Analogue input 2, -10 Vdc... +10 Vdc For joystick inputs, the maximum negative reference is negated "Torq Ref Max".

#### 6="Fieldbus"

Reference is taken from Fieldbus. V1.1.17 Torque Reference ID18.

#### 7="Curve 2"

P2.2.9.3 Torque Ref Max is scaled with G2.15 Curve parameters thus creating actual speed dependent torque reference.

#### 8="Curve 3"

P2.2.9.3 Torque Ref Max is scaled with G2.15 Curve parameters thus creating actual speed dependent torque reference.



## 8.2.4 PTI 0-SPEED

### 2.2.1.8.1 Torque Select ID1933 "Torque Select"

This parameter defines the speed limiting mode in torque control mode. This parameter can be used as single motor control mode selection when no change is made between open loop and closed loop controls.

See P2.2.1.6.1

#### 0= "SpeedControl" - Speed control mode

The drive is forced to operate in speed control mode while the motor control mode parameter is set to torque control mode thus allowing selection of speed control and torque control mode with single parameter e.g. from Fieldbus.

#### 1="MaxFreqLimit" - Positive and negative frequency limits

The speed is not limited by the speed reference, only by the maximum frequency or Positive and Negative frequency limit if set lower than the maximum frequency parameter.

#### 2="RampOutput" – Ramp output for both directions

The speed is limited by reference after the ramp generator, thus the speed will increase with the set ramp time until the actual torque is equal to the reference torque. If the speed is below the reference when the load is removed from the shaft, the speed will increase without ramp.

This is the default selection. For the master-follower system we recommend you to use a selection that allows a little higher reference for the torque follower so that the load will be balanced equally, e.g. window control.

#### 3="Min" – Minimum from speed reference and torque reference.

The minimum of the speed controller output and the torque reference is selected as final torque reference.

#### 4="Max" – Maximum from speed reference and torque reference

The maximum of the speed controller output and the torque reference is selected as final torque reference.

#### 5="Window" – Window control

The speed is limited within a window from the speed reference.

The speed control activation limit is different from the speed limit. The speed needs, therefore, to go first to the "Window Pos" or "Window Neg" limit before the speed controller activates. When the speed controller is active, the speed will be restricted to the limit defined by "Window Pos Off" and "Windows Neg Off" from the "FinalFreqRef".

### 2.2.1.8.2 Torque reference selection ID1932 "Torq Ref Select"

#### 0="Torque Ref Max"

P2.2.9.3 Torque Ref Max is used as torque reference. When the drive is in stop state, the reference is internally forced to zero.

#### 1="Curve 1"

P2.2.9.3 Torque Ref Max is scaled with G2.15 Curve parameters thus creating actual speed dependent torque reference.

#### 2="AI1" - Analogue Input 1.

P2.2.9.3 Torque Ref Max is scaled with Analogue Input 1 signal.

#### 3="AI2" - Analogue Input 2.

P2.2.9.3 Torque Ref Max is scaled with Analogue Input 2 signal.

#### 4="AI1 Joystick"

Analogue input 1, -10 Vdc... +10 Vdc. For joystick inputs the maximum negative reference is negated "Torq Ref Max".

#### 5="AI2 Joystick"

Analogue input 2, -10 Vdc... +10 Vdc For joystick inputs the maximum negative reference is negated "Torq Ref Max".

#### 6="Fieldbus"

Reference is taken from Fieldbus. V1.1.17 Torque Reference ID18.

#### 7="Curve 2"

P2.2.9.3 Torque Ref Max is scaled with G2.15 Curve parameters thus creating actual speed dependent torque reference.

#### 8="Curve 3"

P2.2.9.3 Torque Ref Max is scaled with G2.15 Curve parameters thus creating actual speed dependent torque reference.

## 8.2.5 REGEN MOTOR

### 2.2.1.9.1 License key ID1995 "License Key"

Enter here license code to activate Regen Motor operation for induction motor without encoder.

Frequency range is from 30 Hz to 110 Hz. Starting in range of 40 Hz to 80 Hz with an induction motor that has nominal voltage from 380 Vac to 690 Vac.

Drive will not use torque reference nor torque limits in this mode, limitation needs to be done with Active Current limits and Power Limits.

## 8.2.6 COMMISSIONING

### 2.2.1.10.1 MC Mode

Possibility to freely select the drive operation mode for commissioning purposes. By default, the AC drive will not try to control the DC Link voltage in commissioning mode.

0 = AFE Operation

1 = Frequency control operation

2 = Open Loop Torque Control

3 = Closed Loop Speed Control

4 = Closed Loop Torque Control.

### 2.2.1.10.2 DC Control

Possibility to activate the DC-Link Voltage Controller in commissioning operation.

### 2.2.1.10.3 Torque Select ID1278 "Torque Select"

This parameter defines the speed limiting mode in torque control mode. This parameter can be used as single motor control mode selection when no change is made between open loop and closed loop controls.

See P2.2.1.6.1

#### 0= "SpeedControl" - Speed control mode

The drive is forced to operate in speed control mode while the motor control mode parameter is set to torque control mode thus allowing selection of speed control and torque control mode with single parameter e.g. from Fieldbus.

#### 1="MaxFreqLimit" - Positive and negative frequency limits

The speed is not limited by the speed reference, but only by the maximum frequency or Positive and Negative frequency limit if set lower than the maximum frequency parameter.

#### 2="RampOutput" – Ramp output for both directions

The speed is limited by reference after the ramp generator, thus the speed will increase with the set ramp time until the actual torque is equal to the reference torque. If the speed is below the reference when the load is removed from the shaft, the speed will increase without ramp.

This is the default selection. For master-follower system we recommend you to use a selection that allows a little higher reference for the torque follower, so that the load will be balanced equally, e.g. window control.

#### 3="Min" – Minimum from speed reference and torque reference.

The minimum of the speed controller output and the torque reference is selected as final torque reference.

**4="Max" – Maximum from speed reference and torque reference**

The maximum of the speed controller output and the torque reference is selected as final torque reference.

**5="Window" – Window control**

The speed is limited within a window from the speed reference.

The speed control activation limit is different from the speed limit. The speed needs, therefore, to go first to the "Window Pos" or "Window Neg" limit before the speed controller activates. When the speed controller is active, the speed will be restricted to the limit defined by "Window Pos Off" and "Windows Neg Off" from the "FinalFreqRef"

**2.2.1.10.4 Torque reference selection ID641 "Torq Ref Select"****0="Torque Ref Max"**

P2.2.9.3 Torque Ref Max is used as torque reference. When the drive is in the stop state, the reference is internally forced to zero.

**1="Curve 1"**

P2.2.9.3 Torque Ref Max is scaled with G2.15 Curve parameters thus creating actual speed dependent torque reference.

**2="AI1" - Analogue Input 1.**

P2.2.9.3 Torque Ref Max is scaled with Analogue Input 1 signal.

**3="AI2" - Analogue Input 2.**

P2.2.9.3 Torque Ref Max is scaled with Analogue Input 2 signal.

**4="AI1 Joystick"**

Analogue input 1, -10 Vdc... +10 Vdc. For joystick inputs the maximum negative reference is negated "Torq Ref Max".

**5="AI2 Joystick"**

Analogue input 2, -10 Vdc... +10 Vdc For joystick inputs the maximum negative reference is negated "Torq Ref Max".

**6="Fieldbus"**

Reference is taken from Fieldbus. V1.1.17 Torque Reference ID18.

**7="Curve 2"**

P2.2.9.3 Torque Ref Max is scaled with G2.15 Curve parameters thus creating actual speed dependent torque reference.

**8="Curve 3"**

P2.2.9.3 Torque Ref Max is scaled with G2.15 Curve parameters thus creating actual speed dependent torque reference.

## 8.2.7 DC VOLTAGE REFERENCE

### 2.2.2.1 System Nom. AC ID1201

Set this parameter if the DC voltage reference needs to be different than the nominal voltage of the generator.

### 2.2.2.2 System Nom. DC ID1809

When the nominal DC is given, this value is used as a reference point for the DC Voltage reference instead of the Grid Nominal Voltage. We recommend you to use this for any DC voltage control operation. This parameter is also available in the Grid Converter application and DC-DC Converter application.

### 2.2.2.3 DC Voltage Reference ID1462

This parameter sets the DC Voltage reference in % of Nominal DC voltage.

If P2.2.3.3 Nominal DC is zero then

Nominal DC voltage =  $1.35 * \text{Nominal Voltage (P2.1.2)}$ .

Final DC Voltage Ref (V1.1.2) = Nominal DC Voltage \* DC Voltage Reference

The DC Voltage will be maintained at this level when running in generator mode.

There is internal limitation to reference: For 500V units the maximum limit is 797 Vdc and for 690V units the maximum limit 1099 Vdc.

Maximum limit can be monitored from V1.1.15 DC Ref Max Lim.

**NOTE!** If the DC Voltage exceeds below values in stop state, the AC drive will lose ready state:

- 797 Vdc for 500V unit, trip limit 911 Vdc
- 1099 Vdc for 690V unit, immediate trip limit 1200 Vdc, U2t protection above 1100 Vdc.
- 1136 Vdc for LC 690V voltage class 8 (Order code example: NXA15008\_\_\_\_W)

By default, the internal DC Voltage reference is kept same as the actual DC voltage when the AC drive is in stop state.

### 2.2.2.4 DC Droop ID620

When PTO modes are used in parallel, drooping can be used for current balancing. The DC Voltage reference drooping is set as % of active current reference.

For example, if drooping is 3.00% and the active current is 50%, the DC voltage reference is reduced to 1.5%. With drooping, the paralleled units can be balanced by adjusting the DCVoltReference to slightly different values.

### 2.2.2.5 *Reactive Current Reference* ID1459

This parameter sets the reference for the reactive current in % of the nominal current.

This parameter can be used for power factor correction of the AFE system or reactive power compensation. A positive value gives inductive compensation whereas a negative value gives capacitive compensation.

### 2.2.2.6 *DC voltage filter time* ID1760

This parameter is used to filter the DC voltage reference from the actual value to a set reference value when the control mode is changed to between different operation modes where DC Voltage is controlled or not.

This will prevent overcurrent and current spikes when the control mode is changed.

## 8.2.8 SPEED AND FREQUENCY

### 2.2.3.1 *Speed Reference Select* ID117

0 = Keypad Reference

Reference from keypad E3.2

1 = Analogue Input 1

2 = Analogue Input 2

3 = AI1 Joystick

4 = AI2 Joystick

5 = Fieldbus

Reference taken from V1.3.4 FB Torq Ref ID1140

### 2.2.3.2 *Minimum Frequency* ID101

Defines the minimum frequency of any adjustable reference input (i.e. reference is not a parameter). The minimum frequency is bypassed when jogging speed, preset speed or inching reference is used.

### 2.2.3.3 *Maximum frequency* ID102 *“Max Frequency”*

Defines the maximum frequency limit for both negative and positive directions. Direction dependent frequency limits can be given in “G: Limit Settings \ Frequency Handling”.

**Note:** Do not change this parameter to a lower value than the current output frequency if you change it during running. The change will be executed without ramp.

## 8.2.9 TORQUE CONTROL

### *P2.2.4.1 PTI Torque reference scaling, minimum value ID643 "Torq Ref Min"*

The minimum torque reference for analogue input reference selections. Use negative values to make the AC drive to operate on the generator side, and positive values for motoring side operation.

### *P2.2.4.2 PTI Torque reference scaling, maximum value ID642 "Torq Ref Max"*

The maximum allowed torque reference for positive and negative values. Use negative values to make the AC drive to operate on the generator side, and positive values for motoring side operation.

This is also used for joystick input for negative maximum limit.

### *P2.2.4.3 PTO Torque reference scaling, minimum value ID1926 "Torq Ref Min"*

The minimum torque reference for analogue input reference selections. Use negative values to make the AC drive to operate on the generator side, and positive values for motoring side operation.

### *P2.2.4.4 PTO Torque reference scaling, maximum value ID1927 "Torq Ref Max"*

The maximum allowed torque reference for positive and negative values. Use negative values to make the AC drive to operate on the generator side, and positive values for motoring side operation.

This is also used for joystick input for negative maximum limit.

### *P2.2.4.5 Torque Reference Ramp Up Rate ID1934 "TRefRampUpRate"*

Torque Reference absolute value increase rate.

### *P2.2.4.6 Torque Reference Ramp Down Rate ID1935 "TRefRampDownRate"*

Torque reference absolute value decrease rate when going toward zero.

**8.2.10 RAMP CONTROL*****P2.3.1 Start Function ID1274***

0 = Ramp Start

1 = Flying Start

***P2.3.2 Ramp Time ID103***

Used ramp time for frequency reference while synchronization functions are not used.

***P2.3.3 Acceleration/Deceleration ramp 1 shape ID500***

The start and end of acceleration and deceleration ramps can be smoothed with these parameters. Setting value to 0 gives a linear ramp shape which causes acceleration and deceleration to act immediately to the changes in the reference signal. Setting other value for this parameter produces an S-shaped acceleration/deceleration.



## 8.3 INPUT SIGNALS

### 8.3.1 BASIC SETTINGS

#### P2.4.1.1 Start/Stop logic selection ID300 "Start/Stop Logic"

This parameter defines the start stop logic when using I/O control.

##### 0 "Start – No Act" – Start Drive – No Action

Start 1: closed contact = start command DI "Start 1"

##### 1 "StartP-StopP" – Start Pulse – Stop Pulse

3-wire connection (pulse control):

DIN1: closed contact = start pulse

DIN2: open contact = stop pulse, falling edge.

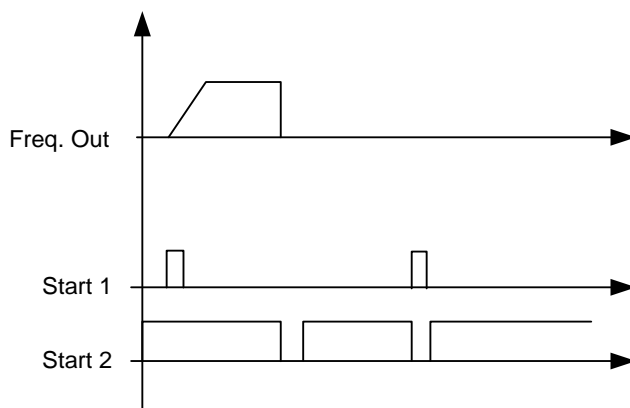

Figure 8-8. Start pulse/ Stop pulse.

The selections including the text '**Rising edge required to start**' must be used to exclude the possibility of an unintentional start when, for example, power is connected or re-connected after a power failure, after a fault reset, after the drive is stopped by Run Enable (Run Enable = False) or when the control place is changed. The Start/Stop contact must be opened before the motor can be started.

##### 2 "RPuls – RPuls" – Rising pulse start – Rising pulse stop

Start 1: closed contact = Start command DI "Start 1"

Start 2: closed contact = Stop command DI "Start 1"

### 2.4.1.2 *Input Inversion ID1091*

Bit selection to invert input signal logic.

B00 = +1 = INV Open Contactor

B01 = +2 = INV Ext. Fault 1

B02 = +4 = INV Ext. Fault 2

B03 = +8 =

B04 = +16 = INV Klixon input 1

B05 = +32 = INV Klixon input 2

B06 = +64 = INV High Ambient temperature

B07 = +128 = INV Input Switch

## 8.3.2 DIGITAL INPUT SIGNALS

### 2.4.2.1 *Start Signal 1 ID403*

Signal selection 1 for the start/stop logic.

### 2.4.2.2 *Start Signal 2 ID404*

Signal selection 1 for the start/stop logic.

### 2.4.2.3 *Open Contactor ID1600*

This parameter is used to choose the input for Contactor Open signal. The signal is used to force the main contactor open (MCC or MCC2) and stop modulating.

When this input is used to stop AFE and to open a main contactor, the DC-link must be discharged and recharged to close the main contactor again and continue modulation

If Force Main Contactor Open signal is not used the option "0.1" = FALSE must be chosen.

### 2.4.2.4 *MainContFeedBack ID1453*

This parameter defines if the drive monitors the status of the main contactor (MCC 1) of the unit. If the monitoring function is used, the unit monitors the status and will not start if the state of the contactor does not correspond to the required status, i.e. is open when it should be closed.

If status of the main contactor is not monitored in the system the option "0.1" = FALSE, must be chosen.

### 2.4.2.5 *Fault Reset ID414*

Contact closed: All faults are reset.

Rising edge.

#### 2.4.2.6 *Ext Fault 1* ID405

Contact closed: Fault is displayed and motor stopped. Fault 51

#### 2.4.2.7 *Ext Fault 2* ID406

Contact open: Fault is displayed and motor stopped. Fault 51

#### 2.4.2.8 *Run Enable* ID407

When signal is low drive will lose Ready status.

Contact open: Start of drive disabled.

Contact closed: Start of drive enabled.

#### 2.4.2.9 *Cooling Monitor* ID750

OK input from the cooling unit.

If status is not monitored in the system the option "0.2" = TRUE must be chosen.

#### 2.4.2.10 *Quick stop* ID1213

Drive stops modulation immediately and opens main contactor

#### 2.4.2.11 *LCL Temperature* ID1179

Digital input from LCL temperature monitoring

#### 2.4.2.12 *RR Enable*

Enables the final run request command. Used for testing purposes when the precharge control is started directly from start command and system must not go to run state.

### 8.3.2.1 *Forced control place*

Digital inputs can be used to bypass parameter P3.1 Control Place, for example, in an emergency situation when the PLC is not able to send command to the drive.

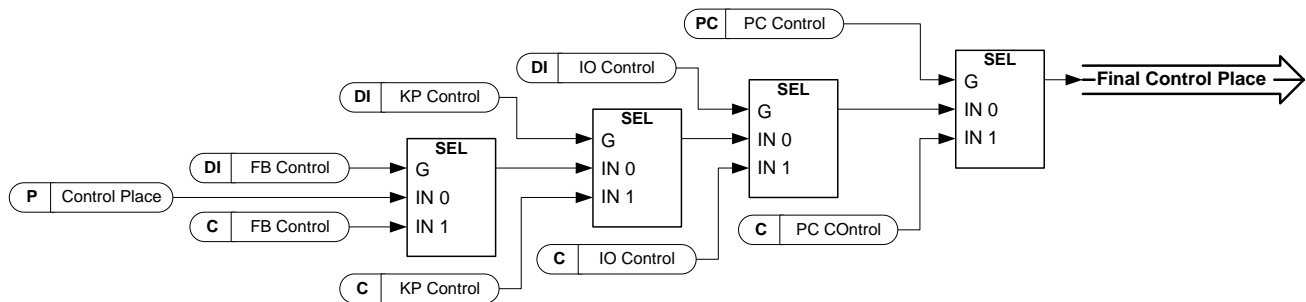

Figure 8-9. Control place selection priority order

#### P2.4.2.13 *Control from I/O terminal* ID409 "I/O Term Control"

Contact closed: Force control place to I/O terminal

#### P2.4.2.14 *Control from keypad* ID410 "Keypad Control"

Contact closed: Force control place to keypad

#### P2.4.2.15 *Control from Fieldbus* ID411 "Keypad Control"

Contact closed: Force control place to fieldbus

**NOTE:** When the control place is changed by force, the values of Start/Stop, Direction and Reference valid in the respective control place are used. The value of parameter ID125 (Keypad Control Place) does not change. When the input opens, the control place is selected according to the keypad control parameter P3.1 Control Place

#### P2.4.2.16 *Power Take Mode 01*

#### P2.4.2.17 *Power Take Mode 10*

Bit selection to change the Power Take mode. Set modes in G2.15

- P2.4.2.18* *Input Power limit Digital input 1*      *ID1917*      *"In. PowerLimit 1"*  
*P2.4.2.19* *Input Power limit Digital input 2*      *ID1918*      *"In.PowerLimit 2"*

With these parameters you can select the desired digital input for controlling the generator power limit. "Gen.PowerLimit 1" and "Gen.PowerLimit 2" activate the respective power limits defined in G2.6.2 Power Handling parameter group. If both inputs are activated, the power limit is zero.

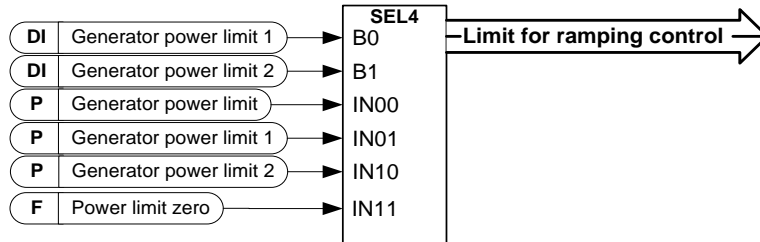

Figure 8-10

- P2.4.2.20* *Output Power limit Digital Input 1*      *ID1919*      *"Out PowerLimit 1"*  
*P2.4.2.21* *Output Power limit Digital input 2*      *ID1920*      *"Out PowerLimit 2"*

With this parameter you can select the desired digital input for controlling the motoring power limit. "Mot.PowerLimit 1" and "Mot.PowerLimit 2" activate the respective power limits defined in parameter group G2.6.2 Power Handling. If both inputs are activated, the power limit is zero.

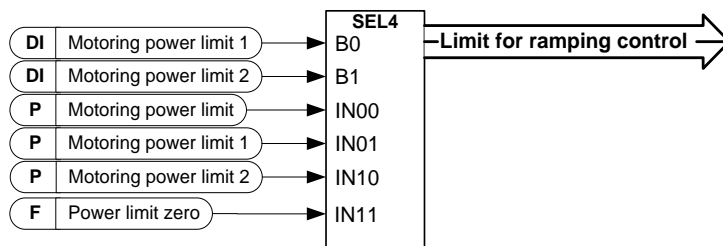

Figure 8-11

#### *P2.4.2.25 Parameter Set 1/Set 2 selection ID496 "Param Set1/Set2"*

With this parameter you can select between Parameter Set 1 and Set 2.

Remember to put the same input for both parameter sets. The parameter sets cannot be changed when the AC drive is in run state.

Digital input = FALSE:

- Set 1 is loaded as the active set

Digital input = TRUE:

- Set 2 is loaded as the active set

When making two parameter sets from the keypad

1. Set all parameters as needed for SET1
2. In "P6.3.1 Parameter Set" select "Store Set1"
3. Set all parameters as needed for SET 1
4. In "P6.3.1 Parameter Set" select "Store Set2"

**Note:** The parameter values are stored only when selecting parameter P6.3.1 Parameter sets Store Set 1 or Store Set 2 or from NCDrive: Drive > Parameter Sets.

#### *P2.4.2.26 Klixon In 1 ID780*

Klixon type temperature monitoring input 1. Low signal will generate warning W66 Klixon.

#### *P2.4.2.27 Klixon In 2 ID781*

Klixon type temperature monitoring input 2. Low signal will generate fault F66 Klixon.

#### *P2.4.2.28 Input Switch ID1209*

Selects the digital input for the status of input switch. The input switch is normally switch fuse unit or main contactor with which the power is fed to the drive. If the input switch feedback is missing, the drive trips on "F55 Input Switch" fault.

#### *P2.4.2.29 Ambient Temp ID783*

Ambient temperature monitoring input Low signal will generate warning W88 Ambient Temp.

### 8.3.3 ANALOGUE INPUTS 1-4

2.4.3.1 AI1 signal selection ID377 "AI1 Signal Sel"

2.4.4.1 AI2 signal selection ID388 "AI2 Signal Sel"

2.4.5.1 AI3 signal selection ID141 "AI3 Signal Sel"

2.4.6.1 AI4 signal selection ID152 "AI4 Signal Sel"

Connect the AI3/AI4 signal to the analogue input of your choice with this parameter.

When the analogue input selection parameter is set to 0.1, you can control the analogue input monitoring variable from Fieldbus by assigning process data input ID number to the monitoring signal. This allows the making of the scaling function in AC drive side to the PLC input signals.

2.4.3.2 Analogue input 1 signal filtering time ID324 "AI1 Filter Time"

2.4.4.2 Analogue input 2 signal filtering time ID329 "AI2 Filter Time"

2.4.5.2 Analogue input 3 signal filtering time ID142 "AI3 Filter Time"

2.4.6.2 Analogue input 4 signal filtering time ID153 "AI3 Filter Time"

First order filtering is used for analogue inputs signals 3 and 4.

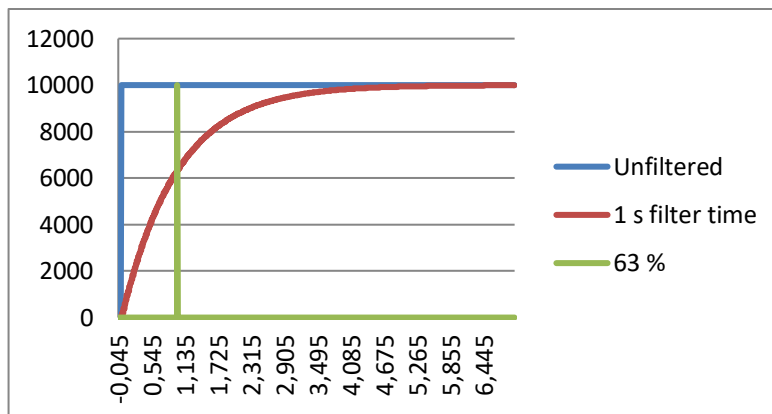

Figure 8-12

2.4.3.3 AI1 custom setting minimum ID321 "AI1 Custom Min"

2.4.3.4 AI1 custom setting maximum ID322 "AI1 Custom Max"

2.4.4.3 AI2 custom setting minimum ID326 "AI2 Custom Min"

2.4.4.4 AI2 custom setting maximum ID327 "AI2 Custom Max"

2.4.5.3 AI3 custom setting minimum ID144 "AI3 Custom Min"

2.4.5.4 AI3 custom setting maximum ID145 "AI3 Custom Max"

2.4.6.3 AI4 custom setting minimum ID155 "AI4 Custom Min"

2.4.6.4 AI4 custom setting maximum ID156 "AI4 Custom Max"

Set the custom minimum and maximum input levels for the AI3 signal within - 160...160%.

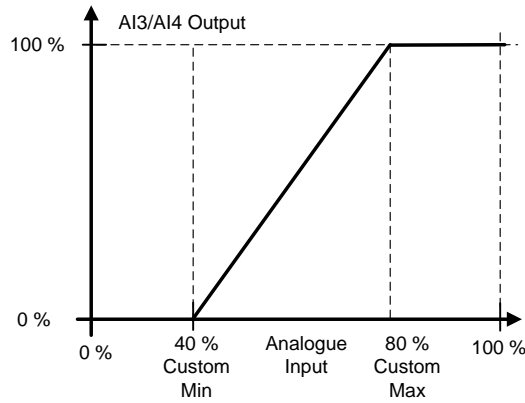

Figure 8-13

- 2.4.3.7 AI1 signal inversion ID387 "AI1 Signal Inv"
- 2.4.4.7 AI2 signal inversion ID398 "AI2 Signal Inv"
- 2.4.5.5 AI3 signal inversion ID151 "AI3 Signal Inv"
- 2.4.6.5 AI4 signal inversion ID162 "AI3 Signal Inv"

The signal inversion function is useful when, for example, the PLC is sending power limit to the drive by using analogue inputs. If the PLC is unable to communicate to the drive, the power limit would normally be zero, but by using the inverted signal logic the zero value from the PLC would mean maximum power limit thus allowing to run the drive for example from the keypad without changing the power limit function parameters.

0 = No inversion

1 = Signal inverted

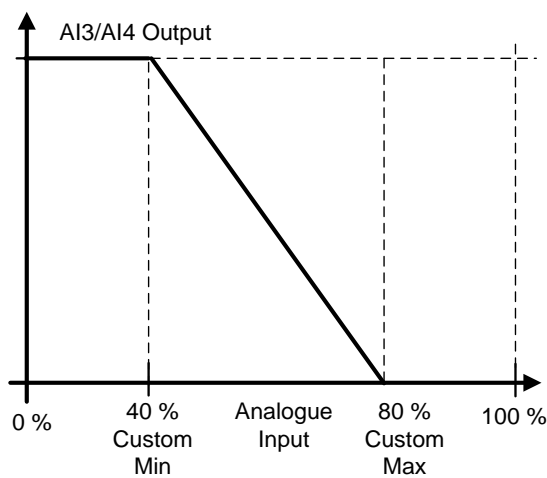

Figure 8-14



### 8.3.3.1 *Analogue input to any parameter*

This function allows control of any parameter by using analogue input. Use these parameters to select the range of control area and the ID number for parameter that is controlled.

|         |  |                        |
|---------|--|------------------------|
| 2.4.3.8 | <i>Analogue input 1, minimum value</i> | ID303 "AI1 Scale Min"  |
| 2.4.3.9 | <i>Analogue input 1, maximum value</i> | ID304 "AI1 Scale Max"  |
| 2.4.4.8 | <i>Analogue input 2, minimum value</i> | ID393 "AI2 Scale Min"  |
| 2.4.4.9 | <i>Analogue input 2, maximum value</i> | ID394 "AI2 Scale Max"  |
| 2.4.5.6 | <i>Analogue input 3, minimum value</i> | ID1037 "AI3 Scale Min" |
| 2.4.5.7 | <i>Analogue input 3, maximum value</i> | ID1038 "AI3 Scale Max" |
| 2.4.6.6 | <i>Analogue input 4, minimum value</i> | ID1039 "AI4 Scale Min" |
| 2.4.6.7 | <i>Analogue input 4, maximum value</i> | ID1040 "AI4 Scale Max" |

These parameters define the range for controlled parameter. All the values are considered to be integers thus when controlling the FWP, you need to set also the digits for decimals, for example, FWP 100.00 needs to be set as 10000.

|          |                          |        |                   |
|----------|--------------------------|--------|-------------------|
| 2.4.3.10 | <i>AI1 Controlled ID</i> | ID1507 | "AI1 Control. ID" |
| 2.4.4.10 | <i>AI2 Controlled ID</i> | ID1511 | "AI2 Control. ID" |
| 2.4.5.8  | <i>AI3 Controlled ID</i> | ID1509 | "AI3 Control. ID" |
| 2.4.6.8  | <i>AI4 Controlled ID</i> | ID1510 | "AI4 Control. ID" |

These parameters define what the controller parameter is.

#### Example:

You want to control the motor field weakening point voltage by an analogue input from 70.00% to 130.00%.

Set Scale min to 7000 = 70.00%

Set Scale max to 13000 = 130.00%

Set Controlled ID to 603 Voltage at field weakening point

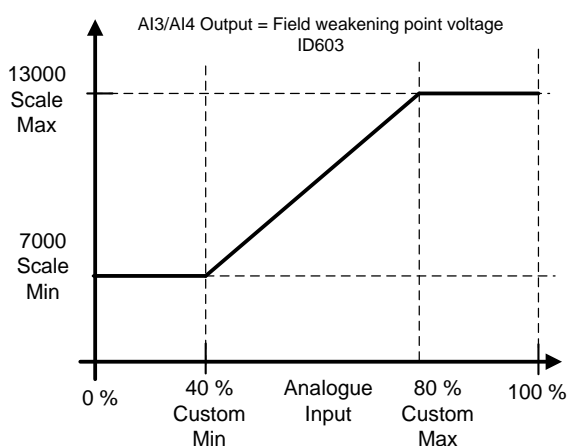

Figure 8-15

Now the analogue input 3 signal 0 V to 10 V (0 mA to 20 mA) will control the field weakening point voltage between 70.00% - 130.00%. When setting the value, the decimals are handled as integer.

## 8.4 OUTPUT SIGNALS

### 8.4.1 DIGITAL OUTPUT SIGNALS

#### 2.5.1.1 *Main Contactor Contr Close*

When P2.5.1.2 is not activated, this output will stay high as long as the MCC needs to be closed. When the signal goes low, the MCC should be opened.

When P2.5.1.2 is activated, this will give only a closing command with two second pulse.

#### 2.5.1.2 *Main Contactor Contr Open*

When this output is selected above 0.9. The AC drive will use the pulse control for the MCC breaker.

P2.5.1.1 is used to close the breaker with a two second pulse.

Opening command is given by P2.5.1.2 with two second pulse.

#### 2.5.1.3 *Ready*

The AC drive is ready to operate.

#### 2.5.1.4 *Run*

The AC drive operates (the drive is modulating).

#### 2.5.1.5 *Fault*

A fault trip has occurred.

#### 2.5.1.6 *Fault, Inverted*

No fault trip has occurred.

#### 2.5.1.7 *At Ref. Speed*

The voltage has reached the set reference.

#### 2.5.1.8 *OverTemp Warn.*

The heatsink temperature exceeds +70°C.

#### 2.5.1.9 *Warning*

General warning signal. Will go low when situation has passed.

If it must remain high, use the Common Alarm signals.

#### 2.5.1.10 *Charge control*

When this is activated, the AC drive will start charging the DC from the start command and go directly to run state. Charge is started from the start command.

#### 2.5.1.11 *Common alarm*

The AC drive has a warning active. This indication needs to be reset separately even if the situation has passed

#### 2.5.1.12 *Ready For Start*

The AC drive has no interlock for starting the charging and going to run state.

#### 2.5.1.13 *Quick Stop Active*

The AC Drive has received an quick stop command.

Fieldbus digital inputs connection

|                  |                              |              |                         |
|------------------|------------------------------|--------------|-------------------------|
| <i>P2.5.1.14</i> | <i>Fieldbus input data 1</i> | <i>ID455</i> | <i>"FB Dig Input 1"</i> |
| <i>P2.5.1.16</i> | <i>Fieldbus input data 2</i> | <i>ID456</i> | <i>"FB Dig Input 2"</i> |
| <i>P2.5.1.18</i> | <i>Fieldbus input data 3</i> | <i>ID457</i> | <i>"FB Dig Input 3"</i> |
| <i>P2.5.1.20</i> | <i>Fieldbus input data 4</i> | <i>ID169</i> | <i>"FB Dig Input 4"</i> |

The data from the Fieldbus main control word can be led to the digital outputs of the AC drive. See the applicable fieldbus board manual for location of these bits.

|                  |   |              |                          |
|------------------|---|--------------|--------------------------|
| <i>P2.5.1.15</i> | <i>Fieldbus digital input 1 parameter</i> | <i>ID891</i> | <i>"FB Dig 1 Par ID"</i> |
| <i>P2.5.1.17</i> | <i>Fieldbus digital input 2 parameter</i> | <i>ID892</i> | <i>"FB Dig 2 Par ID"</i> |
| <i>P2.5.1.19</i> | <i>Fieldbus digital input 3 parameter</i> | <i>ID893</i> | <i>"FB Dig 3 Par ID"</i> |
| <i>P2.5.1.21</i> | <i>Fieldbus digital input 4 parameter</i> | <i>ID894</i> | <i>"FB Dig 4 Par ID"</i> |

With these parameters you can define the parameter to be controlled by using FB Digital input.

**Example:**

All option board inputs are in use and you still want to give DI: DC Brake Command (ID416). You also have a fieldbus board in the drive.

Set parameter ID891 (Fieldbus digital input 1) to 416.

Now you are able to control the DC Braking command from the fieldbus by Profibus control word (bit 11).

It is possible to control any parameter in the same way if values 0=FALSE and 1=TRUE are significant for that parameter. For example, P2.6.5.3 Brake Chopper (ID504) can be controlled on and off using this function (Brake Chopper; 0 = Not Used, 1 = On, Run).

**2.5.1.22** *Generator Operation Active*

The AC drive is in generator operation.

**2.5.1.24** *Temperature limit supervision* **ID450** *"Temp Lim Superv."*

The drive temperature goes beyond the set supervision limits defined in Supervision Lim parameter group. The function can be set to monitor either the high or the low limit. Limit and functions are selected in G2.5.8 Supervision Limits.

**P2.5.1.25** *Encoder 1 supervision function 1* **ID3505****P2.5.1.25** *Encoder 1 supervision function 2* **ID3506**

These functions monitors encode 1 frequency, limit and function is defined in parameter group Supervision Lim. Its possible to set function monitor high or low frequency limit.

**8.4.2 DELAYED DIGITAL OUTPUT 1 & 2***2.5.2.1 Dig.Out 1 Signal**2.4.3.1 Dig.Out 2 Signal*

Connect the delayed DO1 signal to the digital output of your choice with this parameter.

*2.4.2.2 DO1 Content**2.4.3.2 DO2 Content*

0=Not used

1=Ready

2=Run

3=Fault

4=Fault inverted

5=FC overheat warning

6=Ext. fault or warning

7=Ref. fault or warning

8=Warning

9=Reverse

10=SynchronizedToD7

11=Start Command given

12= FB DIN2

13=FB DIN3

14=ID.Bit DO, See P2.4.x.5

*2.4.2.3 DO1 ON Delay**2.4.3.3 DO2 ON Delay**2.4.2.4 DO1 OFF Delay**2.4.3.4 DO2 OFF Delay*

With these parameters you can set on- and off-delays to digital outputs.

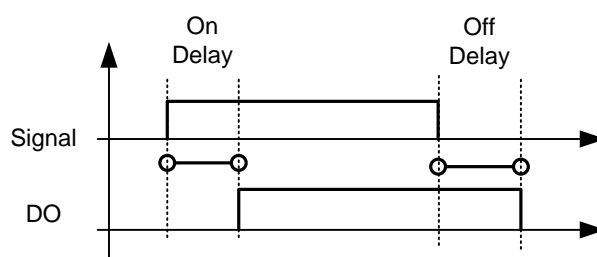

Figure 8-16. Digital outputs 1 and 2, on- and off-delays

#### 2.4.2.5 *ID.Bit Free DO*

#### 2.4.3.5 *ID.Bit Free DO*

Select the signal for controlling the DO. The parameter has to be set in format xxxx.yy where xxxx is the ID number of a signal and yy is the bit number. For example, the value for DO control is 1174.02. 1174 is the ID number of Warning Word 1. So the digital output is ON when bit number 02 of the warning word (ID no. 1174) i.e. *Motor underload* is high.

### 8.4.3 ANALOGUE OUTPUT 1 & 2 & 3

#### 2.4.4.1 *lout 1 signal*

#### 2.4.5.1 *lout 2 signal*

#### 2.4.6.1 *lout 3 signal*

Connect the AO signal to the analogue output of your choice with this parameter. For more information about the TTF programming method, see VACON® the NXS/P User manual.

#### 2.4.4.2 *lout 1 Content*

#### 2.4.5.2 *lout 2 Content*

#### 2.4.6.2 *lout 3 Content*

0=Not used

1=DC Voltage

Scaling: 500 Vac Unit 0-1000 Vac, 690 Vac Unit 0-1317 Vdc

2= Current

Scaled to Nominal Current

3= AC Voltage

Scaled to Nominal Voltage

4=Active Current / Motor Torque

AFE mode: Active Current, Motoring Modes: Motor Torque.

Scaled to 100%.

5= Power

Scaled to 100%

6= Active Current / Motor Torque, bidirectional

AFE mode: Active Current, Motoring Modes: Motor Torque

Scaled to -200% to 200%

7=Power, Bidirectional

Scaled to -200% to 200%

8= AI1

9=AI2

10=FB Analogue Output

11= Line Voltage from OPT-D7

Scaled to Nominal Voltage.

12= Speed

Scaled to Synchronous Speed

13= Control Value output

14= Speed, Bidirectional.

Scaled from  $-2 \times \text{Synchronous speed}$  to  $+2 \times \text{Synchronous Speed}$ .

#### 2.4.4.3 *lout 1 Filter Time*

#### 2.4.5.3 *lout 2 Filter Time*

#### 2.4.6.3 *lout 3 Filter Time*

Defines the filtering time of the analogue output signal. Setting this parameter value 0 will deactivate filtering.

First order filtering is used for analogue output signals.

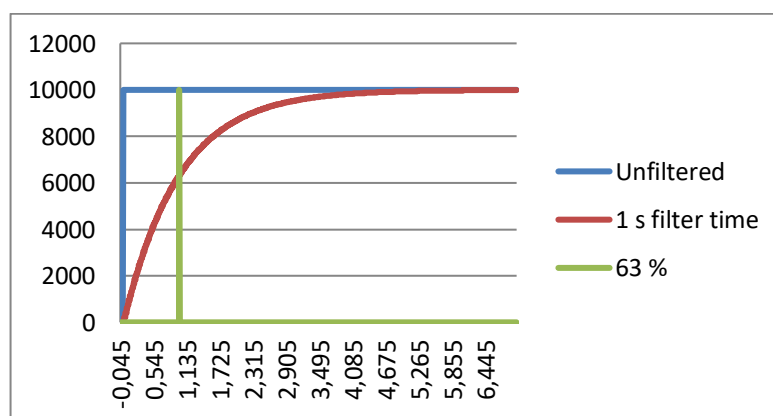

Figure 8-17

#### 2.4.4.4 *lout 1 Invert*

#### 2.4.5.4 *lout 2 Invert*

#### 2.4.6.4 *lout 3 Invert*

Inverts the analogue output signal:

Maximum output signal = Minimum set value

Minimum output signal = Maximum set value

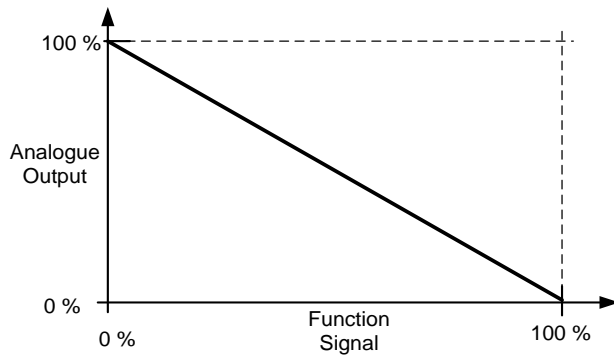

Figure 8-18

2.4.4.5 *lout 1 Minimum*

2.4.5.5 *lout 2 Minimum*

2.4.6.5 *lout 3 Minimum*

0 Set minimum value to 0 mA (0%)

1 Set minimum value to 4 mA (20%)

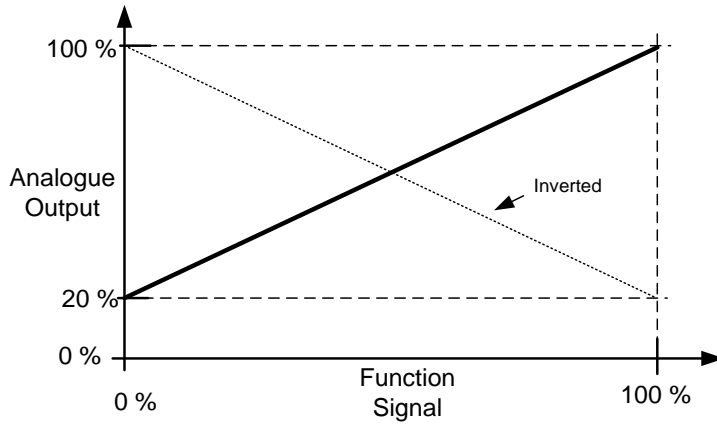

Figure 8-19

2.4.4.6 *lout 1 Scale*

2.4.5.6 *lout 2 Scale*

2.4.6.6 *lout 3 Scale*

Scaling factor for analogue output.

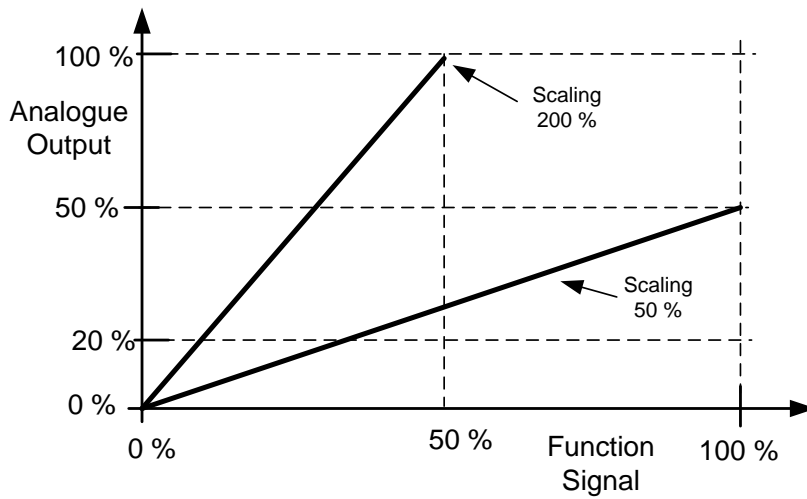

Figure 8-20



**2.4.4.7** *lout 1 Offset***2.4.5.7** *lout 2 Offset***2.4.6.7** *lout 3 Offset*

Add -100.0 to 100.0% to the analogue output.

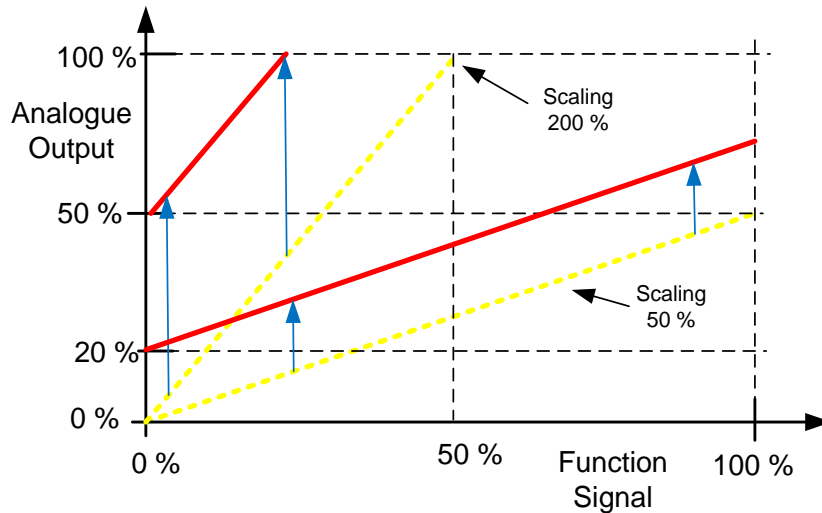

Figure 8-21

**8.4.4** **OPTIONS****P2.5.7.1** *Output inversion* **ID1806**

With this parameter it is possible to select which output signals are inverted.

B00 = +1 = Inver Common Alarm

B01 = +2 = Invert Common Warning

B02 = +4 = Invert delayed output 1

B03 = +8 = Invert delayed output 2

**P2.5.7.2** *DC Supervision Limit* **ID1454**

This parameter defines when the Status Word B10 is high. The bit is high when the DC voltage is above the limit set by this parameter.

**2.5.7.3** *MCC At Stop Command*

Defines action for the MCC when the stop command has been given.

0 = Keep closed

1 = Open MCC when drive has stopped

**2.5.7.4** *MCC close delay*

Defines the delay when RO2 is closed after the AC drive has determined that MCC can be closed.

### 2.5.7.5 *CB Close Mode*

This parameter defines how the closing of circuit breaker is handled.

0 = DC Voltage

Normal AFE operation type circuit breaker control. The circuit breaker is closed when DC voltage is at a required level.

1 = DC Voltage or Start Command

The circuit breaker is closed when DC voltage is at the required level, or from a start command if DC is at a required level. This can be used when the breaker is opened, for example, by a stop command but DC remains high. It is useful when used in a battery system.

2 = Start Command

The circuit breaker is closed from a start command if DC is at a required level.

3 = DC Voltage, Start Command or Pre-Charge Command from FB

The circuit breaker is closed when DC voltage is at the required level, or from a start command if DC is at a required level. This can be used when the breaker is opened, for example, by a stop command but DC remains high. It is useful when used in a battery system. This mode will also close MCB from FB Control Word B0 if DC-Link voltage is at required level.

#### 8.4.5 SUPERVISION LIMITS

Supervision function gives you the possibility to monitor certain values with the limit setting. When the actual value exceeds or goes below the set value a message through a digital output can be given. The torque limit supervision is scalable.

|                 |   |                                 |
|-----------------|---|---------------------------------|
| <b>P2.5.8.1</b> | <b>Drive temperature limit supervision function</b> | <b>ID354 “Temp Lim Superv.”</b> |
| <b>P2.5.8.3</b> | <b>Encoder 1 frequency supervision function 1</b>   | <b>ID3503</b>                   |
| <b>P2.5.8.5</b> | <b>Encoder 1 frequency supervision function 2</b>   | <b>ID3504</b>                   |

- 0 No supervision
- 1 Low limit supervision
- 2 High limit supervision

The following five parameters are used to set a limit value to be monitored with the corresponding parameter above.

|                 |  |                                |
|-----------------|--|--------------------------------|
| <b>P2.5.8.2</b> | <b>Drive temperature limit value</b>     | <b>ID355 “Temp Supv Value”</b> |
| <b>P2.5.8.4</b> | <b>Encoder 1 supervision frequency 1</b> | <b>ID3507</b>                  |
| <b>P2.5.8.6</b> | <b>Encoder 1 supervision frequency 2</b> | <b>ID3508</b>                  |

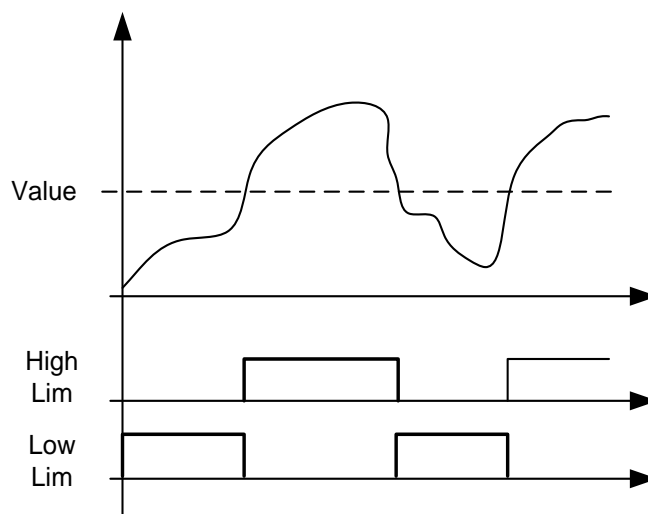

Figure 8-22. Supervision function

## 8.5 LIMIT SETTINGS

### 8.5.1 CURRENT LIMITS

#### 2.6.1.1 Current Limit ID107

Sets the current limit for the regenerative supply unit. Set this to correspond to the maximum required load or peak overload for the unit, bearing in mind that the load might consist of several motor drive units.

Maximum value  $2 * I_H$  depends on the unit size.

#### 2.6.1.2 Output Active Current Limit ID1621

Output active current limit. Limits current flow from DC-Link to AC side in Regen modes.

#### 2.6.1.3 Input Active Current Limit ID1622

Input active current limit. Limits current flow from AC side to DC-Link in Regen modes.

### 8.5.2 POWER LIMITS

#### 2.6.2.1 Output Power Lim ID1290

Drive output power limit.

#### 2.6.2.2 Input Power Lim ID1289

Drive input power limit.

#### 2.6.2.3 Power limit increase rate ID1502 "PowerLimInc.rate"

Defines the power limit increase rate. Decreasing power limit will be in effect immediately.

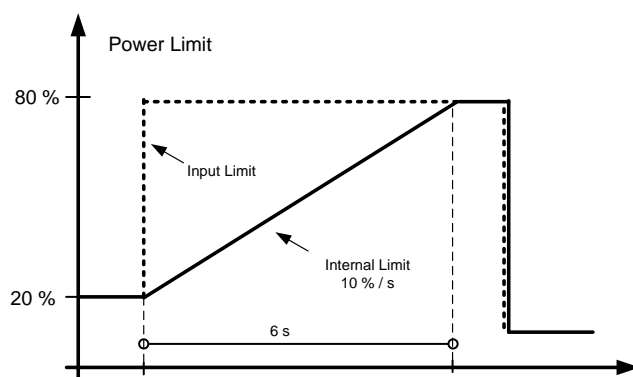

Figure 8-23

### 2.6.2.4 *Input Power Limit Scaling* ID179

This parameter selects if the power limit will be a constant value or changing based on a defined curve1, 2 or 3.

### 2.6.2.5 *Output Power Limit Scaling* ID1088

This parameter selects if the power limit will be a constant value or changing based on defined curve1, 2 or 3.

### P2.6.2.6 *Generator Power limit 1* ID1513 "Gen.PowerLimit 1"

### P2.6.2.7 *Generator Power limit 2* ID1514 "Gen.PowerLimit 2"

Generator side power limit values when limits are activated by digital inputs. When both digital inputs are activated the power limit is forced to zero.

### P2.6.2.8 *Motoring Power limit 1* ID1503 "Mot.PowerLimit 1"

### P2.6.2.9 *Motoring Power limit 2* ID1504 "Mot.PowerLimit 2"

Motoring side power limit values when limits are activated by digital inputs. When both digital inputs are activated the power limit is forced to zero.

### P2.6.2.10 *Undervoltage power limit DC level* ID1611 "UV Power C Level"

This parameter defines the DC voltage level when the special power limit function is activated. When DC voltage goes below this level the power level defined by under voltage power limit will be activated.

### P2.6.2.11 *Undervoltage power limit* ID1613 "UV Power Lim."

Defines the power limit that is used when DC voltage is below parameter Undervoltage power limit DC level (P2.6.2.13). The function is deactivated when this parameter value is zero.

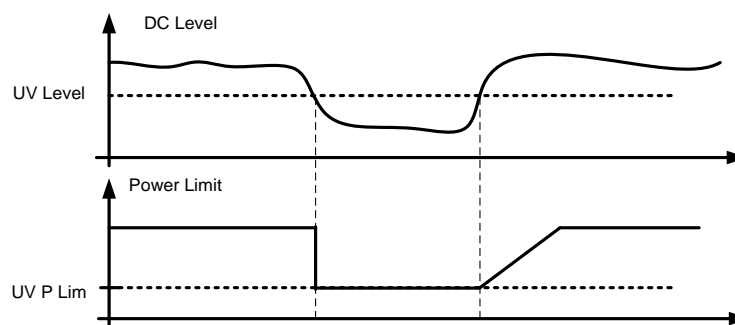

### 8.5.3 FREQUENCY LIMITS

#### 2.6.3.1 *Regen line high frequency limit*

If the AC drive output frequency exceeds this level, the AC drive will trip to line synch fault.

Use this limit as a final protection function for the grid or generator. The protection group has protection functions that will use OPT-D7 information.

#### 2.6.3.2 *Regen line low frequency limit*

If the AC drive output frequency goes below this level, the AC drive will trip to line synch fault.

Use this limit as a final protection function for the grid or generator. The protection group has protection functions that will use OPT-D7 information.

#### 2.6.3.3 *Negative frequency limit*                      *ID1286*                      *“Neg Freq Limit”*

Positive direction frequency limit. When changed in closed loop control mode, the change is made without ramp. Used in Motor Control operation modes.

#### 2.6.3.4 *Positive frequency limit*                      *ID1285*                      *“Pos Freq Limit”*

Negative direction frequency limit. When changed in closed loop control mode, the change is made without ramp. Used in Motor Control operation modes.

**8.5.4 VOLTAGE*****P2.6.4.1 Voltage Low Trip Limit ID1891***

When supply voltage drops below this limit, the AC drive will trip to “Line Synch” fault.

**NOTE:** OPT-D7 is not used for detection.

Use this function for final protection function for grid or generator. The protection group has functions that use OPT-D7 for voltage level protection.

***P2.6.4.2 Voltage High Trip Limit D1892***

When supply voltage increases above this limit, the AC drive will trip to “Line Synch” fault.

**NOTE:** OPT-D7 is not used for detection.

Use this function for final protection function for grid or generator. The protection group has functions that use OPT-D7 for voltage level protection.

### 8.5.5 DC VOLTAGE LIMIT REGULATORS

Parameters to adjust over voltage controllers, no need to adjust unless requested from factory.

#### 8.5.5.1 Open Loop DC voltage regulators

|                                       |               |                        |
|---------------------------------------|---------------|------------------------|
| <i>P2.6.5.1.1 Over Voltage Kp</i>     | <i>ID1468</i> |                        |
| <i>P2.6.5.1.2 Over Voltage Ki</i>     | <i>ID1406</i> |                        |
| <i>P2.6.5.1.3 Over Voltage Kp Add</i> | <i>ID1425</i> |                        |
| <i>P2.6.5.3 Brake chopper</i>         | <i>ID504</i>  | <b>"Brake Chopper"</b> |

When the AC drive is decelerating the motor, the inertia of the motor and the load are fed into an external brake resistor. This enables the drive to decelerate the load with a torque equal to that of acceleration (provided that the correct brake resistor has been selected). See separate VACON® Brake resistor installation manual. Brake chopper test mode generates pulse to resistor every second. If the pulse feedback is wrong (resistor or chopper is missing) fault F12 is generated.

#### 0 = "Not Used" - No brake chopper used

Brake chopper not active or present in the DC link. **NOTE:** The overvoltage controller level is set to a little lower, see parameter P2.6.5.2.

#### 1 = "On, Run" - Brake chopper in use and tested when running.

The drive's own brake chopper is activated and operational when the drive is in Run state. The drive also sends test pulses for feedback from the brake resistor.

#### 2 = "On, Run+Stop" - Used and tested in READY state and when running

Brake chopper is also active when the drive is not in Run state. This option can be used e.g. when other drives are generating but energy levels are low enough to be handled with only one drive.

#### 3 = "On, No test" - Used when running (no testing)

Brake chopper is active in Run state but no test pulse to resistor is generated.

**Note:** In the system menu, there is a parameter "InternBrakeRes". This parameter is used for brake resistor overheating calculations. If an external brake resistor is connected to the drive the parameter should be set to 'Not connected' to disable temperature calculation for the brake resistor.

|                                     |               |                           |
|-------------------------------------|---------------|---------------------------|
| <i>P2.6.5.4 Brake Chopper Level</i> | <i>ID1267</i> | <b>"BrakeChopperLeve"</b> |
|-------------------------------------|---------------|---------------------------|

Brake chopper control activation level in volt.

For 400V Supply:  $400 \cdot 1.35 \cdot 1.18 = 638V$

For 500V Supply:  $500 \cdot 1.35 \cdot 1.18 = 808V$

For 690V Supply:  $690 \cdot 1.35 \cdot 1.18 = 1100V$



### 8.5.5.2 Closed Loop DC voltage regulators

*P2.6.5.2.1 Over Voltage Kp* ID699

*P2.6.5.2.2 Over Voltage Ti* ID698

*P2.6.5.2.3 Over Voltage Kp Add* ID697

#### *P2.6.5.2.4 Over Voltage Control Motoring Torque Limit*

This parameter limits how much motoring torque the AC drive can use to keep the DC-Link Voltage at overvoltage limit.

*P2.6.5.2.5 CL OV On PTI* ID607

OV Controller on PTI Operation

0 = Disabled

1 = Enabled

*P2.6.5.2.6 CL OV Ref On PTI* ID1528

CL Over Voltage reference on PTI operation

*P2.6.5.2.7 Disable Iq Reset on Over Voltage Control* "DisbIqRestOnOVC" ID3501

Disables torque reference reset when over voltage controller activates.

*P2.6.5.2.8 Under Voltage Controller* ID608

Parameter to select if under voltage controller is active also in closed loop control

0 = Off

1 = CL: On, OL: Off

*P2.6.5.2.9 CL Under Voltage Reference* ID1567

Closed Loop under voltage reference level. On start will ramped to set reference from actual DC-Link voltage level after 500 ms.

**8.5.6 TORQUE****P2.6.6.1 Motoring Torque limit ID1287 "MotorTorqueLimit"**

Motoring side torque limit. This limit value is used for all scaling functions and torque limit ramp rate functions if activated.

**P2.6.6.2 Generator Torque limit ID1288 "GenerTorqueLimit"**

Generator side torque limit. This limit is used for all scaling functions generator side torque limit is not included in ramp up rate function.

**P2.6.6.3 Torque limit increase rate ID1819 "TorqueLimInc.rate"**

Defines the torque limit increase rate. Decreasing power limit will be in effect immediately.

**P2.6.6.4 Generator Torque Limit Scaling ID1087**

This parameter selects if torque limit will be a constant value or changing based on a defined curve1, 2 or 3.

**P2.6.6.5 Motoring Torque Limit Scaling ID485**

This parameter selects if torque limit will be a constant value or changing based on a defined curve1, 2 or 3.

**P2.6.6.6 Vdc TorqLimZero ID1992**

When DC-Link voltage level exceeds this level generator torque limit is set to zero. When DC-Link voltage fall below set value generator torque limit is ramped to original level with ramp rate set by ID1993.

**P2.6.6.7 VdcZeroTRampUp ID1993**

Defines returning ramp for generator power torque limit when DC-Link voltage falls below ID1992.

**8.5.7 ACTIVE CURRENT****P2.6.7.1 Active current min limit ID1704****P2.6.7.2 Active current max limit ID1705**

These parameters set the active current minimum and maximum limits for the motoring side operation of the regenerative unit and for the generator side operation of the inverter control. 100.0% is equal to nominal power, defined by System Rated Current.

## 8.6 FLUX CONTROL

### P2.7.1 *Magnetizing current at start* ID627 “Start Magn Curr”

Defines the current that is applied to the motor when the start command is given in closed loop control. At start, this parameter is used together with *Magnetizing time at start* to decrease the time when the motor is able to produce nominal torque. In closed loop, the control output frequency is not forced to zero while magnetization current is applied to the motor.

### P2.7.2 *Magnetizing time at start* ID628 “Start Magn Time”

Defines the time for how long the magnetization current is applied to the motor at start. *Magnetizing current at start* is used to shorten the time when flux is at nominal level. This will improve the torque performance at start. The time needed depends on the motor size. The value varies between 100 ms and 3 s. The bigger the motor the more time it needs. Set this time so that the rotor flux is more than 90% before the speed is released (Start Zero Speed Time ID615) or mechanical brake is released.

### P2.7.3 *Flux reference* ID1250 “FluxReference”

Reference value for rotor flux. Rotor flux can be reduced by changing the magnetization current. This, however, also affects the motor model making the torque calculations a little less accurate. When using this parameter the motor model can compensate the effect of the different magnetization current in torque calculations.

$$[FW]RotorFlux = \left( \frac{f(MotorNomFreq)}{f(Out)} \right)^2 \quad \text{when } f(Out) > f(MotorNomFreq)$$

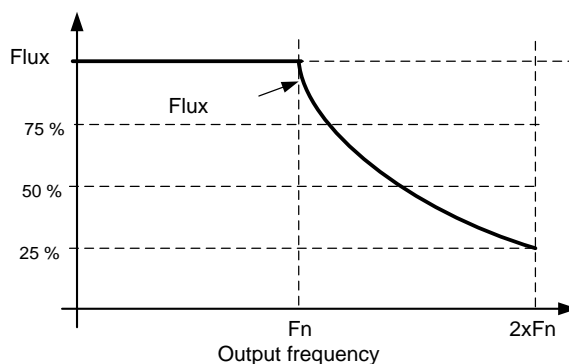

Figure 8-24

## 8.7 MOTOR CONTROL

### Open Loop control

The Open loop control controls the motor without encoder feedback from the motor shaft. The control mode selections 0, 1 and 2 are open loop control modes.

### Slip

Induction motor torque is based on slip. When the load increases, also the slip will increase. The slip is the speed that rotor is behind of stator electrical frequency.

The picture below presents the torque that is produced by an induction motor when connected directly online.

1. Motor Synchronous speed. Motor is taking only magnetization current.
2. Motor nominal operation point. Motor is producing 100% of rated torque and power. Actual shaft speed is motor nominal speed and motor takes nominal current.
3. Pullout torque. This is the point where the motor-produced torque starts to decrease when the slip increases. After this point, the motor will stop if the load is not reduced.

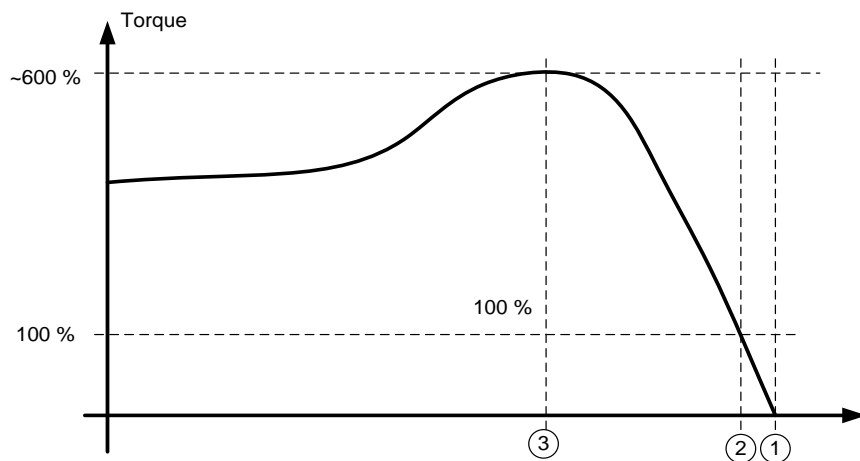

Figure 8-25

In the frequency control, the load will determine the actual shaft speed

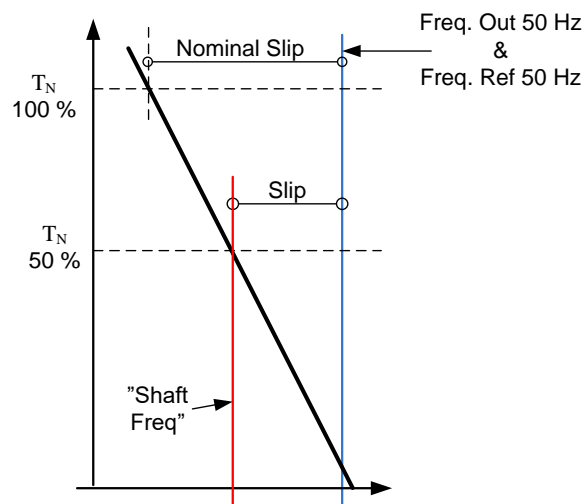

Figure 8-26

### Slip compensation in open loop control

The drive uses motor torque and motor nominal rpm to compensate slip. If the motor nominal rpm is 1440 -> the nominal slip is 60 rpm. And when the motor torque is 50% the slip is 30 rpm. To keep the reference speed the drive must increase the output frequency by 1 Hz.

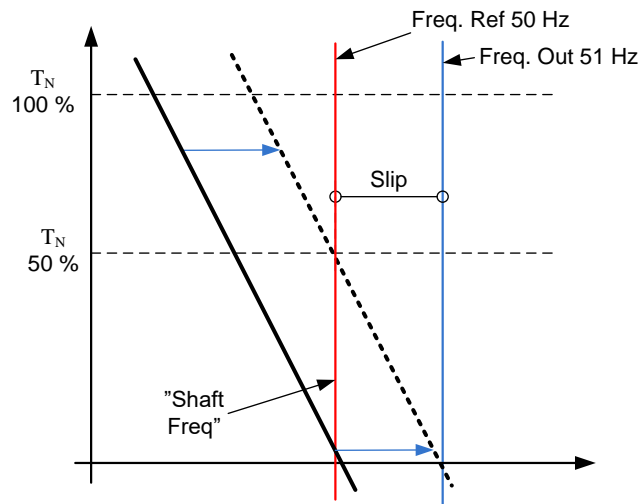

Figure 8-27

### Closed Loop control

Closed loop control controls the motor using the exact information of the motor speed from the encoder. Control mode selections 3 and 4 are closed loop control modes. Using these modes without encoder board (and encoder) will result in encoder fault.

#### P2.8.1 Motor control mode ID600 "Motor Ctrl Mode" (2.6.1)

##### 0 "Open Loop"

Open loop Speed or Torque control

In this control mode the drive can be selected to run in torque control mode. The operation is selected by parameter *TorqueSpeedLimit* in the Torque Reference parameter group. The default selection is torque control mode speed limited by ramp generator output.

##### 1 "Closed Loop"

Closed loop speed or torque control

In this control mode the drive can be selected to run in torque control mode. The operation is selected by parameter *TorqueSpeedLimit* in the Torque Reference parameter group. The default selection is torque control mode speed limited by ramp generator output.

#### 8.7.1 U/F SETTINGS

U/f settings are mainly used in open loop control modes with the exception of the *Field weakening point voltage* that is also used in closed loop control mode as a limit for voltage. U/f settings are

used to control the voltage level that are applied to the motor at different frequencies and different load situations.

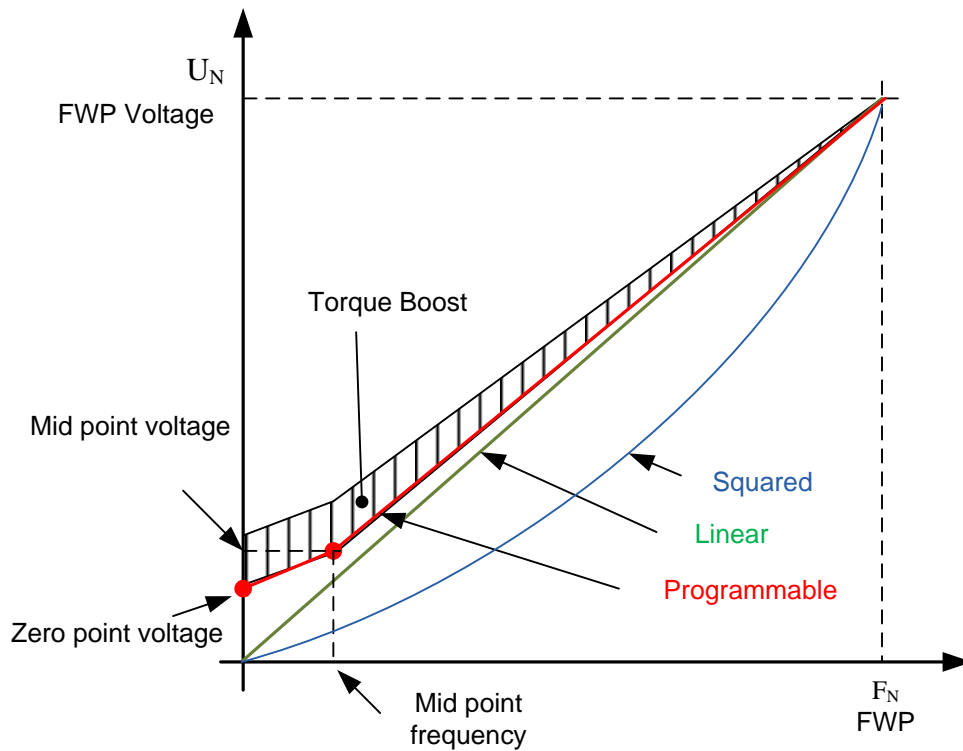

Figure 8-28

What changes are required to start with load from 0 Hz?

- ◆ First set the motor nominal values (Parameter group 2.1).

Option 1: Automatic functions

Step 1: Make identification with rotating motor

Step 2 (If needed): Activate speed control or U/f optimization (Torque boost).

Step 3 (If needed): Activate both speed control and U/f optimization.

Option 2: Manual tuning

Step 1:

Run the motor using 2/3 of motor nominal frequency as the frequency reference. Read the motor current in the monitoring menu or use NCDrive for monitoring. This current must be set as the motor magnetization current.

Change the U/f curve ratio selection to programmable (= 2).

Run the motor with zero frequency reference and increase the motor zero point voltage until the motor current is approximately same as the motor magnetising current. (If the motor is in a low frequency area for only short periods, it is possible to use up to 65% of the motor nominal current).

Set then the midpoint voltage to  $\sqrt{2} * \text{Zero Point Voltage}$   
and

the midpoint frequency to  $(\text{Zero Point Voltage}/100\%)*\text{Nominal frequency of motor}$

Step 2 (If needed): Activate speed control or U/f optimization (Torque boost).

Step 3 (If needed): Activate both speed control and U/f optimization.

*NOTE! In high torque – low speed applications – it is likely that the motor will overheat. If the motor has to run long times under these conditions, special attention must be paid to cooling of the motor. Use external cooling for the motor if the temperature tends to rise too high.*

#### **P2.8.2.1 U/f optimisation ID109 “U/f Optimization”**

**Automatic torque boost** The voltage to the motor changes proportionally to required torque which makes the motor produce more torque at start and when running at low frequencies. Automatic torque boost can be used in applications where starting torque due to starting friction is high, e.g. in conveyors. Even with linear U/f curve, the torque boost has an affect but the best result will be achieved after the identification run when programmable U/f curve is activated.

### P2.8.2.2 U/f ration selection ID108 "U/f Ratio Select"

**Linear:** The voltage of the motor changes linearly from zero point voltage to the field weakening point where the voltage at FWP is supplied to the motor.

0

**Squared:** The voltage of the motor changes from zero point voltage following the squared curve form zero frequency to the field weakening point. The motor runs undermagnetised below the field weakening point and produces less torque. Squared U/f ratio can be used in applications where torque demand is proportional to the square of the speed, e.g. in centrifugal fans and pumps.

1

#### Programmable U/f curve:

2 The U/f curve can be programmed with three different points.

1. Zero point voltage
2. Midpoint frequency and Midpoint voltage.
3. Field weakening point and field weakening point voltage.

Programmable U/f curve can be used if more torque is needed at low frequencies. Make the Identification run for optimal setting (ID631).

#### Linear with flux optimisation:

3 The AC drive starts to search for the minimum motor current in order to save energy. This function can be used in applications with constant motor load, such as fans, pumps etc.

#### Programmable multi U/f points

4 The U/f curve can be programmed with six different points.

1. Zero point voltage
2. Midpoint frequency and Midpoint voltage.
3. Midpoint frequency 2 and Midpoint voltage 2.
4. Midpoint frequency 3 and Midpoint voltage 3.
5. Field weakening point and field weakening point voltage.
6. Field weakening point 2 and field weakening point voltage 2.

Multi programmable U/f points can be used to compensate motor/genera behaviours.



### **P2.8.2.3** *Field weakening point* ID602 “*Field WeakngPnt*”

The field weakening point is the output frequency at which the output voltage reaches the field weakening point voltage.

### **P2.8.2.4** *Voltage at field weakening point* ID603 “*Voltage at FWP*”

Above the frequency at the field weakening point, the output voltage remains at the set maximum value. Below the frequency at the field weakening point, the output voltage depends on the setting of the U/f curve parameters.

When the parameter *Motor nominal frequency* is set, the parameter *Field weakening point* is automatically given the corresponding value. If you need different values for the field weakening point and the maximum output voltage, change these parameters **after** setting the *Nominal frequency*.

In closed loop control this defines the maximum voltage to the motor. It can be increased if sufficient DC voltage is available.

### **P2.8.2.5** *U/f curve, middle point frequency* ID604 “*U/f Mid Freq*”

If the programmable U/f curve has been selected with parameter U/f ratio this parameter defines the middle point frequency of the curve. See also parameter *Middle point voltage*.

When the programmable U/f curve is selected this value is set to 10% of motor nominal frequency.

### **P2.8.2.6** *U/f curve, middle point voltage* ID605 “*U/f mid Voltg*”

If the programmable U/f curve has been selected with the parameter U/f ratio this parameter defines the middle point voltage of the curve. See also parameter *Middle point frequency*.

When the programmable U/f curve is selected this value is set to 10% (of motor nominal voltage).

### **P2.8.2.7** *Output voltage at zero frequency* ID606 “*Zero Freq Voltg*”

This parameter defines the zero frequency voltage of the U/f curve. The default value is unit size dependent.

**NOTE:** If the value of parameter *U/f Ratio Select* is changed this parameter is set to zero.

**P2.8.2.8 U/f curve, middle point frequency 2 ID1592 "U/f Mid Freq 2"**

If the programmable U/f curve has been selected with parameter U/f ratio this parameter defines the middle point frequency of the curve. See also parameter *Middle point voltage*.

When the programmable U/f curve is selected this value is set to 10% of motor nominal frequency.

**P2.8.2.9 U/f curve, middle point voltage 2 ID1593 "U/f mid Voltg 2"**

If the programmable U/f curve has been selected with the parameter U/f ratio this parameter defines the middle point voltage of the curve. See also parameter *Middle point frequency*.

When the programmable U/f curve is selected this value is set to 10% (of motor nominal voltage).

**P2.8.2.10 U/f curve, middle point frequency 3 ID1589 "U/f Mid Freq 3"**

If the programmable U/f curve has been selected with parameter U/f ratio this parameter defines the middle point frequency of the curve. See also parameter *Middle point voltage*.

When the programmable U/f curve is selected this value is set to 10% of motor nominal frequency.

**P2.8.2.11 U/f curve, middle point voltage 3 ID1591 "U/f mid Voltg 3"**

If the programmable U/f curve has been selected with the parameter U/f ratio this parameter defines the middle point voltage of the curve. See also parameter *Middle point frequency*.

When the programmable U/f curve is selected this value is set to 10% (of motor nominal voltage).

**P2.8.2.12 Field weakening point 2 ID1596 "Field WeakngPnt 2"**

The field weakening point is the output frequency at which the output voltage reaches the field weakening point voltage.

*P2.8.2.13 Voltage at field weakening point 2*    *ID1597*    *“Voltage at FWP 2”*

Above the frequency at the field weakening point, the output voltage remains at the set maximum value. Below the frequency at the field weakening point, the output voltage depends on the setting of the U/f curve parameters.

When the parameter *Motor nominal frequency* is set, the parameter *Field weakening point* is automatically given the corresponding value. If you need different values for the field weakening point and the maximum output voltage, change these parameters **after** setting the *Nominal frequency*.

In closed loop control this defines the maximum voltage to the motor. It can be increased if sufficient DC voltage is available.

## 8.7.2 CLOSE LOOP SETTINGS

### P2.8.3.1 *Current control P gain* ID617 *"CurrentControlKp"*

Sets the gain for the current controller. The controller generates the voltage vector reference to the modulator. The gain is also used in open loop flying start. When the Sine filter parameter (parameter P6.7.5 in the System menu) has been set to *Connected* the value of this parameter is changed to 20.00%.

The value is also identified when using a PMS motor and making identification run with rotating motor. At low speed, the motor values may increase up to 300%. At high speed, the motor gain and motor with sine filter may have gain values of 10...40%.

### P2.8.3.3 *Current control Ti* ID657 *"CurrentControlTi"*

Current controller integrator time constant.

### P2.8.3.3 *Slip adjust* ID619 *"Slip Adjust"*

The motor name plate speed is used to calculate the nominal slip. This value is used to adjust the voltage of motor when loaded. The name plate speed is sometimes inaccurate and this parameter can therefore be used to trim the slip. Reducing the slip adjust value increases the motor voltage when the motor is loaded.

### P2.8.3.4 *Speed Error filtering time constant* ID1311 *"SpeedErrorFiltTC"*

Filter time constant for speed reference and actual speed error. Can be used to remove small disturbances from encoder signal.

### P2.8.3.5 *Encoder filter time* ID618 *"Encoder1FiltTime"*

Sets the filter time constant for speed measurement.

The parameter can be used to eliminate encoder signal noise. Too high a filter time reduces speed control stability. Values over 10 ms are not recommended in normal cases.

**P2.8.3.6 Speed Control Torque Chain Select ID1557 "SCTorqueChainSel"**

Values are bit coded. For example, after identification run with rotating motor the value will be 96. If you want to activate an external acceleration compensation you need to add +2 to the existing value.

**B0 +1 = Additional torque limit**

The torque reference chain can be used as an additional torque limit. This option is available in closed loop control mode only.

**B1 +2 = External acceleration compensation**

The torque reference is added to the speed control output, allowing the external controller to give inertia compensation for the drive in speed control mode. This option is available in closed loop control mode only.

**B5&B6, +96 = Internal motor temperature compensation**

When the motor cools down or warms up, the slip of the motor will change. When this function is activated in closed loop control mode, the AC drive will estimate changes in motor resistance and correct the changes of motor slip automatically to achieve the best torque estimation.

This function is automatically activated when identification run with rotating motor is successfully finished. This option is available in closed loop control mode only.

**B11 +2048 = Disable CL Over Voltage Iq reference setting to zero**

This function stabilizes operation when needed to operate continuously against over voltage limit.

**P2.8.3.7 Encoder Selection ID1595 "Encoder Selector"**

With this parameter it is possible to select which encoder input is used for closed loop control. Encoder board OPT-A7 is needed because of the possibility to connect two encoders.

0,1 = Encoder input 1

2 = Encoder input 2

### 8.7.3 PERMANENT MAGNET SYNCHRONOUS MOTOR SETTINGS

There are three ways to know the magnet positions when using the closed loop control. The first one will identify the motor magnet position during every stage when the incremental encoder is used without a Z-pulse. Second one uses the incremental encoder Z-pulse and the third one uses absolute encoder information. See details of selecting correct mode from chapter "Identification function for permanent magnet synchronous motor".

#### P2.8.4.1 PMSM Shaft Position ID649 "PMSMShaftPositio"

Absolute encoder position value corresponding to the shaft position where rotor magnet axis is aligned with the stator U-phase magnet axis will be stored here as a result of the encoder identification run. If incremental encoder with a z-pulse is used, the z-pulse position will be stored instead. Depending on the motor shaft mechanical position, this parameter can have different values, as there is one correct value for each pole-pair of the motor. If the incremental encoder and the z-pulse is used, the first start after a power up is less optimal and the i/f-control (see 6.8.3.2) will be used until the drive finds the z-pulse and is able to synchronize in that.

#### P2.8.4.2 Start Angle Identification Mode ID1691 "StartAngleIdMode"

Start angle, i.e. rotor magnet axis position in respect to the stator U-phase magnet axis. Identification is needed if no absolute encoder or incremental encoder with z-pulse is used. This function defines how the start angle identification is made in those cases. Identification time depends on the motor electrical characteristics but takes typically 50ms...200ms.

In case of absolute encoders, the start angle will read directly from the encoder absolute angle value. On the other hand, incremental encoder z-pulse will be used automatically for synchronization if its position is defined different from zero in P2.8.5.1. Also for absolute encoders, P2.8.5.1 must be different from zero, otherwise it is interpreted that the encoder identification run has not been done and the running will be prohibited except if the absolute channel is bypassed by the start angle identification.

#### NOTE!

ModulatorType (P2.10.2) need to be > 0 to be able to use this function.

#### 0 = Automatic

Decision to use start angle identification is made automatically based on the encoder type connected to the AC drive. This will serve common cases.

#### 1 = Forced

Bypasses the drive automatic logic and forces the start angle identification to be active. Can be used, for example, with absolute encoders to bypass absolute channel information and to use start angle identification instead.

## 2 = On Power UP

As a default, the start angle identification will be repeated in every start if the identification is active. This setting will enable identification only in a first start after drive is powered up. In consecutive starts, angle will be updated based on the encoder pulse count.

## 10 = Disabled

Used when the Z- pulse from the encoder is used for start angle identification.

### *P2.8.4.3 Start Angle Identification Current ID1759 "StartAngleIdCurr"*

This parameter defines the current level that is used in start angle identification. The correct level depends of the motor type used. In general, 50% of the motor nominal current seems to be sufficient, but depending for example on the motor saturation level, higher current might be needed.

### *P2.8.4.4 Polarity Pulse Current ID1566 "PolarityPulseCur"*

This parameter defines the current level for the magnet axis polarity direction check during the start angle identification (P2.8.5.2). Value 0 means that the internal current level is used, which is typically slightly higher than the normal identification current defined by P2.8.5.3. The polarity direction check is seldom needed because the identification itself gives already the right direction. Hence in most cases, this function can be disabled by setting any negative parameter value, which is recommended especially if F1 faults occur during the identification.

### *P2.8.4.5 Start Angle Identification Time ID1755 "StartAngleIdTime"*

The start angle can be determined also by feeding DC current into the motor. The DC current will align the rotor magnet axis with the stator magnet axis. This function is activated by determining the time duration DC current is injected to the motor. Motor must be free to move during the alignment and the time needs to be long enough for shaft oscillations to damp out. Hence, this method is not so practical and is intended to be used mainly for testing purposes or to improve starting in together with i/f-control. DC current level is determined by P2.8.5.6. Also P2.8.5.2 needs to be disabled, otherwise it will override this function.

### 8.7.3.1 I/f Control

I/f-control can be used to start the motor using a constant current control. This is useful especially, if the motor stator resistance is low, which makes the motor current sensitive for u/f-curve tuning at low speed area. I/f-control is activated by setting AdvancedOptions2.B9 = 1 (P2.10.6).

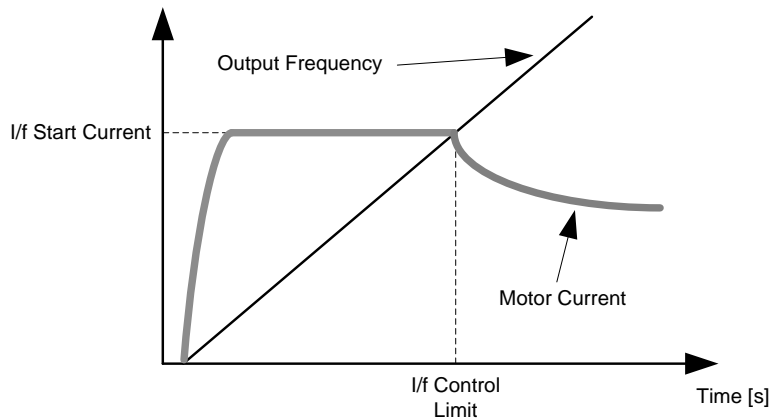

Figure 8-29

#### P2.8.4.6 I/f Current ID1693 "I/f Current"

**NOTE:** I/f Current parameter is used for several different purposes.

#### I/f Control

This parameter defines the current level during I/f control, in percent of the motor nominal current

#### Zero position with incremental encoder and Z-Pulse

In closed loop control utilizing the encoder z-pulse, this parameter defines also the current level used in the start before the z-pulse is received to synchronize with.

#### DC Start Angle identification

This parameter defines the DC Current level when the Start Angle Identification Time is set greater than zero. See P2.8.5.5 Start Angle Identification Time.

#### P2.8.4.7 I/f Control Limit ID1790 "I/f Control Lim"

This parameter sets the speed limit for I/f-control in percent of the motor nominal speed (1000 = 100.0%). I/f-control is used if the speed is below this limit. The operation changes back to normal when the speed is above this limit with 60 rpm hysteresis.



### 8.7.3.2 *Flux current controller*

The flux current controller is used with a PMS motor when running in closed loop control in the field weakening area. This function controls the negative Id current to the PM motor in the field weakening area so that the motor terminal voltage does not increase above the maximum level (set by field weakening point voltage, maximum drive output voltage). The field weakening area operation depends on the motor construction. The motor construction may prohibit operation above the field weakening area.

If there is instability in the field weakening area, gain can be decreased and/or time constant increased.

#### **P2.8.4.8** *Flux Current Kp ID551 "FluxCurrent Kp"*

Defines gain for the flux current controller when using a PMS motor. Depending on the motor construction and the ramp rate that is used to go to the field weakening area, high gain may be needed so that the output voltage does not reach the maximum limit and prevent proper motor control. Too high gain may lead to unstable control. The integration time is more significant in this case for control.

#### **P2.8.4.9** *Flux Current Ti ID652 "FluxCurrent Ti"*

Defines the integration time for the flux current controller when using a PMS motor.

Depending on the motor construction and the ramp rate that is used to go to field weakening area, short integration times may be needed so that the output voltage does not reach the maximum limit and prevent proper motor control. Too fast integration time may also lead to unstable control.

#### **P2.8.4.10** *ExtIdRef ID1730 "ExtIdRef"*

This reference value can be used for the external control of the motor id-current i.e. reactive current. Normally there is no need for that as the control uses already the optimal value. This reference value is additive to the internal values of the AC drive but, for example, the field-weakening controller can override the given reference in field-weakening.

### 8.7.3.3 *D and Q axis voltage drops*

If d-axis and q-axis reactances (voltage drops) are defined, the AC drive calculates the optimal d-axis current reference based on the reactance values and the motor torque in order to account the motor reluctance torque part. In this way, the motor Torque/Current ratio can be increased.

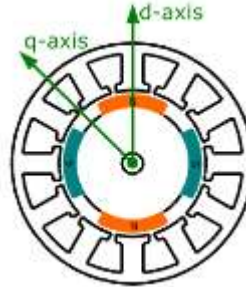

Figure 8-30

#### P2.8.5.11 *Lsd Voltage Drop* ID1757      “Lsd Voltage Drop”

D-axis reactance voltage drop 2560 = 100%.

Gives the % voltage drop across the stator inductance at nominal current and frequency.

$$X_d[\text{Drive scale}] = \frac{X_d[\Omega] * I_n[\text{A}] * \sqrt{3} * 2560}{U_n[\text{V}]}$$

#### P2.8.5.12 *Lsq Voltage Drop* ID1758      “Lsq Voltage Drop”

Q-axis reactance voltage drop 2560 = 100%.

Gives the % voltage drop across the stator inductance at nominal current and frequency.

$$X_q[\text{Drive scale}] = \frac{X_q[\Omega] * I_n[\text{A}] * \sqrt{3} * 2560}{U_n[\text{V}]}$$

#### P2.8.4.13 *I/f Current 2*      ID1694

If current level can be adjusted together with ID1791 to different level based on output frequency. This parameter adjusts the current level of the second point

#### P2.8.4.14 *I/f Control Limit 2*      ID1791

If current level can be adjusted together with ID1694 to different level based on output frequency. This parameter adjusts the frequency level of the second point

*P2.8.4.15 Current Control Kp D ID1761*

*P2.8.4.16 Voltage Margin ID1762*

*P2.8.6.21 Encoder ID Run Mode "EnclIdRunMode" ID680*

This parameter defines how the start angle identification is made for absolute encoder with the identification mode selections 3 / "Enc. ID Run" or 4 / "Ident All".

**0 = Default**

This mode feeds the DC current to the motor and aligns the rotor to find the zero position. The rotor needs to be able to rotate freely to align correctly.

**1 = Current Pulses**

This mode sends current pulses to the motor, and the rotor can be locked to a position, for example with a mechanical brake. This mode should be tested to the motor in use, since all PMSM are not suitable for this identification mode.

**2 = ID with Run**

This method is the most reliable to find the zero position but requires that the motor can be accelerated to 2/3 of motor nominal speed to find the absolute encoder zero position. After 2/3 of nominal speed is reached, the motor is coasted to determine the encoder zero position after the DC brake is applied to make the rotor to stop to stand still. This method can be used also when step-up transforms are used.

#### 8.7.4 STABILIZATION SETTINGS

##### Torque stabiliser

The torque stabiliser is basically a first order high-pass filter for the estimated torque [ $T$ ]. The output of the filter is a frequency correction term  $df$  added to the output frequency reference. The purpose of the torque stabiliser is to stabilise the possible oscillations in the estimated torque. The controller gain is changing linearly between the zero and field weakening point frequencies. The zero and field weakening point gains can be controlled independently with gains. The stabiliser operates at frequencies above 3 Hz.

The discrete implementation of the filter is:

$$\frac{1000}{TorqStabDamp} df_k = \frac{1000}{TorqStabDamp} G(T_k - T_{k-1}) + df_{k-1} = G_f(T_k - T_{k-1}) + df_{k-1}$$

Where  $G_f$  is the total gain of the filter. The gain and the corner frequency of the filter is controlled by the following parameters

##### *P2.8.5.1 Torque stabiliser damping ID1413 "TorqStabDamp"*

If a PMS motor is used in open loop control mode it is recommended to use value 980 instead of 800. The value '980' is set automatically when PMS motor is selected.

This parameter defines the corner frequency of the high-pass filter. The time constant of the filter is calculated as:

$$T_c = T_s \frac{TorqStabDamp}{1000 - TorqStabDamp} = 1ms \frac{TorqStabDamp}{1000 - TorqStabDamp}$$

This means that the corner frequency of the filter is obtained from:

$$\omega_c = \frac{1}{T_c} \text{rad/s}$$

For example, if Torque stabilizer damping = 600, this means that  $T_c = 1.5$  ms and  $\omega_c = 667$  rad/s.

**P2.8.5.2 Torque stabiliser Gain ID1412 "TorqStabGain"**

These parameters define together with the Torque Stabiliser Damping the actual gain of the filter. Torque Stabiliser Gain is the gain at the zero frequency. Torque stabiliser Gain in FWP is the gain at the field-weakening frequency. The gain changes linearly with the frequency between these two points so that the gain is

$$G = \text{TorqStabGainFWP} + \text{TorqStabGain} - \frac{f}{f_{\text{FWP}}} \text{TorqStabGain}, \quad \text{if } f < f_{\text{FWP}}$$

$$G = \text{TorqStabGainFWP}, \quad \text{if } f \geq f_{\text{FWP}}$$

The final gain is obtained by considering the value of Torque Stabiliser Damping and the scaling in which 256 means the gain 1. So, the final and the actual gain of the filter is obtained from

$$G_f = \frac{1000 * G}{256 * \text{TorqStabDamp}}$$

**P2.8.5.3 Torque stabiliser Gain in FWP area ID1414 "TorqStabGainFWP"**

Gain of the torque stabiliser at field weakening point in open loop motor control operation. See details from Torque Stabiliser Gain.

**P2.8.5.4 Torque stabiliser Limit ID1720 "TorqStabLimit"**

This defines how much the torque stabiliser can affect the output frequency.

Flux Circle stabiliser**P2.8.5.5 Flux Circle stabiliser Gain ID1550 "FluxCircleStabG"**

Gain for flux circle stabiliser. This will control the flux to origin when error is detected. The controller output is added to the output frequency. The effect decreases at low frequencies where flux stabiliser has more effect. The parameter is used at frequencies where output voltage is at the maximum limit (set by field weakening point voltage or maximum drive output voltage).

Flux stabiliser

Flux stabilizer is a first order high-pass filter for the estimated flux producing current  $I_d$ . The output of the filter is correcting term  $dU$  added to the output voltage reference. The gain and the corner frequency of the filter is controlled by the following parameters.

**P2.8.5.6 Flux Stabiliser Gain ID1797 "Flux Stab Gain"**

Flux stabilizer gain is 0 at the zero speed and is increased linearly with the frequency to value defined by the Flux Stab Gain which is reached at the 1 Hz.

So, the gain is obtained from

$$G = \text{Flux Stab Gain} * f, \quad \text{if } f < 1 \text{ Hz}$$

$$G = \text{Flux Stab Gain}, \quad \text{if } f \geq 1 \text{ Hz}$$

The gain is scaled by 1000 and the actual gain of the filter is obtained from

$$G_f = \frac{G}{1000} = \frac{\text{Flux Stab Gain}}{1000}$$

**P2.8.5.7 Flux stabiliser TC ID1551 "FluxStab TC"**

Flux Stabiliser TC defines the corner frequency of the high-pass filter. The time constant of the filter is calculated from:

$$T_c = T_s \frac{65536 - 2 * \text{FluxStab TC}}{2 * \text{FluxStab TC}} = 1\text{ms} \left( \frac{65536}{2 * \text{FluxStab TC}} - 1 \right)$$

For example, if Flux Stabiliser TC = 64, this means that  $T_c = 511 \text{ ms}$  and  $\omega_c = 1.96 \text{ rad/s}$ .

Voltage stabiliser

The voltage stabilizer is similar to the torque stabilizer controlling the change in DC-link voltage at frequencies above 3 Hz. It is a first order high-pass filter for the measured DC-link voltage  $U_{dc}$ . The output of the filter is a frequency correction term  $df$  added to the output frequency reference. Gain is adjusted relative to the estimated torque. As the torque increases from 10% to 50% of the motor nominal torque, the controller gain decreases from the voltage stabiliser Gain down to zero. The gain and the corner frequency of the filter are controlled by the following parameters:

**P2.8.5.9 Voltage stabiliser Gain ID1738 "VoltStabGain"**

Voltage Stabilizer Gain is a function of a torque. If the torque is below 15%, the gain is the value defined by the Voltage Stabilizer Gain. If the torque is above 50% the gain is 0. Between 15-50% the gain decreases linearly with the torque from Voltage Stabilizer Gain to 0. In other words,

$$G = \text{VoltStabGain}, \quad \text{if } T < 15\%$$

$$G = \frac{\text{VoltStabGain}}{35\%} (50\% - T(\%)), \quad \text{if } 15\% \leq T < 50\%$$

$$G = 0, \quad \text{if } T > 50\%$$

The final gain is obtained by considering the value of Voltage stabiliser TC and the scaling in which 256 means the gain 1. So, the final and the actual gain of the filter is obtained from

$$G_f = \frac{1000 * G}{256 * \text{VoltStab TC}}$$

**P2.8.5.10 Voltage stabiliser TC ID1552 "VoltageStab TC"**

This parameter defines the corner frequency of the high-pass filter. The time constant of the filter is calculated as

$$T_c = T_s \frac{\text{VoltageStab TC}}{1000 - \text{VoltageStab TC}} = 1\text{ms} \frac{\text{VoltageStab TC}}{1000 - \text{VoltageStab TC}} \text{ms}$$

**P2.8.5.11 Voltage stabiliser Limit ID1553 "VoltStabLimit"**

This parameter sets the limits for the voltage stabilizer output. The maximum and the minimum value for the correction term  $df$  in FreqScale.

### 8.7.5 IDENTIFICATION SETTINGS

#### P2.8.6.1 to

#### P2.8.6.15 Flux 10...150% ID1355 – ID1369

Motor voltage corresponding to 10%...150% of flux as a percentage of Nominal Flux voltage. Measured during identification.

#### P2.8.6.16 Measured Rs voltage drop ID662 "RsVoltageDrop"

The measured voltage drop at stator resistance between two phases with the nominal current of the motor. This parameter is identified during identification run.

This parameter defines the motor stator resistance as a voltage drop at nominal current. The parameter value is defined according to the motor nominal voltage and the current and the actual stator resistance as

$$RsVoltageDrop = 2560 \frac{I_n}{U_n} R_s$$

#### P2.8.6.17 Ir: Add zero point voltage ID664 "IrAddZeroPVoltag"

Defines how much voltage is applied to the motor in zero speed when the torque boost is used.

#### P2.8.6.18 Ir: Add motoring scale ID667 "IrAddMotorScale"

Defines the scaling factor for the motoring side IR-compensation when the torque boost is used.

#### P2.8.6.19 Ir: Add generator scale ID665 "IrAddGeneScale"

Defines the scaling factor for the generator side IR-compensation when the torque boost is used.

#### P2.8.6.20 Measured Ls voltage drop ID673 "LsVoltageDrop"

Leakage inductance voltage drop with nominal current and frequency of the motor. This parameter defines the Ls voltage drop between two phases. Use identification run to determine the optimum setting.

#### P2.8.6.21 Motor BEM Voltage ID674 "Motor BEM Voltage"

Motor-induced back voltage.

#### P2.8.6.22 IU Offset ID668 "IU Offset"

#### P2.8.6.23 IV Offset ID669 "IV Offset"

#### P2.8.6.24 IW Offset ID670 "IW Offset"

Offsets the value for the phase current measurement. Identified during identification run.

#### P2.8.6.25 Estimator Kp ID1782 "Estimator Kp"

Estimator gain for PMS motor. Identified during identification run.

P2.8.6.26 Estimator Ki ID1782



*P2.8.6.26 Voltage Drop ID671 "Voltage Drop"*  
Measured residual voltage error.

*P2.8.6.28 ID Run Curr. Kp ID695*

*P2.8.6.29 FluxSaturatRatio ID682*

*P2.8.6.30 T:Identification ID3520*

*P2.8.6.31 T:IdentOptions ID3521*

**8.7.6 FLYING START*****P2.8.8.1 Flying Start Options ID1770***

- b0** = +1= Disable movement to reverse direction
- b1** = +2=Disable AC Scanning
- b2** = +4=Disable Fly Brake phase
- b3** = +8=Use encoder information for frequency estimate
- b4** = +16=Use frequency reference for initial guess
- b5** = +32=Disable DC scanning for step-up application

***P2.8.8.2 AC magnetization Current ID1810***

Current reference during AC scanning phase.

***P2.8.8.3 AC Scanning Time ID1811***

Reference time for the AC scanning when the motor slip is 1 Hz. If slip is 0.50 Hz, the actual scanning time is double.

***P2.8.8.4 DC magnetization Current ID1812***

Current reference during the DC scanning phase.

***P2.8.8.5 Flux Build Torque DI1814***

Torque reference during the Flux built time.

***P2.8.8.6 Flux Build Time ID1813***

Time when the rotor flux is increased to nominal after the flying start has found the motor actual speed. If zero speed is found, this function is not used.

***P2.8.8.7 Magnetization Phases ID1815******P2.8.8.8 FlyStartPhs1Time ID1718***

## 8.8 SPEED CONTROL SETTINGS

### 8.8.1.1 Open Loop Settings

**P2.9.1** *Speed controller P gain, Open Loop* ID637 "OL Speed Reg P"  
Defines the P gain for the speed controlled in Open Loop control mode.

**P2.9.2** *Speed controller I gain, Open Loop* ID638 "OL Speed Reg I"  
Defines the I gain for the speed controlled in Open Loop control mode.

### 8.8.1.2 Closed Loop Speed Control Settings

Speed control formula:

$$y = Kp \left[ 1 + \frac{1}{Ti s} \right] e$$

$$u(k) = y(k - 1) + Kp[e(k) - e(k - 1) + \frac{Ts}{Ti} e(k)]$$

**P2.9.3** *Speed control P gain* ID613 "Speed Control Kp"  
Gain for the speed controller in closed loop motor control operation. Gain value 100 means that the nominal torque reference is produced at the speed controller output for the frequency error of 1Hz.

**P2.9.4** *Speed control I time* ID614 "Speed Control Ti"  
Sets the integral time constant for the speed controller. Increasing the I-time increases stability but lengthens the speed response time.

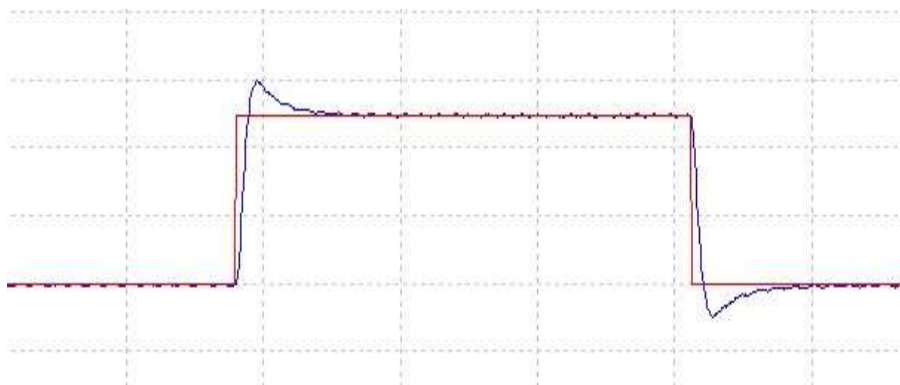

Figure 8-31, Kp 30, Ti 100

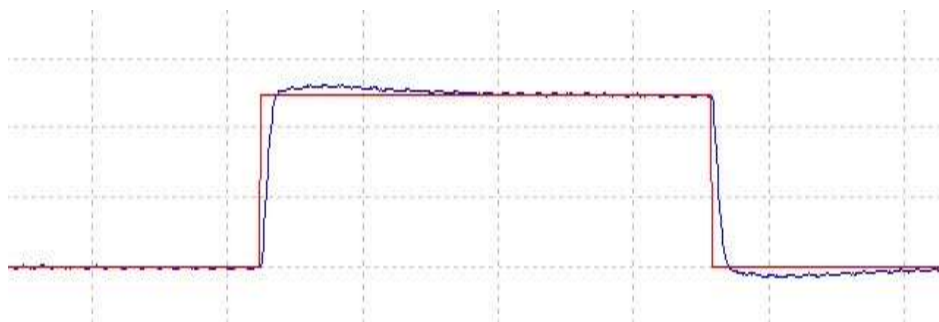
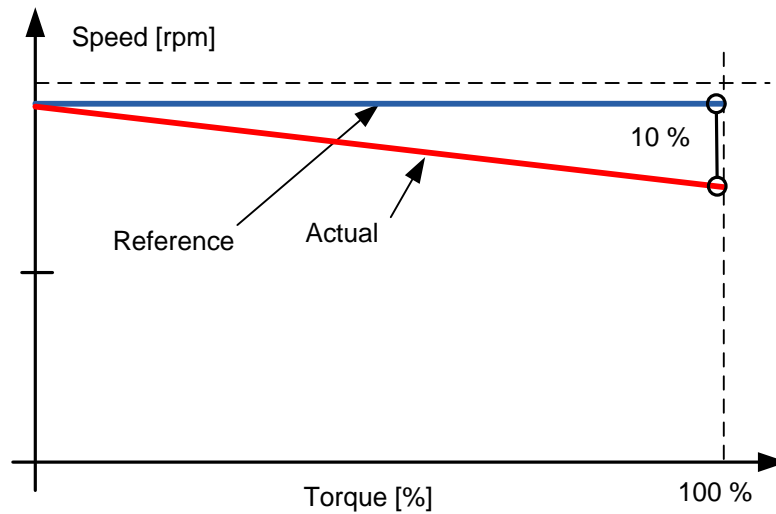

Figure 8-32, Kp 30, Ti 300

### P2.9.5 Load drooping ID647 “LoadDrooping”

The drooping function enables speed drop as a function of load. This parameter sets the value corresponding to the nominal torque of the motor.



**Example:** If load drooping is set to 10% for a motor that has a nominal frequency of 50 Hz and is nominally loaded (100% of torque) the output frequency is allowed to decrease 5 Hz from the frequency reference. The function is used for, for example, when the balanced load is needed for mechanically connected motors.

## 8.9 DRIVE CONTROL

### 2.10.1 *Switching Freq*

The switching frequency of the IGBT Bridge in kHz. Changing the default value may impact on the LCL filter operation.

### 2.10.2 *AFE Options 1*

This packed bit word is made for enabling/disabling different control options for regeneration control.

**B0** = Disable DCV reduction with reactive reference generation with high line voltage.

**B1** = Disable LCL reactive power compensation.

**B5** = Disable all harmonic elimination compensation

This is active by default. When activated, this function will reduce the 5<sup>th</sup> and 7<sup>th</sup> harmonics a bit. This will not reduce harmonics of the grid, only the harmonics of the AFE Unit.

**B8** = Enable double pulse synchronization

This option will generate two synchronization pulses instead of one. It may help synchronization on a weak grid.

**B9** = Enable soft synchronization ( $\geq$  FI9)

This function enables zero crossing detection on FI9 and bigger units. When it is active and there is a connection to the grid with the AC drive in stop state, the Supply Frequency is updated by the detected frequency.

**B12** = Enable floating DC reference. DC-link voltage will follow line voltage.

If the run state AC drive can detect the Supply Voltage, the internal DC Reference is changed when the supply voltage changes, so that the DC Voltage is:

$$DC\ Voltage = Measured\ Supply\ Voltage * 1.35 * DC\ Reference$$

**B13** = Enable use of D7 board for start synchronization.

When the OPT-D7 board is installed, this bit will activate the synchronization by using the voltage angle and frequency information from the D7 board. Note that the phase order needs to be the same in both OPT-D7 and input phases. We also recommend to keep the frequency on the positive side. Note that the Frequency of the D7 board can be the same as the Supply Frequency but the phase order can be still wrong,

### 2.10.3 *AFE Options 2*

This packed bit word is made for enabling/disabling different control options for regeneration control.

B0 = Use encoder fast input for fast Run Enable

### 2.10.4 Start Delay

This parameter defines a starting delay when the run command is given. When programming different delays to the paralleled units, the units will start in sequence. This is needed in parallel units so that the synchronization does not happen simultaneously with all the drives. Simultaneous starting may lead to failed synchronization. Recommended value between the drives is 500 ms.

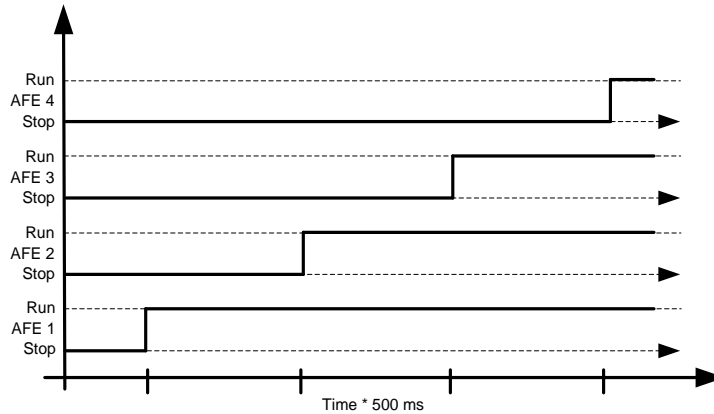

Figure 8-33

### 2.10.5 AdvancedOptions1

This packed bit word is made for enabling/disabling different control options for regeneration control.

### 2.10.6 AdvancedOptions2

This packed bit word is made for enabling/disabling different control options for regeneration control.

### 2.10.7 AdvancedOptions3

This packed bit word is made for enabling/disabling different control options for regeneration control.

### 2.10.8 AdvancedOptions4

This packed bit word is made for enabling/disabling different control options for regeneration control.

### 2.10.9 AdvancedOptions5

This packed bit word is made for enabling/disabling different control options for regeneration control.

### 2.10.10 AdvancedOptions6

This packed bit word is made for enabling/disabling different control options for regeneration control.

### 2.10.11 *AdvancedOptions7*

This packed bit word is made for enabling/disabling different control options for regeneration control.

### 2.10.12 *Modulator type (ID1516)*

This parameter is for changing the modulator type. With ASIC (HW) modulator, the current distortion is lower, but losses are higher compared to a software modulator. We recommend to use Software modulator 1 as a default option.

**0 = Hardware modulator:** ASIC modulator, which is classical third harmonic injection. Spectrum is slightly better compared to Software 1 modulator.

**1 = Software modulator 1:** Symmetric vector modulator with symmetrical zero vectors. Current distortion is less than with software modulator 2 if boosting is used.

**2 = Software modulator 2:** Symmetric BusClamb, in which one switch always conducts 60 degrees either to negative or positive DC-rail. Switching losses are reduced without different heating of upper and lower switches. Spectrum is narrow.

**3 = Software modulator 3:** Unsymmetric BusClamb, in which one switch always conducts 120 degrees to negative DC-rail to reduce switching losses. Drawback is that upper and lower switches are unevenly loaded and spectrum is wide.

**4 = Software modulator 4:** Pure sinewave, sinusoidal modulator without harmonic injection. Dedicated to be used in back to back test benches etc. to avoid circulating third harmonic current. Drawback is that required DC voltage is 15% higher compared to other modulator types.

### 2.10.13 *Control Options*

**B00 = +1 = Reserved**

**B01 = +2 = Reserved**

**B02 = +4 = Reserved**

**B03 = +8 = Disable D7 frequency monitoring for diagnostic. Used for testing purposes.**

**B04 = +16 = Disable D7 voltage monitoring for diagnostic. Used for testing purposes.**

**B05 = +32 = Keep frequency drooping while synchronization to external grid.**

**B06 = +64 = Enable External grid contactor closing on stop state**

**B07 = +128 = Enable changing (temporally) MCC Control output, used to disable MCC close for testing purposes.**

**B08 = +256 = Disable floating DC reference, Island and uGrid modes will follow actual DC**

**B09 = +512 = Reserved**

**B10 = +1024 = Activate Closed Loop type speed limit function in Open Loop**

**B11 = + = Rem**

**B12 = + = Reserved**

**B13 = + = Use Drive own angle information for SG synchronization.**

**B14 = + = Reserved.**

**B15 = + = Reserved.**





**2.10.14 Control Options 2**

B01 = +2 = No longer available, use P2.12.1.13 FaultWarnIndicat

**2.10.15 Synch Kp Start**

[Description needed]

**2.10.16 Capacitor size [%] (ID1460)**

AFE: This parameter defines the reactive current going to the LCL filter capacitor. Compensates the LCL effect to reactive current by adjusting reactive current reference internally. Inductor size is also added to compensation. If set correctly, power factor on the grid side will be one.

$$I_{CAP} = \left( \frac{V_{Grid}}{\sqrt{3}} \right) (2\pi f C_Y)$$

Where  $C_Y$  = Filter capacitance

$$\text{Capacitor size [\%]} = \frac{I_{CAP} * [CurrenScale]}{\text{System Rated Current}} * 100$$

CurrentScale; if no decimals in current value then current scale is 1. If one decimal in current value then current scale is 10. If two decimals in current value, then current scale is 100.

**2.10.17 Inductor size [%] (ID1461)**

AFE:

This parameter defines voltage losses in percentage from nominal voltage at 100% active current. This value is internally added to the reactive current reference thus giving power factor one on the grid side if set correctly together with the Capacitor size. Transformer and feeding cables can be compensated by increasing this value.

$$\text{Inductor size [\%]} = \frac{2\pi f L * 100}{\left( \frac{V_{Grid}}{\sqrt{3}} * [CurrenScale] \right)} \left( \frac{V_{Grid}}{\sqrt{3}} * [CurrenScale] \right)$$

**P2.10.18 Operation Time ID1855**

The parameter that stores the operation time. When application is reloaded, the operation hours will go to zero if this parameter is not updated.

Monitoring signal is in hours with two decimal.

Parameter is in format of:

xx (Years) XX (Monts) XX (Days) XX (Hours) XX Minutes

1211292359 -> 12 years, 11 months, 29 days, 23 hours and 59 minutes.

|                 |                          |               |
|-----------------|--------------------------|---------------|
| <i>P2.10.19</i> | <i>Active Current Kp</i> | <i>ID1455</i> |
| <i>P2.10.20</i> | <i>Active Current Ti</i> | <i>ID1456</i> |
| <i>P2.10.21</i> | <i>Restart Delay</i>     | <i>ID672</i>  |
| <i>P2.10.22</i> | <i>DC Volt. Kp</i>       | <i>ID1451</i> |
| <i>P2.10.23</i> | <i>DC Volt. Ti</i>       | <i>ID1452</i> |
| <i>P2.10.24</i> | <i>Synch Kp</i>          | <i>ID1457</i> |
| <i>P2.10.25</i> | <i>Synch Ti</i>          | <i>ID1458</i> |
| <i>P2.10.26</i> | <i>ModIndexLimit</i>     | <i>ID1936</i> |
| <i>P2.10.27</i> | <i>DCLinkMeasCalib</i>   | <i>ID549</i>  |

To increase the DC-voltage accuracy you may use ID549 to adjust the DC-link voltage measurement shown by the converter. This parameter will add a small gain offset to the measured DC-link voltage value. This feature helps to balance the load sharing for parallel converters.

## 8.10 MASTER FOLLOWER

### 8.10.1 MASTER FOLLOWER: DRIVESYNCH SYSTEM

DriveSynch is used to control parallel drives. Up to four drives can be connected parallelly. The motor can be a single winding motor or there can be several winding motors. VACON® DriveSynch works in open loop and closed loop motor control modes. With closed loop motor control, the encoder feedback needs to be wired only to the master drive. If redundancy is required, it may be necessary to wire the encoder feedback also to follower drives using the double encoder option board OPTA7.

#### Note:

In a DriveSynch system, only Master drive monitoring signals are reliable. Only directly measured values are reliable in follower units. Even the Output Frequency of DriveSynch follower is not directly observed and thus may not show actual output frequency that is controlled by DriveSynch Master Drive.

#### Note!

The maximum switching frequency for the drives using VACON® DriveSynch is 3.6 kHz. Minimum recommended switching frequency in Open Loop control is 1.7 kHz. Minimum recommended switching frequency in Closed Loop control is 2.5 kHz.

#### Note!

The VACON® NXP control board must be VB00761 (NXP3) or newer. OPT-D2 boards needs to VB276J or newer. Master needs to be #1 and cannot be changed.

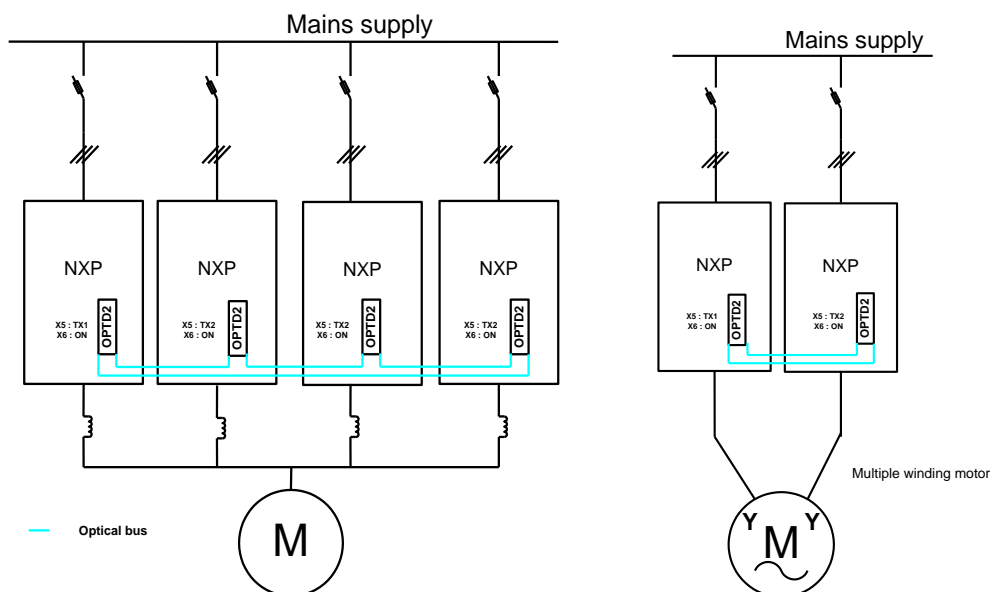

### 8.10.1.1 Redundancy

The units working in parallel with VACON® DriveSynch have a high level of redundancy. The system keeps running without interruption even if any of the follower units is non-functional. In case of a hardware failure, the failed unit need be isolated before the system can be restarted.

The actual level of redundancy, however, needs to be carefully defined considering the motor, load and the requirements of the process.

The master drive unit and the fast drive to drive optical communication has to be functional for the VACON® DriveSynch functionality. The auxiliary power (+24V) must be continuously provided for all the control units including the non-functional drive units in VACON® drive synch system.

It is also a common practice to use (n+1) units, where n is the number of required units for full functionality of the system. In this case, the system is fully operational even if any follower is non-functional.

|   | <b>Master<br/>(D1)</b>  | <b>Follower<br/>(D2)</b>  | <b>Follower<br/>(D3)</b>  | <b>Follower<br/>(D4)</b>  |
|---|---|---|---|---|
| <b>Parameter settings</b>                                       |   |   |   |   |
| Motor Nominal Voltage   | Motor Nominal voltage from the motor name plate   | Motor Nominal voltage from the motor name plate   | Motor Nominal voltage from the motor name plate   | Motor Nominal voltage from the motor name plate   |
| Motor nominal Frequency   | Motor Nominal frequency from the motor name plate   | Motor Nominal frequency from the motor name plate   | Motor Nominal frequency from the motor name plate   | Motor Nominal frequency from the motor name plate   |
| Motor Nominal Current   | Motor Nominal current from the motor name plate / Number of drives in parallel using VACON® Drive Synch | Motor Nominal current from the motor name plate / Number of drives in parallel using VACON® Drive Synch | Motor Nominal current from the motor name plate / Number of drives in parallel using VACON® Drive Synch | Motor Nominal current from the motor name plate / Number of drives in parallel using VACON® Drive Synch |
| Motor COS PHI (Motor nominal power factor)                      | Motor COS PHI from the motor name plate   | Motor COS PHI from the motor name plate   | Motor COS PHI from the motor name plate   | Motor COS PHI from the motor name plate   |
| Motor Nominal Power   | Motor Nominal power from the motor name plate / Number of drives in parallel using VACON® Drive Synch   | Motor Nominal power from the motor name plate / Number of drives in parallel using VACON® Drive Synch   | Motor Nominal power from the motor name plate / Number of drives in parallel using VACON® Drive Synch   | Motor Nominal power from the motor name plate / Number of drives in parallel using VACON® Drive Synch   |
| Master Follower Mode  | Master, DriveSynch  | Follower, DriveSynch  | Follower, DriveSynch  | Follower, DriveSynch  |
| Motor Control Mode (Open Loop)                                  | Open Loop Frequency   | If used as Secondary Master: Open Loop Frequency.<br>When used as Follower: no meaning.                 | No meaning, internally handled. Recommended to have same setting as in master.                          | No meaning, internally handled. Recommended to have same setting as in master.                          |
| Motor Control Mode (Closed Loop)                                | Closed Loop Speed /Torque   | If used as Secondary Master: Closed Loop Speed/Torque.<br>When used as Follower: no meaning.            | No meaning, internally handled Recommended to have same setting as in master.                           | No meaning, internally handled Recommended to have same setting as in master.                           |
| Magnetizing current (needed only for closed loop motor control) | Motor nominal magnetizing current / Number of drives in parallel using VACON® Drive Synch               | Motor nominal magnetizing current / Number of drives in parallel using VACON® Drive Synch               | Motor nominal magnetizing current / Number of drives in parallel using VACON® Drive Synch               | Motor nominal magnetizing current / Number of drives in parallel using VACON® Drive Synch               |
| Switching Frequency   | Max 3.6 KHz   | Same as in Master   | Same as in Master   | Same as in Master   |
| Modulator Type  | 1, Software   | Same as in Master   | Same as in Master   | Same as in Master   |
| Follower Phase shift (single winding motor)                     | 0 degrees   | 0   | 0   | 0   |
| Follower Phase shift (multiple winding motor)                   | 0 degrees   | As per motor name plate   | As per motor name plate   | As per motor name plate   |

### 8.10.2 MASTER FOLLOWER CONFIGURATION

The OPTD2 board in the Master has default jumper selection, X5:1-2. For the followers, the jumper positions have to be changed: **X5:2-3**. This board also has a CAN communication option that is useful for multiple drive monitoring with VACON® NCDriver PC software when commissioning Master Follower functions or line systems. Older boards has X6, leave this to ON (X6:1-2).

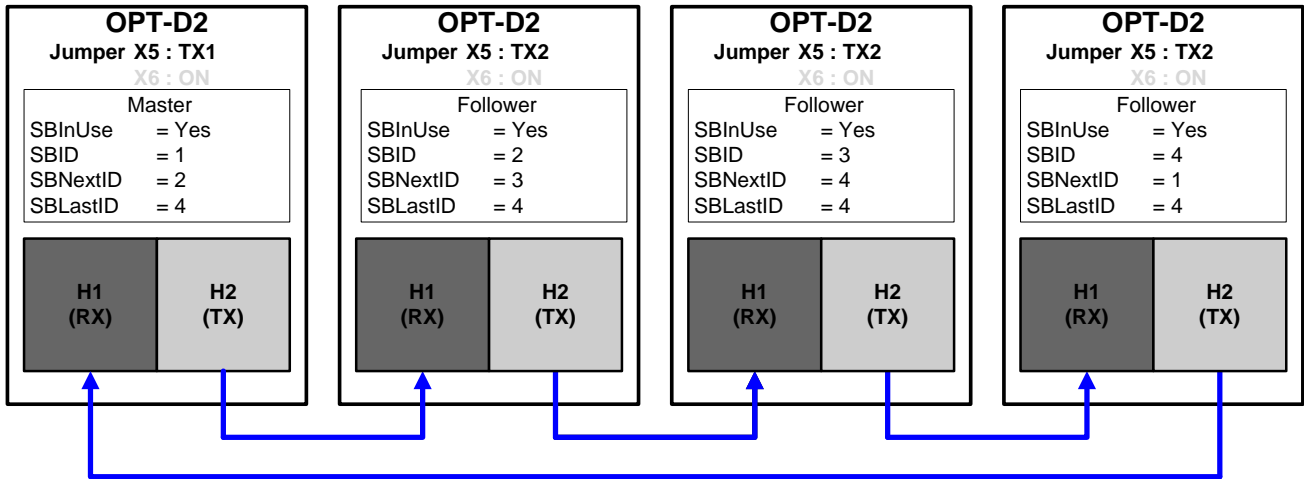

Figure 8-34. System bus physical connections with the OPT-D2 board

#### 2.11.1 MF Mode

This parameter is used when using two drives in Shaft Generator operation and drives need to operate towards the upper system as a single unit.

##### 0 = Single drive

System bus is deactivated.

##### 1 = Not In Use

##### 2 = Not In Use

Drive receives control word from Master and sends some diagnostic information to the Master drive.

##### 3 = DS Master INU

Drive Synch Master operation for INU unit. AFE is not supported.

##### 4 = DS Follower INU

Drive Synch Follower operation for INU unit. AFE is not supported.

##### 5 = Not In Use

##### 6 = Not In Use

#### P2.11.2 Follower drive winding phase shift ID1518 "FollPhaseShift"

Windings phase shift between the master and follower drive. Used with drive synch operation when the motor has multiple windings.

**P2.11.3 DC Voltage balancing gain ID519 “DCVoltageBalGain”**

Multiple wind motor option. Contact the factory before changing this value.



## 8.11 PROTECTIONS

### 8.11.1 GENERAL SETTINGS

#### 2.12.1.1 *Thermistor fault response*

0 = No response

1 = Warning

2 = Fault, stop mode after fault according to ID506

3 = Fault, stop mode after fault always by coasting

Setting the parameter to **0** will deactivate the protection.

#### 2.12.1.2 *LCL Temperature input monitor*

This parameter defines a response to Input filter overtemperature fault. The fault is monitored through digital input.

#### 2.12.1.3 *Max Charge Time*

When drive charging options are used, this parameter defines the maximum time limit for charging.

#### 2.12.1.4 *MCC At Fault*

Defines action for main contactor when drive has a fault.

0 = Keep closed

1 = Open at fault situation.

#### 2.12.1.5 *Quick Stop Response* *ID1543*

This will stop the drive at any case. This parameter is used to select what action is shown on keypad.

0 = No indication

1 = Warning

2 = Fault

#### 2.12.1.6 *Reactive Error Trip Limit* *ID1759*

Limit for reactive current for line fault detection, when reactive current is less than this parameter Line Synch fault is given.

#### 2.12.1.7 *MCC Fault Delay* *ID1521*

Delay for Main contactor open fault. Delay between main contactor control relay close command and main contactor acknowledge signal. If acknowledge signal is not received within this time, a fault F64 will be triggered.

**2.12.1.8 Line Phase Supervision ID702**

Defines the response when the drive notices that one of the input phases is missing.

0 = No response

1 = Warning

2 = Fault, stop mode after fault according to Stop Function

3 = Fault, stop mode after fault always by coasting

**2.12.1.9 Response to the 4mA reference fault ID700**

The 4 mA protection monitors the analogue input signal level from Analogue input 1 and Analogue input 2. The monitoring function is active when signal Custom minimum is greater than 16.00%. A fault or warning is generated when the signal falls below 3.5 mA for 5 seconds or below 0.5 mA for 0.5 seconds.

0 = No response

1 = Warning

2 = Fault,

**P2.12.1.10 Encoder Supervision ID1353**

Encoder supervision gives fault in case there are no pulses from encoder. It is required that the reference is above 1 Hz and that the torque can reach 100% level.

1 = Warning

2 = Fault

3 = Warning; Change to Open Loop

**P2.12.1.11 FaultWarnIndicat ID1940**

With this parameter its possible to select how warning and fault indication as handled to digital outputs and to fieldbus

0 = Static

Static signal, as long as warning or fault is active

1 = Toggle

New fault or warning toggles signal for one second.

2 = Marine

Signal toggles in new fault or warning and status needs to be reset to get signal down.

*P2.12.1.12 Run Enable Indication ID1177*

Response for Run Enable missing. Does not affect run enable function.

0=No Action

1=Warning

2=Fault

### 8.11.2 TEMPERATURE BOARD

PT100 protection function is used to measure temperature and give warning and/or fault when set limits are exceeded. Marine application supports two PT100 boards thus one can be used to motor winding and one for motor bearings.

#### 2.12.2.1 *Temperature Board 1 Channels in use ID739 "TB1 Channels"*

If you have a PT100 input board installed in your AC drive you can choose here the number of PT100 inputs in use. See also the VACON® I/O boards manual.

0 = Not used (ID Write, value of maximum temperature can be written from fieldbus)

1 = PT100 input 1

2 = PT100 input 1 & 2

3 = PT100 input 1 & 2 & 3

4 = PT100 input 2 & 3

5 = PT100 input 3

**Note:** If the selected value is greater than the actual number of used PT100 inputs, the display will read 200°C. If the input is short-circuited the displayed value is -30°C.

#### 2.12.2.2 *TB1 Response ID740 "TB1 Response"*

0 = No response

1 = Warning

2 = Fault, stop mode after fault according to Stop Function

3 = Fault, stop mode after fault always by coasting

#### 2.12.2.3 *TB1 warning limit ID741 "TB1 Warn.Limit"*

Set here the limit at which the PT100 warning will be activated.

#### 2.12.2.4 *TB1 fault limit ID742 "TB1 Fault Lim."*

Set here the limit at which the PT100 fault (F56) will be activated.

#### 2.12.2.5 *Temperature Board 2 Channels in use ID743 "TB2 Numbers"*

If you have a two PT100 input board installed in your AC drive you can choose here the number of PT100 inputs in use in second board. See also the VACON® I/O boards manual.

0 = Not used (ID Write, value of maximum temperature can be written from fieldbus)

1 = PT100 input 1

2 = PT100 input 1 & 2

3 = PT100 input 1 & 2 & 3

4 = PT100 input 2 & 3

5 = PT100 input 3

### 2.12.2.2 *TB2 Response ID740 "TB2 FaultRespo"*

0 = No response

1 = Warning

2 = Fault, stop mode after fault according to Stop Function

3 = Fault, stop mode after fault always by coasting

### 2.12.2.7 *TB 2 warning limit ID745 "TB2 Warn. Lim"*

Set here the limit at which the second PT100 warning will be activated.

### 2.12.2.8 *TB 2 fault limit ID746 "TB2 FaultLim"*

Set here the limit at which the second PT100 fault (F61) will be activated.

### 8.11.2.1 Individual channel monitoring

Individual channel monitoring is activated by setting one of the warning limits (per board) different than zero. Common limits in above parameters will be channel A warning and fault limits. Channel B and C limits are set with below parameters.

#### **P2.12.2.9.1 Channel 1B Warn ID764**

#### **P2.12.2.9.2 Channel 1B Fault ID765**

First board second (1B) channel warning and fault limits.

#### **P2.12.2.9.3 Channel 1C Warn ID768**

#### **P2.12.2.9.4 Channel 1C Fault ID769**

First board third (1C) channel warning and fault limits.

#### **P2.12.2.9.5 Channel 2B Warn ID770**

#### **P2.12.2.9.6 Channel 2B Fault ID771**

Second board second (2B) channel warning and fault limits.

#### **P2.12.2.9.7 Channel 2C Warn ID772**

#### **P2.12.2.9.8 Channel 2C Fault ID773**

Second board third (2C) channel warning and fault limits.

**8.11.3 EARTH FAULT****2.12.3.1 *EarthFlt Response***

2= Fault

3= Fault, Open MAIN contactor

4= Fault, Open NET contactor

5 = Fault, Open Main en NET contactor

**2.12.3.2 *EarthFaultLevel***

This parameter defines the maximum level of earth current in% of unit current.

**8.11.4 EXTERNAL FAULT****2.12.4.1 *Response to external fault 1 ID701 "External Fault 1"*****2.12.4.2 *Response to external fault 2 ID1504 "External Fault 1"***

Defines response when the digital input signal is used to give signal about external condition where the AC drive needs to react. External warning/fault indication can be connected to digital output.

0 = No response

1 = Warning

2 = Fault, stop mode after fault according to Stop Function

3 = Fault, stop mode after fault always by coasting

**2.12.4.3 *External fault delay***

Defines the delay for the external fault, affects both external fault inputs.

**8.11.5 GENERATOR VOLTAGE OPT-D7**

This function monitors the grid voltage by using measurement from the OPT-D7 board.

***P2.12.5.1 Voltage Response ID1880***

0 = No response

1 = Warning

2 = Fault

***P2.12.5.2 Voltage Low Warning Limit ID1893***

Low limit for warning indication. Percentage value from the set supply voltage parameter.

***P2.12.5.3 Voltage Low Trip Limit ID1899***

Low limit for fault indication. Percentage value from the set supply voltage parameter.

***P2.12.5.4 Voltage High Warning Limit ID1895***

High limit for warning indication. Percentage value from the set supply voltage parameter.

***P2.12.5.5 Voltage High Trip Limit ID1799***

High limit for fault indication. Percentage value from set the supply voltage parameter.

***P2.12.5.6 Voltage Trip Delay ID1898***

Delay to fault when the voltage has exceeded fault levels.

**8.11.6 GENERATOR FREQUENCY OPT- D7*****P2.12.6.1 Frequency Error Response***

0 = No response

1 = Warning

2 = Fault

***P2.12.6.2 Freq. low Warning Limit***      ***ID1780***

Low limit for warning indication. Percentage value from the set supply frequency parameter.

***P2.12.6.3 Freq. Low Trip Limit***      ***ID1788***

Low limit for fault indication. Percentage value from the set supply frequency parameter.

***P2.12.6.4 Freq. High Warning Limit***      ***ID1786***

High limit for warning indication. Percentage value from the set supply frequency parameter.

***P2.12.6.5 Freq. High Trip Limit***      ***ID1787***

High limit for fault indication. Percentage value from the set supply frequency parameter.

***P2.12.6.6 Freq. Trip Delay***      ***ID1785***

Delay to fault when the frequency has exceeded fault levels.



### 8.11.7 MOTOR PROTECTION



CAUTION! *The calculated model does not protect the motor if the airflow to the motor is reduced by a blocked air intake grill.*

The motor thermal protection is to protect the motor from overheating. The drive is capable of supplying higher than nominal current to the motor. If the load requires this high current there is a risk that the motor will be thermally overloaded. This is the case especially at low frequencies. At low frequencies the cooling effect of the motor is reduced as well as its capacity. If the motor is equipped with an external fan the load reduction at low speeds is small.

The motor thermal protection is based on a calculated model and it uses the output current of the drive to determine the load on the motor.

The motor thermal protection can be adjusted with parameters. The thermal current  $I_T$  specifies the load current above which the motor is overloaded. This current limit is a function of the output frequency.

#### **P2.12.71 Motor thermal protection response ID704 "Motor Therm Prot"**

Defines the response when the calculated temperature of the motor has reached 105% (monitoring signal).

0 = No response

1 = Warning

2 = Fault, stop mode after fault according to Stop Function

3 = Fault, stop mode after fault always by coasting

#### **P2.12.7.2 Motor ambient temp. factor ID705 "MotAmbTempFactor"**

Defines the temperature factor for conditions where the motor is located. The factor can be set between -100.0%—100.0%.

-100.0% = 0°C,

0.0% = 40°C,

100.0% = 80°C

#### **P2.12.7.3 Motor cooling factor at zero speed ID706 "MTP f0 Current"**

Defines the cooling factor at zero speed in relation to the point where the motor is running at nominal speed without external cooling.

The default value is set assuming that there is no external fan cooling the motor. If an external fan is used, this parameter can be set to 90% (or even higher).

**Note:** The value is set as a percentage of the motor name plate data, (Nominal current of motor), not the AC drive's nominal output current. The motor's nominal current is the current that the motor can withstand in direct on-line use without being overheated.

Setting this parameter does not affect the maximum output current of the drive which is determined by parameter Motor Current Limit alone.

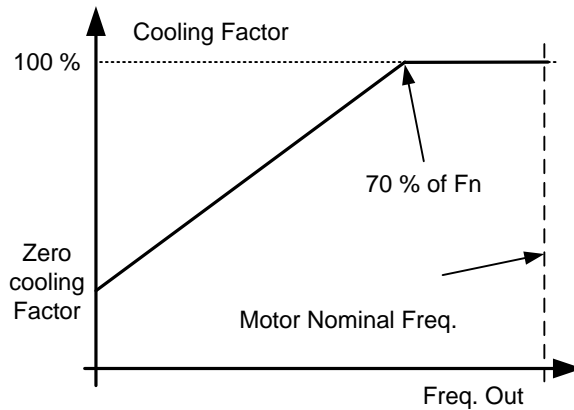

Figure 8-35

#### P2.12.7.5 Motor thermal protection: Time constant ID707 "MTP Motor T"

This time can be set between 1 and 200 minutes.

This is the thermal time constant of the motor. The bigger the motor, the bigger the time constant. The time constant is the time within which the calculated thermal stage has reached 63% of its final value.

The motor thermal time is specific to motor design and it varies between different motor manufacturers. The default value changes between unit sizes.

If the motor's  $t_6$ -time ( $t_6$  is the time in seconds the motor can safely operate at six times the rated current) is known (given by the motor manufacturer), the time constant parameter can be set basing on it. As a rule of thumb, the motor thermal time constant in minutes equals to  $2 \times t_6$ . If the drive is in stop stage, the time constant is internally increased to three times the set parameter value. The cooling in the stop stage is based on convection and the time constant is increased.

#### P2.12.7.5 Motor thermal protection: Motor duty cycle ID708 "Motor Duty Cycle"

The value can be set to 0%...150%.

Setting value to 130% motor calculated temperature will reach nominal temperature with 130% of motor nominal current.

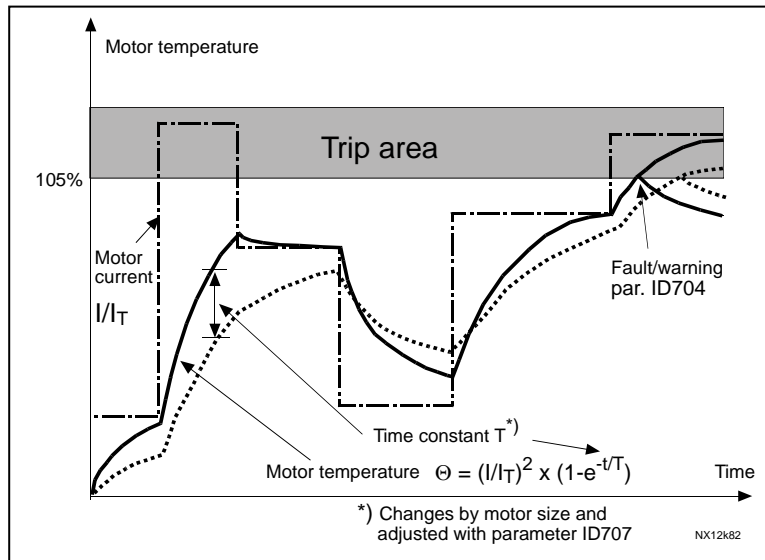

Figure 8-36. Motor temperature calculation

**8.1.1.8 OVER LOAD PROTECTION**

With this function it is possible to select between Current, Torque and Power which one is used for overload protection.

Overload is based on internal counter that is increased when input value is above 105% level and decreased when below 105% level. The increase and decrease happens every 100 ms.

Tripping is made when overload counter value is over 10 000.

Use the parameters to define what is increased (Overload maximum step) at the maximum defined input level (Overload Maximum Input). These points define the slope for the function. For example, the input value is in the middle of 105% and the Overload Maximum Input values counter is increased by a half of the Overload Maximum step.

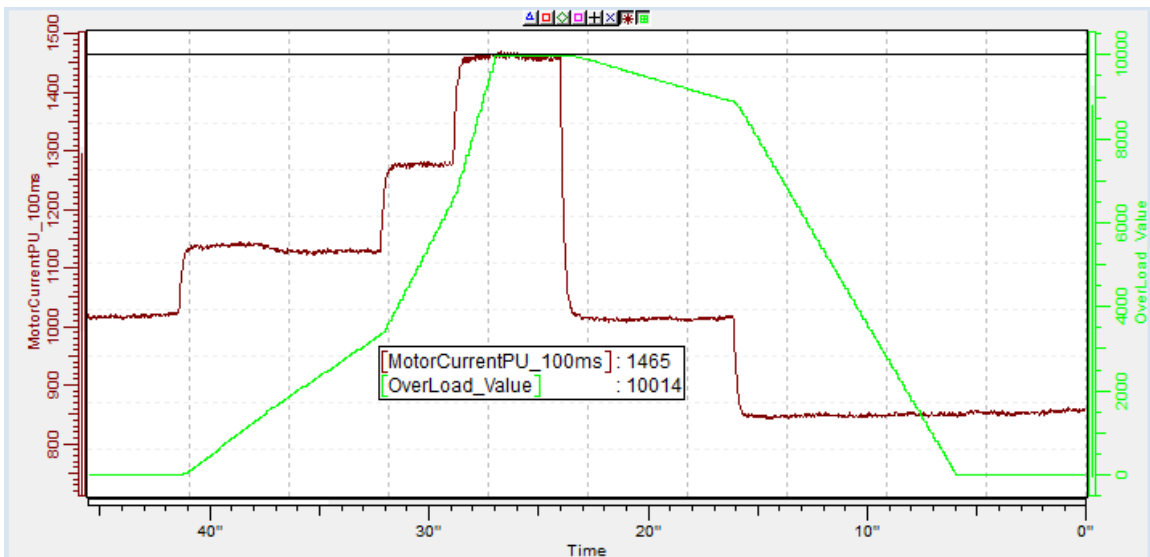

Figure 8-37

**2.12.7.6**    *Response to over load*    *ID1838*    *"OverLoadResponse"*

0 = No response

1 = Warning

2 = Fault

**2.12.7.7**    *Over Load Signal*    *ID1837*    *"OverLoadSignal"*

0 = Not Used

1 = Output Current (FW: MotorCurrentPU\_100ms)

2 = Motor Torque

3 = Motor Power

**2.12.7.8**    *Over Load Maximum Input*    *ID1839*    *"OverLoadMaxIN"*

Input value level where the overload counter is increased with maximum step defined by P2.12.5.10

**2.12.7.9**    *Over Load Maximum Step*    *ID1840*    *"OverLoadMaxStep"*

Step in the overload counter when the input value is at the maximum input level defined by P2.12.5.9.

**8.11.9 FIELDBUS COMMUNICATION****P2.12.8.1 Fieldbus fault Slot D response ID733****P2.12.8.2 Fieldbus fault Slot E response ID761**

Set here the response for a fieldbus fault if the active control place is fieldbus. For more information, see the respective Fieldbus Board Manual.

0 = No response

1 = Warning

2 = Fault, stop mode after fault according to Stop Function

**P2.12.8.3 Fieldbus Watch Dog delay ID1354 "FB WD Delay"**

Defines the delay when a fault is generated when the watch dog pulse is missing from fieldbus. Set the time to zero to disable watchdog monitoring.

**8.11.10 COOLING PROTECTION**

Protection for liquid cooled units. An external sensor is connected to the drive (DI: Cooling Monitor) to indicate if cooling liquid is circulating.

**P2.10.7.1 Cooling fault delay ID751 "Cooling F Delay"**

This parameter defines the delay after which the drive goes to fault state when 'Cooling OK' signal is missing.

**P2.10.7.2 Cooling fault response ID762 "CoolingFaultREsp"**

In some cases it is more important to allow the drive to run even if the cooling liquid is not circulating. Then it is possible to select warning as the response. The drive will then continue running until its internal protection will stop it. If cooling signal loss happens on stop state indication is not stored to fault history if previous fault is already Cooling Fault. In Run State indication is always stored to fault history

0 = Stop State: No Action, Run State: Warning

1 = Stop State: Warning, Run State: Warning

2 = Stop State: Warning, Run State: Fault

3 = Stop State: No Action, Run State: Fault

**8.11.11 PROTECTION OPTIONS**

*2.12.9 Disable stop lock*      *ID1086*      *“Disable StopLock”*

*2.12.10 Fault Simulation*      *ID1569*      *“Fault Simulation”*

With this parameter it is possible to simulate different faults without actually making, for example, an over current situation. In the point of view of the drive interface, the operation is identical to actual fault situation.

**B00** = +1 = Simulates an over current fault (F1)

**B01** = +2 = Simulates an over voltage fault (F2)

**B02** = +4 = Simulates an under voltage fault (F9)

**B03** = +8 = Simulates an output phase supervision fault (F11)

**B04** = +16 = Simulates an earth fault (F3)

**B05** = +32 = Simulates a system fault (F8)

This fault simulation covers a wide range of different faults in drive. See the fault description for details.

**B06** = +64 = Simulates an encoder fault (F43)

**B07** = +128 = Simulates an over temperature warning (W14)

**B08** = +256 = Simulates an over temperature fault (F14)

The warning bit must be active for a fault to appear in simulation. If the fault bit is left active, the drive will go FAULT state at warning limit when the drive temperature rises to the warning level.

**B09** = +512 = Reserved

*P2.12.11 Reset Datalogger*      *ID1857*

-1 = Blocked

0 = No

1 = Yes

## 8.12 FIELDBUS

### 8.12.1 SIGNALS FROM DRIVE TO FIELDBUS

2.13.1 *FB Actual Speed ID* ID1851 "FB Actual ID"

Enter the ID number of the item you wish to use as the Fieldbus Actual Speed - variable.

2.13.2 to

2.13.9 *FB Data Out Selections 1 to 8* ID852-ID859 "FB Data OutX Sel"

With these parameters, you can monitor any monitoring or parameter value from the fieldbus. Enter the ID number of the item you wish to monitor for the value of these parameters.

2.13.10 to

2.13.17 *FB Data Out Selections 9 to 16* ID558-565 "FB Data OutXSel"

These parameters are the same as P2.13.1-.9, but they are only available if a fieldbus board with hardware and software support for 16 process data variables is inserted in option board slot D or E.

### 8.12.2 SIGNALS FROM FIELDBUS TO DRIVE

2.13.18 *FB Reference Selection* ID1850 "FB Reference Sel"

Enter the ID number of the item you wish to use as the Fieldbus Reference -variable

2.13.19 to

2.13.26 *FB Data In Selection 1 to 8* ID876-ID833 "FB Data In X sel"

With these parameters, you can control any parameter value from the fieldbus. Enter the ID number of the item you wish to control for the value of these parameters.

2.13.27 to

2.13.34 *FB Data In Selection 9 to 16* ID550-557 "FB Data InX Sel"

These parameters are the same as P2.13.18-.26, but they are only available if a fieldbus option board with hardware and software support for 16 process data variables is inserted in option board slot D or E.

2.13.35 *FB General Status Word Data* ID897 "GSW Data"

Enter the ID number of the item you wish to send in the Fieldbus General Status Word.

**2.13.36**    *Control Slot Selector*                      *ID1440*                      *"ControlSlotSel."*

This parameter defines which slot is used as the main control place when two fieldbus boards have been installed in the drive. When values 6 or 7 are selected, the drive can use a Fast Fieldbus Mode. When values 8 or 9 are selected the drive can use an Extended Fieldbus mode with 16 process data variables if the used Fieldbus-board hardware and firmware support it. For further details about Fast and Extended modes refer to an appropriate Fieldbus-board manual.

0 = Not Sel.

4 = Slot D, Normal (8 process data variables)

5 = Slot E, Normal (8 process data variables)

6 = Slot D, Fast fieldbus support

7 = slot E, Fast Fieldbus support

8 = Slot D, Extended (16 process data variables)

9 = Slot E, Extended (16 process data variables)

**2.13.37**    *State Machine*                                      *ID896*                                      *"State Machine"*

With this parameter it is possible to select what FB profile is used in application.

0 = Basic

Control as explained in fieldbus manual.

1 = Standard

2 = Generator 1

**2.13.38**    *SW B11 ID.Bit*                                      *ID1912*                                      *"SW B11 ID.Bit"*

**2.13.39**    *SW B12 ID.Bit*                                      *ID1908*                                      *"SW B12 ID.Bit"*

**2.13.40**    *SW B13 ID.Bit*                                      *ID1909*                                      *"SW B13 ID.Bit"*

**2.13.41**    *SW B14 ID.Bit*                                      *ID1911*                                      *"SW B14 ID.Bit"*

Parameters P2.13.38-.41 are used for selecting items for the Fieldbus Status Word bits 11, 12, 13 and 14. Enter the ID number of the item you wish to select.



## 8.13 ID FUNCTIONS

The functions that use the parameter ID number to control and monitor the signal are listed below.

### 8.13.1 VALUE CONTROL

The value control parameters are used to control an input signal parameter.

**P2.14.1.1 Control Input Signal ID**      **ID1580**      **"ContrInSignal ID"**

With this parameter you can select what signal is used to control selected parameter.

**P2.14.1.2 Control Off Limit**      **ID1581**      **"Contrl Off Limit"**

This parameter defines the limit when the selected parameter value is forced to Off value.

**P2.14.1.3 Control On Limit**      **ID1582**      **"Contrl On Limit"**

This parameter defines the limit when the selected parameter value is forced to On value.

**P2.14.1.4 Control Off Value**      **ID1583**      **"Contrl Off Value"**

This parameter defines the value that is used when the used input signal is below Off limit.

**P2.14.1.5 Control On Value**      **ID1584**      **"Contrl On Value"**

This parameter defines the value that is used when the used input signal is above On limit.

**P2.14.1.6 Control Output Signal ID**      **ID1585**      **"ContrlOutSignID"**

This parameter defines which parameter is forced to On and Off values when the selected input signal exceeds the set limits.

P2.14.1.7 Control Mode ID1590 "Control Mode"

This parameter defines how the value control output behaves.

0 = SR ABS

Absolute input value is used to make a step change in the output between On and Off values.

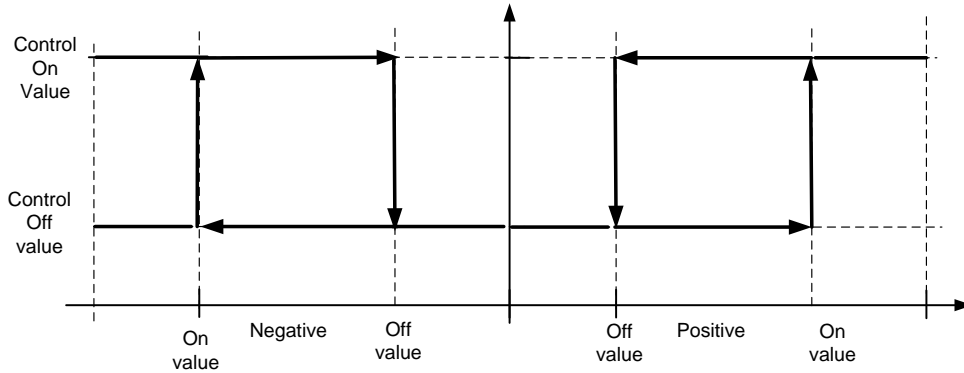

Figure 8-38

1 = Scale ABS

Absolute input value is scaled linearly between On and Off values.

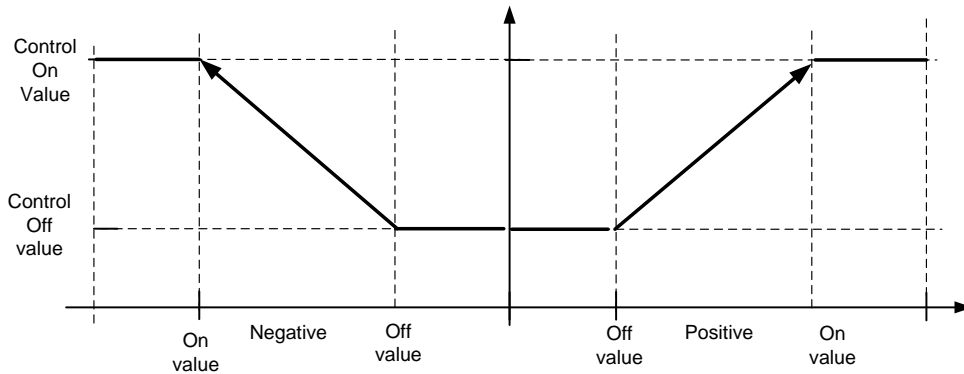

Figure 8-39

**2 = Scale ABS Inverted**

Inverted absolute value is scaled linearly between On and Off values.

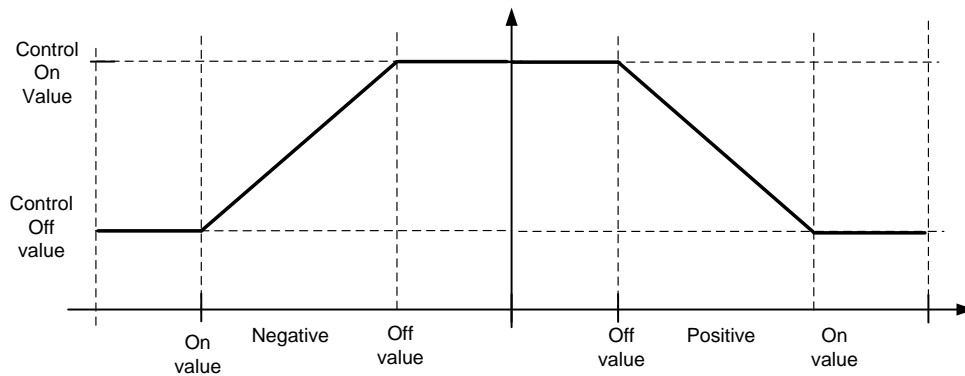

Figure 8-40

**3 = SR**

Input value is used to make a step change in the output between On and Off values.

**4 = Scale ABS**

Input values is scaled linearly between On and Off values.

**5 = Scale Inverted**

Inverted value is scaled linearly between On and Off values

**P2.14.1.8 Control Signal Filtering TC ID1586 "Control Filt TC"**

This parameter is used to filter the scaling function output. Used, for example, when unfiltered torque is used to control a parameter that needs stabilization.

### 8.13.2 DIN ID CONTROL

This function is used to control any parameter between two different values with a digital input. Different values are given for DI 'low' and DI 'high'.

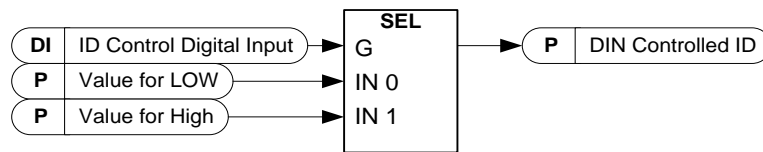

Figure 8-41

**P2.14.2.1** ID Control Digital Input ID1570 "ID Control DIN"

**P2.14.3.1** ID Control Digital Input ID1574 "ID Control DIN"

**P2.14.4.1** ID Control Digital Input ID1578 "ID Control DIN"

Select the digital input to be used for controlling the parameter selected by ID1571.

**P2.14.2.2** DIN Controlled ID ID1571 "Controlled ID"

**P2.14.3.2** DIN Controlled ID ID1575 "Controlled ID"

**P2.14.4.2** DIN Controlled ID ID1579 "Controlled ID"

Select parameter ID controlled by ID1570.

**P2.14.2.3** Value for Low digital input (FALSE) ID1572 "FALSE Value"

**P2.14.3.3** Value for Low digital input (FALSE) ID1576 "FALSE Value"

**P2.14.4.3** Value for Low digital input (FALSE) ID1587 "FALSE Value"

Set here the controlled parameter value when the digital input (ID1570) is LOW for the parameter selected by ID1571. The function does not recognize decimals. Give, therefore, e.g. 10.00 Hz as '1000'.

**P2.14.2.4** Value for High digital input (TRUE) ID1573 "TRUE Value"

**P2.14.3.4** Value for High digital input (TRUE) ID1577 "TRUE Value"

**P2.14.4.4** Value for High digital input (TRUE) ID1588 "TRUE Value"

Set the controlled parameter value when the digital input (ID1570) is HIGH for the parameter selected by ID1571. The function does not recognise decimals. For example, give the value 10.00 Hz as 1000.

### 8.14 CURVE 1 DEFINITION

#### *P2.15.1 0 % Speed*

-

#### *P2.15.25 120 % Speed*

These parameters define a curve that is related to the motor nominal frequency.

The value is a percentage value from the function maximum or the used reference.

For example, if 100% Speed point definition is 90%, the AC drive input power limit is 120% and P2.6.2.4 is set to 2 / Curve1, the drive power limit at nominal speed is 108% (90% from 120%).

### 8.15 CURVE 2 DEFINITION

#### *P2.16.1 0 % Speed*

-

#### *P2.16.25 120 % Speed*

These parameters define a curve that is related to the motor nominal frequency.

The value is a percentage value from the function maximum or the used reference.

For example, if 100% Speed point definition is 90%, the AC drive input power limit is 120% and P2.6.2.4 is set to 2 / Curve1, the drive power limit at nominal speed is 108% (90% from 120%).

### 8.16 CURVE 3 DEFINITION

#### *P2.17.1 0 % Speed*

-

#### *P2.17.25 120 % Speed*

These parameters define a curve that is related to the motor nominal frequency.

The value is a percentage value from the function maximum or the used reference.

For example, if 100% Speed point definition is 90%, the AC drive input power limit is 120% and P2.6.2.4 is set to 2 / Curve1, the drive power limit at nominal speed is 108% (90% from 120%).

**8.17 LINE SYNCH****2.18.1 Delay to coast ID 3001**

This parameter defines delay when modulation will be stopped from internal decision to make the change.

**2.18.2 Delay to open ID 3002**

This parameter defines delay when FC contactor will be opened from internal decision to make the change.

**2.18.3 Delay to close ID 3003**

This parameter defines delay when NET contactor will be closed from internal decision to make the change net.

**2.18.4 Phase offset ID 3006**

This parameter defined FC voltage angle advance to net voltage angle when synchronization command is on. This parameter is adjusted depending on motor load and delay when motor do not have current.

**2.18.5 Frequency hysteresis for synch ID 3004**

Hysteresis for frequency when synchronization function is started.

**2.18.6 Phase hysteresis ID 3007****2.18.7 Frequency hysteresis for change ID 3005**

Hysteresis when changed DOL can be made for frequency. Frequency can be out of hysteresis while angle is within hysteresis.

## 9. KEYPAD CONTROL PARAMETERS

Unlike the parameters listed above, these parameters are located in the **M3** menu of the control keypad. The reference parameters do not have an ID number.

### *P3.1 Control Place ID125 "Control Place"*

The active control place can be changed with this parameter.

Push the Start button for 3 seconds to select the control keypad as the active control place and to copy the Run status information (Run/Stop, direction and reference).

0 = PC Control, Activated by NCDrive

1 = I/O terminal

2 = Keypad

3 = Fieldbus

## 10. STATUS AND CONTROL WORDS IN DETAIL

|                        |  |
|------------------------|--|
| P2.13.20 State machine |  |
| 0 / Basic              | This mode makes the fieldbus control to behave as explained in the relevant fieldbus board manual.   |
| 1 / Standard           | Simple control word that is used in modes where control word from the fieldbus is used as such. For some fieldbus boards this requires bypass operation.   |
| 2 / Generator 1        | This mode uses ProfiDrive type state machine in application level. This mode can be used on fieldbus boards that do not have state machine itself or have the possibility to bypass state machine functionality in option board. |
| 3 / Vacon AFE 2        | This mode uses ProfiDrive type state machine in application level. This mode can be used on fieldbus boards that do not have state machine itself or have the possibility to bypass state machine functionality in option board. |

Table 10-1

### 10.1 BASIC IN BYPASS (o)

| FB Control Word ID1160 |             |  |
|------------------------|-------------|--|
|                        | Signal      | Comment  |
| B00                    | Run         | 0= Stop request<br>1= Start Request                                  |
| B01                    |             |  |
| B02                    | Fault Reset | 0>1 Reset fault.   |
| B03                    | FB DIN1     | Can be used to control RO or directly parameter by ID number. G2.4.1 |
| B04                    | FB DIN2     | Can be used to control RO or directly parameter by ID number. G2.4.1 |
| B05                    | FB DIN3     | Can be used to control RO or directly parameter by ID number. G2.4.1 |
| B06                    | FB DIN4     | Can be used to control RO or directly parameter by ID number. G2.4.1 |
| B07                    | FB DIN5     | Can be used to control RO or directly parameter by ID number. G2.4.1 |
| B08                    |             |  |
| B09                    |             |  |
| B10                    |             |  |
| B11                    |             |  |
| B12                    |             |  |
| B13                    |             |  |
| B14                    |             |  |
| B15                    |             |  |

Table 10-2



## 10.2 FB CONTROL WORD

### 10.2.1 STANDARD (1)

| FB Control Word ID1160 |           |  |
|------------------------|-----------|--|
|                        | Signal    | Comment  |
| B00                    | DC Charge | 0= Open MCB.<br>1= Close DC charge. CB closed automatically.         |
| B01                    |           |  |
| B02                    |           |  |
| B03                    | Run       | 0= AFE is stopped<br>1= AFE is started                               |
| B04                    |           |  |
| B05                    |           |  |
| B06                    |           |  |
| B07                    | Reset     | 0>1 Reset fault.   |
| B08                    |           |  |
| B09                    |           |  |
| B10                    |           |  |
| B11                    | FB DIN1   | Can be used to control RO or directly parameter by ID number. G2.4.1 |
| B12                    | FB DIN2   | Can be used to control RO or directly parameter by ID number. G2.4.1 |
| B13                    | FB DIN3   | Can be used to control RO or directly parameter by ID number. G2.4.1 |
| B14                    | FB DIN4   | Can be used to control RO or directly parameter by ID number. G2.4.1 |
| B15                    |           |  |

Table 10-3

B00: FALSE = Open MCB, TRUE = PreCharge DC

**Open MCB:** Opens MCB if closed, stops precharging if not closed.

**PreCharge DC:** Drive will start precharge if function activated by digital output and control place is fieldbus. When control place is not fieldbus precharging is started from normal start command.

B03: FALSE = Stop Request, TRUE = Start Request

**Stop Request:** Drive will stop .

**Start Request:** Start Command to the drive. Rising edge needed for start.

B07: FALSE = No significance, TRUE = Fault Acknowledge

**Fault Acknowledge:** The group signal is acknowledged with a positive edge.

10.2.2 VACON GENERATOR 1 PROFILE (2)

| FB Control Word ID1160 |                    |  |
|------------------------|--------------------|--|
|                        | Signal             | Comment  |
| B00                    | DC Charge          | 0= Open MCB.<br>1= Close DC charge contactor, CB closed automatically.   |
| B01                    |                    |  |
| B02                    |                    |  |
| B03                    | Run                | 0= AFE is stopped<br>1= AFE is started   |
| B04                    |                    |  |
| B05                    |                    |  |
| B06                    |                    |  |
| B07                    | Reset              | 0>1 Reset fault.   |
| B08                    | DC Voltage Ref B00 | B00   B01<br>0   0 = FB Reference. P2.2.1, if not FB Control & FB Ref > 50.00%<br>0   1 = 110%                       |
| B09                    | DC Voltage Ref B01 | 1   0 = 115%<br>1   1 = 120%   |
| B10                    | Fieldbus Control   | 0= No control from fieldbus<br>1=Control from fieldbus   |
| B11                    | Watchdog           | 0>1>0>1...0.5 sec square wave clock. This is used to check data communication between fieldbus master and the drive. |
| B12                    | FB DIN2            | Can be used to control RO or directly parameter by ID number. G2.4.1   |
| B13                    | FB DIN3            | Can be used to control RO or directly parameter by ID number. G2.4.1   |
| B14                    | FB DIN4            | Can be used to control RO or directly parameter by ID number. G2.4.1   |
| B15                    |                    | Reserved for future use.   |

Table 10-4

B00: FALSE = Open MCB, TRUE = PreCharge DC

**Open MCB:** Opens MCB if closed, stops precharging if not closed.

**PreCharge DC:** Drive will start precharge if function activated by digital output and control place is fieldbus. When control place is not fieldbus precharging is started from normal start command.

B03: FALSE = Stop Request, TRUE = Start Request

**Stop Request:** The AC drive will stop .

**Start Request:** Start Command to the drive. Rising edge needed for start.

B07: FALSE = No significance, TRUE = Fault Acknowledge

**Fault Acknowledge:** The group signal is acknowledged with a positive edge.

B08: FALSE = No Function, TRUE = DC Ref 1

B09: FALSE = No Function, TRUE = DC Ref 2

Table 10-5

| DC Ref | FB Reference | 110.00% | 115.00% | 120.00% |
|--------|--------------|---------|---------|---------|
| B08    | FALSE        | TRUE    | FALSE   | TRUE    |
| B09    | FALSE        | FALSE   | TRUE    | TRUE    |

B10: FALSE = FB Control disabled TRUE = FB Control Enabled

**FB Control Disabled:** The AC drive will not follow the main control word from the Fieldbus. If removed while running, the AC drive will stop.

**FB Control Enabled:** The AC drive follows control word from fieldbus

B11: FALSE = FB WD Pulse Low, TRUE = FB WD Pulse High

**Watch Dog pulse:** This pulse is used to monitor that PLC is alive. If pulse is missing, the AC drive will go to fault state. This function is activated by the P2.7.6 FB WD Delay. When the value is zero, the pulse is not monitored.

**10.2.3 VACON AFE 2 PROFILE (NOT IMPLEMENTED AS OF 1.7.2014)**

| FB Control Word ID1160 |                    |  |
|------------------------|--------------------|--|
|                        | Signal             | Comment  |
| B00                    | DC Charge          | 0= Open MCB.<br>1= Close DC charge contactor, CB closed automatically, see B01.                                      |
| B01                    | CB Close Enable    | 0= Disable Closing of CB<br>1= Enable Closing if CB  |
| B02                    | Forced Restart     | 0= Forced Restart, DC need to go zero before new DC charge.<br>1= Enable Operation                                   |
| B03                    | Run                | 0= AFE is stopped<br>1= AFE is started   |
| B04                    | Floating DC Ref    | 0= Enable floating DC Reference<br>1= Disable floating DC Reference  |
| B05                    | DC Drooping        | 0= Disable DC Drooping (DC Droop 2)<br>1= Enable DC Drooping (DC Droop 1)  |
| B06                    | Power Limit        | 0= Power Limited (5%)<br>1= Power Limit set by parameters  |
| B07                    | Reset              | 0>1 Reset fault.   |
| B08                    | DC Voltage Ref B00 | B00   B01<br>0   0 = FB Reference. P2.2.1, if not FB Control & FB Ref > 50.00%<br>0   1 = 110%                       |
| B09                    | DC Voltage Ref B01 | 1   0 = 115%<br>1   1 = 120%   |
| B10                    | Fieldbus Control   | 0= No control from fieldbus<br>1=Control from fieldbus   |
| B11                    | Watchdog           | 0>1>0>1...0.5 sec square wave clock. This is used to check data communication between fieldbus master and the drive. |
| B12                    | FB DIN2            | Can be used to control RO or directly parameter by ID number. G2.4.1   |
| B13                    | FB DIN3            | Can be used to control RO or directly parameter by ID number. G2.4.1   |
| B14                    | FB DIN4            | Can be used to control RO or directly parameter by ID number. G2.4.1   |
| B15                    |                    | Reserved for future use.   |

Table 10-6

B00: FALSE = Open MCB, TRUE = PreCharge DC

**Open MCB:** Opens MCB if closed, stops precharging if not closed.

**PreCharge DC:** The AC drive will start precharge if the function is activated by the digital output and the control place is fieldbus. When the control place is not fieldbus, precharging is started from the normal start command.

B01: FALSE = (OFF 2), TRUE =

**Coast Stop:**

ON 2:

B03: FALSE = Stop Request, TRUE = Start Request

**Stop Request:** The AC drive will stop .

**Start Request:** Start Command to the AC drive. Rising edge needed for start.

B07: FALSE = No significance, TRUE = Fault Acknowledge

**Fault Acknowledge:** The group signal is acknowledged with a positive edge.

B08: FALSE = No Function, TRUE = DC Ref 1

B09: FALSE = No Function, TRUE = DC Ref 2

*Table 10-7*

| DC Ref | FB Reference | 110.00% | 115.00% | 120.00% |
|--------|--------------|---------|---------|---------|
| B08    | FALSE        | TRUE    | FALSE   | TRUE    |
| B09    | FALSE        | FALSE   | TRUE    | TRUE    |

B10: FALSE = FB Control disabled TRUE = FB Control Enabled

**FB Control Disabled:** The AC drive will not follow the main control word from the Fieldbus. If removed while running, the AC drive will make coasting stop.

**FB Control Enabled:** The AC drive follows the control word from the fieldbus

B11: FALSE = FB WD Pulse Low, TRUE = FB WD Pulse High

**Watch dog pulse:** This pulse is used to monitor that PLC is alive. If pulse is missing, the AC drive will go to fault state. This function is activated by P2.7.6 FB WD Delay. When value is zero, the pulse is not monitored.

## 10.3 FB STATUS WORD

|     | Signal                  | Comment   |
|-----|-------------------------|---|
| b0  | Ready On                | 0=Drive not ready to switch on<br>1=Drive ready to start charging                     |
| b1  | Ready Run               | 0=Drive not ready to run<br>1=Drive ready and MCB is ON                               |
| b2  | Running                 | 0=Drive not running<br>1=Drive in Run state (Modulating)                              |
| b3  | Fault                   | 0=No active fault<br>1=Fault is active  |
| b4  | Run Enable Status       | 0= Run Disabled. Drive in stop state<br>1= Run Enabled. Drive can be started.         |
| b5  | Quick Stop Active       | 0=Quick Stop Active<br>1=Quick Stop not Active  |
| b6  | CB Control OK           | 0= Status opposite of control<br>1= Status and control OK                             |
| b7  | Warning                 | 0= No active warnings<br>1= Warning active  |
| b8  | At Reference            | 0= DC Voltage Ref and Act DC Voltage are not same.                                    |
| b9  | Fieldbus Control Active | 0=Fieldbus control not active<br>1=Fieldbus control active                            |
| b10 | Above Limit             | 0= DC Voltage is below P2.5.5.2 level<br>1=The DC Voltage is above the P2.5.5.2 level |
| b11 |                         | Reserved for future use.  |
| b12 |                         | Reserved for future use.  |
| b13 |                         | Reserved for future use.  |
| b14 | DC Charge DO Control    | 0= DC not charged<br>1= DC Charging Active  |
| b15 | Watchdog                | Same as received on bit 11 of the main control word.                                  |

Table 10-8

B00: FALSE = Not Ready to Switch On, TRUE = Ready to Switch On

**Not Ready to Switch On:** Fault active, DI: Run Enable low, MCB Forced open command active, Quick Stop Active.

**Ready to Switch On:** No Faults, DI: Run Enabled, DI: MCB not forced open, Quick Stop not active.

B01: FALSE = Not Ready To Operate, TRUE = Ready To Operate

**Not Ready To Operate:** CW.B0 = FALSE, DC Not Ready, MCB Control Open, MCB Status Low.

**Ready To Operate:** CW.B0 = TRUE, DC Ready, MCB Control closed, MCB Status High.

B02: FALSE = Drive is not operating, TRUE = Drive is operational

**Drive is not operating:** Drive is not run state (modulating)

**Drive is operational:** Drive is in run state and modulating.

B03: FALSE = No Fault, TRUE = Fault Present

**No Fault:** Drive is not on fault state.

**Fault Present:** Drive is in fault state.

B04: FALSE = Coast Stop Activated, TRUE = Coast Stop Not Activated

**Coast Stop Activated:** DI: Run Enable False, Quick Stop Active, MCB Status Open, MCB Control Open, Enable CB Close, MCB Forced Open.

**Coast Stop Not Activated:** Running Enabled

B05: FALSE = Quick Stop Activated, TRUE = Quick Stop Not Activated

**Quick Stop Activated:** Quick Stop command is active.

**Quick Stop Not Activated:** Quick stop command is not active.

B06: FALSE = CB Control OK, TRUE = CB Control Not OK

**CB Control OK:** CB Control and Drive internal status are the same.

**CB Control Not OK:** Drive internal status to close the MCB is high but application logic request MCB open. This can be case when CB has been opened but DC is connected to battery system. DC needs to be discharged or CB is needed to close.

B07: FALSE = No Warning, TRUE = Warning Present

**No Warning:** There is no warning or the warning has disappeared again.

**Warning Present:** Drive still works; warning in the service/maintenance parameter; no acknowledgement.

B08: FALSE = DC Voltage out of tolerance TRUE = DC Voltage within tolerance

**DC Error Out Of Tolerance Range:**

**DC Error Within Tolerance Range:**

B09: FALSE = No Control Requested, TRUE = Control Requested

**No Control Requested:** Control by the automation system is not possible.

**Control Requested:** The automation system is controlling.

B10: FALSE = DC Not Reached, TRUE = DC Reached Or Exceeded

**DC Not Reached:** DC Voltage is below P2.5.5.1 level

**DC Reached Or Exceeded:** DC Voltage is above the P2.5.5.1 level

B14: FALSE = Charge DO Open, TRUE = Charge DO Closed

**Charge DO Open:** Charging Command not active

**Charge DO Closed:** Charging Command Active

B15: FALSE = FB DW Feedback Low, TRUE = FB DW Feedback High

**FB DW Feedback:** FB Control Word B11 is echoed back to the Fieldbus. Can be used to monitor communication status from the drive.

## 10.4 STATUS WORD (APPLICATION) ID 43

Application Status Word combines different drive statuses to one data word.

| Application Status Word ID43 |                    |                                   |
|------------------------------|--------------------|-----------------------------------|
|                              | FALSE              | TRUE                              |
| b0                           |                    |                                   |
| b1                           | Not in Ready state | Ready                             |
| b2                           | Not Running        | Running                           |
| b3                           | No Fault           | Fault                             |
| b4                           |                    |                                   |
| b5                           |                    |                                   |
| b6                           | Run Disabled       | Run Enable                        |
| b7                           | No Warning         | Warning                           |
| b8                           |                    | Charging Switch closed (internal) |
| b9                           |                    | MCB Control (DO Final)            |
| b10                          |                    | MCB Feedback                      |
| b11                          |                    | DO Charging Active                |
| b12                          | No Run Request     | Run Request                       |
| b13                          |                    |                                   |
| b14                          |                    |                                   |
| b15                          |                    |                                   |

Table 10-9

B01: FALSE = Not Ready, TRUE = Ready

**Not Ready:** DC Voltage low, Fault active

**Ready:** Drive in ready state, start command can be given.

B02: FALSE = Not Running, TRUE = Running

**Not Running:** Drive is not modulating

**Running:** Drive is modulating.

B03: FALSE = No Fault, TRUE = Fault Active

**No Faults:** Drive do not have active faults.

**Fault:** Drive has an active faults.

B06: FALSE = Run Enable Low, TRUE = Run Enable High

**Run Enable Low:** Run Enable command to motor control is low

**Run Enable High:** Run Enable command to motor control is high.

B07: FALSE = No Warning, TRUE = Warning Active

**No Warning:** No warning signals active in the drive

**Warning:** Drive has active warning signal. Warning signal not stop the operation.

B08: FALSE = Charging Switch Open, TRUE = Charging Switch closed

**Charging Switch Open:** DC voltage level is nor reached closing level or has drop below the opening level. This information is from drive motor control.

**Charging switch Closed:** DC voltage level is above closing limit and no interlock active internally.



B09: FALSE = MCB Open command, TRUE = MCB closed command

**MCB Open Command:** Final command to open the MCB from application logic.

**MCB Close Command:** Final close command to MCB from application logic.

B10: FALSE = Main contactor Open, TRUE = Main contactor closed

**MCB Open:** Feedback from MCB, open.

**MCB Closed:** Feedback from MCB, closed.

B11: FALSE = Charge Control Open, TRUE = Charge Control Closed

**Charge Control Open:** Charging Contactor is not controlled.

**Charge Control Closed:** Charging contactor controlled closed.

B12: FALSE = No Run Request, TRUE = Run Request

**No Run Request:** Final Run Request command has not been given to motor control.

**Run Request:** Final Run Request command has been given to motor control.

## 11. PROBLEM SOLVING

While proper information is needed from the problem, we also recommend you to try with the latest application and system software versions available. The software is continuously developed and default settings are improved.

| Type  | Signal Name      | Actual | Unit |
|-------|------------------|--------|------|
| Value | Status Word      | 22374  |      |
| Value | DC Voltage       | 575    | V    |
| Value | Active Current   | -9,8   | %    |
| Value | Reactive Current | -49,6  | %    |
| Value | Current          | 351    | A    |
| Value | Supply Frequency | 50     | Hz   |
| Value | Supply Voltage   | 248,3  | V    |
| Value | DIN Status 1     | 56     |      |

Figure 11-1, The recommended signals for NCDrive

Use the fastest communication speed (Baudrate: 57 600) and a 50 ms update interval for signals for the RS232 communication.

For the CAN communication, use a 1 Mbit communication speed and 7 ms update interval for signals.

When you contact the support, send the \*.trn, \*.par and Service info (\*.txt) files with a description of the situation. If the situation is caused by a fault, take also the Datalogger data from the drive.

Note that Datalogger settings can be changed to catch correct situation and it is also possible to make manual force trig for Datalogger.

Before storing the parameter file, upload the parameters from the drive and save when NCDrive is in the ON-LINE state. If it is possible, do this while the problem is active. You must use original vcn file placed in NCDrive\Applications folder.

It is also helpful to have a single line diagram from the system where problem is faced.

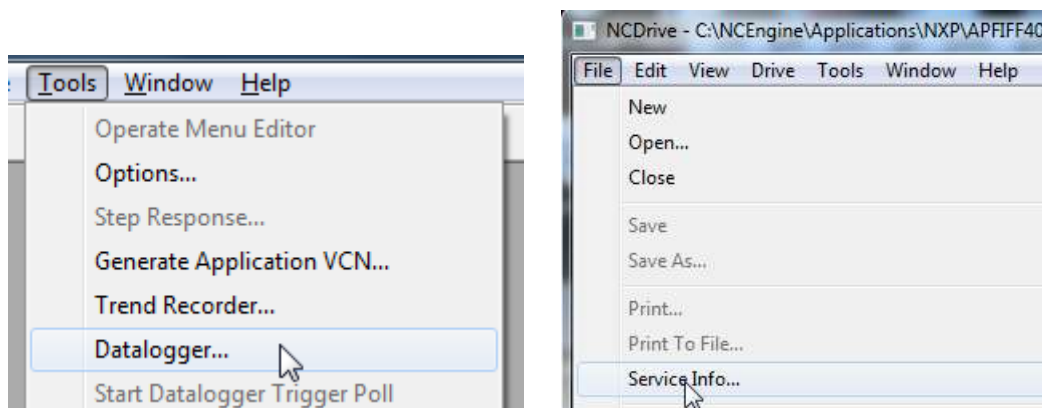

Figure 11-2, Datalogger window opening and Service Info upload.

## 12. FAULT CODES

This chapter includes all fault codes that are possible. However some faults are not possible in the AFE application. In addition, some fault descriptions may be different when compared to a standard AC drive.

### **F1 Over current fault**

The AC drive has detected a high current in the output phase.

S1 = Hardware trip:

Current above  $4 \cdot I_h$

S3 = Current controller supervision.

Current limit too low or current peak value too high.

#### **Possible cause**

- Sudden change in grid frequency
- Sudden change in grid voltage
- Short circuit in in grid while Short Circuit function is not active

#### **Correcting measures**

- Check grid conditions load.
- Activate Short Circuit function

### **F2 Overvoltage fault**

The DC-link voltage has exceeded the AC drive protection limits.

S1 = Hardware trip.

500 Vac unit DC voltage above 911 Vdc

690 Vac unit DC voltage above 1200 Vdc

S2 = Overvoltage control supervision (only 690 Vac unit).

DC voltage has been above 1100 Vdc for too long.

#### **Possible cause and solutions**

- Sudden change in supply voltage or frequency.
- Unstable DC power source in uGrid mode.
- Wrong Grid frequency

#### **Correcting measures**

- Check supply voltage.
- Check DC source.
- Check grid conditions

**F3 Earth fault**

Earth fault protection ensures that the sum of the motor phase currents is zero. The overcurrent protection is always working and protects the AC drive from earth faults with high currents.

S1 = Sum of output phase current is not zero

**Possible cause**

- No transformer on the input/output side.
- Insulation failure

**Correcting measures**

- Contact factory

**F5 Charge switch**

Charge switch status is not correct when the start command is given.

S1 = Charge switch was open when the START command was given.

**Possible cause**

- Charge switch was open when the START command was given.
- Reset the fault and restart.

**Correcting measures**

- Check connection of the feedback from the charging relay.
- Should the fault re-occur, contact your local distributor.

**F6 Emergency stop**

Emergency stop command has been given by using a special option board.

**F7 Saturation fault**

S1 = Hardware failure

**Possible cause and solutions**

-

**Correcting measures**

- Check the isolation resistance and the resistance on the brake resistor.
- Check the capacitors.

## **F8 System Fault**

A system fault indicates several different fault situations in the drive operation.

S1 = Reserved

- Disturbance. Reset the unit and try again.
- If there is a star coupler in the unit, check the fibre connections and phase order.
- Driver board or IGBT broken.
- FR9 and the bigger size drives that do not include a star coupler: the ASIC board (VB00451) is broken.
- FR8 and smaller size drives: control board broken.
- FR8 and smaller size drives: if boards VB00449 / VB00450 are used, the failure might be in there.

S2 = Reserved

S3 = Reserved

S4 = Reserved

S5 = Reserved

S6 = Reserved

S7 = Charge switch

S8 = No power to driver card

S9 = Power unit communication (TX)

S10 = Power unit communication (Trip)

S11 = Power unit comm. (Measurement)

S12 = SystemBus synchronization has failed in DriveSynch operation

S30 = Safe disable inputs are in different state (OPT-AF)

S31 = Thermistor short circuit detected (OPT-AF)

S32 = OPT-AF board has been removed

S33 = OPT-AF board EEPROM error

### **Possible cause and solutions**

- Correcting measures
-

**F9 Undervoltage fault**

DC-link voltage is below the fault voltage limit of the drive.

S1 = DC-link too low during run

S2 = No data from power unit

S3 = Undervoltage control supervision

**Possible cause**

- Too low a supply voltage
- AC drive internal fault
- One of the input fuses is broken.
- External charge switch has not been closed.

**Correcting measures**

- In case of temporary supply voltage break, reset the fault and restart the AC drive.
- Check supply voltage.
- Check function of DC charge.
- Contact your local distributor.

**F10 Line Synchronization Fault**

S1 = Phase supervision diode supply

S2 = Phase supervision active front end

**Possible cause:**

- Input line phase is missing.

**Correcting measures**

- Check supply voltage, fuses and cable.

**F11 Line phase supervision****Possible cause:**

- Current measurement has detected that there is no current in one phase or one phase current is considerably different from other phases.

**Correcting measures**

- Check motor cable and motor.

**F12 Brake chopper supervision**

Brake chopper supervision generates pulses to the brake resistor for response. If no response is received within set limits a fault is generated.

**Possible cause:**

- No brake resistor installed.
- Brake resistor is broken.
- Brake chopper failure.

**Correcting measures:**

- Check brake resistor and cabling.
- If these are ok the chopper is faulty. Contact your local distributor.

**F13 Drive under temperature fault****Possible cause:**

- Heatsink temperature is under  $-10^{\circ}\text{C}$

**Correcting measures:**

-

**F14 Drive over temperature fault****Possible cause:**

- Heatsink temperature is over acceptable limits. See the user manual for the temperature limit. Overtemperature warning is issued before the actual trip limit is reached.

**Correcting measures**

- Check the correct amount and flow of cooling air.
- Check the heatsink for dust.
- Check ambient temperature.
- Make sure that the switching frequency is not too high in relation to ambient temperature and motor load.

**F22 EEPROM checksum fault****Possible cause:**

- Parameter save fault
- Faulty operation
- Component failure

**Correcting measures:**

- Should the fault re-occur, contact your local distributor.

**F24 Counter fault**

Possible cause:

- Values displayed on the counters are incorrect
- 

Correcting measures:

- Have a critical attitude towards values shown on counters.

**F25 Microprocessor watchdog fault**

Possible cause:

- Start-up of the drive has been prevented.
- Run request is ON when a new application is loaded to the drive.

Correcting measures:

- Reset the fault and restart.
- Should the fault re-occur, contact your local distributor.

**F26 Start-Up prevention**

Possible cause:

- Start-up of the drive has been prevented.
- Run request is ON when a new application is loaded to the AC drive

Correcting measures:

- Cancel prevention of start-up if this can be done safely.
- Remove Run Request.

**F29 Thermistor fault**

The thermistor input of the option board has detected too high a motor temperature.

Possible cause:

- LCL is overheated.
- Thermistor cable is broken.

Correcting measures:

- Check LCL cooling and load
- Check thermistor connection (If thermistor input of the option board is not in use it has to be short circuited).



**F31 IGBT temperature**

IGBT Inverter Bridge over temperature protection has detected too high a short term overload current.

Possible cause:

- Too high load
- Identification run has not been made, and this causes the motor to start under magnetized.

Correcting measures:

- Check load.
- Check motor size.
- Make identification Run.

**F32 Fan cooling**

Possible cause:

- Cooling fan of the AC drive does not start when ON command is given.

Correcting measures:

- Contact your local distributor.

**F37 Device change**

Option board or power unit changed.

Possible cause:

- New device of the same type and rating.

Correcting measures:

- Reset. Device is ready for use.

**F38 Device added**

Option board added.

Correcting measures:

- Reset. Device is ready for use. Old board settings will be used.

**F39 Device removed**

Possible cause:

- Option board removed.

Correcting measures:

- Reset. Device no longer available.

**F40 Device unknown**

Unknown option board or drive.

S1 = Unknown device

S2 = Power1 not same type as Power2

Correcting measures:

- Contact the distributor near to you.

**F41 IGBT temperature**

IGBT inverter bridge overtemperature protection has detected too high a short term overload current.

Correcting measures:

- Check load.
- Check motor size.
- Make Identification run.

**F42 Brake resistor over temperature**

S1: Brake resistor high temperature

Calculation for internal brake resistor has exceeded the tripping limit. If the internal brake resistor is not in use set the brake chopper parameter in System menu to 'Not connected'.

S2: Brake resistor resistance is too high

S3: Brake resistor resistance is too low

S4: No brake resistor detected

**F43 Encoder fault**

Encoder fault is issued when the drive is not able to operate in closed loop control mode (encoder is used). See subcodes for details for the reason of the fault:

S1 =Encoder 1 channel A is missing

S2 =Encoder 1 channel B is missing

S3 =Both encoder 1 channels are missing

S4 =Encoder reversed

S5 =Encoder board missing

S6= Serial communication fault

S7=Ch A / Ch B Mismatch

S8=Resolver/Motor polepair mismatch

S9=Missed Start Angle

This fault comes when using PMS motor.

1. Modulation type is ASIC while incremental encoder is used.
  - Change modulator type to Software 1
2. Start identification do not work due low identification current
  - Increase identification current
3. Start angle identification is not working at all because there is no saturation based saliency in the motor
  - Use absolute encoder
4. There are too much noise pick-ups in encoder cable
  - check encoder cable shield and grounding in drive

**F44 Device changed (Default param.)**

Possible cause:

- Option board or power unit changed.
- New device of different type or different rating from the previous one.

Correcting measures:

- Reset
- Set the option board parameters again if option board was changed. Set AC drive parameters again if power unit was changed.

**F45 Device added (default param.)**

Possible cause:

- Option board of different type added.

Correcting measures:

- Reset
- Set the option board parameters again.

**F50 4mA supervision**

Possible cause:

- Current at the analogue input is below 4mA.
- Signal source has failed
- Control cable is broken or loose

Correcting measures:

- Check the current loop circuitry.

**F51 External fault**

Possible cause:

- Digital input fault.

Correcting measures:

- Remove fault situation from external device.

**F52 Keypad communication**

Possible cause:

- The connection between the control keypad or NCDrive and the AC drive is broken.

Correcting measures:

- Check keypad connection and possible keypad cable.

**F53 Fieldbus communication fault on slot D**

Possible cause:

- The data connection between the fieldbus Master and the fieldbus board is broken.
- Watch Dig pulse is missing from PLC, if Control Slot selector is zero or set for slot D.

Correcting measures:

- Check installation.
- If installation is correct contact the nearest VACON® distributor.

**F54 Slot fault**

Possible cause:

- Defective option board or slot

Correcting measures:

- Check board and slot.
- Contact the nearest VACON® distributor.

**F55 Input Switch**

Possible cause:

1. Digital input monitoring indicates that DC or AC input switch is open

Correcting measures:

- Check reason for open input switch.

**F56 PT100 temperature fault**

PT100 protection function is used to measure temperature and give warning and/or fault when set limits are exceeded. Marine application supports two PT100 boards. One can be used for the motor winding and the other for the motor bearings.

Possible cause:

- Temperature limit values set for the PT100 board parameters have been exceeded.

Correcting measures:

- Find the cause of temperature rise

**F57 Identification**

Identification run has failed.

- A1 = Current measurement offset**
- A2 = Identification current level**
- A3 = Acceleration time too long**
- A4 = Identification frequency reference not reached**
- A5 = Too low or high magnetization current**
- A6 = Flux curve outside expected levels**
- A7 = PMSM, Encoder zero position**
- A8 = Too low maximum frequency limit**
- A9 = PMSM, encoder zero pulse not found.**
- A10 = Ls Identification timeout**
- A11 = Ls Identification current**

Possible cause:

1. There was load on the motor shaft when making the identification run with rotating motor.
2. Motoring or generator side torque/power limits are too low to achieve a stable run.

Correcting measures:

- Run command was removed before identification was ready
- Motor is not connected to the AC drive.
- There is load on the motor shaft.
- In some cases, levering the DC-Link voltage may help, for example, by stopping AFE boosting.

**F58 Mechanical brake**

This fault is generated when the acknowledge signal from the brake is used. If the status of the signal is opposite from the control signal for a longer period of time than the delay defined with P2.15.11 *Brake Fault Delay* a fault is generated.

Correcting measures:

- Check the condition and connections of mechanical brake.

**F59 SystemBus communication**

The master drive sends pulses to all follower drives. If the pulses are missing, a system bus communication fault is generated. The master drive also receives pulses back from the follower drives (max. four drives) and generates warnings if pulses are missing.

SystemBus communication is broken between master and follower.

Correcting measures:

- Check expander board parameters.
- Check optical fibre.
- Check option board jumpers.

**F60 Cooling**

Protection for the liquid-cooled units. An external sensor is connected to the drive (DI: Cooling Monitor) to indicate if cooling liquid is circulating. If the drive is in Stop state, only a warning is issued. In Run state a fault is issued and the drive makes a coast stop.

**Possible cause:**

- Liquid cooled drive cooling circulation has failed

**Correcting measures:**

- Check reason for cooling failure from external system.

**F62 Run Disabled**

Run Disable warning signal is issued when Run Enable signal has been removed from the IO.

**F63 Quick stop****Possible cause:**

- A command has been given from a digital input or the fieldbus to make an quick stop.

**Correcting measures:**

- New run command is accepted after the quick stop is reset.

**F64 MCB State Fault**

This function monitors MCB status. Feedback status should correspond to the control signal. Delay to fault is defined by P2.9.1.13 MCB Fault Delay.

F64 A1: Code given by V064 and older versions.

F64 A2: MCB open while requested closed

F64 A3: MCB closed while requested open.

F64 A4: MCB opened externally while unit was in run state.

**Possible cause:**

1. Main circuit breaker has opened while drive controls it to close.
2. Main circuit breaker has closed while drive control it to be open.

**Correcting measures:**

1. Check the main contactor functionality

**F65 PT100 board 2**

PT100 protection function is used to measure temperature and give a warning and/or a fault when the set limits are exceeded. Marine application supports two PT100 boards. One can be used for the motor winding and the other for the motor bearings.

**Possible cause:**

Temperature limit values set for the PT100 board parameters have been exceeded.

The number of inputs selected is higher than what is actually connected.

PT100 cable is broken

**F66 Klixon**

Possible cause:

1. Klixon type temperature sensor has exceeded the triggering limit.

Correcting measures:

- Check reason for temperature trip where klixon sensor is located.

**F67 Fieldbus communication fault on slot E**

Possible cause:

- The data connection between the fieldbus Master and the fieldbus board is broken.
- Watch Dog pulse is missing from PLC, if Control Slot Selector is for slot E.

Correcting measures:

- Check installation.
- If installation is correct contact the nearest VACON® distributor.

**F68 D7 Voltage or frequency fault**

This monitors Grid frequency and voltage.

Possible cause:

- OPT-D7 measurements are not within limits.

**F69 OPT-D7 Missing**

OPT-D7 board is not present for the function that is requested.

Possible cause:

Correcting measures:

**F70 Line Voltage**

Supply voltage is not inside of set hysteresis. Not to be confused with OPT-D7 protections.

**F71 LCL Temperatuer**

LCL Temperature has reached warning limit.

Possible cause:

Correcting measures:

**F72 License**

License has not been given or license code is wrong

Possible cause:

Correcting measures:

**F73 Supply Frequency**

Supply frequency is not inside of set hysteresis. Not to be confused with OPT-D7 protections.



**F80 Charging Fault**

Drive has not reached need voltage at set time

Possible cause:

Correcting measures:

**F81 External Fault 2**

Digital input fault

Possible cause:

Correcting measures:

- Remove fault situation from external device.

**F82 Over Load**

User defined over load limits has been exceeded. See functional description from Motor Protection chapter.

Possible cause:

Correcting measures:

**F88 Ambien temperature**

Possible cause:

1. Temperature sensor has detected too high ambient temperature

Correcting measures:

1. Check reason for high ambient temperature on location where sensor is located.

**F89 Grid Side Fault**

In MF Mode Grid side AFE has a active fault

Possible cause:

Correcting measures:

**F91 Short Circuit**

Drive is operating against current limit

Possible cause:

- There is a short circuit in the grid.

Correcting measures:

**F92 D7 Voltage**

Measured voltage is not within limits set in protection group Grid Voltage D7

Possible cause:

- Voltage reference is below set limit.
- Supply Voltage is below set limit
- There is a short circuit in the grid
- OPT-D7 is installed but not connected
  - o Monitoring can be disabled with Control Options

**F93 D7 Frequency**

Measured frequency is not within limits set in protection group Grid Frequency .

- OPT-D7 is installed but not connected
  - o Monitoring can be disabled with Control Options

# VACON<sup>®</sup>

[www.danfoss.com](http://www.danfoss.com)

Vacon Ltd  
Member of the Danfoss Group  
Runsorintie 7  
65380 Vaasa  
Finland

Document ID:



DPD01916A

Rev. A