



USER'S MANUAL
NXP FREQUENCY CONVERTERS
NXP LIFT APPLICATION
APFIF33

1.	Introduction	3
2.	Programming principle of the Input signals	4
2.1	Defining an input for a certain function on keypad.....	5
2.2	Defining a terminal for a certain function with NCDrive programming tool.....	6
3.	Control I/O	7
4.	NXP Lift Application – Parameter lists.....	8
4.1	Monitoring values (Control keypad: menu M1).....	8
4.2	Basic parameters (Control keypad: Menu M2 → G2.1)	9
4.3	Speed Control Parameters (Control keypad: Menu M2 → G2.2)	9
4.4	Mechanical Brake control parameters (Control keypad: Menu M2 → G2.3).....	11
4.5	Drive control parameters (Control keypad: Menu M2 → G2.4).....	12
4.6	Motor control parameters (Control keypad: Menu M2 → G2.5).....	12
4.7	Identified parameters (Control keypad: Menu M2 → G2.5.19.1).....	13
4.8	Input signals (Control keypad: Menu M2 → G2.6)	15
4.9	Output signals (Control keypad: Menu M2 → G2.7).....	16
4.10	Protections (Control keypad: Menu M2 → G2.8).....	18
4.11	Autorestart parameters (Control keypad: Menu M2 → G2.9)	19
4.12	Evacuation parameters (Control keypad: Menu M2 → G2.10)	20
4.13	Closed loop parameters (Control keypad: Menu M2 → G2.11).....	20
4.14	Keypad control (Control keypad: Menu M3).....	21
4.15	System menu (Control keypad: M6)	21
4.16	Expander boards (Control keypad: Menu M7)	21
5.	Description of parameters	22
5.1	BASIC PARAMETERS	22
5.2	SPEED CONTROL.....	23
5.3	MECHANICAL BRAKE CONTROL	28
5.4	DRIVE CONTROL	36
5.5	MOTOR CONTROL	39
5.6	INPUT SIGNALS	46
5.7	OUTPUT SIGNALS	49
5.8	PROTECTIONS.....	53
5.9	AUTO RESTART PARAMETERS	60
5.10	EVACUATION PARAMETERS	62
5.11	CLOSED LOOP PARAMETERS	64
5.12	KEYPAD CONTROL PARAMETERS	66
6.	Commissioning of the Lift application.....	67
6.1	Installation of the NX drive	67
6.2	General setup of parameters	68
6.3	Tuning of the application	69
7.	Control signal logic in THE LIFT Application.....	73
8.	Fault Tracing.....	74

1. INTRODUCTION

Select the NXP Lift Application in menu **M6** on page *S6.2*.

The NXP Lift Application can be used with modern Lift systems. There are functions included that are required to achieve a smooth ride in the lift car. The I/O interface table includes the most commonly needed signals in lift applications.

In the application, constant speeds are presented in [m/s] and also in [Hz], acceleration and deceleration are presented in [m/s²] and jerks are presented in [ms].

Mechanical brake control logic is designed to achieve smooth departures from and landings to floor level. The brake can be set in various ways to meet the different requirements of lift motors and lift control logic.

The used hardware can be any Vacon NXP frequency converter. In closed loop motor control mode encoder option board is required (NXOPTA4 or NXOPTA5).

The application support also permanent magnet motors. There are a separate menu group for PMM-parameters.

We recommend ENDAT type absolute encoder together with the option board OPTBB to get the best performance for a permanent magnet motor.

Set the parameter P7.3.1.3 to Interpolation = Yes if option board OPTBB is used.

It is also possible to use resolver and then the option board OPTBC is used.

All outputs are freely programmable. The expansion relay R03 and R04 can be assigned to any digital output by the TTF method (see next page).

Digital input functions are freely programmable to any digital input by the TTF method. Start forward and reverse signals are fixed to input DIN1 and DIN2 (see next page).

Motor contactor control is included to allow the frequency converter to control a contactor between frequency converter and motor.

Motor contactor control logic is used only when an output is assigned to motor contactor control.

The contactor closes at start request. The frequency converter starts to run after a delay given by parameter or when the programmed digital input for motor contactor acknowledgement goes high.

We recommend the use of digital input for motor contactor acknowledgement. Then there is no need to adjust the delay time and there will be an alarm if the acknowledgement signal does not come.

2. PROGRAMMING PRINCIPLE OF THE INPUT SIGNALS

The programming principle of the input signal in the NXP Lift Application as well as in the Multipurpose Control Application (and partly in the other applications) is different compared to the conventional method used in other Vacon NX applications.

In the conventional programming method, Function to Terminal Programming Method (FTT), you have a fixed input that you define a certain function for. The applications mentioned above, however, use the Terminal to Function Programming method (TTF) in which the programming process is carried out the other way round: Functions appear as parameters that the operator defines certain input for (see Figure below).

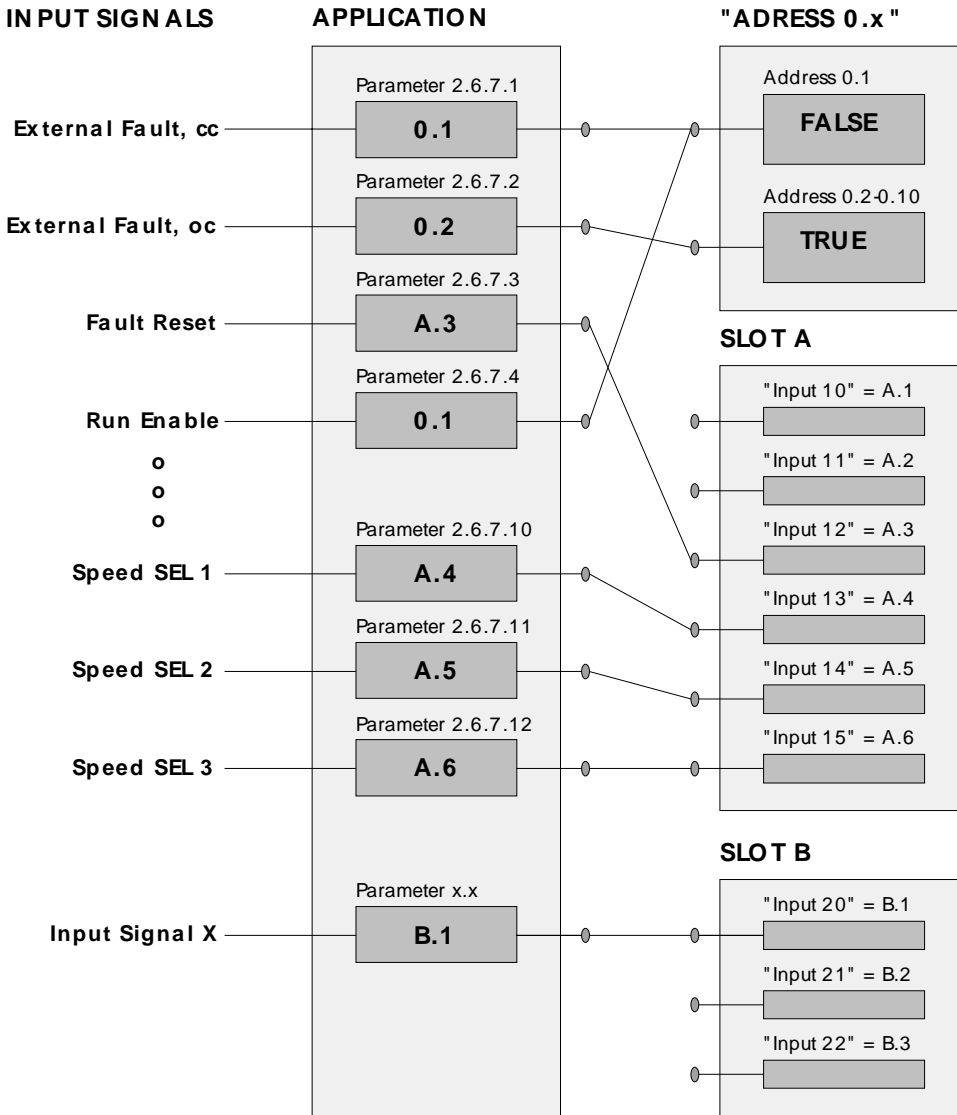
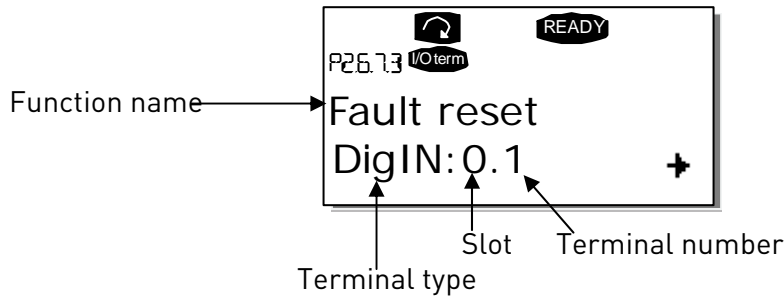

Figure 1. Basic principle of the Terminal to Function Programming method (TTF).

Note: Constant value can be given to input signal. Value 0.1 is a constant FALSE and values from 0.2 through 0.10 are constant TRUE (see Figure 1).

2.1 Defining an input for a certain function on keypad

Connecting a certain function (input signal) to a certain digital input is done by giving the parameter an appropriate value. The value is formed of the *Board slot* on the Vacon NX control board (see Vacon NX User's Manual, Chapter 6.2) and the *respective signal number*, see below.



Example: You want to connect the digital input function *Fault Reset* (parameter 2.6.7.3) to a digital input A.3 on the basic board NXOPTA1, located in Slot A.

First find the parameter 2.6.7.3 on the keypad. Press the *Menu button right* once to enter the edit mode. On the *value line*, you will see the terminal type on the left (DigIN) and on the right, digital input where function is connected.

When the value is blinking, hold down the *Browser button up* or *down* to find the desired board slot and signal number. The program will scroll the board slots starting from **0** and proceeding from **A** to **E** and the I/O numbers from **1** to **10**.

Once you have set the desired value, press the *Enter button* once to confirm the change.



2.2 Defining a terminal for a certain function with NCDrive programming tool

If you use the NCDrive Programming Tool for parametrizing you will have to establish the connection between the function and input/output in the same way as with the control panel. Just pick the address code from the drop-down menu in the *Value* column (see the Figure below).

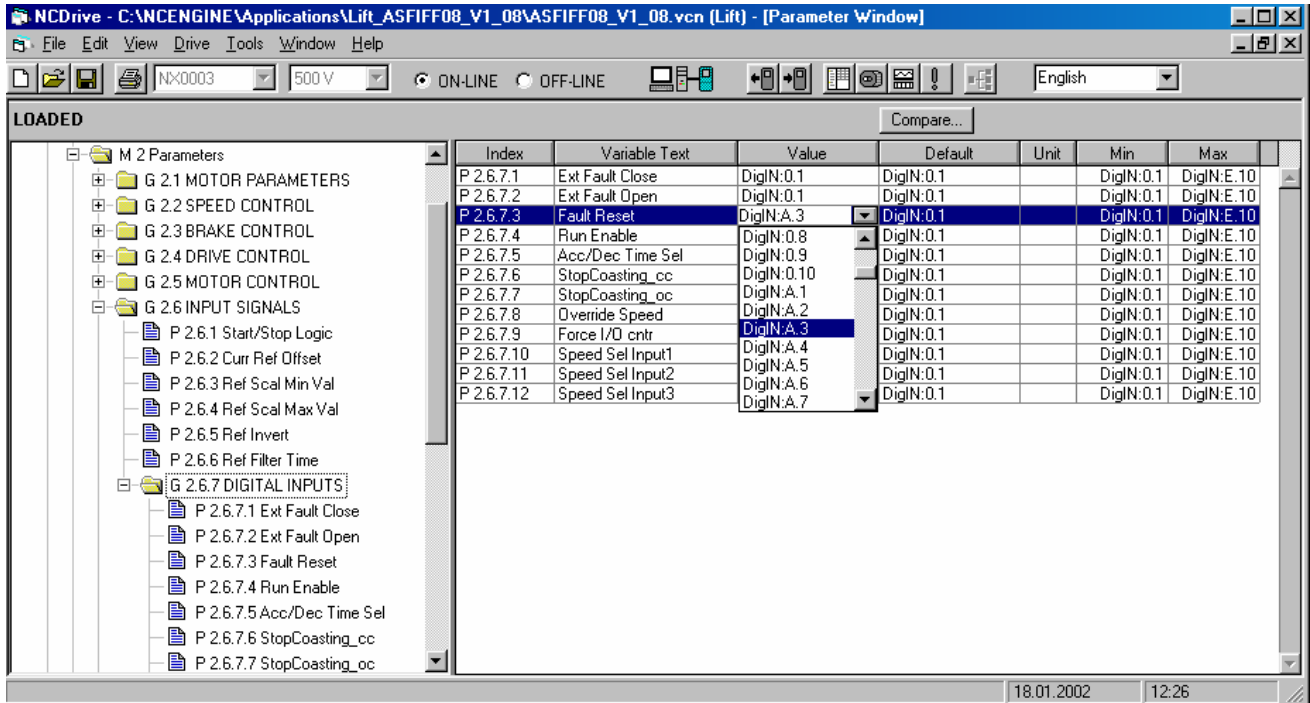

Figure 2. Screenshot of NCDrive programming tool; Entering the address code

Note: Two input signals can be connected to same digital input. However, use this feature very considerably.



3. CONTROL I/O

NXOPTA1			
Terminal		Signal	Description
1	+10V _{ref}	Reference output	Voltage for potentiometer, etc.
2	AI1+	Analogue input, voltage range 0–10V DC	Voltage input frequency reference
3	AI1-	I/O Ground	Ground for reference and controls
4	AI2+	Analogue input, current range 0–20mA	Current input frequency reference
5	AI2-		
6	+24V	Control voltage output	Voltage for switches, etc. max 0.1 A
7	GND	I/O ground	Ground for reference and controls
8	DIN1	Start forward (programmable)	Contact closed = start forward
9	DIN2	Start reverse (programmable)	Contact closed = start reverse
10	DIN3	Fault Reset (programmable)	Contact open = no fault Contact closed = fault
11	CMA	Common for DIN 1–DIN 3	Connect to GND or +24V
12	+24V	Control voltage output	Voltage for switches (see #6)
13	GND	I/O ground	Ground for reference and controls
14	DIN4	Speed reference selection	Programmable speed reference for Inputs DIN4, DIN5, and DIN6: Activity reference Activity reference with direction Binary Reference
15	DIN5		
16	DIN6		
17	CMB	Common for DIN4–DIN6	Connect to GND or +24V
18	AO1+	Output frequency	Programmable Range 0–20 mA/R _L , max. 500Ω
19	AO1-	Analogue output	Programmable Open collector, I _s ≤50mA, U _s ≤48 VDC
20	DO1	Digital output FAULT	
NXOPTA2			
21	R01	Relay output 1 RUN	Programmable
22	R01		
23	R01		
24	R02	Relay output 2 Mechanical brake	Programmable
25	R02		
26	R02		

Table 1. NXP lift application default I/O configuration.

Note: See jumper selections below. More information in Vacon NX User's Manual, Chapter 6.2.2.2.

Jumper block X3: CMA and CMB grounding



-  CMB connected to GND
CMA connected to GND
-  CMB isolated from GND
CMA isolated from GND
-  CMB and CMA internally connected together, isolated from GND

 = Factory default

4. NXP LIFT APPLICATION – PARAMETER LISTS

On the next pages you will find the lists of parameters within the respective parameter groups. The parameter descriptions are given on pages 22 to 63.

Column explanations:

Code	=	Location indication on the keypad; Shows the operator the present parameter number
Parameter	=	Name of parameter
Min	=	Minimum value of parameter
Max	=	Maximum value of parameter
Unit	=	Unit of parameter value; Given if available
Default	=	Value preset by factory
Cust	=	Customer's own setting
ID	=	ID number of the parameter (used with PC tools)
	=	Apply the <i>Terminal to Function</i> method (TTF) to these parameters. See Chapter 2.
	=	On parameter code: Parameter value can only be changed after the frequency converter has been stopped.

4.1 Monitoring values (Control keypad: menu M1)

The monitoring values are the actual values of parameters and signals as well as statuses and measurements. Monitoring values cannot be edited.

See Vacon NX User's Manual, Chapter 7 for more information.

Code	Parameter	Unit	ID	Description
V1.1	Output frequency	Hz	1	Output frequency to motor
V1.2	Frequency reference	Hz	25	Frequency reference to motor control
V1.3	Motor speed	rpm	2	Motor speed in rpm
V1.4	Motor current	A	3	
V1.5	Motor torque	%	4	In % of the nominal motor torque
V1.6	Motor power	%	5	Motor shaft power
V1.7	Motor voltage	V	6	
V1.8	DC link voltage	V	7	
V1.9	Unit temperature	°C	8	Heatsink temperature
V1.10	Voltage input	V	13	AI1
V1.11	Current input	mA	14	AI2
V1.12	DIN1, DIN2, DIN3		15	Digital input statuses
V1.13	DIN4, DIN5, DIN6		16	Digital input statuses
V1.14	DO1, RO1, RO2		17	Digital and relay output statuses
V1.15	ROE1, ROE2, ROE3		35	Expansion relay status (ROE3 reserved for future use)
V1.16	Analogue I _{out}	mA	26	AO1
V1.17	Lift Speed	m/s	1630	Lift speed in m/s
V1.18	Encoder Speed	rpm	1631	
V1.19	UnFiltered Motor Torq	%	1632	
V1.20	Speed ctrl out	%	1633	Torque reference from speed controller output
V1.21	Ramp Down Distance	m	1634	Distance when decelerated from any speed to levelling speed (or zero speed). Value visualizes the effect of different parameters to stopping distance.
V1.22	Pole pair number		1651	Calculated Pole pair number. To be checked.
V1.23	Motor Temperature	%	9	Calculated motor temperature in percent of motor nominal temperature
G1.23	Multimonitor			Three different value can be monitored at the same time

Table 2. Monitoring values

4.2 Basic parameters (Control keypad: Menu M2 → G2.1)

Code	Parameter	Min	Max	Unit	Default	Cust	ID	Note
P2.1.1	Nominal voltage of the motor	180	690	V	NX2: 230V NX5: 400V NX6: 690V		110	Check the rating plate of the motor
P2.1.2	Nominal frequency of the motor	5,00	320,00	Hz	50,00		111	Check the rating plate of the motor
P2.1.3	Nominal speed of the motor	20	20 000	rpm	1440		112	The default applies for a 4-pole motor and a nominal size frequency converter.
P2.1.4	Nominal current of the motor	1 x I _L	2,5 x I _L	A	I _L		113	Check the rating plate of the motor
P2.1.5	Motor cosφ	0,30	1,00		0,85		120	Check the rating plate of the motor
P2.1.6	Current limit	0,1 x I _L	2,5 x I _L	A	1,5 x I _L		107	NOTE: This applies for frequency converters up to FR7. For greater sizes, consult the factory.

Table 3. Basic parameters G2.1

4.3 Speed Control Parameters (Control keypad: Menu M2 → G2.2)

Code	Parameter	Min	Max	Unit	Default	Cust	ID	Note	
P2.2.1	Nominal Linear Speed	0,20	5,00	m/s	1,00		1500	Lift Speed in m/s with motor nominal frequency	
P2.2.2	Speed Reference Selection	0	6	s	0		117	0=Activity Reference 1=Activ ref. with direction 2=Binary reference 3=A11 (Voltage input) 4=A12 (Current input) 5=Fieldbus 6=Keypad	
P2.2.3.x	Speed Reference [m/s]								
P2.2.3.1	Levelling Speed	0,00	par2.2.1	m/s	0,10		1501	Parameters correspond to parameters in group 2.2.4. They will be updated automatically if parameters are changed.	
P2.2.3.2	Full Speed	0,00	par2.2.1	m/s	1,00		1502		
P2.2.3.3	Limited Speed	0,00	par2.2.1	m/s	0,25		1503		
P2.2.3.4	Inspection Speed	0,00	1,5xP2.2.1	m/s	0,50		1504		
P2.2.3.5	Speed Reference 4	0,00	par2.2.1	m/s	0,10		1505		
P2.2.3.6	Speed Reference 5	0,00	par2.2.1	m/s	1,00		1506		
P2.2.3.7	Speed Reference 6	0,00	par2.2.1	m/s	0,25		1507		
P2.2.3.8	Speed Reference 7	0,00	par2.2.1	m/s	0,50		1508		
P2.2.3.9	Override speed	0,00	1,5xP2.2.1	m/s	0,50		1613		
P2.2.4.x	Speed Reference [Hz]								
P2.2.4.1	Levelling Speed	0,00	par2.1.2	Hz	5,00		1604	Parameters correspond to parameters in group 2.2.3. They will be updated automatically if parameters are changed.	
P2.2.4.2	Full Speed	0,00	par2.1.2	Hz	50,00		1605		
P2.2.4.3	Limited Speed	0,00	par2.1.2	Hz	12,50		1606		
P2.2.4.4	Inspection Speed	0,00	1,5xP2.1.2	Hz	25,00		1607		
P2.2.4.5	Speed Reference 4	0,00	par2.1.2	Hz	5,00		1608		
P2.2.4.6	Speed Reference 5	0,00	par2.1.2	Hz	50,00		1609		
P2.2.4.7	Speed Reference 6	0,00	par2.1.2	Hz	12,50		1610		
P2.2.4.8	Speed Reference 7	0,00	par2.1.2	Hz	25,00		1611		
P2.2.4.9	Override speed	0,00	1,5xP2.1.2	Hz	5,00		1612		

Code	Parameter	Min	Max	Unit	Default	Cust	ID	Note
P2.2.5.x	SPEED CURVE 1							
P2.2.5.1	Acceleration	0,20	2,00	m/s ²	0,70		103	
P2.2.5.2	Deceleration	0,20	2,00	m/s ²	0,70		104	
P2.2.5.3	Acceleration increase jerk 1	0,01	1,00	s	0,50		1540	
P2.2.5.4	Acceleration Decrease jerk 1	0,01	1,00	s	0,25		1541	
P2.2.5.5	Deceleration increase jerk 1	0,01	1,00	s	0,25		1542	
P2.2.5.6	Deceleration decrease jerk 1	0,01	1,00	s	0,50		1543	
P2.2.6.x	SPEED CURVE 2							
P2.2.6.1	Internal Ramp Switch	0	par2.1.2	Hz	0		1544	
P2.2.6.2	Acceleration 2	0,20	2,00	m/s ²	0,20		502	
P2.2.6.3	Deceleration 2	0,20	2,00	m/s ²	0,20		503	
P2.2.6.4	Acceleration increase jerk 2	0,01	1,00	s	0,50		1545	
P2.2.6.5	Acceleration decrease jerk 2	0,01	1,00	s	0,50		1546	
P2.2.6.6	Deceleration increase jerk2	0,01	1,00	s	0,50		1547	
P2.2.6.7	Deceleration decrease jerk 2	0,01	1,00	s	0,50		1548	
P2.2.7	Enable jerks	0	1		1		1549	
P2.2.8	Reference hold time	0,00	5,00	s	0,00		1509	Half floor ride function
P2.2.9	Stop State (DIN456)	0	1		0		1614	0=Normal operation 1=Stop if DIN456 are OFF

Table 4. Speed control parameters G2.2

4.4 Mechanical Brake control parameters (Control keypad: Menu M2 → G2.3)

Code	Parameter	Min	Max	Unit	Default	Cust	ID	Note
P2.3.1.x	OPEN LOOP PARAMETERS							
P2.3.1.1	Current limit	0	1,5 x I _n	A	0,2 x I _n		1551	Value is changed when parameter 2.1.4 is set.
P2.3.1.2	Torque limit	0	100,0	%	30,0		1552	
P2.3.1.3	Frequency limit	0	10,00	Hz	1,00		1553	
P2.3.1.4	Brake open delay	0	1,00	s	0,10		1554	
P2.3.1.5	Freq. limit close	0	20,00	Hz	1,00		1555	
P2.3.1.6	Brake close delay	0	5,00	s	0,00		1556	
P2.3.1.7	Max. Freq. brake closed	0	10,00	Hz	4,00		1557	
P2.3.1.8	Mechanical brake reaction time	0	1,00	s	0,05		1558	
P2.3.1.9	DC braking current	0,15 x I _n	1,5 x I _n	A	Varies		507	
P2.3.1.10	DC braking time at start	0,00	60,00	s	0,500		1559	0=DC brake is off at start
P2.3.1.11	DC braking time at stop	0,00	60,00	s	1,000		1560	0=DC brake is off at stop
P2.3.1.12	Frequency to start DC braking during ramp stop	0,10	10,00	Hz	0,50		515	
P2.3.1.13	Delayed Brake	0,00	30,00	s	0,00		1640	
P2.3.1.14	Run Request Closing	0	1		1		1641	0= Inactive 1= Active
P2.3.2.x	CLOSED LOOP PARAMETERS							
P2.3.2.1	Current limit	0	1,5 x I _n	A	0,2 x I _n		1561	Value is changed when parameter 2.1.4 is set.
P2.3.2.2	Torque limit	0	100,0	%	0		1562	
P2.3.2.3	Frequency limit	0	10,00	Hz	0,01		1563	
P2.3.2.4	Brake open delay	0	1,00	s	0,00		1564	
P2.3.2.5	Freq. limit close	0	20,00	Hz	0,01		1565	
P2.3.2.6	Brake close delay	0	5,00	s	0,00		1566	
P2.3.2.7	Max. Freq. brake closed	0	10,00	Hz	0,10		1577	
P2.3.2.8	Mechanical brake reaction time	0	1,00	s	0,05		1558	Same parameter as in Open loop
P2.3.2.9	0Hz time at start	0	2,000	s	0,400		615	
P2.3.2.10	0Hz time at stop	0	2,000	s	0,600		616	
P2.3.2.11	Smooth start time	0	1,00	s	0,10		1568	
P2.3.2.12	Smooth start freq.	0	5,00	Hz	0,02		1569	
P2.3.2.13	Delayed Brake	0,00	30,00	s	0,00		1640	
P2.3.2.14	Run Request Closing	0	1		1		1641	0= Inactive 1= Active
P2.3.2.15	Start Magnetizing Time	0,000	32,000	s	0,150		628	Start magnetizing time, Closed loop control
P2.3.2.16	Start Magnetizing Current	0,00	I _L	s	0,00		627	Start magnetizing current, Closed loop control
P2.3.3.x	DIGITAL INPUTS							
P2.3.3.1	Ext. brake control	0.1	E.10		0.2		1601	See page 4.
P2.3.3.2	Ext. brake supervision	0.1	E.10		0.2		1602	
P2.3.4.x	BRAKE SUPERVISION							
P2.3.4.1	External brake supervision time	0,00	5,00	s	1,00		1603	

Table 5. Mechanical brake control parameters, G2.3

4.5 Drive control parameters (Control keypad: Menu M2 → G2.4)

Code	Parameter	Min	Max	Unit	Default	Cust	ID	Note
P2.4.1	Brake chopper	0	3		1		504	0=Disabled 1=Used when running 2=Ext. brake chopper 3=Used when stopped/running
P2.4.2	Stop function	0	1		2		506	0=Coasting 1=Ramping 2=Stop by Freq. limit
P2.4.3	Frequency limit	0	MaxFreq	Hz	5,00		1624	Used only if par 4.2=2
P2.4.4	Stop distance	0	1,5	m	0,0		1539	0=Not used
P2.4.5	Deceleration increase/ decrease time	0	1,00	s	0,15		1626	S-curve (jerk) time which is active only when Stop by distance is active
P2.4.6	Scaling factor	0	200	%	70		1625	Scaling factor for ramp time
P2.4.7.x	MOTOR CONTACTOR CONTROL PARAMETERS							
P2.4.7.1	Closing time	0,00	2,00	s	0,10		1660	Close delay for motor contactor
P2.4.7.2	Motor Contactor Acknowledgement	0.1	E.10		0.1		1661	Digital feedback signal from motor contactor

Table 6. Drive control parameters, G2.4

4.6 Motor control parameters (Control keypad: Menu M2 → G2.5)

Code	Parameter	Min	Max	Unit	Default	Cust	ID	Note
P2.5.1	Motor control mode	0	1		1		1572	0=Frequency control 1=Speed control, (OL) 2=Speed control, (CL)
P2.5.2	U/f optimisation	0	1		1		1573	0=Not used 1=Automatic torq. boost
P2.5.3	U/f ratio selection	0	3		0		1574	0=Linear 1=Squared 2=Programmable 3=Linear with flux optim.
P2.5.4	Field weakening point	5,00	320,00	Hz	50,00		602	
P2.5.5	Voltage at field weakening point	10,00	200,00	%	100,00		603	$n\% \times U_{nmot}$ Parameter max. value = par. 2.6.7
P2.5.6	U/f curve midpoint frequency	0,00	P2.6.4	Hz	5,00		1575	
P2.5.7	U/f curve midpoint voltage	0,00	100,00	%	10,00		1576	$n\% \times U_{nmot}$
P2.5.8	Output voltage at zero frequency	0,00	40,00	%	1,30		1577	$n\% \times U_{nmot}$
P2.5.9	Switching frequency	1,0	16,0	kHz	Varies		601	Depends on kW
P2.5.10	Overvoltage controller	0	1		1		607	0=Not used 1=Used
P2.5.11	Undervoltage controller	0	1		1		608	0=Not used 1=Used
P2.5.12	Identification	0	3		0		631	0=No action 1=Identification w/o run 2=Identification with run 3=PM-motor angle ident.
P2.5.13	Measured Rs Volt Drop	0	10000				662	
P2.5.14	IrAddGenScale	0	200	%	0		665	

P2.5.15	IrAddMotorScale	0	200	%	100		667	
P2.5.16	OL SpeedCont kp1	0	32767		1000		667	Speed Controller kp1
P2.5.17	OL <SpeedCont ki1	0	32767	ms	10		667	Speed Controller ki1
P2.5.18.x	PERMANENT MAGNET MOTOR PARAMETERS							
P2.5.18.1	Motor type	0	1		0		1650	0=Asynchronous 1=Permanent magnet
P2.5.18.2	Flux Current Kp	0	32000		5000		651	
P2.5.18.3	Flux Current Ti	0	1000	ms	50		652	
P2.5.18.4	PMSM ShaftPosi	0	65565		0		1670	
P2.5.18.5	EnableRsIdentifi	0	1		1		654	0=No 1=Yes
P2.5.18.6	ModIndexLimit	0	200	%	100		655	
P2.5.18.7	Speed control Ti Start	0,0	500,0	ms	15,0		1667	Speed control Ti at start
P2.5.18.8	Speed control start delay	0,00	2,00	s	0,15		1668	How long time Speed control Ti Start is used after
P2.5.18.9	PMSM angle identification mode	0	2		1		1686	0=Identification with DC 1=Automatic Identification 2= Automatic Identification one time
P2.5.18.10	RollBack Controller	0	1		0		1687	0=disabled 1=enabled
P2.5.18.11	RollBack Gain	0	32767		2500		1689	RollBack control Gain
P2.5.18.12	RollBack wup	-2000	2000		3		1690	RollBack control wake up level

Table 7. Motor control parameters, G2.5

4.7 Identified parameters (Control keypad: Menu M2 → G2.5.19.1)

Parameters are updated when the automatic motor identification is done. The identification is activated by parameter P2.5.12 and start order within 20 seconds. It is also possible to change these parameters manually but then a very good knowledge in motor tuning is required.

Since these values are parameters it is possible to save them and copy to another drive.

Code	Parameter	Min	Max	Unit	Default	Cust	ID	Note
P2.5.19.1	Flux 10 %	0	250,0	%	10,0		1355	Flux linearisation point 10%
P2.5.19.2	Flux 20 %	0	250,0	%	20,0		1356	Flux linearisation point 20%
P2.5.19.3	Flux 30 %	0	250,0	%	30,0		1357	Flux linearisation point 30%
P2.5.19.4	Flux 40 %	0	250,0	%	40,0		1358	Flux linearisation point 40%
P2.5.19.5	Flux 50 %	0	250,0	%	50,0		1359	Flux linearisation point 50%
P2.5.19.6	Flux 60 %	0	250,0	%	60,0		1360	Flux linearisation point 60%
P2.5.19.7	Flux 70 %	0	250,0	%	70,0		1361	Flux linearisation point 70%
P2.5.19.8	Flux 80 %	0	250,0	%	80,0		1362	Flux linearisation point 80%
P2.5.19.9	Flux 90 %	0	250,0	%	90,0		1363	Flux linearisation point 90%
P2.5.19.10	Flux 100 %	0	250,0	%	100,0		1364	Flux linearisation point 100%
P2.5.19.11	Flux 110 %	0	250,0	%	110,0		1365	Flux linearisation point 110%
P2.5.19.12	Flux 120 %	0	250,0	%	120,0		1366	Flux linearisation point 120%
P2.5.19.13	Flux 130 %	0	250,0	%	130,0		1367	Flux linearisation point 130%
P2.5.19.14	Flux 140 %	0	250,0	%	140,0		1368	Flux linearisation point 140%
P2.5.19.15	Flux 150 %	0	250,0	%	150,0		1369	Flux linearisation point 150%
P2.5.19.16	Ir add zero point voltage	0	100,00	%	Varies		664	IrAddVoltage for Zero frequency, used with torque boost.
P2.5.19.17	Iu Offset	-32000	32000		10000		668	Offsets value for phase U current measurement.

P2.5.19.18	lv Offset	-32000	32000		0		669	Offsets value for phase V current measurement.
P2.5.19.19	lw Offset	-32000	32000		0		670	Offsets value for phase W current measurement.

4.8 Input signals (Control keypad: Menu M2 → G2.6)

Code	Parameter	Min	Max	Unit	Default	Cust	ID	Note	
								DIN1	DIN2
P2.6.1	Start/Stop logic	0	6		0		300	0 1 2	Start fwdP Start/Stop Start fwd Start rvsP Rvs/Fwd Start rev
P2.6.2	Current reference offset	0	1		1		302	0=No offset 1=4–20 mA	
P2.6.3	Reference scaling minimum value	0,00	par. 2.2.5	Hz	0,00		303	Selects the frequency that corresponds to the min. reference signal 0,00 = No scaling	
P2.6.4	Reference scaling maximum value	0,00	320,00	Hz	0,00		304	Selects the frequency that corresponds to the min. reference signal 0,00 = No scaling	
P2.6.5	Reference inversion	0	1		0		305	0=Not inverted 1=Inverted	
P2.6.6	Reference filter time	0,00	10,00	s	0,10		306	0=No filtering	
P2.6.7.x	DIGITAL INPUTS								
P2.6.7.1	External Fault, closing contact	0.1	E.10		0.1		1513	See page 4.	
P2.6.7.2	External fault, opening contact	0.1	E.10		0.2		1514		
P2.6.7.3	Fault reset	0.1	E.10		A.3		1515		
P2.6.7.4	Run enable	0.1	E.10		0.2		1516		
P2.6.7.5	Acceleration/Decel time selection	0.1	E.10		0.1		1517		
P2.6.7.6	Stop by coast, closing contact	0.1	E.10		0.1		1518		
P2.6.7.7	Stop by coast, opening contact	0.1	E.10		0.2		1519		
P2.6.7.8	Override speed	0.1	E.10		0.1		1520		
P2.6.7.9	Forced I/O control	0.1	E.10		0.1		1521		
P2.6.7.10	Speed selection input 1	0.1	E.10		A.4		1521		
P2.6.7.11	Speed selection input 2	0.1	E.10		A.5		1522		
P2.6.7.12	Speed selection input 3	0.1	E.10		A.6		1523		

Table 8. Input signals, G2.6

4.9 Output signals (Control keypad: Menu M2 → G2.7)

Code	Parameter	Min	Max	Unit	Default	Cust	ID	Note
P2.7.1	Analogue output function	0	8		1		307	0=Not used 1=Output freq. (0– f_{max}) 2=Freq. reference (0– f_{max}) 3=Motor speed (0–Motor nominal speed) 4=Output current (0– I_{nMotor}) 5=Motor torque (0– T_{nMotor}) 6=Motor power (0– P_{nMotor}) 7=Motor voltage (0– U_{nMotor}) 8=DC-link volt (0–1000V)
P2.7.2	Analogue output filter time	0,00	10,00	s	1,00		308	
P2.7.3	Analogue output inversion	0	1		0		309	0=Not inverted 1=Inverted
P2.7.4	Analogue output minimum	0	1		0		310	0=0 mA 1=4 mA
P2.7.5	Anal. output scale	10	1000	%	100		311	
P2.7.6	Digital output 1 function	0	21		3		312	0=Not used 1=Ready 2=Run 3=Fault 4=Fault inverted 5=FC overheat warning 6=Ext. fault or warning 7=Ref. fault or warning 8=Warning 9=Reversed 10=Preset speed 11=At speed 12=Mot. regulator active 13=OP freq. limit superv. 14=Control place: IO 15=ThermalFlt/Wrn 16=FB DigInput1 17=Speed below limit 18=Torque above limit 19=Mech. brake ctrl 20=Mech. brake ctrl inv. 21=Motor contactor ctrl
P2.7.7	Digital output function 1 inverted	0	1		0		1530	0=No inversion 1=Inverted
P2.7.8	Digital output 1 ON delay	0	10,00	s	0,00		1531	Delay content of DO1. 0,00= Delay not in used
P2.7.9	Digital output 1 OFF Delay	0	10,00	S	0,00		1657	Delay content of DO1. 0,00= Delay not in used
P2.7.10	Relay output 1 function	0	21		2		313	As parameter 2.7.6
P2.7.11	Relay output 1 function inverted	0	1		0		1532	0=No inversion 1=Inverted
P2.7.12	Relay output 1 ON delay	0	10,00	s	0,00		1533	Delay content of RO1. 0,00= Delay not in used
P2.7.13	Relay output 1 OFF Delay	0	10,00	S	0,00		1658	Delay content of RO1. 0,00= Delay not in used

Code	Parameter	Min	Max	Unit	Default	Cust	ID	Note
P2.7.14	Relay output 2 function	0	21		19		314	As parameter 2.7.6
P2.7.15	Relay output 2 function inverted	0	1		0		1534	0=No inversion 1=Inverted
P2.7.16	Speed supervision limit	0	P2.2.1	m/s	0,15m/s		1535	
P2.7.17	Motoring torque supervision	0	200.0	%	150.0		1536	
P2.7.18	Generating torque supervision	0	-200.0	%	0		1537	If set to 0 then P2.7.15 defines the limits for motoring and generating modes
P2.7.19	Output frequency limit 1 supervision	0	2		0		315	0=No limit 1=Low limit supervision 2=High limit supervision
P2.7.20	Output frequency limit 1; Supervised value	0,00	320,00	Hz	0,00		316	
P2.7.21.x	EXPANSION RELAYS (not included with standard delivery)							
P2.7.21.1	ROE1 Selection	0			0.1		1680	See page 4.
P2.7.21.2	ROE1 Function	0	21		0		1681	As parameter 2.7.6
P2.7.21.3	ROE1 Inversion	0	1		0		1682	0=No inversion 1=Inverted
P2.7.21.4	ROE2 Selection	0			0.1		1683	See page 4.
P2.7.21.5	ROE2 Function	0	21		0		1684	As parameter 2.7.6
P2.7.21.6	ROE2 Inversion	0	1		0		1685	0=No inversion 1=Inverted

Table 9. Output signals, G2.7

4.10 Protections (Control keypad: Menu M2 → G2.8)

Code	Parameter	Min	Max	Unit	Default	Cust	ID	Note
P2.8.1.x	I/O FAULTS							
P2.8.1.1	Response to reference fault	0	5		0		700	0=No response 1=Warning 2=Warning+Old Freq. 3=Wrrng+PresetFreq 2.8.1.2 4=Fault,stop acc. To 2.4.2 5=Fault,stop by coasting
P2.8.1.2	Reference fault frequency	0,00	Par. 2.1.2	Hz	0,00		728	
P2.8.1.3	Response to ext. fault	0	3		2		701	
P2.8.2.x	GENERAL FAULTS							
P2.8.2.1	Input phase supervision	0	3		0		730	
P2.8.2.2	Response to undervoltage fault	1	3		2		727	
P2.8.2.3	Output phase supervision	0	3		2		702	0=No response 1=Warning 2=Fault,stop acc. To 2.4.2 3=Fault,stop by coasting
P2.8.2.4	Earth fault protection	0	3		2		703	
P2.8.2.5	Response to fb. Fault	0	3		2		733	
P2.8.2.6	Response to slot fault	0			2		734	
P2.8.3.x	MOTOR FAULTS							
P2.8.3.1	Thermal protection of the motor	0	3		2		704	
P2.8.3.2	Motor ambient temperature factor	-100,0	100,0	%	0,0		705	
P2.8.3.3	Motor cooling factor at zero speed	0,0	150,0	%	40,0		706	
P2.8.3.4	Motor thermal time constant	1	200	min	45		707	
P2.8.3.5	Motor duty cycle	0	100	%	100		708	
P2.8.3.6	Stall protection	0	3		0		709	0=No response 1=Warning 2=Fault,stop acc. To 2.4.2 3=Fault,stop by coasting
P2.8.3.7	Stall current	0,1	6000,0	A	1,0		710	
P2.8.3.8	Stall time limit	1,00	120,00	s	15,00		711	
P2.8.3.9	Stall frequency limit	1,0	Par. 2.1.2	Hz	25,0		712	
P2.8.3.10	Response to thermistor fault	0	3		0		732	0=No response 1=Warning 2=Fault,stop acc. To 2.4.2 3=Fault,stop by coasting
P2.8.4.x	LIFT SUPERVISION							
P2.8.4.1	Mechanical brake control fault	0	2		0		1580	0=No action 1=Warning 2=Fault
P2.8.4.2	Shaft speed fault	0	2		0		1581	0=No action 1=Warning 2=Fault
P2.8.4.3	Shaft speed supervision time	0	1,00	s	0,40		1582	

P2.8.4.4.x SHAFT SPEED SUPERV. LIMIT								
P2.8.4.4.1	Shaft speed superv. Limit[m/s]	0	P2.2.1	m/s	0,30		1583	Same parameters with different units
P2.8.4.4.2	Shaft speed superv. Limit [Hz]	0	P2.1.2	Hz	15,00		1584	
P2.8.4.5	Overtorque protection	0	2		0		1585	0=No action 1=Warning 2=Fault
P2.8.4.6	Torque superv. Time	0	1,00	s	0,00		1586	
P2.8.4.7	Response to control conflict	0	2		2		1587	0=No action 1=Warning 2=Fault
P2.8.4.8	Min. current limit	0	P1.1.4	A	0,00		1588	0=No action
P2.8.4.9	0 Hz speed response	0	3		0		1589	0=Not used 1=Warning 2=Warning+Stop 3=Fault

Table 10. Protections, G2.8

4.11 Autorestart parameters (Control keypad: Menu M2 → G2.9)

Code	Parameter	Min	Max	Unit	Default	Cust	ID	Note
P2.9.1	Wait time	0,10	10,00	s	0,50		717	
P2.9.2	Trial time	0,00	60,00	s	30,00		718	
P2.9.3	Start function	0	2		0		719	0=Ramp 1=Not used
P2.9.4	Number of tries after undervoltage trip	0	10		0		720	
P2.9.5	Number of tries after overvoltage trip	0	10		0		721	
P2.9.6	Number of tries after overcurrent trip	0	3		0		722	
P2.9.7	Number of tries after reference trip	0	10		0		723	
P2.9.8	Number of tries after motor temperature fault trip	0	10		0		726	
P2.9.9	Number of tries after external fault trip	0	10		0		725	
P2.9.10	Number of tries after input phase supervision trip	0	10		0		1659	

Table 11. Autorestart parameters, G2.9

4.12 Evacuation parameters (Control keypad: Menu M2 → G2.10)

Code	Parameter	Min	Max	Unit	Default	Cust	ID	Note
P2.10.1	Evacuation mode	0	2	2	0		1590	0=Not used 1=Manual 2=Automatic
P2.10.2	Evacuation input				0.1		1591	See also page 4.
P2.10.3	Control mode	0	3		1		1592	0=Frequency control 1=Speed control
P2.10.4	Direction change delay	0	20,00	s	5,00		1593	
P2.10.5	Test time	0	20,00	s	3,00		1594	
P2.10.6	Current read delay	0	20,00	s	1,50		1595	
P2.10.7	U/f optimisation	0	1		0		1596	0=Not used 1=Automatic torque boost
P2.10.8	U/f-curve mid point frequency	0,00	par. P2.6.4	Hz	5,00		1597	
P2.10.9	U/f-curve mid point voltage	0,00	100,00	%	10,00		1598	
P2.10.10	Output voltage at zero frequency	0,00	40,00	%	1,30		1599	
P2.10.11	DC-brake current	0,00		A	0,00		1663	DC brake current in evacuation mode
P2.10.12	Start DC-brake time	0,000	60,000	S	0,500		1664	DC brake time at start in evacuation mode
P2.10.13.x	MAX SPEED IN EVACUATION							
P2.10.13.1	Max speed in evacuation [m/s]	0	0.4 x P2.2.1	m/s	0,10		1616	Same parameters with different units. Max value is 40% of nom. Value.
P2.10.13.2	Max speed in evacuation [Hz]	0	0.4 x P2.1.2	Hz	5,00		1617	

Table 12. Evacuation parameters, G2.10

4.13 Closed loop parameters (Control keypad: Menu M2 → G2.11)

Code	Parameter	Min	Max	Unit	Default	Cust	ID	Note
P2.11.1	Magnetizing current	0	In	A	0		612	
P2.11.2	Speed control limit	0	Par. 2.11.3		5,00		1618	
P2.11.3	Speed control limit	Par. 2.11.2	0.01Hz		10,00		1619	
P2.11.4	Speed control Kp 1	0	1000		30		1620	
P2.11.5	Speed control Kp 2	0	1000		30		1621	
P2.11.6	Speed control Ti	0	500	ms	30,0		1622	
P2.11.7	Speed control Ti	0	500	ms	30,0		1623	
P2.11.8	Current control Kp	0	100		40		617	
P2.11.9	Current control Ti	0	1000	ms	15		1627	
P2.11.10	Encoder 1 filter time	0	100.0	ms	0.0		618	
P2.11.11	Slip adjust	0	1000	%	100		619	

Table 13. Closed loop parameters, G2.11

4.14 Keypad control (Control keypad: Menu M3)

The parameters for the selection of control place and direction on the keypad are listed below. See the Keypad control menu in the Vacon NX User's Manual.

Code	Parameter	Min	Max	Unit	Default	Cust	ID	Note
P3.1	Control place	1	3		1		125	0=I/O terminal 1=Keypad 2=Fieldbus
R3.2	Keypad reference	Par. 2.1.1	Par. 2.1.2	Hz				
P3.3	Direction (on keypad)	0	1		0		123	0=Forward 1=Reverse
R3.4	Stop button	0	1		1		114	0=Limited function of Stop button 1=Stop button always enabled

Table 14. Keypad control parameters, M3

4.15 System menu (Control keypad: M6)

For parameters and functions related to the general use of the frequency converter, such as application and language selection, customised parameter sets or information about the hardware and software, see Chapter 7.3.6 in the Vacon NX User's Manual.

4.16 Expander boards (Control keypad: Menu M7)

The M7 menu shows the expander and option boards attached to the control board and board-related information. For more information, see Chapter 7.3.7 in the Vacon NX User's Manual.

5. DESCRIPTION OF PARAMETERS

5.1 BASIC PARAMETERS

2.1.1 *Nominal voltage of the motor*

Find this value U_n on the rating plate of the motor. This parameter sets the voltage at the field weakening point ([parameter 2.5.5](#)) to $100\% \times U_{n\text{motor}}$.

2.1.2 *Nominal frequency of the motor*

Find this value f_n on the rating plate of the motor. This parameter sets the field weakening point ([parameter 2.5.4](#)) to the same value.

Nominal frequency of the motor correspond the nominal lift speed ([parameter 2.2.1](#))

2.1.3 *Nominal speed of the motor*

Find this value n_n on the rating plate of the motor.

2.1.4 *Nominal current of the motor*

Find this value I_n on the rating plate of the motor.

2.1.5 *Motor cos phi*

Find this value "cos phi" on the rating plate of the motor.

2.1.6 *Current limit*

This parameter determines the maximum motor current from the frequency converter. To avoid motor overload, set this parameter according to the rated current of the motor. The current limit is 1.5 times the rated current (I_L) by default.

5.2 SPEED CONTROL

2.2.1 *Nominal Linear Speed*

Nominal linear speed corresponds to the lift speed at nominal frequency of the motor ([parameter 2.1.2](#))

Speed parameters in group 2.2.3 are entered in linear magnitudes and parameters in group 2.2.4 are entered in Hz. There is an internal scaling between linear speeds and frequencies. Parameters in both groups correspond to each other. If the value of the nominal linear speed is changed the parameters in group 2.2.3 are recalculated accordingly.

2.2.2 *Speed reference selection*

Defines which frequency reference source is selected when controlled from the I/O control place. Default value is 0.

- 0 = Activity coding
- 1 = Activity coding with direction
- 2 = Binary coding
- 3 = Voltage Input (AI1)
- 4 = Current Input (AI2)
- 5 = Fieldbus
- 6 = Keypad

Speed reference can be determined in three different ways with digital inputs. Digital inputs are programmable (see page 4).

The first column contains the state of the digital inputs (marked as default values DIN4, DIN5 and DIN6). The correct input signal can be programmed with parameters [2.6.7.10](#), [2.6.7.11](#) and [2.6.7.12](#).

The second column contains the parameter and the next column the corresponding speed reference. The priority column defines which speed is activated if more than one digital input is activated. If Speed reference is different when running to different direction the direction is defined in direction column.

0 = Activity coding

Four different constant speeds can be selected.

DIN [4,5,6]	Parameters	SpeedRef	Priority	Direction
[0;0;0]	2.2.3.1/2.2.4.1	(levelling speed)	0 low	irrelevant
[1;0;0]	2.2.3.2/2.2.4.2	(full speed)	1 medium	irrelevant
[0;1;0]	2.2.3.3/2.2.4.3	(limited speed)	2 high	irrelevant
[0;0;1]	2.2.3.4/2.2.4.4	(inspection speed)	3 highest	irrelevant

Table 15. Activity reference.

1 = Activity coding with direction

The constant speeds are selected according to the state of digital inputs and motor direction. Four different speeds per direction are available.

DIN [4,5,6]	Parameters	SpeedRef	Priority	Direction
[0;0;0]	2.2.3.1/2.2.4.1	(levelling speed)	0 low	forward
[1;0;0]	2.2.3.2/2.2.4.2	(full speed)	1 medium	forward
[0;1;0]	2.2.3.3/2.2.4.3	(limited speed)	2 high	forward
[0;0;1]	2.2.3.4/2.2.4.4	(inspection speed)	3 highest	forward
[0;0;0]	2.2.3.5/2.2.4.5	(preset speed 4)	0 low	reverse
[1;0;0]	2.2.3.6/2.2.4.6	(preset speed 5)	1 medium	reverse
[0;1;0]	2.2.3.7/2.2.4.7	(preset speed 6)	2 high	reverse
[0;0;1]	2.2.3.8/2.2.4.8	(preset speed 7)	3 highest	reverse

Table 16. Activity reference with direction.

2 = Binary coding

Eight different constant speeds are selected according to binary word formed through digital inputs.

DIN [4,5,6]	Parameters	SpeedRef	Priority	Direction
[0;0;0]	2.2.3.1/2.2.4.1	(levelling speed)	-	irrelevant
[1;0;0]	2.2.3.2/2.2.4.2	(full speed)	-	irrelevant
[0;1;0]	2.2.3.3/2.2.4.3	(limited speed)	-	irrelevant
[1;1;0]	2.2.3.4/2.2.4.4	(inspection speed)	-	irrelevant
[0;0;1]	2.2.3.5/2.2.4.5	(preset speed 4)	-	irrelevant
[1;0;1]	2.2.3.6/2.2.4.6	(preset speed 5)	-	irrelevant
[0;1;1]	2.2.3.7/2.2.4.7	(preset speed 6)	-	irrelevant
[1;1;1]	2.2.3.8/2.2.4.8	(preset speed 7)	-	irrelevant

Table 17. Binary reference.

Speed reference [m/s] parameters (M2 -> G2.2.3)

Parameters in group 2.2.3 define the speed reference in linear magnitudes [m/s]. Parameters correspond to the parameters of group 2.2.4 and they will be updated automatically if values are changed in the other group. They will also be updated if the value of [parameter 2.2.1](#) is changed.

- 2.2.3.1 *Levelling Speed*
- 2.2.3.2 *Full Speed*
- 2.2.3.3 *Limited Speed*
- 2.2.3.4 *Inspection Speed*
- 2.2.3.5 *Speed reference 4*
- 2.2.3.6 *Speed reference 5*
- 2.2.3.7 *Speed reference 6*
- 2.2.3.8 *Speed reference 7*
- 2.2.3.9 *Override Speed*

Speed Reference [Hz] parameters (M2 -> G2.2.4)

Parameters in group 2.2.4 define the speed reference in frequency [Hz]. The parameters correspond to the parameters in group 2.2.3 and they will be updated automatically if the values in the other group are changed.

- 2.2.4.1 *Levelling Speed*
- 2.2.4.2 *Full Speed*
- 2.2.4.3 *Limited Speed*
- 2.2.4.4 *Inspection Speed*
- 2.2.4.5 *Speed reference 4*
- 2.2.4.6 *Speed reference 5*
- 2.2.4.7 *Speed reference 6*
- 2.2.4.8 *Speed reference 7*
- 2.2.4.9 *Override Speed*

Speed Curve 1 parameters (M2 -> G2.2.5)

Speed curve 1 is used as the default values for acceleration and deceleration and jerks.

- 2.2.5.1 *Acceleration time 1*
- 2.2.5.2 *Deceleration time 1*

Acceleration and deceleration of the lift car are presented in [m/s²]. Acceleration and deceleration curves are affected by the jerk time settings, too.

- 2.2.5.3 *Acc inc jerk 1*
Acceleration increase jerk1.
Jerk times are presented in [ms].
- 2.2.5.4 *Acc dec jerk 1*
Acceleration decrease jerk 1.
- 2.2.5.5 *Dec inc jerk 1*
Deceleration increase jerk 1.
- 2.2.5.6 *Dec dec jerk 1*
Deceleration decrease jerk 1.

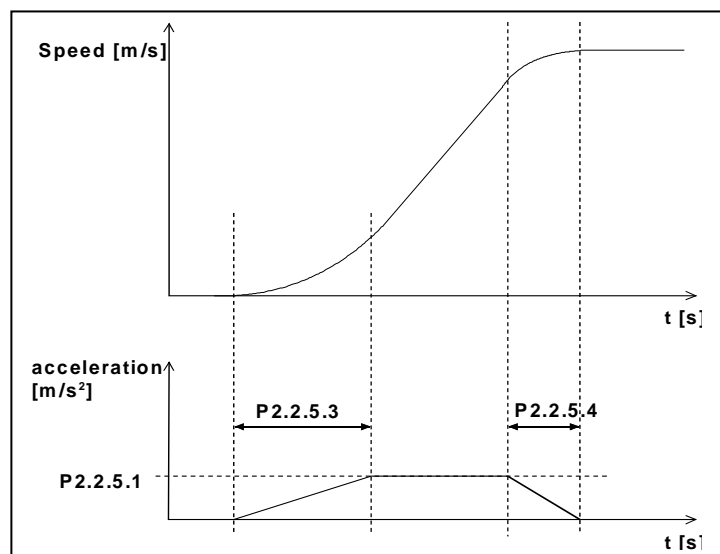

Figure 3. Jerks related to speed and acceleration

Speed Curve 2 parameters (M2 -> G2.2.6)

Parameters in group Speed curve 2 are used when internal ramp switch function is activated (see parameter P2.2.6.1). Then the Speed curve 1 parameters will be replaced by Speed curve 2 parameters. It is also possible to switch to curve 2 by digital input (see parameter P2.6.7.5)

2.2.6.1 Internal Ramp switching frequency

0 = Not used

The purpose is to get another ramp when stopping the lift (from levelling speed)

The ramp set 2 (Speed Curve 2 parameters) can be activated internally. The internal change to ramp set 2 is done when the speed is decelerated below the internal ramp switch frequency and the steady state speed is reached.

NOTE: It is also possible to set the internal ramp switching frequency less or equals to the levelling speed. Then the deceleration at stop will always use speed curve 2 parameters even if the speed newer goes over levelling speed (short floor)

Ramp set 1 (Speed Curve1 parameters) is changed back when the Run request of the frequency converter is inactivated.

Note: If Stop by distance function (parameter 2.4.4) is used the internal ramp switch function is not active.

2.2.6.2 Acceleration time 2

2.2.6.3 Deceleration time 2

Acceleration and deceleration of the lift car are presented in [m/s²]. Acceleration and deceleration curves are affected by the jerk time settings, too.

2.2.6.4 Acc inc jerk 2

Acceleration increase jerk 2. See Figure 3.

2.2.6.5 Acc dec jerk 2

Acceleration decrease jerk 2.

2.2.6.6 Dec inc jerk 2

Deceleration increase jerk 2.

2.2.6.7 Dec dec jerk 2

Deceleration decrease jerk 2.

2.2.7 Enable Jerks

0 = Disabled

1 = Enabled

Acceleration and deceleration rounding with jerks can be disabled by setting this parameter to 0. If set to 0 (Disabled) jerk values have no effect.

2.2.8 Reference Hold Time

The parameter defines the time how long the frequency reference is held after start signal. During that time the speed reference is not changed. This function is also called the 'half floor ride'. The start and stop inputs are not affected by this function.

Reference hold time starts when the frequency is released to nominal value after start. This occurs when the mechanical brake is opened and the brake reaction delay has expired (see page 28).

When reference hold timer has elapsed Acceleration decrease jerk time ([parameter 2.2.5.4](#)) and Deceleration increase jerk time ([parameter 2.2.5.5](#)) affect the speed curve (see picture below).

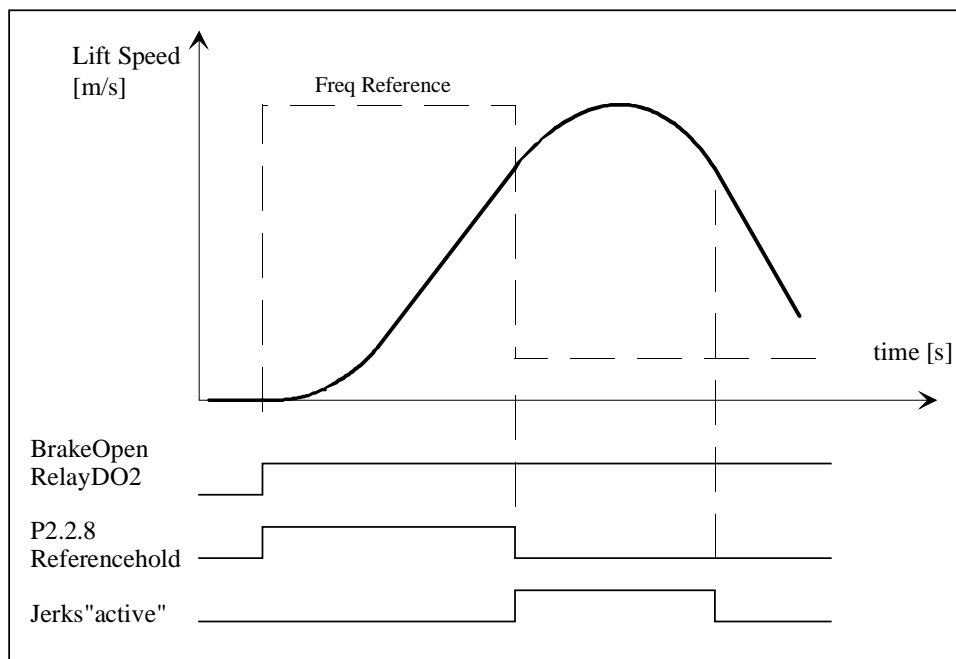

Figure 4. Reference hold time

2.2.9 Stop State (DIN456)

0 = Normal operation

1 = Stop if DIN456 are OFF

Special stop mode when 1 is selected. Stop state is activated when all speed reference inputs are OFF (Default values are DIN4, DIN5 and DIN6, see [parameter 2.2.2](#)).

Note: Even if DIN1 or DIN2 is ON and DIN456 are OFF stop state is activated. Restart requires that DIN1 and DIN2 are switched OFF.

5.3 MECHANICAL BRAKE CONTROL

The mechanical brake control parameters affect the mechanical brake control, the smooth start and stop function and the safety functions.

The mechanical brake can be set to release on current, on torque, on frequency or on external input. The closing can be performed by frequency, by external input or by Run request signal. In case of fault the brake closes immediately without delay.

The mechanical brake control in open loop and in closed loop control mode is different. The parameters are divided in two different groups. The parameters of closed loop control group are not valid in open loop mode and vice versa. There are also some common parameters. Figure 5 and Figure 6 give a graphical presentation of the control logic of the brake control

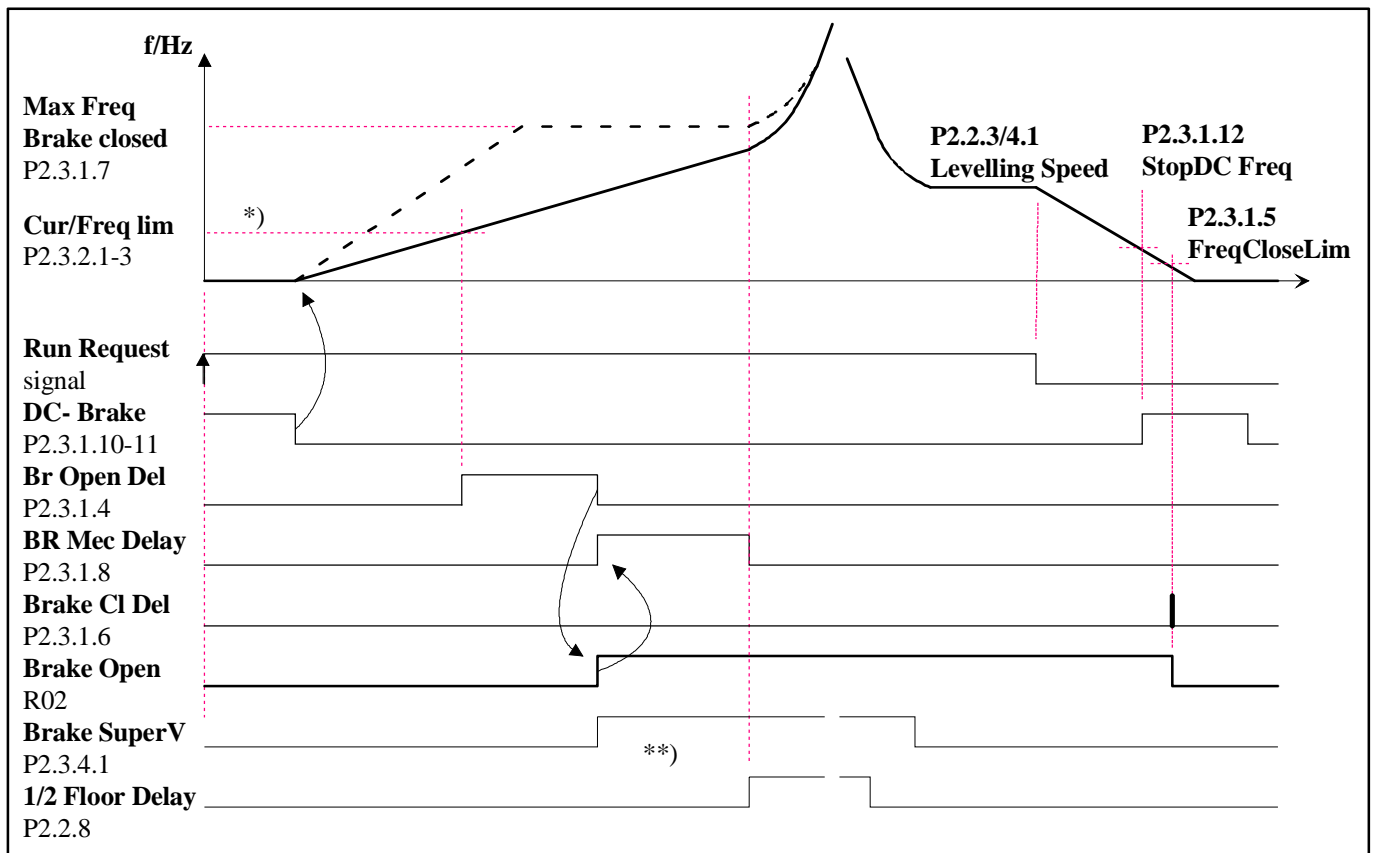

Figure 5. Mechanical brake control logic in open loop.

*) Start signal to Brake open delay when current, freq. and torque exceed limits defined by parameters. External input must be ON if used.

***) During the Brake supervision time the digital input must be switched ON if used.

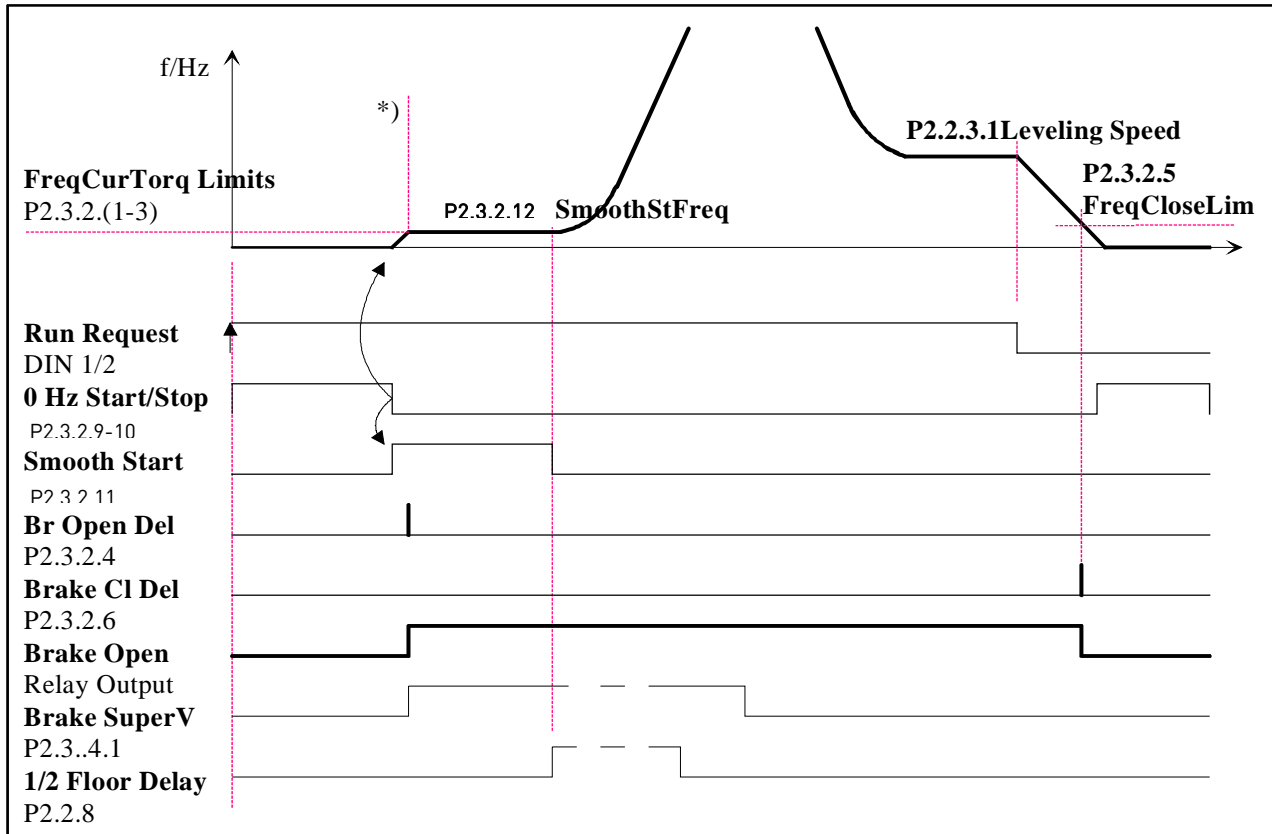

Figure 6. Mechanical brake control logic in closed loop.

*) Start signal to Brake open delay when current, freq. and torque exceed limits defined by parameters. External input must be ON if used.

**) During the Brake supervision time the digital input must be switched ON if used

Mechanical Brake Control Logic

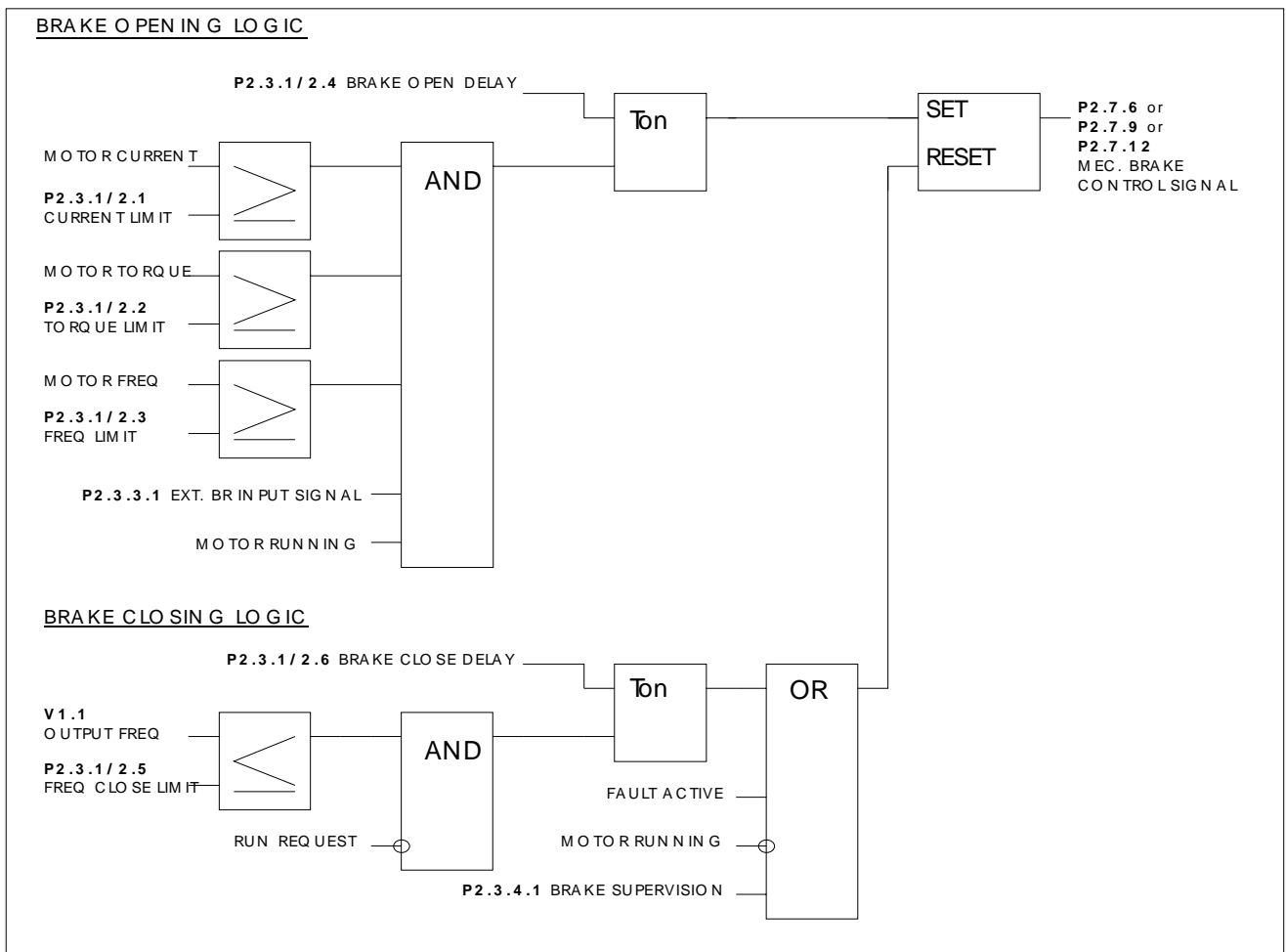

Figure 7. Mechanical brake control logic in open loop.

Mechanical brake control signal can be selected to any digital or relay output to control the external mechanical brake.

In the upper section of Figure 7 you can find the mechanical brake opening logic. Five signals and the delay are required for the mechanical brake to open. If current, torque or frequency signal is not needed for brake opening, then these parameters can be set to zero. The external brake input signal is programmable and any digital input can be used for that purpose.

In the lower section of Figure 7 you can find the mechanical brake closing logic. The brake close circuit has higher priority than the open circuit. So if closing signal is active the mechanical brake will be closed.

The brake will be closed immediately in case of fault or an external supervision signal or when the motor is stopped.

In normal operation the brake will be closed when frequency falls below the Frequency close limit (P2.3.1.5 or P2.3.2.5) and the Run Request signal is switched OFF. If the Frequency close limit signal is not needed for the closing logic it can be set to zero. After the conditions are true there is a brake close delay (P2.3.1.6/P2.3.2.6) after which the brake will be closed.

Open Loop Parameters (M2 -> G2.3.1)

Parameters in group 2.3.1.x are valid in open loop control mode only.
(parameter 2.5.1 = 0 or 1).

2.3.1.1 *Current Limit*

Parameter defines the actual current limit that has to be exceeded for a brake release. If set to zero this condition is excluded. The value is updated always when the nominal current of the motor (parameter 2.1.4) is set (see Figure 7).

2.3.1.2 *Torque limit*

Parameter defines the actual torque limit that has to be exceeded for a brake release. If set to zero this condition is excluded.
100 % corresponds to the calculated nominal torque of the motor (see Figure 7).

2.3.1.3 *Frequency limit*

Parameter defines the actual frequency limit that has to be exceeded for brake release. If set to zero this condition is excluded (see Figure 7).

2.3.1.4 *Opening delay*

Delay which starts when the opening conditions (see parameters 2.3.1.1-2.3.1.3) are TRUE (see Figure 7).

2.3.1.5 *Frequency limit closing*

The output frequency limit for the brake closing. The run request signal needs to be disabled to allow the signal to affect.

2.3.1.6 *Closing delay*

The brake closing is delayed with defined time. If set to zero there is no delay between the brake closing condition and the actual brake closing.

2.3.1.7 *Maximum frequency brake closed*

Output frequency does not exceed this value when mechanical brake is closed. When modifying this parameter make sure that the brake release by frequency (see parameter 2.3.1.3) is possible with new value.

2.3.1.8 *Mechanical brake reaction time*

Mechanical brake reaction time will hold the speed reference for a defined time. This hold time should be set according to the mechanical brake reaction time (see Figure 5).

2.3.1.9 *DC-brake current*

Defines the current injected into the motor during DC-braking.

2.3.1.10 DC-braking time at start

DC-brake is activated when the start command is given. This parameter defines the time before the brake is released.

2.3.1.11 DC-braking time at stop

Determines if braking is ON or OFF and the braking time of the DC-brake when the motor is stopping. The function of the DC-brake depends on the stop function, parameter 2.4.2.

- 0 DC-brake is not used
- >0 DC-brake is in use and its function depends on the Stop function, [par. 2.4.2]. The DC-braking time is determined with this parameter

Par. 2.4.2 = 0; Stop function = Coasting:

After the stop command, the motor coasts to a stop without control of the frequency converter.

With DC-injection, the motor can be electrically stopped in the shortest possible time, without using an optional external-braking resistor.

The braking time is scaled according to the frequency when the DC-braking starts. If the frequency is \geq the nominal frequency of the motor, the set value of parameter 2.3.1.11 determines the braking time. When the frequency is $\leq 10\%$ of the nominal, the braking time is 10% of the set value of parameter 2.3.1.11.

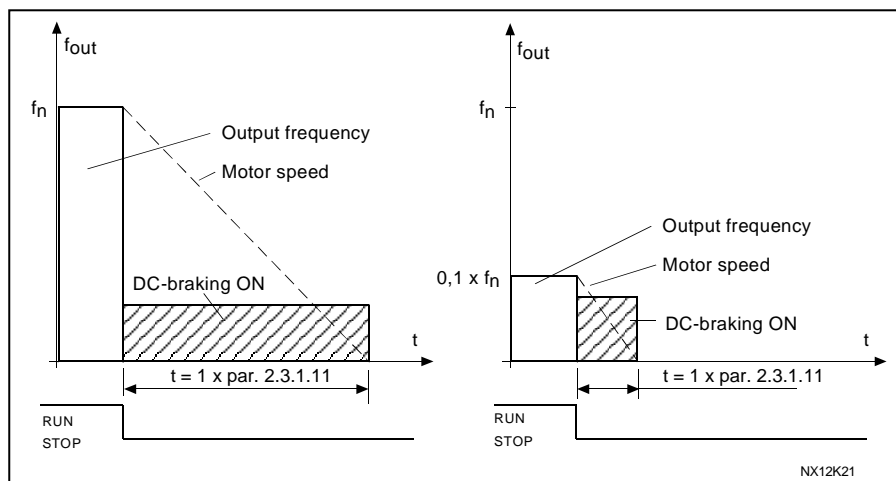

Figure 8. DC-braking time when Stop mode = Coasting.

Par. 2.4.2 = 1; Stop function = Ramp

After the Stop command, the speed of the motor is reduced according to the set deceleration parameters, as fast as possible, to the speed defined with parameter 2.3.1.12, where the DC-braking starts.

The braking time is defined with parameter 2.3.1.11. If high inertia exists, it is recommended to use an external braking resistor for faster deceleration. See Figure 9.

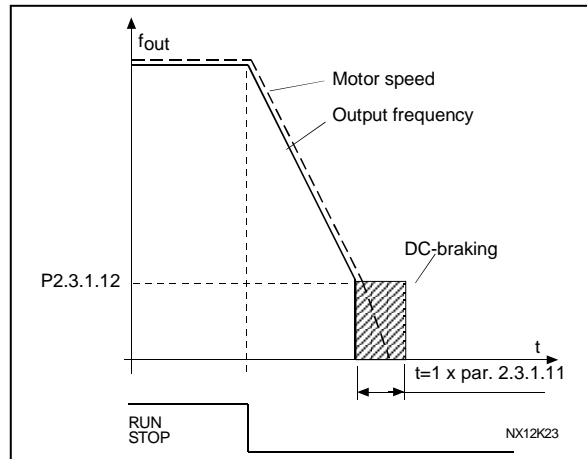

Figure 9. DC-braking time when Stop mode = Ramp

Par. 2.4.2 = 2; Stop function = Stop by frequency. limit

Stop mode depends on the actual frequency of the motor. If frequency is above the frequency limit (par. 2.4.3) then the stop mode is coasting (see Figure 8). If frequency is even or below the frequency limit then the stop mode is ramp (see Figure 9).

2.3.1.12 DC-braking frequency at stop

The output frequency which the DC-braking is applied. See Figure 9

2.3.1.13 Delayed brake

0= Function is not active

Brake can be delayed after brake close command.

Can be used e.g. emergency stop situation to get smooth stop.

2.3.1.14 Run Request Closing

0= Inactivated

1= Activated

Run request signal during brake closing can be inactivated by this parameter. In normal operation Brake close command requires Run request signal to go low. If parameter is 0, then brake will be closed when frequency goes below the limit.

NOTE: If 0 is selected then Frequency limit close (P2.3.1.5 or P2.3.2.5) must be less than maximum frequency brake close (P2.3.1.7 or P2.3.2.7). Otherwise brake control logic does not work.

Closed Loop Parameters (M2 -> G2.3.2)

Parameters in group 2.3.2.x are valid in closed loop motor control mode (parameter 2.5.1 =2) only.

2.3.2.1 *Current Limit*

Parameter defines the actual current limit that has to be exceeded for a brake release. If set to zero this condition is excluded. The value is updated always when the nominal current of the motor (parameter 2.1.4) is set. See Figure 7.

2.3.2.2 *Torque limit*

Parameter defines the actual torque limit that has to be exceeded for a brake release. If set to zero this condition is excluded. 100 % corresponds to the calculated nominal torque of the motor (See Figure 7).

2.3.2.3 *Frequency limit*

Parameter defines the actual frequency limit that has to be exceeded for brake release. If set to zero this condition is excluded (See Figure 7).

2.3.2.4 *Opening delay*

Delay which starts when the opening conditions (see parameters 2.3.2.1-2.3.2.3) are TRUE (See Figure 7).

2.3.2.5 *Frequency limit closing*

The output frequency limit for the brake closing. The run request signal needs to be disabled to allow the signal to affect.

2.3.2.6 *Closing delay*

The brake closing is delayed with defined time. If set to zero there is no delay between the brake closing condition and the actual brake closing.

2.3.2.7 *Maximum frequency brake closed*

Output frequency does not exceed this value when the mechanical brake is closed. When modifying this parameter make sure that the brake release by frequency (parameter 2.3.2.3) is possible with new value.

2.3.2.8 *Mechanical brake reaction time*

Mechanical brake reaction time will hold the speed reference for a defined time. This hold time should be set according to the mechanical brake reaction time (see Figure 5).

2.3.2.9 *Zero Hz time at start*

2.3.2.10 *Zero Hz time at stop*

Zero hertz time during start and stop. Motor can be magnetised and torque generated during that time. Zero Hz time at start should be set longer than the magnetization time. Smooth start time (par 2.3.2.10) will commence straight after zero hertz time. The mechanical brake should be set to release when this change takes place (see Figure 6).

2.3.2.11 *Smooth start time*

The smooth start time function is used in closed loop mode. It cannot be used in open loop. After the start command has been given the drive is rotating the motor shaft with a very low frequency (par 2.3.2.11) to overcome the static friction.

Smooth start time will commence straight after zero hertz time (par 2.3.2.8). The mechanical brake should be set to release when this change takes place. This is achieved through setting the same value for the frequency limit (par 2.3.2.3) and the smooth start frequency (par 2.3.2.11).

When smooth start time has elapsed the frequency will be released.

2.3.2.12 *Smooth start frequency*

Smooth start frequency is a reference frequency that is used with the smooth start time operation. Value should be set very low.

2.3.2.13 *Delayed Brake*

0= Function is not active

Brake can be delayed after brake close command.

Can be used e.g. emergency stop situation to get smooth stop.

2.3.2.14 *Run Request Closing*

0= Inactivated

1= Activated

Run request signal during brake closing can be inactivated by this parameter. In normal operation Brake close command requires Run request signal to go low. If parameter is 0, then brake will be closed when frequency goes below the limit.

NOTE: If 0 is selected then Frequency limit close (P2.3.1.5 or P2.3.2.5) must be less than maximum frequency brake close (P2.3.1.7 or P2.3.2.7). Otherwise brake control logic does not work.

2.3.2.15 *Start magnetizing time*

Define how long time the start magnetizing current defined by P2.3.2.16 is used.

2.3.2.16 *Start magnetizing current*

Define the start magnetizing current. Typical value is I_n . This parameter is set equals to I_n when Motor nominal current (I_n) is set by P2.1.4.

By using this function the motor is magnetized much faster than with ordinary magnetizing current.

Digital Inputs (M2 -> G2.3.3)

All digital inputs (except DIN1 and DIN2) are programmable. See instructions on page 4.

2.3.3.1 External brake control

Programmable digital input for external brake control. If digital input is selected it must be ON before brake can be opened. If input is not used set it to default value (=0.2).

2.3.3.2 External brake supervision

Programmable digital input for external brake supervision. After the mechanical brake is released, the selected input can be used to verify the brake open state. If the input is not used, set it to default value (=0.2).

If the digital input is used it must be activated during the defined time ([parameter 2.3.4.1](#)) from the brake release. If it is not activated, external brake fault is generated. The response to external brake fault can be set with [parameter 2.8.4.1](#).

2.3.4.1 External brake supervision time

A time window within which the external brake supervision input ([par2.3.3.2](#)) has to be activated after the brake is released.

5.4 DRIVE CONTROL

2.4.1 Brake chopper

- 0 = No brake chopper used
- 1 = Brake chopper in use when running
- 2 = External brake chopper
- 3 = Used when stopped/running

When the frequency converter is decelerating the motor, the inertia of the motor and the load are fed into an external brake resistor. This enables the frequency converter to decelerate the load with a torque equal to that of acceleration (provided that the correct brake resistor has been selected). See separate Brake resistor installation manual.

2.4.2 Stop function

Coasting:

- 0 The motor coasts to a halt without any control from the frequency converter, after the Stop command.

Ramp:

- 1 After the Stop command, the speed of the motor is decelerated according to the set deceleration parameters.
If the regenerated energy is high it may be necessary to use an external braking resistor for faster deceleration.

Frequency limit

- 2 Coasting Stop if the motor frequency is above the frequency limit ([par. 2.4.3](#)) when stop request is given. Stop by ramp if the motor frequency is the same or below this parameter when stop request is given.

2.4.3 Frequency limit

Defines the frequency limit for the stop function if selected as the frequency limit (par. 2.4.2=2).

If the motor frequency is above the frequency limit the motor costs to stop and if it is below or the same as the frequency limit the stop function is ramp.

2.4.4 *Stop distance*

0 = Not used

Parameter is active only if stop function is selected as a frequency limit ([parameter 2.4.2=2](#)).

Parameter defines the distance from certain floor switch to complete stop to floor. Parameter value is presented in meters.

Stop value is calculated from Nominal linear speed ([parameter 2.2.1](#)) and from motor nominal frequency ([parameter 2.1.1](#)). The calculated distance is correct only if these two parameters are set correctly and if stop ramp is linear ([parameter 2.4.5=0](#)).

If stop ramp is S-shaped instead of linear (S-curve is used), then stopping distance must be fine-adjusted with [parameter 2.4.6](#).

Note: If Stop by distance function is used the internal ramp switch function ([parameter 2.2.6.1](#)) is not active.

2.4.5 *S-Curve time*

Special deceleration increase and decrease time if stop by distance function is selected. This jerk time is activated when the speed is decelerated below frequency limit and the reference frequency is reached.

Jerk times in Speed Curve 1 group are used if the frequency is above the frequency limit (see Figure 3). Jerk times in Speed Curve 1 group are changed back when the frequency converter enters the stop stage.

2.4.6 *Scaling factor*

Ramp Scaling factor for stop distance function. Stop distance is calculated based on the linear ramp. Stopping distance is accurate only when jerk times are not used ([parameter 2.2.7=0](#) or [2.4.5=0](#)). If jerk times are used the stopping distance will be longer than it should be. Scaling factor can be used to fine-adjust the stopping distance. Scaling factor recalculates the ramp time.

Motor Contactor Control Parameters (M2 -> G2.4.7)

Purpose with motor contactor control is to close the motor contactor first and then start to output current to motor. This logic will be active only if an output relay is programmed for motor contactor control (See Parameter group 2.7)

2.4.7.1 *Closing time*

Set this time slightly above the motor contactor reaction time. After this delay the frequency converter starts to output current to the motor. This time is ignored if the motor contactor acknowledgement signal specified by parameter P2.4.7.2 is used

2.4.7.2 Motor Contactor Acknowledgement

Input signal for the feedback signal that main contactor is closed. Use the motor contactor auxiliary contact (NO) for this purpose. Parameter P2.4.7.1 will be ignored if this signal is in use.

If the Acknowledgement signal does not come within 1s alarm F64 is triggered.

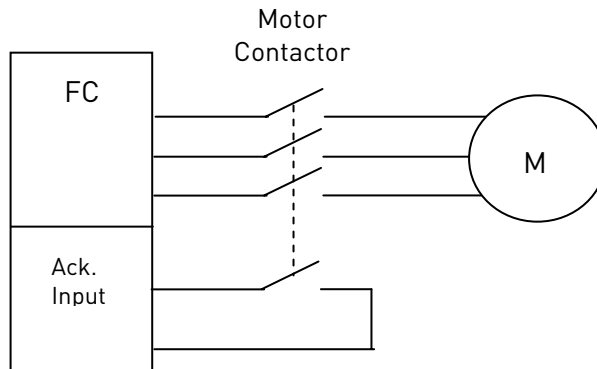

5.5 MOTOR CONTROL

2.5.1 Motor control mode

- | | | |
|---|--------------------|--|
| 0 | Frequency control: | The I/O terminal and keypad references are frequency references and the frequency converter controls the output frequency (output frequency resolution = 0.01 Hz) |
| 1 | Speed control: | The I/O terminal and keypad references are speed references and the frequency converter controls the motor speed (accuracy $\pm 0,5\%$). |
| 2 | Speed control CL | Closed loop speed control mode. The I/O terminal and keypad references are speed references and the frequency converter controls the motor speed. Encoder is required. Closed loop parameters in group G2.11 must be set accordingly |

2.5.2 U/f optimisation

Automatic torque boost The voltage to the motor changes automatically which makes the motor produce sufficient torque to start and run at low frequencies. The voltage increase depends on the motor type and power. Automatic torque boost can be used in applications where starting torque due to starting friction is high, e.g. in conveyors.

NOTE! *In high torque - low speed applications - it is likely that the motor will overheat. If the motor has to run a prolonged time under these conditions, special attention must be paid to cooling the motor. Use external cooling for the motor if the temperature tends to rise too high.*

2.5.3 U/f ratio selection

Linear: The voltage of the motor changes linearly with the frequency in the constant flux area from 0 Hz to the field weakening point where the nominal voltage is supplied to the motor. Linear U/f ratio should be used in constant torque applications. **This default setting should be used if there is no special need for another setting.**

Squared: The voltage of the motor changes following a squared curve form with the frequency in the area from 0 Hz to the field weakening point where the nominal voltage is also supplied to the motor. The motor runs under magnetised below the field weakening point and produces less torque and electromechanical noise. Squared U/f ratio can be used in applications where torque demand of the load is proportional to the square of the speed, e.g. in centrifugal fans and pumps.

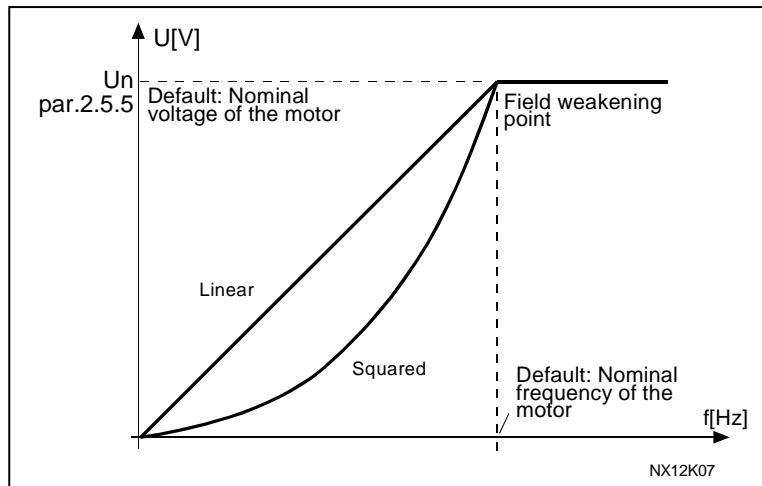

Figure 10. Linear and squared change of motor voltage

Programmable U/f curve:

- 2 The U/f curve can be programmed with three different points. Programmable U/f curve can be used if the other settings do not satisfy the needs of the application.

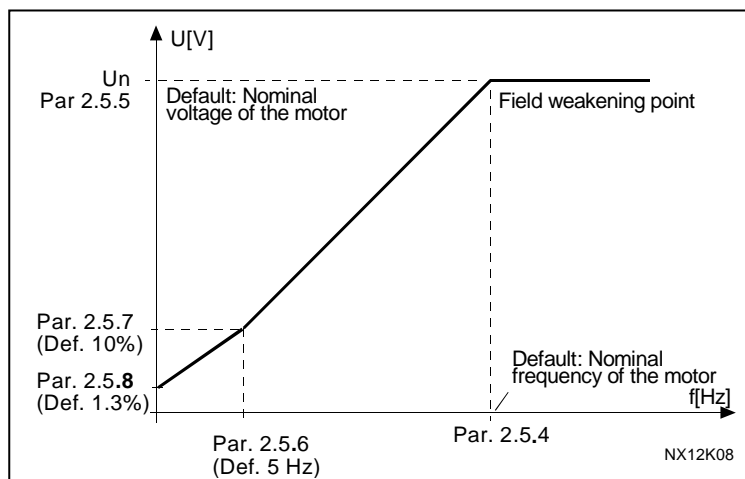

Figure 11. Programmable U/f curve.

Linear with flux optimisation:

- 3 The frequency converter starts to search for the minimum motor current in order to save energy, lower the disturbance level and the noise. This function can be used in applications with constant motor load, such as fans, pumps etc.

2.5.4 Field weakening point

The field weakening point is the output frequency at which the output voltage reaches the set (par. 2.5.5) maximum value.

2.5.5 Voltage at field weakening point

Above the frequency at the field weakening point, the output voltage remains at the set maximum value. Below the frequency at the field weakening point, the output voltage

depends on the setting of the U/f curve parameters. See parameters [2.5.2](#), [2.5.3](#), [2.5.6](#) and [2.5.7](#).

When the parameters [2.1.1](#) and [2.1.2](#) (nominal voltage and nominal frequency of the motor) are set the parameters [2.5.4](#) and [2.5.5](#) are automatically given the corresponding values. If you need different values for the field weakening point and the maximum output voltage, change these parameters **after** setting the parameters [2.1.1](#) and [2.1.2](#).

2.5.6 *U/f curve, middle point frequency*

If the programmable U/f curve has been selected with the parameter [2.5.3](#) this parameter defines the middle point frequency of the curve. See Figure 11.

2.5.7 *U/f curve, middle point voltage*

If the programmable U/f curve has been selected with the parameter [2.5.3](#) this parameter defines the middle point voltage of the curve. See Figure 11.

2.5.8 *Output voltage at zero frequency*

If the programmable U/f curve has been selected with the parameter [2.5.3](#) this parameter defines the zero frequency voltage of the curve. See Figure 11.

2.5.9 *Switching frequency*

Motor noise can be minimised using a high switching frequency. Increasing the switching frequency reduces the capacity of the frequency converter unit. The range of this parameter depends on the size of the frequency converter:

Up to NX5 0061: 1...16 kHz

>NX5 0072: 1...10 kHz

2.5.10 *Overvoltage controller*

2.5.11 *Undervoltage controller*

These parameters allow the under-/overvoltage controllers to be switched out of operation. This may be useful, for example, if the mains supply voltage varies more than -15% to +10% and the application will not tolerate this over-/undervoltage. In this case, the regulator controls the output frequency taking the supply fluctuations into account.

Note: Over-/undervoltage trips may occur when controllers are switched out of operation. Undervoltage controller is turned off automatically if evacuation is active.

0 Controller switched off

1 Controller switched on

2.5.12 Identification

When parameter is set to a value (1-3) the motor must be started within 20 seconds.

NOTE: Correct motor data has to be set before the identification run is done.

Identification modes:

1 = Motor Identification in Open Loop. U/f Curve and RS Voltage Drop is included. Identification is performed in standstill.

2 = Closed loop motor identification with run. The Magnetizing current is determined 15 point flux linearization curve and the rotor time constant. The motor shaft has to be free to rotate.

3 = Permanent magnet motor rotor angle identification.

[P2.5.18.1](#) has to be set to 1. The motor shaft has to be free to rotate.

NOTE: For modes 2 and 3 the mechanical brake has to be opened by hardwiring or by using for example the READY signal temporarily for the output connected to the relay for the mechanical brake. The mechanical brake is not opened automatically due to safety reasons.

2.5.13. Measured RS voltage drop

Measured Voltage drop at stator resistance between two phases of the motor with nom current of motor.

2.5.14 Ir Add Generator Scale

Scaling factor for generator side IR-compensation (0 ... 200%)

2.5.15 Ir Add Motor Scale

Scaling factor for Motor side IR-compensation (0 ... 200%)

2.5.16 Open loop Speed controller kp1

Open loop Speed controller kp1 value

2.5.17 Open loop Speed controller ki1

Open loop Speed controller ki1 value

Permanent magnet motor parameters (M2 -> G2.5.18)

These parameters are only for permanent magnet motors and will take effect when P2.5.18.1 is set to 1. A rotor angle identification has to be done at commissioning by setting parameter [P2.5.12](#) to 3.

2.5.18.1 Motor type

Select used motor type with this parameter.

- 0 Induction motor
- 1 Permanent magnet synchronous motor

2.5.18.2 Flux Current Kp

Defines the gain for the flux current controller when a PMS motor is used.

2.5.18.3 Flux Current Ti

Defines the integration time for the flux current controller when a PMS motor is used.

2.5.18.4 PMSM Shaft Position

Identified zero shaft position when using absolute encoder for PMS motor.

2.5.18.5 Enable Rs Identification

Stator resistance identification at start.

- 0 No
- 1 Yes

2.5.18.6 Modulator index limit

This parameter can be used to increase motor voltage in the field weakening area.

2.5.18.7 Speed Control Ti Start

By this parameter it is possible to set another Speed control Ti value at start. By setting this parameter lower than the Speed control Ti given by [P2.11.6](#) the speed controller will be faster at start.

Speed control Ti at start is active until mechanical brake has opened + [P2.5.18.8](#) time.

2.5.18.8 Speed Control Start Delay

Time definition how long Speed control Ti at start given by [P2.5.18.7](#) will be active after the mechanical brake has opened completely. After time has expired the Speed control Ti given by [P2.11.6](#) is used.

By using a higher speed controller gain (lower Ti) the motor rollback compensation is faster when the mechanical brake opens.

2.5.18.9 PMSM shaft angle identification mode

- 0 Motor shaft angle is forced to zero angle with DC current. [Read the special NOTE !](#)
- 1 Automatic pulse injection at start. I.e. during every start there is approx 50 ms time for angle calibration.
- 2 Automatic pulse injection at every power on during the first run with motor. After this the motor shaft angle is calculated from the pulses as long the frequency converter remains powered.

PMSM shaft angle identification mode. Mode 0 function is activated by setting parameter [2.5.12](#) to 3. Modes 1 and 2 are independent from parameter [2.5.12](#) setting. Mode 0 can be utilized only if the motor shaft is free to rotate. Modes 1 and 2 are suitable for installations where the load is coupled to the motor shaft permanently. Modes 1 and 2 are the recommended modes for lift installations.

2.5.18.10 RollBack controller

Roll-back control is made to reduce the opposite movement in starting mainly in lift drives. This covers also induction motors but is more useful in gearless PM-drives, in which the motor shaft movement is directly transferred to the lift-car movement e.g the counterweight of the lift tends to move the empty lift-car upwards which is not good if the run direction is downwards.

RollBack controller is activated according to wake up level and this controller is disabled after a speed reference is increased from zero thus when the acceleration starts. In practice this controller is active during the time [P2.3.2.9 0 Hz time at start](#)

RollBack controller is disabled / enabled according to this parameter.

- 0 Disabled
- 1 Enabled

2.5.18.11 RollBack controller Gain

RollBackCtrlGain is the gain of the RB-controller. Typically gain value is from 2000 to 5000. This value depends on the overall lifts mechanical structure.

The bigger the gain is the bigger is the impact to the speed control loop and the smaller is the actual lift car's roll back effect after the mechanical brake release.

2.5.18.12 RollBack controller wake up level

RollBack controller wake up level is the threshold to activate the RB-control. Parameter value is compared with measured pulses from encoder signal.

Values below 1,00 can not be set when incremental encoder is connected. When setting decimal value e.g. 0,50 interpolation have to be activated for the Endat encoder from the option board parameters. Decimal values are compared to the phase of sine pulse readable from e.g. Endat encoders.

Decimal portion is significant only when the parameter's value is below 1,00.

*IDENTIFIED PARAMETERS**P2.5.19.1 – P2.5.19.15 Flux linearization points*

Flux 10...150%

Motor voltage corresponding to 10%...150% of flux as a percentage of Nominal Flux voltage.

These parameters are used only in closed loop control

P2.5.19.16 IR Add Zero Point Voltage

Ir Add Voltage for Zero frequency, used with automatic torque boost.

*P2.5.19.17 IU Offset**P2.5.19.18 IV Offset**P2.5.19.19 IW Offset*

Offsets values for phase current measurements

5.6 INPUT SIGNALS

2.6.1 Start/Stop logic selection

- 0 DIN1: closed contact = start forward (rising edge pulse is required)
- DIN2: closed contact = start reverse (rising edge pulse is required)

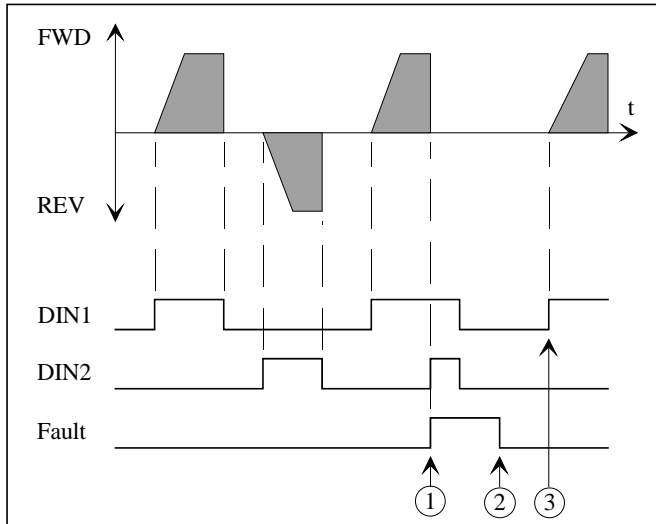

Figure 12. Start forward/Start reverse

- ① If both DIN switches are ON at the same time fault is activated.
- ② Fault reset.
- ③ The drive can be re-started after fault reset and when both DIN switches are in OFF position.

- 1 DIN1: closed contact = start open contact = stop
- DIN2: closed contact = reverse open contact = forward

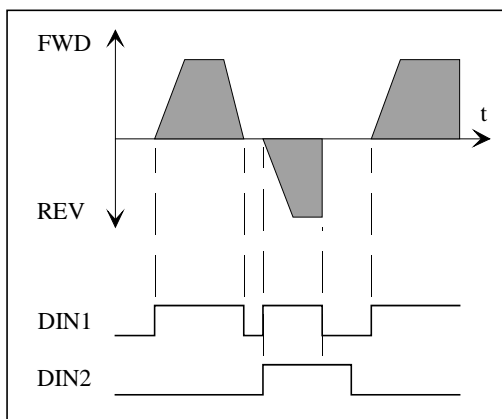

Figure 13. Start, Stop, Reverse

- 3 DIN1: closed contact = start forward
- DIN2: closed contact = start reverse

Sama as selection 0 except rising edge pulse is not required.
 Fault is not activated if both DIN switches are on.

2.6.2 Reference offset for current input

- 0 No offset
- 1 Offset 4 mA ("living zero") provides supervision of zero level signal. The response to reference fault can be programmed with [parameter 2.8.1.1](#).

2.6.3 Reference scaling, minimum value

2.6.4 Reference scaling, maximum value

Setting value limits: $0 \leq \text{par. 2.6.3} \leq \text{par. 2.6.4} \leq \text{par. 2.1.2}$. If parameter 2.6.4 = 0 scaling is set off. The minimum and maximum frequencies are used for scaling.

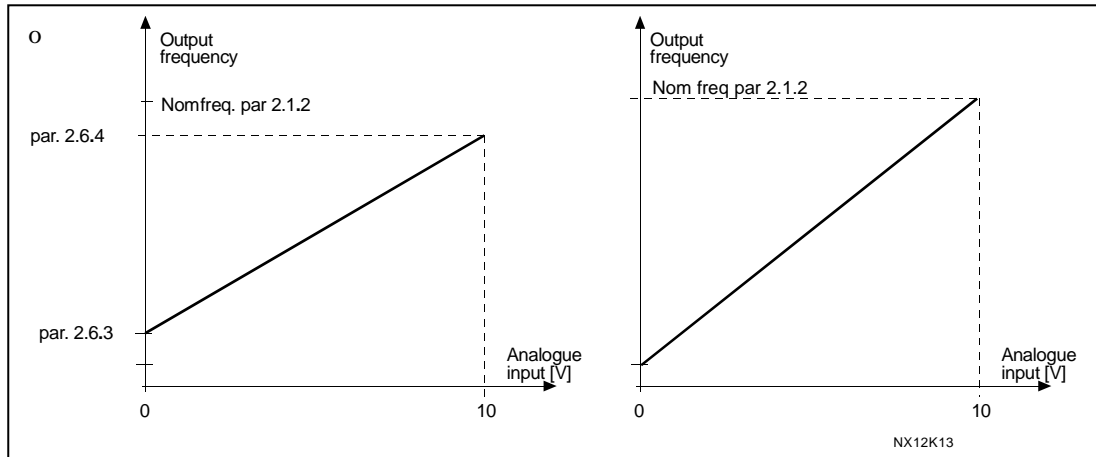

Figure 14. **Left:** Reference scaling; **Right:** No scaling used (par. 2.6.5 = 0).

2.6.5 Reference inversion

Inverts reference signal:
 Max. ref. signal = Min. set freq.
 Min. ref. signal = Max. set freq.

- 0 No inversion
- 1 Reference inverted

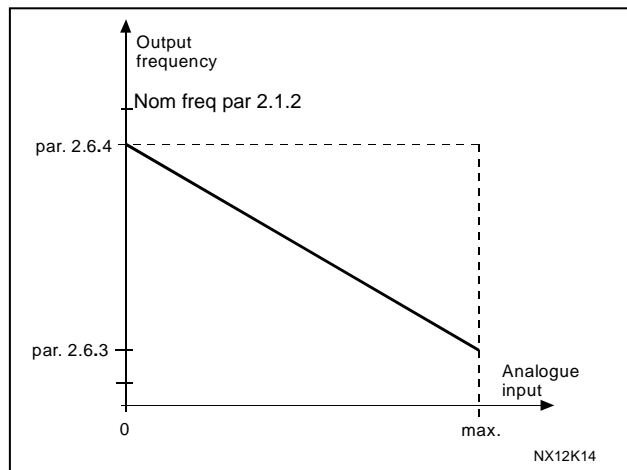

Figure 15. Reference invert.

2.6.6 Reference filter time

Filters out disturbances from the incoming analogue U_{in} signal. Long filtering time makes regulation response slower.

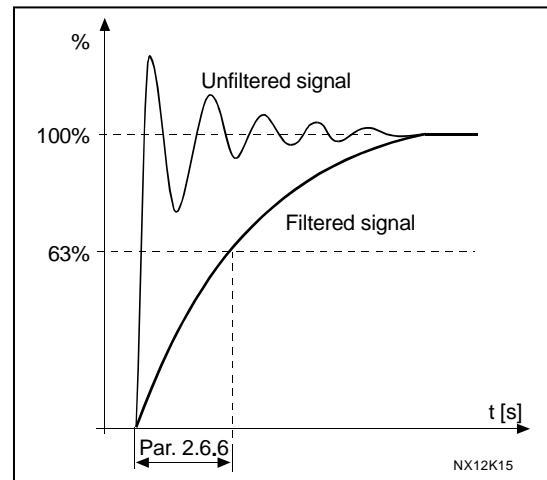

Figure 16. Reference filtering

Digital Inputs (M2 -> G2.6.7)

All digital inputs (except DIN1 and DIN2) are programmable. See instructions on page 4.

- 2.6.7.1 External Fault closing contact
- 2.6.7.2 External Fault opening contact
- 2.6.7.3 Fault Reset
- 2.6.7.4 Run Enable
- 2.6.7.5 Acc/Dec time selection, speed curve to used when the input is activated
- 2.6.7.6 Stop by coast, closing contact
- 2.6.7.7 Stop by coast, opening contact
- 2.6.7.8 Override Speed
- 2.6.7.9 Forced I/O control
- 2.6.7.10 Speed selection input 1
- 2.6.7.11 Speed selection input 2
- 2.6.7.12 Speed selection input 3

Parameters 2.6.7.10-2.6.7.12 are speed reference selection inputs (see also [parameter 2.2.2](#)).

5.7 OUTPUT SIGNALS

2.7.1 Analogue output function

This parameter selects the desired function for the analogue output signal. See Table 9. Output signals, G2. on page 16 for the parameter values.

2.7.2 Analogue output filter time

Defines the filtering time of the analogue output signal.

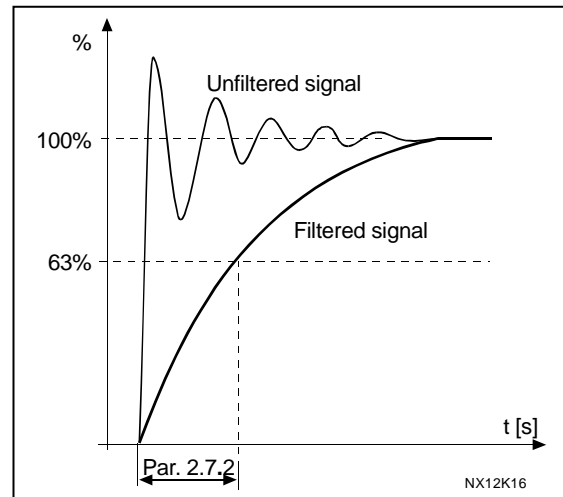

Figure 17. Analogue output filtering

2.7.3 Analogue output invert

Inverts the analogue output signal:

Maximum output signal = Minimum set value

Minimum output signal = Maximum set value

See parameter 2.7.5.

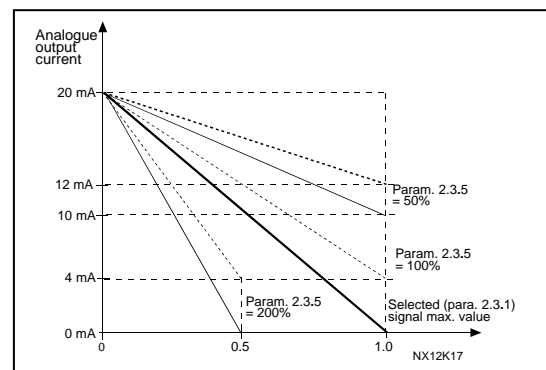

Figure 18. Analogue output invert

2.7.4 Analogue output minimum

Defines the signal minimum to either 0 mA or 4 mA (living zero). Note the difference in analogue output scaling in parameter 2.7.5 (see Figure 17).

- 0 Set minimum value to 0 mA
- 1 Set minimum value to 4 mA

2.7.5 Analogue output scale

Scaling factor for analogue output.

Signal	Max. value of the signal
Output frequency	Nom frequency (par. 2.1.2)
Freq. Reference	Nom frequency (par. 2.1.2)
Motor speed	Motor nom. speed $1 \times n_{nMotor}$
Output current	Motor nom. current $1 \times I_{nMotor}$
Motor torque	Motor nom. torque $1 \times T_{nMotor}$
Motor power	Motor nom. power $1 \times P_{nMotor}$
Motor voltage	$100\% \times U_{nMotor}$
DC-link voltage	1000 V

Table 18. Analogue output scaling

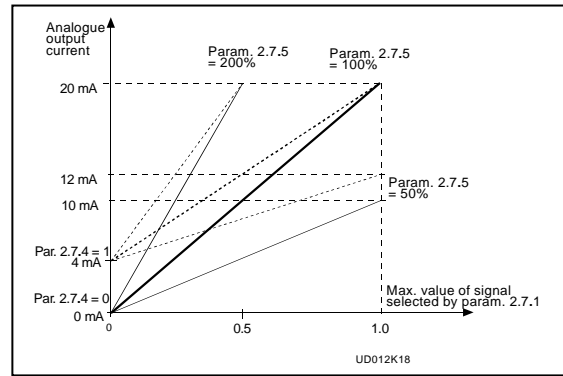

Figure 19. Analogue output scaling

2.7.6 Digital output function

Setting value	Signal content
0 = Not used	Out of operation
	<u>Digital output DO1 sinks the current and programmable relay (RO1, RO2) is activated when:</u>
1 = Ready	The frequency converter is ready to operate
2 = Run	The frequency converter operates (motor is running)
3 = Fault	A fault trip has occurred
4 = Fault inverted	A fault trip <u>not</u> occurred
5 = Vacon overheat warning	The heat-sink temperature exceeds +70°C
6 = External fault or warning	Fault or warning depending on par. 2.7.3
7 = Reference fault or warning	Fault or warning depending on par. 2.7.1 - if analogue reference is 4—20 mA and signal is <4mA
8 = Warning	Always if a warning exists
9 = Reversed	The reverse command has been selected
10 = Preset speed	The preset speed has been selected with digital input
11 = At speed	The output frequency has reached the set reference
12 = Motor regulator activated	Overvoltage or overcurrent regulator was activated
13 = Output frequency supervision	The output frequency goes outside the set low limit/high limit (see parameters 2.7.17 and 2.7.18)
14 = Control from I/O terminals	I/O control mode selected (in menu M3)
15 = Thermal fault/warning	Thermal fault/warning active
16 = Fieldbus DIN1	
17 = Speed below limit	Lift speed goes below limit (par 2.7.16)
18 = Torque limit supervision	Motor torque goes beyond the set supervision low limit/high limit (see par. 2.7.15 and 2.7.16)
19 = Mechanical brake control	External brake ON/OFF control (see parameter Group G2.3)
20 = Mech. brake control inverted	External brake ON/OFF control (see parameter Group G2.3). Output active when brake control is OFF.
21 = Motor contactor control	Motor contactor control (see par. 2.4.7.1 and 2.4.7.2)

Table 19. Output signals via DO1 and output relays RO1, RO2, ROE1 and ROE2.

2.7.7 *Digital output 1 function inverted*

0 = D01 Not inverted
1 = D01 Inverted

2.7.8 *Digital output 1 ON Delay*

Timer On delay for digital output 1.

2.7.9 *Digital output 1 OFF Delay*

Timer OFF delay for digital output 1.

2.7.10 *Relay output 1 function*

See parameter [2.7.6](#).

2.7.11 *Relay output 1 function inverted*

0 = R01 Not inverted
1 = R01 Inverted

2.7.12 *Relay output 1 ON delay*

Timer On delay for relay output 1.

2.7.13 *Relay output 1 OFF Delay*

Timer OFF delay for digital output 1.

2.7.14 *Relay output 2 function*

See parameter [2.7.6](#).

2.7.15 *Relay output 2 function inverted*

0 = R02 Not inverted
1 = R02 Inverted

2.7.16 *Speed supervision limit*

If lift speed is below the speed supervision limit Speed below limit-signal is TRUE. See Table 19 for the "Speed below limit" signal.

2.7.17 *Motoring torque supervision*

Torque limit when operating in motoring mode. If the actual motor torque is above the motor torque supervision limit for a defined time ([par 2.8.4.6](#)) then internal "overtorque"- signal is set. Response to signal can be given by [parameter 2.8.4.5](#).

2.7.18 *Generating torque supervision*

Torque limit when operating in generating mode. If set to 0.0 % this parameter is ignored and the limit is defined by [parameter 2.7.15](#).

2.7.19 Output frequency limit supervision function

- 0 No supervision
- 1 Low limit supervision
- 2 High limit supervision

If the output frequency goes under/over the set limit (P 2.7.18) this function generates a warning message via the digital output DO1 and via the relay output RO1 or RO2 depending on the settings of parameters 2.7.6, 2.7.9 and 2.7.12.

2.7.20 Output frequency limit supervision value

Selects the frequency value supervised by parameter 2.7.17.

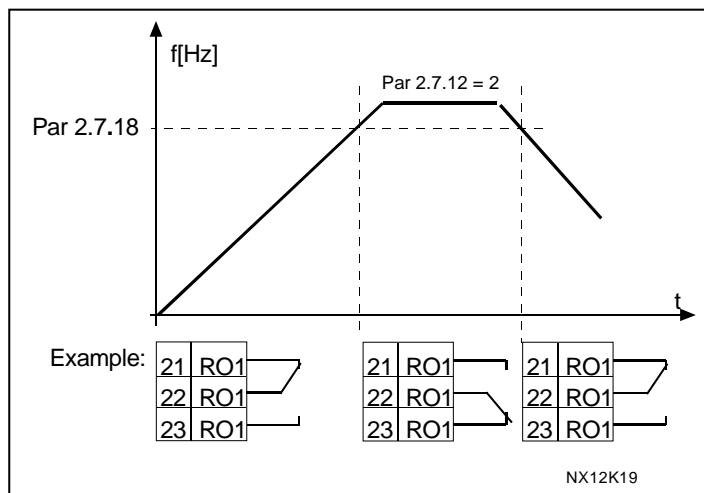

Figure 20. Output frequency supervision

5.8 PROTECTIONS

I/O Faults parameters (M2 -> G2.8.1)

2.8.1.1 *Response to the reference fault*

- 0 = No response
- 1 = Warning
- 2 = Warning, the frequency from 10 seconds back is set as reference
- 3 = Warning, the Preset Frequency (Par. 2.7.2) is set as reference
- 4 = Fault, stop mode after fault according to [parameter 2.4.2](#).
- 5 = Fault, stop mode after fault always by coasting

A warning or a fault action and message is generated if the 4...20 mA reference signal is used and the signal falls below 3.5 mA for 5 seconds or below 0.5 mA for 0.5 seconds. The information can also be programmed into digital output DO1 or relay outputs RO1 and RO2.

2.8.1.2 *4 mA Fault: preset frequency reference*

If the value of parameter 2.7.1 is set to 3 and the 4 mA fault occurs then the frequency reference to the motor is the value of this parameter.

2.8.1.3 *Response to external fault*

- 0 = No response
- 1 = Warning
- 2 = Fault, stop mode after fault according to [parameter 2.4.2](#).
- 3 = Fault, stop mode after fault always by coasting

A warning or a fault action and message is generated from the external fault signal in the programmable digital inputs (see [parameter 2.6.7.1](#)). The information can also be programmed into digital output DO1 and into relay outputs RO1 and RO2.

General faults parameters (M2 -> G2.8.2)

2.8.2.1 *Input phase supervision*

- 0 = No response
- 1 = Warning
- 2 = Fault, stop mode after fault according to [parameter 2.4.2](#).
- 3 = Fault, stop mode after fault always by coasting

The input phase supervision ensures that the input phases of the frequency converter have an approximately equal current.

2.8.2.2 *Response to undervoltage fault*

- 1 = Warning
- 2 = Fault, stop mode after fault according to [parameter 2.4.2](#).
- 3 = Fault, stop mode after fault always by coasting

For the undervoltage limits see Vacon NX User's Manual. Table 4-2.

2.8.2.3 *Output phase supervision*

- 0 = No response
- 1 = Warning
- 2 = Fault, stop mode after fault according to [parameter 2.4.2](#).
- 3 = Fault, stop mode after fault always by coasting

Output phase supervision of the motor ensures that the motor phases have an approximately equal current.

2.8.2.4 *Earth fault protection*

- 0 = No response
- 1 = Warning
- 2 = Fault, stop mode after fault according to [parameter 2.4.2](#).
- 3 = Fault, stop mode after fault always by coasting

Earth fault protection ensures that the sum of the motor phase currents is zero. The overcurrent protection is always working and protects the frequency converter from earth faults with high currents.

2.8.2.5 *Response to fieldbus fault*

- 0 = No response
- 1 = Warning
- 2 = Fault, stop mode after fault according to [parameter 2.4.2](#).
- 3 = Fault, stop mode after fault always by coasting

Set here the response mode for the fieldbus fault if a fieldbus board is used. For more information, see the respective Fieldbus Board Manual.

2.8.2.6 *Response to slot fault*

- 0 = No response
- 1 = Warning
- 2 = Fault, stop mode after fault according to [parameter 2.4.2](#).
- 3 = Fault, stop mode after fault always by coasting

Set here the response mode for a board slot fault due to missing or broken board.

Motor Faults parameters (M2 -> G2.8.3)

Parameters 2.8.3.1—2.8.3.5, Motor thermal protection:

General

The motor thermal protection is to protect the motor from overheating. The Vacon drive is capable of supplying higher than nominal current to the motor. If the load requires this high current there is a risk that the motor will be thermally overloaded. This is the case especially at low frequencies. At low frequencies the cooling effect of the motor is reduced as well as its capacity. If the motor is equipped with an external fan the load reduction at low speeds is small.

The motor thermal protection is based on a calculated model and it uses the output current of the drive to determine the load on the motor.

The motor thermal protection can be adjusted with parameters. The thermal current I_T specify the load current above which the motor is overloaded. This current limit is a function of the output frequency.

The thermal stage of the motor can be monitored on the control keypad display. See Vacon NX User's Manual, Chapter 7.3.1.



CAUTION! *The calculated model does not protect the motor if the airflow to the motor is reduced by blocked air intake grill.*

2.8.3.1 Motor thermal protection

0 = No response

1 = Warning

2 = Fault, stop mode after fault according to [parameter 2.4.2](#).

3 = Fault, stop mode after fault always by coasting

If tripping is selected the drive will stop and activate the fault stage.

Deactivating the protection, i.e. setting parameter to 0, will reset the thermal stage of the motor to 0%.

2.8.3.2 Motor thermal protection: Motor ambient temperature factor

The factor can be set between -100.0%—100.0%.

2.8.3.3 Motor thermal protection: Zero frequency current

The current can be set between 0—150.0% $\times I_{nMotor}$. This parameter sets the value for thermal current at zero frequency. See Figure 21.

The default value is set assuming that there is no external fan cooling the motor. If an external fan is used this parameter can be set to 90% (or even higher).

Note: The value is set as a percentage of the motor name plate data, [parameter 2.1.4](#) (Nominal current of motor), not the drive's nominal output current. The motor's nominal current is the current that the motor can withstand in direct on-line use without being overheated.

If you change the parameter Nominal current of motor, this parameter is automatically restored to the default value.
 Setting this parameter does not affect the maximum output current of the drive which is determined by [parameter 2.1.6](#) alone (Current limit).

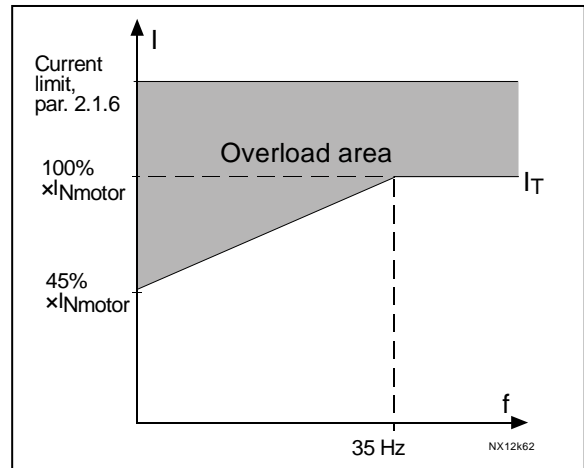

Figure 21. Motor thermal current I_T curve

2.8.3.4 Motor thermal protection: Time constant

This time can be set between 1 and 200 minutes.

This is the thermal time constant of the motor. The bigger the motor, the bigger the time constant. The time constant is the time within which the calculated thermal stage has reached 63% of its final value.

The motor thermal time is specific to the motor design and it varies between different motor manufacturers.

If the motor's t_6 -time (t_6 is the time in seconds the motor can safely operate at six times the rated current) is known (given by the motor manufacturer) the time constant parameter can be set basing on it. As a rule of thumb, the motor thermal time constant in minutes equals to $2 \times t_6$. If the drive is in stop stage the time constant is internally increased to three times the set parameter value. The cooling in the stop stage is based on convection and the time constant is increased. See also Figure 22.

2.8.3.5 Motor thermal protection: Motor duty cycle

Defines how much of the nominal motor load is applied. The value can be set to 0%...100%.

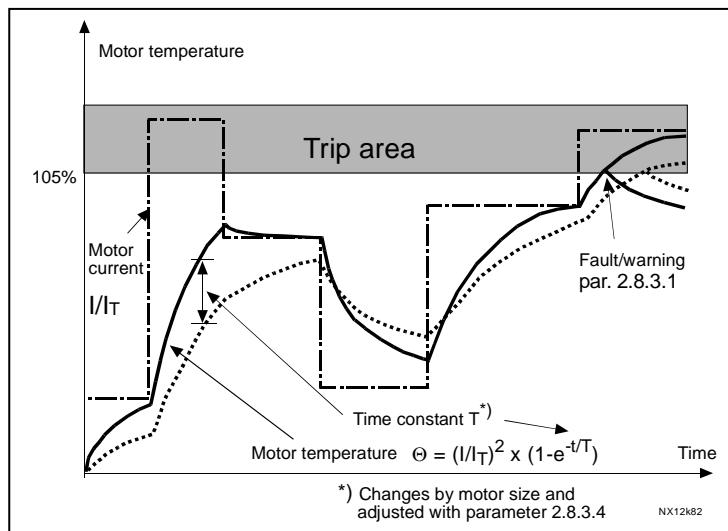

Figure 22. Motor temperature calculation

Parameters 2.8.3.6-2.8.3.9, Stall protection:**General**

The motor stall protection protects the motor from short time overload situations such as one caused by a stalled shaft. The reaction time of the stall protection can be set shorter than that of motor thermal protection. The stall state is defined with two parameters, [2.8.3.7 \(Stall current\)](#) and [2.8.3.9 \(Stall frequency\)](#). If the current is higher than the set limit and output frequency is lower than the set limit, the stall state is true. There is actually no real indication of the shaft rotation. Stall protection is a type of overcurrent protection.

2.8.3.6 Stall protection

- 0 = No response
- 1 = Warning
- 2 = Fault, stop mode after fault according to [parameter 2.4.2](#).
- 3 = Fault, stop mode after fault always by coasting

Setting the parameter to 0 will deactivate the protection and reset the stall time counter.

2.8.3.7 Stall current limit

The current can be set to 0.0...6000.0 A. For a stall stage to occur, the current must have exceeded this limit. See Figure 23. This value is set in percentage of the motor's name plate data ([parameter 2.1.4](#)). If the [parameter 2.1.4](#) Nominal current of motor is changed, this parameter is automatically restored to the default value.

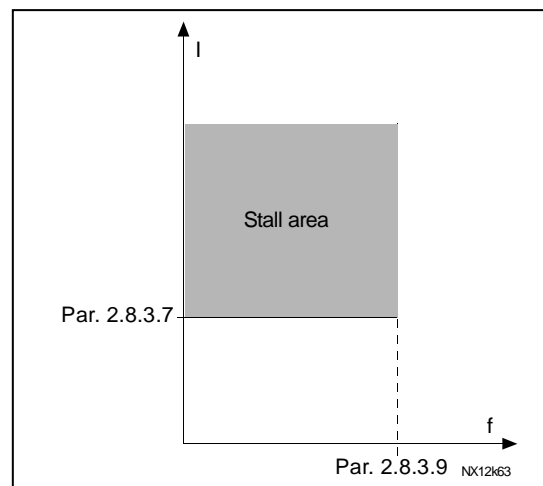

Figure 23. Stall characteristics settings

2.8.3.8 Stall time

This time can be set between 1.0 and 120.0s. This is the maximum time allowed for a stall stage. The stall time is counted by an internal up/down counter. If the stall time counter value goes above this limit the protection will cause a trip (see [parameter 2.8.3.6](#)).

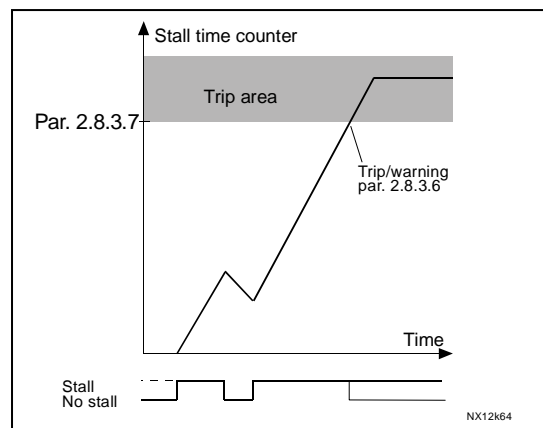

Figure 24. Stall time count

2.8.3.9 Maximum stall frequency

The frequency can be set between $1-f_{\max}$ (par. 2.1.2).

For a stall state to occur, the output frequency must have remained below this limit.

2.8.3.10 Response to thermistor fault

0 = No response

1 = Warning

2 = Fault, stop mode after fault according to parameter 2.4.2.

3 = Fault, stop mode after fault always by coasting

Setting the parameter to 0 will deactivate the protection and reset the stall time counter.

Lift Supervision parameters (M2 -> G2.8.4)

2.8.4.1 Mechanical brake control fault

0 = No response

1 = Warning

2 = Fault, stop mode after fault always by coasting

Mechanical brake supervision fault ensures that the brake is released within the defined time and the external brake supervision does not trigger a fault. With this parameter this function can be turned off.

2.8.4.2 Shaft speed fault

0 = No response

1 = Warning

2 = Fault, stop mode after fault always by coasting

Actual shaft speed according to encoder and calculated shaft speed from motor control are compared and in case the speed difference is more than the set limit (parameter 2.8.4.4) per a defined time (parameter 2.8.4.3) the set action is taken.

This fault is generated only when the mechanical brake is open. i.e. if running against mechanical brake this fault is not generated.

In open loop motor control mode this fault is not generated. See Figure 25.

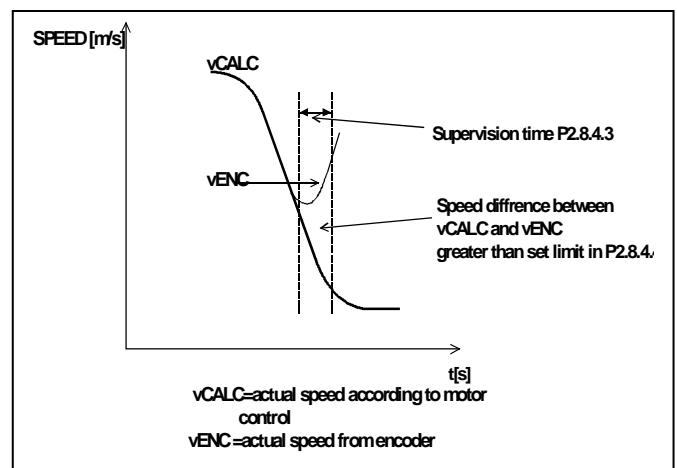

Figure 25. Stall time count

2.8.4.3 Shaft speed supervision time

If the speed difference in shaft speed supervision is greater than the set limit (parameter 2.8.4.2) for a defined supervision time the shaft speed warning or fault is generated. See Figure 25.

2.8.4.4 *Shaft speed supervision limit*

The speed difference between the actual and the calculated lift speed, which will cause tripping. See Figure 25.

Parameter 2.8.4.4.1 is the Shaft speed supervision limit in [m/s] and *Parameter 2.8.4.4.2* is the Shaft speed supervision limit in [Hz].

2.8.4.5 *Response to overtorque protection fault*

0 = No response

1 = Warning

2 = Fault, stop mode after fault always by coasting

The actual torque is compared to torque limits set with [parameter 2.7.15](#) and [parameter 2.7.16](#). If exceeded the defined action is taken.

2.8.4.6 *Torque supervision time*

If torque exceeds limits (set with [parameters 2.7.15](#) and [2.7.16](#)) the overtorque protection fault is activated after the overshoot situation has been present for the defined time. If time is set to zero the fault is activated once the actual torque exceeds the supervision limits. Response to overtorque protection fault is set in parameter 2.8.4.5.

2.8.4.7 *Response to control conflict*

0 = No response

1 = Warning

2 = Fault, stop mode after fault always by coasting

Status of the DIN1 and DIN2 switches is supervised by the application. If they are active at the same time a control conflict fault will be generated. The response to fault is given with this parameter.

2.8.4.8 *Minimum current*

If actual current of the motor is below the minimum current limit fault is activated. The fault is activated only when the mechanical brake is open. 100% correspond to frequency converter nominal current.

2.8.4.9 *0Hz Speed response*

0= Not used

1= Warning

2= Warning + Stop

3= Fault

0 Hz speed supervision is active two seconds after the start command. During that time frequency reference must increase over 0 Hz otherwise fault is activated. Response to fault is given with this parameter.

5.9 AUTO RESTART PARAMETERS

2.9.1 *Automatic restart: Wait time*

Defines the time before the frequency converter tries to automatically restart the motor after the fault has disappeared.

2.9.2 *Automatic restart: Trial time*

The Automatic restart function restarts the frequency converter when the faults selected with parameters 2.9.4 to 2.9.9 have disappeared and the waiting time has elapsed.

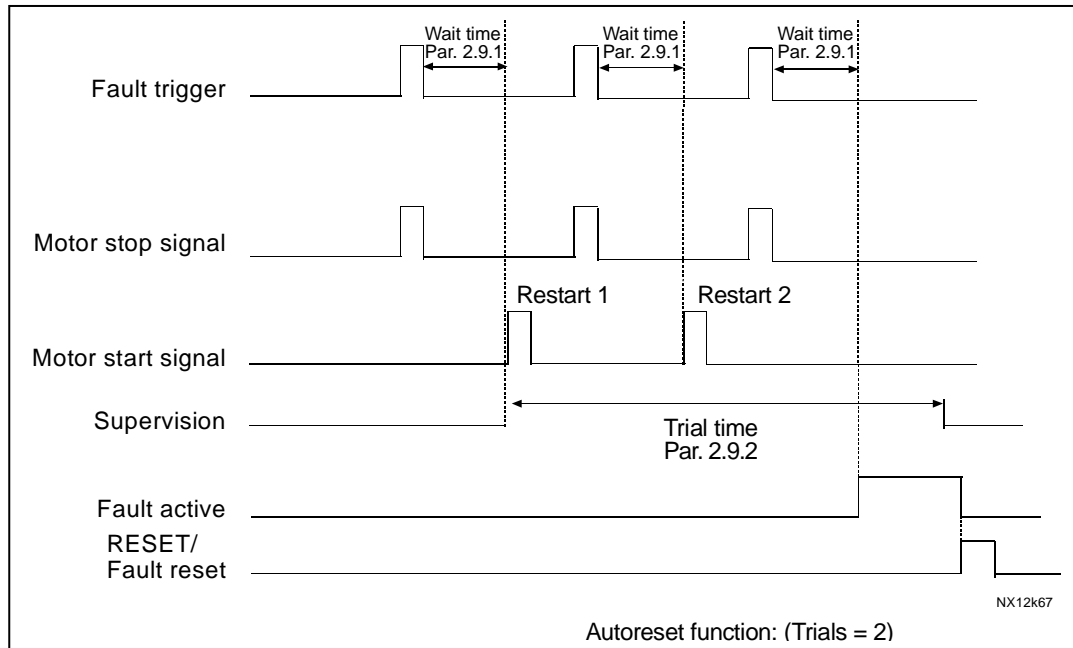

Figure 26. Example of Automatic restart with two restarts.

Parameters 2.9.4 to 2.9.10 determine the maximum number of automatic restarts during the trial time set by parameter 2.9.2. The time count starts from the first autorestart. If the number of faults occurring during the trial time exceeds the values of parameters 2.9.4 to 2.9.10, the fault state becomes active. Otherwise the fault is cleared after the trial time has elapsed and the next fault starts the trial time count again.

If a single fault remains during the trial time, a fault state is true.

2.9.3 *Automatic restart, start function*

The Start function for Automatic restart is fixed to start with ramp in Lift application.

2.9.4 *Automatic restart: Number of tries after undervoltage fault trip*

This parameter determines how many automatic restarts can be made during the trial time set by [parameter 2.9.2](#) after an undervoltage trip.

- 0 = No automatic restart after undervoltage fault trip
- >0 = Number of automatic restarts after undervoltage fault. The fault is reset and the drive is started automatically after the DC-link voltage has returned to the normal level.

2.9.5 *Automatic restart: Number of tries after overvoltage trip*

This parameter determines how many automatic restarts can be made during the trial time set by [parameter 2.9.2](#) after an overvoltage trip.

- 0 = No automatic restart after overvoltage fault trip
- >0 = Number of automatic restarts after overvoltage fault. The fault is reset and the drive is started automatically after the DC-link voltage has returned to the normal level.

2.9.6 *Automatic restart: Number of tries after overcurrent trip*

(NOTE! IGBT temp Fault also included)

This parameter determines how many automatic restarts can be made during the trial time set by [parameter 2.9.2](#).

- 0 = No automatic restart after overcurrent fault trip
- >0 = Number of automatic restarts after overcurrent trip, saturation trip and IGBT temperature faults.

2.9.7 *Automatic restart: Number of tries after reference trip*

This parameter determines how many automatic restarts can be made during the trial time set by [parameter 2.9.2](#).

- 0 = No automatic restart after reference fault trip
- >0 = Number of automatic restarts after the analogue current signal (4...20 mA) has returned to the normal level (≥ 4 mA)

2.9.8 *Automatic restart: Number of tries after motor temperature fault trip*

This parameter determines how many automatic restarts can be made during the trial time set by [parameter 2.9.2](#).

- 0 = No automatic restart after Motor temperature fault trip
- >0 = Number of automatic restarts after the motor temperature has returned to its normal level.

2.9.9 *Automatic restart: Number of tries after external fault trip*

This parameter determines how many automatic restarts can be made during the trial time set by [parameter 2.9.2](#).

- 0 = No automatic restart after External fault trip
- >0 = Number of automatic restarts after External fault trip

2.9.10 *Automatic restart: Number of tries after Input phase supervision fault trip*

This parameter determines how many automatic restarts can be made during the trial time set by [parameter 2.9.2](#).

- 0 = No automatic restart after Input phase supervision fault trip
- >0 = Number of automatic restarts after Input phase supervision fault trip

5.10 EVACUATION PARAMETERS

Evacuation is specially designed for power down situations. When there is power down situation then the 3-phase Mains supply must be disconnected and the 1-phase supply must be connected to Terminals L1-L2. Supply Voltage must be 1-phase 220VAC ($\pm 10\%$). If DC- batteries are used DC-link voltage must remain at least 250 VDC, otherwise under voltage fault will occur.

The Elevator Car can be moved to nearest floor. The maximum Lift speed during the Evacuation is 40% of the Nominal Linear Speed. If Evacuation is activated then Mains supply must be correct, otherwise the Evacuation fault will occur.

2.10.1 *Motor control mode during the evacuation*

- 0 = Not used
- 1 = Manual
- 2 = Automatic

Evacuation Mode is activated or deactivated only in Stop State. In manual mode, the lift controller controls the evacuation process and inputs DIN1 and DIN2 are used normally.

In Automatic mode, the evacuation process is controlled automatically. When the evacuation input (parameter 2.10.2) is switched ON the evacuation is activated. The drive checks the current of the motor in forward direction. After that it checks the current of the motor in backward direction. Then it automatically selects right direction to move. The fault is generated if DIN1 or DIN2 is switched ON during the automatic evacuation process.

2.10.2 *Evacuation input*

Parameter selects the input that activates the evacuation mode.

2.10.3 *Motor control mode*

- 0 = Frequency control: The I/O terminal and panel references are frequency references and the frequency converter controls the output frequency.
- 1 = Speed control: The I/O terminal and panel references are speed references and the frequency converter controls the motor speed (regulation accuracy $\pm 1\%$).
- 2 = Speed control CL: Closed loop speed control mode. The I/O terminal and keypad references are speed references and the frequency converter controls the motor speed. Encoder is required. Closed loop parameters in group G2.11 must be set accordingly.

2.10.4 *Direction change delay*

Time delay between forward and reverse direction test.

2.10.5 *Testing time forward and backward*

Motor current is measured for both running directions of the elevator during automatic evacuation process. This parameter determine the test time for each direction.

2.10.6 Current read delay

Motor current is measured for both running directions of the elevator during automatic evacuation process. This parameter determines the point of time when current is read. Time starts simultaneously with test time.

2.10.7 U/f optimisation in Evacuation

See parameter 2.5.2.

2.10.8 U/f curve mid point frequency in Evacuation

See parameter 2.5.6.

2.10.9 U/f curve mid point voltage in Evacuation

See parameter 2.5.7.

2.10.10 Output voltage at zero frequency Evacuation

See parameter 2.5.8.

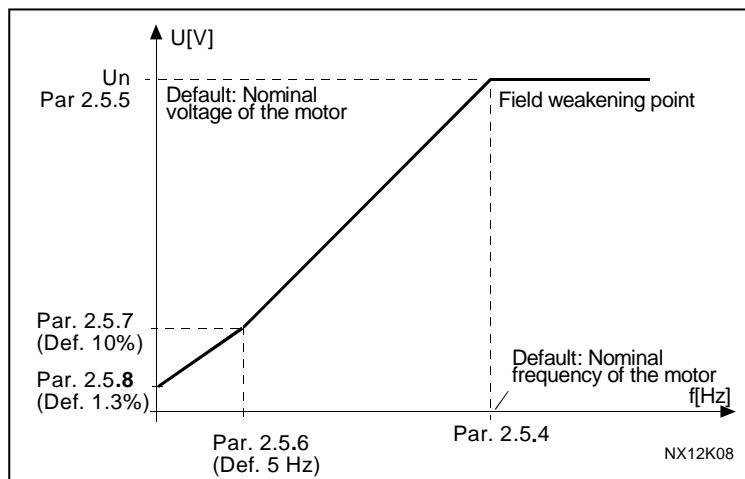

Figure 27. Programmable U/f curve

2.10.11 DC-brake current in Evacuation

Defines the current injected into the motor during DC-braking. By this parameter it is possible to use another DC-brake current in evacuation.

2.10.12 DC-braking time at start in Evacuation

DC-brake is activated when the start command is given. This parameter defines the time before the brake is released.

Maximum speed in Evacuation parameters (M2 -> G2.10.13)

Maximum speed during the evacuation is limited with this parameter. It is possible to give the maximum speed in m/s or in Hz.

Parameter 2.10.13.1 maximum speed in [m/s].

Parameter 2.10.13.2 maximum frequency in [Hz].

5.11 CLOSED LOOP PARAMETERS

2.11.1 *Magnetizing Current*

Rated magnetizing current for the motor. This can also be measured by running the motor with 2/3 of nominal speed without load. If the value is set to 0 the system software estimates the magnetizing current from given motor data.

Automatic motor identification with run (see P2.5.12) measures the motor magnetizing current and updates this parameter.

2.11.2 *Speed Control Limit 1*

2.11.3 *Speed Control Limit 2*

Change limits for speed controller gain and integral time constant. When the output frequency is below the change point 1 (par 2.11.2) the gain value is the same as parameter 11.4. If the output frequency is greater than change point 2 (par 2.11.3) then the gain value is the same as parameter 11.5. Between these two points the change is linear. See Figure 28 and Figure 29.

2.11.4 *Speed Control Kp1*

2.11.5 *Speed Control Kp 2*

Active Speed control gain value (%/ Hz) is P2.11.4 if the output frequency is less than P2.11.2. Active Speed control gain value is P2.11.5 if the output frequency is more than P2.11.3.

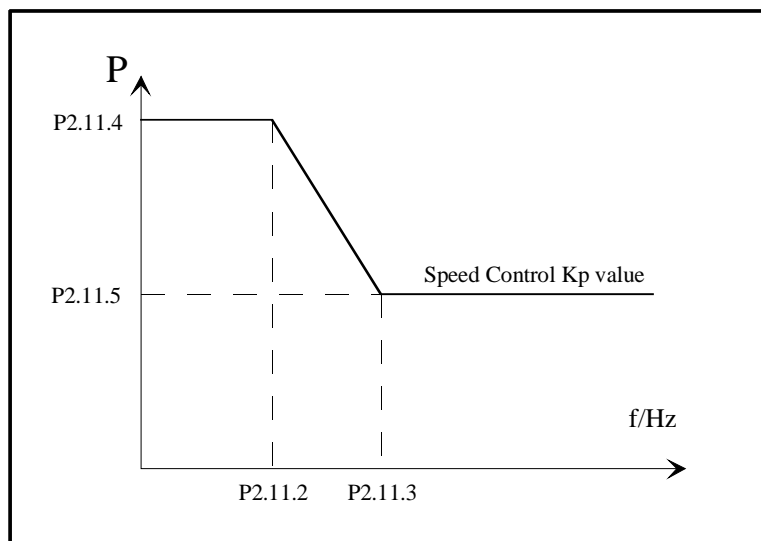

Figure 28. Proportional Speed Control Kp Curve

2.11.6 *Speed Control Ti 1***2.11.7** *Speed Control Ti 2*

Active Integral time constant value for the speed controller is P2.11.6 if the output frequency is less than P2.11.2. If the output frequency is more than P2.11.3 the value is P2.11.7.

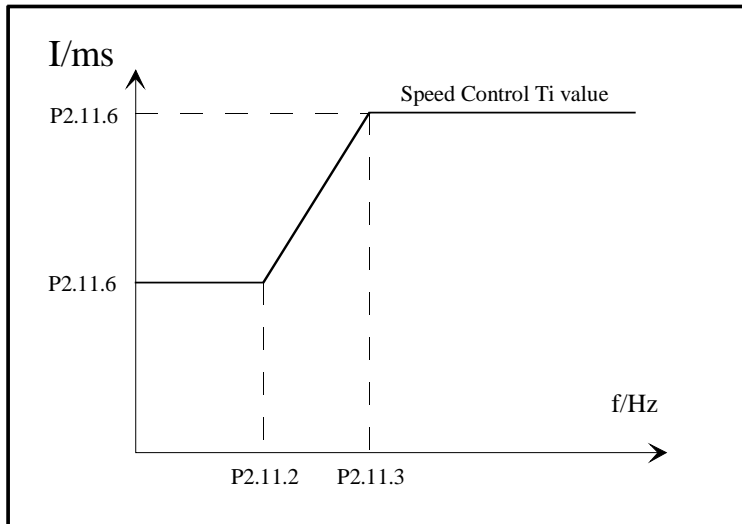

Figure 29. Proportional Speed Control Ti Curve

2.11.8 *Current Control Kp***2.11.9** *Current Control Ti*

P-gain and integral time constant for the current controller. This controller is active only in closed loop mode. It generates the voltage vector reference to the modulator.

2.11.10 *Encoder 1 filter time*

Filter time constant for speed measurement.
Try to adjust this if motor is producing a lot of noise.

2.11.11 *Slip Adjust*

The motor nameplate speed is used to calculate nominal slip. This value should be used to adjust the motor voltage when loaded. Reducing the slip adjust value increases the motor voltage when loaded.

5.12 KEYPAD CONTROL PARAMETERS

3.1 Control Place

The active control place can be changed with this parameter. For more information, see Vacon NX User's Manual, Chapter 7.3.3.1.

Pushing the Start button for 3 seconds selects the control keypad as the active control place and copies the Run status information (Run/Stop, direction and reference).

Note: *If fieldbus or keypad is selected for control place the speed reference (see also [parameter 2.2.2](#)) is changed accordingly.*

Also if fieldbus or keypad is selected for control place the direction can be changed when motor is running. This is not possible if control place is I/O terminal (see [parameter 2.6.1](#)).

3.2 Keypad Reference

The frequency reference can be adjusted from the keypad with this parameter.

The output frequency can be copied as the keypad reference by pushing the Stop button for 3 seconds when you are on any of the pages of menu **M3**. For more information, see Vacon NX User's Manual, Chapter 7.3.3.2.

3.3 Keypad Direction

- 0 Forward: The rotation of the motor is forward, when the keypad is the active control place.
- 1 Reverse: The rotation of the motor is reversed, when the keypad is the active control place.

For more information, see Vacon NX User's Manual, Chapter 7.3.3.3.

3.4 Stop button activated

If you wish to make the Stop button a "hotspot" which always stops the drive regardless of the selected control place, give this parameter the value 1.

See also parameter 3.1.

6. COMMISSIONING OF THE LIFT APPLICATION

6.1 Installation of the NX drive

Please read the NX user's manual for details about installation, cabling and connections. Follow the general commissioning steps 1-10 described in the NX user manual. Please study the Lift application manual carefully for application specific information.

Encoder connections (Closed loop)

- Encoder has to be mounted directly on the motor axis. This is very important for proper function. Encoder must be centered to the motor axis. See figure 30.
- Encoder cable must be a twisted pair cable with individual shield for each pair and main shield. All shields has to be connected to ground terminal in the NX drive. Do not connect ground in both ends (connecting both ends can lead to circulating current in shield)
- Encoder cable must not be installed together with power cables
- Check very carefully the encoder connections and encoder supply voltages.

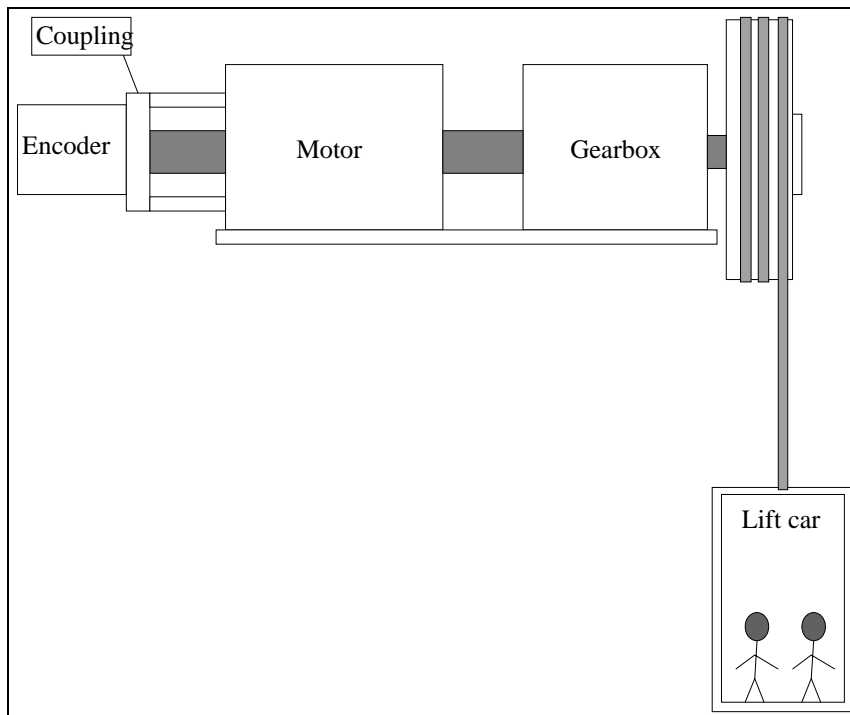

Figure 30

6.2 General setup of parameters

6.2.1 Motor data

Check motor data from the rating plate and put them into Basic Parameter group. Be sure to set up correct motor data.

In case of Permanent magnet motor (PMM) set the parameter 2.5.18.1 to 1. See chapter 6.3.6 for details of PMM commissioning.

6.2.2 Speed parameters

Setup the speed parameters in Speed Control Parameter group.

Nominal linear speed is the lift speed in m/s when motor is running at nominal speed.

In this group also acceleration, deceleration and jerk times can be changed.

Higher jerk time means more S-Shape of the Acceleration and Deceleration ramps. Then start and stop will be smoother. Please note that longer jerk times makes the acceleration and deceleration times longer. The stop distance is also affected.

See figure 31.

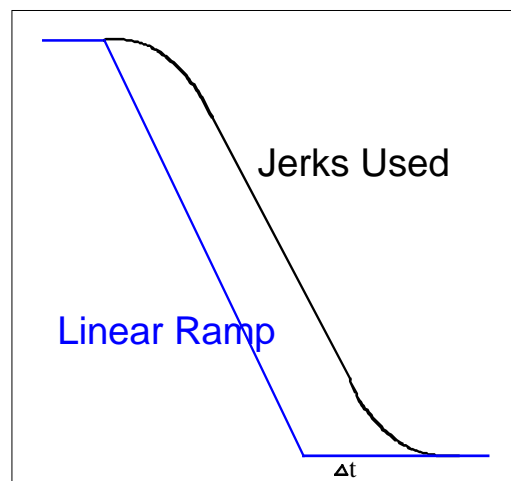

Figure 31

6.2.3 Input and output signals

Setup input and outputs function according to table 8 and 9 in the parameter section. The input and outputs has to be assigned to match actual hardware configuration for actual application.

6.3 Tuning of the application

Correct tuning is very important to get good torque properties also at low speeds. Smooth start and stop of the lift car requires correct tuning.

Please note that problems with tuning also can be related to mechanical problems.

It is easier to tune the lift in closed loop than in open loop.

6.3.1 Open loop tuning operations

1. Set identification parameter (P2.5.12) to 1. Then motor must be started within 20 seconds. Identification is performed in standstill. U/f curve and RS voltage drop is calculated by this operation. The mechanical brake remains closed.
2. Change the U/f-curve ratio selection to programmable mode = 2 (P2.5.3)
3. Check that Automatic torque boost mode is on (is default active)
4. Tune the levelling speed parameters according to the lift mechanics. Typically the levelling speed is 3-5 Hz. Too high speed causes easily high levelling error. Low levelling speed makes the levelling more accurate but it may cause the total lift journey to last longer.
5. Tune the motor nominal speed parameter so that the empty car runs up and down with the same speed when using levelling reference. The speed of the motor should be measured using a hand held encoder directly from the motor shaft.
6. Adjust the acceleration ramps and jerks.
7. Adjust the travelling speed so that the lift speed has at least 1 second steady levelling speed before the stop flag.
8. Adjust the DC brake stop current to nominal motor current and adjust the stop DC brake frequency level up and down to find out the best levelling accuracy.

6.3.4 Closed loop tuning operations

1. Check the encoder Pulse/Revolution rate and set this value to expander menu P7.3.1.1. Parameter is visible only if NXOPTA4 or NXOPTA5 is installed into slot C.
If the automatic motor identification can be done in run mode the tuning steps 3-6 is not needed. See [P2.5.12](#). Then it is enough to check the encoder frequency and direction (see step 4)
2. Set motor control to open loop frequency control (P2.5.1=0).
3. Determination of the magnetizing current I_m : Run the motor with no load at about 2/3 of the nominal frequency.
Read the motor current from the monitoring menu (V1.4) or use NCDrive.
The motor current measured should be the magnetizing current.
This measuring cannot be done if the motor is already connected to the load.

If the magnetizing current cannot be measured it is possible to set the magnetizing current to 0. Then the system software estimates the magnetizing current from given motor data.

Approximate magnetizing current I_m can be also be calculated with following formula:

$$I_m = I_n * (5 * \sqrt{1 - \cos^2 \phi} - 1) / (5 - \sqrt{1 - \cos^2 \phi})$$

4. Check from the expander board menu (V7.3.2.1), that the encoder frequency is approximately the same as the output frequency (V1.1). Check also that the direction is correct.
If the encoder frequency is opposite direction than the output frequency (V1.1), change encoder connection or change parameter P7.3.1.2 to 1
5. Set motor control mode to closed loop speed control (P2.5.1=2)
6. Set the motor magnetising current [P2.11.1](#) (measured or calculated in 5.3)
7. Try to adjust the Encoder filter time parameter [P2.11.12](#) if the motor is producing a lot of noise.
8. If further adjustment is necessary, read next chapter

6.3.5 Fine tuning closed loop

The parameter P2.11.13 (Slip adjust) is to be tuned to get the voltage slightly above the linear U/f-curve when motor is loaded and slightly below when motor is generating.

1. Set motor control mode to frequency control (P2.5.1= 0)
2. Set U/f-curve to linear (P2.5.3=0)
3. Run motor with 35 Hz reference and check motor voltage (V1.7)
4. At 35 Hz, voltage should be $35/50 \cdot 400\text{V} = 280\text{ V}$ for a 400V motor
5. Change Motor control to closed loop (P2.5.1=2)
6. Run with the same reference as in open loop (step3) and check the motor voltage (V1.7)
7. Adjust P2.11.11 (slip adjust) so that motor voltage is slightly above the linear U/f-curve value ($V1.7 > 280\text{ V}$ at 35 Hz reference)
8. If motor is generating, adjust P2.11.11 so that motor voltage is slightly below the linear U/f-curve value.
9. To increase the motor voltage, decrease the value of P2.11.11 or to decrease the motor voltage, increase the value of P2.11.11

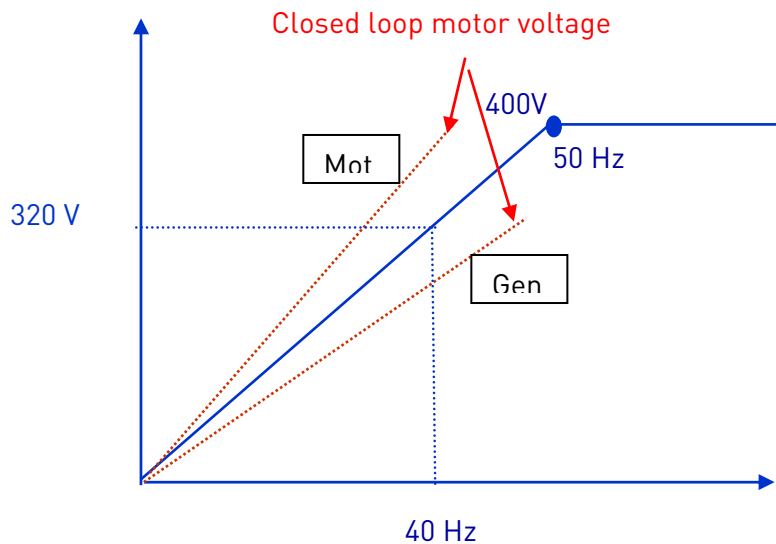

6.3.6 Permanent magnet motor commissioning details

1. Set parameter [P2.5.18.1](#) to 1 (PMM)
2. Set parameter P7.3.1.3 to 1 (Interpolation = Yes) in case of ENDAT absolute encoder.
3. Open the mechanical brake by hardwiring or by using READY for temporary activation of the relay output assigned to the mechanical brake. Due to safety reasons the mechanical brake is not opened automatically when identification run is performed.
4. Run identification run. See [P2.5.12](#).
5. Remove hardwiring or temporary used READY signal for temporary opening of the mechanical brake.
6. Normally it is enough to run identification only once due to the absolute encoder. For example if the encoder is replaced a new identification run is needed.
7. Check that the calculated pole pair number is corresponding to the actual motor by checking the value V1.21 in the monitor menu on the keypad or with NCDrive. This is very important. If the motors name plate nominal frequency and rpm are rounded values.

7. CONTROL SIGNAL LOGIC IN THE LIFT APPLICATION

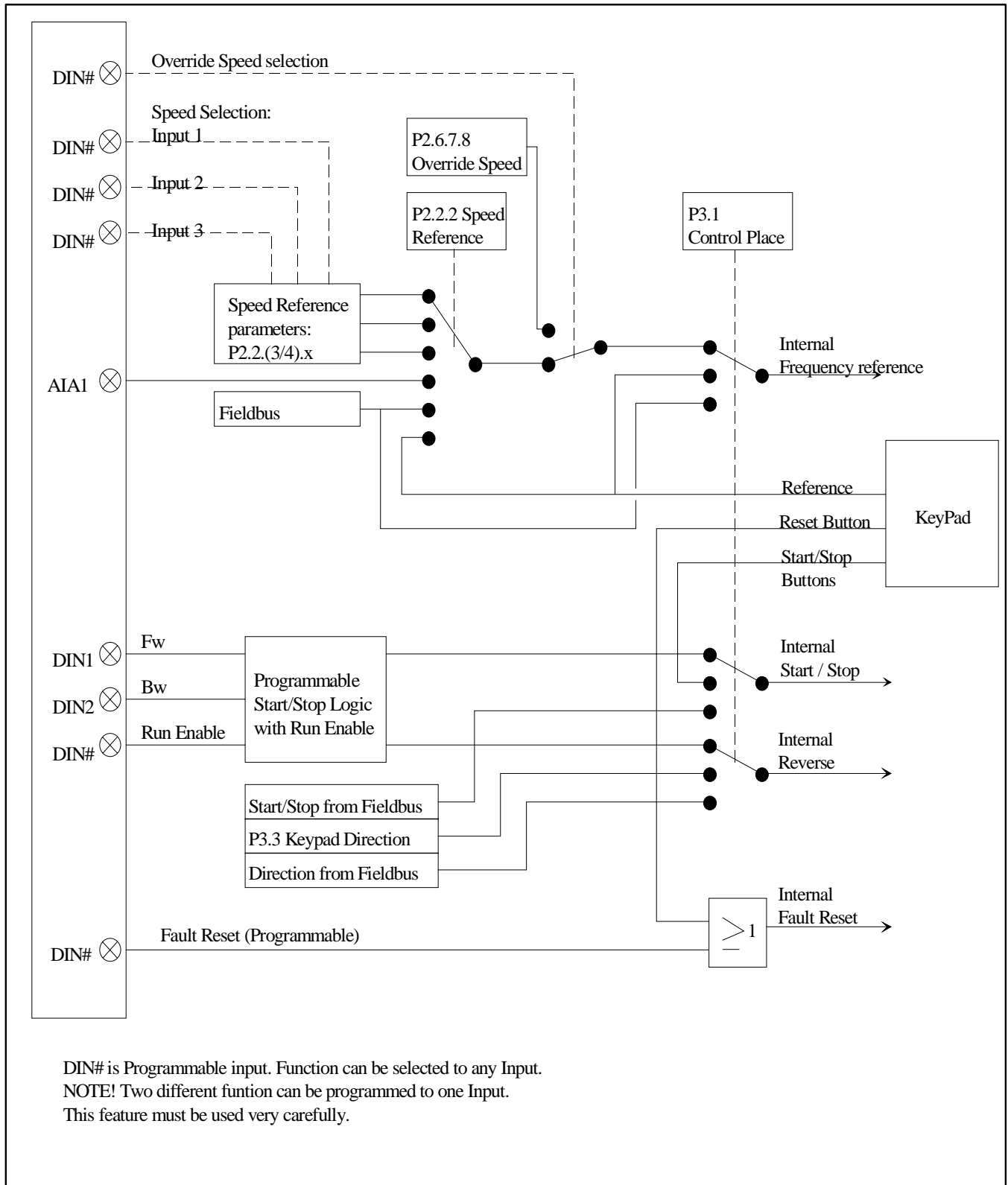

Figure 32. Control signal logic of the Lift Application

8. FAULT TRACING

When a fault is detected by the frequency converter control electronics, the drive is stopped and the symbol **F** together with the ordinal number of the fault, the fault code and a short fault description appear on the display. The fault can be reset with the Reset button on the control keypad or via the I/O terminal. The faults are stored in the Fault History menu, which can be browsed. The different fault codes you will find in the table below.

The fault codes and their possible causes are presented in the table below.

Fault code	Fault	Possible cause
1	Overcurrent	Frequency converter has detected too high a current ($>4 \cdot I_n$) in the motor cable: <ul style="list-style-type: none"> - sudden heavy load increase - short circuit in motor cables - unsuitable motor
2	Overvoltage	The DC-link voltage has exceeded the limits defined in Table 4-1. <ul style="list-style-type: none"> - too short a deceleration time - high overvoltage spikes in utility
3	Earth fault	Current measurement has detected that the sum of motor phase current is not zero. insulation failure in cables or motor
5	Charging switch	The charging switch is open, when the START command has been given. <ul style="list-style-type: none"> - faulty operation - component failure
6	Emergency stop	Stop signal has been given from the option board.
7	Saturation trip	Defective component
8	Unknown fault	The frequency converter troubleshooting system is unable to locate the fault.
9	Undervoltage	DC-link voltage is under the voltage limits defined in Table 4-2 of the Vacon NX User's Manual. Most probable causes: <ul style="list-style-type: none"> - too low a supply voltage - frequency converter internal fault
10	Input line supervision	Input line phase is missing.
11	Output phase supervision	Current measurement has detected that there is no current in one motor phase.
12	Brake chopper supervision	<ul style="list-style-type: none"> - no brake resistor installed - brake resistor is broken - brake chopper failure
13	Frequency converter under-temperature	Heatsink temperature is under -10°C
14	Frequency converter overtemperature	Heatsink temperature is over 90°C . Overtemperature warning is issued when the heatsink temperature exceeds 85°C .
15	Motor stalled	Motor stall protection has tripped.
16	Motor overtemperature	Motor overheating has been detected by frequency converter motor temperature model. Motor is overloaded.
17	Motor underload	Motor underload protection has tripped.

22	EEPROM	- parameter save fault
23	checksum fault	- faulty operation - component failure
24	Changed data warning	Changes may have occurred in the different counter data due to mains interruption
25	Microprocessor watchdog fault	- faulty operation - component failure
29	Thermistor fault	Thermistor is broken.
37	Device change	Option board changed. Different power rating of drive.
38	Device added	Option board added. Drive of different power rating added.
39	Device removed	Option board removed. Drive removed.
40	Device unknown	Unknown option board or drive.
41	IGBT temperature	
43	Encoder fault	Note the exceptional Fault data record. See Param. 7.3.4.3. Additional codes: 1 = Encoder 1 channel A is missing, wrong connection or broken cable 2 = Encoder 1 channel B is missing, wrong connection or broken cable 3 = Both Encoder 1 channels are missing, wrong connection or broken cable 4 = Encoder reversed, channels swapped
50	Analogue input I_{in} < 4mA (selected signal range 4 to 20 mA)	Current at the analogue input is < 4mA. - control cable is broken or loose - signal source has failed
51	External fault	Digital input fault.
52	Keypad communication fault	The connection between the control keypad and the frequency converter is broken.
53	Fieldbus communication fault	The connection from the fieldbus to the frequency converter is broken.
54	SPI communication fault	The connection between the component board and the control board is broken.
55	External brake control	Fault is activated by the mechanical brake control logic. Check parameters and external brake device. See parameter 2.8.4.1
56	Shaft speed	Fault is activated if calculated speed is different compared to actual speed. See parameter 2.8.4.2 .
57	Torque supervision	Actual torque above torque limits. See parameter 2.8.4.6
58	Minimum current	Motor current is less than set limit parameter 2.8.4.8
59	Direction request	Digital inputs DIN1 and DIN2 are ON at the same time. See parameter 2.8.4.7 .
60	Evacuation	Fault is generated during the evacuation process.
61	Zero speed time	Zero current measured later than 2 seconds from start command. See parameter 2.8.4.9 .
62	Evacuation Voltage	Evacuation active and voltage has exceeded the limit value. Evacuation voltage 230VAC $\pm 10\%$
63	Identification fault	The automatic motor identification selected by parameter 2.5.12 not succeeded
64	Motor Contactor	Wrong wiring or programming of Acknowledge input programmed by P2.4.7.2

Table 20. Fault codes

Vaasa

Vacon Oyj (Headquarters and Production)
Runsorintie 7, 65380 Vaasa
firstname.lastname@vacon.com
tel. +358 (0) 201 2121
fax: +358 (0) 201 212 205

Helsinki

Vacon Oyj
Äyritie 12, 01510 Vantaa
tel. +358 (0)201 212 600
fax: +358 (0)201 212 699

Tampere

Vacon Oyj
Alasniitynkatu 30, 33700 Tampere
tel. +358 (0)201 2121
fax: +358 (0)201 212 750

Rotatek Finland Oy

Laserkatu 6, 53850 Lappeenranta
tel. +358 (0)5 6243 870
fax: +358 (0)5 6243 871

Vacon Traction Oy

Alasniitynkatu 30, 33700 Tampere
tel. +358 (0)201 2121
fax: +358 (0)201 212 710

SALES COMPANIES AND REPRESENTATIVE OFFICES:**Austria**

Vacon AT Antriebssysteme GmbH
Aumühlweg 21
2544 Leobersdorf
vacon.austria@vacon.com
tel. +43 2256 651 66
fax: +43 2256 651 66 66

Belgium

Vacon Benelux NV/SA
Interleuvenlaan 62
3001 Heverlee (Leuven)
info@vacon.be
tel. +32 (0)16 394 825
fax: +32 (0)16 394 827

France

Vacon France s.a.s.
Batiment le Sextant
462 rue Benjamin Delessert
ZI de Moissy Cramayel
BP 83
77 554 Moissy Cramayel
www.vacon-france.fr
tel. +33 (0)1 64 13 54 11
fax: +33 (0)1 64 13 54 21

Germany

Vacon GmbH
Gladbecker Str. 425
45329 Essen
tel. +49 (0)201/80670-0
fax: +49 (0)201/80670-93

Great Britain

Vacon Drives (UK) Ltd.
Unit 11, Sunnyside Park
Wheatfield Way, Hinckley
LE10, 1PJ, Leicestershire
vacon.uk@vacon.com
tel. +44 (0)1455 611 515
fax: +44 (0)1455 611 517

Italy

Vacon S.p.A.
Via F.lli Guerra, 35
42100 Reggio Emilia
info@vacon.it
tel. +39 0522 276811
fax: +39 0522 276890

The Netherlands

Vacon Benelux BV
Weide 40, 4206 C.J Gorinchem
vacon.benelux@vacon.com
tel. +31 (0)183 642 970
fax: +31 (0) 183 642 971

Norway

Vacon AS
Langgata 2
3080 Holmestrand
vacon@vacon.no
tel. +47 330 96120
fax: +47 330 96130

PR China

Vacon Plc
Beijing Representative Office
A205, Grand Pacific Garden Mansion
8A Guanhua Road
Beijing 100026
www.vacon.com.cn
vacon.china@vacon.com
tel. +86 10 6581 3734
fax: +86 10 6581 3754

Russia

ZAO Vacon Drives
Bolshaja Jakimanka 31
stroenie 18
109180 Moscow
www.ru.vacon.com
tel. +7 (095) 974 1541
fax: +7 (095) 974 1554

ZAO Vacon Drives

2ya Sovetskaya 7, office 210A
191036 St. Petersburg
www.ru.vacon.com
tel. +7 (812) 332 1114
fax: +7 (812) 279 9053

Singapore

Vacon Plc
Singapore Representative Office
102F Pasir Panjang Road
#02-06 Citilink Warehouse Complex
Singapore 118530
vacon.singapore@vacon.com
tel. +65 6278 8533
fax: +65 6278 1066

Spain

Vacon Drives Ibérica S.A.
Miquel Servet, 2. P.I. Bufalvent
08240 Manresa
www.vacon.es
info@vacon.es
tel. +34 93 877 45 06
fax: +34 93 877 00 09

Sweden

Vacon AB
Torget 1
172 67 Sundbyberg
tel. +46 (0)8 293 055
fax: +46 (0)8 290 755