

VACON[®] NXP
AC DRIVES

**NXP LIFT APPLICATION APFIF33
APPLICATION MANUAL**

VACON[®]

VACON® NXP LIFT APPLICATION MANUAL

INDEX

Document code: DPD02005B
 Software code: APFIFF33
 V2.23 or newer revisions
 Date: 20.10.2017

1.	NXP Lift Application - Introduction	4
1.1	I/O interface	4
1.2	Motor and encoder.....	4
1.3	Contactor and brake control.....	4
2.	Version parameter compatibility issues.....	6
3.	Control I/O	8
4.	Programming principle of the input signals	9
4.1	Defining an Input for a Certain Function on the Keypad.....	9
4.2	Defining an analogue input as digital.....	9
4.3	Defining a Terminal for a Certain Function with VACON® NCDrive Programming Tool.....	10
4.4	Defining unused inputs/outputs.....	10
5.	Monitoring Values (Control keypad: menu M1)	11
5.1	Monitoring values.....	13
5.2	Monitoring values 2.....	14
6.	NXP Lift Application – Parameter lists.....	18
6.1	Basic Parameters (Control keypad: Menu M2 → G2.1)	19
6.2	Speed Profile Parameters (Control keypad: Menu M2 → G2.2)	20
6.3	Mechanical Brake Control Parameters (Control keypad: Menu M2 → G2.3).....	22
6.4	Drive Control Parameters (Control keypad: Menu M2 → G2.4).....	23
6.5	Motor Control Parameters (Control keypad: Menu M2 → G2.5).....	24
6.6	Stabilators (Control keypad: Menu M2 → G2.5.11).....	26
6.7	Identified Parameters (Control keypad: Menu M2 → G2.5.12.x)	27
6.8	Input Signals (Control keypad: Menu M2 → G2.6)	27
6.9	Output Signals (Control keypad: Menu M2 → G2.7).....	29
6.10	Autorestart Parameters (Control keypad: Menu M2 → G2.9).....	32
6.11	Evacuation Parameters (Control keypad: Menu M2 → G2.10).....	33
6.12	Keypad control (Control keypad: Menu M3).....	34
6.13	System menu (Control keypad: Menu M6).....	34
6.14	Expander boards (Control keypad: Menu M7).....	34
7.	Description of parameters	35
7.1	Basic Parameters	35
7.2	Speed profile	39
7.3	Speed reference [m/s] parameters (M2 -> G2.2.9).....	43
7.4	Speed Reference [Hz] parameters (M2 -> G2.2.10)	44
7.5	Speed Curve 1 parameters (M2 -> G2.2.11).....	45
7.6	Speed Curve 2 parameters (M2 -> G2.2.12).....	46
7.7	Mechanical Brake Control	47

7.7.1	Mechanical Brake Control Logic.....	49
7.7.2	Open Loop Parameters (M2 -> G2.3.1).....	50
7.7.3	Closed Loop Parameters (M2 -> G2.3.2).....	54
7.7.4	External brake (M2 -> G2.3.3).....	55
7.7.5	Brake supervision (M2 -> G2.3.4).....	56
7.7.6	Adjusting opening of the brake in closed loop:.....	57
7.8	Drive Control.....	59
7.9	Motor Contactor Control Parameters (M2 -> G2.4.7).....	61
7.10	Advanced Parameters.....	61
7.11	Motor Control.....	63
7.11.1	U/f Settings.....	65
7.11.2	Closed Loop Settings.....	68
7.11.2.1	Rollback.....	72
7.11.3	Permanent magnet synchronous motor settings.....	73
7.11.3.1	D and Q axis voltage drops.....	75
7.11.3.2	Flux current controller.....	75
7.11.4	Stabilization settings.....	77
7.11.4.1	Torque stabiliser.....	77
7.11.4.2	Flux Circle stabiliser.....	78
7.11.4.3	Flux stabiliser.....	78
7.11.4.4	Voltage stabiliser.....	78
7.11.5	Identification settings.....	80
7.12	Input Signals.....	81
7.12.1	Digital Inputs (M2 -> G2.6.7).....	82
7.12.2	Analogue input 1&2.....	83
7.13	Output Signals.....	85
7.13.1.1	Analogue output.....	85
7.13.1.2	Digital outputs.....	87
7.13.1.3	Supervision limits.....	89
7.13.1.4	Expansion relays.....	90
7.14	Protections.....	91
7.15	Lift Supervision parameters (M2 -> G2.8.4).....	97
7.16	Autorestart Parameters.....	99
7.17	Evacuation Parameters.....	102
7.18	Keypad control parameters.....	104
8.	Comissioning of the Lift application.....	105
8.1	Installation of the VACON® NX Drive.....	105
9.	General Setup of the Parameters.....	106
9.1	Motor Data.....	106
9.2	Speed Parameters.....	106
9.2.1	Input and Output Signals.....	106
9.3	Tuning of the Application.....	106
9.3.1	Open Loop Tuning Operations.....	107
9.3.2	Closed Loop Tuning Operations.....	108
9.3.3	Fine Tuning Closed Loop.....	108
10.	Test procedure to check the brake monitoring function.....	110
10.1	Type of connections.....	110
10.1.1	Connections with 10Vcc.....	110
10.1.2	Connections with 24Vcc.....	111

10.2	Brake monitoring activation to fulfil EN-81-1+A3	113
10.3	Brake monitoring fault reset and fault codes.....	113
10.4	Certified.....	113
10.5	Test procedure.....	114
11.	Problem solving	117
12.	Fault Codes	118

1. NXP LIFT APPLICATION - INTRODUCTION

Select the NXP Lift Application in menu **M6** on page *S6.2*.

The VACON® NXP Lift Application can be used with modern Lift systems. This application includes functions that are required to achieve a smooth ride in the lift car. The I/O interface table includes the most commonly needed signals in lift applications.

In the application, constant speeds are presented in [m/s] and also in [Hz], acceleration and deceleration are presented in [m/s²] and jerks are presented in [s].

Note: NXP3 control board is required with NXP Lift Application versions 2.00 and higher (see chapter 10.4).

1.1 I/O interface

All outputs are freely programmable. The expansion relay R03 and R04 can be assigned to any digital output by the TTF method (Terminal To Function).

Digital input functions are freely programmable to any digital input by the TTF method. Start forward and reverse signals are fixed to input DIN1 and DIN2 (see next page).

Analogue inputs can be used for speed and torque reference (car weight compensation) or they can be used as additional digital inputs too.

1.2 Motor and encoder

The used hardware can be any VACON® NXP AC drive. In closed loop motor control mode, an encoder and an option board is required (NXOPTA4, NXOPTA5, NXOPTBE, NXOPTBB or NXOPTAK).

The application supports also permanent magnet motors. There is a separate menu group for PMM-parameters.

We recommend ENDAT type absolute encoder together with the option board OPTBB or OPTBE to get the best performance for a permanent magnet motor.

Set the parameter P7.3.1.3 or P7.3.1.5 to Interpolation = [Yes] if Sin-Cos encoder is used. It is also possible to use resolver and then the option board OPTBC is used.

1.3 Contactor and brake control

Motor contactor control is included to allow the AC drive to control a contactor between AC drive and motor.

Motor contactor control logic is used only when an output is assigned to motor contactor control.

The contactor closes at start request. The AC drive starts to run after a delay given by parameter or when the programmed digital input for motor contactor acknowledgement goes high.

Monitoring of both internally and externally controlled contactor is always recommended to avoid motor control through open contactor e.g. when it opens for safety circuit (may destroy the contactor). Monitoring is active when digital input is assigned to motor contactor feedback. Then there is no need to adjust the delay time and there will be an alarm if the acknowledgement signal does not come.

Mechanical brake control logic is designed to achieve smooth departures from and landings to floor level. The brake can be set in various ways to meet the different requirements of the lift motors and lift control logic.

Application version 211 or newer also fulfil the certification for uncontrolled car movement (EN 81-1:1998+A3:2009). In case of electric traction lifts, one possible solution to fulfil the EN 81-1+A3 the standard, is to use motor brakes supervision in the drive. These brakes must be also certified under EN 81-1+A3. The brakes must be monitored independently one by one. If the brake sequence monitoring is not correct when opening and closing, then the lift must be stopped for further checking. See more info from chapter 9.

2. VERSION PARAMETER COMPATIBILITY ISSUES

APFIF33V215 vs APFIF33V216

- Fixed panel start / stop command handling

APFIF33V213 vs APFIF33V215

- Fixed motor contactor closing time (P2.4.7.1)
- New parameter P2.8.2.8 OutPhFaultDelay
- New parameter P2.8.2.9 OutPhFaultCurLim

APFIF33V211 vs APFIF33V213

- After evacuation, evacuation motor control mode is changed back to normal after the drive has stopped modulation

APFIF33V206 vs APFIF33V211

- Fulfills the certification for uncontrolled car movement (EN 81-1:1998+A3:2009)
- Removed control place change by pressing buttons 3s
- Shaft speed error only when motor running
- No panel fault if control place NCDrive
- Brake can be opened during DC-current in open loop
- Separated brake closing and emergency stop delays
- Evacuation faults F60 and F62 are reset when DC voltage over 500V

Parameter changes:

- P 2.5.10.14 ExtIdRef parameter for PMSM fine tuning
- P 2.5.9.18.4 Rollback control wake up limit initialized to value 3.00 (three encoder pulses)
- P 2.7.10 R01 Function initialized to value 0 (None) (was 2 = Run) for safety reason
 - o Typical value is 1 (Ready) and then safety circuit can be wired through NO contacts
- P 2.5.17.7 SpdCtrl Ti Start removed
- P 2.5.17.8 SpdCtrlStartDel removed
- Separated AI1 And AI2 own parameters
- Added Custom min and Custom max parameters to AI1 and AI2 groups
- Added parameters Ton delay DIN1 and Ton delay DIN2
- Moved rollback parameters from PMSM settings to closed loop group
- Added slip frequency calculation. Max frequency brake closed (OL) uses this value.

- P2.3.1.3 FreqLimitOpen_OL initial value 100 -> 0
- P2.3.1.4 BrakeOpenDelay_OL initial value 10 -> 0
- P2.3.1.7 MaxFreqBrakeClose_OL initial value 400 -> 200 (2Hz)
- P2.3.1-2.8 BrakeReact Time initial value 5 -> 30 (300ms)
- P2.3.2.3 FreqLimitOpen_CL initial value 1 -> 0
- P2.3.2.9 0Hz TimeAtStart_CL initial value 400 -> 800
- P2.3.2.12 SmoothStartFreq_CL initial value 2 -> 0
- P2.3.3.2 ExtBrake SuperV1 initial value 1 -> 0
- P2.3.3.3 ExtBrake SuperV2 initial value 1 -> 0
- P2.3.4.2 ExtBrakeSupVInv Added ID
- P2.5.9.18 RollBack Ctrl initial value 0 -> 1 (rollback can be also used in async motors)
- P2.5.9.20 RollBack Ctrl PreTorq initial value 200 -> 1
- P2.6.2.12 Speed Sel Input3 initial value 16 -> 15
- P2.6.2.13 AngleIDRepeat max value 1 -> 89 (bugfix)
- o PMSM selected - speed cntrl gains 15 -> 10

- brake opening current in CL 5% on motor nominal current -> 0
- brake opening delay in CL 0 -> 30 (300 ms)

Brake control parameters:

- Changed text of F55
- Added F91
- Added P2.3.3.3 "ExtBrake Superv2"
- Added P2.3.4.3 "F55 Spv at Start"
- Added reserved parameters from P3.5 to P3.9, to be able to have the Button to enable the Brake Fault Reset in B3.10,
- Added B3.10 "Reset Brake Spv F"
- Increased the default value of P2.3.4.1 to fulfill +A3. Default 2.00s.
- Default value of P2.3.4.2 "ExtBrkSuplInversion" changed, to work inverted. When system is stopped, brake switches are closed, and 24V are feeding the digital inputs that are supervising the state
- Changed default value of P2.3.4.3 "F55 at Start", = 0/Disable. With that value, the Brake Supervision Fault, is just appearing when stopping at floor, not during the ride

Note: When updating application, it is not recommended to use VACON® NCDrive parameter download function. Instead upload parameters from the unit and make comparison to old parameter file. Application is constantly developed, this includes changing parameter default values, if parameters are directly downloaded to drive, improved default values will be lost.

3. CONTROL I/O

NXOPTA1		Terminal	Signal	Description
	1	+10V _{ref}	Reference output	Voltage for potentiometer, etc.
	2	AI1+	Analogue input, voltage range 0–10V DC	Voltage input frequency reference
	3	AI1-	I/O Ground	Ground for reference and controls
	4	AI2+	Analogue input, current range 0–20mA	Current input frequency reference
	5	AI2-		
	6	+24V	Control voltage output	Voltage for switches, etc. max 0.1 A
	7	GND	I/O ground	Ground for reference and controls
	8	DIN1	Start forward (programmable)	Contact closed = start forward
	9	DIN2	Start reverse (programmable)	Contact closed = start reverse
	10	DIN3	Fault Reset (programmable)	Contact closed = reset fault
	11	CMA	Common for DIN 1–DIN 3	Connect to GND or +24V
	12	+24V	Control voltage output	Voltage for switches (see #6)
	13	GND	I/O ground	Ground for reference and controls
	14	DIN4	Speed reference selection	Programmable speed reference for Inputs DIN4, DIN5, and DIN6: Activity reference Activity reference with direction Binary Reference
	15	DIN5		
16	DIN6			
17	CMB	Common for DIN4–DIN6	Connect to GND or +24V	
	18	AO1+	Output frequency	Programmable
	19	AO1-	Analogue output	Range 0–20 mA/R _L , max. 500Ω
	20	DO1	Digital output FAULT	Programmable Open collector, I _s ≤50mA, U _s ≤48 VDC
NXOPTA2				
	21	R01	Relay output 1 Default: "Not used"	Programmable (typical way is to use READY)
	22	R01		
	23	R01		
	24	R02	Relay output 2 Mechanical brake	Programmable
	25	R02		
	26	R02		

Table 3-3-1. NXP lift application default I/O configuration.

Note: See jumper selections below.
More information in VACON® NXS/P User Manual

**Jumper block X3:
CMA and CMB grounding**

	CMB connected to GND CMA connected to GND
	CMB isolated from GND
	CMA isolated from GND
	CMB and CMA internally connected together, isolated from GND

= Factory default

4. PROGRAMMING PRINCIPLE OF THE INPUT SIGNALS

The programming principle of the input signal in the VACON® NXP Lift Application as well as in the VACON® NXP Multipurpose Control Application (and partly in the other applications) is different compared to the conventional method used in other VACON® NX applications.

In the conventional programming method, Function to Terminal Programming Method (FTT), you have a fixed input that you define a certain function for. The applications mentioned above, however, use the Terminal to Function Programming method (TTF) in which the programming process is carried out the other way around: Functions appear as parameters that the operator defines certain input for.

4.1 Defining an Input for a Certain Function on the Keypad

Connecting a certain function (input signal) to a certain digital input is done by giving the parameter an appropriate value. The value is formed of the Board slot on the VACON® NX control board (see VACON® NXS/P User Manual) and the respective signal number, see below.

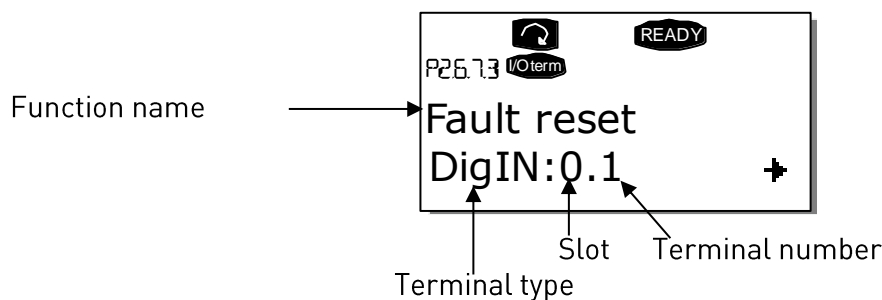

Example: You want to connect the digital input function Fault Reset (parameter 2.6.7.3) to a digital input A.3 on the basic board NXOPTA1, located in Slot A.

First find the parameter 2.6.7.3 on the keypad. Press the Menu button right once to enter the edit mode. On the value line, you will see the terminal type on the left (DigIN) and on the right, digital input where function is connected.

When the value is blinking, hold down the Browser button up or down to find the desired board slot and signal number. The program will scroll the board slots starting from 0 and proceeding from A to E and the I/O numbers from 1 to 10.

Once you have set the desired value, press the Enter button once to confirm the change.



4.2 Defining an analogue input as digital

In lift application, it is possible to use analogue inputs as digital in TTF method. To use it, define SlotF.1 for AI1 and SlotF.2 for AI2. Logical state '0' is when signal level is below 50% and '1' above it. If you want use slotF parameters from VACON® NCDrive you need VACON® NCDrive version 2.0.18 or newer.

4.3 Defining a Terminal for a Certain Function with VACON® NCDrive Programming Tool

If you use the VACON® NCDrive Programming Tool for parametrizing, you will have to establish the connection between the function and input/output in the same way as with the control panel. Just pick the address code from the drop-down menu in the Value column (see the Figure below).

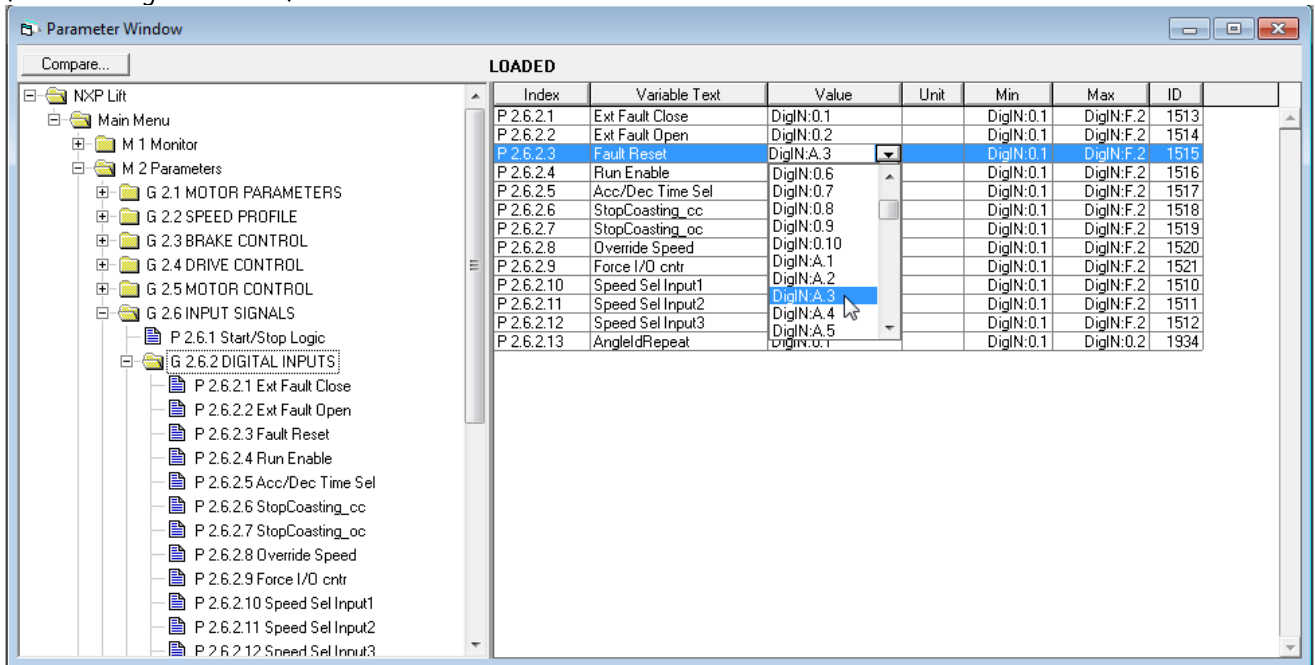

Figure 1. Screenshot from the NCDrive programming tool; Entering the address code

4.4 Defining unused inputs/outputs

All unused inputs and outputs must be given the board slot value 0 and the terminal number value 1 (0.1). The value 0.1 is also the default value for most of the functions. However, if you want to use the values of a digital input signal for e.g. testing purposes only, you can set the board slot value to 0 and the terminal number to any number between 2...10 to place the input to a TRUE state. In other words, the value 1 corresponds to 'open contact' and values 2 to 10 to 'closed contact'.

In case of analogue inputs, giving the value 0.1 for the terminal number corresponds to 0% signal level, value 2 corresponds to 20%, value 3 to 30% and so on. Giving value 10 for the terminal number corresponds to 100% signal level.

5. MONITORING VALUES (CONTROL KEYPAD: MENU M1)

The monitoring values are the actual values of parameters and signals as well as statuses and measurements. Monitoring values cannot be edited.

See VACON® NXS/P User Manual for more information.

Code	Parameter	Unit	ID	Description
V1.1	Output frequency	Hz	1	Output frequency to motor
V1.2	Frequency reference	Hz	25	Frequency reference to motor control
V1.3	Motor speed	rpm	2	Motor speed in rpm
V1.4	Motor current	A	3	
V1.5	Motor torque	%	4	In % of the nominal motor torque
V1.6	Motor power	%	5	Motor shaft power
V1.7	Motor voltage	V	6	
V1.8	DC link voltage	V	7	
V1.9	Unit temperature	°C	8	Heatsink temperature
V1.10	Voltage input	V	13	AI1
V1.11	Current input	mA	14	AI2
V1.12	DIN1, DIN2, DIN3		15	Digital input statuses
V1.13	DIN4, DIN5, DIN6		16	Digital input statuses
V1.14	DO1, RO1, RO2		17	Digital and relay output statuses
V1.15	ROE1, ROE2, ROE3		35	Expansion relay status (ROE3 reserved for future use)
V1.16	Analogue I _{out}	mA	26	AO1
V1.17	Lift Speed	m/s	1630	Lift speed in m/s
V1.18	Encoder Speed	rpm	1631	
V1.19	UnFiltered Motor Torq	%	1632	
V1.20	Speed ctrl out	%	1633	Torque reference from speed controller output
V1.21	Ramp Down Distance	m	1634	Distance when decelerated from any speed to levelling speed (or zero speed). Value visualizes the effect of different parameters to stopping distance.
V1.22	Pole pair number		1651	Calculated Pole pair number. To be checked.
V1.23	Motor Temperature	%	9	Calculated motor temperature in percent of motor nominal temperature
G1.24	Multimonitor			Three different value can be monitored at the same time

Table 5-1 Monitoring values

V1.25	Monitor 2			
V1.25.1	AbsEnc Position	p	54	Absolute position of absolute encoder in slot C
V1.25.2	AbsEnc Revolution	r	55	Absolute position revolutions of absolute encoder in slot C
V1.25.3	Step response	Hz	1132	Freq ramp step response
V1.25.4	AI Torque reference	%	1779	Scaled torque reference from analogue input.
V1.25.5	Torque reference	%	1780	Torque reference to motor control. Value is ramped up after run request.
V1.25.6	DistDecelerated	m	1888	Distance travelled after deceleration started during previous trip.
V1.25.7	Current	A	1113	Unfiltered motor current
V1.25.8	Torque	%	1125	Unfiltered motor torque
V1.25.9	DC Voltage	V	44	Unfiltered DC voltage
V1.25.10	Shaft angle	deg	1169	Shaft angle from encoder
V1.25.11	Shaft rounds	r	1170	Shaft rounds from encoder
V1.25.12	MC Status		64	Motor control status word
V1.25.13	Status Word		43	Application status word
V1.25.13	RegulatorStatus		77	Regulator status word
V1.25.13	Ident. fail		98	Identification failure code

Table 5-2 Monitoring values 2

V1.26	DTF (hidden when DTFMode = 0)			
V1.26.1	Speed m/s Actual	m/s	1993	Actual speed in m/s
V1.26.2	Position mm	mm	1994	Lift position in mm
V1.26.3	Enc Abs Puls Raw	p	1974	
V1.26.4	CarAtFloorArea	Floo	1769	

Table 5-3 DTF

5.1 Monitoring values

- V1.1** *Output frequency* [#,## Hz] ID1
 Output frequency to motor, updated at 10 ms time level.
- V1.2** *Frequency reference* [#,## Hz] ID 25
 Frequency reference to motor control, after speed share function. updates at 1 ms time level.
- V1.3** *Motor speed* [# rpm] ID 2
 Motor speed in rpm
- V1.4** *Motor current* [#.## A] ID 3
 Open loop:
 1 s linear filtering.

 Closed Loop:
 32 ms filtering
- V1.5** *Motor torque* [%] ID 4
 In % of Motor nominal torque.

 Open loop
 1 s linear filtering

 Closed Loop
 32 ms filtering
- V1.6** *Motor Power* [#,# %] ID 5
 Calculated motor power.
- V1.7** *Motor voltage* [#,# V] ID 6
 Calculated motor voltage.
- V1.8** *DC link voltage* [# V] ID 7
 Measured DC voltage, filtered.
- V1.9** *Unit temperature* °C ID 8
 Heatsink temperature.
- V1.10** *Voltage input* [#,## V] ID 13
- V1.11** *Current Input* [#,## mA] ID 14
 Filtered analogue input levels.

V1.12 *DIN1, DIN2, DIN3* *ID 15*

V1.13 *DIN4, DIN5, DIN6* *ID 16*

	DIN1/DIN2/DIN3 status	DIN4/DIN5/DIN6 status
b0	DIN3	DIN6
b1	DIN2	DIN5
b2	DIN1	DIN4

V1.14 *D01, R01, R02* *ID 17*

V1.15 *ROE1, ROE2, ROE3* *ID 35*

	D01, R01, R02 status	ROE1, ROE2, ROE3 status
b0	D01	ROE1
b1	R01	ROE2
b2	R02	ROE3

V1.16 *Analog Iout* *[#,## mA]* *ID 26*

Analogue Output value 0% = 0 mA / 0 V, 100% = 20 mA / 10 V

V1.17 *Lift speed* *[m/s]* *ID 1630*

Linear speed of the lift car.

V1.18 *Encoder speed* *[Hz]* *ID 1631*

Shaft frequency filtered with Encoder1FiltTime.

V1.19 *Motor Torque Unf.* *[#,# %]* *ID 1632*

Actual torque in % of motor nominal torque.

V1.20 *Speed Ctrl Out* *[#,# %]* *ID 1633*

Torque reference from speed controller output.

V1.21 *RampDownDistance* *[#,## m]* *ID 1634*

Ramp down distance from full speed to levelling speed.

V1.21 *PolePairNumber* *[-]* *ID 1651*

Pole pair number calculated by motor control. If the value differs from motor name plate value check the motor nominal frequency and nominal speed.

V1.23 *Motor temperature* *[#,# %]* *ID 9*

Calculated motor temperature
105% is tripping limit if response is fault.

5.2 Monitoring values 2

V1.25.1 *ABS Encoder Position* *ID 54*

Absolute encoder position within one rotation. See encoder manual for scaling.

- V1.25.2 ABS Encoder Revolutions ID 55**
Absolute encoder revolution information.
- V1.25.3 Step response Hz ID 1132**
Frequency error. Compares ramp output to actual encoder frequency with 0.001 Hz accuracy. Can be used for speed control tuning in closed loop control.
- V1.25.4 AI Torque reference [#,#%]ID 1779**
Scaled torque reference from analogue input.
- V1.25.5 Torque reference [#,#%]ID 1780**
Torque reference to motor control. Value is ramped up after run request.
- V1.25.6 Distance decelerated [#,### m] ID 1888**
Distance decelerated during previous trip. Application is counting value after ramped frequency is first time going down within trip.
- V1.25.7 Current A ID 1113**
Unfiltered motor current, recommended signal for NCDrive monitoring.
- V1.25.8 Torque % ID 1125**
Unfiltered motor torque.
- V1.25.9 DC Voltage V ID 44**
Unfiltered DC link voltage.
- V1.25.10 Shaft Angle [###,# deg] ID 1169**
Angle information from incremental encoder. The value is reset when 24 Vdc is removed from the drive.
- V1.25.11 Shaft Rounds ID 1170**
Rounds information from incremental encoder. The value is reset when 24 Vdc is removed from the drive.

V1.25.12 MC Status ID 64

MC Status word combines different motor control statuses to one data word.

Motor Control Status Word ID64		
	FALSE	TRUE
b0	Not in Ready state	Ready
b1	Not Running	Running
b2	Direction Clockwise	Counterclockwise
b3	No Fault	Fault
b4	No Warning	Warning
b5		At reference speed
b6		At Zero Speed
b7		Flux Ready
b8		TC Speed Limiter Active
b9	Encoder Direction	Counterclockwise
b10		Under Voltage Fast stop
b11	No DC brake	DC Brake is active
b12		
b13		Restart delay active
b14		
b15		

V1.25.13 Application Status Word ID 43

Application Status Word combines different drive statuses to one data word.
Recommended signal for NCDrive monitoring.

Application Status Word ID43		
	FALSE	TRUE
b0	Flux not ready	Flux ready (>90 %)
b1	Not in Ready state	Ready
b2	Not Running	Running
b3	No Fault	Fault
b4	Direction Forward	Direction Reverse
b5		At Zero speed
b6	Run Disabled	Run Enable
b7	No Warning	Warning
b8		
b9		
b10	Coasting stop command inactive	Coasting stop command active
b11	No DC Brake	DC Brake is active
b12	No Run Request	Run Request
b13	No Limit Controls Active	Limit control Active
b14	Mechanical brake Closed	Mechanical Brake Open
b15	External Brake supervision signal OFF	External Brake supervision signal ON

V1.25.14 Regulator Status ID 77

Regulator status ID43		
b0	Motoring Current Regulator Status	
b1	Generator Current Regulator Status	
b2	Motoring Torque Regulator Status	For CL monitor B0
b3	Generator Torque Regulator Status	For CL monitor B1
b4	Over Voltage Regulator Status	DC Voltage
b5	Under Voltage Regulator Status	DC Voltage
b6		
b7		
b8		
b9		
b10		
b11		
b12		
b13		
b14		
b15		

V1.25.15 Identfail ID 98



Failure code for failed identification:

- 1 = ID_FAIL_OFFSET
- 2 = ID_FAIL_CURRENT_LEVEL
- 3 = ID_FAIL_ACCEL_TIME
- 4 = ID_FAIL_AT_LIMIT
- 5 = ID_FAIL_MAGN_CURR_LEVEL
- 6 = ID_FAIL_FLUX_CURVE_LEVEL
- 7 = ID_FAIL_PMSM_ENCODER_ZERO_POS
- 8 = ID_FAIL_FREQ_LIM_ERROR
- 9 = ID_FAIL_PMSM_ENCODER_ZERO_PULSE
- 10 = ID_FAIL_LS_IDENT_TIMEOUT
- 11 = ID_FAIL_LS_IDENT_CURRENT

6. NXP LIFT APPLICATION – PARAMETER LISTS

On the next pages, you will find the lists of parameters within the respective parameter groups. Each parameter includes a link to the respective parameter description. The parameter descriptions are given on pages 35 to 104.

Column explanations:

Code	=	Location indication on the keypad; Shows the operator the present parameter number
Parameter	=	Name of parameter
Min	=	Minimum value of parameter
Max	=	Maximum value of parameter
Unit	=	Unit of parameter value; Given if available
Default	=	Value preset by factory
Cust	=	Customer's own setting
ID	=	ID number of the parameter (used with PC tools)
	=	Apply the Terminal to Function method (TTF) to these parameters. See Chapter 4.
	=	On parameter code: Parameter value can only be changed after the AC drive has been stopped.

6.1 Basic Parameters (Control keypad: Menu M2 → G2.1)

Code	Parameter	Min	Max	Unit	Default	Cust	ID	Note
P2.1.1	Motor nominal voltage	20	690	V	NX2: 230V NX5: 400V NX6: 690V		110	Check the rating plate of the motor. Note also the used connection Delta/Star
P2.1.2	Motor nominal frequency	4.00	320.00	Hz	50.00		111	Check the rating plate of the motor
P2.1.3	Motor nominal speed	5	20 000	rpm	1440		112	The default applies for a 4-pole motor and a nominal size AC drive.
P2.1.4	Motor nominal current	0.1 x I _H	2 x I _H	A	I _H		113	Check the rating plate of the motor.
P2.1.5	Motor cosφ	0.30	1.00		0.85		120	Check the rating plate of the motor
P2.1.6	Current limit	0.1 x I _H	2 x I _H	A	I _L		107	Maximum motor current from the drive.
P2.1.7	Magnetizing current	0.00	100.00	A	0.00		612	0.00 A = Drive uses estimated value from motor name plate values
P2.18	Identification	0	4		0		631	0=No action 1=Identification w/o run 2=Identification with run 3=Encoder ID Run NOTE: Set motor control mode to Freq Control before identification!
P2.1.9	Motor type	0	1		0		1650	0=Induction Motor 1=PMS Motor Setting of motor type leads to changes in other parameters.

Table 6-1 Basic parameters G2.1

6.2 Speed Profile Parameters (Control keypad: Menu M2 → G2.2)

Code	Parameter	Min	Max	Unit	Default	Cust	ID	Note
P2.2.1	Nominal Linear Speed	0.20	5.00	m/s	1.00		1500	Lift Speed in m/s with motor nominal frequency
P2.2.2	Speed Reference Selection	0	6	s			117	0=Activity Reference 1=Activ ref. with direction 2=Binary reference 3=A11 (Voltage input) 4=A12 (Current input) 5=Fieldbus 6=Keypad
P2.2.3	Enable jerks	0	1		1		1549	0=Disabled 1=Enabled
P2.2.4	Reference hold time	0.00	5.00	s			1509	Half floor ride function
P2.2.5	Stop State (DIN456)	0	1				1614	0=Normal operation 1=Stop if DIN456 are OFF
P2.2.6	StopDistance 1	0	5.000	m			1777	Distance from full speed to levelling speed. Adjusting this parameter affects automatically to Deceleration time
P2.2.7	StopDistance 2	0	5.000	m			1776	Distance from levelling speed to zero. Adjusting this parameter affects automatically to DecIncJerk 2 and DecDecJerk 2
P2.2.8	Internal Ramp Switch	0	P2.1.2	Hz	0		1544	0 = Not in use This parameter defines frequency level during stopping that after speed curve2 dynamics are taken into use.
P2.2.9.x	SPEED REFERENCE [m/s]							
P2.2.9.1	Levelling Speed	0.00	P2.2.1	m/s	0.10		1501	Parameters correspond to parameters in group 2.2.10. They will be updated automatically if parameters are changed. These parameters are also updated when P2.2.1 is changed.
P2.2.9.2	Full Speed	0.00	P2.2.1	m/s	1.00		1502	
P2.2.9.3	Limited Speed	0.00	P2.2.1	m/s	0.25		1503	
P2.2.9.4	Inspection Speed	0.00	1.5xP2.2.1	m/s	0.50		1504	
P2.2.9.5	Speed Reference 4	0.00	P2.2.1	m/s	0.10		1505	
P2.2.9.6	Speed Reference 5	0.00	P2.2.1	m/s	1.00		1506	
P2.2.9.7	Speed Reference 6	0.00	P2.2.1	m/s	0.25		1507	
P2.2.9.8	Speed Reference 7	0.00	P2.2.1	m/s	0.50		1508	
P2.2.9.9	Override speed	0.00	1,5xP2.2.1	m/s	0.50		1613	
P2.2.10.x	SPEED REFERENCE [Hz]							
P2.2.10.1	Levelling Speed	0.00	par2.1.2	Hz	5.00		1604	Parameters correspond to parameters in group 2.2.9. They will be updated automatically if parameters are changed.
P2.2.10.2	Full Speed	0.00	par2.1.2	Hz	50.00		1605	
P2.2.10.3	Limited Speed	0.00	par2.1.2	Hz	12.50		1606	
P2.2.10.4	Inspection Speed	0.00	1.5xP2.1.2	Hz	25.00		1607	
P2.2.10.5	Speed Reference 4	0.00	par2.1.2	Hz	5.00		1608	
P2.2.10.6	Speed Reference 5	0.00	par2.1.2	Hz	50.00		1609	
P2.2.10.7	Speed Reference 6	0.00	par2.1.2	Hz	12.50		1610	
P2.2.10.8	Speed Reference 7	0.00	par2.1.2	Hz	25.00		1611	
P2.2.10.9	Override speed	0.00	1.5xP2.1.2	Hz	5.00		1612	
P2.2.11.x	SPEED CURVE 1							
P2.2.11.1	Acceleration	0.20	2.00	m/s ²	0.70		103	
P2.2.11.2	Deceleration	0.20	2.00	m/s ²	0.70		104	
P2.2.11.3	Acceleration increase jerk 1	0.01	3.00	s	0.50		1540	

P2.2.11.4	Acceleration Decrease jerk 1	0.01	3.00	s	0.25		1541	
P2.2.11.5	Deceleration increase jerk 1	0.01	3.00	s	0.25		1542	
P2.2.11.6	Deceleration decrease jerk 1	0.01	3.00	s	0.50		1543	
P2.2.12.x	SPEED CURVE 2							
P2.2.12.1	Acceleration 2	0.20	2.00	m/s ²	0.20		502	
P2.2.12.2	Deceleration 2	0.20	2.00	m/s ²	0.20		503	
P2.2.12.3	Acceleration increase jerk 2	0.01	3.00	s	0.50		1545	
P2.2.12.4	Acceleration decrease jerk 2	0.01	3.00	s	0.50		1546	
P2.2.12.5	Deceleration increase jerk2	0.01	3.00	s	0.50		1547	
P2.2.12.6	Deceleration decrease jerk 2	0.01	3.00	s	0.50		1548	

Table 6-2: Speed profile parameters G2.2

6.3 Mechanical Brake Control Parameters (Control keypad: Menu M2 → G2.3)

Code	Parameter	Min	Max	Unit	Default	Cust	ID	Note
P2.3.1.x	OPEN LOOP							
P2.3.1.1	Current limit	0	P2.1.4	A	0.2 x I _n		1551	Value is changed when parameter 2.1.4 Motor Nom Current is set.
P2.3.1.2	Torque limit	0.0	100.0	%	0.0		1552	
P2.3.1.3	Freq. limit open	0.00	P2.1.2	Hz	0.00		1553	
P2.3.1.4	Brake open delay	0.00	10.00	s	0.00		1554	Brake open delay in open loop
P2.3.1.5	Freq. limit close	0.01	P2.1.2	Hz	1.00		1555	
P2.3.1.6	Brake close delay	0.00	10.00	s	0.00		1556	Break open delay in open loop
P2.3.1.7	Max. frequency brake closed	0.00	1.5 x P2.1.2	Hz	2.00		1557	
P2.3.1.8	Mechanical brake reaction time	0.00	10.00	s	0.30		1558	
P2.3.1.9	DC braking current	0.1 x I _n	1.5 x I _n	A	Varies		507	
P2.3.1.10	DC braking time at start	0.000	60.000	s	0.500		1559	0=DC brake is off at start
P2.3.1.11	DC braking time at stop	0.000	60.000	s	1.000		1560	0=DC brake is off at stop
P2.3.1.12	Frequency to start DC braking during ramp stop	0.10	10.00	Hz	0.50		515	Dc-brake is allowed under this frequency limit
P2.3.1.13	Close delay EStop	0.00	30.00	s	0.00		1640	
P2.3.1.14	Run request closing	0	1		1		1641	0= Inactive 1= Active
P2.3.2.x	CLOSED LOOP							
P2.3.2.1	Current limit	0	P2.1.4	A	0.2 x I _n		1561	Value is changed when parameter 2.1.4 Motor Nom Current or 2.1.9 Motor Type is set.
P2.3.2.2	Torque limit	0	100.0	%	0		1562	
P2.3.2.3	Frequency limit	0	P2.1.2	Hz	0.00		1563	
P2.3.2.4	Brake open delay	0	10.00	s	0.00		1564	Break Opening Delay in close loop 100=1.00s
P2.3.2.5	Frequency limit close	0	P2.1.2	Hz	0.01		1565	
P2.3.2.6	Brake close delay	0	10.00	s	0.00		1566	Break Closing Delay in close loop 100=1.00s
P2.3.2.7	Max. frequency brake closed	0	75.00	Hz	0.10		1577	
P2.3.2.8	Mechanical brake reaction time	0	10.00	s	0.30		1558	Same parameter as in Open loop
P2.3.2.9	0Hz time at start	0	2.000	s	0.800		615	
P2.3.2.10	0Hz time at stop	0	2.000	s	0.600		616	
P2.3.2.11	Smooth start time	0	10.00	s	0.10		1568	
P2.3.2.12	Smooth start freq.	0	10.00	Hz	0.00		1569	
P2.3.2.13	Close delay EStop	0.00	30.00	s	0.00		1640	
P2.3.2.14	Run request closing	0	1		1		1641	0= Inactive 1= Active
P2.3.2.15	Start magnetizing time	0.000	32.000	s	0.150		628	Start magnetizing time, Closed loop control
P2.3.2.16	Start magnetizing current	0.00	I _L	s	0.00		627	Start magnetizing current, Closed loop control
P2.3.3.x	DIGITAL INPUTS							
P2.3.3.1	External brake control	0.1	F.2		0.2		1601	See chapter Programming of I/O.

P2.3.3.2	External brake supervision	0.1	F.2		0.1		1602	
P2.3.3.3	External brake supervision2	0.1	F.2		0.1		1838	
P2.3.4.x	BRAKE SUPERVISION							
P2.3.4.1	External brake supervision time	0.00	5.00	s	2.00		1603	
P2.3.4.2	Inverted external brake supervision	0	1		1		1856	0/ Not Inverted = Brake switches normally opened. 1/ Inverted = Brake switches normally closed.
P2.3.4.3	Supervision fault F55 at start	0	1		0		1857	0= Disabled 1= Enabled

Table 6-3. Mechanical brake control parameters, G2.3

6.4 Drive Control Parameters (Control keypad: Menu M2 → G2.4)

Code	Parameter	Min	Max	Unit	Default	Cust	ID	Note
P2.4.1	Brake chopper	0	4		0		504	0=Not used 1=Used when running 2=Ext. brake chopper 3=Used when stopped/running 4=Run, no test
P2.4.2	Stop function	0	2		2		506	0=Coasting 1=Ramping 2=Stop by Freq. limit
P2.4.3	Frequency limit	0	1.5 x P2.1.2	Hz	5.00		1624	Used only if stop function=2
P2.4.4	Stop distance	0	1.5	m	0.0		1539	0=Not used
P2.4.5	S-curve time	0	1.00	s	0.15		1626	S-curve (jerk) time which is active only when Stop by distance is active
P2.4.6	Scaling factor	0	200	%	70		1625	Scaling factor for ramp time
P2.4.7.x	MOTOR CONTACTOR CONTROL							
P2.4.7.1	Closing time	0.00	2,00	s	0.10		1660	Close delay for motor contactor
P2.4.7.2	Motor Contactor Acknowledgement	0.1	F.2		0.1		1661	Digital feedback signal from motor contactor
P2.4.8.x	ADVANCED (Hidden with advanced conceal)							
P2.4.8.1	Modulator Type	0	3		0		1775	Parameter for changing modulator type 0 = ASIC 1 = Software 1 2 = Software 2 3 = Software 3
P2.4.8.2	Advanced Options 1	0	65535		0		1770	
P2.4.8.3	Advanced Options 2	0	65535		0		1771	
P2.4.8.4	Advanced Options 4	0	65535		0		1772	
P2.4.8.5	Advanced Options 5	0	65535		0		1773	
P2.4.8.6	Advanced Options 6	0	65535		0		1774	

Table 6-4. Drive control parameters, G2.4

6.5 Motor Control Parameters (Control keypad: Menu M2 → G2.5)

Code	Parameter	Min	Max	Unit	Default	Cust	ID	Note
P2.5.1	Motor control mode	0	2		1		1572	0=Frequency control 1=Speed control, (OL) 2=Closed loop
P2.5.2	Switching frequency	1.0	16.0	kHz	Varies		601	Depends on kW
P2.5.3	Overvoltage controller	0	1				607	0=Off 1=On
P2.5.4	Undervoltage controller	0	1		1		608	0=Off 1=On
P2.5.5	Measured Rs Volt Drop	0	10000				662	
P2.5.6	OL SpeedCont ki1	0	10000		300		667	Speed Controller ki1
P2.5.7	OL SpeedCont kp1	0	10000	ms	3000		667	Speed Controller kp1
P2.5.8.x	U/F SETTINGS							
P2.5.8.1	U/f optimisation	0	1		1		1573	0=Not used 1=Automatic torq. boost
P2.5.8.2	U/f ratio selection	0	3		0		1574	0=Linear 1=Squared 2=Programmable 3=Linear with flux optim.
P2.5.8.3	Field weakening point	5.00	320.00	Hz	50.00		602	This parameter is changed if P2.1.2 is reset
P2.5.8.4	Voltage at field weakening point	10.00	200.00	%	100.00		603	$n\% \times U_{n\text{mot}}$
P2.5.8.5	U/f curve midpoint frequency	0.00	P2.5.8.3	Hz	5.00		1575	
P2.5.8.6	U/f curve midpoint voltage	0.00	100.00	%	10.00		1576	$n\% \times U_{n\text{mot}}$
P2.5.8.7	Output voltage at zero frequency	0.00	40.00	%	1.30		1577	$n\% \times U_{n\text{mot}}$
P2.5.9.x	CLOSED LOOP							
P2.5.9.1	Speed control limit 1	0	Par. 2.5.9.2		5.00		1618	
P2.5.9.2	Speed control limit 2	Par. 2.5.9.1	0.01Hz		10.00		1619	
P2.5.9.3	Speed control Kp 1	0	1000		30		1620	Speed controller p-gain
P2.5.9.4	Speed control Kp 2	0	1000		30		1621	Speed controller p-gain
P2.5.9.5	Speed control Ti 1	0	500	ms	30.0		1622	Speed controller integrator time constant
P2.5.9.6	Speed control Ti 2	0	500	ms	30.0		1623	Speed controller integrator time constant
P2.5.9.7	Current control Kp	0	100		40.00		617	Current controller p-gain
P2.5.9.8	Current control Ti	0	1000	ms	1.5		1627	Current controller integrator time constant
P2.5.9.9	Encoder 1 filter time	0	100.0	ms	3.0		618	Filter time for actual speed
P2.5.9.10	Slip adjust	0	500	%	70		619	
P2.5.9.11	Torque ramp time	0	1.0	s	0.2		1760	Torque ramp time in start and stop. Used in start if torque reference is used.
P2.5.9.12	Torque reference selection	0	2		0		621	0 = Not used 1 = Torque memory 2 = Torque reference from AI1 or AI2

P2.5.9.13	AI Torque reference	0	1		1		641	Selection of torque reference from AI1 or AI2
P2.5.9.14	Torque reference scaling minimum value	-300.00	300.0	%	0.00		643	Selects the torque that corresponds to the min. reference signal
P2.5.9.15	Torque reference scaling maximum value	-300.00	300.0	%	0.00		642	Selects the torque that corresponds to the max. reference signal
P2.5.9.16	Torque reference add delay	0.0	10.0	s	0.2		1778	Delay from runrequest to adding of torque reference.
P2.5.9.17	ShowAdvancedPar	0	1		0		1969	For fine tuning purposes
P2.5.9.18.x	ROLLBACK							
P2.5.9.18.1	Rollback Controller	0	1		1		1687	0=disabled 1=enabled
P2.5.9.18.2	Rollback Gain	0	32767		2500		1689	RollBack control Gain
P2.5.9.18.3	Rollback control pretorque	0.0	100.0	%	0.1		1691	The initial torque level of the roll back prevention controller after the activation 1000 = 100.0%
P2.5.9.18.4	Rollback control wakeup level	0.01	10.0		3.0		1690	Number of encoder pulses to activate rollback control. Encoder interpolation is needed to activate if values < 1 are used.
P2.5.10.x	PERMANENT MAGNET MOTOR							
P2.5.10.1	PMSM ShaftPosi	0	65565		0		1670	
P2.5.10.2	StartAngle IDmode	0	3		0		1933	0=Automatic 1=ForceAlways 2=AfterPowerUp 3=Defined by digin
P2.5.10.3	StartAngleIDCurr	0	100	%	0.0		1938	Shaft angle identification current level 1000 = 100.0% of motor nominal
P2.5.10.4	Polarity Pulse Current	-10.0	200.0	%	0.0		1800	
P2.5.10.5	Encoder identification mode	0	1		1		1686	0=Identification with DC 1=Automatic Pulse Identification
P2.5.10.6	EnableRsIdentifi	0	1		1		654	0=No 1=Yes
P2.5.10.7	ModIndexLimit	0	200	%	100		655	
P2.5.10.8	Curr 5th amplit	0.0	100.0	%			1868	
P2.5.10.9	Curr 5th phase	0.0	360.0	°			1867	
P2.5.10.10	Lsd Voltage Drop	-32000	32000		0		1757	D-axis reactance voltage drop 2560 = 100%.
P2.5.10.11	Lsq Voltage Drop	-32000	32000		0		1758	Q-axis reactance voltage drop 2560 = 100%.
P2.5.10.12	Flux Current Kp	0	32000		500		651	
P2.5.10.13	Flux Current Ti	0.0	100.0	ms	5.0		652	
P2.5.10.14	External Id Reference	-150.0	150.0	%	0.0		1730	
P2.5.10.15	IdRefAtZeroSpeed	0	150.0	%	0.0		1805	
P2.5.10.16	IdRefMaxFreq	0	P2.1.2	%	0.00		1806	

Table 6-5. Motor control parameters, G2.5

6.6 Stabilators (Control keypad: Menu M2 → G2.5.11)

Code	Parameter	Min	Max	Unit	Default	Cust	ID	Note
P2.5.11.1	Torque Stabilator Damping	0	1000		800		1413	Damping rate of torque stabilizer. Initialized to 980 if PM motor is selected.
P2.5.11.2	Torque Stabilator Gain	0	1000		100		1412	Gain of torque stabilizer.
P2.5.11.3	Torque Stabilator Gain in FWP	0	1000		50		1414	Gain of torque stabilizer at field weakening point.
P2.5.11.4	Torque Stabilator Limit	0	1500		150		1600	Limit of torque stabilator output limit.
P2.5.11.5	Flux Circle Stabilator Gain	0	32767		10000		1550	Gain for flux circle stabilizer.
P2.5.11.6	Flux Stabilator Gain	0	32000		500		1797	Gain of flux stabilizer.
P2.5.11.7	Flux Circle Stabilator TC	0	32700		900		1699	Filter coefficient of id-current stabilizer.
P2.5.11.8	Voltage Stabilator TC	0	1000		900		1698	Damping rate of voltage stabilizer.
P2.5.11.9	Voltage Stabilator Gain	0	100.0	%	10.0		1697	Gain of voltage stabilizer.
P2.5.11.10	Voltage Stabilator Limit	0	320.00	Hz	1.50		1696	Limit of voltage stabilator output limit.

Table 6-6. Stabilisators, G2.5.11

6.7 Identified Parameters (Control keypad: Menu M2 → G2.5.12.x)

Parameters are updated when the automatic motor identification is done. The identification is activated by setting the parameter P2.1.8 and by giving the start command within 20 seconds after the parameter setting. It is also possible to change these parameters manually but then a very good knowledge in motor tuning is required.

Since these values are parameters, it is possible to save them and copy to another drive.

Code	Parameter	Min	Max	Unit	Default	Cust	ID	Note
P2.5.12.1	Flux 10 %	0	2500	%	10		1355	
P2.5.12.2	Flux 20 %	0	2500	%	20		1356	
P2.5.12.3	Flux 30 %	0	2500	%	30		1357	
P2.5.12.4	Flux 40 %	0	2500	%	40		1358	
P2.5.12.5	Flux 50 %	0	2500	%	50		1359	
P2.5.12.6	Flux 60 %	0	2500	%	60		1360	
P2.5.12.7	Flux 70 %	0	2500	%	70		1361	
P2.5.12.8	Flux 80 %	0	2500	%	80		1362	
P2.5.12.9	Flux 90 %	0	2500	%	90		1363	
P2.5.12.10	Flux 100 %	0	2500	%	100		1364	
P2.5.12.11	Flux 110 %	0	2500	%	110		1365	
P2.5.12.12	Flux 120 %	0	2500	%	120		1366	
P2.5.12.13	Flux 130 %	0	2500	%	130		1367	
P2.5.12.14	Flux 140 %	0	2500	%	140		1368	
P2.5.12.15	Flux 150 %	0	2500	%	150		1369	
P2.5.12.16	Rs voltage drop	0	30000		Varies		662	Used for torque calculation in open loop
P2.5.12.17	Ir add zero point voltage	0	30000		Varies		664	
P2.5.12.18	Ir add generator scale	0	30000		Varies		665	
P2.5.12.19	Ir add motoring scale	0	30000		Varies		667	
P2.5.12.20	Ls Voltage Dropp	0	3000		0		673	
P2.5.12.21	Motor BEM Voltage	0,00	320.00	%	0		674	
P2.5.12.22	Iu Offset	-32000	32000		0		668	
P2.5.12.23	Iv Offset	-32000	32000		0		669	
P2.5.12.24	Iw Offset	-32000	32000		0		670	

Table 6-7. Identified parameters, G2.5.12

6.8 Input Signals (Control keypad: Menu M2 → G2.6)

Code	Parameter	Min	Max	Unit	Default	Cust	ID	Note	
P2.6.1	Start/Stop logic	0	2		0		300	0	DIN1
								1	Start fwdP
								2	Start rvsP
DIGITAL INPUTS									
P2.6.2.1	External Fault, closing contact	0.1	F.2	SlotX.Y	0.1		1513	See chapter Programming of I/O on page 9.	
P2.6.2.2	External fault, opening contact	0.1	F.2	SlotX.Y	0.2		1514		
P2.6.2.3	Fault reset	0.1	F.2	SlotX.Y	A.3		1515		
P2.6.2.4	Run enable	0.1	F.2	SlotX.Y	0.2		1516		
P2.6.2.5	Acceleration/Decel time selection	0.1	F.2	SlotX.Y	0.1		1517		

P2.6.2.6	Stop by coast, closing contact	0.1	F.2	SlotX.Y	0.1		1518	
P2.6.2.7	Stop by coast, opening contact	0.1	F.2	SlotX.Y	0.2		1519	
P2.6.2.8	Override speed	0.1	F.2	SlotX.Y	0.1		1520	
P2.6.2.9	Forced I/O control	0.1	F.2	SlotX.Y	0.1		1521	
P2.6.2.10	Speed selection input 1	0.1	F.2	SlotX.Y	A.4		1521	
P2.6.2.11	Speed selection input 2	0.1	F.2	SlotX.Y	A.5		1522	
P2.6.2.12	Speed selection input 3	0.1	F.2	SlotX.Y	A.6		1523	
P2.6.2.13	AngleIdRepeat	0.1	F.2	SlotX.Y	0.1		1934	
P2.6.2.14	DIN1 Ton delay	0,0	1,0	s	0.0		1833	
P2.6.2.15	DIN2 Ton delay	0,0	1,0	s	0.0		1834	
P2.6.3.x	ANALOG INPUTS							
P2.6.3.1.x	ANALOG INPUT1							
P2.6.3.1.1	AI1 Signal selection	0.1	F.2	SlotX.Y	A.1		377	Connect the AI signal to the analogue input of your choice with this parameter.
P2.6.3.1.2	AI1 Current reference offset	0	2		1		302	0=No offset 1=4—20 mA 2=Custom range
P2.6.3.1.3	AI1 Reference scaling minimum value	0.00	320.00	Hz	0.00		303	Selects the frequency that corresponds to the min. reference signal 0.00 = No scaling
P2.6.3.1.4	AI1 Reference scaling maximum value	0.00	320.00	Hz	0.00		304	Selects the frequency that corresponds to the max. reference signal 0.00 = No scaling
P2.6.3.1.5	AI1 Reference inversion	0	1		0		305	0=Not inverted 1=Ref inverted
P2.6.3.1.6	AI1 Reference filter time	0.00	10.00	s	0.10		306	0=No filtering
P2.6.3.1.7	AI Custom min	-160.00	160.00	%	0.00		380	Custom Range: Minimum input
P2.6.3.1.8	AI Custom max	-160.00	160.00	%	0.00		381	Custom Range: Maximum input
P2.6.3.2.x	ANALOG INPUT2							
P2.6.3.2.1	AI2 Signal selection	0.1	F.2	SlotX.Y	A.2		388	Connect the AI signal to the analogue input of your choice with this parameter.
P2.6.3.2.2	AI2 Current reference offset	0	2		1		390	0=No offset 1=4—20 mA 2=Custom range
P2.6.3.2.3	AI2 Reference scaling minimum value	0.00	320.00	Hz	0.00		393	Selects the frequency that corresponds to the min. reference signal 0.00 = No scaling
P2.6.3.2.4	AI2 Reference scaling maximum value	0.00	320.00	Hz	0.00		394	Selects the frequency that corresponds to the max. reference signal 0.00 = No scaling
P2.6.3.2.5	AI2 Reference inversion	0	1		0		398	0=Not inverted 1=Ref inverted
P2.6.3.2.6	AI2 Reference filter time	0.00	10.00	s	0.10		389	0=No filtering
P2.6.3.2.7	A2 Custom min	-160.00	160.00	%	0.00		391	Custom Range:

								Minimum input
P2.6.3.2.8	A2 Custom max	-160.00	160.00	%	0.00		392	Custom Range: Maximum input

Table 6-8. Input signals, G2.6

6.9 Output Signals (Control keypad: Menu M2 → G2.7)

Code	Parameter	Min	Max	Unit	Default	Cust	ID	Note
P2.7.1.x	ANALOG OUTPUTS							
P2.7.1.1	Analogue output function	0	8		1		307	0=Not used 1=Output freq. (0– f_{max}) 2=Freq. reference (0– f_{max}) 3=Motor speed (0–Motor nominal speed) 4=Output current (0– I_{nMotor}) 5=Motor torque (0– T_{nMotor}) 6=Motor power (0– P_{nMotor}) 7=Motor voltage (0– U_{nMotor}) 8=DC-link volt (0–1000V)
P2.7.1.2	Analogue output filter time	0.00	10.00	s	1.00		308	
P2.7.1.3	Analogue output inversion	0	1		0		309	0=Not inverted 1=Inverted
P2.7.1.4	Analogue output minimum	0	1		0		310	0=0 mA 1=4 mA
P2.7.1.5	Anal. output scale	10	1000	%	100		311	
P2.7.2.x	DIGITAL OUTPUTS							
P2.7.2.1	Digital output 1 function	0	22		3		312	0=Not used 1=Ready 2=Run 3=Fault 4=Fault inverted 5=FC overheat warning 6=Ext. fault or warning 7=Ref. fault or warning 8=Warning 9=Reversed 10=Preset speed 11=At speed 12=Mot. regulator active 13=OP freq. limit superv. 14=Control place: IO 15=ThermalFlt/Wrn 16=FB DigInput1 17=Speed below limit 18=Torque above limit 19=Mech. brake ctrl 20=Mech. brake ctrl inv. 21=Motor contactor ctrl 22=DTF InFloor
P2.7.2.2	Digital output function 1 inverted	0	1		0		1530	0=No inversion 1=Inverted
P2.7.2.3	Digital output 1 ON delay	0	10.00	s	0.00		1531	Delay content of DO1. 0.00= Delay not in used
P2.7.2.4	Digital output 1 OFF Delay	0	10.00	s	0.00		1657	Delay content of DO1. 0.00= Delay not in used
P2.7.2.5	Relay output 1 function	0	22		0		313	As digital output function
P2.7.2.6	Relay output 1 function inverted	0	1		0		1532	0=No inversion 1=Inverted

P2.7.2.7	Relay output 1 ON delay	0	10.00	s	0.00		1533	Delay content of RO1. 0.00= Delay not in used
P2.7.2.8	Relay output 1 OFF Delay	0	10.00	s	0.00		1658	Delay content of RO1. 0.00= Delay not in used
P2.7.2.9	Relay output 2 function	0	22		19		314	As digital output function
P2.7.2.10	Relay output 2 function inverted	0	1		0		1534	0=No inversion 1=Inverted
P2.7.3.x	SUPERVISION LIMITS							
P2.7.3.1	Speed supervision limit	0.00	5.00	m/s	0.15		1535	
P2.7.3.2	Motoring torque supervision	0	200.0	%	150.0		1536	
P2.7.3.3	Generating torque supervision	-200	0	%	0.0		1537	If set to 0 then motoring torque supervision defines the limits for motoring and generating modes
P2.7.3.4	Output frequency limit 1 supervision	0	2		0		315	0=No limit 1=Low limit supervision 2=High limit supervision
P2.7.3.5	Output frequency limit 1; Supervised value	0.00	1.5 x P2.1.2	Hz	0.00		316	
P2.7.4.x	EXPANSION RELAYS (not included with standard delivery)							
P2.7.4.1	ROE1 Selection	0	F.2		0.1		1680	See page 4.
P2.7.4.2	ROE1 Function	0	21		0		1681	As digital output function
P2.7.4.3	ROE1 Inversion	0	1		0		1682	0=No inversion 1=Inverted
P2.7.4.4	ROE2 Selection	0	F.2		0.1		1683	See page 4.
P2.7.4.5	ROE2 Function	0	21		0		1684	As digital output function
P2.7.4.6	ROE2 Inversion	0	1		0		1685	0=No inversion 1=Inverted

Table 6-9. Output signals, G2.7

Protections (Control keypad: Menu M2 → G2.8)

Code	Parameter	Min	Max	Unit	Default	Cust	ID	Note
P2.8.1.x	I/O FAULTS							
P2.8.1.1	Response to reference fault	0	5		0		700	0=No response 1=Warning 2=Warning+Old Freq. 3=Wrng+PresetFreq 2.8.1.2 4=Fault,stop acc. To 2.4.2 5=Fault,stop by coasting
P2.8.1.2	Reference fault frequency	0.00	1.5 x P2.1.2	Hz	0.00		728	
P2.8.1.3	Response to ext. fault	0	3		2		701	
P2.8.2.x	GENERAL FAULTS							
P2.8.2.1	Input phase supervision	0	3		0		730	0=No response 1=Warning 2=Fault,stop acc. To 2.4.2 3=Fault,stop by coasting
P2.8.2.2	Response to undervoltage fault	1	3		2		727	
P2.8.2.3	Output phase supervision	0	3		2		702	
P2.8.2.4	Earth fault protection	0	3		2		703	
P2.8.2.5	Response to fieldbus fault	0	3		2		733	
P2.8.2.6	Response to slot fault	0	3		2		734	
P2.8.2.7	SystemOverloadLi	0	100	%	98		1850	
P2.8.2.8	OutPhFaultDelay	0.10	2.00	s	2.00		1821	Delay time for output phase fault
P2.8.2.9	OutPhFaultCurLim	1.0	50.0	%	2.5		1822	Output phase supervision is active when the motor current exceeds this level x I _H
P2.8.3.x	MOTOR FAULTS							
P2.8.3.1	Thermal protection of the motor	0	3		2		704	0=No response 1=Warning 2=Fault,stop acc. To 2.4.2 3=Fault,stop by coasting
P2.8.3.2	Motor ambient temperature factor	-100.0	100.0	%	0.0		705	Ambient temperature factor
P2.8.3.3	Motor cooling factor at zero speed	0.0	150.0	%	40.0		706	Motor cooling ability at zero speed unit
P2.8.3.4	Motor thermal time constant	1	200	min	45		707	Motor Thermal Time Constant in minutes
P2.8.3.5	Motor duty cycle	0	100	%	100		708	
P2.8.3.6	Stall protection	0	3		0		709	0=No response 1=Warning 2=Fault,stop acc. To 2.4.2 3=Fault,stop by coasting
P2.8.3.7	Stall current	0.01	2 x P2.1.4	A	1,3 x P2.1.4		710	When I _n is changed, these values will be reset
P2.8.3.8	Stall time limit	1.00	120.00	s	15.00		711	Max time for stall in
P2.8.3.9	Stall frequency limit	1.0	1.5 x P2.1.2	Hz	25.0		712	Max frequency for stall protection
P2.8.3.10	Response to thermistor fault	0	3		0		732	0=No response 1=Warning 2=Fault,stop acc. To 2.4.2 3=Fault,stop by coasting
P2.8.4.x	LIFT SUPERVISION							
P2.8.4.1	External brake control fault	0	2		0		1580	0=No action 1=Warning 2=Fault

Code	Parameter	Min	Max	Unit	Default	Cust	ID	Note
P2.8.4.2	Shaft speed fault	0	2		0/AM 2/PMSM		1581	0=No action 1=Warning 2=Fault
P2.8.4.3	Shaft speed supervision time	0.00	5.00	Hz	0.40		1582	Shaft Speed supervision time
P2.8.4.4	Shaft speed superv. Limit[m/s]	0	P2.2.1	m/s	0.30		1583	Same parameters with different units
P2.8.4.5	Shaft speed superv. Limit [Hz]	0.00	1.5 x P2.1.2	Hz	15.00		1584	
P2.8.4.6	Overtorque protection	0	2		0		1585	0=No action 1=Warning 2=Fault
P2.8.4.7	Torque superv. Time	0	5.00	s	0.00		1586	
P2.8.4.8	Response to control conflict	0	2		2		1587	0=No action 1=Warning 2=Fault
P2.8.4.9	Min. current limit	0	P2.1.4	A	0.00		1588	0=No action
P2.8.4.10	0 Hz speed response	0	3		0		1589	0=Not used 1=Warning 2=Warning+Stop 3=Fault

Table 6-10. Protections, G2.8

6.10 Autorestart Parameters (Control keypad: Menu M2 → G2.9)

Code	Parameter	Min	Max	Unit	Default	Cust	ID	Note
P2.9.1	Wait time	0.10	10.00	s	0.50		717	
P2.9.2	Trial time	0.00	60.00	s	30.00		718	
P2.9.3	Start function	0	2		0		719	0=Ramping 1=Flying Start 2=System Def.
P2.9.4	Number of tries after undervoltage trip	0	10	x	0		720	
P2.9.5	Number of tries after overvoltage trip	0	10	x	0		721	
P2.9.6	Number of tries after overcurrent trip	0	3	x	0		722	
P2.9.7	Number of tries after reference trip	0	10	x	0		723	
P2.9.8	Number of tries after motor temperature fault trip	0	10	x	0		726	
P2.9.9	Number of tries after external fault trip	0	10	x	0		725	
P2.9.10	Number of tries after input phase supervision trip	0	10	x	0		1659	

Table 6-11. Autorestart parameters, G2.9

6.11 Evacuation Parameters (Control keypad: Menu M2 → G2.10)

Code	Parameter	Min	Max	Unit	Default	Cust	ID	Note
P2.10.1	Evacuation mode	0	2	2	0		1590	0=Not used 1=Manual 2=Automatic
P2.10.2	Evacuation input	0.1	F.2		0.1		1591	See chapter Programming of I/O on page 9.
P2.10.3	Voltage select	0	1		0		1920	0=500V 1=230V
P2.10.4	Motor control mode	0	2		0		1592	0=Frequency control 1=Speed control 2=Closed loop
P2.10.5	Direction change delay	0	20.00	s	5.00		1593	Test Function change delay
P2.10.6	Test time fw/bw	0	20.00	s	3.00		1594	Testing time value
P2.10.7	Current read delay	0	P2.10.5	s	1.50		1595	Testing time value when evacuation mode is ON
P2.10.8	U/f optimization	0	1		0		1596	0=Not used 1=Automatic torque boost
P2.10.9	U/f-curve middle point frequency	0.00	P2.1.2	Hz	5.00		1597	Programmable U/F curve middle point
P2.10.10	U/f-curve middle point voltage	0.00	100.00	%	10.00		1598	Motor voltage at programmable U/F curve middle point
P2.10.11	Output voltage at zero frequency	0.00	40.00	%	1.30		1599	Motor voltage at programmable U/F curve zero point
P2.10.12	DC-brake current	0.00	6.00	A	P2.1.4		1663	DC brake current in evacuation mode (max 5.6 A)
P2.10.13	Start DC-brake time	0.000	60.000	s	0.500		1664	DC brake time at start in evacuation mode
P2.10.14.x	MAX SPEED IN EVACUATION							
P2.10.14.1	Max speed in evacuation [m/s]	0	P2.2.1	m/s	0.1		1616	Same parameters with different units. Max value is 40% of nominal value.
P2.10.14.2	Max speed in evacuation [Hz]	0	P2.1.2	Hz	5.00		1617	

Table 6-12. Evacuation parameters, G2.10

6.12 Keypad control (Control keypad: Menu M3)

The parameters for the selection of control place and direction on the keypad are listed below. See the Keypad control menu in the VACON® NXS/P User Manual.

Code	Parameter	Min	Max	Unit	Default	Cust	ID	Note
P3.1	Control place	1	3		2		125	0=PC Control 1=I/O terminal 2=Keypad 3=Fieldbus
R3.2	Keypad reference	P2.1.1	P2.1.2	Hz	0.00			
P3.3	Direction (on keypad)	0	1		0		123	0=Forward 1=Reverse
P3.4	Stop button	0	1		1		114	0=Limited function of Stop button 1=Stop button always enabled
P3.5	Reserved	0	1		0		0	
P3.6	Reserved	0	1		0		0	
P3.7	Reserved	0	1		0		0	
P3.8	Reserved	0	1		0		0	
P3.9	Reserved	0	1		0		0	
P3.10	Reset brake supervision fault	0	1		0		0	0=Press enter 1=Press reset

Table 6-13. Keypad control parameters, M3

6.13 System menu (Control keypad: Menu M6)

For parameters and functions related to the general use of the AC drive, such as application and language selection, customised parameter sets or information about the hardware and software, see the VACON® NXS/P User Manual.

6.14 Expander boards (Control keypad: Menu M7)

The M7 menu shows the expander and option boards attached to the control board and board-related information. For more information, see the VACON® NXS/P User Manual.

7. DESCRIPTION OF PARAMETERS

7.1 Basic Parameters

P2.1.1 Motor Nominal Voltage ID110 "Motor Nom Voltg"

Find this value U_n on the rating plate of the motor.
This parameters defines nominal voltage at field weakening point.

P2.1.2 Motor Nominal Frequency ID111 "Motor Nom Freq"

Find this value f_n on the rating plate of the motor. This parameter sets the field weakening point to the same value in "G: Motor Control".

Nominal frequency of the motor correspond the nominal lift speed ([parameter 2.2.1](#))

P2.1.3 Motor nominal speed ID112 "Motor Nom Speed"

Find this value n_n on the rating plate of the motor. Note also nominal frequency.

In some cases, the motor nominal speed is shown with one decimal. In this case the practice is to give nearest integer number and adjust the motor nominal frequency so that the drive will calculate the correct PolePairNumber (V 1.22).

P2.1.4 Motor nominal current ID113 "Motor Nom Currnt"

Find this value I_n on the rating plate of the motor. If magnetization current is provided, set also the Magnetization current P2.1.7 before the identification run.

P2.1.5 Motor cos phi ID120 "Motor Cos Phi"

Find this value "cos phi" on the rating plate of the motor.

P2.1.6 Current limit ID107 "Current Limit"

This parameter determines the maximum motor current from the AC drive. To avoid motor overload, set this parameter according to the rated current of the motor. The current limit is 1.5 times the rated current (I_L) by default.

After a power break, the application sets the rated maximum current of the drive to this parameter.

P2.1.7 Magnetizing current ID612 "MagnCurrent"

Set here the motor magnetizing current (no-load current) at 2/3 of motor nominal speed.

When value is zero the magnetization current is calculated from motor nominal parameters

$$\text{Motor Magnetization Current} = \frac{5 * \sin \varphi - 1}{5 - \sin \varphi} * \text{Motor Nominal Current}$$

$$[FW]RotorFlux = \left(\frac{f(MotorNomFreq)}{f(Out)} \right)^2, \text{ when } f(Out) > f(MotorNomFreq)$$

If given before identification run, this is used as reference for U/f tuning when making identification without rotating the motor.

P2.1.8 Identification *ID631 "Identification"*

Identification Run is a part of tuning the motor and the drive specific parameters. It is a tool for commissioning and service of the drive with the aim to find as good parameter values as possible for motors. The automatic motor identification calculates or measures the motor parameters that are needed for optimum motor and speed control.

NOTE: Set motor control mode to Frequency Control before identification.

NOTE: During identification, the drive will not open mechanical brake for safety reasons. If motor rotation requires that brake is opened this needs to be achieved externally.

NOTE: During identification run, the torque and power limits should be above 100%. Also current limit should be above motor nominal current.

NOTE: During identification run, the acceleration time should be below 20 second.

NOTE: If switching frequency is changed after identification, it is recommended to do identification run again.

NOTE: Small motor with long motor cables may require reduction of switching frequency if identification is not successful.

0 = "No Action" No action

No identification requested.

1 = "ID No Run" - Identification without rotating the motor

Current is applied to the motor but shaft will not be rotated. U/f settings are identified. This identification is minimum requirement if motor is only to be used in open loop control. It is however recommended to make always identification with rotating motor if need for closed loop control comes after mechanics are connected to shaft.

Example of behaviour

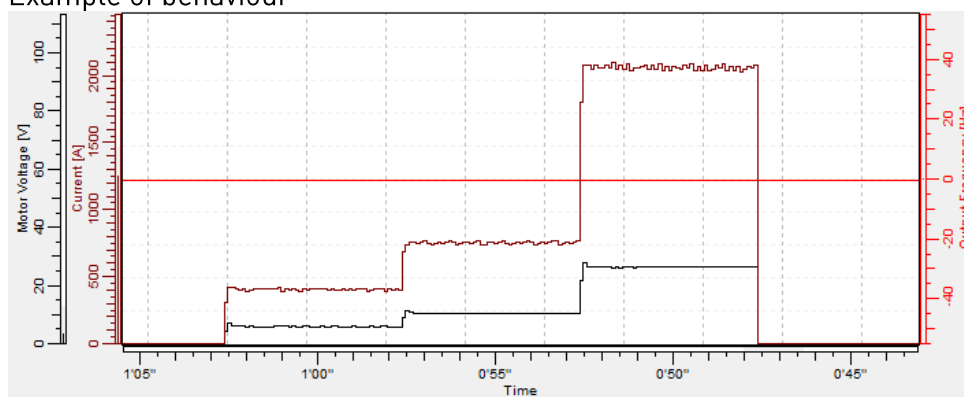

2 = "ID With Run" - Identification with motor rotating

Shaft is rotated during identification.

This identification must be run without load on motor shaft. U/f settings and magnetization current are identified. This identification should be run regardless of the final operation mode (closed loop or open loop) to get the best performance from the motor.

Example of behaviour

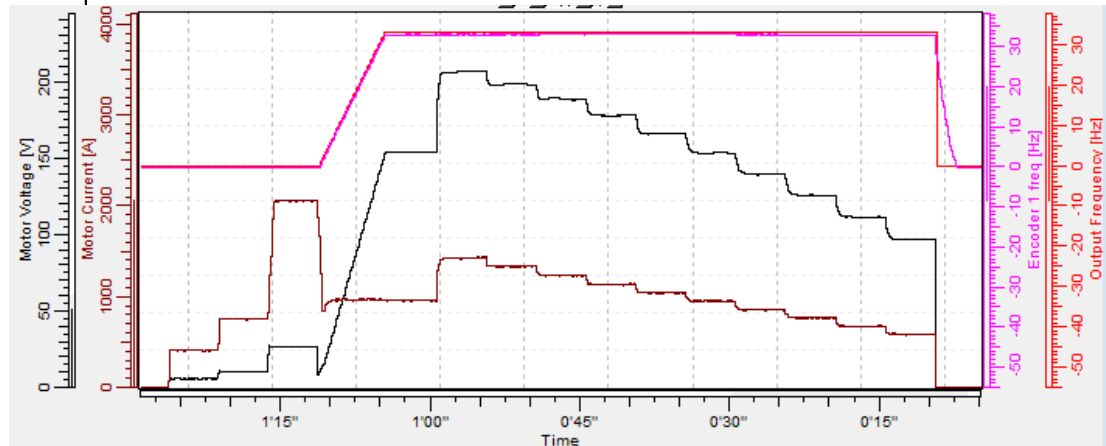

3 = "Enc. ID Run" - Encoder identification run

IM: If performed for induction motor, the encoder pulse number and direction are identified. Can be used if there is no encoder information available. The correct result can be achieved only when motor is unloaded.

PMSM: This selection is used for PMS motor if automatic angle identification is not suitable for used motor (angle is identified automatically in every start if PMSM Shaft Position parameter is zero).

This identification run will update PMSM Shaft Position parameter based on absolute position of the encoder or Z pulse position of incremental type encoder.

With default parameters PMSM Shaft position is searched with pulsed current method. If the motor is not suitable for that and/or shaft can rotate freely during identification DC Current positioning can be used. For more information see parameter "Encoder identification mode" in G: Motor control / PMSM Settings.

Note: Identification needs to be remade if the encoder position related to the motor is changed e.g. due maintenance.

5 = "ID Run Fails" - Identification failed

Identification failed in last attempt.

The basic motor name plate data has to be set correctly before performing the identification run:

- P2.1.1 – P2.1.7. Motor basic data.
- P2.1.7 Magnetization current can also be given if available if given before identification without rotating motor; U/f curve will be tuned according to given magnetization current.

- P2.1.9 Motor Type.

When in closed loop and with an encoder installed, also the parameter for pulses / revolutions (in Menu M7) has to be set.

The automatic identification is activated by setting this parameter to the appropriate value followed by a start command in the requested direction. The start command to the drive has to be given within 20 s. If no start command is given within 20 s, the identification run is cancelled and the parameter will be reset to its default setting. The identification run can be stopped any time with normal stop command and the parameter is reset to its default setting. In case identification run detects fault or other problems, the identification run is completed if possible. After the identification is finished, a warning will be given if not all requested identification types have been completed successfully. During the Identification Run, the brake control is disabled.

Note: After identification is made, the drive requires rising edge of start command.

P2.1.9 **Motor Type** **ID1650** **“Motor Type”**

Select used motor type with this parameter

- 0** **“Induction” - Induction motor**
 -Asynchronous motor
- 1** **“PMSM” - Permanent magnet synchronous motor**
 - Contact factory before using with externally magnetized motor.

See related parameter in “G2.5.10: Motor Control \ PMSM Settings”.

7.2 Speed profile

P2.2.1 Nominal Linear Speed ID 1500 "NominalLinSpeed"

Nominal linear speed corresponds to the lift speed at nominal frequency of the motor ([parameter 2.1.2](#))

Speed parameters in group 2.2.9 are entered in linear magnitudes and parameters in group 2.2.10 are entered in Hz. There is an internal scaling between linear speeds and frequencies. Parameters in both groups correspond to each other. If the value of the nominal linear speed is changed, the parameters in group 2.2.10 are recalculated accordingly.

P2.2.2 Speed reference selection ID 117 "Speed Ref Select"

Defines which frequency reference source is selected when controlled from the I/O control place. Default value is 0.

- 0 = Activity coding
- 1 = Activity coding with direction
- 2 = Binary coding
- 3 = Voltage Input (AI1)
- 4 = Current Input (AI2)
- 5 = Fieldbus
- 6 = Keypad

Speed reference can be determined in three different ways with digital inputs. Digital inputs are programmable (see page 10).

The first column contains the state of the digital inputs (marked as default values DIN4, DIN5 and DIN6). The correct input signal can be programmed with parameters [2.6.2.10](#), [2.6.2.11](#) and [2.6.2.12](#).

The second column contains the parameter and the next column the corresponding speed reference. The priority column defines which speed is activated if more than one digital input is activated. If Speed reference is different when running to different direction the direction is defined in direction column.

0 = Activity coding

Four different constant speeds can be selected.

DIN [4,5,6]	Parameters	SpeedRef	Priority	Direction
[0;0;0]	2.2.9.1/2.2.10.1	{levelling speed}	0 low	irrelevant
[1;0;0]	2.2.9.2/2.2.10.2	{full speed}	1 medium	irrelevant
[0;1;0]	2.2.9.3/2.2.10.3	{limited speed}	2 high	irrelevant
[0;0;1]	2.2.9.4/2.2.10.4	{inspection speed}	3 highest	irrelevant

Table 7-1. Activity reference

1 = Activity coding with direction

The constant speeds are selected according to the state of digital inputs and motor direction. Four different speeds per direction are available.

DIN [4,5,6]	Parameters	SpeedRef	Priority	Direction
[0;0;0]	2.2.9.1/2.2.10.1	(levelling speed)	0 low	forward
[1;0;0]	2.2.9.2/2.2.10.2	(full speed)	1 medium	forward
[0;1;0]	2.2.9.3/2.2.10.3	(limited speed)	2 high	forward
[0;0;1]	2.2.9.4/2.2.10.4	(inspection speed)	3 highest	forward
[0;0;0]	2.2.9.5/2.2.10.5	(preset speed 4)	0 low	reverse
[1;0;0]	2.2.9.6/2.2.10.6	(preset speed 5)	1 medium	reverse
[0;1;0]	2.2.9.7/2.2.10.7	(preset speed 6)	2 high	reverse
[0;0;1]	2.2.9.8/2.2.10.8	(preset speed 7)	3 highest	reverse

Table 7-2. Activity reference with direction

2 = Binary coding

Eight different constant speeds are selected according to binary word formed through digital inputs.

DIN [4,5,6]	Parameters	SpeedRef	Priority	Direction
[0;0;0]	2.2.9.1/2.2.10.1	(levelling speed)	-	irrelevant
[1;0;0]	2.2.9.2/2.2.10.2	(full speed)	-	irrelevant
[0;1;0]	2.2.9.3/2.2.10.3	(limited speed)	-	irrelevant
[1;1;0]	2.2.9.4/2.2.10.4	(inspection speed)	-	irrelevant
[0;0;1]	2.2.9.5/2.2.10.5	(preset speed 4)	-	irrelevant
[1;0;1]	2.2.9.6/2.2.10.6	(preset speed 5)	-	irrelevant
[0;1;1]	2.2.9.7/2.2.10.7	(preset speed 6)	-	irrelevant
[1;1;1]	2.2.9.8/2.2.10.8	(preset speed 7)	-	irrelevant

Table 7-3. Binary reference

P2.2.3 Enable Jerks ID 1549 "Enable Jerks"

0 = Disabled

1 = Enabled

Acceleration and deceleration rounding with jerks can be disabled by setting this parameter to 0. If set to 0 (Disabled) jerk values have no effect.

P2.2.4 Reference Hold Time ID 1509 "Reference hold"

The parameter defines the time how long the frequency reference is held after start signal. During that time the speed reference is not changed.

This function is also called the 'half floor ride'. The start and stop inputs are not affected by this function.

Reference hold time starts when the frequency is released to nominal value after start. This occurs when the mechanical brake is opened and the brake reaction delay and smooth start time has expired.

When reference hold timer has elapsed, the Acceleration decrease jerk time ([parameter 2.2.11.4](#)) and Deceleration increase jerk time ([parameter 2.2.11.5](#)) affect the speed curve (see picture below).

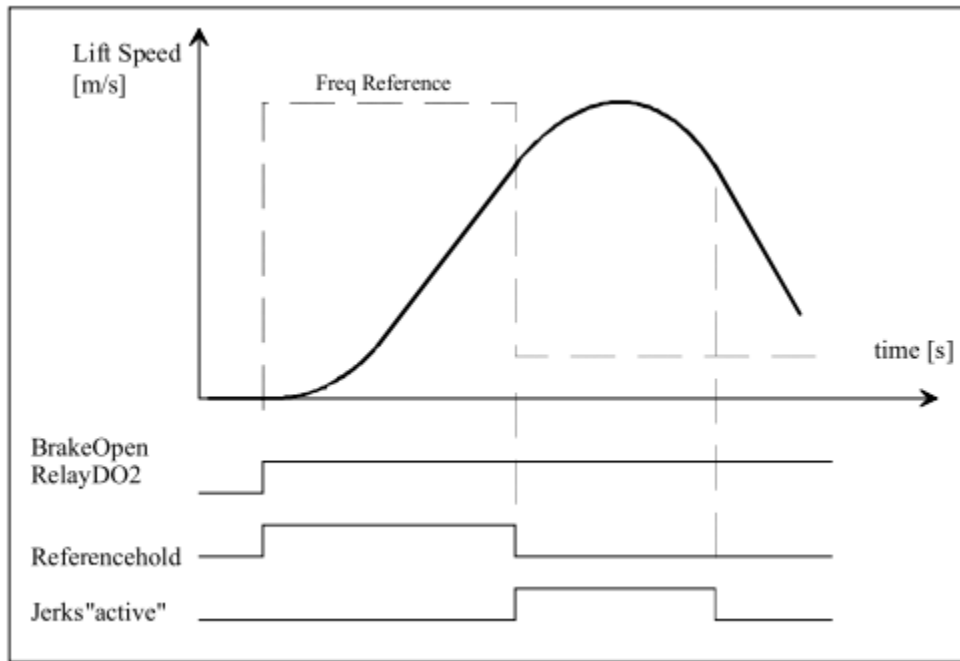

Figure 2. Reference hold time

P2.2.5 Stop State (DIN456) ID 1641 "Stop State"

- 0 = Normal operation
- 1 = Stop if DIN456 are OFF

Special stop mode when 1 is selected. Stop state is activated when all speed reference inputs are OFF (Default values are DIN4, DIN5 and DIN6, see [parameter 2.2.2](#)).

Note: Even if DIN1 or DIN2 is ON and DIN456 are OFF stop state is activated. Restart requires that DIN1 and DIN2 are switched OFF.

P2.2.6 Stop distance 1 ID 1777 "StopDistance1"

Distance from full speed to levelling speed.

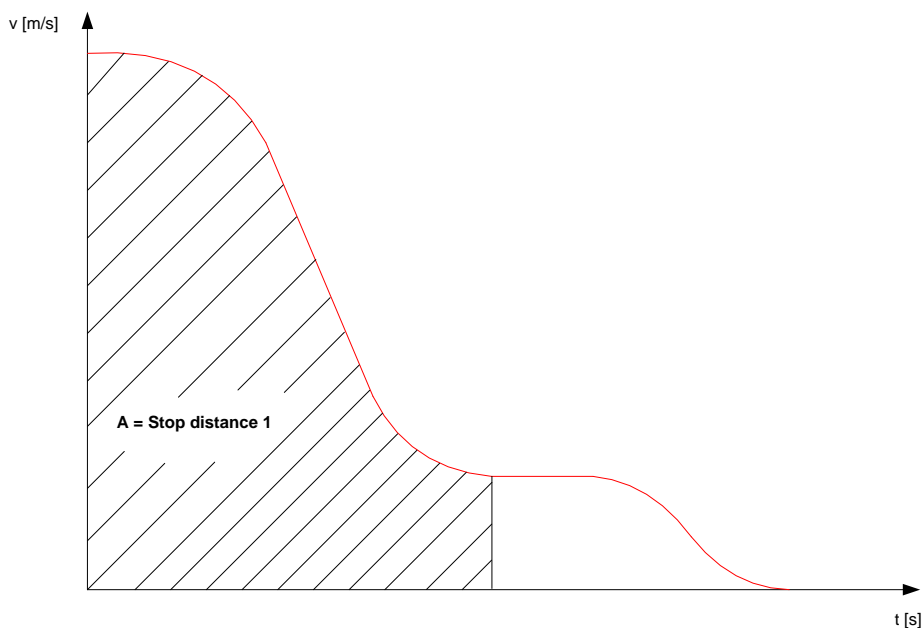

Stop distance 1 is set in meters. When value is set different than zero and different than it was application is calculating and updating DecInc 1 value depending on Nominal speed, levelling speed and DecInc Jerk 1. Calculated value is estimation.

P2.2.7 **Stop distance 2** **ID 1776** **"StopDistance2"**

Distance from levelling speed to zero.

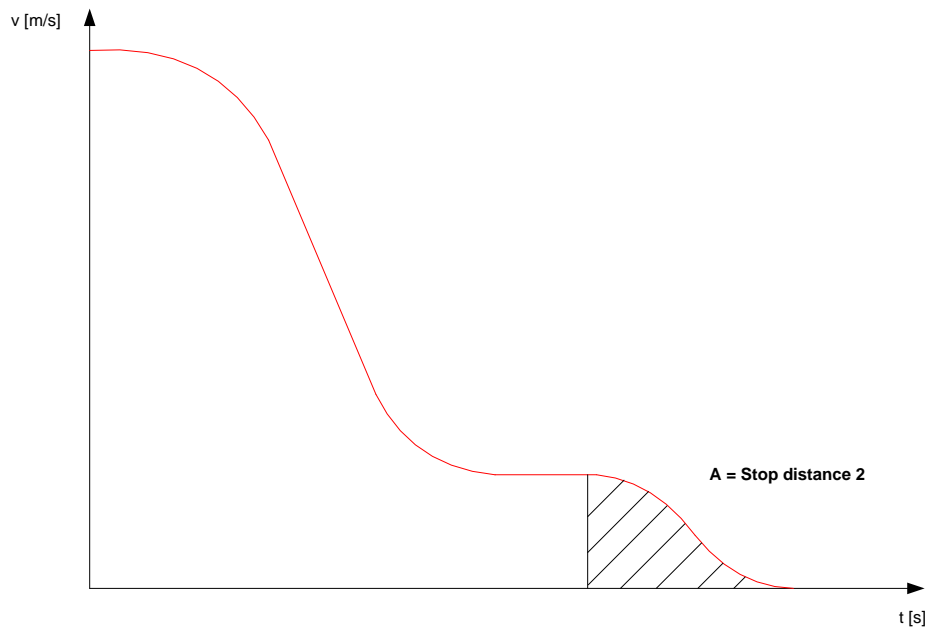

Stop distance 2 is set in meters. When value is set different than zero and different than it was application is calculating and updating DecInc Jerk 2 and DecDec Jerk 2 values depending on Levelling speed.

When value is set different than zero P2.2.8 Internal ramp switch frequency is set to equal than levelling speed frequency.

Calculated value is estimation.

P2.2.8 **Internal Ramp switching frequency** **ID 1544** **"Internal Ramp sw"**

0 = Not used

The purpose is to get another ramp when stopping the lift (from levelling speed).

The ramp set 2 (Speed Curve 2 parameters) can be activated internally. The internal change to ramp set 2 is done when the speed is decelerated below the internal ramp switch frequency and the steady state speed is reached.

NOTE: It is also possible to set the internal ramp switching frequency less or equal to the levelling speed. Then the deceleration at stop will always use speed curve 2 parameters even if the speed never goes over the levelling speed (short floor).

Ramp set 1 (Speed Curve1 parameters) is changed back when the Run request of the AC drive is inactivated.

NOTE: If Stop by distance function (parameter 2.4.4) is used the internal ramp switch function is not active.

7.3 Speed reference [m/s] parameters (M2 -> G2.2.9)

Parameters in group 2.2.9 define the speed reference in linear magnitudes [m/s]. Parameters correspond to the parameters of group 2.2.10 and they will be updated automatically if values are changed in the other group. They will also be updated if the value of parameter 2.2.1 is changed.

P2.2.9.1	<i>Levelling Speed</i>	<i>ID 1501</i>	<i>“Levelling speed”</i>
	This parameter defines the maximum speed of the lift as unit [m/s]. This parameter is also updated if parameter P2.2.10.1 is changed.		
P2.2.9.2	<i>Full Speed</i>	<i>ID 1502</i>	<i>“Full speed”</i>
	This parameter is the maximum speed of the lift and is following parameter P2.2.1. Used unit is [m/s]. This parameter is also updated if P2.2.10.2 is changed.		
P2.2.9.3	<i>Limited Speed</i>	<i>ID 1503</i>	<i>“Limited speed”</i>
P2.2.9.4	<i>Inspection Speed</i>	<i>ID 1504</i>	<i>“Inspection speed”</i>
P2.2.9.5	<i>Speed reference 4</i>	<i>ID 1505</i>	<i>“Speed ref 4”</i>
P2.2.9.6	<i>Speed reference 5</i>	<i>ID 1506</i>	<i>“Speed ref 5”</i>
P2.2.9.7	<i>Speed reference 6</i>	<i>ID 1507</i>	<i>“Speed ref 6”</i>
P2.2.9.8	<i>Speed reference 7</i>	<i>ID 1508</i>	<i>“Speed ref 7”</i>
P2.2.9.9	<i>Override Speed</i>	<i>ID 1613</i>	<i>“Override speed”</i>
	This parameter defines the speed level activated if digital input “Override Speed” is activated in G: Input signals / Digital inputs		

7.4 Speed Reference [Hz] parameters (M2 -> G2.2.10)

Parameters in group 2.2.10 define the speed reference in frequency [Hz]. The parameters correspond to the parameters in group 2.2.9 and they will be updated automatically if the values in the other group are changed.

P2.2.10.1	Levelling Speed	ID 1604	"Levelling speed"
	This parameter defines the maximum speed of the lift as unit [Hz]. This parameter is also updated if parameter P2.2.9.1 is changed.		
P2.2.10.2	Full Speed	ID 1605	"Full speed"
	This parameter is the maximum speed of the lift and is following parameter P2.2.1. Used unit is [Hz]. This parameter is also updated if P2.2.9.2 is changed.		
P2.2.10.3	Limited Speed	ID 1606	"Limited speed"
P2.2.10.4	Inspection Speed	ID 1607	"Inspection speed"
P2.2.10.5	Speed reference 4	ID 1608	"Speed ref 4"
P2.2.10.6	Speed reference 5	ID 1609	"Speed ref 5"
P2.2.10.7	Speed reference 6	ID 1610	"Speed ref 6"
P2.2.10.8	Speed reference 7	ID 1611	"Speed ref 7"
P2.2.10.9	Override Speed	ID 1612	"Override speed"
	This parameter defines the speed level activated if digital input "Override Speed" is activated in G: Input signals / Digital inputs		

7.5 Speed Curve 1 parameters (M2 -> G2.2.11)

Speed curve 1 is used as the default values for acceleration and deceleration and jerks.

P2.2.11.1 Acceleration 1 ID 103 "Acceleration1"

P2.2.11.2 Deceleration 1 ID 104 "Deceleration1"

Acceleration and deceleration of the lift car are presented in [m/s²]. Acceleration and deceleration curves are affected by the jerk time settings, too.

P2.2.11.3 Acc inc jerk 1 ID 1540 "Acc Inc Jerk 1"

Acceleration increase jerk1.
Jerk times are presented in [s].

P2.2.11.4 Acc dec jerk 1 ID 1541 "Acc Dec Jerk 1"

Acceleration decrease jerk 1.

P2.2.11.5 Dec inc jerk 1 ID 1542 "Dec Inc Jerk 1"

Deceleration increase jerk 1.

P2.2.11.6 Dec dec jerk 1 ID 1543 "Dec Dec Jerk 1"

Deceleration decrease jerk 1.

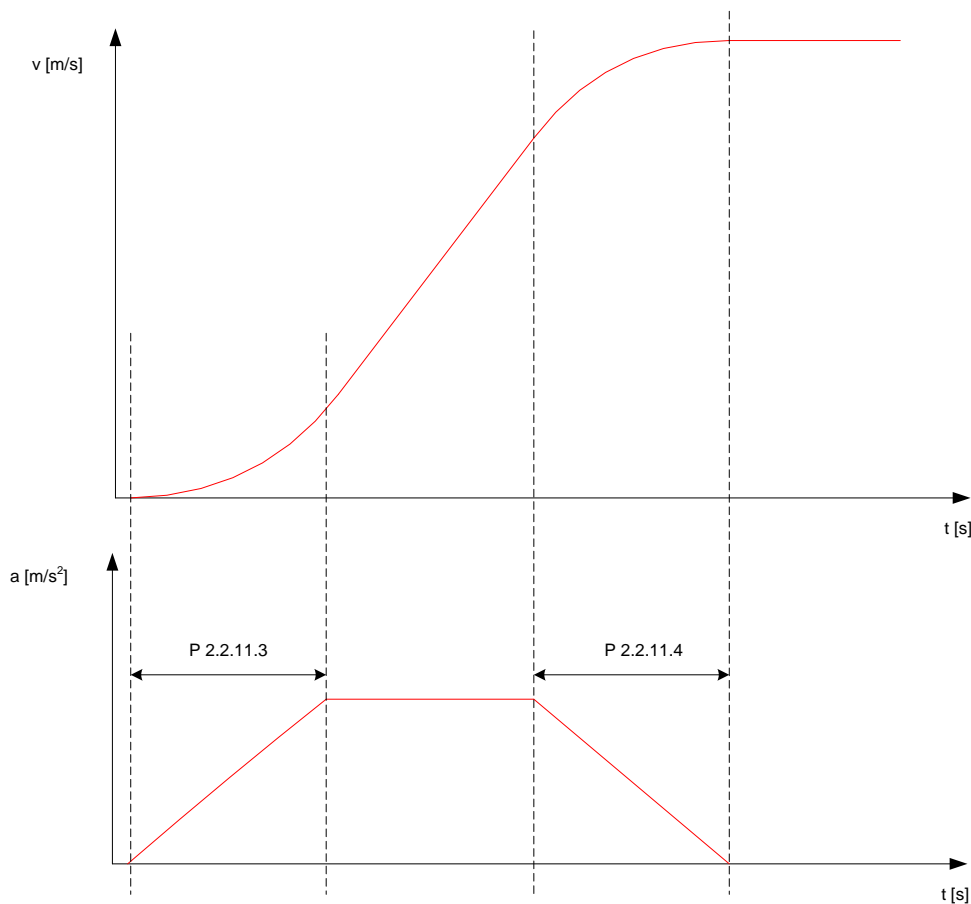

Figure 3: Jerks related to speed and acceleration

7.6 Speed Curve 2 parameters (M2 -> G2.2.12)

Parameters in group Speed curve 2 are used when internal ramp switch function is activated (see parameter P2.2.8). Then the Speed curve 1 parameters will be replaced by Speed curve 2 parameters. It is also possible to switch to curve 2 by digital input (see parameter P2.6.2.5).

<i>P2.2.12.1 Acceleration 2</i>	<i>ID 502</i>	<i>"Acceleration2"</i>
<i>P2.2.12.2 Deceleration 2</i>	<i>ID 503</i>	<i>"Deceleration2"</i>

Acceleration and deceleration of the lift car are presented in [m/s²]. Acceleration and deceleration curves are affected by the jerk time settings, too.

<i>P2.2.12.3 Acc inc jerk 2</i>	<i>ID 1545</i>	<i>"Acc Inc Jerk 2"</i>
---------------------------------	----------------	-------------------------

Acceleration increase jerk 2. See Figure 3.

<i>P2.2.12.4 Acc dec jerk 2</i>	<i>ID 1546</i>	<i>"Acc Dec Jerk 2"</i>
---------------------------------	----------------	-------------------------

Acceleration decrease jerk 2.

<i>P2.2.12.5 Dec inc jerk 2</i>	<i>ID 1547</i>	<i>"Dec Inc Jerk 2"</i>
---------------------------------	----------------	-------------------------

Deceleration increase jerk 2.

<i>P2.2.12.6 Dec dec jerk 2</i>	<i>ID 1548</i>	<i>"Dec Dec Jerk 2"</i>
---------------------------------	----------------	-------------------------

Deceleration decrease jerk 2.

7.7 Mechanical Brake Control

The mechanical brake control parameters affect the mechanical brake control, the smooth start and stop function and the safety functions.

The mechanical brake can be set to release on current, on torque, on frequency or on external input. The closing can be performed by frequency, by external input or by Run request signal. In case of fault the brake closes immediately without delay.

The mechanical brake control in open loop and in closed loop control mode is different. The parameters are divided in two different groups. The parameters of closed loop control group are not valid in open loop mode and vice versa. There are also some common parameters. Figure 4 and Figure 5 give a graphical presentation of the control logic of the brake control.

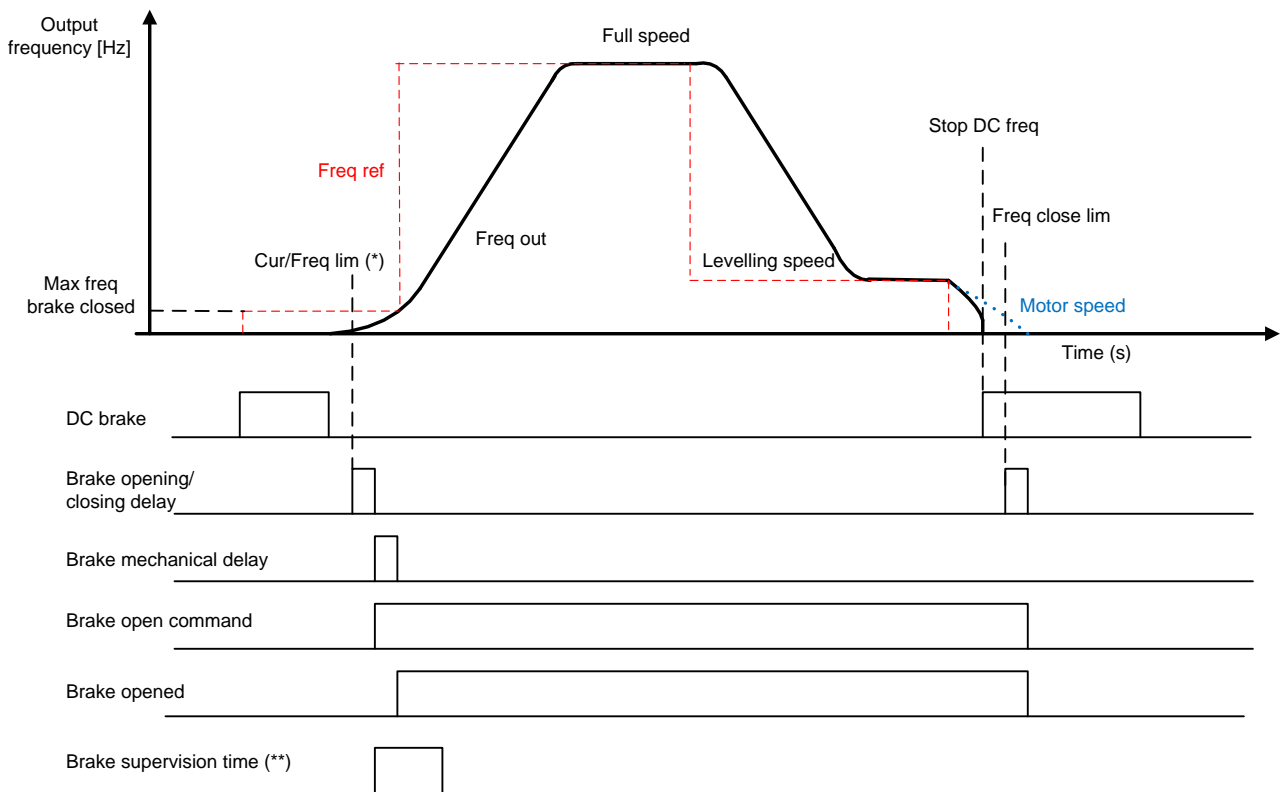

Figure 4. Mechanical brake control logic in open loop.

(*) Start signal to Brake open delay when current, freq. and torque exceed limits defined by parameters. External input must be ON if used.

(**) During the Brake supervision time the digital input must be switched ON if used.

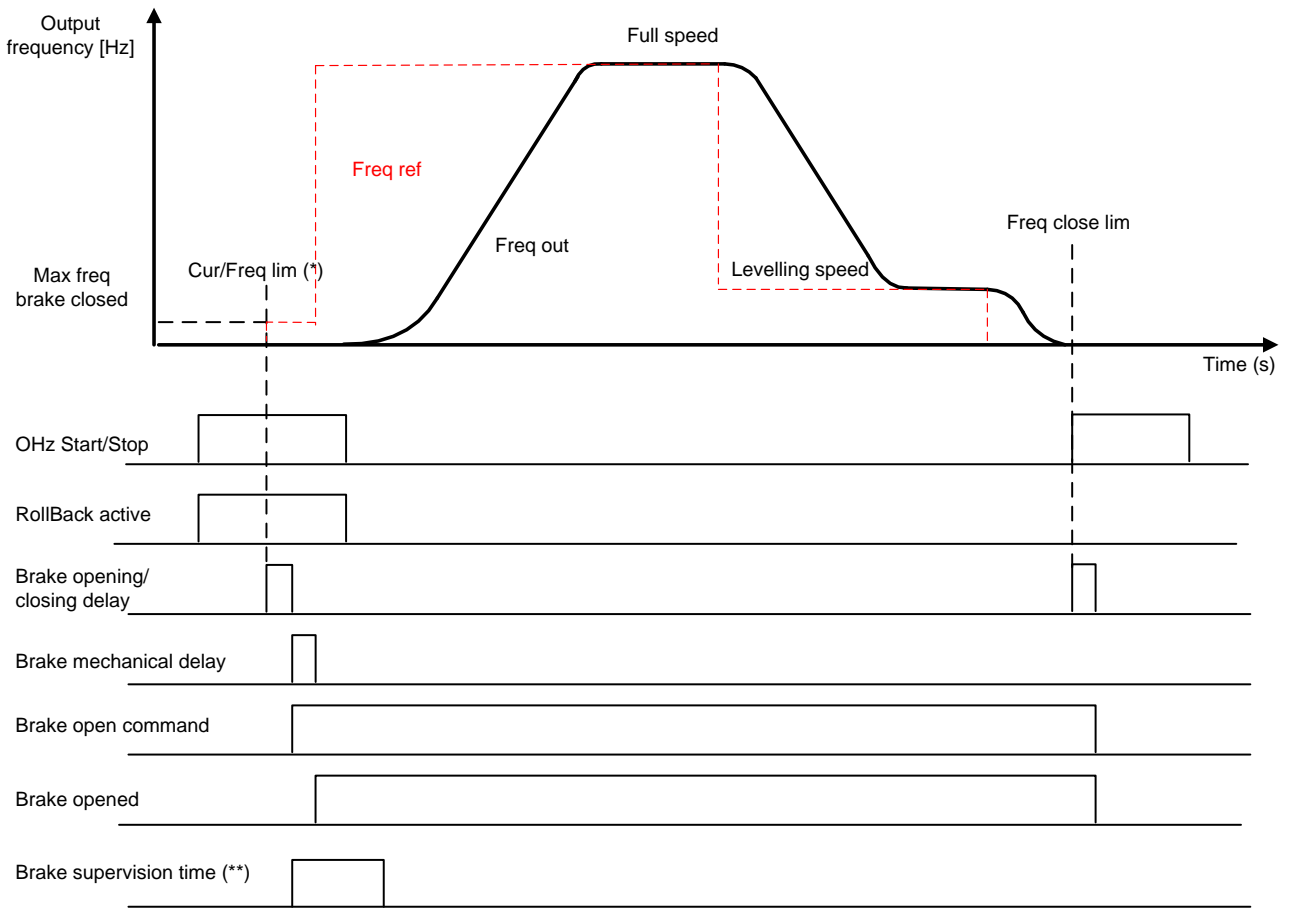

Figure 5. Mechanical brake control logic in closed loop.

*) Start signal to Brake open delay when current, freq. and torque exceed limits defined by parameters. External input must be ON if used.

***) During the Brake supervision time the digital input must be switched ON if used

7.7.1 Mechanical Brake Control Logic

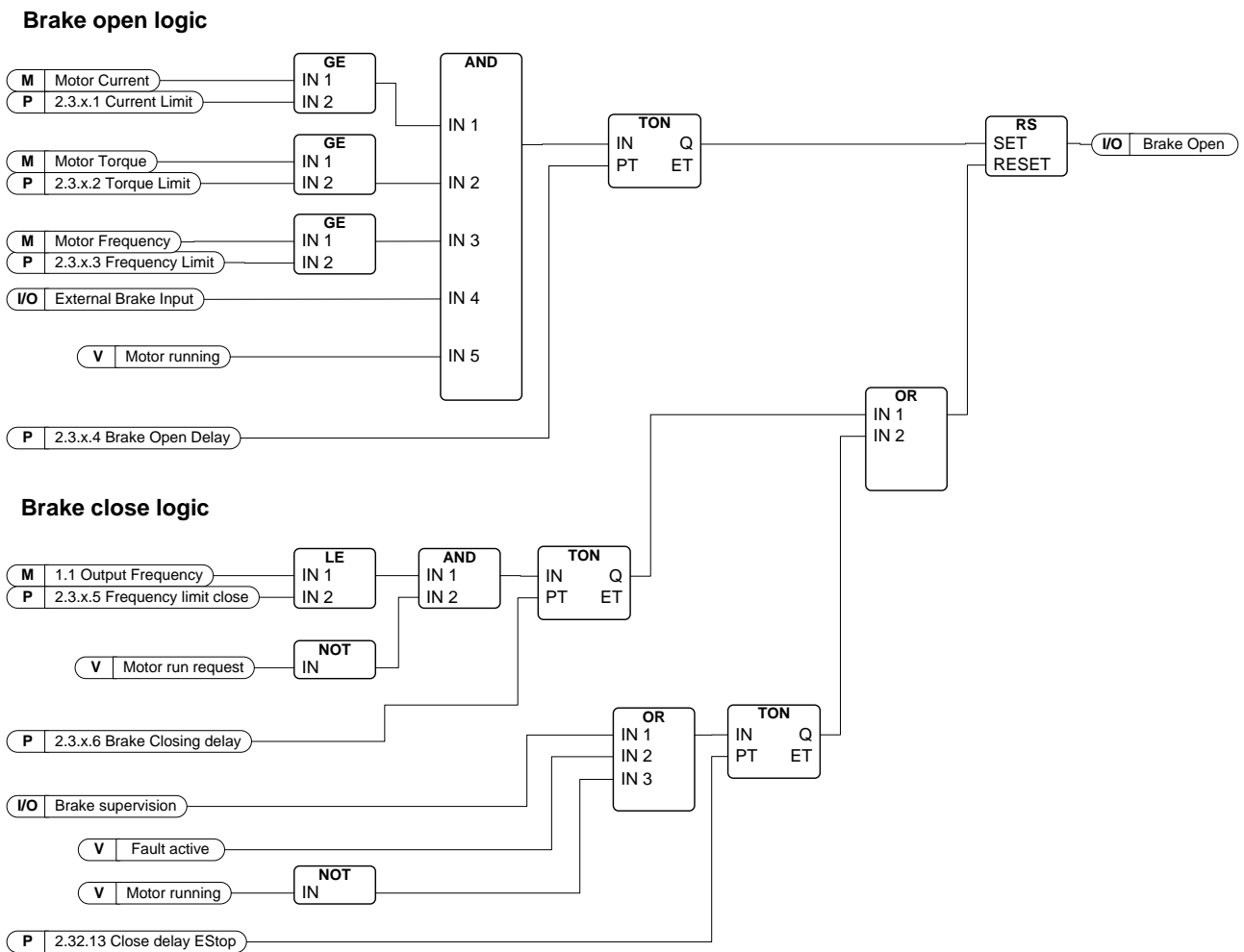

Figure 6. Mechanical brake control logic

Mechanical brake control signal can be selected to any digital or relay output to control the external mechanical brake.

In the upper section of Figure 6 you can find the mechanical brake opening logic. Five signals and the delay are required for the mechanical brake to open. If current, torque or frequency signal is not needed for brake opening, then these parameters can be set to zero. The external brake input signal is programmable and any digital input can be used for that purpose.

In the lower section of Figure 6 you can find the mechanical brake closing logic. The brake close circuit has higher priority than the open circuit. So if closing signal is active the mechanical brake will be closed.

The brake will be closed immediately in case of fault or an external supervision signal or when the motor is stopped.

In normal operation the brake will be closed when frequency falls below the Frequency close limit (P2.3.x.5) and the Run Request signal is switched OFF. If the Frequency close limit signal is not needed for the closing logic it can be set to zero. After the conditions are true there is a brake close delay (P2.3.x.6) after which the brake will be closed.

7.7.2 Open Loop Parameters (M2 -> G2.3.1)

Parameters in group 2.3.1.x are valid in open loop control mode only.
(parameter 2.5.1= 0 or 1).

- P2.3.1.1 Current Limit** [A] ID 1551 "Current Limit"
Parameter defines the actual current limit that has to be exceeded for a brake release. If set to zero this condition is excluded. The value is updated always when the nominal current of the motor (parameter 2.1.4) is set (see Figure 6).
- P2.3.1.2 Torque limit** [%] ID 1552 "Torque Limit"
Parameter defines the actual torque limit that has to be exceeded for a brake release. If set to zero this condition is excluded.
100% corresponds to the calculated nominal torque of the motor (see Figure 6).
- P2.3.1.3 Frequency limit** [Hz] ID 1553 "FreqLimitOpen"
Parameter defines the actual frequency limit that has to be exceeded for brake release. If set to zero this condition is excluded (see Figure 6).
- P2.3.1.4 Opening delay** [s] ID 1554 "BrakeOpen Delay"
Delay starts when the opening conditions (see parameters 2.3.1.1-2.3.1.3) are fulfilled (see Figure 6).
- P2.3.1.5 Frequency limit closing [Hz]** ID 1555 "FreqLimitClose"
The output frequency limit for the brake closing. The run request signal needs to be disabled to allow the signal to affect.
- P2.3.1.6 Closing delay** [s] ID 1556 "BrakeClose Delay"
The brake closing is delayed with defined time. If set to zero there is no delay between the brake closing condition and the actual brake closing.
- P2.3.1.7 Maximum frequency brake closed** [Hz] ID 1557 "MaxFreqBrakeClos"
Output frequency does not exceed this value when mechanical brake is closed. When modifying this parameter make sure that the brake release by frequency (see parameter 2.3.1.3) is possible with new value.
- P2.3.1.8 Mechanical brake reaction time** [s] ID 1558 "BrakeReact Time"
Mechanical brake reaction time will hold the speed reference for a defined time. This hold time should be set according to the mechanical brake reaction time (see Figure 4).
- P2.3.1.9 DC-brake current** [A] ID 507 "DC_Brake Current"
Defines the current injected into the motor during DC-braking.
- P2.3.1.10 DC-braking time at start** [s] ID 1559 "Start DC-Brake Tm"
DC-brake is activated when the start command is given. This parameter defines the time before the brake is released.

P2.3.1.11 DC-braking time at stop

[s] ID 1560

“Stop DC-Brake Tm”

Determines if DC-braking is ON or OFF and the braking time of the DC-brake when the motor is stopping. The function of the DC-brake depends on the stop function, parameter 2.4.2.

- 0 DC-brake is not used
- >0 DC-brake is in use and its function depends on the Stop function, (par. 2.4.2). The DC-braking time is determined with this parameter

Par. 2.4.2 = 0; Stop function = Coasting:

After the stop command, the motor coasts to a stop without control of the AC drive. With DC-injection, the motor can be electrically stopped in the shortest possible time, without using an optional external-braking resistor. The braking time is scaled according to the frequency when the DC-braking starts. If the frequency is \geq the nominal frequency of the motor, the set value of parameter 2.3.1.11 “DC-braking frequency at stop” determines the braking time. When the frequency is $\leq 10\%$ of the nominal, the braking time is 10% of the set value of parameter 2.3.1.11.

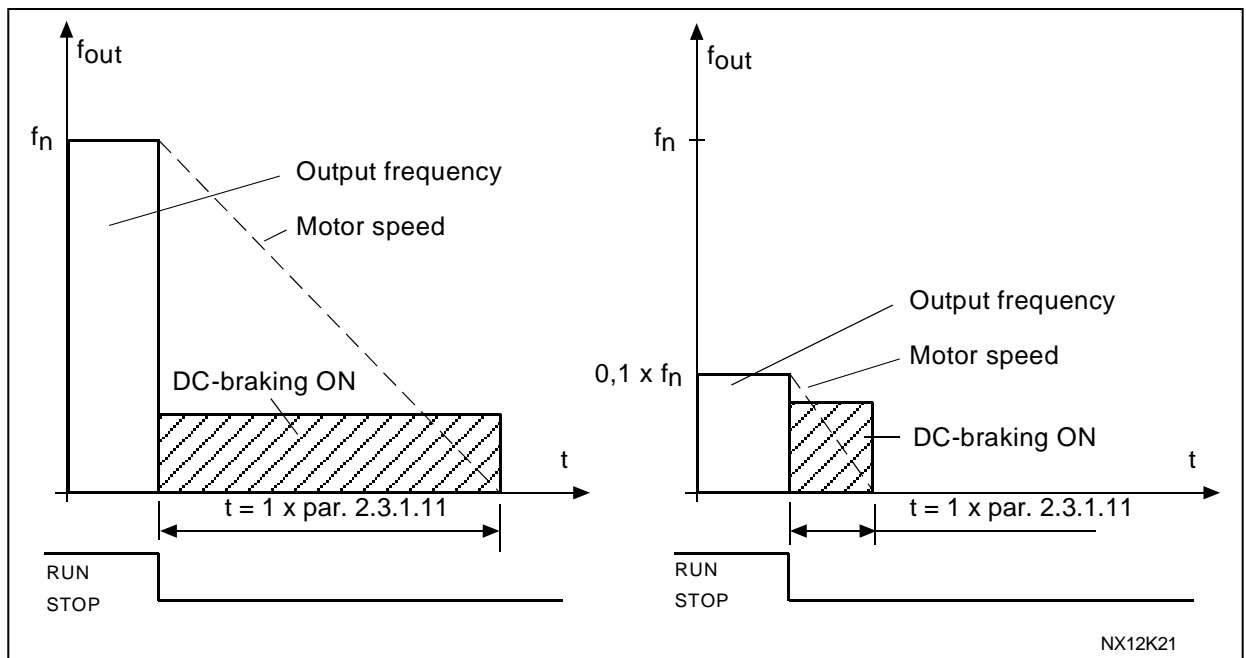

Figure 7. DC-braking time when Stop mode = Coasting.

Par. 2.4.2 = 1; Stop function = Ramp

After the Stop command, the speed of the motor is reduced according to the set deceleration parameters, as fast as possible, to the speed defined with parameter 2.3.1.12, where the DC-braking starts.

The braking time is defined with parameter 2.3.1.11. If high inertia exists, it is recommended to use an external braking resistor for faster deceleration.

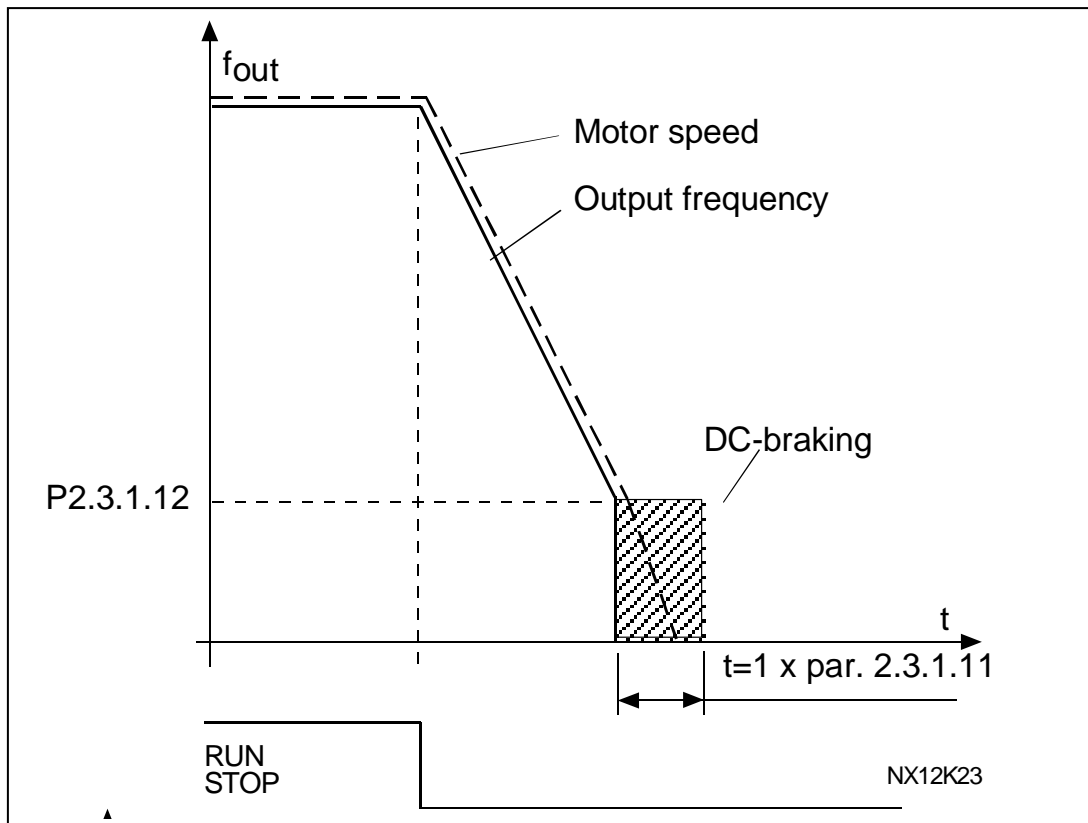

Figure 8. DC-braking time when Stop mode = Ramp

Par. 2.4.2 = 2; Stop function = Stop by frequency. limit

Stop mode depends on the actual frequency of the motor. If frequency is above the frequency limit (par. 2.4.3) then the stop mode is coasting (see Figure 7). If frequency is even or below the frequency limit then the stop mode is ramp (see Figure 8).

P2.3.1.12 DC-braking frequency at stop [Hz] ID 515 "Stop DC-BrakeFr"

The value of output frequency which the DC-braking is applied (See Figure 8).

P2.3.1.13 Close delay EStop [s] ID 1640 "Delayed brake"

0= Function is not active

Can be used e.g. in emergency stop situation to get a smooth stop. This delay is active also in case of fault, emergency stop or if brake supervision signal is lost.

P2.3.1.14 Run Request Closing

[-] ID 1641

"RunReqClosing"

0= Inactivated

1= Activated

Run request signal during brake closing can be inactivated by this parameter. In normal operation Brake close command requires Run request signal to go low. If parameter is 0, then brake will be closed when frequency goes below the limit.

NOTE: If 0 is selected then Frequency limit close (P2.3.1.5 or P2.3.2.5) must be less than maximum frequency brake close (P2.3.1.7 or P2.3.2.7). Otherwise brake control logic does not work.

7.7.3 Closed Loop Parameters (M2 -> G2.3.2)

Parameters in group 2.3.2.x are valid in closed loop motor control mode (parameter 2.5.1 = 2) only.

- | | | | | |
|------------------|---|----------------|-------------------------|---------------------------|
| P2.3.2.1 | Current Limit | [A] | ID 1561 | “Current Limit” |
| | Parameter defines the actual current limit that has to be exceeded for a brake release. If set to zero this condition is excluded. The value is updated always when the nominal current of the motor (parameter 2.1.4) is set (see Figure 6). | | | |
| P2.3.2.2 | Torque limit | [%] | ID 1562 | “Torque Limit” |
| | Parameter defines the actual torque limit that has to be exceeded for a brake release. If set to zero this condition is excluded.
100% corresponds to the calculated nominal torque of the motor (see Figure 6). | | | |
| P2.3.2.3 | Frequency limit | [Hz] | ID 1563 | “FreqLimitOpen” |
| | Parameter defines the actual frequency limit that has to be exceeded for brake release. If set to zero this condition is excluded (see Figure 6). | | | |
| P2.3.2.4 | Opening delay | [s] | ID 1564 | “BrakeOpen Delay” |
| | Delay starts when the opening conditions (see parameters 2.3.2.1-2.3.2.3) are fulfilled (see Figure 6). | | | |
| P2.3.2.5 | Frequency limit closing [Hz] | ID 1565 | “FreqLimitClose” | |
| | The output frequency limit for the brake closing. The run request signal needs to be disabled to allow the signal to affect. | | | |
| P2.3.2.6 | Closing delay | [s] | ID 1566 | “BrakeClose Delay” |
| | The brake closing is delayed with defined time. If set to zero there is no delay between the brake closing condition and the actual brake closing. | | | |
| P2.3.2.7 | Maximum frequency brake closed | [Hz] | ID 1567 | “MaxFreqBrakeClos” |
| | Output frequency does not exceed this value when mechanical brake is closed. When modifying this parameter, make sure that the brake release by frequency (see parameter 2.3.2.3) is possible with new value. | | | |
| P2.3.2.8 | Mechanical brake reaction time | [s] | ID 1558 | “BrakeReact Time” |
| | Mechanical brake reaction time will hold the speed reference for a defined time. This hold time should be set according to the mechanical brake reaction time (see Figure 4). | | | |
| P2.3.2.9 | Zero Hz time at start | [s] | ID 615 | “0 Hz TimeAtStart” |
| P2.3.2.10 | Zero Hz time at stop | [s] | ID 616 | “0 Hz TimeAtStop” |
| | Zero hertz time during start and stop. Motor can be magnetised and torque generated during that time. Zero Hz time at start should be set longer than the magnetization time. Smooth start time (par 2.3.2.10) will commence straight after zero hertz time. The mechanical brake should be set to release when this change takes place (see Figure 4). | | | |

P2.3.2.11 Smooth start time [s] ID 1568 "SmoothStartTime"

The smooth start time function is used in closed loop mode. It cannot be used in open loop. After the start command has been given the drive is rotating the motor shaft with a very low frequency (par 2.3.2.12) to overcome the static friction.

Smooth start time will commence straight after zero hertz time (par 2.3.2.9). The mechanical brake should be set to release when this change takes place. This is achieved through setting the same value for the frequency limit (par 2.3.2.3) and the smooth start frequency (par 2.3.2.12).

When smooth start time has elapsed the frequency will be released.

P2.3.2.12 Smooth start frequency [Hz] ID 1569 "SmoothStartFreq"

Smooth start frequency is a reference frequency that is used with the smooth start time operation. Value should be set very low.

P2.3.2.13 Close delay EStop [s] ID 1642 "CloseDelay EStop"

0= Function is not active

Can be used e.g. in emergency stop situation to get a smooth stop. This delay is active also in case of fault or emergency stop or if brake supervision signal is lost.

P2.3.2.14 Run request closing [-] ID 1643 "RunReqClosing"

0= Inactivated

1= Activated

Run request signal during brake closing can be inactivated by this parameter. In normal operation, the Brake close command requires Run request signal to go low. If parameter is 0, then brake will be closed when frequency goes below the limit.

NOTE: If 0 is selected then Frequency limit close (P2.3.2.5) must be less than maximum frequency brake close (P2.3.2.7). Otherwise brake control logic does not work.

P2.3.2.15 Start magnetizing time [s] ID 628 "Start Magn Time"

Define how long time the start magnetizing current defined by P2.3.2.16 is used.

P2.3.2.16 Start magnetizing current [A] ID 627 "Start Magn Curr"

Define the start magnetizing current. Typical value is I_n . This parameter is set equal than I_n when Motor nominal current (I_n) is set by P2.1.4.

By using this function the motor is magnetized much faster than with ordinary magnetizing current.

7.7.4 External brake (M2 -> G2.3.3)

P2.3.3.1 External brake control [-] ID 1601 "Ext Brake Contrl"

Programmable digital input for external brake control. If digital input is selected it must be ON before brake can be opened. If input is not used set parameter to default value (=0.2 = constant TRUE).

P2.3.3.2 External brake supervision [-] ID 1602 "Ext Brake SuperV"

Programmable digital input for external brake supervision. After the mechanical brake is released, the selected input can be used to verify the brake open state. If the input is not used, set parameter to default value (=0.1 = constant FALSE).

If the digital input is used it must be activated during the defined time (parameter 2.3.4.1) from the brake release. If it is not activated, external brake fault is generated. The response to external brake fault can be set with parameter 2.8.4.1.

P2.3.3.3 External brake supervision 2 [-] ID 1838 "Ext Brake SuperV2"

Look at external brake supervision.

7.7.5 Brake supervision (M2 -> G2.3.4)

P2.3.4.1 External brake supervision time [-] ID 1603 "ExtBrakeSuperVTime"

A time window within the external brake supervision input (parameter 2.3.3.2) has to be activated after the brake is released.

P2.3.4.2 External brake supervision inverted [-] ID 1856 "ExtBrakeSupInvr"

0= Not Inverted (Brake switches normally opened)

1= Inverted (Brake switches normally closed)

This parameter defines the state of the brake switches. The information in this document is based on the switches being normally closed, so the default parameter is 1=Inverted.

P2.3.4.3 Supervision fault F55 at start [-] ID 1857 "F55 Spv at Start"

0= Disabled

1= Enabled

The lift can be stopped at start if a fault is detected. If the parameter is set to Disabled, the lift is not stopped. The fault must be tripped when the lift reaches the destination floor.

7.7.6 Adjusting opening of the brake in closed loop:

Easy start

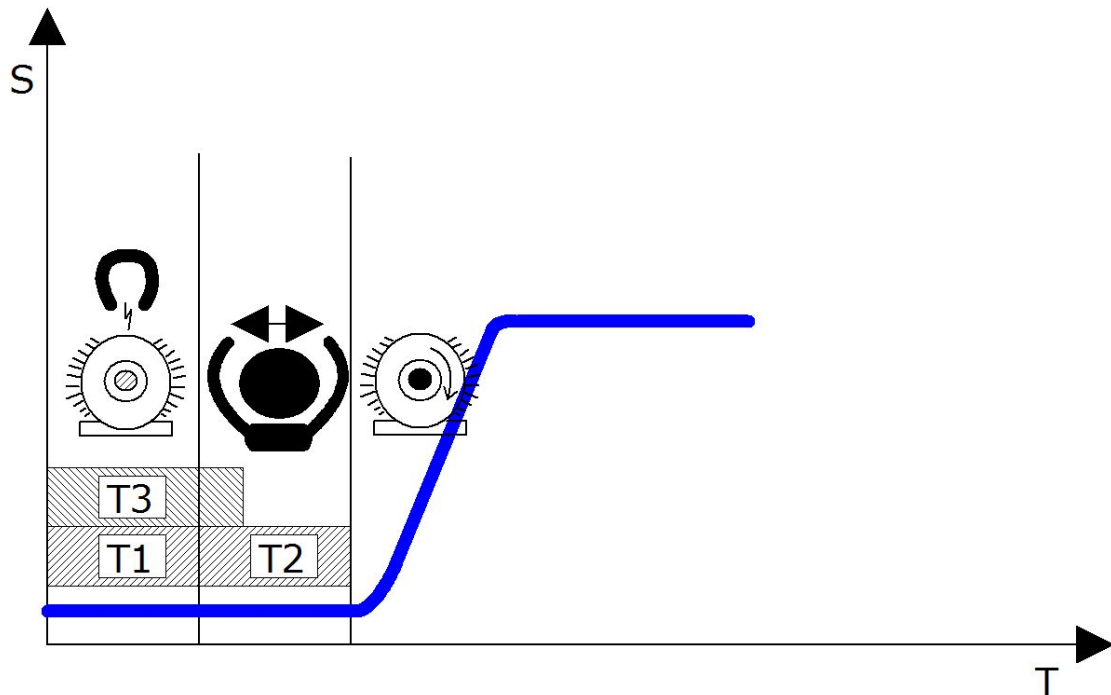

T1: Time to get brake opening conditions

This time starts when AC drive gets drive command. During this time the motor is getting ready to start and AC drive is feeding to motor to get flux ready. Brake can be commanded to open by relay output 1, or relay output 2 after flux is ready. It is possible to make this time smaller by using *Start magnetizing time* parameter and *Start magnetizing current* parameter. If you set *Start magnetizing current* bigger than *magnetizing current*, then flux will be ready earlier. The use of *Start magnetizing current* and *Start magnetizing time* is important for large motors in order to speed up the start.

T2: Mechanical brake reaction time

Parameter: *Mechanical brake reaction time*. The time how long mechanical brake takes to open completely, with contactor delays and so on. If this time is too short, motor is driving against the brake and starting current can be very high.

T3: 0 Hz time at start

This time does not depend on times T1 & T2. This time starts as T1. This time is used to make sure the motor is magnetized when brake really opens. If you set the time of this parameter very long, 1.5s or 2s, you can safely measure opening delays of brake and flux ready time. Set this time slightly above the time it takes to magnetize the motor. (Time to get Flux Ready can be checked by using NcDrive and Global Variable *MC_FluxReady*)

Advanced start with smooth start

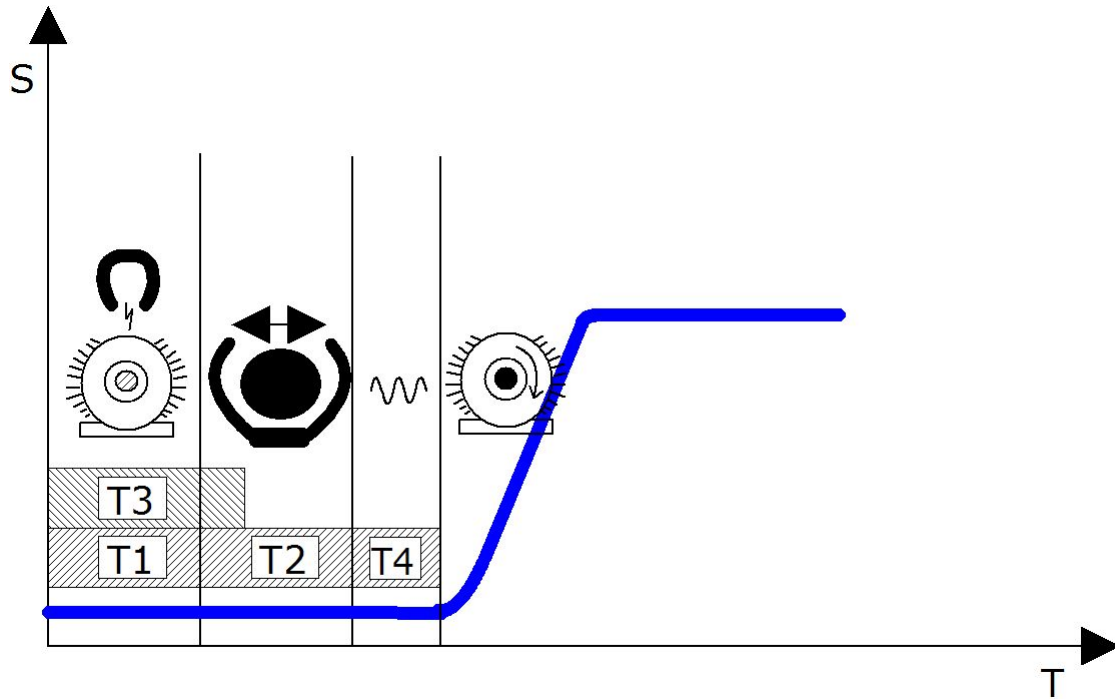

T4: Smooth start

You can add smooth start, if there is some mechanical friction in your system, when starting. The parameter *Smooth start time* adds more time to start together with the parameter *Smooth start frequency*. *Smooth start frequency* should be very small, 0.01Hz or 0.02Hz.

7.8 Drive Control

P2.4.1 Brake chopper [-] ID 504 "Brake Chopper"

When the AC drive is decelerating the motor, the inertia of the motor and the load are fed into an external brake resistor. This enables the drive to decelerate the load with a torque equal to that of the acceleration (provided that the correct brake resistor has been selected). See separate Brake resistor installation manual. Brake chopper test mode generates pulse to the resistor every second. If the pulse feedback is wrong (resistor or chopper is missing), the fault F12 is generated.

0 = "Not Used" - No brake chopper used

Brake chopper not active or present in the DC link. **NOTE:** The overvoltage controller level is set to a little lower.

1 = "On, Run" - Brake chopper in use and tested when running.

The drive's own brake chopper is activated and operational when the drive is in Run state. The drive also sends test pulses for feedback from the brake resistor.

2 = "External" - External brake chopper (no testing)

The system has an item that handles the DC link voltage. This could be a system with AFE or there is an external BCU unit. When this option is selected the drive overvoltage level is set a little higher so that its operation does not conflict with AFE or BCU units.

3 = "On, Run+Stop" - Used and tested in READY state and when running

Brake chopper is also active when the drive is not in Run state. This option can be use e.g. when other drives are generating but energy levels are low enough to be handled with only one drive.

4 = "On, No test" - Used when running (no testing)

Brake chopper is active in Run state but no test pulse to resistor is generated.

Note: In the system menu there is a parameter "InternBrakeRes". This parameter is used for brake resistor overheating calculations. If an external brake resistor is connected to the drive the parameter should be set to 'Not connected' to disable temperature calculation for the brake resistor.

P2.4.2 Stop function [-] ID 506 "Stop Function"

Coasting:

- 0** The motor coasts to a halt without any control from the AC drive, after the Stop command.

Ramp:

- 1** After the Stop command, the speed of the motor is decelerated according to the set deceleration parameters.
If the regenerated energy is high it may be necessary to use an external braking resistor for faster deceleration.

Frequency limit

- 2** Coasting Stop if the motor frequency is above the frequency limit (par. 2.4.3) when stop request is given. Stop by ramp if the motor frequency is the same or below this parameter when stop request is given.

P2.4.3 **Frequency limit** [Hz] ID 1624 “Frequency Limit”

Defines the frequency limit for the stop function if selected as the frequency limit (par. 2.4.2=2).

If the motor frequency is above the frequency limit the motor coasts to stop and if it is below or the same as the frequency limit the stop function is ramp.

P2.4.4 **Stop distance** [m] ID 1602 “StopDistance”

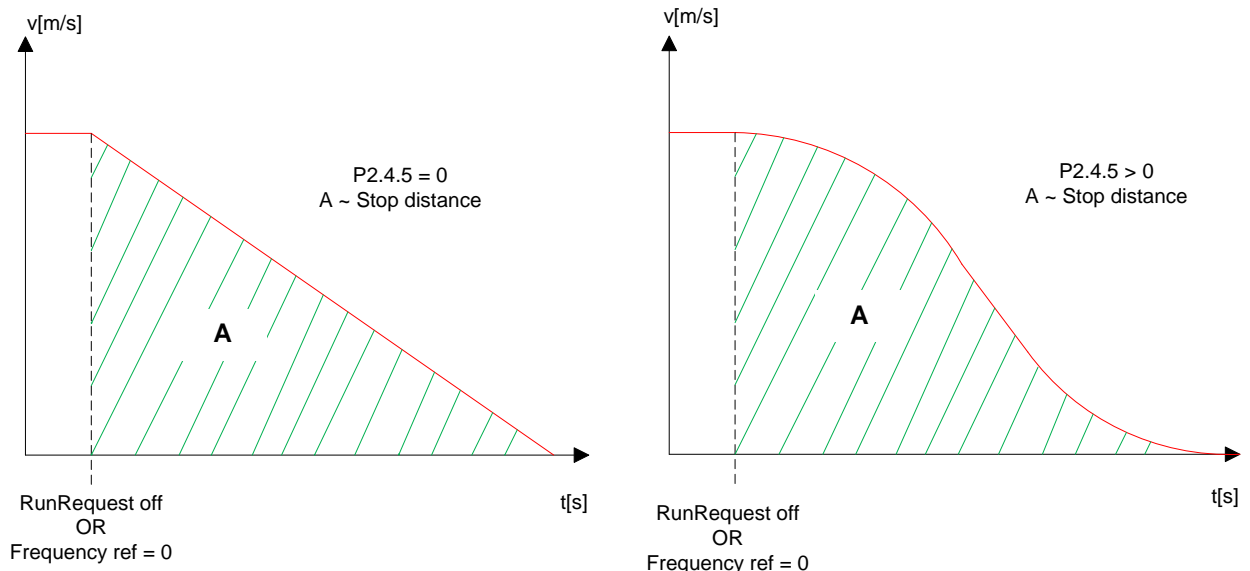

0 = Not used

Function is active only if stop function is selected as a frequency limit ([parameter 2.4.2=2](#)).

Parameter defines the distance from certain floor switch to complete stop to floor. Parameter value is presented in meters.

Stop value is calculated from Nominal linear speed ([parameter 2.2.1](#)) and from motor nominal frequency ([parameter 2.1.2](#)). The calculated distance is correct only if these two parameters are set correctly and if stop ramp is linear (parameter 2.4.5=0).

If stop ramp is S-shaped instead of linear (S-curve is used), then stopping distance must be fine-adjusted with [parameter 2.4.6](#).

Note: If Stop by distance function is used the internal ramp switch function ([parameter 2.2.8](#)) is not active.

P2.4.5 **S-curve time** [s] ID 1626 “StopD Jerk Time”

Special deceleration increase and decrease time if stop by distance function is selected. This jerk time is activated when the speed is decelerated below frequency limit and the reference frequency is reached.

Jerk times in Speed Curve 1 group are used if the frequency is above the frequency limit. Jerk times in Speed Curve 1 group are changed back when the AC drive enters the stop stage.

P2.4.6 *Scaling factor* [%] ID 1625 “RampScaleFactor”

Ramp Scaling factor for stop distance function. Stop distance is calculated based on the linear ramp. Stopping distance is accurate only when jerk times are not used (parameter 2.2.3=0 or parameter 2.4.5=0). If jerk times are used the stopping distance will be longer than it should be. Scaling factor can be used to fine-adjust the stopping distance. Scaling factor recalculates the ramp time.

7.9 Motor Contactor Control Parameters (M2 -> G2.4.7)

Purpose with motor contactor control is to close the motor contactor first and then start to output current to motor. This logic will be active only if an output relay is programmed for motor contactor control (See Parameter group 2.7)

P2.4.7.1 *Closing time*

Set this time slightly above the motor contactor reaction time. After this delay the AC drive starts to output current to the motor. This time is ignored if the motor contactor acknowledgement signal specified by parameter P2.4.7.2 is used

P2.4.7.2 *Motor Contactor Acknowledgement*

Input signal for the feedback signal that main contactor is closed. Use the motor contactor auxiliary contact (NO) for this purpose. Parameter P2.4.7.1 will be ignored if this signal is in use.

If the Acknowledgement signal does not come within 1s alarm F64 is triggered.

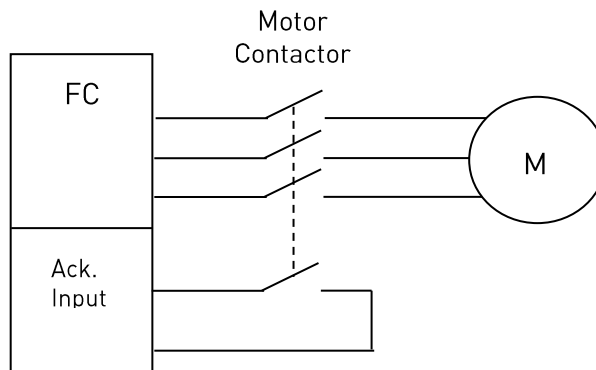

7.10 Advanced Parameters

P2.4.8.1 *Modulator Type* ID1775 “Modulator type”

Select modulator type. Some operations require use of a software modulator.

0 = ASIC modulator

A classical third harmonic injection. The spectrum is slightly better compared to the Software 1 modulator.

NOTE: An ASIC modulator cannot be used when using DriveSynch or PMS motor with an incremental type encoder.

1 = Software Modulator 1

Symmetric vector modulator with symmetrical zero vectors.

Current distortion is less than with software modulator 2 if boosting is used.

NOTE: Recommended for DriveSynch (Set by default when DS activated) and needed when using PMS motor with an incremental encoder.

2 = Software modulator 2

One phase at a time in IGBT switches is not modulated during a 60-degree period of the frequency cycle. The unmodulated phase is connected to either positive or negative DC-bus.

This modulator type reduces switching losses up to two-thirds and all switches become evenly loaded.

BusClamp modulation is useful if the voltage is >80% of the maximum voltage, in other words, when the drive is operating near full speed. Then again, the motor ripple at low speeds is the double compared to selection 1.

3 = Software modulator 3

Unsymmetrical BusClamp in which one switch always conducts 120 degrees to negative DC-rail to reduce switching losses. However, upper and lower switches are unevenly loaded and the spectrum is wide.

P.2.4.8.2 Advanced Options 1 **ID1770** **"AdvancedOptions1"**

Reserved for future use. Some bits are controlled by application software so value may not be always zero.

P.2.4.8.3 Advanced Options 2 **ID1771** **"AdvancedOptions2"**

Reserved for future use. Some bits are controlled by application software so value may not be always zero.

P.2.4.8.4 Advanced Options 4 **ID1772** **"AdvancedOptions4"**

b0 =+1= Activate roll-back prevention control = 1

b1 = +2= Do PMSM start angle ID only once after power up = 1

P.2.4.8.5 Advanced Options 5 **ID1773** **"AdvancedOptions5"**

b0 =+1= PM-motor ctrl bad encoder adjust, 1 = active

P.2.4.8.6 Advanced Options 6 **ID1774** **"AdvancedOptions6"**

Reserved for future use. Some bits are controlled by application software so value may not be always zero.

7.11 Motor Control

P2.5.1 Motor control mode **ID 1572** **"Motor Ctrl Mode"**

- 0 Frequency control: The I/O terminal and keypad references are frequency references and the AC drive controls the output frequency (output frequency resolution = 0.01 Hz)
- 1 Speed control: The I/O terminal and keypad references are speed references and the AC drive controls the motor speed (accuracy ± 0.5%).
- 2 Speed control CL: Closed loop speed control mode. The I/O terminal and keypad references are speed references and the AC drive controls the motor speed. Encoder is required. Closed loop parameters in group G2.5.9 must be set accordingly

P2.5.2 Switching frequency **ID 601** **"Switching Freq"**

Motor noise can be minimised using a high switching frequency. Note, however, that increasing the switching frequency increases losses of the AC drive. Lower frequencies are used when the motor cable is long and the motor is small.

The range of this parameter depends on the size of the AC drive:

Type	Min. [kHz]	Max. [kHz]	Default [kHz]
0003—0061 NX_5 0003—0061 NX_2	1.0	16.0	10.0
0072—0520 NX_5	1.0	10.0	3.6
0041—0062 NX_6 0144—0208 NX_6	1.0	6.0	1.5

Table 7-4. Size-dependent switching frequencies

Note!

The actual switching frequency might be reduced down to 1.5kHz by thermal management functions. This has to be considered when using sine wave filters or other output filters with a low resonance frequency.

Note!

If the switching frequency is changed it is necessary to redo the identification run.

P2.5.3 Overvoltage controller **ID 607** **"Overvolt Contr"**
P2.5.4 Undervoltage controller **ID 608** **"Undervolt Contr"**

These parameters allow the under-/overvoltage controllers to be switched out of operation. This may be useful, for example, if the mains supply voltage varies more than -15% to +10% and the application will not tolerate this over-/undervoltage. In this case, the regulator controls the output frequency taking the supply fluctuations into account.

Note: Over-/undervoltage trips may occur when controllers are switched out of operation. Undervoltage controller is turned off automatically if evacuation is active.

- 0 Controller switched off
- 1 Controller switched on

P2.5.5. Measured RS voltage drop **ID 662** **“MeasRsVoltDrop”**

The measured voltage drop at stator resistance between two phases with the nominal current of the motor. This parameter is identified during identification run.

This parameter defines the motor stator resistance as a voltage drop at nominal current. The parameter value is defined according to motor nominal voltage and the current and the actual stator resistance as

$$RsVoltageDrop = 2560 \frac{I_n}{U_n} R_s$$

P2.5.6 Open loop Speed controller ki1 **ID 1655** **“SpeedContr_ki(OL)”**

Defines the I gain for the speed controlled in Open Loop Speed control mode.

P2.5.7 Open loop Speed controller kp1 **ID 1656** **“SpeedContr_kp(OL)”**

Defines the P gain for the speed controlled in Open Loop Speed control mode.

7.11.1 U/f Settings

U/f settings are mainly used in open loop control modes with the exception of the *Field weakening point voltage* that is also used in closed loop control mode as a limit for voltage. U/f settings are used to control the voltage level that are applied to the motor at different frequencies and different load situations.

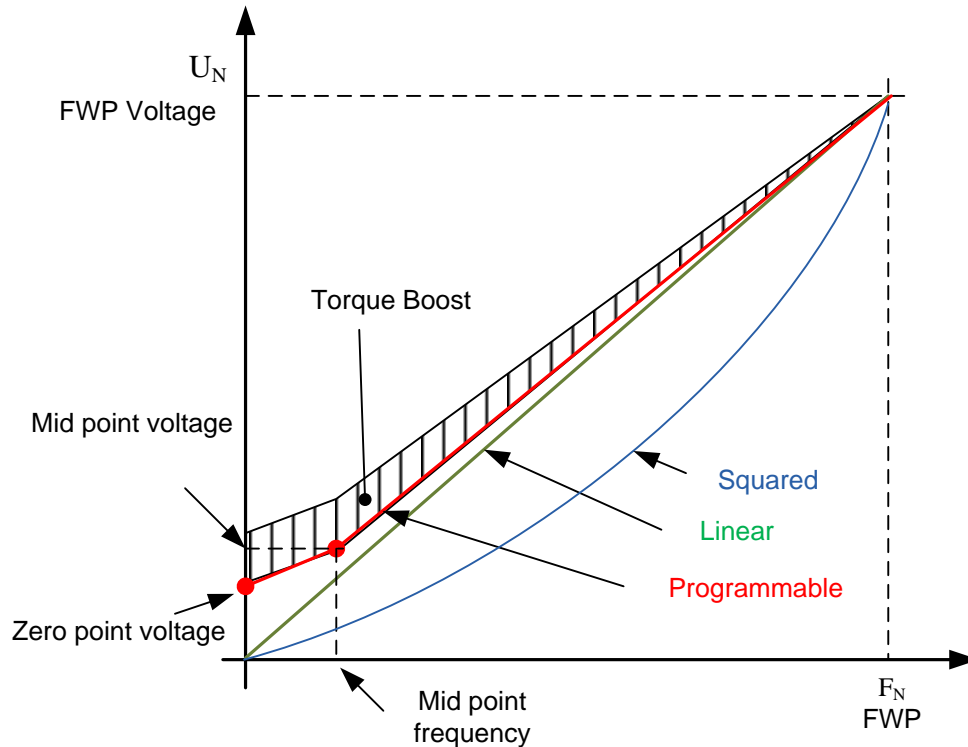

What changes are required to start with load from 0 Hz?

- ◆ First set the motor nominal values (Parameter group 2.1).

Option 1: Automatic functions

Step 1: Make identification with rotating motor

Step 2 (If needed): Activate speed control or U/f optimization (Torque boost).

Step 3 (If needed): Activate both speed control and U/f optimization.

Option 2: Manual tuning

Step 1:

Run the motor using 2/3 of motor nominal frequency as the frequency reference. Read the motor current in the monitoring menu or use VACON® NCDrive for monitoring. This current shall be set as the motor magnetization current.

Change the U/f curve ratio selection to programmable (= 2).

Run the motor with zero frequency reference and increase the motor zero point voltage until the motor current is approximately same as the motor magnetising current. (If the motor is in a low frequency area for only short periods, it is possible to use up to 65% of the motor nominal current).

Set then the midpoint voltage to $\sqrt{2} * \text{Zero Point Voltage}$
and
the midpoint frequency to $(\text{Zero Point Voltage}/100\%)*\text{Nominal frequency of motor}$

Step 2 (If needed): Activate speed control or U/f optimization (Torque boost).

Step 3 (If needed): Activate both speed control and U/f optimization.

NOTE! *In high torque – low speed applications – it is likely that the motor will overheat. If the motor has to run long times under these conditions, special attention must be paid to cooling of the motor. Use external cooling for the motor if the temperature tends to rise too high.*

P2.5.8.1	U/f optimisation	ID1573	“U/f Optimization”
	Automatic torque boost		The voltage to the motor changes proportionally to required torque which makes the motor produce more torque at start and when running at low frequencies. Automatic torque boost can be used in applications where starting torque due to starting friction is high, e.g. in conveyors. Even with linear U/f curve, the torque boost has an affect but the best result will be achieved after the identification run when programmable U/f curve is activated.
P2.5.8.2	U/f ration selection	ID1574	“U/f Ratio Select”
	Linear:		
	0		The voltage of the motor changes linearly from zero point voltage to the field weakening point where the voltage at FWP is supplied to the motor.
	Squared:		
	1		The voltage of the motor changes from zero point voltage following the squared curve form zero frequency to the field weakening point. The motor runs undermagnetised below the field weakening point and produces less torque. Squared U/f ratio can be used in applications where torque demand is proportional to the square of the speed, e.g. in centrifugal fans and pumps.
	Programmable U/f curve:		
	2		The U/f curve can be programmed with three different points. 1. Zero point voltage 2. Midpoint frequency and Midpoint voltage. 3. Field weakening point and field weakening point voltage. Programmable U/f curve can be used if more torque is needed at low frequencies. Make the Identification run for optimal setting (ID631).
	Linear with flux optimisation:		
	3		The AC drive starts to search for the minimum motor current in order to save energy. This function can be used in applications with constant motor load, such as fans, pumps etc.

- P2.5.8.3** *Field weakening point* **ID602** **“Field WeakngPnt”**
 The field weakening point is the output frequency at which the output voltage reaches the field weakening point voltage.
- P2.5.8.4** *Voltage at field weakening point* **ID603** **“Voltage at FWP”**
 Above the frequency at the field weakening point, the output voltage remains at the set maximum value. Below the frequency at the field weakening point, the output voltage depends on the setting of the U/f curve parameters.
 When the parameter *Motor nominal frequency* is set, the parameter *Field weakening point* is automatically given the corresponding value. If you need different values for the field weakening point and the maximum output voltage, change these parameters **after** setting the *Nominal frequency*.
 In closed loop control this defines maximum voltage to the motor, can be increases if sufficient DC voltage is available.
- P2.5.8.5** *U/f curve, middle point frequency* **ID1575** **“U/f Mid Freq”**
 If the programmable U/f curve has been selected with parameter U/f ratio this parameter defines the middle point frequency of the curve. See also parameter *Middle point voltage*.
 When the programmable U/f curve is selected this value is set to 10% of motor nominal frequency.
- P2.5.8.6** *U/f curve, middle point voltage* **ID1576** **“U/f mid Voltg”**
 If the programmable U/f curve has been selected with the parameter U/f ratio this parameter defines the middle point voltage of the curve. See also parameter *Middle point frequency*.
 When the programmable U/f curve is selected this value is set to 10% (of motor nominal voltage).
- P2.5.8.7** *Output voltage at zero frequency* **ID1577** **“Zero Freq Voltg”**
 This parameter defines the zero frequency voltage of the U/f curve. The default value is unit size dependent.
NOTE: If the value of parameter *U/f Ratio Select* is changed this parameter is set to zero.

7.11.2 Closed Loop Settings

Speed control formula:

$$y = Kp \left[1 + \frac{1}{Ti s} \right] e$$

$$u(k) = y(k-1) + Kp[e(k) - e(k-1) + \frac{Ts}{Ti} e(k)]$$

P2.5.9.1	<i>Speed Control Limit 1</i>	ID 1618	"SpeedCtrlLimit1"
P2.5.9.2	<i>Speed Control Limit 2</i>	ID 1619	"SpeedCtrlLimit2"

Change limits for speed controller gain and integral time constant. When the output frequency is below the change point 1 (par 2.5.9.1) the gain value is the same as parameter 2.5.9.3. If the output frequency is greater than change point 2 (par 2.5.9.2) then the gain value is the same as parameter 2.5.9.4. Between these two points the

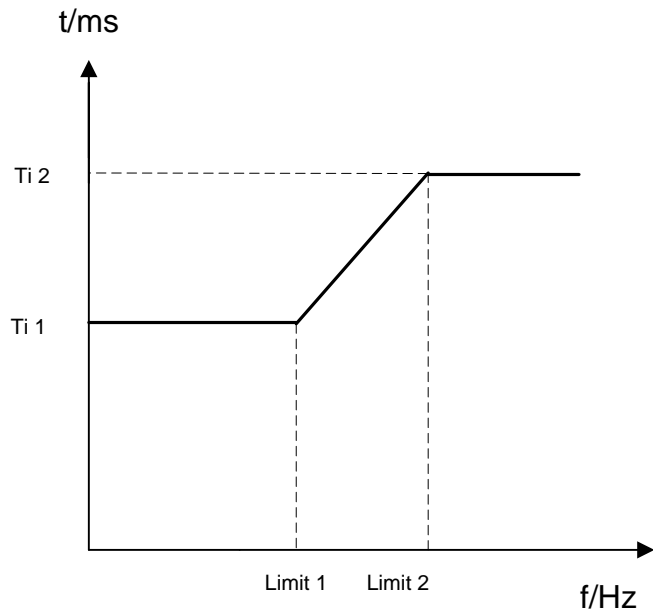

change is linear. See Figure 9 and Figure 10.

P2.5.9.3	<i>Speed Control Kp 1</i>	ID 1620	"Speed Ctrl Kp 1"
P2.5.9.4	<i>Speed Control Kp 2</i>	ID 1621	"Speed Ctrl Kp 2"

Gain for the speed controller in closed loop motor control operation. Gain value 100 means that the nominal torque reference is produced at the speed controller output for the frequency error of 1Hz.

Active Speed control gain value (%/ Hz) is Speed control Kp1 if the output frequency is less than Speed control limit 1. Active Speed control gain value is Speed control Kp2 if the output frequency is more than Speed control limit2. Between these two points the change is linear. See Figure 9 and Figure 10.

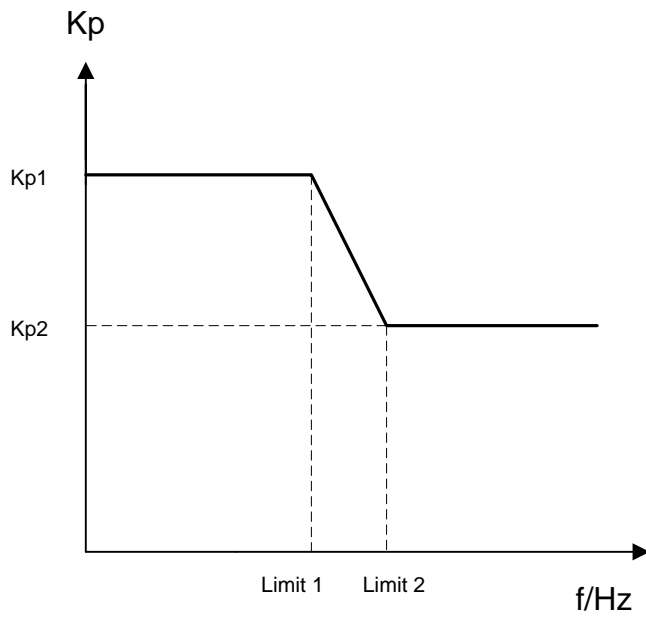
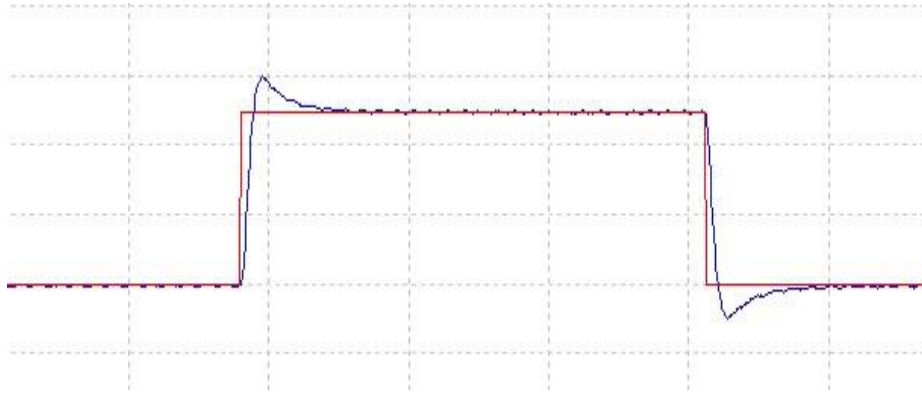

Figure 9. Proportional Speed Control K_p Curve.

P2.5.9.5	Speed Control Ti 1	ID 1622	"Speed Ctrl Ti1"
P2.5.9.6	Speed Control Ti 2	ID 1623	"Speed Ctrl Ti2"

Sets the integral time constant for the speed controller. Increasing the I-time increases stability but lengthens the speed response time.



Kp 30, Ti 100

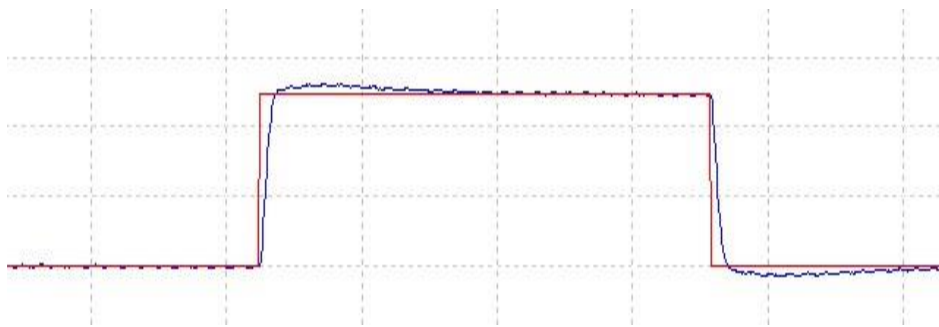

Kp 30, Ti 300

Active Integral time constant value for the speed controller is Speed control Ti 1 if the output frequency is less than Speed control limit 1. If the output frequency is more than Speed control limit 2 the value is Speed control Ti 2.

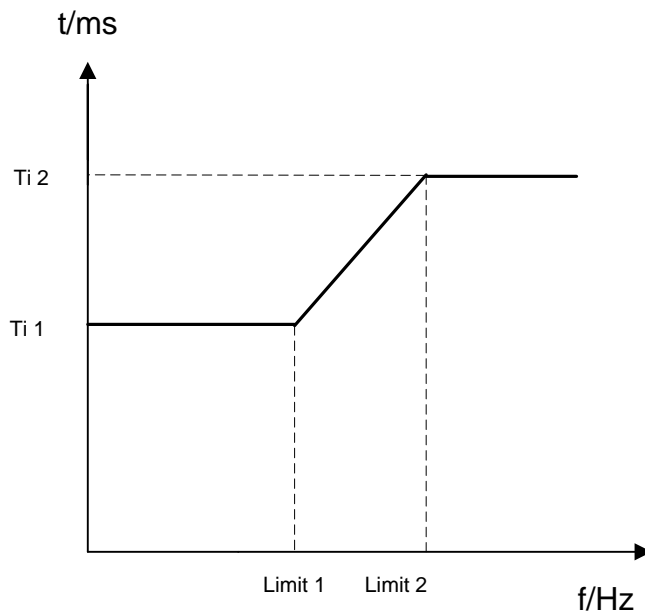

Figure 10. Proportional Speed Control Ti Curve

- P2.5.9.7 Current control P gain ID617** **“CurrentControlKp”**
 Sets the gain for the current controller. The controller generates the voltage vector reference to the modulator. The gain is also used in open loop flying start. When the Sine filter parameter (parameter P6.7.5 in the System menu) has been set to *Connected* the value of this parameter is changed to 20.00%.
- The value is also identified when using a PMS motor and making identification run with rotating motor. At low speed the motor values may increase up to 300%. At high speed motor gain and motor with sine filter may have gain values of 10...40%.
- P2.5.9.8 Current control Ti ID657** **“CurrentControlTi”**
 Current controller integrator time constant.
- P2.5.9.9 Encoder filter time ID618** **“Encoder1FiltTime”**
 Sets the filter time constant for speed measurement.
 The parameter can be used to eliminate encoder signal noise. Too high a filter time reduces speed control stability. Values over 10 ms are not recommended in normal cases.
- P2.5.9.10 Slip adjust ID619** **“Slip Adjust”**
 The motor name plate speed is used to calculate the nominal slip. This value is used to adjust the voltage of motor when loaded. The name plate speed is sometimes inaccurate and this parameter can therefore be used to trim the slip. Reducing the slip adjust value increases the motor voltage when the motor is loaded.
- P2.5.9.11 Torque ramp time ID1760** **“TorqueRampTime”**
 Torque ramp time in start and stop. Used in start if torque reference is used. Used in ramp stop to reduce torque step.
- P2.5.9.12 Torque reference selection ID621** **“TorqueRefSelecti”**
 0= Not Used
 1= Torque memory
 2= Torque reference from AI1 or AI2
 Analogue input can be chosen by parameter P2.5.9.13 Torque Reference. Minimum and maximum values can be chosen by parameters P 2.5.9.14 Torq Ref Min and P2.5.9.15 Torq Ref Max. Filter time can be chosen by parameters P2.6.3.6.1 AI1 Ref Filt Time or P2.6.3.2.6 AI2 Ref Filt Time. Reference signal scaled and filtered signal can be seen in monitoring value V.1.25.4.
- P2.5.9.13 AI Torque reference ID641** **“AI Torque Ref”**
 Can be selected torque reference from A1 or A2 by this parameter.
- P2.5.9.14 Torque reference scaling, minimum value ID643** **“Torq Ref Min”**
 Minimum torque reference for analogue input reference selections.
- P2.5.9.15 Torque reference scaling, maximum value ID642** **“Torq Ref Max”**
 Maximum torque reference for analogue input reference selections.

P2.5.9.16 Torque reference add delay *ID1778* *“TorqueRefAddDelay”*
 Delay from run request to adding of torque reference.

P2.5.9.17 Show advanced parameters *ID1969* *“ShowAdvancedPar”*
 For fine tuning purposes.

7.11.2.1 Rollback

P2.5.18.1 RollBack controller *ID 1687* *“RollBack Ctrl”*
 Roll-back control is made to reduce the opposite movement in starting mainly in lift drives. This covers also induction motors but is more useful in gearless PM-drives, in which the motor shaft movement is directly transferred to the lift-car movement e.g the counterweight of the lift tends to move the empty lift-car upwards which is not good if the run direction is downwards.
 RollBack controller is activated according to wake up level and this controller is disabled after a speed reference is increased from zero thus when the acceleration starts. In practice this controller is active during the time [P2.3.2.9 0 Hz time at start](#)

RollBack controller is disabled / enabled according to this parameter.

- 0 Disabled
- 1 Enabled

P2.5.18.2 RollBack controller Gain *ID 1689* *“RB ctrl Gain”*
 RollBackCtrlGain is the gain of the RB-controller. Typically gain value is from 2000 to 5000. This value depends on the overall lifts mechanical structure.
 The bigger the gain is the bigger is the impact to the speed control loop and the smaller is the actual lift car’s roll back effect after the mechanical brake release.

P2.5.18.3 RollBack controller pretorque *ID 1691* *“RB ctrl Pretorq”*
 Pretorque defines size of torque step applied to motor when wakeup conditions are exceeded. Unit is % from motor nominal torque.

P2.5.18.4 RollBack controller wake up level *ID 1690* *“RB ctrl WakeUp”*
 RollBack controller wake up level is the threshold to activate the RB-control. Parameter value is compared with measured pulses from encoder signal.
 Values below 1.00 cannot be set when incremental encoder is connected. When setting decimal value e.g. 0.50 interpolation have to be activated for the Endat encoder from the option board parameters. Decimal values are compared to the phase of sine pulse readable from e.g. Endat encoders.
 Decimal portion is significant only when the parameter’s value is below 1.00.

7.11.3 Permanent magnet synchronous motor settings

There are three ways to know the magnet positions when using the closed loop control. The first one will identify the motor magnet position during every start when using incremental encoder without Z-pulse. Second one uses incremental encoder Z-pulse and the third one uses absolute encoder information. See details of selecting correct mode from chapter "Identification function for permanent magnet synchronous motor".

P2.5.10.1 PMSM Shaft Position ID1670 "PMSMShaftPositio"

Absolute encoder position value corresponding to the shaft position where rotor magnet axis is aligned with the stator U-phase magnet axis will be stored here as a result of the encoder identification run. If incremental encoder with a z-pulse is used, z-pulse position will be stored instead. Depending on the motor shaft mechanical position, this parameter can have different values, as there is one right value for each pole-pair of the motor.

P2.5.10.2 Start Angle Identification Mode ID1933 "StartAngleIdMode"

Start angle, i.e. rotor magnet axis position in respect to the stator U-phase magnet axis, identification is needed if there are no absolute encoder or incremental encoder used. This function defines how the start angle identification is made in those cases. Identification time depends on the motor electrical characteristics but takes typically 50 ms...200 ms.

In case of absolute encoders, start angle will read directly from the encoder absolute angle value. On the other hand, incremental encoder z-pulse will be used automatically for synchronization if its position is defined different from zero in P2.5.10.1. Also for absolute encoders, P2.5.10.1 must be different from zero, otherwise it is interpreted that the encoder identification run has not been done and the running will be prohibited except if the absolute channel is bypassed by the start angle identification.

0 = Automatic

Decision to use start angle identification is made automatically based on the encoder type connected to the drive. This will serve common cases.
Supports: OPT-A4, OPT-A5, OPT-A7 and OPT-AE boards.

1 = Forced

Bypasses the drive automatic logic and forces the start angle identification to be active. Can be used, for example, with absolute encoders to bypass absolute channel information and to use start angle identification instead.

2 = On Power UP

As a default, start angle identification will be repeated in every start if the identification is active. This setting will enable identification only in a first start after drive is powered up. In consecutive starts, angle will be updated based on the encoder pulse count.

3 = Defined by digital input

Digital input can be connected (TTF) to signal to the drive to implement start angle identification at next start.

P2.5.10.3 Start Angle Identification Current ID1938 "StartAngleIdCurr"

This parameter defines the current level that is used in start angle identification. The correct level depends of the motor type used. In general, 50% of motor nominal current

seems to sufficient, but depending for example on the motor saturation level, higher current might be needed.

P2.5.10.4 Polarity Pulse Current **ID1800** **“PolarityPulseCur”**

This parameter defines the current level for the magnet axis polarity direction check during the start angle identification (P2.5.10.2). Value 0 means that the internal current level is used, which is typically slightly higher than the normal identification current defined by P2.5.10.3. Polarity direction check is seldom needed because the identification itself gives already the right direction. Hence in most cases, this function can disabled by setting any negative parameter value, which is recommended especially if there occurs F1 faults during the identification.

P2.5.10.5 Encoder identification mode **ID1686** **“EncoderIdentMode”**

Defines how the encoder identification is made.

0 = DC Current; motor start angle is defined by feeding DC current into motor for certain time. If motor shaft is free that will automatically turn the rotor to “zero position”. That angle is stored to P2.5.10.1.

1 = Pulse injection; Identification is done by feeding motor with a DC pulses that identifies magnet position. DC pulses are in two different groups. First one identifies zero position and second one makes polarity check. These DC current levels are adjusted by “P2.5.10.3 Start Angle Identification Current” and “P2.5.10.4 Polarity Pulse current”, respectively.

P2.5.10.6 EnableRsIdentification **ID654** **“EnableRsIdentifi”**

This parameter enables the Rs identification during DC brake current operations and in closed loop control for every start. If the identification run was made successfully it is recommended to keep this parameter disabled.

P2.5.10.7 Modulation Index Limit **ID655** **“ModIndexLimit”**

Modulation index in % for closed loop operation. Higher value of motor terminal voltage can be achieved by increasing this value.

7.11.3.1 D and Q axis voltage drops

If d-axis and q-axis reactances (voltage drops) are defined, drive calculates the optimal d-axis current reference based on the reactance values and the motor torque in order to account motor reluctance torque part. In this way, motor Torque/Current ratio can be increased.

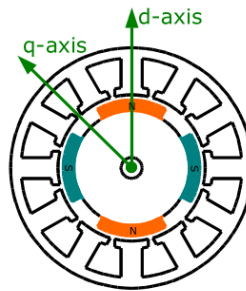

P2.5.10.10 *Lsd Voltage Drop*

ID1757

“Lsd Voltage Drop”

D-axis reactance voltage drop 2560 = 100%.

Gives the % voltage drop across the stator inductance at nominal current and frequency.

$$X_d[\text{Drive scale}] = \frac{X_d[\Omega] * I_n[A] * \sqrt{3}}{U_n[V] * 2560}$$

P2.5.10.11 *Lsq Voltage Drop*

ID1758

“Lsq Voltage Drop”

Q-axis reactance voltage drop 2560 = 100%.

Gives the % voltage drop across the stator inductance at nominal current and frequency.

$$X_q[\text{Drive scale}] = \frac{X_q[\Omega] * I_n[A] * \sqrt{3}}{U_n[V] * 2560}$$

7.11.3.2 Flux current controller

The flux current controller is used with a PMS motor when running in closed loop control in the field weakening area. This function controls negative Id current to PM motor in the field weakening area That motor terminal voltage do not increase above maximum level (set by field weakening point voltage, maximum drive output voltage). Field weakening area operation depends on motor construction and motor construction may prohibit operation above field weakening area.

If there is instability in the field weakening area, gain can be decreased and/or time constant increased.

P2.5.10.12 *Flux Current Kp*

ID 651

“FluxCurrent Kp”

Defines gain for the flux current controller when using a PMS motor. Depending on motor construction and the ramp rate that is used to go to field weakening area high may be needed that output voltage do not reach maximum limit and prevent proper motor control. Too high gain may also lead to unstable control. Integration time is more significant in this case for control.

P2.5.10.13 Flux Current Ti**ID 652****"FluxCurrent Ti"**

Defines the integration time for the flux current controller when using a PMS motor. Depending on motor construction and the ramp rate that is used to go to field weakening area, short integration times may be needed that output voltage do not reach maximum limit and prevent proper motor control. Too fast integration time may also lead to unstable control.

P2.5.10.14 ExtIdRef**ID1730****"ExtIdRef"**

This reference value can be used for the external control of the motor id-current i.e. reactive current. Normally there is no need for that as the control uses already the optimal value. This reference value is additive to drive internal values but, for example, field-weakening controller can override the given reference in field-weakening operation.

P2.5.10.15 IdRefAtZeroSpeed**ID1805****"IdRefAtZeroSpeed"**

If Id current ramping at small frequencies is enabled by setting IdRefMaxFreq > 0, this parameter defines Id current reference value at zero frequency (Figure 11).

P2.5.10.16 IdRefMaxFreq**ID1806****"IdRefAtZeroSpeed"**

Maximum frequency for ramping Id current at small frequencies.

0 = Id current reference ramping is disabled. Value of P2.5.10.15 ExtIdRef is used.
>0 = Id current reference is ramped at small frequencies as illustrated in Figure 11. Id current reference is 0 at frequencies higher than IdRefMaxFreq.

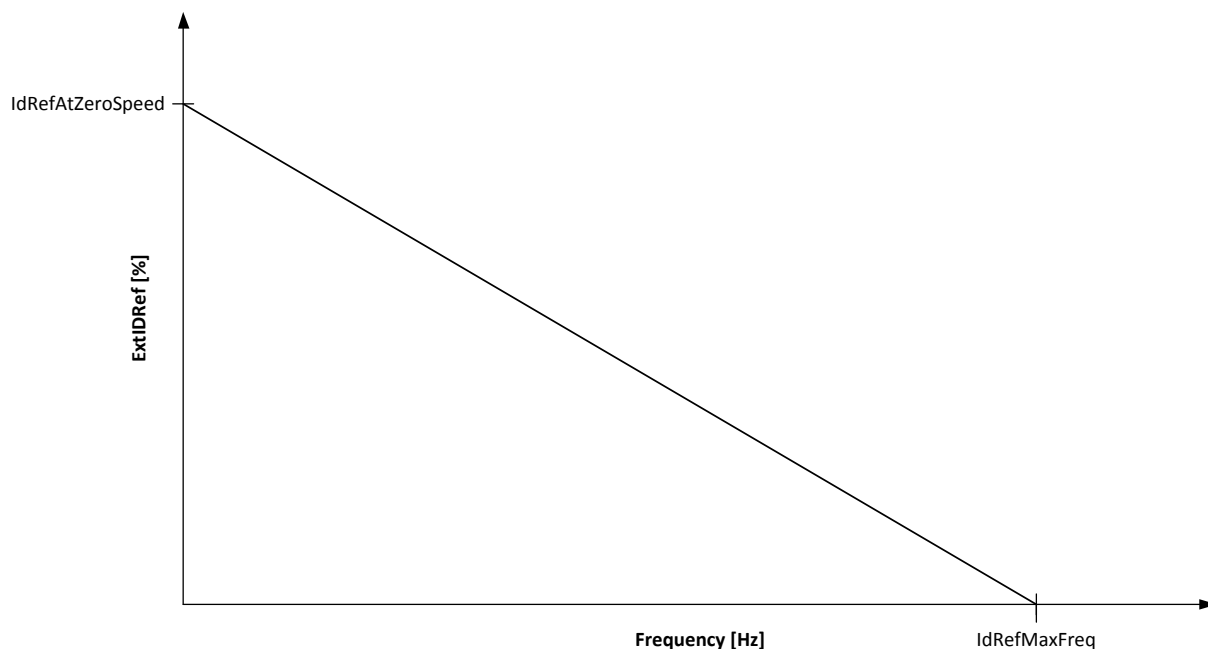

Figure 11 Id current ramping

7.11.4 Stabilization settings

7.11.4.1 Torque stabiliser

The torque stabiliser is basically a first order high-pass filter for the estimated torque [T]. The output of the filter is a frequency correction term df added to the output frequency reference. The purpose of the torque stabiliser is to stabilise the possible oscillations in the estimated torque. The controller gain is changing linearly between the zero and field weakening point frequencies. The zero and field weakening point gains can be controlled independently with gains. The stabiliser operates at frequencies above 3 Hz.

The discrete implementation of the filter is:

$$\frac{1000}{TorqStabDamp} df_k = \frac{1000}{TorqStabDamp} G(T_k - T_{k-1}) + df_{k-1} = G_f(T_k - T_{k-1}) + df_{k-1}$$

Where G_f is the total gain of the filter. The gain and the corner frequency of the filter is controlled by the following parameters

P2.5.11.1 Torque stabiliser damping ID1413 "TorqStabDamp"

If a PMS motor is used in open loop control mode it is recommended to use value 980 instead of 800. The value '980' is set automatically when PMS motor is selected.

This parameter defines the corner frequency of the high-pass filter. The time constant of the filter is calculated as

$$T_c = T_s \frac{TorqStabDamp}{1000 - TorqStabDamp} = 1ms \frac{TorqStabDamp}{1000 - TorqStabDamp}$$

It follows that the corner frequency of the filter is obtained from

$$\omega_c = \frac{1}{T_c} rad/s$$

For example, if Torque stabilizer damping = 600, it follows that $T_c = 1.5$ ms and $\omega_c = 667$ rad/s.

P2.5.11.2 Torque stabiliser Gain ID1412 "TorqStabGain"

These parameters define together with the Torque Stabiliser Damping the actual gain of the filter. Torque Stabiliser Gain is the gain at the zero frequency. Torque stabiliser Gain in FWP is the gain at the field-weakening frequency. The gain changes linearly with the frequency between these two points so that the gain is

$$G = TorqStabGainFWP + TorqStabGain - \frac{f}{f_{FWP}} TorqStabGain, \quad \text{if } f < f_{FWP}$$

$$G = TorqStabGainFWP, \quad \text{if } f \geq f_{FWP}$$

The final gain is obtained by considering the value of Torque Stabiliser Damping and the scaling in which 256 means the gain 1. So, the final and the actual gain of the filter is obtained from

$$G_f = \frac{1000 * G}{256 * TorqStabDamp}$$

P2.5.11.3 Torque stabiliser Gain in FWP area ID1414 “TorqStabGainFWP”

Gain of the torque stabiliser at field weakening point in open loop motor control operation. See details from Torque Stabiliser Gain.

P2.5.11.4 Torque stabiliser Limit ID1600 “TorqStabLimit”

This defines how much torque stabiliser can affect the output frequency.

7.11.4.2 Flux Circle stabiliser

P2.5.11.5 Flux Circle stabiliser Gain ID1550 “FluxCircleStabG”

Gain for flux circle stabiliser. This will control the flux to origin when error is detected. Controller output is added to output frequency. The effect decreases at low frequencies where flux stabiliser has more effect. Used at frequencies where output voltage is at maximum limit (set by field weakening point voltage or maximum drive output voltage).

7.11.4.3 Flux stabiliser

Flux stabilizer is a first order high-pass filter for the estimated flux producing current I_d . The output of the filter is correcting term dU added to the output voltage reference. The gain and the corner frequency of the filter is controlled by the following parameters.

P2.5.11.6 Flux Stabiliser Gain ID1797 “Flux Stab Gain”

Flux stabilizer gain is 0 at the zero speed and is increased linearly with the frequency to value defined by the Flux Stab Gain which is reached at the 1 Hz. So, the gain is obtained from

$$G = \text{Flux Stab Gain} * f, \quad \text{if } f < 1 \text{ Hz}$$

$$G = \text{Flux Stab Gain}, \quad \text{if } f \geq 1 \text{ Hz}$$

The gain is scaled by 1000 and the actual gain of the filter is obtained from

$$G_f = \frac{G}{1000} = \frac{\text{Flux Stab Gain}}{1000}$$

P2.5.11.7 Flux stabiliser TC ID1699 “FluxStab TC”

Flux Stabiliser TC defines the corner frequency of the high-pass filter. The time constant of the filter is calculated from:

$$T_c = T_s \frac{65536 - 2 * \text{FluxStab TC}}{2 * \text{FluxStab TC}} = 1\text{ms} \left(\frac{65536}{2 * \text{FluxStab TC}} - 1 \right)$$

For example, if Flux Stabiliser TC = 64, it follows that $T_c = 511 \text{ ms}$ and $\omega_c = 1.96 \text{ rad/s}$.

7.11.4.4 Voltage stabiliser

The voltage stabilizer is similar to the torque stabilizer controlling the change in DC-link voltage at frequencies above 3 Hz. It is a first order high-pass filter for the measured DC-link voltage U_{dc} . The output of the filter is a frequency correction term df added to the output frequency reference. Gain is adjusted relative to the estimated torque. As the torque increases from 10% to 50% of the motor

nominal torque, the controller gain decreases from the voltage stabiliser Gain down to zero. The gain and the corner frequency of the filter are controlled by the following parameters:

P2.5.11.8 Voltage stabiliser TC **ID1698** **“VoltageStab TC”**

This parameter defines the corner frequency of the high-pass filter. The time constant of the filter is calculated as

$$T_c = T_s \frac{\text{VoltageStab TC}}{1000 - \text{VoltageStab TC}} = 1\text{ms} \frac{\text{VoltageStab TC}}{1000 - \text{VoltageStab TC}} \text{ms}$$

P2.5.11.9 Voltage stabiliser Gain **ID1697** **“VoltStabGain”**

Voltage Stabilizer Gain is a function of a torque. If the torque is below 15%, the gain is the value defined by the Voltage Stabilizer Gain. If the torque is above 50% the gain is 0. Between 15-50% the gain decreases linearly with the torque from Voltage Stabilizer Gain to 0. In other words,

$$G = \text{VoltStabGain}, \quad \text{if } T < 15 \%$$

$$G = \frac{\text{VoltStabGain}}{35\%} (50\% - T(\%)), \quad \text{if } 15\% \leq T < 50 \%$$

$$G = 0, \quad \text{if } T > 50 \%$$

The final gain is obtained by considering the value of Voltage stabiliser TC and the scaling in which 256 means the gain 1. So, the final and the actual gain of the filter is obtained from

$$G_f = \frac{1000 * G}{256 * \text{VoltageStab TC}}$$

P2.5.11.10 Voltage stabiliser Limit **ID1696** **“VoltStabLimit”**

This parameter sets the limits for the voltage stabilizer output. The maximum and the minimum value for the correction term df in FreqScale.

7.11.5 Identification settings

P2.5.12.1 to

P2.5.12.15 Flux 10... 150%

ID1355 – ID1369

Motor voltage corresponding to 10%....150% of flux as a percentage of Nominal Flux voltage. Measured during identification.

P2.5.12.16 Measured Rs voltage drop

ID662

“RsVoltageDrop”

The measured voltage drop at stator resistance between two phases with the nominal current of the motor. This parameter is identified during identification run.

This parameter defines the motor stator resistance as a voltage drop at nominal current. The parameter value is defined according to motor nominal voltage and the current and the actual stator resistance as

$$RsVoltageDrop = 2560 \frac{I_n}{U_n} R_s$$

P2.5.12.17 Ir: Add zero point voltage

ID664

“IrAddZeroPVoltag”

Defines how much voltage is applied to motor in zero speed when torque boost is used.

P2.5.12.18 Ir: Add generator scale

ID665

“IrAddGeneScale”

Defines the scaling factor for generator side IR-compensation when torque boost is used.

P2.5.12.19 Ir: Add motoring scale

ID667

“IrAddMotorScale”

Defines the scaling factor for motoring side IR-compensation when torque boost is used.

P2.5.12.20 Measured Ls voltage drop

ID673

“LsVoltageDrop”

Leakage inductance voltage drop with nominal current and frequency of the motor. This parameter defines the Ls voltage drop between two phases. Use identification run to determine the optimum setting.

P2.5.12.21 Motor BEM Voltage

ID674

“Motor BEM Voltage”

Motor-induced back voltage.

P2.5.12.22 IU Offset

ID668

“IU Offset”

P2.5.12.23 IV Offset

ID669

“IV Offset”

P2.5.12.24 IW Offset

ID670

“IW Offset”

Offsets the value for phase current measurement. Identified during identification run.

7.12 Input Signals

P2.6.1 Start/Stop Logic Selection

ID 300

"Start/stop logic"

- 0 DIN1: closed contact = start forward (rising edge pulse is required)
- DIN2: closed contact = start reverse (rising edge pulse is required)

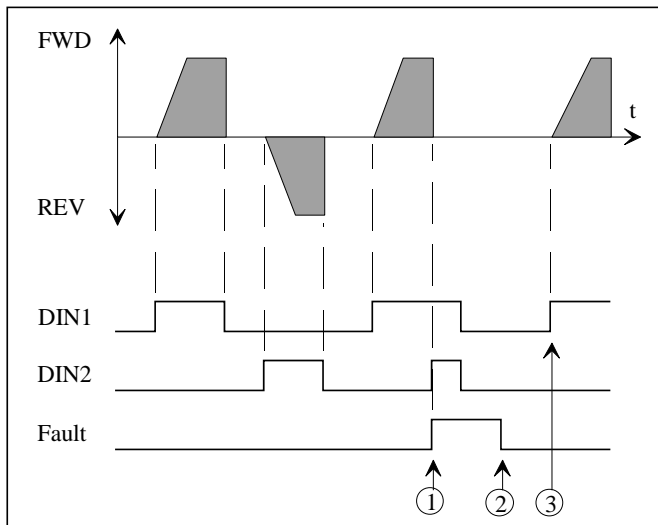

Figure 12. Start forward/Start reverse

- ① If both DIN switches are ON at the same time fault is activated.
- ② Fault reset.
- ③ The drive can be re-started after fault reset and when both DIN switches are in OFF position.

- 1 DIN1: closed contact = start open contact = stop
- DIN2: closed contact = reverse open contact = forward

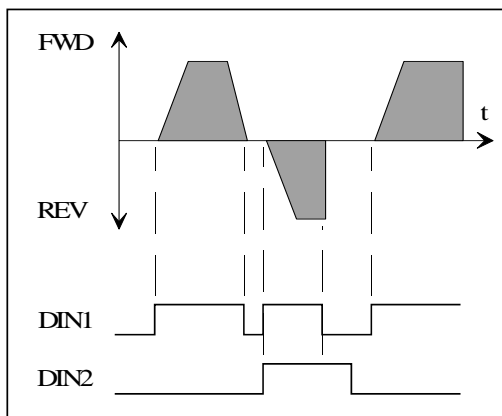

Figure 13. Start, Stop, Reverse

- 8 DIN1: closed contact = start forward
- DIN2: closed contact = start reverse

Sama as selection 0 except rising edge pulse is not required.
Fault is not activated if both DIN switches are on.

7.12.1 Digital Inputs (M2 -> G2.6.7)

All digital inputs (except DIN1 and DIN2) are programmable. See instructions on page 8

P2.6.2.1	External Fault closing contact	ID 1513	"Ext Fault Close"
P2.6.2.2	External Fault opening contact	ID 1514	"Ext Fault Open"
P2.6.2.3	Fault Reset	ID 1515	"Fault Reset"
P2.6.2.4	Run Enable	ID 1516	"Run Enable"
P2.6.2.5	Acc/Dec time selection	ID 1517	"Acc/Dec Time Sel"

Speed curve to used when the input is activated.

P2.6.2.6	Stop by coast, closing contact	ID 1518	"StopCoasting_cc"
P2.6.2.7	Stop by coast, opening contact	ID 1519	"StopCoasting_oc"
P2.6.2.8	Override Speed	ID 1520	"Override Speed"
P2.6.2.9	Forced I/O control	ID 1521	"Force I/O cntr"

P2.6.2.10	Speed selection input 1	ID 1510	"Speed Sel Input1"
P2.6.2.11	Speed selection input 2	ID 1511	"Speed Sel Input2"
P2.6.2.12	Speed selection input 3	ID 1512	"Speed Sel Input3"

Parameters 2.6.2.10-2.6.2.12 are speed reference selection inputs (see also [parameter 2.2.2](#)).

P2.6.2.13	PM motor angle identification repeat	ID 1934	"AngleIDRepeat"
-----------	--------------------------------------	---------	-----------------

Repeat angle identification in start if requested with DIN.

P2.6.2.14	Delayed DIN1	ID 1833	"DIN1 ON Delay"
-----------	--------------	---------	-----------------

Defines the activation delay for digital input DIN1.

P2.6.2.15	Delayed DIN2	ID 1834	"DIN2 ON Delay"
-----------	--------------	---------	-----------------

Defines the activation delay for digital input DIN2.

7.12.2 Analogue input 1&2

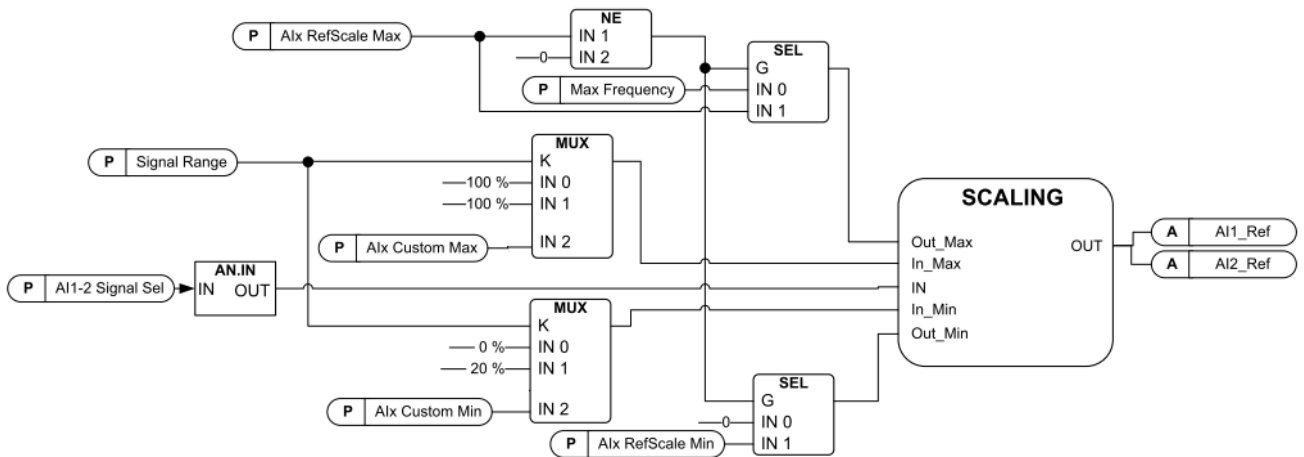

P2.6.3.1.1 AI1 signal selection ID 377 "AI1 Signal Sel"

P2.6.3.2.1 AI2 signal selection ID 388 "AI2 Signal Sel"

Connect the AI1/AI2 signal to the analogue input of your choice with this parameter. For more information about the TTF programming method, see chapter 4.

P2.6.3.1.2 Reference offset for analogue input1 ID 302 "AI1 Offset"

P2.6.3.2.2 Reference offset for analogue input2 ID 390 "AI2 Offset"

- 0 No offset
- 1 Offset 4 mA ("living zero") provides supervision of zero level signal. The response to reference fault can be programmed with [parameter 2.8.1.1](#).
- 2 Custom range it is possible to freely adjust what input level corresponds to the minimum and maximum frequencies.

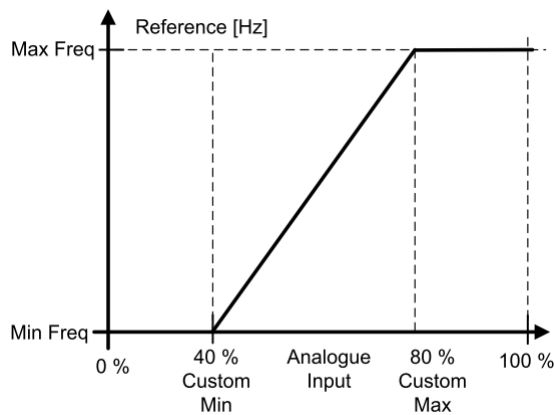

P2.6.3.1.3 AI1 Reference scaling, minimum value ID 303 "AI1 RefScaleMin"

P2.6.3.2.3 AI2 Reference scaling, minimum value ID 393 "AI2 RefScaleMin"

P2.6.3.1.4 AI1 Reference scaling, maximum value ID 304 "AI1 RefScaleMax"

P2.6.3.2.4 AI2 Reference scaling, maximum value ID 394 "AI2 RefScaleMax"

Additional reference scaling. Analogue input reference scaling can be set to a different value than the minimum and maximum frequency. If maximum value = 0 scaling is set off.

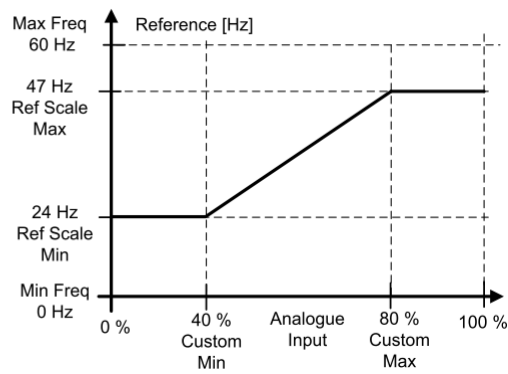
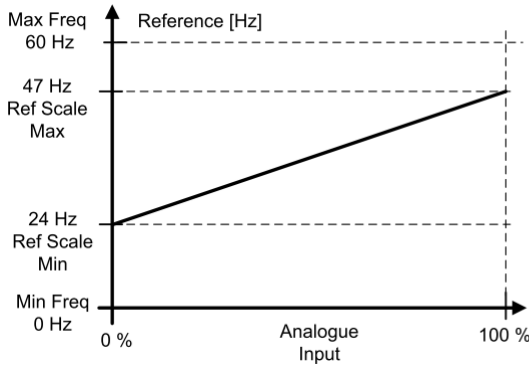

P2.6.3.1.5 AI1 Reference inversion ID305 "AI1 RefInvert"

P2.6.3.2.5 AI2 Reference inversion ID398 "AI2 RefInvert"

Inverts reference signal: Max. ref. signal = Min. set freq. Min. ref. signal = Max. set freq.
 0 No inversion
 1 Reference inverted

P2.6.3.1.6 AI1 Reference filter time ID 306 "AI1 RefFiltTime"

P2.6.3.2.6 AI2 Reference filter time ID 389 "AI2 RefFiltTime"

Filters out disturbances from the incoming analogue signal. Long filtering time makes regulation response slower.

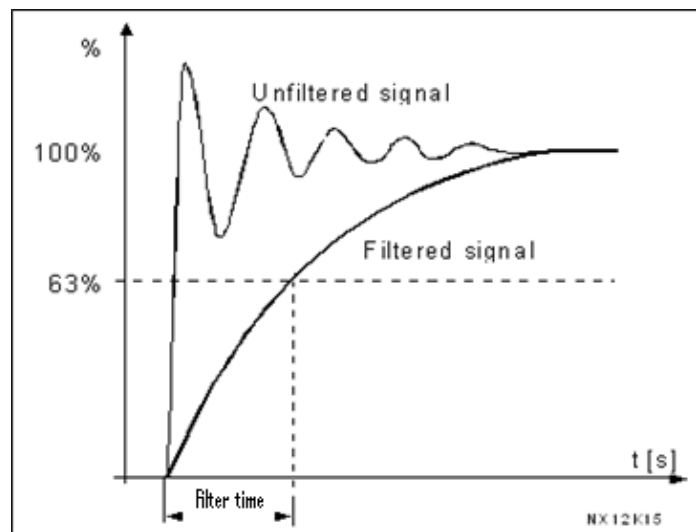

P2.6.3.1.7 AI1 custom minimum setting ID 380 "AI1 Custom Min"

P2.6.3.2.7 AI2 custom minimum setting ID 391 "AI2 Custom Min"

P2.6.3.1.8 AI1 custom maximum setting ID 381 "AI1 Custom Max"

P2.6.3.2.8 AI2 custom maximum setting ID 392 "AI2 Custom Max"

These parameters set the analogue input signal for any input signal span within - 160...160%. E.g. if the signal input scaling is set to 40%...80% the reference can be changed from 8 mA (for Minimum Frequency) to 16 mA (for Maximum Frequency).

7.13 Output Signals

7.13.1.1 Analogue output

P2.7.1.1 Analogue output function ID 307 “lout Content”

This parameter selects the desired function for the analogue output signal. See Table 6-9. Output signals, G2. on page 29 for the parameter values.

P2.7.1.2 Analogue output filter time ID 308 “lout Filter Time”

Defines the filtering time of the analogue output signal.

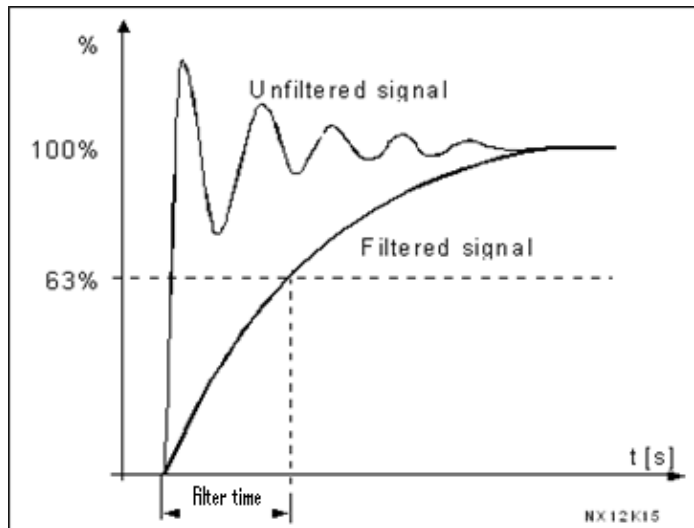

Figure 14. Analogue output filtering

P2.7.1.3 Analogue output inversion ID 309 “lout Invert”

Inverts the analogue output signal:
 Max output signal = Min set value
 Min output signal = Max set value

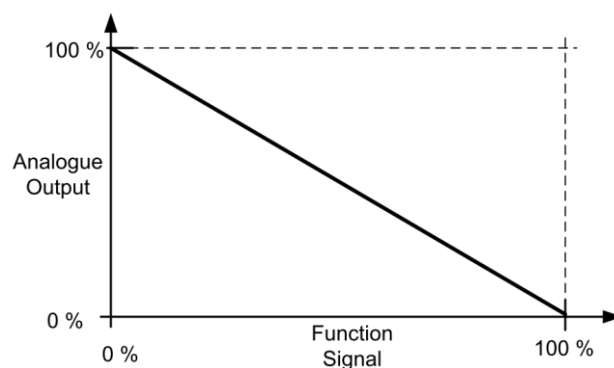

Figure 15. Analogue output invert

P2.7.1.4 Analogue output minimum ID 310 "Iout Minimum"

Defines the signal minimum to either 0 mA or 4 mA (living zero). Note the difference in analogue output scaling in parameter 2.7.1.5 (see Figure 16).

- 0 Set minimum value to 0 mA
- 1 Set minimum value to 4 mA

P2.7.1.5 Analogue output scale ID 311 "Iout Scale"

Scaling factor for analogue output.

Signal	Max. value of the signal
Output frequency	Nom frequency (par. 2.1.2)
Freq. Reference	Nom frequency (par. 2.1.2)
Motor speed	Motor nom. speed $1 \times n_{mMotor}$
Output current	Motor nom. current $1 \times I_{nMotor}$
Motor torque	Motor nom. torque $1 \times T_{nMotor}$
Motor power	Motor nom. power $1 \times P_{nMotor}$
Motor voltage	$100\% \times U_{nmotor}$
DC-link voltage	1000 V

Table 7-5. Analogue output scaling

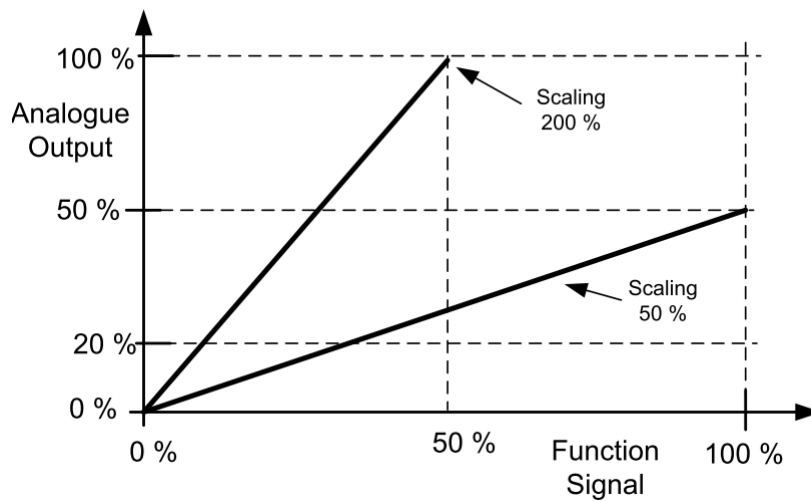

Figure 16. Analogue output scaling

7.13.1.2 Digital outputsP2.7.2.1 **Digital output 1 function**

ID 312

"D01 Function"

Setting value	Signal content
0 = Not used	Out of operation <u>Digital output D01 sinks the current and programmable relay (R01, R02) is activated when:</u>
1 = Ready	The AC drive is ready to operate
2 = Run	The AC drive operates (motor is running)
3 = Fault	A fault trip has occurred
4 = Fault inverted	A fault trip <u>not</u> occurred
5 = Vacon overheat warning	The heat-sink temperature exceeds +70°C
6 = External fault or warning	Fault or warning depending on par. 2.8.1.3
7 = Reference fault or warning	Fault or warning depending on par. 2.8.1.1 - if analogue reference is 4–20 mA and signal is <4mA
8 = Warning	Always if a warning exists
9 = Reversed	The reverse command has been selected
10 = Preset speed	The preset speed has been selected with digital input
11 = At speed	The output frequency has reached the set reference
12 = Motor regulator activated	Overvoltage or overcurrent regulator was activated
13 = Output frequency supervision	The output frequency goes outside the set low limit/high limit
14 = Control from I/O terminals	I/O control mode selected (in menu M3)
15 = Thermal fault/warning	Thermal fault/warning active
16 = Fieldbus DIN1	
17 = Speed below limit	Lift speed goes below limit
18 = Torque limit supervision	Motor torque goes beyond the set supervision low limit/high limit.
19 = Mechanical brake control	External brake ON/OFF control (see parameter Group G2.3).
20 = Mech. brake control inverted	External brake ON/OFF control (see parameter Group G2.3). Output active when brake control is OFF.
21 = Motor contactor control	Motor contactor control
22 = DTF InFloor	Direct to Floor InFloor

Table 7-6. Output signals via D01 and output relays R01, R02, ROE1 and ROE2.

<i>P2.7.2.2</i>	<i>Digital output 1 function inverted</i>	<i>ID 1530</i>	<i>“D01 Inversion”</i>
	0 = D01 Not inverted 1 = D01 Inverted		
<i>P2.7.2.3</i>	<i>Digital output 1 ON Delay</i>	<i>ID 1531</i>	<i>“D01 ON Delay”</i>
	Timer On delay for digital output 1.		
<i>P2.7.2.4</i>	<i>Digital output 1 OFF Delay</i>	<i>ID 1657</i>	<i>“D01 OFF Delay”</i>
	Timer OFF delay for digital output 1.		
<i>P2.7.2.5</i>	<i>Relay output 1 function</i>	<i>ID 313</i>	<i>“R01 Function”</i>
	See parameter 2.7.2.1 .		
<i>P2.7.2.6</i>	<i>Relay output 1 function inverted</i>	<i>ID 1532</i>	<i>“R01 Inversion”</i>
	0 = R01 Not inverted 1 = R01 Inverted		
<i>P2.7.2.7</i>	<i>Relay output 1 ON delay</i>	<i>ID 1533</i>	<i>“R01 ON Delay”</i>
	Timer On delay for relay output 1.		
<i>P2.7.2.8</i>	<i>Relay output 1 OFF Delay</i>	<i>ID 1658</i>	<i>“R01 OFF Delay”</i>
	Timer OFF delay for digital output 1.		
<i>P2.7.2.9</i>	<i>Relay output 2 function</i>	<i>ID 314</i>	<i>“R02 Function”</i>
	See parameter 2.7.2.1 .		
<i>P2.7.2.10</i>	<i>Relay output 2 function inverted</i>	<i>ID 1534</i>	<i>“R02 Inversion”</i>
	0 = R02 Not inverted 1 = R02 Inverted		

7.13.1.3 Supervision limits

Supervision function gives you the possibility to monitor certain values with the limit setting. When the actual value exceeds or goes below the set value a message through a digital output can be given.

P2.7.3.1 Speed supervision limit ID 1535 "SpeedSuperVLimit"

If lift speed is below the speed supervision limit Speed below limit-signal is TRUE. See **Error! Reference source not found.** for the "Speed below limit" signal.

P2.7.3.2 Motoring torque supervision ID 1536 "MotorTorqSuperV"

Torque limit when operating in motoring mode. If the actual motor torque is above the motor torque supervision limit for a defined time (P2.8.4.7) then internal "overtorque"-signal is set. Response to signal can be given by P2.8.4.6.

P2.7.3.3 Generating torque supervision ID 1537 "GenerTorqSuperV"

Torque limit when operating in generating mode. If set to 0.0% this parameter is ignored and the limit is defined by P2.7.3.2.

P2.7.3.4 Output frequency limit supervision function ID 315 "Freq Supv Lim1"

- 0 No supervision
- 1 Low limit supervision
- 2 High limit supervision

If the output frequency goes under/over the set limit this function generates a warning message via the digital output DO1 and via the relay output RO1 or RO2 depending on the settings of parameters 2.7.2.1, 2.7.2.5 and 2.7.2.9.

P2.7.3.5 Output frequency limit supervision value ID 316 "Freq Supv Val1"

Selects the frequency value supervised.

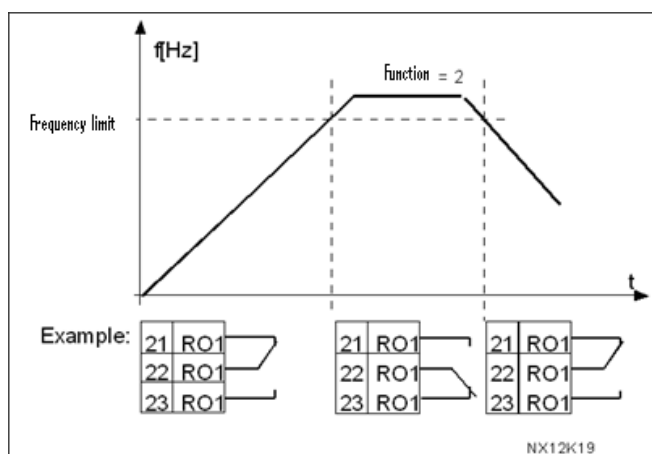

Figure 17. Output frequency supervision

7.13.1.4 Expansion relays

<i>P2.7.4.1 Expansion relay output 1 selection</i>	<i>ID 1680</i>	<i>“ROE1 Selection”</i>
<i>P2.7.4.2 Expansion relay output 1 function</i>	<i>ID 1681</i>	<i>“ROE1 Function”</i>
<i>P2.7.4.3 Expansion relay output 1 inversion</i>	<i>ID 1682</i>	<i>“ROE1 Inversion”</i>
<i>P2.7.4.4 Expansion relay output 2 selection</i>	<i>ID 1683</i>	<i>“ROE2 Selection”</i>
<i>P2.7.4.5 Expansion relay output 2 function</i>	<i>ID 1684</i>	<i>“ROE2 Function”</i>
<i>P2.7.4.6 Expansion relay output 2 inversion</i>	<i>ID 1685</i>	<i>“ROE2 Inversion”</i>

7.14 Protections

I/O Fault parameters (M2 -> G2.8.1)

P2.8.1.1 Response to the reference fault ID 700 "4mA Input Fault"

- 0 = No response
- 1 = Warning
- 2 = Warning, the frequency from 10 seconds back is set as reference
- 3 = Warning, the Preset Frequency (Par. 2.8.1.2) is set as reference
- 4 = Fault, stop mode after fault according to [parameter 2.4.2](#).
- 5 = Fault, stop mode after fault always by coasting

A warning or a fault action and message is generated if the 4...20 mA reference signal is used and the signal falls below 3.5 mA for 5 seconds or below 0.5 mA for 0.5 seconds. The information can also be programmed into digital output DO1 or relay outputs RO1 and RO2.

P2.8.1.2 4 mA Fault: preset frequency reference ID 728 "4mA Fault Freq"

If the value of parameter 2.8.1.1 is set to 3 and the 4 mA fault occurs then the frequency reference to the motor is the value of this parameter.

P2.8.1.3 Response to external fault ID 701 "External Fault"

- 0 = No response
- 1 = Warning
- 2 = Fault, stop mode after fault according to [parameter 2.4.2](#).
- 3 = Fault, stop mode after fault always by coasting

A warning or a fault action and message is generated from the external fault signal in the programmable digital inputs (see [parameter 2.6.2.1](#)). The information can also be programmed into digital output DO1 and into relay outputs RO1 and RO2.

General faults parameters (M2 -> G2.8.2)

P2.8.2.1 Input phase supervision ID 730 "Input Phase Supv"

- 0 = No response
- 1 = Warning
- 2 = Fault, stop mode after fault according to [parameter 2.4.2](#).
- 3 = Fault, stop mode after fault always by coasting

The input phase supervision ensures that the input phases of the AC drive have an approximately equal current.

P2.8.2.2 Response to undervoltage fault ID 727 "UVolt Fault Resp"

- 1 = Warning
- 2 = Fault, stop mode after fault according to [parameter 2.4.2](#).
- 3 = Fault, stop mode after fault always by coasting

For the undervoltage limits see VACON® NXS/P User Manual.

P2.8.2.3	<i>Output phase supervision</i>	ID 702	<i>“OutputPh. Superv”</i>
	0 = No response 1 = Warning 2 = Fault, stop mode after fault according to parameter 2.4.2 . 3 = Fault, stop mode after fault always by coasting		
	Output phase supervision of the motor ensures that the motor phases have an approximately equal current.		
P2.8.2.4	<i>Earth fault protection</i>	ID 703	<i>“Earth Fault”</i>
	0 = No response 1 = Warning 2 = Fault, stop mode after fault according to parameter 2.4.2 . 3 = Fault, stop mode after fault always by coasting		
	Earth fault protection ensures that the sum of the motor phase currents is zero. The overcurrent protection is always working and protects the AC drive from earth faults with high currents.		
P2.8.2.5	<i>Response to fieldbus fault</i>	ID 733	<i>“FBComm FaultResp”</i>
	0 = No response 1 = Warning 2 = Fault, stop mode after fault according to parameter 2.4.2 . 3 = Fault, stop mode after fault always by coasting		
	Set here the response mode for the fieldbus fault if a fieldbus board is used. For more information, see the respective Fieldbus Board Manual.		
P2.8.2.6	<i>Response to slot fault</i>	ID 734	<i>“SlotComFaultResp”</i>
	0 = No response 1 = Warning 2 = Fault, stop mode after fault according to parameter 2.4.2 . 3 = Fault, stop mode after fault always by coasting		
	Set here the response mode for a board slot fault due to missing or broken board.		
P2.8.2.7	<i>System overload limit</i>	ID 1850	<i>“SystemOverloadLim”</i>
P2.8.2.8	<i>Output phase fault delay</i>	ID 1821	<i>“OutPhFaultDelay”</i>
P2.8.2.9	<i>Output phase current limit</i>	ID 1822	<i>“OutPhFaultCurLim”</i>

Motor Fault parameters (M2 -> G2.8.3)

Parameters 2.8.3.1—2.8.3.5, Motor thermal protection:

General

The motor thermal protection is to protect the motor from overheating. The VACON® drive is capable of supplying higher than nominal current to the motor. If the load requires this high current there is a risk that the motor will be thermally overloaded. This is the case especially at low frequencies. At low frequencies the cooling effect of the motor is reduced as well as its capacity. If the motor is equipped with an external fan the load reduction at low speeds is small.

The motor thermal protection is based on a calculated model and it uses the output current of the drive to determine the load on the motor.

The motor thermal protection can be adjusted with parameters. The thermal current I_T specify the load current above which the motor is overloaded. This current limit is a function of the output frequency.

The thermal stage of the motor can be monitored on the control keypad display. See VACON® NXS/P User Manual.



CAUTION! *The calculated model does not protect the motor if the airflow to the motor is reduced by blocked air intake grill.*

P2.8.3.1 Motor thermal protection (MTP) ID 704 "Motor Therm Prot"

0 = No response

1 = Warning

2 = Fault, stop mode after fault according to [parameter 2.4.2](#).

3 = Fault, stop mode after fault always by coasting

If tripping is selected the drive will stop and activate the fault stage.

Deactivating the protection, i.e. setting parameter to 0, will reset the thermal stage of the motor to 0%.

P2.8.3.2 Motor ambient temperature factor ID 705 "MotAmbTempFactor"

The factor can be set between -100.0%—100.0%.

P2.8.3.3 MTP Zero frequency current ID 706 "MTP f0 Current"

The current can be set between 0—150.0% $\times I_{nMotor}$. This parameter sets the value for thermal current at zero frequency. See Figure 18.

The default value is set assuming that there is no external fan cooling the motor. If an external fan is used this parameter can be set to 90% (or even higher).

Note: The value is set as a percentage of the motor name plate data, [parameter 2.1.4](#) (Nominal current of motor), not the drive's nominal output current. The motor's nominal current is the current that the motor can withstand in direct on-line use without being overheated.

If you change the parameter Nominal current of motor, this parameter is automatically restored to the default value.

Setting this parameter does not affect the maximum output current of the drive which is determined by [parameter 2.1.6](#) alone (Current limit).

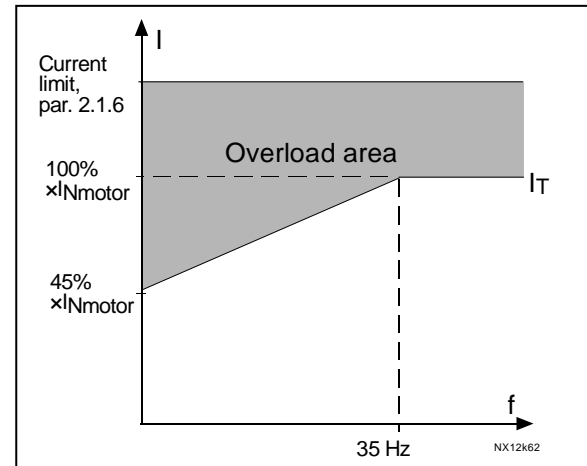

Figure 18. Motor thermal current I_T curve

P2.8.3.4 MTP Time constant

ID 707

“MTP Motor T”

This time can be set between 1 and 200 minutes.

This is the thermal time constant of the motor. The bigger the motor, bigger time constant. The time constant is the time within which the calculated thermal stage has reached 63% of its final value.

The motor thermal time is specific to the motor design and it varies between different motor manufacturers.

If the motor's t_6 -time (t_6 is the time in seconds the motor can safely operate at six times the rated current) is known (given by the motor manufacturer) the time constant parameter can be set basing on it. As a rule of thumb, the motor thermal time constant in minutes equals to $2 \times t_6$. If the drive is in stop stage the time constant is internally increased to three times the set parameter value. The cooling in the stop stage is based on convection and the time constant is increased.

P2.8.3.5 MTP Motor duty cycle

ID 708

"Motor Duty Cycle"

Defines how much of the nominal motor load is applied.
The value can be set to 0%...100%.

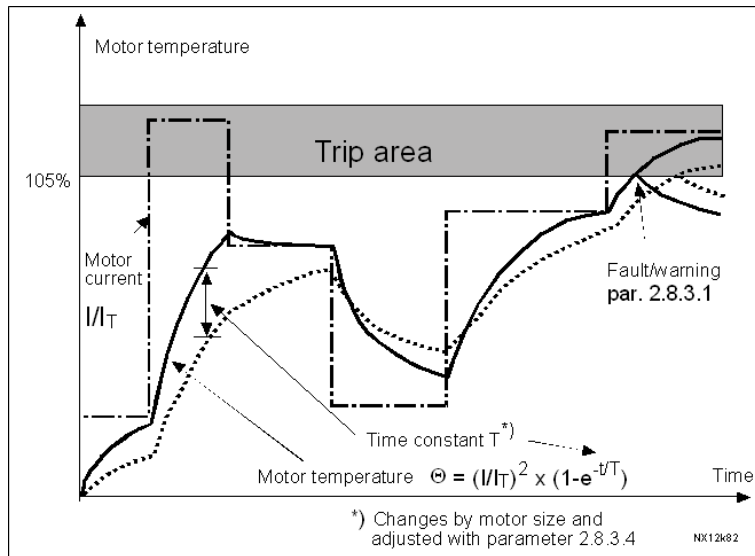

Figure 19. Motor temperature calculation

Stall protection

General:

The motor stall protection protects the motor from short time overload situations such as one caused by a stalled shaft. The reaction time of the stall protection can be set shorter than that of motor thermal protection. The stall state is defined with two parameters, [2.8.3.7 \(Stall current\)](#) and [2.8.3.9 \(Stall frequency\)](#). If the current is higher than the set limit and output frequency is lower than the set limit, the stall state is true. There is actually no real indication of the shaft rotation. Stall protection is a type of overcurrent protection.

P2.8.3.6 Stall protection

ID 709

"Stall Protection"

0 = No response

1 = Warning

2 = Fault, stop mode after fault according to [parameter 2.4.2](#).

3 = Fault, stop mode after fault always by coasting

Setting the parameter to 0 will deactivate the protection and reset the stall time counter.

P2.8.3.7 Stall current limit**ID 710**

The current can be set to 0.0...6000.0 A. For a stall stage to occur, the current must have exceeded this limit. See Figure 20. This value is set in percentage of the motor's name plate data [parameter 2.1.4]. If the parameter 2.1.4 Nominal current of motor is changed, this parameter is automatically restored to the default value.

"Stall Current"

Figure 20. Stall area limits

P2.8.3.8 Stall time**ID 711****"Stall Time****Lim"**

This time can be set between 1.0 and 120.0 s. This is the maximum time allowed for a stall stage. The stall time is counted by an internal up/down counter. If the stall time counter value goes above this limit the protection will cause a trip (see parameter 2.8.3.6).

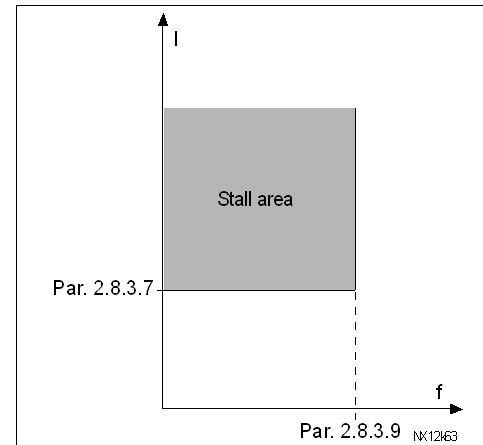
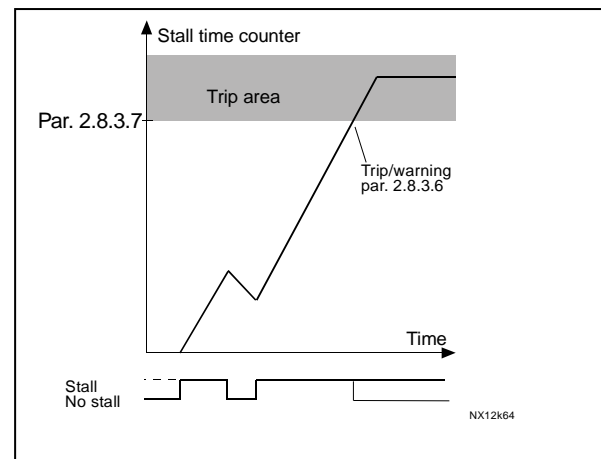

Figure 21. Stall time count

P2.8.3.9 Maximum stall frequency**ID 712****"Stall Freq Lim"**

The frequency can be set between 1-f_{max} (par. 2.1.2).

For a stall state to occur, the output frequency must have remained below this limit.

P2.8.3.10 Response to thermistor fault**ID 732****"ThermistorF.Resp"**

0 = No response

1 = Warning

2 = Fault, stop mode after fault according to parameter 2.4.2.

3 = Fault, stop mode after fault always by coasting

Setting the parameter to 0 will deactivate the protection and reset the stall time counter.

7.15 Lift Supervision parameters (M2 -> G2.8.4)

P2.8.4.1 Mechanical brake control fault ID 1580 "ExtBrake Fault"

- 0 = No response
- 1 = Warning
- 2 = Fault, stop mode after fault always by coasting

Mechanical brake supervision fault ensures that the brake is released within the defined time and the external brake supervision does not trigger a fault. With this parameter this function can be turned off.

P2.8.4.2 Shaft speed fault ID 1581 "ShaftSpeed Fault"

- 0 = No response
- 1 = Warning
- 2 = Fault, stop mode after fault always by coasting

Actual shaft speed according to encoder and calculated shaft speed from motor control are compared and in case the speed difference is more than the set limit (parameter 2.8.4.4) per a defined time (parameter 2.8.4.3) the set action is taken.

In open loop motor control modes, this fault is not generated. See Figure 22.

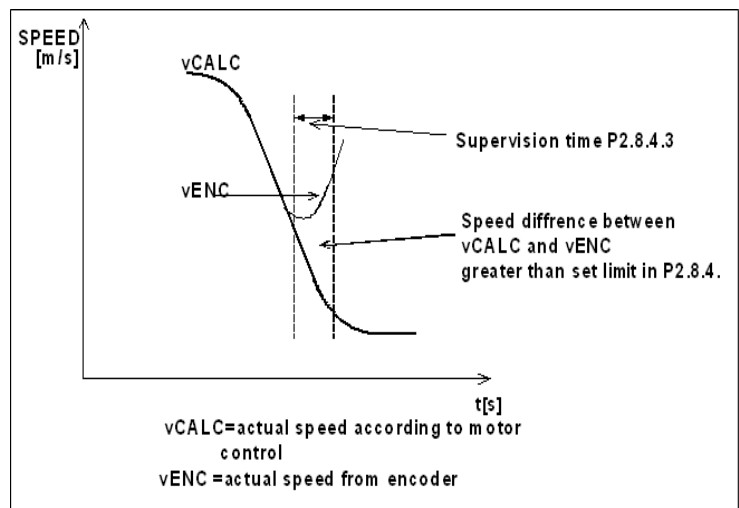

Figure 22. Stall time count

P2.8.4.3 Shaft speed supervision time ID 1582 "ShaftSpeed Time"

If the speed difference in shaft speed supervision is greater than the set limit (parameter 2.8.4.2) for a defined supervision time the shaft speed warning or fault is generated. See Figure 22.

P2.8.4.4 Shaft speed supervision limit ID 1583 "ShaftSpeedLimit"

P2.8.4.5 Shaft speed supervision limit ID 1584 "ShaftSpeedLimit"

The speed difference between the actual and the calculated lift speed, which will cause tripping. See Figure 22.

Parameter 2.8.4.4 is the Shaft speed supervision limit in [m/s] and Parameter 2.8.4.5 is the Shaft speed supervision limit in [Hz].

- P2.8.4.5** *Response to overtorque fault* **ID 1585** **“Over Torq Fault”**
- 0 = No response
 1 = Warning
 2 = Fault, stop mode after fault always by coasting
- The actual torque is compared to torque limits set with [parameter 2.7.3.2](#) and [parameter 2.7.3.3](#). If exceeded the defined action is taken.
- P2.8.4.6** *Torque supervision time* **ID 1586** **“Torq SuperV Time”**
- If torque exceeds limits (set with [parameters 2.7.3.2](#) and [2.7.3.3](#)) the overtorque protection fault is activated after the overshoot situation has been present for the defined time. If time is set to zero the fault is activated once the actual torque exceeds the supervision limits. Response to overtorque protection fault is set in parameter 2.8.4.5.
- P2.8.4.7** *Response to control conflict* **ID 1587** **“Control Conflict”**
- 0 = No response
 1 = Warning
 2 = Fault, stop mode after fault always by coasting
- Status of the DIN1 and DIN2 switches is supervised by the application. If they are active at the same time a control conflict fault will be generated. The response to fault is given with this parameter.
- P2.8.4.8** *Minimum current* **ID 1588** **“Min Current”**
- If actual current of the motor is below the minimum current limit fault is activated. The fault is activated only when the mechanical brake is open. 100% correspond to AC drive nominal current.
- P2.8.4.9** *0Hz Speed response* **ID 1589** **“0HzSpeedResponse”**
- 0= Not used
 1= Warning
 2= Warning + Stop
 3= Fault
- 0 Hz speed supervision is active two seconds after the start command. During that time frequency reference must increase over 0 Hz otherwise fault is activated. Response to fault is given with this parameter.

7.16 Autorestart Parameters

P2.9.1 Automatic restart: Wait time **ID 717** **“Wait Time”**
 Defines the time before the AC drive tries to automatically restart the motor after the fault has disappeared.

P2.9.2 Automatic restart: Trial time **ID 718** **“Trial Time”**
 The Automatic restart function restarts the AC drive when the faults selected with parameters 2.9.4 to 2.9.9 have disappeared and the waiting time has elapsed.

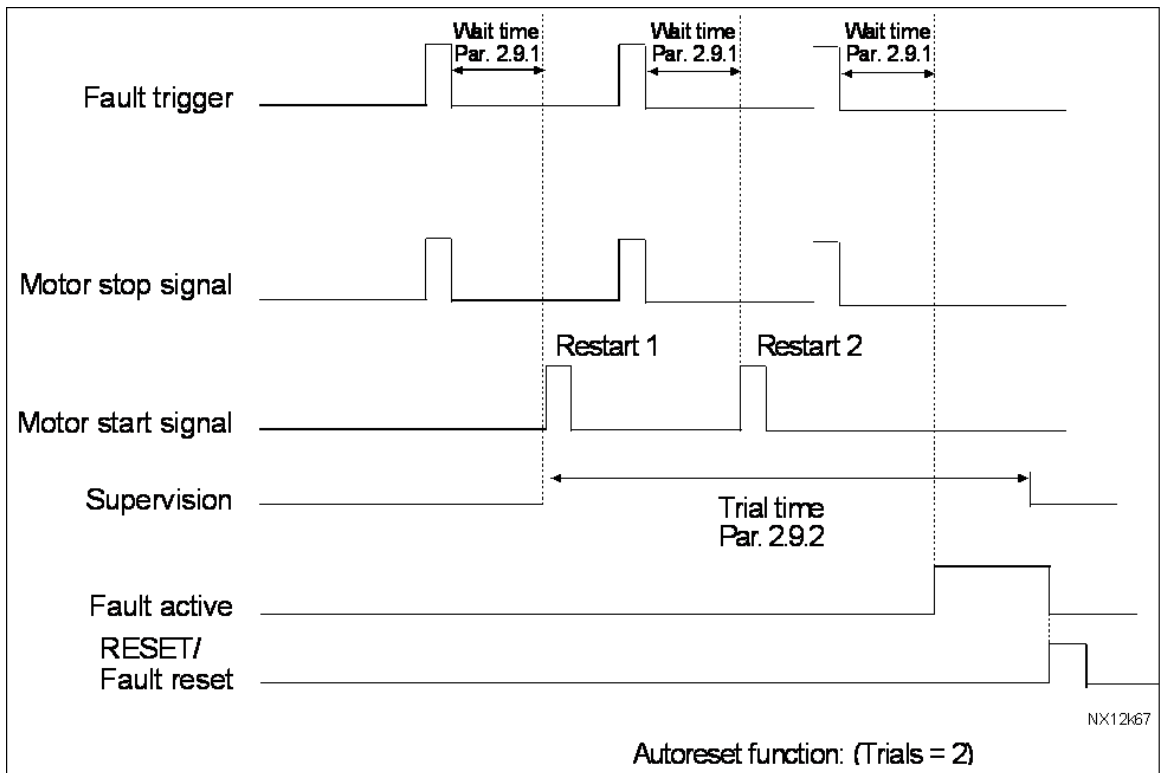

Figure 23. Example of Automatic restart with two restarts.

Parameters 2.9.4 to 2.9.10 determine the maximum number of automatic restarts during the trial time set by parameter 2.9.2. The time count starts from the first autorestart. If the number of faults occurring during the trial time exceeds the values of parameters 2.9.4 to 2.9.10, the fault state becomes active. Otherwise the fault is cleared after the trial time has elapsed and the next fault starts the trial time count again.

If a single fault remains during the trial time, a fault state is true.

P2.9.3 Automatic restart, start function **ID 719** **“Start Function”**

The Start function for Automatic restart is fixed to start with ramp in Lift application.

P2.9.4 **Number of tries after undervoltage fault trip** **ID 720** **“Undervolt. Tries”**

This parameter determines how many automatic restarts can be made during the trial time set by [parameter 2.9.2](#) after an undervoltage trip.

- 0 = No automatic restart after undervoltage fault trip
- >0 = Number of automatic restarts after undervoltage fault. The fault is reset and the drive is started automatically after the DC-link voltage has returned to the normal level.

P2.9.5 **Number of tries after overvoltage trip** **ID 721** **“Overvolt. Tries”**

This parameter determines how many automatic restarts can be made during the trial time set by [parameter 2.9.2](#) after an overvoltage trip.

- 0 = No automatic restart after overvoltage fault trip
- >0 = Number of automatic restarts after overvoltage fault. The fault is reset and the drive is started automatically after the DC-link voltage has returned to the normal level.

P2.9.6 **Number of tries after overcurrent trip** **ID 722** **“Overcurr. Tries”**

(NOTE! IGBT temp Fault also included)

This parameter determines how many automatic restarts can be made during the trial time set by [parameter 2.9.2](#).

- 0 = No automatic restart after overcurrent fault trip
- >0 = Number of automatic restarts after overcurrent trip, saturation trip and IGBT temperature faults.

P2.9.7 **Number of tries after reference trip** **ID 723** **“4mA Fault Tries”**

This parameter determines how many automatic restarts can be made during the trial time set by [parameter 2.9.2](#).

- 0 = No automatic restart after reference fault trip
- >0 = Number of automatic restarts after the analogue current signal (4...20 mA) has returned to the normal level (≥ 4 mA)

P2.9.8 **Number of tries after motor temperature fault trip** **ID 726** **“MotTempF Tries”**

This parameter determines how many automatic restarts can be made during the trial time set by [parameter 2.9.2](#).

- 0 = No automatic restart after Motor temperature fault trip
- >0 = Number of automatic restarts after the motor temperature has returned to its normal level.

P2.9.9 **Number of tries after external fault trip** **ID 725** **“Ext. Fault Tries”**

This parameter determines how many automatic restarts can be made during the trial time set by [parameter 2.9.2](#).

- 0 = No automatic restart after External fault trip
- >0 = Number of automatic restarts after External fault trip

P2.9.10 *Number of tries after Input phase superv. fault trip* ID 725 “InputPhSupVTries”

This parameter determines how many automatic restarts can be made during the trial time set by [parameter 2.9.2](#).

- 0 = No automatic restart after Input phase supervision fault trip
- >0 = Number of automatic restarts after Input phase supervision fault trip

7.17 Evacuation Parameters

Evacuation is specially designed for power down situations. When there is power down situation then the 3-phase mains supply must be disconnected and the 1-phase supply must be connected to terminals L1-L2. Supply Voltage must be 1-phase 220VAC ($\pm 10\%$). If DC- batteries are used DC-link voltage must remain at least 250 VDC, otherwise under voltage fault will occur.

The Elevator Car can be moved to nearest floor. The maximum Lift speed during the Evacuation is 40% of the Nominal Linear Speed. If Evacuation is activated then Mains supply must be correct, otherwise the Evacuation fault will occur.

P2.10.1 Motor control mode during the evacuation ID 1590 "Evacuation Mode"

0 = Not used
1 = Manual
2 = Automatic

Evacuation Mode is activated or deactivated only in Stop State. In manual mode, the lift controller controls the evacuation process and inputs DIN1 and DIN2 are used normally.

In Automatic mode, the evacuation process is controlled automatically. When the evacuation input (parameter 2.10.2) is switched ON the evacuation is activated. The drive checks the current of the motor in forward direction. After that it checks the current of the motor in backward direction. Then it automatically selects right direction to move. The fault is generated if DIN1 or DIN2 is switched ON during the automatic evacuation process.

P2.10.2 Evacuation input ID 1591 "Evacuation input"

Parameter selects the input that activates the evacuation mode.

P2.10.3 Voltage select ID 1920 "VoltageSelect"

Parameter chooses the voltage level that the system is using. Formerly evacuation mode was only possible with 500 V systems.

0 = 500 V
1 = 230 V

P2.10.4 Motor control mode ID 1592 "Motor Ctrl Mode"

0 = Frequency control: The I/O terminal and panel references are frequency references and the AC drive controls the output frequency.
1 = Speed control: The I/O terminal and panel references are speed references and the AC drive controls the motor speed (regulation accuracy $\pm 1\%$).
2 = Speed control CL: Closed loop speed control mode. The I/O terminal and keypad references are speed references and the AC drive controls the motor speed. Encoder is required. Closed loop parameters in group G2.11 must be set accordingly.

P2.10.5 Direction change delay ID 1593 "FunctChangeDelay"

Time delay between forward and reverse direction test.

P2.10.6	Testing time forward and backward	ID 1594	"Test Time Fw/Bw"
	Motor current is measured for both running directions of the elevator during automatic evacuation process. This parameter determine the test time for each direction.		
P2.10.7	Current read delay	ID 1595	"CurrentReadDelay"
	Motor current is measured for both running directions of the elevator during automatic evacuation process. This parameter determines the point of time when current is read. Time starts simultaneously with test time.		
P2.10.8	U/f optimization in Evacuation	ID 1596	"U/f Optimizaton"
	See parameter 2.5.8.1 .		
P2.10.9	U/f curve middle point frequency in Evacuation	ID 1597	"U/f Mid Freq"
	See parameter 2.5.8.5 .		
P2.10.10	U/f curve middle point voltage in Evacuation	ID 1598	"U/f Mid Voltg"
	See parameter 2.5.8.6 .		
P2.10.11	Output voltage at zero frequency Evacuation	ID 1599	"Zero Freq Voltg"
	See parameter 2.5.8.7		
P2.10.12	DC-brake current in Evacuation	ID 1633	"DC-Brake Current"
	Defines the current injected into the motor during DC-braking. By this parameter it is possible to use another DC-brake current in evacuation.		
P2.10.13	DC-braking time at start in Evacuation	ID 1664	"Start DC-Brake Tm"
	DC-brake is activated when the start command is given. This parameter defines the time before the brake is released.		

Maximum speed in Evacuation parameters (M2 -> G2.10.14)

Maximum speed during the evacuation is limited with this parameter.
It is possible to give the maximum speed in m/s or in Hz.

P2.10.14.1	Maximum speed in Evacuation	ID 1616	"MaxSpeedInEva"
P2.10.14.2	Maximum frequency in Evacuation	ID 1617	"Max Freq In Eva"

7.18 Keypad control parameters

Unlike the parameters listed above, these parameters are located in the **M3** menu of the control keypad. The reference parameters do not have an ID number.

P3.1 *Control Place* **ID125** “Control Place”

The active control place can be changed with this parameter.

Pushing the Start button for 3 seconds selects the control keypad as the active control place and copies the Run status information (Run/Stop, direction and reference).

0 = PC Control, Activeted by NCDrive

1 = I/O terminal

2 = Keypad

3 = Fieldbus

R3.2 *Keypad Reference* **No ID** “Keypad Reference”

The frequency reference can be adjusted from the keypad with this parameter.

The output frequency can be copied as the keypad reference by pushing the Stop button for 3 seconds when you are on any of the pages of menu **M3**.

P3.3 *Keypad Direction* **ID123** “Keypad Direction”

0 Forward: The rotation of the motor is forward, when the keypad is the active control place.

1 Reverse: The rotation of the motor is reversed, when the keypad is the active control place.

P3.4 *Stop button activated* **ID114** “StopButtonActive”

If you wish to make the Stop button a "hotspot" which always stops the drive regardless of the selected control place, give this parameter the value 1.

P3.5 *Reserved*

P3.6 *Reserved*

P3.7 *Reserved*

P3.8 *Reserved*

P3.9 *Reserved*

P3.10 *Reset BrakeSpv F*

In order to reset the fault, is not enough just to push the RESET button in the keypad or through VACON® NCDrive. First we need to validate the possibility to reset the drive with B3.10. After that, we can reset the fault as any other fault.

0 = Press enter

1 = Press reset

8. COMMISSIONING OF THE LIFT APPLICATION

8.1 Installation of the VACON® NX Drive

Please read the VACON® NXS/P User Manual for details about installation, cabling and connections. Follow the general commissioning steps described in the VACON® NXS/P User Manual. Please study the Lift application manual carefully for application specific information.

Encoder connections (Closed loop)

- Encoder has to be mounted directly on the motor axis. This is very important for proper function. Encoder must be centred to the motor axis. See figure 30.
- Encoder cable must be a twisted pair cable with individual shield for each pair and main shield. All shields has to be connected to ground terminal in the VACON® NX drive. Do not connect ground in both ends (connecting both ends can lead to circulating current in shield)
- Encoder cable must not be installed together with power cables
- Check very carefully the encoder connections and encoder supply voltages.

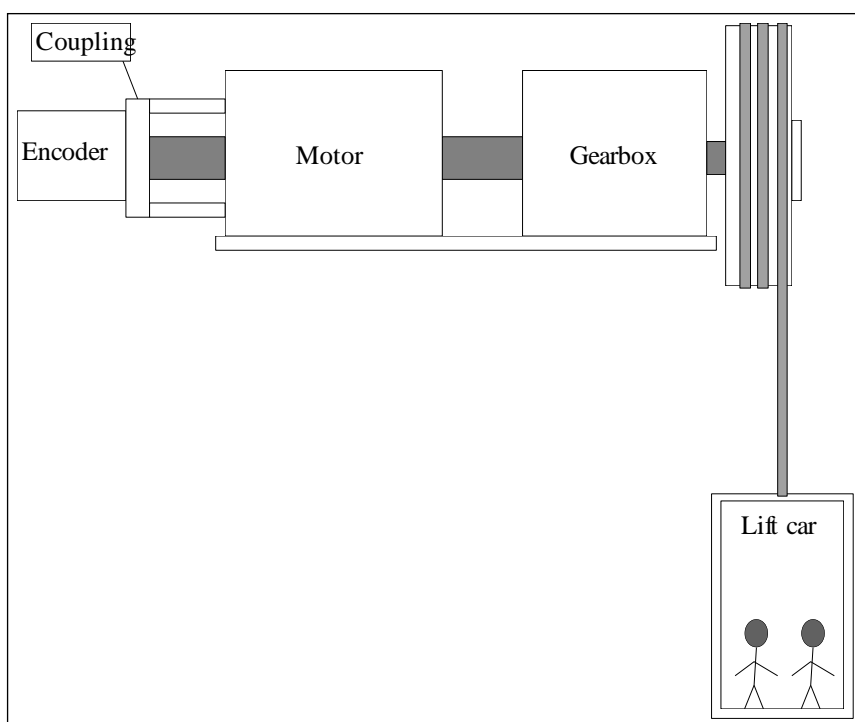

Figure 24. Basic principle of the lift application

9. GENERAL SETUP OF THE PARAMETERS

9.1 Motor Data

Check motor data from the rating plate and put them into Basic Parameter group. Be sure to set up correct motor data.

In case of Permanent magnet motor (PMM) set the parameter [P2.1.9](#) to 1. See [chapter 6.11.3](#) for details of PMM commissioning.

9.2 Speed Parameters

Setup the speed parameters in Speed Control Parameter group. Nominal linear speed is the lift speed in m/s when motor is running at nominal speed. In this group also acceleration, deceleration and jerk times can be changed. Higher jerk time means more S-Shape of the Acceleration and Deceleration ramps. Then start and stop will be smoother. Please note that longer jerk times makes the acceleration and deceleration times longer. The stop distance is also affected. See Figure 25.

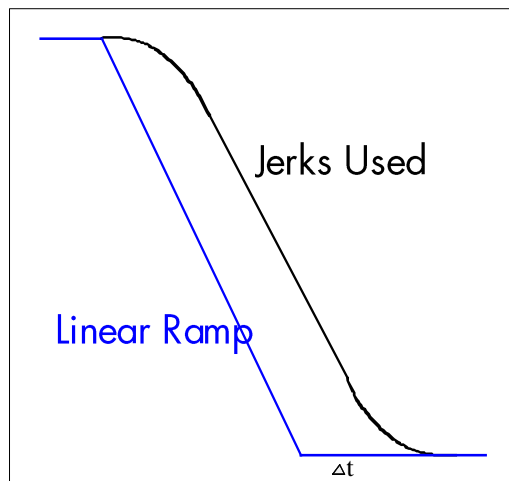

Figure 25. The curve when Jerks is used instead of Linear Ramp

9.2.1 Input and Output Signals

Setup input and outputs function according to table 8 and 9 in the parameter section. The input and outputs has to be assigned to match actual hardware configuration for actual application.

9.3 Tuning of the Application

Correct tuning is very important to get good torque properties also at low speeds. Smooth start and stop of the lift car requires correct tuning. Please note that problems with tuning also can be related to mechanical problems. It is easier to tune the lift in closed loop than in open loop.

9.3.1 Open Loop Tuning Operations

1. Set identification parameter (P2.1.8) to 1. Then motor must be started within 20 seconds. Identification is performed in standstill. U/f curve and RS voltage drop is calculated by this operation. The mechanical brake remains closed. U/f Optimization (P2.5.8.1) is set to zero and U/f ratio select (P2.5.8.2) is set to 2 after successful U/f curve identification.
2. Tune the levelling speed parameters according to the lift mechanics. Typically the levelling speed is 3-5 Hz. Too high speed causes easily high levelling error. Low levelling speed makes the levelling more accurate but it may cause the total lift journey to last longer.
3. Tune the motor nominal speed parameter so that the empty car runs up and down with the same speed when using levelling reference. The speed of the motor should be measured using a hand held encoder directly from the motor shaft.
4. Adjust the acceleration ramps and jerks.
5. Adjust the travelling speed so that the lift speed has at least 1 second steady levelling speed before the stop flag.
6. Adjust the DC brake stop current to nominal motor current and adjust the stop DC brake frequency level up and down to find out the best levelling accuracy.

9.3.2 Closed Loop Tuning Operations

1. Check the encoder Pulse/Revolution rate and set this value to expander menu P7.3.1.1. Parameter is visible only if NXOPTA4 or NXOPTA5 is installed into slot C.
If the automatic motor identification can be done in run mode the tuning steps 3-6 is not needed. See P2.1.8. Then it is enough to check the encoder frequency and direction (see step 4)
2. Set motor control to open loop frequency control (P2.5.1=0).
3. Determination of the magnetizing current I_m : Run the motor with no load at about 2/3 of the nominal frequency.
Read the motor current from the monitoring menu (V1.4) or use VACON® NCDrive. The motor current measured should be the magnetizing current. This measuring cannot be done if the motor is already connected to the load.

If the magnetizing current cannot be measured it is possible to set the magnetizing current to 0. Then the system software estimates the magnetizing current from given motor data.

Approximate magnetizing current I_m can be also be calculated with following formula:

$$I_m = I_n * (5 * \sqrt{1 - \cos^2 \phi} - 1) / (5 - \sqrt{1 - \cos^2 \phi})$$

4. Check from the expander board menu (V7.3.2.1), that the encoder frequency is approximately the same as the output frequency (V1.1). Check also that the direction is correct.
If the encoder frequency is opposite direction than the output frequency (V1.1), change encoder connection or change parameter P7.3.1.2 to 1
5. Set motor control mode to closed loop speed control (P2.5.1=2)
6. Set the motor magnetising current P2.1.7 (measured or calculated in 5.3)
7. Try to adjust the Encoder filter time parameter P2.5.9.9 if the motor is producing a lot of noise.
8. If further adjustments are necessary, read next chapter.

9.3.3 Fine Tuning Closed Loop

The parameter P2.5.9.10 (Slip adjust) is to be tuned to get the voltage slightly above the linear U/f-curve when motor is loaded and slightly below when motor is generating.

1. Set motor control mode to frequency control (P2.5.1= 0)
2. Set U/f-curve to linear (P2.5.8.2=0)
3. Run motor with 35 Hz reference and check motor voltage (V1.7)
4. At 35 Hz, voltage should be $35/50 * 400V = 280 V$ for a 400V motor

5. Change Motor control to closed loop (P2.5.1=2)
6. Run with the same reference as in open loop (step3) and check the motor voltage (V1.7)
7. Adjust P2.5.9.10 (slip adjust) so that motor voltage is slightly above the linear U/f-curve value (V1.7 >
8. 280 V at 35 Hz reference)
9. If motor is generating, adjust P2.5.9.10 so that motor voltage is slightly below the linear U/f-curve value.
10. To increase the motor voltage, decrease the value of P2.5.9.10 or to decrease the motor voltage, increase the value of P2.5.9.10.

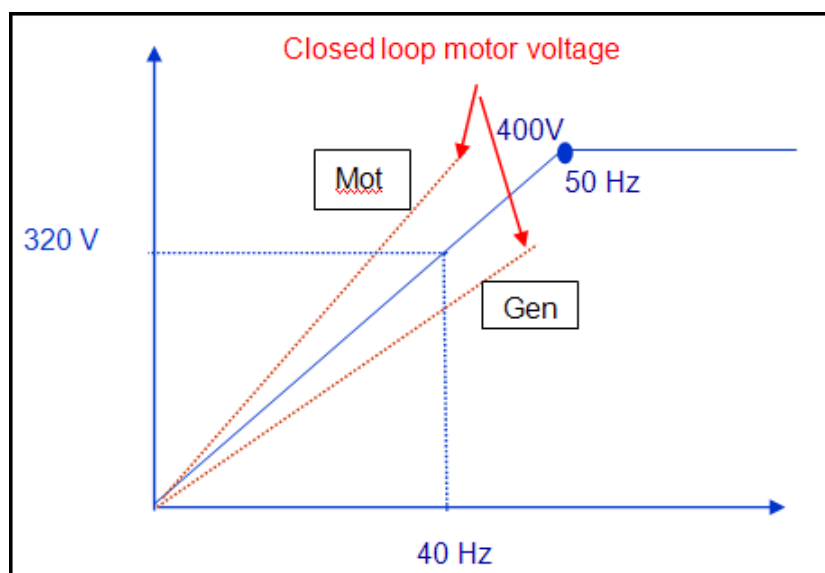

Figure 26. Motor voltage when loaded and generating

10. TEST PROCEDURE TO CHECK THE BRAKE MONITORING FUNCTION

10.1 Type of connections

For the safety functionality, we can use two analogue inputs (10V), or two digital inputs (24V). Below we have three different kind of electrical connections for the brake monitoring. The input supervision functions can be forwarded to any input port. The ports used do not need to be exactly the same than in these examples. Everyone can use the ports more convenient for every case.

10.1.1 Connections with 10Vcc

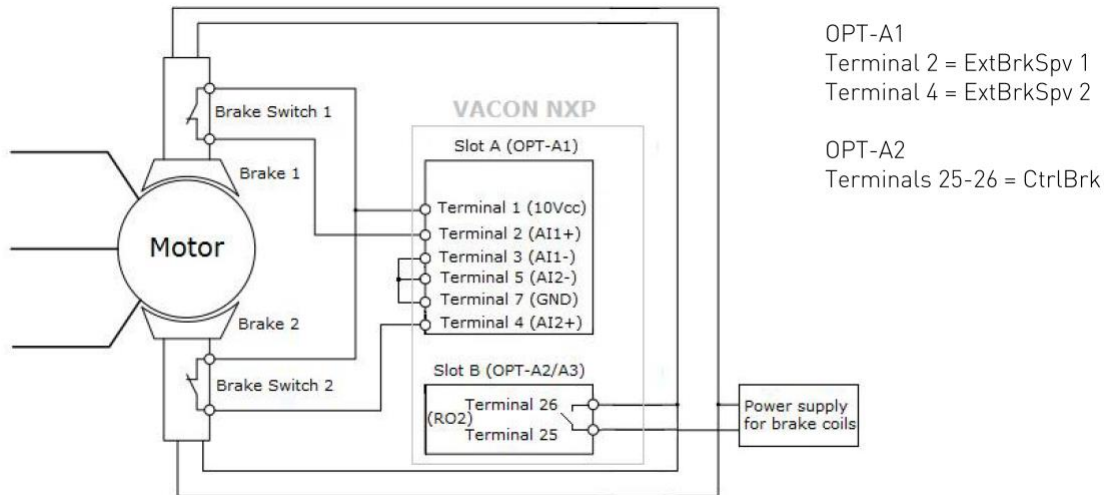
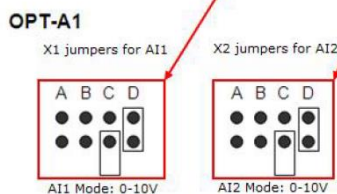
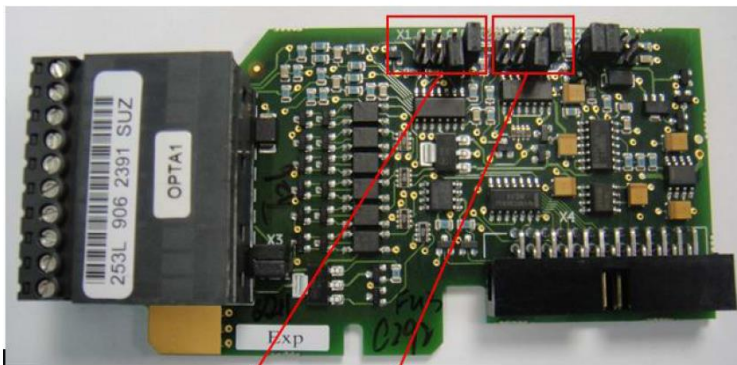

Figure 27. Opt-A1 in slot A



Jumpers working on the brake supervision.

Figure 28. Opt-A1 jumper configuration

Inputs programming to work at 10Vcc:

Brake 1 Supervision 1 (ExtBrkSpv1) through terminal 2 -> P2.3.3.2 = F.1

Brake 1 Supervision 2 (ExtBrkSpv2) through terminal 4 -> P2.3.3.3 = F.2

10.1.2 Connections with 24Vcc

The monitoring can also be done through digital inputs with 24Vcc. It can be used for any of the boards with digital inputs. Below are examples using OPT-A1 in Slot A, or OPT-B1 in Slot E.

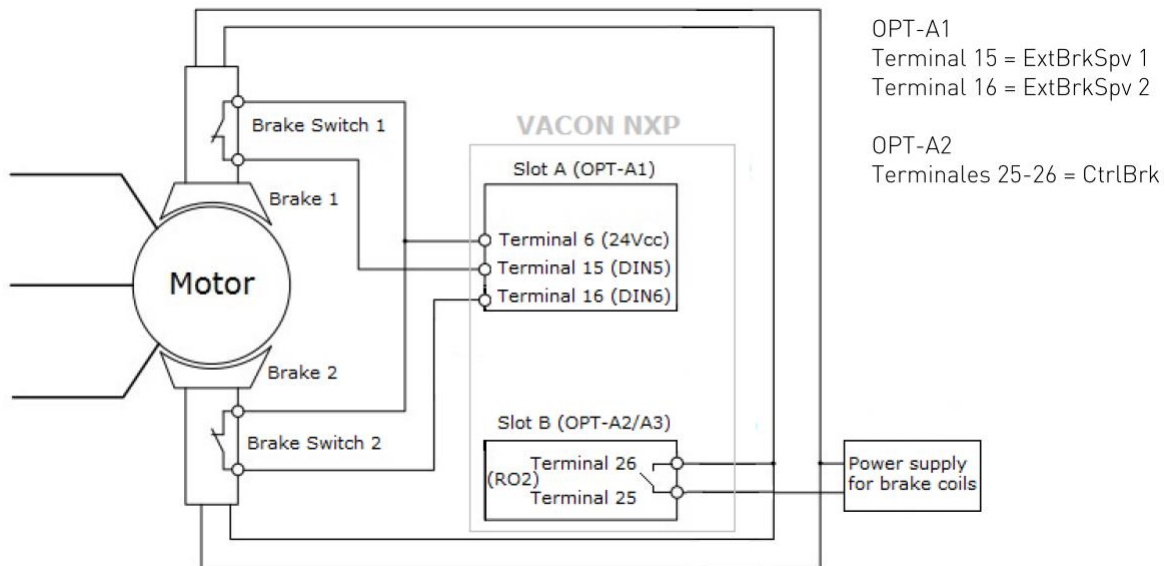
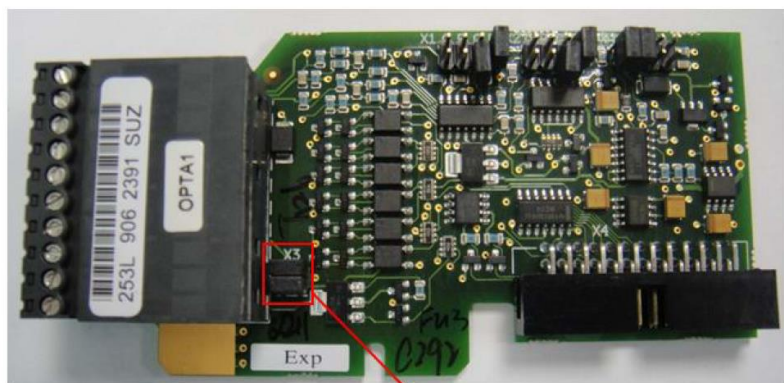
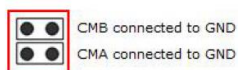

Figure 29. Opt-A1 in slot A



X3 jumper for CMA & CMB



Jumpers working on the brake supervision.

Figure 30. Opt-A1 jumper configuration

Inputs programming to work at 24Vcc in slot A:

Brake 1 Supervision 1 (ExtBrkSpv1) through terminal 2 -> P2.3.3.2 = A.5

Brake 1 Supervision 2 (ExtBrkSpv2) through terminal 4 -> P2.3.3.3 = A.6

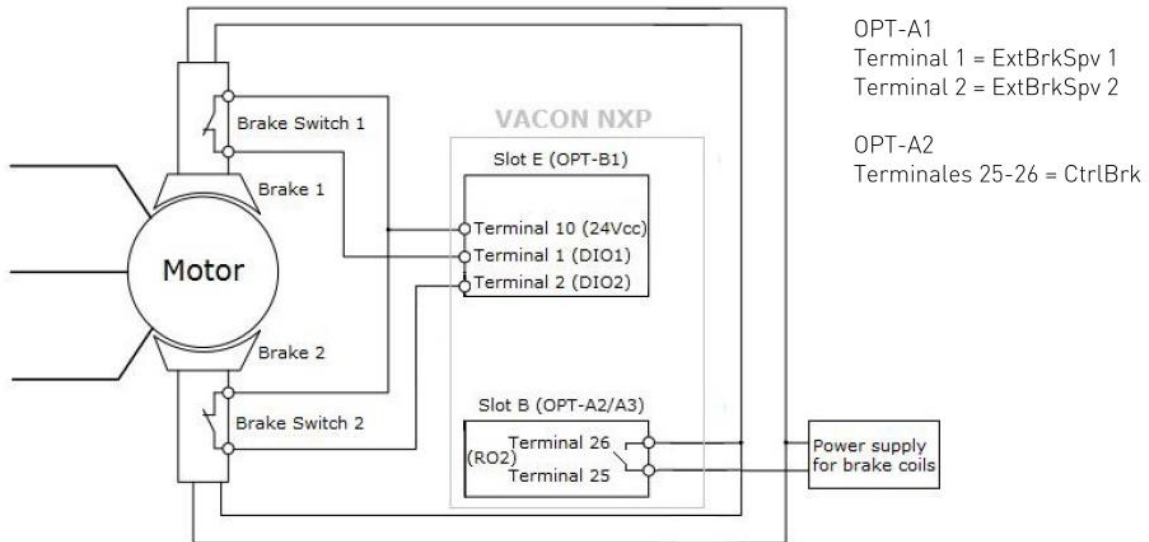
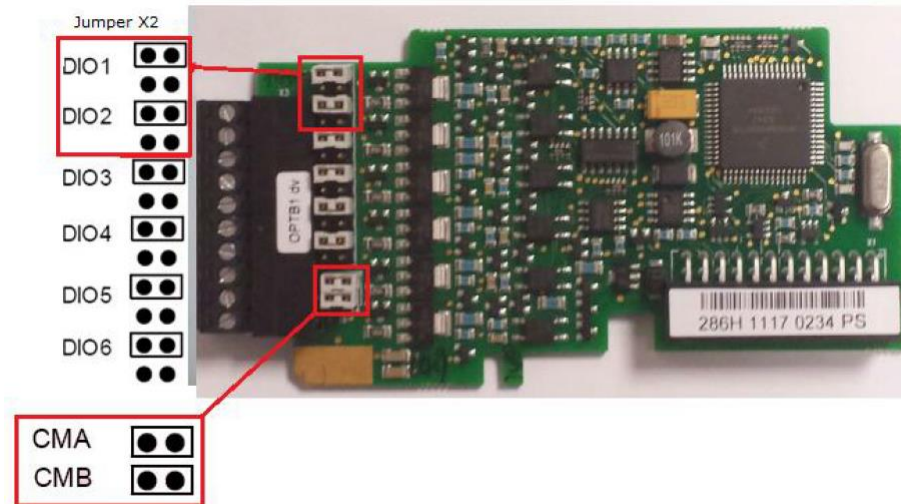

Figure 31. Opt-A1 in slot E



Jumpers working on the brake supervision, if digital inputs are programmed E.1 y E.2

Figure 32. Opt-B1 jumper configuration

Inputs programming to work at 24Vcc in slot E:

Brake 1 Supervision 1 (ExtBrkSpv1) through terminal 2 -> P2.3.3.2 = E.1

Brake 1 Supervision 2 (ExtBrkSpv2) through terminal 4 -> P2.3.3.3 = E.2

10.2 Brake monitoring activation to fulfil EN-81-1+A3

To Enable the safety and fulfil the standard you need to:

- Activate monitoring in:
 - o P2.8.4.1 "ExtBrake Fault" = 2/ Fault
- Program inputs to do the monitoring:
 - o P2.3.3.2 "ExtBrake SuperV" = Program as explained in Point 9.1 of this document.
 - o P2.3.3.3 "ExtBrake SuperV2" = Program as explained in Point 9.1 of this document.

10.3 Brake monitoring fault reset and fault codes

Fault Codes:

F55 – Supervision Brake ON

F91 – Supervision Brake OFF

Fault Reset:

- The Fault is not reset when input power is down. After the drive is switched on again, the fault remains active.
- Just pushing the reset button in keypad, the brake fault is not reset.
- In order to reset the brake fault:
 - o First validate pushing B3.10, that we are willing to reset the brake fault.
 - o After the previous validation in B3.10, the fault can be reset pushing the Reset Button in keypad.

10.4 Certified

VACON® System Software NXP00002V185 and higher are fulfilling the certification.

To fulfil the certification NXP drive must be used, with control board version NXP3.

This board can be identified opening the control box, and looking at the top label, with the reference of the board. See below picture. Reference must be 761x or higher.

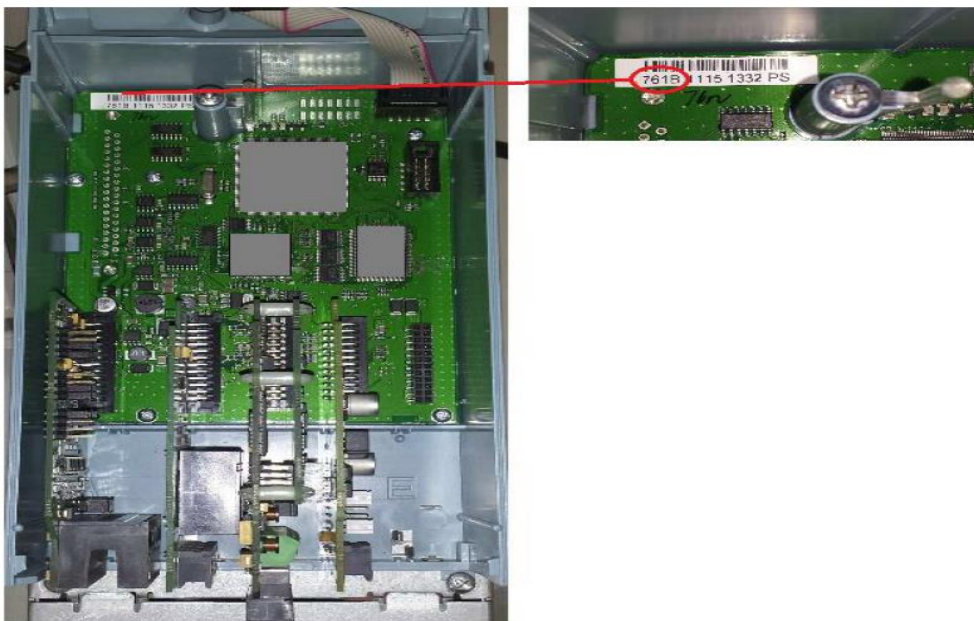

10.5 Test procedure

Following the EN 81-1+A3, the brake supervision safety must be checked in every installation.

In the next flow charts, you can see how to do it. These flow charts are based on the examples done in point 3 of this document. In case of use brake contacts normally open, the test must be done making the jumpers in the opposite way.

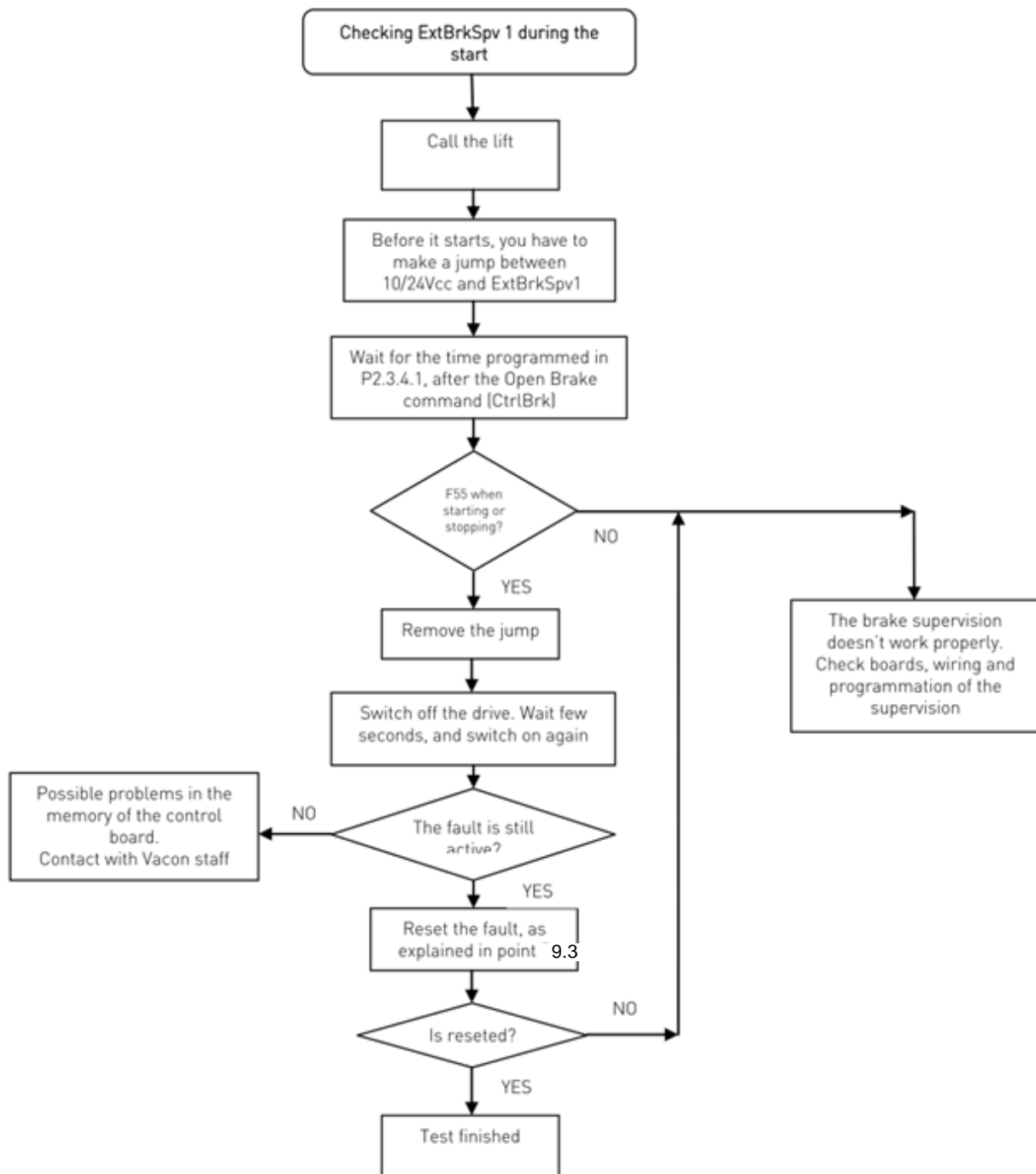

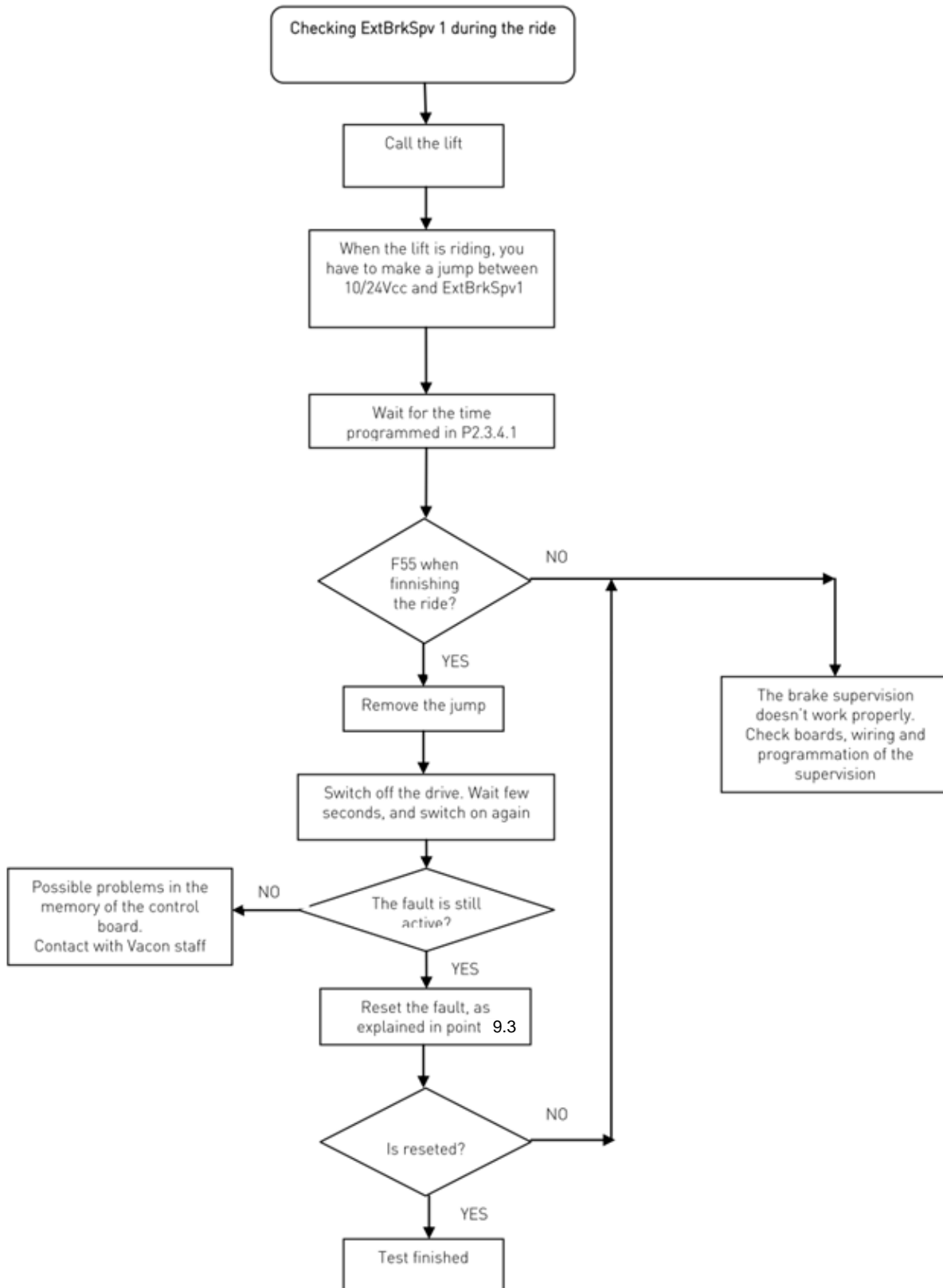

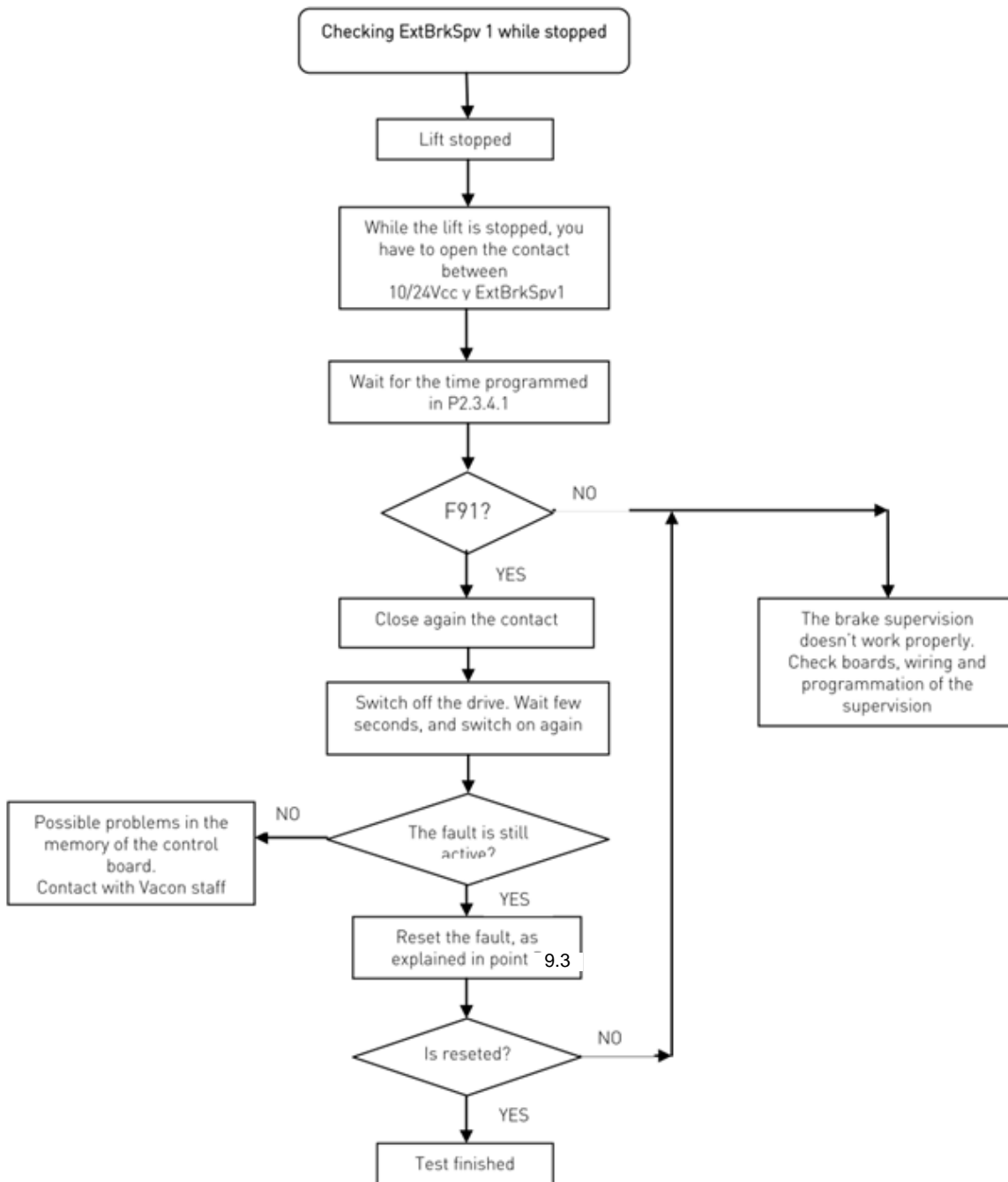

Proceed with the same procedure to check the state of brake 2, through ExtBrkSpv2.

To do the checking with inverted brake switches, just invert the actions to do during the test:

- o Make a jump -> Open the contact
- o Open the contact -> Make a jump

11. PROBLEM SOLVING

While proper information is needed from the problem, it's also recommended to try with latest application- and system software versions available. Software is continuously developed and default settings are improved.

Type	Signal Name	Actual	Unit	Min	
Value	Status Word 1	20583		n	6!
Value	Torque	3,5			1!
Value	Current	4,5			4!
Value	FreqReference	37,29			6!
Value	DC Voltage	550	V	0,0	1!
Value	Output Frequency	37,35	Hz	-65,00	6!
Value	Shaft Frequency	37,27	Hz	-65,00	6!
Value	Motor Voltage	293,4	V	0,0	7!

Figure 33. Recommended signals for VACON® NCDrive

Use the fastest communication speed (Baudrate: 57 600) and a 50 ms update interval for signals for the RS232 communication.

For the CAN communication, use a 1 Mbit communication speed and 7 ms update interval for signals.

When you contact the support, send the *.trn, *.par and Service info (*.txt) files with a description of the situation. If the situation is caused by a fault, take also the Datalogger data from the drive.

Note that Datalogger settings can be changed to catch correct situation and it's also to possible make manual force trig for Datalogger.

Before storing the parameter file, upload the parameters from the drive and save when VACON® NCDrive is in the ON-LINE state. If it is possible, do this while the problem is active.

It is also helpful to have single line diagram from the system where problem is faced.

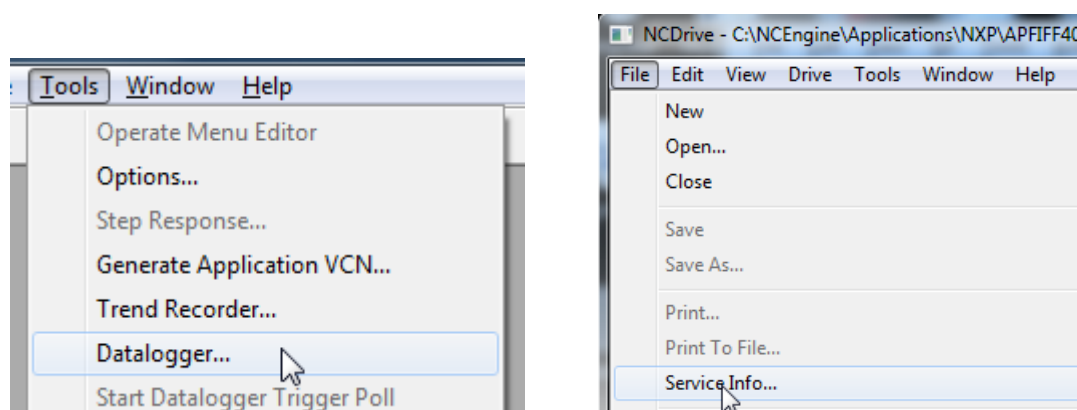

Figure 34. Datalogger window opening and Service Info upload

12. FAULT CODES

F1 *Overcurrent fault*

Drive has detected a high current in the output phase.

S1 = **Hardware trip:** Current above 4*I_h

S2 = **Only in NXS unit**

S3 = **Current controller supervision.** Current limit too low or current peak value too high.

Possible cause and solutions

1. Sudden increase in load
 - Check motor load.
2. Short circuit in motor cables
 - Check motor and cables.
3. Motor is under magnetized at start.
 - Make identification run
4. Unsuitable motor
5. Sine filter is used but drive settings are not correct
 - Activate Sine filter parameter (P6.7.5) in system menu

F2 *Overvoltage fault*

DC-link voltage has exceeded the drive protection limits.

S1 = **Hardware trip.**

500 Vac unit DC voltage above 911 Vdc

690 Vac unit DC voltage above 1200 Vdc

S2 = **Overvoltage control supervision (only 690 Vac unit).**

DC voltage has been above 1100 Vdc for too long.

Possible cause and solutions

1. Too short a deceleration time
 - Increase deceleration time.
 - Use brake chopper and brake resistor.
 - Use Brake chopper unit.
 - Use active front end unit (AFE ARFIF02).
 - Activate overvoltage controller.
2. High overvoltage spikes in supply
 - Activate overvoltage controller.
3. 690 V unit operating too long above 1100 Vdc
 - Check input voltage.

F3 *Earth fault*

Earth fault protection ensures that the sum of the motor phase currents is zero. The overcurrent protection is always working and protects the AC drive from earth faults with high currents.

S1 = **Sum of motor current is not zero**

Possible cause and solutions

1. Insulation failure in cables or motor
 - Check motor cables and motor.

F5 Charge switch

Charge switch status is not correct when start command is given.

S1 = Charge switch was open when START command was given.

Possible cause and solutions

1. Charge switch was open when the START command was given.
 - Check connection of the feedback from charging relay
 - Reset the fault and restart.

Should the fault re-occur, contact your local distributor.

F6 Emergency stop

Emergency stop command has been given by using a special option board.

F7 Saturation fault

S1 = Hardware failure

Possible cause and solutions

1. If there is a brake chopper in use
 - Check the isolation resistance and the resistance on the brake resistor.
2. FR4-FR8: Power module
 - Measure the power module directly from its terminals.
3. Hardware
 - Check the capacitors.

F8 System Fault

A system fault indicates several different fault situations in drive operation.

S1 = Reserved

- Disturbance. Reset the unit and try again.
- If there is star coupler in the unit, check the fibre connections and phase order.
- Driver board or IGBT broken.
- FR9 and the bigger size drives, which includes not star coupler, ASIC board (VB00451) is broken.
- FR8 and smaller size drives: control board broken.
- FR8 and smaller size drives: if there is boards VB00449 / VB00450 in use, failure might be in there.

S2 = Reserved

S3 = Reserved

S4 = Reserved

S5 = Reserved

S6 = Reserved

S7 = Charge switch

S8 = No power to driver card

S9 = Power unit communication (TX)

S10 = Power unit communication (Trip)

S11 = Power unit comm. (Measurement)

S12 = SystemBus synchronization has failed in DriveSynch operation

S30 = Safe disable inputs are in different state (OPT-AF)

S31 = Thermistor short circuit detected (OPT-AF)

S32 = OPT-AF board has been removed

S33 = OPT-AF board EEPROM error

F9 Undervoltage fault

DC-link voltage is below the fault voltage limit of the drive.

S1 = DC-link too low during run

S2 = No data from power unit

S3 = Undervoltage control supervision

Possible cause

1. Too low a supply voltage
2. AC drive internal fault
3. One of the input fuses is broken.
4. External charge switch has not been closed.

Correcting measures

- In case of temporary supply voltage break, reset the fault and restart the AC drive.
- Check supply voltage.
- Check function of DC charge.
- Contact your local distributor.

F10 Input line supervision

S1 = Phase supervision diode supply

S2 = Phase supervision active front end

Possible cause:

1. Input line phase is missing.

Correcting measures

- Check supply voltage, fuses and cable.

F11 Output phase supervision

Current measurement has detected that there is no current in one phase or one phase current is considerably different from other phases.

Correcting measures

- Check motor cable and motor.

F12 Brake chopper supervision

Brake chopper supervision generates pulses to the brake resistor for response. If no response is received within set limits a fault is generated.

Possible cause:

1. No brake resistor installed.
2. Brake resistor is broken.
3. Brake chopper failure.

Correcting measures:

- Check brake resistor and cabling.
- If these are ok the chopper is faulty. Contact your local distributor.

F13 Drive under temperature fault

Possible cause:

1. Heatsink temperature is under -10°C

F14 Drive overtemperature fault

Possible cause:

1. Heatsink temperature is over acceptable limits. See VACON® NXS/P User Manual for the temperature limit. Overtemperature warning is issued before actual trip limit is reached.

Correcting measures

- Check correct amount and flow of cooling air.
- Check the heatsink for dust.
- Check ambient temperature.
- Make sure that switching frequency is not too high in relation to ambient temperature and motor load.

F15 Motor Stalled

The motor stall protection protects the motor from short time overload situations such as one caused by a stalled shaft. The reaction time of the stall protection can be set shorter than that of motor thermal protection. The stall state is defined with two parameters, Stall current and Stall frequency limit. If the current is higher than the set limit and output frequency is lower than the set limit the stall state is true. There is actually no real indication of the shaft rotation. Stall protection is a type of over current protection.

- Check motor and load.

F16 Motor over temperature

Motor overheating has been detected by AC drive motor temperature model. Motor is overloaded.

Possible cause:

1. Motor load is too high.
2. Motor values are set incorrectly.

Correcting measures:

- Decrease motor load.
- If no motor overload exists, check the temperature model parameters.

F17 Motor underload fault

The purpose of the motor underload protection is to ensure that there is load on the motor when the drive is running. If the motor loses its load there might be a problem in the process, e.g. a broken belt or a dry pump.

The underload curve is a squared curve set between the zero frequency and the field weakening point. The protection is not active below 5Hz (the underload time counter is stopped).

The torque values for setting the underload curve are set in percentage which refers to the nominal torque of the motor. The motor's name plate data, parameter motor nominal current and the drive's nominal current I_H are used to find the scaling ratio for the internal torque value.

Correcting measures:

- Check load.

F22 EEPROM checksum fault

Possible cause:

1. Parameter save fault
2. Faulty operation
3. Component failure

Correcting measures:

- Should the fault re-occur, contact your local distributor.

F24 Counter fault

Possible cause:

1. Values displayed on counters are incorrect

Correcting measures:

- Have a critical attitude towards values shown on counters.

F25 Microprocessor watchdog fault

Possible cause:

1. Start-up of the drive has been prevented.
2. Run request is ON when a new application is loaded to the drive.

Correcting measures:

- Reset the fault and restart.
- Should the fault re-occur, contact your local distributor.

F26 Start-Up prevention

Possible cause:

1. Start-up of the drive has been prevented.
2. Run request is ON when a new application is loaded to drive

Correcting measures:

- Cancel prevention of start-up if this can be done safely.
- Remove Run Request.

F29 Thermistor fault

The thermistor input of the option board has detected too high a motor temperature.

Possible cause:

1. Motor is overheated.
2. Thermistor cable is broken.

Correcting measures:

- Check motor cooling and load
- Check thermistor connection (If thermistor input of the option board is not in use it has to be short circuited).

F31 IGBT temperature

IGBT Inverter Bridge overtemperature protection has detected too high a short term overload current.

Possible cause:

1. Too high load

2. Identification run has not been made which causes the motor to start under magnetized.

Correcting measures:

- Check load.
- Check motor size.
- Make identification Run.

F32 Fan cooling

Possible cause:

1. Cooling fan of the AC drive does not start when ON command is given.

Correcting measures:

- Contact your local distributor.

F37 Device change

Option board or power unit changed.

Possible cause:

1. New device of same type and rating.

Correcting measures:

- Reset. Device is ready for use.

F38 Device added

Option board added.

Correcting measures:

- Reset. Device is ready for use. Old board settings will be used.

F39 Device removed

Option board removed.

Correcting measures:

- Reset. Device no longer available.

F40 Device unknown

Unknown option board or drive.

S1 = Unknown device

S2 = Power1 not same type as Power2

Correcting measures:

- Contact the distributor near to you.

F41 IGBT temperature

IGBT inverter bridge overtemperature protection has detected too high a short term overload current.

- Check load.
- Check motor size.
- Make Identification run.

F42 Brake resistor overtemperature**S1: Brake resistor high temperature**

Calculation for internal brake resistor has exceeded the tripping limit. If the internal brake resistor is not in use set the brake chopper parameter in System menu to 'Not connected'.

S2: Brake resistor resistance is too high**S3: Brake resistor resistance is too low****S4: No brake resistor detected****F43 Encoder fault**

Encoder fault is issued when the drive is not able to operate in closed loop control mode (encoder is used). See subcodes for details for the reason of the fault:

S1 =Encoder 1 channel A is missing**S2 =Encoder 1 channel B is missing****S3 =Both encoder 1 channels are missing****S4 =Encoder reversed****S5 =Encoder board missing****S6= Serial communication fault****S7=Ch A / Ch B Mismatch****S8=Resolver/Motor polepair mismatch****S9=Missed Start Angle**

This fault comes when using PMS motor.

1. Modulation type is ASIC while incremental encoder is used.
 - Change modulator type to Software 1
2. Start identification do not work due low identification current
 - Increase identification current
3. Start angle identification is not working at all because there is no saturation based saliency in the motor
 - Use absolute encoder
4. There are too much noise pick-ups in encoder cable
 - check encoder cable shield and grounding in drive

F44 Device changed (Default param.)

Possible cause:

1. Option board or power unit changed.
2. New device of different type or different rating from the previous one.

Correcting measures:

- Reset
- Set the option board parameters again if option board was changed. Set converter parameters again if power unit was changed.

F45 Device added (default param.)

Possible cause:

1. Option board of different type added.

Correcting measures:

- Reset
- Set the option board parameters again.

F50 4mA supervision

Possible cause:

1. Current at the analogue input is below 4mA.
2. Signal source has failed
3. Control cable is broken or loose

Correcting measures:

- Check the current loop circuitry.

F51 External fault

Possible cause:

1. Digital input fault.

Correcting measures:

- Remove fault situation from external device.

F52 Keypad communication

Possible cause:

1. The connection between the control keypad or VACON® NCDrive and the AC drive is broken.

Correcting measures:

- Check keypad connection and possible keypad cable.

F53 Fieldbus communication

Possible cause:

1. The data connection between the fieldbus Master and the fieldbus board is broken.

Correcting measures:

- Check installation.
- If installation is correct contact the nearest distributor.

F54 Slot fault

Possible cause:

1. Defective option board or slot

Correcting measures:

- Check board and slot.
- Contact the nearest distributor.

F55 External brake ON control fault

Possible cause:

- Fault is activated by the mechanical brake control logic.

Correcting measures:

- Check parameters and external brake device. See [parameter 2.8.4.1](#) and chapter 9.

F56 Shaft speed error

Speed error monitoring function compares the encoder frequency and the ramp generator output. This function is used with PMS motors to detect if the motor is out of synchronization.

Possible cause:

1. Motor speed is not the same as the reference. For example, motor speed is limited by torque limit.
2. PMS motor has gone off synchronization.
3. Encoder cable is broken.

F57 Torque supervision

Actual torque above torque limits. See [parameter 2.8.4.6](#)

F58 Minimum current

Motor current is less than set limit [parameter 2.8.4.8](#)

F59 Direction request

Digital inputs DIN1 and DIN2 are ON at the same time. See [parameter 2.8.4.7](#).

F60 Evacuation

Fault is generated during the evacuation process. This error is reset when main power is back.

F61 Zero speed time

Zero current measured later than 2 seconds from start command.
See [parameter 2.8.4.9](#).

F62 Evacuation voltage

Evacuation active and voltage has exceeded the limit value.
Evacuation voltage 230VAC $\pm 10\%$
This error is reset when main power is back.

F63 Identification

Identification run has failed.

Possible cause:

1. There was load on the motor shaft when making the identification run with rotating motor.
2. Motoring or generator side torque/power limits are too low to achieve a stable run.

Correcting measures:

- Run command was removed before identification was ready
- Motor is not connected to the AC drive.
- There is load on the motor shaft.

F64 Motor contactor

Wrong wiring or programming of Acknowledge input programmed by [P2.4.7.2](#) Evacuation voltage 230VAC $\pm 10\%$

F91 External brake OFF control fault

Possible cause:

- Fault is activated by the mechanical brake control logic.

Correcting measures:

- Check parameters and external brake device. See [parameter 2.8.4.1](#) and chapter 9.

VAGON[®]

www.danfoss.com

Vacon Ltd
Member of the Danfoss Group

Runsorintie 7
65380 Vaasa
Finland

Document ID:



Rev. B