

VACON[®] NX

AC DRIVES

**APFIF09 MARINE
APPLICATION MANUAL**

VACON[®]

VACON® MARINE APPLICATION MANUAL

INDEX

Document code: DPD01667B
 Software code: APFIFF09V216
 Date: 11.10.2019

1. APFIFF09 MARINE APPLICATION - INTRODUCTION.....	8
1.1 General	8
1.2 Basic Features	9
1.3 Acronyms	10
2. APFIFF09 Versions compatibility issues	11
3. Control I/O	12
4. “Terminal To Function” (TTF) programming principle.....	13
4.1 Defining an input/output for a certain function on keypad	13
4.2 Defining a terminal for a certain function with NCDrive programming tool.....	14
4.3 Defining unused inputs/outputs.....	15
5. APFIFF09 – MONITORING VALUES	16
5.1 Monitoring values.....	17
5.1.1 Monitoring values 2.....	18
5.1.2 FieldBus Monitoring values.....	19
5.1.3 Master/Follower Monitoring values.....	19
5.1.4 PI Control Monitoring values	20
5.1.5 Frequency Chain.....	20
5.1.6 Torque Chain.....	20
5.1.7 Active Limits.....	20
5.1.8 Functional Safety Monitoring.....	20
5.2 Monitoring values description	22
5.2.1 Monitoring values 2.....	25
5.2.2 FieldBus Monitoring values.....	31
5.2.3 Master / Follower.....	37
5.2.4 PI Control monitoring	40
5.2.5 Frequency Chain.....	41
5.2.6 Torque Chain.....	41
5.2.7 Active Limits.....	42
5.2.8 Functional Safety Monitoring.....	43
5.2.9 Counters	49
6. APFIFF09 – PARAMETER LIST	51
6.1 Basic parameters.....	51
6.2 Reference Handling	52
6.2.1 Basic Settings	52
6.2.2 Constant Reference	52
6.2.3 Power Reference.....	53
6.2.4 Torque Reference.....	53
6.2.5 Prohibit frequency parameters.....	54
6.2.6 Motor Potentiometer	54
6.2.7 Adjust Reference	54
6.3 Ramp Control	55
6.3.1 Basic Settings	55
6.3.2 Quick Stop.....	55
6.3.3 Ramp Control Options	55

6.4	Input Signals.....	56
6.4.1	Basic Settings	56
6.4.2	Digital inputs.....	56
6.4.3	Analogue input 1.....	57
6.4.4	Analogue input 2.....	58
6.4.5	Analogue input 3.....	58
6.4.6	Analogue input 4.....	59
6.4.7	Options	59
6.5	Output Signals.....	60
6.5.1	Digital output signals.....	60
6.5.2	Analogue output 1.....	61
6.5.3	Analogue output 2.....	62
6.5.4	Analogue output 3.....	62
6.5.5	Analogue output 4.....	62
6.5.6	Delayed digital output 1	63
6.5.7	Delayed digital output 2	63
6.5.8	Supervision Limits	64
6.5.9	Output Options	64
6.6	Limit Settings.....	65
6.6.1	Current handling	65
6.6.2	Power Handling.....	65
6.6.3	Torque Handling.....	66
6.6.4	Frequency Handling.....	66
6.6.5	DC-Link Handling.....	67
6.6.6	Limit Settings Options.....	67
6.7	Flux and DC Current handling.....	68
6.7.1	Flux and DC Current handling OL Settings	68
6.7.2	Flux and DC Current handling CL Settings.....	68
6.8	Motor Control	69
6.8.1	Motor Control Basic Settings	69
6.8.2	Open Loop	69
6.8.3	Closed Loop Control Settings	70
6.8.4	PMSM Control settings.....	71
6.8.5	Stabilators.....	72
6.8.6	Tuning parameters	72
6.8.7	Identification parameters	73
6.8.8	Fine tuning parameters	73
6.9	Speed Control.....	74
6.9.1	Speed Control Basic settings.....	74
6.9.2	Speed Control OL Settings	74
6.9.3	Speed Control CL Settings.....	74
6.10	Drive Control	75
6.11	Master Follower	76
6.12	Protections.....	77
6.12.1	Common settings	77
6.12.2	Temperature sensor protections	77
6.12.3	Stall Protection.....	78
6.12.4	Speed error monitoring	78
6.12.5	Motor protection	78
6.12.6	Living Zero monitoring	79
6.12.7	Underload protection.....	79
6.12.8	Earth Fault protection	79
6.12.9	Cooling protection.....	80
6.12.10	Fieldbus protection	80
6.12.11	External Fault.....	80
6.12.12	Encoder Fault.....	80
6.12.13	Options.....	80

6.13	Fieldbus parameters	81
6.14	ID Control Functions	83
6.14.1	Value Control	83
6.14.2	DIN ID Control 1	83
6.14.3	DIN ID Control 2	83
6.14.4	DIN ID Control 3	83
6.14.5	ID Controlled Digital Output 1	84
6.14.6	ID Controlled Digital Output 2	84
6.14.7	Free DIN Delay	84
6.14.8	ID.Bit ID Control	84
6.15	Brake Control	85
6.16	Auto Reset parameters	86
6.17	PI Control Parameters	87
6.18	Functional Safety	87
6.19	Keypad control (Control keypad: Menu M3)	88
6.20	System menu (Control keypad: Menu M6)	88
6.21	Expander boards (Control keypad: Menu M7)	88
7.	APFIFF09 – DESCRIPTION OF PARAMETERS	89
7.1	Basic Parameters	89
7.2	Reference Handling	98
7.2.1	Basic Parameters	99
7.2.2	Constant Reference	102
7.2.3	Power Reference	104
7.2.4	Torque Reference	106
7.2.5	Prohibited frequencies	112
7.2.6	Motor potentiometer	113
7.2.7	Adjust Reference	115
7.3	Ramp control	117
7.3.1	Quick Stop	120
7.3.2	Ramp Options	121
7.4	Input signals	123
7.4.1	Basic Settings	123
7.4.2	Digital inputs	125
7.4.3	Analogue Input 1 & 2	131
7.4.4	Analogue input 3 & 4	136
7.4.5	Inversion control	139
7.5	Output signals	140
7.5.1	Digital output signals	140
7.5.2	Analogue outputs 1 & 2 & 3 & 4	146
7.5.3	Delayed Digital Output 1 & 2	150
7.5.4	Supervision limits	153
7.5.5	Output Options	155
7.6	Limit settings	156
7.6.1	Current limit handling	156
7.6.2	Power limit handling	157
7.6.3	Torque limit handling	161
7.6.4	Frequency limit handling	165
7.6.5	DC Link handling	166
7.6.6	Limit options	169
7.7	DC current and magnetization handling	170
7.7.1	Open loop settings	170
7.7.2	Closed loop settings	174
7.8	Motor Control	176
7.8.1	U/f Settings	180
7.8.2	Close Loop Settings	184
7.8.3	Permanent magnet synchronous motor settings	187

7.8.4	Stabilization settings.....	193
7.8.5	Tuning settings.....	196
7.8.6	Identification settings.....	198
7.8.7	Fine Tuning parameters.....	199
7.9	Speed Control settings.....	200
7.10	Drive Control.....	206
7.11	Master Follower.....	209
7.11.1	Master Follower: Standard system.....	209
7.11.2	Master Follower: DriveSynch system.....	210
7.11.3	Master follower configuration.....	213
7.12	Protections.....	218
7.12.1	General settings.....	218
7.12.2	Temperature sensor protections.....	220
7.12.3	Stall protection.....	222
7.12.4	Speed Error.....	224
7.12.5	Motor Protection.....	225
7.12.6	Over Load Protection.....	228
7.12.7	4mA Protection.....	230
7.12.8	Under load protection.....	231
7.12.9	Earth Fault.....	233
7.12.10	Cooling protection.....	233
7.12.11	Fieldbus communication.....	234
7.12.12	External Fault function.....	235
7.12.13	Encoder Fault function.....	236
7.13	Fieldbus settings.....	237
7.13.1	General settings.....	237
7.14	ID Functions.....	241
7.14.1	Value Control.....	241
7.14.2	DIN ID Control.....	243
7.14.3	ID-controlled DO.....	244
7.14.4	Free DIN Delay.....	245
7.14.5	ID.Bit ID Control.....	245
7.15	Brake Control.....	246
7.15.1	Runaway load protection.....	249
7.15.2	Brake monitoring function.....	250
7.15.3	Closed Loop settings.....	251
7.15.4	Roll Back Control for Closed Loop.....	252
7.15.5	Functions.....	252
7.16	Auto Fault Reset.....	253
7.17	PI Control.....	256
7.18	Functional Safety.....	258
7.19	Keypad control parameters.....	259
8.	Data Logger Trigger Word.....	260
9.	Identification function for permanent magnet synchronous motor.....	261
9.1	Zero position identification with absolute encoder.....	261
9.2	Start position with incremental encoder without Z-pulse input.....	261
9.3	Identification with incremental encoder with Z-pulse input.....	262
10.	Status and control words in detail.....	263
10.1	Fieldbus.....	263
10.1.1	Combination 1, ProfiDrive – Standard with Profibus option board.....	264
10.1.2	Combination 2, ByPass – ProfiDrive; State Diagram.....	265
10.1.3	Combination 3, ByPass – Basic.....	272
11.	Problem solving.....	273

12. Fault codes..... 274

1. APFIFF09 MARINE APPLICATION - INTRODUCTION

Software APFIFF09, Marine application

Marine application has advanced power handling features, with main focus being in different kind of propulsion systems. The application can be used also for winch control where the smooth brake logic makes it possible to use a multi-motor winch system by just entering a few additional parameter settings explained in this manual. Also settings for the permanent magnet motors are covered in this manual.

1.1 General

This application is not kept backwards compatible. Please read the application change note or chapter 2: Marine versions compatibility issues in this manual to see what needs to be noted when updating the application. See also the updated parameter description in VACON® NCDriver when commissioning.

Help is available in VACON® NCDriver through selecting “Variable Text” and pressing “F1”. Below is an example from the Identification parameter help text from the VACON® NCDriver.

Index	Variable Text	Value	Unit	Min	Max	ID
P 2.1.1	Supply Voltage	690	V	0	1000	1201
P 2.1.2	Motor Nom Voltg	550	V	20	690	110
P 2.1.3	Motor Nom Freq	80,00	Hz	6,00	320,00	111
P 2.1.4	Motor Nom Speed	4800	rpm	24	20000	112
P 2.1.5	Motor Nom Currnt	2060	A	0	4120	113
P 2.1.6	Motor Cos Phi	0,85		0,30	1,00	120
P 2.1.7	Motor Nom Power	1890	kW	0	32700	116
P 2.1.8	MagnCurrent	0	A	0	4120	612
P 2.1.9	Identification	0 / No Action		0	5	631
P 2.1.10	Motor Type	1 / PMSM		0	1	650

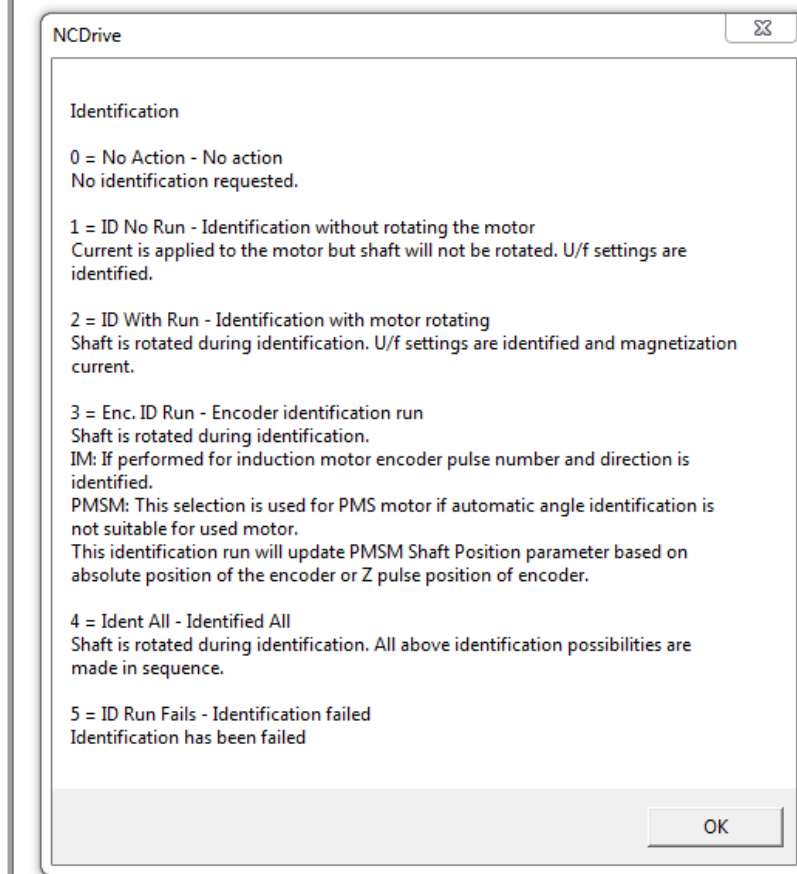

1.2 Basic Features

The Marine application provides a wide range of parameters for controlling induction motors and permanent magnet motors. It can be used for various kinds of different processes which require wide flexibility of I/O signals and only simple PI control logic is needed.

The main focus has been how power reference, power limits and torque limits behave in different situations. The application allows power and torque reference and reference ramp-up rate adjustment to make the operation smooth for ship generators and mechanics.

Flexible ID control possibilities take the application suitability to different process to a new level, allowing any input or actual value to be connected to any parameter with a scaling factor.

Marine application is not considered to be a fast response application. Basic functionality is handled in 20 ms time level. Most of the inputs and output functions are handled in 30 ms time level, and analogue output singles are using pre filtered signals (Torque (1 second linear filtering) , Power, etc.). Power limit functions are handled in 10 ms time level or faster.

Additional functions:

- Joystick input dead zone
- Different power limits by DI or from Fieldbus. Motoring and generating side.
- Master Follower function for steering propeller and double winding motors
- Different torque limits for motoring and generating side
- Cooling monitor input from heat exchange unit with selectable response.
- Brake monitoring input and actual current monitor for immediate brake close.
- Separate speed control tuning for different speeds and loads
- Inching function with two different references
- Possibility to connect FB Process data to any parameter and some monitoring values
- Analogue input 3 and 4 can control any parameter by ID number.
- Support for four analogue output
- Support for two PT100 board
- Power limit ramp up rate adjustment
- Torque limit ramp up rate adjustment
- Automatic power reduction from DC Voltage
- Actual power follower function, power will increase only with allowed rate

1.3 Acronyms

AC	=	Altenating Current
AI	=	Analogue Input
AIO	=	All-In-One Applications
AM	=	Asynchronous Motor
ASIC	=	Application Specific Integrated Circuit
CL	=	Closed Loop
DC	=	Direct Current
DI	=	Digital Input
DO	=	Digital Output
DS	=	DriveSynch
FB	=	Field Bus
FFT	=	Function To Terminal
FW	=	Firmware
FWP	=	Field Weakening Point
FWPV	=	Field Weakening Point Voltage
GE	=	Greater or Equal
HW	=	Hardware
I/f	=	Current / Frequency
Id	=	Magnetization Current
IGBT	=	Insulated Gate Bipolar Transistor
INV	=	Inversion
Iq	=	Torque Producing Current
LT	=	Less Than
MF	=	Master-Follower
OL	=	Open Loop
PID	=	Proportional Integral Derivative
PM	=	Permanent Magnet
PMSM	=	Permanent Magnet Synchronous Motor
PU	=	Per Unit
RO	=	Relay Output
RS	=	Reset Set
SB	=	System Bus
Sep.Ex SM	=	Separately Excitaded Synchronous Motor
SM	=	Synchronous Machine
SPC	=	Speed Control
SQS	=	Sfe Quick Stop
SR	=	Set Reset
SRM	=	Synchronous Reluctance Motor
SS1	=	Safe Stop 1
STO	=	Safe Torque Off
SW	=	Software
TC	=	Torque Control
TC	=	Time Constant
TTF	=	Terminal To Function
U/f	=	Voltage / Frequency
UV	=	Under Voltage

2. APFIFF09 VERSIONS COMPATIBILITY ISSUES

[Latest released and previous versions from this link](#)

V120

- Temperature measurement board 2 has own response parameter.

V122

- Speed error monitoring status bits are moved from Fault Word 2 to Fault Word 10 B0 and from Warning Word 1 to Warning Word 10 B0

V128

- In earlier version, when operating in Ramp Follower mode, the follower brake control closed the brake after the master drive was in stop state. Now brake is closed in this mode at the same time as the master drive is closing the brake.

V215

- Stop Torque Release Time ID changed from 1848 to 1858

Note 1: When updating application, it is not recommended to use VACON® NCDrive parameter download function. Instead, upload the parameters from the unit and make comparison to the old parameter file. Application is constantly developed, this includes changing parameter default values. If parameters are directly downloaded to drive, the improved default values will be lost.

3. CONTROL I/O

Terminal		Signal	Description
1	+10V _{ref}	Reference voltage output	Voltage for potentiometer, etc.
2	AI1+	Analogue input 1. Range 0-10V, R _i = 200kΩ Range 0-20 mA R _i = 250Ω	Analogue input 1 frequency reference. Input range selected by jumpers. Default range: Voltage 0 – 10 V
3	AI1-	I/O Ground	Ground for reference and controls
4	AI2+	Analogue input 2. Range 0-10V, R _i = 200kΩ Range 0-20 mA R _i = 250Ω	Analogue input 2 frequency reference Input range selected by jumpers. Default range: Current 0 – 20 mA
5	AI2-		
6	+24V	Control voltage output	Voltage for switches, etc. max 0.1 A
7	GND	I/O ground	Ground for reference and controls
8	DIN1	Start forward Programmable G2.2.7	Contact closed = start forward Programmable start logic P2.2.1
9	DIN2	Start reverse Programmable G2.2.7	Contact closed = start reverse Programmable logic P2.2.1
10	DIN3	Fault reset Programmable G2.2.7	Contact open = no fault Contact closed = fault
11	CMA	Common for DIN 1–DIN 3	Connect to GND or +24V
12	+24V	Control voltage output	Voltage for switches (see #6)
13	GND	I/O ground	Ground for reference and controls
14	DIN4	Programmable G2.2.7	No function defined at default
15	DIN5	Programmable G2.2.7	No function defined at default
16	DIN6	Programmable G2.2.7	No function defined at default
17	CMB	Common for DIN4–DIN6	Connect to GND or +24V
18	AOA1+	Analogue output 1 Programmable P2.3.1.2	Output range selected by jumpers. Range 0–20 mA. R _L , max. 500Ω Range 0–10 V. R _L > 1kΩ
19	AOA1-		
20	DOA1	Digital output	Programmable Open collector, I _s ≤50mA, U _s ≤48 VDC
NXOPTA2			
21	RO1	Relay output 1 Programmable G2.3.3	Switching capacity 24 VDC / 8 A 250 VAC / 8 A 125 VDC / 0.4 A
22	RO1		
23	RO1		
24	RO2	RELAY OUTPUT 2 Programmable G2.3.3	Programmable No function defined at default
25	RO2		
26	RO2		

Table 3-1. Marine application default I/O configuration and connection example.

Note: See User Manual, chapter Control Connections, for hardware specification and configuration.

Note: See jumper selections below. More information in VACON® NX User Manual.

Jumper block X3: CMA and CMB grounding

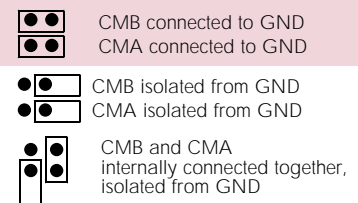

= Factory default

4. “TERMINAL TO FUNCTION” (TTF) PROGRAMMING PRINCIPLE

The programming principle of the input and output signals in the **Multipurpose Control Application NXP** as well as in the **Pump and Fan Control Application** (and partly in the other applications) is different compared to the conventional method used in other VACON® NX applications.

In the conventional programming method, *Function to Terminal Programming Method (FTT)*, you have a fixed input or output that you define a certain function for. The applications mentioned above, however, use the *Terminal to Function Programming method (TTF)* in which the programming process is carried out the other way round: Functions appear as parameters which the operator defines a certain input/output for. See *Warning* on page 14.

4.1 Defining an input/output for a certain function on keypad

Connecting a certain input or output with a certain function (parameter) is done by giving the parameter an appropriate value. The value is formed of the *Board slot* on the VACON® NX control board (see VACON® NX User Manual) and the *respective signal number*, see below.

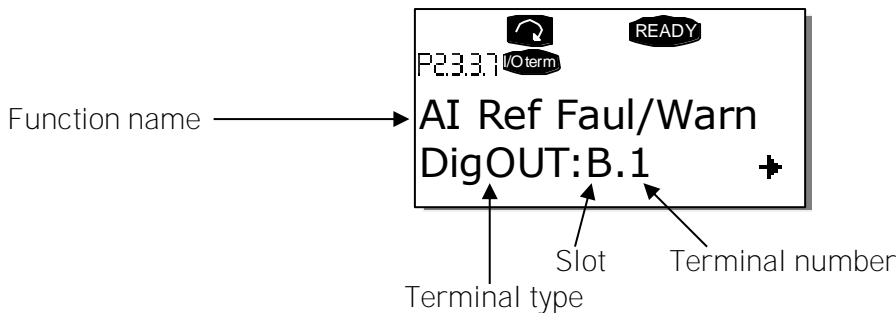

Example: You want to connect the digital output function *Reference fault/warning* (parameter 2.3.3.7) to the digital output DO1 on the basic board NXOPTA1 (see VACON® NX User Manual).

First find the parameter 2.3.3.7 on the keypad. Press the *Menu button right* once to enter the edit mode. On the *value line*, you will see the terminal type on the left (DigIN, DigOUT, An.IN, An.OUT) and on the right, the present input/output the function is connected to (B.3, A.2 etc.), or if not connected, a value (0.#).

When the value is blinking, hold down the *Browser button up* or *down* to find the desired board slot and signal number. The program will scroll the board slots starting from 0 and proceeding from A to E and the I/O selection from 1 to 10.

Once you have set the desired value, press the *Enter button* once to confirm the change.

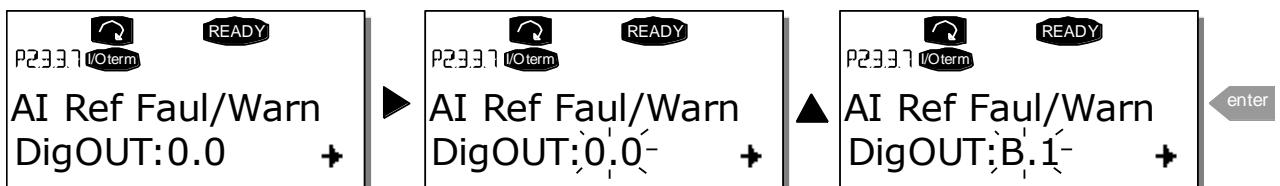

4.2 Defining a terminal for a certain function with NCDrive programming tool

If you use the VACON® NCDrive Programming Tool for parametrizing you will have to establish the connection between the function and input/output in the same way as with the control panel. Just pick the address code from the drop-down menu in the *Value* column (see the Figure below).

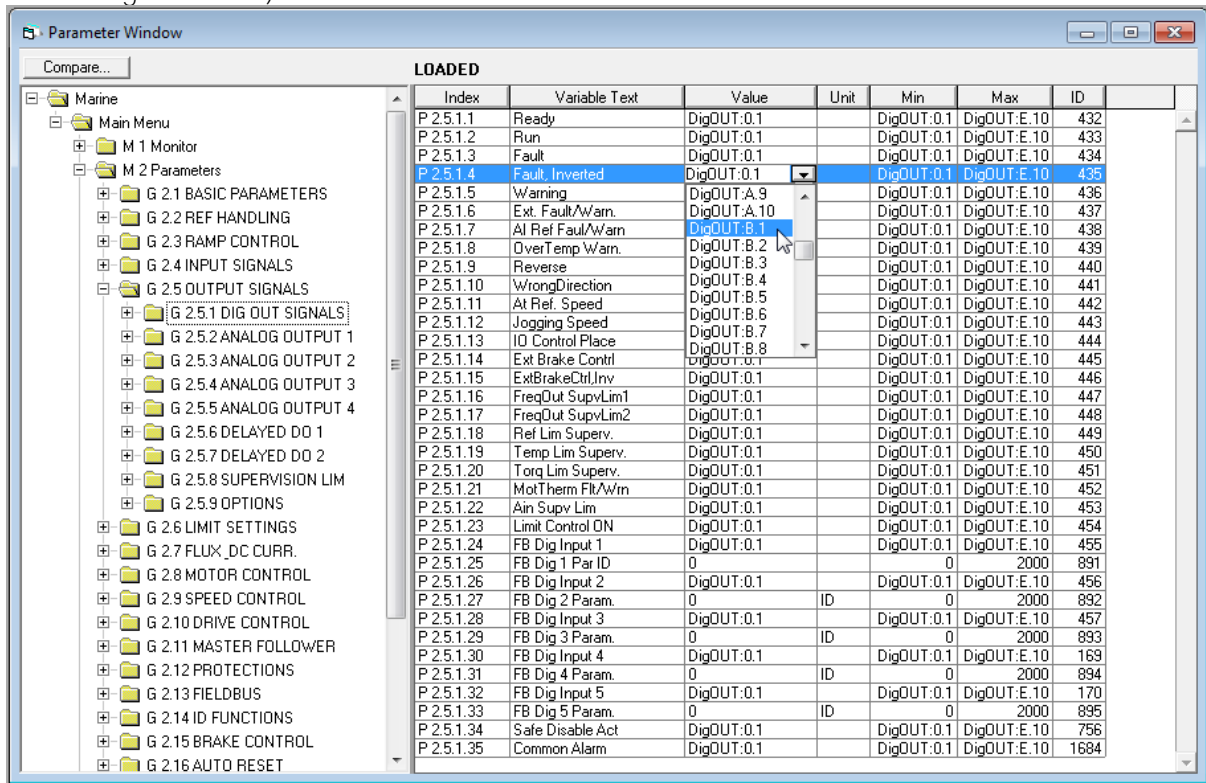



Figure 4-1. Screenshot of NCDrive programming tool; Entering the address code

 WARNING	<p>Be ABSOLUTELY sure not to connect two functions to one and same <u>output</u> in order to avoid function overruns and to ensure flawless operation.</p>
-------------------------------------------------------------------------------------------------------	-------------------------------------------------------------------------------------------------------------------------------------------------------------------

Note: The *inputs*, unlike the *outputs*, cannot be changed in RUN state.

4.3 Defining unused inputs/outputs



All unused inputs and outputs must be given the board slot value **0** and the value **1** also for the terminal number. The value **0.1** is also the default value for most of the functions. However, if you want to use the **values of a digital input signal** for, for example, testing purposes only, you can set the board slot value to **0** and the terminal number to any number between 2...10 to place the input to a TRUE state. In other words, the value **1** corresponds to 'open contact' and values 2 to 10 to 'closed contact'.

In case of analogue inputs, giving the value **1** for the terminal number corresponds to 0% signal level, value **2** corresponds to 20%, value **3** to 30% and so on. Giving value **10** for the terminal number corresponds to 100% signal level.

5. APFIF09 – MONITORING VALUES

On the next pages you will find the lists of parameters within the respective parameter groups. The parameter descriptions are given on pages 89 to 251. Parameter description includes more than is available in this application see parameter list what is available.

Column explanations:

Code	= Location indication on the keypad; Shows the operator the present parameter number
Parameter	= Name of parameter
Min	= Minimum value of parameter
Max	= Maximum value of parameter
Unit	= Unit of parameter value; Given if available
Default	= Value preset by factory
Cust	= Customer's own setting
ID	= ID number of the parameter
	= On parameter code: Parameter value can only be changed after the FC has been stopped.
	= Apply the Terminal to Function method (TTF) to these parameters (see chapter 4)
	= Monitoring value is possible to control from fieldbus by ID number

The manual presents signals that are not normally visible for monitoring, i.e. is not a parameter or standard monitoring signal. These signals are presented with [Letter]. e.g. [FW]MotorRegulatorStatus

[V]	Normal monitoring signal
[P]	Normal parameter in application.
[FW]	Firmware signal, Can be monitored with VACON® NCDrive when signal type is selected Firmware
[A]	Application signal, can be monitored with VACON® NCDrive when signal type is selected Application.
[R]	Reference type parameter on keypad.
[F]	Function. Signal is received as a output of function.
[DI]	Digital input signal.

5.1 Monitoring values

The monitoring values are the actual values of parameters and signals as well as statuses and measurements.

Note for DriveSynch Systems:

In a DriveSynch system, only Master drive monitoring signals are reliable.

Only directly measured values are reliable in follower units. Even the Output Frequency of DriveSynch follower is not directly observed and thus may not show actual output frequency that is controlled by DriveSynch Master Drive.

Code	Parameter	Unit	Form.	ID	Description
V1.1	Output frequency	Hz	###	1	Output frequency to motor
V1.2	Frequency reference	Hz	###	25	Frequency reference to motor control
V1.3	Motor speed	rpm	#	2	Motor speed in rpm
V1.4	Motor current	A	Varies	3	1 s linear filtering
V1.5	Motor torque	%	#, #	4	In % of Motor nominal torque
V1.6	Motor Power	%	#, #	5	
V1.7	Motor voltage	V	#, #	6	Calculated motor voltage
V1.8	DC link voltage	V	#	7	Measured DC voltage, filtered.
V1.9	Unit temperature	°C	#	8	Heatsink temperature
V1.10	Motor temperature	%	#	9	Calculated motor temperature, trip 105%
V1.11	Analogue input 1	%	###	13	AI1, unfiltered.
V1.12	Analogue input 2	%	###	14	AI2, unfiltered.
V1.13	Analogue input 3	%	###	27	AI3, unfiltered.
V1.14	Analogue input 4	%	###	28	AI4, unfiltered.
V1.15	Analogue Out 1	%	###	26	A01
V1.16	Analogue Out 2	%	###	31	A02
V1.17	Analogue Out 3	%	###	32	A03
V1.18	Analogue Out 4	%	###	1526	
V1.19	DIN1, DIN2, DIN3		#	15	Digital input statuses
V1.20	DIN4, DIN5, DIN6		#	16	Digital input statuses
V1.21	Power Reference	%	#, #	1700	Used power reference
V1.22	PT-100 Temperature	C°	#, #	42	Highest temperature of OPTB8 board. 4 s filtering.
G1.23	Multimonitoring items				Displays three selectable monitoring values

Table 5-1. Monitoring values

5.1.1 Monitoring values 2

Code	Parameter	Unit	Form.	ID	Description
V1.24.1	Current	A	Varies	1113	Unfiltered motor current
V1.24.2	Torque	%	#, #	1125	Unfiltered motor torque
V1.24.3	DC Voltage	V	#	44	Unfiltered DC link voltage
V1.24.4	Application Status Word		#	43	
V1.24.5	Shaft Frequency	Hz	#, ##	1124	Unfiltered
V1.24.6	Output Power	kw	Varies	1508	Unfiltered electrical power
V1.24.7	Measured temperature 1	C°	#, #	50	4 s filtering.
V1.24.8	Measured temperature 2	C°	#, #	51	4 s filtering.
V1.24.9	Measured temperature 3	C°	#, #	52	4 s filtering.
V1.24.10	Measured temperature 4	C°	#, #	69	4 s filtering.
V1.24.11	Measured temperature 5	C°	#, #	70	4 s filtering.
V1.24.12	Measured temperature 6	C°	#, #	71	4 s filtering.
V1.24.13	ABS Encoder Revolutions	r	#	55	
V1.24.14	ABS Encoder Position		#	54	
V1.24.15	Step response	Hz	#, ##	1132	
V1.24.16	CosPhiActual		#, ##, ###	68	
V1.24.17	Flux Current	%	#, #	72	
V1.24.18	Regulator Status		#	77	
V1.24.19	Frequency Delta	Hz/s	#, ##	1847	
V1.24.20	Data Logger Trigger Word		#	97	Different status bits to help diagnostic with data logger.
V1.24.21	Encoder 2 Frequency	Hz	#, ##	53	
V1.24.22	Operation Hours	h	#, ##	1856	
V1.24.23	Status Word 2		#	89	
V1.24.24	Rotor Flux	%	#, #	1158	
V1.24.25	Identfail		#	98	
V1.24.26	Motor Power kW	kW	Varies	79	
V1.24.27	Status Word 1+2			33	
V1.24.28	ABS Position High			1957	
V1.24.29	ABS Position 32b			1958	
V1.24.30	Non Ready Cause		#	1608	
V1.24.31	Prevent MC Ready		#	1609	

Table 5-2. Monitoring values 2

5.1.2 FieldBus Monitoring values

Code	Parameter	Unit	Form.	ID	Description
V1.25.1	FB Control Word		#	1160	
V1.25.2	FB Speed Reference		#	875	
V1.25.3	FB Status Word		#	65	
V1.25.4	FB Actual Speed		#	865	
V1.25.5	FB Torque Reference	%	#, #	1140	Default Control of FB PD 1
V1.25.6	FB Limit Scaling	%	#, #, #	46	Default Control of FB PD 2
V1.25.7	FB Adjust Reference	%	#, #, #	47	Default Control of FB PD 3
V1.25.8	FB Analogue Output	%	#, #, #	48	Default Control of FB PD 4
V1.25.9	FB Motor Current	A	#, #	45	Motor current (drive independent) given with one decimal point
V1.25.10	Fault Word 1		#	1172	
V1.25.11	Fault Word 2		#	1173	
V1.25.12	Warning Word 1		#	1174	
V1.25.13	AuxStatusWord		#	1163	
V1.25.14	FB Power Reference		#, #	1703	
V1.25.15	Last Active Fault		#	37	
V1.25.16	AuxControlWord		#	1161	
V1.25.17	Din Status Word		#	56	
V1.25.18	Din Status Word 2		#	57	
V1.25.19	MC Status		#	64	
V1.25.20	Last Active Warning		#	74	
V1.25.21	Shaft Rounds		#	1170	
V1.25.22	Shaft Angle		#	1169	
V1.25.23	Fault Word 10		#	1202	
V1.25.24	Warning Word 10		#	1269	

Table 5-3. FieldBus Monitoring values

5.1.3 Master/Follower Monitoring values

Code	Parameter	Unit	Form.	ID	Description
V1.26.1	SB SystemStatus		#	1601	
V1.26.2	Total Current	A	#, #	80	Sum current of all drives (DS)
V1.26.3	Master CW		#	93	
Code	Parameter	Unit	ID	Description	
V1.26.4.1	Motor Current D1	A	Varies	1616	
V1.26.4.2	Motor Current D2	A	Varies	1605	
V1.26.4.3	Motor Current D3	A	Varies	1606	
V1.26.4.4	Motor Current D4	A	Varies	1607	
V1.26.4.5	Motor Current D5	A	Varies	1810	
V1.26.4.6	Motor Current D6	A	Varies	1811	
V1.26.4.7	Motor Current D7	A	Varies	1812	
V1.26.4.8	Motor Current D8	A	Varies	1813	
Code	Parameter	Unit	ID	Description	
V1.26.5.1	Status Word D1		#	1615	
V1.26.5.2	Status Word D2		#	1602	
V1.26.5.3	Status Word D3		#	1603	
V1.26.5.4	Status Word D4		#	1604	
V1.26.5.5	Status Word D5		#	1814	
V1.26.5.6	Status Word D6		#	1815	
V1.26.5.7	Status Word D7		#	1816	
V1.26.5.8	Status Word D8		#	1817	

Table 5-4. Master/Follower Monitoring values

5.1.4 PI Control Monitoring values

Code	Parameter	Unit	Form.	ID	Description
V1.27.1	PI Reference		#	20	Used PI Reference
V1.27.2	PI Actual Value		#	21	PI Actual value
V1.27.3	PI Output		#	23	PI Output before scaling
V1.27.4	PI Output Scaled		#	1807	Scaled PI Output This is used for ID connection

Table 5-5. PI Control Monitoring values

5.1.5 Frequency Chain

Code	Parameter	Unit	Form.	ID	Description
V1.28.1	Frequency Reference 1	Hz	#,##	1126	
V1.28.2	Frequency Reference 2	Hz	#,##	1127	
V1.28.3	Frequency reference	Hz	#,##	25	Frequency reference to motor control
V1.28.4	Frequency Reference Actual	Hz	#,##	1128	
V1.28.5	Frequency Ramp Out	Hz	#,##	1129	
V1.28.6	Frequency Reference Final	Hz	#,##	1131	
V1.28.7	Encoder Frequency	Hz	#,##	1164	

Table 5-6. Frequency Chain Monitoring values

5.1.6 Torque Chain

Code	Parameter	Unit	Form.	ID	Description
V1.29.1	Torque Reference	%	#,.	18	
V1.29.2	Torque Reference 3	%	#,.	1144	
V1.29.3	Torque Ref Final	%	#,.	1145	
V1.29.4	Speed Control Out	%	#,.	1134	
V1.29.5	Torque Reference Actual	%	#,.	1180	

Table 5-7. Torque Chain Monitoring values

5.1.7 Active Limits

Code	Parameter	Unit	Form.	ID	Description
V1.30.1	Motoring Torque Limit	%	#,.	1950	
V1.30.2	Generator Torque Limit	%	#,.	1951	
V1.30.3	Motoring Power Limit	%	#,.	1952	
V1.30.4	Generator Power Limit	%	#,.	1953	
V1.30.5	Current Limit	A	Varies	1954	
V1.30.6	SPC Positive Limit	%	#,.	1955	
V1.30.7	SPC Negative Limit	%	#,.	1956	

Table 5-8. Active Limits Monitoring values

5.1.8 Functional Safety Monitoring

Code	Signal	Unit	ID	Description
V1.31.1	Safety App Status		1653	
V1.31.2	Integrity Level		1640	
V1.31.3	Acknowledge Mode		1641	
V1.31.4	Safety Encoder Speed	rpm	1642	
V1.31.5	Ramp Selection		1643	
V1.31.6	Function Reached		1644	
V1.31.7	Request DIN		1645	

V1.31.8	Request PLC		1646	
V1.31.9	Function In Use		1647	
V1.31.10	Safety Status Word		1648	
V1.31.11	Safety General Status Word		1649	
V1.31.12	Safety Status		1650	
V1.31.13	Safety Zero Speed		1651	
V1.31.14	SBC Speed	rpm	1652	

5.2 Monitoring values description

Note for DriveSynch Systems:

In a DriveSynch system, only Master drive monitoring signals are reliable.

Only directly measured values are reliable in follower units. Even the Output Frequency of DriveSynch follower is not directly observed and thus may not show actual output frequency that is controlled by DriveSynch Master Drive.

V1.1 *Output frequency* [#,## Hz] ID1

Output frequency to motor, updated at 10 ms time level.

V1.2 *Frequency reference* [#,## Hz] ID 25

Frequency reference to motor control, after speed share function. Updated at 1 ms time level.

V1.3 *Motor speed* [# rpm] ID 2

Motor speed in rpm

V1.4 *Motor current* [A] ID 3

Open loop:

1 s linear filtering.

Closed Loop:

32 ms filtering

Drive Synch Operation Master drive

This value is the total current of the system divided by number of drives in the system (SbLastID). SbLastId cannot be changed; it needs to be set according to how many drives are linked with system bus.

Drive Synch Operation Follower drive

This value is the current of the drive's own power unit.

Current scaling in different size of units

Note: ID45, usually in Process data OUT 3 is scaled to be with one decimal always.

Voltage	Size	Scale
208 – 240 Vac	NX0001 – NX0011	100 – 0.01A
208 – 240 Vac	NX0012 – NX0420	10 – 0.1A
208 – 240 Vac	NX0530	1 – 1A
380 – 500 Vac	NX0003 – NX0007	100 – 0.01A
380 – 500 Vac	NX0009 – NX0300	10 – 0.1A
380 – 500 Vac	NX0385 – NX2643	1 – 1A
525 – 690 Vac	NX0004 – NX0013	100 – 0.01A
525 – 690 Vac	NX0018 – NX0261	10 – 0.1A
525 – 690 Vac	NX0325 – NX1500	1 – 1A

V1.5 *Motor torque* % *ID 4*

In % of Motor nominal torque

Open loop

1 s linear filtering

Closed Loop

32 ms filtering

Drive Synch Operation Follower drive

This value is the torque of the drive's own power calculated in open loop. Motor torque is valid only in Master drive.

V1.6 *Motor Power* % *ID 5*

Calculated motor power. In % of Motor nominal torque. $P = \omega T$

V1.7 *Motor voltage* V *ID 6*

Calculated motor voltage

V1.8 *DC link voltage* V *ID 7*

Measured DC voltage, filtered.

V1.9 *Unit temperature* C *ID 8*

Heatsink temperature

V1.10 *Motor temperature* % *ID 9*

Calculated motor temperature
105% is tripping limit if response is fault.

V1.11 *Analogue input 1%* *ID 13***V1.12** *Analogue input 2%* *ID 14*

Unfiltered analogue input level.

0% = 0 mA / 0 V, -100% = -10 V, 100% = 20 mA / 10 V.

Monitoring scaling is determined by the option board parameter.

V1.13 *Analogue input 3%* *ID 27***V1.14** *Analogue input 4%* *ID 28*

It is possible to adjust this input value from fieldbus when the input terminal selection is 0.1. This way it is possible to adjust the free analogue input from fieldbus and have all analogue input functions available for fieldbus process data.

- V1.15 *Analogue Out 1 % ID 26*
 V1.16 *Analogue Out 2 % ID 31*
 V1.17 *Analogue Out 3 % ID 32*
 V1.18 *Analogue Out 4 % ID 1526*

Analogue Output value 0% = 0 mA / 0 V, 100% = 20 mA / 10 V

- V1.19 *DIN1, DIN2, DIN3 ID 15*
 V1.20 *DIN4, DIN5, DIN6 ID 16*

	DIN1/DIN2/DIN3 status	DIN4/DIN5/DIN6 status
b0	DIN3	DIN6
b1	DIN2	DIN5
b2	DIN1	DIN4

- V1.21 *Power reference % ID 1700*

Power reference monitoring value. If power reference is not selected in the reference group it can be directly written to this monitoring variable from fieldbus and only ramping rate function is active from power reference group.

- V1.22 *PT-100 Temperature C° ID 42*

Highest temperature of OPTB8 board. 4 s filtering.

5.2.1 Monitoring values 2

V1.24.1 Current A ID 1113

Unfiltered motor current, recommended signal for VACON® NCDrive monitoring.

Drive Synch Operation Master drive

This value is the total current of the system divided by number of drives in the system (SbLastID). SbLastId cannot be changed; it needs to be set according to how many drives are linked with system bus.

Drive Synch Operation Follower drive

This value is current of drive own power unit.

V1.24.2 Torque % ID 1125

Unfiltered motor torque.

V1.24.3 DC Voltage V ID 44

Unfiltered DC link voltage.

V1.24.4 Application Status Word ID 43 "Status Word 1"

Application Status Word combines different drive statuses to one data word. Recommended signal for VACON® NCDrive monitoring.

Application Status Word 1 ID43		
	FALSE	TRUE
b0	Flux not ready	Flux ready (>90%)
b1	Not in Ready state	Ready
b2	Not Running	Running
b3	No Fault	Fault
b4	Direction Forward	Direction Reverse
b5	Emergency Stop Active	Emergency Stop NOT Active
b6	Run Disabled	Run Enable
b7	No Warning	Warning
b8	Power positive	Power negative or Gen torque or current limit active
b9	Parameter Set 1 Active (or no set used)	Parameter Set 2 active
b10		Brake Chopper Operating
b11	No DC Brake	DC Brake is active
b12	No Run Request	Run Request
b13	No Limit Controls Active	Limit control Active
b14	External Brake Control OFF	External Brake Control ON
b15	Not used	Not used

V1.24.5 Shaft Frequency Hz ID1124

Shaft Frequency used by motor control.

V1.24.6 Output Power kw ID 1508

Unfiltered electrical drive output power. $P = \sqrt{3}UI \cos \varphi$

Voltage	Size	Scale
208 – 240 Vac	NX0001 – NX0004	100 – 0.01 kW
208 – 240 Vac	NX0007 – NX0300	10 – 0.1 kW
208 – 240 Vac	NX0300 ->	1 – 1 kW
380 – 500 Vac	NX0003	100 – 0.01 kW
380 – 500 Vac	NX0004 – NX0205	10 – 0.1 kW
380 – 500 Vac	NX0261 ->	1 – 1 kW
525 – 690 Vac	NX0004 – NX0005	100 – 0.01 kW
525 – 690 Vac	NX0007 – NX0170	10 – 0.1 kW
525 – 690 Vac	NX0208 ->	1 – 1 kW

V1.24.7 Measured temperature 1 C° ID 50

V1.24.8 Measured temperature 2 C° ID 51

V1.24.9 Measured temperature 3 C° ID 52

V1.24.10 Measured temperature 4 C° ID 69

V1.24.11 Measured temperature 5 C° ID 70

V1.24.12 Measured temperature 6 C° ID 71

Separate measurement from two PT100 board. The signal has 4 s filtering time.

V1.24.13 ABS Encoder Revolutions ID55

Absolute encoder revolution information.

V1.24.14 ABS Encoder Position ID54

Absolute encoder position within one rotation. See encoder manual for scaling.

V1.24.15 Step response Hz ID 1132

Frequency error. Compares ramp output to actual encoder frequency with 0.001 Hz accuracy. Can be used for speed control tuning in closed loop control.

V1.24.16 CosPhiActual ID 68

Estimated Cos Phi value.

V1.24.17 Flux Current ID 72

Flux producing current component 100.0 % equals nominal Flux Current.

V1.24.18 *Regulator Status*

ID 77

Regulator status ID77		
b0	Motoring Current Regulator Status	
b1	Generator Current Regulator Status	
b2	Motoring Torque Regulator Status	For CL monitor B0
b3	Generator Torque Regulator Status	For CL monitor B1
b4	Over Voltage Regulator Status	DC Voltage
b5	Under Voltage Regulator Status	DC Voltage
b6		
b7		
b8		
b9		
b10		
b11		
b12		
b13		
b14		
b15		

V1.24.19 *Frequency Delta*

ID 1847

Change of Final Frequency Reference in Hz/s.

V1.24.20 *Data Logger Trigger Word*

ID 97

Data Logger Trig Word ID97		
	Function	Comment
b0	Fault Status	Logger is triggered when there is a fault
b1	Warning Status	Logger is triggered when there is a warning
b2	Auto Reset Warning	Logger is triggered when there is a fault that has been defined to be automatically reset. This bit can be used to get the first fault situation.
b3	Fault Status OR Warning Status	B0 OR B1 triggering situation has happened
b4	Fault Status OR Auto Reset Warning	B0 OR B2 triggering situation has happened
b5		
b6		
b7		
b8		
b9		
b10		
b11		
b12		
b13		
b14		
b15		

V1.24.21 Encoder 2 Frequency

OPT-A7 board second input encoder frequency.

V1.24.22 Operation Hours

Running state hours.

V1.24.23 Application Status Word 2 ID 89 "Status Word 2"

Different statuses from the drive, useful for ID Control DO functions.

Application Status Word 2 ID89		
	FALSE	TRUE
b0	Value Control SR = FALSE	Value Control SR = TRUE
b1	Closed loop control = FALSE	Closed loop control = TRUE
b2		
b3		
b4		
b5		
b6		
b7		
b8		
b9		
b10		
b11		
b12		
b13		
b14		
b15		

V1.24.24 Rotor Flux ID1158 "Rotor Flux"

Calculated Rotor flux.

V1.24.25 Ident Failure Code [Ident Fail. Code] ID 98

Failure code for failed identification:

- 1 = Current measurement offset
- 2 = Identification current level
- 3 = Acceleration time too long
- 4 = Identification frequency reference not reached
- 5 = Too low or high magnetization current
- 6 = Flux curve outside expected levels
- 7 = PMSM, Encoder zero position
- 8 = Too low maximum frequency limit
- 9 = PMSM, encoder zero pulse not found.
- 10 = Ls Identification timeout
- 11 = Ls Identification current

V1.24.26 MotorPower kW ID79

Drive Output Power subtracted by motor resistive losses. $P = \sqrt{3}UI \cos \varphi - 3RI^2$

Voltage	Size	Scale
208 – 240 Vac	NX0001 – NX0004	100 – 0.01 kW
208 – 240 Vac	NX0007 – NX0300	10 – 0.1 kW
208 – 240 Vac	NX0300 →	1 – 1 kW
380 – 500 Vac	NX0003	100 – 0.01 kW
380 – 500 Vac	NX0004 – NX0205	10 – 0.1 kW
380 – 500 Vac	NX0261 →	1 – 1 kW
525 – 690 Vac	NX0004 – NX0005	100 – 0.01 kW
525 – 690 Vac	NX0007 – NX0170	10 – 0.1 kW
525 – 690 Vac	NX0208 →	1 – 1 kW

V1.24.27 Status Word 1+2 ID33

Application Status Word 1 ID43		
	FALSE	TRUE
b0	Flux not ready	Flux ready (>90%)
b1	Not in Ready state	Ready
b2	Not Running	Running
b3	No Fault	Fault
b4	Direction Forward	Direction Reverse
b5	Emergency Stop Active	Emergency Stop NOT Active
b6	Run Disabled	Run Enable
b7	No Warning	Warning
b8	Power positive	Power negative or Gen torque or current limit active
b9	Parameter Set 1 Active (or no set used)	Parameter Set 2 active
b10		Brake Chopper Operating
b11	No DC Brake	DC Brake is active
b12	No Run Request	Run Request
b13	No Limit Controls Active	Limit control Active
b14	External Brake Control OFF	External Brake Control ON
b15	Not used	Not used
b16	Value Control SR = FALSE	Value Control SR = TRUE
b17	Closed loop control = FALSE	Closed loop control = TRUE

V1.24.28 ABS Position High ID1957

Absolute encoder position bits within one rotation. See encoder manual for scaling.

V1.24.29 ABS Position 32b ID1958

Absolute encoder position within one rotation 32bit value. See encoder manual for scaling.

V1.24.30 *Non Ready Cause*

ID 1608

Non Ready Cause ID1608	
	Signal
b0	Fault is Active
b1	PreventMCReady is set
b2	Charge switch is open
b3	DC Voltage not OK
b4	Power unit state not OK
b5	StartUp Wizard is active
b6	Run Enable is not set
b7	Ready state prevented by STO
b8	
b9	
b10	
b11	
b12	
b13	
b14	
b15	

V1.24.31 *Prevent MC Ready*

ID 1609

Prevent MC Ready ID1609	
	Signal
b0	Endat option board (OPTBB, OPTBE) communication is not initialized after power-up.
b1	Drive sync master has wrong modulator or 1000ms task parameters are not initialized
b2	Drive sync follower delay is active
b3	Drive sync failure in sw modulator double period mode
b4	Charge switch delay is active
b5	AFE fast run disable through ENC C1 is active
b6	100ms task not executed
b7	
b8	
b9	
b10	
b11	
b12	
b13	
b14	
b15	

5.2.2 FieldBus Monitoring values

V1.25.1 *FB Control Word*

ID1160

Control word used in bypass mode. See P2.13.22 and option board ByPass. More details in Chapter 9 Status and Control Word in detail.

Bit	Description	
	Value = 0	Value = 1
b0	OFF	ON, Reset after Fault or b1 and b2
b1	Emergency stop by coast	ON, On normal operation: Keep TRUE
b2	Emergency stop by ramp	ON, On normal operation: Keep TRUE
b3	STOP REQUEST	RUN REQUEST
b4	Force ramp to Zero	Enable Ramp,
b5	Freeze Ramp	Enable Ramp,
b6	Force Ref to Zero	Enable Ramp,
b7	No Action	FAULT RESET (0 -> 1)
b8	No Action	Inching 1
b9	No Action	Inching 2
b10	Disable Profibus control	Enable Profibus control
b11	Fieldbus DIN1=OFF	Fieldbus DIN1=ON (Watchdog pulse)
b12	Fieldbus DIN2=OFF	Fieldbus DIN2=ON
b13	Fieldbus DIN3=OFF	Fieldbus DIN3=ON
b14	Fieldbus DIN4=OFF	Fieldbus DIN4=ON
b15	No Action	No Action

V1.26.2 *FB Speed Reference* ID875

FB Speed Reference from the fieldbus

V1.25.2 *FB Status Word* ID65

ProfiDrive type status word. Not the same as used by Profibus board in ProfiDrive mode. Needs to be selected with P2.14.19 GSW to be used. See details in Chapter 9 Status and Control Word in detail.

Bit	Description	
	Value = 0	Value = 1
b0	Not ready to switch on	Ready to switch on
b1	Not ready to operate	Ready to operate
b2	Not Running	Running
b3	No Fault	Fault
b4	Coast stop Active	Coast stop not active
b5	Quick stop active	Quick stop not active
b6	Switch not inhibited	Switch on inhibit
b7	No Warning	Warning
b8	Speed error	Speed At Reference
b9	No FB Control request	FB Control Active
b10	Fout < Fmax	Fout > Fmax
b11	not used	not used
b12	not used	not used
b13	not used	not used
b14	not used	not used
b15	Fieldbus DIN1=OFF	Fieldbus DIN1=ON (Watchdog pulse)

V1.25.4 *FB Speed Actual* **ID865**

Actual speed value send to fieldbus.

V1.25.3 *FB Torque Reference* % **ID 1140**

Torque reference value from fieldbus
Default Control of FB PD 1

V1.25.4 *FB Limit Scaling* % **ID 46**

Limit scaling input value from fieldbus.
Default Control of FB PD 2.

V1.25.5 *FB Adjust Reference* % **ID 47**

Reference adjustment value from fieldbus.
Default Control of FB PD 3.

V1.25.6 *FB Analog Output* % **ID 48**

Fieldbus value to control analogue output.
Default Control of FB PD 4.

V1.25.7 *FB Motor Current* **A** **ID 45**

Motor current (drive independent) given with one decimal point.

V1.25.8 *Fault Word 1* **ID 1172**

Different faults are collected to two words that can be read from fieldbus or with VACON® NCDrive PC software.

Fault Word 1 ID1172	
Bit	Fault(s)
B0	F1 Over current, F31 IGBT, F41 IGBT
B1	F2 Over Voltage
B2	F9 Under Voltage
B3	F15 Motor Stalled
B4	F3 Earth Fault
B5	F17 Motor Underload
B6	F14 Unit Over Temperature
B7	F16 Motor Temperature, F29 Thermistor,
B8	F10 Input line fault
B9	F42 OR W42 Brake Resistor
B10	
B11	F52 Keypad or F52 PC communication fault
B12	F53 FieldBus fault
B13	F59 System Bus fault
B14	F54 Slot Communication fault
B15	F50 4mA fault

V1.25.9 *Fault Word 2* ID 1173

Fault Word 2 ID1173	
Bit	Fault(s)
B0	F11 Output phase
B1	
B2	F43 Encoder Fault
B3	
B4	
B5	
B6	F51 External fault F81 External fault
B7	F12 or W12 Brake Chopper
B8	
B9	F31 IGBT, F41 IGBT
B10	F58 Brake Fault
B11	F32 Fan Cooling, Warning and Fault. F60 Cooling Failure, Warning and Fault.
B12	
B13	F8 System Fault
B14	
B15	

V1.25.10 *Warning Word 1* ID 1174

Warning Word 1 ID1174	
Bit	Warning(s)
B0	W15 Motor Stalled
B1	W16 Motor Over Temperature, W29 Thermistor
B2	W17 Motor UnderLoad
B3	W10 Input Phase Loss
B4	W11 Output Phase Loss
B5	W30 Safe Torque Off
B6	W43 Encoder Warning
B7	
B8	W14 Unit Over Temperature
B9	W50 4 mA warning
B10	
B11	
B12	
B13	
B14	W58 Brake Warning
B15	W52 Keypad or W52 PC Communication

V1.25.11 *AuxStatusWord* ID 1163

Aux Status Word ID1163		
	Fault	Comment
b0	Reserved	Reserved
b1		Window control active and speed outside of widow
b2	Reserved	Reserved
b3	Reserved	Reserved
b4	Reserved	Reserved
b5	Reserved	Reserved
b6	Reserved	Reserved
b7	Reserved	Reserved
b8	Reserved	Reserved
b9	Reserved	Reserved
b10		Drive in torque control mode
b11	Reserved	Reserved
b12	Reserved	Reserved
b13	Reserved	Reserved
b14	Reserved	Reserved
b15	Reserved	Reserved

V1.25.12 *FB Power Reference* ID1703

Power reference from fieldbus is written to this monitoring signal.

V1.25.13 *Fault History* ID 37

Fault number of the last active fault.

V1.25.14 *AuxControlWord* ID 1161

Aux Control Word ID1161		
	FALSE	TRUE
b0	Reserved	Reserved
b1	Reserved	Reserved
b2	Reserved	Reserved
b3	Reserved	Reserved
b4	Reserved	Reserved
b5	Reserved	Reserved
b6	Reserved	Reserved
b7	No Action	Ext brake is forced open
b8	Reserved	Reserved
b9	No Action	Reset encoder position
b10	Reserved	Reserved
b11	Reserved	Reserved
b12	Reserved	Reserved
b13	Reserved	Reserved
b14	Reserved	Reserved
b15	Reserved	Reserved

V1.2515 *Din Status Word* ID 56

V1.25.16 *Din Status Word 2* ID 57

	DIN StatusWord 1	DIN StatusWord 2
b0	DIN: A.1	DIN: C.5
b1	DIN: A.2	DIN: C.6
b2	DIN: A.3	DIN: D.1
b3	DIN: A.4	DIN: D.2
b4	DIN: A.5	DIN: D.3
b5	DIN: A.6	DIN: D.4
b6	DIN: B.1	DIN: D.5
b7	DIN: B.2	DIN: D.6
b8	DIN: B.3	DIN: E.1
b9	DIN: B.4	DIN: E.2
b10	DIN: B.5	DIN: E.3
b11	DIN: B.6	DIN: E.4
b12	DIN: C.1	DIN: E.5
b13	DIN: C.2	DIN: E.6
b14	DIN: C.3	
b15	DIN: C.4	

V1.25.17 *MC Status* ID 64

This is the value that is also send to fieldbus on those fieldbus that do not use own state machine.

Motor Control Status Word		
	FALSE	TRUE
b0	Not in Ready state	Ready
b1	Not Running	Running
b2	Direction Clockwise	Counter clockwise
b3	No Fault	Fault
b4	No Warning	Warning
b5		At reference speed
b6		At Zero Speed
b7		Flux Ready
b8		TC Speed Limiter Active
b9	Encoder Direction	Counter clockwise
b10		Under Voltage Fast stop
b11	No DC brake	DC Brake is active
b12		
b13		Restart delay active
b14		
b15		

V1.25.18 *Warning* ID 74

Last active warning.

V1.25.19 *Shaft Rounds* ID 1170

Rounds information from incremental encoder. The value is reset when 24 Vdc is removed from the drive.

V1.25.20 Shaft Angle ID 1169

Angle information from incremental encoder. The value is reset when 24 Vdc is removed from the drive.

V1.25.21 Fault Word 10 ID 1202

Fault Word 10 ID1202		
	Fault	Comment
b0	Speed Error	F61
b1		
b2	Over Load Fault Active	F82
b3	No Motor Fault	F83
b4	PT100 Fault	F56 & F65
b5		
b6		
b7		
b8		
b9		
b10		
b11		
b12		
b13		
b14		
b15		

V1.25.22 Warning Word 10 ID 1269

Warning Word 10 ID1269	
Bit	Warning(s)
B0	W61 Speed Error
B1	W3 Earth Fault
B2	W82 Over Load
B3	
B4	W56 or W65 PT100 Warning
B5	
B6	
B7	
B8	
B9	
B10	
B11	
B12	
B13	
B14	
B15	

5.2.3 Master / Follower

The following lists the relevant signals in Master follower system.

Note for DriveSynch Systems:

In a DriveSynch system, only Master drive monitoring signals are reliable. Only directly measured values are reliable in follower units. Even the Output Frequency of DriveSynch follower is not directly observed and thus may not show actual output frequency that is controlled by DriveSynch Master Drive.

V1.26.1 SB SystemStatus ID 1601

D1: Status of all (max 4) drives status in system bus.

D2, D3 and D4: Drive own status B0-B3

System Bus Status Word ID1601	
	FALSE TRUE
b0	Drive 1 in synch
b1	Drive 1 Ready
b2	Drive 1 Running
b3	Drive 1 Fault
b4	Drive 2 in synch
b5	Drive 2 Ready
b6	Drive 2 Running
b7	Drive 2 Fault
b8	Drive 3 in synch
b9	Drive 3 Ready
b10	Drive 3 Running
b11	Drive 3 Fault
b12	Drive 4 in synch
b13	Drive 4 Ready
b14	Drive 4 Running
b15	Drive 4 Fault

V1.26.2 Total Current A ID 80

D1: This value is the current of whole drive synch system.

D2, D3 and D4: This value is the sum current of the drive's own power unit and that of the drives with smaller system bus identification number starting from master drive.

If D2 Master: This value is the current of whole drive synch system.

V1.26.3 Master CW ID93

Master Drive Control Word. Master Sending, Follower receiving.

Master Control Word ID93		
	Master-Follower	DriveSynch Master-Follower
b0	Ready Status	
b1	Run Enable	
b2	Final Run Request	
b3	Fault Reset	Fault Reset
b4	Running	Running
b5	Fault	
b6	Brake Control	Brake Control
b7	WD Pulse	
b8	Brake Control Reference Release	
b9	Data Logger Trigger	Data Logger Trigger
b10	Ramp Stop Active	
b11	Start Delay Active	
b12		
b13		
b14	Disable SB Diagnostic	Disable SB Diagnostic
b15		

V1.26.4.1 Motor Current D1 A ID 1616

D1, D2, D3 and D4: This value is the current of drive own power unit.

V1.26.4.2 Motor Current D2 A ID 1605

D1: This value is the current of drive number two power unit.
D2, D3 and D4: Not updated.

V1.26.4.3 Motor Current D3 A ID 1606

D1: This value is the current of drive number three power unit.
D2, D3 and D4: Not updated.

V1.26.4.4 Motor Current D4 A ID 1607

D1: This value is the current of drive number four power unit.
D2, D3 and D4: Not updated.

V1.26.5.1 Status Word D1 ID 1615

D1: Status Word for D1 without B15
D2, D3 and D4: Status Word that is send to D1.

V1.26.5.2 Status Word D2 ID 1602

D1: D2 Status Word
D2, D3 and D4: Not updated.

V1.26.5.3 Status Word D3 ID 1603

D1: D3 Status Word
 D2,D3 and D4: Not updated.

V1.26.5.4 Status Word D4 ID 1604

D1: D4 Status Word
 D2,D3 and D4: Not updated.

Follower Drive status word		
	FALSE	TRUE
b0	Flux not ready	Flux ready (>90%)
b1	Not in Ready state	Ready
b2	Not Running	Running
b3	No Fault	Fault
b4	Charge Switch Open	Charge Switch Closed
b5	Brake Frequency Limit ON	Brake Frequency Limit OFF
b6	Run Disabled	Run Enable
b7	No Warning	Warning
b8		Follower
b9		Master
b10		Drive Synch In Synch
b11	No DC Brake	DC Brake is active
b12	No Run Request	Run Request
b13	No Limit Controls Active	Limit control Active
b14	External Brake Control OFF	External Brake Control ON
b15		Heard Beat

5.2.4 PI Control monitoring

This PI control uses ID numbers for input and output signal. See detail in PI Control chapter.

V1.27.1 PI Reference ID20

Used PI Reference, reference is selected by ID number.

V1.27.2 PI Actual Value ID21

PI Actual value. Actual input is selected by ID number.

V1.27.3 PI Output ID23

PI Output before scaling. This value uses PI Out High and Low for limiting.

V1.27.4 PI Output Scaled ID1807

Scaled PI Output.

This is used for ID connection. Scaling function is used to scale value more suitable for connected signal. For example, when the output is connected to torque limit, the actual value needs to be -1000 ...+1000 (-100.0%..+100.0%), but PI Out High and Low can be from -30000...+30000 to have more accurate PI control.

5.2.5 Frequency Chain

V1.28.1	Frequency Reference 1	Hz	1126	Frequency reference before speed share. Speed Share is used also for reference direction control.
V1.28.2	Frequency Reference 2	Hz	1126	Frequency reference after speed share and reference adjust but before interpolator.
V1.28.3	Frequency Reference	Hz	25	Frequency reference after interpolator but before second order filtering.
V1.28.4	Frequency Reference Actual	Hz	1128	Frequency reference for ramp control.
V1.28.5	Frequency Ramp Out	Hz	1129	Ramp control output.
V1.28.6	Frequency Reference Final	Hz	1131	Final reference to speed controller. After ramp generator and after Speed Step function, used for closed loop speed tuning when used together with Encoder 1 frequency.
V1.28.7	Encoder 1 Frequency	Hz	1164	Encoder frequency, monitored directly from encoder.

5.2.6 Torque Chain

V1.29.1	Torque reference	%	ID 18	Torque reference value before load share.
V1.29.2	Torque Reference 3	%	1144	Torque reference after load share and before torque step.
V1.29.3	Torque Ref Final	%	1145	Final torque reference in torque reference chain, before acceleration compensation and speed controller output.
V1.29.4	Speed Control Out	%	1134	Closed Loop speed controller output.
V1.29.5	Torque Reference Actual	%	1180	Final torque reference from speed control and torque control. Also includes torque step and acceleration compensation factors.

5.2.7 Active Limits

<i>V1.30.1</i>	<i>Motoring Torque Limit</i>	<i>%</i>	<i>#, #</i>	<i>ID1950</i>
<i>V1.30.2</i>	<i>Generator Torque Limit</i>	<i>%</i>	<i>#, #</i>	<i>ID1951</i>
<i>V1.30.3</i>	<i>Motoring Power Limit</i>	<i>%</i>	<i>#, #</i>	<i>ID1952</i>
<i>V1.30.4</i>	<i>Generator Power Limit</i>	<i>%</i>	<i>#, #</i>	<i>ID1953</i>
<i>V1.30.5</i>	<i>Current Limit</i>	<i>A</i>		<i>ID1954</i>
<i>V1.30.6</i>	<i>SPC Positive Limit</i>	<i>%</i>	<i>#, #</i>	<i>ID1955</i>
<i>V1.30.7</i>	<i>SPC Negative Limit</i>	<i>%</i>	<i>#, #</i>	<i>ID1956</i>

5.2.8 Functional Safety Monitoring

V1.31.1 Safety App Status

ID1653

	FALSE	TRUE
b0	Drive ack not accepted	Advanced safety option board will accept ack from drive
b1	Drive reset not accepted	Advanced safety option board will accept reset from drive
b2		
b3		
b4		
b5		
b6		
b7		
b8		
b9		
b10		
b11		
b12		
b13		
b14		
b15		

V1.31.2 Integrity Level

ID1640

Safety integrity level (SIL) of drive. Considers presence of OPTAF, control board version and power unit topology.

Possible values: 0 (no safety), 2 (SIL2), 3 (SIL3).

V1.31.3 Acknowledge Mode ID1641

Bits indicate whether specific safety functions are acknowledged automatically by advanced safety option board or require acknowledge from outside.

0 = automatic, 1 = manual

	FALSE	TRUE
b0	B0 = Start up (STO active) [ACK-STO-Boot]	
b1	B1 = STO [ACK-STO]	
b2	B2 = SS1 [ACK-SS1]	
b3	B3 = SS2 [ACK-SS2]	
b4	B4 = SQS [ACK-SQS]	
b5	B5 = SLS [ACK-SLS]	
b6	B6 = SSR [ACK-SSR]	
b7	B7 = SMS [ACK-SMS]	
b8	B8 = SSM [ACK-SSM]	
b9	B9 = SAR [ACK-SAR]	
b10	B10 = SDI [ACK-SDI]	
b11		
b12		
b13		
b14		
b15		

V1.31.4 Safety Encoder Speed ID1642

Encoder speed in RPM reported by advanced safety option board.

V1.31.5 Ramp Selection ID1643

B1,B0 = SLS ramp

B3,B2 = SSR ramp

00 = none, 01 = ramp 1, 10 = ramp 2.

V1.31.6 Function Reached ID1644

Advanced safety option board -> Control board safety function status word. For active functions, indicates if a safety function is reached

		FALSE	TRUE
b0	STO		
b1	SS1		
b2	SS2		
b3	SQS		
b4	SSR		
b5	SLS1		
b6	SLS2		
b7	SLS3		
b8	SDI+		
b9	SDI-		
b10	SSM		
b11	SMS		
b12	SAR		
b13	SOS		
b14	SBC		
b15			

V1.31.7 Request DIN ID1645

Advanced safety option board -> Control board safety function request word. Indicates if a function is requested by Digital input of the advanced safety option board.

		FALSE	TRUE
b0	STO		
b1	SS1		
b2	SS2		
b3	SQS		
b4	SSR		
b5	SLS1		
b6	SLS2		
b7	SLS3		
b8	SDI+		
b9	SDI-		
b10	SSM		
b11	SMS		
b12	SAR		
b13			
b14			
b15			

V1.31.8 Request PLC ID1646

Advanced safety option board -> Control board safety function request word.
Indicates if a function is requested by safe PLC.

	FALSE	TRUE
b0	STO	
b1	SS1	
b2	SS2	
b3	SQS	
b4	SSR	
b5	SLS1	
b6	SLS2	
b7	SLS3	
b8	SDI+	
b9	SDI-	
b10	SSM	
b11	SMS	
b12	SAR	
b13		
b14		
b15		

V1.31.9 Function In Use ID1647

Indicates which safety functions have been enabled by configuration

	FALSE	TRUE
b0	STO	
b1	SS1	
b2	SS2	
b3	SQS	
b4	SOS	
b5	SBC	
b6	SLS	
b7	SSR	
b8	SMS	
b9	SSM	
b10	SAR	
b11	SDI	
b12		
b13		
b14		
b15		

V1.31.10 *Safety Status Word* ID1648

Advanced safety option board -> Control board safety function status word.
Indicates if a safety function is active (being executed). 1 = active, 0 = not active

	FALSE	TRUE
b0	STO	
b1	SS1	
b2	SS2	
b3	SQS	
b4	SSR	
b5	SLS1	
b6	SLS2	
b7	SLS3	
b8	SDI+	
b9	SDI-	
b10	SSM	
b11	SMS	
b12	SAR	
b13		
b14		
b15		

V1.31.11 *Safety General Status Word* ID1649

Indicates states of the advanced safety option board input & outputs.

Safety General Status Word ID1649		
	FALSE	TRUE
b0	DIN1	
b1	DIN2	
b2	SIN3	
b3	SIN4	
b4	DOUT1	
b5	DOUT2	
b6	SSM_Above_Max_Limit	
b7	SSM_Below_Max_Limit	
b8	Acknowledge_Requested_DIN	
b9	Acknowledge_Requested_PLC	
b10	Acknowledge_Requested_Drive	
b11	SS1_Ramp_Select	
b12	SS2_Ramp_Select	
b13	Reset_Requested_DIN	
b14	Reset_Requested_PLC	
b15	Reset_Requested_Drive	

V1.31.12 *Safety Status*

ID1650

Safety Status ID1650	
b0	StoAtexBoardDetected
b1	StoLinesActivated
b2	StoFault
b3	StoConfigureError
b4	StoDiagnosticFault
b5	StoThermistorActivated
b6	StoThermistorFaultActive
b7	StoThermistorDiagnosticFault
b8	StoThermistorShortCircuitFault
b9	StoChannel1State
b10	StoChannel2State
b11	StartUpPreventActivated
b12	
b13	
b14	
b15	

V1.31.13 *Safety Zero Speed*

ID1651

Speed value the advanced safety option board uses for determining motor stoppage.

V1.31.14 *SBC Speed* *rpm* ID1652

Indicates the speed the brake is intended to be activated.

If SBC Order = 1 (SBC activated after STO/SOS), SBC will be activated at SBC Speed or after SBC t1.

If SBC Order = 0 (SBC activated before STO/SOS), SBC Speed is neglected.

5.2.9 Counters

Below counter values are not visible as a standard monitoring signal but are accessible with ID numbers from fieldbus.

5.2.9.1 Power On Time counter

This timer is counting when control board is powered (i.e. counting when only 24 Vdc is given to control board).

ID10 *PowerOnTimeTripCounter*

Resettable power on time counter.
UINT value. READ only access.
Use ID1050 to define format.
Use ID1051 to reset value

ID1050 *PowerOnTripCounterUnit*

Read or select power on counter format.
USINT value. WRITE access.
1 = 1 ms
2 = 10 ms
3 = 100 ms
4 = 1 s
5 = 1 min
6 = 1 h (Default)
7 = 1 d

ID1051 *ResetOnTimeTripCounter*

Reset Power on trip counter, rising edge will reset counter.
BOOL value. WRITE access.
Write INT value 1 to reset if Process Data is used.

5.2.9.2 Energy Meter counter monitoring

ID11 *EnergyMeter*

Read ID80 and ID81 to see used format.
UINT value. READ only access.

ID82 *EnergyMeterFormat*

Decimal point place in the value
60 = 6 max number of digits, 0 fractional digits
61 = 6 max number of digits, 1 fractional digits
62 = 6 max number of digits, 2 fractional digits
UINT value. READ only access.

NOTE: Most of the standard applications use ID number ID80 for this variable.

ID81 *EnergyMeterUnit*

Unit for the energy meter
USINT value. READ only access.
1 = kWh
2 = MWh
3 = GWh
4 = TWh

5.2.9.3 *Energy Trip counter monitoring***ID12** *EnergytripCounter*

Energy trip counter, use ID1052 define format.
UINT value. READ only access.
Max. value is 65 535 and after that value is reset to zero and counting is restarted.

ID1052 *EnergyTripCounterUnit*

WRITE access. Unit value can be changed via fieldbus. USINT value.
1 = 0.01 kWh
2 = 0.1 kWh
3 = 1 kWh
4 = 10 kWh
5 = 100 kWh
6 = 1 MWh
7 = 10 MWh
8 = 100 MWh
9 = 1 GWh
10 = 10 GWh

ID1053 *ResetMWhTripCounter*

Reset energy trip counter, rising edge will reset the counter.
BOOL value. Write INT value 1 to reset if Process Data is used.

6. APFIFF09 – PARAMETER LIST

6.1 Basic parameters

Code	Parameter	Min	Max	Unit	Default	Cust	ID	Note
P2.1.1	Minimum frequency	0.00	P2.1.2	Hz	0.00		101	
P2.1.2	Maximum frequency	P2.1.1	320.00	Hz	50.00		102	NOTE: If f_{max} > than the motor synchronous speed, check suitability for motor and drive system
P2.1.3	Motor nominal voltage	180	690	V	NX2: 230V NX5: 400V NX6: 690V		110	Check the rating plate of the motor. Note also used connection Delta/Star
P2.1.4	Motor nominal frequency	8.00	320.00	Hz	50.00		111	Check the rating plate of the motor
P2.1.5	Motor nominal speed	5	20 000	rpm	1440		112	The default applies for a 4-pole motor and a nominal size AC drive.
P2.1.6	Motor nominal current	$0.1 \times I_H$	$2 \times I_H$	A	I_H		113	Check the rating plate of the motor.
P2.1.7	Motor $\cos\phi$	0.30	1.00		0.85		120	Check the rating plate of the motor
P2.1.8	Motor Nominal Power	0.0	3200.0	kW	0.0		116	Check the rating plate of the motor
P2.1.9	Magnetizing current	0.00	100.00	A	0.00		612	0.00 A = Drive uses estimated value from motor name plate values
P2.1.10	Identification	0	10		0		631	0=No action 1=Identification w/o run 2=Identification with run 3=Encoder ID Run 4=Ident All 5=Absolute encoder, locked rotor 6=U/f and Magn.Current 7=DTC ident. NOTE: Set motor control mode to Freq Control before identification!
P2.1.11	Motor type	0	4		0		650	0=Induction Motor 1=PMS Motor 2=Sep.Ex SM 3=Reserved 4=SRM

Table 6-1. Basic parameters, G2.1

6.2 Reference Handling

6.2.1 Basic Settings

Code	Parameter	Min	Max	Unit	Default	Cust	ID	Note
P2.2.1	I/O Reference	0	16		0		117	0=AI1 1=AI2 2=AI1+AI2 3=AI1-AI2 4=AI2-AI1 5=AI1xAI2 6=AI1 Joystick 7=AI2 Joystick 8=Keypad 9=Fieldbus 10=Motor potentiometer 11=AI1, AI2 minimum 12=AI1, AI2 maximum 13=Max frequency 14=AI1/AI2 selection 15=Encoder 1 16=Encoder 2
P2.2.2	Keypad reference selector	0	9		8		121	0=AI1 1=AI2 2=AI1+AI2 3=AI1-AI2 4=AI2-AI1 5=AI1xAI2 6=AI1 Joystick 7=AI2 Joystick 8=Keypad 9=Fieldbus
P2.2.3	Fieldbus control reference	0	9		9		122	See par. 2.2.2
P2.2.4	I/O Reference 2	0	16		1		131	See ID117 & ID422
P2.2.5	Speed Share	-300.00	300.00	%	100.00		1241	
P2.2.6	Load Share	0.0	500.0	%	100.0		1248	

Table 6-2. Reference handling parameters, G2.2

6.2.2 Constant Reference

Code	Parameter	Min	Max	Unit	Default	Cust	ID	Note
P2.2.7.1	Jogging speed reference	0.00	320.00	Hz	5.00		124	
P2.2.7.2	Preset speed 1	0.00	320.00	Hz	10.00		105	Multi-step speed 1
P2.2.7.3	Preset speed 2	0.00	320.00	Hz	15.00		106	Multi-step speed 2
P2.2.7.4	Preset speed 3	0.00	320.00	Hz	20.00		126	Multi-step speed 3
P2.2.7.5	Preset speed 4	0.00	320.00	Hz	25.00		127	Multi-step speed 4
P2.2.7.6	Preset speed 5	0.00	320.00	Hz	30.00		128	Multi-step speed 5
P2.2.7.7	Preset speed 6	0.00	320.00	Hz	40.00		129	Multi-step speed 6
P2.2.7.8	Preset speed 7	0.00	320.00	Hz	50.00		130	Multi-step speed 7
P2.2.7.9	Inching reference 1	-320.00	320.00	Hz	2.00		1239	
P2.2.7.10	Inching reference 2	-320.00	320.00	Hz	-2.00		1240	
P2.2.7.11	Speed step	-50.0	50.0	0.0	0.0		1252	VACON® NCDrive speed tuning

Table 6-3. Constant reference parameters, G2.2.7

6.2.3 Power Reference

Code	Parameter	Min	Max	Unit	Default	Cust	ID	Note
P2.2.8.1	Power Reference	0	5		0		1620	Scaling from 0 to IDxxxx 0=Not used 1=AI1 2=AI2 3=AI3 4=AI4 5=FB Limit Scaling ID46
P2.2.8.2	Maximum Power reference	0.0	300.0	%	120.0		1621	
P2.2.8.3	Power reference Increase Rate	0	10000	%/s	100		1622	

Table 6-4. Power reference input signal selection, G2.2.8

6.2.4 Torque Reference

Code	Parameter	Min	Max	Unit	Default	Cust	ID	Note
P2.2.9.1	Torque reference selection	0	8		0		641	0=Not used 1=AI1 2=AI2 3=AI3 4=AI4 5=AI1 joystick (-10 – 10 V) 6=AI2 joystick (-10 – 10 V) 7=Torque reference from keypad, R3.5 8=FB Torque Reference 9=Master Torque 10=Power Reference
P2.2.9.2	Torque reference max.	-300.0	300.0	%	100		642	
P2.2.9.3	Torque reference min.	-300.0	300.0	%	0.0		643	
P2.2.9.4	Torque reference filtering time	0	32000	ms	0		1244	
P2.2.9.5	Torque Reference Dead Zone	0.0	300.0	%	0.00		1246	
P2.2.9.6	Torque Select	0	5		2		1278	0=Speed Control 1=Maximum freq limit 2=Ramp Output 3=Min 4=Max 5=Window
P2.2.9.7	Window negative	0.00	50.00	Hz	2.00		1305	
P2.2.9.8	Window positive	0.00	50.00	Hz	2.00		1304	
P2.2.9.9	Window negative off	0.00	P2.10.11	Hz	0.00		1307	
P2.2.9.10	Window positive off	0.00	P2.10.12	Hz	0.00		1306	
P2.2.9.11	Torque step	-100.0	100.0	0.0	0.0		1253	

Table 6-5. Torque reference parameters, G2.2.9

6.2.4.1 *Torque Reference OL Settings*

Code	Parameter	Min	Max	Unit	Default	Cust	ID	Note
P2.2.9.11.1	Open loop torque control minimum frequency	0.00	50.00	Hz	3.00		636	
P2.2.9.11.2	Open loop torque controller P gain	0	32000		150		639	
P2.2.9.11.3	Open loop torque controller I gain	0	32000		10		640	

Table 6-6. Torque reference open loop settings, G2.2.9.12

6.2.5 *Prohibit frequency parameters*

Code	Parameter	Min	Max	Unit	Default	Cust	ID	Note
P2.2.10.1	Prohibit frequency range 1 low limit	-1.00	320.00	Hz	0.00		509	0=Not used
P2.2.10.2	Prohibit frequency range 1 high limit	0.00	320.00	Hz	0.00		510	0=Not used
P2.2.10.3	Ramp time factor	0.1	10.0	x	1.0		518	Multiplier of the currently Selected ramp time between prohibit frequency limits.

Table 6-7. Prohibit frequencies, G2.2.10

6.2.6 *Motor Potentiometer*

Code	Parameter	Min	Max	Unit	Default	Cust	ID	Note
P2.2.11.1	Motor potentiometer ramp rate	0.10	2000.00	Hz/s	1.00		331	Ramp rate for motor potentiometer
P2.2.11.2	Motor potentiometer frequency reference memory reset	0	3		1		367	0=No reset 1=Reset in stop state 2=Reset in powered down 3=StopReq;Fout
P2.2.11.3	Motor potentiometer reference copy	0	2		0		366	0=No copy 1=Copy Reference 2=Copy output frequency

Table 6-8. Motor potentiometer, G2.2.11

6.2.7 *Adjust Reference*

Code	Parameter	Min	Max	Unit	Default	Cust	ID	Note
P2.2.12.1	Adjust input	0	5		0		493	0=Not used 1=A11 2=A12 3=A13 4=A14 5=Fieldbus
P2.2.12.2	Adjust minimum	0.0	100.0	%	0.0		494	Adjust limit to decrease ref.
P2.2.12.3	Adjust maximum	0.0	100.0	%	0.0		495	Adjust limit to increase ref.

Table 6-9. Reference adjustment settings, G2.2.12

6.3 Ramp Control

6.3.1 Basic Settings

Code	Parameter	Min	Max	Unit	Default	Cust	ID	Note
P2.3.1	Start function	0	1		0		505	0=Ramp 1=Flying start
P2.3.2	Stop function	0	1		0		506	0=Coasting 1=Ramp
P2.3.3	Acceleration time 1	0.2	3270.0	s	3.0		103	0 Hz to Max frequency
P2.3.4	Deceleration time 1	0.2	3270.0	s	3.0		104	Max frequency to 0 Hz
P2.3.5	Ramp 1 shape	0	100	%	2		500	0=Linear >0=S-curve ramp time
P2.3.6	Acceleration time 2	0.2	3270.0	s	10.0		502	
P2.3.7	Deceleration time 2	0.2	3270.0	s	10.0		503	
P2.3.8	Ramp 2 shape	0	100	%	4		501	0=Linear >0=S-curve ramp time
P2.3.9	Inching Ramp	0.01	320.00	s	1.00		1257	
P2.3.10	Reducing of acc./dec. times	0	5		0		401	Scales active ramp from 100% to 10%. 0=Not used 1=AI1 2=AI2 3=AI3 4=AI4 5=Fieldbus

Table 6-10. Ramp control basic settings, G2.3

6.3.2 Quick Stop

Code	Parameter	Min	Max	Unit	Default	Cust	ID	Note
P2.3.11.1	IO Quick Stop Mode	0	1		0		1276	0=Coasting 1= Ramp
P2.3.11.2	Quick Stop Ramp time	0.1	3200.0	s	10.0		1256	

Table 6-11. Quick Stop settings, G2.3.11

6.3.3 Ramp Control Options

Code	Parameter	Min	Max	Unit	Default	Cust	ID	Note
P2.3.12.1	Ramp: Skip S2	0	1		0		1900	
P2.3.12.2	CL Ramp Follower Encoder Frequency	0	1		0		1902	
P2.3.12.3	Ramp Input Interpolator TC	0	200	ms	20		1184	
P2.3.12.4	ExtntZeroSpedTime	0	1		0		529	0=No 1= Yes

Table 6-12. Quick Stop settings, G2.3.12

6.4 Input Signals

6.4.1 Basic Settings

Code	Parameter	Min	Max	Unit	Default	Cust	ID	Note		
P2.4.1.1	Start/Stop logic selection	0	8		5		300	Start signal 1 (Default: DIN1)	Start signal 2 (Default: DIN2)	
								0	Start fwd	Start rvs
								1	Start/Stop	Reverse
								2	Start/Stop	Run enable
								3	Start pulse	Stop pulse
								4	Start	Mot.Pot UP
								5	Start fwd*	Start rvs*
								6	Start*/Stop	Reverse
								7	Start*/Stop	Run Enable
8	Start Pulse	Stop R Pulse								

Table 6-13. Input signals: basic settings, G2.4.1

* = Rising edge required to start

6.4.2 Digital inputs

Code	Parameter	Min	Default	Cust	ID	Note
P2.4.2.1	Start signal 1	0.1	A.1		403	Forward, See ID300
P2.4.2.2	Start signal 2	0.1	A.2		404	Reverse. See ID300
P2.4.2.3	Run enable	0.1	0.2		407	Motor start enabled (cc)
P2.4.2.4	Reverse	0.1	0.1		412	Direction forward (oc) Direction reverse (cc)
P2.4.2.5	Preset speed 1	0.1	0.1		419	See preset speeds in basing parameter group G2.1
P2.4.2.6	Preset speed 2	0.1	0.1		420	
P2.4.2.7	Preset speed 3	0.1	0.1		421	
P2.4.2.8	Motor potentiometer reference DOWN	0.1	0.1		417	Mot.pot. reference decreases (cc)
P2.4.2.9	Motor potentiometer reference UP	0.1	0.1		418	Mot.pot. reference increases (cc)
P2.4.2.10	Fault reset	0.1	0.1		414	All faults reset (cc)
P2.4.2.11	External fault (close)	0.1	0.1		405	Ext. fault displayed (cc)
P2.4.2.12	External fault (open)	0.1	0.2		406	Ext. fault displayed (oc)
P2.4.2.13	Acc/Dec time selection	0.1	0.1		408	Acc/Dec time 1 (oc) Acc/Dec time 2 (cc)
P2.4.2.14	Acc/Dec prohibit	0.1	0.1		415	Acc/Dec prohibited (cc)
P2.4.2.15	DC braking	0.1	0.1		416	DC braking active (cc)
P2.4.2.16	Jogging speed	0.1	0.1		413	Jogging speed selected for frequency reference (cc)
P2.4.2.17	IO reference 1 / 2 selection	0.1	0.1		422	IO reference selection:14 ID117
P2.4.2.18	Control from I/O terminal	0.1	0.1		409	Force control place to I/O terminal (cc)
P2.4.2.19	Control from keypad	0.1	0.1		410	Force control place to keypad (cc)
P2.4.2.20	Control from fieldbus	0.1	0.1		411	Force control place to fieldbus (cc)
P2.4.2.21	Parameter set 1/set 2 selection	0.1	0.1		496	Closed cont.=Set 2 is used Open cont.=Set 1 is used
P2.4.2.22	Motor control mode 1/2	0.1	0.1		164	Closed cont.=Mode 2 is used Open cont.=Mode 1 is used See par 2.6.1, 2.6.12
P2.4.2.23	External Brake Acknowledge	0.1	0.2		1210	Monitoring signal from mechanical brake
P2.4.2.24	Cooling Monitor	0.1	0.2		750	Used when water cooled unit

Code	Parameter	Min	Default	Cust	ID	Note
P2.4.2.25	Enable Inching	0.1	0.1		532	Enables Inching function
P2.4.2.26	Inching 1	0.1	0.1		531	Inching reference 1 (Default Forward 2 Hz. See P2.4.16). This will start the drive.
P2.4.2.27	Inching 2	0.1	0.1		532	Inching reference 2 (Default Reverse -2 Hz. See P2.4.17). This will start the drive.
P2.4.2.28	Motoring Power limit 1	0.1	0.1		1500	Activates power limit 1
P2.4.2.29	Motoring Power limit 2	0.1	0.1		1501	Activates power limit 2
P2.4.2.30	2 nd frequency Limit	0.1	0.1		1511	Activates second freq. Limit P2.2.7.31 2 nd Freq Limit
P2.4.2.31	Generator Power Limit 1	0.1	0.1		1506	Activates Gen. power limit 1
P2.4.2.32	Generator Power Limit 2	0.1	0.1		1507	Activates Gen. power limit 2
P2.4.2.33	Reset Position	0.1	0.1		1090	
P2.4.2.34	MF Mode 2	0.1	0.1		1092	
P2.4.2.35	Emergency Stop	0.1	0.2		1213	
P2.4.2.36	Motoring Torque Limit 1	0.1	0.1		1624	
P2.4.2.37	Generator Torque Limit 1	0.1	0.1		1626	
P2.4.2.38	PID Activation	0.1	0.1		1804	
P2.4.2.39	Store Parameter Set	0.1	0.1		1753	Stores active parameter set to selected parameter set
P2.4.2.40	Start Place A/B	0.1	0.1		425	Changes start signals between A and B places.
P2.4.2.41	Start signal 1B	0.1	A.1		423	Forward, See ID300
P2.4.2.42	Start signal 2B	0.1	A.2		424	Reverse. See ID300
P2.4.2.43	RunRequest Enable	0.1	0.2		1896	

Table 6-14. Digital input signals, G2.4.2

6.4.3 Analogue input 1

Code	Parameter	Min	Max	Unit	Default	Cust	ID	Note
P2.4.3.1	AI1 signal selection	0.1	E.10		A.1		377	Slot . Board input No.
P2.4.3.2	AI1 Reference Filter TC	0.000	32.000	s	0.000		324	0=No filtering
P2.4.3.3	AI1 signal range	0	3		0		320	0=0...100%* 1=20...100%* 4 mA Fault 2= -10V...+10V* 3= Custom range*
P2.4.3.4	AI1 custom minimum setting	-160.00	160.00	%	0.00		321	Custom Range: Minimum input
P2.4.3.5	AI1 custom maximum setting	-160.00	160.00	%	100.00		322	Custom Range: Maximum input
P2.4.3.6	AI1 reference scaling, minimum value	0.00	320.00	Hz	0.00		303	Selects the frequency that corresponds to the min. reference signal
P2.4.3.7	AI1 reference scaling, maximum value	0.00	320.00	Hz	0.00		304	Selects the frequency that corresponds to the max. reference signal
P2.4.3.8	AI1 joystick Dead Zone	0.00	20.00	%	0.00		384	Dead Zone for joystick input
P2.4.3.9	AI1 sleep limit	0.00	100.00	%	0.00		385	Drive goes to stop if input is below this limit for this time.
P2.4.3.10	AI1 sleep delay	0.00	320.00	s	0.00		386	
P2.4.3.11	AI1 joystick offset	-100.00	100.00	%	0.00		165	Press enter for 1s to set offset

Table 6-15. Analogue input 1 parameters, G2.4.3

*Remember to place jumpers of block X2 accordingly. See VACON® NX User Manual

6.4.4 Analogue input 2

Code	Parameter	Min	Max	Unit	Default	Cust	ID	Note
P2.4.4.1	AI2 signal selection	0.1	E.10		A.2		388	Slot . Board input No.
P2.4.4.2	AI2 filter time	0.000	32.000	s	0.000		329	0=No filtering
P2.4.4.3	AI2 signal range	0	3		1		325	0=0...100%* 1=20...100%* 4 mA Fault 2= -10V...+10V* 3= Custom range*
P2.4.4.4	AI2 custom minimum setting	-160.00	160.00	%	0.00		326	Custom Range: Minimum input
P2.4.4.5	AI2 custom maximum setting	-160.00	160.00	%	100.00		327	Custom Range: Maximum input
P2.4.4.6	AI2 reference scaling, minimum value	0.00	320.00	Hz	0.00		393	Selects the frequency that corresponds to the min. reference signal
P2.4.4.7	AI2 reference scaling, maximum value	0.00	320.00	Hz	0.00		394	Selects the frequency that corresponds to the max. reference signal
P2.4.4.8	AI2 joystick Dead Zone	0.00	20.00	%	0.00		395	Dead Zone for joystick input
P2.4.4.9	AI2 sleep limit	0.00	100.00	%	0.00		396	Drive goes to stop if input is below this limit for this time.
P2.4.4.10	AI2 sleep delay	0.00	320.00	s	0.00		397	
P2.4.4.11	AI2 joystick offset	-100.00	100.00	%	0.00		166	Press enter for 1s to set offset

Table 6-16. Analogue input 2 parameters, G2.4.4

6.4.5 Analogue input 3

Code	Parameter	Min	Max	Unit	Default	Cust	ID	Note
P2.4.5.1	AI3 signal selection	0.1	E.10		0.1		141	Slot . Board input No. If 0.1 ID27 can be controlled from FB
P2.4.5.2	AI3 filter time	0.000	32.000	s	0.000		142	0=No filtering
P2.4.5.3	AI3 custom minimum setting	-160.00	160.00	%	0.00		144	Custom range always active. See ID326
P2.4.5.4	AI3 custom maximum setting	-160.00	160.00	%	100.00		145	Custom range always active. See ID327
P2.4.5.5	AI3 signal inversion	0	1		0		151	0=Not inverted 1=Inverted
P2.4.5.6	AI3 reference scaling, minimum value	-32000	32000		0		1037	Selects the value that corresponds to the min. reference signal
P2.4.5.7	AI3 reference scaling, maximum value	-32000	32000		0		1038	Selects the value that corresponds to the max. reference signal
P2.4.5.8	AI3 Controlled ID	0	10000		0		1509	Select parameter that you want to control by ID number.

Table 6-17. Analogue input 3 parameters, G2.4.5

**Remember to place jumpers of block X2 accordingly.
See VACON® NX User Manual

6.4.6 Analogue input 4

Code	Parameter	Min	Max	Unit	Default	Cust	ID	Note
P2.4.6.1	AI4 signal selection	0.1	E.10		0.1		152	Slot . Board input No. If 0.1 ID28 can be controlled from FB
P2.4.6.2	AI4 filter time	0.000	32.000	s	0.000		153	0=No filtering
P2.4.6.3	AI4 custom minimum setting	-160.00	160.00	%	0.00		155	Custom range always active. See ID326
P2.4.6.4	AI4 custom maximum setting	-160.00	160.00	%	100.00		156	Custom range always active. See ID327
P2.4.6.5	AI4 signal inversion	0	1		0		162	0=Not inverted 1=Inverted
P2.4.6.6	AI3 reference scaling, minimum value	-32000	-32000		0		1039	Selects the value that corresponds to the min. reference signal
P2.4.6.7	AI3 reference scaling, maximum value	-32000	32000		0		1040	Selects the value that corresponds to the max. reference signal
P2.4.6.8	AI4 Controlled ID	0	10000		0		1510	Select parameter that you want to control by ID number.

Table 6-18. Analogue input 4 parameters, G2.4.6

6.4.7 Options

Code	Parameter	Min	Max	Unit	Default	Cust	ID	Note
P2.4.7.1	Input signal inversion Control	0	65535		0		1091	

Table 6-19. Input signal options, G2.4.7

6.5 Output Signals

6.5.1 Digital output signals

Code	Parameter	Min	Default	Cust	ID	Note
P2.5.1.1	Ready	0.1	0.1		432	Ready to Run
P2.5.1.2	Run	0.1	0.1		433	Running
P2.5.1.3	Fault	0.1	0.1		434	Drive in fault state
P2.5.1.4	Inverted fault	0.1	0.1		435	Drive not in fault state
P2.5.1.5	Warning	0.1	0.1		436	Warning active
P2.5.1.6	External fault	0.1	0.1		437	External fault active
P2.5.1.7	Reference fault/warning	0.1	0.1		438	4 mA fault active
P2.5.1.8	Over temperature warning	0.1	0.1		439	Drive over temperature active
P2.5.1.9	Reverse	0.1	0.1		440	Output frequency < 0 Hz
P2.5.1.10	Unrequested direction	0.1	0.1		441	Reference <> Output frequency
P2.5.1.11	At speed	0.1	0.1		442	Reference = Output frequency
P2.5.1.12	Jogging speed	0.1	0.1		443	Jogging or preset speed command active
P2.5.1.13	External control place	0.1	0.1		444	IO control active
P2.5.1.14	External brake control	0.1	0.1		445	See explanations on chapter Brake Control
P2.5.1.15	External brake control, inverted	0.1	0.1		446	
P2.5.1.16	Output frequency limit 1 supervision	0.1	0.1		447	See ID315
P2.5.1.17	Output frequency limit 2 supervision	0.1	0.1		448	See ID346
P2.5.1.18	Reference limit supervision	0.1	0.1		449	See ID350
P2.5.1.19	Temperature limit supervision	0.1	0.1		450	Drive temperature supervision. See ID354
P2.5.1.20	Torque limit supervision	0.1	0.1		451	See ID348
P2.5.1.21	Motor thermal protection	0.1	0.1		452	Thermistor fault or warning
P2.5.1.22	Analogue input supervision limit	0.1	0.1		463	See ID356
P2.5.1.23	Motor regulator activation	0.1	0.1		454	One of limit controller is active
P2.5.1.24	Fieldbus digital input 1	0.1	0.1		455	FB CW B11
P2.5.1.25	FB Dig 1 Parameter	ID0	ID0		891	Select parameter to control
P2.5.1.26	Fieldbus digital input 2	0.1	0.1		456	FB CW B12
P2.5.1.27	FB Dig 2 Parameter	ID0	ID0		892	Select parameter to control
P2.5.1.28	Fieldbus digital input 3	0.1	0.1		457	FB CW B13
P2.5.1.29	FB Dig 3 Parameter	ID0	ID0		893	Select parameter to control
P2.5.1.30	Fieldbus digital input 4	0.1	0.1		169	FB CW B14
P2.5.1.31	FB Dig 4 Parameter	ID0	ID0		894	Select parameter to control
P2.5.1.32	Fieldbus digital input 5	0.1	0.1		170	FB CW B15
P2.5.1.33	FB Dig 5 Parameter	ID0	ID0		895	Select parameter to control
P2.5.1.34	Safe Disable Active	0.1	0.1		756	
P2.5.1.35	Common Alarm	0.1	0.1		1684	

Table 6-20. Digital Output signal parameters, G2.5.1

6.5.2 Analogue output 1

Code	Parameter	Min	Max	Unit	Default	Cust	ID	Note
P2.5.2.1	Analogue output 1 signal selection	0.1	E.10		A.1		464	TTF programming See chapter 3.1 and 3.2
P2.5.2.2	Analogue output 1 function	0	20		1		307	0=Not used (4 mA / 2 V) 1=Output freq. (0— f_{max}) 2=Freq. reference (0— f_{max}) 3=Motor speed (0—Motor nominal speed) 4=Motor current (0— I_{nMotor}) 5=Motor torque (0— T_{nMotor}) 6=Motor power (0— P_{nMotor}) 7=Motor voltage (0— U_{nMotor}) 8=DC-link volt (0—1000V) 9=AI1 10=AI2 11=Output freq. (f_{min} - f_{max}) 12=-2xTorque...+2xTorque 13=-2xPower...+2xPower 14=PT100 temperature 15=FB Analog Output 16= -2xSpeed...+2xSpeed 17= Encoder speed (0—Motor nominal speed) 18=Unit Temperature 19= Value Control Out 20=Drive Output Power
P2.5.2.3	Analogue output 1 filter time	0.00	10.00	s	1.00		308	0=No filtering
P2.5.2.4	Analogue output 1 inversion	0	1		0		309	0=Not inverted 1=Inverted
P2.5.2.5	Analogue output 1 minimum	0	1		0		310	0=0 mA (0%) 1=4 mA (20%)
P2.5.2.6	Analogue output 1 scale	10	1000	%	100		311	
P2.5.2.7	Analogue output 1 offset	-100.00	100.00	%	0.00		375	

Table 6-21. Analogue output 1 parameters, G2.5.2

6.5.3 Analogue output 2

Code	Parameter	Min	Max	Unit	Default	Cust	ID	Note
P2.5.3.1	Analogue output 2 signal selection	0.1	E.10		0.1		471	TTF programming See chapter 3.1 and 3.2
P2.5.3.2	Analogue output 2 function	0	20		4		472	See P2.5.2.2
P2.5.3.3	Analogue output 2 filter time	0.00	10.00	s	1.00		473	0=No filtering
P2.5.3.4	Analogue output 2 inversion	0	1		0		474	0=Not inverted 1=Inverted
P2.5.3.5	Analogue output 2 minimum	0	1		0		475	0=0 mA (0%) 1=4 mA (20%)
P2.5.3.6	Analogue output 2 scale	10	1000	%	100		476	
P2.5.3.7	Analogue output 2 offset	-100.00	100.00	%	0.00		477	

Table 6-22. Analogue output 2 parameters, G2.5.3

6.5.4 Analogue output 3

Code	Parameter	Min	Max	Unit	Default	Cust	ID	Note
P2.5.4.1	Analogue output 3 signal selection	0.1	E.10		0.1		478	TTF programming See chapter 3.1 and 3.2
P2.5.4.2	Analogue output 3 function	0	20		5		479	See P2.5.2.2
P2.5.4.3	Analogue output 3 filter time	0.00	10.00	s	1.00		480	0=No filtering
P2.5.4.4	Analogue output 3 inversion	0	1		0		481	0=Not inverted 1=Inverted
P2.5.4.5	Analogue output 3 minimum	0	1		0		482	0=0 mA (0%) 1=4 mA (20%)
P2.5.4.6	Analogue output 3 scale	10	1000	%	100		483	
P2.5.4.7	Analogue output 3 offset	-100.00	100.00	%	0.00		484	

Table 6-23. Analogue output 3 parameters, G2.5.4

6.5.5 Analogue output 4

Code	Parameter	Min	Max	Unit	Default	Cust	ID	Note
P2.5.5.1	Analogue output 4 signal selection	0.1	E.10		0.1		1527	TTF programming See chapter 3.1 and 3.2
P2.5.5.2	Analogue output 4 function	0	20		5		1520	See P2.5.2.2
P2.5.5.3	Analogue output 4 filter time	0.00	10.00	s	1.00		1521	0=No filtering
P2.5.5.4	Analogue output 4 inversion	0	1		0		1522	0=Not inverted 1=Inverted
P2.5.5.5	Analogue output 4 minimum	0	1		0		1523	0=0 mA (0%) 1=4 mA (20%)
P2.5.5.6	Analogue output 4 scale	10	1000	%	100		1525	
P2.5.5.7	Analogue output 4 offset	-100.00	100.00	%	0.00		1524	

Table 6-24. Analogue output 4 parameters, G2.5.5

6.5.6 Delayed digital output 1

Code	Parameter	Min	Max	Unit	Default	Cust	ID	Note
P2.5.6.1	Digital output 1 signal selection	0.1	E.10		0.1		486	Possibility to invert by ID1091 INV Commands
P2.5.6.2	Digital output 1 function	0	28		1		312	0=Not used 1=Ready 2=Run 3=Fault 4=Fault inverted 5=FC overheat warning 6=Ext. fault or warning 7=Ref. fault or warning 8=Warning 9=Reverse 10=Jogging spd selected 11=At speed 12=Mot. regulator active 13=Freq. limit 1 superv. 14=Freq. limit 2 superv. 15=Torque limit superv. 16=Ref. limit supervision 17=External brake control 18=I/O control place act. 19=FC temp. limit superv. 20=Reference inverted 21=Ext. brake control inverted 22=Therm. fault or warn. 23=On/Off control 24=Fieldbus input data 1 25=Fieldbus input data 2 26=Fieldbus input data 3 27=Warning Set Reset 28=ID.Bit Select
P2.5.6.3	Digital output 1 on delay	0.00	320.00	s	0.00		487	0.00 = On delay not in use
P2.5.6.4	Digital output 1 off delay	0.00	320.00	s	0.00		488	0.00 = Off delay not in use
P2.5.6.5	Invert delayed DO1	0	1		0		1587	0=Not inverted 1=Inverted
P2.5.6.6	ID.Bit Free DO	0.00	2000.15		0.00		1217	

Table 6-25. Delayed digital output 1 parameters, G2.5.6

6.5.7 Delayed digital output 2

Code	Parameter	Min	Max	Unit	Default	Cust	ID	Note
P2.5.7.1	Digital output 2 signal selection	0.1	E.10		0.1		489	Possibility to invert by ID1091 INV Commands
P2.5.7.2	Digital output 2 function	0	28		0		490	See P2.5.6.2
P2.5.7.3	Digital output 2 on delay	0.00	320.00	s	0.00		491	0.00 = On delay not in use
P2.5.7.4	Digital output 2 off delay	0.00	320.00	s	0.00		492	0.00 = Off delay not in use
P2.5.7.5	Invert delayed DO2	0	1		0		1588	0=Not inverted 1=Inverted
P2.5.7.6	ID.Bit Free DO	0.00	2000.15		0.00		1385	

Table 6-26. Delayed digital output 2 parameters, G2.5.7

6.5.8 Supervision Limits

Code	Parameter	Min	Max	Unit	Default	Cust	ID	Note
P2.5.8.1	Output frequency limit 1 supervision	0	2		0		315	0=No limit 1=Low limit supervision 2=High limit supervision
P2.5.8.2	Output frequency limit 1; Supervised value	0.00	320.00	Hz	0.00		316	
P2.5.8.3	Output frequency limit 2 supervision	0	2		0		346	0=No limit 1=Low limit supervision 2=High limit supervision
P2.5.8.4	Output frequency limit 2; Supervised value	0.00	320.00	Hz	0.00		347	
P2.5.8.5	Torque limit supervision	0	4		0		348	0=Not used 1=Low limit supervision 2=High limit supervision 3= ABS(T) , Low limit 4= ABS(T), High limit
P2.5.8.6	Torque limit supervision value	-300.0	300.0	%	100.0		349	
P2.5.8.7	Reducing of torque supervision limit	0	5		0		402	
P2.5.8.8	Reference limit supervision	0	2		0		350	0=Not used 1=Low limit 2=High limit
P2.5.8.9	Reference limit supervision value	0.00	100.0	%	0.00		351	
P2.5.8.10	FC temperature supervision	0	2		0		354	0=Not used 1=Low limit 2=High limit
P2.5.8.11	FC temperature supervised value	-10	100	°C	40		355	
P2.5.8.12	Analogue supervision signal	0	4		0		356	0=Not used 1=A11 2=A12 3=A13 4=A14
P2.5.8.13	Analogue supervision low limit	0.00	100.00	%	10.00		357	Reset limit
P2.5.8.14	Analogue supervision high limit	0.00	100.00	%	90.00		358	Set limit

Table 6-27. Supervision Limit settings, G2.5.8

6.5.9 Output Options

Code	Parameter	Min	Max	Unit	Default	Cust	ID	Note
P2.5.9.1	Output Inversion	0	65535		0		1808	

Table 6-28. Output Options parameters, G2.6.1

6.6 Limit Settings

6.6.1 Current handling

Code	Parameter	Min	Max	Unit	Default	Cust	ID	Note
P2.6.1.1	Current limit	0	2 x I _H	A	I _L		107	Reaching the limit will lower output frequency
P2.6.1.2	Scaling of current limit	0	5		0		399	Scaling from 0 to ID107 0=Not used 1=AI1 2=AI2 3=AI3 4=AI4 5=FB Limit Scaling ID46
P2.6.1.3	Current Limit Kp	1	32000				1451	
P2.6.1.4	Current Limit Ki	1	32000				1452	

Table 6-29. Current handling parameters, G2.6.1

6.6.2 Power Handling

Code	Parameter	Min	Max	Unit	Default	Cust	ID	Note
P2.6.2.1	Power Limit	0.0	300.0	%	300.0		1722	General power limit
P2.6.2.2	Generator Power Limit	0.0	300.0	%	300.0		1290	
P2.6.2.3	Motoring Power Limit	0.0	300.0	%	300.0		1289	
P2.6.2.4	Generator Power Limit 1	0.0	300.0	%	300.0		1513	Power limit activated by DI
P2.6.2.5	Generator Power Limit 2	0.0	300.0	%	300.0		1514	Power limit activated by DI
P2.6.2.6	Power Limit 1	0	300.0	%	100.0		1503	Power limit activated by DI
P2.6.2.7	Power Limit 2	0	300.0	%	50.0		1504	Power limit activated by DI
P2.6.2.8	Power limit ramp rate	0	10000	%/s	100		1502	
P2.6.2.9	Power Follower	0	1		0		1705	0 = No 1 = Yes
P2.6.2.10	Power follower hysteresis	0.0	100.0	%	10.0		1529	
P2.6.2.11	Scaling Motoring Power Limit	0	5		0		179	As parameter P2.6.2 Scaling from 0 to ID1289
P2.6.2.12	Scaling Generator Power Limit	0	5		0		1088	As parameter P2.6.2 Scaling from 0 to ID1290
P2.6.2.13	Under Voltage Power DC Level	0	1200	V	0		1611	
P2.6.2.14	Under Voltage Power Limit	-300.0	300.0	%	0		1612	

Table 6-30. Power handling parameters, G2.6.2

6.6.3 Torque Handling

Code	Parameter	Min	Max	Unit	Default	Cust	ID	Note
P2.6.3.1	Torque Limit	0.0	300.0	%	300.0		609	General maximum limit
P2.6.3.2	Motoring Torque Limit	0.0	300.0	%	300.0		1287	Motoring side torque limit
P2.6.3.3	Generator Torque Limit	0.0	300.0	%	300.0		1288	Generator side torque limit
P2.6.3.4	Motoring Torque Limit 1	0.0	300.0	%	300.0		1625	
P2.6.3.5	Generator Torque limit 1	0.0	300.0	%	300.0		1627	
P2.6.3.6	Torque Follower	0	3		0		1706	0 = Not used 1 = Motoring 2 = Generator 3 = Motoring + Generator
P2.6.3.7	Torque limit increase rate	0	10000	%/s	100		1532	
P2.6.3.8	Torque limit follower hysteresis	0.0	300.0	%	10.0		1533	
P2.6.3.9	Scaling Motoring Torque limit	0	5		0		485	Scaling from 0 to ID1287 0=Not used 1=AI1 2=AI2 3=AI3 4=AI4 5=FB Limit Scaling ID46
P2.6.3.10	Scaling Generator Torque limit	0	5		0		1087	Scaling from 0 to ID1288 As parameter P2.6.3.9

Table 6-31. Torque handling parameters, G2.6.3

6.6.3.1 Torque Handling OL Settings

Code	Parameter	Min	Max	Unit	Default	Cust	ID	Note
P2.6.3.9.1	Torque limit control P-gain	0.0	32000		3000		610	
P2.6.3.9.2	Torque limit control I-gain	0.0	32000		200		611	

Table 6-32. Torque handling open loop parameters, G2.6.3.11

6.6.3.2 Torque Handling CL Settings

Code	Parameter	Min	Max	Unit	Default	Cust	ID	Note
P2.6.3.10.1	SPC Out Limit	0.0	300.0	%	300.0		1382	
P2.6.3.22	SPC Pos Limit	0.0	300.0	%	300.0		646	
P2.6.3.21	SPC Neg Limit	0.0	300.0	%	300.0		645	

Table 6-33. Torque handling closed loop parameters, G2.6.3.12

6.6.4 Frequency Handling

Code	Parameter	Min	Max	Unit	Default	Cust	ID	Note
P2.6.4.1	Max Frequency 2	0.00	320.00	Hz	35.00		1512	Maximum frequency limit that is activated by digital input.
P2.6.4.2	Negative frequency limit	-320.00	320.00	Hz	-320.00		1286	Alternative limit for negative direction
P2.6.4.3	Positive frequency limit	-320.00	320.00	Hz	320.00		1285	Alternative limit for positive direction
P2.6.4.4	Zero Frequency limit	0.00	320.00	Hz	1.00		1283	

Table 6-34. Frequency handling parameters, G2.6.4

6.6.5 DC-Link Handling

Code	Parameter	Min	Max	Unit	Default	Cust	ID	Note
P2.6.5.1	Overvoltage controller	0	2		1		607	0=Not used 1=Used (no ramping) 2=Used (ramping)
P2.6.5.2	Over Voltage Reference selector	0	2		1		1262	0=High Voltage 1=Normal Voltage 2=BrakeChopperLevel
P2.6.5.3	Brake chopper	0	4		0		504	0=Disabled 1=Used when running 2=External brake chopper 3=Used when stopped/running 4=Used when running (no testing)
P2.6.5.4	Brake Chopper Level	5: 605 6: 836	5: 797 6: 1099	V			1267	
P2.6.5.5	Undervoltage controller	0	2		1		608	0=Not used 1=Used (no ramping) 2=Used (ramping to zero)
P2.6.5.6	Under Voltage Ref Selector	0	1		1		1537	0=Under Voltage Ref 1= 0.8 * Estimated DC Volt.
P2.6.5.7	Under Voltage Reference	5: 410 6: 567	5: 540 6: 745	V	Varies		1538	

Table 6-35. DC-link handling parameters, G2.6.5

6.6.5.1 DC-Link Handling CL Settings

Code	Parameter	Min	Max	Unit	Default	Cust	ID	Note
P2.6.5.8.1	Over voltage reference	94.00	130.00	%	118.00		1528	
P2.6.5.8.2	Over voltage motoring side torque limit	0.0	300.0	%	10.0		1623	Maximum motoring torque when over voltage controller is active.
P2.6.5.8.3	CL Under Voltage Reference	60.00	80.00	%	65.00		1567	

Table 6-36. DC-link handling closed loop parameters, G2.6.5.8

6.6.6 Limit Settings Options

Code	Parameter	Min	Max	Unit	Default	Cust	ID	Note
P2.6.6.1	Limit Total Current In Closed Loop	0	1		0		1901	0=No 1=Yes

Table 6-37. Limit settings options, G2.6.6

6.7 Flux and DC Current handling

6.7.1 Flux and DC Current handling OL Settings

Code	Parameter	Min	Max	Unit	Default	Cust	ID	Note
P2.7.1.1	DC braking current	0.00	I _L	A	0.00		507	
P2.7.1.2	DC braking time at start	0.00	600.00	s	0.00		516	0=DC brake is off at start
P2.7.1.3	DC braking time at stop	0.00	600.00	s	0.00		508	0=DC brake is off at stop
P2.7.1.4	Frequency to start DC braking during ramp stop	0.10	10.00	Hz	1.50		515	
P2.7.1.5	Scaling of DC-braking current	0	5		0		400	ID46Scaling from 0 to ID507 0=Not used 1=AI1 2=AI2 3=AI3 4=AI4 5=FB Limit Scaling
P2.7.1.6	DC-Brake Current in Stop	0.00	I _L	A	Varies		1080	
P2.7.1.7	Flux brake	0	1		0		520	0=Off 1=On
P2.7.1.8	Flux braking current	0.00	I _L	A	I _H		519	

Table 6-38. Flux and DC current handling open loop parameters, G2.7.1

6.7.2 Flux and DC Current handling CL Settings

Code	Parameter	Min	Max	Unit	Default	Cust	ID	Note
P2.7.2.1	Magnetizing current at start	0	I _L	A	0.00		627	
P2.7.2.2	Magnetizing time at start	0.0	600.0	s	0.0		628	
P2.7.2.3	Flux Reference	0.0	500.0	%	100.0		1250	
P2.7.2.4	Flux Off Delay	-1	32000	s	0		1402	-1=forever
P2.7.2.5	Stop State Flux	0.0	150.0	%	100.0		1401	
P2.7.2.6	Reduced Flux Level	0.0	500.0	%	100.0		1613	
P2.7.2.7	Reduced Flux Frequency	0.00	32.00	Hz	0.00		1614	

Table 6-39. Flux and DC current handling closed loop parameters, G2.7.2

6.8 Motor Control

6.8.1 Motor Control Basic Settings

Code	Parameter	Min	Max	Unit	Default	Cust	ID	Note
P2.8.1	Motor control mode	0	5		0		600	0=Frequency control 1=OL Speed control 2=Open Loop 3=CL Speed Control 4=Closed Loop 5=Sensorless
P2.8.2	Motor control mode 2	0	5		2		521	See P2.8.1
P2.8.3	Torque Select	0	5		2		1278	0=Speed Control 1=Maximum freq limit 2=Ramp Output 3=Min 4=Max 5=Window

Table 6-40. Motor Control basic parameters, G2.8

6.8.2 Open Loop

Code	Parameter	Min	Max	Unit	Default	Cust	ID	Note
P2.8.4.1	U/f optimisation	0	1		0		109	0=Not used 1=Automatic torque boost
P2.8.4.2	U/f ratio selection	0	3		0		108	0=Linear 1=Squared 2=Programmable 3=Linear with flux optim.
P2.8.4.3	Field weakening point	6.00	320.00	Hz	50.00		602	
P2.8.4.4	Voltage at field weakening point	10.00	200.00	%	100.00		603	n% x U _{nmot}
P2.8.4.5	U/f curve midpoint frequency	0.00	P2.8.3.3	Hz	50.00		604	
P2.8.4.6	U/f curve midpoint voltage	0.00	100.00	%	100.00		605	n% x U _{nmot} Parameter max. value = P2.6.5
P2.8.4.7	Output voltage at zero frequency	0.00	40.00	%	0.00		606	n% x U _{nmot}
P2.8.4.8	I/f Start	0	1		0		534	0=Disabled 1=Enabled
P2.8.4.9	I/f Current	0.0	150.0	%	50.0		1693	
P2.8.4.10	I/f Control Limit	0.0	300.0	%	10.0		1790	
P2.8.4.11	MakeFluxTime	0	32000	ms	200		660	

Table 6-41. Motor Control open loop parameters, G2.8.4

6.8.3 Closed Loop Control Settings

Code	Parameter	Min	Max	Unit	Default	Cust	ID	Note
P2.8.5.1	Current control P gain	0.00	100.00	%	40.00		617	
P2.8.5.2	Current control I Time	0.0	3200.0	ms	1.5		657	
P2.8.5.3	Slip adjust	0	500	%	75		619	
P2.8.5.4	Acceleration compensation	0.00	300.00	s	0.00		626	
P2.8.5.5	Speed Error Filter TC	0	1000	ms	0		1311	
P2.8.5.6	Encoder filter time	0	1000	ms	0		618	
P2.8.5.7	Encoder Selection	0	2		0		1595	0.1=Encoder Input 1 2=Encoder Input 2
P2.8.5.8	SC Torque Chain Select	0	65535		0		1557	Default 96 after identification.
P2.8.5.9	TCDunDampGain	0,00	100,00	%			1576	
P2.8.5.10	TCDynDampTC	0	32000	ms	0		1577	

Table 6-42. Motor Control closed loop parameters, G2.8.5

6.8.4 PMSM Control settings

Code	Parameter	Min	Max	Unit	Default	Cust	ID	Note
P2.8.6.1	PMSM Shaft Position	0	65535		0		649	
P2.8.6.2	Start Angle Identification mode	0	10		0		1691	0=Automatic 1=Forced 2=After Power Up 3=Disabled
P2.8.6.3	Start Angle Identification DC Current	0.0	150.0	%	0.0		1756	
P2.8.6.4	Polarity Pulse Current	-10.0	200.0	%	0.0		1566	
P2.8.6.5	Start Angle ID Time	0	32000	ms	0		1755	
P2.8.6.6	I/f Current	0.0	150.0	%	50.0		1693	
P2.8.6.7	I/f Control Limit	0.0	300.0	%	10.0		1790	
P2.8.6.8	Flux Current Kp	0	32000		5000		651	
P2.8.6.9	Flux Current Ti	0	1000		25		652	
P2.8.6.10	External Id Reference	-150.0	150.0	%	0.0		1730	
P2.8.6.11	Enable Rs Identification	0	1		1		654	0=No 1=Yes
P2.8.6.12	Lsd Voltage Drop	-32000	32000		0		1757	
P2.8.6.13	Lsq Voltage Drop	-32000	32000		0		1758	
P2.8.6.14	EncIDCurrent	0.0	150.0	%	90.0		1734	
P2.8.6.15	Polarity ID Mode	0	1				1737	
P2.8.6.16	Polarity Pulse Length	0	1000	ms	200		1742	
P2.8.6.17	Polarity Detection Angle	0.0	360.0	Deg	1.5		1748	
P2.8.6.18	Angle Identification Mode	0	2				1749	
P2.8.6.19	Current Control Kp d	0	32000	%			1761	
P2.8.6.20	Voltage Margin	0.0	120.0	%			1759	
P2.8.6.21	Encoder ID Run Mode	0	2		0		680	
P2.8.6.22	PMSM Shaft Position High	0	65535		0		681	
P2.8.6.23	Start Angel Offset	-360,0	360,0		0		696	
P2.8.6.24	VoltageCorr. Kp	0,000	32,000		0,100		1783	
P2.8.6.25	VoltageCorr. Ki	0	32000		5000		1784	

Table 6-43. Motor Control PMSM parameters, G2.8.6

6.8.5 Stabilators

Code	Parameter	Min	Max	Unit	Default	Cust	ID	Note
P2.8.7.1	Torque Stabilator Gain	0	1000		100		1412	
P2.8.7.2	Torque Stabilator Damping	0	1000		800		1413	With PMSM use 980
P2.8.7.3	Torque Stabilator Gain in FWP	0	1000		50		1414	
P2.8.7.4	Torque Stabilator Limit	0	1500		150		1720	
P2.8.7.5	Flux Circle Stabilator Gain	0	32767		10000		1550	
P2.8.7.6	Flux Circle Stabilator TC	0	32700		900		1551	
P2.8.7.7	Flux Stabilator Gain	0	32000		500		1797	
P2.8.7.8	Flux Stab Coeff	-30000	30000				1796	
P2.8.7.9	Voltage Stabilator Gain	0	100.0	%	10.0		1738	
P2.8.7.10	Voltage Stabilator TC	0	1000		900		1552	
P2.8.7.11	Voltage Stabilator Limit	0	320.00	Hz	1.50		1553	

Table 6-44. Motor Control stabilator parameters, G2.8.7

6.8.6 Tuning parameters

Code	Parameter	Min	Max	Unit	Default	Cust	ID	Note
P2.8.8.1	Fly Start Options	0	65535		0		1610	
P2.8.8.2	MC Options	0	65535		0		1740	
P2.8.8.3	Resonance Damping Select	0	200		0.00		1760	
P2.8.8.4	Damping Frequency	0	320.0	Hz	0		1763	
P2.8.8.5	Damping Gain	0	32000		0		1764	
P2.8.8.6	Damping Phase	0	360		0.00		1765	
P2.8.8.7	Damping Activation Frequency	0	320.00	%	0		1770	
P2.8.8.8	Damping Filter Time Constant	0	32700		105		1771	
P2.8.8.9	Over Modulation Limit	50	120	%	105		1515	If you have sine filter in use set this to 101%
P2.8.8.10	Modulator Index Limit	0	200	%	100		655	
P2.8.8.11	DC Voltage Filter	0.0	500.0		0.0		1591	
P2.8.8.12	AC magnetization Current	0,0	150,0	%	70,0		1714	
P2.8.8.13	AC Scan Time	0	32000	ms	900		1715	
P2.8.8.14	DC magnetization current	0,0	150,0	%	100,0		1716	
P2.8.8.15	Flux build time	0	10000		300		1704	
P2.8.8.16	Flux build torque	0,0	300,0		10,0		1711	
P2.8.8.17	Flying Start Frequency Accept Limit	0	320.00	Hz	1.50		1903	Flying start minimum frequency
P2.8.8.18	Generator Torque Scale	0	2000		950		658	
P2.8.8.19	GearRatioMultipl	0	32000		1		1558	
P2.8.8.20	GearRatioDivider	0	32000		1		1559	

Table 6-45. Motor Control tuning parameters, G2.8.8

6.8.7 Identification parameters

Code	Parameter	Min	Max	Unit	Default	Cust	ID	Note
P2.8.9.1	Flux 10 %	0	2500	%	10		1355	
P2.8.9.2	Flux 20 %	0	2500	%	20		1356	
P2.8.9.3	Flux 30 %	0	2500	%	30		1357	
P2.8.9.4	Flux 40 %	0	2500	%	40		1358	
P2.8.9.5	Flux 50 %	0	2500	%	50		1359	
P2.8.9.6	Flux 60 %	0	2500	%	60		1360	
P2.8.9.7	Flux 70 %	0	2500	%	70		1361	
P2.8.9.8	Flux 80 %	0	2500	%	80		1362	
P2.8.9.9	Flux 90 %	0	2500	%	90		1363	
P2.8.9.10	Flux 100 %	0	2500	%	100		1364	
P2.8.9.11	Flux 110 %	0	2500	%	110		1365	
P2.8.9.12	Flux 120 %	0	2500	%	120		1366	
P2.8.9.13	Flux 130 %	0	2500	%	130		1367	
P2.8.9.14	Flux 140 %	0	2500	%	140		1368	
P2.8.9.15	Flux 150 %	0	2500	%	150		1369	
P2.8.9.16	Rs voltage drop	0	30000		Varies		662	Used for torque calculation in open loop
P2.8.9.17	Ir add zero point voltage	0	30000		Varies		664	
P2.8.9.18	Ir add generator scale	0	30000		Varies		665	
P2.8.9.19	Ir add motoring scale	0	30000		Varies		667	
P2.8.9.20	Ls Voltage Dropp	0	3000		0		673	
P2.8.9.21	Motor BEM Voltage	0.00	320.00	%	0		674	
P2.8.9.22	Iu Offset	-32000	32000		0		668	
P2.8.9.23	Iv Offset	-32000	32000		0		669	
P2.8.9.24	Iw Offset	-32000	32000		0		670	
P2.8.9.25	Estimator Kp	0	32000				1781	
P2.8.9.26	Estimator Ki	0	32000				1782	
P2.8.9.27	Voltage Drop	0.00	20.00				671	
P2.8.9.28	ID Run Current Kp						695	
P2.8.9.29	Flux Saturation Ratio	0,0	100,0		0,0		682	
P 2.8.10.1	DeadTimeComp.	-10	32000		2000		1751	
P 2.8.10.2	DeadTieContCurL	-3200	32000		100		1752	

Table 6-46. Motor Control Identification parameters, G2.8.9

6.8.8 Fine tuning parameters

Code	Parameter	Min	Max	Unit	Default	Cust	ID	Note
P 2.8.10.1	DeadTHWCompDisab	0	1		0		1750	
P 2.8.10.2	CurrMeasFCompTC	0	65535		0		1554	
P 2.8.10.3	CurrLimOptions	0	65535		0		1702	
P 2.8.10.4	AdConvStartShift	0	65535		0		1701	
P 2.8.10.5	T: Identification	0	65535		0		3520	
P 2.8.10.6	T: IdentOptions	0	65535		0		3521	

Table 6-47. Motor Control Fine tuning parameters, G2.8.10

6.9 Speed Control

6.9.1 Speed Control Basic settings

Code	Parameter	Min	Max	Unit	Default	Cust	ID	Note
P2.9.1	Load drooping	0.00	100.00	%	0.00		620	
P2.9.2	Load Drooping Time	0	32000	ms	0		656	For dynamic changes
P2.9.3	Load Drooping Removal	0	2		0		1534	0=Normal 1= At zero Freq Lim 2=Linear zero to Fnom

Table 6-48. Speed control basic settings, G2.9

6.9.2 Speed Control OL Settings

Code	Parameter	Min	Max	Unit	Default	Cust	ID	Note
P2.9.4.1	Speed controller P gain (open loop)	0	32767		3000		637	
P2.9.4.2	Speed controller I gain (open loop)	0	32767		300		638	

Table 6-49. Speed control OL settings, G2.9.4

6.9.3 Speed Control CL Settings

Code	Parameter	Min	Max	Unit	Default	Cust	ID	Note
P2.9.5.1	Speed control P gain	0	1000		30		613	
P2.9.5.2	Speed control I time	-32000	32000	ms	100		614	Negative value uses 0.1 ms format instead of 1 ms
P2.9.5.3	0-speed time at start	0	32000	ms	100		615	
P2.9.5.4	0-speed time at stop	0	32000	ms	100		616	
P2.9.5.5	SPC f1 Point	0.00	320.00	Hz	0.00		1301	
P2.9.5.6	SPC f0 Point	0.00	320.00	Hz	0.00		1300	
P2.9.5.7	SPC Kp f0	0	1000	%	100		1299	
P2.9.5.8	SPC Kp FWP	0	1000	%	100		1298	
P2.9.5.9	SPC Torque minimum	0	400.0	%	0.0		1296	
P2.9.5.10	SPC Torque minimum Kp	0	1000	%	100		1295	
P2.9.5.11	SPC Kp TC Torque	0	1000	ms	0		1297	

Table 6-50. Speed control CL settings, G2.9.5

6.10 Drive Control

Code	Parameter	Min	Max	Unit	Default	Cust	ID	Note
P2.10.1	Switching frequency	1.0	Varies	kHz	3.6		601	
P2.10.2	Modulator Type	0	3		0		1516	
P2.10.3	Control Options	0	65535		64		1084	
P2.10.4	Control Options 2	0	65535		0		1798	
P2.10.5	Advanced Options 1	0	65535		0		1560	
P2.10.6	Advanced Options 2	0	65535		0		1561	
P2.10.7	Advanced Options 4	0	65535		0		1563	
P2.10.8	Advanced Options 5	0	65535		0		1564	
P2.10.9	Advanced Options 6	0	65535		0		1565	
P2.10.10	Advanced Options 7	0	65535		0		1568	
P2.10.11	Restart Delay	0	65535	s	Varies		1424	
P2.10.12	Restart Delay CL	0	60.000	s	Varies		672	CL and Flying Start
P2.10.13	Operation Time						1855	

Table 6-51. Drive control, G2.10

6.11 Master Follower

Code	Parameter	Min	Max	Unit	Default	Cust	ID	Note
P2.11.1	Master Follower Mode	0	4		0		1324	0=Not Used 1=Master 2=Follower 3=Drive Synch Master 4=Drive Synch Follower
P2.11.2	Follower Speed Reference Select	0	18		17		1081	0=AI1 1=AI2 2=AI1+AI2 3=AI1-AI2 4=AI2-AI1 5=AI1xAI2 6=AI1 Joystick 7=AI2 Joystick 8=Keypad 9=Fieldbus 10=Motor potentiometer 11=AI1, AI2 minimum 12=AI1, AI2 maximum 13=Max frequency 14=AI1/AI2 selection 15=Encoder 1 16=Encoder 2 17=Master Reference 18=Master Ramp Out
P2.11.3	Follower Torque Reference Select	0	10		10		1083	0=Not used 1=AI1 2=AI2 3=AI3 4=AI4 5=AI1 joystick 6=AI2 joystick 7=Torque reference from keypad, R3.5 8=FB Torque Reference 9=Master Torque OL 10=Master Torque CL
P2.11.4	Follower Stop Function	0	2		2		1089	0=Coasting 1=Ramping 2=As Master
P2.11.5	MF Brake Logic	0	2		0		1326	Not used when Ramp follower or in drive sync mode 0=Master or Own 1=Own 2=Master & Own, Master monitors also follower brake status.
P2.11.6	MF Mode 2	0	4		0		1093	See P2.11.1
P2.11.7	System Bus Fault	0	3		1		1082	0=No response 1=Warning 2=Fault, stop acc. to 2.3.2 3=Fault, stop by coasting
P2.11.8	System Bus Fault Delay	0.00	320.00	s	3.00		1352	
P2.11.9	Follower Fault	0	3		0		1536	0=No response 1=Warning 2=Fault, stop acc. to 2.3.2 3=Fault, stop by coasting

Table 6-52. Master Follower Control parameters, G2.11

6.11.1.1 *Drive Synch specific parameters*

Code	Parameter	Min	Max	Unit	Default	Cust	ID	Note
2.11.10.1	Drive Synch Follower fault	0	2				1531	
2.11.10.2	Follower phase shift	0.0	360.0	Dec	0.0		1518	
2.11.10.3	DC Voltage Balance Gain	0	1000		100		1519	
2.11.10.4	SB Last ID 2nd	0	64		0		1799	

Table 6-53. Drive Synch specific parameters, G2.11.10

6.12 Protections

6.12.1 *Common settings*

Code	Parameter	Min	Max	Unit	Default	Cust	ID	Note
P2.12.1.1	Input phase supervision	0	3		0		730	0=No response 1=Warning 2=Fault,stop acc. to 2.3.2 3=Fault,stop by coasting
P2.12.1.2	Response to undervoltage fault	0	1		0		727	0=Fault stored in history 1=Fault not stored
P2.12.1.3	Output phase supervision	0	3		2		702	See P2.12.1.1
P2.12.1.4	Response to slot fault	0	3		2		734	See P2.12.1.1
P2.12.1.5	Safe Disable Response	0	2		1		755	See P2.12.1.1
P2.12.1.6	FaultWarnIndicat	0	2		1		1940	0=Static 1=Toggle 2=Marine

Table 6-54. Common settings, G2.12.1.

6.12.2 *Temperature sensor protections*

Code	Parameter	Min	Max	Unit	Default	Cust	ID	Note
P2.12.2.1	No. of used inputs on board 1	0	5		0		739	0=Not used (ID Write) 1 = Sensor 1 in use 2 = Sensor 1 & 2 in use 3 = Sensor 1 & 2 & 3 in use 4 = Sensor 2 & 3 in use 5 = Sensor 3 in use
P2.12.2.2	Response to temperature fault	0	3		2		740	0=No response 1=Warning 2=Fault,stop acc. to 2.3.2 3=Fault,stop by coasting
P2.12.2.3	Board 1 warning limit	-30.0	200.0	C°	120.0		741	
P2.12.2.4	Board 1 fault limit	-30.0	200.0	C°	130.0		742	
P2.12.2.5	No. of uses inputs on board 2	0	5		0		743	0=Not used (ID Write) 1 = Sensor 1 in use 2 = Sensor 1 & 2 in use 3 = Sensor 1 & 2 & 3 in use 4 = Sensor 2 & 3 in use 5 = Sensor 3 in use

Code	Parameter	Min	Max	Unit	Default	Cust	ID	Note
P2.12.2.6	Response to temperature fault	0	3		2		766	0=No response 1=Warning 2=Fault,stop acc. to 2.3.2 3=Fault,stop by coasting
P2.12.2.7	Board 2 warning limit	-30.0	200.0	C°	120.0		745	
P2.12.2.8	Board 2 fault limit	-30.0	200.0	C°	130.0		746	
P2.12.2.9.1	Channel 1B Warn	-30.0	200.0	C°	0.0		764	
P2.12.2.9.2	Channel 1B Fault	-30.0	200.0	C°	0.0		765	
P2.12.2.9.3	Channel 1C Warn	-30.0	200.0	C°	0.0		768	
P2.12.2.9.4	Channel 1C Fault	-30.0	200.0	C°	0.0		769	
P2.12.2.9.5	Channel 2B Warn	-30.0	200.0	C°	0.0		770	
P2.12.2.9.6	Channel 2B Fault	-30.0	200.0	C°	0.0		771	
P2.12.2.9.7	Channel 2C Warn	-30.0	200.0	C°	0.0		772	
P2.12.2.9.8	Channel 2C Fault	-30.0	200.0	C°	0.0		773	

Table 6-55. PT-100 protections, G2.12.2

6.12.3 Stall Protection

Code	Parameter	Min	Max	Unit	Default	Cust	ID	Note
P2.12.3.1	Stall protection	0	3		0		709	0=No response 1=Warning 2=Fault,stop acc. to 2.3.2 3=Fault,stop by coasting
P2.12.3.2	Stall current	0.1	2 x I _H	A	I _H		710	
P2.12.3.3	Stall time limit	1.00	120.00	s	15.00		711	
P2.12.3.4	Stall frequency limit	1.0	P2.1.2	Hz	25.0		712	

Table 6-56. Stall protection, G2.12.3

6.12.4 Speed error monitoring

Code	Parameter	Min	Max	Unit	Default	Cust	ID	Note
P2.12.4.1	Speed Error Mode	0	3		0		752	0=No response 1=Warning 2=Fault,stop acc. to 2.3.2 3=Fault,stop by coasting
P2.12.4.2	Speed Error Limit	0.0	100.0	%	5.0		753	
P2.12.4.3	Speed Fault Delay	0.00	100.00	S	0.1		754	
P2.12.4.4	Over Speed Fault Response	0	2		1		1819	

Table 6-57. Speed error monitoring, G2.12.4

6.12.5 Motor protection

Code	Parameter	Min	Max	Unit	Default	Cust	ID	Note
P2.12.5.1	Thermal protection of the motor	0	3		2		704	0=No response 1=Warning 2=Fault,stop acc. to 2.3.2 3=Fault,stop by coasting
P2.12.5.2	Motor ambient temperature factor	-100.0	100.0	%	0.0		705	
P2.12.5.3	Motor cooling factor at zero speed	0.0	150.0	%	40.0		706	
P2.12.5.4	Motor thermal time constant	1	200	min	45		707	
P2.12.5.5	Motor duty cycle	0	100	%	100		708	
P2.12.5.6	Response to thermistor fault	0	3		2		732	See P2.12.5.1

Code	Parameter	Min	Max	Unit	Default	Cust	ID	Note
P2.12.5.7	Over Load Response	0	2		1		1838	0=No response 1=Warning 2=Fault
P2.12.5.8	Over Load Signal	0	2		0		1837	0=Not Used 1=Current 2=Torque 3=Power
P2.12.5.9	Over Load Maximum Input	0.0	300.0	%	150.0		1839	
P2.12.5.10	Over Load maximum Step	0	10000		200		1840	
P2.12.5.11	Over Load Minimum Input	0.0	300.0	%	105.0		1849	
P2.12.5.12	Over Current Trip Limit	0	1000.0	%	0		1904	Software over current limit of motor nominal current, 0 = disabled

Table 6-58. Motor protection, G2.12.5

6.12.6 Living Zero monitoring

Code	Parameter	Min	Max	Unit	Default	Cust	ID	Note
P2.12.6.1	Response to 4mA reference fault	0	5		0		700	0=No response 1=Warning 2=Warning+Previous Freq. 3=Wrrng+PresetFreq 2.12.6.2 4=Fault,stop acc. to 2.3.2 5=Fault,stop by coasting
P2.12.6.2	4mA reference fault frequency	0.00	P2.1.2	Hz	0.00		728	

Table 6-59. Living zero monitoring, G2.12.6

6.12.7 Underload protection

Code	Parameter	Min	Max	Unit	Default	Cust	ID	Note
P2.12.7.1	Underload protection	0	3		0		713	0=No response 1=Warning 2=Fault,stop acc. to 2.3.2 3=Fault,stop by coasting
P2.12.7.2	Field weakening area load	10.0	150.0	%	50.0		714	
P2.12.7.3	Zero frequency load	5.0	150.0	%	10.0		715	
P2.12.7.4	Underload protection time limit	2.00	600.00	s	20.00		716	

Table 6-60. Underload protection, G2.12.7

6.12.8 Earth Fault protection

Code	Parameter	Min	Max	Unit	Default	Cust	ID	Note
P2.12.8.1	Earth fault protection	0	3		2		703	0=No response 1=Warning 2=Fault,stop acc. to 2.3.2 3=Fault,stop by coasting
P2.12.8.2	Eart fault current limit	0.0	100.0	%	50.0		1333	

Table 6-61. Earth fault protection, G2.12.8

6.12.9 Cooling protection

Code	Parameter	Min	Max	Unit	Default	Cust	ID	Note
P2.12.9.1	Cooling Fault Response	1	2		2		762	0= No Action, Warning 1= Warning, Warning 2= Warning, Fault 3= No Action, Fault
P2.12.9.2	Cooling Fault delay	0.00	7.00	s	2.00		751	

Table 6-62. Cooling protection, G2.12.9

6.12.10 Fieldbus protection

Code	Parameter	Min	Max	Unit	Default	Cust	ID	Note
P2.12.10.1	FB Fault Slot D	0	5		2		733	0=No Action 1=Warning 2= Fault 3= Fault, stop by coasting 4=Warning; Prev Freq 5=Quick Stop
P2.12.10.2	FB Fault Delay	0.00	60.00	s	0.50		1850	Delay to fault when FB Response is 4
P2.12.10.3	FB Watchdog Delay	0.00	30.00	s	0.00		1354	Delay when WD pulse is missing. 0.00 s = Disabled
P2.12.10.4	FB Fault Slot E	0	5		2		733	See P2.12.10.1

Table 6-63. Fieldbus protection parameters, G2.12.10

6.12.11 External Fault

Code	Parameter	Min	Max	Unit	Default	Cust	ID	Note
P2.12.11.1	Response to external fault 1	0	3		2		701	0=No response 1=Warning 2=Fault, stop acc. to 2.3.2 3=Fault, stop by coasting
P2.12.11.2	Response to external fault 2	0	3		2		747	0=No response 1=Warning 2=Fault, stop acc. to 2.3.2 3=Fault, stop by coasting

Table 6-64. External fault parameters, G2.12.11

6.12.12 Encoder Fault

Code	Parameter	Min	Max	Unit	Default	Cust	ID	Note
P2.12.12.1	Response to encoder fault	1	3		2		1353	1=Warning 2=Fault 3=Warning: To Open Loop
P2.12.12.2	Encoder Fast Hz Limit	0.00	320.00	Hz			1801	
P2.12.12.3	Fast Time Limit	0.00	32.00	s			1805	
P2.12.12.4	Iq Fault Limit	0	300	%			1800	

Table 6-65. Encoder fault parameters, G2.12.12

6.12.13 Options

Code	Parameter	Min	Max	Unit	Default	Cust	ID	Note
P2.12.14	Disable Stop Lock	0	1		0		1086	
P2.12.15	Reset Datalogger	-1	1		0		1857	-1 = Blocked 0 = No 1 = Yes

Table 6-66. Protection options

6.13 Fieldbus parameters

Code	Parameter	Min	Max	Unit	Default	Cust	ID	Note
P2.13.1	Fieldbus min scale	0.00	320.00	Hz	0.00		850	
P2.13.2	Fieldbus max scale	0.00	320.00	Hz	0.00		851	
P2.13.3	Fieldbus process data out 1 selection	0	10000		1		852	Choose monitoring data with parameter ID Def: Output Frequency
P2.13.4	Fieldbus process data out 2 selection	0	10000		2		853	Def: Motor Speed
P2.13.5	Fieldbus process data out 3 selection	0	10000		3		854	Def: Motor Current to FB
P2.13.6	Fieldbus process data out 4 selection	0	10000		4		855	Def: Motor Torque
P2.13.7	Fieldbus process data out 5 selection	0	10000		5		856	Def: Motor Power
P2.13.8	Fieldbus process data out 6 selection	0	10000		6		857	Def: Motor Voltage
P2.13.9	Fieldbus process data out 7 selection	0	10000		7		858	Def: DC-Link Voltage
P2.13.10	Fieldbus process data out 8 selection	0	10000		37		859	Def: Last Active Fault
P2.13.11	Fieldbus process data out 9 selection	0	10000		0		558	Visible with correct hardware and software
P2.13.12	Fieldbus process data out 10 selection	0	10000		0		559	Visible with correct hardware and software
P2.13.13	Fieldbus process data out 11 selection	0	10000		0		560	Visible with correct hardware and software
P2.13.14	Fieldbus process data out 12 selection	0	10000		0		561	Visible with correct hardware and software
P2.13.15	Fieldbus process data out 13 selection	0	10000		0		562	Visible with correct hardware and software
P2.13.16	Fieldbus process data out 14 selection	0	10000		0		563	Visible with correct hardware and software
P2.13.17	Fieldbus process data out 15 selection	0	10000		0		564	Visible with correct hardware and software
P2.13.18	Fieldbus process data out 16 selection	0	10000		0		565	Visible with correct hardware and software
P2.13.19	Fieldbus process data in 1 selection	0	10000		1140		876	Choose controlled data with parameter ID. Def: FB Torque Reference
P2.13.20	Fieldbus process data in 2 selection	0	10000		46		877	Def: FB Limit Scaling
P2.13.21	Fieldbus process data in 3 selection	0	10000		47		878	Def: FB Adjust Reference
P2.13.22	Fieldbus process data in 4 selection	0	10000		48		879	Def: FB Analogue Output.
P2.13.23	Fieldbus process data in 5 selection	0	10000		0		880	Choose controlled data with parameter ID
P2.13.24	Fieldbus process data in 6 selection	0	10000		0		881	Choose controlled data with parameter ID
P2.13.25	Fieldbus process data in 7 selection	0	10000		0		882	Choose controlled data with parameter ID
P2.13.26	Fieldbus process data in 8 selection	0	10000		0		883	Choose controlled data with parameter ID
P2.13.27	Fieldbus process data in 9 selection	0	10000		0		550	Visible with correct hardware and software
P2.13.28	Fieldbus process data in 10 selection	0	10000		0		551	Visible with correct hardware and software
P2.13.29	Fieldbus process	0	10000		0		552	Visible with correct

Code	Parameter	Min	Max	Unit	Default	Cust	ID	Note
	data in 11 selection							hardware and software
P2.13.30	Fieldbus process data in 12 selection	0	10000		0		553	Visible with correct hardware and software
P2.13.31	Fieldbus process data in 13 selection	0	10000		0		554	Visible with correct hardware and software
P2.13.32	Fieldbus process data in 14 selection	0	10000		0		555	Visible with correct hardware and software
P2.13.33	Fieldbus process data in 15 selection	0	10000		0		556	Visible with correct hardware and software
P2.13.34	Fieldbus process data in 16 selection	0	10000		0		557	Visible with correct hardware and software
P2.13.35	General Status Word ID	0	10000		67		897	Choose monitoring data in General Status Word
P2.13.36	FB Actual Speed Mode	0	1		0		1741	0=Calculated 1=Actual
P2.13.37	Control Slot Selector	0	Varies		0		1440	0=Not Sel., 4=Slot D 5=Slot E, 6 = Slot D Fast, 7 = Slot E fast, 8 = Slot D 16, 9= Slot E 16 Note: 6-9 visible with correct hardware and software
P2.13.38	State Machine	1	2		1		896	1 = Standard 2 = ProfiDrive
P2.13.39	FB Custom Minimum	-32000	+32000		0		898	FB Speed Reference Minimum scaling
P2.13.40	FB Custom Maximum	-32000	+32000		+10000		899	FB Speed Reference Maximum Scaling
P2.13.41	SW ID.Bit 11 selection	0	2000.00		0		1628	
P2.13.42	SW ID.Bit 12 selection	0	2000.00		0		1629	
P2.13.43	SW ID.Bit 13 selection	0	2000.00		0		1630	
P2.13.44	SW ID.Bit 14 selection	0	2000.00		0		1631	

Table 6-67. Fieldbus parameters, G2.13

6.14 ID Control Functions

6.14.1 Value Control

Code	Parameter	Min	Max	Unit	Default	Cust	ID	Note
P2.14.1.1	Control Input Signal ID	0	10000	ID	0		1580	
P2.14.1.2	Control Input Off Limit	-32000	32000		0		1581	
P2.14.1.3	Control Input On Limit	-32000	32000		0		1582	
P2.14.1.4	Control Output Off Value	-32000	32000		0		1583	
P2.14.1.5	Control Output On Value	-32000	32000		0		1584	
P2.14.1.6	Control Output Signal ID	0	10000	ID	0		1585	
P2.14.1.7	Control Mode	0	5		0		1586	0=SR ABS 1=Scale ABS 2=Scale INV ABS 3=SR 4=Scale 5=Scale INV
P2.14.1.8	Control Output Filtering rime	0.000	32.000	s	0.000		1721	

Table 6-68. Power reference input signal selection, G2.14.1

6.14.2 DIN ID Control 1

Code	Parameter	Min	Max	Unit	Default	Cust	ID	Note
P2.14.2.1	ID Control DIN	0.1	E.10		0.1		1570	Slot . Board input No.
P2.14.2.2	Controlled ID	0	10000	ID	0		1571	Select ID that is controlled by digital input
P2.14.2.3	False value	-32000	32000		0		1572	Value when DI is low
P2.14.2.4	True value	-32000	32000		0		1573	Value when DI is high

Table 6-69. DIN ID Control parameters, G2.14.2

6.14.3 DIN ID Control 2

Code	Parameter	Min	Max	Unit	Default	Cust	ID	Note
P2.14.3.1	ID Control DIN	0.1	E.10		0.1		1590	Slot . Board input No.
P2.14.3.2	Controlled ID	0	10000	ID	0		1575	Select ID that is controlled by digital input
P2.14.3.3	False value	-32000	32000		0		1592	Value when DI is low
P2.14.3.4	True value	-32000	32000		0		1593	Value when DI is high

Table 6-70. DIN ID Control parameters, G2.14.3

6.14.4 DIN ID Control 3

Code	Parameter	Min	Max	Unit	Default	Cust	ID	Note
P2.14.4.1	ID Control DIN	0.1	E.10		0.1		1578	Slot . Board input No.
P2.14.4.2	Controlled ID	0	10000	ID	0		1579	Select ID that is controlled by digital input
P2.14.4.3	False value	-32000	32000		0		1594	Value when DI is low
P2.14.4.4	True value	-32000	32000		0		1596	Value when DI is high

Table 6-71. DIN ID Control parameters, G2.14.4

6.14.5 ID Controlled Digital Output 1

Code	Parameter	Min	Max	Unit	Default	Cust	ID	Note
P2.14.5.1	ID.Bit Free DO	0.00	2000.15	ID.Bit	0.00		1216	
P2.14.5.2	Free DO Sel	0.1	E.10		0.1		1574	

Table 6-72. ID Controlled Digital Output parameters, G2.14.5

6.14.6 ID Controlled Digital Output 2

Code	Parameter	Min	Max	Unit	Default	Cust	ID	Note
P2.14.6.1	ID.Bit Free DO	0.00	2000.15	ID.Bit	0.00		1386	
P2.14.6.2	Free DO Sel	0.1	E.10		0.1		1574	

Table 6-73. ID Controlled Digital Output parameters, G2.14.6

6.14.7 Free DIN Delay

Code	Parameter	Min	Max	Unit	Default	Cust	ID	Note
P2.14.7.1	ID.Bit Free DIN	0.00	2000.15	ID.Bit	0.00		1832	
P2.14.7.2	On Delay	0.00	320.00	s	0.00		1833	
P2.14.7.3	Off Delay	0.00	320.00	s	0.00		1834	
P2.14.7.4	Mono Time	0.00	320.00	s	0.00		1836	
P2.14.7.5	Control Out ID	0	10000		0		1835	

Table 6-74. ID Controlled Digital Output parameters, G2.14.7

6.14.8 ID.Bit ID Control

Code	Parameter	Min	Max	Unit	Default	Cust	ID	Note
P2.14.8.1	IDbit ID Control	0.00	2000.15	ID.Bit	0.00		1634	
P2.14.8.2	Controlled ID	0.00	10000		0.00		1618	
P2.14.8.3	FALSE Value	-32000	32000		0.00		1632	
P2.14.8.4	TRUE Value	-32000	32000		0.00		1633	

Table 6-75. ID.Bit ID Control parameters, G2.14.7

6.15 Brake Control

Code	Parameter	Min	Max	Unit	Default	Cust	ID	Note
P2.15.1	BrakeMechDelay	0.00	320.00	s	0.00		1544	Time that is required to open the brake
P2.15.2	Brake OFF FreqLim Open Loop	0.00	320.00	Hz	1.50		1535	Opening limit and maximum reference limit when brake is closed.
P2.15.3	Brake OFF FreqLim Closed Loop	0.00	320.00	Hz	0.00		1555	Opening limit and maximum reference limit when brake is closed.
P2.15.4	Brake ON FreqLim +	0.00	320.00	Hz	1.00		1539	Close frequency from positive direction
P2.15.5	Brake ON FreqLim -	0.00	320.00	Hz	1.50		1540	Close frequency from negative direction
P2.15.6	Brake On/Off Current Limit	0.00	320.00	A	0.00		1085	Brake is closed immediately Id current goes below this value.
P2.15.7	Generator Torque limit increase speed level	0.00	320.00	Hz	0.00		1547	Function disabled when zero. Point where Generator torque limit starts to increase.
P2.15.8	Generator Torque limit increase maximum speed limit	0.00	320.00	Hz	100.00		1548	Point where torque value of ID1549 is added to base generator torque limit.
P2.15.9	Generator Torque limit increase maximum addition	0.0	300.0	%	300.0		1549	
P2.15.10	Brake Fault Action	1	3		1		1316	1=Warning 2=Fault, stop acc. to 2.3.2 3=Fault, stop by coasting
P2.15.11	Brake Fault Delay	0.00	320.00	s	0.20		1317	

Table 6-76. Brake control parameters, G2.15

6.15.1.1 Brake Control Start up torque for CL

Code	Parameter	Min	Max	Unit	Default	Cust	ID	Note
P2.15.12.1	Start-up torque	0	3		0		621	0=Not used 1=Torque memory 2=Torque reference 3=Start-up torque fwd/rev
P2.15.12.2	Start-up torque FWD	-300.0	300.0	s	0.0		633	
P2.15.12.3	Start-up torque REV	-300.0	300.0	s	0.0		634	
P2.15.12.4	Start Up Torque Time	-1	10000	ms	-1		1371	-1 = Automatic

Table 6-77. Brake control start up torque parameters, G2.15.12

6.15.1.2 Roll Back Control for CL

Code	Parameter	Min	Max	Unit	Default	Cust	ID	Note
P2.15.13.1	Roll Back Kp				0		1787	
P2.15.13.2	Roll Back Torque				0,0		1788	
P2.15.13.3	Roll Back Level				3		1789	
P2.15.13.4	Roll Back Kp 2				0		1792	

Table 6-78. Brake control roll back control parameters, G2.15.13

6.15.1.3 Functions

Code	Parameter	Min	Max	Unit	Default	Cust	ID	Note
P2.15.14.1	Stop Torque Release Time	0	500	ms	0		1858	

Table 6-79. Functions parameters, G2.14

6.16 Auto Reset parameters

Code	Parameter	Min	Max	Unit	Default	Cust	ID	Note
P2.16.1	Wait time	0.10	10.00	s	0.50		717	
P2.16.2	Trial time	0.00	60.00	s	0.10		718	
P2.16.3	Start function	0	2		2		719	0=Ramp 1=Flying start 2=According to Stop Function
P2.16.4	Number of tries after undervoltage trip	0	10		0		720	
P2.16.5	Number of tries after overvoltage trip	0	10		0		721	
P2.16.6	Number of tries after overcurrent trip	0	3		0		722	
P2.16.7	Number of tries after reference trip	0	10		0		723	
P2.16.8	Number of tries after motor temperature fault trip	0	10		0		726	
P2.16.9	Number of tries after external fault trip	0	10		0		725	
P2.16.10	Number of tries after underload fault trip	0	10		0		738	
P2.16.11	Fault Simulation	0	65535		0		1569	

Table 6-80. Autorestart parameters, G2.16

6.17 PI Control Parameters

Code	Parameter	Min	Max	Unit	Step	Default	ID	Note
P2.17.1	PI controller gain	0.0	1000.0	%		100.0	118	
P2.17.2	PI controller I-time	0.00	320.00	s		1.00	119	
P2.17.3	PI Reference	-32000	32000			0	167	
P2.17.4	PI controller reference signal ID	0	10000			167	332	Default P2.17.3
P2.17.5	PI Actual value ID	0	10000			0	333	
P2.17.6	PI Controller output ID	0	10000			0	1802	
P2.17.7	PI Controller Scale	-32000	32000			1	340	>= 1 = No inversion <=-1 = Inverted 0 = Illegal value
P2.17.8	PI Low limit	-32000	32000				359	
P2.17.9	PI High limit	-32000	32000			10000	360	
P2.17.10	PI Controller Output scale	-3200.0	3200.0	%		100.0	1803	
P2.17.11	PI Stop state value	-32000	32000			0	1806	

Table 6-81. PI controller parameters, G2.17

6.18 Functional Safety

Code	Parameter	Min	Max	Unit	Default	Cust	ID	Note
P2.19.1	SQS Reaction	0	1		1		545	0=No Action 1=Quick Stop
P2.18.2	SS1 Reaction	0	2		1		542	0=No Action 1=Stop 2=Quick Stop
P2.18.3	SS2 Reaction	0	2		1		546	0=No Action 1=Zero Speed 2=Quick Stop
P2.18.4	SDI Reaction	0	1		1		544	0=No Action 1=Disable Dir
P2.18.5	SLS Reaction	0	1		1		543	0=No Action 1=Limit Reference
P2.18.6	SSR Reaction	0	1		1		547	0=No Action 1= Limit Reference

Table 6-82. Functional Safety parameters, G2.18

6.19 Keypad control (Control keypad: Menu M3)

The parameters for the selection of control place and direction on the keypad are listed below. See the Keypad control menu in the VACON® NX User Manual.

Code	Parameter	Min	Max	Unit	Default	Cust	ID	Note
P3.1	Control place	1	3		2		125	0=PC Control 1=I/O terminal 2=Keypad 3=Fieldbus
R3.2	Keypad reference	P2.1.1	P2.1.2	Hz	0.00			
P3.3	Direction (on keypad)	0	1		0		123	0=Forward 1=Reverse
P3.4	Stop button	0	1		1		114	0=Limited function of Stop button 1=Stop button always enabled
R3.5	Torque reference	0.0	100.0	%	0.0			

Table 6-83. Keypad control parameters, M3

6.20 System menu (Control keypad: Menu M6)

For parameters and functions related to the general use of the AC drive, such as application and language selection, customised parameter sets or information about the hardware and software, see the VACON® NX User Manual.

6.21 Expander boards (Control keypad: Menu M7)

The **M7** menu shows the expander and option boards attached to the control board and board-related information. For more information, see the VACON® NX User Manual.

7. APFIFF09 – DESCRIPTION OF PARAMETERS

7.1 Basic Parameters

P2.1.1 Minimum frequency *ID101 “Min Frequency”*

Defines minimum frequency of any adjustable reference input (i.e. when reference is not a parameter). Minimum frequency is bypassed when jogging speed, preset speed or inching reference is used.

P2.1.2 Maximum frequency *ID102 “Max Frequency”*

Defines maximum frequency limit both negative and positive directions. Direction dependent frequency limits can be given in “G: Limit Settings \ Frequency Handling”.

Note: When the AC drive is in run state, do not change this parameter to a value lower than the current output frequency. The change will be executed without ramp.

Note: Max and Min frequencies are used for several scaling functions and are not intended to be adjusted dynamically. Never set maximum frequency to same value or a value below the minimum frequency. When changing the maximum frequency in Marine application, do not give any other command to the drive for 2 seconds so that the software can process the change properly.

P2.1.3 Motor Nominal Voltage *ID110 “Motor Nom Voltg”*

Find this value U_n on the rating plate of the motor.

P2.1.4 Motor Nominal Frequency *ID111 “Motor Nom Freq”*

Find this value f_n on the rating plate of the motor. This parameter sets the field weakening point to the same value in “G: Motor Control \ U/f Settings”.

P2.1.5 Motor nominal speed *ID112 “Motor Nom Speed”*

Find this value n_n on the rating plate of the motor. Note also nominal frequency.

In some cases, the motor nominal speed is shown with one decimal. In this case the practice is to give the nearest integer number and adjust the motor nominal frequency so that the drive will calculate correct $[FW]PolePairNumber$.

P2.1.6 Motor nominal current *ID113 “Motor Nom Currnt”*

Find this value I_n on the rating plate of the motor. If magnetization current is provided, set also Magnetization current P2.1.9 before identification run.

DriveSynch Operation

Motor Nominal current from the motor name plate / Number of drives in parallel using VACON® Drive Synch.

P2.1.7 Motor cos phi *ID120 “Motor Cos Phi”*

Find this value “cos phi” on the rating plate of the motor.

P2.1.8 Motor Nominal Power ID116 "Motor Nom Power"

Find this value on the rating plate of the motor.

Drive Synch Operation

Motor Nominal power from the motor name plate / Number of drives in parallel using VACON® Drive Synch.

P2.1.9 Magnetizing current ID612 "MagnCurrent"

Set here the motor magnetizing current (no-load current).

Can be measured by running motor without load at 2/3 of nominal speed.

When the value is zero, the magnetization current is calculated from motor nominal parameters:

$$\text{Motor Magnetization Current} = \frac{5 * \sin \varphi - 1}{5 - \sin \varphi} * \text{Motor Nominal Current}$$

$$\text{Motor Magnetization Current} = \frac{5 * \sqrt{1 - (\cos \varphi)^2} - 1}{5 - \sqrt{1 - (\cos \varphi)^2}} * \text{Motor Nominal Current}$$

$$[FW]RotorFlux = \left(\frac{f(MotorNomFreq)}{f(Out)} \right)^2, \text{ when } f(Out) > f(MotorNomFreq)$$

If given before identification run, this is used as reference for U/f tuning when making identification without rotating the motor.

DriveSynch Operation

Motor Nominal magnetization current / Number of drives in parallel using VACON® Drive Synch.

P2.1.10 Identification

ID631 "Identification"

Identification Run is a part of tuning the motor and the drive specific parameters. It is a tool for commissioning and service of the drive with the aim to find as good parameter values as possible for most drives. The automatic motor identification calculates or measures the motor parameters that are needed for optimum motor and speed control.

NOTE: Set the motor control mode to Frequency Control before identification!

NOTE: During identification, the drive will not open mechanical brake for safety reasons. If the used identification needs shaft to rotate freely, the mechanical brake needs to be opened externally.

NOTE: During the identification run, the torque and power limits should be above 100%. Also the current limit should be above motor nominal current.

NOTE: During the identification run, the acceleration time should be below 20 second.

NOTE: If switching frequency is changed after the identification, it is recommended to do the identification run again.

NOTE: A small motor with long motor cables may require a reduction of switching frequency if identification is not successful.

The basic motor name plate data must be set correctly before performing the identification run:

- P2.1.3 – P2.1.8. Motor basic data.
- P2.1.9 Magnetization current can also be given if available if given before the identification without rotating motor; U/f curve will be tuned according to given magnetization current.
- P2.1.11 Motor Type.

When in closed loop and with an encoder installed, also the parameter for pulses / revolutions (in Menu M7) have to be set.

The automatic identification is activated by setting this parameter to the appropriate value followed by a start command in the requested direction. The start command to the drive has to be given within 20 s. If no start command is given within 20 s the identification run is cancelled and the parameter will be reset to its default setting. The identification run can be stopped any time with normal stop command and the parameter is reset to its default setting. In case identification run detects fault or other problems, the identification run is completed if possible. After the identification is finished, warning will be given if not all requested identification types have been completed successfully. During Identification Run, the brake control is disabled.

Note: After the identification is made, the drive requires rising edge of start command.

Note: Marine application has all identified values stored to the parameters. There is no need to redo identification if previous parameters are loaded back to the drive, for example, in case the control board is changed.

DriveSynch operation: Activate identification only from the master drive:

0 = "No Action" No action

No identification requested.

1 = "ID No Run" - Identification without rotating the motor

Current is applied to the motor but shaft will not be rotated. U/f settings are identified. This identification is the minimum requirement if the motor is only to be used in open loop control. It is however recommended to make the identification always with a rotating motor in case the closed loop control is needed after the mechanics are connected to shaft.

Example of behaviour

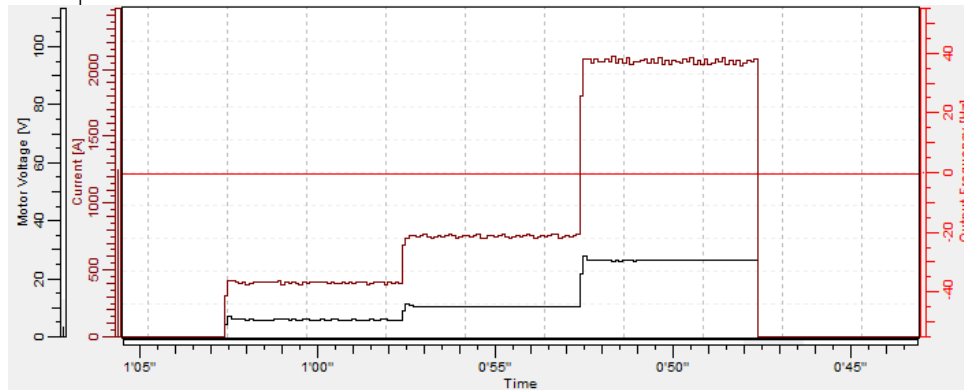

Parameters updated during this identification

AM:

P2.1.9 MagnCurrent
 P2.8.4.2 U/f Ratio Select
 P2.8.4.5 U/f Mid Freq
 P2.8.4.6 U/f Mid Voltg
 P2.8.4.7 Zero Freq Voltg
 P2.8.9.16 RsVoltageDrop
 P2.8.9.17 IrAddZeroPVoltg
 P2.8.9.22-24 Ix Offset

PM:

P2.8.4.2 U/f Ratio Select
 P2.8.4.5 U/f Mid Freq
 P2.8.4.6 U/f Mid Voltg
 P2.8.4.7 Zero Freq Voltg
 P2.8.5.1 CurrentControlKp
 P2.8.6.12 LsdVoltageDrop
 P2.8.6.13 LsqVoltageDrop
 P2.8.6.19 Curr. Contr. Kp d
 P2.8.9.16 RsVoltageDrop
 P2.8.9.17 IrAddZeroPVoltg
 P2.8.9.20 LsVoltageDrop
 P2.8.9.22-24 Ix Offset
 P2.8.9.25 Estimator Kp

2 = "ID With Run" - Identification with motor rotating

The motor shaft needs to be able to rotate freely.

This identification must be run without load on motor shaft. U/f settings and magnetization current are identified. This identification should be run regardless of the final operation mode (closed loop or open loop) to get the best performance from the motor. When identification with motor rotation is successfully finished, the drive starts to use internal slip estimator to compensate the motor temperature, setting SCTorqueChainSelect B5 & B6 true.

Example of behaviour

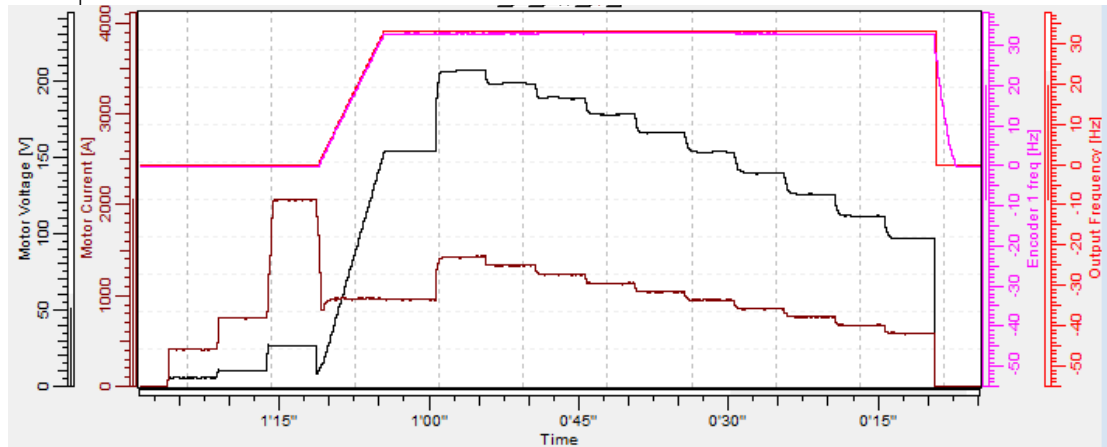

Parameters updated during this identification

AM:

- P2.1.9 MagnCurrent
- P2.8.4.2 U/f Ratio Select
- P2.8.4.5 U/f Mid Freq
- P2.8.4.6 U/f Mid Voltg
- P2.8.4.7 Zero Freq Voltg
- P2.8.9.16 RsVoltageDrop
- P2.8.9.17 IrAddZeroPVoltg
- P2.8.9.22-24 Ix Offset
- P2.8.9.1-15 Flux X %

PM:

- P2.8.4.2 U/f Ratio Select
- P2.8.4.3 Field WeakngPnt
- P2.8.4.5 U/f Mid Freq
- P2.8.4.6 U/f Mid Voltg
- P2.8.4.7 Zero Freq Voltg
- P2.8.5.1 CurrentControlKp
- P2.8.6.12 LsdVoltageDrop
- P2.8.6.13 LsqVoltageDrop
- P2.8.6.19 Curr. Contr. Kp d
- P2.8.9.16 RsVoltageDrop
- P2.8.9.17 IrAddZeroPVoltg
- P2.8.9.20 LsVoltageDrop
- P2.8.9.21 MotorBEMVoltage
- P2.8.9.22-24 Ix Offset
- P2.8.9.25 Estimator Kp

3 = “Enc. ID Run” - Encoder identification run

The motor shaft needs to be able to rotate freely.

PMSM: This selection is used for PMS motor if automatic angle identification is not suitable for used motor (angle is identified automatically in every start if PMSM Shaft Position parameter is zero).

This identification run will update the PMSM Shaft Position parameter based on absolute position of the encoder or Z pulse position of incremental type encoder.

IM: If performed for induction motor encoder pulse number and direction are identified. Can be used if there is no encoder information available, correct result can be achieved only when motor is unloaded.

Note: Identification run needs to be done again if the encoder position related to motor is changed due to maintenance, for example.

Parameters updated during this identification

AM:

P2.1.9 MagnCurrent
 P2.8.4.2 U/f Ratio Select
 P2.8.4.5 U/f Mid Freq
 P2.8.4.6 U/f Mid Voltg
 P2.8.4.7 Zero Freq Voltg
 P2.8.9.16 RsVoltageDrop
 P2.8.9.17 IrAddZeroPVoltg
 P2.8.9.22-24 Ix Offset
 P2.8.9.1-15 Flux X %
 P7.3.1.2 Pulse revolution
 P7.3.1.3 Invert direction

PM:

P2.8.6.1 PMSMShaftPositio
 P2.8.9.22-24 Ix Offset
 P2.8.9.25 Estimator Kp

4 = "Ident All" - Identified All

The motor shaft needs to be able to rotate freely.

All the above identification selections are made in sequence.

Parameters updated during this identification

AM:

P2.1.9 MagnCurrent
 P2.8.4.2 U/f Ratio Select
 P2.8.4.5 U/f Mid Freq
 P2.8.4.6 U/f Mid Voltg
 P2.8.4.7 Zero Freq Voltg
 P2.8.9.16 RsVoltageDrop
 P2.8.9.17 IrAddZeroPVoltg
 P2.8.9.22-24 Ix Offset
 P2.8.9.1-15 Flux X %

PM:

P2.8.4.2 U/f Ratio Select
 P2.8.4.3 Field WeakngPnt
 P2.8.4.5 U/f Mid Freq
 P2.8.4.6 U/f Mid Voltg
 P2.8.4.7 Zero Freq Voltg
 P2.8.5.1 CurrentControlKp
 P2.8.6.12 LsdVoltageDrop
 P2.8.6.13 LsqVoltageDrop
 P2.8.6.19 Curr. Contr. Kp d
 P2.8.9.16 RsVoltageDrop
 P2.8.9.17 IrAddZeroPVoltg
 P2.8.9.20 LsVoltageDrop
 P2.8.9.21 MotorBEMVoltage
 P2.8.9.22-24 Ix Offset
 P2.8.9.25 Estimator Kp
 P2.8.6.1 PMSMShaftPositio

5 = "Enc.ABS.Lock" – Absolute encoder when locked rotor

Identification of the zero position of the absolute encoder when the rotor is locked while using permanent magnet motor.

Shaft needs to be locked during this identification mode.

Parameters updated during this identification

PM:

P2.8.6.1 PMSMShaftPositio
 P2.8.9.22-24 Ix Offset
 P2.8.9.25 Estimator Kp

6 = "U/f + Magn.Curr" – U/f Curve and magnetization current

Shaft is rotated during identification.

This identification selection will not make a saturation curve identification and will open the brake when the start rotation begins.

Because saturation curve run is not made, the running time is shorter and gives possibility to make even if lifting hook is connected.

Example of behaviour

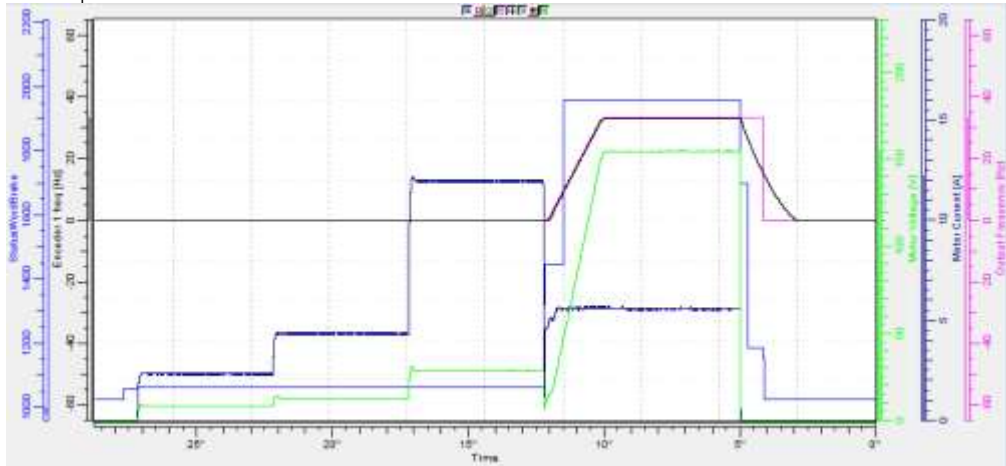

Parameters updated during this identification

- P2.1.9 MagnCurrent
- P2.8.4.2 U/f Ratio Select
- P2.8.4.5 U/f Mid Freq
- P2.8.4.6 U/f Mid Voltg
- P2.8.4.7 Zero Freq Voltg
- P2.8.9.16 RsVoltageDrop
- P2.8.9.17 IrAddZeroPVoltg
- P2.8.9.22-24 Ix Offset

7 = "DTC Ident" – Dead Time Compensation Identification

Current is applied to the motor but shaft will not be rotated.

This identification mode is needed for Sensorless control, Ident All can be used instead of this.

Parameters updated during this identification

- P 2.8.4.2 U/f Ratio Select
- P 2.8.4.5 U/f Mid Freq
- P 2.8.4.6 U/f Mid Voltg
- P 2.8.4.7 Zero Freq Voltg
- P 2.8.9.16 RsVoltageDrop
- P 2.8.9.17 IrAddZeroPVoltg
- P 2.8.9.20 LsVoltageDrop
- P 2.8.9.22 IU Offset
- P 2.8.9.23 IV Offset
- P 2.8.9.24 IW Offset
- P 2.8.9.25 Estimator Kp
- P 2.8.9.27 VoltageDrop
- P 2.8.9.29 FluxSaturatRatio
- P 2.8.9.30 DeadTimeComp.
- P 2.8.9.31 DeadTieContCurL

10 = "ID Run Fails" - Identification failed

Identification failed in last attempt.

P2.1.11 **Motor Type** ID650 **"Motor Type"**

Select used motor type with this parameter

0 "Induction" - Induction motor
- Asynchronous motor

1 "PMSM" - Permanent magnet synchronous motor
- Synchronous Motor

- Contact factory before using with externally magnetized motor.

- If Switching Frequencies above 3.5 kHz are not needed, it is recommended to change to Software Modulator 1 at this point. Read more details in Chapter 6.8.3 Permanent magnet synchronous motor setting and Chapter 8 Identification functions for permanent magnet synchronous motors.

See related parameter in "G2.8.6: Motor Control \ PMSM Control".

2 "Sep.Ex SM" – Separately Excited Synchronous Motor

- This application does not support excitation reference to excitation drive as of 18.1.2018.

3 "Reserved"

4 "SRM"

7.2 Reference Handling

Priority order of Marine application speed reference chain.

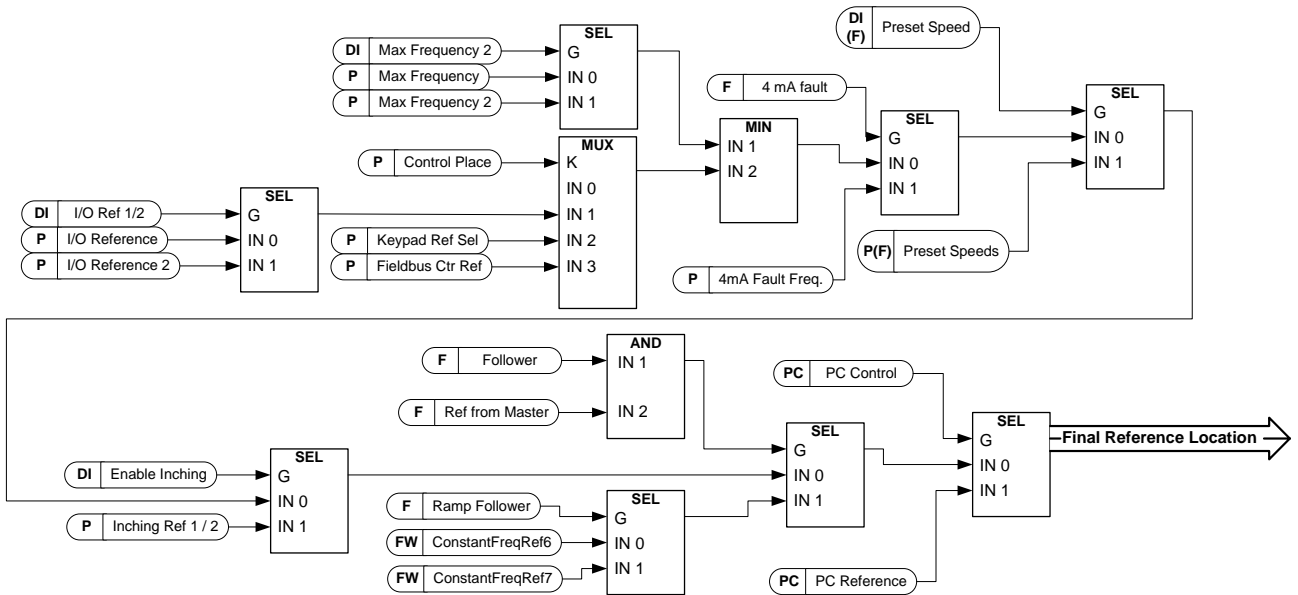

Speed reference chain before ramp control

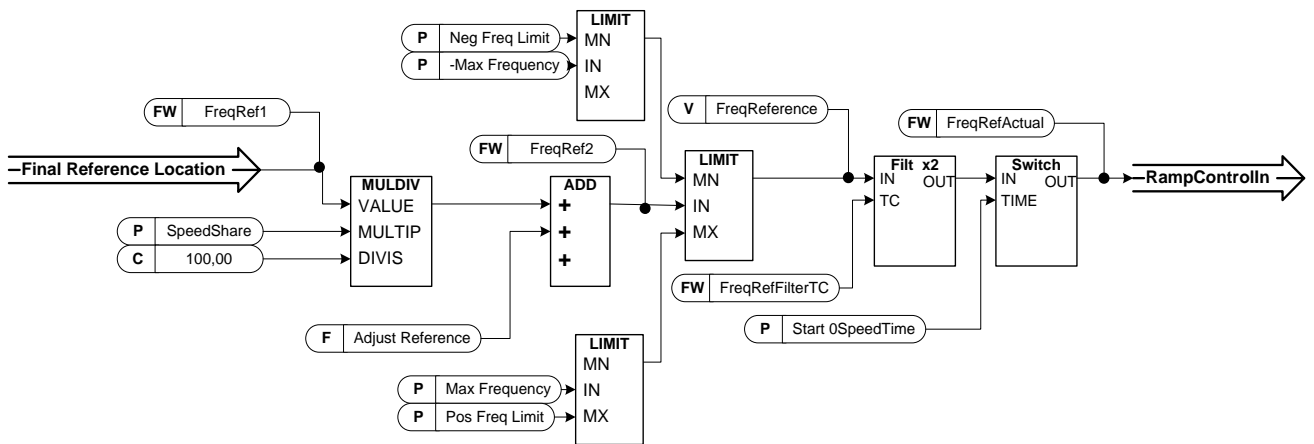

7.2.1 Basic Parameters

P2.2.1 I/O frequency reference selection 1 ID117 "I/O Reference"

Defines which frequency reference source is used when control place is I/O terminal
P3.1 Control Place

0="AI1" - Analogue Input 1.

Signal scaling in "G2.4.2: Input Signals \ Analogue Input 1"

1="AI2" - Analogue Input 2.

Signal scaling in "G2.4.3: Input Signals \ Analogue Input 2"

2="AI1+AI2" - Analogue Input 1 + Analogue Input 2.

With alternative reference scaling in Analogue Input group 100% input values can be set to correspond 25 Hz thus when both are at 100% final reference will be 50 Hz.

3="AI1-AI2"

Analogue Input 1 - Analogue Input 2.

4="AI2-AI1"

Analogue Input 2 - Analogue Input 1.

5="AI1xAI2"

Analogue Input 1 x Analogue Input 2

6="AI1 Joystick"

Analogue input 1, -10 Vdc... +10 Vdc

7="AI2 Joystick"

Analogue input 2, -10 Vdc... +10 Vdc

8="Keypad Ref"

Reference from keypad R3.2

9="Fieldbus"

Reference is taken from Fieldbus, alternative scaling can be selected in "G: Fieldbus"

10="Motor Pot" - Motor potentiometer.

Reference handled with two digital input "G: Input Signals \ Digital Inputs" (increase and decrease). Behaviour adjusted in "G: Ref Handling \ Motor Poten.mete".

11="AI1, AI2 min"

The minimum of Analogue Input 1 and Analogue Input 2 is used as reference.

12="AI1, AI2 max"

The maximum from Analogue Input 1 and Analogue Input 2 is used as reference.

13="Max Freq" - Maximum Frequency

P2.1.2 Max Frequency is used as reference.

14="AI1/AI2 Sel" - AI1/AI2 Selection

Digital Input "I/O Ref 1/2" is used to select between Analogue Input 1 and Analogue Input 2 reference. "I/O Ref 1/2" is used to select between "I/O Reference" and "I/O Reference 2" if selection is different than 14 (this one).

15="Encoder 1"

Reference is read from encoder input 1.

16="Encoder 2"

Reference is read from encoder input 2. This selection is usable with double encoder boards. Could be used, for example, for speed synchronization where two motors need to run at the same speed but not necessarily at the same angle.

P2.2.2 Keypad frequency reference selection ID121 "Keypad Ref Sel"

Defines which frequency reference source is used when control place is keypad P3.1 Control Place

0="AI1" - Analogue Input 1.

Signal scaling in "G2.4.3: Input Signals \ Analogue Input 1"

1="AI2" - Analogue Input 2.

Signal scaling in "G2.4.4: Input Signals \ Analogue Input 2"

2="AI1+AI2" - Analogue Input 1 + Analogue Input 2.

With alternative reference scaling in Analogue Input group 100% input values can be set to correspond 25 Hz. That is, when both are at 100% final reference will be 50 Hz.

3="AI1-AI2"

Analogue Input 1 - Analogue Input 2.

4="AI2-AI1"

Analogue Input 2 - Analogue Input 1.

5="AI1xAI2"

Analogue Input 1 x Analogue Input 2

6="AI1 Joystick"

Analogue input 1, -10 Vdc... +10 Vdc

7="AI2 Joystick"

Analogue input 2, -10 Vdc... +10 Vdc

8="Keypad Ref"

Reference from keypad R3.2

9="Fieldbus"

Reference is taken from Fieldbus, alternative scaling can select in "G: Fieldbus"

P2.2.3 Fieldbus frequency reference selection ID122 "Fieldbus Ctr Ref"

Defines which frequency reference source is selected when control place is Fieldbus P3.1. Control Place

0="AI1" - Analogue Input 1.

Signal scaling in "G2.4.3: Input Signals \ Analogue Input 1"

1="AI2" - Analogue Input 2.

Signal scaling in "G2.4.4: Input Signals \ Analogue Input 2"

2="AI1+AI2" - Analogue Input 1 + Analogue Input 2.

With alternative reference scaling in Analogue Input group 100% input values can be set to correspond 25 Hz thus when both are at 100% final reference will be 50 Hz.

3="AI1-AI2"

Analogue Input 1 - Analogue Input 2.

4="AI2-AI1"

Analogue Input 2 - Analogue Input 1.

5="AI1xAI2"

Analogue Input 1 x Analogue Input 2

6="AI1 Joystick"

Analogue input 1, -10 Vdc... +10 Vdc

7="AI2 Joystick"

Analogue input 2, -10 Vdc... +10 Vdc

8="Keypad Ref"

Reference from keypad R3.2

9="Fieldbus"

Reference is taken from Fieldbus, alternative scaling can select in "G: Fieldbus"

P2.2.4 *I/O frequency reference selection 2* **ID131** **"I/O Reference 2"**

This parameter is used to select different reference input location with digital input P2.4.2.17 I/O Ref. 2. Selections for this are the same as for the I/O frequency reference selection 1.

Other parameters related to function
- Digital input P2.4.2.17 I/O Ref. 1/2

P2.2.5 *Speed share* **ID1241** **"Speed Share"**

Defines the speed reference percentage ratio after the final reference location but before the ramp control. The monitoring value "FreqReference" shows the reference after the speed share function. Used to adjust the reference ration, for example, in a line drive so that the PLC can give the same reference to all drives while the speed share compensate gear ratio affects the line speed.

P2.2.6 *Load Share* **ID1248** **"Load Share"**

Defines the percentage for final torque reference after the final torque reference location selection but before the torque reference step function, torque reference dead zone and reference filtering.

7.2.2 Constant Reference

P2.2.7.1 Jogging speed reference ID124 "Jog Speed Ref"

Defines the jogging speed reference when activated by a digital input. This reference will follow the reverse command if given. Jogging speed has a higher priority than preset speed references.

Related parameters

- Digital Input P2.4.2.16 Jogging Speed

P2.2.7.2	Preset speed 1	ID105	"Preset Speed 1"
P2.2.7.3	Preset speed 2	ID106	"Preset Speed 2"
P2.2.7.4	Preset speed 3	ID126	"Preset Speed 3"
P2.2.7.5	Preset speed 4	ID127	"Preset Speed 4"
P2.2.7.6	Preset speed 5	ID128	"Preset Speed 5"
P2.2.7.7	Preset speed 6	ID129	"Preset Speed 6"
P2.2.7.8	Preset speed 7	ID130	"Preset Speed 7"

Parameter values define the Preset speeds references activated by digital inputs. These references will follow reverse command if given.

Speed	Digital Input Preset speed 1	Digital Input Preset speed 2	Digital Input Preset speed 3
Basic speed	0	0	0
Preset Speed 1	1	0	0
Preset Speed 2	0	1	0
Preset Speed 3	1	1	0
Preset Speed 4	0	0	1
Preset Speed 5	1	0	1
Preset Speed 6	0	1	1
Preset Speed 7	1	1	1

Table 7-1. Preset speeds 1 to 7

Related parameters

Digital inputs P2.4.2.5-7 Preset Speed 1-3

7.2.2.1 Inching function

Inching function will start the drive to reference speed without additional start command regardless of the control place. Inching function requires enabling from digital input before command is accepted. Inching is also disabled if there is a start command active from the active control place.

P2.2.7.9	Inching reference 1	ID1239	"Inching Ref 1"
P2.2.7.10	Inching reference 2	ID1240	"Inching Ref 2"

These parameters define the reference for the inching function. The references are bidirectional and the reverse command does not affect the direction of the inching reference.

Other parameters for inching function

- Digital input selection: Enable Inching
- Digital input selection: Inching 1
- Digital input selection: Inching 2
- Parameter: Inching Ramp

P2.2.7.11 Speed step ID1252 "Speed Step"

VACON® NCDrive parameter to help adjusting the speed controller (see VACON® NCDrive Tools: Step Response). With this tool you can give step to speed reference after the ramp control.

7.2.3 Power Reference

The Power reference mode allows the motor to operate at constant power while speed and torque are changing. This gives a steady load for the generators in changing conditions.

This also gives a fast response for thrusters as torque is increased rapidly after increase of power reference thus making the thrusters to speed up fast to the new reference.

Pure speed control where ramp times are tuned slowly to limit fast power changes on higher speeds makes the response slow, especially when starting from zero speed where thrusters do not create thrust

The change between power reference mode and speed controller mode is made by changing the motor control modes between speed and torque control.

Note: Do not change between open loop and closed loop control modes while the drive is run state.

- P2.8.1 Motor Control Mode; Speed control modes
- P2.8.2 Motor Control Mode 2; Torque control modes
- DI Motor Control mode 1/2; Selection between speed and power control mode
- P2.2.9.1 Torque reference select "10 / Power Ref"

In power reference mode, the drive is operating in torque control mode. Therefore, the torque reference selector needs to be set to value 10 (Power reference) where given power reference is converted to torque reference for the motor control.

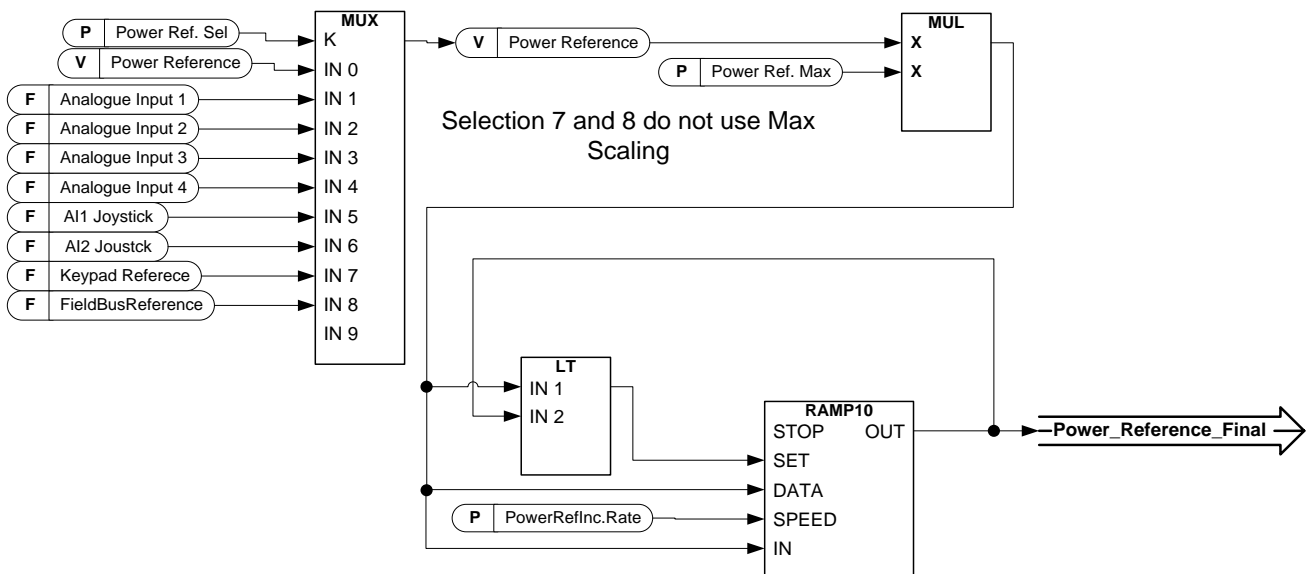

P2.2.8.1 Power Reference Selection ID1620 "Power Ref. Sel"

With this parameter the input source for Power Reference is selected. If this value is set to zero but Torque reference selection is "10= Power Ref", the power reference value can be written directly to the Power Reference monitoring value from Fieldbus or with analogue ID writing function.

0="Not Used"

1="AI1" - Analogue Input 1.

Signal scaling in "G2.4.3: Input Signals \ Analogue Input 1"

2="AI2" - Analogue Input 2.

Signal scaling in "G2.4.4: Input Signals \ Analogue Input 2"

3="AI3"

Signal scaling in "G2.4.5: Input Signals \ Analogue Input 3"

4="AI4"

Signal scaling in "G2.4.6: Input Signals \ Analogue Input 4"

5="AI1 Joystick"

Analogue input 1, -10 Vdc... +10 Vdc

6="AI2 Joystick"

Analogue input 2, -10 Vdc... +10 Vdc

7="Keypad Ref"

Torque reference from keypad R3.6

8="Fieldbus"

Monitoring variable FB Power Reference ID1703

P2.2.8.2 Maximum Power Reference ID1621 "Power Ref. Max"

Scaling factor for power reference input. Scaling is not used when Power reference selection is 7 or 8.

P2.2.8.3 Power reference increase rate ID1621 "PowerRefInc.Rate"

Ramp up rate for power reference. Ramping rate does not have an effect when the reference is decreased. When ramp rate is set to zero ramping is bypassed.

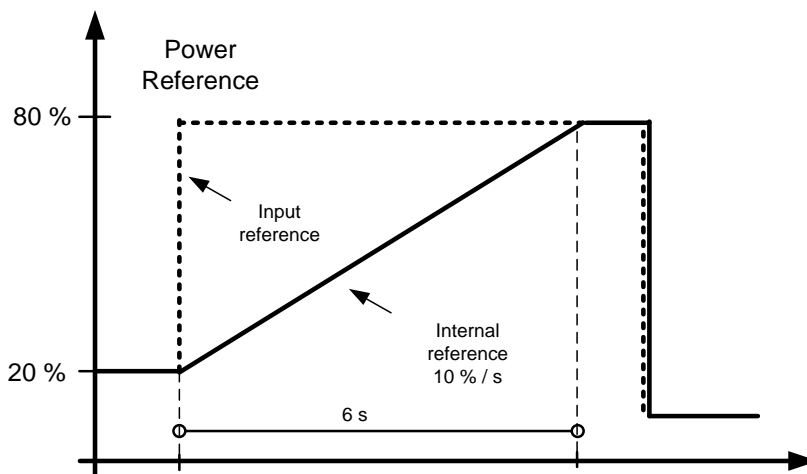

7.2.4 Torque Reference

Motor torque is controlled which allows the motor speed to change depending on the actual load on the motor shaft. Speed limit behaviour is controlled by P2.2.9.6 Torque Select parameter.

For joystick inputs, the maximum negative reference is negated "Torq Ref Max". The minimum is used only for the analogue input selections 1 to 4. Also the maximum negative torque reference maximum is negated "Torq Ref Max".

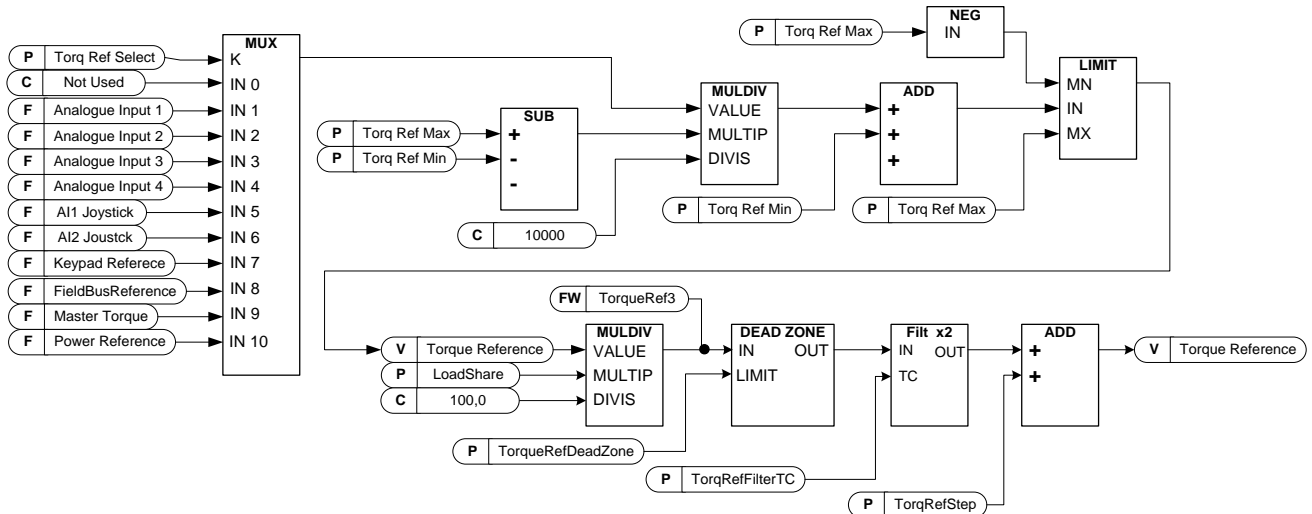

P2.2.9.1 Torque reference selection

ID641 "Torq Ref Select"

0="Not Used"

1="AI1" - Analogue Input 1.

Signal scaling in "G: Input Signals \ Analogue Input 1"

2="AI2" - Analogue Input 2.

Signal scaling in "G: Input Signals \ Analogue Input 2"

3="AI3"

4="AI4"

5="AI1 Joystick"

Analogue input 1, -10 Vdc... +10 Vdc. For joystick inputs the maximum negative reference is negated "Torq Ref Max".

6="AI2 Joystick"

Analogue input 2, -10 Vdc... +10 Vdc For joystick inputs the maximum negative reference is negated "Torq Ref Max".

7="Keypad Ref"

Torque reference from keypad R3.5.

8="Fieldbus"

Reference is taken from Fieldbus. Alternative scaling can be selected in "G: Fieldbus"

9="Master Torque"

Reference is taken from Master drive when using Master Follower function.

10="Power Ref."

Reference is taken from Power reference function. This selection converts given power reference to torque reference for motor control.

P2.2.9.2 Torque reference scaling, maximum value ID641 "Torq Ref Max"

Maximum allowed torque reference for positive and negative values. This is also used for joystick input for negative maximum limit.

P2.2.9.3 Torque reference scaling, minimum value ID642 "Torq Ref Min"

Minimum torque reference for analogue input reference selections 1-4.

P2.2.9.4 Torque reference filtering time ID1244 "TorqRefFilterTC"

Defines the filtering time for torque reference. Filtering is done after load share function and before torque step function.

P2.2.9.5 Torque reference dead zone ID1246 "TorqRefDeadZone"

The small values of the torque reference around zero can be ignored by setting this value greater than zero. When reference is between zero to plus/minus this parameter, the reference is forced to zero.

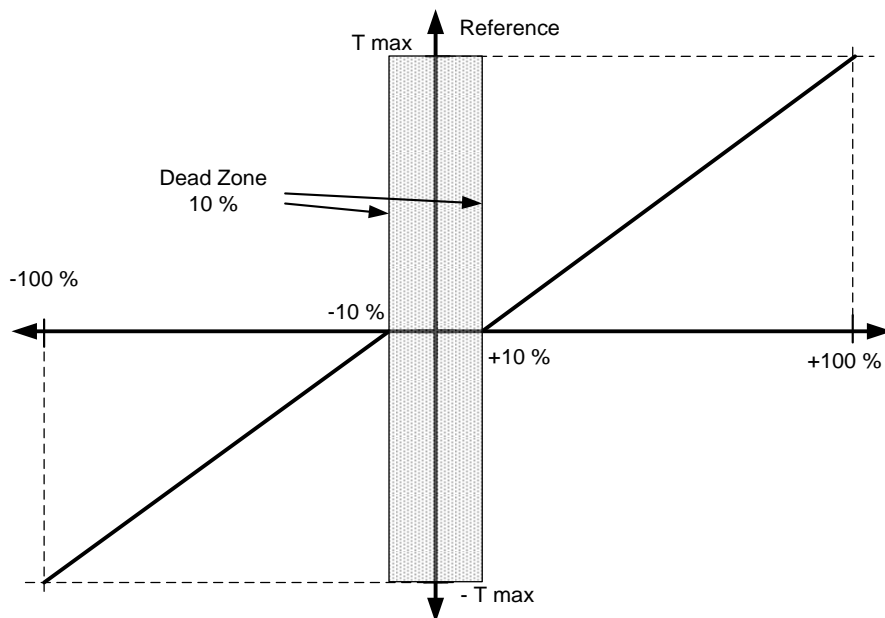

P2.2.9.6 Torque Select ID1278 "Torque Select"

This parameter defines the speed limiting mode in torque control mode. This parameter can be used as single motor control mode selection when no change is made between the open loop and closed loop controls.

0= "SpeedControl" - Speed control mode

The drive is forced to operate in speed control mode while the motor control mode parameter is set to torque control mode thus allowing selection of speed control and torque control mode with single parameter e.g. from Fieldbus.

1="MaxFreqLimit" - Positive and negative frequency limits

Speed is not limited by speed reference, only maximum frequency or Positive and Negative frequency limit if set lower than maximum frequency parameter.

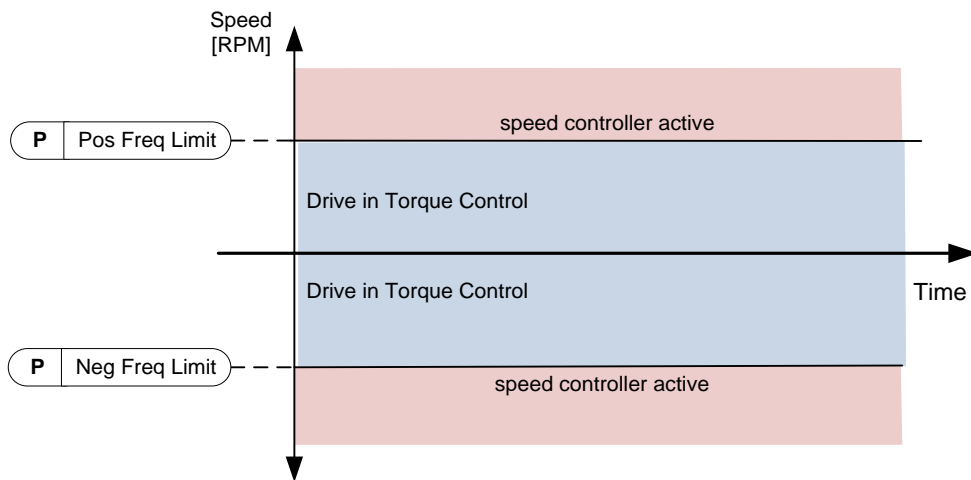

2="RampOutput" – Ramp output for both directions

Speed is limited by reference after ramp generator, thus speed will increase with set ramp time until the actual torque is equal to the reference torque. If speed is below the reference when the load is removed from the shaft, the speed will increase without ramp.

This is the default selection. For master follower system it is recommended to use a selection that allows a little higher reference for torque follower, so that the load will be balanced equally, for example, in window control.

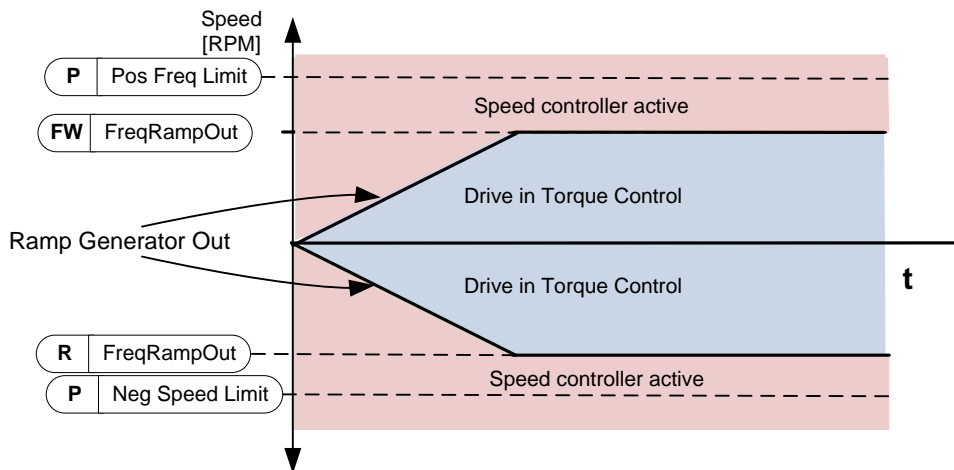

3="Min" – Minimum from speed reference and torque reference.

The minimum of the speed controller output and the torque reference is selected as final torque reference.

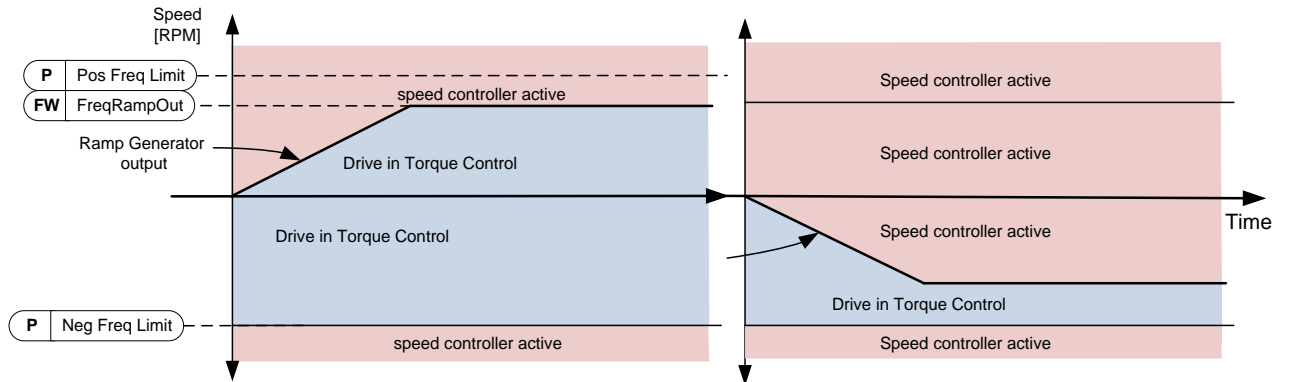

4="Max" – Maximum from speed reference and torque reference

The maximum of the speed controller output and the torque reference is selected as final torque reference.

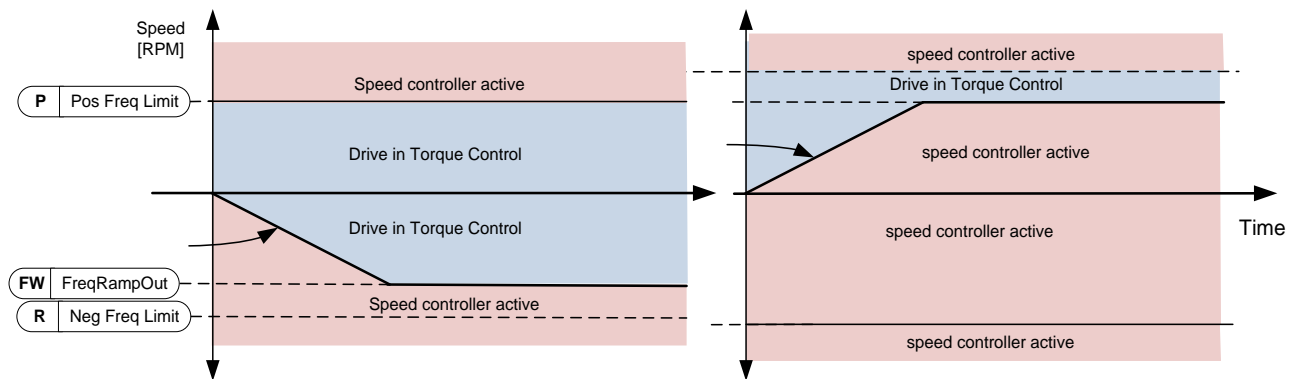

5="Window" – Window control

Speed is limited within window from speed reference.

Speed control activation limit is different from the speed limit. Speed needs, therefore, to go first to "Window Pos" or "Window Neg" limit before the speed controller activates.

When the speed controller is active, the speed will be restricted to limit defined by the "Window Pos Off" and "Windows Neg Off" from the "FinalFreqRef"

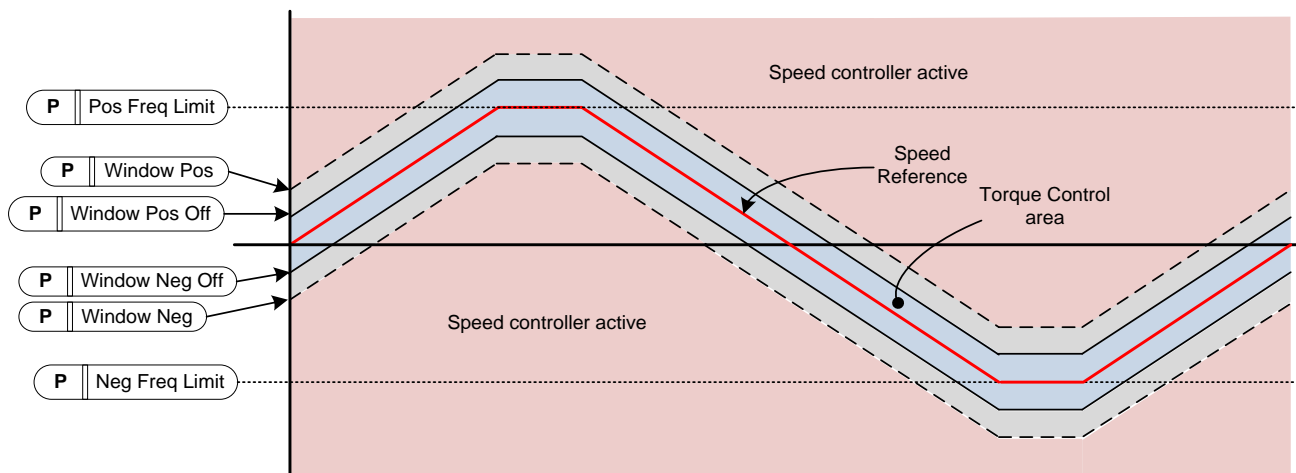

P2.2.9.7 *Window negative* ID1305 "Window Neg"

Defines the size of speed window to negative direction from the speed reference in torque control mode. If both Window Negative Off Limit and Window Positive Off Limit (ID1307 & ID1306) are zero, this parameter is also the speed limit from the Speed Reference in torque control mode. Otherwise this is the speed control activation limit.

P2.2.9.8 *Window positive* ID1304 "Window Pos"

Defines the size of speed window to positive direction from the final speed reference in torque control mode. If both Window Negative Off Limit and Window Positive Off Limit (ID1307 & ID1306) are zero, this parameter is also the speed limit from the "FinalFreqRef". Otherwise this is the speed control activation limit.

P2.2.9.9 *Window negative Off limit* ID1307 "Window Neg Off"

Defines the speed controller negative off limit when the speed controller brings the speed back to the window.

P2.2.9.10 *Window positive Off limit* ID1306 "Window Pos Off"

Defines the speed controller positive off limit when speed controller brings speed back to the window.

P2.2.9.11 *Torque step* ID1253 "Torque Step"

VACON® NCDrive parameter to help adjusting the torque controller (see VACON® NCDrive Tools: Step Response). With this tool you can give step to torque reference.

7.2.4.1 Torque reference OL settings

P2.2.9.11.1 Open loop torque control minimum frequency ID636 "OL TC Min Freq"

Defines the frequency limit below which the AC drive operates in *frequency control mode*.

P2.2.9.11.2 Open loop torque controller P gain ID639 "OL TorqCtrl P"

Defines the gain for open loop torque control.

P2.2.9.11.3 Open loop torque controller I gain ID640 "OL TorqCtrl I"

Defines the integration gain for open loop torque control.

7.2.5 Prohibited frequencies

In some systems it may be necessary to avoid certain frequencies because of mechanical resonance problems. With these parameters, it is possible to set limits for the prohibited frequency region and ramp rate factor to use when frequency is going above this area. When the input reference is increased, the internal reference is kept at the low limit until the input reference is above the high limit.

- P2.2.10.1 Prohibit frequency area 1; Low limit
- P2.2.10.2 Prohibit frequency area 1; High limit

- ID509 "Range 1 Low Lim"
- ID510 "Range 1 High Lim"

Range definition where a different ramp time defined by "RampTimeFactor" is used.

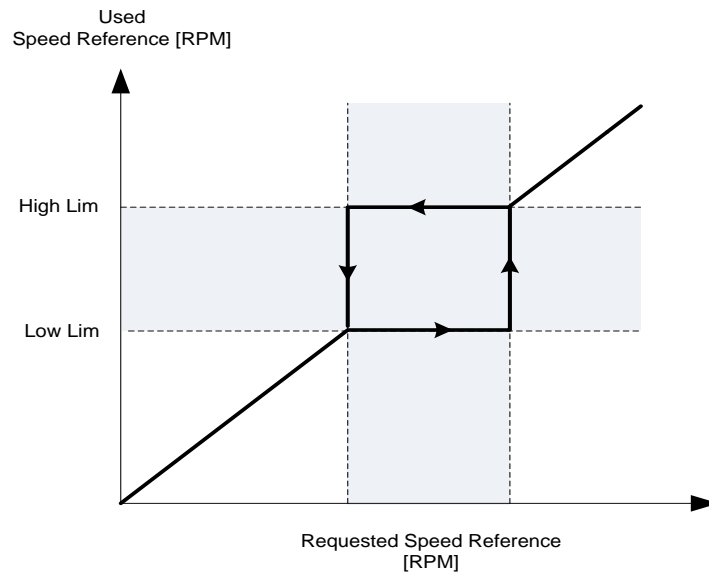

- P2.2.10.3 Ramp time factor for prohibited range

- ID518 "RampTimeFactor"

Multiplier of the currently selected ramp time between prohibit frequency limits.

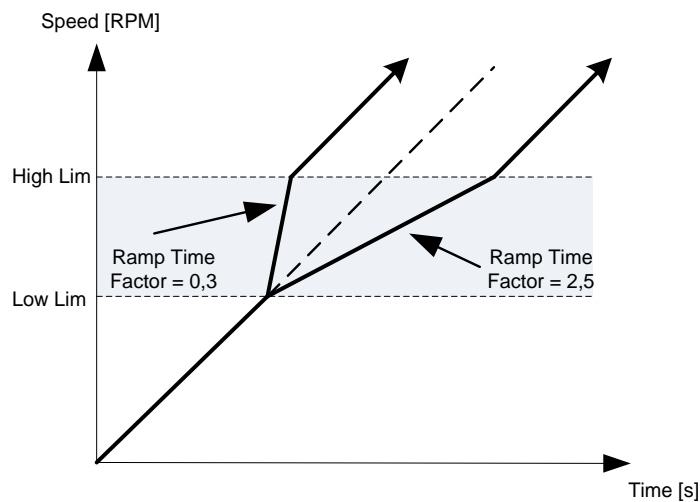
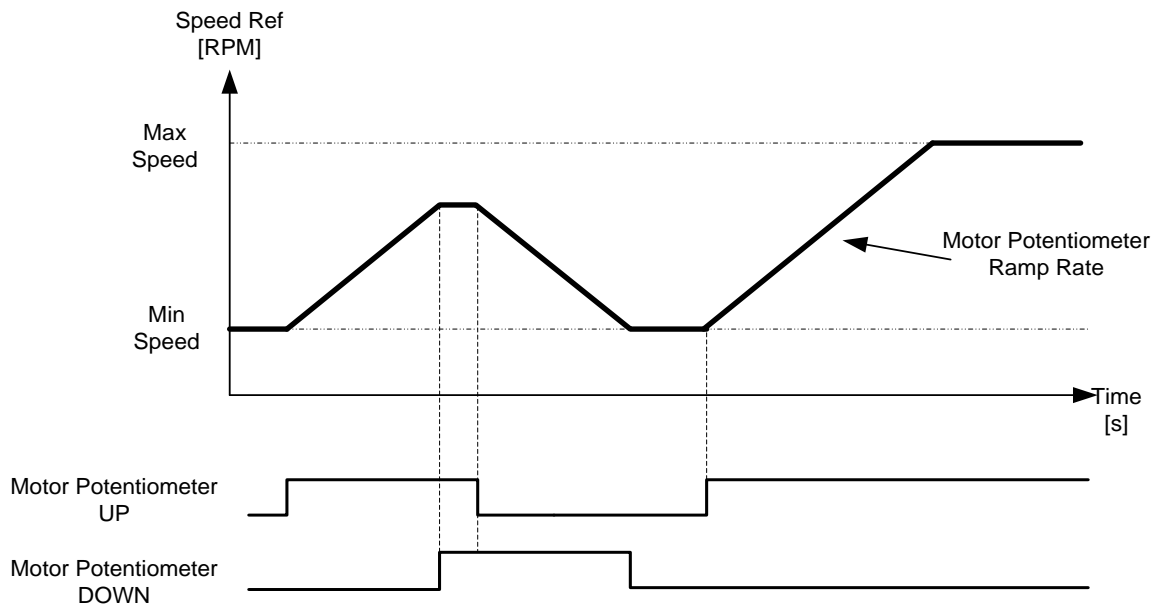

Figure 7-1. Ramp rate scaling between prohibit frequencies

7.2.6 Motor potentiometer

Motor potentiometer is used to control the reference with two digital inputs, one increasing the reference and the other decreasing the reference. The reference change rate can be set by parameter [Hz/s]. Motor potentiometer reference is available in I/O control only. It can be changed only when the drive is in running state.



P2.2.11.1 Motor potentiometer ramp rate ID331 "MotPot Ramp Rate"

Defines the rate of change of the motor potentiometer reference value in Hz/s. Normal ramp times are still active and determine how fast the actual output frequency increases.

P2.2.11.2 Motor potentiometer reference reset ID367 "MotPotRef Reset"

0 "No reset"

Reference is kept past the stop state and stored to memory in case of a power down.

1 "Stop State"

Reference is set to zero when the drive is in stop state. This selection includes power down situations.

2 "Power Down"

Reference is reset only in a power down situation.

3 "StopReq; Fout"

When the stop command is given and the drive is ramping down, the motor potentiometer reference follows the actual output frequency. If new start command is given while ramping down, the drive will stay at the frequency of the moment when start command was given.

Other parameters related to function

- P2.4.2.8 Motor potentiometer DOWN ID417 "Mot Pot Ref Down"
- P2.4.2.9 Motor potentiometer UP ID418 "Mot Pot Ref Up"

P2.2.11.3 Motor potentiometer reference copy ID366 "MotPotRefCopy"

This parameter defines how the reference is handled when the reference input is changed to motor potentiometer in I/O control.

0 "No copy"

Reference is not copied. Depending on "MotPot Reset" function, the drive may start from minimum frequency or from reference that was last used when the drive was run with motor potentiometer.

1 "Reference"

The drive's active reference is copied. If the drive is ramping when the value of motor potentiometer is changed the drive will continue ramping after the change.

This allows the reference copy in stop state unless the "MotPot Reset" function overruns it (e.g. reset in stop state is not selected).

2 "Freq. Output"

Speed at the time of change is copied to reference. If the drive is ramping when the change is made, the drive will stop ramping and keep the present speed.

7.2.7 Adjust Reference

Adjust reference function is used to fine tune the main reference. Adjust reference is added to main reference after "SpeedShare" function.

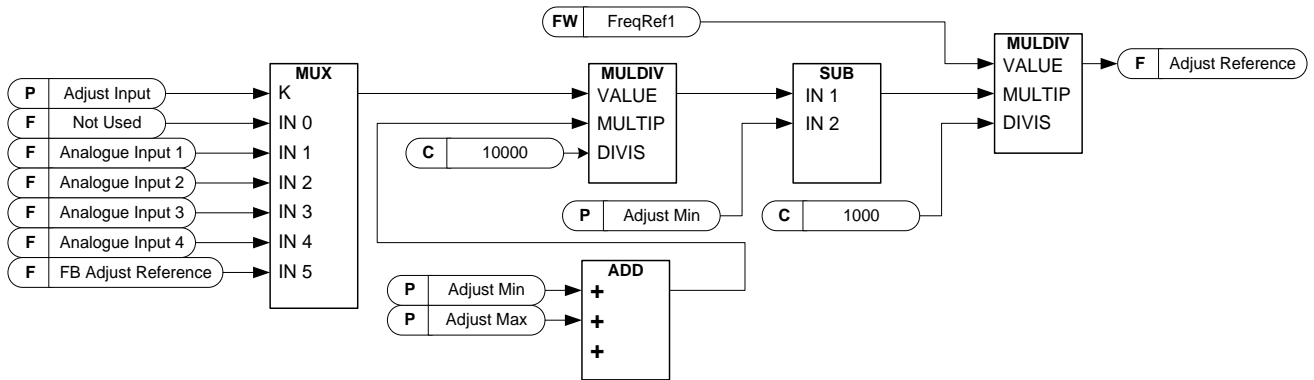

P2.2.12.1 Adjust input ID493 "Adjust Input"

With this parameter you can select the signal according to which the frequency reference to the motor is fine adjusted.

- 0 Not used
- 1 Analogue input 1
- 2 Analogue input 2
- 3 Analogue input 3
- 4 Analogue input 4
- 5 FB Adjust Reference ID47 Monitoring Signal

P2.2.12.2 Adjust minimum ID494 "Adjust minimum"

Percentage that is subtracted from the main reference when adjust input is at minimum.

P2.2.12.3 Adjust maximum ID495 "Adjust Maximum"

These parameters define the minimum and maximum of adjusted signals.

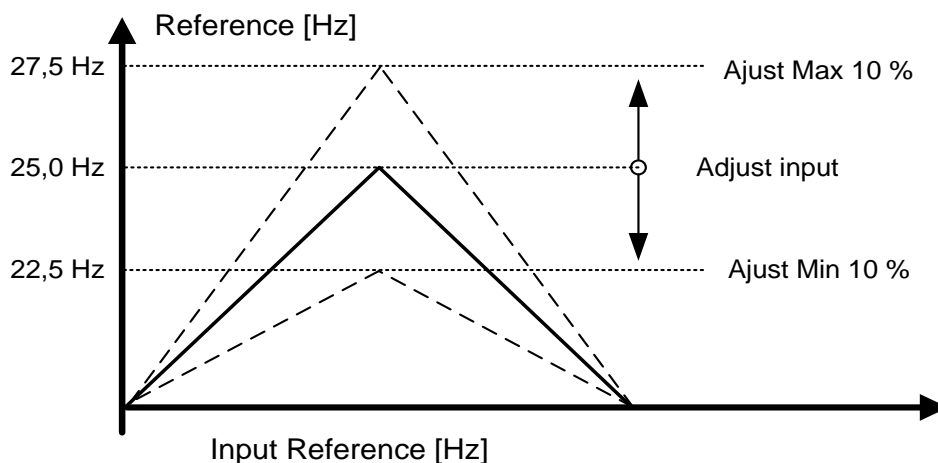

If the minimum and maximum are not equal to zero, the adjustment is not at the middle point of the analogue input or at zero point if -10...+10 Vdc input is used. In the below picture, the minimum is 20% and the maximum 10%.

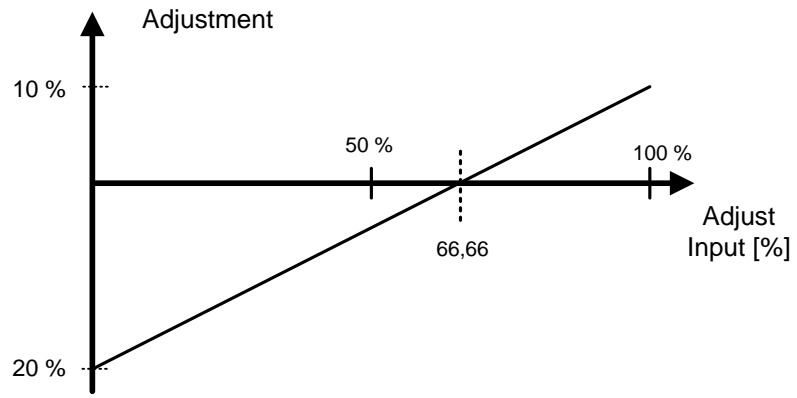

7.3 Ramp control

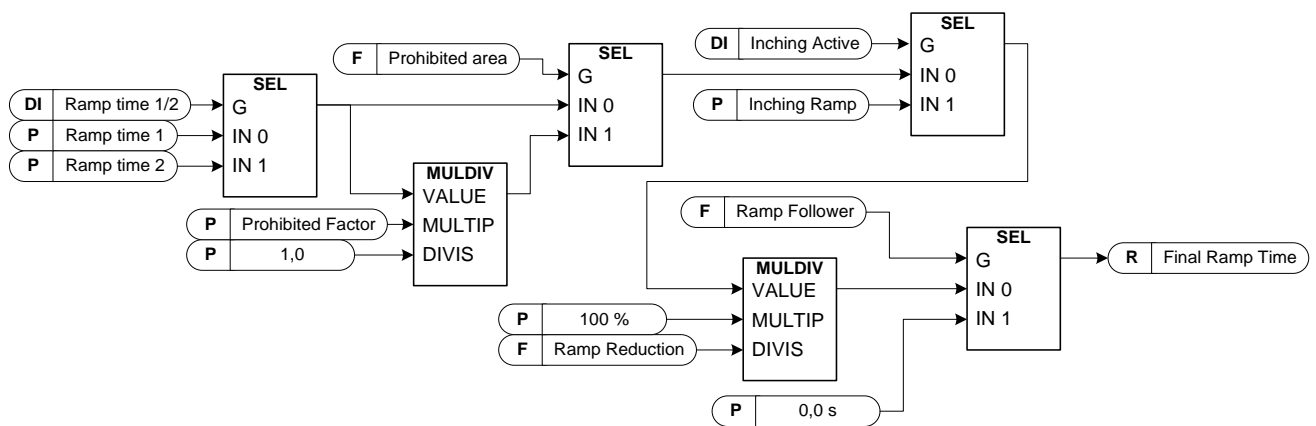

P2.3.1 Start function ID505 "Start Function"

Ramp:

- 0 The AC drive starts from 0 Hz and accelerates to the set reference frequency within the set acceleration time.

Flying start:

- 1 The AC drive is able to start with the motor running by applying current to the motor and searching for the frequency corresponding to the speed the motor is running at. Searching starts from the maximum frequency towards the zero frequency until the correct value is detected.

Use this mode if the motor is coasting when the start command is given. With the flying start it is possible to start the motor from actual speed without forcing the speed to zero before ramping to reference.

Closed loop control will always start like flying start because exact speed of the motor is known from encoder feedback.

P2.3.2 Stop function ID506 "Stop Function"

Coasting:

- 0 Drive stops controlling the motor immediately and allows motor rotate freely.

Ramp:

- 1 After the Stop command, the speed of the motor is decelerated according to the set deceleration parameters to zero speed. DI "Run Enable" will make coasting stop regardless of selected stop function.

P2.3.3 Acceleration time 1 ID103 "Accel Time 1"

This parameter defines the time required for the output frequency to increase from the zero frequency to maximum frequency in the linear ramp. When the ramp shape (ID 500) is used, the total ramp time is longer due to jerks in the beginning and end of acceleration.

P2.3.4 Deceleration time 1 ID104 "Decel Time 1"

This parameter defines the time required for the output frequency to decrease from the maximum frequency to zero frequency in the linear ramp. When the ramp shape (ID 500) is used, the total ramp time is longer due to jerks in the beginning and end of acceleration.

P2.3.5 Acceleration/Deceleration ramp 1 shape ID500 "Ramp 1 Shape"

The start and end of acceleration and deceleration ramps can be smoothed with these parameters. Setting value 0 gives a linear ramp shape which causes acceleration and deceleration to act immediately to the changes in the reference signal. Setting value 1...100% for this parameter produces an S-shaped acceleration/deceleration. Used to reduce mechanical erosion and current spikes when reference is changed.

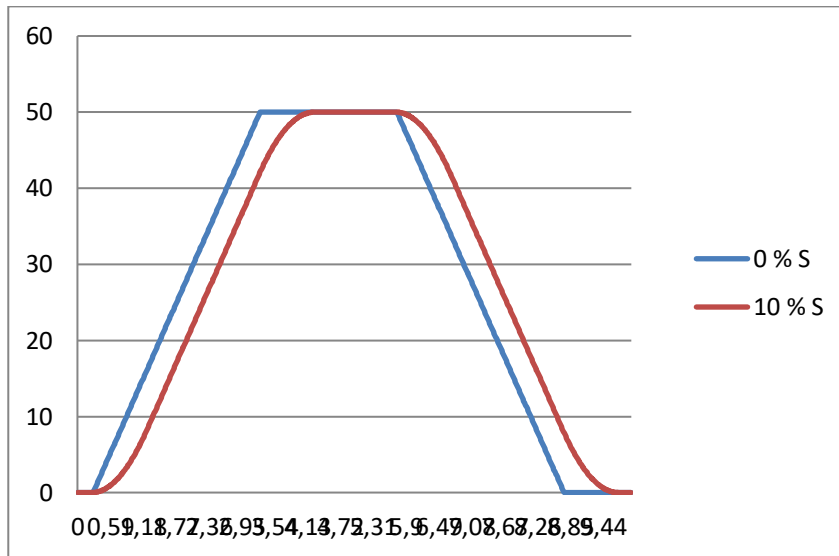

Figure 7-2. 10 % S ramp with 3 s ramp time compared to without S ramp

S-ramp time is noticed first when total ramp time is calculated.

- S-ramp time = jerk time (default 10 s)*ramp shape
- Linear ramp time = (acceleration/deceleration ramp time) – (s-ramp time)
- Total ramp time = s-ramp time + linear ramp time + s-ramp time

When ramp time is 3 s and shape is 10% then total ramp time is 4 s as in the figure 7-2.

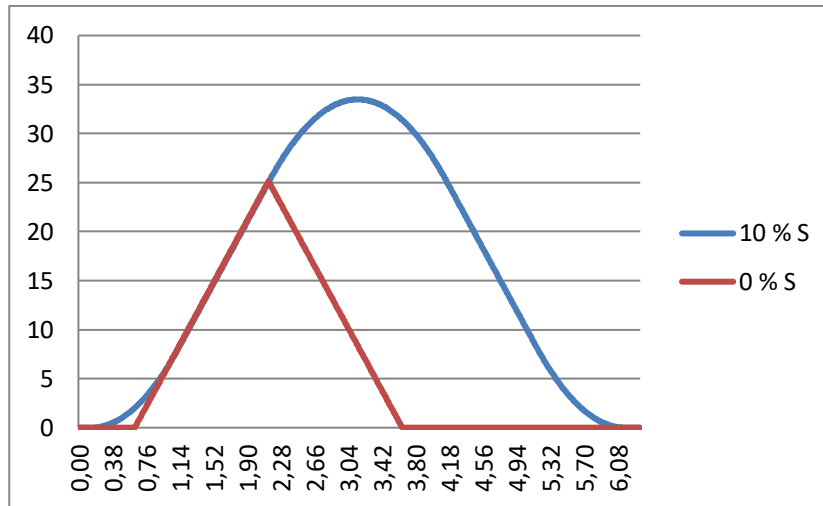

Figure 7-3. 10% S ramp with 3 s ramp time when reference set to zero at 25 Hz

Linear ramp is stopped when 25 Hz is reached in the figure 7-3. However s-ramp is completed in this situation.

P2.3.6 Acceleration time 2 ID502 "Accel Time 2"

P2.3.7 Deceleration time 2 ID503 "Decel"

P2.3.8 Acceleration/Deceleration ramp 2 shape ID501 "Ramp 2 Shape"

These ramp times and ramp shapes are used when the second ramp time is activated by digital input "Acc/Dec Time Sel"

P2.3.9 Inching ramp ID1257 "Inching Ramp"

This parameter defines acceleration and deceleration times when inching is active. Inching function will start the drive to reference without additional start command regardless of control place. Inching function requires enabling from digital input before command is accepted. Inching is also disabled if there is a start command active on the active control place.

Other parameters for inching:

- Parameter: Inching Reference 1
- Parameter: Inching Reference 2
- Digital input selection: Enable Inching
- Digital input selection: Inching 1
- Digital input selection: Inching 2

P2.3.10 Reduction of acceleration and deceleration times ID401

Acceleration and deceleration times can be reduced with the input signal. Input signal level zero means that the ramp times are set by parameters. Maximum level equals one tenth of the value set by parameter.

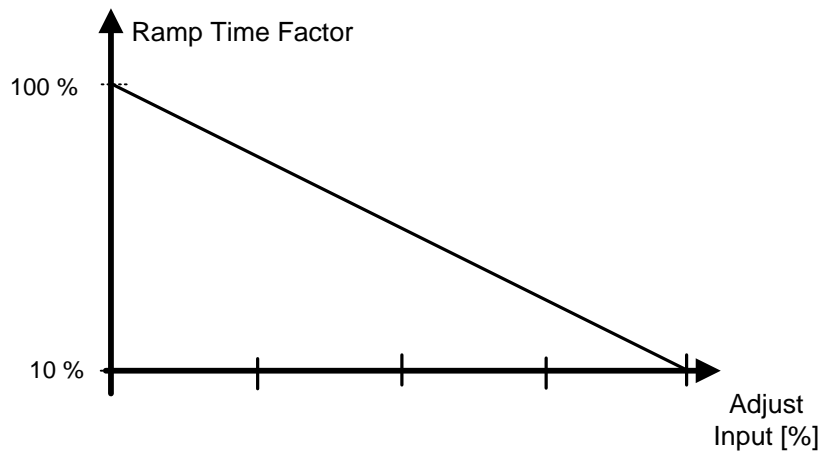

Figure 7-4. Reducing acceleration and deceleration times

7.3.1 Quick Stop

P2.3.11.1 Quick stop mode ID1276 "Quick Stop Mode"

Selects the mode of stopping the drive when quick stop is active.

- It is recommended to use same stop function in follower drives.
- It is recommended to use same ramp time in both drives

0 Coast stop.

1 Ramp stop.

P2.3.11.2 Quick Stop Ramp time ID1256

Ramp time while quick stop with ramp is executed.

7.3.2 Ramp Options

P2.3.12.1 Ramp: Skip S2/S4

ID1900

This function is used to bypass the second corner S ramp (i.e. to avoid the unnecessary speed increase, the blue line in Figure 7-5), when the reference is changed before the final speed is reached. Also S4 is bypassed when the reference is increased while speed is ramping down.

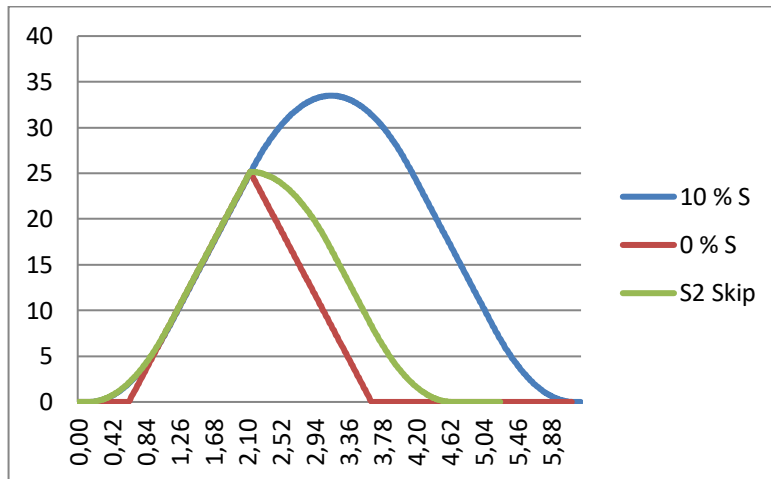

Figure 7-5. Second S curve is bypassed when reference changes at 25 Hz

P2.3.12.2 CL Ramp generator follows encoder ID1902

“CLRmpFollEncFreq”

In a normal situation, the ramp generator is not updated with the actual speed from the encoder (like in open loop control). When the limiting situation has passed (with a step), the speed is accelerated against the limit controller to the reference speed (if speed control is used). In case this parameter is active, the speed will increase with the set ramp times.

This parameter also sets the Ramp Frequency to actual frequency when change from torque control to speed control is made.

Note: Disable this parameter if drive is used for hoisting.

Note: When using under voltage controller function 2 (Ramping to zero speed) this parameter needs to be activated to have similar operation than in open loop control.

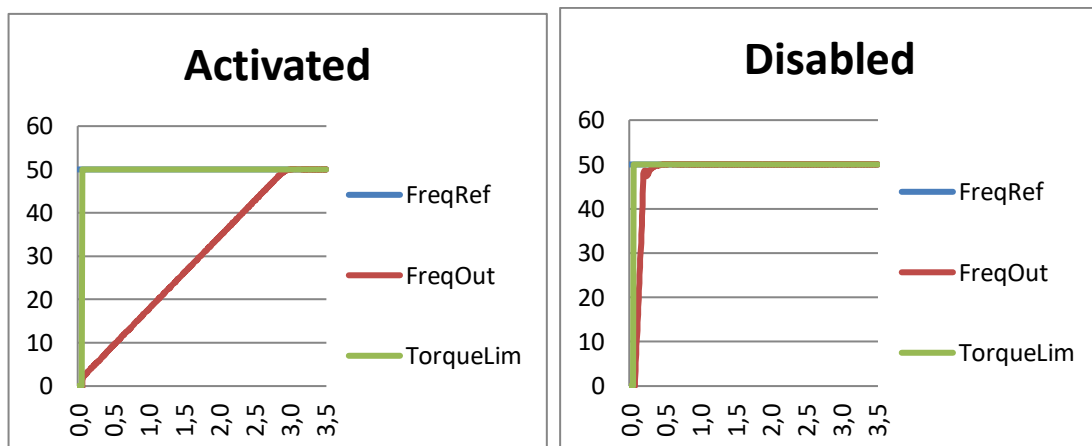

P2.3.12.3 Speed Reference Interpolator TC ID1184 "Ramp In Inter. TC"

Use this parameter to set the time during which the interval speed reference is updated. This function ramps the reference between updated values.

Function is used when the PLC is updating the reference to, for example, 100 ms time level but the drive's own ramp is set much shorter to have fast response. When the reference (Green) is used without interpolator, also the output frequency would behave in the same way causing torque and current spikes every time reference changes. When the interpolator time is set to 100 ms, the output frequency behaves as blue line.

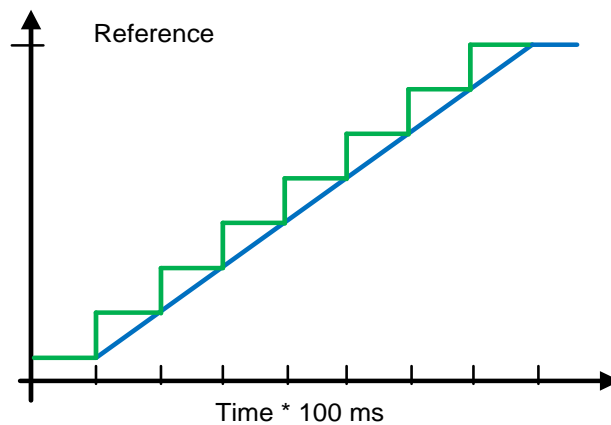

P2.3.12.4 Extend Zero Speed Time ID529 "ExtntZeroSpdTime"

Use this parameter to extend zero speed time until speed is nearly zero.

0 = No

No extension of zero speed time.

1 = Yes

Zero speed is extended until speed is zero.

7.4 Input signals

7.4.1 Basic Settings

P2.4.1.1 Start/Stop logic selection ID300 "Start/Stop Logic"

This parameter defines the start stop logic when using the I/O control. Some of these selections do not include the 'Reverse' command. The Reverse command can be activated by a separate digital input "Reverse".

0 "Forw – Rev" – Forward Start – Reverse Start

Start 1: closed contact = start forward DI "Start 1"

Start 2: closed contact = start reverse DI "Start 2"

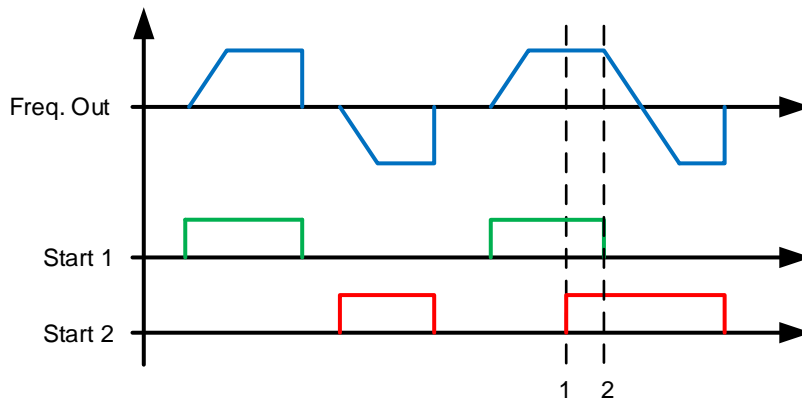

Figure 7-6. Start forward/Start reverse

- ① The first selected direction has the highest priority.
- ② When the DIN1 contact opens the direction of rotation starts the change.

1 "Start – Rev" - Start command – Direction command

Start 1: closed contact = start open contact = stop

Start 2: closed contact = reverse open contact = forward

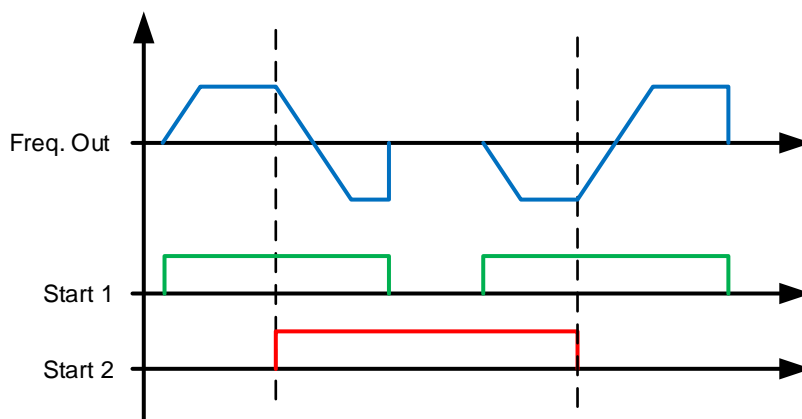

Figure 7-7. Start, Stop, Reverse

2 "Start – Enable" – Start command – Run Enable

DIN1: closed contact = start open contact = stop

DIN2: closed contact = start enabled open contact = start disabled and drive stopped if running

3 “StartP-StopP” – Start Pulse – Stop Pulse

3-wire connection (pulse control):

DIN1: closed contact = start pulse

DIN2: open contact = stop pulse, falling edge.

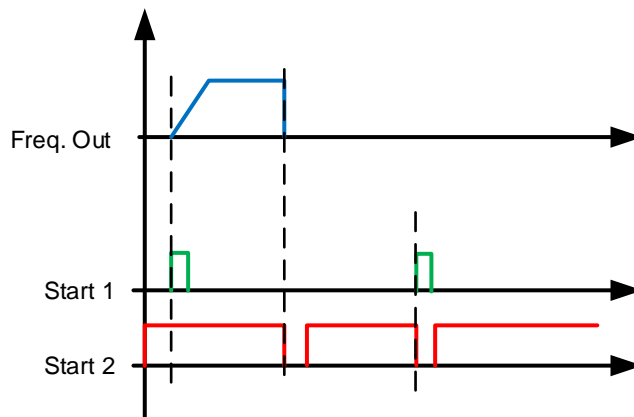

Figure 7-8. Start pulse/ Stop pulse.

The selections including the text 'Rising edge required to start' must be used to exclude the possibility of an unintentional start when, for example, power is connected, re-connected after a power failure, after a fault reset, after the drive is stopped by Run Enable (Run Enable = False) or when the control place is changed. The Start/Stop contact must be opened before the motor can be started.

4 “Strt-MotP UP” – Start – Motor potentiometer UP

DIN1: closed contact = start forward

DIN2: closed contact = Increases motor potentiometer reference, see Motor potentiometer function for more details.

5 “ForwR – RevR” – Forward start rising edge – Reverse start rising edge

DIN1: closed contact = start forward (Rising edge required to start)

DIN2: closed contact = start reverse (Rising edge required to start)

6 “StartR-Rev” - Start command rising edge – Direction command

DIN1: closed contact = start (Rising edge required to start)

open contact = stop

DIN2: closed contact = reverse

open contact = forward

7 “StrtR-Enable” – Start command rising edge – Run Enable

DIN1: closed contact = start (Rising edge required to start)

open contact = stop

DIN2: closed contact = start enabled

open contact = start disabled and drive stopped if running

8 “RPuls-RPuls” – Start rising edge – Stop rising edge

DIN1: closed contact = Start (Rising edge required to start)

DIN2: closed contact = Stop (Rising edge required to stop)

7.4.2 Digital inputs

P2.4.2.1 Start signal 1 ID403 "Start Signal 1"

Signal selection 1 for the start/stop logic.
This is for Start Place A, selected with P2.4.2.39
Default programming A.1.Default Forward start.

P2.4.2.2 Start signal 2 ID404 "Start Signal 2"

Signal selection 2 for the start/stop logic.
This is for Start Place A, selected with P2.4.2.39
Default programming A.2. Default Reverse start.

P2.4.2.3 Run enable ID407 "Run Enable"

When run enable is removed from the drive, the coasting stop is always made.
The drive will also show warning indication when the run is disabled.

Contact open: Start of motor disabled
Contact closed: Start of motor enabled

P2.4.2.4 Reverse ID412 "Reverse"

This reverse command is active when Start signal 2 is not used for reverse command because setting of "Start/Stop logic selection" parameter.

Contact open: Direction forward
Contact closed: Direction reverse

P2.4.2.5 Preset speed 1 ID419 "Preset Speed 1"

P2.4.2.6 Preset speed 2 ID419 "Preset Speed 2"

P2.4.2.7 Preset speed 3 ID419 "Preset Speed 3"

Digital input selections for activating preset speeds.
References are set in the "Constant Reference" parameter group.

Speed	Digital Input Preset speed 1	Digital Input Preset speed 2	Digital Input Preset speed 3
Basic speed	0	0	0
Preset Speed 1	1	0	0
Preset Speed 2	0	1	0
Preset Speed 3	1	1	0
Preset Speed 4	0	0	1
Preset Speed 5	1	0	1
Preset Speed 6	0	1	1
Preset Speed 7	1	1	1

Related parameters

- G2.2.7 Constant Ref

P2.4.2.8 Motor potentiometer DOWN ID417 "Mot Pot Ref Down"

Contact closed: Motor potentiometer reference DECREASES until the contact is opened. See details in G2.2.11 Motor Pot.

P2.4.2.9 Motor potentiometer UP ID418 "Mot Pot Ref Up"

Contact closed: Motor potentiometer reference DECREASES until the contact is opened. See details in G2.2.11 Motor Pot.

P2.4.2.10 Fault reset ID414 "Fault Reset"

Rising edge required to reset fault.

P2.4.2.11 External fault closing contactor ID405 "Ext Fault Close"

External fault input closing contactor, response selected in protection parameter group G2.11.1 Protections / General. Gives fault "51 Ext Fault"

P2.4.2.12 External fault opening contactor ID406 "Ext Fault Open"

External fault input opening contactor, response selected in protection parameter group. Gives fault "51 Ext Fault"

P2.4.2.13 Acceleration/Deceleration time selection ID408 "Acc/Dec Time Sel"

Digital input to select between ramp time 1 and 2, times are set in "Ramp Control" parameter group.

Contact open: Acceleration/Deceleration time 1 selected

Contact closed: Acceleration/Deceleration time 2 selected

P2.4.2.14 Acceleration/Deceleration prohibited ID415 "Acc/Dec Prohibit"

Contact closed: No acceleration or deceleration possible until the contact is opened.

With P2.9.3 Control Options B13 B13, it is possible to select if the deceleration direction is allowed so that the speed is reduced when the reference is smaller than the drive speed at the time.

P2.4.2.15 DC-braking command ID416 "DC Brake Command"

Contact closed: In STOP mode, the DC braking operates until the contact is opened. Current level is set with P2.7.1.16 DCBrakeCurInStop parameter.

P2.4.2.16 Jogging speed ID413 "Jogging Speed"

Contact closed: Jogging speed selected for frequency reference
Reference for jogging speed is set in G2.2.7 Constant Reference group.

P2.4.2.16 I/O Reference 1/2 selection ID422 "I/O Ref. 1/2"

With this parameter you can select either AI1 or AI2 signal for frequency reference if I/O reference selection is "14 / AI1/AI2 Sel".

If selection for P2.2.1 I/O Reference is other than "14 / AI1/AI2 Sel" this digital input will change reference between P2.2.1 I/O Reference and P2.2.4 I/O Reference 2.

7.4.2.1 *Forced control place*

Digital inputs can be used to bypass parameter P3.1 Control Place, for example, in an emergency situation when PLC is not able to send command to the drive.

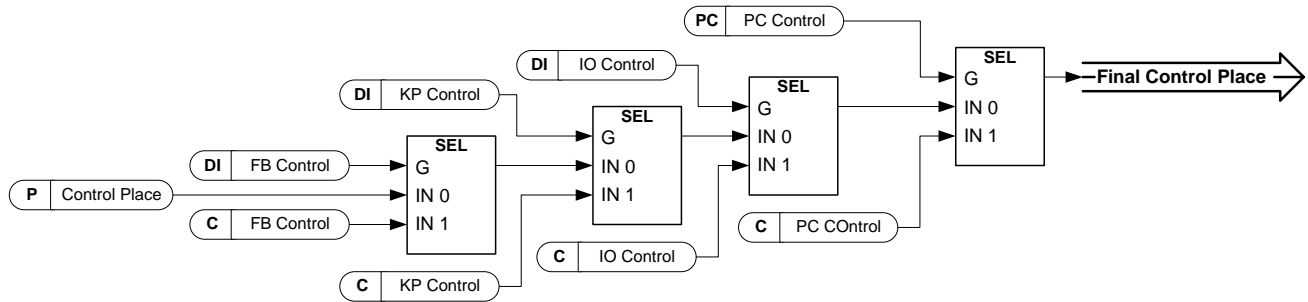

Figure 7-9. Control place selection priority order

P2.4.2.18 Control from I/O terminal ID409 "I/O Term Control"

Contact closed: Force control place to I/O terminal

P2.4.2.19 Control from keypad ID410 "Keypad Control"

Contact closed: Force control place to keypad

P2.4.2.20 Control from Fieldbus ID411 "Fieldbus Control"

Contact closed: Force control place to fieldbus

NOTE: When the control place is forced to change the values of Start/Stop, Direction and Reference valid in the respective control place are used. The value of parameter ID125 (Keypad Control Place) does not change. When the input opens the control place is selected according to keypad control parameter P3.1 Control Place

P2.4.2.21 Parameter Set 1/Set 2 selection ID496 "Param Set1/Set2"

With this parameter you can select between Parameter Set 1 and Set 2. Remember to put the same input for both parameter set. Parameter sets cannot be changed while the drive is in run state.

- Digital input = FALSE:
- Set 1 is loaded as the active set
- Digital input = TRUE:
- Set 2 is loaded as the active set

When making two parameter sets from the keypad

1. Set all parameters as needed for SET1
2. In "P6.3.1 Parameter Set" select "Store Set1"
3. Set all parameters as needed for SET 1
4. In "P6.3.1 Parameter Set" select "Store Set2"

Active Set shown in Status Word B9

Note: The parameter values are stored only when selecting parameter P6.3.1 Parameter sets Store Set 1 or Store Set 2 or from VACON® NCDriver: Drive > Parameter Sets.

P2.4.2.22 Motor control mode 1/2 ID164 "Mot Ctrl Mode1/2"

This digital input is used to change between two motor control mode selection parameters:

- P2.8.1 Motor Ctrl Mode ID600
- P2.8.2 Motor Ctrl Mode2 ID521

Contact is open = Motor control mode 1 is selected

Contact is closed = Motor control mode 2 is selected

When changing between open loop and closed loop control modes, make this change in stop state.

P2.4.2.23 External brake acknowledgment. ID1210 "Ext. Brake ACK"

Connect this input signal to auxiliary contact of mechanical brake. If contact is not closed within the given time when brake is opened, the drive will generate a brake fault F58. The response can be selected in G2.14 Brake Control parameter group.

P2.4.2.24 Cooling monitor ID750 "Cooling Monitor"

When using a liquid-cooled drive, connect this input to the *Cooling OK* signal from VACON® flow control application or any input that shows state of used cooling unit. See details of operation from G2.11.9 cooling parameters group.

7.4.2.2 Inching function

Inching function will start the drive to reference without additional start command regardless of control place. Inching requires enabling from digital input before the command is accepted. Inching is also disabled if there is a start command active on the active control place.

P2.4.2.25 Enable Inching ID532 "Enable Inching"

If you are using inching function the given input must be set TRUE by either digital signal or by setting the parameter value to 0.2.

P2.4.2.26 Inching reference 1 ID530 "Inching 1"**P2.4.2.27 Inching reference 2 ID531 "Inching 2"**

These inputs activate inching reference if inching is enabled. These inputs also start the drive if activated and if there is no Run Request command from anywhere else.

Other parameter for inching function

- | | | | | |
|---|-----------|---------------------|--------|-----------------|
| - | P2.3.9 | Inching Ramp | ID1257 | "Inching Ramp" |
| - | P2.2.7.9 | Inching reference 1 | ID1239 | "Inching Ref 1" |
| - | P2.2.7.10 | Inching reference 2 | ID1240 | "Inching Ref 2" |

- P2.4.2.28 *Motoring Power limit Digital input 1* ID1500 "Mot.PowerLimit 1"
- P2.4.2.29 *Motoring Power limit Digital input 2* ID1501 "Mot.PowerLimit 2"

With this parameter you can select the desired digital input for controlling motoring power limit. "Mot.PowerLimit 1" and "Mot.PowerLimit 2" activates respective power limits defined in parameter group G2.6.2 Power Handling. If both inputs are activated power limit is zero.

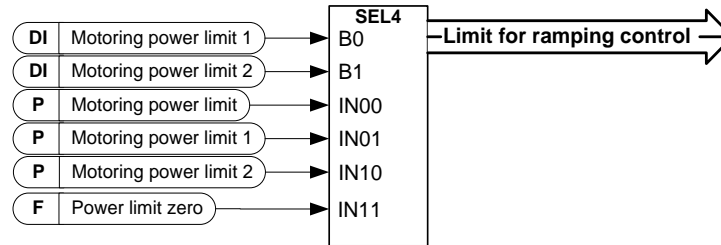

- P2.4.2.30 *Digital input 2nd Frequency Limit* ID1511 "Max frequency 2"

With this parameter you can select the digital input that will limit the maximum frequency to a lower value than what is defined by Maximum Frequency. This limit does not affect any constant references. The limit is set in G2.6.4 Freq. Limit Handling.

- P2.4.2.31 *Generator Power limit Digital input 1* ID1506 "Gen.PowerLimit 1"
- P2.4.2.32 *Generator Power limit Digital input 2* ID1507 "Gen.PowerLimit 2"

With these parameters you can select the desired digital input for controlling the generator power limit. "Gen.PowerLimit 1" and "Gen.PowerLimit 2" activate the respective power limits defined in G2.6.2 Power Handling parameter group. If both inputs are activated, the power limit is zero.

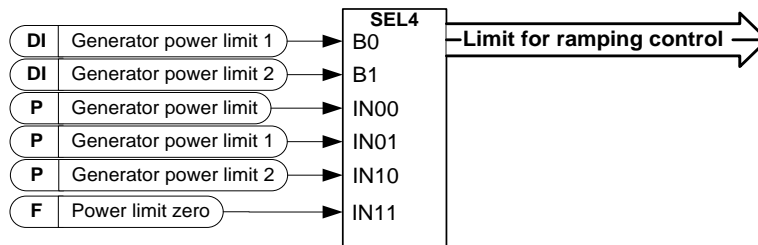

- P2.4.2.33 *Reset encoder counter* ID1090 "Reset Position"

When using encoder, the drive monitors the encoder rotations and angle (V: Shaft Rounds and V:Shaft Angle).

When this input has a rising edge monitoring values V:Shaft Angle (ID1169) and Shaft Rounds (ID1170) are set to zero. Reset command is also included in V: Aux Control Word.

- P2.4.2.34 *Master Follower mode 2* ID1092 "MF Mode 2"

Master Follower mode can be changed with digital input between P2.10.1 MF Mode and P2.10.5: MF Mode 2 in the Master Follower parameter group. This can be used for redundancy purposes, for example, when using a Drive Synch system.

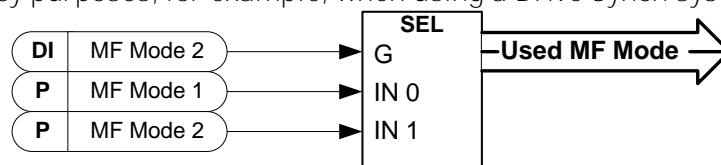

- P2.4.2.35 Quick Stop** **ID1213** **“Quick Stop”**
 Digital input for Quick Stop function
- P2.4.2.36 Motoring Torque Limit 1** **ID1624** **“Mot. Torq. Limit 1”**
 Digital input for activating motoring torque limit 1
- P2.4.2.37 Generator Torque Limit 1** **ID1626** **“Gen. Torq. Limit 1”**
 Digital input for activation generator torque limit 1
- P2.4.2.38 PIC Function Activation** **ID1804** **“PI Activation”**
 Select the digital input that will activate PI controller. Set selection to 0.2 and PI-controller is activated without external wiring.
- P2.4.2.39 Store Parameters** **ID1753** **“Store Param. Set”**
 Stores active set to currently selected parameters set. Selection is done by “Param. Set1/Set2” digital input that is also used to load parameter set to active set.
- P2.4.2.40 Start Place A/B** **ID425** **“Start PlaceA/B”**
 This parameter is used to select if start signal in IO control is monitored from P2.4.2.1 and P2.4.2.2
- P2.4.2.41 Start signal 1B** **ID423** **“Start Signal 1B”**
 Signal selection 1B for the start/stop logic.
 This is for Start Place B, selected with P2.4.2.39
 Default programming 0.1.Default Forward start, selected with P2.4.1.1.
- P2.4.2.42 Start signal 2B** **ID424** **“Start Signal 2B”**
 Signal selection 2B for the start/stop logic.
 This is for Start Place B, selected with P2.4.2.39
 Default programming 0.1. Default Reverse start, selected with P2.4.1.1.
- P2.4.2.43 RR Enable** **ID1896** **“RR Enable”**
 Run Request Enable command. This can be used to disable Start command at its latest point i.e. just before start command is given to motor control. Useful to test function that are related to start command but drive is not wanted to start modulation.

7.4.3 Analogue Input 1 & 2

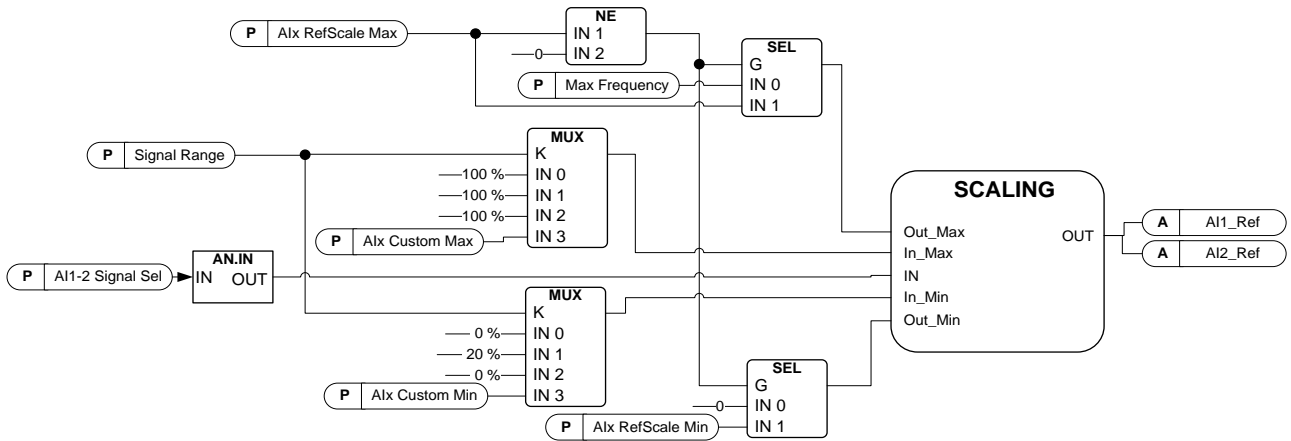

P2.4.3.1 AI1 signal selection ID377 "AI1 Signal Sel"

P2.4.4.1 AI2 signal selection ID388 "AI2 Signal Sel"

Connect the AI1/AI2 signal to the analogue input of your choice with this parameter. For more information about the TTF programming method, see chapter 4.

P2.4.3.2 Analogue input 1 reference filter time ID324 "AI1 Filter Time"

P2.4.4.2 Analogue input 2 reference filter time ID329 "AI2 Filter Time"

First order filtering is used for analogue signals that are used to control, for example, the power limit. Second order filtering is used for frequency reference filtering.

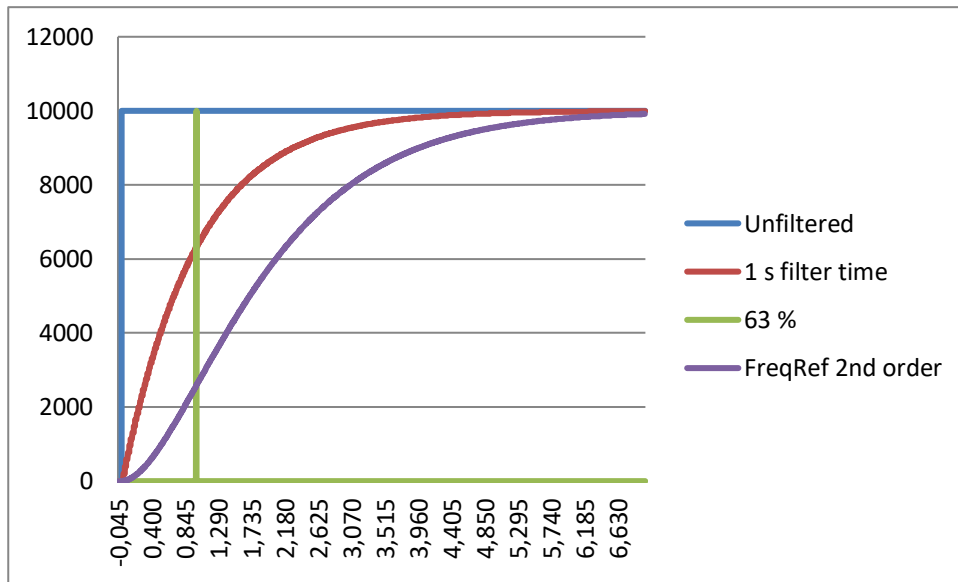

Figure 7-10. AI1 signal filtering

P2.4.3.3 Analogue input signal 1 signal range ID320 "AI1 Signal Range"

P2.4.4.3 Analogue input signal 2 signal range ID325 "AI2 Signal Range"

0 "0-20mA/10V"

Signal input ranges: 0...10 V and 0...20 mA.
Input signal is used from 0% to 100%.

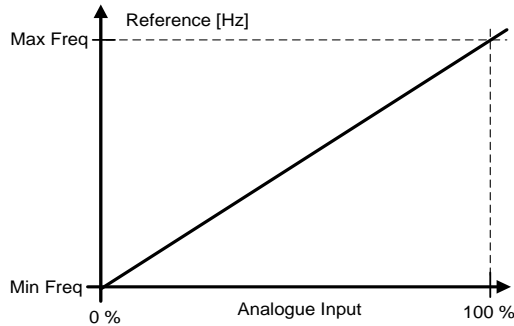

1 "4-20 mA"

Signal input ranges: 4 – 20 mA and 2 – 10 V
Input signal is used from 20% to 100%

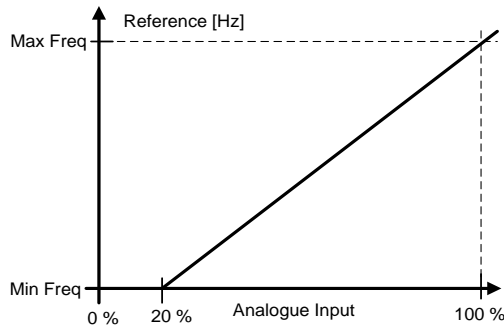

2 "-10 - + 10 V"

Signal input range: -10 V - + 10 V.
Input signal is used from -100% to +100%.

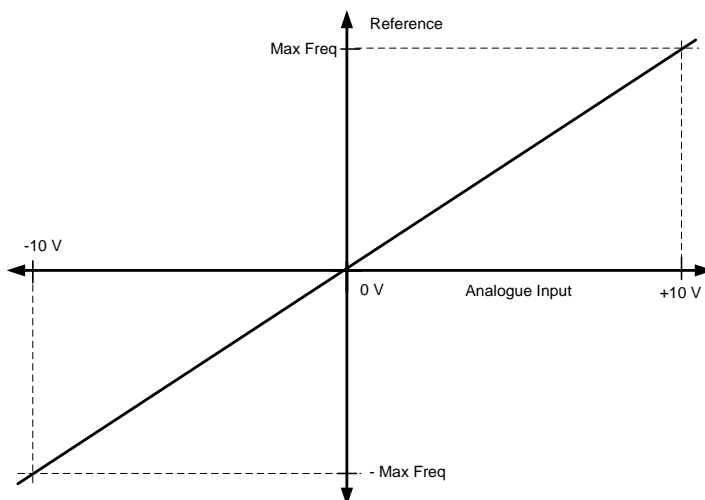

3 “Custom Range”

With custom range, it is possible to freely adjust the input level that corresponds to the minimum and maximum frequencies.

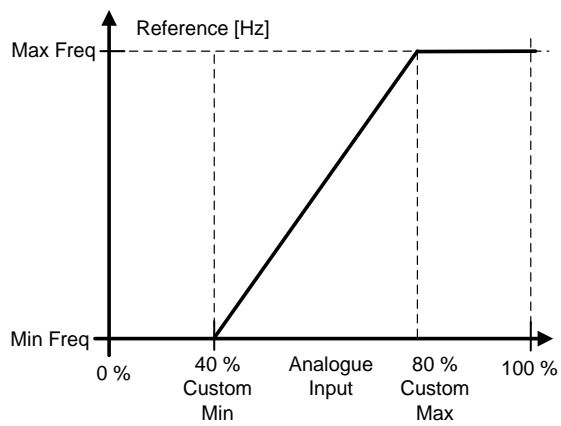

- P2.4.3.4 AI1 custom minimum setting ID321 "AI1 Custom Min"
- P2.4.3.5 AI1 custom maximum setting ID322 "AI1 Custom Max"
- P2.4.4.4 AI2 custom minimum setting ID326 "AI2 Custom Min"
- P2.4.4.5 AI2 custom maximum setting ID327 "AI2 Custom Max"

These parameters set the analogue input signal for any input signal span within -160...160%. For example, if the signal input scaling is set to 40%...80%, the reference can be changed from 8 mA (for Minimum Frequency) to 16 mA (for Maximum Frequency).

- P2.4.3.6 AI1 Reference scaling, minimum value ID303 "AI1 RefScale Min"
- P2.4.3.7 AI1 Reference scaling, maximum value ID304 "AI1 RefScale Max"
- P2.4.4.6 AI2 reference scaling, minimum value ID393 "AI2 RefScale Min"
- P2.4.4.7 AI2 reference scaling, maximum value ID394 "AI2 RefScale Max"

Additional reference scaling. Analogue input reference scaling can be set to a different value than the minimum and maximum frequency.

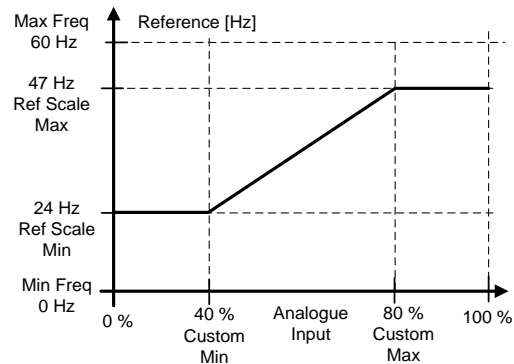
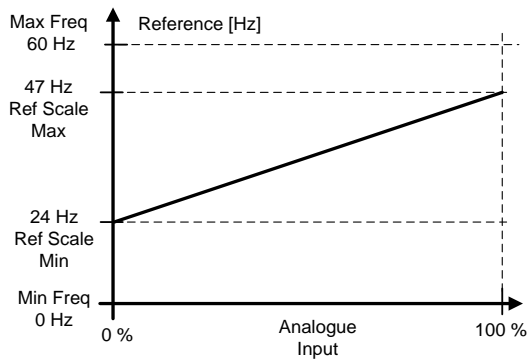

- P2.4.3.8 Analogue Input 1 joystick input dead zone ID382 "AI1 JoysDeadZone"
- P2.4.4.8 Analogue Input 2 joystick input dead zone ID395 "AI2 JoysDeadZone"

The small values of the reference around zero can be ignored by setting this value greater than zero. When the reference lies between zero and ± this parameter, it is forced to zero.

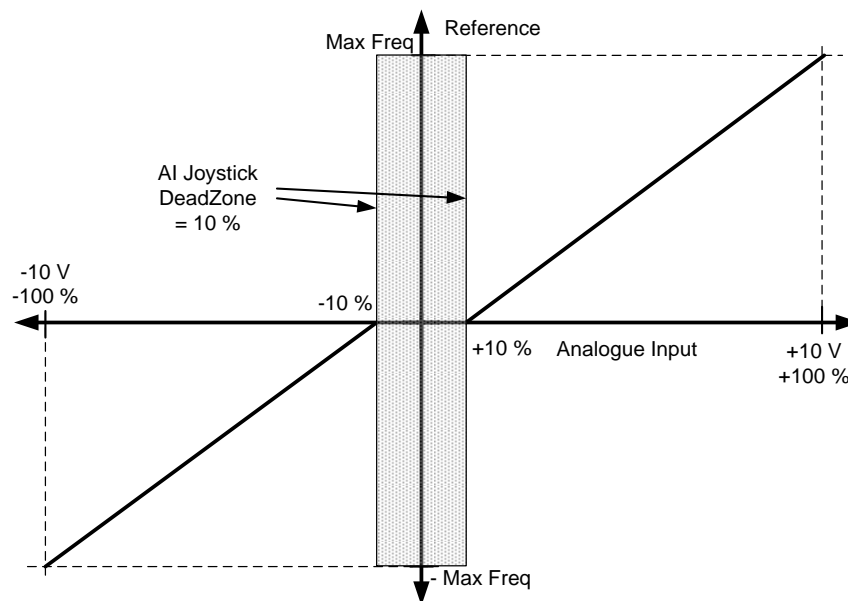

7.4.3.1 *Sleep function*

The drive can be stopped by sleep function when the analogue input falls below a certain value for a certain time and speed functions become active.

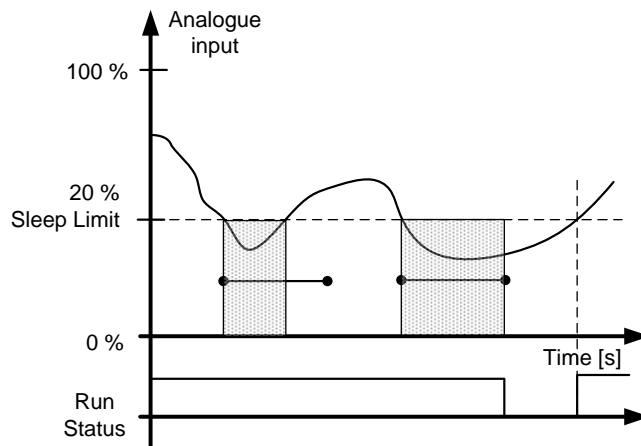

P2.4.3.9 *A11 sleep limit* ID385 "A11 Sleep Limit"

P2.4.4.9 *A12 sleep limit* ID396 "A12 Sleep Limit"

The drive is stopped automatically, if the AI signal level falls below the Sleep limit defined with this parameter. In joystick function, when input is between zero and \pm this parameter the drive will go to sleep state.

P2.4.3.10 *A11 sleep delay* ID386 "A11 Sleep Delay"

P2.4.4.10 *A12 sleep delay* ID397 "A12 Sleep Delay"

This parameter defines the time the analogue input signal has to stay under the sleep limit in order to stop the drive.

P2.4.3.11 *A11 joystick offset* ID165 "A11 Joyst. Offset"

P2.4.4.11 *A12 joystick offset* ID166 "A12 Joyst. Offset"

Defines the frequency zero point as follows:

With this parameter on display, place the potentiometer in the assumed zero point and press *Enter* on keypad.

Note: This will not, however, change the reference scaling.
Press *Reset* button to change the parameter value back to 0.00%.

7.4.4 Analogue input 3 & 4

Analogue Inputs 3 and 4 can be written from fieldbus. Use of analogue scaling for fieldbus signals can be useful, for example, when the PLC is not operational and the drive receives a zero, for example, to the power limit. With analogue input scaling it is possible to use inverted signal and have 100% power limit for emergency run, while the power limit value from PLC is zero.

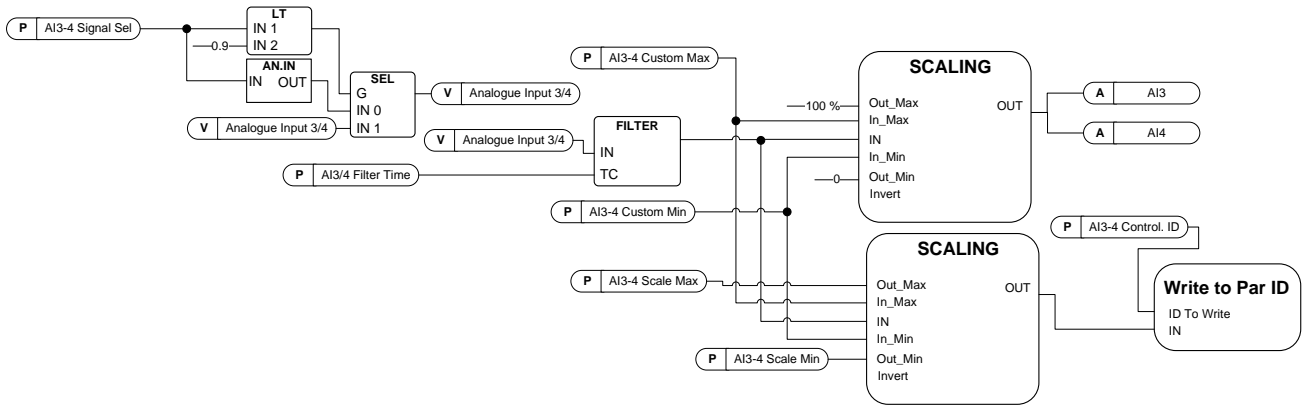

P2.4.5.1 AI3 signal selection ID141 “AI3 Signal Sel”

P2.4.6.1 AI4 signal selection ID152 “AI4 Signal Sel”

Connect the AI3/AI4 signal to the analogue input of your choice with this parameter. For more information, see Chapter 4 “Terminal To Function” (TTF) programming principle.

When the parameter for Analogue input signal selection is set to 0.1, you can control the analogue input monitoring variable from Fieldbus by assigning the Process Data Input ID number to the analogue input monitoring signal thus allowing the PLC input signals to be scaled with analogue input scaling functions.

P2.4.5.2 Analogue input 3 signal filtering time ID142 “AI3 Filter Time”

P2.4.6.2 Analogue input 4 signal filtering time ID153 “AI3 Filter Time”

First order filtering is used for analogue inputs signals 3 and 4.

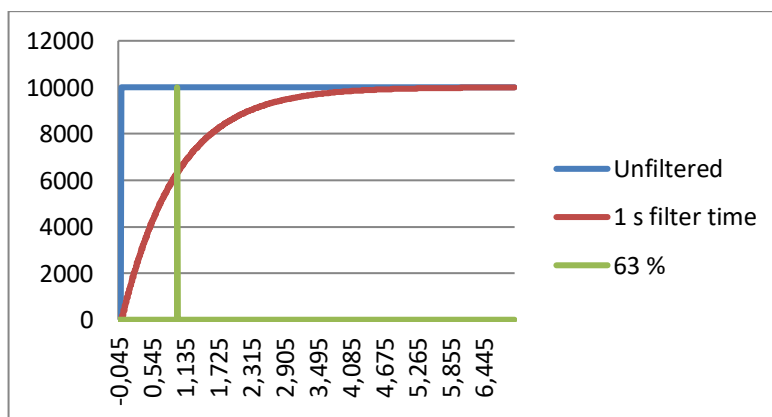

- P2.4.5.3 AI3 custom setting minimum ID144 "AI3 Custom Min"
- P2.4.5.4 AI3 custom setting maximum ID145 "AI3 Custom Max"
- P2.4.6.3 AI4 custom setting minimum ID155 "AI4 Custom Min"
- P2.4.6.4 AI4 custom setting maximum ID156 "AI4 Custom Max"

Set the custom minimum and maximum input levels for the AI3 signal within -160...160%.

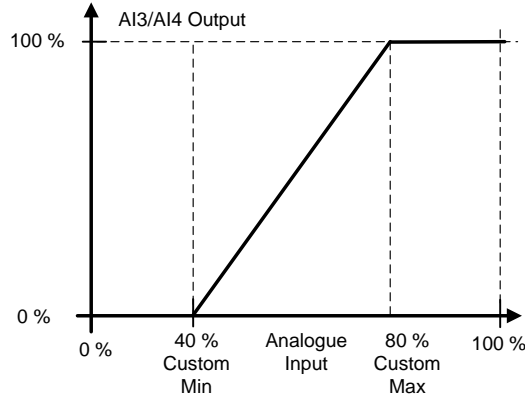

- P2.4.5.5 AI3 signal inversion ID151 "AI3 Signal Inv"
- P2.4.6.5 AI4 signal inversion ID162 "AI3 Signal Inv"

The signal inversion function is useful if, for example, the PLC is sending power limit to the drive using fieldbus. If the PLC is unable to communicate with the drive, the power limit from fieldbus to the drive would be zero. Using an inverted signal logic zero value from PLC would mean maximum power limit. When inversion is needed for the process data signal fieldbus values need to be written to Analogue input monitoring signals. See parameter P2.4.5.1 AI3 Signal selection for details.

- 0 = No inversion
- 1 = Signal inverted

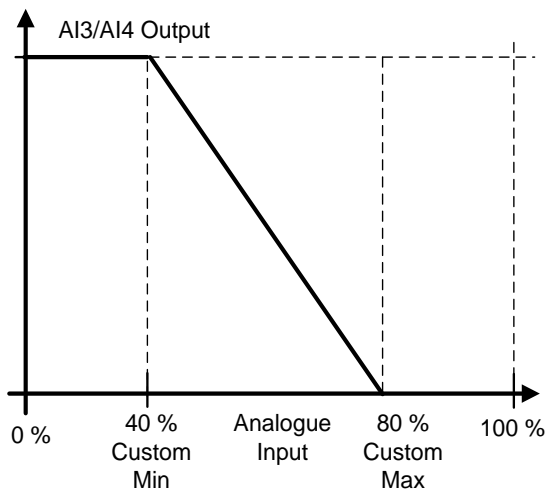

7.4.4.1 *Analogue input to any parameter.*

This function allows control of any parameter by using an analogue input. The parameter selects the range of control area and the ID number for the parameter that is controlled.

<i>P2.4.5.6</i>	<i>Analogue input 3, minimum value</i>	<i>ID1037</i>	<i>"AI3 Scale Min"</i>
<i>P2.4.5.7</i>	<i>Analogue input 3, maximum value</i>	<i>ID1038</i>	<i>"AI3 Scale Max"</i>
<i>P2.4.6.6</i>	<i>Analogue input 4, minimum value</i>	<i>ID1039</i>	<i>"AI4 Scale Min"</i>
<i>P2.4.6.7</i>	<i>Analogue input 4, maximum value</i>	<i>ID1040</i>	<i>"AI4 Scale Max"</i>

These parameters define the range for the controlled parameters. All the values are considered to be integers. This means that when controlling the Field Weakening Point (as in example), you also need to set numbers for decimals. For example FWP 100.00 needs to be set as 10000.

<i>P2.4.5.8</i>	<i>AI3 Controlled ID</i>	<i>ID1509</i>	<i>"AI3 Control. ID"</i>
<i>P2.4.6.8</i>	<i>AI4 Controlled ID</i>	<i>ID1510</i>	<i>"AI4 Control. ID"</i>

These parameters define the controlled parameter.

Example:

You want to control motor field weakening point voltage through an analogue input from 70.00% to 130.00%.

Set Scale min to 7000 = 70.00%

Set Scale max to 13000 = 130.00%

Set Controlled ID to 603 (Voltage at field weakening point)

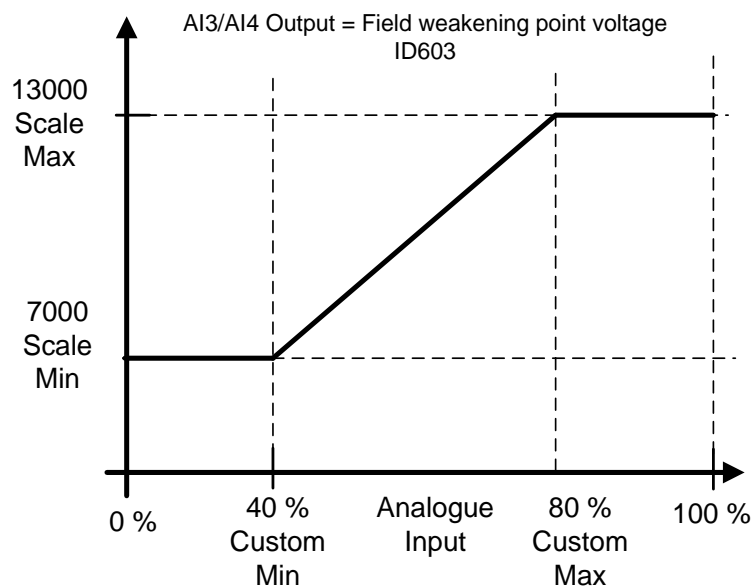

Now analogue input 3 signal 0 V to 10 V (0 mA to 20 mA) will control the field weakening point voltage between 70.00% - 130.00%. When setting the value, remember that decimals are handled as integers.

7.4.5 Inversion control

P2.4.7.1 Inversion Control ID1091 "INV Control"

Inversion control allows you to select which input signal operation will be inverted.

B00 = +1 = Invert external fault 1

B01 = +2 = Invert external fault 2

B02 = +4 = Inverted Run Enable digital input

B03 = +8 = Inverted Brake acknowledge digital input

B04 = +16 = Invert Mot. Torq. Limit 1 digital input.

B05 = +32 = Invert Gen Torq. Limit 1 digital input

B08 = +256 = Motoring Power limit digital input inverted

B09 = +512 = Generator Power limit digital input inverted

7.5 Output signals

7.5.1 Digital output signals

In the Marine application, all output signals are disabled by default.

P2.5.1.1 Ready ID432 "Ready"

The AC drive is ready to operate.

Missing ready signal can be traced by using monitoring values Non Ready Cause (ID1608) and Prevent MC Ready (ID1609).

P2.5.1.2 Run ID433 "Run"

The AC drive is modulating.

P2.5.1.3 Fault ID434 "Fault"

A fault trip has occurred.

P2.5.1.4 Inverted fault ID435 "Fault, Inverted"

No active faults in the drive.

P2.5.1.5 Warning ID436 "Warning"

General warning signal.

P2.5.1.6 External fault or warning ID437 "Ext. Fault/Warn."

Fault or warning depending on parameter Response to external fault. P2.4.2.11 Ext Fault Close and P2.4.2.12 Ext Fault Open are used to trigger a fault. P2.12.1 External fault is used to select response.

P2.5.1.7 Reference fault or warning (4mA) ID438 "AI Ref Faul/Warn"

Fault or warning depending on parameter Response to the 4mA reference fault. Response is selected in G2.11.6.

P2.5.1.8 Drive overtemperature warning ID439 "OverTemp Warn"

Drive temperature has exceeded normal operation conditions. Temperature limit may vary depending on the drive type or size.

P2.5.1.9 Reverse ID440 "Reverse"

Drive output frequency is negative

P2.5.1.10 Wrong direction ID441 "WrongDirection"

Motor rotation direction is different from the requested one. This happens when external force makes the motor rotate in different direction or when the direction change command has been given and the drive is still ramping down to change direction.

P2.5.1.11 At reference speed ID442 "At Ref. Speed"

Induction motor: Speed is within nominal slip of the reference.

PMS motor: Output frequency is within 1 Hz of the reference frequency.

P2.5.1.12 Jogging speed ID413 "Jogging Speed"

Jogging speed command has been given.

P2.5.1.13 IO Control Place ID444 "IO Control Place"

Active control place is I/O terminal defined by the parameter for Control place (P3.1) or forced with digital input function.

7.5.1.1 Brake Control

The mechanical brake control has two parts that need to be synchronically controlled. The first part is the *mechanical brake release* and the second is the *speed reference release*. Whole brake control logic is explained in chapter 6.15 Brake Control.

Conditions to open the brake:

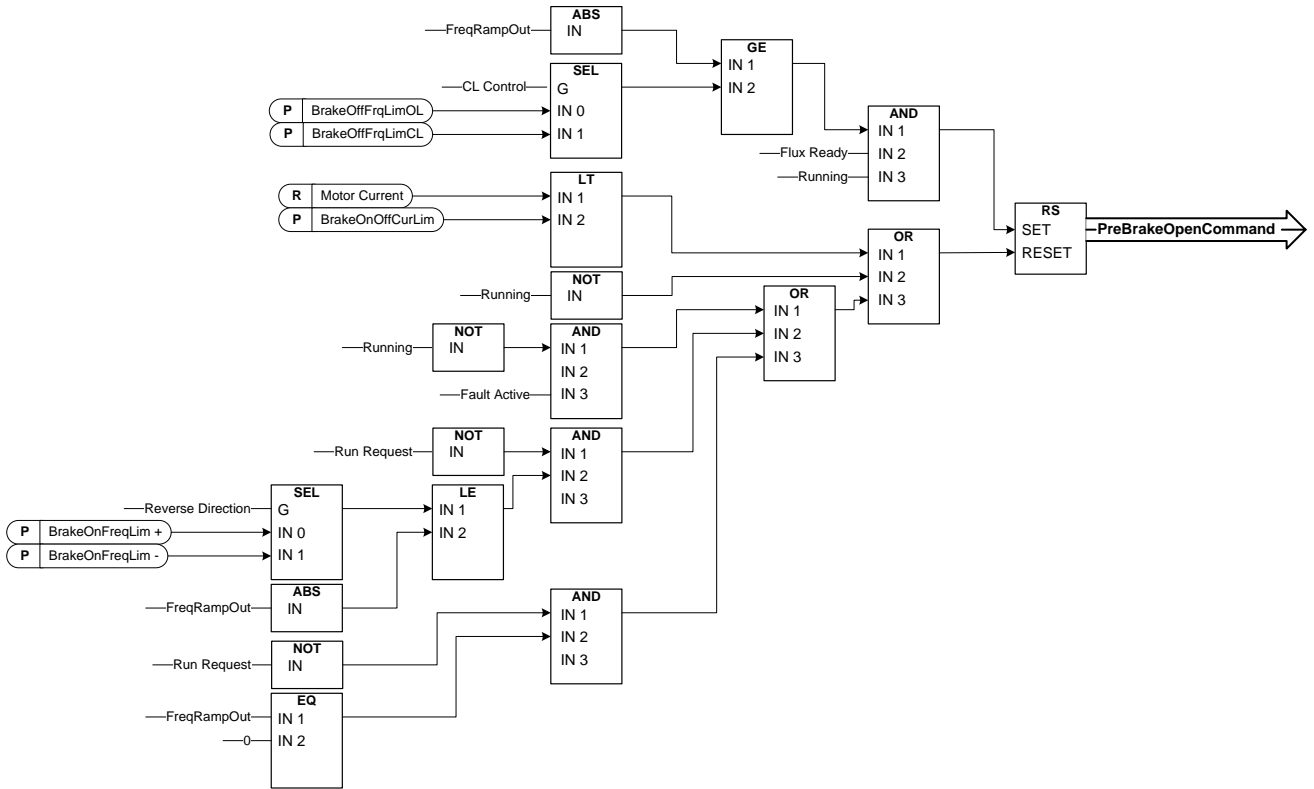

The final brake open command: It is possible that in a Master/Follower system the master drive opens the brake. Also an overriding system may do this without any control from the drive using AucControlWord1.B7. During identification run the brake will not open.

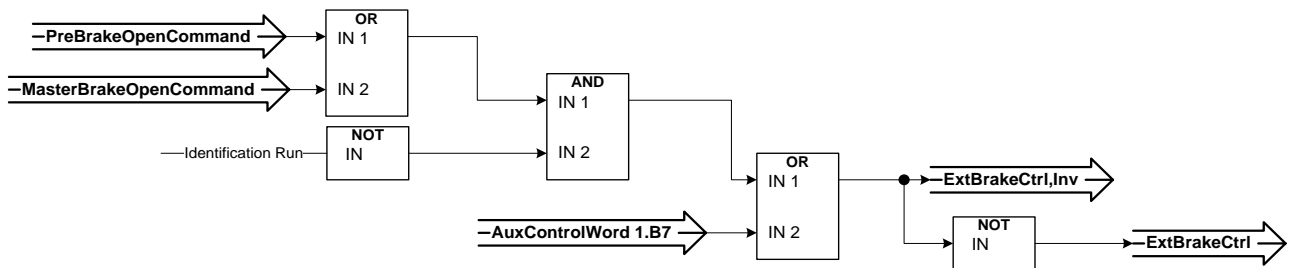

Relay state when control unit is not powered

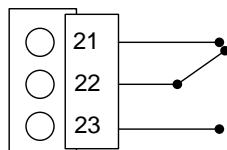

P2.5.1.14 External brake control ID445 “Ext Brake Contrl”

See detailed description about brake operation in G2.15 Brake Control.

External brake ON/OFF control

Example: OPTA2 board R01 :

Brake function ON: Terminals 22-23 are connected (Relay is energized).

Brake function OFF: Terminals 22-23 are open (Relay not energized).

Brake Open Command
Brake function OFF

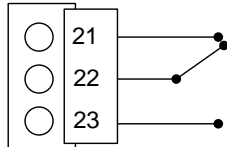

Brake Close Command
Brake function ON

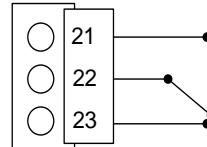

Note: When power from control board is removed, the terminals 22-23 are open.

When using the Master Follower function, the follower drive will open the brake at the same time as the Master even if the Follower’s conditions for brake opening have not been met.

P2.5.1.15 External brake control, inverted ID446 “ExtBrakeCtrl,Inv”

See detail description about brake operation in G2.15 Brake Control

Example: OPTA2 board R01 :

Brake function ON: Terminals 22-23 are open. (Relay not energized)

Brake function OFF: Terminals 22-23 are connected. (Relay is energized).

Brake Open Command
Brake function OFF

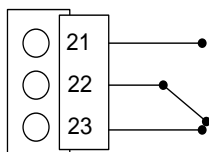

Brake Close Command
Brake function ON

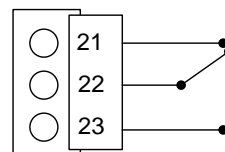

When using the Master Follower function, the follower drive will open the brake at the same time as the Master does even if the Follower’s conditions for brake opening have not been met.

P2.5.1.16 Output frequency limit 1 supervision ID447 “FreqOut SupvLim1”

The output frequency goes outside the set supervision limits defined in Supervision Lim parameter group. The function can be set to monitor either the high or the low limit. Limit and functions are selected in G2.5.8 Supervision Limits.

P2.5.1.17 Output frequency limit 2 supervision ID448 "FreqOut SupvLim2"

The output frequency goes outside the set supervision limits 2 defined in Supervision Lim parameter group. The function can be set to monitor either the high or the low limit. Limit and functions are selected in G2.5.8 Supervision Limits.

P2.5.1.18 Reference limit supervision ID449 "Ref Lim Superv."

Active reference goes beyond the set supervision low limit/high limit defined in Supervision Lim parameter group. The function can be set to monitor either the high or the low limit Limit. The functions are selected in G2.5.8 Supervision Limits.

P2.5.1.19 Temperature limit supervision ID450 "Temp Lim Superv."

The drive temperature goes beyond the set supervision limits defined in Supervision Lim parameter group. The function can be set to monitor either the high or the low limit. Limit and functions are selected in G2.5.8 Supervision Limits.

P2.5.1.20 Torque limit supervision ID451 "Torq Lim Superv."

The motor torque goes beyond the set supervision limits defined in Supervision Lim parameter group. The function can be set to monitor either the high or the low limit. Limit and functions are selected in G2.5.8 Supervision Limits.

P2.5.1.21 Motor thermal protection ID452 "MotTherm Flt/Wrn"

Motor thermistor initiates an overtemperature signal which can be led to a digital output. The response is selected with P2.12.5.6 ThermistorF.Resp.

P2.5.1.22 Analogue input supervision limit ID453 "Ain Supv Lim"

The selected analogue input signal goes beyond the set supervision limits defined in G2.5.8 Supervision Lim parameter group. The function can be set to monitor either the high or the low limit.

P2.5.1.23 Limit Control active ID454 "Limit Control ON"

One or more of the drive limit controllers is active.

7.5.1.2 *Fieldbus digital inputs connection*

<i>P2.5.1.24</i>	<i>Fieldbus input data 1</i>	<i>ID455</i>	<i>"FB Dig Input 1"</i>
<i>P2.5.1.26</i>	<i>Fieldbus input data 2</i>	<i>ID456</i>	<i>"FB Dig Input 2"</i>
<i>P2.5.1.28</i>	<i>Fieldbus input data 3</i>	<i>ID457</i>	<i>"FB Dig Input 3"</i>
<i>P2.5.1.30</i>	<i>Fieldbus input data 4</i>	<i>ID169</i>	<i>"FB Dig Input 4"</i>
<i>P2.5.1.32</i>	<i>Fieldbus input data 5</i>	<i>ID170</i>	<i>"FB Dig Input 5"</i>

The data from the Fieldbus main control word can be directed to the drive's digital outputs. See the related fieldbus board manual for location of these bits.

<i>P2.5.1.25</i>	<i>Fieldbus digital input 1 parameter</i>	<i>ID891</i>	<i>"FB Dig 1 Par ID"</i>
<i>P2.5.1.27</i>	<i>Fieldbus digital input 2 parameter</i>	<i>ID892</i>	<i>"FB Dig 2 Par ID"</i>
<i>P2.5.1.29</i>	<i>Fieldbus digital input 3 parameter</i>	<i>ID893</i>	<i>"FB Dig 3 Par ID"</i>
<i>P2.5.1.31</i>	<i>Fieldbus digital input 4 parameter</i>	<i>ID894</i>	<i>"FB Dig 4 Par ID"</i>
<i>P2.5.1.33</i>	<i>Fieldbus digital input 5 parameter</i>	<i>ID895</i>	<i>"FB Dig 5 Par ID"</i>

With these parameters you can define the parameter to be controlled by using FB Digital input.

Example:

All option board inputs are in use and you still want to give DI: DC Brake Command (ID416). You also have a fieldbus board in the drive.

Set parameter ID891 (Fieldbus digital input 1) to 416.

Now you are able to control DC Braking command from the fieldbus by Profibus control word (bit 11).

It is possible to control any parameter in the same way if values 0=FALSE and 1=TRUE are significant for that parameter. For example, P2.6.5.3 Brake Chopper (ID504) can be controlled on and off using this function (Brake Chopper; 0 = Not Used, 1 = On, Run).

P2.5.1.34 **Safe disable active** *ID756* **"Safe Disable Act"**

Select the digital output to show the status of the Safe Torque Off.

P2.5.1.35 **Common Alarm** *ID1684* **"Common Alarm"**

Digital Output that indicates both warning and fault situations.

7.5.2 Analogue outputs 1 & 2 & 3 & 4

P2.5.2.1	Analogue output 1 signal selection	ID464	"Iout 1 Signal"
P2.5.3.1	Analogue output 2 signal selection	ID471	"Iout 2 Signal"
P2.5.4.1	Analogue output 3, signal selection	ID478	"Iout 3 Signal"
P2.5.5.1	Analogue output 4, signal selection	ID1527	"Iout 4 Signal"

Connect the AO1 signal to the analogue output of your choice with this parameter.

P2.5.2.2	Analogue output function	ID307	"Iout Content"
P2.5.3.2	Analogue output 2 function	ID472	"Iout 2 Content"
P2.5.3.2	Analogue output 3, function	ID479	"Iout 3 Content"
P2.5.3.2	Analogue output 4, function	ID1520	"Iout 4 Content"

This parameter selects the desired function for the analogue output signal.

- 0 "Not used"
Analogue output is forced to 20% (= 2 V/4 mA)
- 1 "O/P Freq" – Drive Output Frequency
Output frequency from zero to maximum frequency.
- 2 "Freq Ref" -
Freq. reference from zero to maximum frequency
- 3 "Motor speed "
Motor speed from zero speed to motor synchronous speed
- 4 "O/P Current" – Drive Output Current
Drive output current from zero to motor nominal current
- 5 "Motor Torque "
Motor torque from zero to motor nominal torque (100%)
- 6 "Motor Power"
Motor power from zero to motor nominal power (100%)
- 7 "Mot Voltage"
Drive output voltage from zero to motor nominal voltage
- 8 "DC-link volt"
500 V unit: DC voltage from zero to 1000 Vdc
690 V unit: DC voltage from zero to 1317 Vdc
- 9 "AI1"
Unfiltered Analogue input 1 signal
- 10 "AI2"
Unfiltered Analogue input 2 signal
- 11 "Fout,min-max"
Output frequency from minimum frequency to maximum frequency

12 “(-2Tn)-(2Tn)”

Motor torque from negative two times motor nominal to positive two times motor nominal torque

13 “(-2Pn)-(2Pn)”

Motor power from negative two times motor nominal to positive two times motor nominal power

14 “PT100 Temp.”

Maximum PT100 temperature value from used input scaling from -30°C to +200°C

15 “FB Data In4”

FB analogue output fieldbus process data value can be connected to analogue output by using monitoring signal ID48 .

16 “(-2nN)-(2nN)”

Motor speed from negative two times nominal to positive two times nominal speed

17 “Enc 1 Speed”

Encoder 1 speed from zero speed to motor synchronous speed

18 “Unit Temp”

Unit temperature scaled from 0 degree to 100 degree.

19 “Value Control”

Value control output

20 “Drive Output Power”

Drive output power scaled from zero to Motor Nominal Power (P2.1.8).

<i>P2.5.2.3</i>	<i>Analogue output filter time</i>	<i>ID308</i>	<i>“Iout Filter Time”</i>
<i>P2.5.3.3</i>	<i>Analogue output 2 filter time</i>	<i>ID473</i>	<i>“Iout 2 Filter T”</i>
<i>P2.5.4.3</i>	<i>Analogue output 3, filter time</i>	<i>ID480</i>	<i>“Iout 3 Filter T”</i>
<i>P2.5.5.3</i>	<i>Analogue output 4, filter time</i>	<i>ID1521</i>	<i>“Iout 4 Filter T”</i>

First order filtering is used for analogue output signals.

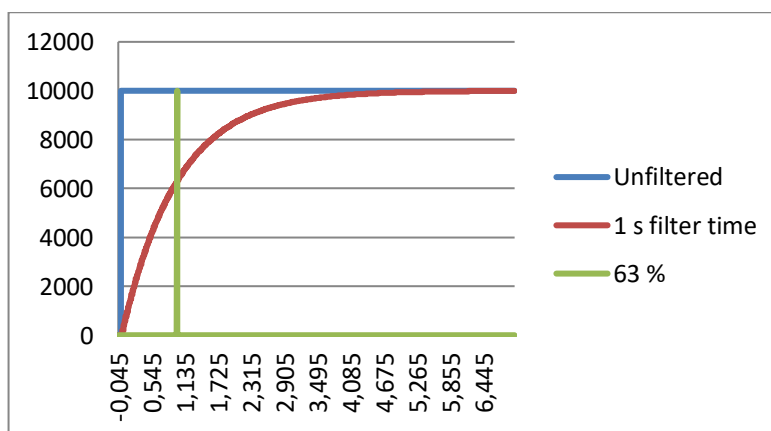

<i>P2.5.2.4</i>	<i>Analogue output inversion</i>	<i>ID309</i>	<i>"Iout Invert"</i>
<i>P2.5.3.4</i>	<i>Analogue output 2 inversion</i>	<i>ID474</i>	<i>"Iout 2 Invert"</i>
<i>P2.5.4.4</i>	<i>Analogue output 3 inversion</i>	<i>ID481</i>	<i>"Iout 3 Invert"</i>
<i>P2.5.5.4</i>	<i>Analogue output 4 inversion</i>	<i>ID1522</i>	<i>"Iout 4 Invert"</i>

Inverts the analogue output signal:

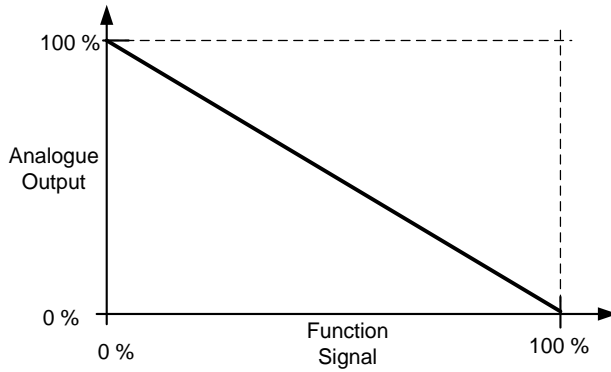

<i>P2.5.2.5</i>	<i>Analogue output minimum</i>	<i>ID310</i>
<i>P2.5.3.5</i>	<i>Analogue output 2 minimum</i>	<i>ID475</i>
<i>P2.5.4.5</i>	<i>Analogue output 3 minimum</i>	<i>ID482</i>
<i>P2.5.5.5</i>	<i>Analogue output 4 minimum</i>	<i>ID1523</i>

Defines the signal minimum to either 0 mA or 4 mA (living zero).

- 0 Set minimum value to 0 mA (0%)
- 1 Set minimum value to 4 mA (20%)

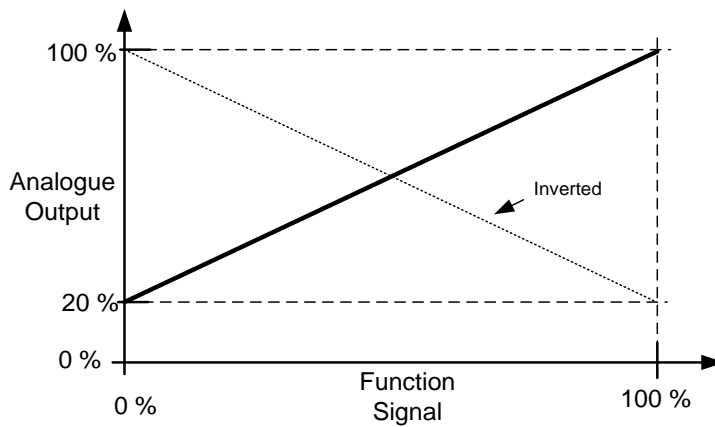

<i>P2.5.2.6</i>	<i>Analogue output scale</i>	<i>ID311</i>	<i>"Iout Scale"</i>
<i>P2.5.3.6</i>	<i>Analogue output 2 scaling</i>	<i>ID476</i>	<i>"Iout 2 Scale"</i>
<i>P2.5.4.6</i>	<i>Analogue output 3 scaling</i>	<i>ID483</i>	<i>"Iout 3 Scale"</i>
<i>P2.5.5.6</i>	<i>Analogue output 4 scaling</i>	<i>ID1525</i>	<i>"Iout 4 Scale"</i>

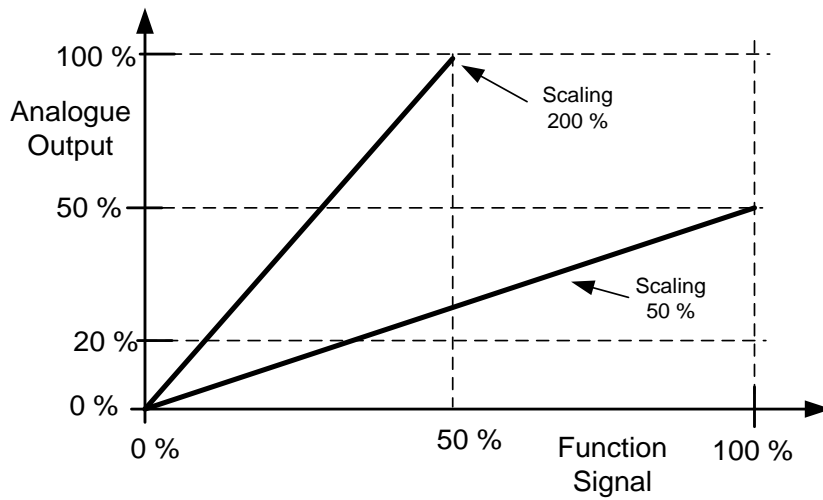

- P2.5.2.7 Analogue output offset* *ID375 "Iout Offset"*
- P2.5.3.7 Analogue output 2 offset* *ID477 "Iout 2 Offset"*
- P2.5.4.7 Analogue output 3 offset* *ID484 "Iout 3 Offset"*
- P2.5.5.7 Analogue output 4 offset* *ID1524 "Iout 4 Offset"*

Defines the offset for the analogue output signal.

In the picture below, the 50% scaling signal has been given 20% offset and the 200% scaling has been given 50% offset.

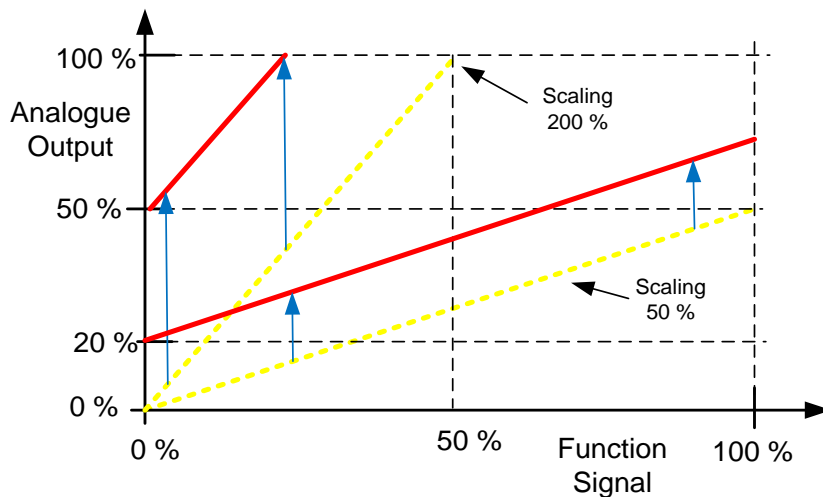

7.5.3 Delayed Digital Output 1 & 2

P2.5.6.1 *Digital output 1 signal selection* **ID486** *“Dig.Out 1 Signal”*

P2.5.7.1 *Digital output 2 signal selection* **ID489** *“Dig.Out 2 Signal”*

Connect the delayed digital output signal to the digital output of your choice with this parameter. For more information about the TTF programming method, see chapter 4.

P2.5.6.2 *Digital output function* **ID312** *“D01 Content”*

P2.5.7.2 *Digital output 2 function* **ID490** *“D02 Content”*

0 = “Not used”

1 = “Ready”

The AC drive is ready to operate.

Common reasons when ‘Ready’ signals are missing:

- Run enable signal is low
- DC Voltage is too low
- DC Voltage is too high

2 = “Run”

The AC drive is modulating.

3 = “Fault”

A fault trip has occurred

4 = “FaultInvert”

No active faults in the drive.

5 = “OverheatWarn”

Drive temperature has exceeded normal operation conditions. Temperature limit may vary depending on drive type and size.

6 = “ExtFaul/Warn”

External fault or warning depending on parameter response to external fault

7 = “RefFaul/Warn”

Fault or warning depending on parameter Response to the 4mA reference fault
- occurs if analogue reference is 4—20 mA and signal is <4mA

8 = “Warning”

Always if a warning is on

9 = “Reversed”

Drive output frequency is negative

10 = “JogSpeedSel”

The jogging, preset or inching speed has been activated with digital input.

11 = “At speed”

Induction motor: speed is within nominal slip of the reference.

PMS motor: output frequency is within 1 Hz of the reference.

12 = “MotorRegAct”

One of the limit regulators is active.

13 = “FreqLim1Sup”

Output frequency limit 1 supervision

The output frequency goes outside the set supervision low limit/high limit.

14 = “FreqLim2up”

Output frequency limit 2 supervision

The output frequency goes outside the set supervision low limit/high limit.

15 = “TorqLimSprv”

Torque limit supervision

The motor torque goes beyond the set supervision low limit/high .

- 16 = "RefLimSprv"**
Reference limit supervision
Active reference goes beyond the set supervision low limit/high limit.
- 17 = "ExtBrakeCont"**
External brake control
External brake ON/OFF control with programmable delay
- 18 = "I/O ContAct"**
Control from I/O terminals
IO control place is active.
- 19 = "TempLimSprv"**
Drive temperature limit supervision.
Drive temperature goes beyond the set supervision limits (par. ID354)
- 20 = "WrongDirecti"**
Motor rotation direction is different from the requested one. This happens if an external force makes the motor to rotate into different direction or when a command for direction change has been given and the drive is still ramping down to change direction.
- 21 = "ExtBrakeInv"**
External brake control inverted
External brake ON/OFF control; Output active when brake control is OFF.
- 22 = "ThermFlt/Wrn"**
Thermistor fault or warning
The thermistor input of option board indicates overtemperature. Fault or warning depending on the response parameter.
- 23 = "AI Supervis"**
Analogue input supervision
Analogue input supervision function, Set Reset type output function.
- 24 = "FB DigInput1"**
Fieldbus digital input data 1
- 25 = "FB DigInput2"**
Fieldbus digital input data 2
- 26 = "FB DigInput3"**
Fieldbus digital input data 3
- 27 = "Warning SR"**
Warning indication that requires pressing of Reset button. Normally the drive will remove warning indication when the fault situation has passed. This output requires that the reset button is pressed before the signal goes low after there has been a warning trigger. If a new warning comes while previous is active this output goes low for 1 second.
- 28 = "ID.Bit"**
Select the signal for controlling the DO. The parameter has to be set in format xxxx.yy where xxxx is the ID number of a signal and yy is the bit number. For example, the value for DO control is 1174.02. 1174 is the ID number of Warning Word 1. So the digital output is ON when bit number 02 of the warning word (ID no. 1174) i.e. Motor underload is high.

<i>P2.5.6.3</i>	<i>Digital output 1 on-delay</i>	<i>ID487</i>	<i>"D01 ON Delay"</i>
<i>P2.5.6.4</i>	<i>Digital output 1 off-delay</i>	<i>ID488</i>	<i>"D01 OFF Delay"</i>
<i>P2.5.7.3</i>	<i>Digital output 2 on-delay</i>	<i>ID491</i>	<i>"D02 ON Delay"</i>
<i>P2.5.7.4</i>	<i>Digital output 2 off-delay</i>	<i>ID492</i>	<i>"D02 OFF Delay"</i>

With these parameters you can set on- and off-delays to digital outputs.

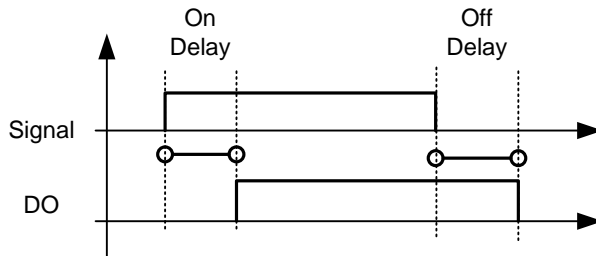
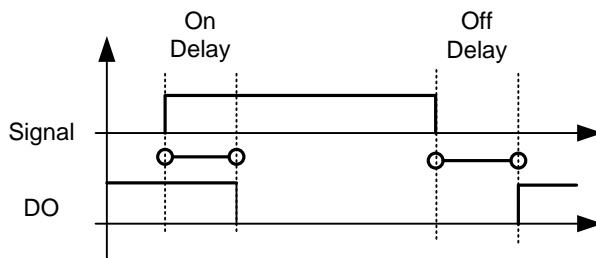

Figure 7-11. Digital outputs 1 and 2, on- and off-delays

<i>P2.5.6.5</i>	<i>Invert digital output 1</i>	<i>ID1587</i>	<i>"INV Delayed DO1"</i>
<i>P2.5.7.5</i>	<i>Invert digital output 2</i>	<i>ID1588</i>	<i>"INV Delayed DO2"</i>

Inverts delayed digital output operation.



<i>P2.5.6.6</i>	<i>ID.Bit Free DO 1</i>	<i>ID1217</i>
<i>P2.5.7.6</i>	<i>ID.Bit Free DO 2</i>	<i>ID1385</i>

Select the signal for controlling the DO. The parameter has to be set in format xxxx.yy where xxxx is the ID number of a signal and yy is the bit number. For example, the value for DO control is 1174.02. 1174 is the ID number of Warning Word 1. So the digital output is ON when bit number 02 of the warning word (ID no. 1174) i.e. *Motor underload* is high.

7.5.4 Supervision limits

Supervision function gives you the possibility to monitor certain values with the limit setting. When the actual value exceeds or goes below the set value a message through a digital output can be given. The torque limit supervision is scalable.

<i>P2.5.8.1</i>	<i>Output frequency limit supervision function</i>	<i>ID315</i>	<i>"Freq Supv Lim 1"</i>
<i>P2.5.8.3</i>	<i>Output frequency limit 2 supervision function</i>	<i>ID346</i>	<i>"Freq Supv Lim 2"</i>
<i>P2.5.8.5</i>	<i>Torque limit, supervision function</i>	<i>ID348</i>	<i>"Torque Supv Lim"</i>
<i>P2.5.8.8</i>	<i>Reference limit, supervision function</i>	<i>ID350</i>	<i>"Ref Superv Lim"</i>
<i>P3.6.8.10</i>	<i>Drive temperature limit supervision function</i>	<i>ID354</i>	<i>"Temp Lim Superv."</i>

- 0 No supervision
- 1 Low limit supervision
- 2 High limit supervision
- 3 ABS(Torque), Low limit supervision
- 4 ABS(Torque), High limit supervision

The following five parameters are used to set a limit value to be monitored with the corresponding parameter above.

<i>P2.5.8.2</i>	<i>Output frequency limit supervision value</i>	<i>ID316</i>	<i>"Freq Dupv Val 1"</i>
<i>P2.5.8.4</i>	<i>Output frequency limit 2 supervision value</i>	<i>ID347</i>	<i>"Freq Supv Val 2"</i>
<i>P2.5.8.6</i>	<i>Torque limit, supervision value</i>	<i>ID349</i>	<i>"Torque Supv Val"</i>
<i>P2.5.8.9</i>	<i>Reference limit, supervision value</i>	<i>ID351</i>	<i>"Ref Superv Value"</i>
<i>P2.5.8.11</i>	<i>Drive temperature limit value</i>	<i>ID355</i>	<i>"Temp Supv Value"</i>

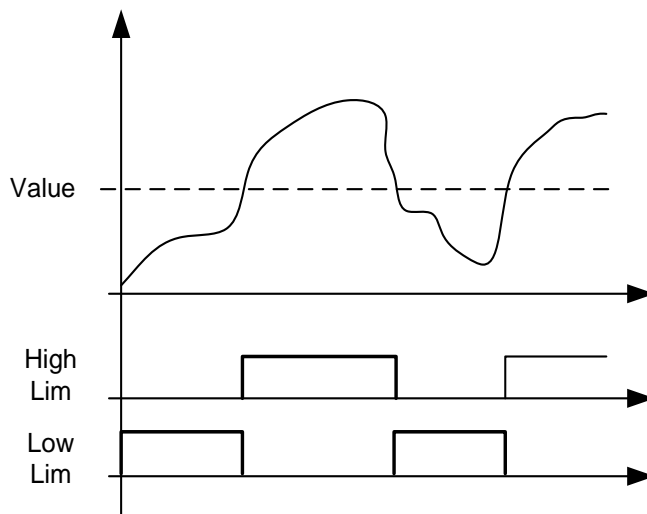

Figure 7-12. Supervision function

P2.5.8.7 Torque Supervision value scaling input ID402 "Torque Superv Scl"

This parameter is used to change the torque limit supervision level between zero and P2.5.8.6 Torque Supv Val.

- 0 = Not used
- 1 = AI1
- 2 = AI2
- 3 = AI3
- 4 = AI4
- 5 = FBLimScaling

7.5.4.1 Analogue input supervision function

The analogue input supervision function will control the selected digital output to close when the analogue input signal has exceeded the high limit and open when the signal goes below the low limit.

P2.5.8.12 Analogue input supervision signal ID356 "Ain Supv Input"

With this parameter you can select the analogue input to be monitored.

- 0 = Not used
- 1 = AI1
- 2 = AI2
- 3 = AI3
- 4 = AI4
- 5 = FBLimScaling

P2.5.8.13 Analogue Low supervision control limit ID357 "Ain Supv Llim"**P2.5.8.14 Analogue High supervision control limit ID358 "Ain Supv Hlim"**

Figure 7-13. An example of On/Off-control

7.5.5 Output Options

P2.5.9.1 Output Inversion ID1808

Invert selected digital output functions.

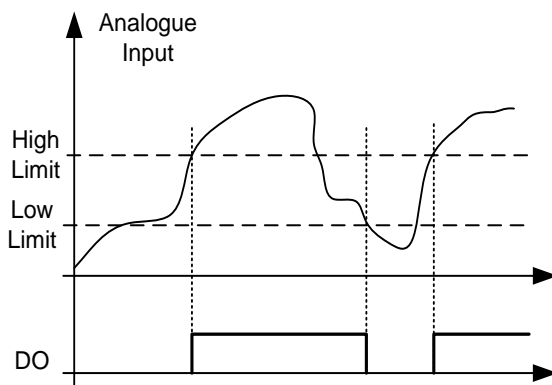
B0 =+1= Inver Common Alarm

7.6 Limit settings

7.6.1 Current limit handling

P2.6.1.1 Current limit ID107 "Current Limit"

This parameter determines the maximum motor current from the AC drive. The parameter's value range differs from size to size.

When the current limit is active the drive output frequency is reduced until current is below the set limit.

In closed loop control, the current limit affects the torque producing current limit, not the total current. This can be changed in options group with the "LimitTotalCurrent" parameter.

In drive synch operation limiting is for average current of units.

P2.6.1.2 Scaling of current limit ID399 "Currnt Lim Sclng"

0 = Not used

1 = AI1

2 = AI2

3 = AI3

4 = AI4

5 = FB Limit Scaling ID46 Monitoring value

This signal will adjust the maximum motor current between 0 and the parameter Motor Current Limit.

P2.6.3 Current Limit Kp ID1451

P-gain of motor side over current controller

P2.6.4 Current Limit Ki ID1452

I-gain of motor side over current controller

7.6.2 Power limit handling

Power limit function is used to limit the drive output power to the motor. You can do this by giving a limiting signal from a primary system that gives information about how much power is available for drive operations.

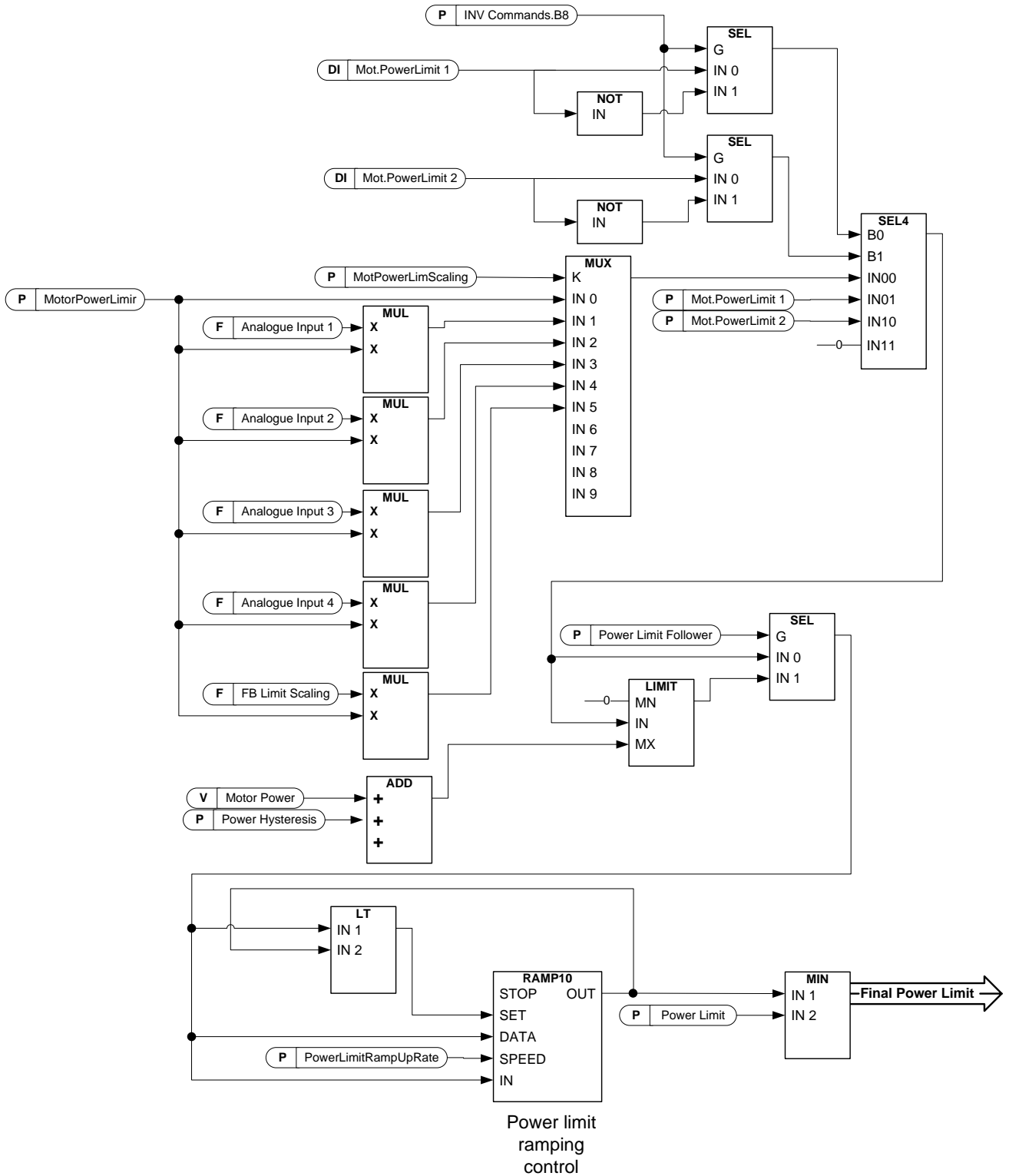

P2.6.2.1 Power Limit ID1722 "Power Limit"

General power limit for both motoring and generator side. This value is the final limit for all scaling functions. This value should not be used for scaling but for the maximum safety limit because the ramp up rate function is ineffective when this parameter is changed.

P2.6.2.2 Generator power limit ID1290 "GenerPower Limit"

Generator side power limit. This limit value is used for all scaling functions and power limit ramp rate functions.

P2.6.2.3 Motoring power limit ID1289 "MotorPowerLimit"

Motoring side power limit. This limit value is used for all scaling functions and power limit ramp rate functions.

P2.6.2.4 Generator Power limit 1 ID1513 "Gen.PowerLimit 1"

P2.6.2.5 Generator Power limit 2 ID1514 "Gen.PowerLimit 2"

Generator side power limit values when limits are activated by digital inputs. When both digital inputs are activated the power limit is forced to zero.

P2.6.2.6 Motoring Power limit 1 ID1503 "Mot.PowerLimit 1"

P2.6.2.7 Motoring Power limit 2 ID1504 "Mot.PowerLimit 2"

Motoring side power limit values when limits are activated by digital inputs. When both digital inputs are activated the power limit is forced to zero.

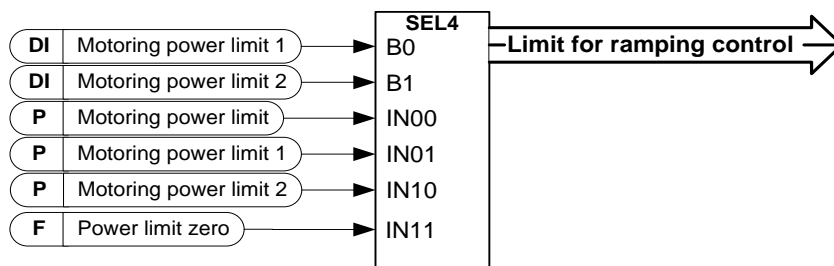

P2.6.2.8 Power limit increase rate ID1502 "PowerLimInc.rate"

Defines the power limit increase rate. Decreasing power limit will be in effect immediately.

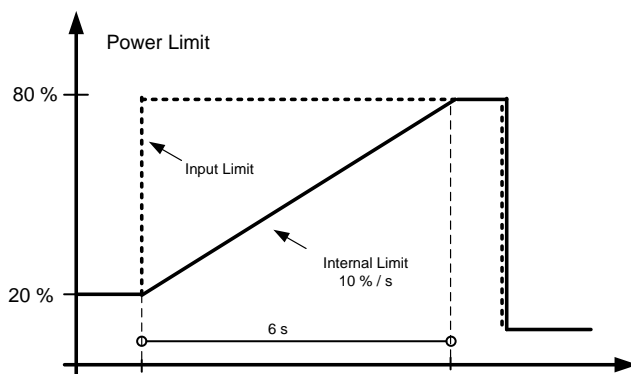

7.6.2.1 *Power follower function*

The power follower function will keep the internal power limit near the actual power so that when power demand increases the increase rate is controlled by the power limit increase rate parameter. This function makes the power increase smoother for the ship generator when, for example, the speed reference is increased or when the propeller gets air and goes back to the water.

P2.6.2.9 *Power Follower ID1705* "Power Follower"

Activates the power follower function.

P2.6.2.10 *Power limit follower hysteresis ID1529* "PowerFoll.Hyst"

Defines the hysteresis of the actual power where the internal power limit is kept while the input power limit is higher than the actual power.

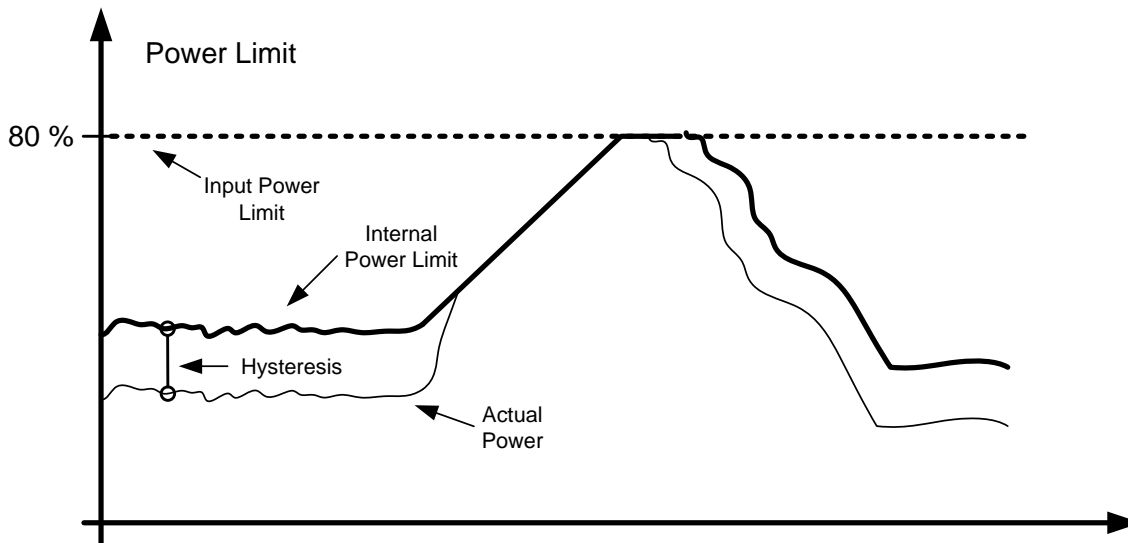

P2.6.2.11 *Scaling of Motoring Power Limit ID179* "MotPowerLimScIng"

The motoring power limit is equal to the parameter Motoring Power Limit if the value 'Not Used' is selected. If any of the inputs is selected, the motoring power limit is scaled between zero and parameter P2.6.2.3 Motoring Power Lim.

- 0 = Parameter
- 1 = AI1
- 2 = AI2
- 3 = AI3
- 4 = AI4
- 5 = FieldBus Scaling ID46 (Monitoring Value)

P2.6.2.12 *Scaling of Generating power limit* ID1088 “GenPowerLimScIng”

The generator power limit is equal to the parameter Generator Power Limit if value 'Not Used' is selected. If any of the inputs is selected, the generator power limit is scaled between zero and parameter P2.6.2.2 Generator Power Lim.

0 = Parameter

1 = AI1

2 = AI2

3 = AI3

4 = AI4

5 = FieldBus Scaling ID46 (Monitoring Value)

P2.6.2.13 *Undervoltage power limit DC level* ID1611 “UV Power C Lev1”

This parameter defines the DC voltage level when the special power limit function is activated. When DC voltage goes below this level the power level defined by undervoltage power limit will be activated.

P2.6.2.14 *Undervoltage power limit* ID1612 “UV Power Lim.”

Defines the power limit that is used when DC voltage is below parameter Undervoltage power limit DC level (P2.6.2.13). The function is deactivated when this parameter value is zero.

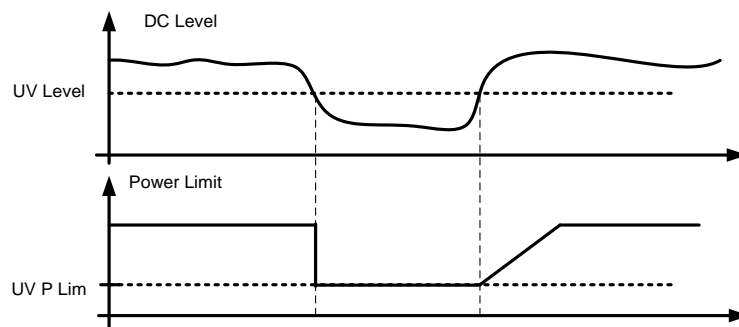

7.6.3 Torque limit handling

7.6.3.1 Motoring torque limit function

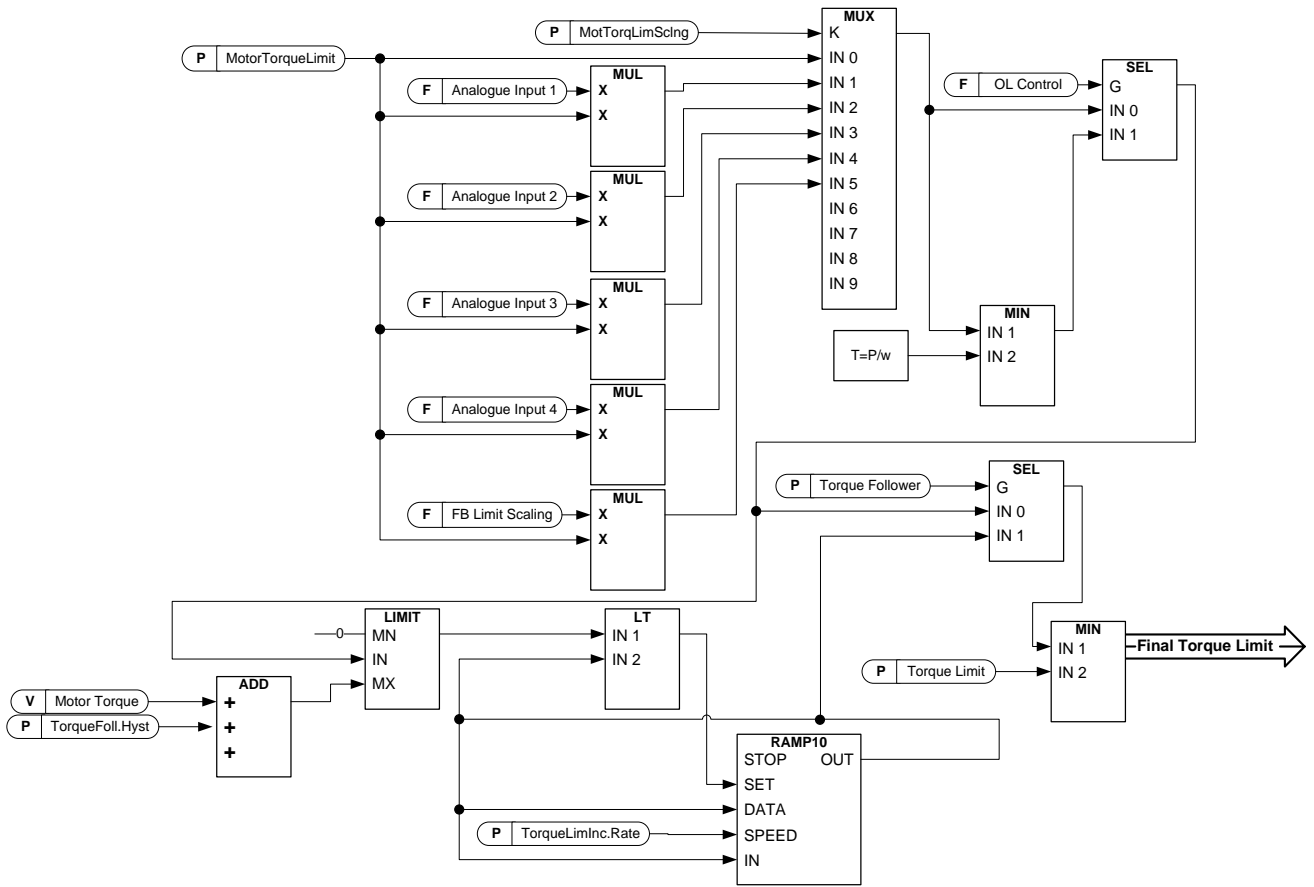

7.6.3.2 Generator torque limit function

Details of “Add to Gen Torq Lim” can be found from Brake Control chapter.

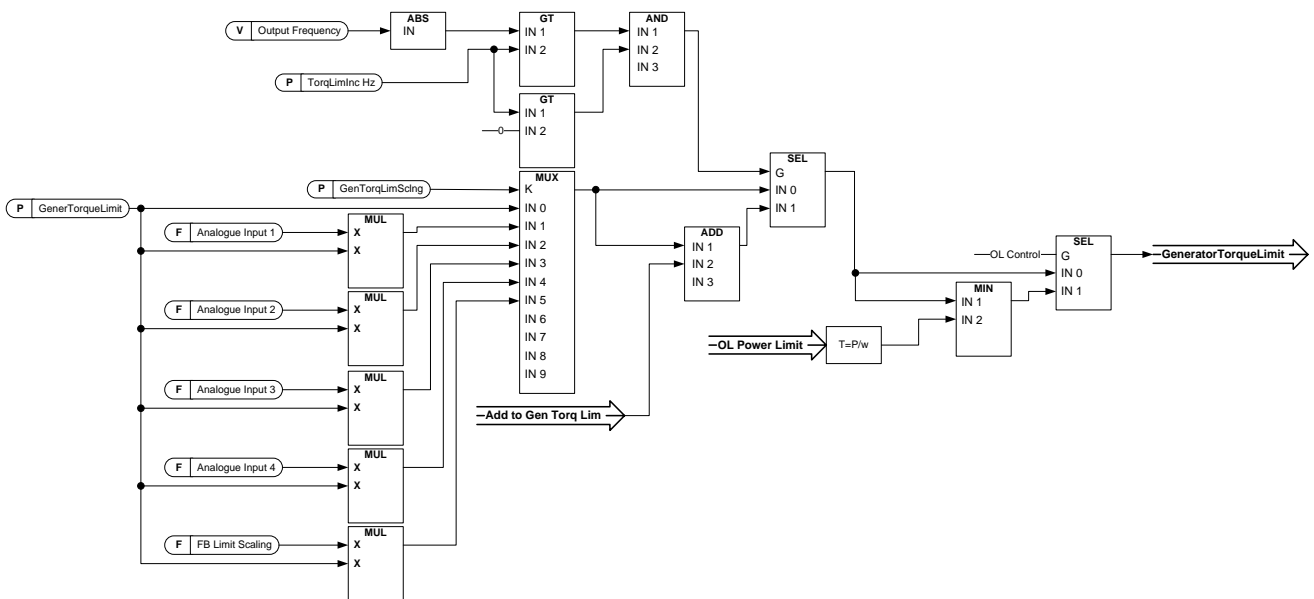

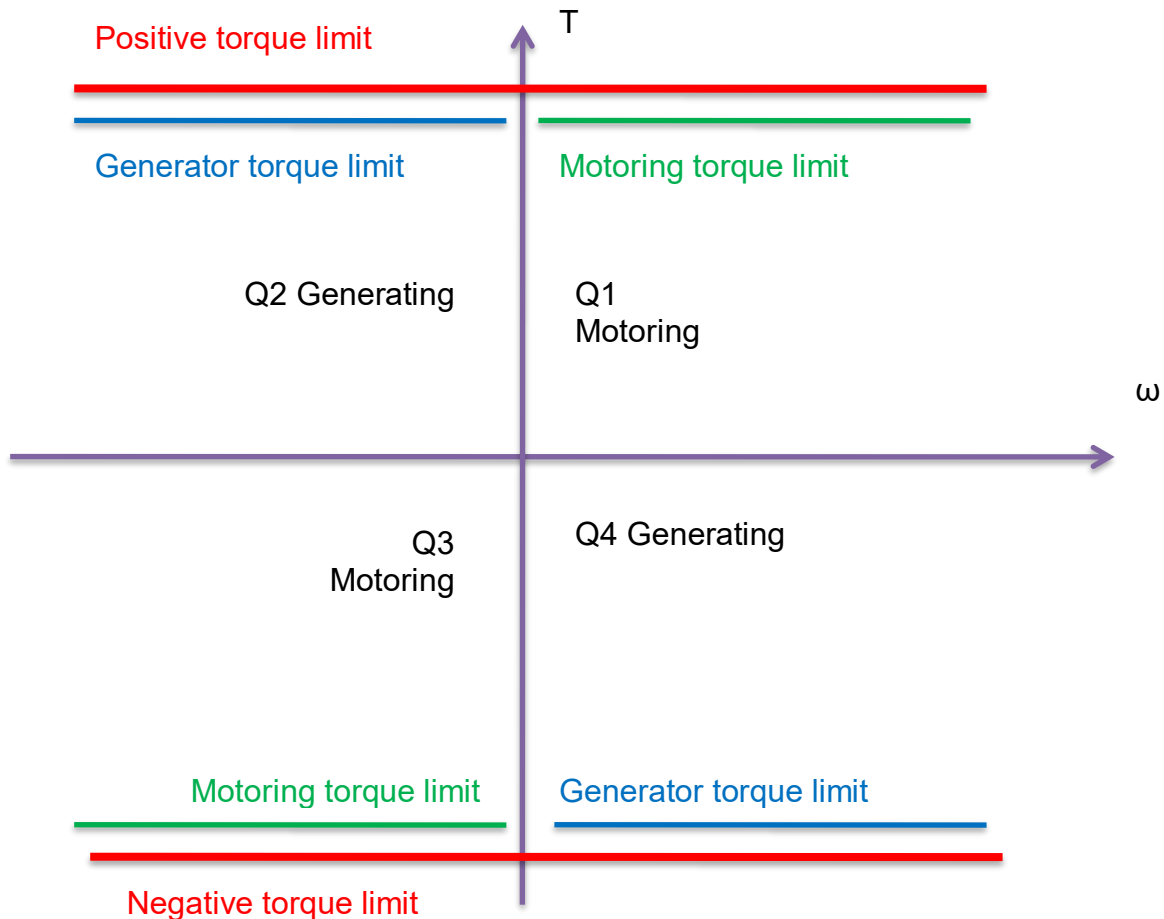

P2.6.3.1 Torque Limit ID609 "Torque Limit"

The general torque limit for both motoring and generator sides. This value is the final limit for all scaling functions. This value should not be used for scaling but for maximum safety limit because the ramp up rate function is ineffective when this parameter is changed. Only the motoring side torque limit has a ramp up limiting function.

P2.6.3.2 Motoring Torque limit ID1287 "MotorTorqueLimit"

Motoring side torque limit. This limit value is used for all scaling functions and torque limit ramp rate functions if activated.

P2.6.3.3 Generator Torque limit ID1288 "GenerTorqueLimit"

Generator side torque limit. This limit is used for all scaling functions generator side torque limit is not included in ramp up rate function.

P2.6.3.4 Motoring Torque limit 1 ID1625 "Mot.TorqueLim 1"

Motoring side torque limit that is activated by digital input.

P2.6.3.5 Generator Torque limit 1 ID1627 "Gen. Torque Lim 1"

Generator side torque limit that is activated by digital input.

7.6.3.3 *Torque follower function*

Torque follower function will keep the internal torque limit near the actual torque so that when the torque demand increases, the increase rate is controlled by the torque limit increase rate parameter. This function can be used together with the power limit ramp rate function because a low power limit at low speed will give high torque and may cause mechanical stress in the system.

P2.6.3.6 *Torque Follower ID1706* "Torque Follower"

Activates the torque follower function and ramp rate limiter function for torque limit.

- 0 = Not used
- 1 = Motoring
- 2 = Generator
- 3 = Motoring + Generator

P2.6.3.7 *Torque limit increase rate ID1532* "TorqueLimInc.rate"

Defines the torque limit increase rate. Decreasing power limit will be in effect immediately.

P2.6.3.8 *Torque limit follower hysteresis ID1533* "TorqueFoll.Hyst"

Defines the hysteresis of the actual torque where the internal torque limit is kept while the input torque limit is higher than the actual torque.

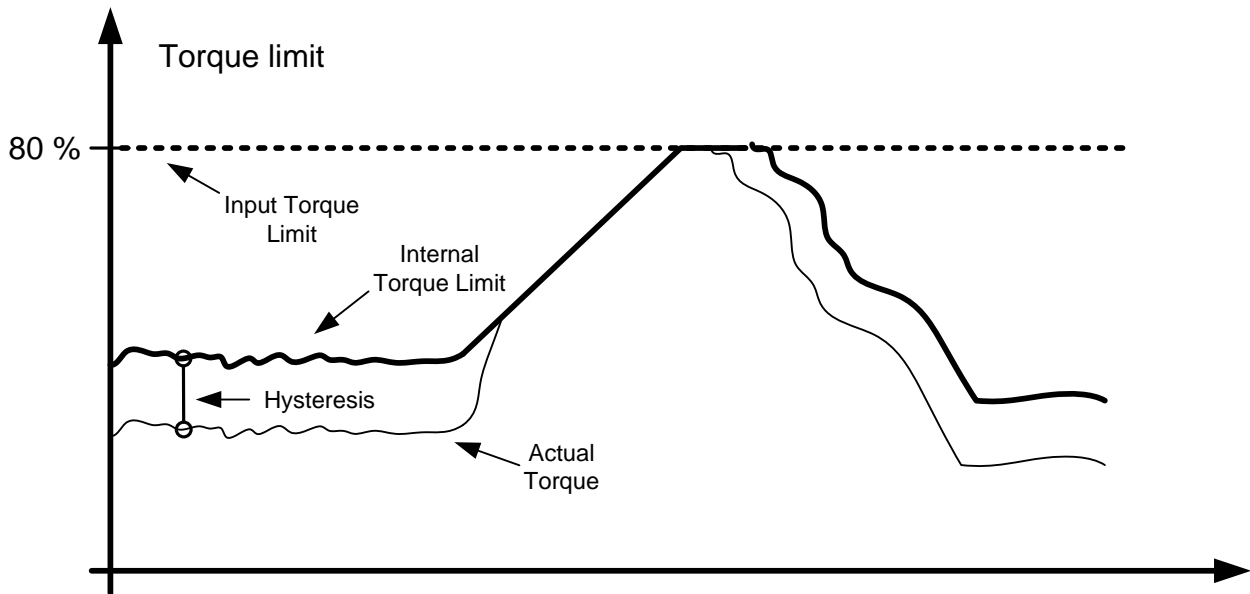

P2.6.3.9 Motoring Torque limit scaling ID485 "MotTorqLimScIng"

The motoring torque limit is equal to parameter Motoring Torque Limit if value 'Not Used' is selected. If any of the inputs is selected the motoring torque limit is scaled between zero and parameter Motoring Torque Limit.

- 0 = Not used
- 1 = AI1
- 2 = AI2
- 3 = AI3
- 4 = AI4
- 5 = FB Limit Scaling ID46 Monitoring value

P2.6.3.10 Generating torque limit scaling ID1087 "GenTorqLimScIng"

The generator torque limit is equal to parameter Generator Torque Limit if value 'Not Used' is selected. If any of the inputs is selected the generator torque limit is scaled between zero and parameter generator torque limit.

- 0 = Not used
- 1 = AI1
- 2 = AI2
- 3 = AI3
- 4 = AI4
- 5 = FB Limit Scaling ID46 Monitoring value

7.6.3.4 Open Loop settings only***P2.6.3.9.1 Torque limit control P-gain ID610 "TorqLimCtrl P"***

This parameter defines the gain of the torque limit controller. It is used in Open Loop control mode only.

P2.6.3.9.2 Torque limit control I-gain ID611 "TorqLimCtrl I"

This parameter determines the I-gain of the torque limit controller. It is used in Open Loop control mode only.

7.6.3.5 Closed Loop settings only***P2.6.3.10.1 Speed Control output limit ID1382 "SPC Out Limit"***

Torque limit for the speed controller. It affects both the positive and negative direction torques.

P2.6.3.10.2 Speed Control positive limit ID646 "SPC Pos Limit"

Positive torque limit for speed controller output.

P2.6.3.10.3 Speed Control negative limit ID645 "SPC Neg Limit"

Negative torque limit for speed controller output.

7.6.4 Frequency limit handling

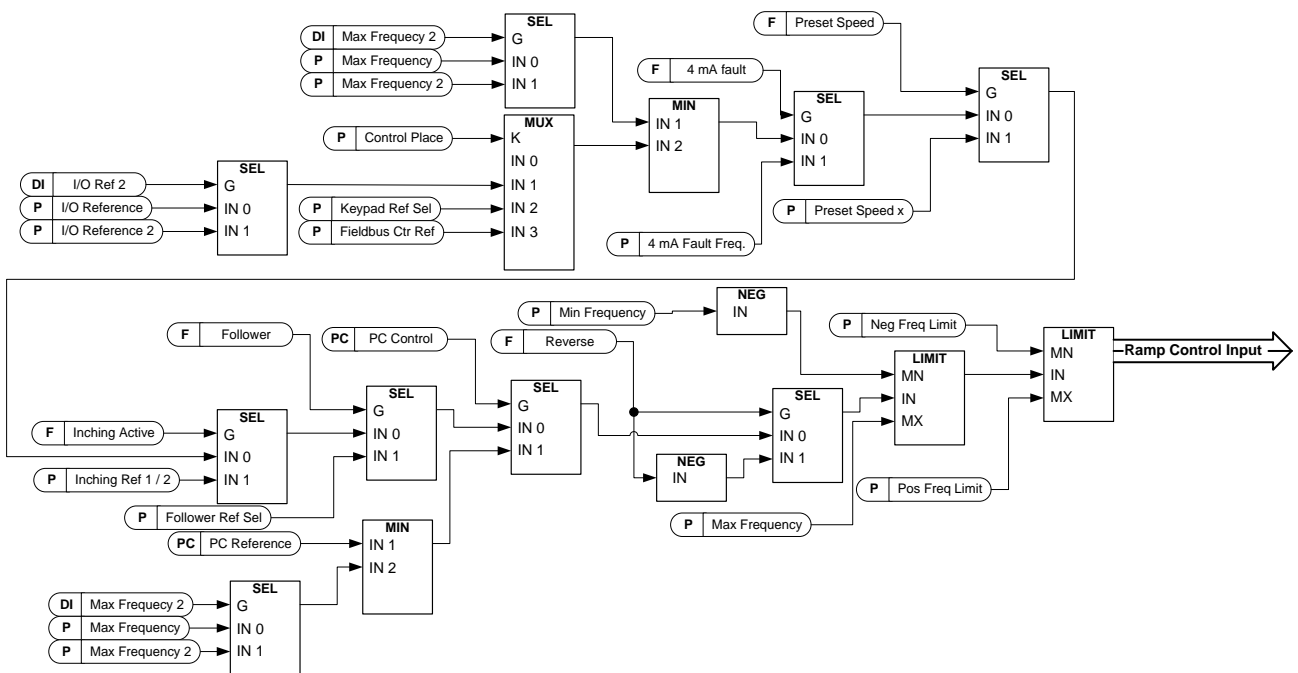

P2.6.4.1 Maximum Frequency Limit 2 ID1512 “Max Frequency 2”

This parameter defines the maximum frequency when the digital input “Max Frequency 2” is activated. This limit does not affect the reference values that are of constant type, for example, the preset speed references. If the actual speed is higher than Max Frequency 2, the limited reference is activated by ramp.

P2.6.4.2 Negative frequency limit ID1286 “Neg Freq Limit”

Positive direction frequency limit. When changed in closed loop limit control mode, the change is made without ramp.

P2.6.4.3 Positive frequency limit ID1285 “Pos Freq Limit”

Negative direction frequency limit. When changed in closed loop control mode, the change is made without ramp.

P2.6.4.4 Zero Frequency limit ID1283 “Zero Freq. Limit”

Defines the zero frequency limit. Used to determine when load drooping is set to zero if load drooping removal function 1 is selected

7.6.5 DC Link handling

P2.6.5.1 Overvoltage controller ID607 “Overvolt Contr”

The parameter selects the behaviour of the overvoltage controller in open loop control. It also activates the closed loop overvoltage controller but the operation is always of type ‘PI’ in closed loop control modes.

0 “Off” - Controller switched off

Both open and closed loop overvoltage controllers are off.

1 “On:NoRamping” – Activated P-Controller type operation

Both open and closed loop controllers are activated.

Open loop controller is a P-type controller.

Closed loop controller is a PI-type controller.

2 “On: Ramping” – Activated PI-Type controller

Both open and closed loop controllers are activated.

Open loop controller is a PI-type controller.

Closed loop controller is PI-type controller (as in selection 1).

P2.6.5.2 Overvoltage Reference Select ID1262 “OverVolt.Ref.Sel”

Overvoltage reference level depending on the status of the brake chopper.

In closed loop control, the overvoltage controller level is adjusted by “OverVoltageRef.”

The parameter can be found in the CL setting parameter group.

ID1262	Brake chopper in use	Brake chopper not in use
0 / High Voltage	500 V Unit: 844 V 690 V Unit: 1164 V	500 V Unit: 797 V 690 V Unit: 1099 V
1 / Norm.Voltage	1.25*Estimated DC nominal voltage	1.18*Estimated DC nominal voltage
2 / BrakeChLevel	1.07*brake chopper level	Brake chopper level

P2.6.5.3 Brake chopper ID504 "Brake Chopper"

When the AC drive is decelerating the motor, the inertia of the motor and the load are fed into an external brake resistor. This enables the drive to decelerate the load with a torque equal to that of acceleration (provided that the correct brake resistor has been selected). See separate Brake resistor installation manual. Brake chopper test mode generates pulse to resistor every second. If the pulse feedback is wrong (resistor or chopper is missing) fault F12 is generated.

Over Voltage Reference Select	Brake chopper level
0 / High voltage	500 V Unit: 797 V 690 V Unit: 1099 V
1 / Norm.Voltage	1.18* Estimated DC nominal voltage
2 / BrakeChLevel	Brake chopper level

0 = "Not Used" - No brake chopper used

Brake chopper not active or present in the DC link. **NOTE:** The overvoltage controller level is set to a little lower, see parameter P2.6.5.2.

1 = "On, Run" - Brake chopper in use and tested when running.

The drive's own brake chopper is activated and operational when the drive is in Run state. The drive also sends test pulses for feedback from the brake resistor.

2 = "External" - External brake chopper (no testing)

The system has an item that handles the DC link voltage. This could be a system with AFE or there is an external BCU unit. When this option is selected the drive overvoltage level is set a little higher so that its operation does not conflict with AFE or BCU units.

3 = "On, Run+Stop" - Used and tested in READY state and when running

Brake chopper is also active when the drive is not in Run state. This option can be used, for example, when other drives are generating but energy levels are low enough to be handled with only one drive.

4 = "On, No test" - Used when running (no testing)

Brake chopper is active in Run state but no test pulse to resistor is generated.

Note: In the system menu, there is a parameter "InternBrakeRes". This parameter is used for brake resistor overheating calculations. If an external brake resistor is connected to the drive the parameter should be set to 'Not connected' to disable temperature calculation for the brake resistor.

P2.6.5.4 Brake Chopper Level ID1267 "BrakeChopperLeve"

Brake chopper control activation level in volt. This parameter is active when "OverVolt.Ref.Sel" is 2 / "BrakeChLevel"

For 400V Supply: $400 * 1.35 * 1.18 = 638V$

For 500V Supply: $500 * 1.35 * 1.18 = 808V$

For 690V Supply: $690 * 1.35 * 1.18 = 1100V$

P2.6.5.5 Undervoltage controller ID608 "Undervolt Contr"

Undervoltage controller will decrease the output frequency in order to get energy from the motor when the DC voltage has dropped to a limit where the undervoltage controller activates trying to keep DC voltage at the minimum level.

0 "Off" - Controller switched off

Both open and closed loop overvoltage controllers are off.

1 "On:NoRamping" – Activated PI-Controller type operation

Both open and closed loop controllers are activated.

If power comes back while drive is at under voltage the controller output frequency will regain the reference value.

2 "On: Ramping" – PI controller type and ramping down.

Both open and closed loop controllers are activated.

If power comes back after under voltage controller has been active, drive will ramp to zero speed using ramp time 2 and generate an under voltage fault (F9) with sub code S3.

Note: In closed loop control, also the parameter "CLrmpFollEncFreq" needs to be activated to achieve identical operation.

P2.6.5.6 Under Voltage Reference Select ID1537 "UnderVoltRef.Sel"

Select the operation level for open loop under voltage controller.

0 "UnderVoltRef"

Under voltage operation level is selected with P2.6.5.7

1 "0.8 * Estimated DC Voltage"

Automatic DC voltage level

P2.6.5.7 Under Voltage Reference OL ID1538 "UnderVoltage Ref"

Set the operation level for open loop under voltage controller when P2.6.5.6 is 0 / UnderVoltageRef.

7.6.5.1 CL Settings**P2.6.5.8.1 Overvoltage reference ID1528 "OverVoltageRef."**

Defines the overvoltage reference level in Closed Loop control mode. Percentage value related to unit nominal voltage DC voltage. Default 118%.

$$690 \text{ Vac} * 1.35 * 118\% = 1099 \text{ Vdc}$$

$$500 \text{ Vac} * 1.35 * 118\% = 796 \text{ Vdc}$$

P2.6.5.8.2 Overvoltage controller motoring torque limit

Defines motoring torque limit, when drive is operating under over voltage controller.

P2.6.5.8.3 CL Under Voltage Reference

Defines the under voltage reference level in Closed Loop control mode. Percentage value related to unit nominal voltage DC voltage. Default 65%.

$$690 \text{ Vac} * 1.35 * 65\% = 605 \text{ Vdc}$$

$$500 \text{ Vac} * 1.35 * 65\% = 438 \text{ Vdc}$$

7.6.6 Limit options

P2.6.6.1 Limit total current ID1901 "LimitTotalCurren"

This function activates the total current limit function in close loop control. Normally in closed loop the current limit only affects the torque producing current.

7.7 DC current and magnetization handling

The DC brake can be used to hold the motor in place (nominal torque at nominal slip). It can be also used to keep the motor warm in places with high humidity and to speed up the generation of rotor flux. Rotor flux is needed in the induction motor to generate torque. The current that is needed to make the nominal flux is defined by the magnetization current parameter but, depending on motor size, nominal flux takes a different time to produce after start command.

Giving a higher current on start to the motor will decrease the time when the motor is able to generate nominal torque.

Blue: Motor Current. Red: Rotor Flux.

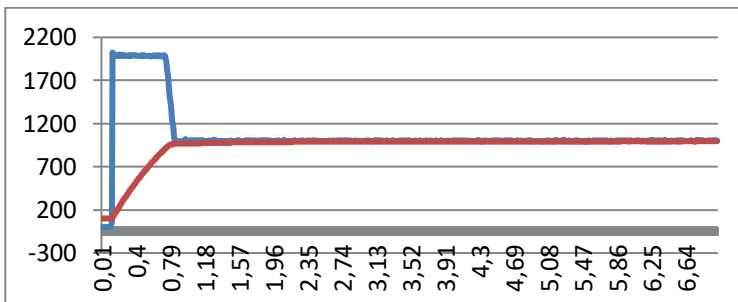
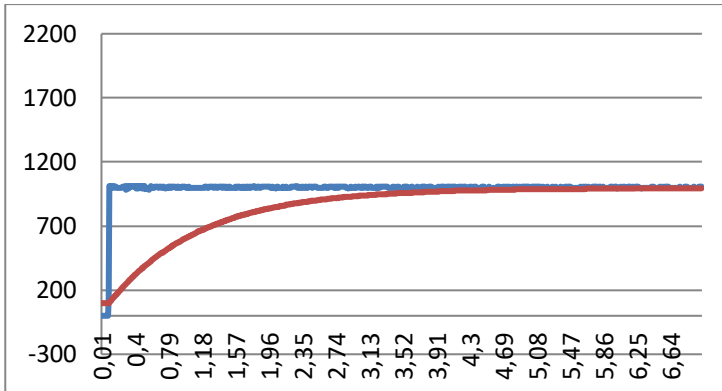

7.7.1 Open loop settings

P2.7.1.1 DC-braking current ID627 "DC-Brake Current"

Defines the current injected into the motor during DC-braking. On start, this parameter is used together with DC Brake time to decrease the time when motor is able to produce nominal torque. When DC brake current is applied to the motor the output frequency is zero.

P2.7.1.2 DC-braking time at start ID507 "Start DC-BrakeTm"

DC-brake is activated when the start command is given. This parameter defines for how long the DC current is given to the motor before acceleration starts. DC brake current at start is used in order to magnetize the motor before running, which will improve the torque performance at start. Needed time depends on motor size, value varying between 100 ms to 3 second. The bigger the motor the more time is needed.

The default setting 0.00 s means that 200 ms is spent to magnetize motor. This 200 ms can be set to zero with parameter "MakeFluxTime".

Activating flying start will disable the DC brake functions at start.

P2.7.1.3 DC-braking time at stop ID508 "Stop D-BrakeTm"

Defines the time to use DC brake at stop. The operation is different depending on the selected stop mode (coasting or ramping).

Stop function = 0 / Coasting:

After the stop command, the motor coasts to a stop without control of the drive.

With DC injection, the motor can be electrically stopped in the shortest possible time, without using an optional external braking resistor.

The braking time is scaled according to the frequency at the moment of stop command. If the frequency is the nominal frequency of the motor or higher, the set value of DC braking time at stop is used as the braking time. When the frequency is below the nominal frequency, the relation between the nominal frequency and the output frequency at the time of stop command will determine the DC braking time. For example, 50-hertz motor is running at 25 Hz when the stop command is given. The DC brake time will be 50% of the DC braking time at stop. If the frequency is below 5 Hz, the minimum DC braking time is 10% of the DC braking time at stop.

DC braking is started after a short restart delay following the stop command if stop function is coasting.

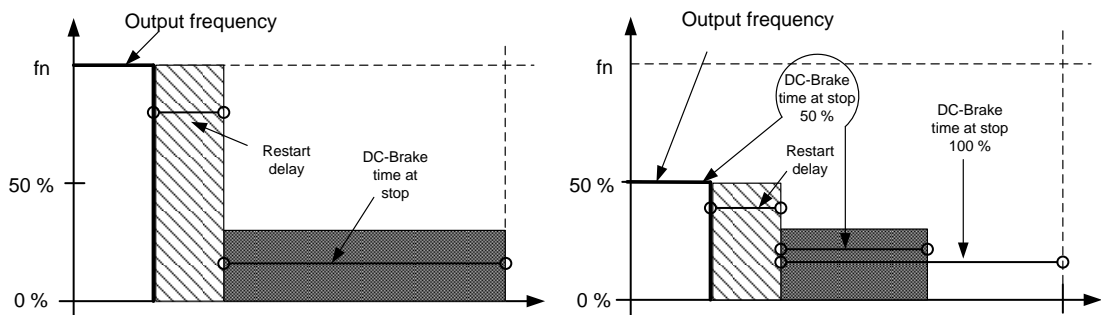

Figure 7-14. DC-braking time when Stop mode = Coasting, from nominal speed and 50 % of nominal speed.

Stop function = Ramp:

After the Stop command, the speed of the motor is reduced according to the set deceleration parameters, to the speed defined with parameter DC braking frequency at stop, where the DC braking starts.

The braking time is defined with parameter *DC braking time at stop*. If high inertia exists, it is recommended to use an external braking resistor for faster deceleration. See Figure 7-15.

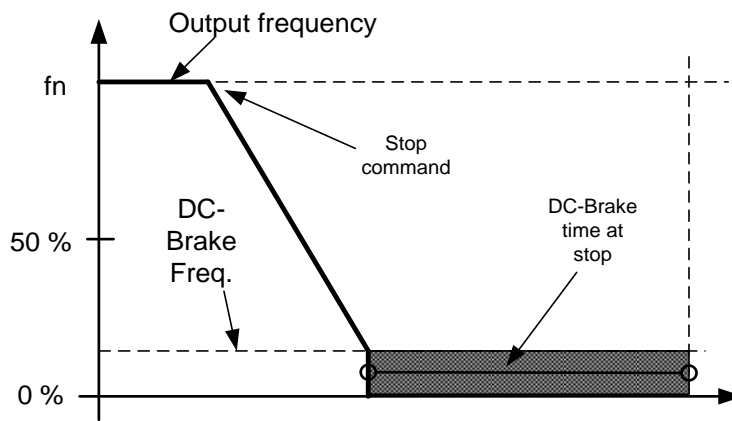

Figure 7-15. DC-braking time when Stop mode = Ramp

P2.7.1.4 DC braking frequency at stop ID515 "Stop D-BrakeFr"

The output frequency at which the DC braking is applied when making ramping stop.

P2.7.1.5 Scaling of DC-braking current ID400 "DC-currnt Sclng"

The DC braking current can be reduced with the free analogue input signal between zero current and the current set with parameter *DC Braking Current*.

0 = Not used

1 = AI1

2 = AI2

3 = AI3

4 = AI4

5 = FB Limit Scaling ID46 Monitoring value

P2.7.1.6 DC brake current in stop ID1080 "DCBrakeCurlnStop"

Defines the current injected to the motor in stop state when the digital input signal "DC Brake Command" is used to activate the DC brake when no run request is active. When the DC brake is activated the drive will indicate being in Run state.

7.7.1.1 *Flux braking*

P2.7.1.7 *Flux brake* ID520 "Flux Brake"

Instead of DC braking, flux braking is a useful way to raise the braking capacity in cases where additional brake resistors are not needed. When braking is needed, the frequency is reduced and the flux in the motor is increased. This increases losses on motor, which in turn increases the motor's capability to brake. Unlike in DC braking, the motor speed remains controlled during braking.

The flux braking can be set ON or OFF.

0 = Flux braking OFF

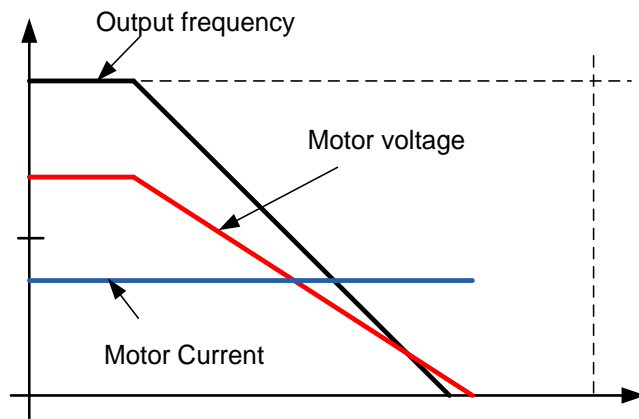

1 = Flux braking ON

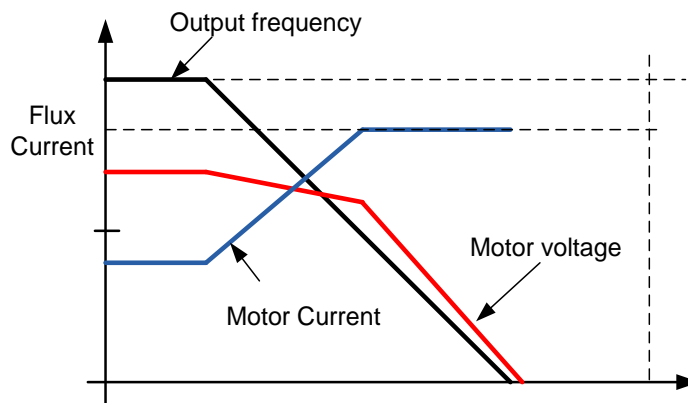

P2.7.1.8 *Flux braking current* ID519 "FluxBrakeCurrent"

Defines the flux braking current value. The value setting range depends on the used unit size.

7.7.2 Closed loop settings

P2.7.2.1 Magnetizing current at start ID627 "Start Magn Curr"

Defines the current that is applied to the motor when the start command is given in closed loop control. At start this parameter is used together with *Magnetizing time at start* to decrease the time when the motor is able to produce nominal torque. In closed loop control output frequency is not forced to zero while magnetization current is applied to motor.

P2.7.2.2 Magnetizing time at start ID628 "Start Magn Time"

Defines the time for how long magnetization current is applied to motor at start. *Magnetizing current at start* is used to shorten the time when flux is at nominal level. This will improve the torque performance at start. The time needed depends on the motor size, value varying between 100 ms to 3 second. The bigger the motor the more time it needs. Set this time so that the rotor flux is more than 90% before speed is released (Start Zero Speed Time ID615) or mechanical brake is released.

P2.7.2.3 Flux reference ID1250 "FluxReference"

Reference value for rotor flux. Rotor flux can be reduced by changing the magnetization current. This, however, also affects the motor model making the torque calculations a little less accurate. When using this parameter the motor model can compensate the effect of the different magnetization current in torque calculations.

$$[FW]RotorFlux = \left(\frac{f(MotorNomFreq)}{f(Out)} \right)^2 \quad \text{when } f(Out) > f(MotorNomFreq)$$

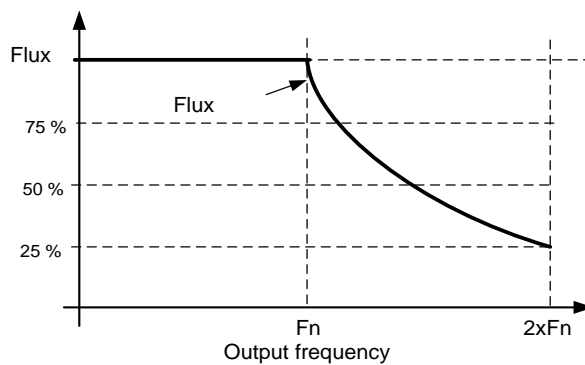

P2.7.2.4 Flux Off Delay ID1402 "Flux Off Delay"

The Flux off delay function will keep the motor magnetized after a stop command thus making the next start faster because flux is already available in the motor. The function is used, for example, in a system where several repeated starts are made in short cycles. The flux level can be adjusted by parameter *Stop State Flux*.

0 = Flux is not maintained in the motor

>0 = Flux off delay in seconds.

-1 = Flux is maintained indefinitely in the motor

P2.7.2.5 *Stop State Flux ID1401* “Stop State Flux”

The amount of flux in percentage of the motor nominal flux maintained in the motor after the drive is stopped. The flux is maintained for the time set by parameter ID1402 *Flux Off Delay*. This parameter can only be used in closed loop motor control.

7.7.2.1 *Reduced flux function*

Reduced flux function is used to decrease the magnetization current below a certain frequency limit. This function is used in systems where high starting torque is not needed. This function CANNOT be used in any situation where motor nominal torque from zero speed is required.

P2.7.2.6 *Reduced Flux frequency*

A frequency point where flux starts to reduce to a level defined by *Reduced Flux Level* toward the zero speed.

P2.7.2.7 *Reduced Flux level*

This parameter defines the flux level when the output frequency is zero. The flux is reduced linearly from ID1614 to zero frequency.

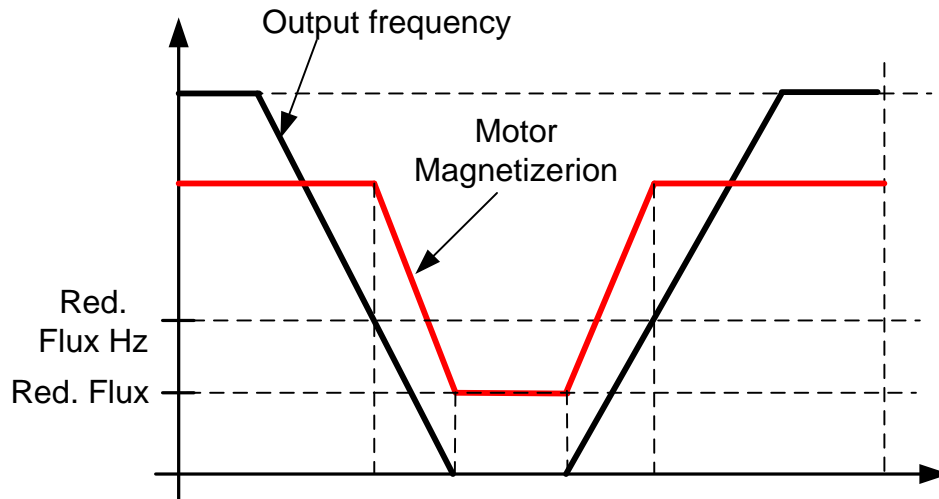

7.8 Motor Control

Open Loop control

Open loop control controls the motor without encoder feedback from the motor shaft. Control mode selections 0, 1 and 2 are open loop control modes.

Slip

Induction motor torque is based on slip. When the load increases, also slip will increase. Slip is the speed that the rotor is left behind the stator electrical frequency.

The below picture presents the torque that is produced by the induction motor when connected directly on line.

1. Motor Synchronous speed. Motor is taking only magnetization current.
2. Motor nominal operation point. Motor is producing 100% of rated torque and power. Actual shaft speed is the motor nominal speed. The motor takes nominal current.
3. Pull out torque. This is the point where the motor produced torque starts to decrease when slip increases. After this point, the motor will stop if load is not reduced.

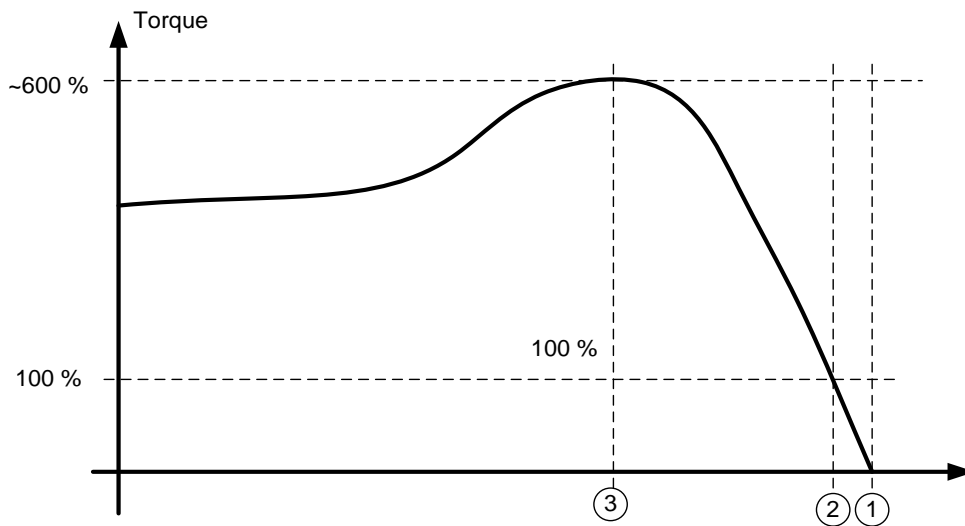

In frequency control, the load will determine the actual shaft speed.

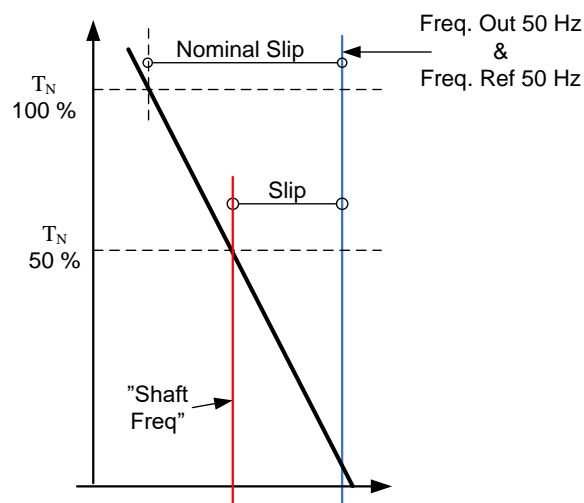

Slip compensation in open loop control

The drive uses motor torque and motor nominal rpm to compensate slip. If the motor nominal rpm is 1440 -> the nominal slip is 60 rpm. And when the motor torque is 50%, the slip is 30 rpm. To keep the reference speed, the drive must increase the output frequency by 1 Hz.

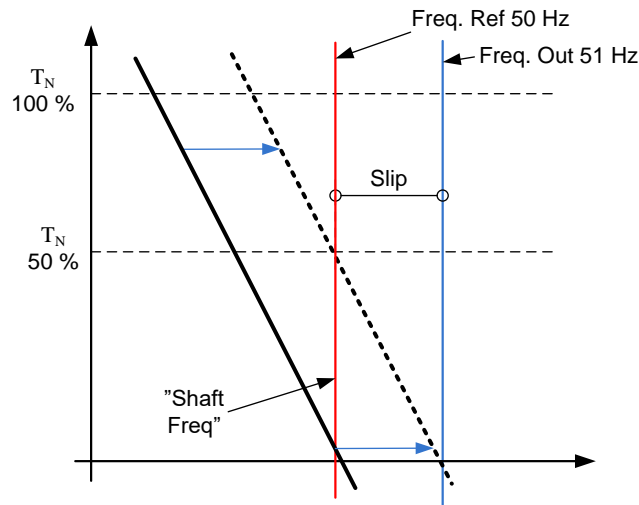

Closed Loop control

Closed loop control controls the motor using the exact information of the motor speed from the encoder. Control mode selections 3 and 4 are closed loop control modes. Using these modes without encoder board (and encoder) will result in encoder fault.

P2.8.1 Motor control mode ID600 “Motor Ctrl Mode” (2.6.1)

0 “Freq Control”

Open loop frequency control:

Drive frequency reference is set to output frequency without slip compensation. Motor speed is defined by motor load.

1 “OL SpeedCont”

Open loop speed control:

Drive frequency reference is set to motor speed reference. Motor speed stays the same regardless of motor load.

2 “Open Loop”

Open loop Speed or Torque control

In this control mode, the drive can be selected to run in torque control mode. The operation is selected by parameter *Torque Select* in the Torque Reference parameter group. The default selection is torque control mode speed limited by ramp generator output.

3 “CL SpeedCtrl”

Close loop speed control

Drive frequency reference is set to motor speed reference. Motor speed stays the same regardless of motor load.

4 “Closed Loop”

Closed loop speed or torque control

In this control mode the drive can be selected to run in torque control mode. The operation is selected by parameter *Torque Select* in the Torque Reference parameter group. The default selection is torque control mode speed limited by ramp generator output.

5 “Sensorless”

Sensorless speed or torque control.

To use this control mode DTC Identification or Ident All is needed to perform.

When the drive is follower and drive synch is enabled, the motor control mode is internally set to Frequency control.

P2.8.2 Motor control mode 2 ID521 “Motor Ctrl Mode2”

With this parameter you can set another motor control mode which is activated with parameter *Mot Ctrl Mode1/2*.

Note: The Motor control mode cannot be changed between open loop and closed loop while the drive is in Run state.

P2.8.3 Torque Select ID1278 (P2.2.9.6) "Torque Select"

This parameter defines the speed limiting mode in torque control mode. This parameter can be used as single motor control mode selection when no change is made between open loop and closed loop controls.

0= "SpeedControl" - Speed control mode

The drive is forced to operate in speed control mode while the motor control mode parameter is set to torque control mode thus allowing selection of speed control and torque control mode with single parameter e.g. from Fieldbus.

1="MaxFreqLimit" - Positive and negative frequency limits

Speed is not limited by speed reference, only maximum frequency or Positive and Negative frequency limit if set lower than maximum frequency parameter.

2="RampOutput" – Ramp output for both directions

Speed is limited by reference after ramp generator, thus speed will increase with set ramp time until actual torque is equal to reference torque. If speed is below the reference when load is removed from the shaft, the speed will increase without ramp.

This is the default selection. For master follower system, it is recommended to use a selection that allows a little higher reference for torque follower that load will be balanced equally, for example, in window control.

3="Min" – Minimum from speed reference and torque reference.

The minimum of the speed controller output and the torque reference is selected as final torque reference.

4="Max" – Maximum from speed reference and torque reference

The maximum of the speed controller output and the torque reference is selected as final torque reference.

5="Window" – Window control

Speed is limited within window from speed reference.

Speed control activation limit is different from the speed limit. Speed needs, therefore, to go first to "Window Pos" or "Window Neg" limit before the speed controller activates, when speed controller is active speed will be restricted to limit defined by "Window Pos Off" and "Windows Neg Off" from the "FinalFreqRef"

7.8.1 U/f Settings

U/f settings are mainly used in open loop control modes with the exception of the *Field weakening point voltage* that is also used in closed loop control mode as a limit for voltage. U/f settings are used to control the voltage level that are applied to the motor at different frequencies and different load situations.

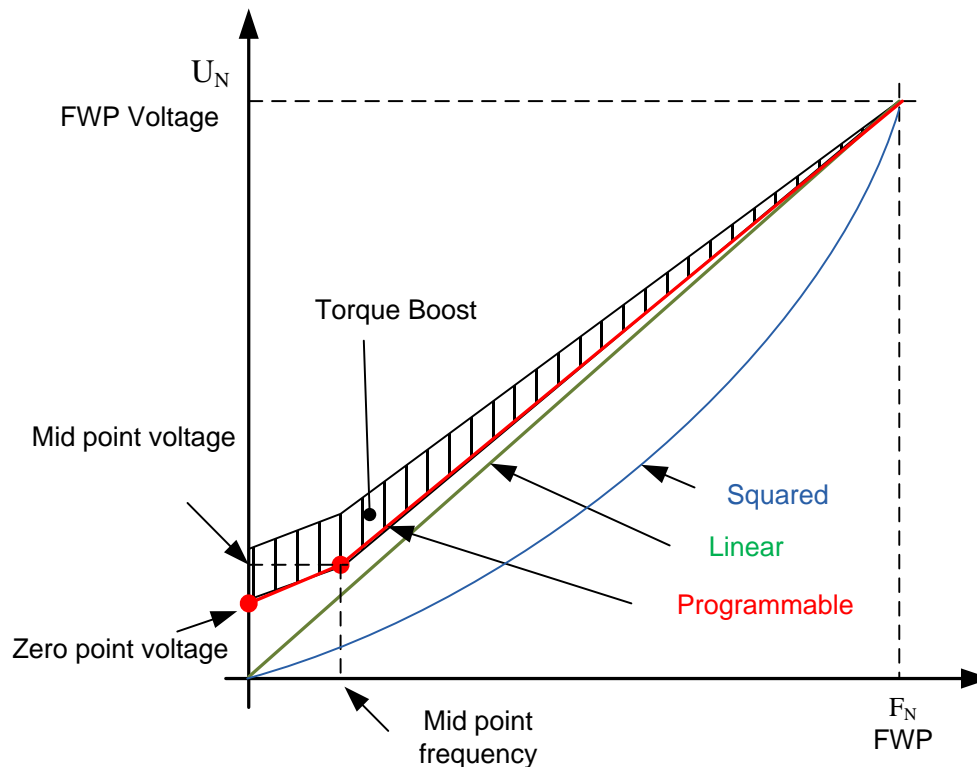

What changes are required to start with load from 0 Hz?

- ◆ First set the motor nominal values (Parameter group 2.1).

Option 1: Automatic functions

Step 1: Make identification with rotating motor

Step 2 (If needed): Activate speed control or U/f optimization (Torque boost).

Step 3 (If needed): Activate both speed control and U/f optimization.

Option 2: Manual tuning

Step 1:

Run the motor using 2/3 of motor nominal frequency as the frequency reference. Read the motor current in the monitoring menu or use VACON® NCDrive for monitoring. This current must be set as the motor magnetization current.

Change the U/f curve ratio selection to programmable (= 2).

Run the motor with zero frequency reference and increase the motor zero point voltage until the motor current is approximately same as the motor magnetising current. (If the

motor is in a low frequency area for only short periods, it is possible to use up to 65% of the motor nominal current).

Set then the midpoint voltage to $\sqrt{2}$ * Zero Point Voltage
and

the midpoint frequency to (Zero Point Voltage/100%)*Nominal frequency of motor)

Step 2 (If needed): Activate speed control or U/f optimization (Torque boost).

Step 3 (If needed): Activate both speed control and U/f optimization.

NOTE! In high torque – low speed applications – it is likely that the motor will overheat. If the motor has to run long times under these conditions, special attention must be paid to cooling of the motor. Use external cooling for the motor if the temperature tends to rise too high.

P2.8.4.1 U/f optimisation ID109 “U/f Optimization”

Automatic torque boost The voltage to the motor changes proportionally to required torque which makes the motor produce more torque at start and when running at low frequencies. Automatic torque boost can be used in applications where starting torque due to starting friction is high, for example, in conveyors. Even with linear U/f curve, the torque boost has an affect but the best result will be achieved after the identification run when programmable U/f curve is activated.

P2.8.4.2 U/f ration selection ID108 “U/f Ratio Select”

Linear:

0 The voltage of the motor changes linearly from zero point voltage to the field weakening point where the voltage at FWP is supplied to the motor.

Squared:

1 The voltage of the motor changes from zero point voltage following the squared curve form zero frequency to the field weakening point. The motor runs under magnetised below the field weakening point and produces less torque. Squared U/f ratio can be used in applications where torque demand is proportional to the square of the speed, for example, in centrifugal fans and pumps.

Programmable U/f curve:

2 The U/f curve can be programmed with three different points.

1. Zero point voltage
2. Midpoint frequency and Midpoint voltage.
3. Field weakening point and field weakening point voltage.

Programmable U/f curve can be used if more torque is needed at low frequencies. Make the Identification run for optimal setting (ID631).

Linear with flux optimisation:

3 The AC drive starts to search for the minimum motor current in order to save energy. This function can be used in applications with constant motor load, such as fans, pumps etc.

P2.8.4.3 Field weakening point ID602 "Field WeakngPnt"

The field weakening point is the output frequency at which the output voltage reaches the field weakening point voltage.

P2.8.4.4 Voltage at field weakening point ID603 "Voltage at FWP"

Above the frequency at the field weakening point, the output voltage remains at the set maximum value. Below the frequency at the field weakening point, the output voltage depends on the setting of the U/f curve parameters.

When the parameter *Motor nominal frequency* is set, the parameter *Field weakening point* is automatically given the corresponding value. If you need different values for the field weakening point and the maximum output voltage, change these parameters **after** setting the *Nominal frequency*.

In closed loop control this defines maximum voltage to the motor, can be increases if sufficient DC voltage is available.

P2.8.4.5 U/f curve, middle point frequency ID604 "U/f Mid Freq"

If the programmable U/f curve has been selected with parameter U/f ratio this parameter defines the middle point frequency of the curve. See also parameter *Middle point voltage*.

When the programmable U/f curve is selected this value is set to 10% of motor nominal frequency.

P2.8.4.6 U/f curve, middle point voltage ID605 "U/f mid Voltg"

If the programmable U/f curve has been selected with the parameter U/f ratio this parameter defines the middle point voltage of the curve. See also parameter *Middle point frequency*.

When the programmable U/f curve is selected this value is set to 10% (of motor nominal voltage).

P2.8.4.7 Output voltage at zero frequency ID606 "Zero Freq Voltg"

This parameter defines the zero frequency voltage of the U/f curve. The default value is unit size dependent.

NOTE: If the value of parameter *U/f Ratio Select* is changed this parameter is set to zero.

7.8.1.1 I/f Control

I/f-control can be used to start the motor using a constant current control. This is useful especially, if the motor stator resistance is low, which makes the motor current sensitive for u/f-curve tuning at low speed area.

P2.8.4.8 *I/f Start* ID534

Activates I/f control

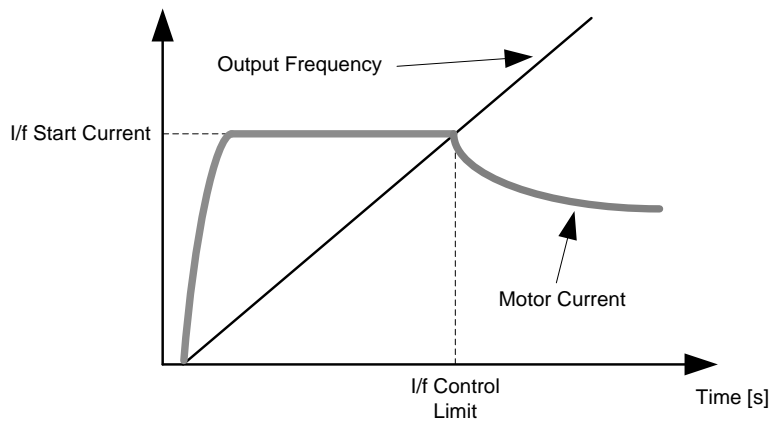

P2.8.4.9 *I/f Current* ID1693 "*I/f Current*"

NOTE: I/f Current parameter is used for several different purposes.

I/f Control

This parameter defines the current level during I/f control, in percent of the motor nominal current

Zero position with incremental encoder and Z-Pulse

In closed loop control utilizing the encoder z-pulse, defines also the current level used in starting before the z-pulse is received to synchronize with.

DC Start Angle identification

This parameter defined DC Current level when Start Angle Identification Time is set greater than zero. See P2.8.5.5 Start Angle Identification Time.

P2.8.4.10 *I/f Control Limit* ID1790 "*I/f Control Lim*"

This parameter sets the frequency limit for I/f-control in per cent of the motor nominal frequency. I/f-control is used if the frequency is below this limit. The operation changes back to normal when the frequency is above this limit with 1 Hz hysteresis.

P2.8.4.11 *MakeFluxTime* ID660

Time for magnetize the motor in ms. In Open Loop control drive will remain in zero speed during this time. Using DC Brake in start will bypass Make Flux Time. During the Make Flux Time voltage reference can be set separately, in Marine application Make Flux Voltage is same as Zero Freq Voltage.

7.8.2 Close Loop Settings

P2.8.5.1 Current control P gain ID617 "CurrentControlKp"

Sets the gain for the current controller. The controller generates the voltage vector reference to the modulator. The gain is also used in open loop flying start. When the Sine filter parameter (parameter P6.7.5 in the System menu) has been set to *Connected* the value of this parameter is changed to 20.00%.

The value is also identified when using a PMS motor and making identification run with rotating motor. At low speed the motor values may increase up to 300%. At high speed motor gain and motor with sine filter may have gain values of 10...40%.

P2.8.5.3 Current control Ti ID657 "CurrentControlTi"

Current controller integrator time constant.

P2.8.5.3 Slip adjust ID619 "Slip Adjust"

The motor name plate speed is used to calculate the nominal slip. This value is used to adjust the voltage of motor when loaded. The name plate speed is sometimes inaccurate and this parameter can therefore be used to trim the slip. Reducing the slip adjust value increases the motor voltage when the motor is loaded.

P2.8.5.4 Acceleration compensation ID626 "Accel.Compens."

Sets the inertia compensation to improve the speed response during acceleration and deceleration. The time is defined as acceleration time to nominal speed with nominal torque. This function is used when the inertia of the system is known to achieve the best speed accuracy when reference is changed.

Acceleration compensation is added to *TorqueReferenceActual* i.e. torque is added after speed controller. The speed controller can, therefore, be tuned only for speed error and the acceleration compensation makes sure that the system inertia does not affect the speed controller.

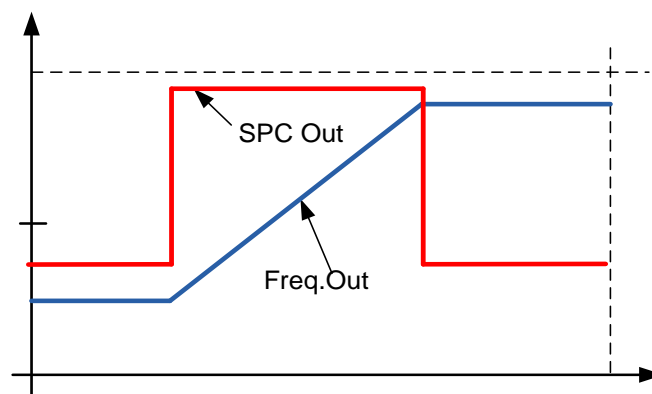

Acceleration compensation not in use

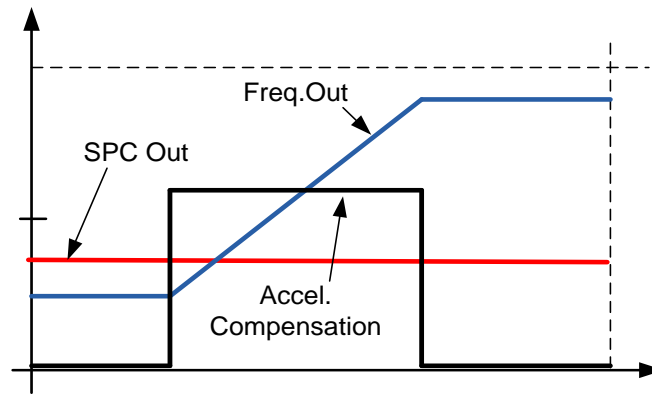

Acceleration compensation in use

$$AccelCompensationTC = J \cdot \frac{2\pi \cdot f_{nom}}{T_{nom}} = J \cdot \frac{(2\pi \cdot f_{nom})^2}{P_{nom}}$$

J = System inertia (kg*m²)

f_{nom} = Motor nominal frequency (Hz)

T_{nom} = Motor nominal torque

P_{nom} = Motor nominal power (kW).

P2.8.5.5 Speed Error filtering time constant ID1311 "SpeedErrorFiltTC"

Filter time constant for speed reference and actual speed error. May be used to remove small disturbances from encoder signal.

P2.8.5.6 Encoder filter time ID618 "Encoder1FiltTime"

Sets the filter time constant for speed measurement.

The parameter can be used to eliminate encoder signal noise. Too high a filter time reduces speed control stability. Values over 10 ms are not recommended in normal cases.

P2.8.5.7 Encoder Selection ID1595 "Encoder Selector"

With this parameter it is possible to select which encoder input is used for closed loop control. Encoder board OPT-A7 is needed because of the possibility to connect two encoders.

0,1 = Encoder input 1

2 = Encoder input 2

P2.8.5.8 Speed Control Torque Chain Select ID1557 "SCTorqueChainSel"

Values are bit coded. For example, after identification run with rotating motor the value will be 96. If you want to activate an external acceleration compensation you need to add +2 to the existing value.

B0 +1 = Additional torque limit

The torque reference chain can be used as an additional torque limit. This option is available in closed loop control mode only.

B1 +2 = External acceleration compensation

The torque reference is added to the speed control output, allowing the external controller to give inertia compensation for the drive in speed control mode. This option is available in closed loop control mode only.

B5&B6, +96 = Internal motor temperature compensation

When the motor cools down or warms up, the slip of the motor will change. When this function is activated in closed loop control mode, the drive will estimate changes in motor resistance and correct the changes of motor slip automatically to achieve the best torque estimation.

This function is automatically activated when identification run with rotating motor is successfully finished. This option is available in closed loop control mode only.

P2.8.5.9 TCDynDampGain ID1576

Dynamic damping gain in closed loop torque control mode.

P2.8.5.10 TCDynDampTC ID1577

Bandpass time constant in ms for dynamic damping

7.8.3 Permanent magnet synchronous motor settings

There are three ways to know the magnet positions when using the closed loop control. The first one will identify the motor magnet position during every start when using incremental encoder without Z-pulse. Second one uses incremental encoder Z-pulse and the third one uses absolute encoder information. See details of selecting correct mode from chapter "Identification function for permanent magnet synchronous motor".

P2.8.6.1 PMSM Shaft Position ID649 "PMSMShaftPositio"

Absolute encoder position value corresponding to the shaft position where rotor magnet axis is aligned with the stator U-phase magnet axis will be stored here as a result of the encoder identification run. If incremental encoder with a z-pulse is used, z-pulse position will be stored instead. Depending on the motor shaft mechanical position, this parameter can have different values, as there is one right value for each pole-pair of the motor. If incremental encoder and the z-pulse is utilized, the first start after power up is less optimal and i/f-control (see 6.8.3.2) will be used until the drive finds the z-pulse and is able to synchronize in that.

P2.8.6.2 Start Angle Identification Mode ID1691 "StartAngleIdMode"

Start angle, i.e. rotor magnet axis position in respect to the stator U-phase magnet axis, identification is needed if there are no absolute encoder or incremental encoder with z-pulse used. This function defines how the start angle identification is made in those cases. Identification time depends on the motor electrical characteristics but takes typically 50ms...200ms.

In case of absolute encoders, start angle will read directly from the encoder absolute angle value. On the other hand, incremental encoder z-pulse will be used automatically for synchronization if it's position is defined different from zero in ID649. Also for absolute encoders, ID649 must be different from zero, otherwise it is interpreted that the encoder identification run has not been done and the running will be prohibited except if the absolute channel is bypassed by the start angle identification.

NOTE!

ModulatorType (P2.10.2) need to be > 0 to be able to use this function.

0 = Automatic

Decision to use start angle identification is made automatically based on the encoder type connected to the drive. This will serve common cases.

Supports: OPT-A4, OPT-A5, OPT-A7 and OPT-AE boards.

1 = Forced

Bypasses the drive automatic logic and forces the start angle identification to be active. Can be used, for example, with absolute encoders to bypass absolute channel information and to use start angle identification instead.

2 = On Power UP

As a default, start angle identification will be repeated in every start if the identification is active. This setting will enable identification only in a first start after drive is powered up. In consecutive starts, angle will be updated based on the encoder pulse count.

10 = Disabled

Used when Z- pulse from encoder is used for start angle identification.

P2.8.6.3 Start Angle Identification Current ID1759 "StartAngleIdCurr"

This parameter defines the current level that is used in start angle identification. The correct level depends of the motor type used. In general, 50% of motor nominal current seems to sufficient, but depending for example on the motor saturation level, higher current might be needed.

P2.8.6.4 Polarity Pulse Current ID1566 "PolarityPulseCur"

This parameters defines the current level for the magnet axis polarity direction check during the start angle identification (P2.8.6.2 / ID1691). Value 0 means that the internal current level is used, which is typically slightly higher than the normal identification current defined by P2.8.6.3 / ID1759. Polarity direction check is seldom needed because the identification itself gives already the right direction. Hence in most cases, this function can disabled by setting any negative parameter value, which is recommended especially if there occurs F1 faults during the identification.

P2.8.6.5 Start Angle Identification Time ID1755 "StartAngleIdTime"

Start angle can be determined also by feeding dc-current into the motor. The dc-current will align the rotor magnet axis with the stator magnet axis. This function is activated by determining how long the dc-current is injected to the motor. The motor must be free to move during the alignment and the time needs to be long enough for the shaft oscillations to damp out. Hence, this method is not very practical and is mainly intended to be used for testing purposes or to improve starting together with i/f-control. Dc-current level is determined by ID1693 / P2.8.6.6. Also ID1691 / P2.8.6.2 needs to disabled, otherwise it will override this function.

7.8.3.1 I/f Control

I/f-control can be used to start the motor using a constant current control. This is useful especially, if the motor stator resistance is low, which makes the motor current sensitive for u/f-curve tuning at low speed area. I/f-control is activated by setting AdvancedOptions2.B9 = 1 (P2.10.6) for PM-motors. Also software modulator is required.

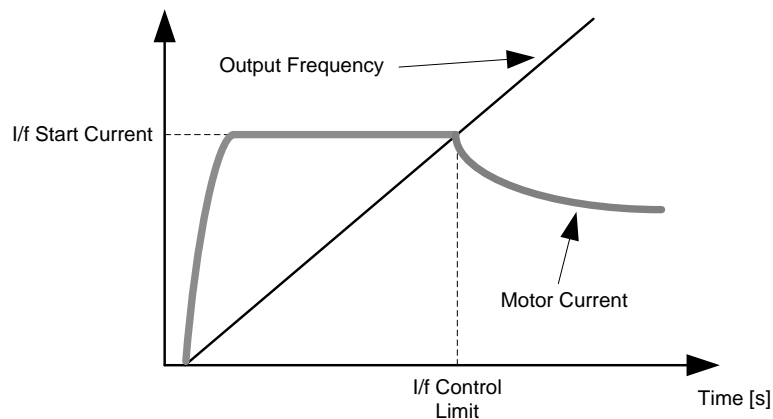

P2.8.6.6 I/f Current ID1693 "I/f Current"

NOTE: I/f Current parameter is used for several different purposes.

I/f Control

This parameter defines the current level during I/f control, in percent of the motor nominal current

Zero position with incremental encoder and Z-Pulse

In closed loop control utilizing the encoder z-pulse, defines also the current level used in starting before the z-pulse is received to synchronize with.

DC Start Angle identification

This parameter defined DC Current level when Start Angle Identification Time is set greater than zero. See P2.8.5.5 Start Angle Identification Time.

P2.8.6.7 I/f Control Limit ID1790 "I/f Control Lim"

This parameter sets the frequency limit for I/f-control in per cent of the motor nominal frequency. I/f-control is used if the frequency is below this limit. The operation changes back to normal when the frequency is above this limit with 1 Hz hysteresis.

7.8.3.2 *Flux current controller*

The flux current controller is used with a PMS motor when running in closed loop control in the field weakening area. This function controls negative Id current to PM motor in the field weakening area that motor terminal voltage do not increase above maximum level (set by field weakening point voltage, maximum drive output voltage) . Field weakening area operation depends on motor construction and motor construction may prohibit operation above field weakening area.

If there is instability in the field weakening area, gain can be decreased and/or time constant increased.

P2.8.6.8 Flux Current Kp ID551 "FluxCurrent Kp"

Defines gain for the flux current controller when using a PMS motor. Depending on motor construction and the ramp rate that is used to go to field weakening area, high integration times may be needed so that output voltage do not reach maximum limit and prevent proper motor control. Too high gain may also lead to unstable control. Integration time is more significant in this case for control.

P2.8.6.9 Flux Current Ti ID652 "FluxCurrent Ti"

Defines the integration time for the flux current controller when using a PMS motor. Depending on motor construction and the ramp rate that is used to go to field weakening area, short integration times may be needed so that output voltage do not reach maximum limit and prevent proper motor control. Too fast integration time may also lead to unstable control.

P2.8.6.10 ExtIdRef ID1730 "ExtIdRef"

This reference value can be used for the external control of the motor id-current i.e. reactive current. Normally there is no need for that as the control uses already the optimal value. This reference value is additive to the drive internal values but, for example, field-weakening controller can override the given reference in field-weakening operation.

P2.8.6.11 EnableRsIdentifi ID654 "EnableRsIdentifi"

This parameter enables the Rs identification during DC brake current operations and in closed loop control for every start. If the identification run was made successfully it is recommended to keep this parameter disabled.

7.8.3.3 *D and Q axis voltage drops*

If d-axis and q-axis reactances (voltage drops) are defined, drive calculates the optimal d-axis current reference based on the reactance values and the motor torque in order to account motor reluctance torque part. In this way, motor Torque/Current ratio can be increased.

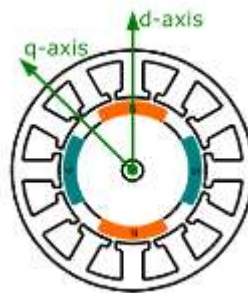

P2.8.6.12 Lsd Voltage Drop ID1757 “Lsd Voltage Drop”

D-axis reactance voltage drop 2560 = 100%.

Gives the % voltage drop across the stator inductance at nominal current and frequency.

$$X_d[\text{Drive scale}] = \frac{X_d[\Omega] * I_n[A] * \sqrt{3} * 2560}{U_n[V]}$$

P2.8.6.13 Lsq Voltage Drop ID1758 “Lsq Voltage Drop”

Q-axis reactance voltage drop 2560 = 100%.

Gives the % voltage drop across the stator inductance at nominal current and frequency.

$$X_q[\text{Drive scale}] = \frac{X_q[\Omega] * I_n[A] * \sqrt{3} * 2560}{U_n[V]}$$

P2.8.6.14 Encoder ID Current % ID1734

Current reference for encoder identification run

P2.8.6.15 Polarity ID Mode ID1737

0 = Current Pulse

1 = Torque Pulse

P2.8.6.16 Polarity Pulse Length ms ID1742

Pulse length for Polarity ID Run.

P2.8.6.17 Polarity Detection Angle Deg ID1748

Detection angle for Polarity ID Run.

P2.8.6.18 Angle Identification Mode ID1749

0 = Current Pulse

1 = High Frequency Sine

2 = Low Frequency Sine

P2.8.6.19 Current Control Kp d % ID1761

Current controller gain for d-axis

P2.8.6.20 Voltage Margin % ID1759

Voltage margin to prevent current controller from saturating.

P2.8.6.21 Encoder ID Run Mode "EncIdRunMode" ID680

This parameter defines how the start angle identification is made for absolute encoder with the identification mode selections 3 / "Enc. ID Run" or 4 / "Ident All".

0 = Default

This mode feeds the DC current to the motor and aligns the rotor to find the zero position. The rotor needs to be able to rotate freely to align correctly.

1 = Current Pulses

This mode sends current pulses to the motor, and the rotor can be locked to a position, for example with a mechanical brake. This mode should be tested to the motor in use, since all PMSM are not suitable for this identification mode.

2 = ID with Run

This method is the most reliable to find the zero position but requires that the motor can be accelerated to 2/3 of motor nominal speed to find the absolute encoder zero position. After 2/3 of nominal speed is reached, the motor is coasted to determine the encoder zero position after the DC brake is applied to make the rotor to stop to stand still. This method can be used also when step-up transforms are used.

P2.8.6.22 PMSM Shaft Position High ID681

High Word of Shaft Position, see P2.8.6.1 PMSM Shaft Position.

P2.8.6.23 Start Angle Offset ID696

Offset angle added to identified start angle.

P2.8.6.24 VoltageCorr. Kp ID1783

Flux integrator drift compensator proportional part

P2.8.6.25 VoltageCorr. Ki ID1784

Flux integrator drift compensator integral part

7.8.4 Stabilization settings

7.8.4.1 Torque stabiliser

The torque stabiliser is basically the first order high-pass filter for the estimated torque [T]. The output of the filter is a frequency correction term df added to the output frequency reference. The purpose of the torque stabiliser is to stabilise the possible oscillations in the estimated torque. The controller gain is changing linearly between the zero and field weakening point frequencies. The zero and field weakening point gains can be controlled independently with gains. The stabiliser operates at frequencies above 3 Hz.

The discrete implementation of the filter is:

$$\frac{1000}{TorqStabDamp} df_k = \frac{1000}{TorqStabDamp} G(T_k - T_{k-1}) + df_{k-1} = G_f(T_k - T_{k-1}) + df_{k-1}$$

Where G_f is the total gain of the filter. The gain and the corner frequency of the filter is controlled by the following parameters

P2.8.7.1 *Torque stabiliser Gain* ID1412 "TorqStabGain"

These parameters define together with the Torque Stabiliser Damping the actual gain of the filter. Torque Stabiliser Gain is the gain at the zero frequency. Torque stabiliser Gain in FWP is the gain at the field-weakening frequency. The gain changes linearly with the frequency between these two points so that the gain is

$$G = TorqStabGainFWP + TorqStabGain - \frac{f}{f_{FWP}} TorqStabGain, \quad \text{if } f < f_{FWP}$$

$$G = TorqStabGainFWP, \quad \text{if } f \geq f_{FWP}$$

The final gain is obtained by considering the value of Torque Stabiliser Damping and the scaling in which 256 means the gain 1. So, the final and the actual gain of the filter is obtained from

$$G_f = \frac{1000 * G}{256 * TorqStabDamp}$$

P2.8.7.2 *Torque stabiliser damping* ID1413 "TorqStabDamp"

If a PMS motor is used in open loop control mode, it is recommended to use value 980 instead of 800. The value '980' is set automatically when PMS motor is selected.

This parameter defines the corner frequency of the high-pass filter. The time constant of the filter is calculated as

$$T_c = T_s \frac{TorqStabDamp}{1000 - TorqStabDamp} = 1ms \frac{TorqStabDamp}{1000 - TorqStabDamp}$$

It follows that the corner frequency of the filter is obtained from

$$\omega_c = \frac{1}{T_c} \text{rad/s}$$

For example, if Torque stabilizer damping = 600, it follows that $T_c = 1.5 \text{ ms}$ and $\omega_c = 667 \text{ rad/s}$.

P2.8.7.3 Torque stabiliser Gain in FWP area ID1414 "TorqStabGainFWP"

Gain of the torque stabiliser at field weakening point in open loop motor control operation. See details from Torque Stabiliser Gain.

P2.8.7.4 Torque stabiliser Limit ID1720 "TorqStabLimit"

This defines how much torque stabiliser can affect output frequency.

7.8.4.2 Flux Circle stabiliser

P2.8.7.5 Flux Circle stabiliser Gain ID1550 "FluxCircleStabG"

Gain for flux circle stabiliser. This will control the flux to stay centralized in the origin when an error is detected. Controller output is added to output frequency. The effect decreases at low frequencies where the flux stabiliser has more effect. This is used at frequencies where output voltage is at maximum limit (set by field weakening point voltage or maximum drive output voltage).

7.8.4.3 Flux stabiliser

Flux stabilizer is the first order high-pass filter for the estimated flux producing current I_d . The output of the filter is correcting term dU added to the output voltage reference. The gain and the corner frequency of the filter is controlled by the following parameters.

P2.8.7.6 Flux Stabiliser Gain ID1797 "Flux Stab Gain"

Flux stabilizer gain is 0 at the zero speed and is increased linearly with the frequency to value defined by the Flux Stab Gain which is reached at the 1 Hz. So, the gain is obtained from

$$G = \text{Flux Stab Gain} * f, \quad \text{if } f < 1 \text{ Hz}$$

$$G = \text{Flux Stab Gain}, \quad \text{if } f \geq 1 \text{ Hz}$$

The gain is scaled by 1000 and the actual gain of the filter is obtained from

$$G_f = \frac{G}{1000} = \frac{\text{Flux Stab Gain}}{1000}$$

P2.8.7.7 Flux stabiliser TC ID1551 "FluxStab TC"

Flux Stabiliser TC defines the corner frequency of the high-pass filter. The time constant of the filter is calculated from:

$$T_c = T_s \frac{65536 - 2 * \text{FluxStab TC}}{2 * \text{FluxStab TC}} = 1\text{ms} \left(\frac{65536}{2 * \text{FluxStab TC}} - 1 \right)$$

For example, if Flux Stabiliser TC = 64, it follows that $T_c = 511 \text{ ms}$ and $\omega_c = 1.96 \text{ rad/s}$.

7.8.4.4 Voltage stabiliser

The voltage stabilizer is similar to the torque stabilizer controlling the change in DC-link voltage at frequencies above 3 Hz. It is the first order high-pass filter for the measured DC-link voltage U_{dc} . The output of the filter is a frequency correction term df added to the output frequency reference. Gain is adjusted relative to the estimated torque. As the torque increases from 10% to 50% of the motor nominal torque, the controller gain decreases from the voltage stabiliser Gain down to zero. The gain and the corner frequency of the filter are controlled by the following parameters:

P2.8.7.9 Voltage stabiliser TC ID1552 "VoltageStab TC"

This parameter defines the corner frequency of the high-pass filter. The time constant of the filter is calculated as

$$T_c = T_s \frac{\text{VoltageStab TC}}{1000 - \text{VoltageStab TC}} = 1ms \frac{\text{VoltageStab TC}}{1000 - \text{VoltageStab TC}} ms$$

P2.8.7.8 Voltage stabiliser Gain ID1738 "VoltStabGain"

Voltage Stabilizer Gain is a function of a torque. If the torque is below 15%, the gain is the value defined by the Voltage Stabilizer Gain. If the torque is above 50% the gain is 0. Between 15-50% the gain decreases linearly with the torque from Voltage Stabilizer Gain to 0. In other words,

$$G = \text{VoltStabGain}, \quad \text{if } T < 15 \%$$

$$G = \frac{\text{VoltStabGain}}{35\%} (50\% - T(\%)), \quad \text{if } 15\% \leq T < 50 \%$$

$$G = 0, \quad \text{if } T > 50 \%$$

The final gain is obtained by considering the value of Voltage stabiliser TC and the scaling in which 256 means the gain 1. So, the final and the actual gain of the filter is obtained from

$$G_f = \frac{1000 * G}{256 * \text{VoltageStab TC}}$$

P2.8.7.10 Voltage stabiliser Limit ID1553 "VoltStabLimit"

This parameter sets the limits for the voltage stabilizer output. The maximum and the minimum value for the correction term df in FreqScale.

7.8.5 Tuning settings

P2.8.7.1 Flying Start Options ID1610

- B0 = +1= Disable movement to reverse direction
- B1 = +2=Disable AC Scanning
- B2 = +4=Reserved (No function).
- B3 = +8=Use encoder information for frequency estimate
- B4 = +16=Use frequency reference for initial guess
- B5 = +32=Disable DC scanning for step-up application

P2.8.8.2 Motor Control Options ID1740

- B00 = +1= Use switching frequency of 3,6 kHz during flying start if below.
- B01 = +2= Analogue output selection 12; torque sign in open loop shows negative on negative direction on motoring side.
- B02 = +4= Enable angle identification in open loop control for PM Motor
- B03 = +8= Reserved
- B04 = +16= Reserved
- B05 = +32=Reserved

P2.8.8.3 Resonance Damping Select ID1760

This feature can be used to dampen the constant frequency torque oscillations in the drive system.

- 0 Not in use
Only monitoring if Resonance damping frequency > 0.0 Hz.
See FW: ResonanceFrequency and FW: ResonanceAmplitude.
- 1 Band pass, Speed Error
Oscillation damping with band pass filter from speed error.
- 2 Band Stop + Band Pass, Speed Error
Oscillation damping with band stop and band pass filter from speed error.
- 3 Band Pass. Iq Current.
Oscillation damping with band pass filter from Iq Actual.

P2.8.8.4 Resonance Damping Frequency ID1763

Frequency of torque oscillations to be damped in Hz.

P2.8.8.5 Resonance Damping Gain ID1764

The gain for the oscillation damping. This changes amplitude of the compensating signal used for oscillation damping.

P2.8.8.6 Resonance Damping Phase ID1765

The compensating signal used for oscillation damping can be phase shifted 0 to 360 degrees using this parameter.

P2.8.8.7 Resonance Damping Activation frequency ID1770

Defines the frequency limit when resonance damping is started.

P2.8.8.8 Resonance Damping Filtering TC ID1771

Filter TC for external feedback (Iq) signal .

P2.8.8.9 Over modulation limit ID1515

Output Voltage Limit for partial modulation in 1%. 100% means maximum sinusoidal modulation. 113% is full six step.
If you have a sine filter in use set this to 96%.

P2.8.8.10 Modulation Index Limit ID655

Modulation index in % for closed loop operation. Higher value of motor terminal voltage can be achieved by increasing this value.

P2.8.8.11 DC Voltage Filtering Time ID1591

Cut off frequency in 0.1Hz for 2nd order butterwort filter used in DCV-compensation.

P2.8.8.12 AC magnetization Current ID1714

Current ref for AC-scanning phases in Flying Start.

P2.8.8.13 AC Scan Time ID1715

Flying Start AC-scanning time reference in ms if slip is 1 Hz actual time depends on motor nom slip.

P2.8.8.14 DC magnetization current ID1716

Current ref for DC-magn phases in Flying Start.

P2.8.8.15 Flux build time ID1704

Flux BuildUp time reference in Flying Start.

P2.8.8.16 Flux build torque ID1711

Torque reference during Flux BuildUp time in Flying Start.

P2.8.8.17 Flying Start Frequency Accept Limit ID1903

Flying start minimum frequency

P2.8.8.18 Generator Torque Scale ID658

Torque scaling factor to linearize usually higher torque in generator side compared to motoring side with same current.

P2.8.8.19 GearRatioMultipl ID1558

Gear ratio multiplier

P2.8.8.20 GearRatioDivider ID1559

Gear ratio divider

7.8.6 Identification settings

P2.8.9.1 to

P2.8.9.15 Flux 10...150% ID1355 – ID1369

Motor voltage corresponding to 10%...150% of flux as a percentage of Nominal Flux voltage. Measured during identification.

P2.8.9.16 Measured Rs voltage drop ID662 "RsVoltageDrop"

The measured voltage drop at stator resistance between two phases with the nominal current of the motor. This parameter is identified during identification run.

This parameter defines the motor stator resistance as a voltage drop at nominal current. The parameter value is defined according to motor nominal voltage and the current and the actual stator resistance as

$$R_s[\text{Drive scale}] = \frac{R_s[\Omega] * I_n[A] * \sqrt{3} * 2560}{U_n[V]}$$

P2.8.9.17 Ir: Add zero point voltage ID664 "IrAddZeroPVoltag"

Defines how much voltage is applied to motor in zero speed when torque boost is used.

P2.8.9.18 Ir: Add generator scale ID665 "IrAddGeneScale"

Defines the scaling factor for generator side IR-compensation when torque boost is used.

P2.8.9.19 Ir: Add motoring scale ID667 "IrAddMotorScale"

Defines the scaling factor for motoring side IR-compensation when torque boost is used.

P2.8.9.20 Measured Ls voltage drop ID673 "LsVoltageDrop"

Leakage inductance voltage drop with nominal current and frequency of the motor. This parameter defines the Ls voltage drop between two phases. Use identification run to determine the optimum setting.

P2.8.9.21 Motor BEM Voltage ID674 "Motor BEM Voltage"

Motor-induced back voltage.

P2.8.9.22 IU Offset ID668 "IU Offset"

P2.8.9.23 IV Offset ID669 "IV Offset"

P2.8.9.24 IW Offset ID670 "IW Offset"

Offsets the value for phase current measurement. Identified during identification run.

P2.8.9.25 Estimator Kp ID1782 "Estimator Kp"

P2.8.9.26 Estimator Ki ID1782 "Estimator Ki"

Estimator gain and Ti for PMS motor. Identified during identification run.

P2.8.9.27 Voltage Drop ID671 "Voltage Drop"

Measured residual voltage error.

P2.8.9.28 ID Run Current Kp ID695 "ID Run Curr.Kp"

Current controller gain during identification fun.

P2.8.9.29 Flux Saturation Ratio ID682

Relative nominal magnetizing current compared to non-saturated value

P2.8.9.30 DeadTimeComp. ID1751

Dead Time Compensation in ns. Identified during 7 / DTC Identification run.

P2.8.9.31 DeadTieContCurL ID1752

Continuous/discontinuous current limit for Dead Time Compensation. Identified during 7 / DTC Identification run.

7.8.7 Fine Tuning parameters

P2.8.10.1 DeadTHWCompDisab ID1750

Hardware dead time compensation 0 = enabled, 1 = disabled

P2.8.10.2 CurrMeasFCompTC ID1554

P2.8.10.3 CurrLimOptions ID1702

P2.8.10.4 AdConvStartShift ID1701

P2.8.10.5 T: Identification ID3520

P2.8.10.6 T: IdentOptions ID3521

7.9 Speed Control settings

P2.9.1 Load drooping ID620 "LoadDrooping"

The drooping function enables speed drop as a function of load. This parameter sets the value corresponding to the nominal torque of the motor.

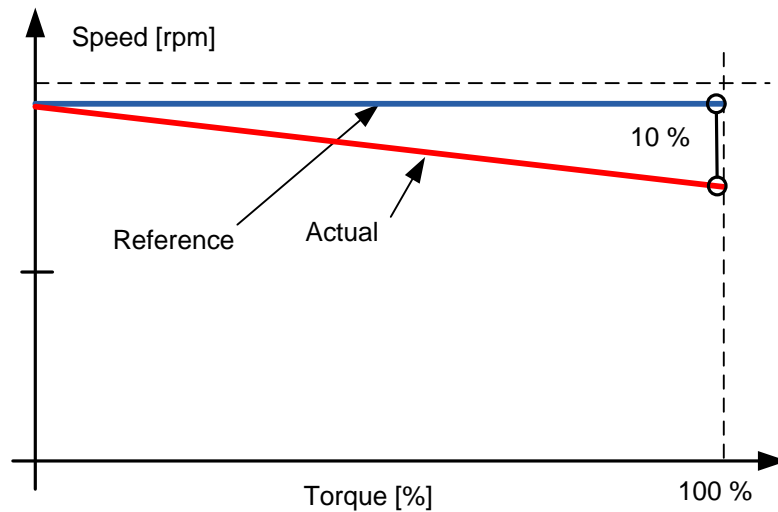

Example: If load drooping is set to 10% for a motor that has a nominal frequency of 50 Hz and is nominally loaded (100% of torque) the output frequency is allowed to decrease 5 Hz from the frequency reference. The function is used for, for example, when the balanced load is needed for mechanically connected motors.

P2.9.2 Load Drooping Time ID656 "LoadDroopingTime"

This function is used in order to achieve a dynamic speed drooping because of changing load. The parameter defines the time during which the speed is restored to the level it was before the load increase.

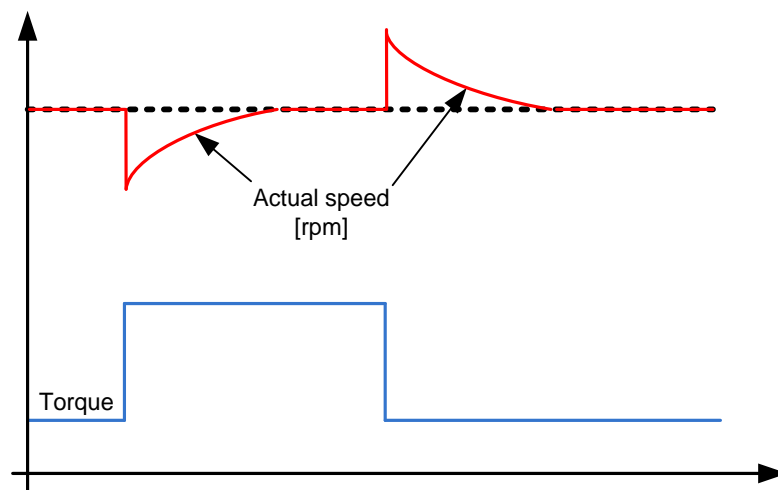

P2.9.3 Load Drooping Removal ID1534 "LoadDroopRemoval"

This function defines how load drooping is removed with reference to speed. It is used in lifting situations when it is necessary to keep to load at the same position without closing the brake. When using option 'Normal' the load will slowly come down depending on load and the drooping factor.

Normal

0 Load Drooping factor is constant through the whole speed range.

Removed below zero frequency limit

1 Load drooping is removed linearly below the zero frequency limit (defined in G2.6.4 Freq. Handling).

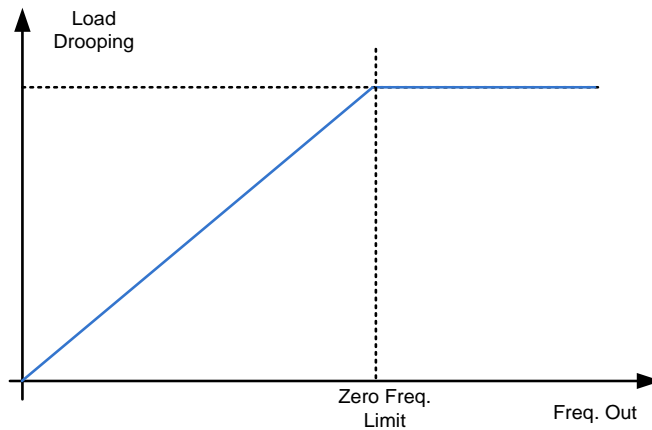

Linearly increased to motor nominal frequency

2 Load drooping is removed linearly from nominal frequency to zero frequency.

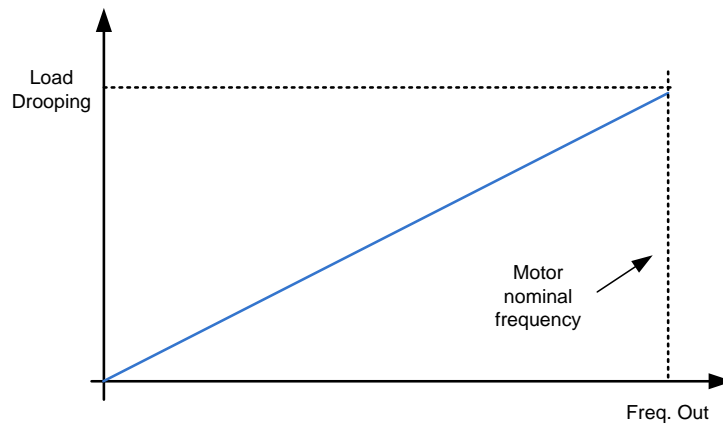

7.9.1.1 Open Loop Settings

P2.9.4.1 *Speed controller P gain, Open Loop ID637 "OL Speed Reg P"*

Defines the P gain for the speed controlled in Open Loop control mode.

P2.9.4.2 *Speed controller I gain, Open Loop ID638 "OL Speed Reg I"*

Defines the I gain for the speed controlled in Open Loop control mode.

7.9.1.2 Closed Loop Speed Control Settings

Speed control formula:

$$y = Kp \left[1 + \frac{1}{Ti s} \right] e$$

$$u(k) = y(k-1) + Kp[e(k) - e(k-1) + \frac{Ts}{Ti} e(k)]$$

P2.9.5.1 *Speed control P gain ID613 "Speed Control Kp"*

Gain for the speed controller in closed loop motor control operation. Gain value 100 means that the nominal torque reference is produced at the speed controller output for the frequency error of 1Hz.

P2.9.5.2 *Speed control I time ID614 "Speed Control Ti"*

Sets the integral time constant for the speed controller. Increasing the I-time increases stability but lengthens the speed response time.

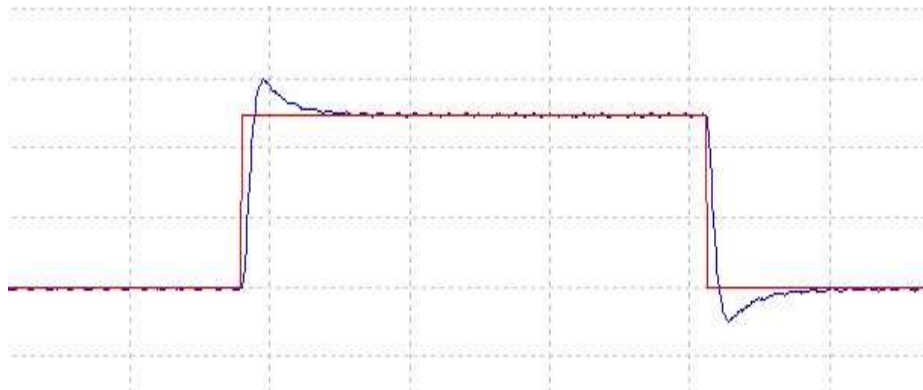

Kp 30, Ti 100

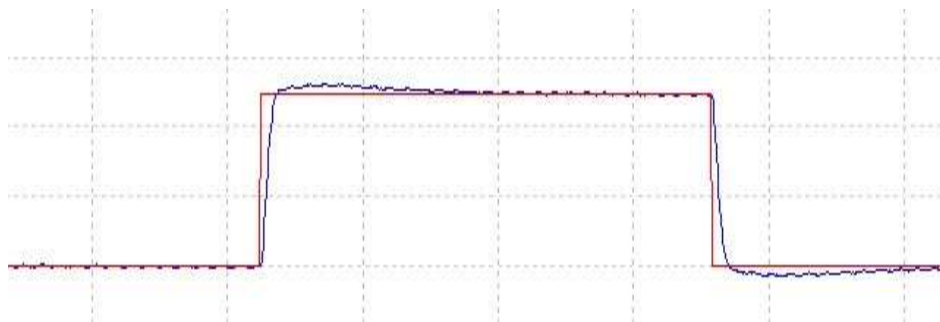

Kp 30, Ti 300

P2.9.5.3 Zero speed time at start ID615 "Start 0SpeedTime"

After giving the start command, the drive will remain at zero speed for the time defined by this parameter. The ramp will be released to follow the set frequency/speed reference after this time has elapsed counted from the instant when the command was given.

P2.9.5.4 Zero speed time at stop ID616 "Stop 0 SpeedTime"

The drive will remain at zero speed with controllers active for the time defined by this parameter after reaching the zero speed when a stop command is given. This parameter has no effect if the selected stop function is *Coasting*. Note that the zero speed time starts when the ramp time is expected to reach the zero speed, not when the actual speed reaches zero. Such situation can happen when the generator power limit is small or the overvoltage controller is active while decelerating.

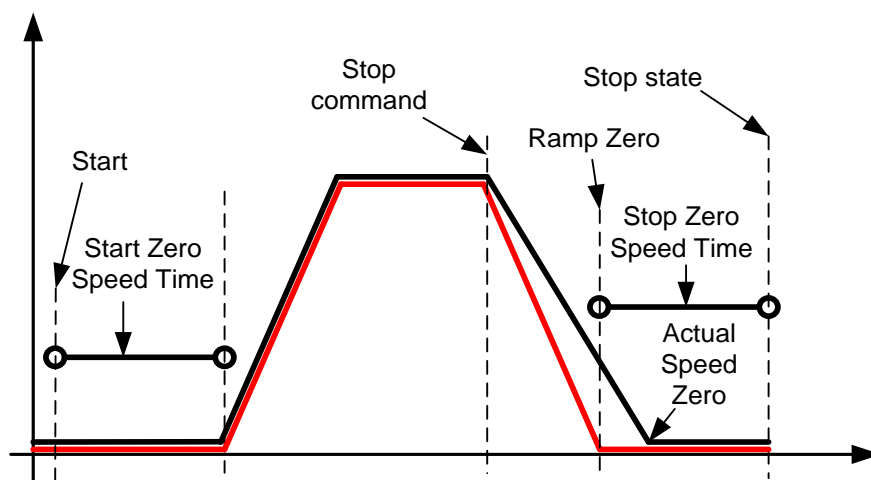

7.9.1.3 Speed controller tuning for different speed areas

The speed controller can be tuned for different gains in different speed areas, for slow speed and above the parameter *Field weakening point*. Gains for different speed areas are percentages of the original Speed Controller Gain value.

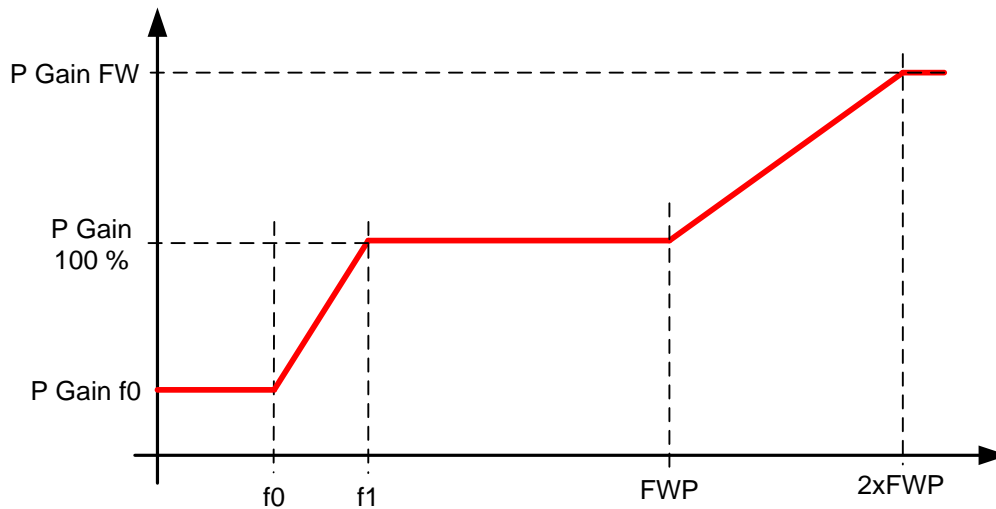

P2.9.5.5 Speed Controller f0 point ID1300 "SPC f0 Point"

The speed level in Hz below which the speed controller gain is *Speed Controller gain f0*.

P2.9.5.6 Speed Controller f1 point ID1301 "SPC f1 Point"

The speed level in Hz above which the speed controller gain is *Speed Controller P gain*. Gain changes linearly between f0 and f1 points.

P2.9.5.7 Speed Controller gain f0 ID1299 "SPC Kp f0"

The relative gain of the speed controller as a percentage of the *Speed Controller P Gain* when the speed is below the level defined by *Speed Controller f0 point*.

P2.9.5.8 Speed controller gain in field weakening area ID1298 "SPC Kp FWP"

Relative gain of the speed controller in field weakening area as a percentage of *Speed Controller P Gain* values. The set value is reached at two times the *Field weakening point*.

7.9.1.4 *Speed controller gain with different loads*

The speed controller can also be tuned for different loads. Speed controller gain is first manipulated by the speed area gain function and this result is then further adjusted by torque related relative gain.

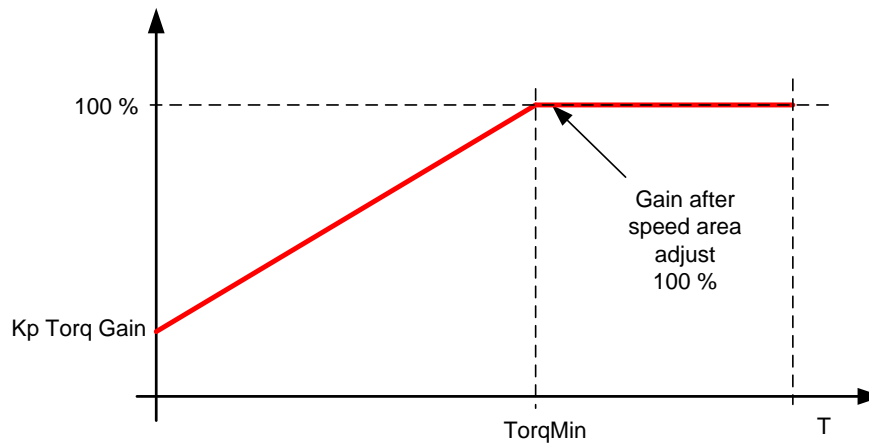

P2.9.5.9 Speed Controller torque minimum ID1296 "SPC Torq Min"

The level of speed controller output which the speed controller gain is changed to with parameter P2.8.5.4.10 "Speed Controller torque minimum gain" using a filter set by parameter P2.8.5.4.11 "Speed Controller torque minimum filtering time". This is in percent of the motor nominal torque.

P2.9.5.10 Speed Controller torque minimum gain ID1295 "SPC Kp Torq Min"

Relative gain as a percentage of the speed controller gain after speed area adjustment when the speed control output is less than the "Speed Controller torque minimum". This parameter is normally used to stabilise the speed controller for a drive system with gear backlash.

P2.9.5.11 Speed Controller torque minimum filtering time ID1297 "SPC Kp TC Torq"

Filtering time for torque. When the speed controller gain is changed below the Speed Controller torque minimum.

7.10 Drive Control

P2.10.1 Switching frequency ID601 “Switching Freq”

Motor noise can be minimised using a high switching frequency. Note, however, that increasing the switching frequency increases losses of the AC drive. Lower frequencies are used when the motor cable is long and the motor is small.

The range of this parameter depends on the size of the AC drive:

Type	Min. [kHz]	Max. [kHz]	Default [kHz]
0003—0061 NX_5 0003—0061 NX_2	1.0	16.0	3.6
0072—0520 NX_5	1.0	10.0	3.6
0041—0062 NX_6 0144—0208 NX_6	1.0	6.0	1.5

Table 7-2. Size-dependent switching frequencies

Note!

The actual switching frequency might be reduced down to 1.5 kHz by thermal management functions. This has to be considered when using sine wave filters or other output filters with a low resonance frequency.

Note!

If the switching frequency is changed, it is necessary to do the identification run again.

DriveSynch operation

When using DriveSynch, the maximum switching frequency is limited to 3.6 kHz.

P2.10.2 Modulator Type ID1516 “Modulator type”

Select modulator type. Some operations require use of a software modulator.

0 = ASIC modulator

A classical third harmonic injection. The spectrum is slightly better compared to the Software 1 modulator.

NOTE: An ASIC modulator cannot be used when using DriveSynch or PMS motor with an incremental type encoder.

1 = Software Modulator 1

Symmetric vector modulator with symmetrical zero vectors.

Current distortion is less than with software modulator 2 if boosting is used.

NOTE: Recommended for DriveSynch (Set by default when DS activated) and needed when using PMS motor with an incremental encoder.

2 = Software modulator 2

One phase at a time in IGBT switches is not modulated during a 60-degree period of the frequency cycle. The unmodulated phase is connected to either positive or negative DC-bus.

This modulator type reduces switching losses up to two-thirds and all switches become evenly loaded.

BusClamp modulation is useful if the voltage is >80% of the maximum voltage, in other words, when the drive is operating near full speed. Then again, the motor ripple at low speeds is the double compared to selection 1.

3 = Software modulator 3

Unsymmetrical BusClamb in which one switch always conducts 120 degrees to negative DC-rail to reduce switching losses. However, upper and lower switches are unevenly loaded and the spectrum is wide.

4 = Software modulator 4:

Pure sinewave, sinusoidal modulator without harmonic injection. Dedicated to be used in back to back test benches etc. to avoid circulating third harmonic current. Drawback is that required DC voltage is 15% higher compared to other modulator types.

P2.10.3 Control Options ID1084 "Control Options"

These parameter functions are dependent of VACON® Marine application version.

B01 = Disable open loop power limit function

B06 = Activate Closed Loop type speed limit function in Open Loop

B07 = Disables switching frequency decrease due to drive temperature rise

B08 = Disable Encoder fault when brake is closed

B12 = Disable Process Data locking function when Profibus communication fails. When using Profibus, an occurring communication fault will lock the process data to previous values. This bit will disable the locking of process data forcing the values to zero. NOTE: This bit can only be used with Profibus.

B13 = Disable only acceleration when using DI Acc/Dec prohibit function

B14 = Disables Modulation Synchronization for Current follower function

B15 = Enables Current Follower function when Drive Synch operation is selected in Mater Follower Mode.

P2.10.4 Control Options 2 ID1798 "ControlOptions2"

These parameter functions are dependent of VACON® Marine application version.

B01 = Power reference speed direction automatic update function.

If Torque Select is RampOutput actual speed is going to zero if reference speed is opposite to actual speed regardless of power reference direction.

P2.10.5 Advanced Options 1 ID1560 "AdvancedOptions1"

B00 = Disable Synchronous modulation

B01 = Use encoder information to slip compensation in Open Loop Speed control

B02 = Disable encoder fault

B03 = Disable slip compensation for reverse direction

B06 = Enable synchronous symmetrical modulation

B07 = Automatically handled by application logic.

B15 = Cosphi = 1 control. This controls the motor reactive power to zero. Possible to use only with PMS motors in closed loop control.

P2.10.6 Advanced Options 2 ID1561 "AdvancedOptions1"

B00 = Sensorless control for PMS motors. This is an open loop control but uses the same control system than the normal closed loop control. Calculations try to estimate the encoder speed instead of using the encoder signal. This mode has speed and torque range limitations and therefore application limitations. A lower

speed controller gain may be required to gain stability. Useful for generator applications.

B04 = Enable Start Positioning damping active if PMSM

B08 = Current optimization for PMS motor. This function activates the current optimization for PMSM motor based on torque calculation and motor parameters. When activated, the optimization starts after 13% of the motor nominal speed and below this a normal U/f curve is used. The activation of this selection requires a performed identification with run.

B09 = I/f control for PMS motors. PMS motor can be started with I/f control. Used with high power motor when there is low resistance in motor and U/f is difficult to tune to be stable.

B13 = Changes automatically depending on Drive Synch operation

P2.10.7 *Advanced Options 4* **ID1563** **"AdvancedOptions4"**

Reserved for future use. Some bits are controlled by application software so value may not be always zero.

P2.10.8 *Advanced Options 5* **ID1564** **"AdvancedOptions5"**

B11 = Current measurement anti-aliasing for low switching frequencies, prevents torque calculation distortions. Requires Software Modulator 1.

P2.10.9 *Advanced Options 6* **ID1565** **"AdvancedOptions6"**

B05 = To reduce aliasing effects in current measurement, it is possible to take an average from all internal samples taken at fast time level. It must be noted, that this mode does not affect the motor control, only monitoring.

P2.10.10 *Advanced Options 7* **ID15658** **"AdvancedOptions7"**

P2.10.11 *Restart Delay* **ID1424** **"Restart Delay OL"**

The time delay within which the drive cannot be restarted after a coast stop and flying start is not in use. Closed Loop control mode and the flying start use a different delay see P2.9.11.

P2.10.12 *Restart Delay Closed Loop & Flying Start* **ID672** **"Restart Delay CL"**

The time delay within which the drive cannot be restarted if flying start is used or the control mode is closed loop.

P2.10.13 *Operation Time* **ID1855**

Stored Operation Time. When application is reloaded operation hours will go zero if this parameter is not updated.

Monitoring signal is in hours with two decimal.

Parameter is in format of:

xx (Years) XX (Monts) XX (Days) XX (Hours) XX Minutes

1211292359 -> 12 years, 11 months, 29 days, 23 hours and 59 minutes.

7.11 Master Follower

7.11.1 Master Follower: Standard system

The Master/Follower function is designed for applications in which the system is run by several VACON® NXP drives and the motor shafts are coupled to each other via gearing, chain, belt etc. The VACON® NXP drives are in closed loop control mode.

The external control signals are connected to the Master VACON® NXP only. The Master controls the Follower(s) via a System bus. The Master station is typically speed-controlled and the other drives follow its torque or speed reference.

Torque control of the Follower should be used when the motor shafts of the Master and Follower drives are coupled solidly to each other by gearing, a chain etc., so that no speed difference between the drives is possible.

Speed control of the Follower should be used when the motor shafts of the Master and the Follower drives are coupled flexibly to each other so that a slight speed difference between the drives is possible. When both the Master and Followers are speed-controlled, drooping is typically also used.

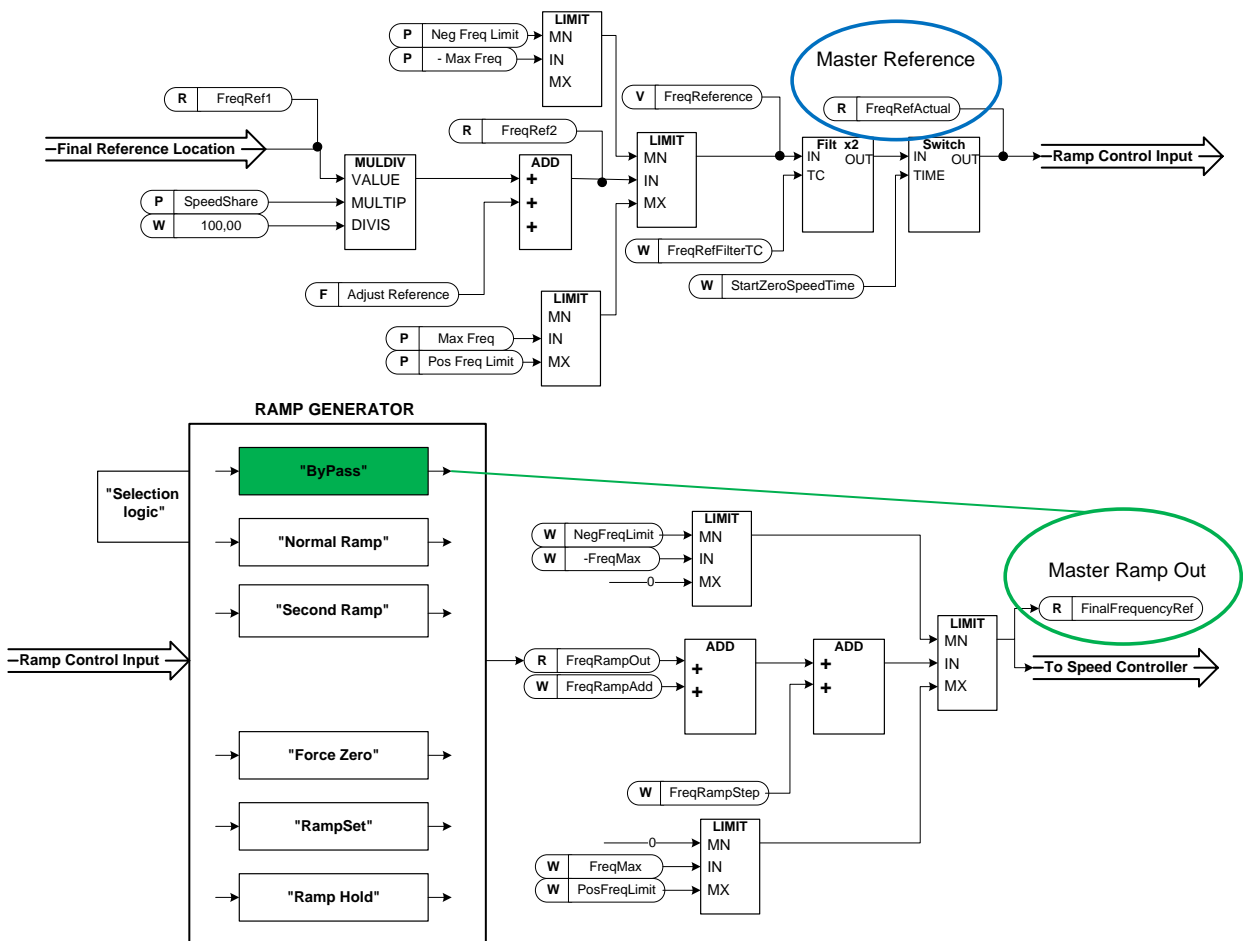

7.11.2 Master Follower: DriveSynch system

DriveSynch is used to control parallel drives. Up to four drives can be connected parallelly. The motor can be a single winding motor or there can be several winding motors.

VACON® DriveSynch works in open loop and closed loop motor control modes. With closed loop motor control, the encoder feedback needs to be wired only to the master drive. If redundancy is required, it may be necessary to wire the encoder feedback also to follower drives using the double encoder option board OPTA7.

Note:

In a DriveSynch system, only Master drive monitoring signals are reliable. Only directly measured values are reliable in follower units. Even the Output Frequency of DriveSynch follower is not directly observed and thus may not show actual output frequency that is controlled by DriveSynch Master Drive.

Note!

The maximum switching frequency for the drives using VACON® DriveSynch is 3.6 kHz. Minimum recommended switching frequency in Open Loop control is 1.7 kHz. Minimum recommended switching frequency in Closed Loop control is 2.5 kHz.

Note!

The VACON® NXP control board must be VB00761 (NXP3) or newer. OPT-D2 boards needs to VB276J or newer. Master needs to be #1 and cannot be changed.

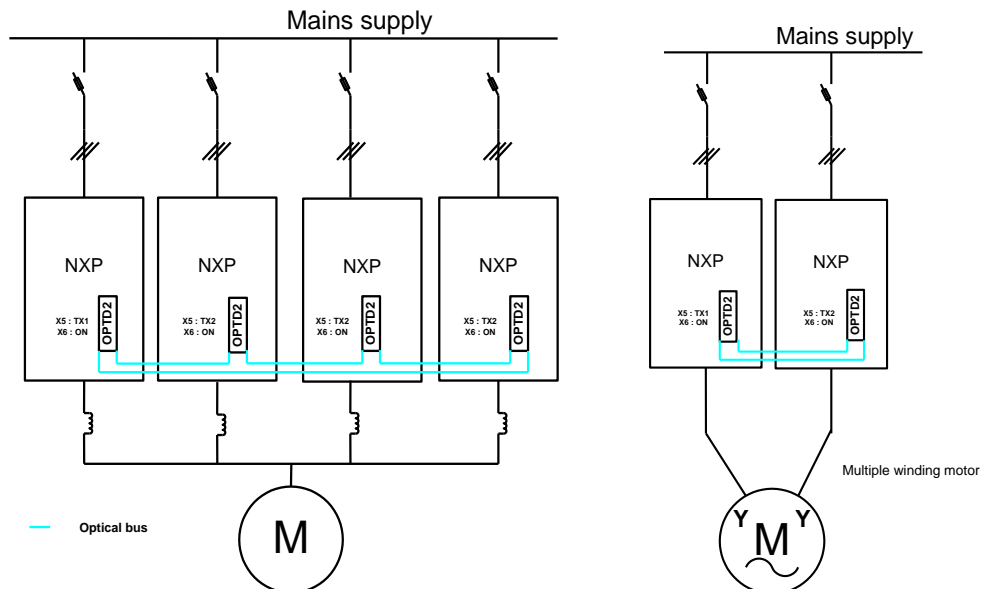

7.11.2.1 *Redundancy*

The units working in parallel with VACON® DriveSynch have a high level of redundancy. The system keeps running without interruption even if any of the follower units is non-functional. In case of a hardware failure, the failed unit need be isolated before the system can be restarted.

The actual level of redundancy, however, needs to be carefully defined considering the motor, load and the requirements of the process.

The master drive unit and the fast drive to drive optical communication has to be functional for the VACON® DriveSynch functionality. The auxiliary power (+24V) must be continuously provided for all the control units including the non-functional drive units in VACON® drive synch system.

It is also a common practice to use (n+1) units, where n is the number of required units for full functionality of the system. In this case, the system is fully operational even if any follower is non-functional.

	Master (D1)	Follower (D2)	Follower (D3)	Follower (D4)
Parameter settings				
Motor Nominal Voltage	Motor Nominal voltage from the motor name plate	Motor Nominal voltage from the motor name plate	Motor Nominal voltage from the motor name plate	Motor Nominal voltage from the motor name plate
Motor nominal Frequency	Motor Nominal frequency from the motor name plate	Motor Nominal frequency from the motor name plate	Motor Nominal frequency from the motor name plate	Motor Nominal frequency from the motor name plate
Motor Nominal Current	Motor Nominal current from the motor name plate / Number of drives in parallel using VACON® Drive Synch	Motor Nominal current from the motor name plate / Number of drives in parallel using VACON® Drive Synch	Motor Nominal current from the motor name plate / Number of drives in parallel using VACON® Drive Synch	Motor Nominal current from the motor name plate / Number of drives in parallel using VACON® Drive Synch
Motor COS PHI (Motor nominal power factor)	Motor COS PHI from the motor name plate	Motor COS PHI from the motor name plate	Motor COS PHI from the motor name plate	Motor COS PHI from the motor name plate
Motor Nominal Power	Motor Nominal power from the motor name plate / Number of drives in parallel using VACON® Drive Synch	Motor Nominal power from the motor name plate / Number of drives in parallel using VACON® Drive Synch	Motor Nominal power from the motor name plate / Number of drives in parallel using VACON® Drive Synch	Motor Nominal power from the motor name plate / Number of drives in parallel using VACON® Drive Synch
Master Follower Mode	Master, DriveSynch	Follower, DriveSynch	Follower, DriveSynch	Follower, DriveSynch
Motor Control Mode (Open Loop)	Open Loop Frequency	If used as Secondary Master: Open Loop Frequency. When used as Follower: no meaning.	No meaning, internally handled. Recommended to have same setting as in master.	No meaning, internally handled. Recommended to have same setting as in master.
Motor Control Mode (Closed Loop)	Closed Loop Speed /Torque	If used as Secondary Master: Closed Loop Speed/Torque. When used as Follower: no meaning.	No meaning, internally handled. Recommended to have same setting as in master.	No meaning, internally handled. Recommended to have same setting as in master.
Magnetizing current (needed only for closed loop motor control)	Motor nominal magnetizing current / Number of drives in parallel using VACON® Drive Synch	Motor nominal magnetizing current / Number of drives in parallel using VACON® Drive Synch	Motor nominal magnetizing current / Number of drives in parallel using VACON® Drive Synch	Motor nominal magnetizing current / Number of drives in parallel using VACON® Drive Synch
Switching Frequency	Max 3.6 KHz	Same as in Master	Same as in Master	Same as in Master
Modulator Type	1, Software	Same as in Master	Same as in Master	Same as in Master
Follower Phase shift (single winding motor)	0 degrees	0	0	0
Follower Phase shift (multiple winding motor)	0 degrees	As per motor name plate	As per motor name plate	As per motor name plate

7.11.3 Master follower configuration

The OPTD2 board in the Master has default jumper selection, X5:1-2. For the followers, the jumper positions have to be changed: X5:2-3. This board also has a CAN communication option that is useful for multiple drive monitoring with VACON® NCDriver PC software when commissioning Master Follower functions or line systems. Older boards has X6, leave this to ON (X6:1-2).

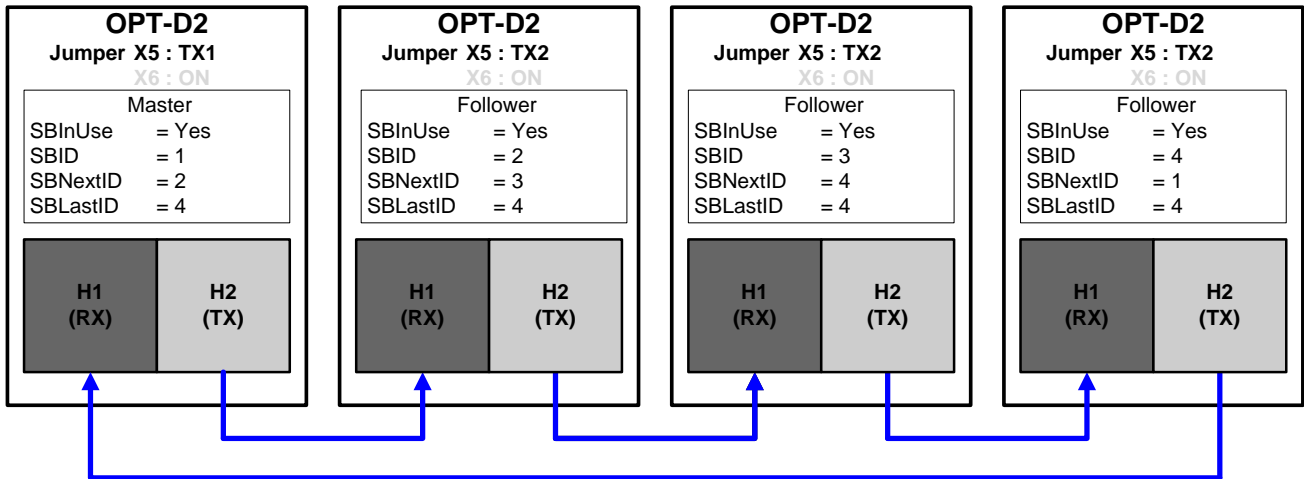

Figure 7-16. System bus physical connections with the OPT-D2 board

P2.11.1 Master/Follower selection ID1324 "MF Mode"

Select the Master Follower mode. When the drive is a follower, the Run Request command is monitored from Master but all references are selectable by parameters.

- 0 = Single drive
System bus is deactivated
- 1 = Master
Drive sends control word to follower drive.
- 2 = Follower
Drive receives control word from Master and sends some diagnostic information to the Master drive.
- 3 = "DSynchMaster" - Drive Synch Master
Drive number 1 must be selected as the parallel drive configuration master (in redundancy mode drive number 2 can be selected as master but certain diagnostic functions are no longer available).
- 4 = "DSynchFlwr" - Drive Synch Follower
Selection for parallel drive configuration follower drive

P2.11.2 Follower reference selection ID1081 "Follower Ref Sel"

Select where the follower drive receives its speed reference from.

0="AI1" - Analogue Input 1.

Signal scaling in "G: Input Signals \ Analogue Input 1"

1="AI2" - Analogue Input 2.

Signal scaling in "G: Input Signals \ Analogue Input 2"

2="AI1+AI2" - Analogue Input 1 + Analogue Input 2.

With alternative reference scaling in Analogue Input group, 100% input values can be set to correspond 25 Hz. In other words, when both are 100% the final reference will be 50 Hz.

3="AI1-AI2"

Analogue Input 1 minus Analogue Input 2.

4="AI2-AI1"

Analogue Input 2 minus Analogue Input 1.

5="AI1xAI2"

Analogue Input 1 x Analogue Input 2

6="AI1 Joystick"

Analogue input 1, -10 Vdc... +10 Vdc

7="AI2 Joystick"

Analogue input 2, -10 Vdc... +10 Vdc

8="Keypad Ref"

Reference from keypad R3.2

9="Fieldbus"

Reference is taken from fieldbus. Alternative scaling can be selected in "G: Fieldbus"

10="Motor Pot" - Motor potentiometer

Reference handled with two digital inputs "G: Input Signals \ Digital Inputs" (increase and decrease). Behaviour adjusted in "G: Ref Handling \ Motor Potente".

11="AI1, AI2 min"

The smaller of Analogue Input 1 and Analogue Input 2 is used as reference.

12="AI1, AI2 max"

The greater of Analogue Input 1 and Analogue Input 2 is used as reference.

13="Max Freq" - Maximum Frequency

P2.1.2 Max Frequency is used as reference.

14="AI1/AI2 Sel" - AI1/AI2 Selection

The digital input "I/O Ref 1/2" is used to select between Analogue Input 1 and Analogue Input 2 reference. "I/O Ref 1/2" is used to elect between "I/O Reference" and "I/O Reference 2" if selection of this parameter is different from 14 (this one).

15="Encoder 1"

Reference is read from encoder input 1.

16="Encoder 2"

Reference is read from encoder input 2. This selection is usable with double encoder boards. Could be utilized, for example, for speed synchronization.

17="Master Reference"

Master reference before ramp generator. When this is selected the follower drive's own ramp times are active and used.

18="Master Ramp Out"

Master reference after ramp generator, before speed controller. When this is selected the follower drive will use the ramp times defined by the Master drive.

P2.11.3 Follower torque reference selection ID1083 "FollowerTorq Sel"

Select the source of torque reference for the follower drive.

0="Not Used"

1="AI1" - Analogue Input 1.

Signal scaling in "G: Input Signals \ Analogue Input 1"

2="AI2" - Analogue Input 2.

Signal scaling in "G: Input Signals \ Analogue Input 2"

3="AI3"

4="AI4"

5="AI1 Joystick"

Analogue input 1, -10 Vdc... +10 Vdc. For joystick inputs, the maximum negative reference is the negative of "Torq Ref Max".

6="AI2 Joystick"

Analogue input 2, -10 Vdc... +10 Vdc For joystick inputs maximum negative reference is the negative of "Torq Ref Max".

7="Keypad Ref"

Torque reference from keypad R3.5

8="Fieldbus"

Reference is taken from fieldbus. Alternative scaling can be selected in "G: Fieldbus"

9="Master Torque"

Reference is taken from Master drive when using the Master Follower function.

P2.11.4 Follower stop function ID1089 "FollowerStopFunction"

When the follower drive does not use the Master Drive Ramp Output as reference this parameter defines how the follower drive will stop as Run request is removed from the Master drive.

0=Coasting; the follower remains in control even if master has stopped to fault.

1=Ramping; the follower remains in control even if master has stopped to fault.

2=As master; the follower behaves as master.

P2.11.5 Master Follower Brake Logic ID1326 "MF Brake Logic"

This parameter defines the brake functionality when operating in Master-Follower mode. This parameter is not active when the follower is operating in Ramp Follower mode (i.e. when the Follower reference selection is "18 = Master Ramp") or when the follower is a DriveSynch follower. In these cases, the follower brake is controlled by master drive.

Note: When the follower reference selection is 17 = "Master Ref", the speed limitation function from brake control are bypassed on follower side.

0 = Master or Own (Default)

Brake is opened when the master or follower brake opening conditions are met in follower drive.

1 = Own

Brake is opened when follower drive own brake opening conditions are met. Also brake is close if follower drive own conditions are met regardless of master status.

2 = Own & Master Speed Release

Brake is opened when the follower drive's own brake opening conditions are met. Also the brake is close if the follower drive's own conditions are met regardless of the master status.

However, Speed is not released until the drive has the feedback from the brake, actual or defined by Mechanical Brake Delay parameter and master has released speed.

When this selection is made also in Master drive, Speed is not released until the master drive has the feedback from the brake actual or defined by Mechanical Brake Delay parameter also from followers

3 = Master

Master drive is controlling the follower drive brake and speed release.

P2.11.6 Master Follower mode 2 selection ID1093 "MF Mode 2"

Selects the Master Follower mode 2 that is used when the DI is activated. When *Follower* is selected, the Run Request command is monitored from the Master and all other references are selectable by parameters. This parameter can be used for redundancy purposes. If the drive number one cannot be operated through a digital input, the drive number 2 can be selected as master.

0 = Single Drive

System bus is deactivated.

1 = Master

Drive sends control word to follower drive.

2 = Follower

Drive received control word from Master and sends some diagnostic information to the Master drive.

3 = "DSynchMaster" - Drive Synch Master

Drive number 1 must be selected as the parallel drive configuration master (in redundancy mode drive number 2 can be selected as master but certain diagnostic functions are no longer available).

4 = "DSynchFlwr" - Drive Synch Follower

Selection for parallel drive configuration follower drive.

P2.11.7 SystemBus communication fault response ID1082 "SB Comm Fault"

Defines the action when the System Bus heartbeat is missing.
The master drive sends a heartbeat signal to all follower drives and this heartbeat is sent back to the master drive.

- 0 = No response
- 1 = Warning
- 2 = Fault, stop mode after fault according to Stop function
- 3 = Fault, stop mode after fault always by coasting

P2.11.8 Systembus fault delay ID1352 "SB fault Delay"

Defines the delay before fault generation when heartbeat is missing.

P2.11.9 Follower Fault ID1536 "Follower Fault"

Defines the response in the Master drive when a fault occurs in any of the follower drives. When one of the drives trips to fault, the master drive will send a command to trigger the Data Logger in all the drives for diagnostic purposes.

- 0 = No response
- 1 = Warning
- 2 = Fault, stop mode after fault according to Stop function
- 3 = Fault, stop mode after fault always by coasting

7.11.3.1 Drive Synch Control parameters**P2.11.10.1 DriveSynch Follower Fault ID1531 "DS Follower Fault"**

Defines the response in the Master drive when a fault occurs in any of the follower drives. When one of the drives trips to fault, the master drive will send a command to trigger the Data Logger in all the drives for diagnostic purposes.

- 0 = No response
- 1 = Warning
- 2 = Fault, stop mode after fault according to Stop function

P2.11.10.2 Follower drive winding phase shift ID1518 "FollPhaseShift"

Windings phase shift between the master and follower drive. Used with drive synch operation when the motor has multiple windings.

P2.11.10.3 DC Voltage balancing gain ID519 "DCVoltageBalGain"

Multiple wind motor option. Contact the factory before changing this value.

P2.11.10.4 SB Last ID 2nd ID1799 "SBLastID 2nd"

With this parameter, it is possible to change the last ID number of the drive from fieldbus.

7.12 Protections

7.12.1 General settings

P2.12.1.1 Input phase supervision ID730 "Input Ph. Superv"

Defines the response when the drive notices that one of the input phases is missing.

0 = No response

1 = Warning

2 = Fault, stop mode after fault according to Stop Function

3 = Fault, stop mode after fault always by coasting

P2.12.1.2 Response to undervoltage fault ID727 "UVolt Fault Resp"

In some applications it is normal that the drive will be powered down when in run state. With this parameter it is possible to choose whether under voltage faults are stored to the fault history of the drive.

0 = Fault stored in fault history

1 = Fault not stored in fault history

Under voltage fault limits:

500 V units: 333 Vdc

690 V units: 460 Vdc

P2.12.1.3 Output phase supervision ID702 "OutputPh. Superv"

Output phase supervision of the motor ensures that the motor phases have an approximately equal current.

0 = No response

1 = Warning

2 = Fault, stop mode after fault according to Stop Function

3 = Fault, stop mode after fault always by coasting

P2.12.1.4 Response to slot fault ID734 "SlotComFaultResp"

Set here the response mode for a board slot fault due to a missing or broken board.

0 = No response

1 = Warning

2 = Fault, stop mode after fault according to Stop Function

3 = Fault, stop mode after fault always by coasting

P2.12.1.5 Safe Torque Off (STO) mode ID755 "SafeDisableResp."

With this parameter it is possible to choose whether the STO signal is handled as fault or warning. The STO input will stop the drive from modulating regardless of this parameter value.

P2.12.1.6 *FaultWarnIndicat* ID1940

With this parameter its possible to select how warning and fault indication as handled to digital outputs and to fieldbus

0 = Static

Static signal, as long as warning or fault is active. Warning will disappear after 10 second when warning situation has passed. Fault requires a reset always.

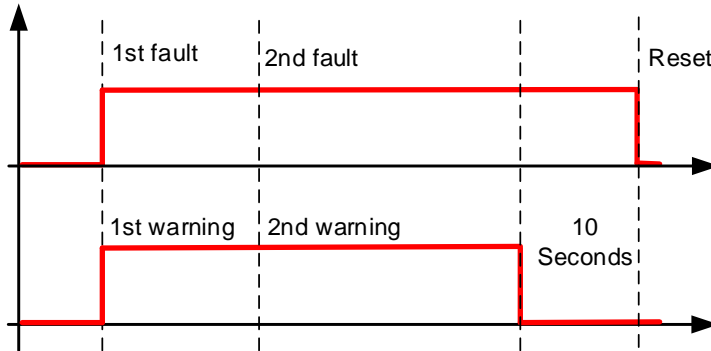

1 = Toggle

If there is a warning or fault already active a new warning or fault will toggle signal for one second.

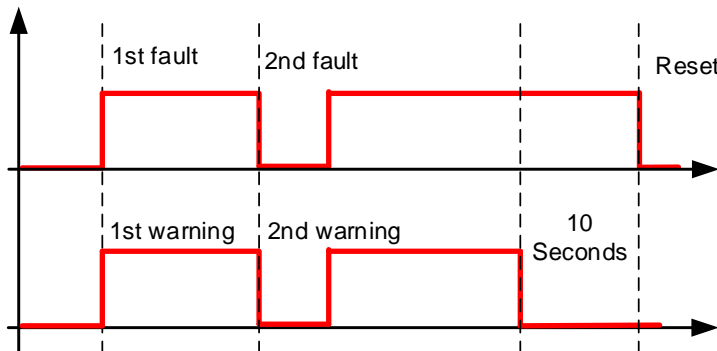

2 = Marine

If there is a warning or fault already active a new warning or fault will toggle signal for one second. Warning status will not disappear automatically after 10 second, to make warning signal disappear a reset signal is needed.

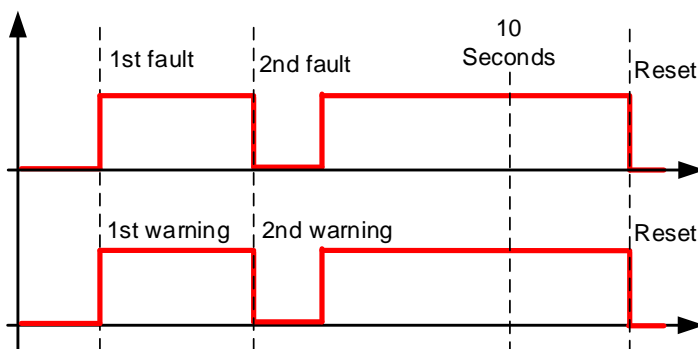

7.12.2 Temperature sensor protections

The temperature protection function is used to measure temperatures and issue warnings and/or faults when the set limits are exceeded. The marine application supports two OPT-BH and OPT-B8 board simultaneously. One can be used for the motor winding and one for the motor bearings.

P2.12.2.1 Number of used inputs in board 1 ID739 "Board1 Channels"

Select used temperature sensor combination with this parameter. See also the VACON® I/O boards manual.

- 0 = Not used (ID Write, value of maximum temperature can be written from fieldbus)
- 1 = Sensor 1 in use
- 2 = Sensor 1 & 2 in use
- 3 = Sensor 1 & 2 & 3 in use
- 4 = Sensor 2 & 3 in use
- 5 = Sensor 3 in use

Note: If the selected value is greater than the actual number of used sensor inputs, the display will read 200°C. If the input is short-circuited the displayed value is -30°C.

P2.12.2.2 Board 1 Temperature response ID740 "Board1 Response"

- 0 = No response
- 1 = Warning
- 2 = Fault, stop mode after fault according to Stop Function
- 3 = Fault, stop mode after fault always by coasting

P2.12.2.3 Board 1 warning limit ID741 "Board1Warn.Limit"

Set here the limit at which the PT100 warning will be activated.
When individual warning and fault limits are activated this is first board first channel (1A).

P2.12.2.5 Board 1 fault limit ID742 "Board1 Fault Lim."

Set here the limit at which the PT100 fault (F56) will be activated.
When individual warning and fault limits are activated this is first board first channel (1A).

P2.12.2.5 Number of used inputs in board 2 ID743 "Board2 Channels"

If you have two temperature sensor boards installed in your AC drive you can choose here the combination inputs in use in the second board. See also the VACON® I/O boards manual.

- 0 = Not used (ID Write, value of maximum temperature can be written from fieldbus)
- 1 = Sensor 1 in use
- 2 = Sensor 1 & 2 in use
- 3 = Sensor 1 & 2 & 3 in use
- 4 = Sensor 2 & 3 in use
- 5 = Sensor 3 in use

P2.12.2.6 Board 2 Temperature response ID766 "Board2 Response"

- 0 = No response
- 1 = Warning
- 2 = Fault, stop mode after fault according to Stop Function
- 3 = Fault, stop mode after fault always by coasting

P2.12.2.7 Board 2 warning limit ID745 "Board2 Warn. Lim"

Set here the limit at which the second temperature sensor board warning will be activated. When individual warning and fault limits are activated this is second board first channel (2A).

P2.12.2.8 Board2 fault limit ID746 "Board2 FaultLim"

Set here the limit at which the second temperature sensor board fault (F61) will be activated. When individual warning and fault limits are activated this is second board first channel (2A).

7.12.2.1 Individual channel monitoring

Individual channel monitoring is activated by setting one of the warning limits (per board) different than zero. Common limits in above parameters will be channel A warning and fault limits. Channel B and C limits are set with below parameters.

P2.12.2.9.1 Channel 1B Warn ID764

P2.12.2.9.2 Channel 1B Fault ID765

First board second (1B) channel warning and fault limits.

P2.12.2.9.3 Channel 1C Warn ID768

P2.12.2.9.4 Channel 1C Fault ID769

First board third (1C) channel warning and fault limits.

P2.12.2.9.5 Channel 2B Warn ID770

P2.12.2.9.6 Channel 2B Fault ID771

Second board second (2B) channel warning and fault limits.

P2.12.2.9.7 Channel 2C Warn ID772

P2.12.2.9.8 Channel 2C Fault ID773

Second board third (2C) channel warning and fault limits.

7.12.3 Stall protection

The motor stall protection protects the motor from short time overload situations such as one caused by a stalled shaft. The reaction time of the stall protection can be set shorter than that of the motor thermal protection. The stall state is defined with two parameters, Stall current and Stall frequency limit. If the current is higher than the set limit and the output frequency is lower than the set limit, the stall state is true. There is actually no real indication of the shaft rotation. Stall protection is a kind of overcurrent protection.

P2.12.3.1 Stall protection ID709 "Stall Protection"

- 0 = No response
- 1 = Warning
- 2 = Fault, stop mode after fault according to Stop Function
- 3 = Fault, stop mode after fault always by coasting

P2.12.3.2 Stall current limit ID710 "Stall Current"

The current can be set to $0 \dots 2 \cdot I_H$. For a stall stage to occur, the current must have exceeded this limit. The software does not allow entering a greater value than $2 \cdot I_H$. If the motor current limit is changed this parameter is automatically recalculated to the value 90% of motor current limit.

Note: This limit must be set below the current limit in order for this function to operate.

P2.12.3.3 Stall frequency limit ID712 "Stall Freq Lim"

The frequency can be set between $1 - f_{\max}$ (Max Frequency).

For a stall state to occur, the output frequency must have remained below this limit for a certain time. This function requires that the output frequency is 1 Hz below the frequency reference before the stall time count is started.

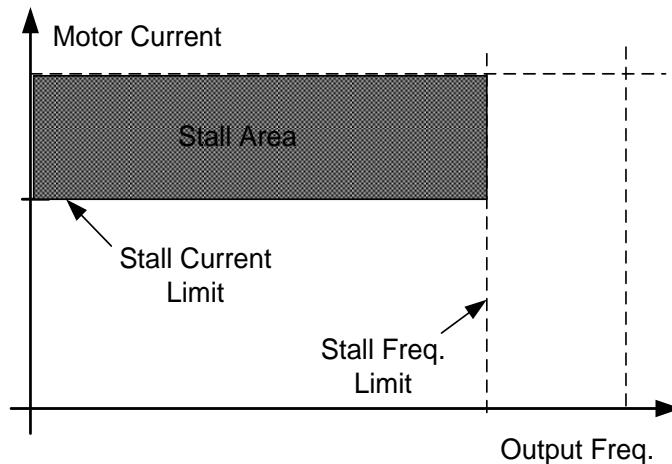

P2.12.3.4 Stall time ID711 "Stall Time Lim"

This is the maximum time allowed for a stall stage. The stall time is counted by an internal up/down counter. If the stall time counter value goes above this limit the protection will cause a trip.

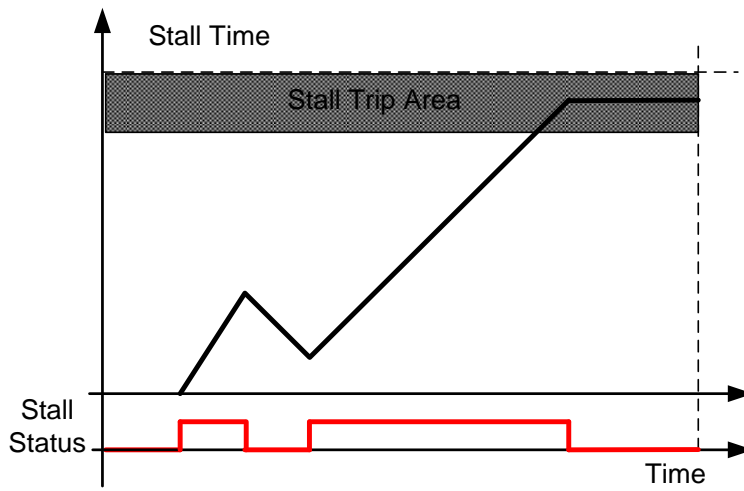

7.12.4 Speed Error

The Speed error monitoring function compares the encoder frequency and the ramp generator output. The function is used with a PMS motor to detect if the motor synchronization is off or to disable the open loop function using the encoder speed for slip compensation. The slip compensation is disabled regardless of the response and needs to be activated again once a speed error is detected (set parameter again or power down the drive).

Note: Disable P2.3.12.2 CLRmpFollEncFreq parameter if drive is used for hoisting and this for detecting runaway load.

P2.12.4.1 Speed error fault function ID752 "Speed Error Mode"

Defines the fault function when the speed reference and the encoder speed are above the set limits.

0 = No response

1 = Warning

2 = Fault, stop mode after fault always by coasting

P2.12.4.2 Speed error maximum difference ID753 "SpeedErrorLimit"

Defines the limit when fault situation is noticed. The difference between the speed reference and the encoder speed. Percentage value is in relation to motor nominal frequency.

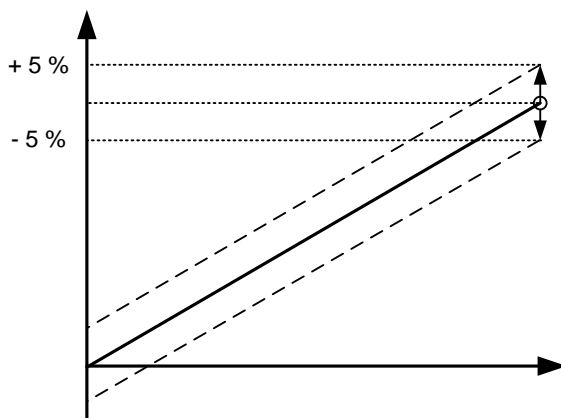

P2.12.4.3 Speed error delay ID754 "Speed Fault Delay"

Defines the delay after which a speed error is considered as a fault.

When used to disable open loop slip compensation based on encoder frequency, it is recommended to set this time to zero to avoid a speed jump at the time of encoder malfunction.

P2.12.4.4 Over Speed Protection ID1812 "OverSpeed F Resp"

Response when motor speed minimum or maximum speed is exceeded by 5 Hz.

7.12.5 Motor Protection



CAUTION! *The calculated model does not protect the motor if the airflow to the motor is reduced by blocked air intake grill.*

The motor thermal protection is designed to protect the motor from overheating. The drive is capable of supplying higher than nominal current to the motor. If the load requires this high current there is a risk that the motor will be thermally overloaded. This is the case especially at low frequencies. At low frequencies, the cooling effect of the motor is reduced as well as its capacity. If the motor is equipped with an external fan the load reduction at low speeds is small.

The motor thermal protection is based on a calculated model and it uses the output current of the drive to determine the load on the motor.

The motor thermal protection can be adjusted with parameters. The thermal current I_T specifies the load current above which the motor is overloaded. This current limit is a function of the output frequency.

P2.12.5.1 Motor thermal protection response ID704 "Motor Therm Prot"

Defines the response when the calculated temperature of the motor has reached 105% (monitoring signal).

0 = No response

1 = Warning

2 = Fault, stop mode after fault according to Stop Function

3 = Fault, stop mode after fault always by coasting

P2.12.5.2 Motor ambient temp. factor ID705 "MotAmbTempFactor"

Defines the temperature factor for conditions where the motor is located. The factor can be set between -100.0%—100.0%.

-100.0% = 0°C,

0.0% = 40°C,

100.0% = 80°C

P2.12.5.3 Motor cooling factor at zero speed ID706 "MTP f0 Current"

Defines the cooling factor at zero speed in relation to the point where the motor is running at nominal speed without external cooling.

The default value is set assuming that there is no external fan cooling the motor. If an external fan is used this parameter can be set to 90% (or even higher).

Note: The value is set as a percentage of the motor name plate data, (Nominal current of motor), not the drive's nominal output current. The motor's nominal current is the current that the motor can withstand in direct on-line use without being overheated.

Setting this parameter does not affect the maximum output current of the drive which is determined by parameter Motor Current Limit alone.

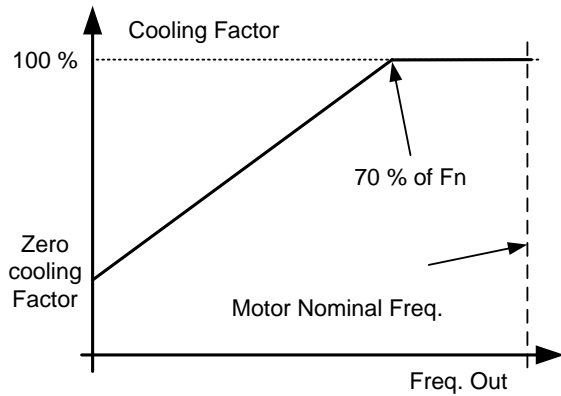

P2.12.5.5 Motor thermal protection: Time constant ID707 “MTP Motor T”

This time can be set between 1 and 200 minutes.

This is the thermal time constant of the motor. The bigger the motor, the bigger the time constant. The time constant is the time within which the calculated thermal stage has reached 63% of its final value.

The motor thermal time is specific to motor design and it varies between different motor manufacturers. The default value changes between unit sizes.

If the motor's t6-time (t6 is the time in seconds the motor can safely operate at six times the rated current) is known (given by the motor manufacturer) the time constant parameter can be set basing on it. As a rule of thumb, the motor thermal time constant in minutes equals to 2xt6. If the drive is in stop stage the time constant is internally increased to three times the set parameter value. The cooling in the stop stage is based on convection and the time constant is increased.

P2.12.5.5 Motor thermal protection: Motor duty cycle ID708 “Motor Duty Cycle”

The value can be set to 0%...150%.

Setting value to 130 % motor calculated temperature will reach nominal temperature with 130 % of motor nominal current.

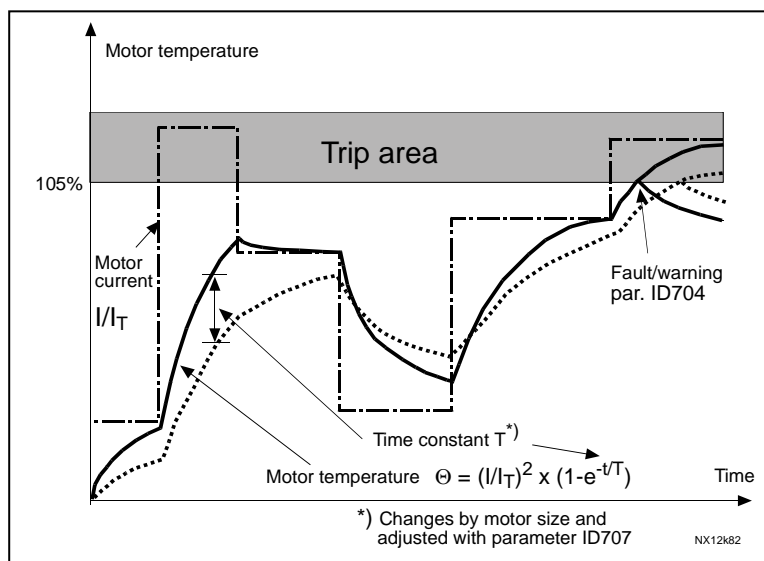

Figure 7-17. Motor temperature calculation

P2.12.5.6 Response to thermistor fault ID732 "ThermistF.Resp"

0 = No response

1 = Warning

2 = Fault, stop mode after fault according to [ID506](#)

3 = Fault, stop mode after fault always by coasting

Setting the parameter to **0** will deactivate the protection.

7.12.6 Over Load Protection

With this function it is possible to select if Current, Torque or Power is used for overload protection. Overload is based on internal counter that is increased when the input value is above 105% level and decreased when below 105% level. The increase and decrease occurs every 100 ms.

Tripping occurs when overload counter value is over 10 000.

With parameters, you can be define the amount of increase (Overload maximum step) at maximum defined input level (Overload Maximum Input). These points define the slope for the function. For example, if the input value is in the middle of 105% and Overload Maximum Input values, the counter is increased by half of the Over Load Maximum step.

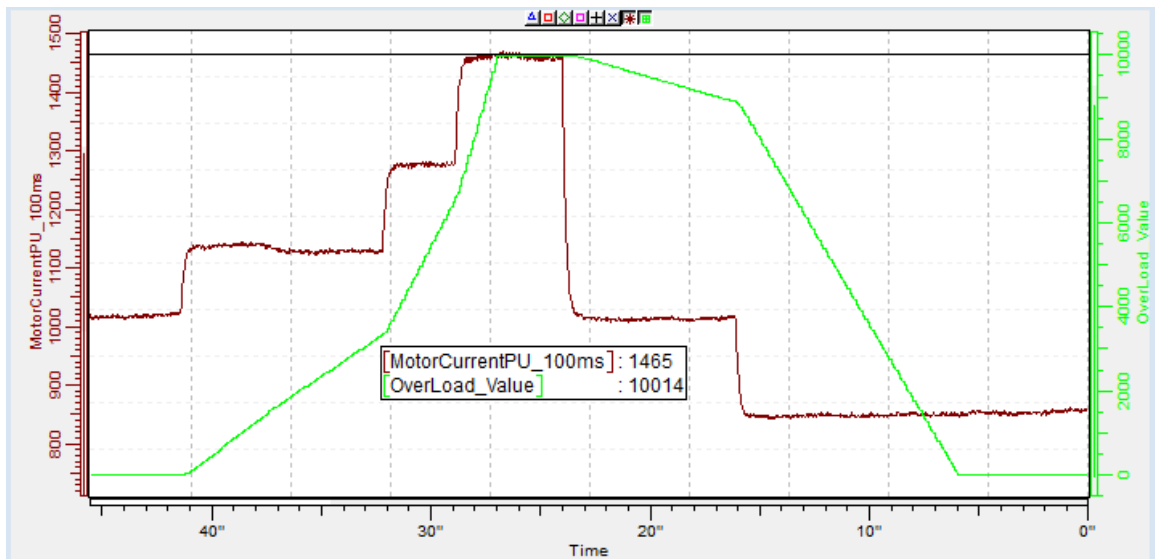

2.12.5.7 Response to over load ID1838 "OverLoadResponse"

- 0 = No response
- 1 = Warning
- 2 = Fault

2.12.5.8 Over Load Signal ID1837 "OverLoadSignal"

- 0 = Not Used
- 1 = Output Current (FW: MotorCurrentPU_100ms)
- 2 = Motor Torque
- 3 = Motor Power

2.12.5.9 Over Load Maximum Input ID1839 "OverLoadMaxIN"

Input value level where overload counter is increased with maximum step defined by P2.12.5.10

2.12.5.10 Over Load Maximum Step ID1840 "OverLoadMaxStep"

Step in the overload counter when input value is at maximum input level defined by P2.12.5.9.

2.12.5.11 Over Load Minimum Input *ID1849* *“OverLoadMinIN”*

Input value level where overload counter is increased or decreased.

2.12.5.12 Software over current trip limit *ID1094* *“OverCurrTripLim”*

Fast software over current limit function, Set current limit related to motor nominal current in % value. Value 0 will disable the function.

7.12.7 4mA Protection

The 4 mA protection monitors the analogue input signal level from Analogue input 1 and Analogue input 2.

The monitoring function is active when signal range 4 mA – 20 mA is selected. A fault or warning is generated when the signal falls below 3.5 mA for 5 seconds or below 0.5 mA for 0.5 seconds.

P2.12.6.1 Response to the 4mA reference fault ID700 “4mA Input Fault”

- 0 = No response
- 1 = Warning
- 2 = Warning, the frequency from 10 seconds back is set as reference
- 3 = Warning, the Preset Frequency is set as reference
- 4 = Fault, stop mode after fault according to Stop Function
- 5 = Fault, stop mode after fault always by coasting
- 6 = Warning, change control place to Fieldbus.

P2.12.6.2 4mA reference fault: preset frequency reference ID728 “4mA Fault Freq.”

If value 3 in parameter P2.12.6.1 is selected and a fault occurs the frequency reference to the motor is the value of this parameter.

7.12.8 Under load protection

The purpose of the motor under load protection is to ensure that there is load on the motor when the drive is running. If the motor loses its load there might be a problem in the process, for example, a broken belt or a dry pump.

The under load curve is a squared curve set between the zero frequency and the field weakening point. The protection is not active below 5 Hz (the under load time counter is stopped).

The torque values for setting the under load curve are set in percent which refers to the nominal torque of the motor. The motor's name plate data, parameter motor nominal current and the drive's nominal current I_H are used to find the scaling ratio for the internal torque value.

P2.12.7.1 Under load protection ID713 "Underload Protec"

- 0 = No response
- 1 = Warning
- 2 = Fault, stop mode after fault according to Stop Function
- 3 = Fault, stop mode after fault always by coasting

If tripping is set active the drive will stop and activate the fault stage.

Deactivating the protection by setting the parameter to 0 will reset the underload time counter to zero.

P2.12.7.2 Under load protection, zero frequency load ID715 "UP F0 Torque"

The torque limit can be set between 5.0—150.0% x T_{nMotor} .

This parameter gives the value for the minimum torque allowed with zero frequency.

P2.12.7.3 Under load protection, field weakening area load ID714 "UP fnom Torque"

The torque limit can be set between 10.0—150.0% x T_{nMotor} .

This parameter gives the value for the minimum torque allowed when the output frequency is above the field weakening point.

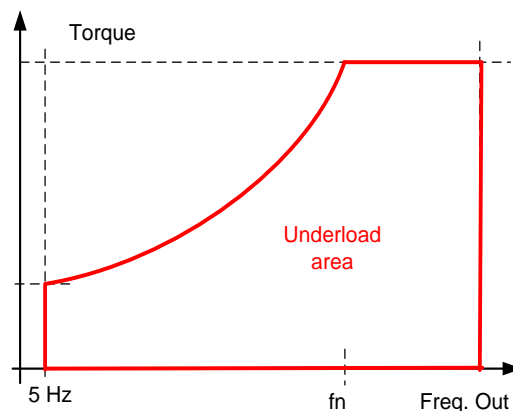

P2.12.7.4 Underload time ID716 "UP Time Limit"

This time can be set between 2.0 and 600.0 s.

This is the maximum time allowed for an underload state to exist. An internal up/down counter counts the accumulated underload time. If the underload counter value goes above this limit the protection will cause a trip according to parameter Underload Protection.

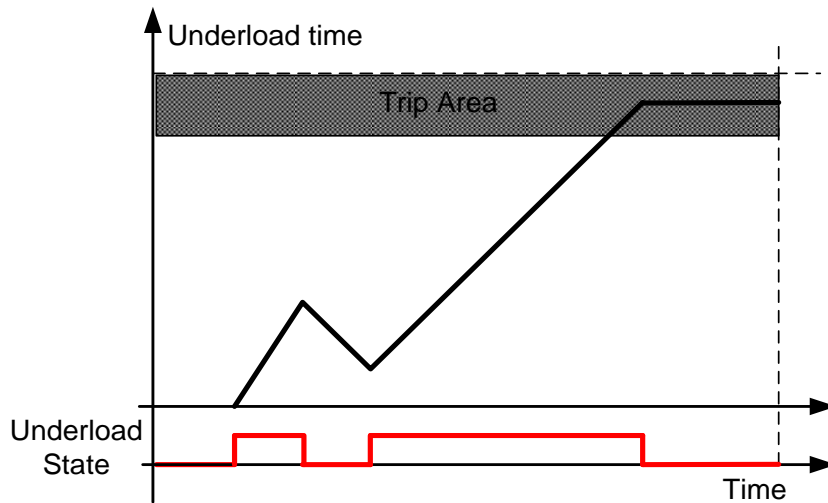

7.12.9 Earth Fault

The earth fault protection ensures that the sum of the motor phase currents is zero. The overcurrent protection is always working and protects the AC drive from earth faults with high currents.

P2.12.8.1 Earth fault protection ID703 "Earth fault"

- 0 = No response
- 1 = Warning
- 2 = Fault, stop mode after fault according to Stop Function
- 3 = Fault, stop mode after fault always by coasting

P2.12.8.2 Earth fault current limit ID1333 "EarthFaultCurLim"

Maximum level for Earth current in % of the unit nominal current.

7.12.10 Cooling protection

Protection for liquid cooled units. An external sensor is connected to the drive (DI: Cooling Monitor) to indicate if cooling liquid is circulating.

P2.12.9.1 Cooling fault delay ID751 "Cooling F Delay"

This parameter defines the delay after which the drive goes to fault state when 'Cooling OK' signal is missing.

P2.12.9.2 Cooling fault response ID762 "CoolingFaultREsp"

In some cases it is more important to allow the drive to run even if the cooling liquid is not circulating. Then it is possible to select warning as the response. The drive will then continue running until its internal protection will stop it. If cooling signal loss happens on stop state indication is not stored to fault history if previous fault is already Cooling Fault. In Run State indication is always stored to fault history

- 0 = Stop State: No Action, Run State: Warning
- 1 = Stop State: Warning, Run State: Warning
- 2 = Stop State: Warning, Run State: Fault
- 3 = Stop State: No Action, Run State: Fault

7.12.11 *Fieldbus communication*

The drive will monitor at least three different indications for fieldbus fault when P2.13.22 State Machine "2 / ProfiDrive" is used:

1. Internal monitoring from the fieldbus protocol.
2. CW.B11 Watchdog pulse (If used)
3. CW.B10 Fieldbus Control (Depending on used State Machine)
4. CW.B15 (Profibus)

If any of these indicates a problem in communication, all other control signals from fieldbus are frozen.

With "FB Fault Delay" parameter, it is possible to select how long the drive can stay running after the fault situation. By setting the parameter to zero, the drive will remain in running state "forever" when 4 / Warning previous frequency is selected. When communication is established again, the drive will wait for 1 second before accepting commands from fieldbus. This allows the use of CW.B10 to indicate from the PLC side that communication is operational in a controlled way.

P2.12.10.1 FieldBus Response Slot D ID733 "FB Fault Slot D"

Set here the response for a fieldbus fault if the active control place is fieldbus. For more information, see the respective Fieldbus Board Manual.

- 0 = No response
- 1 = Warning
- 2 = Fault, stop mode after fault according to Stop Function
- 3 = Fault, stop mode after fault always by coasting
- 4 = Warning, Previous reference from 10 seconds. Forced fault after delay.
- 5 = Quick Stop, Action defined by P2.3.11.1 Quick Stop Mode is taken.
- 6 = Warning, Change control place to IO.

P2.12.10.2 Fieldbus fault delay ID1850 "FB Fault Delay"

This parameter defines for how long the drive will stay in run state after the communication has been lost if fault response is set to 4 / Warning, previous reference. If time is set to zero, the drive will remain running until communication is established and stop command is given.

P2.12.10.3 Fieldbus Watch Dog delay ID1354 "FB WD Delay"

Defines the delay after which a fault is generated if watch dog pulse is missing from fieldbus. Set the time to zero to disable watchdog monitoring.

P2.12.10.4 FieldBus Response Slot E ID733 "FB Fault Slot E"

Set here the response for a fieldbus fault if the active control place is fieldbus. For more information, see the respective Fieldbus Board Manual.

0 = No response

1 = Warning

2 = Fault, stop mode after fault according to Stop Function

3 = Fault, stop mode after fault always by coasting

4 = Warning, Previous reference from 10 seconds. Forced fault after delay.

5 = Quick Stop, Action defined by P2.3.11.1 Quick Stop Mode is taken.

6 = Warning, Change control place to IO.

7.12.12 External Fault function***P2.12.11.1 Response to external fault ID701 "External Fault 1"******P2.12.11.2 Response to external fault ID747 "External Fault 2"***

Defines the response to a digital input signal informing about an external condition where the drive needs to react to. The external warning/fault indication can be connected to a digital output.

0 = No response

1 = Warning

2 = Fault, stop mode after fault according to Stop Function

3 = Fault, stop mode after fault always by coasting

7.12.13 Encoder Fault function

Encoder supervision gives fault in case there are no pulses from encoder. It is required that the reference is above 1 Hz and that the torque can reach 100% level. This torque level can be adjusted by Iq Fault limit parameter. This limit may need adjustment when torque limit is below 100%. Alternative method to detect encoder fault is Speed Error detection.

P2.12.12.1 Encoder Supervision ID1353

Do not select 3 while drive is in run state.

1 = Warning

2 = Fault

3 = Warning; Change to Open Loop

This selection changes operation mode to Open Loop Sensorless when encoder fault is detected.

Note: It's recommended to activate I/f start when this is selection is used and speed remains long period of times in zero speed area.

P2.12.12.2 Encoder Fast Hz Limit ID1801

Frequency limit where detection is made using fast detection.

P2.12.12.3 Fast Time Limit ID1805

Delay to encoder fault when fault happens above Encoder Fast Hz Limit.

P2.12.12.4 Iq Fault Limit ID1800

This defines the Iq current limit that must be exceeded before the situation is determined to be an encoder fault, if pulses are missing from encoder at the same time.

P2.12.13 Disable Stop Lock ID1086

P2.12.14 Reset Datalogger ID1857

-1 = Blocked

0 = No

1 = Yes

7.13 Fieldbus settings

7.13.1 General settings

P2.13.1 Fieldbus reference minimum scaling ID850 "FB Min Scale"

P2.13.2 Fieldbus reference maximum scaling ID851 "FB Max Scale"

Use these two parameters to scale the fieldbus reference signal. If both parameters have the same value the minimum and maximum frequency limits are used for scaling.

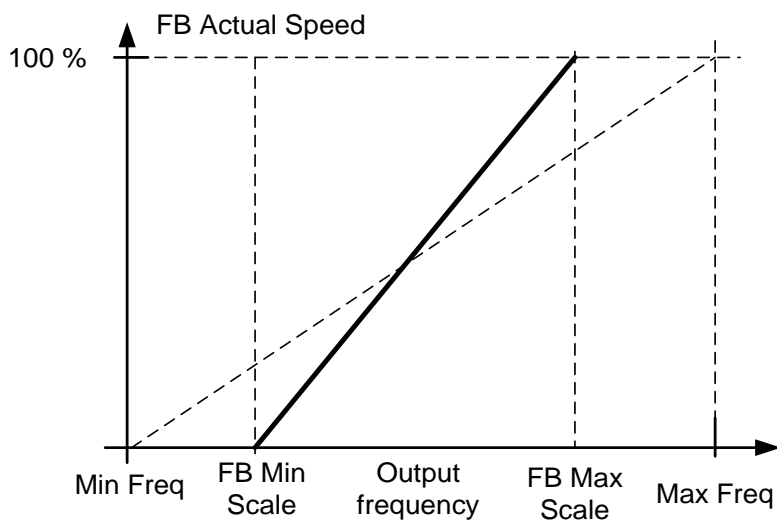
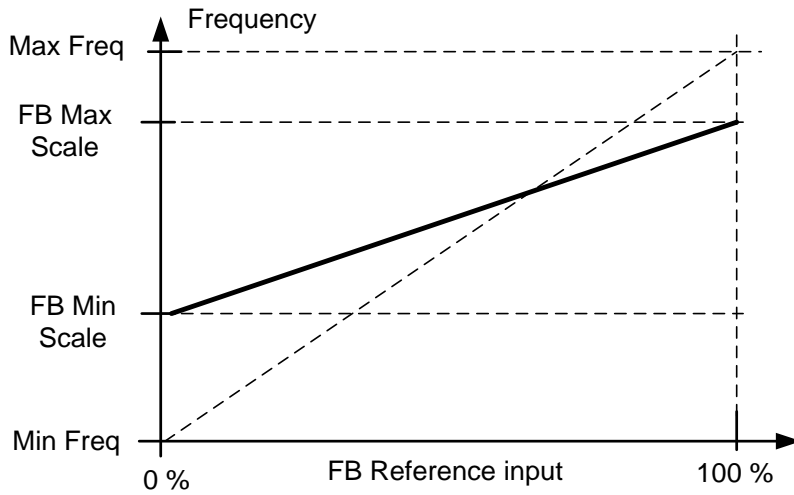

P2.13.3 to**P2.13.10 Fieldbus data OUT selections 1 to 8 ID852-ID859 “FB Data OutX Sel”**

With these parameters, you can monitor any monitoring or parameter value from the fieldbus. Enter the ID number of the item you wish to monitor for the value of these parameters. See monitoring signals for full details of ID numbers.

Default settings:

Data	Value	Unit	Scale	ID
Status Word	Main Status Word			
FB General Status Word	MCStatus			64
FB Actual Speed	Actual Speed	%	0.01 %	
Process data OUT 1	Output Frequency	Hz	0.01 Hz	1
Process data OUT 2	Motor Speed	rpm	1 rpm	2
Process data OUT 3	Motor Current	A	0.1 A	45
Process data OUT 4	Motor Torque	%	0.1 %	4
Process data OUT 5	Motor Power	%	0.1 %	5
Process data OUT 6	Motor Voltage	V	0.1 V	6
Process data OUT 7	DC link voltage	V	1 V	7
Process data OUT 8	Active Fault Code	-	-	37

P2.13.11 to**P2.13.18 Fieldbus data OUT selections 9 to 16 ID558-565 “FB Data OutXSel”**

With these parameters, you can monitor any monitoring or parameter value from the fieldbus. Enter the ID number of the item you wish to monitor for the value of these parameters. See monitoring signals for full details of ID numbers.

Note that these parameters are visible only if a Fieldbus board with support for 16 process data variables is inserted in slots D or E. By default, these parameters are not used.

P2.13.19 to**P2.13.26 Fieldbus data IN selections 1 to 8 ID876-833 “FB Data In X Sel”**

With these parameters, you can control any monitoring or parameter value from the fieldbus. Enter the ID number of the item you wish to control for the value of these parameters. Monitoring signals that can be controlled from fieldbus are shadowed.

Default settings:

Data	Value	Unit	Scale	ID
Reference	Speed Reference	%	0.01%	-
Control Word	Main Control Word	-	-	-
Control Word 2	General Control Word			
Process Data IN1	Torque Reference	%	0.1%	1140
Process Data IN2	Free Analogue INPUT	%	0.01%	46
Process Data IN3	Adjust Input	%	0.01%	47
Process Data IN4	FB Analogue Output	%	0.01%	48
PD4 – PD8	Not Used	-	-	-

P2.13.27 to

P2.13.34 **Fieldbus data IN selections 9 to 16** ID550-557 "FB Data InX Sel"

With these parameters, you can control any monitoring or parameter value from the fieldbus. Enter the ID number of the item you wish to control for the value of these parameters. Monitoring signals that can be controlled from fieldbus are shadowed.

Note that these parameters are visible only if a Fieldbus board with support for 16 process data variables is inserted in slots D or E. By default, these parameters are not used.

P2.13.35 **Fieldbus General Status Word ID** ID897 "GSW ID"

With this parameter it is possible to select which data are sent in FBGeneralStatusWord (see for details and availability in used fieldbus manual).

P2.13.36 **FB Actual Speed ID1741** "FBActualSpeed"

With this it is possible to select which Actual speed is shown on the fieldbus.

0 = Calculated

This selection shows what the ramp generator output is.

Open Loop

In frequency control mode when only the ramp output is shown on the fieldbus and, therefore, the motor slip or any other changes of speed due to load changes are not visible in the actual speed value. However, limiting functions are visible in the ramp output.

Closed Loop

In closed loop control, the limiting functions take place after ramp generator. When speed is limited by, for example, the motoring torque limit, the actual shaft speed may be lower even if FB Actual Speed shows that speed is at reference.

1 = Actual

Open Loop

Motor speed is a calculated value (Monitoring variable Motor Speed) showing the load effect on the speed and slip compensation.

Closed Loop

Motor speed is taken from the actual encoder signal showing the real speed all the time.

P2.13.37 Control Slot selector ID1440 "ControlSlotSel."

This parameter defines which slot is used as the main control place when two fieldbus boards have been installed in the drive. When values 6 or 7 are selected, the drive uses the Fast fieldbus profile. When the Fast fieldbus profile is used, type 'B' boards or other C type boards cannot be used. When values 8 or 9 are selected the drive can use 16 process data variables if the used Fieldbus-board hardware and firmware support it. See the Fieldbus-board manual for further details.

0 = Not Sel.

4 = Slot D, Normal (8 process data variables)

5 = Slot E, Normal (8 process data variables)

6 = Slot D, Fast fieldbus support

7 = Slot E, Fast fieldbus support

8 = Slot D, Extended (16 process data variables)

9 = Slot E, Extended (16 process data variables)

Restrictions when Fast fieldbus support is activated:

1. Set first the Slave Address and the PPO type before selecting the Fast fieldbus mode.
2. Fast fieldbus profile is not available for all fieldbus board, contact factory for more detail.
3. Service data of Profibus board cannot be used.
4. Fieldbus board parameters cannot be accessed.
5. Profibus option board will operate only in ByPass mode.
6. Standard F53 fault detection is not available. WD Pulse monitoring needs to be used to monitor communication faults.

P2.13.38 State Machine

Application has possibility to select what kind of state machine is used.

1: Standard

This mode makes fieldbus control behave as in explained in used fieldbus board manual.

2: ProfiDrive

This mode uses ProfiDrive type state machine in application level. This mode is possible to use on fieldbus boards that does not have state machine itself or has possibility to bypass state machine functionality in option board.

See chapter 9: Status and Control Word in detail

P2.13.39 Fieldbus Custom Minimum ID898 "FB Custom Min"**P2.13.40 Fieldbus Custom Maximum ID899 "FB Custom Max"**

With these parameters it is possible to define fieldbus reference input values scaling. default is 0...10000 (0...100%)

P2.13.41 SW ID.Bit selection B11 ID1628**P2.13.42 SW ID.Bit selection B12 ID1629****P2.13.43 SW ID.Bit selection B13 ID1630****P2.13.44 SW ID.Bit selection B14 ID1631**

Select the bit that used in FB Status Word Bit 11, 12, 13 and 14.

7.14 ID Functions

Listed here are the functions that use the parameter ID number to control and monitor the signal.

7.14.1 Value Control

The value control parameters are used to control an input signal parameter.

P2.14.1.1 Control Input Signal ID ID1580 "ContrInSignal ID"

With this parameter you can select what signal is used to control selected parameter.

P2.14.1.2 Control Off Limit ID1581 "Contrl Off Limit"

This parameter defines the limit when the selected parameter value is forced to Off value.

P2.14.1.3 Control On Limit ID1582 "Contrl On Limit"

This parameter defines the limit when the selected parameter value is forced to On value.

P2.14.1.4 Control Off Value ID1583 "Contrl Off Value"

This parameter defines the value that is used when the used input signal is below Off limit.

P2.14.1.5 Control On Value ID1584 "Contrl On Value"

This parameter defines the value that is used when the used input signal is above On limit.

P2.14.1.6 Control Output Signal ID ID1585 "ContrlOutSignID"

This parameter defines which parameter is forced to On and Off values when selected input signal exceeds the set limits.

P2.14.1.7 Control Mode ID1586 "Control Mode"

This parameter defines how the value control output behaves.

0 = SR ABS

Absolute input value is used to make a step change in the output between On and Off values.

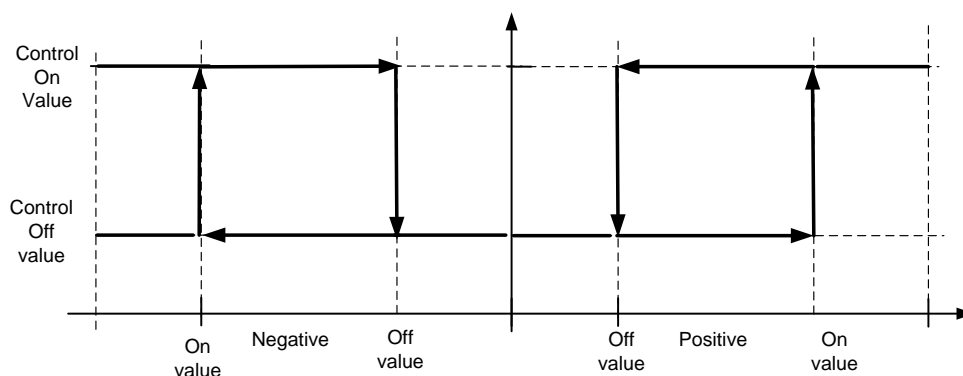

1 = Scale ABS

Absolute input value is scaled linearly between On and Off values.

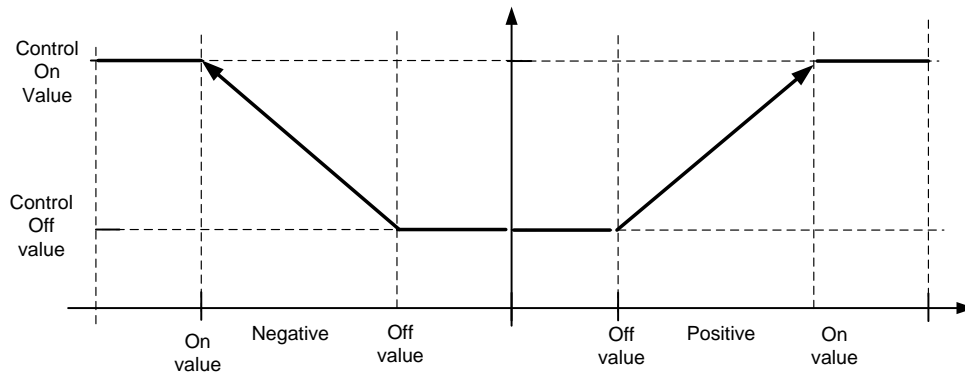

2 = Scale ABS Inverted

Inverted absolute value is scaled linearly between On and Off values.

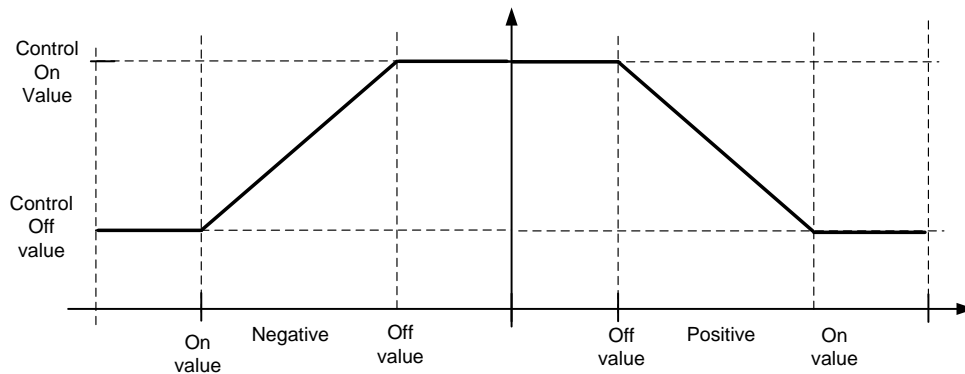

3 = SR

Input value is used to make a step change in the output between On and Off values.

4 = Scale

Input value is scaled linearly between On and Off values.

5 = Scale Inverted

Inverted value is scaled linearly between On and Off values

P2.14.1.8 Control Signal Filtering TC ID1586 "Control Filt TC"

This parameter is used to filter the scaling function output. Used, for example, when the unfiltered torque is used to control a parameter that needs stabilization.

7.14.2 DIN ID Control

This function is used to control any parameter between two different values with a digital input. Different values are given for DI 'low' and DI 'high'.

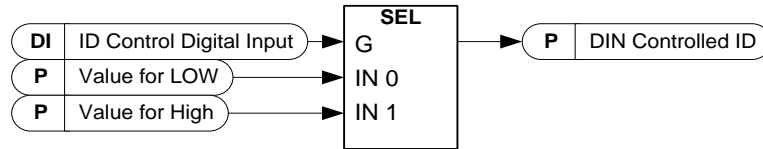

- P2.14.2.1 ID Control Digital Input ID1570 "ID Control DIN"
- P2.14.3.1 ID Control Digital Input ID1590 "ID Control DIN"
- P2.14.4.1 ID Control Digital Input ID1578 "ID Control DIN"

Select digital input to be used for controlling the parameter selected by ID1571, ID1575 and 1579.

- P2.14.2.2 DIN Controlled ID ID1571 "Controlled ID"
- P2.14.3.2 DIN Controlled ID ID1575 "Controlled ID"
- P2.14.4.2 DIN Controlled ID ID1579 "Controlled ID"

Select parameter ID controlled by ID1570.

- P2.14.2.3 Value for Low digital input (FALSE) ID1572 "FALSE Value"
- P2.14.3.3 Value for Low digital input (FALSE) ID1592 "FALSE Value"
- P2.14.4.3 Value for Low digital input (FALSE) ID1594 "FALSE Value"

Set here the controlled parameter value when the digital input (ID1570) is LOW for the parameter selected by ID1571. The function does not recognize decimals. Give, therefore, e.g. 10.00 Hz as '1000'.

- P2.14.2.4 Value for High digital input (TRUE) ID1573 "TRUE Value"
- P2.14.3.4 Value for High digital input (TRUE) ID1593 "TRUE Value"
- P2.14.4.4 Value for High digital input (TRUE) ID1596 "TRUE Value"

Set here the controlled parameter value when the digital input (ID1570) is HIGH for the parameter selected by ID1571. The function does not recognize decimals. Give, therefore, e.g. 10.00 Hz as '1000'.

7.14.3 ID-controlled DO

This function is used to control any Digital output by any status that can be presented as bit. The input signal is selected with the ID number and bit number.

Example: Most of the faults and warnings are normally presented in the common digital output. With the ID-controlled DO function, it is possible to select a specific fault to be connected to the digital output.

Warning Word 1 ID1174		
	Fault	Comment
b0	Motor stalled	W15
b1	Motor over temperature	W16
b2	Motor underload	W17
b3	Input phase loss	W10
b4	Output phase loss	W11
b5	Safe disable	W30 (Not implemented)
b6	FieldBus communication fault in slot D	W53 (Not implemented)
b7	FieldBus communication fault in slot E	W67 (Not implemented)
b8	Drive over temperature	W14
b9	Analogue input < 4mA	W50
b10	Not used	
b11	Emergency stop	W63 (Not implemented)
b12	Run disabled	W62 (Not implemented)
b13	Not used	
b14	Mechanical Brake	W58
b15	Not used	

P2.14.5.1 ID.Bit Free Digital output control 1 ID1216 "ID.Bit Free D01"

P2.14.6.1 ID.Bit Free Digital output control 2 ID1386 "ID.Bit Free D02"

Select the signal for controlling the DO. The parameter has to be set in format xxxx.yy where xxxx is the ID number of a signal and yy is the bit number. For example, the value for DO control is 1174.02. 1174 is the ID number of Warning Word 1. So the digital output is ON when bit number 02 of the warning word (ID no. 1174) i.e. *Motor underload* is high.

P2.14.5.2 Free Digital Output selector ID1574 "Free D01 Sel."

P2.14.6.2 Free Digital Output selector ID1325 "Free D02 Sel."

Select the output terminal to be controlled with the parameter ID.bit Free Digital output control.

7.14.4 Free DIN Delay

This function is used when certain DIN signal needs On or Off delay before actual command is given. For example, Reading from DIN Status Word: DIN1 status giving it a 1.00 s delay and then writing it by ID number to ID403 Start 1, thus giving 1 second delay to start on drive side.

P2.14.7.1 ID.Bit Free Digital input delay ID1832 "ID.Bit Free DIN"

Select digital input from DIN Status Word to be delayed.

P2.14.7.2 On Delay ID1833 "On Delay"

This defines ON delay for the input signal.

P2.14.7.3 Off Delay ID1834 "Off Delay"

This defines OFF delay for the input signal.

P2.14.7.4 Mono Time ID1836 "Mono Time"

This timer makes a pulse that last defined time. Pulse will start after On Delay time.

P2.14.7.5 Control Out ID ID1835 "Control Out ID"

Select the signal ID to be controlled by input signal. If inversion or parameter value other than zero and one is needed this can be connected to DIN ID Control function ID1570, ID1590 or 1578 where desired values can be set and connected to correct parameter.

7.14.5 ID.Bit ID Control

This function is used when it is necessary to control a signal or parameter through e.g. Status Bit. Controlling the parameter is done with the ID of the controlled parameter and the true and false values of this function.

P2.14.8.1 IDbit ID Control ID1634 "IDbit ID Control"

This parameter will be in the format of xxxx.yy where xxxx refers to the ID of the signal and yy refers to individual bit.

P2.14.8.2 Controlled ID ID1618 "Controlled ID"

Select parameter ID controlled by ID1634.

P2.14.8.3 False Value ID1632 "FALSE Value"

Set here the controlled parameter value when the value of ID1634 is LOW for the parameter selected by ID1618. The function does not recognize decimals. Give, therefore, e.g. 10.00 Hz as '1000'.

P2.14.8.4 True Value ID1633 "TRUE Value"

Set here the controlled parameter value when the value of ID1634 is HIGH for the parameter selected by ID1618. The function does not recognize decimals. Give, therefore, e.g. 20.00 Hz as '2000'.

7.15 Brake Control

The mechanical brake control has two parts that need to be synchronically controlled. The first part is the *mechanical brake release* and the second is the *speed reference release*.

Note: Disable P2.3.12.2 CLRmpFollEncFreq parameter if drive is used for hoisting.

Conditions to open the brake:

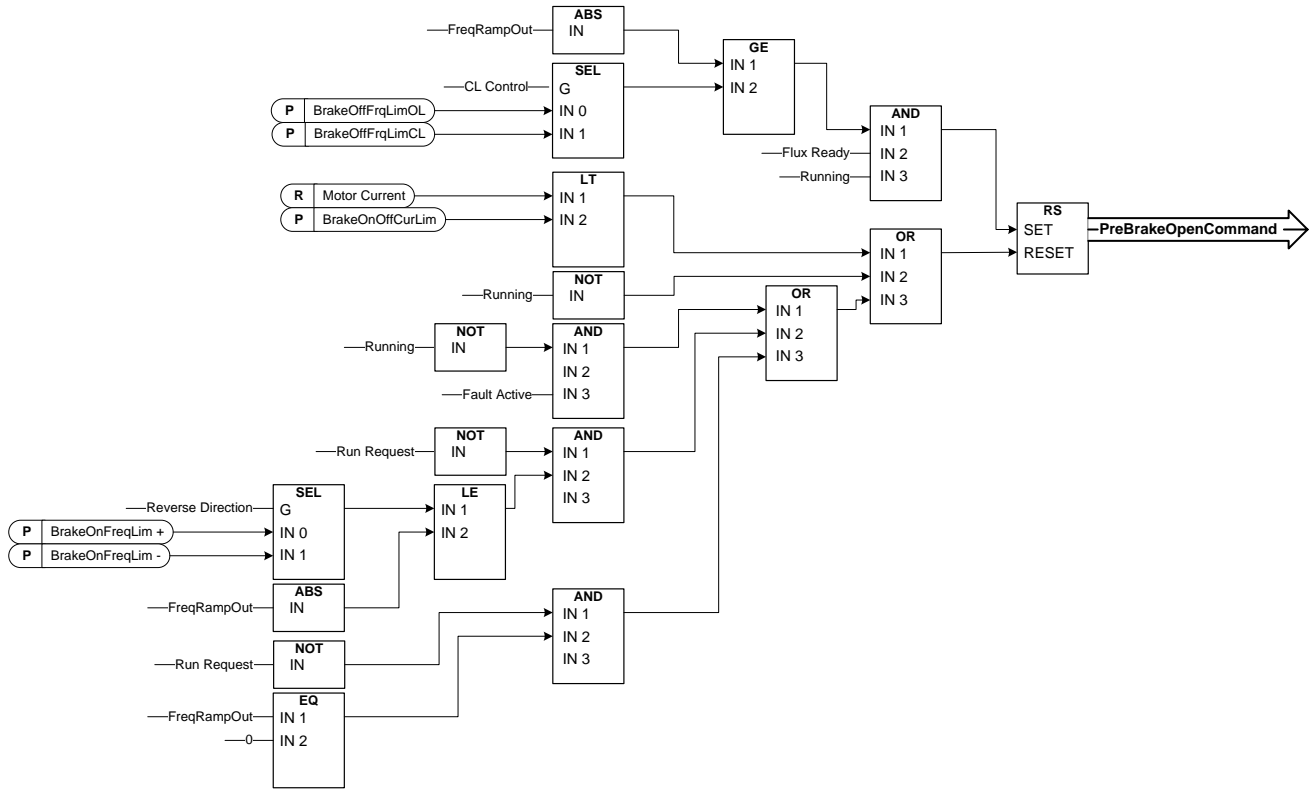

The final brake open command: It is possible that in a Master/Follower system the master drive opens the brake. Also an overriding system may do this without any control from the drive using AucControlWord1.B7. During identification run the brake will not open.

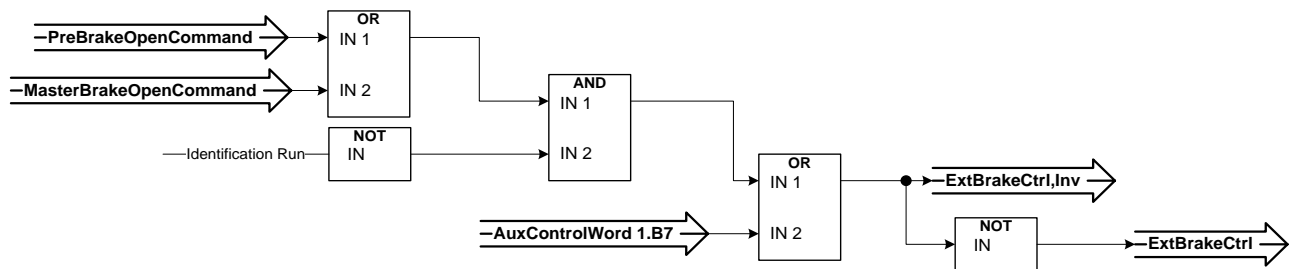

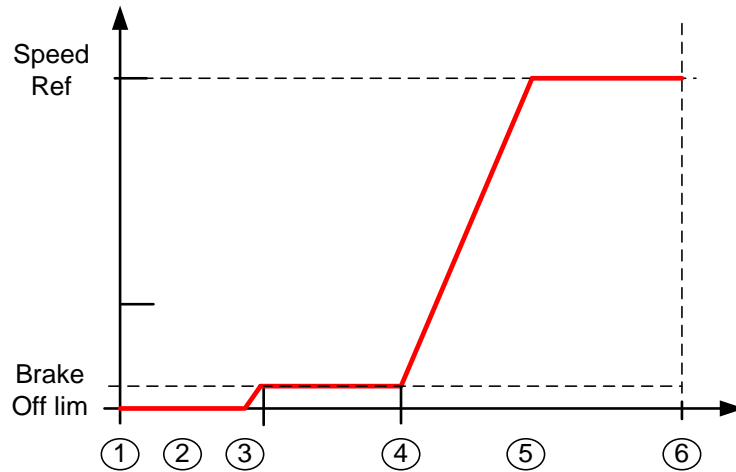

1. Start command
2. Start magnetization is used to build rotor flux fast. The drive *Zero speed time* is used during this.
3. When the rotor flux is > 90% and the start zero time has expired the speed reference is released to BrakeOpenFreq limit.
4. Speed is kept at this speed until feedback is received from the brake acknowledge or when brake mechanical delay time has passed.
5. Speed follows normal reference signal.

Speed reference release function:

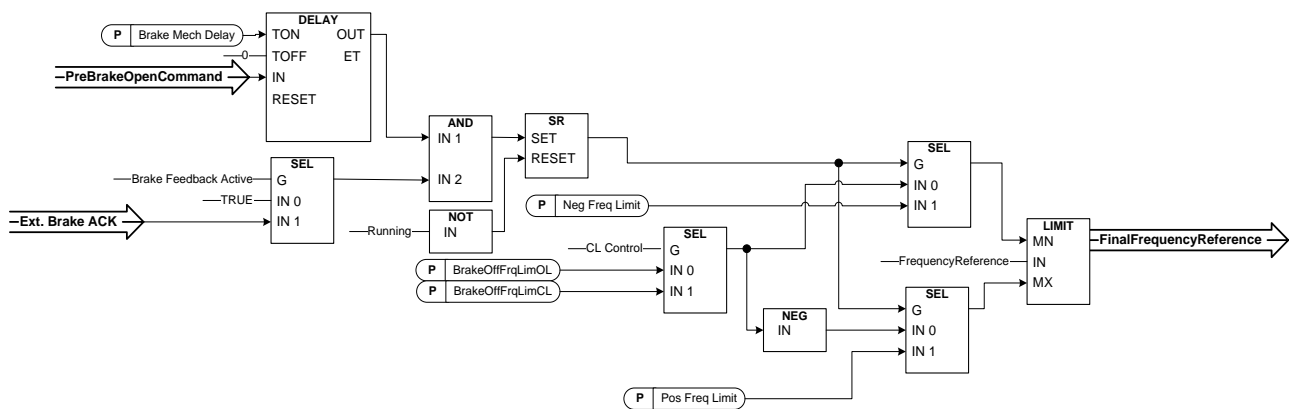

P2.15.1 Mechanical brake reaction time ID1544 "Brake Mech Delay"

After the brake open command has been given, speed is kept at the Brake Open limit until the reaction time has passed. This hold time should be set to correspond to the mechanical brake reaction time. This function is used to avoid current and/or torque spikes eliminating a situation where the motor is run at full speed against the brake. If this parameter is used simultaneously with the brake acknowledge input, both time and brake acknowledgements are needed before the speed reference is released.

P2.15.2 Brake Frequency limit Open Loop ID1535 "BrakeOFFFrqLimOL"

This parameter defines the frequency limit to release the brake.

This value also applies as the maximum frequency reference limit while the brake is closed. In open loop control it is recommended to use a value that is equal to the motor's nominal slip.

P2.15.3 Brake Frequency limit Closed Loop ID1555 "BrakeOFFFreqLimCL"

This parameter defines the frequency limit to release the brake.

This value also applies as the maximum frequency reference limit while the brake is closed. In closed loop control it is recommended to use zero value so that the brake is released while the drive has zero speed at start. If torque is needed to avoid position change at the moment the brake mechanically opens, use the start-up torque function.

P2.15.4 Closing frequency from forward direction ID1539 "BrakeOnFreqLim +"

Output frequency limit to close the brake when the speed approaches zero speed from positive direction. Lifting direction must be given as positive frequency.

P2.15.5 Closing frequency from reverse direction ID1540 "BrakeInFreqLim -"

Output frequency limit to close the brake when the speed approaches zero speed from positive direction. Lowering direction must be given as negative frequency.

P2.15.6 Brake On/Off Current limit ID1085 "BrakeOnOffCurLim"

If motor current is below this value the brake is closed immediately.

It is recommended to set this value to approximately 25% of the magnetization current from the maximum used frequency.

7.15.1 Runaway load protection

Runaway load protection is used to increase the generator torque limit in case when the speed of the load is increasing above the defined frequency limit. Used in cases when upper system is controlling generator torque limit and its needed to drive itself control situation when speed increases too high.

Note! The maximum generator side torque limit is still limited by the General torque limit parameter.

P2.15.7 Generator Torque limit increase speed level ID1547 "TorqLimInc Hz"

The frequency limit at which the generator side torque limit is started to increased when speed of the motor increases (over speed).

P2.15.8 Generator Torque limit increase high speed limit ID1548 "MaxTorqLim Hz"

The frequency level at which point the torque defined by the "Generator Torque Limit increase maximum addition" is added entirely to the final torque limit.

P2.15.9 Generator Torque limit increase added torque ID1549 "MaxTorqLim"

When this parameter is set greater than zero, the generator torque limit increases at high speed is activated. This parameter defines the torque that is added to generator torque limit, linearly starting from ID1547 to ID1548.

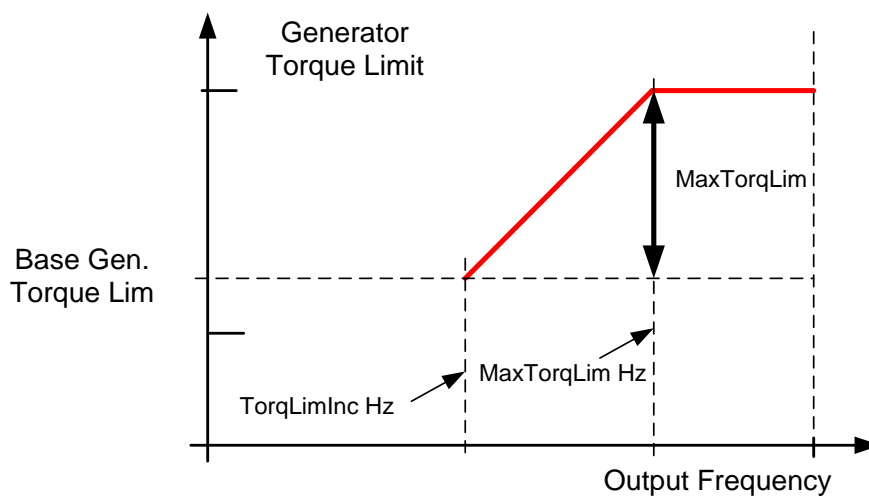
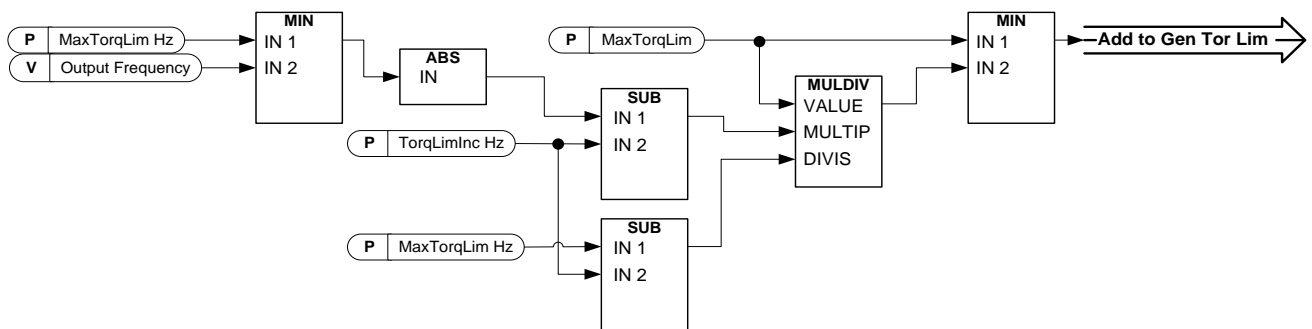

7.15.2 Brake monitoring function

The brake monitoring function is activated when the function Brake acknowledge is used. The brake monitoring function compares the brake feedback to the control signal. In other words, a fault will be issued if the feedback is missing when drive is in Run state and the output frequency is above the opening limit and the fault delay has expired. A fault is also triggered if the brake feedback indicates that the brake is open while the drive is in stop state.

In some cases it is possible that an encoder fault appears when the drive is run against closed brake. The encoder fault can be disabled with Control Options B8 when the drive is controlling the brake to be closed.

P2.15.10 Brake fault response ID1316 "Brake Fault"

Defines the action after detection of a brake fault.

0 = No response

1 = Warning

2 = Fault, stop mode after fault according to Stop Function

3 = Fault, stop mode after fault always by coasting

P2.15.11 Brake fault delay ID1317 "BrakeFaultDelay"

The delay before the brake fault (F58) is activated. Used when there is a mechanical delay in the brake. See digital input signal *External brake acknowledge*.

7.15.3 Closed Loop settings

7.15.3.1 Start Up torque

The start-up torque is used to generate torque against the brake so that when the brake is mechanically opened, there will be no position change because the drive is already generating the torque needed to keep the load in place.

Settings the start-up torque time is set to -1 means that the start-up torque is removed when the drive notices encoder movement. Setting the time greater than 0 will denote the actual time for how long the start-up torque is applied to the motor even if the motor shaft is already rotating thus making the motor accelerate without control until time has expired.

P2.15.12.1 CL: Startup torque ID621 "StartUp Torque!"

0 = Not Used

1 = Torque Memory

Torque memory uses the torque that was used by the speed controller last time the drive was in running state. Normally, this is the torque generated when the zero speed time at stop has expired and the drive has stopped modulation or started the flux off delay function.

2 = Torque Reference

The normal torque reference chain is used (expect TorqueStep) for the start-up torque level. This can be used when the external system knows the load on the shaft when brake is released.

3 = Torque Forward/Reverse

Drive uses torque values defined by the start-up torque forward and reverse.

P2.15.12.2 Start-up torque, forward ID633 "StartupTorq FWD"

Sets the start-up torque for forward direction if selected with parameter Startup Torque.

P2.15.12.3 Start-up torque, reverse ID634 "StartupTorq REV"

Sets the start-up torque for reverse direction if selected with parameter Startup Torque.

P2.15.12.4 Start-Up Torque Time ID1371 "StartupTorq Time"

This parameter defines for how long the start-up torque will be used instead of the speed controller output. If the time is set to -1 the drive will automatically start to use the speed controller when speed change is read from encoder. When the setting is >0 the drive will use this defined torque even if speed changes are read from encoder.

7.15.4 *Roll Back Control for Closed Loop*

Roll Back controller will control the speed to zero when, after the start, the speed reference is zero and when, for example, the brake is opening.

P2.15.13.1 Roll Back Kp ID1787

Gain for Roll Back controller.

P2.15.13.2 Roll Back Torque ID1788

Initial torque level, which is stepwise fed to the motor after the RB is active (in the direction which tends to oppose the RB movement)

P2.15.13.3 Roll Back Level ID1789

Encoder pulses threshold level when roll back controller is active, also speed reference needs to be zero.

P2.15.13.4 Roll Back Kp 2 ID1792

7.15.5 *Functions*

P2.15.14.1 Stop Torque Release Time ID1858

This parameter defines how fast torque is released against closed brake when drive is stopped.

7.16 Auto Fault Reset

The Auto reset function tries to reset the fault automatically during the trial time. An individual fault can be defined to be reset certain number of times before the actual fault indication is given. The function will operate as Automatic Restart function if the start command is received as a static signal. In I/O control of the Marine application, the default start function requires a rising edge command after fault trigger.

P2.16.1 Automatic reset: Wait time ID717 "Wait Time"

Defines the time for the attempted fault reset after the fault trigger has passed.

Note: In case of external fault, remove the cause of fault on the external device. The wait time count starts only when the cause of fault has been removed.

P2.16.2 Automatic reset: Trial time ID718 "Trial Time"

The Automatic reset function keeps trying to reset the faults appearing during the time set with this parameter. If the number of faults during the trial time exceed the value of the respective parameter set with ID720 to ID725 a permanent fault is generated.

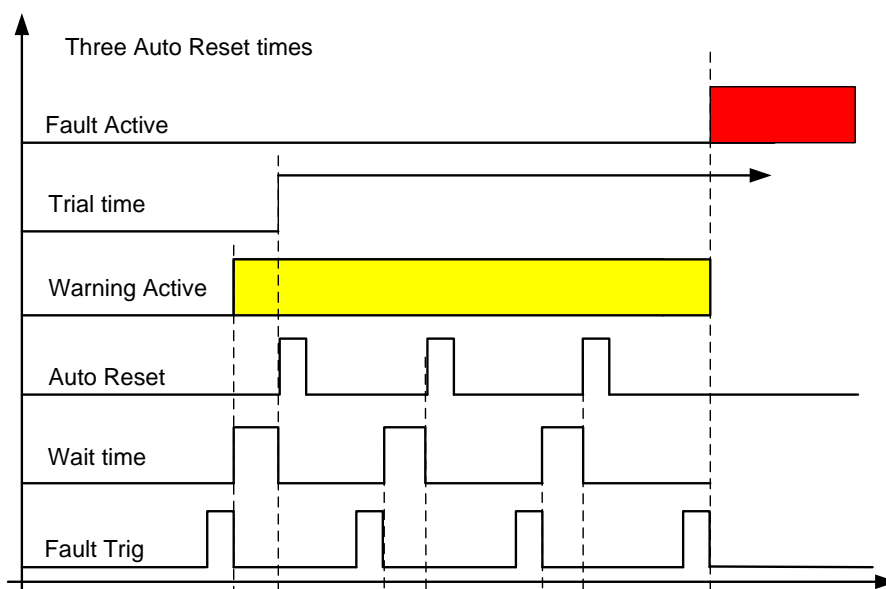

Figure 7-18. Example of Automatic restarts with three restarts

P2.16.3 Automatic restart: Start function ID719 "Start Function"

The Start function for restart is selected with this parameter; restart will take place if there is a static Start command active when an automatic fault reset is made.

- 0 = Start with ramp
- 1 = Flying start
- 2 = Start according to Start Function parameter (Default)

The following 'Number of tries' parameters determine the maximum number of automatic restarts during the trial time. The time count starts from the first autoreset. If the number of faults occurring during the trial time exceeds the values set by number of tries the fault state becomes active.

P2.16.4 *Number of tries after undervoltage fault trip* ID720 *“Undervolt. Tries”*

This parameter determines how many automatic fault resets can be made during the trial time after an under voltage trip.

- 0 = No automatic reset
- >0 = Number of automatic fault resets after undervoltage fault.

P2.16.5 *Number of tries after overvoltage trip* ID721 *“Overvolt. Tries”*

This parameter determines how many automatic fault resets can be made during the trial time after an overvoltage trip.

- 0 = No automatic fault reset after overvoltage fault trip
- >0 = Number of automatic fault resets after overvoltage fault trip.

P2.16.6 *Number of tries after overcurrent trip* ID722 *“Overcurr. Tries”*

(NOTE! IGBT temp faults also included)

This parameter determines how many automatic fault resets can be made during the trial time after overcurrent trip.

- 0 = No automatic fault reset after overcurrent fault trip
- >0 = Number of automatic fault resets after overcurrent trip, saturation trip and IGBT temperature faults.

P2.16.7 *Number of tries after reference trip* ID723 *“4mA Fault Tries”*

This parameter determines how many automatic fault resets can be made during the trial time after 4 mA reference fault.

- 0 = No automatic fault reset after reference fault trip
- >0 = Number of automatic fault resets after the analogue current signal (4...20mA) has returned to the normal level (≥ 4 mA)

P2.16.8 *Number of tries after motor temperature fault trip* ID726 *“MotTempF Tries”*

This parameter determines how many automatic fault resets can be made during the trial time after calculated motor temperature fault trip.

- 0 = No automatic fault reset after Motor temperature fault trip
- >0 = Number of automatic fault resets after the motor temperature has returned to its normal level

P2.16.9 *Number of tries after external fault trip* ID725 *“Ext.Fault Tries”*

This parameter determines how many automatic fault resets can be made during the trial time after external fault trip.

- 0 = No automatic fault reset after External fault trip
- >0 = Number of automatic fault resets after External fault trip

P2.16.10 *Number of tries after underload fault trip* ID738 *“Underload tries”*

This parameter determines how many automatic fault resets can be made during the trial time after underload trip.

- 0 = No automatic fault reset after Underload fault trip
- >0 = Number of automatic fault resets after Underload fault trip

P2.16.11 *Fault Simulation* ID1569 *“Fault Simulation”*

With this parameter it is possible to simulate the different faults without actually making, for example, overcurrent situation. In drive interface point of view, the behaviour is identical to actual fault situation.

- B00 = +1 = Simulates over current fault (F1)
- B01 = +2 = Simulates over voltage fault (F2)
- B02 = +4 = Simulates under voltage fault (F9)
- B03 = +8 = Simulates output phase supervision fault (F11)
- B04 = +16 = Simulates earth fault (F3)
- B05 = +32 = Simulates system fault (F8)

This fault simulation cover wide range of different faults in drive, see fault description for details.

- B06 = +64 = Simulates encoder fault (F43)
- B07 = +128 = Simulates over temperature warning (W14)
- B08 = +256 = Simulates over temperature fault (F14)

Warning bit needs to be active that fault will come in simulation. If fault bit is left active drive will go fault state at warning limit when drive temperature will rise to warning level.

- B09 = +512 = Reserved
- B10 = +1024 = Simulates Fan Cooling fault (F32)

7.17 PI Control

PI Control in system interface application uses ID number to make connection between reference, actual value and output. PIC function will be active when PIC Controller Output ID is higher than zero.

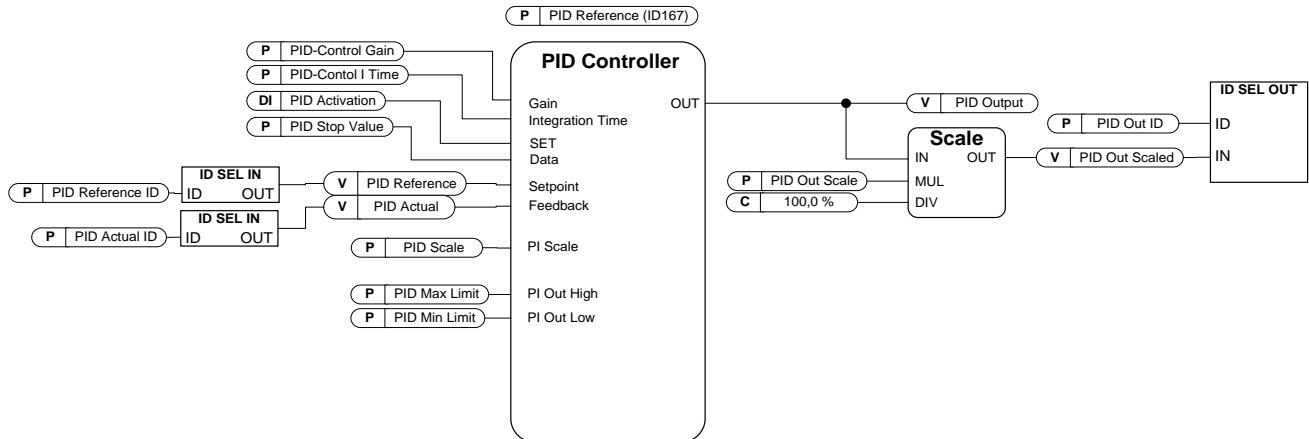

P2.17.1 PI Controller Gain ID118 "PID-Contr Gain"

This parameter defines the gain of the PID controller. If the value of the parameter is set to 100% a change of 10% in the error value causes the controller output to change by 10%. If the parameter value is set to 0 the PID controller operates as I-controller.

P2.17.2 PI Controller I time ID119 "PID-Contr I Time"

The parameter ID119 defines the integration time of the PID controller. If this parameter is set to 1.00 second a change of 10% in the error value causes the controller output to change by 10.00%/s. If the parameter value is set to 0.00 s the PID controller will operate as P controller.

P2.17.3 PI Controller reference ID167 "PID Reference"

PI controller reference from keypad, used also when reference is controlled from Fieldbus.

P2.17.4 PI Controller reference value ID number ID332 "PID Ref ID"

Select ID number of the signal that is used as reference valued for PI controller. Default value is the ID of P2.17.3

P2.17.5 PI Controller actual value ID number ID333 "PID Actual ID"

Select ID number of the signal that is used as actual value for PI controller. PI Actual value can be written from Fieldbus directly to monitoring variable ID21 when this parameters is set to zero.

P2.17.6 PI Controller output ID ID1802 "PID Out ID"

Select ID number of parameter of signal that is controlled by PI controller. When this value is greater than zero, the PI function is operational. This is scaled value by PI Controller Output Scale. Scaling function is used to scale value more suitable for connected signal. For example, when the output is connected to torque limit, the actual value needs to be -1000 ...+1000 (-100.0 %...+100.0 %). But PI Out High and Low can be from -30000...+30000 to have more accurate PI control.

P2.17.7 PI Controller Scale ID340 "PID Scale"

This parameter allows you to invert the error value of the PID controller (and thus the operation of the PID controller).

1 No inversion

-1 Inverted

This value is a multiplier for P and I part of the control thus working as additional gain.

NOTE! Zero is illegal value for PI controller

P2.17.8 PI Controller minimum output ID359 "PID Min Limit"**P2.17.9 PI Controller maximum output ID360 "PID Max Limit"**

With these parameters you can set the minimum and maximum limits for the PID controller output.

These limits are of importance for example when you define the gain and I-time for the PID controller.

P2.17.10 PI Controller output scale ID1803 "PID Out Scale"

This parameter is used to scale PI output to have more controlling are for the PI controller. For example, the PI controller maximum limit can be set to 10000, and by setting scaling to 10%, the PI output can be used directly to motoring torque limit, for instance.

PI Output * Scaling [%] = P2.18.5 -> 10000 * 10 % = 1000, (1000 = 100.0 % of Tn).

P2.17.11 PI Stop state value ID1806 "PID Stop Value"

This value is forced to PI controller out when controller is not activated by digital input P2.2.1.15.

7.18 Functional Safety

P2.18.1 SQS Reaction ID545

0=No Action

1=Quick Stop

Activates same function as Digital Input Quick Stop P2.4.2.25.

P2.18.2 SS1 Reaction ID542

0=No Action

1=Stop

2=Quick Stop

Makes a normal stop command. Uses currently active ramp times

P2.18.3 SS2 Reaction ID546

0=No Action

1=Zero Speed

2=Quick Stop

Reference is forced to zero. Uses currently active ramp times.

P2.18.4 SDI Reaction ID544

0=No Action

1=Disable Dir

Disables direction to selected direction. For ramping down drive uses ramp time P2.3.13

P2.18.5 SLS Reaction ID543

0=No Action

1=Limit Reference

Speed Reference is limited to Safe Board limit – Motor Nominal Slip. Used currently active rap times.

P2.18.6 SSR Reaction ID547

0=No Action

1=Limit Reference

Speed Reference is limited to Safe Board limit – Motor Nominal Slip. Used currently active rap times.

7.19 Keypad control parameters

Unlike the parameters listed above, these parameters are located in the **M3** menu of the control keypad. The reference parameters do not have an ID number.

P3.1 Control Place ID125 "Control Place"

The active control place can be changed with this parameter.

Pushing the Start button for 3 seconds selects the control keypad as the active control place and copies the Run status information (Run/Stop, direction and reference).

0 = PC Control, Activeted by NCDrive

1 = I/O terminal

2 = Keypad

3 = Fieldbus

R3.2 Keypad Reference No ID "Keypad Reference"

The frequency reference can be adjusted from the keypad with this parameter.

The output frequency can be copied as the keypad reference by pushing the Stop button for 3 seconds when you are on any of the pages of menu **M3**.

P3.3 Keypad Direction ID123 "Keypad Direction"

0 Forward: The rotation of the motor is forward, when the keypad is the active control place.

1 Reverse: The rotation of the motor is reversed, when the keypad is the active control place.

P3.4 Stop button activated ID114 "StopButtonActive"

If you wish to make the Stop button a "hotspot" which always stops the drive regardless of the selected control place, give this parameter the value 1.

R3.5 Torque reference No ID "Torque Reference"

Define here the torque reference within 0.0...100.0%.

R3.5 Power reference No ID "Power Reference"

Define here the power reference within 0.0...100.0%.

8. DATA LOGGER TRIGGER WORD

There is a special trigger word in application level that can be used to trigger data logger. This word can be used for triggering when source is selected from Application and original VACON® Marine application vcn is used. Variable is called "DataLoggerTrigWord"

DataLoggerTrigWord ID97		
	Function	Comment
b0	Fault Status	Logger is triggered when there is a fault
b1	Warning Status	Logger is triggered when there is a warning
b2	Auto Reset Warning	Logger is triggered when there is a fault that has been defined to be automatically reset. This bit can be used to get the first fault situation.
b3	Fault Status OR Warning Status	B0 OR B1 triggering situation has happened
b4	Fault Status OR Auto Reset Warning	B0 OR B2 triggering situation has happened
b5		
b6		
b7		
b8		
b9		
b10		
b11		
b12		
b13		
b14		
b15		

9. IDENTIFICATION FUNCTION FOR PERMANENT MAGNET SYNCHRONOUS MOTOR

PM Motor has several zero positioning identification modes. This chapter explains what kind of identification mode is needed to select when using different kind of hardware configuration.

This chapter is addition to P2.1.9 Identification parameter description and P2.8.5.2 Start Angle Identification mode description.

9.1 Zero position identification with absolute encoder.

When using absolute encoder identification is made only once. A new identification is needed if encoder and rotor position changes related to each other.

Motor needs to be able to rotate freely that magnet positions can be identified.

Identification mode in this case is selected by "P2.1.9 Identification" selection "3 / Enc.ID Run".

During identification drive feeds DC current to motor (~90% of motor nominal), this causes motor to move zero position, there may be oscillatory movement on the shaft. When identification is successful "P2.8.5.1 PMSM Shaft Position" is updated, if not successful value is set to zero and identification warning is displayed for 10 seconds (W57). If identification is made several times, result may be different; there are as many positions as there are pole pairs in the motor.

Benefit to use absolute encoder is that magnet position is always known thus motor can be fully loaded from the start.

Related parameters:

P2.1.9	Identification	ID631
P2.8.5.1	PMSM Shaft Position	ID649

9.2 Start position with incremental encoder without Z-pulse input.

When using incremental encoder without Z-pulse, no actual identification is made. However start angle is defined in every start. Identification mode can be selected by "P2.8.5.2 Start Angle Identification Mode". In this case, the encoder identification cannot be done because the zero position cannot be identified without Z-pulse. But identification P2.1.9 Identification selection "2 / ID With Run" is needed to make. Identification at every start will be automatically active if "P2.8.5.1 PMSM Shaft Position" parameter value is zero.

Best result is achieved when the motor has a mechanical brake that prevents shaft movements.

Acceptable result can be achieved also when motor has high load and/or inertia that prevent shaft movements during identification.

Angle identification is done in every start by feeding motor with a DC pulses that identifies magnet position. DC pulses are in two different groups. First one identifies zero position and second one makes polarity check. These DC current levels are adjusted by "P2.8.5.3 Start Angle Identification Current" and "P2.8.5.4 Polarity Pulse current", respectively.

NOTE: Not all motors are suitable for this identification mode. Functionality needs to be tested before production use.

Benefit of this mode is that motor can be fully loaded from the start.

Related parameters:

P2.8.5.2	Start Angle Identification Mode	ID1691
P2.8.5.1	PMSM Shaft Position	ID649
P2.8.5.3	Start Angle Identification Current	ID1759
P2.8.5.4	Polarity Pulse current	ID1566

9.3 Identification with incremental encoder with Z-pulse input.

When using incremental encoder with Z-pulse, identification is made only once. A new identification is needed if encoder and rotor position changes related to each other.

Motor needs to be able to rotate freely that magnet positions can be identified. Identification mode in this case is selected by "P2.1.9 Identification" selection "3 / Enc.ID Run".

During identification, the drive feeds DC current to motor (~90% of motor nominal). This causes the motor to move to zero position. There may be oscillatory movement on the shaft. When motor oscillatory movement has stopped, the motor rotates until Z-pulse is received from the encoder.

When identification is successful, "P2.8.5.1 PMSM Shaft Position" is updated. If the identification is not successful, the value of this parameter is set to zero and an identification warning is displayed for 10 seconds (W57). If identification is made several times, the result may be different, because there are as many positions as there are pole pairs in the motor.

When motor is started and zero position is not "remembered": Drive will start to feed DC current to motor (Defined by "P2.8.5.6 I/f Current") until the Z-pulse is received from the encoder. During this DC injection, the motor may not be able to produce 100% torque. When running without load, the Z-pulse position can be seen in the motor current when current goes nearly to zero.

Related parameters:

P2.1.9 Identification

P2.8.5.1 PMSM Shaft Position

P2.8.5.6 I/f Current

10. STATUS AND CONTROL WORDS IN DETAIL

10.1 Fieldbus

Combination	P7.x.1.4 Operate Mode	P2.13.22 State machine	
1	1 / ProfiDrive	1 / Basic	FB Control and FB Status Word are explained in fieldbus option board manual
2	2 / ByPass Some fieldbus board operate by default in "ByPass" mode	2 / ProfiDrive	<u>Control word</u> is ProfiDrive type and explained in this manual. <u>Status Word</u> is can be selected by ID number, default is ProfiDrive type ID65 V1.26.2 FB Status Word
3	2 / ByPass	1 / Basic	<u>Control word</u> is "Three Bit" control. <u>Status Word</u> is can be selected by ID number, default is ProfiDrive type ID65 V1.26.2 FB Status Word
4	1 / ProfiDrive	2 / ProfiDrive	Drive cannot be operated in this combination from fieldbus.

10.1.1 *Combination 1, ProfiDrive – Standard with Profibus option board*10.1.1.1 *FB Control Word Combination 1, ProfiDrive – Basic with Profibus option board*

FB Control Word for Profibus in Combination 1			
	FALSE	TRUE	Comment
b0	STOP 1 (by ramp)	ON 1	Keep this TRUE
b1	STOP 2 (by cost)	ON 2	Keep this TRUE
b2	STOP 3 (by ramp)	ON 3	Keep this TRUE
b3	RUN DISABLE	ENABLE	Use this for start and stop command
b4	No Action	START	Keep this TRUE
b5	No Action	START	Keep this TRUE
b6	No Action	START	Keep this TRUE
b7	No Action	Fault Reset 0 > 1	Use this for fault reset
b8	No Action	No Action	Not used
b9	No Action	No Action	Not used
b10	Disable Profibus control	Enable fieldbus control	See Profibus manual
b11	Fieldbus DIN1=OFF	Fieldbus DIN1=ON	See P2.5.1.17 -18
b12	Fieldbus DIN2=OFF	Fieldbus DIN2=ON	See P2.5.1.19 -20
b13	Fieldbus DIN3=OFF	Fieldbus DIN3=ON	See P2.5.1.21 -22
b14	Fieldbus DIN4=OFF	Fieldbus DIN4=ON	See P2.5.1.23 -24
b15	Fieldbus DIN5=OFF	Fieldbus DIN5=ON	Not used

10.1.1.2 *FB Status Word Combination 1, ProfiDrive – Basic with Profibus option board*

FB Status Word for Profibus in Combination 1			
	FALSE	TRUE	Comment
b0	Not Ready (initial)	READY 1 (SM)	See Profibus manual
b1	Not Ready	READY 2 (SM)	See Profibus manual
b2	DISABLE	ENABLE (SM)	See Profibus manual
b3	NO FAULT	FAULT ACTIVE	Directly from the drive
b4	STOP 2	NO STOP 2 (SM)	See Profibus manual
b5	STOP 3	NO STOP 3 (SM)	See Profibus manual
b6	START ENABLE	START DISABLE (SM)	See Profibus manual
b7	No Warning	Warning	Directly from the drive
b8	Reference ≠ Actual value	Reference = Actual value	
b9	Fieldbus control OFF	Fieldbus control ON	See Profibus manual
b10	Not used	Not used	
b11	Not used	Not used	
b12	FC Stopped	Running	Directly from the drive
b13	FC not ready	Ready	Directly from the drive
b14	Not used	Not used	
b15	Not used	Not used	

SM = Profibus board State Machine

10.1.2 Combination 2, ByPass – ProfiDrive; State Diagram

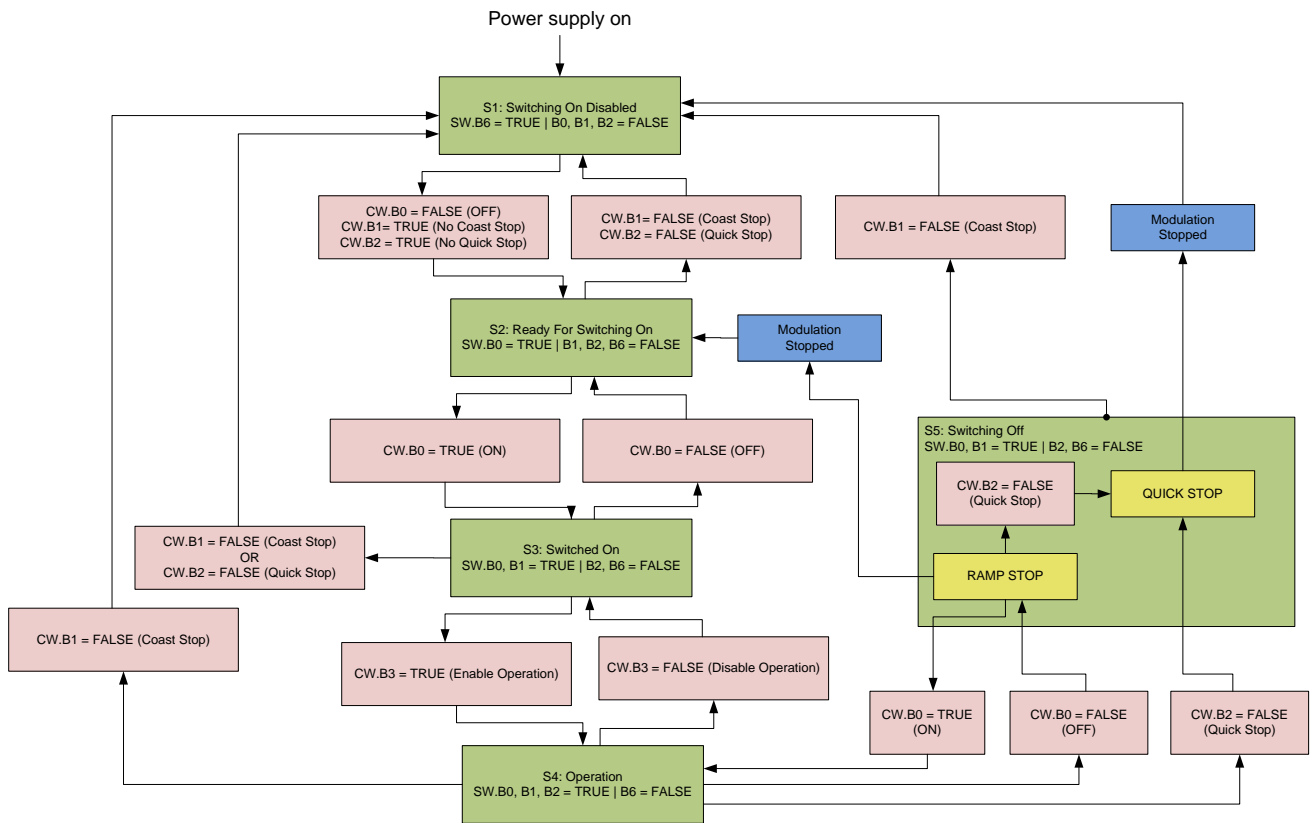

10.1.2.1 State Machine

Coasting Stop

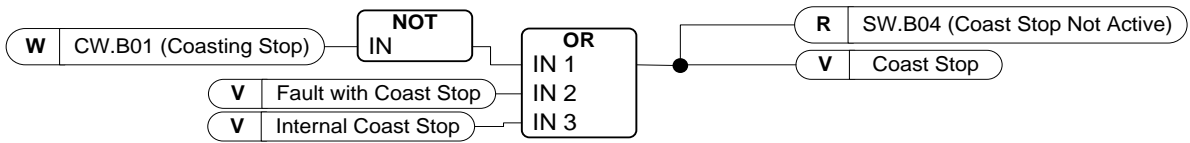

Quick stop

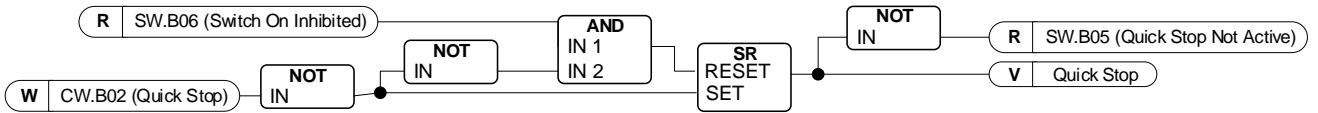

Ready to Switch-On, Operate and Running

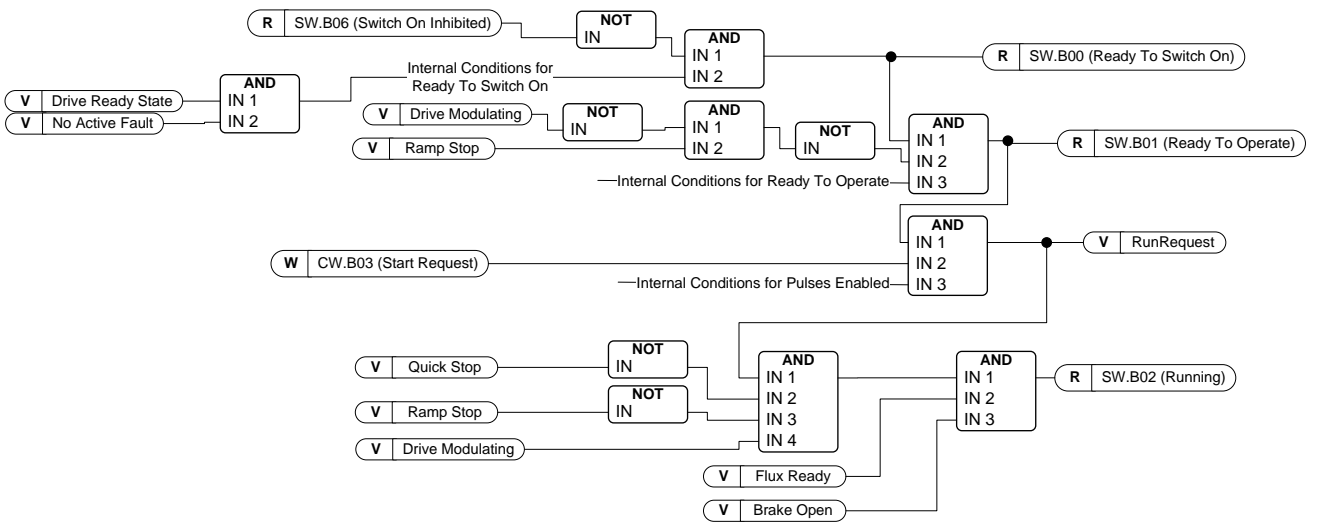

10.1.2.2 *FB Control Word*

FB Control Word ID1160		
	Signal	Comment
b0	ON	0>1 will reset the Switch On Inhibit state and bring the drive to Ready Run. Should be reset after fault, Coast Stop (b1) and Emergency Stop (b2) .
b1	Coasting Stop	0=Coast stop Active 1=Coast stop NOT active
b2	Quick Stop	0=Quick stop Active 1=Quick stop NOT active
b3	Start	Normal start command 0=Stop the drive 1=Start the drive
b4	Ramp Output to Zero	0=Force speed ramp output to zero 1=Release speed ramp output
b5	Ramp Hold	0=Hold speed ramp output 1=Release speed ramp
b6	Ramp Input to Zero	0=Force speed ramp input to zero 1=Release speed ramp input
b7	Fault Reset	0=No Action 1=Reset active faults
b8	Inching 1	Run the drive with defined constant speed 0=No Action 1=Run with constant speed
b9	Inching 2	Run the drive with defined constant speed 0=No Action 1=Run with constant speed
b10	Fieldbus Control Enable	Activate Fieldbus control when P3.1 =3/Fieldbus 0=Fieldbus Control NOT active 1=Activate Fieldbus Control
b11	Watch Dog	0>1>0>1...1 sec square wave clock. This is used to check data communication between Profibus master and the drive. Used to generate FB Communication -Fault.
b12		
b13		
b14		
b15		

B00: FALSE = OFF 1, TRUE = ON 1

OFF 1: Drive will make ramping stop and goes to “Ready to switch-on”. If the drive is in “Switch on Inhibit” state, this bit is used to reset this status.

ON: Voltage connected to drive and/or DC link charged if drive has the control.

B01: FALSE = Coast stop (OFF 2), TRUE = ON 2

Coast Stop: Drive will make coasting stop and goes to “Switch-on Inhibit” state

ON 2: No Coast Stop command

B02: FALSE = Quick Stop (OFF 3), TRUE = ON 3

Quick Stop: Drive will make stop function defined by Quick Stop function parameter.

ON 3: No Quick stop command.

B03: FALSE = Stop Request, TRUE = Start Request

Stop Request: Drive will make stop defined by stop function.

Start Request: Start Command to the drive.

B04: FALSE = Reset Ramp Generator, TRUE = Enable Ramp Generator

This bit has priority over B05 and B06 in Control Word.

Reset Ramp Generator: Closed Loop: Ramp generator is forced to zero, and the drive will make a stop as fast as possible running against the set torque limits or, for example, overvoltage controller.

Enable Ramp Generator: Ramp Generator function is enabled.

To activate Jogging function from fieldbus B04, B05 and B06 needs to be zero.

B05: FALSE = Freeze Ramp Generator, TRUE = Unfreeze Ramp Generator

This bit has priority over B06 but not over B05.

Freeze Ramp Generator: Drive will not accept new reference from Fieldbus, drive remains at the same speed.

Unfreeze Ramp Generator: Drive will follow reference from Fieldbus.

To activate Jogging function from fieldbus B04, B05 and B06 needs to be zero.

B06: FALSE = Disable Set point, TRUE = Enable Set point

This bit has lower priority compared to B04 and B05.

Disable Set point: Reference (FW:FreqRef1) is forced to zero, and the drive will ramp to zero speed

Enable Set point: Drive will follow reference.

To activate Jogging function from fieldbus B04, B05 and B06 needs to be zero.

B07: FALSE = No significance, TRUE = Fault Acknowledge

Fault Acknowledge: The group signal is acknowledged with a positive edge; the drive reaction to a fault depends on the type of fault (refer to "alarm handling in Appendix A.8). If the fault reaction has isolated the voltage, the drive then goes into the "Switching On Inhibited" condition.

10.1.2.3 Jogging function

I/O Jogging Command: Jogging function will start the drive to reference without additional start command regardless of control place when given from IO. Jogging function requires enabling from digital input before command is accepted. Inching is also disabled if there is a start command active from active control place. If both inching references are active at the same time, the drive will stop.

Fieldbus Jogging Command: Jogging command is activated by giving normal start command but the ramp control bits CW.B4, B5 & B6 needs to be zero. Drive needs to be at zero speed before command is accepted and CW.B4, B5 & B6 are active after drive is at zero speed when jogging function is stopped.

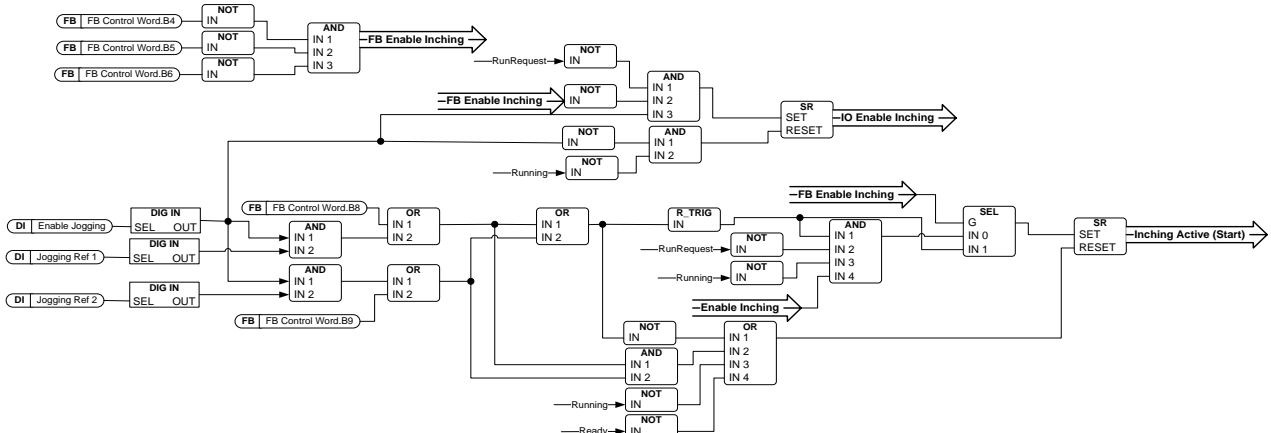

B08: FALSE = No Function, TRUE = Jogging 1

Inching 1: Drive follows reference set by Jogging Ref 1. Function needs to be separately activated by Aux Control Word or by digital input Enable Jogging when IO control used for Jogging.

B09: FALSE = No Function, TRUE = Inching 2

Inching 2: Drive follows reference set by Jogging Ref 2. Function needs to be separately activated by Aux Control Word or by digital input Enable Jogging when IO control used for Jogging.

B10: FALSE = FB Control disabled TRUE = FB Control Enabled

FB Control Disabled: Drive will not follow main control word from Fieldbus. If removed while running, the drive will make coasting stop.

FB Control Enabled: Drive follows control word from fieldbus

B11: FALSE = FB WD Pulse Low, TRUE = FB WD Pulse High

Watch dog pulse: This pulse is used to monitor that PLC is alive. If pulse is missing, the drive will go to fault state. This function is activated by P2.12.10.3 FB WD Delay. When the value is zero, the pulse is not monitored.

10.1.2.4 FB Status Word

FB Status Word ID65		
	Signal	Comment
b0	Ready to switch On	0=The drive NOT ready to switch ON 1=The drive is ready to switch ON
b1	Ready to Operate	0=The drive is NOT ready to run 1=The drive is ready to run
b2	Running	0=The drive is NOT running 1=The drive is running and ready to release the reference
b3	Fault Active	0=No fault active 1=Fault IS active
b4	Coast Stop NOT active	0=Coast stop active 1=Coast stop NOT active
b5	EM Stop not Active	0=Emergency stop active 1=Emergency stop NOT active
b6	Switch On Inhibit	0=No Inhibit 1=The drive is out of fault and coast / emergency stop state.
b7	Warning	0=NO alarm 1=Alarm IS active
b8	Speed At Ref	0=Speed actual is NOT equal to speed reference 1=Speed actual is equal to speed reference
b9	FB Control Active	0=Fieldbus Control NOT active 1=Fieldbus Control active
b10	Above Limit	Indicate if speed actual is below the limit P2.4.16 0=Speed actual is below the speed limit 1=Speed actual is above the speed limit
b11		
b12		
b13		
b14		
b15	Watch Dog Feedback	

B00: FALSE = Not Ready to Switch On, TRUE = Ready to Switch On

Not Ready to Switch On:

Ready to Switch On: Power supply is switched on, electronics initialized, main contactor, if available, has dropped out, pulses are inhibited.

B01: FALSE = Not Ready To Operate, TRUE = Ready To Operate

Not Ready To Operate:

Ready To Operate:

B02: FALSE = Drive is not operating, TRUE = Drive is operational

Drive is not operating: Drive is not run state (modulating)

Drive is operational: Drive is in run state and modulating. Also rotor flux is ready and brake is opened if feedback signal is used.

B03: FALSE = No Fault, TRUE = Fault Present

No Fault: Drive is not on fault state.

Fault Present: Drive is in fault state.

B04: FALSE = Coast Stop Activated, TRUE = Coast Stop Not Activated

Coast Stop Activated: "Coast Stop (OFF 2)" command is present.

Coast Stop Not Activated: Coast stop command is not active.

B05: FALSE = Quick Stop Activated, TRUE = Quick Stop Not Activated

Quick Stop Activated: "Quick Stop (OFF 3)" command is present.

Quick Stop Not Activated: Quick stop command is not active.

B06: FALSE = Switching On Not Inhibit, TRUE = Switching On Inhibited

Switching On Not Inhibit:

Switching On Inhibited: The drive goes only again in the "Switched On" condition with "No Coast Stop AND No Quick Stop" followed by "ON". This means that the "Switching On Inhibited" bit is only set back to zero if the OFF command is set after "No Coast Stop AND No Quick Stop".

B07: FALSE = No Warning, TRUE = Warning Present

No Warning: There is no warning or the warning has disappeared again.

Warning Present: Drive still works; warning in the service/maintenance parameter; no acknowledgement.

B08: FALSE = Speed Error Out Of Tolerance Range, TRUE = Speed Error Within Tolerance Range

Speed Error Out Of Tolerance Range:

Speed Error Within Tolerance Range:

B09: FALSE = No Control Requested, TRUE = Control Requested

No Control Requested: Control by the automation system is not possible, only possible at the device or by another interface.

Control Requested: The automation system is requested to assume control.

B10: FALSE = f Or n Not Reached, TRUE = f Or n Reached Or Exceeded

f Or n Not Reached: Speed is below P2.6.4.5 Above Speed Limit.

f Or n Reached Or Exceeded: Speed is above P2.6.4.5 Above Speed Limit.

B15: FALSE = FB WD Feedback Low, TRUE = FB WD Feedback High

FB WD Feedback: FB Control Word B11 is echoed back to the Fieldbus. Can be used to monitor the communication status from the drive.

10.1.3 Combination 3, ByPass – Basic

10.1.3.1 FB Control Word Combination 3, ByPass – Basic

Main Control Word for Profibus in Combination 3			
	FALSE	TRUE	Comment
b0	STOP	START	
b1	Clockwise	Counter clockwise	
b2	No action	FAULT RESET (0 -> 1)	
b3	FB DIN1	FB DIN1	
b4	FB DIN2	FB DIN2	
b5	FB DIN3	FB DIN3	
b6	FB DIN4	FB DIN4	
b7	FB DIN5	FB DIN5	
b8	Not used	Not used	
b9	Not used	Not used	
b10	Not used	Not used	
b11	Not used	Not used	
b12	Not used	Not used	
b13	Not used	Not used	
b14	Not used	Not used	
b15	Not used	Not used	

10.1.3.2 FB Status Word Combination 3, ByPass – Basic

Most of the fieldbuses use “MCStatus” as Status word that is shown below. For Profibus, the status word can be selected. The default is Combination 2 Status Word, ProfiDrive type ID68 V1.3.2 MainStatusWord. Below Status Word can be selected with P2.10.17 GSW Data by setting it to ID64

FB Status Word for Profibus in Combination 3			
	FALSE	TRUE	Comment
b0	Not Ready	READY	
b1	STOP	RUN	
b2	Clockwise	Counter clockwise	
b3	NO FAULT	FAULT ACTIVE	
b4	No Warning	Warning	
b5	Reference ≠ Actual value	Reference = Actual value	
b6	Speed > Zero	At Zero Speed	
b7	Flux Not Ready	Flux Ready	
b8	TC Speed Limit Active	TC Speed Limit Not Active	
b9	Detected Encoder Direction Clockwise	Encoder Direction Counter clockwise	
b10	UV Fast Stop Active	UV Fast Stop Not Active	
b11	Not used	Not used	
b12	Not used	Not used	
b13	Not used	Not used	
b14	Not used	Not used	
b15	Not used	Not used	

SM = Profibus board State Machine

11. PROBLEM SOLVING

In problem situations it is important to have proper information about the problem.

However, it is recommended first to try with latest application- and system software versions available. Software is continuously developed and default settings are improved.

If the problem persists, contact your local contacts. Before you contact the local contacts, follow the guidelines below so that you give the information they need for problem solving.

Type	Signal Name	Actual	Unit	Min	
Value	Status Word 1	20583			6!
Value	Torque	3,5			1!
Value	Current	4,5			4!
Value	FreqReference	37,29			6!
Value	DC Voltage	550	V		1!
Value	Output Frequency	37,35	Hz	-65,00	6!
Value	Shaft Frequency	37,27	Hz	-65,00	6!
Value	Motor Voltage	293,4	V	0,0	7!

Figure 1. Recommended signals for VACON® NCDrive.

Use the fastest communication speed (Baudrate: 57 600) and a 50 ms update interval for signals for the RS232 communication.

For the CAN communication, use a 1 Mbit communication speed and 7 ms update interval for signals.

When you contact the support, send the *.trn, *.par and Service info (*.txt) files with a description of the situation. If the situation is caused by a fault, take also the Datalogger data from the drive.

Note that Datalogger settings can be changed to catch correct situation and it's also to possible make manual force trig for Datalogger.

Before storing the parameter file, upload the parameters from the drive and save when VACON® NCDrive is in the ON-LINE state. If it is possible, do this while the problem is active.

It is also helpful to have single line diagram from the system where the problem occurs.

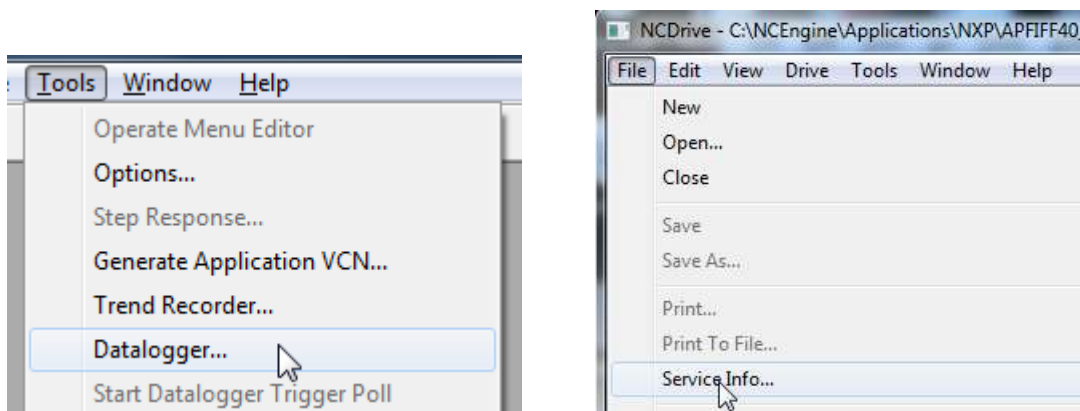

Figure 2. Datalogger window opening and Service Info upload.

12. FAULT CODES

F1 *Overcurrent fault*

There is too high a current ($>4 \cdot I_H$) in the motor cable.

S1 = Hardware trip:

- Current above $4 \cdot I_H$

S3 = Current controller supervision.

- Current limit too low or current peak value too high.

S4 = Software trip:

- User configured software over current limit exceeded.
 - Check Motor Protection for software over current trip limit settings

Possible cause and solutions

- Sudden increase in load
 - Check motor load.
- Short circuit in motor cables
 - Check motor and cables.
- Motor is under magnetized at start.
 - Check motor name plate data.
 - Make identification run
- Sine filter is used but drive settings are not correct
 - Activate Sine filter parameter (P6.7.5) in system menu.

F2 *Overvoltage fault*

DC-link voltage has exceeded the drive protection limits.

S1 = Hardware trip.

- 500 Vac unit DC voltage above 911 Vdc
- 690 Vac unit DC voltage above 1200 Vdc

S2 = Overvoltage control supervision (only 690 Vac unit).

- DC voltage has been above 1100 Vdc for too long.

Possible cause and solutions

- Too short a deceleration time
 - Increase deceleration time.
 - Use brake chopper and brake resistor.
 - Use Brake chopper unit.
 - Use active front end unit.
 - Activate overvoltage controller.
- High overvoltage spikes in supply
 - Activate overvoltage controller.
- High generator side power
 - AFE current/power limit too low

F3 *Earth fault*

Earth fault protection ensures that the sum of the motor phase currents is zero. The overcurrent protection is always working and protects the AC drive from earth faults with high currents.

S1 = Sum of motor current is not zero

- Insulation failure in cables or motor
 - Check motor cables and motor.

F5 Charge switch

Charge switch status is not correct when start command is given.

S1 = Charge switch was open when START command was given.

- Charge switch was open when the START command was given.
 - Check connection of the feedback from charging relay
 - Reset the fault and restart.

Should the fault re-occur, contact your local distributor.

F6 Emergency stop

Emergency stop command has been given by using a special option board.

*F7 Saturation fault***S1 = Hardware failure****Possible cause and solutions**

- If there is a brake chopper in use
 - Check the isolation resistance and the resistance on the brake resistor.
- FR4-FR8: Power module
 - Measure the power module directly from its terminals.
- Hardware
 - Check the capacitors.

F8 System Fault

A system fault indicates several different fault situations in drive operation.

S1 = Reserved

- Disturbance.
 - Reset the unit and try again.
- If there is star coupler in the unit.
 - Check the fibre connections and phase order.
- Driver board or IGBT broken.
- FR9 and the bigger size drives, which includes not star coupler, ASIC board (VB00451) is broken.
 - Change ASIC board
- FR8 and smaller size drives: control board broken.
 - Change control board
- FR8 and smaller size drives: if there is boards VB00449 / VB00450 in use, failure might be in there.
 - Check the boards

S7 = Charge switch

S8 = No power to driver card

S9 = Power unit communication (TX)

S10 = Power unit communication (Trip)

S11 = Power unit comm. (Measurement)

S12 = SystemBus synchronization has failed in DriveSynch operation

S30 = Safe disable inputs are in different state (OPT-AF)

S31 = Thermistor short circuit detected (OPT-AF)

S32 = OPT-AF board has been removed

S33 = OPT-AF board EEPROM error

S34-36 = OPT-AF supply voltage hardware problem detected.

S37-40 = Single hardware problem detected in STO inputs.

S41-43 = Single hardware problem detected in the thermistor input.

S44-46 = Single hardware problem detected in STO inputs or in the thermistor input.

S47 = OPT-AF board mounted in old NXP control board.

S48 = Parameter Expander boards/SlotB/Therm Trip(HW) is set to OFF even if the jumper wire X12 is not cut.

S49 = OPT-AF board mounted in NXS control board.

F9 Under voltage fault

DC-link voltage is below the fault voltage limit of the drive.

S1 = DC-link too low during run

S2 = No data from power unit

S3 = Under voltage controller has been active and speed is ramped to zero with ramp time 2.

Possible cause

Too low a supply voltage

AC drive internal fault

One of the input fuses is broken.

External charge switch has not been closed.

Correcting measures

- In case of temporary supply voltage break, reset the fault and restart the AC drive.
- Check supply voltage.
- Check function of DC charge.
- Contact your local distributor.

F10 Input line supervision

S1 = Phase supervision diode supply

S2 = Phase supervision active front end

Possible cause:

1. Input line phase is missing.

Correcting measures

- Check supply voltage, fuses and cable.

F11 Output phase supervision

Current measurement has detected that there is no current in one phase or one phase current is considerably different from other phases.

Correcting measures

- Check motor cable and motor.

F12 Brake chopper supervision

Brake chopper supervision generates pulses to the brake resistor for response. If no response is received within set limits a fault is generated.

Possible cause:

1. No brake resistor installed.
2. Brake resistor is broken.
3. Brake chopper failure.

Correcting measures:

- Check brake resistor and cabling.
- If these are ok the chopper is faulty. Contact your local distributor.

F13 Drive Under Temperature Fault

Possible cause:

1. Heatsink temperature is under -10°C

F14 Drive Over Temperature Fault

Possible cause:

1. Heatsink temperature is over acceptable limits. See user manual for the temperature limit. Overtemperature warning is issued before actual trip limit is reached.

Correcting measures

- Check correct amount and flow of cooling air.
- Check the heatsink for dust.
- Check ambient temperature.
- Make sure that switching frequency is not too high in relation to ambient temperature and motor load.

F15 Motor Stalled

The motor stall protection protects the motor from short time overload situations such as one caused by a stalled shaft. The reaction time of the stall protection can be set shorter than that of the motor thermal protection. The stall state is defined with two parameters, Stall current and Stall frequency limit. If the current is higher than the set limit and output frequency is lower than the set limit the stall state is true. There is actually no real indication of the shaft rotation. Stall protection is a type of over current protection.

- Check motor and load.

F16 Motor over temperature

Motor overheating has been detected by the AC drive motor temperature mode. The motor is overloaded. Calculated temperature has exceeded 105%.

Possible cause:

1. Motor load is too high.
2. Motor values are set incorrectly.

Correcting measures:

- Decrease motor load.
- If no motor overload exists, check the temperature model parameters.

F17 Motor underload fault

The purpose of the motor underload protection is to ensure that there is load on the motor when the drive is running. If the motor loses its load there might be a problem in the process, for example, a broken belt or a dry pump.

The underload curve is a squared curve set between the zero frequency and the field weakening point. The protection is not active below 5 Hz (the underload time counter is stopped).

The torque values for setting the underload curve are set in percentage which refers to the nominal torque of the motor. The motor's name plate data, parameter motor nominal current and the drive's nominal current I_H are used to find the scaling ratio for the internal torque value.

Correcting measures:

- Check load.

F22 EEPROM checksum fault

Possible cause:

1. Parameter save fault
2. Faulty operation
3. Component failure

Correcting measures:

- Should the fault re-occur, contact your local distributor.

F24 Counter fault

Possible cause:

1. Values displayed on counters are incorrect

Correcting measures:

- Have a critical attitude towards values shown on counters.

F25 Microprocessor watchdog fault

Possible cause:

1. Faulty operation
2. Component failure.

Correcting measures:

- Reset the fault and restart.
- Should the fault re-occur, contact your local distributor.

F26 Start-Up prevention

Possible cause:

1. Start-up of the drive has been prevented.
2. Run request is ON when a new application is loaded to drive

Correcting measures:

- Cancel prevention of start-up if this can be done safely.
- Remove Run Request.

F29 Thermistor fault

The thermistor input of the option board has detected too high a motor temperature.

Possible cause:

1. Motor is overheated.
2. Thermistor cable is broken.

Correcting measures:

- Check motor cooling and load
- Check thermistor connection (If thermistor input of the option board is not in use, it has to be short circuited).

F31 IGBT temperature Hardware

IGBT Inverter Bridge over temperature protection has detected too high a short term overload current.

Possible cause:

1. Too high load
2. Identification run has not been made which causes the motor to start under magnetized.

Correcting measures:

- Check load.
- Check motor size.
- Make identification Run.

F32 Fan cooling

Possible cause:

1. Cooling fan of the AC drive does not start when ON command is given.

Correcting measures:

- Contact your local distributor.

F37 Device change

Option board or power unit changed.

Possible cause:

1. New device of same type and rating.

Correcting measures:

- Reset. Device is ready for use.

F38 Device added

Option board added.

Correcting measures:

- Reset. Device is ready for use. Old board settings will be used.

F39 Device removed

Option board removed.

Correcting measures:

- Reset. Device no longer available.

F40 Device unknown

Unknown option board or drive.

S1 = Unknown device

S2 = Power1 not same type as Power2

Correcting measures:

- Contact the distributor near to you.

F41 IGBT temperature Software

IGBT inverter bridge over temperature protection has detected too high a short term overload current.

- Check load.
- Check motor size.
- Make Identification run.

*F42 Brake resistor overtemperature***S1: Brake resistor high temperature**

Calculation for internal brake resistor has exceeded the tripping limit. If the internal brake resistor is not in use set the brake chopper parameter in System menu to 'Not connected'.

S2: Brake resistor resistance is too high**S3: Brake resistor resistance is too low****S4: No brake resistor detected***F43 Encoder fault*

Encoder fault is issued when the drive is not able to operate in closed loop control mode (encoder is used). See subcodes for details for the reason of the fault:

S1 = Encoder 1 channel A is missing

S2 = Encoder 1 channel B is missing

S3 = Both encoder 1 channels are missing

S4 = Encoder reversed

S5 = Encoder board missing

S6 = Serial communication fault

S7 = Ch A / Ch B Mismatch

S8 = Resolver/Motor pole pair mismatch

S9 = Missed Start Angle

S10 = Sin/Cos encoder feedback is missing.

S11 = Encoder angle is drifting fault.

S12 = Dual speed supervision fault

S13 = Encoder angle supervision fault

S14 = Encoder estimated missing pulse fault, switch from the CL ctrl to the OL sensorless ctrl.

1. Modulation type is ASIC while incremental encoder is used.
 - Change modulator type to Software 1
2. Start identification does not work due low identification current
 - Increase identification current
3. Start angle identification is not working at all because there is no saturation based saliency in the motor
 - Use absolute encoder
4. There are too much noise pick-ups in encoder cable
 - check encoder cable shield and grounding in drive

F44 Device changed (Default param.)

Possible cause:

1. Option board or power unit changed.
2. New device of different type or different rating from the previous one.

Correcting measures:

- Reset
- Set the option board parameters again if option board was changed. Set converter parameters again if power unit was changed.

F45 Device added (default param.)

Possible cause:

1. Option board of different type added.

Correcting measures:

- Reset
- Set the option board parameters again.

F50 4mA supervision

Possible cause:

1. Current at the analogue input is below 4mA.
2. Signal source has failed
3. Control cable is broken or loose

Correcting measures:

- Check the current loop circuitry.

F51 External fault

Possible cause:

1. Digital input fault.

Correcting measures:

- Remove fault situation from external device.

F52 Keypad communication

Possible cause:

1. The connection between the control keypad or VACON® NCDrive and the AC drive is broken.

Correcting measures:

- Check keypad connection and possible keypad cable.

F53 Fieldbus communication Slot D

Possible cause:

1. The data connection between the fieldbus Master and the fieldbus board is broken.

Correcting measures:

- Check installation.
- If installation is correct contact the nearest VACON® distributor.

F54 Slot fault

Possible cause:

1. Defective option board or slot

Correcting measures:

- Check board and slot.
- Contact the nearest VACON® distributor.

F56 Temperature sensor board 1 fault

Temperature protection function is used to measure temperature and give warning and/or fault when set limits are exceeded. Marine application supports two temperature sensor boards simultaneously. One can be used for the motor winding and the other for the motor bearings.

- A1 – Temperature limit has been exceeded.
- A2 – Sensor not wired or not working.
- A3 – Short circuit.

Possible cause:

1. Temperature limit values set for the temperature board parameters have been exceeded

Correcting measures:

- Find the cause of temperature rise
- Check sensor wiring

F57 Identification

Identification run has failed.

- A1 = Current measurement offset
- A2 = Identification current level
- A3 = Acceleration time too long
- A4 = Identification frequency reference not reached
- A5 = Too low or high magnetization current
- A6 = Flux curve outside expected levels
- A7 = PMSM, Encoder zero position
- A8 = Too low maximum frequency limit
- A9 = PMSM, encoder zero pulse not found.
- A10 = Ls Identification timeout
- A11 = Ls Identification current

Possible cause:

1. There was load on the motor shaft when making the identification run with rotating motor.
2. Motoring or generator side torque/power limits are too low to achieve a stable run.
3. Too low torque, current or power limit
4. Too long acceleration time.

Correcting measures:

- Run command was removed before identification was ready
- Motor is not connected to the AC drive.
- There is load on the motor shaft.
- Set limiting parameters 100 % or above
- Set acceleration time smaller than 20 s.
- In some cases, levering the DC-Link voltage may help, for example, by stopping AFE boosting.

F58 Mechanical brake

This fault is generated when the acknowledge signal from the brake is used. If the status of the signal is opposite from the control signal for a longer period of time than the delay defined with P2.15.11 Brake Fault Delay a fault is generated.

Correcting measures:

- Check the condition and connections of mechanical brake.

F59 SystemBus communication

The master drive sends pulses to all follower drives. If the pulses are missing, a system bus communication fault is generated. The master drive also receives pulses back from the follower drives (max. four drives) and generates warnings if pulses are missing.

SystemBus communication is broken between master and follower.

Correcting measures:

- Check expander board parameters.
- Check optical fibre.
- Check option board jumpers.

F60 Cooling

Protection for the liquid-cooled units. An external sensor is connected to the drive (DI: Cooling Monitor) to indicate if cooling liquid is circulating. If the drive is in Stop state only a warning is issued. In Run state a fault is issued and the drive makes a coast stop.

Possible cause:

1. Liquid cooled drive cooling circulation have been failed

Correcting measures:

- Check reason for cooling failure from external system.

F61 Speed Error

Speed error monitoring function compares the encoder frequency and the ramp generator output. This function is used with PMS motors to detect if the motor is out of synchronization or to disable open loop function that uses encoder speed for slip compensation. The slip compensation is disabled regardless of the response and needs to be re-activated once speed error is detected (set parameter again or power down the drive).

Possible cause:

1. Motor speed is not the same as the reference. For example, motor speed is limited by torque limit.
2. PMS motor has gone off synchronization.
3. Encoder cable is broken.

F62 Run Disabled

Run Disable warning signal is issued when Run Enable signal has been removed from the IO.

F63 Quick Stop

Possible cause:

1. A command has been given from a digital input or the fieldbus to make an quick stop.

Correcting measures:

- New run command is accepted after the quick stop is reset.

F64 Input switch open (Not implemented)

Possible cause:

1. Drive input switch is opened

Correcting measures:

- Check the main power switch of the drive.

F65 Temperature sensor board 2 fault

Temperature protection function is used to measure temperature and give warning and/or fault when set limits are exceeded. Marine application supports two temperature sensor boards simultaneously. One can be used for the motor winding and the other for the motor bearings.

A1 – Temperature limit has been exceeded.

A2 – Sensor not wired or not working.

A3 – Short circuit.

Possible cause:

2. Temperature limit values set for the temperature board parameters have been exceeded

Correcting measures:

- Find the cause of temperature rise
- Check sensor wiring

F67 Fieldbus communication Slot E

Possible cause:

1. The data connection between the fieldbus Master and the fieldbus board is broken.

Correcting measures:

- Check installation.
- If installation is correct contact the nearest VACON® distributor.

F74 Follower fault

When using the normal master follower function, this fault code is given if one or more follower drives trip to fault. This fault is also visible when the fault is in the master drive. Check also possible other faults active in the master drive.

Possible cause:

1. Fault in follower drive or in Master drive.

Correcting measures:

- Identify original fault and problem.

F75 Drive Synch follower

When using the normal master follower function, this fault code is given if one or more follower drives trip to fault. This fault is also visible when the fault is in the master drive. Check also possible other faults active in the master drive.

Possible cause:

1. Fault in follower drive or in Master drive.

Correcting measures:

- Identify original fault and problem.

F81 External fault 2

Possible cause:

2. Digital input fault.

Correcting measures:

- Remove fault situation from external device.

F82 Over Load

User-defined overload limits have been exceeded. See functional description from Motor Protection chapter.

F84 Speed Protection

Motor speed has exceeded min or max speed limit by 120 rpm.

Possible cause:

1. Torque Step is too high for the current load.
2. Acceleration compensation has wrong settings.

VAGON®

www.danfoss.com

Vacon Ltd
Member of the Danfoss Group

Runsorintie 7
65380 Vaasa
Finland

Document ID:



Rev. B