

■ Contents

Introduction to FCD 300	3
Software version	3
High voltage warning	4
These rules concern your safety	4
Warning against unintended start	4
Installation	7
Mechanical measurements	7
Mechanical dimensions, FCD, motor mounting	7
Mechanical dimensions, stand alone mounting	7
Mechanical installation	8
General information about electrical installation	10
Electronics purchased without installation box	10
EMC-correct electrical installation	11
Diagram	13
RFI switches J1, J2	13
Location of terminals	14
Mains connection	16
Pre-fuses	16
Motor connection	16
Direction of motor rotation	16
Mains and motor connection with service switch	16
Connection of HAN 10E motor plug for T73	16
Parallel connection of motors	17
Motor cables	17
Motor thermal protection	17
Brake resistor	17
Control of mechanical brake	18
Electrical installation, control cables	19
Connection of sensors to M12 plugs for T53, T63, T73	20
Electrical installation, control terminals	21
PC communication	21
Relay connection	21
Connection examples	22
Programming, FCD 300	26
The LCP 2 control unit, option	26
Parameter selection	29
Operation & Display	31
Setup configuration	31
Load and Motor	39
DC Braking	43
Motortype, par, 147 - FCD 300	48
References & Limits	49
Handling of references	49
Reference function	53
Inputs and outputs	57
Special functions	66
PID functions	68
Handling of feedback	70
Serial communication for FCD 300	77

Control Word according to FC protocol	81
Status Word according to FC Profile	83
Fast I/O FC-profile	84
Control word according to Fieldbus Profile	84
Status word according to Profidrive protocol	85
Serial communication	88
Technical functions	96
All about FCD 300	101
Service	101
Warnings/alarm messages	102
Warning words, extended status words and alarm words	105
Aggressive environments	106
Cleaning	106
Derating for running at low speed	107
Galvanic isolation (PELV)	107
Derating for air pressure	108
Emission test results according to generic standards and PDS product standard	108
General technical data	109
Ordering form - FCD 300	115
Technical data, mains supply 3 x 380 - 480 V	116
Available literature	117
Supplied with the unit	117
Factory Settings	118
Index	125

FCD 300 Series

Operating instructions
Software version: 1.5x



These operating instructions can be used for all FCD 300 Series frequency converters with software version 1.5x. The software version number can be seen from parameter 640 Software version no.



NB!:

Indicates something to be noted by the reader.



Indicates a general warning.



Indicates a high-voltage warning.

■ High voltage warning



The voltage of the frequency converter is dangerous whenever the converter is connected to mains. Incorrect fitting of the motor or frequency converter may cause damage to the equipment, serious injury or death. Consequently, it is essential to comply with the instructions in this manual as well as local and national rules and safety regulations.

■ These rules concern your safety

1. The frequency converter must be disconnected from the mains if repair work is to be carried out. Check that the mains supply has been disconnected and that the prescribed time has passed before removing the inverter part from the installation.
2. The [STOP/RESET] key on the optional control panel does not disconnect the equipment from mains and is thus not to be used as a safety switch.
3. The unit must be properly connected to the earth, the user must be protected against the supply voltage and the motor must be protected against overloading pursuant to prevailing national and local regulations.
4. The earth leakage currents are higher than 3.5 mA.
5. Protection against motor overload is not included in the factory setting. If this function is required,

set parameter 128 *Motor thermal protection* to data value *ETR trip* or data value *ETR warning*. For the North American market: The ETR functions provide overload protection of the motor, class 20, in accordance with NEC.

■ Warning against unintended start

1. The motor can be brought to a stop by means of digital commands, bus commands, references or a local stop, while the frequency converter is connected to mains. If personal safety considerations make it necessary to ensure that no unintended start occurs, these stop functions are not sufficient.
2. While parameters are being changed, the motor may start. Consequently, the stop key [STOP/RESET] on the optional control panel must always be activated, following which data can be modified.
3. A motor that has been stopped may start if faults occur in the electronics of the frequency converter, or if a temporary overload or a fault in the supply mains or the motor connection ceases.



Warning:

It can be extremely dangerous to touch the electrical parts even when the AC line supply has been disconnected.

For FCD 300: wait at least 4 minutes.

■ The decentral concept

The FCD 300 Adjustable speed drive is designed for decentral mounting, e.g. in the food and beverage industry, in the automotive industry, or for other material handling applications.

With the FCD 300 it is possible to utilize the cost saving potential by placing the power electronics decentrally, and thus make the central panels obsolete saving cost, space and effort for installation and wiring.

The unit is flexible in its mounting options for as well stand alone mounting and motor mounting. It is also possible to have the unit pre-mounted on a Danfoss Bauer geared motor (3 in one solution). The basic design with a plugable electronic part and a flexible and "spacious" wiring box is extremely servicefriendly and easy to change electronics without the need for unwiring.

The FCD 300 is a part of the VLT frequency converter family, which means similar functionality, programming, and operating as the other family members.

■ Flexible installation options

1. Stand alone close to the motor ("wall-mounted")

195NA327.10

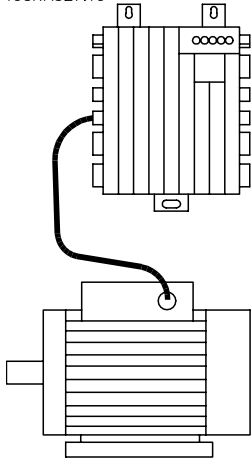

- Free choice of motor brand
- Easy retrofitting to existing motor
- Easy interfacing to motor (short cable)
- Easy access for diagnosis and optimal serviceability

2. Mounted directly on the motor ("motor-mounted")

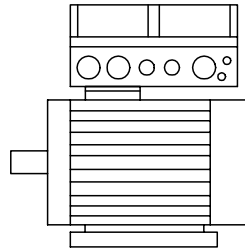

195NA328.10

- Fair choice of motor brands
- No need for screened motor cable

3. "Pre-mounted" on Danfoss Bauer geared motors

195NA329.10

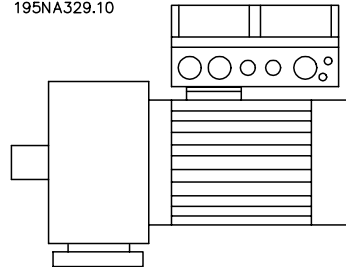

- A fixed combination of motor and electronics supplied by one supplier
- Easy mounting, only one unit
- No need for screened motor cable
- Clear responsibility regarding the complete solution

As the electronic parts are common - same function of terminals, similar operation and similar parts and spare parts for all drives - you are free to mix the three mounting concepts.

■ **Control principle**

A frequency converter rectifies AC voltage from the mains supply into DC voltage, following which it changes this voltage to an AC voltage with variable amplitude and frequency.

The motor thus receives a variable voltage and frequency, which enables infinitely variable speed control of three-phase, standard AC motors.

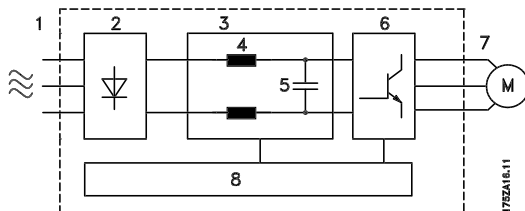

1. Mains voltage

3 x 380 - 480 V AC, 50 / 60 Hz.

2. Rectifier

Three-phase rectifier bridge which rectifies AC voltage into DC voltage.

3. Intermediate circuit

DC voltage $\cong \sqrt{2}$ x mains voltage [V].

4. Intermediate circuit coils

Evens out the intermediate circuit current and limits the load on mains and components (mains transformer, cables, fuses and contactors).

5. Intermediate circuit capacitor

Evens out the intermediate circuit voltage.

6. Inverter

Converts DC voltage into a variable AC voltage with a variable frequency.

7. Motor voltage

Variable AC voltage depending on supply voltage.

Variable frequency: 0.2 - 132 / 1 - 1000 Hz.

8. Control card

Here is the computer that controls the inverter which generates the pulse pattern by which the DC voltage is converted into variable AC voltage with a variable frequency.

■ Mechanical dimensions, FCD, motor mounting

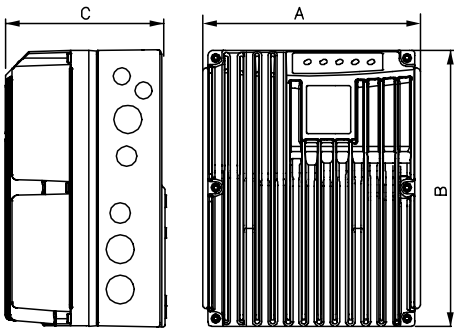

195NA240.11

■ Mechanical dimensions, stand alone mounting

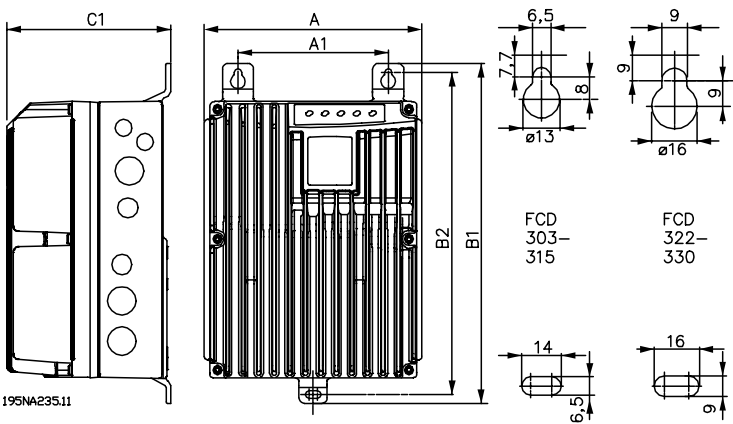

195NA235.11

Installation

Mechanical dimensions in mm	FCD 303-315	FCD 322-335
A	192	258
A1	133	170
B	244	300
B1	300	367
B2	284	346
C	142	151
C1	145	154
Cable Gland sizes	M16, M20, M25 x 1.5 mm	
Space for cable inlets and service switch handle	100-150 mm	

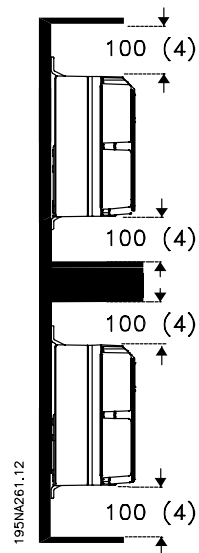

■ Spacing for mechanical installation

All units require a minimum of 100 mm air from other components above and below the enclosure.

■ Mechanical installation



Please pay attention to the requirements that apply to integration and remote mounting. These must be complied with to avoid serious injury or damage, especially when installing large units.

The FCD 300 consists of two parts: The installation part and the electronics part. The two parts must be separated, and the installation part is to be mounted first. After wiring, the electronics is to be fixed to the installation part by the attached 6 screws. For compressing the gasket the screws must be tightened with 2-2.4 Nm, tighten both centre screws first, thereafter the 4 corner screws "cross over".



NB!:

Do not switch on the mains before the 6 screws are tightened.

The FCD 300 can be applied as following:

- Stand alone mounted close to the motor
- Motor mounted

or might be delivered pre mounted on a Danfoss Bauer (geared) motor. Please contact the Danfoss Bauer sales organisation for further information.

The frequency converter is cooled by means of air circulation. For the unit to be able to release its cooling air, the minimum free distance above and below the unit must be minimum 100 mm. To protect the unit from overheating, it must be ensured that the ambient temperature does not rise above the max. temperature stated for the frequency converter and that the 24-hour average temperature is not exceeded. The max. temperature and 24-hour average can be seen in *General technical data*. If the ambient temperature is higher, derating of the frequency converter is to be carried out. See *Derating for ambient temperature*. Please note that the service life of the frequency converter will be reduced if derating for ambient temperature is not considered.

Stand alone mounting ("wall mounting")

For best cooling the unit should be mounted vertically, however where space limitations require it, horizontal mounting is allowable. The integrated 3 wall mounting brackets in the wall mounting version can be used for fixing the installation box to the mounting surface, keeping a distance for possible cleaning between the box and the mounting surface. Use the three supplied washers to protect the paint.

Bolts must be M6 for the FCD 303 - 315 and M8 for FCD 322 - 335.

See *Dimensional Drawings*.

Motor mounting

The installation box should be mounted on the surface of the motor frame, typically instead of the motor terminal box. The motor/geared motor may be mounted with the shaft vertically or horizontally. The unit must not be mounted upside down (the heat sink pointing down). The cooling of the electronics is independent on the motor cooling fan. For mounting directly on Danfoss Bauer geared motors no adaption plate is necessary. For motor mounting (non Danfoss Bauer motors), an adaptor plate should usually be applied. For that purpose a neutral plate incl gasket and screws for attaching to the installation box is available. The appropriate drillings and gasket for the motor housing are applied locally. Please make sure, that the mechanical strength of the mounting screws and the threads are sufficient for the application. The specified resistance against mechanical vibrations does not cover the mounting onto a non Danfoss Bauer motor, as the stability of the motor frame and threads are outside Danfoss Drive's control and responsibility and the same applies to the enclosure class. Please be aware, that the frequency converter may not be used to lift the motor/geared motor.

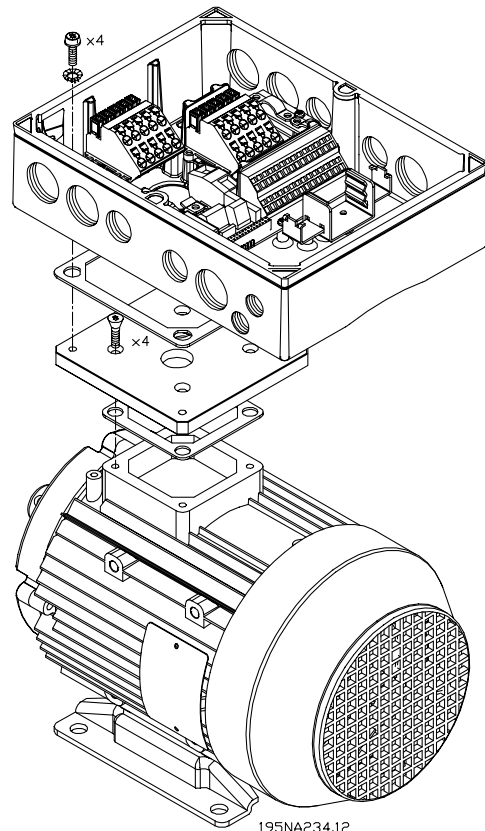

1. Prepare the adaptor plate for mounting on the motor by drilling the fixing holes and the hole for the cables.
2. Mount the plate on the motor with the normal terminal box gasket.
3. Knock out the 4 screw holes for mounting the adaptor plate (outer holes).
4. Mount the terminal box onto the motor by the 4 sealing screws and the gasket supplied.
Use the supplied star washers for securing PE connection according to EN 60204. The screws must be tightened with 5 Nm.

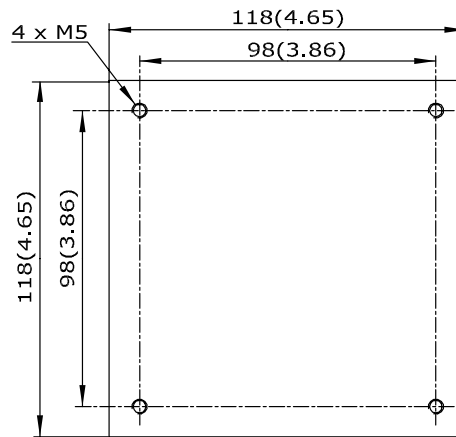

195NA312.11

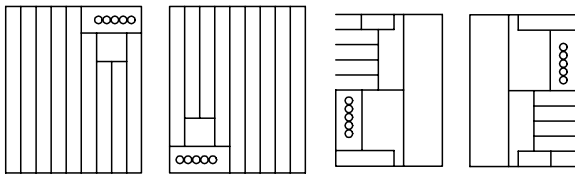

Universal adaptorplate

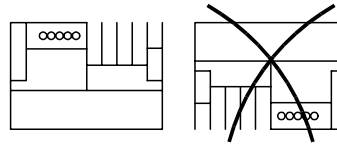

195NA310.10

Allowed mounting positions

■ General information about electrical installation

■ High voltage warning



The voltage of the frequency converter is dangerous whenever the equipment is connected to mains. Incorrect installation of the motor or frequency converter may cause damage to the equipment, serious injury or death. Comply with the instructions in this manual, as well as national and local rules and safety regulations. Touching the electrical parts may be fatal - even after the equipment has been disconnected from mains: Wait at least 4 minutes for current dissipate.



NB!

It is the responsibility of the user or installer to ensure correct earthing and protection in accordance with national and local standards.

■ Cables

The control cable and the mains cable should be installed separately from motor cables to prevent noise transfer. As a rule a distance of 20 cm is sufficient, but it is recommended that the distance is as great as possible, particularly when cables are installed in parallel over large distances.

For sensitive signal cables such as telephone or data cables the greatest possible distance is recommended. Please note that the required distance depends on the installation and the sensitivity of the signal cables, and that for this reason exact values cannot be given.

When being placed in cable trays, sensitive cables may not be placed in the same cable tray as the motor cable. If signal cables run across power cables, this is done at an angle of 90 degrees. Remember that all noise-filled inlet and outlet cables to a cabinet must be screened/armoured. See also *EMC-compliant electrical installation*.

Cable glands

It must be assured that appropriate cable glands needed for the environment are chosen and carefully mounted.

■ Screened/armoured cables

The screen must have low HF impedance, which is achieved by a braided screen of copper, aluminium or iron. Screen reinforcement intended for mechanical protection, for example, is not suitable for EMC-correct installation. See also *Use of EMC-correct cables*.

■ Extra protection

ELCB relays, multiple protective earthing or earthing can be used as extra protection, provided that local safety regulations are complied with. In the case of an earth fault, a DC content may develop in the faulty current. Never use an RCD (ELCB relay), type A, as it is not suitable for DC faulty currents. If ELCB relays are used, local regulations must be complied with. If ELCB relays are used, they must be:

- Suitable for protecting equipment with a DC content in the faulty current (3-phase bridge rectifier)
- Suitable for a pulse-shaped, brief discharge on power-up
- Suitable for a high leakage current.

See also RCD Application Note MN.90.GX.02.

■ High voltage test

A high voltage test can be performed by short-circuiting terminals U, V, W, L1, L2 and L3, and applying max. 2160 V DC in 1 sec. between this short-circuit and PE-terminal.

■ Electronics purchased without installation box

If the electronic part is purchased without the Danfoss installation part, the earth connection must be suitable for high leakage current. Use of original Danfoss installation box or installation kit 175N2207 is recommended.

■ Caution



PE connection

The metal pin in the corner(s) of the electronic part and the bronze spring in the corner(s) of the installation box are essential for the **protective earth** connection. Make sure they are not loosened, removed, or violated in any way.

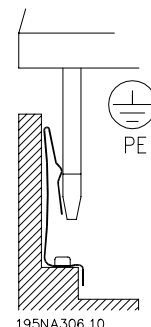



NB!:

Do not plug/unplug the electronic part with mains voltage switched on.

■ Protective earth

The earth connection serves several purposes.

- Safety earth (Protective earth, PE)
The equipment must be properly earthed according to local regulation. This equipment has a leakage current > 3.5 mA AC. It must be connected to an earth connection complying with the local rules for high leakage current equipment. Typically, this implies that the PE conductors must be mechanically enhanced (minimum cross section 10 mm²) or duplicated
- Noise "clamping" (high frequencies)
Stable communication between units call for screening of the communication cables (1).

Cables must be properly attached to screen clamps provided for that purpose.

- Equalisation of voltage potential (low frequencies)
To reduce alignment currents in the screen of the communication cable, always apply a short earthing cable between units that are connected to the same communication cable (2) or connect to an earthed frame (3).
- Potential equalization: All metal parts, where the motors are fastened, must be potential equalized

PE connections, voltage equalising cables and the screen of the communication cable should be connected to the same potential (4).

Keep the conductor as short as possible and use the greatest possible surface area.

The numbering refers to the figure.

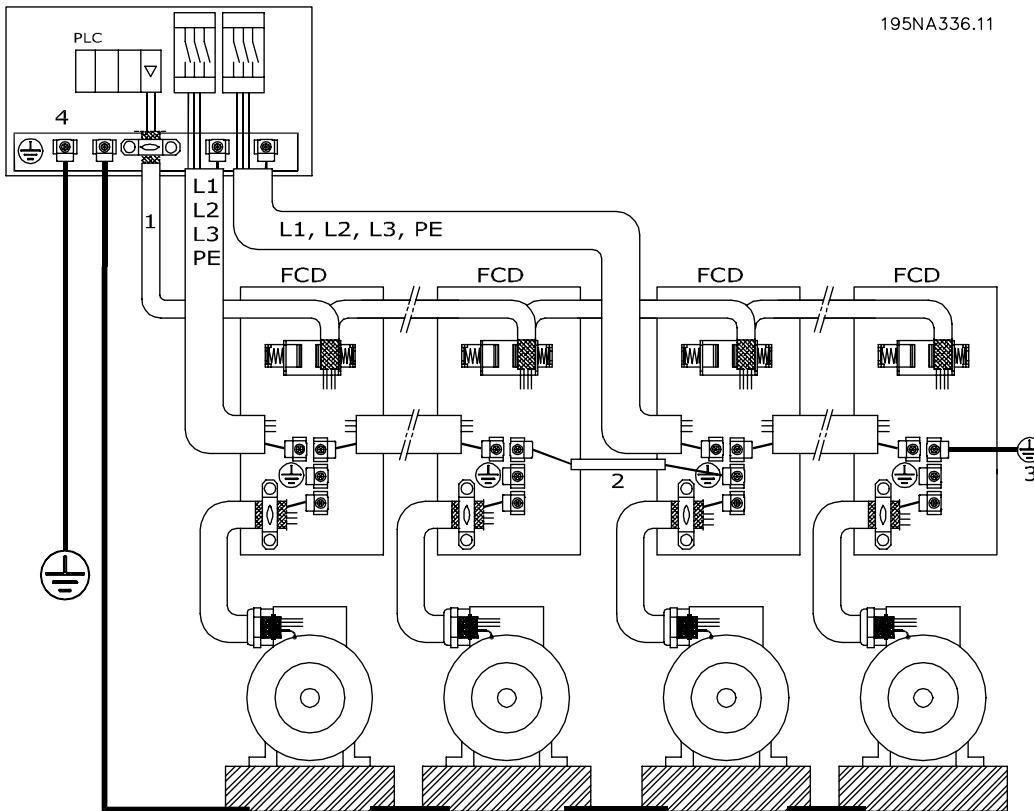

Proper installation earthing

■ EMC-correct electrical installation

General points to be observed to ensure EMC-correct electrical installation.

- Use only screened/armoured motor cables and screened/armoured control cables.
- Connect the screen to earth at both ends.

- Avoid installation with twisted screen ends (pigtails), since this ruins the screening effect at high frequencies. Use cable clamps instead.
- Don't remove the cable screen between the cable clamp and the terminal.

■ ATEX correct installation

The following issues must be taken into account when installing the FCD 300 in ATEX zone 22 environments:

- Motor must be designed, tested and certified by the motor manufacturer for variable speed application
- Motor must be designed for Zone 22 operation.
I.e. with type of protection "tD" acc. to EN61241-0 and -1 or EN50281-1-1.
- Motor must be provided with thermistor protection. The thermistor protection must either be connected to an external thermistor relay, with EC Type Examination Certificate or compatible with the FCD 300 thermistor input.
If the FCD 300 thermistor protection is used, the thermistor must be wired to terminals 31a and 31b, and thermistor trip activated by programming parameter 128 to thermistor trip [2]. See parameter 128 for further details.
- Cable entries must be chosen for the enclosure protection to be maintained. It must also be ensured that the cable entries comply with the requirements for clamping force and mechanical strengths as described in EN 50014:2000.
- The FCD must be installed with appropriate earth connecting according to local/national regulations.
- The installation, inspection and maintenance of electrical apparatus for use in combustible dusts, must only be carried out by personnel that is trained and familiar with the concept of protection.

For a declaration of conformity, please consult your local Danfoss representative.

■ Diagram

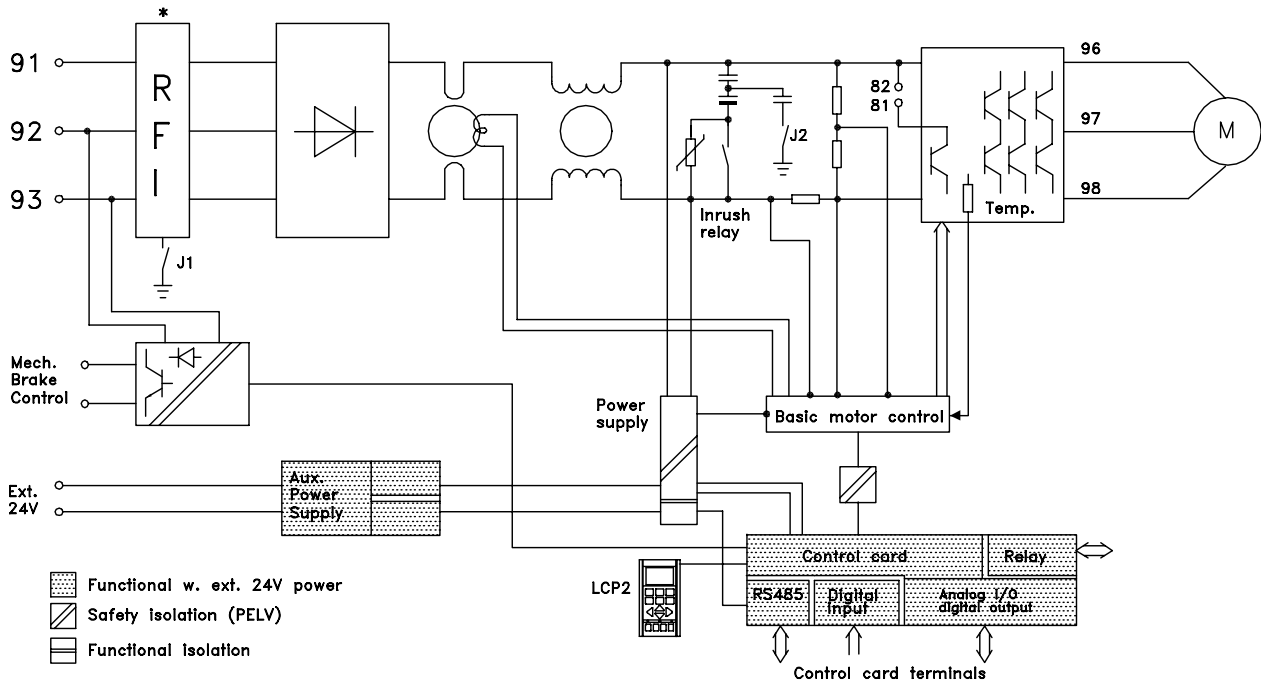

195NA204.11

* Integrated brake and mechanical brake control and external 24 V are options.

■ RFI switches J1, J2

J1 and J2 must be removed at IT mains and delta grounded mains with phase to earth voltage > 300 V also during earth failure. J1 and J2 can be removed to reduce leakage current. Caution: No correct RFI filtering.

Installation

■ Location of terminals

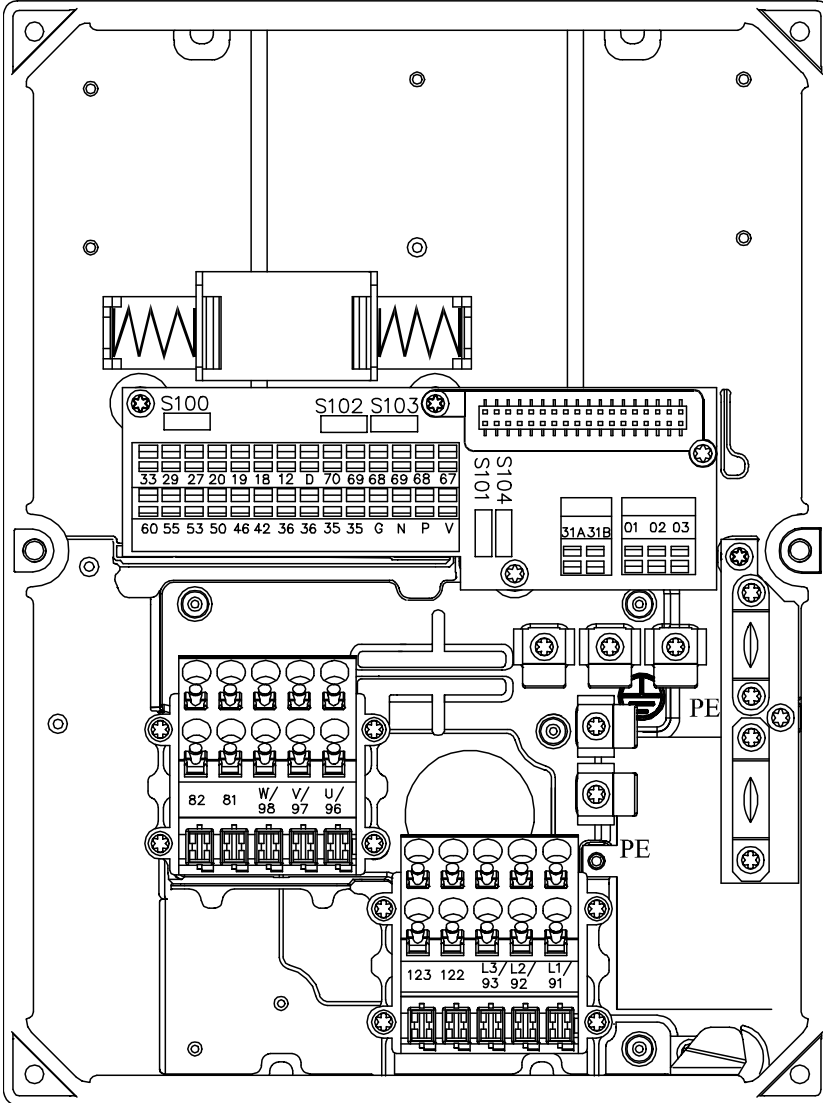

195NA307.10

T11, T12, T16, T52, T56

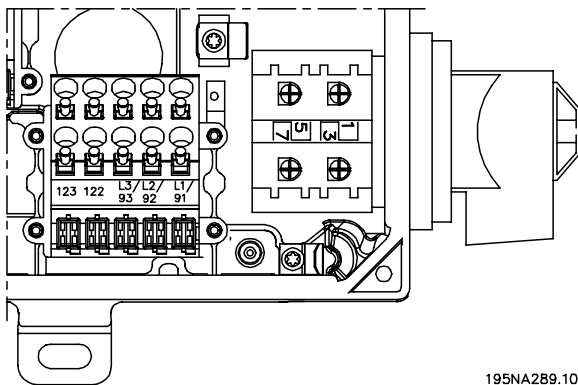

195NA289.10

T22, T26, T62, T66 versions with service switch

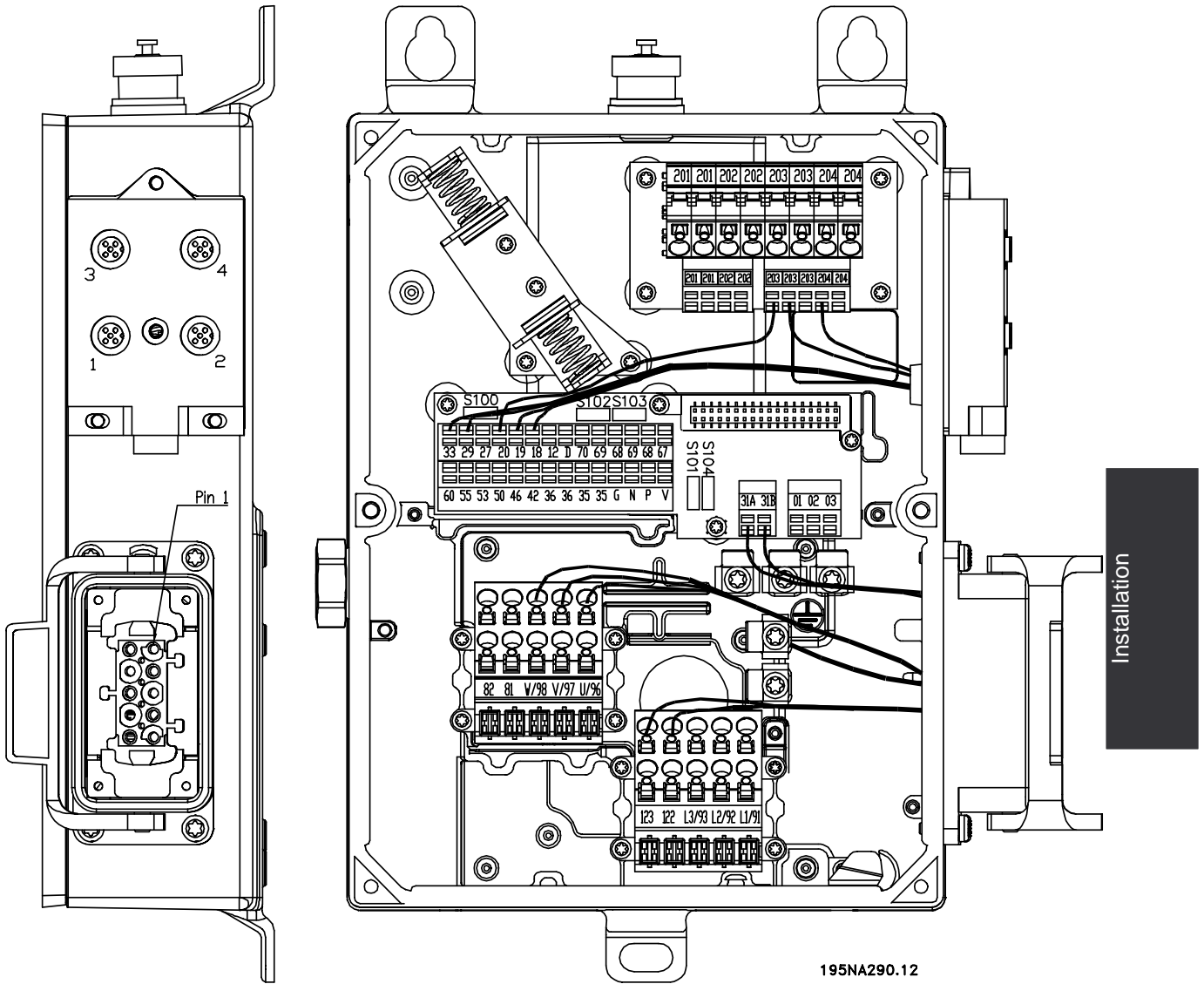

195NA290.12

T73 version with motor plug and sensor plugs
Version is supplied from Danfoss with wiring as shown

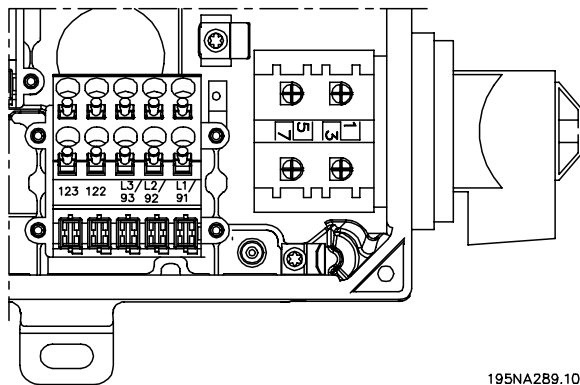

195NA289.10

T63 version with service switch (no motor plug)

■ Mains connection

No.	91	92	93	Mains voltage 3 x 380-480 V
	L1	L2	L3	
	PE	Earth connection		



NB!

Please check that the mains voltage fits the mains voltage of the frequency converter, which can be seen from the nameplate.

See *Technical data* for correct dimensioning of cable cross-section.

■ Pre-fuses

See *Technical data* for correct dimensioning of pre-fuses.

■ Motor connection

Connect the motor to terminals 96, 97, 98.
Connect earth to PE-terminal.

No.	96	97	98	Motor voltage 0-100% of mains voltage
	U	V	W	3 wires out of motor
	U1	V1	W1	6 wires out of motor, Delta connected
	W2	U2	V2	
	U1	V1	W1	6 wires out of motor, Star connected
	U2, V2, W2 to be interconnected separately (optional terminal block)			
	PE	Earth connection		

See *Technical data* for correct dimensioning of cable cross-section.

All types of three-phase asynchronous standard motors can be connected to a frequency converter. Normally, small motors are star-connected (230/400 V, Δ /Y). Large motors are delta-connected (400/690 V, Δ /Y). The correct connection mode and voltage can be read from the motor nameplate.



NB!

In motors without phase insulation paper, an LC filter should be fitted on the output of the frequency converter.

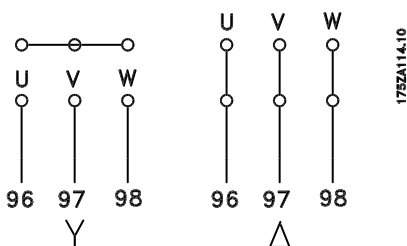

■ Direction of motor rotation

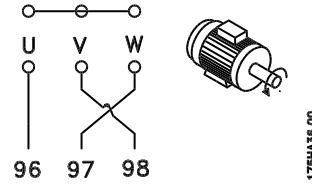
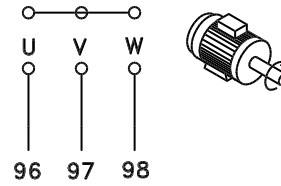

The factory setting is for clockwise rotation with the frequency converter transformer output connected as follows:

Terminal 96 connected to U-phase.

Terminal 97 connected to V-phase.

Terminal 98 connected to W-phase.

The direction of rotation can be changed by switching two phases on the motor terminals.

■ Mains and motor connection with service switch

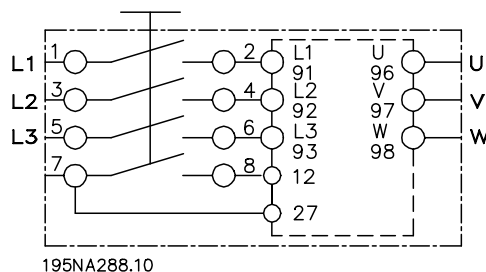
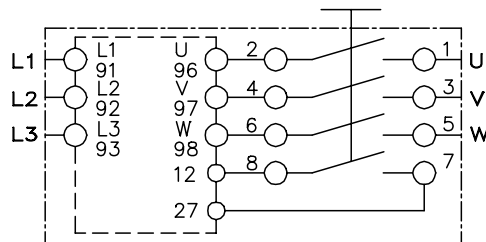

■ Connection of HAN 10E motor plug for T73

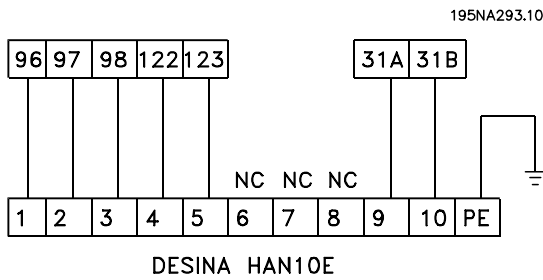

HAN 10E pin no 1 - Motor phase U
 HAN 10E pin no 2 - Motor phase V
 HAN 10E pin no 3 - Motor phase W
 HAN 10E pin no 4 - Motor brake, see *Operating Instructions MG.04.BX.YY*, terminal 122
 HAN 10E pin no 5 - Motor brake, see *Operating Instructions MG.04.BX.YY*, terminal 123
 HAN 10E pin no 9 - Motor thermistor, see *Operating Instructions MG.04.BX.YY*, terminal 31A
 HAN 10E pin no 10 - Motor thermistor, see *Operating Instructions MG.04.BX.YY*, terminal 31B
 PE = protective earth

■ Parallel connection of motors

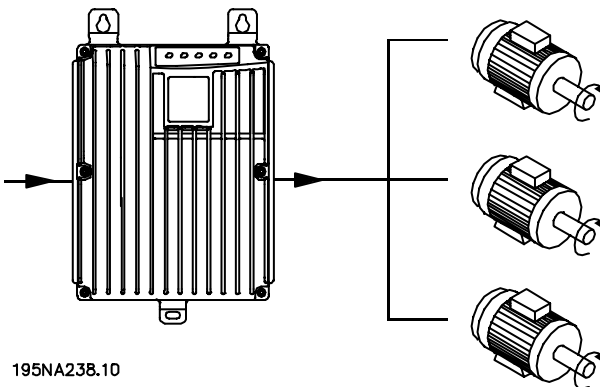

The frequency converter is able to control several motors connected in parallel. If the motors are to have different rpm values, use motors with different rated rpm values. Motor rpm is changed simultaneously, which means that the ratio between the rated rpm values is maintained across the range. The total current consumption of the motors is not to exceed the maximum rated output current I_{INV} for the frequency converter.

Problems may arise at the start and at low rpm values if the motor sizes are widely different. This is because the small motors' relatively high ohmic resistance in the stator calls for a higher voltage at the start and at low rpm values.

In systems with motors connected in parallel, the electronic thermal relay (ETR) of the frequency

converter cannot be used as motor protection for the individual motor. For this reason further motor protection must be used, e.g. thermistors in each motor (or an individual thermal relay).



NB!

Parameter 107 *Automatic motor tuning, AMT* cannot be used when motors are connected in parallel. Parameter 101 *Torque characteristic* must be set to *Special motor characteristics* [8] when motors are connected in parallel.

■ Motor cables

See Technical data for correct dimensioning of motor cable cross-section and length. Always comply with national and local regulations on cable cross-section.



NB!

If an unscreened/unarmoured cable is used, some EMC requirements are not complied with, see *EMC test results* in the Design Guide.

If the EMC specifications regarding emission are to be complied with, the motor cable must be screened/armoured, unless otherwise stated for the RFI filter in question. It is important to keep the motor cable as short as possible so as to reduce the noise level and leakage currents to a minimum. The motor cable screen must be connected to the metal cabinet of the frequency converter and to the metal cabinet of the motor. The screen connections are to be made with the biggest possible surface area (cable clamp). This is enabled by different installation devices in different frequency converters. Mounting with twisted screen ends (pigtailed) is to be avoided, since these spoil the screening effect at high frequencies. If it is necessary to break the screen to install a motor isolator or motor relay, the screen must be continued at the lowest possible HF impedance.

■ Motor thermal protection

The electronic thermal relay in UL-approved frequency converters has received the UL-approval for single motor protection, when parameter 128 *Motor thermal protection* has been set for *ETR Trip* and parameter 105 *Motor current, $I_{M, N}$* has been programmed to the rated motor current (see motor nameplate).

■ Brake resistor

No.	81 (optional function)	82 (optional function)	Brake resistor terminals
	R-	R+	

The connection cable to the brake resistor must be screened/armoured. Connect the screen to the metal cabinet of the frequency converter and to the metal cabinet of the brake resistor by means of cable clamps. Dimension the cross-section of the brake cable to match the brake torque.

See chapter *Dynamic Braking* in the *Design Guide MG.90.FX.YY* for dimensioning of brake resistors.



NB!:

Please note that voltages up to 850 V DC occur on the terminals.

■ Control of mechanical brake

No.	122 (optional function)	123 (optional function)	
	MBR+	MBR-	Mechanical brake (UDC=0.45 X Mains Voltage) Max 0.8 A

In lifting/lowering applications you need to be able to control an electromagnetic brake. The brake is controlled using the special mechanical brake control/supply terminals 122/123.

When the output frequency exceeds the brake cut out value set in par. 138, the brake is released if the motor current exceeds the preset value in parameter 140. When stopping the brake is engaged when the output frequency is less than the brake engaging frequency, which is set in par. 139.

If the frequency converter is at alarm status or in an overvoltage situation the mechanical brake is cut in immediately.

If not using the special mechanical brake control/supply terminals (122-123), select *Mechanical brake control* in parameter 323 or 341 for applications with an electromagnetic brake.

A relay output or digital output (terminal 46) can be used. See *Connection of mechanical brake* for further details.

■ Electrical installation, control cables

Control cables must be screened/armoured. The screen must be connected to the frequency converter chassis by means of a clamp. Normally, the screen must also be connected to the chassis of the controlling unit (use the instructions for the unit in question). In connection with very long control cables

and analogue signals, in rare cases depending on the installation, 50/60 Hz earth loops may occur because of noise transmitted from mains supply cables. In this connection, it may be necessary to break the screen and possibly insert a 100 nF capacitor between the screen and the chassis.

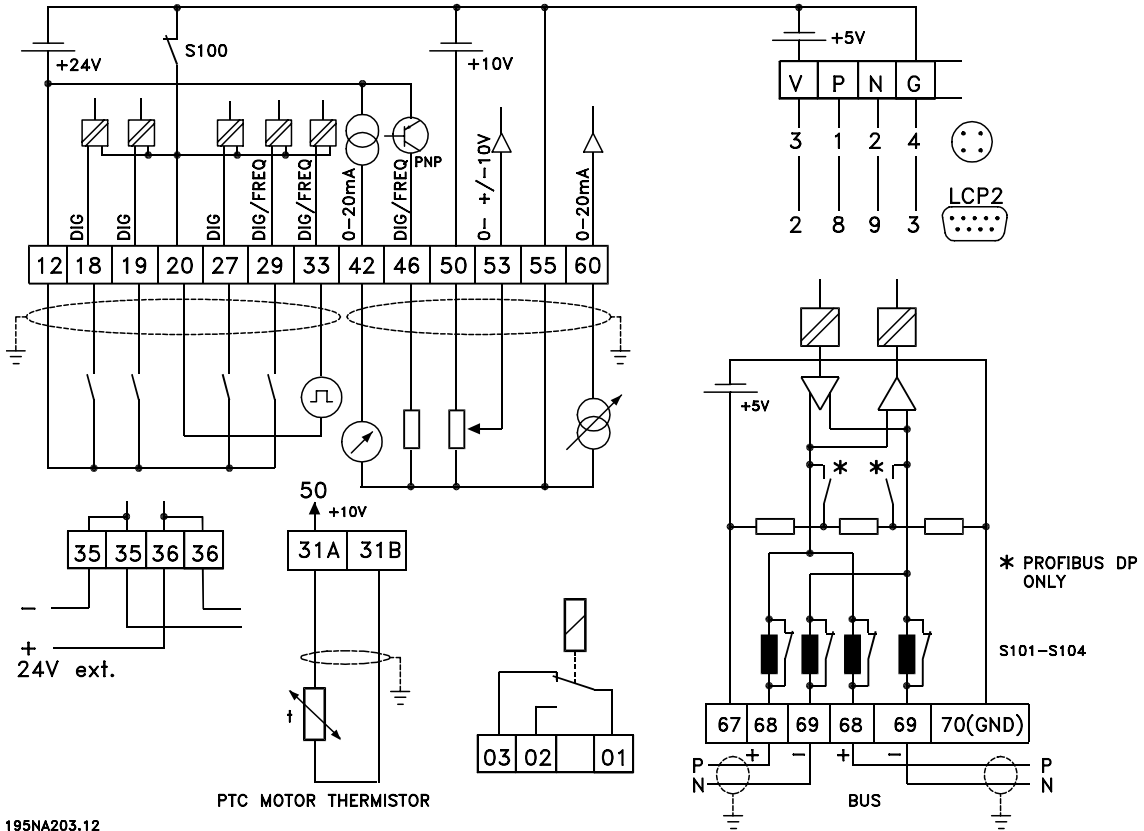

195NA203.12

Switches S101-104

Bus line coils, leave switches ON

Installation

■ Connection of sensors to M12 plugs for T53, T63, T73

195NA292.11

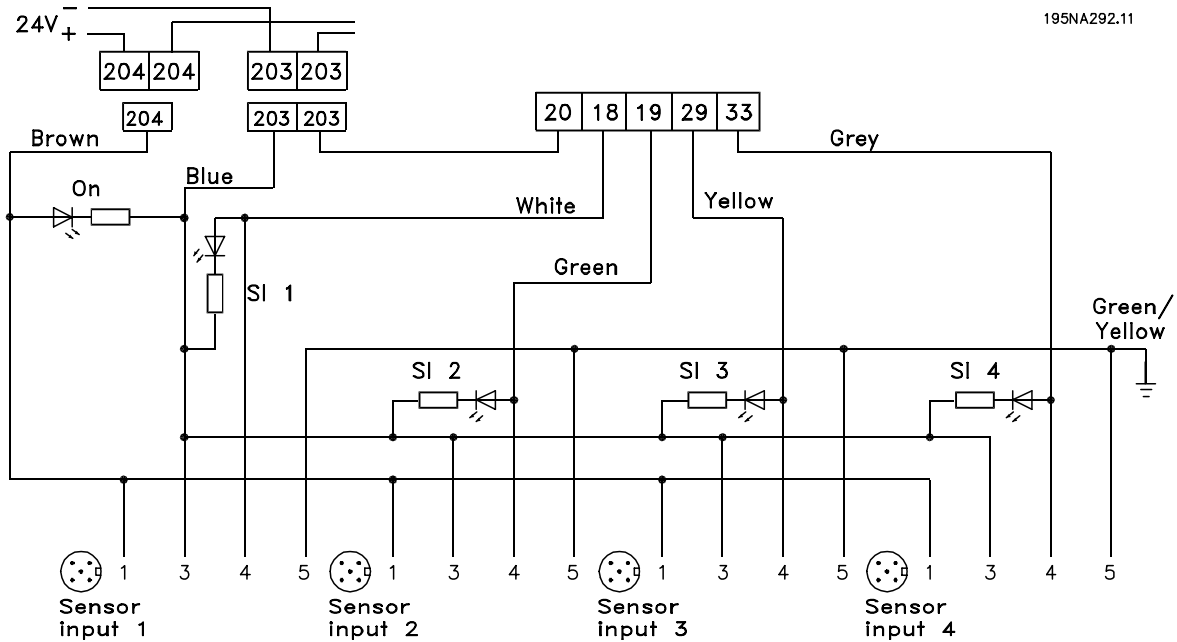

For rating specifications see the *Operating Instructions* MG.04.BX.YY, digital inputs terminals 18, 19, 29, 33.
Terminals 203/204 are used for sensor supply.
Terminal 203 = common

Terminal 204 = +24 V
Terminals 201/202 can be used for a separate 24 V supply.

■ Electrical installation, control terminals

See section entitled *Earthing of screened/armoured control cables* in the Design Guide for the correct termination of control cables.

No.	Function
01-03	Relay outputs 01-03 can be used for indicating status and alarms/warnings.
12	24 V DC voltage supply.
18-33	Digital inputs.
20, 55	Common frame for input and output terminals. Can be separated with switch S100
31a, 31b	Motor thermistor
35	Common (-) for external 24 V control back up supply. Optional.
36	External + 24 V control back up supply. Optional.
42	Analog output for displaying frequency, reference, current or torque.
46	Digital output for displaying status, warnings or alarms, as well as frequency output.
50	+10 V DC supply voltage for potentiometer
53	Analogue voltage input 0 - +/- 10 V DC.
60	Analogue current input 0/4 - 20 mA.
67	+ 5 V DC supply voltage to Profibus.
68, 69	Fieldbus serial communication*
70	Ground for terminals 67, 68 and 69. Normally this terminal is not to be used.
D	For future use
V	+5V, red
P	RS485(+), LCP2/PC, yellow
N	RS485(-), LCP2/PC, green
G	OV, blue

* See *VLT 2800/FCM 300/FCD 300 Profibus DP V1 Operating Instructions* (MG.90.AX.YY), *VLT 2800/FCD 300 DeviceNet Operating Instructions* (MG.90.BX.YY) or *FCD 300 AS-interface Operating Instructions* (MG.04.EX.YY).

■ PC communication

Connect to terminals P and N for PC-access to single parameters. Motor and field bus communication should be stopped before performing automatic transfer of multiple parameters.

On non-fieldbus and Profibus variants, terminals 68 and 69 can be used provided Profibus communication is stopped.

■ Relay connection

See parameter 323 *Relay output* for programming of relay output.

No.	01 - 02	1 - 2 make (normally open)
	01 - 03	1 - 3 break (normally closed)

■ LCP 2 plug, optional

An LCP 2 control unit can be connected to a plug which is optionally mounted in the housing. Ordering number: 175N0131.

LCP control units with ordering number 175Z0401 are not to be connected.

■ Installation of 24 Volt external supply (optional)

24 V external DC supply can be used as low-voltage supply to the control card. This enables full operation of the LCP2 and serial bus (incl. parameter setting) without connection to mains.

Please note that a warning of low voltage will be given when 24 V DC has been connected; however there will be no tripping.



NB!:

Use 24 V DC supply of type PELV to ensure correct galvanic isolation (type PELV) on the control terminals of the VLT frequency converter.



Beware of unintended start of the motor, if the mains power is applied during operation on the external 24 V back up supply.

■ Software version 1.5x

A Field bus equipped FCD shows the status *Unit ready* even with bridged terminals 12-27 and cannot be set into RUNNING mode by digital inputs alone until one of the following parameters is set:

- Par. 502 is set to *Digital input* or *Logic and* or
- Par. 833 or 928 is set to *Disable* or
- Par. 678 is set to *Standard version*

The field bus status word at power up might be different (typically 0603h instead of 0607h) until the first valid control word is sent. After sending the first valid control word (bit 10 = Data valid) the status is exactly as in earlier software versions.

■ Connection examples

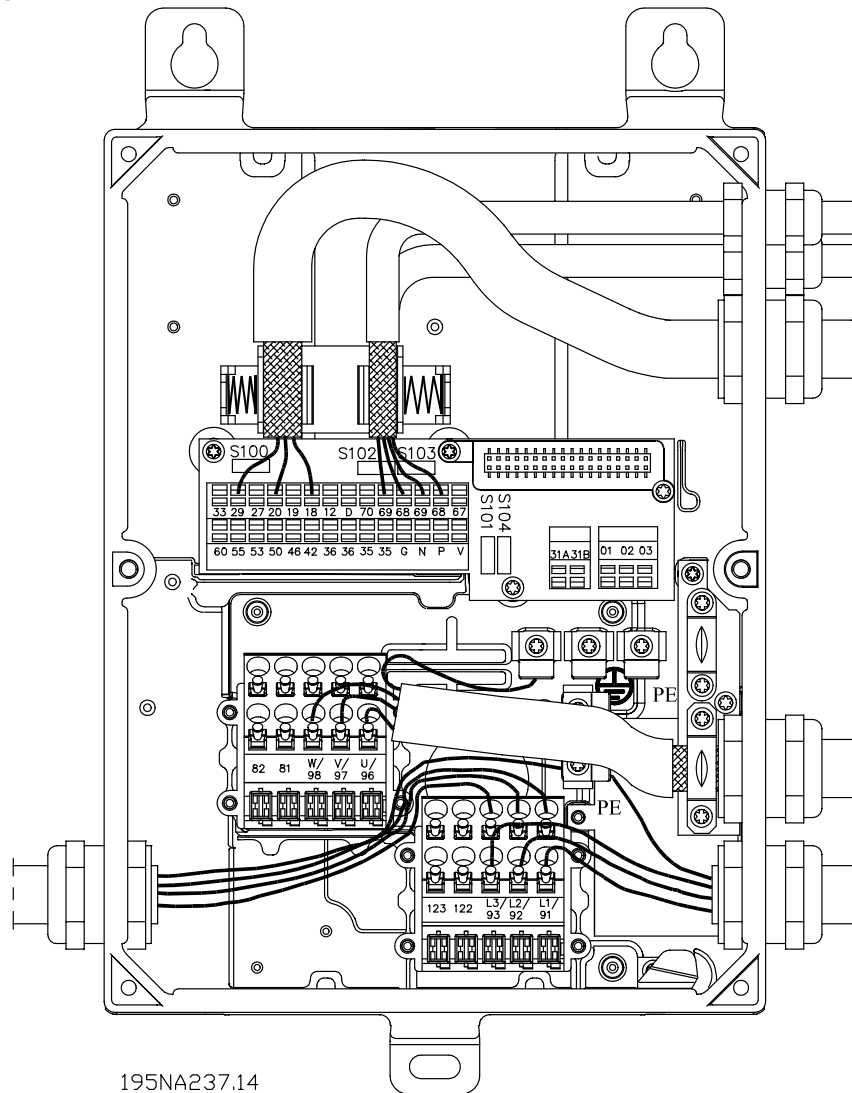

195NA237.14

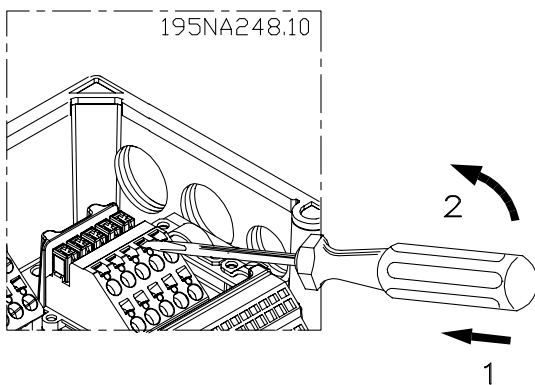

NB!:

Avoid leading the cables over the plugs to the electronics.

Don't loosen screw fixing the spring for the PE connection.



NB!

In the *connection examples* below, it should be noted, that the Switch S100 must not be changed from factory settings (on).

Start/stop

Start/stop using terminal 18 and coasting stop using terminal 27.

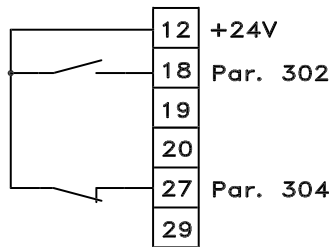

195NA011.11

Par. 302 *Digital input = Start* [7]

Par. 304 *Digital input = Coasting stop inverted* [2]

For Precise start/stop the following settings are made:

Par. 302 *Digital input = Precise start/stop* [27]

Par. 304 *Digital input = Coasting stop inverted* [2]

Pulse start/stop

Pulse start using terminal 18 and pulse stop using terminal 19. In addition, the jog frequency is activated via terminal 29.

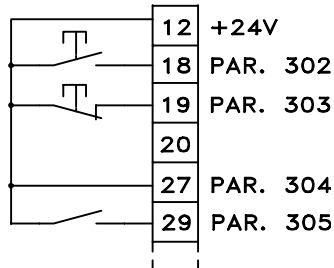

195NA012.11

Par. 302 *Digital input = Pulse start* [8]

Par. 303 *Digital input = Stop inverted* [6]

Par. 304 *Digital input = Coasting stop inverted* [2]

Par. 305 *Digital input = Jog* [13]

Speed up/down

Speed up/down using terminals 29/33.

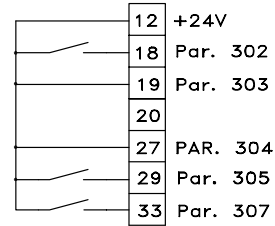

195NA249.10

Par. 302 *Digital input = Start* [7]

Par. 303 *Digital input = Freeze reference* [14]

Par. 305 *Digital input = Speed up* [16]

Par. 307 *Digital input = Speed down* [17]

Potentiometer reference

Voltage reference via a potentiometer.

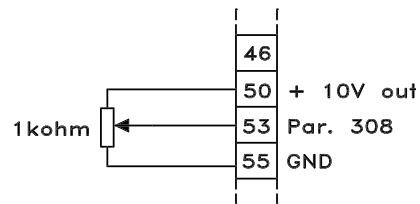

195NA016.10

Par. 308 *Analog input = Reference* [1]

Par. 309 *Terminal 53, min. scaling = 0 Volt*

Par. 310 *Terminal 53, max. scaling = 10 Volt*

Connection of a 2-wire transmitter

Connection of a 2-wire transmitter as feedback to terminal 60.

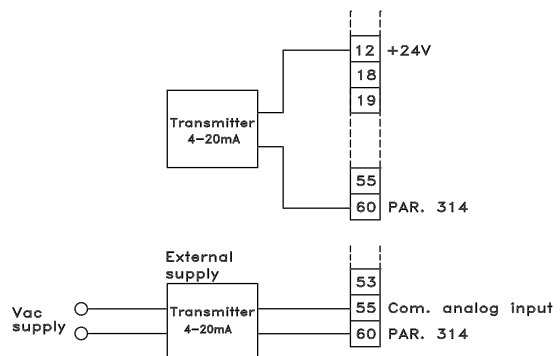

195NA013.11

Par. 314 *Analog input = Feedback* [2]

Par. 315 *Terminal 60, min. scaling = 4 mA*

Par. 316 *Terminal 60, max. scaling = 20 mA*

■ 4-20 mA reference

4-20 mA reference on terminal 60 and speed feedback signal on terminal 53.

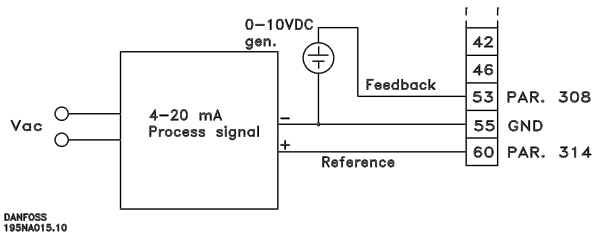

DANFOSS
195NA015.10

- Par. 100 Configuration = Speed closed loop [1]
- Par. 308 Analogue input = Feedback [2]
- Par. 309 Terminal 53, min. scaling = 0 Volt
- Par. 310 Terminal 53, max. scaling = 10 Volt
- Par. 314 Analogue input = Reference [1]
- Par. 309 Terminal 60, min. scaling = 4 mA
- Par. 310 Terminal 60, max. scaling = 20 mA

Par. 100 Configuration = Speed regulation open loop [0]

Par. 200 Output frequency range = Both directions, 0-132 Hz [1]

Par. 203 Reference range = Min. ref. - Max. ref. [0]

Par. 204 Min. reference = - 50 Hz

Par. 205 Max. reference = 50 Hz

Par. 302 Digital input = Start [7]

Par. 304 Digital input = Coasting stop inverted [2]

Par. 308 Analogue input = Reference [1]

Par. 309 Terminal 53, min. scaling = 0 Volt.

Par. 310 Terminal 53, max. scaling = 10 Volt.

■ Preset references

Switch between 8 preset references via two digital inputs and Setup 1 and Setup 2.

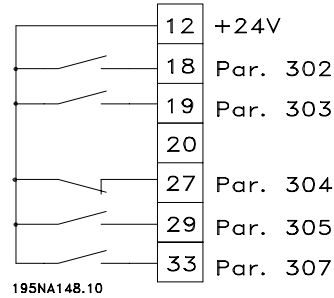

195NA148.10

Par. 004 Active Setup = Multisetup 1 [5]

Par. 204 Min. reference = 0 Hz

Par. 205 Max. reference = 50 Hz

Par. 302 Digital input = Start [7]

Par. 303 Digital input = Choice of Setup, lsb [31]

Par. 304 Digital input = Coasting stop inverted [2]

Par. 305 Digital input = Preset ref., lsb [22]

Par. 307 Digital input = Preset ref., msb [23]

■ 50 Hz anti-clockwise to 50 Hz clockwise.

With internally supplied potentiometer.

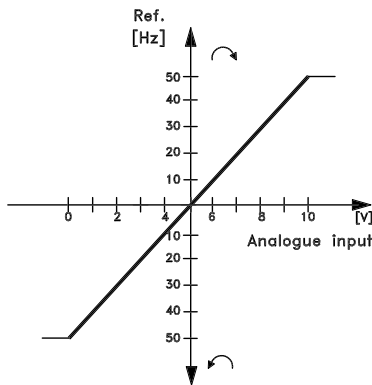

175ZA037.12

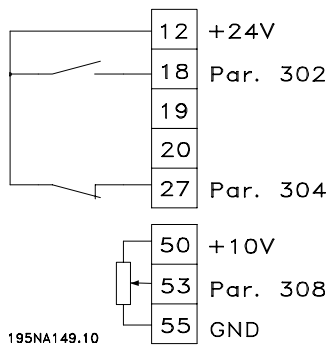

195NA149.10

Setup 1 contains the following preset references:

Par. 215 Preset reference 1 = 5.00%

Par. 216 Preset reference 2 = 10.00%

Par. 217 Preset reference 3 = 25.00%

Par. 218 Preset reference 4 = 35.00%

Setup 2 contains the following preset references:

Par. 215 Preset reference 1 = 40.00%

Par. 216 Preset reference 2 = 50.00%

Par. 217 Preset reference 3 = 70.00%

Par. 218 Preset reference 4 = 100.00%

This table shows what the output frequency is:

Preset ref., msb	Preset ref., lsb	Selection of Setup	Output frequency[Hz]
0	0	0	2.5
0	1	0	5
1	0	0	10
1	1	0	17.5
0	0	1	20
0	1	1	25
1	0	1	35
1	1	1	50

Use of the relay for 230 V AC brake

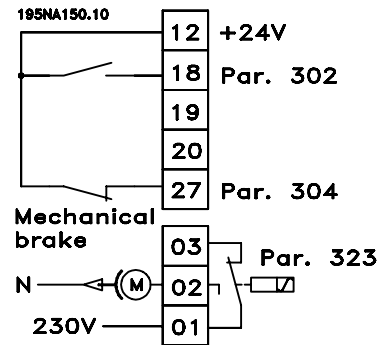

■ Connection of mechanical brake

Using terminal 122/123

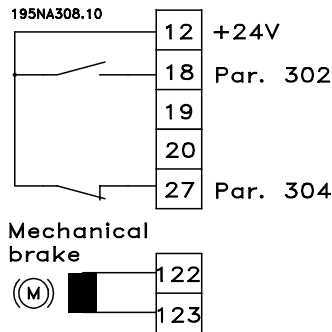

Par. 302 Digital input = Start [7]
 Par. 304 Digital input = Coasting stop inverted [2]
 See also par. 138, 139, 140

Mechanical brake with accelerator winding

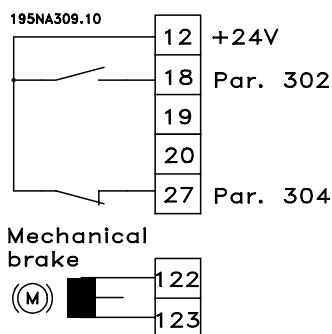

Par. 302 Digital input = Start [7]
 Par. 304 Digital input = Coasting stop inverted [2]
 See also par. 138, 139, 140

Par. 302 Digital input = Start [7]
 Par. 304 Digital input = Coasting stop inverted [2]
 Par. 323 Relay output = Mechanical brake control [25]
 See also par. 138, 139, 140

Mechanical brake control [25] = '0' => Brake is closed.
 Mechanical brake control [25] = '1' => The brake is open.
 See more detailed parameter settings under Control of mechanical brake.

NB!
 Do not use the internal relay for DC brakes or brake voltages > 250 V.

■ Counter stop via terminal 33

The start signal (terminal 18) must be active, i.e. logical '1', until the output frequency is equal to the reference. The start signal (terminal 18 = logical '0') must then be removed before the counter value in parameter 344 has managed to stop the VLT frequency converter.

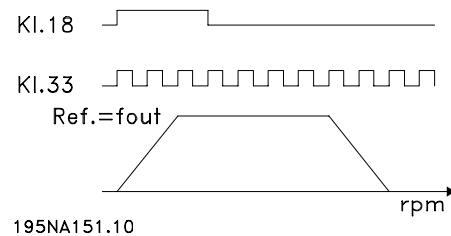

Par. 307 Digital input = Pulse input [30]
 Par. 343 Precise stop function = Counter stop with reset [1]
 Par. 344 Counter value = 100000

Installation

■ The LCP 2 control unit, option

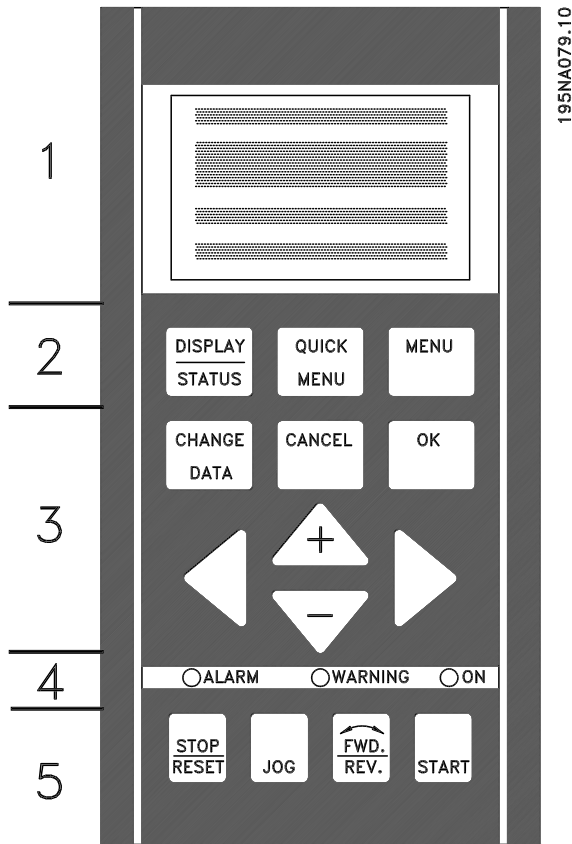

The FCD 300 can be combined with an LCP control unit (Local Control Panel - LCP 2) which makes up a complete interface for operation and programming of the frequency converter. The LCP 2 control unit can be attached up to three metres from the frequency converter, e.g. on a front panel, using an accessory kit.

The control panel is divided into five functional groups:

1. Display.
2. Keys used to change the display function.
3. Keys used to change the programme parameters.
4. Indicator lamps.
5. Local control keys.

All data is displayed via a 4-line alphanumeric display, which during normal operation will be able to continuously display 4 items of operating data and 3 operating modes. During programming all information needed for quick, effective parameter setup of the frequency converter will be displayed. As a supplement to the display, there are three indicator lamps for voltage (ON), warning (WARNING) and alarm (ALARM). All frequency converter parameter Setups can be changed immediately from the control panel, unless this function has been programmed as *Locked* [1] via parameter 018 *Lock for data changes*.

■ Control keys for parameter Setup

The control keys are divided into functions, in such a way that the keys between the display and the indicator lamps are used for parameter Setup, including selection of the display's view mode during normal operation.

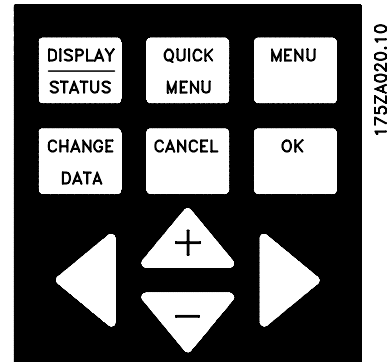

[DISPLAY/STATUS] is used to select the display's view mode or to change back to Display mode from either Quick Menu or Menu mode.

[QUICK MENU] provides access to the parameters used in the Quick Menu. It is possible to switch between Quick Menu and Menu mode.

[MENU] gives access to all parameters. It is possible to switch between Menu mode and Quick Menu.

[CHANGE DATA] is used to change a parameter that has been selected either in Menu mode or Quick Menu.

[CANCEL] is used if a change to the selected parameter is not to be implemented.

[OK] is used to confirm a change to a selected parameter.

[+ / -] are used for selecting parameters and for changing parameter values.

These keys are also used in Display mode to switch between the readouts of operating variables.

[< >] are used for selecting parameter group and to move the cursor when changing a numerical value.

Indicator lamps

At the bottom of the control panel are a red alarm lamp, a yellow warning lamp and a green voltage indicator lamp.



If certain threshold values are exceeded, the alarm and/or warning lamp are activated, while a status or alarm text is shown on the display.



NB!:

The voltage indicator lamp is activated when voltage is connected to the frequency converter.

Local control

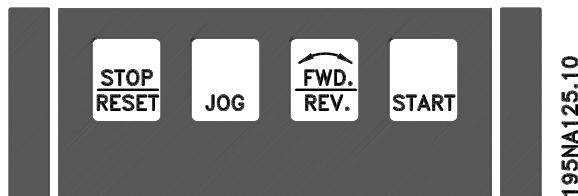

[STOP/RESET] is used for stopping the motor connected or for resetting the frequency converter after a drop-out (trip). Can be set to active or inactive via parameter 014 *Local stop*. If stop is activated Display line 2 will flash.



NB!:

If an external stop function is not selected and the **[STOP/RESET]** key is set to inactive, the motor can only be stopped by disconnecting the voltage to the motor or the frequency converter.

[JOG] changes the output frequency to a preset frequency while the key is held down. Can be set to active or inactive via parameter 015 *Local jog*.

[FWD / REV] changes the direction of rotation of the motor, which is indicated by means of the arrow on the display. Can be set to active or inactive via parameter 016 *Local reversing*. The **[FWD/REV]** key is only active when parameter 002 *Local/remote operation* is set to *Local control*.

[START] is used to start the frequency converter. Is always active, but cannot override a stop command.



NB!:

If the local control keys are set to inactive, these will both become active when the frequency converter is set to *Local control* and *Remote control* via parameter 002 *Local/remote operation*, with the exception of **[FWD/REV]**, which is only active in *Local control*.

Display mode



In normal operation, up to 4 different display data items can optionally be shown continuously: 1,1, 1,2, 1,3 and 2. The present operation status or alarms and warnings that have been generated are displayed in line 2 in the form of a number.

In the event of alarms this is displayed in lines 3 and 4 with explanatory text.

A warning will appear flashing in line 2 with explanatory text in line 1. The active Setup will also appear on the display.

The arrow indicates the selected direction of rotation. Here the frequency converter shows that it has an active reversing signal. The body of the arrow will disappear if a stop command is given, or if the output frequency drops below 0.1 Hz.

The bottom line displays the frequency transformer's status. The scrollbar shows which operating values can be displayed in lines 1 and 2 in Display mode. Changes are made using the [+ / -] keys.

Switching between AUTO and HAND modes

By activating the **[CHANGE DATA]** key in **[DISPLAY MODE]** the display will indicate the mode of the frequency converter.

Switch mode by using [+/-] key **[HAND...AUTO]**

In **[HAND]** mode the reference can be changed by **[+]** or **[-]** keys.

Operating data	Unit
Resulting reference	[%]
Resulting reference	[unit]
Feedback	[unit]
Output frequency	[Hz]
Output frequency x scaling	[-]
Motor current	[A]
Torque	[%]
Power	[kW]
Power	[HP]
Motor voltage	[V]
DC link voltage	[V]
Thermal load motor	[%]
Thermal load	[%]
Hours run	[hours]
Digital input	[binary]
Pulse input 29	[Hz]
Pulse input 29	[Hz]
Pulse input 33	[Hz]
External reference	[%]
Status word	[hex]
Heatsink temperature	[°C]
Alarm word	[hex]
Control word	[hex]
Warning word	[hex]
Extended status word	[hex]
Analogue input 53	[V]
Analogue input 60	[mA]

Three operating data items can be shown in the first display line, and one operating variable can be shown in the second display line. Is programmed via parameters 009, 010, 011 and 012 *Display readout* .

■ Display modes

The LCP control unit has different display modes, which depend on the mode selected for the frequency converter.

Display mode I:

This display mode is standard after startup or initialisation.

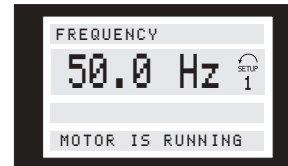

Line 2 shows the data value of an operating data item with unit, and line 1 contains a text that explains line 2. In the example, *Frequency* has been selected as readout via parameter 009 *Large display readout*. In normal operation, another variable can be entered immediately using the [+ / -] keys.

Display mode II:

Switch between Display modes I and II is performed by briefly pressing the [DISPLAY / STATUS] key.

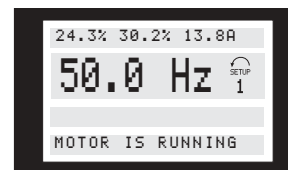

In this mode, all data values for four operating data items with any pertaining units are shown, see table. In the example, the following have been selected: *Frequency, Reference, Torque and Current* as readout in the first and second line.

Display mode III:

This display mode is called up as long as the [DISPLAY / STATUS] key is held down. When the key is released it switches back to Display mode II, unless the key is held down for less than approx. 1 sec., in which case the system always reverts to Display mode I.

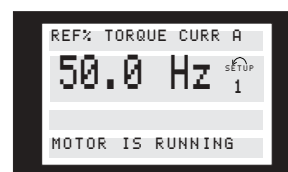

Here you can read out the parameter names and units for operating data in the first and second lines. Line 2 in the display remains unchanged.

Display mode IV:

This display mode can be called up during operation if a change has to be made in another Setup without stopping the frequency converter. This function is activated in parameter 005 *Programming Setup*.

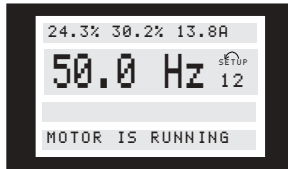

Here the programming Setup number 2 will flash to the right of the active Setup.

Parameter Setup

A frequency converter's comprehensive work area can be accessed via a large number of parameters, making it possible to adapt its functionality for a specific application. To provide a better overview of the many parameters, there is a choice of two programming modes - Menu mode and Quick Menu mode. The former provides access to all parameters. The latter takes the user through the parameters, which make it possible to start operating the frequency converter in most cases, in accordance with the Setup made. Regardless of the mode of programming, a change of a parameter will take effect and be visible both in the Menu mode and in the Quick menu mode.

Structure for Quick menu mode v Menu mode

In addition to having a name, each parameter is linked up with a number which is the same regardless of the programming mode. In Menu mode, parameters will be split into groups, with the first digit (left) of the parameter number indicating the group number of the parameter in question.

- Using the [QUICK MENU] key, it is possible to get access to the most important parameters of the frequency converter. After programming, the frequency converter is in most cases ready for operation. Scroll through the Quick menu using the [+ / -] keys and change the data values by pressing [CHANGE DATA] + [OK].
- The Menu mode allows choosing and changing all parameters as required. However, some parameters will be "shaded off", depending on the choice in parameter 100 *Configuration*.

Quick menu with LCP 2 control unit

Start Quick Setup by pressing the [QUICK MENU] key, which will bring out the following display values:



At the bottom of the display, the parameter number and name are given together with the status/value of the first parameter under the Quick menu. The first time the [QUICK MENU] key is pressed after the unit has been switched on, the readouts always start in pos. 1 - see table below.

Pos.	Parameter no.	Unit
1	001 Language	
2	102 Motor power	[kW]
3	103 Motor voltage	[V]
4	104 Motor frequency	[Hz]
5	105 Motor current	[A]
6	106 Rated motor speed	[rpm]
7	107 AMT	
8	204 Minimum reference	[Hz]
9	205 Maximum reference	[Hz]
10	207 Ramp-up time	[sec]
11	208 Ramp-down time	[sec]
12	002 Local/remote operation	
13	003 Local reference	[Hz]

Parameter selection

Menu mode is started by pressing the [MENU] key, which produces the following readout on the display:

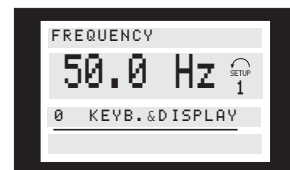

Line 3 on the display shows the parameter group number and name.

In Menu mode, the parameters are divided into groups. Selection of parameter group is effected using the [< >] keys.

The following parameter groups will be accessible:

Group no.	Parameter group
0	Operation & Display
1	Load & Motor
2	References & Limits
3	Inputs & Outputs
4	Special functions
5	Serial communication
6	Technical functions

When the required parameter group has been selected, each parameter can be chosen by means of the [+ / -] keys:

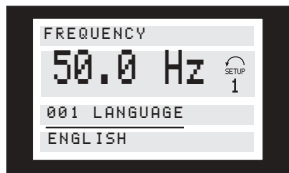

The 3rd line of the display shows the parameter number and name, while the status/value of the selected parameter is shown in line 4.

Changing data

Regardless of whether a parameter has been selected under the Quick menu or the Menu mode, the procedure for changing data will be the same. Pressing the [CHANGE DATA] key gives access to changing the selected parameter, following which the underlining in line 4 will flash on the display. The procedure for changing data depends on whether the selected parameter represents a numerical data value or a text value.

Changing a data value

If the selected parameter is a text value, the text value is changed by means of the [+ / -] keys.

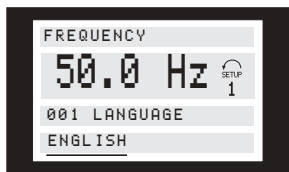

The bottom display line will show the value that will be entered (saved) when acknowledgment is given [OK].

Change of numeric data value

If the selected parameter is represented by a numerical data value, a digit is first chosen using the [< >] keys.

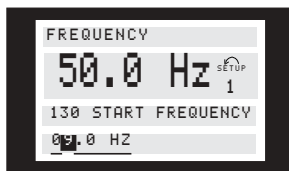

The selected digit can then be changed infinitely variably using the [+ / -] keys:

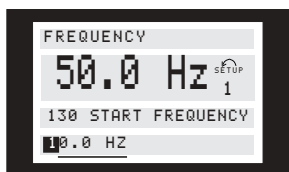

The chosen digit is indicated by the digit flashing. The bottom display line shows the data value that will be entered (saved) when signing off with [OK].

Manual initialisation



NB!:

Manual initialisation is not possible on the LCP 2 175N0131 control unit. It is, however, possible to perform an initialisation via par. 620 *Operation mode*:

The following parameters are not changed when initialising via par. 620 *Operation mode*.

- par. 500 *Address*
- par. 501 *Baud rate*
- par. 600 *Operating hours*
- par. 601 *Hours run*
- par. 602 *kWh counter*
- par. 603 *Number of power-ups*
- par. 604 *Number of overtemperatures*
- par. 605 *Number of overvoltages*
- par. 615-617 *Fault log*
- par. 678 *Configure Control Card*

■ Operation & Display

001 Language

(LANGUAGE)

Value:

★English (ENGLISH)	[0]
German (DEUTSCH)	[1]
French (FRANCAIS)	[2]
Danish (DANSK)	[3]
Spanish (ESPANOL)	[4]
Italian (ITALIANO)	[5]

Function:

This parameter is used to choose the language to be shown in the display whenever the LCP control unit is connected.

Description of choice:

There is a choice of the languages shown. The factory setting may vary.

002 Local/remote operation

(OPERATION SITE)

Value:

★Remote operation (REMOTE)	[0]
Local operation (LOCAL)	[1]

Function:

There is a choice of two different modes of operation of the frequency converter; *Remote operation* [0] or *Local operation* [1]. See also parameter 013 *Local control* if *Local operation* [1] is selected.

Description of choice:

If *Remote operation* [0] is selected, the frequency converter is controlled via:

1. the control terminals or via serial communication.
2. the [START] key. This cannot, however, override stop commands transmitted via the digital inputs or via serial communication.
3. the [STOP/RESET] and [JOG] keys, on the condition that these are active.

If *Local operation* [1], is selected, the frequency converter is controlled via:

1. the [START] key. This cannot, however, override stop commands via the digital inputs (see parameter 013 *Local control*).
2. the [STOP/RESET] and [JOG] keys, on the condition that these are active.
3. the [FWD/REV] key, on the condition that is has been selected as active in parameter 016 *Local reversing*, and that parameter 013 *Local control*

★ = factory setting. () = display text [] = value for use in communication via serial communication port

is set at *Local control and open loop* [1] or *Local control as parameter 100* [3]. Parameter 200 *Output frequency range* is set at *Both directions*.

4. parameter 003 *Local reference* where the reference can be set using the [+] and [-] keys.
5. an external control command that can be connected to the digital inputs (see parameter 013 *Local control*).



NB!:

The [JOG] and [FWD/REV] keys are located on the LCP control unit.

003 Local reference

(LOCAL REFERENCE)

Value:

Par. 013 *Local control* must be set to [1] or [2]:

0 - f_{MAX} (par. 202) ★ 50 Hz

Par. 013 *Local control* must be set to [3] or [4].

Ref_{MIN} - Ref_{MAX} (par. 204-205) ★ 0,0

Function:

In this parameter, the local reference can be set manually. The unit of the local reference depends on the configuration selected in parameter 100 *Configuration*.

Description of choice:

In order to protect the local reference, parameter 002 *Local/remote operation* must be set to *Local operation* [1]. Local reference cannot be set via serial communication.

■ Setup configuration

There is a choice of four Setups (parameter Setups), which can be programmed independently of one another. The active Setup can be selected in parameter 004 *Active Setup*. When an LCP control unit is connected, the active Setup number will be appear in the display under "Setup". It is also possible to preset the frequency converter to *Multisetup*, so that it is possible to shift Setups using the digital inputs or serial communication. Setup shift can be used in a plant in which, for example, one Setup is used for daytime operation and another one at night time. In parameter 006 *Setup copying* it is possible to copy from one Setup to another. Using parameter 007 *LCP copy* all Setups can be transferred from one frequency converter to another by moving the LCP control panel.

First all parameter values are copied to the LCP control panel, which can then be moved to another frequency converter. Here all parameter values can be copied from the LCP control unit to the frequency converter.

	[2]
Setup 3 (SETUP 3)	[3]
Setup 4 (SETUP 4)	[4]
★Active Setup (ACTIVE SETUP)	[5]

■ Setup shift

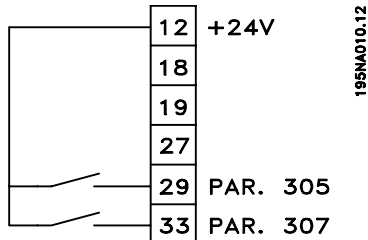

- Selection of Setup via terminals 29 and 33.

Par. 305 Digital input = Selection of Setup, lsb [31]
 Par. 307 Digital input = Selection of Setup, msb [32]
 Par. 004 Active setup = Multi Setup [5]

004 Active Setup

(ACTIVE SETUP)

Value:

Factory Setup (FACTORY SETUP)	[0]
★Setup 1 (SETUP 1)	[1]
Setup 2 (SETUP 2)	[2]
Setup 3 (SETUP 3)	[3]
Setup 4 (SETUP 4)	[4]
Multi Setup (MULTI SETUP)	[5]

Function:

The active parameter Setup is selected here. All parameters can be programmed in four individual parameter Setups. Shifts between Setups can be made in this parameter via a digital input or via serial communication.

Description of choice:

Factory Setup [0] contains the factory-set parameter values. Setup 1-4 [1]-[4] are four individual Setups which can be selected as required. Multi Setup [5] is used where remote-controlled shifts between the four Setups via a digital input or via serial communication is required.

005 Programming Setup

(EDIT SETUP)

Value:

Factory Setup (FACTORY SETUP)	[0]
Setup 1 (SETUP 1)	[1]
Setup 2 (SETUP 2)	

★ = factory setting. () = display text [] = value for use in communication via serial communication port

Function:

You can select which Setup you want to programme during operation (applies both via the control panel and the serial communication port). It is, for example, possible to programme Setup 2 [2], while the active Setup is set to Setup 1 [1] in parameter 004 Active Setup .

Description of choice:

Factory Setup [0] contains the factory-set data and can be used as a source of data if the other Setups are to be reset to a known status. Setup 1-4 [1]-[4] are individual Setups that can be programmed freely during operation. If Active Setup [5] is selected, the programming Setup will be equal to parameter 004 Active Setup .



NB!:

If data is modified or copied to the active Setup, the modifications have an immediate effect on the unit's operation.

006 Setup copying

(SETUP COPY)

Value:

★No copying (NO COPY)	[0]
Copy to Setup 1 from # (COPY TO SETUP 1)	[1]
Copy to Setup 2 from # (COPY TO SETUP 2)	[2]
Copy to Setup 3 from # (COPY TO SETUP 3)	[3]
Copy to Setup 4 from # (COPY TO SETUP 4)	[4]
Copy to all Setups from # (COPY TO ALL)	[5]

Function:

You can copy from the selected active Setup in parameter 005 Programming setup to the selected Setup or Setups in this parameter.



NB!:

Copying is only possible in Stop (motor stopped in connection with a stop command).

Description of choice:

Copying begins when the required copying function has been selected and the [OK]/[CHANGE DATA]

key has been pushed. The display indicates when copying is in progress.

007 LCP copy

(LCP COPY)

Value:

★No copying (NO COPY)	[0]
Upload all parameters (UPL. ALL PAR.)	[1]
Download all parameters (DWNL. ALL PAR.)	[2]
Download size-independent parameters (DWNL.OUTPIND.PAR.)	[3]

Function:

Parameter 007 *LCP copy* is used if you want to use the LCP 2 control panel's integral copy function. The function is used if you want to copy all parameter setups from one frequency converter to another by moving the LCP 2 control panel.

Description of choice:

Select *Upload all parameters* [1] if you want all parameter values to be transferred to the control panel. Select *Download all parameters* [2] if all parameter values transferred are to be copied to the frequency converter to which the control panel is attached. Select *Download size-independent par.* [3] if you only want to download the size-independent parameters. This is used when downloading to a frequency converter with a different rated power size than that from which the parameter setup originates.



NB!:

Upload/download can only be performed in stop mode. Download can only be performed to a frequency converter with the same software version number, see parameter 626 *Database identification no.*

008 Display scaling of output frequency

(FREQUENCY SCALE)

Value:

0.01 - 100.00 ★ 1.00

Function:

In this parameter, the factor is selected by which the output frequency is to be multiplied. The value is shown in the display, provided parameters 009-012 *Display readout* have been set to *Output frequency x scaling* [5].

Description of choice:

Set the required scaling factor.

009 Large display readout

(DISPLAY LINE 2)

Value:

No readout (NONE)	[0]
Resulting reference [%] (REFERENCE [%])	[1]
Resulting reference [unit] (REFERENCE [UNIT])	[2]
Feedback [unit] (FEEDBACK [UNIT])	[3]
★Frequency [Hz] (FREQUENCY [HZ])	[4]
Output frequency x scaling (FREQUENCY X SCALE)	[5]
Motor current [A] (MOTOR CURRENT [A])	[6]
Torque [%] (TORQUE [%])	[7]
Power [kW] (POWER [KW])	[8]
Power [HP] (POWER [HP][US])	[9]
Motor voltage [V] (MOTOR VOLTAGE [V])	[11]
DC link voltage [V] (DC LINK VOLTAGE [V])	[12]
Thermal load motor [%] (MOTOR THERMAL [%])	[13]
Thermal load [%] (FC. THERMAL[%])	[14]
Running hours [Hours] (RUNNING HOURS))	[15]
Digital input [Bin] (DIGITAL INPUT[BIN])	[16]
Analog input 53 [V] (ANALOG INPUT 53 [V])	[17]
Analog input 60 [mA] (ANALOG INPUT 60 [MA])	[19]
Pulse reference [Hz] (PULSE INPUT 33. [HZ])	[20]
External reference [%] (EXTERNAL REF. [%])	[21]
Status word [Hex] (STATUS WORD [HEX])	[22]
Heatsink temperature [°C] (HEATSINK TEMP [°C])	[25]
Alarm word [Hex] (ALARM WORD [HEX])	[26]
Control word [Hex] (CONTROL WORD [HEX])	[27]
Warning word [Hex] (WARNING WORD [HEX])	[28]
Extended status word [Hex] (EXT. STATUS [HEX])	[29]
Communication option card warning (COMM OPT WARN [HEX])	[30]
Pulse count (PULSE COUNTER)	[31]
Pulse input 29 (PULSE INPUT 29)	[32]

★ = factory setting. () = display text [] = value for use in communication via serial communication port

Function:

In this parameter you can select the data value that you wish to display in the LCP control unit display line 2 when the frequency converter is switched on. The display will also be included in the scrollbar in display mode. In parameters 010-012 *Display readout* you can select a further three data values, which are displayed in display line 1.

Description of choice:

No readout can only be selected in parameters 010-012 *Small display readout*.

Resulting reference [%] gives, as a percentage, the resulting reference in the range from Minimum reference, Ref_{MIN} to Maximum reference, Ref_{MAX}.

Reference [unit] gives the resulting reference with unit Hz in *Open loop*. In *Closed loop* the reference unit is selected in parameter 416 *Process units*.

Feedback [unit] gives the resulting signal value using the unit/scaling selected in parameter 414 *Minimum feedback, FB_{LOW}*, 415 *Maximum feedback, FB_{HIGH}* and 416 *Process units*.

Frequency [Hz] gives the output frequency of the frequency converter.

Output frequency x scaling [-] equals the present output frequency f_M multiplied by the factor set in parameter 008 *Display scaling of output frequency*.

Motor current [A] gives the phase current of the motor measured as an effective value.

Torque [%] denotes the motor's present load in relation to the motor's rated torque.

Power [kW] gives the present power that the motor is absorbing in kW.

Power [HP] gives the present power that the motor is absorbing in HP.

Motor voltage [V] gives the voltage supplied to the motor.

DC link voltage [V] gives the intermediate circuit voltage of the frequency converter.

Thermal load motor [%] gives the calculated/estimated load on the motor. 100 % is the cut-out limit.

Thermal load [%] gives the calculated/estimated thermal load on the frequency converter. 100 % is the cut-out limit.

Running hours [Hours] gives the number of hours that the motor has run since the last reset in parameter 619 *Reset of running hours counter*.

Digital input [Binary code] gives the signal status from the 5 digital inputs (18, 19, 27, 29 and 33). Terminal 18 corresponds to the bit on the extreme left. '0' = no signal, '1' = signal connected.

Analog input 53 [V] gives the voltage value of terminal 53.

Analog input 60 [mA] gives the present value of terminal 60.

Pulse input 33[Hz] gives the frequency in Hz connected to terminal 33.

External reference [%] gives the sum of external references as a percentage (sum of analogue/pulse/serial communication) in the range from Minimum reference, Ref_{MIN} to Maximum reference, Ref_{MAX}.

Status word [Hex] gives one or several status conditions in a Hex code. See *Serial communication* in the *Design Guide* for further information.

Heatsink temp.[°C] gives the present heatsink temperature of the frequency converter. The cut-out limit is 90-100 °C, while cutting back in occurs at 70 ± 5 °C.

Alarm word [Hex] gives one or several alarms in hex code. See *Serial communication* in the *Design Guide* for further information.

Control word [Hex] gives the control word for the frequency converter. See *Serial communication* in the *Design Guide* for further information.

Warning word [Hex] gives one or several warnings in hex code. See *Serial communication* in the *Design Guide* for further information.

Extended status word [Hex] gives one or several status modes in Hex code. See *Serial communication* in the *Design Guide* for further information.

Communication option card warning [Hex] gives a warning word if there is a fault in the communication bus. Only active if communication options are installed. If there are no communication options 0 Hex is displayed.

Pulse input 29[Hz] gives the frequency in Hz connected to terminal 29.

Pulse count gives the number of pulses that the unit has registered.

010 Small display line 1.1

(DISPLAY LINE 1.1)

Value:

See par. 009 *Large display readout*

★ Analog input 53 [V] [17]

Function:

In this parameter, the first of three data values can be selected that is to be displayed in the LCP control unit display, line 1, position 1. This is a useful function, e.g. when setting the PID regulator, as it gives a view of process reactions to reference changes. The display readout is activated by pushing the [DISPLAY STATUS] key.

Description of choice:

See parameter 009 *Large display readout*.

011 Small display readout 1.2

(DISPLAY LINE 1.2)

Value:

See parameter 009 *Large display readout*

★ Motor current [A][6]

Function:

See the functional description given under parameter 010 *Small display readout*.

Description of choice:

See parameter 009 *Large display readout*.

012 Small display readout 1.3

(DISPLAY LINE 1.3)

Value:

See parameter 009 *Large display readout*

★ Feedback [unit] [3]

Function:

See the functional description given under parameter 010 *Small display readout*.

Description of choice:

See parameter 009 *Large display readout*.

013 Local control

(LOC CTRL/CONFIG.)

Value:

Local not active (DISABLE)	[0]
Local control and open loop without slip compensation (LOC CTRL/OPEN LOOP)	[1]
Remote-operated control and open loop without slip compensation (LOC+DIG CTRL)	[2]
Local control as parameter 100 (LOC CTRL/AS P100)	[3]
★Remote-operated control as parameter 100 (LOC+DIG CTRL/AS P100)	[4]

Function:

This is where the required function is selected if, in parameter 002 *Local/remote operation*, *Local operation* [1] has been chosen.

Description of choice:

If *Local not active* [0] is selected, it is not possible to set a reference via parameter 003 *Local reference*. In order to enable a shift to *Local not active* [0], parameter 002 *Local/remote operation* must be set to *Remote operation* [0].

Local control and open loop [1] is used if the motor speed is to be set via parameter 003 *Local reference*. When this choice is made, parameter 100 *Configuration* automatically shifts to *Speed regulation, open loop* [0].

Remote-operated control and open loop [2] functions in the same way as *Local control and open loop* [1]; however, the frequency converter can also be controlled via the digital inputs.

For selections [1-2] control is shifted to open loop, no slip compensation.

Local control as parameter 100 [3] is used when the motor speed is to be set via parameter 003 *Local reference*, but without parameter 100 *Configuration* automatically shifting to *Speed regulation, open loop* [0].

Remote-operated control as parameter 100 [4] works the same way as *Local control as parameter 100* [3]; however, the frequency converter can also be controlled via the digital inputs.

★ = factory setting. () = display text [] = value for use in communication via serial communication port

Shifting from *Remote operation* to *Local operation* in parameter 002 *Local/remote operation*, while this parameter has been set to *Remote-operated control and open loop* [1]: The present motor frequency and direction of rotation will be maintained. If the present direction of rotation does not respond to the reversing signal (negative reference), the reference will be set to 0.

Shifting from *Local operation* to *Remote operation* in parameter 002 *Local/remote control*, while this parameter has been set to *Remote-operated control and open loop* [1]: The configuration selected in parameter 100 *Configuration* will be active. The shift will be smooth.

Shifting from *Remote control* to *Local control* in parameter 002 *Local/remote operation*, while this parameter has been set to *Remote-operated control as parameter 100* [4]: the present reference will be maintained. If the reference signal is negative, the local reference will be set to 0.

Shifting from *Local operation* to *Remote operation* in parameter 002 *Local/remote operation*, while this parameter has been set to *Remote operation*: The local reference will be replaced by the remote-operated reference signal.

014 Local stop (LOCAL STOP)

Value:

Not active (DISABLE)	[0]
★Active (ENABLE)	[1]

Function:

In this parameter, the local [STOP]-key can be engaged or disengaged on the control panel and on the LCP control panel.

Description of choice:

If *Not active* [0] is selected in this parameter, the [STOP]-key will be inactive.



NB!:

If *Not active* [0] is selected, the motor cannot be stopped by means of the [STOP]-key.

015 Local jog (LOCAL JOGGING)

Value:

★Not active (DISABLE)	[0]
Active (ENABLE)	[1]

★ = factory setting. () = display text [] = value for use in communication via serial communication port

Function:

In this parameter, the jog function on the LCP control panel can be engaged/disengaged.

Description of choice:

If *Not active* [0] is selected in this parameter, the [JOG]-key will be inactive.

016 Local reversing (LOCAL REVERSING)

Value:

★Not active (DISABLE)	[0]
Active (ENABLE)	[1]

Function:

In this parameter you can select/deselect the reversing function on the LCP control panel. The key can only be used if parameter 002 *Local/remote operation* is set to *Local operation* [1] and parameter 013 *Localcontrol to Local control, open loop* [1] or *Local control as parameter 100* [3].

Description of choice:

If *Disable* [0] is selected in this parameter, the [FWD/REV] key will be disabled. See also parameter 200 *Output frequency range*.

017 Local reset of trip (LOCAL RESET)

Value:

Not active (DISABLE)	[0]
★Active (ENABLE)	[1]

Function:

In this parameter, the reset function on the control panel can be engaged/disengaged.

Description of choice:

If *Not active* [0] is selected in this parameter, the reset function will be inactive.



NB!:

Select *Not active* [0], only if an external reset signal has been connected via the digital inputs.

018 Lock for data changes (DATA CHANGE LOCK)

Value:

★Not locked (NOT LOCKED)	[0]
Locked (LOCKED)	[1]

Function:

In this parameter, it is possible to 'lock' the controls to disable data changes via the control keys.

Description of choice:

If *Locked* [1] is selected, data changes in the parameters cannot be made; however, it will still be possible to make data changes via serial communication. Parameter 009-012 *Display readout* can be changed via the control panel.

019 Operating mode at power-up, local operation

(POWER UP ACTION)

Value:

- Auto restart, use saved reference (AUTO RESTART) [0]
- ★Forced stop, use saved reference (LOCAL=STOP) [1]
- Forced stop, set ref. to 0 (LOCAL=STOP, REF=0) [2]

Function:

Setting of the required operating mode when the mains voltage is engaged. This function can only be active if *Local operation* [1] has been selected in parameter 002 *Local/remote operation*.

Description of choice:

Auto restart, use saved ref. [0] is selected if the frequency converter is to start using the local reference (set in parameter 003 *Local reference*) and the start/stop state given via the control keys immediately prior to the mains voltage being cut out.

Forced stop, use saved ref. [1] is selected if the frequency converter is to remain stopped when the mains voltage is engaged, until the [START]-key is activated. After a start command the motor speed is ramped up to the saved reference in parameter 003 *Local reference*.

Forced stop, set ref. to 0 [2] is selected if the frequency converter is to remain stopped when the mains voltage is cut back in. Parameter 003 *Local reference* is to be zeroed.



NB!:

In remote operation (parameter 002 *Local/remote operation*) the start/stop state at the time of mains connection will depend on the external control signals. If *Pulse start* [8] is selected in parameter 302 *Digital input*, the motor will remain stopped after mains connection.

020 Lock for Hand mode

(LOCK HAND MODE)

Value:

- ★Not active (DISABLE) [0]
- Active (ENABLE) [1]

Function:

In this parameter you can select whether it should be possible or not to switch between Auto- and Hand mode. In Auto mode the frequency converter is controlled by external signals whereas the frequency converter in Hand mode is controlled via a local reference directly from the control unit.

Description of choice:

If *Not active* [0] is selected in this parameter, the Hand mode function will be inactive. This blocking can be activated as desired. If *Active* [1] is selected you can switch between Auto- and Hand mode.



NB!:

This parameter is only valid for LCP 2.

024 Userdefined Quick Menu

(USER QUICKMENU)

Value:

- ★Not active (DISABLE) [0]
- Active (ENABLE) [1]

Function:

In this parameter you can select the standard setup of the Quick menu key on the control panel and the LCP 2 control panel.

Using this function, in parameter 025 *Quick Menu setup* the user can select up to 20 parameters for the Quick Menu key.

Description of choice:

If *not active* [0] is selected, the standard setup of the Quick Menu key is active.

If *Active* [1] is selected, the user-defined Quick Menu is active.

★ = factory setting. () = display text [] = value for use in communication via serial communication port

025 Quick Menu setup

(QUICK MENU SETUP)

Value:

[Index 1 - 20] Value: 0 - 999 ★ 000

Function:

In this parameter you define which parameters are required in the Quick Menu when parameter 024 *User-defined Quick Menu* is set to *Active* [1]. Up to 20 parameters can be selected for the user-defined Quick Menu.



NB!:

Please note that this parameter can only be set using an LCP 2 control panel. See *Order form*.

Description of choice:

The Quick Menu is set up as follows:

1. Select parameter 025 *Quick Menu setup* and press [CHANGE DATA].
2. Index 1 indicates the first parameter in Quick Menu. You can scroll between the index numbers using the [+ / -] keys. Select Index 1.
3. Using [< >] you can scroll between the three figures. Press the [<] key once and the last number in the parameter number can be selected using the [+ / -] keys. Set Index 1 to 100 for parameter 100 *Configuration*.
4. Press [OK] when Index 1 has been set to 100.
5. Repeat steps 2 - 4 until all parameters required have been set to the Quick Menu key.
6. Press [OK] to complete the Quick Menu setup. If parameter 100 *Configuration* is selected at Index 1, Quick Menu will start with this parameter every time Quick Menu is activated.

Please note that parameter 024 *User-defined Quick Menu* and parameter 025 *Quick Menu setup* are reset to the factory setting during initialisation.

026 LED Status

(LED STATUS)

Value:

★Overload (OVERLOAD)	[0]
Therm. warn/alarm 36 (OVERTEMP)	[1]
Thermistor/ETR (THERMAL MOTOR)	[2]
Digital input 18 (DIGITAL INPUT 18)	[3]
Digital input 19 (DIGITAL INPUT 19)	[4]
Digital input 27 (DIGITAL INPUT 27)	[5]
Digital input 29 (DIGITAL INPUT 29)	[6]
Digital input 33 (DIGITAL INPUT 33)	[7]
As relay par. 323 (AS RELAY / P323)	[8]

★ = factory setting. () = display text [] = value for use in communication via serial communication port

As dig.outp. par. 341 (AD DIG. OUT. / P341) [9]
 As mech.brake output
 (AS MECH. BRAKE OUTPUT) [10]

Function:

This parameter enables the user to visualize different situations using the Status LED.

Description of choice:

Select the function to be visualized.

■ Load and Motor

■ Configuration

Selection of configuration and torque characteristics has an effect on which parameters can be seen in the display. If *Open loop* [0] is selected, all parameters relating to PID regulation will be filtered out. This means that the user only sees the parameters that are relevant for a given application.

100 Configuration

(CONFIGURATION)

Value:

★Speed control, open loop (SPEED OPEN LOOP)	[0]
Speed control, closed loop (SPEED CLOSED LOOP)	[1]
Process control, closed loop (PROCESS CLOSED LOOP)	[3]

Function:

This parameter is used to select the configuration to which the frequency converter is to be adapted. This makes adaptation to a given application simple, since the parameters not used in a given configuration are hidden (not active).

Description of choice:

If *Speed control, open loop* [0] is selected, normal speed control is obtained (without feedback signal) with automatic load and slip compensation to ensure a constant speed at varying loads. Compensations are active, but may be disabled in parameter 134 *Load compensation* and parameter 136 *Slip compensation* as required.

If *Speed control, closed loop* [1] is selected, better speed accuracy is obtained. A feedback signal must be added, and the PID regulator must be set in parameter group 400 *Special functions*.

If *Process control, closed loop* [3] is selected, the internal process regulator is activated to enable precise control of a process in relation to a given process signal. The process signal can be set to the relevant process unit or as a percentage. A feedback signal must be added from the process and the process regulator must be set in parameter group 400 *Special functions*. Process closed loop is not active if a DeviceNet card is mounted and Instance 20/70 or 21/71 is chosen in parameter 904 *Instance types*.

101 Torque characteristic

(TORQUE CHARACT)

Value:

★Constant torque (CONSTANT TORQUE)	[1]
Variable torque low (TORQUE: LOW)	[2]
Variable torque medium (TORQUE: MED)	[3]
Variable torque high (TORQUE: HIGH)	[4]
Variable torque low with CT start (VT LOW CT START)	[5]
Variable torque medium with CT start (VT MED CT START)	[6]
Variable torque high with CT start (VT HIGH CT START)	[7]
Special motor mode (SPECIAL MOTOR MODE)	[8]

CT = Constant torque

Function:

This parameter enables a choice of principle for adaptation of the U/f ratio of the frequency converter to the torque characteristic of the load. See par. 135 *U/f ratio*.

Description of choice:

If *Constant torque* [1] is selected, a load-dependent U/f characteristic is obtained, in which output voltage and output frequency are increased at increasing loads in order to maintain constant magnetization of the motor.

Select *Variable torque low* [2], *Variable torque medium* [3] or *Variable torque high* [4], if the load is square (centrifugal pumps, fans).

Variable torque - low with CT start [5], - *medium with CT start* [6] or *high with CT start* [7], are selected if you need a greater breakaway torque than can be achieved with the three first characteristics.



NB!:

Load and slip compensation are not active if variable torque or special motor mode have been selected.

★ = factory setting. () = display text [] = value for use in communication via serial communication port

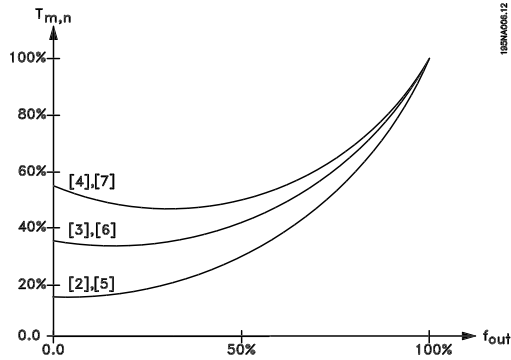

Select *Special motor mode* [8], if a special U/f setting is needed that is to be adapted to the present motor. The break points are set in parameters 423-428 *Voltage/frequency* .



NB!:

Please note that if a value set in the nameplate parameters 102-106 is changed, there will be an automatic change of parameter 108 *Stator resistance* and 109 *Stator reactance*.

102 Motor power $P_{M,N}$

(MOTOR POWER)

Value:

0.18 - 4 kW ★ Depends on unit

Function:

Here you must set a power value [kW] $P_{M,N}$, corresponding to the motor's rated power. The factory sets a rated power value [kW] $P_{M,N}$, that depends on the type of unit.

Description of choice:

Set a value that matches the nameplate data on the motor. Settings between two sizes below and one size over the factory setting are possible.

103 Motor voltage $U_{M,N}$

(MOTOR VOLTAGE)

Value:

50 - 999 V ★ 400 V

Function:

This is where to set the rated motor voltage $U_{M,N}$ for either star Y or delta Δ .

Description of choice:

Select a value that corresponds to the nameplate data on the motor, regardless of the frequency converter's mains voltage.

104 Motor frequency $f_{M,N}$

(MOTOR FREQUENCY)

Value:

24-1000 Hz ★ 50 Hz

Function:

This is where to select the rated motor frequency $f_{M,N}$.

Description of choice:

Select a value that corresponds to the nameplate data on the motor.

105 Motor current $I_{M,N}$

(MOTOR CURRENT)

Value:

0,01 - I_{MAX} ★ Depends on choice of motor

Function:

The nominal, rated current of the motor $I_{M,N}$ forms part of the frequency converter calculation of features such as torque and motor thermal protection.

Description of choice:

Set a value that corresponds to the nameplate data on the motor. Set the motor current $I_{M,N}$ taking into account whether the motor is star-connected Y or delta-connected Δ .

106 Rated motor speed

(MOTOR NOM. SPEED)

Value:

100 - $f_{M,N} \times 60$ (max. 60000 rpm)
★ Depends on parameter 104 *Motor frequency*, $f_{M,N}$

Function:

This is where to set the value that corresponds to the rated motor speed $n_{M,N}$ that can be seen from the nameplate data.

Description of choice:

Select a value that corresponds to the nameplate data on the motor.

★ = factory setting. () = display text [] = value for use in communication via serial communication port



NB!:

The max. value equals $f_{M,N} \times 60$. $f_{M,N}$ to be set in parameter 104 *Motor frequency*, $f_{M,N}$.

107 Automatic motor tuning, AMT

(AUTO MOTOR TUN.)

Value:

- ★Optimisation off (AMT OFF) [0]
- Optimisation on (AMT START) [2]

Function:

Automatic motor tuning is an algorithm that measures stator resistance R_S without the motor axle turning. This means that the motor is not delivering any torque. AMT can be used with benefit when initialising units where the user wishes to optimise adjustment of the frequency converter to the motor being used. This is used in particular when the factory setting does not sufficiently cover the motor.

For the best possible tuning of the frequency converter it is recommended that AMT is performed on a cold motor. It should be noted that repeated AMT runs can cause heating of the motor, resulting in an increase in the stator resistance R_S . As a rule, however, this is not critical.

AMT is performed as follows:

Start AMT:

1. Give a STOP signal.
2. Parameter 107 *Automatic motor tuning* is set at value [2] *Optimisation on*.
3. A START signal is given and parameter 107 *Automatic motor tuning* is reset to [0] when AMT has been completed.

In factory setting START requires terminals 18 and 27 to be connected to terminal 12.

Complete AMT:

AMT is completed by giving a RESET signal. Parameter 108 *Stator resistance*, R_S is updated with the optimised value.

Interrupting AMT:

AMT can be interrupted during the optimisation procedure by giving a STOP signal.

When using the AMT function the following points should be observed:

- For AMT to be able to define the motor parameters as well as possible, the correct type plate data for

the motor connected to the frequency converter must be keyed into parameters 102 to 106.

- Alarms will appear in the display if faults arise during tuning of the motor.
- As a rule the AMT function will be able to measure the R_S values for motors that are 1-2 times larger or smaller than the frequency converter's nominal size.
- If you wish to interrupt automatic motor tuning, press the [STOP/RESET] key.



NB!:

AMT may not be performed on motors connected in parallel, nor may setup changes be made while AMT is running.

Description of choice:

Select *Optimisation on* [2] if you want the frequency converter to perform automatic motor tuning.

108 Stator resistance R_S

(STATOR RESISTAN)

Value:

0.000 - X.XXX Ω ★ Depends on choice of motor

Function:

After setting of parameters 102-106 *Nameplate data*, a number of adjustments of various parameters is carried out automatically, including stator resistance R_S . A manually entered R_S must apply to a cold motor. The shaft performance can be improved by fine-tuning R_S and X_S , see procedure below.



NB!:

Parameters 108 *Stator resistance R_S* and 109 *Stator reactance X_S* are normally not to be changed if nameplate data has been set.

Description of choice:

R_S can be set as follows:

1. Use the factory settings of R_S which the frequency converter itself chooses on the basis of the motor nameplate data.
2. The value is stated by the motor supplier.
3. The value is obtained through manual measurements: R_S can be calculated by measuring the resistance $R_{PHASE-PHASE}$ between two phase terminals. **$R_S = 0.5 \times R_{PHASE-PHASE}$** .
4. R_S is set automatically when AMT has been completed. See parameter 107 *Auto motor adaption*.

109 Stator reactance X_S
(STATOR REACTANCE)
Value:

0.00 - X,XX Ω

★ Depends on choice of motor

Function:

After setting of parameters 102-106 *Nameplate data*, a number of adjustments of various parameters are made automatically, including stator reactance X_S. The shaft performance can be improved by fine-tuning R_S and X_S, see procedure below.

Description of choice:

X_S can be set as follows:

1. The value is stated by the motor supplier.
2. The value is obtained through manual measurements X_S is obtained by connecting a motor to mains and measuring the phase-phase voltage U_M and the idle current I_L.

$$X_S = \frac{U_M}{\sqrt{3} \times I_L} - \frac{X_L}{2}$$

X_L: See parameter 142.

3. Use the factory settings of X_S which the frequency converter itself chooses on the basis of the motor nameplate data.

117 Resonance dampening
(RESONANCE DAMP.)
Value:

0 - 100 % ★ 0 %

Function:

Reduces the output voltage when running at low load for avoiding resonance phenomena.

Description of choice:

If 0 is selected, there will be no reduction. If 100 % is selected, the voltage is reduced to 50% at no load.

119 High start torque
(HIGH START TORQ.)
Value:

0.0 - 0.5 sec. ★ 0.0 sec.

Function:

To ensure a high start torque approx. 1.8 x I_{INV}. can be permitted for max. 0.5 sec. The current is, however, limited by the frequency converter's (inverter's) safety limit. 0 sec. corresponds to no high start torque.

Description of choice:

Set the necessary time for which a high start torque is required.

120 Start delay
(START DELAY)
Value:

0.0 - 10.0 sec. ★ 0.0 sec.

Function:

This parameter enables a delay of the start-up time after the conditions for start have been fulfilled. When the time has passed, the output frequency will start by ramping up to the reference.

Description of choice:

Set the necessary time before commencing to accelerate.

121 Start function
(START FUNCTION)
Value:

- DC hold during start delay time (DC HOLD/DELAY TIME) [0]
- DC brake during start delay time (DC BRAKE/DELAY TIME) [1]
- ★Coasting during start delay time (COAST/DELAY TIME) [2]
- Start frequency/voltage clockwise (CLOCKWISE OPERATION) [3]
- Start frequency/voltage in reference direction (VERTICAL OPERATION) [4]

Function:

This is where to choose the required mode during the start delay time (parameter 120 *Start delay time*).

Description of choice:

Select *DC hold during start delay time* [0] to energize the motor with a DC hold voltage during the start delay time. Set voltage in parameter 137 *DC hold voltage*.

Choose *DC brake during start delay time* [1] to energize the motor with a DC brake voltage during the start delay time. Set voltage in parameter 132 *DC brake voltage*.

Choose *Coasting during start delay time* [2] and the motor will not be controlled by the frequency converter during the start delay time (inverter turned off).

★ = factory setting. () = display text [] = value for use in communication via serial communication port

Choose *Start frequency/voltage clockwise* [3] to obtain the function described in parameter 130 *Start frequency* and 131 *Voltage at start* during start delay time. Regardless of the value assumed by the reference signal, the output frequency equals the setting in parameter 130 *Start frequency* and the output voltage will correspond to the setting in parameter 131 *Voltage at start* .

This functionality is typically used in hoist applications. It is used in particular in applications in which a cone anchor motor is applied, where the direction of rotation is to start clockwise followed by the reference direction.

Select *Start frequency/voltage in reference direction* [4] to obtain the function described in parameter 130 *Start frequency* and 131 *Voltage at start* during the start delay time.

The direction of rotation of the motor will always follow in the reference direction. If the reference signal equals zero, the output frequency will equal 0 Hz, while the output voltage will correspond to the setting in parameter 131 *Voltage at start*. If the reference signal is different from zero, the output frequency will equal parameter 130 *Start frequency* and the output voltage will equal parameter 131 *Voltage at start*. This functionality is used typically for hoist applications with counterweight. It is used in particular for applications in which a cone anchor motor is applied. The cone anchor motor can break away using parameter 130 *Start frequency* and parameter 131 *Voltage at start*.

**122 Function at stop
(FUNCTION AT STOP)**

Value:

★Coasting (COAST)	[0]
DC hold (DC HOLD)	[1]

Function:
This is where to choose the function of the frequency converter after the output frequency has become lower than the value in parameter 123 *The min. frequency for activation of function at stop* or after a stop command and when the output frequency has been ramped down to 0 Hz.

Description of choice:
Select *Coasting* [0] if the frequency converter is to 'let go' of the motor (inverter turned off).
Select DC hold [1] if parameter 137 *DC hold voltage* is to be activated.

**123 Min. frequency for activation of function at stop
(MIN.F.FUNC.STOP)**

Value:

0,1 - 10 Hz	★ 0,1 Hz
-------------	----------

Function:
In this parameter, the output frequency is set at which the function selected in parameter 122 *Function at stop* is to be activated.

Description of choice:
Set the required output frequency.

 **NB!:**
If parameter 123 is set higher than parameter 130, then the start delay function (parameter 120 and 121) will be skipped.

 **NB!:**
If parameter 123 is set too high, and DC hold has been chosen in parameter 122, the output frequency will jump to the value in parameter 123 without ramping up. This may cause an overcurrent warning / alarm.

DC Braking
During DC braking DC voltage is supplied to the motor, and this will cause the shaft to be brought to a standstill. In parameter 132 *DC brake voltage* DC brake voltage can be preset from 0-100%. Max. DC brake voltage depends on the motor data selected. In parameter 126 *DC braking time* DC braking time is determined and in parameter 127 *DC brake cut-in frequency* the frequency at which DC braking becomes active is selected. If a digital input is programmed to *DC braking inverse* [5] and shifts from logic '1' to logic '0', DC braking will be activated. When a stop command becomes active, DC braking is activated when the output frequency is less than the brake cut-in frequency.

 **NB!:**
DC braking may not be used if the inertia in the motor shaft is more than 20 times greater than the motor's internal inertia.

★ = factory setting. () = display text [] = value for use in communication via serial communication port

126 DC brake time

(DC BRAKING TIME)

Value:

0 - 60 sec. ★ 10 sec

Function:

In this parameter, the DC brake time is set at which parameter 132 *DC brake voltage* is to be active.

Description of choice:

Set the required time.

127 DC brake cut-in frequency

(DC BRAKE CUT-IN)

Value:

0.0 (OFF) - par. 202
Output frequency high limit, f_{MAX} ★ OFF

Function:

In this parameter, the DC brake cut-in frequency is set at which the DC brake is to be activated in connection with a stop command.

Description of choice:

Set the required frequency.

128 Thermal motor protection

(MOT.THERM PROTEC)

Value:

- ★No protection (NO PROTECTION) [0]
- Thermistor warning (THERMISTOR WARN) [1]
- Thermistor trip (THERMISTOR TRIP) [2]
- ETR warning 1 (ETR WARNING 1) [3]
- ETR trip 1 (ETR TRIP 1) [4]
- ETR warning 2 (ETR WARNING 2) [5]
- ETR trip 2 (ETR TRIP 2) [6]
- ETR warning 3 (ETR WARNING 3) [7]
- ETR trip 3 (ETR TRIP 3) [8]
- ETR warning 4 (ETR WARNING 4) [9]
- ETR trip 4 (ETR TRIP 4) [10]

Function:

The frequency converter can monitor the motor temperature in two different ways:

- Via a PTC thermistor that is mounted on the motor. The thermistor is connected between terminal 31a / 31b. *Thermistor* is to be selected if a possibly integrated thermistor in the motor is to be able

to stop the frequency converter if the motor overheats. The cut-out value is 3 kΩ.

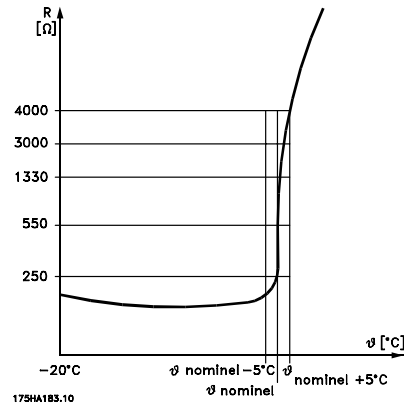

If a motor features a Klixon thermal switch instead, this can also be connected to the input. If motors operate in parallel, the thermistors/thermal switches can be connected in series (total resistance lower than 3 kΩ).

- Thermal load calculation (ETR - Electronic Thermal Relay), based on present load and time. This is compared with the rated motor current $I_{M,N}$ and rated motor frequency $f_{M,N}$. The calculations take into account the need for lower loading at low speeds due to the motor's internal ventilation being reduced.

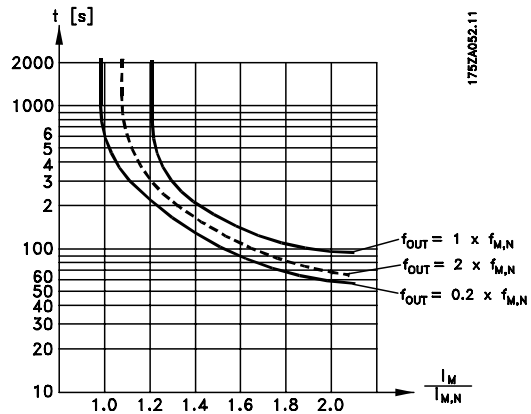

ETR functions 1-4 correspond to Setup 1-4. ETR functions 1-4 do not begin to calculate the load until you switch to the Setup in which they have been selected. This means that you can use the ETR function even when changing between two or more motors.

Description of choice:

- Select *No protection* [0] if you do not want a warning or trip when a motor is overloaded.
- Select *Thermistor warning* [1] if you want a warning when the connected becomes too hot.
- Select *Thermistor trip* [2] if you want a trip when the connected thermistor becomes too hot.

★ = factory setting. () = display text [] = value for use in communication via serial communication port

Select *ETR warning* if you want a warning when the motor is overloaded according to the calculations. You can also programme the frequency converter to give a warning signal via the digital output. Select *ETR Trip* if you want a trip when the motor is overloaded according to the calculations. Select *ETR warning 1-4* if you want a warning when the motor is overloaded according to the calculations. You can also programme the frequency converter to give a warning signal via one of the digital outputs. Select *ETR Trip 1-4* if you want a trip when the motor is overloaded according to the calculations.



NB!:

This function cannot protect the individual motors in the case of motors linked in parallel.

130 Start frequency (START FREQUENCY)

Value:
0.0 - 10.0 Hz ★ 0.0 Hz

Function:
The start frequency is active for the time set in parameter 120 *Start delay*, after a start command. The output frequency will 'jump' to the next preset frequency. Certain motors, such as conical anchor motors, need an extra voltage/start frequency (boost) at start to disengage the mechanical brake. To achieve this parameters 130 *Start frequency* and 131 *Initial voltage* are used.

Description of choice:
Set the required start frequency. It is a precondition that parameter 121 *Start function*, is set to *Start frequency/voltage clockwise* [3] or *Start frequency voltage in reference direction* [4] and that in parameter 120 *Start delay* a time is set and a reference signal is present.



NB!:

If parameter 123 is set higher than parameter 130, the start delay function (parameter 120 and 121) will be skipped.

131 Initial voltage (INITIAL VOLTAGE)

Value:
0.0 - 200.0 V ★ 0.0 V

Function:
Initial voltage is active for the time set in parameter 120 *Start delay*, after a start command. This
★ = factory setting. () = display text [] = value for use in communication via serial communication port

parameter can be used for example for lifting/dropping applications (conical anchor motors).

Description of choice:
Set the required voltage necessary to cut out the mechanical brake. It is assumed that parameter 121 *Start function*, is set to *Start frequency/voltage clockwise* [3] or *Start frequency/voltage in reference direction* [4] and that in parameter 120 *Start delay* a time is set, and that a reference signal is present.

132 DC brake voltage (DC BRAKE VOLTAGE)

Value:
0 - 100% of max. DC brake voltage ★ 0%

Function:
In this parameter, the DC brake voltage is set which is to be activated at stop when the DC brake frequency set in parameter 127 *DC brake cut-in frequency* is reached, or if *DC braking inverse* is active via a digital input or via serial communication. Subsequently, the DC brake voltage will be active for the time set in parameter 126 *DC brake time*.

Description of choice:
To be set as a percentage value of the max. DC brake voltage, which depends on the motor.

133 Start voltage (START VOLTAGE)

Value:
0.00 - 100.00 V ★ Depends on unit

Function:
A higher start torque can be obtained by increasing the start voltage. Small motors (< 1.0 kW) normally require a high start voltage.

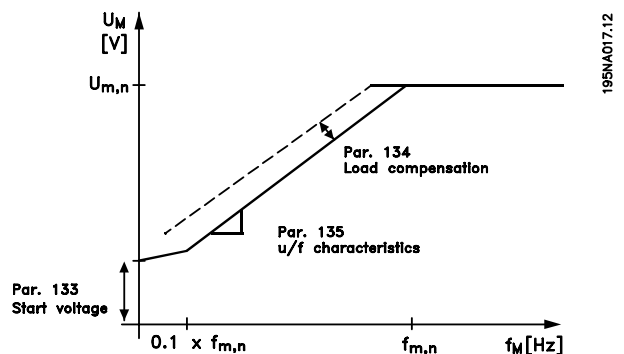

Description of choice:

The factory setting will be suitable for most applications, the value may need to be increased gradually for high torque application.



Warning: If the use of start voltage is exaggerated, this may lead to over-energizing and overheating of the motor and the frequency converter may cut out.

134 Load compensation

(LOAD COMPENSATION)

Value:

0.0 - 300.0% ★ 100.0%

Function:

In this parameter, the load characteristic is set. By increasing the load compensation, the motor is given an extra voltage and frequency supplement at increasing loads. This is used e.g. in motors/applications in which there is a big difference between the full-load current and idle-load current of the motor.



NB!:

If this value is set too high, the frequency converter may cut out because of overcurrent.

Description of choice:

If the factory setting is not adequate, load compensation must be set to enable the motor to start at the given load.



Warning: Should be set to 0% in connection with synchronous and parallel-coupled motors and in the case of quick load changes. Too high load compensation may lead to instability.

135 U/f-ratio

(U/F RATIO)

Value:

0.00 - 20.00 V/Hz ★ Depends on unit

Function:

This parameter enables a shift in the ratio between output voltage (U) and output frequency (f) linearly, so as to ensure correct energizing of the motor and thus optimum dynamics, accuracy and efficiency. The U/f-ratio only affects the voltage characteristic if a selection has been made of *Constant torque* [1] parameter 101 *Torque characteristic*.

Description of choice:

The U/f-ratio is only to be changed if it is not possible to set the correct motor data in parameter 102-109. The value programmed in the factory settings is based on idle operation.

136 Slip compensation

(SLIP COMP.)

Value:

-500 - +500% of rated slip compensation ★ 100%

Function:

Slip compensation is calculated automatically, on the basis of such data as the rated motor speed $n_{M,N}$. In this parameter, the slip compensation can be fine-tuned, thereby compensating for tolerances on the value for $n_{M,N}$. Slip compensation is only active if a selection has been made of *Speedregulation, open loop* [0] in parameter 100 *Configuration* and *Constant torque* [1] in parameter 101 *Torque characteristic*.

Description of choice:

Key in a % value.

137 DC hold voltage

(DC HOLD VOLTAGE)

Value:

0 - 100% of max. DC hold voltage ★ 0%

Function:

This parameter is used to keep the motor (holding torque) at start/stop.

Description of choice:

This parameter can only be used if a selection has been made of *DC hold* in parameter 121 *Start function* or 122 *Function at stop*. To be set as a percentage value of the max. DC hold voltage, which depends on the choice of motor.

138 Brake cut out value

(BRAKE CUT OUT)

Value:

0.5 - 132.0/1000.0 Hz ★ 3.0 Hz

Function:

Here you can select the frequency at which the external brake is released, via the output defined in

parameter 323 *Relay output 1-3* or 341 *Digital output, terminal 46* (optionally also terminal 122 and 123).

Description of choice:

Set the required frequency.

139 Brake cut in frequency

(BRAKE CUT IN)

Value:

0.5 - 132.0/1000.0 Hz ★ 3.0 Hz

Function:

Here you can select the frequency at which the external brake is activated; this takes place via the output defined in parameter 323 *Relay output 1-3* or 341 *Digital output terminal 46* (Optionally also 122 and 123).

Description of choice:

Set the required frequency.

140 Current, minimum value

(CURRENT MIN VAL)

Value:

0 % - 100 % of inverter output current ★ 0 %

Function:

This is where the user selects the minimum motor current running for the mechanical brake to be released. Current monitoring is only active from stop until the point when the brake is released.

Description of choice:

This is an extra safety precaution, aimed at guaranteeing that the load is not lost during start of a lifting/lowering operation.

142 Leakage reactance X_L

(LEAK. REACTANCE)

Value:

0.000 - XXX,XXX Ω
★ Depends on choice of motor
 X_L is sum of rotor and stator leakage reactance.

Function:

After setting of parameters 102-106 *Nameplate data*, a number of adjustments of various parameter is made automatically, including the leakage reactance X_L . The shaft performance can be improved by fine-tuning the leakage reactance X_L .



NB!:

Parameter 142 *The leakage reactance X_L* is normally not to be changed if the nameplate data have been set, parameters 102-106.

Description of choice:

X_L can be set as follows:

1. The value is stated by the motor supplier.
2. Use the factory settings of X_L which the frequency converter itself chooses on the basis of the motor nameplate data.

144 Gain AC brake

(GAIN AC BRAKE)

Value:

1.00 - 1.50 ★ 1.30

Function:

This parameter is used to set the AC brake. Using par. 144 it is possible to adjust the size of the generator torque that can be applied to the motor without the intermediate circuit voltage exceeding the warning level.

Description of choice:

The value is increased if a greater possible brake torque is required. If 1.0 is selected, this corresponds to the AC brake being inactive.



NB!:

If the value in par. 144 is increased, the motor current will simultaneously increase significantly when generator loads are applied.

The parameter should therefore only be changed if it is guaranteed during measurement that the motor current in all operating situations will never exceed the maximum permitted current in the motor. *Please note:* that the current cannot be read out from the display.

146 Reset voltage vector

(RESET VECTOR)

Value:

*Off (OFF) [0]
Reset (RESET) [1]

Function:

When the voltage vector is reset it is set to the same starting point each time a new process commences.

Description of choice:

Select reset (1) when running unique processes each time they arise. This will enable repetitive precision

★ = factory setting. () = display text [] = value for use in communication via serial communication port

when stopping to be improved. Select Off (0) for example for lifting/lowering operations or synchronous motors. It is an advantage that the motor and the frequency converter are always synchronized.

147 Motor type**(MOTOR TYPE)****Value:**

*General (GENERAL)	[0]
Danfoss Bauer (DANFOSS BAUER)	[1]

Function:

This parameter selects the type of motor connected to the frequency converter.

Description of choice:

The value can be selected general for most motor brands. Select Danfoss Bauer for optimal settings for Danfoss Bauer gear motors.

References & Limits

200 Output frequency range (OUT FREQ. RNG/ROT)

Value:

- ★ Only clockwise, 0 - 132 Hz (132 HZ CLOCKWISE) [0]
- Both directions, 0 - 132 Hz (132 HZ BOTH DIRECT) [1]
- Anti-clockwise only, 0 - 132 Hz (132 HZ COUNTER CLOCK) [2]
- Clockwise only, 0 - 1000 Hz (1000 HZ CLOCK WISE) [3]
- Both directions, 0 - 1000 Hz (1000 HZ BOTH DIRECT) [4]
- Anti-clockwise only, 0 - 1000 Hz (1000 HZ COUNTER CLOCK) [5]

Function:

This parameter guarantees protection against unwanted reversing. Furthermore, the maximum output frequency can be selected that is to apply regardless of the settings of other parameters. This parameter has no function if *Process regulation, closed loop* has been selected in parameter 100 *Configuration*.

Description of choice:

Select the required direction of rotation as well as the maximum output frequency. Please note that if *Clockwise only* [0]/[3] or *Anti-clockwise only* [2]/[5] is selected, the output frequency will be limited to the range f_{MIN} - f_{MAX} . If *Both directions* [1]/[4] is selected, the output frequency will be limited to the range $\pm f_{MAX}$ (the minimum frequency is of no significance).

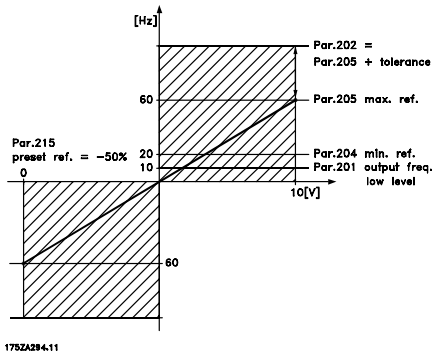

201 Output frequency low limit, f_{MIN} (MIN OUTPUT FREQ)

Value:

0.0 - f_{MAX} ★ 0.0 Hz

Function:

In this parameter, a minimum motor frequency limit can be selected that corresponds to the minimum speed at which the motor is allowed to run. If *Both directions* has been selected in parameter 200 *Output frequency range*, the minimum frequency is of no significance.

Description of choice:

The value chosen can range from 0.0 Hz to the frequency set in parameter 202 *Output frequency high limit, f_{MAX}* .

202 Output frequency high limit, f_{MAX} (MAX. OUTPUT FREQ)

Value:

f_{MIN} - 132/1000 Hz (par. 200 *Output frequency range*) ★ 132 Hz

Function:

In this parameter, a maximum output frequency limit can be selected that corresponds to the highest speed at which the motor is allowed to run.



NB!:

The output frequency of the frequency converter can never assume a value higher than 1/10 of the switching frequency (parameter 411 *Switching frequency*).

Description of choice:

A value can be selected from f_{MIN} to the value chosen in parameter 200 *Output frequency range*.

Handling of references

Handling of references is described in the block diagram below. The block diagram shows how a change in one parameter can affect the resulting reference.

Parameters 203 to 205 *Reference* and parameter 214 *Reference function* define how the handling of references can be performed. The parameters mentioned can be active in both closed and open loop.

Remote controlled references are defined as:

- External references, such as analogue inputs 53 and 60, pulse references via terminal 33 and references from serial communication.

★ = factory setting. () = display text [] = value for use in communication via serial communication port

- Preset references.

The resulting reference can be shown on the LCP control unit's display by selecting *Reference [%]* in parameters 009-012 *Display readout* and can be shown as one unit by selecting *Reference [unit]*.

The sum of the external references can be shown on the LCP control unit's display as a % of the area from *Minimum reference, Ref_{MIN}* to *Maximum reference, Ref_{MAX}*. Select *External reference, % [25]* in parameters 009-012 *Display readout* if a readout is desired.

It is possible to have both references and external references simultaneously. In parameter 214

Reference function a selection can be made to determine how preset references should be added to the external references.

There is also an independent local reference in parameter 003 *Local reference*, in which the resulting reference is set using the [+/-] keys. When the local reference has been selected, the output frequency range is limited by parameter 201 *Output frequency low limit, f_{MIN}* and parameter 202 *Output frequency high limit, f_{MAX}*.

The local reference unit depends on the selection in parameter 100 *Configuration*.

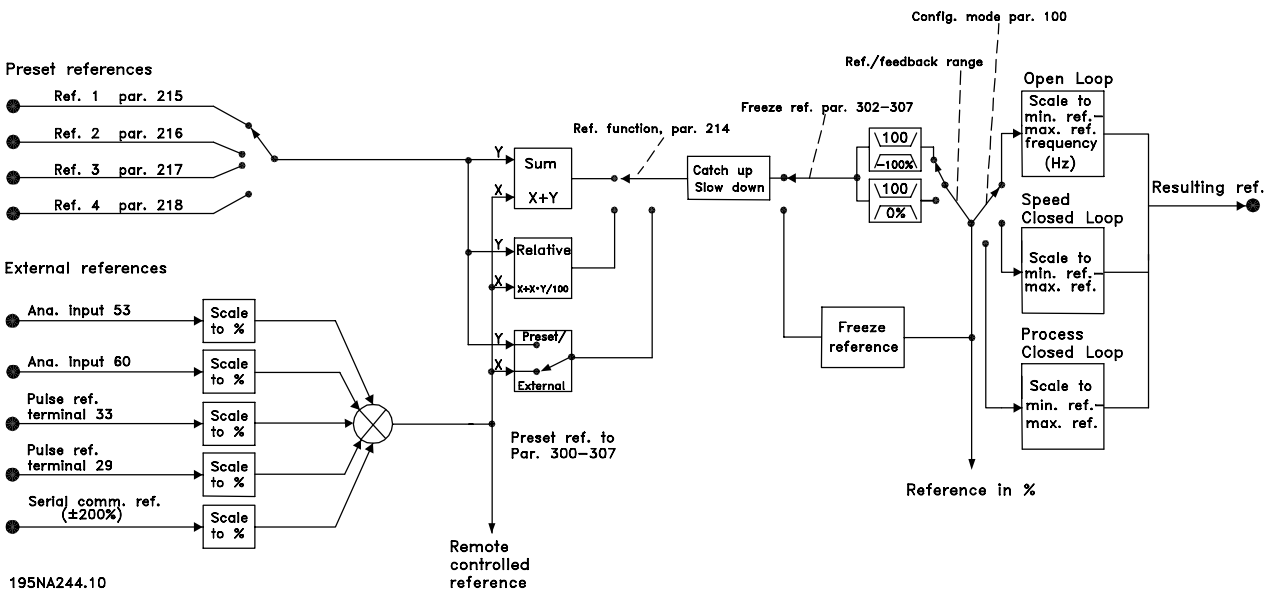

★ = factory setting. () = display text [] = value for use in communication via serial communication port

203 Reference range

(REFERENCE RANGE)

Value:

- ★Min. reference - Max reference (MIN - MAX) [0]
- Max. reference - Max. reference (-MAX - +MAX) [1]

Function:

In this parameter you select whether the reference signal must be positive or whether it can be both positive and negative. The minimum limit may be a negative value, unless in parameter 100 *Configuration* a selection has been made of *Speed regulation, closed loop*. You should select *Min ref. - Max. ref.* [0], if *Process regulation, closed loop* [3] has been selected in parameter 100 *Configuration*.

Description of choice:

Select the required range.

204 Minimum reference, Ref_{MIN}

(MIN.REFERENCE)

Value:

- Par. 100 *Config.* = *Open loop* [0].
- 100,000.000 - par. 205 *Ref_{MAX}* ★ 0.000 Hz

- Par. 100 *Config.* = *Closed loop* [1]/[3].
- Par. 414 *Minimum feedback* - par. 205 *Ref_{MAX}* ★ 0.000 rpm/par 416

Function:

Minimum reference is an expression of the minimum possible value of the total of all references. If in parameter 100 *Configuration*, *Speed regulation, closed loop* [1] or *Process regulation, closed loop* [3] is selected, the minimum reference is limited by parameter 414 *Minimum feedback*. Minimum reference is ignored if the local reference is active.

The reference unit can be defined from the following table:

Par. 100 <i>Configuration</i>	Unit
Open loop [0]	Hz
Speed reg, closed loop [1]	rpm
Process reg, closed loop [3]	Par. 416

Description of choice:

The minimum reference is preset if the motor has to run at a minimum speed, regardless of whether the resulting reference is 0.

205 Maximum reference, Ref_{MAX}

(MAX.REFERENCE)

Value:

- Par. 100 *Config.* = *Open loop* [0].
- Par. 204 *Ref_{MIN}* - 1000.000 Hz ★ 50.000 Hz

- Par. 100 *Config.* = *Closed loop* [1]/[3].
- Par. 204 *Ref_{MIN}* - Par. 415 *Max. feedback* ★ 50.000 rpm/par 416

Function:

The maximum reference gives the highest value that can be assumed by the sum of all references. If *Closed loop* [1]/[3] is selected in parameter 100 *Configuration* the maximum reference cannot exceed the value in parameter 415 *Maximum feedback*. Maximum reference is ignored if the local reference is active.

The reference unit can be defined from the following table:

Par. 100 <i>Configuration</i>	Unit
Open loop [0]	Hz
Speed reg, closed loop [1]	rpm
Process reg, closed loop [3]	Par. 416

Description of choice:

Maximum reference is set, if the speed of the motor is to be max. the set value, regardless of the whether the resulting reference is greater than the maximum reference.

206 Ramp type

(RAMP TYPE)

Value:

- ★Linear (LINEAR) [0]
- Sin shaped (SIN SHAPED) [1]
- Sin² shaped (S-SHAPED 2) [2]

Function:

You can choose between a linear, an S-shaped and an S² ramp process.

Description of choice:

Select the required ramp type depending on the required acceleration/deceleration process.

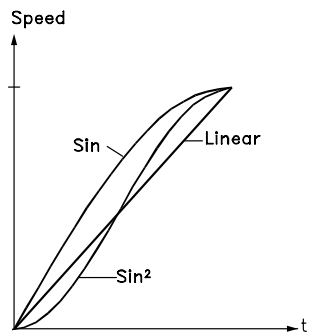

207 Ramp-up time 1

(RAMP-UP TIME 1)

Value:

0.02 - 3600.00 sec ★ 3.00 sec

Function:

The ramp-up time is the acceleration time from 0 Hz to the rated motor frequency $f_{M,N}$ (parameter 104 *Motor frequency*, $f_{M,N}$). It is assumed that the output current will not reach the current limit (set in parameter 221 *Current limit* I_{LIM}).

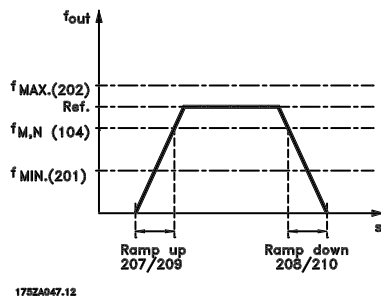

Description of choice:

Set the required ramp-up time.

208 Ramp-down time 1

(RAMP DOWN TIME 1)

Value:

0.02 - 3600.00 sec ★ 3.00 sec

Function:

The ramp-down time is the deceleration time from the rated motor frequency $f_{M,N}$ (parameter 104 *Motor frequency*, $f_{M,N}$) to 0 Hz, provided no overvoltage arises in the inverter because of generating operation of the motor.

Description of choice:

Set the required ramp-down time.

209 Ramp-up time 2

(RAMP UP TIME 2)

Value:

0.02 - 3600.00 sec ★ 3.00 sec

Function:

See description of parameter 207 *Ramp-up time 1*.

Description of choice:

Set the required ramp-up time. Shift from ramp 1 to ramp 2 by activating *Ramp 2* via a digital input.

210 Ramp-down time 2

(RAMP DOWN TIME 2)

Value:

0.02 - 3600.00 sec ★ 3.00 sec

Function:

See description of parameter 208 *Ramp-down time 1*.

Description of choice:

Set the required ramp-down time. Shift from ramp 1 to ramp 2 by activating *Ramp 2* via a digital input.

211 Jog ramp time

(JOG RAMP TIME)

Value:

0.02 - 3600.00 sec ★ 3.00 sec

Function:

The jog ramp time is the acceleration/deceleration time from 0 Hz to the rated motor frequency $f_{M,N}$ (parameter 104 *Motor frequency*, $f_{M,N}$). It is assumed that the output current will not reach the current limit (set in parameter 221 *Current limit* I_{LIM}).

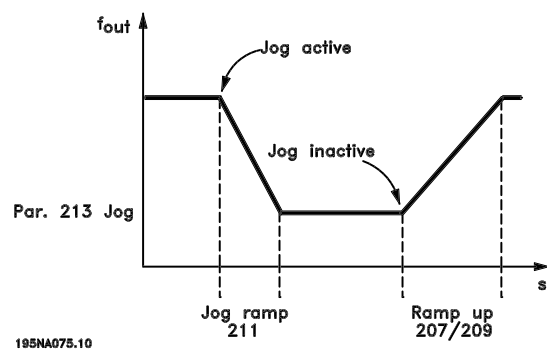

The jog ramp time starts if a jog-signal is given via the LCP control panel, one of the digital inputs or the serial communication port.

Description of choice:

Set the required ramp time.

212 Quick-stop ramp-down time

(Q STOP RAMP TIME)

Value:

0.02 - 3600.00 sec. ★ 3.00 sec

Function:

The quick-stop ramp-down time is the deceleration time from the rated motor frequency to 0 Hz, provided no overvoltage arises in the inverter because of generating operation of the motor, or if the generated current exceeds the current limit in parameter 221 *Current limit I_{LIM}*. Quick-stop is activated via one of the digital inputs or the serial communication.

Description of choice:

Set the required ramp-down time.

213 Jog frequency

(JOG FREQUENCY)

Value:

0.0 - Par. 202 Output frequency high limit, f_{MAX}
★ 10.0 Hz

Function:

Jog frequency f_{JOG} means a fixed output frequency that the frequency converter supplies to the motor when the Jog function is activated. Jog can be activated via the digital inputs, serial communication or via the LCP control panel, on the condition that this is active in parameter 015 *Local jog*.

Description of choice:

Set the required frequency.

Reference function

The example shows how the resulting reference is calculated when *Preset references* is used together with *Sum* and *Relative* in parameter 214 *Reference function*. The formula for the calculation of the resulting reference can be seen in the section entitled *All about the FCD 300*. See also the drawing in *Handling of references*.

The following parameters are preset:

Par. 204 <i>Minimum reference</i>	10 Hz
Par. 205 <i>Maximum reference</i>	50 Hz
Par. 215 <i>Preset reference</i>	15 %
Par. 308 <i>Term.53, Analogue input</i>	Reference
Par. 309 <i>Term.53, min. scaling</i>	0 V
Par. 310 <i>Term.53, max. scaling</i>	10 V

When parameter 214 *Reference function* is set to *Sum* [0] one of the preset *Preset references*(par. 215-218) is added to the external references as a percentage of the reference range. If terminal 53 is applied an analogue input voltage of 4 Volt will be the resulting reference:

Par. 214 *Reference function* = Sum [0]:

Par. 204 <i>Minimum reference</i>	10.0 Hz
Reference contribution at 4 Volt	16.0 Hz
Par. 215 <i>Preset reference</i>	6.0 Hz
Resulting reference	32.0 Hz

When parameter 214 *Reference function* is set to *Relative* [1] the defined *Preset references* (par. 215-218) are added as a percentage of the total of the present external references. If terminal 53 is applied to an analogue input voltage of 4 Volt the resulting reference will be:

Par. 214 *Reference function* = Relative [1]:

Par. 204 <i>Minimum reference</i>	10.0 Hz
Reference effect at 4 Volt	16.0 Hz
Par. 215 <i>Preset reference</i>	2.4 Hz
Resulting reference	28.4 Hz

The graph shows the resulting reference in relation to the external reference, which varies from 0-10 Volt. Parameter 214 *Reference function* is programmed to *Sum* [0] and *Relative* [1] respectively. Also shown is a graph in which parameter 215 *Preset reference 1* is programmed to 0 %.

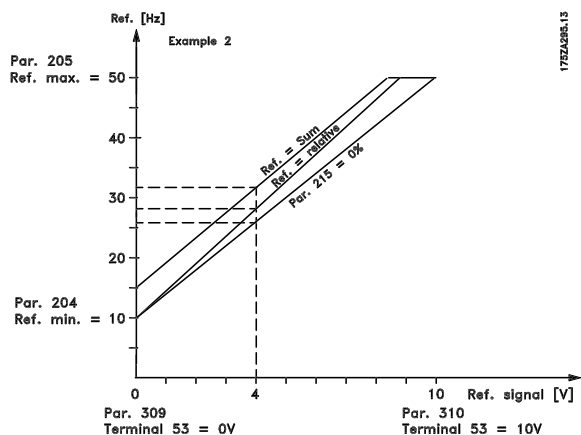

★ = factory setting. () = display text [] = value for use in communication via serial communication port

214 Reference function (REF FUNCTION)

Value:

★Sum (SUM)	[0]
Relative (RELATIVE)	[1]
External/preset (EXTERNAL/PRESET)	[2]

Function:

It is possible to define how preset references are to be added to the other references; for this purpose, use *Sum* or *Relative*. It is also possible by using the *External/preset* to select whether a shift between external references and preset references is required. External reference is the sum of the analogue references, pulse references and any references from serial communication.

Description of choice:

If *Sum* [0] is selected, one of the adjusted preset references (parameters 215-218 *Preset reference*) is summarized as a percentage of the reference range ($Ref_{MIN} - Ref_{MAX}$), added to the other external references.

If *Relative* [1] is selected, one of the added preset references (parameters 215-218 *Preset reference*) is summarized as a percentage of the sum of present external references.

If *External/preset* [2] is selected, it is possible via a digital input to shift between external references or preset references. Preset references will be a percentage value of the reference range.



NB!:

If *Sum* or *Relative* is selected, one of the preset references will always be active. If the preset references are to be without influence, they must be set to 0% (factory setting).

215 Preset reference 1 (PRESET REF. 1)

216 Preset reference 2 (PRESET REF. 2)

217 Preset reference 3 (PRESET REF. 3)

218 Preset reference 4 (PRESET REF. 4)

Value:

-100.00% - +100.00% ★ 0.00%
of the reference range/external reference

Function:

Four different preset references can be programmed in parameters 215-218 *Preset reference*. The preset reference is stated as a percentage of the reference range ($Ref_{MIN} - Ref_{MAX}$) or as a percentage of the other external references, depending on the choice made in parameter 214 *Reference function*.

The choice between preset references can be made via the digital inputs or via serial communication.

Preset ref., msb	Preset ref. lsb	
0	0	Preset ref. 1
0	1	Preset ref. 2
1	0	Preset ref. 3
1	1	Preset ref. 4

Description of choice:

Set the preset reference(s) that is/are to be the options.

219 Catch up/ Slow down reference (CATCH UP/SLW DWN)

Value:

0.00 - 100% of the given reference ★ 0.00%

Function:

In this parameter, the percentage value can be set which will either be added to or deducted from the remote-controlled references.

The remote-controlled reference is the sum of preset references, analogue references, pulse reference and any references from serial communication.

Description of choice:

If *Catch up* is active via a digital input, the percentage value in parameter 219 *Catch up/Slow down reference* will be added to the remote-controlled reference.

If *Slow down* is active via a digital input, the percentage value in parameter 219 *Catch up/Slow down reference* will be deducted from the remote-controlled reference.

221 Current limit, I_{LIM} (CURRENT LIMIT)

Value:

0 - XXX.X % of par. 105 ★ 160 %

Function:

In this parameter, the maximum output current I_{LIM} is set. The factory-set value corresponds to the maximum output current I_{MAX} . If the current limit is to be used as motor protection, set the rated motor current. If the current limit is set above 100% (the rated output current of the frequency converter, I_{INV}), the frequency converter can only handle a load intermittently, i.e. for short periods at a time. After the load has been higher than I_{INV} , it must be ensured that for a period the load is lower than I_{INV} . Please note that if the current limit is set at a lower value than I_{INV} , the acceleration torque will be reduced to the same extent.

★ = factory setting. () = display text [] = value for use in communication via serial communication port

Description of choice:

Set the required maximum output current I_{LIM} .

223 Warning: Low current, I_{LOW}

(WARN. CURRENT LO)

Value:

0.0 - par. 224 *Warning: High current, I_{HIGH}* ★ 0.0 A

Function:

If the output current falls below the preset limit I_{LOW} a warning is given. Parameters 223-228 *Warning functions* are out of function during ramp-up after a start command and after a stop command or during stop. The warning functions are activated when the output frequency has reached the resulting reference. The signal outputs can be programmed to give a warning signal via terminal 46 and via the relay output.

Description of choice:

The lower signal limit of the output current I_{LOW} must be programmed within the normal working range of the frequency converter.

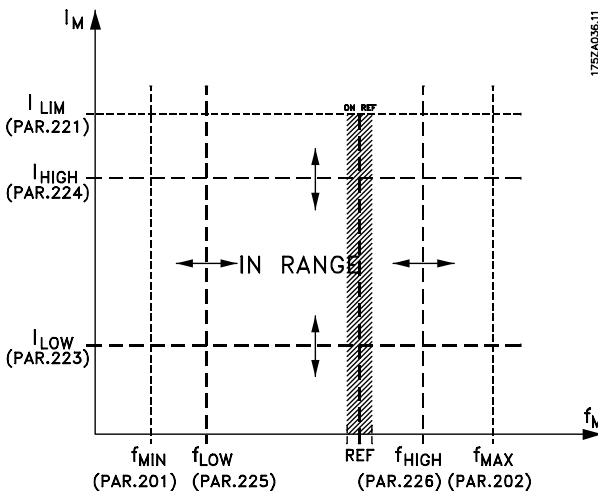

224 Warning: High current, I_{HIGH}

(WARN. CURRENT HI)

Value:

0 - I_{MAX} ★ I_{MAX}

Function:

If the output current exceeds the preset limit I_{HIGH} a warning is given. Parameters 223-228 *Warning functions* do not work during ramp-up after a start command and after stop command or during stop. The warning functions are activated when the output frequency has reached the resulting reference. The signal

★ = factory setting. () = display text [] = value for use in communication via serial communication port

outputs can be programmed to give a warning signal via terminal 46 and via the relay output.

Description of choice:

The output current's upper signal limit I_{HIGH} must be programmed within the frequency converter's normal operating range. See drawing at parameter 223 *Warning: Low current, I_{LOW}* .

225 Warning: Low frequency, f_{LOW}

(WARN.FREQ. LOW)

Value:

0.0 - par. 226

Warn.: High frequency, f_{HIGH} ★ 0.0 Hz

Function:

If the output frequency falls below the preset limit f_{LOW} , a warning is given. Parameters 223-228 *Warning functions* are out of function during ramp-up after a start command and after stop command or during stop. The warning functions are activated when the output frequency has reached the resulting reference. The signal outputs can be programmed to give a warning signal via terminal 46 and via the relay output.

Description of choice:

The lower signal limit of the output frequency f_{LOW} must be programmed within the normal operating range of the frequency converter. See drawing at parameter 223 *Warning: Low current, I_{LOW}* .

226 Warning: High frequency f_{HIGH}

(WARN.FREQ.HIGH)

Value:

Par. 200 *Frequency range* = 0-132 Hz [0]/[1].

par. 225 f_{LOW} - 132 Hz ★ 132.0 Hz

Par. 200 *Frequency range* = 0-1000 Hz [2]/[3].

par. 225 f_{LOW} - 1000 Hz ★ 132.0 Hz

Function:

If the output frequency exceeds the preset limit f_{HIGH} a warning is given. Parameters 223-228 *Warning functions* do not work during ramp-up after a start command and after stop command or during stop. The warning functions are activated when the output frequency has reached the resulting reference. The signal

outputs can be programmed to give a warning signal via terminal 46 and via the relay output.

Description of choice:

The output frequency's upper signal limit f_{HIGH} must be programmed within the frequency converter's normal operating range. See drawing at parameter 223 *Warning: Low current, I_{LOW}* .

227 Warning: Low feedback, FB_{LOW}
(WARN.FEEDB. LOW)
Value:

-100,000.000 - par. 228 *Warn.: FB_{HIGH}* ★ -4000.000

Function:

If the feedback signal falls below the preset limit FB_{LOW} , a warning is given. Parameters 223-228 *Warning functions* are out of function during ramp-up after a start command and after a stop command or during stop. The warning functions are activated when the output frequency has reached the resulting reference. The signal outputs can be programmed to give a warning signal via terminal 46 and via the relay output. The unit for feedback in Closed loop is programmed in parameter 416 *Process units*.

Description of choice:

Set the required value within the feedback range (parameter 414 *Minimum feedback, FB_{MIN}* and 415 *Maximum feedback, FB_{MAX}*).

228 Warning: High feedback, FB_{HIGH}
(WARN.FEEDB HIGH)
Value:

Par. 227 *Warn.: FB_{LOW}* - 100,000.000★ 4000.000

Function:

If the feedback signal gets above the preset limit FB_{HIGH} , a warning is given. Parameters 223-228 *Warning functions* are out of function during ramp-up after a start command and after a stop command or during stop. The warning functions are activated when the output frequency has reached the resulting reference. The signal outputs can be programmed to give a warning signal via terminal 46 and via the relay output. The unit for feedback in Closed loop is programmed in parameter 416 *Process units*.

Description of choice:

Set the required value within the feedback range (parameter 414 *Minimum feedback, FB_{MIN}* and 415 *Maximum feedback, FB_{MAX}*).

229 Frequency bypass, bandwidth
(FREQ BYPASS B.W.)
Value:

0 (OFF) - 100 Hz ★ 0 Hz

Function:

Some systems call for some output frequencies to be avoided because of mechanical resonance problems in the system. In parameters 230-231 *Frequency bypass* these output frequencies can be programmed. In this parameter a bandwidth can be defined on either side of these frequencies.

Description of choice:

The frequency set in this parameter will be centered around parameters 230 *Frequency bypass 1* and 231 *Frequency bypass 2*.

230 Frequency bypass 1 (FREQ. BYPASS 1)
231 Frequency bypass 2 (FREQ. BYPASS 2)
Value:

0 - 1000 Hz ★ 0.0 Hz

Function:

Some systems call for some output frequencies to be avoided because of mechanical resonance problems in the system.

Description of choice:

Enter the frequencies to be avoided. See also parameter 229 *Frequency bypass, bandwidth*.

★ = factory setting. () = display text [] = value for use in communication via serial communication port

■ Inputs and outputs

Digital inputs	Term. no.	18	19	27	29	33
	par. no.	302	303	304	305	307
Value:						
No function	(NO OPERATION)	[0]	[0]	[0]	[0]	★[0]
Reset	(RESET)	[1]	[1]	[1]	[1]	[1]
Coasting stop inverse	(MOTOR COAST INVERSE)	[2]	[2]	[2]	[2]	[2]
Reset and coasting inverse	(RESET AND COAST INV.)	[3]	[3]	★[3]	[3]	[3]
Quick-stop inverse	(QUICK-STOP INVERSE)	[4]	[4]	[4]	[4]	[4]
DC braking inverse	(DC-BRAKE INVERSE)	[5]	[5]	[5]	[5]	[5]
Stop inverse	(STOP INVERSE)	[6]	[6]	[6]	[6]	[6]
Start	(START)	★[7]	[7]	[7]	[7]	[7]
Pulse start	(LATCHED START)	[8]	[8]	[8]	[8]	[8]
Reversing	(REVERSING)	[9]	★[9]	[9]	[9]	[9]
Reversing and start	(START REVERSING)	[10]	[10]	[10]	[10]	[10]
Start clockwise	(ENABLE FORWARD)	[11]	[11]	[11]	[11]	[11]
Start anti-clockwise	(ENABLE REVERSE)	[12]	[12]	[12]	[12]	[12]
Jog	(JOGGING)	[13]	[13]	[13]	★[13]	[13]
Freeze reference	(FREEZE REFERENCE)	[14]	[14]	[14]	[14]	[14]
Freeze output frequency	(FREEZE OUTPUT)	[15]	[15]	[15]	[15]	[15]
Speed up	(SPEED UP)	[16]	[16]	[16]	[16]	[16]
Speed down	(SPEED DOWN)	[17]	[17]	[17]	[17]	[17]
Catch-up	(CATCH-UP)	[19]	[19]	[19]	[19]	[19]
Slow-down	(SLOW-DOWN)	[20]	[20]	[20]	[20]	[20]
Ramp 2	(RAMP 2)	[21]	[21]	[21]	[21]	[21]
Preset ref, LSB	(PRESET REF, LSB)	[22]	[22]	[22]	[22]	[22]
Preset ref, MSB	(PRESET REF, MSB)	[23]	[23]	[23]	[23]	[23]
Preset reference on	(PRESET REFERENCE ON)	[24]	[24]	[24]	[24]	[24]
Precise stop, inverse	(PRECISE STOP INV.)	[26]	[26]			
Precise start/stop	(PRECISE START/STOP)	[27]	[27]			
Pulse reference	(PULSE REFERENCE)				[28] ¹	[28]
Pulse feedback	(PULSE FEEDBACK)				[29] ¹	[29]
Pulse input	(PULSE INPUT)					[30]
Selection of Setup, lsb	(SETUP SELECT LSB)	[31]	[31]	[31]	[31]	[31]
Selection of Setup, msb	(SETUP SELECT MSB)	[32]	[32]	[32]	[32]	[32]
Reset and start	(RESET AND START)	[33]	[33]	[33]	[33]	[33]
Encoder reference	(ENCODER REFERENCE)				[34] ²	[34] ²
Encoder feedback	(ENCODER FEEDBACK)				[35] ²	[35] ²
Encoder input	(ENCODER INPUT)				[36] ²	[36] ²

¹ Cannot be selected if *Pulse output* is selected in par. 341 *Digital output terminal 46*.

² Settings are identical for terminal 29 and 33.

Function:

In these parameters 302-307 *Digital inputs* it is possible to choose between the different enabled functions related to the digital inputs (terminals 18-33).

Description of choice:

No operation is selected if the frequency converter is not to react to signals transmitted to the terminal.

Reset resets the frequency converter after an alarm; however, a few alarms cannot be reset (trip locked) without first disconnecting the mains supply and reconnecting it. See table under *List of warnings and alarms*. Reset is activated on the leading edge of the signal.

Coasting stop inverse is used for making the frequency converter "let go" of the motor immediately (output transistors are "turned off"), which means that the motor runs freely to stop. Logic '0' leads to coasting to stop.

Reset and coasting inverse are used to activate motor coast simultaneously with reset. Logical '0' means motor coast stop and reset. Reset is activated on the falling edge.

Quick stop inverse is used for activating the quick-stop ramp down set in parameter 212 *Quick stop ramp-down time*. Logic '0' leads to quick stop.

DC-braking inverse is used for stopping the motor by energizing it with a DC voltage for a given time, see parameters 126, 127 and 132 *DC brake*. Please note that this function is only active if the value in parameter 126 *DC braking time* and 132 *DC brake voltage* is different from 0. Logic '0' leads to DC braking.

Stop inverse, a logic '0' means that the motor speed is ramped down to stop via the selected ramp.



None of the stop commands mentioned above are to be used as repair switches. Check that all voltage inputs are disconnected and that the prescribed time (4 mins.) has passed before repair work is commenced.

Start is selected if a start/stop command is required. Logic '1' = start, logic '0' = stop.

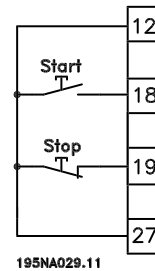

195NA029.11

Latched start, if a pulse is applied for min. 14 ms, the frequency converter will start the motor, provided no stop command has been given. The motor can be stopped by briefly activating *Stop inverse*.

Reversing is used for changing the direction of rotation of the motor shaft. Logic '0' will not lead to reversing. Logic '1' will lead to reversing. The reverse signal only changes the direction of rotation, it does not activate the start. Is not active at *Process regulation, closed loop*. See also parameter 200 *Output frequency range/direction*.

Reversing and start is used for start/stop and for reversing with the same signal. No active start command is allowed at the same time. Is not active for *Process regulation, closed loop*. See also parameter 200 *Output frequency range/direction*.

Start clockwise is used if you want the motor shaft only to be able to rotate clockwise when started. Should not be used for *Process regulation, closed loop*.

Start anticlockwise is used if you want the motor shaft only to be able to rotate anticlockwise when started. Should not be used for *Process regulation, closed loop*. See also parameter 200 *Output frequency range/direction*.

Jog is used to override the output frequency to the jog frequency set in parameter 213 *Jog frequency*. Jog is active regardless of whether a start command has been given, yet not when *Coast stop, Quick-stop* or *DC braking* are active.

Freeze reference freezes the present reference. The reference can now only be changed via *Speed up* and *Speed down*. If *freeze reference* is active, it will be saved after a stop command and in the event of mains failure.

Freeze output freezes the present output frequency (in Hz). The output frequency can now only be changed via *Speed up* and *Speed down*.



NB!

If *Freeze output* is active the frequency converter can only be stopped if you select *Motor coast*, *Quick stop* or *DC braking* via a digital input.

Speed up and *Speed down* are selected if digital control of the up/down speed is required. This function is only active if *Freeze reference* or *Freeze output frequency* has been selected.

If *Speed up* is active the reference or output frequency will be increased, and if *Speed down* is active the reference or output frequency will be reduced. The output frequency is changed via the preset ramp times in parameters 209-210 *Ramp 2*.

One pulse (logic '1' minimum high for 14 ms and a minimum break time of 14 ms) will lead to a speed change of 0.1 % (reference) or 0.1 Hz (output frequency). Example:

Term.	Term.	Freeze ref/ freeze outp.	Function
29	33		
0	0	1	No speed change
0	1	1	Speed up
1	0	1	Speed down
1	1	1	Speed down

Freeze reference can be changed even if the frequency converter has stopped. The reference will also be saved if the mains are disconnected

Catch-up/Slow-down is selected if the reference value is to be increased or reduced by a programmable percentage value set in parameter 219 *Catch-up/Slow-down reference* .

Slow-down	Catch-up	Function
0	0	Unchanged speed
0	1	Increase by % value
1	0	Reduce by % value
1	1	Reduce by % value

Ramp 2 is selected if a shift between ramp 1 (parameters 207-208) and ramp 2 (parameters 209-210) is required. Logic '0' leads to ramp 1 and logic '1' leads to ramp 2.

Preset reference, lsb and *Preset reference, msb* makes it possible to select one of the four preset references, see the table below:

Preset ref. msb	Preset ref. lsb	Function
0	0	Preset ref. 1
0	1	Preset ref. 2
1	0	Preset ref. 3
1	1	Preset ref. 4

Preset reference on is used for shifting between remote-controlled reference and preset reference. It is assumed that External/preset [2] has been selected in parameter 214 *Reference function*. Logic '0' = remote-controlled references are active, logic '1' = one of the four preset references is active, as can be seen from the table above.

Precise stop, inverse is selected to obtain a high degree of accuracy when a stop command is repeated. A logic 0 means that the motor speed is ramped down to stop via the selected ramp.

Precise start/stop is selected to obtain a high degree of accuracy when a start and stop command is repeated.

Pulse reference is selected if the reference signal applied is a pulse train (frequency). 0 Hz corresponds to parameter 204 *Minimum reference, Ref_{MIN}*. The frequency set in parameter 327/328 *Pulse Max 33/29* corresponds to parameter 205 *Maximum reference Ref_{MAX}*.

Pulse feedback is selected if the feedback signal used is a pulse train (frequency). In parameter 327/328 *Pulse Max 33/29* the maximum pulse feedback frequency is set.

Pulse input is selected if a specific number of pulses must lead to a *Precise stop*, see parameter 343 *Precise stop* and parameter 344 *Counter value*.

Selection of Setup, lsb and *Selection of Setup, msb* gives the possibility to select one of the four setups. It is, however, a condition that parameter 004 is set to *Multisetup*.

Reset and start can be used as a start function. If 24 V are connected to the digital input, this will cause the frequency converter to reset and the motor will ramp up to the preset reference.

Encoder reference is selected if the reference signal applied is a pulse train (frequency). 0 Hz corresponds to parameter 204 *Minimum reference, Ref_{MIN}*. The frequency set in parameter 327/328 *Pulse Max 33/29* corresponds to parameter 205 *Maximum reference Ref_{MAX}*.

Encoder feedback is selected if the feedback signal used is a pulse train (frequency). In parameter 327/328 *Pulse Max 33/29* the maximum pulse feedback frequency is set.

Encoder input is selected if a specific number of pulses must lead to a *Precise stop*, see parameter 343 *Precise stop* and parameter 344 *Counter value*.

★ = factory setting. () = display text [] = value for use in communication via serial communication port

All encoder settings are used in connection with dual track encoders with direction recognition.
 A track connected to terminal 29.
 B track connected to terminal 33.

308 Terminal 53, analogue input voltage
(AI [V]53FUNCT.)
Value:

No function (NO OPERATION)	[0]
★Reference (REFERENCE)	[1]
Feedback (FEEDBACK)	[2]
Wobble (WOBB.DELTA FREQ [%])	[10]

Function:

In this parameter it is possible to select the function required to be connected to terminal 53. Scaling of the input signal is made in parameter 309 *Terminal 53, min. scaling* and parameter 310 *Terminal 53, max. scaling*.

Description of choice:

No function [0]. Is selected if the frequency converter is not to react to signals connected to the terminal.
Reference [1]. If this function is selected, the reference can be changed by means of an analogue reference signal. If reference signals are connected to more than one input, these reference signals must be added up. If a voltage feedback signal is connected, select *Feedback* [2] on terminal 53.
Wobble [10]

The delta frequency can be controlled by the analog input. If *WOBB.DELTA FREQ* is selected as analog input (par. 308 or par. 314) the value selected in par. 702 equals 100 % analog input.

Example: Analog input = 4-20 mA, Delta freq. par. 702 = 5 Hz → 4 mA = 0 Hz and 20 mA = 5 Hz.

If this function is chosen, see Wobble Instruction MI28JXYY for further information.

309 Terminal 53 Min. scaling
(AI 53 SCALE LOW)
Value:

0.0 - 10.0 Volt ★ 0.0 Volt

Function:

This parameter is used for setting the signal value that is to correspond to the minimum reference or the minimum feedback, parameter 204 *Minimum reference, Ref_{MIN}* / 414 *Minimum feedback, FB_{MIN}*.

Description of choice:

Set the required voltage value. For reasons of accuracy, compensation should be made for voltage loss in long signal cables. If the Time out function is to be used (parameter 317 *Time out* and 318 *Function after time out*), the value set must be higher than 1 Volt.

310 Terminal 53 Max. scaling
(AI 53 SCALE HIGH)
Value:

0 - 10.0 Volt ★ 10.0 Volt

Function:

This parameter is used for setting the signal value that is to correspond to the maximum reference value or maximum feedback, parameter 205 *Maximum reference, Ref_{MAX}* / 414 *Maximum feedback, FB_{MAX}*.

Description of choice:

Set the required voltage value. For reasons of accuracy, compensation should be made for voltage losses in long signal cables.

314 Terminal 60, analogue input current
(AI [MA] 60 FUNCT)
Value:

No function (NO OPERATION)	[0]
Reference (REFERENCE)	[1]
★Feedback (FEEDBACK)	[2]
Wobble (WOBB.DELTA FREQ [%])	[10]

Function:

This parameter allows a choice between the different functions available for the input, terminal 60. Scaling of the input signal is effected in parameter 315 *Terminal 60, min. scaling* and parameter 316 *Terminal 60, max. scaling*.

Description of choice:

No function [0]. Is selected if the frequency converter is not to react to signals connected to the terminal.
Reference [1]. If this function is selected, the reference can be changed by means of an analogue reference signal. If reference signals are connected to more than one input, these reference signals must be added up. If one current feedback signal is connected, select *Feedback* [2] on terminal 60.
Wobble [10]

★ = factory setting. () = display text [] = value for use in communication via serial communication port

The delta frequency can be controlled by the analog input. If *WOBB.DELTA FREQ* is selected as analog input (par. 308 or par. 314) the value selected in par. 702 equals 100 % analog input.

Example: Analog input = 4-20 mA, Delta freq. par. 702 = 5 Hz → 4 mA = 0 Hz and 20 mA = 5 Hz. If this function is chosen, see Wobble Instruction MI28JXYY for further information.

315 Terminal 60 Min. scaling (AI 60 SCALE LOW)

Value:

0.0 - 20.0 mA ★ 4.0 mA

Function:

In this parameter you can set the signal value that will correspond to the minimum reference or minimum feedback, parameter 204 *Minimum reference*, Ref_{MIN} / 414 *Minimum feedback*, FB_{MIN} .

Description of choice:

Set the required current value. If the Time out function is to be used (parameter 317 *Time out* and 318 *Function after time out*) the value set must be higher than 2 mA.

316 Terminal 60 Max. scaling (AI 60 SCALE HIGH)

Value:

0.0 - 20.0 mA ★ 20.0 mA

Function:

This parameter is used for setting the signal value that is to correspond to the maximum reference value, parameter 205 *Maximum reference value*, Ref_{MAX} .

Description of choice:

Set the required current value.

317 Time out (LIVE ZERO TIME O)

Value:

1 - 99 sec. ★ 10 sec.

Function:

If the signal value of the reference or feedback signal connected to one of the input terminals 53 or 60 falls below 50 % of the minimum scaling for a period longer than the time set, the function selected in parameter 318 *Function after time out* will be activated. This

★ = factory setting. () = display text [] = value for use in communication via serial communication port

function is only active if in parameter 309 *Terminal 53, min. scaling* a value higher than 1 Volt has been selected, or if in parameter 315 *Terminal 60, min. scaling* a value higher than 2 mA has been selected.

Description of choice:

Set the required time.

318 Function after time out (LIVE ZERO FUNCT.)

Value:

- ★No operation (NO OPERATION) [0]
- Freeze output frequency (FREEZE OUTPUT FREQ.) [1]
- Stop (STOP) [2]
- Jog (JOG) [3]
- Max. speed (MAX SPEED) [4]
- Stop and trip (STOP AND TRIP) [5]

Function:

This parameter allows a choice of the function to be activated after the expiry of the Time out (parameter 317 *Time out*). If a time-out function occurs at the same time as a bus time-out function (parameter 513 *Bus time interval function*), the time-out function in parameter 318 will be activated.

Description of choice:

- The output frequency of the frequency converter can be:
- frozen at the present frequency [1]
 - overruled to stop [2]
 - overruled to jog frequency [3]
 - overruled to max. output frequency [4]
 - overruled to stop with subsequent trip [5]

319 Analogue output terminal 42 (AO 42 FUNCTION)

Value:

- No function (NO OPERATION) [0]
- External reference min.-max. 0-20 mA (REF MIN-MAX = 0-20 MA) [1]
- External reference min.-max. 4-20 mA (REF MIN-MAX = 4-20 MA) [2]
- Feedback min.-max. 0-20 mA (FB MIN-MAX = 0-20 MA) [3]
- Feedback min.-max. 4-20 mA (FB MIN-MAX = 4-20 MA) [4]
- Output frequency 0-max 0-20 mA (O-FMAX = 0-20 MA) [5]
- Output frequency 0-max 4-20 mA (O-FMAX = 4-20 MA) [6]

★Output current 0-I _{INV} 0-20 mA (0-I _{INV} = 0-20 MA)	[7]
Output current 0-I _{INV} 4-20 mA (0-I _{INV} = 4-20 MA)	[8]
Output power 0-P _{M,N} 0-20 mA (0-P _{NOM} = 0-20 MA)	[9]
Output power 0-P _{M,N} 4-20 mA (0-P _{NOM} = 4-20 MA)	[10]
Inverter temperature 20-100 °C 0-20 mA (TEMP 20-100 C=0-20 MA)	[11]
Inverter temperature 20-100 °C 4-20 mA (TEMP 20-100 C=4-20 MA)	[12]

Function:

The analogue output can be used for stating a process value. It is possible to choose two types of output signals 0 - 20 mA or 4 - 20 mA. If used as a voltage output (0 - 10 V), a pull-down resistor of 500 Ω must be fitted to common (terminal 55). If the output is used as a current output the resulting resistance from the equipment connected may not exceed 500 Ω.

Description of choice:

No function. Is selected if the analogue output is not to be used.

External Ref_{MIN} - Ref_{MAX} 0-20 mA/4-20 mA.

An output signal is obtained, which is proportional to the resulting reference value in the interval Minimum reference, Ref_{MIN} - Maximum reference, Ref_{MAX} (parameters 204/205).

FB_{MIN}-FB_{MAX} 0-20 mA/ 4-20 mA.

An output signal is obtained, which is proportional to the feedback value in the interval Minimum feedback, FB_{MIN} - Maximum feedback, FB_{MAX} (parameter 414/415).

0-f_{MAX} 0-20 mA/4-20 mA.

An output signal is obtained, which is proportional to the output frequency in the interval 0 - f_{MAX} (parameter 202 *Output frequency, high limit, f_{MAX}*).

0 - I_{INV} 0-20 mA/4-20 mA.

An output signal is obtained, which is proportional to the output current in the interval 0 - I_{INV}

0 - P_{M,N} 0-20 mA/4-20 mA.

An output signal is obtained, which is proportional to the present output power. 20 mA corresponds to the value set in parameter 102 *Motor power, P_{M,N}*.

0 - Temp._{MAX} 0-20 mA/4-20 mA.

An output signal is obtained, which is proportional to the present heatsink temperature. 0/4 mA corresponds to a heatsink temperature of less than 20 °C, and 20 mA corresponds to 100 °C.

323 Relay output 1-3
(RELAY 1-3 FUNCT.)
Value:

★No function (NO OPERATION)	[0]
Unit ready (UNIT READY)	[1]
Enable/no warning (ENABLE/NO WARNING)	[2]
Running (RUNNING)	[3]
Running in reference, no warning (RUN ON REF/NO WARN)	[4]
Running, no warnings (RUNNING/NO WARNING)	[5]
Running in reference range, no warnings (RUN IN RANGE/ NO WARN)	[6]
Ready - mains voltage within range (RDY NO OVER/UNDERVOL)	[7]
Alarm or warning (ALARM OR WARNING)	[8]
Current higher than current limit, par. 221 (CURRENT LIMIT)	[9]
Alarm (ALARM)	[10]
Output frequency higher than f _{LOW} par. 225 (ABOVE FREQUENCY LOW)	[11]
Output frequency lower than f _{HIGH} par. 226 (BELOW FREQUENCY HIGH)	[12]
Output current higher than I _{LOW} par. 223 (ABOVE CURRENT LOW)	[13]
Output current lower than I _{HIGH} par. 224 (BELOW CURRENT HIGH)	[14]
Feedback higher than FB _{LOW} par. 227 (ABOVE FEEDBACK LOW)	[15]
Feedback lower than FB _{HIGH} par. 228 (UNDER FEEDBACK HIGH)	[16]
Relay 123 (RELAY 123)	[17]
Reversing (REVERSE)	[18]
Thermal warning (THERMAL WARNING)	[19]
Local operation (LOCAL MODE)	[20]
Out of frequency range par. 225/226 (OUT OF FREQ RANGE)	[22]
Out of current range (OUT OF CURRENT RANGE)	[23]
Out of feedback range (OUT OF FDBK. RANGE)	[24]
Mechanical brake control (MECH. BRAKE CONTROL)	[25]

★ = factory setting. () = display text [] = value for use in communication via serial communication port

Control word bit 11
(CTRL W. BIT 11) [26]

Function:

The relay output can be used for giving the present status or warning. The output is activated (1–2 make) when a given condition is fulfilled.

Description of choice:

No function. Is selected if the frequency converter is not to react to signals.

Unit ready, there is a supply voltage on the control card of the frequency converter, and the frequency converter is ready for operation.

Enable, no warning, the frequency converter is ready for operation, but no start command has been given. No warning.

Running, a start command has been given.

Running in reference, no warning speed according to reference.

Running, no warning, a start command has been given. No warning.

Ready - mains voltage within range, the frequency converter is ready for use; the control card is receiving a supply voltage; and there are no active control signals on the inputs. The mains voltage lies within the voltage limits.

Alarm or warning, the output is activated by an alarm or warning.

Current limit, the output current is higher than the value programmed in parameter 221 Current limit I_{LIM} .

Alarm, The output is activated by an alarm.

Output frequency higher than f_{LOW} , the output frequency is higher than the value set in parameter 225 *Warning: Low frequency, f_{LOW} .*

Output frequency lower than f_{HIGH} , the output frequency is lower than the value set in parameter 226 *Warning: High frequency, f_{HIGH} .*

Output current higher than I_{LOW} , the output current is higher than the value set in parameter 223 *Warning: Low current, I_{LOW} .*

Output current lower than I_{HIGH} , the output current is lower than the value set in parameter 224 *Warning: High current, I_{HIGH} .*

Feedback higher than FB_{LOW} , the feedback value is higher than the value set in parameter 227 *Warning: Low feedback, FB_{LOW} .*

Feedback lower than FB_{HIGH} , the feedback value is lower than the value set in parameter 228 *Warning: High current, I_{HIGH} .*

Relay 123 is only used in connection with Profidrive.

Reversing, The relay output is activated when the direction of motor rotation is anti-clockwise. When the direction of motor rotation is clockwise, the value is 0 V DC.

Thermal warning, above the temperature limit in either the motor or the frequency converter, or from a thermistor connected to a digital input.

Local operation, the output is active when in parameter 002 *Local/remote operation, Local operation* [1] has been selected.

Out of the frequency range, the output frequency is out of the programmed frequency range in parameters 225 and 226.

Out of the current range, the motor current is out of the programmed range in parameters 223 and 224.

Out of the feedback range, the feedback signal is out of the programmed range in parameters 227 and 228.

Mechanical brake control, enables you to control an external mechanical brake (see section about control of mechanical brake in the Design Guide).

Control word bit 11, bit 11 of the control word, the relay output will be set/reset according to bit 11.

327 Pulse Max. 33

(PULSE MAX 33)

Value:

150 - 110000 Hz

★ 5000 Hz

Function:

This parameter is used for setting the signal value that corresponds to the maximum value set in parameter 205 *Maximum reference, Ref_{MAX}* or to the maximum feedback value set in parameter 415 *Maximum feedback, FB_{MAX} .*

★ = factory setting. () = display text [] = value for use in communication via serial communication port

Description of choice:

Set the required pulse reference or pulse feedback to be connected to terminal 33.

**328 Pulse Max. 29
(PULSE MAX 29)**
Value:

1000 - 110000 Hz ★ 5000 Hz

Function:

This parameter is used for setting the signal value that corresponds to the maximum value set in parameter 205 *Maximum reference, Ref_{MAX}* or to the maximum feedback value set in parameter 415 *Maximum feedback, FB_{MAX}*.

Description of choice:

Set the required pulse reference or pulse feedback to be connected to terminal 29.

**341 Digital output terminal 46
(DO 46 FUNCTION)**
Value:

★No function (NO OPERATION)	[0]
Value [0] - [20] see parameter 323	
Pulse reference (PULSE REFERENCE)	[21]
Value [22] - [25] see parameter 323	
Pulse feedback (PULSE FEEDBACK)	[26]
Output frequency (PULSE OUTPUTFREQ)	[27]
Pulse current (PULSE CURRENT)	[28]
Pulse power (PULSE POWER)	[29]
Pulse temperature (PULSE TEMP)	[30]
Control word bit 12 (CTRL. W. BIT 12)	[31]

Function:

The digital output can be used for giving the present status or warning. The digital output (terminal 46) gives a 24 V DC signal when a given condition is fulfilled.

Description of choice:

External Ref_{MIN} - Ref_{MAX} Par. 0-342.

An output signal is obtained, which is proportional to the resulting reference value in the interval Minimum reference, Ref_{MIN} - Maximum reference, Ref_{MAX} (parameters 204/205).

FB_{MIN}-FB_{MAX} Par. 0-342.

An output signal is obtained, which is proportional to the feedback value in the interval Minimum feedback, FB_{MIN} - Maximum feedback, FB_{MAX} (parameter 414/415).

0-f_{MAX} Par. 0-342.

★ = factory setting. () = display text [] = value for use in communication via serial communication port

An output signal is obtained, which is proportional to the output frequency in the interval 0 - f_{MAX} (parameter 202 *Output frequency, high limit, f_{MAX}*).

0 - I_{INV}. Par. 0-342.

An output signal is obtained, which is proportional to the output current in the interval 0 - I_{INV}.

0 - P_{M,N} Par. 0-342.

An output signal is obtained, which is proportional to the present output power. Par. 342 corresponds to the value set in parameter 102 *Motor power, P_{M,N}*.

0 - Temp._{MAX} Par. 0-342.

An output signal is obtained, which is proportional to the present heatsink temperature. 0 Hz corresponds to a heatsink temperature of less than 20 °C, and 20 mA corresponds to 100 °C.

Control word bit 12, bit 12 of the control word. The digital output will be set/reset according to bit 12.

**342 Terminal 46, max. pulse scaling
(DO 46 MAX. PULS)**
Value:

150 - 10000 Hz ★ 5000 Hz

Function:

This parameter is used for setting the pulse output signal's maximum frequency.

Description of choice:

Set the required frequency.

**343 Precise stop function
(PRECISE STOP)**
Value:

★Precise ramp stop (NORMAL)	[0]
Counter stop with reset (COUNT STOP RESET)	[1]
Counter stop without reset (COUNT STOP NO RESET)	[2]
Speed-compensated stop (SPD CMP STOP)	[3]
Speed-compensated counter stop with reset (SPD CMP CSTOP W. RES)	[4]
Speed-compensated counter stop without reset (SPD CMP CSTOP NO RES)	[5]

Function:

In this parameter you select which stop function is performed in response to a stop command. All six

data selections contain a precise stop routine, thus ensuring a high level of repeat accuracy. The selections are a combination of the functions described below.

 **NB!** Pulse start [8] may not be used together with the precise stop function.

Description of choice:

Precise ramp stop [0] is selected to achieve high repetitive precision at the stopping point.

Counter stop. Once it has received a pulse start signal the frequency converter runs until the number of pulses programmed by the user have been received at input terminal 33. In this way an internal stop signal will activate the normal ramp down time (parameter 208). The counter function is activated (starts timing) at the flank of the start signal (when it changes from stop to start).

Speed compensated stop. To stop at precisely the same point, regardless of the present speed, a stop signal received is delayed internally when the present speed is lower than the maximum speed (set in parameter 202).

Reset. *Counter stop* and *Speed-compensated stop* can be combined with or without reset.

Counter stop with reset [1]. After each precise stop the number of pulses counted during ramp down 0 Hz is reset.

Counter stop without reset [2]. The number of pulses counted during ramp down to 0 Hz is deducted from the counter value in parameter 344.

344 Counter value

(PULSE COUNT PRE.)

Value:

0 - 999999 ★ 100000 pulses

Function:

In this parameter you can select the counter value to be used in the integrated precise stop function (parameter 343).

Description of choice:

The factory setting is 100000 pulses. The highest frequency (max. resolution) that can be registered at terminal 33 is 67.6 kHz.

349 Speed comp delay

(SPEED COMP DELAY)

Value:

0 ms - 100 ms ★ 10 ms

Function:

In this parameter the user can set the system's delay time (Sensor, PLC, etc.). If you are running speed-compensated stop, the delay time at different frequencies has a major influence on the way in which you stop.

Description of choice:

The factory setting is 10 ms. This means that it is assumed that the total delay from the Sensor, PLC and other hardware corresponds to this setting.

 **NB!** Only active for speed-compensated stop.

★ = factory setting. () = display text [] = value for use in communication via serial communication port

■ Special functions

**400 Brake function
(BRAKE FUNCTION)**

Value:

★Off (OFF)	[0]
Resistor brake (RESISTOR)	[1]
AC brake (AC BRAKE)	[4]

Function:

Resistor brake [1] is selected if the frequency converter has a brake resistor connected to terminals 81, 82. A higher intermediate circuit voltage is permitted during braking (generated operation) when a brake resistor is connected.

AC brake [4] can be selected to improve braking without using brake resistors. Please note that *AC brake* [4] is not as effective as *Resistor brake* [1].

Description of choice:

Select *Resistor brake* [1] if a brake resistor is connected. Select *AC brake* [4] if short-term generated loads occur. See parameter 144 *Gain AC brake* to set the brake.



NB!:

A change of selection will not become active until the mains voltage has been disconnected and reconnected.

**405 Reset function
(RESET MODE)**

Value:

★Manual reset (MANUAL RESET)	[0]
Automatic reset x 1 (AUTOMATIC X 1)	[1]
Automatic reset x 3 (AUTOMATIC X 3)	[3]
Automatic reset x 10 (AUTOMATIC X 10)	[10]
Reset at power-up (RESET AT POWER UP)	[11]

Function:

This parameter makes it possible to select whether reset and restart after a trip are to be manual or whether the frequency converter is to be reset and restarted automatically. Furthermore, it is possible to select the number of times a restart is to be attempted. The time between each attempt is set in parameter 406 *Automatic restart time*.

Description of choice:

If *Manual reset* [0] is selected, reset is to be carried out via the [STOP/RESET] key, a digital input or serial communication. If the frequency converter is to carry out an automatic reset and restart after a trip, select data value [1], [3] or [10].

If *Reset at power-up* [11] is selected, the frequency converter will carry out a reset if there has been a fault in connection with the mains failure.



The motor may start without warning.

**406 Automatic restart time
(AUTORESTART TIME)**

Value:

0 - 10 sec. ★ 5 sec.

Function:

This parameter allows setting of the time from tripping until the automatic reset function begins. It is assumed that automatic reset has been selected in parameter 405 *Reset function*.

Description of choice:

Set the required time.

**409 Trip delay overcurrent, I_{LIM}
(TRIP DELAY CUR.)**

Value:

0 - 60 sec. (61=OFF) ★ OFF

Function:

When the frequency converter registers that the output current has reached the current limit I_{LIM} (parameter 221 *Current limit*) and remains there for the preset time, it is disconnected. Can be used to protect the application, like the ETR will protect the motor if selected.

Description of choice:

Select how long the frequency converter should maintain the output current at the current limit I_{LIM} before it disconnects. At OFF parameter 409 *Trip delay overcurrent, I_{LIM}* is not working, i.e. disconnection will not take place.

★ = factory setting. () = display text [] = value for use in communication via serial communication port

411 Switching frequency

(SWITCH FREQ.)

Value:

3000 - 14000 Hz ★ 4500 Hz

Function:

The set value determines the switching frequency of the inverter. If the switching frequency is changed, this may help to minimise possible acoustic noise from the motor.



NB!:

The output frequency of the frequency converter can never assume a value higher than 1/10 of the switching frequency.

Description of choice:

When the motor is running, the switching frequency is adjusted in parameter 411 *Switching frequency* until the frequency has been obtained at which the motor is as low-noise as possible.



NB!:

The switching frequency is reduced automatically as a function of the load.
See *Temperature-Dependent Switching Frequency under Special Conditions*.

413 Overmodulation function

(OVERMODULATION)

Value:

Off (OFF) [0]
★ On (ON) [1]

Function:

This parameter allows connection of the overmodulation function for the output voltage.

Description of choice:

Off [0] means that there is no overmodulation of the output voltage, which means that torque ripple on the motor shaft is avoided. This can be a good feature, e.g. on grinding machines. *On* [1] means that an output voltage can be obtained which is greater than the mains voltage (up to 5 %).

414 Minimum feedback, FB_{MIN}

(MIN. FEEDBACK)

Value:

-100,000.000 - par. 415 FB_{MAX} ★ 0.000

Function:

Parameter 414 *Minimum feedback*, FB_{MIN} and 415 *Maximum feedback*, FB_{MAX} are used to scale the

★ = factory setting. () = display text [] = value for use in communication via serial communication port

display text to make it show the feedback signal in a process unit proportionally to the signal on the input.

Description of choice:

Set the value to be shown on the display as the minimum feedback signal value on the selected feedback input (parameters 308/314 *Analogue inputs*).

415 Maximum feedback, FB_{MAX}

(MAX. FEEDBACK)

Value:

FB_{MIN} - 100,000.000 ★ 1500.000

Function:

See description of parameter 414 *Minimum feedback*, FB_{MIN}.

Description of choice:

Set the value to be shown on the display when the maximum feedback has been obtained on the selected feedback input (parameter 308/314 *Analogue inputs*).

416 Process units

(REF/FEEDB. UNIT)

Value:

★ No unit (NO UNIT)	[0]
% (%)	[1]
ppm (PPM)	[2]
rpm (RPM)	[3]
bar (BAR)	[4]
Cycles/min (CYCLE/MI)	[5]
Pulses/s (PULSE/S)	[6]
Units/s (UNITS/S)	[7]
Units/min. (UNITS/MI)	[8]
Units/h (UNITS/H)	[9]
°C (°C)	[10]
Pa (PA)	[11]
l/s (L/S)	[12]
m ³ /s (M ³ /S)	[13]
l/min. (L/M)	[14]
m ³ /min. (M ³ /MIN)	[15]
l/h (L/H)	[16]
m ³ /h (M ³ /H)	[17]
Kg/s (KG/S)	[18]
Kg/min. (KG/MIN)	[19]
Kg/hour (KG/H)	[20]
Tons/min. (T/MIN)	[21]
Tons/hour (T/H)	[22]
Metres (M)	[23]
Nm (NM)	[24]
m/s (M/S)	[25]

m/min. (M/MIN)	[26]
°F (°F)	[27]
ln wg (IN WG)	[28]
gal/s (GAL/S)	[29]
Ft ³ /s (FT ³ /S)	[30]
Gal/min. (GAL/MIN)	[31]
Ft ³ /min. (FT ³ /MIN)	[32]
Gal/h (GAL/H)	[33]
Ft ³ /h (FT ³ /H)	[34]
Lb/s (LB/S)	[35]
Lb/min. (LB/MIN)	[36]
Lb/hour (LB/H)	[37]
Lb ft (LB FT)	[38]
Ft/s (FT/S)	[39]
Ft/min. (FT/MIN)	[40]

Function:

Select among different units to be shown on the display. The unit is read out if an LCP control unit can be connected, and if *Reference [unit]* [2] or *Feedback [unit]* [3] has been selected in one of parameters 009-012 *Display read-out*, and in Display mode. The unit is used in *Closed loop* also as a unit for Minimum/Maximum reference and Minimum/Maximum feedback.

Description of choice:

Select the required unit for the reference/feedback signal.

■ **FCD 300 Regulators**

The FCD 300 has two integrated PID regulators, one to regulate speed and one to regulate processes. Speed regulation and process regulation require a feedback signal back to an input. There are a number of settings for both PID regulators that are made in the same parameters, but selection of regulator type will affect the selections that have to be made in the shared parameters. In parameter 100 *Configuration* it is possible to select regulator type, *Speed regulation, closed loop* [1] or *Process regulation, closed loop* [3].

Speed regulation

This PID regulation is optimised for use in applications in which there is a need to maintain a particular motor speed. The parameters that are specific for the speed regulator are parameter 417 to parameter 421.

Process regulation

The PID regulator maintains a constant process mode (pressure, temperature, flow, etc.) and adjusts the motor speed on the basis of the reference/setpoint and feedback signal.

A transmitter provides the PID regulator with a feedback signal from the process as an expression of the process's actual mode. The feedback signal varies as the process load varies.

This means that there is a variance between the reference/setpoint and the actual process mode. This variance is compensated by the PID regulator by means of the output frequency being regulated up or down in relation to the variance between the reference/setpoint and the feedback signal.

The integrated PID regulator in the frequency converter has been optimised for use in process applications. This means that there are a number of special functions available in the frequency converter. Previously it was necessary to obtain a system to handle these special functions by installing extra I/O modules and programming the system. With the frequency converter the need to install extra modules can be avoided. The parameters that are specific to the Process Regulator are parameter 437 to parameter 444.

■ **PID functions**

Unit of reference/feedback

When *Speed regulation, closed loop* is selected in parameter 100 *Configuration* the unit of reference/feedback is always rpm.

When *Process regulation, closed loop* is selected in parameter 100 *Configuration* the unit is defined in parameter 416 *Process units*.

Feedback

A feedback range must be preset for both regulators. At the same time this feedback range limits the potential reference range so that if the sum of all references lies outside the feedback range, the reference will be limited to lie within the feedback range. The feedback signal must be connected to a terminal on the frequency converter. If feedback

★ = factory setting. () = display text [] = value for use in communication via serial communication port

is selected on two terminals simultaneously, the two signals will be added together.

Use the overview below to determine which terminal is to be used and which parameters are to be programmed.

Feedback type	Terminal	Parameters
Pulse	29, 33	305, 307, 327, 328
Voltage	53	308, 309, 310
Current	60	314, 315, 316

A correction can be made for loss of voltage in long signal cables when a transmitter with a voltage output is used. This is done in parameter group 300 *Min./Max scaling*.

Parameters 414/415 *Minimum/Maximum feedback* must also be preset to a value in the process unit corresponding to the minimum and maximum scaling values for signals that are connected to the terminal.

Reference

In parameter 205 *Maximum reference*, Ref_{MAX} it is possible to preset a maximum reference that scales the sum of all references, i.e. the resulting reference. The minimum reference in parameter 204 is an expression of the minimum value that the resulting reference can assume.

All references will be added together and the sum will be the reference against which regulation will take place. It is possible to limit the reference range to a range that is smaller than the feedback range. This can be an advantage if you want to avoid an unintentional change to an external reference making the sum of the references move too far away from the optimal reference. The reference range cannot exceed the feedback range.

If preset references are desired, they are preset in parameters 215 to 218 *Preset reference*.

See description *Reference Function and Handling of References*.

If a current signal is used as the feedback signal, it will only be possible to use voltage as an analogue reference. Use the overview below to determine which terminal is to be used and which parameters are to be programmed.

Reference type	Terminal	Parameters
Pulse	29, 33	305, 307, 327, 328
Voltage	53	308, 309, 310
Current	60	314, 315, 316
Preset references		215-218
Bus reference	68+69	

Note that the bus reference can only be preset via serial communication.



NBI:

It is best to preset terminals that are not being used to *No function* [0].

Differentiator gain limit

If very rapid variations occur in an application in either the reference signal or the feedback signal, the deviation between the reference/setpoint and the process's actual mode will change quickly. The differentiator can then become too dominant. This is because it is reacting to the deviation between the reference and the process's actual mode, and the quicker the variance changes the more powerful the differentiator's frequency contribution becomes. The differentiator's frequency contribution can therefore be limited in such a way that both a reasonable differentiation time for slow changes and an appropriate frequency contribution for quick changes can be preset. This is done using the speed regulation in parameter 420 *Speed PID Differentiator gain limit* and Process regulation in parameter 443 *Process PID Differentiator gain limit*.

Lowpass filter

If there is a lot of noise in the feedback signal, these can be dampened using an integrated lowpass filter. A suitable lowpass filter time constant is preset. If the lowpass filter is preset to 0.1 s, the cut-off frequency will be 10 RAD/sec , corresponding to $(10 / 2 \times \pi) = 1.6 \text{ Hz}$. This will mean that all currents/voltages that vary by more than 1.6 oscillations per second will be dampened. In other words, there will only be regulation on the basis of a feedback signal that varies by a frequency of less than 1.6 Hz. The appropriate time constant is selected in Speed Regulation in parameter 421 *Speed PID lowpass filter time* and in Process Regulation in parameter 444 *Process PID lowpass filter time*.

Inverse regulation

Normal regulation means that the motor speed is increased when the reference/setpoint is greater than the feedback signal. If it is necessary to run inverse regulation, in which the speed is reduced when the reference/setpoint is greater than the feedback signal, parameter 437 *PID normal/inverted control* must be programmed at *Inverted*.

Anti Windup

★ = factory setting. () = display text [] = value for use in communication via serial communication port

In the factory the process regulator is preset with an active anti windup function. This function means that when either a frequency limit, a current limit or a voltage limit is reached, the integrator is initialised at a frequency corresponding to the present output frequency. This is a means of avoiding the integration of a variance between the reference and the process's actual mode that cannot be deregulated by means of a change of speed. This function can be deselected in parameter 438 *Process PID anti windup*.

Starting conditions

In some applications the optimal setting of the process regulator will mean that a relatively long period of time will pass before the required process condition is achieved. In these applications it can be a good idea to define an output frequency to which the frequency converter must run the motor before the process regulator is activated. This is done by programming a start frequency in parameter 439 *Process PID start frequency*.

■ Handling of feedback

Feedback handling is depicted in this flowchart.

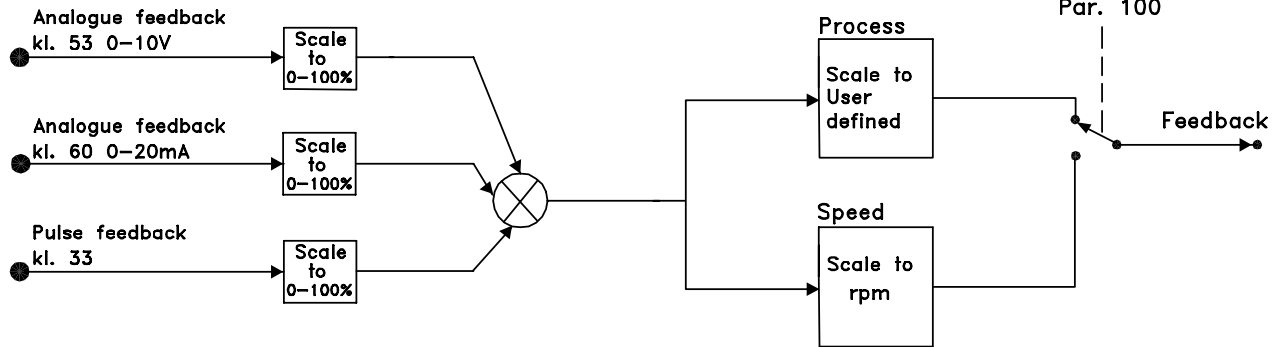

195NA019.11



NB!:

Parameters 417-421 are only used, if in parameter 100 *Configuration* the selection made is *Speed regulation, closed loop* [1].

417 Speed PID proportional gain

(SPEED PROP GAIN)

Value:

0.000 (OFF) - 1.000 ★ 0.010

Function:

Proportional gain indicates how many times the fault (deviation between the feedback signal and the setpoint) is to be amplified.

Description of choice:

Quick regulation is obtained at high amplification, but if the amplification is too high, the process may become unstable in the case of overshooting.

418 Speed PID integral time

(SPEED INT. TIME)

Value:

20.00 - 999.99 ms (1000 = OFF) ★ 100 ms

Function:

The integral time determines how long the PID regulator takes to correct the error. The greater the error, the quicker the integrator frequency contribution will increase. The integral time is the time the integrator needs to achieve the same change as the proportional amplification.

Description of choice:

Quick regulation is obtained through a short integral time. However, if this time is too short, it can make the process unstable. If the integral time is long, major deviations from the required reference may occur, since the process regulator will take long to regulate if an error has occurred.

419 Speed PID differential time

(SPEED DIFF. TIME)

Value:

0.00 (OFF) - 200.00 ms ★ 20.00 ms

Function:

The differentiator does not react to a constant error. It only makes a contribution when the error changes. The quicker the error changes, the stronger the gain

from the differentiator will be. The contribution is proportional to the speed at which errors change.

Description of choice:

Quick control is obtained by a long differential time. However, if this time is too long, it can make the process unstable. When the differential time is 0 ms, the D-function is not active.

420 Speed PID D- gain limit

(SPEED D-GAIN LIM)

Value:

5.0 - 50.0 ★ 5.0

Function:

It is possible to set a limit for the gain provided by the differentiator. Since the D-gain increases at higher frequencies, limiting the gain may be useful. This enables obtaining a pure D-gain at low frequencies and a constant D-gain at higher frequencies.

Description of choice:

Select the required gain limit.

421 Speed PID lowpass filter time

(SPEED FILT. TIME)

Value:

20 - 500 ms ★ 100 ms

Function:

Noise in the feedback signal is dampened by a first order lowpass filter to reduce the noise's impact on the regulation. This might be an advantage, e.g. if there is a great amount of noise on the signal. See drawing.

★ = factory setting. () = display text [] = value for use in communication via serial communication port

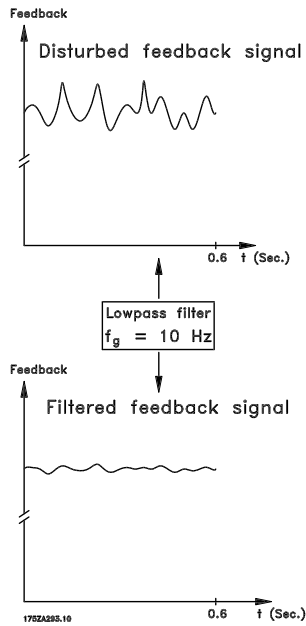

Description of choice:

If a time constant (t) of 100 ms is programmed, the cut-off frequency for the lowpass filter will be $1/0.1 = 10$ RAD/sec., corresponding to $(10 / 2 \times \pi) = 1.6$ Hz. The PID regulator will then only regulate a feedback signal that varies with a frequency of less than 1.6 Hz. If the feedback signal varies by a higher frequency than 1.6 Hz, it will be dampened by the lowpass filter.

423 U1 voltage

(U1 VOLTAGE)

Value:

0.0 - 999.0 V ★ par. 103

Function:

Parameters 423-428 are used when in parameter 101 *Torque characteristic* a selection has been made of *Special motor characteristic* [8]. It is possible to determine a U/f characteristic on the basis of four definable voltages and three frequencies. The voltage at 0 Hz is set in parameter 133 *Start voltage*.

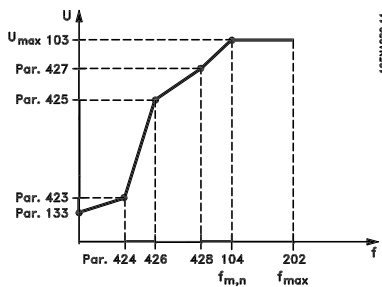

Description of choice:

Set the output voltage (U1) that is to match the first output frequency (F1), parameter 424 *F1 frequency*.

424 F1 frequency

(F1 FREQUENCY)

Value:

0.0 - par. 426 *F2 frequency*

★ Par. 104 *Motor frequency*

Function:

See parameter 423 *U1 voltage* .

Description of choice:

Set the output frequency (F1) that is to match the first output voltage (U1), parameter 423 *U1 voltage* .

425 U2 voltage

(U2 VOLTAGE)

Value:

0.0 - 999.0 V

★ par. 103

Function:

See parameter 423 *U1 voltage*.

Description of choice:

Set the output voltage (U2) that is to match the second output frequency (F2), parameter 426 *F2 frequency*.

426 F2 frequency

(F2 FREQUENCY)

Value:

Par. 424 *F1 frequency* - par. 428 *F3 frequency*

★ Par. 104 *Motor frequency*

Function:

See parameter 423 *U1 voltage*.

Description of choice:

Set the output frequency (F2) that is to match the second output voltage (U2), parameter 425 *U2 voltage* .

427 U3 voltage

(U3 VOLTAGE)

Value:

0.0 - 999.0 V ★ par. 103

Function:

See parameter 423 *U1 voltage*.

Description of choice:

Set the output voltage (U3) that is to match the third output frequency (F3), parameter 428 *F3 frequency*.

428 F3 frequency

(F3 FREQUENCY)

Value:

Par. 426 *F2 frequency* - 1000 Hz
★ Par. 104 *Motor frequency*

Function:

See parameter 423 *U1 voltage*.

Description of choice:

Set the output frequency (F3) that is to match the third output voltage (U3), parameter 427 *U3 voltage*.



NB!:

Parameters 437-444 are only used if in parameter 100 *Configuration* a selection has been made of *Process regulation, closed loop*. [3].

437 Process PID normal/inverse control

(PROC NO/INV CTRL)

Value:

★Normal (NORMAL) [0]
Inverse (INVERSE) [1]

Function:

It is possible to choose whether the process regulator is to increase/reduce the output frequency if there is a deviation between the reference/setpoint and the actual process mode.

Description of choice:

If the frequency converter is to reduce the output frequency in case the feedback signal increases, select *Normal* [0].
If the frequency converter is to increase the output frequency in case the feedback signal increases, select *Inverse* [1].

438 Proces PID anti windup

(PROC ANTI WINDUP)

Value:

Not active (DISABLE) [0]
★Active (ENABLE) [1]

Function:

It is possible to select whether the process regulator is to continue regulating on a deviation even if it is not possible to increase/reduce the output frequency.

Description of choice:

The factory setting is *Enable* [1], which means that the integration link is initialised in relation to the actual output frequency if either the current limit, the voltage limit or the max./min. frequency has been reached. The process regulator will not engage again until either the error is zero or its sign has changed. Select *Disable* [0] if the integrator is to continue integrating on the deviation, even if it is not possible to remove the fault by such control.



NB!:

If *Disable* [0] is selected, it will mean that when the deviation changes its sign, the integrator will first have to integrate down from the level obtained as a result of the former error, before any change in output frequency occurs.

439 Process PID start frequency

(PROC START VALUE)

Value:

f_{MIN} - f_{MAX} (parameter 201/202)
★ Par. 201 *Output frequency, low limit, f_{MIN}*

Function:

When the start signal comes, the frequency converter will react in the form of *Open loop* and will not change to *Closed loop* until the programmed start frequency is reached. This makes it possible to set a frequency that corresponds to the speed at which the process normally runs, which will enable the required process conditions to be reached sooner.

Description of choice:

Set the required start frequency.



NB!:

If the frequency converter is running at the current limit before the required start frequency is obtained, the process regulator will not be activated. For the regulator to be activated anyway, the start frequency must be lower to the required output frequency. This can be done during operation.

440 Process PID proportional gain (PROC. PROP. GAIN)

Value:

0.0 - 10.00 ★ 0.01

Function:

The proportional gain indicates the number of times the deviation between the setpoint and the feedback signal is to be applied.

Description of choice:

Quick regulation is obtained by a high gain, but if the gain is too high, the process may become unstable due to overshoot.

441 Process PID integration time (PROC. INTEGR. T.)

Value:

0.01 - 9999.99 (OFF) ★ OFF

Function:

The integrator provides an increasing gain at a constant error between the reference/setpoint and the feedback signal. The greater the error, the quicker the integrator frequency contribution will increase. The integral time is the time needed by the integrator to make the same change as the proportional gain.

Description of choice:

Quick regulation is obtained at a short integral time. However, this time may become too short, which can make the process unstable due to overshoot. If the integral time is long, major deviations from the required setpoint may occur, since the process regulator will take a long time to regulate in relation to a given error.

442 Process PID differentiation time (PROC. DIFF. TIME)

Value:

0.00 (OFF) - 10.00 sec. ★ 0.00 sec.

Function:

The differentiator does not react to a constant error. It only makes a gain when an error changes. The quicker the deviation changes, the stronger the gain from the differentiator. The gain is proportional to the speed at which the deviation changes.

Description of choice:

Quick regulation is obtained with a long differentiation time. However, this time may become too long, which can make the process unstable due to overshoot.

443 Process PID diff. gain limit (PROC. DIFF.GAIN)

Value:

5.0 - 50.0 ★ 5.0

Function:

It is possible to set a limit for the differentiator gain. The differentiator gain will increase if there are fast changes, which is why it can be beneficial to limit this gain. Thereby a pure differentiator gain is obtained at slow changes and a constant differentiator gain where quick changes to the deviation occur.

Description of choice:

Select a differentiator gain limit as required.

444 Process PID lowpass filter time (PROC FILTER TIME)

Value:

0.02 - 10.00 ★ 0.02

Function:

Noise in the feedback signal is dampened by a first order lowpass filter to reduce the noise's impact on the process regulation. This can be an advantage e.g. if there is a lot of noise on the signal.

Description of choice:

Select the required time constant (t). If a time constant (t) of 0.1 s is programmed, the cut-off frequency for the lowpass filter will be $1/0.1 = 10 \text{ RAD/sec.}$, corresponding to $(10 / 2 \times \pi) = 1.6 \text{ Hz.}$ The process regulator will thus only regulate a feedback signal that varies by a frequency lower than 1.6 Hz. If the

feedback signal varies by a higher frequency than 1.6 Hz, it will be dampened by the lowpass filter.

- Flying start does not work at lower values than 250 rpm.

445 Flying start

(FLYINGSTART)

Value:

★Off (DISABLE)	[0]
OK - same direction (OK-SAME DIRECTION)	[1]
OK - both directions (OK-BOTH DIRECTIONS)	[2]
DC brake and start (DC-BRAKE BEF. START)	[3]

Function:

This function makes it possible to 'catch' a rotating motor shaft, which is no longer controlled by the frequency converter, e.g. because of a mains drop-out. The function is activated each time a start command is enabled. For the frequency converter to be able to 'catch' the rotating motor shaft, the motor speed must be lower than the frequency that corresponds to the frequency in parameter 202 *Output frequency, high limit, f_{MAX}*.

Description of choice:

Select *Disable* [0] if this function is not required.

Select *OK - same direction* [1] if the motor shaft is only able to rotate in the same direction when cutting in. *OK - same direction* [1] should be selected if in parameter 200 *Output frequency range* a selection has been of *Clockwise only*.

Select *OK - both directions* [2] if the motor is able to rotate in both directions when cutting in.

Select *DC brake and start* [3] if the frequency converter is to be able to brake the motor using the DC brake first, followed by start. It is assumed that parameters 126-127/132 *DC brake* are enabled. In the case of higher 'Windmilling' (rotating motor) effects, the frequency converter is not able to 'catch' a rotating motor without selecting *DC brake and start*.

Limitations:

- Too low inertia will lead to load acceleration, which can be dangerous or prevent correct catching of a rotating motor. Use the DC brake instead.
- If the load is driven, e.g. by 'Windmilling' (rotating motor) effects, the unit may cut out because of overvoltage.

451 Speed PID feedforward factor

(FEEDFORWARD FACT)

Value:

0 - 500 % ★ 100 %

Function:

This parameter is only active if in parameter 100 *Configuration* the selection made is *Speed regulation, closed loop*. The FF function sends a larger or smaller part of the reference signal outside the PID controller in such a way that the PID controller only has an influence on part of the control signal. Any change to the set point will thus have a direct effect on the motor speed. The FF factor provides high dynamism when changing the set point and less overshoot.

Description of choice:

The required % value can be selected in the interval $f_{MIN} - f_{MAX}$. Values over 100 % are used if the set point variations are only small.

452 Controller range

(PID CONTR. RANGE)

Value:

0 - 200 % ★ 10 %

Function:

This parameter is only active if in parameter 100 *Configuration* the selection made is *Speed regulation, closed loop*.

The controller range (bandwidth) limits the output from the PID controller as a % of motor frequency $f_{M,N}$.

Description of choice:

The required % value can be selected for motor frequency $f_{M,N}$. If the controller range is reduced the speed variations will be less during initial tuning.

455 Frequency range monitor

(MON. FREQ. RANGE)

Value:

Disable	[0]
★Enable	[1]

Function:

This parameter is used if warning 35 *Out of frequency range* must be turned off in the display in process

★ = factory setting. () = display text [] = value for use in communication via serial communication port

control closed loop. This parameter does not affect the extended status word.

Description of choice:

Select *Enable* [1] to enable the readout in the display if warning 35 *Out of frequency range* occurs. Select *Disable* [0] to disable the readout in the display if warning 35 *Out of frequency range* occurs.

456 Brake Voltage Reduce

(BRAKE VOL REDUCE)

Value:

0 - 200 V ★ 0

Function:

The user sets the voltage by which the level for resistor braking is reduced. It is only active when resistor in parameter 400 is selected.

Description of choice:

The greater the reduction value, the faster the reaction to a generator overload. Should only be used if there are problems with overvoltage in the intermediate circuit.



NB!:

A change of selection will not become active until the mains voltage has been disconnected and reconnected.

★ = factory setting. () = display text [] = value for use in communication via serial communication port

Serial communication for FCD 300

Protocols

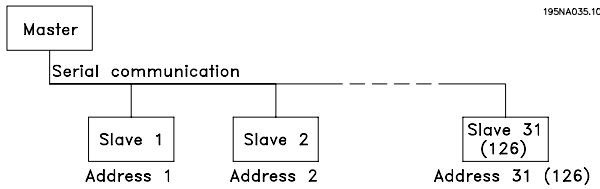

All frequency converters are equipped with an RS 485 port as standard, which makes it possible to choose between two protocols. The two protocols that can be selected in parameter 512 *Telegram Profile*, are:

- Profidrive protocol
- Danfoss FC protocol

To select Danfoss FC protocol, parameter 512 *Telegram Profile* is set to *FC protocol* [1].

Telegram Traffic

Control and response telegrams

Telegram traffic in a master-slave system is controlled by the master. A maximum of 31 slaves can be connected to a master, unless repeaters are used. If repeaters are used, a maximum of 126 slaves can be connected to a master.

The master constantly sends telegrams addressed to the slaves and waits for response telegrams from them. The slave's response time is a maximum of 50 ms.

Only a slave that has received an error-free telegram, addressed to that slave can send a response telegram.

Broadcast

A master can send the same telegram simultaneously to all slaves connected to the bus. During this broadcast communication the slave does not send any response telegrams back to the master as to whether the telegram has been correctly received. Broadcast communication is set up in address format (ADR), see *Telegram structure*.

Content of a character (byte)

Each character transferred begins with a start bit. Then 8 data bits are transferred, corresponding to a byte. Each character is secured via a parity bit, which is set at "1" when it reaches parity (i.e. when there is an equal number of 1's in the 8 data bits and the parity bit in total). A character is completed by a stop bit, thus consisting of 11 bits in all.

195NA036.10

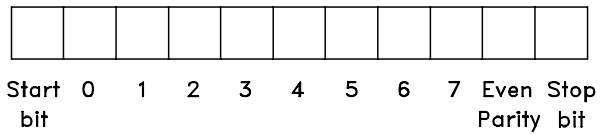

Telegram Structure

Each telegram begins with a start character (STX) = 02 Hex, followed by a byte that denotes the length of the telegram (LGE) and a byte that denotes the address of the frequency converter (ADR). Then follows a number of data bytes (variable, depending on the type of telegram). The telegram is completed by a data control byte (BCC).

195NA099.10

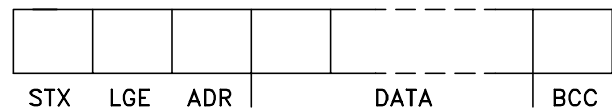

Telegram timing

The communication speed between a master and a slave depends on the baud rate. The frequency converter's baud rate must be the same as the master's baud rate and be selected in parameter 501 *Baudrate*. After a response telegram from the slave, there must be a pause of at least 2 characters (22 bits) before the master can send a new telegram. At a baud rate of 9600 baud there must be a pause of at least 2.3 ms. When the master has completed the telegram, the slave's response time back to the master will be a maximum of 20 ms, and there will be a pause of at least 2 characters.

195NA038.10

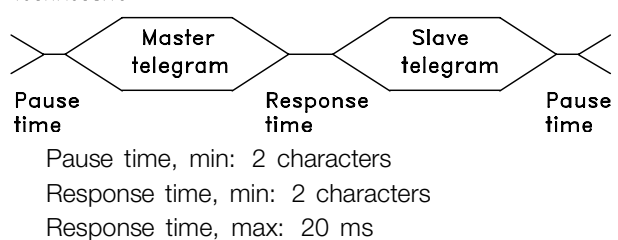

The time between the individual characters in a telegram may not exceed 2 characters and the telegram must be completed within 1.5 x nominal telegram time. At a baud rate of 9600 baud and a telegram length of 16 bytes the telegram will be completed after 27.5 msec.

195NA039.10

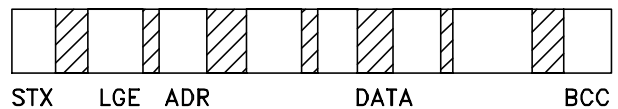

= Time between characters

Telegram length (LGE)

The telegram length is the number of data bytes plus the address byte ADR plus the data control byte BCC.

The length of telegrams with 4 data bytes is:

$$LGE = 4 + 1 + 1 = 6 \text{ bytes}$$

The length of telegrams with 12 data bytes is:

$$LGE = 12 + 1 + 1 = 14 \text{ bytes}$$

The length of telegrams containing texts is 10+n bytes. 10 represents the fixed characters, while the 'n' is variable (depending on the length of the text).

Frequency converter address (ADR)

Two different address formats are used, with the frequency converter's address range being either 1-31 or 1-126.

1. Address format 1-31

The byte for address range 1-31 has the following profile:

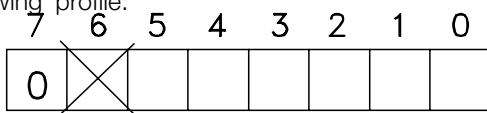

195NA040.10

- Bit 7 = 0 (address format 1-31 active)
- Bit 6 is not used
- Bit 5 = 1: Broadcast, address bits (0-4) are not used
- Bit 5 = 0: No Broadcast
- Bit 0-4 = Frequency converter address 1-31

2. Address format 1-126

The byte for address range 1 - 126 has the following profile:

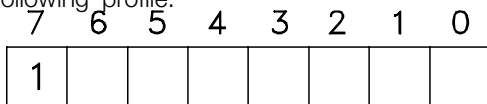

195NA041.10

- Bit 7 = 1 (address format 1-126 active)
- Bit 0-6 = Frequency converter address 1-126
- Bit 0-6 = 0 Broadcast

The slave sends the address byte back unchanged in the response telegram to the master.

Example:

writing to frequency converter address 22 (16H) with address format 1-31:

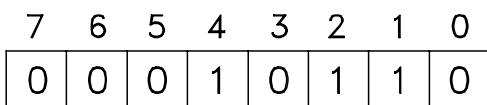

195NA042.10

Data control byte (BCC)

The data control byte is explained in this example: Before the first byte in the telegram is received, the Calculated CheckSum (BCS) is 0.

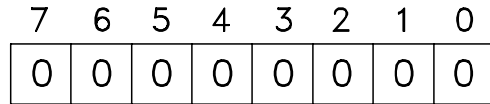

195NA043.10

When the first byte (02H) has been received:

BCS = BCC EXOR "first byte"

(EXOR = exclusive-or)

BCS = 0 0 0 0 0 0 0 0 (00 H)

EXOR

1. byte = 0 0 0 0 0 0 1 0 (02H)

BCC = 0 0 0 0 0 0 1 0 (02H)

Each subsequent byte gates with BCS EXOR and produces a new BCC, e.g.:

BCS = 0 0 0 0 0 0 1 0 (02H)

EXOR

2nd byte = 1 1 0 1 0 1 1 0 (D6H)

BCC = 1 1 0 1 0 1 0 0 (D4H)

■ Data Character (byte)

The structure of data blocks depends on the type of telegram. There are three types of telegram, and the type of telegram applies for both control telegrams (master⇒slave) and response telegrams (slave⇒master). The three types of telegram are:

- Parameter block, used to transfer parameters between master and slave. The data block is made up of 12 bytes (6 words) and also contains the process block.

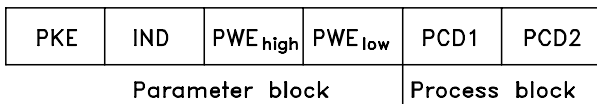

- The process block is made up of a data block of four bytes (2 words) and contains:
 - Control word and reference value
 - Status word and present output frequency (from slave to master)

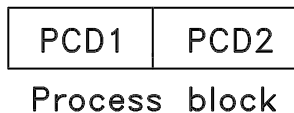

- Text block, which is used to read or write texts via the data block.

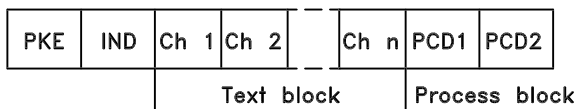

Parameter commands and responses (AK).

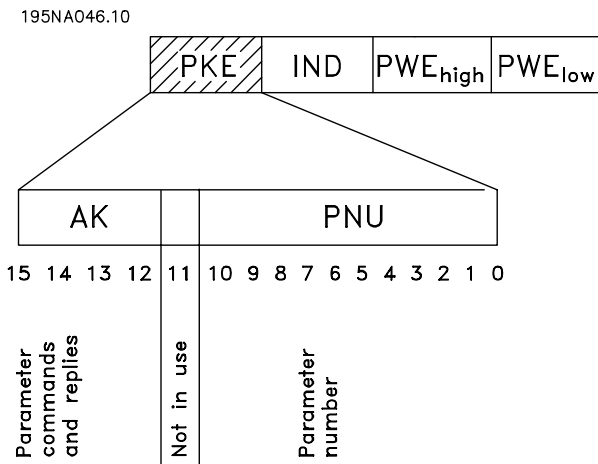

Bits no. 12-15 are used to transfer parameter commands from master to slave and the slave's processed responses back to the master.

Parameter commands master⇒slave				
Bit no.				
15	14	13	12	Parameter command
0	0	0	0	No command
0	0	0	1	Read parameter value
0	0	1	0	Write parameter value in RAM (word)
0	0	1	1	Write parameter value in RAM (double word)
1	1	0	1	Write parameter value in RAM and EEPROM (double word)
1	1	1	0	Write parameter value in RAM and EEPROM (word)
1	1	1	1	Read/write text

Response slave⇒master				
Bit no.				
15	14	13	12	Response
0	0	0	0	No response
0	0	0	1	Parameter value transferred (word)
0	0	1	0	Parameter value transferred (double word)
0	1	1	1	Command cannot be performed
1	1	1	1	Text transferred

If the command cannot be performed the slave sends this response: 0111 *Command cannot be performed* and gives the following fault report in the parameter value (PWE):

Response (0111)	Fault report
0	The parameter number used does not exist
1	There is no write access to the defined parameter
2	Data value exceeds the parameter's limits
3	The sub index used does not exist
4	The parameter is not the array type
5	The data type does not match the defined parameter
17	Data change in the defined parameter is not possible in the frequency converter's present mode. Certain parameters can only be changed when the motor is turned off
130	There is no bus access to the defined parameter
131	Data change is not possible because factory Setup is selected

Parameter number (PNU)

Bits no. 0-10 are used to transfer parameter numbers. The relevant parameter's function is defined in the parameter description in the section entitled *Programming*.

Index



Index is used together with the parameter number to read/write-access parameters that have an index, e.g. parameter 615 *Error code*. The index is made up of 2 bytes, one lowbyte and one highbyte, but only the lowbyte is used as an index.

Example - Index:

The first error code (index [1]) in parameter 615 *Error code* must be read.

PKE = 1267 Hex (read parameter 615 *Error code*.)

IND = 0001 Hex - Index no. 1.

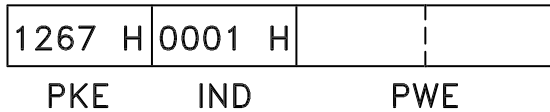

The frequency converter will respond in the parameter value block (PWE) with a fault code value from 1 - 99. See *Summary of Warnings and Alarms* to identify the fault code.

Parameter value (PWE)

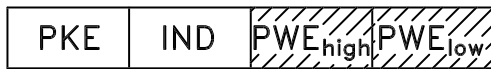

The parameter value block consists of 2 words (4 bytes), and the value depends on the defined command (AK). If the master prompts for a parameter value, the PWE block does not contain a value.

If you wish the master to change a parameter value (write), the new value is written in the PWE block and sent to the slave.

If the slave responds to a parameter request (read command), the present parameter value in the PWE block is transferred and returned to the master.

If a parameter contains not a numerical value, but several data options, e.g. parameter 001 *Language* where [0] corresponds to *English*,

and [3] corresponds to *Danish*, the data value is selected by entering the value in the PWE block. See *Example - Selecting a data value*.

Via serial communication it is only possible to read parameters that have data type 9 (text string). Parameter 621 - 635 *Nameplate data* is data type 9. For example, in parameter 621 *Unit type* it is possible to read the unit size and mains voltage range.

When a text string is transferred (read) the length of the telegram is variable, as the texts are of different lengths. The telegram length is defined in the telegram's second byte, known as LGE.

To be able to read a text via the PWE block the parameter command (AK) must be set to 'F' Hex.

The index character is used to indicate whether it is a read or write command.

In a read command the index must have the following format:

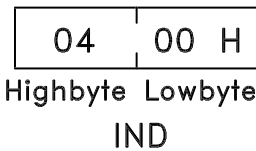

Some frequency converters have parameters to which a text may be written. To be able to write a text via the PWE block the parameter command (AK) must be set to 'F' Hex.

For a write command the text must have the following format:

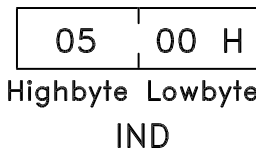

Data types supported by frequency transformer:

Data types	Description
3	Integer 16
4	Integer 32
5	Unsigned 8
6	Unsigned 16
7	Unsigned 32
9	Text string

Unsigned means that there is no operational sign in the telegram.

Example - Write a parameter value:

Parameter 202 *Output frequency high limit, f_{MAX}* to be changed to 100 Hz. The value must be recalled after a mains failure, so it is written in EEPROM.

PKE = E0CA Hex - Write for parameter 202

Output frequency high limit, f_{MAX}

IND = 0000 Hex

PWE_{HIGH} = 0000 Hex

PWE_{LOW} = 03E8 Hex - Data value 1000, corresponding to 100 Hz, see conversion.

E0CA H	0000 H	0000 H	03E8 H
PKE	IND	PWE _{high}	PWE _{low}

The response from the slave to the master will be:

10CA H	0000 H	0000 H	03E8 H
PKE	IND	PWE _{high}	PWE _{low}

Example - Selection of a data value:

You wish to select kg/hour [20] in parameter 416 *Process units*. The value must be recalled after a mains failure, so it is written in EEPROM.

PKE = E19F Hex - Write for parameter

416 *Process units*

IND = 0000 Hex

PWE_{HIGH} = 0000 Hex

PWE_{LOW} = 0014 Hex - Select data option kg/hour [20]

E1A0 H	0000 H	0000 H	0014 H
PKE	IND	PWE _{high}	PWE _{low}

The response from the slave to the master will be:

11A0 H	0000 H	0000 H	0014 H
PKE	IND	PWE _{high}	PWE _{low}

Example - Reading a parameter value:

The value in parameter 207 *Ramp up time 1* is required.

The master sends the following request:

PKE = 10CF Hex - read parameter 207

Ramp up time 1

IND = 0000 Hex

PWE_{HIGH} = 0000 Hex

PWE_{LOW} = 0000 Hex

10CF H	0000 H	0000 H	0000 H
PKE	IND	PWE _{high}	PWE _{low}

If the value in parameter 207 *Ramp-up time 1* is 10 sec., the response from the slave to the master will be:

10CF H	0000 H	0000 H	000A H
PKE	IND	PWE _{high}	PWE _{low}

Conversion:

Under the section entitled *Factory Settings* the various attributes of each parameter are displayed. As a parameter value can only be transferred as a whole number, a conversion factor must be used to transfer decimals.

Example:

Parameter 201 *Output frequency, low limit f_{MIN}* has a conversion factor of 0.1. If you wish to preset the minimum frequency to 10 Hz, the value 100 must be transferred, as a conversion factor of 0.1 means that the value transferred is multiplied by 0.1. The value 100 will thus be perceived as 10.0.

Conversion table

Conversion index	Conversion factor
73	0.1
2	100
1	10
0	1
-1	0.1
-2	0.01
-3	0.001
-4	0.0001
-5	0.00001

■ Process Words

The block of process words is divided into two blocks of 16 bits, which always occur in the defined sequence.

195NA066.10

PCD1	PCD2
------	------

	PCD 1	PCD 2
Control telegram (master⇒slave)	Control word	Reference-value
Control telegram (slave⇒master)	Status word	Present outp. frequency

■ Control Word according to FC protocol

To select *FC protocol* in the control word, parameter 512 *Telegram Profile* must be set to *FC protocol* [1].

The control word is used to send commands from a master (e.g. a PC) to a slave (frequency converter).

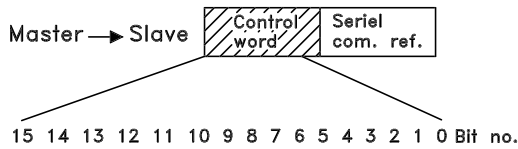

Bit	Bit = 0	Bit = 1
00		Preset ref. lsb
01		Preset ref. msb
02	DC braking	
03	Coasting stop	
04	Quick stop	
05	Freeze outp. freq.	
06	Ramp stop	Start
07		Reset
08		Jog
09	Ramp 1	Ramp 2
10	Data not valid	Data valid
11	No function	Relay output
12	No function	Digital output
13	Select Setup, lsb	
14	Select Setup, msb	
15		Reversing

Bit 00/01:

Bit 00/01 is used to select between the two pre-programmed references (parameters 215-218 *Preset reference*) according to the following table:

Preset ref.	Parameter	Bit 01	Bit 00
1	215	0	0
2	216	0	1
3	217	1	0
4	218	1	1



NB!:

In parameter 508 *Selection of preset reference* a selection is made to define how Bit 00/01 gates with the corresponding function on the digital inputs.

Bit 02, DC brake:

Bit 02 = '0' causes DC braking and stop. Brake voltage and duration are preset in parameters 132 *DC brake voltage* and parameter 126 *DC braking time*. Note: In parameter 504 *DC brake* a selection is made to define how Bit 02 gates with the corresponding function on a digital input.

Bit 03, Coasting stop:

Bit 03 = '0' causes the frequency converter to immediately "let go" of the motor (the output transistors are "shut off"), so that it coasts to a standstill.

Bit 03 = '1' causes the frequency converter to be able start the motor if the other starting conditions have been fulfilled. Note: In parameter 502 *Coasting stop* a selection is made to define how Bit 03 gates with the corresponding function on a digital input.

Bit 04, Quick stop:

Bit 04 = '0' causes a stop, in which the motor's speed is ramped down to stop via parameter 212 *Quick stop ramp-down time*.

Bit 05, Freeze output frequency:

Bit 05 = '0' causes the present output frequency (in Hz) to freeze. The frozen output frequency can now only be changed by means of the digital inputs programmed to *Speed up* and *Speed down*.



NB!:

If *Freeze output* is active, the frequency converter cannot be stopped via Bit 06 *Start* or via a digital input. The frequency converter can only be stopped by the following:

- Bit 03 Coasting stop
- Bit 02 DC braking
- Digital input programmed to *DC braking*, *Coasting stop* or *Reset and coasting stop*.

Bit 06, Ramp stop/start:

Bit 06 = '0' causes a stop, in which the motor's speed is ramped down to stop via the selected *ramp down* parameter.

Bit 06 = '1' causes the frequency converter to be able to start the motor, if the other starting conditions have been fulfilled. Note: In parameter 505 *Start* a selection is made to define how Bit 06 Ramp stop/start gates with the corresponding function on a digital input.

Bit 07, Reset:

Bit 07 = '0' does not cause a reset.

Bit 07 = '1' causes the reset of a trip. Reset is activated on the signal's leading edge, i.e. when changing from logic '0' to logic '1'.

Bit 08, Jog:

Bit 08 = '1' causes the output frequency to be determined by parameter 213 *Jog frequency*.

Bit 09, Selection of ramp 1/2:

Bit 09 = "0" means that ramp 1 is active (parameters 207/208). Bit 09 = "1" means that ramp 2 (parameters 209/210) is active.

Bit 10, Data not valid/Data valid:

Is used to tell the frequency converter whether the control word is to be used or ignored. Bit 10 = '0' causes the control word to be ignored, Bit 10 = '1' causes the control word to be used. This function is relevant, because the control word is always contained in the telegram, regardless of which type of telegram is used, i.e. it is possible to turn off the control word if you do not wish to use it in connection with updating or reading parameters.

Bit 11, No function:

Bit 11 = relay output control.

Bit 12, No function:

Bit 12 = digital output control.

Bit 13/14, Selection of Setup:

Bits 13 and 14 are used to choose from the four menu Setups according to the following table:

Setup	Bit 14	Bit 13
1	0	0
2	0	1
3	1	0
4	1	1

The function is only possible when *Multi-Setups* is selected in parameter 004 *Active Setup*.

Note: I parameter 507 *Selection of Setup* a selection is made to define how Bit 13/14 gates with the corresponding function on the digital inputs.

Bit 15 Reversing:

Bit 15 = '0' causes no reversing.

Bit 15 = '1' causes reversing.

Note: In the factory setting reversing is set to *digital* in parameter 506 *Reversing*. Bit 15 only causes reversing when either *Ser. communication*, *Logic or* or *Logic and* is selected.

■ Status Word according to FC Profile

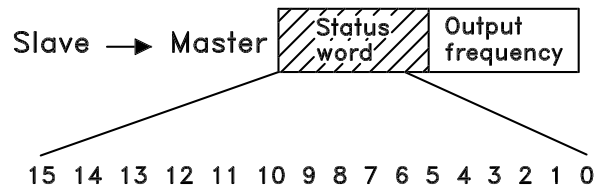

The status word is used to inform the master (e.g. a PC) of the slave's (frequency converter) mode. Slave⇒Master.

Bit	Bit = 0	Bit = 1
00		Control ready
01		Drive ready
02	Coasting stop	
03	No trip	Trip
04	Not used	
05	Not used	
06		Trip lock
07	No warning	Warning
08	Speed ≠ ref.	Speed = ref.
09	Local control	Ser. communi.
10	Outside frequency range	Frequency limit OK
11		Motor running
12		
13		Voltage warn.
14		Current limit
15		Thermal warn.

Bit 00, Control ready:

Bit 00 = '1'. The frequency converter is ready for operation.

Bit 00 = '0'. The frequency converter is not ready for operation.

Bit 01, Drive ready:

Bit 01 = '1'. The frequency converter is ready for operation, but there is an active coasting command via the digital inputs or via serial communication.

Bit 02, Coasting stop:

Bit 02 = '0'. The frequency converter has released the motor.

Bit 02 = '1'. The frequency converter can start the motor when a start command is given.

Bit 03, No trip/trip:

Bit 03 = '0' means that the frequency converter is not in fault mode.

Bit 03 = '1' means that the frequency converter is tripped, and that it needs a reset signal for operation to be reestablished.

Bit 04, Not used:

Bit 04 is not used in the status word.

Bit 05, Not used:

Bit 05 is not used in the status word.

Bit 06, Trip lock:

Bit 06 = '0' means that the frequency converter is not trip locked.

Bit 06 = '1' means that the frequency converter is trip locked and it cannot be reset before the mains supply has been removed. The trip can be reset either with 24 V external control back up or after the power is connected again.

Bit 07, No warning/warning:

Bit 07 = '0' means that there are no warnings.

Bit 07 = '1' means that a warning has occurred.

Bit 08, Speed ≠ ref/speed = ref.:

Bit 08 = '0' means that the motor is running, but that the present speed is different from the preset speed reference. It might, for example, be the case while the speed is being ramped up/down during start/stop.

Bit 08 = '1' means that the motor's present speed is the same as the preset speed reference.

Bit 09, Local operation/serial communication control:

Bit 09 = '0' means that [STOP/RESET] is activated on the control unit, or that *Local control* in parameter 002 *Local/remote operation* is selected. It is not possible to control the frequency converter via serial communication.

Bit 09 = '1' means that it is possible to control the frequency converter via serial communication.

Bit 10, Outside frequency range:

Bit 10 = '0', if the output frequency has reached the value in parameter 201 *Output frequency low limit* or parameter 202 *Output frequency high limit*. Bit 10 = "1" means that the output frequency is within the defined limits.

Bit 11, Running/not running:

Bit 11 = '0' means that the motor is not running.

Bit 11 = '1' means that the frequency converter has a start signal or that the output frequency is greater than 0 Hz.

Bit 13, Voltage warning high/low:

Bit 13 = '0' means that there are no voltage warnings.

Bit 13 = '1' means that the DC voltage in the frequency converter's intermediate circuit is too low or too high.

Bit 14, Current limit:

Bit 14 = '0' means that the output current is less than the value in parameter 221 *Current Limit I_{LIM}*.

Bit 14 = '1' means that the output current is greater than the value in parameter 221 *Current Limit I_{LIM}* and that the frequency converter will trip after a set period of time.

Bit 15, Thermal warning:

Bit 15 = '0' means that there is no thermal warning.

Bit 15 = '1' means that the temperature limit has been exceeded in either the motor, frequency converter or from a thermistor that is connected to a digital input.

■ Fast I/O FC-profile

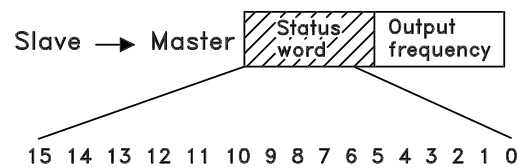

The *Fast I/O FC-profile* can be used to monitor the digital inputs just by reading the status word. The input status in the status word reflects the actual input state (High or Low) regardless of the selected digital input function. The fast I/O profile(s) will only be available in drives fitted with Profibus. The response time from input changes until it is available on the Profibus is approximately 10 mS.

Bit	Bit =0	Bit =1
00		Control ready
01		Drive ready
02	Coasting stop	
03	No trip	Trip
04	Not used	
05	Digital input 27	0: Input LOW/ 1: Input HIGH
06		Trip lock
07	No warning	Warning
08	Speed ≠ ref.	Speed = ref.
09	Local control	Ser. communication
10	Outside frequency range	Frequency limit OK
11		Motor OK
12	Digital input 18	0: Input LOW/ 1: Input HIGH
13	Digital input 19	0: Input LOW/ 1: Input HIGH
14	Digital input 29	0: Input LOW/ 1: Input HIGH
15	Digital input 33	0: Input LOW/ 1: Input HIGH

■ Control word according to Fieldbus Profile

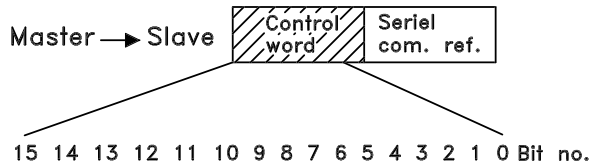

To select *Profdrive* in the control word, parameter 512 *Telegram Profile* must be set to *Profdrive* [0].

The control word is used to send commands from a master (e.g. a PC) to a slave (frequency converter). Master⇒Slave.

Bit	Bit = 0	Bit =1
00	OFF 1	ON 1
01	OFF 2	ON 2
02	OFF 3	ON 3
03	Coasting stop	
04	Quick stop	
05	Freeze outp. freq.	
06	Ramp stop	Start
07	Reset	
08	Bus jog 1	
09	Bus jog 2	
10	Data not valid	Data valid
11	Slow down	
12	Catch-up	
13	Select Setup (lsb)	
14	Select Setup (msb)	
15	Reversing	

Bit 00-01-02, OFF1-2-3/ON1-2-3:

Bit 00-01-02 = '0' causes ramp stop, which uses the ramp time in parameters 207/208 or 209/210. If *Relay 123* is selected in parameter 323 *Relay output*, the output relay will be activated when the output frequency is 0 Hz.

Bit 00-01-02 = '1' means that the frequency converter can start the motor if the other starting conditions are fulfilled.

Bit 03, Coasting stop:

See description under *Control word according to FC protocol*.

Bit 04, Quick stop:

See description under *Control word according to FC protocol*.

Bit 05, Freeze output frequency:

See description under *Control word according to FC protocol*.

Bit 06, Ramp stop/start:

See description under *Control word according to FC protocol*.

Bit 07, Reset:

See description under *Control word according to FC protocol*.

Bit 08, Jog 1:

Bit 08 = "1" means that the output frequency is determined by parameter 09 *Bus jog 1*.

Bit 09, Jog 2:

Bit 09 = "1" means that the output frequency is determined by parameter 510 *Bus jog 2*.

Bit 10, Data not valid/Data valid:

See description under *Control word according to FC protocol*.

Bit 11, Slow-down:

Used to reduce the speed reference by the value in parameter 219 *Catch-up/slow-down reference*. Bit 11 = '0' does not cause any change to the reference. Bit 11 = '1' means that the reference is reduced.

Bit 12, Catch-up:

Used to increase the speed reference by the value in parameter 219 *Catch-up/slow-down reference*. Bit 12 = '0' does not cause any change to the reference. Bit 12 = '1' means that the reference is increased. If both *Slow down* and *Catch-up* are activated (Bits 11 and 12 = "1"), slow down has the highest priority, i.e. that the speed reference is reduced.

Bit 13/14, Selection of Setup:

See description under *Control word according to FC protocol*.

Bit 15 Reversing:

See description under *Control word according to FC protocol*.

■ Status word according to Profidrive protocol

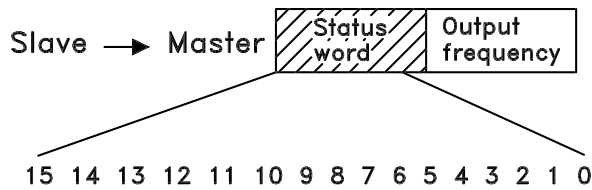

The status word is used to inform the master (e.g. a PC) of the slave's (frequency converter) mode. Slave⇒Master.

Bit	Bit = 0	Bit = 1
00		Control ready
01		Drive ready
02	Coasting stop	
03	No trip	Trip
04	ON 2	OFF 2
05	ON 3	OFF 3
06	Start enable	Start disable
07		Warning
08	Speed ≠ ref.	Speed = ref.
09	Local control	Ser. communi.
10	Outside frequency range	Frequency limit OK
11		Motor running
12		
13		Voltage warn.
14		Current limit
15		Thermal warn.

Bit 00, Control not ready/ready:

Bit 00 = '0' means that the Bit 00, 01 or 02 in the control word are "0" (OFF1, OFF2 or OFF3) or the frequency converter is not ready for operation.

Bit 00 = '1' means that the frequency converter is ready for operation.

Bit 01, Drive ready:

See description under *Status word according to FC protocol*.

Bit 02, Coasting stop:

Bit 02 = '0' means that Bits 00, 02 or 03 in the control word are "0" (OFF1, OFF3 or Coasting stop).

Bit 02 = '1' means that Bits 00, 01, 02 and 03 in the control word are "1", and that the frequency converter has not tripped.

Bit 03, No trip/trip:

See description under *Status word according to FC protocol*.

Bit 04, ON 2/OFF 2:

Bit 04 = '0' means that Bit 01 in the control word = '1'.
Bit 04 = '1' means that Bit 01 in the control word = '0'.

Bit 05, ON 3/OFF 3:

Bit 05 = '0' means that Bit 02 in the control word = '1'.
Bit 05 = '1' means that Bit 02 in the control word = '0'.

Bit 06, Start enable/start disable:

Bit 06 = '1' after reset of a trip, after activation of OFF2 or OFF3 and after connection of mains voltage. *Start disable* is reset by setting Bit 00 in the control word to '0', and Bit 01, 02 and 10 are set to '1'.

Bit 07, Warning:

See description under *Status word according to FC protocol*.

Bit 08, Speed:

See description under *Status word according to FC protocol*.

Bit 09, No warning/warning:

See description under *Status word according to FC protocol*.

Bit 10, Speed ≠ ref/speed = ref.:

See description under *Status word according to FC protocol*.

Bit 11, Running/not running:

See description under *Status word according to FC protocol*.

Bit 13, Voltage warning high/low:

See description under *Status word according to FC protocol*.

Bit 14, Current limit:

See description under *Status word according to FC protocol*.

Bit 15, Thermal warning:

See description under *Status word according to FC protocol*.

■ Serial communication reference

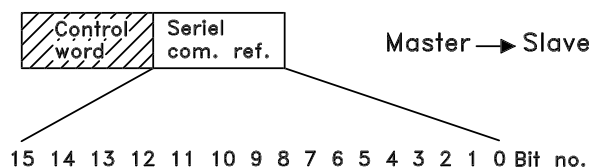

The serial communication reference is transferred to the frequency converter as a 16-bit word. The value is transferred in whole numbers 0 - ±32767 (±200%). 16384 (4000 Hex) corresponds to 100%.

The serial communication reference has the following format: 0-16384 (4000 Hex) ≅ 0-100% (Par. 204 *Minimum ref.* - Par. 205 *Maximum ref.*).

It is possible to change the direction of rotation via the serial reference. This is done by converting the binary reference value to 2' complement. See example.

Example - Control word and serial communication ref.:

The frequency converter is to receive a start command and the reference is to be set to 50% (2000 Hex) of the reference range.
Control word = 047F Hex ⇒ Start command.
Reference = 2000 Hex ⇒ 50% reference.

047F H	2000 H
Control word	Reference

The frequency converter is to receive a start command and the reference is to be set to -50% (-2000 Hex) of the reference range.

The reference value is first converted to 1' complement, and then 1 is added binarily to obtain 2' complement:

2000 Hex	0010 0000 0000 0000 0000
1' complement	1101 1111 1111 1111 1111
	+ 1
2' complement	1110 0000 0000 0000 0000

Control word = 047F Hex ⇒ Start command.
Reference = E000 Hex ⇒ -50% reference.

047F H	E000 H
Control word	Reference

Example - Status word and current output frequency:

The master receives a status message from the frequency converter that the current output frequency is 50% of the output frequency range.

Par. 201 *Output frequency low limit* = 0 Hz
Par. 202 *Output frequency high limit* = 50 Hz

Status word = 0F03 Hex.

Output frequency = 2000 Hex ⇒ 50% of the frequency range, corresponding to 25 Hz.

0F03 H	2000 H
Status word	Output frequency

■ Present output frequency

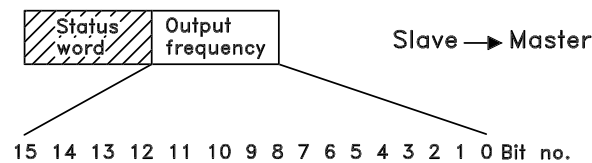

The value of the frequency converter's present output frequency is transferred as a 16-bit word. The value is transferred as whole numbers 0 - ±32767 (±200%).
16384 (4000 Hex) corresponds to 100%.

Output frequency has the following format:
0-16384 (4000 Hex) ≅ 0-100% (Par. 201 *Output frequency low limit* - Par. 202 *Output frequency high limit*).

Serial communication

500 Address (BUS ADDRESS)

Value:

Parameter 500 Protocol = FC protocol [0]	
0 - 247	★ 1
Parameter 500 Protocol = Metasys N2 [1]	
1 - 255	★ 1
Parameter 500 Protocol = MODBUS RTU [3]	
1 - 247	★ 1

Function:

This parameter allows the allocation of an address to each frequency converter in a serial communication network.

Description of choice:

The individual frequency converter must be allocated a unique address.
If the number of units connected (frequency converters + master) is higher than 31, a repeater must be used.
Parameter 500 Address cannot be selected via the serial communication, but must be preset via the control unit.

501 Baudrate (BAUDRATE)

Value:

300 Baud (300 BAUD)	[0]
600 Baud (600 BAUD)	[1]
1200 Baud (1200 BAUD)	[2]
2400 Baud (2400 BAUD)	[3]
4800 Baud (4800 BAUD)	[4]
★9600 Baud (9600 BAUD)	[5]

Function:

This parameter is for programming the speed at which data is transmitted via the serial port. Baud rate is defined as the number of bits transmitted per second.

Description of choice:

The frequency converter's transmission speed must be set at a value corresponding to the transmission speed of the master.
Parameter 501 Baudrate cannot be selected via the serial port, but must be preset via the operating unit.

502 Coasting Stop

(COASTING SELECT)

Value:

Digital input (DIGITAL INPUT)	[0]
Serial port (SERIAL PORT)	[1]
Logic and (LOGIC AND)	[2]
★Logic or (LOGIC OR)	[3]

Function:

Parameters 502-508 allow a choice between controlling the frequency converter via the digital inputs and/or via the serial port.

If *Serial port* [1] is selected, the relevant command can only be activated if a command is given via the serial port.

In the case of *Logic and* [2] the function must also be activated via a digital input.

Description of choice:

The table below shows when the motor is running and when it is coasting, when each of the following is selected: *Digital input* [0], *Serial port* [1], *Logic and* [2] or *Logic or* [3].



NB!:

Note that *Coasting stop* and Bit 03 in the control word are active at logic '0'.

Digital input [0]		
Dig. input	Ser. port	Function
0	0	Coasting
0	1	Coasting
1	0	Motor running
1	1	Motor running

Serial port [1]		
Dig. input	Ser. port	Function
0	0	Coasting
0	1	Motor running
1	0	Coasting
1	1	Motor running

Logic and [2]		
Dig. input	Ser. port	Function
0	0	Coasting
0	1	Motor running
1	0	Motor running
1	1	Motor running

★ = factory setting. () = display text [] = value for use in communication via serial communication port

Logic or [3]		
Dig. input	Ser. port	Function
0	0	Coasting
0	1	Coasting
1	0	Coasting
1	1	Motor running

Logic or [3]		
Dig. input	Serial port	Function
0	0	Quick-stop
0	1	Quick-stop
1	0	Quick-stop
1	1	Motor running

503 Quick-stop

(Q STOP SELECT)

Value:

Digital input (DIGITAL INPUT)	[0]
Serial port (SERIAL PORT)	[1]
Logic and (LOGIC AND)	[2]
★Logic or (LOGIC OR)	[3]

Function:

See function description for parameter 502
Coasting stop.

Description of choice:

The table below shows when the motor is running and when it is in Quick-stop mode, when each of the following is selected: *Digital input* [0], *Serial port* [1], *Logic and* [2] or *Logic or* [3].



NB!:

Note that *Quick-stop inverse* and Bit 04 in the control word are active at logic '0'.

Digital input [0]		
Dig. input	Serial port	Function
0	0	Quick-stop
0	1	Quick-stop
1	0	Motor running
1	1	Motor running

Serial port [1]		
Dig. input	Serial port	Function
0	0	Quick-stop
0	1	Motor running
1	0	Quick-stop
1	1	Motor running

Logic and [2]		
Dig. input	Serial port	Function
0	0	Quick-stop
0	1	Motor running
1	0	Motor running
1	1	Motor running

504 DC brake

(DC BRAKE SELECT)

Value:

Digital input (DIGITAL INPUT)	[0]
Serial port (SERIAL PORT)	[1]
Logic and (LOGIC AND)	[2]
★Logic or (LOGIC OR)	[3]

Function:

See function description for parameter 502
Coasting stop.

Description of choice:

The table below shows when the motor is running and the DC braking when each of the following is selected *Digital input* [0], *Serial port* [1], *Logic and* [2] or *Logic or* [3].



NB!:

Note that *DC braking inverse* and Bit 02 in the control word are active at logic '0'.

Digital input [0]		
Dig. input	Ser. port	Function
0	0	DC braking
0	1	DC braking
1	0	Motor running
1	1	Motor running

Serial port [1]		
Dig. input	Ser. port	Function
0	0	DC braking
0	1	Motor running
1	0	DC braking
1	1	Motor running

Logic and [2]		
Dig. input	Ser. port	Function
0	0	DC braking
0	1	Motor running
1	0	Motor running
1	1	Motor running

★ = factory setting. () = display text [] = value for use in communication via serial communication port

Logic or [3]		
Dig. input	Ser. port	Function
0	0	DC braking
0	1	DC braking
1	0	DC braking
1	1	Motor running

505 Start (START SELECT)

Value:

Digital input (DIGITAL INPUT)	[0]
Serial port (SERIAL PORT)	[1]
Logic and (LOGIC AND)	[2]
★Logic or (LOGIC OR)	[3]

Function:

See function description for parameter 502
Coasting stop.

Description of choice:

The table below shows when the motor has stopped and when the frequency converter has a start command when each of the following is selected: *Digital input* [0], *Serial port* [1], *Logic and* [2] or *Logic or* [3].

Digital input [0]		
Dig. input	Ser. port	Function
0	0	Stop
0	1	Stop
1	0	Start
1	1	Start

Serial port [1]		
Dig. input	Ser. port	Function
0	0	Stop
0	1	Start
1	0	Stop
1	1	Start

Logic and [2]		
Dig. input	Ser. port	Function
0	0	Stop
0	1	Stop
1	0	Stop
1	1	Start

Logic or [3]		
Dig. input	Ser. port	Function
0	0	Stop
0	1	Start
1	0	Start
1	1	Start

506 Reversing

(REVERSING SELECT)

Value:

Digital input (DIGITAL INPUT)	[0]
Serial port (SERIAL PORT)	[1]
Logic and (LOGIC AND)	[2]
★Logic or (LOGIC OR)	[3]

Function:

See function description for parameter 502
Coasting stop.

Description of choice:

The table below shows when the motor is running clockwise and anti-clockwise when each of the following is selected: *Digital input* [0], *Serial port* [1], *Logic and* [2] or *Logic or* [3].

Digital input [0]		
Dig. input	Ser. port	Function
0	0	Clockwise
0	1	Clockwise
1	0	Anti-clockwise
1	1	Anti-clockwise

Serial port [1]		
Dig. input	Ser. port	Function
0	0	Clockwise
0	1	Anti-clockwise
1	0	Clockwise
1	1	Anti-clockwise

Logic and [2]		
Dig. input	Ser. port	Function
0	0	Clockwise
0	1	Clockwise
1	0	Clockwise
1	1	Anti-clockwise

Logic or [3]		
Dig. input	Ser. port	Function
0	0	Clockwise
0	1	Anti-clockwise
1	0	Anti-clockwise
1	1	Anti-clockwise

507 Selection of Setup

(SETUP SELECT)

Value:

Digital input (DIGITAL INPUT)	[0]
Serial communication (SERIAL PORT)	[1]
Logic and (LOGIC AND)	[2]
★Logic or (LOGIC OR)	[3]

★ = factory setting. () = display text [] = value for use in communication via serial communication port

Function:

See function description of parameter 502
Coasting stop.

Description of choice:

The table below shows which Setup (parameter 004 *Active Setup*) is selected for each of the following: *Digital input* [0], *Serial communication* [1], *Logic and* [2] or *Logic or* [3].

Digital input [0]

Setup msb	Setup lsb	Function
0	0	Setup 1
0	1	Setup 2
1	0	Setup 3
1	1	Setup 4

Serial communication [1]

Setup msb	Setup lsb	Function
0	0	Setup 1
0	1	Setup 2
1	0	Setup 3
1	1	Setup 4

Logic and [2]

Bus Setup msb	Bus Setup lsb	Dig. Setup msb	Dig. Setup lsb	Setup no.
0	0	0	0	1
0	0	0	1	1
0	0	1	0	1
0	0	1	1	1
0	1	0	0	1
0	1	0	1	2
0	1	1	0	1
0	1	1	1	2
1	0	0	0	1
1	0	0	1	1
1	0	1	0	3
1	0	1	1	3
1	1	0	0	1
1	1	0	1	2
1	1	1	0	3
1	1	1	1	4

Logic or [3]

Bus Setup msb	Bus Setup lsb	Dig. Setup msb	Dig. Setup lsb	Setup no.
0	0	0	0	1
0	0	0	1	2
0	0	1	0	3
0	0	1	1	4
0	1	0	0	2
0	1	0	1	2
0	1	1	0	4
0	1	1	1	4
1	0	0	0	3
1	0	0	1	4
1	0	1	0	3
1	0	1	1	4
1	1	0	0	4
1	1	0	1	4
1	1	1	0	4
1	1	1	1	4

508 Selection of preset ref.

(PRES.REF. SELECT)

Value:

Digital input (DIGITAL INPUT)	[0]
Serial communication (SERIAL PORT)	[1]
Logic and (LOGIC AND)	[2]
★Logic or (LOGIC OR)	[3]

Function:

See function description of parameter 502
Coasting stop.

Description of choice:

Preset references via serial communication are active when parameter 512 *Telegram profile* is set to *FC protocol* [1].

509 Bus jog 1 (BUS JOG 1 FREQ.)

510 Bus jog 2 (BUS JOG 2 FREQ.)

Value:

0.0 - par. 202 *Output frequency high limit*

★ 10,0 Hz

Function:

If parameter 512 *Telegram Profile* shows the selection *Profdrive* [0], two fixed speeds (Jog 1 or Jog 2) can be selected via the serial port.

The function is the same as in parameter 213 *Jog frequency* .

★ = factory setting. () = display text [] = value for use in communication via serial communication port

Description of choice:

Jog frequency f_{JOG} can be selected between 0 Hz and f_{MAX} .

been exceeded. If choices [1] to [5] are activated the output relay will be deactivated.

512 Telegram Profile

(TELEGRAM PROFILE)

Value:

Profidrive (PROFIDRIVE)	[0]
★FC protocol (FC PROTOCOL)	[1]
Fast I/O FC-profile (FAST I/O FC-PROFILE)	[2]

Description of choice:

The output frequency of the frequency converter can be frozen at the present value, stop the motor, be frozen at parameter 213 *Jogging frequency*, be frozen at parameter 202 *Output frequency, high limit f_{MAX}* or stop and activate a cut out.

Function:

It is possible to choose between three different control word profiles.

Description of choice:

Select the desired control word profile. See *Serial port for FCD 300* for further details of control word profiles.

513 Bus time interval

(BUS TIMEOUT TIME)

Value:

1 - 99 sec. ★ 1 sec.

Function:

In this parameter it is possible to preset the maximum time expected to elapse between receipt of two consecutive telegrams. If this time is exceeded, the serial communication is assumed to have stopped and the desired reaction is preset in parameter 514 *Bus time interval function*.

Description of choice:

Preset the required time.

514 Bus time interval function

(BUS TIMEOUT FUNC)

Value:

★Off (OFF)	[0]
Freeze output frequency (FREEZE OUTPUT)	[1]
Stop (STOP)	[2]
Jogging (JOGGING)	[3]
Max. speed (MAX SPEED)	[4]
Stop and trip (STOP AND TRIP)	[5]

Function:

In this parameter you can select the required reaction for the frequency converter when the preset time in parameter 513 *Bus time interval* has

★ = factory setting. () = display text [] = value for use in communication via serial communication port

515-544 Data readout				
Value:				
Par. no.	Description	Display text	Unit	Update interval
515	Res. reference	(REFERENCE %)	%	
516	Res. reference [Unit]	(REFERENCE [UNIT])	Hz, rpm	
517	Feedback [Unit]	(FEEDBACK [UNIT])	Par. 416	
518	Frequency	(FREQUENCY)	Hz	
519	Frequency x scale	(FREQUENCY X SCALE)	Hz	
520	Motor current	(MOTOR CURRENT)	Amp	
521	Torque	(TORQUE)	%	
522	Power[kW]	(POWER (KW))	kW	
523	Power[HP]	(POWER (HP))	HP	
524	Motor voltage	(MOTOR VOLTAGE)	V	
525	DC-link voltage	(DC LINK VOLTAGE)	V	
526	Thermal load motor	(MOTOR THERMAL)	%	
527	Thermal load inverter	(INV. THERMAL)	%	
528	Digital input	(DIGITAL INPUT)	Bin	
529	Term.53, analogue input	(ANALOG INPUT 53)	V	
531	Term.60, analogue input	(ANALOG INPUT 60)	mA	
532	Term. 33, pulse input	(PULSE INPUT 33)	Hz	
533	External ref.	(EXT. REF.%)	%	
534	Status word, Hex	(STATUS WORD)	Hex	
537	Inverter temperature	(INVERTER TEMP.)	°C	
538	Alarm word	(ALARM WORD)	Hex	
539	Control word	(CONTROL WORD)	Hex	
540	Warning word	(WARN. WORD)	Hex	
541	Extended status word	(EXT. STATUS WORD)	Hex	
544	Pulse count	(PULSE COUNT)		
545	Term. 29, pulse input	(PULSE INPUT 29)	Hz	

Function:

These parameters can be read out via the serial communication port and the LCP display. See also parameters 009-012 *Display readout*.



NB!:

Parameters 515-541 can only be read out via the serial communication port.

Description of choice:

Resulting reference %, parameter 515:

Gives the resulting reference as a percentage in the range from Minimum reference, Ref_{MIN} to Maximum reference, Ref_{MAX}. See also *Dealing with references*.

Resulting reference [unit], parameter 516:

Gives the resulting reference in Hz in Open loop (parameter 100). In a closed loop the reference unit is selected in parameter 416 *Process units*.

Feedback [unit], parameter 517:

Gives the resulting feedback value with the unit/scaling selected in parameters 414, 415 and 416. See also dealing with feedback.

Frequency [Hz], parameter 518:

Gives the output frequency from the frequency converter.

Frequency x scaling [-], parameter 519:

corresponds to the present output frequency f_M multiplied by the factor preset in parameter 008 *Display scaling of output frequency*.

★ = factory setting. () = display text [] = value for use in communication via serial communication port

Motor current [A], parameter 520:

Gives the motor's phase current measured as an effective value.

Torque [Nm], parameter 521:

Gives the motor's present load in relation to the motor's rated torque.

Power [kW], parameter 522:

Gives the present power absorbed by the motor in kW.

Power [HP], parameter 523:

Gives the present power absorbed by the motor in HP.

Motor voltage, parameter 524:

Gives the voltage being supplied to the motor.

DC link voltage, parameter 525:

Gives the intermediate circuit voltage in the frequency converter.

Thermal load, motor [%], parameter 526:

Gives the calculated/estimated thermal load on the motor. 100% is the cut-out limit. See also parameter 128 *Thermal motor protection*.

Thermal load INV [%], parameter 527:

Gives the calculated/estimated thermal load on the frequency converter. 100% is the cut-out limit.

Digital input, parameter 528:

Gives the signal status from the 5 digital inputs (18, 19, 27, 29 and 33). Input 18 corresponds to the bit on the extreme left. '0' = no signal, '1' = connected signal.

Terminal 53 analogue input [V], parameter 529:

Gives the voltage value for the signal on terminal 53.

Terminal 60 analogue input [mA], parameter 531:

Gives the present value for the signal on terminal 60.

Pulse input 33[Hz], parameter 532:

Gives a pulse frequency in Hz connected to terminal 33.

External reference, parameter 533:

Gives the sum of external references as a percentage (sum of analogue/pulse/serial communication) in the range from Minimum reference, Ref_{MIN} to Maximum reference, Ref_{MAX}.

Status word, parameter 534:

Gives the present status word for the frequency converter in Hex. See *Serial communication for the VLT 2800*.

Inverter temperature, parameter 537:

Gives the present inverter temperature on the frequency converter. The cut-out limit is 90-100 °C, with cut back in at 70 ± 5 °C.

Alarm word, parameter 538:

Gives in Hex code which alarm is on the frequency converter. See *Warning word, extended status word and alarm word*.

Control word, parameter 539:

Gives the present control word on the frequency converter in Hex. See *Serial communication for the FCD 300*.

Warning word, parameter 540:

States whether there is a warning on the frequency converter in Hex. See *Warning word, extended status word and alarm word*.

Extended status word, parameter 541:

States whether there is a warning on the frequency converter in Hex code. See *Warning word, extended status word and alarm word*.

Pulse count, parameter 544:

This parameter can be read out via the LCP display (009-012). When you run with counter stop, this parameter enables you, either with or without reset, to read the number of pulses registered by the device. The highest frequency is 67.6 kHz, while the lowest is 5 Hz. The counter is reset when counter stop is restarted.

Pulse input 29[Hz], parameter 545:

Gives a pulse frequency in Hz connected to terminal 29.

561 Protocol

(PROTOCOL)

Value:

★FC protocol (FC PROTOKOL)	[0]
Metasys N2 (METASYS N2)	[1]
Modbus RTU	[3]

Function:

There is a choice of three different protocols.

Description of choice:

Select the required control word protocol.

For further information about using the Metasys N2 Protocol see MG91CX and Modbus RTU see MG10SX.

570 Modbus parity and message framing

(M.BUS PAR./FRAME)

Value:

(EVEN/1 STOPBIT)	[0]
(ODD/1 STOPBIT)	[1]
★ (NO PARITY/1 STOPBIT)	[2]
(NO PARITY/2 STOPBIT)	[3]

Function:

This parameter sets up the drive's Modbus RTU interface to communicate properly with the master controller. The parity (EVEN, ODD, or NO PARITY) must be set to match the setting of the master controller.

Description of choice:

Select the parity that matches the setting for the Modbus master controller. Even or odd parity is sometimes used to allow a transmitted word to be checked for errors. Because Modbus RTU uses the more efficient CRC (Cyclic Redundancy Check) method of checking for errors, parity checking is seldom used in Modbus RTU networks.

571 Modbus communications timeout

(M.BUS COM.TIME.)

Value:

10 ms - 2000 ms	★ 100 ms
-----------------	----------

Function:

This parameter determines the maximum amount of time that the drive's Modbus RTU will wait between characters that are sent by the master controller. When this amount of time expires, the drive's Modbus RTU interface will assume that it has received the entire message.

Description of choice:

Generally, the value of 100 ms is sufficient for Modbus RTU networks, although some Modbus RTU networks may operate on a timeout value as short as 35 ms. If this value is set too short, the drive's Modbus RTU interface may miss a part of the message. Since the CRC check will not be valid, the drive will ignore the message. The resulting retransmissions of messages will slow communications on the network. If this value is set too long, the drive will wait longer than necessary to determine that the message is completed. This will delay the drive's response to the message and possibly cause the master controller to time out. The resulting retransmissions of messages will slow communications on the network.

★ = factory setting. () = display text [] = value for use in communication via serial communication port

■ Technical functions
600-605 Operating Data
Value:

Par. no.	Description	Display text	Unit	Range
600	Operating hours	(OPERATING HOURS)	Hours	0-130,000.0
601	Hours run	(RUNNING HOURS)	Hours	0-130,000.0
602	kWh counter	(KWH COUNTER)	kWh	Depends on unit
603	Number of power-up's	(POWER UP'S)	Number of times	0-9999
604	Number of overtemperatures	(OVER TEMP'S)	Number of times	0-9999
605	Number of overvoltages	(OVER VOLT'S)	Number of times	0-9999

Function:

These parameters can be read out via the serial communication port and the LCP control unit.

Description of choice:

Parameter 600, Operating hours:

Gives the number of hours the frequency converter has been operating. The value is saved every hour and when there is a mains failure. This value cannot be reset.

Parameter 601, Hours run:

Gives the number of hours the motor has been operating since the reset in parameter 619 *Reset of hours-run counter*. The value is saved every hour and when there is a mains failure.

Parameter 602, kWh counter:

Gives the frequency converter's output energy in kWh. The calculation is based on the mean kW value over one hour. This value can be reset using parameter 618 *Reset of kWh counter*.
Range: 0 - depends on unit.

Parameter 603, Number of power-ups:

Gives the number of power-ups of the supply voltage undertaken on the frequency converter.

Parameter 604, Number of overtemperatures:

Gives the number of overtemperature faults that have been registered on the frequency converter's heat sink.

Parameter 605, Number of overvoltages:

Gives the number of overvoltages of the intermediate circuit voltage in the frequency converter. This is only counted when Alarm 7 *Overvoltage* is active.

NB!

Parameters 615-617 *Fault log* cannot be read out via the integral control unit.

615 Fault log: Error code
(F.LOG: ERROR COD)
Value:

[Index 1 - 10] Error code: 0 - 99

Function:

In this parameter it is possible to see the reason for a trip (cut-out of the frequency converter) occurring. 10 [1-10] log values are defined.

The lowest log number [1] contains the latest/most recently saved data value. The highest log number [10] contains the oldest data value saved. If a trip occurs, it is possible to see the cause, time and a possible value of the output current or output voltage.

Description of choice:

Given as a fault code, in which the number refers to a table. See the table in *Warnings/alarm messages*.

616 Fault log: Time
(F.LOG: TIME)
Value:

[Index 1 - 10] Hours: 0 - 130,000.0

Function:

In this parameter it is possible to see the total number of operating hours in connection with the last 10 trips. 10 [1-10] log values are denoted. The lowest log number [1] contains the latest/most recently saved data value, and the highest log number [10] contains the oldest data value.

Description of choice:

Read out as one value.

617 Fault log: Value

(F.LOG: VALUE)

Value:

[Index 1 - 10] Value: 0 - 9999

Function:

In this parameter it is possible to see at which value a trip occurred. The unit of the value depends on which alarm is active in parameter 615 *Fault log: Fault code*.

Description of choice:

Read out as one value.

618 Reset of kWh counter

(RESET KWH COUNT)

Value:

★No reset (DO NOT RESET) [0]
Reset (RESET COUNTER) [1]

Function:

Resetting parameter 602 *kWh counter* to zero.

Description of choice:

If *Reset* [1] is selected and you press the [OK] key, the frequency converter's kWh counter is reset to zero. This parameter cannot be selected via serial communication.



NB!:

When the [OK] key is activated, the counter is reset to zero.

619 RESET RUNNING HOURS COUNTER

(RESET RUN. HOUR)

Value:

★No reset (DO NOT RESET) [0]
Reset (RESET COUNTER) [1]

Function:

Resetting of parameter 601 *Hours run* to zero.

Description of choice:

If *Reset* [1] is selected and you press the [OK] key, the frequency converter's parameter 601 is reset to zero *Hours run*. This parameter cannot be selected via serial communication.



NB!:

When the [OK] key is activated the parameter is reset to zero.

620 Operation Mode

(OPERATION MODE)

Value:

★Normal operation (NORMAL OPERATION) [0]
Control card test (CONTROL CARD TEST) [2]
Initialise (INITIALIZE) [3]

Function:

In addition to its normal function, this parameter can be used to test the control card.

There is also the opportunity to perform an initialisation at the factory setting for all parameters in all Setups, with the exception of parameters 500 *Address*, 501 *Baudrate*, 600-605 *Operating data* and 615-617 *Fault log*.

Description of choice:

Normal function [0] is used for normal operation of the motor.

Control card test [2] is selected if you wish to check the control card's analog/digital inputs, analog/digital outputs, relay outputs and 10 V and 24 V voltages.

The test is performed as follows:

18 - 19 - 27 - 29 - 33 - 46 are connected.

20 - 55 are connected.

42 - 60 are connected.

01 - 50 are connected.

02 - 53 are connected.

03 - 31B are connected.

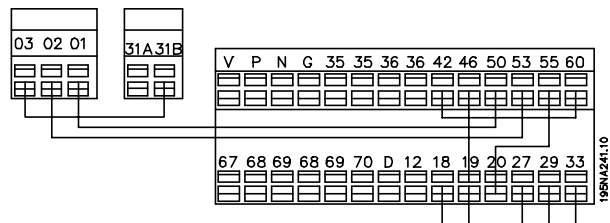

Use the following procedure for the control card test:

1. Select control card test.
2. Disconnect the mains voltage and wait until the light in the display has disappeared.
3. Mount according to drawing and description.
4. Connect the mains voltage.
5. The frequency converter automatically undertakes a test of the control card.

If the LEDs are flashing a code (4 LEDs alternatively), the control card test has failed (see the section *Internal faults* for further details). Change the control card to start up the frequency converter.

If the frequency converter comes into Normal/Display mode, the test is OK. Remove the test connector and the frequency converter is ready for operation. Parameter 620 *Operating mode* is automatically set to *Normal operation* [0].

★ = factory setting. () = display text [] = value for use in communication via serial communication port

Initialisation [3] is selected if you wish to use the unit's factory setting.

Procedure for initialisation:

1. Select *Initialisation* [3].
 2. Disconnect the mains voltage and wait until the light in the display has disappeared.
 3. Connect the mains voltage.
 4. An initialisation is performed in all parameters in all Setups, with the exception of parameters 500 *Address*, 501 *Baudrate*, 600-605 *Operating data* and 615-617 *Fault log*.
-

621-642 Nameplate
Value:

Par. no	Description	Display text
621	Unit type	(DRIVE TYPE)
624	Software version	(SOFTWARE VERSION)
625	LCP identification no.	(LCP VERSION)
626	Database identification no.	(DATABASE VER.)
627	Power parts version	(POWER UNIT DB ID)
628	Application option type	(APP. OPTION)
630	Communication option type	(COM. OPTION)
632	BMC software identification	(BMC-SOFTWARE ID)
634	Unit identification for communication	(UNIT ID)
635	Software parts no.	(SW. PART NO.)
640	Software version	(SOFTWARE VERSION)
641	BMC-software identification	(BMC2 SW)
642	Power card identification	(POWER ID)

Function:

The unit's main data can be read out from parameters 621 to 635 *Nameplate* using the LCP control unit or serial communication. Parameters 640 - 642 can also be seen on the unit's integral display.

Description of choice:

Parameter 621 Nameplate: Unit type:

Gives unit size and mains voltage.

Example: FCD 311 380-480 V.

Parameter 624 Nameplate: Software version no.

The unit's present software version number appears here.

Example: V 1.00

Parameter 625 Nameplate: LCP ID number:

The ID number of the unit's LCP appears here.

Example: ID 1.42 2 kB

Parameter 626 Nameplate: Database ID number:

The ID number of the software's database appears here.

Example: ID 1.14.

Parameter 627 Nameplate: Power section version:

The ID number of the unit's power section appears here.

Example: ID 1.15.

Parameter 628 Nameplate: Application option type:
Here you can see which types of application options are installed in the frequency converter.

Parameter 630 Nameplate: Communication option type:

Here you can see which types of communication options are installed in the frequency converter.

Parameter 632 Nameplate: BMC software identification:

The ID number of the BMC software appears here.

Parameter 634 Nameplate: Unit identification for communication:

The ID number for communication appears here.

Parameter 635 Nameplate: Software section no.:

The software section number appears here.

Parameter 640 Nameplate: Software version:

The unit's present software version number appears here. Example: 1.00

Parameter 641 Nameplate: BMC software identification:

The ID number of the BMC software appears here.

Parameter 642 Nameplate: Power card identification:

The ID number of the unit's power part appears here. Example: 1.15

★ = factory setting. () = display text [] = value for use in communication via serial communication port

678 Configure Control Card**(CONFIG CONTROL CARD)****Value:**

Standard version (STANDARD VERSION)	[1]
Profibus 3 Mbaud Version (PROFIBUS 3 MB VER.)	[2]
Profibus 12 Mbaud Version (PROFIBUS 12 MB VER.)	[3]

Function:

This parameter enables a configuration of a Profibus Control Card. The default value depends on the produced unit, also being the maximum obtainable value. This means, that a control card only can be down graded to a lower performance version.

■ Service

■ Diagnostics

The actual status can be read on the outside of the FCD products. Five LEDs signal the actual status of the unit with the meaning described in the table.

Further detailed status information can be obtained using a local control panel (LCP2 – see photo). This can be connected on the outside (without opening the enclosure) if the LCP2-plug shown on the drawing is installed. The LCP2 is an easy-to-navigate user-friendly interface used to access and adjust all parameters. It displays parameters in six different languages.

The FCD 300 holds a log with valuable information on failure. Information on the most recent 10 faults is stored and indexed in three different parameters to help diagnosis.

Parameter 616 stores the time of the fault as measured by the internal clock.

Parameter 617 holds a fault code telling the type of fault detected.

Parameter 618 stores a measurement relevant for the case. Typically the intermediate circuit voltage or output current measured immediately before failure.

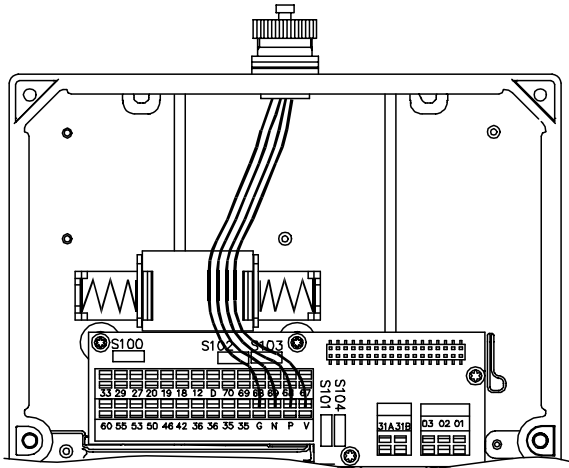

195NA340.10

LCP2-plug



195NA354.10

Local Control Panel

LED diagnostics on decentralised FCD 300

No	Name	Colour	OK status	Alternatives	Function
1	Status	Yellow	Off	Off	Status of the FCD is OK
				On	Corresponding to parameter setting. For further information see <i>Design Guide</i> - parameter number 26 and DeviceNet manual for specific DeviceNet signalling
2	Bus	Green	On (If bus option is present, else Off)	On	OK status for the field bus used (Not relevant for non field bus device)
				Slow flashing	Local operation or local stop
				Fast flashing	Interface working, but no communication with master (See field bus manual for specific info) (Not relevant for non field bus device)
				Off	Status for the field bus <i>not</i> OK (not relevant for non field bus device)
3	Alarm	Red	Off	Off	No alarm is present
				Flashing	Flashing while trip/trip lock is present
4	Warning	Yellow	Off	Off	No warning is present
				Flashing	Flashing while warning situation is present
5	On	Green	On	On	The unit is supplied by mains power or 24 V DC
				Off	Mains power or 24 V DC is missing

All about FCD 300

■ Warnings/alarm messages

A warning or an alarm will appear in the LEDs on the LCP2. A warning will be shown until the fault has been corrected, while an alarm will continue to flash until the [STOP/RESET] key is activated. The table shows the various warnings and alarms shown in the LCP2, and whether the fault locks the frequency converter. After a *Trip locked* (alarm and warning LEDs flash at the same time), the mains supply is cut off and the fault is corrected. The mains supply is reconnected and the frequency converter is reset. The frequency converter is now ready. A *Trip* can be reset manually in three ways:

1. Via the operating key [STOP/RESET].

2. Via a digital input.

3. Via serial communication.

It is also possible to choose an automatic reset in parameter 405 *Reset function*. When a cross appears in both warning and alarm, this can mean that a warning comes before an alarm. It can also mean that it is possible for the user to programme whether a warning or an alarm will appear for a given fault. For example, this is possible in parameter 128 *Motor thermal protection*. After a trip the motor will coast, and alarm and warning will blink on the frequency converter, but if the fault disappears only the alarm will blink. After a reset the frequency converter will be ready to start operation again.

No.	Description	Warning	Alarm	Trip locked
2	Live zero error (LIVE ZERO ERROR)	X	X	X
4	Mains phase loss (MAINS PHASE LOSS)	X	X	X
5	Voltage warning high (DC LINK VOLTAGE HIGH)	X		
6	Voltage warning low (DC LINK VOLTAGE LOW)	X		
7	Overvoltage (DC LINK OVERVOLT)	X	X	X
8	Undervoltage (DC LINK UNDERVOLT)	X	X	X
9	Inverter overload (INVERTER TIME)	X	X	
10	Motor overloaded (MOTOR, TIME)	X	X	
11	Motor thermistor (MOTOR THERMISTOR)	X	X	
12	Current limit (CURRENT LIMIT)	X	X	
13	Overcurrent (OVERCURRENT)	X	X	X
14	Earth fault (EARTH FAULT)		X	X
15	Switch mode fault (SWITCH MODE FAULT)		X	X
16	Short-circuit (CURR. SHORT CIRCUIT)		X	X
17	Serial communication timeout (STD BUS TIMEOUT)	X	X	
18	HPFB bus timeout (HPFB TIMEOUT)	X	X	
33	Out of frequency range (OUT FREQ RNG/ROT LIM)	X		
34	HPFB communication fault (PROFIBUS OPT. FAULT)	X	X	
35	Inrush fault (INRUSH FAULT)		X	X
36	Overtemperature (OVERTEMPERATURE)	X	X	
37-45	Internal fault (INTERNAL FAULT)		X	X
50	AMT not possible		X	
51	AMT fault re. nameplate data (AMT TYPE.DATA FAULT)		X	
54	AMT wrong motor (AMT WRONG MOTOR)		X	
55	AMT timeout (AMT TIMEOUT)		X	
56	AMT warning during AMT (AMT WARN. DURING AMT)		X	
99	Locked (LOCKED)	X		

LED indication

Warning	yellow
Alarm	red
Trip locked	yellow and red

WARNING/ALARM 2: Live zero fault

The voltage or current signal on terminal 53 or 60 is below 50% of the preset value in parameter 309 or 315 *Terminal, min. scaling*.

WARNING/ALARM 4: Mains phase fault

No phase on mains supply side. Check the supply voltage to the frequency converter. This fault is only active in 3-phase mains supply. The alarm can only occur when the load is pulsing. In this instance the pulses must be dampened, e.g. using an inertia disc.

WARNING 5: Voltage warning high

If the intermediate circuit voltage (UDC) is higher than *Voltage warning high* the frequency converter will give a warning and the motor will continue to run unchanged. If the UDC remains above the voltage warning limit, the inverter will trip after a set time. The time depends on the device, and is set at 5 - 10 sec. Note: The frequency converter will trip with an alarm 7 (overvoltage). A voltage warning can occur when the connected mains voltage is too high. Check whether the supply voltage is suitable for the frequency converter, see *Technical data*. A voltage warning can also occur if the motor frequency is reduced too quickly due to ramp down time being too short.

WARNING 6: Voltage warning low

If the intermediate circuit voltage (UDC) is lower than *Voltage warning low* the frequency converter will give a warning and the motor will continue to run unchanged. If the UDC remains below the voltage warning limit, the inverter will trip after a set time. The time depends on the device, and is set at 2 - 25 sec. Note: The frequency converter will trip with an alarm 5 (undervoltage). A voltage warning can occur when the connected mains voltage is too low. Check whether the supply voltage is suitable for the frequency converter, see *Technical data*. When the frequency converter is switched off a brief warning 6 (and warning 8) appears.

WARNING/ALARM 7: Overvoltage

If the intermediate voltage (UDC) goes over the inverter's *Overvoltage limit* the inverter will be switched off until the UDC has once more fallen below the overvoltage limit. If the UDC remains above the overvoltage limit the inverter will trip after a set time. The time depends on the device, and is set at 5 - 10 sec. An overvoltage in the UDC can occur when the motor frequency is reduced too quickly due to ramp down time being too short. Note: *Voltage warning high* (warning 5) will thus also be able to generate an alarm 7.

WARNING/ALARM 8: Undervoltage

If the intermediate circuit voltage (UDC) is lower than the inverter's *Undervoltage limit* the inverter will be switched off until the UDC once more goes above the undervoltage limit. If the UDC remains under the *undervoltage limit*, the inverter will trip after a set time. The time depends on the device, and is set at 2 - 15 sec. An undervoltage can occur when the connected mains voltage is too low. Check whether the supply voltage is suitable for the frequency converter, see *Technical data*. When the frequency converter is switched off a warning 8 (and warning 6) is displayed

briefly. Note: *Voltage warning low* (warning 6) will thus also be able to generate an alarm 8.

WARNING/ALARM 9: Inverter overload

Electronic thermal inverter protection indicates that the frequency converter is close to tripping due to overloading (output current too high for too long). The counter for electronic thermal inverter protection gives a warning at 98% and trips at 100% accompanied by an alarm. The frequency converter cannot be reset until the counter drops below 90%. This fault arises because the frequency converter has been overloaded for too long.

WARNING/ALARM 10: Motor overloaded

According to the electronic thermal inverter protection the motor is too hot. In parameter 128 the user can select whether the VLT frequency converter should emit a warning or an alarm when the counter reaches 100%. This fault is due to the motor being overloaded by more than 100% for too long. Check that motor parameters 102–106 are set correctly.

WARNING/ALARM 11: Motor thermistor

The motor is too hot or the thermistor/thermistor connection has been disconnected. In parameter 128 *Thermal motor protection* the user can select whether the frequency transformer emits a warning or an alarm. Check that the PTC thermistor is correctly connected between terminals 31a and 31b.

WARNING/ALARM 12: Current limit

The output current is greater than the value in parameter 221 *Current Limit LIM*, and the frequency converter will trip after a set time, selected in parameter 409 *Trip delay overcurrent*.

WARNING/ALARM 13: Overcurrent

The inverter's peak current limit (approx. 200% of rated output current) has been exceeded. The warning will last approx. 1-2 sec, and the frequency converter will then trip and emit an alarm. Switch off the frequency converter and check whether the motor shaft can be turned, and whether the size of the motor is suitable for the frequency converter.

ALARM 14: Earth fault

There is a discharge from the output phases to earth, either in the cable between the frequency converter and the motor, or in the motor. Turn off the frequency converter and remove the earth fault.

ALARM 15: Switch mode fault

Fault in switch mode power supply (internal supply). Contact your Danfoss supplier.

ALARM 16: Short-circuit

There is a short-circuit on the motor terminals or in the motor. Disconnect the mains supply to the frequency converter and remove the short-circuit.

WARNING/ALARM 17: Serial communication timeout

There is no serial communication to the frequency converter. The warning will only be active when 514 *Bus timeout function* is set to a value other than OFF. If parameter 514 *Bus timeout function* is set to *Stop and trip* [5], it will first give a warning and then ramp down and trip out accompanied by an alarm. Parameter 513 *Bus timeout* can if required be increased

WARNING/ALARM 18: HPFB bus timeout

There is no serial communication to the frequency converter's communication option card. This warning will only be active when parameter 804 *Bus timeout function* is set to a value other than OFF. If parameter 804 *Bus timeout function* is set to *Stop and trip*, it will first give a warning and then ramp down and trip out accompanied by an alarm. Parameter 803 *Bus timeout* can if required be increased.

WARNING 33: Out of frequency range

This warning is active if the output frequency has reached *Output frequency low limit* (parameter 201) or *Output frequency high limit* (parameter 202). If the VLT frequency converter is in *Process regulation, closed loop* (parameter 100) the warning will be active in the display. If the VLT frequency converter is in another mode than *Process regulation, closed loop*, bit 008000 *Out of frequency range* in extended status word will be active, but there will not be a warning in the display.

WARNING/ALARM 34: HPFB communication fault

Communication fault only occurs in Profibus versions.

ALARM 35: Inrush fault

This alarm occurs when the frequency converter has been connected to the mains supply too many times within 1 minute.

WARNING/ALARM 36: Overtemperature

If the internal temperature rises above 75 - 85 °C (depending on the device) the frequency converter will emit a warning, and the motor will continue to run unchanged. If the temperature continues to rise, the switch frequency is reduced automatically. See *Temperature-dependent switching frequency*.

If the internal temperature of the heatsink rises above 92 - 100 °C (depending on the unit) the frequency converter will cut out. The temperature fault cannot be reset until the temperature of the internal heatsink has dropped to below 70 °C. The tolerance is ± 5 °C. The temperature can be caused by the following:

- The ambient temperature too high.
- Motor cable too long.
- Too high mains voltage.

ALARM 37–45: Internal fault

Internal faults 0–8 will be indicated in LED's Alarm, Warning, Bus, Status as a flashing code.

Alarm 37, internal fault number 0: Communication fault between control card and BMC2.

Alarm 38, internal fault number 1: Flash EEPROM fault on control card.

Alarm 39, internal fault number 2: RAM fault on control card

Alarm 40, internal fault number 3: Calibration constant in EEPROM.

Alarm 41, internal fault number 4: Data values in EEPROM.

Alarm 42, internal fault number 5: Fault in motor parameter database.

Alarm 43, internal fault number 6: General power card fault.

Alarm 44, internal fault number 7: Minimum software version of control card or BMC2

Alarm 45, internal fault number 8: I/O fault (digital input/output, relay or analog input/output)

NB!:

When restarting after an alarm 38-45, the VLT frequency converter will display an alarm 37. In parameter 615 the actual alarm code can be read.

ALARM 50: AMT not possible

One of the following three possibilities can occur:

- The calculated R_S value falls outside permitted limits.
- The motor current in at least one of the motor phases is too low.
- The motor in use is probably too small for AMT calculations to be performed.

ALARM 51: AMT Fault re. nameplate data

There is inconsistency between the registered motor data. Check the motor data for the relevant setup.

ALARM 54: AMT incorrect motor

AMT cannot be performed on the motor being used.

ALARM 55: AMT timeout

Calculations are taking too long, possibly due to noise on the motor cables.

ALARM 56: AMT warning during AMT

A frequency converter warning is given while AMT is being performed.

WARNING 99: Locked

See parameter 18.

Warning words, extended status words and alarm words

Warning words, status words and alarm words appear in the display in Hex format. If there are several warnings, status words or alarms, a total of all the warnings, status words or alarms will be displayed. Warning words, status words and alarm words can also be read out using the serial bus in parameters 540, 541 and 538 respectively.

Bit (Hex)	Warning words
000008	HPFB bus timeout
000010	Standard bus timeout
000040	Current limit
000080	Motor thermistor
000100	Motor overload
000200	Inverter overload
000400	Undervolt
000800	Overvolt
001000	Voltage warning low
002000	Voltage warning high
004000	Phase loss
010000	Live zero error
400000	Out of frequency range
800000	Profibus communication fault
40000000	Switch mode warning
80000000	Heat sink temperature high

Bit (Hex)	Extended status words
000001	Ramping
000002	AMT running
000004	Start forw./reverse
000008	Slow down
000010	Catch-up
000020	Feedback high
000040	Feedback low
000080	Output current high
000100	Output current low
000200	Output frequency high
000400	Output frequency low
002000	Braking
008000	Out of frequency range

Bit (Hex)	Alarm words
000002	Triplock
000004	AMT tuning fail
000040	HPFP bus timeout
000080	Standard bus timeout
000100	Curr. short circuit
000200	Switch mode fault
000400	Earth fault
000800	Overcurrent
002000	Motor thermistor
004000	Motor overload
008000	Inverter overload
010000	Undervolt
020000	Overvolt
040000	Phase loss
080000	Live zero error
100000	Heat sink temperature too high
2000000	Profibus communication fault
8000000	Inrush fault
10000000	Internal fault

Spare parts

The complete electronic part can be used as a spare part. The following four parts can replace all FCD 303-330 with and without Profibus.

For servicing DeviceNet and AS-interface units an additional control card is required to upgrade the electronic spare part.

FCD 303 178B1484

FCD 307 178B1485

FCD 315 178B1486

FCD 330 178B2301

The parts can be downsized one size simply by selecting the correct motor size, and the Profibus functionality can be changed/eliminated in Parameter 678.

The control card can also be replaced for repair of the electronic part.

Profibus, 12 MB control card 175N2338

DeviceNet control card 175N2325

AS-interface control card 175N2324

For servicing the installation box a kit containing various parts, plugs, and terminal PCB can be ordered 175N2121.

Service tool kit 175N2404

It is normally not possible to operate the FCD300 with open lid. Using the service tool kit, the electronic part and the installation box can be connected without joining them. This might be helpful if measurements on input/output terminals are required during servicing.

■ Aggressive environments

As the FCD 300 is enclosed up to IP66 it is well suited for use in moderate aggressive environments.

■ Cleaning

The enclosure (IP66/NEMA type 4x indoor) will offer protection against dirt and water ingress, and is designed suitable for cleaning as performed in food and beverage plants with the concentrations of cleaning solvent as recommended by the manufacturer. High pressure cleaning in very short distance or long time with hot water may damage gaskets and labels. For exceptions see section *Brake resistors*.

■ Derating for running at low speed

When a motor is connected to a frequency converter, it is necessary to ensure adequate cooling of the motor. At low rpm values, the motor fan is not able to supply an adequate volume of cooling air. This problem occurs when the load torque is constant (e.g. with a conveyor belt) across the full regulating range. The reduced amount of ventilation determines the permissible torque in continuous operation. If the motor is to run continuously at an rpm lower than half the rated value, extra cooling air must be supplied to the motor. Instead of providing extra cooling, it is possible to reduce the motor load ratio. This can be done by selecting a larger motor. However, the design of the frequency converter puts limits on the size of motors that can be connected to the frequency converter.

■ Derating for ambient temperature

The ambient temperature ($T_{AMB,MAX}$) is the maximum temperature allowed. The average ($T_{AMB,AVG}$) measured over 24 hours, must be at least 5 °C lower. If the frequency converter operates at temperatures above 40 °C, a derating of the rated output current is necessary.

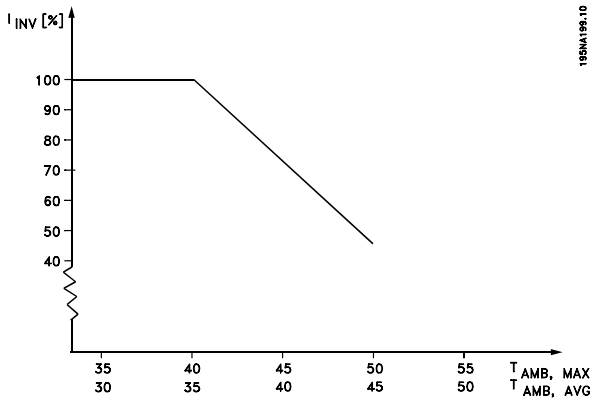

FCD 303-305 +10 °C
 FCD 307 +5 °C
 FCD 335 -5 °C

■ Galvanic isolation (PELV)

PELV (Protective Extra Low Voltage) isolation is achieved by inserting galvanic isolators between the control circuits and circuits that are connected to the mains potential. These separators are designed to meet the requirements for increased separation by means of having the necessary creepage and air clearance. These requirements are described in standard EN 50 178. It is also a requirement

that installation is carried out as described in local/national PELV regulations.

All control terminals, terminals for serial communication and relay terminals are safely separated from the mains potential, i.e. they comply with the PELV requirements. Circuits that are connected to control terminals 12, 18, 19, 20, 27, 29, 33, 42, 46, 50, 53, 55 and 60 are galvanically connected to one another. If switch S100 is opened the potentials of the group 18, 19, 20, 27, 29, 33 are separated from all other input/output. In that case terminal 12 cannot be used for supply for the digital inputs on these terminals. Serial communication connected to terminals 67 - 70 is galvanically isolated from the control terminals, although this is only a functional isolation. The relay contacts on terminals 1 - 3 are isolated from the other control circuits with increased isolation, i.e. PELV is observed for these, even though there is mains potential in the relay terminals.

The circuit elements described below form the safe electric separation. They fulfill the requirements for increased isolation and associated testing pursuant to EN 50 178.

1. Transformer and optical separation in voltage supply.
2. Optical isolation between Basic Motor Control and control card
3. Isolation between the control card and the power part.
4. Relay contacts and terminals relating to other circuits on the control card.

PELV isolation of the control card is guaranteed under the following condition:

- There may be max. 300 V between phase and earth.

A motor thermistor connected to terminals 31a-31b must be double isolated to obtain PELV. Danfoss Bauer provides double isolated thermistors.

See also the section *Diagram* in the Design Guide.

■ Derating for air pressure

Below 1000 m derating is not necessary.

Above 1000 m the ambient temperature (T_{AMB}) or max. output current (I_{MAX}) must be derated in accordance with the diagram below:

1. Derating of output current versus altitude at $T_{AMB} = \text{max. } 40\text{ }^{\circ}\text{C}$.
2. Derating of max. T_{AMB} versus altitude at 100% output current.

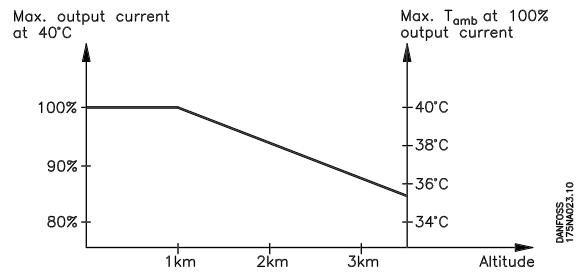

■ Emission test results according to generic standards and PDS product standard

The following test results are achieved on a system consisting of a FCD 300 400 V screened/armoured control cable, control box with potentiometer, screened/armoured motor cable, screened/armoured brake cable as well as LCP with cable.

VLT FCD 300 with class 1A RFI-filter	Product standard/environment	Basic standard
Complies	EN 50081-2/Industry	EN55011 group 1 class A
Complies	EN 61800-3/First environment restricted distribution	CISPR 11 group 1 class A
Complies	EN 61800-3/Second environment unrestricted distribution	CISPR 11 group 2 class A

FCD 303-315	10 m screened/armoured motor cable
FCD 322-335	5 m screened/armoured motor cable ¹

¹ For 10 m cable please contact Danfoss.



NB!:

FCD 300 with class 1A RFI-filter is a product of the restricted sales distribution class according to IEC 61800-3. In a domestic environment this product may cause radio interference in which case the user may be required to take adequate measures.

■ General technical data

Mains supply (L1, L2, L3):

Supply voltage FCD 305-335 380-480 V	3 x 380/400/415/440/480 V ±10%
Supply frequency	50/60 Hz
Max. imbalance on supply voltage	± 2.0% of rated supply voltage
Power factor (400 V) / cos. Φ_1	0.90 / 1.0 at rated load
Number of connections at supply input L1, L2, L3	2 times/min.
Max. short-circuit value fuses	100,000 A
Max. short-circuit value circuit breakers	10,000 A
<i>See Special Conditions section in the Design Guide</i>	

Output data (U, V, W):

Output voltage	0 - 100% of supply voltage
Output frequency	0.2 - 132 Hz, 1 - 1000 Hz
Rated motor voltage, 380-480 V units	380/400/415/440/460/480 V
Rated motor frequency	50/60 Hz
Switching on output	Unlimited
Ramp times	0.02 - 3600 sec.

Torque characteristics:

Starting torque (parameter 101 Torque characteristic = Constant torque)	160% in 1 min.*
Starting torque (parameter 101 Torque characteristics = Variable torque)	160% in 1 min.*
Starting torque (parameter 119 <i>High starting torque</i>)	180% for 0.5 sec.*
Overload torque (parameter 101 Torque characteristic = Constant torque)	160%*
Overload torque (parameter 101 Torque characteristic = Variable torque)	160%*

*Percentage relates to frequency converter's nominal current.

Control card, digital inputs:

Number of programmable digital inputs	5
Terminal number	18, 19, 27, 29, 33
Voltage level	0 - 24 V DC (PNP positive logic)
Voltage level, logic '0'	< 5 V DC
Voltage level, logic '1'	> 10 V DC
Maximum voltage on input	28 V DC
Input resistance, R_i (terminals 18, 19, 27)	approx. 4 k Ω
Input resistance, R_i (terminal 29, 33)	approx. 2 k Ω

All digital inputs are galvanically isolated from the supply voltage (PELV) and other high-voltage terminals, and can be functionally separated from other control terminals by opening switch S100. See section entitled Galvanic Isolation.

Control card, analogue inputs:

Number of analogue voltage inputs	1 pcs.
Terminal number	53
Voltage level	$\pm 0 - 10$ V DC (scaleable)
Input resistance, R_i	approx. $10\text{ k}\Omega$
Max. voltage	20 V

Number of analogue current inputs	1 pcs.
Terminal number	60
Current level	$0/4 - 20$ mA (scaleable)
Input resistance, R_i	approx. $300\ \Omega$
Max. current	30 mA

Resolution for analogue inputs	10 bit
Accuracy of analogue inputs	Max. error 1% of full scale
Scan interval	13.3 msec

The analogue inputs are galvanically isolated from the supply voltage (PELV) and other high-voltage terminals. See section entitled Galvanic Isolation.

Control card, pulse inputs:

Number of programmable pulse inputs	2
Terminal number	29, 33
Max. frequency at terminal 29/33	110 kHz (Push-pull)
Max. frequency at terminal 29/33	5 kHz (open collector)
Min. frequency at terminal 33	4 Hz
Min. frequency at terminal 29	30 Hz
Voltage level	0 - 24 V DC (PNP positive logic)
Voltage level, logic '0'	< 5 V DC
Voltage level, logic '1'	> 10 V DC
Maximum voltage on input	28 V DC
Input resistance, R_i	approx. $2\text{ k}\Omega$
Scan interval	13.3 msec
Resolution	10 bit
Accuracy (100 Hz- 1 kHz) terminal 33	Max. error: 0.5% of full scale
Accuracy (1 kHz - 67.6 kHz) terminal 33	Max. error: 0.1% of full scale

The pulse input is galvanically isolated from the supply voltage (PELV) and other high-voltage terminals. See section entitled Galvanic Isolation.

Control card, digital/frequency output:

Number of programmable digital/pulse outputs	1 pcs.
Terminal number	46
Voltage level at digital/frequency output	0 - 24 V DC (O.C PNP)
Max. output current at digital/frequency output	25 mA.
Max. load at digital/frequency output	$1\text{ k}\Omega$
Max. capacity at frequency output	10 nF
Minimum output frequency at frequency output	16 Hz
Maximum output frequency at frequency output	10 kHz
Accuracy on frequency output	Max. error: 0.2 % of full scale
Resolution on frequency output	10 bit

The digital output is galvanically isolated from the supply voltage (PELV) and other high-voltage terminals. See section entitled Galvanic Isolation.

Control card, analog output:

Number of programmable analog outputs	1
Terminal number	42
Current range at analog output	0/4 - 20 mA
Max. load to common at analog output	500 Ω
Accuracy on analog output	Max. error: 1.5 % of full scale
Resolution on analog output	10 bit

The analog output is galvanically isolated from the supply voltage (PELV) and other high-voltage terminals. See section entitled Galvanic Isolation.

Control card, 24 V DC output:

Terminal number	12
Max. load supplied from mains / 24 V external	240/65 mA

The 24 V DC supply is galvanically isolated from the supply voltage (PELV), but has the same potential as the analogue and digital inputs and outputs. See section entitled Galvanic Isolation.

Control card, 10 V DC output:

Terminal number	50
Output voltage	10.5 V ±0.5 V
Max. load	15 mA

The 10 V DC supply is galvanically isolated from the supply voltage (PELV) and other high-voltage terminals. See section entitled Galvanic Isolation.

Control card, RS 485 serial communication:

Terminal number	68 (TX+, RX+), 69 (TX-, RX-)
Terminal number 67	+ 5 V
Terminal number 70	Common for terminals 67, 68 and 69

Full galvanic isolation. See section entitled Galvanic Isolation.

Relay outputs:¹⁾

Number of programmable relay outputs	1
Terminal number, control card (resistive and inductive load)	1-3 (break), 1-2 (make)
Max. terminal load (AC1) on 1-3, 1-2, control card	250 V AC, 2 A, 500 VA
Max. terminal load (DC1 (IEC 947)) on 1-3, 1-2, control card	25 V DC, 2 A /50 V DC, 1A, 50W
Min. terminal load (AC/DC) on 1-3, 1-2, control card	24 V DC 10 mA, 24 V AC 100 mA

The relay contact is separated from the rest of the circuit by strengthened isolation. See section entitled Galvanic Isolation.

Note: Rated values resistive load - cosphi >0.8 for up to 300,000 operations.
 Inductive loads at cosphi 0.25 approximately 50% load or 50% life time.

External 24 Volt DC supply:

Terminal nos	35, 36
Voltage range	21-28 V (max. 37 V DC for 10 sec.)
Max. voltage ripple	2 V DC
Power consumption with/without mains supply	<1W/5-12W

Reliable galvanic isolation: Full galvanic isolation if the external 24 V DC supply is also of the PELV type.

Sensor supply (T63, T73):

Terminal nos	201, 202, 203, 204
--------------------	--------------------

Cable lengths and cross sections:

Max. motor cable length, screened/armoured cable	10 m
Max. motor cable length, unscreened/unarmoured cable	10 m
<i>Max. cross section to motor, see next section.</i>	
Max. cross section to control wires, rigid wire	4.0 mm ² /10 AWG
Max. cross section to control cables, flexible cable	2.5 mm ² /12 AWG
Max. cross section to control cables, cable with ferrules	2.5 mm ² /12 AWG
Max. cross section extra terminals for 24 V ext, T73 version, rigid cables	6.0 mm ² /9 AWG
Max. cross section extra terminals for 24 V ext, T73 version, flexible cable	4 mm ² /10 AWG
Max. cross section extra terminals for 24 V ext, T73 version, cable with ferrules	4 mm ² /10 AWG
Max. cross section PE	10 mm ² /7 AWG
Max. cross section external PE for T73 version	16 mm ² / 5 AWG

If UL/cUL is to be complied with, cable with temperature class 60/75°C must be used. Use copper wires only.

When complying with EN 55011 1A the motor cable must be screened/armoured. See EMC emission.

 Control characteristics:

Frequency range	0.2 - 132 Hz, 1 - 1000 Hz
Resolution of output frequency	0.013 Hz, 0.2 - 1000 Hz
Repeat accuracy of <i>Precise start/stop</i> (terminals 18, 19)	≤ ± 0.5 msec
System response time (terminals 18, 19, 27, 29, 33)	≤ 26.6 msec
Speed control range (open loop)	1:15 of synchronous speed
Speed control range (open loop) <1.1 kW	approximately 1:10 of synchronous speed (motor dependent)
Speed control range (closed loop)	1:120 of synchronous speed
Speed accuracy (open loop) <1.1 kW	150 - 3600 rpm: Max. error of ±23 rpm
Speed accuracy (open loop) >0.75 kW	90 - 3600 rpm: Max. error of ±23 rpm
Speed accuracy (closed loop)	30 - 3600 rpm: Max. error of ±7.5 rpm

All control characteristics are based on a 4-pole asynchronous motor

 Surroundings:

Enclosure	IP 66, TYPE 4x (indoor)
Enclosure T73 version	IP 65, TYPE 12
Vibration test	1.0 g
Max. relative humidity	95% <i>see Air humidity in the Design Guide</i>
Ambient temperature (FCD 335 max. 35 °C)	Max. 40 °C (24-hour average max. 35 °C)
<i>Derating for ambient temperature, see special conditions in the Design Guide</i>	
Min. ambient temperature during full-scale operation	0 °C
Min. ambient temperature at reduced performance	- 10 °C
Temperature during storage/transport	-25 - +65/70 °C
Max. altitude above sea level	1000 m

Derating for air pressure, see special conditions in the Design Guide

EMC standards used, Emission

EN 50081-1-2, EN 61800-3, EN 55011

EMC standards used, immunity

EN

61000-6-2, EN 61000-4-2, EN 61000-4-3, EN 61000-4-4, EN 61000-4-5, EN 61000-4-6

See section on special conditions in the Design Guide

Safeguards:

- Electronic thermal motor protection against overload.
- Temperature monitoring of the power module ensures that the frequency converter cuts out if the temperature reaches 100 °C. An overload temperature cannot be reset until the temperature of the power module is below 70 °C.
- The frequency converter is protected against short-circuits on motor terminals U, V, W.
- If a mains phase is missing, the frequency converter will cut out.
- Monitoring of the intermediate circuit voltage ensures that the frequency converter cuts out if the intermediate circuit voltage is too low or too high.
- The frequency converter is protected against earth fault on motor terminals U, V, W.

The below explanations refer to the ordering form.

Power sizes (positions 1-6):

0,37 kW – 3,3 kW (See power size selection table)

Application range (position 7):

- P-process

Mains voltage (positions 8-9):

- T4 - 380-480 V three phase supply voltage

Enclosure (positions 10-12):

The enclosure offers protection against dusty, wet, and aggressive environment

- P66 - Protected IP66 enclosure (exceptions see Installation box T00, T73)

Hardware variant (positions 13-14):

- ST - Standard hardware
- EX - 24 V external supply for backup of control card
- EB - 24 V external supply for backup of control card, control and supply of mechanical brake and an additional brake chopper

RFI filter (positions 15-16):

- R1 - Compliance with class A1 filter

Display unit (LCP) (positions 17-18):

Connection possibility for display and keypad

- D0 - No pluggable display connector in the unit
- DC - Display connector plug mounted (not available with "only right side" installation box variants)

Fieldbus option card (positions 19-21):

A wide selection of high performance fieldbus options is available (integrated)

- F00 - No fieldbus option built in
- F10 - Profibus DP V0/V1 3 Mbaud
- F12 - Profibus DP V0/V1 12 Mbaud
- F30 - DeviceNet
- F70 - AS-interface

Installation box (positions 22-24):

- T00 - No Installation box
- T11 - Installation box, motor mount, metric thread, only right side
- T12 - Installation box, motor mount, metric thread, double side
- T16 - Installation box, motor mount, NPT thread, double side
- T22 - Installation box, motor mount, metric thread, double side, service switch
- T26 - Installation box, motor mount, NPT thread, double side, service switch
- T51 - Installation box, wall mount, metric thread, only right side
- T52 - Installation box, wall mount, metric thread, double side
- T56 - Installation box, wall mount, NPT thread, double side
- T62 - Installation box, wall mount, metric thread, double side, service switch
- T66 - Installation box, wall mount, NPT thread, double side, service switch
- T63 - Installation box, wall mount, metric thread, double side, service switch, sensor plugs
- T73 - Installation box, wall mount, metric thread, double side, motor plug, sensor plugs, Viton gasket

Coating (positions 25-26):

The IP66 enclosure offers protection of the drive against aggressive environments, which practically eliminates the need for coated printed circuit boards.

- C0 - Non coated boards

■ Ordering form - FCD 300

FCD 3 P T4 P66 R1 D F T C

Power sizes
e.g. 315

303
305
307
311
315
322
330
335

Application range
P

Mains voltage
T4

Enclosure
P66

Hardware variant
ST
EX
EB

RFI filter
R1

Display unit (LCP)
DO
DC

Fieldbus option card
F00
F10
F12
F30
F70

Installation box
T00
T11
T12
T16
T22
T26
T51
T52
T56
T62
T63
T66
T73

Coating
C0
C1

No. units of this type

Required delivery date

Ordered by:

Date: _____

Take a copy of the ordering forms.
Fill them in and send or fax your order to the nearest office of the Danfoss sales organisation

195NA377.10

All about FCD 300

■ Technical data, mains supply 3 x 380 - 480 V

According to international standards	Type	303	305	307	311	315	322	330	335**	
Output current (3 x 380-480V)	I_{INV} [A]	1.4	1.8	2.2	3.0	3.7	5.2	7.0	7.6	
	I_{MAX} (60s) [A]	2.2	2.9	3.5	4.8	5.9	8.3	11.2	11.4	
Output power (400 V)	S_{INV} [KVA]	1.0	1.2	1.5	2.0	2.6	3.6	4.8	5.3	
	Typical shaft output	$P_{M,N}$ [kW]	0.37	0.55	0.75	1.1	1.5	2.2	3.0	3.3
Typical shaft output	$P_{M,N}$ [HP]	0.50	0.75	1.0	1.5	2.0	3.0	4.0	5*	
Max. cable cross section, motor	[mm ² /AWG] ¹⁾	4/10	4/10	4/10	4/10	4/10	4/10	4/10	4/10	
Input current (3 x 380-480 V)	$I_{L,N}$ [A]	1.2	1.6	1.9	2.6	3.2	4.7	6.1	6.8	
	$I_{L,MAX}$ (60s)[A]	1.9	2.6	3.0	4.2	5.1	7.5	9.8	10.2	
Max. cable cross section, power	[mm ² /AWG] ¹⁾	4/10	4/10	4/10	4/10	4/10	4/10	4/10	4/10	
Max. pre-fuses	[IEC]/UL ²⁾ [A]	25/25	25/25	25/25	25/25	25/25	25/25	25/25	25/25	
Efficiency ³⁾	[%]	96								
Power loss at max. load	[W]	22	29	40	59	80	117	160	190	
Weight	[kg]	5.8	5.8	5.8	5.8	5.8	9.5	9.5	9.5	

* At mains voltage min 3 x 460 - 480 V

** t_{amb} max. 35° C.

1. American Wire Gauge. Max. cable cross section is the largest cable cross section that can be attached to the terminals. Always observe national and local regulations.

2. Typr gG / gL pre fuses or corrsponding circuit brakrs should be used.

If you want to maintain UL/cUL branch circuit fuses according to NEC should be used. Alternatively a circuit braker Danfoss type CTI 25 MB or equivalent should be used.

To be placed for protection in a circuit that is capable of supplying a maximum of 100,000 amps for fuses / 10,000 amps for circuit brakrs.

3. Measured using a 10 m screened/armoured motor cable with a rated load and rated frequency.

■ Supplied with the unit

Below is a list of the literature available for FCD 300. It must be noted that there may be deviations from one country to the next.

Supplied with the unit:

Operating instructions MG.04.BX.YY

Various literature for FCD 300:

Data sheet MD.04.AX.YY

Design Guide - Decentral Solutions MG.90.FX.YY

Communication with FCD 300:

Profibus DP V1 Operating Instructions MG.90.AX.YY

DeviceNet Operating Instructions MG.90.BX.YY

AS-i Operating Instructions MG.04.EX.YY

X = version number

YY = language version

■ Factory settings

PNU #	Parameter description	Factory setting	Changes during operation	4-setup	Conv. index	Data type
001	Language	English	Yes	No	0	5
002	Local/remote operation	Remote-controlled	Yes	Yes	0	5
003	Local reference	000,000.000	Yes	Yes	-3	4
004	Active Setup	Setup 1	Yes	No	0	5
005	Programming Setup	Active Setup	Yes	No	0	5
006	Setup copying	No copying	No	No	0	5
007	LCP copy	No copying	No	No	0	5
008	Display scaling	1.00	Yes	Yes	-2	6
009	Large display readout	Frequency [Hz]	Yes	Yes	0	5
010	Small display line 1.1	Reference [%]	Yes	Yes	0	5
011	Small display line 1.2	Motor current [A]	Yes	Yes	0	5
012	Small display line 1.3	Power [kW]	Yes	Yes	0	5
013	Local control	Remote control as par. 100	Yes	Yes	0	5
014	Local stop/reset	Active	Yes	Yes	0	5
015	Local jog	Not active	Yes	Yes	0	5
016	Local reversing	Not active	Yes	Yes	0	5
017	Local reset of trip	Active	Yes	Yes	0	5
018	Data change lock	Not locked	Yes	Yes	0	5
019	Operating status at power up	Forced stop, use saved ref.	Yes	Yes	0	5
020	Lock for Hand mode	Active	Yes	No	0	5
024	User-defined Quick Menu	Not active	Yes	No	0	5
025	Quick Menu Setup	000	Yes	No	0	6
026	LED Status	Overload	Yes	Yes	0	5

4-Setup:

'Yes' means that the parameter can be programmed individually in each of the four Setups, i.e. one single parameter can have four different data values. No' means that the data value will be the same in all Setups.

Conversion index:

This number refers to a conversion figure to be used when writing or reading via serial communication with a frequency converter.

Conversion index	Conversion factor
73	0.1
2	100
1	10
0	1
-1	0.1
-2	0.01
-3	0.001
-4	0.0001
-5	0.00001

Data type:

Data type shows the type and length of the telegram.

Data type	Description
3	Integer 16
4	Integer 32
5	Unsigned 8
6	Unsigned 16
7	Unsigned 32
9	Text string

See also *Serial communication*.

■ Factory settings

PNU #	Parameter-description	Factory setting	Changes during operation	4-setup	Conv. index	Data-type
100	Configuration	Speed reg., open loop	No	Yes	0	5
101	Torque characteristics	Constant torque	Yes	Yes	0	5
102	Motor power $P_{M,N}$	depends on unit	No	Yes	1	6
103	Motor voltage $U_{M,N}$	depends on unit	No	Yes	-2	6
104	Motor frequency $f_{M,N}$	50 Hz	No	Yes	-1	6
105	Motor current $I_{M,N}$	depends on motor selected	No	Yes	-2	7
106	Rated motor speed	depends on par. 102	No	Yes	0	6
107	Automatic motor adjustment	Optimisation off	No	Yes	0	5
108	Stator resistance R_s	depends on motor selected	No	Yes	-3	7
109	Stator reactance X_s	depends on motor selected	No	Yes	-2	7
117	Resonance dampening	0 %	Yes	Yes	0	5
119	High start torque	0.0 sec	No	Yes	-1	5
120	Start delay	0.0 sec	No	Yes	-1	5
121	Start function	Coast in start del.	No	Yes	0	5
122	Function at stop	Coast	No	Yes	0	5
123	Min. freq. for activation of par. 122	0.1 Hz	No	Yes	-1	5
126	DC braking time	10 sec.	Yes	Yes	-1	6
127	DC brake engaging frequency	OFF	Yes	Yes	-1	6
128	Thermal motor protection	No protection	Yes	Yes	0	5
130	Start frequency	0.0 Hz	No	Yes	-1	5
131	Voltage at start	0.0 V	No	Yes	-1	6
132	DC brake voltage	0%	Yes	Yes	0	5
133	Start voltage	depends on unit	Yes	Yes	-2	6
134	Load compensation	100 %	Yes	Yes	-1	6
135	U/f-ratio	depends on unit	Yes	Yes	-2	6
136	Slip compensation	100 %	Yes	Yes	-1	3
137	DC hold voltage	0%	No	Yes	0	5
138	Brake cut out value	3.0 Hz	Yes	Yes	-1	6
139	Brake cut in frequency	3.0 Hz	Yes	Yes	-1	6
140	Current, minimum value	0%	No	Yes	0	5
142	Leak reactance	depends on motor selected	No	Yes	-3	7
144	AC brake factor	1.30	No	Yes	-2	5
146	Reset voltage vector	Off	Yes	Yes	0	5
147	Motor type	General				

■ Factory Settings

PNU #	Parameter description	Factory setting	Changes during operation	4-setup	Conv. index	Data type
200	Output frequency range	Clockwise only, 0-132 Hz	No	Yes	0	5
201	Output frequency, low limit f_{MIN}	0.0 Hz	Yes	Yes	-1	6
202	Output frequency, high limit f_{MAX}	132 Hz	Yes	Yes	-1	6
203	Reference range	Min ref.-Max ref.	Yes	Yes	0	5
204	Minimum ref Ref_{MIN}	0.000 Hz	Yes	Yes	-3	4
205	Maximum ref Ref_{MAX}	50.000 Hz	Yes	Yes	-3	4
206	Ramp type	Linear	Yes	Yes	0	5
207	Ramp-up time 1	3.00 sec.	Yes	Yes	-2	7
208	Ramp-down time 1	3.00 sec.	Yes	Yes	-2	7
209	Ramp-up time 2	3.00 sec.	Yes	Yes	-2	7
210	Ramp-down time 2	3.00 sec.	Yes	Yes	-2	7
211	Jog ramp time	3.00 sec.	Yes	Yes	-2	7
212	Quick stop ramp-down time	3.00 sec.	Yes	Yes	-2	7
213	Jog frequency	10.0 Hz	Yes	Yes	-1	6
214	Reference function	Sum	Yes	Yes	0	5
215	Preset reference 1	0.00%	Yes	Yes	-2	3
216	Preset reference 2	0.00%	Yes	Yes	-2	3
217	Preset reference 3	0.00%	Yes	Yes	-2	3
218	Preset reference 4	0.00%	Yes	Yes	-2	3
219	Catch up/slow down reference	0.00%	Yes	Yes	-2	6
221	Current limit	160 %	Yes	Yes	-1	6
223	Warn. Low current	0.0 A	Yes	Yes	-1	6
224	Warn. High current	I_{MAX}	Yes	Yes	-1	6
225	Warn. Low frequency	0.0 Hz	Yes	Yes	-1	6
226	Warn. High frequency	132.0 Hz	Yes	Yes	-1	6
227	Warn. Low Feedback	-4000.000	Yes	Yes	-3	4
228	Warn. High Feedback	4000.000	Yes	Yes	-3	4
229	Frequency bypass, bandwidth	0 Hz (OFF)	Yes	Yes	0	6
230	Frequency bypass 1	0.0 Hz	Yes	Yes	-1	6
231	Frequency bypass 2	0.0 Hz	Yes	Yes	-1	6

■ Factory settings

PNU #	Parameter description	Factory setting	Changes during operation	4-setup	Conv. index	Data type
302	Digital input, term. 18	Start	Yes	Yes	0	5
303	Digital input, term. 19	Reversing	Yes	Yes	0	5
304	Digital input, term. 27	Reset and coast inverse	Yes	Yes	0	5
305	Digital input, term. 29	Jog	Yes	Yes	0	5
307	Digital input, term. 33	No function	Yes	Yes	0	5
308	Term. 53, analogue input voltage	Reference	Yes	Yes	0	5
309	Term. 53, min scaling	0.0 V	Yes	Yes	-1	6
310	Term. 53, max scaling	10.0 V	Yes	Yes	-1	6
314	Term. 60, analogue input current	No function	Yes	Yes	0	5
315	Term. 60, min scaling	0.0 mA	Yes	Yes	-4	6
316	Term. 60, max scaling	20.0 mA	Yes	Yes	-4	6
317	Time out	10 sec.	Yes	Yes	-1	5
318	Function after timeout	No function	Yes	Yes	0	5
319	Term. 42, analogue output	0-I _{MAX} = 0-20 mA	Yes	Yes	0	5
323	Relay output	No function	Yes	Yes	0	5
327	Pulse Max. 33	5000 Hz	Yes	Yes	0	7
328	Pulse Max. 29	5000 Hz	Yes	Yes	0	7
341	Term. 46 digital output	No function	Yes	Yes	0	5
342	Term. 46 Max. pulse output	5000 Hz	Yes	Yes	0	6
343	Precise stop function	Normal ramp stop	No	Yes	0	5
344	Counter value	100000 pulses	No	Yes	0	7
349	Speed comp delay	10 ms	Yes	Yes	-3	6

■ Factory settings

PNU #	Parameter description	Factory setting	Changes during operation	4-setup	Conv. index	Data type
400	Brake function	Depends on unit type	Yes	No	0	5
405	Reset function	Manual reset	Yes	Yes	0	5
406	Aut. restart time	5 sec.	Yes	Yes	0	5
409	Trip delay overcurrent	Off (61 sec.)	Yes	Yes	0	5
411	Switching frequency	4.5 kHz	Yes	Yes	0	6
413	Overmodulation function	On	Yes	Yes	0	5
414	Min. feedback	0.000	Yes	Yes	-3	4
415	Max. feedback	1500.000	Yes	Yes	-3	4
416	Process units	No unit	Yes	Yes	0	5
417	Speed PID propor.ampl.	0.010	Yes	Yes	-3	6
418	Speed PID intergra.	100 ms	Yes	Yes	-5	7
419	Speed PID differentiation time	20.00 ms	Yes	Yes	-5	7
420	Speed PID diff. amplification limit	5.0	Yes	Yes	-1	6
421	Speed PID lowpass filter	20 ms	Yes	Yes	-3	6
423	U1 voltage	par. 103	Yes	Yes	-1	6
424	F1 frequency	Par. 104	Yes	Yes	-1	6
425	U2 voltage	par. 103	Yes	Yes	-1	6
426	F2 frequency	par. 104	Yes	Yes	-1	6
427	U3 voltage	par. 103	Yes	Yes	-1	6
428	F3 frequency	par. 104	Yes	Yes	-1	6
437	Proc. PID no/inv.	Normal	Yes	Yes	0	5
438	Proc. PID anti wind.	Active	Yes	Yes	0	5
439	Proc. PID start frequency	Par. 201	Yes	Yes	-1	6
440	Proc. PID start proportional ampl.	0.01	Yes	Yes	-2	6
441	Proc. PID integration time	Off (9999.99 s)	Yes	Yes	-2	7
442	Proc. PID differentiation time	Off (0.00 s).	Yes	Yes	-2	6
443	Proc. PID diff. ampl. limit	5.0	Yes	Yes	-1	6
444	Proc. PID lowpass filter time	0.02 s	Yes	Yes	-2	6
445	Flying start	Not possible	Yes	Yes	0	5
451	Speed PID feedforward factor	100%	Yes	Yes	0	6
452	Controller range	10 %	Yes	Yes	-1	6
455	Frequency range monitor	Enable	Yes		0	5
456	Brake voltage reduce	0	Yes	Yes	0	5

■ Factory settings

PNU #	Parameter description	Factory setting	Changes during operation	4-setup	Conv. index	Data type
500	Address	1	Yes	No	0	5
501	Baudrate	9600 Baud	Yes	No	0	5
502	Coasting stop	Logic or	Yes	Yes	0	5
503	Quick stop	Logic or	Yes	Yes	0	5
504	DC brake	Logic or	Yes	Yes	0	5
505	Start	Logic or	Yes	Yes	0	5
506	Reversing	Logic or	Yes	Yes	0	5
507	Selection of Setup	Logic or	Yes	Yes	0	5
508	Selection of preset ref.	Logic or	Yes	Yes	0	5
509	Bus jog 1	10.0 Hz	Yes	Yes	-1	6
510	Bus jog 2	10.0 Hz	Yes	Yes	-1	6
512	Telegram profile	FC protocol	No	Yes	0	5
513	Bus time interval	1 sec.	Yes	Yes	0	5
514	Bus time interval function	Off	Yes	Yes	0	5
515	Data readout: Reference %		No	No	-1	3
516	Data readout: Reference [unit]		No	No	-3	4
517	Data readout: Feedback [unit]		No	No	-3	4
518	Data readout: Frequency		No	No	-1	3
519	Data readout: Frequency x scaling		No	No	-1	3
520	Data readout: Motor current		No	No	-2	7
521	Data readout: Torque		No	No	-1	3
522	Data readout: Power [kW]		No	No	1	7
523	Data readout: Power [HP]		No	No	-2	7
524	Data readout: Motor voltage [V]		No	No	-1	6
525	Data readout: DC Link voltage		No	No	0	6
526	Data readout: Motor thermal load		No	No	0	5
527	Data readout: Inverter thermal load		No	No	0	5
528	Data readout: Digital input		No	No	0	5
529	Data readout: Analogue input, term. 53		No	No	-1	5
531	Data readout: Analogue input, term. 60		No	No	-4	5
532	Data readout: Pulse input, term. 33		No	No	-1	7
533	Data readout: External reference		No	No	-1	6
534	Data readout: Status word		No	No	0	6
537	Data readout: Inverter temperature		No	No	0	5
538	Data readout: Alarm word		No	No	0	7
539	Data readout: Control word		No	No	0	6
540	Data readout: Warning word		No	No	0	7
541	Data readout: Extended status word		No	No	0	7
544	Data readout: Pulse count		No	No	0	7
545	Data readout: Pulse input, term. 29		No	No	-1	7

■ Factory settings

PNU #	Parameter description	Factory setting	Changes during operation	4-setup	Conv. index	Data type
600	Operating hours		No	No	73	7
601	Hours run		No	No	73	7
602	kWh counter		No	No	2	7
603	Number of cut ins		No	No	0	6
604	Number of overtemperatures		No	No	0	6
605	Number of overvoltages		No	No	0	6
615	Fault log: Error code		No	No	0	5
616	Fault log: Time		No	No	0	7
617	Fault log: Value		No	No	0	3
618	Reset of kWh counter	No reset	Yes	No	0	7
619	Reset of running hours counter	No reset	Yes	No	0	5
620	Operation mode	Normal operation	Yes	No	0	5
621	Nameplate: Unit type		No	No	0	9
624	Nameplate: Software version		No	No	0	9
625	Nameplate: LCP identification no.		No	No	0	9
626	Nameplate: Database identification no.		No	No	-2	9
627	Nameplate: Power parts version		No	No	0	9
628	Nameplate: Application option type		No	No	0	9
630	Nameplate: Communication option type		No	No	0	9
632	Nameplate: BMC software identification		No	No	0	9
634	Nameplate: Unit identification for communication		No	No	0	9
635	Nameplate: Software parts no.		No	No	0	9
640	Software version		No	No	-2	6
641	BMC software identification		No	No	-2	6
642	Power card identification		No	No	-2	6
678	Configure Control Card	Depends on unit type	No	No	0	5

■ Index

A

AC brake 66
 Active Setup 32
 Address 88
 Aggressive environments 106
 Analogue input 60
 Analogue output 61
 Automatic motor tuning, 41

B

Baudrate 88
 Brake cut in frequency 47
 Brake cut out value 46
 Brake function 66
 Brake resistor 17
 Brake Voltage Reduce 76
 Bus jog 91
 Bus time interval 92

C

Cable lengths and cross sections: 112
 Cables 10
 Catch up 54
 Cleaning 106
 Connection of a 2-wire transmitter 23
 Connection of mechanical brake 25
 Constant torque 39
 Control cable 10
 Control cables 19
 Control of mechanical brake 18
 Control principle 6
 Control Word 81, 84
 Counter stop via terminal 33 25
 Counter value 65
 Current limit, 54
 Current, minimum value 47

D

Data Character (byte) 79
 Data readout 92
 DC brake time 44
 DC brake voltage 45
 DC Braking 43
 DC hold voltage 46
 Derating 107, 108
 Derating for running at low speed 107
 Diagram 13
 Differentiator 69

Digital inputs 58
 Digital output 64
 Direction of motor rotation 16
 Display mode 27
 Display mode 26
 Display scaling of output frequency 33

E

Electrical installation, control cables 19
 EMC-correct electrical installation 11
 ETR - Electronic Thermal Relay 44
 Extra protection 10

F

feedback range 68
 Factory settings 118
 Fast I/O FC-profile 84
 Fault log 96
 Feedback 67, 70
 Fieldbus 84
 Flying start 75
 Four Setups 32
 Frequency bypass, bandwidth 56
 Function at stop 43
 Fuses 116

G

Gain AC brake 47
 Galvanic isolation (PELV) 107

H

Hand mode 37
 Handling of references 49
 High voltage warning 4, 10

I

Initialise 97
 Internal fault 104

J

Jog frequency 53
 Jog ramp time 52

L

Language 31
 LCP 2 26
 LCP 2 plug, optional 21

Setting up DMS
300

LCP copy	33
Leakage reactance.....	47
Literature	117
Load compensation	46
Local reference	31
Lock for data changes	36
Lowpass filter	69

M

mains cable.....	10
Mains connection	16
Manual initialisation.....	30
Mechanical brake	18, 25
Mechanical dimensions, FCD, motor mounting	7
Mechanical dimensions, stand alone mounting.....	7
Mechanical installation	8
Motor cable.....	112
Motor cables	17
Motor connection	16
Motor current.....	40
Motor frequency	40
Motor plug and sensor plugs.....	15
Motor power.....	40
Motor thermal protection.....	17
Motor type	48
Motor voltage	40

N

Nameplate data.....	99
---------------------	----

O

Operating Data.....	96
Operating mode at power-up, local operation.....	37
Ordering form - FCD 300	115
Output frequency.....	49
Overmodulation function	67

P

PELV	107
product standard.....	108
Parallel connection of motors	17
PC communication	21
PID functions	68
Potentiometer reference	23
Precise stop function	64
Preset reference	54
Preset references.....	24
Process control, closed loop.....	39
Process PID	73
Process regulation	68

Process units.....	67
Programming Setup	32
Protocol.....	94
Protocols	77
Pulse Max. 29	64
Pulse Max. 33	63
Pulse start/stop	23

Q

Quick Menu setup	38
Quick menu, userdefined.....	37
Quick-stop ramp-down time	53

R

Ramp type	51
Ramp-down time.....	52
Ramp-up time.....	52
Rated motor speed	40
Reference	69
Reference function.....	54
Reference,	51
Relative.....	54
Relay connection	21
Relay output 1-3	62
Reset function.....	66
Reset voltage vector.....	47
Resonance dampening	42
Reversing,	58
RFI switches	13

S

Slow down.....	54
Screened/armoured cables	10
Sensor supply (T63, T73)	111
Sensors	20
Setup copying	32
Setup shift	32
Setups	31
Slip compensation	46
Special motor mode.....	39
Speed comp delay.....	65
Speed control, closed loop.....	39
Speed control, open loop.....	39
Speed PID	71
Speed regulation	68
Speed up/down	23
Start	75
Start delay	42
Start frequency.....	45
Start function.....	42

Start torque	42
Start voltage	45
Start/stop	23
Stator reactance	42
Stator resistance	41
Status LED	38
Status Word	83, 85
Sum	54
Surroundings:	112
Switching frequency	67

T

Telegram Profile	92
Telegram Structure	77
Telegram Traffic	77
Terminal 42	61
Terminal 53	60
Terminal 60	60
Terminals	16, 23
Thermal motor protection	44
Thermistor	44
Time out	61
Torque characteristic	39

U

U/f-ratio	46
-----------------	----

V

Variable torque	39
-----------------------	----

W

Warning functions	55
Warning words, extended status words and alarm words.....	105
Warnings/alarm messages	102

2

24 V DC	111
24 V DC supply	21

4

4-20 mA reference	24
4-Setup:	118