





1 Quick Guide

1

1.1 Safety

1.1.1 Warnings

	<p>High Voltage Warning: The voltage of the adjustable frequency drive is dangerous whenever it is connected to AC line power. Incorrect installation of the motor or adjustable frequency drive may cause damage to the equipment, serious injury or death. Consequently, it is essential to comply with the instructions in this manual as well as local and national rules and safety regulations.</p>
	<p>Warning: Touching the electrical parts may be fatal - even after the equipment has been disconnected from line power. Also make sure that other voltage inputs have been disconnected (linkage of DC intermediate circuit). Be aware that there may be high voltage on the DC link even when the LEDs are turned off. Before touching any potentially live parts of the adjustable frequency drive, wait at least 4 minutes for all M1, M2 and M3 sizes. Wait at least 15 minutes for all M4 and M5 sizes.</p>
	<p>Leakage Current: The ground leakage current from the adjustable frequency drive exceeds 3.5 mA. According to IEC 61800-5-1, a reinforced protective ground connection must be ensured by means of a min. of 0.016 in² [10 mm²] Cu or an additional PE wire - with the same cable cross-section as the line power wiring, which must be terminated separately.</p> <p>Residual Current Device: This product can cause a DC current in the protective conductor. Where a residual current device (RCD) is used for extra protection, only an RCD of Type B (time delayed) shall be used on the supply side of this product. See also Danfoss Application Note on RCD, MN.90.GX.YY. Protective grounding of the adjustable frequency drive and the use of RCDs must always follow national and local regulations.</p>
	<p>Motor Thermal Protection: Motor overload protection is possible by setting Parameter 1-90 Motor thermal protection to the value ETR trip. For the North American market: Implemented ETR function provide class 20 motor overload protection, in accordance with NEC.</p>
	<p>Installation at high altitudes: For altitudes above 6,600 feet [2 km], please contact Danfoss regarding PELV.</p>

1.1.2 Safety Instructions

- Make sure the adjustable frequency drive is properly grounded.
- Do not remove AC line input connections, motor connections or other power connections while the adjustable frequency drive is connected to line power.
- Protect users against supply voltage.
- Protect the motor against overloading according to national and local regulations.
- The ground leakage current exceeds 3.5 mA.
- The [OFF] key is not a safety switch. It does not disconnect the adjustable frequency drive from line power.

1

1.2 Introduction

1.2.1 Available Literature



This Quick Guide contains the basic information necessary for installing and running the drive.

If more information is needed, the literature below can be downloaded from:
<http://www.danfoss.com/BusinessAreas/DrivesSolutions/Documentations>

Title	Literature no.
VLT Micro Drive FC 51 Instruction Manual	MG.02.AX.YY
VLT Micro Drive FC 51 Quick Guide	MG.02.BX.YY
VLT Micro Drive FC 51 Programming Guide	MG.02.CX.YY
FC 51 LCP Mounting Instruction	MI.02.AX.YY
FC 51 De-coupling Plate Mounting Instruction	MI.02.BX.YY
FC 51 Remote Mounting Kit Mounting Instruction	MI.02.CX.YY
FC 51 DIN Rail Kit Mounting Instruction	MI.02.DX.YY
FC 51 IP21 Kit Mounting Instruction	MI.02.EX.YY
FC 51 Nema1 Kit Mounting Instruction	MI.02.FX.YY

X = Revision Number, Y = Language code

1.2.2 Approvals



1.2.3 IT Line power



IT Line power

Installation on an isolated line power source, i.e., IT line power.
 Max. supply voltage allowed when connected to line power: 440 V.

As an option, Danfoss offers recommended line filters for improved harmonics performance.

1.2.4 Avoiding Unintended Start

While the adjustable frequency drive is connected to line power, the motor can be started/stopped using digital commands, bus commands, references or via the Local Control Panel.

- Disconnect the adjustable frequency drive from line power whenever personal safety considerations make it necessary to avoid unintended start of any motors.
- To avoid unintended start, always activate the [OFF] key before changing parameters.

1.2.5 Disposal Instructions



Equipment containing electrical components may not be disposed of together with domestic waste. It must be separately collected with electrical and electronic waste according to local and currently valid legislation.

1.3 Installation

1.3.1 Before Commencing Repair Work

1. Disconnect FC 51 from line power (and external DC supply, if present.)
2. Wait for 4 minutes (M1, M2 and M3) and 15 minutes (M4 and M5) for the DC link to discharge.
3. Disconnect the DC bus terminals and brake terminals (if present)
4. Remove motor cable

1.3.2 Side-by-Side Installation

The adjustable frequency drive can be mounted side-by-side for IP20 rating units and requires 3.4 in. [100 mm] clearance above and below for cooling. Please refer to the specifications near the end of this document for details on environmental ratings for the adjustable frequency drive.

1.3.3 Mechanical Dimensions

A template for drilling can be found on the flap of the packaging.

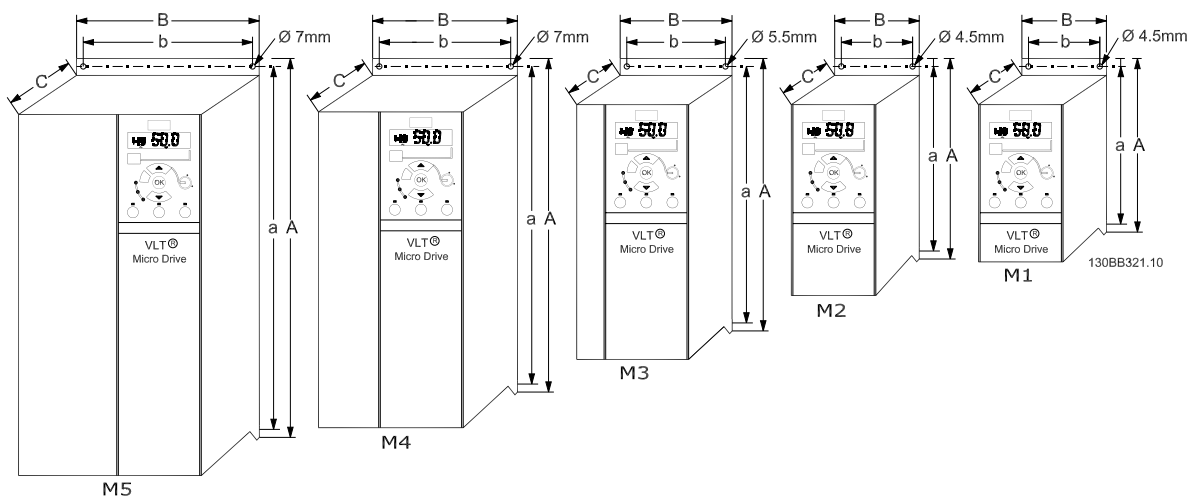

Figure 1.1: Mechanical dimensions.

Frame Size	Power (kW)			Height (mm)			Width (mm)		Depth ¹⁾ (mm)	Max. Weight
	1 X 200–240 V	3 X 200–240 V	3 X 380–480 V	A	A (incl. decoupling plate)	a	B	b	C	Kg
M1	0.18–0.75	0.25–0.75	0.37–0.75	150	205	140.4	70	55	148	1.1
M2	1.5	1.5	1.5–2.2	176	230	166.4	75	59	168	1.6
M3	2.2	2.2–3.7	3.0–7.5	239	294	226	90	69	194	3.0
M4			11.0–15.0	292	347.5	272.4	125	97	241	6.0
M5			18.5–22.0	335	387.5	315	165	140	248	9.5

¹⁾ For LCP with potentiometer, add 0.3 in [7.6 mm].

Table 1.1: Mechanical Dimensions



All cabling must comply with national and local regulations on cable cross-sections and ambient temperature. Copper conductors required, (140°–167°F [60°–75°C]) recommended.

Details of terminal tightening torques.

Frame Size	Power (kW)			Torque (Nm)					
	1 x 200–240 V	3 x 200–240 V	3 x 380–480 V	Line	Motor	DC connection/Brake	Control Terminals	Ground	Relay
M1	0.18–0.75	0.25–0.75	0.37–0.75	1.4	0.7	Spade ¹⁾	0.15	3	0.5
M2	1.5	1.5	1.5–2.2	1.4	0.7	Spade ¹⁾	0.15	3	0.5
M3	2.2	2.2–3.7	3.0–7.5	1.4	0.7	Spade ¹⁾	0.15	3	0.5
M4			11.0–15.0	1.25	1.25	1.25	0.15	3	0.5
M5			18.5–22.0	1.25	1.25	1.25	0.15	3	0.5

¹⁾ Spade connectors (0.25 in [6.3 mm] Faston plugs)

Table 1.2: Tightening of terminals.

1.3.5 Fuses

Branch circuit protection:

In order to protect the installation against electrical and fire hazards, all branch circuits in an installation, switch gear, machines, etc. must be short-circuited and overcurrent protected according to national/international regulations.

Short circuit protection:

Danfoss recommends using the fuses mentioned in the following tables to protect service personnel or other equipment in case of an internal failure in the unit or short circuit on DC link. The adjustable frequency drive provides full short circuit protection in case of a short circuit on the motor or brake output.

Overcurrent protection:

Provide overload protection to avoid overheating of the cables in the installation. Overcurrent protection must always be carried out according to national regulations. Fuses must be designed for protection in a circuit capable of supplying a maximum of 100,000 A_{rms} (symmetrical), 480 V maximum.

Non UL compliance:

If UL/cUL is not to be complied with, Danfoss recommends using the fuses mentioned in the table below, which will ensure compliance with EN50178/IEC61800-5-1:

In case of malfunction, not following the fuse recommendation may result in damage to the adjustable frequency drive.

FC 51	UL						Max. fuses non-UL
	Bussmann	Bussmann	Bussmann	Littel fuse	Ferraz-Shawmut	Ferraz-Shawmut	
1 X 200–240 V							
kW	Type RK1	Type J	Type T	Type RK1	Type CC	Type RK1	Type gG
0K18 - 0K37	KTN-R15	JKS-15	JJN-15	KLN-R15	ATM-R15	A2K-15R	16A
0K75	KTN-R25	JKS-25	JJN-25	KLN-R25	ATM-R25	A2K-25R	25A
1K5	KTN-R35	JKS-35	JJN-35	KLN-R35	-	A2K-35R	35A
2K2	KTN-R45	JKS-45	JJN-45	KLN-R45	-	A2K-45R	40A
3 x 200–240 V							
0K25	KTN-R10	JKS-10	JJN-10	KLN-R10	ATM-R10	A2K-10R	10A
0K37	KTN-R15	JKS-15	JJN-15	KLN-R15	ATM-R15	A2K-15R	16A
0K75	KTN-R20	JKS-20	JJN-20	KLN-R20	ATM-R20	A2K-20R	20A
1K5	KTN-R25	JKS-25	JJN-25	KLN-R25	ATM-R25	A2K-25R	25A
2K2	KTN-R40	JKS-40	JJN-40	KLN-R40	ATM-R40	A2K-40R	40A
3K7	KTN-R40	JKS-40	JJN-40	KLN-R40	-	A2K-40R	40A
3 x 380–480 V							
0K37–0K75	KTS-R10	JKS-10	JJS-10	KLS-R10	ATM-R10	A6K-10R	10A
1K5	KTS-R15	JKS-15	JJS-15	KLS-R15	ATM-R15	A6K-15R	16A
2K2	KTS-R20	JKS-20	JJS-20	KLS-R20	ATM-R20	A6K-20R	20A
3K0	KTS-R40	JKS-40	JJS-40	KLS-R40	ATM-R40	A6K405R	40A
4K0	KTS-R40	JKS-40	JJS-40	KLS-R40	ATM-R40	A6K-40R	40A
5K5	KTS-R40	JKS-40	JJS-40	KLS-R40	-	A6K-40R	40A
7K5	KTS-R40	JKS-40	JJS-40	KLS-R40	-	A6K-40R	40A
11K0	KTS-R60	JKS-60	JJS-60	KLS-R60	-	A6K-60R	63A
15K0	KTS-R60	JKS-60	JJS-60	KLS-R60	-	A6K-60R	63A
18K5	KTS-R60	JKS-60	JJS-60	KLS-R60	-	A6K-60R	80A
22K0	KTS-R60	JKS-60	JJS-60	KLS-R60	-	A6K-60R	80A

Table 1.3: Fuses



1

1.3.6 Connecting to Line Power and Motor

The adjustable frequency drive is designed to operate all standard three-phased asynchronous motors. The adjustable frequency drive is designed to accept line power/motor cables with a maximum cross-section of 0.006 in² [4 mm²]/10 AWG (M1, M2 and M3) and maximum cross-section 0.0248 in² [16 mm²]/6 AWG (M4 and M5).

- Use a shielded/armored motor cable to comply with EMC emission specifications, and connect this cable to both the decoupling plate and the motor metal.
- Keep motor cable as short as possible to reduce the noise level and leakage currents.
- For further details on mounting of the decoupling plate, please see instruction MI.02.BX.YY.
- Also see EMC-Correct Installation in Instruction Manual MG.02.AX.YY.

Step 1: First, mount the ground wires to the ground terminal.

Step 2: Connect motor to terminals U, V and W.

Step 3: Mount the line power supply to terminals L1/L, L2 and L3/N (3-phase) or L1/L and L3/N (single-phase) and tighten.

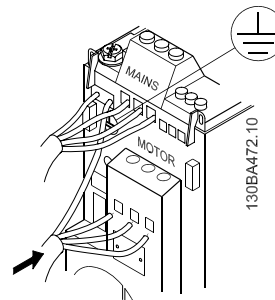

Figure 1.2: Mounting of ground cable, line power and motor wires.

1.3.7 Control Terminals

All control cable terminals are located underneath the terminal cover in front of the adjustable frequency drive. Remove the terminal cover using a screwdriver.

See back of terminal cover for outlines of control terminals and switches.

Do not operate switches with power on the adjustable frequency drive. Parameter 6-19 must be set according to Switch 4 position.

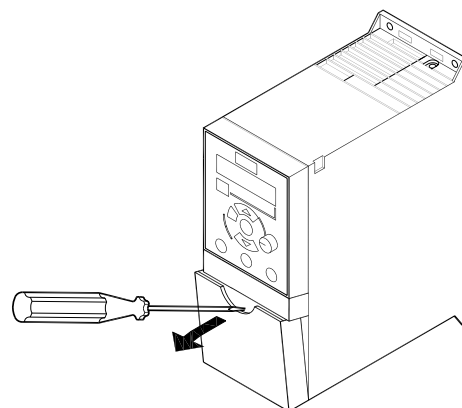

Figure 1.3: Removing the terminal cover.

Switch 1:	*OFF = PNP terminals 29 ON = NPN terminals 29
Switch 2:	*OFF = PNP terminal 18, 19, 27 and 33 ON = NPN terminal 18, 19, 27 and 33
Switch 3:	No function
Switch 4:	*OFF = Terminal 53 0-10 V ON = Terminal 53 0/4-20 mA

* = default setting

Table 1.4: Settings for S200 Switches 1-4

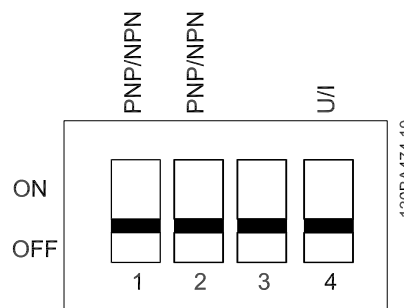

Figure 1.4: S200 Switches 1-4.

The illustration below shows all control terminals of the adjustable frequency drive. Applying Start (term. 18) and an analog reference (term. 53 or 60) makes the adjustable frequency drive run.

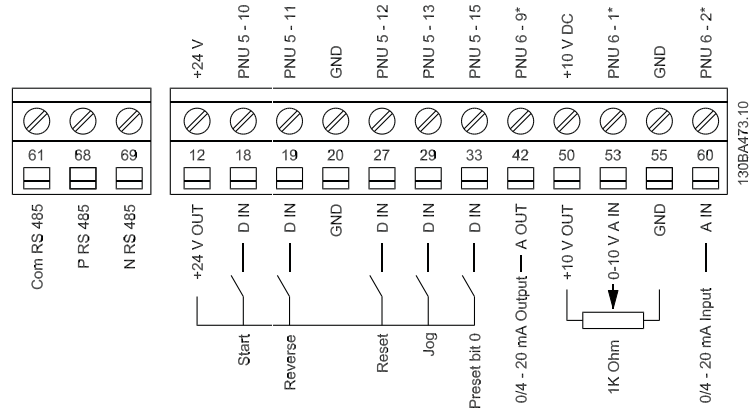

Figure 1.5: Overview of control terminals in the PNP configuration and factory settings.

1.3.8 Power Circuit - Overview

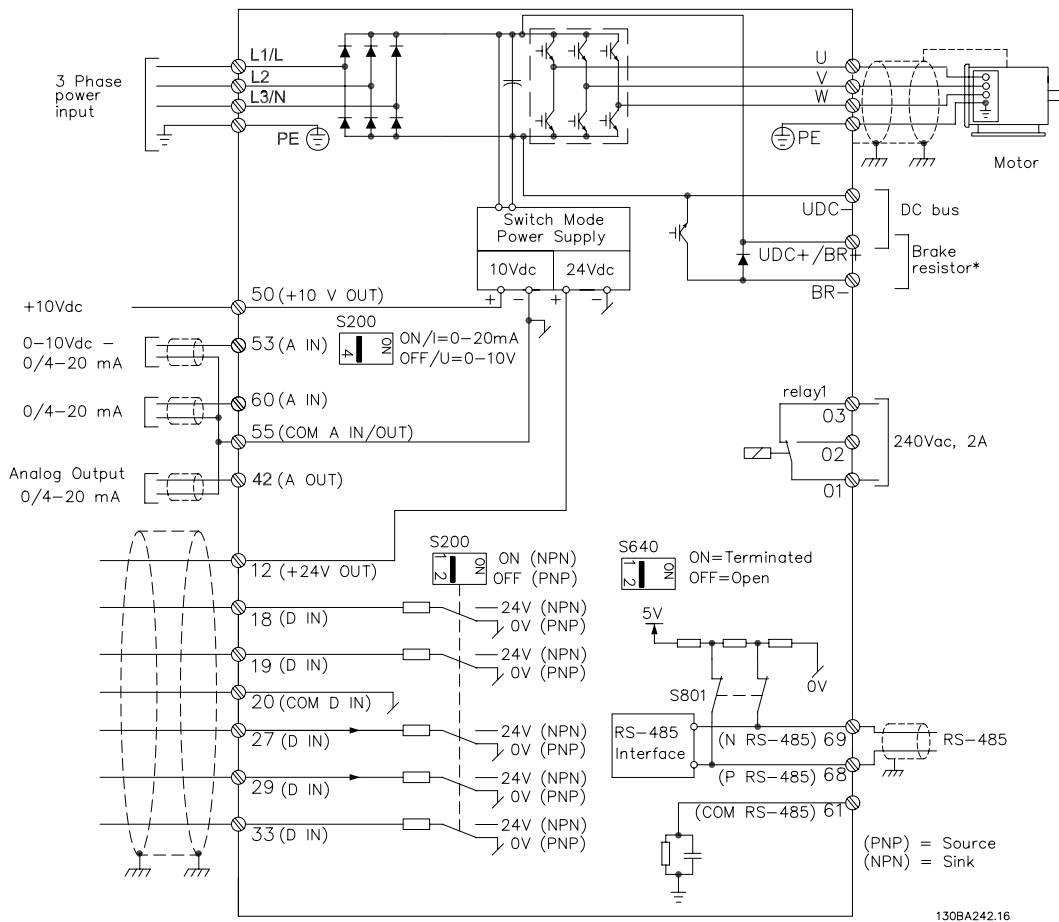

Figure 1.6: Diagram showing all electrical terminals.

* Brake (BR+ and BR-) are not applicable for frame M1.

Brake resistors are available from Danfoss.

Improved power factor and EMC performance can be achieved by installing optional Danfoss line filters.

Danfoss power filters can also be used for load sharing.

1.3.9 Load sharing/Brake

Use 0.25 in [6.3 mm] insulated Faston plugs designed for high voltage for DC (load sharing and brake).

Contact Danfoss or see instruction no. MI.50.Nx.02 for load sharing and instruction no. MI.90.Fx.02 for brake.

Load sharing: Connect terminals -UDC and +UDC/+BR.

Brake: Connect terminals -BR and +UDC/+BR (Not applicable for frame M1).



Note that voltage levels of up to 850 V DC may occur between terminals +UDC/+BR and -UDC. Not short circuit-protected.

1.4 Programming

1.4.1 Programming with LCP

For detailed information on programming, please see *Programming Guide*, MG.02.CX.YY.



NOTE!

The adjustable frequency drive can also be programmed from a PC via RS485 COM port by installing the MCT-10 Set-up Software.

This software can either be ordered using code number 130B1000 or downloaded from the Danfoss website: www.danfoss.com/BusinessAreas/DrivesSolutions/softwaredownload

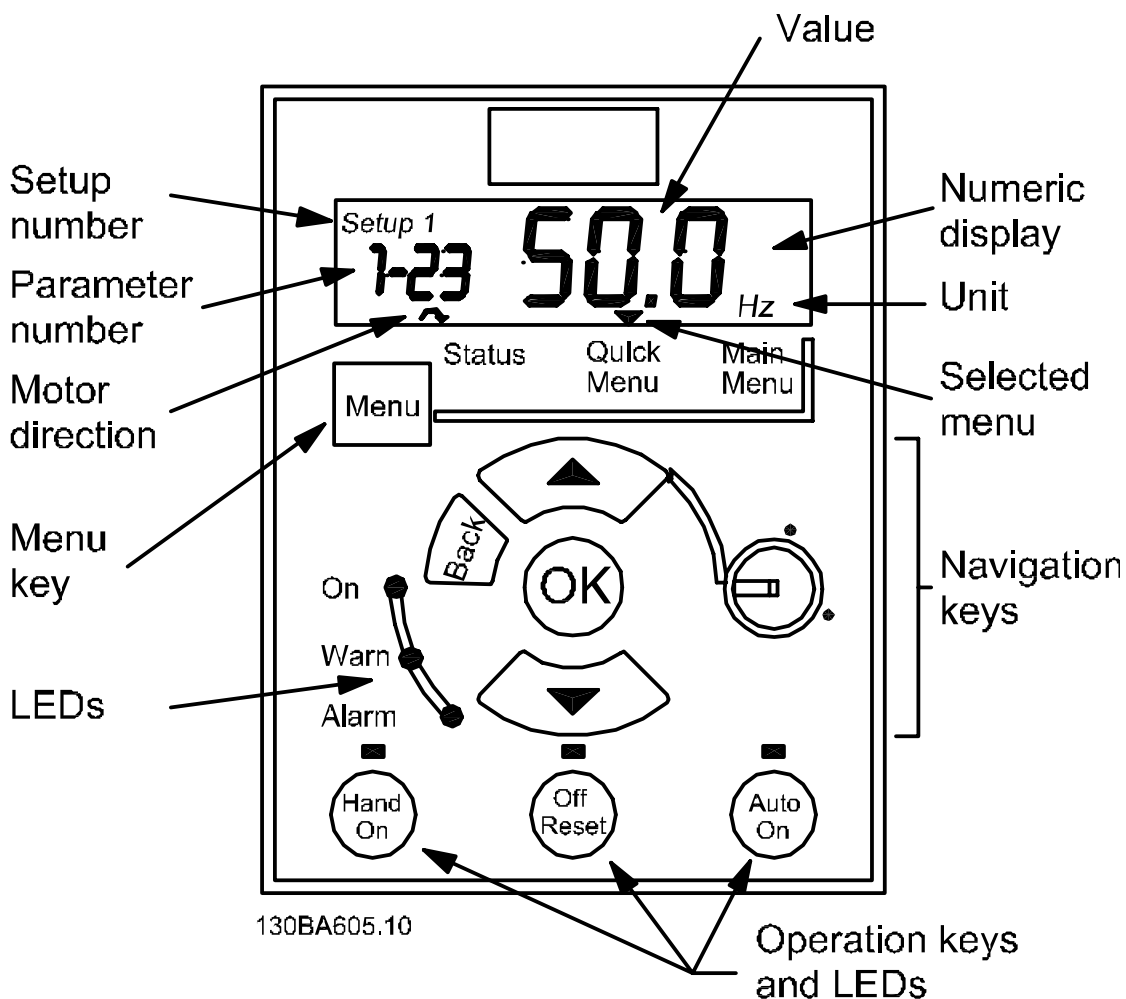

Figure 1.7: Description of LCP buttons and display

Use the [MENU] key to select one of the following menus:

Status:

For readouts only.

Quick Menu:

For access to Quick Menus 1 and 2, respectively.

Main Menu:

For access to all parameters.

Navigation Keys:

[Back]: For moving to the previous step or layer in the navigation structure.

Arrows [▲] [▼]: For navigating between parameter groups, parameters and within parameters.

[OK]: For selecting a parameter and for accepting changes to parameter settings.

Operation Keys:

A yellow light above the operation keys indicates the active key.

[Hand on]: Starts the motor and enables control of the adjustable frequency drive via the LCP.

[Off/Reset]: Stops the motor (off). If in alarm mode the alarm will be reset.

[Auto on]: The adjustable frequency drive is controlled either via control terminals or serial communication.

[Potentiometer] (LCP12): The potentiometer works in two ways depending on the mode in which the adjustable frequency drive is running.

In *Auto Mode*, the potentiometer acts as an extra programmable analog input.

In *Hand on Mode* the potentiometer controls local reference.

Arrows [▲] and [▼] toggle between the choices in each menu.

The display indicates the status mode with a small arrow above "Status".

The Quick Menu gives easy access to the most frequently used parameters.

1. To enter the Quick Menu, press the [MENU] key until the indicator in display is placed above *Quick Menu*.
2. Use [▲] [▼] to select either QM1 or QM2, then press [OK].
3. Use [▲] [▼] to browse through the parameters in the Quick Menu.
4. Press [OK] to select a parameter.
5. Use [▲] [▼] to change the value of a parameter setting.
6. Press [OK] to accept the change.
7. To exit, press either [Back] twice to enter *Status*, or press [Menu] once to enter *Main Menu*.

No	Name	Range	Default	Function
1-20	Motor Power [kW]/[HP]	[0.09kW/0.12HP–30kW/40HP]	Unit dependent	Enter motor power from nameplate data
1-22	Motor Voltage	[50–999V]	230/400	Enter motor voltage from nameplate data
1-23	Motor Frequency	[20–400 Hz]	50	Enter motor frequency from nameplate data
1-24	Motor Current	[0.01–100.00 A]	Unit dependent	Enter motor current from nameplate data
1-25	Motor nominal speed	[100–9999 RPM]	Unit dependent	Enter motor nominal speed from nameplate data
1-29	Automatic Motor Tuning (AMT)	[0] = off [2] = Enable AMT	[0] = off	Use AMT to optimize motor performance. 1. Stop VLT 2. Choose [2] 3. "Hand On"
3-02	Minimum reference	[-4999 - 4999]	0	Enter value for minimum reference
3-03	Maximum reference	[-4999 - 4999]	50.00	Enter value for maximum reference
3-41	Ramp-up time 1	[0.05–3600s]	3.00 (10.00 ¹⁾)	Ramp-up time from 0 to rated motor frequency par. 1-23
3-42	Ramp-down time 1	[0.05–3600s]	3.00 (10.00 ¹⁾)	Ramp-down time from rated motor frequency par. 1-23 to 0

¹⁾ M4 and M5 only

Table 1.5: Basic Settings Quick Menu 1

The main menu gives access to all parameters.

1. To enter the main menu, press the [MENU] key until the indicator in display is placed above *Main Menu*.
2. Use [▲] [▼] to browse through the parameter groups.
3. Press [OK] to select a parameter group.
4. Use [▲] [▼] to browse through the parameters in the specific group.
5. Press [OK] to select the parameter.
6. Use [▲] [▼] to set/change the parameter value.
7. Press [OK] to accept the value.
8. To exit, press either [Back] twice to enter *Quick Menu*, or press [Menu] once to enter *Status*.

1.5 Parameter Overview

Parameter Overview	1-XX Load/Motor	1-33 Stator Leakage Reactance (X1)	1-XX Reference Limits
0-XX Operation/Display	1-0X General Settings	[0hm] * Dep. on motor data	3-00 Reference Range
0-03 Regional Settings	1-00 Configuration Mode	[0hm] * Dep. on motor data	*[0] Min - Max
*[0] International	*[0] Speed open-loop	[0hm] * Dep. on motor data	[1] -Max - +Max
[1] US	[3] Process	1-50 Motor Magnetization at 0 Speed	3-02 Minimum Reference
0-04 Oper. State at Power-up (Hand)	1-01 Motor Control Principle	0-300% * 100%	3-03 Maximum Reference
[0] Resume	[0] U/f	1-52 Min Speed Norm. Magnet. [Hz]	3-1X References
*[1] Forced stop, ref = old	*[1] VVC+	0.0-10.0 Hz * 0.0 Hz	3-10 Preset Reference
[2] Forced stop, ref = 0	1-03 Torque Characteristics	1-55 U/f Characteristic - U	-100.0-100.0% * 0.00%
0-1X Set-up Handling	[0] Constant torque	0-999.9 V	3-11 Jog Speed [Hz]
0-10 Active Set-up	[2] Automatic Energy Optim.	1-56 U/f Characteristic - F	0.0-400.0 Hz * 5.0 Hz
*[1] Set-up 1	1-05 Local Mode Configuration	0-400 Hz	3-12 Catch up/slow-down Value
[2] Set-up 2	[0] Speed Open-loop	1-6X Load Depen. Setting	0.00-100.0% * 0.00%
[9] Multi Set-up	*[2] As config in par. 1-00	1-60 Low Speed Load Compensation	
0-11 Edit Set-up	1-2X Motor Data	0-199% * 100%	
*[1] Set-up 1	1-20 Motor Power [kW] [HP]	1-61 High Speed Load Compensation	
[2] Set-up 2	[1] 0.09 kW/0.12 HP	0-199% * 100%	
[9] Active Set-up	[2] 0.12 kW/0.16 HP	1-62 Slip Compensation	
0-12 Link Set-ups	[3] 0.18 kW/0.25 HP	-400-399% * 100%	
[0] Not Linked	[4] 0.25 kW/0.33 HP	1-63 Slip Compensation Time Constant	
*[20] Linked	[5] 0.37 kW/0.50 HP	0.05-5.00 s * 0.10 s	
0-31 Custom Readout Min Scale	[6] 0.55 kW/0.75 HP	1-7X Start Adjustments	
0.00 - 9999.00 * 0.00	[7] 0.75 kW/1.00 HP	1-71 Start Delay	
0-32 Custom Readout Max Scale	[8] 1.10 kW/1.50 HP	0.0-10.0 s * 0.0 s	
0.00-9999.00 * 100.0	[9] 1.50 kW/2.00 HP	1-72 Start Function	
0-4X LCP keypad	[10] 2.20 kW/3.00 HP	[0] DC hold / delay time	
0-40 [Hand on] Key on LCP	[11] 3.00 kW/4.00 HP	[1] DC brake / delay time	
[0] Disabled	[12] 3.70 kW/5.00 HP	*[2] Coast / delay time	
*[1] Enabled	[13] 4.00 kW/5.40 HP	1-73 Flying Start	
0-41 [Off / Reset] Key on LCP	[14] 5.50 kW/7.50 HP	*[0] Disabled	
[0] Disable All	[15] 7.50 kW/10.00 HP	[1] Enabled	
*[1] Enable All	[16] 11.00 kW/15.00 HP	1-8X Stop Adjustments	
[2] Enable Reset Only	[17] 15.00 kW/20.00 HP	1-80 Function at Stop	
0-42 [Auto on] Key on LCP	[18] 18.50 kW/25.00 HP	*[0] Coast	
[0] Disabled	[19] 22.00 kW/29.50 HP	[1] DC hold	
*[1] Enabled	[20] 30.00 kW/40.00 HP	1-82 Min Speed for Funct. at Stop [Hz]	
0-5X Copy/Save	1-22 Motor Voltage	0.0-20.0 Hz * 0.0 Hz	
0-50 LCP Copy	50-999 V * 230-400 V	1-90 Motor Thermal Protection	
*[0] No copy	1-23 Motor Frequency	*[0] No protection	
[1] All to LCP	20-400 Hz * 50 Hz	[1] Thermistor warning	
[2] All from LCP	1-24 Motor Current	[2] Thermistor trip	
[3] Size indep. from LCP	0.01-100.0 A * Motor type dep.	[3] Etr warning	
0-51 Set-up Copy	1-25 Motor Nominal Speed	[4] Etr trip	
*[0] No copy	100-9999 rpm * Motor type dep.	1-93 Thermistor Resource	
[1] Copy from set-up 1	1-29 Automatic Motor Tuning (AMT)	*[0] None	
[2] Copy from set-up 2	*[0] Off	[0] None	
[9] Copy from Factory set-up	[2] Enable AMT		
0-6X Password	1-3X Adv. Motor Data		
0-60 (Main) Menu Password	1-30 Stator Resistance (Rs)		
0 - 999 * 0	[0hm] * Dep. on motor data		

3-14 Preset Relative Reference -100.0–100.0% * 0.00%	[16-18] Preset ref bit 0-2	[25] Reverse
3-15 Reference Resource 1 [0] No function	[19] Freeze reference	[26] Bus ok
*[1] Analog Input 53	[20] Freeze output	[28] Brake, NoWarn
[2] Analog input 60	[21] Speed up	[29] Brake ready/NoFault
[8] Pulse input 33	[22] Slow	[30] Brakefault (IGBT)
[11] Local bus ref	[23] Set-up select bit 0	[32] Mech.brake control
[21] LCP Potentiometer	[28] Catch up	[36] Control word bit 11
3-16 Reference Resource 2 [0] No function	[29] Slow-down	[51] Local ref. active
[1] Analog Input 53	[34] Ramp bit 0	[52] Remote ref. active
*[2] Analog input 60	[60] Counter A (up)	[53] No alarm
[8] Pulse input 33	[61] Counter A (down)	[54] Start cmd active
*[1.1] Local bus ref	[62] Reset counter A	[55] Running reverse
[21] LCP Potentiometer	[63] Counter B (up)	[56] Drive in hand mode
3-17 Reference Resource 3 [0] No function	[64] Counter B (down)	[57] Drive in auto mode
[1] Analog Input 53	[65] ResetCounter B	[60-63] Comparator 0-3
[2] Analog input 60	5-11 Terminal 19 Digital Input	[70-73] Logic rule 0-3
[8] Pulse input 33	See par. 5-10. * [10] Reversing	[81] SL digital output B
*[1.1] Local bus ref	5-12 Terminal 27 Digital Input	5-5X Pulse Input
[21] LCP Potentiometer	See par. 5-10. * [1] Reset	5-55 Terminal 33 Low Frequency
3-18 Relative Scaling Ref. Resource * [0] No function	5-13 Terminal 29 Digital Input	20–4999 Hz * 20 Hz
[1] Analog Input 53	See par. 5-10. * [14] Jog	5-56 Terminal 33 High Frequency
[2] Analog input 60	5-15 Terminal 33 Digital Input	21–5000 Hz * 5000 Hz
[8] Pulse input 33	See par. 5-10. * [16] Preset ref bit 0	5-57 Term. 33 Low Ref./Feedb. Value
*[1.1] Local bus ref	[26] Precise Stop Inverse	-4999–4999 * 0.000
[21] LCP Potentiometer	[27] Start, Precise Stop	5-58 Term. 33 High Ref./Feedb. Value
3-19 Relative Scaling Ref. Resource * [0] No function	[32] Pulse Input	-4999–4999 * 50.000
[1] Analog Input 53	5-4X Relays	6-XX Analog In/Out
[2] Analog input 60	5-40 Function Relay	6-0X Analog I/O Mode
[8] Pulse input 33	* [0] No operation	1–99 s * 10 s
[11] Local bus ref	[1] Control ready	6-01 Live Zero TimeoutFunction
[21] LCP Potentiometer	[2] Drive ready	* [0] Off
3-4X Ramp 1	[3] Drive ready, Remote	[1] Freeze output
3-40 Ramp 1 Type	[4] Enable / No warning	[2] Stop
* [0] Linear	[5] Drive running	[3] Jogging
[2] Sine2 ramp	[6] Running / No warning	[4] Max speed
3-41 Ramp 1 Ramp-up Time	[7] Run in range / No warning	[5] Stop and trip
0.05–3600 s * 3.00 s (10.00 s ^{1/1})	[8] Run on ref / No warning	6-1X Analog Input 1
3-42 Ramp 1 Ramp-down Time	[9] Alarm	6-10 Terminal 53 Low Voltage
0.05–3600 s * 3.00 s (10.00 s ^{1/1})	[10] Alarm or warning	0.00–9.99 V * 0.07 V
3-5X Ramp 2	[12] Out of current range	6-11 Terminal 53 High Voltage
3-50 Ramp 2 Type	[13] Below current, low	0.01–10.00 V * 10.00 V
* [0] Linear	[14] Above current, high	6-12 Terminal 53 Low Current
[2] Sine2 ramp	[21] Thermal warning	0.00–19.99 mA * 0.14 mA
3-51 Ramp 2 Ramp-up Time	[22] Ready, No thermal warning	
0.05–3600 s * 3.00 s (10.00 s ^{1/1})	[23] Remote ready, No thermal warning	
3-52 Ramp 2 Ramp-down Time	[24] Ready, Voltage ok	
0.05–3600 s * 3.00 s (10.00 s ^{1/1})		

1) M4 and M5 only

<p>6-13 Terminal 53 High Current 0.01–20.00 mA * 20.00 mA</p> <p>6-14 Term. 53 Low Ref./Feedb. Value -4999–4999 * 0.000</p> <p>6-15 Term. 53 High Ref./Feedb. Value -4999–4999 * 50.000</p> <p>6-16 Terminal 53 Filter Time Constant 0.01–10.00 s * 0.01 s</p> <p>6-19 Terminal 53 mode *[0] Voltage mode [1] Current mode</p> <p>6-2X Analog Input 2</p> <p>6-22 Terminal 60 Low Current 0.00–19.99 mA * 0.14 mA</p> <p>6-23 Terminal 60 High Current 0.01–20.00 mA * 20.00 mA</p> <p>6-24 Term. 60 Low Ref./Feedb. Value -4999–4999 * 0.000</p> <p>6-25 Term. 60 High Ref./Feedb. Value -4999–4999 * 50.00</p> <p>6-26 Terminal 60 Filter Time Constant 0.01–10.00 s * 0.01 s</p> <p>6-8X LCP potentiometer</p> <p>6-81 LCP potm. Low Reference -4999–4999 * 0.000</p> <p>6-82 LCP potm. High Reference -4999–4999 * 50.00</p> <p>6-9X Analog Output xx</p> <p>6-90 Terminal 42 Mode *[0] 0–20 mA [1] 4–20 mA [2] Digital Output</p> <p>6-91 Terminal 42 Analog Output *[0] No operation [10] Output Frequency [11] Reference [12] Feedback [13] Motor Current [16] Power [20] Bus Reference</p> <p>6-92 Terminal 42 Digital Output See par. 5–40 *[0] No Operation [80] SL Digital Output A</p>	<p>6-93 Terminal 42 Output Min Scale 0.00–200.0% * 0.00%</p> <p>6-94 Terminal 42 Output Max Scale 0.00–200.0% * 100.0%</p> <p>7-XX Controllers</p> <p>7-2X Process Ctrl. Feedb</p> <p>7-20 Process CL Feedback 1 Resource *[0] NoFunction [1] Analog Input 53 [2] Analog Input 60 [8] PulseInput33 [1.1] LocalBusRef</p> <p>7-3X Process PI</p> <p>Ctrl. 7-30 Process PI Normal/ Inverse Ctrl *[0] Normal [1] Inverse</p> <p>7-31 Process PI Anti Windup [0] Disable *[1] Enable</p> <p>7-32 Process PI Start Speed 0.0–200.0 Hz * 0.0 Hz</p> <p>7-33 Process PI Proportional Gain 0.00–10.00 * 0.01</p> <p>7-34 Process PI Integral Time 0.10–9999 s * 9999 s</p> <p>7-38 Process PI Feed Forward Factor 0–400% * 0%</p> <p>7-39 On Reference Bandwidth 0–200% * 5%</p> <p>8-XX Comm. and Options</p> <p>8-0X General Settings</p> <p>8-01 Control Site *[0] Digital and ControlWord [1] Digital only [2] ControlWord only</p> <p>8-02 Control Word Source [0] None *[1] FC RS485</p> <p>8-03 Control Word Timeout Time 0.1–6500 s * 1.0 s</p> <p>8-04 Control Word Timeout Function *[0] Off [1] Freeze Output [2] Stop [3] Jogging</p>	<p>8-9X Bus Jog / Feedback</p> <p>8-94 Bus feedback 1 0x8000–0x7FFF * 0</p> <p>13-XX Smart Logic</p> <p>13-0X SLC Settings</p> <p>13-00 SL Controller Mode *[0] Off [1] On</p> <p>13-01 Start Event [0] False [1] True</p> <p>[2] Running</p> <p>[3] InRange</p> <p>[4] OnReference</p> <p>[7] OutOfCurrentRange</p> <p>[8] BelowLow</p> <p>[9] AboveHigh</p> <p>[16] ThermalWarning</p> <p>[17] MainOutOfRange</p> <p>[18] Reversing</p> <p>[19] Warning</p> <p>[20] Alarm_Trip</p> <p>[21] Alarm_TripLock</p> <p>[22–25] Comparator 0–3</p> <p>[26–29] LogicRule0–3</p> <p>[33] DigitalInput_18</p> <p>[34] DigitalInput_19</p> <p>[35] DigitalInput_27</p> <p>[36] DigitalInput_29</p> <p>[38] DigitalInput_33</p> <p>*[39] StartCommand</p> <p>[40] DriveStopped</p> <p>13-02 Stop Event See par. 13-01 * [40] DriveStopped</p> <p>13-03 Reset SLC *[0] Do not reset [1] Reset SLC</p>	<p>[4] Max. Speed</p> <p>[5] Stop and trip</p> <p>8-06 Reset Control Word Timeout *[0] No Function [1] Do reset</p> <p>8-3X FC Port Settings</p> <p>8-30 Protocol *[0] FC [2] Modbus</p> <p>8-31 Address 1–247 * 1</p> <p>8-32 FC Port Baud Rate [0] 2400 Baud [1] 4800 Baud *[2] 9600 Baud [3] 19200 Baud [4] 38400 Baud</p> <p>8-33 FC Port Parity *[0] Even Parity, 1 Stop Bit [1] Odd Parity, 1 Stop Bit [2] No Parity, 1 Stop Bit [3] No Parity, 2 Stop Bits</p> <p>8-35 Minimum Response Delay 0.001–0.5 * 0.010 s</p> <p>8-36 Max Response Delay 0.100–10.00 s * 5.000 s</p> <p>8-5X Digital/Bus</p> <p>[0] DigitalInput</p> <p>[1] Bus</p> <p>[2] LogicAnd</p> <p>*[3] LogicOr</p> <p>8-51 Quick Stop Select See par. 8-50 * [3] LogicOr</p> <p>8-52 DC Brake Select See par. 8-50 * [3] LogicOr</p> <p>8-53 Start Select See par. 8-50 * [3] LogicOr</p> <p>8-54 Reversing Select See par. 8-50 * [3] LogicOr</p> <p>8-55 Set-up Select See par. 8-50 * [3] LogicOr</p> <p>8-56 Preset Reference Select See par. 8-50 * [3] LogicOr</p>
--	--	--	---

13-1X Comparators	[1] NoAction	14-22 Operation Mode	16-1X Motor Status
13-10 Comparator Operand	[2] SelectSetup1	*[0] Normal Operation	16-10 Power [kW]
*[0] Disabled	[3] SelectSetup2	[2] Initialization	16-11 Power [hp]
[1] Reference	[10-17] SelectPresetRef0-7	14-26 Action At Inverter Fault	16-12 Motor Voltage [V]
[2] Feedback	[18] SelectRamp1	*[0] Trip	16-13 Frequency [Hz]
[3] MotorSpeed	[19] SelectRamp2	[1] Warning	16-14 Motor Current [A]
[4] MotorCurrent	[22] Run	14-4X Energy Optimizing	16-15 Frequency [%]
[6] MotorPower	[23] RunReverse	14-41 AEO Minimum Magnetization	16-18 Motor Thermal [%]
[7] MotorVoltage	[24] Stop	40-75% * 66%	16-3X Drive Status
[8] DCLinkVoltage	[25] Qstop	15-XX Drive Information	16-30 DC Link Voltage
[12] AnalogInput53	[26] DCstop	15-0X Operating Data	16-34 Heatsink Temp.
[13] AnalogInput60	[27] Coast	15-00 Operating Days	16-35 Inverter Thermal
[18] PulseInput33	[28] FreezeOutput	15-01 Running Hours	16-36 Inv. Nom. Current
[20] AlarmNumber	[29] StartTimer0	15-02 kWh Counter	16-37 Inv. Max. Current
[30] CounterA	[30] StartTimer1	15-03 Power-ups	16-38 SL Controller State
[31] CounterB	[31] StartTimer2	15-04 Overtemps	16-5X Ref. / Feedb.
13-11 Comparator Operator	[32] Set Digital Output A Low	15-05 Overvolts	16-50 External Reference
[0] Less Than	[33] Set Digital Output B Low	15-06 Reset kWh Counter	16-51 Pulse Reference
*[1] Approximately equals	[38] Set Digital Output A High	*[0] Do not reset	16-52 Feedback [Unit]
[2] Greater Than	[39] Set Digital Output B High	[1] Reset counter	16-6X Inputs / Outputs
13-12 Comparator Value	[60] ResetCounterA	15-07 Reset Running Hours Counter	16-60 Digital Input 18, 19, 27, 33
-9999-9999 * 0.0	[61] ResetCounterB	*[0] Do not reset	0-1111
13-2X Timers	14-XX Special Functions	[1] Reset counter	16-61 Digital Input 29
13-20 SL Controller Timer	14-0X Inverter Switching	15-3X Fault Log	0-1
0.0-3600 s * 0.0 s	14-01 Switching Frequency	15-30 Fault Log: Error Code	16-62 Analog Input 53 (volt)
13-4X Logic Rules	[0] 2 kHz	15-4X Drive Identification	16-63 Analog Input 53 (current)
13-40 Logic Rule Boolean 1	*[1] 4 kHz	15-40 FC Type	16-64 Analog Input 60
See par. 13-01 * [0] False	[2] 8 kHz	15-41 Power Section	16-65 Analog Output 42 [mA]
[30] - [32] SL Timeout 0-2	[4] 16 kHz	15-42 Voltage	16-68 Pulse Input [Hz]
13-41 Logic Rule Operator 1	14-03 Overmodulation	15-43 Software Version	16-71 Relay Output [bin]
*[0] Disabled	[0] Off	15-46 Adjustable Frequency Drive Order.	16-72 Counter A
[1] And	*[1] On	No	16-73 Counter B
[2] Or	14-1X Line power monitoring	15-48 LCP ID No	16-8X Ser.Com.Bus / FC Port
[3] And not	14-12 Function at line imbalance	15-51 Adjustable Frequency Drive Serial No	16-86 FC Port REF 1
[4] Or not	*[0] Trip	16-XX Data Readouts	0x8000-0x7FFFF
[5] Not and	[1] Warning	16-0X General Status	16-9X Diagnosis Readouts
[6] Not or	[2] Disabled	16-00 Control Word	16-90 Alarm Word
[7] Not and not	14-2X Trip Reset	0-0xFFFF	0-0xFFFFFFF
[8] Not or not	14-20 Reset Mode	16-01 Reference [Unit]	16-92 Warning Word
13-42 Logic Rule Boolean 2	*[0] Manual reset	-4999-4999 * 0.000	0-0xFFFFFFF
See par. 13-40 * [0] False	[1-9] AutoReset 1-9	16-02 Reference %	16-94 Ext. Status Word
13-43 Logic Rule Operator 2	[10] AutoReset 10	-200.0-200.0% * 0.0%	0-0xFFFFFFF
See par. 13-41 * [0] Disabled	[11] AutoReset 15	16-03 Status Word	18-8X Motor Resistors
13-44 Logic Rule Boolean 3	[12] AutoReset 20	16-05 Main Actual Value [%]	18-80 Stator Resistance (High resolution)
See par. 13-40 * [0] False	[13] Infinite auto reset	-200.0-200.0% * 0.0%	0.000-99.990 ohm * 0.000 ohm
13-5X States	14-21 Automatic Restart Time	16-09 Custom Readout	18-81 Stator Leakage Reactance (High resolution)
13-51 SL Controller Event	0-600 s * 10 s	Dep. on par. 0-31, 0-32 and 4-14	0.000-99.990 ohm * 0.000 ohm
See par. 13-40 * [0] False			
13-52 SL Controller Action			
*[0] Disabled			

1.6 Troubleshooting

No.	Description	Warning	Alarm	Trip Lock	Error	Cause of Problem
2	Live zero error	X	X			Signal on terminal 53 or 60 is less than 50% of the value set in par. 6-10, 6-12 and 6-22.
4	Line phase loss ¹⁾	X	X	X		Missing phase on the supply side, or a voltage imbalance that is too high. Check supply voltage.
7	DC overvoltage ¹⁾	X	X			Intermediate circuit voltage exceeds the limit.
8	DC undervoltage ¹⁾	X	X			Intermediate circuit voltage drops below the "voltage warning low" limit.
9	Inverter overloaded	X	X			More than 100% load for too long.
10	Motor ETR overtemperature	X	X			Motor is too hot due to more than 100% load for too long.
11	Motor thermistor overtemperature	X	X			The thermistor or the thermistor connection is disconnected.
12	Torque limit	X				Torque exceeds the value set in either par. 4-16 or 4-17.
13	Overcurrent	X	X	X		Inverter peak current limit is exceeded.
14	Ground fault		X	X		Discharge from output phases to ground.
16	Short Circuit		X	X		Short-circuit in the motor or on the motor terminals.
17	Control word timeout	X	X			No communication to the adjustable frequency drive.
25	Brake resistor short-circuited		X	X		Brake resistor is short-circuited, thus the brake function is disconnected.
27	Brake chopper short-circuited		X	X		Brake transistor is short-circuited, thus the brake function is disconnected.
28	Brake check		X			Brake resistor is not connected/working
29	Power board overtemp	X	X	X		Heatsink cut-out temperature has been reached.
30	Motor phase U missing		X	X		Motor phase U is missing. Check the phase.
31	Motor phase V missing		X	X		Motor phase V is missing. Check the phase.
32	Motor phase W missing		X	X		Motor phase W is missing. Check the phase.
38	Internal fault		X	X		Contact local Danfoss supplier.
44	Ground fault		X	X		Discharge from output phases to ground.
47	Control Voltage Fault		X	X		24 V DC may be overloaded.
51	AMT check U_{nom} and I_{nom}		X			Wrong setting for motor voltage and/or motor current.
52	AMT low I_{nom}		X			Motor current is too low. Check settings.
59	Current limit	X				VLT overload.
63	Mechanical Brake Low		X			Actual motor current has not exceeded the "release brake" current in the "start delay" time window.
80	Drive Initialized to Default Value		X			All parameter settings are initialized to default settings.
84	The connection between drive and LCP is lost.				X	No communication between LCP and adjustable frequency drive.
85	Button disabled				X	See parameter group 0-4* <i>LCP</i>
86	Copy fail				X	An error occurred while copying from adjustable frequency drive to LCP or vice versa.
87	LCP data invalid				X	Occurs when copying from LCP if the LCP contains erroneous data - or if no data was uploaded to the LCP.
88	LCP data not compatible				X	Occurs when copying from LCP if data are moved between adjustable frequency drives with major differences in software versions.
89	Parameter read-only				X	Occurs when trying to write to a read-only parameter.
90	Parameter database busy				X	LCP and RS485 connection are trying to update parameters simultaneously.
91	Parameter value is not valid in this mode				X	Occurs when trying to write an illegal value to a parameter.
92	Parameter value exceeds the min/max limits				X	Occurs when trying to set a value outside the range.
nw run	Not While RUNNING				X	Parameter can only be changed when the motor is stopped.
Err.	An incorrect password was entered				X	Occurs when using an incorrect password for changing a password-protected parameter.

¹⁾ These faults may be caused by line power distortions. Installing a Danfoss line filter may rectify this problem.

Table 1.6: Warnings and AlarmsCode list

1

1.7 Specifications

1.7.1 Line power Supply 1 x 200–240 V AC

Normal overload 150% for 1 minute

Adjustable frequency drive	PK18	PK37	PK75	P1K5	P2K2
Typical Shaft Output [kW]	0.18	0.37	0.75	1.5	2.2
Typical Shaft Output [HP]	0.25	0.5	1	2	3

IP 20	Frame M1	Frame M1	Frame M1	Frame M2	Frame M3
-------	----------	----------	----------	----------	----------

Output current

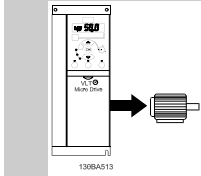

Continuous (1 x 200–240 V) [A]	1.2	2.2	4.2	6.8	9.6
Intermittent (1 x 200–240 V) [A]	1.8	3.3	6.3	10.2	14.4
Max. cable size: (line power, motor) [mm ² /AWG]	4/10				

Max. input current

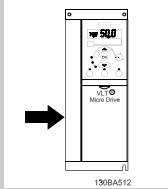

Continuous (1 x 200–240 V) [A]	3.3	6.1	11.6	18.7	26.4
Intermittent (1 x 200–240 V) [A]	4.5	8.3	15.6	26.4	37.0
Max. electrical fuses [A]	See section Fuses.				
Environment					
Estimated power loss [W], Best case/ Typical ¹⁾	12.5/ 15.5	20.0/ 25.0	36.5/ 44.0	61.0/ 67.0	81.0/ 85.1
Weight enclosure IP20 [kg]	1.1	1.1	1.1	1.6	3.0
Efficiency [%], Best case/Typical ¹⁾	95.6/ 94.5	96.5/ 95.6	96.6/ 96.0	97.0/ 96.7	96.9/ 97.1

Table 1.7: Line Power Supply 1 x 200–240 V AC

1. At rated load conditions.

1.7.2 Line Power Supply 3 x 200–240 V AC

Normal overload 150% for 1 minute

Adjustable frequency drive	PK25	PK37	PK75	P1K5	P2K2	P3K7
Typical Shaft Output [kW]	0.25	0.37	0.75	1.5	2.2	3.7
Typical Shaft Output [HP]	0.33	0.5	1	2	3	5

IP 20	Frame M1	Frame M1	Frame M1	Frame M2	Frame M3	Frame M3
-------	----------	----------	----------	----------	----------	----------

Output current

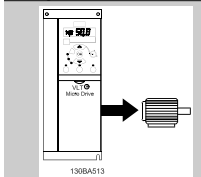

Continuous (3 x 200–240 V) [A]	1.5	2.2	4.2	6.8	9.6	15.2
Intermittent (3 x 200–240 V) [A]	2.3	3.3	6.3	10.2	14.4	22.8
Max. cable size: (line power, motor) [mm ² /AWG]	4/10					

Max. input current

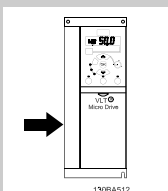

Continuous (3 x 200–240 V) [A]	2.4	3.5	6.7	10.9	15.4	24.3
Intermittent (3 x 200–240 V) [A]	3.2	4.6	8.3	14.4	23.4	35.3
Max. electrical fuses [A]	See section Fuses.					
Environment						
Estimated power loss [W], Best case/ Typical ¹⁾	14.0/ 20.0	19.0/ 24.0	31.5/ 39.5	51.0/ 57.0	72.0/ 77.1	115.0/ 122.8
Weight enclosure IP20 [kg]	1.1	1.1	1.1	1.6	3.0	3.0
Efficiency [%], Best case/Typical ¹⁾	96.4/ 94.9	96.7/ 95.8	97.1/ 96.3	97.4/ 97.2	97.2/ 97.4	97.3/ 97.4

Table 1.8: Line power supply 3 x 200–240 V AC

1. At rated load conditions.

1.7.3 Line Power Supply 3 x 380–480 V AC

Normal overload 150% for 1 minute

Adjustable frequency drive	PK37	PK75	P1K5	P2K2	P3K0	P4K0	
Typical Shaft Output [kW]	0.37	0.75	1.5	2.2	3.0	4.0	
Typical Shaft Output [HP]	0.5	1	2	3	4	5	
IP 20	Frame M1	Frame M1	Frame M2	Frame M2	Frame M3	Frame M3	
Output current							
	Continuous (3 x 380–440 V) [A]	1.2	2.2	3.7	5.3	7.2	9.0
	Intermittent (3 x 380–440 V) [A]	1.8	3.3	5.6	8.0	10.8	13.7
	Continuous (3 x 440–480 V) [A]	1.1	2.1	3.4	4.8	6.3	8.2
	Intermittent (3 x 440–480 V) [A]	1.7	3.2	5.1	7.2	9.5	12.3
	Max. cable size: (line power, motor) [mm ² / AWG]						4/10
Max. input current							
	Continuous (3 x 380–440 V) [A]	1.9	3.5	5.9	8.5	11.5	14.4
	Intermittent (3 x 380–440 V) [A]	2.6	4.7	8.7	12.6	16.8	20.2
	Continuous (3 x 440–480 V) [A]	1.7	3.0	5.1	7.3	9.9	12.4
	Intermittent (3 x 440–480 V) [A]	2.3	4.0	7.5	10.8	14.4	17.5
	Max. electrical fuses [A]	See section Fuses.					
	Environment						
	Estimated power loss [W], Best case/ Typical ¹⁾	18.5/ 25.5	28.5/ 43.5	41.5/ 56.5	57.5/ 81.5	75.0/ 101.6	98.5/ 133.5
	Weight enclosure IP20 [kg]	1.1	1.1	1.6	1.6	3.0	3.0
Efficiency [%], Best case/ Typical ¹⁾	96.8/ 95.5	97.4/ 96.0	98.0/ 97.2	97.9/ 97.1	98.0/ 97.2	98.0/ 97.3	

Table 1.9: Line power supply 3 x 380–480 V AC

- At rated load conditions.

Normal overload 150% for 1 minute

Adjustable frequency drive	P5K5	P7K5	P11K	P15K	P18K	P22K	
Typical Shaft Output [kW]	5.5	7.5	11	15	18.5	22	
Typical Shaft Output [HP]	7.5	10	15	20	25	30	
IP 20	Frame M3	Frame M3	Frame M4	Frame M4	Frame M5	Frame M5	
Output current							
	Continuous (3 x 380–440 V) [A]	12.0	15.5	23.0	31.0	37.0	43.0
	Intermittent (3 x 380–440 V) [A]	18.0	23.5	34.5	46.5	55.5	64.5
	Continuous (3 x 440–480 V) [A]	11.0	14.0	21.0	27.0	34.0	40.0
	Intermittent (3 x 440–480 V) [A]	16.5	21.3	31.5	40.5	51.0	60.0
	Max. cable size: (line power, motor) [mm ² / AWG]	4/10			16/6		
Max. input current							
	Continuous (3 x 380–440 V) [A]	19.2	24.8	33.0	42.0	34.7	41.2
	Intermittent (3 x 380–440 V) [A]	27.4	36.3	47.5	60.0	49.0	57.6
	Continuous (3 x 440–480 V) [A]	16.6	21.4	29.0	36.0	31.5	37.5
	Intermittent (3 x 440–480 V) [A]	23.6	30.1	41.0	52.0	44.0	53.0
	Max. electrical fuses [A]	See section Fuses.					
	Environment						
	Estimated power loss [W], Best case/ Typical ¹⁾	131.0/ 166.8	175.0/ 217.5	290.0/ 342.0	387.0/ 454.0	395.0/ 428.0	467.0/ 520.0
	Weight enclosure IP20 [kg]	3.0	3.0				
Efficiency [%], Best case/ Typical ¹⁾	98.0/ 97.5	98.0/ 97.5	97.8/ 97.4	97.7/ 97.4	98.1/ 98.0	98.1/ 97.9	

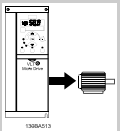
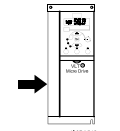
Table 1.10: Line power supply 3 x 380–480 V AC

- At rated load conditions.

Protection and Features:

- Electronic thermal motor protection against overload.
- Temperature monitoring of the heatsink ensures that the adjustable frequency drive trips in case of overtemperature
- The adjustable frequency drive is protected against short-circuits between motor terminals U, V, W.
- If a motor phase is missing, the frequency trips and issues an alarm.
- If a line phase is missing, the adjustable frequency drive trips or issues a warning (depending on the load).
- Monitoring of the intermediate circuit voltage ensures that the adjustable frequency drive trips if the intermediate circuit voltage is too low or too high.
- The adjustable frequency drive is protected against ground faults on motor terminals U, V, W.

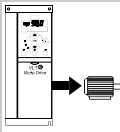
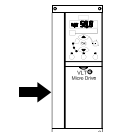
Line power supply (L1/L, L2, L3/N):

Supply voltage	200–240 V \pm 10%
Supply voltage	380–480 V \pm 10%
Supply frequency	50/60 Hz
Max. imbalance temporary between line phases	3.0% of rated supply voltage
True Power Factor (λ)	\geq 0.4 nominal at rated load
Displacement Power Factor ($\cos\phi$) near unity	(> 0.98)
Switching on input supply L1/L, L2, L3/N (power-ups)	maximum 2 times/min.
Environment according to EN60664-1	overvoltage category III/pollution degree 2

The unit is suitable for use on a circuit capable of delivering not more than 100,000 RMS symmetrical Amperes, 240/480 V maximum.

Motor output (U, V, W):

Output voltage	0–100% of supply voltage
Output frequency	0–200 Hz (VVC+), 0–400 Hz (u/f)
Switching on output	Unlimited
Ramp times	0.05–3600 sec.

Cable lengths and cross-sections:

Max. motor cable length, shielded/armored (EMC-correct installation)	50 ft [15 m]
Max. motor cable length, unshielded/unarmored	164 ft [50 m]
Max. cross-section to motor, line power*	
Connection to load sharing/brake (M1, M2, M3)	0.25 in [6.3 mm] insulated Faston plugs
Max. cross-section to load sharing/brake (M4, M5)	0.0248 in ² [16 mm ²]/6AWG
Maximum cross-section to control terminals, rigid wire	0.023 in ² [1.5 mm ²]/16 AWG (2 x 0.00112 ² in [0.75 mm ²])
Maximum cross-section to control terminals, flexible cable	0.0016 in ² [1 mm ²]/18 AWG
Maximum cross-section to control terminals, cable with enclosed core	0.0008 in ² [0.5 mm ²]/20 AWG
Minimum cross-section to control terminals	0.00039 in ² [0.25 mm ²]

** See tables for line power supply for more information!*

Digital inputs (pulse/encoder inputs):

Programmable digital inputs (pulse/encoder)	5 (1)
Terminal number	18, 19, 27, 29, 33,
Logic	PNP or NPN
Voltage level	0–24 V DC
Voltage level, logic '0' PNP	< 5 V DC
Voltage level, logic '1' PNP	> 10 V DC
Voltage level, logic '0' NPN	> 19 V DC
Voltage level, logic '1' NPN	< 14 V DC
Maximum voltage on input	28 V DC
Input resistance, R_i	approx. 4 k
Max. pulse frequency at terminal 33	5000 Hz

Min. pulse frequency at terminal 33	20 Hz
Analog inputs:	
Number of analog inputs	2
Terminal number	53, 60
Voltage mode (Terminal 53)	Switch S200=OFF(U)
Current mode (Terminal 53 and 60)	Switch S200=ON(I)
Voltage level	0–10 V
Input resistance, R_i	approx. 10 k Ω
Max. voltage	20 V
Current level	0/4 to 20 mA (scaleable)
Input resistance, R_i	approx. 200 Ω
Max. current	30 mA
Analog output:	
Number of programmable analog outputs	1
Terminal number	42
Current range at analog output	0/4–20 mA
Max. load to common at analog output	500 Ω
Max. voltage at analog output	17 V
Accuracy on analog output	Max. error: 0.8% of full scale
Resolution on analog output	8 bit
Control card, RS-485 serial communication:	
Terminal number	68 (P,TX+, RX+), 69 (N,TX-, RX-)
Terminal number 61	Common for terminals 68 and 69
Control card, 24 V DC output:	
Terminal number	12
Max. load (M1 and M2)	160 mA
Max. load (M3)	30 mA
Max. load (M4 and M5)	200 mA
Relay output:	
Programmable relay output	1
Relay 01 Terminal number	01-03 (break), 01-02 (make)
Max. terminal load (AC-1) ¹⁾ on 01-02 (NO) (resistive load)	250 V AC, 2 A
Max. terminal load (AC-15) ¹⁾ on 01-02 (NO) (inductive load @ $\cos\phi$ 0.4)	250 V AC, 0.2 A
Max. terminal load (DC-1) ¹⁾ on 01-02 (NO) (resistive load)	30 V DC, 2 A
Max. terminal load (DC-13) ¹⁾ on 01-02 (NO) (inductive load)	24 V DC, 0.1A
Max. terminal load (AC-1) ¹⁾ on 01-03 (NC) (resistive load)	250 V AC, 2 A
Max. terminal load (AC-15) ¹⁾ on 01-03 (NC) (inductive load @ $\cos\phi$ 0.4)	250 V AC, 0.2 A
Max. terminal load (DC-1) ¹⁾ on 01-03 (NC) (resistive load)	30 V DC, 2 A
Min. terminal load on 01-03 (NC), 01-02 (NO)	24 V DC 10 mA, 24 V AC 20 mA
Environment according to EN 60664-1	overvoltage category III/pollution degree 2
<i>1) IEC 60947 part 4 and 5</i>	
Control card, 10 V DC output:	
Terminal number	50
Output voltage	10.5 V \pm 0.5 V
Max. load	25 mA



All inputs, outputs, circuits, DC supplies and relay contacts are galvanically isolated from the supply voltage (PELV) and other high-voltage terminals.

Surroundings:

Enclosure	IP 20
Enclosure kit available.	IP 21, TYPE 1
Vibration test	1.0 g
Max. relative humidity	5–95% (IEC 60721-3-3; Class 3K3 (non-condensing) during operation)
Aggressive environment (IEC 60721-3-3), coated	class 3C3
Test method according to IEC 60068-2-43 H2S (10 days)	
Ambient temperature	Max. 104°F [40°C]

Derating for high ambient temperature, see section on special conditions

Minimum ambient temperature during full-scale operation	32°F [0°C]
Minimum ambient temperature at reduced performance	14°F [-10°C]
Temperature during storage/transport	-13°–149°/158°F [-25°–+65°/70°C]
Maximum altitude above sea level without derating	3280 ft [1000 m]
Maximum altitude above sea level with derating	9842 ft [3000 m]

Derating for high altitude, see section on special conditions.

Safety standards	EN/IEC 61800-5-1, UL 508C
EMC standards, Emission	EN 61800-3, EN 61000-6-3/4, EN 55011, IEC 61800-3 EN 61800-3, EN 61000-6-1/2, EN 61000-4-2, EN 61000-4-3,
EMC standards, Immunity	EN 61000-4-4, EN 61000-4-5, EN 61000-4-6

See section on special conditions

1.8 Special Conditions

1.8.1 Derating for Ambient Temperature

The ambient temperature measured over 24 hours should be at least 9°F [5°C] lower than the max. ambient temperature.

If the adjustable frequency drive is operated at a high ambient temperature, the continuous output current should be decreased.

The adjustable frequency drive has been designed for operation at max 122°F [50°C] ambient temperature with one motor size smaller than nominal. Continuous operation at full load at 122°F [50°C] ambient temperature will reduce the lifetime of the adjustable frequency drive.

1.8.2 Derating for Low Air Pressure

The cooling capability of air is decreased at low air pressure.

For altitudes above 6,600 feet [2000 m], please contact Danfoss regarding PELV.

Below altitudes of 3,280 ft [1,000 m], no derating is necessary, but at 3,280 ft [1,000 m] and higher, the ambient temperature or maximum output current should be decreased.

Decrease the output by 1% per 328 ft [100 m] higher than an altitude of 3,289 ft [1000 m], or reduce the max. ambient temperature by 1 degree per 656 ft [200 m].

1.8.3 Derating for Running at Low Speeds

When a motor is connected to an adjustable frequency drive, it is necessary to make sure that the cooling of the motor is adequate.

A problem may occur at low speeds in constant torque applications. Running continuously at low speeds – below half the nominal motor speed – may require additional air cooling. Alternatively, choose a larger motor (one size up).

1.9 Options for VLT Micro Drive

Ordering No	Description
132B0100	VLT Control Panel LCP 11 w/o potentiometer
132B0101	VLT Control Panel LCP 12 with potentiometer
132B0102	Remote Mounting Kit for LCP incl. 10 ft [3 m] cable IP55 with LCP 11, IP21 with LCP 12
132B0103	Nema Type 1 kit for M1 frame
132B0104	Type 1 kit for M2 frame
132B0105	Type 1 kit for M3 frame
132B0106	De-coupling plate kit for M1 and M2 frames
132B0107	De-coupling plate kit for M3 frame
132B0108	IP21 for M1 frame
132B0109	IP21 for M2 frame
132B0110	IP21 for M3 frame
132B0111	DIN rail mounting kit for M1 frame
132B0120	Type 1 kit for M4 frame
132B0121	Type 1 kit for M5 frame
132B0122	De-coupling plate kit for M4 and M5 frames

Danfoss line filters and brake resistors are available upon request.