

## Contents

<b>1. Safety</b>	<b>3</b>
Safety Instructions	3
Software Version and Approvals	3
General Warning	3
Avoid unintended Start	4
Before Commencing Repair Work	4
<b>2. Introduction</b>	<b>5</b>
Type Code	5
<b>3. Programming</b>	<b>7</b>
How to Programme	7
Programming with MCT-10 Set-up Software	7
Programming with the LCP 11 or LCP 12	7
Status Menu	9
Quick Menu	9
Main Menu	10
<b>4. Parameter Descriptions</b>	<b>11</b>
Parameter group 0: Operation/Display	11
Parameter Group 1: Load/Motor	15
Parameter Group 2: Brakes	22
Parameter Group 3: Reference/Ramps	25
Parameter Group 4: Limits/Warnings	30
Parameter Group 5: Digital In/Out	33
Parameter Group 6: Analogue In/Out	37
Parameter Group 7: Controllers	42
Parameter Group 8: Communication	44
Parameter Group 13: Smart Logic	48
Parameter Group 14: Special Functions	55
Parameter Group 15: Drive Information	57
Parameter Group 16: Data Readouts	59
16-09 Custom Readout	59
<b>5. Parameter Lists</b>	<b>63</b>
Conversion Index	67
Change during operation	67
2-Set-up	67
Type	67
0-** Operation/Display	68
1-** Load/Motor	69

2-** Brakes	70
3-** Reference/Ramps	71
4-** Limits/Warnings	72
5-** Digital In/Out	73
6-** Analog In/Out	74
7-** Controllers	75
8-** Comm. and Options	76
13-** Smart Logic	77
14-** Special Functions	78
15-** Drive Information	79
16-** Data Readouts	80
<b>6. Troubleshooting</b>	<b>81</b>
Alarm, Warning and Extended Status Word	82
<b>Index</b>	<b>83</b>

## 1. Safety

1

### 1.1.1. High Voltage Warning



The voltage of the frequency converter is dangerous whenever it is connected to mains. Incorrect installation of the motor or frequency converter may cause damage to the equipment, serious injury or death. Consequently, it is essential to comply with the instructions in this manual as well as local and national rules and safety regulations.

### 1.1.2. Safety Instructions

- Make sure the frequency converter is properly connected to earth.
- Do not remove mains connections, motor connections or other power connections while the frequency converter is connected to power.
- Protect users against supply voltage.
- Protect the motor against overloading according to national and local regulations.
- The earth leakage current exceeds 3.5 mA.
- The [OFF] key is not a safety switch. It does not disconnect the frequency converter from mains.

### 1.1.3. Software Version and Approvals

**Software Version  
Programming Guide  
VLT Micro Drive  
FC 51 Series**



This Programming Guide can be used for all VLT Micro Drive frequency drives with software version 2.1x.

The software version number can be read in parameter 15-43.

### 1.1.4. General Warning



**Warning:**

Touching the electrical parts may be fatal - even after the equipment has been disconnected from mains. Also make sure that other voltage inputs have been disconnected (linkage of DC intermediate circuit). Be aware that there may be high voltage on the DC link even when the LEDs are turned off. Before touching any potentially live parts of the frequency converter, wait at least 4 minutes for all sizes. Shorter time is allowed only if indicated on the nameplate for the specific unit.

**Leakage Current**

The earth leakage current from the frequency converter exceeds 3.5 mA. According to IEC 61800-5-1 a reinforced Protective Earth connection must be ensured by means of a min. 10mm<sup>2</sup> Cu or an additional PE wire - with the same cable cross section as the Mains wiring - must be terminated separately.

**Residual Current Device**

This product can cause a DC current in the protective conductor. Where a residual current device (RCD) is used for extra protection, only an RCD of Type B (time delayed) shall be used on the supply side of this product. See also Danfoss Application Note on RCD, MN. 90.GX.YY.

Protective earthing of the frequency converter and the use of RCDs must always follow national and local regulations.



Motor overload protection is possible by setting Parameter 1-90 Motor thermal protection to the value ETR trip. For the North American market: ETR functions provide class 20 motor overload protection, in accordance with NEC.

**Installation in high altitudes:**

For altitudes above 2 km, please contact Danfoss regarding PELV.

**1.1.5. IT Mains****IT Mains**

Installation on isolated mains source, i.e. IT mains.

Max. supply voltage allowed when connected to mains: 440 V.

As an option, Danfoss offers line filters for improved harmonics performance.

**1.1.6. Avoid unintended Start**

While the frequency converter is connected to mains, the motor can be started/stopped using digital commands, bus commands, references or via the Local Control Panel.

- Disconnect the frequency converter from mains whenever personal safety considerations make it necessary to avoid unintended start of any motors.
- To avoid unintended start, always activate the [OFF] key before changing parameters.

**1.1.7. Disposal Instruction**

Equipment containing electrical components must not be disposed of together with domestic waste. It must be separately collected with electrical and electronic waste according to local and currently valid legislation.

**1.1.8. Before Commencing Repair Work**

1. Disconnect FC 51 from mains (and external DC supply, if present.)
2. Wait for 4 minutes for discharge of the DC-link.
3. Disconnect DC bus terminals and brake terminals (if present)
4. Remove motor cable

## 2. Introduction

### 2.1.1. FC Identification

Below is an example of the frequency converter nameplate sticker. This sticker is located on the top of each frequency converter and shows the ratings, serial number, warnings catalog number, and other relevant data for each unit. See following tables for details, how to read the Type code string.



Illustration 2.1: This example shows the identification sticker.

### 2.1.2. Type Code

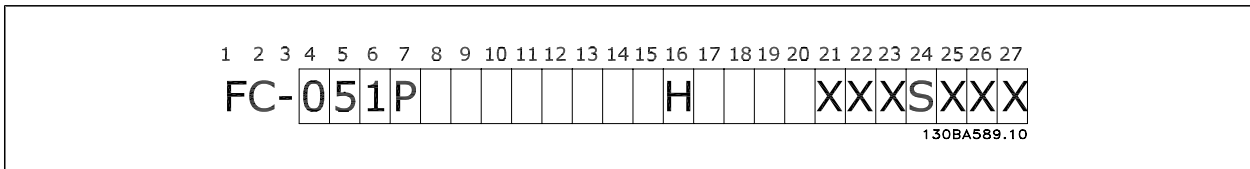

Description	Pos	Possible choice
Product group	1-3	Adjustable Frequency Converters
Series and product type	4-6	Micro Drive
Power size	7-10	0.18 - 7.5 kW
Mains voltage	11-12	S2: Single phase 200 - 240 V AC T 2: Three phase 200 - 240 V AC T 4: Three phase 380 - 480 V AC
Enclosure	13-15	IP20/Chassis
RFI filter	16-17	HX: No RFI filter H1: RFI filter class A1/B H3: RFI filter A1/B (reduced cable length)
Brake	18	B: Brake chopper included X: No brake chopper included
Display	19	X: No Local Control Panel N: Numerical Local Control Panel (LCP) P: Numerical Local Control Panel (LCP) with potentiometer
Coating PCB	20	C: Coated PCB X: No coated PCB
Mains option	21	X: No mains option
Adaptation A	22	X: No adaptation
Adaptation B	23	X: No adaptation
Software release	24-27	SXXX: Latest release - std. software

Table 2.1: Type code description

### 2.1.3. Symbols

Symbols used in this Programming Guide.



**NB!**

Indicates something to be noted by the reader.



Indicates a general warning.



Indicates a high-voltage warning.

\*

Indicates default setting

### 2.1.4. Abbreviations and Standards

Abbreviations:	Terms:	SI-units:	I-P units:
	Acceleration	m/s <sup>2</sup>	ft/s <sup>2</sup>
AWG	American wire gauge		
Auto Tune	Automatic Motor Tuning		
°C	Celsius		
	Current	A	Amp
I <sub>LIM</sub>	Current limit		
	Energy	J = N·m	ft-lb, Btu
°F	Fahrenheit		
FC	Frequency Converter		
	Frequency	Hz	Hz
kHz	Kilohertz		
LCP	Local Control Panel		
mA	Milliampere		
ms	Millisecond		
min	Minute		
MCT	Motion Control Tool		
M-TYPE	Motor Type Dependent		
Nm	Newton Metres		in-lbs
I <sub>M,N</sub>	Nominal motor current		
f <sub>M,N</sub>	Nominal motor frequency		
P <sub>M,N</sub>	Nominal motor power		
U <sub>M,N</sub>	Nominal motor voltage		
par.	Parameter		
PELV	Protective Extra Low Voltage		
	Power	W	Btu/hr, hp
	Pressure	Pa = N/m <sup>2</sup>	psi, psf, ft of water
I <sub>INV</sub>	Rated Inverter Output Current		
RPM	Revolutions Per Minute		
SR	Size Related		
	Temperature	°C	°F
	Time	s	s,hr
T <sub>LIM</sub>	Torque limit		
	Voltage	V	V

Table 2.2: Abbreviation and Standards table .

## 3. Programming

### 3.1. How to Programme

#### 3.1.1. Programming with MCT-10 Set-up Software

The frequency converter can be programmed from a PC via RS485 com-port by installing the MCT-10 Set-up Software.

This software can either be ordered using code number 130B1000 or downloaded from the Danfoss Web site: [www.danfoss.com](http://www.danfoss.com), Business Area: Motion Controls.

Please refer to manual MG.10.RX.YY.

#### 3.1.2. Programming with the LCP 11 or LCP 12

The LCP is divided into four functional groups:

1. Numeric display.
2. Menu key.
3. Navigation keys.
4. Operation keys and indicator lights (LEDs).

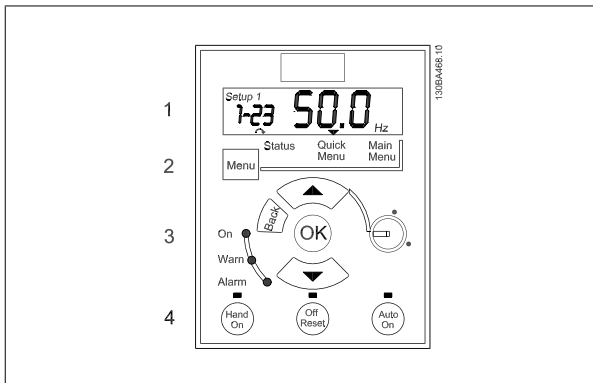

Illustration 3.1: LCP 12 with potentiometer

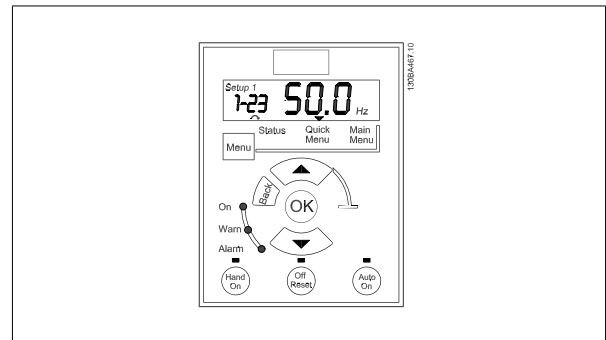

Illustration 3.2: LCP 11 without potentiometer

#### The display:

A number of information can be read from the display.

**Set-up number** shows the active set-up and the edit set-up. If the same set-up acts as both active and edit set-up, only that set-up number is shown (factory setting).

When active and edit set-up differ, both numbers are shown in the display (Setup 12). The number flashing, indicates the edit set-up.

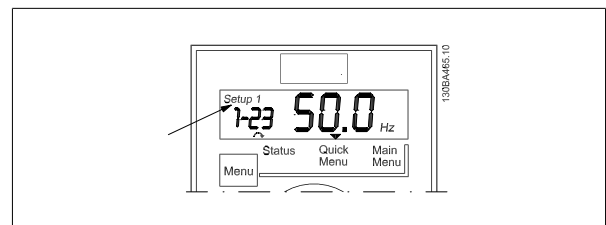

Illustration 3.3: Indicating Set-up

The small digits to the left are the selected parameter number.

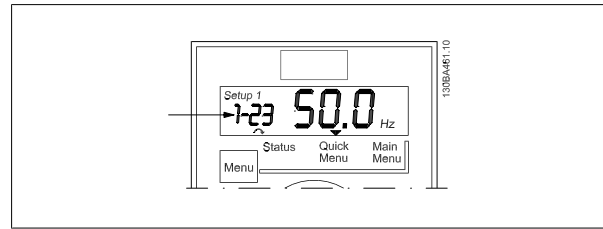

Illustration 3.4: Indicating selected par. no.

The large digits in the middle of the display show the value of the selected parameter.

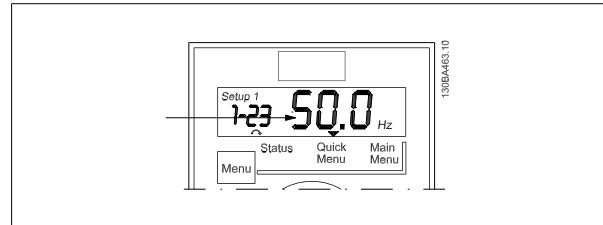

Illustration 3.5: Indicating value of selected par.

The right side of the display shows the unit of the selected parameter. This can be either Hz, A, V, kW, HP, %, s or RPM.

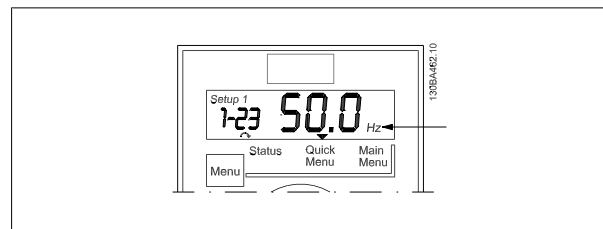

Illustration 3.6: Indicating unit of selected par.

Motor direction is shown to the bottom left of the display - indicated by a small arrow pointing either clockwise or counterclockwise.

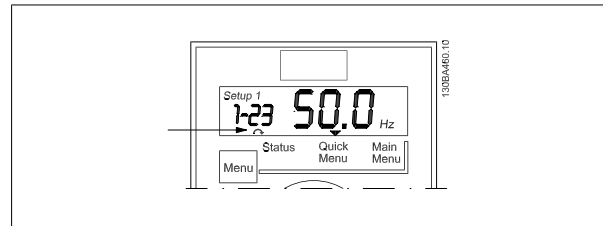

Illustration 3.7: Indicating motor direction

Use the [MENU] key to select one of the following menus:

#### Status Menu:

The Status Menu is either in *Readout Mode* or *Hand on Mode*. In *Readout Mode* the value of the currently selected readout parameter is shown in the display.

In *Hand on Mode* the local LCP reference is displayed.

#### Quick Menu:

Displays Quick Menu parameters and their settings. Parameters in the Quick Menu can be accessed and edited from here. Most applications can be run by setting the parameters in the Quick Menus.

#### Main Menu:

Displays Main Menu parameters and their settings. All parameters can be accessed and edited here. A parameter overview is found later in this manual.

#### Indicator lights:

- Green LED: The frequency converter is on.
- Yellow LED: Indicates a warning. Please see section *Troubleshooting*
- Flashing red LED: Indicates an alarm. Please see section *Troubleshooting*



#### Navigation Keys:

[Back]: For moving to the previous step or layer in the navigation structure.

Arrows [▲] [▼]: For maneuvering between parameter groups, parameters and within parameters.

[OK]: For selecting a parameter and for accepting changes to parameter settings.

#### Operation Keys:

A yellow light above the operation keys indicates the active key.

[Hand on]: Starts the motor and enables control of the frequency converter via the LCP.

[Off/Reset]: The motor stops except in alarm mode. In that case the motor will be reset.

[Auto on]: The frequency converter is controlled either via control terminals or serial communication.

[Potentiometer] (LCP12): The potentiometer works in two ways depending on the mode in which the frequency converter is running.

In *Auto Mode* the potentiometer acts as an extra programmable analog input.

In *Hand on Mode* the potentiometer controls local reference.

## 3.2. Status Menu

After power up the Status Menu is active. Use the [MENU] key to toggle between Status, Quick Menu and Main Menu.

Arrows [▲] and [▼] toggles between the choices in each menu.

The display indicates the status mode with a small arrow above "Status".

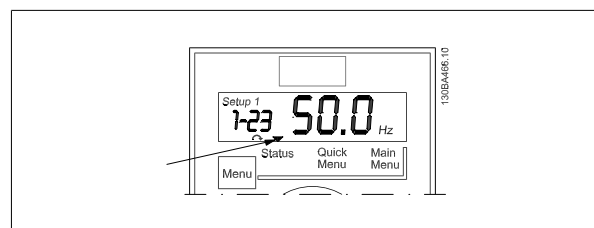

Illustration 3.8: Indicating Status mode

## 3.3. Quick Menu

The Quick Menu gives easy access to the most frequently used parameters.

1. To enter the Quick Menu, press [MENU] key until indicator in display is placed above *Quick Menu*.
2. Use [▲] [▼] to select either QM1 or QM2, then press [OK].
3. Use [▲] [▼] to browse through the parameters in the Quick Menu.
4. Press [OK] to select a parameter.
5. Use [▲] [▼] to change the value of a parameter setting.
6. Press [OK] to accept the change.
7. To exit, press either [Back] twice to enter *Status*, or press [Menu] once to enter *Main Menu*.

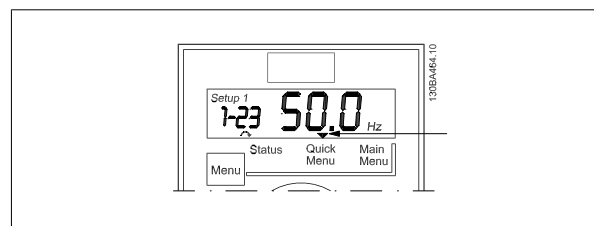

Illustration 3.9: Indicating Quick Menu mode

### 3.4. Main Menu

The Main Menu gives access to all parameters.

1. To enter the Main Menu, press [MENU] key until indicator in display is placed above *Main Menu*.
2. Use [▲] [▼] to browse through the parameter groups.
3. Press [OK] to select a parameter group.
4. Use [▲] [▼] to browse through the parameters in the specific group.
5. Press [OK] to select the parameter.
6. Use [▲] [▼] to set/change the parameter value.
7. Press [OK] to accept the value.
8. To exit, press either [Back] twice to enter *Quick Menu*, or press [Menu] once to enter *Status*.

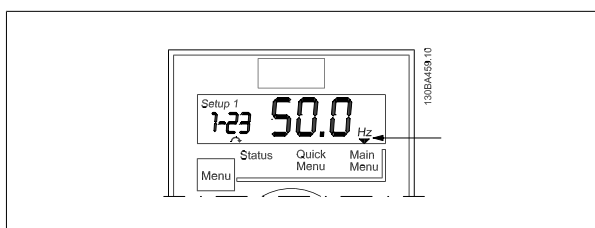

Illustration 3.10: Indicating Main Menu mode

## 4. Parameter Descriptions

### 4.1. Parameter group 0: Operation/Display

#### 0-03 Regional Settings

**Option:**

**Function:**

In order to meet the needs for different default settings in different parts of the world, par. 0-03, *Regional Settings*, is implemented in the frequency converter. The selected setting influences the default setting of the motor nominal frequency.

[0] *	International	Sets default of par. 1-23, <i>Motor Frequency</i> , to 50 Hz, shows par. 1-20 in kW.
[1]	US	Sets default of par. 1-23, <i>Motor Frequency</i> , to 60 Hz, shows par. 1-20 in HP.



**NB!**

This parameter cannot be adjusted while motor runs.

#### 0-04 Operating State at Power-up (Hand Mode)

**Option:**

**Function:**

This parameter controls whether or not the frequency converter should start running the motor when powering up after a power down in Hand mode.



**NB!**

If LCP with potentiometer is mounted, reference is set according to actual potentiometer value.

[0]	Resume	Frequency converter starts in same Hand or Off State as when powered off. Local reference is stored and used after power-up.
[1] *	Forced Stop, Ref=Old	Frequency converter powers up in Off State meaning that motor is stopped after power up. Local reference is stored and used after power-up.
[2]	Forced Stop, Ref=0	Frequency converter powers up in Off State meaning that motor is stopped after power up. Local reference is set to 0. Thus motor will not start running before local reference has been increased.

#### 4.1.1. 0-1\* Set-up Handling

User defined parameters and miscellaneous external inputs (eg. bus, LCP, analog/digital inputs, feedback, etc.) controls the functionality of the frequency converter.

A complete set of all parameters controlling the frequency converter is called a set-up. The frequency converter contains 2 set-ups, *Set-up1* and *Set-up 2*.

Furthermore, a fixed set of factory settings can be copied into one or more set-ups.

Some of the advantages of having more than one set-up in the frequency converter are

- Run motor in one set-up (*Active Set-up*) while updating parameters in another set-up (*Edit Set-up*)
- Connect various motors (one at a time) to frequency converter. Motor data for various motors can be placed in different set-ups.
- Rapidly change settings of frequency converter and/or motor while motor is running (eg. ramp time or preset references) via bus or digital inputs.

The *Active Set-up* can be set as *Multi Set-up* where the active set-up is selected via input on a digital input terminal and/or via the bus control word.



**NB!**  
*Factory Set-up* cannot be used as *Active Set-up*.

**0-10 Active Set-up**

**Option:**

**Function:**

*Active Set-up* controls the motor.  
 Shifts between set-ups can only happen when

- the motor is coasted

OR

- the set-ups between which the shift happens are linked to each other (see par. 0-12, *Linked Set-ups*).

If changing between set-ups that are not linked, the change will not happen before motor is coasted.



**NB!**  
 The motor is only considered stopped when it is coasted.

[1] *	Set-up 1	<i>Set-up 1</i> is active.
[2]	Set-up 2	<i>Set-up 2</i> is active.
[9]	Multi Set-up	Select the active set-up via digital input and/or bus, see par. 5-1* choice [23].

**0-11 Edit Set-up**

**Option:**

**Function:**

The *Edit Set-up* is for updating parameters in the frequency converter from either LCP or bus. It can be identical or different from the *Active Set-up*.

All set-ups can be edited during operation, independently of the active set-up.

[1] *	Set-up 1	Update parameters in <i>Set-up 1</i> .
[2]	Set-up 2	Update parameters in <i>Set-up 2</i> .
[9]	Active Set-up	Update parameters in set-up selected as <i>Active Set-up</i> (see par. 0-10).

**0-12 Link Set-ups**

**Option:**

**Function:**

The link ensures synchronizing of the "not changeable during operation" parameter values enabling shift from one set-up to another during operation.

If the set-ups are not linked, a change between them is not possible while the motor is running. Thus the set-up change does not occur until the motor is coasted.

[0]	Not linked	Leaves parameters unchanged in both set-ups and cannot be changed while motor runs.
[1] *	Linked	Copy parameters "not changeable during operation" parameter values into presently selected <i>Edit Set-up</i> .



**NB!**  
 This parameter cannot be changed while motor runs.

**4.1.2. 0-31 Custom Readout Min Scale**

**0-31 Custom Readout Min Scale**

**Range:**

**Function:**

0.00 \* [0.00 – 9999.00 ]

It is possible to create a customized readout related to the output frequency of the unit. The value entered in par. 0-31 will be shown at 0 Hz. The readout can be shown in the LCP display when in Status Mode or it can be read in par. 16-09

### 4.1.3. 0-32 Custom Readout Max Scale

#### 0-32 Custom Readout Max Scale

<b>Range:</b> 100.0* [0.00 – 9999.00]	<b>Function:</b> It is possible to create a customized readout related to the output frequency of the unit. The value entered in par. 0-32 will be shown at the frequency programmed in par. 4-14 Motor Speed High Limit. The readout can be shown in the LCP display when in Status Mode or it can be read in par. 16-09
--	--

### 4.1.4. 0-4\* LCP Keypad

The frequency converter can operate in the following three modes: *Hand*, *Off* and *Auto*.

*Hand*: The frequency converter is locally operated and does not allow any remote control. By activating Hand a start signal is given.

*OFF*: The frequency converter stops with a normal stop ramp. When Off is chosen the frequency converter can only be started by pressing either Hand or Auto on the LCP.

*Auto*: In Auto-mode the frequency converter can be remote controlled (bus/digital).

#### 0-40 [Hand on] Key on LCP

<b>Option:</b> [0] Disabled	<b>Function:</b> Hand-on key has no function.
[1] * Enabled	Hand-on key is functional.

#### 0-41 [Off/Reset] Key on LCP

<b>Option:</b> [0] Disable Off/Reset	<b>Function:</b> Off/reset key has no function.
[1] * Enable Off/Reset	Stop signal and reset of any faults.
[2] Enable Reset Only	Reset only. Stop (Off) function is disabled.

#### 0-42 [Auto on] Key on LCP

<b>Option:</b> [0] Disabled	<b>Function:</b> Auto-on key has no function.
[1] * Enabled	Auto-on key is functional.

### 4.1.5. 0-5\* Copy/Save

#### 0-50 LCP Copy

<b>Option:</b>	<b>Function:</b> The detachable LCP of the frequency converter can be used for storing setups, and thus for transferring data when moving parameter settings from one frequency converter to another.
----------------	--

**NB!**  
*LCP Copy* can only be activated from the LCP and ONLY when the motor is coasted.

[1] All to LCP	Copy all setups from the frequency converter into the LCP.
[2] All from LCP	Copy all setups from LCP to frequency converter.
[3] Size indep. from LCP	Copy non motor size dependent data from LCP to frequency converter

#### 0-51 Set-up Copy

<b>Option:</b>	<b>Function:</b> Use this function to copy a set-up content into the <i>Edit Set-up</i> . In order to be able to make a set-up copy ensure that <ul style="list-style-type: none"> <li>• the motor is coasted</li> <li>• par. 0-10, <i>Active Set-up</i>, is set to either <i>Set-up 1</i> [1] or <i>Set-up 2</i> [2]</li> </ul>
----------------	--



**NB!**

The keyboard/parameter database are blocked while Set-up Copy is running.

[0 ] *	No Copy	Copy function is inactive
[1]	Copy from Set-up 1	Copy from <i>Set-up 1</i> to edit set-up chosen in par. 0-11, <i>Edit Set-up</i> .
[2]	Copy from Set-up 2	Copy from <i>Set-up 2</i> to edit set-up chosen in par. 0-11, <i>Edit Set-up</i> .
[9]	Copy from Factory Set-up	Copy from Factory Settings to edit set-up chosen in par. 0-11, <i>Edit set-up</i> .

4

4.1.6. 0-6\* Password

**0-60 (Main) Menu Password**

**Range:**

**Function:**

Use password for protection against unintended change of sensitive parameters, eg. motor parameters. Password protected parameters can always be read, but cannot be edited without entering the password.

0 * [0 - 999]	Enter the password for access to Main Menu via the [Main Menu] key. Select the number that should allow for changing other parameter values. 0 means there is no password.
---------------	--



**NB!**

A password only has affect on the LCP - not on the bus communication.



**NB!**

Pressing buttons [MENU], [OK] and down will unlock the password. This will automatically enter the parameter editing screen in Quick Menu or Main Menu.

## 4.2. Parameter Group 1: Load/Motor

### 1-00 Configuration Mode

**Option:**

**Function:**

Use this parameter for selecting the application control principle to be used when a Remote Reference is active.



**NB!**

Changing this parameter will reset parameters 3-00, 3-02 and 3-03 to their default values.



**NB!**

This parameter cannot be adjusted while motor runs.

[0] \* Speed Open Loop For normal speed control (References).

[3] Process Closed Loop Enables process closed loop control. See par. group 7-3\* for further information on PI-controller. When running in process closed loop, par. 4-10 *Motor Speed Direction* must be set to *Clockwise* [0]

### 1-01 Motor Control Principle

**Option:**

**Function:**

[0] U/f Is used for parallel connected motors and/or special motor applications. The U/f settings are set in parameters 1-55 and 1-56.



**NB!**

When running U/f control slip- and load compensations are not included.

[1] \* VVC+ Normal running mode, including slip- and load compensations.

### 1-03 Torque Characteristics

**Option:**

**Function:**

With more torque characteristics it is possible to run low energy consuming, as well as high torque applications.

[0] \* Constant Torque Motor shaft output provides constant torque under variable speed control.

[2] Automatic Energy Optim. This function automatically optimizes energy consumption in centrifugal pump and fan applications. See par. 14-41 *AEO Minimum Magnetisation*.

### 1-05 Hand Mode Configuration

**Option:**

**Function:**

This parameter is only relevant when parameter 1-00 *Configuration Mode* is set to *Process Closed Loop* [3]. The parameter is used for determining the reference or setpoint handling when changing from Auto Mode to Hand Mode on the LCP.

[0] Speed Open Loop In Hand Mode the drive always runs in Open Loop configuration regardless of setting in par. 1-00 *Configuration Mode*. Local potentiometer (if present) or Arrow up/down determines output frequency limited by Motor Speed High/Low Limit (parameters 4-14 and 4-12).

[2] \* As configuration in par. 1-00 If par. 1-00 *Configuration Mode* is set to *Open Loop* [1] function is as described above. If par. 1-00 is set to *Process Closed Loop* [3] changing from Auto mode to Hand mode results in a setpoint change via local potentiometer or Arrow up/down. The change is limited by Reference Max/Min (parameters 3-02 and 3-03).

#### 4.2.1. 1-2\* Motor Data

Enter the correct motor nameplate data (power, voltage, frequency, current and speed).

Run AMT, see par. 1-29.

Factory settings for advanced motor data, par. 1-3\*, are automatically calculated.

**NB!**

Parameters in parameter group 1.2\* cannot be adjusted while motor runs.

**1-20 Motor Power [kW]/[HP] ( $P_{m,n}$ )****Option:****Function:**

Enter motor power from nameplate data.

Two sizes down, one size up from nominal VLT rating.

[1]	0.09 kW/0.12 HP
[2]	0.12 kW/0.16 HP
[3]	0.18kW/0.25 HP
[4]	0.25 kW/0.33 HP
[5]	0.37kW/0.50 HP
[6]	0.55 kW/0.75 HP
[7]	0.75 kW/1.00 HP
[8]	1.10 kW/1.50 HP
[9]	1.50 kW/2.00 HP
[10]	2.20 kW/3.00 HP
[11]	3.00 kW/4.00 HP
[12]	3.70 kW/5.00 HP
[13]	4.00 kW/5.40 HP
[14]	5.50 kW/7.50 HP
[15]	7.50 kW/10.0 HP
[16]	11.00 kW/15.00 HP

**NB!**

Changing this parameter affects par. 1-22 to 1-25, 1-30, 1-33 and 1-35.

**1-22 Motor Voltage ( $U_{m,n}$ )****Range:**

230/400 V [50 - 999 V]

**Function:**

Enter motor voltage from nameplate data.

**1-23 Motor Frequency ( $f_{m,n}$ )****Range:**

50 Hz\* [20-400 Hz]

**Function:**

Enter motor frequency from nameplate data.

**1-24 Motor Current ( $I_{m,n}$ )****Range:**

M-type dependent\* [0.01 - 26.00 A]

**Function:**

Enter motor current from nameplate data.

**1-25 Motor Nominal Speed ( $n_{m,n}$ )****Range:**

M-type Dependent\* [100 - 9999 RPM]

**Function:**

Enter motor nominal speed from nameplate data.

**1-29 Automatic Motor Tuning (AMT)****Option:****Function:**

Use AMT to optimize motor performance.



**NB!**  
This parameter cannot be changed while motor runs.

1. Stop the frequency converter – make sure motor is at standstill
2. Choose [2] Enable AMT
3. Apply start signal
  - Via LCP: Press Hand On
  - Or in Remote On mode: Apply start signal on terminal 18

[0] *	Off	AMT function is disabled.
[2]	Enable AMT	AMT function starts running.

**NB!**  
To gain optimum tuning of frequency converter, run AMT on a cold motor.

### 4.2.2. 1-3\* Adv. Motor Data

Adjust advanced motor data using one of these methods:

1. Run AMT on cold motor. Frequency converter measures value from motor.
2. Enter  $X_1$  value manually. Obtain value from motor supplier.
3. Use  $R_s$ ,  $X_1$ , and  $X_2$  default setting. Frequency converter establishes setting based on motor nameplate data.

**NB!**  
These parameters cannot be changed while motor runs.

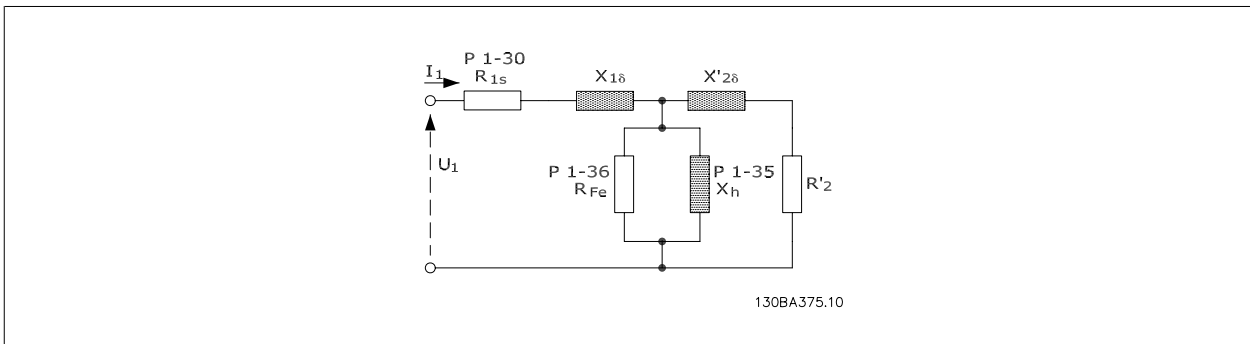

**1-30 Stator Resistance ( $R_s$ )**

**Range:** Depending on motor data\* [Ohm]      **Function:** Set stator resistance value.

**1-33 Stator Leakage Reactance ( $X_1$ )**

**Range:** Depending on motor data\* [Ohm]      **Function:** Set stator leakage reactance of motor.

**1-35 Main Reactance ( $X_2$ )**

**Range:** Depending on motor data\* [Ohm]      **Function:** Set motor main reactance.

### 4.2.3. 1-5\* Load Independent Setting

This parameter group is for setting the load independent motor settings.

#### 1-50 Motor Magnetization at Zero Speed

<b>Range:</b>	<b>Function:</b>
100 %* [ 0 - 300%]	This parameter enables different thermal load on motor when running at low speed. Enter a percentage of rated magnetizing current. If setting is too low, motor shaft torque may be reduced.

#### 1-52 Min. Speed Normal Magnetizing [Hz]

<b>Range:</b>	<b>Function:</b>
0.0 Hz* [0.0 - 10.0 Hz]	Use this parameter along with par. 1-50, <i>Motor Magnetizing at Zero Speed</i> . Set frequency required for normal magnetizing current. If frequency is set lower than motor slip frequency, par. 1-50, <i>Motor Magnetizing at Zero Speed</i> is inactive.

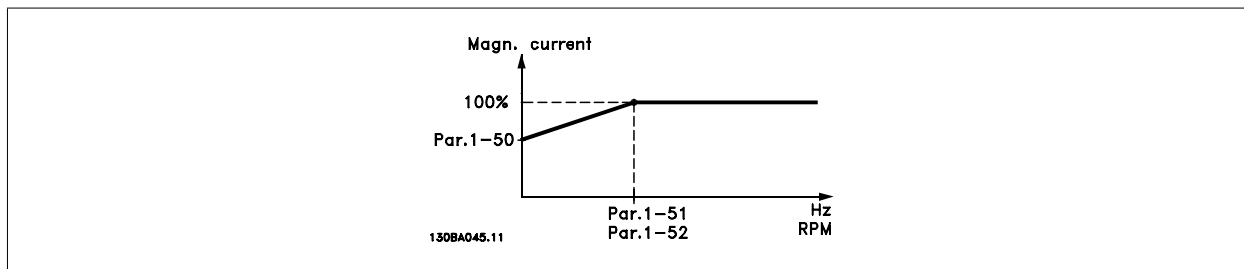

#### 1-55 U/f Characteristic - U

<b>Range:</b>	<b>Function:</b>
0.0 V* [0.0 - 999.9 V]	This parameter is an array parameter [0-5] and is only functional when par. 1-01, <i>Motor Control Principle</i> is set to <i>U/f[0]</i> . Enter voltage at each frequency point to manually form a U/f characteristic matching motor. Frequency points are defined in par. 1-56, <i>U/f characteristics - F</i> .

#### 1-56 U/f Characteristic - F

<b>Range:</b>	<b>Function:</b>
0.0 Hz* [0.0 - 1000.0 Hz]	This parameter is an array parameter [0-5] and is only functional when par. 1-01, <i>Motor Control Principle</i> is set to <i>U/f[0]</i> . Enter frequency points to manually form a U/f characteristic matching motor. Voltage at each point is defined in par. 1-55, <i>U/f Characteristic - U</i> . Make a U/f characteristic based on 6 definable voltages and frequencies, see below figure. Simplify U/f characteristics by merging 2 or more points (voltages and frequencies), respectively, are set equal.

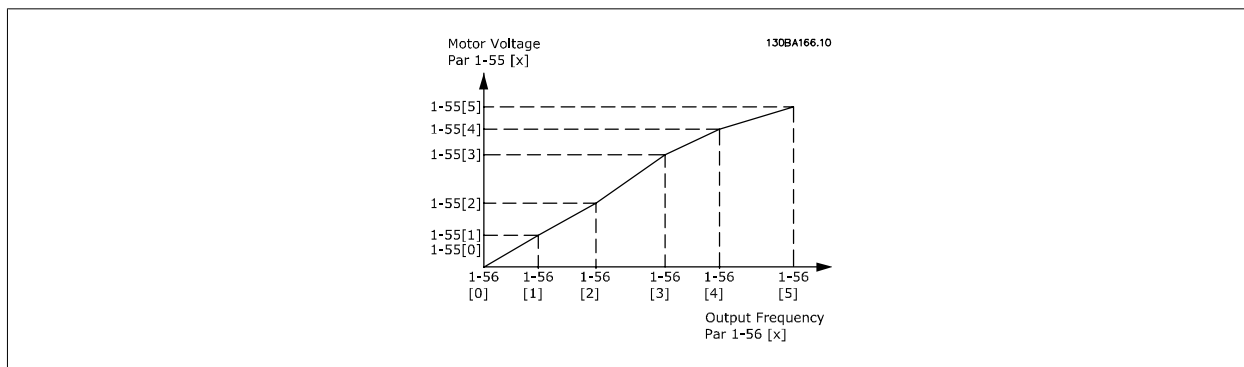

Illustration 4.1: Fig. 1 U/f characteristics

4



**NB!**  
For par. 1-56 the following applies  
[0]  $\leq$  [1]  $\leq$  [2]  $\leq$  [3]  $\leq$  [4]  $\leq$  [5]

#### 4.2.4. 1-6\* Load Dependent setting

Parameters for adjusting the load dependent motor settings.

##### 1-60 Low Speed Load Compensation

**Range:**

**Function:**

Use this parameter to gain optimum U/f characteristic when running at low speed.

100 %\* [0-199 %]

Enter percentage in relation to load when motor runs at low speed.  
Change-over point is automatically calculated based on motor size.

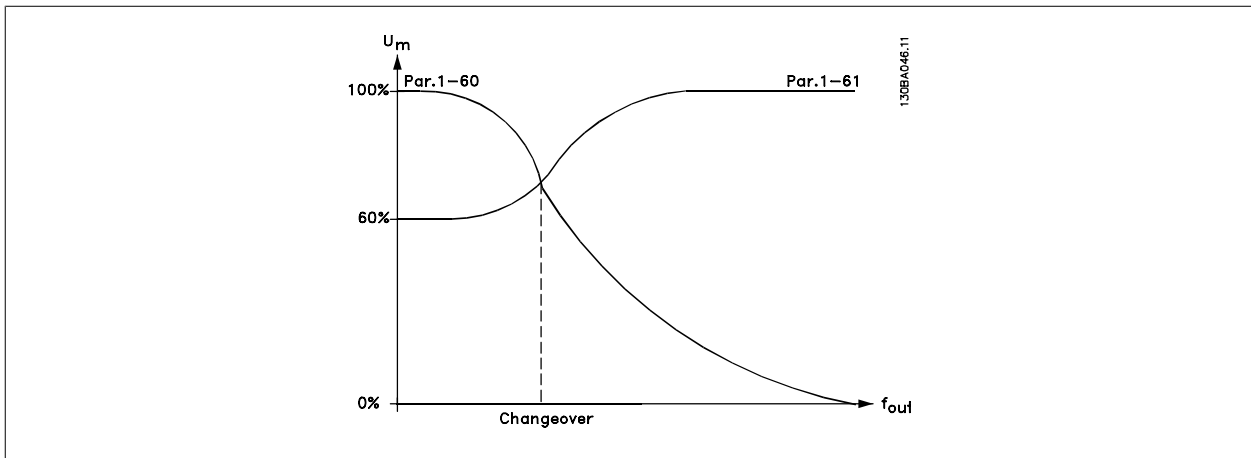

##### 1-61 High Speed Load Compensation

**Range:**

**Function:**

Use this parameter to obtain optimum load compensation when running at high speed.

100 %\* [0 - 199 %]

Enter percentage to compensate in relation to load when motor runs at high speed.  
Change-over point is automatically calculated based on motor size.

##### 1-62 Slip Compensation

**Range:**

**Function:**

Compensation for load dependent motor slip.

100 %\* [-400 - 399 %]

Slip compensation is calculated automatically based on rated motor speed,  $n_{M,N}$ .



**NB!**

This function is only active when par. 1-00, *Configuration Mode*, is set to *Speed Open Loop* [0], and when par. 1-01, *Motor Control Principle*, is set to *VVC+* [1].

##### 1-63 Slip Compensation Time

**Range:**

**Function:**

0.10 s [0.05 - 5.00 s]

Enter slip compensation reaction speed. A high value results in slow reaction whereas a low value results in quick reaction.

If low-frequency resonance problems arise, use longer time setting.

### 4.2.5. 1-7\* Start Adjustments

Considering the need for various start functions in different applications, it is possible to select a number of functions in this parameter group.

#### 1-71 Start Delay

**Range:**

0.0 s\* [0.0 - 10.0 s]

**Function:**

The start delay defines the time to pass from a start command is given until the motor starts accelerating. Setting start delay to 0.0 sec. disables *Start Function*, [1-72], when start command is given.

Enter the time delay required before commencing acceleration.  
Par. 1-72 *Start Function* is active during *Start delay time*.

#### 1-72 Start Function

**Option:**

[0]

DC Hold/Delay Time

**Function:**

Motor is energized with DC holding current (par. 2-00) during start delay time.

[1]

DC Brake/Delay Time

Motor is energized with DC braking current (par. 2-01) during start delay time.

[2]\*

Coast/Delay Time

Inverter is coasted during start delay time (inverter off).

#### 1-73 Flying Start

**Option:**

[0]\*

Disabled

**Function:**

The Flying Start parameter is used to catch a spinning motor after eg. mains drop-out.



This function is not suitable for hoisting applications.

[1]

Enabled

Flying start is not required.

Frequency converter enabled to catch spinning motor.

**NB!**

When flying start is enabled par. 1-71, *Start Delay*, and par. 1-72, *Start Function*, have no function.

### 4.2.6. 1-8\* Stop Adjustments

To meet the need for various stop functions in different application these parameters offer some special stop features for the motor.

#### 1-80 Function at Stop

**Option:**

[0]\*

Coast

**Function:**

The selected function at stop is active in following situations:

- Stop command is given and output speed is ramped down to *Min. Speed for Activating Functions at Stop*.
- Start command is removed (standby), and output speed is ramped down to *Min. Speed for Activating Functions at Stop*.
- DC-brake command is given, and DC-brake time has passed
- While running and calculated output speed is below *Min. Speed for Activating Functions at Stop*.

[1]

DC hold

The motor is energized with a DC current. See par. 2-00 *DC Hold Current* for more information.

#### 1-82 Min. Speed For Function at Stop [Hz]

**Range:**

0.0 Hz\* [0.0 - 20.0 Hz]

**Function:**

Set the speed at which to activate par. 1-80 *Function at Stop*.

### 4.2.7. 1-9\* Motor Temperature

With an estimated motor temperature monitor the frequency converter is able to estimate motor temperature without having a thermistor mounted. It is thus possible to receive a warning or an alarm, if motor temperature exceeds upper operational limit.

#### 1-90 Motor Thermal Protection

**Option:**

**Function:**

Using ETR (Electronic Terminal Relay) the motor temperature is calculated based on frequency, speed and time. Danfoss recommends using The ETR function, if a thermistor is not present.

**NB!**  
ETR calculation is based on motor data from group 1-2\*.

[0] *	No Protection	Disables temperature monitoring.
[1]	Thermistor Warning	A thermistor connected to either digital or analog input gives a warning if upper limit of motor temperature range is exceeded, (see par. 1-93, <i>Thermistor Resource</i> ).
[2]	Thermistor Trip	A thermistor connected to either digital or analog input gives an alarm and makes the frequency converter trip if upper limit of motor temperature range is exceeded, (see par. 1-93, <i>Thermistor Resource</i> ).
[3]	ETR Warning	If calculated upper limit of motor temperature range is exceeded, a warning occurs.
[4]	ETR Trip	If 90% of calculated upper limit of motor temperature range is exceeded, an alarm occurs and frequency converter trips.

**NB!**  
When the ETR function has been selected the drive will store the recorded temperature at power down and this temperature will resume at power up regardless of the elapsed time. Changing par. 1-90 back to [0] No Protection will reset the recorded temperature.

#### 1-93 Thermistor Resource

**Option:**

**Function:**

Select the thermistor input terminal.

[0] *	None	No thermistor is connected.
[1]	Analog Input 53	Connect thermistor to analog input terminal 53.

**NB!**  
Analog input 53 cannot be selected for other purposes when selected as thermistor resource.

[6]	Digital input 29	Connect thermistor to digital input terminal 29. While this input functions as thermistor input, it will not respond to the function chosen in par. 5-13, <i>Digital Input 29</i> . The value of par. 5-13 remains however unchanged in parameter database while function is inactive.
-----	------------------	---

Input Digital/ Analog	Supply Voltage	Threshold Cut-out Values
Digital	10 V	<800 ohm - >2.9k ohm
Analog	10 V	<800 ohm - >2.9k ohm

## 4.3. Parameter Group 2: Brakes

### 4.3.1. 2-\*\* Brakes

#### 4.3.2. 2-0\* DC-Brake

The purpose of DC-brake function is to brake a rotating motor by applying DC-current to the motor.

##### 2-00 DC Hold Current

**Range:**

50%\* [0 - 100%]

**Function:**

This parameter either holds the motor (holding torque) or pre-heats the motor.

The parameter is active if *DC Hold* has been selected in either par. 1-72 *Start Function* or par. 1-80 *Function at Stop*.

Enter a value for holding current as a percentage of the rated motor current set in par. 1-24 *Motor Current*. 100% DC holding current corresponds to  $I_{M,N}$ .

**NB!**

Avoid 100% current too long as it may overheat the motor.

##### 2-01 DC Brake Current

**Range:**

50 %\* [0 - 150%]

**Function:**

Set DC-current needed to brake rotating motor.

Activate DC-brake in one of the four following ways:

1. DC-brake command, see par. 5-1\* choice [5]
2. DC Cut-in function, see par. 2-04
3. DC-brake selected as start function, see par. 1-72
4. DC-brake in connection with *Flying Start*, par. 1-73.

##### 2-02 DC-Braking Time

**Range:**

10.0 s\* [0.0 - 60 s]

**Function:**

DC-braking time defines the period during which *DC-brake current* is applied to the motor.

Set the time DC-braking current, set in par. 2-01, must be applied.

**NB!**

If DC-brake is activated as start function, DC-brake time is defined by *start delay time*.

##### 2-04 DC-Brake Cut-in Speed

**Range:**

0.0 Hz\* [0.0 - 400.0 Hz]

**Function:**

Set DC-brake cut-in speed to activate DC braking current, set in par. 2-01, when ramping down.

When set to 0 the function is off.

### 4.3.3. 2-1\* Brake Energy Function

Use the parameters in this group for selecting dynamic braking parameters.

#### 2-10 Brake Function

**Option:**

**Function:**

**Resistor Brake:**

The resistor brake limits voltage in the intermediate circuit when the motor acts as generator. Without brake resistor, the frequency converter eventually trips.

The resistor brake consumes surplus energy resulting from motor braking. A frequency converter with brake stops a motor faster than without a brake, which is used in many applications. Requires connection of external brake resistor.

An alternative to the resistor brake is the AC brake.

**NB!**  
Resistor brake is only functional in frequency converters with integrated dynamic brake. An external resistor must be connected.

**AC Brake:**

The AC brake consumes surplus energy by creating power loss in the motor.

It is important to keep in mind that an increase in power loss causes motor temperature to rise.

[0] *	Off	No brake function.
[1]	Resistor Brake	Resistor brake is active.
[2]	AC Brake	AC brake is active.

#### 2-11 Brake Resistor (Ohm)

**Range:**

5 Ω\* [5 - 5000 Ω]

**Function:**

Set brake resistor value.

#### 2-16 AC Brake, Max Current

**Range:**

100.0 %\* [0.0 - 150.0 %]

**Function:**

Enter max. permissible current for AC-braking to avoid overheating of motor.  
100% equals motor current set in par. 1-24.

#### 2-17 Over-Voltage Control

**Option:**

**Function:**

Use Over-voltage Control (OVC) to reduce the risk of the frequency converter tripping due to an over voltage on the DC link caused by generative power from the load.

An over-voltage occurs eg. if the ramp down time is set too short compared to the actual load inertia.

[0] *	Disabled	The OVC is not active/required.
[1]	Enabled, not at stop	OVC is running unless a stop signal is active.
[2]	Enabled	OVC is running, also when a stop signal is active.

**NB!**  
If Resistor Brake has been chosen in par. 2-10 *Brake Function* the OVC is not active even though enabled in this parameter.

### 4.3.4. 2-2\* Mechanical Brake

For hoisting applications an electro-magnetic brake is required. The brake is controlled by a relay, which releases the brake when activated.

The brake activates if frequency converter trips or a coast command is given. Furthermore, it activates when motor speed is ramped down below the speed set in par. 2-22, *Active Brake Speed*.

**2-20 Release Brake Current****Range:**

0.00 A\* [0.00 - 100 A]

**Function:**

Select motor current at which mechanical brake releases.



If start delay time has passed, and motor current is below *Release brake current*, frequency converter trips.

**2-22 Activating Mechanical Brake****Range:**

0 Hz\* [0 - 400 Hz]

**Function:**

If the motor is stopped using ramp, the mechanical brake is activated when motor speed is less than *Active Brake Speed*.

Motor is ramped down to stop in the following situations:

- A start command is removed (stand by)
- A stop command is activated
- Quick-stop is activated (Q-stop ramp is used)

Select motor speed at which mechanical brake activates when ramping down.

Mechanical brake automatically activates if frequency converter trips or reports an alarm.



## 4.4. Parameter Group 3: Reference/Ramps

### 4.4.1. 3-\*\* Reference/Ramps

Parameters for reference handling, definition of limitations, and configuration of the frequency converter's reaction to changes

### 4.4.2. 3-0\* Reference Limits

Parameters for setting the reference unit, limits and ranges.

#### 3-00 Reference Range

**Option:**

**Function:**

Select the range of reference and feedback signals. Values can be both positive and negative, unless par. 1-00, *Configuration Mode*, is set to *Process Closed Loop* [3]. In that case only positive values are allowed.

[0] \* Min - Max

Reference setpoint ranges can have positive values only.  
Select this if running in Process Closed Loop.

[1] -Max - +Max

Ranges can have both positive and negative values.

#### 3-02 Minimum Reference

**Range:**

**Function:**

0.00\* [-4999 - 4999]

Enter value for minimum reference.

The sum of all internal and external references are clamped (limited) to the minimum reference value, par. 3-02.

#### 3-03 Maximum Reference

**Range:**

**Function:**

50.00\* [-4999 - 4999]

Maximum Reference is adjustable in the range Minimum Reference - 4999.

Enter value for Maximum Reference.

The sum of all internal and external references are clamped (limited) to the maximum reference value, par. 3-03.

### 4.4.3. 3-1\* References

Parameters for setting up the reference sources. Select the preset references for the corresponding digital inputs in parameter group 5.1\*, *Digital Inputs*.

#### 3-10\* Preset Reference

**Option:**

**Function:**

Each parameter set-up contains 8 preset references which are selectable via 3 digital inputs or bus.

[18] Bit2	[17] Bit1	[16] Bit0	Preset reference no.
0	0	0	0
0	0	1	1
0	1	0	2
0	1	1	3
1	0	0	4
1	0	1	5
1	1	0	6
1	1	1	7

Table 4.1: Par. 5-1\* selection [16], [17] and [18]

[0.00] \* -100.00 - 100.00%

Enter the different preset references using array programming.  
Normally, 100% = value set in par. 3-03, *Maximum Reference*.

However, there are exceptions if par. 3-00 is set to *Min - Max*, [0].  
 Example 1:  
 Par. 3-02 is set to 20 and par. 3-03 is set to 50. In this case 0% = 0 and 100% = 50.  
 Example 2:  
 Par. 3-02 is set to -70 and par. 3-03 is set to 50. In this case 0% = 0 and 100% = 70.

### 3-11 Jog Speed [Hz]

**Range:**

5.0 Hz [0.0 - 400.0 Hz]

**Function:**

Jog speed is a fixed output speed and overrules the selected reference speed, see par. 5-1\* selection [14].  
 If the motor is stopped while in jog mode, the jog signal acts as a start signal.  
 Removing the jog signal makes the motor run according to the selected configuration.

Select speed to function as jog speed.

### 3-12 Catch Up/Slow Down Value

**Range:**

0% \* [0 - 100%]

**Function:**

The *Catch-up/Slowdown function* is activated by an input command (see par. 5-1\*, choice [28]/[29]). If the command is active, the Catch-up/Slowdown value (in %) is added to the reference function as follows:

$$Reference = Reference + Reference \times \frac{Catchup\ Slowdown}{100}$$

$$Reference = Reference - Reference \times \frac{Catchup\ Slowdown}{100}$$

When the input command is inactivated, the reference returns to its original value ie. Reference = Reference + 0.

### 3-14 Preset Relative Reference

**Range:**

0.00% [-100.00 - 100.00%]

**Function:**

Define fixed value in % to be added to variable value defined in par. 3-18, *Relative Scaling Reference Source*. The sum of fixed and variable values (labelled Y in illustration below) is multiplied with actual reference (labelled X in illustration). This product is added to actual reference  $X + X \times \frac{Y}{100}$

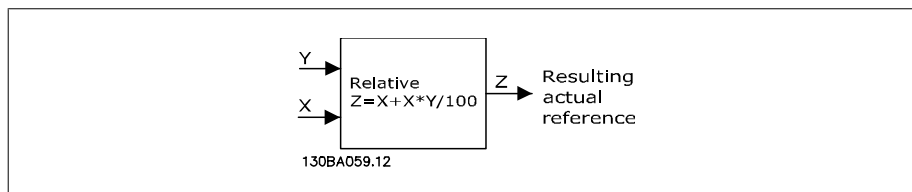

### 3-15 Reference 1 Source

**Option:**

**Function:**

Par. 3-15, 3-16 and 3-17 define up to three different reference signals. The sum of these reference signals defines the actual reference.

[0]	No Function	No reference signal is defined.
[1] *	Analog Input 53	Use signals from analog input 53 as reference, see par. 6-1*.
[2]	Analog Input 60	Use signals from analog input 60 as reference, see par. 6-2*.
[8]	Pulse input 33	Use signals from pulse input as reference, see par. 5-5*.
[11]	Local Bus Reference	Use signals from local bus as reference, see par. 8-9*.
[21]	LCP Potentiometer	Use signals from LCP potentiometer as reference, see par. 6-8*.

### 3-16 Reference 2 Source

**Option:**

**Function:**

See Par. 3-15 for description.

[0]	No Function	No reference signal is defined.
[1]	Analog Input 53	Use signals from analog input 53 as reference.

[2] *	Analog Input 60	Use signals from analog input 60 as reference.
[8]	Pulse input 33	Use signals from pulse input as reference, see par. 5-5*.
[11]	Local Bus Reference	Use signals from local bus as reference.
[21]	LCP Potentiometer	Use signals from LCP potentiometer as reference.

**3-17 Reference 3 Source**

**Option:** **Function:**  
See Par. 3-15 for description.

[0]	No Function	No reference signal is defined.
[1]	Analog Input 53	Use signals from analog input 53 as reference.
[2]	Analog Input 60	Use signals from analog input 60 as reference.
[8]	Pulse input 33	Use signals from pulse input as reference, see par. 5-5*.
[11] *	Local Bus Reference	Use signals from local bus as reference.
[21]	LCP Potentiometer	Use signals from LCP potentiometer as reference.

**3-18 Relative Scaling Reference Source**

**Option:** **Function:**  
Select the source for a variable value to be added to the fixed value defined in par. 3-14, *Preset Relative Reference*.

[0] *	No Function	The function is disabled
[1]	Analog Input 53	Select analog input 53 as relative scaling reference source.
[2]	Analog Input 60	Select analog input 54 as relative scaling reference source.
[8]	Pulse Input 33	Select pulse input 33 as relative scaling reference source.
[11]	Local Bus Reference	Select local bus ref. as relative scaling reference source.
[21]	LCP Potentiometer	Select LCP potentiometer as relative scaling reference source.

**4.4.4. 3-4\* Ramp 1**

A linear ramp is characterized by ramping up at a constant speed until the desired motor speed has been reached. Some overshoot may be experienced when reaching speed, which may cause speed jerks for a short while before stabilizing. An S-ramp accelerates more smoothly thus compensating for jerks when the speed is reached.

See the below figure for a comparison of the two ramp types.

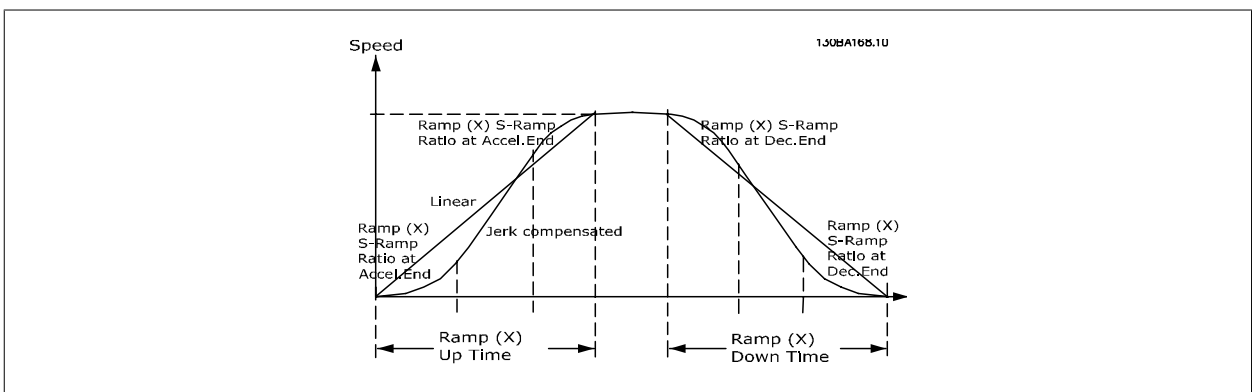

**Ramp Times:**

Ramp up: Acceleration time from 0 to nominal motor frequency (par. 1-23).  
Deceleration time from nominal motor frequency (par. 1-23) to 0.

**Limitation:**

Too short ramp up time can result in Torque limit warning (W12) and/or DC over voltage warning (W7). Ramping is stopped when the frequency converter has reached Torque limit motor mode (par. 4-16).

Too short ramp down time can result in Torque limit warning (W12) and/or DC over voltage warning (W7). Ramping is stopped when the frequency converter reaches the Torque limit generator mode (par. 4-17) and/or the internal DC over voltage limit.

**3-40 Ramp1 Type**

Option:	Function:
[0] * Linear	Constant acceleration/deceleration.
[2] S-ramp	Smooth jerk compensated acceleration/deceleration.

**3-41 Ramp1 Ramp-up Time**

Range:	Function:
3.00 s* [0.05 - 3600.00 s]	Enter ramp-up time from 0 Hz to rated motor frequency ( $f_{M,N}$ ) set in par. 1-23. Choose a ramp-up time ensuring that torque limit is not exceeded, see par. 4-16.

**3-42 Ramp1 Ramp-down Time**

Range:	Function:
3.00* [0.05 - 3600.00 s]	Enter ramp down time from rated motor frequency ( $f_{M,N}$ ) in par. 1-23 to 0 Hz. Choose a ramp down time that does not cause over-voltage in inverter due to regenerative operation of motor. Furthermore, regenerative torque must not exceed limit set in par. 4-17.

**4.4.5. 3-5\* Ramp2**

See par. 3-4\* for a description of ramp types.

**NB!**

Ramp2 - alternative ramp times:  
Changing from Ramp1 to Ramp2 is done via the digital input. See par. 5-1\*, selection [34].

**3-50 Ramp2 Type**

Option:	Function:
[0] * Linear	Constant acceleration/deceleration.
[2] S-ramp	Smooth jerk compensated acceleration/deceleration.

**3-51 Ramp2 Ramp-up Time**

Range:	Function:
3.00 s* [0.05 - 3600.00 s]	Enter ramp-up time from 0 Hz to rated motor frequency ( $f_{M,N}$ ) set in par. 1-23. Choose a ramp-up time ensuring that torque limit is not exceeded, see par. 4-16.

**3-52 Ramp2 Ramp-down Time**

Range:	Function:
3.00 s [0.05 - 3600.00 s]	Enter ramp down time from rated motor frequency ( $f_{M,N}$ ) in par. 1-23 to 0 Hz. Choose a ramp down time that does not cause over-voltage in inverter due to regenerative operation of motor. Furthermore, regenerative torque must not exceed limit set in par. 4-17.

**4.4.6. 3-8\* Other Ramps**

This section contains parameters for Jog and Quick Stop Ramps.

With a Jog Ramp you can both ramp up and down whereas you can only ramp down with the Quick Stop Ramp.

**3-80 Jog Ramp Time****Range:**

3.00 s\* [0.05 - 3600.00 s]

**Function:**

A linear ramp applicable when Jog is activated. See par. 5-1\*, selection [14].

Ramp up time = Ramp down time.

Jog Ramp time starts upon activation of a jog signal via a selected digital input or serial communication port.

**3-81 Quick Stop Ramp Time****Range:**

3.00 s\* [0.05 - 3600.00 s]

**Function:**

A linear ramp applicable when Q-stop is activated. See par. 5-1\*, selection [4].

## 4.5. Parameter Group 4: Limits/Warnings

### 4.5.1. 4-\*\* Motor Limits

Parameter group for configuring limits and warning.

### 4.5.2. 4-1\* Motor Limits

Use these parameters for defining the speed, torque and current working range for the motor.

4

#### 4-10 Motor Speed Direction

**Option:**
**Function:**

If terminals 96, 97 and 98 are connected to U, V and W respectively, the motor runs clockwise when seen from the front.

**NB!**

This parameter cannot be adjusted while the motor is running

[0]	Clockwise	The motor shaft rotates in clockwise direction. This setting prevents the motor from running in counterclockwise direction. If par. 1-00 <i>Configuration mode</i> has been set to <i>Process Closed Loop</i> [3] this parameter must always be set to <i>Clockwise</i> .
[1]	Counterclockwise	The motor shaft rotates in counterclockwise direction. This setting prevents the motor from running in clockwise direction.
[2] *	Both	With this setting the motor can run in both directions. However, the output frequency is limited to the range: Motor Speed Low Limit (par. 4-12) to Motor Speed High Limit (par. 4-14).

#### 4-12 Motor Speed Low Limit

**Range:**

0.0 Hz\* [0.0 - 400.0 Hz]

**Function:**

Set the *Minimum Motor Speed Limit* corresponding to the minimum output frequency of the motor shaft.

**NB!**

As the minimum output frequency is an absolute value, it cannot be deviated from.

#### 4-14 Motor Speed High Limit

**Range:**

65.0 Hz\* [0.0 - 400.0 Hz]

**Function:**

Set the *Maximum Motor Speed* corresponding to the maximum output frequency of the motor shaft.

**NB!**

As the maximum output frequency is an absolute value, it cannot be deviated from.

#### 4-16 Torque Limit in Motor Mode

**Range:**

150 %\* [0 - 400%]

**Function:**

Set the torque limit for motor operation.

The setting is not automatically reset to default when changing settings in par. 1-00 to 1-25 *Load & Motor*.

#### 4-17 Torque Limit in Generator Mode

**Range:**

100 %\* [0 - 400%]

**Function:**

Set the torque limit for generator mode operation.

The setting is not automatically reset to default when changing settings in par. 1-00 to 1-25 *Load & Motor*.

### 4.5.3. 4-5\* Adjustable Warnings

Parameter group containing adjustable warning limits for current, speed, reference and feedback.

Warnings are shown in display, programmed output or serial bus.

#### 4-50 Warning Current Low

**Range:**

0.00 A\* [0.00 - 26.00 A]

**Function:**

Use this parameter to set a lower limit for the current range.  
 If current drops below the set limit, warning bit 8 is set in par. 16-94.  
 Output Relay can be configured to indicate this warning. LCP warning light does not light when this parameter's set limit is reached.

Set value for low current limit.

#### 4-51 Warning Current High

**Range:**

26.00 A\* [0.00 - 26.00 A]

**Function:**

Use this parameter to set an upper limit for the current range.  
 If current exceeds the set limit, warning bit 7 is set in par. 16-94.  
 Output Relay can be configured to indicate this warning. LCP warning light does not light when this parameter's set limit is reached.

Set upper current limit.

#### 4-58 Missing Motor Phase Function

**Option:**

- [0] Off
- [1]\* On

**Function:**

A missing motor phase causes the motor torque to drop. This monitor may be disabled for special purposes (eg. small motors running pure U/f mode), but as there is a risk of overheating the motor, Danfoss strongly recommends that the function is *On*.  
 A missing motor phases causes the frequency converter to trip and report an alarm.



**NB!**  
This parameter cannot be changed while motor runs.

- Function is disabled.
- Function is enabled.

### 4.5.4. 4-6\* Speed Bypass

In some applications mechanical resonance may occur. Avoid resonance points by creating a bypass. The frequency converter ramps through the bypass area thereby passing mechanical resonance points quickly.

#### 4-61 Speed Bypass From [Hz]

**Range:**

0.0 Hz\* [0.0 - 400.0 Hz]

**Function:**

Array [2]

Enter either the lower or upper limit of the speeds to be avoided.  
 It does not matter whether Bypass From or Bypass To is the upper or lower limit, however the Speed Bypass function is disabled if the two parameters are set to the same value.

**4-63 Speed Bypass To [Hz]**

**Range:**

**Function:**

Array [2]

0.0 Hz\* [0.0 - 400.0 Hz]

Enter either the upper or lower limit of the speed area to be avoided.  
Make sure to enter the **opposite** limit of that in par. 4-61 *Speed Bypass From [Hz]*.



## 4.6. Parameter Group 5: Digital In/Out

### 4.6.1. 5-\*\* Digital In/Out

The following describes all digital input command functions and signals.

### 4.6.2. 5-1\* Digital Inputs

Parameters for configuring the functions for the input terminals.

The digital inputs are used for selecting various functions in the frequency converter. All digital inputs can be set to the following:

[0]	No Operation	The frequency converter will not react to signals transmitted to the terminal.
[1]	Reset	Reset the frequency converter after a Trip/Alarm. Not all alarms can be reset.
[2]	Coast Inverse	Coasting stop, inverted input (NC). The frequency converter leaves the motor in free mode.
[3]	Coast and reset inv.	Reset and coasting stop inverted input (NC). The frequency converter resets and leaves the motor in free mode.
[4]	Quick stop inverse	Inverted input (NC). Generates a stop in accordance with the quick-stop ramp time set in par. 3-81. When motor stops, shaft is in free mode.
[5]	DC-brake inv.	Inverted input for DC braking (NC). Stops motor by energizing it with DC current for a certain time period, see par. 2-01. Function is only active when value in par. 2-02 is different from 0.
[6]	Stop inv.	Stop inverted function. Generates stop function when selected terminal goes from logical level "1" to "0". Stop is performed according to selected ramp time.
[8]	Start	Select start for a start/stop command. 1 = Start, 0 = stop.
[9]	Latched start	Motor starts if a pulse is applied for min. 2 ms. Motor stops when Stop inverse is activated.
[10]	Reversing	Change direction of motor shaft rotation. Reversing signal only changes direction of rotation; it does not activate start function. Select <i>Both directions</i> [2] in par. 4.10. 0 = normal, 1 = reversing.
[11]	Start reversing	Use for start/stop and for reversing at the same time. Signals on start [8] are not allowed at the same time. 0 = stop, 1 = start reversing.
[12]	Enable start forward	Use if motor shaft must rotate clockwise at start.
[13]	Enable start reverse	Use if motor shaft must rotate counterclockwise at start.
[14]	Jog	Use for activating jog speed. See par. 3-11.
[16]	Preset ref bit 0	Preset ref bit 0, 1 and 2 enables a choice between one of the eight preset references according to the table below.
[17]	Preset ref bit 1	Same as preset ref bit 0 [16], see par. 3-10.
[18]	Preset ref bit 2	Same as preset ref bit 0 [16].
[19]	Freeze reference	Freeze actual reference. The frozen reference is now the point of enable/condition for Speed up and Speed down to be used. If Speed up/down is used, speed change always follows ramp 2 (par. 3-51 and 3-52) in the range par. 3-02 <i>Minimum Reference</i> - par. 3-03 <i>Maximum Reference</i> .
[20]	Freeze output	Freeze the actual motor frequency (Hz). The frozen motor frequency is now the point of enable/condition for Speed up and Speed down to be used. If Speed up/down is used, the speed change always follows ramp 2 in the range par. 4-12, <i>Motor Speed Low Limit</i> - par. 4-14, <i>Motor Speed High Limit</i> .
		 <p><b>NB!</b> When freeze output is active, the frequency converter cannot be stopped via a low <i>Start</i> [8] signal. Stop the frequency converter via a terminal programmed for Coasting Inverse [2] or Coast and reset, inverse [3].</p>
[21]	Speed up	Select Speed up and Speed down if digital control of the up/down speed is desired (motor potentiometer). Activate this function by selecting either Freeze reference or Freeze output. When Speed up is activated for less than 400 ms. the resulting reference will be increased by 0.1%. If Speed up is activated for more than 400 ms. the resulting reference will ramp according to ramp 2 in par. 3-51.
[22]	Speed down	Same as Speed up [21].

[23]	Setup select bit 0	Set par. 0-10 <i>Active set-up</i> to Multi set-up. Logic 0 = set-up 1, Logic 1 = Set-up 2.
[26]	Precise stop inverse (only terminal 33)	Prolong the stop signal to give a precise stop independent of scan time. The function is available for terminal 33 only.
[27]	Start, precise stop (only terminal 33)	As [26], but including Start.
[28]	Catch up	Select Catch up/Slow down to increase or reduce the resulting reference value by the percentage set in par. 3-12.
[29]	Slow down	Same as Catch up [28]
[32]	Pulse input (only terminal 33)	Select Pulse input when using a pulse sequence as either reference or feedback. Scaling is done in par. group 5-5*.
[34]	Ramp bit 0	Logic 0 = Ramp1, see par. 3-4*. Logic 1 = Ramp2, see par. 3-5*.
[60]	Counter A (up)	Input for counter A.
[61]	Counter A (down)	Input for counter A.
[62]	Reset counter A	Input for reset of counter A.
[63]	Counter B (up)	Input for counter B.
[64]	Counter B (down)	Input for counter B.
[65]	Reset counter B	Input for reset of counter B.

#### 5-10 Terminal 18 Digital Input

**Option:**

[8] \* Start

**Function:**

 Select function from available digital input range.  
See par. 5-1\* for choices.

#### 5-11 Terminal 19 Digital Input

**Option:**

[10] \* Reversing

**Function:**

 Select function from available digital input range.  
See par. 5-1\* for choices.

#### 5-12 Terminal 27 Digital Input

**Option:**

[1] \* Reset

**Function:**

 Select function from available digital input range.  
See par. 5-1\* for choices.

#### 5-13 Terminal 29 Digital Input

**Option:**

[14] \* Jog

**Function:**

 Select function from available digital input range.  
See par. 5-1\* for choices.

#### 5-15 Terminal 33 Digital Input

**Option:**

[16] \* Preset bit 0

**Function:**

 Select function from available digital input range.  
See par. 5-1\* for choices.

### 4.6.3. 5-4\* Relays

Parameter group for configuring timing and output functions for relays.

[0]	No Operation	Default for all digital and relay outputs.
[1]	Control Ready	Control board receives supply voltage.
[2]	Drive Ready	Frequency converter is ready for operation and applies supply signal on control board.
[3]	Drive Ready, Remote	Frequency converter is ready for operation in Auto On-mode.

[4]	Enable/No Warning	Frequency converter is ready for operation. No start or stop command is given. No warnings are present.
[5]	Drive Running	Motor is running.
[6]	Running/No Warning	Motor runs, and no warning are present.
[7]	Run in Range/No Warning	Motor runs within programmed current ranges, see parameters 4-50 and 4-51. No warnings are present.
[8]	Run on ref/No Warning	Motor runs at reference speed.
[9]	Alarm	An alarm activates output.
[10]	Alarm on Warning	An alarm or warning activates output.
[12]	Out of Current Range	Motor current is outside range set in parameters 4-50 and 4-51.
[13]	Below Current, low	Motor current is lower than set in par. 4-50.
[14]	Above Current, high	Motor current is higher than set in par. 4-51.
[21]	Thermal Warning	Thermal warning is present when temperature exceeds limit in motor, frequency converter, brake resistor or thermistor.
[22]	Ready, No Thermal Warning	Frequency converter is ready for operation and no over-temperature warning is present.
[23]	Remote Ready, No Thermal Warning	Frequency converter is ready for operation in Auto mode, and no over-temperature warning is present.
[24]	Ready, Voltage OK	Frequency converter is ready for operation and mains voltage is within specified voltage range.
[25]	Reverse	Motor runs/is ready to run clockwise when logic = 0 and counter clockwise when logic = 1. Output changes as soon as reversing signal is applied.
[26]	Bus OK	Active communication (no time-out) via serial communication port.
[28]	Brake, No Warn	Brake is active, and no warnings are present.
[29]	Brake Ready/No Fault	Brake is ready for operation, and no faults are present.
[30]	Brake Fault (IGBT)	Protects frequency converter if fault on brake modules is present. Use relay to cut out main voltage from frequency converter.
[32]	Mech. Brake Control	Enables control of external mechanical brake, see parameter group 2-2*.
[36]	Control Word Bit 11	Bit 11 in control word controls relay.
[51]	Local Ref Active	
[52]	Remote Ref Active	
[53]	No Alarm	
[54]	Start Cmd Active	
[55]	Running Reverse	
[56]	Drive in Hand Mode	
[57]	Drive in Auto Mode	
[60]	Comparator 0	See par. group 13-1*. If comparator 0 is evaluated as TRUE, output goes high. Otherwise, it is low.
[61]	Comparator 1	See par. group 13-1*. If comparator 1 is evaluated as TRUE, output goes high. Otherwise, it is low.
[62]	Comparator 2	See par. group 13-1*. If comparator 2 is evaluated as TRUE, output goes high. Otherwise, it is low.
[63]	Comparator 3	See par. group 13-1*. If comparator 3 is evaluated as TRUE, output goes high. Otherwise, it is low.
[70]	Logic Rule 0	See par. 13-4*. If Logic Rule 1 is evaluated as TRUE, output goes high. Otherwise, it is low.
[71]	Logic Rule 1	See par. 13-4*. If Logic Rule 2 is evaluated as TRUE, output goes high. Otherwise, it is low.
[72]	Logic Rule 2	See par. 13-4*. If Logic Rule 3 is evaluated as TRUE, output goes high. Otherwise, it is low.
[73]	Logic Rule 3	See par. 13-4*. If Logic Rule 3 is evaluated as TRUE, output goes high. Otherwise, it is low.
[81]	SL Digital Output B	See par. 13-52 <i>SL Control Action</i> . When Smart Logic Action <i>Set dig. out. A high</i> [39] is executed, input goes high. When Smart Logic Action <i>Set dig. out. A low</i> [33] is executed, input goes low.

#### 5-40 Function Relay

##### Option:

[0] \* No Operation

##### Function:

Select function from available relay output range.

#### 4.6.4. 5-5\* Pulse Input

Set par. 5-15 to choice [32] pulse input. Now terminal 33 handles a pulse input in the range from Low frequency, par. 5-55, to High frequency, par. 5-56. Scale frequency input via par. 5-57 and par. 5-58.

##### 5-55 Terminal 33 Low Frequency

<b>Range:</b>	<b>Function:</b>
20 Hz* [20 - 4999 Hz]	Enter low frequency corresponding to low motor shaft speed (i.e. low reference value) in par. 5-57.

##### 5-56 Terminal 33 High Frequency

<b>Range:</b>	<b>Function:</b>
5000 Hz* [21 - 5000 Hz]	Enter high frequency corresponding to high motor shaft speed (i.e. high reference value) in par. 5-58.

##### 5-57 Terminal 33 Low Ref./Feedb. Value

<b>Range:</b>	<b>Function:</b>
0.000* [-4999 - 4999]	Set reference/feedback value corresponding to low pulse frequency value set in par. 5-55.

##### 5-58 Terminal 33 High Ref./Feedb. Value

<b>Range:</b>	<b>Function:</b>
50.000* [-4999 - 4999]	Set reference/feedback value corresponding to high pulse frequency value set in par. 5-56.

## 4.7. Parameter Group 6: Analogue In/Out

### 4.7.1. 6-\*\* Analog In/Out

Parameter group for configuring analog inputs and outputs.

### 4.7.2. 6-0\* Analog I/O Mode

Parameter group for setting up the analog I/O configuration.

#### 6-00 Live Zero Timeout Time

**Range:**

10 s [1 - 99 s]

**Function:**

The Live Zero function is used for monitoring the signal on an analog input. If the signal disappears, a *Live Zero* warning is reported.

Set delay time before *Live Zero Timeout Function* is applied (par. 6-01).

If the signal reappears during the set delay, timer will be reset.

When live zero is detected, the frequency converter freezes output frequency and starts *Live Zero Timeout* timer.

#### 6-01 Live Zero Timeout Function

**Option:**

[0] \* Off

[1] Freeze output

[2] Stop

[3] Jogging

[4] Max Speed

[5] Stop and Trip

**Function:**

Function is activated if input signal is below 50% of value set in parameters 6-10, 6-12 or 6-22.

Function is disabled.

Output frequency remains at value it had when live zero was detected.

Frequency converter ramps down to 0 Hz. Remove live zero error condition before restarting frequency converter.

Frequency converter ramps to jog speed, see par. 3-41.

Frequency converter ramps to Motor Speed High Limit, see par. 4-14.

Frequency converter ramps down to 0 Hz and then trips. Remove live zero condition and activate reset before restarting the frequency converter.

### 4.7.3. 6-1\* Analog Input 1

Parameters for configuring scaling and limits for analog input 1 (terminal 53).

**NB!**

Micro switch 4 in position U:

Parameters 6-10 and 6-11 are active.

Micro switch in position I:

Parameters 6-12 and 6-13 are active.

See *VLT® Micro Drive FC 51 Quick Guide*

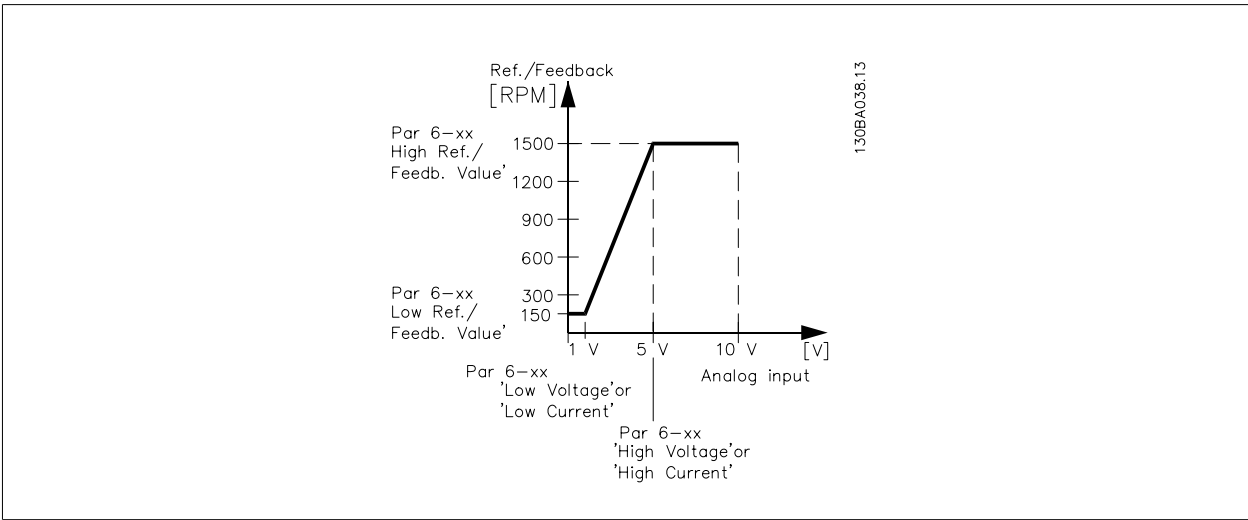

**6-10 Terminal 53 Low Voltage**

**Range:** **Function:**  
 This scaling value should correspond to minimum reference value set in par. 6-14. See also section *Reference Handling*.

0.07 V\* [0.00 - 9.90 V] Enter low voltage value.

**!** The value must be set to min. 1V in order to activate the Live Zero Timeout function in par. 6-01.

**6-11 Terminal 53 High Voltage**

**Range:** **Function:**  
 This scaling value should correspond to maximum reference value set in par. 6-15.

10.0 V\* [0.10 - 10.00 V] Enter high voltage value.

**6-12 Terminal 53 Low Current**

**Range:** **Function:**  
 This reference signal should correspond to minimum reference value set in par. 3-02.

0.14 mA\* [0.00 - 19.90 mA] Enter low current value.

**!** The value must be set to min. 2 mA in order to activate the Live Zero Timeout function in par. 6-01.

**6-13 Terminal 53 High Current**

**Range:** **Function:**  
 This reference signal should correspond to the maximum reference value set in par. 6-15.

20.00 mA\* [0.10 - 20.00 mA] Enter high current value.

**6-14 Terminal 53 Low Ref./Feedb. Value**

**Range:** **Function:**  
 The scaling value corresponding to the low voltage/low current set in parameters 6-10 and 6-12.

0.000\* [-4999 - 4999] Enter analog input scaling value.

**6-15 Terminal 53 High Ref./Feedb. Value**

**Range:**

**Function:**

The scaling value corresponding to the maximum reference feedback value set in parameters 6-11 and 6-13.

50.000\* [-4999.000 - 4999.000]

Enter analog input scaling value.

**6-16 Terminal 53 Filter Time Constant**

**Range:**

**Function:**

A first-order digital low pass filter time constant for suppressing electrical noise in terminal 53. A high time constant value improves dampening but also increases time delay through the filter.

0.01 s\* [0.01 - 10.00 s]

Enter time constant.

**6-19 Terminal 53 Mode**

**Option:**

**Function:**

Select the input to be present on terminal 53.

Par. 6-19 MUST be set according to Micro switch 4 setting.

[0] \* Voltage Mode

[1] Current Mode

**4.7.4. 6-2\* Analog Input 2**

Parameters for configuring scaling and limits for analog input 2, terminal 60.

**6-22 Terminal 60 Low Current**

**Range:**

**Function:**

This reference signal should correspond to minimum reference value set in par. 3-02.

0.14 mA\* [0.00 - 19.90 mA]

Enter low current value.

The value must be set to min. 2 mA in order to activate the Live Zero Timeout function in par. 6-01.

**6-23 Terminal 60 High Current**

**Range:**

**Function:**

This reference signal should correspond to the high current value set in par. 6-25.

20.00 mA\* [0.10 - 20.00 mA]

Enter high current value.

**6-24 Terminal 60 Low Ref./Feedb. Value**

**Range:**

**Function:**

The scaling value should correspond to the minimum reference feedback value set in par. 3-02.

0.000\* [-4999 - 4999]

Enter analog input scaling value.

**6-25 Terminal 60 High Ref./Feedb. Value**

**Range:**

**Function:**

The scaling value should correspond to the maximum reference feedback value set in par. 3-03.

50.00\* [-4999 - 4999]

Enter analog input scaling value.

**6-26 Terminal 60 Filter Time Constant**

**Range:**

**Function:**

A first-order digital low pass filter time constant for suppressing electrical noise in terminal 54. A high time constant value improves dampening, but also increases time delay through the filter.

**NB!**  
This parameter cannot be changed while motor runs.

0.01 s\* [0.01 - 10.00 s]

Enter time constant.

4

**4.7.5. 6-8\* LCP Potentiometer**

The LCP potentiometer can be selected either as Reference Resource or Relative Reference Resource.

**NB!**  
In Hand mode the LCP potentiometer functions as local reference.

**6-81 LCP Potentiometer Low Ref. Value**

**Range:**

**Function:**

The scaling value corresponding to 0.

0.000\* [-4999 - 4999]

Enter low reference value.

The reference value corresponding to potentiometer turned fully counterclockwise (0 degrees).

**6-82 LCP Potentiometer High Ref. Value**

**Range:**

**Function:**

The scaling value corresponding to the maximum reference feedback value set in par. 3-03.

50.00\* [-4999 - 4999]

Enter high reference value.

The reference value corresponding to potentiometer turned fully clockwise (200 degrees).

**4.7.6. 6-9\* Analog Output**

These parameters are for configuring the analog outputs of the frequency converter.

**6-90 Terminal 42 Mode**

**Option:**

**Function:**

[0] \* 0 - 20 mA

Range for analog outputs is 0-20 mA

[1] 4-20 mA

Range for analog outputs is 4 - 20 mA

[2] Digital

Functions as slow reacting digital output. Set value to either 0 mA (off) or 20 mA (on), see par. 6-92.

**6-91 Terminal 42 Analog Output**

**Option:**

**Function:**

Select the function for terminal 42 as an analog output.

[0] \* No Operation

[10] Output Frequency

[11] Reference

[12] Feedback

[13] Motor Current

[16] Power

[20] Bus Control



**6-92 Terminal 42 Digital Output**

**Option:**

**Function:**

See par. 5-4\*, *Relays*, for choices and descriptions.

[0] \* No Operation

[80] SL Digital Output A See par. 13-52 *SL Control Action*. When Smart Logic Action *Set dig. out. A high* [38] is executed, input goes high. When Smart Logic Action *Set dig. out. A low* [32] is executed, input goes low.

**6-93 Terminal 42 Output Min. Scale**

**Range:**

0.00 % [0.00 - 200.00%]

**Function:**

Scale minimum output of selected analog signal at terminal 42 as percentage of maximum signal value. E.g. if 0 mA (or 0 Hz) is desired at 25% of maximum output value, programme 25%. Scaling values up to 100% can never be higher than corresponding setting in par. 6-52.

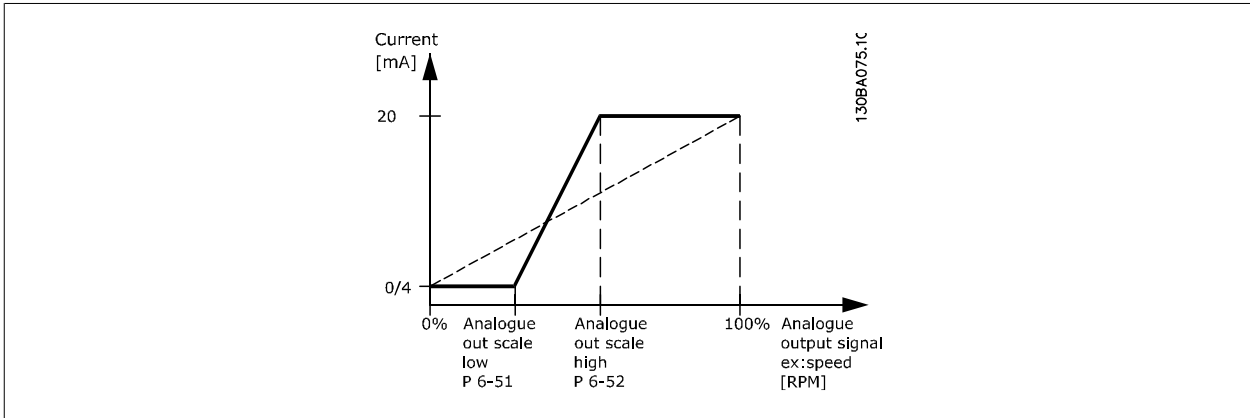

**6-94 Terminal 42 Output Max. Scale**

**Range:**

100.00%\* [0.00 - 200.00%]

**Function:**

Scale maximum output of selected analog signal at terminal 42. Set value to maximum value of current signal output. Scale output to give a current lower than 20 mA at full scale; or 20 mA at an output below 100% of maximum signal value.

If 20 mA is the desired output current at a value between 0 - 100% of the full-scale output, programme percentage value in the parameter, i.e. 50% = 20 mA. If a current between 4 and 20 mA is desired at maximum output (100%), calculate percentage value as follows:

$$\frac{20 \text{ mA}}{\text{desired maximum current}} \times 100 \%$$

i.e.

$$10 \text{ mA} = \frac{20}{10} \times 100 = 200 \%$$

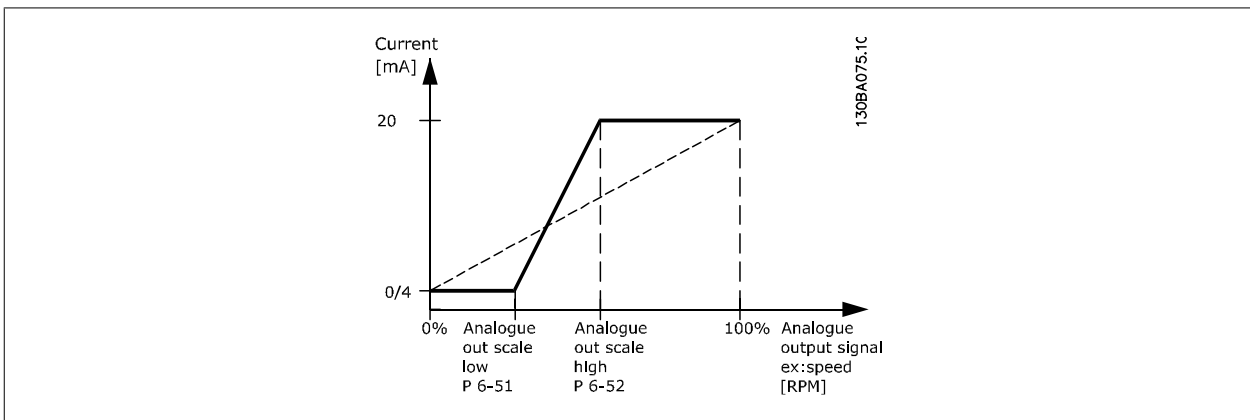

## 4.8. Parameter Group 7: Controllers

### 4.8.1. 7-\*\* Controllers

Parameters group for configuring application controls.

### 4.8.2. 7-2\* Process Ctrl. Feedb

Select feedback sources and handling for Process PI Control.



**NB!**

Set par. 3-15 to [0] *No Function* in order to use Analog Input as a feedback signal.

#### 7-20 Process CL Feedback Resources

**Option:**                      **Function:**  
Select input to function as feedback signal.

[0] *	No Function
[1]	Analog Input 53
[2]	Analog Input 60
[8]	Pulse Input 33
[11]	Local Bus Ref.

### 4.8.3. 7-3\* Process PI Control

#### 7-30 Process PI Normal/Inverse Control

Option:	Function:
[0] *	Normal Feedback larger than setpoint result in a speed reduction. Feedback less than setpoint result in a speed increase.
[1]	Inverse Feedback larger than setpoint result in a speed increase. Feedback less than setpoint result in a speed reduction.

#### 7-31 Process PI Anti Windup

Option:	Function:
[0]	Disable Regulation of a given error will continue even when the output frequency cannot be increased/decreased.
[1] *	Enable PI-controller ceases from regulating a given error when the output frequency cannot be increased/decreased.

#### 7-32 Process PI Start Speed

Range:	Function:
0.0 Hz* [0.0 - 200.0 Hz]	Until the set motor speed has been reached the frequency converter operates in Open Loop mode.

#### 7-33 Process PI Proportional Gain

Option:	Function:
[0.01] *    0.00 - 10.00	Enter the value for the P proportional gain, i.e. the multiplication factor of the error between the set point and the feedback signal. <b>Note!</b> 0.00 = Off.

#### 7-34 Process PI Integral Time

Range:	Function:
9999.00 s* [0.10 - 9999.00 s]	The integrator provides an increasing gain at a constant error between the set point and the feedback signal. The integral time is the time needed by the integrator to reach the same gain as the proportional gain.

**7-38 Process Feed Forward Factor****Range:**

0%\* [0 - 400%]

**Function:**

The FF factor sends a part of the reference signal around the PI controller which then only affects part of the control signal.

By activating the FF factor less overshoot and high dynamics are gained when changing the setpoint.

This parameter is always active when par. 1-00 *Configuration Mode* is set to *Process* [3].

**7-39 On Reference Bandwidth****Range:**

5% [0 - 200% ]

**Function:**

Enter the value for the On Reference Bandwidth.

The PI control error is the difference between setpoint and feedback and when this is less than the value set in this parameter the On Reference is active.

## 4.9. Parameter Group 8: Communication

### 4.9.1. 8-\*\* Communication

Parameter group for configuring communication.

### 4.9.2. 8-0\* General Settings

Use this parameter group for configuring the general settings for communication.

#### 8-01 Control Site

Option:	Function:
[0] * Digital and Control Word	Use both digital input and control word as control.
[1] Digital Only	Use digital input as control.
[2] Control Word Only	Use control word only as control.



**NB!**

The setting in this parameter overrules settings in par. 8-50 to 8-56.

#### 8-02 Control Word Source

Option:	Function:
[0] None	Function is inactive
[1] * FC RS485	Monitoring control word source is done via serial communication port RS485.

#### 8-03 Control Word Timeout Time

Range:	Function:
1.0 s* [0.1 - 6500 s]	Enter time to pass before control word timeout function (par. 8-04) must be carried out.

#### 8-04 Control Word Timeout Function

Option:	Function:
	Select the action to be taken in case of a timeout.
[0] * Off	No function.
[1] Freeze Output	Freeze output until communication resumes.
[2] Stop	Stop with auto restart when communication resumes.
[3] Jogging	Run motor at jog frequency until communication resumes.
[4] Max. Speed	Run motor at max. frequency until communication resumes.
[5] Stop and Trip	Stop motor, then reset frequency converter in order to restart either via LCP or digital input.

#### 8-06 Reset Control Word Timeout

Option:	Function:
	Resetting the control word timeout will remove any timeout function.
[0] * No Function	Control word timeout is not reset.
[1] Do Reset	Control word timeout is reset, and parameter goes into <i>No Function</i> state.

### 4.9.3. 8-3\* FC Port Settings

Parameters for configuring the FC Port.

#### 4.9.4. 8-30 Protocol

##### 8-30 Protocol

**Option:**
**Function:**

Select the protocol to be used. Note that changing protocol will not be effective until after powering off the frequency converter.

[0] \* FC

[2] Modbus RTU

##### 8-31 Address

**Range:**
**Function:**

Select the address for the bus.

1\* [1 - 126]

FC-bus range is 1-126.  
Modbus range is 1-247.

##### 8-32 FC Port Baud Rate

**Option:**
**Function:**

Select baud rate for FC Port.

**NB!**

Changing baud rate will be effective after responding to any ongoing bus-requests.

[0] 2400 Baud

[1] 4800 Baud

[2] \* 9600 Baud

[3] 19200 Baud

[4] 38400 Baud

##### 8-33 FC Port Parity

**Option:**
**Function:**

This parameter only affects Modbus as FC bus always has even parity.

[0] \* Even Parity (1 stopbit)

[1] Odd parity

[2] No Parity (1 stopbit) Select this for Modbus RTU

[3] No Parity (2 stopbit)

##### 8-35 Minimum Response Delay

**Range:**
**Function:**

0.010 s\* [0.001 - 0.500 s]

Specify minimum delay time between receiving a request and transmitting a response.

##### 8-36 Max Response Delay

**Range:**
**Function:**

5.000 s\* [0.010 - 10.00 s]

Specify maximum permissible delay time between transmitting a request and receiving a response. Exceeding this time delay causes control word timeout.

#### 4.9.5. 8-5\* Digital/Bus

Parameters for configuring control word Digital/Bus merging.

**NB!**

Parameters are only active when par. 8-01, *Control SItc*, is set to *Digital and control word* [0].

#### 8-50 Coasting Select

Option:	Function:
	Select control of coasting function via digital input and/or bus.
[0] Digital Input	Activation via a digital input.
[1] Bus	Activation via serial communication port.
[2] LogicAnd	Activation via serial communication port and a digital input.
[3] * LogicOr	Activation via serial communication port or a digital input.

#### 8-51 Quick Stop Select

Option:	Function:
	Select control of quick stop function via digital input and/or bus.
[0] Digital Input	Activation via a digital input.
[1] Bus	Activation via serial communication port.
[2] LogicAnd	Activation via serial communication port and a digital input.
[3] * LogicOr	Activation via serial communication port or a digital input.

#### 8-52 DC Brake Select

Option:	Function:
	Select control of DC brake via digital input and/or bus.
[0] Digital Input	Activation via a digital input.
[1] Bus	Activation via serial communication port.
[2] LogicAnd	Activation via serial communication port and a digital input.
[3] * LogicOr	Activation via serial communication port or a digital input.

#### 8-53 Start Select

Option:	Function:
	Select control of start function via digital input and/or bus.
[0] Digital Input	Activation via a digital input.
[1] Bus	Activation via serial communication port.
[2] LogicAnd	Activation via serial communication port and a digital input.
[3] * LogicOr	Activation via serial communication port or a digital input.

#### 8-54 Reversing Select

Option:	Function:
	Select control of reversing function via digital input and/or bus.
[0] Digital Input	Activation via a digital input.
[1] Bus	Activation via serial communication port.
[2] LogicAnd	Activation via serial communication port and a digital input.
[3] * LogicOr	Activation via serial communication port or a digital input.

#### 8-55 Set-up Select

Option:	Function:
	Select control of set-up selection via digital input and/or bus.
[0] Digital Input	Activation via a digital input.
[1] Bus	Activation via serial communication port.

[2]	LogicAnd	Activation via serial communication port and a digital input.
[3] *	LogicOr	Activation via serial communication port or a digital input.

#### 8-56 Preset Reference Select

**Option:**
**Function:**

Select control of Preset Reference selection via digital input and/or bus.

[0]	Digital Input	Activation via a digital input.
[1]	Bus	Activation via serial communication port.
[2]	LogicAnd	Activation via serial communication port and a digital input.
[3] *	LogicOr	Activation via serial communication port or a digital input.

#### 4.9.6. 8-9\* Bus Feedback

Parameter for configuring bus feedback.

#### 8-94 Bus Feedback 1

**Range:**
**Function:**

0\* [0x8000 - 0x7FFF]

Bus feedback is delivered via FC or Modbus by writing the feedback value into this parameter.

## 4.10. Parameter Group 13: Smart Logic

### 4.10.1. 13-\*\* Programming Features

Smart Logic Control (SLC) is a sequence of user defined actions (par. 13-52 [X]) executed by the SLC when the associated user defined event (par. 13-51 [X]) is set to *True*.

Events and actions are linked in pairs, meaning that when an event is true, the linked action is carried out. After this the next event is evaluated and its belonging action carried out and so on. Only one event is evaluated at the time.

If an event is evaluated as *False*, the SLC takes no action during the scan interval and no other events are evaluated.

It is possible to programme from 1 to 20 events and actions.

When the last event/action has been executed, the sequence starts again from event/action [0].

The drawing shows an example with three events/actions:

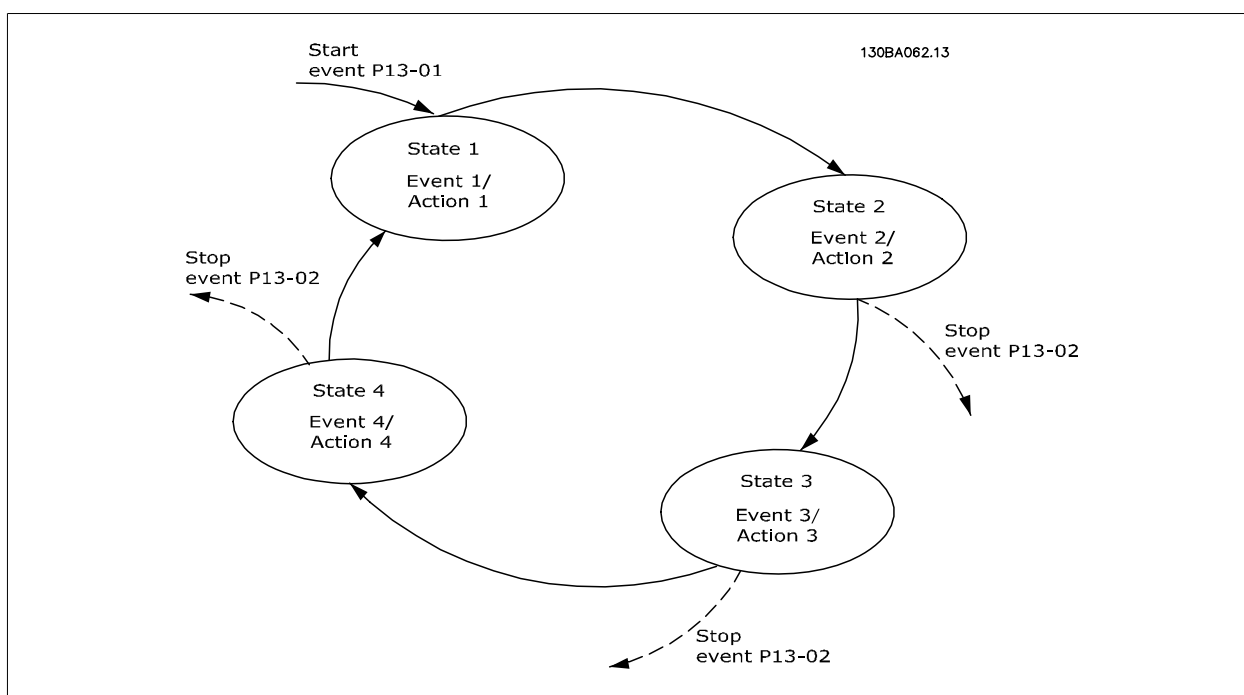

#### Starting and stopping the SLC:

Start the SLC by selecting *On* [1] in par. 13-00. The SLC starts evaluating Event 0, and if this is evaluated as TRUE, the SLC continues its cycle.

The SLC stops when the *Stop Event*, par. 13-02, is TRUE. The SLC can also be stopped by selecting *Off* [0] in par. 13-00.

To reset all SLC parameters select *Reset SLC* [1] in par. 13-03 and start programming from scratch.

### 4.10.2. 13-0\* SLC Settings

Use SLC settings to activate, deactivate and reset the Smart Logic Control.

#### 13-00 SL Controller Mode

**Option:**

[0] \*      Off

**Function:**

Function is disabled.



[1]	On	SLC is active.
-----	----	----------------

### 13-01 Start Event

**Option:**
**Function:**

Select input to activate Smart Logic Control.

[0]	False	Enters <i>False</i> in logic rule.
[1]	True	Enters <i>True</i> in logic rule.
[2]	Running	See par. 5-4* [5] for description.
[3]	InRange	See par. 5-4* [7] for description.
[4]	OnReference	See par. 5-4* [8] for description.
[7]	Out of Current Range	See par. 5-4* [12] for description.
[8]	BelowILow	See par. 5-4* [13] for description.
[9]	AboveIHigh	See par. 5-4* [14] for description.
[16]	ThermalWarning	See par. 5-4* [21] for description.
[17]	MainsOutOfRange	Mains voltage is outside the specified voltage range.
[18]	Reversing	See par. 5-4* [25] for description.
[19]	Warning	A warning is active.
[20]	Alarm_Trip	A trip alarm is active.
[21]	Alarm_TripLock	A trip lock alarm is active.
[22]	Comparator 0	Use result of comparator 0 in logic rule.
[23]	Comparator 1	Use result of comparator 1 in logic rule.
[24]	Comparator 2	Use result of comparator 2 in logic rule.
[25]	Comparator 3	Use result of comparator 3 in logic rule.
[26]	LogicRule 0	Use result of logic rule 0 in logic rule.
[27]	LogicRule 1	Use result of logic rule 1 in logic rule.
[28]	LogicRule 2	Use result of logic rule 2 in logic rule.
[29]	LogicRule 3	Use result of logic rule 3 in logic rule.
[33]	DigitalInput_18	Use value of DI 18 in logic rule.
[34]	DigitalInput_19	Use value of DI 19 in logic rule.
[35]	DigitalInput_27	Use value of DI 27 in logic rule.
[36]	DigitalInput_29	Use value of DI 29 in logic rule.
[38]	DigitalInput_33	
[39] *	StartCommand	This event is <i>True</i> , if frequency converter is started by any means (digital input or other).
[40]	DriveStopped	This event is <i>True</i> , if frequency converter is stopped or coasted by any means (digital input or other).

### 13-02 Stop Event

**Option:**
**Function:**

Select input to activate Smart Logic Control.

[0]	False	Enters <i>False</i> in logic rule.
[1]	True	Enters <i>True</i> in logic rule.
[2]	Running	See par. 5-4* [5] for description.
[3]	InRange	See par. 5-4* [7] for description.
[4]	OnReference	See par. 5-4* [8] for description.
[7]	Out of Current Range	See par. 5-4* [12] for description.
[8]	BelowILow	See par. 5-4* [13] for description.
[9]	AboveIHigh	See par. 5-4* [14] for description.
[16]	ThermalWarning	See par. 5-4* [21] for description.
[17]	MainsOutOfRange	Mains voltage is outside the specified voltage range.

[18]	Reversing	See par. 5-4* [25] for description.
[19]	Warning	A warning is active.
[20]	Alarm_Trip	A trip alarm is active.
[21]	Alarm_TripLock	A trip lock alarm is active.
[22]	Comparator 0	Use result of comparator 0 in logic rule.
[23]	Comparator 1	Use result of comparator 1 in logic rule.
[24]	Comparator 2	Use result of comparator 2 in logic rule.
[25]	Comparator 3	Use result of comparator 3 in logic rule.
[26]	LogicRule 0	Use result of logic rule 0 in logic rule.
[27]	LogicRule 1	Use result of logic rule 1 in logic rule.
[28]	LogicRule 2	Use result of logic rule 2 in logic rule.
[29]	LogicRule 3	Use result of logic rule 3 in logic rule.
[30]	SL Timeout0	Use result of timer 0 in logic rule.
[31]	SL Timeout1	Use result of timer 1 in logic rule.
[32]	SL Timeout2	Use result of timer 2 in logic rule.
[33]	DigitalInput_18	Use value of DI 18 in logic rule.
[34]	DigitalInput_19	Use value of DI 19 in logic rule.
[35]	DigitalInput_27	Use value of DI 27 in logic rule.
[36]	DigitalInput_29	Use value of DI 29 in logic rule.
[38]	DigitalInput_33	
[39]	StartCommand	This event is <i>True</i> , if frequency converter is started by any means (digital input or other).
[40] *	DriveStopped	This event is <i>True</i> , if frequency converter is stopped or coasted by any means (digital input or other).

#### 13-03 Reset SLC

##### Option:

##### Function:

[0] *	Do Not Reset	Retains all settings programmed in parameter group 13.
[1]	Reset SLC	Reset all group 13 parameters to default settings.

### 4.10.3. 13-1\* Comparators

Comparators are used for comparing continuous variables (i.e. output frequency, output current, analog input etc.) to fixed preset values. In addition, there are digital values that will be compared to fixed time values. See explanation in par. 13-10. Comparators are evaluated once in each scan interval. Use the result (TRUE or FALSE) directly. All parameters in this parameter group are array parameters with index 0 to 5. Select index 0 to programme Comparator 0, select index 1 to programme Comparator 1, and so on.

#### 13-10 Comparator Operand

##### Array [4]

		Select variable to be monitored by comparator.
[0] *	Disabled	Comparator is disabled.
[1]	Reference	Resulting remote reference (not local) as a percentage.
[2]	Feedback	Feedback in [Hz].
[3]	MotorSpeed	Motor speed in Hz.
[4]	MotorCurrent	Motor current in [A].
[6]	MotorPower	Motor power in either [kW] or [hp].
[7]	MotorVoltage	Motor voltage in [V].
[8]	DCLinkVoltage	DC-link voltage in [V].
[12]	AnalogInput53	Expressed as a percentage.
[13]	AnalogInput60	Expressed as a percentage.
[18]	PulseInput33	Expressed as a percentage.

[20]	AlarmNumber	Shows number of the alarm.
[30]	CounterA	Number of counts.
[31]	CounterB	Number of counts.

### 13-11 Comparator Operator

#### Array [4]

		Select operator to be used in comparison.
[0]	Less Than <	Result of evaluation is <i>True</i> if variable selected in par. 13-10 is smaller than fixed value in par. 13-12. Result is <i>False</i> if variable selected in par. 13-10 is greater than fixed value in par. 13-12.
[1] *	Approximately equals ≈	Result of evaluation is <i>True</i> if variable selected in par. 13-10 is approximately equal to fixed value in par. 13-12.
[2]	Greater Than >	Inverse logic of option [0].

### 13-12 Comparator Value

#### Array [4]

0.0* [-9999 - 9999]	Enter "trigger level" for variable monitored by this comparator.
---------------------	--

#### 4.10.4. 13-2\* Timers

Use the timer results to define an event (par. 13-51) or as boolean input in a logic rule (par. 13-40, 13-42 or 13-44).

When timer value has elapsed timer changes state from *False* to *True*.

### 13-20 SLC Controller Timer

#### Array [3]

0.0 s* [0.0 - 3600 s]	Enter value to define duration of the <i>False</i> output from programmed timer. A timer is only <i>False</i> if it is started by an action and until the given timer value has elapsed.
-----------------------	--

#### 4.10.5. 13-4\* Logic Rules

Combine up to three boolean inputs (TRUE / FALSE inputs) from timers, comparators, digital inputs, status bits and events using the logical operators AND, OR, and NOT. Select boolean inputs for the calculation in par. 13-40, 13-42, and 13-44. Define the operators used to logically combine the selected inputs in par. 13-41 and 13-43.

##### Priority of calculation

The results of par. 13-40, 13-41, and 13-42 are calculated first. The outcome (TRUE / FALSE) of this calculation is combined with the settings of par. 13-43 and 13-44, yielding the final result (TRUE / FALSE) of the logic rule.

### 13-40 Logic Rule Boolean 1

#### Array [4]

		Select first boolean input for selected logic rule.
[0] *	False	Enters <i>False</i> in logic rule.
[1]	True	Enters <i>True</i> in logic rule.
[2]	Running	See par. 5-4* [5] for description.
[3]	InRange	See par. 5-4* [7] for description.
[4]	OnReference	See par. 5-4* [8] for description.
[7]	Out of Current Range	See par. 5-4* [12] for description.
[8]	BelowILow	See par. 5-4* [13] for description.
[9]	AboveIHigh	See par. 5-4* [14] for description.
[16]	ThermalWarning	See par. 5-4* [21] for description.
[17]	MainsOutOfRange	Mains voltage is outside the specified voltage range.
[18]	Reversing	See par. 5-4* [25] for description.

[19]	Warning	A warning is active.
[20]	Alarm_Trip	A trip alarm is active.
[21]	Alarm_TripLock	A trip lock alarm is active.
[22]	Comparator 0	Use result of comparator 0 in logic rule.
[23]	Comparator 1	Use result of comparator 1 in logic rule.
[24]	Comparator 2	Use result of comparator 2 in logic rule.
[25]	Comparator 3	Use result of comparator 3 in logic rule.
[26]	LogicRule 0	Use result of logic rule 0 in logic rule.
[27]	LogicRule 1	Use result of logic rule 1 in logic rule.
[28]	LogicRule 2	Use result of logic rule 2 in logic rule.
[29]	LogicRule 3	Use result of logic rule 3 in logic rule.
[30]	SL Timeout0	Use result of timer 0 in logic rule.
[31]	SL Timeout1	Use result of timer 1 in logic rule.
[32]	SL Timeout2	Use result of timer 2 in logic rule.
[33]	DigitalInput_18	Use value of DI 18 in logic rule.
[34]	DigitalInput_19	Use value of DI 19 in logic rule.
[35]	DigitalInput_27	Use value of DI 27 in logic rule.
[36]	DigitalInput_29	Use value of DI 29 in logic rule.
[38]	DigitalInput_33	
[39]	StartCommand	This event is <i>True</i> , if frequency converter is started by any means (digital input or other).
[40]	DriveStopped	This event is <i>True</i> , if frequency converter is stopped or coasted by any means (digital input or other).

### 13-41 Logic Rule Operator 1

#### Array [4]

		Select first logical operator to use on boolean inputs from par. 13-40 and 13-42.
[0] *	Disabled	Ignores parameters 13-42, 13-43 and 13-44.
[1]	And	Evaluates expression [13-40] AND [13-42].
[2]	Or	Evaluates expression [13-40] OR [13-42].
[3]	And not	Evaluates expression [13-40] AND NOT [13-42].
[4]	Or not	Evaluates expression [13-40] OR NOT [13-42].
[5]	Not and	Evaluates expression NOT [13-40] and [13-42].
[6]	Not or	Evaluates expression NOT [13-40] OR [13-42].
[7]	Not and not	Evaluates expression NOT [13-40] AND NOT [13-42].
[8]	Not or not	Evaluates expression NOT [13-40] OR NOT [13-42].

### 13-42 Logic Rule Boolean 2

#### Array [4]

		Select second boolean input for selected logic rule. See par. 13-40 for choices and descriptions.
--	--	--

### 13-43 Logic Rule Operator 2

#### Array [4]

		Select second logical operator to use on boolean inputs calculated in par. 13-40, 13-41, and 13-42 and the boolean input from par. 13-42.
[0] *	Disabled	Ignores parameter 13-44.
[1]	And	Evaluates expression [13-40/13-42] AND [13-44].
[2]	Or	Evaluates expression [13-40/13-42] OR [13-44].
[3]	And not	Evaluates expression [13-40/13-42] AND NOT [13-44].
[4]	Or not	Evaluates expression [13-40/13-42] OR NOT [13-44].

[5]	Not and	Evaluates expression NOT [13-40/13-42] and [13-44].
[6]	Not or	Evaluates expression NOT [13-40/13-42] OR [13-44].
[7]	Not and not	Evaluates expression NOT [13-40/13-42] AND NOT [13-44].
[8]	Not or not	Evaluates expression NOT [13-40/13-42] OR NOT [13-44].

**13-44 Logic Rule Boolean 3**

Array [4]

Select third boolean input for selected logic rule.  
See par. 13-40 for choices and descriptions.

**4.10.6. 13-5\* States**

Parameters for programming the Smart Logic Controller.

**13-51 SL Controller Event**

Array [20]

Select boolean input to define Smart Controller Event.  
See par. 13-40 for choices and descriptions.

**13-52 SL Controller Action**

Array [20]

Select action corresponding to SLC event. Actions are executed when corresponding event (par. 13-51) is evaluated as *True*.

[0] *	Disabled	Function is disabled.
[1]	No Action	No action is taken.
[2]	Select Set-up1	Changes active set-up to Set-up 1.
[3]	Select Set-up2	Changes active set-up to Set-up 2.
[10]	SelectPresetRef0	Selects preset reference 0
[11]	SelectPresetRef1	Selects preset reference 1
[12]	SelectPresetRef2	Selects preset reference 2
[13]	SelectPresetRef3	Selects preset reference 3
[14]	SelectPresetRef4	Selects preset reference 4
[15]	SelectPresetRef5	Selects preset reference 5
[16]	SelectPresetRef6	Selects preset reference 6
[17]	SelectPresetRef7	Selects preset reference 7
[18]	SelectRamp1	Selects ramp 1
[19]	SelectRamp2	Selects ramp 2
[22]	Run	Issues start command to frequency converter.
[23]	RunReverse	Issues start reverse command to frequency converter.
[24]	Stop	Issues stop command to frequency converter.
[25]	Qstop	Issues quick stop command to frequency converter.
[26]	DCstop	Issues DC stop command to frequency converter.
[27]	Coast	Frequency converter coasts immediately. All stop commands including coast command stop the SLC.
[28]	Freeze Output	Freezes output frequency.
[29]	StartTimer0	Starts timer 0.
[30]	StartTimer1	Starts timer 1
[31]	StartTimer2	Starts timer 2
[32]	SetDO42Low	Set Digital output 42 low.
[33]	SetRelayLow	Set Relay low.
[38]	SetDO42High	Set Digital output 42 high.

[39]	SetRelayHigh	Set Relay high.
[60]	ResetCounterA	Resets counter A to 0.
[61]	ResetCounterB	Resets counter B to 0.

## 4.11. Parameter Group 14: Special Functions

### 4.11.1. 14-\*\* Special Functions

Parameter group for configuring special frequency converter functions.

### 4.11.2. Inverter Switching 14-0\*

Parameters for configuring the inverter switching.

#### 14-01 Switching Frequency

**Option:** **Function:**  
Select the switching frequency in order to minimize e.g. acoustic noise and power loss or maximizing efficiency.

[0] 2 KHz

[1] \* 4 KHz

[2] 8 KHz

[4] 16 KHz

#### 14-03 Overmodulation

**Option:** **Function:**  
This feature allows more accurate speed control near and over nominal speed (50/60 Hz). Another advantage with overmodulation is the ability of staying at a constant speed even though mains is dropping.

[0] Off Disables the overmodulation function to avoid torque ripple on the motor shaft.

[1] \* On Connects the overmodulation function to obtain an output voltage up to 15% greater than mains voltage.

### 4.11.3. 14-1\* Mains Monitoring

This parameter group supplies functions for handling imbalance on mains.

#### 14-12 Functions at Mains Imbalance

**Option:** **Function:**  
Operation under severe mains imbalance conditions reduces drive lift time.  
Select function to take place when severe mains imbalance is detected.

[0] \* Trip Frequency converter trips.

[1] Warning Frequency converter issues a warning.

[2] Disabled No action taken.

### 4.11.4. Trip Reset, 14-2\*

Parameters for configuring auto reset handling, special trip handling and control card self test or initialisation.

#### 14-20 Reset Mode

**Option:** **Function:**  
Select reset function after tripping. Once reset, frequency converter can be restarted.

[0] \* Manual Reset Perform reset via [reset]-button or digital inputs.

[1] AutoReset 1 Performs one automatic reset after tripping.

[2] AutoReset 2 Performs two automatic resets after tripping.

[3] AutoReset 3 Performs three automatic resets after tripping.

[4] AutoReset 4 Performs four automatic resets after tripping.

[5] AutoReset 5 Performs five automatic resets after tripping.

[6]	AutoReset 6	Performs six automatic resets after tripping.
[7]	AutoReset 7	Performs seven automatic resets after tripping.
[8]	AutoReset 8	Performs eight automatic resets after tripping.
[9]	AutoReset 9	Performs nine automatic resets after tripping.
[10]	AutoReset 10	Performs ten automatic resets after tripping.
[11]	AutoReset 15	Performs fifteen automatic resets after tripping.
[12]	AutoReset 20	Performs twenty automatic resets after tripping.
[13]	Infinite auto reset	Performs an infinite number of automatic resets after tripping.



Motor may start without warning.

#### 14-21 Automatic Restart Time

**Range:**

10 s\* [0 - 600 s]

**Function:**

Enter time interval from trip to start of automatic reset function. This parameter is active when par. 14-20, *Reset Mode*, is set to *Automatic Reset* [1] - [13].

#### 14-22 Operation Mode

**Option:**

[0] \* Normal Operation

**Function:**

Use this parameter for specifying normal operation or to initialize all parameters, except par. 15-03, 15-04 and 15-05.

Frequency converter runs normal operation.

[2] Initialization

Resets all parameters to default settings, except for 15-03, 15-04 and 15-05. Frequency converter resets during next power-up.

Par. 14-22 also reverts to default setting *Normal Operation* [0].

### 4.11.5. 14-4\* Energy Optimizing

These parameters are for adjusting the energy optimization level in both Variable Torque (VT) and Automatic Energy Optimization (AEO) modes.

#### 14-41 AEOMinimum Magnetization

**Range:**

66%\* [40 - 75%]

**Function:**

Enter the minimum allowable magnetization for AEO. Selecting a low value reduces energy loss in the motor, but may also reduce resistance to sudden load changes.



## 4.12. Parameter Group 15: Drive Information

### 4.12.1. 15-\*\* Drive Information

Parameter group containing information on operating data, hardware configuration, software version, etc.

### 4.12.2. 15-0\* Operating Data

Parameter group containing operating data e.g. Operating Hours, kWh counters, Power Ups, etc.

### 4.12.3. 15-00 Operating Time

#### 15-00 Operating Time

**Range:**

0 days\* [0 - 65535 days]

**Function:**

View running hours of frequency converter.  
The value is saved at power off and cannot be reset.

#### 15-01 Running Hours

**Range:**

0\* [0 - 2147483647]

**Function:**

View running hours of motor.  
The value is saved at power off and can be reset in par. 15-07, *Reset Running Hours Counter*.

#### 15-02 kWh Counter

**Range:**

0 [0 - 65535]

**Function:**

View power consumption in kWh as a mean value over one hour.  
Reset counter in par. 15-06, *Reset kWh Counter*.

#### 15-03 Power Ups

**Range:**

0 [0 - 2147483647]

**Function:**

View number of times frequency converter has been powered up.  
Counter cannot be reset.

#### 15-04 Over Temps

**Range:**

0 [0 - 65535]

**Function:**

View number of times frequency converter has tripped due to over temperature.  
Counter cannot be reset.

#### 15-05 Over Volts

**Range:**

0\* [0 - 65535]

**Function:**

View number of times frequency converter has tripped due to over voltage.  
Counter cannot be reset.

#### 15-06 Reset kWh Counter

**Option:**

[0] \* Do Not Reset

**Function:**

Counter is not reset.

[1] Reset Counter

Counter is reset.

#### 15-07 Reset Running Hours Counter

**Option:**

[0] \* Do Not Reset

**Function:**

Counter is not reset.

[1] Reset Counter

Counter is reset.

#### 4.12.4. 15-3\* Fault Log

This parameter group contains a fault log showing reasons for the ten latest trips.

##### 15-30 Fault Log: Error Code

<b>Range:</b>	<b>Function:</b>
0 [0 - 255]	View error code and look it up in VLT Micro Operating Instructions.

#### 4.12.5. Drive Identification, 15-4\*

Parameters containing read only information about the hardware and software configuration of the frequency converter.

##### 15-40 FC Type

<b>Option:</b>	<b>Function:</b>
	View FC type.

##### 15-41 Power Section

<b>Option:</b>	<b>Function:</b>
	View power section of frequency converter.

##### 15-42 Voltage

<b>Option:</b>	<b>Function:</b>
	View voltage of frequency converter.

##### 15-43 Software Version

<b>Option:</b>	<b>Function:</b>
	View software version of frequency converter.

##### 15-46 Frequency Converter Ordering No

<b>Option:</b>	<b>Function:</b>
	View ordering number for re-ordering frequency converter in its original configuration.

##### 15-48 LCP ID No

<b>Option:</b>	<b>Function:</b>
	View LCP ID number.

##### 15-51 Frequency Converter Serial Number

<b>Option:</b>	<b>Function:</b>
	View frequency converter serial number.

## 4.13. Parameter Group 16: Data Readouts

### 4.13.1. 16-\*\* Data Readouts

Parameter group for data read-outs, e.g. actual references, voltages, control, alarm, warning and status words.

### 4.13.2. 16-0\* General Status

Parameters for reading the general status, e.g. the calculated reference, the active control word, status.

#### 16-00 Control Word

**Range:**

0\* [0 - 65535]

**Function:**

View latest valid control word sent to frequency converter via serial communication port.

#### 16-01 Reference [Unit]

**Range:**

0.000\* [-4999.000 - 4999.000]

**Function:**

View total remote reference. Total reference is sum of pulse, analog, preset, LCP potentiometer, local bus and freeze reference.

#### 16-02 Reference %

**Range:**

0.0\* [-200.0 - 200.0%]

**Function:**

View total remote reference in percent. Total reference is sum of pulse, analog, preset, LCP potentiometer, local bus and freeze reference.

#### 16-03 Status Word

**Range:**

0\* [0 - 65535]

**Function:**

View status word sent to frequency converter via serial communication port.

#### 16-05 Main Actual Value %

**Range:**

0.00\* [-100.00 - 100.00%]

**Function:**

View two-byte word sent with status word to bus Master reporting main actual value.

### 4.13.3. 16-09 Custom Readout

#### 16-09 Custom Readout

**Range:**

0.00\* [0.00 - 9999.00%]

**Function:**

Customized readout based on the settings of par. 0-31, par. 0-32 and par. 4-14

### 4.13.4. 16-1\* Motor Status

Parameters for reading the motor status values.

#### 16-10 Power [kW]

**Range:**

0 kW\* [0 - 99 kW]

**Function:**

View output power in kW.

#### 16-11 Power [hp]

**Range:**

0 hp [0 - 99 hp]

**Function:**

View output power in hp.

#### 16-12 Motor Voltage

<b>Range:</b>	<b>Function:</b>
0.0* [0.0 - 999.9 V]	View motor phase voltage.

#### 16-13 Frequency

<b>Range:</b>	<b>Function:</b>
0.0 Hz* [0.0 - 400.0 Hz]	View output frequency in Hz.

#### 16-14 Motor Current

<b>Range:</b>	<b>Function:</b>
0.00 A* [0.00 - 655 A]	View motor phase current.

#### 16-15 Frequency [%]

<b>Range:</b>	<b>Function:</b>
0.00* [-100.00 - 100.00%]	View a two-byte word reporting actual motor frequency as a percentage of par. X-XX

#### 16-18 Motor Thermal

<b>Range:</b>	<b>Function:</b>
0%* [0 - 100%]	View calculated thermal motor load as percentage of estimated thermal motor load.

### 4.13.5. 16-3\* Drive Status

Parameters for reporting the status of the frequency converter.

#### 16-30 DC Link Voltage

<b>Range:</b>	<b>Function:</b>
0 V* [0 - 10000 V]	View DC-link voltage.

#### 16-34 Heat Sink Temp.

<b>Range:</b>	<b>Function:</b>
0* [0 - 255°C]	View heat sink temperature of frequency converter.

#### 16-35 Inverter Thermal

<b>Range:</b>	<b>Function:</b>
0%* [0 - 100%]	View calculated thermal load on frequency converter in relation to estimated thermal load on frequency converter.

#### 16-36 Inv. Nom. Current

<b>Range:</b>	<b>Function:</b>
0.00 A* [0.01 - 655A]	View continuous nominal inverter current.

#### 16-37 Inv. Max. Current

<b>Range:</b>	<b>Function:</b>
0.00 A* [0.1 - 655A]	View intermittent maximum inverter current (150%).

#### 16-38 SL Controller State

<b>Range:</b>	<b>Function:</b>
0* [0 - 255]	View number of active SLC state.

### 4.13.6. 16-5\* Ref. & Feedb.

Parameters for reporting the reference and feedback input.

#### 16-50 External Reference

<b>Range:</b>	<b>Function:</b>
0.0%* [-200.0 - 200.0%]	View sum of all external references in percent.

#### 16-51 Pulse Reference

<b>Range:</b>	<b>Function:</b>
0.0 %* [-200.0 - 200.0%]	View actual pulse input converted to a reference in percent.

#### 16-52 Feedback

<b>Range:</b>	<b>Function:</b>
0.000* [-4999.000 - 4999.000]	View analog or pulse feedback in Hz.

### 4.13.7. 16-6\* Inputs and Outputs

Parameters for reporting the digital and analog IO ports.

#### 16-60 Digital Input 18, 19, 27, 33

<b>Range:</b>	<b>Function:</b>
0* [0 - 1111]	View signal states from active digital inputs.

#### 16-61 Digital Input 29

<b>Range:</b>	<b>Function:</b>
0* [0 - 1]	View signal state on digital input 29.

#### 16-62 Analog Input 53 (volt)

<b>Range:</b>	<b>Function:</b>
0.00* [0.00 - 10.00 V]	View input voltage on analog input terminal.

#### 16-63 Analog Input 53 (current)

<b>Range:</b>	<b>Function:</b>
0.00* [0.00 - 20.00 mA]	View input current on analog input terminal.

#### 16-64 Analog Input 60

<b>Range:</b>	<b>Function:</b>
0.00* [0.00 - 20.00 mA]	View actual value at input 60 either as reference or protection value.

#### 16-65 Analog Output 42 [mA]

<b>Range:</b>	<b>Function:</b>
0.00 mA* [0.00 - 20.00 mA]	View output current on analog output 42.

#### 16-68 Pulse Input

<b>Range:</b>	<b>Function:</b>
20 Hz* [20 - 5000 Hz]	View input frequency on pulse input terminal.

#### 16-71 Relay Output [bin]

<b>Range:</b>	<b>Function:</b>
0* [0 - 1]	View relay setting.

#### 16-72 Counter A

<b>Range:</b>	<b>Function:</b>
0* [-32768 - 32767]	View present value of Counter A.

#### 16-73 Counter B

<b>Range:</b>	<b>Function:</b>
0* [-32768 - 32767]	View present value of Counter B.

#### 4.13.8. 16-8\* FC Port

Parameter for viewing references from FC Port.

#### 16-86 FC Port REF 1

<b>Range:</b>	<b>Function:</b>
0* [0x8000 - 0x7FFF]	View currently received reference from FC Port.

#### 4.13.9. 16-9\* Diagnosis Read-Out

Parameters displaying alarm, warning and extended status words.

#### 16-90 Alarm Word

<b>Range:</b>	<b>Function:</b>
0* [0 - 0xFFFFFFFF]	Via alarm word sent via serial communication port in hex code.

#### 16-92 Warning Word

<b>Range:</b>	<b>Function:</b>
0* [0 - 0xFFFFFFFF]	View warning word sent via serial communication port in hex code.

#### 16-94 Ext. Status Word

<b>Range:</b>	<b>Function:</b>
0* [0 - 0xFFFFFFFF]	View extended warning word sent via serial communication port in hex code.

## 5. Parameter Lists

Parameter Overview	
<b>0-** Operation/Display</b>	
<b>0-0* Basic Settings</b>	
<b>0-03 Regional Settings</b>	
*[0] International	
[1] US	
<b>0-04 Oper. State at Power-up (Hand)</b>	
[0] Resume	
*[1] Forced stop, ref = old	
[2] Forced stop, ref = 0	
<b>0-1* Set-up Handling</b>	
<b>0-10 Active Set-up</b>	
*[1] Setup 1	
[2] Setup 2	
[9] Multi Setup	
<b>0-11 Edit Set-up</b>	
*[1] Setup 1	
[2] Setup 2	
[9] Active Setup	
<b>0-12 Link Setups</b>	
[0] Not Linked	
*[20] Linked	
<b>0-31 Custom Readout Min Scale</b>	
0.00 - 9999.00	
*0.00	
<b>0-32 Custom Readout Max Scale</b>	
0.00 - 9999.00	
*100.0	
<b>0-4* LCP Keypad</b>	
<b>0-40 [Hand on] Key on LCP</b>	
[0] Disabled	
*[1] Enabled	
<b>0-41 [Off / Reset] Key on LCP</b>	
[0] Disable All	
*[1] Enable All	
[2] Enable Reset Only	
<b>0-42 [Auto on] Key on LCP</b>	
[0] Disabled	
*[1] Enabled	
<b>0-5* Copy/Save</b>	
<b>0-50 LCP Copy</b>	
*[0] No copy	
[1] All to LCP	
[2] All from LCP	
[3] Size indep. from LCP	
<b>0-51 Set-up Copy</b>	
*[0] No copy	
[1] Copy from setup 1	
[2] Copy from setup 2	
[9] Copy from Factory setup	
<b>0-6* Password</b>	
<b>0-60 (Main) Menu Password</b>	
0 - 999 * 0	
<b>1-** Load/Motor</b>	
<b>1-0* General Settings</b>	
<b>1-00 Configuration Mode</b>	
*[0] Speed open loop	
[3] Process	
<b>1-01 Motor Control Principle</b>	
[0] U/f	
*[1] VVC+	
<b>1-03 Torque Characteristics</b>	
*[0] Constant torque	
[2] Automatic Energy Optim.	
<b>1-05 Local Mode Configuration</b>	
[0] Speed Open Loop	
*[2] As config in param. 1-00	
<b>1-2* Motor Data</b>	
<b>1-20 Motor Power [kW] [HP]</b>	
[1] 0.09 kW/0.12 HP	
[2] 0.12 kW/0.16 HP	
[3] 0.18 kW/0.25 HP	
[4] 0.25 kW/0.33 HP	
[5] 0.37 kW/0.50 HP	
[6] 0.55 kW/0.75 HP	
[7] 0.75 kW/1.00 HP	
[8] 1.10 kW/1.50 HP	
[9] 1.50 kW/2.00 HP	
[10] 2.20 kW/3.00 HP	
[11] 3.00 kW/4.00 HP	
[12] 3.70 kW/5.00 HP	
[13] 4.00 kW/5.40 HP	
[14] 5.50 kW/7.50 HP	
[15] 7.50 kW/10.00 HP	
[16] 11.00 kW/15.00 HP	
<b>1-22 Motor Voltage</b>	
50 - 999 V * 230 - 400 V	
<b>1-23 Motor Frequency</b>	
20 - 400 Hz * 50 Hz	
<b>1-24 Motor Current</b>	
0.01 - 26.00 A * Motor type dep.	
<b>1-25 Motor Nominal Speed</b>	
100 - 9999 rpm * Motor type dep.	
<b>1-29 Automatic Motor Tuning (AMT)</b>	
*[0] Off	
[2] Enable AMT	
<b>1-3* Adv. Motor Data</b>	
<b>1-30 Stator Resistance (Rs)</b>	
[Ohm] * Dep. on motor data	
<b>1-33 Stator Leakage Reactance (Xl)</b>	
[Ohm] * Dep. on motor data	
<b>1-35 Main Reactance (Xh)</b>	
[Ohm] * Dep. on motor data	
<b>1-5* Load Indep. Setting</b>	
<b>1-50 Motor Magnetisation at 0 Speed</b>	
0 - 300 % * 100 %	
<b>1-52 Min Speed Norm. Magnet. [Hz]</b>	
0.0 - 10.0 Hz * 0.0 Hz	
<b>1-55 U/f Characteristic - U</b>	
0 - 999.9 V	
<b>1-56 U/f Characteristic - F</b>	
0 - 400 Hz	
<b>1-6* Load Depen. Setting</b>	
<b>1-60 Low Speed Load Compensation</b>	
0 - 199 % * 100 %	
<b>1-61 High Speed Load Compensation</b>	
0 - 199 % * 100 %	
<b>1-62 Slip Compensation</b>	
-400 - 399 % * 100 %	
<b>1-63 Slip Compensation Time Constant</b>	
0.05 - 5.00 s * 0.10 s	
<b>1-7* Start Adjustments</b>	
<b>1-71 Start Delay</b>	
0.0 - 10.0 s * 0.0 s	
<b>1-72 Start Function</b>	
[0] DC hold / delay time	
[1] DC brake / delay time	
*[2] Coast / delay time	
<b>1-73 Flying Start</b>	
*[0] Disabled	
[1] Enabled	
<b>1-8* Stop Adjustments</b>	
<b>1-80 Function at Stop</b>	
*[0] Coast	
[1] DC hold	
<b>1-82 Min Speed for Funct. at Stop [Hz]</b>	
0.0 - 20.0 Hz * 0.0 Hz	
<b>1-9* Motor Temperature</b>	
<b>1-90 Motor Thermal Protection</b>	
*[0] No protection	
[1] Thermistor warning	
[2] Thermistor trip	
[3] Etr warning	
[4] Etr trip	
<b>1-93 Thermistor Resource</b>	
*[0] None	
<b>2-** Brakes</b>	
<b>2-0* DC-Brake</b>	
<b>2-00 DC Hold Current</b>	
0 - 150 % * 50 %	
<b>2-01 DC Brake Current</b>	
0 - 150 % * 50 %	
<b>2-02 DC Braking Time</b>	
0.0 - 60.0 s * 10.0 s	
<b>2-04 DC Brake Cut In Speed</b>	
0.0 - 400.0 Hz * 0.0 Hz	
<b>2-1* Brake Energy Funct.</b>	
<b>2-10 Brake Function</b>	
*[0] Off	
[1] Resistor brake	
[2] AC brake	
<b>2-11 Brake Resistor (ohm)</b>	
5 - 5000 * 5	
<b>2-16 AC Brake, Max current</b>	
0 - 150 % * 100 %	
<b>2-17 Over-voltage Control</b>	
*[0] Disabled	
[1] Enabled (not at stop)	
[2] Enabled	
<b>2-2* Mechanical Brake</b>	
<b>2-20 Release Brake Current</b>	
0.00 - 100.0 A * 0.00 A	
<b>2-22 Activate Brake Speed [Hz]</b>	
0.0 - 400.0 Hz * 0.0 Hz	
<b>3-** Reference / Ramps</b>	
<b>3-0* Reference Limits</b>	
<b>3-00 Reference Range</b>	
*[0] Min - Max	
[1] -Max - +Max	
<b>3-02 Minimum Reference</b>	
-4999 - 4999 * 0.000	
<b>3-03 Maximum Reference</b>	
-4999 - 4999 * 50.00	
<b>3-1* References</b>	
<b>3-10 Preset Reference</b>	
-100.0 - 100.0 % * 0.00 %	
<b>3-11 Jog Speed [Hz]</b>	
0.0 - 400.0 Hz * 5.0 Hz	
<b>3-12 Catch up/slow Down Value</b>	
0.00 - 100.0 % * 0.00 %	

<p><b>3-14 Preset Relative Reference</b> -100.0 - 100.0 % * 0.00 %</p> <p><b>3-15 Reference Resource 1</b> [0] No function *[1] Analog Input 53 [2] Analog input 60 [8] Pulse input 33 [11] Local bus ref [21] LCP Potentiometer</p> <p><b>3-16 Reference Resource 2</b> [0] No function [1] Analog Input 53 *[2] Analog input 60 [8] Pulse input 33 [11] Local bus ref [21] LCP Potentiometer</p> <p><b>3-17 Reference Resource 3</b> [0] No function [1] Analog Input 53 [2] Analog input 60 [8] Pulse input 33 *[11] Local bus ref [21] LCP Potentiometer</p> <p><b>3-18 Relative Scaling Ref. Resource</b> *[0] No function [1] Analog Input 53 [2] Analog input 60 [8] Pulse input 33 [11] Local bus ref [21] LCP Potentiometer</p> <p><b>3-4* Ramp 1</b> <b>3-40 Ramp 1 Type</b> *[0] Linear [2] Sine2 ramp</p> <p><b>3-41 Ramp 1 Ramp up Time</b> 0.05 - 3600 s * 3.00 s</p> <p><b>3-42 Ramp 1 Ramp Down Time</b> 0.05 - 3600 s * 3.00 s</p> <p><b>3-5* Ramp 2</b> <b>3-50 Ramp 2 Type</b> *[0] Linear [2] Sine2 ramp</p> <p><b>3-51 Ramp 2 Ramp up Time</b> 0.05 - 3600 s * 3.00 s</p> <p><b>3-52 Ramp 2 Ramp down Time</b> 0.05 - 3600 s * 3.00 s</p> <p><b>3-8* Other Ramps</b></p>	<p><b>3-80 Jog Ramp Time</b> 0.05 - 3600 s * 3.00 s</p> <p><b>3-81 Quick Stop Ramp Time</b> 0.05 - 3600 s * 3.00 s</p> <p><b>4-* * Limits / Warnings</b></p> <p><b>4-1* Motor Limits</b></p> <p><b>4-10 Motor Speed Direction</b> [0] Clockwise [1] CounterClockwise *[2] Both</p> <p><b>4-12 Motor Speed Low Limit [Hz]</b> 0.0 - 400.0 Hz * 0.0 Hz</p> <p><b>4-14 Motor Speed High Limit [Hz]</b> 0.1 - 400.0 Hz * 65.0 Hz</p> <p><b>4-16 Torque Limit Motor Mode</b> 0 - 400 % * 150 %</p> <p><b>4-17 Torque Limit Generator Mode</b> 0 - 400 % * 100 %</p> <p><b>4-5* Adj. Warnings</b></p> <p><b>4-50 Warning Current Low</b> 0.00 - 26.00 A * 0.00 A</p> <p><b>4-51 Warning Current High</b> 0.00 - 26.00 A * 26.00 A</p> <p><b>4-58 Missing Motor Phase Function</b> [0] Off *[1] On</p> <p><b>4-6* Speed Bypass</b></p> <p><b>4-61 Bypass Speed From [Hz]</b> 0.0 - 400.0 Hz * 0.0 Hz</p> <p><b>4-63 Bypass Speed To [Hz]</b> 0.0 - 400.0 Hz * 0.0 Hz</p> <p><b>5-1* Digital Inputs</b></p> <p><b>5-10 Terminal 18 Digital Input</b> [0] No function [1] Reset [2] Coast inverse [3] Coast and reset inv. [4] Quick stop inverse [5] DC-brake inv. [6] Stop inv *[8] Start [9] Latched start [10] Reversing [11] Start reversing [12] Enable start forward [13] Enable start reverse [14] Jog</p>	<p><b>3-80 Jog Ramp Time</b> 0.05 - 3600 s * 3.00 s</p> <p><b>3-81 Quick Stop Ramp Time</b> 0.05 - 3600 s * 3.00 s</p> <p><b>4-* * Limits / Warnings</b></p> <p><b>4-1* Motor Limits</b></p> <p><b>4-10 Motor Speed Direction</b> [0] Clockwise [1] CounterClockwise *[2] Both</p> <p><b>4-12 Motor Speed Low Limit [Hz]</b> 0.0 - 400.0 Hz * 0.0 Hz</p> <p><b>4-14 Motor Speed High Limit [Hz]</b> 0.1 - 400.0 Hz * 65.0 Hz</p> <p><b>4-16 Torque Limit Motor Mode</b> 0 - 400 % * 150 %</p> <p><b>4-17 Torque Limit Generator Mode</b> 0 - 400 % * 100 %</p> <p><b>4-5* Adj. Warnings</b></p> <p><b>4-50 Warning Current Low</b> 0.00 - 26.00 A * 0.00 A</p> <p><b>4-51 Warning Current High</b> 0.00 - 26.00 A * 26.00 A</p> <p><b>4-58 Missing Motor Phase Function</b> [0] Off *[1] On</p> <p><b>4-6* Speed Bypass</b></p> <p><b>4-61 Bypass Speed From [Hz]</b> 0.0 - 400.0 Hz * 0.0 Hz</p> <p><b>4-63 Bypass Speed To [Hz]</b> 0.0 - 400.0 Hz * 0.0 Hz</p> <p><b>5-1* Digital Inputs</b></p> <p><b>5-10 Terminal 18 Digital Input</b> [0] No function [1] Reset [2] Coast inverse [3] Coast and reset inv. [4] Quick stop inverse [5] DC-brake inv. [6] Stop inv *[8] Start [9] Latched start [10] Reversing [11] Start reversing [12] Enable start forward [13] Enable start reverse [14] Jog</p>	<p><b>5-11 Terminal 19 Digital Input</b> See par. 5-10. * [10] Reversing</p> <p><b>5-12 Terminal 27 Digital Input</b> See par. 5-10. * [1] Reset</p> <p><b>5-13 Terminal 29 Digital Input</b> See par. 5-10. * [14] Jog</p> <p><b>5-15 Terminal 33 Digital Input</b> See par. 5-10. * [16] Preset ref bit 0</p> <p><b>5-16 Precision Stop Inverse</b> [27] Start, Precise Stop [32] Pulse Input</p> <p><b>5-4* Relays</b></p> <p><b>5-40 Function Relay</b> *[0] No operation [1] Control ready [2] Drive ready [3] Drive ready, Remote [4] Enable / No warning [5] Drive running [6] Running / No warning [7] Run in range / No warning [8] Run on ref / No warning [9] Alarm [10] Alarm or warning [12] Out of current range [13] Below current, low [14] Above current, high [21] Thermal warning [22] Ready, No thermal warning [23] Remote ready, No thermal warning [24] Ready, Voltage ok</p>	<p>[16-18] Preset ref bit 0-2 [19] Freeze reference [20] Freeze output [21] Speed up [22] Speed down [23] Setup select bit 0 [28] Catch up [29] Slow down [34] Ramp bit 0 [60] Counter A (up) [61] Counter A (down) [62] Reset counter A [63] Counter B (up) [64] Counter B (down) [65] ResetCounter B</p> <p><b>5-5 Terminal 33 Low Frequency</b> 20 - 4999 Hz * 20 Hz</p> <p><b>5-56 Terminal 33 High Frequency</b> 21 - 5000 Hz * 5000 Hz</p> <p><b>5-57 Term. 33 Low Ref./Feedb. Value</b> -4999 - 4999 * 0.000</p> <p><b>5-58 Term. 33 High Ref./Feedb. Value</b> -4999 - 4999 * 50.000</p> <p><b>6-* * Analog In/Out</b></p> <p><b>6-0* Analog I/O Mode</b></p> <p><b>6-00 Live Zero Timeout Time</b> 1 - 99 s * 10 s</p> <p><b>6-01 Live Zero TimeoutFunction</b> *[0] Off [1] Freeze output [2] Stop [3] Jogging [4] Max speed [5] Stop and trip</p> <p><b>6-1* Analog Input 1</b></p> <p><b>6-10 Terminal 53 Low Voltage</b> 0.00 - 9.99 V * 0.07 V</p> <p><b>6-11 Terminal 53 High Voltage</b> 0.01 - 10.00 V * 10.00 V</p> <p><b>6-12 Terminal 53 Low Current</b> 0.00 - 19.99 mA * 0.14 mA</p>
---	---	---	--	--



<p><b>6-13 Terminal 53 High Current</b> 0.01 - 20.00 mA * 20.00 mA</p> <p><b>6-14 Term. 53 Low Ref./Feedb. Value</b> -4999 - 4999 * 0.000</p> <p><b>6-15 Term. 53 High Ref./Feedb. Value</b> -4999 - 4999 * 50.000</p> <p><b>6-16 Terminal 53 Filter Time Constant</b> 0.01 - 10.00 s * 0.01 s</p> <p><b>6-19 Terminal 53 mode</b> *[0] Voltage mode [1] Current mode</p> <p><b>6-2* Analog Input 2</b></p> <p><b>6-22 Terminal 60 Low Current</b> 0.00 - 19.99 mA * 0.14 mA</p> <p><b>6-23 Terminal 60 High Current</b> 0.01 - 20.00 mA * 20.00 mA</p> <p><b>6-24 Term. 60 Low Ref./Feedb. Value</b> -4999 - 4999 * 0.000</p> <p><b>6-25 Term. 60 High Ref./Feedb. Value</b> -4999 - 4999 * 50.00</p> <p><b>6-26 Terminal 60 Filter Time Constant</b> 0.01 - 10.00 s * 0.01 s</p> <p><b>6-8* LCP potentiometer</b></p> <p><b>6-81 LCP potm. Low Reference</b> -4999 - 4999 * 0.000</p> <p><b>6-82 LCP potm. High Reference</b> -4999 - 4999 * 50.00</p> <p><b>6-9* Analog Output xx</b></p> <p><b>6-90 Terminal 42 Mode</b> *[0] 0-20 mA [1] 4-20 mA [2] Digital Output</p> <p><b>6-91 Terminal 42 Analog Output</b> *[0] No operation [10] Output Frequency [11] Reference [12] Feedback [13] Motor Current [16] Power [20] BusControl</p> <p><b>6-92 Terminal 42 Digital Output</b> See par. 5-40 *[0] No Operation [80] SL Digital Output A</p>	<p><b>6-93 Terminal 42 Output Min Scale</b> 0.00 - 200.0 % * 0.00 %</p> <p><b>6-94 Terminal 42 Output Max Scale</b> 0.00 - 200.0 % * 100.0 %</p> <p><b>7-** Controllers</b></p> <p><b>7-2* Process Ctrl. Feedb</b></p> <p><b>7-20 Process CL Feedback 1 Resource</b> *[0] NoFunction [1] Analog Input 53 [2] Analog Input 60 [8] PulseInput33 [11] LocalBusRef</p> <p><b>7-3* Process PI</b></p> <p><b>Ctrl. 7-30 Process PI Normal/ Inverse Ctrl</b> *[0] Normal [1] Inverse</p> <p><b>7-31 Process PI Anti Windup</b> [0] Disable *[1] Enable</p> <p><b>7-32 Process PI Start Speed</b> 0.0 - 200.0 Hz * 0.0 Hz</p> <p><b>7-33 Process PI Proportional Gain</b> 0.00 - 10.00 * 0.01</p> <p><b>7-34 Process PI Integral Time</b> 0.10 - 9999 s * 9999 s</p> <p><b>7-38 Process PI Feed Forward Factor</b> 0 - 400 % * 0 %</p> <p><b>7-39 On Reference Bandwidth</b> 0 - 200 % * 5 %</p> <p><b>8-** Comm. and Options</b></p> <p><b>8-0* General Settings</b> *[0] Digital and ControlWord [1] Digital only [2] ControlWord only</p> <p><b>8-02 Control Word Source</b> [0] None *[1] FC RS485</p> <p><b>8-03 Control Word Timeout Time</b> 0.1 - 6500 s * 1.0 s</p> <p><b>8-04 Control Word Timeout Function</b> *[0] Off [1] Freeze Output [2] Stop [3] Jogging</p>	<p><b>8-9* Bus Jog / Feedback</b></p> <p><b>8-94 Bus feedback 1</b> 0x8000 - 0x7FFF * 0</p> <p><b>13-** Smart Logic</b></p> <p><b>13-0* SLC Settings</b></p> <p><b>13-00 SL Controller Mode</b> *[0] Off [1] On</p> <p><b>13-01 Start Event</b> [0] False [1] True [2] Running [3] InRange [4] OnReference [7] OutOfCurrentRange [8] BelowLow [9] AboveHigh [16] ThermalWarning [17] MainOutOfRange [18] Reversing [19] Warning [20] Alarm_Trip [21] Alarm_TripLock [22-25] Comparator 0-3 [26-29] LogicRule0-3 [33] DigitalInput_18 [34] DigitalInput_19 [35] DigitalInput_27 [36] DigitalInput_29 [38] DigitalInput_33 *[39] StartCommand [40] DriveStopped</p> <p><b>13-02 Stop Event</b> See par. 13-01 * [40] DriveStopped</p> <p><b>13-03 Reset SLC</b> *[0] Do not reset [1] Reset SLC</p> <p><b>13-1* Comparators</b></p>	<p>[4] Max. Speed [5] Stop and trip</p> <p><b>8-06 Reset Control Word Timeout</b> *[0] No Function [1] Do reset</p> <p><b>8-3* FC Port Settings</b></p> <p><b>8-30 Protocol</b> *[0] FC [2] Modbus</p> <p><b>8-31 Address</b> 1 - 247 * 1</p> <p><b>8-32 FC Port Baud Rate</b> [0] 2400 Baud [1] 4800 Baud *[2] 9600 Baud [3] 19200 Baud *[4] 38400 Baud</p> <p><b>8-33 FC Port Parity</b> *[0] Even Parity, 1 Stop Bit [1] Odd Parity, 1 Stop Bit [2] No Parity, 1 Stop Bit [3] No Parity, 2 Stop Bits</p> <p><b>8-35 Minimum Response Delay</b> 0.001-0.5 * 0.010 s</p> <p><b>8-36 Max Response Delay</b> 0.100 - 10.00 s * 5.000 s</p> <p><b>8-5* Digital/Bus</b></p> <p><b>8-50 Coasting Select</b> [0] DigitalInput [1] Bus [2] LogicAnd *[3] LogicOr</p> <p><b>8-51 Quick Stop Select</b> See par. 8-50 * [3] LogicOr</p> <p><b>8-52 DC Brake Select</b> See par. 8-50 * [3] LogicOr</p> <p><b>8-53 Start Select</b> See par. 8-50 * [3] LogicOr</p> <p><b>8-54 Reversing Select</b> See par. 8-50 * [3] LogicOr</p> <p><b>8-55 Set-up Select</b> See par. 8-50 * [3] LogicOr</p> <p><b>8-56 Preset Reference Select</b> See par. 8-50 * [3] LogicOr</p>
---	---	---	--

<b>13-10 Comparator Operand</b>	[1] NoAction [2] SelectSetup1 [3] SelectSetup2 [10-17] SelectPresetRef0-7 [18] SelectRamp1 [19] SelectRamp2 [22] Run [23] RunReverse [24] Stop [25] Qstop [26] DCstop [27] Coast [28] FreezeOutput [29] StartTimer0 [30] StartTimer1 [31] StartTimer2 [32] Set Digital Output A Low [33] Set Digital Output B Low [38] Set Digital Output A High [39] Set Digital Output B High [60] ResetCounterA [61] ResetCounterB	<b>14-22 Operation Mode</b> *[0] Normal Operation [2] Initialisation <b>14-26 Action At Inverter Fault</b> *[0] Trip [1] Warning <b>14-4 * Energy Optimising</b> <b>14-41 AEO Minimum Magnetisation</b> 40 - 75 % * 66 % <b>15- * Drive Information</b> <b>15-0 * Operating Data</b> 15-00 Operating Days 15-01 Running Hours 15-02 kWh Counter 15-03 Power Ups 15-04 Over Temps 15-05 Over Volts 15-06 Reset kWh Counter *[0] Do not reset [1] Reset counter 15-07 Reset Running Hours Counter *[0] Do not reset [1] Reset counter <b>15-3 * Fault Log</b> 15-30 Fault Log: Error Code <b>15-4 * Drive Identification</b> 15-40 FC Type 15-41 Power Section 15-42 Voltage 15-43 Software Version 15-46 Frequency Converter Order. No 15-48 LCP Id No 15-51 Frequency Converter Serial No <b>16- * Data Readouts</b> <b>16-0 * General Status</b> 16-00 Control Word 0 - 0XFFFF 16-01 Reference [Unit] -4999 - 4999 16-02 Reference % -200.0 - 200.0 % 16-03 Status Word 0 - 0XFFFF 16-05 Main Actual Value [%] -200.0 - 200.0 % 16-09 Custom Readout Dep. on par. 0-31, 0-32 and 4-14	<b>16-1 * Motor Status</b> 16-10 Power [kW] 16-11 Power [hp] 16-12 Motor Voltage [V] 16-13 Frequency [Hz] 16-14 Motor Current [A] 16-15 Frequency [%] 16-18 Motor Thermal [%] <b>16-3 * Drive Status</b> 16-30 DC Link Voltage 16-34 Heatsink Temp. 16-35 Inverter Thermal 16-36 Inv. Nom. Current 16-37 Inv. Max. Current 16-38 SL Controller State <b>16-5 * Ref. / Feedb.</b> 16-50 External Reference 16-51 Pulse Reference 16-52 Feedback [Unit] <b>16-6 * Inputs / Outputs</b> 16-60 Digital Input 18,19,27,33 0 - 1111 16-61 Digital Input 29 0 - 1 16-62 Analog Input 53 (volt) 16-63 Analog Input 53 (current) 16-64 Analog Input 60 16-65 Analog Output 42 [mA] 16-68 Pulse Input [Hz] 16-71 Relay Output [bin] 16-72 Counter A 16-73 Counter B <b>16-8 * Fieldbus / FC Port</b> 16-86 FC Port REF 1 0x8000 - 0x7FFFF <b>16-9 * Diagnosis Readouts</b> 16-90 Alarm Word 0 - 0XFFFFFFF 16-92 Warning Word 0 - 0XFFFFFFF 16-94 Ext. Status Word 0 - 0XFFFFFFF
<b>13-11 Comparator Operator</b>	[1] NoAction [2] SelectSetup1 [3] SelectSetup2 [10-17] SelectPresetRef0-7 [18] SelectRamp1 [19] SelectRamp2 [22] Run [23] RunReverse [24] Stop [25] Qstop [26] DCstop [27] Coast [28] FreezeOutput [29] StartTimer0 [30] StartTimer1 [31] StartTimer2 [32] Set Digital Output A Low [33] Set Digital Output B Low [38] Set Digital Output A High [39] Set Digital Output B High [60] ResetCounterA [61] ResetCounterB	<b>14-0 * Inverter Switching</b> 14-01 Switching Frequency [0] 2 kHz *[1] 4 kHz [2] 8 kHz [4] 16 kHz 14-03 Overmodulation [0] Off *[1] On <b>14-12 Function at mains imbalance</b> *[0] Trip [1] Warning [2] Disabled <b>14-2 * Trip Reset</b> 14-20 Reset Mode *[0] Manual reset [1-9] AutoReset 1-9 [10] AutoReset 10 [11] AutoReset 15 [12] AutoReset 20 [13] Infinite auto reset 14-21 Automatic Restart Time 0 - 600 s * 10 s	
<b>13-12 Comparator Value</b>	[1] NoAction [2] SelectSetup1 [3] SelectSetup2 [10-17] SelectPresetRef0-7 [18] SelectRamp1 [19] SelectRamp2 [22] Run [23] RunReverse [24] Stop [25] Qstop [26] DCstop [27] Coast [28] FreezeOutput [29] StartTimer0 [30] StartTimer1 [31] StartTimer2 [32] Set Digital Output A Low [33] Set Digital Output B Low [38] Set Digital Output A High [39] Set Digital Output B High [60] ResetCounterA [61] ResetCounterB	<b>14-0 * Inverter Switching</b> 14-01 Switching Frequency [0] 2 kHz *[1] 4 kHz [2] 8 kHz [4] 16 kHz 14-03 Overmodulation [0] Off *[1] On <b>14-12 Function at mains imbalance</b> *[0] Trip [1] Warning [2] Disabled <b>14-2 * Trip Reset</b> 14-20 Reset Mode *[0] Manual reset [1-9] AutoReset 1-9 [10] AutoReset 10 [11] AutoReset 15 [12] AutoReset 20 [13] Infinite auto reset 14-21 Automatic Restart Time 0 - 600 s * 10 s	
<b>13-2 * Timers</b>	[1] NoAction [2] SelectSetup1 [3] SelectSetup2 [10-17] SelectPresetRef0-7 [18] SelectRamp1 [19] SelectRamp2 [22] Run [23] RunReverse [24] Stop [25] Qstop [26] DCstop [27] Coast [28] FreezeOutput [29] StartTimer0 [30] StartTimer1 [31] StartTimer2 [32] Set Digital Output A Low [33] Set Digital Output B Low [38] Set Digital Output A High [39] Set Digital Output B High [60] ResetCounterA [61] ResetCounterB	<b>14-0 * Inverter Switching</b> 14-01 Switching Frequency [0] 2 kHz *[1] 4 kHz [2] 8 kHz [4] 16 kHz 14-03 Overmodulation [0] Off *[1] On <b>14-12 Function at mains imbalance</b> *[0] Trip [1] Warning [2] Disabled <b>14-2 * Trip Reset</b> 14-20 Reset Mode *[0] Manual reset [1-9] AutoReset 1-9 [10] AutoReset 10 [11] AutoReset 15 [12] AutoReset 20 [13] Infinite auto reset 14-21 Automatic Restart Time 0 - 600 s * 10 s	
<b>13-20 SL Controller Timer</b>	[1] NoAction [2] SelectSetup1 [3] SelectSetup2 [10-17] SelectPresetRef0-7 [18] SelectRamp1 [19] SelectRamp2 [22] Run [23] RunReverse [24] Stop [25] Qstop [26] DCstop [27] Coast [28] FreezeOutput [29] StartTimer0 [30] StartTimer1 [31] StartTimer2 [32] Set Digital Output A Low [33] Set Digital Output B Low [38] Set Digital Output A High [39] Set Digital Output B High [60] ResetCounterA [61] ResetCounterB	<b>14-0 * Inverter Switching</b> 14-01 Switching Frequency [0] 2 kHz *[1] 4 kHz [2] 8 kHz [4] 16 kHz 14-03 Overmodulation [0] Off *[1] On <b>14-12 Function at mains imbalance</b> *[0] Trip [1] Warning [2] Disabled <b>14-2 * Trip Reset</b> 14-20 Reset Mode *[0] Manual reset [1-9] AutoReset 1-9 [10] AutoReset 10 [11] AutoReset 15 [12] AutoReset 20 [13] Infinite auto reset 14-21 Automatic Restart Time 0 - 600 s * 10 s	
<b>13-30 SL Controller Timer</b>	[1] NoAction [2] SelectSetup1 [3] SelectSetup2 [10-17] SelectPresetRef0-7 [18] SelectRamp1 [19] SelectRamp2 [22] Run [23] RunReverse [24] Stop [25] Qstop [26] DCstop [27] Coast [28] FreezeOutput [29] StartTimer0 [30] StartTimer1 [31] StartTimer2 [32] Set Digital Output A Low [33] Set Digital Output B Low [38] Set Digital Output A High [39] Set Digital Output B High [60] ResetCounterA [61] ResetCounterB	<b>14-0 * Inverter Switching</b> 14-01 Switching Frequency [0] 2 kHz *[1] 4 kHz [2] 8 kHz [4] 16 kHz 14-03 Overmodulation [0] Off *[1] On <b>14-12 Function at mains imbalance</b> *[0] Trip [1] Warning [2] Disabled <b>14-2 * Trip Reset</b> 14-20 Reset Mode *[0] Manual reset [1-9] AutoReset 1-9 [10] AutoReset 10 [11] AutoReset 15 [12] AutoReset 20 [13] Infinite auto reset 14-21 Automatic Restart Time 0 - 600 s * 10 s	
<b>13-40 Logic Rule Boolean 1</b>	[1] NoAction [2] SelectSetup1 [3] SelectSetup2 [10-17] SelectPresetRef0-7 [18] SelectRamp1 [19] SelectRamp2 [22] Run [23] RunReverse [24] Stop [25] Qstop [26] DCstop [27] Coast [28] FreezeOutput [29] StartTimer0 [30] StartTimer1 [31] StartTimer2 [32] Set Digital Output A Low [33] Set Digital Output B Low [38] Set Digital Output A High [39] Set Digital Output B High [60] ResetCounterA [61] ResetCounterB	<b>14-0 * Inverter Switching</b> 14-01 Switching Frequency [0] 2 kHz *[1] 4 kHz [2] 8 kHz [4] 16 kHz 14-03 Overmodulation [0] Off *[1] On <b>14-12 Function at mains imbalance</b> *[0] Trip [1] Warning [2] Disabled <b>14-2 * Trip Reset</b> 14-20 Reset Mode *[0] Manual reset [1-9] AutoReset 1-9 [10] AutoReset 10 [11] AutoReset 15 [12] AutoReset 20 [13] Infinite auto reset 14-21 Automatic Restart Time 0 - 600 s * 10 s	
<b>13-41 Logic Rule Operator 1</b>	[1] NoAction [2] SelectSetup1 [3] SelectSetup2 [10-17] SelectPresetRef0-7 [18] SelectRamp1 [19] SelectRamp2 [22] Run [23] RunReverse [24] Stop [25] Qstop [26] DCstop [27] Coast [28] FreezeOutput [29] StartTimer0 [30] StartTimer1 [31] StartTimer2 [32] Set Digital Output A Low [33] Set Digital Output B Low [38] Set Digital Output A High [39] Set Digital Output B High [60] ResetCounterA [61] ResetCounterB	<b>14-0 * Inverter Switching</b> 14-01 Switching Frequency [0] 2 kHz *[1] 4 kHz [2] 8 kHz [4] 16 kHz 14-03 Overmodulation [0] Off *[1] On <b>14-12 Function at mains imbalance</b> *[0] Trip [1] Warning [2] Disabled <b>14-2 * Trip Reset</b> 14-20 Reset Mode *[0] Manual reset [1-9] AutoReset 1-9 [10] AutoReset 10 [11] AutoReset 15 [12] AutoReset 20 [13] Infinite auto reset 14-21 Automatic Restart Time 0 - 600 s * 10 s	
<b>13-42 Logic Rule Boolean 2</b>	[1] NoAction [2] SelectSetup1 [3] SelectSetup2 [10-17] SelectPresetRef0-7 [18] SelectRamp1 [19] SelectRamp2 [22] Run [23] RunReverse [24] Stop [25] Qstop [26] DCstop [27] Coast [28] FreezeOutput [29] StartTimer0 [30] StartTimer1 [31] StartTimer2 [32] Set Digital Output A Low [33] Set Digital Output B Low [38] Set Digital Output A High [39] Set Digital Output B High [60] ResetCounterA [61] ResetCounterB	<b>14-0 * Inverter Switching</b> 14-01 Switching Frequency [0] 2 kHz *[1] 4 kHz [2] 8 kHz [4] 16 kHz 14-03 Overmodulation [0] Off *[1] On <b>14-12 Function at mains imbalance</b> *[0] Trip [1] Warning [2] Disabled <b>14-2 * Trip Reset</b> 14-20 Reset Mode *[0] Manual reset [1-9] AutoReset 1-9 [10] AutoReset 10 [11] AutoReset 15 [12] AutoReset 20 [13] Infinite auto reset 14-21 Automatic Restart Time 0 - 600 s * 10 s	
<b>13-43 Logic Rule Operator 2</b>	[1] NoAction [2] SelectSetup1 [3] SelectSetup2 [10-17] SelectPresetRef0-7 [18] SelectRamp1 [19] SelectRamp2 [22] Run [23] RunReverse [24] Stop [25] Qstop [26] DCstop [27] Coast [28] FreezeOutput [29] StartTimer0 [30] StartTimer1 [31] StartTimer2 [32] Set Digital Output A Low [33] Set Digital Output B Low [38] Set Digital Output A High [39] Set Digital Output B High [60] ResetCounterA [61] ResetCounterB	<b>14-0 * Inverter Switching</b> 14-01 Switching Frequency [0] 2 kHz *[1] 4 kHz [2] 8 kHz [4] 16 kHz 14-03 Overmodulation [0] Off *[1] On <b>14-12 Function at mains imbalance</b> *[0] Trip [1] Warning [2] Disabled <b>14-2 * Trip Reset</b> 14-20 Reset Mode *[0] Manual reset [1-9] AutoReset 1-9 [10] AutoReset 10 [11] AutoReset 15 [12] AutoReset 20 [13] Infinite auto reset 14-21 Automatic Restart Time 0 - 600 s * 10 s	
<b>13-44 Logic Rule Boolean 3</b>	[1] NoAction [2] SelectSetup1 [3] SelectSetup2 [10-17] SelectPresetRef0-7 [18] SelectRamp1 [19] SelectRamp2 [22] Run [23] RunReverse [24] Stop [25] Qstop [26] DCstop [27] Coast [28] FreezeOutput [29] StartTimer0 [30] StartTimer1 [31] StartTimer2 [32] Set Digital Output A Low [33] Set Digital Output B Low [38] Set Digital Output A High [39] Set Digital Output B High [60] ResetCounterA [61] ResetCounterB	<b>14-0 * Inverter Switching</b> 14-01 Switching Frequency [0] 2 kHz *[1] 4 kHz [2] 8 kHz [4] 16 kHz 14-03 Overmodulation [0] Off *[1] On <b>14-12 Function at mains imbalance</b> *[0] Trip [1] Warning [2] Disabled <b>14-2 * Trip Reset</b> 14-20 Reset Mode *[0] Manual reset [1-9] AutoReset 1-9 [10] AutoReset 10 [11] AutoReset 15 [12] AutoReset 20 [13] Infinite auto reset 14-21 Automatic Restart Time 0 - 600 s * 10 s	
<b>13-51 SL Controller Event</b>	[1] NoAction [2] SelectSetup1 [3] SelectSetup2 [10-17] SelectPresetRef0-7 [18] SelectRamp1 [19] SelectRamp2 [22] Run [23] RunReverse [24] Stop [25] Qstop [26] DCstop [27] Coast [28] FreezeOutput [29] StartTimer0 [30] StartTimer1 [31] StartTimer2 [32] Set Digital Output A Low [33] Set Digital Output B Low [38] Set Digital Output A High [39] Set Digital Output B High [60] ResetCounterA [61] ResetCounterB	<b>14-0 * Inverter Switching</b> 14-01 Switching Frequency [0] 2 kHz *[1] 4 kHz [2] 8 kHz [4] 16 kHz 14-03 Overmodulation [0] Off *[1] On <b>14-12 Function at mains imbalance</b> *[0] Trip [1] Warning [2] Disabled <b>14-2 * Trip Reset</b> 14-20 Reset Mode *[0] Manual reset [1-9] AutoReset 1-9 [10] AutoReset 10 [11] AutoReset 15 [12] AutoReset 20 [13] Infinite auto reset 14-21 Automatic Restart Time 0 - 600 s * 10 s	
<b>13-52 SL Controller Action</b>	[1] NoAction [2] SelectSetup1 [3] SelectSetup2 [10-17] SelectPresetRef0-7 [18] SelectRamp1 [19] SelectRamp2 [22] Run [23] RunReverse [24] Stop [25] Qstop [26] DCstop [27] Coast [28] FreezeOutput [29] StartTimer0 [30] StartTimer1 [31] StartTimer2 [32] Set Digital Output A Low [33] Set Digital Output B Low [38] Set Digital Output A High [39] Set Digital Output B High [60] ResetCounterA [61] ResetCounterB	<b>14-0 * Inverter Switching</b> 14-01 Switching Frequency [0] 2 kHz *[1] 4 kHz [2] 8 kHz [4] 16 kHz 14-03 Overmodulation [0] Off *[1] On <b>14-12 Function at mains imbalance</b> *[0] Trip [1] Warning [2] Disabled <b>14-2 * Trip Reset</b> 14-20 Reset Mode *[0] Manual reset [1-9] AutoReset 1-9 [10] AutoReset 10 [11] AutoReset 15 [12] AutoReset 20 [13] Infinite auto reset 14-21 Automatic Restart Time 0 - 600 s * 10 s	

### 5.2.1. Conversion Index

The various attributes of each parameter are displayed in the section *Factory Settings*. Parameter values are transferred as whole numbers only. Conversion factors are therefore used to transfer decimals according to the table below.

Example:

Par. 1-24 *Motor Current* has a conversion index of -2 (i.e. conversion factor of 0.01 according to the table below). To set the parameter to 2.25 A, transfer the value 225 via Modbus. The Conversion Factor of 0.01 means that the value transferred is multiplied by 0.01 in the drive. The value 225 transferred on the bus is thus perceived as 2.25 A in the drive.

Conversion index	Conversion factor
2	10
1	100
0	1
-1	0.1
-2	0.01
-3	0.001
-4	0.0001
-5	0.00001

Table 5.1: Conversion table

### 5.2.2. Change during operation

"TRUE" means that the parameter can be changed while the frequency converter is in operation and "FALSE" means that the frequency converter must be stopped before a change can be made.

### 5.2.3. 2-Set-up

"All set-up": The parameter can be set individually in each of the two set-ups, i.e. one single parameter can have two different data values.

"1 set-up": Data value will be the same in both set-ups.

### 5.2.4. Type

Data Type	Description	Type
2	Integer 8	Int8
3	Integer 16	Int16
4	Integer 32	Int32
5	Unsigned 8	UInt8
6	Unsigned 16	UInt16
7	Unsigned 32	UInt32
9	Visible string	VisibleString

## 5.2.5. 0-.\* Operation/Display

Parameter Number	Parameter Description	Default Value	2 Setup	Change During Operation	Conversion Index	Type
0 - 03	Regional Settings	[0] International	1 set-up	FALSE	-	Uint8
0 - 04	Operating State at Power-up (Hand)	[1] Forced stop ref=old	All set-ups	TRUE	-	Uint8
0 - 10	Active Set-up	[1] Set-up 1	1 set-up	TRUE	-	Uint8
0 - 11	Edit Set-up	[1] Set-up 1	1 set-up	TRUE	-	Uint8
0 - 12	Link Setups	[20] Linked	All set-ups	FALSE	-	Uint8
0 - 40	[Hand on] Key on LCP	[1] Enabled	All set-ups	TRUE	-	Uint8
0 - 41	[Off / Reset] Key on LCP	[1] Enable All	All set-ups	TRUE	-	Uint8
0 - 42	[Auto on] Key on LCP	[1] Enabled	All set-ups	TRUE	-	Uint8
0 - 50	LCP Copy	[0] No copy	1 set-up	FALSE	-	Uint8
0 - 51	Set-up Copy	[0] No copy	1 set-up	FALSE	-	Uint8
0 - 60	Main Menu Password	0	1 set-up	TRUE	0	Uint16

**5.2.6. 1-\*\*- Load/Motor**

Parameter Number	Parameter Description	Default Value	2 Setup	Change During Operation	Conversion Index	Type
1-00	Configuration Mode	[0] Speed open loop	All set-ups	TRUE	-	Uint8
1-01	Motor Control Principle	[1] VVC+	All set-ups	FALSE	-	Uint8
1-03	Torque Characteristics	[0] Constant torque	All set-ups	TRUE	-	Uint8
1-05	Hand Mode Configuration	[2] As mode par 1-00	All set-ups	TRUE	-	Uint8
1-20	Motor Power		All set-ups	FALSE	-	Uint8
1-22	Motor Voltage		All set-ups	FALSE	0	Uint16
1-23	Motor Frequency		All set-ups	FALSE	0	Uint16
1-24	Motor Current		All set-ups	FALSE	-2	Uint16
1-25	Motor Nominal Speed		All set-ups	FALSE	0	Uint16
1-29	Automatic Motor Tuning (AMT)	[0] Off	1 set-up	FALSE	-	Uint8
1-30	Stator Resistance (Rs)		All set-ups	FALSE	-2	Uint16
1-33	Stator Leakage Reactance (X1)		All set-ups	FALSE	-2	Uint32
1-35	Main Reactance (Xh)		All set-ups	FALSE	-2	Uint32
1-50	Motor Magnetisation at Zero Speed	100%	All set-ups	TRUE	0	Uint16
1-52	Min Speed Normal Magnetising [Hz]	0 Hz	All set-ups	TRUE	-1	Uint16
1-55	U/f Characteristic - U		All set-ups	TRUE	0	Uint16
1-56	U/f Characteristic - F		All set-ups	TRUE	0	Uint16
1-60	Low Speed Load Compensation	100%	All set-ups	TRUE	0	Uint16
1-61	High Speed Load Compensation	100%	All set-ups	TRUE	0	Uint16
1-62	Slip Compensation	100%	All set-ups	TRUE	0	Uint16
1-63	Slip Compensation Time Constant	0.1 s	All set-ups	TRUE	-2	Uint16
1-71	Start Delay	0 s	All set-ups	TRUE	-1	Uint8
1-72	Start Function	[2] Coast/delay time	All set-ups	TRUE	-	Uint8
1-73	Flying Start	[0] Disabled	All set-ups	FALSE	-	Uint8
1-80	Function at Stop	[0] Coast	All set-ups	TRUE	-	Uint8
1-82	Min Speed for Function at Stop [Hz]	0 Hz	All set-ups	TRUE	-1	Uint16
1-90	Motor Thermal Protection	[0] No protection	All set-ups	TRUE	-	Uint8
1-93	Thermistor Resource	[0] None	All set-ups	FALSE	-	Uint8

## 5.2.7. 2-.\* Brakes

Parameter Number	Parameter Description	Default Value	2 Setup	Change During Operation	Conversion Index	Type
2 - 00	DC Hold Current	50%	All set-ups	TRUE	0	Uint16
2 - 01	DC Brake Current	50%	All set-ups	TRUE	0	Uint16
2 - 02	DC Braking Time	10 s	All set-ups	TRUE	-1	Uint16
2 - 04	DC Brake Cut In Speed	0 Hz	All set-ups	TRUE	-1	Uint16
2 - 10	Brake Function	[0] Off	All set-ups	TRUE	-	Uint8
2 - 11	Brake Resistor (ohm)	100%	All set-ups	TRUE	0	Uint16
2 - 16	AC Brake, Max current	[0] Disabled	All set-ups	TRUE	-	Uint16
2 - 17	Over-voltage Control	0 A	All set-ups	TRUE	-2	Uint8
2 - 20	Release Brake Current	0 Hz	All set-ups	TRUE	-1	Uint32
2 - 22	Activate Brake Speed [Hz]		All set-ups	TRUE		Uint16

### 5.2.8. 3-\*\*- Reference/Ramps

Parameter Number	Parameter Description	Default Value	2 Setup	Change During Operation	Conversion Index	Type
3 - 00	Reference Range	[0] Min - Max	All set-ups	TRUE	-	Uint8
3 - 02	Minimum Reference	0	All set-ups	TRUE	-3	Int32
3 - 03	Maximum Reference	50	All set-ups	TRUE	-3	Int32
3 - 10	Preset Reference	0%	All set-ups	TRUE	-2	Int16
3 - 11	Jog Speed [Hz]	5 Hz	All set-ups	TRUE	-1	Uint16
3 - 12	Catch up/slow Down Value	0%	All set-ups	TRUE	-2	Int16
3 - 14	Preset Relative Reference	0%	All set-ups	TRUE	-2	Int16
3 - 15	Reference Resource 1	[1] Analog in 53	All set-ups	TRUE	-	Uint8
3 - 16	Reference Resource 2	[2] Analog in 60	All set-ups	TRUE	-	Uint8
3 - 17	Reference Resource 3	[11] Local bus reference	All set-ups	TRUE	-	Uint8
3 - 18	Relative Scaling Reference Resource	[0] No function	All set-ups	TRUE	-	Uint8
3 - 40	Ramp 1 Type	[0] Linear	All set-ups	TRUE	-	Uint8
3 - 41	Ramp 1 Ramp up Time	3 s	All set-ups	TRUE	-2	Uint32
3 - 42	Ramp 1 Ramp Down Time	3 s	All set-ups	TRUE	-2	Uint32
3 - 50	Ramp 2 Type	[0] Linear	All set-ups	TRUE	-	Uint8
3 - 51	Ramp 2 Ramp up Time	3 s	All set-ups	TRUE	-2	Uint32
3 - 52	Ramp 2 Ramp down Time	3 s	All set-ups	TRUE	-2	Uint32
3 - 80	Jog Ramp Time	3 s	All set-ups	TRUE	-2	Uint32
3 - 81	Quick Stop Ramp Time	3 s	1 set-up	TRUE	-2	Uint32

### 5.2.9. 4-.\* Limits/Warnings

Parameter Number	Parameter Description	Default Value	2 Setup	Change During Operation	Conversion Index	Type
4 - 10	Motor Speed Direction	[2] Both directions	All set-ups	FALSE	-	Uint8
4 - 12	Motor Speed Low Limit [Hz]	0 Hz	All set-ups	FALSE	-1	Uint16
4 - 14	Motor Speed High Limit [Hz]	65 Hz	All set-ups	FALSE	-1	Uint16
4 - 16	Torque Limit Motor Mode	150%	All set-ups	TRUE	0	Uint16
4 - 17	Torque Limit Generator Mode	100%	All set-ups	TRUE	0	Uint16
4 - 50	Warning Current Low	0 A	All set-ups	TRUE	-2	Uint32
4 - 51	Warning Current High	26 A	All set-ups	TRUE	-2	Uint32
4 - 58	Missing Motor Phase Function	[1] On	All set-ups	FALSE	-	Uint8
4 - 61	Bypass Speed From [Hz]	0 Hz	All set-ups	TRUE	-1	Uint16
4 - 63	Bypass Speed To [Hz]	0 Hz	All set-ups	TRUE	-1	Uint16



### 5.2.10. 5-\*\*-\*\* Digital In/Out

Parameter Number	Parameter Description	Default Value	2 Setup	Change During Operation	Conversion Index	Type
5 - 10	Terminal 18 Digital Input	[8] Start	All set-ups	TRUE	-	Uint8
5 - 11	Terminal 19 Digital Input	[10] Reversing	All set-ups	TRUE	-	Uint8
5 - 12	Terminal 27 Digital Input	[1] Reset	All set-ups	TRUE	-	Uint8
5 - 13	Terminal 29 Digital Input	[14] Jog	All set-ups	TRUE	-	Uint8
5 - 15	Terminal 33 Digital Input	[16] Preset ref bit 0	All set-ups	TRUE	-	Uint8
5 - 40	Function Relay	[0] No operation	All set-ups	TRUE	-	Uint8
5 - 55	Terminal 33 Low Frequency	20 Hz	All set-ups	TRUE	0	Uint16
5 - 56	Terminal 33 High Frequency	5000 Hz	All set-ups	TRUE	0	Uint16
5 - 57	Terminal 33 Low Ref./Feedb. Value	0	All set-ups	TRUE	-3	Int32
5 - 58	Terminal 33 High Ref./Feedb. Value	50	All set-ups	TRUE	-3	Int32

## 5.2.11. 6-.\* Analog In/Out

Parameter Number	Parameter Description	Default Value	2 Setup	Change During Operation	Conversion Index	Type
6 - 00	Live Zero Timeout Time	10 s	All set-ups	TRUE	0	Uint8
6 - 01	Live Zero TimeoutFunction	[0] Off	All set-ups	TRUE	-	Uint8
6 - 10	Terminal 53 Low Voltage	0.07 V	All set-ups	TRUE	-2	Uint16
6 - 11	Terminal 53 High Voltage	10 V	All set-ups	TRUE	-2	Uint16
6 - 12	Terminal 53 Low Current	0.14 mA	All set-ups	TRUE	-2	Uint16
6 - 13	Terminal 53 High Current	20 mA	All set-ups	TRUE	-2	Uint16
6 - 14	Terminal 53 Low Ref./Feedb. Value	0	All set-ups	TRUE	-3	Int32
6 - 15	Terminal 53 High Ref./Feedb. Value	50	All set-ups	TRUE	-3	Int32
6 - 16	Terminal 53 Filter Time Constant	0.01 s	All set-ups	TRUE	-2	Uint16
6 - 19	Terminal 53 mode	[0] Voltage mode	1 set-up	TRUE	-	Uint8
6 - 22	Terminal 60 Low Current	0.14 mA	All set-ups	TRUE	-2	Uint16
6 - 23	Terminal 60 High Current	20 mA	All set-ups	TRUE	-2	Uint16
6 - 24	Terminal 60 Low Ref./Feedb. Value	0	All set-ups	TRUE	-3	Int32
6 - 25	Terminal 60 High Ref./Feedb. Value	50	All set-ups	TRUE	-3	Int32
6 - 26	Terminal 60 Filter Time Constant	0.01 s	All set-ups	TRUE	-2	Uint16
6 - 81	LCP potentiometer Low Ref.	0	All set-ups	TRUE	-3	Int32
6 - 82	LCP potentiometer High Ref.	50	All set-ups	TRUE	-3	Int32
6 - 90	Terminal 42 Mode	[0] 0-20 mA	All set-ups	TRUE	-	Uint8
6 - 91	Terminal 42 Analog Output	[0] No operation	All set-ups	TRUE	-	Uint8
6 - 92	Terminal 42 Digital Output	[0] No operation	All set-ups	TRUE	-	Uint8
6 - 93	Terminal 42 Output Min Scale	0%	All set-ups	TRUE	-2	Uint16
6 - 94	Terminal 42 Output Max Scale	100%	All set-ups	TRUE	-2	Uint16

### 5.2.12. 7-\*\*-\*\* Controllers

Parameter Number	Parameter Description	Default Value	2 Setup	Change During Operation	Conversion Index	Type
7 - 20	Process CL Feedback 1 Resource	[0] No function	All set-ups	TRUE	-	Uint8
7 - 30	Process PI Normal/ Inverse Control	[0] Normal	All set-ups	TRUE	-	Uint8
7 - 31	Process PI Anti Windup	[1] Enabled	All set-ups	TRUE	-	Uint8
7 - 32	Process PI Start Speed	0 Hz	All set-ups	TRUE	-1	Uint16
7 - 33	Process PI Proportional Gain	0.01	All set-ups	TRUE	-2	Uint16
7 - 34	Process PI Integral Time	9999 s	All set-ups	TRUE	-2	Uint32
7 - 38	Process PI Feed Forward Factor	0%	All set-ups	TRUE	0	Uint16
7 - 39	On Reference Bandwidth	5%	All set-ups	TRUE	0	Uint8

## 5.2.13. 8-.\* Comm. and Options

Parameter Number	Parameter Description	Default Value	2 Setup	Change During Operation	Conversion Index	Type
8 - 01	Control Site	[0] Digital and ctrl.word	All set-ups	TRUE	-	Uint8
8 - 02	Control Word Source	[1] FC RS485	All set-ups	TRUE	-	Uint8
8 - 03	Control Word Timeout Time	1 s	1 set-up	TRUE	-1	Uint16
8 - 04	Control Word Timeout Function	[0] Off	1 set-up	TRUE	-	Uint8
8 - 06	Reset Control Word Timeout	[0] No function	1 set-up	TRUE	-	Uint8
8 - 30	Protocol	[0] FC	1 set-up	TRUE	0	Uint8
8 - 31	Address	1	1 set-up	TRUE	0	Uint8
8 - 32	FC Port Baud Rate	[2] 9600 Baud	1 set-up	TRUE	-	Uint8
8 - 33	FC Port Parity	[0] Even Parity 1 Stop Bit	1 set-up	TRUE	-	Uint8
8 - 35	Minimum Response Delay	0.01 s	1 set-up	TRUE	-3	Uint16
8 - 36	Max Response Delay	5 s	1 set-up	TRUE	-3	Uint16
8 - 50	Coasting Select	[3] Logic OR	All set-ups	TRUE	-	Uint8
8 - 51	Quick Stop Select	[3] Logic OR	All set-ups	TRUE	-	Uint8
8 - 52	DC Brake Select	[3] Logic OR	All set-ups	TRUE	-	Uint8
8 - 53	Start Select	[3] Logic OR	All set-ups	TRUE	-	Uint8
8 - 54	Reversing Select	[3] Logic OR	All set-ups	TRUE	-	Uint8
8 - 55	Set-up Select	[3] Logic OR	All set-ups	TRUE	-	Uint8
8 - 56	Preset Reference Select	[3] Logic OR	All set-ups	TRUE	-	Uint8
8 - 94	Bus feedback 1	0	All set-ups	TRUE	0	Int16

**5.2.14. 13-.\* Smart Logic**

Parameter Number	Parameter Description	Default Value	2 Setup	Change During Operation	Conversion Index	Type
13 - 00	SL Controller Mode	[0] Off	1 set-up	TRUE	-	UInt8
13 - 01	Start Event	[39] Start command	1 set-up	TRUE	-	UInt8
13 - 02	Stop Event	[40] Drive stopped	1 set-up	TRUE	-	UInt8
13 - 03	Reset SLC	[0] Do not reset	1 set-up	TRUE	-	UInt8
13 - 10	Comparator Operand	[0] Disabled	1 set-up	TRUE	-	UInt8
13 - 11	Comparator Operator	[1] ApproxEqual	1 set-up	TRUE	-	UInt8
13 - 12	Comparator Value	0	1 set-up	TRUE	-1	Int32
13 - 20	SL Controller Timer	0 s	1 set-up	TRUE	-1	UInt32
13 - 40	Logic Rule Boolean 1	[0] False	1 set-up	TRUE	-	UInt8
13 - 41	Logic Rule Operator 1	[0] Disabled	1 set-up	TRUE	-	UInt8
13 - 42	Logic Rule Boolean 2	[0] False	1 set-up	TRUE	-	UInt8
13 - 43	Logic Rule Operator 2	[0] Disabled	1 set-up	TRUE	-	UInt8
13 - 44	Logic Rule Boolean 3	[0] False	1 set-up	TRUE	-	UInt8
13 - 51	SL Controller Event	[0] False	1 set-up	TRUE	-	UInt8
13 - 52	SL Controller Action	[0] Disabled	1 set-up	TRUE	-	UInt8

### 5.2.15. 14-.\*.\* Special Functions

Parameter Number	Parameter Description	Default Value	2 Setup	Change During Operation	Conversion Index	Type
14 - 01	Switching Frequency	[1] 4.0 kHz	All set-ups	TRUE	-	Uint8
14 - 03	Overmodulation	[1] On	All set-ups	FALSE	-	Uint8
14 - 12	Function at Mains Imbalance	[0] Trip	All set-ups	TRUE	-	Uint8
14 - 20	Reset Mode	[0] Manual reset	All set-ups	TRUE	-	Uint8
14 - 21	Automatic Restart Time	10 s	All set-ups	TRUE	0	Uint16
14 - 22	Operation Mode	[0] Normal operation	1 set-up	TRUE	-	Uint8
14 - 26	Action At Inverter Fault	[0] Trip	All set-ups	TRUE	-	Uint8
14 - 41	AEO Minimum Magnetisation	66 %	All set-ups	TRUE	0	Uint8

**5.2.16. 15-.\*.\* Drive Information**

Parameter Number	Parameter Description	Default Value	2 Setup	Change During Operation	Conversion Index	Type
15 - 00	Operating Time	0	1 set-up	TRUE	0	Uint32
15 - 01	Running Hours	0	1 set-up	TRUE	0	Uint32
15 - 02	kWh Counter	0	1 set-up	TRUE	0	Uint32
15 - 03	Power Up's	0	1 set-up	TRUE	0	Uint32
15 - 04	Over Temp's	0	1 set-up	TRUE	0	Uint16
15 - 05	Over Volt's	0	1 set-up	TRUE	0	Uint16
15 - 06	Reset kWh Counter	[0] Do not reset	1 set-up	TRUE	-	Uint8
15 - 07	Reset Running Hours Counter	[0] Do not reset	1 set-up	TRUE	-	Uint8
15 - 30	Fault Log: Error Code	0	1 set-up	TRUE	0	Uint8
15 - 40	FC Type		1 set-up	FALSE	0	VisibleString
15 - 41	Power Section		1 set-up	FALSE	0	VisibleString
15 - 42	Voltage		1 set-up	FALSE	0	VisibleString
15 - 43	SW ID Control Card		1 set-up	FALSE	0	VisibleString
15 - 46	Frequency Converter Ordering No		1 set-up	FALSE	0	VisibleString
15 - 48	LCP Id No		1 set-up	FALSE	0	VisibleString
15 - 51	Frequency Converter Serial Number		1 set-up	FALSE	0	VisibleString

5.2.17. 16-.\*.\* Data Readouts

Parameter Number	Parameter Description	Default Value	2 Setup	Change During Operation	Conversion Index	Type
16 - 00	Control Word	0	1 set-up	TRUE	0	Uint16
16 - 01	Reference [Unit]	0	1 set-up	TRUE	-3	Int32
16 - 02	Reference %	0	1 set-up	TRUE	-1	Int16
16 - 03	Status Word	0	1 set-up	TRUE	0	Uint16
16 - 05	Main Actual Value [%]	0	1 set-up	TRUE	-2	Int16
16 - 10	Power [kW]	0	1 set-up	TRUE	-3	Uint16
16 - 11	Power [hp]	0	1 set-up	TRUE	-3	Uint16
16 - 12	Motor Voltage	0	1 set-up	TRUE	0	Uint16
16 - 13	Frequency	0	1 set-up	TRUE	-1	Uint16
16 - 14	Motor Current	0	1 set-up	TRUE	-2	Uint16
16 - 15	Frequency [%]	0	1 set-up	TRUE	-1	Uint16
16 - 18	Motor Thermal	0	1 set-up	TRUE	0	Uint8
16 - 30	DC Link Voltage	0	1 set-up	TRUE	0	Uint16
16 - 34	Heatsink Temp.	0	1 set-up	TRUE	0	Uint8
16 - 35	Inverter Thermal	0	1 set-up	TRUE	0	Uint8
16 - 36	Inv. Nom. Current	0	1 set-up	TRUE	-2	Uint16
16 - 37	Inv. Max. Current	0	1 set-up	TRUE	-2	Uint16
16 - 38	SL Controller State	0	1 set-up	TRUE	0	Uint8
16 - 50	External Reference	0	1 set-up	TRUE	-1	Int16
16 - 51	Pulse Reference	0	1 set-up	TRUE	-1	Int16
16 - 52	Feedback [Unit]	0	1 set-up	TRUE	-3	Int32
16 - 60	Digital input 18,19,27,33	0	1 set-up	TRUE	0	Uint16
16 - 61	Digital input 29	0	1 set-up	TRUE	0	Uint16
16 - 62	Analog Input 53 (V)	0	1 set-up	TRUE	-2	Uint16
16 - 63	Analog Input 53 (mA)	0	1 set-up	TRUE	-2	Uint16
16 - 64	Analog Input 60	0	1 set-up	TRUE	-2	Uint16
16 - 65	Analog Output 42 [mA]	0	1 set-up	TRUE	-2	Uint16
16 - 68	Pulse input 33	20	1 set-up	TRUE	0	Uint16
16 - 71	Relay Output [bin]	0	1 set-up	TRUE	0	Uint8
16 - 72	Counter A	0	1 set-up	TRUE	0	Int16
16 - 73	Counter B	0	1 set-up	TRUE	0	Int16
16 - 86	FC Port REF 1	0	1 set-up	TRUE	0	Int16
16 - 90	Alarm Word	0	1 set-up	TRUE	0	Uint32
16 - 92	Warning Word	0	1 set-up	TRUE	0	Uint32
16 - 94	Ext. Status Word	0	1 set-up	TRUE	0	Uint32



## 6. Troubleshooting

No.	Description	Warning	Alarm	Trip Lock	Error	Cause of Problem
2	Live zero error	X	X			Signal on terminal 53 or 60 is less than 50% of value set in par. 6-10, 6-12 and 6-22.
4	Mains phase loss <sup>1)</sup>	X	X	X		Missing phase on supply side, or too high voltage imbalance. Check supply voltage.
7	DC over voltage <sup>1)</sup>	X	X			Intermediate circuit voltage exceeds limit.
8	DC under voltage <sup>1)</sup>	X	X			Intermediate circuit voltage drops below "voltage warning low" limit.
9	Inverter overloaded	X	X			More than 100% load for too long.
10	Motor ETR over temperature	X	X			Motor is too hot due to more than 100% load for too long.
11	Motor thermistor over temperature	X	X			Thermistor or thermistor connection is disconnected.
12	Torque limit	X				Torque exceeds value set in either par. 4-16 or 4-17.
13	Over Current	X	X	X		Inverter peak current limit is exceeded.
14	Earth fault		X	X		Discharge from output phases to ground.
16	Short Circuit		X	X		Short-circuit in motor or on motor terminals.
17	Control word timeout	X	X			No communication to frequency converter.
25	Brake resistor short-circuited	X	X	X		Brake resistor is short-circuited, thus brake function is disconnected.
27	Brake chopper short-circuited	X	X	X		Brake transistor is short-circuited, thus brake function is disconnected.
28	Brake check		X			Brake resistor is not connected/working
29	Power board over temp	X	X	X		Heat-sink cut-out temperature has been reached.
30	Motor phase U missing		X	X		Motor phase U is missing. Check the phase.
31	Motor phase V missing		X	X		Motor phase V is missing. Check the phase.
32	Motor phase W missing		X	X		Motor phase W is missing. Check the phase.
38	Internal fault		X	X		Contact local Danfoss supplier.
47	Control Voltage Fault	X	X	X		24 V DC may be overloaded.
51	AMT check $I_{nom}$ and $I_{nom}$		X			Wrong setting for motor voltage and/or motor current.
52	AMT low $I_{nom}$		X			Motor current is too low. Check settings.
59	Current limit	X				VLTR overload.
63	Mechanical Brake Low		X			Actual motor current has not exceeded "release brake" current within "start delay" time window.
80	Drive Initialised to Default Value		X			All parameter settings are initialized to default settings.
84	The connection between drive and LCP is lost				X	No communication between LCP and frequency converter
85	Button disabled				X	See parameter group 0-4* LCP
86	Copy fail				X	An error occurred while copying from frequency converter to LCP or vice versa.
87	LCP data invalid				X	Occurs when copying from LCP if the LCP contains erroneous data - or if no data was uploaded to the LCP.
88	LCP data not compatible				X	Occurs when copying from LCP if data are moved between frequency converters with major differences in software versions.
89	Parameter read only				X	Occurs when trying to write to a read-only parameter.
90	Parameter database busy				X	LCP and RS485 connection are trying to update parameters simultaneously.
91	Parameter value is not valid in this mode				X	Occurs when trying to write an illegal value to a parameter.
92	Parameter value exceeds the min/max limits				X	Occurs when trying to set a value outside the range.
nw run	Not While RUNNING				X	Parameter can only be changed when the motor is stopped.
Err.	A wrong password was entered				X	Occurs when using a wrong password for changing a password-protected parameter.

<sup>1)</sup> These faults may be caused by mains distortions. Installing Danfoss Line Filter may rectify this problem.

Table 6.1: Code list

### 6.1.1. Alarm, Warning and Extended Status Word

Bit	Hex	Dec	Par 1690	Par 1692	Par 1694
			AlarmWord	WarningWord	ExtendedStatusWord
0	1	1	Brake check		Ramping
1	2	2	Pwr.card temp	Pwr.card temp	
2	4	4	Earth Fault		Start CW/CCW
3	8	8			Slow down
4	10	16	Ctrl.word TO	Ctrl.word TO	Catch up
5	20	32	Over Current	Over Current	
6	40	64		Torque limit	
7	80	128	Motor th over	Motor th over	Output current high
8	100	256	Motor ETR over	Motor ETR over	Output current low
9	200	512	Inverter overload	Inverter overload	
10	400	1024	DC under volt	DC under volt	
11	800	2048	DC over volt	DC over volt	
12	1000	4096	Short Circuit		
13	2000	8192			Braking
14	4000	16384	Mains ph. loss	Mains ph. loss	
15	8000	32768	"AMT Not OK"		OVC active
16	10000	65536	Live zero error	Live zero error	AC brake
17	20000	131072	Internal fault		
18	40000	262144			
19	80000	524288	U phase loss		
20	100000	1048576	V phase loss		
21	200000	2097152	W phase loss		
22	400000	4194304			
23	800000	8388608	Control Voltage Fault		
24	1000000	16777216			
25	2000000	33554432		Current limit	
26	4000000	67108864	Brake resistor shortcircuit		
27	8000000	134217728	Brake IGBT shortcircuit		
28	10000000	268435456		MotorPhaseMissing	
29	20000000	536870912	Drive initialised		
30	40000000	1073741824		Undefined	
31	80000000	2147483648	Mech. brake low		DatabaseBusy

## Index

### A

Abbreviations And Standards	6
Active Set-up	7, 53
Active Set-up	34
Active Set-up	11, 12, 13, 63, 68

### B

Brake Resistor	23, 35
Brake Resistor	70
Brake Resistor (ohm)	63
Brake Resistor Short-circuited	81

### D

Dc-brake	20, 22, 33, 64
Dc-brake	63
Display	7
Disposal Instruction	4
Drive Identification, 15-4*	58

### E

Earth Leakage Current	3, 4
Edit Set-up	7
Edit Set-up	11, 12, 13, 63, 68
Electronic Waste	4

### G

General Warning	6
-----------------	---

### H

Hand Mode	64
Hand Mode	40
Hand Mode	11, 15, 35, 69

### I

Indicator Lights	8
Isolated Mains Source	4
It Mains	4

### L

Leakage Current	4
Load Compensation	19, 63, 69
Load Compensations	15

### M

Main Menu	8
Motor Direction	8
Motor Overload Protection	4
Motor Phase	60
Motor Phase	31, 64, 72
Motor Status	59
Motor Temperature	21, 23
Motor Temperature	63

### N

Navigation Keys	9
Not Changeable During Operation	12

**O**

Operation Keys	9
Over-voltage Control	23, 63, 70

**P**

Parameter Number	8
------------------	---

**Q**

Quick Menu	8
------------	---

**R**

Rated Magnetizing Current	18
Readout Mode	8
Residual Current Device	4

**S**

Serial Communication	9, 29, 35, 44, 46, 47, 59, 62
Set-up Number	7
Set-up Software	7
Slip Compensation	19, 63, 69
Special Functions	55
Status Menu	8

**T**

Thermal Load	18, 60
Thermistor	21
Thermistor	63
Thermistor Resource	69
Trip Reset, 14-2*	55
Type Code String	5

**U**

Unit	8
------	---

**V**

Value	8
-------	---