



# Programming Guide

VLT® Micro Drive

Contents

<b>1 Safety</b>	<b>3</b>
1.1.1 High Voltage Warning	3
1.1.2 Safety Instructions	3
1.1.3 Software Version and Approvals	3
1.1.4 General Warning	3
1.1.5 IT Mains	4
1.1.6 Avoid unintended Start	4
1.1.8 Before Commencing Repair Work	4
<b>2 Introduction</b>	<b>5</b>
2.1.1 FC Identification	5
2.1.2 Type Code	6
<b>3 Programming</b>	<b>8</b>
3.1 How to Programme	8
3.1.1 Programming with MCT-10 Set-up Software	8
3.1.2 Programming with the LCP 11 or LCP 12	8
3.2 Status Menu	9
3.3 Quick Menu	10
3.4 Main Menu	10
<b>4 Parameter Descriptions</b>	<b>11</b>
4.1 Parameter Group 0: Operation/Display	11
4.2 Parameter Group 1: Load/Motor	14
4.3 Parameter Group 2: Brakes	19
4.4 Parameter Group 3: Reference/Ramps	21
4.5 Parameter Group 4: Limits/Warnings	25
4.6 Parameter Group 5: Digital In/Out	28
4.7 Parameter Group 6: Analogue In/Out	32
4.8 Parameter Group 7: Controllers	36
4.9 Parameter Group 8: Communication	37
4.10 Parameter Group 13: Smart Logic	40
4.11 Parameter Group 14: Special Functions	45
4.12 Parameter Group 15: Drive Information	47
4.13 Parameter Group 16: Data Readouts	48
<b>5 Parameter Lists</b>	<b>50</b>
5.1.1 Conversion Index	54
5.1.2 Change during operation	54
5.1.3 2-Set-up	54

5.1.4 Type	54
5.1.5 0-** Operation/Display	55
5.1.6 1-** Load/Motor	55
5.1.7 2-** Brakes	55
5.1.8 3-** Reference/Ramps	56
5.1.9 4-** Limits/Warnings	56
5.1.10 5-** Digital In/Out	56
5.1.11 6-** Analog In/Out	57
5.1.12 7-** Controllers	57
5.1.13 8-** Comm. and Options	57
5.1.14 13-** Smart Logic	58
5.1.15 14-** Special Functions	58
5.1.16 15-** Drive Information	58
5.1.17 16-** Data Readouts	59
<b>6 Troubleshooting</b>	<b>60</b>
6.1.1 Alarm, Warning and Extended Status Word	62
<b>Index</b>	<b>66</b>

# 1 Safety

## 1.1.1 High Voltage Warning

### **⚠ WARNING**

The voltage of the frequency converter is dangerous whenever it is connected to mains. Incorrect installation of the motor or frequency converter may cause damage to the equipment, serious injury or death. Consequently, it is essential to comply with the instructions in this manual as well as local and national rules and safety regulations.

## 1.1.2 Safety Instructions

### **CAUTION**

Prior to using functions directly or indirectly influencing personal safety (e.g. Safe Stop, Fire Mode or other functions either forcing the motor to stop or attempting to keep it functioning) a thorough risk analysis and system test must be carried through. The system tests must include testing failure modes regarding the control signaling (analog and digital signals and serial communication).





### **NOTE**

Before using Fire Mode, contact Danfoss

- Make sure the frequency converter is properly connected to earth.
- Do not remove mains connections, motor connections or other power connections while the frequency converter is connected to power.
- Protect users against supply voltage.
- Protect the motor against overloading according to national and local regulations.
- The earth leakage current exceeds 3.5mA.
- The [OFF] key is not a safety switch. It does not disconnect the frequency converter from mains.

## 1.1.3 Software Version and Approvals

Software Version  
Programming Guide  
VLT® Micro Drive FC 51  
FC 51 Series

This Programming Guide can be used for all VLT® Micro Drive FC 51 frequency drives with software version 2.6X.  
The software version number can be read in *15-43 Software Version*.

## 1.1.4 General Warning

### **⚠ WARNING**

#### Warning

Touching the electrical parts may be fatal - even after the equipment has been disconnected from mains. Also make sure that other voltage inputs have been disconnected (linkage of DC intermediate circuit). Be aware that there may be high voltage on the DC link even when the LEDs are turned off. Before touching any potentially live parts of the frequency converter, wait at least 4 min for all sizes. Shorter time is allowed only if indicated on the nameplate for the specific unit.

**CAUTION**

**Leakage Current**

The earth leakage current from the frequency converter exceeds 3.5 mA. According to IEC 61800-5-1 a reinforced Protective Earth connection must be ensured by means of a min. 10mm<sup>2</sup> Cu or an additional PE wire - with the same cable cross section as the Mains wiring - must be terminated separately.

**Residual Current Device**

This product can cause a DC current in the protective conductor. Where a residual current device (RCD) is used for extra protection, only an RCD of Type B (time delayed) shall be used on the supply side of this product. See also Danfoss Application Note on RCD, MN.90.GX.YY. Protective earthing of the frequency converter and the use of RCDs must always follow national and local regulations.

**CAUTION**

Motor overload protection is possible by setting 1-90 Motor Thermal Protection to the value ETR trip. For the North American market: ETR functions provide class 20 motor overload protection, in accordance with NEC.

**WARNING**

**Installation in high altitudes:**

For altitudes above 2km, please contact Danfoss regarding PELV.

1.1.5 IT Mains

**CAUTION**

**IT Mains**

Installation on isolated mains source, i.e. IT mains.  
Max. supply voltage allowed when connected to mains: 440 V.

As an option, Danfoss offers line filters for improved harmonics performance.

1.1.6 Avoid unintended Start

While the frequency converter is connected to mains, the motor can be started/stopped using digital commands, bus commands, references or via the Local Control Panel.

- Disconnect the frequency converter from mains whenever personal safety considerations make it necessary to avoid unintended start of any motors.
- To avoid unintended start, always activate the [OFF] key before changing parameters.

1.1.7 Disposal Instruction

	<p>Equipment containing electrical components must not be disposed of together with domestic waste.</p> <p>It must be separately collected with electrical and electronic waste according to local and currently valid legislation.</p>
--	---

1.1.8 Before Commencing Repair Work

1. Disconnect FC 51 from mains (and external DC supply, if present.)
2. Wait for 4 minutes (M1, M2 and M3) and 15 minutes (M4 and M5) for discharge of the DC-link.
3. Disconnect DC bus terminals and brake terminals (if present)
4. Remove motor cable

## 2 Introduction

### 2.1.1 FC Identification

Below is an example of the frequency converter nameplate sticker. This sticker is located on the top of each frequency converter and shows the ratings, serial number, warnings catalog number, and other relevant data for each unit. See *Table 2.1* for details, how to read the Type code string.

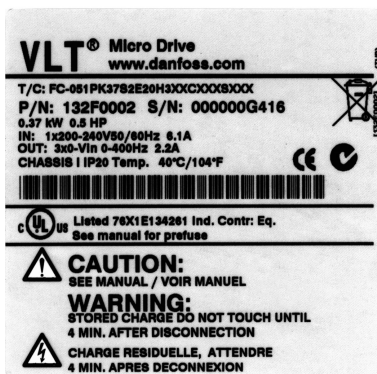

130BA505

Illustration 2.1 This example shows the identification sticker.

2.1.2 Type Code

2

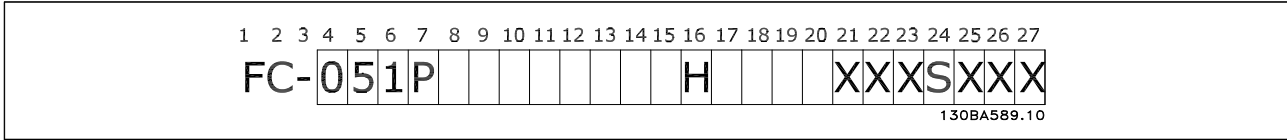

Description	Pos.	Possible choice
Product group	1-3	Adjustable Frequency converters
Series and product type	4-6	Micro Drive
Power size	7-10	0.18 - 7.5kW
Mains voltage	11-12	S2: Single phase 200 - 240V AC T 2: Three phase 200 - 240V AC T 4: Three phase 380 - 480V AC
Enclosure	13-15	IP20/Chassis
RFI filter	16-17	HX: No RFI filter H1: RFI filter class A1/B H3:RFI filter A1/B (reduced cable length*)
Brake	18	B: Brake chopper included (from 1.5kW and up) X: No brake chopper included
Display	19	X: No Local Control Panel N: Numerical Local Control Panel (LCP) P: Numerical Local Control Panel (LCP) with potentiometer
Coating PCB	20	C: Coated PCB X: No coated PCB
Mains option	21	X: No mains option
Adaptation A	22	X: No adaptation
Adaptation B	23	X: No adaptation
Software release	24-27	SXXX: Latest release - std. software

**Table 2.1 Type Code Description**

\*See VLT® Micro Drive FC 51 Design Guide, MG02K1YY

### 2.1.3 Warnings and Approvals

Symbols used in this Programming Guide.

#### Symbols

The following symbols are used in this manual.



Indicates a potentially hazardous situation which, if not avoided, could result in death or serious injury.



Indicates a potentially hazardous situation which, if not avoided, may result in minor or moderate injury. It may also be used to alert against unsafe practices.

#### CAUTION

Indicates a situation that may result in equipment or property-damage-only accidents.

### 2.1.4 Abbreviations and Standards

Abbreviations	Terms	SI-units	I-P units
a	Acceleration	m/s <sup>2</sup>	ft/s <sup>2</sup>
AWG	American wire gauge		
Auto Tune	Automatic Motor Tuning		
°C	Celsius		
I	Current	A	Amp
I <sub>LIM</sub>	Current limit		
IT mains	Mains supply with star point in transformer floating to ground		
Joule	Energy	J = N·m	ft-lb, Btu
°F	Fahrenheit		
FC	Frequency converter		
f	Frequency	Hz	Hz
kHz	Kilohertz	kHz	kHz
LCP	Local Control Panel		
mA	Milliampere		
ms	Millisecond		
min	Minute		
MCT	Motion Control Tool		
M-TYPE	Motor Type Dependent		
Nm	Newton Metres		in-lbs
I <sub>M,N</sub>	Nominal motor current		
f <sub>M,N</sub>	Nominal motor frequency		
P <sub>M,N</sub>	Nominal motor power		
U <sub>M,N</sub>	Nominal motor voltage		
PELV	Protective Extra Low Voltage		
Watt	Power	W	Btu/hr, hp
Pascal	Pressure	Pa = N/m <sup>2</sup>	psi, psf, ft of water
I <sub>INV</sub>	Rated Inverter Output Current		
RPM	Revolutions Per Minute		
SR	Size Related		
T	Temperature	C	F
t	Time	s	s,hr
T <sub>LIM</sub>	Torque limit		
U	Voltage	V	V

Table 2.2 Abbreviation and Standards Table



### 3 Programming

#### 3.1 How to Programme

3

##### 3.1.1 Programming with MCT-10 Set-up Software

The frequency converter can be programmed from a PC via RS485 com-port by installing the MCT-10 Set-up Software.

This software can either be ordered using code number 130B1000 or downloaded from the Danfoss Web site: [www.danfoss.com](http://www.danfoss.com), Business Area: Motion Controls.

Please refer to manual MG.10.RX.YY.

##### 3.1.2 Programming with the LCP 11 or LCP 12

The LCP is divided into four functional groups:

1. Numeric display.
2. Menu key.
3. Navigation keys.
4. Operation keys and indicator lights (LEDs).

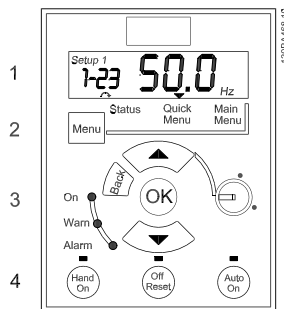

Illustration 3.1 LCP 12 with Potentiometer

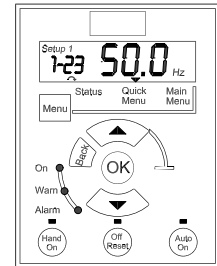

Illustration 3.2 LCP 11 without Potentiometer

**The display:**

Different information can be read from the display.

**Set-up number** shows the active set-up and the edit set-up. If the same set-up acts as both active and edit set-up, only that set-up number is shown (factory setting). When active and edit set-up differ, both numbers are shown in the display (Setup 12). The number flashing, indicates the edit set-up.

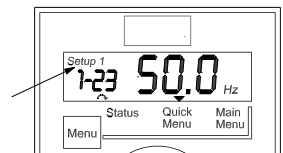

Illustration 3.3 Indicating Set-up

The small digits to the left are the selected **parameter number**.

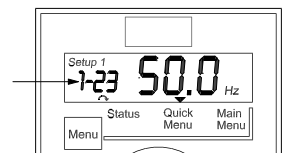

Illustration 3.4 Indicating Selected Parameter No.

The large digits in the middle of the display show the **value** of the selected parameter.



Illustration 3.5 Indicating Value of Selected Parameter.

The right side of the display shows the **unit** of the selected parameter. This can be either Hz, A, V, kW, HP, %, s or RPM.



Illustration 3.6 Indicating Unit of Selected Parameter.

**Motor direction** is shown to the bottom left of the display - indicated by a small arrow pointing either clockwise or counterclockwise.



Illustration 3.7 Indicating Motor Direction

Use the [MENU] key to select one of the following menus

**Status Menu:**

The Status Menu is either in *Readout Mode* or *Hand on Mode*. In *Readout Mode* the value of the currently selected readout parameter is shown in the display.

In *Hand on Mode* the local LCP reference is displayed.

**Quick Menu:**

Displays Quick Menu parameters and their settings. Parameters in the Quick Menu can be accessed and edited from here. Most applications can be run by setting the parameters in the Quick Menus.

**Main Menu:**

Displays Main Menu parameters and their settings. All parameters can be accessed and edited here. See *5 Parameter Lists* for parameter overview.

**Indicator lights:**

- Green LED: The frequency converter is on.
- Yellow LED: Indicates a warning. Please see section *Troubleshooting*
- Flashing red LED: Indicates an alarm. Please see section *Troubleshooting*

**Navigation Keys:**

**[Back]:** For moving to the previous step or layer in the navigation structure.

**Arrows [▲] [▼]:** For maneuvering between parameter groups, parameters and within parameters.

**[OK]:** For selecting a parameter and for accepting changes to parameter settings.

**Operation Keys:**

A yellow light above the operation keys indicates the active key.

**[Hand on]:** Starts the motor and enables control of the frequency converter via the LCP.

**[Off/Reset]:** The motor stops except in alarm mode. In that case the motor will be reset.

**[Auto on]:** The frequency converter is controlled either via control terminals or serial communication.

**[Potentiometer] (LCP12):** The potentiometer works in two ways depending on the mode in which the frequency converter is running.

In *Auto Mode* the potentiometer acts as an extra programmable analog input.

In *Hand on Mode* the potentiometer controls local reference.

3.2 Status Menu

After power up the Status Menu is active. Use the [MENU] key to toggle between Status, Quick Menu and Main Menu.

Arrows [▲] and [▼] toggles between the choices in each menu.

The display indicates the status mode with a small arrow above "Status".

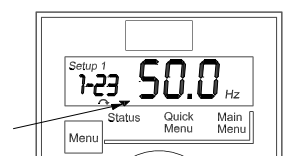

Illustration 3.8 Indicating Status Mode

### 3.3 Quick Menu

The Quick Menu gives easy access to the most frequently used parameters.

3

1. To enter the Quick Menu, press [Menu] key until indicator in display is placed above *Quick Menu*.
2. Use [▲] [▼] to select either QM1 or QM2, then press [OK].
3. Use [▲] [▼] to browse through the parameters in the Quick Menu.
4. Press [OK] to select a parameter.
5. Use [▲] [▼] to change the value of a parameter setting.
6. Press [OK] to accept the change.
7. To exit, press either [Back] twice to enter *Status*, or press [Menu] once to enter *Main Menu*.



Illustration 3.9 Indicating Quick Menu Mode

### 3.4 Main Menu

The Main Menu gives access to all parameters.

1. To enter the Main Menu, press [Menu] key until indicator in display is placed above *Main Menu*.
2. Use [▲] [▼] to browse through the parameter groups.
3. Press [OK] to select a parameter group.
4. Use [▲] [▼] to browse through the parameters in the specific group.
5. Press [OK] to select the parameter.
6. Use [▲] [▼] to set/change the parameter value.
7. Press [OK] to accept the value.
8. To exit, press either [Back] twice to enter *Quick Menu*, or press [Menu] once to enter *Status*.



Illustration 3.10 Indicating Main Menu Mode

## 4 Parameter Descriptions

### 4.1 Parameter Group 0: Operation/Display

#### 0-03 Regional Settings

Option:	Function:
	In order to meet the needs for different default settings in different parts of the world, <i>0-03 Regional Settings</i> , is implemented in the frequency converter. The selected setting influences the default setting of the motor nominal frequency.
[0] *	International Sets default of <i>1-23 Motor Frequency</i> , to 50 Hz, shows <i>1-20 Motor Power</i> in kW.
[1]	US Sets default of <i>1-23 Motor Frequency</i> , to 60 Hz, shows <i>1-20 Motor Power</i> in HP. <b>NOTE</b> This parameter cannot be changed while motor runs.

#### 0-04 Operating State at Power-up (Hand Mode)

Option:	Function:
	This parameter controls whether or not the frequency converter start running the motor when powering up after a power down in Hand mode. <b>NOTE</b> If LCP with potentiometer is mounted, reference is set according to actual potentiometer value.
[0]	Resume Frequency converter starts in same Hand or Off State as when powered off. Local reference is stored and used after power-up.
[1] *	Forced Stop, Ref=Old Frequency converter powers up in Off State meaning that motor is stopped after power up. Local reference is stored and used after power-up.
[2]	Forced Stop, Ref=0 Frequency converter powers up in Off State meaning that motor is stopped after power up. Local reference is set to 0. Thus motor will not start running before local reference has been increased.

#### 4.1.1 0-1\* set-up Handling

User-defined parameters and miscellaneous external inputs (eg. bus, LCP, analog/digital inputs, feedback, etc.) controls the functionality of the frequency converter.

A complete set of all parameters controlling the frequency converter is called a set-up. The frequency converter contains 2 set-ups, *Set-up1* and *Set-up 2*. Furthermore, a fixed set of factory settings can be copied into one or more set-ups.

Some of the advantages of having more than one set-up in the frequency converter are

- Run motor in one set-up (Active Set-up) while updating parameters in another set-up (Edit Set-up)
- Connect various motors (one at a time) to frequency converter. Motor data for various motors can be placed in different set-ups.
- Rapidly change settings of frequency converter and/or motor while motor is running (eg. ramp time or preset references) via bus or digital inputs.

The *Active Set-up* can be set as *Multi Set-up* where the active set-up is selected via input on a digital input terminal and/or via the bus control word.

#### NOTE

**Factory Set-up cannot be used as Active Set-up.**

#### 0-10 Active Set-up

Option:	Function:
	<p><i>Active Set-up</i> controls the motor. Shifts between set-ups can only happen when</p> <ul style="list-style-type: none"> <li>• the motor is coasted</li> </ul> <p>OR</p> <ul style="list-style-type: none"> <li>• the set-ups between which the shift happens are linked to each other (see <i>0-12 Linked Set-ups</i>). <p>If changing between set-ups that are not linked, the change will not happen before motor is coasted.</p> <p><b>NOTE</b> The motor is only considered stopped when it is coasted.</p> </li></ul>

**0-10 Active Set-up**

Option:	Function:
[1 ] * Set-up 1	Set-up 1 is active.
[2] Set-up 2	Set-up 2 is active.
[9] Multi Set-up	Select the active set-up via digital input and/or bus, see 5-1* <i>Digital Inputs</i> choice [23].

**0-11 Edit Set-up**

Option:	Function:
	The <i>Edit Set-up</i> is for updating parameters in the frequency converter from either LCP or bus. It can be identical or different from the <i>Active Set-up</i> . All set-ups can be edited during operation, independently of the active set-up.
[1 ] * Set-up 1	Update parameters in <i>Set-up 1</i> .
[2] Set-up 2	Update parameters in <i>Set-up 2</i> .
[9] Active Set-up	Update parameters in set-up selected as <i>Active Set-up</i> (see 0-10 <i>Active Set-up</i> ).

**0-12 Link Set-ups**

Option:	Function:
	The link ensures synchronizing of the “not changeable during operation ” parameter values enabling shift from one set-up to another during operation. If the set-ups are not linked, a change between them is not possible while the motor is running. Thus the set-up change does not occur until the motor is coasted.
[0] Not linked	Leaves parameters unchanged in both set-ups and cannot be changed while motor runs.
[1 ] * Linked	Copy parameters “not changeable during operation” parameter values into presently selected <i>Edit Set-up</i> . <b>NOTE</b> This parameter cannot be changed while motor runs.

**0-31 Custom Readout Min Scale**

Range:	Function:
0.00 * [0.00 – 9999.00 ]	It is possible to create a customized readout related to the output frequency of the unit. The value entered in 0-31 <i>Custom Readout Min Scale</i> will be shown at 0 Hz. The readout can be shown in the LCP display when in Status Mode or it can be read in 16-09 <i>Custom Readout</i>

**0-32 Custom Readout Max Scale**

Range:	Function:
100.0* [0.00 – 9999.00]	It is possible to create a customized readout related to the output frequency of the unit. The value entered in 0-32 <i>Custom Readout Max Scale</i> will be shown at the frequency programmed in 4-14 <i>Motor Speed High Limit</i> . The readout can be shown in the LCP display when in Status Mode or it can be read in 16-09 <i>Custom Readout</i>

**4.1.2 0-4\* LCP**

The frequency converter can operate in the following three modes: *Hand*, *Off* and *Auto*.

*Hand*: The frequency converter is locally operated and does not allow any remote control. By activating Hand a start signal is given.

*Off*: The frequency converter stops with a normal stop ramp. When Off is chosen the frequency converter can only be started by pressing either Hand or Auto on the LCP.

*Auto*: In Auto-mode the frequency converter can be remote controlled (bus/digital).

**0-40 [Hand on] Key on LCP**

Option:	Function:
[0] Disabled	Hand-on key has no function.
[1 ] * Enabled	Hand-on key is functional.

**0-41 [Off/Reset] Key on LCP**

Option:	Function:
[0] Disable Off/Reset	Off/reset key has no function.
[1 ] * Enable Off/Reset	Stop signal and reset of any faults.
[2] Enable Reset Only	Reset only. Stop (Off) function is disabled.

**0-42 [Auto on] Key on LCP**

Option:	Function:
[0] Disabled	Auto-on key has no function.
[1 ] * Enabled	Auto-on key is functional.

### 4.1.3 0-5\* Copy/Save

0-50 LCP Copy		
Option:	Function:	
	The detachable LCP of the frequency converter can be used for storing setups, and thus for transferring data when moving parameter settings from one frequency converter to another. <b>NOTE</b> <i>LCP Copy can only be activated from the LCP and ONLY when the motor is coasted.</i>	
[1]	All to LCP	Copy all setups from the frequency converter into the LCP.
[2]	All from LCP	Copy all setups from LCP to frequency converter.
[3]	Size independent from LCP	Copy non motor size dependent data from LCP to frequency converter

0-51 Set-up Copy		
Option:	Function:	
	Use this function to copy a set-up content into the <i>Edit Set-up</i> . In order to be able to make a set-up copy ensure that <ul style="list-style-type: none"> <li>the motor is coasted</li> <li>0-10 <i>Active Set-up, Active Set-up</i>, is set to either <i>Set-up 1</i> [1] or <i>Set-up 2</i> [2]</li> </ul> <b>NOTE</b> The keyboard/parameter database are blocked while <i>Set-up Copy</i> is running.	
[0] *	No Copy	Copy function is inactive
[1]	Copy from Set-up 1	Copy from <i>Set-up 1</i> to edit set-up chosen in <i>0-11 Edit Set-up</i> .
[2]	Copy from Set-up 2	Copy from <i>Set-up 2</i> to edit set-up chosen in <i>0-11 Edit Set-up</i> .
[9]	Copy from Factory Set-up	Copy from Factory Settings to edit set-up chosen in <i>0-11 Edit set-up</i> .

### 4.1.4 0-6\* Password

0-60 (Main) Menu Password		
Range:	Function:	
	Use password for protection against unintended change of sensitive parameters, eg. motor parameters.	
0 *	[0 - 999]	Enter the password for access to Main Menu via the [Main Menu] key. Select the number that should allow for changing other parameter values. 0 means there is no password.

#### NOTE

A password has affect on the LCP - not on the bus communication.

#### NOTE

Pressing buttons [MENU], [OK] and down will unlock the password. This will automatically enter the parameter editing screen in Quick Menu or Main Menu.

0-61 Access to Main/Quick Menu w/o Password		
Option:	Function:	
[0] *	Full access	Select Full Access [0] to disable the password in <i>0-60 (Main) Menu Password</i> .
[1]	LCP: Read Only	Select Read Only [1] to block unauthorized editing of Main/Quick menu parameter.
[2]	LCP: No Access	Select No Access [2] to block unauthorized editing and viewing of Main/Quick menu parameter.

## 4.2 Parameter Group 1: Load/Motor

### 1-00 Configuration Mode

**Option:**      **Function:**

		Use this parameter for selecting the application control principle to be used when a Remote Reference is active. <b>NOTE</b> Changing this parameter will reset 3-00 Reference Range, 3-02 Minimum Reference and 3-03 Maximum Reference to their default values. <b>NOTE</b> This parameter cannot be adjusted while motor runs.
[0] *	Speed Open Loop	For normal speed control (References).
[3]	Process Closed Loop	Enables process closed loop control. See parameter group 7-3* Process PI Control for further information on PI-controller.

### 1-01 Motor Control Principle

**Option:**      **Function:**

[0]	U/f	Is used for parallel connected motors and/or special motor applications. The U/f settings are set in 1-55 U/f Characteristic -U and 1-56 U/f Characteristic -F. <b>NOTE</b> When running U/f control slip- and load compensations are not included.
[1] *	VVC+	Normal running mode, including slip- and load compensations.

### 1-03 Torque Characteristics

**Option:**      **Function:**

		With more torque characteristics it is possible to run low energy consuming, as well as high torque applications.
[0] *	Constant Torque	Motor shaft output provides constant torque under variable speed control.
[2]	Automatic Energy Optimisation	This function automatically optimizes energy consumption in centrifugal pump and fan applications. See 14-41 AEO Minimum Magnetisation.

### 1-05 Hand Mode Configuration

**Option:**      **Function:**

		This parameter is only relevant when 1-00 Configuration Mode is set to Process Closed Loop [3]. The parameter is used for determining the reference or setpoint handling when changing from Auto Mode to Hand Mode on the LCP.
[0]	Speed Open Loop	In Hand Mode the drive always runs in Open Loop configuration regardless of setting in 1-00 Configuration Mode. Local potentiometer (if present) or Arrow up/down determines output frequency limited by Motor Speed High/Low

### 1-05 Hand Mode Configuration

**Option:**      **Function:**

		Limit (4-14 Motor Speed High Limit and 4-12 Motor Speed Low Limit).
[2] *	As configuration in 1-00 Configuration Mode.	If 1-00 Configuration Mode is set to Open Loop [1] function is as described above. If 1-00 Configuration Mode is set to Process Closed Loop [3] changing from Auto mode to Hand mode results in a setpoint change via local potentiometer or Arrow up/down. The change is limited by Reference Max/Min (3-02 Minimum Reference and 3-03 Maximum Reference).

#### 4.2.1 1-2\* Motor Data

Enter the correct motor nameplate data (power, voltage, frequency, current and speed).

Run AMT, see 1-29 Automatic Motor Tuning (AMT).

Factory settings for advanced motor data, parameter group 1-3\* Adv. Motor Data, are automatically calculated.

#### NOTE

Parameters in parameter group 1.2\* Motor Data cannot be adjusted while motor runs.

### 1-20 Motor Power [kW]/[HP] (P<sub>m,n</sub>)

**Option:**      **Function:**

		Enter motor power from nameplate data. Two sizes down, one size up from nominal VLT rating.
[1]	0.09 kW/0.12 HP	
[2]	0.12 kW/0.16 HP	
[3]	0.18kW/0.25 HP	
[4]	0.25 kW/0.33 HP	
[5]	0.37kW/0.50 HP	
[6]	0.55 kW/0.75 HP	
[7]	0.75 kW/1.00 HP	
[8]	1.10 kW/1.50 HP	
[9]	1.50 kW/2.00 HP	
[10]	2.20 kW/3.00 HP	
[11]	3.00 kW/4.00 HP	
[12]	3.70 kW/5.00 HP	
[13]	4.00 kW/5.40 HP	
[14]	5.50 kW/7.50 HP	
[15]	7.50 kW/10.0 HP	
[16]	11.00 kW/15.00 HP	
[17]	15.00 kW/20.00 HP	
[18]	18.50 kW/25.00 HP	
[19]	22.00 kW/29.50 HP	
[20]	30.00 kW/40.00 HP	

**NOTE**

Changing this parameter affects parameters 1-22 Motor Voltage to 1-25 Motor Frequency, 1-30 Stator Resistance, 1-33 Stator Leakage Reactance and 1-35 Main Reactance.

1-22 Motor Voltage (U <sub>m,n</sub> )		
<b>Range:</b>	<b>Function:</b>	
230/400 V [50 - 999 V]	Enter motor voltage from nameplate data.	

1-23 Motor Frequency (f <sub>m,n</sub> )		
<b>Range:</b>	<b>Function:</b>	
50 Hz* [20-400 Hz]	Enter motor frequency from nameplate data.	

1-24 Motor Current (I <sub>m,n</sub> )		
<b>Range:</b>	<b>Function:</b>	
M-type dependent* [0.01 - 100.00 A]	Enter motor current from nameplate data.	

1-25 Motor Nominal Speed (n <sub>m,n</sub> )		
<b>Range:</b>	<b>Function:</b>	
M-type Dependent* [100 - 9999 RPM]	Enter motor nominal speed from nameplate data.	

**1-29 Automatic Motor Tuning (AMT)**

Option:	Function:
	Use AMT to optimize motor performance. <b>NOTE</b> This parameter cannot be changed while motor runs.  <ol style="list-style-type: none"> <li>Stop the frequency converter - make sure motor is at standstill</li> <li>Choose [2] Enable AMT</li> <li>Apply start signal - Via LCP: Press [Hand On] - Or in Remote On mode: Apply start signal on terminal 18</li> </ol>
[0] *	Off AMT function is disabled.
[2]	Enable AMT <b>NOTE</b> To gain optimum tuning of frequency converter, run AMT on a cold motor.

4.2.2 1-3\* Adv. Motor Data

Adjust advanced motor data using one of these methods:

- Run AMT on cold motor. frequency converter measures value from motor.
- Enter X<sub>1</sub> value manually. Obtain value from motor supplier.
- Use R<sub>s</sub>, X<sub>1</sub>, and X<sub>2</sub> default setting. The frequency converter establishes setting based on motor nameplate data.

**NOTE**

These parameters cannot be changed while the motor runs.

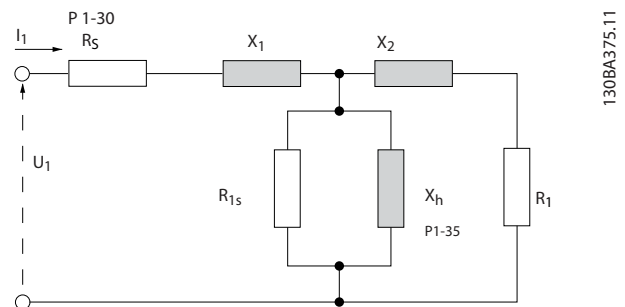

**1-30 Stator Resistance (R<sub>s</sub>)**

<b>Range:</b>	<b>Function:</b>	
Depending on motor data*	[Ohm]	Set stator resistance value.

**1-33 Stator Leakage Reactance (X<sub>1</sub>)**

<b>Range:</b>	<b>Function:</b>	
Depending on motor data*	[Ohm]	Set stator leakage reactance of motor.

**1-35 Main Reactance (X<sub>2</sub>)**

<b>Range:</b>	<b>Function:</b>	
Depending on motor data*	[Ohm]	Set motor main reactance.

4.2.3 1-5\* Load Independent Setting

This parameter group is for setting the load independent motor settings.

**1-50 Motor Magnetization at Zero Speed**

<b>Range:</b>	<b>Function:</b>	
	This parameter enables different thermal load on motor when running at low speed.	
100 %*	[ 0 - 300%]	Enter a percentage of rated magnetizing current . If setting is too low, motor shaft torque may be reduced.



**1-52 Min. Speed Normal Magnetizing [Hz]**

**Range:**                      **Function:**

		Use this parameter along with 1-50 Motor Magnetizing at Zero Speed.
0.0 Hz*	[0.0 - 10.0 Hz]	Set frequency required for normal magnetizing current. If frequency is set lower than motor slip frequency, 1-50 Motor Magnetizing at Zero Speed is inactive.

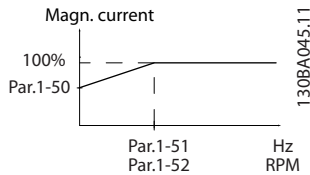

**1-55 U/f Characteristic - U**

**Range:**                      **Function:**

		This parameter is an array parameter [0-5] and is only functional when 1-01 Motor Control Principle is set to U/f [0].
0.0 V*	[0.0 - 999.9 V]	Enter voltage at each frequency point to manually form a U/f characteristic matching motor. Frequency points are defined in 1-56 U/f characteristics - F.

**1-56 U/f Characteristic - F**

**Range:**                      **Function:**

		This parameter is an array parameter [0-5] and is only functional when 1-01 Motor Control Principle is set to U/f [0].
0.0 Hz*	[0.0 - 1000.0 Hz]	Enter frequency points to manually form a U/f characteristic matching motor. Voltage at each point is defined in 1-55 U/f Characteristic - U. Make a U/f characteristic based on 6 definable voltages and frequencies, see below figure. Simplify U/f characteristics by merging 2 or more points (voltages and frequencies), respectively, are set equal.

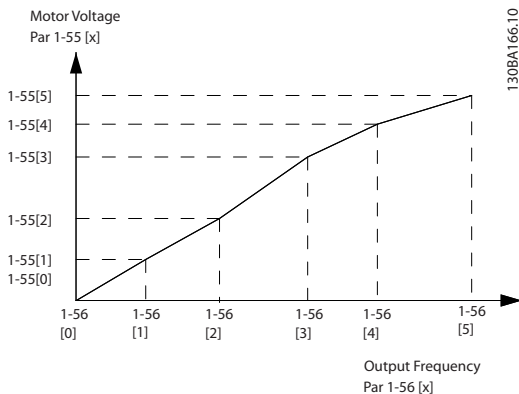

Illustration 4.1 U/f Characteristics

**NOTE**

For 1-56 U/f characteristics - F the following applies [0] ≤ [1] ≤ [2] ≤ [3] ≤ [4] ≤ [5]

**4.2.4 1-6\* Load Dependent setting**

Parameters for adjusting the load-dependent motor settings.

**1-60 Low Speed Load Compensation**

**Range:**                      **Function:**

		Use this parameter to gain optimum U/f characteristic when running at low speed.
100 %*	[0-199 %]	Enter percentage in relation to load when motor runs at low speed. Change-over point is automatically calculated based on motor size.

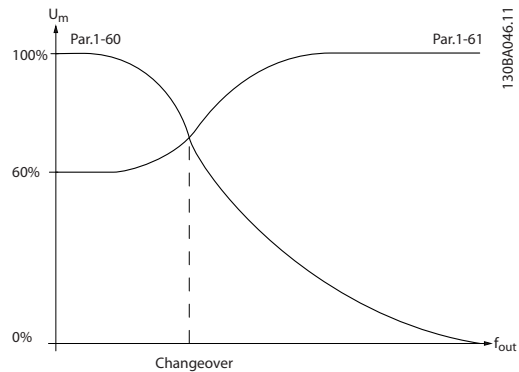

**1-61 High Speed Load Compensation**

**Range:**                      **Function:**

		Use this parameter to obtain optimum load compensation when running at high speed.
100 %*	[0 - 199 %]	Enter percentage to compensate in relation to load when motor runs at high speed. Change-over point is automatically calculated based on motor size.

**1-62 Slip Compensation**

**Range:**                      **Function:**

100 %*	[-400 - 399 %]	Compensation for load dependent motor slip. Slip compensation is calculated automatically based on rated motor speed, n <sub>M,N</sub> .
<b>NOTE</b> This function is only active when 1-00 Configuration Mode, is set to Speed Open Loop [0], and when 1-01 Motor Control Principle, is set to VVC+ [1].		

**1-63 Slip Compensation Time**

Range:		Function:
0.10 s	[0.05 - 5.00 s]	Enter slip compensation reaction speed. A high value results in slow reaction whereas a low value results in quick reaction. If low-frequency resonance problems arise, use longer time setting.

**4.2.5 1-7\* Start Adjustments**

Considering the need for various start functions in different applications, it is possible to select a number of functions in this parameter group.

**1-71 Start Delay**

Range:		Function:
		The start delay defines the time to pass from a start command is given until the motor starts accelerating. Setting start delay to 0.0 sec. disables 1-72 Start Function, when start command is given.
0.0 s*	[0.0 - 10.0 s]	Enter the time delay required before commencing acceleration. 1-72 Start Function is active during Start delay time.

**1-72 Start Function**

Option:	Function:	
[0]	DC Hold/Delay Time	Motor is energised with DC holding current (2-00 DC Hold Current) during start delay time.
[1]	DC Brake/Delay Time	Motor is energised with DC braking current (2-01 DC Brake Current) during start delay time.
[2] *	Coast/Delay Time	Inverter is coasted during start delay time (inverter off).

**1-73 Flying Start**

Option:	Function:	
		The Flying Start parameter is used to catch a spinning motor after eg. mains drop-out. <b>NOTE</b> <b>This function is not suitable for hoisting applications.</b>
[0] *	Disabled	Flying start is not required.
[1]	Enabled	Frequency converter enabled to catch spinning motor. <b>NOTE</b> <b>When flying start is enabled 1-71 Start Delay, and 1-72 Start Function, have no function.</b>

**4.2.6 1-8\* Stop Adjustments**

To meet the need for various stop functions in different application these parameters offer some special stop features for the motor.

**1-80 Function at Stop**

Option:	Function:	
		The selected function at stop is active in following situations: <ul style="list-style-type: none"> <li>Stop command is given and output speed is ramped down to <i>Min. Speed for Function at Stop</i>.</li> <li>Start command is removed (standby), and output speed is ramped down to <i>Min. Speed for Function at Stop</i>.</li> <li>DC-brake command is given, and DC-brake time has passed</li> <li>While running and calculated output speed is below <i>Min. Speed for Function at Stop</i>.</li> </ul>
[0] *	Coast	The inverter is coasted.
[1]	DC hold	The motor is energised with a DC current. See 2-00 DC Hold Current for more information.

**1-82 Min. Speed For Function at Stop [Hz]**

Range:	Function:	
0.0 Hz*	[0.0 - 20.0 Hz]	Set the speed at which to activate 1-80 Function at Stop.

**4.2.7 1-9\* Motor Temperature**

With an estimated motor temperature monitor the frequency converter is able to estimate motor temperature without having a thermistor mounted. It is thus possible to receive a warning or an alarm, if motor temperature exceeds upper operational limit.

**1-90 Motor Thermal Protection**

Option:	Function:	
		Using ETR (Electronic Terminal Relay) the motor temperature is calculated based on frequency, speed and time. Danfoss recommends using The ETR function, if a thermistor is not present. <b>NOTE</b> <b>ETR calculation is based on motor data from parameter group 1-2* Motor Data.</b>
[0] *	No Protection	Disables temperature monitoring.
[1]	Thermistor Warning	A thermistor connected to either digital or analog input gives a warning if upper limit of motor temperature range is exceeded, (see 1-93 Thermistor Resource).
[2]	Thermistor Trip	A thermistor connected to either digital or analog input gives an alarm and makes the

**1-90 Motor Thermal Protection**
**Option:                      Function:**

		frequency converter trip if upper limit of motor temperature range is exceeded, (see <i>1-93 Thermistor Resource</i> ).
[3]	ETR Warning	If calculated upper limit of motor temperature range is exceeded, a warning occurs.
[4]	ETR Trip	If 90% of calculated upper limit of motor temperature range is exceeded, an alarm occurs and frequency converter trips.

**NOTE**

When the ETR function has been selected the drive will store the recorded temperature at power down and this temperature will resume at power up regardless of the elapsed time. Changing *1-90 Motor Thermal Protection* back to [0] No Protection will reset the recorded temperature.

**1-93 Thermistor Resource**
**Option:                      Function:**

		Select the thermistor input terminal.									
[0] *	None	No thermistor is connected.									
[1]	Analog Input 53	Connect thermistor to analog input terminal 53. <b>NOTE</b> Analog input 53 cannot be selected for other purposes when selected as thermistor resource.									
[6]	Digital input 29	Connect thermistor to digital input terminal 29. While this input functions as thermistor input, it will not respond to the function chosen in <i>5-13 Digital Input 29</i> . The value of <i>5-13 Digital Input 29</i> remains however unchanged in parameter database while function is inactive.									
		<table border="1"> <thead> <tr> <th>Input Digital/ Analog</th> <th>Supply Voltage</th> <th>Threshold Cut-out Values</th> </tr> </thead> <tbody> <tr> <td>Digital</td> <td>10 V</td> <td>&lt;800 ohm - &gt;2.9k ohm</td> </tr> <tr> <td>Analog</td> <td>10 V</td> <td>&lt;800 ohm - &gt;2.9k ohm</td> </tr> </tbody> </table>	Input Digital/ Analog	Supply Voltage	Threshold Cut-out Values	Digital	10 V	<800 ohm - >2.9k ohm	Analog	10 V	<800 ohm - >2.9k ohm
Input Digital/ Analog	Supply Voltage	Threshold Cut-out Values									
Digital	10 V	<800 ohm - >2.9k ohm									
Analog	10 V	<800 ohm - >2.9k ohm									

### 4.3 Parameter Group 2: Brakes

#### 4.3.1 2-\*\* Brakes

#### 4.3.2 2-0\* DC-Brake

The purpose of DC-brake function is to brake a rotating motor by applying DC-current to the motor.

##### 2-00 DC Hold Current

Range:	Function:
	This parameter either holds the motor (holding torque) or pre-heats the motor. The parameter is active if <i>DC Hold</i> has been selected in either <i>1-72 Start Function</i> or <i>1-80 Function at Stop</i> .
50%* [0 - 100%]	Enter a value for holding current as a percentage of the rated motor current set in <i>1-24 Motor Current</i> . 100% DC holding current corresponds to $I_{M,N}$ .

### NOTE

Avoid 100% current too long as it may overheat the motor.

##### 2-01 DC Brake Current

Range:	Function:
50 %* [0 - 150%]	Set DC-current needed to brake rotating motor. Activate DC-brake in one of the four following ways: <ol style="list-style-type: none"> <li>DC-brake command, see <i>5-1* Digital Inputs</i> choice [5]</li> <li>DC Cut-in function, see <i>2-04 DC-Brake Cut-in Speed</i></li> <li>DC-brake selected as start function, see <i>1-72 Start Function</i></li> <li>DC-brake in connection with <i>Flying Start</i>, <i>1-73 Flying Start</i>.</li> </ol>

##### 2-02 DC-Braking Time

Range:	Function:
	DC-braking time defines the period during which <i>DC-brake current</i> is applied to the motor.
10.0 s* [0.0 - 60 s]	Set the time DC-braking current, set in <i>2-01 DC Brake Current</i> , must be applied.

### NOTE

If DC-brake is activated as start function, DC-brake time is defined by *start delay time*.

##### 2-04 DC-Brake Cut-in Speed

Range:	Function:
0.0 Hz* [0.0 - 400.0 Hz]	Set DC-brake cut-in speed to activate DC braking current, set in <i>2-01 DC Brake Current</i> , when ramping down. When set to 0 the function is off.

#### 4.3.3 2-1\* Brake Energy Function

Use the parameters in this group for selecting dynamic braking parameters.

##### 2-10 Brake Function

Option:	Function:
	<p><b>Resistor Brake:</b></p> <p>The resistor brake limits voltage in the intermediate circuit when the motor acts as generator. Without brake resistor, the frequency converter eventually trips.</p> <p>The resistor brake consumes surplus energy resulting from motor braking. A frequency converter with brake, stops a motor faster than without a brake, which is used in many applications. Requires connection of external brake resistor.</p> <p>An alternative to the resistor brake is the AC brake.</p> <p><b>NOTE</b></p> <p><b>Resistor brake is only functional in frequency converters with integrated dynamic brake. An external resistor must be connected.</b></p> <p><b>AC Brake:</b></p> <p>The AC brake consumes surplus energy by creating power loss in the motor. It is important to keep in mind that an increase in power loss causes motor temperature to rise.</p>
[0] * Off	No brake function.
[1] Resistor Brake	Resistor brake is active.
[2] AC Brake	AC brake is active.

##### 2-11 Brake Resistor (Ohm)

Range:	Function:
5 Ω* [5 - 5000 Ω]	Set brake resistor value.

##### 2-16 AC Brake, Max Current

Range:	Function:
100.0 %* [0.0 - 150.0 %]	Enter max. permissible current for AC-braking to avoid overheating of motor. 100% equals motor current set in <i>1-24 Motor Current</i> .

**2-17 Over-Voltage Control**
**Option:**                      **Function:**

		Use Over-voltage Control (OVC) to reduce the risk of the frequency converter tripping due to an over voltage on the DC link caused by generative power from the load. An over-voltage occurs eg. if the ramp down time is set too short compared to the actual load inertia.
[0] *	Disabled	The OVC is not active/required.
[1]	Enabled, not at stop	OVC is running unless a stop signal is active.
[2]	Enabled	OVC is running, also when a stop signal is active.

**NOTE**

If Resistor Brake has been chosen in 2-10 Brake Function the OVC is not active even though enabled in this parameter.

**2-22 Activating Mechanical Brake**
**Range:**                      **Function:**

		If the motor is stopped using ramp, the mechanical brake is activated when motor speed is less than <i>Active Brake Speed</i> . Motor is ramped down to stop in the following situations: <ul style="list-style-type: none"> <li>• A start command is removed (stand by)</li> <li>• A stop command is activated</li> <li>• Quick-stop is activated (Q-stop ramp is used)</li> </ul>
0 Hz*	[0 - 400 Hz]	Select motor speed at which mechanical brake activates when ramping down. Mechanical brake automatically activates if frequency converter trips or reports an alarm.

**4.3.4 2-2\* Mechanical Brake**

For hoisting applications an electro-magnetic brake is required. The brake is controlled by a relay, which releases the brake when activated.

The brake activates if frequency converter trips or a coast command is given. Furthermore, it activates when motor speed is ramped down below the speed set in 2-22 *Active Brake Speed*.

**2-20 Release Brake Current**
**Range:**                      **Function:**

0.00 A*	[0.00 - 100 A]	Select motor current at which mechanical brake releases. <div style="border: 1px solid black; padding: 5px; display: inline-block;"> <b>CAUTION</b> </div> If start delay time has passed, and motor current is below <i>Release brake current</i> , frequency converter trips.
---------	----------------	---

## 4.4 Parameter Group 3: Reference/Ramps

### 4.4.1 3-\*\* Reference/Ramps

Parameters for reference handling, definition of limitations, and configuration of the frequency converter's reaction to changes

### 4.4.2 3-0\* Reference Limits

Parameters for setting the reference unit, limits and ranges.

#### 3-00 Reference Range

Option:	Function:
	Select the range of reference and feedback signals.
[0] * Min - Max	Reference setpoint ranges can have positive values only. Select this if running in Process Closed Loop.
[1] -Max - +Max	Ranges can have both positive and negative values. If potentiometer is used to adjust motor running in both direction, set reference range to -Max Reference to Max Reference by PNU3-00=[1] Choose hand on mode by LCP. Adjust the potentiometer to minimum, the motor can run in anti-clockwise with max speed. Then adjust the potentiometer to maximum, the motor will ramp down to 0 and run clockwise with max speed.

#### 3-02 Minimum Reference

Range:	Function:
0.00* [-4999 - 4999]	Enter value for minimum reference. The sum of all internal and external references are clamped (limited) to the minimum reference value, 3-02 <i>Minimum Reference</i> .

#### 3-03 Maximum Reference

Range:	Function:
50.00* [-4999 - 4999]	Maximum Reference is adjustable in the range Minimum Reference - 4999. Enter value for Maximum Reference. The sum of all internal and external references are clamped (limited) to the maximum reference value, 3-03 <i>Maximum Reference</i> .

### 4.4.3 3-1\* References

Parameters for setting up the reference sources. Select the preset references for the corresponding digital inputs in parameter group, 5.1\* *Digital Inputs*.

#### 3-10 Preset Reference

Option:	Function:																																				
	Each parameter set-up contains 8 preset references which are selectable via 3 digital inputs or bus.  <table border="1"> <thead> <tr> <th>[18] Bit2</th> <th>[17] Bit1</th> <th>[16] Bit0</th> <th>[16] Bit0</th> </tr> </thead> <tbody> <tr><td>0</td><td>0</td><td>0</td><td>0</td></tr> <tr><td>0</td><td>0</td><td>1</td><td>1</td></tr> <tr><td>0</td><td>1</td><td>0</td><td>2</td></tr> <tr><td>0</td><td>1</td><td>1</td><td>3</td></tr> <tr><td>1</td><td>0</td><td>0</td><td>4</td></tr> <tr><td>1</td><td>0</td><td>1</td><td>5</td></tr> <tr><td>1</td><td>1</td><td>0</td><td>6</td></tr> <tr><td>1</td><td>1</td><td>1</td><td>7</td></tr> </tbody> </table> <b>Table 4.1 Par. 5-1* Digital Inputs selection [16], [17] and [18]</b>	[18] Bit2	[17] Bit1	[16] Bit0	[16] Bit0	0	0	0	0	0	0	1	1	0	1	0	2	0	1	1	3	1	0	0	4	1	0	1	5	1	1	0	6	1	1	1	7
[18] Bit2	[17] Bit1	[16] Bit0	[16] Bit0																																		
0	0	0	0																																		
0	0	1	1																																		
0	1	0	2																																		
0	1	1	3																																		
1	0	0	4																																		
1	0	1	5																																		
1	1	0	6																																		
1	1	1	7																																		
[0.00] * -100.00 - 100.00%	Enter the different preset references using array programming. Normally, 100% = value set in 3-03 <i>Maximum Reference</i> . However, there are exceptions if 3-00 <i>Reference Range</i> is set to <i>Min - Max</i> , [0]. Example 1: 3-02 <i>Minimum Reference</i> is set to 20 and 3-03 <i>Maximum Reference</i> is set to 50. In this case 0% = 0 and 100% = 50. Example 2: 3-02 <i>Minimum Reference</i> is set to -70 and 3-03 <i>Maximum Reference</i> is set to 50. In this case 0% = 0 and 100% = 70.																																				

#### 3-11 Jog Speed [Hz]

Range:	Function:
5.0 Hz [0.0 - 400.0 Hz]	Jog speed is a fixed output speed and overrules the selected reference speed, see 5-1* <i>Digital Inputs</i> selection [14]. If the motor is stopped while in jog mode, the jog signal acts as a start signal. Removing the jog signal makes the motor run according to the selected configuration. Select speed to function as jog speed.

3-12 Catch Up/Slow Down Value		
Range:	Function:	
0% *	[0 - 100%]	<p>The <i>Catch-up/Slowdown function</i> is activated by an input command (see 5-1* <i>Digital Inputs</i>, choice [28]/[29]). If the command is active, the Catch-up/Slowdown value (in %) is added to the reference function as follows:</p> $Reference = Reference + Reference \times \frac{Catchup\ Slowdown}{100}$ $Reference = Reference - Reference \times \frac{Catchup\ Slowdown}{100}$ <p>When the input command is inactivated, the reference returns to its original value ie. Reference = Reference + 0.</p>

3-14 Preset Relative Reference		
Range:	Function:	
0.00% *	[-100.00 - 100.00%]	<p>Define fixed value in % to be added to variable value defined in 3-18 <i>Relative Scaling Reference Source</i>.</p> <p>The sum of fixed and variable values (labeled Y in illustration below) is multiplied with actual reference (labeled X in illustration). This product is added to actual reference</p> $X + X \times \frac{Y}{100}$ <div style="text-align: center;"> <p style="font-size: small;">130BA059.12</p> </div>

3-15 Reference 1 Source		
Option:	Function:	
		3-15 <i>Reference 1 Source</i> , 3-16 <i>Reference 2 Source</i> and 3-17 <i>Reference 3 Source</i> define up to three different reference signals. The sum of these reference signals defines the actual reference.
[0]	No Function	No reference signal is defined.
[1] *	Analog Input 53	Use signals from analog input 53 as reference, see 6-1* <i>Analog Input 1</i> .
[2]	Analog Input 60	Use signals from analog input 60 as reference, see 6-2* <i>Analog Input 2</i> .
[8]	Pulse input 33	Use signals from pulse input as reference, see 5-5* <i>Pulse Input</i> .
[11]	Local Bus Reference	Use signals from local bus as reference, see 8-9* <i>Bus Feedback</i> .
[21]	LCP Potentiometer	Use signals from LCP potentiometer as reference, parameter group 6-8* <i>LCP Potentiometer</i> .

3-16 Reference 2 Source		
Option:	Function:	
		See 3-15 <i>Reference 1 Source</i> for description.
[0]	No Function	No reference signal is defined.
[1]	Analog Input 53	Use signals from analog input 53 as reference.
[2] *	Analog Input 60	Use signals from analog input 60 as reference.
[8]	Pulse input 33	Use signals from pulse input as reference, see parameter group 5-5* <i>Pulse Input</i> .
[11]	Local Bus Reference	Use signals from local bus as reference.
[21]	LCP Potentiometer	Use signals from LCP potentiometer as reference.

3-17 Reference 3 Source		
Option:	Function:	
		See 3-15 <i>Reference 2 Source</i> for description.
[0]	No Function	No reference signal is defined.
[1]	Analog Input 53	Use signals from analog input 53 as reference.
[2]	Analog Input 60	Use signals from analog input 60 as reference.
[8]	Pulse input 33	Use signals from pulse input as reference, see parameter group 5-5* <i>Pulse Input</i> .
[11] *	Local Bus Reference	Use signals from local bus as reference.
[21]	LCP Potentiometer	Use signals from LCP potentiometer as reference.

3-18 Relative Scaling Reference Source		
Option:	Function:	
		Select the source for a variable value to be added to the fixed value defined in 3-14 <i>Preset Relative Reference</i> .
[0] *	No Function	The function is disabled
[1]	Analog Input 53	Select analog input 53 as relative scaling reference source.
[2]	Analog Input 60	Select analog input 60 as relative scaling reference source.
[8]	Pulse Input 33	Select pulse input 33 as relative scaling reference source.
[11]	Local Bus Reference	Select local bus ref. as relative scaling reference source.
[21]	LCP Potentiometer	Select LCP potentiometer as relative scaling reference source.



### 4.4.4 3-4\* Ramp 1

A linear ramp is characterized by ramping up at a constant speed until the desired motor speed has been reached. Some overshoot may be experienced when reaching speed, which may cause speed jerks for a short while before stabilizing.

An S-ramp accelerates more smoothly thus compensating for jerks when the speed is reached.

See the below figure for a comparison of the two ramp types.

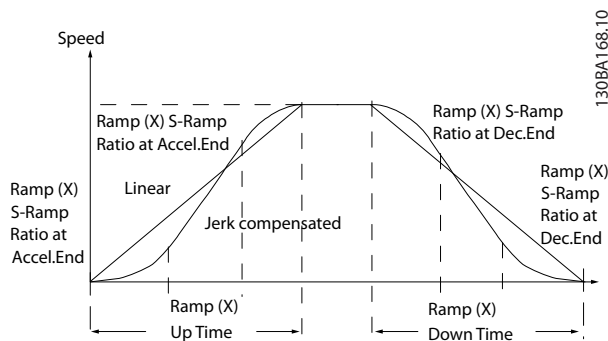

#### Ramp Times:

Ramp up: Acceleration time from 0 to nominal motor frequency (1-23 Motor Frequency).

Deceleration time from nominal motor frequency (1-23 Motor Frequency) to 0.

#### Limitation:

Too short ramp up time can result in Torque limit warning (W12) and/or DC over voltage warning (W7). Ramping is stopped when the frequency converter has reached Torque limit motor mode (4-16 Torque Limit in Motor Mode).

Too short ramp down time can result in Torque limit warning (W12) and/or DC over voltage warning (W7).

Ramping is stopped when the frequency converter reaches the Torque limit generator mode (4-17 Torque Limit in Generator Mode) and/or the internal DC over voltage limit.

#### 3-40 Ramp1 Type

**Option: Function:**

[0] *	Linear	Constant acceleration/deceleration.
[2]	S-ramp	Smooth jerk compensated acceleration/deceleration.

#### 3-41 Ramp1 Ramp-up Time

**Range: Function:**

Size related*	[0.05 - 3600.00 s]	Enter ramp-up time from 0 Hz to rated motor frequency ( $f_{M,N}$ ) set in 1-23 Motor Frequency. Choose a ramp-up time ensuring that torque limit is not exceeded, see 4-16 Torque Limit in Motor Mode.
---------------	--------------------	---

#### 3-42 Ramp1 Ramp-down Time

**Range: Function:**

Size related*	[0.05 - 3600.00 s]	Enter ramp down time from rated motor frequency ( $f_{M,N}$ ) in 1-23 Motor Frequency to 0 Hz. Choose a ramp down time that does not cause over-voltage in inverter due to regenerative operation of motor. Furthermore, regenerative torque must not exceed limit set in 4-17 Torque Limit in Generator Mode.
---------------	--------------------	--

4

### 4.4.5 3-5\* Ramp2

See parameter group 3-4\* Ramp 1 for a description of ramp types.

#### NOTE

**Ramp2 - alternative ramp times:**

Changing from Ramp1 to Ramp2 is done via the digital input. See 5-1\* Digital Inputs, selection [34].

#### 3-50 Ramp2 Type

**Option: Function:**

[0] *	Linear	Constant acceleration/deceleration.
[2]	S-ramp	Smooth jerk compensated acceleration/deceleration.

#### 3-51 Ramp2 Ramp-up Time

**Range: Function:**

Size related*	[0.05 - 3600.00 s]	Enter ramp-up time from 0 Hz to rated motor frequency ( $f_{M,N}$ ) set in 1-23 Motor Frequency. Choose a ramp-up time ensuring that torque limit is not exceeded, see 4-16 Torque Limit in Motor Mode.
---------------	--------------------	---

#### 3-52 Ramp2 Ramp-down Time

**Range: Function:**

Size related	[0.05 - 3600.00 s]	Enter ramp down time from rated motor frequency ( $f_{M,N}$ ) in 1-23 Motor Frequency to 0 Hz. Choose a ramp down time that does not cause over-voltage in inverter due to regenerative operation of motor. Furthermore, regenerative torque must not exceed limit set in 4-17 Torque Limit in Generator Mode.
--------------	--------------------	--



#### 4.4.6 3-8\* Other Ramps

This section contains parameters for Jog and Quick Stop Ramps.

With a Jog Ramp you can both ramp up and down whereas you can only ramp down with the Quick Stop Ramp.

**4**

##### 3-80 Jog Ramp Time

Range:		Function:
Size related*	[0.05 - 3600.00 s]	A linear ramp applicable when Jog is activated. See 5-1* <i>Digital Inputs</i> , selection [14]. Ramp up time = Ramp down time. Jog Ramp time starts upon activation of a jog signal via a selected digital input or serial communication port.

##### 3-81 Quick Stop Ramp Time

Range:		Function:
Size related*	[0.05 - 3600.00 s]	A linear ramp applicable when Q-stop is activated. See 5-1* <i>Digital Inputs</i> , selection [4].

## 4.5 Parameter Group 4: Limits/Warnings

### 4.5.1 4-\*\* Motor Limits

Parameter group for configuring limits and warning.

### 4.5.2 4-1\* Motor Limits

Use these parameters for defining the speed, torque and current working range for the motor.

4-10 Motor Speed Direction		
Option:	Function:	
		If terminals 96, 97 and 98 are connected to U, V and W respectively, the motor runs clockwise when seen from the front. <b>NOTE</b> This parameter cannot be adjusted while the motor is running
[0]	Clockwise	The motor shaft rotates in clockwise direction. This setting prevents the motor from running in counterclockwise direction.
[1]	Counter-clockwise	The motor shaft rotates in counterclockwise direction. This setting prevents the motor from running in clockwise direction.
[2] *	Both	With this setting the motor can run in both directions. However, the output frequency is limited to the range: Motor Speed Low Limit (4-12 Motor Speed Low Limit) to Motor Speed High Limit (4-14 Motor Speed High Limit).

4-12 Motor Speed Low Limit		
Range:	Function:	
0.0 Hz* [0.0 - 400.0 Hz]	Set the <i>Minimum Motor Speed Limit</i> corresponding to the minimum output frequency of the motor shaft. <b>NOTE</b> As the minimum output frequency is an absolute value, it cannot be deviated from.	

4-14 Motor Speed High Limit		
Range:	Function:	
65.0 Hz* [0.0 - 400.0 Hz]	Set the <i>Maximum Motor Speed</i> corresponding to the maximum output frequency of the motor shaft. <b>NOTE</b> As the maximum output frequency is an absolute value, it cannot be deviated from.	

4-16 Torque Limit in Motor Mode		
Range:	Function:	
150 %* [0 - 400%]	Set the torque limit for motor operation. The setting is not automatically reset to default when changing settings in 1-00 Configuration Mode to 1-25 Load & Motor.	

4-17 Torque Limit in Generator Mode		
Range:	Function:	
100 %* [0 - 400%]	Set the torque limit for generator mode operation. The setting is not automatically reset to default when changing settings in 1-00 Configuration Mode to 1-25 Load & Motor.	

### 4.5.3 4-4\* Adjustable Warnings 2

4-40 Warning Frequency Low		
Range:	Function:	
0.00Hz* [0.0Hz- Depend on the value of 4-41 Warning Frequency High]	Use this parameter to set a lower limit for the frequency range. When the motor speed falls below this limit, the display reads SPEED LOW. Warning bit 10 is set in 16-94 Ext. Status Word. Output Relay can be configured to indicate this warning. LCP warning light does not light when this parameter set limit is reached.	

4-41 Warning Frequency High		
Range:	Function:	
400.0Hz* [Depend on the value of 4-40 Warning Frequency Low - 400.0Hz]	Use this parameter to set a higher limit for the frequency range. When the motor speed exceeds this limit, the display reads SPEED HIGH. Warning bit 9 is set in 16-94 Ext. Status Word. Output Relay can be configured to indicate this warning. LCP warning light does not light when this parameter set limit is reached.	

#### 4.5.4 4-5\* Adjustable Warnings

Parameter group containing adjustable warning limits for current, speed, reference and feedback.

Warnings are shown in display, programmed output or serial bus.

4-50 Warning Current Low		
Range:	Function:	
		Use this parameter to set a lower limit for the current range. If current drops below the set limit, warning bit 8 is set in <i>16-94 Ext. Status Word</i> . Output Relay can be configured to indicate this warning. LCP warning light does not light when this parameter's set limit is reached.
0.00 A*	[0.00 - 26.00 A]	Set value for low current limit.

4-51 Warning Current High		
Range:	Function:	
		Use this parameter to set an upper limit for the current range. If current exceeds the set limit, warning bit 7 is set in <i>16-94 Ext. Status Word</i> . Output Relay can be configured to indicate this warning. LCP warning light does not light when this parameter's set limit is reached.
26.00 A*	[0.00 - 26.00 A]	Set upper current limit.

4-54 Warning Reference Low		
Range:	Function:	
- 4999.000*	[-4999.000- Depend on the value of <i>4-55 Warning Reference High</i> ]	Use this parameter to set a lower limit for the reference range. When the actual reference falls below this limit, the display reads Reference Low. Warning bit 20 is set in <i>16-94 Ext. Status Word</i> . Output Relay can be configured to indicate this warning. LCP warning light does not light when this parameter set limit is reached.

4-55 Warning Reference High		
Range:	Function:	
4999.000*	[Depend on the value of <i>4-54 Warning Reference Low-4999.000</i> ]	Use this parameter to set a higher limit for the reference range. When the actual reference exceeds this limit, the display reads Reference High. Warning bit 19 is set in <i>16-94 Ext. Status Word</i> . Output Relay can be configured to indicate this warning. LCP warning light does not light when this parameter set limit is reached.

4-56 Warning Feedback Low		
Range:	Function:	
- 4999.000*	[-4999.000- Depend on the value of <i>4-57 Warning Feedback High</i> ]	Use this parameter to set a lower limit for the feedback range. When the feedback falls below this limit, the display reads Feedback Low. Warning bit 6 is set in <i>16-94 Ext. Status Word</i> . Output Relay can be configured to indicate this warning. LCP warning light does not light when this parameter set limit is reached.

4-57 Warning Feedback High		
Range:	Function:	
4999.000*	[Depend on the value of <i>4-56 Warning Feedback Low - 4999.000</i> ]	Use this parameter to set a higher limit for the feedback range. When the feedback exceeds this limit, the display reads Feedback High. Warning bit 5 is set in <i>16-94 Ext. Status Word</i> . Output Relay can be configured to indicate this warning. LCP warning light does not light when this parameter set limit is reached.

4-58 Missing Motor Phase Function		
Option:	Function:	
		A missing motor phase causes the motor torque to drop. This monitor may be disabled for special purposes (eg. small motors running pure U/f mode), but as there is a risk of overheating the motor, Danfoss strongly recommends that the function is <i>On</i> . A missing motor phase causes the frequency converter to trip and report an alarm. <b>NOTE</b> <b>This parameter cannot be changed while motor runs.</b>
[0]	Off	Function is disabled.
[1] *	On	Function is enabled.

### 4.5.5 4-6\* Speed Bypass

In some applications mechanical resonance may occur. Avoid resonance points by creating a bypass. The frequency converter ramps through the bypass area thereby passing mechanical resonance points quickly.

#### 4-61 Speed Bypass From [Hz]

Range:		Function:
		Array [2]
0.0 Hz*	[0.0 - 400.0 Hz]	Enter either the lower or upper limit of the speeds to be avoided. It does not matter whether Bypass From or Bypass To is the upper or lower limit, however the Speed Bypass function is disabled if the two parameters are set to the same value.

#### 4-63 Speed Bypass To [Hz]

Range:		Function:
		Array [2]
0.0 Hz*	[0.0 - 400.0 Hz]	Enter either the upper or lower limit of the speed area to be avoided. Make sure to enter the <b>opposite</b> limit of that in <i>4-61 Speed Bypass From [Hz]</i> .

## 4.6 Parameter Group 5: Digital In/Out

### 4.6.1 5-\*\* Digital In/Out

The following describes all digital input command functions and signals.

### 4.6.2 5-1\* Digital Inputs

Parameters for configuring the functions for the input terminals.

The digital inputs are used for selecting various functions in the frequency converter. All digital inputs can be set to the following:

[0]	No Operation	The frequency converter will not react to signals transmitted to the terminal.
[1]	Reset	Reset the frequency converter after a Trip/Alarm. Not all alarms can be reset.
[2]	Coast Inverse	Coasting stop, inverted input (NC). The frequency converter leaves the motor in free mode.
[3]	Coast and reset inv.	Reset and coasting stop inverted input (NC). The frequency converter resets and leaves the motor in free mode.
[4]	Quick stop inverse	Inverted input (NC). Generates a stop in accordance with the quick-stop ramp time set in 3-81 <i>Quick Stop Ramp Time</i> . When motor stops, shaft is in free mode.
[5]	DC-brake inv.	Inverted input for DC braking (NC). Stops motor by energizing it with DC current for a certain time period, see 2-01 <i>DC Brake Current</i> . Function is only active when value in 2-02 <i>DC-Braking Time</i> is different from 0.
[6]	Stop inv.	Stop inverted function. Generates stop function when selected terminal goes from logical level "1" to "0". Stop is performed according to selected ramp time.
[8]	Start	Select start for a start/stop command. 1 = Start, 0 = stop.
[9]	Latched start	Motor starts if a pulse is applied for min. 2 ms. Motor stops when Stop inverse is activated.
[10]	Reversing	Change direction of motor shaft rotation. Reversing signal only changes direction of rotation; it does not activate start function. Select <i>Both directions</i> [2] in 4.10 <i>Motor Speed Direction</i> . 0 = normal, 1 = reversing.
[11]	Start reversing	Use for start/stop and for reversing at the same time. Signals on start [8] are not allowed at the same time. 0 = stop, 1 = start reversing.
[12]	Enable start forward	Use if motor shaft must rotate clockwise at start.

[13]	Enable start reverse	Use if motor shaft must rotate counter-clockwise at start.
[14]	Jog	Use for activating jog speed. See 3-11 <i>Jog Speed</i> .
[16]	Preset reference bit 0	Preset reference bit 0, 1 and 2 enables a choice between one of the eight preset references according to the table below.
[17]	Preset reference bit 1	Same as preset reference bit 0 [16], see 3-10 <i>Preset Reference</i> .
[18]	Preset reference bit 2	Same as preset reference bit 0 [16].
[19]	Freeze reference	Freeze actual reference. The frozen reference is now the point of enable/condition for Speed up and Speed down to be used. If Speed up/down is used, speed change always follows ramp 2 (3-51 <i>Ramp2 Ramp-up Time</i> and 3-52 <i>Ramp2 Ramp-down Time</i> ) in the range 3-02 <i>Minimum Reference</i> - 3-03 <i>Maximum Reference</i> .
[20]	Freeze output	Freeze the actual motor frequency (Hz). The frozen motor frequency is now the point of enable/condition for Speed up and Speed down to be used. If Speed up/down is used, the speed change always follows ramp 2 in the range 4-12 <i>Motor Speed Low Limit</i> - 4-14 <i>Motor Speed High Limit</i> . <b>NOTE</b> When freeze output is active, the frequency converter cannot be stopped via a low Start [8] signal. Stop the frequency converter via a terminal programmed for Coasting Inverse [2] or Coast and reset, inverse [3].
[21]	Speed up	Select Speed up and Speed down if digital control of the up/down speed is desired (motor potentiometer). Activate this function by selecting either Freeze reference or Freeze output. When Speed-up is activated for less than 400 ms. the resulting reference will be increased by 0.1%. If Speed-up is activated for more than 400 ms. the resulting reference will ramp according to ramp 2 in 3-51 <i>Ramp2 Ramp-up Time</i> .
[22]	Speed down	Same as Speed-up [21].
[23]	Setup select bit 0	Set 0-10 <i>Active set-up</i> to Multi set-up. Logic 0 = set up 1, Logic 1 = Set up 2.
[26]	Precise stop inverse (only terminal 33)	Prolong the stop signal to give a precise stop independent of scan time. The function is available for terminal 33 only.
[27]	Start, precise stop (only terminal 33)	As [26], but including Start.

[28]	Catch up	Select Catch up/Slow down to increase or reduce the resulting reference value by the percentage set in 3-12 <i>Catch Up/Slow Down Value</i>
[29]	Slow down	Same as Catch up [28]
[32]	Pulse input (only terminal 33)	Select Pulse input when using a pulse sequence as either reference or feedback. Scaling is done in parameter group 5-5* <i>Pulse Input</i>
[34]	Ramp bit 0	Logic 0 = Ramp1, see 3-4* <i>Ramp1</i> Logic 1 = Ramp2, see 3-5* <i>Ramp2</i> .
[60]	Counter A (up)	Input for counter A.
[61]	Counter A (down)	Input for counter A.
[62]	Reset counter A	Input for reset of counter A.
[63]	Counter B (up)	Input for counter B.
[64]	Counter B (down)	Input for counter B.
[65]	Reset counter B	Input for reset of counter B.

**5-10 Terminal 18 Digital Input**

**Option:**      **Function:**

[8] *	Start	Select function from available digital input range. See parameter group 5-1* <i>Digital Inputs</i> for choices.
-------	-------	---

**5-11 Terminal 19 Digital Input**

**Option:**      **Function:**

[10] *	Reversing	Select function from available digital input range. See 5-1* <i>Digital Inputs</i> for choices.
--------	-----------	---

**5-12 Terminal 27 Digital Input**

**Option:**      **Function:**

[1] *	Reset	Select function from available digital input range. See 5-1* <i>Digital Inputs</i> * for choices.
-------	-------	---

**5-13 Terminal 29 Digital Input**

**Option:**      **Function:**

[14] *	Jog	Select function from available digital input range. See 5-1* <i>Digital Inputs</i> for choices.
--------	-----	---

**5-15 Terminal 33 Digital Input**

**Option:**      **Function:**

[16] *	Preset bit 0	Select function from available digital input range. See 5-1* <i>Digital Inputs</i> for choices.
--------	--------------	---

**4.6.3 5-3\* Digital Outputs**

**5-34 On delay, Terminal 42 Digital Output**

**Range:**      **Function:**

0.01s*	[0.00 - 600.00s]	Enter the delay of the DO cut-in time.If the Selected Event condition changes before the On delay timer expires, the DO output is unaffected.The function to control the DO See 6-92 <i>Terminal 42 Digital Output</i> .
--------	------------------	--

**5-35 Off delay, Terminal 42 Digital Output**

**Range:**      **Function:**

0.01s*	[0.00- 600.00s]	Enter the delay of the DO cut-off time.If the Selected Event condition changes before the off delay timer expires, the DO output is unaffected.The function to control the DO See 6-92 <i>Terminal 42 Digital Output</i> .
--------	-----------------	--

**4.6.4 5-4\* Relays**

Parameter group for configuring timing and output functions for relays.

[0]	No Operation	Default for all digital and relay outputs.
[1]	Control Ready	Control board receives supply voltage.
[2]	Drive Ready	Frequency converter is ready for operation and applies supply signal on control board.
[3]	Drive Ready, Remote	Frequency converter is ready for operation in Auto On-mode.
[4]	Enable/No Warning	Frequency converter is ready for operation. No start or stop command is given. No warnings are present.
[5]	Drive Running	Motor is running.
[6]	Running/No Warning	Motor runs, and no warning are present.
[7]	Run in Range/No Warning	Motor runs within programmed current ranges, see 4-50 <i>Warning Current Low</i> and 4-51 <i>Warning Current High</i> . No warnings are present.
[8]	Run on ref/No Warning	Motor runs at reference speed.
[9]	Alarm	An alarm activates output.
[10]	Alarm on Warning	An alarm or warning activates output.
[12]	Out of Current Range	Motor current is outside range set in 4-50 <i>Warning Current Low</i> and 4-51 <i>Warning Current High</i> .
[13]	Below Current, low	Motor current is lower than set in 4-50 <i>Warning Current Low</i> .
[14]	Above Current, high	Motor current is higher than set in 4-51 <i>Warning Current High</i> .
[16]	Below Frequency, low	Motor speed is lower than set in 4-40 <i>Warning Frequency Low</i> .

[17]	Above Frequency, high	Motor speed is higher than set in 4-41 <i>Warning Frequency High.</i>
[19]	Below Feedback, low	Feedback is lower than set in 4-56 <i>Warning Feedback Low.</i>
[20]	Above Feedback, high	Feedback is higher than set in 4-57 <i>Warning Feedback High.</i>
[21]	Thermal Warning	Thermal warning is present when temperature exceeds limit in motor, frequency converter, brake resistor or thermistor.
[22]	Ready, No Thermal Warning	Frequency converter is ready for operation and no over-temperature warning is present.
[23]	Remote Ready, No Thermal Warning	Frequency converter is ready for operation in Auto mode, and no over-temperature warning is present.
[24]	Ready, Voltage OK	Frequency converter is ready for operation and mains voltage is within specified voltage range.
[25]	Reverse	Motor runs/is ready to run clockwise when logic = 0 and counter clockwise when logic = 1. Output changes as soon as reversing signal is applied.
[26]	Bus OK	Active communication (no time-out) via serial communication port.
[28]	Brake, No Warn	Brake is active, and no warnings are present.
[29]	Brake Ready/No Fault	Brake is ready for operation, and no faults are present.
[30]	Brake Fault (IGBT)	Protects frequency converter if fault on brake modules is present. Use relay to cut out main voltage from frequency converter.
[32]	Mech. Brake Control	Enables control of external mechanical brake, see 2-2* <i>Mechanical Brake.</i>
[36]	Control Word Bit 11	Bit 11 in control word controls relay.
[41]	Below Reference, low	Reference is lower than set in 4-54 <i>Warning Reference Low.</i>
[42]	Above Reference, high	Reference is higher than set in 4-55 <i>Warning Reference High.</i>
[51]	Local Reference Active	
[52]	Remote Reference Active	
[53]	No Alarm	
[54]	Start Cmd Active	
[55]	Running Reverse	
[56]	Drive in Hand Mode	
[57]	Drive in Auto Mode	
[60]	Comparator 0	See 13-1* <i>Comparators.</i> If comparator 0 is evaluated as TRUE, output goes high. Otherwise, it is low.

[61]	Comparator 1	See 13-1* <i>Comparators.</i> If comparator 1 is evaluated as TRUE, output goes high. Otherwise, it is low.
[62]	Comparator 2	See 13-1* <i>Comparators.</i> If comparator 2 is evaluated as TRUE, output goes high. Otherwise, it is low.
[63]	Comparator 3	See 13-1* <i>Comparators.</i> If comparator 3 is evaluated as TRUE, output goes high. Otherwise, it is low.
[70]	Logic Rule 0	See 13-4* <i>Logic Rules.</i> If Logic Rule 1 is evaluated as TRUE, output goes high. Otherwise, it is low.
[71]	Logic Rule 1	See 13-4* <i>Logic Rules.</i> If Logic Rule 2 is evaluated as TRUE, output goes high. Otherwise, it is low.
[72]	Logic Rule 2	See 13-4* <i>Logic Rules.</i> If Logic Rule 3 is evaluated as TRUE, output goes high. Otherwise, it is low.
[73]	Logic Rule 3	See 13-4* <i>Logic Rules.</i> If Logic Rule 3 is evaluated as TRUE, output goes high. Otherwise, it is low.
[81]	SL Digital Output B	See 13-52 <i>SL Control Action.</i> When Smart Logic Action <i>Set dig. out. A high</i> [39] is executed, input goes high. When Smart Logic Action <i>Set dig. out. A low</i> [33] is executed, input goes low.

#### 5-40 Function Relay

**Option:**                      **Function:**

[0] *	No Operation	Select function from available relay output range.
-------	--------------	--

#### 5-41 On delay, Relay

**Option:**                      **Function:**

[0.01s] *	[0.00 - 600.00s]	Enter the delay of the relay cut-in time. If the Selected Event condition changes before the On delay timer expires, the relay output is unaffected. The function to control the relay see 5-40 <i>Function Relay.</i>
-----------	------------------	--

#### 5-42 Off delay, Relay

**Option:**                      **Function:**

[0.01s] *	[0.00 - 600.00s]	Enter the delay of the relay cut-off time. If the Selected Event condition changes before the off delay timer expires, the relay output is unaffected. The function to control the relay see 5-40 <i>Function Relay.</i>
-----------	------------------	--

### 4.6.5 5-5\* Pulse Input

Set *5-15 Terminal 33 Digital Input* to choice [32] pulse input. Now terminal 33 handles a pulse input in the range from Low frequency, *5-55 Terminal 33 Low Frequency*, to *5-56 Terminal 33 High Frequency*. Scale frequency input via *5-57 Terminal 33 Low Ref./Feedb. Value* and *5-58 Terminal 33 High Ref./Feedb. Value*.

#### 5-55 Terminal 33 Low Frequency

Range:		Function:
20 Hz*	[20 - 4999 Hz]	Enter low frequency corresponding to low motor shaft speed (i.e. low reference value) in <i>5-57 Terminal 33 Low Ref./Feedb. Value</i> .

#### 5-56 Terminal 33 High Frequency

Range:		Function:
5000 Hz*	[21 - 5000 Hz]	Enter high frequency corresponding to high motor shaft speed (i.e. high reference value) in <i>5-58 Terminal 33 High Ref./Feedb. Value</i> .

#### 5-57 Terminal 33 Low Ref./Feedb. Value

Range:		Function:
0.000*	[-4999 - 4999]	Set reference/feedback value corresponding to low pulse frequency value set in <i>5-55 Terminal 33 Low Frequency</i> .

#### 5-58 Terminal 33 High Ref./Feedb. Value

Range:		Function:
50.000*	[-4999 - 4999]	Set reference/feedback value corresponding to high pulse frequency value set in <i>5-56 Terminal 33 High Frequency</i> .



## 4.7 Parameter Group 6: Analogue In/Out

### 4.7.1 6-\*\* Analog In/Out

Parameter group for configuring analog inputs and outputs.

### 4.7.2 6-0\* Analog I/O Mode

Parameter group for setting up the analog I/O configuration.

#### 6-00 Live Zero Timeout Time

**Range:**            **Function:**

		The Live Zero function is used for monitoring the signal on an analog input. If the signal disappears, a <i>Live Zero</i> warning is reported.
10 s*	[1 - 99 s]	Set delay time before <i>Live Zero Timeout Function</i> is applied (6-01 <i>Live Zero Timeout Time</i> ). If the signal reappears during the set delay, timer will be reset. When live zero is detected, the frequency converter freezes output frequency and starts <i>Live Zero Timeout</i> timer.

#### 6-01 Live Zero Timeout Function

**Option:**            **Function:**

		Function is activated if input signal is below 50% of value set in 6-10 <i>Terminal 53 Low Voltage</i> , 6-12 <i>Terminal 53 Low Current</i> or 6-22 <i>Terminal 60 Low Current</i> .
[0] *	Off	Function is disabled.
[1]	Freeze output	Output frequency remains at value it had when live zero was detected.
[2]	Stop	Frequency converter ramps down to 0 Hz. Remove live zero error condition before restarting frequency converter.
[3]	Jogging	Frequency converter ramps to jog speed, see 3-11 <i>Jog Speed</i> .
[4]	Max Speed	Frequency converter ramps to Motor Speed High Limit, see 4-14 <i>Motor Speed High Limit</i> .
[5]	Stop and Trip	Frequency converter ramps down to 0 Hz and then trips. Remove live zero condition and activate reset before restarting the frequency converter.

### 4.7.3 6-1\* Analog Input 1

Parameters for configuring scaling and limits for analog input 1 (terminal 53).

#### NOTE

Micro switch 4 in position U:

6-10 *Terminal 53 Low Voltage* and 6-11 *Terminal 53 High Voltage* are active.

Micro switch 4 in position I:

6-12 *Terminal 53 Low Current* and 6-13 *Terminal 53 High Current* are active.

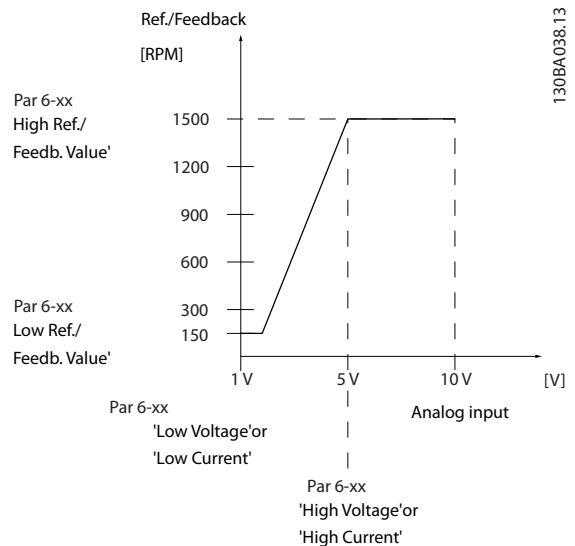
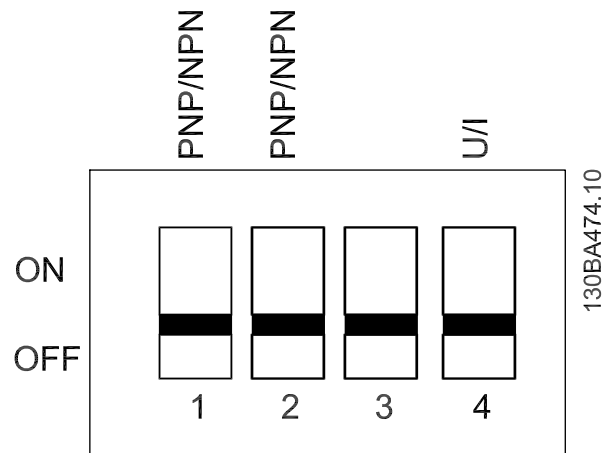

**6-10 Terminal 53 Low Voltage**
**Range:**                      **Function:**

		This scaling value should correspond to minimum reference value set in 6-14 <i>Terminal 53 Low Ref./Feedb. Value</i> . See also section <i>Reference Handling</i> .
0.07 V*	[0.00 - 9.90 V]	Enter low voltage value.

**⚠ CAUTION**

The value must be set to min. 1V in order to activate the Live Zero Timeout function in 6-01 *Live Zero Timeout Function*.

**6-11 Terminal 53 High Voltage**
**Range:**                      **Function:**

		This scaling value should correspond to maximum reference value set in 6-15 <i>Terminal 53 High Ref./Feedb. Value</i> .
10.0 V*	[0.10 - 10.00 V]	Enter high voltage value.

**6-12 Terminal 53 Low Current**
**Range:**                      **Function:**

		This reference signal should correspond to minimum reference value set in 6-14 <i>Terminal 53 Low Ref./Feedb. Value</i> .
0.14 mA*	[0.00 - 19.90 mA]	Enter low current value.

**⚠ CAUTION**

The value must be set to min. 2 mA in order to activate the Live Zero Timeout function in 6-01 *Live Zero Timeout Function*.

**6-13 Terminal 53 High Current**
**Range:**                      **Function:**

		This reference signal should correspond to the maximum reference value set in 6-15 <i>Terminal 53 High Ref./Feedb. Value</i> .
20.00 mA*	[0.10 - 20.00 mA]	Enter high current value.

**6-14 Terminal 53 Low Ref./Feedb. Value**
**Range:**                      **Function:**

		The scaling value corresponding to the low voltage/low current set in 6-10 <i>Terminal 53 Low Voltage</i> and 6-12 <i>Terminal 53 Low Current</i> .
0.000*	[-4999 - 4999]	Enter analog input scaling value.

**6-15 Terminal 53 High Ref./Feedb. Value**
**Range:**                      **Function:**

		The scaling value corresponding to the high voltage/high current set in 6-11 <i>Terminal 53 High Voltage</i> and 6-13 <i>Terminal 53 High Current</i> .
50.000*	[-4999.000 - 4999.000]	Enter analog input scaling value.

**6-16 Terminal 53 Filter Time Constant**
**Range:**                      **Function:**

		A first-order digital low pass filter time constant for suppressing electrical noise in terminal 53. A high time constant value improves dampening but also increases time delay through the filter.
0.01 s*	[0.01 - 10.00 s]	Enter time constant.

**6-19 Terminal 53 Mode**
**Option:**                      **Function:**

		Select the input to be present on terminal 53.
		<b>⚠ CAUTION</b> 6-19 <i>Terminal 53 Mode</i> MUST be set according to Micro switch 4 setting.
[0] *	Voltage Mode	
[1]	Current Mode	

**4.7.4 6-2\* Analog Input 2**

Parameters for configuring scaling and limits for analog input 2, terminal 60.

**6-22 Terminal 60 Low Current**
**Range:**                      **Function:**

		This reference signal should correspond to minimum reference value set in 6-24 <i>Terminal 60 Low Ref./Feedb. Value</i> .
0.14 mA*	[0.00 - 19.90 mA]	Enter low current value.

**⚠ CAUTION**

The value must be set to min. 2 mA in order to activate the Live Zero Timeout function in 6-01 *Live Zero Timeout Time*.

6-23 Terminal 60 High Current		
Range:	Function:	
		This reference signal should correspond to the high current value set in 6-25 Terminal 60 High Ref./Feedb. Value.
20.00 mA*	[0.10 - 20.00 mA]	Enter high current value.

6-24 Terminal 60 Low Ref./Feedb. Value		
Range:	Function:	
		The scaling value corresponding to the low current set in 6-22 Terminal 60 Low Current.
0.000*	[-4999 - 4999]	Enter analog input scaling value.

6-25 Terminal 60 High Ref./Feedb. Value		
Range:	Function:	
		The scaling value corresponding to the high current set in 6-23 Terminal 60 High Current.
50.00*	[-4999 - 4999]	Enter analog input scaling value.

6-26 Terminal 60 Filter Time Constant		
Range:	Function:	
		A first-order digital low pass filter time constant for suppressing electrical noise in terminal 60. A high time constant value improves dampening, but also increases time delay through the filter.
<b>NOTE</b> This parameter cannot be changed while motor runs.		
0.01 s*	[0.01 - 10.00 s]	Enter time constant.

#### 4.7.5 6-8\* LCP Potentiometer

The LCP potentiometer can be selected either as Reference Resource or Relative Reference Resource.

#### NOTE

In Hand mode the LCP potentiometer functions as local reference.

6-80 LCP Potmeter Enable		
Option:	Function:	
		If LCP Potmeter is disabled, Arrow key can adjust local reference and Potmeter value doesn't give any reference in Auto/Hand mode.
[0]	Disabled	
[1] *	Enable	

6-81 LCP Potentiometer Low Ref. Value		
Range:	Function:	
		The scaling value corresponding to 0.
0.000*	[-4999 - 4999]	Enter low reference value. The reference value corresponding to potentiometer turned fully counter-clockwise (0 degrees).

6-82 LCP Potentiometer High Ref. Value		
Range:	Function:	
		The scaling value corresponding to the maximum reference feedback value set in 3-03 Maximum Reference.
50.00*	[-4999 - 4999]	Enter high reference value. The reference value corresponding to potentiometer turned fully clockwise (200 degrees).

#### 4.7.6 6-9\* Analog Output

These parameters are for configuring the analog outputs of the frequency converter.

6-90 Terminal 42 Mode		
Option:	Function:	
[0] *	0 - 20 mA	Range for analog outputs is 0-20 mA
[1]	4-20 mA	Range for analog outputs is 4 - 20 mA
[2]	Digital output	Functions as slow reacting digital output. Set value to either 0 mA (off) or 20 mA (on), see 6-92 Terminal 42 Digital Output.

6-91 Terminal 42 Analog Output		
Option:	Function:	
		Select the function for terminal 42 as an analog output.
[0] *	No Operation	
[10]	Output Frequency [0-100Hz]	
[11]	Reference (REF min-max)	3-02 Minimum Reference to 3-03 Minimum Reference.
[12]	Feedback (FB min-max)	
[13]	Motor Current (0-I <sub>max</sub> )	16-37 Inv. Max. Current is I <sub>max</sub> .
[16]	Power (0-P <sub>nom</sub> )	1-20 Motor Power is P <sub>nom</sub> (motor).
[19]	DC Link Voltage (0-1000V)	
[20]	Bus Reference [0.0% - 100.0%]	The analog output will follow the reference value set on the RS485 bus.

6-92 Terminal 42 Digital Output		
Option:	Function:	
		See 5-4* Relays, for choices and descriptions.
[0] *	No Operation	

**6-92 Terminal 42 Digital Output**

**Option:**                      **Function:**

[80]	SL Digital Output A	See 13-52SL Control Action. When Smart Logic Action Set dig. out. A high [38] is executed, input goes high. When Smart Logic Action Set dig. out. A low [32] is executed, input goes low.
------	---------------------	---

**6-93 Terminal 42 Output Min. Scale**

**Range:**                      **Function:**

0.00 %	[0.00 - 200.00%]	Scale minimum output of selected analog signal at terminal 42 as percentage of maximum signal value. E.g. if 0mA (or 0Hz) is desired at 25% of maximum output value, program 25%. Scaling values up to 100% can never be higher than corresponding setting in 6-94 Terminal 42 Output Min. Scale.
--------	------------------	---

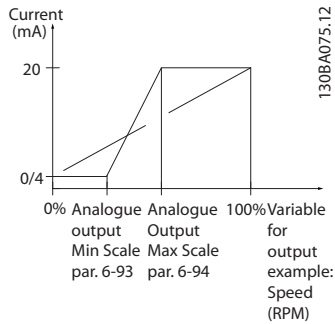

**6-94 Terminal 42 Output Max. Scale**

**Range:**                      **Function:**

100.00%*	[0.00 - 200.00%]	Scale maximum output of selected analog signal at terminal 42. Set value to maximum value of current signal output. Scale output to give a current lower than 20mA at full scale; or 20mA at an output below 100% of maximum signal value. If 20mA is the desired output current at a value between 0 - 100% of the full-scale output, programme percentage value in the parameter, i.e. 50% = 20mA. If a current between 4 and 20mA is desired at maximum output (100%), calculate percentage value as follows: $\frac{20 \text{ mA}}{\text{desired maximum current}} \times 100 \%$ i.e. $10 \text{ mA} = \frac{20}{10} \times 100 = 200 \%$
----------	------------------	--

## 4.8 Parameter Group 7: Controllers

### 4.8.1 7-\*\* Controllers

Parameters group for configuring application controls.

### 4.8.2 7-2\* Process Ctrl. Feedback

Select feedback sources and handling for Process PI Control.

#### NOTE

Set 3-15 Reference 1 Source to [0] No Function in order to use Analog Input as a feedback signal.

In order to use analog input as a feedback resource, do not use the same resource as reference resource in 3-15, 3-16 and 3-17.

#### 7-20 Process CL Feedback Resources

**Option:**                      **Function:**

Option:	Function:
	Select input to function as feedback signal.
[0] *	No Function
[1]	Analog Input 53
[2]	Analog Input 60
[8]	Pulse Input 33
[11]	Local Bus Ref.

### 4.8.3 7-3\* Process PI Control

#### 7-30 Process PI Normal/Inverse Control

**Option:**                      **Function:**

Option:	Function:
[0] *	Normal Feedback larger than setpoint result in a speed reduction. Feedback less than setpoint result in a speed increase.
[1]	Inverse Feedback larger than setpoint result in a speed increase. Feedback less than setpoint result in a speed reduction.

#### 7-31 Process PI Anti Windup

**Option:**                      **Function:**

Option:	Function:
[0]	Disable Regulation of a given error will continue even when the output frequency cannot be increased/ decreased.
[1] *	Enable PI-controller ceases from regulating a given error when the output frequency cannot be increased/ decreased.

#### 7-32 Process PI Start Speed

**Range:**                      **Function:**

Range:	Function:
0.0 Hz*	[0.0 - 200.0 Hz] Until the set motor speed has been reached the frequency converter operates in Open Loop mode.

#### 7-33 Process PI Proportional Gain

**Option:**                      **Function:**

Option:	Function:
[0.01] *	0.00 - 10.00 Enter the value for the P proportional gain, i.e. the multiplication factor of the error between the set point and the feedback signal. <b>Note!</b> <b>NOTE</b> 0.00 = Off.

#### 7-34 Process PI Integral Time

**Range:**                      **Function:**

Range:	Function:
9999.00 s*	[0.10 - 9999.00 s] The integrator provides an increasing gain at a constant error between the set point and the feedback signal. The integral time is the time needed by the integrator to reach the same gain as the proportional gain.

#### 7-38 Process Feed Forward Factor

**Range:**                      **Function:**

Range:	Function:
0%*	[0 - 400%] The FF factor sends a part of the reference signal around the PI controller which then only affects part of the control signal. By activating the FF factor less overshoot and high dynamics are gained when changing the setpoint. This parameter is always active when 1-00 Configuration Mode is set to Process [3].

#### 7-39 On Reference Bandwidth

**Range:**                      **Function:**

Range:	Function:
5%	[0 - 200%] Enter the value for the On Reference Bandwidth. The PI control error is the difference between setpoint and feedback and when this is less than the value set in this parameter the On Reference is active.

## 4.9 Parameter Group 8: Communication

### 4.9.1 8-\*\* Communication

Parameter group for configuring communication.

### 4.9.2 8-0\* General Settings

Use this parameter group for configuring the general settings for communication.

#### 8-01 Control Site

Option:	Function:
[0] * Digital and Control Word	Use both digital input and control word as control.
[1] Digital Only	Use digital input as control.
[2] Control Word Only	Use control word only as control. <b>NOTE</b> The setting in this parameter overrules settings in 8-50 Coasting Select to 8-56 Preset Reference Select.

#### 8-02 Control Word Source

Option:	Function:
[0] None	Function is inactive
[1] * FC RS485	Monitoring control word source is done via serial communication port RS485.

#### 8-03 Control Word Timeout Time

Range:	Function:
1.0 s* [0.1 - 6500 s]	Enter time to pass before control word timeout function (8-04 Control Word Timeout Function) must be carried out.

#### 8-04 Control Word Timeout Function

Option:	Function:
	Select the action to be taken in case of a timeout.
[0] * Off	No function.
[1] Freeze Output	Freeze output until communication resumes.
[2] Stop	Stop with auto restart when communication resumes.
[3] Jogging	Run motor at jog frequency until communication resumes.
[4] Max. Speed	Run motor at max. frequency until communication resumes.
[5] Stop and Trip	Stop motor, then reset frequency converter in order to restart either via LCP or digital input.

#### 8-06 Reset Control Word Timeout

Option:	Function:
	Resetting the control word timeout will remove any timeout function.
[0] * No Function	Control word timeout is not reset.
[1] Do Reset	Control word timeout is reset, and parameter goes into [0] No Function state.

### 4.9.3 8-3\* FC Port Settings

Parameters for configuring the FC Port.

### 4.9.4 8-30 Protocol

#### 8-30 Protocol

Option:	Function:
	Select the protocol to be used. Note that changing protocol will not be effective until after powering off the frequency converter.
[0] * FC	
[2] Modbus RTU	

#### 8-31 Address

Range:	Function:
	Select the address for the bus.
1* [1 - Protocol-dependent]	FC-bus range is 1-126. Modbus range is 1-247.

#### 8-32 FC Port Baud Rate

Option:	Function:
	Select baud rate for FC Port. <b>NOTE</b> Changing baud rate will be effective after responding to any ongoing bus-requests.
[0] 2400 Baud	
[1] 4800 Baud	
[2] * 9600 Baud	When choosing FC bus in 8-30
[3] * 19200 Baud	When choosing Modbus in 8-30
[4] 38400 Baud	

#### 8-33 FC Port Parity

Option:	Function:
	This parameter only affects Modbus as FC bus always has even parity.
[0] * Even Parity (1 stopbit)	
[1] Odd parity	
[2] No Parity (1 stopbit)	Select this for Modbus RTU
[3] No Parity (2 stopbit)	

#### 8-35 Minimum Response Delay

Range:	Function:
0.010 s* [0.001 - 0.500 s]	Specify minimum delay time between receiving a request and transmitting a response.

8-36 Max Response Delay		
Range:	Function:	
5.000 s*	[0.010 - 10.00 s]	Specify maximum permissible delay time between transmitting a request and receiving a response. Exceeding this time delay causes control word timeout.

#### 4.9.5 8-4\* FC MC Protocol Set

#### 4.9.6 8-43 FC Port PCD Read Configuration

8-43 FC Port PCD Read Configuration		
Array [16]		
Option:	Function:	
[0] *	None	
[1]	1500 Operation Hours	
[2]	1501 Running Hours	
[3]	1502 kWh Counter	
[4]	1600 Control Word	
[5]	1601 Reference [Unit]	
[6]	1602 Reference %	
[7]	1603 Status Word	
[8]	1605 Main Actual Value [%]	
[9]	1609 Custom Readout	
[10]	1610 Power [kW]	
[11]	1611 Power [hp]	
[12]	1612 Motor Voltage	
[13]	1613 Frequency	
[14]	1614 Motor Current	
[15]	1615 Frequency [%]	
[16]	1618 Motor Thermal	
[17]	1630 DC Link Voltage	
[18]	1634 Heatsink Temp.	
[19]	1635 Inverter Thermal	
[20]	1638 SL Controller State	
[21]	1650 External Reference	
[22]	1651 Pulse Reference	
[23]	1652 Feedback [Unit]	
[24]	1660 Digital Input 18,19,27,33	
[25]	1661 Digital Input 29	
[26]	1662 Analog Input 53(V)	
[27]	1663 Analog Input 53(mA)	
[28]	1664 Analog Input 60	
[29]	1665 Analog Output 42 [mA]	
[30]	1668 Freq. Input 33 [Hz]	
[31]	1671 Relay Output [bin]	
[32]	1672 Counter A	
[33]	1673 Counter B	
[34]	1690 Alarm Word	
[35]	1692 Warning Word	
[36]	1694 Ext. Status Word	
		Select the parameters to be assigned to PCD's of

8-43 FC Port PCD Read Configuration		
Array [16]		
Option:	Function:	
		telegrams. The number of available PCDs depends on the telegrams. This table is not for array [0] and array [1]. For these two arrays, index 1 is fixed to [7] and index 2 is fixed to [8]. These two arrays can't be changed by end user.

#### 4.9.7 8-5\* Digital/Bus

Parameters for configuring control word Digital/Bus merging.

### NOTE

Parameters are only active when 8-01 Control Site, is set to Digital and control word [0].

8-50 Coasting Select		
Option:	Function:	
		Select control of coasting function via digital input and/or bus.
[0]	Digital Input	Activation via a digital input.
[1]	Bus	Activation via serial communication port.
[2]	LogicAnd	Activation via serial communication port and a digital input.
[3] *	LogicOr	Activation via serial communication port or a digital input.

8-51 Quick Stop Select		
Option:	Function:	
		Select control of quick stop function via digital input and/or bus.
[0]	Digital Input	Activation via a digital input.
[1]	Bus	Activation via serial communication port.
[2]	LogicAnd	Activation via serial communication port and a digital input.
[3] *	LogicOr	Activation via serial communication port or a digital input.

8-52 DC Brake Select		
Option:	Function:	
		Select control of DC brake via digital input and/or bus.
[0]	Digital Input	Activation via a digital input.
[1]	Bus	Activation via serial communication port.
[2]	LogicAnd	Activation via serial communication port and a digital input.
[3] *	LogicOr	Activation via serial communication port or a digital input.

**8-53 Start Select**
**Option:                      Function:**

		Select control of start function via digital input and/or bus.
[0]	Digital Input	Activation via a digital input.
[1]	Bus	Activation via serial communication port.
[2]	LogicAnd	Activation via serial communication port and a digital input.
[3] *	LogicOr	Activation via serial communication port or a digital input.

**8-54 Reversing Select**
**Option:                      Function:**

		Select control of reversing function via digital input and/or bus.
[0]	Digital Input	Activation via a digital input.
[1]	Bus	Activation via serial communication port.
[2]	LogicAnd	Activation via serial communication port and a digital input.
[3] *	LogicOr	Activation via serial communication port or a digital input.

**8-55 Set-up Select**
**Option:                      Function:**

		Select control of set-up selection via digital input and/or bus.
[0]	Digital Input	Activation via a digital input.
[1]	Bus	Activation via serial communication port.
[2]	LogicAnd	Activation via serial communication port and a digital input.
[3] *	LogicOr	Activation via serial communication port or a digital input.

**8-56 Preset Reference Select**
**Option:                      Function:**

		Select control of Preset Reference selection via digital input and/or bus.
[0]	Digital Input	Activation via a digital input.
[1]	Bus	Activation via serial communication port.
[2]	LogicAnd	Activation via serial communication port and a digital input.
[3] *	LogicOr	Activation via serial communication port or a digital input.

#### 4.9.8 8-9\* Bus Feedback

Parameter for configuring bus feedback.

**8-94 Bus Feedback 1**
**Range:                      Function:**

0*	[0x8000 - 0x7FFF]	Bus feedback is delivered via FC or Modbus by writing the feedback value into this parameter.
----	-------------------	---



## 4.10 Parameter Group 13: Smart Logic

### 4.10.1 13-\*\* Programming Features

Smart Logic Control (SLC) is a sequence of user-defined actions (13-52 *SL Controller Action* [X]) executed by the SLC when the associated user-defined event (13-51 *SL Controller Event* [X]) is set to *True*.

Events and actions are linked in pairs, meaning that when an event is true, the linked action is carried out. After this the next event is evaluated and its belonging action carried out and so on. Only one event is evaluated at the time.

If an event is evaluated as *False*, the SLC takes no action during the scan interval and no other events are evaluated.

It is possible to programme from 1 to 20 events and actions.

When the last event/action has been executed, the sequence starts again from event/action [0].

The drawing shows an example with three events/actions:

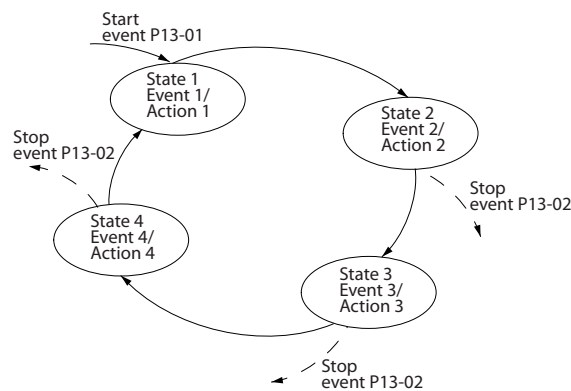

130BA062.13

#### Starting and stopping the SLC:

Start the SLC by selecting *On* [1] in 13-00 *SL Controller Mode*. The SLC starts evaluating Event 0, and if this is evaluated as *TRUE*, the SLC continues its cycle.

The SLC stops when the *Stop Event*, 13-02 *Stop Event*, is *TRUE*. The SLC can also be stopped by selecting *Off* [0] in 13-00 *SL Controller Mode*.

To reset all SLC parameters select *Reset SLC* [1] in 13-03 *Reset* and start programming from scratch.

### 4.10.2 13-0\* SLC Settings

Use SLC settings to activate, deactivate and reset the Smart Logic Control.

#### 13-00 SL Controller Mode

Option:	Function:
[0] *	Off Function is disabled.
[1]	On SLC is active.

#### 13-01 Start Event

Option:	Function:
	Select input to activate Smart Logic Control.
[0]	False Enters <i>False</i> in logic rule.
[1]	True Enters <i>True</i> in logic rule.
[2]	Running See parameter group 5-4* Relays [5] for description.
[3]	InRange See parameter group 5-4* Relays [7] for description.
[4]	OnReference See parameter group 5-4* Relays [8] for description.
[7]	Out of Current Range See parameter group 5-4* Relays [12] for description.
[8]	BelowLow See parameter group 5-4* Relays [13] for description.
[9]	AboveHigh See parameter group 5-4* Relays [14] for description.
[16]	ThermalWarning See parameter group 5-4* Relays [21] for description.
[17]	MainsOutOfRange Mains voltage is outside the specified voltage range.
[18]	Reversing See parameter group 5-4* Relays [25] for description.
[19]	Warning A warning is active.
[20]	Alarm_Trip A trip alarm is active.
[21]	Alarm_TripLock A trip lock alarm is active.
[22]	Comparator 0 Use result of comparator 0 in logic rule.
[23]	Comparator 1 Use result of comparator 1 in logic rule.
[24]	Comparator 2 Use result of comparator 2 in logic rule.
[25]	Comparator 3 Use result of comparator 3 in logic rule.
[26]	LogicRule 0 Use result of logic rule 0 in logic rule.
[27]	LogicRule 1 Use result of logic rule 1 in logic rule.
[28]	LogicRule 2 Use result of logic rule 2 in logic rule.
[29]	LogicRule 3 Use result of logic rule 3 in logic rule.
[33]	DigitallInput_18 Use value of DI 18 in logic rule.
[34]	DigitallInput_19 Use value of DI 19 in logic rule.
[35]	DigitallInput_27 Use value of DI 27 in logic rule.

#### 13-01 Start Event

Option:	Function:
[36]	DigitallInput_29 Use value of DI 29 in logic rule.
[38]	DigitallInput_33
[39] *	StartCommand This event is <i>True</i> , if frequency converter is started by any means (digital input or other).
[40]	DriveStopped This event is <i>True</i> , if frequency converter is stopped or coasted by any means (digital input or other).

#### 13-02 Stop Event

Option:	Function:
	Select input to activate Smart Logic Control.
[0]	False Enters <i>False</i> in logic rule.
[1]	True Enters <i>True</i> in logic rule.
[2]	Running See parameter group 5-4* Relays [5] for description.
[3]	InRange See parameter group 5-4* Relays [7] for description.
[4]	OnReference See parameter group 5-4* Relays [8] for description.
[7]	Out of Current Range See parameter group 5-4* Relays [12] for description.
[8]	BelowLow See parameter group 5-4* Relays [13] for description.
[9]	AboveHigh See parameter group 5-4* Relays [14] for description.
[16]	ThermalWarning See parameter group 5-4* Relays [21] for description.
[17]	MainsOutOfRange Mains voltage is outside the specified voltage range.
[18]	Reversing See parameter group 5-4* Relays [25] for description.
[19]	Warning A warning is active.
[20]	Alarm_Trip A trip alarm is active.
[21]	Alarm_TripLock A trip lock alarm is active.
[22]	Comparator 0 Use result of comparator 0 in logic rule.
[23]	Comparator 1 Use result of comparator 1 in logic rule.
[24]	Comparator 2 Use result of comparator 2 in logic rule.
[25]	Comparator 3 Use result of comparator 3 in logic rule.
[26]	LogicRule 0 Use result of logic rule 0 in logic rule.
[27]	LogicRule 1 Use result of logic rule 1 in logic rule.
[28]	LogicRule 2 Use result of logic rule 2 in logic rule.
[29]	LogicRule 3 Use result of logic rule 3 in logic rule.
[30]	SL Timeout0 Use result of timer 0 in logic rule.

**13-02 Stop Event**

Option:	Function:
[31] SL Timeout1	Use result of timer 1 in logic rule.
[32] SL Timeout2	Use result of timer 2 in logic rule.
[33] DigitalInput_18	Use value of DI 18 in logic rule.
[34] DigitalInput_19	Use value of DI 19 in logic rule.
[35] DigitalInput_27	Use value of DI 27 in logic rule.
[36] DigitalInput_29	Use value of DI 29 in logic rule.
[38] DigitalInput_33	
[39] StartCommand	This event is <i>True</i> , if frequency converter is started by any means (digital input or other).
[40] * DriveStopped	This event is <i>True</i> , if frequency converter is stopped or coasted by any means (digital input or other).

**13-03 Reset SLC**

Option:	Function:
[0] * Do Not Reset	Retains all settings programmed in parameter group 13.
[1] Reset SLC	Reset all group 13 parameters to default settings.

4.10.3 13-1\* Comparators

Comparators are used for comparing continuous variables (i.e. output frequency, output current, analog input etc.) to fixed preset values.

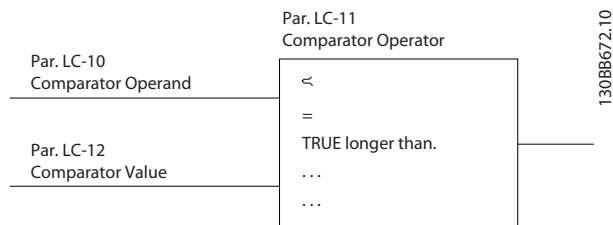

In addition, there are digital values that will be compared to fixed time values. See explanation in *13-10 Comparator Operand*. Comparators are evaluated once in each scan interval. Use the result (TRUE or FALSE) directly. All parameters in this parameter group are array parameters with index 0 to 5. Select index 0 to programme Comparator 0, select index 1 to programme Comparator 1, and so on.

**13-10 Comparator Operand**

Array [4]

Option:	Function:
[0] * Disabled	Select variable to be monitored by comparator.
[1] Reference	Comparator is disabled.
[2] Feedback	Resulting remote reference (not local) as a percentage.
	Feedback in [Hz].

**13-10 Comparator Operand**

Array [4]

Option:	Function:
[3] MotorSpeed	Motor speed in Hz.
[4] MotorCurrent	Motor current in [A].
[6] MotorPower	Motor power in either [kW] or [hp].
[7] MotorVoltage	Motor voltage in [V].
[8] DCLinkVoltage	DC-link voltage in [V].
[12] AnalogInput53	Expressed as a percentage.
[13] AnalogInput60	Expressed as a percentage.
[18] PulseInput33	Expressed as a percentage.
[20] AlarmNumber	Shows number of the alarm.
[30] CounterA	Number of counts.
[31] CounterB	Number of counts.

**13-11 Comparator Operator**

Array [4]

Option:	Function:
[0] Less Than <	Select operator to be used in comparison. Result of evaluation is <i>True</i> if variable selected in <i>13-10 Comparator Operand</i> is smaller than fixed value in <i>13-12 Comparator Value</i> . Result is <i>False</i> if variable selected in <i>13-10 Comparator Operand</i> is greater than fixed value in <i>13-12 Comparator Value</i> .
[1] * Approximately equals ≈	Result of evaluation is <i>True</i> if variable selected in <i>13-10 Comparator Operand</i> is approximately equal to fixed value in <i>13-12 Comparator Value</i> .
[2] Greater Than >	Inverse logic of option [0].

**13-12 Comparator Value**

Array [4]

Range:	Function:
0.0* [-9999 - 9999]	Enter "trigger level" for variable monitored by this comparator.

4.10.4 13-2\* Timers

Use the timer results to define an event (*13-51 SL Controller Action*) or as boolean input in a logic rule (*13-40 Logic Rule Boolean 1*, *13-42 Logic Rule Boolean 2* or *13-44 Logic Rule Boolean 3*).

When timer value has elapsed timer changes state from *False* to *True*.

**13-20 SLC Controller Timer**

Array [3]

**Range:**                      **Function:**

0.0 s*	[0.0 - 3600 s]	Enter value to define duration of the <i>False</i> output from programmed timer. A timer is only <i>False</i> if it is started by an action and until the given timer value has elapsed.
--------	----------------	--

**4.10.5 13-4\* Logic Rules**

Combine up to three boolean inputs (TRUE / FALSE inputs) from timers, comparators, digital inputs, status bits and events using the logical operators AND, OR, and NOT. Select boolean inputs for the calculation in *13-40 Logic Rule Boolean 1*, *13-42 Logic Rule Boolean 2* and *13-44 Logic Rule Boolean 3*. Define the operators used to logically combine the selected inputs in *13-41 Logic Rule Operator 1* and *13-43 Logic Rule Operator 2*.

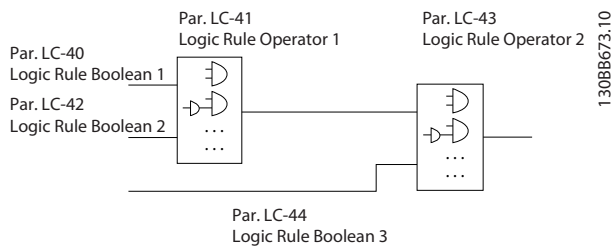

**Priority of calculation**

The results of *13-40 Logic Rule Boolean 1*, *13-41 Logic Rule Operator 1* and *13-42 Logic Rule Boolean 2* are calculated first. The outcome (TRUE / FALSE) of this calculation is combined with the settings of *13-43 Logic Rule Operator 2* and *13-44 Logic Rule Boolean 3*, yielding the final result (TRUE / FALSE) of the logic rule.

**13-40 Logic Rule Boolean 1**

Array [4]

**Option:**                      **Function:**

		Select first boolean input for selected logic rule.
[0] *	False	Enters <i>False</i> in logic rule.
[1]	True	Enters <i>True</i> in logic rule.
[2]	Running	See parameter group <i>5-4* Relays</i> [5] for description.
[3]	InRange	See parameter group <i>5-4* Relays</i> [7] for description.
[4]	OnReference	See parameter group <i>5-4* Relays</i> [8] for description.
[7]	Out of Current Range	See parameter group <i>5-4* Relays</i> [12] for description.
[8]	BelowLow	See parameter group <i>5-4* Relays</i> [13] for description.
[9]	AboveHigh	See parameter group <i>5-4* Relays</i> [14] for description.

**13-40 Logic Rule Boolean 1**

Array [4]

**Option:**                      **Function:**

[16]	ThermalWarning	See parameter group <i>5-4* Relays</i> [21] for description.
[17]	MainsOutOfRange	Mains voltage is outside the specified voltage range.
[18]	Reversing	See parameter group <i>5-4* Relays</i> [25] for description.
[19]	Warning	A warning is active.
[20]	Alarm_Trip	A trip alarm is active.
[21]	Alarm_TripLock	A trip lock alarm is active.
[22]	Comparator 0	Use result of comparator 0 in logic rule.
[23]	Comparator 1	Use result of comparator 1 in logic rule.
[24]	Comparator 2	Use result of comparator 2 in logic rule.
[25]	Comparator 3	Use result of comparator 3 in logic rule.
[26]	LogicRule 0	Use result of logic rule 0 in logic rule.
[27]	LogicRule 1	Use result of logic rule 1 in logic rule.
[28]	LogicRule 2	Use result of logic rule 2 in logic rule.
[29]	LogicRule 3	Use result of logic rule 3 in logic rule.
[30]	SL Timeout0	Use result of timer 0 in logic rule.
[31]	SL Timeout1	Use result of timer 1 in logic rule.
[32]	SL Timeout2	Use result of timer 2 in logic rule.
[33]	DigitalInput_18	Use value of DI 18 in logic rule.
[34]	DigitalInput_19	Use value of DI 19 in logic rule.
[35]	DigitalInput_27	Use value of DI 27 in logic rule.
[36]	DigitalInput_29	Use value of DI 29 in logic rule.
[38]	DigitalInput_33	
[39]	StartCommand	This event is <i>True</i> , if frequency converter is started by any means (digital input or other).
[40]	DriveStopped	This event is <i>True</i> , if frequency converter is stopped or coasted by any means (digital input or other).

**13-41 Logic Rule Operator 1**

Array [4]

**Option:**                      **Function:**

		Select first logical operator to use on boolean inputs from par. <i>13-40 Logic Rule Boolean 1</i> and <i>13-42 Logic Rule Boolean 2</i> .
[0] *	Disabled	Ignores <i>13-42 Logic Rule Boolean 2</i> , <i>13-43 Logic Rule Operator 2</i> and <i>13-44 Logic Rule Boolean 3</i> .
[1]	And	Evaluates expression [13-40] AND [13-42].
[2]	Or	Evaluates expression [13-40] OR [13-42].
[3]	And not	Evaluates expression [13-40] AND NOT [13-42].
[4]	Or not	Evaluates expression [13-40] OR NOT [13-42].
[5]	Not and	Evaluates expression NOT [13-40] and [13-42].
[6]	Not or	Evaluates expression NOT [13-40] OR [13-42].

**13-41 Logic Rule Operator 1**

Array [4]

**Option: Function:**

[7]	Not and not	Evaluates expression NOT [13-40] AND NOT [13-42].
[8]	Not or not	Evaluates expression NOT [13-40] OR NOT [13-42].

**13-42 Logic Rule Boolean 2**

Array [4]

**Option: Function:**

		Select second boolean input for selected logic rule. See 13-40 Logic Rule Boolean 1 for choices and descriptions.
--	--	---

**13-43 Logic Rule Operator 2**

Array [4]

**Option: Function:**

		Select second logical operator to use on boolean inputs calculated in 13-40 Logic Rule Boolean 1, 13-41 Logic Rule Operator 1, and 13-42 Logic Rule Boolean 2 and the boolean input from 13-42 Logic Rule Boolean 2.
[0] *	Disabled	Ignores 13-44 Logic Rule Boolean 3.
[1]	And	Evaluates expression [13-40/13-42] AND [13-44].
[2]	Or	Evaluates expression [13-40/13-42] OR [13-44].
[3]	And not	Evaluates expression [13-40/13-42] AND NOT [13-44].
[4]	Or not	Evaluates expression [13-40/13-42] OR NOT [13-44].
[5]	Not and	Evaluates expression NOT [13-40/13-42] and [13-44].
[6]	Not or	Evaluates expression NOT [13-40/13-42] OR [13-44].
[7]	Not and not	Evaluates expression NOT [13-40/13-42] AND NOT [13-44].
[8]	Not or not	Evaluates expression NOT [13-40/13-42] OR NOT [13-44].

**13-44 Logic Rule Boolean 3**

Array [4]

**Option: Function:**

		Select third boolean input for selected logic rule. See 13-40 Logic Rule Boolean 1 for choices and descriptions.
--	--	--

4.10.6 13-5\* States

**13-51 SL Controller Event**

Array [20]

**Option: Function:**

		Select boolean input to define Smart Controller Event.
--	--	--

**13-51 SL Controller Event**

Array [20]

**Option: Function:**

		See 13-40 Logic Rule Boolean 1 for choices and descriptions.
--	--	--

**13-52 SL Controller Action**

Array [20]

**Option: Function:**

		Select action corresponding to SLC event. Actions are executed when corresponding event (13-51 SL Controller Event) is evaluated as True.
[0] *	Disabled	Function is disabled.
[1]	No Action	No action is taken.
[2]	Select Set-up1	Changes active set-up to Set-up 1.
[3]	Select Set-up2	Changes active set-up to Set-up 2.
[10]	SelectPresetRef0	Selects preset reference 0
[11]	SelectPresetRef1	Selects preset reference 1
[12]	SelectPresetRef2	Selects preset reference 2
[13]	SelectPresetRef3	Selects preset reference 3
[14]	SelectPresetRef4	Selects preset reference 4
[15]	SelectPresetRef5	Selects preset reference 5
[16]	SelectPresetRef6	Selects preset reference 6
[17]	SelectPresetRef7	Selects preset reference 7
[18]	SelectRamp1	Selects ramp 1
[19]	SelectRamp2	Selects ramp 2
[22]	Run	Issues start command to frequency converter.
[23]	RunReverse	Issues start reverse command to frequency converter.
[24]	Stop	Issues stop command to frequency converter.
[25]	Qstop	Issues quick stop command to frequency converter.
[26]	DCstop	Issues DC stop command to frequency converter.
[27]	Coast	Frequency converter coasts immediately. All stop commands including coast command stop the SLC.
[28]	Freeze Output	Freezes output frequency.
[29]	StartTimer0	Starts timer 0.
[30]	StartTimer1	Starts timer 1
[31]	StartTimer2	Starts timer 2
[32]	SetDO42Low	Set Digital output 42 low.
[33]	SetRelayLow	Set Relay low.
[38]	SetDO42High	Set Digital output 42 high.
[39]	SetRelayHigh	Set Relay high.
[60]	ResetCounterA	Resets counter A to 0.
[61]	ResetCounterB	Resets counter B to 0.

### 4.11 Parameter Group 14: Special Functions

#### 4.11.1 14-\*\* Special Functions

Parameter group for configuring special frequency converter functions.

#### 4.11.2 14-0\* Inverter Switching

##### 14-01 Switching Frequency

Option:	Function:
	Select the switching frequency in order to minimize e.g. acoustic noise and power loss or maximizing efficiency.
[0]	2 KHz
[1] *	4 KHz
[2]	8 KHz
[4]	16 KHz

#### NOTE

For 18.5 kW and 22 kW drives, the option [4] is not available.

##### 14-03 Overmodulation

Option:	Function:
	This feature allows more accurate speed control near and over nominal speed (50/60 Hz). Another advantage with overmodulation is the ability of staying at a constant speed even though main is dropping.
[0]	Off Disables the overmodulation function to avoid torque ripple on the motor shaft.
[1] *	On Connects the overmodulation function to obtain an output voltage up to 15% greater than mains voltage.

#### 4.11.3 14-1\* Mains Monitoring

This parameter group supplies functions for handling imbalance on mains.

##### 14-12 Functions at Mains Imbalance

Option:	Function:
	Operation under severe mains imbalance conditions reduces drive lift time. Select function to take place when severe mains imbalance is detected.
[0] *	Trip Frequency converter trips.
[1]	Warning Frequency converter issues a warning.
[2]	Disabled No action taken.

Parameters for configuring auto reset handling, special trip handling and control card self test or initialisation.

##### 14-20 Reset Mode

Option:	Function:
	Select reset function after tripping. Once reset, frequency converter can be restarted.
[0] *	Manual Reset Perform reset via [reset]-button or digital inputs.
[1]	AutoReset 1 Performs one automatic reset after tripping.
[2]	AutoReset 2 Performs two automatic resets after tripping.
[3]	AutoReset 3 Performs three automatic resets after tripping.
[4]	AutoReset 4 Performs four automatic resets after tripping.
[5]	AutoReset 5 Performs five automatic resets after tripping.
[6]	AutoReset 6 Performs six automatic resets after tripping.
[7]	AutoReset 7 Performs seven automatic resets after tripping.
[8]	AutoReset 8 Performs eight automatic resets after tripping.
[9]	AutoReset 9 Performs nine automatic resets after tripping.
[10]	AutoReset 10 Performs ten automatic resets after tripping.
[11]	AutoReset 15 Performs fifteen automatic resets after tripping.
[12]	AutoReset 20 Performs twenty automatic resets after tripping.
[13]	Infinite auto reset Performs an infinite number of automatic resets after tripping.

**CAUTION**  
Motor may start without warning.

##### 14-21 Automatic Restart Time

Range:	Function:
10 s* [0 - 600 s]	Enter time interval from trip to start of automatic reset function. This parameter is active when 14-20 Reset Mode, is set to Automatic Reset [1] - [13].

##### 14-22 Operation Mode

Option:	Function:
	Use this parameter for specifying normal operation or to initialize all parameters, except 15-03 Power Ups, 15-04 Over Temps and 15-05 Over Volts.
[0] *	Normal Operation Frequency converter runs normal operation.
[2]	Initialization Resets all parameters to default settings, except for 15-03 Power Ups, 15-04 Over Temps and 15-05 Over Volts. Frequency converter resets during next power-up.

**14-22 Operation Mode**
**Option:                      Function:**

		14-22 <i>Operation Mode</i> also reverts to default setting <i>Normal Operation</i> [0].
--	--	--

**14-26 Trip Delay at Inverter Fault**
**Range:                      Function:**

[Size related]	0 - 30 s	When the frequency converter detects an over-voltage in the set time trip will be effected after the set time. If value = 0, <i>protection mode</i> is disabled <b>NOTE</b> It is recommended to disable <i>protection mode</i> in hoisting applications.
Application dependent*	[0 - 35 s]	When the frequency converter detects an over-voltage in the set time trip will be effected after the set time. If value = 0, <i>protection mode</i> is disabled <b>NOTE</b> It is recommended to disable <i>protection mode</i> in hoisting applications.

4

## 4.11.4 14-4\* Energy Optimizing

These parameters are for adjusting the energy optimization level in both Variable Torque (VT) and Automatic Energy Optimization (AEO) modes.

**14-41 AEO Minimum Magnetization**
**Range:                      Function:**

66%*	[40 - 75%]	Enter the minimum allowable magnetization for AEO. Selecting a low value reduces energy loss in the motor, but may also reduce resistance to sudden load changes.
------	------------	---



## 4.12 Parameter Group 15: Drive Information

Parameter group containing information on operating data, hardware configuration, software version, etc.

### 15-00 Operating Time

Range:	Function:
0 days* [0 - 65535 days]	View how many days the frequency converter has been powered up. The value is saved at power off and cannot be reset.

### 15-01 Running Hours

Range:	Function:
0* [0 - 2147483647]	View running hours of motor. The value is saved at power off and can be reset in <i>15-07 Reset Running Hours Counter</i> .

### 15-02 kWh Counter

Range:	Function:
0 [0 - 65535]	View power consumption in kWh as a mean value over one hour. Reset counter in <i>15-06 Reset kWh Counter</i> .

### 15-03 Power Ups

Range:	Function:
0 [0 - 2147483647]	View number of times frequency converter has been powered up. Counter cannot be reset.

### 15-04 Over Temps

Range:	Function:
0 [0 - 65535]	View number of times frequency converter has tripped due to over temperature. Counter cannot be reset.

### 15-05 Over Volts

Range:	Function:
0* [0 - 65535]	View number of times frequency converter has tripped due to over voltage. Counter cannot be reset.

### 15-06 Reset kWh Counter

Option:	Function:
[0] *	Do Not Reset Counter is not reset.
[1]	Reset Counter Counter is reset.

### 15-07 Reset Running Hours Counter

Option:	Function:
[0] *	Do Not Reset Counter is not reset.
[1]	Reset Counter Counter is reset.

## 4.12.1 15-3\* Fault Log

This parameter group contains a fault log showing reasons for the ten latest trips.

### 15-30 Fault Log: Error Code

Range:	Function:
0 [0 - 255]	View error code and look it up in VLT Micro Operating Instructions.

## 4.12.2 15-4\* Drive Identification

Parameters containing read only information about the hardware and software configuration of the frequency converter.

### 15-40 FC Type

Option:	Function:
	View FC type.

### 15-41 Power Section

Option:	Function:
	View power section of frequency converter.

### 15-42 Voltage

Option:	Function:
	View voltage of frequency converter.

### 15-43 Software Version

Option:	Function:
	View software version of frequency converter.

### 15-46 Frequency converter Ordering No

Option:	Function:
	View ordering number for re-ordering frequency converter in its original configuration.

### 15-48 LCP ID No

Option:	Function:
	View LCP ID number.

### 15-51 Frequency converter Serial Number

Option:	Function:
	View frequency converter serial number.



## 4.13 Parameter Group 16: Data Readouts

**16-00 Control Word**

Range:		Function:
0*	[0 - 65535]	View latest valid control word sent to frequency converter via serial communication port.

**16-01 Reference [Unit]**

Range:		Function:
0.000*	[-4999.000 - 4999.000]	View total remote reference. Total reference is sum of pulse, analog, preset, LCP potentiometer, local bus and freeze reference.

**16-02 Reference %**

Range:		Function:
0.0*	[-200.0 - 200.0%]	View total remote reference in percent. Total reference is sum of pulse, analog, preset, LCP potentiometer, local bus and freeze reference.

**16-03 Status Word**

Range:		Function:
0*	[0 - 65535]	View status word sent to frequency converter via serial communication port.

**16-05 Main Actual Value %**

Range:		Function:
0.00*	[-100.00 - 100.00%]	View two-byte word sent with status word to bus Master reporting main actual value.

**16-09 Custom Readout**

Range:		Function:
0.00*	[0.00 - 9999.00%]	
		Customized readout based on the settings of 0-31 <i>Custom Readout Min Scale</i> , 0-32 <i>Custom Readout Max Scale</i> and 4-14 <i>Motor Speed High Limit</i>

## 4.13.1 16-1\* Motor Status

**16-10 Power [kW]**

Range:		Function:
0 kW*	[0 - 99 kW]	View output power in kW.

**16-11 Power [hp]**

Range:		Function:
0 hp	[0 - 99 hp]	View output power in hp.

**16-12 Motor Voltage**

Range:		Function:
0.0*	[0.0 - 999.9 V]	View motor phase voltage.

**16-13 Frequency**

Range:		Function:
0.0 Hz*	[0.0 - 400.0 Hz]	View output frequency in Hz.

**16-14 Motor Current**

Range:		Function:
0.00 A*	[0.00 - 655 A]	View motor phase current.

**16-15 Frequency [%]**

Range:		Function:
0.00*	[-100.00 - 100.00%]	View a two-byte word reporting actual motor frequency as a percentage of 4-14 <i>Motor Speed High Limit</i>

**16-18 Motor Thermal**

Range:		Function:
0%*	[0 - 100%]	View calculated thermal motor load as percentage of estimated thermal motor load.

## 4.13.2 16-3\* Drive Status

**16-30 DC Link Voltage**

Range:		Function:
0 V*	[0 - 10000 V]	View DC-link voltage.

**16-34 Heat Sink Temp.**

Range:		Function:
0*	[0 - 255°C]	View heat sink temperature of frequency converter.

**16-35 Inverter Thermal**

Range:		Function:
0%*	[0 - 100%]	View calculated thermal load on frequency converter in relation to estimated thermal load on frequency converter.

**16-36 Inv. Nom. Current**

Range:		Function:
0.00 A*	[0.01 - 655A]	View continuous nominal inverter current.

**16-37 Inv. Max. Current**

Range:		Function:
0.00 A*	[0.1 - 655A]	View intermittent maximum inverter current (150%).

**16-38 SL Controller State**

Range:		Function:
0*	[0 - 255]	View number of active SLC state.

## 4.13.3 16-5\* Ref. &amp; Feedb.

**16-50 External Reference**

Range:		Function:
0.0%*	[-200.0 - 200.0%]	View sum of all external references in percent.

**16-51 Pulse Reference**

Range:		Function:
0.0 %*	[-200.0 - 200.0%]	View actual pulse input converted to a reference in percent.

**16-52 Feedback**

Range:		Function:
0.000*	[-4999.000 - 4999.000]	View analog or pulse feedback in Hz.

## 4.13.4 16-6\* Inputs and Outputs

**16-60 Digital Input 18, 19, 27, 33**

Range:		Function:
0*	[0 - 1111]	View signal states from active digital inputs.

**16-61 Digital Input 29**

Range:		Function:
0*	[0 - 1]	View signal state on digital input 29.

**16-62 Analog Input 53 (volt)**

Range:		Function:
0.00*	[0.00 - 10.00 V]	View input voltage on analog input terminal.

**16-63 Analog Input 53 (current)**

Range:		Function:
0.00*	[0.00 - 20.00 mA]	View input current on analog input terminal.

**16-64 Analog Input 60**

Range:		Function:
0.00*	[0.00 - 20.00 mA]	View actual value at input 60 either as reference or protection value.

**16-65 Analog Output 42 [mA]**

Range:		Function:
0.00 mA*	[0.00 - 20.00 mA]	View output current on analog output 42.

**16-68 Pulse Input**

Range:		Function:
20 Hz*	[20 - 5000 Hz]	View input frequency on pulse input terminal.

**16-71 Relay Output [bin]**

Range:		Function:
0*	[0 - 1]	View relay setting.

**16-72 Counter A**

Range:		Function:
0*	[-32768 - 32767]	View present value of Counter A.

**16-73 Counter B**

Range:		Function:
0*	[-32768 - 32767]	View present value of Counter B.

## 4.13.5 16-8\* FC Port

Parameter for viewing references from FC Port.

**16-86 FC Port REF 1**

Range:		Function:
0*	[0x8000 - 0x7FFF]	View currently received reference from FC Port.

## 4.13.6 16-9\* Diagnosis Read-Outs

**16-90 Alarm Word**

Range:		Function:
0*	[0 - 0xFFFFFFFF]	Via alarm word sent via serial communication port in hex code.

**16-92 Warning Word**

Range:		Function:
0*	[0 - 0xFFFFFFFF]	View warning word sent via serial communication port in hex code.

**16-94 Ext. Status Word**

Range:		Function:
0*	[0 - 0xFFFFFFFF]	View extended warning word sent via serial communication port in hex code.

## 5 Parameter Lists

5

Parameter Overview	
<b>0-XX Operation/Display</b>	
<b>0-0X Basic Settings</b>	
<b>0-03 Regional Settings</b>	
*[0] International	
[1] US	
<b>0-04 Oper. State at Power-up (Hand)</b>	
[0] Resume	
[1] Forced stop, ref = old	
[2] Forced stop, ref = 0	
<b>0-1X Set-up Handling</b>	
<b>0-10 Active Set-up</b>	
*[1] Setup 1	
[2] Setup 2	
[9] Multi Setup	
<b>0-11 Edit Set-up</b>	
*[1] Setup 1	
[2] Setup 2	
[9] Active Setup	
<b>0-12 Link Setups</b>	
[0] Not Linked	
*[20] Linked	
<b>0-31 Custom Readout Min Scale</b>	
0.00 - 9999.00	
*0.00	
<b>0-32 Custom Readout Max Scale</b>	
0.00 - 9999.00	
*100.0	
<b>0-4X LCP Keypad</b>	
<b>0-40 [Hand on] Key on LCP</b>	
[0] Disabled	
*[1] Enabled	
<b>0-41 [Off / Reset] Key on LCP</b>	
[0] Disable All	
[1] Enable All	
[2] Enable Reset Only	
<b>0-42 [Auto on] Key on LCP</b>	
[0] Disabled	
*[1] Enabled	
<b>0-5X Copy/Save</b>	
<b>0-50 LCP Copy</b>	
*[0] No copy	
[1] All to LCP	
[2] All from LCP	
[3] Size indep. from LCP	
<b>0-51 Set-up Copy</b>	
*[0] No copy	
[1] Copy from setup 1	
[2] Copy from setup 2	
[9] Copy from Factory setup	
<b>0-6X Password</b>	
100 - 9999 rpm * Motortype dep.	
<b>0-60 (Main) Menu Password</b>	
0 - 999 * 0	
<b>0-61 Access to Main/Quick Menu w/o Password</b>	
*[0] Full access	
[1] LCP: Read Only	
[2] LCP: No Access	
<b>1-XX Load/Motor</b>	
<b>1-0X General Settings</b>	
<b>1-00 Configuration Mode</b>	
*[0] Speed open loop	
[3] Process	
<b>1-01 Motor Control Principle</b>	
[0] U/f	
*[1] VVC+	
<b>1-03 Torque Characteristics</b>	
*[0] Constant torque	
[2] Automatic Energy Optim.	
<b>1-05 Local Mode Configuration</b>	
[0] Speed Open Loop	
*[2] As config in par. 1-00	
<b>1-2X Motor Data</b>	
<b>1-20 Motor Power [kW] [HP]</b>	
[1] 0.09kW/0.12HP	
[2] 0.12kW/0.16HP	
[3] 0.18kW/0.25HP	
[4] 0.25kW/0.33HP	
[5] 0.37kW/0.50HP	
[6] 0.55kW/0.75HP	
[7] 0.75kW/1.00HP	
[8] 1.10kW/1.50HP	
[9] 1.50kW/2.00HP	
[10] 2.20kW/3.00HP	
[11] 3.00kW/4.00HP	
[12] 3.70kW/5.00HP	
[13] 4.00kW/5.40HP	
[14] 5.50kW/7.50HP	
[15] 7.50kW/10.00HP	
[16] 11.00kW/15.00HP	
[17] 15.00kW/20.00HP	
[18] 18.50kW/25.00HP	
[19] 22.00kW/29.50HP	
[20] 30.00kW/40.00HP	
<b>1-22 Motor Voltage</b>	
50 - 999V * 230 - 400V	
<b>1-23 Motor Frequency</b>	
20 - 400Hz * 50Hz	
<b>1-24 Motor Current</b>	
0.01 - 100.00A * Motortype dep.	
<b>1-25 Motor Nominal Speed</b>	
100 - 9999 rpm * Motortype dep.	
<b>1-29 Automatic Motor Tuning (AMT)</b>	
*[0] Off	
[2] EnableAMT	
<b>1-3X Adv. Motor Data</b>	
<b>1-30 Stator Resistance (Rs)</b>	
[Ohm] * Dep. on motor data	
<b>1-33 Stator Leakage Reactance (X1)</b>	
[Ohm] * Dep. on motor data	
<b>1-35 Main Reactance (Xh)</b>	
[Ohm] * Dep. on motor data	
<b>1-5X Load Indep. Setting</b>	
<b>1-50 Motor Magnetisation at 0 Speed</b>	
0 - 300% * 100%	
<b>1-52 Min Speed Norm. Magnet. [Hz]</b>	
0.0 - 10.0Hz * 0.0Hz	
<b>1-55 U/f Characteristic - U</b>	
0 - 999.9V	
<b>1-56 U/f Characteristic - F</b>	
0 - 400Hz	
<b>1-6X Load Depen. Setting</b>	
<b>1-60 Low Speed Load Compensation</b>	
0 - 199% * 100%	
<b>1-61 High Speed Load Compensation</b>	
0 - 199% * 100%	
<b>1-62 Slip Compensation</b>	
-400 - 399% * 100%	
<b>1-63 Slip Compensation Time Constant</b>	
0.05 - 5.00s * 0.10s	
<b>1-7X Start Adjustments</b>	
<b>1-71 Start Delay</b>	
0.0 - 10.0s * 0.0s	
<b>1-72 Start Function</b>	
[0] DC hold / delay time	
[1] DC brake / delay time	
*[2] Coast / delay time	
<b>1-73 Flying Start</b>	
*[0] Disabled	
[1] Enabled	
<b>1-8X Stop Adjustments</b>	
<b>1-80 Function at Stop</b>	
*[0] Coast	
[1] DC hold	
<b>1-82 Min Speed for Funct. at Stop [Hz]</b>	
0.0 - 20.0 Hz * 0.0 Hz	
<b>1-9X Motor Thermal Protection</b>	
<b>1-90 Motor Thermal Protection</b>	
*[0] No protection	
[1] Thermistor warning	
[2] Thermistor trip	
[3] Etr warning	
<b>1-93 Thermistor Resource</b>	
*[0] None	
[1] Analog input 53	
[6] Digital input 29	
<b>2-XX Brakes</b>	
<b>2-0XDC-Brake</b>	
<b>2-00 DC Hold Current</b>	
0 - 150% * 50%	
<b>2-01 DC Brake Current</b>	
0 - 150% * 50%	
<b>2-02 DC Braking Time</b>	
0.0 - 60.0 s * 10.0 s	
<b>2-04 DC Brake Cut In Speed</b>	
0.0 - 400.0Hz * 0.0Hz	
<b>2-1X Brake Energy Funct.</b>	
<b>2-10 Brake Function</b>	
*[0] Off	
[1] Resistor brake	
[2] AC brake	
<b>2-11 Brake Resistor (ohm)</b>	
5 - 5000 * 5	
<b>2-16 AC Brake, Max current</b>	
0 - 150% * 100%	
<b>2-17 Over-voltage Control</b>	
*[0] Disabled	
[1] Enabled (not at stop)	
[2] Enabled	
<b>2-2* Mechanical Brake</b>	
<b>2-20 Release Brake Current</b>	
0.00 - 100.0A * 0.00A	
<b>2-22 Activate Brake Speed [Hz]</b>	
0.0 - 400.0Hz * 0.0Hz	
<b>3-XX Reference / Ramps</b>	
<b>3-0X Reference Limits</b>	
<b>3-00 Reference Range</b>	
*[0] Min - Max	
[1] -Max - +Max	
<b>3-02 Minimum Reference</b>	
-4999 - 4999 * 0.000	
<b>3-03 Maximum Reference</b>	
-4999 - 4999 * 50.00	
<b>3-1X References</b>	
<b>3-10 Preset Reference</b>	
-100.0 - 100.0% * 0.00%	
<b>3-11 Jog Speed [Hz]</b>	
0.0 - 400.0Hz * 5.0Hz	
<b>3-12 Catch up/slow Down Value</b>	
0.00 - 100.0% * 0.00%	
<b>3-14 Preset Relative Reference</b>	
-100.0 - 100.0% * 0.00%	

<p><b>3-15 Reference Resource 1</b>          [0] No function          * [1] Analog Input 53          [2] Analog input 60          [8] Pulse input 33          [11] Local bus ref          [21] LCP Potentiometer</p> <p><b>3-16 Reference Resource 2</b>          [0] No function          [1] Analog Input 53          * [2] Analog input 60          [8] Pulse input 33          * [11] Local bus ref          [21] LCP Potentiometer</p> <p><b>3-17 Reference Resource 3</b>          [0] No function          [1] Analog Input 53          [2] Analog input 60          [8] Pulse input 33          * [11] Local bus ref          [21] LCP Potentiometer</p> <p><b>3-18 Relative Scaling Ref. Resource</b>          [0] No function          [1] Analog Input 53          [2] Analog input 60          [8] Pulse input 33          [11] Local bus ref          [21] LCP Potentiometer</p> <p><b>3-4X Ramp 1</b>          * [0] Linear          [2] Sine2 ramp</p> <p><b>3-41 Ramp 1 Ramp up Time</b>          0.05 - 3600 s * 3.00 s (10.00 s<sup>1/1</sup>)</p> <p><b>3-42 Ramp 1 Ramp Down Time</b>          0.05 - 3600 s * 3.00 s (10.00 s<sup>1/1</sup>)</p> <p><b>3-5X Ramp 2</b>          * [0] Linear          [2] Sine2 ramp</p> <p><b>3-51 Ramp 2 Ramp up Time</b>          0.05 - 3600 s * 3.00 s (10.00 s<sup>1/1</sup>)</p> <p><b>3-52 Ramp 2 Ramp down Time</b>          0.05 - 3600 s * 3.00 s (10.00 s<sup>1/1</sup>)</p> <p><b>3-8X Other Ramps</b></p> <p><b>3-80 Jog Ramp Time</b>          0.05 - 3600 s * 3.00 s (10.00 s<sup>1/1</sup>)</p> <p><b>3-81 Quick Stop Ramp Time</b>          0.05 - 3600 s * 3.00 s (10.00 s<sup>1/1</sup>)</p>	<p><b>4-XX Limits / Warnings</b>  <b>4-1X Motor Limits</b>  <b>4-10 Motor Speed Direction</b>          [0] Clockwise if Par. 1-00 is set to [3]          [1] CounterClockwise          * [2] Both if Par. 1-00 is set to [0]  <b>4-12 Motor Speed Low Limit [Hz]</b>          0.0 - 400.0Hz * 0.0Hz  <b>4-14 Motor Speed High Limit [Hz]</b>          0.1 - 400.0Hz * 65.0Hz  <b>4-16 Torque Limit Motor Mode</b>          0 - 400% * 150%  <b>4-17 Torque Limit Generator Mode</b>          0 - 400% * 100%  <b>4-4X Adj. Warnings 2</b>  <b>4-40 Warning Frequency Low</b>          0.00 - Value of 4-41Hz * 0.0Hz  <b>4-41 Warning Frequency High</b>          Value of 4-40 - 400.0Hz * 400.0Hz  <b>4-5X Adj. Warnings</b>  <b>4-50 Warning Current Low</b>          0.00 - 100.00A * 0.00A  <b>4-51 Warning Current High</b>          0.00 - 100.00 A * 100.00 A  <b>4-54 Warning Reference Low</b>          -4999.000 - Value of 4-55 * -4999.000  <b>4-55 Warning Reference High</b>          Value of 4-54 - 4999.000 * 4999.000  <b>4-56 Warning Feedback Low</b>          -4999.000 - Value of 4-57 * -4999.000  <b>4-57 Warning Feedback High</b>          Value of 4-56 - 4999.000 * 4999.000  <b>4-58 Missing Motor Phase Function</b>          [0] Off          * [1] On  <b>4-6X Speed Bypass</b>  <b>4-61 Bypass Speed From [Hz]</b>          0.0 - 400.0 Hz * 0.0 Hz  <b>4-63 Bypass Speed To [Hz]</b>          0.0 - 400.0 Hz * 0.0 Hz  <b>5-1X Digital Inputs</b>  <b>5-10 Terminal 18 Digital Input</b>          [0] No function          [1] Reset          [2] Coast inverse          [3] Coast and reset inv.          [4] Quick stop inverse          [5] DC-brake inv.          [6] Stop inv</p>	<p>* [8] Start          [9] Latched start          [10] Reversing          [11] Start reversing          [12] Enable start forward          [13] Enable start reverse          [14] Jog          [16-18] Preset ref bit 0-2          [19] Freeze reference          [20] Freeze output          [21] Speed up          [22] Speed down          [23] Setup select bit 0          [28] Catch up          [29] Slow down          [34] Ramp bit 0          [60] Counter A (up)          [61] Counter A (down)          [62] Reset counter A          [63] Counter B (up)          [64] Counter B (down)          [65] ResetCounter B  <b>5-11 Terminal 19 Digital Input</b>          See par. 5-10. * [10] Reversing  <b>5-12 Terminal 27 Digital Input</b>          See par. 5-10. * [1] Reset  <b>5-13 Terminal 29 Digital Input</b>          See par. 5-10. * [14] Jog  <b>5-15 Terminal 33 Digital Input</b>          See par. 5-10. * [16] Preset ref bit 0          [26] Precise Stop Inverse          [27] Start, Precise Stop          [32] Pulse Input  <b>5-3X Digital Outputs</b>  <b>5-34 On Delay, Terminal 42 Digital Output</b>          0.00 - 600.00 s * 0.01 s  <b>5-35 Off Delay, Terminal 42 Digital Output</b>          0.00 - 600.00 s * 0.01 s  <b>5-4X Relays</b>  <b>5-40 Function Relay</b>          * [0] No operation          [1] Control ready          [2] Drive ready          [3] Drive ready, Remote          [4] Enable / No warning          [5] Drive running          [6] Running / No warning          [7] Run in range / No warning          [8] Run on ref / No warning          [9] Alarm</p>	<p>[10] Alarm or warning          [12] Out of current range          [13] Below current, low          [14] Above current, high          [16] Below frequency, low          [17] Above frequency, high          [19] Below feedback, low          [20] Above feedback, high          [21] Thermal warning          [22] Ready, No thermal warning          [23] Remote ready, No thermal warning          [24] Ready, Voltage ok          [25] Reverse          [26] Bus ok          [28] Brake, NoWarn          [29] Brake ready/NoFault          [30] BrakeFault (IGBT)          [32] Mech.brake control          [36] Control word bit 11          [41] Below reference, low          [42] Above reference, high          [51] Local ref. active          [52] Remote ref. active          [53] No alarm          [54] Start cmd active          [55] Running reverse          [56] Drive in hand mode          [57] Drive in auto mode          [60-63] Comparator 0-3          [70-73] Logic rule 0-3          [81] SL digital output B  <b>5-41 On Delay, Relay</b>          0.00 - 600.00 s * 0.01 s  <b>5-42 Off Delay, Relay</b>          0.00 - 600.00 s * 0.01 s  <b>5-5X Pulse Input</b>  <b>5-55 Terminal 33 Low Frequency</b>          20 - 4999Hz * 20Hz  <b>5-56 Terminal 33 High Frequency</b>          21 - 5000Hz * 5000Hz  <b>5-57 Term. 33 Low Ref./Feedb. Value</b>          -4999 - 4999 * 0.000  <b>5-58 Term. 33 High Ref./Feedb. Value</b>          -4999 - 4999 * 50.000  <b>6-XX Analog In/Out</b>  <b>6-00 Live Zero Timeout Time</b>          1 - 99 s * 10 s</p>
---	---	---	--

<sup>1/1</sup> M4 and M5 only

<p><b>6-01 Live Zero Timeout/Function</b>          * [0] Off          [1] Freeze output          [2] Stop          [3] Jogging          [4] Max speed          [5] Stop and trip</p> <p><b>6-1X Analog Input 1</b>          6-10 Terminal 53 Low Voltage          0.00 - 9.99V * 0.07V          6-11 Terminal 53 High Voltage          0.01 - 10.00V * 10.00V          6-12 Terminal 53 Low Current          0.00 - 19.99mA * 0.14mA          6-13 Terminal 53 High Current          0.01 - 20.00mA * 20.00mA          6-14 Term. 53 Low Ref./Feedb. Value          -4999 - 4999 * 0.000          6-15 Term. 53 High Ref./Feedb. Value          -4999 - 4999 * 50.000          6-16 Terminal 53 Filter Time Constant          0.01 - 10.00 s * 0.01 s          6-19 Terminal 53 mode          * [0] Voltage mode          [1] Current mode</p> <p><b>6-2X Analog Input 2</b>          6-22 Terminal 60 Low Current          0.00 - 19.99mA * 0.14mA          6-23 Terminal 60 High Current          0.01 - 20.00mA * 20.00mA          6-24 Term. 60 Low Ref./Feedb. Value          -4999 - 4999 * 0.000          6-25 Term. 60 High Ref./Feedb. Value          -4999 - 4999 * 50.000          6-26 Terminal 60 Filter Time Constant          0.01 - 10.00 s * 0.01 s</p> <p><b>6-8X LCP potentiometer</b>          6-80 LCP LCP Potmeter Enable          [0] Disabled          [1] * Enable</p> <p><b>6-81 LCP potm. Low Reference</b>          -4999 - 4999 * 0.000  <b>6-82 LCP potm. High Reference</b>          -4999 - 4999 * 50.000</p> <p><b>6-9X Analog Output xx</b>          6-90 Terminal 42 Mode          * [0] 0-20mA          [1] 4-20mA          [2] Digital Output</p> <p><b>6-91 Terminal 42 Analog Output</b>          * [0] No operation          [10] Output Frequency          [11] Reference</p>	<p>[12] Feedback          [13] Motor Current          [16] Power          [20] Bus Reference</p> <p><b>6-92 Terminal 42 Digital Output</b>          See par. 5-40          * [0] No Operation          [80] SL Digital Output A</p> <p><b>6-93 Terminal 42 Output Min Scale</b>          0.00 - 200.0% *          0.00%</p> <p><b>6-94 Terminal 42 Output Max Scale</b>          0.00 - 200.0% * 100.0%</p> <p><b>7-XX Controllers</b>          7-2X Process Ctrl. Feedb          7-20 Process CL Feedback 1 Resource          * [0] NoFunction          [1] Analog Input 53          [2] Analog input 60          [8] PulseInp33          [11] LocalBusRef</p> <p><b>7-3X Process PI</b>          Ctrl. 7-30 Process PI Normal/ Inverse Ctrl          * [0] Normal          [1] Inverse</p> <p><b>7-31 Process PI Anti Windup</b>          [0] Disable          * [1] Enable</p> <p><b>7-32 Process PI Start Speed</b>          0.0 - 200.0 Hz * 0.0 Hz</p> <p><b>7-33 Process PI Proportional Gain</b>          0.00 - 10.00 * 0.01</p> <p><b>7-34 Process PI Integral Time</b>          0.10 - 9999 s * 9999 s</p> <p><b>7-38 Process PI Feed Forward Factor</b>          0 - 400% * 0%</p> <p><b>7-39 On Reference Bandwidth</b>          0 - 200 % * 5 %</p> <p><b>8-XX Comm. and Options</b>  <b>8-0X General Settings</b>          8-01 Control Site          * [0] Digital and ControlWord          [1] Digital only          [2] ControlWord only</p> <p><b>8-02 Control Word Source</b>          [0] None          * [1] FC RS485</p> <p><b>8-03 Control Word Timeout Time</b>          0.1 - 6500 s * 1.0 s</p> <p><b>8-04 Control Word Timeout Function</b>          * [0] Off          [1] Freeze Output          [2] Stop</p>	<p>[3] Jogging          [4] Max. Speed          [5] Stop and trip</p> <p><b>8-06 Reset Control Word Timeout</b>          * [0] No Function          [1] Do reset</p> <p><b>8-3X FC Port Settings</b>  <b>8-30 Protocol</b>          * [0] FC          [2] Modbus</p> <p><b>8-31 Address</b>          1 - 247 * 1</p> <p><b>8-32 FC Port Baud Rate</b>          [0] 2400 Baud          [1] 4800 Baud          * [2] 9600 Baud For choosing FC bus in 8-30          * [3] 19200 Baud For choosing FC bus in 8-30          * [4] 38400 Baud</p> <p><b>8-33 FC Port Parity</b>          * [0] Even Parity, 1 Stop Bit          [1] Odd Parity, 1 Stop Bit          [2] No Parity, 1 Stop Bit          [3] No Parity, 2 Stop Bits</p> <p><b>8-35 Minimum Response Delay</b>          0.001-0.5 * 0.010 s</p> <p><b>8-36 Max Response Delay</b>          0.100 - 10.00 s * 5.000 s</p> <p><b>8-4* FC MC protocol set</b>  <b>8-43 FC Port PCD Read Configuration</b>          * [0] None Expressionlimit          [1] [1500] Operation Hours          [2] [1501] Running Hours          [3] [1502] kWh Counter          [4] [1600] Control Word          [5] [1601] Reference [Unit]          [6] [1602] Reference %          [7] [1603] Status Word          [8] [1605] Main Actual Value [%]          [9] [1609] Custom Readout          [10] [1610] Power [kW]          [11] [1611] Power [hp]          [12] [1612] Motor Voltage          [13] [1613] Frequency          [14] [1614] Motor Current          [15] [1615] Frequency [%]          [16] [1618] Motor Thermal          [17] [1630] DC Link Voltage          [18] [1634] Heatsink Temp.          [19] [1635] Inverter Thermal          [20] [1638] SL Controller State          [21] [1650] External Reference          [22] [1651] Pulse Reference</p>	<p>[23] [1652] Feedback [Unit]          [24] [1660] Digital Input 18,19,27,33          [25] [1661] Digital Input 29          [26] [1662] Analog Input 53(V)          [27] [1663] Analog Input 53(mA)          [28] [1664] Analog Input 60          [29] [1665] Analog Output 42 [mA]          [30] [1668] Freq. Input 33 [Hz]          [31] [1671] Relay Output [bin]          [32] [1672] Counter A          [33] [1673] Counter[34] [1690] Alarm Word          [34] [1690] Alarm Word          [35] [1692] Warning Word          [36] [1694] Ext. Status Word</p> <p><b>8-5X Digital/Bus</b>  <b>8-50 Coasting Select</b>          [0] DigitalInpnt          [1] Bus          [2] LogicAnd          * [3] LogicOr</p> <p><b>8-51 Quick Stop Select</b>          See par. 8-50 * [3] LogicOr</p> <p><b>8-52 DC Brake Select</b>          See par. 8-50 * [3] LogicOr</p> <p><b>8-53 Start Select</b>          See par. 8-50 * [3] LogicOr</p> <p><b>8-54 Reversing Select</b>          See par. 8-50 * [3] LogicOr</p> <p><b>8-55 Set-up Select</b>          See par. 8-50 * [3] LogicOr</p> <p><b>8-56 Preset Reference Select</b>          See par. 8-50 * [3] LogicOr</p> <p><b>8-9X Bus Jog / Feedback</b>  <b>8-94 Bus feedback 1</b>          0x8000 - 0x7FFF * 0</p> <p><b>13-XX Smart Logic</b>  <b>13-0X SLC Settings</b>  <b>13-00 SL Controller Mode</b>          * [0] Off          [1] On</p> <p><b>13-01 Start Event</b>          [0] False          [1] True          [2] Running          [3] InRange          [4] OnReference          [7] OutOfCurrentRange          [8] BelowLow          [9] AboveHigh          [16] ThermalWarning          [17] MainOutOfRange          [18] Reversing          [19] Warning</p>
--	---	---	---

[20] Alarm_Trip	[6] Not or	<b>14-2X Trip Reset</b>	0 - 0XFFFF
[21] Alarm_TripLock	[7] Not and not	<b>14-20 Reset Mode</b>	<b>16-05 Main Actual Value [%]</b>
[22-25] Comparator 0-3	[8] Not or not	*[0] Manual reset	-200.0 - 200.0 %
[26-29] LogicRule0-3	[8] Not or not	[1-9] AutoReset 1-9	<b>16-09 Custom Readout</b>
[33] DigitalInput_18	See par. 13-40	[10] AutoReset 10	Dep. on par. 0-31, 0-32 and 4-14
[34] DigitalInput_19	See par. 13-41 * [0] Disabled	[11] AutoReset 15	<b>16-1X Motor Status</b>
[35] DigitalInput_27	See par. 13-41 * [0] Disabled	[12] AutoReset 20	<b>16-10 Power [kW]</b>
[36] DigitalInput_29	See par. 13-40	[13] Infinite auto reset	<b>16-11 Power [hp]</b>
[38] DigitalInput_33	See par. 13-40	<b>14-21 Automatic Restart Time</b>	<b>16-12 Motor Voltage [V]</b>
*[39] StartCommand	<b>13-5X States</b>	0 - 600 s * 10 s	<b>16-13 Frequency [Hz]</b>
[40] DriveStopped	<b>13-51 SL Controller Event</b>	<b>14-22 Operation Mode</b>	<b>16-14 Motor Current [A]</b>
<b>13-02 Stop Event</b>	See par. 13-40	*[0] Normal Operation	<b>16-15 Frequency [%]</b>
<b>13-03 Reset SLC</b>	<b>13-52 SL Controller Action</b>	[2] Initialisation	<b>16-18 Motor Thermal [%]</b>
[*0] Do not reset	*[0] Disabled	<b>14-26 Action At Inverter Fault</b>	<b>16-3X Drive Status</b>
[1] Reset SLC	[1] NoAction	*[0] Trip	<b>16-30 DC Link Voltage</b>
<b>13-1X Comparators</b>	[2] SelectSetup1	[1] Warning	<b>16-34 Heatsink Temp.</b>
<b>13-10 Comparator Operand</b>	[3] SelectSetup2	<b>14-4X Energy Optimising</b>	<b>16-35 Inverter Thermal</b>
[*0] Disabled	[10-17] SelectPresetRef0-7	<b>14-41 AEO Minimum Magnetisation</b>	<b>16-36 Inv.Norm. Current</b>
[1] Reference	[18] SelectRamp1	40 - 75% * 66%	<b>16-37 Inv. Max. Current</b>
[2] Feedback	[19] SelectRamp2	<b>15-XX Drive Information 15-0X Operating Data</b>	<b>16-38 SL Controller State</b>
[3] MotorSpeed	[22] Run	<b>15-00 Operating Days</b>	<b>16-5X Ref. / Feedb.</b>
[4] MotorCurrent	[24] Stop	<b>15-01 Running Hours</b>	<b>16-50 External Reference</b>
[6] MotorPower	[25] Ostop	<b>15-02 kWh Counter</b>	<b>16-51 Pulse Reference</b>
[7] MotorVoltage	[26] DCstop	<b>15-03 Power Ups</b>	<b>16-52 Feedback [Unit]</b>
[8] DCLinkVoltage	[27] Coast	<b>15-04 Over Temps</b>	<b>16-6X Inputs / Outputs</b>
[12] AnalogInput53	[28] FreezeOutput	<b>15-05 Over Volts</b>	<b>16-60 Digital Input 18,19,27,33</b>
[13] AnalogInput60	[29] StartTimer0	<b>15-06 Reset kWh Counter</b>	0 - 1111
[18] PulseInput33	[30] StartTimer1	*[0] Do not reset	<b>16-61 Digital Input 29</b>
[20] AlarmNumber	[31] StartTimer2	[1] Reset counter	0 - 1
[30] CounterA	et Digital Output B High	<b>15-07 Reset Running Hours Counter</b>	<b>16-62 Analog Input 53 (volt)</b>
[31] CounterB	[32] Set Digital Output A Low	*[0] Do not reset	<b>16-63 Analog Input 53 (current)</b>
<b>13-11 Comparator Operator</b>	[33] Set Digital Output B Low	[1] Reset counter	<b>16-64 Analog Input 60</b>
[0] Less Than	[38] Set Digital Output A High	<b>15-3X Fault Log</b>	<b>16-65 Analog Output 42 [mA] 16-68 Pulse Input [Hz]</b>
*[1] Approximately equals	[39] Set Digital Output B High	<b>15-30 Fault Log: Error Code</b>	<b>16-71 Relay Output [bin]</b>
[2] Greater Than	[60] ResetCounterA	<b>15-4X Drive Identification</b>	<b>16-72 Counter A</b>
<b>13-12 Comparator Value</b>	[61] ResetCounterB	<b>15-40 FC Type</b>	<b>16-73 Counter B</b>
-9999 - 9999 * 0.0	<b>14-XX Special Functions</b>	<b>15-41 Power Section</b>	<b>16-8X Fieldbus / FC Port</b>
<b>13-2X Timers</b>	<b>14-0X Inverter Switching</b>	<b>15-42 Voltage</b>	<b>16-86 FC Port REF 1</b>
<b>13-20 SL Controller Timer</b>	<b>14-01 Switching Frequency</b>	<b>15-43 Software Version</b>	0x8000 - 0x7FFF
0.0 - 3600 s * 0.0 s	[0] 2kHz	<b>15-46 Frequency converter Order. No</b>	<b>16-9X Diagnosis Readouts</b>
<b>13-4X Logic Rules</b>	*[1] 4kHz	<b>15-48 LCP Id No</b>	<b>16-90 Alarm Word</b>
<b>13-40 Logic Rule Boolean 1</b>	[2] 8kHz	<b>15-51 Frequency converter Serial No</b>	0 - 0XFFFFFFF
See par. 13-01 * [0] False	[4] 16kHz not available for M5	<b>16-XX Data Readouts</b>	<b>16-92 Warning Word</b>
[30] - [32] SL Time-out 0-2	<b>14-03 Overmodulation</b>	<b>16-0X General Status</b>	0 - 0XFFFFFFF
<b>13-41 Logic Rule Operator 1</b>	[0] Off	<b>16-00 Control Word</b>	<b>16-94 Ext. Status Word</b>
*[0] Disabled	*[1] On	0 - 0XFFFF	0 - 0XFFFFFFF
[1] And	<b>14-1X Mains monitoring</b>	<b>16-01 Reference [Unit]</b>	<b>18-XX Extended Motor Data</b>
[2] Or	<b>14-12 Function at mains imbalance</b>	-4999 - 4999	<b>18-8X Motor Resistors</b>
[3] And not	*[0] Trip	<b>16-02 Reference %</b>	<b>18-80 Stator Resistance (High resolution)</b>
[4] Or not	[1] Warning	-200.0 - 200.0 %	0.000 - 99,990 ohm * 0.000 ohm
[5] Not and	[2] Disabled	<b>16-03 Status Word</b>	<b>18-81 Stator Leakage Reactance (High resolution)</b>
			0.000 - 99,990 ohm * 0.000 ohm

### 5.1.1 Conversion Index

The various attributes of each parameter are displayed in the section *Factory Settings*. Parameter values are transferred as whole numbers only. Conversion factors are therefore used to transfer decimals according to *Table 5.1*.

Example:

*1-24 Motor Current* has a conversion index of -2 (i.e. conversion factor of 0.01 according to *Table 5.1*). To set the parameter to 2.25 A, transfer the value 225 via Modbus. The Conversion Factor of 0.01 means that the value transferred is multiplied by 0.01 in the drive. The value 225 transferred on the bus is thus perceived as 2.25 A in the frequency converter.

Conversion index	Conversion factor
2	10
1	100
0	1
-1	0.1
-2	0.01
-3	0.001
-4	0.0001
-5	0.00001

Table 5.1 Conversion table

### 5.1.2 Change during operation

“TRUE” means that the parameter can be changed while the frequency converter is in operation and “FALSE” means that the frequency converter must be stopped before a change can be made.

### 5.1.3 2-Set-up

“All set-up”: The parameter can be set individually in each of the two set-ups, i.e. one single parameter can have two different data values.

“1 set-up”: Data value will be the same in both set-ups.

### 5.1.4 Type

Data Type	Description	Type
2	Integer 8	Int8
3	Integer 16	Int16
4	Integer 32	Int32
5	Unsigned 8	UInt8
6	Unsigned 16	UInt16
7	Unsigned 32	UInt32
9	Visible string	VisibleString



### 5.1.5 0-\*\* Operation/Display

Parameter Number	Parameter Description	Default Value	2 Setup	Change During Operation	Conversion Index	Type
0 - 03	Regional Settings	[0] International	1 set-up	FALSE	-	Uint8
0 - 04	Operating State at Power-up (Hand)	[1] Forced stop ref=old	All set-ups	TRUE	-	Uint8
0 - 10	Active Set-up	[1] Set-up 1	1 set-up	TRUE	-	Uint8
0 - 11	Edit Set-up	[1] Set-up 1	1 set-up	TRUE	-	Uint8
0 - 12	Link Setups	[20] Linked	All set-ups	FALSE	-	Uint8
0 - 31	Custom Readout Min Scale	0	1 set-up	TRUE	-2	Int32
0 - 32	Custom Readout Max Scale	0	1 set-up	TRUE	-2	Int32
0 - 40	[Hand on] Key on LCP	[1] Enabled	All set-ups	TRUE	-	Uint8
0 - 41	[Off / Reset] Key on LCP	[1] Enable All	All set-ups	TRUE	-	Uint8
0 - 42	[Auto on] Key on LCP	[1] Enabled	All set-ups	TRUE	-	Uint8
0 - 50	LCP Copy	[0] No copy	1 set-up	FALSE	-	Uint8
0 - 51	Set-up Copy	[0] No copy	1 set-up	FALSE	-	Uint8
0 - 60	Main Menu Password	0	1 set-up	TRUE	0	Uint16
0 - 61	Access to Main/Quick menu w/o Password	0	1 set-up	TRUE	-	Uint8

5

### 5.1.6 1-\*\* Load/Motor

Parameter Number	Parameter Description	Default Value	2 Setup	Change During Operation	Conversion Index	Type
1 - 00	Configuration Mode	[0] Speed open loop	All set-ups	TRUE	-	Uint8
1 - 01	Motor Control Principle	[1] VVC+	All set-ups	FALSE	-	Uint8
1 - 03	Torque Characteristics	[0] Constant torque	All set-ups	TRUE	-	Uint8
1 - 05	Hand Mode Configuration	[2] As mode 1-00 Configuration Mode	All set-ups	TRUE	-	Uint8
1 - 20	Motor Power		All set-ups	FALSE	-	Uint8
1 - 22	Motor Voltage		All set-ups	FALSE	0	Uint16
1 - 23	Motor Frequency		All set-ups	FALSE	0	Uint16
1 - 24	Motor Current		All set-ups	FALSE	-2	Uint16
1 - 25	Motor Nominal Speed		All set-ups	FALSE	0	Uint16
1 - 29	Automatic Motor Tuning (AMT)	[0] Off	1 set-up	FALSE	-	Uint8
1 - 30	Stator Resistance (Rs)		All set-ups	FALSE	-2	Uint16
1 - 33	Stator Leakage Reactance (X1)		All set-ups	FALSE	-2	Uint32
1 - 35	Main Reactance (Xh)		All set-ups	FALSE	-2	Uint32
1 - 50	Motor Magnetisation at Zero Speed	100%	All set-ups	TRUE	0	Uint16
1 - 52	Min Speed Normal Magnetising [Hz]	0 Hz	All set-ups	TRUE	-1	Uint16
1 - 55	U/f Characteristic - U		All set-ups	TRUE	0	Uint16
1 - 56	U/f Characteristic - F		All set-ups	TRUE	0	Uint16
1 - 60	Low Speed Load Compensation	100%	All set-ups	TRUE	0	Uint16
1 - 61	High Speed Load Compensation	100%	All set-ups	TRUE	0	Uint16
1 - 62	Slip Compensation	100%	All set-ups	TRUE	0	Int16
1 - 63	Slip Compensation Time Constant	0.1 s	All set-ups	TRUE	-2	Uint16
1 - 71	Start Delay	0 s	All set-ups	TRUE	-1	Uint8
1 - 72	Start Function	[2] Coast/delay time	All set-ups	TRUE	-	Uint8
1 - 73	Flying Start	[0] Disabled	All set-ups	FALSE	-	Uint8
1 - 80	Function at Stop	[0] Coast	All set-ups	TRUE	-	Uint8
1 - 82	Min Speed for Function at Stop [Hz]	0 Hz	All set-ups	TRUE	-1	Uint16
1 - 90	Motor Thermal Protection	[0] No protection	All set-ups	TRUE	-	Uint8
1 - 93	Thermistor Resource	[0] None	All set-ups	FALSE	-	Uint8

### 5.1.7 2-\*\* Brakes

Parameter Number	Parameter Description	Default Value	2 Setup	Change During Operation	Conversion Index	Type
2 - 00	DC Hold Current	50%	All set-ups	TRUE	0	Uint16
2 - 01	DC Brake Current	50%	All set-ups	TRUE	0	Uint16
2 - 02	DC Braking Time	10 s	All set-ups	TRUE	-1	Uint16
2 - 04	DC Brake Cut In Speed	0 Hz	All set-ups	TRUE	-1	Uint16
2 - 10	Brake Function	[0] Off	All set-ups	TRUE	-	Uint8
2 - 11	Brake Resistor (ohm)		All set-ups	TRUE	0	Uint16
2 - 16	AC Brake, Max current	100%	All set-ups	TRUE	0	Uint16
2 - 17	Over-voltage Control	[0] Disabled	All set-ups	TRUE	-	Uint8
2 - 20	Release Brake Current	0 A	All set-ups	TRUE	-2	Uint32
2 - 22	Activate Brake Speed [Hz]	0 Hz	All set-ups	TRUE	-1	Uint16



### 5.1.8 3-\*\* Reference/Ramps

Parameter Number	Parameter Description	Default Value	2 Setup	Change During Operation	Conversion Index	Type
3 - 00	Reference Range	[0] Min - Max	All set-ups	TRUE	-	Uint8
3 - 02	Minimum Reference	0	All set-ups	TRUE	-3	Int32
3 - 03	Maximum Reference	50	All set-ups	TRUE	-3	Int32
3 - 10	Preset Reference	0%	All set-ups	TRUE	-2	Int16
3 - 11	Jog Speed [Hz]	5 Hz	All set-ups	TRUE	-1	Uint16
3 - 12	Catch up/slow Down Value	0%	All set-ups	TRUE	-2	Int16
3 - 14	Preset Relative Reference	0%	All set-ups	TRUE	-2	Int16
3 - 15	Reference Resource 1	[1] Analog in 53	All set-ups	TRUE	-	Uint8
3 - 16	Reference Resource 2	[2] Analog in 60	All set-ups	TRUE	-	Uint8
3 - 17	Reference Resource 3	[11] Local bus reference	All set-ups	TRUE	-	Uint8
3 - 18	Relative Scaling Reference Resource	[0] No function	All set-ups	TRUE	-	Uint8
3 - 40	Ramp 1 Type	[0] Linear	All set-ups	TRUE	-	Uint8
3 - 41	Ramp 1 Ramp up Time	3 s	All set-ups	TRUE	-2	Uint32
3 - 42	Ramp 1 Ramp Down Time	3 s	All set-ups	TRUE	-2	Uint32
3 - 50	Ramp 2 Type	[0] Linear	All set-ups	TRUE	-	Uint8
3 - 51	Ramp 2 Ramp up Time	3 s	All set-ups	TRUE	-2	Uint32
3 - 52	Ramp 2 Ramp down Time	3 s	All set-ups	TRUE	-2	Uint32
3 - 80	Jog Ramp Time	3 s	All set-ups	TRUE	-2	Uint32
3 - 81	Quick Stop Ramp Time	3 s	1 set-up	TRUE	-2	Uint32

### 5.1.9 4-\*\* Limits/Warnings

Parameter Number	Parameter Description	Default Value	2 Setup	Change During Operation	Conversion Index	Type
4 - 10	Motor Speed Direction	[2] Both directions	All set-ups	FALSE	-	Uint8
4 - 12	Motor Speed Low Limit [Hz]	0 Hz	All set-ups	FALSE	-1	Uint16
4 - 14	Motor Speed High Limit [Hz]	65 Hz	All set-ups	FALSE	-1	Uint16
4 - 16	Torque Limit Motor Mode	150%	All set-ups	TRUE	0	Uint16
4 - 17	Torque Limit Generator Mode	100%	All set-ups	TRUE	0	Uint16
4 - 40	Warning Frequency Low	0Hz	All set-ups	TRUE	-1	Uint16
4 - 41	Warning Frequency High	400Hz	All set-ups	TRUE	-1	Uint16
4 - 50	Warning Current Low	0 A	All set-ups	TRUE	-2	Uint32
4 - 51	Warning Current High	26 A	All set-ups	TRUE	-2	Uint32
4 - 54	Warning Reference Low	-4999	All set-ups	TRUE	-3	Int32
4 - 55	Warning Reference High	4999	All set-ups	TRUE	-3	Int32
4 - 56	Warning Feedback Low	-4999	All set-ups	TRUE	-3	Int32
4 - 57	Warning Feedback High	4999	All set-ups	TRUE	-3	Int32
4 - 58	Missing Motor Phase Function	[1] On	All set-ups	FALSE	-	Uint8
4 - 61	Bypass Speed From [Hz]	0 Hz	All set-ups	TRUE	-1	Uint16
4 - 63	Bypass Speed To [Hz]	0 Hz	All set-ups	TRUE	-1	Uint16

### 5.1.10 5-\*\* Digital In/Out

Parameter Number	Parameter Description	Default Value	2 Setup	Change During Operation	Conversion Index	Type
5 - 10	Terminal 18 Digital Input	[8] Start	All set-ups	TRUE	-	Uint8
5 - 11	Terminal 19 Digital Input	[10] Reversing	All set-ups	TRUE	-	Uint8
5 - 12	Terminal 27 Digital Input	[1] Reset	All set-ups	TRUE	-	Uint8
5 - 13	Terminal 29 Digital Input	[14] Jog	All set-ups	TRUE	-	Uint8
5 - 15	Terminal 33 Digital Input	[16] Preset ref bit 0	All set-ups	TRUE	-	Uint8
5 - 34	On Delay, Terminal 42 Digital Output	0.01s	All set-ups	TRUE	-2	Uint16
5 - 35	Off Delay, Terminal 42 Digital Output	0.01s	All set-ups	TRUE	-2	Uint16
5 - 40	Function Relay	[0] No operation	All set-ups	TRUE	-	Uint8
5 - 41	On Delay, Relay	0.01s	All set-ups	TRUE	-2	Uint16
5 - 42	Off Delay, Relay	0.01s	All set-ups	TRUE	-2	Uint16
5 - 55	Terminal 33 Low Frequency	20 Hz	All set-ups	TRUE	0	Uint16
5 - 56	Terminal 33 High Frequency	5000 Hz	All set-ups	TRUE	0	Uint16
5 - 57	Terminal 33 Low Ref./Feedb. Value	0	All set-ups	TRUE	-3	Int32
5 - 58	Terminal 33 High Ref./Feedb. Value	50	All set-ups	TRUE	-3	Int32

## 5.1.11 6-\*\* Analog In/Out

Parameter Number	Parameter Description	Default Value	2 Setup	Change During Operation	Conversion Index	Type
6 - 00	Live Zero Timeout Time	10 s	All set-ups	TRUE	0	Uint8
6 - 01	Live Zero TimeoutFunction	[0] Off	All set-ups	TRUE	-	Uint8
6 - 10	Terminal 53 Low Voltage	0.07 V	All set-ups	TRUE	-2	Uint16
6 - 11	Terminal 53 High Voltage	10 V	All set-ups	TRUE	-2	Uint16
6 - 12	Terminal 53 Low Current	0.14 mA	All set-ups	TRUE	-2	Uint16
6 - 13	Terminal 53 High Current	20 mA	All set-ups	TRUE	-2	Uint16
6 - 14	Terminal 53 Low Ref./Feedb. Value	0	All set-ups	TRUE	-3	Int32
6 - 15	Terminal 53 High Ref./Feedb. Value	50	All set-ups	TRUE	-3	Int32
6 - 16	Terminal 53 Filter Time Constant	0.01 s	All set-ups	TRUE	-2	Uint16
6 - 19	Terminal 53 mode	[0] Voltage mode	1 set-up	TRUE	-	Uint8
6 - 22	Terminal 60 Low Current	0.14 mA	All set-ups	TRUE	-2	Uint16
6 - 23	Terminal 60 High Current	20 mA	All set-ups	TRUE	-2	Uint16
6 - 24	Terminal 60 Low Ref./Feedb. Value	0	All set-ups	TRUE	-3	Int32
6 - 25	Terminal 60 High Ref./Feedb. Value	50	All set-ups	TRUE	-3	Int32
6 - 26	Terminal 60 Filter Time Constant	0.01 s	All set-ups	TRUE	-2	Uint16
6 - 80	LCP Potmeter Enable	1	1 set-up	FALSE	-	Uint8
6 - 81	LCP potentiometer Low Ref.	0	All set-ups	TRUE	-3	Int32
6 - 82	LCP potentiometer High Ref.	50	All set-ups	TRUE	-3	Int32
6 - 90	Terminal 42 Mode	[0] 0-20 mA	All set-ups	TRUE	-	Uint8
6 - 91	Terminal 42 Analog Output	[0] No operation	All set-ups	TRUE	-	Uint8
6 - 92	Terminal 42 Digital Output	[0] No operation	All set-ups	TRUE	-	Uint8
6 - 93	Terminal 42 Output Min Scale	0%	All set-ups	TRUE	-2	Uint16
6 - 94	Terminal 42 Output Max Scale	100%	All set-ups	TRUE	-2	Uint16

## 5.1.12 7-\*\* Controllers

Parameter Number	Parameter Description	Default Value	2 Setup	Change During Operation	Conversion Index	Type
7 - 20	Process CL Feedback 1 Resource	[0] No function	All set-ups	TRUE	-	Uint8
7 - 30	Process PI Normal/ Inverse Control	[0] Normal	All set-ups	TRUE	-	Uint8
7 - 31	Process PI Anti Windup	[1] Enabled	All set-ups	TRUE	-	Uint8
7 - 32	Process PI Start Speed	0 Hz	All set-ups	TRUE	-1	Uint16
7 - 33	Process PI Proportional Gain	0.01	All set-ups	TRUE	-2	Uint16
7 - 34	Process PI Integral Time	9999 s	All set-ups	TRUE	-2	Uint32
7 - 38	Process PI Feed Forward Factor	0%	All set-ups	TRUE	0	Uint16
7 - 39	On Reference Bandwidth	5%	All set-ups	TRUE	0	Uint8

## 5.1.13 8-\*\* Comm. and Options

Parameter Number	Parameter Description	Default Value	2 Setup	Change During Operation	Conversion Index	Type
8 - 01	Control Site	[0] Digital and ctrl.word	All set-ups	TRUE	-	Uint8
8 - 02	Control Word Source	[1] FC RS485	All set-ups	TRUE	-	Uint8
8 - 03	Control Word Timeout Time	1 s	1 set-up	TRUE	-1	Uint16
8 - 04	Control Word Timeout Function	[0] Off	1 set-up	TRUE	-	Uint8
8 - 06	Reset Control Word Timeout	[0] No function	1 set-up	TRUE	-	Uint8
8 - 30	Protocol	[0] FC	1 set-up	TRUE	0	Uint8
8 - 31	Address	1	1 set-up	TRUE	0	Uint8
8 - 32	FC Port Baud Rate	[2] 9600 Baud	1 set-up	TRUE	-	Uint8
8 - 33	FC Port Parity	[0] Even Parity 1 Stop Bit	1 set-up	TRUE	-	Uint8
8 - 35	Minimum Response Delay	0.01 s	1 set-up	TRUE	-3	Uint16
8 - 36	Max Response Delay	5 s	1 set-up	TRUE	-3	Uint16
8 - 43	FC Port PCD Read Configuration	0	1 set-up	TRUE	-	Uint8
8 - 50	Coasting Select	[3] Logic OR	All set-ups	TRUE	-	Uint8
8 - 51	Quick Stop Select	[3] Logic OR	All set-ups	TRUE	-	Uint8
8 - 52	DC Brake Select	[3] Logic OR	All set-ups	TRUE	-	Uint8
8 - 53	Start Select	[3] Logic OR	All set-ups	TRUE	-	Uint8
8 - 54	Reversing Select	[3] Logic OR	All set-ups	TRUE	-	Uint8
8 - 55	Set-up Select	[3] Logic OR	All set-ups	TRUE	-	Uint8
8 - 56	Preset Reference Select	[3] Logic OR	All set-ups	TRUE	-	Uint8
8 - 94	Bus feedback 1	0	All set-ups	TRUE	0	Int16

## 5.1.14 13-\*\* Smart Logic

Parameter Number	Parameter Description	Default Value	2 Setup	Change During Operation	Conversion Index	Type
13 - 00	SL Controller Mode	[0] Off	1 set-up	TRUE	-	UInt8
13 - 01	Start Event	[39] Start command	1 set-up	TRUE	-	UInt8
13 - 02	Stop Event	[40] Drive stopped	1 set-up	TRUE	-	UInt8
13 - 03	Reset SLC	[0] Do not reset	1 set-up	TRUE	-	UInt8
13 - 10	Comparator Operand	[0] Disabled	1 set-up	TRUE	-	UInt8
13 - 11	Comparator Operator	[1] ApproxEqual	1 set-up	TRUE	-	UInt8
13 - 12	Comparator Value	0	1 set-up	TRUE	-1	Int32
13 - 20	SL Controller Timer	0 s	1 set-up	TRUE	-1	UInt32
13 - 40	Logic Rule Boolean 1	[0] False	1 set-up	TRUE	-	UInt8
13 - 41	Logic Rule Operator 1	[0] Disabled	1 set-up	TRUE	-	UInt8
13 - 42	Logic Rule Boolean 2	[0] False	1 set-up	TRUE	-	UInt8
13 - 43	Logic Rule Operator 2	[0] Disabled	1 set-up	TRUE	-	UInt8
13 - 44	Logic Rule Boolean 3	[0] False	1 set-up	TRUE	-	UInt8
13 - 51	SL Controller Event	[0] False	1 set-up	TRUE	-	UInt8
13 - 52	SL Controller Action	[0] Disabled	1 set-up	TRUE	-	UInt8

## 5.1.15 14-\*\* Special Functions

Parameter Number	Parameter Description	Default Value	2 Setup	Change During Operation	Conversion Index	Type
14 - 01	Switching Frequency	[1] 4.0 kHz	All set-ups	TRUE	-	UInt8
14 - 03	Overmodulation	[1] On	All set-ups	FALSE	-	UInt8
14 - 12	Function at Mains Imbalance	[0] Trip	All set-ups	TRUE	-	UInt8
14 - 20	Reset Mode	[0] Manual reset	All set-ups	TRUE	-	UInt8
14 - 21	Automatic Restart Time	10 s	All set-ups	TRUE	0	UInt16
14 - 22	Operation Mode	[0] Normal operation	1 set-up	TRUE	-	UInt8
14 - 26	Action At Inverter Fault	[0] Trip	All set-ups	TRUE	-	UInt8
14 - 41	AEO Minimum Magnetisation	66 %	All set-ups	TRUE	0	UInt8

## 5.1.16 15-\*\* Drive Information

Parameter Number	Parameter Description	Default Value	2 Setup	Change During Operation	Conversion Index	Type
15 - 00	Operating Time	0	1 set-up	TRUE	0	UInt32
15 - 01	Running Hours	0	1 set-up	TRUE	0	UInt32
15 - 02	kWh Counter	0	1 set-up	TRUE	0	UInt32
15 - 03	Power Up's	0	1 set-up	TRUE	0	UInt32
15 - 04	Over Temp's	0	1 set-up	TRUE	0	UInt16
15 - 05	Over Volt's	0	1 set-up	TRUE	0	UInt16
15 - 06	Reset kWh Counter	[0] Do not reset	1 set-up	TRUE	-	UInt8
15 - 07	Reset Running Hours Counter	[0] Do not reset	1 set-up	TRUE	-	UInt8
15 - 30	Fault Log: Error Code	0	1 set-up	TRUE	0	UInt8
15 - 40	FC Type		1 set-up	FALSE	0	VisibleString
15 - 41	Power Section		1 set-up	FALSE	0	VisibleString
15 - 42	Voltage		1 set-up	FALSE	0	VisibleString
15 - 43	SW ID Control Card		1 set-up	FALSE	0	VisibleString
15 - 46	Frequency converter Ordering No		1 set-up	FALSE	0	VisibleString
15 - 48	LCP Id No		1 set-up	FALSE	0	VisibleString
15 - 51	Frequency converter Serial Number		1 set-up	FALSE	0	VisibleString

## 5.1.17 16-\*\* Data Readouts

Parameter Number	Parameter Description	Default Value	2 Setup	Change During Operation	Conversion Index	Type
16 - 00	Control Word	0	1 set-up	TRUE	0	Uint16
16 - 01	Reference [Unit]	0	1 set-up	TRUE	-3	Int32
16 - 02	Reference %	0	1 set-up	TRUE	-1	Int16
16 - 03	Status Word	0	1 set-up	TRUE	0	Uint16
16 - 05	Main Actual Value [%]	0	1 set-up	TRUE	-2	Int16
16 - 09	Custom Readout	0	1 set-up	TRUE	-2	Int32
16 - 10	Power [kW]	0	1 set-up	TRUE	-3	Uint16
16 - 11	Power [hp]	0	1 set-up	TRUE	-3	Uint16
16 - 12	Motor Voltage	0	1 set-up	TRUE	0	Uint16
16 - 13	Frequency	0	1 set-up	TRUE	-1	Uint16
16 - 14	Motor Current	0	1 set-up	TRUE	-2	Uint16
16 - 15	Frequency [%]	0	1 set-up	TRUE	-1	Uint16
16 - 18	Motor Thermal	0	1 set-up	TRUE	0	Uint8
16 - 30	DC Link Voltage	0	1 set-up	TRUE	0	Uint16
16 - 34	Heatsink Temp.	0	1 set-up	TRUE	0	Uint8
16 - 35	Inverter Thermal	0	1 set-up	TRUE	0	Uint8
16 - 36	Inv. Nom. Current	0	1 set-up	TRUE	-2	Uint16
16 - 37	Inv. Max. Current	0	1 set-up	TRUE	-2	Uint16
16 - 38	SL Controller State	0	1 set-up	TRUE	0	Uint8
16 - 50	External Reference	0	1 set-up	TRUE	-1	Int16
16 - 51	Pulse Reference	0	1 set-up	TRUE	-1	Int16
16 - 52	Feedback [Unit]	0	1 set-up	TRUE	-3	Int32
16 - 60	Digital input 18,19,27,33	0	1 set-up	TRUE	0	Uint16
16 - 61	Digital input 29	0	1 set-up	TRUE	0	Uint8
16 - 62	Analog Input 53 (V)	0	1 set-up	TRUE	-2	Uint16
16 - 63	Analog Input 53 (mA)	0	1 set-up	TRUE	-2	Uint16
16 - 64	Analog Input 60	0	1 set-up	TRUE	-2	Uint16
16 - 65	Analog Output 42 [mA]	0	1 set-up	TRUE	-2	Uint16
16 - 68	Pulse input 33	20	1 set-up	TRUE	0	Uint16
16 - 71	Relay Output [bin]	0	1 set-up	TRUE	0	Uint8
16 - 72	Counter A	0	1 set-up	TRUE	0	Int16
16 - 73	Counter B	0	1 set-up	TRUE	0	Int16
16 - 86	FC Port REF 1	0	1 set-up	TRUE	0	Int16
16 - 90	Alarm Word	0	1 set-up	TRUE	0	Uint32
16 - 92	Warning Word	0	1 set-up	TRUE	0	Uint32
16 - 94	Ext. Status Word	0	1 set-up	TRUE	0	Uint32

## 6 Troubleshooting

A warning or an alarm is signalled by the relevant LED on the front of the frequency converter and indicated by a code on the display.

A warning remains active until its cause is no longer present. Under certain circumstances operation of the motor may still be continued. Warning messages may be critical, but are not necessarily so.

In the event of an alarm, the frequency converter will have tripped. Alarms must be reset to restart operation once their cause has been rectified.

### This may be done in four ways:

1. By using the [RESET] control button on the LCP.
2. Via a digital input with the "Reset" function.
3. Via serial communication.

### NOTE

After a manual reset using the [RESET] button on the LCP, the [AUTO ON] or [HAND ON] button must be pressed to restart the motor.

If an alarm cannot be reset, the reason may be that its cause has not been rectified, or the alarm is trip-locked (see also table on following page).

### **CAUTION**

Alarms that are trip-locked offer additional protection, means that the mains supply must be switched off before the alarm can be reset. After being switched back on, the frequency converter is no longer blocked and may be reset as described above once the cause has been rectified.

Alarms that are not trip-locked can also be reset using the automatic reset function in *14-20 Reset Mode* (Warning: automatic wake-up is possible!)

If a warning and alarm is marked against a code in the table on the following page, this means that either a warning occurs before an alarm, or it can be specified whether it is a warning or an alarm that is to be displayed for a given fault.

This is possible, for instance, in *1-90 Motor Thermal Protection*. After an alarm or trip, the motor carries on coasting, and the alarm and warning flash on the frequency converter. Once the problem has been rectified, only the alarm continues flashing.

No.	Description	Warning	Alarm	Trip Lock	Error	Parameter Reference
2	Live zero error	(X)	(X)			6-01
4	Mains phase loss	(X)	(X)	(X)		14-12
7	DC over voltage	X	X			
8	DC under voltage	X	X			
9	Inverter overloaded	X	X			
10	Motor ETR over temperature	(X)	(X)			1-90
11	Motor thermistor over temperature	(X)	(X)			1-90
13	Over Current	X	X	X		
14	Earth fault	X	X	X		
16	Short Circuit		X	X		
17	Control word timeout	(X)	(X)			8-04
25	Brake resistor short-circuited		X	X		
27	Brake chopper short-circuited		X	X		
28	Brake Check		X			
29	Power board over temp		X	X		
30	Motor phase U missing		(X)	(X)		4-58
31	Motor phase V missing		(X)	(X)		4-58
32	Motor phase W missing		(X)	(X)		4-58
38	Internal fault		X	X		
44	Earth fault 2		X	X		
47	Control Voltage Fault		X	X		
51	AMT check $U_{nom}$ and $I_{nom}$		X			

No.	Description	Warning	Alarm	Trip Lock	Error	Parameter Reference
52	AMT low $I_{nom}$		X			
53	AMT motor too big		X			
54	AMT motor too small		X			
55	AMT Parameter out of range		X			
63	Mechanical Brake Low		X			
80	Drive Initialized to Default Value		X			
84	The connection between drive and LCP is lost				X	
85	Button disabled				X	
86	Copy fail				X	
87	LCP data invalid				X	
88	LCP data not compatible				X	
89	Parameter read only				X	
90	Parameter database busy				X	
91	Parameter value is not valid in this mode				X	
92	Parameter value exceeds the min/max limits				X	

**Table 6.1 Alarm/Warning Code List**

(X) Dependent on parameter

A trip is the action when an alarm has appeared. The trip will coast the motor and can be reset by pressing the reset button or make a reset by a digital input (parameter group 5-1\* [1]). The original event that caused an alarm cannot damage the frequency converter or cause dangerous conditions. A trip lock is an action when an alarm occurs, which may cause damage to frequency converter or connected parts. A Trip Lock situation can only be reset by a power cycling.

LED indication	
Warning	yellow
Alarm	flashing red

The alarm words, warning words and extended status words can be read out via serial bus or optional fieldbus for diagnosis. See also 16-90 Alarm Word, 16-92 Warning Word and 16-94 Ext. Status Word.

## 6.1.1 Alarm, Warning and Extended Status Word

			Par 16-90	Par 16-92	Par 16-94
Bit	Hex	Dec	AlarmWord	WarningWord	ExtendedStatusWord
0	1	1	Brake check		Ramping
1	2	2	Pwr.card temp	Pwr.card temp	AMT running
2	4	4	Earth Fault		Start CW/CCW
3	8	8			Slow down
4	10	16	Ctrl.word TO	Ctrl.word TO	Catch up
5	20	32	Over Current	Over Current	Above Feedback High
6	40	64		Torque limit	Below Feedback Low
7	80	128	Motor th over	Motor th over	Output current high
8	100	256	Motor ETR over	Motor ETR over	Output current low
9	200	512	Inverter overload	Inverter overload	Above Frequency High
10	400	1024	DC under volt	DC under volt	Below Frequency Low
11	800	2048	DC over volt	DC over volt	
12	1000	4096	Short Circuit		
13	2000	8192			Braking
14	4000	16384	Mains ph. loss	Mains ph. loss	
15	8000	32768	"AMT Not OK"		OVC active
16	10000	65536	Live zero error	Live zero error	AC brake
17	20000	131072	Internal fault		
18	40000	262144			
19	80000	524288	U phase loss		Above Reference High
20	100000	1048576	V phase loss		Below Reference Low
21	200000	2097152	W phase loss		Local Ref./Remote Ref.
22	400000	4194304			
23	800000	8388608	Control Voltage Fault		
24	1000000	16777216			
25	2000000	33554432		Current limit	
26	4000000	67108864	Brake resistor short-circuit		
27	8000000	134217728	Brake IGBT short-circuit		
28	10000000	268435456	M4/M5: Earth Fault (Desat)	MotorPhaseMissing	
29	20000000	536870912	Drive initialised		
30	40000000	1073741824		Undefined	
31	80000000	2147483648	Mech. brake low		DatabaseBusy

The alarm words, warning words and extended status words can be read out via serial bus for diagnose. See also *16-94 Ext. Status Word*.

**WARNING/ALARM 2, Live zero error**

Signal on terminal 53 or 60 is less than 50% of value set in *6-10 Terminal 53 Low Voltage*, *6-12 Terminal 53 Low Current* and *6-22 Terminal 60 Low Current*.

**WARNING/ALARM 4, Mains phase loss**

A phase is missing on the supply side, or the mains voltage imbalance is too high. This message also appears for a fault in the input rectifier on the frequency converter.

**Troubleshooting:** Check the supply voltage and supply currents to the frequency converter. The fault may be caused by mains distortions. Installing Danfoss Line Filter may rectify this problem.

**WARNING/ALARM 7, DC overvoltage**

If the intermediate circuit voltage exceeds the limit, the frequency converter trips after a time.

**Troubleshooting**

Connect a brake resistor

Extend the ramp time

Change the ramp type

Activate the functions in *2-10 Brake Function*

Increase *14-26 Trip Delay at Inverter Fault*

The fault may be caused by mains distortions. Installing Danfoss Line Filter may rectify this problem.

**WARNING/ALARM 8, DC under voltage**

If the intermediate circuit voltage (DC link) drops below the under voltage limit, the frequency converter checks if a 24V DC backup supply is connected. If no 24V DC backup supply is connected, the frequency converter trips after a fixed time delay. The time delay varies with unit size.



**Troubleshooting:**

Check that the supply voltage matches the frequency converter voltage.

Perform input voltage test

Perform soft charge circuit test

**WARNING/ALARM 9, Inverter overload**

The frequency converter is about to cut out because of an overload (too high current for too long). The counter for electronic, thermal inverter protection gives a warning at 98% and trips at 100%, while giving an alarm. The frequency converter *cannot* be reset until the counter is below 90%.

The fault is that the frequency converter is overloaded by more than 100% for too long.

**Troubleshooting**

Compare the output current shown on the LCP with the frequency converter rated current.

Compare the output current shown on the LCP with measured motor current.

Display the Thermal Drive Load on the LCP and monitor the value. When running above the frequency converter continuous current rating, the counter should increase. When running below the frequency converter continuous current rating, the counter should decrease.

See the derating section in the *Design Guide* for more details if a high switching frequency is required.

**WARNING/ALARM 10, Motor overload temperature**

According to the electronic thermal protection (ETR), the motor is too hot. Select whether the frequency converter gives a warning or an alarm when the counter reaches 100% in *1-90 Motor Thermal Protection*. The fault occurs when the motor is overloaded by more than 100% for too long.

**Troubleshooting**

Check for motor overheating.

Check if the motor is mechanically overloaded

Check that the motor current set in *1-24 Motor Current* is correct.

Ensure that Motor data in parameters 1-20 through 1-25 are set correctly.

Running AMT in 1-29 Automatic Motor Tuning (AMT). The inverter peak current limit (approx. 200% of the rated current) is exceeded. The warning will last approx. 8-12 sec., then the frequency converter trips and issues an alarm. Turn off the frequency converter and check if the motor shaft can be turned and if the motor size matches the frequency converter. If extended mechanical brake control is selected, trip can be reset externally. may tune the frequency

converter to the motor more accurately and reduce thermal loading.

**WARNING/ALARM 11, Motor thermistor over temp**

The thermistor might be disconnected. Select whether the frequency converter gives a warning or an alarm in *1-90 Motor Thermal Protection*.

**Troubleshooting**

Check for motor overheating.

Check if the motor is mechanically overloaded.

**WARNING/ALARM 13, Over current**

The inverter peak current limit (approx. 200% of the rated current) is exceeded. The warning will last approx. 8-12 sec., then the frequency converter trips and issues an alarm. Turn off the frequency converter and check if the motor shaft can be turned and if the motor size matches the frequency converter. If extended mechanical brake control is selected, trip can be reset externally.

**Troubleshooting:**

Remove power and check if the motor shaft can be turned.

Check that the motor size matches the frequency converter.

Check parameters 1-20 through 1-25. for correct motor data.

**ALARM 14, Earth (ground) fault**

There is current from the output phases to earth, either in the cable between the frequency converter and the motor or in the motor itself.

**Troubleshooting:**

Remove power to the frequency converter and repair the earth fault.

Check for earth faults in the motor by measuring the resistance to ground of the motor leads and the motor with a megohmmeter.

**ALARM 16, Short circuit**

There is short-circuiting in the motor or motor wiring.

Remove power to the frequency converter and repair the short circuit.

**WARNING/ALARM 17, Control word timeout**

There is no communication to the frequency converter. The warning will only be active when *8-04 Control Word Timeout Function* is NOT set to OFF.

If *8-04 Control Word Timeout Function* is set to *Stop and Trip*, a warning appears and the frequency converter ramps down until it trips, while giving an alarm. 8-03 Control Word Timeout Time could possibly be increased.

**Troubleshooting:**

Check connections on the serial communication cable.

Increase *8-03 Control Word Timeout Time*



Check the operation of the communication equipment.

Verify a proper installation based on EMC requirements.

#### **WARNING 25, Brake resistor short circuit**

The brake resistor is monitored during operation. If a short circuit occurs, the brake function is disabled and the warning appears. The frequency converter is still operational but without the brake function. Remove power to the frequency converter and replace the brake resistor (see 2-15 *Brake Check*).

#### **WARNING/ALARM 27, Brake chopper fault**

The brake transistor is monitored during operation and if a short circuit occurs, the brake function is disabled and a warning is issued. The frequency converter is still operational but, since the brake transistor has short-circuited, substantial power is transmitted to the brake resistor, even if it is inactive.

Remove power to the frequency converter and remove the brake resistor.

#### **WARNING/ALARM 28, Brake check failed**

The brake resistor is not connected or not working.

#### **ALARM 29, Heatsink temp**

The maximum temperature of the heatsink has been exceeded. The temperature fault will not reset until the temperature falls below a defined heatsink temperature. The trip and reset points are different based on the frequency converter power size.

##### **Troubleshooting:**

Check for the following conditions.

Ambient temperature too high.

Motor cable too long.

Incorrect airflow clearance above and below the frequency converter

Blocked airflow around the frequency converter.

Damaged heatsink fan.

Dirty heatsink.

#### **ALARM 30, Motor phase U missing**

Motor phase U between the frequency converter and the motor is missing.

Remove power from the frequency converter and check motor phase U.

#### **ALARM 31, Motor phase V missing**

Motor phase V between the frequency converter and the motor is missing.

Remove power from the frequency converter and check motor phase V.

#### **ALARM 32, Motor phase W missing**

Motor phase W between the frequency converter and the motor is missing.

Remove power from the frequency converter and check motor phase W.

#### **ALARM 38, Internal fault**

##### **Troubleshooting**

Cycle power

Check that the option is properly installed

Check for loose or missing wiring

It may be necessary to contact your Danfoss supplier or service department. Note the code number for further troubleshooting directions.

#### **WARNING 47, 24V supply low**

The 24 V DC is measured on the control card. The external 24V DC backup power supply may be overloaded, otherwise contact your Danfoss supplier.

#### **ALARM 51, AMT check $U_{nom}$ and $I_{nom}$**

The settings for motor voltage, motor current, and motor power are wrong. Check the settings in parameters 1-20 to 1-25.

#### **ALARM 55, AMT Parameter out of range**

The parameter values of the motor are outside of the acceptable range. AMA will not run.

#### **ALARM 63, Mechanical brake low**

The actual motor current has not exceeded the "release brake" current within the "Start delay" time window.

#### **ALARM 80, Unit initialised to default value**

Parameter settings are initialised to default settings after a manual reset. Reset the unit to clear the alarm.

#### **ALARM 84, The connection between drive and LCP is lost**

Try to reassemble the LCP gently.

#### **ALARM 85, Button disabled**

See parameter group 0-4\* LCP

#### **ALARM 86, Copy fail**

An error occurred while copying from frequency converter to LCP or vice versa.

#### **ALARM 87, LCP data invalid**

Occurs when copying from LCP if the LCP contains erroneous data - or if no data was uploaded to the LCP.

#### **ALARM 88, LCP data not compatible**

Occurs when copying from LCP if data are moved between frequency converters with major differences in software versions.

#### **WARNING 89, Parameter read only**

Occurs when trying to write to a read-only parameter.

#### **ALARM 90, Parameter database busy**

LCP and RS485 connection are trying to update parameters simultaneously.

#### **ALARM 91, Parameter value is not valid in this mode**

Occurs when trying to write an illegal value to a parameter.

**ALARM 92, Parameter value exceeds the min/max limits**

Occurs when trying to set a value outside the range.

Parameter can only be changed when the motor is stopped. Err. A wrong password was entered, occurs when using a wrong password for changing a password-protected parameter.

**Index**

**A**  
**Abbreviations And Standards**..... 7  
**Active Set-up**..... 8, 44, 28, 11, 13, 50, 55  
**Alarm, Warning And Extended Status Word**..... 62  
**Alarm/Warning Code List**..... 61  
**Alarms And Warnings**..... 60  
**Analog In/Out**..... 57  
**Automatic Motor Tuning (AMT)**..... 15

**B**  
**Brake**  
    Resistor..... 19, 30, 55  
    Resistor (ohm)..... 50  
**Brakes**..... 55

**C**  
**Comm. And Options**..... 57  
**Controllers**..... 57  
**Conversion Index**..... 54  
**Current Rating**..... 63

**D**  
**Data Readouts**..... 59  
**DC-brake**..... 17, 19, 28, 51  
**DC-Brake**..... 50  
**Derating**..... 63  
**Digital In/Out**..... 56  
**Display**..... 8  
**Disposal Instruction**..... 4  
**Drive**  
    Identification..... 47  
    Information..... 58

**E**  
**Earth Leakage Current**..... 3, 4  
**Edit Set-up**..... 8, 11, 12, 13, 50, 55  
**Electronic Waste**..... 4

**H**  
**Hand Mode**..... 51, 34, 11, 14, 30, 55

**I**  
**Indicator Lights**..... 9  
**Isolated Mains Source**..... 4  
**IT Mains**..... 4

**L**  
**LCP**  
    11..... 8  
    12..... 8  
**Leakage Current**..... 4  
**Limits/Warnings**..... 56  
**Load**  
    Compensation..... 16, 50, 55  
    Compensations..... 14  
**Load/Motor**..... 55

**M**  
**Main Menu**..... 9, 10  
**Maximum Reference**..... 21  
**MCT-10 Set-up Software**..... 1  
**Minimum Reference**..... 21  
**Motor**  
    Current..... 63, 64, 15  
    Data..... 63  
    Direction..... 9  
    Frequency..... 15  
    Nominal Speed..... 15  
    Overload Protection..... 4  
    Phase..... 48, 26, 51, 56  
    Power..... 64, 14  
    Status..... 48  
    Temperature..... 17, 19, 50  
    Voltage..... 15

**N**  
**Navigation Keys**..... 9  
**Not Changeable During Operation**..... 12

**O**  
**Operation Keys**..... 9  
**Operation/Display**..... 55  
**Output Current**..... 63  
**Over-voltage Control**..... 20, 50, 55

**P**  
**Parameter Number**..... 8

**Q**  
**Quick Menu**..... 9, 10

**R**  
**Ramp1**  
    Ramp-down Time..... 23  
    Ramp-up Time..... 23  
**Rated Magnetizing Current**..... 15  
**Readout Mode**..... 9

---

Reference/Ramps.....	56
Reset.....	63, 64
Residual Current Device.....	4
S	
Serial Communication.....	9, 24, 30, 37, 38, 39, 48, 49
Set-up	
Number.....	8
Software.....	8
Slip Compensation.....	16, 17, 50, 55
Smart Logic.....	58
Special Functions.....	45, 58
Status Menu.....	9
Switching Frequency.....	63
Symbols.....	7
T	
Thermal Load.....	15, 48
Thermistor	
Thermistor.....	17, 63, 50
Resource.....	55
Trip Reset.....	45
Troubleshooting.....	60
Type Code String.....	5
U	
Unit.....	9
V	
Value.....	8



[www.danfoss.com/drives](http://www.danfoss.com/drives)

---

Danfoss can accept no responsibility for possible errors in catalogues, brochures and other printed material. Danfoss reserves the right to alter its products without notice. This also applies to products already on order provided that such alterations can be made without subsequential changes being necessary in specifications already agreed. All trademarks in this material are property of the respective companies. Danfoss and the Danfoss logotype are trademarks of Danfoss A/S. All rights reserved.

---

