

Instruction Manual

FCD 300

According to UL508C, frequency converters supplied as of May 9, 2013 shall be:

- a. Provided with motor load and speed sensitivity overload protection with thermal memory retention (ETR function),
- b. Provided with means to accept and act upon a signal from a thermal sensor or switch imbedded in the motor or from an external protection relay, or
- c. Marked to indicate that the equipment is not incorporating internal overload protection for the motor load and is intended to be used with external or remote overload protection.

Danfoss VLT® frequency converters comply with UL508C thermal memory retention requirements [UL508C par. 20.1.11(a)] as of the following software releases:

Drive series	Type code	SW version with ETR function
VLT® AutomationDrive	FC 30x	6.81, Dec. 2012
VLT® AutomationDrive	FC 322	2.03, Mar. 2013
VLT® AQUA	FC 20x	2.03, Mar. 2013
VLT® HVAC	FC 102	4.01, Mar. 2013
VLT® HVAC Basic	FC 101	2.50, Apr. 2013
VLT® Refrigeration	FC 103	1.20, Apr. 2013
VLT® Decentral Drive	FCD 302	6.81, Dec. 2012
VLT® Decentral Drive	FCD 300	1.58, May 2013
VLT® Drivemotor	FCM 300	3.24, May 2013
VLT® 2800	VLT2800	3.23, May 2013
VLT® Micro	FC 51	3.10, May 2013

For any drive series not mentioned above or for units supplied with earlier software versions, ensure that:

- The frequency converter is configured to react on input from a motor thermal sensor or switch [UL508C par 20.1.11 (b) and 56.7]. Refer to the Design Guide for wiring and programming information..
- The motor is equipped with an external over-temperature protection device [UL508C par 20.1.11 (c) and 56.7], or
- The motor circuit includes a separate overload relay [UL508C par 56.6].

1.1.1 UL508C-Konformität

a) über last- und drehzahlabhängigen Motorüberlastschutz mit thermischem Gedächtnis (ETR-Funktion) verfügen, b) über Vorrichtungen zur Quittierung von und Reaktion auf Signale eines in den Motor integrierten Thermosensors oder -schalters oder eines externen Schutzrelais verfügen oder c) entsprechend gekennzeichnet sein, wenn das Gerät keinen internen Überlastschutz für die Motorlast besitzt

und mit externem oder ferngesteuertem Überlastschutz zu betreiben ist. Danfoss VLT® Frequenzumrichter entsprechen den Anforderungen hinsichtlich des thermische Gedächtnisses nach UL508C [UL508C Par. 20.1.11(a)] ab den folgenden Software-Versionen:

Nach UL508C müssen ab dem 9. Mai 2013 gelieferte Frequenzumrichter:

- a. über last- und drehzahlabhängigen Motorüberlastschutz mit thermischem Gedächtnis (ETR-Funktion) verfügen,
- b. über Vorrichtungen zur Quittierung von und Reaktion auf Signale eines in den Motor integrierten Thermosensors oder -schalters oder eines externen Schutzrelais verfügen oder
- c. entsprechend gekennzeichnet sein, wenn das Gerät keinen internen Überlastschutz für die Motorlast besitzt und mit externem oder ferngesteuertem Überlastschutz zu betreiben ist.

Danfoss VLT® Frequenzumrichter entsprechen den Anforderungen hinsichtlich des thermische Gedächtnisses nach UL508C [UL508C Par. 20.1.11(a)] ab den folgenden Software-Versionen:

Umrichter-Baureihe	Typencode	SW-Version einschl. ETR-Funktion
VLT® AutomationDrive	FC 30x	6.81, Dec. 2012
VLT® AutomationDrive	FC 322	2.03, Mar. 2013
VLT® AQUA	FC 20x	2.03, Mar. 2013
VLT® HVAC	FC 102	4.01, Mar. 2013
VLT® HVAC Basic	FC 101	2.50, Apr. 2013
VLT® Refrigeration	FC 103	1.20, Apr. 2013
VLT® Decentral Drive	FCD 302	6.81, Dec. 2012
VLT® Decentral Drive	FCD 300	1.58, May 2013
VLT® Drivemotor	FCM 300	3.24, May 2013
VLT® 2800	VLT2800	3.23, May 2013
VLT® Micro	FC 51	3.10, May 2013

Achten Sie bei Umrichter-Baureihen, die nicht in der Tabelle aufgeführt sind, sowie bei Geräten, die mit früheren Software-Versionen ausgestattet sind, auf Folgendes:

- Der Frequenzumrichter ist so konfiguriert, dass er auf Signal eines Motor-Thermosensors oder -schalters reagiert [UL508C Par. 20.1.11 (b) und 56.7]. Siehe das Projektierungshandbuch für Informationen zu Verdrahtung und Programmierung.
- Der Motor ist mit einer externen Überhitzungsschutzvorrichtung ausgestattet [UL508C Par. 20.1.11 (c) und 56.7], oder
- der Motorstromkreis enthält ein separates Überlastrelais. [UL508C Par. 56.6].

1.1.2 Conformité UL508C

Conformément à la norme UL508C, les variateurs de fréquence fournis à partir du 9 mai 2013 doivent être:

- munis d'une protection surcharge de la charge moteur et de la sensibilité à la vitesse avec sauvegarde de la capacité thermique (fonction ETR),
- fournis avec des moyens d'accepter et d'agir lorsqu'un signal est émis par un capteur ou un interrupteur thermique intégré dans le moteur ou par un relais de protection externe, ou
- marqués de sorte à indiquer que l'équipement ne comprend pas de protection surcharge interne de la charge moteur et est destiné à une protection surcharge externe ou distante

Les variateurs de fréquence Danfoss VLT® sont conformes aux exigences de sauvegarde de la capacité thermique de la norme UL508C [UL508C par. 20.1.11(a)] en ce qui concerne les versions logicielles suivantes:

Gamme de variateur	Code de type	Version logicielle comprenant la fonction ETR
VLT® AutomationDrive	FC 30x	6.81, Dec. 2012
VLT® AutomationDrive	FC 322	2.03, Mar. 2013
VLT® AQUA	FC 20x	2.03, Mar. 2013
VLT® HVAC	FC 102	4.01, Mar. 2013
VLT® HVAC Basic	FC 101	2.50, Apr. 2013
VLT® Refrigeration	FC 103	1.20, Apr. 2013
VLT® Decentral Drive	FCD 302	6.81, Dec. 2012
VLT® Decentral Drive	FCD 300	1.58, May 2013
VLT® Drivemotor	FCM 300	3.24, May 2013
VLT® 2800	VLT2800	3.23, May 2013
VLT® Micro	FC 51	3.10, May 2013

Pour toute gamme de variateur non mentionnée ci-dessus ou pour les unités fournies avec des versions logicielles plus anciennes, s'assurer que:

- Le variateur de fréquence est configuré de façon à réagir à l'entrée d'un capteur/interrupteur thermique de moteur [UL508C par 20.1.11 (b) et 56.7]. Se reporter au manuel de configuration pour les informations de câblage et de programmation.
- Le moteur est équipé d'un dispositif de protection externe contre les surtempératures [UL508C par. 20.1.11(c)] et 56.7], ou
- Le circuit du moteur comprend un relais de surcharge séparé. [UL508C par 56.6].

1.1.3 Conformidad con UL508C

De acuerdo con la norma UL508C, los convertidores de frecuencia suministrados a partir del 9 de mayo de 2013 incluirán:

- Una protección de sobrecarga para la carga del motor y la sensibilidad a la velocidad con una retención de memoria térmica (función ETR),
- Los medios necesarios para aceptar y actuar al recibir una señal de un sensor térmico, del interruptor integrado en el motor, de un relé de protección externo o
- Un distintivo para indicar que el equipo no incluye una protección de sobrecarga interna para la carga del motor y que está destinado para su uso con una protección de sobrecarga externa o remota.

Los convertidores de frecuencia VLT® de Danfoss cumplen los requisitos de la norma UL508C de retención de memoria térmica [UL508C par. 20.1.11(a)], a partir de los siguientes softwares puestos a la venta:

Serie de convertidor	Código descriptivo	Versión de SW que incluye la función ETR
VLT® AutomationDrive	FC 30x	6.81, Dec. 2012
VLT® AutomationDrive	FC 322	2.03, Mar. 2013
VLT® AQUA	FC 20x	2.03, Mar. 2013
VLT® HVAC	FC 102	4.01, Mar. 2013
VLT® HVAC Basic	FC 101	2.50, Apr. 2013
VLT® Refrigeration	FC 103	1.20, Apr. 2013
VLT® Decentral Drive	FCD 302	6.81, Dec. 2012
VLT® Decentral Drive	FCD 300	1.58, May 2013
VLT® Drivemotor	FCM 300	3.24, May 2013
VLT® 2800	VLT2800	3.23, May 2013
VLT® Micro	FC 51	3.10, May 2013

Para cualquier serie de convertidor de frecuencia no mencionada anteriormente o para las unidades suministradas con versiones de software anteriores, asegúrese de que:

- El convertidor de frecuencia está configurado para reaccionar ante la entrada del sensor / interruptor térmico del motor [UL508C par 20.1.11 (b) y 56.7]. Consulte la Guía de Diseño para obtener más información sobre el cableado y la programación.
- El motor está equipado con un dispositivo de protección externo contra la sobretemperatura [UL508C par 20.1.11 (c) y 56.7] o
- El circuito del motor incluye un relé de sobrecarga independiente. [UL508C par 56.6].

Contents

1 Introduction to FCD 300	1-1
High Voltage Warning	1-2
These Rules Concern Your Safety	1-2
Warning against Unintended Start	1-2
2 Installation	2-1
Mechanical Dimensions, Motor Mounting	2-1
Mechanical Dimensions, Stand-alone Mounting	2-1
General information about electrical installation	2-4
Electronics Purchased without Installation Box	2-5
EMC-compliant Electrical Installation	2-7
Diagram	2-7
RFI Switches J1, J2	2-8
Electrical Installation	2-8
Location of Terminals	2-8
AC line input connections	2-10
Pre-fuses	2-10
Motor Connection	2-10
Direction of Motor Rotation	2-11
Line Power and Motor Connection with Service Switch	2-11
Connection of HAN 10E Motor Plug for T73	2-12
Parallel Connection of Motors	2-12
Motor Cables	2-13
Motor thermal protection	2-13
Brake Resistor	2-13
Control of Mechanical Brake	2-14
Electrical Installation, Control Cables	2-14
Connection of Sensors to M12 Plugs for T63 and T73	2-15
Electrical Installation, Control Terminals	2-15
PC Communication	2-16
Relay Connection	2-16
Connection examples	2-17
3 Programming	3-1
LCP Control Unit	3-1
The LCP 2 Control Unit, Option	3-1
Parameter Selection	3-6

Parameter Group 0-** Operation & Display	3-8
Setup Configuration	3-8
Parameter Group 1-** Load and Motor	3-14
DC Braking	3-18
Parameter Group 2-** References & Limits	3-22
Reference Handling	3-23
Reference Function	3-26
Parameter Group 3-** Inputs and Outputs	3-29
Parameter Group 4-** Special Functions	3-35
PID Functions	3-38
Handling of Feedback	3-39
Serial Communication	3-44
Control Word According to FC Protocol	3-49
Status Word According to FC Profile	3-51
Fast I/O FC Profile	3-52
Control Word According to Serial Communication Bus Profile	3-52
Status Word According to Profidrive Protocol	3-53
Parameter Group 5-** Serial communication	3-56
Parameter Group 6-** Technical Functions	3-62
4 All about FCD 300	4-1
Service	4-1
Warnings/Alarm Messages	4-3
Warning Words, Extended Status Words and Alarm Words	4-5
Aggressive Environments	4-6
Cleaning	4-6
Derating for Running at Low Speed	4-7
Galvanic Isolation (PELV)	4-7
Derating for Air Pressure	4-8
Emission Test Results according to Generic Standards and PDS Product Standard	4-8
General Technical Data	4-9
Ordering Form	4-15
Available literature	4-16
Factory Settings	4-17
5 Index	5-1

1 Introduction to FCD 300

FCD 300 Series
Instruction Manual
Software version: 1.5.x



This Instruction Manual can be used for all FCD 300 Series adjustable frequency drives with software version 1.5.x. The software version number can be seen in parameter 640 Software version no.



NOTE!

Indicates something to be noted by the reader.



Indicates a general warning.



Indicates a high-voltage warning.

1

1.2.1 High Voltage Warning

The voltage of the adjustable frequency drive is dangerous whenever the drive is connected to AC line power. Incorrect installation of the motor or adjustable frequency drive may cause damage to the equipment, serious injury or death. Consequently, it is essential to comply with the instructions in this manual as well as local and national rules and safety regulations.



The Protective Extra Low Voltage (PELV) requirements stated in IEC 61800-5-1 are not fulfilled at altitudes higher than 6,562 ft [2,000 m]. For 200 V adjustable frequency drives, the requirements are not fulfilled at altitudes higher than 16,404 ft [5,000 m]. Please contact Danfoss Drives for further information.

1.2.2 These Rules Concern Your Safety

1. The adjustable frequency drive must be disconnected from line power if repair work is to be carried out. Make sure that the line power supply has been disconnected and that the prescribed time has passed before removing the inverter part from the installation.
2. The [STOP/RESET] key on the optional control panel does not disconnect the equipment from line power and is thus not to be used as a safety switch.
3. The unit must be properly grounded, the user must be protected against the supply voltage, and the motor must be protected against overloading in accordance with prevailing national and local regulations.
4. The ground leakage currents are higher than 3.5 mA.
5. Protection against motor overload is not included in the factory setting. If this function is required, set parameter 128 *Motor thermal protection* to data value *ETR trip* or data value *ETR warning*. For the North American market: The ETR functions provide overload protection of the motor, class 20, in accordance with NEC.

1.2.3 Warning against Unintended Start

1. The motor can be brought to a stop by means of digital commands, bus commands, references or a local stop, while the adjustable frequency drive is connected to line power. If personal safety considerations make it necessary to ensure that no unintended start occurs, these stop functions are not sufficient.
2. While parameters are being changed, the motor may start. Consequently, the stop key [STOP/RESET] on the optional control panel must always be activated, following which data can be modified.
3. A motor that has been stopped may start if faults occur in the electronics of the adjustable frequency drive, or if a temporary overload or a fault in the supply line power or the motor connection ceases.



**It can be extremely dangerous to touch the electrical parts even when the AC line supply has been disconnected.
For FCD 300: Wait at least 4 minutes.**

1.3.1 The Decentral Concept

The FCD 300 adjustable speed drive is designed for decentral mounting, e.g., in the food and beverage industry, in the automotive industry, and for other material handling applications.

With the FCD 300 it is possible to utilize the cost saving potential by placing the power electronics decentrally, and thus make the central panels obsolete, saving money, space and effort for installation and wiring.

The unit is flexible in its mounting options including both stand-alone mounting and motor mounting. It is also possible to have the unit pre-mounted on a Danfoss Bauer geared motor (3 in one solution). The basic design with a pluggable electronic part and a flexible and "spacious" wiring box is extremely service-friendly; it is easy to replace electronics without having to unwire.

The FCD 300 is a part of the VLT adjustable frequency drive family, which means similar functionality, programming, and operating as the other family members.

1.3.2 Flexible Installation Options

1. Stand-alone close to the motor ("wall-mounted")

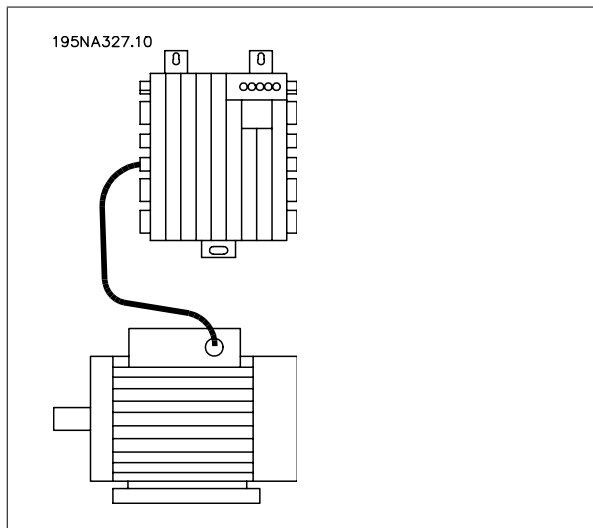

- Free choice of motor brand
- Easy retrofitting to existing motor
- Easy interfacing to motor (short cable)
- Easy access for diagnosis and optimal serviceability

2. Mounted directly on the motor ("motor-mounted")

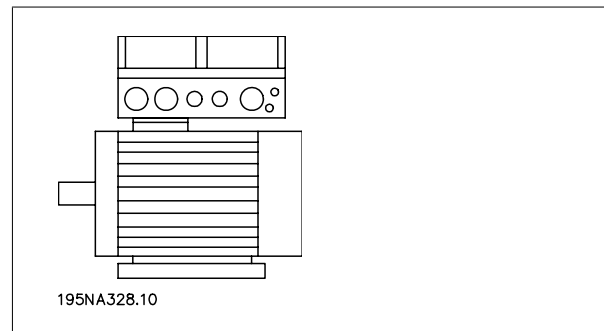

- Fair choice of motor brands
- No need for shielded motor cable

1

3. "Pre-mounted" on Danfoss Bauer geared motors

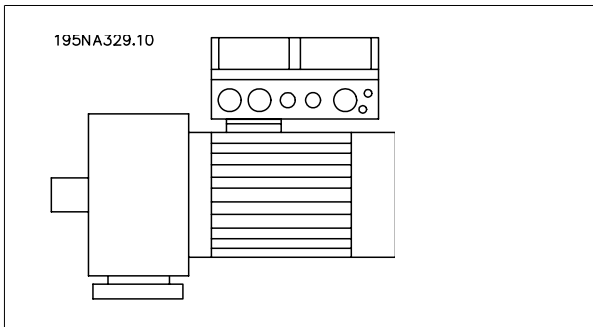

- A fixed combination of motor and electronics supplied by one supplier
- Easy mounting, only one unit
- No need for shielded motor cable
- Clear responsibility regarding the complete solution

As the electronic parts are common - same function of terminals, similar operation and similar parts and spare parts for all drives - you are free to mix the three mounting concepts.

1.3.3 Control Principle

An adjustable frequency drive rectifies AC voltage from the line power supply into DC voltage, following which, it changes this voltage to AC voltage with variable amplitude and frequency.

The motor thus receives a variable voltage and frequency, which enables infinitely variable speed control of three-phase, standard AC motors.

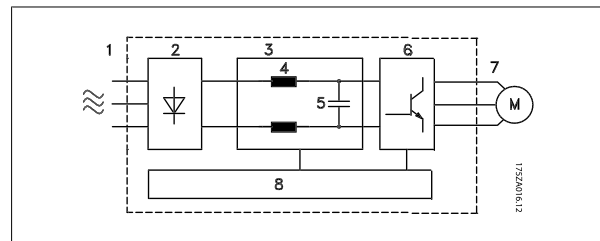

1. AC line voltage
3 x 380–480 V AC, 50 / 60 Hz.
2. Rectifier
Three-phase rectifier bridge which rectifies AC voltage into DC voltage.
3. Intermediate circuit
DC voltage $\cong \sqrt{2} \times$ AC line voltage [V].
4. Intermediate circuit coils
Evens out the intermediate circuit current and limits the load on line power and components (line power transformer, cables, fuses and contactors).
5. Intermediate circuit capacitor
Evens out the intermediate circuit voltage.
6. Inverter
Converts DC voltage into a variable AC voltage with a variable frequency.
7. Motor voltage
Variable AC voltage depending on supply voltage.
Variable frequency: 0.2–132 / 1–1000 Hz.
8. Control card
Here is the computer that controls the inverter which generates the pulse pattern by which the DC voltage is converted into variable AC voltage with a variable frequency.

2 Installation

2.1.1 Mechanical Dimensions, Motor Mounting

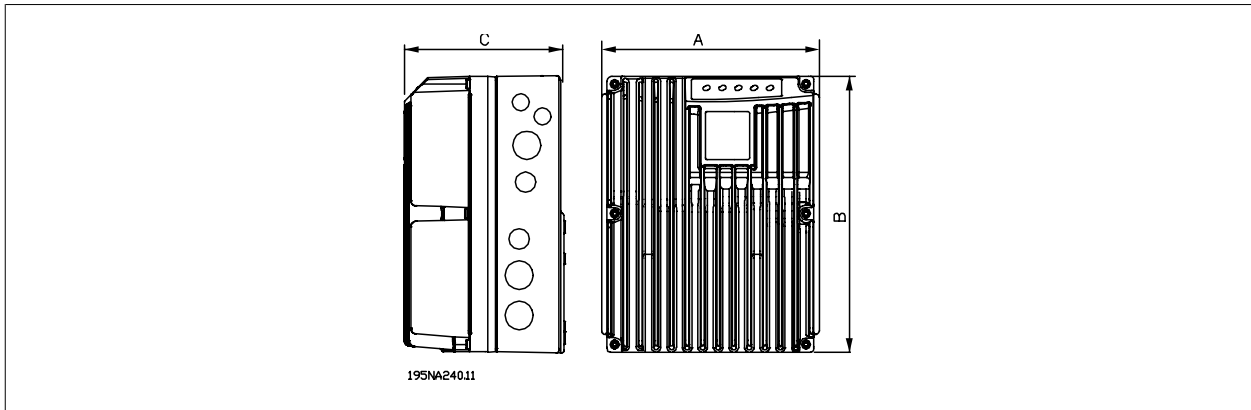

2

2.1.2 Mechanical Dimensions, Stand-alone Mounting

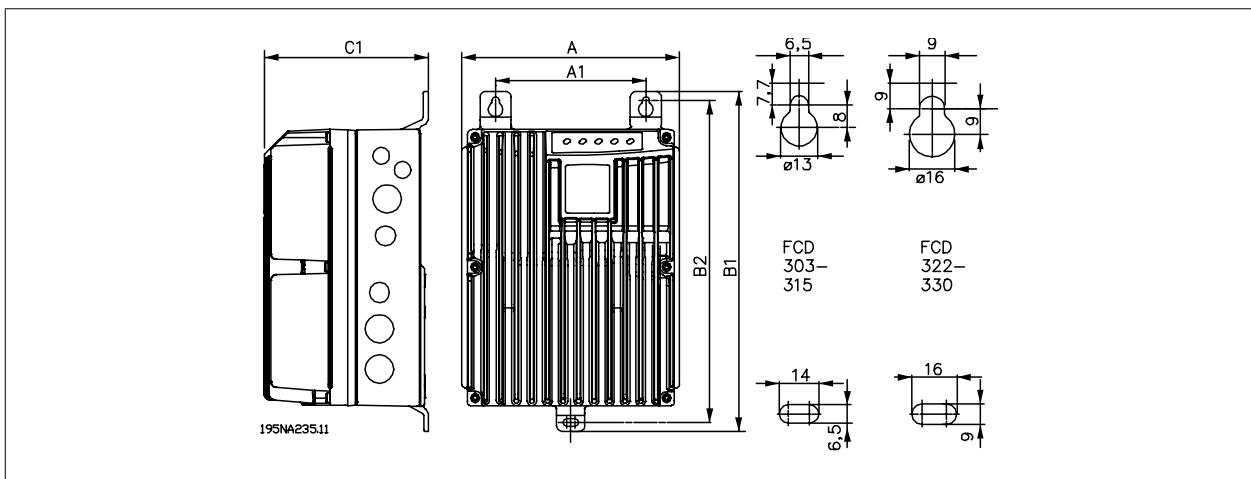

Mechanical dimensions in mm	FCD 303-315	FCD 322-335
A	192	258
A1	133	170
B	244	300
B1	300	367
B2	284	346
C	142	151
C1	145	154
Cable connector sizes	M16, M20, M25 x 1.5 mm	
Space for cable inlets and service switch handle 4-6 in	[100-150 mm]	

2.1.3 Spacing for Mechanical Installation

All units require a minimum of 4 in [100 mm] air from other components above and below the enclosure.

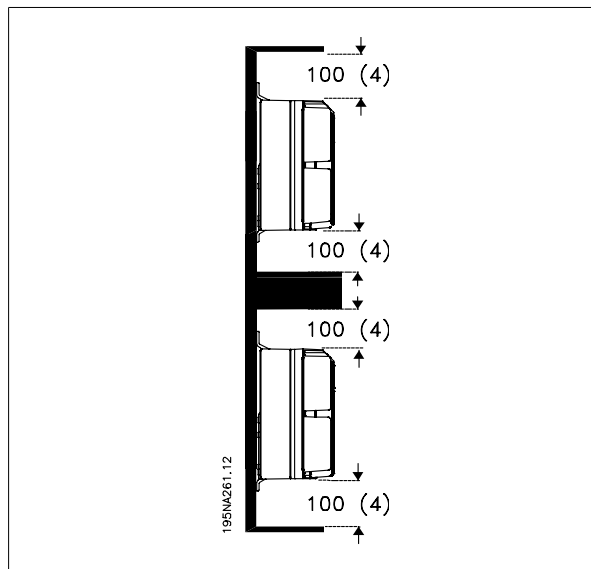

Please pay attention to the requirements that apply to integration and remote mounting. These must be complied with to avoid serious injury or damage, especially when installing large units.

The FCD 300 consists of two parts: The installation part and the electronics part.

The two parts must be separated, and the installation part is to be mounted first. After wiring, the electronics is to be fixed to the installation part by the attached 6 screws. For compressing the gasket, the screws must be tightened with 2–2.4 Nm, tighten both center screws first; thereafter, the 4 corner screws “cross over”.



NOTE!

Do not switch on line power before the 6 screws are tightened.

The FCD 300 can be applied as following:

- Stand alone mounted close to the motor
- Motor mounted

or might be delivered pre-mounted on a Danfoss Bauer (geared) motor. Please contact the Danfoss Bauer sales organization for further information.

The adjustable frequency drive is cooled by air circulation. For the unit to be able to release its cooling air, the minimum free distance above and below the unit must be *minimum of 4 in [100 mm]*. To protect the unit from overheating, it must be ensured that the ambient temperature does not rise above the max. temperature stated for the adjustable frequency drive and that the 24-hour average temperature is not exceeded. The max. temperature and 24-hour average can be seen in *General Technical Data*. If the ambient temperature is higher, derating of the adjustable frequency drive is to be carried out. See *Derating for Ambient Temperature*. Please note that the service life of the adjustable frequency drive will be reduced if derating for ambient temperature is not considered.

Stand-alone mounting (Wall Mounting)

For best cooling, the unit should be mounted vertically; however, where space limitations require it, horizontal mounting is allowable. The three integrated wall mounting brackets in the wall mounting version can be used for fixing the installation box to the mounting surface, keeping a distance for possible cleaning between the box and the mounting surface. Use the three supplied washers to protect the paint.

Bolts must be M6 for the FCD 303 - 315 and M8 for FCD 322 - 335.

See *Dimensional Drawings*.

Motor mounting

The installation box should be mounted on the surface of the motor frame, typically instead of the motor terminal box. The motor/geared motor may be mounted with the shaft vertically or horizontally. The unit must not be mounted upside down (the heatsink pointing down). The cooling of the electronics is independent on the motor cooling fan. No adaption plate is necessary for mounting directly on Danfoss Bauer geared motors. For motor mounting (non-Danfoss Bauer motors), an adaptor plate should usually be applied. For that purpose, a neutral plate incl. gasket and screws for attaching to the installation box is available. The appropriate drillings and gasket for the motor housing are applied locally. Please make sure, that the mechanical strength of the mounting screws and the threads are sufficient for the application. The specified resistance against mechanical vibrations does not cover the mounting onto a non-Danfoss Bauer motor, as the stability of the motor frame and threads are outside Danfoss Drive's control and responsibility and the same applies to the enclosure class. Please be aware that the adjustable frequency drive may not be used to lift the motor/geared motor.

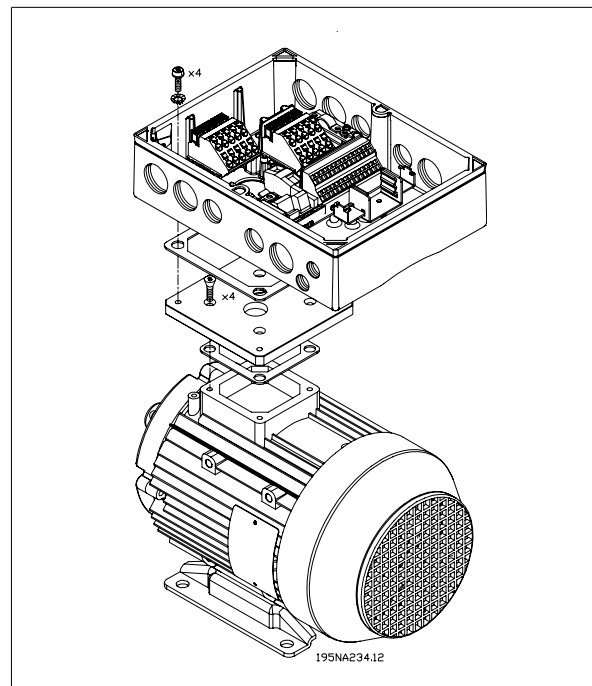

1. Prepare the adaptor plate for mounting on the motor by drilling the fixing holes and the hole for the cables.
2. Mount the plate on the motor with the normal terminal box gasket.
3. Knock out the 4 screw holes for mounting the adaptor plate (outer holes).
4. Mount the terminal box onto the motor by the 4 sealing screws and the gasket supplied.

Use the supplied star washers for securing PE connection according to EN 60204. The screws must be tightened with 5 Nm.

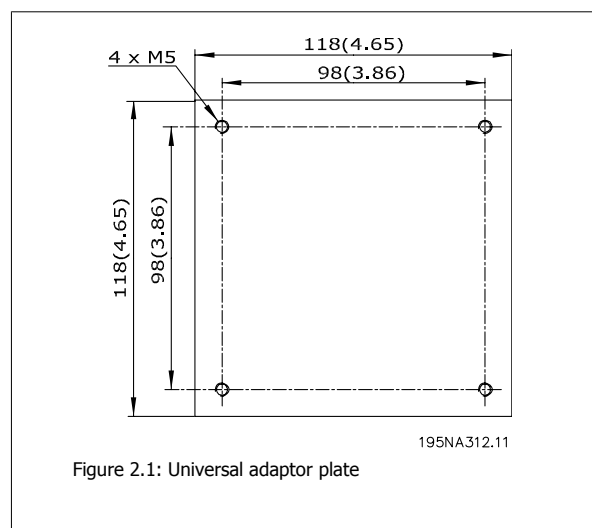

Figure 2.1: Universal adaptor plate

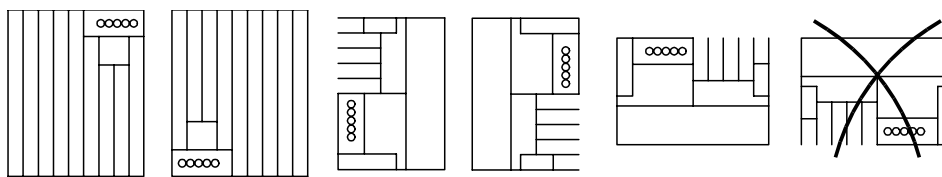

Figure 2.2: Allowed mounting positions

195NA310.10

2.3 General information about electrical installation

2.3.1 High Voltage Warning



The voltage of the adjustable frequency drive is dangerous whenever the equipment is connected to line power. Incorrect installation of the motor or adjustable frequency drive may cause damage to the equipment, serious injury or death. Comply with the instructions in this manual, as well as national and local rules and safety regulations.

Touching the electrical parts may be fatal - even after the equipment has been disconnected from line power: Wait at least 4 minutes for current dissipate.



NOTE!

It is the responsibility of the user or installer to ensure correct grounding and protection in accordance with national and local standards.

2.3.2 Cables

The control cable and the line cable should be installed separately from motor cables to prevent noise transfer. As a rule, a distance of 8 in [20 cm] is sufficient, but it is recommended that the distance be as great as possible, particularly when cables are installed in parallel over large distances.

For sensitive signal cables such as telephone or data cables, the greatest possible distance is recommended. Please note that the required distance depends on the installation and the sensitivity of the signal cables, and that for this reason exact values cannot be given.

When being placed in cable trays, sensitive cables may not be placed in the same cable tray as the motor cable. If signal cables run across power cables, this is done at an angle of 90 degrees. Remember that all noise-filled inlet and outlet cables to a cabinet must be shielded/armored.

See also *EMC-compliant electrical installation*.

Cable connectors

It must be assured that appropriate cable connectors needed for the environment are chosen and carefully mounted.

2.3.3 Shielded/Armored Cables

The shield must have low HF impedance, which is achieved by a braided shield of copper, aluminum or iron. Shield reinforcement intended for mechanical protection, for example, is not suitable for EMC-compliant installation. See also *Use of EMC-compliant Cables*.

2.3.4 Extra Protection

ELCB relays, multiple protective grounding or grounding can be used as extra protection, provided that local safety regulations are complied with. In the case of a ground fault, a DC content may develop in the faulty current. Never use an RCD (ELCB relay), type A, as it is not suitable for DC faulty currents. If ELCB relays are used, local regulations must be complied with. If ELCB relays are used, they must be:

- Suitable for protecting equipment with a DC content in the faulty current (3-phase bridge rectifier)
- Suitable for a pulse-shaped, brief discharge on power-up
- Suitable for a high leakage current.

See also RCD Application Note MN.90.GX.02.

2.3.5 High Voltage Test

A high voltage test can be performed by short-circuiting terminals U, V, W, L1, L2 and L3, and applying max. 2160 V DC in 1 sec. between this short-circuit and PE terminal.

2.3.6 Electronics Purchased without Installation Box

If the electronic part is purchased without the Danfoss installation part, the ground connection must be suitable for high leakage current. Use of original Danfoss installation box or installation kit 175N2207 is recommended.

2.3.7 Caution



PE connection
The metal pin in the corner(s) of the electronic part and the bronze spring in the corner(s) of the installation box are essential for the *protective ground* connection. Make sure they are not loosened, removed, or violated in any way.



NOTE!
Do not plug/unplug the electronic part with AC line voltage switched on.

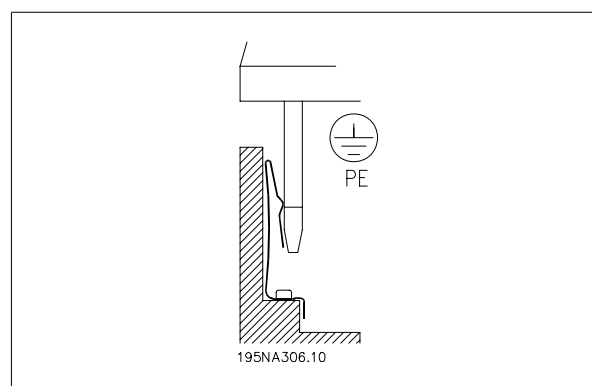

2.3.8 Protective Ground

The ground connection serves several purposes.

- Safety ground (Protective Ground, PE)
The equipment must be properly grounded according to local regulations. This equipment has a leakage current > 3.5 mA AC. It must be connected to an ground connection complying with the local rules for high leakage current equipment.
Typically, this implies that the PE conductors must be mechanically enhanced (minimum cross-section 0.016 in² [10 mm²]) or duplicated.
- Noise "clamping" (high frequencies)
Stable communication between units call for shielding the communication cables (1). Cables must be properly attached to shield clamps provided for that purpose.
- Equalization of voltage potential (low frequencies)
To reduce alignment currents in the shield of the communication cable, always apply a short grounding cable between units that are connected to the same communication cable (2) or connect to a grounded frame (3).
- Potential equalization: All metal parts, where the motors are fastened, must be potential equalized

PE connections, voltage-equalizing cables and the shield of the communication cable should be connected to the same potential (4).

Keep the conductor as short as possible and use the greatest possible surface area.

The numbering refers to the figure.

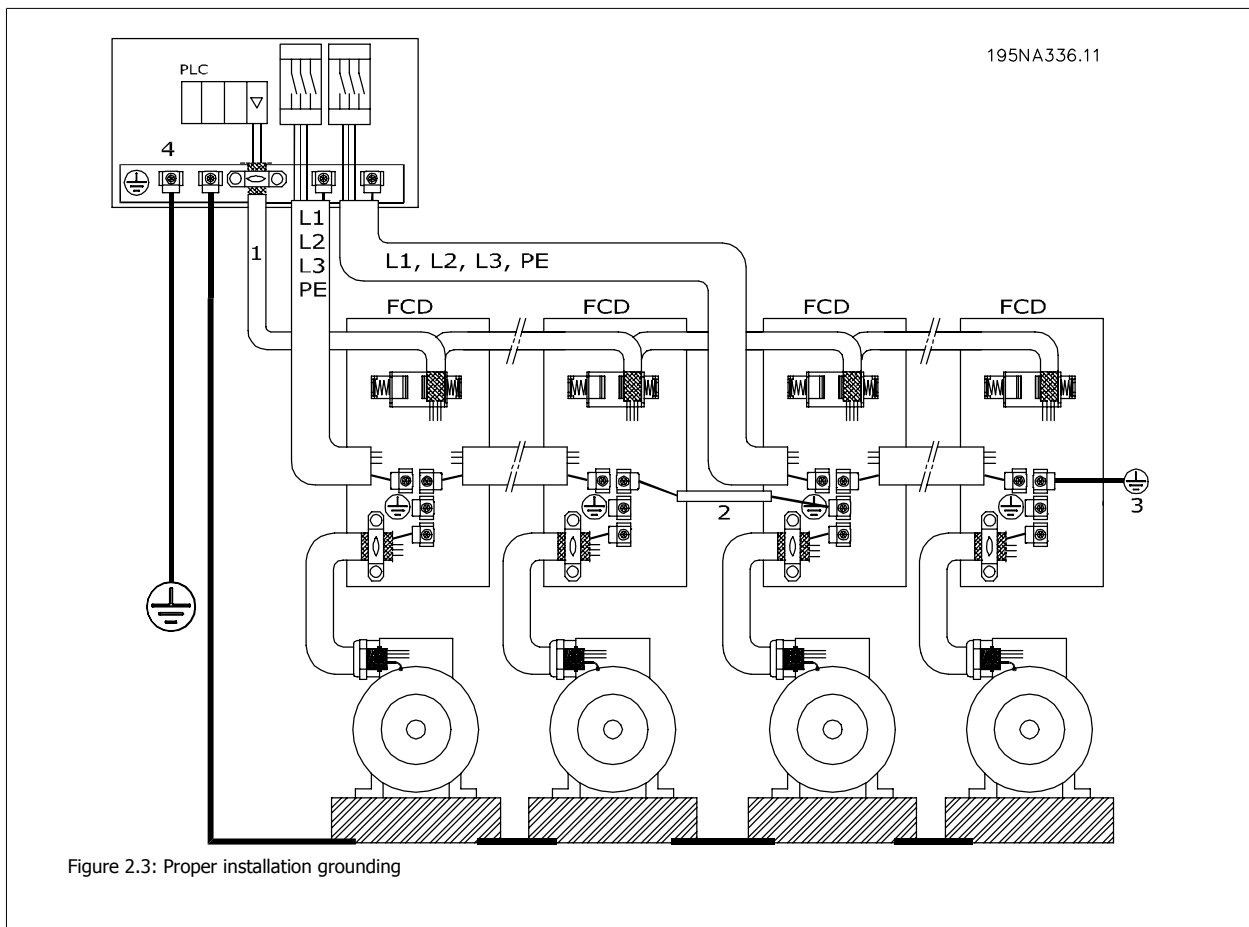

2.3.9 EMC-compliant Electrical Installation

General points to be observed to ensure EMC-compliant electrical installation.

- Use only shielded/armored motor cables and shielded/armored control cables.
- Connect the shield to ground at both ends.
- Avoid installation with twisted shield ends (pigtailed), since this ruins the shielding effect at high frequencies. Use cable clamps instead.
- Don't remove the cable shield between the cable clamp and the terminal.

2.3.10 ATEX correct installation

The following issues must be taken into account when installing the FCD 300 in ATEX zone 22 environments:

- Motor must be designed, tested and certified by the motor manufacturer for variable speed application
- Motor must be designed for Zone 22 operation. I.e. with type of protection "tD" acc. to EN61241-0 and -1 or EN50281-1-1.
- Motor must be provided with thermistor protection. The thermistor protection must either be connected to an external thermistor relay, with EC Type Examination Certificate or compatible with the FCD 300 thermistor input.

If the FCD 300 thermistor protection is used, the thermistor must be wired to terminals 31a and 31b, and thermistor trip activated by programming parameter 128 to thermistor trip [2]. See parameter 128 for further details.

- Cable entries must be chosen for the enclosure protection to be maintained. It must also be ensured that the cable entries comply with the requirements for clamping force and mechanical strengths as described in EN 50014:2000.
- The FCD must be installed with appropriate earth connecting according to local/national regulations.
- The installation, inspection and maintenance of electrical apparatus for use in combustible dusts, must only be carried out by personnel that is trained and familiar with the concept of protection.

For a declaration of conformity, please consult your local Danfoss representative.

2.4 Diagram

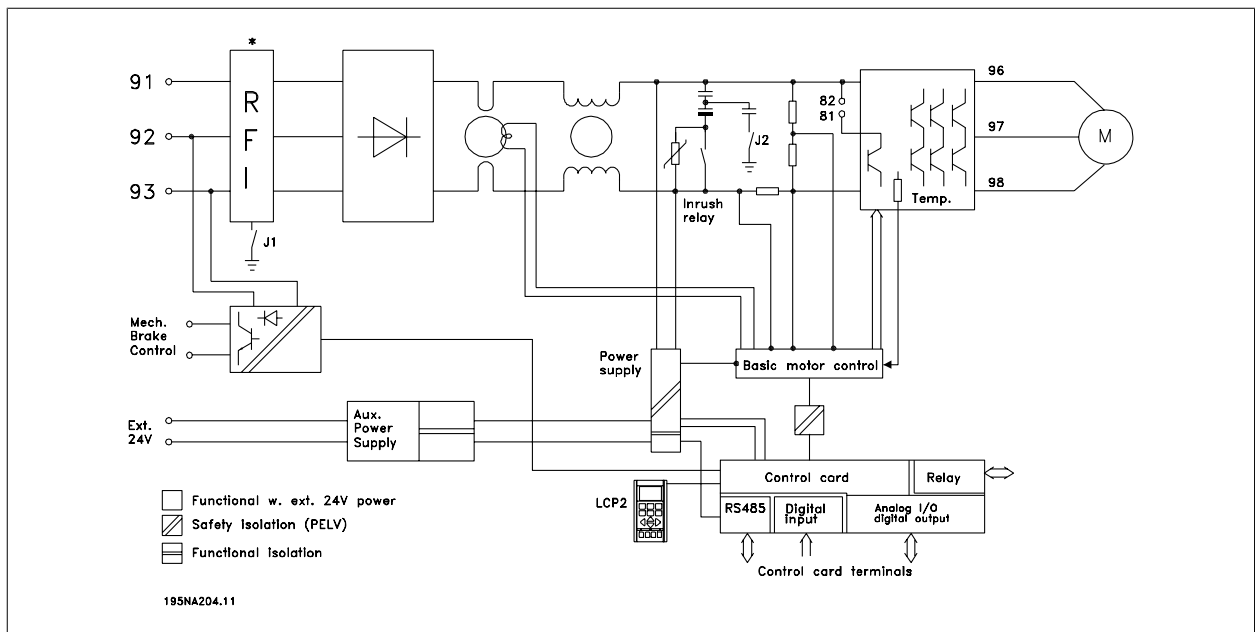

* Integrated brake and mechanical brake control and external 24 V are options.

2.4.1 RFI Switches J1, J2

J1 and J2 must be removed at IT line power and delta-grounded line power with phase to ground voltage > 300 V also during ground failure.

J1 and J2 can be removed to reduce leakage current.

Caution: No correct RFI filtering.

2

2.5 Electrical Installation

2.5.1 Location of Terminals

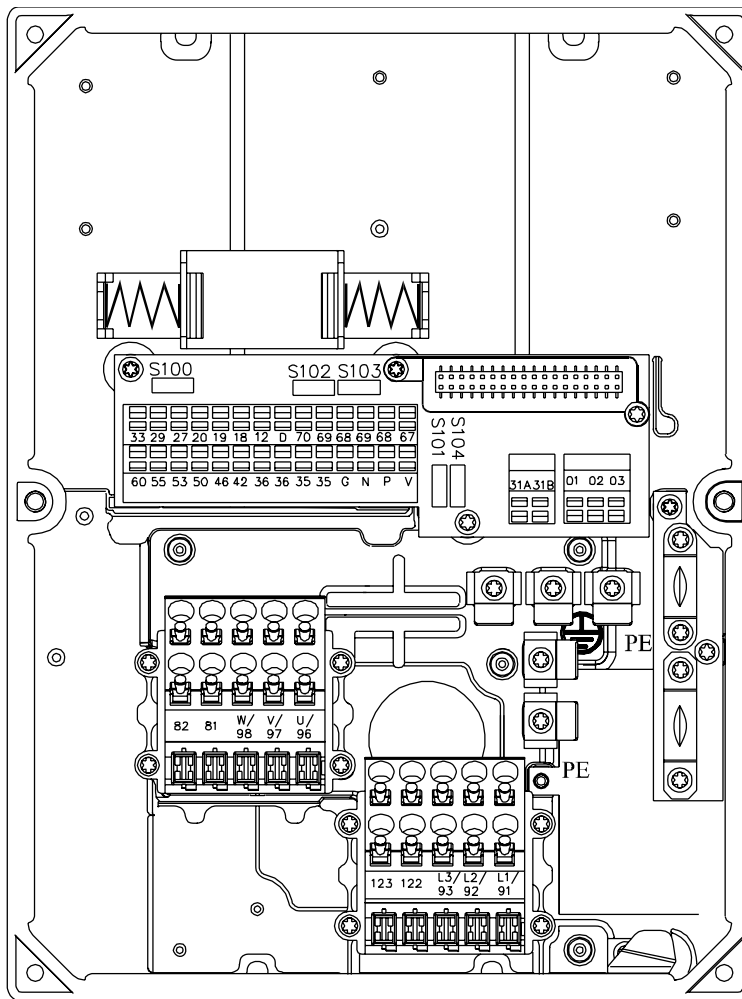

195NA307.10

Figure 2.4: T12, T16, T52, T56

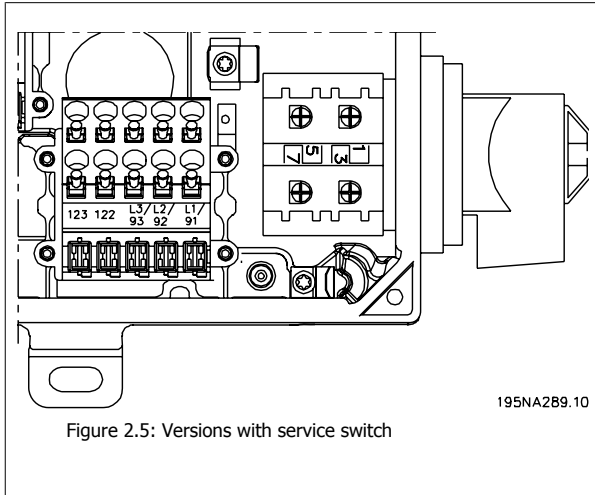

Figure 2.5: Versions with service switch

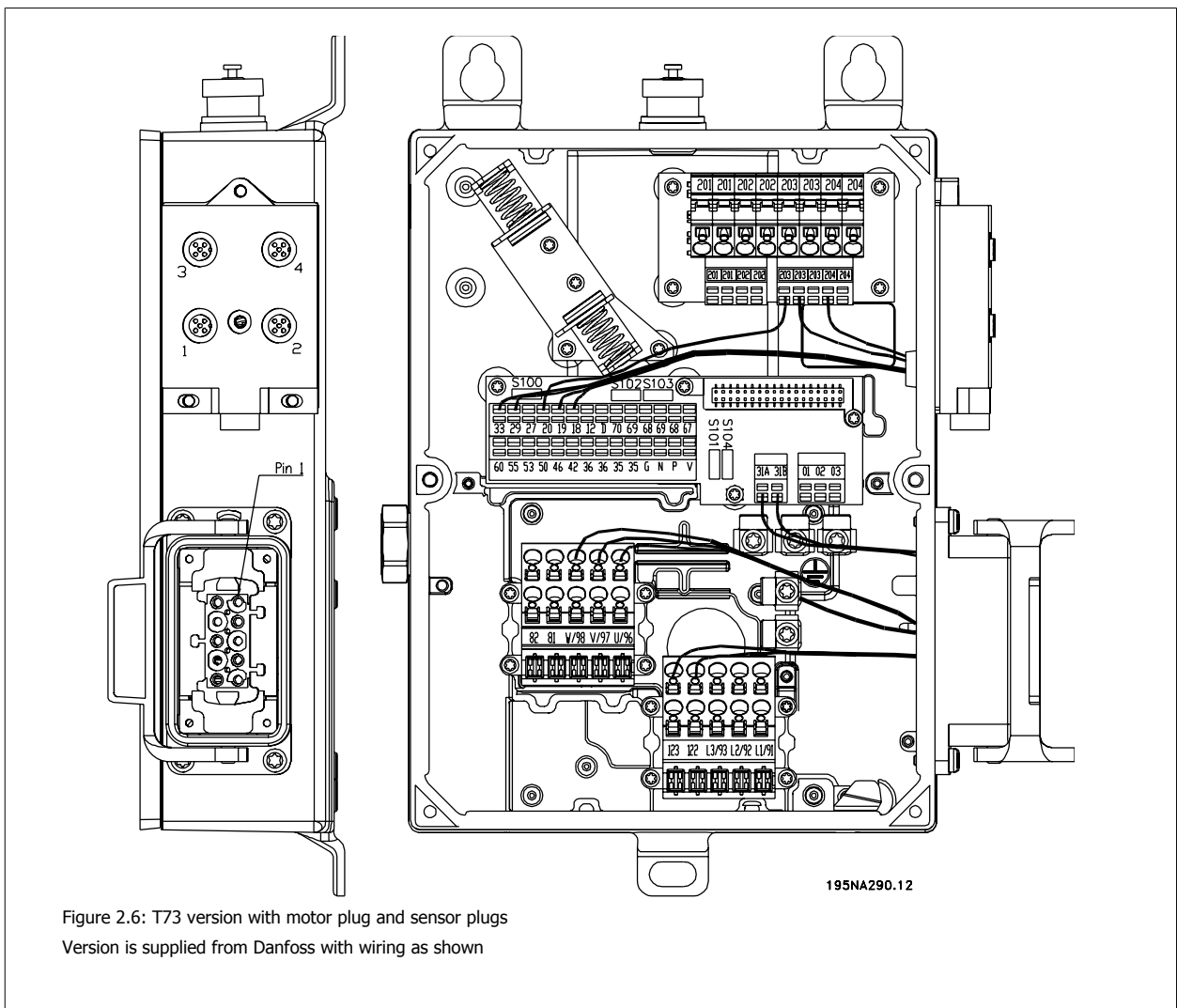

Figure 2.6: T73 version with motor plug and sensor plugs
Version is supplied from Danfoss with wiring as shown

2.5.2 AC line input connections



NOTE!

Please make sure that the AC line voltage fits the AC line voltage of the adjustable frequency drive, which can be seen from the nameplate.

No.	91	92	93	AC line voltage 3 x 380–480 V
	L1	L2	L3	
	PE			Ground connection

See *Technical Data* for correct dimensioning of cable cross-section.

2.5.3 Pre-fuses

See *Technical Data* for correct dimensioning of pre-fuses.

2.5.4 Motor Connection

Connect the motor to terminals 96, 97, 98. Connect ground to PE terminal.

No.	96	97	98	Motor voltage 0–100% of AC line voltage
	U	V	W	3 wires out of motor
	U1	V1	W1	6 wires out of motor, Delta-connected
	W2	U2	V2	
	U1	V1	W1	6 wires out of motor, Star-connected
				U2, V2, W2 to be interconnected separately (optional terminal block)
	PE			Ground connection

See *Technical Data* for correct dimensioning of cable cross-section.

All types of three-phase asynchronous standard motors can be connected to an adjustable frequency drive. Normally, small motors are star-connected (230/400 V, Δ / Y), while large motors are delta-connected (400/690 V, Δ / Y). The correct connection mode and voltage can be read from the motor nameplate.



NOTE!

In motors without phase insulation paper, an LC filter should be fitted on the output of the adjustable frequency drive.

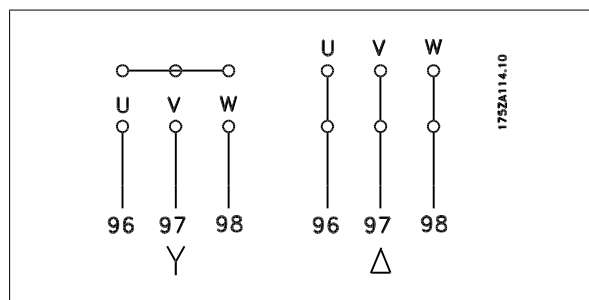

2.5.5 Direction of Motor Rotation

The factory setting is for clockwise rotation with the adjustable frequency drive transformer output connected as follows:

Terminal 96 connected to U-phase.

Terminal 97 connected to V-phase.

Terminal 98 connected to W-phase.

The direction of rotation can be changed by switching two phases on the motor terminals.

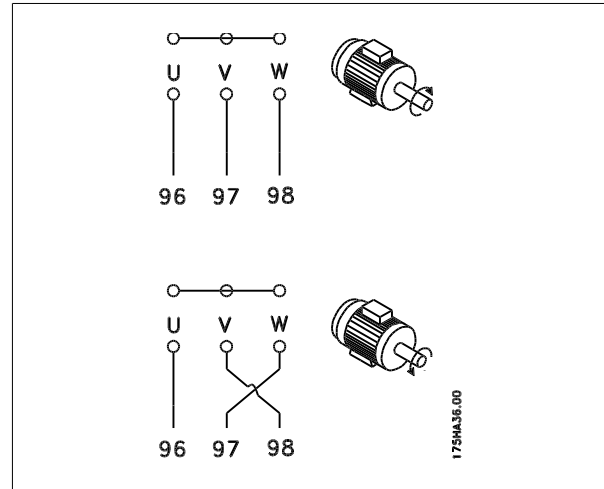

2.5.6 Line Power and Motor Connection with Service Switch

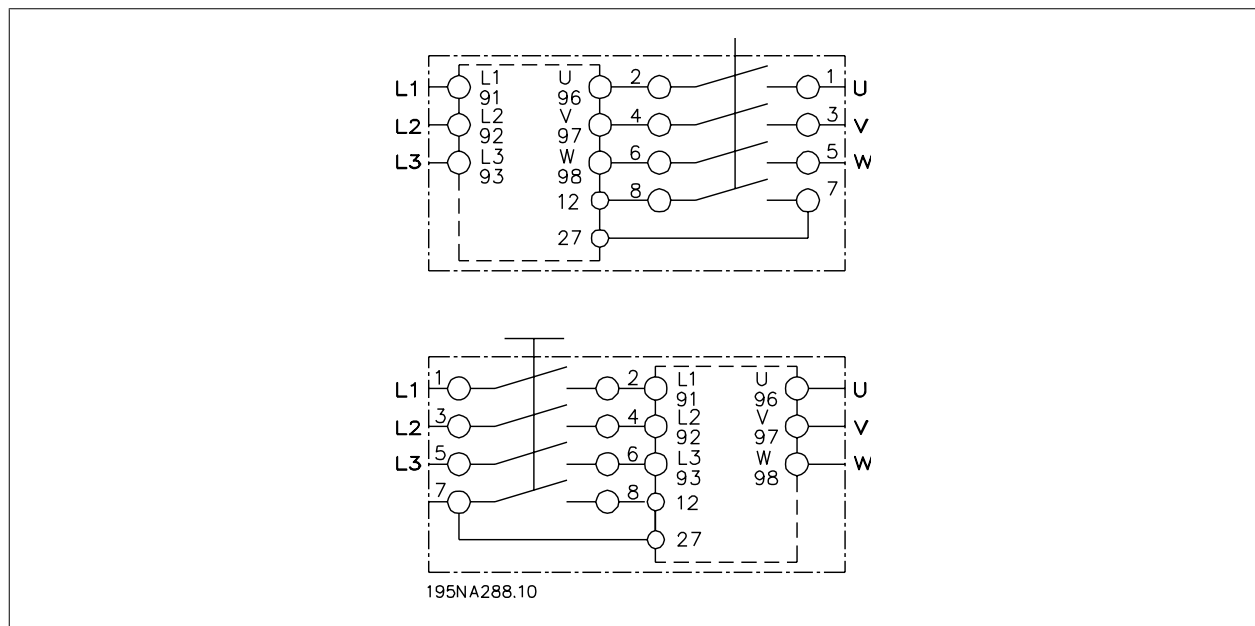

2.5.7 Connection of HAN 10E Motor Plug for T73

HAN 10E pin no 1 - Motor phase U

HAN 10E pin no 2 - Motor phase V

HAN 10E pin no 3 - Motor phase W

HAN 10E pin no 4 - Motor brake, see *Instruction Manual MG.04.BX.YY*, terminal 122

HAN 10E pin no 5 - Motor brake, see *Instruction Manual MG.04.BX.YY*, terminal 123

HAN 10E pin no 9 - Motor thermistor, see *Instruction Manual MG.04.BX.YY*, terminal 31A

HAN 10E pin no 10 - Motor thermistor, see *Instruction Manual MG.04.BX.YY*, terminal 31B

PE = protective ground

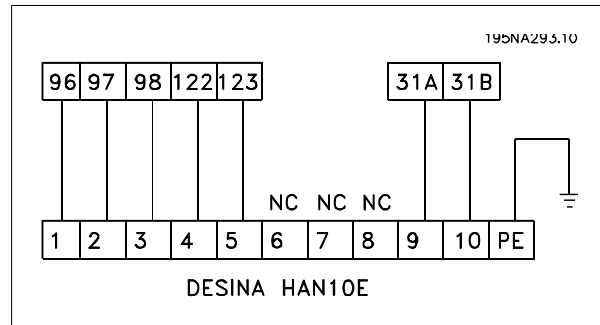

2.5.8 Parallel Connection of Motors

The adjustable frequency drive is able to control several motors connected in parallel. If the motors are to have different rpm values, use motors with different rated rpm values. Motor rpm is changed simultaneously, which means that the ratio between the rated rpm values is maintained across the range. The total current consumption of the motors is not to exceed the maximum rated output current I_{INV} for the adjustable frequency drive.

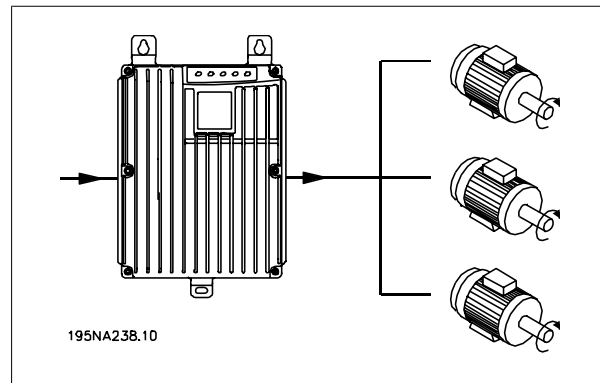

Problems may arise at the start and at low rpm values if the motor sizes are widely different. This is because the small motors' relatively high ohmic resistance in the stator calls for a higher voltage at the start and at low rpm values.

In systems with motors connected in parallel, the electronic thermal relay (ETR) of the adjustable frequency drive cannot be used as motor protection for the individual motor. For this reason, further motor protection must be used, e.g., thermistors in each motor (or an individual thermal relay).



NOTE!

Parameter 107 *Automatic motor tuning, AMT* cannot be used when motors are connected in parallel. Parameter 101 *Torque characteristic* must be set to *Special motor characteristics* [8] when motors are connected in parallel.

2.5.9 Motor Cables

See Technical data for correct dimensioning of motor cable cross-section and length. Always comply with national and local regulations on cable cross-section.



NOTE!
If an unshielded/unarmored cable is used, some EMC requirements are not complied with, see EMC test results in the Design Guide.

If the EMC specifications regarding emissions are to be complied with, the motor cable must be shielded/armored unless otherwise stated for the RFI filter in question. It is important to keep the motor cable as short as possible so as to reduce the noise level and leakage currents to a minimum. The motor cable shield must be connected to the metal cabinets of the adjustable frequency drive and the motor. The shield connections are to be made with the largest possible surface area (cable clamp). This is enabled by different installation devices in different adjustable frequency drives. Connecting with twisted shield ends (pigtails) is to be avoided, as these spoil the shielding effect at high frequencies. If it is necessary to break the shield to install a motor isolator or motor relay. The shield must be continued at the lowest possible HF impedance.

2.5.10 Motor thermal protection

The electronic thermal relay in UL approved variable frequency drives has received the UL approval for single motor protection, when parameter 128 *Motor thermal protection* has been set for *ETR Trip* and parameter 105 *Motor current, I_{M,N}* has been programmed to the rated motor current (see motor nameplate).

2.5.11 Brake Resistor

No.	81 (optional function) R-	82 (optional function) R+	Brake resistor terminals
-----	------------------------------	------------------------------	--------------------------

The connection cable to the brake resistor must be shielded/armored. Connect the shield to the metal cabinet of the adjustable frequency drive and to the metal cabinet of the brake resistor by means of cable clamps. Dimension the cross-section of the brake cable to match the brake torque.

See chapter *Dynamic Braking* in the *Design Guide MG.90.FX.YY* for dimensioning of brake resistors.



NOTE!
Please note that voltages up to 850 V DC occur on the terminals.

2.5.12 Control of Mechanical Brake

No.	122 (optional function) MBR+	123 (optional function) MBR-	Mechanical brake (UDC=0.45 X AC Line Voltage) Max 0.8 A
-----	---------------------------------	---------------------------------	---

2

In lifting/lowering applications, you need to be able to control an electromagnetic brake. The brake is controlled using the special mechanical brake control/supply terminals 122/123.

When the output frequency exceeds the brake cut-out value set in par. 138, the brake is released if the motor current exceeds the preset value in parameter 140. When stopping, the brake is engaged when the output frequency is less than the brake engaging frequency, which is set in par. 139.

If the adjustable frequency drive is at alarm status or in an overvoltage situation, the mechanical brake is cut in immediately.

If not using the special mechanical brake control/supply terminals (122-123), select *Mechanical brake control* in parameter 323 or 341 for applications with an electromagnetic brake.

A relay output or digital output (terminal 46) can be used. See *Connection of mechanical brake* for further details.

2.5.13 Electrical Installation, Control Cables

Control cables must be shielded/armored. The shield must be connected to the adjustable frequency drive chassis by means of a clamp. Normally, the shield must also be connected to the chassis of the controlling unit (use the instructions for the unit in question). In connection with very long control cables and analog signals, in rare cases depending on the installation, 50/60 Hz ground loops may occur because of noise transmitted from line power supply cables. In this connection, it may be necessary to break the shield and possibly insert a 100 nF capacitor between the shield and the chassis.

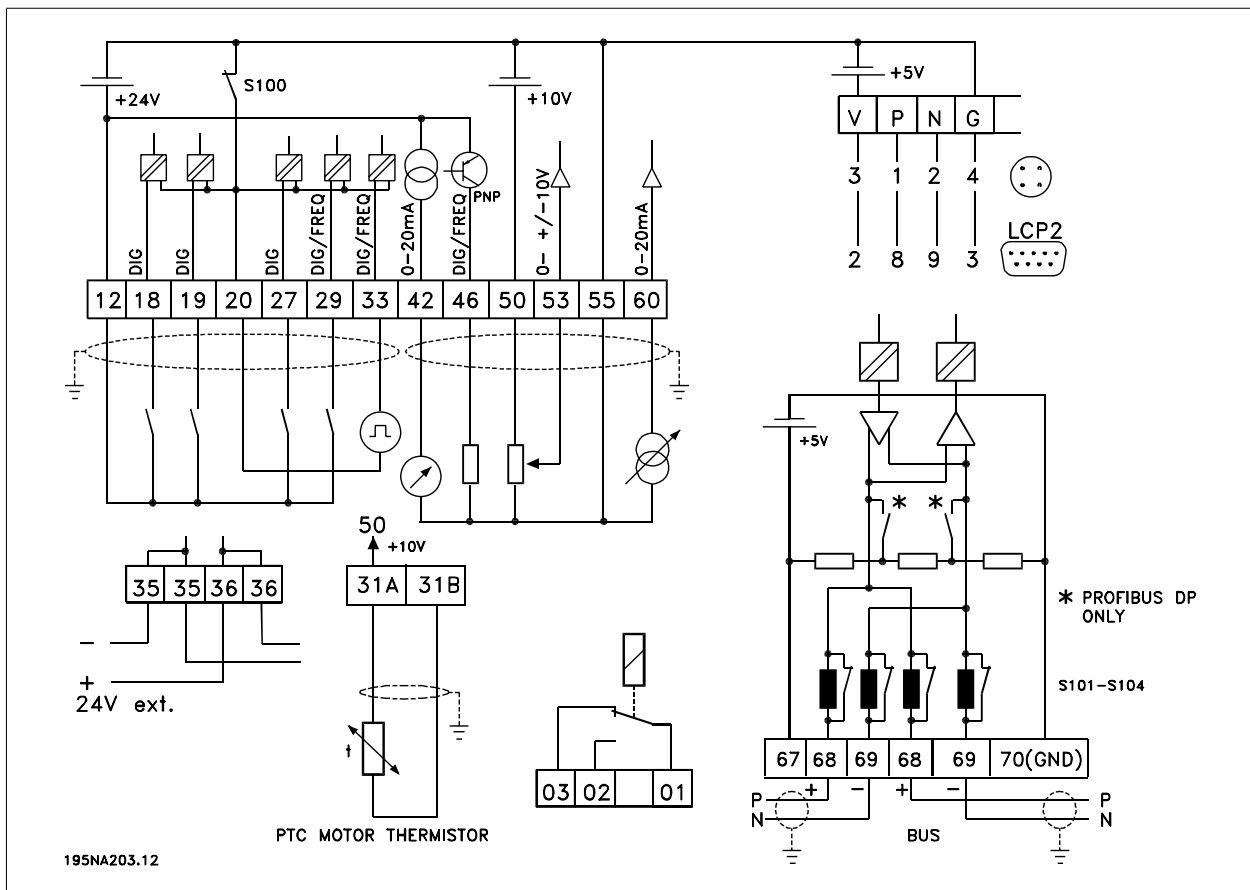

Switches S101-104
Bus line coils, leave switches ON

2.5.14 Connection of Sensors to M12 Plugs for T63 and T73

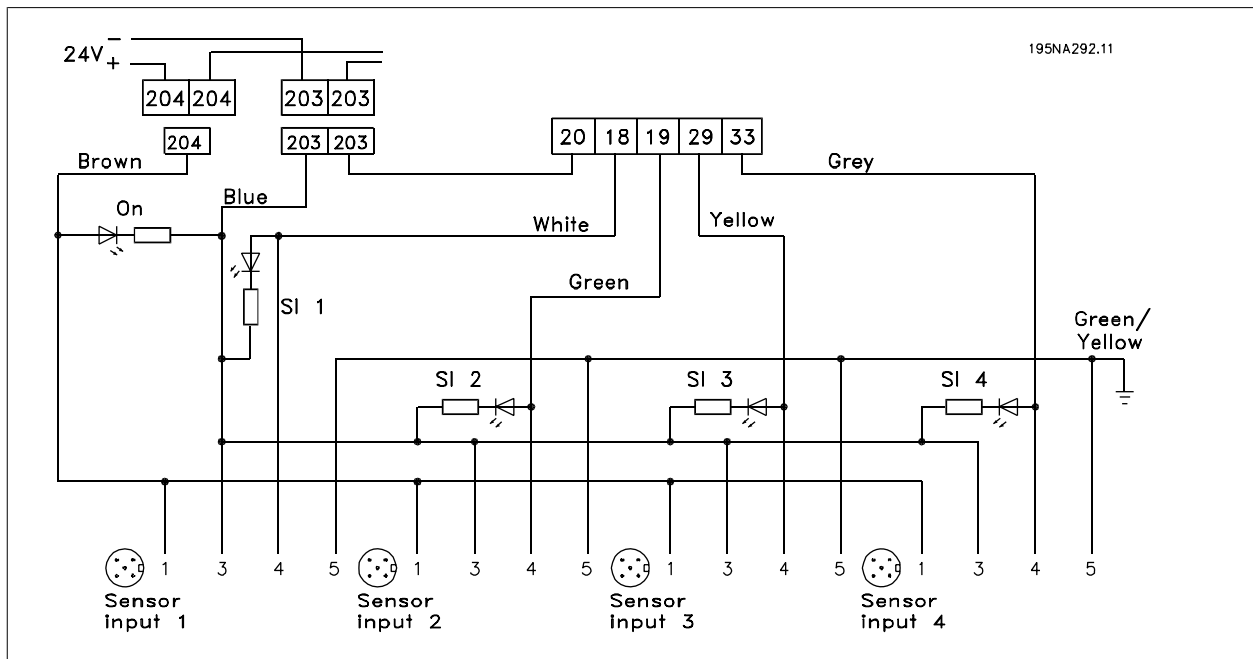

For rating specifications see *General technical data*, digital inputs terminals 18, 19, 29, 33.

Terminals 203/204 are used for sensor supply.

Terminal 203 = common

Terminal 204 = +24 V

Terminals 201/202 can be used for a separate 24 V supply.

2.5.15 Electrical Installation, Control Terminals

See section entitled *Grounding of shielded/armored control cables* in the Design Guide for the correct termination of control cables.

No.	Function
01-03	Relay outputs 01-03 can be used for indicating status and alarms/warnings.
12	24 V DC voltage supply.
18-33	Digital inputs.
20, 55	Common frame for input and output terminals. Can be separated with switch S100
31a, 31b	Motor thermistor
35	Common (-) for external 24 V control backup supply. Optional.
36	External + 24 V control backup supply. Optional.
42	Analog output for displaying frequency, reference, current or torque.
46	Digital output for displaying status, warnings or alarms, as well as frequency output.
50	+10 V DC supply voltage for potentiometer
53	Analog voltage input 0-+/-10 V DC.
60	Analog current input 0/4-20 mA.
67	+ 5 V DC supply voltage to Profibus.
68, 69	Serial communication bus*
70	Ground for terminals 67, 68 and 69. Normally, this terminal is not to be used.
D	For future use
V	+5V, red
P	RS485(+), LCP2/PC, yellow
N	RS485(-), LCP2/PC, green
G	OV, blue

* See *VLT 2800/FCM 300/FCD 300 Profibus DPV1 Instruction Manual* (MG.90.AX.YY), *VLT 2800/FCD 300 DeviceNet Instruction Manual* (MG.90.BX.YY) or *FCD 300 AS-Interface Instruction Manual* (MG.04.EX.YY).

2

2.5.16 PC Communication

Connect to terminals P and N for PC access to single parameters. Motor and serial communication should be stopped before performing automatic transfer of multiple parameters.

On non-serial communication bus and Profibus variants, terminals 68 and 69 can be used provided Profibus communication is stopped.

2.5.17 Relay Connection

See parameter 323 *Relay output* for programming of relay output.

No.	01 - 02	1 - 2 make (normally open)
	01 - 03	1 - 3 break (normally closed)

2.5.18 LCP 2 Plug, Optional

An LCP 2 control unit can be connected to a plug which is optionally mounted in the housing. Ordering number: 175N0131.

LCP control units with ordering number 175Z0401 are not to be connected.

2.5.19 Installation of 24 Volt External Supply (Optional)

24 V external DC supply can be used as low-voltage supply to the control card. This enables full operation of the LCP2 and serial bus (incl. parameter setting) without a connection to line.

Please note that a warning of low voltage will be given when 24 V DC has been connected; however, there will be no tripping.



NOTE!

Use 24 V DC supply of type PELV to ensure correct galvanic isolation (type PELV) on the control terminals of the VLT adjustable frequency drive.



Beware of unintended start of the motor if line power is applied during operation on the external 24 V backup supply.

2.5.20 Software Version 1.5x

An FCD equipped with a serial communication bus shows the status *Unit ready* even with bridged terminals 12-27 and cannot be set into RUNNING mode by digital inputs alone until one of the following parameters is set:

- Par. 502 is set to *Digital input* or *Logic and* or
- Par. 833 or 928 is set to *Disable* or
- Par. 678 is set to *Standard version*

The serial communication bus status word at power-up might be different (typically 0603h instead of 0607h) until the first valid control word is sent. After sending the first valid control word (bit 10 = Data valid), the status is exactly as in earlier software versions.

2.6 Connection examples

2

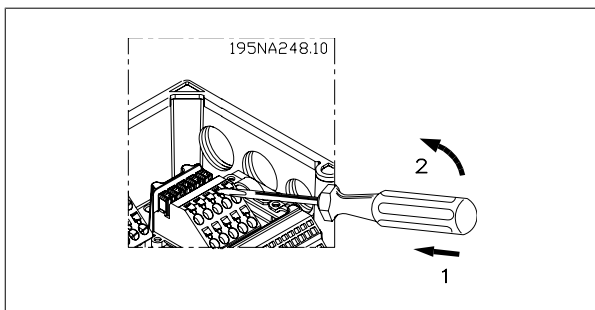
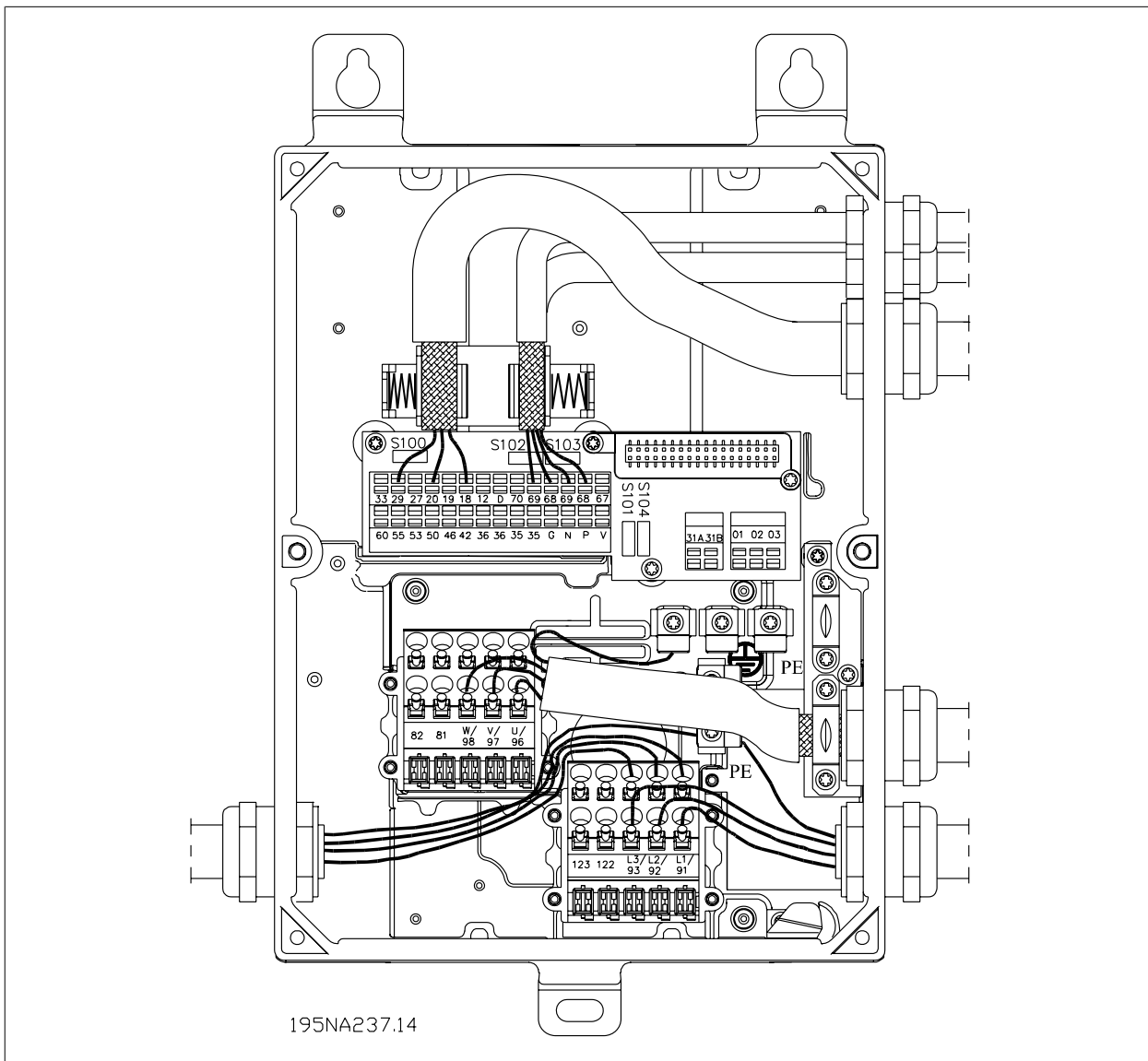

**NOTE!**

Avoid leading the cables over the plugs to the electronics.
Don't loosen the screw keeping the spring in place for the PE connection.

2

**NOTE!**

In the *connection examples* below, it should be noted that the factory settings (on) for the Switch S100 must not be changed.

2.6.1 Start/Stop

Start/stop using terminal 18 and coasting stop using terminal 27.

Par. 302 *Digital input* = *Start* [7]

Par. 304 *Digital input* = *Coasting stop inverted* [2]

For Precise start/stop the following settings are made:

Par. 302 *Digital input* = *Precise start/stop* [27]

Par. 304 *Digital input* = *Coasting stop inverted* [2]

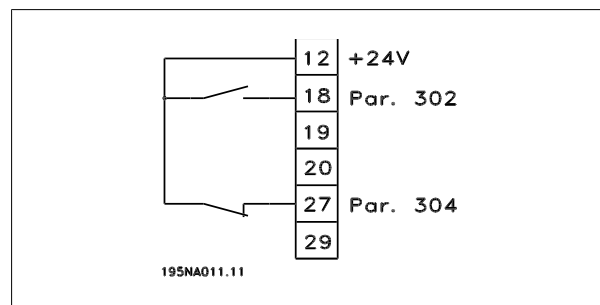

2.6.2 Pulse Start/Stop

Pulse start using terminal 18 and pulse stop using terminal 19. In addition, the jog frequency is activated via terminal 29.

Par. 302 *Digital input* = *Pulse start* [8]

Par. 303 *Digital input* = *Stop inverted* [6]

Par. 304 *Digital input* = *Coasting stop inverted* [2]

Par. 305 *Digital input* = *Jog* [13]

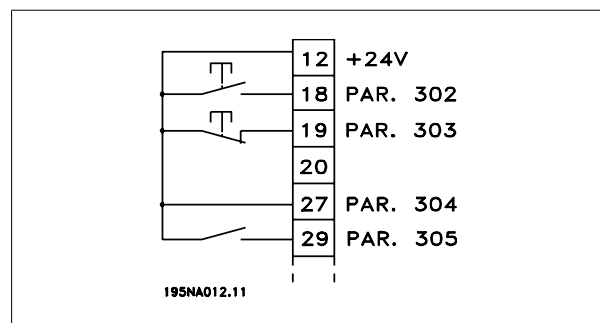

2.6.3 Speed Up/Down

Speed up/down using terminals 29/33.

- Par. 302 *Digital input = Start* [7]
- Par. 303 *Digital input = Freeze reference* [14]
- Par. 305 *Digital input = Speed up* [16]
- Par. 307 *Digital input = Slow* [17]

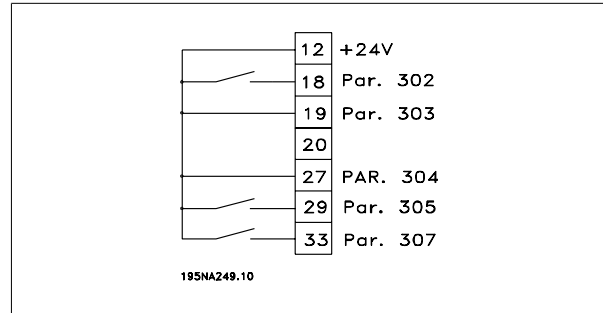

2.6.4 Potentiometer Reference

Voltage reference via a potentiometer.

- Par. 308 *Analog input = Reference* [1]
- Par. 309 *Terminal 53, min. scaling = 0 Volt*
- Par. 310 *Terminal 53, max. scaling = 10 Volt*

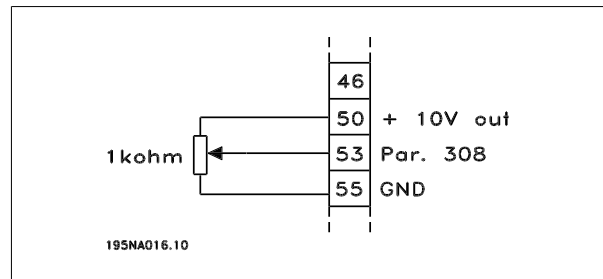

2.6.5 Connection of a 2-Wire Transmitter

Connection of a 2-wire transmitter as feedback to terminal 60.

- Par. 314 *Analog input = Feedback* [2]
- Par. 315 *Terminal 60, min. scaling = 4 mA*
- Par. 316 *Terminal 60, max. scaling = 20 mA*

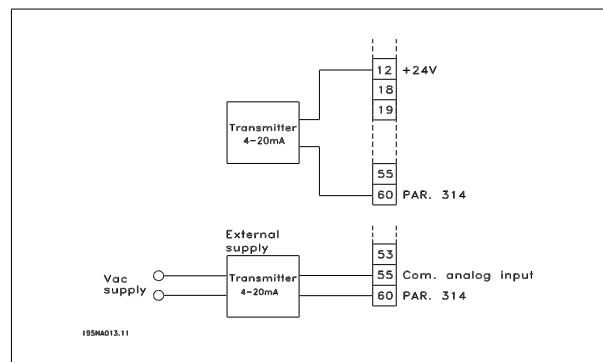

2.6.6 4-20 mA Reference

4-20 mA reference on terminal 60 and speed feedback signal on terminal 53.

2

- Par. 100 Configuration = Speed closed-loop [1]
- Par. 308 Analog input = Feedback [2]
- Par. 309 Terminal 53, min. scaling = 0 Volt
- Par. 310 Terminal 53, max. scaling = 10 Volt
- Par. 314 Analog input = Reference [1]
- Par. 309 Terminal 60, min. scaling = 4 mA
- Par. 310 Terminal 60, max. scaling = 20 mA

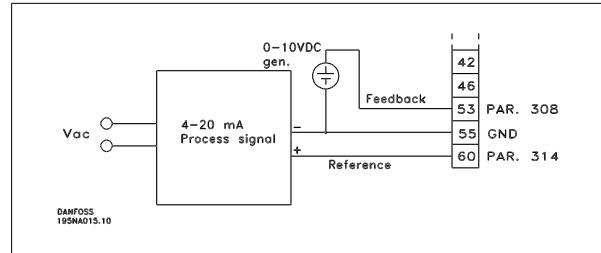

2.6.7 50 Hz Counter-clockwise to 50 Hz Clockwise

With internally supplied potentiometer.

- Par. 100 Configuration = Speed regulation open-loop [0]
- Par. 200 Output frequency ranges = Both directions, 0-132 Hz [1]
- Par. 203 Reference range = Min. ref. - Max. ref. [0]
- Par. 204 Min. reference = -50 Hz
- Par. 205 Max. reference = 50 Hz
- Par. 302 Digital input = Start [7]
- Par. 304 Digital input = Coasting stop inverted [2]
- Par. 308 Analog input = Reference [1]
- Par. 309 Terminal 53, min. scaling = 0 Volt.
- Par. 310 Terminal 53, max. scaling = 10 Volt.

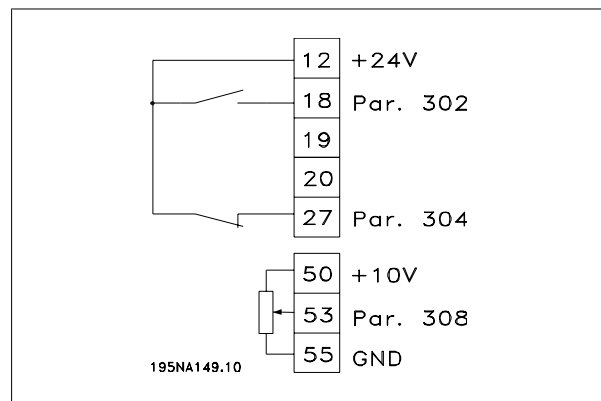
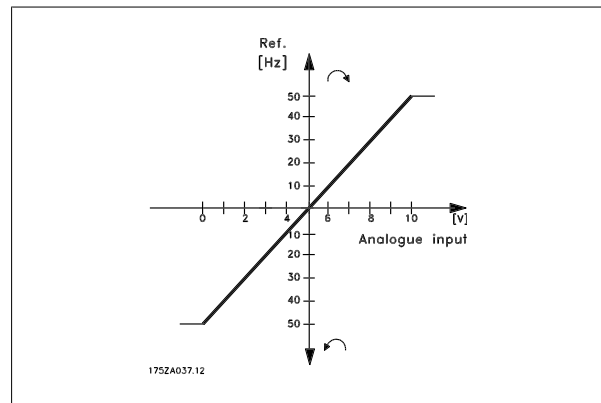

2.6.8 Preset References

Switch between 8 preset references via two digital inputs and Setup 1 and Setup 2.

- Par. 004 *Active Setup = Multisetup 1* [5]
- Par. 204 *Min. reference = 0 Hz*
- Par. 205 *Max. reference = 50 Hz*
- Par. 302 *Digital input = Start* [7]
- Par. 303 *Digital input = Choice of Setup, lsb* [31]
- Par. 304 *Digital input = Coasting stop inverted* [2]
- Par. 305 *Digital input = Preset ref., lsb* [22]
- Par. 307 *Digital input = Preset ref., msb* [23]

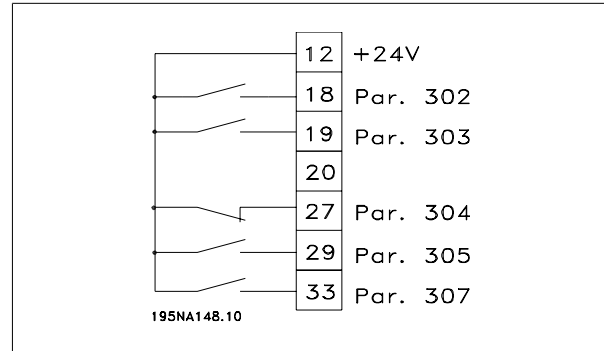

Setup 1 contains the following preset references:

- Par. 215 *Preset reference 1 = 5.00%*
- Par. 216 *Preset reference 2 = 10.00%*
- Par. 217 *Preset reference 3 = 25.00%*
- Par. 218 *Preset reference 4 = 35.00%*

Setup 2 contains the following preset references:

- Par. 215 *Preset reference 1 = 40.00%*
- Par. 216 *Preset reference 2 = 50.00%*
- Par. 217 *Preset reference 3 = 70.00%*
- Par. 218 *Preset reference 4 = 100.00%*

This table shows what the output frequency is:

Preset ref., msb	Preset ref., lsb	Selection of Setup	Output frequency [Hz]
0	0	0	2.5
0	1	0	5
1	0	0	10
1	1	0	17.5
0	0	1	20
0	1	1	25
1	0	1	35
1	1	1	50

2.6.9 Connection of Mechanical Brake

Using terminal 122/123

- Par. 302 *Digital input = Start* [7]
 - Par. 304 *Digital input = Coasting stop inverted* [2]
- See also par. 138, 139, 140

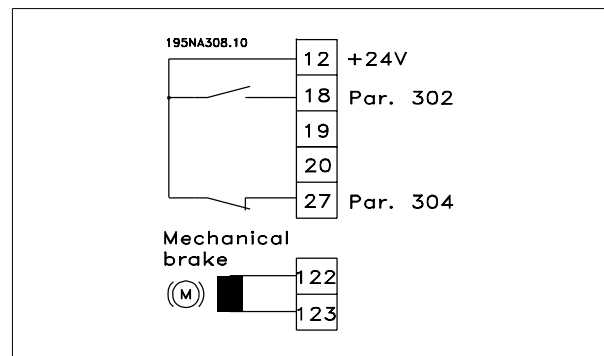

2

Mechanical brake with accelerator winding

Par. 302 *Digital input = Start* [7]

Par. 304 *Digital input = Coasting stop inverted* [2]

See also par. 138, 139, 140

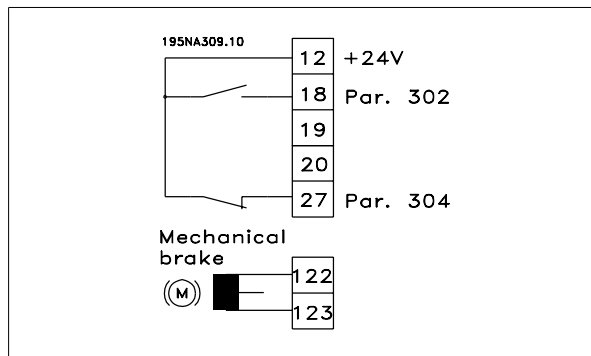

Use of the relay for 230 V AC brake

Par. 302 *Digital input = Start* [7]

Par. 304 *Digital input = Coasting stop inverted* [2]

Par. 323 *Relay output = Mechanical brake control* [25]

See also par. 138, 139, 140

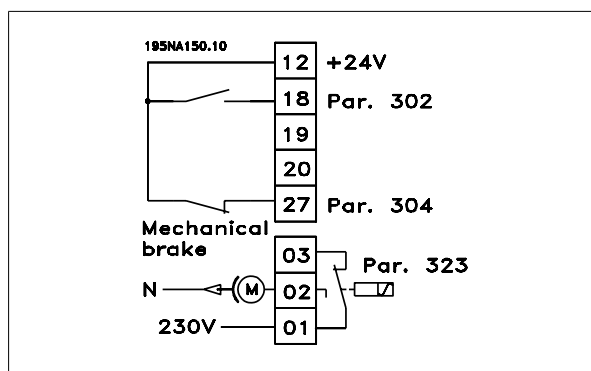

Mechanical brake control [25] = '0' => Brake is closed.
Mechanical brake control [25] = '1' => The brake is open.
 See more detailed parameter settings under *Control of mechanical brake*.

NOTE!
Do not use the internal relay for DC brakes or brake voltages > 250 V.

2.6.10 Counter Stop via Terminal 33

The start signal (terminal 18) must be active, i.e., logical '1', until the output frequency is equal to the reference. The start signal (terminal 18 = logical '0') must then be removed before the counter value in parameter 344 has managed to stop the VLT adjustable frequency drive.

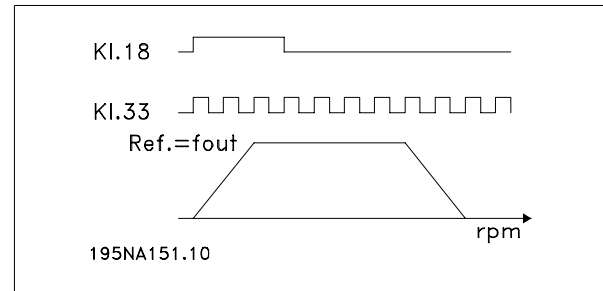

Par. 307 *Digital input = Pulse input* [30]

Par. 343 *Precise stop function = Counter stop with reset* [1]

Par. 344 *Counter value = 100000*

2

3 Programming

3.1 LCP Control Unit

3.1.1 The LCP 2 Control Unit, Option

The FCD 300 can be combined with an LCP control unit (Local Control Panel - LCP 2) which makes up a complete interface for operation and programming of the adjustable frequency drive. The LCP 2 control unit can be attached up to 10 ft [3 m] from the adjustable frequency drive, e.g., on a front panel, using an accessory kit.

The control panel is divided into five functional groups:

1. Display.
2. Keys used to change the display function.
3. Keys used to change the program parameters.
4. LEDs.
5. Local control keys.

All data is displayed via a 4-line alphanumeric display, which during normal operation will be able to continuously display 4 items of operating data and 3 operating modes. During programming, all information needed for quick, effective parameter setup of the adjustable frequency drive will be displayed. As a supplement to the display, there are three LEDs for voltage (ON), warning (WARNING) and alarm (ALARM). All adjustable frequency drive parameter setups can be changed immediately from the control panel, unless this function has been programmed as *Locked* [1] via parameter 018 *Lock for data changes*.

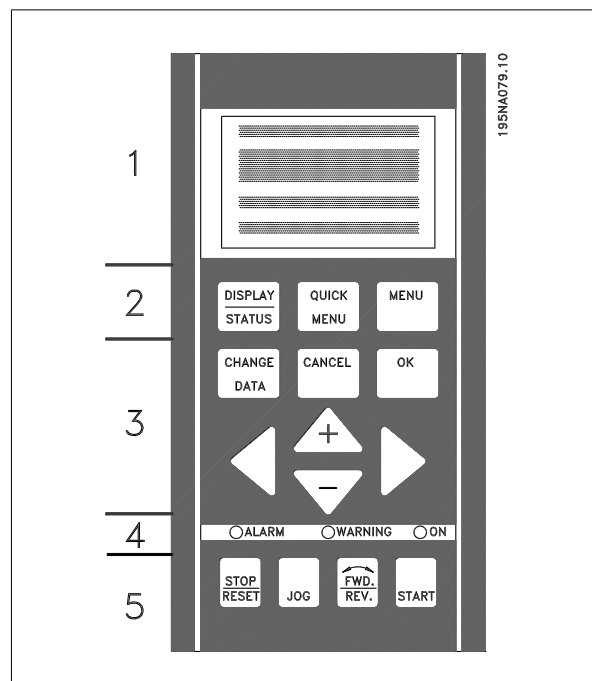

3.1.2 Control Keys for Parameter Setup

The control keys are divided into functions, in such a way that the keys between the display and the LEDs are used for parameter setup, including selection of the display's view mode during normal operation.

3

[DISPLAY/STATUS] is used to select the display's view mode or to change back to Display mode from either quick menu or menu mode.

[QUICK MENU] provides access to the parameters used in the quick menu. It is possible to switch between quick menu and menu mode.

[MENU] gives access to all parameters. It is possible to switch between menu mode and quick menu.

[CHANGE DATA] is used to change a parameter that has been selected either in menu mode or quick menu.

[CANCEL] is used if a change to the selected parameter is not to be implemented.

[OK] is used to confirm a change to a selected parameter.

[+ / -] are used for selecting parameters and for changing parameter values.

These keys are also used in display mode to switch between the readouts of operating variables.

[< >] are used for selecting parameter group and to move the cursor when changing a numerical value.

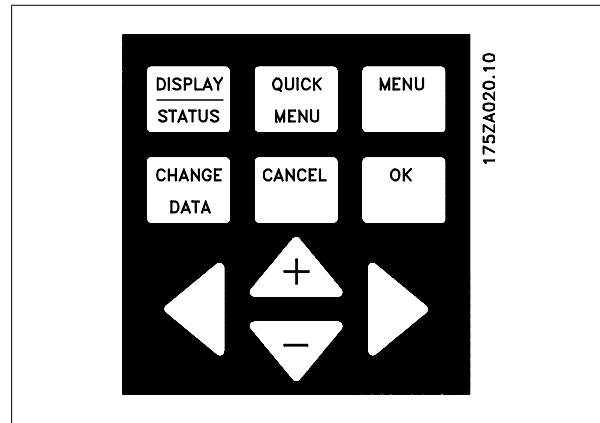

3.1.3 LEDs

At the bottom of the control panel are a red alarm LED, a yellow warning LED and a green voltage LED.

If certain threshold values are exceeded, the alarm and/or warning LED are activated, while a status or alarm text is shown on the display.

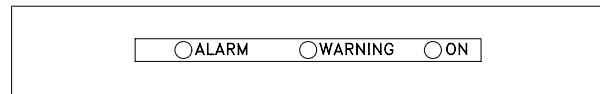

NOTE!

The voltage LED is activated when voltage is connected to the adjustable frequency drive.

3.1.4 Local Control

[STOP/RESET] is used for stopping the motor connected or for resetting the adjustable frequency drive after a drop-out (trip). Can be set to active or inactive via parameter 014 *Local stop*. If stop is activated Display line 2 will flash.

NOTE!
If an external stop function is not selected and the [STOP/RESET] key is set to inactive, the motor can only be stopped by disconnecting the voltage to the motor or the adjustable frequency drive.

[JOG] changes the output frequency to a preset frequency while the key is held down. Can be set to active or inactive via parameter 015 *Local jog*.

[FWD / REV] changes the direction of rotation of the motor, which is indicated by means of the arrow on the display. Can be set to active or inactive via parameter 016 *Local reversing*. The [FWD/REV] key is only active when parameter 002 *Local/remote operation* is set to *Local control*.

[START] is used to start the adjustable frequency drive. Is always active, but cannot override a stop command.

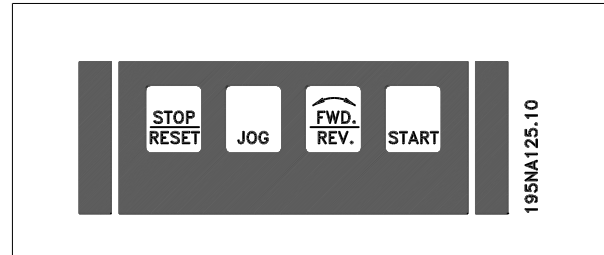

3

NOTE!
If the local control keys are set to inactive, these will both become active when the adjustable frequency drive is set to *Local control* and *Remote control* via parameter 002 *Local/remote operation*, with the exception of [FWD/REV], which is only active in *Local control*.

3.1.5 Display Mode



In normal operation, up to 4 different display data items can optionally be shown continuously: 1,1, 1,2, 1,3 and 2. The present operation status or alarms and warnings that have been generated are displayed in line 2 as a number.

In the event of alarms, this is displayed in lines 3 and 4 with explanatory text.

A warning will appear flashing in line 2 with explanatory text in line 1. The active setup will also appear on the display.

The arrow indicates the selected direction of rotation. Here the adjustable frequency drive shows that it has an active reversing signal. The body of the arrow will disappear if a stop command is given, or if the output frequency drops below 0.1 Hz.

The bottom line displays the frequency transformer's status. The scrollbar shows which operating values can be displayed in lines 1 and 2 in display mode. Changes are made using the [+ / -] keys.

Switching between AUTO and HAND modes

By activating the [CHANGE DATA] key in [DISPLAY MODE], the display will indicate the mode of the adjustable frequency drive.

Switch mode by using [+/-] key [HAND...AUTO]

In [HAND] mode, the reference can be changed by [+] or [-] keys.

Operating data	Unit
Resulting reference	[%]
Resulting reference	[unit]
Feedback	[unit]
Output frequency	[Hz]
Output frequency x scaling	[-]
Motor current	[A]
Torque	[%]
Power	[kW]
Power	[HP]
Motor voltage	[V]
DC link voltage	[V]
Thermal load motor	[%]
Thermal load	[%]
Hours run	[hours]
Digital input	[binary]
Pulse input 29	[Hz]
Pulse input 29	[Hz]
Pulse input 33	[Hz]
External reference	[%]
Status word	[hex]
Heatsink temperature	[°C]
Alarm word	[hex]
Control word	[hex]
Warning word	[hex]
Extended status word	[hex]
Analog input 53	[V]
Analog input 60	[mA]

Three operating data items can be shown in the first display line, and one operating variable can be shown in the second display line. Is programmed via parameters 009, 010, 011 and 012 *Display readout*.

3.1.6 Display Modes

The LCP control unit has different display modes, which depend on the mode selected for the adjustable frequency drive.

Display mode I:

This display mode is standard after startup or initialization.

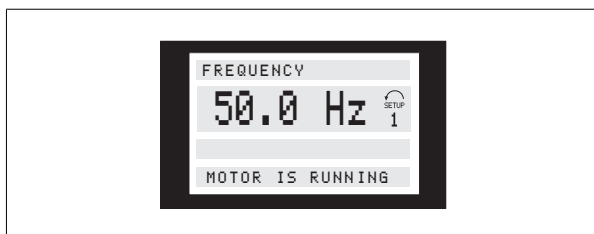

Line 2 shows the data value of an operating data item with unit, and line 1 contains a text that explains line 2. In the example, *Frequency* has been selected as readout via parameter 009 *Large display readout*. In normal operation, another variable can be entered immediately using the [+ / -] keys.

Display mode II:

Switch between display modes I and II is performed by briefly pressing the [DISPLAY / STATUS] key.

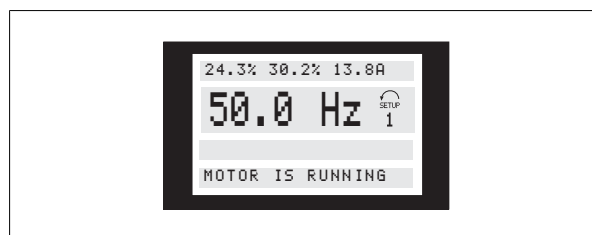

In this mode, all data values for four operating data items with any pertaining units are shown, see table. In the example, the following have been selected: *Frequency*, *Reference*, *Torque* and *Current* as readout in the first and second line.

Display mode III:

This display mode is called up as long as the [DISPLAY / STATUS] key is held down. When the key is released it switches back to display mode II, unless the key is held down for less than approx. 1 sec., in which case the system always reverts to display mode I.



Here you can read out the parameter names and units for operating data in the first and second lines. Line 2 in the display remains unchanged.

Display mode IV:

This display mode can be called up during operation if a change has to be made in another setup without stopping the adjustable frequency drive. This function is activated in parameter 005 *Programming Setup*.

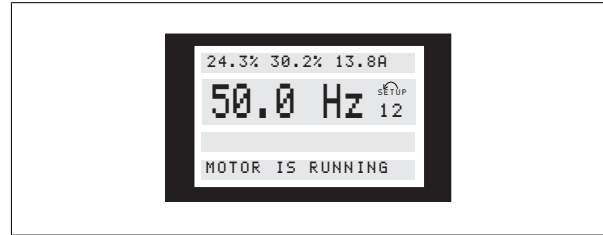

Here the programming Setup number 2 will flash to the right of the active setup.

3.1.7 Parameter Setup

An adjustable frequency drive's comprehensive work area can be accessed via a large number of parameters, making it possible to adapt its functionality for a specific application. To provide a better overview of the many parameters, there is a choice of two programming modes - menu mode and quick menu mode. The former provides access to all parameters. The latter takes the user through the parameters, which make it possible to start operating the adjustable frequency drive in most cases, in accordance with the setup made. Regardless of the mode of programming, a change of a parameter will take effect and be visible both in the menu mode and in the quick menu mode.

Structure for quick menu mode v menu mode

In addition to having a name, each parameter is linked up with a number which is the same regardless of the programming mode. In menu mode,

parameters will be split into groups, with the first digit (left) of the parameter number indicating the group number of the parameter in question.

- Using the [QUICK MENU] key, it is possible to get access to the most important parameters of the adjustable frequency drive. After programming, the adjustable frequency drive is, in most cases, ready for operation. Scroll through the quick menu using the [+ / -] keys and change the data values by pressing [CHANGE DATA] + [OK].
- The menu mode allows choosing and changing all parameters as required. However, some parameters will be "shaded off", depending on the choice in parameter 100 *Configuration*.

3.1.8 Quick Menu with LCP 2 Control Unit

Start Quick Setup by pressing the [QUICK MENU] key, which will bring out the following display values:

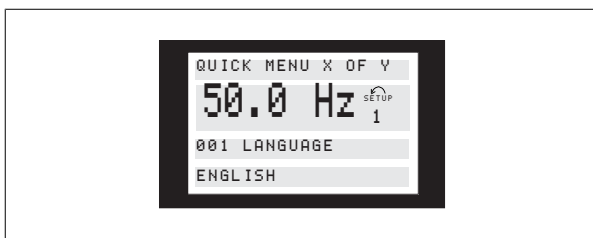

At the bottom of the display, the parameter number and name are given together with the status/value of the first parameter under the quick

menu. The first time the [QUICK MENU] key is pressed after the unit has been switched on, the readouts always start in pos. 1 - see table below.

Pos.	Parameter no.	Unit
1	001 Language	
2	102 Motor power	[kW]
3	103 Motor voltage	[V]
4	104 Motor frequency	[Hz]
5	105 Motor current	[A]
6	106 Rated motor speed	[rpm]
7	107 AMT	
8	204 Minimum reference	[Hz]
9	205 Maximum reference	[Hz]
10	207 Ramp-up time	[sec]
11	208 Ramp-down time	[sec]
12	002 Local/remote operation	
13	003 Local reference	[Hz]

3.1.9 Parameter Selection

Menu mode is started by pressing the [MENU] key, which produces the following readout on the display:

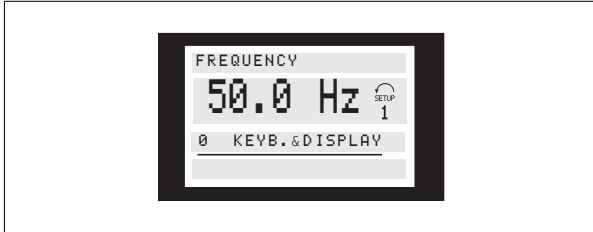

Line 3 on the display shows the parameter group number and name.

In menu mode, the parameters are divided into groups. Selection of parameter group is effected using the [< >] keys.

The following parameter groups will be accessible:

Group no.	Parameter group
0	Operation & Display
1	Load & Motor
2	References & Limits
3	Inputs & Outputs
4	Special functions
5	Serial communication
6	Technical functions

When the required parameter group has been selected, each parameter can be chosen by means of the [+ / -] keys:

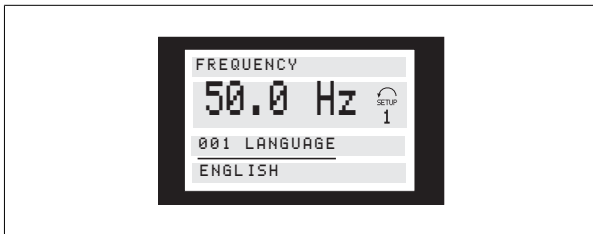

The third line of the display shows the parameter number and name, while the status/value of the selected parameter is shown in line 4.

Changing data

Regardless of whether a parameter has been selected under the quick menu or the menu mode, the procedure for changing data will be the same. Pressing the [CHANGE DATA] key gives access to changing the selected parameter, following which the underlining in line 4 will flash on

the display. The procedure for changing data depends on whether the selected parameter represents a numerical data value or a text value.

Changing a data value

If the selected parameter is a text value, the text value is changed by means of the [+ / -] keys.

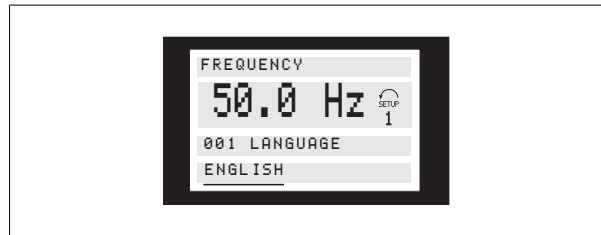

The bottom display line will show the value that will be entered (saved) when acknowledgment is given [OK].

Change of numeric data value

If the selected parameter is represented by a numerical data value, a digit is first chosen using the [< >] keys.

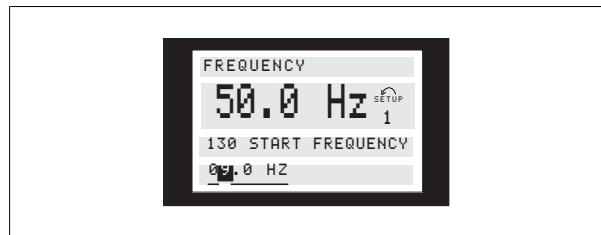

The selected digit can then be changed infinitely variably using the [+ / -] keys:

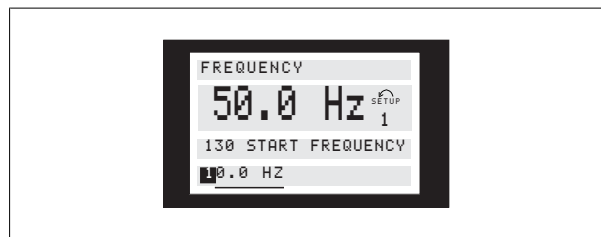

The chosen digit is indicated by the digit flashing. The bottom display line shows the data value that will be entered (saved) when signing off with [OK].

3.1.10 Manual Initialization

**NOTE!**

Manual initialization is not possible on the LCP 2 175N0131 control unit. It is, however, possible to perform an initialization via par. 620 *Operation mode*.

The following parameters are not changed when initializing via par. 620 *Operation mode*.

- par. 500 *Address*
- par. 501 *Baud rate*
- par. 600 *Operating hours*
- par. 601 *Hours run*
- par. 602 *kWh counter*
- par. 603 *Number of power-ups*
- par. 604 *Number of overtemperatures*
- par. 605 *Number of overvoltages*
- par. 615-617 *Fault log*
- par. 678 *Configure Control Card*

3.2 Parameter Group 0-** Operation & Display

001 Language

Value:

* English (ENGLISH)	[0]
German (DEUTSCH)	[1]
French (FRANCAIS)	[2]
Danish (DANSK)	[3]
Spanish (ESPAÑOL)	[4]
Italian (ITALIANO)	[5]

Function:

This parameter is used to choose the language to be shown in the display whenever the LCP control unit is connected.

Description of choice:

There is a choice of the languages shown. The factory setting may vary.

002 Local/remote operation

Value:

* Remote operation (REMOTE)	[0]
Local operation (LOCAL)	[1]

Function:

There is a choice of two different modes of operation of the variable frequency drive. *Remote operation* [0] or *Local operation* [1]. See also parameter 013 *Local control* if *Local operation* [1] is selected.

Description of choice:

If *Remote operation* [0] is selected, the variable frequency drive is controlled via:

1. the control terminals or via serial communication.
2. the [START] key. This cannot, however, override stop commands transmitted via the digital inputs or via serial communication.
3. the [STOP/RESET] and [JOG] keys, on the condition that these are active.

If *Local operation* [1], is selected, the variable frequency drive is controlled via:

1. the [START] key. This cannot, however, override stop commands via the digital inputs (see parameter 013 *Local control*).
2. the [STOP/RESET] and [JOG] keys, on the condition that these are active.
3. the [FWD/REV] key, on the condition that it has been selected as active in parameter 016 *Local reversing*, and that parameter 013 *Local control* is set at *Local control and open loop* [1] or *Local control as parameter 100* [3]. Parameter 200 *Output frequency range* is set at *Both directions*.
4. parameter 003 *Local reference* where the reference can be set using the [+] and [-] keys.
5. an external control command that can be connected to the digital inputs (see parameter 013 *Local control*).



NOTE!

The [JOG] and [FWD/REV] keys are located on the LCP control unit.

003 Local reference

Value:

Par. 013 <i>Local control</i> must be set to [1] or [2]:	
0 - f _{MAX} (par. 205)	* 50 Hz
Par. 013 <i>Local control</i> must be set to [3] or [4].	
Ref _{MIN} - Ref _{MAX} (par. 204-205)	* 0.0

Function:

In this parameter, the local reference can be set manually. The unit of the local reference depends on the configuration selected in parameter 100 *Configuration*.

Description of choice:

In order to protect the local reference, parameter 002 *Local/remote operation* must be set to *Local operation* [1]. Local reference cannot be set via serial communication.

3.2.1 Setup Configuration

There is a choice of four Setups (parameter setups), which can be programmed independently of one another. The active setup can be selected in parameter 004 *Active Setup*. When an LCP control unit is connected, the active setup number will appear in the display under "Setup". It is also possible to preset the adjustable frequency drive to *Multisetup*, so that it is possible to shift setups using the digital inputs or serial communication. Setup shift can be used in a plant in which, for example, one setup is used for daytime operation and another one at night time. In

parameter 006 *Setup copying* it is possible to copy from one setup to another. Using parameter 007 *LCP copy*, all setups can be transferred from one adjustable frequency drive to another by moving the LCP control panel. First all parameter values are copied to the LCP control panel, which can then be moved to another adjustable frequency drive. Here all parameter values can be copied from the LCP control unit to the adjustable frequency drive.

3.2.2 Setup Shift

- Selection of Setup via terminals 29 and 33.
 Par. 305 *Digital input = Selection of Setup, lsb* [31]
 Par. 307 *Digital input = Selection of Setup, msb* [32]
 Par. 004 *Active setup = Multi Setup* [5]

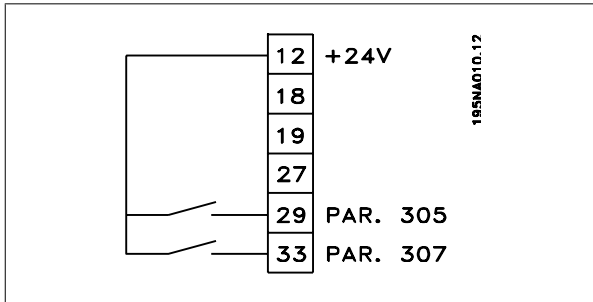

004 Active Setup	
Value:	
Factory Setup (FACTORY SETUP)	[0]
* Setup 1 (setup 1)	[1]
Setup 2 (setup 2)	[2]
Setup 3 (setup 3)	[3]
Setup 4 (setup 4)	[4]
Multi Setup (MULTI SETUP)	[5]

Function:
 The active parameter Setup is selected here. All parameters can be programmed in four individual parameter Setups. Shifts between Setups can be made in this parameter via a digital input or via serial communication.

Description of choice:
Factory Setup [0] contains the factory-set parameter values. *Setup 1-4* [1]-[4] are four individual setups which can be selected as required. *Multi Setup* [5] is used where remote-controlled shifts between the four Setups via a digital input or via serial communication is required.

005 Programming Set-up	
Value:	
Factory Set-up (FACTORY SET-UP)	[0]
Set-up 1 (set-up 1)	[1]
Set-up 2 (set-up 2)	[2]
Set-up 3 (set-up 3)	[3]
Set-up 4 (set-up 4)	[4]
* Active Set-up (ACTIVE SET-UP)	[5]

Function:
 You can select the desired set-up to program during operation (this applies both via the control panel and the serial communication port). For example, it is possible to program *Set-up 2* [2] while the active set-up is set to *Set-up 1* [1] in parameter 004 *Active Set-up*.

Description of choice:

Factory Set-up [0] contains the factory-set data and can be used as a source of data if the other set-ups are to be reset to a known status. *Setup 1-4* [1]-[4] consists of individual set-ups that can be programmed freely during operation. If *Active Set-up* [5] is selected, the programming set-up will be equal to parameter 004 *Active Set-up*.



NOTE!
 If data is modified or copied to the active set-up, the modifications have an immediate effect on the unit's operation.

006 Setup copying

Value:	
* No copying (NO COPY)	[0]
Copy to Setup 1 from # (COPY TO SETUP 1)	[1]
Copy to Setup 2 from # (COPY TO SETUP 2)	[2]
Copy to Setup 3 from # (COPY TO SETUP 3)	[3]
Copy to Setup 4 from # (COPY TO SETUP 4)	[4]
Copy to all Setups from # (copy to all)	[5]

Function:
 You can copy from the selected active Setup in parameter 005 *Programming setup* to the selected Setup or Setups in this parameter.



NOTE!
 Copying is only possible in Stop (motor stopped in connection with a stop command).

Description of choice:

Copying begins when the required copying function has been selected and the [OK]/[CHANGE DATA] key has been pushed. The display indicates when copying is in progress.

007 LCP copy

Value:	
* No copying (NO COPY)	[0]
Upload all parameters (UPL. ALL PAR.)	[1]
Download all parameters (DWNL. ALL PAR.)	[2]
Download size-independent parameters (DWNL.OUTPIND.PAR.)	[3]

Function:
 Parameter 007 *LCP copy* is used if you want to use the LCP 2 control panel's integral copy function. The function is used if you want to copy all parameter setups from one variable frequency drive to another by moving the LCP 2 control panel.

Description of choice:

Select *Upload all parameters* [1] if you want all parameter values to be transferred to the control panel. Select *Download all parameters* [2] if all parameter values transferred are to be copied to the frequency converter to which the control panel is attached. Select *Download size-independent par.* [3] if you only want to download the size-independent parameters. This is used when downloading to a variable frequency drive with a different rated power size than that from which the parameter setup originates.

**NOTE!**

Upload/download can only be performed in stop mode. Download can only be performed to a frequency converter with the same software version number, see parameter 626 *Database identification no.*

008 Display scaling of output frequency**Value:**

0.01–100.00 * 1.00

Function:

In this parameter, the factor is selected by which the output frequency is to be multiplied. The value is shown in the display, provided parameters 009-012 *Display readout* have been set to *Output frequency x scaling* [5].

Description of choice:

Set the required scaling factor.

009 Large display readout**Value:**

No readout (none)	[0]
Resulting reference [%] (reference [%])	[1]
Resulting reference [unit] (reference [unit])	[2]
Feedback [unit] (feedback [unit])	[3]
* Frequency [Hz] (Frequency [Hz])	[4]
Output frequency x scaling (frequency x scale)	[5]
Motor current [A] (Motor current [A])	[6]
Torque [%] (Torque [%])	[7]
Power [kW] (Power [kW])	[8]
Power [HP] (Power [HP] [US])	[9]
Motor voltage [V] (Motor voltage [V])	[11]
DC link voltage [V] (DC link voltage [V])	[12]
Thermal load motor [%] (Motor thermal [%])	[13]
Thermal load [%] (FC. thermal [%])	[14]
Running hours [Hours] (RUNNING HOURS)	[15]

Digital input [Bin] (Digital input [bin])	[16]
Analog input 53 [V] (analog input 53 [V])	[17]
Analog input 60 [mA] (analog input 60 [mA])	[19]
Pulse reference [Hz] (Pulse INPUT 33. [Hz])	[20]
External reference [%] (external ref. [%])	[21]
Status word [Hex] (Status word [hex])	[22]
Heatsink temperature [°C] (Heatsink temp [°C])	[25]
Alarm word [Hex] (Alarm word [hex])	[26]
Control word [Hex] (Control word [Hex])	[27]
Warning word [Hex] (warning word [Hex])	[28]
Extended status word [Hex] (Ext. status [hex])	[29]
Communication option card warning (COMM OPT WARN [HEX])	[30]
Pulse count (PULSE COUNTER)	[31]
Pulse input 29 (PULSE INPUT 29)	[32]

Function:

In this parameter, you can select the data value that you wish to display in the LCP control unit display line 2 when the adjustable frequency drive is switched on. The display will also be included in the scrollbar in display mode. In parameters 010-012 *Display readout*, you can select a further three data values, which are displayed in display line 1.

Description of choice:

No readout can only be selected in parameters 010-012 *Small display readout*.

Resulting reference [%] indicates the resulting reference as a percentage and in the range from minimum reference, Ref_{MIN} to maximum reference, Ref_{MAX}.

Reference [unit] gives the resulting reference with unit Hz in *Open-loop*. In *Closed-loop*, the reference unit is selected in parameter 416 *Process units*.

Feedback [unit] gives the resulting signal value using the unit/scaling selected in parameter 414 *Minimum feedback*, FB_{LOW}, 415 *Maximum feedback*, FB_{HIGH} and 416 *Process units*.

Frequency [Hz] gives the output frequency of the adjustable frequency drive.

Output frequency x scaling [-] equals the present output frequency f_M multiplied by the factor set in parameter 008 *Display scaling of output frequency*.

Motor current [A] gives the phase current of the motor measured as an effective value.

Torque [%] denotes the motor's present load in relation to the motor's rated torque.

Power [kW] gives the present power that the motor is absorbing in kW.

Power [HP] gives the present power that the motor is absorbing in HP.

Motor voltage [V] gives the voltage supplied to the motor.

DC link voltage [V] gives the intermediate circuit voltage of the adjustable frequency drive.

Thermal load motor [%] gives the calculated/estimated load on the motor. 100% is the cut-out limit.

Thermal load [%] gives the calculated/estimated thermal load on the adjustable frequency drive. 100% is the cut-out limit.

Running hours [Hours] gives the number of hours that the motor has run since the last reset in parameter 619 *Reset of running hours counter*.

Digital input [Binary code] gives the signal status from the 5 digital inputs (18, 19, 27, 29 and 33). Terminal 18 corresponds to the bit on the extreme left. `0' = no signal, `1' = signal connected.

Analog input 53 [V] gives the voltage value of terminal 53.

Analog input 60 [mA] gives the present value of terminal 60.

Pulse input 33 [Hz] gives the frequency in Hz connected to terminal 33. External reference [%] gives the sum of external references as a percentage (sum of analog/pulse/serial communication) in the range from minimum reference, Ref_{MIN} to maximum reference, Ref_{MAX}.

Status word [Hex] gives one or several status conditions in a Hex code. See *Serial communication* in the *Design Guide* for further information.

Heatsink temp. [°C] gives the present heatsink temperature of the adjustable frequency drive. The cut-out limit is 194°–212°F [90°–100°C], while cutting back in occurs at 158° ± 9°F [70° ± 5°C].

Alarm word [Hex] gives one or several alarms in hex code. See *Serial communication* in the *Design Guide* for further information.

Control word [Hex] gives the control word for the adjustable frequency drive. See *Serial communication* in the *Design Guide* for further information.

Warning word [Hex] gives one or several warnings in hex code. See *Serial communication* in the *Design Guide* for further information.

Extended status word [Hex] gives one or several status modes in Hex code. See *Serial communication* in the *Design Guide* for further information.

Communication option card warning [Hex] gives a warning word if there is a fault in the communication bus. Only active if communication options are installed.

If there are no communication options, 0 Hex is displayed.

Pulse input 29 [Hz] gives the frequency in Hz connected to terminal 29.

Pulse count gives the number of pulses that the unit has registered.

010	Small display line 1.1
Value:	
See par. 009 <i>Large display readout</i> * Analog input 53 [V] [17]	
Function:	

In this parameter, the first of three data values can be selected that is to be displayed in the LCP control unit display, line 1, position 1. This is a useful function, e.g., when setting the PID regulator, as it gives a view of process reactions to reference changes. The display readout is activated by pushing the [DISPLAY STATUS] key.

Description of choice:

See parameter 009 *Large display readout*.

011	Small display readout 1.2
Value:	
See parameter 009 <i>Large display readout</i> * Motor current [A] [6]	

Function:
See the functional description given under parameter 010 *Small display readout*.

Description of choice:

See parameter 009 *Large display readout*.

012	Small display readout 1.3
Value:	
See parameter 009 <i>Large display readout</i> * Feedback [unit] [3]	

Function:
See the functional description given under parameter 010 *Small display readout*.

Description of choice:

See parameter 009 *Large display readout*.

013	Local control
Value:	
Local not active (DISABLE)	[0]
Local control and open-loop without slip compensation (LOC CTRL/OPEN LOOP)	[1]
Remote-operated control and open-loop without slip compensation (LOC+DIG CTRL)	[2]
Local control as parameter 100 (LOC CTRL/AS P100)	[3]
* Remote-operated control as parameter 100 (LOC+DIG CTRL/AS P100)	[4]

Function:
This is where the required function is selected if, in parameter 002 *Local/remote operation*, *Local operation* [1] has been chosen.

Description of choice:

If *Local not active* [0] is selected, it is not possible to set a reference via parameter 003 *Local reference*.

In order to enable a shift to *Local not active* [0], parameter 002 *Local/remote operation* must be set to *Remote operation* [0].

Local control and open loop [1] is used if the motor speed is to be set via parameter 003 *Local reference*. When this choice is made, parameter 100 *Configuration* automatically shifts to *Speed regulation, open-loop* [0].

Remote-operated control and open-loop [2] functions in the same way as *Local control and open-loop* [1]; however, the adjustable frequency drive can also be controlled via the digital inputs.

For selections [1-2] control is shifted to open-loop, no slip compensation. *Local control as parameter 100* [3] is used when the motor speed is to be set via parameter 003 *Local reference*, but *without* parameter 100 *Configuration* automatically shifting to *Speed regulation, open loop* [0].

Remote-operated control as parameter 100 [4] works the same way as *Local control as parameter 100* [3]; however, the adjustable frequency drive can also be controlled via the digital inputs.

Shifting from *Remote operation* to *Local operation* in parameter 002 *Local/remote operation*, while this parameter has been set to *Remote-operated control and open-loop* [1]: The present motor frequency and direction of rotation will be maintained. If the present direction of rotation does not respond to the reversing signal (negative reference), the reference will be set to 0.

Shifting from *Local operation* to *Remote operation* in parameter 002 *Local/remote control*, while this parameter has been set to *Remote-operated control and open-loop* [1]: The configuration selected in parameter 100 *Configuration* will be active. The shift will be smooth.

Shifting from *Remote control* to *Local control* in parameter 002 *Local/remote operation*, while this parameter has been set to *Remote-operated control as parameter 100* [4]: the present reference will be maintained. If the reference signal is negative, the local reference will be set to 0.

Shifting from *Local operation* to *Remote operation* in parameter 002 *Local/remote operation*, while this parameter has been set to *Remote operation*: The local reference will be replaced by the remote-operated reference signal.

014 Local stop

Value:

Not active (DISABLE) [0]

* Active (ENABLE) [1]

Function:

In this parameter, the local [STOP]-key can be engaged or disengaged on the control panel and on the LCP control panel.

Description of choice:

If *Not active* [0] is selected in this parameter, the [STOP]-key will be inactive.



NOTE!

If *Not active* [0] is selected, the motor cannot be stopped by means of the [STOP]-key.

015 Local jog

Value:

* Not active (DISABLE) [0]

Active (ENABLE) [1]

Function:

In this parameter, the jog function on the LCP control panel can be engaged/disengaged.

Description of choice:

If *Not active* [0] is selected in this parameter, the [JOG] key will be inactive.

016 Local reverse

Value:

* Not active (DISABLE) [0]

Active (ENABLE) [1]

Function:

In this parameter you can select/deselect the reverse function on the LCP control panel. The key can only be used if parameter 002 *Local/remote operation* is set to *Local operation* [1] and parameter 013 *Localcontrol to Local control, open loop* [1] or *Local control as parameter 100* [3].

Description of choice:

If *Disable* [0] is selected in this parameter, the [FWD/REV] key will be disabled. See also parameter 200 *Output frequency range*.

017 Local reset of trip

Value:

Not active (DISABLE) [0]

* Active (ENABLE) [1]

Function:

In this parameter, the reset function on the control panel can be engaged/disengaged.

Description of choice:

If *Not active* [0] is selected in this parameter, the reset function will be inactive.



NOTE!

Select *Not active* [0], only if an external reset signal has been connected via the digital inputs.

018 Lock for data changes

Value:

* Not locked (NOT LOCKED) [0]

Locked (LOCKED) [1]

Function:

In this parameter, it is possible to 'lock' the controls to disable data changes via the control keys.

Description of choice:

If *Locked* [1] is selected, data changes in the parameters cannot be made; however, it will still be possible to make data changes via serial communication. Parameter 009-012 *Display readout* can be changed via the control panel.

019 Operating mode at power-up, local operation

Value:

- Auto restart, use saved reference (AUTO RESTART) [0]
- * Forced stop, use saved reference (LOCAL=STOP) [1]
- Forced stop, set ref. to 0 (LOCAL=STOP, REF=0) [2]

Function:

Setting of the required operating mode when AC line voltage is engaged. This function can only be active if *Local operation* [1] has been selected in parameter 002 *Local/remote operation*.

Description of choice:

Auto restart, use saved ref. [0] is selected if the adjustable frequency drive is to start using the local reference (set in parameter 003 *Local reference*) and the start/stop state given via the control keys immediately prior to the AC line voltage being cut out.

Forced stop, use saved ref. [1] is selected if the adjustable frequency drive is to remain stopped when the AC line voltage is engaged, until the [START] key is activated. After a start command, the motor speed is ramped up to the saved reference in parameter 003 *Local reference*.

Forced stop, set ref. to 0 [2] is selected if the adjustable frequency drive is to remain stopped when the AC line voltage is cut back in. Parameter 003 *Local reference* is to be zeroed.



NOTE!

In remote operation (parameter 002 *Local/remote operation*), the start/stop state at the time of AC line input connections will depend on the external control signals. If *Pulse start* [8] is selected in parameter 302 *Digital input*, the motor will remain stopped after AC line input connections.

020 Lock for Hand mode

Value:

- * Not active (DISABLE) [0]
- Active (ENABLE) [1]

Function:

In this parameter you can select whether it should be possible or not to switch between Auto- and Hand mode. In Auto mode the variable frequency drive is controlled by external signals whereas the variable frequency drive in Hand mode is controlled via a local reference directly from the control unit.

Description of choice:

If *Not active* [0] is selected in this parameter, the Hand mode function will be inactive. This blocking can be activated as desired. If *Active* [1] is selected you can switch between Auto- and Hand mode.



NOTE!

This parameter is only valid for LCP 2.

024 User-defined Quick Menu

Value:

- * Not active (Disable) [0]
- Active (Enable) [1]

Function:

In this parameter, you can select the standard setup of the quick menu key on the control panel and the LCP 2 control panel.

Using this function, in parameter 025 *Quick Menu setup*, the user can select up to 20 parameters for the Quick Menu key.

Description of choice:

If *not active* [0] is selected, the standard setup of the Quick Menu key is active.

If *Active* [1] is selected, the user-defined Quick Menu is active.

025 Quick Menu setup

Value:

- [Index 1 - 20] Value: 0 - 999 * 000

Function:

In this parameter you define which parameters are required in the Quick Menu when parameter 024 *User-defined Quick Menu* is set to *Active* [1].

Up to 20 parameters can be selected for the user-defined Quick Menu.



NOTE!

Please note that this parameter can only be set using an LCP 2 control panel. See *Order form*.

Description of choice:

The Quick Menu is set up as follows:

1. Select parameter 025 *Quick Menu setup* and press [CHANGE DATA].
2. Index 1 indicates the first parameter in Quick Menu. You can scroll between the index numbers using the [+ / -] keys. Select Index 1.
3. Using [< >] you can scroll between the three figures. Press the [<] key once and the last number in the parameter number can be selected using the [+ / -] keys. Set Index 1 to 100 for parameter 100 *Configuration*.
4. Press [OK] when Index 1 has been set to 100.
5. Repeat steps 2 - 4 until all parameters required have been set to the Quick Menu key.
6. Press [OK] to complete the Quick Menu setup.

If parameter 100 *Configuration* is selected at Index 1, Quick Menu will start with this parameter every time Quick Menu is activated.

Please note that parameter 024 *User-defined Quick Menu* and parameter 025 *Quick Menu setup* are reset to the factory setting during initialisation.

026	LED Status
Value:	
* Overload (Overload)	[0]
Therm. warn/alarm 36 (Overtemp)	[1]
Thermistor/ETR (Thermal Motor)	[2]
Digital input 18 (Digital Input 18)	[3]
Digital input 19 (Digital Input 19)	[4]
Digital input 27 (Digital Input 27)	[5]
Digital input 29 (Digital Input 29)	[6]

Digital input 33 (Digital Input 33)	[7]
As relay par. 323 (As relay / P323)	[8]
As dig.outp. par. 341 (Ad Dig. Out. / P341)	[9]
As mech.brake output (As mech. brake output)	[10]

Function:

This parameter enables the user to visualize different situations using the status LED.

Description of choice:

Select the function to be visualized.

3.3 Parameter Group 1-** Load and Motor

3.3.1 Configuration

Selection of configuration and torque characteristics has an effect on which parameters can be seen in the display. If *Open loop* [0] is selected, all parameters relating to PID regulation will be filtered out. This means that the user only sees the parameters that are relevant for a given application.

100	Configuration
Value:	
* Speed control, open-loop (SPEED OPEN-LOOP)	[0]
Speed control, closed-loop (SPEED CLOSED-LOOP)	[1]
Process control, closed-loop (PROCESS CLOSED-LOOP)	[3]

Function:

This parameter is used to select the configuration to which the adjustable frequency drive is to be adapted. This makes adaptation to a given application simple, since the parameters not used in a given configuration are hidden (not active).

Description of choice:

If *Speed control, open-loop* [0] is selected, normal speed control is obtained (without feedback signal) with automatic load and slip compensation to ensure a constant speed at varying loads. Compensations are active, but may be disabled in parameter 134 *Load compensation* and parameter 136 *Slip compensation* as required.

If *Speed control, closed-loop* [1] is selected, better speed accuracy is obtained. A feedback signal must be added, and the PID regulator must be set in parameter group 400 *Special functions*.

If *Process control, closed-loop* [3] is selected, the internal process regulator is activated to enable precise control of a process in relation to a given process signal. The process signal can be set to the relevant process unit or as a percentage. A feedback signal must be added from the process and the process regulator must be set in parameter group 400 *Special*

functions. Process closed-loop is not active if a DeviceNet card is mounted and Instance 20/70 or 21/71 is chosen in parameter 904 *Instance types*.

101	Torque characteristic
Value:	
* Constant torque (Constant torque)	[1]
Variable torque low (torque: low)	[2]
Variable torque medium (torque: med)	[3]
Variable torque high (torque: high)	[4]
Variable torque low with CT start (VT LOW CT START)	[5]
Variable torque medium with CT start (VT MED CT START)	[6]
Variable torque high with CT start (VT HIGH CT START)	[7]
Special motor mode (Special motor mode)	[8]

CT = Constant torque

Function:

This parameter enables a choice of principle for adaptation of the U/f ratio of the adjustable frequency drive to the torque characteristic of the load. See par. 135 *U/f ratio*.

Description of choice:

If *Constant torque* [1] is selected, a load-dependent U/f characteristic is obtained, in which output voltage and output frequency are increased at increasing loads in order to maintain constant magnetization of the motor.

Select *Variable torque low* [2], *Variable torque medium* [3] or *Variable torque high* [4], if the load is square (centrifugal pumps, fans).

Variable torque - low with CT start [5], - medium with CT start [6] or high with CT start [7], are selected if you need a greater breakdown torque than can be achieved with the three first characteristics.



NOTE!

Load and slip compensation are not active if variable torque or special motor mode have been selected.

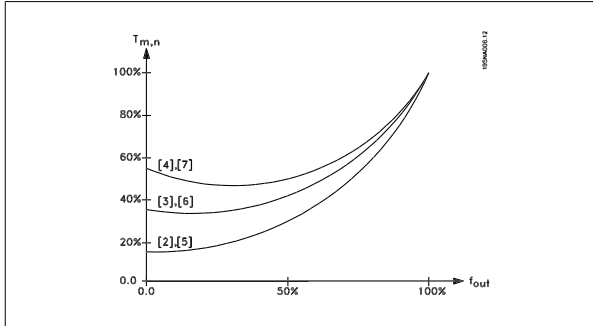

Select *Special motor mode* [8], if a special U/f setting is needed that is to be adapted to the present motor. The break points are set in parameters 423-428 *Voltage/frequency*.



NOTE!

Please note that if a value set in the nameplate parameters 102-106 is changed, there will be an automatic change of parameter 108 *Stator resistance* and 109 *Stator reactance*.

102 Motor power $P_{M,N}$

Value:

0.18 - 4 kW * Depends on unit

Function:

Here you must set a power value [kW] $P_{M,N}$, corresponding to the motor's rated power. The factory sets a rated power value [kW] $P_{M,N}$, that depends on the type of unit.

Description of choice:

Set a value that matches the nameplate data on the motor. Settings between two sizes below and one size over the factory setting are possible.

103 Motor voltage $U_{M,N}$

Value:

50 - 999 V * 400 V

Function:

This is where to set the rated motor voltage $U_{M,N}$ for either star Y or delta Δ .

Description of choice:

Select a value that corresponds to the nameplate data on the motor, regardless of the variable frequency drive's AC line voltage.

104 Motor frequency $f_{M,N}$

Value:

24-1000 Hz * 50 Hz

Function:

This is where to select the rated motor frequency $f_{M,N}$.

Description of choice:

Select a value that corresponds to the nameplate data on the motor.

105 Motor current $I_{M,N}$

Value:

0,01 - I_{MAX} * Depends on choice of motor

Function:

The nominal, rated current of the motor $I_{M,N}$ forms part of the variable frequency drive calculation of features such as torque and motor thermal protection.

Description of choice:

Set a value that corresponds to the nameplate data on the motor. Set the motor current $I_{M,N}$ taking into account whether the motor is star-connected Y or delta-connected Δ .

106 Rated motor speed

Value:

100 - $f_{M,N} \times 60$ * Depends on parameter 104 *Motor frequency*, (max. 60000 rpm) $f_{M,N}$

Function:

This is where to set the value that corresponds to the rated motor speed $n_{M,N}$ that can be seen from the nameplate data.

Description of choice:

Select a value that corresponds to the nameplate data on the motor.



NOTE!

The max. value equals $f_{M,N} \times 60$. $f_{M,N}$ to be set in parameter 104 *Motor frequency*, $f_{M,N}$.

107 Automatic motor tuning, AMT

Value:

- * Optimization off (AMT off) [0]
- Optimisation on (AMT start) [2]

Function:

Automatic motor tuning is an algorithm that measures stator resistance R_s without the motor axle turning. This means that the motor is not delivering any torque.

AMT can be used with benefit when initializing units where the user wishes to optimize adjustment of the variable frequency drive to the motor being used. This is used in particular when the factory setting does not sufficiently cover the motor.

For the best possible tuning of the variable frequency drive it is recommended that AMT is performed on a cold motor. It should be noted that repeated AMT runs can cause heating of the motor, resulting in an increase in the stator resistance R_s . As a rule, however, this is not critical. AMT is performed as follows:

Start AMT:

1. Give a STOP signal.
2. Parameter 107 *Automatic motor tuning* is set at value [2] *Optimization on*.
3. A START signal is given and parameter 107 *Automatic motor tuning* is reset to [0] when AMT has been completed.

In factory setting START requires terminals 18 and 27 to be connected to terminal 12.

Complete AMT:

AMT is completed by giving a RESET signal. Parameter 108 *Stator resistance*, R_S is updated with the optimized value.

Interrupting AMT:

AMT can be interrupted during the optimization procedure by giving a STOP signal.

When using the AMT function the following points should be observed:

- For AMT to be able to define the motor parameters as well as possible, the correct type plate data for the motor connected to the variable frequency drive must be keyed into parameters 102 to 106.
- Alarms will appear in the display if faults arise during tuning of the motor.
- As a rule the AMT function will be able to measure the R_S values for motors that are 1-2 times larger or smaller than the variable frequency drive's nominal size.
- If you wish to interrupt automatic motor tuning, press the [STOP/RESET] key.



NOTE!

AMT may not be performed on motors connected in parallel, nor may setup changes be made while AMT is running.

Description of choice:

Select *Optimization on* [2] if you want the frequency converter to perform automatic motor tuning.

108 Stator resistance R_S

Value:

0.000 - X.XXX Ω * Depends on choice of motor

Function:

After setting of parameters 102-106 *Nameplate data*, a number of adjustments of various parameters is carried out automatically, including stator resistance R_S . A manually entered R_S must apply to a cold motor. The shaft performance can be improved by fine-tuning R_S and X_S , see procedure below.



NOTE!

Parameters 108 *Stator resistance R_S* and 109 *Stator reactance X_S* are normally not to be changed if nameplate data has been set.

Description of choice:

R_S can be set as follows:

1. Use the factory settings of R_S which the variable frequency drive itself chooses on the basis of the motor nameplate data.
2. The value is stated by the motor supplier.
3. The value is obtained through manual measurements: R_S can be calculated by measuring the resistance $R_{\text{PHASE-PHASE}}$ between two phase terminals. $R_S = 0.5 \times R_{\text{PHASE-PHASE}}$.
4. R_S is set automatically when AMT has been completed. See parameter 107 *Auto motor adaption*.

109 Stator reactance X_S

Value:

0.00 - X,XX Ω * Depends on choice of motor

Function:

After parameters 102-106 *Nameplate data* are set, a number of parameters are adjusted automatically, including stator reactance X_S . The shaft performance can be improved by fine-tuning R_S and X_S ; see procedure below.

Description of choice:

X_S can be set as follows:

1. The value is stated by the motor supplier.
2. The value is obtained through manual measurements; X_S is obtained by connecting a motor to line power and measuring the phase-phase voltage U_M and the idle current I_ϕ .

$$X_S = \frac{U_M}{\sqrt{3} \times I_\phi} - \frac{X_L}{2}$$

X_L : See parameter 142.

3. Use the factory settings of X_S , which the adjustable frequency drive itself chooses on the basis of the motor nameplate data.

117 Resonance dampening

Value:

0 - 100 % * 0 %

Function:

Reduces the output voltage when running at low load for avoiding resonance phenomena.

Description of choice:

If 0 is selected, there will be no reduction. If 100 % is selected, the voltage is reduced to 50% at no load.

119 High start torque

Value:
0.0 - 0.5 sec. * 0.0 sec.

Function:

To ensure a high start torque approx. $1.8 \times I_{INV}$ can be permitted for max. 0.5 sec. The current is, however, limited by the variable frequency drive's (inverter's) safety limit. 0 sec. corresponds to no high start torque.

Description of choice:

Set the necessary time for which a high start torque is required.

120 Start delay

Value:
0.0 - 10.0 sec. * 0.0 sec.

Function:

This parameter enables a delay of the start-up time after the conditions for start have been fulfilled. When the time has passed, the output frequency will start by ramping up to the reference.

Description of choice:

Set the necessary time before commencing to accelerate.

121 Start function

Value:

- DC hold during start delay time (DC HOLD/DELAY TIME) [0]
- DC brake during start delay time (DC BRAKE/DELAY TIME) [1]
- * Coasting during start delay time (COAST/DELAY TIME) [2]
- Start frequency/voltage clockwise (CLOCKWISE OPERATION) [3]
- Start frequency/voltage in reference direction (VERTICAL OPERATION) [4]

Function:

This is where to choose the required mode during the start delay time (parameter 120 *Start delay time*).

Description of choice:

Select *DC hold during start delay time* [0] to energize the motor with a DC hold voltage during the start delay time. Set voltage in parameter 137 *DC hold voltage*.

Choose *DC brake during start delay time* [1] to energize the motor with a DC brake voltage during the start delay time. Set voltage in parameter 132 *DC brake voltage*.

Choose *Coasting during start delay time* [2] and the motor will not be controlled by the adjustable frequency drive during the start delay time (inverter turned off).

Choose *Start frequency/voltage clockwise* [3] to obtain the function described in parameter 130 *Start frequency* and 131 *Voltage at start* during start delay time. Regardless of the value assumed by the reference signal, the output frequency equals the setting in parameter 130 *Start frequency* and the output voltage will correspond to the setting in parameter 131 *Voltage at start*.

This functionality is typically used in hoist applications. In particular, it is used in applications in which a cone anchor motor is applied, where the direction of rotation is to start clockwise followed by the reference direction.

Select *Start frequency/voltage in reference direction* [4] to obtain the function described in parameter 130 *Start frequency* and 131 *Voltage at start* during the start delay time.

The direction of rotation of the motor will always follow in the reference direction. If the reference signal equals zero, the output frequency will equal 0 Hz, while the output voltage will correspond to the setting in parameter 131 *Voltage at start*. If the reference signal is different from zero, the output frequency will equal parameter 130 *Start frequency* and the output voltage will equal parameter 131 *Voltage at start*. This functionality is used typically for hoist applications with counterweight. It is used in particular for applications in which a cone anchor motor is applied. The cone anchor motor can break away using parameter 130 *Start frequency* and parameter 131 *Voltage at start*.

122 Function at stop

Value:

- * Coasting (COAST) [0]
- DC hold (DC HOLD) [1]

Function:

This is where to choose the function of the variable frequency drive after the output frequency has become lower than the value in parameter 123 *The min. frequency for activation of function at stop* or after a stop command and when the output frequency has been ramped down to 0 Hz.

Description of choice:

Select *Coasting* [0] if the variable frequency drive is to 'let go' of the motor (inverter turned off).

Select DC hold [1] if parameter 137 *DC hold voltage* is to be activated.

123 Min. frequency for activation of function at stop

Value:

0.1 - 10 Hz * 0.1 Hz

Function:

In this parameter, the output frequency is set to the value at which the function selected in parameter 122 *Function at stop* is to be activated.

Description of choice:

Set the required output frequency.



NOTE!

If parameter 123 is set higher than parameter 130, then the start delay function (parameter 120 and 121) will be skipped.



NOTE!

If parameter 123 is set too high and DC hold has been chosen in parameter 122, the output frequency will jump to the value in parameter 123 without ramping up. This may cause an overcurrent warning/alarm.

3.3.2 DC Braking

During DC braking DC voltage is supplied to the motor, and this will cause the shaft to be brought to a standstill. In parameter 132 *DC brake voltage* DC brake voltage can be preset from 0-100%. Max. DC brake voltage depends on the motor data selected.

In parameter 126 *DC braking time* DC braking time is determined and in parameter 127 *DC brake cut-in frequency* the frequency at which DC braking becomes active is selected. If a digital input is programmed to *DC braking inverse* [5] and shifts from logic '1' to logic '0', DC braking will be activated. When a stop command becomes active, DC braking is activated when the output frequency is less than the brake cut-in frequency.



NOTE!

DC braking may not be used if the inertia in the motor shaft is more than 20 times greater than the motor's internal inertia.

126 DC brake time

Value:

0 - 60 sec. * 10 sec

Function:

In this parameter, the DC brake time is set at which parameter 132 *DC brake voltage* is to be active.

Description of choice:

Set the required time.

127 DC brake cut-in frequency

Value:

0.0 (OFF) - par. 202
Output frequency high limit, f_{MAX} * OFF

Function:

In this parameter, the DC brake cut-in frequency is set at which the DC brake is to be activated in connection with a stop command.

Description of choice:

Set the required frequency.

128 Thermal motor protection

Value:

* No protection (NO PROTECTION)	[0]
Thermistor warning (THERMISTOR WARN)	[1]
Thermistor trip (THERMISTOR TRIP)	[2]
ETR warning 1 (ETR WARNING 1)	[3]
ETR trip 1 (ETR TRIP 1)	[4]
ETR warning 2 (ETR WARNING 2)	[5]
ETR trip 2 (ETR TRIP 2)	[6]
ETR warning 3 (ETR WARNING 3)	[7]
ETR trip 3 (ETR TRIP 3)	[8]

ETR warning 4 (ETR WARNING 4) [9]

ETR trip 4 (ETR TRIP 4) [10]

Function:

The variable frequency drive can monitor the motor temperature in two different ways:

- Via a PTC thermistor that is mounted on the motor. The thermistor is connected between terminal 31a / 31b. *Thermistor* is to be selected if a possibly integrated thermistor in the motor is to be able to stop the variable frequency drive if the motor overheats. The cut-out value is 3 k Ω .

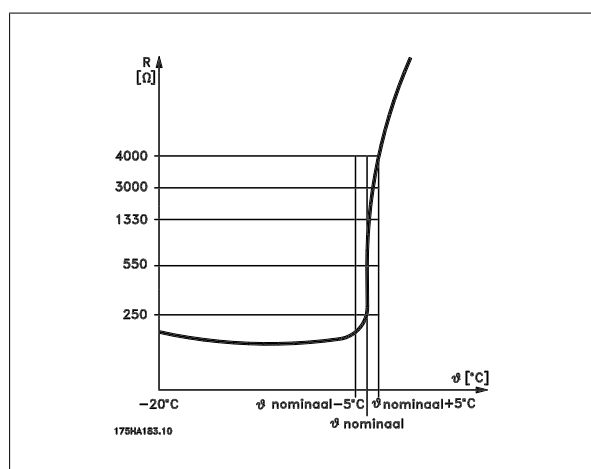

If a motor features a Klaxon thermal switch instead, this can also be connected to the input. If motors operate in parallel, the thermistors/thermal switches can be connected in series (total resistance lower than 3 k Ω).

- Thermal load calculation (ETR - Electronic Thermal Relay), based on present load and time. This is compared with the rated motor current $I_{M,N}$ and rated motor frequency $f_{M,N}$. The calculations take into account the need for lower loading at low speeds due to the motor's internal ventilation being reduced.

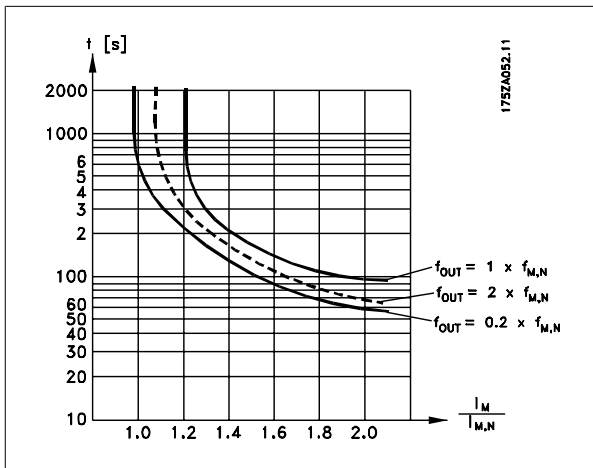

ETR functions 1-4 correspond to Setup 1-4. ETR functions 1-4 do not begin to calculate the load until you switch to the Setup in which they have been selected. This means that you can use the ETR function even when changing between two or more motors.

Description of choice:

Select *No protection* [0] if you do not want a warning or trip when a motor is overloaded.

Select *Thermistor warning* [1] if you want a warning when the connected thermistor becomes too hot.

Select *Thermistor trip* [2] if you want a trip when the connected thermistor becomes too hot.

Select *ETR warning* if you want a warning when the motor is overloaded according to the calculations. You can also program the variable frequency drive to give a warning signal via the digital output.

Select *ETR Trip* if you want a trip when the motor is overloaded according to the calculations.

Select *ETR warning 1-4* if you want a warning when the motor is overloaded according to the calculations. You can also program the variable frequency drive to give a warning signal via one of the digital outputs.

Select *ETR Trip 1-4* if you want a trip when the motor is overloaded according to the calculations.



NOTE!

This function cannot protect the individual motors in the case of motors linked in parallel.

130 Start frequency

Value:

0.0 - 10.0 Hz * 0.0 Hz

Function:

The start frequency is active for the time set in parameter 120 *Start delay*, after a start command. The output frequency will 'jump' to the next preset frequency. Certain motors, such as conical anchor motors, need an extra voltage/start frequency (boost) at start to disengage the mechanical brake. To achieve this parameters 130 *Start frequency* and 131 *Initial voltage* are used.

Description of choice:

Set the required start frequency. It is a precondition that parameter 121 *Start function*, is set to *Start frequency/voltage clockwise* [3] or *Start frequency/voltage in reference direction* [4] and that in parameter 120 *Start delay* a time is set and a reference signal is present.



NOTE!

If parameter 123 is set higher than parameter 130, the start delay function (parameter 120 and 121) will be skipped.

131 Initial voltage

Value:

0.0-200.0 V * 0.0 V

Function:

Initial voltage is active for the time set in parameter 120 *Start delay*, after a start command. For example, this parameter can be used for lifting/dropping applications (conical anchor motors).

Description of choice:

Set the required voltage necessary to cut out the mechanical brake. It is assumed that parameter 121 *Start function*, is set to *Start frequency/voltage clockwise* [3] or *Start frequency/voltage in reference direction* [4] and that in parameter 120 *Start delay* a time is set, and that a reference signal is present.

132 DC brake voltage

Value:

0 - 100% of max. DC brake voltage * 0%

Function:

In this parameter, the DC brake voltage is set which is to be activated at stop when the DC brake frequency set in parameter 127 *DC brake cut-in frequency* is reached, or if *DC braking inverse* is active via a digital input or via serial communication. Subsequently, the DC brake voltage will be active for the time set in parameter 126 *DC brake time*.

Description of choice:

To be set as a percentage value of the max. DC brake voltage, which depends on the motor.

133 Start voltage**Value:**

0.00 - 100.00 V * Depends on unit

Function:

A higher start torque can be obtained by increasing the start voltage. Small motors (< 1.0 HP) normally require a high start voltage.

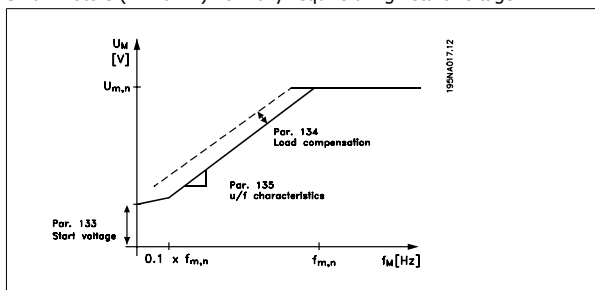
**Description of choice:**

The factory setting will be suitable for most applications, the value may need to be increased gradually for high torque application.



Warning: If the use of start voltage is exaggerated, this may lead to over-energizing and overheating of the motor and the variable frequency drive may cut out.

134 Load compensation**Value:**

0.0 - 300.0% * 100.0%

Function:

In this parameter, the load characteristic is set. By increasing the load compensation, the motor is given an extra voltage and frequency supplement at increasing loads. This is used e.g. in motors/applications in which there is a big difference between the full-load current and idle-load current of the motor.

**NOTE!**

If this value is set too high, the variable frequency drive may cut out because of overcurrent.

Description of choice:

If the factory setting is not adequate, load compensation must be set to enable the motor to start at the given load.



Warning: Should be set to 0% in connection with synchronous and parallel-coupled motors and in the case of quick load changes. Too high load compensation may lead to instability.

135 U/f-ratio**Value:**

0.00 - 20.00 V/Hz * Depends on unit

Function:

This parameter enables a shift in the ratio between output voltage (U) and output frequency (f) linearly, so as to ensure correct energizing of the motor and thus optimum dynamics, accuracy and efficiency. The U/

f-ratio only affects the voltage characteristic if a selection has been made of *Constant torque* [1] parameter 101 *Torque characteristic*.

Description of choice:

The U/f-ratio is only to be changed if it is not possible to set the correct motor data in parameter 102-109. The value programmed in the factory settings is based on idle operation.

136 Slip compensation**Value:**

-500 - +500% of rated slip compensation * 100%

Function:

Slip compensation is calculated automatically, on the basis of such data as the rated motor speed $n_{M,N}$. In this parameter, the slip compensation can be fine-tuned, thereby compensating for tolerances on the value for $n_{M,N}$. Slip compensation is only active if a selection has been made of *Speedregulation, open loop* [0] in parameter 100 *Configuration* and *Constant torque* [1] in parameter 101 *Torque characteristic*.

Description of choice:

Key in a % value.

137 DC hold voltage**Value:**

0 - 100% of max. DC hold voltage * 0%

Function:

This parameter is used to keep the motor (holding torque) at start/stop.

Description of choice:

This parameter can only be used if a selection has been made of *DC hold* in parameter 121 *Start function* or 122 *Function at stop*. To be set as a percentage value of the max. DC hold voltage, which depends on the choice of motor.

138 Brake cut out value**Value:**

0.5 - 132.0/1000.0 Hz * 3.0 Hz

Function:

Here you can select the frequency at which the external brake is released, via the output defined in parameter 323 *Relay output 1-3* or 341 *Digital output, terminal 46* (optionally also terminal 122 and 123).

Description of choice:

Set the required frequency.

139 Brake cut in frequency**Value:**

0.5 - 132.0/1000.0 Hz * 3.0 Hz

Function:

Here you can select the frequency at which the external brake is activated; this takes place via the output defined in parameter 323 *Relay output 1-3* or 341 *Digital output terminal 46* (Optionally also 122 and 123).

Description of choice:

Set the required frequency.

140 Current, minimum value

Value:
0 % - 100 % of inverter output current * 0 %

Function:
This is where the user selects the minimum motor current running for the mechanical brake to be released. Current monitoring is only active from stop until the point when the brake is released.

Description of choice:
This is an extra safety precaution, aimed at guaranteeing that the load is not lost during start of a lifting/lowering operation.

142 Leakage reactance X_L

Value:
0.000 - XXX,XXX Ω * Depends on choice of motor
 X_L is the sum of rotor and stator leakage reactance.

Function:
After setting of parameters 102-106 *Nameplate data*, a number of adjustments of various parameters is made automatically, including the leakage reactance X_L . The shaft performance can be improved by fine-tuning the leakage reactance X_L .



NOTE!
Parameter 142 *The leakage reactance X_L* is normally not to be changed if the nameplate data has been set, parameters 102-106.

Description of choice:
 X_L can be set as follows:
1. The value is stated by the motor supplier.
2. Use the factory settings of X_L , which the adjustable frequency drive itself chooses on the basis of the motor nameplate data.

144 Gain AC brake

Value:
1.00 - 1.50 * 1.30

Function:
This parameter is used to set the AC brake. Using par. 144 it is possible to adjust the size of the generator torque that can be applied to the motor without the intermediate circuit voltage exceeding the warning level.

Description of choice:
The value is increased if a greater possible brake torque is required. If 1.0 is selected, this corresponds to the AC brake being inactive.



NOTE!
If the value in par. 144 is increased, the motor current will simultaneously increase significantly when generator loads are applied. The parameter should therefore only be changed if it is guaranteed during measurement that the motor current in all operating situations will never exceed the maximum permitted current in

the motor. *Please note:* that the current cannot be read out from the display.

146 Reset voltage vector

Value:
*Off (OFF) [0]
Reset (RESET) [1]

Function:
When the voltage vector is reset it is set to the same starting point each time a new process commences.

Description of choice:
Select reset (1) when running unique processes each time they arise. This will enable repetitive precision when stopping to be improved. Select Off (0) for example for lifting/lowering operations or synchronous motors. It is an advantage that the motor and the variable frequency drive are always synchronized.

147 Motor type

Value:
*General (GENERAL) [0]
Danfoss Bauer (DANFOSS BAUER) [1]

Function:
This parameter selects the type of motor connected to the adjustable frequency drive.

Description of choice:
The value can be selected general for most motor brands. Select Danfoss Bauer for optimal settings for Danfoss Bauer gear motors.

3.4 Parameter Group 2-** References & Limits

200	Output frequency range
Value:	
* Only clockwise, 0–132 Hz (132 Hz CLOCKWISE)	[0]
Both directions, 0–132 Hz (132 Hz BOTH DIRECT)	[1]
Counter-clockwise only, 0–132 Hz (132 Hz COUNTER CLOCK)	[2]
Clockwise only, 0–1000 Hz (1,000 Hz CLOCK WISE)	[3]
Both directions, 0–1000 Hz (1,000 Hz BOTH DIRECT)	[4]
Counter-clockwise only, 0–1000 Hz (1,000 Hz COUNTER CLOCK)	[5]

Function:

This parameter guarantees protection against unwanted reversing. Furthermore, the maximum output frequency that is to apply regardless of the settings of other parameters can be selected. This parameter has no function if *Process regulation, closed-loop* has been selected in parameter 100 *Configuration*.

Description of choice:

Select the required direction of rotation as well as the maximum output frequency. Please note that if Clockwise only [0]/[3] or Counter-clockwise only [2]/[5] is selected, the output frequency will be limited to the range f_{MIN} - f_{MAX} . If *Both directions* [1]/[4] is selected, the output frequency will be limited to the range $\pm f_{MAX}$ (the minimum frequency is of no significance).

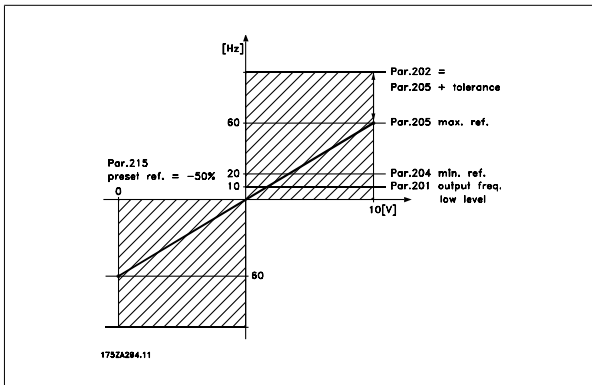

201	Output frequency low limit, f_{MIN}
Value:	
0.0 - f_{MAX}	* 0.0 Hz
Function:	
In this parameter, a minimum motor frequency limit can be selected that corresponds to the minimum speed at which the motor is allowed to run. If <i>Both directions</i> has been selected in parameter 200 <i>Output frequency range</i> , the minimum frequency is of no significance.	
Description of choice:	
The value chosen can range from 0.0 Hz to the frequency set in parameter 202 <i>Output frequency high limit, f_{MAX}</i> .	

202	Output frequency high limit, f_{MAX}
Value:	
f_{MIN} - 132/1,000 Hz (par. 200 <i>Output frequency ranges</i>)	* 132 Hz
Function:	
In this parameter, a maximum output frequency limit can be selected that corresponds to the highest speed at which the motor is allowed to run.	



NOTE!

The output frequency of the adjustable frequency drive can never assume a value higher than 1/10 of the switching frequency (parameter 411 *Switching frequency*).

Description of choice:

A value can be selected from f_{MIN} to the value chosen in parameter 200 *Output frequency ranges*.

3.4.1 Reference Handling

Reference handling is described in the block diagram below. The block diagram shows how a change in one parameter can affect the resulting reference.

Parameters 203 to 205 *Reference* and parameter 214 *Reference function* define how reference handling can be performed. The parameters mentioned can be active in both closed-loop and open-loop.

Remote controlled references are defined as:

- External references, such as analogue inputs 53 and 60, pulse references via terminal 33 and references from serial communication.
- Preset references.

The resulting reference can be shown on the LCP control unit's display by selecting *Reference [%]* in parameters 009-012 *Display readout* and can be shown as one unit by selecting *Reference [unit]*. The sum of the external references can be shown on the LCP control unit's display as a %

of the area from *Minimum reference, Ref_{MIN}* to *Maximum reference, Ref_{MAX}*. Select *External reference, % [25]* in parameters 009-012 *Display readout* if a readout is desired.

It is possible to have both references and external references simultaneously. In parameter 214 *Reference function*, a selection can be made to determine how preset references should be added to the external references.

There is also an independent local reference in parameter 003 *Local reference*, in which the resulting reference is set using the [+/-] keys. When the local reference has been selected, the output frequency ranges is limited by parameter 201 *Output frequency low limit, f_{MIN}* and parameter 202 *Output frequency high limit, f_{MAX}*.

The local reference unit depends on the selection in parameter 100 *Configuration*.

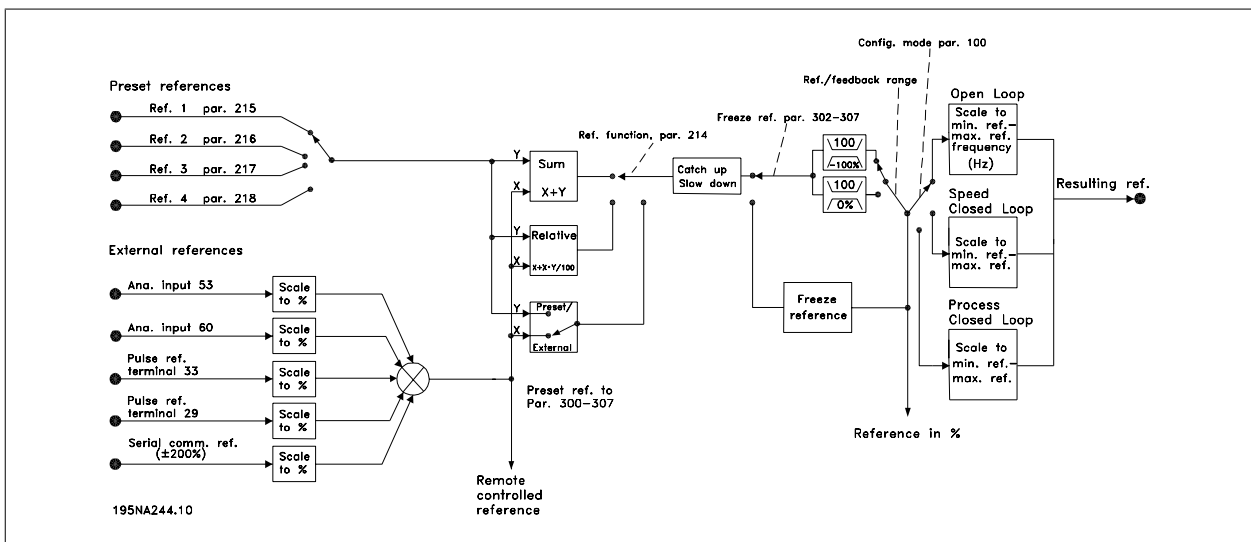

203	Reference range
Value:	
* Min. reference - Max reference (min - max)	[0]
-Max. reference - Max. reference	
(-max - +max)	[1]
Function:	

In this parameter you select whether the reference signal must be positive or whether it can be both positive and negative. The minimum limit may be a negative value, unless in parameter 100 *Configuration* a selection has been made of *Speed regulation, closed loop*. You should select *Min ref. - Max. ref. [0]*, if *Process regulation, closed loop [3]* has been selected in parameter 100 *Configuration*.

Description of choice:
Select the required range.

204	Minimum reference, Ref_{MIN}
Value:	
Par. 100 <i>Config.</i> = <i>Open loop [0]</i> .-100,000.000 - par. 205 Ref _{MAX}	* 0.000 Hz
Par. 100 <i>Config.</i> = <i>Closed loop [1]/[3]</i> .-Par. 414 <i>Minimum feedback</i> - par. 205 Ref _{MAX}	* 0.000 rpm/par 416

Function:
Minimum reference is an expression of the minimum possible value of the total of all references. If in parameter 100 *Configuration*, *Speed regulation, closed loop [1]* or *Process regulation, closed loop [3]* is selected, the

minimum reference is limited by parameter 414 *Minimum feedback*. Minimum reference is ignored if the local reference is active.

The reference unit can be defined from the following table:

Par. 100 Configuration	Unit
Open loop [0]	Hz
Speed reg, closed loop [1]	rpm
Process reg, closed loop [3]	Par. 416

Description of choice:

The minimum reference is preset if the motor has to run at a minimum speed, regardless of whether the resulting reference is 0.

205 Maximum reference, Ref_{MAX}

Value:

Par. 100 Config. = Open loop [0]. Par. 204 Ref_{MIN} - 1000.000 Hz * 50.000 Hz
 Par. 100 Config. = Closed loop [1]/[3]. Par. 204 Ref_{MIN} - Par. 415 Max. feedback * 50.000 rpm/par 416

Function:

The maximum reference gives the highest value that can be assumed by the sum of all references. If *Closed loop* [1]/[3] is selected in parameter 100 Configuration the maximum reference cannot exceed the value in parameter 415 *Maximum feedback*.

Maximum reference is ignored if the local reference is active.

The reference unit can be defined from the following table:

Par. 100 Configuration	Unit
Open loop [0]	Hz
Speed reg, closed loop [1]	rpm
Process reg, closed loop [3]	Par. 416

Description of choice:

Maximum reference is set, if the speed of the motor is to be max. the set value, regardless of the whether the resulting reference is greater than the maximum reference.

206 Ramp type

Value:

- * Linear (Linear) [0]
- Sine shaped (S-SHAPED) [1]
- Sine² shaped (S-SHAPED 2) [2]

Function:

You can choose between a linear, a sine-shaped and a sine²-shaped ramp process.

Description of choice:

Select the required ramp type depending on requirements for the acceleration/deceleration process.

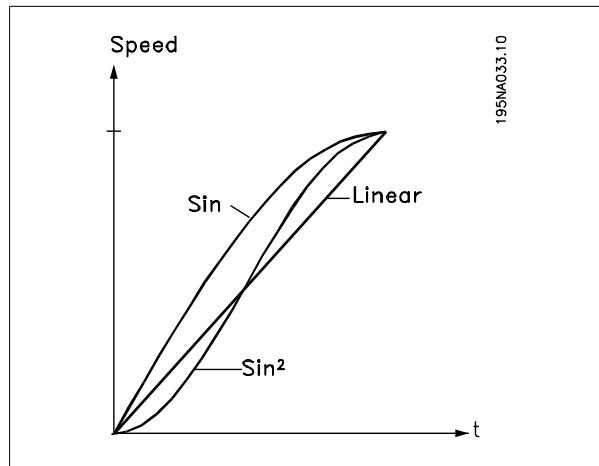

207 Ramp-up time 1

Value:

0.02 - 3600.00 sec * 3.00 sec

Function:

The ramp-up time is the acceleration time from 0 Hz to the rated motor frequency $f_{M,N}$ (parameter 104 *Motor frequency, f_{M,N}*). It is assumed that the output current will not reach the current limit (set in parameter 221 *Current limit I_{LIM}*).

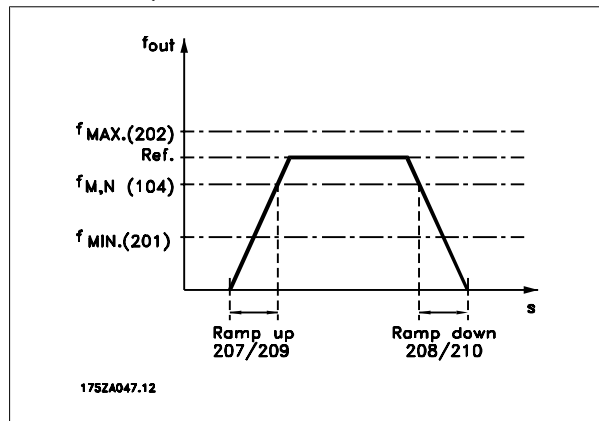

Description of choice:

Set the required ramp-up time.

208 Ramp-down time 1

Value:
0.02 - 3600.00 sec * 3.00 sec

Function:
The ramp-down time is the deceleration time from the rated motor frequency $f_{M,N}$ (parameter 104 *Motor frequency, $f_{M,N}$*) to 0 Hz, provided no overvoltage arises in the inverter because of generating operation of the motor.

Description of choice:
Set the required ramp-down time.

209 Ramp-up time 2

Value:
0.02 - 3600.00 sec. * 3.00 sec

Function:
See description of parameter 207 *Ramp-up time 1*.

Description of choice:
Set the required ramp-up time. Shift from ramp 1 to ramp 2 by activating *Ramp 2* via a digital input.

210 Ramp-down time 2

Value:
0.02 - 3600.00 sec. * 3.00 sec

Function:
See description of parameter 208 *Ramp-down time 1*.

Description of choice:
Set the required ramp-down time. Shift from ramp 1 to ramp 2 by activating *Ramp 2* via a digital input.

211 Jog ramp time

Value:
0.02 - 3600.00 sec. * 3.00 sec

Function:
The jog ramp time is the acceleration/deceleration time from 0 Hz to the rated motor frequency $f_{M,N}$ (parameter 104 *Motor frequency, $f_{M,N}$*). It is assumed that the output current will not reach the current limit (set in parameter 221 *Current limit I_{LIM}*).

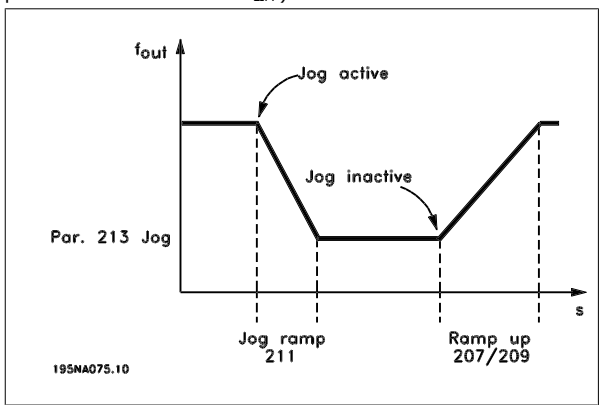

The jog ramp time starts if a jog-signal is given via the LCP control panel, one of the digital inputs or the serial communication port.

Description of choice:
Set the required ramp time.

212 Quick-stop ramp-down time

Value:
0.02 - 3600.00 sec. * 3.00 sec

Function:
The quick-stop ramp-down time is the deceleration time from the rated motor frequency to 0 Hz, provided no overvoltage arises in the inverter because of generating operation of the motor, or if the generated current exceeds the current limit in parameter 221 *Current limit I_{LIM}* . Quick-stop is activated via one of the digital inputs or the serial communication.

Description of choice:
Set the required ramp-down time.

213 Jog frequency

Value:
0.0 - Par. 202 Output frequency high limit, f_{MAX} * 10.0 Hz

Function:
Jog frequency f_{JOG} means a fixed output frequency that the adjustable frequency drive supplies to the motor when the jog function is activated. Jog can be activated via the digital inputs, serial communication or via the LCP control panel, on the condition that this is active in parameter 015 *Local jog*.

Description of choice:
Set the required frequency.

3.4.2 Reference Function

The example shows how the resulting reference is calculated when *Preset references* is used together with *Sum* and *Relative* in parameter 214 *Reference function*. The formula for the calculation of the resulting reference can be seen in the section entitled *All about the FCD 300*. See also the drawing in *Reference Handling*.

3

The following parameters are preset:	
Par. 204 <i>Minimum reference</i>	10 Hz
Par. 205 <i>Maximum reference</i>	50 Hz
Par. 215 <i>Preset reference</i>	15 %
Par. 308 <i>Term. 53, Analog input</i>	Reference
Par. 309 <i>Term. 53, min. scaling</i>	0 V
Par. 310 <i>Term. 53, max. scaling</i>	10 V

When parameter 214 *Reference function* is set to *Sum* [0] one of the preset *Preset references* (par. 215-218) is added to the external references as a percentage of the reference range. If terminal 53 is applied, an analog input voltage of 4 Volt will be the resulting reference:

Par. 214 <i>Reference function</i> = Sum [0]:	
Par. 204 <i>Minimum reference</i>	10.0 Hz
Reference contribution at 4 Volt	16.0 Hz
Par. 215 <i>Preset reference</i>	6.0 Hz
Resulting reference	32.0 Hz

When parameter 214 *Reference function* is set to *Relative* [1], the defined *Preset references* (par. 215-218) are added as a percentage of the total of the present external references. If terminal 53 is applied to an analog input voltage of 4 Volt, the resulting reference will be:

Par. 214 <i>Reference function</i> = Relative [1]:	
Par. 204 <i>Minimum reference</i>	10.0 Hz
Reference effect at 4 Volt	16.0 Hz
Par. 215 <i>Preset reference</i>	2.4 Hz
Resulting reference	28.4 Hz

The graph shows the resulting reference in relation to the external reference, which varies from 0–10 Volt. Parameter 214 *Reference function* is programmed to *Sum* [0] and *Relative* [1], respectively. Also shown is a graph in which parameter 215 *Preset reference 1* is programmed to 0 %.

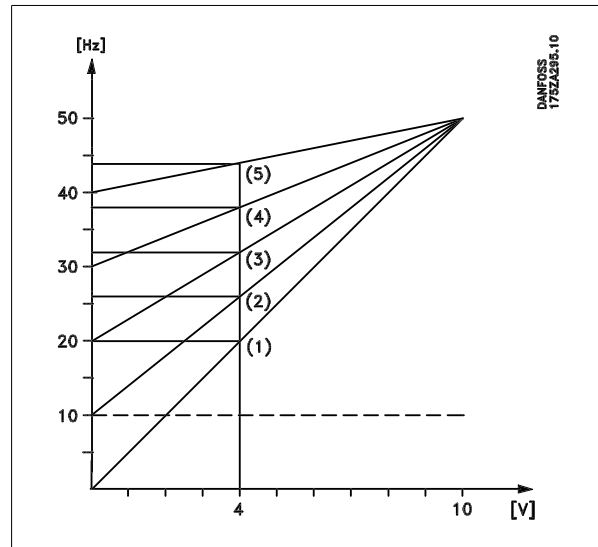

214 Reference function	
Value:	
* Sum (sum)	[0]
Relative (relative)	[1]
External/preset (external/preset)	[2]

Function:
It is possible to define how preset references are to be added to the other references; for this purpose, use *Sum* or *Relative*. It is also possible by using the *External/preset* to select whether a shift between external references and preset references is required.
External reference is the sum of the analog references, pulse references and any references from serial communication.

Description of choice:
If *Sum* [0] is selected, one of the adjusted preset references (parameters 215-218 *Preset reference*) is summarized as a percentage of the reference range ($Ref_{MIN} - Ref_{MAX}$), added to the other external references.
If *Relative* [1] is selected, one of the added preset references (parameters 215-218 *Preset reference*) is summarized as a percentage of the sum of present external references.
If *External/preset* [2] is selected, it is possible via a digital input to shift between external references or preset references. Preset references will be a percentage value of the reference range.



NOTE!
If *Sum* or *Relative* is selected, one of the preset references will always be active. If the preset references

are to be without influence, they must be set to 0% (factory setting).

215	Preset reference 1 (PRESET REF. 1)
216	Preset reference 2 (PRESET REF. 2)
217	Preset reference 3 (PRESET REF. 3)
218	Preset reference 4 (PRESET REF. 4)
Value:	
-100.00%--+100.00%	* 0.00%
of the reference range/external reference	

Function:
Four different preset references can be programmed in parameters 215-218 *Preset reference*. The preset reference is stated as a percentage of the reference range (Ref_{MIN} - Ref_{MAX}) or as a percentage of the other external references, depending on the choice made in parameter 214 *Reference function*. The choice between preset references can be made via the digital inputs or via serial communication.

Preset ref., msb	Preset ref. lsb	
0	0	Preset ref. 1
0	1	Preset ref. 2
1	0	Preset ref. 3
1	1	Preset ref. 4

Description of choice:
Set the preset reference(s) that is/are to be the options.

219	Catch up/ Slow down reference
Value:	
0.00 - 100% of the given reference	* 0.00%

Function:
In this parameter, the percentage value can be set which will either be added to or deducted from the remote-controlled references. The remote-controlled reference is the sum of preset references, analog references, pulse reference and any references from serial communication.

Description of choice:
If *Catch up* is active via a digital input, the percentage value in parameter 219 *Catch up/Slow down reference* will be added to the remote-controlled reference.
If *Slow down* is active via a digital input, the percentage value in parameter 219 *Catch up/Slow down reference* will be deducted from the remote-controlled reference.

221	Current limit, I_{LIM}
Value:	
0 - XXX.X % of par. 105	* 160 %
Function:	

In this parameter, the maximum output current I_{LIM} is set. The factory-set value corresponds to the maximum output current I_{MAX}. If the current limit is to be used as motor protection, set the rated motor current. If the current limit is set above 100% (the rated output current of the variable frequency drive, I_{INV.}), the variable frequency drive can only handle a load

intermittently, i.e. for short periods at a time. After the load has been higher than I_{INV.}, it must be ensured that for a period the load is lower than I_{INV.}. Please note that if the current limit is set at a lower value than I_{INV.}, the acceleration torque will be reduced to the same extent.

Description of choice:
Set the required maximum output current I_{LIM}.

223	Warning: Low current, I_{LOW}
Value:	
0.0 - par. 224 <i>Warning: High current, I_{HIGH}</i>	* 0.0 A
Function:	

If the output current falls below the preset limit I_{LOW} a warning is given. Parameters 223-228 *Warning functions* are out of function during ramp-up after a start command and after a stop command or during stop. The warning functions are activated when the output frequency reaches the resulting reference. The signal outputs can be programmed to give a warning signal via terminal 46 and via the relay output.

Description of choice:
The lower signal limit of the output current I_{LOW} must be programmed within the normal working range of the unit.

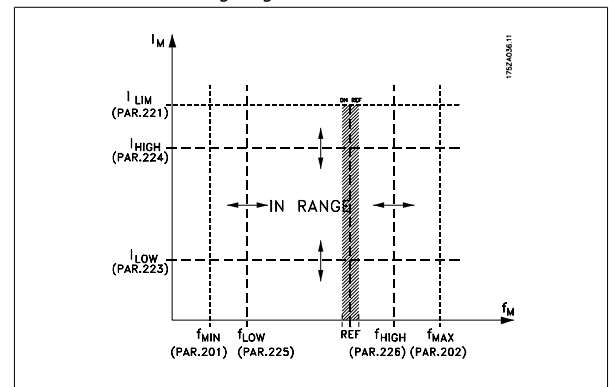

224	Warning: High current, I_{HIGH}
Value:	
0 - I _{MAX}	* I _{MAX}
Function:	

If the output current exceeds the preset limit I_{HIGH} a warning is given. Parameters 223-228 *Warning functions* do not work during ramp-up after a start command and after stop command or during stop. The warning functions are activated when the output frequency has reached the resulting reference. The signal outputs can be programmed to give a warning signal via terminal 46 and via the relay output.

Description of choice:
The output current's upper signal limit I_{HIGH} must be programmed within the variable frequency drive's normal operating range. See drawing at parameter 223 *Warning: Low current, I_{LOW}*.

225 Warning: Low frequency, f_{LOW} **Value:**

0.0 - par. 226

Warn.: High frequency, f_{HIGH} * 0.0 Hz**Function:**

If the output frequency falls below the preset limit f_{LOW} , a warning is given.

Parameters 223-228 *Warning functions* are out of function during ramp-up after a start command and after stop command or during stop. The warning functions are activated when the output frequency has reached the resulting reference. The signal outputs can be programmed to give a warning signal via terminal 46 and via the relay output.

Description of choice:

The lower signal limit of the output frequency f_{LOW} must be programmed within the normal operating range of the variable frequency drive. See drawing at parameter 223 *Warning: Low current, I_{LOW}* .

226 Warning: High frequency f_{HIGH} **Value:**

Par. 200 *Frequency range* = 0-132 Hz [0]/[1]. par. 225 f_{LOW} - 132 Hz * 132.0 Hz

Par. 200 *Frequency range* = 0-1000 Hz [2]/[3]. par. 225 f_{LOW} - 1000 Hz * 132.0 Hz

Function:

If the output frequency exceeds the preset limit f_{HIGH} a warning is given. Parameters 223-228 *Warning functions* do not work during ramp-up after a start command and after stop command or during stop. The warning functions are activated when the output frequency has reached the resulting reference. The signal outputs can be programmed to give a warning signal via terminal 46 and via the relay output.

Description of choice:

The output frequency's upper signal limit f_{HIGH} must be programmed within the variable frequency drive's normal operating range. See drawing at parameter 223 *Warning: Low current, I_{LOW}* .

227 Warning: Low feedback, FB_{LOW} **Value:**-100,000.000 - par. 228 Warn.: FB_{HIGH} * -4000.000**Function:**

If the feedback signal falls below the preset limit FB_{LOW} , a warning is given.

Parameters 223-228 *Warning functions* are out of function during ramp-up after a start command and after a stop command or during stop. The warning functions are activated when the output frequency has reached the resulting reference. The signal outputs can be programmed to give a

warning signal via terminal 46 and via the relay output. The unit for feedback in Closed loop is programmed in parameter 416 *Process units*.

Description of choice:

Set the required value within the feedback range (parameter 414 *Minimum feedback, FB_{MIN}* and 415 *Maximum feedback, FB_{MAX}*).

228 Warning: High feedback, FB_{HIGH} **Value:**Par. 227 Warn.: FB_{LOW} - 100,000.000 * 4000.000**Function:**

If the feedback signal gets above the preset limit FB_{HIGH} , a warning is given.

Parameters 223-228 *Warning functions* are out of function during ramp-up after a start command and after a stop command or during stop. The warning functions are activated when the output frequency has reached the resulting reference. The signal outputs can be programmed to give a warning signal via terminal 46 and via the relay output. The unit for feedback in Closed loop is programmed in parameter 416 *Process units*.

Description of choice:

Set the required value within the feedback range (parameter 414 *Minimum feedback, FB_{MIN}* and 415 *Maximum feedback, FB_{MAX}*).

229 Frequency bypass, bandwidth**Value:**

0 (OFF) - 100 Hz * 0 Hz

Function:

Some systems call for some output frequencies to be avoided because of mechanical resonance problems in the system. In parameters 230-231 *Frequency bypass*, these output frequencies can be programmed. In this parameter, a bandwidth can be defined on either side of these frequencies.

Description of choice:

The frequency set in this parameter will be centered around parameters 230 *Frequency bypass 1* and 231 *Frequency bypass 2*.

230 Frequency bypass 1 (FREQ. BYPASS 1)**231 Frequency bypass 2 (FREQ. BYPASS 2)****Value:**

0 - 1000 Hz * 0.0 Hz

Function:

Some systems call for some output frequencies to be avoided because of mechanical resonance problems in the system.

Description of choice:

Enter the frequencies to be avoided. See also parameter 229 *Frequency bypass, bandwidth*.

3.5 Parameter Group 3-** Inputs and Outputs

Digital inputs	Term. no. par. no.	18 302	19 303	27 304	29 305	33 307
Value:						
No function	(NO OPERATION)	[0]	[0]	[0]	[0]	*[0]
Reset	(RESET)	[1]	[1]	[1]	[1]	[1]
Coasting stop inverse	(MOTOR COAST INVERSE)	[2]	[2]	[2]	[2]	[2]
Reset and coasting inverse	(RESET AND COAST INV.)	[3]	[3]	*[3]	[3]	[3]
Quick-stop inverse	(QUICK-STOP INVERSE)	[4]	[4]	[4]	[4]	[4]
DC braking inverse	(DC BRAKE INVERSE)	[5]	[5]	[5]	[5]	[5]
Stop inverse	(STOP INVERSE)	[6]	[6]	[6]	[6]	[6]
Start	(START)	*[7]	[7]	[7]	[7]	[7]
Pulse start	(LATCHED START)	[8]	[8]	[8]	[8]	[8]
Reversing	(REVERSING)	[9]	*[9]	[9]	[9]	[9]
Reversing and start	(START REVERSING)	[10]	[10]	[10]	[10]	[10]
Start clockwise	(ENABLE FORWARD)	[11]	[11]	[11]	[11]	[11]
Start counter-clockwise	(ENABLE REVERSE)	[12]	[12]	[12]	[12]	[12]
Jog	(JOGGING)	[13]	[13]	[13]	*[13]	[13]
Freeze reference	(FREEZE REFERENCE)	[14]	[14]	[14]	[14]	[14]
Freeze output frequency	(FREEZE OUTPUT)	[15]	[15]	[15]	[15]	[15]
Speed up	(SPEED UP)	[16]	[16]	[16]	[16]	[16]
Slow	(SLOW)	[17]	[17]	[17]	[17]	[17]
Catch up	(CATCH UP)	[19]	[19]	[19]	[19]	[19]
Slow-down	(SLOW-DOWN)	[20]	[20]	[20]	[20]	[20]
Ramp 2	(RAMP 2)	[21]	[21]	[21]	[21]	[21]
Preset ref, LSB	(PRESET REF, LSB)	[22]	[22]	[22]	[22]	[22]
Preset ref, MSB	(PRESET REF, MSB)	[23]	[23]	[23]	[23]	[23]
Preset reference on	(PRESET REFERENCE ON)	[24]	[24]	[24]	[24]	[24]
Precise stop, inverse	(PRECISE STOP INV.)	[26]	[26]			
Precise start/stop	(PRECISE START/STOP)	[27]	[27]			
Pulse reference	(PULSE REFERENCE)				[28] ¹	[28]
Pulse feedback	(PULSE FEEDBACK)				[29] ¹	[29]
Pulse input	(PULSE INPUT)					[30]
Selection of Setup, lsb	(SETUP SELECT LSB)	[31]	[31]	[31]	[31]	[31]
Selection of Setup, msb	(SETUP SELECT MSB)	[32]	[32]	[32]	[32]	[32]
Reset and start	(RESET AND START)	[33]	[33]	[33]	[33]	[33]
Encoder reference	(ENCODER REFERENCE)				[34] ²	[34] ²
Encoder feedback	(ENCODER FEEDBACK)				[35] ²	[35] ²
Encoder input	(ENCODER INPUT)				[36] ²	[36] ²

¹ Cannot be selected if *Pulse output* is selected in par. 341 *Digital output terminal 46*.² Settings are identical for terminal 29 and 33.

Function:

In these parameters 302-307 *Digital inputs*, it is possible to choose between the different enabled functions related to the digital inputs (terminals 18-33).

Description of choice:

No operation is selected if the adjustable frequency drive is not to react to signals transmitted to the terminal.

Reset resets the adjustable frequency drive after an alarm; however, a few alarms cannot be reset (trip locked) without first disconnecting the line power supply and reconnecting it. See table under *List of warnings and alarms*. Reset is activated on the leading edge of the signal.

Coasting stop inverse is used for making the adjustable frequency drive "let go" of the motor immediately (output transistors are "turned off"), which means that the motor runs freely to stop. Logic '0' leads to coasting to stop.

Reset and coasting inverse are used to activate motor coast simultaneously with reset. Logical '0' means motor coast stop and reset. Reset is activated on the falling edge.

Quick stop inverse is used for activating the quick stop ramp-down set in parameter 212 *Quick stop ramp-down time*. Logic '0' leads to quick stop.

DC braking inverse is used for stopping the motor by energizing it with DC voltage for a given time, see parameters 126, 127 and 132 *DC brake*. Please note that this function is only active if the value in parameter 126 *DC braking time* and 132 *DC brake voltage* is different from 0. Logic '0' leads to DC braking.

Stop inverse, a logic '0' means that the motor speed is ramped down to stop via the selected ramp.



None of the stop commands mentioned above are to be used as repair switches. Make sure that all voltage inputs are disconnected and that the prescribed time (4 minutes.) has passed before repair work is commenced.

Start is selected if a start/stop command is required. Logic '1' = start, logic '0' = stop.

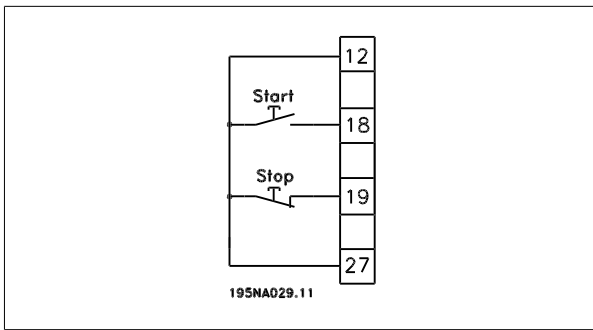

Latched start if a pulse is applied for min. 14 ms, the adjustable frequency drive will start the motor, provided no stop command has been given. The motor can be stopped by briefly activating *Stop inverse*.

Reversing is used for changing the direction of rotation of the motor shaft. Logic '0' will not lead to reversing. Logic '1' will lead to reversing. The reverse signal only changes the direction of rotation, it does not activate the start. Is not active at *Process regulation, closed-loop*. See also parameter 200 *Output frequency ranges/direction*.

Reversing and start is used for start/stop and for reversing with the same signal. No active start command is allowed at the same time. Is not active for *Process regulation, closed-loop*. See also parameter 200 *Output frequency ranges/direction*.

Start clockwise is used if you want the motor shaft only to be able to rotate clockwise when started. Should not be used for *Process regulation, closed-loop*.

Start counter-clockwise is used if you want the motor shaft only to be able to rotate counter-clockwise when started. Should not be used for *Process regulation, closed-loop*. See also parameter 200 *Output frequency ranges/direction*.

Jog is used to override the output frequency to the jog frequency set in parameter 213 *Jog frequency*. Jog is active regardless of whether a start command has been given, yet not when *Coast stop, Quick stop or DC braking* are active.

Freeze reference freezes the present reference. The reference can now only be changed via *Speed up* and *Slow*. If *freeze reference* is active, it will be saved after a stop command and in the event of line failure.

Freeze output freezes the present output frequency (in Hz). The output frequency can now only be changed via *Speed up* and *Slow*.



NOTE!

If *Freeze output* is active the adjustable frequency drive can only be stopped if you select *Motor coast, Quick stop or DC braking* via a digital input.

Speed up and *Slow* are selected if digital control of the up/down speed is required. This function is only active if *Freeze reference* or *Freeze output frequency* has been selected.

If *Speed up* is active the reference or output frequency will be increased, and if *Slow* is active the reference or output frequency will be reduced. The output frequency is changed via the preset ramp times in parameters 209-210 *Ramp 2*.

One pulse (logic '1' minimum high for 14 ms and a minimum break time of 14 ms) will lead to a speed change of 0.1% (reference) or 0.1 Hz (output frequency). Example:

Term. 29	Term. 33	Freeze ref/freeze outp.	Function
0	0	1	No speed change
0	1	1	Speed up
1	0	1	Slow
1	1	1	Slow

Freeze reference can be changed even if the adjustable frequency drive has stopped. The reference will also be saved if the line power is disconnected

Catch up/Slow-down is selected if the reference value is to be increased or reduced by a programmable percentage value set in parameter 219 *Catch up/Slow-down reference*.

Slow-down	Catch up	Function
0	0	Unchanged speed
0	1	Increase by % value
1	0	Reduce by % value
1	1	Reduce by % value

Ramp 2 is selected if a shift between ramp 1 (parameters 207-208) and ramp 2 (parameters 209-210) is required. Logic '0' leads to ramp 1 and logic '1' leads to ramp 2.

Preset reference, lsb and *Preset reference, msb* makes it possible to select one of the four preset references, see the table below:

Preset ref. msb	Preset ref. lsb	Function
0	0	Preset ref. 1
0	1	Preset ref. 2
1	0	Preset ref. 3
1	1	Preset ref. 4

Preset reference on is used for shifting between remote-controlled reference and preset reference. It is assumed that External/preset [2] has been selected in parameter 214 *Reference function*. Logic '0' means that remote-controlled references are active, while logic '1' means that one of the four preset references is active, as can be seen from the table above.

Precise stop, inverse is selected to obtain a high degree of accuracy when a stop command is repeated. A logic 0 means that the motor speed is ramped down to stop via the selected ramp.

Precise start/stop is selected to obtain a high degree of accuracy when a start and stop command is repeated.

Pulse reference is selected if the reference signal applied is a pulse train (frequency). 0 Hz corresponds to parameter 204 *Minimum reference, Ref_{MIN}*. The frequency set in parameter 327/328 *Pulse Max 33/29* corresponds to parameter 205 *Maximum reference Ref_{MAX}*.

Pulse feedback is selected if the feedback signal used is a pulse train (frequency). In parameter 327/328 *Pulse Max 33/29*, the maximum pulse feedback frequency is set.

Pulse input is selected if a specific number of pulses must lead to a *Precise stop*, see parameter 343 *Precise stop* and parameter 344 *Counter value*. *Selection of Setup, lsb* and *Selection of Setup, msb* provides the option of selecting one of the four setups. It is, however, a condition that parameter 004 is set to *Multisetup*.

Reset and start can be used as a start function. If 24 V are connected to the digital input, this will cause the adjustable frequency drive to reset, and the motor will ramp up to the preset reference.

Encoder reference is selected if the reference signal applied is a pulse train (frequency). 0 Hz corresponds to parameter 204 *Minimum reference, Ref_{MIN}*. The frequency set in parameter 327/328 *Pulse Max 33/29* corresponds to parameter 205 *Maximum reference Ref_{MAX}*.

Encoder feedback is selected if the feedback signal used is a pulse train (frequency). In parameter 327/328 *Pulse Max 33/29*, the maximum pulse feedback frequency is set.

Encoder input is selected if a specific number of pulses must lead to a *Precise stop*, see parameter 343 *Precise stop* and parameter 344 *Counter value*.

All encoder settings are used in connection with dual track encoders with direction recognition.

A track connected to terminal 29.

B track connected to terminal 33.

308 Terminal 53, analogue input voltage

Value:

- No function (NO OPERATION) [0]
- * Reference (reference) [1]
- Feedback (feedback) [2]
- Wobble (WOBB.DELTA FREQ [%]) [10]

Function:

In this parameter, it is possible to select the function required to be connected to terminal 53. Scaling of the input signal is made in parameter 309 *Terminal 53, min. scaling* and parameter 310 *Terminal 53, max. scaling*.

Description of choice:

No function [0]. Is selected if the adjustable frequency drive is not to react to signals connected to the terminal. *Reference* [1]. If this function is selected, the reference can be changed by means of an analog reference signal. If reference signals are connected to more than one input, these reference signals must be added up. If a voltage feedback signal is connected, select *Feedback* [2] on terminal 53.

Wobble [10]

The delta frequency can be controlled by the analog input. If *WOBB.DELTA FREQ* is selected as analog input (par. 308 or par. 314) the value selected in par. 702 equals 100 % analog input.

Example: Analog input = 4-20 mA, Delta freq. par. 702 = 5 Hz → 4 mA = 0 Hz and 20 mA = 5 Hz. If this function is chosen, see Wobble Instruction MI28JXY for further information.

309 Terminal 53 Min. scaling

Value:

- 0.0 - 10.0 Volt * 0.0 Volt

Function:

This parameter is used for setting the signal value that is to correspond to the minimum reference or the minimum feedback, parameter 204 *Minimum reference, Ref_{MIN}* | 414 *Minimum feedback, FB_{MIN}*.

Description of choice:

Set the required voltage value. For reasons of accuracy, compensation should be made for voltage loss in long signal cables. If the Time out

function is to be used (parameter 317 *Time out* and 318 *Function after time out*), the value set must be higher than 1 Volt.

310 Terminal 53 Max. scaling

Value:

- 0 - 10.0 Volt * 10.0 Volt

Function:

This parameter is used for setting the signal value that is to correspond to the maximum reference value or maximum feedback, parameter 205 *Maximum reference, Ref_{MAX}* | 414 *Maximum feedback, FB_{MAX}*.

Description of choice:

Set the required voltage value. For reasons of accuracy, compensation should be made for voltage losses in long signal cables.

314 Terminal 60, analogue input current

Value:

- No function (no operation) [0]
- Reference (reference) [1]
- * Feedback (feedback) [2]
- Wobble (WOBB.DELTA FREQ [%]) [10]

Function:

This parameter allows a choice between the different functions available for the input, terminal 60. Scaling of the input signal is effected in parameter 315 *Terminal 60, min. scaling* and parameter 316 *Terminal 60, max. scaling*.

Description of choice:

No function [0]. Is selected if the adjustable frequency drive is not to react to signals connected to the terminal. *Reference* [1]. If this function is selected, the reference can be changed by means of an analog reference signal. If reference signals are connected to more than one input, these reference signals must be added up.

If one current feedback signal is connected, select *Feedback* [2] on terminal 60.

Wobble [10]

The delta frequency can be controlled by the analog input. If *WOBB.DELTA FREQ* is selected as analog input (par. 308 or par. 314) the value selected in par. 702 equals 100 % analog input.

Example: Analog input = 4-20 mA, Delta freq. par. 702 = 5 Hz → 4 mA = 0 Hz and 20 mA = 5 Hz. If this function is chosen, see Wobble Instruction MI28JXY for further information.

315 Terminal 60 Min. scaling**Value:**

0.0 - 20.0 mA * 4.0 mA

Function:

In this parameter, you can set the signal value that will correspond to the minimum reference or minimum feedback, parameter 204 *Minimum reference*, Ref_{MIN} | 414 *Minimum feedback*, FB_{MIN} .

Description of choice:

Set the required current value. If the Timeout function is to be used (parameter 317 *Time out* and 318 *Function after time out*), the value set must be higher than 2 mA.

316 Terminal 60 Max. scaling**Value:**

0.0-20.0 mA * 20.0 mA

Function:

This parameter is used for setting the signal value that is to correspond to the maximum reference value, parameter 205 *Maximum reference value*, Ref_{MAX} .

Description of choice:

Set the required current value.

317 Time out**Value:**

1 - 99 sec. * 10 sec.

Function:

If the signal value of the reference or feedback signal connected to one of the input terminals 53 or 60 falls below 50 % of the minimum scaling for a period longer than the time set, the function selected in parameter 318 *Function after time out* will be activated. This function is only active if in parameter 309 *Terminal 53, min. scaling* a value higher than 1 Volt has been selected, or if in parameter 315 *Terminal 60, min. scaling* a value higher than 2 mA has been selected.

Description of choice:

Set the required time.

318 Function after timeout**Value:**

- * No operation (NO OPERATION) [0]
- Freeze output frequency (FREEZE OUTPUT FREQ.) [1]
- Stop (stop) [2]
- Jog (jog) [3]
- Max. speed (MAX SPEED) [4]
- Stop and trip (STOP AND TRIP) [5]

Function:

This parameter allows a choice of the function to be activated after the timeout expires (parameter 317 *Timeout*). If a timeout function occurs at the same time as a bus timeout function (parameter 513 *Bus time interval function*), the timeout function in parameter 318 will be activated.

Description of choice:

The output frequency of the adjustable frequency drive can be:

- frozen at the present frequency [1]
- overruled to stop [2]
- overruled to jog frequency [3]
- overruled to max. output frequency [4]
- overruled to stop with subsequent trip [5]

319 Analog output terminal 42**Value:**

- No function (NO OPERATION) [0]
- External reference min.-max. 0-20 mA (ref min-max = 0-20 mA) [1]
- External reference min.-max. 4-20 mA (ref min-max = 4-20 mA) [2]
- Feedback min.-max. 0-20 mA (fb min-max = 0-20 mA) [3]
- Feedback min.-max. 4-20 mA (fb min-max = 4-20 mA) [4]
- Output frequency 0-max 0-20 mA (0-fmax = 0-20 mA) [5]
- Output frequency 0-max 4-20 mA (0-fmax = 4-20 mA) [6]
- * Output current 0-I_{INV} 0-20 mA (0-iinv = 0-20 mA) [7]
- Output current 0-I_{INV} 4-20 mA (0-iinv = 4-20 mA) [8]
- Output power 0-P_{M,N} 0-20 mA (0-Pnom = 0-20 mA) [9]
- Output power 0-P_{M,N} 4-20 mA (0-Pnom = 4-20 mA) [10]
- Inverter temperature 68-212 °F [20-100 °C] 0-20 mA (TEMP 20-100 C=0-20 mA) [11]
- Inverter temperature 68-212 °F [20-100 °C] 4-20 mA (TEMP 20-100 C=4-20 mA) [12]

Function:

The analog output can be used for stating a process value. It is possible to choose two types of output signals 0-20 mA or 4-20 mA.

If used as a voltage output (0-10 V), a pull-down resistor of 500 Ω must be fitted to common (terminal 55). If the output is used as a current output, the resulting resistance from the equipment connected may not exceed 500 Ω.

Description of choice:

No function. Is selected if the analog output is not to be used.

External Ref_{MIN} - Ref_{MAX} 0-20 mA/4-20 mA.

An output signal is obtained, which is proportional to the resulting reference value in the interval Minimum reference, Ref_{MIN} - Maximum reference, Ref_{MAX} (parameters 204/205).

FB_{MIN}-FB_{MAX} 0-20 mA/ 4-20 mA.

An output signal is obtained, which is proportional to the feedback value in the interval Minimum feedback, FB_{MIN} - Maximum feedback, FB_{MAX} (parameter 414/415).

$0-f_{MAX}$ 0-20 mA/4-20 mA.

An output signal is obtained, which is proportional to the output frequency in the interval 0 - f_{MAX} (parameter 202 *Output frequency, high limit, f_{MAX}*).

$0 - I_{INV}$ 0-20 mA/4-20 mA.

An output signal is obtained, which is proportional to the output current in the interval 0 - I_{INV}

$0 - P_{M,N}$ 0-20 mA/4-20 mA.

An output signal is obtained, which is proportional to the present output power. 20 mA corresponds to the value set in parameter 102 *Motor power, $P_{M,N}$* .

$0 - Temp_{MAX}$ 0-20 mA/4-20 mA.

An output signal is obtained, which is proportional to the present heatsink temperature. 0/4 mA corresponds to a heatsink temperature of less than 68 °F [20 °C], and 20 mA corresponds to 100 °C.

Relay 123 (RELAY 123)	[17]
Reverse (REVERSE)	[18]
Thermal warning (THERMAL WARNING)	[19]
Local operation (LOCAL MODE)	[20]
Out of frequency range par. 225/226 (out of freq range)	[22]
Out of current range (out of current range)	[23]
Out of feedback range (out of fdbk. range)	[24]
Mechanical brake control (Mech. brake control)	[25]
Control word bit 11 (CTRL W. BIT 11)	[26]

Function:

The relay output can be used for giving the present status or warning. The output is activated (1-2 make) when a given condition is fulfilled.

Description of choice:

No function. Is selected if the variable frequency drive is not to react to signals.

Unit ready, there is a supply voltage on the control card of the variable frequency drive, and the variable frequency drive is ready for operation.

Enable, no warning, the variable frequency drive is ready for operation, but no start command has been given. No warning.

Running, a start command has been given.

Running in reference, no warning speed according to reference.

Running, no warning, a start command has been given. No warning.

Ready - AC supply voltage within range, the variable frequency drive is ready for use; the control card is receiving a supply voltage; and there are no active control signals on the inputs. The AC line voltage lies within the voltage limits.

Alarm or warning, the output is activated by an alarm or warning.

Current limit, the output current is higher than the value programmed in parameter 221 Current limit I_{LIM} .

Alarm, The output is activated by an alarm.

Output frequency higher than f_{LOW} , the output frequency is higher than the value set in parameter 225 *Warning: Low frequency, f_{LOW} .*

Output frequency lower than f_{HIGH} , the output frequency is lower than the value set in parameter 226 *Warning: High frequency, f_{HIGH} .*

Output current higher than I_{LOW} , the output current is higher than the value set in parameter 223 *Warning: Low current, I_{LOW} .*

Output current lower than I_{HIGH} , the output current is lower than the value set in parameter 224 *Warning: High current, I_{HIGH} .*

Feedback higher than FB_{LOW} , the feedback value is higher than the value set in parameter 227 *Warning: Low feedback, FB_{LOW} .*

Feedback lower than FB_{HIGH} , the feedback value is lower than the value set in parameter 228 *Warning: High current, I_{HIGH} .*

Relay 123 is only used in connection with Profidrive.

Reverse, The relay output is activated when the direction of motor rotation is counter-clockwise. When the direction of motor rotation is clockwise, the value is 0 V DC.

323 Relay output 1-3

Value:

* No function (no operation)	[0]
Unit ready (unit ready)	[1]
Enable/no warning (enable/no warning)	[2]
Running (RUNNING)	[3]
Running in reference, no warning (run on ref/no warn)	[4]
Running, no warnings (RUNNING/NO WARNING)	[5]
Running in reference range, no warnings (RUN IN RANGE/ NO WARN)	[6]
Ready - AC line voltage within range (RDY NO OVER/UNDERVOL)	[7]
Alarm or warning (ALARM OR WARNING)	[8]
Current higher than current limit, par. 221 (Current limit)	[9]
Alarm (ALARM)	[10]
Output frequency higher than f_{LOW} par. 225 (above frequency low)	[11]
Output frequency lower than f_{HIGH} par. 226 (below frequency high)	[12]
Output current higher than I_{LOW} par. 223 (above current low)	[13]
Output current lower than I_{HIGH} par. 224 (below current high)	[14]
Feedback higher than FB_{LOW} par. 227 (above feedback low)	[15]
Feedback lower than FB_{HIGH} par. 228 (under feedback high)	[16]

Thermal warning, above the temperature limit in either the motor or the variable frequency drive, or from a thermistor connected to a digital input. *Local operation*, the output is active when in parameter 002 *Local/remote operation*, *Local operation* [1] has been selected.

Out of the frequency range, the output frequency is out of the programmed frequency range in parameters 225 and 226.

Out of the current range, the motor current is out of the programmed range in parameters 223 and 224.

Out of the feedback range, the feedback signal is out of the programmed range in parameters 227 and 228.

Mechanical brake control, enables you to control an external mechanical brake (see section about control of mechanical brake in the Design Guide).

Control word bit 11, bit 11 of the control word, the relay output will be set/reset according to bit 11.

327 Pulse Max. 33

Value:

150 - 110000 Hz * 5000 Hz

Function:

This parameter is used for setting the signal value that corresponds to the maximum value set in parameter 205 *Maximum reference*, Ref_{MAX} or to the maximum feedback value set in parameter 415 *Maximum feedback*, FB_{MAX} .

Description of choice:

Set the required pulse reference or pulse feedback to be connected to terminal 33.

328 Pulse Max. 29

Value:

1000 - 110000 Hz * 5000 Hz

Function:

This parameter is used for setting the signal value that corresponds to the maximum value set in parameter 205 *Maximum reference*, Ref_{MAX} or to the maximum feedback value set in parameter 415 *Maximum feedback*, FB_{MAX} .

Description of choice:

Set the required pulse reference or pulse feedback to be connected to terminal 29.

341 Digital output terminal 46

Value:

* No function (NO OPERATION)	[0]
Value [0] - [20] see parameter 323	
Pulse reference (PULSE REFERENCE)	[21]
Value [22] - [25] see parameter 323	
Pulse feedback (PULSE FEEDBACK)	[26]
Output frequency (PULSE OUTPUTFREQ)	[27]
Pulse current (PULSE CURRENT)	[28]
Pulse power (PULSE POWER)	[29]
Pulse temperature (PULSE TEMP)	[30]
Control word bit 12 (CTRL. W. BIT 12)	[31]

Function:

The digital output can be used for giving the present status or warning. The digital output (terminal 46) gives a 24 V DC signal when a given condition is fulfilled.

Description of choice:

External Ref_{MIN} - Ref_{MAX} Par. 0-342.

An output signal is obtained, which is proportional to the resulting reference value in the interval Minimum reference, Ref_{MIN} - Maximum reference, Ref_{MAX} (parameters 204/205).

FB_{MIN} - FB_{MAX} Par. 0-342.

An output signal is obtained, which is proportional to the feedback value in the interval Minimum feedback, FB_{MIN} - Maximum feedback, FB_{MAX} (parameter 414/415).

0- f_{MAX} Par. 0-342.

An output signal is obtained, which is proportional to the output frequency in the interval 0 - f_{MAX} (parameter 202 *Output frequency, high limit*, f_{MAX}).

0 - I_{INV} Par. 0-342.

An output signal is obtained, which is proportional to the output current in the interval 0 - I_{INV} .

0 - $P_{M,N}$ Par. 0-342.

An output signal is obtained, which is proportional to the present output power. Par. 342 corresponds to the value set in parameter 102 *Motor power*, $P_{M,N}$.

0 - $Temp_{MAX}$ Par. 0-342.

An output signal is obtained, which is proportional to the present heatsink temperature. 0 Hz corresponds to a heatsink temperature of less than 68 °F (20 °C), and 20 mA corresponds to 212 °F (100 °C).

Control word bit 12, bit 12 of the control word. The digital output will be set/reset according to bit 12.

342 Terminal 46, max. pulse scaling

Value:

150 - 10000 Hz * 5000 Hz

Function:

This parameter is used for setting the pulse output signal's maximum frequency.

Description of choice:

Set the required frequency.

343 Precise stop function

Value:

* Precise ramp stop (normal)	[0]
Counter stop with reset (Count stop reset)	[1]
Counter stop without reset (Count stop no reset)	[2]
Speed-compensated stop (Spd cmp stop)	[3]
Speed-compensated counter stop with reset (Spd cmp cstop w. res)	[4]
Speed-compensated counter stop without reset (Spd cmp cstop no res)	[5]

Function:

In this parameter you select which stop function is performed in response to a stop command. All six data selections contain a precise stop routine, thus ensuring a high level of repeat accuracy.

The selections are a combination of the functions described below.



NOTE!

Pulse start [8] may not be used together with the precise stop function.

Description of choice:

Precise ramp stop [0] is selected to achieve high repetitive precision at the stopping point.

Counter stop. Once it has received a pulse start signal the adjustable frequency drive runs until the number of pulses programmed by the user have been received at input terminal 33. In this way an internal stop signal will activate the normal ramp down time (parameter 208).

The counter function is activated (starts timing) at the flank of the start signal (when it changes from stop to start).

Speed compensated stop. To stop at precisely the same point, regardless of the present speed, a stop signal received is delayed internally when the present speed is lower than the maximum speed (set in parameter 202).

Reset. *Counter stop* and *Speed-compensated stop* can be combined with or without reset.

Counter stop with reset [1]. After each precise stop the number of pulses counted during ramp down 0 Hz is reset.

Counter stop without reset [2]. The number of pulses counted during ramp down to 0 Hz is deducted from the counter value in parameter 344.

344 Counter value

Value:

0 - 999999 *** 100,000 pulses**

Function:

In this parameter, you can select the counter value to be used in the integrated precise stop function (parameter 343).

Description of choice:

The factory setting is 100,000 pulses. The highest frequency (max. resolution) that can be registered at terminal 33 is 67.6 kHz.

349 Speed comp delay

Value:

0 ms - 100 ms *** 10 ms**

Function:

In this parameter the user can set the system's delay time (Sensor, PLC, etc.). If you are running speed-compensated stop, the delay time at different frequencies has a major influence on the way in which you stop.

Description of choice:

The factory setting is 10 ms. This means that it is assumed that the total delay from the Sensor, PLC and other hardware corresponds to this setting.



NOTE!

Only active for speed-compensated stop.

3.6 Parameter Group 4-** Special Functions

400 Brake function

Value:

- * Off (off)** [0]
- Resistor brake (Resistor) [1]
- AC brake (AC Brake) [4]

Function:

Resistor brake [1] is selected if the variable frequency drive has a brake resistor connected to terminals 81, 82. A higher intermediate circuit voltage is permitted during braking (generated operation) when a brake resistor is connected.

AC brake [4] can be selected to improve braking without using brake resistors. Please note that *AC brake* [4] is not as effective as *Resistor brake* [1].

Description of choice:

Select *Resistor brake* [1] if a brake resistor is connected. Select *AC brake* [4] if short-term generated loads occur. See parameter 144 *Gain AC brake* to set the brake.



NOTE!

A change of selection will not become active until the AC line voltage has been disconnected and reconnected.

405 Reset function

Value:

- * Manual reset (manual reset)** [0]
- Automatic reset x 1 (AUTOMATIC x 1) [1]
- Automatic reset x 3 (AUTOMATIC x 3) [3]
- Automatic reset x 10 (AUTOMATIC x 10) [10]
- Reset at power-up (RESET AT POWER-UP) [11]

Function:

This parameter makes it possible to select whether reset and restart after a trip are to be manual or whether the adjustable frequency drive is to be reset and restarted automatically. Furthermore, it is possible to select

the number of times a restart is to be attempted. The time between each attempt is set in parameter 406 *Automatic restart time*.

Description of choice:

If *Manual reset* [0] is selected, reset is to be carried out via the [STOP/RESET] key, a digital input or serial communication. If the adjustable frequency drive is to carry out an automatic reset and restart after a trip, select data value [1], [3] or [10].

If *Reset at power-up* [11] is selected, the adjustable frequency drive will carry out a reset if there has been a fault in connection with the line failure.



The motor may start without warning.

406 Automatic restart time

Value:

0 - 10 sec. * 5 sec.

Function:

This parameter allows setting of the time from tripping until the automatic reset function begins. It is assumed that automatic reset has been selected in parameter 405 *Reset function*.

Description of choice:

Set the required time.

409 Trip delay overcurrent, I_{LIM}

Value:

0-60 sec. (61=OFF) * OFF

Function:

When the adjustable frequency drive registers that the output current has reached the current limit I_{LIM} (parameter 221 *Current limit*) and remains there for the preset time, it is disconnected. Can be used to protect the application, like the ETR will protect the motor if selected.

Description of choice:

Select how long the adjustable frequency drive should maintain the output current at the current limit I_{LIM} before it disconnects. At OFF parameter 409 *Trip delay overcurrent, I_{LIM}* is not working, i.e., disconnection will not take place.

411 Switching frequency

Value:

3000 - 14000 Hz * 4500 Hz

Function:

The set value determines the switching frequency of the inverter. If the switching frequency is changed, this may help to minimize possible acoustic noise from the motor.



NOTE!

The output frequency of the variable frequency drive can never assume a value higher than 1/10 of the switching frequency.

Description of choice:

When the motor is running, the switching frequency is adjusted in parameter 411 *Switching frequency* until the frequency has been obtained at which the motor is as low-noise as possible.



NOTE!

The switching frequency is reduced automatically as a function of the load. See *Temperature-Dependent Switching Frequency* under *Special Conditions*.

413 Overmodulation function

Value:

Off (off) [0]

* On (on) [1]

Function:

This parameter allows connection of the overmodulation function for the output voltage.

Description of choice:

Off [0] means that there is no overmodulation of the output voltage, which means that torque ripple on the motor shaft is avoided. This can be a good feature, e.g., on grinding machines. *On* [1] means that an output voltage can be obtained which is greater than the AC line voltage (up to 5%).

414 Minimum feedback, FB_{MIN}

Value:

-100,000.000 - par. 415 FB_{MAX} * 0.000

Function:

Parameter 414 *Minimum feedback, FB_{MIN}* and 415 *Maximum feedback, FB_{MAX}* are used to scale the display text to make it show the feedback signal in a process unit proportionally to the signal on the input.

Description of choice:

Set the value to be shown on the display as the minimum feedback signal value on the selected feedback input (parameters 308/314 *Analog inputs*).

415 Maximum feedback, FB_{MAX}

Value:

FB_{MIN} - 100,000.000 * 1500.000

Function:

See description of parameter 414 *Minimum feedback, FB_{MIN}* .

Description of choice:

Set the value to be shown on the display when the maximum feedback has been obtained on the selected feedback input (parameter 308/314 *Analog inputs*).

416	Process units
Value:	
* No unit (No unit)	[0]
% (%)	[1]
ppm (ppm)	[2]
rpm (rpm)	[3]
bar (bar)	[4]
Cycles/min. (CYCLE/MIN.)	[5]
Pulses/sec. (PULSE/SEC.)	[6]
Units/sec. (UNITS/SEC.)	[7]
Units/min. (UNITS/MIN.)	[8]
Units/h (Units/h)	[9]
°C (°C)	[10]
Pa (pa)	[11]
l/s (l/s)	[12]
m ³ /s (m3/s)	[13]
l/min. (l/min.)	[14]
m ³ /min. (m3/min)	[15]
l/h (l/h)	[16]
m ³ /h (m3/h)	[17]
kg/sec. (kg/sec.)	[18]
kg/min. (kg/min.)	[19]
kg/hour (kg/h)	[20]
tons/min. (T/min)	[21]
tons/hour (T/h)	[22]
Meters (m)	[23]

Nm (nm)	[24]
m/sec. (m/sec.)	[25]
m/min. (m/min)	[26]
°F (°F)	[27]
In wg (in wg)	[28]
gal/sec. (gal/sec.)	[29]
ft ³ /sec. (ft3/sec.)	[30]
gal/min. (gal/min)	[31]
ft ³ /min. (ft3/min)	[32]
gal/h (gal/h)	[33]
ft ³ /h (ft3/h)	[34]
lb/sec. (lb/sec.)	[35]
lb/min. (lb/min.)	[36]
lb/hour (lb/h)	[37]
lb ft (lb ft)	[38]
ft/s (ft/s)	[39]
ft/min. (ft/min.)	[40]
psi (psi)	[41]

Function:
 Select which of the different units are to be shown on the display. The unit is read out if an LCP control unit can be connected, and if *Reference [unit]* [2] or *Feedback [unit]* [3] has been selected in one of parameters 009-012 *Display readout*, and in display mode. The unit is used in *Closed-loop* also as a unit for minimum/maximum reference and minimum/maximum feedback.

Description of choice:
 Select the required unit for the reference/feedback signal.

3.6.1 FCD 300 Regulators

The FCD 300 has two integrated PID regulators, one to regulate speed and one to regulate processes.

Speed regulation and process regulation require a feedback signal back to an input. There are a number of settings for both PID regulators that are made in the same parameters, but selection of regulator type will affect the selections that have to be made in the shared parameters.

In parameter 100 *Configuration* it is possible to select regulator type, *Speed regulation, closed loop* [1] or *Process regulation, closed loop* [3].

Speed regulation

This PID regulation is optimized for use in applications in which there is a need to maintain a particular motor speed. The parameters that are specific for the speed regulator are parameter 417 to parameter 421.

Process regulation

The PID regulator maintains a constant process mode (pressure, temperature, flow, etc.) and adjusts the motor speed on the basis of the reference/setpoint and feedback signal.

A transmitter provides the PID regulator with a feedback signal from the process as an expression of the process's actual mode. The feedback signal varies as the process load varies.

This means that there is a variance between the reference/setpoint and the actual process mode. This variance is compensated by the PID regulator by means of the output frequency being regulated up or down in relation to the variance between the reference/setpoint and the feedback signal.

The integrated PID regulator in the variable frequency drive has been optimized for use in process applications. This means that there are a number of special functions available in the variable frequency drive.

Previously it was necessary to obtain a system to handle these special functions by installing extra I/O modules and programming the system. With the variable frequency drive the need to install extra modules can be avoided. The parameters that are specific to the Process Regulator are parameter 437 to parameter 444.

3.6.2 PID Functions

Unit of reference/feedback

When *Speed regulation, closed-loop* is selected in parameter 100 *Configuration*, the unit of reference/feedback is always rpm.

When *Process regulation, closed-loop* is selected in parameter 100 *Configuration*, the unit is defined in parameter 416 *Process units*.

Feedback

A feedback range must be preset for both regulators. At the same time, this feedback range limits the potential reference range so that if the sum of all references lies outside the feedback range, the reference will be limited to lie within the feedback range.

The feedback signal must be connected to a terminal on the adjustable frequency drive. If feedback is selected on two terminals simultaneously, the two signals will be added together.

Use the overview below to determine which terminal is to be used and which parameters are to be programmed.

Feedback type	Terminal	Parameters
Pulse	29, 33	305, 307, 327, 328
Voltage	53	308, 309, 310
Current	60	314, 315, 316

A correction can be made for loss of voltage in long signal cables when a transmitter with a voltage output is used. This is done in parameter group 300 *Min./Max scaling*.

Parameters 414/415 *Minimum/Maximum feedback* must also be preset to a value in the process unit corresponding to the minimum and maximum scaling values for signals that are connected to the terminal.

Reference

In parameter 205 *Maximum reference, Ref_{MAX}*, it is possible to preset a maximum reference that scales the sum of all references, i.e., the resulting reference.

The minimum reference in parameter 204 is an expression of the minimum value that the resulting reference can assume.

All references will be added together and the sum will be the reference against which regulation will take place. It is possible to limit the reference range to a range that is smaller than the feedback range. This can be an advantage if you want to avoid an unintentional change to an external reference making the sum of the references move too far away from the optimal reference. The reference range cannot exceed the feedback range.

If preset references are desired, they are preset in parameters 215 to 218 *Preset reference*. See description *Reference Function* and *Reference Handling*.

If a current signal is used as the feedback signal, it will only be possible to use voltage as an analog reference. Use the overview below to deter-

mine which terminal is to be used and which parameters are to be programmed.

Reference type	Terminal	Parameters
Pulse	29, 33	305, 307, 327, 328
Voltage	53	308, 309, 310
Current	60	314, 315, 316
Preset references		215-218
Bus reference	68+69	

Note that the bus reference can only be preset via serial communication.



NOTE!

It is best to preset terminals that are not being used to *No function* [0].

Differentiator gain limit

If very rapid variations occur in an application in either the reference signal or the feedback signal, the deviation between the reference/setpoint and the process's actual mode will change quickly. The differentiator can then become too dominant. This is because it is reacting to the deviation between the reference and the process's actual mode, and the quicker the variance changes the more powerful the differentiator's frequency contribution becomes. The differentiator's frequency contribution can therefore be limited in such a way that both a reasonable differentiation time for slow changes and an appropriate frequency contribution for quick changes can be preset. This is done using the speed regulation in parameter 420 *Speed PID Differentiator gain limit* and Process regulation in parameter 443 *Process PID Differentiator gain limit*.

Low-pass filter

If there is a lot of noise in the feedback signal, it can be dampened using an integrated low-pass filter. A suitable low-pass filter time constant is preset.

If the low-pass filter is preset to 0.1 s, the cut-off frequency will be 10 RAD/sec, corresponding to $(10 / 2 \times \pi) = 1.6$ Hz. This will mean that all currents/voltages that vary by more than 1.6 oscillations per second will be dampened. In other words, there will only be regulation on the basis of a feedback signal that varies by a frequency of less than 1.6 Hz. The appropriate time constant is selected in Speed Regulation in parameter 421 *Speed PID low-pass filter time* and in Process Regulation in parameter 444 *Process PID low-pass filter time*.

Inverse regulation

Normal regulation means that the motor speed is increased when the reference/setpoint is greater than the feedback signal. If it is necessary to run inverse regulation, where the speed is reduced when the reference/setpoint is greater than the feedback signal, parameter 437 *PID normal/inverted control* must be programmed at *Inverted*.

Counter-Windup

In the factory, the process regulator is preset with an active counter-windup function. This function means that when either a frequency limit, a current limit or a voltage limit is reached, the integrator is initialized at a frequency corresponding to the present output frequency. This is a means of avoiding the integration of a variance between the reference

and the process's actual mode that cannot be deregulated by means of a change of speed. This function can be deselected in parameter 438 *Process PID counter-windup*.

Starting conditions

In some applications, the optimal setting of the process regulator will mean that a relatively long period of time will pass before the required process condition is achieved. In these applications, it can be a good idea to define an output frequency to which the adjustable frequency drive must run the motor before the process regulator is activated. This is done by programming a start frequency in parameter 439 *Process PID start frequency*.

3.6.3 Handling of Feedback

Feedback handling is depicted in this flowchart.

The flowchart shows which parameters can affect the handling of feedback and how. A choice can be made between voltage, current and pulse feedback signals.

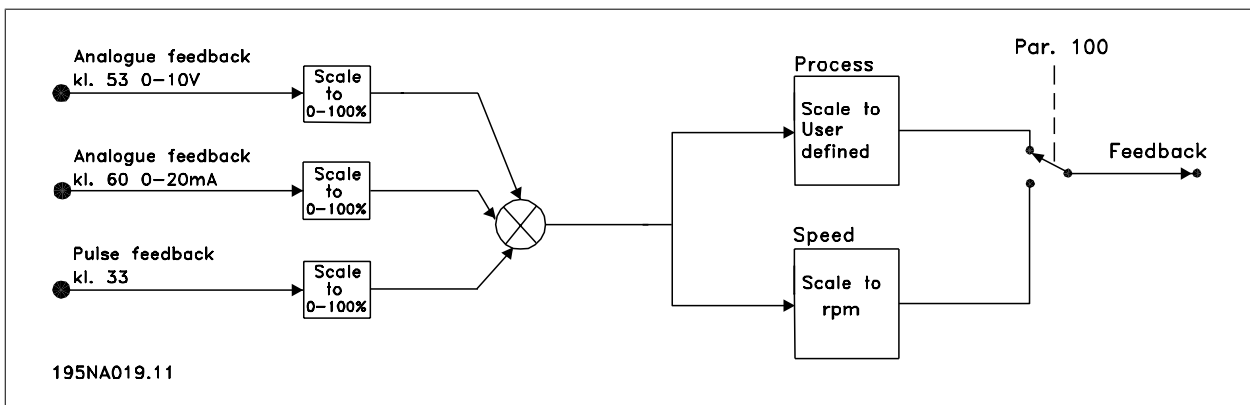

NOTE!
Parameters 417-421 are only used, if in parameter 100 Configuration the selection made is *Speed regulation, closed loop* [1].

417	Speed PID proportional gain
Value:	0.000 (OFF) - 1.000 * 0.010
Function:	Proportional gain indicates how many times the fault (deviation between the feedback signal and the setpoint) is to be amplified.
Description of choice:	Quick regulation is obtained at high amplification, but if the amplification is too high, the process may become unstable in the case of overshooting.

418 Speed PID integral time

Value:
20.00 - 999.99 ms (1000 = OFF) * 100 ms

Function:
The integral time determines how long the PID regulator takes to correct the error. The greater the error, the quicker the integrator frequency contribution will increase. The integral time is the time the integrator needs to achieve the same change as the proportional amplification.

Description of choice:
Quick regulation is obtained through a short integral time. However, if this time is too short, it can make the process unstable. If the integral time is long, major deviations from the required reference may occur, since the process regulator will take long to regulate if an error has occurred.

419 Speed PID differential time

Value:
0.00 (OFF) - 200.00 ms * 20.00 ms

Function:
The differentiator does not react to a constant error. It only makes a contribution when the error changes. The quicker the error changes, the stronger the gain from the differentiator will be. The contribution is proportional to the speed at which errors change.

Description of choice:
Quick control is obtained by a long differential time. However, if this time is too long, it can make the process unstable. When the differential time is 0 ms, the D-function is not active.

420 Speed PID D- gain limit

Value:
5.0 - 50.0 * 5.0

Function:
It is possible to set a limit for the gain provided by the differentiator. Since the D-gain increases at higher frequencies, limiting the gain may be useful. This enables obtaining a pure D-gain at low frequencies and a constant D-gain at higher frequencies.

Description of choice:
Select the required gain limit.

421 Speed PID lowpass filter time

Value:
20 - 500 ms * 100 ms

Function:
Noise in the feedback signal is dampened by a first order lowpass filter to reduce the noise's impact on the regulation. This might be an advantage, e.g. if there is a great amount of noise on the signal. See drawing.

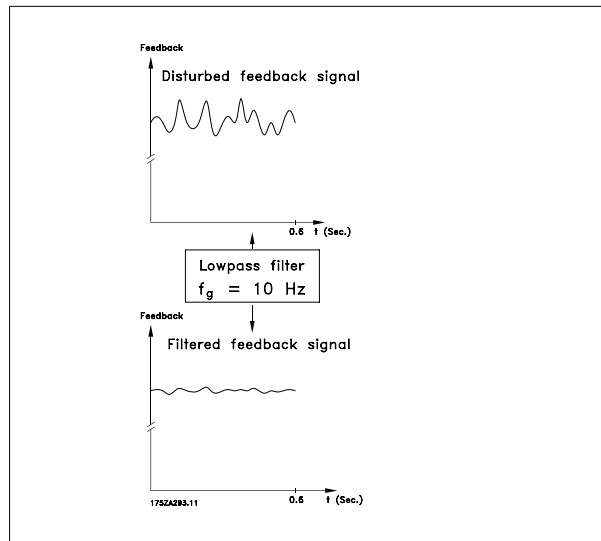

Description of choice:
If a time constant (t) of 100 ms is programmed, the cut-off frequency for the lowpass filter will be $1/0.1 = 10 \text{ RAD/sec.}$, corresponding to $(10 / 2 \times \pi) = 1.6 \text{ Hz}$. The PID regulator will then only regulate a feedback signal that varies with a frequency of less than 1.6 Hz. If the feedback signal varies with a higher frequency than 1.6 Hz, it will be dampened by the lowpass filter.

423 U1 voltage

Value:
0.0 - 999.0 V * par. 103

Function:
Parameters 423-428 are used when in parameter 101 *Torque characteristic* a selection has been made of *Special motor characteristic* [8]. It is possible to determine a U/f characteristic on the basis of four definable voltages and three frequencies. The voltage at 0 Hz is set in parameter 133 *Start voltage*.

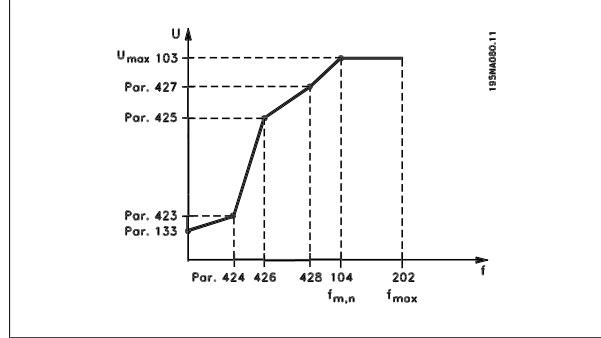

Description of choice:
Set the output voltage (U1) that is to match the first output frequency (F1), parameter 424 *F1 frequency*.

424 F1 frequency

Value:
0.0 - par. 426 *F2 frequency* * Par. 104 *Motor frequency*

Function:
See parameter 423 *U1 voltage* .

Description of choice:
Set the output frequency (F1) that is to match the first output voltage (U1), parameter 423 *U1 voltage* .

425 U2 voltage

Value:
0.0 - 999.0 V * par. 103

Function:
See parameter 423 *U1 voltage*.

Description of choice:
Set the output voltage (U2) that is to match the second output frequency (F2), parameter 426 *F2 frequency*.

426 F2 frequency

Value:
Par. 424 *F1 frequency* - par. 428 *F3 frequency* * Par. 104 *Motor frequency*

Function:
See parameter 423 *U1 voltage*.

Description of choice:
Set the output frequency (F2) that is to match the second output voltage (U2), parameter 425 *U2 voltage*.

427 U3 voltage

Value:
0.0-999.0 V * par. 103

Function:
See parameter 423 *U1 voltage*.

Description of choice:
Set the output voltage (U3) that is to match the third output frequency (F3), parameter 428 *F3 frequency* .

428 F3 frequency

Value:
Par. 426 *F2 frequency* - 1000 Hz * Par. 104 *Motor frequency*

Function:
See parameter 423 *U1 voltage*.

Description of choice:
Set the output frequency (F3) that is to match the third output voltage (U3), parameter 427 *U3 voltage* .

NOTE!
Parameters 437-444 are only used if in parameter 100 *Configuration* a selection has been made of *Process regulation, closed loop*. [3].

437 Process PID normal/inverse control

Value:
* Normal (normal) [0]
Inverse (inverse) [1]

Function:
It is possible to choose whether the process regulator is to increase/reduce the output frequency if there is a deviation between the reference/setpoint and the actual process mode.

Description of choice:
If the variable frequency drive is to reduce the output frequency in case the feedback signal increases, select *Normal* [0]. If the variable frequency drive is to increase the output frequency in case the feedback signal increases, select *Inverse* [1].

438 Process PID counter-windup

Value:
Not active (DISABLE) [0]
* Active (ENABLE) [1]

Function:
It is possible to select whether the process regulator is to continue regulating on a deviation even if it is not possible to increase/reduce the output frequency.

Description of choice:
The factory setting is *Enable* [1], which means that the integration link is initialized in relation to the actual output frequency if either the current limit, the voltage limit or the max./min. frequency has been reached. The process regulator will not engage again until either the error is zero or its sign has changed. Select *Disable* [0] if the integrator is to continue integrating on the deviation, even if it is not possible to remove the fault by such control.

NOTE!
If *Disable* [0] is selected, it means that when the deviation changes its sign, the integrator will first have to integrate down from the level obtained as a result of the former error, before any change in output frequency occurs.

439 Process PID start frequency

Value:
 $f_{MIN} - f_{MAX}$ (parameter 201/202) * Par. 201 *Output frequency, low limit, f_{MIN}*

Function:
When the start signal comes, the variable frequency drive will react in the form of *Open loop* and will not change to *Closed loop* until the programmed start frequency is reached. This makes it possible to set a frequency

that corresponds to the speed at which the process normally runs, which will enable the required process conditions to be reached sooner.

Description of choice:

Set the required start frequency.



NOTE!

If the variable frequency drive is running at the current limit before the required start frequency is obtained, the process regulator will not be activated. For the regulator to be activated anyway, the start frequency must be lower to the required output frequency. This can be done during operation.

3

440 Process PID proportional gain

Value:

0.0–10.00 * 0.01

Function:

The proportional gain indicates the number of times the deviation between the setpoint and the feedback signal is to be applied.

Description of choice:

Quick regulation is obtained by a high gain, but if the gain is too high, the process may become unstable due to overshoot.

441 Process PID integration time

Value:

0.01 - 9999.99 (OFF) * OFF

Function:

The integrator provides an increasing gain at a constant error between the reference/setpoint and the feedback signal. The greater the error, the quicker the integrator frequency contribution will increase. The integral time is the time needed by the integrator to make the same change as the proportional gain.

Description of choice:

Quick regulation is obtained at a short integral time. However, this time may become too short, which can make the process unstable due to overshoot. If the integral time is long, major deviations from the required setpoint may occur, since the process regulator will take a long time to regulate in relation to a given error.

442 Process PID differentiation time

Value:

0.00 (OFF) - 10.00 sec. * 0.00 sec.

Function:

The differentiator does not react to a constant error. It only makes a gain when an error changes. The quicker the deviation changes, the stronger the gain from the differentiator. The gain is proportional to the speed at which the deviation changes.

Description of choice:

Quick regulation is obtained with a long differentiation time. However, this time may become too long, which can make the process unstable due to overshoot.

443 Process PID diff. gain limit

Value:

5.0–50.0 * 5.0

Function:

It is possible to set a limit for the differentiator gain. The differentiator gain will increase if there are fast changes, which is why it can be beneficial to limit this gain. A pure differentiator gain is thereby obtained at slow changes, and a constant differentiator gain where quick changes to the deviation occur.

Description of choice:

Select a differentiator gain limit as required.

444 Process PID lowpass filter time

Value:

0.02 - 10.00 * 0.02

Function:

Noise in the feedback signal is dampened by a first order lowpass filter to reduce the noise's impact on the process regulation. This can be an advantage e.g. if there is a lot of noise on the signal.

Description of choice:

Select the required time constant (t). If a time constant (t) of 0.1 s is programmed, the cut-off frequency for the lowpass filter will be $1/0.1 = 10 \text{ RAD/sec.}$, corresponding to $(10 / 2 \times \pi) = 1.6 \text{ Hz.}$ The process regulator will thus only regulate a feedback signal that varies by a frequency lower than 1.6 Hz. If the feedback signal varies by a higher frequency than 1.6 Hz, it will be dampened by the lowpass filter.

445 Flying start

Value:

- * Off (DISABLE) [0]
- OK - same direction [1]
- OK - both directions [2]
- DC brake and start [3]
- (DC-BRAKE BEF. START)

Function:

This function makes it possible to 'catch' a rotating motor shaft, which is no longer controlled by the adjustable frequency drive, e.g., because of a line drop-out. The function is activated each time a start command is enabled. For the adjustable frequency drive to be able to 'catch' the rotating motor shaft, the motor speed must be lower than the frequency that corresponds to the frequency in parameter 202 *Output frequency, high limit, f_{MAX}*.

Description of choice:

Select *Disable* [0] if this function is not required.

Select *OK - same direction* [1] if the motor shaft is only able to rotate in the same direction when cutting in. *OK - same direction* [1] should be selected if in parameter 200 *Output frequency ranges* a selection has been of *Clockwise only*.

Select *OK - both directions* [2] if the motor is able to rotate in both directions when cutting in.

Select *DC brake and start* [3] if the adjustable frequency drive is to be able to brake the motor using the DC brake first, followed by start. It is assumed that parameters 126-127/132 *DC brake* are enabled. In the case of higher 'Windmilling' (rotating motor) effects, the adjustable frequency drive is not able to 'catch' a rotating motor without selecting *DC brake and start*.

Limitations:

- Too low inertia will lead to load acceleration, which can be dangerous or prevent correct catching of a rotating motor. Use the DC brake instead.
- If the load is driven, e.g., by 'Windmilling' (rotating motor) effects, the unit may cut out because of overvoltage.
- Flying start does not work at lower values than 250 rpm.

451 Speed PID feedforward factor

Value:
0 - 500 % * 100 %

Function:
This parameter is only active if in parameter 100 *Configuration* the selection made is *Speed regulation, closed-loop*. The FF function sends a larger or smaller part of the reference signal outside the PID controller in such a way that the PID controller only has an influence on part of the control signal. Any change to the setpoint will thus have a direct effect on the motor speed. The FF factor provides high dynamism and less overswing when changing the setpoint.

Description of choice:
The required % value can be selected in the interval $f_{MIN} - f_{MAX}$. Values over 100% are used if the setpoint variations are only small.

452 Controller range

Value:
0 - 200 % * 10 %

Function:
This parameter is only active if *Speed regulation, closed-loop* is made in parameter 100 *Configuration*. The controller range (bandwidth) limits the output from the PID controller as a % of motor frequency $f_{M,N}$.

Description of choice:
The required % value can be selected for motor frequency $f_{M,N}$. If the controller range is reduced, the speed variations will be less during initial tuning.

455 Frequency range monitor

Value:
Disable [0]
* Enable [1]

Function:
This parameter is used if warning 35 *Out of frequency range* must be turned off in the display in process control closed loop. This parameter does not affect the extended status word.

Description of choice:
Select *Enable* [1] to enable the readout in the display if warning 35 *Out of frequency range* occurs. Select *Disable* [0] to disable the readout in the display if warning 35 *Out of frequency range* occurs.

456 Brake Voltage Reduce

Value:
0 - 200 V * 0

Function:
The user sets the voltage by which the level for resistor braking is reduced. It is only active when resistor in parameter 400 is selected.

Description of choice:
The greater the reduction value, the faster the reaction to a generator overload. Should only be used if there are problems with overvoltage in the intermediate circuit.



NOTE!

A change of selection will not become active until the AC line voltage has been disconnected and reconnected.

3.7 Serial Communication

3.7.1 Protocols

All adjustable frequency drives are equipped with an RS 485 port as standard, which makes it possible to choose between two protocols. The two protocols that can be selected in parameter 512 *Message Profile*, are:

- Profidrive protocol
- Danfoss FC protocol

To select Danfoss FC protocol, parameter 512 *Message Profile* is set to *FC protocol* [1].

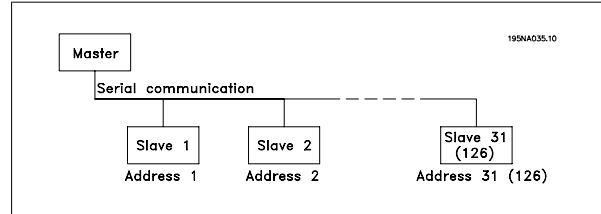

3.7.2 Telegram Traffic

Control and response telegrams

Telegram traffic in a master-slave system is controlled by the master. A maximum of 31 slaves can be connected to a master, unless repeaters are used. If repeaters are used, a maximum of 126 slaves can be connected to a master.

The master constantly sends telegrams addressed to the slaves and waits for response telegrams from them. The slave's response time is a maximum of 50 ms.

Only a slave that has received an error-free telegram, addressed to that slave can send a response telegram.

Broadcast

A master can send the same telegram simultaneously to all slaves connected to the bus. During this broadcast communication the slave does not send any response telegrams back to the master as to whether the telegram has been correctly received. Broadcast communication is set up in address format (ADR), see *Telegram structure*.

Content of a character (byte)

Each character transferred begins with a start bit. Then 8 data bits are transferred, corresponding to a byte. Each character is secured via a parity bit, which is set at "1" when it reaches parity (i.e. when there is an equal number of 1's in the 8 data bits and the parity bit in total). A character is completed by a stop bit, thus consisting of 11 bits in all.

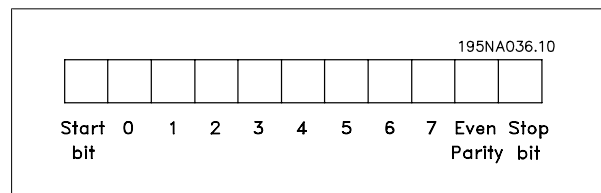

3.7.3 Message Structure

Each message begins with a start character (STX) = 02 Hex, followed by a byte that denotes the length of the message (LGE) and a byte that denotes the address of the adjustable frequency drive (ADR). Then follows a number of data bytes (variable, depending on the type of message). The message is completed by a data control byte (BCC).

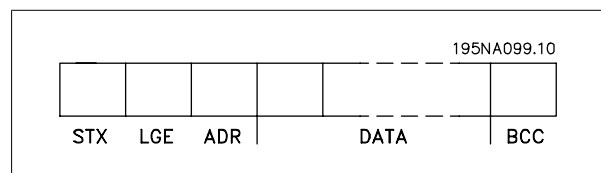

Message timing

The communication speed between a master and a slave depends on the baud rate. The adjustable frequency drive's baud rate must be the same as the master's baud rate and be selected in parameter 501 *Baudrate*.

After a response message from the slave, there must be a pause of at least 2 characters (22 bits) before the master can send a new message. At a baud rate of 9600 baud, there must be a pause of at least 2.3 ms. When the master has completed the message, the slave's response time back to the master will be a maximum of 20 ms, and there will be pause of at least 2 characters.

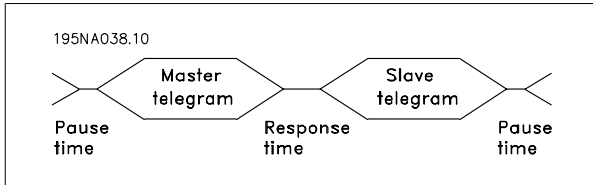

- Pause time, min: 2 characters
- Response time, min: 2 characters
- Response time, max: 20 ms

The time between the individual characters in a message may not exceed 2 characters and the message must be completed within 1.5 x nominal message time. At a baud rate of 9600 baud and a message length of 16 bytes, the message will be completed after 27.5 msec.

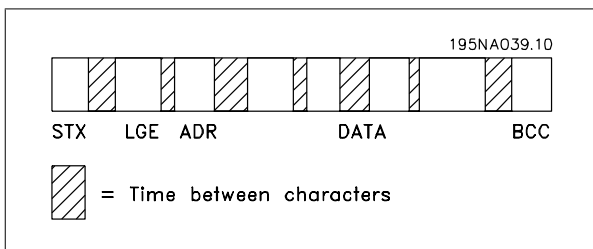

Message length (LGE)

The message length is the number of data bytes plus the address byte ADR plus the data control byte BCC.

- The length of messages with 4 data bytes is:
LGE = 4 + 1 + 1 = 6 bytes
- The length of messages with 12 data bytes is:
LGE = 12 + 1 + 1 = 14 bytes

The length of messages containing texts is 10+n bytes. 10 represents the fixed characters, while the 'n' is variable (depending on the length of the text).

Adjustable frequency drive address (ADR)

Two different address formats are used, with the adjustable frequency drive's address range being either 1-31 or 1-126.

1. Address format 1-31

The byte for address range 1-31 has the following profile:

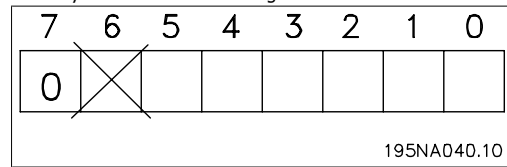

- Bit 7 = 0 (address format 1-31 active)
- Bit 6 is not used
- Bit 5 = 1: Broadcast, address bits (0-4) are not used
- Bit 5 = 0: No Broadcast
- Bit 0-4 = Adjustable frequency drive address 1-31

2. Address format 1-126

The byte for address range 1 - 126 has the following profile:

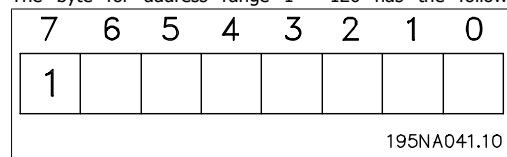

- Bit 7 = 1 (address format 1-126 active)
- Bit 0-6 = Adjustable frequency drive address 1-126
- Bit 0-6 = 0 Broadcast

The slave sends the address byte back unchanged in the response message to the master.

Example:

writing to adjustable frequency drive address 22 (16H) with address format 1-31:

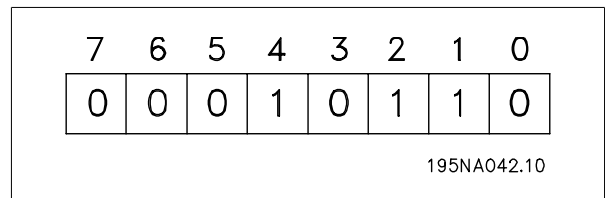

Data control byte (BCC)

The data control byte is explained in this example:

Before the first byte in the message is received, the Calculated CheckSum (BCS) is 0.

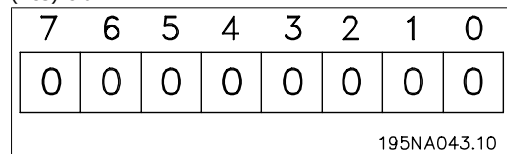

When the first byte (02H) has been received:

BCS = BCC EXOR "first byte"

(EXOR = exclusive-or)

BCS	= 0 0 0 0 0 0 0 0 (00 H)
EXOR	
1. byte	= 0 0 0 0 0 0 1 0 (02H)
BCC	= 0 0 0 0 0 0 1 0 (02H)

BCS	= 0 0 0 0 0 0 1 0 (02H)
EXOR	
2nd byte	= 1 1 0 1 0 1 1 0 (D6H)
BCC	= 1 1 0 1 0 1 0 0 (D4H)

Each subsequent byte gates with BCS EXOR and produces a new BCC, e.g.:

3.7.4 Data Character (Byte)

The structure of data blocks depends on the type of message. There are three types of message, and the type of message applies for both control messages (masterslave) and response messages (slavemaster). The three types of message are:

- Parameter block, used to transfer parameters between master and slave. The data block is made up of 12 bytes (6 words) and also contains the process block.

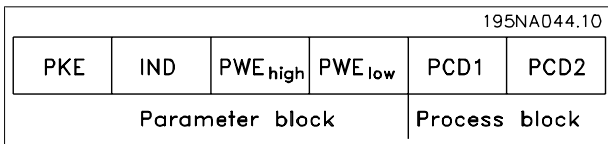

- The process block is made up of a data block of four bytes (2 words) and contains:
 - Control word and reference value
 - Status word and present output frequency (from slave to master)

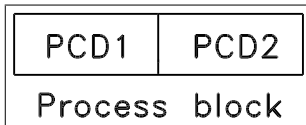

- Text block, which is used to read or write texts via the data block.

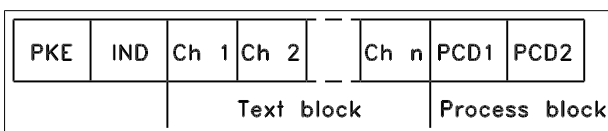

Parameter commands and responses (AK).

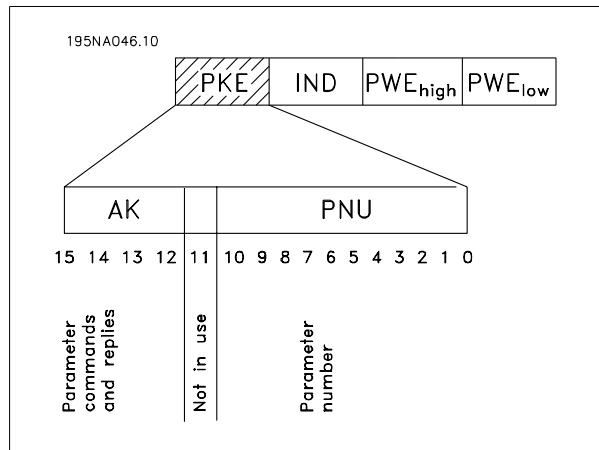

Bits no. 12-15 are used to transfer parameter commands from master to slave and the slave's processed responses back to the master.

Parameter commands masterslave					
Bit no.	15	14	13	12	Response
	0	0	0	0	No command
	0	0	0	1	Read parameter value
	0	0	1	0	Write parameter value in RAM (word)
	0	0	1	1	Write parameter value in RAM (double word)
	1	1	0	1	Write parameter value in RAM and EEPROM (double word)
	1	1	1	0	Write parameter value in RAM and EEPROM (word)
	1	1	1	1	Read/write text

Response slavemaster					
Bit no.	15	14	13	12	Response
	0	0	0	0	No response
	0	0	0	1	Parameter value transferred (word)
	0	0	1	0	Parameter value transferred (double word)
	0	1	1	1	Command cannot be performed
	1	1	1	1	Text transferred

If the command cannot be performed the slave sends this response: 0111 *Command cannot be performed* and gives the following fault report in the parameter value (PWE):

Response (0111)	Fault report
0	The parameter number used does not exist
1	There is no write access to the defined parameter
2	Data value exceeds the parameter's limits
3	The sub index used does not exist
4	The parameter is not the array type.
5	The data type does not match the defined parameter
17	Data change in the defined parameter is not possible in the adjustable frequency drive's present mode. Certain parameters can only be changed when the motor is turned off
130	There is no bus access to the defined parameter
131	Data change is not possible because factory setup is selected

Parameter number (PNU)

Bits no. 0-10 are used to transfer parameter numbers. The relevant parameter's function is defined in the parameter description in the section entitled *Programming*.

Index



Index is used together with the parameter number to read/write access parameters that have an index, e.g., parameter 615 *Error code*. The index is made up of 2 bytes, one lowbyte and one highbyte, but only the lowbyte is used as an index.

Example - Index:

The first error code (index [1]) in parameter 615 *Error code* must be read.
 PKE = 1267 Hex (read parameter 615 *Error code*.)
 IND = 0001 Hex - Index no. 1.

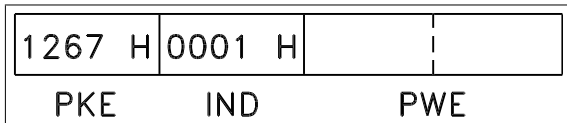

The adjustable frequency drive will respond in the parameter value block (PWE) with a fault code value from 1–99. See *Summary of Warnings and Alarms* to identify the fault code.

Parameter value (PWE)

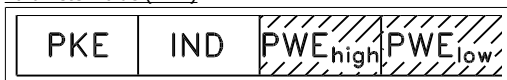

The parameter value block consists of 2 words (4 bytes), and the value depends on the defined command (AK). If the master prompts for a parameter value, the PWE block does not contain a value.

If you wish the master to change a parameter value (write), the new value is written in the PWE block and sent to the slave.

If the slave responds to a parameter request (read command), the present parameter value in the PWE block is transferred and returned to the master.

If a parameter contains not a numerical value, but several data options, e.g., parameter 001 *Language* where [0] corresponds to *English*, and [3] corresponds to *Danish*, the data value is selected by entering the value in the PWE block. See *Example - Selecting a data value*.

Via serial communication it is only possible to read parameters that have data type 9 (text string). Parameter 621 - 635 *Nameplate data* is data type 9. For example, in parameter 621 *Unit type* it is possible to read the unit size and AC line voltage range.

When a text string is transferred (read) the length of the message is variable, as the texts are of different lengths. The message length is defined in the message's second byte, known as LGE.

To be able to read a text via the PWE block, the parameter command (AK) must be set to 'F' Hex.

The index character is used to indicate whether it is a read or write command.

In a read command, the index must have the following format:

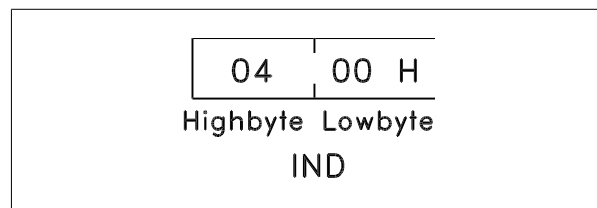

Some adjustable frequency drives have parameters to which a text may be written. To be able to write a text via the PWE block, the parameter command (AK) must be set to 'F' Hex.

For a write command, the text must have the following format:

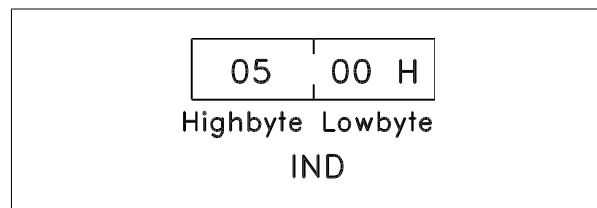

Data types supported by frequency transformer:

Data types	Description
3	Integer 16
4	Integer 32
5	Unsigned 8
6	Unsigned 16
7	Unsigned 32
9	Text string

3

Unsigned means that there is no operational sign in the message.

Example - Write a parameter value:

Parameter 202 *Output frequency high limit, f_{MAX}* to be changed to 100 Hz. The value must be recalled after a line failure, so it is written in EEPROM.

PKE = E0CA Hex - Write for parameter 202 *Output frequency high limit, f_{MAX}*
 IND = 0000 Hex
 PWE_{HIGH} = 0000 Hex
 PWE_{LOW} = 03E8 Hex - Data value 1000, corresponding to 100 Hz, see conversion.

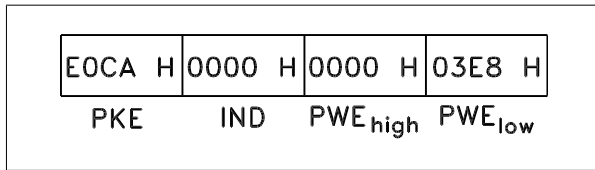

The response from the slave to the master will be:

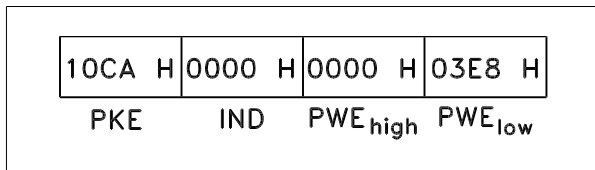

Example - Selection of a data value:

You wish to select kg/hour [20] in parameter 416 *Process units*. The value must be recalled after a line failure, so it is written in EEPROM.

PKE = E19F Hex - Write for parameter 416 *Process units*
 IND = 0000 Hex
 PWE_{HIGH} = 0000 Hex
 PWE_{LOW} = 0014 Hex - Select data option kg/hour [20]

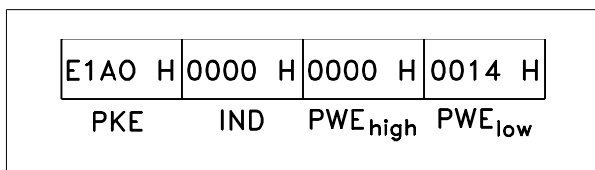

The response from the slave to the master will be:

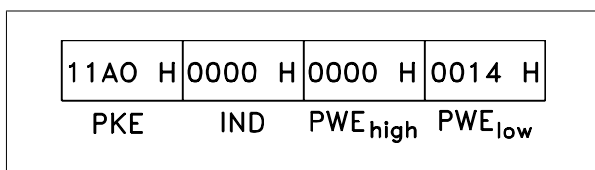

Example - Reading a parameter value:

The value in parameter 207 *Ramp-up time 1* is required.

The master sends the following request:

PKE = 10CF Hex - read parameter 207 *Ramp-up time 1*
 IND = 0000 Hex
 PWE_{HIGH} = 0000 Hex
 PWE_{LOW} = 0000 Hex

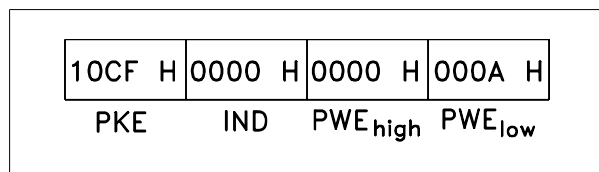
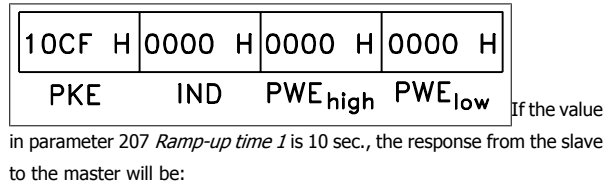

Conversion:

Under the section entitled *Factory Settings*, the various attributes of each parameter are displayed. As a parameter value can only be transferred as a whole number, a conversion factor must be used to transfer decimals.

Example:

Parameter 201 *Output frequency, low limit f_{MIN}* has a conversion factor of 0.1. If you wish to preset the minimum frequency to 10 Hz, the value 100 must be transferred, as a conversion factor of 0.1 means that the value transferred is multiplied by 0.1. The value 100 will thus be perceived as 10.0.

Conversion table	
Conversion index	Conversion factor
73	0.1
2	100
1	10
0	1
-1	0.1
-2	0.01
-3	0.001
-4	0.0001
-5	0.00001

3.7.5 Process Words

The block of process words is divided into two blocks of 16 bits, which always occur in the defined sequence.

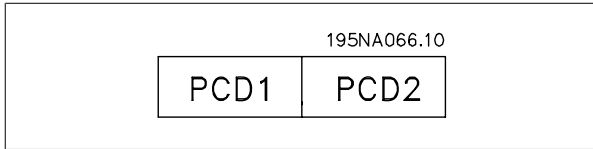

	PCD 1	PCD 2
Control message (master → slave)	Control word	Reference value
Control message (slave → master)	Status word	Present outp. frequency

3.7.6 Control Word According to FC Protocol

To select *FC protocol* in the control word, parameter 512 *Message Profile* must be set to *FC protocol*[1].

The control word is used to send commands from a master (e.g., a PC) to a slave (adjustable frequency drive).

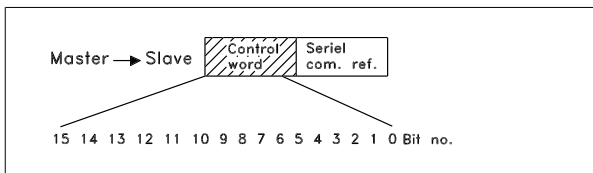

NOTE!

In parameter 508 *Selection of preset reference*, a selection is made to define how Bit 00/01 gates with the corresponding function on the digital inputs.

Bit	Bit = 0	Bit = 1
00		Preset ref. lsb
01		Preset ref. msb
02	DC braking	
03	Coasting stop	
04	Quick stop	
05	Freeze outp. freq.	
06	Ramp stop	Start
07		Reset
08		Jog
09	Ramp 1	Ramp 2
10	Data not valid	Data valid
11	No function	Relay output
12	No function	Digital output
13	Select Setup, lsb	
14	Select Setup, msb	
15		Reversing

Bit 00/01:

Bit 00/01 is used to select between the two pre-programmed references (parameters 215-218 *Preset reference*) according to the following table:

Preset ref.	Parameter	Bit 01	Bit 00
1	215	0	0
2	216	0	1
3	217	1	0
4	218	1	1

Bit 02, DC brake:

Bit 02 = '0' causes DC braking and stop. Brake voltage and duration are preset in parameters 132 *DC brake voltage* and parameter 126 *DC braking time*. Note: In parameter 504 *DC brake*, a selection is made to define how Bit 02 gates with the corresponding function on a digital input.

Bit 03, Coasting stop:

Bit 03 = '0' causes the adjustable frequency drive to immediately "let go" of the motor (the output transistors are "shut off"), so that it coasts to a standstill.

Bit 03 = '1' causes the adjustable frequency drive to be able to start the motor if the other starting conditions have been fulfilled. Note: In parameter 502 *Coasting stop*, a selection is made to define how Bit 03 gates with the corresponding function on a digital input.

Bit 04, Quick stop:

Bit 04 = '0' causes a stop, in which the motor's speed is ramped down to stop via parameter 212 *Quick stop ramp-down time*.

Bit 05, Freeze output frequency:

Bit 05 = '0' causes the present output frequency (in Hz) to freeze. The frozen output frequency can now only be changed by means of the digital inputs programmed to *Speed up* and *Slow*.

**NOTE!**

If *Freeze output* is active, the adjustable frequency drive cannot be stopped via Bit 06 *Start* or via a digital input. The adjustable frequency drive can only be stopped by the following:

- Bit 03 Coasting stop
- Bit 02 DC braking
- Digital input programmed to *DC braking*, *Coasting stop* or *Reset and coasting stop*.

Bit 06, Ramp stop/start:

Bit 06 = '0' causes a stop, in which the motor's speed is ramped down to stop via the selected *ramp-down* parameter.

Bit 06 = '1' causes the adjustable frequency drive to be able to start the motor, if the other starting conditions have been fulfilled. Note: In parameter 505 *Start*, a selection is made to define how Bit 06 Ramp stop/start gates with the corresponding function on a digital input.

Bit 07, Reset:

Bit 07 = '0' does not cause a reset.

Bit 07 = '1' causes the reset of a trip. Reset is activated on the signal's leading edge, e.g., when changing from logic '0' to logic '1'.

Bit 08, Jog:

Bit 08 = '1' causes the output frequency to be determined by parameter 213 *Jog frequency*.

Bit 09, Selection of ramp 1/2:

Bit 09 = "0" means that ramp 1 is active (parameters 207/208). Bit 09 = "1" means that ramp 2 (parameters 209/210) is active.

Bit 10, Data not valid/Data valid:

Is used to tell the adjustable frequency drive whether the control word is to be used or ignored. Bit 10 = '0' causes the control word to be ignored, Bit 10 = '1' causes the control word to be used. This function is relevant, because the control word is always contained in the message, regardless of which type of message is used, i.e., it is possible to turn off the control word if you do not wish to use it in connection with updating or reading parameters.

Bit 11, No function:

Bit 11 = relay output control.

Bit 12, No function:

Bit 12 = digital output control.

Bit 13/14, Selection of Setup:

Bits 13 and 14 are used to choose from the four menu setups according to the following table:

Setup	Bit 14	Bit 13
1	0	0
2	0	1
3	1	0
4	1	1

The function is only possible when *Multi-Setups* is selected in parameter 004 *Active Setup*.

Note: In parameter 507 *Selection of Setup*, a selection is made to define how Bit 13/14 gates with the corresponding function on the digital inputs.

Bit 15 Reversing:

Bit 15 = '0' causes no reversing.

Bit 15 = '1' causes reversing.

Note: In the factory setting, reversing is set to *digital* in parameter 506 *Reversing*. Bit 15 only causes reversing when either *Ser. communication*, *Logic or* or *Logic and* is selected.

3.7.7 Status Word According to FC Profile

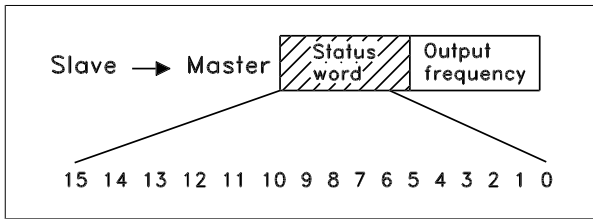

The status word is used to inform the master (e.g., a PC) of the slave's (adjustable frequency drive) mode. Slave⇒Master.

Bit	Bit = 0	Bit = 1
00		Control ready
01		Drive ready
02	Coasting stop	
03	No trip	Trip
04	Not used	
05	Not used	
06		Trip lock
07	No warning	Warning
08	Speed ≠ ref.	Speed = ref.
09	Local control	Ser. communi.
10	Outside frequency ranges	Frequency limit OK
11		Motor running
12		
13		Voltage warn.
14		Current limit
15		Thermal warn.

Bit 00, Control ready:

Bit 00 = '1'. The adjustable frequency drive is ready for operation.
 Bit 00 = '0'. The adjustable frequency drive is not ready for operation.

Bit 01, Drive ready:

Bit 01 = '1'. The adjustable frequency drive is ready for operation, but there is an active coasting command via the digital inputs or via serial communication.

Bit 02, Coasting stop:

Bit 02 = '0'. The adjustable frequency drive has released the motor.
 Bit 02 = '1'. The adjustable frequency drive can start the motor when a start command is given.

Bit 03, No trip/trip:

Bit 03 = '0' means that the adjustable frequency drive is not in fault mode.
 Bit 03 = '1' means that the adjustable frequency drive is tripped, and that it needs a reset signal for operation to be reestablished.

Bit 04, Not used:

Bit 04 is not used in the status word.

Bit 05, Not used:

Bit 05 is not used in the status word.

Bit 06, Trip lock:

Bit 06 = '0' means that the adjustable frequency drive is not trip-locked.
 Bit 06 = '1' means that the adjustable frequency drive is trip locked, and it cannot be reset before the line power supply has been removed. The trip can be reset either with 24 V external control backup or after the power is connected again.

Bit 07, No warning/warning:

Bit 07 = '0' means that there are no warnings.
 Bit 07 = '1' means that a warning has occurred.

Bit 08, Speed≠ ref/speed = ref.:

Bit 08 = '0' means that the motor is running, but that the present speed is different from the preset speed reference. It might, for example, be the case while the speed is being ramped up/down during start/stop.
 Bit 08 = '1' means that the motor's present speed is the same as the preset speed reference.

Bit 09, Local operation/serial communication control:

Bit 09 = '0' means that [STOP/RESET] is activated on the control unit, or that *Local control* in parameter 002 *Local/remoted operation* is selected. It is not possible to control the adjustable frequency drive via serial communication.
 Bit 09 = '1' means that it is possible to control the adjustable frequency drive via serial communication.

Bit 10, Outside frequency ranges:

Bit 10 = '0', if the output frequency has reached the value in parameter 201 *Output frequency low limit* or parameter 202 *Output frequency high limit*. Bit 10 = "1" means that the output frequency is within the defined limits.

Bit 11, Running/not running:

Bit 11 = '0' means that the motor is not running.
 Bit 11 = '1' means that the adjustable frequency drive has a start signal or that the output frequency is greater than 0 Hz.

Bit 13, Voltage warning high/low:

Bit 13 = '0' means that there are no voltage warnings.
 Bit 13 = '1' means that the DC voltage in the adjustable frequency drive's intermediate circuit is too low or too high.

Bit 14, Current limit:

Bit 14 = '0' means that the output current is less than the value in parameter 221 *Current Limit I_{LIM}*.
 Bit 14 = '1' means that the output current is greater than the value in parameter 221 *Current Limit I_{LIM}* and that the adjustable frequency drive will trip after a set period of time.

Bit 15, Thermal warning:

Bit 15 = '0' means that there is no thermal warning.

Bit 15 = '1' means that the temperature limit has been exceeded in either the motor, adjustable frequency drive or from a thermistor that is connected to a digital input.

3.7.8 Fast I/O FC Profile

3

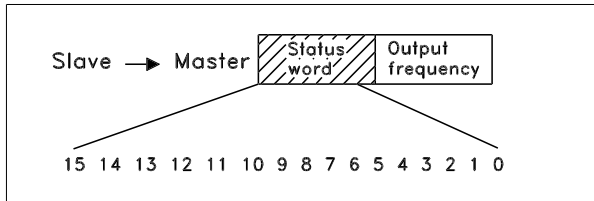

The *Fast I/O FC profile* can be used to monitor the digital inputs just by reading the status word. The input status in the status word reflects the actual input state (High or Low) regardless of the selected digital input function.

The response time from input changes until it is available on the Profibus is approximately 10 ms.

NOTE!
 The fast I/O profile(s) will only be available in drives fitted with Profibus.

Bit	Bit =0	Bit =1
00		Control ready
01		Drive ready
02	Coasting stop	
03	No trip	Trip
04	Not used	
05	Digital input 27	0: Input LOW/ 1: Input HIGH
06		Trip lock
07	No warning	Warning
08	Speed ≠ ref.	Speed = ref.
09	Local control	Ser. communication
10	Outside frequency ranges	Frequency limit OK
11		Motor OK
12	Digital input 18	0: Input LOW/ 1: Input HIGH
13	Digital input 19	0: Input LOW/ 1: Input HIGH
14	Digital input 29	0: Input LOW/ 1: Input HIGH
15	Digital input 33	0: Input LOW/ 1: Input HIGH

3.7.9 Control Word According to Serial Communication Bus Profile

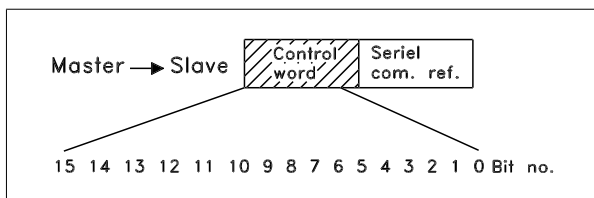

To select *Profidrive* in the control word, parameter 512 *Message Profile* must be set to *Profidrive* [0].

The control word is used to send commands from a master (e.g., a PC) to a slave (adjustable frequency drive). MasterSlave.

Bit	Bit = 0	Bit =1
00	OFF 1	ON 1
01	OFF 2	ON 2
02	OFF 3	ON 3
03	Coasting stop	
04	Quick stop	
05	Freeze outp. freq.	
06	Ramp stop	Start
07		Reset
08		Bus jog 1
09		Bus jog 2
10	Data not valid	Data valid
11		Slow-down
12		Catch up
13	Select Setup (lsb)	
14	Select Setup (msb)	
15		Reversing

Bit 00-01-02, OFF1-2-3/ON1-2-3:

Bit 00-01-02 = '0' causes ramp stop, which uses the ramp time in parameters 207/208 or 209/210.

If *Relay 123* is selected in parameter 323 *Relay output*, the output relay will be activated when the output frequency is 0 Hz.

Bit 00-01-02 = '1' means that the adjustable frequency drive can start the motor if the other starting conditions are fulfilled.

Bit 03, Coasting stop:

See description under *Control word according to FC protocol*.

Bit 04, Quick stop:

See description under *Control word according to FC protocol*.

Bit 05, Freeze output frequency:

See description under *Control word according to FC protocol*.

Bit 06, Ramp stop/start:

See description under *Control word according to FC protocol*.

Bit 07, Reset:

See description under *Control word according to FC protocol*.

Bit 08, Jog 1:

Bit 08 = "1" means that the output frequency is determined by parameter 09 *Bus jog 1*.

Bit 09, Jog 2:

Bit 09 = "1" means that the output frequency is determined by parameter 510 *Bus jog 2*.

Bit 10, Data not valid/Data valid:

See description under *Control word according to FC protocol*.

Bit 11, Slow-down:

Used to reduce the speed reference by the value in parameter 219 *Catch up/slow-down reference*.

Bit 11 = '0' does not cause any change to the reference.

Bit 11 = '1' means that the reference is reduced.

Bit 12, Catch up:

Used to increase the speed reference by the value in parameter 219 *Catch up/slow-down reference*.

Bit 12 = '0' does not cause any change to the reference.

Bit 12 = '1' means that the reference is increased.

If both *Slow-down* and *Catch up* are activated (Bits 11 and 12 = "1"), slow-down has the highest priority, i.e., that the speed reference is reduced.

Bit 13/14, Selection of Setup:

See description under *Control word according to FC protocol*.

Bit 15 Reversing:

See description under *Control word according to FC protocol*.

3.7.10 Status Word According to Profidrive Protocol

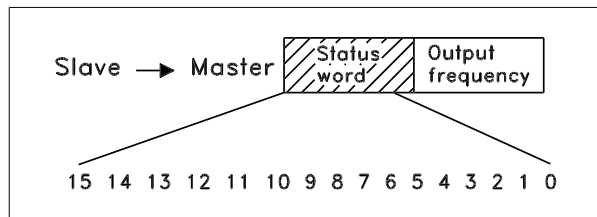

The status word is used to inform the master (e.g., a PC) of the slave's (adjustable frequency drive) mode. SlaveMaster.

Bit	Bit = 0	Bit = 1
00		Control ready
01		Drive ready
02	Coasting stop	
03	No trip	Trip
04	ON 2	OFF 2
05	ON 3	OFF 3
06	Start enable	Start disable
07		Warning
08	Speed ref.	Speed = ref.
09	Local control	Ser. communi.
10	Outside frequency ranges	Frequency limit OK
11		Motor running
12		
13		Voltage warn.
14		Current limit
15		Thermal warn.

Bit 00, Control not ready/ready:

Bit 00 = '0' means that the Bit 00, 01 or 02 in the control word are '0' (OFF1, OFF2 or OFF3) or the adjustable frequency drive is not ready for operation.

Bit 00 = '1' means that the adjustable frequency drive is ready for operation.

Bit 01, Drive ready:

See description under *Status word according to FC protocol*.

Bit 02, Coasting stop:

Bit 02 = '0' means that Bits 00, 02 or 03 in the control word are "0" (OFF1, OFF3 or Coasting stop).

Bit 02 = '1' means that Bits 00, 01, 02 and 03 in the control word are "1", and that the adjustable frequency drive has not tripped.

Bit 03, No trip/trip:

See description under *Status word according to FC protocol*.

Bit 04, ON 2/OFF 2:

Bit 04 = '0' means that Bit 01 in the control word = '1'.

Bit 04 = '1' means that Bit 01 in the control word = '0'.

Bit 05, ON 3/OFF 3:

Bit 05 = '0' means that Bit 02 in the control word = '1'.
 Bit 05 = '1' means that Bit 02 in the control word = '0'.

Bit 06, Start enable/start disable:

Bit 06 = '1' after reset of a trip, after activation of OFF2 or OFF3 and after connection of line voltage. *Start disable* is reset by setting Bit 00 in the control word to '0', and Bit 01, 02 and 10 are set to '1'.

Bit 07, Warning:

See description under *Status word according to FC protocol*.

Bit 08, Speed:

See description under *Status word according to FC protocol*.

Bit 09, No warning/warning:

See description under *Status word according to FC protocol*.

Bit 10, Speed ref/speed = ref.:

See description under *Status word according to FC protocol*.

Bit 11, Running/not running:

See description under *Status word according to FC protocol*.

Bit 13, Voltage warning high/low:

See description under *Status word according to FC protocol*.

Bit 14, Current limit:

See description under *Status word according to FC protocol*.

Bit 15, Thermal warning:

See description under *Status word according to FC protocol*.

3.7.11 Serial Communication Reference

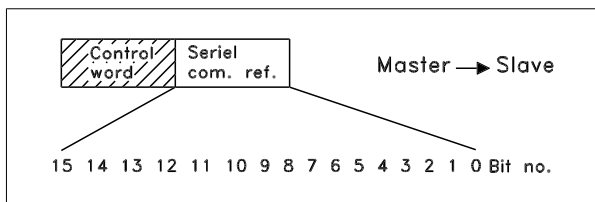

The serial communication reference is transferred to the adjustable frequency drive as a 16-bit word. The value is transferred in whole numbers 0–±32767 (±200%).
 16384 (4000 Hex) corresponds to 100%.

The serial communication reference has the following format: 0–16384 (4000 Hex) ≅ 0–100% (Par. 204 *Minimum ref.* - Par. 205 *Maximum ref.*).

It is possible to change the direction of rotation via the serial reference. This is done by converting the binary reference value to 2' complement. See example.

Example - Control word and serial communication ref.:

The adjustable frequency drive is to receive a start command and the reference is to be set to 50% (2000 Hex) of the reference range.
 Control word = 047F Hex ⇒ Start command.
 Reference = 2000 Hex ⇒ 50% reference.

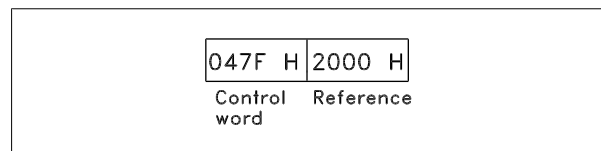

The adjustable frequency drive is to receive a start command and the reference is to be set to -50% (-2000 Hex) of the reference range. The reference value is first converted to 1' complement, and then 1 is added binary to obtain 2' complement:

2000 Hex	0010 0000 0000 0000 0000
1' complement	1101 1111 1111 1111 1111
	+ 1
2' complement	1110 0000 0000 0000 0000

Control word = 047F Hex ⇒ Start command.
 Reference = E000 Hex ⇒ -50% reference.

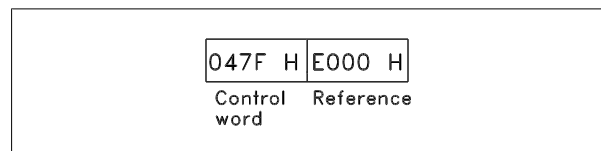

3.7.12 Present Output Frequency

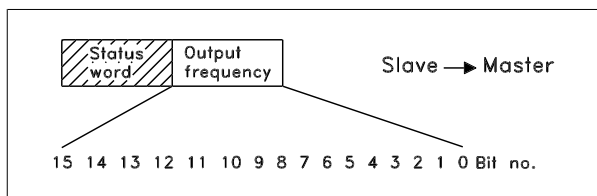

The value of the adjustable frequency drive's present output frequency is transferred as a 16-bit word. The value is transferred as whole numbers 0–±32767 (±200%).
16384 (4000 Hex) corresponds to 100%.

Output frequency has the following format:
0–16384 (4000 Hex) ≅ 0–100% (Par. 201 *Output frequency low limit* - Par. 202 *Output frequency high limit*).

Example - Status word and current output frequency:
The master receives a status message from the adjustable frequency drive that the current output frequency is 50% of the output frequency ranges.
Par. 201 *Output frequency low limit* = 0 Hz
Par. 202 *Output frequency high limit* = 50 Hz

Status word = 0F03 Hex.
Output frequency = 2000 Hex ⇒ 50% of the frequency ranges, corresponding to 25 Hz.

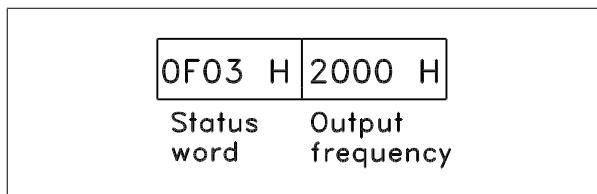

3.8 Parameter Group 5-** Serial communication

500 Address

Value:

Parameter 500 Protocol = FC protokol [0]	0 - 247	* 1
Parameter 500 Protocol = Metasys N2 [1]	1 - 255	* 1
Parameter 500 Protocol = MODBUS RTU [3]	1 - 247	* 1

Function:

This parameter allows the allocation of an address to each variable frequency drive in a serial communication network.

Description of choice:

The individual variable frequency drive must be allocated a unique address.

If the number of units connected (variable frequency drives + master) is higher than 31, a repeater must be used.

Parameter 500 *Address* cannot be selected via the serial communication, but must be preset via the control unit.

501 Baudrate

Value:

300 Baud (300 BAUD)	[0]
600 Baud (600 BAUD)	[1]
1200 Baud (1200 BAUD)	[2]
2400 Baud (2400 BAUD)	[3]
4800 Baud (4800 BAUD)	[4]
* 9600 Baud (9600 BAUD)	[5]

Function:

This parameter is for programming the speed at which data is transmitted via the serial port. Baud rate is defined as the number of bits transmitted per second.

Description of choice:

The variable frequency drive's transmission speed must be set at a value corresponding to the transmission speed of the master.

Parameter 501 *Baudrate* cannot be selected via the serial port, but must be preset via the operating unit.

502 Coasting Stop

Value:

Digital input (DIGITAL INPUT)	[0]
Serial port (SERIAL PORT)	[1]
Logic and (LOGIC AND)	[2]
* Logic or (LOGIC OR)	[3]

Function:

Parameters 502-508 allow a choice between controlling the adjustable frequency drive via the digital inputs and/or via the serial port.

If *Serial port* [1] is selected, the relevant command can only be activated if a command is given via the serial port.

In the case of *Logic and* [2], the function must also be activated via a digital input.

Description of choice:

The table below shows when the motor is running and when it is coasting, when each of the following is selected: *Digital input* [0], *Serial port* [1], *Logic and* [2] or *Logic or* [3].



NOTE!

Note that *Coasting stop* and Bit 03 in the control word are active at logic '0'.

Digital input [0]

Dig. input	Ser. port	Function
0	0	Coasting
0	1	Coasting
1	0	Motor running
1	1	Motor running

Serial port [1]

Dig. input	Ser. port	Function
0	0	Coasting
0	1	Motor running
1	0	Coasting
1	1	Motor running

Logic and [2]

Dig. input	Ser. port	Function
0	0	Coasting
0	1	Motor running
1	0	Motor running
1	1	Motor running

Logic or [3]

Dig. input	Ser. port	Function
0	0	Coasting
0	1	Coasting
1	0	Coasting
1	1	Motor running

503 Quick stop

Value:

Digital input (DIGITAL INPUT)	[0]
Serial port (SERIAL PORT)	[1]
Logic and (LOGIC AND)	[2]
* Logic or (LOGIC OR)	[3]

Function:

See function description for parameter 502 *Coasting stop*.

Description of choice:

The table below shows when the motor is running and when it is in quick stop mode, when each of the following is selected: *Digital input* [0], *Serial port* [1], *Logic and* [2] or *Logic or* [3].



NOTE!

Note that *Quick-stop inverse* and Bit 04 in the control word are active at logic '0'.

Digital input [0]		
Dig. input	Serial port	Function
0	0	Quick stop
0	1	Quick stop
1	0	Motor running
1	1	Motor running

Serial port [1]		
Dig. input	Serial port	Function
0	0	Quick stop
0	1	Motor running
1	0	Quick stop
1	1	Motor running

Logic and [2]		
Dig. input	Serial port	Function
0	0	Quick stop
0	1	Motor running
1	0	Motor running
1	1	Motor running

Logic or [3]		
Dig. input	Serial port	Function
0	0	Quick stop
0	1	Quick stop
1	0	Quick stop
1	1	Motor running

504 DC brake

- Value:**
- Digital input (DIGITAL INPUT) [0]
 - Serial port (SERIAL PORT) [1]
 - Logic and (LOGIC AND) [2]
 - * Logic or (LOGIC OR) [3]

Function:

See function description for parameter 502 *Coasting stop*.

Description of choice:

The table below shows when the motor is running and the DC braking when each of the following is selected *Digital input [0]*, *Serial port [1]*, *Logic and [2]* or *Logic or [3]*.



NOTE!

Note that *DC braking inverse* and Bit 02 in the control word are active at logic '0'.

Digital input [0]		
Dig. input	Ser. port	Function
0	0	DC braking
0	1	DC braking
1	0	Motor running
1	1	Motor running

Serial port [1]		
Dig. input	Ser. port	Function
0	0	DC braking
0	1	Motor running
1	0	DC braking
1	1	Motor running

Logic and [2]		
Dig. input	Ser. port	Function
0	0	DC braking
0	1	Motor running
1	0	Motor running
1	1	Motor running

Logic or [3]		
Dig. input	Ser. port	Function
0	0	DC braking
0	1	DC braking
1	0	DC braking
1	1	Motor running

505 Start

- Value:**
- Digital input (DIGITAL INPUT) [0]
 - Serial port (SERIAL PORT) [1]
 - Logic and (LOGIC AND) [2]
 - * Logic or (LOGIC OR) [3]

Function:

See function description for parameter 502 *Coasting stop*.

Description of choice:

The table below shows when the motor has stopped and when the adjustable frequency drive has a start command when each of the following is selected: *Digital input [0]*, *Serial port [1]*, *Logic and [2]* or *Logic or [3]*.

Digital input [0]		
Dig. input	Ser. port	Function
0	0	Stop
0	1	Stop
1	0	Start
1	1	Start

Serial port [1]		
Dig. input	Ser. port	Function
0	0	Stop
0	1	Start
1	0	Stop
1	1	Start

Logic and [2]

Dig. input	Ser. port	Function
0	0	Stop
0	1	Stop
1	0	Stop
1	1	Start

Logic or [3]

Dig. input	Ser. port	Function
0	0	Stop
0	1	Start
1	0	Start
1	1	Start

506 Reversing

- Value:**
- Digital input (DIGITAL INPUT) [0]
 - Serial port (SERIAL PORT) [1]
 - Logic and (LOGIC AND) [2]
 - * Logic or (LOGIC OR) [3]

Function:
See function description for parameter 502 *Coasting stop*.

Description of choice:
The table below shows when the motor is running clockwise and counter-clockwise when each of the following is selected: *Digital input [0]*, *Serial port [1]*, *Logic and [2]* or *Logic or [3]*.

Digital input [0]

Dig. input	Ser. port	Function
0	0	Clockwise
0	1	Clockwise
1	0	Counter-clockwise
1	1	Counter-clockwise

Serial port [1]

Dig. input	Ser. port	Function
0	0	Clockwise
0	1	Counter-clockwise
1	0	Clockwise
1	1	Counter-clockwise

Logic and [2]

Dig. input	Ser. port	Function
0	0	Clockwise
0	1	Clockwise
1	0	Clockwise
1	1	Counter-clockwise

Logic or [3]

Dig. input	Ser. port	Function
0	0	Clockwise
0	1	Counter-clockwise
1	0	Counter-clockwise
1	1	Counter-clockwise

507 Selection of Setup

- Value:**
- Digital input (DIGITAL INPUT) [0]
 - Serial communication (SERIAL PORT) [1]
 - Logic and (LOGIC AND) [2]
 - * Logic or (LOGIC OR) [3]

Function:
See function description of parameter 502 *Coasting stop*.

Description of choice:
The table below shows which setup (parameter 004 *Active Setup*) is selected for each of the following: *Digital input [0]*, *Serial communication [1]*, *Logic and [2]* or *Logic or [3]*.

Digital input [0]

Setup msb	Setup lsb	Function
0	0	Setup 1
0	1	Setup 2
1	0	Setup 3
1	1	Setup 4

Serial communication [1]

Setup msb	Setup lsb	Function
0	0	Setup 1
0	1	Setup 2
1	0	Setup 3
1	1	Setup 4

Logic and [2]

Bus Setup msb	Bus Setup lsb	Dig. Setup msb	Dig. Setup lsb	Setup no.
0	0	0	0	1
0	0	0	1	1
0	0	1	0	1
0	0	1	1	1
0	1	0	0	1
0	1	0	1	2
0	1	1	0	1
0	1	1	1	2
1	0	0	0	1
1	0	0	1	1
1	0	1	0	3
1	0	1	1	3
1	1	0	0	1
1	1	0	1	2
1	1	1	0	3
1	1	1	1	4

Logic or [3]

Bus Setup msb	Bus Setup lsb	Dig. Setup msb	Dig. Setup lsb	Setup no.
0	0	0	0	1
0	0	0	1	2
0	0	1	0	3
0	0	1	1	4
0	1	0	0	2
0	1	0	1	2
0	1	1	0	4
0	1	1	1	4
1	0	0	0	3
1	0	0	1	4
1	0	1	0	3
1	0	1	1	4
1	1	0	0	4
1	1	0	1	4
1	1	1	0	4
1	1	1	1	4

508 Selection of preset ref.

- Value:**
- Digital input (DIGITAL INPUT) [0]
 - Serial communication (SERIAL PORT) [1]
 - Logic and (LOGIC AND) [2]
 - * Logic or (LOGIC OR) [3]

Function:

See function description of parameter 502 *Coasting stop*.

Description of choice:

Preset references via serial communication are active when parameter 512 *Message profile* is set to *FC protocol* [1].

509 Bus jog 1 (BUS JOG 1 FREQ.)

510 Bus jog 2 (BUS JOG 2 FREQ.)

Value:

0.0 - par. 202 *Output frequency high limit* * 10.0 Hz

Function:

If parameter 512 *Message Profile* shows the selection *Profidrive* [0], two fixed speeds (Jog 1 or Jog 2) can be selected via the serial port.

The function is the same as in parameter 213 *Jog frequency*.

Description of choice:

Jog frequency f_{JOG} can be selected between 0 Hz and f_{MAX} .

512 Telegram Profile

Value:

- Profidrive (Profidrive) [0]
- * FC protocol (FC protocol) [1]
- Fast I/O FC-profile (Fast I/O FC-profile) [2]

Function:

It is possible to choose between three different control word profiles.

Description of choice:

Select the desired control word profile.

See *Serial port for FCD 300* for further details of control word profiles.

513 Bus time interval

Value:

1 - 99 sec. * 1 sec.

Function:

In this parameter it is possible to preset the maximum time expected to elapse between receipt of two consecutive telegrams. If this time is exceeded, the serial communication is assumed to have stopped and the desired reaction is preset in parameter 514 *Bus time interval function*.

Description of choice:

Preset the required time.

514 Bus time interval function

Value:

- * Off (off) [0]
- Freeze output frequency (FREEZE OUTPUT) [1]
- Stop (STOP) [2]
- Jogging (JOGGING) [3]
- Max. speed (MAX SPEED) [4]
- Stop and trip (STOP AND TRIP) [5]

Function:

In this parameter, you can select the required reaction for the adjustable frequency drive when the preset time in parameter 513 *Bus time interval* has been exceeded. If choices [1] to [5] are activated, the output relay will be deactivated.

Description of choice:

The output frequency of the adjustable frequency drive can be frozen at the present value, stop the motor, be frozen at parameter 213 *Jogging*

frequency, be frozen at parameter 202 *Output frequency, high limit f_{MAX}* or stop and activate a cut-out.

515-544 Data readout**Value:**

Par. no.	Description	Display text	Unit
515	Res. reference	(REFERENCE %)	%
516	Res. reference [Unit]	(REFERENCE [UNIT])	Hz, rpm
517	Feedback [Unit]	(FEEDBACK [UNIT])	Par. 416
518	Frequency	(FREQUENCY)	Hz
519	Frequency x scale	(FREQUENCY X SCALE)	Hz
520	Motor current	(MOTOR CURRENT)	Amp
521	Torque	(TORQUE)	%
522	Power[kW]	(POWER (KW))	kW
523	Power [HP]	(POWER (HP))	HP
524	Motor voltage	(MOTOR VOLTAGE)	V
525	DC-link voltage	(DC LINK VOLTAGE)	V
526	Thermal load motor	(MOTOR THERMAL)	%
527	Thermal load inverter	(INV. THERMAL)	%
528	Digital input	(DIGITAL INPUT)	Bin
529	Term. 53, analog input	(ANALOG INPUT 53)	V
531	Term. 60, analog input	(ANALOG INPUT 60)	mA
532	Term. 33, pulse input	(PULSE INPUT 33)	Hz
533	External ref.	(EXT. REF.%)	%
534	Status word, Hex	(STATUS WORD)	Hex
537	Inverter temperature	(INVERTER TEMP.)	°C
538	Alarm word	(ALARM WORD)	Hex
539	Control word	(CONTROL WORD)	Hex
540	Warning word	(WARN. WORD)	Hex
541	Extended status word	(EXT. STATUS WORD)	Hex
544	Pulse count	(PULSE COUNT)	
545	Term. 29, pulse input	(PULSE INPUT 29)	Hz

Function:

These parameters can be read out via the serial communication port and the LCP display. See also parameters 009-012 *Display readout*.

**NOTE!**

Parameters 515-541 can only be read out via the serial communication port.

Description of choice:

Resulting reference %, parameter 515:

Gives the resulting reference as a percentage in the range from Minimum reference, Ref_{MIN} to Maximum reference, Ref_{MAX}. See also *Dealing with references*.

Resulting reference [unit], parameter 516:

gives the resulting reference in Hz in open-loop (parameter 100). In a closed-loop, the reference unit is selected in parameter 416 *Process units*.

Feedback [unit], parameter 517:

Gives the resulting feedback value with the unit/scaling selected in parameters 414, 415 and 416. See also *dealing with feedback*.

Frequency [Hz], parameter 518:

Gives the output frequency from the adjustable frequency drive.

Frequency x scaling [-], parameter 519:

corresponds to the present output frequency f_M multiplied by the factor preset in parameter 008 *Display scaling of output frequency*.

Motor current [A], parameter 520:

Gives the motor's phase current measured as an effective value.

Torque [Nm], parameter 521:

Gives the motor's present load in relation to the motor's rated torque.

Power [kW], parameter 522:

Gives the present power absorbed by the motor in kW.

Power [HP], parameter 523:

Gives the present power absorbed by the motor in HP.

Motor voltage, parameter 524:

Gives the voltage being supplied to the motor.

DC link voltage, parameter 525:

Gives the intermediate circuit voltage in the adjustable frequency drive.

Thermal load, motor [%], parameter 526:

Gives the calculated/estimated thermal load on the motor. 100% is the cut-out limit. See also parameter 128 *Thermal motor protection*.

Thermal load INV [%], parameter 527:

Gives the calculated/estimated thermal load on the adjustable frequency drive. 100% is the cut-out limit.

Digital input, parameter 528:

Gives the signal status from the 5 digital inputs (18, 19, 27, 29 and 33).

Input 18 corresponds to the bit on the extreme left. '0' = no signal, '1' = connected signal.

Terminal 53 analog input [V], parameter 529:

Gives the voltage value for the signal on terminal 53.

Terminal 60 analog input [mA], parameter 531:

Gives the present value for the signal on terminal 60.

Pulse input 33 [Hz], parameter 532:

Gives a pulse frequency in Hz connected to terminal 33.

External reference, parameter 533:

Gives the sum of external references as a percentage (sum of analog/pulse/serial communication) in the range from the minimum reference, Ref_{MIN} to the maximum reference, Ref_{MAX}.

Status word, parameter 534:

Gives the present status word for the adjustable frequency drive in Hex. See *Serial communication for the VLT 2800*.

Inverter temperature, parameter 537:

Gives the present inverter temperature on the adjustable frequency drive. The cut-out limit is 194°–212°F [90°–100°C], with cut back in at 158° ± 9°F [70° ± 5°C].

Alarm word, parameter 538:

Indicates in Hex code which alarm is on the adjustable frequency drive. See *Warning word, extended status word and alarm word*.

Control word, parameter 539:

Gives the present control word on the adjustable frequency drive in Hex. See *Serial communication for the FCD 300*.

Warning word, parameter 540:

States whether there is a warning on the adjustable frequency drive in Hex. See *Warning word, extended status word and alarm word*.

Extended status word, parameter 541:

States whether there is a warning on the adjustable frequency drive in Hex code. See *Warning word, extended status word and alarm word*.

Pulse count, parameter 544:

This parameter can be read out via the LCP display (009–012). When you run with counter stop, this parameter enables you, either with or without reset, to read the number of pulses registered by the device. The highest frequency is 67.6 kHz, while the lowest is 5 Hz. The counter is reset when counter stop is restarted.

Pulse input 29 [Hz], parameter 545:

Gives a pulse frequency in Hz connected to terminal 29.

561	Protocol
Value:	
* FC protocol (FC PROTOKOL)	[0]
Metasys N2 (METASYS N2)	[1]
Modbus RTU	[3]
Function:	
There is a choice of three different protocols.	
Description of choice:	
Select the required control word protocol.	

For further information about using the Metasys N2 Protocol, see MG91CX; for Modbus RTU, see MG10SX.

570	Modbus parity and message framing
Value:	
(EVEN/1 STOPBIT)	[0]
(ODD/1 STOPBIT)	[1]
* (NO PARITY/1 STOPBIT)	[2]
(NO PARITY/2 STOPBIT)	[3]

Function:
This parameter sets up the drive's Modbus RTU interface to communicate properly with the master controller. The parity (EVEN, ODD, or NO PARITY) must be set to match the setting of the master controller.

Description of choice:
Select the parity that matches the setting for the Modbus master controller. Even or odd parity is sometimes used to allow a transmitted word to be checked for errors. Because Modbus RTU uses the more efficient CRC (Cyclic Redundancy Check) method of checking for errors, parity checking is seldom used in Modbus RTU networks.

571	Modbus communications timeout
Value:	
10–2000 ms	* 100 ms

Function:
This parameter determines the maximum amount of time that the drive's Modbus RTU will wait between characters that are sent by the master controller. When this amount of time expires, the drive's Modbus RTU interface will assume that it has received the entire message.

Description of choice:
Generally, the value of 100 ms is sufficient for Modbus RTU networks, although some Modbus RTU networks may operate on a timeout value as short as 35 ms.

If this value is set too short, the drive's Modbus RTU interface may miss a part of the message. Since the CRC check will not be valid, the drive will ignore the message. The resulting retransmissions of messages will slow communications on the network.

If this value is set too long, the drive will wait longer than necessary to determine that the message is completed. This will delay the drive's response to the message and possibly cause the master controller to time out. The resulting retransmissions of messages will slow communications on the network.

3.9 Parameter Group 6-** Technical Functions

600-605 Operating Data

Value:

Par. no.	Description	Display text	Unit	Range
600	Operating hours	(OPERATING HOURS)	Hours	0–130,000.0
601	Hours run	(RUNNING HOURS)	Hours	0–130,000.0
602	kWh counter	(KWH COUNTER)	kWh	Depends on unit
603	Number of power-ups	(POWER-UPS)	Number of times	0-9999
604	Number of overtemperatures	(OVERTEMPS)	Number of times	0-9999
605	Number of overvoltages	(OVERTOLTS)	Number of times	0-9999

Function:

These parameters can be read out via the serial communication port and the LCP control unit.

Description of choice:

Parameter 600, Operating hours:

Gives the number of hours the adjustable frequency drive has been operating. The value is saved every hour and when there is a line failure. This value cannot be reset.

Parameter 601, Hours run:

Gives the number of hours the motor has been operating since the reset in parameter 619 *Reset of hours-run counter*. The value is saved every hour and when there is a line failure.

Parameter 602, kWh counter:

Gives the adjustable frequency drive's output energy in kWh. The calculation is based on the mean kW value over one hour. This value can be reset using parameter 618 *Reset of kWh counter*.

Range: 0 - depends on unit.

Parameter 603, Number of power-ups:

Gives the number of power-ups of the supply voltage undertaken on the adjustable frequency drive.

Parameter 604, Number of overtemperatures:

gives the number of overtemperature faults that have been registered on the adjustable frequency drive's heatsink.

Parameter 605, Number of overvoltages:

gives the number of overvoltages of the intermediate circuit voltage in the adjustable frequency drive. This is only counted when Alarm 7 *Over-voltage* is active.



NOTE!

Parameters 615-617 *Fault log* cannot be read out via the integral control unit.

615 Fault log: Error code

Value:

[Index 1 - 10] Error code: 0 - 99

Function:

In this parameter it is possible to see the reason for a trip (cut-out of the variable frequency drive) occurring. 10 [1-10] log values are defined.

The lowest log number [1] contains the latest/most recently saved data value. The highest log number [10] contains the oldest data value saved.

If a trip occurs, it is possible to see the cause, time and a possible value of the output current or output voltage.

Description of choice:

Given as a fault code, in which the number refers to a table. See the table in *Warnings/alarm messages*.

616 Fault log: Time

Value:

[Index 1 - 10] Hours: 0–130,000.0

Function:

In this parameter, it is possible to see the total number of operating hours in connection with the last 10 trips.

10 [1-10] log values are denoted. The lowest log number [1] contains the latest/most recently saved data value, and the highest log number [10] contains the oldest data value.

Description of choice:

Read out as one value.

617 Fault log: Value

Value:

[Index 1 - 10] Value: 0 - 9999

Function:

In this parameter it is possible to see at which value a trip occurred. The unit of the value depends on which alarm is active in parameter 615 *Fault log: Fault code*.

Description of choice:

Read out as one value.

618 Reset of kWh counter

Value:

- * No reset (DO NOT RESET) [0]
- Reset (RESET COUNTER) [1]

Function:

Resetting parameter 602 *kWh counter* to zero.

Description of choice:

If *Reset [1]* is selected and you press the [OK] key, the variable frequency drive's kWh counter is reset to zero. This parameter cannot be selected via serial communication.



NOTE!

When the [OK] key is activated, the counter is reset to zero.

619 RESET RUNNING HOURS COUNTER

Value:

- * No reset (DO NOT RESET) [0]
- Reset (RESET COUNTER) [1]

Function:

Resetting of parameter 601 *Hours run* to zero.

Description of choice:

If *Reset*[1] is selected and you press the [OK] key, the variable frequency drive's parameter 601 is reset to zero *Hours run*. This parameter cannot be selected via serial communication.



NOTE!

When the [OK] key is activated the parameter is reset to zero.

620 Operation Mode

Value:

- * Normal operation (NORMAL OPERATION) [0]
- Control card test (CONTROL CARD TEST) [2]
- Initialize (INITIALIZE) [3]

Function:

In addition to its normal function, this parameter can be used to test the control card.

There is also the opportunity to perform an initialization at the factory setting for all parameters in all setups, with the exception of parameters 500 *Address*, 501 *Baud rate*, 600-605 *Operating data* and 615-617 *Fault log*.

Description of choice:

Normal function [0] is used for normal operation of the motor. Control card test [2] is selected if you wish to check the control card's analog/digital inputs, analog/digital outputs, relay outputs and 10 V and 24 V voltages.

The test is performed as follows:

- 18 - 19 - 27 - 29 - 33 - 46 are connected.
- 20 - 55 are connected.
- 42 - 60 are connected.
- 01 - 50 are connected.
- 02 - 53 are connected.
- 03 - 31B are connected.

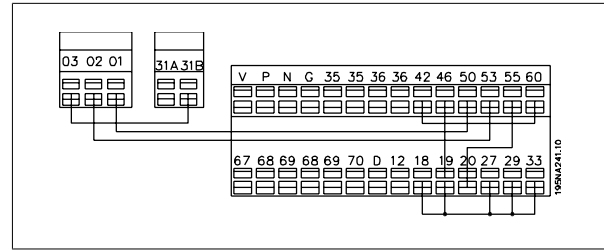

Use the following procedure for the control card test:

1. Select control card test.
2. Disconnect the AC line voltage and wait until the light in the display has disappeared.
3. Mount according to drawing and description.
4. Connect the AC line voltage.
5. The adjustable frequency drive automatically undertakes a test of the control card.

If the LEDs are flashing a code (4 LEDs alternatively), the control card test has failed (see the section *Internal faults* for further details). Change the control card to start up the adjustable frequency drive.

If the adjustable frequency drive comes into normal/display mode, the test is OK. Remove the test connector and the adjustable frequency drive is ready for operation. Parameter 620 *Operating mode* is automatically set to *Normal operation* [0].

Initialization [3] is selected if you wish to use the unit's factory setting.

Procedure for initialization:

1. Select *Initialization* [3].
2. Disconnect the AC line voltage and wait until the light in the display has disappeared.
3. Connect the AC line voltage.
4. An initialization is performed in all parameters in all setups, with the exception of parameters 500 *Address*, 501 *Baud rate*, 600-605 *Operating data* and 615-617 *Fault log*.

621-642 Unit Information

Par. no	Description	Display text
621	Unit type	(DRIVE TYPE)
624	Software version	(SOFTWARE VERSION)
625	LCP identification no.	(LCP VERSION)
626	Database identification no.	(DATABASE VER.)
627	Power parts version	(POWER UNIT DB ID)
628	Application option type	(APP. OPTION)
630	Communication option type	(COM. OPTION)
632	BMC software identification	(BMC SOFTWARE ID)
634	Unit identification for communication	(UNIT ID)
635	Software parts no.	(SW. PART NO.)
640	Software version	(SOFTWARE VERSION)
641	BMC software identification	(BMC2 SW)
642	Power card identification	(POWER ID)

Function:

The unit's main data can be read out from parameters 621 to 635 *Nameplate* using the LCP control unit or serial communication. Parameters 640-642 can also be seen on the unit's integral display.

Description of choice:

Parameter 621 Nameplate: Unit type:

Gives unit size and AC line voltage.

Example: FCD 311 380–480 V.

Parameter 624 Nameplate: Software version no.

The unit's present software version number appears here.

Example: V 1.00

Parameter 625 Nameplate: LCP ID number:

The ID number of the unit's LCP appears here.

Example: ID 1.42 2 kB

Parameter 626 Nameplate: Database ID number:

The ID number of the software's database appears here.

Example: ID 1.14.

Parameter 627 Nameplate: Power section version:

The ID number of the unit's power section appears here.

Example: ID 1.15.

Parameter 628 Nameplate: Application option type:

Here you can see which types of application options are installed in the adjustable frequency drive.

Parameter 630 Nameplate: Communication option type:

Here you can see which types of communication options are installed in the adjustable frequency drive.

Parameter 632 Nameplate: BMC software identification:

The ID number of the BMC software appears here.

Parameter 634 Nameplate: Unit identification for communication:

The ID number for communication appears here.

Parameter 635 Nameplate: Software section no.:

The software section number appears here.

Parameter 640 Nameplate: Software version:

The unit's present software version number appears here. Example: 1.00

Parameter 641 Nameplate: BMC software identification:

The ID number of the BMC software appears here.

Parameter 642 Nameplate: Power card identification:

The ID number of the unit's power part appears here. Example: 1.15

678 Configure Control Card**Value:**

Standard version (STANDARD VERSION)	[1]
Profibus 3 Mbaud Version (PROFIBUS 3 MB VER.)	[2]
Profibus 12 Mbaud Version (PROFIBUS 12 MB VER.)	[3]

Function:

This parameter enables a configuration of a Profibus control card. The default value depends on the produced unit, which is also the maximum obtainable value. This means that a control card can only be downgraded to a lower performance version.

4 All about FCD 300

4.1 Service

4.1.1 Diagnostics

The actual status can be read on the outside of the FCD products. Five LEDs signal the actual status of the unit with the meaning described in the table.

Further detailed status information can be obtained using a local control panel (LCP2 – see photo). This can be connected on the outside (without opening the enclosure) if the LCP2 plug shown on the drawing is installed. The LCP2 is an easy-to-navigate user-friendly interface used to access and adjust all parameters. It displays parameters in six different languages.

The FCD 300 holds a log with valuable information on failure. Information on the most recent 10 faults is stored and indexed in three different parameters to help diagnosis.

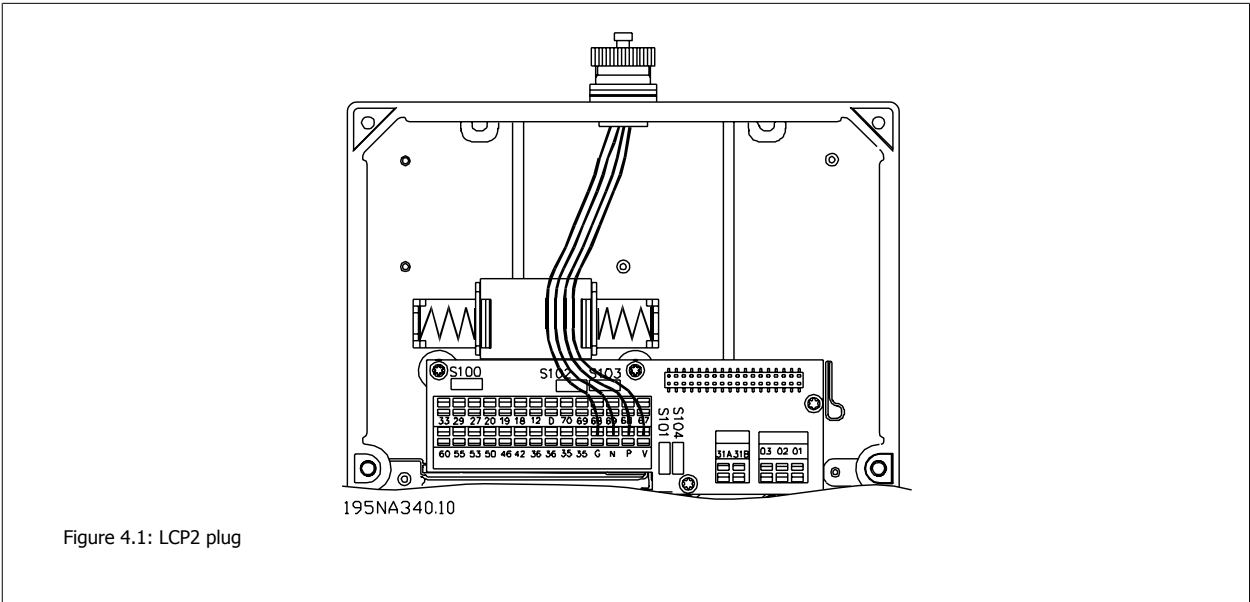

Parameter 616 stores the time of the fault as measured by the internal clock.

Parameter 617 holds a fault code telling the type of fault detected.

Parameter 618 stores a measurement relevant for the case. Typically the intermediate circuit voltage or output current measured immediately before failure.



No	Name	Color	OK status	Alternatives	Function
1	Status	Yellow	Off	Off	Status of the FCD is OK
				On	Corresponding to parameter setting. For further information, see <i>Design Guide</i> - parameter number 26 and DeviceNet manual for specific DeviceNet signaling
2	Bus	Green	On (If bus option is present, else Off)	On	OK status for the serial communication bus used (Not relevant for non-serial communication bus device)
				Slow flashing	Local operation or local stop
				Fast flashing	Interface working, but no communication with master (See serial communication bus manual for specific info) (Not relevant for non-serial communication bus device)
				Off	Status for the serial communication bus <i>not</i> OK (not relevant for non-serial communication bus device)
3	Alarm	Red	Off	Off	No alarm is present
				Flashing	Flashing while trip/trip lock is present
4	Warning	Yellow	Off	Off	No warning is present
				Flashing	Flashing while warning situation is present
5	On	Green	On	On	The unit is supplied by line power or 24 V DC
				Off	Line power or 24 V DC is missing

Table 4.1: LED diagnostics on decentralized FCD 300

4.1.2 Warnings/Alarm Messages

A warning or an alarm will appear in the LEDs on the LCP2. A warning will be shown until the fault has been corrected, while an alarm will continue to flash until the [STOP/RESET] key is activated. The table shows the various warnings and alarms shown in the LCP2, and whether the fault locks the adjustable frequency drive. After a *Trip locked* (alarm and warning LEDs flash at the same time), the line power supply is cut off and the fault is corrected. The line power supply is reconnected and the adjustable frequency drive is reset. The adjustable frequency drive is now ready. A *Trip* can be reset manually in three ways:

1. Via the operating key [STOP/RESET].
2. Via a digital input.
3. Via serial communication.

It is also possible to choose an automatic reset in parameter 405 *Reset function*. When a cross appears in both warning and alarm, this can mean that a warning comes before an alarm. It can also mean that it is possible for the user to program whether a warning or an alarm will appear for a given fault. For example, this is possible in parameter 128 *Motor thermal protection*. After a trip, the motor will coast, and alarm and warning will blink on the adjustable frequency drive; but if the fault disappears, only the alarm will blink. After a reset, the adjustable frequency drive will be ready to start operation again.



No.	Description	Warning	Alarm	Trip locked
2	Live zero error (LIVE ZERO ERROR)	X	X	X
4	Mains phase loss (MAINS PHASE LOSS)	X	X	X
5	Voltage warning high (DC LINK VOLTAGE HIGH)	X		
6	Voltage warning low (DC LINK VOLTAGE LOW)	X		
7	Overvoltage (DC LINK OVERVOLT)	X	X	X
8	Undervoltage (DC LINK UNDERVOLT)	X	X	X
9	Inverter overload (INVERTER TIME)	X	X	
10	Motor overloaded (MOTOR, TIME)	X	X	
11	Motor thermistor (MOTOR THERMISTOR)	X	X	
12	Current limit (CURRENT LIMIT)	X	X	
13	Overcurrent (OVERCURRENT)	X	X	X
14	Ground fault (GROUND FAULT)		X	X
15	Switch mode fault (SWITCH MODE FAULT)		X	X
16	Short-circuit (CURR. SHORT CIRCUIT)		X	X
17	Serial communication timeout (STD BUS TIMEOUT)	X	X	
18	HPFB bus timeout (HPFB TIMEOUT)	X	X	
33	Out of frequency ranges (OUT FREQ RNG/ROT LIM)	X		
34	HPFB communication fault (PROFIBUS OPT. FAULT)	X	X	
35	Inrush fault (INRUSH FAULT)		X	X
36	Overtemperature (OVERTEMPERATURE)	X	X	
37-45	Internal fault (INTERNAL FAULT)		X	X
50	AMT not possible		X	
51	AMT fault re. nameplate data (AMT TYPE.DATA FAULT)		X	
54	AMT wrong motor (AMT WRONG MOTOR)		X	
55	AMT timeout (AMT TIMEOUT)		X	
56	AMT warning during AMT (AMT WARN. DURING AMT)		X	
99	Locked (LOCKED)	X		

LED indication	
Warning	yellow
Alarm	red
Trip locked	yellow and red

WARNING/ALARM 2: Live zero fault

The voltage or current signal on terminal 53 or 60 is below 50% of the preset value in parameter 309 or 315 *Terminal, min. scaling*.

WARNING/ALARM 4: Mains phase fault

No phase on the line power supply side. Check the supply voltage to the adjustable frequency drive. This fault is only active in 3-phase line power supply. The alarm can only occur when the load is pulsing. In this instance, the pulses must be dampened by using an inertia disc, for example.

WARNING 5: Voltage warning high

If the intermediate circuit voltage (UDC) is higher than *Voltage warning high*, the adjustable frequency drive will give a warning, and the motor will continue to run unchanged. If the UDC remains above the voltage warning limit, the inverter will trip after a set time. The time depends on the device and is set at 5-10 sec. Note: The adjustable frequency drive will trip with an alarm 7 (overvoltage). A voltage warning can occur when the connected AC line voltage is too high. Check whether the supply voltage is suitable for the adjustable frequency drive, see *Technical data*. A voltage warning can also occur if the motor frequency is reduced too quickly due to ramp down time being too short.

WARNING 6: Voltage warning low

If the intermediate circuit voltage (UDC) is lower than *Voltage warning low*, the adjustable frequency drive will give a warning, and the motor will continue to run unchanged. If the UDC remains below the voltage warning limit, the inverter will trip after a set time. The time depends on the device and is set at 2–25 sec. Note: The adjustable frequency drive will trip with an alarm 5 (undervoltage). A voltage warning can occur when the connected AC line voltage is too low. Check whether the supply voltage is suitable for the adjustable frequency drive, see *Technical data*. When the adjustable frequency drive is switched off, a brief warning 6 (and warning 8) appears.

WARNING/ALARM 7: Overvoltage

If the intermediate voltage (UDC) goes over the inverter's *Overvoltage limit*, the inverter will be switched off until the UDC has once more fallen below the overvoltage limit. If the UDC remains above the overvoltage limit, the inverter will trip after a set time. The time depends on the device and is set at 5-10 sec. An overvoltage in the UDC can occur when the motor frequency is reduced too quickly due to ramp-down time being too short. Note: *Voltage warning high* (warning 5) will thus also be able to generate an alarm 7.

WARNING/ALARM 8: Undervoltage

If the intermediate circuit voltage (UDC) is lower than the inverter's *Undervoltage limit*, the inverter will be switched off until the UDC once more goes above the undervoltage limit. If the UDC remains under the *undervoltage limit*, the inverter will trip after a set time. The time depends on the device and is set at 2-15 sec. An undervoltage can occur when the connected AC line voltage is too low. Check whether the supply voltage is suitable for the adjustable frequency drive, see *Technical data*. When the adjustable frequency drive is switched off a warning 8 (and warning 6) is displayed briefly. Note: *Voltage warning low* (warning 6) will thus also be able to generate an alarm 8.

Alarm/warning limits:		
	Without brake	With brake
FCD 300	3 x 380–480 V [VDC]	3 x 380–480 V [VDC]
Undervoltage	410	410
Voltage warning low	440	440
Voltage warning high	765	800
Overvoltage	820	820

WARNING/ALARM 9: Inverter overload

Electronic thermal inverter protection indicates that the adjustable frequency drive is close to tripping due to overloading (output current too high for too long). The counter for electronic thermal inverter protection gives a warning at 98% and trips at 100%, and it is accompanied by an alarm. The adjustable frequency drive cannot be reset until the counter drops below 90%. This fault arises because the adjustable frequency drive has been overloaded for too long.

WARNING/ALARM 10: Motor overloaded

According to the electronic thermal inverter protection, the motor is too hot. In parameter 128, the user can select whether the VLT adjustable frequency drive should emit a warning or an alarm when the counter reaches 100%. This fault is due to the motor being overloaded by more than 100% for too long. Make sure that motor parameters 102–106 are set correctly.

WARNING/ALARM 11: Motor thermistor

The motor is too hot or the thermistor/thermistor connection has been disconnected. In parameter 128, *Thermal motor protection*, the user can select whether the frequency transformer emits a warning or an alarm. Make sure that the PTC thermistor is connected correctly between terminals 31a and 31b.

WARNING/ALARM 12: Current limit

The output current is greater than the value in parameter 221 *Current Limit LIM*, and the adjustable frequency drive will trip after the amount of time selected in parameter 409 *Trip delay overcurrent*.

WARNING/ALARM 13: Overcurrent

The inverter's peak current limit (approximately 200% of rated output current) has been exceeded. The warning will last approximately 1-2 sec, and the adjustable frequency drive will then trip and emit an alarm. Switch off the adjustable frequency drive and check whether the motor shaft can be turned and whether the size of the motor is suitable for the adjustable frequency drive.

ALARM 14: Ground fault

There is a discharge from the output phases to ground, either in the cable between the adjustable frequency drive and the motor, or in the motor. Turn off the adjustable frequency drive and remove the ground fault.

ALARM 15: Switch mode fault

Fault in switch mode power supply (internal supply). Contact your Danfoss supplier.

ALARM 16: Short-circuit

There is a short-circuit on the motor terminals or in the motor. Disconnect the line power supply to the adjustable frequency drive and remove the short-circuit.

WARNING/ALARM 17: Serial communication timeout

There is no serial communication to the adjustable frequency drive. The warning will only be active when 514 *Bus timeout function* is set to a value other than OFF. If parameter 514, *Bus timeout function*, is set to *Stop and trip* [5], it will first give a warning and then ramp down and trip out accompanied by an alarm. Parameter 513 *Bus timeout* can be increased, if required.

WARNING/ALARM 18: HPFB bus timeout

There is no serial communication to the adjustable frequency drive's communication option card. This warning will only be active when parameter 804 *Bus timeout function* is set to a value other than OFF. If parameter 804 *Bus timeout function* is set to *Stop and trip*, it will first give a warning and then ramp down and trip out accompanied by an alarm. Parameter 803 *Bus timeout* can be increased, if required.

WARNING 33: Out of frequency ranges

This warning is active if the output frequency has reached *Output frequency low limit* (parameter 201) or *Output frequency high limit* (parameter 202). If the VLT adjustable frequency drive is in *Process regulation, closed-loop* (parameter 100), the warning will be active in the display. If the VLT adjustable frequency drive is in another mode than *Process regulation, closed-loop*, bit 008000 *Out of frequency ranges* in extended status word will be active, but there will not be a warning in the display.

WARNING/ALARM 34: HPFB communication fault

Communication fault only occurs in Profibus versions.

ALARM 35: Inrush fault

This alarm occurs when the adjustable frequency drive has been connected to the line power supply too many times within 1 minute.

WARNING/ALARM 36: Overtemperature

If the internal temperature rises above 167°–185°F [75°–85°C] (depending on the device), the adjustable frequency drive will emit a warning, and the motor will continue to run unchanged. If the temperature continues to rise, the switch frequency is reduced automatically. See *Temperature-dependent switching frequency*.

If the internal temperature of the heatsink rises above 197–212°F [92–100°C] (depending on the unit), the adjustable frequency drive will cut out. The temperature fault cannot be reset until the temperature of the internal heatsink has dropped to below 158°F [70°C]. The tolerance is ± 9°F [± 5°C]. The temperature increase can be caused by the following:

- Ambient temperature too high.
- Motor cable too long.
- AC line voltage too high.

ALARM 37–45: Internal fault

Internal faults 0–8 will be indicated in the LEDs' Alarm, Warning, Bus, Status as a flashing code.

Alarm 37, internal fault number 0: Communication fault between control card and BMC2.

Alarm 38, internal fault number 1: Flash EEPROM fault on control card.

Alarm 39, internal fault number 2: RAM fault on control card

Alarm 40, internal fault number 3: Calibration constant in EEPROM.

Alarm 41, internal fault number 4: Data values in EEPROM.

Alarm 42, internal fault number 5: Fault in motor parameter database.

Alarm 43, internal fault number 6: General power card fault.

Alarm 44, internal fault number 7: Minimum software version of control card or BMC2

Alarm 45, internal fault number 8: I/O fault (digital input/output, relay or analog input/output)

NOTE!
When restarting after an alarm 38-45, the VLT adjustable frequency drive will display an alarm 37. In parameter 615, the actual alarm code can be read.

ALARM 50: AMT not possible

One of the following three possibilities can occur:

- The calculated R_s value falls outside permitted limits.
- The motor current in at least one of the motor phases is too low.
- The motor in use is probably too small for AMT calculations to be performed.

ALARM 51: AMT Fault re. nameplate data

There is inconsistency between the registered motor data. Check the motor data for the relevant setup.

ALARM 54: AMT incorrect motor

AMT cannot be performed on the motor being used.

ALARM 55: AMT timeout

Calculations are taking too long possibly due to noise on the motor cables.

ALARM 56: AMT warning during AMT

An adjustable frequency drive warning is given while AMT is being performed.

WARNING 99: Locked

See parameter 18.

4.1.3 Warning Words, Extended Status Words and Alarm Words

Warning words, status words and alarm words appear in the display in Hex format. If there are several warnings, status words or alarms, a total of all the warnings, status words or alarms will be displayed. Warning words, status words and alarm words can also be read out using the serial bus in parameters 540, 541 and 538 respectively.

Bit (Hex)	Warning words
000008	HPFB bus timeout
000010	Standard bus timeout
000040	Current limit
000080	Motor thermistor
000100	Motor overload
000200	Inverter overload
000400	Undervolt
000800	Overvolt
001000	Voltage warning low
002000	Voltage warning high
004000	Phase loss
010000	Live zero error
400000	Out of frequency ranges
800000	Profibus communication fault
40000000	Switch mode warning
80000000	Heatsink temperature high

Bit (Hex)	Extended status words
000001	Ramping
000002	AMT running
000004	Start forw./reverse
000008	Slow-down
000010	Catch up
000020	Feedback high
000040	Feedback low
000080	Output current high
000100	Output current low
000200	Output frequency high
000400	Output frequency low
002000	Braking
008000	Out of frequency ranges

Bit (Hex)	Alarm words
000002	Triplock
000004	AMT tuning fail
000040	HPFP bus timeout
000080	Standard bus timeout
000100	Curr. short circuit
000200	Switch mode fault
000400	Ground fault
000800	Overcurrent
002000	Motor thermistor
004000	Motor overload
008000	Inverter overload
010000	Undervolt
020000	Overvolt
040000	Phase loss
080000	Live zero error
100000	Heatsink temperature too high
2000000	Profibus communication fault
8000000	Inrush fault
10000000	Internal fault

4.1.4 Spare Parts

The complete electronic part can be used as a spare part. The following four parts can replace all FCD 303-330 with and without Profibus. For servicing DeviceNet and AS-interface units, an additional control card is required to upgrade the electronic spare part.

FCD 303	178B1484
FCD 307	178B1485
FCD 315	178B1486
FCD 330	178B2301

The parts can be downsized one size simply by selecting the correct motor size, and the Profibus functionality can be changed/eliminated in Parameter 678.

The control card can also be replaced for repair of the electronic part.

Profibus, 12 MB control card	175N2338
DeviceNet control card	175N2325
AS-interface control card	175N2324

For servicing the installation box a kit containing various parts, plugs, and terminal PCB can be ordered 175N2121.

Service tool kit 175N2404

It is normally not possible to operate the FCD300 with an open lid. Using the service tool kit, the electronic part and the installation box can be connected without joining them. This might be helpful if measurements on input/output terminals are required during servicing.

4.2.1 Aggressive Environments

As the FCD 300 is enclosed up to IP66, it is well suited for use in moderate aggressive environments.

4.2.2 Cleaning

The enclosure (IP66/NEMA type 4x indoor) will offer protection against dirt and water ingress, and is designed to be suitable for the cleaning required in food and beverage plants at the concentrations of cleaning solvent recommended by the manufacturer. High pressure cleaning at a very short distance or for an extended period of time with hot water may damage gaskets and labels. For exceptions, see section *Brake resistors*.

4.3.1 Derating for Running at Low Speed

When a motor is connected to an adjustable frequency drive, it is necessary to ensure adequate cooling of the motor. At low rpm values, the motor fan is not able to supply an adequate volume of cooling air. This problem occurs when the load torque is constant (e.g., with a conveyor belt) across the full regulating range. The reduced amount of ventilation determines the permissible torque in continuous operation. If the motor is to run continuously at an rpm lower than half the rated value, extra cooling air must be supplied to the motor. Instead of providing extra cooling, it is possible to reduce the motor load ratio. This can be done by selecting a larger motor. However, the design of the adjustable frequency drive puts limits on the size of motors that can be connected to the adjustable frequency drive.

4.3.2 Derating for Ambient Temperature

The ambient temperature ($T_{AMB,MAX}$) is the maximum temperature allowed. The average ($T_{AMB,AVG}$) measured over 24 hours, must be at least 41°F [5°C] lower. If the adjustable frequency drive operates at temperatures above 104°F [40°C], a derating of the rated output current is necessary.

FCD 303-305 50°F [+10°C]

FCD 307 41°F [+5°C]

FCD 335 23°F [-5°C]

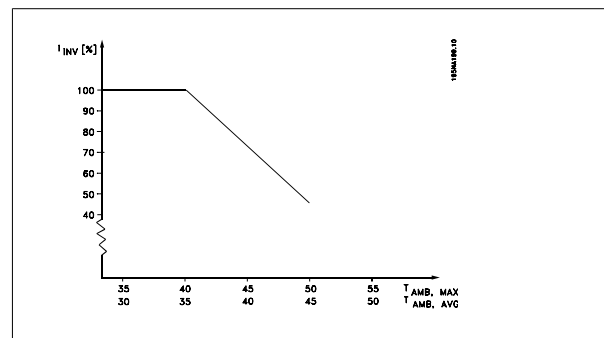

4.3.3 Galvanic Isolation (PELV)

PELV (Protective Extra Low Voltage) isolation is achieved by inserting galvanic isolators between the control circuits and circuits that are connected to the line power potential. These separators are designed to meet the requirements for increased separation by means of having the necessary creepage and air clearance. These requirements are described in standard EN 50 178. It is also a requirement that installation is carried out as described in local/national PELV regulations.

All control terminals, terminals for serial communication and relay terminals are safely separated from the line power potential, which is to say that they comply with the PELV requirements. Circuits that are connected to control terminals 12, 18, 19, 20, 27, 29, 33, 42, 46, 50, 53, 55 and 60 are galvanically connected to one another. If switch S100 is opened the potentials of the group 18, 19, 20, 27, 29, 33 are separated from all other input/output. In that case, terminal 12 cannot be used for supply for the digital inputs on these terminals.

Serial communication connected to terminals 67–70 is galvanically isolated from the control terminals, although this is only a functional isolation.

The relay contacts on terminals 1–3 are isolated from the other control circuits with increased isolation, i.e., PELV is observed for these, even though there is line power potential in the relay terminals.

The circuit elements described below form the safe electric separation. They fulfill the requirements for increased isolation and associated testing pursuant to EN 50 178.

1. Transformer and optical separation in voltage supply.
2. Optical isolation between basic motor control and control card
3. Isolation between the control card and the power part.
4. Relay contacts and terminals relating to other circuits on the control card.

PELV isolation of the control card is guaranteed under the following condition:

- There may be max. 300 V between phase and ground.

A motor thermistor connected to terminals 31a-31b must be double isolated to obtain PELV. Danfoss Bauer provides double isolated thermistors.

See also the section *Diagram* in the Design Guide.

4.3.4 Derating for Air Pressure

4

Below 3280 ft. [1000 m], derating is not necessary.

Above 3280 ft. [1000 m], the ambient temperature (T_{AMB}) or max. output current (I_{MAX}) must be derated in accordance with the diagram below:

1. Derating of output current versus altitude at $T_{AMB} = \text{max. } 104^{\circ}\text{F}$ [40°C].
2. Derating of max. T_{AMB} versus altitude at 100% output current.

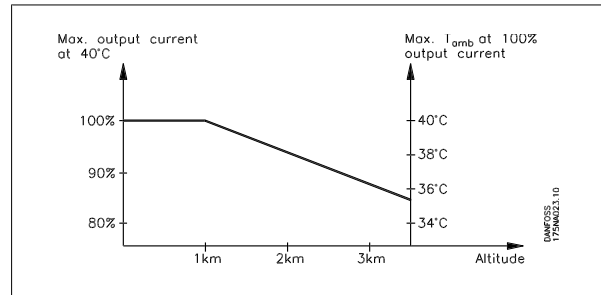

4.3.5 Emission Test Results according to Generic Standards and PDS Product Standard

The following test results are achieved on a system consisting of a FCD 300 400 V shielded/armored control cable, control box with potentiometer, shielded/armored motor cable, shielded/armored brake cable as well as LCP with cable.

VLT FCD 300 with class 1A RFI filter	Product standard/environment	Basic standard
Complies	EN 50081-2/Industry	EN55011 group 1 class A
Complies	EN 61800-3/First environment restricted distribution	CISPR 11 group 1 class A
Complies	EN 61800-3/Second environment unrestricted distribution	CISPR 11 group 2 class A

FCD 303-315	10 m shielded/armored motor cable
FCD 322-335	16.5 ft [5 m] shielded/armored motor cable ¹

¹ For 33 ft [10 m] cable, please contact Danfoss.



NOTE!

FCD 300 with a class 1A RFI filter is a product of the restricted sales distribution class according to IEC 61800-3. In a domestic environment, this product may cause radio interference; if this occurs, the user may be required to take adequate measures.

4.4 General Technical Data

Line power supply (L1, L2, L3):

Supply voltage	3 x 380/400/415/440/480 V ±10%
Supply frequency	50/60 Hz
Max. imbalance on supply voltage	± 2.0% of rated supply voltage
Power factor (400 V) / cos. Φ_1	0.90 / 1.0 at rated load
Number of connections at supply input L1, L2, L3	2 times/min.
Max. short-circuit value fuses	100,000 A
Max. short-circuit value circuit breakers	10,000 A

See Special Conditions section in the Design Guide

Output data (U, V, W):

Output voltage	0–100% of supply voltage
Output frequency	0.2–132 Hz, 1–1000 Hz
Rated motor voltage, 380–480 V units	380/400/415/440/460/480 V
Rated motor frequency	50/60 Hz
Switching on output	Unlimited
Ramp times	0.02–3600 sec.

Torque characteristics:

Starting torque (parameter 101 Torque characteristic = Continuous torque)	160% in 1 min.*
Starting torque (parameter 101 Torque characteristics = Variable torque)	160% in 1 min.*
Starting torque (parameter 119 <i>High starting torque</i>)	180% for 0.5 sec.*
Overload torque (parameter 101 Torque characteristic = Continuous torque)	160%*
Overload torque (parameter 101 Torque characteristic = Variable torque)	160%*

**Percentage relates to adjustable frequency drive's nominal current.*

Control card, digital inputs:

Number of programmable digital inputs	5
Terminal number	18, 19, 27, 29, 33
Voltage level	0–24 V DC (PNP positive logic)
Voltage level, logic '0'	< 5 V DC
Voltage level, logic '1'	> 10 V DC
Maximum voltage on input	28 V DC
Input resistance, R_i (terminals 18, 19, 27)	approx. 4 k Ω
Input resistance, R_i (terminal 29, 33)	approximately 2 k Ω

All digital inputs are galvanically isolated from the supply voltage (PELV) and other high-voltage terminals, and can be functionally separated from other control terminals by opening switch S100. See section entitled Galvanic Isolation.

Control card, analog inputs:

Number of analog voltage inputs	1 pcs.
Terminal number	53
Voltage level	0 - ± 10 V DC (scaleable)
Input resistance, R_i	approx. 10 k Ω
Max. voltage	20 V
Number of analog current inputs	1 pcs.
Terminal number	60
Current level	0/4–20 mA (scaleable)
Input resistance, R_i	approx. 300 Ω
Max. current	30 mA

Resolution for analog inputs	10 bit
Accuracy of analog inputs	Max. error 1% of full scale
Scan interval	13.3 msec

The analog inputs are galvanically isolated from the supply voltage (PELV) and other high-voltage terminals. See section entitled Galvanic Isolation.

Control card, pulse inputs:

Number of programmable pulse inputs	2
Terminal number	29, 33
Max. frequency at terminal 29/33	110 kHz (Push-pull)
Max. frequency at terminal 29/33	5 kHz (open collector)
Min. frequency at terminal 33	4 Hz
Min. frequency at terminal 29	30 Hz
Voltage level	0–24 V DC (PNP positive logic)
Voltage level, logic '0'	< 5 V DC
Voltage level, logic '1'	> 10 V DC
Maximum voltage on input	28 V DC
Input resistance, R _i	approximately 2 kΩ
Scan interval	13.3 msec
Resolution	10 bit
Accuracy (100 Hz–1 kHz) terminal 33	Max. error: 0.5% of full scale
Accuracy (1–67.6 kHz) terminal 33	Max. error: 0.1% of full scale

The pulse input is galvanically isolated from the supply voltage (PELV) and other high-voltage terminals. See section entitled Galvanic Isolation.

Control card, digital/frequency outputs:

Number of programmable digital/pulse outputs	1
Terminal number	46
Voltage level at digital/frequency output	0–24 V DC (O.C PNP)
Max. output current at digital/frequency output	25 mA.
Max. load at digital/frequency output	1 kΩ
Max. capacity at frequency output	10 nF
Minimum output frequency at frequency output	16 Hz
Maximum output frequency at frequency output	10 kHz
Accuracy on frequency output	Max. error: 0.2% of full scale
Resolution on frequency output	10 bit

The digital output is galvanically isolated from the supply voltage (PELV) and other high-voltage terminals. See section entitled Galvanic Isolation.

Control card, analog output:

Number of programmable analog outputs	1
Terminal number	42
Current range at analog output	0/4 - 20 mA
Max. load to common at analog output	500 Ω
Accuracy on analog output	Max. error: 1.5 % of full scale
Resolution on analog output	10 bit

The analog output is galvanically isolated from the supply voltage (PELV) and other high-voltage terminals. See section entitled Galvanic Isolation.

Control card, 24 V DC output:

Terminal number	12
Max. load supplied from AC lines / 24 V external	240/65 mA

The 24 V DC supply is galvanically isolated from the supply voltage (PELV), but has the same potential as the analog and digital inputs and outputs. See section entitled Galvanic Isolation.

Control card, 10 V DC output:

Terminal number	50
Output voltage	10.5 V ±0.5 V
Max. load	15 mA

The 10 V DC supply is galvanically isolated from the supply voltage (PELV) and other high-voltage terminals. See section entitled Galvanic Isolation.

Control card, RS 485 serial communication:

Terminal number	68 (TX+, RX+), 69 (TX-, RX-)
Terminal number 67	+ 5 V
Terminal number 70	Common for terminals 67, 68 and 69

Full galvanic isolation. See section entitled Galvanic Isolation.

Relay outputs:¹⁾

Number of programmable relay outputs	1
Terminal number, control card (resistive and inductive load)	1-3 (break), 1-2 (make)
Max. terminal load (AC1) on 1-3, 1-2, control card	250 V AC, 2 A, 500 VA
Max. terminal load (DC1 (IEC 947)) on 1-3, 1-2, control card	25 V DC, 2 A / 50 V DC, 1A, 50W
Min. terminal load (AC/DC) on 1-3, 1-2, control card	24 V DC 10 mA, 24 V AC 100 mA

The relay contact is separated from the rest of the circuit by strengthened isolation.

Note: Rated values resistive load - cosphi >0.8 for up to 300,000 operations.
Inductive loads at cosphi 0.25 approximately 50% load or 50% life time.

External 24 Volt DC supply:

Terminal nos	35, 36
Voltage range	21-28 V (max. 37 V DC for 10 sec.)
Max. voltage ripple	2 V DC
Power consumption with/without power supply	<1W/5-12W

Reliable galvanic isolation: Full galvanic isolation if the external 24 V DC supply is also of the PELV type.

Sensor supply (T63, T73):

Terminal nos	201, 202, 203, 204
--------------	--------------------

Cable lengths and cross sections:

Max. motor cable length, shielded/armoured cable	30 ft (10 m)
Max. motor cable length, unshielded/unarmoured cable	30 ft (10 m)

Max. cross section to motor, see next section.

Max. cross section to control wires, rigid wire	0.15 in ² /10 AWG
Max. cross section to control cables, flexible cable	0.1 in ² /12 AWG
Max. cross section to control cables, cable with ferrules	0.1 in ² /12 AWG
Max. cross section extra terminals for 24 V ext, T73 version, rigid cables	0.25 in ² /9 AWG
Max. cross section extra terminals for 24 V ext, T73 version, flexible cable	0.1 in ² /10 AWG
Max. cross section extra terminals for 24 V ext, T73 version, cable with ferrules	0.1 in ² /10AWG
Max. cross section PE	0.4 in ² /7 AWG
Max. cross section external PE for T73 version	0.625 in ² / 5 AWG

If UL/cUL is to be complied with, cable with temperature class 140/165°F (60/75°C) must be used. Use copper wires only.

When complying with EN 55011 1A the motor cable must be shielded/armoured. See EMC emission.

Control characteristics:

Frequency range	0.2 - 132 Hz, 1 - 1000 Hz
Resolution of output frequency	0.013 Hz, 0.2 - 1000 Hz
Repeat accuracy of <i>Precise start/stop</i> (terminals 18, 19)	≤ ± 0.5 msec
System response time (terminals 18, 19, 27, 29, 33)	≤ 26.6 msec
Speed control range (open loop)	1:15 of synchronous speed
Speed control range (open loop) <1.1 kW	approximately 1:10 of synchronous speed (motor dependent)
Speed control range (closed loop)	1:120 of synchronous speed
Speed accuracy (open loop) <1.1 HP	150 - 3600 rpm: Max. error of ±23 rpm
Speed accuracy (open loop) >0.75 HP	90 - 3600 rpm: Max. error of ±23 rpm
Speed accuracy (closed loop)	30 - 3600 rpm: Max. error of ±7.5 rpm

All control characteristics are based on a 4-pole asynchronous motor

Surroundings:

Enclosure	IP 66, TYPE 4x (indoor)
Enclosure T73 version	IP 65, TYPE 12
Vibration test	1.0 g
Max. relative humidity	95% see <i>Air humidity in the Design Guide</i>
Ambient temperature (FCD 335 max. 95°F [35°C])	Max. 104°F [40°C] (24-hour average max. 95°F [35°C])

Derating for ambient temperature, see special conditions in the Design Guide

Min. ambient temperature during full-scale operation	32°F [0°C]
Min. ambient temperature at reduced performance	14°F [- 10°C]
Temperature during storage/transport	-13°—+149°/158°F [-25°—+65°/70°C]
Max. altitude above sea level	3280 ft [1000 m]

Derating for air pressure, see special conditions in the Design Guide

EMC standards used, Emission	EN 50081-1-2, EN 61800-3, EN 55011
EMC standards used, immunity	EN 61000-6-2, EN 61000-4-2, EN 61000-4-3, EN 61000-4-4, EN 61000-4-5, EN 61000-4-6

See section on special conditions in the Design Guide

Safeguards:

- Electronic thermal motor protection against overload.
- Temperature monitoring of the power module ensures that the adjustable frequency drive cuts out if the temperature reaches 212°F [100°C]. An overload temperature cannot be reset until the temperature of the power module is below 158°F [70°C].
- The adjustable frequency drive is protected against short-circuits on motor terminals U, V, W.
- If a line phase is missing, the adjustable frequency drive will cut out.
- Monitoring of the intermediate circuit voltage ensures that the adjustable frequency drive cuts out if the intermediate circuit voltage is too low or too high.
- The adjustable frequency drive is protected against ground fault on motor terminals U, V, W.

4.5 Ordering

The below explanations refer to the ordering form.

Power sizes (positions 1-6):

0.5–4 hp [0.37–3.3 kW] (See power size selection table)

Application range (position 7):

- P-process

AC line voltage (positions 8-9):

- T4 - 380–480 V three-phase supply voltage

Enclosure (positions 10-12):

The enclosure offers protection against dusty, wet, and aggressive environment

- P66 - Protected IP66 enclosure (exceptions see Installation box T00, T73)

Hardware variant (positions 13-14):

- ST - Standard hardware
- EX - 24 V external supply for backup of control card
- EB - 24 V external supply for backup of control card, control and supply of mechanical brake and an additional brake chopper

RFI filter (positions 15-16):

- R1 - Compliance with class A1 filter

Display unit (LCP) (positions 17-18):

Connection option for display and keypad

- D0 - No pluggable display connector in the unit
- DC - Display connector plug mounted (not available with "only right side" installation box variants)

Serial communication option card (positions 19-21):

A wide selection of high performance serial communication options is available (integrated)

- F00 - No serial communication option built in
- F10 - Profibus DP V0/V1 3 Mbaud
- F12 - Profibus DP V0/V1 12 Mbaud
- F30 - DeviceNet
- F70 - AS-interface

Installation box (positions 22-24):

- T00 - No Installation box
- T11 - Installation box, motor mount, metric thread, only right side
- T12 - Installation box, motor mount, metric thread, double side
- T16 - Installation box, motor mount, NPT thread, double side
- T22 - Installation box, motor mount, metric thread, double side, service switch
- T26 - Installation box, motor mount, NPT thread, double side, service switch
- T51 - Installation box, wall mount, metric thread, only right side
- T52 - Installation box, wall mount, metric thread, double side
- T56 - Installation box, wall mount, NPT thread, double side
- T62 - Installation box, wall mount, metric thread, double side, service switch
- T66 - Installation box, wall mount, NPT thread, double side, service switch
- T63 - Installation box, wall mount, metric thread, double side, service switch, sensor plugs
- T73 - Installation box, wall mount, metric thread, double side, motor plug, sensor plugs, Viton gasket

Coating (positions 25-26):

The IP66 enclosure offers protection of the drive against aggressive environments, which practically eliminates the need for coated-printed circuit boards.

- C0 - Non coated boards

4.5.1 Ordering Form

FCD 3 P T4 P66 R1 D F T C

Power sizes
e.g. 315

303
305
307
311
315
322
330
335

Application range
P

Mains voltage
T4

Enclosure
P66

Hardware variant
ST
EX
EB

RFI filter
R1

Display unit (LCP)
DO
DC

Fieldbus option card
F00
F10
F12
F30
F70

Installation box
T00
T11
T12
T16
T22
T26
T51
T52
T56
T62
T63
T66
T73

Coating
C0
C1

No. units of this type

Required delivery date

Ordered by:

Date: _____

Take a copy of the ordering forms.
Fill them in and send or fax your order to the nearest office of the Danfoss sales organisation

195NA377.10

4.6 Technical Data, Line Power Supply 3 x 380–480 V

According to international standards	Type	303	305	307	311	315	322	330	335**	
	Output current (3 x 380–480 V)	I_{INV} [A]	1.4	1.8	2.2	3.0	3.7	5.2	7.0	7.6
		I_{MAX} (60s) [A]	2.2	2.9	3.5	4.8	5.9	8.3	11.2	11.4
	Output power (400 V)	S_{INV} [KVA]	1.0	1.2	1.5	2.0	2.6	3.6	4.8	5.3
	Typical shaft output	$P_{M,N}$ [kW]	0.37	0.55	0.75	1.1	1.5	2.2	3.0	3.3
	Typical shaft output	$P_{M,N}$ [HP]	0.50	0.75	1.0	1.5	2.0	3.0	4.0	5*
Max. cable cross-section, motor	[mm ² /AWG] ¹⁾	4/10	4/10	4/10	4/10	4/10	4/10	4/10	4/10	
	Input current (3 x 380–480 V)	$I_{L,N}$ [A]	1.2	1.6	1.9	2.6	3.2	4.7	6.1	6.8
		$I_{L,MAX}$ (60s) [A]	1.9	2.6	3.0	4.2	5.1	7.5	9.8	10.2
	Max. cable cross-section, power	[mm ² /AWG] ¹⁾	4/10	4/10	4/10	4/10	4/10	4/10	4/10	4/10
	Max. pre-fuses	[IEC]/UL ²⁾ [A]	25/25	25/25	25/25	25/25	25/25	25/25	25/25	25/25
	Efficiency ³⁾	[%]	96							
	Power loss at max. load	[W]	22	29	40	59	80	117	160	190
	Weight	[kg]	5.8	5.8	5.8	5.8	5.8	9.5	9.5	9.5

* At AC line voltage min 3 x 460–480 V

** t_{amb} max. 95°F [35°C].

1. American Wire Gauge. Max. cable cross-section is the largest cable cross-section that can be attached to the terminals. Always observe national and local regulations.
2. Typr gG / gL pre fuses or corresponding circuit breakers should be used.
If you want to maintain UL/cUL branch circuit fuses according to NEC should be used. Alternatively a circuit breaker Danfoss type CTI 25 MB or equivalent should be used.
To be placed for protection in a circuit that is capable of supplying a maximum of 100,000 amps for fuses / 10,000 amps for circuit breakers.
3. Measured using an 33 ft [10 m] shielded/armored motor cable with a rated load and rated frequency.

4.7 Available literature

Below is a list of the literature available for FCD 300. It must be noted that there may be deviations from one country to the next.

Supplied with the unit:

Instruction Manual MG.04.BX.YY

Various literature for FCD 300:

Data sheet MD.04.AX.YY

Instructions for FCD 300:

Sensor and servo interface for 6 x M12 plugs MI.04.DX.YY

Machine Mounting Brackets MI.04.CX.YY

Data Cable MI.90.HX.YY

Installation Box MI.04.BX.YY

Communication with FCD 300:

Profibus DP V1 Instruction Manual MG.90.AX.YY

DeviceNet Instruction Manual MG.90.BX.YY

AS-i Instruction Manual MG.04.EX.YY

Modbus RTU Instruction Manual MG.10.SX.YY

X = version number

YY = language version

4.8 Factory Settings

PNU #	Parameterdescription	Factory setting	Changes during operation	4-setup	Conv. index	Data type
001	Language	English	Yes	No	0	5
002	Local/remote operation	Remote-controlled	Yes	Yes	0	5
003	Local reference	000,000.000	Yes	Yes	-3	4
004	Active Setup	Setup 1	Yes	No	0	5
005	Programming Setup	Active Setup	Yes	No	0	5
006	Setup copying	No copying	No	No	0	5
007	LCP copy	No copying	No	No	0	5
008	Display scaling	1.00	Yes	Yes	-2	6
009	Large display readout	Frequency [Hz]	Yes	Yes	0	5
010	Small display line 1.1	Reference [%]	Yes	Yes	0	5
011	Small display line 1.2	Motor current [A]	Yes	Yes	0	5
012	Small display line 1.3	Power [kW]	Yes	Yes	0	5
013	Local control	Remote control as par. 100	Yes	Yes	0	5
014	Local stop/reset	Active	Yes	Yes	0	5
015	Local jog	Not active	Yes	Yes	0	5
016	Local reversing	Not active	Yes	Yes	0	5
017	Local reset of trip	Active	Yes	Yes	0	5
018	Data change lock	Not locked	Yes	Yes	0	5
019	Operating status at power-up	Forced stop, use saved ref.	Yes	Yes	0	5
020	Lock for hand mode	Active	Yes	No	0	5
024	User-defined quick menu	Not active	Yes	No	0	5
025	Quick Menu Set-up	000	Yes	No	0	6
026	LED Status	Overload	Yes	Yes	0	5

4

4-Setup:

'Yes' means that the parameter can be programmed individually in each of the four set-ups, i.e., one single parameter can have four different data values. No' means that the data value will be the same in all set-ups.

Conversion index:

This number refers to a conversion figure to be used when writing or reading via serial communication with an adjustable frequency drive.

See also *Serial communication*.

Conversion index	Conversion factor
73	0.1
2	100
1	10
0	1
-1	0.1
-2	0.01
-3	0.001
-4	0.0001
-5	0.00001

Data type:

Data type shows the type and length of the message.

Data type	Description
3	Integer 16
4	Integer 32
5	Unsigned 8
6	Unsigned 16
7	Unsigned 32
9	Text string

4

PNU #	Parameter-description	Factory setting	Changes during operation	4-setup	Conv. index	Data type
100	Configuration	Speed reg., open-loop	No	Yes	0	5
101	Torque characteristics	Constant torque	Yes	Yes	0	5
102	Motor power $P_{M,N}$	depends on unit	No	Yes	1	6
103	Motor voltage $U_{M,N}$	depends on unit	No	Yes	-2	6
104	Motor frequency $f_{M,N}$	50 Hz	No	Yes	-1	6
105	Motor current $I_{M,N}$	depends on motor selected	No	Yes	-2	7
106	Rated motor speed	depends on par. 102	No	Yes	0	6
107	Automatic motor adjustment	Optimization off	No	Yes	0	5
108	Stator resistance R_S	depends on motor selected	No	Yes	-3	7
109	Stator reactance X_S	depends on motor selected	No	Yes	-2	7
117	Resonance dampening	0 %	Yes	Yes	0	5
119	High start torque	0.0 sec	No	Yes	-1	5
120	Start delay	0.0 sec	No	Yes	-1	5
121	Start function	Coast in start del.	No	Yes	0	5
122	Function at stop	Coast	No	Yes	0	5
123	Min. freq. for activation of par. 122	0.1 Hz	No	Yes	-1	5
126	DC braking time	10 sec.	Yes	Yes	-1	6
127	DC brake engaging frequency	OFF	Yes	Yes	-1	6
128	Thermal motor protection	No protection	Yes	Yes	0	5
130	Start frequency	0.0 Hz	No	Yes	-1	5
131	Voltage at start	0.0 V	No	Yes	-1	6
132	DC brake voltage	0%	Yes	Yes	0	5
133	Start voltage	depends on unit	Yes	Yes	-2	6
134	Load compensation	100 %	Yes	Yes	-1	6
135	U/f ratio	depends on unit	Yes	Yes	-2	6
136	Slip compensation	100 %	Yes	Yes	-1	3
137	DC hold voltage	0%	No	Yes	0	5
138	Brake cut-out value	3.0 Hz	Yes	Yes	-1	6
139	Brake cut-in frequency	3.0 Hz	Yes	Yes	-1	6
140	Current, minimum value	0%	No	Yes	0	5
142	Leak reactance	depends on motor selected	No	Yes	-3	7
144	AC brake factor	1.30	No	Yes	-2	5
146	Reset voltage vector	Off	Yes	Yes	0	5
147	Motor type	General				

PNU #	Parameter description	Factory setting	Changes during operation	4-setup	Conv. index	Data type
200	Output frequency ranges	Clockwise only, 0–132 Hz	No	Yes	0	5
201	Output frequency, low limit f_{MIN}	0.0 Hz	Yes	Yes	-1	6
202	Output frequency, high limit f_{MAX}	132 Hz	Yes	Yes	-1	6
203	Reference range	Min ref.-Max ref.	Yes	Yes	0	5
204	Minimum ref Ref_{MIN}	0.000 Hz	Yes	Yes	-3	4
205	Maximum ref Ref_{MAX}	50.000 Hz	Yes	Yes	-3	4
206	Ramp type	Linear	Yes	Yes	0	5
207	Ramp-up time 1	3.00 sec.	Yes	Yes	-2	7
208	Ramp-down time 1	3.00 sec.	Yes	Yes	-2	7
209	Ramp-up time 2	3.00 sec.	Yes	Yes	-2	7
210	Ramp-down time 2	3.00 sec.	Yes	Yes	-2	7
211	Jog ramp time	3.00 sec.	Yes	Yes	-2	7
212	Quick stop ramp-down time	3.00 sec.	Yes	Yes	-2	7
213	Jog frequency	10.0 Hz	Yes	Yes	-1	6
214	Reference function	Sum	Yes	Yes	0	5
215	Preset reference 1	0.00%	Yes	Yes	-2	3
216	Preset reference 2	0.00%	Yes	Yes	-2	3
217	Preset reference 3	0.00%	Yes	Yes	-2	3
218	Preset reference 4	0.00%	Yes	Yes	-2	3
219	Catch up/slow-down reference	0.00%	Yes	Yes	-2	6
221	Current limit	160 %	Yes	Yes	-1	6
223	Warn. Low current	0.0 A	Yes	Yes	-1	6
224	Warn. High current	I_{MAX}	Yes	Yes	-1	6
225	Warn. Low frequency	0.0 Hz	Yes	Yes	-1	6
226	Warn. High frequency	132.0 Hz	Yes	Yes	-1	6
227	Warn. Low Feedback	-4000.000	Yes	Yes	-3	4
228	Warn. High Feedback	4000.000	Yes	Yes	-3	4
229	Frequency bypass, bandwidth	0 Hz (OFF)	Yes	Yes	0	6
230	Frequency bypass 1	0.0 Hz	Yes	Yes	-1	6
231	Frequency bypass 2	0.0 Hz	Yes	Yes	-1	6

PNU #	Parameter description	Factory setting	Changes during operation	4-setup	Conv. index	Data type
302	Digital input, term. 18	Start	Yes	Yes	0	5
303	Digital input, term. 19	Reversing	Yes	Yes	0	5
304	Digital input, term. 27	Reset and coast inverse	Yes	Yes	0	5
305	Digital input, term. 29	Jog	Yes	Yes	0	5
307	Digital input, term. 33	No function	Yes	Yes	0	5
308	Term. 53, analog input voltage	Reference	Yes	Yes	0	5
309	Term. 53, min scaling	0.0 V	Yes	Yes	-1	6
310	Term. 53, max scaling	10.0 V	Yes	Yes	-1	6
314	Term. 60, analog input current	No function	Yes	Yes	0	5
315	Term. 60, min scaling	0.0 mA	Yes	Yes	-4	6
316	Term. 60, max scaling	20.0 mA	Yes	Yes	-4	6
317	Timeout	10 sec.	Yes	Yes	-1	5
318	Function after timeout	No function	Yes	Yes	0	5
319	Term. 42, analog output	0- I_{MAX} = 0-20 mA	Yes	Yes	0	5
323	Relay output	No function	Yes	Yes	0	5
327	Pulse Max. 33	5000 Hz	Yes	Yes	0	7
328	Pulse Max. 29	5000 Hz	Yes	Yes	0	7
341	Term. 46 digital output	No function	Yes	Yes	0	5
342	Term. 46 Max. pulse output	5000 Hz	Yes	Yes	0	6
343	Precise stop function	Normal ramp stop	No	Yes	0	5
344	Counter value	100000 pulses	No	Yes	0	7
349	Speed comp delay	10 ms	Yes	Yes	-3	6

PNU #	Parameter description	Factory setting	Changes during operation	4-setup	Conv. index	Data type
400	Brake function	Depends on unit type	Yes	No	0	5
405	Reset function	Manual reset	Yes	Yes	0	5
406	Aut. restart time	5 sec	Yes	Yes	0	5
409	Trip delay overcurrent	Off (61 sec.)	Yes	Yes	0	5
411	Switching frequency	4.5 kHz	Yes	Yes	0	6
413	Overmodulation function	On	Yes	Yes	0	5
414	Min. feedback	0.000	Yes	Yes	-3	4
415	Max. feedback	1500.000	Yes	Yes	-3	4
416	Process units	No unit	Yes	Yes	0	5
417	Speed PID propor. ampl.	0.010	Yes	Yes	-3	6
418	Speed PID intergra.	100 ms	Yes	Yes	-5	7
419	Speed PID differentiation time	20.00 ms	Yes	Yes	-5	7
420	Speed PID diff. amplification limit	5.0	Yes	Yes	-1	6
421	Speed PID low-pass filter	20 ms	Yes	Yes	-3	6
423	U1 voltage	par. 103	Yes	Yes	-1	6
424	F1 frequency	Par. 104	Yes	Yes	-1	6
425	U2 voltage	par. 103	Yes	Yes	-1	6
426	F2 frequency	par. 104	Yes	Yes	-1	6
427	U3 voltage	par. 103	Yes	Yes	-1	6
428	F3 frequency	par. 104	Yes	Yes	-1	6
437	Proc. PID no/inv.	Normal	Yes	Yes	0	5
438	Proc. PID counter-wind.	Active	Yes	Yes	0	5
439	Proc. PID start frequency	Par. 201	Yes	Yes	-1	6
440	Proc. PID start proportional ampl.	0.01	Yes	Yes	-2	6
441	Proc. PID integration time	Off (9,999.99 s)	Yes	Yes	-2	7
442	Proc. PID differentiation time	Off (0.00 s).	Yes	Yes	-2	6
443	Proc. PID diff. ampl. limit	5.0	Yes	Yes	-1	6
444	Proc. PID low-pass filter time	0.02 s	Yes	Yes	-2	6
445	Flying start	Not possible	Yes	Yes	0	5
451	Speed PID feedforward factor	100%	Yes	Yes	0	6
452	Controller range	10 %	Yes	Yes	-1	6
455	Frequency ranges monitor	Enable	Yes		0	5
456	Brake voltage reduce	0	Yes	Yes	0	5

PNU #	Parameterdescription	Factory setting	Changes during operation	4-setup	Conv. index	Data type
500	Address	1	Yes	No	0	5
501	Baudrate	9600 Baud	Yes	No	0	5
502	Coasting stop	Logic or	Yes	Yes	0	5
503	Quick stop	Logic or	Yes	Yes	0	5
504	DC brake	Logic or	Yes	Yes	0	5
505	Start	Logic or	Yes	Yes	0	5
506	Reversing	Logic or	Yes	Yes	0	5
507	Selection of Setup	Logic or	Yes	Yes	0	5
508	Selection of preset ref.	Logic or	Yes	Yes	0	5
509	Bus jog 1	10.0 Hz	Yes	Yes	-1	6
510	Bus jog 2	10.0 Hz	Yes	Yes	-1	6
512	Message profile	FC protocol	No	Yes	0	5
513	Bus time interval	1 sec	Yes	Yes	0	5
514	Bus time interval function	Off	Yes	Yes	0	5
515	Data readout: Reference %		No	No	-1	3
516	Data readout: Reference [unit]		No	No	-3	4
517	Data readout: Feedback [unit]		No	No	-3	4
518	Data readout: Frequency		No	No	-1	3
519	Data readout: Frequency x scaling		No	No	-1	3
520	Data readout: Motor current		No	No	-2	7
521	Data readout: Torque		No	No	-1	3
522	Data readout: Power [kW]		No	No	1	7
523	Data readout: Power [HP]		No	No	-2	7
524	Data readout: Motor voltage [V]		No	No	-1	6
525	Data readout: DC Link voltage		No	No	0	6
526	Data readout: Motor thermal load		No	No	0	5
527	Data readout: Inverter thermal load		No	No	0	5
528	Data readout: Digital input		No	No	0	5
529	Data readout: Analog input, term. 53		No	No	-1	5
531	Data readout: Analog input, term. 60		No	No	-4	5
532	Data readout: Pulse input, term. 33		No	No	-1	7
533	Data readout: External reference		No	No	-1	6
534	Data readout: Status word		No	No	0	6
537	Data readout: Inverter temperature		No	No	0	5
538	Data readout: Alarm word		No	No	0	7
539	Data readout: Control word		No	No	0	6
540	Data readout: Warning word		No	No	0	7
541	Data readout: Extended status word		No	No	0	7
544	Data readout: Pulse count		No	No	0	7
545	Data readout: Pulse input, term. 29		No	No	-1	7

PNU #	Parameterdescription	Factory setting	Changes during operation	4-setup	Conv. index	Data type
600	Operating hours		No	No	73	7
601	Hours run		No	No	73	7
602	kWh counter		No	No	2	7
603	Number of cut-ins		No	No	0	6
604	Number of overtemperatures		No	No	0	6
605	Number of overvoltages		No	No	0	6
615	Fault log: Error code		No	No	0	5
616	Fault log: Time		No	No	0	7
617	Fault log: Value		No	No	0	3
618	Reset of kWh counter	No reset	Yes	No	0	7
619	Reset of running hours counter	No reset	Yes	No	0	5
620	Operation mode	Normal operation	Yes	No	0	5
621	Nameplate: Unit type		No	No	0	9
624	Nameplate: Software version		No	No	0	9
625	Nameplate: LCP identification no.		No	No	0	9
626	Nameplate: Database identification no.		No	No	-2	9
627	Nameplate: Power parts version		No	No	0	9
628	Nameplate: Application option type		No	No	0	9
630	Nameplate: Communication option type		No	No	0	9
632	Nameplate: BMC software identification		No	No	0	9
634	Nameplate: Unit identification for communication		No	No	0	9
635	Nameplate: Software parts no.		No	No	0	9
640	Software version		No	No	-2	6
641	BMC software identification		No	No	-2	6
642	Power card identification		No	No	-2	6
678	Configure Control Card	Depends on unit type	No	No	0	5

Index

2

24 V Dc	4-11
24 V Dc Supply	2-16

4

4-20 Ma Reference	2-20
4-setup:	4-17

A

Ac Brake	3-35
Ac Line Input Connections	2-10
Active Setup	3-9
Address	3-56
Aggressive Environments	4-6
Analog Output	3-32
Analogue Input	3-31
Automatic Motor Tuning,	3-15

B

Baudrate	3-56
Brake Cut In Frequency	3-20
Brake Cut Out Value	3-20
Brake Function	3-35
Brake Resistor	2-13
Brake Voltage Reduce	3-43
Bus Jog	3-59
Bus Time Interval	3-59

C

Cable Lengths And Cross Sections:	4-11
Cables	2-4
Catch Up	3-27
Cleaning	4-6
Connection Of A 2-wire Transmitter	2-19
Connection Of Mechanical Brake	2-21
Constant Torque	3-14
Control Cable	2-4
Control Cables	2-14
Control Of Mechanical Brake	2-14
Control Principle	1-4
Control Word	3-49, 3-52
Counter Stop Via Terminal 33	2-23
Counter Value	3-35
Current Limit,	3-27
Current, Minimum Value	3-21

D

Data Character (byte)	3-46
Data Readout	3-60
Dc Brake Time	3-18
Dc Brake Voltage	3-19
Dc Braking	3-18
Dc Hold Voltage	3-20
Derating	4-7, 4-8
Derating For Running At Low Speed	4-7
Diagram	2-7
Differentiator	3-38

Digital Inputs	3-29
Digital Output	3-34
Direction Of Motor Rotation	2-11
Display Mode	3-2
Display Mode	3-3
Display Scaling Of Output Frequency	3-10

E

Electrical Installation, Control Cables	2-14
Emc-compliant Electrical Installation	2-7
Etr - Electronic Thermal Relay	3-18
Extra Protection	2-5

F

Factory Settings	4-17
Fast I/o Fc Profile	3-52
Fault Log	3-62
Feedback	3-39
Feedback Range	3-38
Feedback,	3-36
Flying Start	3-42
Four Setups	3-9
Frequency Bypass, Bandwidth	3-28
Function At Stop	3-17
Fuses	4-16

G

Gain Ac Brake	3-21
Galvanic Isolation (pelv)	4-7

H

Hand Mode	3-13
High Voltage Warning	1-2, 2-4

I

Initialize	3-63
Internal Fault	4-5

J

Jog Frequency	3-25
Jog Ramp Time	3-25

L

Language	3-8
Lcp 2	3-1
Lcp 2 Plug, Optional	2-16
Lcp Copy	3-9
Leakage Reactance	3-21
Line Cable	2-4
Literature	4-16
Load Compensation	3-20
Local Reference	3-8
Lock For Data Changes	3-12
Low-pass Filter	3-38

M

Manual Initialization	3-7
-----------------------	-----

Mechanical Brake	2-14
Mechanical Brake	2-22
Mechanical Dimensions, Motor Mounting	2-1
Mechanical Dimensions, Stand-alone Mounting	2-1
Mechanical Installation	2-2
Message Structure	3-44
Motor Cable	4-11
Motor Cables	2-13
Motor Connection	2-10
Motor Current	3-15
Motor Frequency	3-15
Motor Plug And Sensor Plugs	2-9
Motor Power	3-15
Motor Thermal Protection	2-13
Motor Type	3-21
Motor Voltage	3-15

O

Operating Data	3-62
Operating Mode At Power-up, Local Operation	3-13
Ordering Form	4-15
Output Frequency	3-22
Overmodulation Function	3-36

P

Parallel Connection Of Motors	2-12
Pc Communication	2-16
Pelv	4-7
Pid Functions	3-38
Potentiometer Reference	2-19
Precise Stop Function	3-34
Preset Reference	3-27
Preset References	2-21
Process Control, Closed-loop	3-14
Process Pid	3-41
Process Regulation	3-37
Process Units	3-37
Product Standard	4-8
Programming Set-up	3-9
Protocol	3-61
Protocols	3-44
Pulse Max. 29	3-34
Pulse Max. 33	3-34
Pulse Start/stop	2-18

Q

Quick Menu Setup	3-13
Quick Menu, User-defined	3-13
Quick-stop Ramp-down Time	3-25

R

Ramp Type	3-24
Ramp-down Time	3-25
Ramp-up Time	3-24
Rated Motor Speed	3-15
Reference	3-38
Reference Function	3-26
Reference Handling	3-23
Reference,	3-23
Relative	3-26

Relay Connection	2-16
Relay Output 1-3	3-33
Reset Function	3-35
Reset Voltage Vector	3-21
Resonance Dampening	3-16
Reversing	3-30
Rfi Switches	2-8

S

Sensor Supply (t63, T73)	4-11
Sensors	2-15
Serial Communication Bus	3-52
Setup Copying	3-9
Setup Shift	3-9
Setups	3-8
Shielded/armored Cables	2-4
Slip Compensation	3-20
Slow Down	3-27
Special Motor Mode	3-14
Speed Comp Delay	3-35
Speed Control, Closed-loop	3-14
Speed Control, Open-loop	3-14
Speed Pid	3-39
Speed Regulation	3-37
Speed Up/down	2-19
Start	3-42
Start Delay	3-17
Start Frequency	3-19
Start Function	3-17
Start Torque	3-17
Start Voltage	3-20
Start/stop	2-18
Stator Reactance	3-16
Stator Resistance	3-16
Status Led	3-14
Status Word	3-51, 3-53
Sum	3-26
Surroundings:	4-12
Switching Frequency	3-36

T

Telegram Profile	3-59
Telegram Traffic	3-44
Terminal 42	3-32
Terminal 53	3-31
Terminal 60	3-31
Terminals	2-10, 2-19
Thermal Motor Protection	3-18
Thermistor	3-18
Time Out	3-32
Torque Characteristic	3-14

U

U/f-ratio	3-20
Unit Information	3-63

V

Variable Torque	3-14
-----------------	------

W

Warning Functions	3-27
Warning Words, Extended Status Words And Alarm Words	4-5
Warnings/alarm Messages	4-3



www.danfoss.com/drives

Danfoss shall not be responsible for any errors in catalogs, brochures or other printed material. Danfoss reserves the right to alter its products at any time without notice, provided that alterations to products already on order shall not require material changes in specifications previously agreed upon by Danfoss and the Purchaser. All trademarks in this material are property of the respective companies. Danfoss and the Danfoss logotype are trademarks of Danfoss A/S. All rights reserved.

Danfoss Drives

4401 N. Bell School Rd.
Loves Park IL 61111 USA
Phone: 1-800-432-6367
1-815-639-8600
Fax: 1-815-639-8000
www.danfossdrives.com

Danfoss Drives

8800 W. Bradley Rd.
Milwaukee, WI 53224 USA
Phone: 1-800-621-8806
1-414-355-8800
Fax: 1-414-355-6117
www.danfossdrives.com

