

Contents

1 Introduction	1-1
2 How to Program	2-1
Local Control Panel	2-1
How to operate the graphical LCP (GLCP)	2-1
Quick Menu Mode	2-10
Function Set-ups	2-13
Main Menu Mode	2-16
3 Parameter Description	3-1
Parameter Selection	3-1
Main Menu - Operation and Display - Group 0	3-1
Main Menu - Load and Motor - Group 1	3-18
Main Menu - Brakes - Group 2	3-30
Main Menu - Reference/Ramps - Group 3	3-33
Main Menu - Limits/Warnings - Group 4	3-40
Main Menu - Digital In/Out - Group 5	3-47
Main Menu - Analog In/Out - Group 6	3-80
Main Menu - Communications and Options - Group 8	3-91
Main Menu - Profibus - Group 9	3-101
Main Menu - CAN Ser. Com. Bus - Group 10	3-110
Main Menu - LonWorks - Group 11	3-117
Main Menu - Smart Logic - Group 13	3-118
Main Menu - Special Functions -Group 14	3-134
Main Menu - Adjustable Frequency Drive Information - Group 15	3-143
Main Menu - Data Readouts - Group 16	3-151
Main Menu - Data Readouts 2 - Group 18	3-162
Main Menu - Adjustable Frequency Drive Closed-loop - Group 20	3-165
Main Menu - Extended Closed-loop - FC 100 - Group 21	3-182
Main Menu - Application Functions - FC 100 - Group 22	3-196
Main Menu - Time-based Functions - FC 100 - Group 23	3-212
Main Menu - Application Functions 2 - Group 24	3-228
Main Menu - Cascade Controller - Group 25	3-235
Main Menu - Analog I/O Option MCB 109 - Group 26	3-250
4 Troubleshooting	4-1
Alarms and warnings	4-1
Alarm words	4-4

Warning words	4-5
Extended status words	4-6
Fault messages	4-7
5 Parameter Lists	5-1
Parameter Options	5-1
Default settings	5-1
0-** Operation and Display	5-2
1-** Load / Motor	5-4
2-** Brakes	5-5
3-** Reference / Ramps	5-6
4-** Limits / Warnings	5-7
5-** Digital In / Out	5-8
6-** Analog In / Out	5-10
8-** Communication and Options	5-12
9-** Profibus	5-13
10-** CAN Fieldbus	5-14
11-** LonWorks	5-15
13-** Smart Logic Controller	5-16
14-** Special Functions	5-17
15-** FC Information	5-18
16-** Data Readouts	5-20
18-** Info & Readouts	5-22
20-** FC Closed-loop	5-23
21-** Ext. Closed-loop	5-24
22-** Application Functions	5-26
23-** Time-based Functions	5-28
24-** Application Functions 2	5-29
25-** Cascade Controller	5-30
26-** Analog I / O Option MCB 109	5-32
6 Index	6-1

1 Introduction**1**

VLT HVAC Drive FC 100 Series Software version: 2.8.x



This guide can be used with all VLT HVAC Drive adjustable frequency drives with software version 2.8.x.

The current software version number can be read from par.15-43 *Software Version*.

2 How to Program

2.1 Local Control Panel

2.1.1 How to operate the graphical LCP (GLCP)

2

The following instructions are valid for the GLCP (LCP 102).

The GLCP is divided into four functional groups:

1. Graphical display with status lines.
2. Menu keys and indicator lights (LEDs) - selecting mode, changing parameters and switching between display functions.
3. Navigation keys and indicator lights (LEDs).
4. Operation keys and indicator lights (LEDs).

Graphical display:

The LCD display is back lit with a total of 6 alpha-numeric lines. All data is displayed on the LCP which can show up to five operating variables while in [Status] mode.

Display lines:

- a. **Status line:** Status messages displaying icons and graphics.
- b. **Line 1-2:** Operator data lines displaying data and variables defined or chosen by the user. By pressing the [Status] key, up to one extra line can be added.
- c. **Status line:** Status messages displaying text.

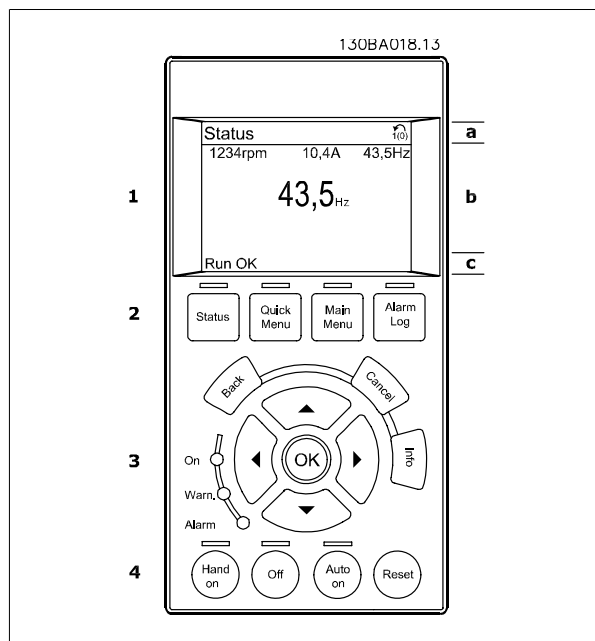

The display is divided into 3 sections:

Top section (a) shows the status when in status mode or up to 2 variables when not in status mode and in the case of an alarm/warning.

2

The number of the Active Set-up (selected as the Active Set-up in par.0-10 *Active Set-up*) is shown. When programming in another set-up than the Active Set-up, the number of the set-up being programmed appears to the right in brackets.

The **Middle section** (b) shows up to 5 variables with related unit, regardless of status. In case of an alarm/warning, the warning is shown instead of the variables.

It is possible to toggle between three status readout displays by pressing the [Status] key. Operating variables with different formatting are shown in each status screen - see below.

Several values or measurements can be linked to each of the displayed operating variables. The values / measurements to be displayed can be defined via par.0-20 *Display Line 1.1 Small*, par. 0-21 *Display Line 1.2 Small*, par. 0-22 *Display Line 1.3 Small*, par. 0-23 *Display Line 2 Large* and par. 0-24 *Display Line 3 Large*, which can be accessed via [QUICK MENU], "Q3 Function Set-ups", "Q3-1 General Settings", "Q3-13 Display Settings".

Each value/measurement readout parameter selected in par.0-20 *Display Line 1.1 Small* to par. 0-24 *Display Line 3 Large* has its own scale and number of digits after a possible decimal point. Larger numeric values are displayed with few digits after the decimal point.

Ex.: Current readout

5.25 A; 15.2 A 105 A.

Status display I:

This readout state is standard after start-up or initialization.

Use [INFO] to obtain information about the value/measurement linked to the displayed operating variables (1.1, 1.2, 1.3, 2, and 3).

See the operating variables shown in the display in this illustration. 1.1, 1.2 and 1.3 are shown in small size. 2 and 3 are shown in medium size.

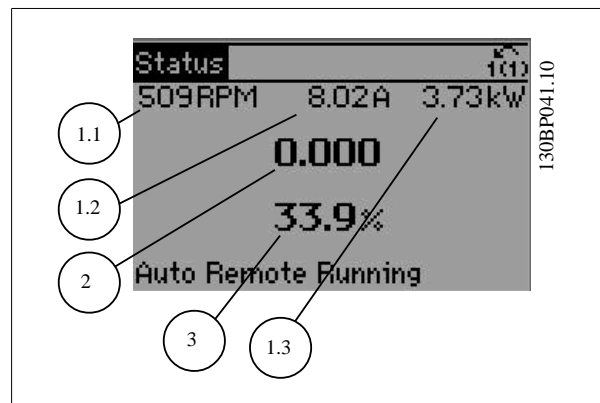

Status display II:

See the operating variables (1.1, 1.2, 1.3, and 2) shown in the display in this illustration.

In the example, Speed, Motor current, Motor power and Frequency are selected as variables in the first and second lines.

1.1, 1.2 and 1.3 are shown in small size. 2 is shown in large size.

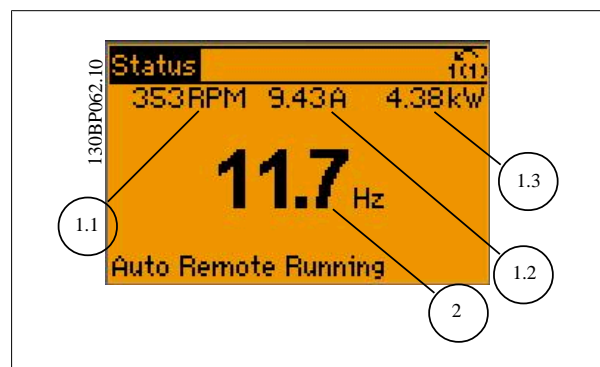

Status display III:

This state displays the event and action of the Smart Logic Control. For further information, see the section *Smart Logic Control*.



The **Bottom section** always shows the state of the adjustable frequency drive in status mode.

Display Contrast Adjustment

Press [status] and [▲] for darker display

Press [status] and [▼] for brighter display

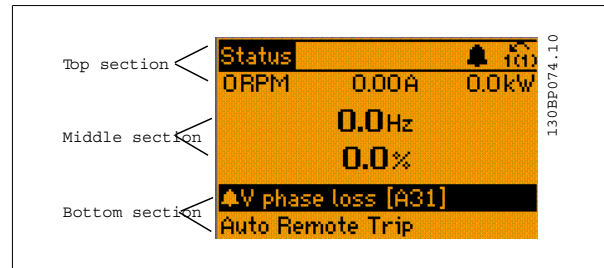

Indicator lights (LEDs):

If certain threshold values are exceeded, the alarm and/or warning LED lights up. A status and alarm text appears on the control panel. The On LED is activated when the adjustable frequency drive receives power from AC line voltage, a DC bus terminal, or an external 24 V supply. At the same time, the back light is on.

- Green LED/On: Control section is working.
- Yellow LED/Warn.: Indicates a warning.
- Flashing Red LED/Alarm: Indicates an alarm.

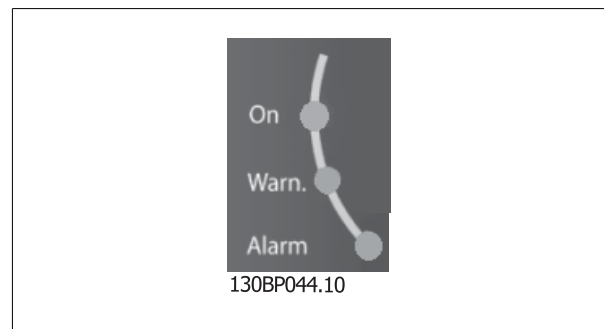

GLCP keys

Menu keys

The menu keys are divided into functions. The keys below the display and LEDs are used for parameter set-up, including choice of display indication during normal operation.

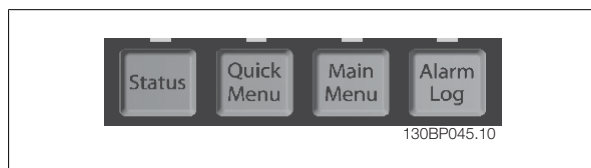

2

[Status]

indicates the status of the adjustable frequency drive and/or the motor. Three different readouts can be chosen by pressing the [Status] key: 5 line readouts, 4 line readouts or Smart Logic Control.

Use [Status] for selecting the mode of display or for changing back to display mode from either the quick menu mode, main menu mode or alarm mode. Also use the [Status] key to toggle single or double readout mode.

[Quick Menu]

allows quick set-up of the adjustable frequency drive. **The most common VLT HVAC Drive functions can be programmed here.**

The [Quick Menu] consists of:

- **My Personal Menu**
- **Quick Set-up**
- **Function Set-up**
- **Changes Made**
- **Loggings**

The Function Set-up provides quick and easy access to all parameters required for the majority of VLT HVAC Drive applications including most VAV and CAV supply and return fans, cooling tower fans, primary, secondary and condenser water pumps and other pump, fan and compressor applications. Among other features, it also includes parameters for selecting which variables to display on the LCP, digital preset speeds, scaling of analog references, closed-loop single zone and multi-zone applications and specific functions related to fans, pumps and compressors.

The Quick Menu parameters can be accessed immediately unless a password has been created via par.0-60 *Main Menu Password*, par.0-61 *Access to Main Menu w/o Password*, par.0-65 *Personal Menu Password* or par.0-66 *Access to Personal Menu w/o Password*.

It is possible to switch directly between Quick Menu mode and Main Menu mode.

[Main Menu]

is used for programming all parameters. The Main Menu parameters can be accessed immediately unless a password has been created via par.0-60 *Main Menu Password*, par.0-61 *Access to Main Menu w/o Password*, par.0-65 *Personal Menu Password* or par.0-66 *Access to Personal Menu w/o Password*. For the majority of VLT HVAC Drive applications, it is not necessary to access the Main Menu parameters but instead the Quick Menu, Quick Set-up and Function Set-up provide the simplest and quickest access to parameters that are typically required.

It is possible to switch directly between Main Menu mode and Quick Menu mode.

A parameter shortcut can be carried out by pressing the [Main Menu] key for 3 seconds. The parameter shortcut allows direct access to any parameter.

[Alarm Log]

displays an alarm list of the last five alarms (numbered A1-A5). To obtain additional details about an alarm, use the arrow keys to navigate to the alarm number and press [OK]. Information is displayed about the condition of the adjustable frequency drive before it enters alarm mode.

The Alarm log button on the LCP allows access to both the alarm log and the maintenance log.

[Back]

reverts to the previous step or layer in the navigation structure.

[Cancel]

last change or command will be canceled as long as the display has not been changed.

[Info]

displays information about a command, parameter, or function in any display window. [Info] provides detailed information when needed. Exit Info mode by pressing either [Info], [Back], or [Cancel].

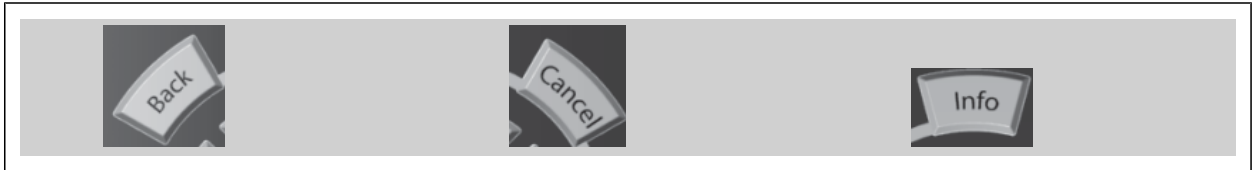

Navigation Keys

The four navigation arrows are used to navigate between the different choices available in **[Quick Menu]**, **[Main Menu]** and **[Alarm Log]**. Use the keys to move the cursor.

[OK] is used for choosing a parameter marked by the cursor and for enabling the change of a parameter.



Operation Keys for local control are found at the bottom of the control panel.

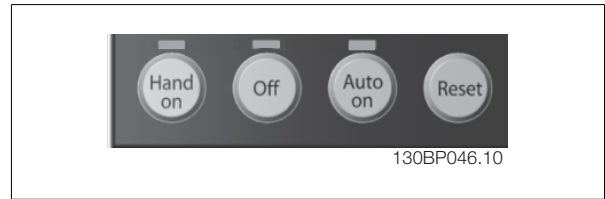

[Hand On]

enables control of the adjustable frequency drive via the GLCP. [Hand On] also starts the motor, and it is now possible to enter the motor speed data by means of the arrow keys. The key can be selected as *Enable* [1] or *Disable* [0] via par.0-40 *[Hand on] Key on LCP*.

The following control signals will still be active when [Hand On] is activated:

- [Hand On] - [Off] - [Auto on]
- Reset
- Coasting stop inverse
- Reversing
- Set-up select lsb - Set-up select msb
- Stop command from serial communication
- Quick stop
- DC brake

NOTE!
External stop signals activated by means of control signals or a serial bus will override a "start" command via the LCP.

[Off]

stops the connected motor. The key can be selected as Enable [1] or Disable [0] via par.0-41 *[Off] Key on LCP*. If no external stop function is selected and the [Off] key is inactive the motor can only be stopped by disconnecting the line power supply.

[Auto on]

enables the adjustable frequency drive to be controlled via the control terminals and/or serial communication. When a start signal is applied on the control terminals and/or the bus, the adjustable frequency drive will start. The key can be selected as Enable [1] or Disable [0] via par.0-42 *[Auto on] Key on LCP*.

**NOTE!**

An active HAND-OFF-AUTO signal via the digital inputs has higher priority than the control keys [Hand on] – [Auto on].

[Reset]

is used for resetting the adjustable frequency drive after an alarm (trip). It can be selected as *Enable* [1] or *Disable* [0] via par.0-43 *[Reset] Key on LCP*.

The parameter shortcut can be carried out by holding down the [Main Menu] key for 3 seconds. The parameter shortcut allows direct access to any parameter.

2.1.2 How to operate numeric LCP (NLCP)

The following instructions are valid for the NLCP (LCP 101).

The control panel is divided into four functional groups:

1. Numeric display.
2. Menu key and indicator lights (LEDs) - changing parameters and switching between display functions.
3. Navigation keys and indicator lights (LEDs).
4. Operation keys and indicator lights (LEDs).

**NOTE!**

Parameter copy is not possible with Numeric Local Control Panel (LCP101).

Select one of the following modes:

Status Mode: Displays the status of the adjustable frequency drive or the motor.

If an alarm occurs, the NLCP automatically switches to status mode.

A number of alarms can be displayed.

Quick Set-up or Main Menu Mode: Display parameters and parameter settings.

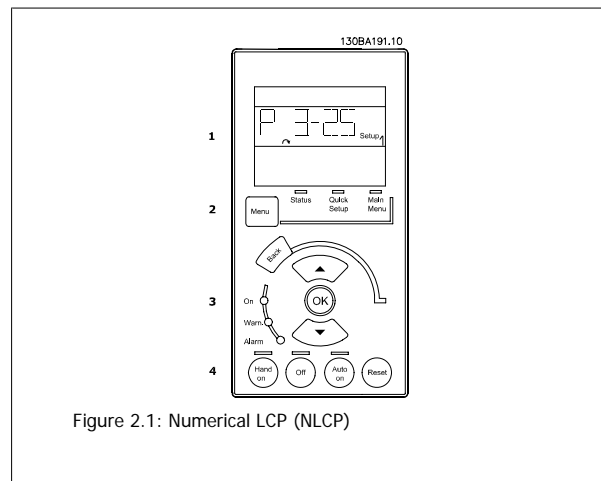

Figure 2.1: Numerical LCP (NLCP)

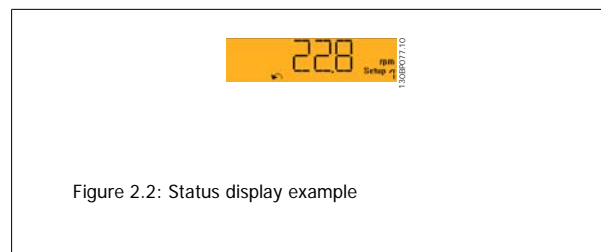

Figure 2.2: Status display example

Indicator lights (LEDs):

- Green LED/On: Indicates if control section is on.
- Yellow LED/Wrn.: Indicates a warning.
- Flashing red LED/Alarm: Indicates an alarm.

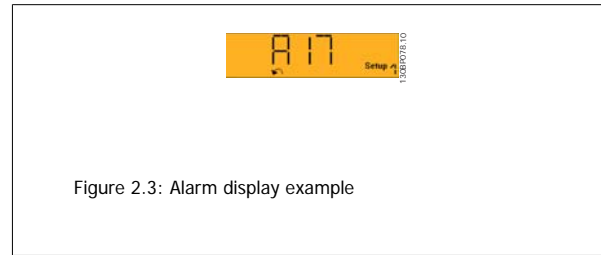

Figure 2.3: Alarm display example

2

Menu key

[Menu] Select one of the following modes:

- Status
- Quick Set-up
- Main Menu

Main Menu is used for programming all parameters.

The parameters can be accessed immediately unless a password has been created via par.0-60 *Main Menu Password*, par.0-61 *Access to Main Menu w/o Password*, par.0-65 *Personal Menu Password* or par.0-66 *Access to Personal Menu w/o Password*.

Quick Set-up is used to set up the adjustable frequency drive using only the most essential parameters.

The parameter values can be changed using the up/down arrows when the value is flashing.

Select Main Menu by pressing the [Menu] key a number of times until the Main Menu LED is lit.

Select the parameter group [xx-__] and press [OK]

Select the parameter [__-xx] and press [OK]

If the parameter is an array parameter, select the array number and press [OK]

Select the wanted data value and press [OK]

Navigation Keys [Back] for stepping backwards

Arrow [▼] [▲] keys are used for navigating between parameter groups, parameters and within parameters.

[OK] is used for choosing a parameter marked by the cursor and for enabling the change of a parameter.

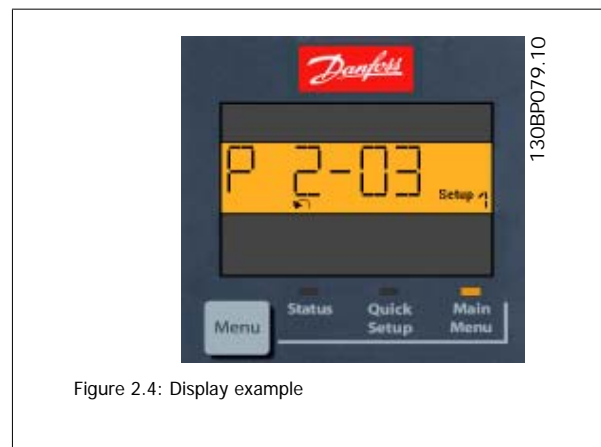

Figure 2.4: Display example

Operation Keys

Keys for local control are found at the bottom of the control panel.

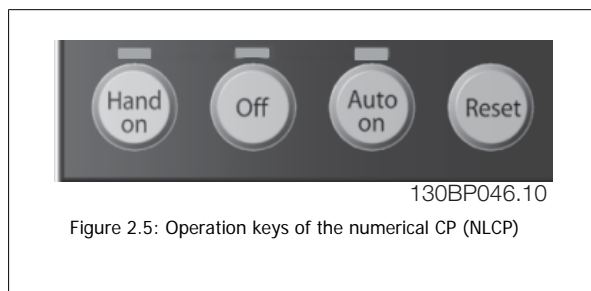

Figure 2.5: Operation keys of the numerical CP (NLCP)

[Hand on] enables control of the adjustable frequency drive via the LCP. [Hand on] also starts the motor and it is now possible to enter the motor speed data by means of the arrow keys. The key can be selected as *Enable* [1] or *Disable* [0] via par.0-40 *[Hand on] Key on LCP*.

External stop signals activated by means of control signals or a serial bus will override a 'start' command via the LCP.

The following control signals will still be active when [Hand on] is activated:

- [Hand on] - [Off] - [Auto on]
- Reset
- Coasting stop inverse
- Reversing
- Set-up select lsb - Set-up select msb
- Stop command from serial communication
- Quick stop
- DC brake

[Off] stops the connected motor. The key can be selected as *Enable* [1] or *Disable* [0] via par.0-41 *[Off] Key on LCP*.

If no external stop function is selected and the [Off] key is inactive, the motor can be stopped by disconnecting the line power supply.

[Auto on] enables the adjustable frequency drive to be controlled via the control terminals and/or serial communication. When a start signal is applied on the control terminals and/or the bus, the adjustable frequency drive will start. The key can be selected as *Enable* [1] or *Disable* [0] via par.0-42 *[Auto on] Key on LCP*.

**NOTE!**

An active HAND-OFF-AUTO signal via the digital inputs has higher priority than the control keys [Hand on] [Auto on].

[Reset] is used for resetting the adjustable frequency drive after an alarm (trip). It can be selected as *Enable* [1] or *Disable* [0] via par.0-43 *[Reset] Key on LCP*.

2.1.3 Quick Transfer of Parameter Settings between Multiple Adjustable Frequency Drives

Once the set-up of an adjustable frequency drive is complete, we recommend that you store the data in the LCP or on a PC via MCT 10 Set-up Software Tool.

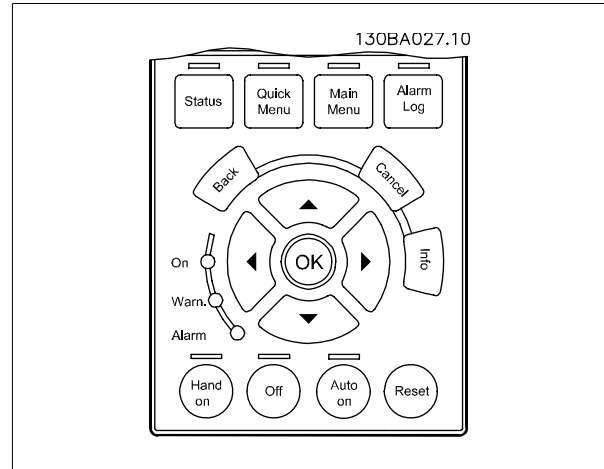

Data storage in LCP:

1. Go to par.0-50 *LCP Copy*
2. Press the [OK] key.
3. Select "All to LCP"
4. Press the [OK] key.

All parameter settings are now stored in the LCP indicated by the progress bar. When 100% is reached, press [OK].



NOTE!

Stop the motor before performing this operation.

You can now connect the LCP to another adjustable frequency drive and copy the parameter settings to this adjustable frequency drive as well.

Data transfer from the LCP to the adjustable frequency drive:

1. Go to par.0-50 *LCP Copy*
2. Press the [OK] key.
3. Select "All from LCP"
4. Press the [OK] key.

The parameter settings stored in the LCP are now transferred to the adjustable frequency drive indicated by the progress bar. When 100% is reached, press [OK].



NOTE!

Stop the motor before performing this operation.

2.1.4 Parameter Set-up

The adjustable frequency drive can be used for practically all assignments, thus offering a significant number of parameters. The series offers a choice between two programming modes - the Quick Menu mode and the Main Menu mode.

The latter provides access to all parameters. The former takes the user through a few parameters making it possible to **program the majority of VLT HVAC Drive applications**.

Regardless of the mode of programming, you can change a parameter both in quick menu mode and in main menu mode.

2.1.5 Quick Menu Mode

Parameter Data

The graphical display (GLCP) provides access to all parameters listed under the quick menus. The numeric display (NLCP) only provides access to the quick set-up parameters. To set parameters using the [Quick Menu] button - enter or change parameter data or settings in accordance with the following procedure:

1. Press Quick Menu button
2. Use the [▲] and [▼] buttons to find the parameter you want to change
3. Press [OK].
4. Use [▲] and [▼] buttons to select the correct parameter setting
5. Press [OK].
6. To move to a different digit within a parameter setting, use the [◀] and [▶] buttons
7. Highlighted area indicates digit selected for change
8. Press [Cancel] button to disregard change, or press [OK] to accept change and enter the new setting

Example of Changing Parameter Data

Assume parameter 22-60 is set to [Off]. However, you want to monitor the fan belt condition - non-broken or broken - according to the following procedure:

1. Press Quick Menu key
2. Choose Function Set-ups with the [▼] button
3. Press [OK].
4. Choose Application Settings with the [▼] button
5. Press [OK].
6. Press [OK] again for Fan Functions
7. Choose Broken Belt Function by pressing [OK]
8. With [▼] button, choose [2] Trip

The adjustable frequency drive will now trip if a broken fan belt is detected.

Select [My Personal Menu] to display personal parameters:

Select [My Personal Menu] to display only the parameters, which have been pre-selected and programmed as personal parameters. For example, an AHU or pump OEM may have pre-programmed personal parameters to be in My Personal Menu during factory commissioning to make on-site commissioning/ fine tuning simpler. These parameters are selected in par.0-25 *My Personal Menu*. Up to 20 different parameters can be programmed in this menu.

Select [Changes Made] to get information about:

- the last 10 changes. Use the up/down navigation keys to scroll between the last 10 changed parameters.
- the changes made since default setting.

Select [Loggings]:

to get information about the display line readouts. The information is shown as graphs.

Only display parameters selected in par.0-20 *Display Line 1.1 Small* and par. 0-24 *Display Line 3 Large* can be viewed. It is possible to store up to 120 samples in the memory for later reference.

Efficient Parameter Set-up for VLT HVAC Drive Applications:

The parameters can easily be set up for the vast majority of the VLT HVAC Drive applications only by using the **[Quick Set-up]** option.

After pressing [Quick Menu], the different choices in the quick menu are listed. See also illustration 6.1 below and tables Q3-1 to Q3-4 in the following *Function Set-ups* section.

Example of using the Quick Set-up option:

Assume you want to set the ramp-down time to 100 seconds!

1. Select [Quick Setup]. The first par.0-01 *Language* in Quick Set-up appears
2. Press [▼] repeatedly until par.3-42 *Ramp 1 Ramp-down Time* appears with the default setting of 20 seconds
3. Press [OK].
4. Use the [◀] button to highlight the third digit before the comma.
5. Change '0' to '1' by using the [▲] button.
6. Use the [▶] button to highlight the digit '2'.
7. Change '2' to '0' with the [▼] button.
8. Press [OK].

The new ramp-down time is now set to 100 seconds.

It is recommended to do the set-up in the order listed.



NOTE!
A complete description of the function is found in the parameter sections of this manual.

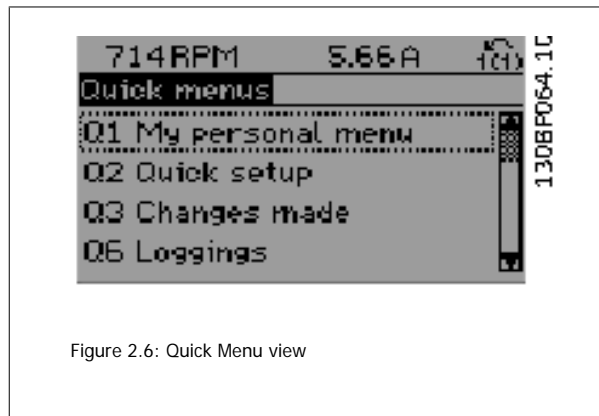

Figure 2.6: Quick Menu view

The Quick Set-up menu gives access to the 13 most important setup parameters of the adjustable frequency drive. After programming the adjustable frequency drive will, in most cases, be ready for operation. The 13 (see footnote) Quick Set-up parameters are shown in the table below. A complete description of the function is given in the parameter description sections of this manual.

Par.	[Units]
par.0-01 <i>Language</i>	
par.1-20 <i>Motor Power [kW]</i>	[kW]
par.1-21 <i>Motor Power [HP]</i>	[HP]
par.1-22 <i>Motor Voltage</i>	[V]
par.1-23 <i>Motor Frequency</i>	[Hz]
par.1-24 <i>Motor Current</i>	[A]
par.1-25 <i>Motor Nominal Speed</i>	[RPM]
par.1-28 <i>Motor Rotation Check</i>	[Hz]
par.3-41 <i>Ramp 1 Ramp-up Time</i>	[s]
par.3-42 <i>Ramp 1 Ramp-down Time</i>	[s]
par.4-11 <i>Motor Speed Low Limit [RPM]</i>	[RPM]
par.4-12 <i>Motor Speed Low Limit [Hz]</i>	[Hz]
par.4-13 <i>Motor Speed High Limit [RPM]</i>	[RPM]
par.4-14 <i>Motor Speed High Limit [Hz]</i>	[Hz]
par.3-19 <i>Jog Speed [RPM]</i>	[RPM]
par.3-11 <i>Jog Speed [Hz]</i>	[Hz]
par.5-12 <i>Terminal 27 Digital Input</i>	
par.5-40 <i>Function Relay</i>	

Table 2.1: Quick Set-up parameters

*The display showing depends on choices made in par.0-02 *Motor Speed Unit* and par.0-03 *Regional Settings*. The default settings of par.0-02 *Motor Speed Unit* and par.0-03 *Regional Settings* depend on which region of the world the adjustable frequency drive is supplied to but can be re-programmed as required.

** par.5-40 *Function Relay*, is an array, where one may choose between Relay1 [0] or Relay2 [1]. The standard setting is Relay1 [0] with the default choice Alarm [9].

See the parameter description later in this chapter under Function Set-up parameters.

For detailed information about settings and programming, see the *VLT HVAC Drive Programming Guide, MG.11.CX.YY*

x=version number

y=language

**NOTE!**

If [No Operation] is selected in par.5-12 *Terminal 27 Digital Input*, no connection to +24 V on terminal 27 is necessary to enable start.
If [Coast Inverse] (factory default value) is selected in par.5-12 *Terminal 27 Digital Input*, a connection to +24 V is necessary to enable start.

2.1.6 Function Set-ups

The Function set-up provides quick and easy access to all parameters required for the majority of VLT HVAC Drive applications including most VAV and CAV supply and return fans, cooling tower fans, primary, secondary and condenser water pumps and other pump, fan and compressor applications.

How to access Function set-up - example



Figure 2.7: Step 1: Turn on the adjustable frequency drive (yellow LED lights)

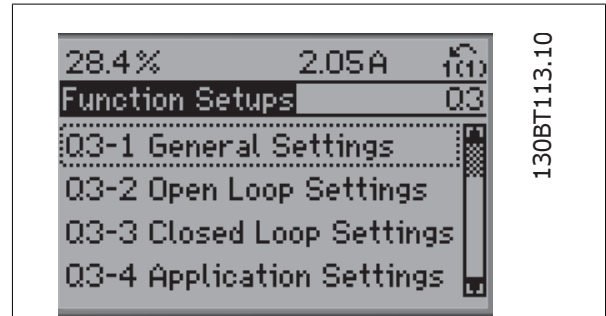

Figure 2.10: Step 4: Function set-ups choices appear. Choose 03-1 *General Settings*. Press [OK].

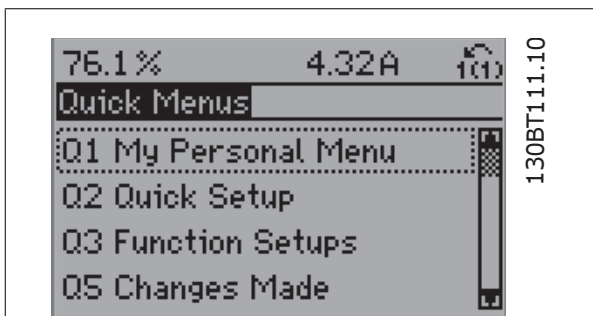

Figure 2.8: Step 2: Press the [Quick Menus] button (quick menu choices appear).

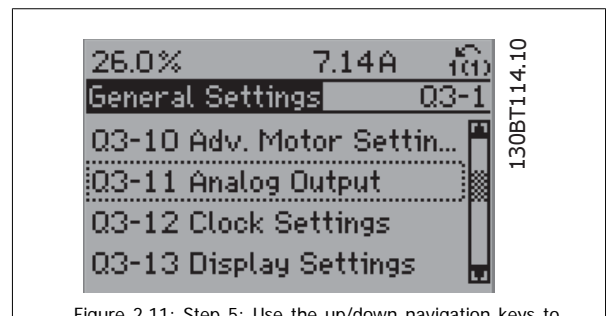

Figure 2.11: Step 5: Use the up/down navigation keys to scroll down to , e.g., 03-11 *Analog Outputs*. Press [OK].

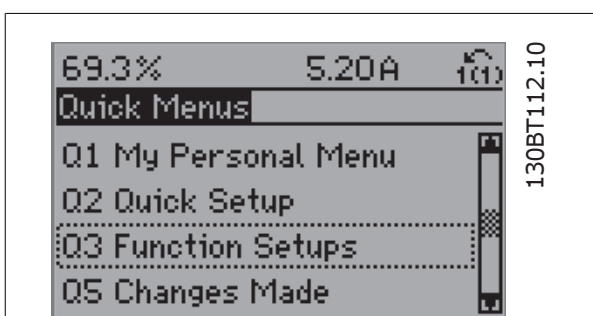

Figure 2.9: Step 3: Use the up/down navigation keys to scroll down to Function set-ups. Press [OK].

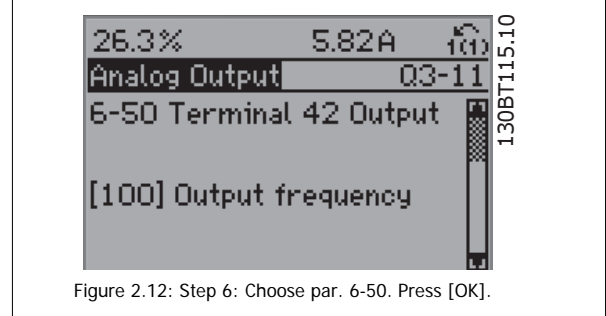

Figure 2.12: Step 6: Choose par. 6-50. Press [OK].

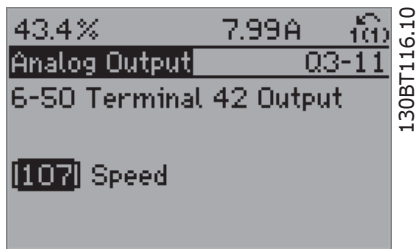

Figure 2.13: Step 7: Use the up/down navigation keys to navigate between the different choices. Press [OK].

Function Set-ups parameters

The Function Set-ups parameters are grouped in the following way:

Q3-1 General Settings			
Q3-10 Adv. Motor Settings	Q3-11 Analog Output	Q3-12 Clock Settings	Q3-13 Display Settings
par.1-90 <i>Motor Thermal Protection</i>	par.6-50 <i>Terminal 42 Output</i>	par.0-70 <i>Set Date and Time</i>	par.0-20 <i>Display Line 1.1 Small</i>
par.1-93 <i>Thermistor Source</i>	par.6-51 <i>Terminal 42 Output Min Scale</i>	par.0-71 <i>Date Format</i>	par.0-21 <i>Display Line 1.2 Small</i>
par.1-29 <i>Automatic Motor Adaptation (AMA)</i>	par.6-52 <i>Terminal 42 Output Max Scale</i>	par.0-72 <i>Time Format</i>	par.0-22 <i>Display Line 1.3 Small</i>
par.14-01 <i>Switching Frequency</i>		par.0-74 <i>DST/Summertime</i>	par.0-23 <i>Display Line 2 Large</i>
par.4-53 <i>Warning Speed High</i>		par.0-76 <i>DST/Summertime Start</i>	par.0-24 <i>Display Line 3 Large</i>
		par.0-77 <i>DST/Summertime End</i>	par.0-37 <i>Display Text 1</i>
			par.0-38 <i>Display Text 2</i>
			par.0-39 <i>Display Text 3</i>

Q3-2 Open-loop Settings	
Q3-20 Digital Reference	Q3-21 Analog Reference
par.3-02 <i>Minimum Reference</i>	par.3-02 <i>Minimum Reference</i>
par.3-03 <i>Maximum Reference</i>	par.3-03 <i>Maximum Reference</i>
par.3-10 <i>Preset Reference</i>	par.6-10 <i>Terminal 53 Low Voltage</i>
par.5-13 <i>Terminal 29 Digital Input</i>	par.6-11 <i>Terminal 53 High Voltage</i>
par.5-14 <i>Terminal 32 Digital Input</i>	par.6-12 <i>Terminal 53 Low Current</i>
par.5-15 <i>Terminal 33 Digital Input</i>	par.6-13 <i>Terminal 53 High Current</i>
	par.6-14 <i>Terminal 53 Low Ref./Feedb. Value</i>
	par.6-15 <i>Terminal 53 High Ref./Feedb. Value</i>

Q3-3 Closed-loop Settings		
Q3-30 Single Zone Int. Setpoint	Q3-31 Single Zone Ext. Setpoint	Q3-32 Multi Zone / Adv
par.1-00 Configuration Mode	par.1-00 Configuration Mode	par.1-00 Configuration Mode
par.20-12 Reference/Feedback Unit	par.20-12 Reference/Feedback Unit	par.3-15 Reference 1 Source
par.20-13 Minimum Reference/Feedb.	par.20-13 Minimum Reference/Feedb.	par.3-16 Reference 2 Source
par.20-14 Maximum Reference/Feedb.	par.20-14 Maximum Reference/Feedb.	par.20-00 Feedback 1 Source
par.6-22 Terminal 54 Low Current	par.6-10 Terminal 53 Low Voltage	par.20-01 Feedback 1 Conversion
par.6-24 Terminal 54 Low Ref./Feedb. Value	par.6-11 Terminal 53 High Voltage	par.20-02 Feedback 1 Source Unit
par.6-25 Terminal 54 High Ref./Feedb. Value	par.6-12 Terminal 53 Low Current	par.20-03 Feedback 2 Source
par.6-26 Terminal 54 Filter Time Constant	par.6-13 Terminal 53 High Current	par.20-04 Feedback 2 Conversion
par.6-27 Terminal 54 Live Zero	par.6-14 Terminal 53 Low Ref./Feedb. Value	par.20-05 Feedback 2 Source Unit
par.6-00 Live Zero Timeout Time	par.6-15 Terminal 53 High Ref./Feedb. Value	par.20-06 Feedback 3 Source
par.6-01 Live Zero Timeout Function	par.6-22 Terminal 54 Low Current	par.20-07 Feedback 3 Conversion
par.20-21 Setpoint 1	par.6-24 Terminal 54 Low Ref./Feedb. Value	par.20-08 Feedback 3 Source Unit
par.20-81 PID Normal/ Inverse Control	par.6-25 Terminal 54 High Ref./Feedb. Value	par.20-12 Reference/Feedback Unit
par.20-82 PID Start Speed [RPM]	par.6-26 Terminal 54 Filter Time Constant	par.20-13 Minimum Reference/Feedb.
par.20-83 PID Start Speed [Hz]	par.6-27 Terminal 54 Live Zero	par.20-14 Maximum Reference/Feedb.
par.20-93 PID Proportional Gain	par.6-00 Live Zero Timeout Time	par.6-10 Terminal 53 Low Voltage
par.20-94 PID Integral Time	par.6-01 Live Zero Timeout Function	par.6-11 Terminal 53 High Voltage
par.20-70 Closed-loop Type	par.20-81 PID Normal/ Inverse Control	par.6-12 Terminal 53 Low Current
par.20-71 Tuning Mode	par.20-82 PID Start Speed [RPM]	par.6-13 Terminal 53 High Current
par.20-72 PID Output Change	par.20-83 PID Start Speed [Hz]	par.6-14 Terminal 53 Low Ref./Feedb. Value
par.20-73 Minimum Feedback Level	par.20-93 PID Proportional Gain	par.6-15 Terminal 53 High Ref./Feedb. Value
par.20-74 Maximum Feedback Level	par.20-94 PID Integral Time	par.6-16 Terminal 53 Filter Time Constant
par.20-79 PID Auto Tuning	par.20-70 Closed-loop Type	par.6-17 Terminal 53 Live Zero
	par.20-71 Tuning Mode	par.6-20 Terminal 54 Low Voltage
	par.20-72 PID Output Change	par.6-21 Terminal 54 High Voltage
	par.20-73 Minimum Feedback Level	par.6-22 Terminal 54 Low Current
	par.20-74 Maximum Feedback Level	par.6-23 Terminal 54 High Current
	par.20-79 PID Auto Tuning	par.6-24 Terminal 54 Low Ref./Feedb. Value
		par.6-25 Terminal 54 High Ref./Feedb. Value
		par.6-26 Terminal 54 Filter Time Constant
		par.6-27 Terminal 54 Live Zero
		par.6-00 Live Zero Timeout Time
		par.6-01 Live Zero Timeout Function
		par.4-56 Warning Feedback Low
		par.4-57 Warning Feedback High
		par.20-20 Feedback Function
		par.20-21 Setpoint 1
		par.20-22 Setpoint 2
		par.20-81 PID Normal/ Inverse Control
		par.20-82 PID Start Speed [RPM]
		par.20-83 PID Start Speed [Hz]
		par.20-93 PID Proportional Gain
		par.20-94 PID Integral Time
		par.20-70 Closed-loop Type
		par.20-71 Tuning Mode
		par.20-72 PID Output Change
		par.20-73 Minimum Feedback Level
		par.20-74 Maximum Feedback Level
		par.20-79 PID Auto Tuning

Q3-4 Application Settings		
Q3-40 Fan Functions	Q3-41 Pump Functions	Q3-42 Compressor Functions
par.22-60 <i>Broken Belt Function</i>	par.22-20 <i>Low Power Auto Set-up</i>	par.1-03 <i>Torque Characteristics</i>
par.22-61 <i>Broken Belt Torque</i>	par.22-21 <i>Low Power Detection</i>	par.1-71 <i>Start Delay</i>
par.22-62 <i>Broken Belt Delay</i>	par.22-22 <i>Low Speed Detection</i>	par.22-75 <i>Short Cycle Protection</i>
par.4-64 <i>Semi-Auto Bypass Set-up</i>	par.22-23 <i>No-Flow Function</i>	par.22-76 <i>Interval between Starts</i>
par.1-03 <i>Torque Characteristics</i>	par.22-24 <i>No-Flow Delay</i>	par.22-77 <i>Minimum Run Time</i>
par.22-22 <i>Low Speed Detection</i>	par.22-40 <i>Minimum Run Time</i>	par.5-01 <i>Terminal 27 Mode</i>
par.22-23 <i>No-Flow Function</i>	par.22-41 <i>Minimum Sleep Time</i>	par.5-02 <i>Terminal 29 Mode</i>
par.22-24 <i>No-Flow Delay</i>	par.22-42 <i>Wake-up Speed [RPM]</i>	par.5-12 <i>Terminal 27 Digital Input</i>
par.22-40 <i>Minimum Run Time</i>	par.22-43 <i>Wake-up Speed [Hz]</i>	par.5-13 <i>Terminal 29 Digital Input</i>
par.22-41 <i>Minimum Sleep Time</i>	par.22-44 <i>Wake-up Ref./FB Difference</i>	par.5-40 <i>Function Relay</i>
par.22-42 <i>Wake-up Speed [RPM]</i>	par.22-45 <i>Setpoint Boost</i>	par.1-73 <i>Flying Start</i>
par.22-43 <i>Wake-up Speed [Hz]</i>	par.22-46 <i>Maximum Boost Time</i>	par.1-86 <i>Trip Speed Low [RPM]</i>
par.22-44 <i>Wake-up Ref./FB Difference</i>	par.22-26 <i>Dry Pump Function</i>	par.1-87 <i>Trip Speed Low [Hz]</i>
par.22-45 <i>Setpoint Boost</i>	par.22-27 <i>Dry Pump Delay</i>	
par.22-46 <i>Maximum Boost Time</i>	par.22-80 <i>Flow Compensation</i>	
par.2-10 <i>Brake Function</i>	par.22-81 <i>Square-linear Curve Approximation</i>	
par.2-16 <i>AC Brake Max. Current</i>	par.22-82 <i>Work Point Calculation</i>	
par.2-17 <i>Over-voltage Control</i>	par.22-83 <i>Speed at No-Flow [RPM]</i>	
par.1-73 <i>Flying Start</i>	par.22-84 <i>Speed at No-Flow [Hz]</i>	
par.1-71 <i>Start Delay</i>	par.22-85 <i>Speed at Design Point [RPM]</i>	
par.1-80 <i>Function at Stop</i>	par.22-86 <i>Speed at Design Point [Hz]</i>	
par.2-00 <i>DC Hold/Preheat Current</i>	par.22-87 <i>Pressure at No-Flow Speed</i>	
par.4-10 <i>Motor Speed Direction</i>	par.22-88 <i>Pressure at Rated Speed</i>	
	par.22-89 <i>Flow at Design Point</i>	
	par.22-90 <i>Flow at Rated Speed</i>	
	par.1-03 <i>Torque Characteristics</i>	
	par.1-73 <i>Flying Start</i>	

See also *VLT HVAC Drive Programming Guide* for a detailed description of the Function Set-ups parameter groups.

2.1.7 Main Menu Mode

Select main menu mode by pressing the [Main Menu] key. The readout below appears on the display.

The middle and bottom sections on the display show a list of parameter groups which can be chosen by toggling the up and down buttons.

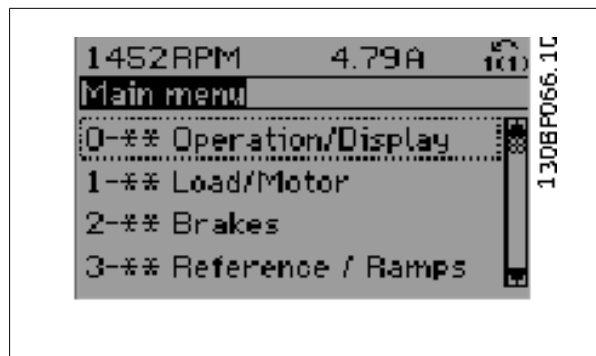

Each parameter has a name and number which remain the same regardless of the programming mode. In main menu mode, the parameters are divided into groups. The first digit of the parameter number (from the left) indicates the parameter group number.

All parameters can be changed in the main menu. However, depending on the choice of configuration (par.1-00 *Configuration Mode*), some parameters can be hidden.

2.1.8 Parameter Selection

In main menu mode, the parameters are divided into groups. You select a parameter group by means of the navigation keys.

The following parameter groups are accessible:

Group no.	Parameter group:
0	Operation/Display
1	Load/Motor
2	Brakes
3	References/Ramps
4	Limits/Warnings
5	Digital In/Out
6	Analog In/Out
8	Comm. and Options
9	Profibus
10	CAN Ser. Com. Bus
11	LonWorks
13	Smart Logic
14	Special Functions
15	Adjustable Frequency Drive Information
16	Data Readouts
18	Data Readouts 2
20	Drive Closed-loop
21	Ext. Closed-loop
22	Application Functions
23	Time-based Functions
25	Cascade Controller
26	Analog I/O Option MCB 109

After selecting a parameter group, choose a parameter by means of the navigation keys.

The middle section on the display shows the parameter number and name as well as the selected parameter value.

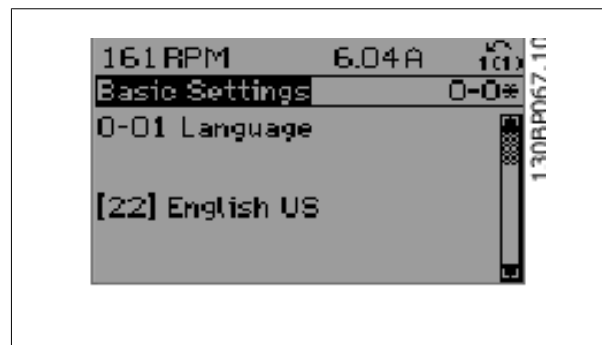

2.1.9 Changing Data

The procedure for changing data is the same whether you select a parameter in the quick menu or the main menu mode. Press [OK] to change the selected parameter.

The procedure for changing data depends on whether the selected parameter represents a numerical data value or a text value.

2.1.10 Changing a Text Value

If the selected parameter is a text value, change the text value by means of the [▲] [▼] navigation keys.

The up key increases the value, and the down key decreases the value. Place the cursor on the value you want to save and press [OK].



2.1.11 Changing a Group of Numeric Data Values

If the chosen parameter represents a numeric data value, change the chosen data value by means of the [◀] [▶] navigation keys as well as the [▲] [▼] navigation keys. Use the [◀] [▶] navigation keys to move the cursor horizontally.

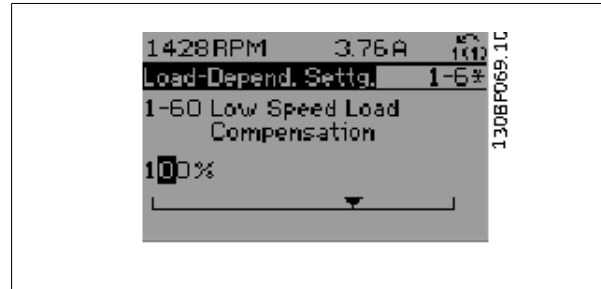

Use the [▲] [▼] navigation keys to change the data value. The up key enlarges the data value, and the down key reduces the data value. Place the cursor on the value you want to save and press [OK].

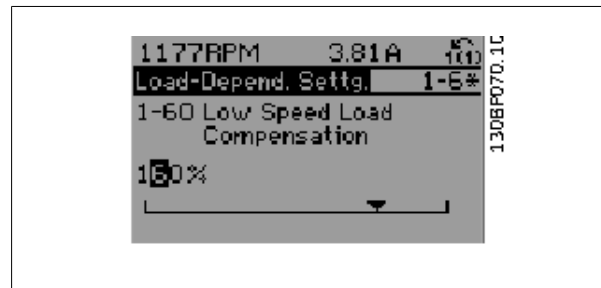

2.1.12 Changing a Data Value, Step-by-Step

Certain parameters can be changed step by step or infinitely varying. This applies to par.1-20 *Motor Power [kW]*, par.1-22 *Motor Voltage* and par.1-23 *Motor Frequency*.

The parameters are changed both as a group of numeric data values and as numeric data values infinitely varying.

2.1.13 Readout and Programming of Indexed Parameters

Parameters are indexed when placed in a rolling stack.

par.15-30 *Alarm Log: Error Code* to par.15-33 *Alarm Log: Date and Time* contain a fault log which can be read out. Choose a parameter, press [OK], and use the up/down navigation keys to scroll through the value log.

Use par.3-10 *Preset Reference* as another example:

Choose the parameter, press [OK], and use the up/down navigation keys to scroll through the indexed values. To change the parameter value, select the indexed value and press [OK]. Change the value by using the up/down keys. Press [OK] to accept the new setting. Press [CANCEL] to abort. Press [Back] to leave the parameter.

2.1.14 Initialization to Default Settings

Initialize the adjustable frequency drive to default settings in two ways:

Recommended initialization (via par.14-22 *Operation Mode*)

- | | |
|---|---|
| <ol style="list-style-type: none"> 1. Select par.14-22 <i>Operation Mode</i> 2. Press [OK]. 3. Select "Initialization" 4. Press [OK]. | <ol style="list-style-type: none"> 5. Cut off the line power supply and wait until the display turns off. 6. Reconnect the line power supply - the adjustable frequency drive is now reset. 7. Change par.14-22 <i>Operation Mode</i> back to <i>Normal Operation</i>. |
|---|---|

NOTE!
Resets parameters selected in Personal Menu with default factory setting.

par.14-22 *Operation Mode* initializes all except:

- par.14-50 *RFI 1*
- par.8-30 *Protocol*
- par.8-31 *Address*
- par.8-32 *Baud Rate*
- par.8-35 *Minimum Response Delay*
- par.8-36 *Max Response Delay*
- par.8-37 *Max Inter-Char Delay*
- par.15-00 *Operating Hours* to par.15-05 *Over Volts*
- par.15-20 *Historic Log: Event* to par.15-22 *Historic Log: Time*
- par.15-30 *Alarm Log: Error Code* to par.15-32 *Alarm Log: Time*

Manual initialization

1. Disconnect from line power and wait until the display turns off.
- 2a. Press [Status] - [Main Menu] - [OK] at the same time while powering up for LCP 102, Graphical Display
- 2b. Press [Menu] while powering up for LCP 101, Numerical Display
3. Release the keys after 5 s.
4. The adjustable frequency drive is now programmed according to default settings.

This procedure initializes all except: par.15-00 *Operating Hours*; par.15-03 *Power-ups*; par.15-04 *Over Temps*; par.15-05 *Over Volts*.

NOTE!
When you carry out manual initialization, you also reset serial communication, par.14-50 *RFI 1* and fault log settings.
Removes parameters selected in par.25-00 *Cascade Controller*.

NOTE!
After initialization and power cycling, the display will not show any information until after a couple of minutes.

2

3 Parameter Description

3.1 Parameter Selection

Parameters for the adjustable frequency drive are grouped into various parameter groups for easy selection of the correct parameters for optimized operation of the adjustable frequency drive.

The vast majority of VLT HVAC Drive applications can be programmed using the Quick Menu button and selecting the parameters under Quick Set-up and Function Set-ups.

Descriptions and default settings of parameters may be found under the section Parameter Lists at the back of this manual.



0-xx Operation/Display	10-xx CAN Serial Communication Bus
1-xx Load/Motor	11-xx LonWorks
2-xx Brakes	13-xx Smart Logic Controller
3-xx Reference/Ramps	14-xx Special Functions
4-xx Limits/ Warnings	15-xx Adjustable Frequency Drive Information
5-xx Digital In/Out	16-xx Data Readouts
6-xx Analog In/Out	18-xx Info & Readouts
8-xx Comm. and Options	20-xx Adjustable Frequency Drive Closed-loop
9-xx Profibus	21-xx Ext. Closed-loop
	22-xx Application Functions
	23-xx Time Based Functions
	24-xx Application Functions 2
	25-xx Cascade Controller
	26-xx Analog I/O Option MCB 109

3.2 Main Menu - Operation and Display - Group 0

3.2.1 0-** Operation / Display

Parameters related to the fundamental functions of the adjustable frequency drive, function of the LCP buttons and configuration of the LCP display.

3.2.2 0-0* Basic Settings

Parameter group for basic adjustable frequency drive settings.

0-01 Language

Option:
Function:

Defines the language to be used in the display.

The adjustable frequency drive can be delivered with 2 different language packages. English and German are included in both packages. The English cannot be erased or manipulated.

[0] *	English	Part of Language packages 1 - 2
[1]	Deutsch	Part of Language packages 1 - 2
[2]	Francais	Part of Language package 1
[3]	Dansk	Part of Language package 1
[4]	Spanish	Part of Language package 1
[5]	Italiano	Part of Language package 1
[6]	Svenska	Part of Language package 1
[7]	Nederlands	Part of Language package 1
[10]	Chinese	Language package 2
[20]	Suomi	Part of Language package 1
[22]	English US	Part of Language package 1
[27]	Greek	Part of Language package 1
[28]	Bras.port	Part of Language package 1
[36]	Slovenian	Part of Language package 1
[39]	Korean	Part of Language package 2
[40]	Japanese	Part of Language package 2
[41]	Turkish	Part of Language package 1
[42]	Trad.Chinese	Part of Language package 2
[43]	Bulgarian	Part of Language package 1
[44]	Srpski	Part of Language package 1
[45]	Romanian	Part of Language package 1
[46]	Magyar	Part of Language package 1
[47]	Czech	Part of Language package 1
[48]	Polski	Part of Language package 1
[49]	Russian	Part of Language package 1
[50]	Thai	Part of Language package 2
[51]	Bahasa Indonesia	Part of Language package 2

0-02 Motor Speed Unit

Option:

Function:

This parameter cannot be adjusted while the motor is running. The display showing depends on settings in par.0-02 *Motor Speed Unit* and par.0-03 *Regional Settings*. The default setting of par.0-02 *Motor Speed Unit* and par.0-03 *Regional Settings* depends on which region of the world the adjustable frequency drive is supplied to, but can be re-programmed as required.

	<p>NOTE!</p> <p>Changing the <i>Motor Speed Unit</i> will reset certain parameters to their initial value. It is recommended to select the motor speed unit first before modifying other parameters.</p>
---	---

- | | | |
|-------|-----|--|
| [0] | RPM | Selects display of motor speed variables and parameters (i.e. references, feedbacks and limits) in terms of motor speed (RPM). |
| [1] * | Hz | Selects display of motor speed variables and parameters (i.e., references, feedbacks and limits) in terms of output frequency to the motor (Hz). |

0-03 Regional Settings

Option:

Function:

This parameter cannot be adjusted while the motor is running. The display showing depends on settings in par.0-02 *Motor Speed Unit* and par.0-03 *Regional Settings*. The default setting of par.0-02 *Motor Speed Unit* and par.0-03 *Regional Settings* depends on which region of the world the adjustable frequency drive is supplied to but can be re-programmed as required.

- | | | |
|-------|---------------|---|
| [0] * | International | Sets par.1-20 <i>Motor Power [kW]</i> units to [kW] and the default value of par.1-23 <i>Motor Frequency</i> [50 Hz]. |
| [1] | North America | Sets par.1-21 <i>Motor Power [HP]</i> units to HP and the default value of par.1-23 <i>Motor Frequency</i> to 60 Hz. |

The setting not used is made invisible.

0-04 Operating State at Power-up

Option:

Function:

Select the operating mode upon reconnection of the adjustable frequency drive to AC line voltage after power-down when operating in hand (local) mode.

- | | | |
|-------|----------------------|---|
| [0] * | Resume | Resumes operation of the adjustable frequency drive maintaining the same local reference and the same start/stop condition (applied by [Hand On]/[Off] on the LCP or Hand Start via a digital input as before the adjustable frequency drive was powered down. |
| [1] | Forced stop, ref=old | Uses saved reference [1] to stop the adjustable frequency drive but at the same time retain in memory the local speed reference prior to power-down. After AC line voltage is reconnected and after receiving a start command (using the LCP [Hand On] button or Hand Start command via a digital input), the adjustable frequency drive restarts and operates at the retained speed reference. |

0-05 Local Mode Unit

Option:
Function:

Defines if the local reference unit should be displayed in terms of the motor shaft speed (in RPM/Hz) or as percent.

[0] * As Motor Speed Unit

[1] %

3

3.2.3 0-1* Set-up Operations

Define and control the individual parameter set-ups.

The adjustable frequency drive has four parameter set-ups that can be programmed independently of each other. This makes the adjustable frequency drive very flexible and able to meet the requirements of many different VLT HVAC Drive system control schemes often saving the cost of external control equipment. For example, these can be used to program the adjustable frequency drive to operate according to one control scheme in one set-up (e.g., daytime operation) and another control scheme in another set-up (e.g., night set back). Alternatively, they can be used by an AHU or packaged unit OEM to identically program all their factory-fitted adjustable frequency drives to the same parameters on different equipment models within a range, and then during production/commissioning, only need a specific set-up selection depending on which model the adjustable frequency drive is installed on within that range.

The active set-up (i.e., the set-up in which the adjustable frequency drive is currently operating) can be selected in par.0-10 *Active Set-up* and is displayed in the LCP. Using Multi set-up, it is possible to switch between set-ups with the adjustable frequency drive running or stopped, via digital input or serial communication commands (e.g., for night set back). If it is necessary to change set-ups while running, ensure par.0-12 *This Set-up Linked to* is programmed as required. For the majority of VLT HVAC Drive applications, it will not be necessary to program par.0-12 *This Set-up Linked to* even if a set-up must be changed while running. For very complex applications which use the full flexibility of the multiple set-ups, it may be required. Using par.0-11 *Programming Set-up*, it is possible to edit parameters in any of the set-ups during adjustable frequency drive operation in its active set-up; this set-up can be different than the one being edited. Using par.0-51 *Set-up Copy*, it is possible to copy parameter settings between the set-ups to enable quicker commissioning if similar parameter settings are required in different set-ups.

0-10 Active Set-up

Option:
Function:

Select the set-up in which the adjustable frequency drive is to operate.

Use par.0-51 *Set-up Copy* to copy a set-up to one or all other set-ups. To avoid conflicting settings of the same parameter within two different set-ups, link the set-ups together using par.0-12 *This Set-up Linked to*. Stop the adjustable frequency drive before switching between set-ups, where parameters marked 'not changeable during operation' have different values.

Parameters that are 'not changeable during operation' are marked FALSE in the parameter lists in the section Parameter Lists.

[0] Factory setup

Cannot be changed. It contains the Danfoss data set, and can be used as a data source when returning the other set-ups to a known state.

[1] * Set-up 1

Set-up 1 [1] to *Set-up 4* [4] are the four separate parameter set-ups within which all parameters can be programmed.

[2] Set-up 2

[3] Set-up 3

[4] Set-up 4

[9] Multi setup

Is used for remote selection of set-ups using digital inputs and the serial communication port. This set-up uses the settings from par.0-12 *This Set-up Linked to*.

0-11 Programming Set-up

Option:

Function:

		Select the set-up to be edited (i.e., programmed) during operation; either the active set-up or one of the inactive set-ups. The set-up number being edited is displayed in the LCP in (brackets).
[0]	Factory setup	cannot be edited, but it is useful as a data source to return the other set-ups to a known state.
[1]	Set-up 1	<i>Set-up 1</i> [1] to <i>Set-up 4</i> [4] can be edited freely during operation, independently of the active set-up.
[2]	Set-up 2	
[3]	Set-up 3	
[4]	Set-up 4	
[9] *	Active Set-up	(i.e., the set-up in which the adjustable frequency drive is operating) can also be edited during operation. Editing parameters in the chosen set-up would normally be done from the LCP but it is also possible from any of the serial communication ports.

0-12 This Set-up Linked to

Option:

Function:

This parameter only needs to be programmed if changing set-ups is required while the motor is running. It ensures that parameters that are 'not changeable during operation' have the same setting in all relevant set-ups.

To enable conflict-free changes from one set-up to another while the adjustable frequency drive is running, link set-ups containing parameters that are not changeable during operation. The link will ensure the proper synchronization of the 'not changeable during operation' parameter values when moving from one set-up to another during operation. 'Not changeable during operation' parameters can be identified by the label FALSE in the parameter lists in the section *Parameter Lists*.

The par.0-12 *This Set-up Linked to* feature is used when Multi set-up in par.0-10 *Active Set-up* is selected. Multi set-up can be used to move from one set-up to another during operation (i.e., while the motor is running).

Example:

Use Multi set-up to shift from Set-up 1 to Set-up 2 while the motor is running. Program parameters in Set-up 1 first, then ensure that Set-up 1 and Set-up 2 are synchronized (or 'linked'). Synchronization can be performed in two ways:

1. Change the edit set-up to *Set-up 2* [2] in par.0-11 *Programming Set-up* and set par.0-12 *This Set-up Linked to* to *Set-up 1* [1]. This will start the linking (synchronizing) process.

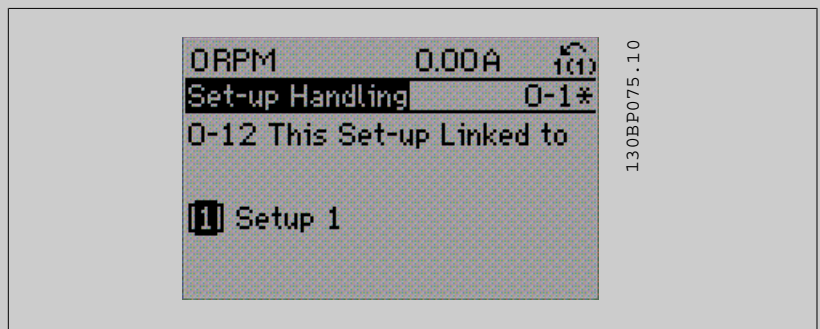

OR

2. While still in Set-up 1, using par.0-50 *LCP Copy*, copy Set-up 1 to Set-up 2. Then set par. 0-12 *This Set-up Linked to* to *Set-up 2* [2]. This will start the linking process.

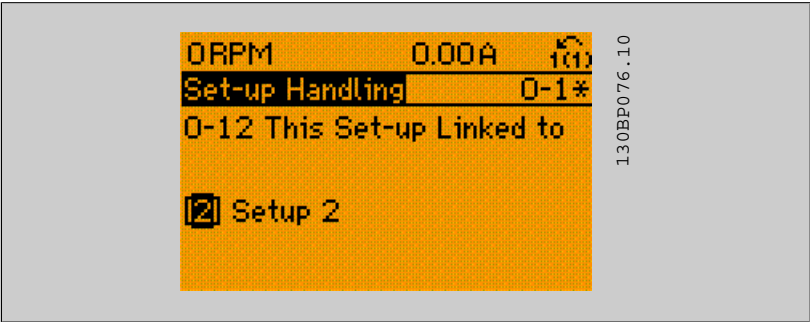

After the link is complete, par.0-13 *Readout: Linked Set-ups* will read {1,2} to indicate that all 'not changeable during operation' parameters are now the same in Set-up 1 and Set-up 2. If there are changes to a 'not changeable during operation' parameter, e.g. par.1-30 *Stator Resistance (Rs)* in Set-up 2, they will also be changed automatically in Set-up 1. A switch between Set-up 1 and Set-up 2 during operation is now possible.

- [0] * Not linked
- [1] Set-up 1
- [2] Set-up 2
- [3] Set-up 3
- [4] Set-up 4

0-13 Readout: Linked Set-ups

Array [5]

Range:

0 N/A* [0 - 255 N/A]

Function:

View a list of all the set-ups linked by means of par.0-12 *This Set-up Linked to*. The parameter has one index for each parameter set-up. The parameter value displayed for each index represents which set-ups are linked to that parameter set-up.

Index	LCP value
0	{0}
1	{1,2}
2	{1,2}
3	{3}
4	{4}

Table 3.2: Example: Set-up 1 and Set-up 2 are linked

0-14 Readout: Prog. Set-ups / Channel

Range:

0 N/A* [-2147483648 - 2147483647 N/A]

Function:

View the setting of par.0-11 *Programming Set-up* for each of the four different communication channels. When the number is displayed in hex, as it is in the LCP, each number represents one channel.

Numbers 1-4 represent a set-up number; 'F' means factory setting; and 'A' means active set-up. The channels are, from right to left: LCP, Adjustable Frequency Drive bus, USB, HPFB1.5.

Example: The number AAAAAA21h means that the Adjustable Frequency Drive bus selected Set-up 2 in par.0-11 *Programming Set-up*, the LCP selected Set-up 1 and all others used the active set-up.

3.2.4 0-2* LCP Display

Define the variables displayed in the Graphical Local Control Panel.

NOTE!
Refer to par.0-37 *Display Text 1*, par.0-38 *Display Text 2* and par.0-39 *Display Text 3* for information on how to write display texts.

0-20 Display Line 1.1 Small

Option:	Function:
	Select a variable for display in line 1, left position.
[0] * None	No display value selected
[37] Display Text 1	Enables an individual text string to be written, for display in the LCP or to be read via serial communication.
[38] Display Text 2	Enables an individual text string to be written, for display in the LCP or to be read via serial communication.
[39] Display Text 3	Enables an individual text string to be written, for display in the LCP or to be read via serial communication.
[89] Date and Time Readout	Displays the current date and time.
[953] Profibus Warning Word	Displays Profibus communication warnings.
[1005] Readout Transmit Error Counter	View the number of CAN control transmission errors since the last power-up.
[1006] Readout Receive Error Counter	View the number of CAN control receipt errors since the last power-up.
[1007] Readout Bus Off Counter	View the number of bus-off events since the last power-up.
[1013] Warning Parameter	View a DeviceNet-specific warning word. One separate bit is assigned to every warning.
[1115] LON Warning Word	Shows the LON-specific warnings.
[1117] XIF Revision	Shows the version of the external interface file of the Neuron C chip on the LON option.
[1118] LonWorks Revision	
[1501] Running Hours	View the number of running hours of the motor.
[1502] kWh Counter	View the line power consumption in kWh.
[1600] Control Word	View the control word sent from the adjustable frequency drive via the serial communication port in hex code.
[1601] Reference [Unit]	Total reference (sum of digital/analog/preset/bus/freeze ref./catch up and slow-down) in selected unit.
[1602] * Reference %	Total reference (sum of digital/analog/preset/bus/freeze ref./catch up and slow-down) in percent.
[1603] Status Word	Present status word
[1605] Main Actual Value [%]	View the two-byte word sent with the status word to the bus master reporting the main actual value.
[1609] Custom Readout	View the user-defined readouts as defined in par.0-30 <i>Custom Readout Unit</i> , par.0-31 <i>Custom Readout Min Value</i> and par.0-32 <i>Custom Readout Max Value</i> .
[1610] Power [kW]	Actual power consumed by the motor in kW.

[1611]	Power [hp]	Actual power consumed by the motor in HP.
[1612]	Motor voltage	Voltage supplied to the motor.
[1613]	Frequency	
[1614]	Motor Current	Phase current of the motor measured as effective value.
[1615]	Frequency [%]	Motor frequency, i.e., the output frequency from the adjustable frequency drive in percent.
[1616]	Torque [Nm]	Present motor load as a percentage of the rated motor torque.
[1617]	Speed [RPM]	Motor speed reference. Actual speed will depend on slip compensation being used (compensation set in par.1-62 <i>Slip Compensation</i>). If not used, actual speed will be the value read in the display minus motor slip.
[1618]	Motor Thermal	Thermal load on the motor, calculated by the ETR function. See also parameter group 1-9* Motor Temperature.
[1622]	Torque [%]	Shows the actual torque produced, in percentage.
[1630]	DC Link Voltage	Intermediate circuit voltage in the adjustable frequency drive.
[1632]	Brake Energy /s	
[1633]	Brake Energy /2 min	
[1634]	Heatsink Temp.	Present heatsink temperature of the adjustable frequency drive. The cut-out limit is 203° ± 9°F [95° ± 5° C]; cutting back in occurs at 158° ± 9°F [70° ± 5°C].
[1635]	Inverter Thermal	
[1636]	Inv. Nom. Current	Nominal current of the adjustable frequency drive
[1637]	Inv. Max. Current	Maximum current of the adjustable frequency drive
[1638]	SL Controller State	
[1639]	Control Card Temp.	Temperature of the control card.
[1650]	External Reference	Sum of the external reference as a percentage, i.e., the sum of analog/pulse/bus.
[1652]	Feedback [Unit]	Reference value from programmed digital input(s).
[1653]	Digi Pot Reference	View the contribution of the digital potentiometer to the actual reference Feedback.
[1654]	Feedback 1 [Unit]	View the value of Feedback 1. See also par. 20-0*.
[1655]	Feedback 2 [Unit]	View the value of Feedback 2. See also par. 20-0*.
[1656]	Feedback 3 [Unit]	View the value of Feedback 3. See also par. 20-0*.
[1658]	PID Output [%]	Returns the drive closed loop PID controller output value in percent.
[1660]	Digital Input	Displays the status of the digital inputs. Signal low = 0; Signal high = 1. Regarding order, see par.16-60 <i>Digital Input</i> . Bit 0 is at the extreme right.
[1661]	Terminal 53 Switch Setting	Setting of input terminal 53. Current = 0; Voltage = 1.
[1662]	Analog Input 53	Actual value at input 53 either as a reference or protection value.
[1663]	Terminal 54 Switch Setting	Setting of input terminal 54. Current = 0; Voltage = 1.
[1664]	Analog Input 54	Actual value at input 54 either as reference or protection value.
[1665]	Analog Output 42 [mA]	Actual value at output 42 in mA. Use par.6-50 <i>Terminal 42 Output</i> to select the variable to be represented by output 42.
[1666]	Digital Output [bin]	Binary value of all digital outputs.

[1667]	Pulse Input #29 [Hz]	
[1668]	Pulse Input #33 [Hz]	
[1669]	Pulse Output #27 [Hz]	Actual value of pulses applied to terminal 27 in digital output mode.
[1670]	Pulse Output #29 [Hz]	Actual value of pulses applied to terminal 29 in digital output mode.
[1671]	Relay Output [bin]	View the setting of all relays.
[1672]	Counter A	View the present value of Counter A.
[1673]	Counter B	View the present value of Counter B.
[1675]	Analog In X30/11	
[1676]	Analog In X30/12	
[1677]	Analog Out X30/8 [mA]	
[1680]	Fieldbus CTW 1	Control word (CTW) received from the bus master.
[1682]	Fieldbus REF 1	Main reference value sent with control word via the serial communications network, e.g., from the BMS, PLC or other master controller.
[1684]	Comm. Option Status	Extended serial communication bus option status word.
[1685]	FC Port CTW 1	Control word (CTW) received from the bus master.
[1686]	FC Port REF 1	Status word (STW) sent to the bus master.
[1690]	Alarm Word	One or more alarms in a Hex code (used for serial communications)
[1691]	Alarm word 2	One or more alarms in a Hex code (used for serial communications)
[1692]	Warning Word	One or more warnings in a Hex code (used for serial communications)
[1693]	Warning word 2	One or more warnings in a Hex code (used for serial communications)
[1694]	Ext. Status Word	One or more status conditions in a Hex code (used for serial communications)
[1695]	Ext. Status Word 2	One or more status conditions in a Hex code (used for serial communications)
[1696]	Maintenance Word	The bits reflect the status for the programmed preventive maintenance events in parameter group 23-1*
[1830]	Analog Input X42/1	Shows the value of the signal applied to terminal X42/1 on the Analog I/O card.
[1831]	Analog Input X42/3	Shows the value of the signal applied to terminal X42/3 on the Analog I/O card.
[1832]	Analog Input X42/5	Shows the value of the signal applied to terminal X42/5 on the Analog I/O card.
[1833]	Analog Out X42/7 [V]	Shows the value of the signal applied to terminal X42/7 on the Analog I/O card.
[1834]	Analog Out X42/9 [V]	Shows the value of the signal applied to terminal X42/9 on the Analog I/O card.
[1835]	Analog Out X42/11 [V]	Shows the value of the signal applied to terminal X42/11 on the Analog I/O card.
[2117]	Ext. 1 Reference [Unit]	The value of the reference for extended Closed-loop Controller 1
[2118]	Ext. 1 Feedback [Unit]	The value of the feedback signal for extended Closed-loop Controller 1
[2119]	Ext. 1 Output [%]	The value of the output from extended Closed-loop Controller 1
[2137]	Ext. 2 Reference [Unit]	The value of the reference for extended Closed-loop Controller 2
[2138]	Ext. 2 Feedback [Unit]	The value of the feedback signal for extended Closed-loop Controller 2
[2139]	Ext. 2 Output [%]	The value of the output from extended Closed-loop Controller 2
[2157]	Ext. 3 Reference [Unit]	The value of the reference for extended Closed-loop Controller 3

[2158]	Ext. 3 Feedback [Unit]	The value of the feedback signal for extended Closed-loop Controller 3
[2159]	Ext. 3 Output [%]	The value of the output from extended Closed-loop Controller 3
[2230]	No-Flow Power	The calculated No-Flow Power for the actual operating speed
[2316]	Maintenance Text	
[2580]	Cascade Status	Status for the operation of the cascade controller
[2581]	Pump Status	Status for the operation of each individual pump controlled by the cascade controller
[3110]	Bypass Status Word	
[3111]	Bypass Running Hours	

**NOTE!**

Consult the *VLT HVAC Drive Programming Guide, MG.11.CX.YY* for detailed information.

0-21 Display Line 1.2 Small**Option:****Function:**

Select a variable for display in line 1, middle position.

[1614] * Motor Current

The options are the same as those listed in par.0-20 *Display Line 1.1 Small*.

0-22 Display Line 1.3 Small**Option:****Function:**

Select a variable for display in line 1, right position.

[1610] * Power [kW]

The options are the same as those listed in par.0-20 *Display Line 1.1 Small*.

0-23 Display Line 2 Large**Option:****Function:**

Select a variable for display in line 2.

[1613] * Frequency

The options are the same as those listed in par.0-20 *Display Line 1.1 Small*.

0-24 Display Line 3 Large**Option:****Function:**

[1502] * kWh Counter

Select a variable for display in line 3. The options are the same as listed for par. 0-20.

0-25 My Personal Menu

Array [20]

Range:**Function:**

0 N/A* [0 - 9999 N/A]

Define up to 20 parameters to appear in the Q1 Personal Menu, accessible via the [Quick Menu] key on the LCP. The parameters will be displayed in the Q1 Personal Menu in the order they are programmed into this array parameter. Delete parameters by setting the value to '0000'.

For example, this can be used to provide quick, simple access to just one or up to 20 parameters which require changing on a regular basis (e.g., for plant maintenance reasons) or by an OEM to enable simple commissioning of their equipment.

3.2.5 0-3*LCP Custom Readout

It is possible to customize the display elements for various purposes: *Custom Readout. Value proportional to speed (linear, squared or cubed depending on unit selected in par.0-30 *Custom Readout Unit*) *Display Text. Text string stored in a parameter.

Custom Readout

The calculated value to be displayed is based on settings in par.0-30 *Custom Readout Unit*, par.0-31 *Custom Readout Min Value* (linear only), par.0-32 *Custom Readout Max Value*, par.4-13 *Motor Speed High Limit [RPM]*, par.4-14 *Motor Speed High Limit [Hz]* and actual speed.

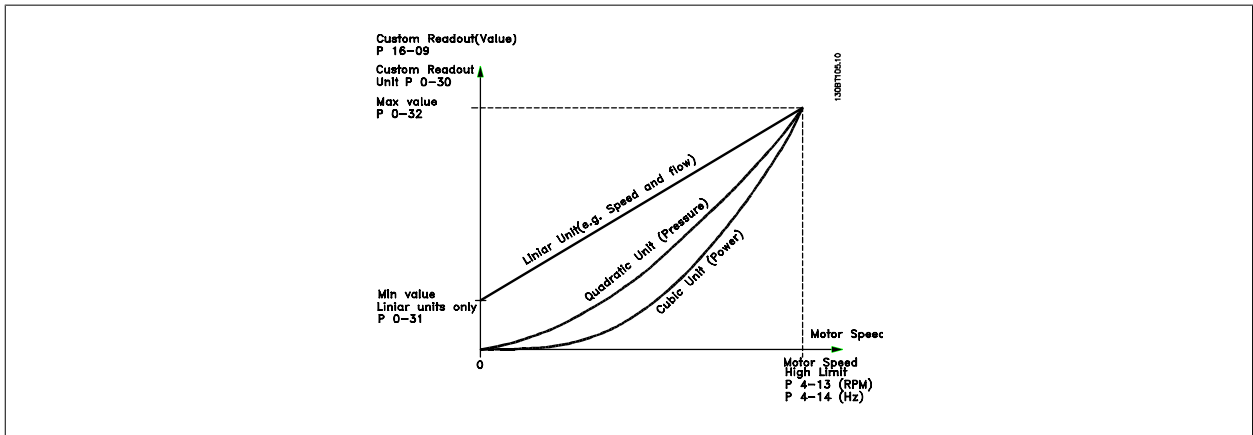

The relation will depend on the type of unit selected in par.0-30 *Custom Readout Unit*:

Unit Type	Speed Relation
Dimensionless	Linear
Speed	
Flow, volume	
Flow, mass	
Velocity	
Length	
Temperature	
Pressure	Quadratic
Power	Cubic

0-30 Custom Readout Unit

Option:

Function:

Program a value to be shown in the display of the LCP. The value has a linear, squared or cubed relation to speed. This relation depends on the unit selected (see table above). The actual calculated value can be read in par.16-09 *Custom Readout*, and/or shown in the display by selecting Custom Readout [16-09] in par.0-20 *Display Line 1.1 Small* to par. 0-24 *Display Line 3 Large*.

- [0]
- [1] * %
- [5] PPM
- [10] min
- [11] RPM
- [12] PULSE/s
- [20] liter / sec.

[21]	liter / min
[22]	liter / hr.
[23]	m ³ / sec.
[24]	m ³ /min
[25]	m ³ / hr.
[30]	kg / sec.
[31]	kg/min
[32]	kg / hr.
[33]	ton / min
[34]	ton / hr.
[40]	m / sec.
[41]	m/min
[45]	m
[60]	°C
[70]	mbar
[71]	bar
[72]	Pa
[73]	kPa
[74]	m WG
[75]	mm Hg
[80]	kW
[120]	GPM
[121]	gal / sec.
[122]	gal/min
[123]	gal / hr.
[124]	CFM
[125]	ft ³ /s
[126]	ft ³ /min
[127]	ft ³ /h
[130]	lbs / sec.
[131]	lbs / min.
[132]	lbs / hr.
[140]	ft/s
[141]	ft/min
[145]	ft
[160]	°F
[170]	psi
[171]	lb/in ²
[172]	in. wtr. gage
[173]	ft WG
[174]	in Hg
[180]	HP

0-31 Custom Readout Min Value

Range:

0.00 Cus- [0.00 - 100.00 CustomReadoutUnit]
tomReadou-
tUnit*

Function:

This parameter allows the choice of the min. value of the custom defined readout (occurs at zero speed). It is only possible to select a value different to 0 when selecting a linear unit in par. 0-30 *Custom Readout Unit*. For quadratic and cubic units, the minimum value will be 0.

0-32 Custom Readout Max Value

Range:

100.00 Cus- [par. 0-31 - 999999.99 CustomRea-
tomReadou-
doutUnit]
tUnit*

Function:

This parameter sets the max value to be shown when the speed of the motor has reached the set value for (par.4-13 *Motor Speed High Limit [RPM]* and par.4-14 *Motor Speed High Limit [Hz]*).

0-37 Display Text 1

Range:

0 N/A* [0 - 0 N/A]

Function:

In this parameter, it is possible to write an individual text string for display in the LCP or to be read via serial communication. If it is to be displayed permanently, select Display Text 1 in par. 0-20 *Display Line 1.1 Small*, par. 0-21 *Display Line 1.2 Small*, par. 0-22 *Display Line 1.3 Small*, par. 0-23 *Display Line 2 Large* or par. 0-24 *Display Line 3 Large*. Use the ▲ or ▼ buttons on the LCP to change a character. Use the ◀ and ▶ buttons to move the cursor. When a character is highlighted by the cursor, it can be changed. Use the ▲ or ▼ buttons on the LCP to change a character. A character can be inserted by placing the cursor between two characters and pressing ▲ or ▼.

0-38 Display Text 2

Range:

0 N/A* [0 - 0 N/A]

Function:

In this parameter, it is possible to write an individual text string for display in the LCP or to be read via serial communication. If it is to be displayed permanently, select Display Text 2 in par. 0-20 *Display Line 1.1 Small*, par. 0-21 *Display Line 1.2 Small*, par. 0-22 *Display Line 1.3 Small*, par. 0-23 *Display Line 2 Large* or par. 0-24 *Display Line 3 Large*. Use the ▲ or ▼ buttons on the LCP to change a character. Use the ◀ and ▶ buttons to move the cursor. When a character is highlighted by the cursor, this character can be changed. A character can be inserted by placing the cursor between two characters and pressing ▲ or ▼.

0-39 Display Text 3

Range:

0 N/A* [0 - 0 N/A]

Function:

In this parameter, it is possible to write an individual text string for display in the LCP or to be read via serial communication. If it is to be displayed permanently, select Display Text 3 in par. 0-20 *Display Line 1.1 Small*, par. 0-21 *Display Line 1.2 Small*, par. 0-22 *Display Line 1.3 Small*, par. 0-23 *Display Line 2 Large* or par. 0-24 *Display Line 3 Large*. Use the ▲ or ▼ buttons on the LCP to change a character. Use the ◀ and ▶ buttons to move the cursor. When a character is highlighted by the cursor, this character can be changed. A character can be inserted by placing the cursor between two characters and pressing ▲ or ▼.

3.2.6 LCP Keypad, 0-4*

Enable, disable and password-protect individual keys on the LCP.

0-40 [Hand on] Key on LCP

Option:	Function:
[0] Disabled	No function
[1] * Enabled	[Hand on] Key enabled
[2] Password	Avoid unauthorized start in hand mode. If par.0-40 <i>[Hand on] Key on LCP</i> is included in the My Personal Menu, then define the password in par.0-65 <i>Personal Menu Password</i> . Otherwise, define the password in par.0-60 <i>Main Menu Password</i> .

0-41 [Off] Key on LCP

Option:	Function:
[0] Disabled	No function
[1] * Enabled	[Off] Key is enabled
[2] Password	Avoid unauthorized stop. If par.0-41 <i>[Off] Key on LCP</i> is included in the My Personal Menu, then define the password in par.0-65 <i>Personal Menu Password</i> . Otherwise, define the password in par.0-60 <i>Main Menu Password</i> .

0-42 [Auto on] Key on LCP

Option:	Function:
[0] Disabled	No function
[1] * Enabled	[Auto on] Key is enabled
[2] Password	Avoid unauthorized start in auto mode. If par.0-42 <i>[Auto on] Key on LCP</i> is included in the My Personal Menu, then define the password in par.0-65 <i>Personal Menu Password</i> . Otherwise, define the password in par.0-60 <i>Main Menu Password</i> .

0-43 [Reset] Key on LCP

Option:	Function:
[0] Disabled	No function
[1] * Enabled	[Reset] Key is enabled
[2] Password	Avoid unauthorized resetting. If par.0-43 <i>[Reset] Key on LCP</i> is included in the par.0-25 <i>My Personal Menu</i> , then define the password in par.0-65 <i>Personal Menu Password</i> . Otherwise, define the password in par.0-60 <i>Main Menu Password</i> .

3.2.7 0-5* Copy / Save

Copy parameter settings between set-ups and to/from the LCP.

0-50 LCP Copy

Option:	Function:
[0] * No copy	No function
[1] All to LCP	Copies all parameters in all set-ups from the adjustable frequency drive memory to the LCP memory. For service purposes, it is recommended to copy all parameters to the LCP after commissioning.
[2] All from LCP	Copies all parameters in all set-ups from the LCP memory to the adjustable frequency drive memory.
[3] Size indep. of LCP	Copies only the parameters that are independent of the motor size. The latter selection can be used to program several adjustable frequency drives with the same function without disturbing motor data which are already set.

This parameter cannot be adjusted while the motor is running.

0-51 Set-up Copy

Option:	Function:
[0] * No copy	No function
[1] Copy to set-up 1	Copies all parameters in the present Programming Set-up (defined in par.0-11 <i>Programming Set-up</i>) to Set-up 1.
[2] Copy to set-up 2	Copies all parameters in the present Programming Set-up (defined in par.0-11 <i>Programming Set-up</i>) to Set-up 2.
[3] Copy to set-up 3	Copies all parameters in the present Programming Set-up (defined in par.0-11 <i>Programming Set-up</i>) to Set-up 3.
[4] Copy to set-up 4	Copies all parameters in the present Programming Set-up (defined in par.0-11 <i>Programming Set-up</i>) to Set-up 4.
[9] Copy to all	Copies the parameters in the present set-up over to each of the Set-ups 1 to 4.

3.2.8 0-6* Password

Define password access to menus.

0-60 Main Menu Password

Range:	Function:
100 N/A* [0 - 999 N/A]	Define the password for access to the main menu via the [Main Menu] key. If par.0-61 <i>Access to Main Menu w/o Password</i> is set to <i>Full access</i> [0], this parameter will be ignored.

0-61 Access to Main Menu w/o Password

Option:	Function:
[0] * Full access	Disables password defined in par.0-60 <i>Main Menu Password</i> .
[1] Read-only	Prevent unauthorized editing of main menu parameters.
[2] No access	Prevent unauthorized viewing and editing of main menu parameters.
[16] All: No access	

If *Full access* [0] is selected then par.0-60 *Main Menu Password*, par.0-65 *Personal Menu Password* and par.0-66 *Access to Personal Menu w/o Password* will be ignored.

0-65 Personal Menu Password

Range:

200 N/A* [0 - 999 N/A]

Function:

Define the password for access to the My Personal Menu via the [Quick Menu] key. If par. 0-66 *Access to Personal Menu w/o Password* is set to *Full access* [0], this parameter will be ignored.

0-66 Access to Personal Menu w/o Password

Option:

[0] * Full access

[1] Read-only

[2] No access

[16] All: No access

Function:

Disables password defined in par.0-65 *Personal Menu Password*.

Prevents unauthorized viewing and editing of My Personal Menu parameters.

If par.0-61 *Access to Main Menu w/o Password* is set to *Full access* [0], this parameter will be ignored.

3.2.9 Clock Settings, 0-7*

Set the time and date of the internal clock. The internal clock can be used, for example, for timed actions, energy log, trend analysis, date/time stamps on alarms, logged data and preventive maintenance.

It is possible to program the clock for Daylight Saving Time/summertime, weekly working days/non-working days including 20 exceptions (holidays, etc.). Although the clock settings can be set via the LCP, they can also be set along with timed actions and preventative maintenance functions using the MCT10 software tool.

NOTE!

The adjustable frequency drive has no back-up of the clock function and the set date/time will reset to default (2000-01-01 00:00) after a power-down unless a Real Time Clock module with back-up is installed. If no module with back-up is installed, it is recommended that the clock function is only used if the adjustable frequency drive is integrated into the BMS using serial communications, with the BMS maintaining synchronization of control equipment clock times. In par.0-79 *Clock Fault*, it is possible to program for a warning in case the clock has not been set properly, e.g., after a power-down.

NOTE!

If mounting an Analog I/O MCB 109 option card, a battery back-up of the date and time is included.

0-70 Set Date and Time

Range:

0 N/A* [0 - 0 N/A]

Function:

Sets the date and time of the internal clock. The format to be used is set in par.0-71 *Date Format* and par.0-72 *Time Format*.

0-71 Date Format

Option:

[0] * YYYY-MM-DD

[1] * DD-MM-YYYY

[2] MM/DD/YYYY

Function:

Sets the date format to be used in the LCP.

0-72 Time Format

Option:	Function:
	Sets the time format to be used in the LCP.
[0] * 24 h	
[1] 12 h	

0-74 DST/Summertime

Option:	Function:
	Choose how Daylight Saving Time/Summertime should be handled. For manual DST/Summertime enter the start date and end date in par.0-76 <i>DST/Summertime Start</i> and par.0-77 <i>DST/Summertime End</i> .
[0] * OFF	
[2] Manual	

0-76 DST/Summertime Start

Range:	Function:
0 N/A* [0 - 0 N/A]	Sets the date and time when summertime/DST starts. The date is programmed in the format selected in par.0-71 <i>Date Format</i> .

0-77 DST/Summertime End

Range:	Function:
0 N/A* [0 - 0 N/A]	Sets the date and time when summertime/DST ends. The date is programmed in the format selected in par.0-71 <i>Date Format</i> .

0-79 Clock Fault

Option:	Function:
	Enables or disables the clock warning when the clock has not been set, or has been reset due to a power-down and no backup is installed.
[0] * Disabled	
[1] Enabled	

0-81 Working Days

Array with 7 elements [0] - [6] displayed below parameter number in display. Press OK and step between elements by means of ▲ and ▼ buttons on the LCP.

Option:	Function:
	Specify whether each weekday is a workday or a non-workday. First element of the array is Monday. The workdays are used for timed actions.
[0] * No	
[1] Yes	

0-82 Additional Working Days

Array with 5 elements [0] - [4] displayed below parameter number in display. Press OK and step between elements by means of ▲ and ▼ buttons on the LCP.

Range:	Function:
0 N/A* [0 - 0 N/A]	Defines dates for additional working days that normally would be non-working days according to par.0-82 <i>Additional Working Days</i> .

0-83 Additional Non-Working Days

Array with 15 elements [0] - [14] displayed below parameter number in display. Press OK and step between elements by means of ▲ and ▼ buttons on the LCP.

Range:

0 N/A* [0 - 0 N/A]

Function:

Defines dates for additional working days that normally would be non-working days according to par.0-81 *Working Days*.

0-89 Date and Time Readout

Range:

0 N/A* [0 - 0 N/A]

Function:

Displays the current date and time. The date and time is updated continuously. The clock will not begin counting until a setting different from default has been made in par. 0-70 *Set Date and Time*.

3

3.3 Main Menu - Load and Motor - Group 1

3.3.1 General Settings, 1-0*

Define whether the adjustable frequency drive operates in open-loop or closed-loop.

1-00 Configuration Mode

Option:

[0] * Open-loop

Function:

Motor speed is determined by applying a speed reference or by setting desired speed when in hand mode.

Open-loop is also used if the adjustable frequency drive is part of a closed-loop control system based on an external PID controller providing a speed reference signal as output.

[3] Closed-loop

Motor speed will be determined by a reference from the built-in PID controller varying the motor speed as part of a closed-loop control process (e.g., constant pressure or flow). The PID controller must be configured in par. 20-** or via the function set-ups accessed by pressing the [Quick Menu] button.

NOTE!

This parameter cannot be changed when the motor is running.

NOTE!

When set for closed-loop, the commands reversing and start reversing will not reverse the direction of the motor.

1-03 Torque Characteristics

Option:

Function:

[0]	Compressor torque	<i>Compressor</i> [0]: For speed control of screw and scroll compressors. Provides a voltage which is optimized for a constant torque load characteristic of the motor in the entire range down to 10 Hz.
[1]	Variable torque	<i>Variable Torque</i> [1]: For speed control of centrifugal pumps and fans. Also to be used when controlling more than one motor from the same adjustable frequency drive (e.g., multiple condenser fans or cooling tower fans). Provides a voltage which is optimized for a squared torque load characteristic of the motor.
[2]	Auto Energy Optim. CT	<i>Auto Energy Optimization Compressor</i> [2]: For optimum energy efficient speed control of screw and scroll compressors. Provides a voltage which is optimized for a constant torque load characteristic of the motor in the entire range down to 15Hz, but in addition, the AEO feature will adapt the voltage exactly to the current load situation, thereby reducing energy consumption and audible noise from the motor. To obtain optimal performance, the motor power factor cos phi must be set correctly. This value is set in par.14-43 <i>Motor Cos-Phi</i> . The parameter has a default value which is automatically adjusted when the motor data is programmed. These settings will typically ensure optimum motor voltage but if the motor power factor cos phi requires tuning, an AMA function can be carried out using par.1-29 <i>Automatic Motor Adaptation (AMA)</i> . It is very rarely necessary to adjust the motor power factor parameter manually.
[3] *	Auto Energy Optim. VT	<i>Auto Energy Optimization VT</i> [3]: For optimum energy efficient speed control of centrifugal pumps and fans. Provides a voltage which is optimized for a squared torque load characteristic of the motor but in addition the AEO feature will adapt the voltage exactly to the current load situation, thereby reducing energy consumption and audible noise from the motor. To obtain optimal performance, the motor power factor cos phi must be set correctly. This value is set in par.14-43 <i>Motor Cos-Phi</i> . The parameter has a default value and is automatically adjusted when the motor data is programmed. These settings will typically ensure optimum motor voltage but if the motor power factor cos phi requires tuning, an AMA function can be carried out using par.1-29 <i>Automatic Motor Adaptation (AMA)</i> . It is very rarely necessary to adjust the motor power factor parameter manually.

3.3.2 1-2* Motor Data

Parameter group 1-2* comprises input data from the nameplate on the connected motor.

Parameters in parameter group 1-2* cannot be adjusted while the motor is running.



NOTE!
Changing the value of these parameters affects the setting of other parameters.

1-20 Motor Power [kW]

Range:

Function:

4.00 kW* [0.09 - 3000.00 kW]	Enter the nominal motor power (in kW) according to the motor nameplate data. The default value corresponds to the nominal rated output of the unit. This parameter cannot be adjusted while the motor is running. Depending on the choices made in par.0-03 <i>Regional Settings</i> , either par.1-20 <i>Motor Power [kW]</i> or par.1-21 <i>Motor Power [HP]</i> is made invisible.
------------------------------	--

1-21 Motor Power [HP]

Range:

4.00 hp* [0.09 - 3000.00 hp]

Function:

Enter the nominal motor power in HP according to the motor nameplate data. The default value corresponds to the nominal rated output of the unit.

This parameter cannot be adjusted while the motor is running.

Depending on the choices made in par.0-03 *Regional Settings*, either par.1-20 *Motor Power [kW]* or par.1-21 *Motor Power [HP]* is made invisible.

1-22 Motor Voltage

Range:

400. V* [10. - 1000. V]

Function:

Enter the nominal motor voltage according to the motor nameplate data. The default value corresponds to the nominal rated output of the unit.

This parameter cannot be adjusted while the motor is running.

1-23 Motor Frequency

Range:

50. Hz* [20 - 1000 Hz]

Function:

Select the motor frequency value from the motor nameplate data. For 87 Hz operation with 230/400 V motors, set the nameplate data for 230 V/50 Hz. Adapt par.4-13 *Motor Speed High Limit [RPM]* and par.3-03 *Maximum Reference* to the 87 Hz application.

NOTE!

This parameter cannot be adjusted while the motor is running.

1-24 Motor Current

Range:

7.20 A* [0.10 - 10000.00 A]

Function:

Enter the nominal motor current value from the motor nameplate data. This data is used for calculating motor torque, motor thermal protection, etc.

NOTE!

This parameter cannot be adjusted while the motor is running.

1-25 Motor Nominal Speed

Range:

1420. RPM* [100 - 60000 RPM]

Function:

Enter the nominal motor speed value from the motor nameplate data. This data is used for calculating automatic motor compensations.

NOTE!

This parameter cannot be changed while the motor is running.

1-28 Motor Rotation Check

Option:

Function:

		Following installation and connection of the motor, this function allows the correct motor rotation direction to be verified. Enabling this function overrides any bus commands or digital inputs, except External Interlock and Safe Stop (if included).
[0] *	OFF	Motor Rotation Check is not active.
[1]	Enabled	Motor Rotation Check is enabled. Once enabled, display shows: "Please Note! Motor may run in wrong direction".

Pressing [OK], [Back] or [Cancel] will dismiss the message and display a new message: "Press [Hand on] to start the motor. Press [Cancel] to abort". Pressing [Hand on] starts the motor at 5 Hz in forward direction and the display shows: "Motor is running. Check if motor rotation direction is correct. Press [Off] to stop the motor". Pressing [Off] stops the motor and resets par.1-28 *Motor Rotation Check*. If motor rotation direction is incorrect, two motor phase cables should be interchanged. **IMPORTANT:**

Line power must be removed before disconnecting motor phase cables.

1-29 Automatic Motor Adaptation (AMA)

Option:

Function:

		The AMA function optimizes dynamic motor performance by automatically optimizing the advanced motor parameters par.1-30 <i>Stator Resistance (Rs)</i> to par.1-35 <i>Main Reactance (Xh)</i> while the motor is stationary.
[0] *	Off	No function
[1]	Enable complete AMA	performs AMA of the stator resistance R_s , the rotor resistance R_r , the stator leakage reactance X_1 , the rotor leakage reactance X_2 and the main reactance X_h .
[2]	Enable reduced AMA	performs a reduced AMA of the stator resistance R_s in the system only. Select this option if an LC filter is used between the adjustable frequency drive and the motor.

Activate the AMA function by pressing [Hand on] after selecting [1] or [2]. See also the section *Automatic Motor Adaptation*. After a normal sequence, the display will read: "Press [OK] to finish AMA". After pressing the [OK] key, the adjustable frequency drive is ready for operation.

Note:

- For the best adaptation of the adjustable frequency drive, run AMA on a cold motor
- AMA cannot be performed while the motor is running.

NOTE!
It is important to set motor par. 1-2* *Motor Data* correctly, since these form part of the AMA algorithm. An AMA must be performed to achieve optimum dynamic motor performance. It may take up to 10 min., depending on the motor power rating.

NOTE!
Avoid generating external torque during AMA

**NOTE!**

If one of the settings in par. 1-2* Motor Data is changed, par.1-30 *Stator Resistance (Rs)* to par.1-39 *Motor Poles*, the advanced motor parameters, will return to the default setting.

This parameter cannot be adjusted while the motor is running.

**NOTE!**

Full AMA should be run without filter only while reduced AMA should be run with filter.

3

See section *Automatic Motor Adaptation* - application example.

3.3.3 1-3* Adv. Motor Data

Parameters for advanced motor data. The motor data in par.1-30 *Stator Resistance (Rs)* to par.1-39 *Motor Poles* must match the relevant motor in order to run the motor optimally. The default settings are figures based on common motor parameter values from normal standard motors. If the motor parameters are not set correctly, a malfunction of the adjustable frequency drive system may occur. If the motor data is not known, running an AMA (Automatic Motor Adaptation) is recommended. See the *Automatic Motor Adaptation* section. The AMA sequence will adjust all motor parameters except the moment of inertia of the rotor and the iron loss resistance (par.1-36 *Iron Loss Resistance (Rfe)*).

Par. 1-3* and par. 1-4* cannot be adjusted while the motor is running.

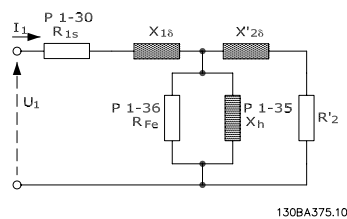

Figure 3.1: Motor equivalent diagram for an asynchronous motor

1-30 Stator Resistance (Rs)

Range:

1.4000 [0.0140 - 140.0000 Ohm]
Ohm*

Function:

Set the stator resistance value. Enter the value from a motor data sheet or perform an AMA on a cold motor. This parameter cannot be adjusted while the motor is running.

1-35 Main Reactance (Xh)

Range:

100.0000 [1.0000 - 10000.0000 Ohm]
Ohm*

Function:

Set the main reactance of the motor using one of these methods:

1. Run an AMA on a cold motor. The adjustable frequency drive will measure the value from the motor.
2. Enter the X_h value manually. Obtain the value from the motor supplier.
3. Use the X_h default setting. The adjustable frequency drive establishes the setting on the basis of the motor nameplate data.



NOTE!

This parameter cannot be adjusted while running.

1-36 Iron Loss Resistance (Rfe)

Range:

10000.000 [0 - 10000.000 Ohm]
Ohm*

Function:

Enter the equivalent iron loss resistance (R_{Fe}) value to compensate for iron losses in the motor. The R_{Fe} value cannot be found by performing an AMA. The R_{Fe} value is especially important in torque control applications. If R_{Fe} is unknown, leave par. 1-36 *Iron Loss Resistance (Rfe)* on default setting.

3



NOTE!

This parameter cannot be adjusted while the motor is running.

1-39 Motor Poles

Range:

4. N/A* [2 - 100 N/A]

Function:

Enter the number of motor poles.

Poles	~ n_n @ 50 Hz	~ n_n @60 Hz
2	2700 - 2880	3250 - 3460
4	1350 - 1450	1625 - 1730
6	700 - 960	840 - 1153

The table shows the number of poles for normal speed ranges of various motor types. Define motors designed for other frequencies separately. The motor pole value is always an even number, because it refers to the total number of poles, not pairs of poles. The adjustable frequency drive creates the initial setting of par. 1-39 *Motor Poles* based on par. 1-23 *Motor Frequency* and par. 1-25 *Motor Nominal Speed*.

This parameter cannot be adjusted while the motor is running.

3.3.4 1-5* Load Indep. Setting

Parameters for setting the load-independent motor settings.

1-50 Motor Magnetization at Zero Speed

Range:

100 %* [0 - 300 %]

Function:

Use this parameter along with par.1-51 *Min Speed Normal Magnetizing [RPM]* to obtain a different thermal load on the motor when running at low speed.

Enter a value which is a percentage of the rated magnetizing current. If the setting is too low, the torque on the motor shaft may be reduced.

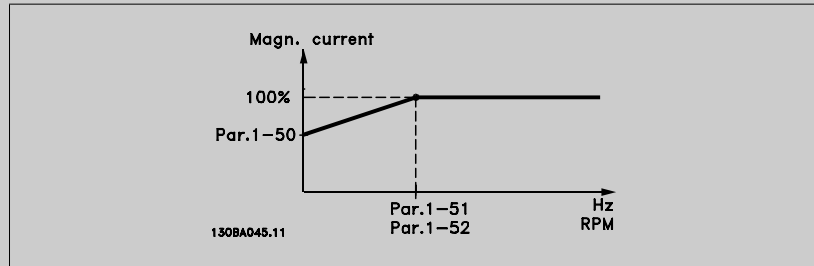

1-51 Min Speed Normal Magnetizing [RPM]

Range:

15. RPM* [10 - 300 RPM]

Function:

Set the required speed for normal magnetizing current. If the speed is set lower than the motor slip speed, par.1-50 *Motor Magnetization at Zero Speed* and par.1-51 *Min Speed Normal Magnetizing [RPM]* are of no significance.

Use this parameter along with par.1-50 *Motor Magnetization at Zero Speed*. See drawing for par. 1-50 *Motor Magnetization at Zero Speed*.

1-52 Min Speed Normal Magnetizing [Hz]

Range:

0.5 Hz* [0.3 - 10.0 Hz]

Function:

Set the required frequency for normal magnetizing current. If the frequency is set lower than the motor slip frequency, par.1-50 *Motor Magnetization at Zero Speed* and par.1-51 *Min Speed Normal Magnetizing [RPM]* are inactive.

Use this parameter along with par.1-50 *Motor Magnetization at Zero Speed*. See drawing for par. 1-50 *Motor Magnetization at Zero Speed*.

3.3.5 1-6* Load Depend. Setting

Parameters for adjusting the load-dependent motor settings.

1-60 Low Speed Load Compensation

Range:

100 %* [0 - 300 %]

Function:

Enter the % value to compensate voltage in relation to load while the motor is running at low speed, and obtain the optimum U/f characteristic. The motor size determines the frequency ranges within which this parameter is active.

Motor size	Change-over
0.3–10 hp [0.25–7.5 kW]	< 10 Hz
15–60 hp [11–45 kW]	< 5 Hz
75–738 hp [55–550 kW]	< 3-4 Hz

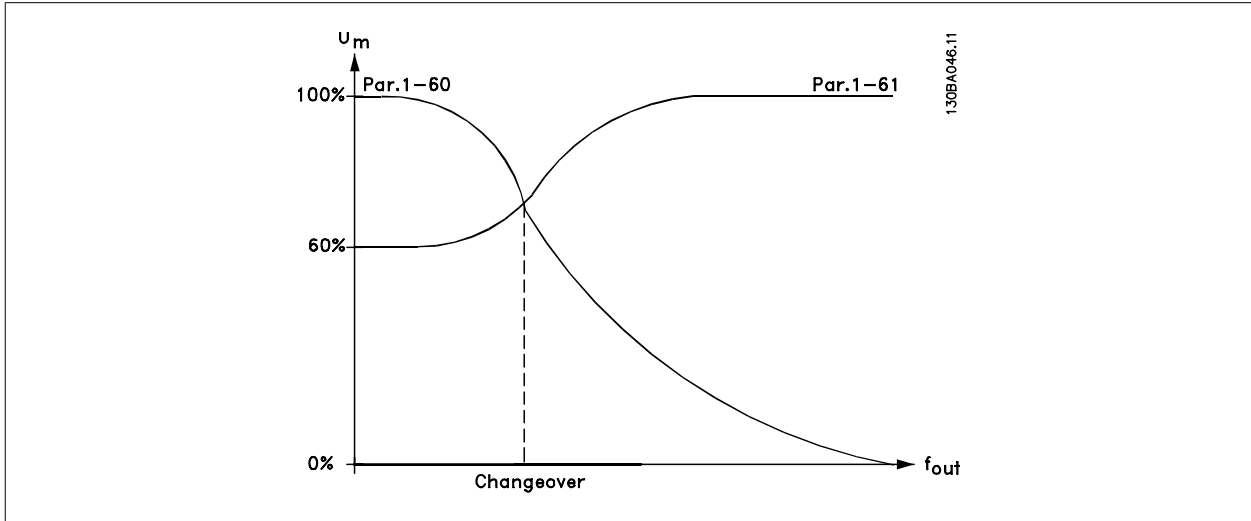

1-61 High Speed Load Compensation

Range:

100 %* [0 - 300 %]

Function:

Enter the % value to compensate voltage in relation to load while the motor is running at high speed, and obtain the optimum U/f characteristic. The motor size determines the frequency ranges within which this parameter is active.

Motor size	Change-over
0.3-10 hp [0.25-7.5 kW]	> 10 Hz
15-60 hp [11-45 kW]	< 5 Hz
75-738 hp [55-550 kW]	< 3-4 Hz

1-62 Slip Compensation

Range:

0 %* [-500 - 500 %]

Function:

Enter the % value for slip compensation to compensate for tolerances in the value of $n_{M,N}$. Slip compensation is calculated automatically, i.e., on the basis of the rated motor speed $n_{M,N}$.

1-63 Slip Compensation Time Constant

Range:

0.10 s* [0.05 - 5.00 s]

Function:

Enter the slip compensation reaction speed. A high value results in slow reaction, and a low value results in quick reaction. If low-frequency resonance problems arise, use a longer time setting.

1-64 Resonance Dampening

Range:

100 %* [0 - 500 %]

Function:

Enter the resonance dampening value. Set par.1-64 *Resonance Dampening* and par.1-65 *Resonance Dampening Time Constant* to help eliminate high-frequency resonance problems. To reduce resonance oscillation, increase the value of par.1-64 *Resonance Dampening*.

1-65 Resonance Dampening Time Constant

Range:

5 ms* [5 - 50 ms]

Function:

Set par.1-64 *Resonance Dampening* and par.1-65 *Resonance Dampening Time Constant* to help eliminate high-frequency resonance problems. Enter the time constant that provides the best dampening.

3.3.6 1-7* Start Adjustments

Parameters for setting special motor start features.

1-71 Start Delay

Range:

0.0 s* [0.0 - 120.0 s]

Function:

The function selected in par.1-80 *Function at Stop* is active in the delay period. Enter the time delay required before commencing acceleration.

1-73 Flying Start

Option:

[0] * Disabled

[1] Enabled

Function:

This function makes it possible to catch a motor that is spinning freely due to a line drop-out. When par.1-73 *Flying Start* is enabled, par.1-71 *Start Delay* has no function. Search direction for flying start is linked to the setting in par.4-10 *Motor Speed Direction*. *Clockwise* [0]: Flying start search in clockwise direction. If not successful, a DC brake is carried out. *Both Directions* [2]: The flying start will first make a search in the direction determined by the last reference (direction). If unable to find the speed, it will search in the other direction. If not successful, a DC brake will be activated in the time set in par.2-02 *DC Braking Time*. Start will then take place from 0 Hz.

Select *Disable* [0] if this function is not required

Select *Enable* [1] to enable the adjustable frequency drive to “catch” and control a spinning motor.

3.3.7 1-8* Stop Adjustments

Parameters for setting special stop features for the motor.

1-80 Function at Stop

Option:

[0] * Coast

[1] DC Hold/Motor Preheat

Function:

Select the adjustable frequency drive function after a stop command or after the speed is ramped down to the settings in par.1-81 *Min Speed for Function at Stop [RPM]*.

Leaves motor in free mode.

Energizes motor with a DC holding current (see par.2-00 *DC Hold/Preheat Current*).

1-81 Min Speed for Function at Stop [RPM]

Range:

3. RPM* [0 - 600 RPM]

Function:

Set the speed at which to activate par.1-80 *Function at Stop*.

1-82 Min Speed for Function at Stop [Hz]

Range:

0.1 Hz* [0.0 - 20.0 Hz]

Function:

Set the output frequency at which to activate par.1-80 *Function at Stop*.

3.3.8 Trip at Motor Speed Low Limit

In par.4-11 *Motor Speed Low Limit [RPM]* and par.4-12 *Motor Speed Low Limit [Hz]*, it is possible to set a minimum speed for the motor in order to ensure proper oil distribution.

In some cases, e.g., if operating in current limit because of a defect in the compressor, the output motor speed can be suppressed below Motor Speed Low Limit. To prevent damage to the compressor, it is possible to set trip limit. If the motor speed drops below this limit, the adjustable frequency drive will trip and issue an alarm (A49).

Reset will take place according to the selected function in par.14-20 *Reset Mode*.

If the trip must take place at a rather exact speed (RPM), it is recommended to set par.0-02 *Motor Speed Unit* for RPM and use slip compensation, which can be set in par.1-62 *Slip Compensation*.

NOTE!
To achieve the highest accuracy with the slip compensation, an Automatic Motor Adaptation (AMA) should be performed. To be enabled in par.1-29 *Automatic Motor Adaptation (AMA)*.

NOTE!
Trip will not be active when using a normal stop or coast command.

1-86 Trip Speed Low [RPM]

Range:	Function:	
0 RPM* [0 - par. 4-13 RPM]	If the trip speed is set to 0, the function is not active.	

NOTE!
This parameter is only available if par.0-02 *Motor Speed Unit* is set to [RPM].

1-87 Trip Speed Low [Hz]

Range:	Function:	
0.0 Hz* [0.0 - par. 4-14 Hz]	If the trip speed is set to 0, the function is not active.	

NOTE!
This parameter is only available if par.0-02 *Motor Speed Unit* is set to [RPM].

3.3.9 1-9* Motor Temperature

Parameters for setting the temperature protection features for the motor.

1-90 Motor Thermal Protection

Option:

Function:

The adjustable frequency drive determines the motor temperature for motor protection in two different ways:

- Via a thermistor sensor connected to one of the analog or digital inputs (par.1-93 *Thermistor Source*).
- Via calculation (ETR = Electronic Thermal Relay) of the thermal load, based on the actual load and time. The calculated thermal load is compared with the rated motor current $I_{M,N}$ and the rated motor frequency $f_{M,N}$. The calculations estimate the need for a lower load at lower speed due to less cooling from the fan incorporated in the motor.

[0]	No protection	If the motor is continuously overloaded and no warning or trip of adjustable frequency drive is wanted.
[1]	Thermistor warning	Activates a warning when the connected thermistor in the motor reacts in the event of motor over-temperature.
[2]	Thermistor trip	Stops (trips) the adjustable frequency drive when the connected thermistor in the motor reacts in the event of motor overtemperature.
[3]	ETR warning 1	
[4] *	ETR trip 1	
[5]	ETR warning 2	
[6]	ETR trip 2	
[7]	ETR warning 3	
[8]	ETR trip 3	
[9]	ETR warning 4	
[10]	ETR trip 4	

ETR (Electronic Thermal Relay) functions 1-4 will calculate the load when the set-up where they were selected is active. For example, ETR-3 starts calculating when Set-up 3 is selected. For the North American market: The ETR functions provide class 20 motor overload protection in accordance with NEC.

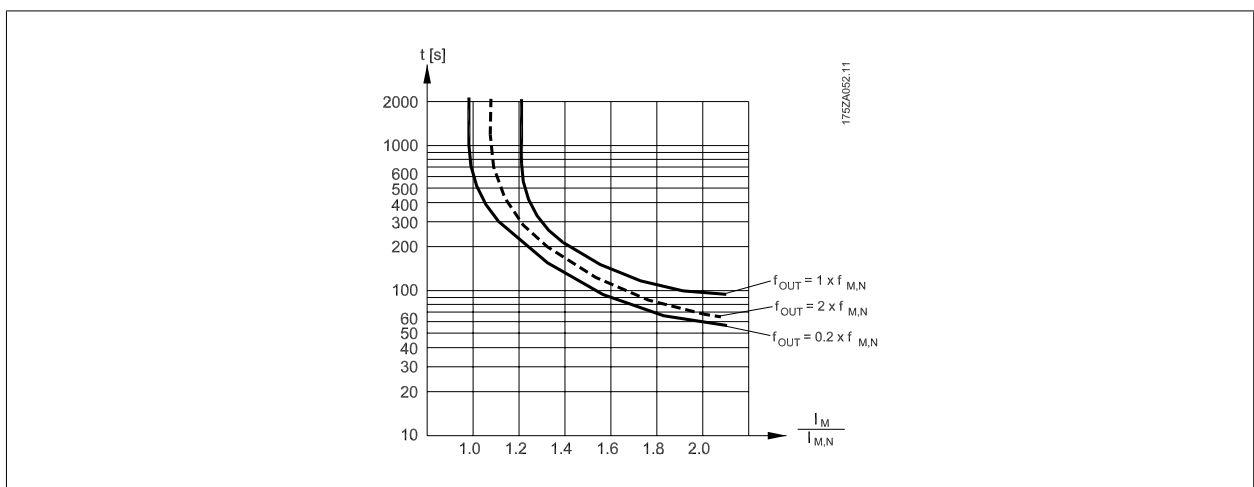

NOTE!

Danfoss recommends using 24 V DC as the thermistor supply voltage.

1-91 Motor External Fan

Option:

Function:

[0] * No

No external fan is required, i.e. the motor is derated at low speed.

[1] Yes

Applies an external motor fan (external ventilation), so that no derating of the motor is required at low speed. The graph below is followed if the motor current is lower than nominal motor current (see par.1-24 *Motor Current*). If the motor current exceeds nominal current, the operation time still decreases as if no fan were installed.

3

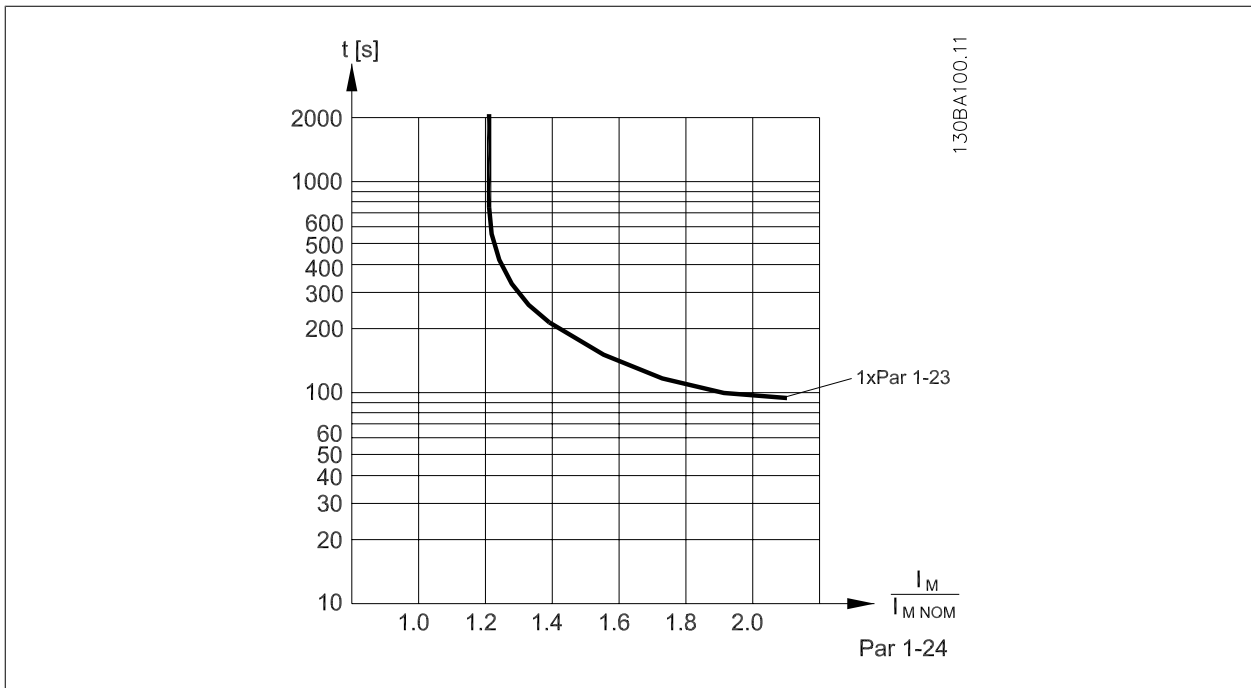

1-93 Thermistor Source

Option:

Function:

Select the input to which the thermistor (PTC sensor) should be connected. An analog input option [1] or [2] cannot be selected if the analog input is already in use as a reference source (selected in par.3-15 *Reference 1 Source*, par.3-16 *Reference 2 Source* or par.3-17 *Reference 3 Source*). When using MCB112, choice [0] *None* must always be selected.

[0] * None

[1] Analog input 53

[2] Analog input 54

[3] Digital input 18

[4] Digital input 19

[5] Digital input 32

[6] Digital input 33

**NOTE!**

This parameter cannot be adjusted while the motor is running.

**NOTE!**

Digital inputs should be set to "No operation" - see par. 5-1*.

3.4 Main Menu - Brakes - Group 2

3.4.1 2-0* DC Brakes

Parameter group for configuring the DC brake and DC hold functions.

2-00 DC Hold/Preheat Current

Range:

50 %* [0 - 160. %]

Function:

Enter a value for holding current as a percentage of the rated motor current $I_{M,N}$ set in par. 1-24 *Motor Current*. 100% DC holding current corresponds to $I_{M,N}$.
This parameter holds the motor (holding torque) or pre-heats the motor.
This parameter is active if [1] DC hold/Preheat is selected in par.1-80 *Function at Stop*.

**NOTE!**

The maximum value depends on the rated motor current.

NOTE!

Avoid 100% current for too long, as it may damage the motor. It may damage the motor.

2-01 DC Brake Current

Range:

50 %* [0 - 1000. %]

Function:

Enter a value for current as a percentage of the rated motor current $I_{M,N}$, see par.1-24 *Motor Current*. 100% DC braking current corresponds to $I_{M,N}$.
DC brake current is applied on a stop command, when the speed is lower than the limit set in par. 2-03 *DC Brake Cut-in Speed [RPM]*; when the DC Brake Inverse function is active; or via the serial communication port. The braking current is active during the time period set in par.2-02 *DC Braking Time*.

**NOTE!**

The maximum value depends on the rated motor current.

NOTE!

Avoid 100% current for too long, as it may damage the motor. It may damage the motor.

2-02 DC Braking Time

Range:

10.0 s* [0.0 - 60.0 s]

Function:

Set the duration of the DC braking current set in par.2-01 *DC Brake Current*, once activated.

2-03 DC Brake Cut-in Speed [RPM]

Range:

0 RPM* [0 - par. 4-13 RPM]

Function:

Set the DC brake cut-in speed for activation of the DC braking current set in par.2-01 *DC Brake Current*, upon a stop command.

3.4.2 2-1* Brake Energy Funct.

Parameter group for selecting dynamic braking parameters.

2-10 Brake Function

Option:

[0] * Off

Function:

No brake resistor installed.

[1] Resistor brake

Brake resistor incorporated in the system, for dissipation of surplus braking energy as heat. Connecting a brake resistor allows a higher DC link voltage during braking (generating operation). The resistor brake function is only active in adjustable frequency drives with an integral dynamic brake.

[2] AC brake

2-11 Brake Resistor (ohm)

Range:

50. Ohm* [5. - 32000. Ohm]

Function:

Set the brake resistor value in Ohms. This value is used for monitoring the power to the brake resistor in par.2-13 *Brake Power Monitoring*. This parameter is only active in adjustable frequency drives with an integral dynamic brake.
If the selection is xxxx use this parameter. If the selection is xxx.xx, use par. 3-81 *Quick Stop Ramp Time*.

2-12 Brake Power Limit (kW)

Range:

5.000 kW* [0.001 - 500.000 kW]

Function:

Set the monitoring limit of the braking energy transmitted to the resistor. The monitoring limit is a product of the maximum duty cycle (120 sec.) and the maximum power of the brake resistor at that duty cycle. See the formula below.

For 200–240 V units:

$$P_{resistor} = \frac{390^2 \times dutytime}{R \times 120}$$

For 380–480 V units

$$P_{resistor} = \frac{778^2 \times dutytime}{R \times 120}$$

For 380–500 V units

$$P_{resistor} = \frac{810^2 \times dutytime}{R \times 120}$$

For 575–600 V units

$$P_{resistor} = \frac{943^2 \times dutytime}{R \times 120}$$

This parameter is only active in adjustable frequency drives with an integral dynamic brake.

2-13 Brake Power Monitoring

Option:
Function:

This parameter is only active in adjustable frequency drives with an integral dynamic brake. This parameter enables monitoring of the power to the brake resistor. The power is calculated on the basis of the resistance (par.2-11 *Brake Resistor (ohm)*), the DC-link voltage, and the resistor duty time.

[0] *	Off	No braking energy monitoring is required.
[1]	Warning	Activates a warning on the display when the power transmitted over 120 s exceeds 100% of the monitoring limit (par.2-12 <i>Brake Power Limit (kW)</i>). The warning disappears when the transmitted power falls below 80% of the monitoring limit.
[2]	Trip	Trips the adjustable frequency drive and displays an alarm when the calculated power exceeds 100% of the monitoring limit.
[3]	Warning and trip	Activates both of the above, including warning, trip and alarm.

If power monitoring is set to *Off* [0] or *Warning* [1], the brake function remains active even if the monitoring limit is exceeded. This may lead to thermal overload of the resistor. It is also possible to generate a warning via a relay/digital output. The measuring accuracy of the power monitoring depends on the accuracy of the resistance of the resistor (better than $\pm 20\%$).

2-15 Brake Check

Option:
Function:

Select type of test and monitoring function to check the connection to the brake resistor, or whether a brake resistor is present, and then display a warning or an alarm in the event of a fault. The brake resistor disconnection function is tested during power-up. However, the brake IGBT test is performed when there is no braking. A warning or trip disconnects the brake function.

The testing sequence is as follows:

1. The DC link ripple amplitude is measured for 300 ms without braking.
2. The DC link ripple amplitude is measured for 300 ms with the brake turned on.
3. If the DC link ripple amplitude while braking is lower than the DC link ripple amplitude before braking + 1%. Brake check failed, return a warning or alarm.
4. If the DC link ripple amplitude while braking is higher than the DC link ripple amplitude before braking + 1%. Brake check OK.

[0] *	Off	Monitors brake resistor and brake IGBT for a short-circuit during operation. If a short-circuit occurs, a warning appears.
[1]	Warning	Monitors brake resistor and brake IGBT for a short-circuit, and to run a test for brake resistor disconnection during power-up.
[2]	Trip	Monitors for a short-circuit or disconnection of the brake resistor, or a short-circuit of the brake IGBT. If a fault occurs, the adjustable frequency drive cuts out while displaying an alarm (trip-locked).
[3]	Stop and trip	Monitors for a short-circuit or disconnection of the brake resistor, or a short-circuit of the brake IGBT. If a fault occurs, the adjustable frequency drive ramps down to coast and then trips. A trip lock alarm is displayed.
[4]	AC brake	

NOTE!

NB!: Remove a warning arising in connection with *Off* [0] or *Warning* [1] by cycling the line power supply. The fault must be corrected first. For *Off* [0] or *Warning* [1], the adjustable frequency drive keeps running even if a fault is located.

2-17 Over-voltage Control

Option:

Function:

[0]	Disabled	No OVC required.
[2] *	Enabled	Activates OVC.

NOTE!
The ramp time is automatically adjusted to avoid tripping of the adjustable frequency drive.

3.5 Main Menu - Reference/Ramps - Group 3

3.5.1 3-0* Reference Limits

Parameters for setting the reference unit, limits and ranges.

Please also see par. 20-0* for information on settings in closed-loop.

3-02 Minimum Reference

Range:

Function:

0.000 Ref- [-999999.999 - par. 3-03 ReferenceFeed-ceFeedbackUnit] backUnit*
Enter the Minimum Reference. The minimum reference is the lowest value obtainable by summing all references. The minimum reference value and unit matches the configuration choice made in par.1-00 *Configuration Mode* and par.20-12 *Reference/Feedback Unit*, respectively.

NOTE!
This parameter is used in open-loop only.

3-03 Maximum Reference

Range:

Function:

50.000 Ref- [par. 3-02 - 999999.999 ReferenceFeed-ceFeedbackUnit] backUnit*
Enter the maximum acceptable value for the remote reference. The Maximum Reference value and unit matches the configuration choice made in par.1-00 *Configuration Mode* and par.20-12 *Reference/Feedback Unit*, respectively.

NOTE!
If operating with par. 1-00, Configuration Mode set for Closed-loop [3], par. 20-14, Maximum Reference/Feedb. must be used.

3-04 Reference Function

Option:

Function:

[0] *	Sum	Sums both external and preset reference sources.
[1]	External/Preset	Use either the preset or the external reference source.

Shift between external and preset via a command on a digital input.

3.5.2 3-1* References

Parameters for setting up the reference sources.

Select the preset reference(s). Select *Preset ref. bit 0 / 1 / 2* [16], [17] or [18] for the corresponding digital inputs in parameter group 5.1*.

3-10 Preset Reference

Array [8]

Range:

0.00 %* [-100.00 - 100.00 %]

Function:

Enter up to eight different preset references (0–7) in this parameter, using array programming. The preset reference is stated as a percentage of the value Ref_{MAX} (par.3-03 *Maximum Reference*, for closed-loop see par.20-14 *Maximum Reference/Feedb.*). When using preset references, select *Preset ref. bit 0 / 1 / 2* [16], [17] or [18] for the corresponding digital inputs in parameter group 5-1* *Digital Inputs*.

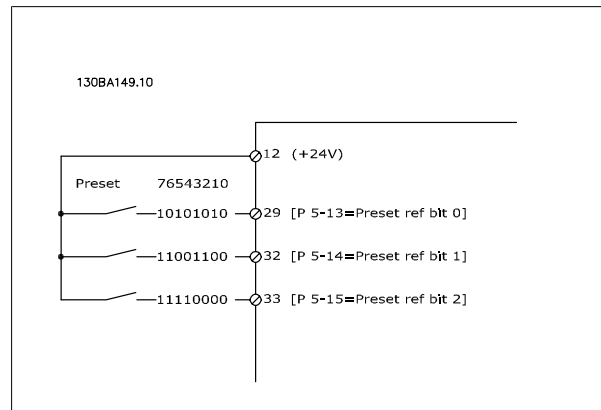
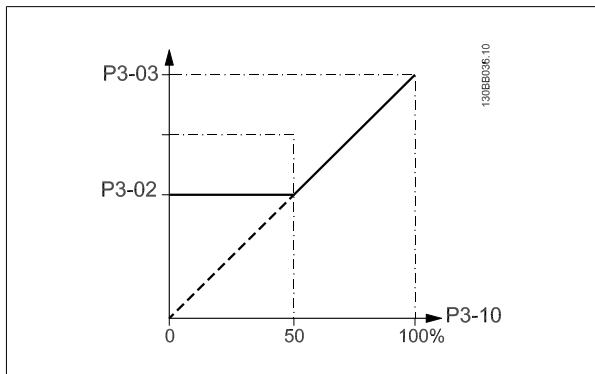

3-11 Jog Speed [Hz]

Range:

10.0 Hz* [0.0 - par. 4-14 Hz]

Function:

The jog speed is a fixed output speed at which the adjustable frequency drive is running when the jog function is activated.
See also par.3-80 *Jog Ramp Time*.

3-13 Reference Site

Option:

Function:

Select which reference site to activate.

[0] * Linked to Hand / Auto

Use local reference when in hand mode; or remote reference when in auto mode.

[1] Remote

Use remote reference in both hand mode and auto mode.

[2] Local

Use local reference in both hand mode and auto mode.



NOTE!

When set to Local [2], the adjustable frequency drive will start with this setting again following a 'power-down'.

3-14 Preset Relative Reference

Range:

0.00 %* [-100.00 - 100.00 %]

Function:

The actual reference, X, is increased or decreased with the percentage Y, set in par.3-14 *Preset Relative Reference*. This results in the actual reference Z. Actual reference (X) is the sum of the inputs selected in par.3-15 *Reference 1 Source*, par.3-16 *Reference 2 Source*, par.3-17 *Reference 3 Source* and par.8-02 *Control Source*.

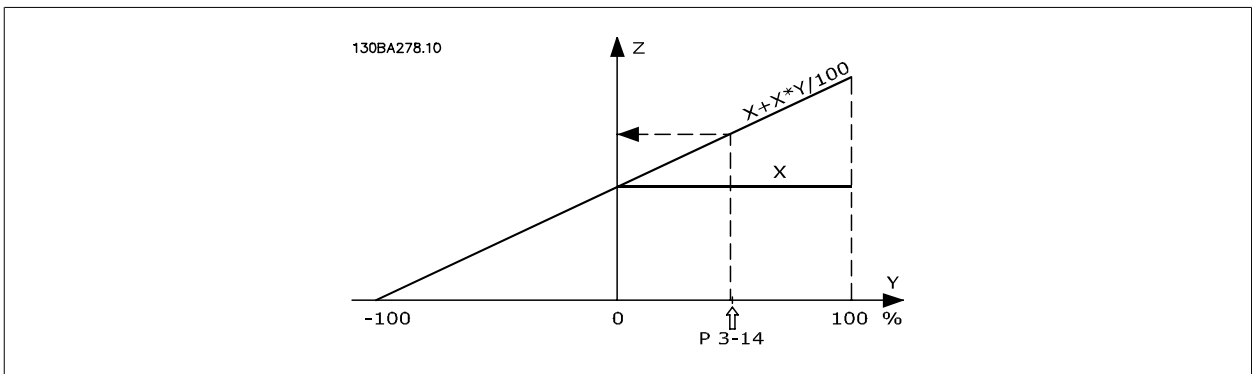
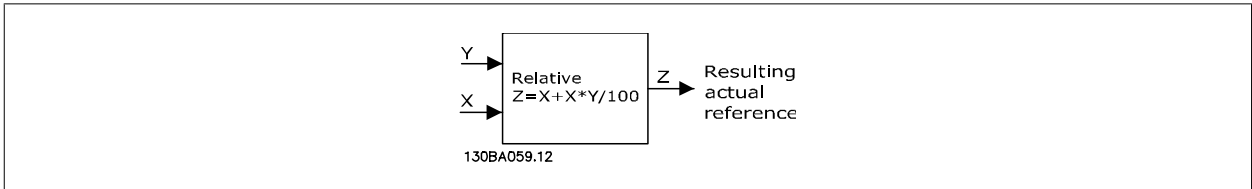

3

3-15 Reference 1 Source

Option:

Function:

Select the reference input to be used for the first reference signal. par.3-15 *Reference 1 Source*, par.3-16 *Reference 2 Source* and par.3-17 *Reference 3 Source* define up to three different reference signals. The sum of these reference signals defines the actual reference.

This parameter cannot be adjusted while the motor is running.

[0] No function

[1] * Analog input 53

[2] Analog input 54

[7] Pulse input 29

[8] Pulse input 33

[20] Digital pot.meter

[21] Analog input X30/11

[22] Analog input X30/12

[23] Analog Input X42/1

[24] Analog Input X42/3

[25] Analog Input X42/5

[30] Ext. Closed-loop 1

[31] Ext. Closed-loop 2

[32] Ext. Closed-loop 3

3-16 Reference 2 Source

Option:
Function:

Select the reference input to be used for the second reference signal. par.3-15 *Reference 1 Source*, par.3-16 *Reference 2 Source* and par.3-17 *Reference 3 Source* define up to three different reference signals. The sum of these reference signals defines the actual reference.

This parameter cannot be adjusted while the motor is running.

[0] No function

[1] Analog input 53

[2] Analog input 54

[7] Pulse input 29

[8] Pulse input 33

[20] * Digital pot.meter

[21] Analog input X30/11

[22] Analog input X30/12

[23] Analog Input X42/1

[24] Analog Input X42/3

[25] Analog Input X42/5

[30] Ext. Closed-loop 1

[31] Ext. Closed-loop 2

[32] Ext. Closed-loop 3

3-17 Reference 3 Source

Option:
Function:

Select the reference input to be used for the third reference signal. par.3-15 *Reference 1 Source*, par.3-16 *Reference 2 Source* and par.3-17 *Reference 3 Source* define up to three different reference signals. The sum of these reference signals defines the actual reference.

This parameter cannot be adjusted while the motor is running.

[0] * No function

[1] Analog input 53

[2] Analog input 54

[7] Pulse input 29

[8] Pulse input 33

[20] Digital pot.meter

[21] Analog input X30/11

[22] Analog input X30/12

[23] Analog Input X42/1

[24] Analog Input X42/3

[25] Analog Input X42/5

[30] Ext. Closed-loop 1

[31] Ext. Closed-loop 2

[32] Ext. Closed-loop 3

3-19 Jog Speed [RPM]

Range:

300. RPM* [0 - par. 4-13 RPM]

Function:

Enter a value for the jog speed n_{JOG} , which is a fixed output speed. The adjustable frequency drive runs at this speed when the jog function is activated. The maximum limit is defined in par. . See also par.3-80 *Jog Ramp Time*.

3.5.3 3-4* Ramp 1

Configure the ramp parameter, ramping times, for each of the two ramps (par. 3-4* and par. 3-5*).

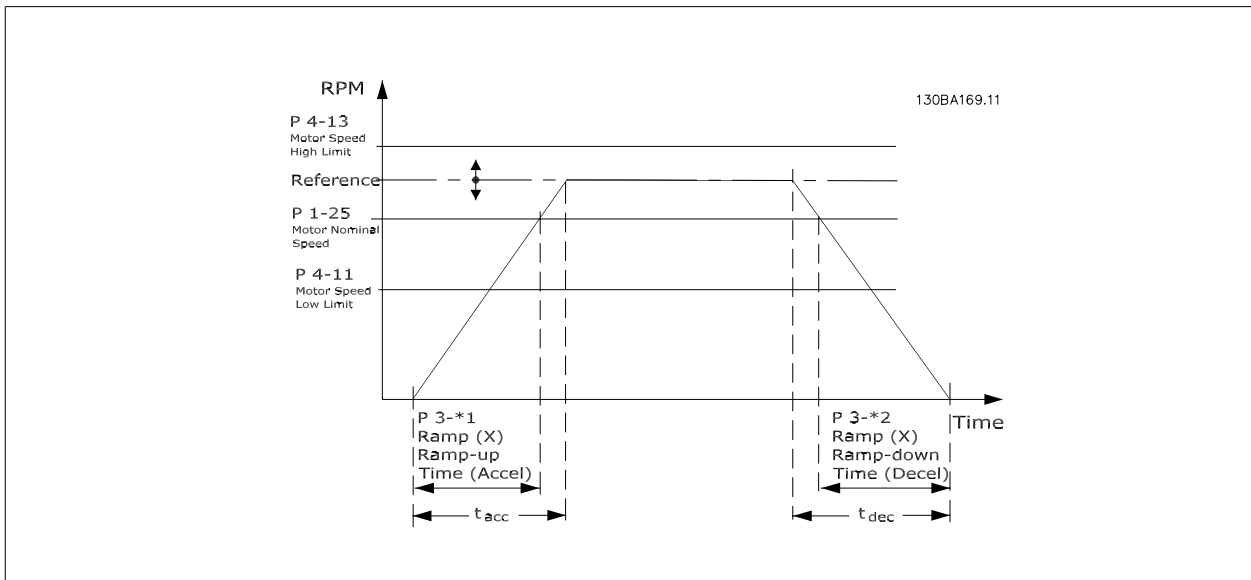

3-41 Ramp 1 Ramp-up Time

Range:

10.00 s* [1.00 - 3600.00 s]

Function:

Enter the ramp-up time, i.e., the acceleration time from 0 RPM to par.1-25 *Motor Nominal Speed*. Choose a ramp-up time such that the output current does not exceed the current limit in par. 4-18 *Current Limit* during ramping. See ramp-down time in par.3-42 *Ramp 1 Ramp-down Time*.

$$par.3 - 41 = \frac{t_{acc} \times n_{norm} [par.1 - 25]}{ref[rpm]} [s]$$

3-42 Ramp 1 Ramp-down Time

Range:

20.00 s* [1.00 - 3600.00 s]

Function:

Enter the ramp-down time, i.e., the deceleration time from par.1-25 *Motor Nominal Speed* to 0 RPM. Choose a ramp-down time such that no overvoltage arises in the inverter due to regenerative operation of the motor, and such that the generated current does not exceed the current limit set in par.4-18 *Current Limit*. See ramp-up time in par.3-41 *Ramp 1 Ramp-up Time*.

$$par.3 - 42 = \frac{t_{dec} \times n_{norm} [par.1 - 25]}{ref[rpm]} [s]$$

3.5.4 3-5* Ramp 2

Choosing ramp parameters, see 3-4*.

3-51 Ramp 2 Ramp-up Time

Range:

10.00 s* [1.00 - 3600.00 s]

Function:

Enter the ramp-up time, i.e., the acceleration time from 0 RPM to par.1-25 *Motor Nominal Speed*. Choose a ramp-up time such that the output current does not exceed the current limit in par. 4-18 *Current Limit* during ramping. See ramp-down time in par.3-52 *Ramp 2 Ramp-down Time*.

$$par. 3 - 51 = \frac{t_{acc} \times n_{norm} [par. 1 - 25]}{ref [rpm]} [s]$$

3-52 Ramp 2 Ramp-down Time

Range:

20.00 s* [1.00 - 3600.00 s]

Function:

Enter the ramp-down time, i.e., the deceleration time from par.1-25 *Motor Nominal Speed* to 0 RPM. Choose a ramp-down time such that no overvoltage arises in the inverter due to regenerative operation of the motor, and such that the generated current does not exceed the current limit set in par.4-18 *Current Limit*. See ramp-up time in par.3-51 *Ramp 2 Ramp-up Time*.

$$par.3 - 52 = \frac{t_{dec} \times n_{norm} [par. 1 - 25]}{ref [rpm]} [s]$$

3.5.5 3-8* Other Ramps

Configure parameters for special ramps such as jog or quick stop, for example.

3-80 Jog Ramp Time

Range:

20.00 s* [1.00 - 3600.00 s]

Function:

Enter the jog ramp time, i.e., the acceleration/deceleration time between 0 RPM and the rated motor speed ($n_{M,N}$) (set in par.1-25 *Motor Nominal Speed*). Ensure that the resultant output current required for the given jog ramp time does not exceed the current limit in par.4-18 *Current Limit*. The jog ramp time starts upon activation of a jog signal via the control panel, a selected digital input, or the serial communication port.

$$par. 3 - 80 = \frac{t_{jog} \times n_{norm} [par. 1 - 25]}{jog\ speed [par. 3 - 19]} [s]$$

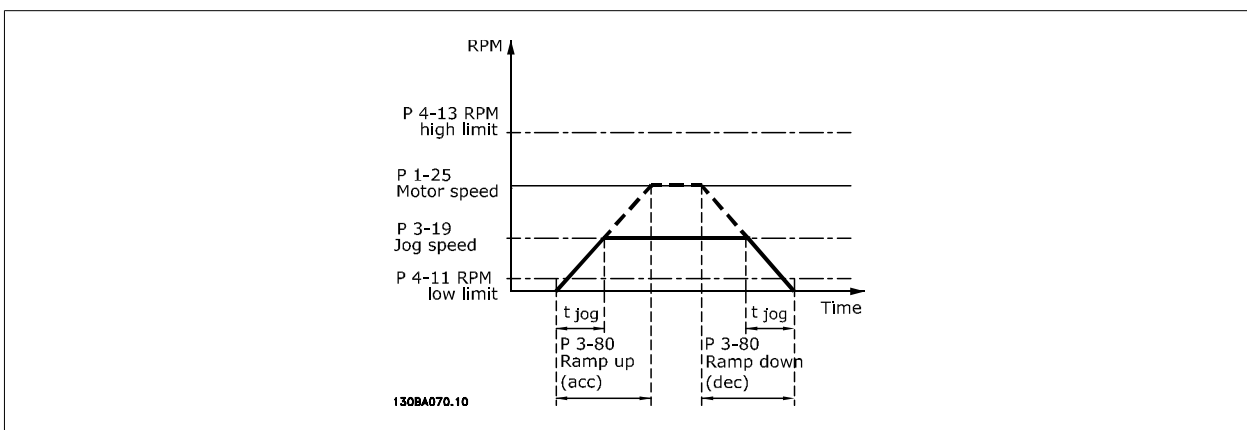

3.5.6 3-9* Digital Pot.Meter

The digital potentiometer function allows the user to increase or decrease the actual reference by adjusting the set-up of the digital inputs using the functions INCREASE, DECREASE or CLEAR. To activate the function, at least one digital input must be set up to INCREASE or DECREASE.

3-90 Step Size

Range:

0.10 %* [0.01 - 200.00 %]

Function:

Enter the increment size required for INCREASE/DECREASE, as a percentage of the synchronous motor speed, n_s . If INCREASE/DECREASE is activated, the resulting reference will be increased/decreased by the amount set in this parameter.

3-91 Ramp Time

Range:

1.00 s [0.00 - 3600.00 s]

Function:

Enter the ramp time, i.e., the time for adjustment of the reference from 0% to 100% of the specified digital potentiometer function (INCREASE, DECREASE or CLEAR).
If INCREASE / DECREASE is activated for longer than the ramp delay period specified in par. 3-95 *Ramp Delay*, the actual reference will be ramped up / down according to this ramp time. The ramp time is defined as the time used to adjust the reference by the step size specified in par. 3-90 *Step Size*.

3-92 Power Restore

Option:

[0] * Off

Function:

Resets the Digital Potentiometer reference to 0% after power-up.

[1] On

Restores the most recent Digital Potentiometer reference at power-up.

3-93 Maximum Limit

Range:

100 %* [-200 - 200 %]

Function:

Set the maximum permissible value for the resultant reference. This is advisable if the Digital Potentiometer is used for fine tuning of the resulting reference.

3-94 Minimum Limit

Range:

0 %* [-200 - 200 %]

Function:

Set the minimum permissible value for the resultant reference. This is advisable if the Digital Potentiometer is used for fine tuning of the resulting reference.

3-95 Ramp Delay

Range:

1.000 N/A* [0.000 - 3600.000 N/A]

Function:

Enter the delay required from activation of the digital potentiometer function until the adjustable frequency drive starts to ramp the reference. With a delay of 0 ms, the reference starts to ramp as soon as INCREASE/DECREASE is activated. See also par.3-91 *Ramp Time*.

3

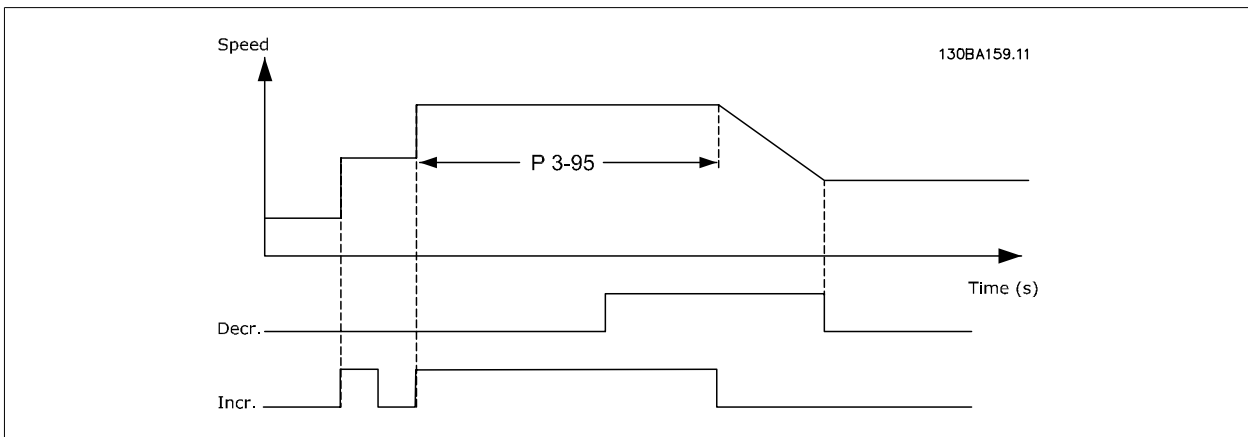
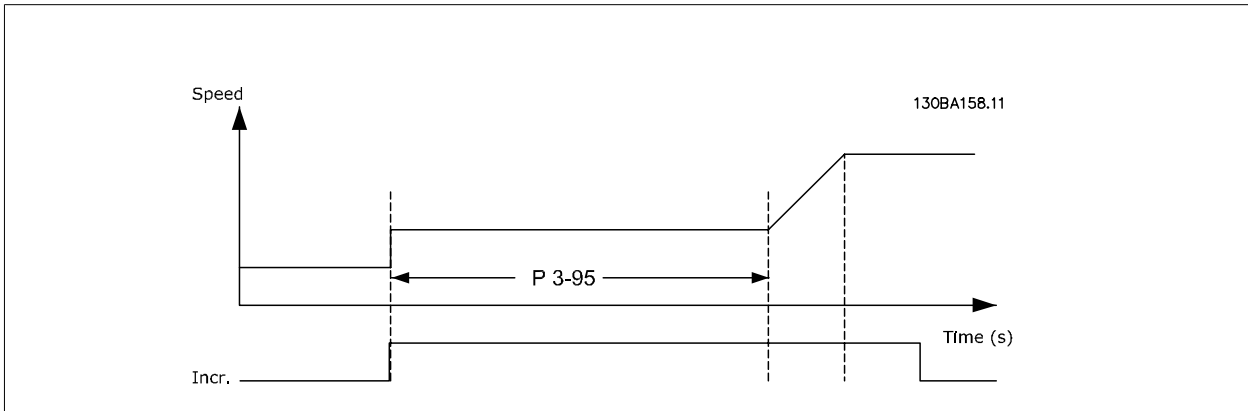

3.6 Main Menu - Limits/Warnings - Group 4

3.6.1 4-** Limits and Warnings

Parameter group for configuring limits and warnings.

3.6.2 4-1* Motor Limits

Define torque, current and speed limits for the motor, and the reaction of the adjustable frequency drive when the limits are exceeded.

A limit may generate a message on the display. A warning will always generate a message on the display or on the serial communication bus. A monitoring function may initiate a warning or a trip, upon which the adjustable frequency drive will stop and generate an alarm message.

4-10 Motor Speed Direction

Option:

Function:

Selects the motor speed direction required.
Use this parameter to prevent unwanted reversing.

[0] Clockwise

Only operation in a clockwise direction will be allowed.

[2] * Both directions

Operation in both a clockwise and anti-clockwise direction will be allowed.



NOTE!
The setting in par.4-10 *Motor Speed Direction* has impact on the Flying Start in par.1-73 *Flying Start*.

4-11 Motor Speed Low Limit [RPM]

Range:	Function:
0 RPM* [0 - par. 4-13 RPM]	Enter the minimum limit for motor speed. The Motor Speed Low Limit can be set to correspond to the manufacturer's recommended minimum motor speed. The Motor Speed Low Limit must not exceed the setting in par.4-13 <i>Motor Speed High Limit [RPM]</i> .

4-12 Motor Speed Low Limit [Hz]

Range:	Function:
0 Hz* [0 - par. 4-14 Hz]	Enter the minimum limit for motor speed. The motor speed low limit can be set to correspond to the minimum output frequency of the motor shaft. The Speed Low Limit must not exceed the setting in par.4-14 <i>Motor Speed High Limit [Hz]</i> .

4-13 Motor Speed High Limit [RPM]

Range:	Function:
1500. RPM* [par. 4-11 - 60000. RPM]	Enter the maximum limit for motor speed. The Motor Speed High Limit can be set to correspond to the manufacturer's maximum rated motor. The Motor Speed High Limit must exceed the setting in par.4-11 <i>Motor Speed Low Limit [RPM]</i> . Only par.4-11 <i>Motor Speed Low Limit [RPM]</i> or par. 4-12 <i>Motor Speed Low Limit [Hz]</i> will be displayed, depending on other parameters in the main menu, and depending on default settings dependant on global location.



NOTE!
The output frequency value of the adjustable frequency drive must not exceed a value higher than 1/10 of the switching frequency.



NOTE!
Any changes in par.4-13 *Motor Speed High Limit [RPM]* will reset the value in par.4-53 *Warning Speed High* to the same value as set in par.4-13 *Motor Speed High Limit [RPM]*.

4-14 Motor Speed High Limit [Hz]

Range:	Function:
50/60.0 Hz* [par. 4-12 - par. 4-19 Hz]	Enter the maximum limit for motor speed. The Motor Speed High Limit can be set to correspond to the manufacturer's recommended maximum of the motor shaft. The Motor Speed High Limit must exceed the in par.4-12 <i>Motor Speed Low Limit [Hz]</i> . Only par.4-11 <i>Motor Speed Low Limit [RPM]</i> or par.4-12 <i>Motor Speed Low Limit [Hz]</i> will be displayed, depending on other parameters in the main menu, and depending on default settings dependant on global location.



NOTE!
Max. output frequency cannot exceed 10% of the inverter switching frequency (par.14-01 *Switching Frequency*).

4-16 Torque Limit Motor Mode

Range:

110.0 %* [0.0 - 1000.0 %]

Function:

Enter the maximum torque limit for motor operation. The torque limit is active in the speed range up to and including the rated motor speed set in par.1-25 *Motor Nominal Speed*. To protect the motor from reaching the stalling torque, the default setting is 1.1 x the rated motor torque (calculated value). See also par.14-25 *Trip Delay at Torque Limit* for further details.

If a setting in par.1-00 *Configuration Mode* to par.1-28 *Motor Rotation Check* is changed, par. 4-16 *Torque Limit Motor Mode* is not automatically reset to the default setting.

4-17 Torque Limit Generator Mode

Range:

100.0 %* [0.0 - 1000.0 %]

Function:

Enter the maximum torque limit for generator mode operation. The torque limit is active in the speed range up to and including the rated motor speed (par.1-25 *Motor Nominal Speed*). Refer to par. 14-25 *Trip Delay at Torque Limit* for further details.

If a setting in par.1-00 *Configuration Mode* to par.1-28 *Motor Rotation Check* is changed, par. 4-17 *Torque Limit Generator Mode* is not automatically reset to the default settings.

4-18 Current Limit

Range:

110.0 %* [1.0 - 1000.0 %]

Function:

Enter the current limit for motor and generator operation. To protect the motor from reaching stalling torque, the default setting is 1.1 x the rated motor current (set in par. 1-24). If a setting in par. 1-00 to par. 1-26 is changed, par.4-16 *Torque Limit Motor Mode* to par.4-18 *Current Limit* are not automatically reset to the default settings.

4-19 Max Output Frequency

Range:

100.0 Hz* [1.0 - 1000.0 Hz]

Function:

Enter the maximum output frequency value. par.4-19 *Max Output Frequency* specifies the absolute limit on the adjustable frequency drive output frequency for improved safety in applications where accidental overspeeding must be avoided. This absolute limit applies to all configurations and is independent of the setting in par.1-00 *Configuration Mode*. This parameter cannot be adjusted while the motor is running.

3.6.3 4-5* Adj. Warnings

Define adjustable warning limits for current, speed, reference and feedback.

NOTE!
Not visible in display, only in VLT Motion Control Tool, MCT 10.

Warnings are shown on display, programmed output or serial bus.

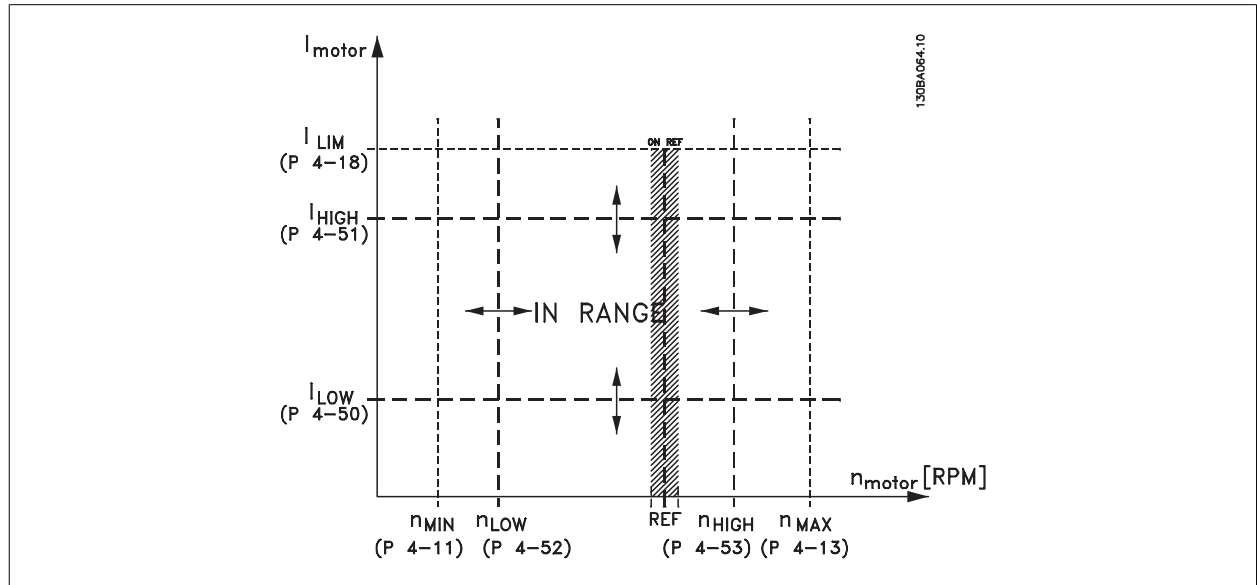

4-50 Warning Current Low

Range:	Function:	
0.00 A* [0.00 - par. 4-51 A]	Enter the I_{LOW} value. When the motor current falls below this limit (I_{LOW}), the display reads CURRENT LOW. The signal outputs can be programmed to produce a status signal on terminal 27 or 29, and on relay output 01 or 02. Refer to the drawing in this section.	

4-51 Warning Current High

Range:	Function:	
par. 16-37 [par. 4-50 - par. 16-37 A] A*	Enter the I_{HIGH} value. When the motor current exceeds this limit (I_{HIGH}), the display reads CURRENT HIGH. The signal outputs can be programmed to produce a status signal on terminal 27 or 29, and on relay output 01 or 02. Refer to the drawing in this section.	

4-52 Warning Speed Low

Range:	Function:	
0 RPM* [0 - par. 4-53 RPM]	Enter the n_{LOW} value. When the motor speed falls below this limit (n_{LOW}), the display reads SPEED LOW. The signal outputs can be programmed to produce a status signal on terminal 27 or 29, and on relay output 01 or 02. Program the lower signal limit of the motor speed, n_{LOW} , within the normal working range of the adjustable frequency drive. Refer to the drawing in this section.	

4-53 Warning Speed High

Range:

 par. 4-13 [par. 4-52 - par. 4-13 RPM]
RPM*

Function:

 Enter the n_{HIGH} value. When the motor speed exceeds this limit (n_{HIGH}), the display reads SPEED HIGH. The signal outputs can be programmed to produce a status signal on terminal 27 or 29, and on relay output 01 or 02. Program the upper signal limit of the motor speed, n_{HIGH} , within the normal working range of the adjustable frequency drive. Refer to the drawing in this section.

NOTE!

 Any changes in par.4-13 *Motor Speed High Limit [RPM]* will reset the value in par.4-53 *Warning Speed High* to the same value as set in par.4-13 *Motor Speed High Limit [RPM]*.

 If a different value is needed in par.4-53 *Warning Speed High*, it must be set after programming of par.4-13 *Motor Speed High Limit [RPM]*!

4-54 Warning Reference Low

Range:

 -999999.99 [-999999.999 - par. 4-55 N/A]
9 N/A*

Function:

Enter the lower reference limit. When the actual reference falls below this limit, the display indicates Ref Low. The signal outputs can be programmed to produce a status signal on terminal 27 or 29 and on relay output 01 or 02.

4-55 Warning Reference High

Range:

 999999.999 [par. 4-54 - 999999.999 N/A]
N/A*

Function:

Enter the upper reference limit. When the actual reference exceeds this limit, the display reads Ref High. The signal outputs can be programmed to produce a status signal on terminal 27 or 29 and on relay output 01 or 02.

4-56 Warning Feedback Low

Range:

 -999999.99 [-999999.999 - par. 4-57 Proc-
9 Proc-essCtrlUnit]
essCtrlU-
nit*

Function:

Enter the lower feedback limit. When the feedback falls below this limit, the display reads Feedb Low. The signal outputs can be programmed to produce a status signal on terminal 27 or 29 and on relay output 01 or 02.

4-57 Warning Feedback High

Range:

 999999.999 [par. 4-56 - 999999.999 ProcessCtr-
ProcessCtr- lUnit]
lUnit*

Function:

Enter the upper feedback limit. When the feedback exceeds this limit, the display reads Feedb High. The signal outputs can be programmed to produce a status signal on terminal 27 or 29 and on relay output 01 or 02.

4-58 Missing Motor Phase Function

Option:

 [0] Off

[1] * On

Function:

 Displays an alarm in the event of a missing motor phase.

Select 100 ms to have a short detection time and alarm in the event of a missing motor phase. 100 ms is recommended for hoisting applications.

No alarm is displayed if a missing motor phase occurs.

An alarm is displayed if a missing motor phase occurs.



NOTE!

This parameter cannot be adjusted while the motor is running.

3.6.4 4-6* Speed Bypass

Define the speed bypass areas for the ramps.

Some systems call for avoiding certain output frequencies or speeds due to resonance problems in the system. A maximum of four frequency or speed ranges can be avoided.

4-60 Bypass Speed From [RPM]

Array [4]

Range:

0 RPM* [0 - par. 4-13 RPM]

Function:

Some systems call for avoiding certain output speeds due to resonance problems in the system. Enter the lower limits of the speeds to be avoided.

4-61 Bypass Speed From [Hz]

Array [4]

Range:

0 Hz* [0.0 - par. 4-14 Hz]

Function:

Some systems call for avoiding certain output speeds due to resonance problems in the system. Enter the lower limits of the speeds to be avoided.

4-62 Bypass Speed to [RPM]

Array [4]

Range:

0 RPM* [0 - par. 4-13 RPM]

Function:

Some systems call for avoiding certain output speeds due to resonance problems in the system. Enter the upper limits of the speeds to be avoided.

4-63 Bypass Speed To [Hz]

Array [4]

Range:

0 Hz* [0.0 - par. 4-14 Hz]

Function:

Some systems call for avoiding certain output speeds due to resonance problems in the system. Enter the upper limits of the speeds to be avoided.

3.6.5 Semi-Automatic Bypass Speed Set-up

The Semi-Automatic Bypass Speed Set-up can be used to facilitate the programming of the frequencies to be skipped due to resonances in the system.

The following process is to be carried out:

1. Stop the motor.
2. Select Enabled in par.4-64 *Semi-Auto Bypass Set-up*.
3. Press *Hand On* on the LCP to start the search for frequency bands causing resonances. The motor will ramp up according to the ramp set.
4. When sweeping through a resonance band, press *OK* on the LCP when leaving the band. The current frequency will be stored as the first element in par.4-62 *Bypass Speed to [RPM]* or par.4-63 *Bypass Speed To [Hz]* (array). Repeat this for each resonance band identified at the ramp-up (maximum four can be adjusted).
5. When maximum speed has been reached, the motor will automatically begin to ramp-down. Repeat the above procedure when speed is leaving the resonance bands during the deceleration. The current frequencies registered when pressing *OK* will be stored in par.4-60 *Bypass Speed From [RPM]* or par.4-61 *Bypass Speed From [Hz]*.
6. When the motor has ramped down to stop, press *OK*. The par.4-64 *Semi-Auto Bypass Set-up* will automatically reset to Off. The adjustable frequency drive will stay in *Hand* mode until *Off* or *Auto On* are pressed on the LCP.

If the frequencies for a certain resonance band are not registered in the right order (frequency values stored in *By Pass Speed To* are higher than those in *By Pass Speed From*) or if they do not have the same numbers of registrations for the *By Pass From* and *By Pass To*, all registrations will be canceled and the following message is displayed: *Collected speed areas overlapping or not completely determined. Press [Cancel] to abort.*

4-64 Semi-Auto Bypass Set-up

Option:	Function:
[0] * OFF	No function
[1] Enabled	Starts the semi-automatic bypass set-up and continue with the procedure described above.

3.7 Main Menu - Digital In/Out - Group 5

3.7.1 5-** Digital In/Out

Parameter group for configuring the digital input and output.

3.7.2 5-0* Digital I/O Mode

Parameters for configuring the input and output using NPN and PNP.

5-00 Digital I/O Mode

Option:

Function:

Digital inputs and programmed digital outputs are pre-programmable for operation either in PNP or NPN systems.

[0] * PNP - Active at 24 V

Action on positive directional pulses (0). PNP systems are pulled down to GND.

[1] NPN - Active at 0V

Action on negative directional pulses (1). NPN systems are pulled up to + 24 V, internally in the adjustable frequency drive.



NOTE!

This parameter cannot be adjusted while the motor is running.

5-01 Terminal 27 Mode

Option:

Function:

[0] * Input

Defines terminal 27 as a digital input.

[1] Output

Defines terminal 27 as a digital output.

Please note that this parameter cannot be adjusted while the motor is running.

5-02 Terminal 29 Mode

Option:

Function:

[0] * Input

Defines terminal 29 as a digital input.

[1] Output

Defines terminal 29 as a digital output.

This parameter cannot be adjusted while the motor is running.

3.7.3 5-1* Digital Inputs

Parameters for configuring the input functions for the input terminals.

The digital inputs are used for selecting various functions in the adjustable frequency drive. All digital inputs can be set to the following functions:

Digital input function	Select	Terminal
No operation	[0]	All *terminal 19, 32, 33
Reset	[1]	All
Coast inverse	[2]	27
Coast and reset inverse	[3]	All
DC brake inverse	[5]	All
Stop inverse	[6]	All
External interlock	[7]	All
Start	[8]	All *terminal 18
Latched start	[9]	All
Reversing	[10]	All
Start reversing	[11]	All
Jog	[14]	All *terminal 29
Preset reference on	[15]	All
Preset ref bit 0	[16]	All
Preset ref bit 1	[17]	All
Preset ref bit 2	[18]	All
Freeze reference	[19]	All
Freeze output	[20]	All
Speed up	[21]	All
Slow	[22]	All
Set-up select bit 0	[23]	All
Set-up select bit 1	[24]	All
Pulse input	[32]	terminal 29, 33
Ramp bit 0	[34]	All
Line failure inverse	[36]	All
Fire mode	[37]	All
Run Permissive	[52]	All
Hand start	[53]	All
Auto-start	[54]	All
DigiPot Increase	[55]	All
DigiPot Decrease	[56]	All
DigiPot Clear	[57]	All
Counter A (up)	[60]	29, 33
Counter A (down)	[61]	29, 33
Reset Counter A	[62]	All
Counter B (up)	[63]	29, 33
Counter B (down)	[64]	29, 33
Reset Counter B	[65]	All
Sleep Mode	[66]	All
Reset Maintenance Word	[78]	All
Lead Pump Start	[120]	All
Lead Pump Alternation	[121]	All
Pump 1 Interlock	[130]	All
Pump 2 Interlock	[131]	All
Pump 3 Interlock	[132]	All

3.7.4 Digital Inputs, 5-1* continued

All = Terminals 18, 19, 27, 29, 32, 33, X30/2, X30/3, X30/4. X30/ are the terminals on MCB 101.

Functions dedicated to only one digital input are stated in the associated parameter.

All digital inputs can be programmed to these functions:

[0]	No operation	No reaction to signals transmitted to terminal.
[1]	Reset	Resets adjustable frequency drive after a TRIP/ALARM. Not all alarms can be reset.
[2]	Coast inverse	Leaves motor in free mode. Logic '0' => coasting stop. (Default Digital input 27): Coasting stop, inverted input (NC).

[3] Coast and reset inverse Reset and coasting stop Inverted input (NC).
Leaves motor in free mode and resets the adjustable frequency drive. Logic '0' => coasting stop and reset.

[5] DC brake inverse Inverted input for DC braking (NC).
Stops motor by energizing it with a DC current for a certain time period. See par.2-01 *DC Brake Current* to par.2-03 *DC Brake Cut-in Speed [RPM]*. The function is only active when the value in par.2-02 *DC Braking Time* is different from 0. Logic '0' => DC braking.

[6] Stop inverse Stop Inverted function. Generates a stop function when the selected terminal goes from logical level '1' to '0'. The stop is performed according to the selected ramp time (par.3-42 *Ramp 1 Ramp-down Time*, par.3-52 *Ramp 2 Ramp-down Time*, par. 3-62, par. 3-72).



NOTE!
When the adjustable frequency drive is at the torque limit and has received a stop command, it may not stop by itself. To ensure that the adjustable frequency drive stops, configure a digital output to *Torque limit & stop* [27] and connect this digital output to a digital input that is configured as coast.

[7] External Interlock Same function as Coasting stop, inverse, but External Interlock generates the alarm message 'external fault' on the display when the terminal which is programmed for Coast Inverse is logic '0'. The alarm message will also be active via digital outputs and relay outputs, if programmed for External Interlock. The alarm can be reset using a digital input or the [RESET] key if the cause for the External Interlock has been removed. A delay can be programmed in par.22-00 *External Interlock Delay*, External Interlock Time. After applying a signal to the input, the reaction described above will be delayed with the time set in par.22-00 *External Interlock Delay*.

[8] Start Select start for a start/stop command. Logic '1' = start, logic '0' = stop.
(Default Digital input 18)

[9] Latched start Motor starts, if a pulse is applied for min. 2 ms. Motor stops when Stop inverse is activated

[10] Reversing Changes direction of motor shaft rotation. Select Logic '1' to reverse. The reversing signal only changes the direction of rotation. It does not activate the start function. Select both directions in par.4-10 *Motor Speed Direction*.
(Default Digital input 19).

[11] Start reversing Used for start/stop and for reversing on the same wire. Signals on start are not allowed at the same time.

[14] Jog Used for activating jog speed. See par.3-11 *Jog Speed [Hz]*.
(Default Digital input 29)

[15] Preset reference on Used for shifting between external reference and preset reference. It is assumed that *External/preset* [1] has been selected in par.3-04 *Reference Function*. Logic '0' = external reference active; logic '1' = one of the eight preset references is active.

[16] Preset ref bit 0 Enables a choice between one of the eight preset references according to the table below.

[17] Preset ref bit 1 Enables a choice between one of the eight preset references according to the table below.

[18] Preset ref bit 2 Enables a choice between one of the eight preset references according to the table below.

Preset ref. bit	2	1	0
Preset ref. 0	0	0	0
Preset ref. 1	0	0	1
Preset ref. 2	0	1	0
Preset ref. 3	0	1	1
Preset ref. 4	1	0	0
Preset ref. 5	1	0	1
Preset ref. 6	1	1	0
Preset ref. 7	1	1	1

[19]	Freeze ref	Freezes actual reference. The frozen reference is now the point of enable/condition for Speed up and Slow to be used. If Speed up/down is used, the speed change always follows ramp 2 (par. 3-51 <i>Ramp 2 Ramp-up Time</i> and par.3-52 <i>Ramp 2 Ramp-down Time</i>) in the range 0 - par. 3-03 <i>Maximum Reference</i> . (For closed-loop, see par.20-14 <i>Maximum Reference/Feedb.</i>).
[20]	Freeze output	Freezes actual motor frequency (Hz). The frozen motor frequency is now the point of enable/condition for Speed up and Slow to be used. If Speed up/down is used, the speed change always follows ramp 2 (par.3-51 <i>Ramp 2 Ramp-up Time</i> and par.3-52 <i>Ramp 2 Ramp-down Time</i>) in the range 0 - par.1-23 <i>Motor Frequency</i> .
		<div style="border: 1px solid black; padding: 5px;">  <p>NOTE! When Freeze output is active, the adjustable frequency drive cannot be stopped via a low 'start [13]' signal. Stop the adjustable frequency drive via a terminal programmed for Coasting inverse [2] or Coast and reset, inverse [3].</p> </div>
[21]	Speed up	For digital control of the up/down speed is desired (motor potentiometer). Activate this function by selecting either Freeze reference or Freeze output. When Speed up is activated for less than 400 msec., the resulting reference will be increased by 0.1%. If Speed up is activated for more than 400 msec., the resulting reference will ramp according to Ramp 1 in par.3-41 <i>Ramp 1 Ramp-up Time</i> .
[22]	Slow	Same as Speed up [21].
[23]	Set-up select bit 0	Selects one of the four set-ups. Set par. 0-10 to Multi Set-up.
[24]	Set-up select bit 1	Same as Set-up select bit 0 [23]. (Default Digital input 32)
[32]	Pulse input	Select Pulse input when using a pulse sequence as either reference or feedback. Scaling is done in par. group 5-5*.
[34]	Ramp bit 0	Select which ramp to use. Logic "0" will select ramp 1 while logic "1" will select ramp 2.
[36]	Line failure inverse	Select to activate function selected in par.14-10 <i>Line Failure</i> . Line failure is active in the Logic "0" situation.
[37]	Fire mode	A signal applied will put the adjustable frequency drive into fire mode and all other commands will be disregarded. See 24-0* <i>Fire Mode</i> .
[52]	Run Permissive	The input terminal, for which the Run permissive has been programmed must be logic "1" before a start command can be accepted. Run permissive has a logic 'AND' function related to the terminal which is programmed for <i>START</i> [8], <i>Jog</i> [14] or <i>Freeze Output</i> [20], which means that in order to start running the motor, both conditions must be fulfilled. If Run Permissive is programmed on multiple terminals, Run permissive needs only be logic '1' on one of the terminals for the function to be carried out. The digital output signal for Run Request (<i>Start</i> [8], <i>Jog</i> [14] or <i>Freeze output</i> [20]) programmed in par. 5-3*, or par. 5-4*, will not be affected by Run Permissive.
[53]	Hand start	A signal applied will put the adjustable frequency drive into hand mode as if button <i>Hand On</i> on the LCP has been pressed and a normal stop command will be overridden. If disconnecting the signal, the motor will stop. To make any other start commands valid, another digital input must be assigned to <i>Auto-Start</i> and a signal applied to this. The <i>Hand On</i> and <i>Auto On</i> buttons on the LCP has no impact. The <i>Off</i> button on the LCP will override <i>Hand Start</i> and <i>Auto-Start</i> . Press either the <i>Hand On</i> or <i>Auto On</i> button to make <i>Hand Start</i> and <i>Auto Start</i> active again. If no signal on neither <i>Hand Start</i> nor <i>Auto-Start</i> , the motor will stop regardless of any normal Start command applied. If signal applied to both <i>Hand Start</i> and <i>Auto-Start</i> , the function will be <i>Auto-Start</i> . If pressing the <i>Off</i> button on the LCP the motor will stop regardless of signals on <i>Hand Start</i> and <i>Auto-Start</i> .
[54]	Auto-start	A signal applied will put the adjustable frequency drive into auto mode as if the LCP button <i>Auto On</i> has been pressed. See also <i>Hand Start</i> [53]
[55]	DigiPot Increase	Uses the input as an INCREASE signal to the Digital Potentiometer function described in parameter group 3-9*
[56]	DigiPot Decrease	Uses the input as a DECREASE signal to the Digital Potentiometer function described in parameter group 3-9*

[57]	DigiPot Clear	Uses the input to CLEAR the Digital Potentiometer reference described in parameter group 3-9*
[60]	Counter A (up)	(Terminal 29 or 33 only) Input for increment counting in the SLC counter.
[61]	Counter A (down)	(Terminal 29 or 33 only) Input for decrement counting in the SLC counter.
[62]	Reset Counter A	Input for reset of counter A.
[63]	Counter B (up)	(Terminal 29 and 33 only) Input for increment counting in the SLC counter.
[64]	Counter B (down)	(Terminal 29 and 33 only) Input for decrement counting in the SLC counter.
[65]	Reset Counter B	Input for reset of counter B.
[66]	Sleep Mode	Forces the adjustable frequency drive into sleep mode (see par. 22-4*). Reacts on the rising edge of signal applied!
[78]	Reset Preventive Maintenance Word	Resets all data in par.16-96 <i>Maintenance Word</i> to 0.

The below setting options are all related to the cascade controller. Wiring diagrams and settings for parameter, see group 25-** for more details.

[120]	Lead Pump Start	Starts/stops the lead pump (controlled by the adjustable frequency drive). A start requires that also a System Start signal has been applied, e.g., to one of the digital inputs set for <i>Start</i> [8]!
[121]	Lead Pump Alternation	Forces alternation of the lead pump in a cascade controller. par.25-50 <i>Lead Pump Alternation</i> , must be set to either <i>At Command</i> [2] or <i>At Staging or At Command</i> [3]. par.25-51 <i>Alternation Event</i> , can be set to any of the four options.

[130 - 138] Pump1 Interlock - Pump9 Interlock For the above 9 setting options, par. 25-10 must be set to *On* [1]. The function will also depend on the setting in par.25-05 *Fixed Lead Pump*. If set to *No* [0], then Pump1 refers to the pump controlled by relay RELAY1, etc. If set to *Yes* [1], Pump1 refers to the pump controlled by the adjustable frequency drive only (without any of the built-in relays involved) and Pump2 to the pump controlled by the relay RELAY1. Variable speed pump (lead) cannot be interlocked.
See below table:

Setting in Par. 5-1*	Setting in par.25-06 <i>Number Of Pumps</i>	
	[0] No	[1] Yes
[130] Pump1 Interlock	Controlled by RELAY1 (only if not lead pump)	Adjustable frequency drive controlled (cannot be interlocked)
[131] Pump2 Interlock	Controlled by RELAY2	Controlled by RELAY1
[132] Pump3 Interlock	Controlled by RELAY3	Controlled by RELAY2
[133] Pump4 Interlock	Controlled by RELAY4	Controlled by RELAY3
[134] Pump5 Interlock	Controlled by RELAY5	Controlled by RELAY4
[135] Pump6 Interlock	Controlled by RELAY6	Controlled by RELAY5
[136] Pump7 Interlock	Controlled by RELAY7	Controlled by RELAY6
[137] Pump8 Interlock	Controlled by RELAY8	Controlled by RELAY7
[138] Pump9 Interlock	Controlled by RELAY9	Controlled by RELAY8

5-10 Terminal 18 Digital Input

Option:	Function:
[0]	No operation
[1]	Reset
[2]	Coast inverse
[3]	Coast and Reset Inv
[5]	DC brake inverse
[6]	Stop inverse
[7]	External interlock

[8] *	Start	Same options and functions as par. 5-1*, except for <i>Pulse input</i> .
[9]	Latched start	
[10]	Reverse	
[11]	Start reverse	
[14]	Jog	
[15]	Preset reference on	
[16]	Preset ref bit 0	
[17]	Preset ref bit 1	
[18]	Preset ref bit 2	
[19]	Freeze reference	
[20]	Freeze output	
[21]	Speed up	
[22]	Slow	
[23]	Set-up select bit 0	
[24]	Set-up select bit 1	
[34]	Ramp bit 0	
[36]	Mains failure inverse	
[37]	Fire Mode	
[52]	Run permissive	
[53]	Hand start	
[54]	Auto-start	
[55]	DigiPot increase	
[56]	DigiPot decrease	
[57]	DigiPot clear	
[62]	Reset Counter A	
[65]	Reset Counter B	
[66]	Sleep Mode	
[78]	Reset Preventive Maintenance Word	
[120]	Lead Pump Start	
[121]	Lead Pump Alternation	
[130]	Pump 1 Interlock	
[131]	Pump 2 Interlock	
[132]	Pump 3 Interlock	

5-11 Terminal 19 Digital Input

Option:	Function:	
[0] *	No operation	Same options and functions as 5-1*, except for <i>Pulse input</i> .
[1]	Reset	
[2]	Coast inverse	
[3]	Coast and Reset Inv	
[5]	DC brake inverse	
[6]	Stop inverse	
[7]	External interlock	
[8]	Start	

[9]	Latched start
[10]	Reverse
[11]	Start reverse
[14]	Jog
[15]	Preset reference on
[16]	Preset ref bit 0
[17]	Preset ref bit 1
[18]	Preset ref bit 2
[19]	Freeze reference
[20]	Freeze output
[21]	Speed up
[22]	Slow
[23]	Set-up select bit 0
[24]	Set-up select bit 1
[34]	Ramp bit 0
[36]	Mains failure inverse
[37]	Fire Mode
[52]	Run permissive
[53]	Hand start
[54]	Auto-start
[55]	DigiPot increase
[56]	DigiPot decrease
[57]	DigiPot clear
[62]	Reset Counter A
[65]	Reset Counter B
[66]	Sleep Mode
[78]	Reset Preventive Maintenance Word
[120]	Lead Pump Start
[121]	Lead Pump Alternation
[130]	Pump 1 Interlock
[131]	Pump 2 Interlock
[132]	Pump 3 Interlock

5-12 Terminal 27 Digital Input

Option:	Function:
	Same options and functions as par. 5-1*, except for <i>Pulse input</i> .
[0] *	No operation
[1]	Reset
[2]	Coast inverse
[3]	Coast and Reset Inv
[5]	DC brake inverse
[6]	Stop inverse
[7]	External interlock
[8]	Start

[9] Latched start

[10] Reverse

[11] Start reverse

[14] Jog

[15] Preset reference on

[16] Preset ref bit 0

[17] Preset ref bit 1

[18] Preset ref bit 2

[19] Freeze reference

[20] Freeze output

[21] Speed up

[22] Slow

[23] Set-up select bit 0

[24] Set-up select bit 1

[34] Ramp bit 0

[36] Mains failure inverse

[37] Fire Mode

[52] Run permissive

[53] Hand start

[54] Auto-start

[55] DigiPot increase

[56] DigiPot decrease

[57] DigiPot clear

[62] Reset Counter A

[65] Reset Counter B

[66] Sleep Mode

[78] Reset Preventive Maintenance Word

[120] Lead Pump Start

[121] Lead Pump Alternation

[130] Pump 1 Interlock

[131] Pump 2 Interlock

[132] Pump 3 Interlock

5-13 Terminal 29 Digital Input

Option:**Function:**

[0] No operation

[1] Reset

[2] Coast inverse

[3] Coast and Reset Inv

[5] DC brake inverse

[6] Stop inverse

[7] External interlock

[8] Start

[9] Latched start

[10]	Reverse	
[11]	Start reverse	
[14] *	Jog	Same options and functions as par. 5-1*.
[15]	Preset reference on	
[16]	Preset ref bit 0	
[17]	Preset ref bit 1	
[18]	Preset ref bit 2	
[19]	Freeze reference	
[20]	Freeze output	
[21]	Speed up	
[22]	Slow	
[23]	Set-up select bit 0	
[24]	Set-up select bit 1	
[30]	Counter input	
[32]	Pulse input	
[34]	Ramp bit 0	
[36]	Mains failure inverse	
[37]	Fire Mode	
[52]	Run permissive	
[53]	Hand start	
[54]	Auto-start	
[55]	DigiPot increase	
[56]	DigiPot decrease	
[57]	DigiPot clear	
[60]	Counter A (up)	
[61]	Counter A (down)	
[62]	Reset Counter A	
[63]	Counter B (up)	
[64]	Counter B (down)	
[65]	Reset Counter B	
[66]	Sleep Mode	
[78]	Reset Preventive Maintenance Word	
[120]	Lead Pump Start	
[121]	Lead Pump Alternation	
[130]	Pump 1 Interlock	
[131]	Pump 2 Interlock	
[132]	Pump 3 Interlock	

5-14 Terminal 32 Digital Input

Option:	Function:
[0] *	No operation Same options and functions as par. 5-1*, except for <i>Pulse input</i> .
[1]	Reset
[2]	Coast inverse
[3]	Coast and Reset Inv

[5]	DC brake inverse
[6]	Stop inverse
[7]	External interlock
[8]	Start
[9]	Latched start
[10]	Reverse
[11]	Start reverse
[14]	Jog
[15]	Preset reference on
[16]	Preset ref bit 0
[17]	Preset ref bit 1
[18]	Preset ref bit 2
[19]	Freeze reference
[20]	Freeze output
[21]	Speed up
[22]	Slow
[23]	Set-up select bit 0
[24]	Set-up select bit 1
[34]	Ramp bit 0
[36]	Mains failure inverse
[37]	Fire Mode
[52]	Run permissive
[53]	Hand start
[54]	Auto-start
[55]	DigiPot increase
[56]	DigiPot decrease
[57]	DigiPot clear
[62]	Reset Counter A
[65]	Reset Counter B
[66]	Sleep Mode
[78]	Reset Preventive Maintenance Word
[120]	Lead Pump Start
[121]	Lead Pump Alternation
[130]	Pump 1 Interlock
[131]	Pump 2 Interlock
[132]	Pump 3 Interlock

5-15 Terminal 33 Digital Input

Option:
Function:

[0] *	No operation	Same options and functions as par. 5-1* Digital Inputs.
[1]	Reset	
[2]	Coast inverse	
[3]	Coast and Reset Inv	
[5]	DC brake inverse	

[6]	Stop inverse
[7]	External interlock
[8]	Start
[9]	Latched start
[10]	Reverse
[11]	Start reverse
[14]	Jog
[15]	Preset reference on
[16]	Preset ref bit 0
[17]	Preset ref bit 1
[18]	Preset ref bit 2
[19]	Freeze reference
[20]	Freeze output
[21]	Speed up
[22]	Slow
[23]	Set-up select bit 0
[24]	Set-up select bit 1
[30]	Counter input
[32]	Pulse input
[34]	Ramp bit 0
[36]	Mains failure inverse
[37]	Fire Mode
[52]	Run permissive
[53]	Hand start
[54]	Auto-start
[55]	DigiPot increase
[56]	DigiPot decrease
[57]	DigiPot clear
[60]	Counter A (up)
[61]	Counter A (down)
[62]	Reset Counter A
[63]	Counter B (up)
[64]	Counter B (down)
[65]	Reset Counter B
[66]	Sleep Mode
[78]	Reset Preventive Maintenance Word
[120]	Lead Pump Start
[121]	Lead Pump Alternation
[130]	Pump 1 Interlock
[131]	Pump 2 Interlock
[132]	Pump 3 Interlock

5-16 Terminal X30/2 Digital Input

Option:	Function:
[0] * No operation	This parameter is active when option module MCB 101 is installed in the adjustable frequency drive. It has the same options and functions as par. 5-1* except for <i>Pulse input</i> [32].
[1] Reset	
[2] Coast inverse	
[3] Coast and Reset Inv	
[5] DC brake inverse	
[6] Stop inverse	
[7] External interlock	
[8] Start	
[9] Latched start	
[10] Reverse	
[11] Start reverse	
[14] Jog	
[15] Preset reference on	
[16] Preset ref bit 0	
[17] Preset ref bit 1	
[18] Preset ref bit 2	
[19] Freeze reference	
[20] Freeze output	
[21] Speed up	
[22] Slow	
[23] Set-up select bit 0	
[24] Set-up select bit 1	
[34] Ramp bit 0	
[36] Mains failure inverse	
[37] Fire Mode	
[52] Run permissive	
[53] Hand start	
[54] Auto-start	
[55] DigiPot increase	
[56] DigiPot decrease	
[57] DigiPot clear	
[62] Reset Counter A	
[65] Reset Counter B	
[66] Sleep Mode	
[78] Reset Preventive Maintenance Word	
[120] Lead Pump Start	
[121] Lead Pump Alternation	
[130] Pump 1 Interlock	
[131] Pump 2 Interlock	
[132] Pump 3 Interlock	

5-17 Terminal X30/3 Digital Input

Option:
Function:

[0] * No operation This parameter is active when option module MCB 101 is installed in the adjustable frequency drive. It has the same options and functions as par. 5-1* except for *Pulse input* [32].

[1] Reset

[2] Coast inverse

[3] Coast and Reset Inv

[5] DC brake inverse

[6] Stop inverse

[7] External interlock

[8] Start

[9] Latched start

[10] Reverse

[11] Start reverse

[14] Jog

[15] Preset reference on

[16] Preset ref bit 0

[17] Preset ref bit 1

[18] Preset ref bit 2

[19] Freeze reference

[20] Freeze output

[21] Speed up

[22] Slow

[23] Set-up select bit 0

[24] Set-up select bit 1

[34] Ramp bit 0

[36] Mains failure inverse

[37] Fire Mode

[52] Run permissive

[53] Hand start

[54] Auto-start

[55] DigiPot increase

[56] DigiPot decrease

[57] DigiPot clear

[62] Reset Counter A

[65] Reset Counter B

[66] Sleep Mode

[78] Reset Preventive Maintenance Word

[120] Lead Pump Start

[121] Lead Pump Alternation

[130] Pump 1 Interlock

[131] Pump 2 Interlock

[132] Pump 3 Interlock

5-18 Terminal X30/4 Digital Input

Option:
Function:

[0] * No operation This parameter is active when option module MCB 101 is installed in the adjustable frequency drive. It has the same options and functions as par. 5-1* except for *Pulse input* [32].

[1] Reset

[2] Coast inverse

[3] Coast and Reset Inv

[5] DC brake inverse

[6] Stop inverse

[7] External interlock

[8] Start

[9] Latched start

[10] Reverse

[11] Start reverse

[14] Jog

[15] Preset reference on

[16] Preset ref bit 0

[17] Preset ref bit 1

[18] Preset ref bit 2

[19] Freeze reference

[20] Freeze output

[21] Speed up

[22] Slow

[23] Set-up select bit 0

[24] Set-up select bit 1

[34] Ramp bit 0

[36] Mains failure inverse

[37] Fire Mode

[52] Run permissive

[53] Hand start

[54] Auto-start

[55] DigiPot increase

[56] DigiPot decrease

[57] DigiPot clear

[62] Reset Counter A

[65] Reset Counter B

[66] Sleep Mode

[78] Reset Preventive Maintenance Word

[120] Lead Pump Start

[121] Lead Pump Alternation

[130] Pump 1 Interlock

[131] Pump 2 Interlock

[132] Pump 3 Interlock

3.7.5 5-3* Digital Outputs

Parameters for configuring the output functions for the output terminals. The two solid state digital outputs are common for terminals 27 and 29. Set the I/O function for terminal 27 in par.5-01 *Terminal 27 Mode* and set the I/O function for terminal 29 in par.5-02 *Terminal 29 Mode*. These parameters cannot be adjusted while the motor is running.

		The digital outputs can be programmed with these functions:
[0]	No operation	<i>Default for all digital outputs and relay outputs</i>
[1]	Control ready	The control board receives supply voltage.
[2]	Drive ready	The adjustable frequency drive is ready for operation and applies a supply signal on the control board.
[3]	Drive ready / remote control	The adjustable frequency drive is ready for operation and is in Auto On mode.
[4]	Stand-by / no warning	The adjustable frequency drive is ready for operation. No start or stop command is been given (start/disable). There are no warnings.
[5]	Running	The motor is running.
[6]	Running / no warning	The output speed is higher than the speed set in par.1-81 <i>Min Speed for Function at Stop [RPM]</i> . The motor is running and there are no warnings.
[8]	Run on reference / no warning	The motor runs at reference speed.
[9]	Alarm	An alarm activates the output. There are no warnings.
[10]	Alarm or warning	An alarm or a warning activates the output.
[11]	At torque limit	The torque limit set in par.4-16 <i>Torque Limit Motor Mode</i> or par. 1-17 has been exceeded.
[12]	Out of current range	The motor current is outside the range set in par.4-18 <i>Current Limit</i> .
[13]	Below current, low	The motor current is lower than set in par.4-50 <i>Warning Current Low</i> .
[14]	Above current, high	The motor current is higher than set in par.4-51 <i>Warning Current High</i> .
[15]	Out of speed range	The output speed is outside the range set in par.4-52 <i>Warning Speed Low</i> and par.4-53 <i>Warning Speed High</i> .
[16]	Below speed, low	The output speed is lower than the setting in par.4-52 <i>Warning Speed Low</i> .
[17]	Above speed, high	The output speed is higher than the setting in par.4-53 <i>Warning Speed High</i> .
[18]	Out of feedback range	The feedback is outside the range set in par.4-56 <i>Warning Feedback Low</i> and par.4-57 <i>Warning Feedback High</i> .
[19]	Below feedback, low	The feedback is below the limit set in par.4-56 <i>Warning Feedback Low</i> .
[20]	Above feedback, high	The feedback is above the limit set in par.4-57 <i>Warning Feedback High</i> .
[21]	Thermal warning	The thermal warning turns on when the temperature exceeds the limit in the motor, the adjustable frequency drive, the brake resistor, or the thermistor.
[25]	Reverse	<i>Reversing. Logic '1' = relay activated, 24 V DC when CW rotation of the motor. Logic '0' = relay not activated, no signal, when CCW rotation of the motor.</i>
[26]	Bus OK	Active communication (no timeout) via the serial communication port.
[27]	Torque limit and stop	Use in performing a coasting stop and in torque limit condition. If the adjustable frequency drive has received a stop signal and is at the torque limit, the signal is Logic '0'.
[28]	Brake, no warning	The brake is active and there are no warnings.
[29]	Brake ready, no fault	The brake is ready for operation and there are no faults.
[30]	Brake fault (IGBT)	The output is Logic '1' when the brake IGBT is short-circuited. Use this function to protect the adjustable frequency drive if there is a fault on the brake modules. Use the output/relay to cut out the AC line voltage from the adjustable frequency drive.
[35]	External Interlock	External Interlock function has been activated via one of the digital inputs.

[40]	Out of ref range	
[41]	Below reference low	
[42]	Above reference high	
[45]	Bus Ctrl	
[46]	Bus Ctrl 1 if timeout	
[47]	Bus Ctrl 0 if timeout	
[55]	Pulse output	
[60]	Comparator 0	See par. group 13-1*. If Comparator 0 is evaluated as TRUE, the output will go high. Otherwise, it will be low.
[61]	Comparator 1	See par. group 13-1*. If Comparator 2 is evaluated as TRUE, the output will go high. Otherwise, it will be low.
[62]	Comparator 2	See par. group 13-1*. If Comparator 2 is evaluated as TRUE, the output will go high. Otherwise, it will be low.
[63]	Comparator 3	See par. group 13-1*. If Comparator 3 is evaluated as TRUE, the output will go high. Otherwise, it will be low.
[64]	Comparator 4	See par. group 13-1*. If Comparator 4 is evaluated as TRUE, the output will go high. Otherwise, it will be low.
[65]	Comparator 5	See par. group 13-1*. If Comparator 5 is evaluated as TRUE, the output will go high. Otherwise, it will be low.
[70]	Logic Rule 0	See par. group 13-4*. If Logic Rule 0 is evaluated as TRUE, the output will go high. Otherwise, it will be low.
[71]	Logic Rule 1	See par. group 13-4*. If Logic Rule 1 is evaluated as TRUE, the output will go high. Otherwise, it will be low.
[72]	Logic Rule 2	See par. group 13-4*. If Logic Rule 2 is evaluated as TRUE, the output will go high. Otherwise, it will be low.
[73]	Logic Rule 3	See par. group 13-4*. If Logic Rule 3 is evaluated as TRUE, the output will go high. Otherwise, it will be low.
[74]	Logic Rule 4	See par. group 13-4*. If Logic Rule 4 is evaluated as TRUE, the output will go high. Otherwise, it will be low.
[75]	Logic Rule 5	See par. group 13-4*. If Logic Rule 5 is evaluated as TRUE, the output will go high. Otherwise, it will be low.
[80]	SL Digital Output A	See par.13-52 <i>SL Controller Action</i> . The input will go high whenever the Smart Logic Action [38] <i>Set dig. out. A high</i> is executed. The input will go low whenever the Smart Logic Action [32] <i>Set dig. out. A low</i> is executed.
[81]	SL Digital Output B	See par.13-52 <i>SL Controller Action</i> . The input will go high whenever the Smart Logic Action [39] <i>Set dig. out. B high</i> is executed. The input will go low whenever the Smart Logic Action [33] <i>Set dig. out. B low</i> is executed.
[82]	SL Digital Output C	See par.13-52 <i>SL Controller Action</i> . The input will go high whenever the Smart Logic Action [40] <i>Set dig. out. C high</i> is executed. The input will go low whenever the Smart Logic Action [34] <i>Set dig. out. C low</i> is executed.
[83]	SL Digital Output D	See par.13-52 <i>SL Controller Action</i> . The input will go high whenever the Smart Logic Action [41] <i>Set dig. out. D high</i> is executed. The input will go low whenever the Smart Logic Action [35] <i>Set dig. out. D low</i> is executed.
[84]	SL Digital Output E	See par.13-52 <i>SL Controller Action</i> . The input will go high whenever the Smart Logic Action [42] <i>Set dig. out. E high</i> is executed. The input will go low whenever the Smart Logic Action [36] <i>Set dig. out. E low</i> is executed.

[85]	SL Digital Output F	See par.13-52 <i>SL Controller Action</i> . The input will go high whenever the Smart Logic Action [43] <i>Set dig. out. F high</i> is executed. The input will go low whenever the Smart Logic Action [37] <i>Set dig. out. F low</i> is executed.
[160]	No alarm	The output is high when no alarm is present.
[161]	Running reverse	The output is high when the adjustable frequency drive is running counter-clockwise (the logical product of the status bits 'running' AND 'reverse').
[165]	Local reference active	The output is high when par.3-13 <i>Reference Site</i> = [2] Local or when par.3-13 <i>Reference Site</i> = [0] <i>Linked to hand auto</i> at the same time as the LCP is in [Hand on] mode.
[166]	Remote reference active	The output is high when par.3-13 <i>Reference Site</i> [1] or <i>Linked to hand/auto</i> [0] while the LCP is in [Auto on] mode.
[167]	Start command active	The output is high when there is an active Start command (i.e., via digital input bus connection or [Hand on] or [Auto on], and no Stop or Start command is active.
[168]	Drive in hand mode	The output is high when the adjustable frequency drive is in Hand on mode (as indicated by the LED light above [Hand on]).
[169]	Drive in auto mode	The output is high when the adjustable frequency drive is in Hand on mode (as indicated by the LED light above [Auto on]).
[180]	Clock Fault	The clock function has been reset to default (2000-01-01) because of a power failure.
[181]	Preventive Maintenance	One or more of the preventive maintenance events programmed in par.23-10 <i>Maintenance Item</i> has passed the time for the specified action in par.23-11 <i>Maintenance Action</i> .
[190]	No-Flow	A no-flow situation or minimum speed situation has been detected if enabled in par.22-21 <i>Low Power Detection</i> and/or par.22-22 <i>Low Speed Detection</i> .
[191]	Dry Pump	A dry pump condition has been detected. This function must be enabled in par.22-26 <i>Dry Pump Function</i> .
[192]	End of Curve	A pump running with max. speed for a period of time without reaching the set pressure has been detected. To enable this function, see par.22-50 <i>End of Curve Function</i> .
[193]	Sleep Mode	The adjustable frequency drive/system has set to sleep mode. See par. 22-4*.
[194]	Broken Belt	A broken belt condition has been detected. This function must be enabled in par.22-60 <i>Broken Belt Function</i> .
[195]	Bypass Valve Control	The bypass valve control (Digital/Relay output in the adjustable frequency drive) is used for compressor systems to unload the compressor during start-up by using a bypass valve. After the Start command is given, the bypass valve will be open until the adjustable frequency drive reaches par. 4-11 <i>Motor Speed Low Limit [RPM]</i> . After the limit has been reached the bypass valve will be closed, allowing the compressor to operate normally. This procedure will not be activated again before a new start is initiated and the adjustable frequency drive speed is zero during the receiving of start signal. par.1-71 <i>Start Delay</i> can be used in order to delay the motor start. The bypass valve control principle:

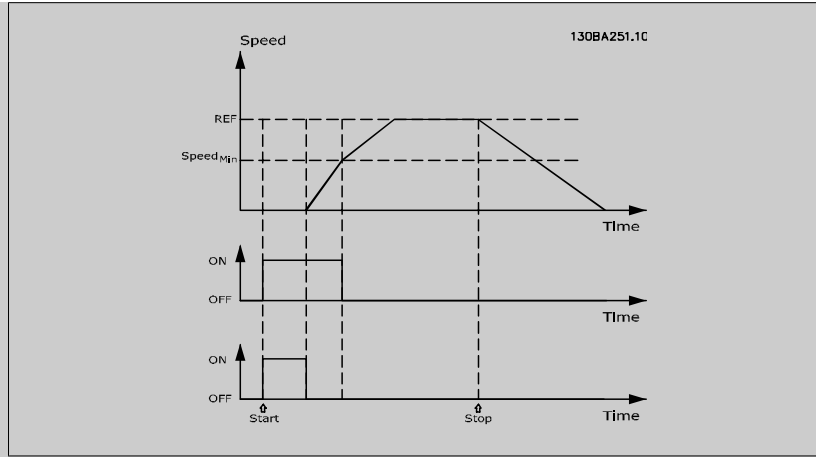

- [196] Fire Mode The adjustable frequency drive is operating in fire mode. See parameter group 24-0* *Fire Mode*.
- [197] Fire Mode was act. The adjustable frequency drive has been operating in fire mode, but is now back in normal operation.
- [198] Drive Bypass To be used as signal for activating an external electromechanical bypass switching the motor direct on line. See 24-1* *Drive Bypass*.

If enabling the Drive Bypass function, the adjustable frequency drive is no longer Safety Certified (for using the Safe Stop in versions where included).

The below setting options are all related to the cascade controller.
Wiring diagrams and settings for parameter, see group 25-** for more details.

- [200] Full Capacity All pumps running and at full speed
- [201] Pump1 Running One or more of the pumps controlled by the cascade controller are running. The function will also depend on the setting of in par. 25-06 *Number Of Pumps*. If set to *No* [0] Pump 1 refers to the pump controlled by relay RELAY1 etc. If set to *Yes* [1], Pump 1 refers to the pump controlled by the adjustable frequency drive only (without any of the built-in relays involved) and Pump 2 to the pump controlled by the relay RELAY1. See the table below:
- [202] Pump2 Running See [201]
- [203] Pump3 Running See [201]

Setting in Par. 5-3*	Setting in par. 25-06 <i>Number Of Pumps</i>	
	[0] No	[1] Yes
[200] Pump 1 Running	Controlled by RELAY1	Adjustable frequency drive controlled
[201] Pump 2 Running	Controlled by RELAY2	Controlled by RELAY1
[203] Pump 3 Running	Controlled by RELAY3	Controlled by RELAY2

5-30 Terminal 27 Digital Output

Option:

Function:

- [0] * No operation Same options and functions as par. 5-3*.
- [1] Control ready
- [2] Drive ready
- [3] Drive rdy/rem ctrl
- [4] Stand-by / no warning

[5]	Running
[6]	Running / no warning
[8]	Run on ref/no warn
[9]	Alarm
[10]	Alarm or warning
[11]	At torque limit
[12]	Out of current range
[13]	Below current, low
[14]	Above current, high
[15]	Out of speed range
[16]	Below speed, low
[17]	Above speed, high
[18]	Out of feedb. range
[19]	Below feedback, low
[20]	Above feedback, high
[21]	Thermal warning
[25]	Reverse
[26]	Bus OK
[27]	Torque limit stop
[28]	Brake: No Brake War
[29]	Brake ready, no fault
[30]	Brake fault (IGBT)
[35]	External Interlock
[40]	Out of ref range
[41]	Below reference, low
[42]	Above ref, high
[45]	Bus ctrl.
[46]	Bus ctrl, 1 if timeout
[47]	Bus ctrl, 0 if timeout
[55]	Pulse output
[60]	Comparator 0
[61]	Comparator 1
[62]	Comparator 2
[63]	Comparator 3
[64]	Comparator 4
[65]	Comparator 5
[70]	Logic rule 0
[71]	Logic rule 1
[72]	Logic rule 2
[73]	Logic rule 3
[74]	Logic rule 4
[75]	Logic rule 5
[80]	SL digital output A

[81]	SL digital output B
[82]	SL digital output C
[83]	SL digital output D
[84]	SL digital output E
[85]	SL digital output F
[160]	No alarm
[161]	Running reverse
[165]	Local ref active
[166]	Remote ref active
[167]	Start cmd. active
[168]	Hand mode
[169]	Auto mode
[180]	Clock Fault
[181]	Prev. Maintenance
[190]	No-Flow
[191]	Dry Pump
[192]	End Of Curve
[193]	Sleep Mode
[194]	Broken Belt
[195]	Bypass Valve Control
[196]	Fire Mode Active
[197]	Fire Mode Was Active
[198]	Bypass Mode Active
[200]	Full capacity
[201]	Pump 1 running
[202]	Pump 2 running
[203]	Pump 3 running

5-31 Terminal 29 digital Output

Option:
Function:

[0] *	No operation	Same options and functions as par. 5-3*, Digital Outputs.
[1]	Control ready	
[2]	Drive ready	
[3]	Drive rdy/rem ctrl	
[4]	Stand-by / no warning	
[5]	Running	
[6]	Running / no warning	
[8]	Run on ref/no warn	
[9]	Alarm	
[10]	Alarm or warning	
[11]	At torque limit	
[12]	Out of current range	
[13]	Below current, low	
[14]	Above current, high	

[15]	Out of speed range
[16]	Below speed, low
[17]	Above speed, high
[18]	Out of feedb. range
[19]	Below feedback, low
[20]	Above feedback, high
[21]	Thermal warning
[25]	Reverse
[26]	Bus OK
[27]	Torque limit stop
[28]	Brake: No Brake War
[29]	Brake ready, no fault
[30]	Brake fault (IGBT)
[35]	External Interlock
[40]	Out of ref range
[41]	Below reference, low
[42]	Above ref, high
[45]	Bus ctrl.
[46]	Bus ctrl, 1 if timeout
[47]	Bus ctrl, 0 if timeout
[55]	Pulse output
[60]	Comparator 0
[61]	Comparator 1
[62]	Comparator 2
[63]	Comparator 3
[64]	Comparator 4
[65]	Comparator 5
[70]	Logic rule 0
[71]	Logic rule 1
[72]	Logic rule 2
[73]	Logic rule 3
[74]	Logic rule 4
[75]	Logic rule 5
[80]	SL digital output A
[81]	SL digital output B
[82]	SL digital output C
[83]	SL digital output D
[84]	SL digital output E
[85]	SL digital output F
[160]	No alarm
[161]	Running reverse
[165]	Local ref active
[166]	Remote ref active

[167] Start cmd. active

[168] Hand mode

[169] Auto mode

[180] Clock Fault

[181] Prev. Maintenance

[190] No-Flow

[191] Dry Pump

[192] End Of Curve

[193] Sleep Mode

[194] Broken Belt

[195] Bypass Valve Control

[196] Fire Mode Active

[197] Fire Mode Was Active

[198] Bypass Mode Active

[200] Full capacity

[201] Pump 1 running

[202] Pump 2 running

[203] Pump 3 running

5-32 Term X30/6 Digi Out (MCB 101)

Option:
Function:

[0] * No operation This parameter is active when option module MCB 101 is mounted in the adjustable frequency drive.

[1] Control ready

[2] Drive ready

[3] Drive rdy/rem ctrl

[4] Stand-by / no warning

[5] Running

[6] Running / no warning

[8] Run on ref/no warn

[9] Alarm

[10] Alarm or warning

[11] At torque limit

[12] Out of current range

[13] Below current, low

[14] Above current, high

[15] Out of speed range

[16] Below speed, low

[17] Above speed, high

[18] Out of feedb. range

[19] Below feedback, low

[20] Above feedback, high

[21] Thermal warning

[25] Reverse

[26] Bus OK

[27]	Torque limit stop
[28]	Brake: No Brake War
[29]	Brake ready, no fault
[30]	Brake fault (IGBT)
[35]	External Interlock
[40]	Out of ref range
[41]	Below reference, low
[42]	Above ref, high
[45]	Bus ctrl.
[46]	Bus ctrl, 1 if timeout
[47]	Bus ctrl, 0 if timeout
[55]	Pulse output
[60]	Comparator 0
[61]	Comparator 1
[62]	Comparator 2
[63]	Comparator 3
[64]	Comparator 4
[65]	Comparator 5
[70]	Logic rule 0
[71]	Logic rule 1
[72]	Logic rule 2
[73]	Logic rule 3
[74]	Logic rule 4
[75]	Logic rule 5
[80]	SL digital output A
[81]	SL digital output B
[82]	SL digital output C
[83]	SL digital output D
[84]	SL digital output E
[85]	SL digital output F
[160]	No alarm
[161]	Running reverse
[165]	Local ref active
[166]	Remote ref active
[167]	Start cmd. active
[168]	Hand mode
[169]	Auto mode
[180]	Clock Fault
[181]	Prev. Maintenance
[190]	No-Flow
[191]	Dry Pump
[192]	End Of Curve
[193]	Sleep Mode

[194]	Broken Belt
[195]	Bypass Valve Control
[196]	Fire Mode Active
[197]	Fire Mode Was Active
[198]	Bypass Mode Active
[200]	Full capacity
[201]	Pump 1 running
[202]	Pump 2 running
[203]	Pump 3 running

5-33 Term X30/7 Digi Out (MCB 101)

Option:	Function:
[0] *	No operation This parameter is active when option module MCB 101 is mounted in the adjustable frequency drive.
[1]	Control ready
[2]	Drive ready
[3]	Drive rdy/rem ctrl
[4]	Stand-by / no warning
[5]	Running
[6]	Running / no warning
[8]	Run on ref/no warn
[9]	Alarm
[10]	Alarm or warning
[11]	At torque limit
[12]	Out of current range
[13]	Below current, low
[14]	Above current, high
[15]	Out of speed range
[16]	Below speed, low
[17]	Above speed, high
[18]	Out of feedb. range
[19]	Below feedback, low
[20]	Above feedback, high
[21]	Thermal warning
[25]	Reverse
[26]	Bus OK
[27]	Torque limit stop
[28]	Brake: No Brake War
[29]	Brake ready, no fault
[30]	Brake fault (IGBT)
[35]	External Interlock
[40]	Out of ref range
[41]	Below reference, low
[42]	Above ref, high
[45]	Bus ctrl.

[46]	Bus ctrl, 1 if timeout
[47]	Bus ctrl, 0 if timeout
[60]	Comparator 0
[61]	Comparator 1
[62]	Comparator 2
[63]	Comparator 3
[64]	Comparator 4
[65]	Comparator 5
[70]	Logic rule 0
[71]	Logic rule 1
[72]	Logic rule 2
[73]	Logic rule 3
[74]	Logic rule 4
[75]	Logic rule 5
[80]	SL digital output A
[81]	SL digital output B
[82]	SL digital output C
[83]	SL digital output D
[84]	SL digital output E
[85]	SL digital output F
[160]	No alarm
[161]	Running reverse
[165]	Local ref active
[166]	Remote ref active
[167]	Start cmd. active
[168]	Hand mode
[169]	Auto mode
[180]	Clock Fault
[181]	Prev. Maintenance
[190]	No-Flow
[191]	Dry Pump
[192]	End Of Curve
[193]	Sleep Mode
[194]	Broken Belt
[195]	Bypass Valve Control
[200]	Full capacity
[201]	Pump 1 running
[202]	Pump 2 running
[203]	Pump 3 running

3.7.6 5-4* Relays

Parameters for configuring the timing and the output functions for the relays.

5-40 Function Relay

Array [8]

(Relay 1 [0], Relay 2 [1])

Option MCB 105: Relay 7 [6], Relay 8 [7] and Relay 9 [8])

Option:

Function:

Option:	Function:
[0] * No operation	Select options to define the function of the relays. The selection of each mechanical relay is realized in an array parameter.
[1] Control ready	
[2] Drive ready	
[3] Drive rdy/rem ctrl	
[4] Stand-by / no warning	
[5] Running	
[6] Running / no warning	
[8] Run on ref/no warn	
[9] Alarm	
[10] Alarm or warning	
[11] At torque limit	
[12] Out of current range	
[13] Below current, low	
[14] Above current, high	
[15] Out of speed range	
[16] Below speed, low	
[17] Above speed, high	
[18] Out of feedb. range	
[19] Below feedback, low	
[20] Above feedback, high	
[21] Thermal warning	
[25] Reverse	
[26] Bus OK	
[27] Torque limit stop	
[28] Brake: No Brake War	
[29] Brake ready, no fault	
[30] Brake fault (IGBT)	
[35] External Interlock	
[36] Control word bit 11	
[37] Control word bit 12	
[40] Out of ref range	
[41] Below reference, low	
[42] Above ref, high	
[45] Bus ctrl.	
[46] Bus ctrl, 1 if timeout	

[47]	Bus ctrl, 0 if timeout
[60]	Comparator 0
[61]	Comparator 1
[62]	Comparator 2
[63]	Comparator 3
[64]	Comparator 4
[65]	Comparator 5
[70]	Logic rule 0
[71]	Logic rule 1
[72]	Logic rule 2
[73]	Logic rule 3
[74]	Logic rule 4
[75]	Logic rule 5
[80]	SL digital output A
[81]	SL digital output B
[82]	SL digital output C
[83]	SL digital output D
[84]	SL digital output E
[85]	SL digital output F
[160]	No alarm
[161]	Running reverse
[165]	Local ref active
[166]	Remote ref active
[167]	Start cmd. active
[168]	Hand mode
[169]	Auto mode
[180]	Clock Fault
[181]	Prev. Maintenance
[190]	No-Flow
[191]	Dry Pump
[192]	End Of Curve
[193]	Sleep Mode
[194]	Broken Belt
[195]	Bypass Valve Control
[196]	Fire Mode Active
[197]	Fire Mode Was Active
[198]	Bypass Mode Active
[211]	Cascade Pump 1
[212]	Cascade Pump 2
[213]	Cascade Pump 3

5-41 On Delay, Relay

Array [8](Relay 1 [0], Relay 2 [1], Relay 3 [2], Relay 4 [3], Relay 5 [4], Relay 6 [5], Relay 7 [6], Relay 8 [7], Relay 9 [8])

Range:

0.01 s* [0.01 - 600.00 s]

Function:

Enter the delay of the relay cut-in time. Select one of available mechanical relays and MCO 105 in an array function. See par.5-40 *Function Relay*. Relay 3-6 are included in MCB 112 (ATEX).

3

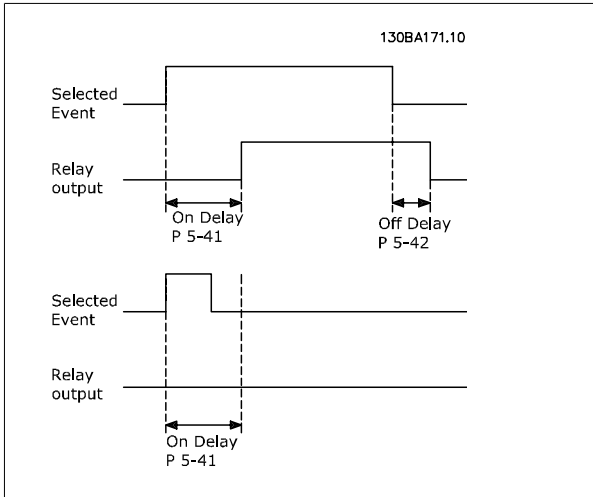

5-42 Off Delay, Relay

Array [8] (Relay 1 [0], Relay 2 [1], Relay 3 [2], Relay 4 [3], Relay 5 [4], Relay 6 [5], Relay 7 [6], Relay 8 [7], Relay 9 [8])

Range:

0.01 s* [0.01 - 600.00 s]

Function:

Enter the delay of the relay cut-out time. Select one of available mechanical relays and MCO 105 in an array function. See par.5-40 *Function Relay*.

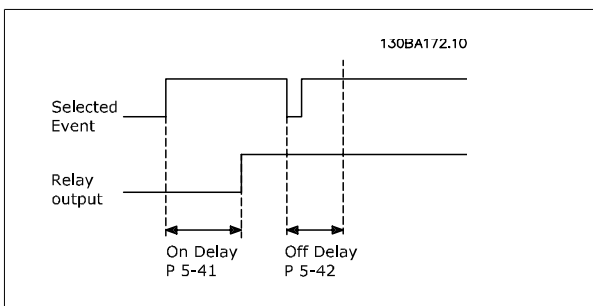

If the selected event condition changes before the on or off delay timer expires, the relay output is unaffected.

3.7.7 5-5* Pulse Input

The pulse input parameters are used to define an appropriate window for the impulse reference area by configuring the scaling and filter settings for the pulse inputs. Input terminals 29 or 33 act as frequency reference inputs. Set terminal 29 (par.5-13 *Terminal 29 Digital Input*) or terminal 33 (par. 5-15 *Terminal 33 Digital Input*) to *Pulse input* [32]. If terminal 29 is used as an input, then set par.5-02 *Terminal 29 Mode to Input* [0].

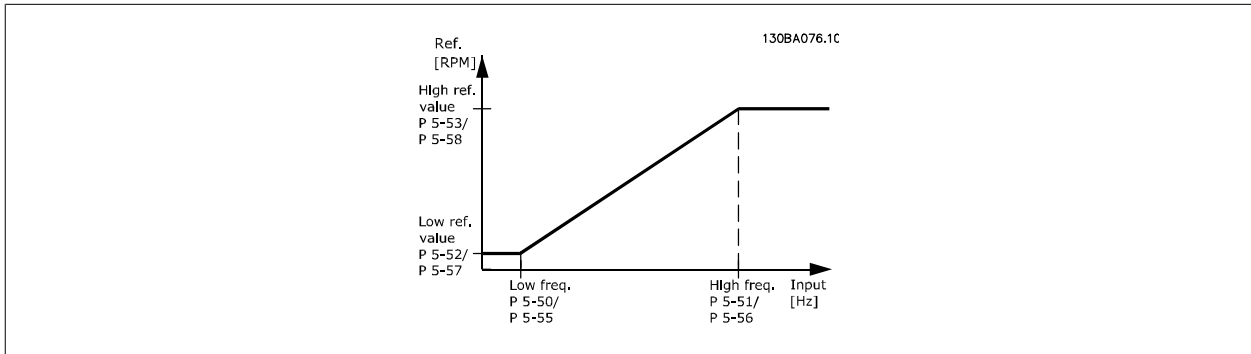

5-50 Term. 29 Low Frequency

Range: 100 Hz* [0 - 110000 Hz]
Function: Enter the low frequency limit corresponding to the low motor shaft speed (i.e., low reference value) in par.5-52 *Term. 29 Low Ref./Feedb. Value*. Refer to the diagram in this section.

5-51 Term. 29 High Frequency

Range: 100 Hz* [0 - 110000 Hz]
Function: Enter the high frequency limit corresponding to the high motor shaft speed (i.e. high reference value) in par.5-53 *Term. 29 High Ref./Feedb. Value*.

5-52 Term. 29 Low Ref./Feedb. Value

Range: 0.000 N/A* [-999999.999 - 999999.999 N/A]
Function: Enter the low reference value limit for the motor shaft speed [RPM]. This is also the lowest feedback value, see also par.5-57 *Term. 33 Low Ref./Feedb. Value*.

5-53 Term. 29 High Ref./Feedb. Value

Range: 100.000 N/ A* [-999999.999 - 999999.999 N/A]
Function: Enter the high reference value [RPM] for the motor shaft speed and the high feedback value, see also par.5-58 *Term. 33 High Ref./Feedb. Value*.

5-54 Pulse Filter Time Constant #29

Range: 100 ms* [1 - 1000 ms]
Function: Enter the pulse filter time constant. The pulse filter dampens oscillations of the feedback signal, which is an advantage if there is a lot of noise in the system. A high time constant value results in better damping, but also increases the time delay through the filter. This parameter cannot be adjusted while the motor is running.

5-55 Term. 33 Low Frequency

Range: 100 Hz* [0 - 110000 Hz]
Function: Enter the low frequency corresponding to the low motor shaft speed (i.e., low reference value) in par.5-57 *Term. 33 Low Ref./Feedb. Value*.

5-56 Term. 33 High Frequency**Range:**

100 Hz* [0 - 110000 Hz]

Function:

Enter the high frequency corresponding to the high motor shaft speed (i.e., high reference value) in par.5-58 *Term. 33 High Ref./Feedb. Value*.

5-57 Term. 33 Low Ref./Feedb. Value**Range:**

0.000 N/A* [-999999.999 - 999999.999 N/A]

Function:

Enter the low reference value [RPM] for the motor shaft speed. This is also the low feedback value, see also par.5-52 *Term. 29 Low Ref./Feedb. Value*.

5-58 Term. 33 High Ref./Feedb. Value**Range:**

100.000 N/A* [-999999.999 - 999999.999 N/A]

Function:

Enter the high reference value [RPM] for the motor shaft speed. See also par.5-53 *Term. 29 High Ref./Feedb. Value*.

5-59 Pulse Filter Time Constant #33**Range:**

100 ms* [1 - 1000 ms]

Function:

Enter the pulse filter time constant. The low-pass filter reduces the influence on, and dampens oscillations in, the feedback signal from the control. This is an advantage, if, for example, there is a great amount of noise in the system. This parameter cannot be adjusted while the motor is running.

3.7.8 5-6* Pulse Outputs

Parameters for configuring the scaling and output functions of pulse outputs. The pulse outputs are designated for terminals 27 or 29. Select terminal 27 output in par.5-01 *Terminal 27 Mode* and terminal 29 output in par.5-02 *Terminal 29 Mode*.

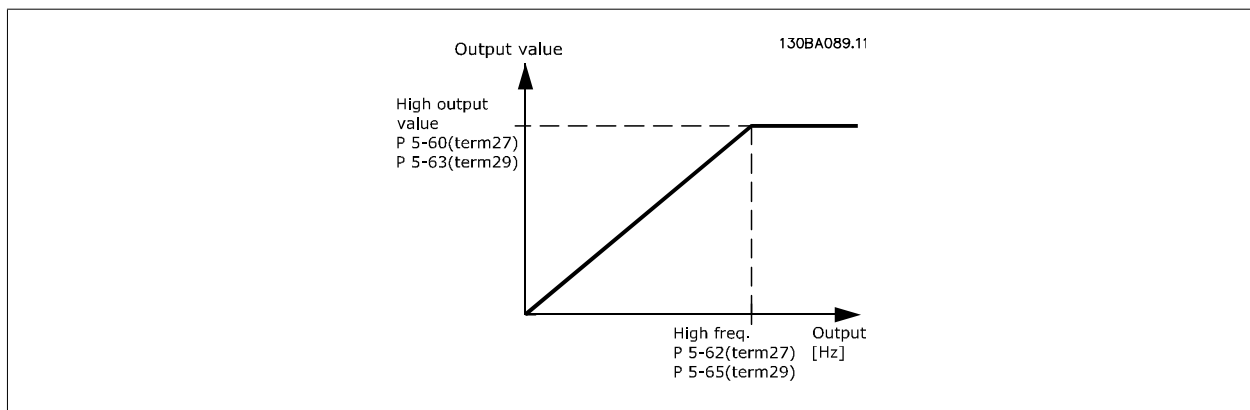

Options for readout output variables:

[0]	No operation
[45]	Bus ctrl.
[48]	Bus ctrl., timeout
[100]	Output frequency
[101]	Reference
[102]	Feedback
[103]	Motor current
[104]	Torque relative to limit
[105]	Torque relative to rated
[106]	Power
[107]	Speed
[108]	Torque
[109]	Max Out Freq
[113]	Ext. Closed-loop
[114]	Ext. Closed-loop
[115]	Ext. Closed-loop

5-60 Terminal 27 Pulse Output Variable

Option:

Function:

[0] *	No operation	Same options and functions as par. 5-6*. Select the operation variable assigned for terminal 27 readouts. This parameter cannot be adjusted while the motor is running.
[45]	Bus ctrl.	
[48]	Bus ctrl., timeout	
[100]	Output frequency	
[101]	Reference	
[102]	Feedback	
[103]	Motor current	
[104]	Torque rel to limit	
[105]	Torq relate to rated	
[106]	Power	
[107]	Speed	
[113]	Ext. Closed-loop 1	
[114]	Ext. Closed-loop 2	
[115]	Ext. Closed-loop 3	

5-62 Pulse Output Max Freq #27

Range:

Function:

5000 Hz*	[0 - 32000 Hz]	Set the maximum frequency for terminal 27, corresponding to the output variable selected in par. 5-60 <i>Terminal 27 Pulse Output Variable</i> . This parameter cannot be adjusted while the motor is running.
----------	----------------	---

5-63 Terminal 29 Pulse Output Variable

Option:
Function:

[0] * No operation
Select the variable for viewing on the terminal 29 display.
This parameter cannot be adjusted while the motor is running.

[45] Bus ctrl.

[48] Bus ctrl., timeout

[100] Output frequency

[101] Reference

[102] Feedback

[103] Motor current

[104] Torque rel to limit

[105] Torq relate to rated

[106] Power

[107] Speed

[113] Ext. Closed-loop 1

[114] Ext. Closed-loop 2

[115] Ext. Closed-loop 3

5-65 Pulse Output Max Freq #29

Range:
Function:

5000 Hz* [0 - 32000 Hz]
Set the maximum frequency for terminal 29 corresponding to the output variable set in par. 5-63 *Terminal 29 Pulse Output Variable*.
This parameter cannot be adjusted while the motor is running.

5-66 Terminal X30/6 Pulse Output Variable

Option:
Function:

[0] * No operation
Select the variable for readout on terminal X30/6.
This parameter cannot be adjusted while the motor is running.
This parameter is active when option module MCB 101 is installed in the adjustable frequency drive.

[45] Bus ctrl.

[48] Bus ctrl., timeout

[100] Output frequency

[101] Reference

[102] Feedback

[103] Motor current

[104] Torque rel to limit

[105] Torq relate to rated

[106] Power

[107] Speed

[113] Ext. Closed-loop 1

[114] Ext. Closed-loop 2

[115] Ext. Closed-loop 3

5-68 Pulse Output Max Freq #X30/6

Range:

5000. Hz* [0-32000 Hz]

Function:

Select the maximum frequency on terminal X30/6 referring to the output variable in par.5-66 *Terminal X30/6 Pulse Output Variable*. This parameter cannot be adjusted while the motor is running. This parameter is active when option module MCB 101 is mounted in the adjustable frequency drive.

3.7.9 5-9*Bus Controlled

This parameter group selects digital and relay outputs via a serial communication bus setting.

5-90 Digital & Relay Bus Control

Range:

0 N/A* [0 - 2147483647 N/A]

Function:

This parameter holds the state of the digital outputs and relays that is controlled by bus. A logical '1' indicates that the output is high or active. A logical '0' indicates that the output is low or inactive.

Bit 0	CC Digital Output Terminal 27
Bit 1	CC Digital Output Terminal 29
Bit 2	GPIO Digital Output Terminal X 30/6
Bit 3	GPIO Digital Output Terminal X 30/7
Bit 4	CC Relay 1 output terminal
Bit 5	CC Relay 2 output terminal
Bit 6	Option B Relay 1 output terminal
Bit 7	Option B Relay 2 output terminal
Bit 8	Option B Relay 3 output terminal
Bit 9-15	Reserved for future terminals
Bit 16	Option C Relay 1 output terminal
Bit 17	Option C Relay 2 output terminal
Bit 18	Option C Relay 3 output terminal
Bit 19	Option C Relay 4 output terminal
Bit 20	Option C Relay 5 output terminal
Bit 21	Option C Relay 6 output terminal
Bit 22	Option C Relay 7 output terminal
Bit 23	Option C Relay 8 output terminal
Bit 24-31	Reserved for future terminals

5-93 Pulse Out #27 Bus Control

Range:

0.00 %* [0.00 - 100.00 %]

Function:

Contains the frequency to apply to the digital output terminal 27, when it is configured as [Bus Controlled].

5-94 Pulse Out #27 Timeout Preset

Range:

0.00 %* [0.00 - 100.00 %]

Function:

Contains the frequency to apply to the digital output terminal 27 when it is configured as [Bus Controlled Timeout] and timeout is detected.

5-95 Pulse Out #29 Bus Control

Range:

0.00 %* [0.00 - 100.00 %]

Function:

Contains the frequency to apply to the digital output terminal 29 when it is configured as [Bus Controlled].

5-96 Pulse Out #29 Timeout Preset

Range:	Function:
0.00 %* [0.00 - 100.00 %]	Contains the frequency to apply to the digital output terminal 29 when it is configured as [Bus Controlled Timeout] and timeout is detected

5-97 Pulse Out #X30/6 Bus Control

Range:	Function:
0.00 %* [0.00 - 100.00 %]	Contains the frequency to apply to the digital output terminal 27 when it is configured as [Bus Controlled].

5-98 Pulse Out #X30/6 Timeout Preset

Range:	Function:
0.00 %* [0.00 - 100.00 %]	Contains the frequency to apply to the digital output terminal 6 when it is configured as [Bus Controlled Timeout] and timeout is detected.

3.8 Main Menu - Analog In/Out - Group 6

3.8.1 6-** Analog In/Out

Parameter group for configuring the analog input and output.

3.8.2 6-0* Analog I/O Mode

Parameter group for setting up the analog I/O configuration.

The adjustable frequency drive is equipped with 2 analog inputs: Terminal 53 and 54. The analog inputs can freely be allocated to either voltage (0–10 V) or current input (0/4–20 mA)



NOTE!

Thermistors may be connected to either an analog or a digital input.

6-00 Live Zero Timeout Time

Range:	Function:
10 s* [1 - 99 s]	Enter the Live Zero Timeout time period. Live Zero Timeout Time is active for analog inputs, (i.e., terminal 53 or terminal 54), allocated to current and used as reference or feedback sources. If the reference signal value associated with the selected current input falls below 50% of the value set in par.6-10 <i>Terminal 53 Low Voltage</i> , par.6-12 <i>Terminal 53 Low Current</i> , par.6-20 <i>Terminal 54 Low Voltage</i> or par.6-22 <i>Terminal 54 Low Current</i> for a time period longer than the time set in par. 6-00 <i>Live Zero Timeout Time</i> , the function selected in par.6-01 <i>Live Zero Timeout Function</i> will be activated.

6-01 Live Zero Timeout Function

Option:

Function:

Select the timeout function. The function set in par.6-01 *Live Zero Timeout Function* will be activated if the input signal on terminal 53 or 54 is below 50% of the value in par.6-10 *Terminal 53 Low Voltage*, par.6-12 *Terminal 53 Low Current*, par.6-20 *Terminal 54 Low Voltage* or par.6-22 *Terminal 54 Low Current* for a time period defined in par.6-00 *Live Zero Timeout Time*. If several timeouts occur simultaneously, the adjustable frequency drive prioritizes the timeout functions as follows:

1. par.6-01 *Live Zero Timeout Function*
2. par.8-04 *Control Timeout Function*

The output frequency of the adjustable frequency drive can be:

- [1] frozen at the present value
- [2] overruled to stop
- [3] overruled to jog speed
- [4] overruled to max. speed
- [5] overruled to stop with subsequent trip

[0] * Off

[1] Freeze output

[2] Stop

[3] Jogging

[4] Max. speed

[5] Stop and trip

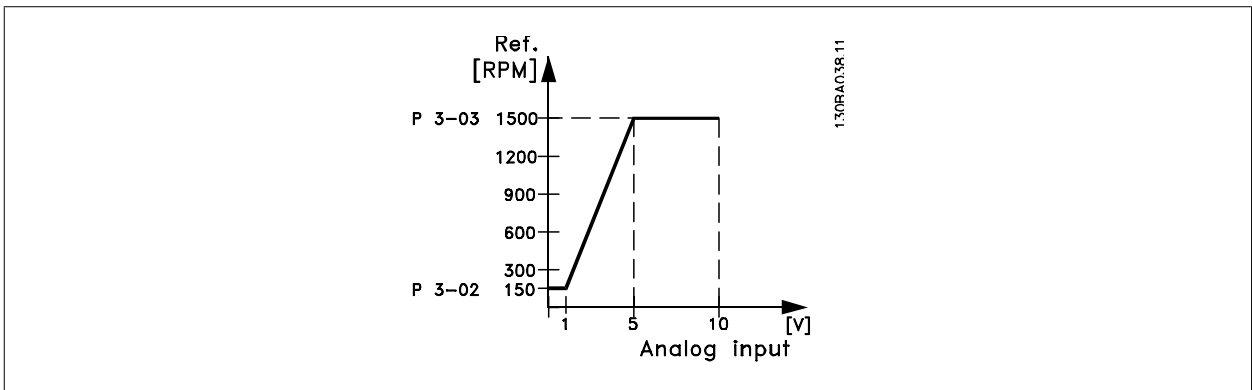

6-02 Fire Mode Live Zero Timeout Function

Option:

Function:

The function set in par.6-01 *Live Zero Timeout Function* will be activated if the input signal on analog inputs is below 50% of the value defined in parameter group 6-1* to 6-6* "Terminal xx Low Current" or "Terminal xx Low Voltage" for a time period defined in par.6-00 *Live Zero Timeout Time*.

[0] * Off

[1] Freeze output

[2] Stop

[3] Jogging

[4] Max. speed

3.8.3 6-1* Analog Input 1

Parameters for configuring the scaling and limits for analog input 1 (terminal 53).

6-10 Terminal 53 Low Voltage

Range:

0.07 V* [0.00 - par. 6-11 V]

Function:

Enter the low voltage value. This analog input scaling value should correspond to the low reference/feedback value set in par.6-14 *Terminal 53 Low Ref./Feedb. Value*.

6-11 Terminal 53 High Voltage

Range:

10.00 V* [par. 6-10 - 10.00 V]

Function:

Enter the high voltage value. This analog input scaling value should correspond to the high reference/feedback value set in par.6-15 *Terminal 53 High Ref./Feedb. Value*.

6-12 Terminal 53 Low Current

Range:

4.00 mA* [0.00 - par. 6-13 mA]

Function:

Enter the low current value. This reference signal should correspond to the low reference/feedback value, set in par.6-14 *Terminal 53 Low Ref./Feedb. Value*. The value must be set at >2 mA in order to activate the Live Zero Timeout Function in par.6-01 *Live Zero Timeout Function*.

6-13 Terminal 53 High Current

Range:

20.00 mA* [par. 6-12 - 20.00 mA]

Function:

Enter the high current value corresponding to the high reference/feedback set in par.6-15 *Terminal 53 High Ref./Feedb. Value*.

6-14 Terminal 53 Low Ref./Feedb. Value

Range:

0.000 N/A* [-999999.999 - 999999.999 N/A]

Function:

Enter the analog input scaling value that corresponds to the low voltage/low current set in par. 6-10 *Terminal 53 Low Voltage* and par.6-12 *Terminal 53 Low Current*.

6-15 Terminal 53 High Ref./Feedb. Value

Range:

50.000 N/A* [-999999.999 - 999999.999 N/A]

Function:

Enter the analog input scaling value that corresponds to the high voltage/high current value set in par.6-11 *Terminal 53 High Voltage* and par.6-13 *Terminal 53 High Current*.

6-16 Terminal 53 Filter Time Constant

Range:

0.001 s* [0.001 - 10.000 s]

Function:

Enter the time constant. This is a first-order digital low pass filter time constant for suppressing electrical noise in terminal 53. A high time constant value improves damping, but also increases the time delay through the filter.

This parameter cannot be adjusted while the motor is running.

6-17 Terminal 53 Live Zero

Option:
Function:

This parameter makes it possible to disable the Live Zero monitoring. For example, this is to be used if the analog outputs are used as part of a de-central I/O system (e.g., when not used as part of any adjustable frequency drive related control functions, but for feeding a building management system with data).

[0] Disabled

[1] * Enabled

3.8.4 6-2* Analog Input 2

Parameters for configuring the scaling and limits for analog input 2 (terminal 54).

6-20 Terminal 54 Low Voltage		
Range:		Function:
0.07 V* [0.00 - par. 6-21 V]		Enter the low voltage value. This analog input scaling value should correspond to the low reference/feedback value, set in par.6-24 <i>Terminal 54 Low Ref./Feedb. Value</i> .
6-21 Terminal 54 High Voltage		
Range:		Function:
10.00 V* [par. 6-20 - 10.00 V]		Enter the high voltage value. This analog input scaling value should correspond to the high reference/feedback value set in par.6-25 <i>Terminal 54 High Ref./Feedb. Value</i> .
6-22 Terminal 54 Low Current		
Range:		Function:
4.00 mA* [0.00 - par. 6-23 mA]		Enter the low current value. This reference signal should correspond to the low reference/feedback value, set in par.6-24 <i>Terminal 54 Low Ref./Feedb. Value</i> . The value must be set at >2 mA in order to activate the Live Zero Timeout Function in par.6-01 <i>Live Zero Timeout Function</i> .
6-23 Terminal 54 High Current		
Range:		Function:
20.00 mA* [par. 6-22 - 20.00 mA]		Enter the high current value corresponding to the high reference/feedback value set in par. 6-25 <i>Terminal 54 High Ref./Feedb. Value</i> .
6-24 Terminal 54 Low Ref./Feedb. Value		
Range:		Function:
0.000 N/A* [-999999.999 - 999999.999 N/A]		Enter the analog input scaling value that corresponds to the low voltage/low current value set in par.6-20 <i>Terminal 54 Low Voltage</i> and par.6-22 <i>Terminal 54 Low Current</i> .
6-25 Terminal 54 High Ref./Feedb. Value		
Range:		Function:
100.000 N/A* [-999999.999 - 999999.999 N/A]		Enter the analog input scaling value that corresponds to the high voltage/high current value set in par.6-21 <i>Terminal 54 High Voltage</i> and par.6-23 <i>Terminal 54 High Current</i> .
6-26 Terminal 54 Filter Time Constant		
Range:		Function:
0.001 s* [0.001 - 10.000 s]		Enter the time constant. This is a first-order digital low pass filter time constant for suppressing electrical noise in terminal 54. A high time constant value improves damping, but also increases the time delay through the filter. This parameter cannot be adjusted while the motor is running.

6-27 Terminal 54 Live Zero

Option:
Function:

This parameter makes it possible to disable the Live Zero monitoring. For example, this to be used if the analog outputs are used as part of a de-central I/O system (e.g., when used not as part of any adjustable frequency drive related control functions, but for feeding a building management system with data).

[0] Disabled

[1] * Enabled

3.8.5 6-3* Analog Input 3 MCB 101

Parameter group for configuring the scale and limits for analog input 3 (X30/11) placed on option module MCB 101.

6-30 Terminal X30/11 Low Voltage

Range:
Function:

0.07 V* [0.00 - par. 6-31 V]

Sets the analog input scaling value to correspond to the low reference/feedback value (set in par. 6-34 *Term. X30/11 Low Ref./Feedb. Value*).

6-31 Terminal X30/11 High Voltage

Range:
Function:

10.00 V* [par. 6-30 - 10.00 V]

Sets the analog input scaling value to correspond to the high reference/feedback value (set in par. 6-35 *Term. X30/11 High Ref./Feedb. Value*).

6-34 Term. X30/11 Low Ref./Feedb. Value

Range:
Function:

0.000 N/A* [-999999.999 - 999999.999 N/A]

Sets the analog input scaling value to correspond to the low voltage value (set in par. 6-30 *Terminal X30/11 Low Voltage*).

6-35 Term. X30/11 High Ref./Feedb. Value

Range:
Function:

100.000 N/A* [-999999.999 - 999999.999 N/A]

Sets the analog input scaling value to correspond to the high voltage value (set in par. 6-31 *Terminal X30/11 High Voltage*).

6-36 Term. X30/11 Filter Time Constant

Range:
Function:

0.001 s* [0.001 - 10.000 s]

A 1st order digital low pass filter time constant for suppressing electrical noise on terminal X30/11. par. 6-36 *Term. X30/11 Filter Time Constant* cannot be changed while the motor is running.

6-37 Term. X30/11 Live Zero

Option:
Function:

This parameter makes it possible to disable Live Zero monitoring. For example, this may be used if the analog outputs are used as part of a decentral I/O system (e.g., when not part of any adjustable frequency drive-related control functions, but feeding a building management system with data).

[0] * Disabled

[1] * Enabled

3.8.6 6-4* Analog Input 4 MCB 101

Parameter group for configuring the scale and limits for analog input 4 (X30/12) placed on option module MCB 101.

6-40 Terminal X30/12 Low Voltage

Range:

0.07 V* [0.00 - par. 6-41 V]

Function:

Sets the analog input scaling value to correspond to the low reference/feedback value set in par. 6-44 *Term. X30/12 Low Ref./Feedb. Value*.

6-41 Terminal X30/12 High Voltage

Range:

10.00 V* [par. 6-40 - 10.00 V]

Function:

Sets the analog input scaling value to correspond to the high reference/feedback value set in par. 6-45 *Term. X30/12 High Ref./Feedb. Value*.

6-44 Term. X30/12 Low Ref./Feedb. Value

Range:

0.000 N/A* [-999999.999 - 999999.999 N/A]

Function:

Sets the analog output scaling value to correspond to the low voltage value set in par. 6-40 *Terminal X30/12 Low Voltage*.

6-45 Term. X30/12 High Ref./Feedb. Value

Range:

100.000 N/A* [-999999.999 - 999999.999 N/A]

Function:

Sets the analog input scaling value to correspond to the high voltage value set in par. 6-41 *Terminal X30/12 High Voltage*.

6-46 Term. X30/12 Filter Time Constant

Range:

0.001 s* [0.001 - 10.000 s]

Function:

A 1st order digital low pass filter time constant for suppressing electrical noise on terminal X30/12. par. 6-46 *Term. X30/12 Filter Time Constant* cannot be changed while the motor is running.

6-47 Term. X30/12 Live Zero

Option:
Function:

This parameter makes it possible to disable Live Zero monitoring. For example, this may be used if the analog outputs are used as part of a decentral I/O system (e.g., when not part of any adjustable frequency drive-related control functions, but feeding a building management system with data).

[0] * Disabled

[1] * Enabled

3.8.7 6-5* Analog Output 1

Parameters for configuring the scaling and limits for analog output 1, i.e., Terminal 42. Analog outputs are current outputs: 0/4–20 mA. Common terminal (terminal 39) is the same terminal and has the same electrical potential for analog common and digital common connection. Resolution on analog output is 12 bit.

6-50 Terminal 42 Output

Option:

Function:

Select the function of Terminal 42 as an analog current output. A motor current of 20 mA corresponds to I_{max} .

[0] *	No operation	
[100]	Output frequency	: 0–100 Hz, (0–20 mA)
[101]	Reference	: Minimum reference - Maximum reference, (0–20 mA)
[102]	Feedback	: -200% to +200% of par.20-14 <i>Maximum Reference/Feedb.</i> , (0–20 mA)
[103]	Motor current	: 0 - Inverter Max. Current (par. 16-37), (0–20 mA)
[104]	Torque rel to limit	: 0 - Torque limit (par.4-16 <i>Torque Limit Motor Mode</i>), (0–20 mA)
[105]	Torq relate to rated	: 0 - Motor rated torque, (0–20 mA)
[106]	Power	: 0 - Motor rated power, (0–20 mA)
[107]	Speed	: 0 - Speed High Limit (par.4-13 <i>Motor Speed High Limit [RPM]</i> and par.4-14 <i>Motor Speed High Limit [Hz]</i>), (0–20 mA)
[113]	Ext. Closed-loop 1	: 0–100%, (0–20 mA)
[114]	Ext. Closed-loop 2	: 0–100%, (0–20 mA)
[115]	Ext. Closed-loop 3	: 0–100%, (0–20 mA)
[130]	Output freq. 4-20mA	: 0–100 Hz
[131]	Reference 4-20mA	: Minimum Reference - Maximum Reference
[132]	Feedback 4-20mA	: -200% to +200% of par.20-14 <i>Maximum Reference/Feedb.</i>
[133]	Motor cur. 4-20mA	: 0 - Inverter Max. Current (par.16-37 <i>Inv. Max. Current</i>)
[134]	Torq.% lim 4-20 mA	: 0 - Torque limit (par.4-16 <i>Torque Limit Motor Mode</i>)
[135]	Torq.% nom 4-20 mA	: 0 - Motor rated torque
[136]	Power 4-20mA	: 0 - Motor rated power
[137]	Speed 4-20mA	: 0 - Speed High Limit (4-13 and 4-14)
[139]	Bus ctrl.	: 0–100%, (0–20 mA)
[140]	Bus ctrl. 4-20 mA	: 0 - 100%
[141]	Bus ctrl t.o.	: 0–100%, (0–20 mA)
[142]	Bus ctrl 4-20mA t.o.	: 0 - 100%
[143]	Ext. Closed-loop 1 4-20 mA	: 0 - 100%
[144]	Ext. Closed-loop 2 4-20 mA	: 0 - 100%
[145]	Ext. Closed-loop 3 4-20 mA	: 0 - 100%

NOTE!

Values for setting the minimum reference is found in open-loop par.3-02 *Minimum Reference* and for closed-loop par.20-13 *Minimum Reference/Feedb.* - values for maximum reference for open-loop is found in par.3-03 *Maximum Reference* and for closed-loop par.20-14 *Maximum Reference/Feedb.*

6-51 Terminal 42 Output Min Scale

Range:

0.00 %* [0.00 - 200.00 %]

Function:

Scale for the minimum output (0 or 4 mA) of the analog signal at terminal 42.
Set the value to be the **percentage** of the full range of the variable selected in par.6-50 *Terminal 42 Output*.

3

6-52 Terminal 42 Output Max Scale

Range:

100.00 %* [0.00 - 200.00 %]

Function:

Scale for the maximum output (20 mA) of the analog signal at terminal 42.
Set the value to be the percentage of the full range of the variable selected in par.6-50 *Terminal 42 Output*.

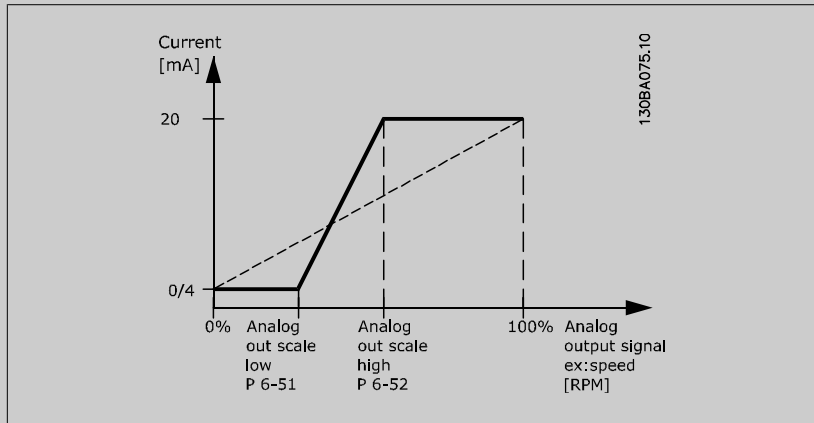

It is possible to get a value lower than 20 mA at full scale by programming values >100% by using a formula as follows:

$$20 \text{ mA} / \text{desired maximum current} \times 100 \%$$

i.e. $10 \text{ mA} : \frac{20 \text{ mA}}{10 \text{ mA}} \times 100 \% = 200 \%$

EXAMPLE 1:

Variable value= OUTPUT FREQUENCY, range = 0–100 Hz

Range needed for output = 0–50 Hz

Output signal 0 or 4 mA is needed at 0 Hz (0% of range) - set par.6-51 *Terminal 42 Output Min Scale* to 0%

Output signal 20 mA is needed at 50 Hz (50% of range) - set par.6-52 *Terminal 42 Output Max Scale* to 50%

3

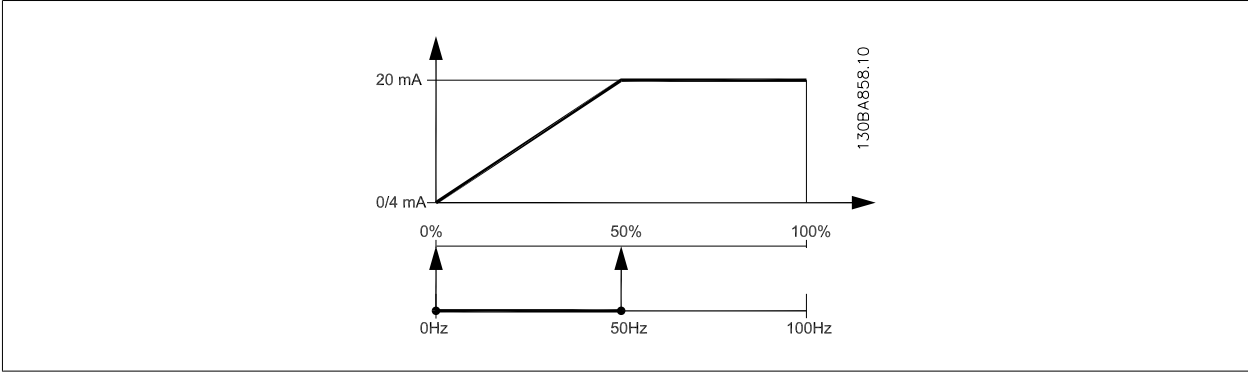

EXAMPLE 2:

Variable= FEEDBACK, range= -200% to +200%

Range needed for output= 0–100%

Output signal 0 or 4 mA is needed at 0% (50% of range) - set par.6-51 *Terminal 42 Output Min Scale* to 50%

Output signal 20 mA is needed at 100% (75% of range) - set par.6-52 *Terminal 42 Output Max Scale* to 75%

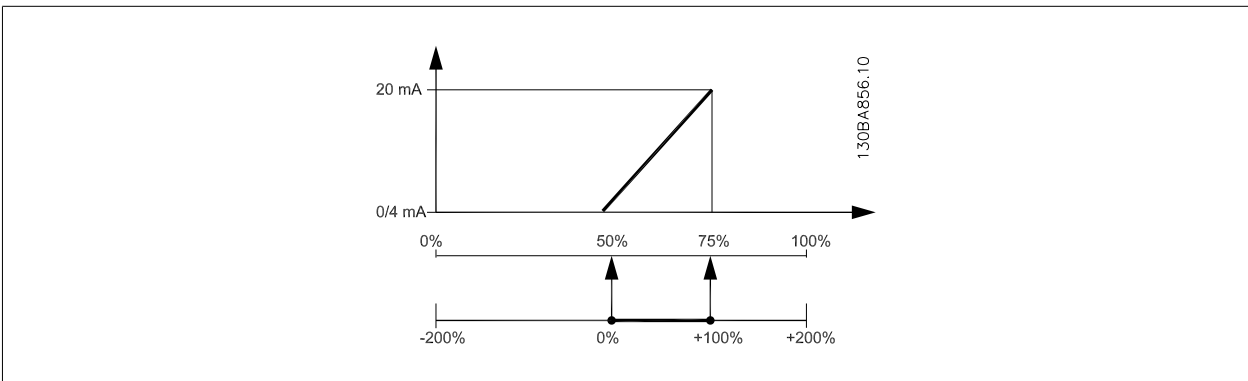

EXAMPLE 3:

Variable value= REFERENCE, range= Min ref - Max ref

Range needed for output= Min ref (0%) - Max ref (100%), 0–10 mA

Output signal 0 or 4 mA is needed at Min ref - set par.6-51 *Terminal 42 Output Min Scale* to 0%

Output signal 10 mA is needed at Max ref (100% of range) - set par.6-52 *Terminal 42 Output Max Scale* to 200% (20 mA / 10 mA x 100%=200%).

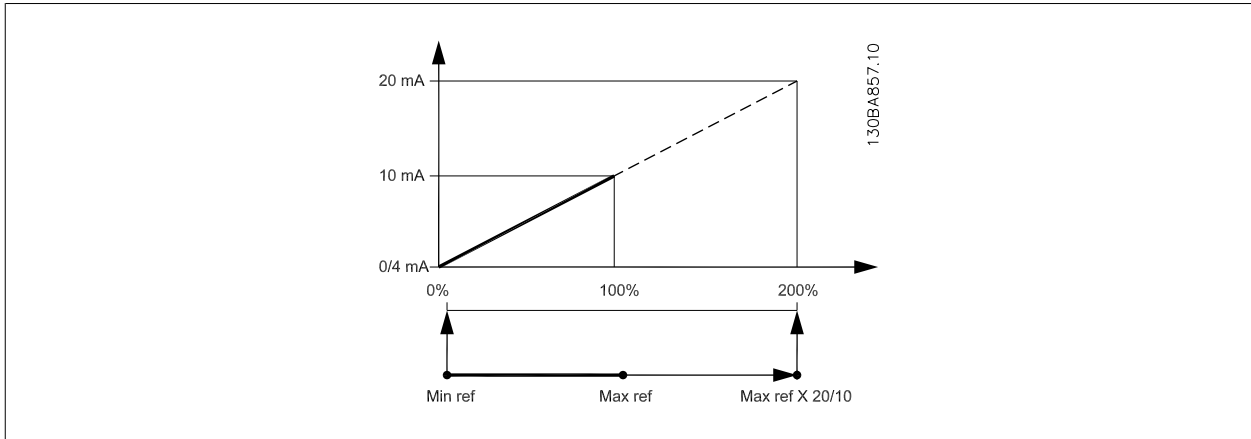

3

6-53 Terminal 42 Output Bus Control

Range:	Function:
0.00 %* [0.00 - 100.00 %]	Holds the level of Output 42 if controlled by bus.

6-54 Terminal 42 Output Timeout Preset

Range:	Function:
0.00 %* [0.00 - 100.00 %]	Holds the preset level of Output 42. In case of a bus timeout and a timeout function is selected in par.6-50 <i>Terminal 42 Output</i> , the output will preset to this level.

3.8.8 6-6* Analog Output 2 MCB 101

Analog outputs are current outputs: 0/4–20 mA. Common terminal (terminal X30/8) is the same terminal and electrical potential for analog common connection. Resolution on analog output is 12 bit.

6-60 Terminal X30/8 Output

Option:	Function:
[0] *	No operation
[100]	Output frequency
[101]	Reference
[102]	Feedback
[103]	Motor current
[104]	Torque rel to limit
[105]	Torq relate to rated
[106]	Power
[107]	Speed
[113]	Ext. Closed-loop 1

[114]	Ext. Closed-loop 2
[115]	Ext. Closed-loop 3
[130]	Output freq. 4-20mA
[131]	Reference 4-20mA
[132]	Feedback 4-20mA
[133]	Motor cur. 4-20mA
[134]	Torq.% lim 4-20 mA
[135]	Torq.% nom 4-20 mA
[136]	Power 4-20mA
[137]	Speed 4-20mA
[139]	Bus ctrl.
[140]	Bus ctrl. 4-20 mA
[141]	Bus ctrl t.o.
[142]	Bus ctrl 4-20mA t.o.
[143]	Ext. Closed-loop 1 4-20 mA
[144]	Ext. Closed-loop 2 4-20 mA
[145]	Ext. Closed-loop 3 4-20 mA

6-61 Terminal X30/8 Min. Scale

Range:

0.00 %* [0.00 - 200.00 %]

Function:

Scales the minimum output of the selected analog signal on terminal X30/8. Scale the minimum value as a percentage of the maximum signal value, i.e., 0 mA (or 0 Hz) is desired at 25% of the maximum output value and 25% is programmed. The value can never be higher than the corresponding setting in par.6-62 *Terminal X30/8 Max. Scale* if value is below 100%.

This parameter is active when option module MCB 101 is mounted in the adjustable frequency drive.

6-62 Terminal X30/8 Max. Scale

Range:

100.00 %* [0.00 - 200.00 %]

Function:

Scales the maximum output of the selected analog signal on terminal X30/8. Scale the value to the desired maximum value of the current signal output. Scale the output to give a lower current than 20 mA at full scale or 20 mA at an output below 100% of the maximum signal value. If 20 mA is the desired output current at a value between 0%–100% of the full-scale output, program the percentage value in the parameter, i.e., 50% = 20 mA. If a current between 4 and 20 mA is desired at maximum output (100%), calculate the percentage value as follows:

$$20 \text{ mA} / \text{desired maximum current} \times 100 \%$$

$$\text{i.e. } 10 \text{ mA} : \frac{20 \text{ mA}}{10 \text{ mA}} \times 100 \% = 200 \%$$

6-63 Terminal X30/8 Output Bus Control

Range:

0.00 %* [0.00 - 100.00 %]

Function:

Contains the value to apply to the output terminal when it is configured as [Bus Controlled].

6-64 Terminal X30/8 Output Timeout Preset

Range:

0.00 %* [0.00 - 100.00 %]

Function:

Contains the value to apply to the output terminal when it is configured as [Bus Controlled Timeout] and timeout is detected.

3.9 Main Menu - Communications and Options - Group 8

3.9.1 8-** Comm. and Options

Parameter group for configuring communications and options.

3.9.2 8-0* General Settings

General settings for communications and options.

8-01 Control Site

Option:	Function:
	The setting in this parameter overrides the settings in par.8-50 <i>Coasting Select</i> to par.8-56 <i>Preset Reference Select</i> .
[0] * Digital and ctrl. word	Control by using both digital input and control word.
[1] Digital only	Control by using digital inputs only.
[2] Control word only	Control by using control word only.

8-02 Control Source

Option:	Function:
	Select the source of the control word: one of two serial interfaces or four installed options. During initial power-up, the adjustable frequency drive automatically sets this parameter to <i>Option A</i> [3] if it detects a valid serial communication bus option installed in slot A. If the option is removed, the adjustable frequency drive detects a change in the configuration, sets par.8-02 <i>Control Source</i> back to default setting <i>Adjustable Frequency Drive Port</i> , and the adjustable frequency drive then trips. If an option is installed after initial power-up, the setting of par.8-02 <i>Control Source</i> will not change but the adjustable frequency drive will trip and display: Alarm 67 <i>Option Changed</i> .
[0] None	
[1] FC RS-485	
[2] FC USB	
[3] * Option A	
[4] Option B	
[5] Option C0	
[6] Option C1	
[30] External Can	

NOTE!
This parameter cannot be adjusted while the motor is running.

8-03 Control Timeout Time

Range:

60.0 s* [1.0 - 18000.0 s]

Function:

Enter the maximum time expected to pass between the reception of two consecutive messages. If this time is exceeded, it indicates that the serial communication has stopped. The function selected in par.8-04 *Control Timeout Function Control Timeout Function* will then be carried out.

In LonWorks, the following variables will trigger the Control Word Time parameter:

nviStartStop
nviReset Fault
nviControlWord
nviDrvSpeedStpt
nviRefPcnt
nviRefHz

8-04 Control Timeout Function

Option:
Function:

Select the timeout function. The timeout function is activated when the control word fails to be updated within the time period specified in par.8-03 *Control Timeout Time*. Choice [20] only appears after setting the N2 protocol.

[0] *	Off
[1]	Freeze output
[2]	Stop
[3]	Jogging
[4]	Max. speed
[5]	Stop and trip
[7]	Select setup 1
[8]	Select setup 2
[9]	Select setup 3
[10]	Select setup 4
[20]	N2 Override Release

In LonWorks, the timeout function is also activated when the following SNVTs fail to be updated within the time period specified in par.8-03 *Control Timeout Time*:

nviStartStop	nviDrvSpeedStpt
nviReset Fault	nviRefPcnt
nviControlWord	nviRefHz

8-05 End-of-Timeout Function

Option:
Function:

Select the action after receiving a valid control word following a timeout. This parameter is active only when par.8-04 *Control Timeout Function* is set to [Set-up 1-4].

[0]	Hold set-up	Retains the set-up selected in par.8-04 <i>Control Timeout Function</i> and displays a warning, until par.8-06 <i>Reset Control Timeout</i> toggles. Then the adjustable frequency drive resumes its original set-up.
[1] *	Resume set-up	Resumes the set-up active prior to the timeout.

8-06 Reset Control Timeout

Option:	Function:
	This parameter is active only when the choice <i>Hold set-up</i> [0] has been selected in par.8-05 <i>End-of-Timeout Function</i> .
[0] * Do not reset	Retains the set-up specified in par.8-04 <i>Control Timeout Function</i> , [Select set-up 1-4] following a control timeout.
[1] Do reset	Returns the adjustable frequency drive to the original set-up following a control word timeout. When the value is set to <i>Do reset</i> [1], the adjustable frequency drive performs the reset and then immediately reverts to the <i>Do not reset</i> [0] setting.

8-07 Diagnosis Trigger

Option:	Function:
	This parameter has no function for LonWorks.
[0] * Disable	
[1] Trigger on alarms	
[2] Trigger alarm/warn.	

3.9.3 8-1* Ctrl. Word Settings

Parameters for configuring the option control word profile.

8-10 Control Profile

Option:	Function:
	Select the interpretation of the control and status words corresponding to the installed serial communication bus. Only the selections valid for the serial communication bus installed in slot A will be visible in the LCP display.
[0] * FC profile	
[1] PROFIdrive profile	
[5] ODVA	
[7] CANopen DSP 402	

8-13 Configurable Status Word STW

Option:	Function:
	This parameter enables configuration of bits 12 – 15 in the status word.
[0] No function	
[1] * Profile Default	Function corresponds to the profile default selected in par.8-10 <i>Control Profile</i> .
[2] Alarm 68 Only	Only set in case of an Alarm 68.
[3] Trip excl Alarm 68	Set in case of a trip, except if the trip is executed by an Alarm 68.
[16] T37 DI status	The bit indicates the status of terminal 37. "0" indicates T37 is low (safe stop) "1" indicates T37 is high (normal)

3.9.4 8-3* Adjustable Frequency Drive Port Settings

Parameters for configuring the Adjustable Frequency Drive Port.

8-30 Protocol

Option:

Function:

Protocol selection for the integrated Adjustable Frequency Drive (standard) Port (RS 485) on the control card.

Parameter group 8-7* is only visible when Adjustable Frequency Drive Option [9] is chosen.

[0] *	FC	Communication according to the FC protocol as described in the <i>VLT HVAC Drive Design Guide, RS 485 Installation and Set-up</i> .
[1]	FC MC	Same as Adjustable Frequency Drive [0] but to be used when downloading SW to the adjustable frequency drive or uploading dll files (containing information regarding parameters available in the adjustable frequency drive and their interdependencies) to the Motion Control Tool MCT10.
[2]	Modbus RTU	Communication according to the Modbus RTU protocol as described in the <i>VLT HVAC Drive Design Guide, RS 485 Installation and Set-up</i> .
[3]	Metasys N2	Communication protocol. The N2 software protocol is designed to be general in nature in order to accommodate the unique properties each device may have. Please see separate manual <i>VLT HVAC Drive Metasys MG.11.Gx.yy</i> .
[9]	FC Option	To be used when a gateway is connected to the integrated RS 485 port, e.g., the BACnet gateway. The following changes will take place: -The address for the adjustable frequency drive port will be set to 1 and par. 8-31 Address, is now used to set the address for the gateway on the network, e.g., BACnet. Please see separate manual VLT HVAC Drive BACnet, MG.11.Dx.yy. -The baud rate for the adjustable frequency drive port will be set to a fixed value (115,200 Baud) and par. 8-32 Baud Rate, is now used to set the baud rate for the network port (e.g., BACnet) on the gateway.
[20]	LEN	



NOTE!

Further details can be found in the BACnet and Metasys manuals.

8-31 Address

Range:

Function:

1. N/A* [1. - 126. N/A]

Enter the address for the adjustable frequency drive (standard) port.
Valid range: 1–126.

8-32 Baud Rate

Option:	Function:
	The baud rate selection depends on the protocol selection in par.8-30 <i>Protocol</i> .
[0]	2400 Baud
[1]	4800 Baud
[2] *	9600 Baud
[3]	19200 Baud
[4]	38400 Baud
[5]	57600 Baud
[6]	76800 Baud
[7]	115200 Baud

Default refers to the FC Protocol.

8-33 Parity / Stop Bits

Option:	Function:
	Parity and Stop Bits for the protocol par.8-30 <i>Protocol</i> using the Adjustable Frequency Drive Port. For some of the protocols, not all options will be visible. Default depends on the protocol selected.
[0] *	Even Parity, 1 Stop Bit
[1]	Odd Parity, 1 Stop Bit
[2]	No Parity, 1 Stop Bit
[3]	No Parity, 2 Stop Bits

8-35 Minimum Response Delay

Range:	Function:
10. ms* [5. - 10000. ms]	Specify the minimum delay time between receiving a request and transmitting a response. This is used for overcoming modem turnaround delays.

8-36 Max Response Delay

Range:	Function:
10001. ms* [11. - 10001. ms]	Specify the maximum permissible delay time between transmitting a request and receiving a response. Exceeding this delay time will cause control word timeout.

8-37 Max Inter-Char Delay

Range:	Function:
25.00 ms* [0.00 - 35.00 ms]	Specify the maximum permissible time interval between receiving two bytes. This parameter activates timeout if transmission is interrupted.

8-40 Telegram selection

Option:
Function:

Enables use of freely configurable messages or standard messages for the adjustable frequency drive port.

[1] * Standard telegram 1

[101] PPO 1

[102] PPO 2

[103] PPO 3

[104] PPO 4

[105] PPO 5

[106] PPO 6

[107] PPO 7

[108] PPO 8

[200] Custom telegram 1

3.9.5 8-5* Digital/Bus

Parameters for configuring the control word Digital/Bus merging.

8-50 Coasting Select

Option:
Function:

Select control of the coasting function via the terminals (digital input) and/or via the bus.

[0] Digital input

[1] Bus

Activates Start command via the serial communication port or serial communication option.

[2] Logic AND

Activates Start command via the serial communication bus/serial communication port, AND additionally via one of the digital inputs.

[3] * Logic OR

Activates Start command via the serial communication bus/serial communication port OR via one of the digital inputs.

NOTE!

This parameter is active only when par.8-01 *Control Site* is set to [0] *Digital and control word*.

8-52 DC Brake Select

Option:
Function:

Select control of the DC brake via the terminals (digital input) and/or via the serial communication bus.

[0] Digital input

[1] Bus

Activates Start command via the serial communication port or serial communication option.

[2] Logic AND

Activates Start command via the serial communication bus/serial communication port, AND additionally via one of the digital inputs.

[3] * Logic OR

Activates Start command via the serial communication bus/serial communication port OR via one of the digital inputs.



NOTE!

This parameter is active only when par.8-01 *Control Site* is set to [0] *Digital and control word*.

8-53 Start Select

Option:

Function:

Select control of the adjustable frequency drive start function via the terminals (digital input) and/or via the serial communication bus.

[0] Digital input

Activates Start command via a digital input.

[1] Bus

Activates Start command via the serial communication port or serial communication option.

[2] Logic AND

Activates Start command via the serial communication bus/serial communication port, AND additionally via one of the digital inputs.

[3] * Logic OR

Activates Start command via the serial communication bus/serial communication port OR via one of the digital inputs.



NOTE!

This parameter is active only when par.8-01 *Control Site* is set to [0] *Digital and control word*.

8-54 Reverse Select

Option:

Function:

Select control of the adjustable frequency drive reverse function via the terminals (digital input) and/or via the serial communication bus.

[0] * Digital input

Activates Reverse command via a digital input.

[1] Bus

Activates Reverse command via the serial communication port or serial communication option.

[2] Logic AND

Activates Reverse command via the serial communication bus/serial communication port, AND additionally via one of the digital inputs.

[3] Logic OR

Activates Reverse command via the serial communication bus/serial communication port OR via one of the digital inputs.



NOTE!

This parameter is active only when par.8-01 *Control Site* is set to [0] *Digital and control word*.

8-55 Set-up Select

Option:	Function:
	Select control of the adjustable frequency drive set-up selection via the terminals (digital input) and/or via the serial communication bus.
[0] Digital input	Activates the set-up selection via a digital input.
[1] Bus	Activates the set-up selection via the serial communication port or serial communication option.
[2] Logic AND	Activates the set-up selection via the serial communication bus/serial communication port, AND additionally via one of the digital inputs.
[3] * Logic OR	Activate the set-up selection via the serial communication bus/serial communication port OR via one of the digital inputs.

**NOTE!**

This parameter is active only when par.8-01 *Control Site* is set to [0] *Digital and control word*.

8-56 Preset Reference Select

Option:	Function:
	Select control of the adjustable frequency drive Preset Reference selection via the terminals (digital input) and/or via the serial communication bus.
[0] Digital input	Activates Preset Reference selection via a digital input.
[1] Bus	Activates Preset Reference selection via the serial communication port or serial communication option.
[2] Logic AND	Activates Preset Reference selection via the serial communication bus/serial communication port, AND additionally via one of the digital inputs.
[3] * Logic OR	Activates the Preset Reference selection via the serial communication bus/serial communication port OR via one of the digital inputs.

**NOTE!**

This parameter is active only when par.8-01 *Control Site* is set to [0] *Digital and control word*.

3.9.6 8-7* BACnet

BACnet configuration

8-70 BACnet Device Instance

Range:	Function:
1 N/A* [0 - 4194304 N/A]	Enter a unique ID number for the BACnet device.

**NOTE!**

This parameter is active only when par.8-30 *Protocol* is set to [9] *Adjustable Frequency Drive Option*.

8-72 MS/TP Max Masters

Range:	Function:
127 N/A* [0 - 127 N/A]	Define the address of the master which holds the highest address in this network. Decreasing this value optimizes polling for the token.

 **NOTE!**
This parameter is active only when par.8-30 *Protocol* is set to [9] *Adjustable Frequency Drive Option*.

8-73 MS/TP Max Info Frames

Range:	Function:
1 N/A* [1 - 65534 N/A]	Define how many info/data frames the device is allowed to send while holding the token.

 **NOTE!**
This parameter is active only when par.8-30 *Protocol* is set to [9] *Adjustable Frequency Drive Option*.

8-74 "Startup I am"

Option:	Function:
[0] * Send at power-up	Choose whether the device should send the "I-Am" service message only at power-up or continuously with an interval of approx. 1 min.
[1] Continuously	

 **NOTE!**
This parameter is active only when par.8-30 *Protocol* is set to [9] *Adjustable Frequency Drive Option*.

8-75 Initialization Password

Range:	Function:
0 N/A* [0 - 0 N/A]	Enter the password needed for execution of Drive Re-initialization from BACnet.

 **NOTE!**
This parameter is active only when par.8-30 *Protocol* is set to [9] *Adjustable Frequency Drive Option*.

3.9.7 8-8* Adjustable Frequency Drive Port Diagnostics

These parameters are used for monitoring the bus communication via the Adjustable Frequency Drive Port.

8-80 Bus Message Count

Range:	Function:
0 N/A* [0 - 0 N/A]	This parameter shows the number of valid messages detected on the bus.

8-81 Bus Error Count**Range:**

0 N/A* [0 - 0 N/A]

Function:

This parameter shows the number of messages with faults (e.g., CRC fault), detected on the bus.

8-82 Slave Message Count**Range:**

0 N/A* [0 - 0 N/A]

Function:

This parameter shows the number of valid messages addressed to the slave, sent by the adjustable frequency drive.

8-83 Slave Error Count**Range:**

0 N/A* [0 - 0 N/A]

Function:

This parameter shows the number of error messages, which could not be executed by the adjustable frequency drive.

3.9.8 8-9* Bus Jog

Parameters for configuring the Bus Jog.

8-90 Bus Jog 1 Speed**Range:**

100 RPM* [0 - par. 4-13 RPM]

Function:

Enter the jog speed. This is a fixed jog speed activated via the serial port or serial communication bus option.

8-91 Bus Jog 2 Speed**Range:**

200 RPM* [0 - par. 4-13 RPM]

Function:

Enter the jog speed. This is a fixed jog speed activated via the serial port or serial communication bus option.

8-94 Bus Feedback 1**Range:**

0 N/A* [-200 - 200 N/A]

Function:Write a feedback to this parameter via the serial communication port or serial communication bus option. This parameter must be selected in par.20-00 *Feedback 1 Source*, par.20-03 *Feedback 2 Source* or par.20-06 *Feedback 3 Source* as a feedback source.**8-95 Bus Feedback 2****Range:**

0 N/A* [-200 - 200 N/A]

Function:See par.8-94 *Bus Feedback 1* for further details.**8-96 Bus Feedback 3****Range:**

0 N/A* [-200 - 200 N/A]

Function:See par.8-94 *Bus Feedback 1* for further details.

3.10 Main Menu - Profibus - Group 9

3.10.1 9-** Profibus

Parameter group for all Profibus-specific parameters.

9-15 PCD Write Configuration

Array [10]

Option:

Function:

Select the parameters to be assigned to PCD 3 to 10 of the messages. The number of available PCDs depends on the message type. The values in PCD 3 to 10 will then be written to the selected parameters as data values. Alternatively, specify a standard Profibus message in par.9-22 *Telegram Selection*.

[0] *	None
[302]	Minimum Reference
[303]	Maximum Reference
[341]	Ramp 1 Ramp-up Time
[342]	Ramp 1 Ramp-down Time
[351]	Ramp 2 Ramp-up Time
[352]	Ramp 2 Ramp-down Time
[380]	Jog Ramp Time
[381]	Quick Stop Ramp Time
[411]	Motor Speed Low Limit [RPM]
[413]	Motor Speed High Limit [RPM]
[416]	Torque Limit Motor Mode
[417]	Torque Limit Generator Mode
[590]	Digital & Relay Bus Control
[593]	Pulse Out #27 Bus Control
[595]	Pulse Out #29 Bus Control
[597]	Pulse Out #X30/6 Bus Control
[653]	Terminal 42 Output Bus Control
[663]	Terminal X30/8 Output Bus Control
[890]	Bus Jog 1 Speed
[891]	Bus Jog 2 Speed
[894]	Bus Feedback 1
[895]	Bus Feedback 2
[896]	Bus Feedback 3
[1680]	Fieldbus CTW 1
[1682]	Fieldbus REF 1
[2013]	Minimum Reference/Feedb.
[2014]	Maximum Reference/Feedb.
[2643]	Terminal X42/7 Output Bus Control
[2653]	Terminal X42/9 Output Bus Control
[2663]	Terminal X42/11 Output Bus Control

9-16 PCD Read Configuration

Array [10]

Option:**Function:**

Select the parameters to be assigned to PCD 3 to 10 of the messages. The number of available PCDs depends on the message type. PCDs 3 to 10 contain the current data values of the selected parameters. For a standard Profibus message, see par.9-22 *Telegram Selection*.

[0] *	None
[894]	Bus Feedback 1
[895]	Bus Feedback 2
[896]	Bus Feedback 3
[1600]	Control Word
[1601]	Reference [Unit]
[1602]	Reference %
[1603]	Status Word
[1605]	Main Actual Value [%]
[1609]	Custom Readout
[1610]	Power [kW]
[1611]	Power [hp]
[1612]	Motor voltage
[1613]	Frequency
[1614]	Motor Current
[1615]	Frequency [%]
[1616]	Torque [Nm]
[1617]	Speed [RPM]
[1618]	Motor Thermal
[1622]	Torque [%]
[1630]	DC Link Voltage
[1632]	Brake Energy /s
[1633]	Brake Energy /2 min
[1634]	Heatsink Temp.
[1635]	Inverter Thermal
[1638]	SL Controller State
[1639]	Control Card Temp.
[1650]	External Reference
[1652]	Feedback [Unit]
[1653]	Digi Pot Reference
[1654]	Feedback 1 [Unit]
[1655]	Feedback 2 [Unit]
[1656]	Feedback 3 [Unit]
[1660]	Digital Input
[1661]	Terminal 53 Switch Setting
[1662]	Analog Input 53
[1663]	Terminal 54 Switch Setting
[1664]	Analog Input 54

[1665]	Analog Output 42 [mA]
[1666]	Digital Output [bin]
[1667]	Pulse Input #29 [Hz]
[1668]	Pulse Input #33 [Hz]
[1669]	Pulse Output #27 [Hz]
[1670]	Pulse Output #29 [Hz]
[1671]	Relay Output [bin]
[1672]	Counter A
[1673]	Counter B
[1675]	Analog In X30/11
[1676]	Analog In X30/12
[1677]	Analog Out X30/8 [mA]
[1684]	Comm. Option Status
[1685]	FC Port CTW 1
[1690]	Alarm Word
[1691]	Alarm word 2
[1692]	Warning Word
[1693]	Warning word 2
[1694]	Ext. Status Word
[1695]	Ext. Status Word 2
[1696]	Maintenance Word
[1830]	Analog Input X42/1
[1831]	Analog Input X42/3
[1832]	Analog Input X42/5
[1833]	Analog Out X42/7 [V]
[1834]	Analog Out X42/9 [V]
[1835]	Analog Out X42/11 [V]

9-18 Node Address

Range:	Function:
126 N/A* [0 - 126. N/A]	Enter the station address in this parameter or alternatively in the hardware switch. In order to adjust the station address in par.9-18 <i>Node Address</i> , the hardware switch must be set to 126 or 127 (i.e., all switches set to 'on'). Otherwise, this parameter will display the actual setting of the switch.

9-22 Telegram Selection

Option:
Function:

Select a standard Profibus message configuration for the adjustable frequency drive as an alternative to using the freely configurable messages in par.9-15 *PCD Write Configuration* and par. 9-16 *PCD Read Configuration*.

[1]	Standard telegram 1
[101]	PPO 1
[102]	PPO 2
[103]	PPO 3
[104]	PPO 4
[105]	PPO 5
[106]	PPO 6
[107]	PPO 7
[108] *	PPO 8
[200]	Custom telegram 1

9-23 Parameters for Signals

Array [1000]

Option:
Function:

This parameter contains a list of signals available for selection in par.9-15 *PCD Write Configuration* and par.9-16 *PCD Read Configuration*.

[0] *	None
[302]	Minimum Reference
[303]	Maximum Reference
[341]	Ramp 1 Ramp-up Time
[342]	Ramp 1 Ramp-down Time
[351]	Ramp 2 Ramp-up Time
[352]	Ramp 2 Ramp-down Time
[380]	Jog Ramp Time
[381]	Quick Stop Ramp Time
[411]	Motor Speed Low Limit [RPM]
[413]	Motor Speed High Limit [RPM]
[416]	Torque Limit Motor Mode
[417]	Torque Limit Generator Mode
[590]	Digital & Relay Bus Control
[593]	Pulse Out #27 Bus Control
[595]	Pulse Out #29 Bus Control
[597]	Pulse Out #X30/6 Bus Control
[653]	Terminal 42 Output Bus Control
[663]	Terminal X30/8 Output Bus Control
[890]	Bus Jog 1 Speed
[891]	Bus Jog 2 Speed
[894]	Bus Feedback 1
[895]	Bus Feedback 2

[896]	Bus Feedback 3
[1600]	Control Word
[1601]	Reference [Unit]
[1602]	Reference %
[1603]	Status Word
[1605]	Main Actual Value [%]
[1609]	Custom Readout
[1610]	Power [kW]
[1611]	Power [hp]
[1612]	Motor voltage
[1613]	Frequency
[1614]	Motor Current
[1615]	Frequency [%]
[1616]	Torque [Nm]
[1617]	Speed [RPM]
[1618]	Motor Thermal
[1622]	Torque [%]
[1630]	DC Link Voltage
[1632]	Brake Energy /s
[1633]	Brake Energy /2 min
[1634]	Heatsink Temp.
[1635]	Inverter Thermal
[1638]	SL Controller State
[1639]	Control Card Temp.
[1650]	External Reference
[1652]	Feedback [Unit]
[1653]	Digi Pot Reference
[1654]	Feedback 1 [Unit]
[1655]	Feedback 2 [Unit]
[1656]	Feedback 3 [Unit]
[1660]	Digital Input
[1661]	Terminal 53 Switch Setting
[1662]	Analog Input 53
[1663]	Terminal 54 Switch Setting
[1664]	Analog Input 54
[1665]	Analog Output 42 [mA]
[1666]	Digital Output [bin]
[1667]	Pulse Input #29 [Hz]
[1668]	Pulse Input #33 [Hz]
[1669]	Pulse Output #27 [Hz]
[1670]	Pulse Output #29 [Hz]
[1671]	Relay Output [bin]
[1672]	Counter A

[1673]	Counter B
[1675]	Analog In X30/11
[1676]	Analog In X30/12
[1677]	Analog Out X30/8 [mA]
[1680]	Fieldbus CTW 1
[1682]	Fieldbus REF 1
[1684]	Comm. Option Status
[1685]	FC Port CTW 1
[1690]	Alarm Word
[1691]	Alarm word 2
[1692]	Warning Word
[1693]	Warning word 2
[1694]	Ext. Status Word
[1695]	Ext. Status Word 2
[1696]	Maintenance Word
[1830]	Analog Input X42/1
[1831]	Analog Input X42/3
[1832]	Analog Input X42/5
[1833]	Analog Out X42/7 [V]
[1834]	Analog Out X42/9 [V]
[1835]	Analog Out X42/11 [V]
[2013]	Minimum Reference/Feedb.
[2014]	Maximum Reference/Feedb.
[2643]	Terminal X42/7 Output Bus Control
[2653]	Terminal X42/9 Output Bus Control
[2663]	Terminal X42/11 Output Bus Control

9-27 Parameter Edit

Option:
Function:

Parameters can be edited via Profibus, the standard RS485 interface, or the LCP.

[0]	Disabled	Disables editing via Profibus.
[1] *	Enabled	Enables editing via Profibus.

9-28 Process Control

Option:
Function:

Process control (setting of the control word, speed reference, and process data) is possible via either Profibus or standard serial communication bus but not both simultaneously. Local control is always possible via the LCP. Control via process control is possible via either terminals or serial communication bus depending on the settings in par.8-50 *Coasting Select* to par.8-56 *Preset Reference Select*.

[0]	Disable	Disables process control via Profibus, and enables process control via standard serial communication bus or Profibus Master class 2.
[1] *	Enable cyclic master	Enables process control via Profibus Master Class 1, and disables process control via standard serial communication bus or Profibus Master class 2.

9-53 Profibus Warning Word

Range:	Function:
0 N/A* [0 - 65535 N/A]	This parameter displays Profibus communication warnings. Please refer to the <i>Profibus Instruction Manual</i> for further information.

Read only

Bit:	Meaning:
0	Connection with DP master is not ok
1	Not used
2	FDLNDL (Serial Communication Bus Data link Layer) is not ok
3	Clear data command received
4	The actual value is not updated
5	Baud rate search
6	PROFIBUS ASIC is not transmitting
7	Initialization of PROFIBUS is not ok
8	The adjustable frequency drive is tripped.
9	Internal CAN error
10	Wrong configuration data from PLC
11	Wrong ID sent by PLC
12	Internal error occurred
13	Not configured
14	Timeout active
15	Warning 34 active

9-63 Actual Baud Rate

Option:	Function:
	This parameter displays the actual Profibus baud rate. The Profibus Master automatically sets the baud rate.

[0]	9.6 kbit/s
[1]	19.2 kbit/s
[2]	93.75 kbit/s
[3]	187.5 kbit/s
[4]	500 kbit/s
[6]	1500 kbit/s
[7]	3000 kbit/s
[8]	6000 kbit/s
[9]	12000 kbit/s
[10]	31.25 kbit/s
[11]	45.45 kbit/s
[255] *	No baud rate found

9-65 Profile Number

Range:	Function:
0 N/A* [0 - 0 N/A]	This parameter contains the profile identification. Byte 1 contains the profile number and byte 2 the version number of the profile.

NOTE!
This parameter is not visible via LCP.

9-70 Programming Set-up

Option:	Function:
	Select the set-up to be edited.
[0] Factory setup	Uses default data. This option can be used as a data source to return the other set-ups to a known state.
[1] Set-up 1	Edits Set-up 1.
[2] Set-up 2	Edits Set-up 2.
[3] Set-up 3	Edits Set-up 3.
[4] Set-up 4	Edits Set-up 4.
[9] * Active Set-up	Follows the active set-up selected in par.0-10 <i>Active Set-up</i> .

This parameter is unique to LCP and serial communication busses. See also par.0-11 *Programming Set-up*.

9-71 Profibus Save Data Values

Option:	Function:
	Parameter values changed via Profibus are not automatically stored in non-volatile memory. Use this parameter to activate a function that stores parameter values in the EEPROM non-volatile memory, so changed parameter values will be retained at power-down.
[0] * Off	Deactivates the non-volatile storage function.
[1] Store edit setup	
[2] Store all setups	Stores all parameter values for all set-ups in the non-volatile memory. The selection returns to <i>Off</i> [0] when all parameter values have been stored.

9-72 ProfibusDriveReset

Option:	Function:
[0] * No action	
[1] Power-on reset	Resets the adjustable frequency drive upon power-up, as for power-cycle.
[3] Comm option reset	Resets the Profibus option only, useful after changing certain settings in parameter group 9-**, e.g., par.9-18 <i>Node Address</i> . When reset, the adjustable frequency drive disappears from the serial communication bus, which may cause a communication error from the master.

9-80 Defined Parameters (1)

Array [116]
No LCP access
Read only

Range:	Function:
0 N/A* [0 - 9999 N/A]	This parameter displays a list of all the defined adjustable frequency drive parameters available for Profibus.

9-81 Defined Parameters (2)

Array [116]
 No LCP access
 Read only

Range:

0 N/A* [0 - 9999 N/A]

Function:

This parameter displays a list of all the defined adjustable frequency drive parameters available for Profibus.

9-82 Defined Parameters (3)

Array [116]
 No LCP access
 Read only

Range:

0 N/A* [0 - 9999 N/A]

Function:

This parameter displays a list of all the defined adjustable frequency drive parameters available for Profibus.

9-83 Defined Parameters (4)

Array [116]
 No LCP access
 Read only

Range:

0 N/A* [0 - 9999 N/A]

Function:

This parameter displays a list of all the defined adjustable frequency drive parameters available for Profibus.

9-90 Changed Parameters (1)

Array [116]
 No LCP access
 Read only

Range:

0 N/A* [0 - 9999 N/A]

Function:

This parameter displays a list of all the adjustable frequency drive parameters deviating from default setting.

9-91 Changed Parameters (2)

Array [116]
 No LCP access
 Read only

Range:

0 N/A* [0 - 9999 N/A]

Function:

This parameter displays a list of all the adjustable frequency drive parameters deviating from default setting.

9-92 Changed Parameters (3)

Array [116]
 No LCP access
 Read only

Range:

0 N/A* [0 - 9999 N/A]

Function:

This parameter displays a list of all the adjustable frequency drive parameters deviating from default setting.

9-94 Changed parameters (5)

Array [116]

No LCP Address

Read only

Range:

0 N/A* [0 - 9999 N/A]

Function:

This parameter displays a list of all the adjustable frequency drive parameters deviating from default setting.

3

3.11 Main Menu - CAN Ser. Com. Bus - Group 10

3.11.1 10-** DeviceNet and CAN serial communication bus

Parameter group for DeviceNet CAN serial communication bus parameters.

3.11.2 10-0* Common Settings

Parameter group for configuring common settings for CAN serial communication bus options.

10-00 CAN Protocol

Option:

[1] * DeviceNet

Function:

View the active CAN protocol.

**NOTE!**

The options depend on installed option

10-01 Baud Rate Select

Option:

[16] 10 Kbps

[17] 20 Kbps

[18] 50 Kbps

[19] 100 Kbps

[20] * 125 Kbps

[21] 250 Kbps

[22] 500 Kbps

[23] 800 Kbps

[24] 1000 Kbps

Function:

Select the serial communication bus transmission speed. The selection must correspond to the transmission speed of the master and the other serial communication bus nodes.

10-02 MAC ID

Range:

63. N/A* [0 - 63. N/A]

Function:

Selection of station address. Every station connected to the same DeviceNet network must have an unambiguous address.

10-05 Readout Transmit Error Counter

Range:	Function:
0 N/A* [0 - 255 N/A]	View the number of CAN control transmission errors since the last power-up.

10-06 Readout Receive Error Counter

Range:	Function:
0 N/A* [0 - 255 N/A]	View the number of CAN control receipt errors since the last power-up.

10-07 Readout Bus Off Counter

Range:	Function:
0 N/A* [0 - 255 N/A]	View the number of Bus Off events since the last power-up.

3.11.3 10-1 * DeviceNet

Parameters specific to the DeviceNet serial communication bus.

10-10 Process Data Type Selection

Option:	Function:
	<p>Select the Instance (message) for data transmission. The instances available are dependent upon the setting of par.8-10 <i>Control Profile</i>.</p> <p>When par.8-10 <i>Control Profile</i> is set to [0] <i>FC profile</i>, par.10-10 <i>Process Data Type Selection</i> options [0] and [1] are available.</p> <p>When par.8-10 <i>Control Profile</i> is set to [5] <i>ODVA</i>, par.10-10 <i>Process Data Type Selection</i> options [2] and [3] are available.</p> <p>Instances 100/150 and 101/151 are Danfoss-specific. Instances 20/70 and 21/71 are ODVA-specific AC drive profiles.</p> <p>For guidelines in message selection, please refer to the DeviceNet Instruction Manual.</p> <p>Note that a change to this parameter will be executed immediately.</p>

[0] *	INSTANCE 100/150
[1]	INSTANCE 101/151
[2]	INSTANCE 20/70
[3]	INSTANCE 21/71

10-11 Process Data Config Write

Option:
Function:

Select the process write data for I/O assembly instances 101/151. Elements [2] and [3] of this array can be selected. Elements [0] and [1] of the array are fixed.

[0] *	None
[302]	Minimum Reference
[303]	Maximum Reference
[341]	Ramp 1 Ramp-up Time
[342]	Ramp 1 Ramp-down Time
[351]	Ramp 2 Ramp-up Time
[352]	Ramp 2 Ramp-down Time
[380]	Jog Ramp Time
[381]	Quick Stop Ramp Time
[411]	Motor Speed Low Limit [RPM]
[413]	Motor Speed High Limit [RPM]
[416]	Torque Limit Motor Mode
[417]	Torque Limit Generator Mode
[590]	Digital & Relay Bus Control
[593]	Pulse Out #27 Bus Control
[595]	Pulse Out #29 Bus Control
[597]	Pulse Out #X30/6 Bus Control
[653]	Terminal 42 Output Bus Control
[663]	Terminal X30/8 Output Bus Control
[890]	Bus Jog 1 Speed
[891]	Bus Jog 2 Speed
[894]	Bus Feedback 1
[895]	Bus Feedback 2
[896]	Bus Feedback 3
[1680]	Fieldbus CTW 1
[1682]	Fieldbus REF 1
[2013]	Minimum Reference/Feedb.
[2014]	Maximum Reference/Feedb.
[2643]	Terminal X42/7 Output Bus Control
[2653]	Terminal X42/9 Output Bus Control
[2663]	Terminal X42/11 Output Bus Control

10-12 Process Data Config Read

Option:
Function:

Select the process read data for I/O assembly instances 101/151. Elements [2] and [3] of this array can be selected. Elements [0] and [1] of the array are fixed.

[0] *	None
[894]	Bus Feedback 1
[895]	Bus Feedback 2
[896]	Bus Feedback 3

[1600]	Control Word
[1601]	Reference [Unit]
[1602]	Reference %
[1603]	Status Word
[1605]	Main Actual Value [%]
[1609]	Custom Readout
[1610]	Power [kW]
[1611]	Power [hp]
[1612]	Motor voltage
[1613]	Frequency
[1614]	Motor Current
[1615]	Frequency [%]
[1616]	Torque [Nm]
[1617]	Speed [RPM]
[1618]	Motor Thermal
[1622]	Torque [%]
[1630]	DC Link Voltage
[1632]	Brake Energy /s
[1633]	Brake Energy /2 min
[1634]	Heatsink Temp.
[1635]	Inverter Thermal
[1638]	SL Controller State
[1639]	Control Card Temp.
[1650]	External Reference
[1652]	Feedback [Unit]
[1653]	Digi Pot Reference
[1654]	Feedback 1 [Unit]
[1655]	Feedback 2 [Unit]
[1656]	Feedback 3 [Unit]
[1660]	Digital Input
[1661]	Terminal 53 Switch Setting
[1662]	Analog Input 53
[1663]	Terminal 54 Switch Setting
[1664]	Analog Input 54
[1665]	Analog Output 42 [mA]
[1666]	Digital Output [bin]
[1667]	Pulse Input #29 [Hz]
[1668]	Pulse Input #33 [Hz]
[1669]	Pulse Output #27 [Hz]
[1670]	Pulse Output #29 [Hz]
[1671]	Relay Output [bin]
[1672]	Counter A
[1673]	Counter B

[1675]	Analog In X30/11
[1676]	Analog In X30/12
[1677]	Analog Out X30/8 [mA]
[1684]	Comm. Option Status
[1685]	FC Port CTW 1
[1690]	Alarm Word
[1691]	Alarm word 2
[1692]	Warning Word
[1693]	Warning word 2
[1694]	Ext. Status Word
[1695]	Ext. Status Word 2
[1696]	Maintenance Word
[1830]	Analog Input X42/1
[1831]	Analog Input X42/3
[1832]	Analog Input X42/5
[1833]	Analog Out X42/7 [V]
[1834]	Analog Out X42/9 [V]
[1835]	Analog Out X42/11 [V]

10-13 Warning Parameter

Range:

0 N/A* [0 - 65535 N/A]

Function:

View a DeviceNet-specific warning word. One bit is assigned to every warning. Refer to the DeviceNet Instruction Manual (MG.33.DX.YY) for further information.

Bit:	Meaning:
0	Bus not active
1	Explicit connection timeout
2	I/O connection
3	Retry limit reached
4	Actual is not updated
5	CAN bus off
6	I/O send error
7	Initialization error
8	No bus supply
9	Bus off
10	Error passive
11	Error warning
12	Duplicate MAC ID Error
13	RX queue overrun
14	TX queue overrun
15	CAN overrun

10-14 Net Reference

Read only from LCP

Option:

[0] * Off

[1] On

Function:

Select the reference source in instance 21/71 and 20/70.

Enables reference via analog/digital inputs.

Enables reference via the serial communication bus.

10-15 Net Control

Read only from LCP

Option:	Function:
	Select the control source in Instance 21/71 and 20/70.
[0] * Off	Enables control via analog/digital inputs.
[1] On	Enable control via the serial communication bus.

3.11.4 10-2* COS Filters

Parameters for configuring COS filter settings.

10-20 COS Filter 1

Range:	Function:
0 N/A* [0 - 65535 N/A]	Enter the value for COS Filter 1 to set up the filter mask for the status word. When operating in COS (Change-Of-State), this function filters out bits in the status word that should not be sent if they change.

10-21 COS Filter 2

Range:	Function:
0 N/A* [0 - 65535 N/A]	Enter the value for COS Filter 2, to set up the filter mask for the Main Actual Value. When operating in COS (Change-Of-State), this function filters out bits in the Main Actual Value that should not be sent if they change.

10-22 COS Filter 3

Range:	Function:
0 N/A* [0 - 65535 N/A]	Enter the value for COS Filter 3, to set up the filter mask for PCD 3. When operating in COS (Change-Of-State), this function filters out bits in PCD 3 that should not be sent if they change.

10-23 COS Filter 4

Range:	Function:
0 N/A* [0 - 65535 N/A]	Enter the value for COS Filter 4 to set up the filter mask for PCD 4. When operating in COS (Change-Of-State), this function filters out bits in PCD 4 that should not be sent if they change.

3.11.5 10-3* Parameter Access

Parameter group providing access to indexed parameters and defining programming set-up.

10-30 Array Index

Range:	Function:
0 N/A* [0 - 255 N/A]	View array parameters. This parameter is valid only when a DeviceNet serial communication bus is installed.

10-31 Store Data Values

Option:
Function:

Parameter values changed via DeviceNet are not automatically stored in non-volatile memory. Use this parameter to activate a function that stores parameter values in the EEPROM non-volatile memory, so that changed parameter values will be retained at power-down.

[0] * Off

Deactivates the non-volatile storage function.

[1] Store edit setup

Stores all parameter values from the active set-up in the non-volatile memory. The selection returns to Off [0] when all values have been stored.

[2] Store all setups

Stores all parameter values for all set-ups in the non-volatile memory. The selection returns to Off [0] when all parameter values have been stored.

10-32 Devicenet Revision

Range:
Function:

0 N/A* [0 - 65535 N/A]

View the DeviceNet revision number. This parameter is used for EDS file creation.

10-33 Store Always

Option:
Function:

[0] * Off

Deactivates non-volatile storage of data.

[1] On

Stores parameter data received via DeviceNet in EEPROM non-volatile memory as default.

10-39 Devicenet F Parameters

Array [1000]

No LCP access

Range:
Function:

0 N/A* [0 - 0 N/A]

This parameter is used to configure the adjustable frequency drive via DeviceNet and build the EDS file.

3.12 Main Menu - LonWorks - Group 11

3.12.1 LonWorks, 11-***

Parameter group for all LonWorks specific parameters.

Parameters related to LonWorks ID.

11-00 Neuron ID

Range:	Function:
0 N/A* [0 - 0 N/A]	View the Neuron chip's unique Neuron ID number.

11-10 Drive Profile

Option:	Function:
	This parameter allows selecting between LONMARK Functional Profiles.
[0] * VSD profile	The Danfoss Profile and the Node Object are common for all profiles.
[1] Pump controller	

11-15 LON Warning Word

Range:	Function:
0 N/A* [0 - 65535 N/A]	This parameter contains the LON specific warnings.

Bit	Status
0	Internal fault
1	Internal fault
2	Internal fault
3	Internal fault
4	Internal fault
5	Invalid type change for nvoAnIn1
6	Invalid type change for nvoAnIn2
7	Invalid type change for nvo109AnIn1
8	Invalid type change for nvo109AnIn2
9	Invalid type change for nvo109AnIn3
10	Initialization error
11	Internal communication error
12	Software revision mismatch
13	Bus not active
14	Option not present
15	LON input (nvi/nci) exceeds limits

11-17 XIF Revision

Range:	Function:
0 N/A* [0 - 0 N/A]	This parameter contains the version of the external interface file on the Neuron C chip on the LON option.

11-18 LonWorks Revision

Range:	Function:
0 N/A* [0 - 0 N/A]	This parameter contains the software version of the application program on the Neuron C chip on the LON option.

11-21 Store Data Values

Option:

Function:

This parameter is used to activate storing of data in non-volatile memory.

[0] * Off

Store function is inactive.

[2] Store all setups

Stores all parameter values in the EEPROM. The value returns to *Off* when all parameter values have been stored.

3

3.13 Main Menu - Smart Logic - Group 13

3.13.1 13-** Prog. Features Prog. Features

Smart Logic Control (SLC) is essentially a sequence of user defined actions (see par.13-52 *SL Controller Action [x]*) executed by the SLC when the associated user defined *event* (see par.13-51 *SL Controller Event [x]*) is evaluated as TRUE by the SLC. Events and *actions* are each numbered and linked together in pairs. This means that when *event* [0] is fulfilled (attains the value TRUE), *action* [0] is executed. After this, the conditions of *event* [1] will be evaluated and if evaluated TRUE, *action* [1] will be executed and so on. Only one *event* will be evaluated at any time. If an *event* is evaluated as FALSE, nothing happens (in the SLC) during the current scan interval and no other *events* will be evaluated. This means that when the SLC starts, it evaluates *event* [0] (and only *event* [0]) each scan interval. Only when *event* [0] is evaluated TRUE, will the SLC execute *action* [0] and start evaluating *event* [1]. It is possible to program from 1 to 20 *events* and *actions*.

When the last *event / action* has been executed, the sequence starts over again from *event* [0] / *action* [0]. The illustration shows an example with three events/actions:

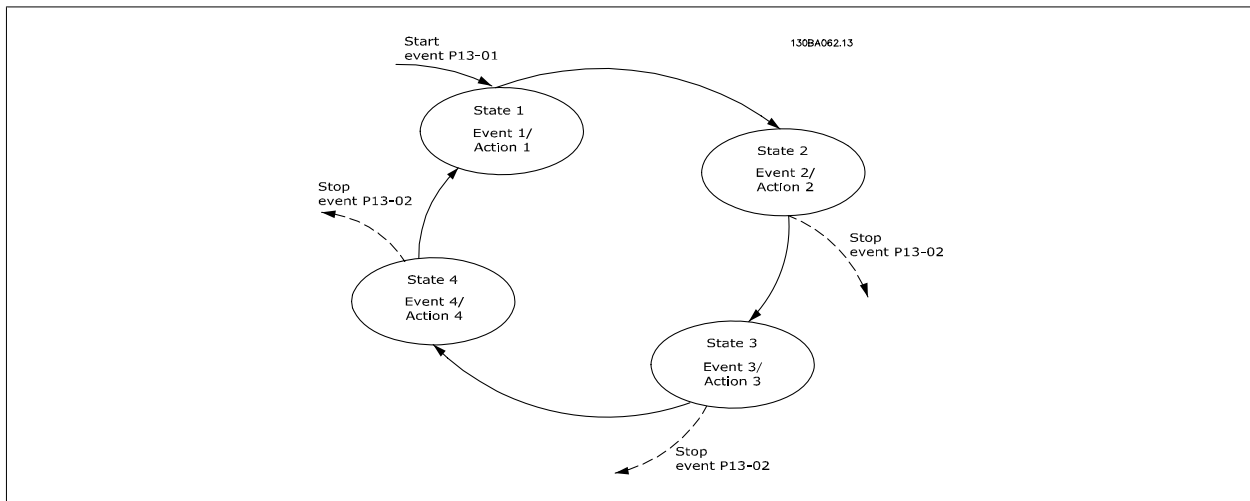

Starting and stopping the SLC:

Starting and stopping the SLC can be done by selecting *On* [1] or *Off* [0] in par.13-00 *SL Controller Mode*. The SLC always starts in state 0 (where it evaluates *event* [0]). The SLC starts when the start event (defined in par.13-01 *Start Event*) is evaluated as TRUE (provided that *On* [1] is selected in par.13-00 *SL Controller Mode*). The SLC stops when the *Stop Event* (par.13-02 *Stop Event*) is TRUE. par.13-03 *Reset SLC* resets all SLC parameters and starts programming from scratch.

3.13.2 13-0* SLC Settings

Use the SLC settings to activate, deactivate and reset the Smart Logic Control.

13-00 SL Controller Mode

Option:	Function:
[0] * Off	Disables the Smart Logic Controller.
[1] On	Enables the Smart Logic Controller.

13-01 Start Event

Option:	Function:
	Select the Boolean (TRUE or FALSE) input to activate Smart Logic Control.
[0] * FALSE	Enters the fixed value of FALSE in the logic rule.
[1] TRUE	Enters the fixed value TRUE in the logic rule.
[2] Running	See parameter group 5-3* for further description.
[3] In range	See parameter group 5-3* for further description.
[4] On reference	See parameter group 5-3* for further description.
[5] Torque limit	See parameter group 5-3* for further description.
[6] Current limit	See parameter group 5-3* for further description.
[7] Out of current range	See parameter group 5-3* for further description.
[8] Below I low	See parameter group 5-3* for further description.
[9] Above I high	See parameter group 5-3* for further description.
[10] Out of speed range	
[11] Below speed low	See parameter group 5-3* for further description.
[12] Above speed high	See parameter group 5-3* for further description.
[13] Out of feedb. range	
[14] Below feedb. low	
[15] Above feedb. high	
[16] Thermal warning	See parameter group 5-3* for further description.
[17] Mains out of range	See parameter group 5-3* for further description.
[18] Reverse	See parameter group 5-3* for further description.
[19] Warning	See parameter group 5-3* for further description.
[20] Alarm (trip)	See parameter group 5-3* for further description.
[21] Alarm (trip lock)	See parameter group 5-3* for further description.
[22] Comparator 0	Use the result of comparator 0 in the logic rule.
[23] Comparator 1	Use the result of comparator 1 in the logic rule.
[24] Comparator 2	Use the result of comparator 2 in the logic rule.
[25] Comparator 3	Use the result of comparator 3 in the logic rule.
[26] Logic rule 0	Use the result of logic rule 0 in the logic rule.

[27]	Logic rule 1	Use the result of logic rule 1 in the logic rule.
[28]	Logic rule 2	Use the result of logic rule 2 in the logic rule.
[29]	Logic rule 3	Use the result of logic rule 3 in the logic rule.
[33]	Digital input DI18	Use the value of DI18 in the logic rule (High = TRUE).
[34]	Digital input DI19	Use the value of DI19 in the logic rule (High = TRUE).
[35]	Digital input DI27	Use the value of DI27 in the logic rule (High = TRUE).
[36]	Digital input DI29	Use the value of DI29 in the logic rule (High = TRUE).
[37]	Digital input DI32	Use the value of DI32 in the logic rule (High = TRUE).
[38]	Digital input DI33	Use the value of DI33 in the logic rule (High = TRUE).
[39]	Start command	This event is TRUE if the adjustable frequency drive is started by any means (either via digital input, serial communication bus or other).
[40]	Drive stopped	This event is TRUE if the adjustable frequency drive is stopped or coasted by any means (either via digital input, serial communication bus or other).
[41]	Reset Trip	This event is TRUE if the adjustable frequency drive is tripped (but not trip-locked) and the reset button is pressed.
[42]	Auto Reset Trip	This event is TRUE if the adjustable frequency drive is tripped (but not trip-locked) and an automatic reset is issued.
[43]	OK Key	This event is TRUE if the OK key on the LCP is pressed.
[44]	Reset Key	This event is TRUE if the Reset key on the LCP is pressed.
[45]	Left Key	This event is TRUE if the Left key on the LCP is pressed.
[46]	Right Key	This event is TRUE if the Right key on the LCP is pressed.
[47]	Up Key	This event is TRUE if the Up key on the LCP is pressed.
[48]	Down Key	This event is TRUE if the Down key on the LCP is pressed.
[50]	Comparator 4	Use the result of comparator 4 in the logic rule.
[51]	Comparator 5	Use the result of comparator 5 in the logic rule.
[60]	Logic rule 4	Use the result of logic rule 4 in the logic rule.
[61]	Logic rule 5	Use the result of logic rule 5 in the logic rule.

13-02 Stop Event

Option:

Function:

Select the Boolean (TRUE or FALSE) input to deactivate Smart Logic Control.

[0] *	FALSE	Enters the fixed value of FALSE in the logic rule.
[1]	TRUE	Enters the fixed value TRUE in the logic rule.
[2]	Running	See parameter group 5-3* for further description.
[3]	In range	See parameter group 5-3* for further description.
[4]	On reference	See parameter group 5-3* for further description.
[5]	Torque limit	See parameter group 5-3* for further description.
[6]	Current limit	See parameter group 5-3* for further description.

[7]	Out of current range	See parameter group 5-3* for further description.
[8]	Below I low	See parameter group 5-3* for further description.
[9]	Above I high	See parameter group 5-3* for further description.
[10]	Out of speed range	
[11]	Below speed low	See parameter group 5-3* for further description.
[12]	Above speed high	See parameter group 5-3* for further description.
[13]	Out of feedb. range	See parameter group 5-3* for further description.
[14]	Below feedb. low	See parameter group 5-3* for further description.
[15]	Above feedb. high	See parameter group 5-3* for further description.
[16]	Thermal warning	See parameter group 5-3* for further description.
[17]	Mains out of range	See parameter group 5-3* for further description.
[18]	Reverse	See parameter group 5-3* for further description.
[19]	Warning	See parameter group 5-3* for further description.
[20]	Alarm (trip)	See parameter group 5-3* for further description.
[21]	Alarm (trip lock)	See parameter group 5-3* for further description.
[22]	Comparator 0	Use the result of comparator 0 in the logic rule.
[23]	Comparator 1	Use the result of comparator 1 in the logic rule.
[24]	Comparator 2	Use the result of comparator 2 in the logic rule.
[25]	Comparator 3	Use the result of comparator 3 in the logic rule.
[26]	Logic rule 0	Use the result of logic rule 0 in the logic rule.
[27]	Logic rule 1	Use the result of logic rule 1 in the logic rule.
[28]	Logic rule 2	Use the result of logic rule 2 in the logic rule.
[29]	Logic rule 3	Use the result of logic rule 3 in the logic rule.
[30]	SL Timeout 0	Use the result of timer 0 in the logic rule.
[31]	SL Timeout 1	Use the result of timer 1 in the logic rule.
[32]	SL Timeout 2	Use the result of timer 2 in the logic rule.
[33]	Digital input DI18	Use the value of DI18 in the logic rule (High = TRUE).
[34]	Digital input DI19	Use the value of DI19 in the logic rule (High = TRUE).
[35]	Digital input DI27	Use the value of DI27 in the logic rule (High = TRUE).
[36]	Digital input DI29	Use the value of DI29 in the logic rule (High = TRUE).
[37]	Digital input DI32	Use the value of DI32 in the logic rule (High = TRUE).
[38]	Digital input DI33	Use the value of DI33 in the logic rule (High = TRUE).
[39]	Start command	This event is TRUE if the adjustable frequency drive is started by any means (either via digital input, serial communication bus or other).
[40]	Drive stopped	This event is TRUE if the adjustable frequency drive is stopped or coasted by any means (either via digital input, serial communication bus or other).

[41]	Reset Trip	This event is TRUE if the adjustable frequency drive is tripped (but not trip-locked) and the reset button is pressed.
[42]	Auto Reset Trip	This event is TRUE if the adjustable frequency drive is tripped (but not trip-locked) and an automatic reset is issued.
[43]	OK Key	This event is TRUE if the OK key on the LCP is pressed.
[44]	Reset Key	This event is TRUE if the Reset key on the LCP is pressed.
[45]	Left Key	This event is TRUE if the Left key on the LCP is pressed.
[46]	Right Key	This event is TRUE if the Right key on the LCP is pressed.
[47]	Up Key	This event is TRUE if the Up key on the LCP is pressed.
[48]	Down Key	This event is TRUE if the Down key on the LCP is pressed.
[50]	Comparator 4	Use the result of comparator 4 in the logic rule.
[51]	Comparator 5	Use the result of comparator 5 in the logic rule.
[60]	Logic rule 4	Use the result of logic rule 4 in the logic rule.
[61]	Logic rule 5	Use the result of logic rule 5 in the logic rule.
[70]	SL Timeout 3	Use the result of timer 3 in the logic rule.
[71]	SL Timeout 4	Use the result of timer 4 in the logic rule.
[72]	SL Timeout 5	Use the result of timer 5 in the logic rule.
[73]	SL Timeout 6	Use the result of timer 6 in the logic rule.
[74]	SL Timeout 7	Use the result of timer 7 in the logic rule.
[80]	No Flow	
[81]	Dry Pump	
[82]	End of Curve	
[83]	Broken Belt	

13-03 Reset SLC

Option:
Function:

[0] *	Do not reset SLC	Retains programmed settings in all group 13 parameters (13-*).
[1]	Reset SLC	Resets all group 13 parameters (13-*) to default settings.

3.13.3 13-1* Comparators

Comparators are used for comparing continuous variables (i.e., output frequency, output current, analog input, etc.) to fixed preset values. In addition, there are digital values that will be compared to fixed time values. See explanation in par.13-10 *Comparator Operand*. Comparators are evaluated once in each scan interval. Use the result (TRUE or FALSE) directly. All parameters in this parameter group are array parameters with an index of 0 to 5. Select index 0 to program Comparator 0, select index 1 to program Comparator 1, etc.

13-10 Comparator Operand

Array [4]

Option:

Function:

Select the variable to be monitored by the comparator.

[0] * DISABLED

[1] Reference

[2] Feedback

[3] Motor speed

[4] Motor current

[5] Motor torque

[6] Motor power

[7] Motor voltage

[8] DC-link voltage

[9] Motor thermal

[10] VLT temp.

[11] Heat sink temp.

[12] Analog input AI53

[13] Analog input AI54

[14] Analog input AIFB10

[15] Analog input AIS24V

[17] Analog input AICCT

[18] Pulse input FI29

[19] Pulse input FI33

[20] Alarm number

[30] Counter A

[31] Counter B

13-11 Comparator Operator

Array [6]

Option:

Function:

[0] * <

Select < [0] for the result of the evaluation to be TRUE, when the variable selected in par. 13-10 *Comparator Operand* is smaller than the fixed value in par.13-12 *Comparator Value*. The result will be FALSE, if the variable selected in par.13-10 *Comparator Operand* is greater than the fixed value in par.13-12 *Comparator Value*.

[1] = (equal)

Select ≈ [1] for the result of the evaluation to be TRUE, when the variable selected in par. 13-10 *Comparator Operand* is approximately equal to the fixed value in par.13-12 *Comparator Value*.

[2] >

Select > [2] for the inverse logic of option < [0].

13-12 Comparator Value

Array [6]

Range:

0 N/A* [-100000.000 - 100000.000 N/A]

Function:

Enter the 'trigger level' for the variable that is monitored by this comparator. This is an array parameter containing comparator values 0 to 5.

3

3.13.4 13-2* Timers

This parameter group consists of timer parameters.

Use the result (TRUE or FALSE) from *timers* directly to define an *event* (see par.13-51 *SL Controller Event*), or as Boolean input in a *logic rule* (see par.13-40 *Logic Rule Boolean 1*, par.13-42 *Logic Rule Boolean 2* or par.13-44 *Logic Rule Boolean 3*). A timer is only FALSE when started by an action (i.e., Start timer 1 [29]) until the timer value entered in this parameter is elapsed. Then it becomes TRUE again.

All parameters in this parameter group are array parameters with an index of 0 to 2. Select index 0 to program Timer 0, select index 1 to program Timer 1, and so on.

13-20 SL Controller Timer

Array [3]

Range:

0 N/A* [0.000 - 360000.000 N/A]

Function:

Enter the value to define the duration of the FALSE output from the programmed timer. A timer is only FALSE if it is started by an action (i.e., *Start timer 1* [29]) and until the given timer value has elapsed.

3.13.5 13-4* Logic Rules

Combine up to three Boolean inputs (TRUE / FALSE inputs) from timers, comparators, digital inputs, status bits and events using the logical operators AND, OR, and NOT. Select Boolean inputs for the calculation in par.13-40 *Logic Rule Boolean 1*, par.13-42 *Logic Rule Boolean 2* and par.13-44 *Logic Rule Boolean 3*. Define the operators used to logically combine the selected inputs in par.13-41 *Logic Rule Operator 1* and par.13-43 *Logic Rule Operator 2*.

Priority of calculation

The results of par.13-40 *Logic Rule Boolean 1*, par.13-41 *Logic Rule Operator 1* and par.13-42 *Logic Rule Boolean 2* are calculated first. The outcome (TRUE / FALSE) of this calculation is combined with the settings of par.13-43 *Logic Rule Operator 2* and par.13-44 *Logic Rule Boolean 3*, yielding the final result (TRUE / FALSE) of the logic rule.

13-40 Logic Rule Boolean 1

Array [6]

Option:

[0] * FALSE

Function:

Enters the fixed value of FALSE in the logic rule.

[1] TRUE

Enters the fixed value TRUE in the logic rule.

[2] Running

See parameter group 5-3* for further description.

[3] In range

See parameter group 5-3* for further description.

[4] On reference

See parameter group 5-3* for further description.

[5] Torque limit

See parameter group 5-3* for further description.

[6] Current limit

See parameter group 5-3* for further description.

[7] Out of current range

See parameter group 5-3* for further description.

[8] Below I low

See parameter group 5-3* for further description.

[9]	Above I high	See parameter group 5-3* for further description.
[10]	Out of speed range	
[11]	Below speed low	See parameter group 5-3* for further description.
[12]	Above speed high	See parameter group 5-3* for further description.
[13]	Out of feedb. range	See parameter group 5-3* for further description.
[14]	Below feedb. low	See parameter group 5-3* for further description.
[15]	Above feedb. high	See parameter group 5-3* for further description.
[16]	Thermal warning	See parameter group 5-3* for further description.
[17]	Mains out of range	See parameter group for further description.
[18]	Reverse	See parameter group 5-3* for further description.
[19]	Warning	See parameter group 5-3* for further description.
[20]	Alarm (trip)	See parameter group 5-3* for further description.
[21]	Alarm (trip lock)	See parameter group 5-3* for further description.
[22]	Comparator 0	Use the result of comparator 0 in the logic rule.
[23]	Comparator 1	Use the result of comparator 1 in the logic rule.
[24]	Comparator 2	Use the result of comparator 2 in the logic rule.
[25]	Comparator 3	Use the result of comparator 3 in the logic rule.
[26]	Logic rule 0	Use the result of logic rule 0 in the logic rule.
[27]	Logic rule 1	Use the result of logic rule 1 in the logic rule.
[28]	Logic rule 2	Use the result of logic rule 2 in the logic rule.
[29]	Logic rule 3	Use the result of logic rule 3 in the logic rule.
[30]	SL Timeout 0	Use the result of timer 0 in the logic rule.
[31]	SL Timeout 1	Use the result of timer 1 in the logic rule.
[32]	SL Timeout 2	Use the result of timer 2 in the logic rule.
[33]	Digital input DI18	Use the value of DI18 in the logic rule (High = TRUE).
[34]	Digital input DI19	Use the value of DI19 in the logic rule (High = TRUE).
[35]	Digital input DI27	Use the value of DI27 in the logic rule (High = TRUE).
[36]	Digital input DI29	Use the value of DI29 in the logic rule (High = TRUE).
[37]	Digital input DI32	Use the value of DI32 in the logic rule (High = TRUE).
[38]	Digital input DI33	Use the value of DI33 in the logic rule (High = TRUE).
[39]	Start command	This logic rule is TRUE if the adjustable frequency drive is started by any means (either via digital input, serial communication bus or other).
[40]	Drive stopped	This logic rule is TRUE if the adjustable frequency drive is stopped or coasted by any means (either via digital input, serial communication bus or other).
[41]	Reset Trip	This logic rule is TRUE if the adjustable frequency drive is tripped (but not trip-locked) and the reset button is pressed.

[42]	Auto Reset Trip	This logic rule is TRUE if the adjustable frequency drive is tripped (but not trip-locked) and an automatic reset is issued.
[43]	OK Key	This logic rule is TRUE if the OK key on the LCP is pressed.
[44]	Reset Key	This logic rule is TRUE if the Reset key on the LCP is pressed.
[45]	Left Key	This logic rule is TRUE if the Left key on the LCP is pressed.
[46]	Right Key	This logic rule is TRUE if the Right key on the LCP is pressed.
[47]	Up Key	This logic rule is TRUE if the Up key on the LCP is pressed.
[48]	Down Key	This logic rule is TRUE if the Down key on the LCP is pressed.
[50]	Comparator 4	Use the result of comparator 4 in the logic rule.
[51]	Comparator 5	Use the result of comparator 5 in the logic rule.
[60]	Logic rule 4	Use the result of logic rule 4 in the logic rule.
[61]	Logic rule 5	Use the result of logic rule 5 in the logic rule.
[70]	SL Timeout 3	Use the result of timer 3 in the logic rule.
[71]	SL Timeout 4	Use the result of timer 4 in the logic rule.
[72]	SL Timeout 5	Use the result of timer 5 in the logic rule.
[73]	SL Timeout 6	Use the result of timer 6 in the logic rule.
[74]	SL Timeout 7	Use the result of timer 7 in the logic rule.
[80]	No Flow	
[81]	Dry Pump	
[82]	End of Curve	
[83]	Broken Belt	

13-41 Logic Rule Operator 1

Array [6]

Option:

Function:

Select the first logical operator to use on the Boolean inputs from par.13-40 *Logic Rule Boolean 1* and par.13-42 *Logic Rule Boolean 2*.
[13 -XX] signifies the Boolean input of par. 13-*

[0] *	DISABLED	Ignores par. , par.13-43 <i>Logic Rule Operator 2</i> , and par.13-44 <i>Logic Rule Boolean 3</i> .
[1]	AND	Evaluates the expression [13-40] AND [13-42].
[2]	OR	evaluates the expression [13-40] OR [13-42].
[3]	AND NOT	evaluates the expression [13-40] AND NOT [13-42].
[4]	OR NOT	evaluates the expression [13-40] OR NOT [13-42].
[5]	NOT AND	evaluates the expression NOT [13-40] AND [13-42].
[6]	NOT OR	evaluates the expression NOT [13-40] OR [13-42].
[7]	NOT AND NOT	evaluates the expression NOT [13-40] AND NOT [13-42].
[8]	NOT OR NOT	evaluates the expression NOT [13-40] OR NOT [13-42].

13-42 Logic Rule Boolean 2

Array [6]

Option:

Function:

Select the second Boolean (TRUE or FALSE) input for the selected logic rule.

See par.13-40 *Logic Rule Boolean 1* for further descriptions of choices and their functions.

[0] * FALSE

[1] TRUE

[2] Running

[3] In range

[4] On reference

[5] Torque limit

[6] Current limit

[7] Out of current range

[8] Below I low

[9] Above I high

[10] Out of speed range

[11] Below speed low

[12] Above speed high

[13] Out of feedb. range

[14] Below feedb. low

[15] Above feedb. high

[16] Thermal warning

[17] Mains out of range

[18] Reverse

[19] Warning

[20] Alarm (trip)

[21] Alarm (trip lock)

[22] Comparator 0

[23] Comparator 1

[24] Comparator 2

[25] Comparator 3

[26] Logic rule 0

[27] Logic rule 1

[28] Logic rule 2

[29] Logic rule 3

[30] SL Timeout 0

[31] SL Timeout 1

[32] SL Timeout 2

[33] Digital input DI18

[34] Digital input DI19

[35] Digital input DI27

[36] Digital input DI29

[37] Digital input DI32

[38]	Digital input DI33
[39]	Start command
[40]	Drive stopped
[41]	Reset Trip
[42]	Auto Reset Trip
[43]	OK Key
[44]	Reset Key
[45]	Left Key
[46]	Right Key
[47]	Up Key
[48]	Down Key
[50]	Comparator 4
[51]	Comparator 5
[60]	Logic rule 4
[61]	Logic rule 5
[70]	SL Timeout 3
[71]	SL Timeout 4
[72]	SL Timeout 5
[73]	SL Timeout 6
[74]	SL Timeout 7
[80]	No Flow
[81]	Dry Pump
[82]	End of Curve
[83]	Broken Belt

13-43 Logic Rule Operator 2

Array [6]

Option:

Function:

Select the second logical operator to be used on the Boolean input calculated in par.13-40 *Logic Rule Boolean 1*, par.13-41 *Logic Rule Operator 1*, and par.13-42 *Logic Rule Boolean 2*, and the Boolean input coming from par.13-42 *Logic Rule Boolean 2*.

[13-44] signifies the Boolean input of par.13-44 *Logic Rule Boolean 3*.

[13-40/13-42] signifies the Boolean input calculated in par.13-40 *Logic Rule Boolean 1*, par.13-41 *Logic Rule Operator 1*, and par.13-42 *Logic Rule Boolean 2*. DISABLED [0] (factory setting). select this option to ignore par.13-44 *Logic Rule Boolean 3*.

[0] *	DISABLED
[1]	AND
[2]	OR
[3]	AND NOT
[4]	OR NOT
[5]	NOT AND
[6]	NOT OR
[7]	NOT AND NOT
[8]	NOT OR NOT

13-44 Logic Rule Boolean 3

Array [6]

Option:

Function:

Select the third Boolean (TRUE or FALSE) input for the selected logic rule.

See par.13-40 *Logic Rule Boolean 1* for further descriptions of choices and their functions.

[0] * FALSE

[1] TRUE

[2] Running

[3] In range

[4] On reference

[5] Torque limit

[6] Current limit

[7] Out of current range

[8] Below I low

[9] Above I high

[10] Out of speed range

[11] Below speed low

[12] Above speed high

[13] Out of feedb. range

[14] Below feedb. low

[15] Above feedb. high

[16] Thermal warning

[17] Mains out of range

[18] Reverse

[19] Warning

[20] Alarm (trip)

[21] Alarm (trip lock)

[22] Comparator 0

[23] Comparator 1

[24] Comparator 2

[25] Comparator 3

[26] Logic rule 0

[27] Logic rule 1

[28] Logic rule 2

[29] Logic rule 3

[30] SL Timeout 0

[31] SL Timeout 1

[32] SL Timeout 2

[33] Digital input DI18

[34] Digital input DI19

[35] Digital input DI27

[36] Digital input DI29

[37] Digital input DI32

[38] Digital input DI33

[39] Start command

[40] Drive stopped

[41] Reset Trip

[42] Auto Reset Trip

[43] OK Key

[44] Reset Key

[45] Left Key

[46] Right Key

[47] Up Key

[48] Down Key

[50] Comparator 4

[51] Comparator 5

[60] Logic rule 4

[61] Logic rule 5

[70] SL Timeout 3

[71] SL Timeout 4

[72] SL Timeout 5

[73] SL Timeout 6

[74] SL Timeout 7

[80] No Flow

[81] Dry Pump

[82] End of Curve

[83] Broken Belt

3.13.6 13-5* States

Parameters for programming the Smart Logic Controller.

13-51 SL Controller Event

Array [20]

Option:

Function:

Select the Boolean input (TRUE or FALSE) to define the smart logic controller event.

See par.13-02 *Stop Event* for further descriptions of choices and their functions.

[0] * FALSE

[1] TRUE

[2] Running

[3] In range

[4] On reference

[5] Torque limit

[6] Current limit

[7] Out of current range

[8] Below I low

[9] Above I high

[10] Out of speed range

[11] Below speed low

[12] Above speed high

[13] Out of feedb. range

[14] Below feedb. low

[15] Above feedb. high

[16] Thermal warning

[17] Mains out of range

[18] Reverse

[19] Warning

[20] Alarm (trip)

[21] Alarm (trip lock)

[22] Comparator 0

[23] Comparator 1

[24] Comparator 2

[25] Comparator 3

[26] Logic rule 0

[27] Logic rule 1

[28] Logic rule 2

[29] Logic rule 3

[30] SL Timeout 0

[31] SL Timeout 1

[32] SL Timeout 2

[33] Digital input DI18

[34] Digital input DI19

[35] Digital input DI27

[36] Digital input DI29

[37] Digital input DI32

[38] Digital input DI33

[39] Start command

[40] Drive stopped

[41] Reset Trip

[42] Auto Reset Trip

[43] OK Key

[44] Reset Key

[45] Left Key

[46] Right Key

[47] Up Key

[48] Down Key

[50] Comparator 4

[51] Comparator 5

[60] Logic rule 4

[61] Logic rule 5

[70] SL Timeout 3

[71] SL Timeout 4

[72] SL Timeout 5

[73] SL Timeout 6

[74] SL Timeout 7

[80] No Flow

[81] Dry Pump

[82] End of Curve

[83] Broken Belt

13-52 SL Controller Action

Array [20]

Option:
Function:

Select the action corresponding to the SLC event. Actions are executed when the corresponding event (defined in par.13-51 *SL Controller Event*) is evaluated as true. The following actions are available for selection:

[0] * DISABLED

[1] No action

[2] Select set-up 1 Changes the active set-up (par.0-10 *Active Set-up*) to '1'.[3] Select set-up 2 Changes the active set-up (par.0-10 *Active Set-up*) to '2'.[4] Select set-up 3 Changes the active set-up (par.0-10 *Active Set-up*) to '3'.[5] Select set-up 4 Changes the active set-up (par.0-10 *Active Set-up*) to '4'. If the set-up is changed, it will merge with other set-up commands coming from either the digital inputs or via a serial communication bus.

[10] Select preset ref 0 Selects preset reference 0.

[11] Select preset ref 1 Selects preset reference 1.

[12] Select preset ref 2 Selects preset reference 2.

[13] Select preset ref 3 Selects preset reference 3.

[14] Select preset ref 4 Selects preset reference 4.

[15] Select preset ref 5 Selects preset reference 5.

[16] Select preset ref 6 Selects preset reference 6.

[17] Select preset ref 7 Selects preset reference 7. If the active preset reference is changed, it will merge with other preset reference commands coming from either the digital inputs or via a serial communication bus.

[18] Select ramp 1 Selects ramp 1

[19] Select ramp 2 Selects ramp 2

[22] Run Issues a start command to the adjustable frequency drive.

[23] Run reverse Issues a start reverse command to the adjustable frequency drive.

[24] Stop Issues a stop command to the adjustable frequency drive.

[26] Dcstop

[27] Coast The adjustable frequency drive coasts immediately. All stop commands including the coast command stop the SLC.

[28]	Freeze output	Freezes the output frequency of the adjustable frequency drive.
[29]	Start timer 0	Starts timer 0, see par.13-20 <i>SL Controller Timer</i> for further description.
[30]	Start timer 1	Starts timer 1, see par.13-20 <i>SL Controller Timer</i> for further description.
[31]	Start timer 2	Starts timer 2, see par.13-20 <i>SL Controller Timer</i> for further description.
[32]	Set digital out A low	Any output with 'digital output 1' selected is low (off).
[33]	Set digital out B low	Any output with 'digital output 2' selected is low (off).
[34]	Set digital out C low	Any output with 'digital output 3' selected is low (off).
[35]	Set digital out D low	Any output with 'digital output 4' selected is low (off).
[36]	Set digital out E low	Any output with 'digital output 5' selected is low (off).
[37]	Set digital out F low	Any output with 'digital output 6' selected is low (off).
[38]	Set digital out A high	Any output with 'digital output 1' selected is high (closed).
[39]	Set digital out B high	Any output with 'digital output 2' selected is high (closed).
[40]	Set digital out C high	Any output with 'digital output 3' selected is high (closed).
[41]	Set digital out D high	Any output with 'digital output 4' selected is high (closed).
[42]	Set digital out E high	Any output with 'digital output 5' selected is high (closed).
[43]	Set digital out F high	Any output with 'digital output 6' selected is high (closed).
[60]	Reset Counter A	Resets Counter A to zero.
[61]	Reset Counter B	Resets Counter A to zero.
[70]	Start Timer 3	Starts timer 3, see par.13-20 <i>SL Controller Timer</i> for further description.
[71]	Start Timer 4	Starts timer 4, see par.13-20 <i>SL Controller Timer</i> for further description.
[72]	Start Timer 5	Starts timer 5, see par.13-20 <i>SL Controller Timer</i> for further description.
[73]	Start Timer 6	Starts timer 6, see par.13-20 <i>SL Controller Timer</i> for further description.
[74]	Start Timer 7	Starts timer 7, see par.13-20 <i>SL Controller Timer</i> for further description.
[80]	Sleep Mode	

3.14 Main Menu - Special Functions -Group 14

3.14.1 14-** Special Functions

Parameter group for configuring special adjustable frequency drive functions.

3

3.14.2 Inverter Switching 14-0*

Parameters for configuring the inverter switching.

14-00 Switching Pattern

Option:
Function:

Select the switching pattern: 60° AVM or SFAVM.

[0] * 60 AVM

[1] SFAVM

14-01 Switching Frequency

Option:
Function:

Select the inverter switching frequency. Changing the switching frequency can help to reduce acoustic noise from the motor.

NOTE!

The output frequency value of the adjustable frequency drive must never exceed 1/10 of the switching frequency. When the motor is running, adjust the switching frequency in par.14-01 *Switching Frequency* until the motor is as noiseless as possible. See also par.14-00 *Switching Pattern* and the section *Derating*.

[0] 1.0 kHz

[1] 1.5 kHz

[2] 2.0 kHz

[3] 2.5 kHz

[4] 3.0 kHz

[5] 3.5 kHz

[6] 4.0 kHz

[7] * 5.0 kHz

[8] 6.0 kHz

[9] 7.0 kHz

[10] 8.0 kHz

[11] 10.0 kHz

[12] 12.0 kHz

[13] 14.0 kHz

[14] 16.0 kHz

14-03 Overmodulation

Option:	Function:
[0] Off	Selects no overmodulation of the output voltage in order to avoid torque ripple on the motor shaft.
[1] * On	The overmodulation function generates an extra voltage of up to 8% of U_{max} output voltage without overmodulation, which results in an extra torque of 10–12% in the middle of the oversynchronous range (from 0% at nominal speed rising to approximately 12% at double nominal speed).

14-04 PWM Random

Option:	Function:
[0] * Off	No change of the acoustic motor switching noise.
[1] On	Transforms the acoustic motor switching noise from a clear ringing tone to a less noticeable 'white' noise. This is achieved by slightly and randomly altering the synchronism of the pulse width modulated output phases.

3.14.3 14-1* Line Power On/Off

Parameters for configuring line failure monitoring and handling.

14-10 Line Failure

Option:	Function:
[0] * No function	Select the function at which the adjustable frequency drive must act, when the threshold set in par. 14-11 <i>Line Voltage at Line Fault</i> has been reached or a <i>Line Failure Inverse</i> command is activated via one of the digital inputs (par. 5-1*).
[1] Ctrl. ramp-down	The energy left in the capacitor bank will be used to "drive" the motor, but will be discharged.
[3] Coasting	The adjustable frequency drive will perform a controlled ramp-down. par.2-10 <i>Brake Function</i> must be set to <i>Off</i> [0].
[4] Kinetic backup	The inverter will turn off and the capacitor bank will back up the control card, thus ensuring a faster restart when line power is reconnected (for short power zags).
[4] Kinetic backup	The adjustable frequency drive will ride through by controlling speed for generative operation of the motor utilizing the moment of inertia of the system as long as sufficient energy is present.

 **NOTE!**
 For best performance of controlled ramp-down and kinetic back-up, par.1-03 *Torque Characteristics* should be set to *Compressor* [0] or *Variable Torque* [1] (no automatic energy optimization should be active).

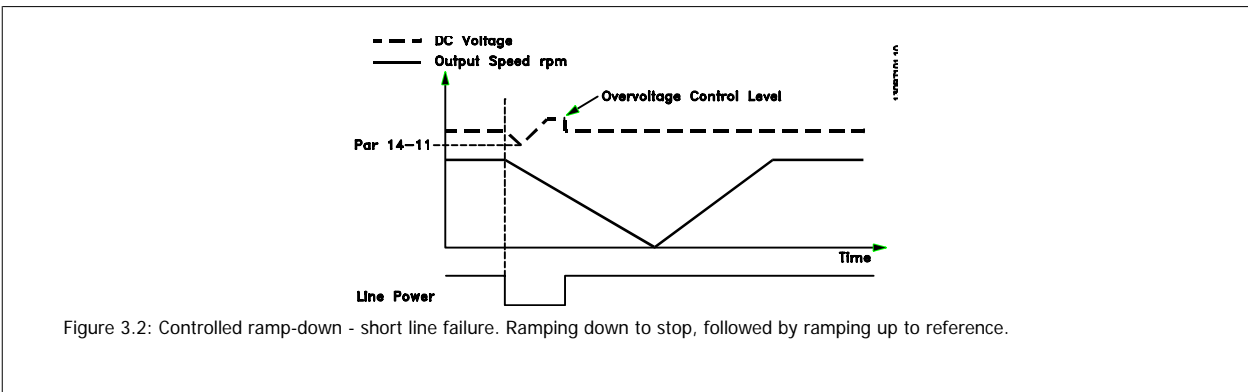

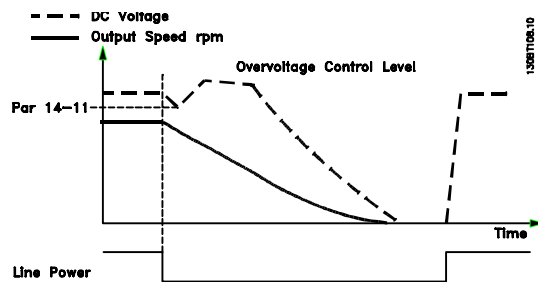

Figure 3.3: Controlled ramp-down, longer line failure. Ramping down as long as the energy in the system allows for it, then the motor is coasted.

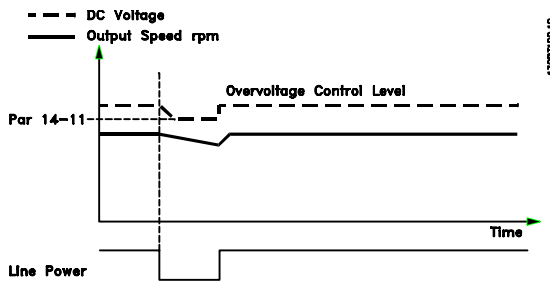

Figure 3.4: Kinetic back-up, short line failure. Ride through as long as the energy in the system allows for it.

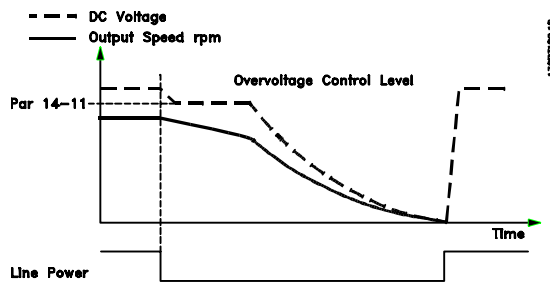

Figure 3.5: Kinetic back-up, longer line failure. The motor is coasted as soon as the energy in the system is too low.

14-11 Line Voltage at Line Fault

Range:

342. V* [180 - 600 V]

Function:

This parameter defines the threshold voltage at which the selected function in par.14-10 *Line Failure* should be activated.

14-12 Function at Mains Imbalance

Option:	Function:
	Operating under severe line imbalance conditions reduces the lifetime of the motor. Conditions are considered severe if the motor operates continuously near nominal load (such as when a pump or fan runs near full speed). When a severe line imbalance is detected:
[0] * Trip	Select <i>Trip</i> [0] to trip the adjustable frequency drive.
[1] Warning	Select <i>Warning</i> [1] to issue a warning.
[2] Disabled	select <i>Disabled</i> [2] for no action.
[3] Derate	Select <i>Derate</i> [3] for derating the adjustable frequency drive.

3.14.4 14-2* Trip Reset

Parameters for configuring auto reset handling, special trip handling and control card self test or initialization.

14-20 Reset Mode

Option:	Function:
	Select the reset function after tripping. Once reset, the adjustable frequency drive can be restarted.
[0] * Manual reset	Select <i>Manual reset</i> [0] to perform a reset via [RESET] or via the digital inputs.
[1] Automatic reset x 1	Select <i>Automatic reset x 1...x20</i> [1]-[12] to perform between one and twenty automatic resets after tripping.
[2] Automatic reset x 2	
[3] Automatic reset x 3	
[4] Automatic reset x 4	
[5] Automatic reset x 5	
[6] Automatic reset x 6	
[7] Automatic reset x 7	
[8] Automatic reset x 8	
[9] Automatic reset x 9	
[10] Automatic reset x 10	
[11] Automatic reset x 15	
[12] Automatic reset x 20	
[13] Infinite auto reset	Select <i>Infinite Automatic Reset</i> [13] for continuous resetting after tripping.

 **NOTE!**
The motor may start without warning. If the specified number of AUTOMATIC RESETS is reached within 10 minutes, the adjustable frequency drive enters Manual reset [0] mode. After the Manual reset is performed, the setting of par.14-20 *Reset Mode* reverts to the original selection. If the number of automatic resets is not reached within 10 minutes, or when a Manual reset is performed, the internal AUTOMATIC RESET counter returns to zero.

 **NOTE!**
Automatic reset will also be active for resetting safe stop function in firmware version < 4.3x.

**NOTE!**

The setting in par.14-20 *Reset Mode* is disregarded in case fire mode is active (see par. 24-0*, Fire Mode).

14-21 Automatic Restart Time

Range:

10 s* [0 - 600 s]

Function:

Enter the time interval from trip to start of the automatic reset function. This parameter is active when par.14-20 *Reset Mode* is set to *Automatic reset* [1] - [13].

14-22 Operation Mode

Option:**Function:**

Use this parameter to specify normal operation, to perform tests or to initialize all parameters except par.15-03 *Power-ups*, par.15-04 *Over Temps* and par.15-05 *Over Volts*. This function is active only when the power is cycled (power off-power on) to the adjustable frequency drive.

[0] * Normal operation

Select *Normal operation* [0] for normal operation of the adjustable frequency drive with the motor in the selected application.

[1] Control card test

Select *Control card test* [1] to test the analog and digital inputs and outputs and the +10 V control voltage. The test requires a test connector with internal connections.

Use the following procedure for the control card test:

1. Select *Control card test* [1].
2. Disconnect the line power supply and wait for the light in the display to go out.
3. Set switches S201 (A53) and S202 (A54) = 'ON' / I.
4. Insert the test plug (see below).
5. Connect to the line power supply.
6. Carry out various tests.
7. The results are displayed on the LCP and the adjustable frequency drive moves into an infinite loop.
8. par.14-22 *Operation Mode* is automatically set to normal operation. Carry out a power cycle to start up in normal operation after a control card test.

If the test is OK:

LCP readout: Control Card OK.

Disconnect the line power supply and remove the test plug. The green LED on the control card will light up.

If the test fails:

LCP readout: Control Card I/O failure.

Replace the adjustable frequency drive or control card. The red LED on the control card is turned on. To test the plugs, connect/group the following terminals as shown below: (18 - 27 - 32), (19 - 29 - 33) and (42 - 53 - 54).

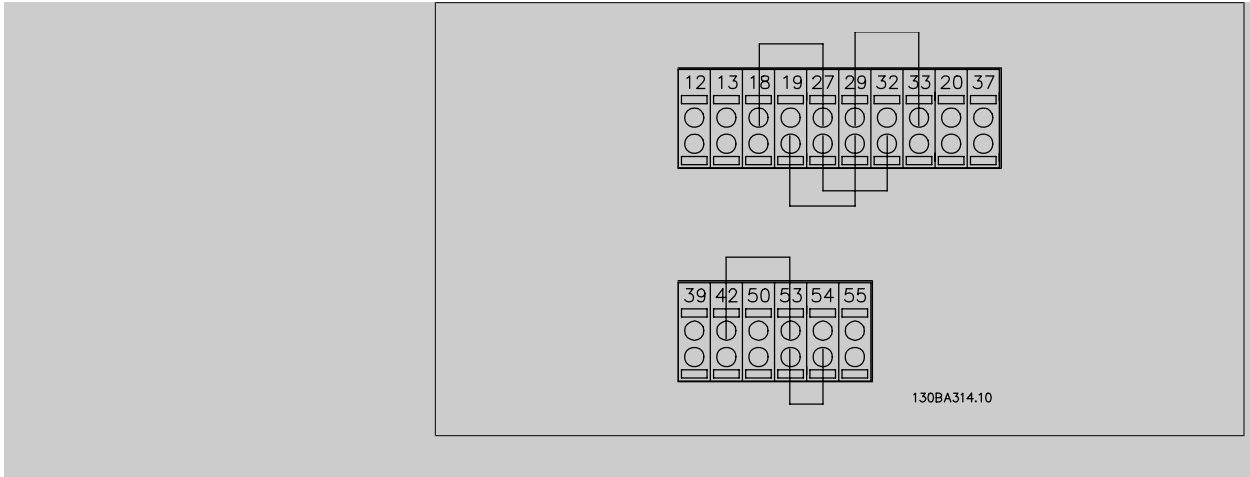

[2] Initialization Select *Initialization* [2] to reset all parameter values to default settings, except for par.15-03 *Power-ups*, par.15-04 *Over Temps* and par.15-05 *Over Volts*. The adjustable frequency drive will reset during the next power-up.
par.14-22 *Operation Mode* will also revert to the default setting *Normal operation* [0].

[3] Boot mode

14-25 Trip Delay at Torque Limit

Range:

60 s* [0 - 60 s]

Function:

Enter the torque limit trip delay in seconds. When the output torque reaches the torque limits (par. 4-16 *Torque Limit Motor Mode* and par. 4-17 *Torque Limit Generator Mode*), a warning is triggered. When the torque limit warning has been continuously present for the period specified in this parameter, the adjustable frequency drive trips. Disable the trip delay by setting the parameter to 60 s = OFF. Thermal adjustable frequency drive monitoring will still remain active.

14-26 Trip Delay at Inverter Fault

Range:

0. s* [0 - 35 s]

Function:

When the adjustable frequency drive detects an overvoltage in the set time, tripping will be affected after the set time.

14-29 Service Code

Range:

0 N/A* [-2147483647 - 2147483647 N/A]

Function:

Service use only.

3.14.5 14-3* Current Limit Control

The adjustable frequency drive features an integral current limit controller which is activated when the motor current, and thus the torque, is higher than the torque limits set in par.4-16 *Torque Limit Motor Mode* and par.4-17 *Torque Limit Generator Mode*.

When the current limit is reached during motor operation or regenerative operation, the adjustable frequency drive will try to reduce torque below the preset torque limits as quickly as possible without losing control of the motor.

While the current control is active, the adjustable frequency drive can only be stopped by setting a digital input to *Coast inverse* [2] or *Coast and reset inv.* [3]. Any signal on terminals 18 to 33 will not be active until the adjustable frequency drive is no longer near the current limit.

By using a digital input set to *Coast inverse* [2] or *Coast and reset inv.* [3], the motor does not use the ramp-down time, since the adjustable frequency drive is coasted.

14-30 Current Lim Cont, Proportional Gain

Range:

100 %* [0 - 500 %]

Function:

Enter the proportional gain value for the current limit controller. Selection of a high value makes the controller react faster. Too high a setting leads to controller instability.

14-31 Current Lim Contr, Integration Time

Range:

0.020 s* [0.002 - 2.000 s]

Function:

Controls the current limit control integration time. Setting it to a lower value makes it react faster. A setting too low leads to control instability.

3.14.6 14-4*Energy Optimization

Parameters for adjusting the energy optimization level in both Variable Torque (VT) and Automatic Energy Optimization (AEO) mode.

Automatic Energy Optimization is only active if par.1-03 *Torque Characteristics*, is set for either *Auto Energy Optim. Compressor* [2] or *Auto Energy Optim. VT* [3].

14-40 VT Level

Range:

66 %* [40 - 90 %]

Function:

Enter the level of motor magnetization at low speed. Selection of a low value reduces energy loss in the motor, but also reduces load capability. This parameter cannot be adjusted while the motor is running.

14-41 AEO Minimum Magnetization

Range:

40. %* [40 - 75 %]

Function:

Enter the minimum allowable magnetization for AEO. Selection of a low value reduces energy loss in the motor, but can also reduce resistance to sudden load changes.

14-42 Minimum AEO Frequency

Range:

10 Hz* [5 - 40 Hz]

Function:

Enter the minimum frequency at which the Automatic Energy Optimization (AEO) is to be active.

14-43 Motor Cos-Phi

Range:

0.66 N/A* [0.40 - 0.95 N/A]

Function:

The cos(phi) setpoint is automatically set for optimum AEO performance during AMA. This parameter should normally not be altered. However, in some situations it may be necessary to enter a new value to fine tune.

3.14.7 14-5* Environment

These parameters help the adjustable frequency drive to operate under special environmental conditions.

14-50 RFI 1

Option:	Function:
[0] Off	Select <i>Off</i> [0] only if the adjustable frequency drive is fed by an isolated line power source, i.e., from a special IT line power source. In this mode, the internal RFI filter capacitors between chassis and the line power RFI filter circuit are cut out to avoid damage to the intermediate circuit and to reduce the ground capacity currents according to IEC 61800-3.
[1] * On	Select <i>On</i> [1] to ensure that the adjustable frequency drive complies with EMC standards.

14-52 Fan Control

Option:	Function:
[0] * Auto	Select the minimum speed of the main fan. Select Auto [0] to run the fan only when the internal temperature of the adjustable frequency drive is in the range 95°F [+35°C] to approximately 131°F [+55°C]. The fan will run at low speed at 95°F [+35°C] and at full speed at approximately 131°F [+55°C].
[1] On 50%	
[2] On 75%	
[3] On 100%	

14-53 Fan Monitor

Option:	Function:
[0] Disabled	Select which action the adjustable frequency drive should take in case a fan fault is detected.
[1] * Warning	
[2] Trip	

3.14.8 14-6* Auto Derate

This group contains parameters for derating the adjustable frequency drive in case of high temperature.

14-60 Function at Overtemperature

Option:	Function:
[0] * Trip	If either heatsink or control card temperature exceeds a factory-programmed temperature limit, a warning will be activated. If the temperature increases further, select whether the adjustable frequency drive should trip (trip locked) or derate the output current. The adjustable frequency drive will trip (trip locked) and generate an alarm. Power must be cycled to reset the alarm, but will not allow restart of the motor until the heatsink temperature has dropped below the alarm limit.
[1] Derate	If the critical temperature is exceeded, the output current will be reduced until the allowable temperature has been reached.

3.14.9 No Trip at Inverter Overload

In some pump systems, the adjustable frequency drive has not been sized properly to yield the current needed in all points of the operational flow-head characteristic. At these points, the pump will need a current higher than the rated current of the adjustable frequency drive. The adjustable frequency drive can yield 110% of the rated current continuously for 60 sec. If still overloaded, the adjustable frequency drive will normally trip (causing the pump to stop by coasting) and provide an alarm.

3

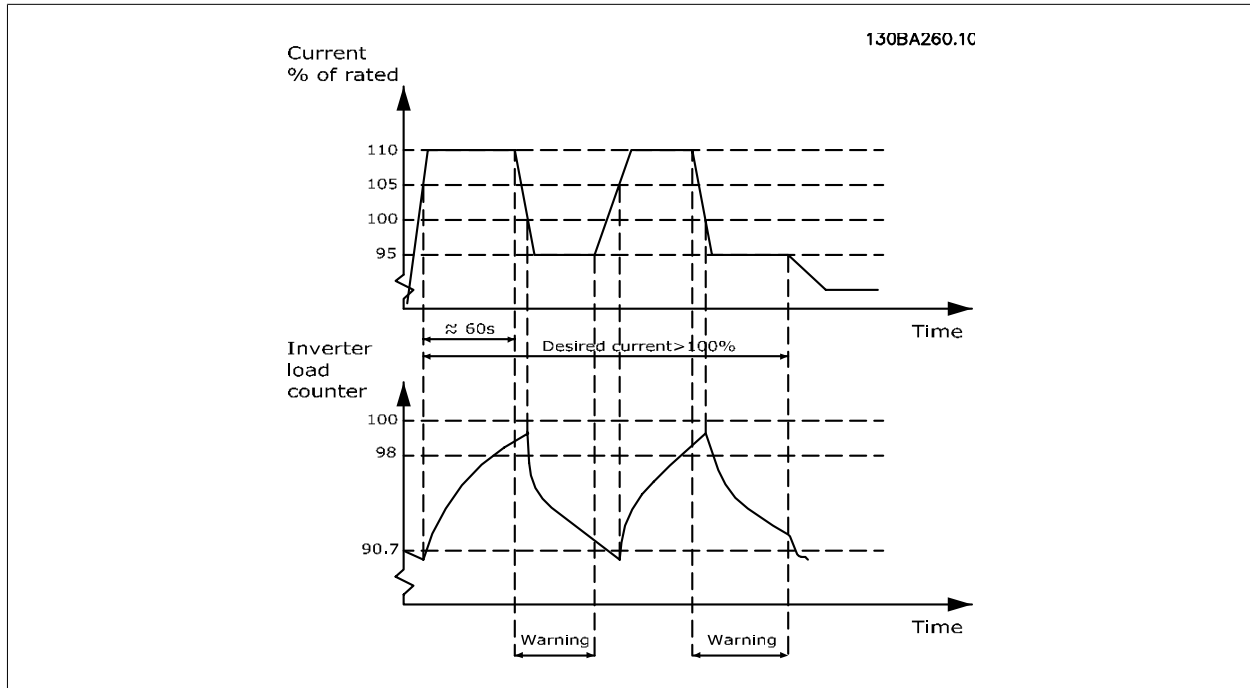

It may be preferable to run the pump at reduced speed for a while in case it is not possible to run continuously at demanded capacity.

Select *Function at Inverter Overload*, par.14-61 *Function at Inverter Overload* to automatically reduce pump speed until the output current is below 100% of the rated current (set in par.14-62 *Inv. Overload Derate Current*).

The *Function at Inverter Overload* is an alternative to letting the adjustable frequency drive trip.

The adjustable frequency drive estimates the load on the power section by means of an inverter load counter, which will cause a warning at 98% and a reset of the warning at 90%. At the value 100%, the adjustable frequency drive trips and provides an alarm.

Status for the counter can be read in par.16-35 *Inverter Thermal*.

If par.14-61 *Function at Inverter Overload* is set to Derate, the pump speed will be reduced when the counter exceeds 98, and stay reduced until the counter has dropped below 90.7.

If par.14-62 *Inv. Overload Derate Current* is set, for example, to 95% a steady overload will cause the pump speed to fluctuate between values corresponding to 110% and 95% of rated output current for the adjustable frequency drive.

14-61 Function at Inverter Overload

Option:

Function:

Is used in case of steady overload beyond the thermal limits (110% for 60 sec.).

[0] * Trip

Choose Trip [0] to make the adjustable frequency drive trip and provide an alarm.

[1] Derate

Derate [1] to reduce pump speed in order to decrease the load on the power section and allowing this to cool down.

14-62 Inv. Overload Derate Current

Range:	Function:
95 %* [50 - 100 %]	Defines the desired current level (in % of rated output current for the adjustable frequency drive) when running with reduced pump speed after load on the adjustable frequency drive has exceeded the allowable limit (110% for 60 sec.).

3.15 Main Menu - Adjustable Frequency Drive Information - Group 15

3.15.1 15-** Drive Information

Parameter group containing adjustable frequency drive information such as operating data, hardware configuration and software versions.

3.15.2 15-0* Operating Data

Parameter group containing operating data, such as operating hours, kWh counters, power-ups, etc.

15-00 Operating Hours

Range:	Function:
0 h* [0 - 2147483647 h]	View how many hours the adjustable frequency drive has run. The value is saved when the adjustable frequency drive is turned off.

15-01 Running Hours

Range:	Function:
0 h* [0 - 2147483647 h]	View how many hours the motor has run. Reset the counter in par.15-07 <i>Reset Running Hours Counter</i> . The value is saved when the adjustable frequency drive is turned off.

15-02 kWh Counter

Range:	Function:
0 kWh* [0 - 2147483647 kWh]	Registering the power consumption of the motor as a mean value over one hour. Reset the counter in par.15-06 <i>Reset kWh Counter</i> .

15-03 Power-ups

Range:	Function:
0 N/A* [0 - 2147483647 N/A]	View the number of times the adjustable frequency drive has been powered up.

15-04 Over Temps

Range:	Function:
0 N/A* [0 - 65535 N/A]	View the number of adjustable frequency drive temperature faults which have occurred.

15-05 Over Volts

Range:	Function:
0 N/A* [0 - 65535 N/A]	View the number of adjustable frequency drive overvoltages which have occurred.

15-06 Reset kWh Counter

Option:	Function:
[0] * Do not reset	Select <i>Do not reset</i> [0] if no reset of the kWh counter is desired.
[1] Reset counter	Select <i>Reset</i> [1] and press [OK] to reset the kWh counter to zero (see par.15-02 <i>kWh Counter</i>).

**NOTE!**

The reset is carried out by pressing [OK].

15-07 Reset Running Hours Counter

Option:	Function:
[0] * Do not reset	Select <i>Do not reset</i> [0] if no reset of the Running Hours counter is desired.
[1] Reset counter	Select <i>Reset counter</i> [1] and press [OK] to reset the Running Hours counter (par.15-01 <i>Running Hours</i>) and par.15-08 <i>Number of Starts</i> to zero (see also par.15-01 <i>Running Hours</i>).

15-08 Number of Starts

Range:	Function:
0 N/A* [0 - 2147483647 N/A]	This is a readout parameter only. The counter shows the numbers of starts and stops caused by a normal Start/Stop command and/or when entering/leaving sleep mode.

**NOTE!**

This parameter will be reset when resetting par.15-07 *Reset Running Hours Counter*.

3.15.3 15-1* Data Log Settings

The Data Log enables continuous logging of up to 4 data sources (par.15-10 *Logging Source*) at individual rates (par.15-11 *Logging Interval*). A trigger event (par.15-12 *Trigger Event*) and window (par.15-14 *Samples Before Trigger*) are used to start and stop the logging conditionally.

15-10 Logging Source

Array [4]

Option:	Function:
	Select which variables are to be logged.
[0] * None	
[1600] Control Word	
[1601] Reference [Unit]	
[1602] Reference %	
[1603] Status Word	
[1610] Power [kW]	
[1611] Power [hp]	
[1612] Motor voltage	
[1613] Frequency	
[1614] Motor Current	
[1616] Torque [Nm]	

[1617]	Speed [RPM]
[1618]	Motor Thermal
[1622]	Torque [%]
[1630]	DC Link Voltage
[1632]	Brake Energy /s
[1633]	Brake Energy /2 min
[1634]	Heatsink Temp.
[1635]	Inverter Thermal
[1650]	External Reference
[1652]	Feedback [Unit]
[1654]	Feedback 1 [Unit]
[1655]	Feedback 2 [Unit]
[1656]	Feedback 3 [Unit]
[1660]	Digital Input
[1662]	Analog Input 53
[1664]	Analog Input 54
[1665]	Analog Output 42 [mA]
[1666]	Digital Output [bin]
[1675]	Analog In X30/11
[1676]	Analog In X30/12
[1677]	Analog Out X30/8 [mA]
[1690]	Alarm Word
[1691]	Alarm word 2
[1692]	Warning Word
[1693]	Warning word 2
[1694]	Ext. Status Word
[1695]	Ext. Status Word 2
[1830]	Analog Input X42/1
[1831]	Analog Input X42/3
[1832]	Analog Input X42/5
[1833]	Analog Out X42/7 [V]
[1834]	Analog Out X42/9 [V]
[1835]	Analog Out X42/11 [V]
[3110]	Bypass Status Word

15-11 Logging Interval

Range:	Function:
0 N/A* [0 - 86400.000 N/A]	Enter the interval in milliseconds between each sampling of the variables to be logged.

15-12 Trigger Event

Option:
Function:

Selects the trigger event. When the trigger event occurs, a window is applied to freeze the log. The log will then retain a specified percentage of samples before the occurrence of the trigger event (par.15-14 *Samples Before Trigger*).

[0] *	FALSE
[1]	TRUE
[2]	Running
[3]	In range
[4]	On reference
[5]	Torque limit
[6]	Current limit
[7]	Out of current range
[8]	Below I low
[9]	Above I high
[10]	Out of speed range
[11]	Below speed low
[12]	Above speed high
[13]	Out of feedb. range
[14]	Below feedb. low
[15]	Above feedb. high
[16]	Thermal warning
[17]	Mains out of range
[18]	Reverse
[19]	Warning
[20]	Alarm (trip)
[21]	Alarm (trip lock)
[22]	Comparator 0
[23]	Comparator 1
[24]	Comparator 2
[25]	Comparator 3
[26]	Logic rule 0
[27]	Logic rule 1
[28]	Logic rule 2
[29]	Logic rule 3
[33]	Digital input DI18
[34]	Digital input DI19
[35]	Digital input DI27
[36]	Digital input DI29
[37]	Digital input DI32
[38]	Digital input DI33
[50]	Comparator 4
[51]	Comparator 5
[60]	Logic rule 4

[61] Logic rule 5

15-13 Logging Mode

Option:

Function:

[0] * Log always

Select *Log always* [0] for continuous logging.

[1] Log once on trigger

Select *Log once on trigger* [1] to conditionally start and stop logging using par.15-12 *Trigger Event* and par.15-14 *Samples Before Trigger*.

15-14 Samples Before Trigger

Range:

Function:

50 N/A* [0 - 100 N/A]

Enter the percentage of all samples prior to a trigger event which are to be retained in the log. See also par.15-12 *Trigger Event* and par.15-13 *Logging Mode*.

3.15.4 15-2* Historic Log

View up to 50 logged data items via the array parameters in this parameter group. For all parameters in the group, [0] is the most recent data and [49] the oldest data. Data is logged every time an *event* occurs (not to be confused with SLC events). *Events* in this context are defined as a change in one of the following areas:

1. Digital input
2. Digital outputs (not monitored in this SW release)
3. Warning word
4. Alarm word
5. Status word
6. Control word
7. Extended status word

Events are logged with value, and time stamp in msec. The time interval between two events depends on how often *events* occur (maximum once every scan time). Data logging is continuous but if an alarm occurs, the log is saved and the values can be viewed on the display. This feature is useful, for example when carrying out service following a trip. View the historic log contained in this parameter via the serial communication port or via the display.

15-20 Historic Log: Event

Array [50]

Range:

Function:

0 N/A* [0 - 255 N/A]

View the event type of the logged events.

15-21 Historic Log: Value

Array [50]

Range:

0 N/A* [0 - 2147483647 N/A]

Function:

View the value of the logged event. Interpret the event values according to this table:

Digital input	Decimal value. See par. 16-60 <i>Digital Input</i> for description after converting to binary value.
Digital output (not monitored in this SW release)	Decimal value. See par. DR-66 <i>Digital Output [bin]</i> for description after converting to binary value.
Warning word	Decimal value. See par. DR-92 <i>Warning Word</i> for description.
Alarm word	Decimal value. See par. DR-90 <i>Alarm Word</i> for description.
Status word	Decimal value. See par. 16-03 <i>Status Word</i> for description after converting to binary value.
Control word	Decimal value. See par. 16-00 <i>Control Word</i> for description.
Extended status word	Decimal value. See par. DR-94 <i>Ext. Status Word</i> for description.

15-22 Historic Log: Time

Array [50]

Range:

0 ms* [0 - 2147483647 ms]

Function:

View the time at which the logged event occurred. Time is measured in ms since adjustable frequency drive start. The max. value corresponds to approx. 24 days which means that the count will restart at zero after this time period.

3.15.5 15-3* Alarm Log

Parameters in this group are array parameters, where up to 10 fault logs can be viewed. [0] is the most recent logged data, and [9] the oldest. Error codes, values and time stamp can be viewed for all logged data.

15-30 Alarm Log: Error Code

Array [10]

Range:

0 N/A* [0 - 255 N/A]

Function:View the error code and look up its meaning in the *Troubleshooting* chapter.

15-31 Alarm Log: Value

Array [10]

Range:

0 N/A* [-32767 - 32767 N/A]

Function:

View an extra description of the error. This parameter is mostly used in combination with alarm 38 'internal fault'.

15-32 Alarm Log: Time

Array [10]

Range:

0 s* [0 - 2147483647 s]

Function:

View the time when the logged event occurred. Time is measured in seconds from adjustable frequency drive start-up.

15-33 Alarm Log: Date and Time

Range:

0 N/A* [0 - 0 N/A]

Function:

Array parameter; Date & Time 0-9: This parameter shows at which time the logged event occurred.

3.15.6 15-4* Drive Identification

Parameters containing read only information about the hardware and software configuration of the adjustable frequency drive.

15-40 FC Type		
Range:		Function:
0 N/A* [0 - 0 N/A]		View the adjustable frequency drive type. The readout is identical to the adjustable frequency drive series power field of the type code definition, characters 1-6.
15-41 Power Section		
Range:		Function:
0 N/A* [0 - 0 N/A]		View the adjustable frequency drive type. The readout is identical to the adjustable frequency drive series power field of the type code definition, characters 7-10.
15-42 Voltage		
Range:		Function:
0 N/A* [0 - 0 N/A]		View the adjustable frequency drive type. The readout is identical to the adjustable frequency drive series power field of the type code definition, characters 11-12.
15-43 Software Version		
Range:		Function:
0 N/A* [0 - 0 N/A]		View the combined SW version (or 'package version') consisting of power SW and control SW.
15-44 Ordered Typecode String		
Range:		Function:
0 N/A* [0 - 0 N/A]		View the type code string used for re-ordering the adjustable frequency drive in its original configuration.
15-45 Actual Typecode String		
Range:		Function:
0 N/A* [0 - 0 N/A]		View the actual type code string.
15-46 Adj Freq Dr Ordering No.		
Range:		Function:
0 N/A* [0 - 0 N/A]		View the 8-digit ordering number used for re-ordering the adjustable frequency drive in its original configuration.
15-47 Power Card Ordering No.		
Range:		Function:
0 N/A* [0 - 0 N/A]		View the power card ordering number.
15-48 LCP ID Num.		
Range:		Function:
0 N/A* [0 - 0 N/A]		View the LCP ID number.
15-49 SW ID Control Card		
Range:		Function:
0 N/A* [0 - 0 N/A]		View the control card software version number.

15-50 SW ID Power Card**Range:**

0 N/A* [0 - 0 N/A]

Function:

View the power card software version number.

15-51 Adj Freq Dr Serial No.**Range:**

0 N/A* [0 - 0 N/A]

Function:

View the adjustable frequency drive serial number.

15-53 Power Card Serial Number**Range:**

0 N/A* [0 - 0 N/A]

Function:

View the power card serial number.

3.15.7 15-6* Option Ident.

This read-only parameter group contains information about the hardware and software configuration of the options installed in slots A, B C0 and C1.

15-60 Option Mounted**Range:**

0 N/A* [0 - 0 N/A]

Function:

View the installed option type.

15-61 Option SW Version**Range:**

0 N/A* [0 - 0 N/A]

Function:

View the installed option software version.

15-62 Option Ordering No**Range:**

0 N/A* [0 - 0 N/A]

Function:

Shows the ordering number for the installed options.

15-63 Option Serial No**Range:**

0 N/A* [0 - 0 N/A]

Function:

View the installed option serial number.

3.15.8 15-9* Parameter Info

Parameter lists

15-92 Defined Parameters

Array [1000]

Range:

0 N/A* [0 - 9999 N/A]

Function:

View a list of all defined parameters in the adjustable frequency drive. The list ends with 0.

15-93 Modified Parameters

Array [1000]

Range:

0 N/A* [0 - 9999 N/A]

Function:

View a list of the parameters that have been changed from their default setting. The list ends with 0. Changes may not be visible until up to 30 seconds after implementation.

15-99 Parameter Metadata

Array [23]

Range:

0 N/A* [0 - 9999 N/A]

Function:

This parameter contains data used by the MCT10 software tool.

3.16 Main Menu - Data Readouts - Group 16

3.16.1 16-** Data Readouts

Parameter group for data readouts, such as current references, voltages, control, alarm, warning and status words.

3.16.2 16-0* General Status

Parameters for reading the general status, such as the calculated reference, the active control word and status.

16-00 Control Word

Range:

0 N/A* [0 - 65535 N/A]

Function:

View the control word sent from the adjustable frequency drive via the serial communication port in hex code.

16-01 Reference [Unit]

Range:

0.000 Ref- [-999999.000 - 999999.000 ReferenceFeed-enceFeedbackUnit] backUnit*

Function:

View the present reference value applied on impulse or analog basis in the unit resulting from the configuration selected in par.1-00 *Configuration Mode* (Hz, Nm or RPM).

16-02 Reference %

Range:

0.0 %* [-200.0 - 200.0 %]

Function:

16-03 Status Word

Range:

0 N/A* [0 - 65535 N/A]

Function:

View the status word sent from the adjustable frequency drive via the serial communication port in hex code.

16-05 Main Actual Value [%]

Range:

0.00 %* [-100.00 - 100.00 %]

Function:

View the two-byte word sent with the status word to the bus master reporting the main actual value.

16-09 Custom Readout

Range:
0.00 Cus- [-999999.99 - 999999.99 Custom-
tomReadou-ReadoutUnit]
tUnit*
Function:
View the user-defined readouts as defined in par.0-30 *Custom Readout Unit*, par.0-31 *Custom Readout Min Value* and par.0-32 *Custom Readout Max Value*.

3.16.3 16-1* Motor Status

Parameters for reading the motor status values.

16-10 Power [kW]

Range:

0.00 kW* [0.00 - 1000.00 kW]

Function:

View the motor power in kW. The value shown is calculated on the basis of the actual motor voltage and motor current. The value is filtered, and therefore approx. 30 ms may pass from when an input value changes to when the data readout values change.

16-11 Power [hp]

Range:

0.00 hp* [0.00 - 1000.00 hp]

Function:

View the motor power in HP. The value shown is calculated on the basis of the actual motor voltage and motor current. The value is filtered, and therefore approximately 30 ms may pass from when an input value changes to when the data readout values change.

16-12 Motor voltage

Range:

0.0 V* [0.0 - 6000.0 V]

Function:

View the motor voltage, a calculated value used for controlling the motor.

16-13 Frequency

Range:

0.0 Hz* [0.0 - 6500.0 Hz]

Function:

View the motor frequency, without resonance dampening.

16-14 Motor Current

Range:

0.00 A* [0.00 - 1856.00 A]

Function:

View the motor current measured as a mean value, IRMS. The value is filtered, and thus approximately 30 ms may pass from when an input value changes to when the data readout values change.

16-15 Frequency [%]

Range:

0.00 %* [-100.00 - 100.00 %]

Function:

16-16 Torque [Nm]**Range:**

0.0 Nm* [-30000.0 - 30000.0 Nm]

Function:

View the torque value with sign, applied to the motor shaft. Linearity is not exact between 110% motor current and torque in relation to the rated torque. Some motors supply more than 160% torque. Consequently, the minimum and maximum values will depend on the maximum motor current, as well as the motor type being used. The value is filtered, and thus approx. 1.3 seconds may pass from when an input changes value to when the data readout values change.

16-17 Speed [RPM]**Range:**

0 RPM* [-30000 - 30000 RPM]

Function:

View the current motor RPM.

16-18 Motor Thermal**Range:**

0 %* [0 - 100 %]

Function:

View the calculated thermal load on the motor. The cut-out limit is 100%. The basis for calculation is the ETRElectronic Thermal Overload function selected in par.1-90 *Motor Thermal Protection*.

16-22 Torque [%]**Range:**

0 %* [-200 - 200 %]

Function:

This is a readout parameter only.

Shows the actual torque yielded in percentage of the rated torque, based on the setting of the motor size and rated speed in par.1-20 *Motor Power [kW]* or par.1-21 *Motor Power [HP]* and par.1-25 *Motor Nominal Speed*.

This is the value monitored by the *Broken Belt Function* set in par. 22-6*.

3.16.4 16-3* Drive Status

Parameters for reporting the status of the adjustable frequency drive.

16-30 DC Link Voltage**Range:**

0 V* [0 - 10000 V]

Function:

View a measured value. The value is filtered with an 30 ms time constant.

16-32 Brake Energy /s**Range:**

0.000 kW* [0.000 - 675000.000 kW]

Function:

View the braking energy transmitted to an external brake resistor, stated as an instantaneous value.

16-33 Brake Energy /2 min**Range:**

0.000 kW* [0.000 - 500.000 kW]

Function:

View the braking energy transmitted to an external brake resistor. The mean power is calculated on an average basis for the most recent 120 seconds.

16-34 Heatsink Temp.**Range:**

0 C* [0 - 255 C]

Function:

16-35 Inverter Thermal**Range:**

0 %* [0 - 100 %]

Function:

View the percentage load on the inverter.

16-36 Inv. Nom. Current**Range:**

10.00 A* [0.01 - 10000.00 A]

Function:

View the inverter nominal current, which should match the nameplate data on the connected motor. The data is used for motor protection, calculating torque, etc.

16-37 Inv. Max. Current**Range:**

16.00 A* [0.01 - 10000.00 A]

Function:

View the inverter maximum current, which should match the nameplate data on the connected motor. The data is used for motor protection, calculating torque, etc.

16-38 SL Controller State**Range:**

0 N/A* [0 - 100 N/A]

Function:

View the state of the event under execution by the SL controller.

16-39 Control Card Temp.**Range:**

0 C* [0 - 100 C]

Function:**16-40 Logging Buffer Full****Option:**

[0] * No

[1] Yes

Function:View whether the logging buffer is full (see par. 15-1*). The logging buffer will never be full when par.15-13 *Logging Mode* is set to *Log always* [0].**3.16.5 16-5* Ref. & Feedb.**

Parameters for reporting the reference and feedback input.

16-50 External Reference**Range:**

0.0 N/A* [-200.0 - 200.0 N/A]

Function:

View the total reference, the sum of digital, analog, preset, bus and freeze references, plus catch-up and slow-down.

16-52 Feedback [Unit]**Range:**

0.000 Proc-essCtrlUnit [-999999.999 - 999999.999 Proc-essCtrlUnit]

Function:View value of resulting feedback value after processing of Feedback 1-3 (see par.16-54 *Feedback 1 [Unit]*, par.16-55 *Feedback 2 [Unit]* and par. 16-56) in the feedback manager.

nit*

See par. 20-0* *Feedback*.The value is limited by settings in par. 20-13 and par. 20-14. Units as set in par.20-12 *Reference/Feedback Unit*.

16-53 Digi Pot Reference

Range:	Function:
0.00 N/A* [-200.00 - 200.00 N/A]	View the contribution of the digital potentiometer to the actual reference.

16-54 Feedback 1 [Unit]

Range:	Function:
0.000 Proc- [-999999.999 - 999999.999 Proc- essCtrlU- essCtrlUnit] nit*	View value of Feedback 1, see par. 20-0* <i>Feedback</i> . The value is limited by settings in par. and par. . Units as set in par.20-12 <i>Reference/Feedback Unit</i> .

16-55 Feedback 2 [Unit]

Range:	Function:
0.000 Proc- [-999999.999 - 999999.999 Proc- essCtrlU- essCtrlUnit] nit*	View value of Feedback 2, see par. 20-0* <i>Feedback</i> . The value is limited by settings in par. 20-13 and par. 20-14. Units as set in par.20-12 <i>Reference/Feedback Unit</i> .

16-56 Feedback 3 [Unit]

Range:	Function:
0.000 Proc- [-999999.999 - 999999.999 Proc- essCtrlU- essCtrlUnit] nit*	View value of Feedback 3, see par. 20-0* <i>Feedback</i> . The value is limited by settings in par.20-13 <i>Minimum Reference/Feedb.</i> and par.20-14 <i>Maximum Reference/Feedb.</i> . Units as set in par.20-12 <i>Reference/Feedback Unit</i> .

16-58 PID Output [%]

Range:	Function:
0.0 %* [0.0 - 100.0 %]	This parameter returns the Drive Closed-loop PID controller output value in percent.

3.16.6 16-6* Inputs and Outputs

Parameters for reporting the digital and analog IO ports.

16-60 Digital Input

Range:

0 N/A* [0 - 1023 N/A]

Function:

View the signal states from the active digital inputs. Example: Input 18 corresponds to bit no. 5, '0' = no signal, '1' = connected signal. Bit 6 works in the opposite way, on = '0', off = '1' (safe stop input).

Bit 0	Digital input term. 33
Bit 1	Digital input term. 32
Bit 2	Digital input term. 29
Bit 3	Digital input term. 27
Bit 4	Digital input term. 19
Bit 5	Digital input term. 18
Bit 6	Digital input term. 37
Bit 7	Digital input GP I/O term. X30/4
Bit 8	Digital input GP I/O term. X30/3
Bit 9	Digital input GP I/O term. X30/2
Bit 10-63	Reserved for future terminals

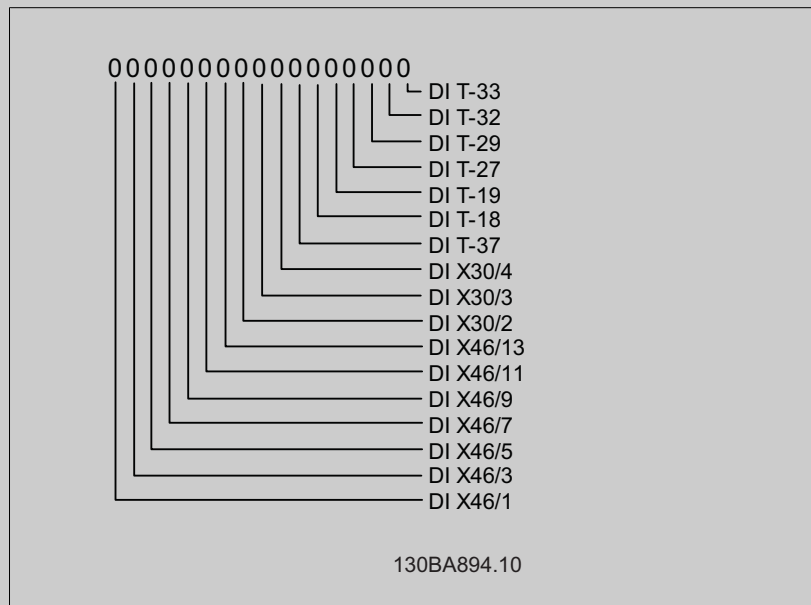

16-61 Terminal 53 Switch Setting

Option:

Function:

View the setting of input terminal 53. Current = 0; Voltage = 1.

[0] * Current

[1] Voltage

[2] Pt 1000 [°C]

[3] Pt 1000 [°F]

[4] Ni 1000 [°C]

[5] Ni 1000 [°F]

16-62 Analog Input 53

Range:	Function:
0.000 N/A* [-20.000 - 20.000 N/A]	View the actual value at input 53.

16-63 Terminal 54 Switch Setting

Option:	Function:
	View the setting of input terminal 54. Current = 0; Voltage = 1.

- [0] * Current
- [1] Voltage
- [2] Pt 1000 [°C]
- [3] Pt 1000 [°F]
- [4] Ni 1000 [°C]
- [5] Ni 1000 [°F]

16-64 Analog Input 54

Range:	Function:
0.000 N/A* [-20.000 - 20.000 N/A]	View the actual value at input 54.

16-65 Analog Output 42 [mA]

Range:	Function:
0.000 N/A* [0.000 - 30.000 N/A]	View the actual value at output 42 in mA. The value shown reflects the selection in par.6-50 <i>Terminal 42 Output</i> .

16-66 Digital Output [bin]

Range:	Function:
0 N/A* [0 - 15 N/A]	View the binary value of all digital outputs.

16-67 Pulse Input #29 [Hz]

Range:	Function:
0 N/A* [0 - 130000 N/A]	View the actual frequency rate on terminal 29.

16-68 Pulse Input #33 [Hz]

Range:	Function:
0 N/A* [0 - 130000 N/A]	View the actual value of the frequency applied at terminal 33 as an impulse input.

16-69 Pulse Output #27 [Hz]

Range:	Function:
0 N/A* [0 - 40000 N/A]	View the actual value of impulses applied to terminal 27 in digital output mode.

16-70 Pulse Output #29 [Hz]

Range:	Function:
0 N/A* [0 - 40000 N/A]	View the actual value of pulses to terminal 29 in digital output mode.

16-71 Relay Output [bin]

Range:

0 N/A* [0 - 31 N/A]

Function:

View the settings of all relays.

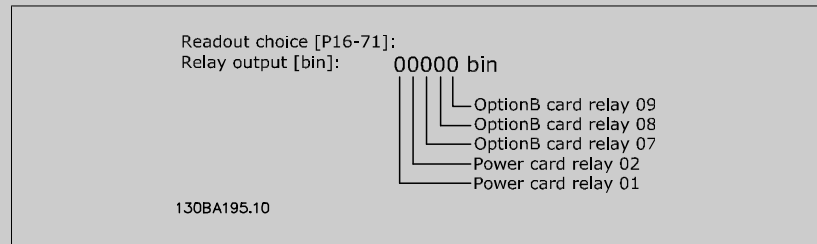

16-72 Counter A

Range:

0 N/A* [-2147483648 - 2147483647 N/A]

Function:

View the present value of Counter A. Counters are useful as comparator operands, see par. 13-10 *Comparator Operand*.

The value can be reset or changed either via digital inputs (parameter group 5-1*) or by using an SLC action (par.13-52 *SL Controller Action*).

16-73 Counter B

Range:

0 N/A* [-2147483648 - 2147483647 N/A]

Function:

View the present value of Counter B. Counters are useful as comparator operands (par.13-10 *Comparator Operand*).

The value can be reset or changed either via digital inputs (parameter group 5-1*) or by using an SLC action (par.13-52 *SL Controller Action*).

16-75 Analog In X30/11

Range:

0.000 N/A* [-20.000 - 20.000 N/A]

Function:

View the actual value at input X30/11 of MCB 101.

16-76 Analog In X30/12

Range:

0.000 N/A* [-20.000 - 20.000 N/A]

Function:

View the actual value at input X30/12 of MCB 101.

16-77 Analog Out X30/8 [mA]

Range:

0.000 N/A* [0.000 - 30.000 N/A]

Function:

View the actual value at input X30/8 in mA.

3.16.7 16-8* Ser. Com. Bus & Adjustable Frequency Drive Port

Parameters for reporting the BUS references and control words.

16-80 Fieldbus CTW 1

Range:

0 N/A* [0 - 65535 N/A]

Function:

View the two-byte control word (CTW) received from the bus master. Interpretation of the control word depends on the serial communication bus option installed and the control word profile selected in par.8-10 *Control Profile*.

For more information, refer to the relevant serial communication bus manual.

16-82 Fieldbus REF 1		
Range:		Function:
0 N/A* [-200 - 200 N/A]		View the two-byte word sent with the control word from the bus master to set the reference value. For more information, refer to the relevant serial communication bus manual.
16-84 Comm. Option Status		
Range:		Function:
0 N/A* [0 - 65535 N/A]		View the extended serial communication bus comm. option status word. For more information, refer to the relevant serial communication bus manual.
16-85 FC Port CTW 1		
Range:		Function:
0 N/A* [0 - 65535 N/A]		View the two-byte control word (CTW) received from the bus master. Interpretation of the control word depends on the serial communication bus option installed and the control word profile selected in par.8-10 <i>Control Profile</i> .
16-86 FC Port REF 1		
Range:		Function:
0 N/A* [-200 - 200 N/A]		View the two-byte status word (STW) sent to the bus master. Interpretation of the status word depends on the serial communication bus option installed and the control word profile selected in par.8-10 <i>Control Profile</i> .

3.16.8 16-9* Diagnosis Readouts

Parameters displaying alarm, warning and extended status words.

16-90 Alarm Word		
Range:		Function:
0 N/A* [0 - 4294967295 N/A]		View the alarm word sent via the serial communication port in hex code.
16-91 Alarm word 2		
Range:		Function:
0 N/A* [0 - 4294967295 N/A]		View the alarm word 2 sent via the serial communication port in hex code.
16-92 Warning Word		
Range:		Function:
0 N/A* [0 - 4294967295 N/A]		View the warning word sent via the serial communication port in hex code.
16-93 Warning word 2		
Range:		Function:
0 N/A* [0 - 4294967295 N/A]		View the warning word 2 sent via the serial communication port in hex code.
16-94 Ext. Status Word		
Range:		Function:
0 N/A* [0 - 4294967295 N/A]		Returns the extended status word sent via the serial communication port in hex code.

16-95 Ext. Status Word 2

Range:

0 N/A* [0 - 4294967295 N/A]

Function:

Returns the extended warning word 2 sent via the serial communication port in hex code.

16-96 Maintenance Word

Range:

0 N/A* [0 - 4294967295 N/A]

Function:

Readout of the Preventive Maintenance Word. The bits reflect the status for the programmed preventive maintenance events in parameter group 23-1*. 13 bits represent combinations of all the possible items:

- Bit 0: Motor bearings
- Bit 1: Pump bearings
- Bit 2: Fan bearings
- Bit 3: Valve
- Bit 4: Pressure transmitter
- Bit 5: Flow transmitter
- Bit 6: Temperature transmitter
- Bit 7: Pump seals
- Bit 8: Fan belt
- Bit 9: Filter
- Bit 10: Drive cooling fan
- Bit 11: Drive system health check
- Bit 12: Warranty
- Bit 13: Maintenance Text 0
- Bit 14: Maintenance Text 1
- Bit 15: Maintenance Text 2
- Bit 16: Maintenance Text 3
- Bit 17: Maintenance Text 4

Position 4→	Valve	Fan bearings	Pump bearings	Motor bearings
Position 3 →	Pump seals	Temperature transmitter	Flow transmitter	Pressure transmitter
Position 2 →	Drive system health check	Drive cooling fan	Filter	Fan belt
Position 1→				Warranty
0 _{hex}	-	-	-	-
1 _{hex}	-	-	-	+
2 _{hex}	-	-	+	-
3 _{hex}	-	-	+	+
4 _{hex}	-	+	-	-
5 _{hex}	-	+	-	+
6 _{hex}	-	+	+	-
7 _{hex}	-	+	+	+
8 _{hex}	+	-	-	-
9 _{hex}	+	-	-	+
A _{hex}	+	-	+	-
B _{hex}	+	-	+	+
C _{hex}	+	+	-	-
D _{hex}	+	+	-	+
E _{hex}	+	+	+	-
F _{hex}	+	+	+	+

Example:

The Preventive Maintenance Word shows 040A_{hex}.

Position	1	2	3	4
hex value	0	4	0	A

The first digit 0 indicates that no items from the fourth row requires maintenance
 The second digit 4 refers to the third row indicating that the drive cooling fan requires maintenance
 The third digit 0 indicates that no items from the second row requires maintenance
 The fourth digit A refers to the top row indicating that the valve and the pump bearings require maintenance

3.17 Main Menu - Data Readouts 2 - Group 18

3.17.1 18-0* Maintenance Log

This group contains the last 10 preventive maintenance logs. Maintenance Log 0 is the latest log and Maintenance Log 9 the oldest.

By selecting one of the logs and pressing OK, the maintenance item, action and time of the occurrence can be found in par.18-00 *Maintenance Log: Item* – par.18-03 *Maintenance Log: Date and Time*.

The Alarm log button on the LCP allows access to both the Alarm log and Maintenance log.

18-00 Maintenance Log: Item

Array [10]

Range:

0 N/A* [0 - 255 N/A]

Function:

Locate the meaning of the maintenance item in the description of par.23-10 *Maintenance Item*.

18-01 Maintenance Log: Action

Array [10]

Range:

0 N/A* [0 - 255 N/A]

Function:

Locate the meaning of the maintenance item in the description of par.23-11 *Maintenance Action*.

18-02 Maintenance Log: Time

Array [10]

Range:

0 s* [0 - 2147483647 s]

Function:

Shows when the logged event occurred. Time is measured in seconds since last power-up.

18-03 Maintenance Log: Date and Time

Array [10]

Range:

0 N/A* [0 - 0 N/A]

Function:

Shows when the logged event occurred.



NOTE!

This requires that the date and time is programmed in par.0-70 *Set Date and Time*.

The date format depends on the setting in par.0-71 *Date Format*, while the time format depends on the setting in par.0-72 *Time Format*.



NOTE!

The adjustable frequency drive has no back-up of the clock function and the set date/time will reset to default (2000-01-01 00:00) after a power-down unless a Real Time Clock module with back-up is installed. In par.0-79 *Clock Fault*, it is possible to program for a warning in case clock has not been set properly, e.g., after a power-down. Setting the clock incorrectly will affect the time stamps for the maintenance events.

**NOTE!**

When mounting an Analog I/O MCB 109 option card, a battery back-up of date and time is included.

3.17.2 18-1* Fire Mode Log

The log covers the latest 10 faults which have been suppressed by the fire mode function. See *par. 24-0**, *Fire Mode*. The log can be viewed either via the below parameters or by pressing the Alarm Log button on the LCP and select Fire Mode Log. It is not possible to reset the fire mode log.

18-10 Fire Mode Log: Event

Range:

0 N/A* [0 - 255 N/A]

Function:

This parameter contains an array with 10 elements. The number read represents an error code, which corresponds to a specific alarm. This can be found in the Troubleshooting section in the Design Guide.

18-11 Fire Mode Log: Time

Range:

0 s* [0 - 2147483647 s]

Function:

This parameter contains an array with 10 elements. The parameter shows at which time the logged event occurred. Time is measured in seconds since the first start of the motor.

18-12 Fire Mode Log: Date and Time

Range:

0 N/A* [0 - 0 N/A]

Function:

This parameter contains an array with 10 elements. The parameter shows at which date and time the logged event occurred. The function relies on whether the current date and time has been set in *par.0-70 Set Date and Time*. Note: There is no built-in battery back-up of the clock. An external back-up must be used, for example, the one in the MCB109 Analog I/O option card. See *Clock Settings, 0-7**.

3.17.3 18-3* Analog I/O

18-30 Analog Input X42/1

Range:

0.000 N/A* [-20.000 - 20.000 N/A]

Function:

Readout of the value of the signal applied to terminal X42/1 on the Analog I/O Card. The units of the value shown in the LCP will correspond to the mode selected in *par.26-00 Terminal X42/1 Mode*.

18-31 Analog Input X42/3

Range:

0.000 N/A* [-20.000 - 20.000 N/A]

Function:

Readout of the value of the signal applied to terminal X42/3 on the Analog I/O Card. The units of the value shown in the LCP will correspond to the mode selected in *par.26-01 Terminal X42/3 Mode*.

18-32 Analog Input X42/5**Range:**

0.000 N/A* [-20.000 - 20.000 N/A]

Function:

Readout of the value of the signal applied to terminal X42/5 on the Analog I/O Card.
The units of the value shown in the LCP will correspond to the mode selected in par.26-02 *Terminal X42/5 Mode*.

18-33 Analog Out X42/7 [V]**Range:**

0.000 N/A* [0.000 - 30.000 N/A]

Function:

Readout of the value of the signal applied to terminal X42/7 on the Analog I/O Card.
The value shown reflects the selection in par.26-40 *Terminal X42/7 Output*.

18-34 Analog Out X42/9 [V]**Range:**

0.000 N/A* [0.000 - 30.000 N/A]

Function:

Readout of the value of the signal applied to terminal X42/9 on the Analog I/O Card.
The value shown reflects the selection in par.26-50 *Terminal X42/9 Output*.

18-35 Analog Out X42/11 [V]**Range:**

0.000 N/A* [0.000 - 30.000 N/A]

Function:

Readout of the value of the signal applied to terminal X42/11 on the Analog I/O Card.
The value shown reflects the selection in par.26-60 *Terminal X42/11 Output*.

3.18 Main Menu - Adjustable Frequency Drive Closed-loop - Group 20

3.18.1 20-** Adjustable Frequency Drive Closed-loop

This parameter group is used for configuring the closed-loop PID controller, that controls the output frequency of the adjustable frequency drive.

3.18.2 20-0* Feedback

This parameter group is used to configure the feedback signal for the adjustable frequency drive's closed-loop PID controller. Whether the adjustable frequency drive is in closed-loop mode or open-loop mode, the feedback signals can also be shown on the adjustable frequency drive's display, be used to control an adjustable frequency drive analog output, and be transmitted over various serial communication protocols.

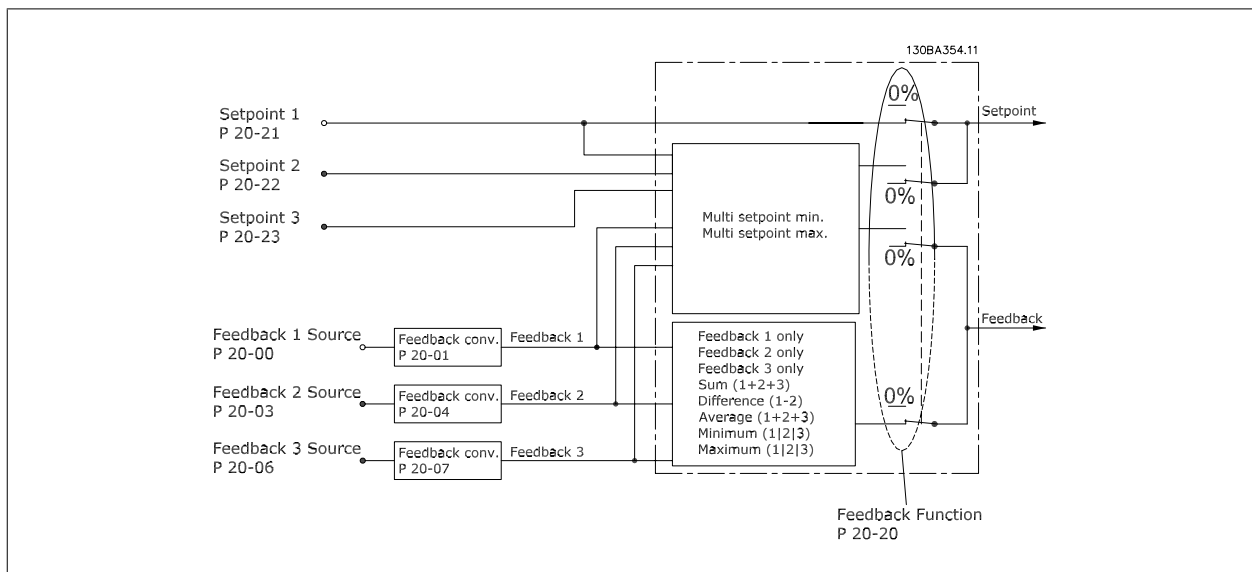

20-00 Feedback 1 Source

Option:

Function:

Up to three different feedback signals can be used to provide the feedback signal for the adjustable frequency drive's PID controller. This parameter defines which input will be used as the source of the first feedback signal. Analog input X30/11 and Analog input X30/12 refer to inputs on the optional general purpose I/O board.

- [0] No function
- [1] Analog input 53
- [2] * Analog input 54
- [3] Pulse input 29
- [4] Pulse input 33
- [7] Analog input X30/11
- [8] Analog input X30/12
- [9] Analog Input X42/1
- [10] Analog Input X42/3

[11]	Analog Input X42/5
[100]	Bus feedback 1
[101]	Bus feedback 2
[102]	Bus feedback 3

**NOTE!**

If a feedback is not used, its source must be set to *No Function* [0]. par.20-20 *Feedback Function* determines how the three possible feedbacks will be used by the PID controller.

3

20-01 Feedback 1 Conversion

Option:**Function:**

This parameter allows a conversion function to be applied to Feedback 1.

[0] *	Linear	<i>Linear</i> [0] has no effect on the feedback.
[1]	Square root	<i>Square root</i> [1] is commonly used when a pressure sensor is used to provide flow feedback (($flow \propto \sqrt{pressure}$)).
[2]	Pressure to temperature	<i>Pressure to temperature</i> [2] is used in compressor applications to provide temperature feedback using a pressure sensor. The temperature of the refrigerant is calculated using the following formula: $Temperature = \frac{A2}{(\ln(Pe + 1) - A1)} - A3$, where A1, A2 and A3 are refrigerant-specific constants. The refrigerant must be selected in par.20-30 <i>Refrigerant</i> . par.20-21 <i>Setpoint 1</i> through par. 20-23 <i>Setpoint 3</i> allow the values of A1, A2 and A3 to be entered for a refrigerant that is not listed in par.20-30 <i>Refrigerant</i> .

20-02 Feedback 1 Source Unit

Option:**Function:**

This parameter determines the unit that is used for this feedback source, prior to applying the feedback conversion of par.20-01 *Feedback 1 Conversion*. This unit is not used by the PID controller.

[0] *	
[1]	%
[5]	PPM
[10]	min
[11]	RPM
[12]	PULSE/s
[20]	liter / sec.
[21]	liter / min
[22]	liter / hr.
[23]	m ³ / sec.
[24]	m ³ /min
[25]	m ³ / hr.
[30]	kg / sec.
[31]	kg/min
[32]	kg / hr.
[33]	ton / min
[34]	ton / hr.

[40]	m / sec.
[41]	m/min
[45]	m
[60]	°C
[70]	mbar
[71]	bar
[72]	Pa
[73]	kPa
[74]	m WG
[75]	mm Hg
[80]	kW
[120]	GPM
[121]	gal / sec.
[122]	gal/min
[123]	gal / hr.
[124]	CFM
[125]	ft ³ /s
[126]	ft ³ /min
[127]	ft ³ /h
[130]	lbs / sec.
[131]	lbs / min.
[132]	lbs / hr.
[140]	ft/s
[141]	ft/min
[145]	ft
[160]	°F
[170]	psi
[171]	lb/in ²
[172]	in. wtr. gage
[173]	ft WG
[174]	in Hg
[180]	HP

3

 **NOTE!**
 This parameter is only available when using pressure to temperature feedback conversion.
 If the choice Linear [0] is selected in par.20-01 *Feedback 1 Conversion*, then the setting of any choice in par.20-02 *Feedback 1 Source Unit* does not matter as conversion will be one-to-one.

20-03 Feedback 2 Source

Option:
Function:

See par.20-00 *Feedback 1 Source* for details.

[0] *	No function
[1]	Analog input 53
[2]	Analog input 54
[3]	Pulse input 29
[4]	Pulse input 33
[7]	Analog input X30/11
[8]	Analog input X30/12
[9]	Analog Input X42/1
[10]	Analog Input X42/3
[11]	Analog Input X42/5
[100]	Bus feedback 1
[101]	Bus feedback 2
[102]	Bus feedback 3

20-04 Feedback 2 Conversion

Option:
Function:

See par.20-01 *Feedback 1 Conversion* for details.

[0] *	Linear
[1]	Square root
[2]	Pressure to temperature

20-05 Feedback 2 Source Unit

Option:
Function:

See par.20-02 *Feedback 1 Source Unit* for details.

[0] *	
[1]	%
[5]	PPM
[10]	min
[11]	RPM
[12]	PULSE/s
[20]	liter / sec.
[21]	liter / min
[22]	liter / hr.
[23]	m ³ / sec.
[24]	m ³ /min
[25]	m ³ / hr.
[30]	kg / sec.
[31]	kg/min
[32]	kg / hr.
[33]	ton / min
[34]	ton / hr.

[40]	m / sec.
[41]	m/min
[45]	m
[60]	°C
[70]	mbar
[71]	bar
[72]	Pa
[73]	kPa
[74]	m WG
[75]	mm Hg
[80]	kW
[120]	GPM
[121]	gal / sec.
[122]	gal/min
[123]	gal / hr.
[124]	CFM
[125]	ft ³ /s
[126]	ft ³ /min
[127]	ft ³ /h
[130]	lbs / sec.
[131]	lbs / min.
[132]	lbs / hr.
[140]	ft/s
[141]	ft/min
[145]	ft
[160]	°F
[170]	psi
[171]	lb/in ²
[172]	in. wtr. gage
[173]	ft WG
[174]	in Hg
[180]	HP

20-06 Feedback 3 Source

Option:
Function:

See par.20-00 *Feedback 1 Source* for details.

[0] *	No function
[1]	Analog input 53
[2]	Analog input 54
[3]	Pulse input 29
[4]	Pulse input 33
[7]	Analog input X30/11
[8]	Analog input X30/12
[9]	Analog Input X42/1
[10]	Analog Input X42/3
[11]	Analog Input X42/5
[100]	Bus feedback 1
[101]	Bus feedback 2
[102]	Bus feedback 3

20-07 Feedback 3 Conversion

Option:
Function:

See par.20-01 *Feedback 1 Conversion* for details.

[0] *	Linear
[1]	Square root
[2]	Pressure to temperature

20-08 Feedback 3 Source Unit

Option:
Function:

See par.20-02 *Feedback 1 Source Unit* for details.

[0] *	
[1]	%
[5]	PPM
[10]	min
[11]	RPM
[12]	PULSE/s
[20]	liter / sec.
[21]	liter / min
[22]	liter / hr.
[23]	m ³ / sec.
[24]	m ³ /min
[25]	m ³ / hr.
[30]	kg / sec.
[31]	kg/min
[32]	kg / hr.
[33]	ton / min
[34]	ton / hr.

[40]	m / sec.
[41]	m/min
[45]	m
[60]	°C
[70]	mbar
[71]	bar
[72]	Pa
[73]	kPa
[74]	m WG
[75]	mm Hg
[80]	kW
[120]	GPM
[121]	gal / sec.
[122]	gal/min
[123]	gal / hr.
[124]	CFM
[125]	ft ³ /s
[126]	ft ³ /min
[127]	ft ³ /h
[130]	lbs / sec.
[131]	lbs / min.
[132]	lbs / hr.
[140]	ft/s
[141]	ft/min
[145]	ft
[160]	°F
[170]	psi
[171]	lb/in ²
[172]	in. wtr. gage
[173]	ft WG
[174]	in Hg
[180]	HP

20-12 Reference/Feedback Unit

Option:

Function:

This parameter determines the unit that is used for the setpoint reference and feedback that the PID controller will use for controlling the output frequency of the adjustable frequency drive.

[0] *	
[1]	%
[5]	PPM
[10]	min
[11]	RPM
[12]	PULSE/s
[20]	liter / sec.

[21]	liter / min
[22]	liter / hr.
[23]	m ³ / sec.
[24]	m ³ /min
[25]	m ³ / hr.
[30]	kg / sec.
[31]	kg/min
[32]	kg / hr.
[33]	ton / min
[34]	ton / hr.
[40]	m / sec.
[41]	m/min
[45]	m
[60]	°C
[70]	mbar
[71]	bar
[72]	Pa
[73]	kPa
[74]	m WG
[75]	mm Hg
[80]	kW
[120]	GPM
[121]	gal / sec.
[122]	gal/min
[123]	gal / hr.
[124]	CFM
[125]	ft ³ /s
[126]	ft ³ /min
[127]	ft ³ /h
[130]	lbs / sec.
[131]	lbs / min.
[132]	lbs / hr.
[140]	ft/s
[141]	ft/min
[145]	ft
[160]	°F
[170]	psi
[171]	lb/in ²
[172]	in. wtr. gage
[173]	ft WG
[174]	in Hg
[180]	HP

20-13 Minimum Reference/Feedb.

Range:

0.000 Proc- [-999999.999 - par. 20-14 Proc-
essCtrlU- essCtrlUnit]
nit*

Function:

Enter the desired minimum value for the remote reference when operating with par. 1-00, Configuration Mode set for Closed-loop [3] operation. Units are set in par. 20-12, Reference/Feedback Unit.

Minimum feedback will be -200% of either the value set in par. 20-13 or in par. 20-14, whichever numeric value is the highest.



NOTE!

If operating with par.1-00, Configuration Mode set for Open-loop [0], par. 3-02, Minimum Reference must be used.

20-14 Maximum Reference/Feedb.

Range:

100.000 [par. 20-13 - 999999.999 Proc-
ProcessCtr- essCtrlUnit]
lUnit*

Function:

Enter the maximum reference/feedback for closed-loop operation. The setting determines the highest value obtainable by summing all reference sources for closed-loop operation. The setting determines 100% feedback in open-loop and closed-loop (total feedback range: -200% to +200%).

NOTE!

If operating with par.1-00 *Configuration Mode* set for Open-loop [0], par.3-03 *Maximum Reference* must be used.



NOTE!

The dynamics of the PID controller will depend on the value set in this parameter. Please also see par.20-93 *PID Proportional Gain*. Par. 20-13 and par. 20-14 also determine the feedback range when using feedback for display readout with par.1-00 *Configuration Mode* set for Open-loop [0]. Same condition as above.

3.18.3 20-2* Feedback & Setpoint

This parameter group is used to determine how the adjustable frequency drive's PID controller will use the three possible feedback signals to control the output frequency of the adjustable frequency drive. This group is also used to store the three internal setpoint references.

20-20 Feedback Function

Option:

[0] Sum

Function:

This parameter determines how the three possible feedbacks will be used to control the output frequency of the adjustable frequency drive.

Sum [0] sets up the PID controller to use the sum of Feedback 1, Feedback 2 and Feedback 3 as the feedback.



NOTE!

Any unused feedbacks must be set to *No Function* in par.20-00 *Feedback 1 Source*, par.20-03 *Feedback 2 Source*, or par.20-06 *Feedback 3 Source*.

The sum of Setpoint 1 and any other references that are enabled (see par. group 3-1*) will be used as the PID controller's setpoint reference.

[1] Difference *Difference* [1] sets up the PID controller to use the difference between Feedback 1 and Feedback 2 as the feedback. Feedback 3 will not be used with this selection. Only Setpoint 1 will be used. The sum of Setpoint 1 and any other references that are enabled (see par. group 3-1*) will be used as the PID controller's setpoint reference.

[2] Average *Average* [2] sets up the PID controller to use the average of Feedback 1, Feedback 2 and Feedback 3 as the feedback.

**NOTE!**

Any unused feedbacks must be set to *No Function* in par.20-00 *Feedback 1 Source*, par.20-03 *Feedback 2 Source*, or par.20-06 *Feedback 3 Source*. The sum of Setpoint 1 and any other references that are enabled (see par. group 3-1*) will be used as the PID Controller's setpoint reference.

[3] * Minimum *Minimum* [3] sets up the PID controller to compare Feedback 1, Feedback 2 and Feedback 3 and use the lowest value as the feedback.

**NOTE!**

Any unused feedbacks must be set to *No Function* in par.20-00 *Feedback 1 Source*, par.20-03 *Feedback 2 Source*, or par.20-06 *Feedback 3 Source*. Only setpoint 1 will be used. The sum of Setpoint 1 and any other references that are enabled (see par. group 3-1*) will be used as the PID controller's setpoint reference.

[4] Maximum *Maximum* [4] sets up the PID controller to compare Feedback 1, Feedback 2 and Feedback 3 and use the highest value as the feedback.

**NOTE!**

Any unused feedbacks must be set to *No Function* in par.20-00 *Feedback 1 Source*, par.20-03 *Feedback 2 Source*, or par.20-06 *Feedback 3 Source*.

Only Setpoint 1 will be used. The sum of Setpoint 1 and any other references that are enabled (see par. group 3-1*) will be used as the PID controller's setpoint reference.

[5] Multi Setpoint Min *Multi-setpoint minimum* [5] sets up the PID controller to calculate the difference between Feedback 1 and Setpoint 1, Feedback 2 and Setpoint 2, and Feedback 3 and Setpoint 3. It will use the feedback/setpoint pair in which the feedback is the farthest below its corresponding setpoint reference. If all feedback signals are above their corresponding setpoints, the PID controller will use the feedback/setpoint pair in which the difference between the feedback and setpoint is the least.

**NOTE!**

If only two feedback signals are used, the feedback that is not to be used must be set to *No Function* in par.20-00 *Feedback 1 Source*, par.20-03 *Feedback 2 Source* or par.20-06 *Feedback 3 Source*. Note that each setpoint reference will be the sum of its respective parameter value (par.20-21 *Setpoint 1*, par. 20-22 *Setpoint 2* and par.20-23 *Setpoint 3*) and any other references that are enabled (see par. group 3-1*).

[6] Multi Setpoint Max *Multi-setpoint maximum* [6] sets up the PID controller to calculate the difference between Feedback 1 and Setpoint 1, Feedback 2 and Setpoint 2, and Feedback 3 and Setpoint 3. It will use the feedback/setpoint pair in which the feedback is farthest above its corresponding setpoint reference. If all feedback signals are below their corresponding setpoints, the PID controller will use the feedback/setpoint pair in which the difference between the feedback and the setpoint reference is the least.

NOTE!
 If only two feedback signals are used, the feedback that is not to be used must be set to *No Function* in par.20-00 *Feedback 1 Source*, par.20-03 *Feedback 2 Source* or par.20-06 *Feedback 3 Source*. Note that each setpoint reference will be the sum of its respective parameter value (par.20-21 *Setpoint 1*, par.20-22 *Setpoint 2* and par.20-23 *Setpoint 3*) and any other references that are enabled (see par. group 3-1*).

NOTE!
 Any unused feedback must be set to "No function" in its Feedback Source parameter: par.20-00 *Feedback 1 Source*, par.20-03 *Feedback 2 Source* or par.20-06 *Feedback 3 Source*.

The feedback resulting from the function selected in par.20-20 *Feedback Function* will be used by the PID controller to control the output frequency of the adjustable frequency drive. This feedback can also: be shown on the adjustable frequency drive's display, be used to control an adjustable frequency drive's analog output, and be transmitted over various serial communication protocols.

The adjustable frequency drive can be configured to handle multi-zone applications. Two different multi-zone applications are supported:

- Multi-zone, single setpoint
- Multi-zone, multi setpoint

The difference between the two is illustrated by the following examples:

Example 1: Multi-zone, single setpoint

In an office building, a VAV (variable air volume) VLT HVAC Drive system must ensure a minimum pressure at selected VAV boxes. Due to the varying pressure losses in each duct, the pressure at each VAV box cannot be assumed to be the same. The minimum pressure required is the same for all VAV boxes. This control method can be set up by setting par.20-20 *Feedback Function* to option [3], Minimum, and entering the desired pressure in par.20-21 *Setpoint 1*. The PID controller will increase the speed of the fan if any one feedback is below the setpoint, and decrease the speed of the fan if all feedbacks are above the setpoint.

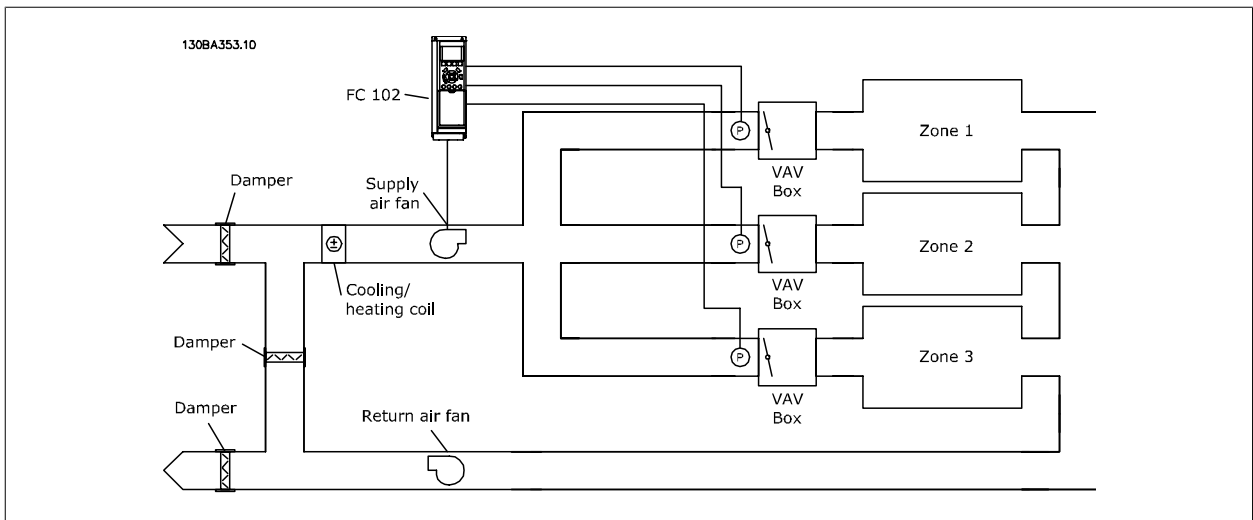

Example 2: Multi-zone, multi setpoint

The previous example can be used to illustrate the use of multi-zone, multi-setpoint control. If the zones require different pressures for each VAV box, each setpoint may be specified in par.20-21 *Setpoint 1*, par.20-22 *Setpoint 2* and par.20-23 *Setpoint 3*. By selecting *Multi-setpoint minimum*, [5], in par.20-20 *Feedback Function*, the PID controller will increase the speed of the fan if any one of the feedbacks is below its setpoint and decrease the speed of the fan if all feedbacks are above their individual setpoints.

20-21 Setpoint 1

Range:

0.000 Proc- [-999999.999 - 999999.999 Proc-
essCtrlU- essCtrlUnit]
nit*

Function:

Setpoint 1 is used in closed-loop mode to enter a setpoint reference that is used by the adjustable frequency drive's PID controller. See the description of par.20-20 *Feedback Function*.

NOTE!

Setpoint reference entered here is added to any other references that are enabled (see par. group 3-1*).

20-22 Setpoint 2

Range:

0.000 Proc- [-999999.999 - 999999.999 Proc-
essCtrlU- essCtrlUnit]
nit*

Function:

Setpoint 2 is used in closed-loop mode to enter a setpoint reference that may be used by the adjustable frequency drive's PID controller. See the description of *Feedback Function*, par. 20-20 *Feedback Function*.

NOTE!

The setpoint reference entered here is added to any other references that are enabled (see par. group 3-1*).

20-23 Setpoint 3

Range:

0.000 Proc- [-999999.999 - 999999.999 Proc-
essCtrlU- essCtrlUnit]
nit*

Function:

Setpoint 3 is used in closed-loop mode to enter a setpoint reference that may be used by the adjustable frequency drive's PID controller. See the description of par.20-20 *Feedback Function*.

NOTE!

The setpoint reference entered here is added to any other references that are enabled (see par. group 3-1*).

3.18.4 20-3* Feedback Adv. Conversion

In air conditioning compressor applications it is often useful to control the system based on the temperature of the refrigerant. However, it is generally more convenient to directly measure its pressure. This parameter group allows the adjustable frequency drive's PID controller to convert refrigerant pressure measurements into temperature values.

20-30 Refrigerant

Option:

Function:

Select the refrigerant used in the compressor application. This parameter must be specified correctly for the pressure to temperature conversion to be accurate. If the refrigerant used is not listed in choices [0] through [6], select *User defined* [7], use par.20-31 *User-defined Refrigerant A1*, par. 20-32 *User-defined Refrigerant A2* and par.20-33 *User-defined Refrigerant A3* to provide A1, A2 and A3 for the equation below:

$$Temperature = \frac{A2}{(\ln(Pe + 1) - A1)} - A3$$

[0] * R22

[1] R134a

[2] R404a

[3] R407c

[4] R410a

[5] R502

[6] R744

[7] User-defined

20-31 User-defined Refrigerant A1

Range:

Function:

10.0000 N/ [8.0000 - 12.0000 N/A]
A*

Use this parameter to enter the value of coefficient A1 when par.20-30 *Refrigerant* is set to *User-defined* [7].

20-32 User-defined Refrigerant A2

Range:

Function:

-2250.00 N/ [-3000.00 - -1500.00 N/A]
A*

Use this parameter to enter the value of coefficient A2 when par.20-30 *Refrigerant* is set to *User-defined* [7].

20-33 User-defined Refrigerant A3

Range:

Function:

250.000 N/ [200.000 - 300.000 N/A]
A*

Use this parameter to enter the value of coefficient A3 when par.20-30 *Refrigerant* is set to *User-defined* [7].

3.18.5 20-7* PID autotuning

The adjustable frequency drive PID closed-loop controller (parameters 20-**, Adjustable Frequency Drive Closed-loop) can be autotuned, simplifying and saving time during commissioning, while ensuring accurate PID control adjustment. To use autotuning, it is necessary for the adjustable frequency drive to be configured for closed-loop in par.1-00 *Configuration Mode*.

A graphical local control panel (LCP) must be used in order to react on messages during the autotuning sequence.

Enabling par.20-79 *PID Auto Tuning*, puts the adjustable frequency drive into autotuning mode. The LCP then directs the user with on-screen instructions.

The fan/pump is started by pressing [Auto On] button on the LCP and applying a start signal. The speed is adjusted manually by pressing the [▲] or [▼] navigation keys on the LCP to a level where the feedback is around the system setpoint.

**NOTE!**

It is not possible to run the motor at maximum or minimum speed, when manually adjusting the motor speed due to the need of giving the motor a step in the speed during autotuning.

PID autotuning functions by introducing step changes while operating at a steady state and then monitoring the feedback. From the feedback response, the required values for par.20-93 *PID Proportional Gain* and par.20-94 *PID Integral Time* are calculated. par.20-95 *PID Differentiation Time* is set to value 0 (zero). par.20-81 *PID Normal/ Inverse Control* is determined during tuning process.

These calculated values are presented on the LCP and the user can decide whether to accept or reject them. Once accepted, the values are written to the relevant parameters and autotuning mode is disabled in par.20-79 *PID Auto Tuning*. Depending on the system being controlled, the time required to carry out autotuning could be several minutes.

It is advised to set the ramp times in par.3-41 *Ramp 1 Ramp-up Time*, par.3-42 *Ramp 1 Ramp-down Time* or par.3-51 *Ramp 2 Ramp-up Time* and par.3-52 *Ramp 2 Ramp-down Time* according to the load inertia before carrying out PID autotuning. If PID autotuning is carried out with slow ramp times, the autotuned parameters will typically result in very slow control. Excessive feedback sensor noise should be removed using the input filter (parameter groups 6-**, 5-5* and 26-**, Terminal 53/54 Filter Time Constant/Pulse Filter Time Constant #29/33) before activating PID autotuning. In order to obtain the most accurate controller parameters, it is advised to carry out PID autotuning, when the application is running in typical operation, i.e., with a typical load.

20-70 Closed-loop Type

Option:**Function:**

This parameter defines the application response. The default mode should be sufficient for most applications. If the application response speed is known, it can be selected here. This will decrease the time needed for carrying out PID autotuning. The setting has no impact on the value of the tuned parameters and is used only for the autotuning sequence.

- [0] * Auto
- [1] Fast Pressure
- [2] Slow Pressure
- [3] Fast Temperature
- [4] Slow Temperature

20-71 Tuning Mode

Option:**Function:**

- [0] * Normal Normal setting of this parameter will be suitable for pressure control in fan systems.
- [1] Fast Fast setting would generally be used in pumping systems, where a faster control response is desirable.

20-72 PID Output Change

Range:**Function:**

0.10 N/A* [0.01 - 0.50 N/A]

This parameter sets the magnitude of step change during autotuning. The value is a percentage of full speed. This means that if the maximum output frequency in par.4-13 *Motor Speed High Limit [RPM]*/par.4-14 *Motor Speed High Limit [Hz]* is set to 50 Hz, 0.10 is 10% of 50 Hz, which is 5 Hz. This parameter should be set to a value resulting in feedback changes of between 10% and 20% for best tuning accuracy.

20-73 Minimum Feedback Level

Range:

-999999.00 [-999999.999 - par. 20-74 Proc-essCtrlUnit]

Function:

The minimum allowable feedback level should be entered here in user units as defined in par. 20-12 *Reference/Feedback Unit*. If the level falls below par.20-73 *Minimum Feedback Level*, autotuning is aborted and an error message will appear on the LCP.

20-74 Maximum Feedback Level

Range:

999999.000 [par. 20-73 - 999999.999 Proc-essCtrlUnit]

Function:

The maximum allowable feedback level should be entered here in user units as defined in par. 20-12 *Reference/Feedback Unit*. If the level rises above par.20-74 *Maximum Feedback Level*, autotuning is aborted and an error message will appear on the LCP.

20-79 PID Auto Tuning

Option:

- [0] * Disabled
- [1] Enabled

Function:

This parameter starts the PID autotuning sequence. Once the autotuning has successfully completed and the settings have been accepted or rejected by the user, by pressing [OK] or [Cancel] buttons on the LCP at the end of tuning, this parameter is reset to [0] Disabled.

3.18.6 20-8* PID Basic Settings

This parameter group is used to configure the basic operation of the adjustable frequency drive's PID controller, including how it responds to a feedback that is above or below the setpoint, the speed at which it first starts functioning, and when it will indicate that the system has reached the setpoint.

20-81 PID Normal/ Inverse Control

Option:

- [0] * Normal
- [1] Inverse

Function:

Normal [0] causes the adjustable frequency drive's output frequency to decrease when the feedback is greater than the setpoint reference. This is common for pressure-controlled supply fan and pump applications.

Inverse [1] causes the adjustable frequency drive's output frequency to increase when the feedback is greater than the setpoint reference. This is common for temperature-controlled cooling applications, such as cooling towers.

20-82 PID Start Speed [RPM]

Range:

0 RPM* [0 - par. 4-13 RPM]

Function:

When the adjustable frequency drive is first started, it initially ramps up to this output speed in open-loop mode, following the active ramp-up time. When the output speed programmed here is reached, the adjustable frequency drive will automatically switch to closed-loop mode and the PID controller will begin to function. This is useful in applications in which the driven load must first quickly accelerate to a minimum speed when it is started.



NOTE!

This parameter will only be visible if par.0-02 *Motor Speed Unit* is set to [0], RPM.

20-83 PID Start Speed [Hz]

Range:

0 Hz* [0.0 - par. 4-14 Hz]

Function:

When the adjustable frequency drive is first started, it initially ramps up to this output frequency in open-loop mode, following the active ramp-up time. When the output frequency programmed here is reached, the adjustable frequency drive will automatically switch to closed-loop mode and the PID controller will begin to function. This is useful in applications in which the driven load must first quickly accelerate to a minimum speed when it is started.

NOTE!

This parameter will only be visible if par.0-02 *Motor Speed Unit* is set to [1], Hz.

20-84 On Reference Bandwidth

Range:

5 %* [0 - 200 %]

Function:

When the difference between the feedback and the setpoint reference is less than the value of this parameter, the adjustable frequency drive's display will show "Run on Reference". This status can be communicated externally by programming the function of a digital output for *Run on Reference/No Warning* [8]. In addition, for serial communications, the On Reference status bit of the adjustable frequency drive's status word will be high (1).

The *On Reference Bandwidth* is calculated as a percentage of the setpoint reference.

3.18.7 20-9* PID Controller

This group provides the ability to manually adjust this PID controller. By adjusting the PID controller parameters the control performance may be improved. See section **PID** in the VLT HVAC Drive Design Guide, *MG.11.Bx.yy* for guidelines on adjusting the PID controller parameters.

20-91 PID Anti Windup

Option:

[0] Off

Function:

Off [0] The integrator will continue to change value also after output has reached one of the extremes. This can afterwards cause a delay of change of the output of the controller.

[1]* On

On [1] The integrator will be locked if the output of the built-in PID controller has reached one of the extremes (min or max value) and therefore not able to add further change to the value of the process parameter controlled. This allows the controller to respond more quickly when it again can control the system.

20-93 PID Proportional Gain

Range:

0.50 N/A* [0.00 - 10.00 N/A]

Function:

The proportional gain indicates the number of times the error between the setpoint and the feedback signal is to be applied.

If (Error x Gain) jumps with a value equal to what is set in par.20-14 *Maximum Reference/Feedb.*, the PID controller will try to change the output speed equal to what is set in par.4-13 *Motor Speed High Limit [RPM]*/par.4-14 *Motor Speed High Limit [Hz]* but in practice of course limited by this setting. The proportional band (error causing output to change from 0%–100%) can be calculated by means of the formula:

$$\left(\frac{1}{\text{Proportional Gain}} \right) \times (\text{Max Reference})$$

NOTE!

Always set the desired for par.20-14 *Maximum Reference/Feedb.* before setting the values for the PID controller in par. group 20-9*.

20-94 PID Integral Time

Range:

20.00 s* [0.01 - 10000.00 s]

Function:

Over time, the integrator accumulates a contribution to the output from the PID controller as long as there is a deviation between the reference/setpoint and feedback signals. The contribution is proportional to the size of the deviation. This ensures that the deviation (error) approaches zero. Quick response on any deviation is obtained when the integral time is set to a low value. Setting it too low, however, may cause the control to become unstable.

The value set, is the time needed for the integrator to add the same contribution as the proportional part for a certain deviation.

If the value is set to 10,000, the controller will act as a pure proportional controller with a P-band based on the value set in par.20-93 *PID Proportional Gain*. When no deviation is present, the output from the proportional controller will be 0.

20-95 PID Differentiation Time

Range:

0.00 s* [0.00 - 10.00 s]

Function:

The differentiator monitors the rate of change of the feedback. If the feedback is changing quickly, it will adjust the output of the PID controller to reduce the rate of change of the feedback. Quick PID controller response is obtained when this value is large. However, if too large of a value is used, the adjustable frequency drive's output frequency may become unstable.

Differentiation time is useful in situations where extremely fast adjustable frequency drive response and precise speed control are required. It can be difficult to adjust this for proper system control. Differentiation time is not commonly used in VLT HVAC Drive applications. Therefore, it is generally best to leave this parameter at 0 or OFF.

20-96 PID Diff. Gain Limit

Range:

5.0 N/A* [1.0 - 50.0 N/A]

Function:

The differentiator of a PID controller responds to the rate of change of the feedback. As a result, an abrupt change in the feedback can cause the differentiator to make a very large change in the PID controller's output. This parameter limits the maximum effect that the PID controller's differentiator can produce. A smaller value reduces the maximum effect of the PID controller's differentiator.

This parameter is only active when par.20-95 *PID Differentiation Time* is not set to OFF (0 s).

3.19 Main Menu - Extended Closed-loop - FC 100 - Group 21

3.19.1 21-** Ext. Closed-loop

The FC 102 offers 3 extended closed-loop PID controllers in addition to the PID controller. These can be configured independently to control either external servos (valves, dampers, etc.) or be used together with the internal PID controller to improve the dynamic responses to setpoint changes or load disturbances.

The extended closed-loop PID controllers may be interconnected or connected to the PID closed-loop controller to form a dual loop configuration.

In order to control a modulating device (e.g., a valve motor), this device must be a positioning servo motor with built-in electronics accepting either a 0–10 V (signal from Analog I/O card MCB 109) or a 0/4–20 mA (signal from control card and/or General Purpose I/O card MCB 101) control signal.

The output function can be programmed in the following parameters:

- Control Card, terminal 42: par.6-50 *Terminal 42 Output* (setting [113]...[115] or [149]...[151], Ext. Closed-loop 1/2/3
- General Purpose I/O card MCB 101, terminal X30/8: par.6-60 *Terminal X30/8 Output*, (setting [113]...[115] or [149]...[151], Ext. Closed-loop 1/2/3
- Analog I/O card MCB 109, terminal X42/7...11: par.26-40 *Terminal X42/7 Output*, par.26-50 *Terminal X42/9 Output*, par.26-60 *Terminal X42/11 Output* (setting [113]...[115], Ext. Closed-loop 1/2/3

General Purpose I/O card and Analog I/O card are optional cards.

3.19.2 21-0* Extended CL autotuning

The extended PID closed-loop PID controllers (*par. 21-**, Ext. Closed-loop*) can each be autotuned, simplifying and saving time during commissioning, while ensuring accurate PID control adjustment.

To use PID autotuning, it is necessary for the relevant extended PID controller to have been configured for the application.

A graphical local control panel (LCP) must be used in order to react on messages during the autotuning sequence.

Enabling autotuning par.21-09 *PID Auto Tuning* puts the relevant PID controller into PID autotuning mode. The LCP then directs the user with on-screen instructions.

PID autotuning functions by introducing step changes and then monitoring the feedback. From the feedback response, the required values for PID Proportional Gain, par.21-21 *Ext. 1 Proportional Gain* for EXT CL 1, par.21-41 *Ext. 2 Proportional Gain* for EXT CL 2 and par.21-61 *Ext. 3 Proportional Gain* for EXT CL 3 and Integral Time, par.21-22 *Ext. 1 Integral Time* for EXT CL 1, par.21-42 *Ext. 2 Integral Time* for EXT CL 2 and par.21-62 *Ext. 3 Integral Time* for EXT CL 3 are calculated. PID Differentiation Time, par.21-23 *Ext. 1 Differentiation Time* for EXT CL 1, par.21-43 *Ext. 2 Differentiation Time* for EXT CL 2 and par.21-63 *Ext. 3 Differentiation Time* for EXT CL 3 are set to value 0 (zero). Normal / Inverse, par.21-20 *Ext. 1 Normal/Inverse Control* for EXT CL 1, par.21-40 *Ext. 2 Normal/Inverse Control* for EXT CL 2 and par.21-60 *Ext. 3 Normal/Inverse Control* for EXT CL 3 are determined during the tuning process.

These calculated values are presented on the LCP and the user can decide whether to accept or reject them. Once accepted, the values are written to the relevant parameters and PID autotuning mode is disabled in par.21-09 *PID Auto Tuning*. Depending on the system being controlled the time required to carry out PID autotuning could be several minutes.

Excessive feedback sensor noise should be removed using the input filter (parameter groups 6-**,5-5* and 26-**, Terminal 53/54 Filter Time Constant/ Pulse Filter Time Constant #29/33) before activating PID autotuning.

21-00 Closed-loop Type

Option:

Function:

This parameter defines the application response. The default mode should be sufficient for most applications. If the relative application speed is known, it can be selected here. This will decrease the time needed for carrying out PID autotuning. The setting has no impact on the value of the tuned parameters and is used only for the PID autotuning sequence.

- [0] * Auto
- [1] Fast Pressure
- [2] Slow Pressure
- [3] Fast Temperature
- [4] Slow Temperature

21-01 Tuning Mode

Option:

Function:

- [0] * Normal
Normal setting of this parameter will be suitable for pressure control in fan systems.
- [1] Fast
Fast setting would generally be used in pumping systems, where a faster control response is desirable.

21-02 PID Output Change

Range:

Function:

0.10 N/A* [0.01 - 0.50 N/A]

This parameter sets the magnitude of step change during autotuning. The value is a percentage of full operating range. This means that if maximum analog output voltage is set to 10 V, 0.10 is 10% of 10 V, which is 1 V. This parameter should be set to a value resulting in feedback changes of between 10% and 20% for best tuning accuracy.

21-03 Minimum Feedback Level

Range:

Function:

-999999.00 [-999999.999 - par. 21-04 N/A]
0 N/A*

The minimum allowable feedback level should be entered here in user units as defined in par. 21-10 Ext. 1 Ref./Feedback Unit for EXT CL 1, par.21-30 Ext. 2 Ref./Feedback Unit for EXT CL 2 or par.21-50 Ext. 3 Ref./Feedback Unit for EXT CL 3. If the level falls below par.21-03 *Minimum Feedback Level*, PID autotuning is aborted and an error message will appear on the LCP.

21-04 Maximum Feedback Level

Range:

Function:

999999.000 [par. 21-03 - 999999.999 N/A]
N/A*

The maximum allowable feedback level should be entered here in user units as defined in par. 21-10 Ext. 1 Ref./Feedback Unit for EXT CL 1, par.21-30 Ext. 2 Ref./Feedback Unit for EXT CL 2 or par.21-50 Ext. 3 Ref./Feedback Unit for EXT CL 3. If the level rises above par.21-04 *Maximum Feedback Level*, PID autotuning is aborted and an error message will appear on the LCP.

21-09 PID Auto Tuning

Option: **Function:**
 This parameter enables selection of the extended PID controller to be autotuned and starts the PID autotuning for that controller. Once the autotuning has successfully completed and the settings have been accepted or rejected by the user, by pressing [OK] or [Cancel] buttons on the LCP at the end of tuning, this parameter is reset to [0] Disabled.

- [0] * Disabled
- [1] Enabled Ext PID 1
- [2] Enabled Ext PID 2
- [3] Enabled Ext PID 3

3.19.3 21-1* Closed-loop 1 Ref/Feedback

Configure Extended Closed-loop 1 Controller reference and feedback.

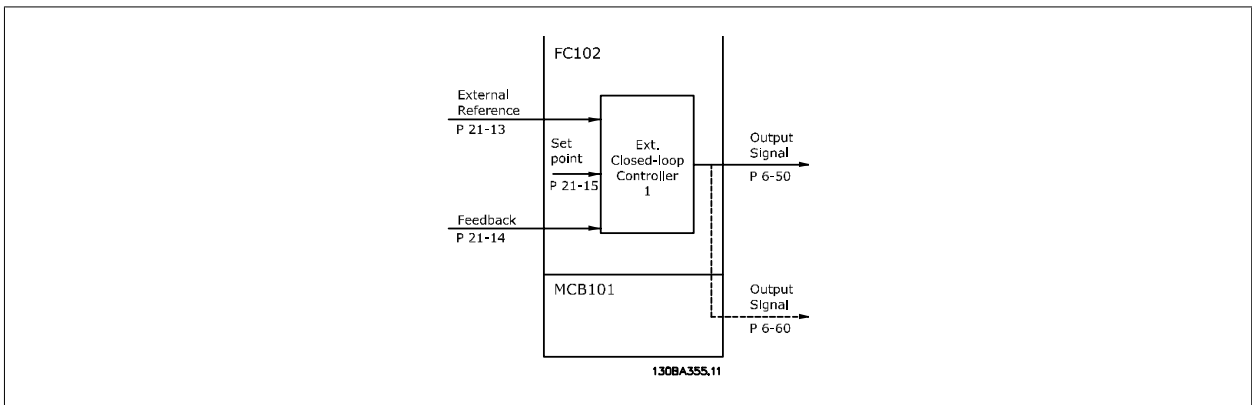

21-10 Ext. 1 Ref./Feedback Unit

Option: **Function:**
 Select the unit for the reference and feedback.

- [0]
- [1] * %
- [5] PPM
- [10] min
- [11] RPM
- [12] PULSE/s
- [20] liter / sec.
- [21] liter / min
- [22] liter / hr.
- [23] m³ / sec.
- [24] m³/min
- [25] m³ / hr.
- [30] kg / sec.
- [31] kg/min

[32]	kg / hr.
[33]	ton / min
[34]	ton / hr.
[40]	m / sec.
[41]	m/min
[45]	m
[60]	°C
[70]	mbar
[71]	bar
[72]	Pa
[73]	kPa
[74]	m WG
[75]	mm Hg
[80]	kW
[120]	GPM
[121]	gal / sec.
[122]	gal/min
[123]	gal / hr.
[124]	CFM
[125]	ft ³ /s
[126]	ft ³ /min
[127]	ft ³ /h
[130]	lbs / sec.
[131]	lbs / min.
[132]	lbs / hr.
[140]	ft/s
[141]	ft/min
[145]	ft
[160]	°F
[170]	psi
[171]	lb/in ²
[172]	in. wtr. gage
[173]	ft WG
[174]	in Hg
[180]	HP

21-11 Ext. 1 Minimum Reference

Range:	Function:
0.000 Ex- [-999999.999 - par. 21-12 Ex- Select the minimum for the closed-loop 1 controller. tPID1Unit* tPID1Unit]	

21-12 Ext. 1 Maximum Reference

Range:

100.000 Ex- [par. 21-11 - 999999.999 Ex-
tPID1Unit* tPID1Unit]

Function:

Select the maximum for the Closed-loop 1 Controller.

The dynamics of the PID controller will depend on the value set in this parameter. Please see also par.21-21 *Ext. 1 Proportional Gain*.

3

NOTE!

Always set the desired value for par.21-12 *Ext. 1 Maximum Reference* before setting the values for the PID controller in par. 20-9*.

21-13 Ext. 1 Reference Source

Option:
Function:

This parameter defines which input on the adjustable frequency drive should be treated as the source of the reference signal for the closed-loop 1 controller. Analog input X30/11 and Analog input X30/12 refer to inputs on the General Purpose I/O.

[0] *	No function
[1]	Analog input 53
[2]	Analog input 54
[7]	Pulse input 29
[8]	Pulse input 33
[20]	Digital pot.meter
[21]	Analog input X30/11
[22]	Analog input X30/12
[23]	Analog Input X42/1
[24]	Analog Input X42/3
[25]	Analog Input X42/5
[30]	Ext. Closed-loop 1
[31]	Ext. Closed-loop 2
[32]	Ext. Closed-loop 3

21-14 Ext. 1 Feedback Source

Option:

Function:

This parameter defines which input on the adjustable frequency drive should be treated as the source of the feedback signal for the closed-loop 1 controller. Analog input X30/11 and Analog input X30/12 refer to inputs on the General Purpose I/O .

- [0] * No function
- [1] Analog input 53
- [2] Analog input 54
- [3] Pulse input 29
- [4] Pulse input 33
- [7] Analog input X30/11
- [8] Analog input X30/12
- [9] Analog Input X42/1
- [10] Analog Input X42/3
- [11] Analog Input X42/5
- [100] Bus feedback 1
- [101] Bus feedback 2
- [102] Bus feedback 3

21-15 Ext. 1 Setpoint

Range:

Function:

0.000 Ex- [par. 21-11 - par. 21-12 Ex- tPID1Unit* tPID1Unit] The setpoint reference is used in extended 1 closed-loop. Ext.1 Setpoint is added to the value from the Ext.1 Reference source selected in par.21-13 *Ext. 1 Reference Source*.

21-17 Ext. 1 Reference [Unit]

Range:

Function:

0.000 Ex- [-999999.999 - 999999.999 Ex- tPID1Unit* tPID1Unit] Readout of the reference value for the closed-loop 1 controller.

21-18 Ext. 1 Feedback [Unit]

Range:

Function:

0.000 Ex- [-999999.999 - 999999.999 Ex- tPID1Unit* tPID1Unit] Readout of the feedback value for the closed-loop 1 controller.

21-19 Ext. 1 Output [%]

Range:

Function:

0 %* [0 - 100 %] Readout of the output value for the closed-loop 1 controller.

3.19.4 21-2* Closed-loop 1 PID

Configure the closed-loop 1 PID controller.

21-20 Ext. 1 Normal/Inverse Control

Option:

Function:

- [0] * Normal Select *Normal* [0] if the output should be reduced when feedback is higher than the reference.
- [1] Inverse Select *Inverse* [1] if the output should be increased when feedback is higher than the reference.

21-21 Ext. 1 Proportional Gain

Range:

0.01 N/A* [0.00 - 10.00 N/A]

Function:

The proportional gain indicates the number of times the error between the setpoint and the feedback signal is to be applied.

If (Error x Gain) jumps with a value equal to what is set in par.20-14 *Maximum Reference/Feedb.*, the PID controller will try to change the output speed equal to what is set in par. 4-13/4-14, Motor Speed High Limit, but in practice of course limited by this setting.

The proportional band (error causing output to change from 0%–100%) can be calculated by means of the formula:

$$\left(\frac{1}{\text{Proportional Gain}} \right) \times (\text{Max Reference})$$

NOTE!

Always set the desired for par.20-14 *Maximum Reference/Feedb.* before setting the values for the PID controller in par. group 20-9*.

21-22 Ext. 1 Integral Time

Range:

10000.00 s* [0.01 - 10000.00 s]

Function:

Over time, the integrator accumulates a contribution to the output from the PID controller as long as there is a deviation between the reference/setpoint and feedback signals. The contribution is proportional to the size of the deviation. This ensures that the deviation (error) approaches zero. Quick response on any deviation is obtained when the integral time is set to a low value. Setting it too low, however, may cause the control to become unstable.

The value set is the time needed for the integrator to add the same contribution as the proportional part for a certain deviation.

If the value is set to 10,000, the controller will act as a pure proportional controller with a P-band based on the value set in par.20-93 *PID Proportional Gain*. When no deviation is present, the output from the proportional controller will be 0.

21-23 Ext. 1 Differentiation Time

Range:

0.00 s* [0.00 - 10.00 s]

Function:

The differentiator does not react to a constant error. It only provides a gain when the feedback changes. The quicker the feedback changes, the stronger the gain from the differentiator.

21-24 Ext. 1 Dif. Gain Limit

Range:

5.0 N/A* [1.0 - 50.0 N/A]

Function:

Set a limit for the differentiator gain (DG). The DG will increase if there are fast changes. Limit the DG to obtain a pure differentiator gain at slow changes and a constant differentiator gain where quick changes occur.

3.19.5 21-3* Closed-loop 2 Ref/Fb

Configure Extended Closed-loop 2 Controller reference and feedback.

21-30 Ext. 2 Ref./Feedback Unit

Option:

Function:

See par.21-10 *Ext. 1 Ref./Feedback Unit* for details

[0]	
[1] *	%
[5]	PPM
[10]	min
[11]	RPM
[12]	PULSE/s
[20]	liter / sec.
[21]	liter / min
[22]	liter / hr.
[23]	m ³ / sec.
[24]	m ³ /min
[25]	m ³ / hr.
[30]	kg / sec.
[31]	kg/min
[32]	kg / hr.
[33]	ton / min
[34]	ton / hr.
[40]	m / sec.
[41]	m/min
[45]	m
[60]	°C
[70]	mbar
[71]	bar
[72]	Pa
[73]	kPa
[74]	m WG
[75]	mm Hg
[80]	kW
[120]	GPM
[121]	gal / sec.
[122]	gal/min
[123]	gal / hr.
[124]	CFM
[125]	ft ³ /s
[126]	ft ³ /min
[127]	ft ³ /h
[130]	lbs / sec.

[131]	lbs / min.
[132]	lbs / hr.
[140]	ft/s
[141]	ft/min
[145]	ft
[160]	°F
[170]	psi
[171]	lb/in ²
[172]	in. wtr. gage
[173]	ft WG
[174]	in Hg
[180]	HP

21-31 Ext. 2 Minimum Reference

Range:
Function:

0.000 Ex- [-999999.999 - par. 21-32 Ex- See par.21-11 *Ext. 1 Minimum Reference* for details.
tPID2Unit* tPID2Unit]

21-32 Ext. 2 Maximum Reference

Range:
Function:

100.000 Ex- [par. 21-31 - 999999.999 Ex- See par.21-12 *Ext. 1 Maximum Reference* for details.
tPID2Unit* tPID2Unit]

21-33 Ext. 2 Reference Source

Option:
Function:

See par.21-13 *Ext. 1 Reference Source* for details.

[0] *	No function
[1]	Analog input 53
[2]	Analog input 54
[7]	Pulse input 29
[8]	Pulse input 33
[20]	Digital pot.meter
[21]	Analog input X30/11
[22]	Analog input X30/12
[23]	Analog Input X42/1
[24]	Analog Input X42/3
[25]	Analog Input X42/5
[30]	Ext. Closed-loop 1
[31]	Ext. Closed-loop 2
[32]	Ext. Closed-loop 3

21-34 Ext. 2 Feedback Source

Option:	Function:
	See par.21-14 <i>Ext. 1 Feedback Source</i> for details.
[0] *	No function
[1]	Analog input 53
[2]	Analog input 54
[3]	Pulse input 29
[4]	Pulse input 33
[7]	Analog input X30/11
[8]	Analog input X30/12
[9]	Analog Input X42/1
[10]	Analog Input X42/3
[11]	Analog Input X42/5
[100]	Bus feedback 1
[101]	Bus feedback 2
[102]	Bus feedback 3

21-35 Ext. 2 Setpoint

Range:	Function:
0.000 Ex- [par. 21-31 - par. 21-32 Ex- tPID2Unit* tPID2Unit]	See par.21-15 <i>Ext. 1 Setpoint</i> for details.

21-37 Ext. 2 Reference [Unit]

Range:	Function:
0.000 Ex- [-999999.999 - 999999.999 Ex- tPID2Unit* tPID2Unit]	See par.21-17 <i>Ext. 1 Reference [Unit]</i> , <i>Ext. 1 Reference [Unit]</i> , for details.

21-38 Ext. 2 Feedback [Unit]

Range:	Function:
0.000 Ex- [-999999.999 - 999999.999 Ex- tPID2Unit* tPID2Unit]	See par.21-18 <i>Ext. 1 Feedback [Unit]</i> for details.

21-39 Ext. 2 Output [%]

Range:	Function:
0 %* [0 - 100 %]	See par.21-19 <i>Ext. 1 Output [%]</i> for details.

3.19.6 21-4* Closed-loop 2 PID

Configure the Closed-loop 2 PID controller.

21-40 Ext. 2 Normal/Inverse Control

Option:	Function:
	See par.21-20 <i>Ext. 1 Normal/Inverse Control</i> for details.
[0] *	Normal
[1]	Inverse

21-41 Ext. 2 Proportional Gain**Range:**

0.01 N/A* [0.00 - 10.00 N/A]

Function:See par.21-21 *Ext. 1 Proportional Gain* for details.**21-42 Ext. 2 Integral Time****Range:**10000.00 [0.01 - 10000.00 s]
s***Function:**See par.21-22 *Ext. 1 Integral Time* for details.**21-43 Ext. 2 Differentiation Time****Range:**

0.00 s* [0.00 - 10.00 s]

Function:See par.21-23 *Ext. 1 Differentiation Time* for details.**21-44 Ext. 2 Dif. Gain Limit****Range:**

5.0 N/A* [1.0 - 50.0 N/A]

Function:See par.21-24 *Ext. 1 Dif. Gain Limit* for details.**3.19.7 21-5* Closed-loop 3 Ref/Fb**

Configure Extended Closed-loop 3 Controller reference and feedback.

21-50 Ext. 3 Ref./Feedback Unit**Option:****Function:**See par.21-10 *Ext. 1 Ref./Feedback Unit* for details.

[0]

[1] * %

[5] PPM

[10] min

[11] RPM

[12] PULSE/s

[20] liter / sec.

[21] liter / min

[22] liter / hr.

[23] m³ / sec.[24] m³/min[25] m³ / hr.

[30] kg / sec.

[31] kg/min

[32] kg / hr.

[33] ton / min

[34] ton / hr.

[40] m / sec.

[41] m/min

[45] m

[60] °C

[70]	mbar
[71]	bar
[72]	Pa
[73]	kPa
[74]	m WG
[75]	mm Hg
[80]	kW
[120]	GPM
[121]	gal / sec.
[122]	gal/min
[123]	gal / hr.
[124]	CFM
[125]	ft ³ /s
[126]	ft ³ /min
[127]	ft ³ /h
[130]	lbs / sec.
[131]	lbs / min.
[132]	lbs / hr.
[140]	ft/s
[141]	ft/min
[145]	ft
[160]	°F
[170]	psi
[171]	lb/in ²
[172]	in. wtr. gage
[173]	ft WG
[174]	in Hg
[180]	HP

21-51 Ext. 3 Minimum Reference

Range:

Function:

0.000 Ex- [-999999.999 - par. 21-52 Ex- See par.21-11 *Ext. 1 Minimum Reference* for details.
tPID3Unit* tPID3Unit]

21-52 Ext. 3 Maximum Reference

Range:

Function:

100.000 Ex- [par. 21-51 - 999999.999 Ex- See par.21-12 *Ext. 1 Maximum Reference* for details.
tPID3Unit* tPID3Unit]

21-53 Ext. 3 Reference Source

Option:
Function:

See par.21-13 *Ext. 1 Reference Source* for details.

[0] *	No function
[1]	Analog input 53
[2]	Analog input 54
[7]	Pulse input 29
[8]	Pulse input 33
[20]	Digital pot.meter
[21]	Analog input X30/11
[22]	Analog input X30/12
[23]	Analog Input X42/1
[24]	Analog Input X42/3
[25]	Analog Input X42/5
[30]	Ext. Closed-loop 1
[31]	Ext. Closed-loop 2
[32]	Ext. Closed-loop 3

21-54 Ext. 3 Feedback Source

Option:
Function:

See par.21-14 *Ext. 1 Feedback Source* for details.

[0] *	No function
[1]	Analog input 53
[2]	Analog input 54
[3]	Pulse input 29
[4]	Pulse input 33
[7]	Analog input X30/11
[8]	Analog input X30/12
[9]	Analog Input X42/1
[10]	Analog Input X42/3
[11]	Analog Input X42/5
[100]	Bus feedback 1
[101]	Bus feedback 2
[102]	Bus feedback 3

21-55 Ext. 3 Setpoint

Range:
Function:

0.000 Ex- [par. 21-51 - par. 21-52 Ex- See par.21-15 *Ext. 1 Setpoint* for details.
tPID3Unit* tPID3Unit]

21-57 Ext. 3 Reference [Unit]

Range:
Function:

0.000 Ex- [-999999.999 - 999999.999 Ex- See par.21-17 *Ext. 1 Reference [Unit]* for details.
tPID3Unit* tPID3Unit]

21-58 Ext. 3 Feedback [Unit]

Range: 0.000 Ex- [-999999.999 - 999999.999 Ex- tPID3Unit* tPID3Unit]
Function: See par.21-18 *Ext. 1 Feedback [Unit]* for details.

21-59 Ext. 3 Output [%]

Range: 0 %* [0 - 100 %]
Function: See par.21-19 *Ext. 1 Output [%]* for details.

3.19.8 21-6* Closed-loop 3 PID

Configure the closed-loop 3 PID controller.

21-60 Ext. 3 Normal/Inverse Control

Option: [0] * Normal
 [1] Inverse
Function: See par.21-20 *Ext. 1 Normal/Inverse Control* for details.

21-61 Ext. 3 Proportional Gain

Range: 0.01 N/A* [0.00 - 10.00 N/A]
Function: See par.21-21 *Ext. 1 Proportional Gain* for details.

21-62 Ext. 3 Integral Time

Range: 10000.00 s* [0.01 - 10000.00 s]
Function: See par.21-22 *Ext. 1 Integral Time* for details.

21-63 Ext. 3 Differentiation Time

Range: 0.00 s* [0.00 - 10.00 s]
Function: See par.21-23 *Ext. 1 Differentiation Time* for details.

21-64 Ext. 3 Dif. Gain Limit

Range: 5.0 N/A* [1.0 - 50.0 N/A]
Function: See par.21-24 *Ext. 1 Dif. Gain Limit* for details.

3.20 Main Menu - Application Functions - FC 100 - Group 22

This group contains parameters used for monitoring VLT HVAC Drive applications.

22-00 External Interlock Delay

Range:

0 s* [0 - 600 s]

Function:

Only relevant if one of the digital inputs in par. 5-1* has been programmed for *External Interlock* [7]. The external interlock timer will introduce a delay after the signal has been removed from the digital input programmed for External Interlock, before a reaction takes place.

3

3.20.1 22-2* No-Flow Detection

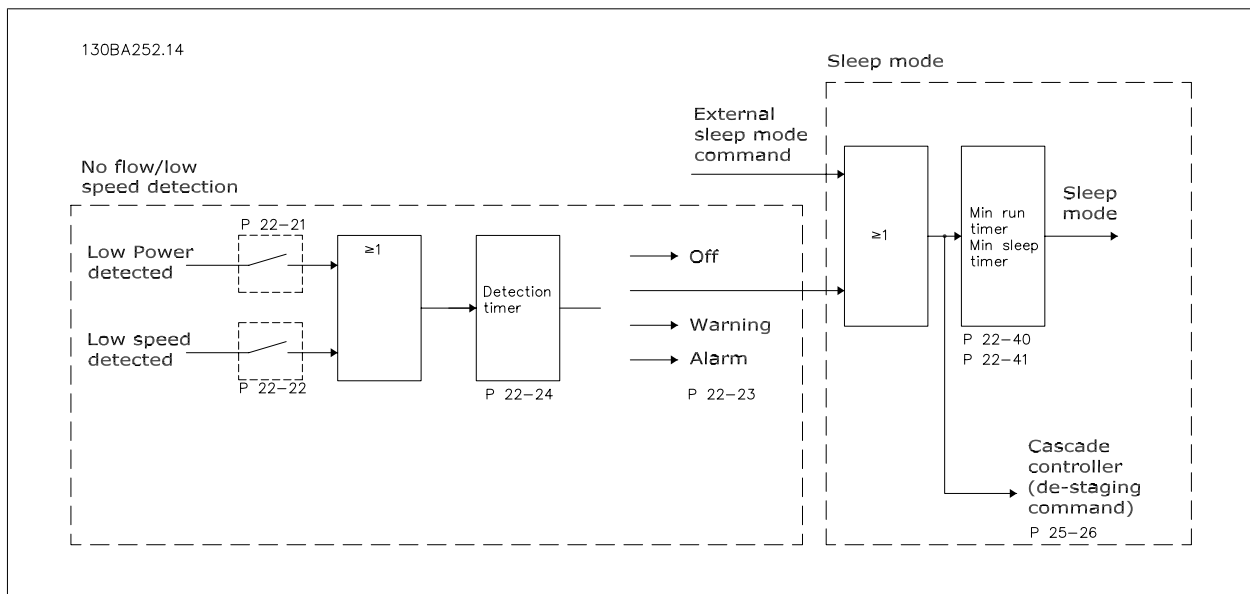

The adjustable frequency drive includes functions for detecting if the load conditions in the system allow the motor to be stopped:

*Low Power Detection

*Low Speed Detection

One of these two signals must be active for a set time (par.22-24 *No-Flow Delay*) before selected action takes place. Possible actions to select (par. 22-23 *No-Flow Function*): No action, Warning, Alarm, Sleep Mode.

No Flow Detection:

This function is used for detecting a no flow situation in pump systems where all valves can be closed. Can be used both when controlled by the integrated PI controller in the adjustable frequency drive or an external PI controller. The actual configuration must be programmed in par.1-00 *Configuration Mode*.

Configuration mode for

- Integrated PI Controller: Closed-loop
- External PI Controller: Open-loop



Carry out No Flow tuning before setting the PI controller parameters!

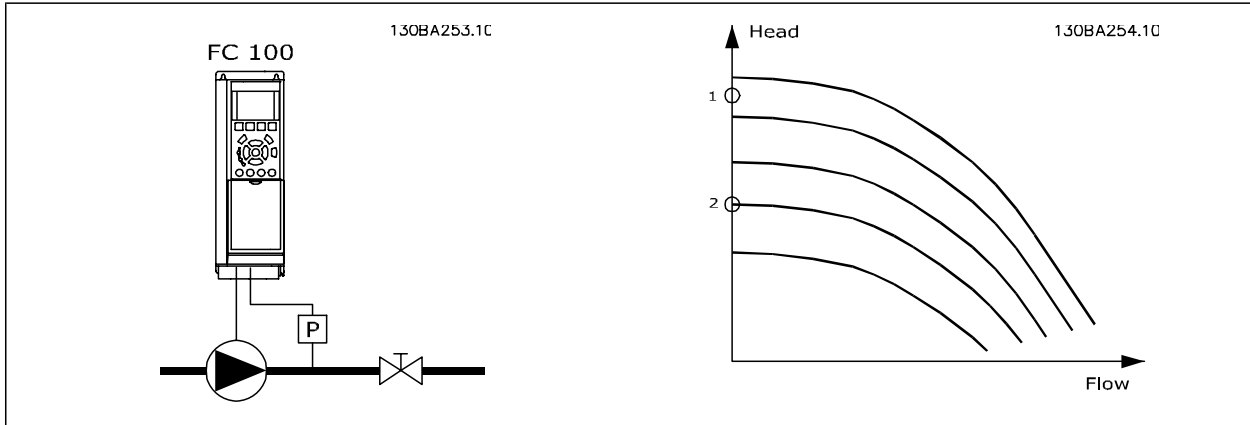

No Flow Detection is based on the measurement of speed and power. For a certain speed, the adjustable frequency drive calculates the power at no flow.

This coherence is based on the adjustment of two sets of speed and associated power at no flow. By monitoring the power, it is possible to detect no flow conditions in systems with fluctuating suction pressure or if the pump has a flat characteristic towards low speed.

The two sets of data must be based on measurement of power at approx. 50% and 85% of maximum speed with the valve(s) closed. The data are programmed in the par. 22-3*. It is also possible to run a *Low Power Auto Set-up* (par.22-20 *Low Power Auto Set-up*), automatically stepping through the commissioning process and also automatically storing the data measured. The adjustable frequency drive must be set for open-loop in par. 1-00 *Configuration Mode*, when carrying out the Auto Set-up (See No Flow Tuning par. 22-3*).

If to use the integrated PI controller, carry out No Flow tuning before setting the PI controller parameters!

Low speed detection:

Low Speed Detection gives a signal if the motor is operating with minimum speed as set in par.4-11 *Motor Speed Low Limit [RPM]* or par.4-12 *Motor Speed Low Limit [Hz]*. Actions are common with No Flow Detection (individual selection not possible).

The use of Low Speed Detection is not limited to systems with a no flow situation, but can be used in any system where operation at minimum speed allows for a stop of the motor until the load calls for a speed higher than minimum speed, e.g., systems with fans and compressors.

In pump systems, ensure that the minimum speed in par.4-11 *Motor Speed Low Limit [RPM]* or par.4-12 *Motor Speed Low Limit [Hz]* has been set high enough for detection as the pump can run with a rather high speed even with valves closed.

Dry pump detection:

No Flow Detection can also be used for detecting if the pump has run dry (low power consumption-high speed). Can be used with both the integrated PI controller and an external PI controller.

The condition for Dry Pump signal:

- Power consumption below no flow level

and

- Pump running at maximum speed or maximum reference open-loop, whichever is lowest.

The signal must be active for a set time (par.22-27 *Dry Pump Delay*) before selected action takes place.

Possible Actions to select (par.22-26 *Dry Pump Function*):

- Warning
- Alarm

No Flow Detection must be enabled (par.22-23 *No-Flow Function*) and commissioned (par. 22-3* , *No Power Tuning*).

22-20 Low Power Auto Set-up

Option:
Function:

When set for *Enabled*, an auto set-up sequence is activated, automatically setting speed to approx. 50% and 85% of rated motor speed (par.4-13 *Motor Speed High Limit [RPM]*, par.4-14 *Motor Speed High Limit [Hz]*). At those two speeds, the power consumption is automatically measured and stored. Before enabling Auto Set-up:

1. Close valve(s) in order to create a no-flow condition
2. The adjustable frequency drive must be set for open-loop (par.1-00 *Configuration Mode*). Note that it is important also to set par.1-03 *Torque Characteristics*.

[0] * OFF

[1] Enabled

NOTE!

Auto set-up must be done when the system has reached normal operating temperature!

NOTE!

It is important that the par.4-13 *Motor Speed High Limit [RPM]* or par.4-14 *Motor Speed High Limit [Hz]* is set to the max. operational speed of the motor!

It is important to do the auto set-up before configuring the integrated PI controller as settings will be reset when changing from closed to open-loop in par.1-00 *Configuration Mode*.

NOTE!

Carry out the tuning with the same settings in par.1-03 *Torque Characteristics*, as for operation after the tuning.

22-21 Low Power Detection

Option:
Function:

[0] * Disabled

[1] Enabled

If selecting Enabled, the low power detection commissioning must be carried out in order to set the parameters in group 22-3* for proper operation!

22-22 Low Speed Detection

Option:
Function:

[0] * Disabled

[1] Enabled

Select Enabled for detecting when the motor operates with a speed as set in par.4-11 *Motor Speed Low Limit [RPM]* or par.4-12 *Motor Speed Low Limit [Hz]*.

22-23 No-Flow Function

Option:

Function:

Common actions for low power detection and low speed detection (Individual selections not possible).

- [0] * OFF
- [1] Sleep Mode
- [2] Warning Messages in the Local Control Panel display (if mounted) and/or signal via a relay or a digital output.
- [3] Alarm The adjustable frequency drive trips and the motor stays stopped until reset.

22-24 No-Flow Delay

Range:

Function:

Set the time. Low Power/Low Speed must remain detected to activate signal for actions. If detection disappears before the timer runs out, the timer will be reset.

- 10 s* [1 - 600 s]

22-26 Dry Pump Function

Option:

Function:

Low Power Detection must be Enabled (par.22-21 *Low Power Detection*) and commissioned (using either par. 22-3*, *No Flow Power Tuning*, or par.22-20 *Low Power Auto Set-up*) in order to use dry pump detection.

- [0] * OFF
- [1] Warning Messages in the Local Control Panel display (if mounted) and/or signal via a relay or a digital output.
- [2] Alarm The adjustable frequency drive trips and the motor stays stopped until reset.

22-27 Dry Pump Delay

Range:

Function:

Defines for how long the dry pump condition must be active before activating a warning or alarm.

- 10 s* [0 - 600 s]

3.20.2 22-3* No-Flow Power Tuning

Tuning Sequence, if not choosing *Auto Set-up* in par.22-20 *Low Power Auto Set-up*:

1. Close the main valve to stop flow
2. Run with motor until the system has reached normal operating temperature
3. Press Hand On button on the LCP and adjust speed for approx. 85% of rated speed. Note the exact speed
4. Read the power consumption either by looking for the actual power in the data line in the LCP or call par.16-10 *Power [kW]* or par.16-11 *Power [hp]* in the main menu. Note the power readout
5. Change the speed to approx. 50% of rated speed. Note the exact speed
6. Read the power consumption either by looking for the actual power in the data line in the LCP or call par.16-10 *Power [kW]* or par.16-11 *Power [hp]* in the main menu. Note the power readout
7. Program the speeds used in par.22-32 *Low Speed [RPM]*, par.22-33 *Low Speed [Hz]*, par.22-36 *High Speed [RPM]* and par.22-37 *High Speed [Hz]*
8. Program the associated power values in par.22-34 *Low Speed Power [kW]*, par.22-35 *Low Speed Power [HP]*, par.22-38 *High Speed Power [kW]* and par.22-39 *High Speed Power [HP]*
9. Switch back by means of *Auto On* or *Off*

**NOTE!**

Set par.1-03 *Torque Characteristics* before tuning takes place.

3

22-30 No-Flow Power**Range:**

0.00 kW* [0.00 - 0.00 kW]

Function:

Readout of calculated no-flow power at actual speed. If power drops to the display value, the adjustable frequency drive will consider the condition as a no-flow situation.

22-31 Power Correction Factor**Range:**

100 %* [1 - 400 %]

Function:

Make corrections to the calculated power at par.22-30 *No-Flow Power*.
If No Flow is detected when it should not be detected, the setting should be decreased. However, if No Flow is not detected when it should be detected, the setting should be increased to above 100%.

22-32 Low Speed [RPM]**Range:**

0 RPM* [0 - par. 22-36 RPM]

Function:

To be used if par.0-02 *Motor Speed Unit* has been set for RPM (parameter not visible if Hz selected).
Set used speed to the 50% level.
This function is used for storing values needed to tune No-flow Detection.

22-33 Low Speed [Hz]**Range:**

0 Hz* [0.0 - par. 22-37 Hz]

Function:

To be used if par.0-02 *Motor Speed Unit* has been set for Hz (parameter not visible if RPM selected).
Set used speed to the 50% level.
The function is used for storing values needed to tune No-flow Detection.

22-34 Low Speed Power [kW]**Range:**

0 kW* [0.00 - 0.00 kW]

Function:

To be used if par.0-03 *Regional Settings* has been set for International (parameter not visible if North America selected).
Set power consumption to 50% speed level.
This function is used for storing values needed to tune No-flow Detection.

22-35 Low Speed Power [HP]**Range:**

0 hp* [0.00 - 0.00 hp]

Function:

To be used if par.0-03 *Regional Settings* has been set for North America (parameter not visible if International selected).
Set power consumption to 50% speed level.
This function is used for storing values needed to tune No-flow Detection.

22-36 High Speed [RPM]**Range:**

0 RPM* [0 - par. 4-13 RPM]

Function:

To be used if par.0-02 *Motor Speed Unit* has been set for RPM (parameter not visible if Hz selected).
Set used speed for the 85% level.
The function is used for storing values needed to tune No-flow Detection.

22-37 High Speed [Hz]

Range:

0.0 Hz* [0.0 - par. 4-14 Hz]

Function:

To be used if par.0-02 *Motor Speed Unit* has been set for Hz (parameter not visible if RPM selected). Set used speed for the 85% level.
The function is used for storing values needed to tune No-flow Detection.

22-38 High Speed Power [kW]

Range:

0 kW* [0.00 - 0.00 kW]

Function:

To be used if par.0-03 *Regional Settings* has been set for International (parameter not visible if North America selected).
Set power consumption to 85% speed level.
This function is used for storing values needed to tune No-flow Detection.

22-39 High Speed Power [HP]

Range:

0 hp* [0.00 - 0.00 hp]

Function:

To be used if par.0-03 *Regional Settings* has been set for North America (parameter not visible if International selected).
Set power consumption to 85% speed level.
This function is used for storing values needed to tune No-flow Detection.

3.20.3 22-4* Sleep Mode

If the load on the system allows for stop of the motor and the load is monitored, the motor can be stopped by activating the sleep mode function. This is not a normal stop command, but ramps the motor down to 0 RPM and stops energizing the motor. When in sleep mode, certain conditions are monitored to find out when load has been applied to the system again.

Sleep mode can be activated either from the No Flow Detection/Minimum Speed Detection (must be programmed via parameters for No-Flow Detection, see the signal flow diagram in parameter group 22-2*, No-Flow Detection) or via an external signal applied to one of the digital inputs (must be programmed via the parameters for configuration of the digital inputs, par. 5-1* selecting [66] Sleep Mode). Sleep mode is activated only when no wake-up conditions are present.

To make it possible to use, for example, an electro-mechanical flow switch to detect a no flow condition and activate sleep mode, the action takes place at raising edge of the external signal applied (otherwise, the adjustable frequency drive would never come out of sleep mode as the signal would be steady connected).

	<p>NOTE! If sleep mode is to be based on No Flow Detection/Minimum Speed, remember to choose Sleep Mode [1] in par.22-23 <i>No-Flow Function</i>.</p>
--	--

If par.25-26 *Destage At No-Flow* is set for Enabled, activating sleep mode will send a command to the cascade controller (if enabled) to start de-staging lag pumps (fixed speed) before stopping the lead pump (variable speed).

When entering sleep mode, the lower status line in the Local Control Panel shows Sleep Mode.

See also signal flow chart in section 22-2* *No Flow Detection*.

There are three different ways of using the sleep mode function:

3

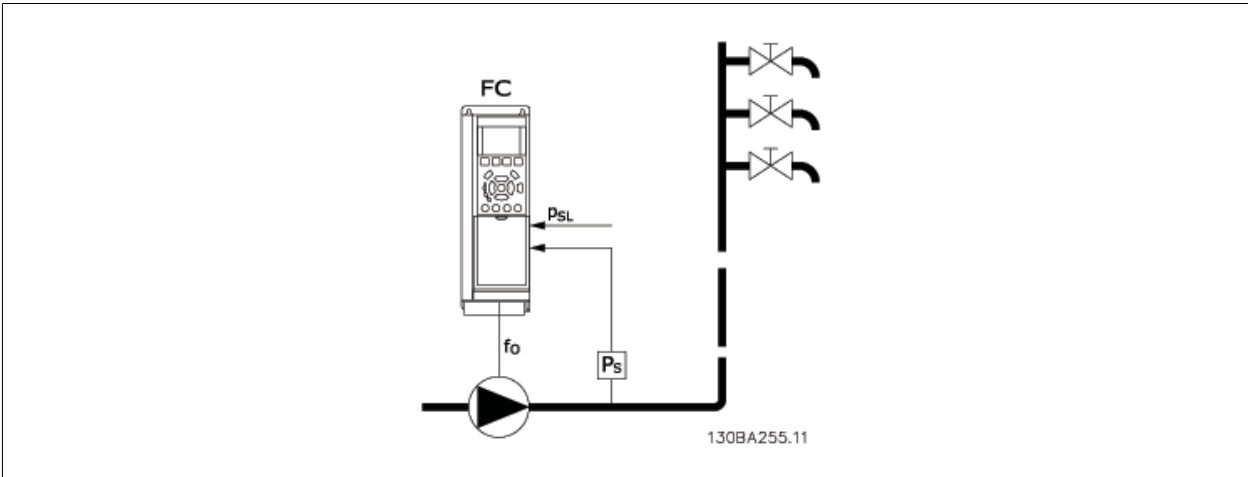

1) Systems where the integrated PI controller is used for controlling pressure or temperature, for example, to boost systems with a pressure feedback signal applied to the adjustable frequency drive from a pressure transducer. par.1-00 *Configuration Mode* must be set for closed-loop and the PI controller configured for desired reference and feedback signals.

Example: Boost system.

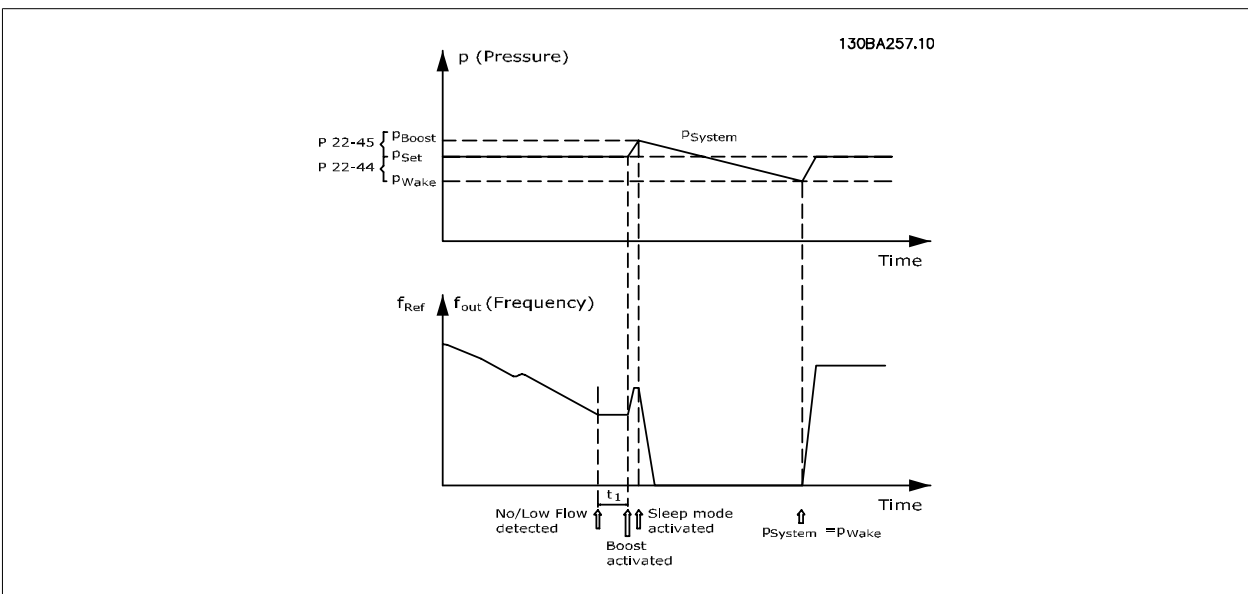

If no flow is detected, the adjustable frequency drive will increase the setpoint for pressure to ensure a slight overpressure in the system (boost to be set in par.22-45 *Setpoint Boost*).

The feedback from the pressure transducer is monitored and when this pressure has dropped with a set percentage below the normal setpoint for pressure (Pset), the motor will ramp up again and pressure will be controlled for reaching the set value (Pset).

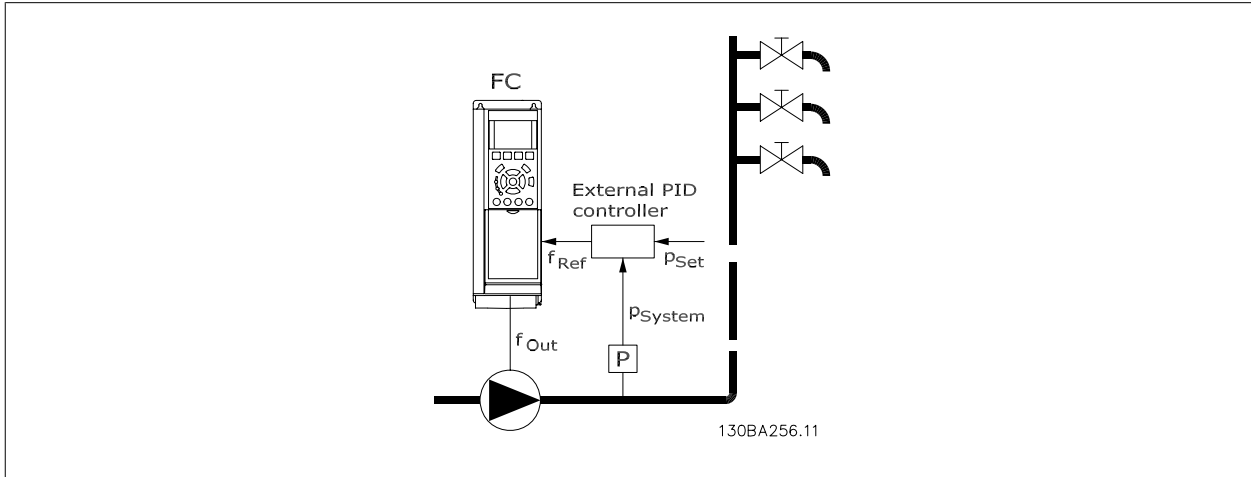

2) In systems where the pressure or temperature is controlled by an external PI controller, the wake-up conditions cannot be based on feedback from the pressure/temperature transducer as the setpoint is not known. In the example with a boost system, desired pressure Pset is not known. par. 1-00 *Configuration Mode* must be set for Open-loop.
 Example: Boost system.

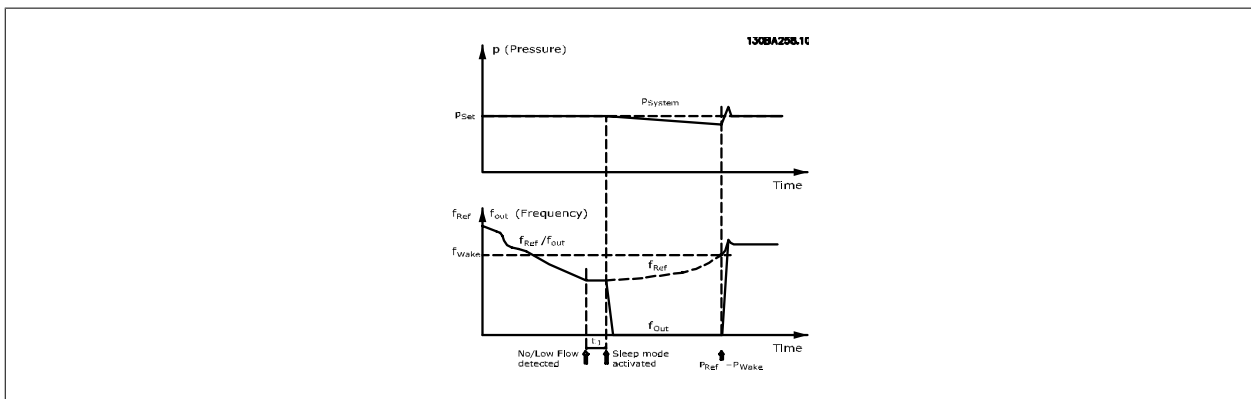

When low power or low speed is detected the motor is stopped, but the reference signal (f_{ref}) from the external controller is still monitored and because of the low pressure created, the controller will increase the reference signal to gain pressure. When the reference signal has reached a set value f_{wake} , the motor restarts,.

The speed is set manually by an external reference signal (Remote Reference). The settings (par. 22-3*) for tuning of the No Flow function must be set to default.

Configuration possibilities, overview:

	Internal PI Controller (par.1-00 <i>Configuration Mode</i> : Closed-loop)		External PI controller or manual control (par.1-00 <i>Configuration Mode</i> : Open-loop)	
	Sleep mode	Wake up	Sleep mode	Wake up
No Flow detection (pumps only)	Yes		Yes (except manual setting of speed)	
Low speed detection	Yes		Yes	
External signal	Yes		Yes	
Pressure/Temperature (transmitter connected)		Yes		No
Output frequency		No		Yes

**NOTE!**

Sleep mode will not be active when Local Reference is active (set speed manually by means of arrow buttons on the LCP). See par. 3-13 *Reference Site*.

Does not work in hand mode. Auto set-up in open-loop must be carried out before setting input/output in closed-loop.

22-40 Minimum Run Time**Range:**

10 s* [0 - 600 s]

Function:

Set the desired minimum running time for the motor after a start command (digital input or bus) before entering sleep mode.

22-41 Minimum Sleep Time**Range:**

10 s* [0 - 600 s]

Function:

Set the desired minimum time for staying in sleep mode. This will override any wake-up conditions.

22-42 Wake-up Speed [RPM]**Range:**

0 RPM* [par. 4-11 - par. 4-13 RPM]

Function:

To be used if par.0-02 *Motor Speed Unit* has been set for RPM (parameter not visible if Hz selected). Only to be used if par.1-00 *Configuration Mode* is set for open-loop and speed reference is applied by an external controller.
Set the reference speed at which sleep mode should be canceled.

22-43 Wake-up Speed [Hz]**Range:**

0 Hz* [par. 4-12 - par. 4-14 Hz]

Function:

To be used if par.0-02 *Motor Speed Unit* has been set for Hz (parameter not visible if RPM selected). Only to be used if par.1-00 *Configuration Mode* is set for open-loop and speed reference is applied by an external controller controlling the pressure.
Set the reference speed at which sleep mode should be canceled.

22-44 Wake-up Ref./FB Difference**Range:**

10 %* [0 - 100 %]

Function:

Only to be used if par.1-00 *Configuration Mode* is set for closed-loop and the integrated PI controller is used for controlling the pressure.
Set the pressure drop allowed in percentage of setpoint for the pressure (Pset) before canceling the sleep mode.

**NOTE!**

If used in application where the integrated PI controller is set for inverse control (e.g., cooling tower applications) in par.20-71 *Tuning Mode*, the value set in par.22-44 *Wake-up Ref./FB Difference* will automatically be added.

22-45 Setpoint Boost

Range:

0 %* [-100 - 100 %]

Function:

Only to be used if par.1-00 *Configuration Mode*, is set for closed-loop and the integrated PI controller is used. For example, in systems with constant pressure control, it is advantageous to increase the system pressure before the motor is stopped. This will extend the time during which the motor is stopped and help to avoid frequent start/stop.

Set the desired over pressure/temperature as a percentage of the setpoint for the pressure (Pset)/ temperature before entering sleep mode.

If set at 5%, the boost pressure will be Pset*1.05. The negative values can be used, for example, for cooling tower control, where a negative change is needed.

22-46 Maximum Boost Time

Range:

60 s* [0 - 600 s]

Function:

Only to be used if par.1-00 *Configuration Mode* is set for closed-loop and the integrated PI controller is used for controlling the pressure.

Set the maximum time for which boost mode will be allowed. If the set time is exceeded, sleep mode will be entered and will not wait for the set boost pressure to be reached.

3.20.4 22-5* End of Curve

The End of Curve conditions occur when a pump is yielding a too large volume to ensure the set pressure. This can occur if there is a leakage in the distribution pipe system after the pump causing the pump to operate at the end of the pump characteristic, valid for the max. speed set in par. 4-13 *Motor Speed High Limit [RPM]* or par.4-14 *Motor Speed High Limit [Hz]*.

If the feedback is 2.5% of the programmed value in par.20-14 *Maximum Reference/Feedb.* (or numerical value of par.20-13 *Minimum Reference/Feedb.* whichever is highest) below the setpoint for the desired pressure for a set time (par.22-51 *End of Curve Delay*), and the pump is running with max. speed set in par.4-13 *Motor Speed High Limit [RPM]* or par.4-14 *Motor Speed High Limit [Hz]*, - the function selected in par.22-50 *End of Curve Function* will take place.

It is possible to get a signal on one of the digital outputs by selecting End of Curve [192] in par. 5-3* *Digital Outputs* and/or par. 5-4* *Relays*. The signal will be present, when an End of Curve condition occurs and the selection in par.22-50 *End of Curve Function*, is different from Off. The end of curve function can only be used when operating with the built-in PID controller (closed-loop in par.1-00 *Configuration Mode*).

22-50 End of Curve Function

Option:

[0] * OFF

Function:

End of Curve monitoring not active.

[1] Warning

A warning is issued in the display [W94].

[2] Alarm

An alarm is issued and the adjustable frequency drive trips. A message [A94] appears in the display.



NOTE!

Automatic restart will reset the alarm and start the system again.

22-51 End of Curve Delay

Range:

10 s* [0 - 600 s]

Function:

When an end of curve condition is detected, a timer is activated. When the time set in this parameter expires and the End of Curve condition has been steady in the entire period, the function set in par. 22-50 *End of Curve Function* will be activated. If the condition disappears before the timer expires, the timer will be reset.

3.20.5 22-6* Broken Belt Detection

Broken belt detection can be used in both closed-loop and open-loop systems for pumps, fans and compressors. If the estimated motor torque is below the broken belt torque value (par.22-61 *Broken Belt Torque*) and the adjustable frequency drive output frequency is above or equal to 15 Hz, the broken belt function (par.22-60 *Broken Belt Function*) is performed.

22-60 Broken Belt Function

Option:
Function:

Selects the action to be performed if the broken belt condition is detected.

[0] * OFF

[1] Warning

[2] Trip

22-61 Broken Belt Torque

Range:
Function:

10 %* [0 - 100 %]

Sets the broken belt torque as a percentage of the rated motor torque.

22-62 Broken Belt Delay

Range:
Function:

10 s [0 - 600 s]

Sets the time for which the broken belt conditions must be active before carrying out the action selected in par.22-60 *Broken Belt Function*.

3.20.6 22-7* Short Cycle Protection

When controlling refrigeration compressors, often there will be a need for limiting the numbers of starts. One way to do this is to ensure a minimum run time (time between a start and a stop) and a minimum interval between starts.

This means that any normal stop command can be overridden by the *Minimum Run Time* function (par.22-77 *Minimum Run Time*) and any normal start command (Start/Jog/Freeze) can be overridden by the *Interval Between Starts* function (par.22-76 *Interval between Starts*).

None of the two functions are active if *Hand On* or *Off* modes have been activated via the LCP. If selecting *Hand On* or *Off*, the two timers will be reset to 0, and not start counting until *Auto* is pressed and an active start command applied.

NOTE!

A Coast command or missing Run Permissive signal will override both Minimum Run Time and Interval Between Starts functions.

22-75 Short Cycle Protection

Option:
Function:

[0] * Disabled

Timer set in par.22-76 *Interval between Starts* is disabled.

[1] Enabled

Timer set in par.22-76 *Interval between Starts* is enabled.

22-76 Interval between Starts

Range:
Function:

par. 22-77 [par. 22-77 - 3600 s]
s*

Sets the time desired as minimum time between two starts. Any normal start command (Start/Jog/Freeze) will be disregarded until the timer has expired.

22-77 Minimum Run Time

Range:

0 s* [0 - par. 22-76 s]

Function:

Sets the time desired as minimum run time after a normal start command (Start/Jog/Freeze). Any normal stop command will be disregarded until the set time has expired. The timer will start counting following a normal start command (Start/Jog/Freeze).

The timer will be overridden by a Coast (Inverse) or an External Interlock command.



NOTE!

Does not work in cascade mode.

3.20.7 22-8* Flow Compensation

It is sometimes the case that it is not possible for a pressure transducer to be placed at a remote point in the system and it can only be located close to the fan/pump outlet. Flow compensation operates by adjusting the setpoint according to the output frequency, which is almost proportional to flow, thus compensating for higher losses at higher flow rates.

H_{DESIGN} (Required pressure) is the setpoint for closed-loop (PI) operation of the adjustable frequency drive and is set as for closed-loop operation without flow compensation.

It is recommended to use slip compensation and RPM as unit.

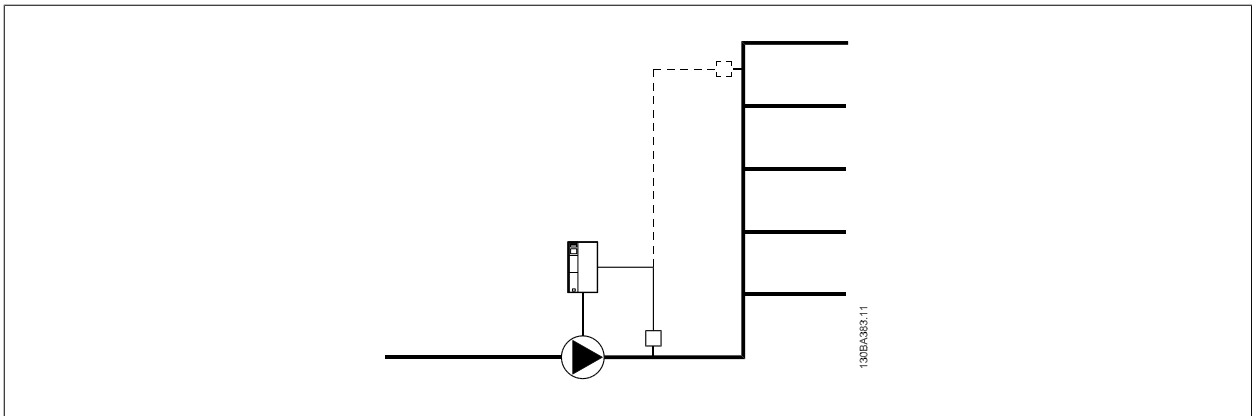

NOTE!

When flow compensation is used with the cascade controller (parameter group 25-**), the actual setpoint will not depend on speed (flow) but on the number of pumps cut in. See below:

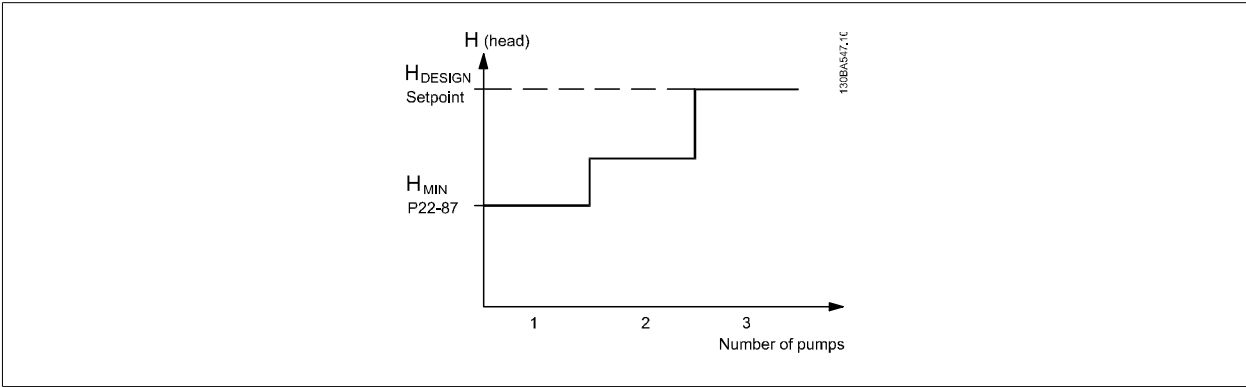

There are two methods which can be employed, depending upon whether or not the Speed at System design Working Point is known.

Parameter used	Speed at Design Point	Speed at Design Point	Cascade Controller
	KNOWN	UNKNOWN	
Flow Compensation, 22-80	+	+	+
Square-Linear Curve Approximation, 22-81	+	+	-
Work Point Calculation, 22-82	+	+	-
Speed at No Flow, 22-83/84	+	+	-
Speed at Design Point, 22-85/86	+	-	-
Pressure at No Flow, 22-87	+	+	+
Pressure at Rated Speed, 22-88	-	+	-
Flow at Design Point, 22-89	-	+	-
Flow at Rated Speed, 22-90	-	+	-

22-80 Flow Compensation

Option:	Function:
[0] * Disabled	[0] <i>Disabled:</i> Setpoint compensation not active.
[1] Enabled	[1] <i>Enabled:</i> Setpoint compensation is active. Enabling this parameter allows the Flow Compensated Setpoint operation.

22-81 Square-linear Curve Approximation

Range:	Function:
100 %* [0 - 100 %]	<p>Example 1: Adjustment of this parameter allows the shape of the control curve to be adjusted. 0 = Linear 100% = Ideal shape (theoretical).</p>

NOTE!
Please note: Not visible when running in cascade.

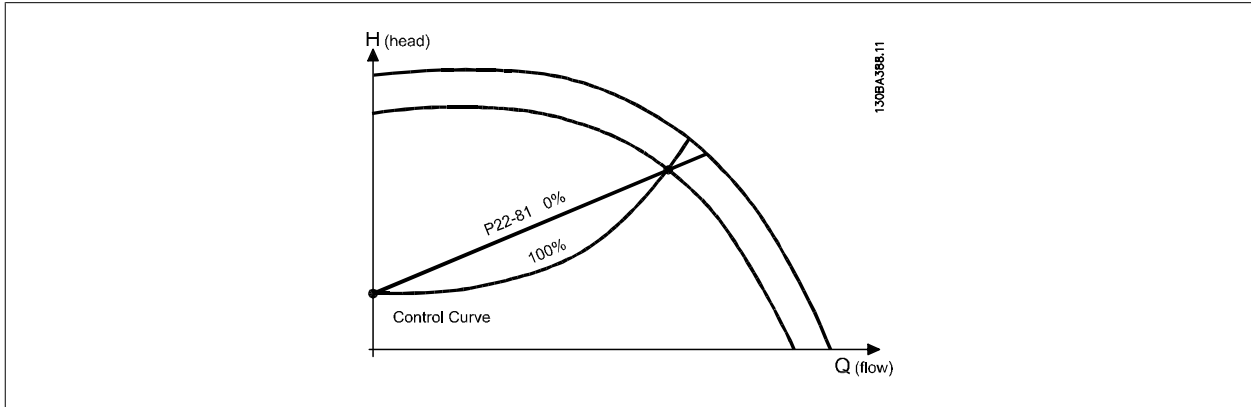

22-82 Work Point Calculation

Option:

Function:

Example 1: Speed at System Design Working Point is known:

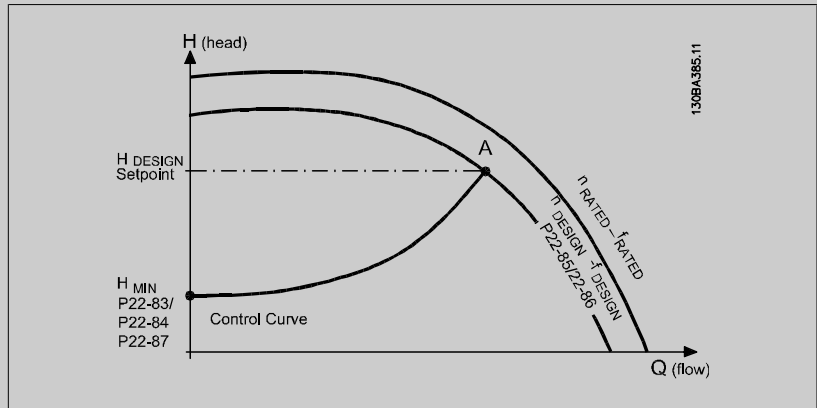

From the data sheet showing characteristics for the specific equipment at different speeds, simply reading across from the H_{DESIGN} point and the Q_{DESIGN} point allows us to find point A, which is the system design working point. The pump characteristics at this point should be identified and the associated speed programmed. Closing the valves and adjusting the speed until H_{MIN} has been achieved allows the speed at the no flow point to be identified. Adjustment of par.22-81 *Square-linear Curve Approximation* then allows the shape of the control curve to be adjusted infinitely.

Example 2:

Speed at System Design Working Point is not known: Where the Speed at System Design Working Point is unknown, another reference point on the control curve needs to be determined by means of the data sheet. By looking at the curve for the rated speed and plotting the design pressure (H_{DESIGN} , Point C), the flow at that pressure Q_{RATED} can be determined. Similarly, by plotting the design flow (Q_{DESIGN} , Point D), the pressure H_{D} at that flow can be determined. Knowing these two points on the pump curve, along with H_{MIN} described above, allows the adjustable frequency drive to calculate the reference point B and thus to plot the control curve that will also include the system design working point A.

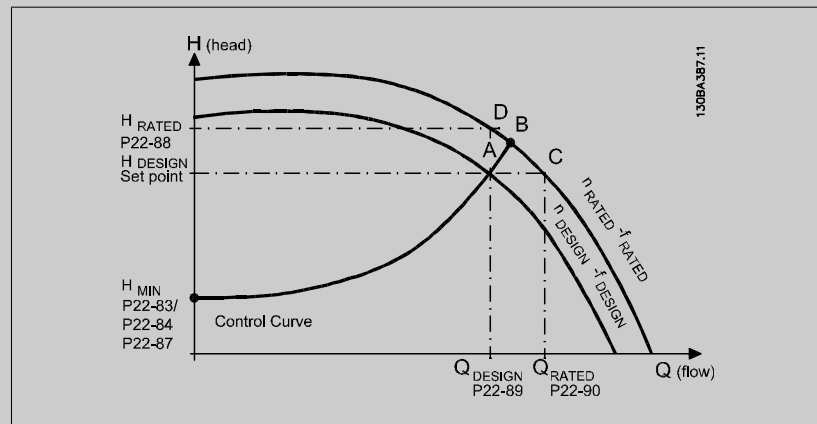

[0] * Disabled

Disabled [0]: Work Point Calculation not active. To be used if speed at design point is known (see table above).

[1] Enabled

Enabled [1]: Work Point Calculation is active. Enabling this parameter allows the calculation of the unknown System Design Working Point at 50/60 Hz speed, from the input data set in par. 22-83 *Speed at No-Flow [RPM]* par.22-84 *Speed at No-Flow [Hz]*, par.22-87 *Pressure at No-Flow Speed*, par.22-88 *Pressure at Rated Speed*, par.22-89 *Flow at Design Point* and par.22-90 *Flow at Rated Speed*.

22-83 Speed at No-Flow [RPM]**Range:**

300. RPM* [0 - par. 22-85 RPM]

Function:

Resolution 1 RPM.

The speed of the motor at which the flow is zero and the minimum pressure H_{MIN} is achieved should be entered here in RPM. Alternatively, the speed in Hz can be entered in par.22-84 *Speed at No-Flow [Hz]*. If it has been decided to use RPM in par.0-02 *Motor Speed Unit*, then par.22-85 *Speed at Design Point [RPM]* should also be used. Closing the valves and reducing the speed until minimum pressure H_{MIN} is achieved will determine this value.

22-84 Speed at No-Flow [Hz]**Range:**

50.0 Hz* [0.0 - par. 22-86 Hz]

Function:

Resolution 0.033 Hz.

The speed of the motor at which flow has effectively stopped and minimum pressure H_{MIN} is achieved should be entered here in Hz. Alternatively, the speed in RPM can be entered in par.22-83 *Speed at No-Flow [RPM]*. If it has been decided to use Hz in par.0-02 *Motor Speed Unit*, then par. 22-86 *Speed at Design Point [Hz]* should also be used. Closing the valves and reducing the speed until minimum pressure H_{MIN} is achieved will determine this value.

22-85 Speed at Design Point [RPM]

Range:	Function:
1500. RPM* [par. 22-83 - 60000. RPM]	Resolution 1 RPM. Only visible when par.22-82 <i>Work Point Calculation</i> is set to <i>Disable</i> . The speed of the motor at which the system design working point is achieved should be entered here in RPM. Alternatively, the speed in Hz can be entered in par.22-86 <i>Speed at Design Point [Hz]</i> . If it has been decided to use RPM in par.0-02 <i>Motor Speed Unit</i> , then par.22-83 <i>Speed at No-Flow [RPM]</i> should also be used.

22-86 Speed at Design Point [Hz]

Range:	Function:
50/60.0 [par. 22-84 - par. 4-19 Hz] Hz*	Resolution 0.033 Hz. Only visible when par.22-82 <i>Work Point Calculation</i> is set to <i>Disable</i> . The speed of the motor at which the system design working point is achieved should be entered here in Hz. Alternatively, the speed in RPM can be entered in par.22-85 <i>Speed at Design Point [RPM]</i> . If it has been decided to use Hz in par.0-02 <i>Motor Speed Unit</i> , then par.22-83 <i>Speed at No-Flow [RPM]</i> should also be used.

22-87 Pressure at No-Flow Speed

Range:	Function:
0.000 N/A* [0.000 - par. 22-88 N/A]	Enter the pressure H_{MIN} corresponding to Speed at No Flow in Reference/Feedback Units.

22-88 Pressure at Rated Speed

Range:	Function:
999999.999 [par. 22-87 - 999999.999 N/A] N/A*	Enter the value corresponding to the Pressure at Rated Speed, in Reference/Feedback Units. This value can be defined using the pump datasheet.

22-89 Flow at Design Point

Range:	Function:
0.000 N/A* [0.000 - 999999.999 N/A]	Enter the value corresponding to the Flow at Design Point. No units necessary.

22-90 Flow at Rated Speed

Range:	Function:
0.000 N/A* [0.000 - 999999.999 N/A]	Enter the value corresponding to Flow at Rated Speed. This value can be defined using the pump datasheet.

3.21 Main Menu - Time-based Functions - FC 100 - Group 23

3.21.1 23-0* Timed Actions

Use *Timed Actions* for actions needing to be performed on a daily or weekly basis, e.g., different references for working hours / non-working hours. Up to 10 Timed Actions can be programmed in the adjustable frequency drive. The Timed Action number is selected from the list when entering parameter group 23-0* from the LCP. par.23-00 *ON Time* – par.23-04 *Occurrence* then refer to the selected Timed Action number. Each timed action is divided into an ON time and an OFF time, in which two different actions may be performed.

The actions programmed in timed actions are merged with corresponding actions from digital inputs, control work via bus and Smart Logic Controller, according to merge rules set up in 8-5*, digital/bus.



NOTE!

The clock (parameter group 0-7*) must be correctly programmed for timed actions to function correctly.



NOTE!

When mounting an Analog I/O MCB109 option card, a battery backup of the date and time is included.

NOTE!

The PC-based configuration tool MCT 10 includes a special guide for easy programming of timed actions.

23-00 ON Time

Array [10]

Range:

0 N/A* [0 - 0 N/A]

Function:

Sets the ON time for the timed action.



NOTE!

The adjustable frequency drive has no backup of the clock function and the set date/time will reset to default (2000-01-01 00:00) after a power-down unless a Real Time Clock module with backup is installed. In par.0-79 *Clock Fault*, it is possible to program a warning for cases when the clock has not been set properly, e.g., after a power-down.

23-01 ON Action

Arra [10]

Option:

Function:

Select the action during ON Time. See par.13-52 *SL Controller Action* for descriptions of the options.

[0] * DISABLED

[1] No action

[2] Select set-up 1

[3] Select set-up 2

[4] Select set-up 3

[5]	Select set-up 4
[10]	Select preset ref 0
[11]	Select preset ref 1
[12]	Select preset ref 2
[13]	Select preset ref 3
[14]	Select preset ref 4
[15]	Select preset ref 5
[16]	Select preset ref 6
[17]	Select preset ref 7
[18]	Select ramp 1
[19]	Select ramp 2
[22]	Run
[23]	Run reverse
[24]	Stop
[26]	Dcstop
[27]	Coast
[28]	Freeze output
[29]	Start timer 0
[30]	Start timer 1
[31]	Start timer 2
[32]	Set digital out A low
[33]	Set digital out B low
[34]	Set digital out C low
[35]	Set digital out D low
[36]	Set digital out E low
[37]	Set digital out F low
[38]	Set digital out A high
[39]	Set digital out B high
[40]	Set digital out C high
[41]	Set digital out D high
[42]	Set digital out E high
[43]	Set digital out F high
[60]	Reset Counter A
[61]	Reset Counter B
[70]	Start Timer 3
[71]	Start Timer 4
[72]	Start Timer 5
[73]	Start Timer 6
[74]	Start Timer 7

NOTE!

For choices [32] - [43], see also par. group 5-3*, *Digital Outputs* and 5-4*, *Relays*.

23-02 OFF Time

Array [10]

Range:

0 N/A* [0 - 0 N/A]

Function:

Sets the OFF time for the timed action.

NOTE!

The adjustable frequency drive has no backup of the clock function and the set date/time will reset to default (2000-01-01 00:00) after a power-down unless a Real Time Clock module with backup is installed. In par.0-79 *Clock Fault*, it is possible to program a warning for cases when the clock has not been set properly, e.g., after a power-down.

23-03 OFF Action

Array [10]

Option:
Function:
Select the action during OFF Time. See par.13-52 *SL Controller Action* for descriptions of the options.

[0] *	DISABLED
[1]	No action
[2]	Select set-up 1
[3]	Select set-up 2
[4]	Select set-up 3
[5]	Select set-up 4
[10]	Select preset ref 0
[11]	Select preset ref 1
[12]	Select preset ref 2
[13]	Select preset ref 3
[14]	Select preset ref 4
[15]	Select preset ref 5
[16]	Select preset ref 6
[17]	Select preset ref 7
[18]	Select ramp 1
[19]	Select ramp 2
[22]	Run
[23]	Run reverse
[24]	Stop
[26]	Dcstop
[27]	Coast
[28]	Freeze output
[29]	Start timer 0
[30]	Start timer 1
[31]	Start timer 2
[32]	Set digital out A low
[33]	Set digital out B low
[34]	Set digital out C low

- [35] Set digital out D low
- [36] Set digital out E low
- [37] Set digital out F low
- [38] Set digital out A high
- [39] Set digital out B high
- [40] Set digital out C high
- [41] Set digital out D high
- [42] Set digital out E high
- [43] Set digital out F high
- [60] Reset Counter A
- [61] Reset Counter B
- [70] Start Timer 3
- [71] Start Timer 4
- [72] Start Timer 5
- [73] Start Timer 6
- [74] Start Timer 7

23-04 Occurrence

Array [10]

Option:

Function:

Select the day(s) to which the timed action applies. Specify working/non-working days in par. 0-81 *Working Days*, par.0-82 *Additional Working Days* and par.0-83 *Additional Non-Working Days*.

- [0] * All days
- [1] Working days
- [2] Non-working days
- [3] Monday
- [4] Tuesday
- [5] Wednesday
- [6] Thursday
- [7] Friday
- [8] Saturday
- [9] Sunday

3.21.2 23-1* Maintenance

Wear and tear calls for periodic inspection and service of elements in the application, e.g., motor bearings, feedback sensors and seals or filters. Using Preventive Maintenance, service intervals may be programmed into the adjustable frequency drive. The adjustable frequency drive will give a message when maintenance is required. 20 Preventive Maintenance Events can be programmed into the adjustable frequency drive. The following must be specified for each event:

- Maintenance item (e.g., "Motor Bearings")
- Maintenance action (e.g., "Replace")
- Maintenance Time Base (e.g., "Running Hours" or a specific date and time)
- Maintenance Time Interval or the date and time of next maintenance

**NOTE!**

To disable a preventive maintenance event, the associated par.23-12 *Maintenance Time Base* must be set to *Disabled* [0].

Preventive maintenance can be programmed from the LCP, but use of the PC-based VLT Motion Control Tool MCT10 is recommended.

3

ID	Name	Setup 1	Setup 2	Setup 3	Setup 4
2310.0	Maintenance Item	Motor bearings	Motor bearings	Motor bearings	Motor bearings
2310.1	Maintenance Item	Motor bearings	Motor bearings	Motor bearings	Motor bearings
2310.2	Maintenance Item	Motor bearings	Motor bearings	Motor bearings	Motor bearings
2310.3	Maintenance Item	Motor bearings	Motor bearings	Motor bearings	Motor bearings
2310.4	Maintenance Item	Motor bearings	Motor bearings	Motor bearings	Motor bearings
2310.5	Maintenance Item	Motor bearings	Motor bearings	Motor bearings	Motor bearings
2310.6	Maintenance Item	Motor bearings	Motor bearings	Motor bearings	Motor bearings
2310.7	Maintenance Item	Motor bearings	Motor bearings	Motor bearings	Motor bearings
2310.8	Maintenance Item	Motor bearings	Motor bearings	Motor bearings	Motor bearings
2310.9	Maintenance Item	Motor bearings	Motor bearings	Motor bearings	Motor bearings
2310.10	Maintenance Item	Motor bearings	Motor bearings	Motor bearings	Motor bearings
2310.11	Maintenance Item	Motor bearings	Motor bearings	Motor bearings	Motor bearings
2310.12	Maintenance Item	Motor bearings	Motor bearings	Motor bearings	Motor bearings
2310.13	Maintenance Item	Motor bearings	Motor bearings	Motor bearings	Motor bearings
2310.14	Maintenance Item	Motor bearings	Motor bearings	Motor bearings	Motor bearings
2310.15	Maintenance Item	Motor bearings	Motor bearings	Motor bearings	Motor bearings
2310.16	Maintenance Item	Motor bearings	Motor bearings	Motor bearings	Motor bearings
2310.17	Maintenance Item	Motor bearings	Motor bearings	Motor bearings	Motor bearings
2310.18	Maintenance Item	Motor bearings	Motor bearings	Motor bearings	Motor bearings
2310.19	Maintenance Item	Motor bearings	Motor bearings	Motor bearings	Motor bearings
2311.0	Maintenance Action	Lubricate	Lubricate	Lubricate	Lubricate
2311.1	Maintenance Action	Lubricate	Lubricate	Lubricate	Lubricate
2311.2	Maintenance Action	Lubricate	Lubricate	Lubricate	Lubricate
2311.3	Maintenance Action	Lubricate	Lubricate	Lubricate	Lubricate
2311.4	Maintenance Action	Lubricate	Lubricate	Lubricate	Lubricate
2311.5	Maintenance Action	Lubricate	Lubricate	Lubricate	Lubricate
2311.6	Maintenance Action	Lubricate	Lubricate	Lubricate	Lubricate

130BA492.10

The LCP indicates (with a wrench-icon and an "M") when it is time for a preventive maintenance action, and can be programmed to be indicated on a digital output in parameter group 5-3*. The preventive maintenance status may be read in par.16-96 *Maintenance Word*. A preventive maintenance indication can be reset from a digital input, the adjustable frequency drive bus or manually from the LCP through par.23-15 *Reset Maintenance Word*.

A maintenance log with the latest 10 log entries can be read from parameter group 18-0* and via the Alarm log button on the LCP after selecting Maintenance Log.

23-10 Maintenance Item

Option:**Function:**

Select the item to be associated with the preventive maintenance event.

- [1] * Motor bearings
- [2] Fan bearings
- [3] Pump bearings
- [4] Valve
- [5] Pressure transmitter
- [6] Flow transmitter
- [7] Temperature transmitter

[8]	Pump seals
[9]	Fan belt
[10]	Filter
[11]	Drive cooling fan
[12]	Drive system health check
[13]	Warranty
[20]	User-defined 1
[21]	User-defined 2
[22]	User-defined 3
[23]	User-defined 4
[24]	User-defined 5
[25]	user-defined 6

 **NOTE!**
 The preventive maintenance events are defined in a 20-element array. Hence, each preventive maintenance event must use the same array element index in par.23-10 *Maintenance Item* to par.23-14 *Maintenance Date and Time*.

23-11 Maintenance Action

Option: **Function:**
 Select the action to be associated with the preventive maintenance event.

[1] *	Lubricate
[2]	Clean
[3]	Replace
[4]	Inspect/Check
[5]	Overhaul
[6]	Renew
[7]	Check
[20]	Maintenance Text 0
[21]	Maintenance Text 1
[22]	Maintenance Text 2
[23]	Maintenance Text 3
[24]	Maintenance Text 4
[25]	Maintenance Text 5

23-12 Maintenance Time Base

Option:
Function:

Select the time base to be associated with the preventive maintenance event.

[0] * Disabled

Disabled [0] must be used when disabling the preventive maintenance event.

[1] Running Hours

Running Hours [1] is the number of hours the motor has been running. Running hours are not reset at power-on. The *Maintenance Time Interval* must be specified in par.23-13 *Maintenance Time Interval*.

[2] Operating Hours

Operating Hours [2] is the number of hours the adjustable frequency drive has been running. Operating hours are not reset at power-on. The *Maintenance Time Interval* must be specified in par. 23-13 *Maintenance Time Interval*.

[3] Date & Time

Date & Time [3] uses the internal clock. The date and time of the next maintenance occurrence must be specified in par.23-14 *Maintenance Date and Time*.

23-13 Maintenance Time Interval

Range:
Function:

1 h* [1 - 2147483647 h]

Set the interval associated with the current preventive maintenance event. This parameter is only used if *Running Hours* [1] or *Operating Hours* [2] is selected in par.23-12 *Maintenance Time Base*. The timer is reset from par.23-15 *Reset Maintenance Word*.

Example:

A preventive maintenance event is set up for Monday at 8:00. par.23-12 *Maintenance Time Base* is *Operating hours* [2] and par.23-13 *Maintenance Time Interval* is 7 x 24 hours=168 hours. The next maintenance event will be indicated the following Monday at 8:00. If this maintenance event is not reset until Tuesday at 9:00, the next occurrence will be the following Tuesday at 9:00.

23-14 Maintenance Date and Time

Range:
Function:

0 N/A* [0 - 0 N/A]

Set the date and time for next maintenance occurrence if the preventive maintenance event is based on date/time. The date format depends on the setting in par.0-71 *Date Format* while the time format depends on the setting in par.0-72 *Time Format*.

NOTE!

The adjustable frequency drive has no back-up of the clock function and the set date/time will reset to default (2000-01-01 00:00) after a power-down. In par. 0-79 *Clock Fault*, it is possible to program for a warning in case the clock has not been set properly, e.g., after a power-down.

The time set must be at least one hour from the current time!

NOTE!

When mounting an Analog I/O MCB109 option card, a battery back-up of the date and time is included.

23-15 Reset Maintenance Word

Option:

Function:

Set this parameter to *Do reset* [1] to reset the Maintenance Word in par.16-96 *Maintenance Word* and reset the message displayed in the LCP. This parameter will change back to *Do not reset* [0] when pressing OK.

[0] * Do not reset

[1] Do reset



NOTE!

When messages are reset - Maintenance Item, Action and Maintenance Date/Time are not cancelled. par.23-12 *Maintenance Time Base* is set to Disabled [0].

23-16 Maintenance Text

Range:

Function:

0 N/A* [0 - 0 N/A]

6 individual texts (Maintenance Text 0...Maintenance Text 5) can be written for use in either par. 23-10 *Maintenance Item* or par.23-11 *Maintenance Action*.
The text is written according to the guidelines in par.0-37 *Display Text 1*.

3.21.3 23-5* Energy Log

The adjustable frequency drive is continuously accumulating the consumption of the motor controlled, based on the actual power yielded by the adjustable frequency drive.

These data can be used for an Energy Log function allowing the user to compare and structure the information about the energy consumption related to time.

There are basically two functions:

- Data related to a pre-programmed period, defined by a set date and time for start
- Data related to a predefined period back in time, e.g., the last seven days within the pre-programmed period

For each of the above two functions, the data are stored in a number of counters allowing for selecting the time frame and a split on hours, days or weeks.

The period/split (resolution) can be set in par.23-50 *Energy Log Resolution*.

The data are based on the value registered by the kWh counter in the adjustable frequency drive. This counter value can be read in par.15-02 *kWh Counter* containing the accumulated value since the first power-up or latest reset of the counter (par.15-06 *Reset kWh Counter*).

All data for the energy log are stored in counters which can be read from par.23-53 *Energy Log*.

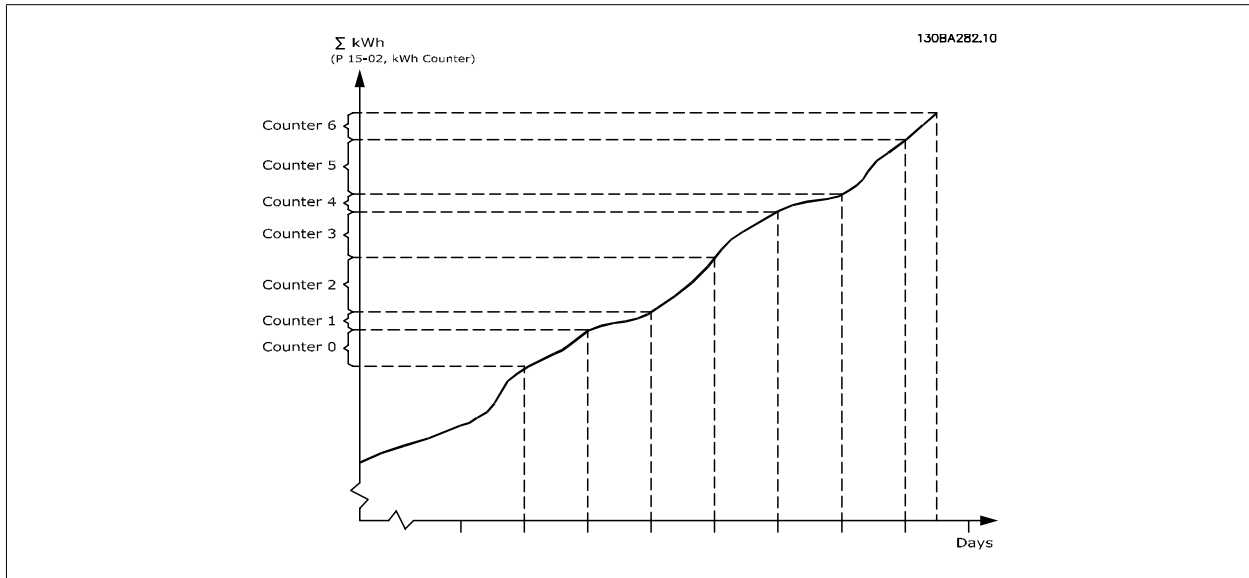

Counter 00 will always contain the oldest data. A counter will cover a period from XX:00 to XX:59 if hours or 00:00 to 23:59 if days.

If logging either the last hours or last days, the counters will shift contents at XX:00 every hour or at 00:00 every day.

The counter with the highest index will always be subject to updates (containing data for the current hour since XX:00 or the current day since 00:00).

The contents of counters can be displayed as bars on LCP. Select *Quick Menu, Loggings, Energy Log: Trending Continued Bin / Trending Timed Bin / Trending Comparison*.

23-50 Energy Log Resolution

Option:

Function:

Select the desired type of period for logging of consumption. Hour of Day [0], Day of Week [1] or Day of Month [2]. The counters contain the logging data from the programmed date/time for start (par.23-51 *Period Start*) and the numbers of hours/days as programmed for (par.23-50 *Energy Log Resolution*).

The logging will start on the date programmed in par.23-51 *Period Start*, and continue until one day/week/month has gone. Last 24 Hours [5], Last 7 Days [6] or Last 5 Weeks [7]. The counters contain data for one day, one week or five weeks back in time and up to the current time.

The logging will start at the date programmed in par.23-51 *Period Start*. In all cases, the period split will refer to operating hours (time where adjustable frequency drive is powered up).

- [0] Hour of Day
- [1] Day of Week
- [2] Day of Month
- [5] * Last 24 Hours
- [6] Last 7 Days
- [7] Last 5 Weeks



NOTE!

The adjustable frequency drive has no back-up of the clock function and the set date/time will reset to default (2000-01-01 00:00) after a power-down unless a Real Time Clock module with back-up is installed. Consequently, the logging will be stopped until date/time is readjusted in par.0-70 *Set Date and Time*. In par.0-79 *Clock Fault*, it is possible to program for a warning in case the clock has not been set properly, e.g., after a power-down.

23-51 Period Start

Range:

0 N/A* [0 - 0 N/A]

Function:

Set the date and time at which the energy log starts update of the counters. First data will be stored in counter [00] and start at the time/date programmed in this parameter.

Date format will depend on setting in par.0-71 *Date Format* and time format on setting in par. 0-72 *Time Format*.



NOTE!

When mounting an Analog I/O MCB109 option card, a battery back-up of the date and time is included.

23-53 Energy Log

Range:

0 N/A* [0 - 4294967295 N/A]

Function:

Array with a number of elements equal to the number of counters ([00]-[xx] below parameter number in display). Press OK and Step between elements by means of ▲ and ▼ buttons on the Local Control Panel.

Array elements:

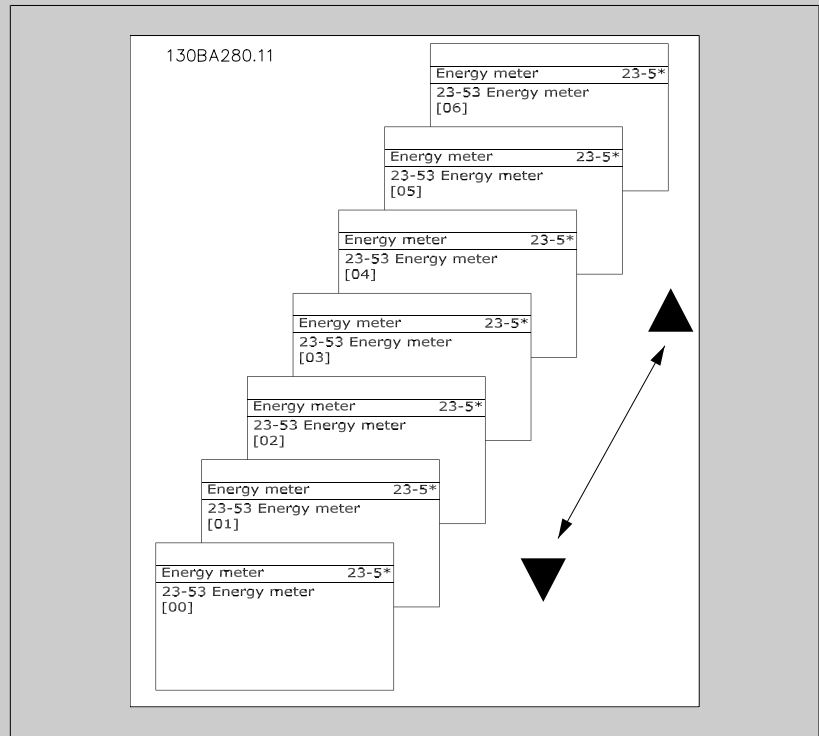

Data from latest period is stored in the counter with the highest index.

At power-down, all counter values are stored and resumed at next power-up.



NOTE!

All counters are automatically reset when changing the setting in par.23-50 *Energy Log Resolution*. At overflow the update of the counters will stop at maximum value.

**NOTE!**

When mounting an Analog I/O MCB109 option card, a battery back-up of the date and time is included.

23-54 Reset Energy Log

Option:**Function:**

Select *Do reset* [1] to reset all values in the Energy Log counters shown in par.23-53 *Energy Log*. After pressing OK, the setting of the parameter value will automatically change to *Do not reset* [0].

[0] * Do not reset

[1] Do reset

3

3.21.4 23-6* Trending

Trending is used to monitor a process variable over a period of time and record how often the data falls into each of ten user-defined data ranges. This is a convenient tool to get a quick overview indicating where to put focus for improvement of operation.

Two sets of data for trending can be created in order to make it possible to compare current values for a selected operating variable with data for a certain reference period, for the same variable. This reference period can be pre-programmed (par.23-63 *Timed Period Start* and par.23-64 *Timed Period Stop*). The two sets of data can be read from par.23-61 *Continuous Bin Data* (current) and par.23-62 *Timed Bin Data* (reference).

It is possible to create trending for following operation variables:

- Power
- Current
- Output frequency
- Motor Speed

The trending function includes ten counters (forming a bin) for each set of data containing the numbers of registrations reflecting how often the operating variable is within each of ten pre-defined intervals. The sorting is based on a relative value of the variable.

The relative value for the operating variable is

Actual/Rated * 100%.

for Power and Current and

Actual/Max * 100%

for Output Frequency and Motor Speed.

The size of each interval can be adjusted individually, but will default be 10% for each. Power and current can exceed rated value, but those registrations will be included in the 90%–100% (MAX) counter.

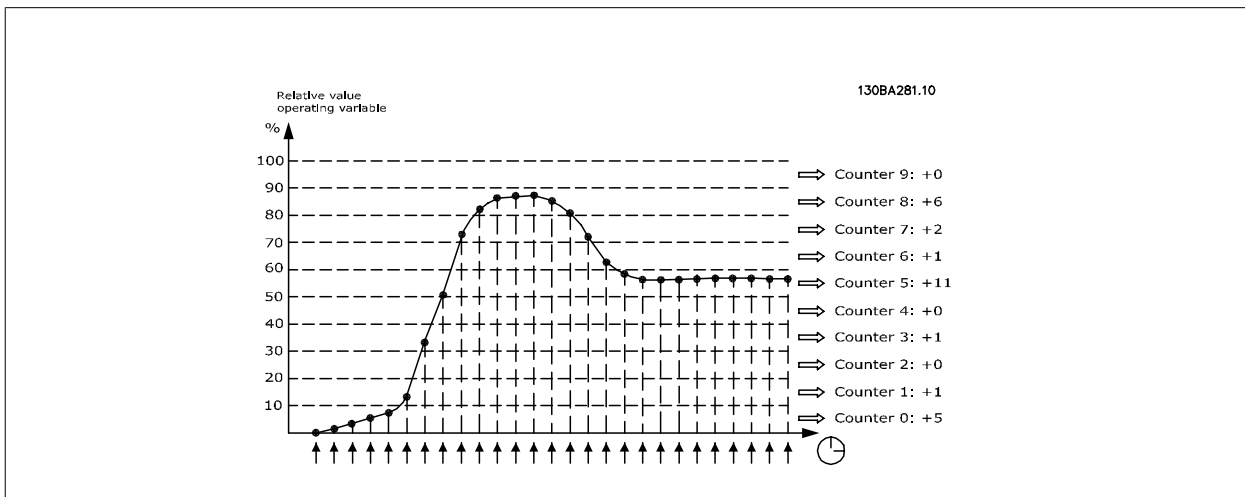

Once a second, the value of the operating variable selected is registered. If a value has been registered to equal 13%, the counter "10%–<20%" will be updated with the value "1". If the value stays at 13% for 10s, then "10" will be added to the counter value.

The contents of counters can be displayed as bars on LCP. Select *Quick Menu > Loggings: Trending Continued Bin / Trending Timed Bin / Trending Comparison*.

NOTE!
The counters start counting whenever the adjustable frequency drive is powered up. The power cycle will shortly after a reset zero the counters. EEPROM data are updated once per hour.

23-60 Trend Variable

Option:	Function:
[0] * Power [kW]	Select the desired operating variable to be monitored for trending. Power yielded to the motor. Reference for the relative value is the rated motor power programmed in par.1-20 <i>Motor Power [kW]</i> or par.1-21 <i>Motor Power [HP]</i> . Actual value can be read in par. 16-10 <i>Power [kW]</i> or par.16-11 <i>Power [hp]</i> .
[1] Current [A]	Output current to the motor. Reference for the relative value is the rated motor current programmed in par.1-24 <i>Motor Current</i> . Actual value can be read in par.16-14 <i>Motor Current</i> .
[2] Frequency [Hz]	Output frequency to the motor. Reference for the relative value is the maximum output frequency programmed in par.4-14 <i>Motor Speed High Limit [Hz]</i> . Actual value can be read in par.16-13 <i>Frequency</i> .
[3] Motor Speed [RPM]	Speed of the motor. Reference for relative value is the maximum motor speed programmed in par. 4-13 <i>Motor Speed High Limit [RPM]</i> .

23-61 Continuous Bin Data

Range:

0 N/A* [0 - 4294967295 N/A]

Function:

Array with 10 elements ([0]-[9] below parameter number in display). Press OK and step between elements by means of ▲ and ▼ buttons on the LCP.

10 counters with the frequency of occurrence for the operating variable monitored, sorted according to the following intervals:

Counter [0]: 0%–<10%

Counter [1]: 10%–<20%

Counter [2]: 20%–<30%

Counter [3]: 30%–<40%

Counter [4]: 40%–<50%

Counter [5]: 50%–<60%

Counter [6]: 60%–<70%

Counter [7]: 70%–<80%

Counter [8]: 80%–<90%

Counter [9]: 90%–<100% or Max

The above minimum limits for the intervals are the default limits. These can be changed in par. 23-65 *Minimum Bin Value*.

Starts to count when the adjustable frequency drive is powered up for the first time. All counters can be reset to 0 in par. 23-66 *Reset Continuous Bin Data*.

23-62 Timed Bin Data

Range:

0 N/A* [0 - 4294967295 N/A]

Function:

Array with 10 elements ([0]-[9] below parameter number in display). Press OK and step between elements by means of ▲ and ▼ buttons on the LCP.

10 counters with the frequency of occurrence for the operating data monitored sorted according to the intervals as for par. 23-61 *Continuous Bin Data*.

Starts to count at the date/time programmed in par. 23-63 *Timed Period Start*, and stops at the time/date programmed in par. 23-64 *Timed Period Stop*. All counters can be reset to 0 in par. 23-67 *Reset Timed Bin Data*.

23-63 Timed Period Start

Range:

0 N/A* [0 - 0 N/A]

Function:

Set the date and time at which trending starts the update of the timed bin counters.

Date format will depend on setting in par. 0-71 *Date Format*, and time format on setting in par. 0-72 *Time Format*.

NOTE!

The adjustable frequency drive has no back-up of the clock function and the set date/time will reset to default (2000-01-01 00:00) after a power-down unless a Real Time Clock module with back-up is installed. Consequently, logging will be stopped until the date/time is readjusted in par. 0-70 *Set Date and Time*. In par. 0-79 *Clock Fault*, it is possible to program for a warning in case the clock has not been set properly, e.g., after a power-down.



NOTE!

When mounting an Analog I/O MCB109 option card, a battery back-up of the date and time is included.

23-64 Timed Period Stop

Range:

0 N/A* [0 - 0 N/A]

Function:

Set the date and time at which the trend analyses must stop update of the timed bin counters.

Date format will depend on setting in par.0-71 *Date Format*, and time format on setting in par. 0-72 *Time Format*.

3



NOTE!

When mounting an Analog I/O MCB109 option card, a battery back-up of the date and time is included.

23-65 Minimum Bin Value

Range:

0 %* [0 - 100. %]

Function:

Array with 10 elements ([0]–[9] below parameter number in display). Press OK and step between elements by means of ▲ and ▼ buttons on the LCP.

Set the minimum limit for each interval in par.23-61 *Continuous Bin Data* and par.23-62 *Timed Bin Data*. Example: if selecting *counter* [1] and changing setting from 10% to 12%, *counter* [0] will be based on the interval 0%–<12% and *counter* [1] on interval 12%–<20%.

23-66 Reset Continuous Bin Data

Option:

- [0] * Do not reset
- [1] Do reset

Function:

Select *Do reset* [1] to reset all values in par.23-61 *Continuous Bin Data*.

After pressing OK, the setting of the parameter value will automatically change to *Do not reset* [0].

23-67 Reset Timed Bin Data

Option:

- [0] * Do not reset
- [1] Do reset

Function:

Select *Do reset* [1] to reset all counters in par.23-62 *Timed Bin Data*.

After pressing OK, the setting of the parameter value will automatically change to *Do not reset* [0].

3.21.5 23-8* Payback Counter

The adjustable frequency drive includes a feature which can give a rough calculation on payback in cases where the adjustable frequency drive has been installed in an existing plant to ensure energy savings by changing from fixed to variable speed control. Reference for the savings is a set value to represent the average power yielded before the upgrade with variable speed control.

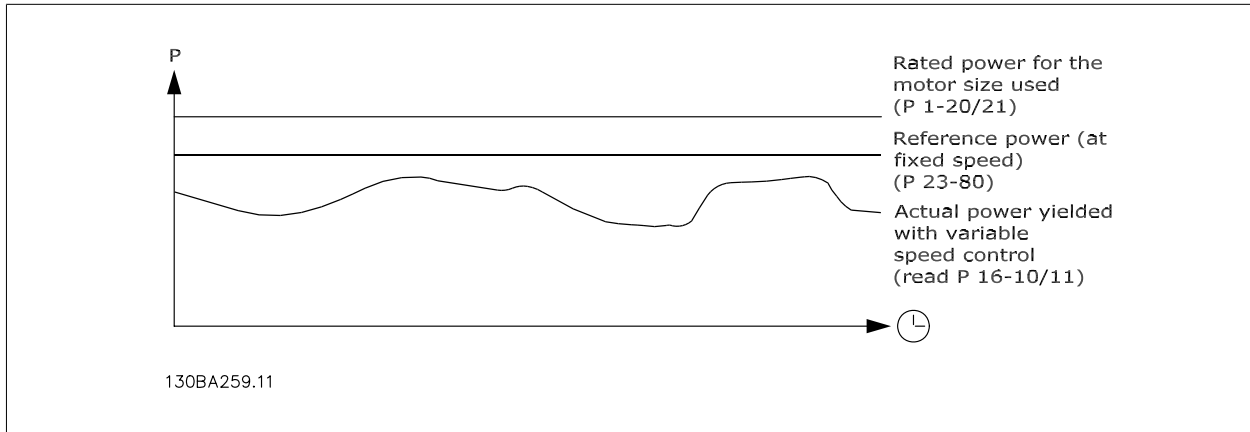

The difference between the Reference Power at fixed speed and the Actual Power yielded with speed control represent the actual savings.

As value for the fixed speed case, the rated motor size (kW) is multiplied with a factor (set in %) representing the power produced at fixed speed. The difference between this reference power and the actual power is accumulated and stored. The difference in energy can be read in par.23-83 *Energy Savings*.

The accumulated value for the difference in power consumption is multiplied with the energy cost in local currency and the investment is subtracted. This calculation for Cost Savings can also be read in par.23-84 *Cost Savings*.

$$Cost\ Savings = \left\{ \sum_{t=0}^t [(Rated\ Motor\ Power * Power\ Reference\ Factor) - Actual\ Power\ Consumption] \times Energy\ Cost \right\} - Investment\ Cost$$

Break even (payback) occurs when the value read in the parameter turns from negative to positive.

It is not possible to reset the Energy Savings counter, but the counter can be stopped any time by setting par.23-80 *Power Reference Factor* to 0.

Parameter overview:

Parameter for settings		Parameters for readout	
Rated Motor Power	par.1-20 <i>Motor Power [kW]</i>	Energy Savings	par.23-83 <i>Energy Savings</i>
Power Reference Factor in %	par.23-80 <i>Power Reference Factor</i>	Actual Power	par.16-10 <i>Power [kW]</i> , par.16-11 <i>Power [hp]</i>
Energy Cost per kWh	par.23-81 <i>Energy Cost</i>	Cost Savings	par.23-84 <i>Cost Savings</i>
Investment	par.23-82 <i>Investment</i>		

23-80 Power Reference Factor

Range:

100 %* [0 - 100 %]

Function:

Set the percentage of the rated motor size (set in par.1-20 *Motor Power [kW]* or par.1-21 *Motor Power [HP]*) which is supposed to represent the average power yielded at the time running with fixed speed (before upgrade with variable speed control).
Must be set to a value different from zero to start counting.

23-81 Energy Cost

Range:

1.00 N/A* [0.00 - 999999.99 N/A]

Function:

Set the current cost for a kWh in local currency. If the energy cost is changed later on, it will impact the calculation for the entire period!

23-82 Investment

Range:

0 N/A* [0 - 999999999 N/A]

Function:

Set the value of the investment spent on upgrading the plant with speed control, in same currency as used in par.23-81 *Energy Cost*.

23-83 Energy Savings

Range:

0 kWh* [0 - 0 kWh]

Function:

This parameter allows for a readout of the accumulated difference between the reference power and the actual output power.

If the motor size is set in HP (par.1-21 *Motor Power [HP]*), the equivalent kW value will be used for the Energy Savings.

23-84 Cost Savings

Range:

0 N/A* [0 - 2147483647 N/A]

Function:

This parameter allows a readout of the calculation based on the above equation (in local currency).

3.22 Main Menu - Application Functions 2 - Group 24

3.22.1 24-0* Fire Mode



NOTE!

Please note the adjustable frequency drive is only one component of the VLT HVAC Drive system. Correct function of fire mode depends on the correct design and selection of system components. Ventilation systems working in life safety applications have to be approved by the local fire authorities. ***Non-interruption of the adjustable frequency drive due to fire mode operation may cause overpressure and result in damage to VLT HVAC Drive system and components, including dampers and air ducts. The adjustable frequency drive itself may be damaged and it may cause damage or fire. Danfoss accepts no responsibility for errors, malfunctions, personal injury or any damage to the adjustable frequency drive itself or components herein, VLT HVAC Drive systems and components herein or other property when the adjustable frequency drive has been programmed for fire mode. In no event shall Danfoss be liable to the end user or any other party for any direct or indirect, special or consequential damage or loss suffered by such party, which has occurred due to the adjustable frequency drive being programmed and operated in fire mode.***

3

Background

Fire mode is for use in critical situations, where it is imperative for the motor to keep running, regardless of the adjustable frequency drive's normal protective functions. These could be ventilation fans in tunnels or stairwells for instance, where continued operation of the fan facilitates safe evacuation of personnel in the event of a fire. Some selections of the fire mode function cause alarms and trip conditions to be disregarded, enabling the motor to run without interruption.

Activation

Fire mode is activated only via digital input terminals. See par. 5-1* Digital Inputs.

Messages in display

When fire mode is activated, the display will show a status message "Fire Mode" and a warning "Fire Mode".

Once fire mode is again deactivated, the status messages will disappear and the warning will be replaced by the warning "Fire M Was Active". This message can only be reset by power-cycling the adjustable frequency drive supply. If, while the adjustable frequency drive is active in fire mode, a warranty-affecting alarm (see par.24-09 *Fire Mode Alarm Handling*) should occur, the display will show the warning "Fire M Limits Exceeded".

Digital and relay outputs can be configured for the status messages "Fire Mode Active" and the warning "Fire M Was Active". See par. 5-3* and par. 5-4*. "Fire M was Active" messages can also be accessed in the warning word via serial communication. (See relevant documentation).

The status messages "Fire Mode" can be accessed via the extended status word.

Message	Type	LCP	Digital Out/Relay	Warning Word 2	Ext. Status Word 2
Fire Mode	Status	+	+		+ (bit 25)
Fire Mode	Warning	+			
Fire M was Active	Warning	+	+	+ (bit 3)	
Fire M Limits Exceeded	Warning	+	+		

Log

An overview of events related to fire mode can be viewed in the fire mode log, par. 18-1*, or via the Alarm Log button on the LCP.

The log will include up to 10 of the latest events. Warranty-affecting alarms will have a higher priority as the two other types of events.

The log cannot be reset!

Following events are logged:

*Warranty affecting alarms (see par.24-09 *Fire Mode Alarm Handling*, Fire Mode Alarm Handling)

*Fire Mode activated

*Fire Mode deactivated

All other alarms occurring while fire mode activated will be logged as usual.

NOTE!
During fire mode operation all stop commands to the adjustable frequency drive will be ignored, including Coast/Coast inverse and External Interlock. However, if your adjustable frequency drive incorporates "Safe-Stop", this function is still active. See Section "How to Order / Ordering Form Type Code"

NOTE!
If in fire mode, it is desired to use the live zero function, then it will also be active for analog inputs other than that used for fire mode setpoint/feedback. Should the feedback to any of those other analog inputs be lost, for example a cable is burned, live zero function will operate. If this is undesirable, the live zero function must be disabled for those other inputs.
Desired live zero function, if a signal is missing when fire mode is active, must be set in par.6-02 *Fire Mode Live Zero Timeout Function*.
Warning for live zero will have a higher priority than the warning "Fire Mode".

24-00 Fire Mode Function

Option:	Function:
[0] * Disabled	Fire Mode Function is not active.
[1] Enabled	In this mode, the motor will continue to operate in a clockwise direction. Speed will depend on what is selected in <i>par 24-01, Fire Mode Configuration</i> .
[2] Enabled - Reverse	In this mode, the motor will continue to operate in a counter-clockwise direction. Works only in open-loop. See <i>par 24-01, Fire Mode Configuration</i> .
[3] Enabled - Coast	When this mode is enabled, the output is disabled and the motor is allowed to coast to stop.

NOTE!
In the above, alarms are produced or ignored in accordance with the selection in par.24-09 *Fire Mode Alarm Handling*.

24-01 Fire Mode Configuration

Option:	Function:
[0] * Open-loop	When fire mode is active, the motor will run with a fixed speed based on a reference set. The unit will be the same as selected in par.0-02 <i>Motor Speed Unit</i> .
[3] Closed-loop	When fire mode is active, the built-in PID controller will control the speed based on the setpoint and a feedback signal, selected in par.24-07 <i>Fire Mode Feedback Source</i> . The unit to be selected in par. 24-02 <i>Fire Mode Unit</i> . If the motor is also controlled by the built-in PID controller when in normal operation, the same transmitter can be used for both cases by selecting the same source.

NOTE!
The PID controller can be adjusted with par.24-09 *Fire Mode Alarm Handling*, [2] Trip, All Alarms/Test.

**NOTE!**

If Enable-Run Reverse is selected in par.24-00 *Fire Mode Function*, Closed-loop cannot be selected in par.24-01 *Fire Mode Configuration*.

24-02 Fire Mode Unit**Option:****Function:**

Select the desired unit when fire mode is active and running in closed-loop.

[0] *

[1] %

[2] rpm

[3] Hz

[4] Nm

[5] PPM

[10] min

[11] RPM

[12] PULSE/s

[20] liter / sec.

[21] liter / min

[22] liter / hr.

[23] m³ / sec.[24] m³/min[25] m³ / hr.

[30] kg / sec.

[31] kg/min

[32] kg / hr.

[33] ton / min

[34] ton / hr.

[40] m / sec.

[41] m/min

[45] m

[60] °C

[70] mbar

[71] bar

[72] Pa

[73] kPa

[74] m WG

[75] mm Hg

[80] kW

[120] GPM

[121] gal / sec.

[122] gal/min

[123] gal / hr.

[124] CFM

[125] ft³/s

[126] ft³/min

[127] ft³/h

[130] lbs / sec.

[131] lbs / min.

[132] lbs / hr.

[140] ft/s

[141] ft/min

[145] ft

[160] °F

[170] psi

[171] lb/in²

[172] in. wtr. gage

[173] ft WG

[174] in Hg

[180] HP

24-03 Fire Mode Min Reference

Range:

0 FireMo- [-999999.999 - par. 24-04 FireMo-
deUnit* deUnit]

Function:

Minimum value for the reference/setpoint (limiting the sum of value in par.24-05 *Fire Mode Preset Reference* and value of signal on input selected in par.24-06 *Fire Mode Reference Source*).
If running in open-loop when fire mode is active, the unit is chosen by the setting of par.0-02 *Motor Speed Unit*. For closed-loop, the unit is selected in par.24-02 *Fire Mode Unit*.

24-04 Fire Mode Max Reference

Range:

50.000 Fire- [par. 24-03 - 999999.999 FireMo-
ModeUnit* deUnit]

Function:

Maximum value for the reference/setpoint (limiting the sum of value in par.24-05 *Fire Mode Preset Reference* and value of signal on input selected in par.24-06 *Fire Mode Reference Source*).
If running in open-loop when fire mode is active, the unit is chosen by the setting of par.0-02 *Motor Speed Unit*. For closed-loop, the unit is selected in par.24-02 *Fire Mode Unit*.

24-05 Fire Mode Preset Reference

Range:

0.00 %* [-100.00 - 100.00 %]

Function:

Enter the required preset reference/setpoint as a percentage of the Fire Mode Max Reference set in par.24-04 *Fire Mode Max Reference*. The set value will be added to the value represented by the signal on the analog input selected in par.24-06 *Fire Mode Reference Source, Fire Mode Reference Source*.

24-06 Fire Mode Reference Source

Option:
Function:

Select the external reference input to be used for fire mode. This signal will be added to the value set in par.24-06 *Fire Mode Reference Source*.

[0] *	No function
[1]	Analog input 53
[2]	Analog input 54
[7]	Pulse input 29
[8]	Pulse input 33
[20]	Digital pot.meter
[21]	Analog input X30/11
[22]	Analog input X30/12
[23]	Analog Input X42/1
[24]	Analog Input X42/3
[25]	Analog Input X42/5

24-07 Fire Mode Feedback Source

Option:
Function:

Select the feedback input to be used for the fire mode feedback signal when fire mode is active. If the motor also is controlled by the built-in PID controller when in normal operation, the same transmitter can be used for both cases by selecting the same source.

[0] *	No function
[1]	Analog input 53
[2]	Analog input 54
[3]	Pulse input 29
[4]	Pulse input 33
[7]	Analog input X30/11
[8]	Analog input X30/12
[9]	Analog Input X42/1
[10]	Analog Input X42/3
[11]	Analog Input X42/5
[100]	Bus feedback 1
[101]	Bus feedback 2
[102]	Bus feedback 3

24-09 Fire Mode Alarm Handling

Option:
Function:

[0]	Trip and Reset at Critical Alarms	If this mode is selected, the adjustable frequency drive will continue to run, ignoring most alarms, EVEN IF DOING SO MAY RESULT IN DAMAGE OF THE ADJUSTABLE FREQUENCY DRIVE. Critical alarms are alarms, which cannot be suppressed but a restart attempt is possible (Infinity Automatic Reset).
[1] *	Trip at Critical Alarms	In case of a critical alarm, the adjustable frequency drive will trip and not auto-restart (Manual Reset).
[2]	Trip at All Alarms - Test	It is possible to test the operation of fire mode, but all alarm states are activated normally (Manual Reset).



NOTE!
 Warranty-affecting alarms. Certain alarms can affect the lifetime of the adjustable frequency drive. If one of these ignored alarms occur while in fire mode, a log of the event is stored in the fire mode log.
 Here the 10 latest events of warranty-affecting alarms, fire mode activation and fire mode deactivation are stored.



NOTE!
 The setting in par.14-20 *Reset Mode* is disregarded if fire mode is active (see par. 24-0*, *Fire Mode*).

No:	Description	Critical Alarms	Warranty Affecting Alarms
4	Line ph. Loss		x
7	DC overvolt	x	
8	DC undervolt	x	
9	Inverter overloaded		x
13	Overcurrent	x	
14	Ground fault	x	
16	Short circuit	x	
29	Power card temp		x
33	Soft-charge fault		x
38	Internal fault		x
65	Ctrl. card temp		x
68	SafeStop	x	

3.22.2 24-1* Drive Bypass

The adjustable frequency drive includes a feature, which can be used to automatically activate an external electro-mechanical bypass in case of a trip/trip lock of the adjustable frequency drive or the event of a fire mode coast (see par.24-00 *Fire Mode Function*).

The bypass will switch the motor to operation direct on line. The external bypass is activated by means of one of the digital outputs or relays in the adjustable frequency drive, when programmed in par. 5-3* or par. 5-4*.



NOTE!
 Important! After enabling the Drive Bypass function, the adjustable frequency drive is no longer Safety Certified (for using the Safe Stop in versions, where included).

To deactivate the drive bypass at normal operation (fire mode not activated), one of following actions must be carried out:

- Press the Off button on the LCP, (or program two of the digital inputs for Hand On-Off-Auto).
- Activate External Interlock via digital input
- Carry out Power Cycling.



NOTE!
 The drive bypass cannot be deactivated if in fire mode. It can be deactivated only by either removing the fire mode command signal or the power supply to the adjustable frequency drive!

When the drive bypass function is activated, the display on the Local Control Panel will show the status message Drive Bypass. This message has a higher priority than the fire mode status messages. When the automatic drive bypass function is enabled, it will cut in the external bypass according to the below sequence:

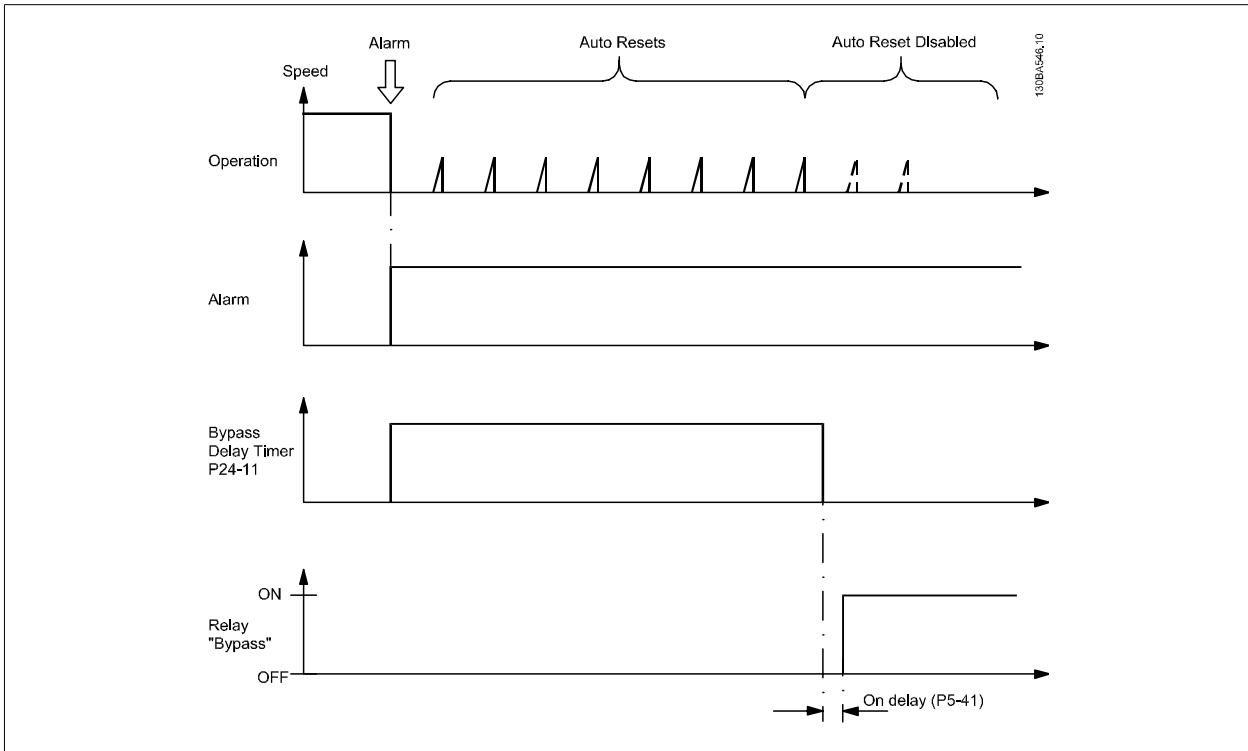

Status can be read in the Extended Status Word 2, bit number 24.

24-10 Bypass Function

Option:

Function:

This parameter determines, what circumstances will activate the drive bypass function:

[0] * Disabled

[1] Enabled

If in normal operation, the automatic drive bypass function will be activated at following conditions:

At a Trip Lock or a Trip. After the programmed number of reset attempts, programmed in par. 14-20 *Reset Mode* or if the bypass delay timer (par.24-11 *Bypass Delay Time*) expires before reset attempts have been completed

When in fire mode, the bypass function will operate under following conditions:

When experiencing a trip at critical alarms, a coast or if the bypass delay timer expires before reset attempts have completed when [2] Enabled in fire mode. The bypass function will operate at trip at critical alarms, coast or if the bypass delay timer expires before reset attempts have been completed.

[2] Enabled (Fire Mode Only)



NOTE!

Important! After enabling the drive bypass function, the safe stop function (in versions, where included) no longer complies with standard EN 954-1, Cat. 3 installations.

24-11 Bypass Delay Time

Range:

0 s* [0 - 600 s]

Function:

Programmable in 1 s increments. Once the bypass function is activated in accordance with the setting in par.24-10 *Bypass Function*, the bypass delay timer begins to operate. If the adjustable frequency drive has been set for a number of restart attempts, the timer will continue to run while the adjustable frequency drive tries to restart. If the motor restarts within the time period of the bypass delay timer, then the timer is reset.

If the motor fails to restart at the end of the bypass delay time, the drive bypass relay will be activated, which will have been programmed for Bypass in par.5-40 *Function Relay*. If a [Relay Delay] has also been programmed in par.5-41 *On Delay, Relay, [Relay]* or par.5-42 *Off Delay, Relay, [Relay]*, then this time must also elapse before the relay action is performed.

Where no restart attempts are programmed, the timer will run for the delay period set in this parameter and will then activate the drive bypass relay, which will have been programmed for Bypass in par.5-40 *Function Relay, Function Relay*. If a relay delay has also been programmed in par. 5-41 *On Delay, Relay, On Delay, Relay* or par.5-42 *Off Delay, Relay, [Relay]*, then this time must also elapse before the relay action is performed.

3

3.23 Main Menu - Cascade Controller - Group 25

3.23.1 25-** Cascade Controller

Parameters for configuring the basic cascade controller for sequence control of multiple pumps. For a more application oriented description and wiring examples, see section *Application Examples, Basic Cascade Controller*.

To configure the cascade controller to the actual system and the desired control strategy, it is recommended to follow the below sequence, starting with par. 25-0* *System Settings* and next par. 25-5* *Alternation Settings*. These parameter can normally be set in advance.

Parameters in 25-2* *Bandwidth Settings* and 25-4* *Staging settings*, will often be dependent on the dynamic of the system and final adjustment to be done at the commissioning of the plant.

NOTE!

The cascade controller is supposed to operate in closed-loop controlled by the built-in PI controller (closed-loop selected in *Configuration Mode*, par.1-00 *Configuration Mode*). If *Open-loop* is selected in par.1-00 *Configuration Mode*, all fixed speed pumps will be destaged, but the variable speed pump will still be controlled by the adjustable frequency drive, now as an open-loop configuration:

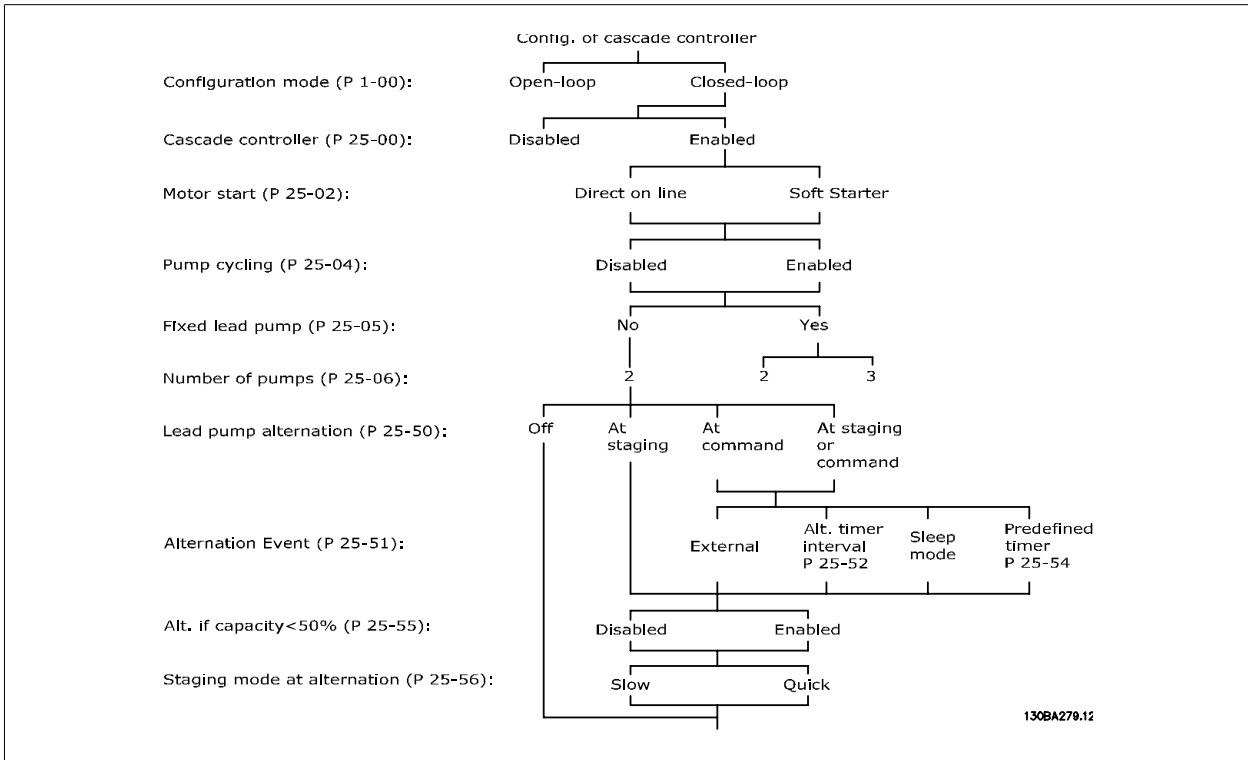

3.23.2 25-0* System Settings

Parameters related to control principles and configuration of the system.

25-00 Cascade Controller

Option:

Function:

For operation of multiple devices (pump/fan) systems where capacity is adapted to actual load by means of speed control combined with on/off control of the devices. For simplicity, only pump systems are described.

[0] * Disabled

The cascade controller is not active. All built-in relays assigned to pump motors in the cascade function will be de-energized. If a variable speed pump is connected to the adjustable frequency drive directly (not controlled by a built-in relay); this pump/fan will be controlled as a single pump system.

[1] Enabled

25-02 Motor Start

Option:

Function:

Motors are directly connected to the line power with a contactor or a soft starter. When the value of par.25-02 *Motor Start* is set to an option other than *Direct on Line* [0], then par.25-50 *Lead Pump Alternation* is automatically set to the default of *Direct on Line* [0].

[0] * Direct on Line

Each fixed speed pump is directly connected to line via a contactor.

[1] Soft Starter

Each fixed speed pump is connected to line via a soft starter.

[2] Star-Delta

25-04 Pump Cycling

Option:

Function:

To provide equal hours of operation with fixed speed pumps, the pump use can be cycled. The selection of pump cycling is either "first in – last out" or equal running hours for each pump.

[0] * Disabled The fixed speed pumps will be connected in the order 1 – 2 and disconnected in the order 2 – 1. (First in – last out).

[1] Enabled The fixed speed pumps will be connected/disconnected to have equal running hours for each pump.

25-05 Fixed Lead Pump

Option:

Function:

Fixed Lead Pump means that the variable speed pump is connected directly to the adjustable frequency drive, and if a contactor is applied between adjustable frequency drive and pump, this contactor will not be controlled by the adjustable frequency drive.
If operating with par.25-50 *Lead Pump Alternation* set to other than *Off*[0], this parameter must be set to *No* [0].

[0] No The lead pump function can alternate between the pumps controlled by the two built in relays. One pump must be connected to the built-in RELAY 1, and the other pump to RELAY 2. The pump function (Cascade Pump1 and Cascade Pump2) will automatically be assigned to the relays (maximum two pumps can in this case be controlled from the adjustable frequency drive).

[1] * Yes The lead pump will be fixed (no alternation) and connected directly to the adjustable frequency drive. The par.25-50 *Lead Pump Alternation* is automatically set to *Off* [0]. Built-in relays Relay 1 and Relay 2 can be assigned to separate fixed speed pumps. A total of three pumps can be controlled by the adjustable frequency drive.

25-06 Number Of Pumps

Range:

Function:

2 N/A* [2 - 9. N/A] The number of pumps connected to the cascade controller including the variable speed pump. If the variable speed pump is connected directly to the adjustable frequency drive and the other fixed speed pumps (lag pumps) are controlled by the two built-in relays, three pumps can be controlled. If both the variable speed and fixed speed pumps are to be controlled by built-in relays, only two pumps can be connected.

If par.25-05 *Fixed Lead Pump, Fixed Lead Pump*, is set to *No* [0]: one variable speed pump and one fixed speed pump; both controlled by a built-in relay. If par.25-05 *Fixed Lead Pump, Fixed Lead Pump*, is set to *Yes* [1]: one variable speed pump and one fixed speed pump controlled by a built-in relay.

One lead pump, see par.25-05 *Fixed Lead Pump*. Two fixed speed pumps controlled by built-in relays.

3.23.3 25-2* Bandwidth Settings

Parameters for setting the bandwidth within which the pressure will be allowed to operate before staging/de-staging fixed speed pumps. Also includes various timers to stabilize the control.

25-20 Staging Bandwidth

Range:

10 %* [1 - par. 25-21 %]

Function:

Set the staging bandwidth (SBW) percentage to accommodate normal system pressure fluctuation. In cascade control systems, to avoid frequent switching of fixed speed pumps, the desired system pressure is typically kept within a bandwidth rather than at a constant level.

The SBW is programmed as a percentage of par.20-13 *Minimum Reference/Feedb.* and par. 20-14 *Maximum Reference/Feedb.*. For example, if the setpoint is 5 bar and the SBW is set to 10%, a system pressure between 4.5 and 5.5 bar is tolerated. No staging or de-staging will occur within this bandwidth.

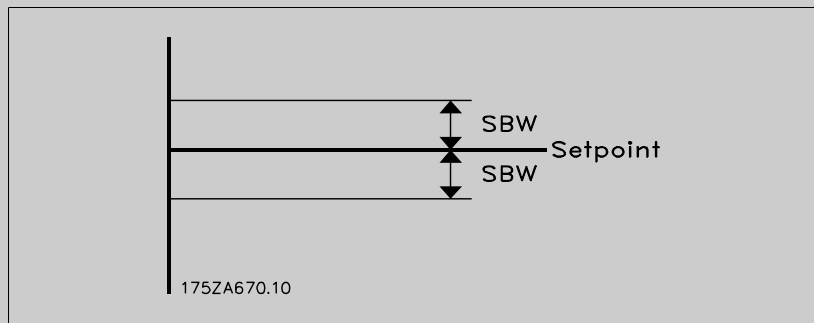

25-21 Override Bandwidth

Range:

100 %* [par. 25-20 - 100 %]

Function:

When a large and quick change in the system demand occurs (such as a sudden water demand), the system pressure rapidly changes and an immediate staging or de-staging of a fixed speed pump becomes necessary to match the requirement. The override bandwidth (OBW) is programmed to override the staging/de-staging timer (par.25-23 *SBW Staging Delay* and par.25-24 *SBW De-staging Delay*) for immediate response.

The OBW must always be programmed to a higher value than the value set in *Staging Bandwidth* (SBW), par.25-20 *Staging Bandwidth*. The OBW is a percentage of par. . and par. .

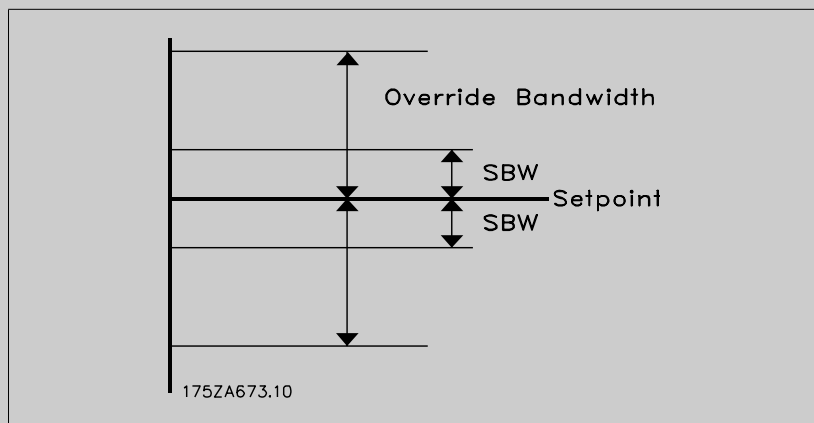

Setting the OBW too close to the SBW could defeat the purpose with frequent staging at momentary pressure changes. Setting the OBW too high might lead to unacceptably high or low pressure in the

system while the SBW timers are running. The value can be optimized with increased familiarity with the system. See par.25-25 *OBW Time*.

To avoid unintended staging during the commissioning phase and fine tuning of the controller, initially leave the OBW at the factory setting of 100% (Off). When the fine tuning is completed, the OBW should be set to the desired value. An initial value of 10% is suggested.

25-22 Fixed Speed Bandwidth

Range:

par. 25-20 [par. 25-20 - par. 25-21 %]
%*

Function:

When the cascade control system is running normally and the adjustable frequency drive issues a trip alarm, it is important to maintain the system head. The cascade controller does this by continuing to stage/de-stage the fixed speed pump on and off. Due to the fact that keeping the head at the setpoint would require frequent staging and de-staging when only a fixed speed pump is running, a wider Fixed Speed Bandwidth (FSBW) is used instead of SBW. It is possible to stop the fixed speed pumps, in case of an alarm situation, by pressing the LCP OFF or HAND ON keys or if the signal programmed for Start on digital input goes low.

If the issued alarm is a trip-lock alarm, the cascade controller must stop the system immediately by cutting out all the fixed speed pumps. This is basically the same as Emergency Stop (Coast/Coast inverse Command) for the cascade controller.

25-23 SBW Staging Delay

Range:

15 s* [0 - 3000 s]

Function:

Immediate staging of a fixed speed pump is not desirable when a momentary pressure drop in the system exceeds the staging bandwidth (SBW). Staging is delayed by the length of time programmed. If the pressure increases to within the SBW before the timer has elapsed, the timer is reset.

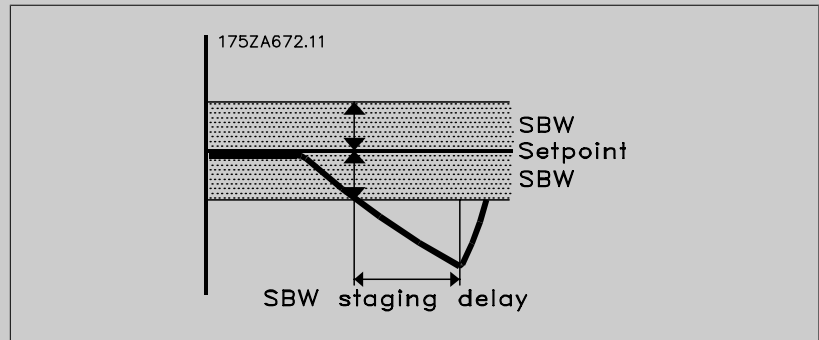

25-24 SBW De-staging Delay

Range:

15 s* [0 - 3000 s]

Function:

Immediate de-staging of a fixed speed pump is not desirable during a momentary pressure increase in the system that exceeds the staging bandwidth (SBW). De-staging is delayed by the length of time programmed. If the pressure decreases to within the SBW before the timer has elapsed, the timer is reset.

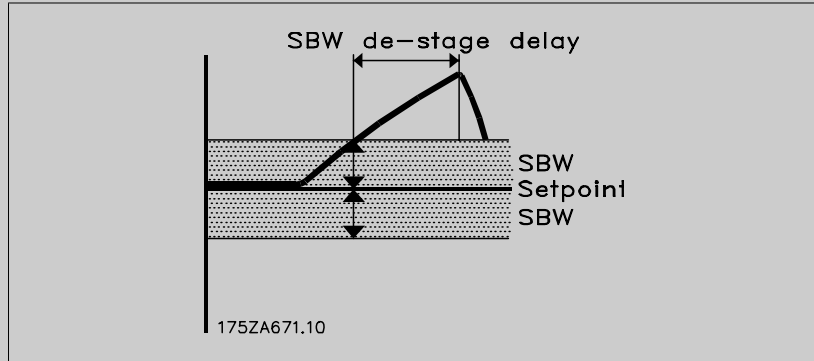

25-25 OBW Time

Range:

10 s* [0 - 300 s]

Function:

Staging a fixed speed pump creates a momentary pressure peak in the system, which might exceed the override bandwidth (OBW). It is not desirable to de-stage a pump in response to a staging pressure peak. The OBW time can be programmed to prevent staging until the system pressure has stabilized and normal control has been established. Set the timer to a value that allows the system to stabilize after staging. The 10-second factory setting is appropriate in most applications. In highly dynamic systems, a shorter time may be desirable.

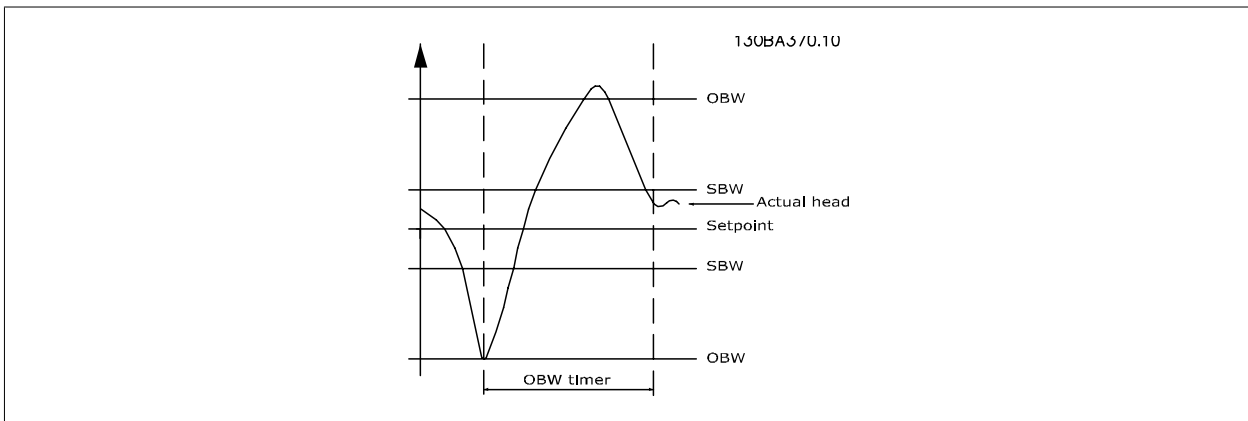

25-26 Destage At No-Flow

Option:
Function:

The de-stage at the no-flow parameter ensures that when a no-flow situation occurs, the fixed speed pumps will be de-staged one-by-one until the no-flow signal disappears. This requires that no-flow detection is active. See par. 22-2*.

If De-stage at No-Flow is disabled the Cascade Controller does not change the normal behavior of the system.

[0] * Disabled

[1] Enabled

25-27 Stage Function

Option:

Function:

If the stage function is set to *Disabled* [0], par.25-28 *Stage Function Time* will not be activated.

[0] Disabled

[1] * Enabled

25-28 Stage Function Time

Range:

15 s* [0 - 300 s]

Function:

Stage function time is programmed to avoid frequent staging of the fixed speed pumps. The stage function time starts if it is *Enabled* [1] by par.25-27 *Stage Function*, and when the variable speed pump is running at *Motor Speed High Limit*, par.4-13 *Motor Speed High Limit [RPM]* or par.4-14 *Motor Speed High Limit [Hz]*, with at least one fixed speed pump in the stop position. When the programmed value of the timer expires, a fixed speed pump is staged.

25-29 Destage Function

Option:

Function:

The de-stage function ensures that the lowest number of pumps are running to save energy and to avoid dead head water circulation in the variable speed pump. If the de-stage function is set to *Disabled* [0], the par.25-30 *Destage Function Time* will not be activated.

[0] Disabled

[1] * Enabled

25-30 Destage Function Time

Range:

15 s* [0 - 300 s]

Function:

The de-stage function timer is programmable to avoid frequent staging/de-staging of the fixed speed pumps. The de-stage function time starts when the adjustable speed pump is running at par.4-11 *Motor Speed Low Limit [RPM]* or par.4-12 *Motor Speed Low Limit [Hz]*, with one or more fixed speed pumps in operation and system requirements satisfied. In this situation, the adjustable speed pump contributes a little to the system. When the programmed value of the timer expires, a stage is removed, avoiding dead head water circulation in the adjustable speed pump.

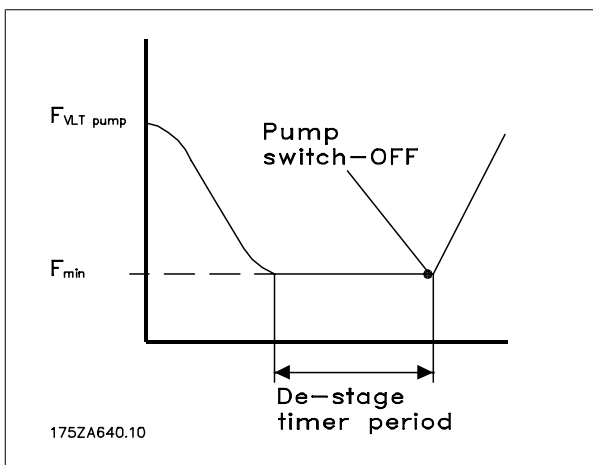

3.23.4 25-4* Staging Settings

Parameters determining conditions for staging/de-staging the pumps.

25-40 Ramp-down Delay

Range:

10.0 s* [0.0 - 120.0 s]

Function:

When adding a fixed speed pump controlled by a soft starter, it is possible to delay the ramp-down of the lead pump until a preset time following the start of the fixed speed pump in order to eliminate pressure surges or water hammering in the system.

Only to be used if *Soft Starter* [1] is selected in par.25-02 *Motor Start*.

25-41 Ramp-up Delay

Range:

2.0 s* [0.0 - 12.0 s]

Function:

When removing a fixed speed pump controlled by a soft starter, it is possible to delay the ramp up of the lead pump until a preset time after stopping the fixed speed pump to eliminate pressure surges or water hammer in the system.

Only to be used if *Soft Starter* [1] is selected in par.25-02 *Motor Start*.

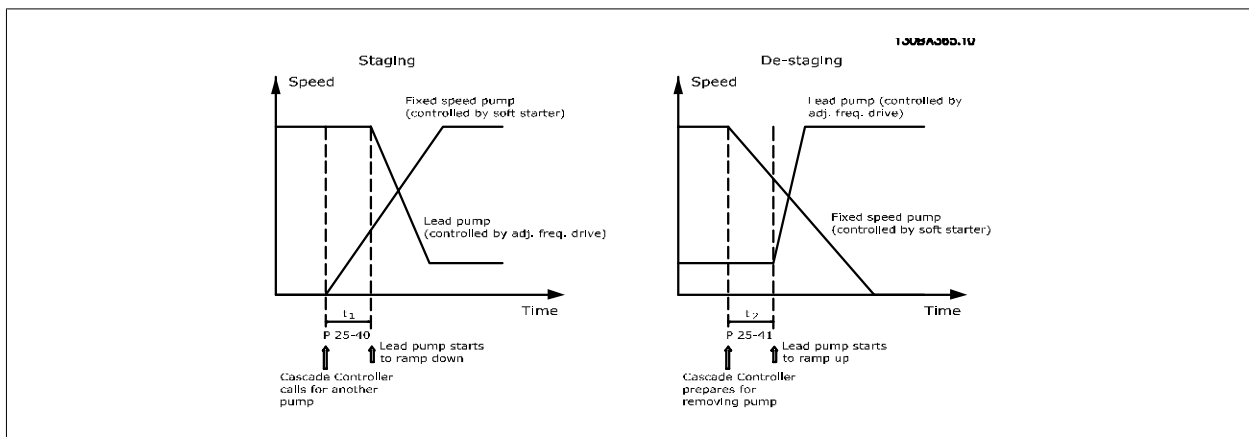

25-42 Staging Threshold

Range:

0 %* [0 - 100 %]

Function:

When adding a fixed speed pump, in order to prevent an overshoot of pressure, the variable speed pump ramps down to a lower speed. When the variable speed pump reaches the "Staging Speed" the fixed speed pump is staged on. The staging threshold is used to calculate the speed of the variable speed pump when the "cut-in point" of the fixed speed pump occurs. The calculation of the staging threshold is the ratio of par.4-11 *Motor Speed Low Limit [RPM]* or par.4-12 *Motor Speed Low Limit [Hz]*, to the par.4-13 *Motor Speed High Limit [RPM]* or par.4-14 *Motor Speed High Limit [Hz]*, expressed in percent.

Staging Threshold must range from $STAGE\% = \frac{LOW}{HIGH} \times 100\%$

to 100%, where n_{LOW} is Motor Speed Low Limit and n_{HIGH} is Motor Speed High Limit.

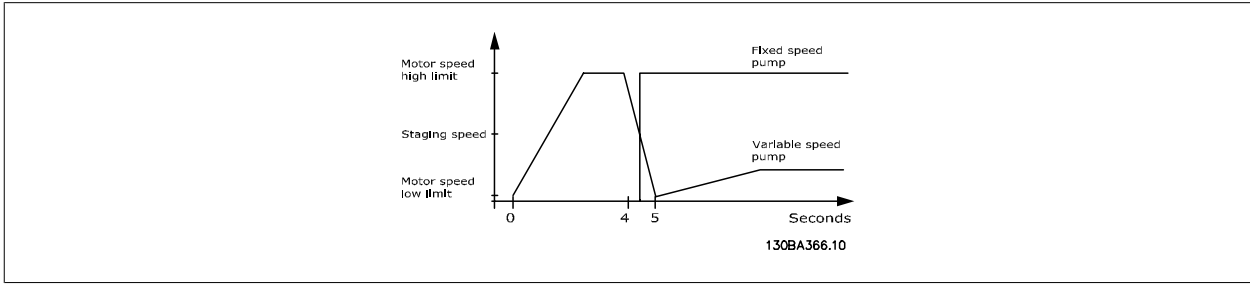

25-43 De-staging Threshold

Range:

0 %* [0 - 100 %]

Function:

When removing a fixed speed pump, in order to prevent an undershoot of pressure, the variable speed pump ramps up to a higher speed. When the variable speed pump reaches the "De-staging Speed" the fixed speed pump is de-staged. The De-staging Threshold is used to calculate the speed of the variable speed pump when the de-staging of the fixed speed pump occurs. The calculation of the De-staging Threshold is the ratio of par.4-11 *Motor Speed Low Limit [RPM]* or par.4-12 *Motor Speed Low Limit [Hz]*, to the par.4-13 *Motor Speed High Limit [RPM]* or par.4-14 *Motor Speed High Limit [Hz]*, expressed in percent.

De-staging Threshold must range from $STAGE\% = \frac{LOW}{HIGH} \times 100\%$ to 100%, where n_{LOW} is Motor Speed Low Limit and n_{HIGH} is Motor Speed High Limit.

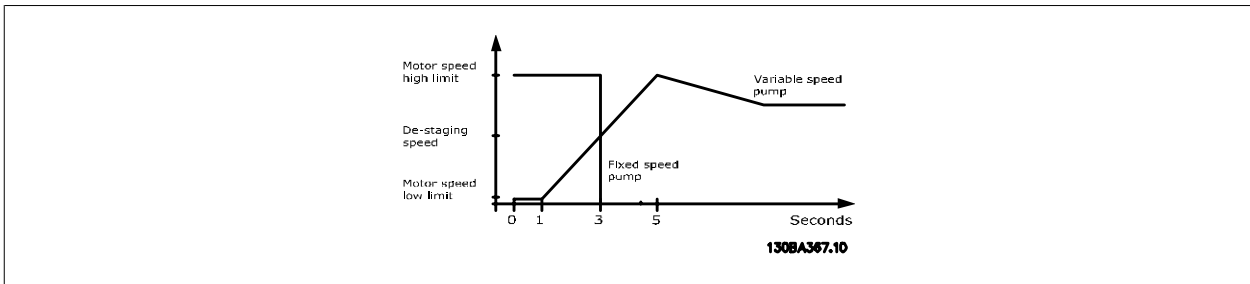

25-44 Staging Speed [RPM]

Range:

0 RPM* [0 - 0 RPM]

Function:

Readout of the below calculated value for Staging Speed. When adding a fixed speed pump, the variable speed pump ramps down to a lower speed in order to prevent an overshoot of pressure. When the variable speed pump reaches the "Staging Speed" the fixed speed pump is staged on. Staging Speed calculation is based on par.25-42 *Staging Threshold*, and par.4-13 *Motor Speed High Limit [RPM]*.

Staging Speed is calculated with the following formula:

$$STAGE = \frac{STAGE\%}{HIGH} \times 100$$

where n_{HIGH} is Motor Speed High Limit and $n_{STAGE100\%}$ is the value of Staging Threshold.

25-45 Staging Speed [Hz]

Range:

0.0 Hz* [0.0 - 0.0 Hz]

Function:

Readout of the below calculated value for Staging Speed. When adding a fixed speed pump, the variable speed pump ramps down to a lower speed in order to prevent an overshoot of pressure. When the variable speed pump reaches the "Staging Speed" the fixed speed pump is staged on. Staging Speed calculation is based on par.25-42 *Staging Threshold*, and par.4-14 *Motor Speed High Limit [Hz]*.

Staging Speed is calculated with the following formula:

$$STAGE = HIGH \frac{STAGE\%}{100}$$

where n_{HIGH} is Motor Speed High Limit and $n_{STAGE100\%}$ is the value of Staging Threshold.

25-46 De-staging Speed [RPM]

Range:

0 RPM* [0 - 0 RPM]

Function:

Readout of the below calculated value for De-staging Speed. When removing a fixed speed pump, in order to prevent an undershoot of pressure, the variable speed pump ramps up to a higher speed. When the variable speed pump reaches the "De-staging Speed" the fixed speed pump is de-staged. De-staging Speed is calculated based on par.25-43 *De-staging Threshold*, and par.4-13 *Motor Speed High Limit [RPM]*.

De-staging Speed is calculated with the following formula:

$$DE-STAGE = HIGH \frac{DE-STAGE\%}{100}$$

where n_{HIGH} is Motor Speed High Limit and $n_{DESTAGE100\%}$ is the value of De-staging Threshold.

25-47 De-staging Speed [Hz]

Range:

0.0 Hz* [0.0 - 0.0 Hz]

Function:

Readout of the below calculated value for De-staging Speed. When removing a fixed speed pump, in order to prevent an undershoot of pressure, the variable speed pump ramps up to a higher speed. When the variable speed pump reaches the "De-staging Speed" the fixed speed pump is de-staged. De-staging Speed is calculated based on par.25-43 *De-staging Threshold*, and par.4-14 *Motor Speed High Limit [Hz]*.

De-staging Speed is calculated with the following formula:

$$DE-STAGE = HIGH \frac{DE-STAGE\%}{100}$$

where n_{HIGH} is Motor Speed High Limit and $n_{DESTAGE100\%}$ is the value of De-staging Threshold.

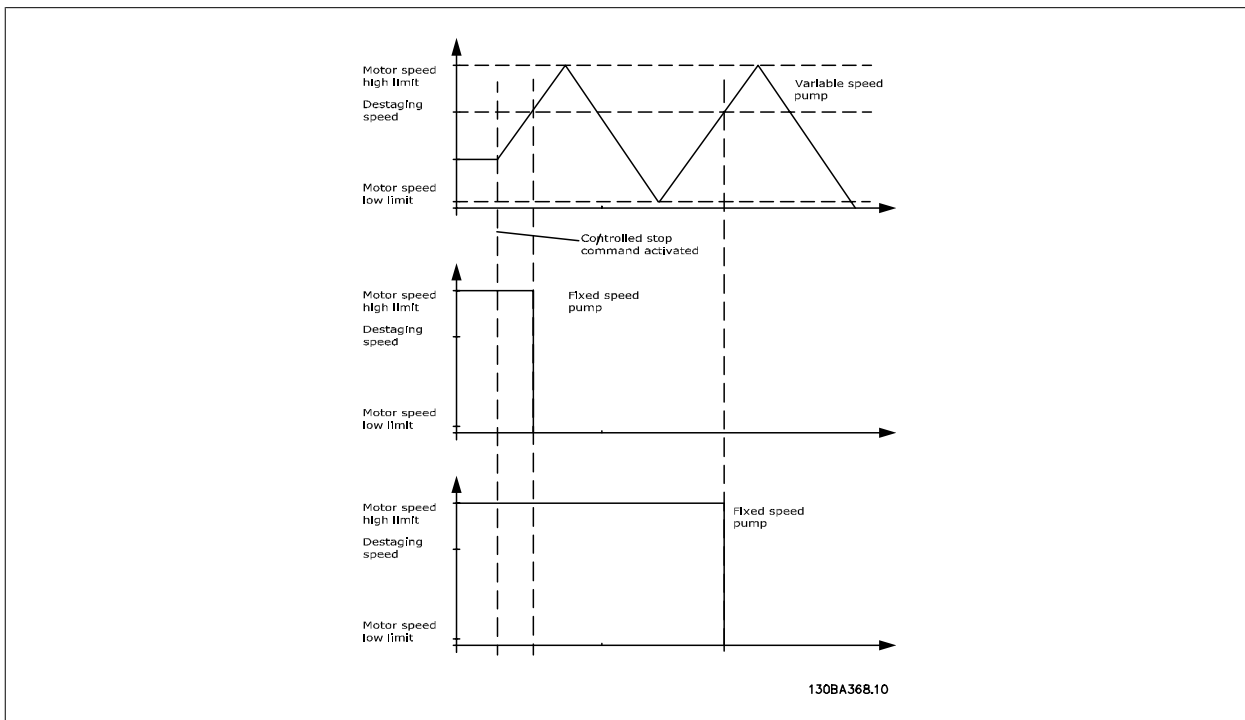

3.23.5 25-5* Alternation Settings

Parameters for defining the conditions for alternation of the variable speed pump (lead), if selected as part of the control strategy.

25-50 Lead Pump Alternation

Option:

Function:

Lead pump alternation equalizes the use of pumps by periodically changing the pump that is speed controlled. This ensures that pumps are equally used over time. Alternation equalizes the usage of pumps by always choosing the pump with the lowest number of used hours to stage on next.

[0] *	OFF	No alternation of lead pump function will take place. It is not possible to set this parameter to options other than <i>Off</i> [0] if par.25-02 <i>Motor Start</i> is set other than <i>Direct on Line</i> [0].
[1]	At staging	Alternation of the lead pump function will take place when staging another pump.
[2]	At command	Alternation of the lead pump function will take place at an external command signal or a pre-programmed event. See par.25-51 <i>Alternation Event</i> for available options.
[3]	At staging or at command	Alternation of the variable speed (lead) pump will take place at staging or the "At Command" signal. (See above.)



NOTE!

It is not possible to select other than *Off* [0] if par.25-05 *Fixed Lead Pump* is set to *Yes* [1].

25-51 Alternation Event

Option:
Function:

This parameter is only active if the options *At Command* [2] or *At Staging or Command* [3] have been selected in par.25-50 *Lead Pump Alternation*. If an alternation event is selected, the alternation of lead pump takes place every time the event occurs.

[0] *	External	Alternation takes place when a signal is applied to one of the digital inputs on the terminal strip and this input has been assigned to <i>Lead Pump Alternation</i> [121] in par. 5-1*, <i>Digital Inputs</i> .
[1]	Alternation Time Interval	Alternation takes place every time par.25-52 <i>Alternation Time Interval</i> expires.
[2]	Sleep Mode	Alternation takes place each time the lead pump goes into sleep mode. par.20-23 <i>Setpoint 3</i> must be set to <i>Sleep Mode</i> [1] or an external signal applied for this function.
[3]	Predefined Time	Alternation takes place at a defined time of the day. If par.25-54 <i>Alternation Predefined Time</i> is set, the alternation is carried out every day at the specified time. Default time is midnight (00:00 or 12:00 AM depending on the time format).

25-52 Alternation Time Interval

Range:
Function:

24 h* [1 - 999 h]

If *Alternation Time Interval* [1] option in par.25-51 *Alternation Event* is selected, the alternation of the variable speed pump takes place every time the Alternation Time Interval expires (can be checked out in par.25-53 *Alternation Timer Value*).

25-53 Alternation Timer Value

Range:
Function:

0 N/A* [0 - 0 N/A]

Readout parameter for the Alternation Time Interval value set in par.25-52 *Alternation Time Interval*.

25-54 Alternation Predefined Time

Range:
Function:

0 N/A* [0 - 0 N/A]

If option *Predefined Time* [3] in par.25-51 *Alternation Event* is selected, the variable speed pump alternation is carried out every day at the specified time set in Alternation Predefined Time. Default time is midnight (00:00 or 12:00 AM depending on the time format).

25-55 Alternate if Load < 50%

Option:
Function:

If Alternation If Capacity <50% is enabled, the pump alternation can only occurs if the capacity is equal to or below 50%. The capacity calculation is the ratio of running pumps (including the variable speed pump) to the total number of available pumps (including variable speed pump, but not those interlocked).

$$Capacity = \frac{N_{RUNNING}}{N_{TOTAL}} \times 100\%$$

For the basic cascade controller, all pumps are equal size.

[0]	Disabled	The lead pump alternation will take place at any pump capacity.
[1] *	Enabled	The lead pump function will be alternated only if the numbers of pumps running are providing less than 50% of total pump capacity.



NOTE!

Only valid if par.25-50 *Lead Pump Alternation* is different from *Off* [0].

25-56 Staging Mode at Alternation

Option:

Function:

This parameter is only active if the option selected in par.25-50 *Lead Pump Alternation* is different from *Off* [0].

Two types of staging and de-staging of pumps are possible. Slow transfer makes staging and de-staging smooth. Quick transfer makes staging and de-staging as fast as possible; the variable speed pump is just cut out (coasted).

[0] * Slow

At alternation, the variable speed pump is ramped up to maximum speed and then ramped down to a stand still.

[1] Quick

At alternation, the variable speed pump is ramped up to maximum speed and then coasted to stand still.

3

The below figure is an example of the slow transfer staging. The variable speed pump (top graph) and one fixed speed pump (bottom graph) are running before the staging command. When the *Slow* [0] transfer command is activated, an alternation is carried out by ramping the variable speed pump to par.4-13 *Motor Speed High Limit [RPM]* or par.4-14 *Motor Speed High Limit [Hz]*, and then decelerated to zero speed. After a "Delay Before Starting Next Pump" (par.25-58 *Run Next Pump Delay*) the next lead pump (middle graph) is accelerated and another original lead pump (top graph) is added after the "Delay Before Running On Line Power" (par.25-59 *Run-on Line Delay*) as a fixed speed pump. The next lead pump (middle graph) is decelerated to Motor Speed Low Limit and then allowed to vary speed to maintain system pressure.

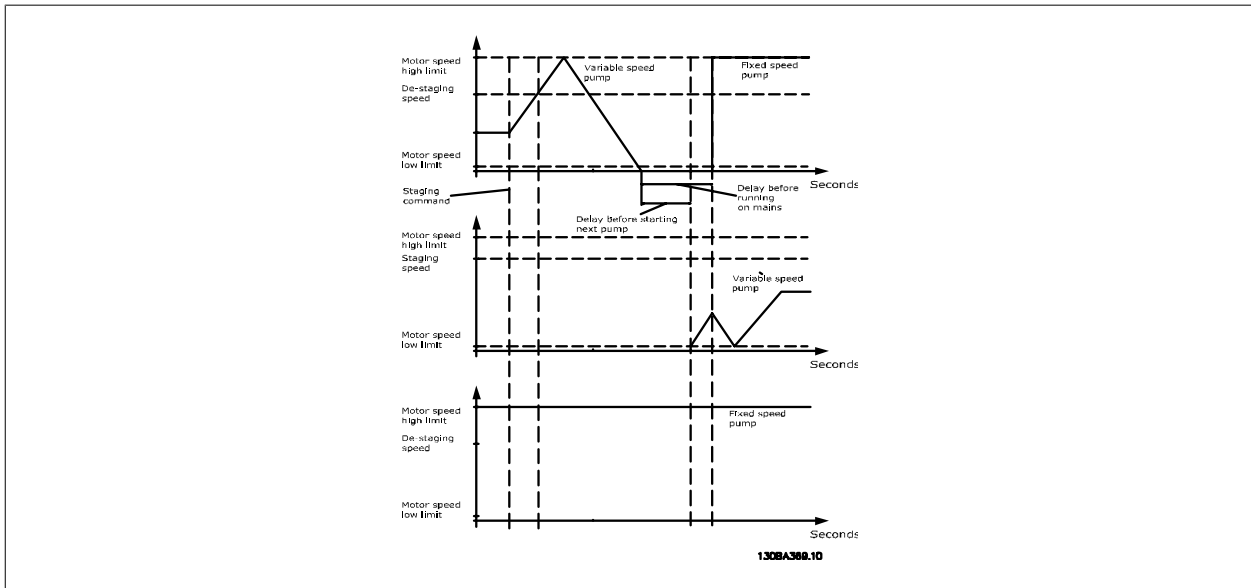

25-58 Run Next Pump Delay

Range:

0.1 s* [0.1 - 5.0 s]

Function:

This parameter is only active if the option selected in par.25-50 *Lead Pump Alternation*, is different from *Off* [0].

This parameter sets the time between stopping the old variable speed pump and starting another pump as a new variable speed pump. Refer to par.25-56 *Staging Mode at Alternation*, the illustration for description of staging and alternation.

25-59 Run-on Line Delay

Range:

0.5 s* [par. 25-58 - 5.0 s]

Function:

This parameter is only active if the option selected in par.25-50 *Lead Pump Alternation* is different from *Off* [0].

This parameter sets the time between stopping the old variable speed pump and starting this pump as a new fixed speed pump. Refer to par.25-56 *Staging Mode at Alternation* the illustration for description of staging and alternation.

3.23.6 25-8* Status

Readout parameters informing about the operating status of the cascade controller and the pumps controlled.

25-80 Cascade Status

Range:

0 N/A* [0 - 0 N/A]

Function:

Readout of the status of the cascade controller.

25-81 Pump Status

Range:

0 N/A* [0 - 0 N/A]

Function:

Pump Status shows the status for the number of pumps selected in par.25-06 *Number Of Pumps*. It is a readout of the status for each of the pumps showing a string, which consists of pump number and the current status of the pump.

Example: Readout is with the abbreviation like "1:D 2:O". This means that pump 1 is running and speed controlled by the adjustable frequency drive and pump 2 is stopped.

25-82 Lead Pump

Range:

0 N/A* [0 - par. 25-06 N/A]

Function:

Readout parameter for the actual variable speed pump in the system. The Lead Pump parameter is updated to reflect the current variable speed pump in the system when an alternation takes place. If no lead pump is selected (Cascade Controller disabled or all pumps interlocked), the display will show NONE.

25-83 Relay Status

Array [2]

Range:

0 N/A* [0 - 0 N/A]

Function:

Readout of the status for each of the relays assigned to control the pumps. Every element in the array represents a relay. If a relay is activated, the corresponding element is set to "On". If a relay is deactivated, the corresponding element is set to "Off".

25-84 Pump ON Time

Array [2]

Range:

0 h* [0 - 2147483647 h]

Function:

Readout of the value for Pump ON Time. The Cascade Controller has separate counters for the pumps and for the relays that control the pumps. Pump ON Time monitors the "operating hours" of each pump. The value of each Pump ON Time counter can be reset to 0 by writing in the parameter, e.g., if the pump is replaced in case of service.

25-85 Relay ON Time

Array [2]

Range:

0 h* [0 - 2147483647 h]

Function:

Readout of the value for Relay ON time. The Cascade Controller has separate counters for the pumps and for the relays that control the pumps. Pump cycling is always done based on the relay counters, otherwise it would always use the new pump if a pump is replaced and its value in par.25-84 *Pump ON Time* is reset. In order to use par.25-04 *Pump Cycling* the Cascade Controller is monitoring the Relay ON time.

25-86 Reset Relay Counters

Option:

Function:

Resets all elements in par.25-85 *Relay ON Time* counters.

[0] * Do not reset

[1] Do reset

3.23.7 25-9* Service

Parameters used in case of service on one or more of the pumps controlled.

25-90 Pump Interlock

Array [2]

Option:

Function:

In this parameter, it is possible to disable one or more of the fixed lead pumps. For example, the pump will not be selected for staging on, even if it is the next pump in the operation sequence. It is not possible to disable the lead pump with the pump interlock command. The digital input interlocks are selected as *Pump 1-3 Interlock* [130 – 132] in *par. 5-1*, Digital Inputs*.

[0] * Off

The pump is active for staging/de-staging.

[1] On

The pump interlock command is given. If a pump is running, it is immediately de-staged. If the pump is not running, it is not allowed to stage on.

25-91 Manual Alternation

Range:

0 N/A* [0 - par. 25-06 N/A]

Function:

Readout parameter for the actual variable speed pump in the system. The Lead Pump parameter is updated to reflect the current variable speed pump in the system when an alternation takes place. If no lead pump is selected (Cascade Controller disabled or all pumps interlocked), the display will show NONE.

3.24 Main Menu - Analog I/O Option MCB 109 - Group 26

3.24.1 Analog I/O Option MCB 109, 26-**

The Analog I/O Option MCB 109 extends the functionality of VLT HVAC Drive adjustable frequency drives, by adding a number of additional, programmable analog inputs and outputs. This could be especially useful in building management system installations where the adjustable frequency drive may be used as de-central I/O, obviating the need for an outstation and thus reducing costs.

3

Consider the diagram:

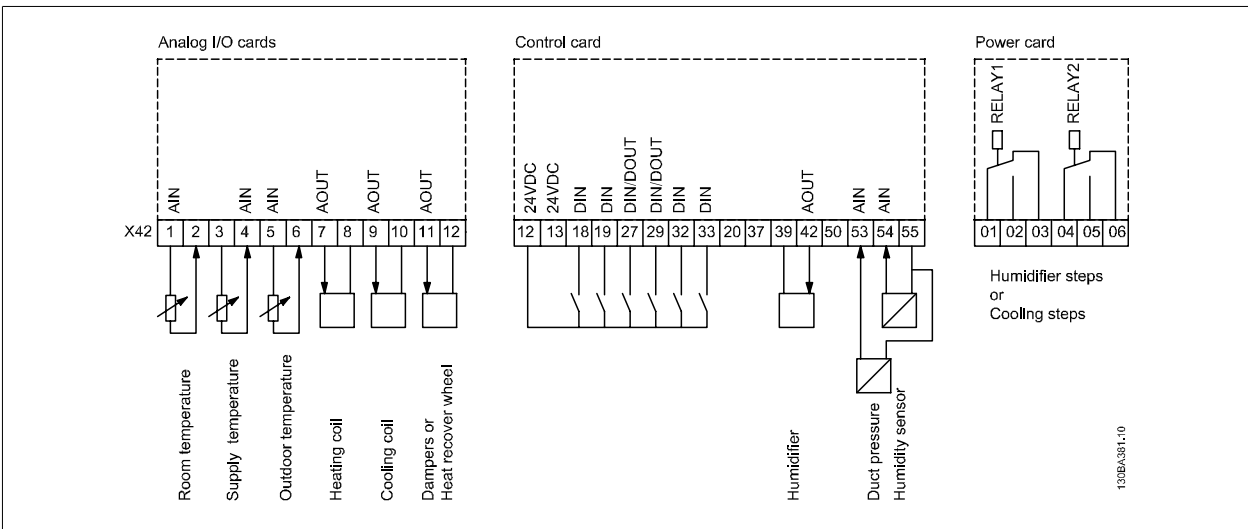
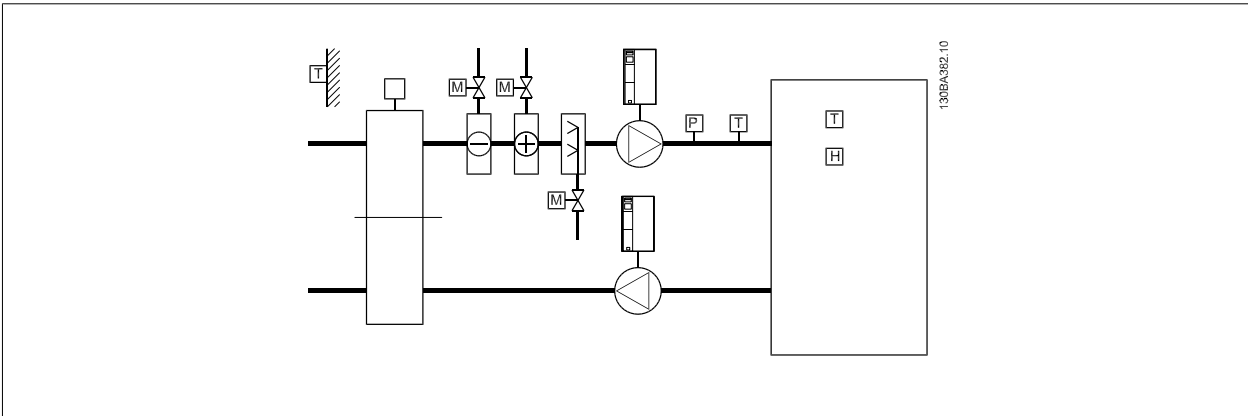

This shows a typical Air Handling Unit (AHU). As can be seen, the addition of the Analog I/O option offers the possibility to control all of the functions from the adjustable frequency drive, such as inlet, return and exhaust dampers or heating/cooling coils with temperature and pressure measurements being read by the adjustable frequency drive.

NOTE!
The maximum current for the analog outputs 0-10 V is 1 mA.



NOTE!

Where Live Zero Monitoring is used, it is important that any analog inputs not being used for the frequency controller, i.e., being used as part of the building management system decentral I/O, should have their Live Zero function disabled.

Terminal	Parameters	Terminal	Parameters	Terminal	Parameters
Analog inputs		Analog inputs		Relays	
X42/1	par.26-00 <i>Terminal X42/1 Mode, 26-1*</i>	53	6-1*	Relay 1 Term 1, 2, 3	5-4*
X42/3	par.26-01 <i>Terminal X42/3 Mode, 26-2*</i>	54	6-2*	Relay 2 Term 4, 5, 6	5-4*
X42/5	par.26-02 <i>Terminal X42/5 Mode, 26-3*</i>				
Analog outputs		Analog output			
X42/7	26-4*	42	6-5*		
X42/9	26-5*				
X42/11	26-6*				

Table 3.3: Relevant parameters

It is also possible to read the analog inputs, write to the analog outputs and control the relays, using communication via the serial bus. In this instance, these are the relevant parameters.

Terminal	Parameters	Terminal	Parameters	Terminal	Parameters
Analog inputs (read)		Analog inputs (read)		Relays	
X42/1	par.18-30 <i>Analog Input X42/1</i>	53	par.16-62 <i>Analog Input 53</i>	Relay 1 Term 1, 2, 3	par.16-71 <i>Relay Output [bin]</i>
X42/3	par.18-31 <i>Analog Input X42/3</i>	54	par.16-64 <i>Analog Input 54</i>	Relay 2 Term 4, 5, 6	par.16-71 <i>Relay Output [bin]</i>
X42/5	par.18-32 <i>Analog Input X42/5</i>				
Analog outputs (write)		Analog output (write)			
X42/7	par.18-33 <i>Analog Out X42/7 [V]</i>	42	par.6-53 <i>Terminal 42 Output Bus Control</i>	NOTE! The relay outputs must be enabled via Control Word Bit 11 (Relay 1) and Bit 12 (Relay 2)	
X42/9	par.18-34 <i>Analog Out X42/9 [V]</i>				
X42/11	par.18-35 <i>Analog Out X42/11 [V]</i>				

Table 3.4: Relevant parameters

Setting of on-board Real Time Clock.

The Analog I/O option incorporates a real time clock with battery back-up. This can be used as a back-up of the clock function included in the adjustable frequency drive as standard. See section Clock Settings, par. 0-7*.

The Analog I/O option can be used for the control of devices such as servos or valves, using the extended closed-loop facility, thus removing control from the building management system. See section Parameters: Ext. Closed-loop – FC 100 par. 21-*. There are three independent closed-loop PID controllers.

26-00 Terminal X42/1 Mode

Option:
Function:

Terminal X42/1 can be programmed as an analog input accepting a voltage or input from either Pt1000 (1000 Ω at 0°C) or Ni 1000 (1000 Ω at 0°C) temperature sensors. Select the desired mode. *Pt 1000*, [2] and *Ni 1000* [4] if operating in Celsius - Pt 1000 [3] and Ni 1000 [5] if operating in Fahrenheit.

Notice: If the input is not in use, it must be set for Voltage!

If set for temperature and used as feedback, the unit must be set for either Celsius or Fahrenheit (par.20-12 *Reference/Feedback Unit*, par.21-10 *Ext. 1 Ref./Feedback Unit*, par.21-30 *Ext. 2 Ref./Feedback Unit* or par.21-50 *Ext. 3 Ref./Feedback Unit*).

[1] * Voltage

[2] Pt 1000 [°C]

[3] Pt 1000 [°F]

[4] Ni 1000 [°C]

[5] Ni 1000 [°F]

26-01 Terminal X42/3 Mode

Option:
Function:

Terminal X42/3 can be programmed as an analog input accepting a voltage or input from either Pt 1000 or Ni 1000 temperature sensors. Select the desired mode.

Pt 1000, [2] and Ni 1000, [4] if operating in Celsius - Pt 1000, [3] and Ni 1000, [5] if operating in Fahrenheit.

Notice: If the input is not in use, it must be set for Voltage!

If set for temperature and used as feedback, the unit must be set for either Celsius or Fahrenheit (par.20-12 *Reference/Feedback Unit*, par.21-10 *Ext. 1 Ref./Feedback Unit*, par.21-30 *Ext. 2 Ref./Feedback Unit* or par.21-50 *Ext. 3 Ref./Feedback Unit*).

[1] * Voltage

[2] Pt 1000 [°C]

[3] Pt 1000 [°F]

[4] Ni 1000 [°C]

[5] Ni 1000 [°F]

26-02 Terminal X42/5 Mode

Option:
Function:

Terminal X42/5 can be programmed as an analog input accepting a voltage or input from either Pt 1000 (1000 Ω at 0° C) or Ni 1000 (1000 Ω at 0° C) temperature sensors. Select the desired mode. Pt 1000, [2] and Ni 1000, [4] if operating in Celsius - Pt 1000, [3] and Ni 1000, [5] if operating in Fahrenheit.

Notice: If the input is not in use, it must be set for Voltage!

If set for temperature and used as feedback, the unit must be set for either Celsius or Fahrenheit (par.20-12 *Reference/Feedback Unit*, par.21-10 *Ext. 1 Ref./Feedback Unit*, par.21-30 *Ext. 2 Ref./Feedback Unit* or par.21-50 *Ext. 3 Ref./Feedback Unit*).

[1] * Voltage

[2] Pt 1000 [°C]

[3] Pt 1000 [°F]

[4] Ni 1000 [°C]

[5] Ni 1000 [°F]

26-10 Terminal X42/1 Low Voltage

Range:	Function:
0.07 V* [0.00 - par. 6-31 V]	Enter the low voltage value. This analog input scaling value should correspond to the low reference/feedback value set in par.26-14 <i>Term. X42/1 Low Ref./Feedb. Value.</i>

26-11 Terminal X42/1 High Voltage

Range:	Function:
10.00 V* [par. 6-30 - 10.00 V]	Enter the high voltage value. This analog input scaling value should correspond to the high reference/feedback value set in par.26-15 <i>Term. X42/1 High Ref./Feedb. Value.</i>

26-14 Term. X42/1 Low Ref./Feedb. Value

Range:	Function:
0.000 N/A* [-999999.999 - 999999.999 N/A]	Enter the analog input scaling value that corresponds to the low voltage value set in par. 26-10 <i>Terminal X42/1 Low Voltage.</i>

26-15 Term. X42/1 High Ref./Feedb. Value

Range:	Function:
100.000 N/A* [-999999.999 - 999999.999 N/A]	Enter the analog input scaling value that corresponds to the high voltage value set in par. 26-11 <i>Terminal X42/1 High Voltage.</i>

26-16 Term. X42/1 Filter Time Constant

Range:	Function:
0.001 s* [0.001 - 10.000 s]	Enter the time constant. This is a first-order digital low pass filter time constant for suppressing noise in terminal X42/1. A high time constant value improves dampening but also increases the time delay through the filter. This parameter cannot be adjusted while the motor is running.

26-17 Term. X42/1 Live Zero

Option:	Function:
	This parameter makes it possible to enable the live zero monitoring, for example where the analog input is a part of the adjustable frequency drive control, rather than being used as part of a decentral I/O system, such as a building management system.
[0] Disabled	
[1] * Enabled	

26-20 Terminal X42/3 Low Voltage

Range:	Function:
0.07 V* [0.00 - par. 6-31 V]	Enter the low voltage value. This analog input scaling value should correspond to the low reference/feedback value set in par.26-24 <i>Term. X42/3 Low Ref./Feedb. Value.</i>

26-21 Terminal X42/3 High Voltage

Range:	Function:
10.00 V* [par. 6-30 - 10.00 V]	Enter the high voltage value. This analog input scaling value should correspond to the high reference/feedback value set in par.26-25 <i>Term. X42/3 High Ref./Feedb. Value.</i>

26-24 Term. X42/3 Low Ref./Feedb. Value

Range:	Function:
0.000 N/A* [-999999.999 - 999999.999 N/A]	Enter the analog input scaling value that corresponds to the low voltage value set in par. 26-20 <i>Terminal X42/3 Low Voltage.</i>

26-25 Term. X42/3 High Ref./Feedb. Value**Range:**100.000 N/ [-999999.999 - 999999.999 N/A]
A***Function:**Enter the analog input scaling value that corresponds to the high voltage value set in par. 26-21 *Terminal X42/3 High Voltage*.**26-26 Term. X42/3 Filter Time Constant****Range:**

0.001 s* [0.001 - 10.000 s]

Function:

Enter the time constant. This is a first-order digital low pass filter time constant for suppressing noise in terminal X42/3. A high time constant value improves dampening but also increases the time delay through the filter. This parameter cannot be adjusted while the motor is running.

26-27 Term. X42/3 Live Zero**Option:**[0] Disabled
[1] * Enabled**Function:**

This parameter makes it possible to enable the live zero monitoring, for example where the analog input is a part of the adjustable frequency drive control, rather than being used as part of a decentral I/O system, such as a building management system.

26-30 Terminal X42/5 Low Voltage**Range:**

0.07 V* [0.00 - par. 6-31 V]

Function:Enter the low voltage value. This analog input scaling value should correspond to the low reference/feedback value set in par.26-34 *Term. X42/5 Low Ref./Feedb. Value*.**26-31 Terminal X42/5 High Voltage****Range:**

10.00 V* [par. 6-30 - 10.00 V]

Function:Enter the high voltage value. This analog input scaling value should correspond to the high reference/feedback value set in par.26-35 *Term. X42/5 High Ref./Feedb. Value*.**26-34 Term. X42/5 Low Ref./Feedb. Value****Range:**

0.000 N/A* [-999999.999 - 999999.999 N/A]

Function:Enter the analog input scaling value that corresponds to the low voltage value set in par. 26-30 *Terminal X42/5 Low Voltage*.**26-35 Term. X42/5 High Ref./Feedb. Value****Range:**100.000 N/ [-999999.999 - 999999.999 N/A]
A***Function:**Enter the analog input scaling value that corresponds to the high voltage value set in par. 26-21 *Terminal X42/3 High Voltage*.**26-36 Term. X42/5 Filter Time Constant****Range:**

0.001 s* [0.001 - 10.000 s]

Function:

Enter the time constant. This is a first-order digital low pass filter time constant for suppressing noise in terminal X42/5. A high time constant value improves dampening but also increases the time delay through the filter. This parameter cannot be adjusted while the motor is running.

26-37 Term. X42/5 Live Zero

Option:

Function:

This parameter makes it possible to enable the live zero monitoring, for example where the analog input is a part of the adjustable frequency drive control, rather than being used as part of a decentral I/O system, such as a building management system.

- [0] Disabled
- [1] * Enabled

26-40 Terminal X42/7 Output

Option:

Function:

Set the function of terminal X42/7 as an analog voltage output.

- [0] * No operation
- [100] Output frequency
- [101] Reference
- [102] Feedback
- [103] Motor current
- [104] Torque rel to limit
- [105] Torq relate to rated
- [106] Power
- [107] Speed
- [113] Ext. Closed-loop 1
- [114] Ext. Closed-loop 2
- [115] Ext. Closed-loop 3
- [139] Bus ctrl.
- [141] Bus ctrl t.o.

26-41 Terminal X42/7 Min. Scale

Range:

Function:

0.00 %* [0.00 - 200.00 %]

Scale the minimum output of the selected analog signal at terminal X42/7, as a percentage of the maximum signal level, for example if a 0 V (or 0 Hz) is desired at 25% of the maximum output value. Then program 25%. Scaling values up to 100% can never be higher than the corresponding setting in par.26-42 *Terminal X42/7 Max. Scale*.
See principle graph for par.6-51 *Terminal 42 Output Min Scale*.

26-42 Terminal X42/7 Max. Scale

Range:

Function:

100.00 %* [0.00 - 200.00 %]

Scale the maximum output of the selected analog signal at terminal X42/7. Set the value to the maximum value of the voltage signal output. Scale the output to give a voltage lower than 10V at full scale; or 10V at an output below 100% of the maximum signal value. If 10 V is the desired output current at a value between 0–100% of the full-scale output, program the percentage value in the parameter, i.e., 50% = 10 V. If a voltage between 0 and 10V is desired at maximum output, calculate the percentage as follows:

$$\left(\frac{10V}{\text{desired maximum voltage}} \right) \times 100\%$$

i.e.

$$5V : \frac{10V}{5V} \times 100\% = 200\%$$

See principle graph for par.6-52 *Terminal 42 Output Max Scale*.

26-43 Terminal X42/7 Output Bus Control

Range:

0.00 %* [0.00 - 100.00 %]

Function:

Holds the level of terminal X42/7 if controlled by the bus.

26-44 Terminal X42/7 Output Timeout Preset

Range:

0.00 %* [0.00 - 100.00 %]

Function:

Holds the preset level of terminal X42/7.

In case of a bus timeout and a timeout function is selected in par.26-50 *Terminal X42/9 Output*, the output will preset to this level.

26-50 Terminal X42/9 Output

Option:
Function:

Set the function of terminal X42/9.

[0] * No operation

[100] Output frequency

[101] Reference

[102] Feedback

[103] Motor current

[104] Torque rel to limit

[105] Torq relate to rated

[106] Power

[107] Speed

[113] Ext. Closed-loop 1

[114] Ext. Closed-loop 2

[115] Ext. Closed-loop 3

[139] Bus ctrl.

[141] Bus ctrl t.o.

26-51 Terminal X42/9 Min. Scale

Range:

0.00 %* [0.00 - 200.00 %]

Function:
Scale the minimum output of the selected analog signal at terminal X42/9, as a percentage of the maximum signal level, for example if a 0 V is desired at 25% of the maximum output value. Then program 25%. Scaling values up to 100% can never be higher than the corresponding setting in par.26-52 *Terminal X42/9 Max. Scale*.See principle graph for par.6-51 *Terminal 42 Output Min Scale*.

26-52 Terminal X42/9 Max. Scale

Range:

100.00 %* [0.00 - 200.00 %]

Function:

Scale the maximum output of the selected analog signal at terminal X42/9. Set the value to the maximum value of the voltage signal output. Scale the output to give a voltage lower than 10V at full scale; or 10V at an output below 100% of the maximum signal value. If 10 V is the desired output current at a value between 0–100% of the full-scale output, program the percentage value in the parameter, i.e., 50% = 10 V. If a voltage between 0 and 10V is desired at maximum output, calculate the percentage as follows:

$$\left(\frac{10V}{\text{desired maximum voltage}}\right) \times 100\%$$

i.e.

$$5V : \frac{10V}{5V} \times 100\% = 200\%$$

See principle graph for par.6-52 *Terminal 42 Output Max Scale*.

26-53 Terminal X42/9 Output Bus Control

Range:

0.00 %* [0.00 - 100.00 %]

Function:

Holds the level of terminal X42/9 if controlled by bus.

26-54 Terminal X42/9 Output Timeout Preset

Range:

0.00 %* [0.00 - 100.00 %]

Function:

Holds the preset level of terminal X42/9.

In case of a bus timeout and a timeout function is selected in par.26-60 *Terminal X42/11 Output* the output will preset to this level.

26-60 Terminal X42/11 Output

Option:

Function:

Set the function of terminal X42/11.

[0] * No operation

[100] Output frequency

[101] Reference

[102] Feedback

[103] Motor current

[104] Torque rel to limit

[105] Torq relate to rated

[106] Power

[107] Speed

[113] Ext. Closed-loop 1

[114] Ext. Closed-loop 2

[115] Ext. Closed-loop 3

[139] Bus ctrl.

[141] Bus ctrl t.o.

26-61 Terminal X42/11 Min. Scale

Range:

0.00 %* [0.00 - 200.00 %]

Function:

Scale the minimum output of the selected analog signal at terminal X42/11, as a percentage of the maximum signal level, for example if a 0 V is desired at 25% of the maximum output value. Then program 25%. Scaling values up to 100% can never be higher than the corresponding setting in par.26-62 *Terminal X42/11 Max. Scale*.

See principle graph for par.6-51 *Terminal 42 Output Min Scale*.

26-62 Terminal X42/11 Max. Scale

Range:

100.00 %* [0.00 - 200.00 %]

Function:

Scale the maximum output of the selected analog signal at terminal X42/9. Set the value to the maximum value of the voltage signal output. Scale the output to give a voltage lower than 10V at full scale; or 10V at an output below 100% of the maximum signal value. If 10 V is the desired output current at a value between 0–100% of the full-scale output, program the percentage value in the parameter, i.e., 50% = 10 V. If a voltage between 0 and 10V is desired at maximum output, calculate the percentage as follows:

$$\left(\frac{10V}{\text{desired maximum voltage}} \right) \times 100\%$$

i.e.

$$5V : \frac{10V}{5V} \times 100\% = 200\%$$

See principle graph for par.6-52 *Terminal 42 Output Max Scale*.

26-63 Terminal X42/11 Output Bus Control

Range:

0.00 %* [0.00 - 100.00 %]

Function:

Holds the level of terminal X42/11 if controlled by bus.

26-64 Terminal X42/11 Output Timeout Preset

Range:

0.00 %* [0.00 - 100.00 %]

Function:

Holds the preset level of terminal X42/11.

In case a bus timeout and a timeout function are selected, the output will preset to this level.

4 Troubleshooting

4.1.1 Alarms and warnings

A warning or an alarm is signaled by the relevant LED on the front of the adjustable frequency drive, indicated by a code on the display.

A warning remains active until its cause is no longer present. Under certain circumstances, operation of the motor may still be continued. Warning messages may be critical, but are not necessarily so.

In the event of an alarm, the adjustable frequency drive will have tripped. Alarms must be reset to restart operation once their cause has been rectified. This may be done in four ways:

1. By using the [RESET] control button on the LCP control panel.
2. Via a digital input with the "Reset" function.
3. Via serial communication/optional serial communication bus.
4. By resetting automatically using the [Auto Reset] function, which is a default setting for the adjustable frequency drive, see par.14-20 *Reset Mode* in *VLT HVAC Drive Programming Guide, MG.11.Cx.yy*

**NOTE!**

After a manual reset using the [RESET] button on the LCP, the [AUTO ON] button must be pressed to restart the motor.

If an alarm cannot be reset, the reason may be that its cause has not been rectified, or the alarm is trip-locked (see also table on following page).

Alarms that are trip-locked offer additional protection; this means that the line power supply must be switched off before the alarm can be reset. After being switched back on, the adjustable frequency drive is no longer blocked and may be reset as described above, once the cause has been rectified.

Alarms that are not trip-locked can also be reset using the automatic reset function in par.14-20 *Reset Mode* (Warning: automatic wake-up is possible!)

If a warning and alarm is marked against a code in the table on the following page, this means that either a warning occurs before an alarm, or that it can be specified whether it is a warning or an alarm that is to be displayed for a given fault.

This is possible, for instance, in par.1-90 *Motor Thermal Protection*. After an alarm or trip, the motor carries on coasting, and the alarm and warning flash on the adjustable frequency drive. Once the problem has been rectified, only the alarm continues flashing.

No.	Description	Warning	Alarm/Trip	Alarm/Trip Lock	Parameter Reference
1	10 Volts low	X			
2	Live zero error	(X)	(X)		par.6-01 <i>Live Zero Time-out Function</i>
3	No motor	(X)			par.1-80 <i>Function at Stop</i>
4	Line phase loss	(X)	(X)	(X)	par.14-12 <i>Function at Mains Imbalance</i>
5	DC link voltage high	X			
6	DC link voltage low	X			
7	DC overvoltage	X	X		
8	DC undervoltage	X	X		
9	Inverter overloaded	X	X		
10	Motor ETR overtemperature	(X)	(X)		par.1-90 <i>Motor Thermal Protection</i>
11	Motor thermistor overtemperature	(X)	(X)		par.1-90 <i>Motor Thermal Protection</i>
12	Torque limit	X	X		
13	Overcurrent	X	X	X	
14	Ground fault	X	X	X	
15	Incomp. HW		X	X	
16	Short Circuit		X	X	
17	Control word timeout	(X)	(X)		par.8-04 <i>Control Timeout Function</i>
22	Hoist mech. brake	X			
23	Internal fans				
24	External fans				
25	Brake resistor short-circuited	X			
26	Brake resistor power limit	(X)	(X)		par.2-13 <i>Brake Power Monitoring</i>
27	Brake chopper short-circuited	X	X		
28	Brake check	(X)	(X)		par.2-15 <i>Brake Check</i>
29	Power board overtemp.	X	X	X	
30	Motor phase U missing	(X)	(X)	(X)	par.4-58 <i>Missing Motor Phase Function</i>
31	Motor phase V missing	(X)	(X)	(X)	par.4-58 <i>Missing Motor Phase Function</i>
32	Motor phase W missing	(X)	(X)	(X)	par.4-58 <i>Missing Motor Phase Function</i>
33	Soft-charge fault		X	X	
34	Serial communication bus fault	X	X		
36	Line failure				
37	Phase imbalance	X	X		
38	Internal fault		X	X	
39	Heatsink sensor		X		
40	Overload T27				
41	Overload T29				
42	Overload X30/6-7				
46	Pwr. card supply		X		
47	24 V supply low	X	X	X	
48	1.8 V supply low		X	X	
49	Speed limit				
50	AMA calibration failed		X		
51	AMA check U_{nom} and I_{nom}		X		
52	AMA low I_{nom}		X		
53	AMA motor too big		X		
54	AMA motor too small		X		
55	AMA parameter out of range		X		
56	AMA interrupted by user		X		
57	AMA timeout		X		
58	AMA internal fault	X	X		
59	Current limit	X			
60	External interlock				
61	Tracking error	X	X		
62	Output Frequency at Maximum Limit	X			
64	Voltage Limit	X			
65	Control Board Overtemperature	X	X	X	
66	Heatsink Temperature Low	X			
67	Option Configuration Has Changed		X		
68	Safe Stop Activated		X		
69	Pwr. card temp.		X		
70	Illegal FC configuration				

Table 4.1: Alarm/Warning code list 1/2

No.	Description	Warning	Alarm/Trip	Alarm/Trip Lock	Parameter Reference
90	Feedback mon.		X		
91	Analog input 54 wrong settings		X		
92	No-Flow	X	X		Par. 22-2*
93	Dry Pump	X	X		Par. 22-2*
94	End of Curve	X	X		Par. 22-5*
95	Broken Belt	X	X		Par. 22-6*
96	Start Delayed	X			Par. 22-7*
250	New spare part		X		
251	New type code		X		

Table 4.2: Alarm/Warning code list 2/2

(X) Dependent on parameter

LED indication	
Warning	yellow
Alarm	flashing red
Trip-locked	yellow and red

Alarm Word and Extended Status Word					
Bit	Hex	Dec	Alarm Word	Warning Word	Extended Status Word
0	00000001	1	Brake Check	Brake Check	Ramping
1	00000002	2	Pwr. Card Temp	Pwr. Card Temp	AMA Running
2	00000004	4	Ground Fault	Ground Fault	Start CW/CCW
3	00000008	8	Ctrl.Card Temp	Ctrl.Card Temp	Slow Down
4	00000010	16	Ctrl. Word TO	Ctrl. Word TO	Catch Up
5	00000020	32	Overcurrent	Overcurrent	Feedback High
6	00000040	64	Torque Limit	Torque Limit	Feedback Low
7	00000080	128	Motor Th Over	Motor Th Over	Output Current High
8	00000100	256	Motor ETR Over	Motor ETR Over	Output Current Low
9	00000200	512	Inverter Overld.	Inverter Overld.	Output Freq High
10	00000400	1024	DC Undervolt	DC Undervolt	Output Freq Low
11	00000800	2048	DC Overvolt	DC Overvolt	Brake Check OK
12	00001000	4096	Short Circuit	DC Voltage Low	Braking Max
13	00002000	8192	Soft-charge fault	DC Voltage High	Braking
14	00004000	16384	Line ph. Loss	Line ph. Loss	Out of Speed Range
15	00008000	32768	AMA Not OK	No Motor	OVC Active
16	00010000	65536	Live Zero Error	Live Zero Error	
17	00020000	131072	Internal Fault	10 V Low	
18	00040000	262144	Brake Overload	Brake Overload	
19	00080000	524288	U-phase Loss	Brake Resistor	
20	00100000	1048576	V-phase Loss	Brake IGBT	
21	00200000	2097152	W-phase Loss	Speed Limit	
22	00400000	4194304	Ser. Com. Bus Fault	Ser. Com. Bus Fault	
23	00800000	8388608	24 V Supply Low	24 V Supply Low	
24	01000000	16777216	Line Failure	Line Failure	
25	02000000	33554432	1.8 V Supply Low	Current Limit	
26	04000000	67108864	Brake Resistor	Low Temp	
27	08000000	134217728	Brake IGBT	Voltage Limit	
28	10000000	268435456	Option Change	Unused	
29	20000000	536870912	Drive Initialized	Unused	
30	40000000	1073741824	Safe Stop	Unused	

Table 4.3: Description of Alarm Word, Warning Word and Extended Status Word

The alarm words, warning words and extended status words can be read out for diagnosis via serial bus or optional serial communication bus. See also par.16-90 *Alarm Word*, par.16-92 *Warning Word* and par.16-94 *Ext. Status Word*.

4.1.2 Alarm words

Alarm word, par.16-90 *Alarm Word*

Bit (Hex)	Alarm Word (par.16-90 <i>Alarm Word</i>)
00000001	Brake check
00000002	Power card overtemperature
00000004	Ground fault
00000008	Ctrl. card overtemperature
00000010	Control word timeout
00000020	Overcurrent
00000040	Torque limit
00000080	Motor thermistor overtemp.
00000100	Motor ETR overtemperature
00000200	Inverter overloaded
00000400	DC link undervoltage
00000800	DC link overvoltage
00001000	Short circuit
00002000	Soft-charge fault
00004000	Line phase loss
00008000	AMA not OK
00010000	Live zero error
00020000	Internal fault
00040000	Brake overload
00080000	Motor phase U is missing
00100000	Motor phase V is missing
00200000	Motor phase W is missing
00400000	Serial communication bus fault
00800000	24 V supply fault
01000000	Line failure
02000000	1.8 V supply fault
04000000	Brake resistor short circuit
08000000	Brake chopper fault
10000000	Option change
20000000	Drive initialized
40000000	Safe Stop
80000000	Not used

Alarm word 2, par.16-91 *Alarm word 2*

Bit (Hex)	Alarm Word 2 (par.16-91 <i>Alarm word 2</i>)
00000001	Service Trip, read / Write
00000002	Reserved
00000004	Service Trip, Typecode / Spare part
00000008	Reserved
00000010	Reserved
00000020	No Flow
00000040	Dry Pump
00000080	End of Curve
00000100	Broken Belt
00000200	Not used
00000400	Not used
00000800	Reserved
00001000	Reserved
00002000	Reserved
00004000	Reserved
00008000	Reserved
00010000	Reserved
00020000	Not used
00040000	Fans error
00080000	ECB error
00100000	Reserved
00200000	Reserved
00400000	Reserved
00800000	Reserved
01000000	Reserved
02000000	Reserved
04000000	Reserved
08000000	Reserved
10000000	Reserved
20000000	Reserved
40000000	Reserved
80000000	Reserved

4.1.3 Warning words

Warning word , par.16-92 *Warning Word*

Bit (Hex)	Warning Word (par.16-92 <i>Warning Word</i>)
00000001	Brake check
00000002	Power card overtemperature
00000004	Ground fault
00000008	Ctrl. card overtemperature
00000010	Control word timeout
00000020	Overcurrent
00000040	Torque limit
00000080	Motor thermistor overtemp.
00000100	Motor ETR overtemperature
00000200	Inverter overloaded
00000400	DC link undervoltage
00000800	DC link overvoltage
00001000	DC link voltage low
00002000	DC link voltage high
00004000	Line phase loss
00008000	No motor
00010000	Live zero error
00020000	10 V low
00040000	Brake resistor power limit
00080000	Brake resistor short circuit
00100000	Brake chopper fault
00200000	Speed limit
00400000	Serial Communication Bus comm. fault
00800000	24 V supply fault
01000000	Line failure
02000000	Current limit
04000000	Low temperature
08000000	Voltage limit
10000000	Encoder loss
20000000	Output frequency limit
40000000	Not used
80000000	Not used

Warning word 2, par.16-93 *Warning word 2*

Bit (Hex)	Warning Word 2 (par.16-93 <i>Warning word 2</i>)
00000001	Start Delayed
00000002	Stop Delayed
00000004	Clock Failure
00000008	Reserved
00000010	Reserved
00000020	No Flow
00000040	Dry Pump
00000080	End of Curve
00000100	Broken Belt
00000200	Not used
00000400	Reserved
00000800	Reserved
00001000	Reserved
00002000	Reserved
00004000	Reserved
00008000	Reserved
00010000	Reserved
00020000	Not used
00040000	Fans warning
00080000	ECB warning
00100000	Reserved
00200000	Reserved
00400000	Reserved
00800000	Reserved
01000000	Reserved
02000000	Reserved
04000000	Reserved
08000000	Reserved
10000000	Reserved
20000000	Reserved
40000000	Reserved
80000000	Reserved

4.1.4 Extended status words

Extended status word, par.16-94 *Ext. Status Word*

Bit (Hex)	Extended Status Word (par.16-94 <i>Ext. Status Word</i>)
00000001	Ramping
00000002	AMA tuning
00000004	Start CW/CCW
00000008	Not used
00000010	Not used
00000020	Feedback high
00000040	Feedback low
00000080	Output current high
00000100	Output current low
00000200	Output frequency high
00000400	Output frequency low
00000800	Brake check OK
00001000	Braking max
00002000	Braking
00004000	Out of speed range
00008000	OVC active
00010000	AC brake
00020000	Password Timelock
00040000	Password Protection
00080000	Reference high
00100000	Reference low
00200000	Local Ref./Remote Ref.
00400000	Reserved
00800000	Reserved
01000000	Reserved
02000000	Reserved
04000000	Reserved
08000000	Reserved
10000000	Reserved
20000000	Reserved
40000000	Reserved
80000000	Reserved

Extended status word 2, par.16-95 *Ext. Status Word 2*

Bit (Hex)	Extended Status Word 2 (par. 16-95 <i>Ext. Status Word 2</i>)
00000001	Off
00000002	Hand / Auto
00000004	Not used
00000008	Not used
00000010	Not used
00000020	Relay 123 active
00000040	Start Prevented
00000080	Control ready
00000100	Drive ready
00000200	Quick Stop
00000400	DC Brake
00000800	Stop
00001000	Standby
00002000	Freeze Output Request
00004000	Freeze Output
00008000	Jog Request
00010000	Jog
00020000	Start Request
00040000	Start
00080000	Start Applied
00100000	Start Delay
00200000	Sleep
00400000	Sleep Boost
00800000	Running
01000000	Bypass
02000000	Fire Mode
04000000	Reserved
08000000	Reserved
10000000	Reserved
20000000	Reserved
40000000	Reserved
80000000	Reserved

4.1.5 Fault messages

WARNING 1, 10 Volts low:

The 10 V voltage from terminal 50 on the control card is below 10 V. Remove some of the load from terminal 50, as the 10 V supply is overloaded. Max. 15 mA or minimum 590 Ω.

WARNING/ALARM 2, Live zero error:

The signal on terminal 53 or 54 is less than 50% of the value set in par. 6-10 *Terminal 53 Low Voltage*, par.6-12 *Terminal 53 Low Current*, par. 6-20 *Terminal 54 Low Voltage*, or par.6-22 *Terminal 54 Low Current* respectively.

WARNING/ALARM 3, No motor:

No motor has been connected to the output of the adjustable frequency drive.

WARNING/ALARM 4, Mains phase loss:

A phase is missing on the supply side, or the line voltage imbalance is too high.

This message also appears in case of a fault in the input rectifier on the adjustable frequency drive.

Check the supply voltage and supply currents to the adjustable frequency drive.

WARNING 5, DC link voltage high:

The intermediate circuit voltage (DC) is higher than the overvoltage limit of the control system. The adjustable frequency drive is still active.

WARNING 6, DC-link voltage low:

The intermediate circuit voltage (DC) is below the undervoltage limit of the control system. The adjustable frequency drive is still active.

WARNING/ALARM 7, DC overvoltage:

If the intermediate circuit voltage exceeds the limit, the adjustable frequency drive trips after a time.

Possible corrections:

Select **Over Voltage Control** function in par.2-17 *Over-voltage Control*

Connect a brake resistor

Extend the ramp time

Activate functions in par.2-10 *Brake Function*

Increase par.14-26 *Trip Delay at Inverter Fault*

Selecting OVC function will extend the ramp times.

Alarm/warning limits:			
Voltage Range	3 x 200–240 V AC [VDC]	3 x 380–500 V AC [VDC]	3 x 550–600 V AC [VDC]
Undervoltage	185	373	532
Voltage warning low	205	410	585
Voltage warning high (w/o brake - w/ brake)	390/405	810/840	943/965
Overvoltage	410	855	975

The voltages stated are the intermediate circuit voltage of the adjustable frequency drive with a tolerance of ± 5%. The corresponding AC line voltage is the intermediate circuit voltage (DC link) divided by 1.35.

WARNING/ALARM 8, DC undervoltage:

If the intermediate circuit voltage (DC) drops below the “voltage warning low” limit (see table above), the adjustable frequency drive checks if 24 V backup supply is connected.

If no 24 V backup supply is connected, the adjustable frequency drive trips after a given time depending on the unit.

To check whether the supply voltage matches the adjustable frequency drive, see the section *General Specifications*.

WARNING/ALARM 9, Inverter overloaded:

The adjustable frequency drive is about to cut out because of an overload (too high current for too long). The counter for electronic, thermal inverter protection gives a warning at 98% and trips at 100%, while giving an alarm. You cannot reset the adjustable frequency drive until the counter is below 90%.

The fault is that the adjustable frequency drive is overloaded by more than nominal current for too long.

WARNING/ALARM 10, Motor ETR overtemperature:

According to the electronic thermal protection (ETR), the motor is too hot. You can choose if you want the adjustable frequency drive to give a warning or an alarm when the counter reaches 100% in par.1-90 *Motor Thermal Protection*. The fault is that the motor is overloaded by more than nominal current for too long. Make sure that the motor par. 1-24 *Motor Current* is set correctly.

WARNING/ALARM 11, Motor thermistor overtemp:

The thermistor or the thermistor connection is disconnected. You can choose if you want the adjustable frequency drive to give a warning or an alarm in par.1-90 *Motor Thermal Protection*. Check that the thermistor is connected correctly between terminal 53 or 54 (analog voltage input) and terminal 50 (+ 10 Volts supply), or between terminal 18 or 19 (digital input PNP only) and terminal 50. If a KTY sensor is used, check for correct connection between terminal 54 and 55.

WARNING/ALARM 12, Torque limit:

The torque is higher than the value in par.4-16 *Torque Limit Motor Mode* (in motor operation) or the torque is higher than the value in par. 4-17 *Torque Limit Generator Mode* (in regenerative operation).

WARNING/ALARM 13, Overcurrent:

The inverter peak current limit (approx. 200% of the rated current) is exceeded. The warning will last approx. 8-12 sec., then the adjustable frequency drive trips and issues an alarm. Turn off the adjustable frequency drive and check if the motor shaft can be turned and if the motor size matches the adjustable frequency drive.

ALARM 14, Ground fault:

There is a discharge from the output phases to ground, either in the cable between the adjustable frequency drive and the motor or in the motor itself.

Turn off the adjustable frequency drive and remove the ground fault.

ALARM 15, Incomplete hardware:

A fitted option is not handled by the present control board (hardware or software).

ALARM 16, Short circuit:

There is short-circuiting in the motor or on the motor terminals.
Turn off the adjustable frequency drive and remove the short circuit.

WARNING/ALARM 17, Control word timeout:

There is no communication to the adjustable frequency drive.
The warning will only be active when par.8-04 *Control Timeout Function* is NOT set to OFF.
If par.8-04 *Control Timeout Function* is set to *Stop* and *Trip*, a warning appears and the adjustable frequency drive ramps down to zero speed, while giving an alarm.
par.8-03 *Control Timeout Time* could possibly be increased.

WARNING 22, Hoist Mech. Brake:

The report value will show what kind it is.

- 0 = The torque ref. was not reached before timeout
- 1 = There was no brake feedback before timeout

WARNING 23, Internal fans:

External fans have failed due to defect hardware or fans not mounted.

WARNING 24, External fan fault:

The fan warning function is an extra protective function that checks if the fan is running/mounted. The fan warning can be disabled in par. 14-53 *Fan Monitor*, [0] Disabled.

WARNING 25, Brake resistor short-circuited:

The brake resistor is monitored during operation. If it short-circuits, the brake function is disconnected and the warning appears. The adjustable frequency drive still works, but without the brake function. Turn off the adjustable frequency drive and replace the brake resistor (see par. 2-15 *Brake Check*).

ALARM/WARNING 26, Brake resistor power limit:

The power transmitted to the brake resistor is calculated as a percentage, as a mean value over the last 120 s, on the basis of the resistance value of the brake resistor (par.2-11 *Brake Resistor (ohm)*) and the intermediate circuit voltage. The warning is active when the dissipated braking energy is higher than 90%. If *Trip* [2] has been selected in par.2-13 *Brake Power Monitoring*, the adjustable frequency drive cuts out and issues this alarm, when the dissipated braking energy is higher than 100%.

WARNING/ALARM 27, Brake chopper fault:

The brake transistor is monitored during operation and if it short-circuits, the brake function disconnects and the warning comes up. The adjustable frequency drive is still able to run, but since the brake transistor has short-circuited, substantial power is transmitted to the brake resistor, even if it is inactive.
Turn off the adjustable frequency drive and remove the brake resistor.



Warning: There is a risk of substantial power being transmitted to the brake resistor if the brake transistor is short-circuited.

ALARM/WARNING 28, Brake check failed:

Brake resistor fault: the brake resistor is not connected/working.

WARNING/ALARM 29, Drive overtemperature:

If the enclosure is IP00, IP20/Nema1 or IP21/TYP 1, the cut-out temperature of the heatsink is 203° ± 41°F [95° ± 5°C]. The temperature fault cannot be reset, until the temperature of the heatsink is below 158°F [70°C].

The fault could be:

- Ambient temperature too high
- Too long motor cable

ALARM 30, Motor phase U missing:

Motor phase U between the adjustable frequency drive and the motor is missing.
Turn off the adjustable frequency drive and check motor phase U.

ALARM 31, Motor phase V missing:

Motor phase V between the adjustable frequency drive and the motor is missing.
Turn off the adjustable frequency drive and check motor phase V.

ALARM 32, Motor phase W missing:

Motor phase W between the adjustable frequency drive and the motor is missing.
Turn off the adjustable frequency drive and check motor phase W.

ALARM 33, Soft-charge fault:

Too many power-ups have occurred within a short time period. See the chapter *General Specifications* for the allowed number of power-ups within one minute.

WARNING/ALARM 34, Fieldbus communication fault:

The serial communication bus on the communication option card is not working.

WARNING/ALARM 36, Mains failure:

This warning/alarm is only active if the supply voltage to the adjustable frequency drive is lost and par.14-10 *Line Failure* is NOT set to OFF. Possible correction: check the fuses to the adjustable frequency drive

WARNING/ALARM 37, Phase Imbalance:

There is a current imbalance between the power units.

ALARM 38, Internal fault:

Contact your local Danfoss supplier.

ALARM 39, Heatsink Sensor:

No feedback from the heatsink sensor.

WARNING 40, Overload of Digital Output Terminal 27

Check the load connected to terminal 27 or remove the short-circuit connection. Check par.5-00 *Digital I/O Mode* and par.5-01 *Terminal 27 Mode*.

WARNING 41, Overload of Digital Output Terminal 29:

Check the load connected to terminal 29 or remove the short-circuit connection. Check par.5-00 *Digital I/O Mode* and par.5-02 *Terminal 29 Mode*.

WARNING 42, Overload of Digital Output On X30/6:

Check the load connected to X30/6 or remove short circuit connection. Check par.5-32 *Term X30/6 Digi Out (MCB 101)*.

WARNING 42, Overload of Digital Output On X30/7:

Check the load connected to X30/7 or remove short circuit connection. Check par.5-33 *Term X30/7 Digi Out (MCB 101)*.

ALARM 46, Pwr. card supply:

The supply on the power card is out of range.

WARNING 47, 24 V supply low:

The external 24 V DC backup power supply may be overloaded, otherwise contact your Danfoss supplier.

ALARM 48, 1.8 V supply low:

Contact your Danfoss supplier.

WARNING 49, Speed limit:

The speed has been limited by range in par.4-11 *Motor Speed Low Limit [RPM]* and par.4-13 *Motor Speed High Limit [RPM]*.

ALARM 50, AMA calibration failed:

Contact your Danfoss supplier.

ALARM 51, AMA check Unom and Inom:

The setting of motor voltage, motor current, and motor power is presumably wrong. Check the settings.

ALARM 52, AMA low Inom:

The motor current is too low. Check the settings.

ALARM 53, AMA motor too big:

The motor is too big for the AMA to be carried out.

ALARM 54, AMA motor too small:

The motor is too small for the AMA to be carried out.

ALARM 55, AMA par. out of range:

The par. values found from the motor are outside acceptable range.

ALARM 56, AMA interrupted by user:

The AMA has been interrupted by the user.

ALARM 57, AMA timeout:

Try to start the AMA again a number of times, until the AMA is carried out. Please note that repeated runs may heat the motor to a level where the resistances R_s and R_r are increased. In most cases, however, this is not critical.

WARNING/ALARM 58, AMA internal fault:

Contact your Danfoss supplier.

WARNING 59, Current limit:

The current is higher than the value in par.4-18 *Current Limit*.

WARNING 60, External Interlock:

External Interlock has been activated. To resume normal operation, apply 24 V DC to the terminal programmed for external interlock and reset the adjustable frequency drive (via bus, digital I/O or by pressing [Reset]).

WARNING/ALARM 61, Tracking Error:

Tracking error. Contact your supplier.

WARNING 62, Output Frequency at Maximum Limit:

The output frequency is limited by the value set in par.4-19 *Max Output Frequency*

WARNING 64, Voltage Limit:

The load and speed combination demands a motor voltage higher than the actual DC-link voltage.

WARNING/ALARM/TRIP 65, Control Card Overtemperature:

Control card overtemperature: The cut-out temperature of the control card is 176°F [80°C].

WARNING 66, Heatsink Temperature Low:

The heatsink temperature is measured as 32°F [0°C]. This could indicate that the temperature sensor is defective and thus the fan speed is increased to the maximum in case the power part or control card is very hot.

If the temperature is below 59°F [15°C], the warning will be present.

ALARM 67, Option Configuration has Changed:

One or more options has either been added or removed since the last power-down.

ALARM 68, Safe Stop:

Safe Stop has been activated. To resume normal operation, apply 24 V DC to terminal 37 then send a reset signal (via bus, digital I/O or by pressing [Reset]).

ALARM 69, Pwr. Card Temp:

Power card overtemperature.

ALARM 70, Illegal FC Configuration:

The current control board and power board combination is illegal.

ALARM 90, Feedback Mon.:**ALARM 91, Analog Input 54 Wrong Settings:**

Switch S202 must be set in position OFF (voltage input) when a KTY sensor is connected to analog input terminal 54.

ALARM 92, No-Flow:

A no load situation has been detected for the system. See parameter group 22-2*.

ALARM 93, Dry Pump:

A no-flow situation and high speed indicates that the pump has run dry. See parameter group 22-2*.

ALARM 94, End of Curve:

Feedback stays lower than the setpoint, which may indicate a leakage in the pipe system. See parameter group 22-5*.

ALARM 95, Broken Belt:

Torque is below the torque level set for no load indicating a broken belt. See parameter group 22-6*.

ALARM 96, Start Delayed:

Start of the motor has been delayed due to short cycle protection being active. See parameter group 22-7*.

ALARM 250, New Spare Part:

The power or switch mode power supply has been exchanged. The adjustable frequency drive type code must be restored in EEPROM. Select the correct type code in par. 14-23 *Typecode Setting* according to the label on unit. Remember to select 'Save to EEPROM' to complete.

ALARM 251, New Type Code:

The adjustable frequency drive has a new type code.

5 Parameter Lists

5.1 Parameter Options

5.1.1 Default settings

Changes during operation:

“TRUE” means that the parameter can be changed while the adjustable frequency drive is in operation, and “FALSE” means that the adjustable frequency drive must be stopped before a change can be made.

4 set-up:

'All set-up': the parameter can be set individually in each of the four set-ups, i. e., one single parameter can have four different data values.

'1 set-up': data value will be the same in all set-ups.

SR:

Size related

N/A:

No default value available.

Conversion index:

This number refers to a conversion figure used when writing or reading by means of an adjustable frequency drive.

Conv. index	100	67	6	5	4	3	2	1	0	-1	-2	-3	-4	-5	-6
Conv. factor	1	1/60	1000000	100000	10000	1000	100	10	1	0.1	0.01	0.001	0.0001	0.00001	0.000001

Data type	Description	Type
2	Integer 8	Int8
3	Integer 16	Int16
4	Integer 32	Int32
5	Unsigned 8	UInt8
6	Unsigned 16	UInt16
7	Unsigned 32	UInt32
9	Visible String	VisStr
33	Normalized value 2 bytes	N2
35	Bit sequence of 16 Boolean variables	V2
54	Time difference w/o date	TimD

5.1.2 0-**-** Operation and Display

Par. No. #	Parameter description	Default value (SR = Size related)	4 set-up	Change during operation	Conversion Index	Type
0-0* Basic Settings						
0-01	Language	[0] English	1 set-up	TRUE	-	UInt8
0-02	Motor Speed Unit	[1] Hz	2 set-ups	FALSE	-	UInt8
0-03	Regional Settings	[0] International	2 set-ups	FALSE	-	UInt8
0-04	Operating State at Power-up	[0] Resume	All set-ups	TRUE	-	UInt8
0-05	Local Mode Unit	[0] As Motor Speed Unit	2 set-ups	FALSE	-	UInt8
0-1* Set-up Operations						
0-10	Active Set-up	[1] Set-up 1	1 set-up	TRUE	-	UInt8
0-11	Programming Set-up	[9] Active Set-up	All set-ups	TRUE	-	UInt8
0-12	This Set-up Linked to	[0] Not linked	All set-ups	FALSE	-	UInt8
0-13	Readout: Linked Set-ups	0 N/A	All set-ups	FALSE	0	UInt16
0-14	Readout: Prog. Set-ups / Channel	0 N/A	All set-ups	TRUE	0	Int32
0-2* LCP Display						
0-20	Display Line 1.1 Small	1602	All set-ups	TRUE	-	UInt16
0-21	Display Line 1.2 Small	1614	All set-ups	TRUE	-	UInt16
0-22	Display Line 1.3 Small	1610	All set-ups	TRUE	-	UInt16
0-23	Display Line 2 Large	1613	All set-ups	TRUE	-	UInt16
0-24	Display Line 3 Large	1502	All set-ups	TRUE	-	UInt16
0-25	My Personal Menu	ExpressionLimit	1 set-up	TRUE	0	UInt16
0-3* LCP Cust. Readout						
0-30	Custom Readout Unit	[1] %	All set-ups	TRUE	-	UInt8
0-31	Custom Readout Min Value	ExpressionLimit	All set-ups	TRUE	-2	Int32
0-32	Custom Readout Max Value	100.00 CustomReadoutUnit	All set-ups	TRUE	-2	Int32
0-37	Display Text 1	0 N/A	1 set-up	TRUE	0	VisStr[25]
0-38	Display Text 2	0 N/A	1 set-up	TRUE	0	VisStr[25]
0-39	Display Text 3	0 N/A	1 set-up	TRUE	0	VisStr[25]
0-4* LCP Keypad						
0-40	[Hand on] Key on LCP	[1] Enabled	All set-ups	TRUE	-	UInt8
0-41	[Off] Key on LCP	[1] Enabled	All set-ups	TRUE	-	UInt8
0-42	[Auto on] Key on LCP	[1] Enabled	All set-ups	TRUE	-	UInt8
0-43	[Reset] Key on LCP	[1] Enabled	All set-ups	TRUE	-	UInt8
0-44	[Off/Reset] Key on LCP	[1] Enabled	All set-ups	TRUE	-	UInt8
0-45	[Drive Bypass] Key on LCP	[1] Enabled	All set-ups	TRUE	-	UInt8
0-5* Copy/Save						
0-50	LCP Copy	[0] No copy	All set-ups	FALSE	-	UInt8
0-51	Set-up Copy	[0] No copy	All set-ups	FALSE	-	UInt8

Par. No. #	Parameter description	Default value (SR = Size related)	4 set-up	Change during operation	Conversion Index	Type
0-6* Password						
0-60	Main Menu Password	100 N/A	1 set-up	TRUE	0	Uint16
0-61	Access to Main Menu w/o Password	[0] Full access	1 set-up	TRUE	-	Uint8
0-65	Personal Menu Password	200 N/A	1 set-up	TRUE	0	Uint16
0-66	Access to Personal Menu w/o Password	[0] Full access	1 set-up	TRUE	-	Uint8
0-7* Clock Settings						
0-70	Set Date and Time	ExpressionLimit	All set-ups	TRUE	0	TimeOfDay
0-71	Date Format	null	1 set-up	TRUE	-	Uint8
0-72	Time Format	null	1 set-up	TRUE	-	Uint8
0-74	DST/Summertime	[0] OFF	1 set-up	TRUE	-	Uint8
0-76	DST/Summertime Start	ExpressionLimit	1 set-up	TRUE	0	TimeOfDay
0-77	DST/Summertime End	ExpressionLimit	1 set-up	TRUE	0	TimeOfDay
0-79	Clock Fault	null	1 set-up	TRUE	-	Uint8
0-81	Working Days	null	1 set-up	TRUE	-	Uint8
0-82	Additional Working Days	ExpressionLimit	1 set-up	TRUE	0	TimeOfDay
0-83	Additional Non-Working Days	ExpressionLimit	1 set-up	TRUE	0	TimeOfDay
0-89	Date and Time Readout	0 N/A	All set-ups	TRUE	0	VisStr[25]

5.1.3 1- * Load / Motor

Par. No. #	Parameter description	Default value (SR = Size related)	4-set-up	Change during operation	Conversion Index	Type
1-0* General Settings						
1-00	Configuration Mode	null	All set-ups	TRUE	-	Uint8
1-03	Torque Characteristics	[3] Auto Energy Optim. VT	All set-ups	TRUE	-	Uint8
1-2* Motor Data						
1-20	Motor Power [kW]	ExpressionLimit	All set-ups	FALSE	1	Uint32
1-21	Motor Power [HP]	ExpressionLimit	All set-ups	FALSE	-2	Uint32
1-22	Motor Voltage	ExpressionLimit	All set-ups	FALSE	0	Uint16
1-23	Motor Frequency	ExpressionLimit	All set-ups	FALSE	0	Uint16
1-24	Motor Current	ExpressionLimit	All set-ups	FALSE	-2	Uint32
1-25	Motor Nominal Speed	ExpressionLimit	All set-ups	FALSE	67	Uint16
1-28	Motor Rotation Check	[0] OFF	All set-ups	FALSE	-	Uint8
1-29	Automatic Motor Adaptation (AMA)	[0] Off	All set-ups	FALSE	-	Uint8
1-3* Addl. Motor Data						
1-30	Stator Resistance (Rs)	ExpressionLimit	All set-ups	FALSE	-4	Uint32
1-31	Rotor Resistance (Rr)	ExpressionLimit	All set-ups	FALSE	-4	Uint32
1-35	Main Reactance (Xh)	ExpressionLimit	All set-ups	FALSE	-4	Uint32
1-36	Iron Loss Resistance (Rfe)	ExpressionLimit	All set-ups	FALSE	-3	Uint32
1-39	Motor Poles	ExpressionLimit	All set-ups	FALSE	0	Uint8
1-5* Load-Indep. Setting						
1-50	Motor Magnetization at Zero Speed	100 %	All set-ups	TRUE	0	Uint16
1-51	Min Speed Normal Magnetizing [RPM]	ExpressionLimit	All set-ups	TRUE	67	Uint16
1-52	Min Speed Normal Magnetizing [Hz]	ExpressionLimit	All set-ups	TRUE	-1	Uint16
1-6* Load-Depend. Settg.						
1-60	Low Speed Load Compensation	100 %	All set-ups	TRUE	0	Int16
1-61	High Speed Load Compensation	100 %	All set-ups	TRUE	0	Int16
1-62	Slip Compensation	0 %	All set-ups	TRUE	0	Int16
1-63	Slip Compensation Time Constant	ExpressionLimit	All set-ups	TRUE	-2	Uint16
1-64	Resonance Dampening	100 %	All set-ups	TRUE	0	Uint16
1-65	Resonance Dampening Time Constant	5 ms	All set-ups	TRUE	-3	Uint8
1-7* Start Adjustments						
1-71	Start Delay	0.0 s	All set-ups	TRUE	-1	Uint16
1-73	Flying Start	[0] Disabled	All set-ups	FALSE	-	Uint8
1-8* Stop Adjustments						
1-80	Function at Stop	[0] Coast	All set-ups	TRUE	-	Uint8
1-81	Min Speed for Function at Stop [RPM]	ExpressionLimit	All set-ups	TRUE	67	Uint16
1-82	Min Speed for Function at Stop [Hz]	ExpressionLimit	All set-ups	TRUE	-1	Uint16
1-86	Trip Speed Low [RPM]	0 RPM	All set-ups	TRUE	67	Uint16
1-87	Trip Speed Low [Hz]	0.0 Hz	All set-ups	TRUE	-1	Uint16
1-9* Motor Temperature						
1-90	Motor Thermal Protection	[4] ETR trip 1	All set-ups	TRUE	-	Uint8
1-91	Motor External Fan	[0] No	All set-ups	TRUE	-	Uint16
1-93	Thermistor Source	[0] None	All set-ups	TRUE	-	Uint8

5.1.4 2- ** Brakes

Par. No. #	Parameter description	Default value (SR = Size related)	4-set-up	Change during operation	Conversion Index	Type
2-0* DC Brake						
2-00	DC Hold/Preheat Current	50 %	All set-ups	TRUE	0	Uint8
2-01	DC Brake Current	50 %	All set-ups	TRUE	0	Uint16
2-02	DC Braking Time	10.0 s	All set-ups	TRUE	-1	Uint16
2-03	DC Brake Cut-in Speed [RPM]	ExpressionLimit	All set-ups	TRUE	67	Uint16
2-04	DC Brake Cut-in Speed [Hz]	ExpressionLimit	All set-ups	TRUE	-1	Uint16
2-1* Brake Energy Funct.						
2-10	Brake Function	[0] Off	All set-ups	TRUE	-	Uint8
2-11	Brake Resistor (ohm)	ExpressionLimit	All set-ups	TRUE	0	Uint16
2-12	Brake Power Limit (kW)	ExpressionLimit	All set-ups	TRUE	0	Uint32
2-13	Brake Power Monitoring	[0] Off	All set-ups	TRUE	-	Uint8
2-15	Brake Check	[0] Off	All set-ups	TRUE	-	Uint8
2-16	AC Brake Max. Current	100.0 %	All set-ups	TRUE	-1	Uint32
2-17	Over-voltage Control	[2] Enabled	All set-ups	TRUE	-	Uint8

5.1.5 3- * Reference / Ramps

Par. No. #	Parameter description	Default value (SR = Size related)	4-set-up	Change during operation	Conversion index	Type
3-0* Reference Limits						
3-02	Minimum Reference	ExpressionLimit	All set-ups	TRUE	-3	Int32
3-03	Maximum Reference	ExpressionLimit	All set-ups	TRUE	-3	Int32
3-04	Reference Function	null	All set-ups	TRUE	-	UInt8
3-1* References						
3-10	Preset Reference	0.00 %	All set-ups	TRUE	-2	Int16
3-11	Jog Speed [Hz]	ExpressionLimit	All set-ups	TRUE	-1	UInt16
3-13	Reference Site	[0] Linked to Hand / Auto	All set-ups	TRUE	-	UInt8
3-14	Preset Relative Reference	0.00 %	All set-ups	TRUE	-2	Int32
3-15	Reference 1 Source	[1] Analog input 53	All set-ups	TRUE	-	UInt8
3-16	Reference 2 Source	[20] Digital pot.meter	All set-ups	TRUE	-	UInt8
3-17	Reference 3 Source	[0] No function	All set-ups	TRUE	-	UInt8
3-19	Jog Speed [RPM]	ExpressionLimit	All set-ups	TRUE	67	UInt16
3-4* Ramp 1						
3-41	Ramp 1 Ramp-up Time	ExpressionLimit	All set-ups	TRUE	-2	UInt32
3-42	Ramp 1 Ramp-down Time	ExpressionLimit	All set-ups	TRUE	-2	UInt32
3-5* Ramp 2						
3-51	Ramp 2 Ramp-up Time	ExpressionLimit	All set-ups	TRUE	-2	UInt32
3-52	Ramp 2 Ramp-down Time	ExpressionLimit	All set-ups	TRUE	-2	UInt32
3-8* Other Ramps						
3-80	Jog Ramp Time	ExpressionLimit	All set-ups	TRUE	-2	UInt32
3-81	Quick Stop Ramp Time	ExpressionLimit	2 set-ups	TRUE	-2	UInt32
3-9* Digital Pot. meter						
3-90	Step Size	0.10 %	All set-ups	TRUE	-2	UInt16
3-91	Ramp Time	1.00 s	All set-ups	TRUE	-2	UInt32
3-92	Power Restore	[0] Off	All set-ups	TRUE	-	UInt8
3-93	Maximum Limit	100 %	All set-ups	TRUE	0	Int16
3-94	Minimum Limit	0 %	All set-ups	TRUE	0	Int16
3-95	Ramp Delay	1.000 N/A	All set-ups	TRUE	-3	TimD

5.1.6 4- ** Limits / Warnings

Par. No. #	Parameter description	Default value (SR = Size related)	4-set-up	Change during operation	Conversion Index	Type
4-1 * Motor Limits						
4-10	Motor Speed Direction	[2] Both directions	All set-ups	FALSE	-	Uint8
4-11	Motor Speed Low Limit [RPM]	ExpressionLimit	All set-ups	TRUE	67	Uint16
4-12	Motor Speed Low Limit [Hz]	ExpressionLimit	All set-ups	TRUE	-1	Uint16
4-13	Motor Speed High Limit [RPM]	ExpressionLimit	All set-ups	TRUE	67	Uint16
4-14	Motor Speed High Limit [Hz]	ExpressionLimit	All set-ups	TRUE	-1	Uint16
4-16	Torque Limit Motor Mode	110.0 %	All set-ups	TRUE	-1	Uint16
4-17	Torque Limit Generator Mode	100.0 %	All set-ups	TRUE	-1	Uint16
4-18	Current Limit	ExpressionLimit	All set-ups	TRUE	-1	Uint32
4-19	Max Output Frequency	ExpressionLimit	All set-ups	FALSE	-1	Uint16
4-5 * Adj. Warnings						
4-50	Warning Current Low	0.00 A	All set-ups	TRUE	-2	Uint32
4-51	Warning Current High	ImaxVLT (P1637)	All set-ups	TRUE	-2	Uint32
4-52	Warning Speed Low	0 RPM	All set-ups	TRUE	67	Uint16
4-53	Warning Speed High	outputSpeedHighLimit (P413)	All set-ups	TRUE	67	Uint16
4-54	Warning Reference Low	-999999.999 N/A	All set-ups	TRUE	-3	Int32
4-55	Warning Reference High	999999.999 N/A	All set-ups	TRUE	-3	Int32
4-56	Warning Feedback Low	-999999.999 ProcessCtrlUnit	All set-ups	TRUE	-3	Int32
4-57	Warning Feedback High	999999.999 ProcessCtrlUnit	All set-ups	TRUE	-3	Int32
4-58	Missing Motor Phase Function	[1] On	All set-ups	TRUE	-	Uint8
4-6 * Speed Bypass						
4-60	Bypass Speed From [RPM]	ExpressionLimit	All set-ups	TRUE	67	Uint16
4-61	Bypass Speed From [Hz]	ExpressionLimit	All set-ups	TRUE	-1	Uint16
4-62	Bypass Speed To [RPM]	ExpressionLimit	All set-ups	TRUE	67	Uint16
4-63	Bypass Speed To [Hz]	ExpressionLimit	All set-ups	TRUE	-1	Uint16
4-64	Semi-Auto Bypass Set-up	[0] OFF	All set-ups	FALSE	-	Uint8

5.1.7 5- * Digital In / Out

Par. No. #	Parameter description	Default value (SR = Size related)	4-set-up	Change during operation	Conversion Index	Type
5-0* Digital I/O mode						
5-00	Digital I/O Mode	[0] PNP - Active at 24 V	All set-ups	FALSE	-	Uint8
5-01	Terminal 27 Mode	[0] Input	All set-ups	TRUE	-	Uint8
5-02	Terminal 29 Mode	[0] Input	All set-ups	TRUE	-	Uint8
5-1* Digital Inputs						
5-10	Terminal 18 Digital Input	[8] Start	All set-ups	TRUE	-	Uint8
5-11	Terminal 19 Digital Input	[0] No operation	All set-ups	TRUE	-	Uint8
5-12	Terminal 27 Digital Input	null	All set-ups	TRUE	-	Uint8
5-13	Terminal 29 Digital Input	[14] Jog	All set-ups	TRUE	-	Uint8
5-14	Terminal 32 Digital Input	[0] No operation	All set-ups	TRUE	-	Uint8
5-15	Terminal 33 Digital Input	[0] No operation	All set-ups	TRUE	-	Uint8
5-16	Terminal X30/2 Digital Input	[0] No operation	All set-ups	TRUE	-	Uint8
5-17	Terminal X30/3 Digital Input	[0] No operation	All set-ups	TRUE	-	Uint8
5-18	Terminal X30/4 Digital Input	[0] No operation	All set-ups	TRUE	-	Uint8
5-3* Digital Outputs						
5-30	Terminal 27 Digital Output	[0] No operation	All set-ups	TRUE	-	Uint8
5-31	Terminal 29 digital Output	[0] No operation	All set-ups	TRUE	-	Uint8
5-32	Term. X30/6 Digi Out (MCB 101)	[0] No operation	All set-ups	TRUE	-	Uint8
5-33	Term X30/7 Digi Out (MCB 101)	[0] No operation	All set-ups	TRUE	-	Uint8
5-4* Relays						
5-40	Function Relay	null	All set-ups	TRUE	-	Uint8
5-41	On Delay, Relay	0.01 s	All set-ups	TRUE	-2	Uint16
5-42	Off Delay, Relay	0.01 s	All set-ups	TRUE	-2	Uint16
5-5* Pulse Input						
5-50	Term. 29 Low Frequency	100 Hz	All set-ups	TRUE	0	Uint32
5-51	Term. 29 High Frequency	100 Hz	All set-ups	TRUE	0	Uint32
5-52	Term. 29 Low Ref./Feedb. Value	0.000 N/A	All set-ups	TRUE	-3	Int32
5-53	Term. 29 High Ref./Feedb. Value	100.000 N/A	All set-ups	TRUE	-3	Int32
5-54	Pulse Filter Time Constant #29	100 ms	All set-ups	FALSE	-3	Uint16
5-55	Term. 33 Low Frequency	100 Hz	All set-ups	TRUE	0	Uint32
5-56	Term. 33 High Frequency	100 Hz	All set-ups	TRUE	0	Uint32
5-57	Term. 33 Low Ref./Feedb. Value	0.000 N/A	All set-ups	TRUE	-3	Int32
5-58	Term. 33 High Ref./Feedb. Value	100.000 N/A	All set-ups	TRUE	-3	Int32
5-59	Pulse Filter Time Constant #33	100 ms	All set-ups	FALSE	-3	Uint16

Par. No. #	Parameter description	Default value	4-set-up	Change during operation	Conversion Index	Type
5-6* Pulse Output						
5-60	Terminal 27 Pulse Output Variable	[0] No operation	All set-ups	TRUE	-	Uint8
5-62	Pulse Output Max Freq #27	5000 Hz	All set-ups	TRUE	0	Uint32
5-63	Terminal 29 Pulse Output Variable	[0] No operation	All set-ups	TRUE	-	Uint8
5-65	Pulse Output Max Freq #29	5000 Hz	All set-ups	TRUE	0	Uint32
5-66	Terminal X30/6 Pulse Output Variable	[0] No operation	All set-ups	TRUE	-	Uint8
5-68	Pulse Output Max Freq #X30/6	5000 Hz	All set-ups	TRUE	0	Uint32
5-9* Bus Controlled						
5-90	Digital & Relay Bus Control	0 N/A	All set-ups	TRUE	0	Uint32
5-93	Pulse Out #27 Bus Control	0.00 %	All set-ups	TRUE	-2	N2
5-94	Pulse Out #27 Timeout Preset	0.00 %	1 set-up	TRUE	-2	Uint16
5-95	Pulse Out #29 Bus Control	0.00 %	All set-ups	TRUE	-2	N2
5-96	Pulse Out #29 Timeout Preset	0.00 %	1 set-up	TRUE	-2	Uint16
5-97	Pulse Out #X30/6 Bus Control	0.00 %	All set-ups	TRUE	-2	N2
5-98	Pulse Out #X30/6 Timeout Preset	0.00 %	1 set-up	TRUE	-2	Uint16

5.1.8 6- ** Analog In / Out

Par. No. #	Parameter description	Default value (SR = Size related)	4-set-up	Change during operation	Conversion Index	Type
6-0* Analog I/O Mode						
6-00	Live Zero Timeout Time	10 s	All set-ups	TRUE	0	UInt8
6-01	Live Zero Timeout Function	[0] Off	All set-ups	TRUE	-	UInt8
6-02	Fire Mode Live Zero Timeout Function	[0] Off	All set-ups	TRUE	-	UInt8
6-1* Analog Input 53						
6-10	Terminal 53 Low Voltage	0.07 V	All set-ups	TRUE	-2	Int16
6-11	Terminal 53 High Voltage	10.00 V	All set-ups	TRUE	-2	Int16
6-12	Terminal 53 Low Current	4.00 mA	All set-ups	TRUE	-5	Int16
6-13	Terminal 53 High Current	20.00 mA	All set-ups	TRUE	-5	Int16
6-14	Terminal 53 Low Ref./Feedb. Value	0.000 N/A	All set-ups	TRUE	-3	Int32
6-15	Terminal 53 High Ref./Feedb. Value	ExpressionLimit	All set-ups	TRUE	-3	Int32
6-16	Terminal 53 Filter Time Constant	0.001 s	All set-ups	TRUE	-3	UInt16
6-17	Terminal 53 Live Zero	[1] Enabled	All set-ups	TRUE	-	UInt8
6-2* Analog Input 54						
6-20	Terminal 54 Low Voltage	0.07 V	All set-ups	TRUE	-2	Int16
6-21	Terminal 54 High Voltage	10.00 V	All set-ups	TRUE	-2	Int16
6-22	Terminal 54 Low Current	4.00 mA	All set-ups	TRUE	-5	Int16
6-23	Terminal 54 High Current	20.00 mA	All set-ups	TRUE	-5	Int16
6-24	Terminal 54 Low Ref./Feedb. Value	0.000 N/A	All set-ups	TRUE	-3	Int32
6-25	Terminal 54 High Ref./Feedb. Value	100.000 N/A	All set-ups	TRUE	-3	Int32
6-26	Terminal 54 Filter Time Constant	0.001 s	All set-ups	TRUE	-3	UInt16
6-27	Terminal 54 Live Zero	[1] Enabled	All set-ups	TRUE	-	UInt8
6-3* Analog Input X30/11						
6-30	Terminal X30/11 Low Voltage	0.07 V	All set-ups	TRUE	-2	Int16
6-31	Terminal X30/11 High Voltage	10.00 V	All set-ups	TRUE	-2	Int16
6-34	Term. X30/11 Low Ref./Feedb. Value	0.000 N/A	All set-ups	TRUE	-3	Int32
6-35	Term. X30/11 High Ref./Feedb. Value	100.000 N/A	All set-ups	TRUE	-3	Int32
6-36	Term. X30/11 Filter Time Constant	0.001 s	All set-ups	TRUE	-3	UInt16
6-37	Term. X30/11 Live Zero	[1] Enabled	All set-ups	TRUE	-	UInt8
6-4* Analog Input X30/12						
6-40	Terminal X30/12 Low Voltage	0.07 V	All set-ups	TRUE	-2	Int16
6-41	Terminal X30/12 High Voltage	10.00 V	All set-ups	TRUE	-2	Int16
6-44	Term. X30/12 Low Ref./Feedb. Value	0.000 N/A	All set-ups	TRUE	-3	Int32
6-45	Term. X30/12 High Ref./Feedb. Value	100.000 N/A	All set-ups	TRUE	-3	Int32
6-46	Term. X30/12 Filter Time Constant	0.001 s	All set-ups	TRUE	-3	UInt16
6-47	Term. X30/12 Live Zero	[1] Enabled	All set-ups	TRUE	-	UInt8

Par. No. #	Parameter description	Default value (SR = Size related)	4-set-up	Change during operation	Conversion Index	Type
6-5* Analog Output 42						
6-50	Terminal 42 Output	null	All set-ups	TRUE	-	Uint8
6-51	Terminal 42 Output Min Scale	0.00 %	All set-ups	TRUE	-2	Int16
6-52	Terminal 42 Output Max Scale	100.00 %	All set-ups	TRUE	-2	Int16
6-53	Terminal 42 Output Bus Control	0.00 %	All set-ups	TRUE	-2	IN2
6-54	Terminal 42 Output Timeout Preset	0.00 %	1 set-up	TRUE	-2	Uint16
6-6* Analog Output X30/8						
6-60	Terminal X30/8 Output	[0] No operation	All set-ups	TRUE	-	Uint8
6-61	Terminal X30/8 Min. Scale	0.00 %	All set-ups	TRUE	-2	Int16
6-62	Terminal X30/8 Max. Scale	100.00 %	All set-ups	TRUE	-2	Int16
6-63	Terminal X30/8 Output Bus Control	0.00 %	All set-ups	TRUE	-2	IN2
6-64	Terminal X30/8 Output Timeout Preset	0.00 %	1 set-up	TRUE	-2	Uint16

5.1.9 8- * * Communication and Options

Par. No. #	Parameter description	Default value (SR = Size related)	4-set-up	Change during operation	Conversion index	Type
8-0* General Settings						
8-01	Control Site	null	All set-ups	TRUE	-	Uint8
8-02	Control Source	null	All set-ups	TRUE	-	Uint8
8-03	Control Timeout Time	ExpressionLimit	1 set-up	TRUE	-1	Uint32
8-04	Control Timeout Function	[0] Off	1 set-up	TRUE	-	Uint8
8-05	End-of-Timeout Function	[1] Resume set-up	1 set-up	TRUE	-	Uint8
8-06	Reset Control Timeout	[0] Do not reset	All set-ups	TRUE	-	Uint8
8-07	Diagnosis Trigger	[0] Disable	2 set-ups	TRUE	-	Uint8
8-1* Control Settings						
8-10	Control Profile	[0] FC profile	All set-ups	TRUE	-	Uint8
8-13	Configurable Status Word STW	[1] Profile Default	All set-ups	TRUE	-	Uint8
8-3* FC Port Settings						
8-30	Protocol	null	1 set-up	TRUE	-	Uint8
8-31	Address	ExpressionLimit	1 set-up	TRUE	0	Uint8
8-32	Baud Rate	null	1 set-up	TRUE	-	Uint8
8-33	Parity / Stop Bits	null	1 set-up	TRUE	-	Uint8
8-35	Minimum Response Delay	ExpressionLimit	1 set-up	TRUE	-3	Uint16
8-36	Max Response Delay	ExpressionLimit	1 set-up	TRUE	-3	Uint16
8-37	Max Inter-Char Delay	ExpressionLimit	1 set-up	TRUE	-5	Uint16
8-4* FC MC protocol set						
8-40	Telegram selection	[1] Standard telegram 1	2 set-ups	TRUE	-	Uint8
8-5* Digital/Bus						
8-50	Coasting Select	[3] Logic OR	All set-ups	TRUE	-	Uint8
8-52	DC Brake Select	[3] Logic OR	All set-ups	TRUE	-	Uint8
8-53	Start Select	[3] Logic OR	All set-ups	TRUE	-	Uint8
8-54	Reverse Select	null	All set-ups	TRUE	-	Uint8
8-55	Set-up Select	[3] Logic OR	All set-ups	TRUE	-	Uint8
8-56	Preset Reference Select	[3] Logic OR	All set-ups	TRUE	-	Uint8
8-7* BACnet						
8-70	BACnet Device Instance	1 N/A	1 set-up	TRUE	0	Uint32
8-72	MS/TP Max Masters	127 N/A	1 set-up	TRUE	0	Uint8
8-73	MS/TP Max Info Frames	1 N/A	1 set-up	TRUE	0	Uint16
8-74	"Startup 1 am"	[0] Send at power-up	1 set-up	TRUE	-	Uint8
8-75	Initialization Password	ExpressionLimit	1 set-up	TRUE	0	VisStr[20]
8-8* FC Port Diagnostics						
8-80	Bus Message Count	0 N/A	All set-ups	TRUE	0	Uint32
8-81	Bus Error Count	0 N/A	All set-ups	TRUE	0	Uint32
8-82	Slave Message Count	0 N/A	All set-ups	TRUE	0	Uint32
8-83	Slave Error Count	0 N/A	All set-ups	TRUE	0	Uint32
8-89	Diagnostics Count	0 N/A	1 set-up	TRUE	0	Uint32
8-9* Bus Jog						
8-90	Bus Jog 1 Speed	100 RPM	All set-ups	TRUE	67	Uint16
8-91	Bus Jog 2 Speed	200 RPM	All set-ups	TRUE	67	Uint16
8-94	Bus Feedback 1	0 N/A	1 set-up	TRUE	0	N2
8-95	Bus Feedback 2	0 N/A	1 set-up	TRUE	0	N2
8-96	Bus Feedback 3	0 N/A	1 set-up	TRUE	0	N2

5.1.10 9--** Profibus**

Par. No. #	Parameter description	Default value (SR = Size related)	4-set-up	Change during operation	Conversion index	Type
9-00	Setpoint	0 N/A	All set-ups	TRUE	0	Uint16
9-07	Actual Value	0 N/A	All set-ups	FALSE	0	Uint16
9-15	PCD Write Configuration	ExpressionLimit	2 set-ups	TRUE	-	Uint16
9-16	PCD Read Configuration	ExpressionLimit	2 set-ups	TRUE	-	Uint16
9-18	Node Address	126 N/A	1 set-up	TRUE	0	Uint8
9-22	Telegram Selection	[108] PPO 8	1 set-up	TRUE	-	Uint8
9-23	Parameters for Signals	0	All set-ups	TRUE	-	Uint16
9-27	Parameter Edit	[1] Enabled	2 set-ups	FALSE	-	Uint16
9-28	Process Control	[1] Enable cyclic master	2 set-ups	FALSE	-	Uint8
9-44	Fault Message Counter	0 N/A	All set-ups	TRUE	0	Uint16
9-45	Fault Code	0 N/A	All set-ups	TRUE	0	Uint16
9-47	Fault Number	0 N/A	All set-ups	TRUE	0	Uint16
9-52	Fault Situation Counter	0 N/A	All set-ups	TRUE	0	Uint16
9-53	Profibus Warning Word	0 N/A	All set-ups	TRUE	0	Uint16
9-63	Actual Baud Rate	[255] No baud rate found	All set-ups	TRUE	-	V2
9-64	Device Identification	0 N/A	All set-ups	TRUE	0	Uint16
9-65	Profile Number	0 N/A	All set-ups	TRUE	0	OctStr[2]
9-67	Control Word 1	0 N/A	All set-ups	TRUE	0	V2
9-68	Status Word 1	0 N/A	All set-ups	TRUE	0	V2
9-71	Profibus Save Data Values	[0] Off	All set-ups	TRUE	-	Uint8
9-72	ProfibusDriveReset	[0] No action	1 set-up	FALSE	-	Uint8
9-80	Defined Parameters (1)	0 N/A	All set-ups	FALSE	0	Uint16
9-81	Defined Parameters (2)	0 N/A	All set-ups	FALSE	0	Uint16
9-82	Defined Parameters (3)	0 N/A	All set-ups	FALSE	0	Uint16
9-83	Defined Parameters (4)	0 N/A	All set-ups	FALSE	0	Uint16
9-84	Defined Parameters (5)	0 N/A	All set-ups	FALSE	0	Uint16
9-90	Changed Parameters (1)	0 N/A	All set-ups	FALSE	0	Uint16
9-91	Changed Parameters (2)	0 N/A	All set-ups	FALSE	0	Uint16
9-92	Changed Parameters (3)	0 N/A	All set-ups	FALSE	0	Uint16
9-93	Changed Parameters (4)	0 N/A	All set-ups	FALSE	0	Uint16
9-94	Changed parameters (5)	0 N/A	All set-ups	FALSE	0	Uint16

5.1.11 10-** CAN Fieldbus

Par. No. #	Parameter description	Default value (SR = Size related)	4-set-up	Change during operation	Conversion Index	Type
10-0* Common Settings						
10-00	CAN Protocol	null	2 set-ups	FALSE	-	Uint8
10-01	Baud Rate Select	null	2 set-ups	TRUE	-	Uint8
10-02	MAC ID	ExpressionLimit	2 set-ups	TRUE	0	Uint8
10-05	Readout Transmit Error Counter	0 N/A	All set-ups	TRUE	0	Uint8
10-06	Readout Receive Error Counter	0 N/A	All set-ups	TRUE	0	Uint8
10-07	Readout Bus Off Counter	0 N/A	All set-ups	TRUE	0	Uint8
10-1* DeviceNet						
10-10	Process Data Type Selection	null	All set-ups	TRUE	-	Uint8
10-11	Process Data Config Write	ExpressionLimit	2 set-ups	TRUE	-	Uint16
10-12	Process Data Config Read	ExpressionLimit	2 set-ups	TRUE	-	Uint16
10-13	Warning Parameter	0 N/A	All set-ups	TRUE	0	Uint16
10-14	Net Reference	[0] Off	2 set-ups	TRUE	-	Uint8
10-15	Net Control	[0] Off	2 set-ups	TRUE	-	Uint8
10-2* COS Filters						
10-20	COS Filter 1	0 N/A	All set-ups	FALSE	0	Uint16
10-21	COS Filter 2	0 N/A	All set-ups	FALSE	0	Uint16
10-22	COS Filter 3	0 N/A	All set-ups	FALSE	0	Uint16
10-23	COS Filter 4	0 N/A	All set-ups	FALSE	0	Uint16
10-3* Parameter Access						
10-30	Array Index	0 N/A	2 set-ups	TRUE	0	Uint8
10-31	Store Data Values	[0] Off	All set-ups	TRUE	-	Uint8
10-32	DeviceNet Revision	ExpressionLimit	All set-ups	TRUE	0	Uint16
10-33	Store Always	[0] Off	1 set-up	TRUE	-	Uint8
10-34	DeviceNet Product Code	120 N/A	1 set-up	TRUE	0	Uint16
10-39	DeviceNet F Parameters	0 N/A	All set-ups	TRUE	0	Uint32

5.1.12 11-**-** LonWorks

Par. No. #	Parameter description	Default value (SR = Size related)	4-set-up	Change during operation	Conversion index	Type
11-0* LonWorks ID						
11-00	Neuron ID	0 N/A	All set-ups	TRUE	0	OctStr[6]
11-1* LON Functions						
11-10	Drive Profile	[0] VSD profile	All set-ups	TRUE	-	Uint8
11-15	LON Warning Word	0 N/A	All set-ups	TRUE	0	Uint16
11-17	XIF Revision	0 N/A	All set-ups	TRUE	0	VisStr[5]
11-18	LonWorks Revision	0 N/A	All set-ups	TRUE	0	VisStr[5]
11-2* LON Param. Access						
11-21	Store Data Values	[0] Off	All set-ups	TRUE	-	Uint8

5.1.13 13-.* Smart Logic Controller

Par. No. #	Parameter description	Default value (SR = Size related)	4-set-up	Change during operation	Conversion index	Type
13-0* SLC Settings						
13-00	SL Controller Mode	null	2 set-ups	TRUE	-	Uint8
13-01	Start Event	null	2 set-ups	TRUE	-	Uint8
13-02	Stop Event	null	2 set-ups	TRUE	-	Uint8
13-03	Reset SLC	[0] Do not reset SLC	All set-ups	TRUE	-	Uint8
13-1* Comparators						
13-10	Comparator Operand	null	2 set-ups	TRUE	-	Uint8
13-11	Comparator Operator	null	2 set-ups	TRUE	-	Uint8
13-12	Comparator Value	ExpressionLimit	2 set-ups	TRUE	-3	Int32
13-2* Timers						
13-20	SL Controller Timer	ExpressionLimit	1 set-up	TRUE	-3	TimD
13-4* Logic Rules						
13-40	Logic Rule Boolean 1	null	2 set-ups	TRUE	-	Uint8
13-41	Logic Rule Operator 1	null	2 set-ups	TRUE	-	Uint8
13-42	Logic Rule Boolean 2	null	2 set-ups	TRUE	-	Uint8
13-43	Logic Rule Operator 2	null	2 set-ups	TRUE	-	Uint8
13-44	Logic Rule Boolean 3	null	2 set-ups	TRUE	-	Uint8
13-5* States						
13-51	SL Controller Event	null	2 set-ups	TRUE	-	Uint8
13-52	SL Controller Action	null	2 set-ups	TRUE	-	Uint8

5.1.14 14- ** Special Functions

Par. No. #	Parameter description	Default value (SR = Size related)	4-set-up	Change during operation	Conversion Index	Type
14-0* Inverter Switching						
14-00	Switching Pattern	[0] 60 AVM	All set-ups	TRUE	-	Uint8
14-01	Switching Frequency	null	All set-ups	TRUE	-	Uint8
14-03	Overmodulation	[1] On	All set-ups	FALSE	-	Uint8
14-04	PWM Random	[0] Off	All set-ups	TRUE	-	Uint8
14-1* Mains On/Off						
14-10	Line Failure	[0] No function	All set-ups	FALSE	-	Uint8
14-11	Line Voltage at Line Fault	ExpressionLimit	All set-ups	TRUE	0	Uint16
14-12	Function at Mains Imbalance	[0] Trip	All set-ups	TRUE	-	Uint8
14-2* Reset Functions						
14-20	Reset Mode	null	All set-ups	TRUE	-	Uint8
14-21	Automatic Restart Time	10 s	All set-ups	TRUE	0	Uint16
14-22	Operation Mode	[0] Normal operation	All set-ups	TRUE	-	Uint8
14-23	Typecode Setting	null	2 set-ups	FALSE	-	Uint8
14-25	Trip Delay at Torque Limit	60 s	All set-ups	TRUE	0	Uint8
14-26	Trip Delay at Inverter Fault	ExpressionLimit	All set-ups	TRUE	0	Uint8
14-28	Production Settings	[0] No action	All set-ups	TRUE	-	Uint8
14-29	Service Code	0 N/A	All set-ups	TRUE	0	Int32
14-3* Current Limit Ctrl.						
14-30	Current Lim Cont, Proportional Gain	100 %	All set-ups	FALSE	0	Uint16
14-31	Current Lim Contr, Integration Time	0.020 s	All set-ups	FALSE	-3	Uint16
14-4* Energy Optimizing						
14-40	VT Level	66 %	All set-ups	FALSE	0	Uint8
14-41	AEO Minimum Magnetization	ExpressionLimit	All set-ups	TRUE	0	Uint8
14-42	Minimum AEO Frequency	10 Hz	All set-ups	TRUE	0	Uint8
14-43	Motor Cos-Phi	ExpressionLimit	All set-ups	TRUE	-2	Uint16
14-5* Environment						
14-50	RFI 1	[1] On	1 set-up	FALSE	-	Uint8
14-52	Fan Control	[0] Auto	All set-ups	TRUE	-	Uint8
14-53	Fan Monitor	[1] Warning	All set-ups	TRUE	-	Uint8
14-6* Auto Derate						
14-60	Function at Overtemperature	[0] Trip	All set-ups	TRUE	-	Uint8
14-61	Function at Inverter Overload	[0] Trip	All set-ups	TRUE	-	Uint8
14-62	Inv. Overload Derate Current	95 %	All set-ups	TRUE	0	Uint16



5.1.15 15- ** FC Information

Par. No. #	Parameter description	Default value (SR = Size related)	4-set-up	Change during operation	Conversion index	Type
15-0* Operating Data						
15-00	Operating Hours	0 h	All set-ups	FALSE	74	UInt32
15-01	Running Hours	0 h	All set-ups	FALSE	74	UInt32
15-02	kWh Counter	0 kWh	All set-ups	FALSE	75	UInt32
15-03	Power-ups	0 N/A	All set-ups	FALSE	0	UInt32
15-04	Over Temps	0 N/A	All set-ups	FALSE	0	UInt16
15-05	Over Volts	0 N/A	All set-ups	FALSE	0	UInt16
15-06	Reset kWh Counter	[0] Do not reset	All set-ups	TRUE	-	UInt8
15-07	Reset Running Hours Counter	[0] Do not reset	All set-ups	TRUE	-	UInt8
15-08	Number of Starts	0 N/A	All set-ups	FALSE	0	UInt32
15-1* Data Log Settings						
15-10	Logging Source	0	2 set-ups	TRUE	-	UInt16
15-11	Logging Interval	ExpressionLimit	2 set-ups	TRUE	-3	TimD
15-12	Trigger Event	[0] FALSE	1 set-up	TRUE	-	UInt8
15-13	Logging Mode	[0] Log always	2 set-ups	TRUE	-	UInt8
15-14	Samples Before Trigger	50 N/A	2 set-ups	TRUE	0	UInt8
15-2* Historic Log						
15-20	Historic Log: Event	0 N/A	All set-ups	FALSE	0	UInt8
15-21	Historic Log: Value	0 N/A	All set-ups	FALSE	0	UInt32
15-22	Historic Log: Time	0 ms	All set-ups	FALSE	-3	UInt32
15-23	Historic Log: Date and Time	ExpressionLimit	All set-ups	FALSE	0	TimeOfDay
15-3* Alarm Log						
15-30	Alarm Log: Error Code	0 N/A	All set-ups	FALSE	0	UInt8
15-31	Alarm Log: Value	0 N/A	All set-ups	FALSE	0	Int16
15-32	Alarm Log: Time	0 s	All set-ups	FALSE	0	UInt32
15-33	Alarm Log: Date and Time	ExpressionLimit	All set-ups	FALSE	0	TimeOfDay
15-4* Drive Identification						
15-40	FC Type	0 N/A	All set-ups	FALSE	0	VisStr[6]
15-41	Power Section	0 N/A	All set-ups	FALSE	0	VisStr[20]
15-42	Voltage	0 N/A	All set-ups	FALSE	0	VisStr[20]
15-43	Software Version	0 N/A	All set-ups	FALSE	0	VisStr[5]
15-44	Ordered Typecode String	0 N/A	All set-ups	FALSE	0	VisStr[40]
15-45	Actual Typecode String	0 N/A	All set-ups	FALSE	0	VisStr[40]
15-46	Adj Freq Dr Ordering No.	0 N/A	All set-ups	FALSE	0	VisStr[8]
15-47	Power Card Ordering No.	0 N/A	All set-ups	FALSE	0	VisStr[8]
15-48	LCP ID Num.	0 N/A	All set-ups	FALSE	0	VisStr[20]
15-49	SW ID Control Card	0 N/A	All set-ups	FALSE	0	VisStr[20]
15-50	SW ID Power Card	0 N/A	All set-ups	FALSE	0	VisStr[20]
15-51	Adj Freq Dr Serial No.	0 N/A	All set-ups	FALSE	0	VisStr[10]
15-53	Power Card Serial Number	0 N/A	All set-ups	FALSE	0	VisStr[19]

Par. No. #	Parameter description	Default value (SR = Size related)	4-set-up	Change during operation	Conversion index	Type
15-6* Option Ident						
15-60	Option Mounted	0 N/A	All set-ups	FALSE	0	VisStr[30]
15-61	Option SW Version	0 N/A	All set-ups	FALSE	0	VisStr[20]
15-62	Option Ordering No	0 N/A	All set-ups	FALSE	0	VisStr[8]
15-63	Option Serial No	0 N/A	All set-ups	FALSE	0	VisStr[18]
15-70	Option in Slot A	0 N/A	All set-ups	FALSE	0	VisStr[30]
15-71	Slot A Option SW Version	0 N/A	All set-ups	FALSE	0	VisStr[20]
15-72	Option in Slot B	0 N/A	All set-ups	FALSE	0	VisStr[30]
15-73	Slot B Option SW Version	0 N/A	All set-ups	FALSE	0	VisStr[20]
15-74	Option in Slot C0	0 N/A	All set-ups	FALSE	0	VisStr[30]
15-75	Slot C0 Option SW Version	0 N/A	All set-ups	FALSE	0	VisStr[20]
15-76	Option in Slot C1	0 N/A	All set-ups	FALSE	0	VisStr[30]
15-77	Slot C1 Option SW Version	0 N/A	All set-ups	FALSE	0	VisStr[20]
15-9* Parameter Info						
15-92	Defined Parameters	0 N/A	All set-ups	FALSE	0	Uint16
15-93	Modified Parameters	0 N/A	All set-ups	FALSE	0	Uint16
15-98	Drive Identification	0 N/A	All set-ups	FALSE	0	VisStr[40]
15-99	Parameter Metadata	0 N/A	All set-ups	FALSE	0	Uint16

5.1.16 16- ** Data Readouts

Par. No. #	Parameter description	Default value (SR = Size related)	4-set-up	Change during operation	Conversion index	Type
16-0* General Status						
16-00	Control Word	0 N/A	All set-ups	FALSE	0	V2
16-01	Reference [Unit]	0.000 ReferenceFeedbackUnit	All set-ups	FALSE	-3	Int32
16-02	Reference %	0.0 %	All set-ups	FALSE	-1	Int16
16-03	Status Word	0 N/A	All set-ups	FALSE	0	V2
16-05	Main Actual Value [%]	0.00 %	All set-ups	FALSE	-2	N2
16-09	Custom Readout	0.00 CustomReadoutUnit	All set-ups	FALSE	-2	Int32
16-1* Motor Status						
16-10	Power [kW]	0.00 kW	All set-ups	FALSE	1	Int32
16-11	Power [hp]	0.00 hp	All set-ups	FALSE	-2	Int32
16-12	Motor voltage	0.0 V	All set-ups	FALSE	-1	Uint16
16-13	Frequency	0.0 Hz	All set-ups	FALSE	-1	Uint16
16-14	Motor Current	0.00 A	All set-ups	FALSE	-2	Int32
16-15	Frequency [%]	0.00 %	All set-ups	FALSE	-2	N2
16-16	Torque [Nm]	0.0 Nm	All set-ups	FALSE	-1	Int32
16-17	Speed [RPM]	0 RPM	All set-ups	FALSE	67	Int32
16-18	Motor Thermal	0 %	All set-ups	FALSE	0	Uint8
16-22	Torque [%]	0 %	All set-ups	FALSE	0	Int16
16-3* Drive Status						
16-30	DC Link Voltage	0 V	All set-ups	FALSE	0	Uint16
16-32	Brake Energy /s	0.000 kW	All set-ups	FALSE	0	Uint32
16-33	Brake Energy /2 min	0.000 kW	All set-ups	FALSE	0	Uint32
16-34	Heatsink Temp.	0 °C	All set-ups	FALSE	100	Uint8
16-35	Inverter Thermal	0 %	All set-ups	FALSE	0	Uint8
16-36	Inv. Nom. Current	ExpressionLimit	All set-ups	FALSE	-2	Uint32
16-37	Inv. Max. Current	ExpressionLimit	All set-ups	FALSE	-2	Uint32
16-38	SL Controller State	0 N/A	All set-ups	FALSE	0	Uint8
16-39	Control Card Temp.	0 °C	All set-ups	FALSE	100	Uint8
16-40	Logging Buffer Full	[0] No	All set-ups	TRUE	-	Uint8
16-5* Ref. & Feedb.						
16-50	External Reference	0.0 N/A	All set-ups	FALSE	-1	Int16
16-52	Feedback [Unit]	0.000 ProcessCtrlUnit	All set-ups	FALSE	-3	Int32
16-53	Digi Pot Reference	0.00 N/A	All set-ups	FALSE	-2	Int16
16-54	Feedback 1 [Unit]	0.000 ProcessCtrlUnit	All set-ups	FALSE	-3	Int32
16-55	Feedback 2 [Unit]	0.000 ProcessCtrlUnit	All set-ups	FALSE	-3	Int32
16-56	Feedback 3 [Unit]	0.000 ProcessCtrlUnit	All set-ups	FALSE	-3	Int32
16-58	PID Output [%]	0.0 %	All set-ups	TRUE	-1	Int16

Par. No. #	Parameter description	Default value (SR = Size related)	4-set-up	Change during operation	Conversion Index	Type
16-6* Inputs & Outputs						
16-60	Digital Input	0 N/A	All set-ups	FALSE	0	UInt16
16-61	Terminal 53 Switch Setting	[0] Current	All set-ups	FALSE	-	UInt8
16-62	Analog Input 53	0.000 N/A	All set-ups	FALSE	-3	Int32
16-63	Terminal 54 Switch Setting	[0] Current	All set-ups	FALSE	-	UInt8
16-64	Analog Input 54	0.000 N/A	All set-ups	FALSE	-3	Int32
16-65	Analog Output 42 [mA]	0.000 N/A	All set-ups	FALSE	-3	Int16
16-66	Digital Output [bin]	0 N/A	All set-ups	FALSE	0	Int16
16-67	Pulse Input #29 [Hz]	0 N/A	All set-ups	FALSE	0	Int32
16-68	Pulse Input #33 [Hz]	0 N/A	All set-ups	FALSE	0	Int32
16-69	Pulse Output #27 [Hz]	0 N/A	All set-ups	FALSE	0	Int32
16-70	Pulse Output #29 [Hz]	0 N/A	All set-ups	FALSE	0	Int32
16-71	Relay Output [bin]	0 N/A	All set-ups	FALSE	0	Int16
16-72	Counter A	0 N/A	All set-ups	TRUE	0	Int32
16-73	Counter B	0 N/A	All set-ups	TRUE	0	Int32
16-75	Analog In X30/11	0.000 N/A	All set-ups	FALSE	-3	Int32
16-76	Analog In X30/12	0.000 N/A	All set-ups	FALSE	-3	Int32
16-77	Analog Out X30/8 [mA]	0.000 N/A	All set-ups	FALSE	-3	Int16
16-8* Fieldbus & FC Port						
16-80	Fieldbus CTW 1	0 N/A	All set-ups	FALSE	0	V2
16-82	Fieldbus REF 1	0 N/A	All set-ups	FALSE	0	N2
16-84	Comm. Option Status	0 N/A	All set-ups	FALSE	0	V2
16-85	FC Port CTW 1	0 N/A	All set-ups	FALSE	0	V2
16-86	FC Port REF 1	0 N/A	All set-ups	FALSE	0	N2
16-9* Diagnosis Readouts						
16-90	Alarm Word	0 N/A	All set-ups	FALSE	0	UInt32
16-91	Alarm word 2	0 N/A	All set-ups	FALSE	0	UInt32
16-92	Warning Word	0 N/A	All set-ups	FALSE	0	UInt32
16-93	Warning word 2	0 N/A	All set-ups	FALSE	0	UInt32
16-94	Ext. Status Word	0 N/A	All set-ups	FALSE	0	UInt32
16-95	Ext. Status Word 2	0 N/A	All set-ups	FALSE	0	UInt32
16-96	Maintenance Word	0 N/A	All set-ups	FALSE	0	UInt32

5.1.17 18-.* Info & Readouts

Par. No. #	Parameter description	Default value (SR = Size related)	4-set-up	Change during operation	Conversion index	Type
18-0* Maintenance Log						
18-00	Maintenance Log: Item	0 N/A	All set-ups	FALSE	0	Unit8
18-01	Maintenance Log: Action	0 N/A	All set-ups	FALSE	0	Unit8
18-02	Maintenance Log: Time	0 s	All set-ups	FALSE	0	Unit32
18-03	Maintenance Log: Date and Time	ExpressionLimit	All set-ups	FALSE	0	TimeOfDay
18-1* Fire Mode Log						
18-10	Fire Mode Log: Event	0 N/A	All set-ups	FALSE	0	Unit8
18-11	Fire Mode Log: Time	0 s	All set-ups	FALSE	0	Unit32
18-12	Fire Mode Log: Date and Time	ExpressionLimit	All set-ups	FALSE	0	TimeOfDay
18-3* Inputs & Outputs						
18-30	Analog Input X42/1	0.000 N/A	All set-ups	FALSE	-3	Int32
18-31	Analog Input X42/3	0.000 N/A	All set-ups	FALSE	-3	Int32
18-32	Analog Input X42/5	0.000 N/A	All set-ups	FALSE	-3	Int32
18-33	Analog Out X42/7 [V]	0.000 N/A	All set-ups	FALSE	-3	Int16
18-34	Analog Out X42/9 [V]	0.000 N/A	All set-ups	FALSE	-3	Int16
18-35	Analog Out X42/11 [V]	0.000 N/A	All set-ups	FALSE	-3	Int16

5.1.18 20- ** FC Closed-loop

Par. No. #	Parameter description	Default value (SR = Size related)	4-set-up	Change during operation	Conversion index	Type
20-0* Feedback						
20-00	Feedback 1 Source	[2] Analog input 54	All set-ups	TRUE	-	Ujnt8
20-01	Feedback 1 Conversion	[0] Linear	All set-ups	FALSE	-	Ujnt8
20-02	Feedback 1 Source Unit	null	All set-ups	TRUE	-	Ujnt8
20-03	Feedback 2 Source	[0] No function	All set-ups	TRUE	-	Ujnt8
20-04	Feedback 2 Conversion	[0] Linear	All set-ups	FALSE	-	Ujnt8
20-05	Feedback 2 Source Unit	null	All set-ups	TRUE	-	Ujnt8
20-06	Feedback 3 Source	[0] No function	All set-ups	TRUE	-	Ujnt8
20-07	Feedback 3 Conversion	[0] Linear	All set-ups	FALSE	-	Ujnt8
20-08	Feedback 3 Source Unit	null	All set-ups	TRUE	-	Ujnt8
20-12	Reference/Feedback Unit	null	All set-ups	TRUE	-	Ujnt8
20-13	Minimum Reference/Feedb.	0.000 ProcessCtrlUnit	All set-ups	TRUE	-3	Int32
20-14	Maximum Reference/Feedb.	100.000 ProcessCtrlUnit	All set-ups	TRUE	-3	Int32
20-2* Feedback & Setpoint						
20-20	Feedback Function	[3] Minimum	All set-ups	TRUE	-	Ujnt8
20-21	Setpoint 1	0.000 ProcessCtrlUnit	All set-ups	TRUE	-3	Int32
20-22	Setpoint 2	0.000 ProcessCtrlUnit	All set-ups	TRUE	-3	Int32
20-23	Setpoint 3	0.000 ProcessCtrlUnit	All set-ups	TRUE	-3	Int32
20-3* Feedback Adv. Conv.						
20-30	Refrigerant	[0] R22	All set-ups	TRUE	-	Ujnt8
20-31	User-defined Refrigerant A1	10.0000 N/A	All set-ups	TRUE	-4	Ujnt32
20-32	User-defined Refrigerant A2	-2250.00 N/A	All set-ups	TRUE	-2	Int32
20-33	User-defined Refrigerant A3	250.000 N/A	All set-ups	TRUE	-3	Ujnt32
20-7* PID Auto Tuning						
20-70	Closed-loop Type	[0] Auto	2 set-ups	TRUE	-	Ujnt8
20-71	Tuning Mode	[0] Normal	2 set-ups	TRUE	-	Ujnt8
20-72	PID Output Change	0.10 N/A	2 set-ups	TRUE	-2	Ujnt16
20-73	Minimum Feedback Level	-999999.000 ProcessCtrlUnit	2 set-ups	TRUE	-3	Int32
20-74	Maximum Feedback Level	999999.000 ProcessCtrlUnit	2 set-ups	TRUE	-3	Int32
20-79	PID Auto Tuning	[0] Disabled	All set-ups	TRUE	-	Ujnt8
20-8* PID Basic Settings						
20-81	PID Normal/ Inverse Control	[0] Normal	All set-ups	TRUE	-	Ujnt8
20-82	PID Start Speed [RPM]	ExpressionLimit	All set-ups	TRUE	67	Ujnt16
20-83	PID Start Speed [Hz]	ExpressionLimit	All set-ups	TRUE	-1	Ujnt16
20-84	On Reference Bandwidth	5 %	All set-ups	TRUE	0	Ujnt8
20-9* PID Controller						
20-91	PID Anti Windup	[1] On	All set-ups	TRUE	-	Ujnt8
20-93	PID Proportional Gain	0.50 N/A	All set-ups	TRUE	-2	Ujnt16
20-94	PID Integral Time	20.00 s	All set-ups	TRUE	-2	Ujnt32
20-95	PID Differentiation Time	0.00 s	All set-ups	TRUE	-2	Ujnt16
20-96	PID Diff. Gain Limit	5.0 N/A	All set-ups	TRUE	-1	Ujnt16



5.1.19 21- Ext. Closed-loop**

Par. No. #	Parameter description	Default value (SR = Size related)	4-set-up	Change during operation	Conversion Index	Type
21-0* Ext. PID Auto-tuning						
21-00	Closed-loop Type	[0] Auto	2 set-ups	TRUE	-	Uint8
21-01	Tuning Mode	[0] Normal	2 set-ups	TRUE	-	Uint8
21-02	PID Output Change	0.10 N/A	2 set-ups	TRUE	-2	Uint16
21-03	Minimum Feedback Level	-999999.000 N/A	2 set-ups	TRUE	-3	Int32
21-04	Maximum Feedback Level	999999.000 N/A	2 set-ups	TRUE	-3	Int32
21-09	PID Auto Tuning	[0] Disabled	All set-ups	TRUE	-	Uint8
21-1* Ext. CL 1 Ref./Fb.						
21-10	Ext. 1 Ref./Feedback Unit	[1] %	All set-ups	TRUE	-	Uint8
21-11	Ext. 1 Minimum Reference	0.000 ExtPID1Unit	All set-ups	TRUE	-3	Int32
21-12	Ext. 1 Maximum Reference	100.000 ExtPID1Unit	All set-ups	TRUE	-3	Int32
21-13	Ext. 1 Reference Source	[0] No function	All set-ups	TRUE	-	Uint8
21-14	Ext. 1 Feedback Source	[0] No function	All set-ups	TRUE	-	Uint8
21-15	Ext. 1 Setpoint	0.000 ExtPID1Unit	All set-ups	TRUE	-3	Int32
21-17	Ext. 1 Reference [Unit]	0.000 ExtPID1Unit	All set-ups	TRUE	-3	Int32
21-18	Ext. 1 Feedback [Unit]	0.000 ExtPID1Unit	All set-ups	TRUE	-3	Int32
21-19	Ext. 1 Output [%]	0 %	All set-ups	TRUE	0	Int32
21-2* Ext. CL 1 PID						
21-20	Ext. 1 Normal/Inverse Control	[0] Normal	All set-ups	TRUE	-	Uint8
21-21	Ext. 1 Proportional Gain	0.01 N/A	All set-ups	TRUE	-2	Uint16
21-22	Ext. 1 Integral Time	10000.00 s	All set-ups	TRUE	-2	Uint32
21-23	Ext. 1 Differentiation Time	0.00 s	All set-ups	TRUE	-2	Uint16
21-24	Ext. 1 Dif. Gain Limit	5.0 N/A	All set-ups	TRUE	-1	Uint16
21-3* Ext. CL 2 Ref./Fb.						
21-30	Ext. 2 Ref./Feedback Unit	[1] %	All set-ups	TRUE	-	Uint8
21-31	Ext. 2 Minimum Reference	0.000 ExtPID2Unit	All set-ups	TRUE	-3	Int32
21-32	Ext. 2 Maximum Reference	100.000 ExtPID2Unit	All set-ups	TRUE	-3	Int32
21-33	Ext. 2 Reference Source	[0] No function	All set-ups	TRUE	-	Uint8
21-34	Ext. 2 Feedback Source	[0] No function	All set-ups	TRUE	-	Uint8
21-35	Ext. 2 Setpoint	0.000 ExtPID2Unit	All set-ups	TRUE	-3	Int32
21-37	Ext. 2 Reference [Unit]	0.000 ExtPID2Unit	All set-ups	TRUE	-3	Int32
21-38	Ext. 2 Feedback [Unit]	0.000 ExtPID2Unit	All set-ups	TRUE	-3	Int32
21-39	Ext. 2 Output [%]	0 %	All set-ups	TRUE	0	Int32
21-4* Ext. CL 2 PID						
21-40	Ext. 2 Normal/Inverse Control	[0] Normal	All set-ups	TRUE	-	Uint8
21-41	Ext. 2 Proportional Gain	0.01 N/A	All set-ups	TRUE	-2	Uint16
21-42	Ext. 2 Integral Time	10000.00 s	All set-ups	TRUE	-2	Uint32
21-43	Ext. 2 Differentiation Time	0.00 s	All set-ups	TRUE	-2	Uint16
21-44	Ext. 2 Dif. Gain Limit	5.0 N/A	All set-ups	TRUE	-1	Uint16

Par. No. #	Parameter description	Default value (SR = Size related)	4-set-up	Change during operation	Conversion Index	Type
21-5* Ext. Cl. 3 Ref./Fb.						
21-50	Ext. 3 Ref./Feedback Unit	[1] %	All set-ups	TRUE	-	Uint8
21-51	Ext. 3 Minimum Reference	0.000 ExtPID3Unit	All set-ups	TRUE	-3	Int32
21-52	Ext. 3 Maximum Reference	100.000 ExtPID3Unit	All set-ups	TRUE	-3	Int32
21-53	Ext. 3 Reference Source	[0] No function	All set-ups	TRUE	-	Uint8
21-54	Ext. 3 Feedback Source	[0] No function	All set-ups	TRUE	-	Uint8
21-55	Ext. 3 Setpoint	0.000 ExtPID3Unit	All set-ups	TRUE	-3	Int32
21-57	Ext. 3 Reference [Unit]	0.000 ExtPID3Unit	All set-ups	TRUE	-3	Int32
21-58	Ext. 3 Feedback [Unit]	0.000 ExtPID3Unit	All set-ups	TRUE	-3	Int32
21-59	Ext. 3 Output [%]	0 %	All set-ups	TRUE	0	Int32
21-6* Ext. Cl. 3 PID						
21-60	Ext. 3 Normal/Inverse Control	[0] Normal	All set-ups	TRUE	-	Uint8
21-61	Ext. 3 Proportional Gain	0.01 N/A	All set-ups	TRUE	-2	Uint16
21-62	Ext. 3 Integral Time	10000.00 s	All set-ups	TRUE	-2	Uint32
21-63	Ext. 3 Differentiation Time	0.00 s	All set-ups	TRUE	-2	Uint16
21-64	Ext. 3 Dif. Gain Limit	5.0 N/A	All set-ups	TRUE	-1	Uint16



5.1.20 22-.* Application Functions

Par. No. #	Parameter description	Default value (SR = Size related)	4-set-up	Change during operation	Conversion index	Type
22-0* Miscellaneous						
22-00	External Interlock Delay	0 s	All set-ups	TRUE	0	Uint16
22-2* No-Flow Detection						
22-20	Low Power Auto Set-up	[0] OFF	All set-ups	FALSE	-	Uint8
22-21	Low Power Detection	[0] Disabled	All set-ups	TRUE	-	Uint8
22-22	Low Speed Detection	[0] Disabled	All set-ups	TRUE	-	Uint8
22-23	No-Flow Function	[0] OFF	All set-ups	TRUE	-	Uint8
22-24	No-Flow Delay	10 s	All set-ups	TRUE	0	Uint16
22-26	Dry Pump Function	[0] OFF	All set-ups	TRUE	-	Uint8
22-27	Dry Pump Delay	10 s	All set-ups	TRUE	0	Uint16
22-3* No-Flow Power Tuning						
22-30	No-Flow Power	0.00 kW	All set-ups	TRUE	1	Uint32
22-31	Power Correction Factor	100 %	All set-ups	TRUE	0	Uint16
22-32	Low Speed [RPM]	ExpressionLimit	All set-ups	TRUE	67	Uint16
22-33	Low Speed [Hz]	ExpressionLimit	All set-ups	TRUE	-1	Uint16
22-34	Low Speed Power [kW]	ExpressionLimit	All set-ups	TRUE	1	Uint32
22-35	Low Speed Power [HP]	ExpressionLimit	All set-ups	TRUE	-2	Uint32
22-36	High Speed [RPM]	ExpressionLimit	All set-ups	TRUE	67	Uint16
22-37	High Speed [Hz]	ExpressionLimit	All set-ups	TRUE	-1	Uint16
22-38	High Speed Power [kW]	ExpressionLimit	All set-ups	TRUE	1	Uint32
22-39	High Speed Power [HP]	ExpressionLimit	All set-ups	TRUE	-2	Uint32
22-4* Sleep Mode						
22-40	Minimum Run Time	10 s	All set-ups	TRUE	0	Uint16
22-41	Minimum Sleep Time	10 s	All set-ups	TRUE	0	Uint16
22-42	Wake-up Speed [RPM]	ExpressionLimit	All set-ups	TRUE	67	Uint16
22-43	Wake-up Speed [Hz]	ExpressionLimit	All set-ups	TRUE	-1	Uint16
22-44	Wake-up Ref./FB Difference	10 %	All set-ups	TRUE	0	Int8
22-45	Setpoint Boost	0 %	All set-ups	TRUE	0	Int8
22-46	Maximum Boost Time	60 s	All set-ups	TRUE	0	Uint16
22-5* End of Curve						
22-50	End of Curve Function	[0] OFF	All set-ups	TRUE	-	Uint8
22-51	End of Curve Delay	10 s	All set-ups	TRUE	0	Uint16
22-6* Broken Belt Detection						
22-60	Broken Belt Function	[0] OFF	All set-ups	TRUE	-	Uint8
22-61	Broken Belt Torque	10 %	All set-ups	TRUE	0	Uint8
22-62	Broken Belt Delay	10 s	All set-ups	TRUE	0	Uint16

Par. No. #	Parameter description	Default value (SR = Size related)	4-set-up	Change during operation	Conversion Index	Type
22-7* Short Cycle Protection						
22-75	Short Cycle Protection	[0] Disabled	All set-ups	TRUE	-	Uint8
22-76	Interval between Starts	start_to_start_min_on_time (P2277)	All set-ups	TRUE	0	Uint16
22-77	Minimum Run Time	0 s	All set-ups	TRUE	0	Uint16
22-8* Flow Compensation						
22-80	Flow Compensation	[0] Disabled	All set-ups	TRUE	-	Uint8
22-81	Square-linear Curve Approximation	100 %	All set-ups	TRUE	0	Uint8
22-82	Work Point Calculation	[0] Disabled	All set-ups	TRUE	-	Uint8
22-83	Speed at No-Flow [RPM]	ExpressionLimit	All set-ups	TRUE	67	Uint16
22-84	Speed at No-Flow [Hz]	ExpressionLimit	All set-ups	TRUE	-1	Uint16
22-85	Speed at Design Point [RPM]	ExpressionLimit	All set-ups	TRUE	67	Uint16
22-86	Speed at Design Point [Hz]	ExpressionLimit	All set-ups	TRUE	-1	Uint16
22-87	Pressure at No-Flow Speed	0.000 N/A	All set-ups	TRUE	-3	Int32
22-88	Pressure at Rated Speed	999999.999 N/A	All set-ups	TRUE	-3	Int32
22-89	Flow at Design Point	0.000 N/A	All set-ups	TRUE	-3	Int32
22-90	Flow at Rated Speed	0.000 N/A	All set-ups	TRUE	-3	Int32

5.1.21 23-.* Time-based Functions

Par. No. #	Parameter description	Default value (SR = Size related)	4-set-up	Change during operation	Conversion index	Type
23-0* Timed Actions						
23-00	ON Time	ExpressionLimit	2 set-ups	TRUE	0	TimeOfDayWoDate
23-01	ON Action	[0] DISABLED	2 set-ups	TRUE	-	Uint8
23-02	OFF Time	ExpressionLimit	2 set-ups	TRUE	0	TimeOfDayWoDate
23-03	OFF Action	[0] DISABLED	2 set-ups	TRUE	-	Uint8
23-04	Occurrence	[0] All days	2 set-ups	TRUE	-	Uint8
23-1* Maintenance						
23-10	Maintenance Item	[1] Motor bearings	1 set-up	TRUE	-	Uint8
23-11	Maintenance Action	[1] Lubricate	1 set-up	TRUE	-	Uint8
23-12	Maintenance Time Base	[0] Disabled	1 set-up	TRUE	-	Uint8
23-13	Maintenance Time Interval	1 h	1 set-up	TRUE	74	Uint32
23-14	Maintenance Date and Time	ExpressionLimit	1 set-up	TRUE	0	TimeOfDay
23-1* Maintenance Reset						
23-15	Reset Maintenance Word	[0] Do not reset	All set-ups	TRUE	-	Uint8
23-16	Maintenance Text	0 N/A	1 set-up	TRUE	0	VisStrf[20]
23-5* Energy Log						
23-50	Energy Log Resolution	[5] Last 24 Hours	2 set-ups	TRUE	-	Uint8
23-51	Period Start	ExpressionLimit	2 set-ups	TRUE	0	TimeOfDay
23-53	Energy Log	0 N/A	All set-ups	TRUE	0	Uint32
23-54	Reset Energy Log	[0] Do not reset	All set-ups	TRUE	-	Uint8
23-6* Trending						
23-60	Trend Variable	[0] Power [kW]	2 set-ups	TRUE	-	Uint8
23-61	Continuous Bin Data	0 N/A	All set-ups	TRUE	0	Uint32
23-62	Timed Bin Data	0 N/A	All set-ups	TRUE	0	Uint32
23-63	Timed Period Start	ExpressionLimit	2 set-ups	TRUE	0	TimeOfDay
23-64	Timed Period Stop	ExpressionLimit	2 set-ups	TRUE	0	TimeOfDay
23-65	Minimum Bin Value	ExpressionLimit	2 set-ups	TRUE	0	Uint8
23-66	Reset Continuous Bin Data	[0] Do not reset	All set-ups	TRUE	-	Uint8
23-67	Reset Timed Bin Data	[0] Do not reset	All set-ups	TRUE	-	Uint8
23-8* Payback Counter						
23-80	Power Reference Factor	100 %	2 set-ups	TRUE	0	Uint8
23-81	Energy Cost	1.00 N/A	2 set-ups	TRUE	-2	Uint32
23-82	Investment	0 N/A	2 set-ups	TRUE	0	Uint32
23-83	Energy Savings	0 kWh	All set-ups	TRUE	75	Int32
23-84	Cost Savings	0 N/A	All set-ups	TRUE	0	Int32

5.1.22 24- ** Application Functions 2

Par. No. #	Parameter description	Default value (SR = Size related)	4-set-up	Change during operation	Conversion Index	Type
24-0* Fire Mode						
24-00	Fire Mode Function	[0] Disabled	2 set-ups	TRUE	-	Uint8
24-01	Fire Mode Configuration	[0] Open-loop	All set-ups	TRUE	-	Uint8
24-02	Fire Mode Unit	null	All set-ups	TRUE	-	Uint8
24-03	Fire Mode Min Reference	ExpressionLimit	All set-ups	TRUE	-3	Int32
24-04	Fire Mode Max Reference	ExpressionLimit	All set-ups	TRUE	-3	Int32
24-05	Fire Mode Preset Reference	0.00 %	All set-ups	TRUE	-2	Int16
24-06	Fire Mode Reference Source	[0] No function	All set-ups	TRUE	-	Uint8
24-07	Fire Mode Feedback Source	[0] No function	All set-ups	TRUE	-	Uint8
24-09	Fire Mode Alarm Handling	[1] Trip at Critical Alarms	2 set-ups	FALSE	-	Uint8
24-1* Drive Bypass						
24-10	Bypass Function	[0] Disabled	2 set-ups	TRUE	-	Uint8
24-11	Bypass Delay Time	0 s	2 set-ups	TRUE	0	Uint16

5.1.23 25- ** Cascade Controller

Par. No. #	Parameter description	Default value (SR = Size related)	4-set-up	Change during operation	Conversion index	Type
25-0* System Settings						
25-00	Cascade Controller	[0] Disabled	2 set-ups	FALSE	-	Uint8
25-02	Motor Start	[0] Direct on Line	2 set-ups	FALSE	-	Uint8
25-04	Pump Cycling	[0] Disabled	All set-ups	TRUE	-	Uint8
25-05	Fixed Lead Pump	[1] Yes	2 set-ups	FALSE	-	Uint8
25-06	Number Of Pumps	2 N/A	2 set-ups	FALSE	0	Uint8
25-2* Bandwidth Settings						
25-20	Staging Bandwidth	10 %	All set-ups	TRUE	0	Uint8
25-21	Override Bandwidth	100 %	All set-ups	TRUE	0	Uint8
25-22	Fixed Speed Bandwidth	casco_staging_bandwidth (P2520)	All set-ups	TRUE	0	Uint8
25-23	SBW Staging Delay	15 s	All set-ups	TRUE	0	Uint16
25-24	SBW De-staging Delay	15 s	All set-ups	TRUE	0	Uint16
25-25	OBW Time	10 s	All set-ups	TRUE	0	Uint16
25-26	Destage At No-Flow	[0] Disabled	All set-ups	TRUE	-	Uint8
25-27	Stage Function	[1] Enabled	All set-ups	TRUE	-	Uint8
25-28	Stage Function Time	15 s	All set-ups	TRUE	0	Uint16
25-29	Destage Function	[1] Enabled	All set-ups	TRUE	-	Uint8
25-30	Destage Function Time	15 s	All set-ups	TRUE	0	Uint16
25-4* Staging Settings						
25-40	Ramp-down Delay	10.0 s	All set-ups	TRUE	-1	Uint16
25-41	Ramp-up Delay	2.0 s	All set-ups	TRUE	-1	Uint16
25-42	Staging Threshold	ExpressionLimit	All set-ups	TRUE	0	Uint8
25-43	De-staging Threshold	ExpressionLimit	All set-ups	TRUE	0	Uint8
25-44	Staging Speed [RPM]	0 RPM	All set-ups	TRUE	67	Uint16
25-45	Staging Speed [Hz]	0.0 Hz	All set-ups	TRUE	-1	Uint16
25-46	De-staging Speed [RPM]	0 RPM	All set-ups	TRUE	67	Uint16
25-47	De-staging Speed [Hz]	0.0 Hz	All set-ups	TRUE	-1	Uint16
25-5* Alternation Settings						
25-50	Lead Pump Alternation	[0] OFF	All set-ups	TRUE	-	Uint8
25-51	Alternation Event	[0] External	All set-ups	TRUE	-	Uint8
25-52	Alternation Time Interval	24 h	All set-ups	TRUE	74	Uint16
25-53	Alternation Timer Value	0 N/A	All set-ups	TRUE	0	VisStr[7]
25-54	Alternation Predefined Time	ExpressionLimit	All set-ups	TRUE	0	TimeOfDayWoDate
25-55	Alternate if Load < 50%	[1] Enabled	All set-ups	TRUE	-	Uint8
25-56	Staging Mode at Alternation	[0] Slow	All set-ups	TRUE	-	Uint8
25-58	Run Next Pump Delay	0.1 s	All set-ups	TRUE	-1	Uint16
25-59	Run-on Line Delay	0.5 s	All set-ups	TRUE	-1	Uint16

Par. No. #	Parameter description	Default value	4-set-up	Change during operation	Conversion index	Type
25-8* Status						
25-80	Cascade Status	0 N/A	All set-ups	TRUE	0	VisStr[25]
25-81	Pump Status	0 N/A	All set-ups	TRUE	0	VisStr[25]
25-82	Lead Pump	0 N/A	All set-ups	TRUE	0	Ulim8
25-83	Relay Status	0 N/A	All set-ups	TRUE	0	VisStr[4]
25-84	Pump ON Time	0 h	All set-ups	TRUE	74	Ulim32
25-85	Relay ON Time	0 h	All set-ups	TRUE	74	Ulim32
25-86	Reset Relay Counters	[0] Do not reset	All set-ups	TRUE	-	Ulim8
25-9* Service						
25-90	Pump Interlock	[0] Off	All set-ups	TRUE	-	Ulim8
25-91	Manual Alternation	0 N/A	All set-ups	TRUE	0	Ulim8

5.1.24 26- * Analog I / O Option MCB 109

Par. No. #	Parameter description	Default value (SR = Size related)	4-set-up	Change during operation	Conversion Index	Type
26-0* Analog I/O Mode						
26-00	Terminal X42/1 Mode	[1] Voltage	All set-ups	TRUE	-	Uint8
26-01	Terminal X42/3 Mode	[1] Voltage	All set-ups	TRUE	-	Uint8
26-02	Terminal X42/5 Mode	[1] Voltage	All set-ups	TRUE	-	Uint8
26-1* Analog Input X42/1						
26-10	Terminal X42/1 Low Voltage	0.07 V	All set-ups	TRUE	-2	Int16
26-11	Terminal X42/1 High Voltage	10.00 V	All set-ups	TRUE	-2	Int16
26-14	Term. X42/1 Low Ref./Feedb. Value	0.000 N/A	All set-ups	TRUE	-3	Int32
26-15	Term. X42/1 High Ref./Feedb. Value	100.000 N/A	All set-ups	TRUE	-3	Int32
26-16	Term. X42/1 Filter Time Constant	0.001 s	All set-ups	TRUE	-3	Uint16
26-17	Term. X42/1 Live Zero	[1] Enabled	All set-ups	TRUE	-	Uint8
26-2* Analog Input X42/3						
26-20	Terminal X42/3 Low Voltage	0.07 V	All set-ups	TRUE	-2	Int16
26-21	Terminal X42/3 High Voltage	10.00 V	All set-ups	TRUE	-2	Int16
26-24	Term. X42/3 Low Ref./Feedb. Value	0.000 N/A	All set-ups	TRUE	-3	Int32
26-25	Term. X42/3 High Ref./Feedb. Value	100.000 N/A	All set-ups	TRUE	-3	Int32
26-26	Term. X42/3 Filter Time Constant	0.001 s	All set-ups	TRUE	-3	Uint16
26-27	Term. X42/3 Live Zero	[1] Enabled	All set-ups	TRUE	-	Uint8
26-3* Analog Input X42/5						
26-30	Terminal X42/5 Low Voltage	0.07 V	All set-ups	TRUE	-2	Int16
26-31	Terminal X42/5 High Voltage	10.00 V	All set-ups	TRUE	-2	Int16
26-34	Term. X42/5 Low Ref./Feedb. Value	0.000 N/A	All set-ups	TRUE	-3	Int32
26-35	Term. X42/5 High Ref./Feedb. Value	100.000 N/A	All set-ups	TRUE	-3	Int32
26-36	Term. X42/5 Filter Time Constant	0.001 s	All set-ups	TRUE	-3	Uint16
26-37	Term. X42/5 Live Zero	[1] Enabled	All set-ups	TRUE	-	Uint8
26-4* Analog Output X42/7						
26-40	Terminal X42/7 Output	[0] No operation	All set-ups	TRUE	-	Uint8
26-41	Terminal X42/7 Min. Scale	0.00 %	All set-ups	TRUE	-2	Int16
26-42	Terminal X42/7 Max. Scale	100.00 %	All set-ups	TRUE	-2	Int16
26-43	Terminal X42/7 Output Bus Control	0.00 %	All set-ups	TRUE	-2	N2
26-44	Terminal X42/7 Output Timeout Preset	0.00 %	1 set-up	TRUE	-2	Uint16
26-5* Analog Output X42/9						
26-50	Terminal X42/9 Output	[0] No operation	All set-ups	TRUE	-	Uint8
26-51	Terminal X42/9 Min. Scale	0.00 %	All set-ups	TRUE	-2	Int16
26-52	Terminal X42/9 Max. Scale	100.00 %	All set-ups	TRUE	-2	Int16
26-53	Terminal X42/9 Output Bus Control	0.00 %	All set-ups	TRUE	-2	N2
26-54	Terminal X42/9 Output Timeout Preset	0.00 %	1 set-up	TRUE	-2	Uint16
26-6* Analog Output X42/11						
26-60	Terminal X42/11 Output	[0] No operation	All set-ups	TRUE	-	Uint8
26-61	Terminal X42/11 Min. Scale	0.00 %	All set-ups	TRUE	-2	Int16
26-62	Terminal X42/11 Max. Scale	100.00 %	All set-ups	TRUE	-2	Int16
26-63	Terminal X42/11 Output Bus Control	0.00 %	All set-ups	TRUE	-2	N2
26-64	Terminal X42/11 Output Timeout Preset	0.00 %	1 set-up	TRUE	-2	Uint16

Index

“

“startup I Am” 8-74 3-99

1

1-3* Adv. Motor Data 3-22

18-0* Maintenance Log 3-162

2

22-2* No-flow Detection 3-196

5

5-1* Digital Inputs 3-48

5-6* Pulse Outputs 3-76

6

6-0* Analog I/o Mode 3-80

A

Acceleration Time 3-37

Access To Main Menu W/o Password 0-61 3-15

Access To Personal Menu W/o Password 0-66 3-16

Active Set-up 0-10 3-4

Actual Baud Rate 9-63 3-107

Actual Typecode String 15-45 3-149

Additional Non-working Days 0-83 3-18

Additional Working Days 0-82 3-17

Address 8-31 3-94

Adj Freq Dr Ordering No. 15-46 3-149

Adj Freq Dr Serial No. 15-51 3-150

Adjustable Frequency Drive Closed-loop 3-165

Aeo Minimum Magnetization 14-41 3-140

Alarm Log 3-148

Alarm Log: Date And Time 15-33 3-148

Alarm Log: Error Code 15-30 3-148

Alarm Log: Time 15-32 3-148

Alarm Log: Value 15-31 3-148

Alarm Word 4-4

Alarm Word 16-90 3-159

Alarm Word 2 16-91 3-159

Alarms And Warnings 4-1

Alternate If Load < 50% 25-55 3-246

Alternation Event 25-51 3-246

Alternation Predefined Time 25-54 3-246

Alternation Time Interval 25-52 3-246

Alternation Timer Value 25-53 3-246

Analog I/o Option Mcb 109, 26-*** 3-250

Analog In X30/11 16-75 3-158

Analog In X30/12 16-76 3-158

Analog Input 53 16-62 3-157

Analog Input 54 16-64 3-157

Analog Input Scaling Value 3-254

Analog Input X42/1 18-30 3-163

Analog Input X42/3 18-31 3-163

Analog Input X42/5 18-32 3-164

[Analog Out X30/8 Ma] 16-77 3-158

[Analog Out X42/11 V] 18-35 3-164

[Analog Out X42/7 V] 18-33	3-164
[Analog Out X42/9 V] 18-34	3-164
[Analog Output 42 Ma] 16-65	3-157
Array Index 10-30	3-115
Auto Derate	3-141
Auto Energy Optimization Compressor	3-19
Auto Energy Optimization Vt	3-19
[Auto On] Key On Lcp 0-42	3-14
Automatic Motor Adaptation (ama) 1-29	3-21
Automatic Restart Time 14-21	3-138

B

Bacnet	3-98
Bacnet Device Instance 8-70	3-98
Baud Rate 8-32	3-95
Baud Rate Select 10-01	3-110
Brake Check 2-15	3-32
Brake Energy /2 Min 16-33	3-153
Brake Energy /s 16-32	3-153
Brake Function 2-10	3-31
Brake Power Limit (kw) 2-12	3-31
Brake Power Monitoring 2-13	3-32
Brake Resistor (ohm) 2-11	3-31
Broken Belt Delay 22-62	3-206
Broken Belt Detection	3-206
Broken Belt Function 22-60	3-206
Broken Belt Torque 22-61	3-206
Bus Controlled	3-79
Bus Error Count 8-81	3-100
Bus Feedback 1 8-94	3-100
Bus Feedback 2 8-95	3-100
Bus Feedback 3 8-96	3-100
Bus Jog 1 Speed 8-90	3-100
Bus Jog 2 Speed 8-91	3-100
Bus Message Count 8-80	3-99
Bypass Delay Time 24-11	3-235
Bypass Function 24-10	3-234
[Bypass Speed From Hz] 4-61	3-45
[Bypass Speed From Rpm] 4-60	3-45
[Bypass Speed To Hz] 4-63	3-45
[Bypass Speed To Rpm] 4-62	3-45

C

Can Protocol 10-00	3-110
Cascade Controller	3-235, 3-236
Cascade Status 25-80	3-248
Changed Parameters (1) 9-90	3-109
Changed Parameters (2) 9-91	3-109
Changed Parameters (3) 9-92	3-109
Changed Parameters (5) 9-94	3-110
Changes Made	2-10
Changing A Data Value	2-18
Changing A Group Of Numeric Data Values	2-18
Changing A Text Value	2-17
Changing Data	2-17
Changing Parameter Data	2-10
Clock Fault 0-79	3-17
Clock Settings, 0-7*	3-16
Closed-loop Type 20-70	3-178, 3-183
Coast Inverse	2-12
Coasting	2-5
Coasting Select 8-50	3-96

Comm. Option Status 16-84	3-159
Communication Option	4-8
Comparator Operand 13-10	3-123
Comparator Operator 13-11	3-123
Comparator Value 13-12	3-124
Configurable Status Word Stw 8-13	3-93
Configuration	3-93
Configuration Mode 1-00	3-18
Continuous Bin Data 23-61	3-224
Control Card Temp. 16-39	3-154
Control Profile 8-10	3-93
Control Site 8-01	3-91
Control Source 8-02	3-91
Control Timeout Function 8-04	3-92
Control Timeout Time 8-03	3-92
Control Word 16-00	3-151
Cooling	3-28
Cos Filter 1 10-20	3-115
Cos Filter 2 10-21	3-115
Cos Filter 3 10-22	3-115
Cos Filter 4 10-23	3-115
Cost Savings 23-84	3-227
Counter A 16-72	3-158
Counter B 16-73	3-158
Current Lim Cont, Proportional Gain 14-30	3-140
Current Lim Contr, Integration Time 14-31	3-140
Current Limit 4-18	3-42
Current Limit Control	3-140
Custom Readout 16-09	3-152
Custom Readout Max Value 0-32	3-13
Custom Readout Min Value 0-31	3-13
Custom Readout Unit 0-30	3-11

D

Data Log Settings	3-144
Date And Time Readout 0-89	3-18
Date Format 0-71	3-16
Dc Brake Current 2-01	3-30
[Dc Brake Cut-in Speed Rpm] 2-03	3-31
Dc Brake Select 8-52	3-96
Dc Braking Time 2-02	3-30
Dc Hold/preheat Current 2-00	3-30
Dc Link	4-7
Dc Link Voltage 16-30	3-153
Default Settings	5-1
Default Settings	2-19
Defined Parameters 15-92	3-151
Defined Parameters (1) 9-80	3-108
Defined Parameters (2) 9-81	3-109
Defined Parameters (3) 9-82	3-109
Defined Parameters (4) 9-83	3-109
Destage At No-flow 25-26	3-240
Destage Function 25-29	3-241
Destage Function Time 25-30	3-241
[De-staging Speed Hz] 25-47	3-244
[De-staging Speed Rpm] 25-46	3-244
De-staging Threshold 25-43	3-243
Devicenet	3-111
Devicenet And Can Serial Communication Bus	3-110
Devicenet F Parameters 10-39	3-116
Devicenet Revision 10-32	3-116
Diagnosis Trigger 8-07	3-93
Digi Pot Reference 16-53	3-155

Digital & Relay Bus Control 5-90	3-79
Digital I/o Mode 5-00	3-47
Digital Input 16-60	3-156
Digital Inputs, 5-1* Continued	3-48
[Digital Output Bin] 16-66	3-157
Display Line 1.1 Small 0-20	3-7
Display Line 1.3 Small, 0-22	3-10
Display Line 2 Large, 0-23	3-10
Display Text 1 0-37	3-13
Display Text 2 0-38	3-13
Display Text 3 0-39	3-13
Drive Bypass	3-233
Drive Identification	3-149
Drive Information	3-143
Drive Profile 11-10	3-117
Dry Pump Delay 22-27	3-199
Dry Pump Function 22-26	3-199
Dst/summertime 0-74	3-17
Dst/summertime End 0-77	3-17
Dst/summertime Start 0-76	3-17

E

Electronic Thermal Overload	3-153
End Of Curve	3-205
End Of Curve Delay 22-51	3-205
End Of Curve Function 22-50	3-205
End-of-timeout Function 8-05	3-92
Energy Cost 23-81	3-227
Energy Log	3-219, 3-221
Energy Log Resolution 23-50	3-220
Energy Optimization	3-140
Energy Savings 23-83	3-227
Environment	3-141
Etr	3-153, 4-7
Example Of Changing Parameter Data	2-10
Ext. 1 Dif. Gain Limit 21-24	3-188
Ext. 1 Differentiation Time 21-23	3-188
Ext. 1 Feedback Source 21-14	3-187
[Ext. 1 Feedback Unit] 21-18	3-187
Ext. 1 Integral Time 21-22	3-188
Ext. 1 Maximum Reference 21-12	3-186
Ext. 1 Minimum Reference 21-11	3-185
Ext. 1 Normal/inverse Control 21-20	3-187
[Ext. 1 Output %] 21-19	3-187
Ext. 1 Proportional Gain 21-21	3-188
Ext. 1 Ref./feedback Unit 21-10	3-184
Ext. 1 Reference Source 21-13	3-186
[Ext. 1 Reference Unit] 21-17	3-187
Ext. 1 Setpoint 21-15	3-187
Ext. 2 Dif. Gain Limit 21-44	3-192
Ext. 2 Differentiation Time 21-43	3-192
Ext. 2 Feedback Source 21-34	3-191
[Ext. 2 Feedback Unit] 21-38	3-191
Ext. 2 Integral Time 21-42	3-192
Ext. 2 Maximum Reference 21-32	3-190
Ext. 2 Minimum Reference 21-31	3-190
Ext. 2 Normal/inverse Control 21-40	3-191
[Ext. 2 Output %] 21-39	3-191
Ext. 2 Proportional Gain 21-41	3-192
Ext. 2 Ref./feedback Unit 21-30	3-189
Ext. 2 Reference Source 21-33	3-190
[Ext. 2 Reference Unit] 21-37	3-191
Ext. 2 Setpoint 21-35	3-191

Ext. 3 Dif. Gain Limit 21-64	3-195
Ext. 3 Differentiation Time 21-63	3-195
Ext. 3 Feedback Source 21-54	3-194
[Ext. 3 Feedback Unit] 21-58	3-195
Ext. 3 Integral Time 21-62	3-195
Ext. 3 Maximum Reference 21-52	3-193
Ext. 3 Minimum Reference 21-51	3-193
Ext. 3 Normal/inverse Control 21-60	3-195
[Ext. 3 Output %] 21-59	3-195
Ext. 3 Proportional Gain 21-61	3-195
Ext. 3 Ref./feedback Unit 21-50	3-192
Ext. 3 Reference Source 21-53	3-194
[Ext. 3 Reference Unit] 21-57	3-194
Ext. 3 Setpoint 21-55	3-194
Ext. Status Word 16-94	3-159
Ext. Status Word 2 16-95	3-160
Extended CI Autotuning	3-182
Extended Status Word	4-6
Extended Status Word 2	4-6
External Interlock Delay 22-00	3-196
External Reference 16-50	3-154
F	
Fan Control 14-52	3-141
Fan Monitor 14-53	3-141
Fault Messages	4-7
Fc Port Ctw 1 16-85	3-159
Fc Port Ref 1 16-86	3-159
Fc Type 15-40	3-149
Feedback	3-165
Feedback & Setpoint	3-173
Feedback 1 Conversion 20-01	3-166
Feedback 1 Source 20-00	3-165
Feedback 1 Source Unit 20-02	3-166
[Feedback 1 Unit] 16-54	3-155
Feedback 2 Conversion 20-04	3-168
Feedback 2 Source 20-03	3-168
Feedback 2 Source Unit 20-05	3-168
[Feedback 2 Unit] 16-55	3-155
Feedback 3 Conversion 20-07	3-170
Feedback 3 Source 20-06	3-170
Feedback 3 Source Unit 20-08	3-170
[Feedback 3 Unit] 16-56	3-155
Feedback Adv. Conversion	3-176
Feedback Function 20-20	3-173
[Feedback Unit] 16-52	3-154
Fieldbus Ctw 1 16-80	3-158
Fieldbus Ref 1 16-82	3-159
Fire Mode	3-228
Fire Mode Alarm Handling 24-09	3-232
Fire Mode Configuration 24-01	3-229
Fire Mode Feedback Source 24-07	3-232
Fire Mode Function 24-00	3-229
Fire Mode Live Zero Timeout Function 6-02	3-81
Fire Mode Log: Date And Time 18-12	3-163
Fire Mode Log: Event 18-10	3-163
Fire Mode Log: Time 18-11	3-163
Fire Mode Max Reference 24-04	3-231
Fire Mode Min Reference 24-03	3-231
Fire Mode Preset Reference 24-05	3-231
Fire Mode Reference Source 24-06	3-232
Fire Mode Unit 24-02	3-230
Fixed Lead Pump 25-05	3-237

Fixed Speed Bandwidth 25-22	3-239
Flow At Design Point 22-89	3-211
Flow At Rated Speed 22-90	3-211
Flow Compensation	3-207, 3-208
Flying Start 1-73	3-26
Frequency 16-13	3-152
[Frequency %] 16-15	3-152
Function At Inverter Overload 14-61	3-142
Function At Mains Imbalance 14-12	3-137
Function At Overtemperature 14-60	3-141
Function At Stop 1-80	3-26
Function Relay 5-40	3-72
Function Set-ups	2-13

G

General Settings, 1-0*	3-18
Graphical Display	2-1

H

[Hand On] Key On Lcp 0-40	3-14
Heatsink Temp. 16-34	3-153
[High Speed Hz] 22-37	3-201
High Speed Load Compensation 1-61	3-25
[High Speed Power Hp] 22-39	3-201
[High Speed Power Kw] 22-38	3-201
[High Speed Rpm] 22-36	3-200
Historic Log	3-147
Historic Log: Event 15-20	3-147
Historic Log: Time 15-22	3-148
Historic Log: Value 15-21	3-148
How To Operate The Graphical (glcp)	2-1

I

Indicator Lights	2-3
Initialization	2-19
Initialization Password 8-75	3-99
Intermediate Circuit	4-7
Interval Between Starts 22-76	3-206
Inv. Max. Current 16-37	3-154
Inv. Nom. Current 16-36	3-154
Inv. Overload Derate Current 14-62	3-143
Inverter Thermal 16-35	3-154
Investment 23-82	3-227
Iron Loss Resistance (rfe) 1-36	3-23

J

Jog Ramp Time 3-80	3-38
[Jog Speed Hz] 3-11	3-34
[Jog Speed Rpm] 3-19	3-37

K

Keypad, 0-4*	3-14
Kty Sensor	4-7
Kwh Counter 15-02	3-143

L

Language 0-01	3-2
Language Package 1	3-2
Language Package 2	3-2

Lcp 102	2-1
Lcp Copy 0-50	3-15
Lcp Id Num. 15-48	3-149
Lead Pump 25-82	3-248
Lead Pump Alternation 25-50	3-245
Leds	2-1
Line Failure 14-10	3-135
Line Power On/off	3-135
Line Voltage At Line Fault 14-11	3-136
Live Zero Timeout Function 6-01	3-81
Live Zero Timeout Time 6-00	3-80
Local Mode Unit 0-05	3-4
Local Reference	3-3
Logging Buffer Full 16-40	3-154
Logging Interval 15-11	3-145
Logging Mode 15-13	3-147
Logging Source 15-10	3-144
Loggings	2-11
Logic Rule Boolean 1 13-40	3-124
Logic Rule Boolean 2 13-42	3-127
Logic Rule Boolean 3 13-44	3-129
Logic Rule Operator 1 13-41	3-126
Logic Rule Operator 2 13-43	3-128
Lon Warning Word 11-15	3-117
Lonworks	3-117
Lonworks Revision 11-18	3-117
Low Power Auto Set-up 22-20	3-198
Low Power Detection 22-21	3-198
Low Speed Detection 22-22	3-198
[Low Speed Hz] 22-33	3-200
Low Speed Load Compensation 1-60	3-24
[Low Speed Power Hp] 22-35	3-200
[Low Speed Power Kw] 22-34	3-200
[Low Speed Rpm] 22-32	3-200
 M	
Mac Id 10-02	3-110
[Main Actual Value %] 16-05	3-152
Main Menu - Adjustable Frequency Drive Information - Group 15	3-143
Main Menu Mode	2-4, 2-10
Main Menu Mode	2-16
Main Menu Password 0-60	3-15
Main Menu Structure	3-1
Main Reactance	3-21
Main Reactance (Xh) 1-35	3-22
Maintenance Action 23-11	3-217
Maintenance Date And Time 23-14	3-218
Maintenance Item 23-10	3-216
Maintenance Log: Action 18-01	3-162
Maintenance Log: Date And Time 18-03	3-162
Maintenance Log: Item 18-00	3-162
Maintenance Log: Time 18-02	3-162
Maintenance Text 23-16	3-219
Maintenance Time Base 23-12	3-218
Maintenance Time Interval 23-13	3-218
Maintenance Word 16-96	3-160
Manual Alternation 25-91	3-249
Manual Initialization	2-19
Max Inter-char Delay 8-37	3-95
Max Output Frequency 4-19	3-42
Max Response Delay 8-36	3-95
Maximum Boost Time 22-46	3-205
Maximum Feedback Level 20-74	3-179, 3-183

Maximum Limit 3-93	3-39
Maximum Reference 3-03	3-33
Maximum Reference/feedb. 20-14	3-173
[Min Speed For Function At Stop Hz] 1-82	3-26
[Min Speed For Function At Stop Rpm] 1-81	3-26
[Min Speed Normal Magnetizing Hz] 1-52	3-24
[Min Speed Normal Magnetizing Rpm] 1-51	3-24
Minimum Ae0 Frequency 14-42	3-140
Minimum Bin Value 23-65	3-225
Minimum Feedback Level 20-73	3-179, 3-183
Minimum Limit 3-94	3-39
Minimum Reference 3-02	3-33
Minimum Reference/feedb. 20-13	3-173
Minimum Response Delay 8-35	3-95
Minimum Run Time 22-40	3-204, 3-207
Minimum Sleep Time 22-41	3-204
Missing Motor Phase Function 4-58	3-44
Modified Parameters 15-93	3-151
Motor Cos-phi 14-43	3-140
Motor Current 1-24	3-20, 3-152
Motor External Fan 1-91	3-29
Motor Frequency 1-23	3-20
Motor Magnetization At Zero Speed 1-50	3-24
Motor Nominal Speed 1-25	3-20
Motor Poles 1-39	3-23
[Motor Power Hp] 1-21	3-20
[Motor Power Kw] 1-20	3-19
Motor Protection	3-28
Motor Rotation Check 1-28	3-21
Motor Speed Direction 4-10	3-40
[Motor Speed High Limit Hz] 4-14	3-41
[Motor Speed High Limit Rpm] 4-13	3-41
[Motor Speed Low Limit Hz] 4-12	3-41
[Motor Speed Low Limit Rpm] 4-11	3-41
Motor Speed Unit 0-02	3-3
Motor Start 25-02	3-236
Motor Status	3-152
Motor Thermal 16-18	3-153
Motor Thermal Protection 1-90	3-28
Motor Voltage 16-12	3-152
Motor Voltage 1-22	3-20
Ms/tp Max Info Frames 8-73	3-99
Ms/tp Max Masters 8-72	3-99
My Personal Menu	2-10
N	
Net Control 10-15	3-115
Net Reference 10-14	3-114
Neuron Id 11-00	3-117
Nlcp	2-6
No Operation	2-12
No Trip At Inverter Overload	3-142
Node Address 9-18	3-103
No-flow Delay 22-24	3-199
No-flow Function 22-23	3-199
No-flow Power 22-30	3-200
Number Of Pumps 25-06	3-237
Number Of Starts 15-08	3-144
O	
Obw Time 25-25	3-240
Occurrence 23-04	3-215

Off Action 23-03	3-214
Off Delay, Relay 5-42	3-74
Off Time 23-02	3-214
[Off] Key On Lcp 0-41	3-14
On Action 23-01	3-212
On Delay, Relay 5-41	3-74
On Reference Bandwidth 20-84	3-180
On Time 23-00	3-212
Operating Hours 15-00	3-143
Operating Mode	3-3
Operating State At Power-up 0-04	3-3
Operation Mode 14-22	3-138
Option Ident.	3-150
Option Mounted 15-60	3-150
Option Ordering No 15-62	3-150
Option Serial No 15-63	3-150
Option Sw Version 15-61	3-150
Ordered Typecode String 15-44	3-149
Over Temps 15-04	3-143
Over Volts 15-05	3-143
Overmodulation 14-03	3-135
Override Bandwidth 25-21	3-238
Over-voltage Control 2-17	3-33

P

Parameter Access	3-115
Parameter Data	2-10
Parameter Edit 9-27	3-106
Parameter Info	3-151
Parameter Metadata 15-99	3-151
Parameter Options	5-1
Parameter Selection	2-17
Parameter Set-up	2-10
Parameters For Signals 9-23	3-104
Parity / Stop Bits 8-33	3-95
Pcd Read Configuration 9-16	3-102
Pcd Write Configuration 9-15	3-101
Period Start 23-51	3-221
Personal Menu Password 0-65	3-16
Pid Anti Windup 20-91	3-180
Pid Auto Tuning 20-79	3-179, 3-184
Pid Autotuning	3-177
Pid Basic Settings	3-179
Pid Controller	3-180
Pid Diff. Gain Limit 20-96	3-181
Pid Differentiation Time 20-95	3-181
Pid Integral Time 20-94	3-181
Pid Normal/ Inverse Control 20-81	3-179
[Pid Output %] 16-58	3-155
Pid Output Change 20-72	3-178, 3-183
Pid Proportional Gain 20-93	3-180
[Pid Start Speed Hz] 20-83	3-180
[Pid Start Speed Rpm] 20-82	3-179
Power Card Ordering No. 15-47	3-149
Power Card Serial Number 15-53	3-150
Power Correction Factor 22-31	3-200
[Power Hp] 16-11	3-152
[Power Kw] 16-10	3-152
Power Reference Factor 23-80	3-226
Power Restore 3-92	3-39
Power Section 15-41	3-149
Power-ups 15-03	3-143
Preset Reference 3-10	3-34

Preset Reference Select 8-56	3-98
Preset Relative Reference 3-14	3-35
Pressure At No-flow Speed 22-87	3-211
Pressure At Rated Speed 22-88	3-211
Process Control 9-28	3-106
Process Data Config Read 10-12	3-112
Process Data Config Write 10-11	3-112
Process Data Type Selection 10-10	3-111
Profibus Save Data Values 9-71	3-108
Profibus Warning Word 9-53	3-107
Profibusdrivereset 9-72	3-108
Profile Number 9-65	3-107
Programming Set-up 0-11	3-5, 3-108
Protocol 8-30	3-94
Pulse Filter Time Constant #29 5-54	3-75
Pulse Filter Time Constant #33 5-59	3-76
[Pulse Input #29 Hz] 16-67	3-157
[Pulse Input #33 Hz] 16-68	3-157
Pulse Out #27 Bus Control 5-93	3-79
Pulse Out #27 Timeout Preset 5-94	3-79
Pulse Out #29 Bus Control 5-95	3-79
Pulse Out #29 Timeout Preset 5-96	3-80
Pulse Out #x30/6 Bus Control 5-97	3-80
Pulse Out #x30/6 Timeout Preset 5-98	3-80
[Pulse Output #27 Hz] 16-69	3-157
[Pulse Output #29 Hz] 16-70	3-157
Pulse Output Max Freq #27 5-62	3-77
Pulse Output Max Freq #29 5-65	3-78
Pulse Output Max Freq #x30/6 5-68	3-79
Pump Cycling 25-04	3-237
Pump Interlock 25-90	3-249
Pump On Time 25-84	3-248
Pump Status 25-81	3-248
Pwm Random 14-04	3-135

Q

Quick Menu	2-4
Quick Menu Mode	2-4, 2-10
Quick Menu Mode	2-10
Quick Transfer Of Parameter Settings Between Multiple Adjustable Frequency Drives	2-9

R

Ramp 1 Ramp-down Time 3-42	3-37
Ramp 1 Ramp-up Time 3-41	3-37
Ramp 2 Ramp-down Time 3-52	3-38
Ramp 2 Ramp-up Time 3-51	3-38
Ramp Delay 3-95	3-39
Ramp Time 3-91	3-39
Ramp-down Delay 25-40	3-242
Ramp-up Delay 25-41	3-242
Readout And Programming Of Indexed Parameters	2-18
Readout Bus Off Counter 10-07	3-111
Readout Receive Error Counter 10-06	3-111
Readout Transmit Error Counter 10-05	3-111
Readout: Linked Set-ups 0-13	3-6
Readout: Prog. Set-ups / Channel 0-14	3-6
Reference % 16-02	3-151
Reference 1 Source 3-15	3-35
Reference 2 Source 3-16	3-36
Reference 3 Source 3-17	3-36
Reference Function 3-04	3-33
Reference Site 3-13	3-34

[Reference Unit] 16-01	3-151
Reference/feedback Unit 20-12	3-171
Refrigerant 20-30	3-177
Regional Settings 0-03	3-3
Relay On Time 25-85	3-249
[Relay Output Bin] 16-71	3-158
Relay Outputs	3-61
Relay Status 25-83	3-248
Reset Continuous Bin Data 23-66	3-225
Reset Control Timeout 8-06	3-93
Reset Energy Log 23-54	3-222
Reset Kwh Counter 15-06	3-144
Reset Maintenance Word 23-15	3-219
Reset Mode 14-20	3-137
Reset Relay Counters 25-86	3-249
Reset Running Hours Counter 15-07	3-144
Reset Slc 13-03	3-122
Reset Timed Bin Data 23-67	3-225
[Reset] Key On Lcp 0-43	3-14
Resonance Dampening 1-64	3-25
Resonance Dampening Time Constant 1-65	3-25
Reverse Select 8-54	3-97
Rfi 1 14-50	3-141
Run Next Pump Delay 25-58	3-247
Running Hours 15-01	3-143
Run-on Line Delay 25-59	3-248

S

Samples Before Trigger 15-14	3-147
Sbw De-staging Delay 25-24	3-240
Sbw Staging Delay 25-23	3-239
Semi-auto Bypass Set-up 4-64	3-46
Service Code 14-29	3-139
Set Date And Time 0-70	3-16
Setpoint 1 20-21	3-176
Setpoint 2 20-22	3-176
Setpoint 3 20-23	3-176
Setpoint Boost 22-45	3-205
Set-up Copy 0-51	3-15
Set-up Select 8-55	3-98
Short Cycle Protection	3-206
SI Controller Action 13-52	3-132
SI Controller Event 13-51	3-130
SI Controller Mode 13-00	3-119
SI Controller State 16-38	3-154
SI Controller Timer 13-20	3-124
Slave Error Count 8-83	3-100
Slave Message Count 8-82	3-100
Sleep Mode	3-201
Slip Compensation 1-62	3-25
Slip Compensation Time Constant 1-63	3-25
Software Version	1-1, 3-149
Special Functions	3-134
[Speed At Design Point Hz] 22-86	3-211
[Speed At Design Point Rpm] 22-85	3-211
[Speed At No-flow Hz] 22-84	3-210
[Speed At No-flow Rpm] 22-83	3-210
[Speed Rpm] 16-17	3-153
Square-linear Curve Approximation 22-81	3-208
Stage Function 25-27	3-241
Stage Function Time 25-28	3-241
Staging Bandwidth 25-20	3-238
Staging Mode At Alternation 25-56	3-247

[Staging Speed Hz] 25-45	3-244
[Staging Speed Rpm] 25-44	3-243
Staging Threshold 25-42	3-242
Start Delay 1-71	3-26
Start Event 13-01	3-119
Start Select 8-53	3-97
Stator Leakage Reactance	3-21
Stator Resistance (rs) 1-30	3-22
Status	2-4
Status Messages	2-1
Status Word 16-03	3-151
Step Size 3-90	3-39
Step-by-step	2-18
Stop Event 13-02	3-120
Store Always 10-33	3-116
Store Data Values 10-31	3-116, 3-118
Sw Id Control Card 15-49	3-149
Sw Id Power Card 15-50	3-150
Switching Frequency 14-01	3-134
Switching Pattern 14-00	3-134

T

Telegram Selection 8-40	3-96
Telegram Selection 9-22	3-104
Term. X30/6 Digi Out (mcb 101) 5-32	3-68
Term. X30/7 Digi Out (mcb 101) 5-33	3-70
Term. 29 High Frequency 5-51	3-75
Term. 29 High Ref./feedb. Value 5-53	3-75
Term. 29 Low Frequency 5-50	3-75
Term. 29 Low Ref./feedb. Value 5-52	3-75
Term. 33 High Frequency 5-56	3-76
Term. 33 High Ref./feedb. Value 5-58	3-76
Term. 33 Low Frequency 5-55	3-75
Term. 33 Low Ref./feedb. Value 5-57	3-76
Term. X30/11 Filter Time Constant 6-36	3-84
Term. X30/11 High Ref./feedb. Value 6-35	3-84
Term. X30/11 Live Zero 6-37	3-84
Term. X30/11 Low Ref./feedb. Value 6-34	3-84
Term. X30/12 Filter Time Constant 6-46	3-85
Term. X30/12 High Ref./feedb. Value 6-45	3-85
Term. X30/12 Live Zero 6-47	3-85
Term. X30/12 Low Ref./feedb. Value 6-44	3-85
Term. X42/1 Filter Time Constant 26-16	3-253
Term. X42/1 High Ref./feedb. Value 26-15	3-253
Term. X42/1 Live Zero 26-17	3-253
Term. X42/1 Low Ref./feedb. Value 26-14	3-253
Term. X42/3 Filter Time Constant 26-26	3-254
Term. X42/3 High Ref./feedb. Value 26-25	3-254
Term. X42/3 Live Zero 26-27	3-254
Term. X42/3 Low Ref./feedb. Value 26-24	3-253
Term. X42/5 Filter Time Constant 26-36	3-254
Term. X42/5 High Ref./feedb. Value 26-35	3-254
Term. X42/5 Live Zero 26-37	3-255
Term. X42/5 Low Ref./feedb. Value 26-34	3-254
Terminal 18 Digital Input 5-10	3-51
Terminal 19 Digital Input 5-11	3-52
Terminal 27 Digital Input 5-12	3-53
Terminal 27 Digital Output 5-30	3-64
Terminal 27 Mode 5-01	3-47
Terminal 27 Pulse Output Variable 5-60	3-77
Terminal 29 Digital Input 5-13	3-54
Terminal 29 Digital Output 5-31	3-66
Terminal 29 Mode 5-02	3-47

Terminal 29 Pulse Output Variable 5-63	3-78
Terminal 32 Digital Input 5-14	3-55
Terminal 33 Digital Input 5-15	3-56
Terminal 42 Output 6-50	3-86
Terminal 42 Output Bus Control 6-53	3-89
Terminal 42 Output Max Scale 6-52	3-87
Terminal 42 Output Min Scale 6-51	3-87
Terminal 42 Output Timeout Preset 6-54	3-89
Terminal 53 Filter Time Constant 6-16	3-82
Terminal 53 High Current 6-13	3-82
Terminal 53 High Ref./feedb. Value 6-15	3-82
Terminal 53 High Voltage 6-11	3-82
Terminal 53 Live Zero 6-17	3-82
Terminal 53 Low Current 6-12	3-82
Terminal 53 Low Ref./feedb. Value 6-14	3-82
Terminal 53 Low Voltage 6-10	3-82
Terminal 53 Switch Setting 16-61	3-156
Terminal 54 Filter Time Constant 6-26	3-83
Terminal 54 High Current 6-23	3-83
Terminal 54 High Ref./feedb. Value 6-25	3-83
Terminal 54 High Voltage 6-21	3-83
Terminal 54 Live Zero 6-27	3-84
Terminal 54 Low Current 6-22	3-83
Terminal 54 Low Ref./feedb. Value 6-24	3-83
Terminal 54 Low Voltage 6-20	3-83
Terminal 54 Switch Setting 16-63	3-157
Terminal X30/11 High Voltage 6-31	3-84
Terminal X30/11 Low Voltage 6-30	3-84
Terminal X30/12 High Voltage 6-41	3-85
Terminal X30/12 Low Voltage 6-40	3-85
Terminal X30/2 Digital Input 5-16	3-58
Terminal X30/3 Digital Input 5-17	3-59
Terminal X30/4 Digital Input 5-18	3-60
Terminal X30/6 Pulse Output Variable 5-66	3-78
Terminal X30/8 Max. Scale 6-62	3-90
Terminal X30/8 Min. Scale 6-61	3-90
Terminal X30/8 Output 6-60	3-89
Terminal X30/8 Output Bus Control 6-63	3-90
Terminal X30/8 Output Timeout Preset 6-64	3-90
Terminal X42/1 High Voltage 26-11	3-253
Terminal X42/1 Low Voltage 26-10	3-253
Terminal X42/1 Mode 26-00	3-252
Terminal X42/11 Max. Scale 26-62	3-258
Terminal X42/11 Min. Scale 26-61	3-258
Terminal X42/11 Output 26-60	3-257
Terminal X42/11 Output Bus Control 26-63	3-258
Terminal X42/11 Output Timeout Preset 26-64	3-258
Terminal X42/3 High Voltage 26-21	3-253
Terminal X42/3 Low Voltage 26-20	3-253
Terminal X42/3 Mode 26-01	3-252
Terminal X42/5 High Voltage 26-31	3-254
Terminal X42/5 Low Voltage 26-30	3-254
Terminal X42/5 Mode 26-02	3-252
Terminal X42/7 Max. Scale 26-42	3-255
Terminal X42/7 Min. Scale 26-41	3-255
Terminal X42/7 Output 26-40	3-255
Terminal X42/7 Output Bus Control 26-43	3-256
Terminal X42/7 Output Timeout Preset 26-44	3-256
Terminal X42/9 Max. Scale 26-52	3-257
Terminal X42/9 Min. Scale 26-51	3-256
Terminal X42/9 Output 26-50	3-256
Terminal X42/9 Output Bus Control 26-53	3-257
Terminal X42/9 Output Timeout Preset 26-54	3-257

Thermal Load	3-24, 3-153
Thermistor	3-28
Thermistor Source 1-93	3-29
This Set-up Linked To 0-12	3-5
Time Format 0-72	3-17
Timed Actions	3-212
Timed Bin Data 23-62	3-224
Timed Period Start 23-63	3-224
Timed Period Stop 23-64	3-225
[Torque %] 16-22	3-153
Torque Characteristics 1-03	3-19
Torque Limit Generator Mode 4-17	3-42
Torque Limit Motor Mode 4-16	3-42
[Torque Nm] 16-16	3-153
Trend Variable 23-60	3-223
Trending	3-222
Trigger Event 15-12	3-146
Trip At Motor Speed Low Limit	3-27
Trip Delay At Inverter Fault 14-26	3-139
Trip Delay At Torque Limit 14-25	3-139
Trip Reset	3-137
[Trip Speed Low Hz] 1-87	3-27
[Trip Speed Low Rpm] 1-86	3-27
Troubleshooting	4-1
Tuning Mode 20-71	3-178, 3-183

U

User-defined Refrigerant A1 20-31	3-177
User-defined Refrigerant A2 20-32	3-177
User-defined Refrigerant A3 20-33	3-177

V

Voltage 15-42	3-149
Vt Level 14-40	3-140

W

Wake-up Ref./fb Difference 22-44	3-204
[Wake-up Speed Hz] 22-43	3-204
[Wake-up Speed Rpm] 22-42	3-204
Warning Current High 4-51	3-43
Warning Current Low 4-50	3-43
Warning Feedback High 4-57	3-44
Warning Feedback Low 4-56	3-44
Warning Parameter 10-13	3-114
Warning Reference High 4-55	3-44
Warning Reference Low 4-54	3-44
Warning Speed High 4-53	3-44
Warning Speed Low 4-52	3-43
Warning Word	4-5
Warning Word 16-92	3-159
Warning Word 2 16-93	3-159, 4-5
Work Point Calculation 22-82	3-209
Working Days 0-81	3-17

X

Xif Revision 11-17	3-117
--------------------	-------