

Contents

1 How to Program	1-1
Local Control Panel	1-1
How to operate the Graphical LCP (GLCP)	1-1
Display Mode	1-7
Display Mode - Selection of Displayed Variables	1-7
How to operate the numeric LCP (NLCP)	1-8
Parameter Set-up	1-10
2 Parameter Description	2-1
Main Menu - Operation and Display - Group 0	2-2
Main Menu - Load and Motor - Group 1	2-17
Main Menu - Brakes - Group 2	2-28
Main Menu - Reference/Ramps - Group 3	2-31
Main Menu - Limits/Warnings - Group 4	2-40
Main Menu - Digital In/Out - Group 5	2-46
Main Menu - Analog In/Out - Group 6	2-79
Main Menu - Communications and Options - Group 8	2-89
Main Menu - Profibus - Group 9	2-97
Main Menu - CAN Serial Communication Bus - Group 10	2-106
Main Menu - Smart Logic - Group 13	2-112
Main Menu - Special Functions - Group 14	2-128
Main Menu - Adjustable Frequency Drive Information - Group 15	2-135
Main Menu - Data Readouts - Group 16	2-143
Main Menu - Data Readouts 2 - Group 18	2-153
Main Menu - FC Closed-loop - Group 20	2-155
Main Menu - Extended Closed-loop - Group 21	2-166
Main Menu - Application Functions - Group 22	2-179
Main Menu - Time-based Functions - Group 23	2-194
Main Menu - Cascade Controller - Group 25	2-209
Main Menu - Analog I/O Option MCB 109 - Group 26	2-223
Main menu – Water application – Group 29	2-231
Main Menu - Bypass Option - Group 31	2-233
3 Parameter Lists	3-1
Parameter Options	3-1
Default settings	3-1
0-** Operation/Display	3-2

1-** Load/Motor	3-4
2-** Brakes	3-5
3-** Reference / Ramps	3-6
4-** Limits / Warnings	3-7
5-** Digital In/Out	3-8
6-** Analog In/Out	3-10
8-** Comm. and Options	3-12
9-** Profibus	3-13
10-**CAN Ser. Com. Bus	3-14
13-** Smart Logic	3-15
14-** Special Functions	3-16
15-** FC Information	3-17
16-** Data Readouts	3-19
18-** Data Readouts 2	3-21
20-** FC Closed-loop	3-22
21-** Ext. Closed-loop	3-23
22-** Application Functions	3-25
23-** Timed Actions	3-27
25-** Cascade Controller	3-28
26-** Analog I/O Option MCB 109	3-30
Cascade CTL Option 27-**	3-31
29-** Water Application Functions	3-33
31-** Bypass Option	3-34
4 Index	4-1

1 How to Program

1

1.1 Local Control Panel

1.1.1 How to operate the Graphical LCP (GLCP)

The following instructions are valid for the GLCP (LCP 102).

The GLCP is divided into four functional groups:

1. Graphical display with status lines.
2. Menu keys and LEDs - for selecting mode, changing parameters and switching between display functions.
3. Navigation keys and indicator lights (LEDs).
4. Operation keys and LEDs.

Graphical display:

The LCD display is backlit with a total of 6 alpha-numeric lines. All data is displayed on the LCP, which can show up to five operating variables while in [Status] mode.

Display lines:

- a. **Status line:** Status messages displaying icons and graphics.
- b. **Line 1-2:** Operator data lines displaying data and variables defined or chosen by the user. By pressing the [Status] key, up to one extra line can be added.
- c. **Status line:** Status messages displaying text.

The display is divided into three sections:

Top section (a)

shows the status when in status mode, or up to two variables when not in status mode and in the case of an alarm/warning.

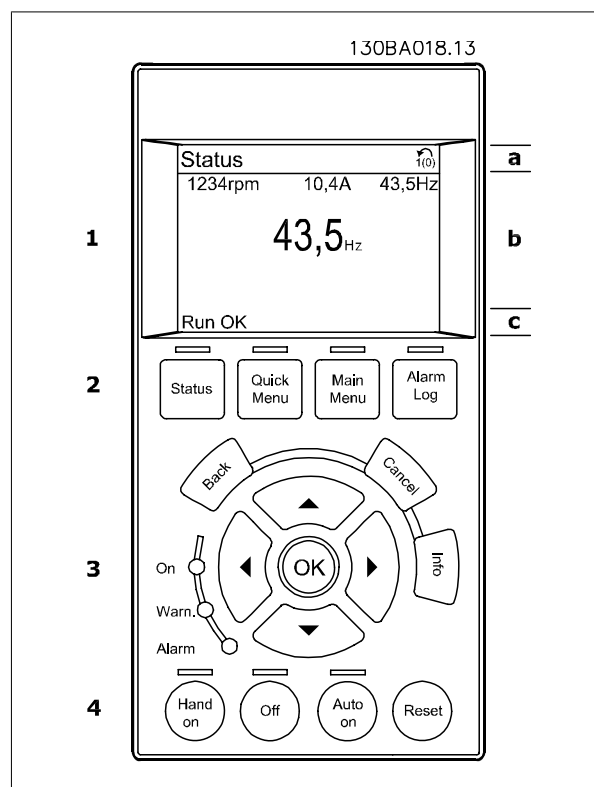

The number of the active set-up (selected as the active set-up in par. 0-10) is shown. When programming in a set-up other than the active set-up, the number of the set-up being programmed appears to the right in brackets.

1

Middle section (b)

shows up to 5 variables with related unit, regardless of status. In case of an alarm/warning, the warning is shown instead of the variables.

It is possible to toggle between three status readout displays by pressing the [Status] key.

Operating variables with different formatting are shown in each status screen - see below.

Several values or measurements can be linked to each of the displayed operating variables. The values/measurements to be displayed can be defined via par. 0-20, 0-21, 0-22, 0-23, and 0-24, which can be accessed via [QUICK MENU], "Q3 Function Set-ups", "Q3-1 General Settings", "Q3-11 Display Settings".

Each value/measurement readout parameter selected in par. 0-20 to par. 0-24 has its own scale and number of digits after a possible decimal point. Larger numeric values are displayed with few digits after the decimal point.

Ex.: Current readout
5.25 A; 15.2 A 105 A.

Status display I

This readout state is standard after start-up or initialization.

Use [INFO] to obtain information about the value/measurement linked to the displayed operating variables (1.1, 1.2, 1.3, 2 and 3).

See the operating variables shown in the display in this illustration. 1.1, 1.2 and 1.3 are shown in small size, while 2 and 3 are shown in medium size.

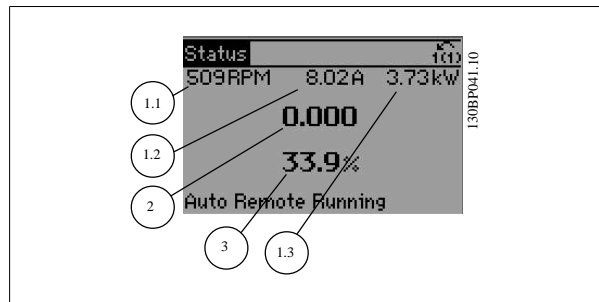

Status display II

See the operating variables (1.1, 1.2, 1.3 and 2) shown in the display in this illustration.

In the example, Speed, Motor current, Motor power and Frequency are selected as variables in the first and second lines.

1.1, 1.2 and 1.3 are shown in small size, while 2 is shown in large size.

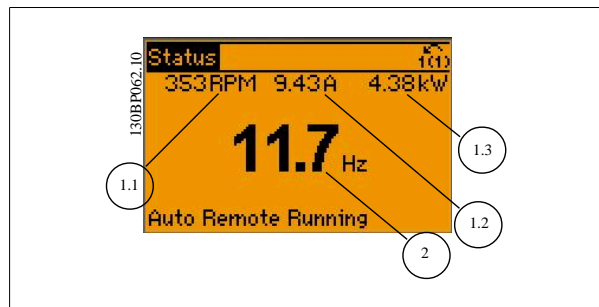

Status display III:

This state displays the event and action of the smart logic control. For further information, see the section *Smart Logic Control*.

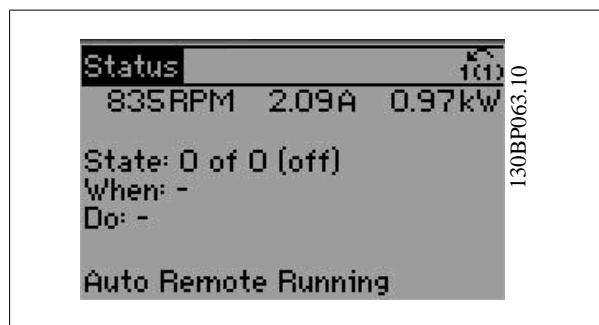

Bottom section

always shows the state of the adjustable frequency drive in status mode.

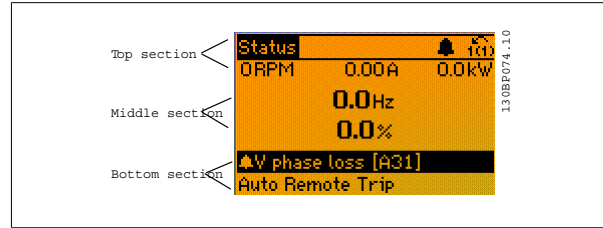

Display Contrast Adjustment

Press [status] and [▲] for darker display.

Press [status] and [▼] for brighter display.

LEDs:

If certain threshold values are exceeded, the alarm and/or warning LED lights up. A status and alarm text appears on the control panel.

The On LED is activated when the adjustable frequency drive receives power from AC line voltage, a DC bus terminal or an external 24 V supply. At the same time, the back light is on.

- Green LED/On: Control section is working.
- Yellow LED/Warn.: Indicates a warning.
- Flashing Red LED/Alarm: Indicates an alarm.

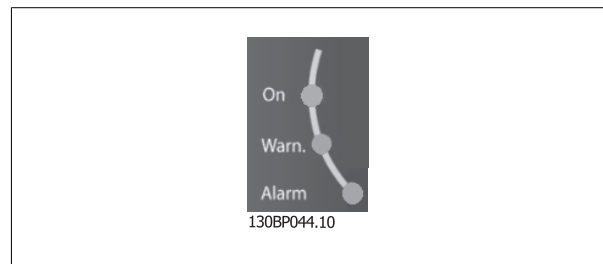

GLCP keys

Menu keys

The menu keys are divided into functions. The keys below the display and LEDs are used for parameter set-up, including display indication selection during normal operation.

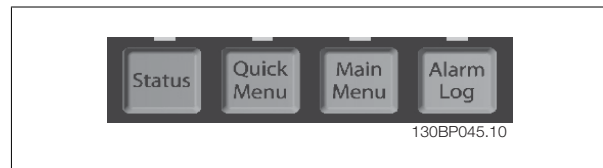

[Status]

Indicates the status of the adjustable frequency drive and/or the motor. Three different readouts can be chosen by pressing the [Status] key:

5-line readouts, 4-line readouts or smart logic control.

Use [Status] for selecting the mode of display or for changing back to display mode from either the quick menu mode, main menu mode or alarm mode.

The [Status] key can also be used to toggle between single and double readout modes.

[Quick Menu]

Allows quick set-up of the adjustable frequency drive. **The most common functions can be programmed here.**

The [Quick Menu] consists of:

- Q1: My Personal Menu
- Q2: Quick Set-up
- Q3: Function Set-ups
- Q5: Changes Made
- Q6: Loggings

The function set-up provides quick and easy access to all parameters required for the majority of water and wastewater applications including variable torque, constant torque, pumps, dosing pumps, well pumps, booster pumps, mixer pumps, aeration blowers and other pump and fan applications. Among other features, it also includes parameters for selecting which variables to display on the LCP, digital preset speeds, scaling of analog references, closed-loop single zone and multi-zone applications and specific functions related to water and wastewater applications.

The quick menu parameters can be accessed immediately, unless a password has been created via par. 0-60, 0-61, 0-65 or 0-66.

It is possible to switch directly between Quick Menu mode and Main Menu mode.

[Main Menu]

is used for programming all parameters.

The main menu parameters can be accessed immediately unless a password has been created via par. 0-60, 0-61, 0-65 or 0-66. For the majority of water and wastewater applications it is not necessary to access the main menu parameters, but instead the quick menu, quick set-up and function set-ups provide the simplest and quickest access to the typical required parameters.

It is possible to switch directly between Main Menu mode and Quick Menu mode.

Parameter shortcut can be carried out by pressing down the [Main Menu] key for 3 seconds. The parameter shortcut allows direct access to any parameter.

[Alarm Log]

displays an Alarm list of the last five alarms (numbered A1-A5). For additional details on a particular alarm, use the arrow keys to navigate to the alarm number and press [OK]. Information is displayed about the condition of the adjustable frequency drive before it enters alarm mode.

[Back]

reverts to the previous step or layer in the navigation structure.

[Cancel]

the last change or command will be canceled as long as the display has not been changed.

[Info]

displays information about a command, parameter or function in any display window. [Info] provides detailed information when needed.

Exit Info mode by pressing either [Info], [Back] or [Cancel].

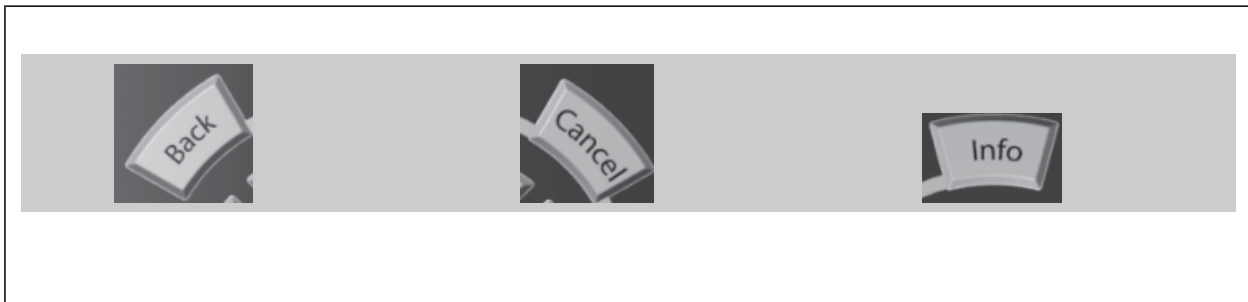

Navigation Keys

The four navigation arrows are used to navigate between the different choices available in [Quick Menu], [Main Menu] and [Alarm Log]. Use the keys to move the cursor.

[OK]

is used for choosing a parameter marked by the cursor and for enabling the change of a parameter.



Operation Keys

for local control are found at the bottom of the control panel.



[Hand On]

enables control of the adjustable frequency drive via the GLCP. [Hand on] also starts the motor, and makes it possible to give the motor speed reference using the arrow keys. The key can be *Enabled* [1] or *Disabled* [0] via par. 0-40 [Hand on] Key on LCP.

The following control signals will still be active when [Hand on] is activated:

- [Hand on] - [Off] - [Auto on]
- Reset
- Coasting stop inverse (motor coasting to stop)
- Reversing
- Set-up select lsb - Set-up select msb
- Stop command from serial communication
- Quick stop
- DC brake

**NOTE!**

External stop signals activated by using control signals or a serial bus will override a "start" command via the LCP.

[Off]

stops the connected motor. The key can be *Enabled* [1] or *Disabled* [0] via par. 0-41 [Off] key on LCP. If no external stop function is selected and the [Off] key is inactive, the motor can only be stopped by disconnecting the line power supply.

[Auto On]

enables the adjustable frequency drive to be controlled via the control terminals and/or serial communication. When a start signal is applied to the control terminals and/or the bus, the adjustable frequency drive will start. The key can be *Enabled* [1] or *Disabled* [0] via par. 0-42 [Auto on] key on LCP.

**NOTE!**

An active HAND-OFF-AUTO signal via the digital inputs has higher priority than the control keys [Hand on] – [Auto on].

[Reset]

is used for resetting the adjustable frequency drive after an alarm (trip). The key can be *Enabled* [1] or *Disabled* [0] via par. 0-43 Reset Keys on LCP.

The parameter shortcut

can be carried out by holding down the [Main Menu] key for 3 seconds. The parameter shortcut allows direct access to any parameter.

1

1.1.2 Quick Transfer of Parameter Settings between Multiple Adjustable Frequency Drives

Once the set-up of an adjustable frequency drive is complete, we recommend that you store the data in the LCP or on a PC via MCT 10 Set-up Software Tool.

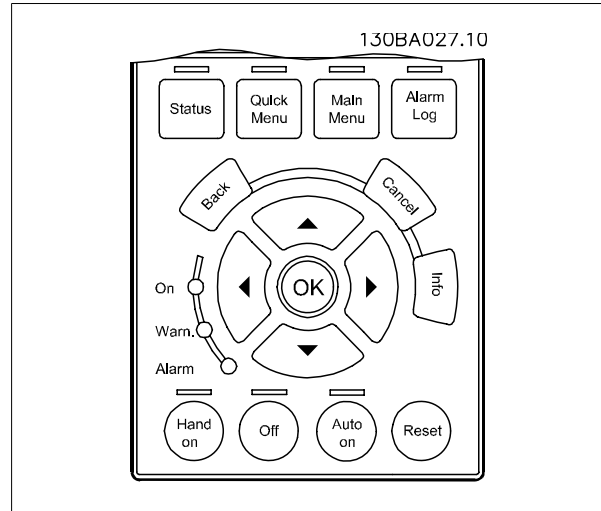

Data storage in LCP:

1. Go to par.0-50 *LCP Copy*
2. Press the [OK] key.
3. Select "All to LCP"
4. Press the [OK] key.

All parameter settings are now stored in the LCP indicated by the progress bar. When 100% is reached, press [OK].



NOTE!

Stop the motor before performing this operation.

You can now connect the LCP to another adjustable frequency drive and copy the parameter settings to this adjustable frequency drive as well.

Data transfer from the LCP to the adjustable frequency drive:

1. Go to par.0-50 *LCP Copy*
2. Press the [OK] key.
3. Select "All from LCP"
4. Press the [OK] key.

The parameter settings stored in the LCP are now transferred to the adjustable frequency drive indicated by the progress bar. When 100% is reached, press [OK].



NOTE!

Stop the motor before performing this operation.

1.1.3 Display Mode

In normal operation, up to 5 different operating variables can be indicated continuously in the middle section: 1.1, 1.2, and 1.3 as well as 2 and 3.

1.1.4 Display Mode - Selection of Displayed Variables

It is possible to toggle between three status readout screens by pressing the [Status] key. Operating variables with different formatting are shown in each status screen - see below.

Several measurements can be linked to each of the operating variables. Define the links via par. 0-20, 0-21, 0-22, 0-23 and 0-24.

Each readout parameter selected in par. 0-20 to par. 0-24 has its own scale and digits after a possible decimal point. The larger the numeric value for a parameter, the fewer digits displayed after the decimal point.

Ex.: Current readout below: 5.25 A; 15.2 A 105 A.

Status screen I

This readout state is standard after start-up or initialization. Use [INFO] to obtain information about the measurement links to the displayed operating variables (1.1, 1.2, 1.3, 2, and 3). See the operating variables shown in the screen in this illustration. 1.1, 1.2 and 1.3 are shown in small size, while 2 and 3 are shown in medium size.

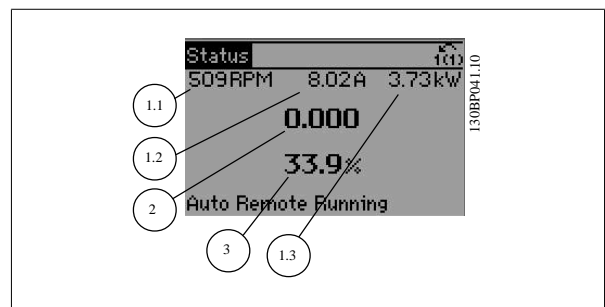

Status screen II:

See the operating variables (1.1, 1.2, 1.3, and 2) shown in the screen in this illustration. In the example, Speed, Motor current, Motor power and Frequency are selected as variables in the first and second. 1.1, 1.2 and 1.3 are shown in small size, while 2 is shown in large size.

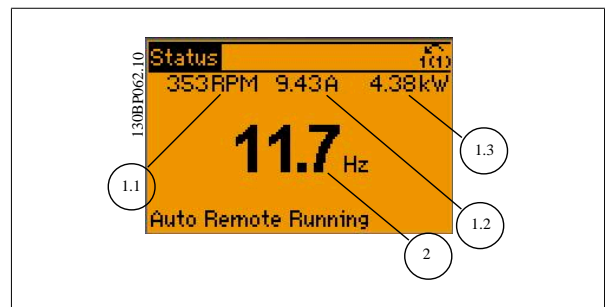

In both status screen I and II, it is possible to select other operating variables by pressing ▲ or ▼ .

Status screen III:

This state displays the event and action of the smart logic control. For further information, see the section *Smart Logic Control*.

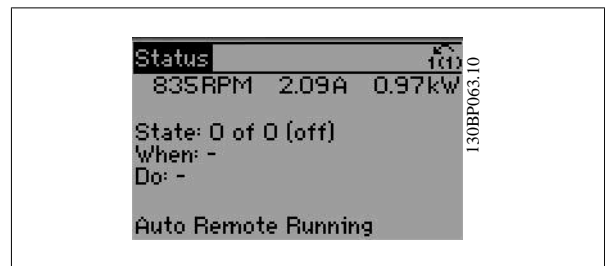

1.1.5 How to operate the numeric LCP (NLCP)

The following instructions are valid for the NLCP (LCP 101).

The control panel is divided into four functional groups:

1. Numeric display.
2. Menu key and LEDs - changing parameters and switching between display functions.
3. Navigation keys and LEDs.
4. Operation keys and LEDs.



NOTE!

Parameter copy is not possible with the Numeric Local Control Panel (LCP101).

Select one of the following modes:

Status Mode: Displays the status of the adjustable frequency drive or the motor.

If an alarm occurs, the NLCP automatically switches to status mode.

A number of alarms can be displayed.

Quick Set-up or Main Menu Mode: Display parameters and parameter settings.

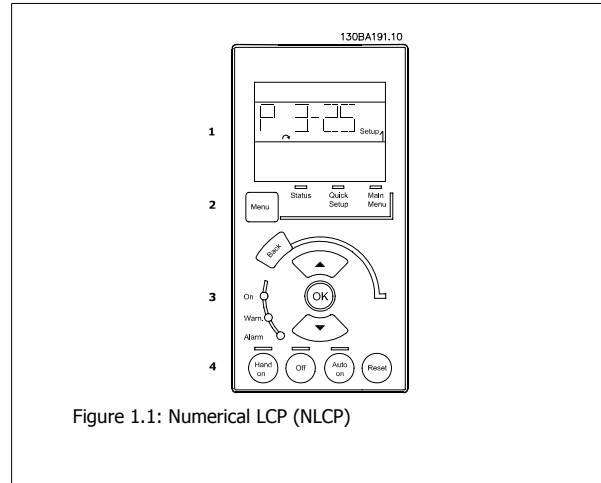

Figure 1.1: Numerical LCP (NLCP)

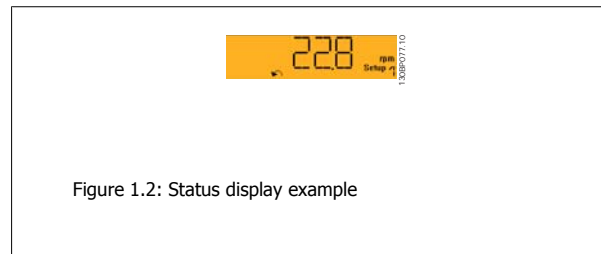

Figure 1.2: Status display example

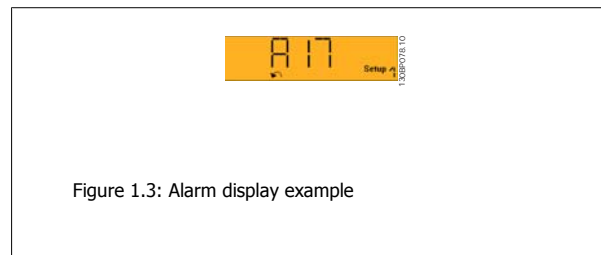

Figure 1.3: Alarm display example

LEDs:

- Green LED/On: Indicates whether control section is on.
- Yellow LED/Wrn.: Indicates a warning.
- Flashing red LED/Alarm: Indicates an alarm.

Menu key

[Menu] Select one of the following modes:

- Status
- Quick Set-up
- Main Menu

Main Menu

is used for programming all parameters.

The parameters can be accessed immediately unless a password has been created via par.0-60 *Main Menu Password*, par.0-61 *Access to Main Menu w/o Password*, par.0-65 *Personal Menu Password* or par.0-66 *Access to Personal Menu w/o Password*.

Quick Set-up is used to set up the adjustable frequency drive using only the most essential parameters.

The parameter values can be changed using the up/down arrows when the value is flashing.

Select the main menu by pressing the [Menu] key a number of times until the main menu LED is lit.

Select the parameter group [xx-__] and press [OK].

Select the parameter [_-xx] and press [OK].
 If the parameter is an array parameter, select the array number and press [OK].
 Select the desired data value and press [OK].

Navigation Keys

[Back]

for stepping backwards

Arrow [▲] [▼]

keys are used for navigating between parameter groups, parameters and within parameters.

[OK]

is used for choosing a parameter marked by the cursor and for enabling the change of a parameter.

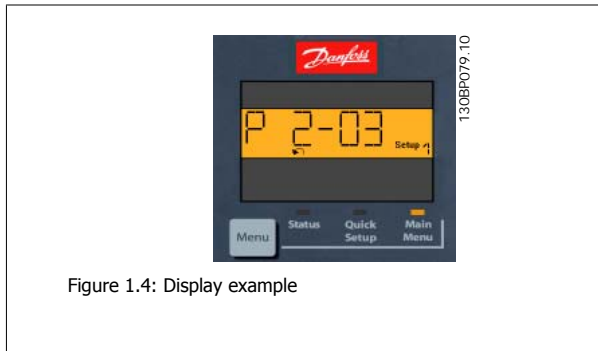

Figure 1.4: Display example

Operation Keys

Keys for local control are found at the bottom of the control panel.

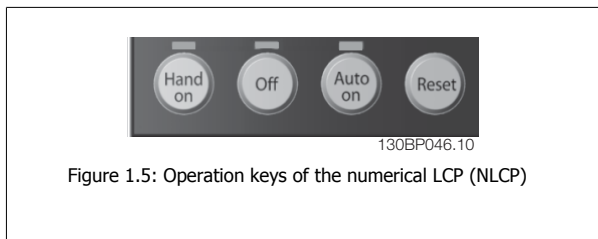

Figure 1.5: Operation keys of the numerical LCP (NLCP)

[Hand on]

enables control of the adjustable frequency drive via the LCP. [Hand on] also starts the motor and makes it possible to enter the motor speed data by means of the arrow keys. The key can be *Enabled* [1] or *Disabled* [0] via par.0-40 [Hand on] Key on LCP.

External stop signals activated by means of control signals or a serial bus will override a 'start' command via the LCP.

The following control signals will still be active when [Hand on] is activated:

- [Hand on] - [Off] - [Auto on]
- Reset
- Coasting stop inverse
- Reversing
- Set-up select lsb - Set-up select msb
- Stop command from serial communication
- Quick stop
- DC brake

[Off]

stops the connected motor. The key can be *Enabled* [1] or *Disabled* [0] via par.0-41 [Off] Key on LCP.

If no external stop function is selected and the [Off] key is inactive, the motor can be stopped by disconnecting the line power supply.

[Auto on]

enables the adjustable frequency drive to be controlled via the control terminals and/or serial communication. When a start signal is applied to the control terminals and/or the bus, the adjustable frequency drive will start. The key can be *Enabled* [1] or *Disabled* [0] via par.0-42 [Auto on] Key on LCP.

NOTE!
 An active HAND-OFF-AUTO signal via the digital inputs has higher priority than the control keys [Hand on] [Auto on].

[Reset]

is used for resetting the adjustable frequency drive after an alarm (trip). The key can be *Enabled* [1] or *Disabled* [0] via par.0-43 *[Reset] Key on LCP*.

1.1.6 Parameter Set-up

The adjustable frequency drive can be used for a wide range of assignments, and thus offers a significant number of parameters. The series offers a choice between two programming modes - a Quick Menu mode and a Main Menu mode.

The latter provides access to all parameters. The former takes the user through a few parameters making it possible to **program the majority of water/ wastewater applications**.

Regardless of the mode of programming, you can change a parameter both in quick menu mode and in main menu mode.

1.1.7 Quick Menu Mode

The GLCP provides access to all parameters listed under the quick menus. To set parameters using the **[Quick Menu]** button:

Pressing **[Quick Menu]** the list indicates the different areas contained in the quick menu.

Efficient Parameter Set-up for Water Applications

The parameters can easily be set up for the vast majority of the water and wastewater applications only by using the **[Quick Menu]**.

The best way to set parameters using the [Quick Menu] is by following the steps below:

1. Press **[Quick Set-up]** for selecting basic motor settings, ramp times, etc.
2. Press **[Function Set-ups]** for setting up the required functionality of the adjustable frequency drive - if not already covered by the settings in **[Quick Set-up]**.
3. Choose between *General Settings*, *Open-loop Settings* and *Closed-loop Settings*.

It is recommended to do the set-up in the order listed.

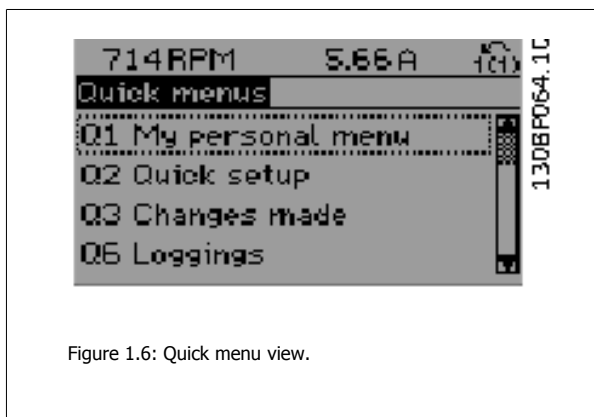

Figure 1.6: Quick menu view.

Par.	Designation	[Units]
0-01	Language	
1-20	Motor Power	[kW]
1-22	Motor Voltage	[V]
1-23	Motor Frequency	[Hz]
1-24	Motor Current	[A]
1-25	Motor Nominal Speed	[RPM]
3-41	Ramp 1 Ramp-up Time	[s]
3-42	Ramp 1 Ramp-down Time	[s]
4-11	Motor Speed Low Limit	[RPM]
4-13	Motor Speed High Limit	[RPM]
1-29	Automatic Motor Adaptation (AMA)	

Table 1.1: Quick Set-up parameters

If *No Operation* is selected in terminal 27, no connection to +24 V on terminal 27 is necessary to enable start.

If *Coast Inverse* (factory default value) is selected in Terminal 27, a connection to +24 V is necessary to enable start.

NOTE!

For detailed parameter descriptions, please see the following section on *Commonly Used Parameters - Explanations*.

1.1.8 Q3 Function Set-ups

The function set-up provides quick and easy access to all parameters required for the majority of water and wastewater applications including variable torque, constant torque, pumps, dosing pumps, well pumps, booster pumps, mixer pumps, aeration blowers and other pump and fan applications. Among other features, it also includes parameters for selecting which variables to display on the LCP, digital preset speeds, scaling of analog references, closed-loop single zone and multi-zone applications and specific functions related to water and wastewater applications.

Example of how to access Function Set-up:

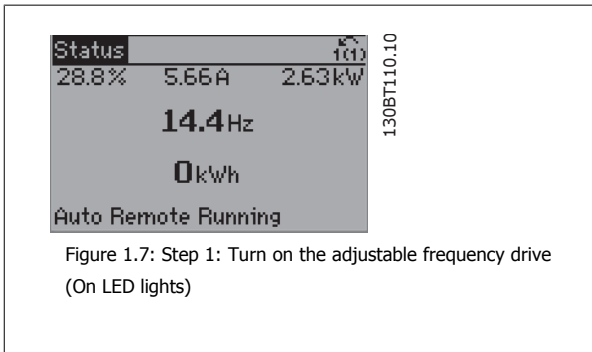

Figure 1.7: Step 1: Turn on the adjustable frequency drive (On LED lights)

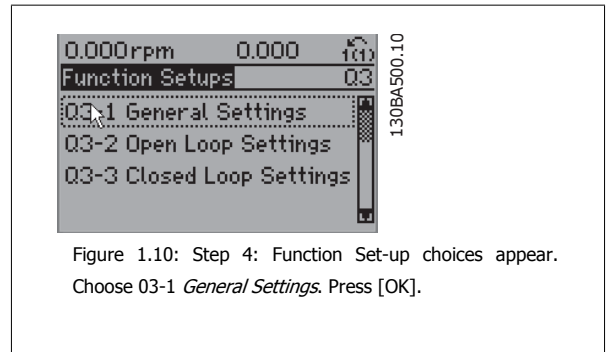

Figure 1.10: Step 4: Function Set-up choices appear. Choose Q3-1 *General Settings*. Press [OK].

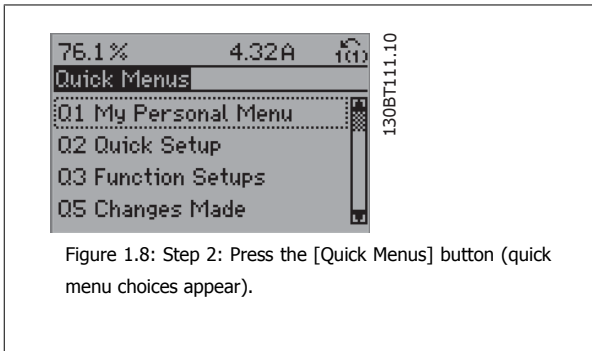

Figure 1.8: Step 2: Press the [Quick Menus] button (quick menu choices appear).

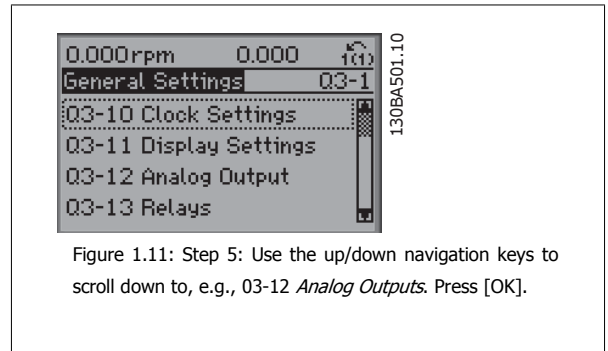

Figure 1.11: Step 5: Use the up/down navigation keys to scroll down to, e.g., Q3-12 *Analog Outputs*. Press [OK].

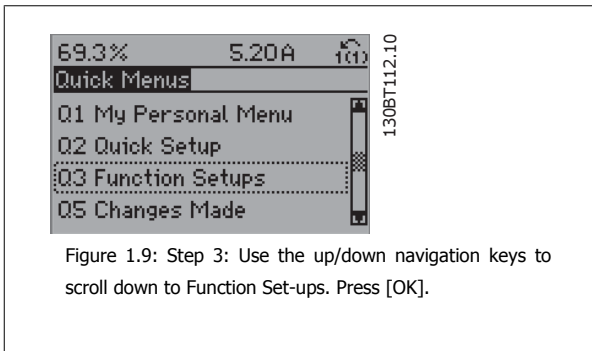

Figure 1.9: Step 3: Use the up/down navigation keys to scroll down to Function Set-ups. Press [OK].

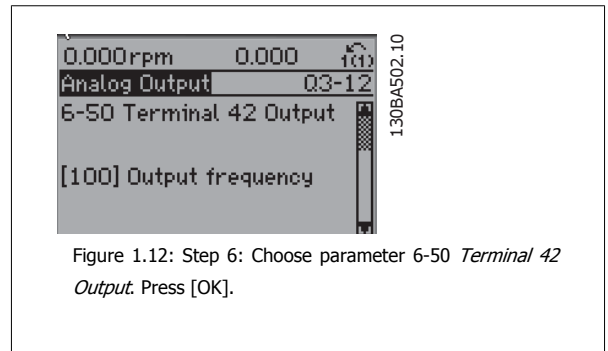

Figure 1.12: Step 6: Choose parameter 6-50 *Terminal 42 Output*. Press [OK].

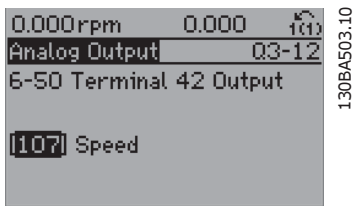

Figure 1.13: Step 7: Use the up/down navigation keys to select between the different choices. Press [OK].

The Function Set-up parameters are grouped in the following way:

Q3-1 General Settings			
Q3-10 Clock Settings	Q3-11 Display Settings	Q3-12 Analog Output	Q3-13 Relays
0-70 Set Date and Time	0-20 Display Line 1.1 Small	6-50 Terminal 42 Output	Relay 1 ⇒ 5-40 Function Relay
0-71 Date Format	0-21 Display Line 1.2 Small	6-51 Terminal 42 Output Min Scale	Relay 2 ⇒ 5-40 Function Relay
0-72 Time Format	0-22 Display Line 1.3 Small	6-52 Terminal 42 Output Max Scale	Option relay 7 ⇒ 5-40 Function Relay
0-74 DST/Summertime	0-23 Display Line 2 Large		Option relay 8 ⇒ 5-40 Function Relay
0-76 DST/Summertime Start	0-24 Display Line 3 Large		Option relay 9 ⇒ 5-40 Function Relay
0-77 DST/Summertime End	0-37 Display Text 1		
	0-38 Display Text 2		
	0-39 Display Text 3		

Q3-2 Open-loop Settings	
Q3-20 Digital Reference	Q3-21 Analog Reference
3-02 Minimum Reference	3-02 Minimum Reference
3-03 Maximum Reference	3-03 Maximum Reference
3-10 Preset Reference	6-10 Terminal 53 Low Voltage
5-13 Terminal 29 Digital Input	6-11 Terminal 53 High Voltage
5-14 Terminal 32 Digital Input	6-14 Terminal 53 Low Ref/Feedb. Value
5-15 Terminal 33 Digital Input	6-15 Terminal 53 High Ref/Feedb. Value

Q3-3 Closed-loop Settings	
Q3-30 Feedback Settings	Q3-31 PID Settings
1-00 Configuration Mode	20-81 PID Normal/Inverse Control
20-12 Reference/Feedb.Unit	20-82 PID Start Speed [RPM]
3-02 Minimum Reference	20-21 Setpoint 1
3-03 Maximum Reference	20-93 PID Proportional Gain
6-20 Terminal 54 Low Voltage	20-94 PID Integral Time
6-21 Terminal 54 High Voltage	
6-24 Terminal 54 Low Ref/Feedb Value	
6-25 Terminal 54 High Ref/Feedb Value	
6-00 Live Zero Timeout Time	
6-01 Live Zero Timeout Function	

1.1.9 Main Menu Mode

Both the GLCP and NLCP provide access to main menu mode. Select main menu mode by pressing the [Main Menu] key. Illustration 6.2 shows the resulting readout, which appears on the display of the GLCP.

Lines 2 through 5 on the display show a list of parameter groups which can be chosen by toggling the up and down buttons.

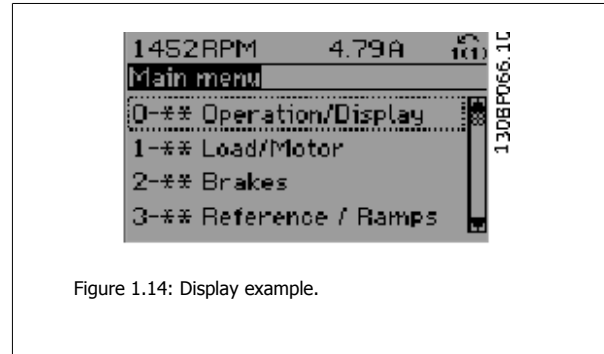

Figure 1.14: Display example.

Each parameter has a name and number which remain the same regardless of the programming mode. In main menu mode, the parameters are divided into groups. The first digit of the parameter number (from the left) indicates the parameter group number.

All parameters can be changed in the main menu. The configuration of the unit (par.1-00 *Configuration Mode*) will determine other parameters available for programming. For example, selecting Closed-loop enables additional parameters related to closed-loop operation. Option cards added to the unit enable additional parameters associated with the option device.

1.1.10 Parameter Selection

In main menu mode, the parameters are divided into groups. Select a parameter group using the navigation keys.

The following parameter groups are accessible:

Group no.	Parameter group:
0	Operation/Display
1	Load/Motor
2	Brakes
3	References/Ramps
4	Limits/Warnings
5	Digital In/Out
6	Analog In/Out
8	Comm. and Options
9	Profibus
10	CAN Ser. Com. Bus
11	LonWorks
13	Smart Logic
14	Special Functions
15	Drive Information
16	Data Readouts
18	Data Readouts 2
20	Drive Closed-loop
21	Ext. Closed-loop
22	Application Functions
23	Time-based Functions
24	Fire Mode
25	Cascade Controller
26	Analog I/O Option MCB 109

Table 1.2: Parameter groups.

1

After selecting a parameter group, choose a parameter using the navigation keys.

The middle section on the GLCP display shows the parameter number and name, as well as the selected parameter value.

Figure 1.15: Display example.

1.1.11 Changing Data

The procedure for changing data is the same whether you select a parameter in the quick menu or main menu mode. Press [OK] to change the selected parameter.

The procedure for changing data depends on whether the selected parameter represents a numerical data value or a text value.

1.1.12 Changing a Text Value

If the selected parameter is a text value, it can be changed by using the up/down navigation keys.

The up key increases the value, and the down key decreases the value. Place the cursor on the value to be saved and press [OK].

Figure 1.16: Display example.

1.1.13 Changing a Group of Numeric Data Values

If the chosen parameter represents a numeric data value, change the chosen data value using the <> navigation keys as well as the up/down navigation keys. Use the <> navigation keys to move the cursor horizontally.

Figure 1.17: Display example.

Use the up/down navigation keys to change the data value. The up key increases the data value, while the down key reduces it. Place the cursor on the value to be saved and press [OK].

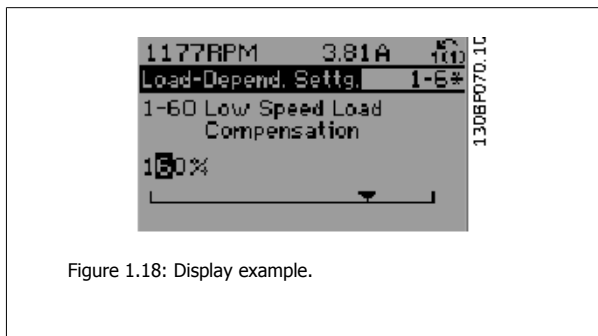

Figure 1.18: Display example.

1.1.14 Changing Data Values, Step-by-Step

Certain parameters can be changed step-by-step or by an infinite number of variables. This applies to par.1-20 *Motor Power [kW]*, par. 1-22 *Motor Voltage* and par.1-23 *Motor Frequency*.

The parameters are changed both as a group of numeric data values, and as numeric data values using an infinite number of variables.

1.1.15 Read-out and Programming of Indexed Parameters

Parameters are indexed when placed in a rolling stack.

par.15-30 *Alarm Log: Error Code* to par.15-32 *Alarm Log: Time* contain a fault log which can be read out. Choose a parameter, press [OK], and use the up/down navigation keys to scroll through the value log.

Use par.3-10 *Preset Reference* as another example:

Choose the parameter, press [OK], and use the up/down navigation keys to scroll through the indexed values. To change the parameter value, select the indexed value and press [OK]. Change the value by using the up/down keys. Press [OK] to accept the new setting. Press [Cancel] to abort. Press [Back] to leave the parameter.

1.1.16 Initialization to Default Settings

Initialize the adjustable frequency drive using default settings in two ways:

Recommended initialization (via par.14-22 *Operation Mode*)

1. Select par.14-22 *Operation Mode*
2. Press [OK]
3. Select "Initialization"
4. Press [OK]
5. Cut off the line power supply and wait until the display turns off.
6. Reconnect the line power supply - the adjustable frequency drive is now reset.
7. Change par.14-22 *Operation Mode* back to *Normal Operation*.

NOTE!
Resets parameters selected in Personal Menu with default factory setting.

par.14-22 *Operation Mode* initializes all except:
 par. 14-50 *RFI 1*
 par. 8-30 *Protocol*
 par.8-31 *Address*
 par.8-32 *Baud Rate*
 par.8-35 *Minimum Response Delay*
 par.8-36 *Max Response Delay*
 par.8-37 *Max Inter-Char Delay*
 par.15-00 *Operating Hours* to par.15-05 *Over Volts*
 par.15-20 *Historic Log: Event* to par.15-22 *Historic Log: Time*
 par.15-30 *Alarm Log: Error Code* to par.15-32 *Alarm Log: Time*

Manual initialization

1. Disconnect from the line power and wait until the display turns off.
 - 2a. Press [Status] - [Main Menu] - [OK] at the same time the LCP 102, Graphical Display is powering up.
 - 2b. Press [Menu] while the LCP 101, Numerical Display is powering up.
 3. Release the keys after 5 s.
 4. The adjustable frequency drive is now programmed according to default settings.
- This procedure initializes all except: par.15-00 *Operating Hours*; par.15-03 *Power-ups*; par.15-04 *Over Temps*; par.15-05 *Over Volts*.



NOTE!

When you carry out manual initialization, you also reset serial communication, par. 14-50 *RFI 1* and fault log settings.
 Removes parameters selected in par.25-00 *Cascade Controller*.



NOTE!

After initialization and power cycling, the display will not show any information until after a couple of minutes.

2 Parameter Description

2.1.1 Parameter Set-up

Overview of parameter groups

Group	Title	Function
0-	Operation/Display	Parameters related to the fundamental functions of the adjustable frequency drive, function of the LCP buttons and configuration of the LCP display.
1-	Load / Motor	Parameter group for motor settings.
2-	Brakes	Parameter group for setting brake features in the adjustable frequency drive.
3-	Reference/Ramps	Parameters for reference handling, defining limitations, and configuring the reaction of the adjustable frequency drive to changes.
4-	Limits/Warnings	Parameter group for configuring limits and warnings.
5-	Digital In/Out	Parameter group for configuring the digital inputs and outputs.
6-	Analog In/Out	Parameter group for configuring the analog inputs and outputs.
8-	Communication and Options	Parameter group for configuring communications and options.
9-	Profibus	Parameter group for Profibus-specific parameters.
10-	DeviceNet Serial Communication Bus	Parameter group for DeviceNet-specific parameters.
11-	LonWorks	Parameter group for LonWorks parameters
13-	Smart Logic	Parameter group for Smart Logic Control
14-	Special Functions	Parameter group for configuring special adjustable frequency drive functions.
15-	Drive Information	Parameter group containing adjustable frequency drive information such as operating data, hardware configuration and software versions.
16-	Data Readouts	Parameter group for data readouts, such as current references, voltages, control, alarm, warning and status words.
18-	Info and Readouts	This parameter group contains the last 10 Preventive Maintenance logs.
20-	Drive Closed-loop	This parameter group is used for configuring the closed-loop PID controller that controls the output frequency of the unit.
21-	Extended Closed-loop	Parameters for configuring the three extended closed-loop PID controllers.
22-	Application Functions	These parameters monitor water applications.
23-	Time-based Functions	These parameters are for actions to be performed on a daily or weekly basis, such as different references for working hours/non-working hours.
25-	Basic Cascade Controller Functions	Parameters for configuring the basic cascade controller for sequence control of multiple pumps.
26-	Analog I/O Option MCB 109	Parameters for configuring the Analog I/O Option MCB 109.
27-	Extended Cascade Control	Parameters for configuring the extended cascade control.
29-	Water Application Functions	Parameters for setting water specific functions.
31-	Bypass Option	Parameters for configuring the bypass option

Table 2.1: Parameter Groups

Parameter descriptions and selections are displayed on the Graphic LCP or Numeric LCP in the display area (See Section 5 for details.) Access the parameters by pressing the [Quick Menu] or [Main Menu] key on the control panel. The quick menu is used primarily for commissioning the unit at start-up by providing those parameters necessary to commence operations. The main menu provides access to all the parameters for detailed application programming.

All digital input/output and analog input/output terminals are multifunctional. All terminals have factory default functions suitable for the majority of water applications but if other special functions are required, they must be programmed in parameter group 5 or 6.

2.2 Main Menu - Operation and Display - Group 0

2.2.1 0-*** Operation / Display

Parameters related to the fundamental functions of the adjustable frequency drive, function of the LCP buttons and configuration of the LCP display.

2.2.2 0-0* Basic Settings

Parameter group for basic adjustable frequency drive settings.

0-01 Language

Option:
Function:

Defines the language to be used in the display.

[0] * English UK

0-02 Motor Speed Unit

Option:
Function:

This parameter cannot be adjusted while the motor is running.
The display showing depends on settings in par.0-02 *Motor Speed Unit* and par.0-03 *Regional Settings*. The default setting of par.0-02 *Motor Speed Unit* and par.0-03 *Regional Settings* depends on which region of the world the adjustable frequency drive is supplied to, but can be re-programmed as required.

NOTE!

Changing the *Motor Speed Unit* will reset certain parameters to their initial value. It is recommended to select the motor speed unit first before modifying other parameters.

[0] RPM

Selects display of motor speed variables and parameters (i.e. references, feedbacks and limits) in terms of motor speed (RPM).

[1] * Hz

Selects display of motor speed variables and parameters (i.e., references, feedbacks and limits) in terms of output frequency to the motor (Hz).

0-03 Regional Settings

Option:
Function:

This parameter cannot be adjusted while the motor is running.
The display showing depends on settings in par.0-02 *Motor Speed Unit* and par.0-03 *Regional Settings*. The default setting of par.0-02 *Motor Speed Unit* and par.0-03 *Regional Settings* depends on which region of the world the adjustable frequency drive is supplied to but can be re-programmed as required.

[0] * International

Sets par.1-20 *Motor Power [kW]* units to [kW] and the default value of par.1-23 *Motor Frequency* [50 Hz].

[1] North America

Sets par.1-21 *Motor Power [HP]* units to HP and the default value of par.1-23 *Motor Frequency* to 60 Hz.

The setting not used is made invisible.

0-04 Operating State at Power-up		
Option:		Function:
		Select the operating mode upon reconnection of the adjustable frequency drive to AC line voltage after a power-down when operating in hand (local) mode.
[0] *	Resume	Resumes operation of the adjustable frequency drive maintaining the same local reference and the same start/stop condition (applied by [Hand On]/[Off] on the LCP or Hand Start via a digital input as before the adjustable frequency drive was powered down.
[1]	Forced stop, ref=old	Uses saved reference [1] to stop the adjustable frequency drive, while retaining the local speed reference prior to power-down in its memory. After the AC line voltage is reconnected, and after receiving a start command (using the LCP [Hand On] button or hand start command via a digital input), the adjustable frequency drive restarts and operates at the retained speed reference.

2.2.3 0-1* Set-up Operations

Define and control the individual parameter set-ups.

The adjustable frequency drive has four parameter set-ups that can be programmed independently of each other. This makes the adjustable frequency drive very flexible and able to meet the requirements of many different AQUA system control schemes, often saving on the costs of external control equipment. For example, these can be used to program the adjustable frequency drive to operate according to one control scheme in one set-up (e.g., daytime operation) and another control scheme in another set-up (e.g., night set back). Alternatively, they can be used by an AHU or packaged unit OEM to identically program all their factory fitted adjustable frequency drives for different equipment models within a given range to have the same parameters; and then, during production/commissioning, simply select a specific set-up depending on which model within that range the adjustable frequency drive is installed.

The active set-up (i.e., the set-up in which the adjustable frequency drive is currently operating) can be selected in parameter 0-10 and is displayed in the LCP. Using Multi set-up, it is possible to switch between set-ups with the adjustable frequency drive running or stopped, via digital input or serial communication commands (for night set back, etc.). If it is necessary to change set-ups while running, ensure that parameter 0-12 is programmed as required. For the majority of AQUA applications, it will not be necessary to program parameter 0-12 even if change of set up while running is required; however, for very complex applications using the full flexibility of the multiple set-ups, it may be required. Using parameter 0-11, it is possible to edit parameters within any of the set-ups while continuing the adjustable frequency drive operation in its active set-up, which can be a different set-up than that being edited. Using parameter 0-51, it is possible to copy parameter settings between the set-ups to enable quicker commissioning if similar parameter settings are required in different set-ups.

0-10 Active Set-up		
Option:		Function:
		Select the set-up in which the adjustable frequency drive is to operate. Use par.0-51 <i>Set-up Copy</i> to copy a set-up to one or all other set-ups. To avoid conflicting settings of the same parameter within two different set-ups, link the set-ups together using par.0-12 <i>This Set-up Linked to</i> . Stop the adjustable frequency drive before switching between set-ups, where parameters marked 'not changeable during operation' have different values. Parameters that are 'not changeable during operation' are marked FALSE in the parameter lists in the section Parameter Lists.
[0]	Factory setup	Cannot be changed. It contains the Danfoss data set, and can be used as a data source when returning the other set-ups to a known state.
[1] *	Set-up 1	<i>Set-up 1</i> [1] to <i>Set-up 4</i> [4] are the four separate parameter set-ups within which all parameters can be programmed.
[2]	Set-up 2	
[3]	Set-up 3	
[4]	Set-up 4	

[9]	Multi setup	Is used for remote selection of set-ups using digital inputs and the serial communication port. This set-up uses the settings from par.0-12 <i>This Set-up Linked to</i> .
-----	-------------	--

0-11 Programming Set-up

Option:	Function:
[0]	Factory setup
[1]	Set-up 1
[2]	Set-up 2
[3]	Set-up 3
[4]	Set-up 4
[9] *	Active Set-up

Select the set-up to be edited (i.e., programmed) during operation; either the active set-up or one of the inactive set-ups. The set-up number being edited is displayed in the LCP in (brackets).

cannot be edited, but it is useful as a data source to return the other set-ups to a known state.

Set-up 1 [1] to *Set-up 4* [4] can be edited freely during operation, independently of the active set-up.

(i.e., the set-up in which the adjustable frequency drive is operating) can also be edited during operation. Editing parameters in the chosen set-up would normally be done from the LCP but it is also possible from any of the serial communication ports.

0-12 This Set-up Linked to

Option:	Function:
	<p>This parameter only needs to be programmed if changing set-ups is required while the motor is running. It ensures that parameters that are 'not changeable during operation' have the same setting in all relevant set-ups.</p> <p>To enable conflict-free changes from one set-up to another while the adjustable frequency drive is running, link set-ups containing parameters that are not changeable during operation. The link will ensure the proper synchronization of the 'not changeable during operation' parameter values when moving from one set-up to another during operation. 'Not changeable during operation' parameters can be identified by the label FALSE in the parameter lists in the section <i>Parameter Lists</i>.</p> <p>The par.0-12 <i>This Set-up Linked to</i> feature is used when Multi set-up in par.0-10 <i>Active Set-up</i> is selected. Multi set-up can be used to move from one set-up to another during operation (i.e., while the motor is running).</p> <p>Example:</p> <p>Use Multi set-up to shift from Set-up 1 to Set-up 2 while the motor is running. Program parameters in Set-up 1 first, then ensure that Set-up 1 and Set-up 2 are synchronized (or 'linked'). Synchronization can be performed in two ways:</p> <ol style="list-style-type: none"> 1. Change the edit set-up to <i>Set-up 2</i> [2] in par.0-11 <i>Programming Set-up</i> and set par.0-12 <i>This Set-up Linked to</i> to <i>Set-up 1</i> [1]. This will start the linking (synchronizing) process.

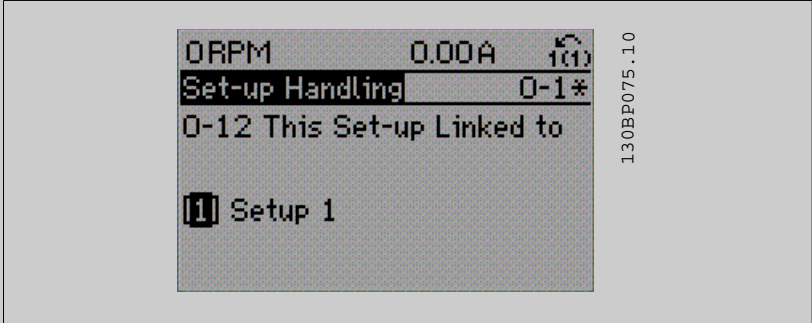

OR

2. While still in Set-up 1, using par.0-50 *LCP Copy*, copy Set-up 1 to Set-up 2. Then set par. 0-12 *This Set-up Linked to to Set-up 2* [2]. This will start the linking process.

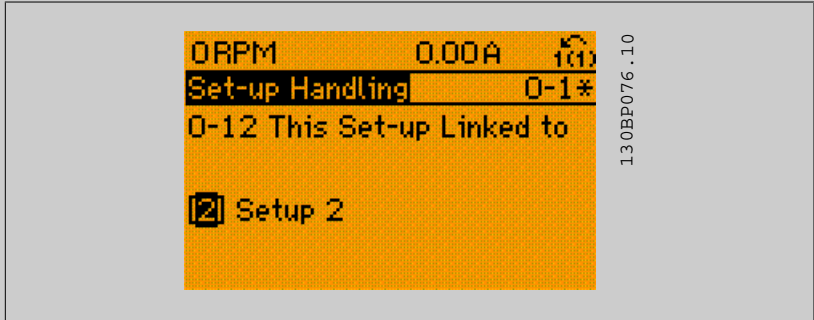

After the link is complete, par.0-13 *Readout: Linked Set-ups* will read {1,2} to indicate that all 'not changeable during operation' parameters are now the same in Set-up 1 and Set-up 2. If there are changes to a 'not changeable during operation' parameter, e.g. par.1-30 *Stator Resistance (Rs)* in Set-up 2, they will also be changed automatically in Set-up 1. A switch between Set-up 1 and Set-up 2 during operation is now possible.

- [0] * Not linked
- [1] Set-up 1
- [2] Set-up 2
- [3] Set-up 3
- [4] Set-up 4

0-13 Readout: Linked Set-ups

Array [5]

Range:

0 N/A* [0 - 255 N/A]

Function:

View a list of all the set-ups linked by means of par.0-12 *This Set-up Linked to*. The parameter has one index for each parameter set-up. The parameter value displayed for each index represents which set-ups are linked to that parameter set-up.

Index	LCP value
0	{0}
1	{1,2}
2	{1,2}
3	{3}
4	{4}

Table 2.2: Example: Set-up 1 and Set-up 2 are linked

0-14 Readout: Prog. Set-ups / Channel

Range:

0 N/A* [-2147483648 - 2147483647 N/A]

Function:

View the setting of par.0-11 *Programming Set-up* for each of the four different communication channels. When the number is displayed in hex, as it is in the LCP, each number represents one channel.

Numbers 1-4 represent a set-up number; 'F' means factory setting; and 'A' means active set-up. The channels are, from right to left: LCP, FC bus, USB, HPFB1.5.

Example: The number AAAAAA21h means that the FC bus selected Set-up 2 in par.0-11 *Programming Set-up*, the LCP selected Set-up 1 and all others used the active set-up.

2.2.4 0-2* LCP Display

Define the variables displayed in the Graphical Local Control Panel.

2



NOTE!

Please refer to par.0-37 *Display Text 1*, par.0-38 *Display Text 2* and par.0-39 *Display Text 3* for information on how to write display texts.

0-20 Display Line 1.1 Small

Option:	Function:
	Select a variable for display in line 1, left position.
[0] None	No display value selected
[37] Display Text 1	Present control word
[38] Display Text 2	Enables an individual text string to be written, for display in the LCP or to be read via serial communication.
[39] Display Text 3	Enables an individual text string to be written, for display in the LCP or to be read via serial communication.
[89] Date and Time Readout	Displays the current date and time.
[953] Profibus Warning Word	Displays Profibus communication warnings.
[1005] Readout Transmit Error Counter	View the number of CAN control transmission errors since the last power-up.
[1006] Readout Receive Error Counter	View the number of CAN control receipt errors since the last power-up.
[1007] Readout Bus-off Counter	View the number of bus-off events since the last power-up.
[1013] Warning Parameter	View a DeviceNet-specific warning word. One separate bit is assigned to every warning.
[1115] LON Warning Word	Shows the LON-specific warnings.
[1117] XIF Revision	Shows the version of the external interface file of the Neuron C chip on the LON option.
[1118] LON Works Revision	Shows the software version of the application program of the Neuron C chip on the LON option.
[1500] Operating Hours	View the number of running hours of the adjustable frequency drive.
[1501] Running Hours	View the number of running hours of the motor.
[1502] kWh Counter	View the line power consumption in kWh.
[1600] Control Word	View the control word sent from the adjustable frequency drive via the serial communication port in hex code.
[1601] * Reference [Unit]	Total reference (sum of digital/analog/preset/bus/freeze ref./catch up and slow-down) in selected unit.
[1602] Reference %	Total reference (sum of digital/analog/preset/bus/freeze ref./catch up and slow-down) as a percentage.
[1603] Status Word	Present status word
[1605] Main Actual Value [%]	One or more warnings in a Hex code
[1609] Custom Readout	View the user-defined readouts as defined in par. 0-30, 0-31 and 0-32.
[1610] Power [kW]	Actual power consumed by the motor in kW.
[1611] Power [hp]	Actual power consumed by the motor in HP.
[1612] Motor Voltage	Voltage supplied to the motor.
[1613] Motor Frequency	Motor frequency, i.e., the output frequency from the adjustable frequency drive in Hz.
[1614] Motor Current	Phase current of the motor measured as effective value.
[1615] Frequency [%]	Motor frequency, i.e., the output frequency from the adjustable frequency drive as a percentage.

[1616]	Torque [Nm]	Present motor load as a percentage of the rated motor torque.
[1617]	Speed [RPM]	Speed in RPM (revolutions per minute), i.e., the motor shaft speed in closed-loop based on the entered motor nameplate data, the output frequency and the load on the adjustable frequency drive.
[1618]	Motor Thermal	Thermal load on the motor, calculated by the ETR function. See also parameter group 1-9* Motor Temperature.
[1622]	Torque [%]	Shows the actual torque produced as a percentage.
[1630]	DC Link Voltage	Intermediate circuit voltage in the adjustable frequency drive.
[1632]	BrakeEnergy/s	Present braking energy transferred to an external brake resistor. Stated as an instantaneous value.
[1633]	BrakeEnergy/2 min	Braking energy transferred to an external brake resistor. The mean power is calculated continuously for the latest 120 seconds.
[1634]	Heatsink Temp.	Present heatsink temperature of the adjustable frequency drive. The cut-out limit is $203 \pm 9^{\circ}\text{F}$ ($95 \pm 5^{\circ}\text{C}$); cutting back in occurs at $158 \pm 9^{\circ}\text{F}$ ($70 \pm 5^{\circ}\text{C}$).
[1635]	Thermal Drive Load	Percentage load of the inverters
[1636]	Inv. Nom. Current	Nominal current of the adjustable frequency drive.
[1637]	Inv. Max. Current	Maximum current of the adjustable frequency drive.
[1638]	SL Control State	State of the event executed by the control.
[1639]	Control Card Temp.	Temperature of the control card.
[1650]	External Reference	Sum of the external reference as a percentage, i.e., the sum of analog/pulse/bus.
[1652]	Feedback [Unit]	Signal value in units from the programmed digital input(s).
[1653]	Digi Pot Reference	View the contribution of the digital potentiometer to the actual reference feedback.
[1654]	Feedback 1 [Unit]	View the value of Feedback 1. See also par. 20-0*.
[1655]	Feedback 2 [Unit]	View the value of Feedback 2. See also par. 20-0*.
[1656]	Feedback 3 [Unit]	View the value of Feedback 3. See also par. 20-0*.
[1660]	Digital Input	Displays the status of the 6 digital input terminals (18, 19, 27, 29, 32 and 33). Input 18 corresponds to the bit at the far left. Signal low = 0; Signal high = 1
[1661]	Terminal 53 Switch Setting	Setting of input terminal 53. Current = 0; Voltage = 1.
[1662]	Analog Input 53	Actual value at input 53 either as a reference or protection value.
[1663]	Terminal 54 Switch Setting	Setting of input terminal 54. Current = 0; Voltage = 1.
[1664]	Analog Input 54	Actual value at input 54 either as reference or protection value.
[1665]	Analog Output 42 [mA]	Actual value at output 42 in mA. Use par. 6-50 to select the variable to be represented by output 42.
[1666]	Digital Output [bin]	Binary value of all digital outputs.
[1667]	Freq. Input #29 [Hz]	Actual value of the frequency applied at terminal 29 as a pulse input.
[1668]	Freq. Input #33 [Hz]	Actual value of the frequency applied at terminal 33 as a pulse input.
[1669]	Pulse Output #27 [Hz]	Actual value of pulses applied to terminal 27 in digital output mode.
[1670]	Pulse Output #29 [Hz]	Actual value of pulses applied to terminal 29 in digital output mode.
[1671]	Relay Output [bin]	View the setting of all relays.
[1672]	Counter A	View the present value of Counter A.
[1673]	Counter B	View the present value of Counter B.
[1675]	Analog input X30/11	Actual value of the signal on input X30/11 (General Purpose I/O Card. Option)
[1676]	Analog input X30/12	Actual value of the signal on input X30/12 (General Purpose I/O Card. Optional)
[1677]	Analog output X30/8 [mA]	Actual value at output X30/8 (General Purpose I/O Card. Optional) Use Par. 6-60 to select the variable to be shown.
[1680]	Serial com. bus CTW 1	Control word (CTW) received from the bus master.

[1682]	Serial com. bus REF 1	Main reference value sent with control word via the serial communications network, such as from the BMS, PLC or another master controller, for example.
[1684]	Comm. Option STW	Extended serial communication bus option status word.
[1685]	FC Port CTW 1	Control word (CTW) received from the bus master.
[1686]	FC Port REF 1	Status word (STW) sent to the bus master.
[1690]	Alarm Word	One or more alarms in a Hex code (used for serial communications).
[1691]	Alarm Word 2	One or more alarms in a Hex code (used for serial communications).
[1692]	Warning Word	One or more warnings in a Hex code (used for serial communications).
[1693]	Warning Word 2	One or more warnings in a Hex code (used for serial communications).
[1694]	Ext. Status Word	One or more status conditions in a Hex code (used for serial communications).
[1695]	Ext. Status Word 2	One or more status conditions in a Hex code (used for serial communications).
[1696]	Maintenance Word	The bits reflect the status for the programmed preventive maintenance events in parameter group 23-1*.
[1830]	Analog Input X42/1	Shows the value of the signal applied to terminal X42/1 on the analog I/O card.
[1831]	Analog Input X42/3	Shows the value of the signal applied to terminal X42/3 on the analog I/O card.
[1832]	Analog Input X42/5	Shows the value of the signal applied to terminal X42/5 on the analog I/O card.
[1833]	Analog Out X42/7 [V]	Shows the value of the signal applied to terminal X42/7 on the analog I/O card.
[1834]	Analog Out X42/9 [V]	Shows the value of the signal applied to terminal X42/9 on the analog I/O card.
[1835]	Analog Out X42/11 [V]	Shows the value of the signal applied to terminal X42/11 on the analog I/O card.
[2117]	Ext. 1 Reference [Unit]	The value of the reference for extended closed-loop controller 1.
[2118]	Ext. 1 Feedback [Unit]	The value of the feedback signal for extended closed-loop controller 1.
[2119]	Ext. 1 Output [%]	The value of the output from extended closed-loop controller 1.
[2137]	Ext. 2 Reference [Unit]	The value of the reference for extended closed-loop controller 2.
[2138]	Ext. 2 Feedback [Unit]	The value of the feedback signal for extended closed-loop controller 2.
[2139]	Ext. 2 Output [%]	The value of the output from extended closed-loop controller 2.
[2157]	Ext. 3 Reference [Unit]	The value of the reference for extended closed-loop controller 3.
[2158]	Ext. 3 Feedback [Unit]	The value of the feedback signal for extended closed-loop controller 3.
[2159]	Ext. Output [%]	The value of the output from extended closed-loop controller 3.
[2230]	No-Flow Power	The calculated no-flow power for the actual operating speed.
[2580]	Cascade Status	Status for the operation of the cascade controller.
[2581]	Pump Status	Status for the operation of each individual pump controlled by the cascade controller.

**NOTE!**

Please consult the VLT® AQUA Drive Programming Guide, MG.20.OX.YY for detailed information.

0-21 Display Line 1.2 Small**Option:****Function:**

Select a variable for display in line 1, middle position.

[1662] * Analog input 53

The options are the same as those listed for par. 0-20 *Display Line 1.1 Small*.

0-22 Display Line 1.3 Small**Option:****Function:**

Select a variable for display in line 1, right position.

[1614] * Motor Current

The options are the same as those listed for par. 0-20 *Display Line 1.1 Small*.

0-23 Display Line 2 Large

Option:

[1615] * Frequency

Function:

Select a variable for display in line 2. The options are the same as those listed for par. 0-20 *Display Line 1.1 Small*.

0-24 Display Line 3 Large

Option:

[1652] * Feedback [Unit]

Function:

Select a variable for display in line 2. The options are the same as those listed for par. 0-20 *Display Line 1.1 Small*.

0-25 My Personal Menu

Array [50]

Range:

0 N/A* [0-9999 N/A]

Function:

Define up to 50 parameters to appear in the Q1 Personal Menu, accessible via the [Quick Menu] key on the LCP. The parameters will be displayed in the Q1 Personal Menu in the order they are programmed into this array parameter. Delete parameters by setting the value to 0000. For example, this can be used to provide quick, simple access to just one or up to 50 parameters which require changing on a regular basis (e.g., for plant maintenance reasons) or by an OEM to enable simple commissioning of their equipment.

2.2.5 LCP Custom Readout, Par. 0-3*

It is possible to customize the display elements for various purposes: *Custom Readout. Value proportional to speed (linear, squared or cubed depending on unit selected in par.0-30 *Custom Readout Unit*) *Display Text. Text string stored in a parameter.

Custom Readout

The calculated value to be displayed is based on settings in par.0-30 *Custom Readout Unit*, par.0-31 *Custom Readout Min Value* (linear only), par. 0-32 *Custom Readout Max Value*, par.4-13 *Motor Speed High Limit [RPM]*, par. 4-14 *Motor Speed High Limit [Hz]* and actual speed.

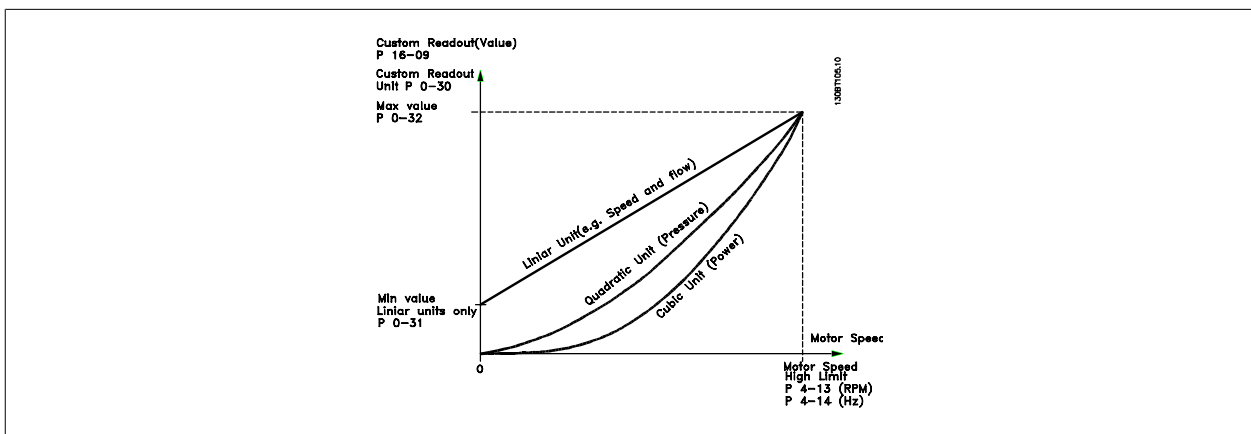

The relation will depend on the type of unit selected in par.0-30 *Custom Readout Unit*.

Unit Type	Speed Relation
Dimensionless	Linear
Speed	
Flow, volume	
Flow, mass	
Velocity	
Length	
Temperature	
Pressure	Quadratic
Power	Cubic

0-30 Custom Readout Unit

Option:

Function:

Program a value to be shown in the display of the LCP. The value has a linear, squared or cubed relation to speed. This relation depends on the unit selected (see table above). The actual calculated value can be read in par.16-09 *Custom Readout*, and/or shown in the display by selecting Custom Readout [16-09] in par. 0-20 *Display Line 1.1 Small* to par. 0-24 *Display Line 3 Large*.

[0]

[1] * %

[5] PPM

[10] min

[11] RPM

[12] PULSE/s

[20] liter / sec.

[21] liter / min

[22] liter / hr.

[23] m³ / sec.[24] m³/min[25] m³ / hr.

[30] kg / sec.

[31] kg/min

[32] kg / hr.

[33] ton / min

[34] ton / hr.

[40] m / sec.

[41] m/min

[45] m

[60] °C

[70] mbar

[71] bar

[72] Pa

[73] kPa

[74] m WG

[75]

[80] kW

[120]	GPM
[121]	gal / sec.
[122]	gal/min
[123]	gal / hr.
[124]	CFM
[125]	ft ³ /s
[126]	ft ³ /min
[127]	ft ³ /h
[130]	lbs / sec.
[131]	lbs / min.
[132]	lbs / hr.
[140]	ft/s
[141]	ft/min
[145]	ft
[160]	°F
[170]	psi
[171]	lb/in ²
[172]	in. wtr. gage
[173]	ft WG
[174]	
[180]	HP

0-31 Custom Readout Min Value

Range:	Function:
0.00 Cus- [0.00 - 100.00 CustomReadoutUnit] tomReadou- tUnit*	This parameter allows the choice of the min. value of the custom defined readout (occurs at zero speed). It is only possible to select a value different to 0 when selecting a linear unit in par. 0-30 <i>Custom Readout Unit</i> . For quadratic and cubic units, the minimum value will be 0.

0-32 Custom Readout Max Value

Range:	Function:
100.00 Cus- [par. 0-31 - 999999.99 CustomRea- tomReadou- doutUnit] tUnit*	This parameter sets the max value to be shown when the speed of the motor has reached the set value for (par.4-13 <i>Motor Speed High Limit [RPM]</i> and par. 4-14 <i>Motor Speed High Limit [Hz]</i>).

0-37 Display Text 1

Range:	Function:
0 N/A* [0 - 0 N/A]	In this parameter, it is possible to write an individual text string for display in the LCP or to be read via serial communication. If to be displayed permanently, select Display Text 1 in par. 0-20 <i>Display Line 1.1 Small</i> , par. 0-21 <i>Display Line 1.2 Small</i> , par. 0-22 <i>Display Line 1.3 Small</i> , par. 0-23 <i>Display Line 2 Large</i> or par. 0-24 <i>Display Line 3 Large</i> . Use the ▲ or ▼ buttons on the LCP to change a character. Use the ◀ and ▶ buttons to move the cursor. When a character is highlighted by the cursor, it can be changed. Use the ▲ or ▼ buttons on the LCP to change a character. A character can be inserted by placing the cursor between two characters and pressing ▲ or ▼.

0-38 Display Text 2

Range:

0 N/A* [0 - 0 N/A]

Function:

In this parameter, it is possible to write an individual text string for display in the LCP or to be read via serial communication. If to be displayed permanently select Display Text 2 in par. 0-20 *Display Line 1.1 Small*, par. 0-21 *Display Line 1.2 Small*, par. 0-22 *Display Line 1.3 Small*, par. 0-23 *Display Line 2 Large* or par. 0-24 *Display Line 3 Large*. Use the ▲ or ▼ buttons on the LCP to change a character. Use the ◀ and ▶ buttons to move the cursor. When a character is highlighted by the cursor, this character can be changed. A character can be inserted by placing the cursor between two characters and pressing ▲ or ▼.

0-39 Display Text 3

Range:

0 N/A* [0 - 0 N/A]

Function:

In this parameter, it is possible to write an individual text string for display in the LCP or to be read via serial communication. If to be displayed permanently, select Display Text 3 in par. 0-20 *Display Line 1.1 Small*, par. 0-21 *Display Line 1.2 Small*, par. 0-22 *Display Line 1.3 Small*, par. 0-23 *Display Line 2 Large* or par. 0-24 *Display Line 3 Large*. Use the ▲ or ▼ buttons on the LCP to change a character. Use the ◀ and ▶ buttons to move the cursor. When a character is highlighted by the cursor, this character can be changed. A character can be inserted by placing the cursor between two characters and pressing ▲ or ▼.

2.2.6 LCP Keypad, 0-4*

Enable, disable and password protect individual keys on the LCP.

0-40 [Hand on] Key on LCP

Option:

[0] Disabled

Function:

No function

[1]* Enabled

[Hand on] Key enabled

[2] Password

Avoid unauthorized start in hand mode. If par.0-40 *[Hand on] Key on LCP* is included in the My Personal Menu, then define the password in par.0-65 *Personal Menu Password*0-65 Personal Menu Password. Otherwise, define the password in par.0-60 *Main Menu Password*0-60 Main Menu Password.

0-41 [Off] Key on LCP

Option:

[0] Disabled

Function:

No function

[1]* Enabled

[Off] Key is enabled.

[2] Password

Avoid unauthorized stop. If par.0-41 *[Off] Key on LCP* is included in the My Personal Menu, then define the password in par.0-65 *Personal Menu Password*0-65 Personal Menu Password. Otherwise, define the password in par.0-60 *Main Menu Password*0-60 Main Menu Password.

0-42 [Auto on] Key on LCP		
Option:		Function:
[0]	Disabled	No function
[1] *	Enabled	[Auto on] Key is enabled
[2]	Password	Avoid unauthorized start in auto mode. If par.0-42 [Auto on] Key on LCP is included in the My Personal Menu, then define the password in par.0-65 <i>Personal Menu Password</i> . Otherwise, define the password in par.0-60 <i>Main Menu Password</i> .

0-43 [Reset] Key on LCP		
Option:		Function:
[0]	Disabled	No function
[1] *	Enabled	[Reset] Key is enabled.
[2]	Password	Avoid unauthorized resetting. If par.0-43 [Reset] Key on LCP is included in the par. 0-25 <i>My Personal Menu</i> , then define the password in par.0-65 <i>Personal Menu Password</i> . Otherwise, define the password in par.0-60 <i>Main Menu Password</i> .

2.2.7 0-5* Copy/Save

Copy parameter settings between set-ups and to/from the LCP.

0-50 LCP Copy		
Option:		Function:
[0] *	No copy	No function
[1]	All to LCP	Copies all parameters in all set-ups from the adjustable frequency drive memory to the LCP memory. For service purposes it is recommended to copy all parameters to the LCP after commissioning.
[2]	All from LCP	Copies all parameters in all set-ups from the LCP memory to the adjustable frequency drive memory.
[3]	Size indep. of LCP	Copies only the parameters that are independent of the motor size. The latter selection can be used to program several adjustable frequency drives with the same function without disturbing motor data that are already set.

This parameter cannot be adjusted while the motor is running.

0-51 Set-up Copy		
Option:		Function:
[0] *	No copy	No function
[1]	Copy to set-up 1	Copies all parameters in the present Programming Set-up (defined in par.0-11 <i>Programming Set-up</i>) to Set-up 1.
[2]	Copy to set-up 2	Copies all parameters in the present Programming Set-up (defined in par.0-11 <i>Programming Set-up</i>) to Set-up 2.
[3]	Copy to set-up 3	Copies all parameters in the present Programming Set-up (defined in par.0-11 <i>Programming Set-up</i>) to Set-up 3.
[4]	Copy to set-up 4	Copies all parameters in the present Programming Set-up (defined in par.0-11 <i>Programming Set-up</i>) to Set-up 4.
[9]	Copy to all	Copies the parameters in the present set-up over to each of the set-ups 1 to 4.

2.2.8 0-6* Password

Define password access to menus.

0-60 Main Menu Password

Range:	Function:
100 N/A* [0 - 999 N/A]	Define the password for access to the main menu via the [Main Menu] key. If par.0-61 <i>Access to Main Menu w/o Password</i> is set to <i>Full access</i> [0], this parameter will be ignored.

0-61 Access to Main Menu w/o Password

Option:	Function:
[0] * Full access	Disables password defined in par.0-60 <i>Main Menu Password</i> .
[1] Read-only	Prevent unauthorized editing of main menu parameters.
[2] No access	Prevent unauthorized viewing and editing of main menu parameters.

[16]

If *Full access* [0] is selected then par.0-60 *Main Menu Password*, par.0-65 *Personal Menu Password* and par.0-66 *Access to Personal Menu w/o Password* will be ignored.

0-65 Personal Menu Password

Range:	Function:
200 N/A* [0 - 999 N/A]	Define the password for access to the My Personal Menu via the [Quick Menu] key. If par.0-66 <i>Access to Personal Menu w/o Password</i> is set to <i>Full access</i> [0], this parameter will be ignored.

0-66 Access to Personal Menu w/o Password

Option:	Function:
[0] * Full access	Disables password defined in par.0-65 <i>Personal Menu Password</i> .
[1] Read-only	Prevents unauthorized editing of My Personal Menu parameters.
[2] No access	Prevents unauthorized viewing and editing of My Personal Menu parameters.

[16]

If par.0-61 *Access to Main Menu w/o Password* is set to *Full access* [0], this parameter will be ignored.

2.2.9 Clock Settings, 0-7*

Set the time and date of the internal clock. The internal clock can be used for such functions as: timed actions, energy log, trend analysis, date/time stamps on alarms, logged data and preventive maintenance.

It is possible to program the clock for daylight saving time/summertime, weekly working days/non-working days with 20 exceptions (holidays, etc.). Although the clock settings can be set via the LCP, they can also be set along with timed actions and preventative maintenance functions using the MCT10 software tool.

 **NOTE!**
 The adjustable frequency drive has no backup of the clock function, and the set date/time will reset to default (2000-01-01 00:00) after a power-down unless a real time clock module with backup is installed. If no module with back up is installed, it is recommended that the clock function only be used if the adjustable frequency drive is integrated into an external system using serial communications, with the system maintaining synchronization of control equipment clock times. In par. 0-79, *Clock Fault*, it is possible to program for a warning in case the clock has not been set properly, e.g., after a power-down.

0-70 Set Date and Time

Range:
 2000-01-01 [2000-01-01 00:00]
 00:00 –
 2099-12-01
 23:59 *

Function:
 Sets the date and time of the internal clock. The format to be used is set in par. 0-71 and 0-72.

 **NOTE!**
 This parameter does not display the actual time. This can be read in par. 0-89. The clock will not begin counting until a setting different from default has been made.

0-71 Date Format

Option:	Function:
[0] * YYYY-MM-DD	Sets the date format to be used in the LCP.
[1] DD-MM-YYYY	Sets the date format to be used in the LCP.
[2] MM/DD/YYYY	Sets the date format to be used in the LCP.

0-72 Time Format

Option:	Function:
[0] * 24 h	Sets the time format to be used in the LCP.
[1] 12 h	

0-73 Time Zone Offset

Option:	Function:
[0.00] -12.00–13.00	Sets the time zone offset to UTC; this is needed for automatic DST adjustment.

0-74 DST/Summertime

Option:	Function:
[0] * OFF	Choose how Daylight Saving Time/Summertime should be handled. For manual DST/Summertime enter the start date and end date in par.0-76 <i>DST/Summertime Start</i> and par.0-77 <i>DST/Summertime End</i> .
[2] Manual	

0-76 DST/Summertime Start

Range:	Function:
0 N/A* [0 - 0 N/A]	Sets the date and time when Summertime/DST starts. The date is programmed in the format selected in par. 0-71 <i>Date Format</i> .

0-77 DST/Summertime End

Range:	Function:
0 N/A* [0 - 0 N/A]	Sets the date and time when Summertime/DST ends. The date is programmed in the format selected in par. 0-71 <i>Date Format</i> .

0-79 Clock Fault

Option:
Function:

Enables or disables the clock warning when the clock has not been set, or has been reset due to a power-down and no backup is installed.

[0] * Disabled

[1] Enabled

0-81 Working Days

Array with 7 elements [0] - [6] displayed below parameter number in display. Press OK and step between elements by means of ▲ and ▼ buttons on the LCP.

Option:
Function:

Specify whether each weekday is a workday or a non-workday. First element of the array is Monday. The workdays are used for timed actions.

[0] * No

[1] Yes

0-82 Additional Working Days

Array with 5 elements [0] - [4] displayed below parameter number in display. Press OK and step between elements by means of ▲ and ▼ buttons on the LCP.

Range:
Function:

0 N/A* [0 - 0 N/A]

Defines dates for additional working days that normally would be non-working days according to par.0-82 *Additional Working Days*.

0-83 Additional Non-Working Days

Array with 15 elements [0] - [14] displayed below parameter number in display. Press OK and step between elements by means of ▲ and ▼ buttons on the LCP.

Range:
Function:

0 N/A* [0 - 0 N/A]

Defines dates for additional working days that normally would be non-working days according to par.0-81 *Working Days*.

0-89 Date and Time Readout

Range:
Function:

0 N/A* [0 - 0 N/A]

Displays the current date and time. The date and time is updated continuously. The clock will not begin counting until a setting different from default has been made in par. 0-70 *Set Date and Time*.

2.3 Main Menu - Load and Motor - Group 1

2.3.1 General Settings, 1-0*

Define whether the adjustable frequency drive operates in open-loop or closed-loop.

1-00 Configuration Mode

Option:	Function:
[0] * Open-loop	Motor speed is determined by applying a speed reference or by setting desired speed when in hand mode. Open-loop is also used if the adjustable frequency drive is part of a closed-loop control system based on an external PID controller providing a speed reference signal as output.
[3] Closed-loop	Motor speed will be determined by a reference from the built-in PID controller varying the motor speed as part of a closed-loop control process (e.g., constant pressure or flow). The PID controller must be configured in par. 20-** or via the function set-ups accessed by pressing the [Quick Menu] button.

NOTE!
This parameter cannot be changed when the motor is running.

NOTE!
When set for closed-loop, the commands reversing and start reversing will not reverse the direction of the motor.

1-03 Torque Characteristics

Option:	Function:
[0] Constant Torque	For speed control of screw and scroll compressors. Provides a voltage that is optimized for a constant torque load characteristic of the motor in the entire range down to 15 Hz.
[1] Variable torque	For speed control of centrifugal pumps and fans. Also to be used when controlling more than one motor from the same adjustable frequency drive (multiple condenser fans or cooling tower fans, etc.). Provides a voltage that is optimized for the squared torque load characteristic of the motor.
[2] Auto Energy Optim. CT	For optimum energy and efficient speed control of screw and scroll compressors. Provides a voltage that is optimized for a constant torque load characteristic of the motor in the entire range down to 15 Hz. In addition, the AEO feature will adapt the voltage exactly to the current load situation, thereby reducing energy consumption and audible noise from the motor. To obtain optimal performance, the motor power factor cos-phi must be set correctly. This value is set in par. 14-43, Motor cos-phi. The parameter has a default value that is automatically adjusted when the motor data is programmed. These settings will typically ensure optimum motor voltage, but if the motor power factor cos-phi requires tuning, an AMA function can be carried out using par. 1-29, Automatic Motor Adaptation (AMA). It is very rarely necessary to adjust the motor power factor parameter manually.
[3] * Auto Energy Optim. VT	For optimum energy efficient speed control of centrifugal pumps and fans. Provides a voltage that is optimized for a squared torque load characteristic of the motor. In addition the AEO feature will adapt the voltage exactly to the current load situation, thereby reducing energy consumption and audible noise from the motor. To obtain optimal performance, the motor power factor cos-phi must be set correctly. This value is set in par. 14-43, Motor cos-phi. The parameter has a default value and is automatically adjusted when the motor data is programmed. These settings will typically

ensure optimum motor voltage, but if the motor power factor $\cos\phi$ requires tuning, an AMA function can be carried out using par. 1-29, Automatic Motor Adaptation (AMA). It is very rarely necessary to adjust the motor power factor parameter manually.

2

2.3.2 1-2* Motor Data

Parameter group 1-2* comprises input data from the nameplate on the connected motor.

Parameters in parameter group 1-2* cannot be adjusted while the motor is running.

**NOTE!**

Changing the value of these parameters affects the setting of other parameters.

1-20 Motor Power [kW]

Range:

4.00 kW* [0.09 - 3000.00 kW]

Function:

Enter the nominal motor power (in kW) according to the motor nameplate data. The default value corresponds to the nominal rated output of the unit.

This parameter cannot be adjusted while the motor is running. Depending on the choices made in par.0-03 *Regional Settings*, either par.1-20 *Motor Power [kW]* or par.1-21 *Motor Power [HP]* is made invisible.

1-21 Motor Power [HP]

Range:

4.00 hp* [0.09 - 3000.00 hp]

Function:

Enter the nominal motor power (in HP) according to the motor nameplate data. The default value corresponds to the nominal rated output of the unit.

This parameter cannot be adjusted while the motor is running. Depending on the choices made in par. 0-03 *Regional Settings*, either par.1-20 *Motor Power [kW]* or par.1-21 *Motor Power [HP]* Motor Power is made invisible.

1-22 Motor Voltage

Range:

Size rela- [200-1000 V]
ted*

Function:

Enter the nominal motor voltage according to the motor nameplate data. The default value corresponds to the nominal rated output of the unit.

This parameter cannot be adjusted while the motor is running.

1-23 Motor Frequency

Range:

50. Hz* [20 - 1000 Hz]

Function:

Select the motor frequency value from the motor nameplate data. For 87 Hz operation with 230/400 V motors, set the nameplate data for 230 V/50 Hz. Adapt par.4-13 *Motor Speed High Limit [RPM]* and par.3-03 *Maximum Reference* to the 87 Hz application.

**NOTE!**

This parameter cannot be adjusted while the motor is running.

1-24 Motor Current

Range:	Function:
7.20 A* [0.10 - 10000.00 A]	Enter the nominal motor current value from the motor nameplate data. This data is used for calculating motor torque, motor thermal protection, etc.

NOTE!
This parameter cannot be adjusted while the motor is running.

1-25 Motor Nominal Speed

Range:	Function:
1420. RPM* [100 - 60000 RPM]	

NOTE!
This parameter cannot be changed while the motor is running.

1-28 Motor Rotation Check

Option:	Function:
	Following installation and connection of the motor, this function allows the correct motor rotation direction to be verified. Enabling this function overrides any bus commands or digital inputs, except external interlock and safe stop (if included).
[0] * OFF	Motor Rotation Check is not active.
[1] Enabled	Motor Rotation Check is enabled. Once enabled, display shows: "Please Note! Motor may run in wrong direction".

Pressing [OK], [Back] or [Cancel] will dismiss the message and display a new message: "Press [Hand on] to start the motor. Press [Cancel] to abort". Pressing [Hand on] starts the motor at 5 Hz in forward direction and the display shows: "Motor is running. Check if motor rotation direction is correct. Press [Off] to stop the motor". Pressing [Off] stops the motor and resets par.1-28 *Motor Rotation Check*. If motor rotation direction is incorrect, two motor phase cables should be interchanged. **IMPORTANT:**

Line power must be removed before disconnecting motor phase cables.

1-29 Automatic Motor Adaptation (AMA)

Option:	Function:
	The AMA function optimizes dynamic motor performance by automatically optimizing the advanced motor parameters par.1-30 <i>Stator Resistance (Rs)</i> to par.1-35 <i>Main Reactance (Xh)</i> while the motor is stationary.
[0] * Off	No function
[1] Enable complete AMA	performs AMA of the stator resistance R_s , the rotor resistance R_r , the stator leakage reactance X_1 , the rotor leakage reactance X_2 and the main reactance X_h .
[2] Enable reduced AMA	performs a reduced AMA of the stator resistance R_s in the system only. Select this option if an LC filter is used between the adjustable frequency drive and the motor.

Activate the AMA function by pressing [Hand on] after selecting [1] or [2]. See also the section *Automatic Motor Adaptation*. After a normal sequence, the display will read: "Press [OK] to finish AMA". After pressing the [OK] key, the adjustable frequency drive is ready for operation.

Note:

- For the best adaptation of the adjustable frequency drive, run AMA on a cold motor.
- AMA cannot be performed while the motor is running.

**NOTE!**

It is important to set motor par. 1-2* Motor Data correctly, since these form part of the AMA algorithm. An AMA must be performed to achieve optimum dynamic motor performance. It may take up to 10 min., depending on the motor power rating.

**NOTE!**

Avoid generating external torque during AMA

**NOTE!**

If one of the settings in par. 1-2* Motor Data is changed, par.1-30 *Stator Resistance (Rs)* to par.1-39 *Motor Poles*, the advanced motor parameters will return to default setting.
This parameter cannot be adjusted while the motor is running.

**NOTE!**

Full AMA should be run without filter only while reduced AMA should be run with filter.

See section *Automatic Motor Adaptation* - application example.

2.3.3 1-3* Addl. Motor Data

Parameters for advanced motor data. The motor data in par.1-30 *Stator Resistance (Rs)* to par.1-39 *Motor Poles* must match the relevant motor in order to run the motor optimally. The default settings are figures based on common motor parameter values from normal standard motors. If the motor parameters are not set correctly, a malfunction of the adjustable frequency drive system may occur. If the motor data is not known, running an AMA (Automatic Motor Adaptation) is recommended. See the *Automatic Motor Adaptation* section. The AMA sequence will adjust all motor parameters except the moment of inertia of the rotor and the iron loss resistance (par.1-36 *Iron Loss Resistance (Rfe)*).

Par. 1-3* and par. 1-4* cannot be adjusted while the motor is running.

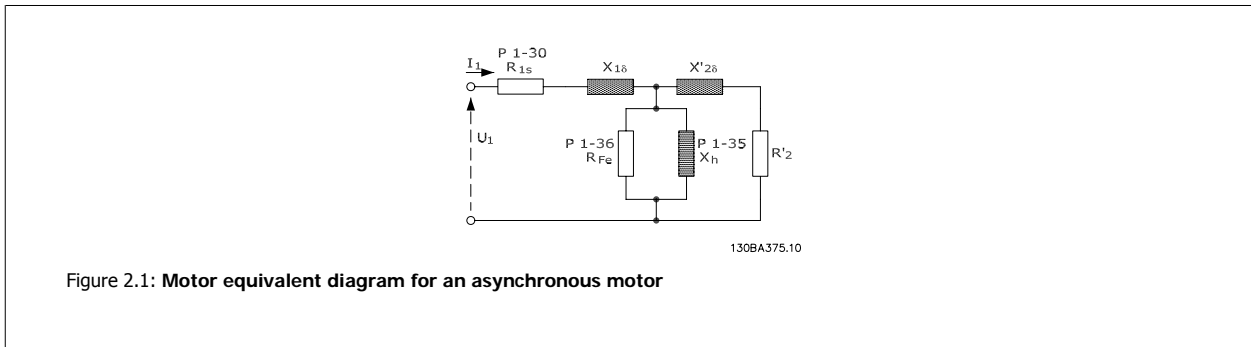

Figure 2.1: Motor equivalent diagram for an asynchronous motor

1-30 Stator Resistance (Rs)

Range:

1.4000 [0.0140 - 140.0000 Ohm]
Ohm*

Function:

Set the stator resistance value. Enter the value from a motor data sheet or perform an AMA on a cold motor. This parameter cannot be adjusted while the motor is running.

1-35 Main Reactance (Xh)

Range:

100.0000 [1.0000 - 10000.0000 Ohm]
Ohm*

Function:

Set the main reactance of the motor using one of these methods:

1. Run an AMA on a cold motor. The adjustable frequency drive will measure the value from the motor.
2. Enter the X_h value manually. Obtain the value from the motor supplier.
3. Use the X_h default setting. The adjustable frequency drive establishes the setting on the basis of the motor nameplate data.



NOTE!

This parameter cannot be adjusted while running.

1-36 Iron Loss Resistance (Rfe)

Range:

10000.000 [0 - 10000.000 Ohm]
Ohm*

Function:

Enter the equivalent iron loss resistance (R_{Fe}) value to compensate for iron losses in the motor. The R_{Fe} value cannot be found by performing an AMA. The R_{Fe} value is especially important in torque control applications. If R_{Fe} is unknown, leave par. 1-36 *Iron Loss Resistance (Rfe)* on default setting.



NOTE!

This parameter cannot be adjusted while the motor is running.

1-39 Motor Poles

Range:

4. N/A* [2 - 100 N/A]

Function:

Enter the number of motor poles.

Poles	~n _n @ 50 Hz	~n _n @60 Hz
2	2700 - 2880	3250 - 3460
4	1350 - 1450	1625 - 1730
6	700 - 960	840 - 1153

The table shows the number of poles for normal speed ranges of various motor types. Separately define motors designed for other frequencies. The motor pole value is always an even number, as it refers to the total number of poles, not pairs of poles. The adjustable frequency drive creates the initial setting of par.1-39 *Motor Poles* based on par.1-23 *Motor Frequency Motor Frequency* and par. 1-25 *Motor Nominal Speed Motor Nominal Speed*.

This parameter cannot be adjusted while the motor is running.

2.3.4 1-5* Load Indep. Setting

Parameters for setting the load-independent motor settings.

1-50 Motor Magnetization at Zero Speed

Range:

100 %* [0 - 300 %]

Function:

Use this par. along with par.1-51 *Min Speed Normal Magnetizing [RPM]* to obtain a different thermal load on the motor when running at low speed.

Enter a value that is a percentage of the rated magnetizing current. If the setting is too low, the torque on the motor shaft may be reduced.

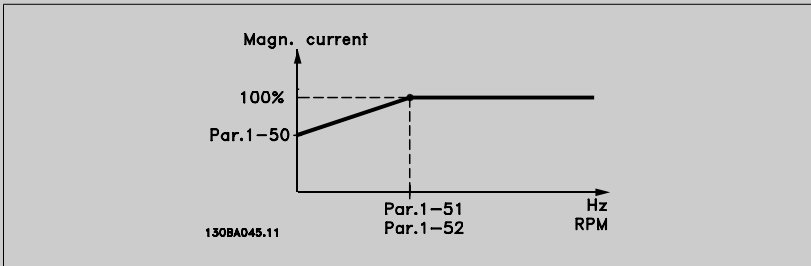

1-51 Min Speed Normal Magnetizing [RPM]

Range:

15. RPM* [10 - 300 RPM]

Function:

Set the required speed for normal magnetizing current. If the speed is set lower than the motor slip speed, par.1-50 *Motor Magnetization at Zero Speed* and par.1-51 *Min Speed Normal Magnetizing [RPM]* are of no significance.

Use this par. along with par.1-50 *Motor Magnetization at Zero Speed*. See drawing for par. 1-50 *Motor Magnetization at Zero Speed*.

1-52 Min Speed Normal Magnetizing [Hz]

Range:

0.5 Hz* [0.3 - 10.0 Hz]

Function:

Set the required frequency for normal magnetizing current. If the frequency is set lower than the motor slip frequency, par.1-50 *Motor Magnetization at Zero Speed* and par.1-51 *Min Speed Normal Magnetizing [RPM]*. are inactive.

Use this par. along with par.1-50 *Motor Magnetization at Zero Speed*. See drawing for par. 1-50 *Motor Magnetization at Zero Speed*.

2.3.5 1-6* Load Depend. Setting

Parameters for adjusting the load-dependent motor settings.

1-60 Low Speed Load Compensation

Range:

100 %* [0 - 300 %]

Function:

Enter the % value to compensate voltage in relation to load while the motor is running at low speed, and obtain the optimum U/f characteristic. The motor size determines the frequency ranges within which this parameter is active.

Motor size	Change-over
0.3–10 hp [0.25–7.5 kW]	< 10 Hz
15–60 hp [11–45 kW]	< 5 Hz
75–738 hp [55–550 kW]	< 3–4 Hz

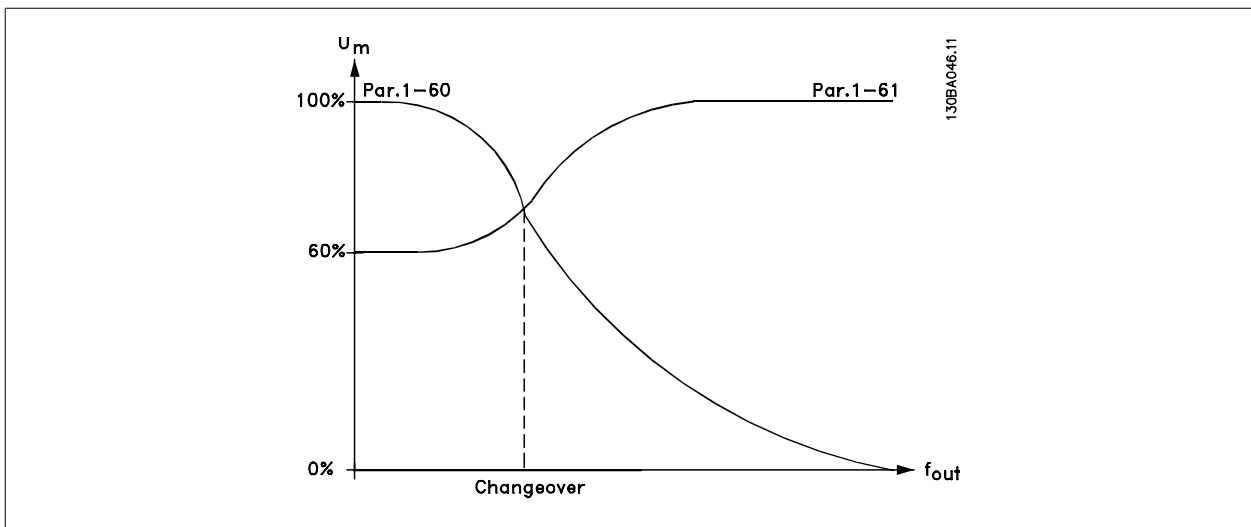

1-61 High Speed Load Compensation

Range:

100 %* [0 - 300 %]

Function:

Enter the % value to compensate voltage in relation to load while the motor is running at high speed, and obtain the optimum U/f characteristic. The motor size determines the frequency ranges within which this parameter is active.

Motor size	Change-over
0.3–10 hp [0.25–7.5 kW]	> 10 Hz
15–60 hp [11–45 kW]	< 5 Hz
75–738 hp [55–550 kW]	< 3–4 Hz

1-62 Slip Compensation

Range:

0 %* [-500 - 500 %]

Function:

Enter the % value for slip compensation to compensate for tolerances in the value of $n_{m,N}$. Slip compensation is calculated automatically, i.e., on the basis of the rated motor speed $n_{m,N}$.

1-63 Slip Compensation Time Constant

Range:

0.10 s* [0.05 - 5.00 s]

Function:

Enter the slip compensation reaction speed. A high value results in slow reaction, and a low value results in quick reaction. If low-frequency resonance problems arise, use a longer time setting.

1-64 Resonance Dampening

Range:

100 %* [0 - 500 %]

Function:

Enter the resonance dampening value. Set par.1-64 *Resonance Dampening* and par.1-65 *Resonance Dampening Time Constant* to help eliminate high-frequency resonance problems. To reduce resonance oscillation, increase the value of par.1-64 *Resonance Dampening*.

1-65 Resonance Dampening Time Constant

Range:

5 ms* [5 - 50 ms]

Function:

Set par.1-64 *Resonance Dampening* and par.1-65 *Resonance Dampening Time Constant* to help eliminate high-frequency resonance problems. Enter the time constant that provides the best dampening.

2.3.6 1-7* Start Adjustments

Parameters for setting special motor start features.

1-71 Start Delay

Range:

0.0 s* [0.0 - 120.0 s]

Function:

The function selected in par.1-80 *Function at Stop* is active in the delay period. Enter the time delay required before commencing acceleration.

1-73 Flying Start

Option:

[0]* Disabled

[1] Enabled

Function:

This function makes it possible to catch a motor in both directions that is spinning freely due to a line drop-out.

No function

Enables the adjustable frequency drive to "catch" and control a spinning motor.

When par. 1-73 is enabled, par. 1-71 *Start Delay* has no function.

Search direction for a flying start is linked to the setting in par. 4-10, Motor Speed Direction.

Clockwise [0]: Flying start search in clockwise direction. If not successful, a DC brake is carried out.

Both Directions [2]: The flying start will first make a search in the direction determined by the last reference (direction). If unable to find the speed, it will search in the other direction. If not successful, a DC brake will be activated in the time set in par. 2-02, Braking Time. Start will then take place from 0 Hz.

1-74 Start Speed [RPM]

Range:

0 RPM* [0-600 RPM]

Function:

This par can be used for hoist applications (cone rotor).

Set a motor start speed. After the start signal, the output speed leaps to set value. Set the start function in par. 1-72 *Start Function* to [3], [4] or [5], and set a start delay time in par. 1-71 *Start Delay*.

1-75 Start Speed [Hz]

Range:	Function:
0 Hz* [0.0–500.0 Hz]	This par can be used for hoist applications (cone rotor). Set a motor start speed. After the start signal, the output speed leaps to set value. Set the start function in par. H-32 <i>Start Function</i> to [3], [4] or [5], and set a start delay time in par. F-24 <i>Holding Time</i> .

1-76 Start Current

Range:	Function:
0.00 A* [0.00 - par. 1-24 A]	This par can be used for hoist applications (cone rotor). Some motors, e.g., cone rotor motors, need extra current/starting speed to disengage the rotor. To obtain this boost, set the required current in par.1-76 <i>Start Current</i> . Set par.1-74 <i>Start Speed [RPM]</i> . Set par. 1-72 <i>Start Function</i> to [3] or [4], and set a start delay time in par. 1-71 <i>Start Delay</i> .

2.3.7 1-8* Stop Adjustments

Parameters for setting special stop features for the motor.

1-80 Function at Stop

Option:	Function:
[0] * Coast	Select the adjustable frequency drive function after a stop command or after the speed is ramped down to the settings in par.1-81 <i>Min Speed for Function at Stop [RPM]</i> . Leaves motor in free mode.
[1] DC Hold/Motor Preheat	Energizes motor with a DC holding current (see par.2-00 <i>DC Hold/Preheat Current</i>).

1-81 Min Speed for Function at Stop [RPM]

Range:	Function:
3. RPM* [0 - 600 RPM]	Set the speed at which to activate par.1-80 <i>Function at Stop</i> .

1-82 Min Speed for Function at Stop [Hz]

Range:	Function:
0.1 Hz* [0.0 - 20.0 Hz]	Set the output frequency at which to activate par.1-80 <i>Function at Stop</i> .

2.3.8 1-9* Motor Temperature

Parameters for setting the temperature protection features for the motor.

1-90 Motor Thermal Protection

Option:	Function:
	The adjustable frequency drive determines the motor temperature for motor protection in two different ways: <ul style="list-style-type: none"> Via a thermistor sensor connected to one of the analog or digital inputs (par.1-93 <i>Thermistor Source</i>).

- Via calculation (ETR = Electronic Thermal Relay) of the thermal load, based on the actual load and time. The calculated thermal load is compared with the rated motor current $I_{M,N}$ and the rated motor frequency $f_{M,N}$. The calculations estimate the need for a lower load at lower speed due to less cooling from the fan incorporated in the motor.

[0]	No protection	If the motor is continuously overloaded and no warning or trip of adjustable frequency drive is wanted.
[1]	Thermistor warning	Activates a warning when the connected thermistor in the motor reacts in the event of motor over-temperature.
[2]	Thermistor trip	Stops (trips) the adjustable frequency drive when the connected thermistor in the motor reacts in the event of motor overtemperature.
[3]	ETR warning 1	
[4] *	ETR trip 1	
[5]	ETR warning 2	
[6]	ETR trip 2	
[7]	ETR warning 3	
[8]	ETR trip 3	
[9]	ETR warning 4	
[10]	ETR trip 4	

ETR (Electronic Thermal Relay) functions 1-4 will calculate the load when the set-up where they were selected is active. For example, ETR starts calculating when set-up 3 is selected. For the North American market: The ETR functions provide class 20 motor overload protection in accordance with NEC.

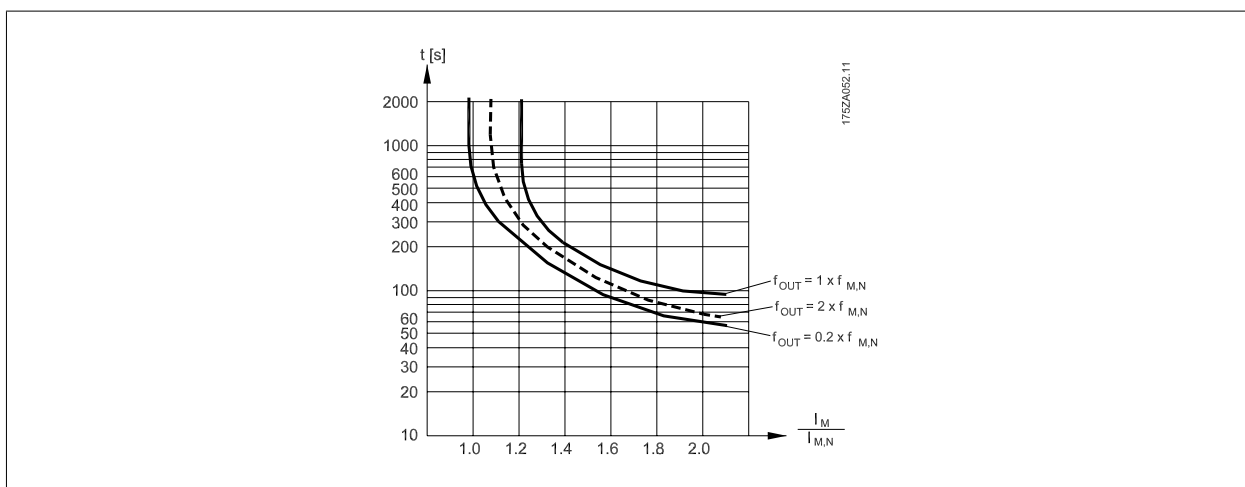

NOTE!

Danfoss recommends using 24 V DC as the thermistor supply voltage.

1-91 Motor External Fan

Option:

Function:

[0] *	No	No external fan is required, i.e. the motor is derated at low speed.
[1]	Yes	Applies an external motor fan (external ventilation), so that no derating of the motor is required at low speed. The graph below is followed if the motor current is lower than nominal motor current (see par.1-24 <i>Motor Current</i>). If the motor current exceeds nominal current, the operation time still decreases as if no fan were installed.

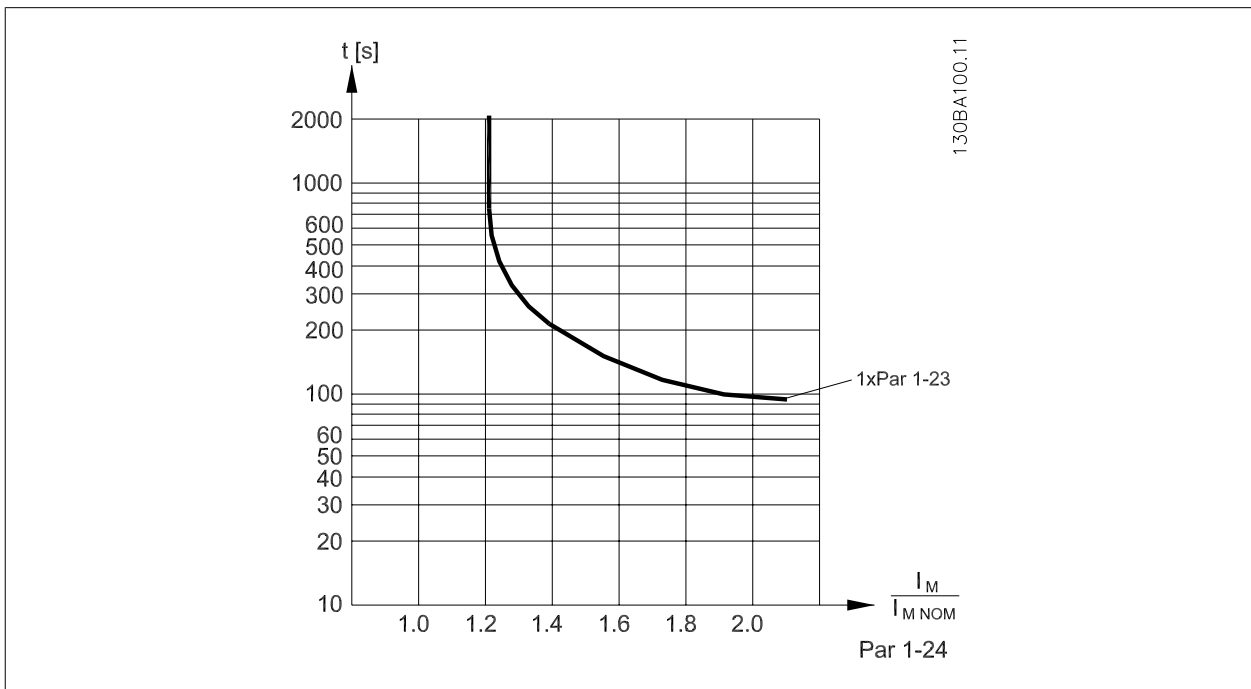

1-93 Thermistor Source

Option:

Function:

Select the input to which the thermistor (PTC sensor) should be connected. An analog input option [1] or [2] cannot be selected if the analog input is already in use as a reference source (selected in par.3-15 *Reference 1 Source*, par.3-16 *Reference 2 Source* or par.3-17 *Reference 3 Source*). When using the MCB112, choice [0] *None* must always be selected.

- [0] * None
- [1] Analog input 53
- [2] Analog input 54
- [3] Digital input 18
- [4] Digital input 19
- [5] Digital input 32
- [6] Digital input 33

NOTE!
This parameter cannot be adjusted while the motor is running.

NOTE!
Digital inputs should be set to "No operation" - see par. 5-1*.

2.4 Main Menu - Brakes - Group 2

2.4.1 2-0* DC Brakes

Parameter group for configuring the DC brake and DC hold functions.

2-00 DC Hold/Preheat Current

Range:

50 %* [0 - 160. %]

Function:

Enter a value for holding current as a percentage of the rated motor current $I_{M,N}$ set in par. 1-24 *Motor Current*. 100% DC holding current corresponds to $I_{M,N}$.
This parameter holds the motor (holding torque) or pre-heats the motor.
This parameter is active if [1] DC hold/Preheat is selected in par.1-80 *Function at Stop*.

NOTE!

The maximum value depends on the rated motor current.

NOTE!

Avoid 100% current for too long, as it may damage the motor. It may damage the motor.

2-01 DC Brake Current

Range:

50 %* [0 - 1000. %]

Function:

Enter a value for current as a percentage of the rated motor current $I_{M,N}$, see par.1-24 *Motor Current*. 100% DC braking current corresponds to $I_{M,N}$.
DC brake current is applied on a stop command, when the speed is lower than the limit set in par. 2-03 *DC Brake Cut-in Speed [RPM]*; when the DC Brake Inverse function is active; or via the serial communication port. The braking current is active during the time period set in par.2-02 *DC Braking Time*.

NOTE!

The maximum value depends on the rated motor current.

NOTE!

Avoid 100% current for too long, as it may damage the motor. It may damage the motor.

2-02 DC Braking Time

Range:

10.0 s* [0.0 - 60.0 s]

Function:

Set the duration of the DC braking current set in par.2-01 *DC Brake Current*, once activated.

2-03 DC Brake Cut-in Speed [RPM]

Range:

0 RPM* [0 - par. 4-13 RPM]

Function:

Set the DC brake cut-in speed for activation of the DC braking current set in par.2-01 *DC Brake Current*, upon a stop command.

2.4.2 2-1* Brake Energy Funct.

Parameter group for selecting dynamic braking parameters.

2-10 Brake Function

Option:	Function:
[0] * Off	No brake resistor installed.
[1] Resistor brake	Brake resistor incorporated in the system, for dissipation of surplus braking energy as heat. Connecting a brake resistor allows a higher DC link voltage during braking (generating operation). The resistor brake function is only active in adjustable frequency drives with an integral dynamic brake.
[2] AC brake	

2-11 Brake Resistor (ohm)

Range:	Function:
50. Ohm* [5. - 32000. Ohm]	Set the brake resistor value in Ohms. This value is used for monitoring the power to the brake resistor in par.2-13 <i>Brake Power Monitoring</i> . This parameter is only active in adjustable frequency drives with an integral dynamic brake. If the selection is xxxx, use this parameter. If the selection is xxx.xx, use par. 3-81 <i>Quick Stop Ramp Time</i> .

2-12 Brake Power Limit (kW)

Range:	Function:
5.000 kW* [0.001 - 500.000 kW]	Set the monitoring limit of the braking energy transmitted to the resistor. The monitoring limit is a product of the maximum duty cycle (120 sec.) and the maximum power of the brake resistor at that duty cycle. See the formula below.

For 200–240 V units:

$$P_{resistor} = \frac{390^2 \times dutytime}{R \times 120}$$

For 380–480 V units:

$$P_{resistor} = \frac{778^2 \times dutytime}{R \times 120}$$

For 525–600 V units:

$$P_{resistor} = \frac{943^2 \times dutytime}{R \times 120}$$

This parameter is only active in adjustable frequency drives with an integral dynamic brake.

2-13 Brake Power Monitoring

Option:	Function:
[0] * Off	No braking energy monitoring is required.
[1] Warning	This parameter is only active in adjustable frequency drives with an integral dynamic brake. This parameter enables monitoring of the power to the brake resistor. The power is calculated on the basis of the resistance (par.2-11 <i>Brake Resistor (ohm)</i> (Ohm)), the DC link voltage, and the resistor duty time. Activates a warning on the display when the power transmitted over 120 s exceeds 100% of the monitoring limit (par.2-12 <i>Brake Power Limit (kW)</i>). The warning disappears when the transmitted power falls below 80% of the monitoring limit.
[2] Trip	Trips the adjustable frequency drive and displays an alarm when the calculated power exceeds 100% of the monitoring limit.
[3] Warning and trip	Activates both of the above, including warning, trip and alarm.

If power monitoring is set to *Off*[0] or *Warning*[1], the brake function remains active even if the monitoring limit is exceeded. This may lead to thermal overload of the resistor. It is also possible to generate a warning via a relay/digital output. The measuring accuracy of the power monitoring depends on the accuracy of the resistance of the resistor (better than ± 20%).

2-15 Brake Check

Option:
Function:

Select type of test and monitoring function to check the connection to the brake resistor, or whether a brake resistor is present, and then display a warning or an alarm in the event of a fault. The brake resistor disconnection function is tested during power-up. However, the brake IGBT test is performed when there is no braking. A warning or trip disconnects the brake function.

The testing sequence is as follows:

1. The DC link ripple amplitude is measured for 300 ms without braking.
2. The DC link ripple amplitude is measured for 300 ms with the brake turned on.
3. If the DC link ripple amplitude while braking is lower than the DC link ripple amplitude before braking + 1%. Brake check failed, return a warning or alarm.
4. If the DC link ripple amplitude while braking is higher than the DC link ripple amplitude before braking + 1%. Brake check OK.

[0] *	Off	Monitors brake resistor and brake IGBT for a short-circuit during operation. If a short-circuit occurs, a warning appears.
[1]	Warning	Monitors brake resistor and brake IGBT for a short-circuit, and to run a test for brake resistor disconnection during power-up.
[2]	Trip	Monitors for a short-circuit or disconnection of the brake resistor, or a short-circuit of the brake IGBT. If a fault occurs, the adjustable frequency drive cuts out while displaying an alarm (trip-locked).
[3]	Stop and trip	Monitors for a short-circuit or disconnection of the brake resistor, or a short-circuit of the brake IGBT. If a fault occurs, the adjustable frequency drive ramps down to coast and then trips. A trip lock alarm is displayed.
[4]	AC brake	

NOTE!

NB!: Remove a warning arising in connection with *Off*[0] or *Warning* [1] by cycling the line power supply. The fault must be corrected first. For *Off*[0] or *Warning* [1], the adjustable frequency drive keeps running even if a fault is located.

2-17 Over-voltage Control

Option:
Function:

Overvoltage control (OVC) reduces the risk of the adjustable frequency drive tripping due to an overvoltage on the DC link caused by generative power from the load.

[0]	Disabled	No OVC required.
[2] *	Enabled	Activates OVC.

NOTE!

The ramp time is automatically adjusted to avoid tripping of the adjustable frequency drive.

2.5 Main Menu - Reference/Ramps - Group 3

2.5.1 3-0* Reference Limits

Parameters for setting the reference unit, limits and ranges.

3-02 Minimum Reference

Range:

0.000 Ref- [-999999.999 - par. 3-03 ReferenceFeed-ceFeedbackUnit] backUnit*

Function:

Enter the Minimum Reference. The Minimum Reference is the lowest value obtainable by adding all references together. The Minimum Reference value and unit matches the configuration choice made in par.1-00 *Configuration Mode* and par. 20-12 *Reference/Feedback Unit*, respectively.



NOTE!

This parameter is used in open-loop only.

3-03 Maximum Reference

Range:

50.000 Ref- [par. 3-02 - 999999.999 ReferenceFeed-ceFeedbackUnit] backUnit*

Function:

Enter the maximum reference. The maximum reference is the highest value obtainable by adding all references together. The Maximum Reference value and unit matches the configuration choice made in par.1-00 *Configuration Mode* and par. 20-12 *Reference/Feedback Unit*, respectively.



NOTE!

This parameter is used in open-loop only.

3-04 Reference Function

Option:

[0] * Sum

Function:

Sums both external and preset reference sources.

[1] External/Preset

Use either the preset or the external reference source.

Shift between external and preset via a command on a digital input.

2.5.2 3-1* References

Parameters for setting up the reference sources.

Select the preset reference(s). *Select Preset ref. bit 0 / 1 / 2* [16], [17] or [18] for the corresponding digital inputs in parameter group 5.1*.

3-10 Preset Reference

Array [8]

Range:

0.00 %* [-100.00 - 100.00 %]

Function:

Enter up to eight different preset references (0-7) in this parameter using array programming. The preset reference is stated as a percentage of the value Ref_{MAX} (par. 3-03 Maximum Reference) or as a percentage of the other external references. If a Ref_{MIN} different from 0 (Par. 3-02 Minimum Reference) is programmed, the preset reference is calculated as a percentage of the full reference range, i.e., on the basis of the difference between Ref_{MAX} and Ref_{MIN}. Afterwards, the value is added to Ref_{MIN}. When using preset references, select Preset ref. bit 0 / 1 / 2 [16], [17] or [18] for the corresponding digital inputs in parameter group 5.1* Digital Inputs.

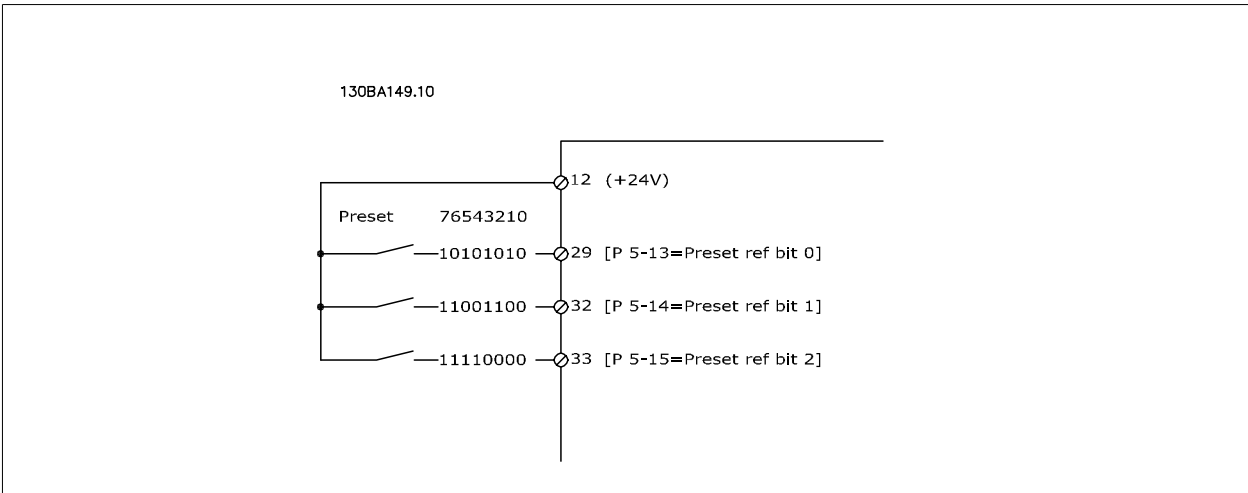

3-11 Jog Speed [Hz]

Range:

10.0 Hz* [0.0 - par. 4-14 Hz]

Function:

The jog speed is a fixed output speed at which the adjustable frequency drive is running when the jog function is activated.
See also par.3-80 *Jog Ramp Time*.

3-13 Reference Site

Option:

- [0] * Linked to Hand / Auto
- [1] Remote
- [2] Local

Function:

Select which reference site to activate.

- Use local reference when in hand mode; or remote reference when in auto mode.
- Use remote reference in both hand mode and auto mode.
- Use local reference in both hand mode and auto mode.



NOTE!

When set to Local [2], the adjustable frequency drive will start with this setting again following a 'power-down'.

3-14 Preset Relative Reference

Range:

0.00 %* [-100.00 - 100.00 %]

Function:

The actual reference, X, is increased or decreased with the percentage Y, set in par.3-14 *Preset Relative Reference*. This results in the actual reference Z. Actual reference (X) is the sum of the inputs selected in par.3-15 *Reference 1 Source*, par.3-16 *Reference 2 Source*, par.3-17 *Reference 3 Source* and par. 8-02 *Control Source*.

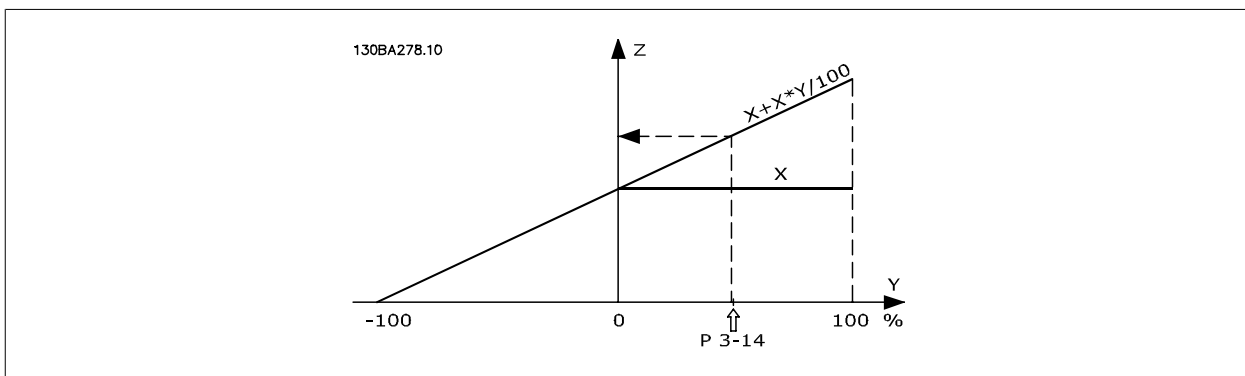
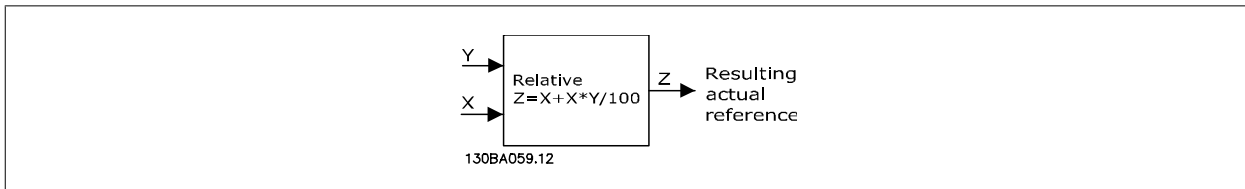

3-15 Reference 1 Source

Option:

Function:

Select the reference input to be used for the first reference signal. par.3-15 *Reference 1 Source*, par.3-16 *Reference 2 Source* and par.3-17 *Reference 3 Source* define up to three different reference signals. The sum of these reference signals defines the actual reference.

This parameter cannot be adjusted while the motor is running.

[0] No function

[1] * Analog input 53

[2] Analog input 54

[7] Pulse input 29

[8] Pulse input 33

[20] Digital pot.meter

[21] Analog input X30/11

[22] Analog input X30/12

[23] Analog Input X42/1

[24] Analog Input X42/3

[25] Analog Input X42/5

[30] Ext. Closed-loop 1

[31] Ext. Closed-loop 2

[32] Ext. Closed-loop 3

3-16 Reference 2 Source**Option:****Function:**

Select the reference input to be used for the second reference signal. par.3-15 *Reference 1 Source*, par.3-16 *Reference 2 Source* and par.3-17 *Reference 3 Source* define up to three different reference signals. The sum of these reference signals defines the actual reference.

This parameter cannot be adjusted while the motor is running.

[0] No function

[1] Analog input 53

[2] Analog input 54

[7] Pulse input 29

[8] Pulse input 33

[20] * Digital pot.meter

[21] Analog input X30/11

[22] Analog input X30/12

[23] Analog Input X42/1

[24] Analog Input X42/3

[25] Analog Input X42/5

[30] Ext. Closed-loop 1

[31] Ext. Closed-loop 2

[32] Ext. Closed-loop 3

3-17 Reference 3 Source**Option:****Function:**

Select the reference input to be used for the third reference signal. par.3-15 *Reference 1 Source*, par.3-16 *Reference 2 Source* and par.3-17 *Reference 3 Source* define up to three different reference signals. The sum of these reference signals defines the actual reference.

This parameter cannot be adjusted while the motor is running.

[0] * No function

[1] Analog input 53

[2] Analog input 54

[7] Pulse input 29

[8] Pulse input 33

[20] Digital pot.meter

[21] Analog input X30/11

[22] Analog input X30/12

[23] Analog Input X42/1

[24] Analog Input X42/3

[25] Analog Input X42/5

[30] Ext. Closed-loop 1

[31] Ext. Closed-loop 2

[32] Ext. Closed-loop 3

3-19 Jog Speed [RPM]

Range:

300. RPM* [0 - par. 4-13 RPM]

Function:

Enter a value for the jog speed n_{JOG} , which is a fixed output speed. The adjustable frequency drive runs at this speed when the jog function is activated. The maximum limit is defined in par. . See also par.3-80 *Jog Ramp Time*.

2.5.3 3-4* Ramp 1

Configure the ramp parameter, ramp times, for each of the two ramps (par. 3-4* and par. 3-5*).

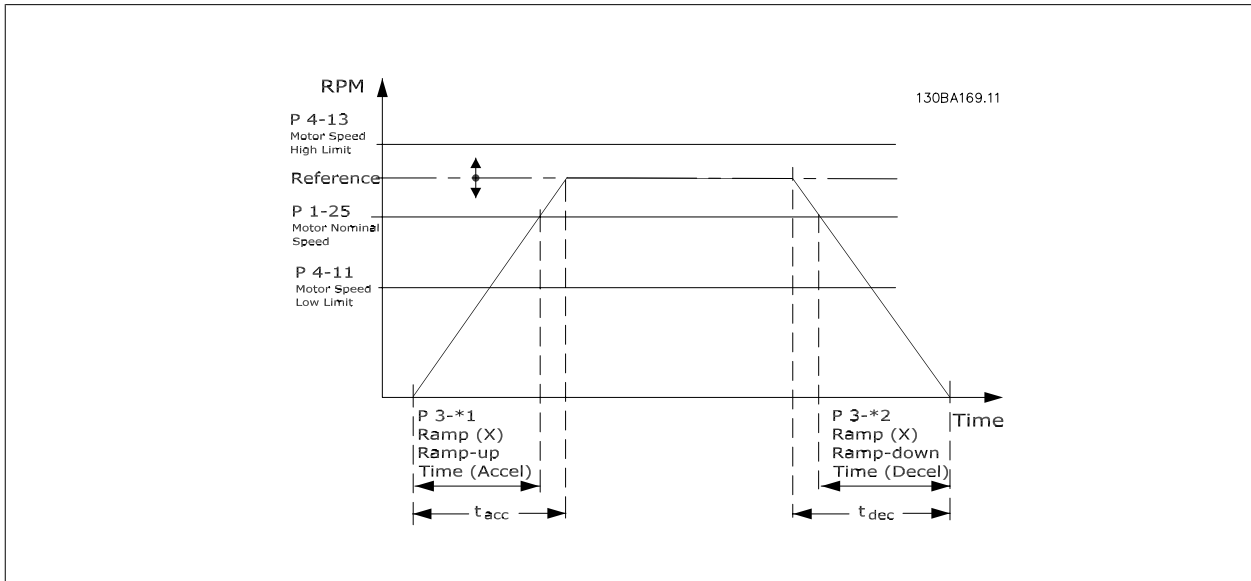

3-41 Ramp 1 Ramp-up Time

Range:

10.00 s* [1.00 - 3600.00 s]

Function:

Enter the ramp-up time, i.e., the acceleration time from 0 RPM to par. 1-25. Choose a ramp-up time such that the output current does not exceed the current limit in par. 4-18 during ramping. See ramp-down time in par.3-42 *Ramp 1 Ramp-down Time*.

$$par.3 - 41 = \frac{t_{acc} \times n_{norm} [par.1 - 25]}{ref[rpm]} [s]$$

See drawing above!

3-42 Ramp 1 Ramp-down Time

Range:

20.00 s* [1.00 - 3600.00 s]

Function:

Enter the ramp-down time, i.e., the deceleration time from par.1-25 *Motor Nominal Speed* to 0 RPM. Choose a ramp-down time such that no overvoltage arises in the inverter due to regenerative operation of the motor, and such that the generated current does not exceed the current limit set in par. 4-18 *Current Limit*. See ramp-up time in par.3-41 *Ramp 1 Ramp-up Time*.

$$par.3 - 42 = \frac{t_{dec} \times n_{norm} [par.1 - 25]}{ref[rpm]} [s]$$

2.5.4 3-5* Ramp 2

Choosing ramp parameters, see 3-4*.

3-51 Ramp 2 Ramp-up Time

Range:

10.00 s* [1.00 - 3600.00 s]

Function:

Enter the ramp-up time, i.e. the acceleration time from 0 RPM to par.1-25 *Motor Nominal Speed*. Choose a ramp-up time such that the output current does not exceed the current limit in par. 4-18 *Current Limit* during ramping. See ramp-down time in par.3-52 *Ramp 2 Ramp-down Time*.

$$par. 3 - 51 = \frac{tacc \times nnorm [par. 1 - 25]}{ref[rpm]} [s]$$

3-52 Ramp 2 Ramp-down Time

Range:

20.00 s* [1.00 - 3600.00 s]

Function:

Enter the ramp-down time, i.e., the deceleration time from par.1-25 *Motor Nominal Speed* to 0 RPM. Choose a ramp-down time such that no overvoltage arises in the inverter due to regenerative operation of the motor, and such that the generated current does not exceed the current limit set in par. 4-18 *Current Limit*. See ramp-up time in par.3-51 *Ramp 2 Ramp-up Time*.

$$par.3 - 52 = \frac{tdec \times nnorm [par. 1 - 25]}{ref[rpm]} [s]$$

2.5.5 3-8* Other Ramps

Configure parameters for special ramps such as jog or quick stop, for example.

3-80 Jog Ramp Time

Range:

20.00 s* [1.00 - 3600.00 s]

Function:

Enter the jog ramp time, i.e. the acceleration/deceleration time between 0 RPM and the rated motor speed ($n_{M,N}$) (set in par.1-25 *Motor Nominal Speed*). Ensure that the resultant output current required for the given jog ramp time does not exceed the current limit in par. 4-18 *Current Limit*. The jog ramp time starts upon activation of a jog signal via the control panel, a selected digital input or the serial communication port.

$$par. 3 - 80 = \frac{tjog \times nnorm [par. 1 - 25]}{jog\ speed [par. 3 - 19]} [s]$$

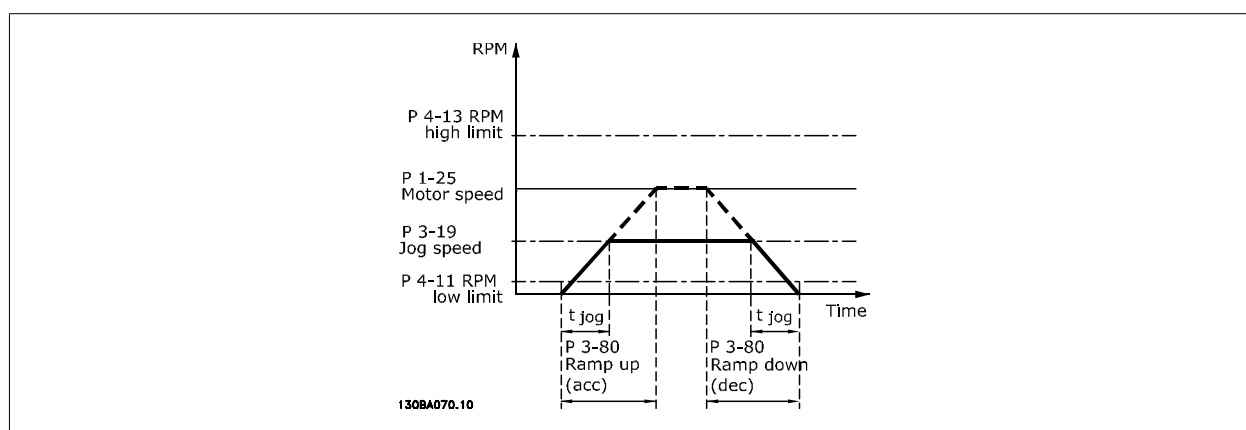

3-84 Initial Ramp Time

Range:

0 s* [0–60 s]

Function:

Enter the initial ramp-up time from zero speed to Motor Speed Low Limit, par. 4-11 or 4-12. Submersible deep well pumps can be damaged by running below minimum speed. A fast ramp time below minimum pump speed is recommended. This parameter may be applied as a fast ramp rate from zero speed to Motor Speed Low Limit.

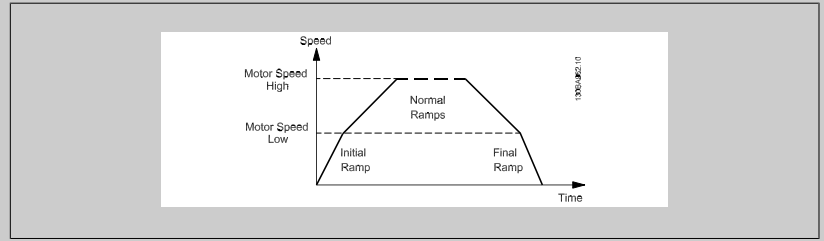

3-85 Check Valve Ramp Time

Range:

0 s* [0–60 s]

Function:

In order to protect ball check valves in a stop situation, the check valve ramp can be utilized as a slow ramp rate from par.4-11 *Motor Speed Low Limit [RPM]* or par.4-12 *Motor Speed Low Limit [Hz]*, to Check Valve Ramp End Speed, set by the user in par. 3-86 or par. 3-87. When par. 3-85 is different from 0 seconds, the Check Valve Ramp Time is effectuated and will be used to ramp down the speed from Motor Speed Low Limit to the Check Valve End Speed in par. 3-86 or par. 3-87.

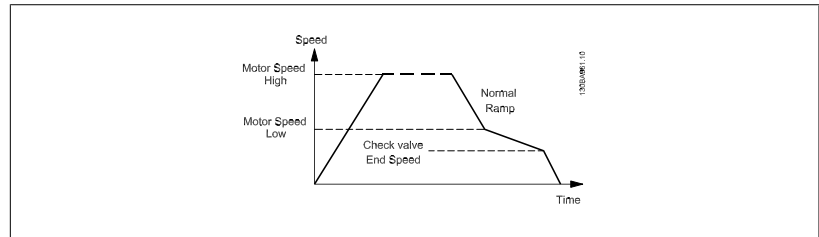

3-86 Check Valve Ramp End Speed [RPM]

Range:

0 [RPM]* [0 – Motor Speed Low Limit [RPM]]

Function:

Set the speed in [RPM] below Motor Speed Low Limit where the Check Valve is expected to be closed and the Check Valve no longer shall be active.

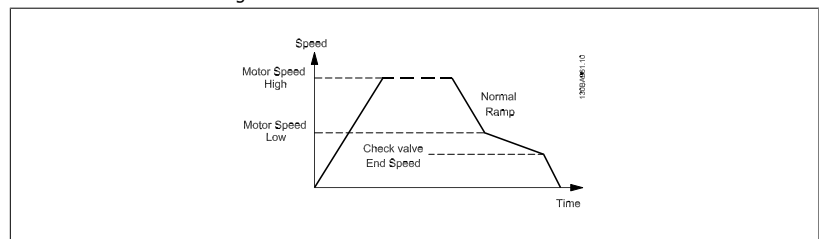

3-87 Check Valve Ramp End Speed [Hz]

Range:

0 [Hz]* [0 – Motor Speed Low Limit [Hz]]

Function:

Set the speed in [Hz] below Motor Speed Low Limit where the Check Valve Ramp will no longer be active.

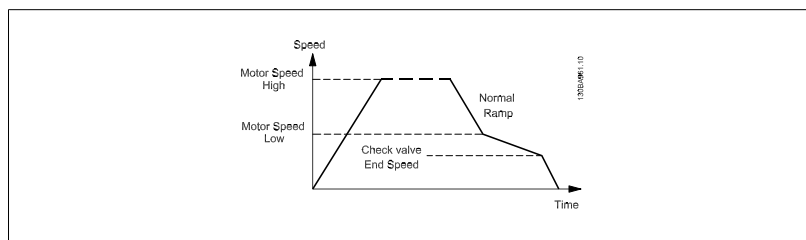

3-88 Final Ramp Time

Range:

0 [s]* [0 – 60 [s]]

Function:

Enter the Final Ramp Time to be used when ramping down from Motor Speed Low Limit, par. 4-11 or 4-12, to zero speed.

Submersible deep well pumps can be damaged by running below minimum speed. A fast ramp time below minimum pump speed is recommended. This parameter may be applied as a fast ramp rate from Motor Speed Low Limit to zero speed.

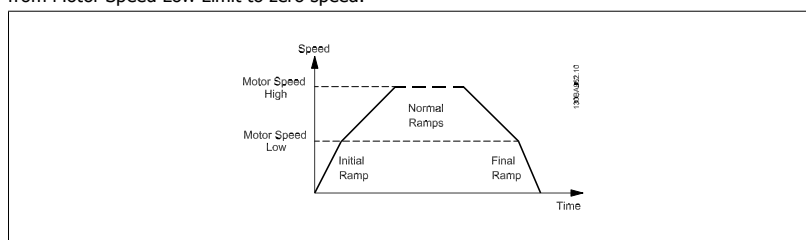

2.5.6 Digital Potentiometer

The digital potentiometer function allows the user to increase or decrease the actual reference by adjusting the set-up of the digital inputs using the functions INCREASE, DECREASE or CLEAR. To activate the function, at least one digital input must be set up to INCREASE or DECREASE.

3-90 Step Size

Range:

0.10 %* [0.01 - 200.00 %]

Function:

Enter the increment size required for INCREASE/DECREASE, as a percentage of the synchronous motor speed, n_s . If INCREASE/DECREASE is activated, the resulting reference will be increased/decreased by the amount set in this parameter.

3-91 Ramp Time

Range:

1.00 s [0.00 - 3600.00 s]

Function:

Enter the ramp time, i.e., the time for adjustment of the reference from 0% to 100% of the specified digital potentiometer function (INCREASE, DECREASE or CLEAR).

If INCREASE / DECREASE is activated for longer than the ramp delay period specified in par. 3-95 *Ramp Delay*, the actual reference will be ramped up / down according to this ramp time. The ramp time is defined as the time used to adjust the reference by the step size specified in par. 3-90 *Step Size*.

3-92 Power Restore

Option:

[0] * Off

Function:

Resets the digital potentiometer reference to 0% after power-up.

[1] On

Restores the most recent digital potentiometer reference at power-up.

3-93 Maximum Limit

Range: 100 %* [-200 - 200 %]
Function: Set the maximum permissible value for the resulting reference. This is advisable if the digital potentiometer is used for fine tuning of the resulting reference.

3-94 Minimum Limit

Range: 0 %* [-200 - 200 %]
Function: Set the minimum permissible value for the resulting reference. This is advisable if the digital potentiometer is used for fine tuning of the resulting reference.

3-95 Ramp Delay

Range: 1.000 N/A* [0.000 - 3600.000 N/A]
Function: Enter the delay required from activation of the digital potentiometer function until the adjustable frequency drive starts to ramp the reference. With a delay of 0 ms, the reference starts to ramp as soon as INCREASE/DECREASE is activated. See also par.3-91 *Ramp Time*.

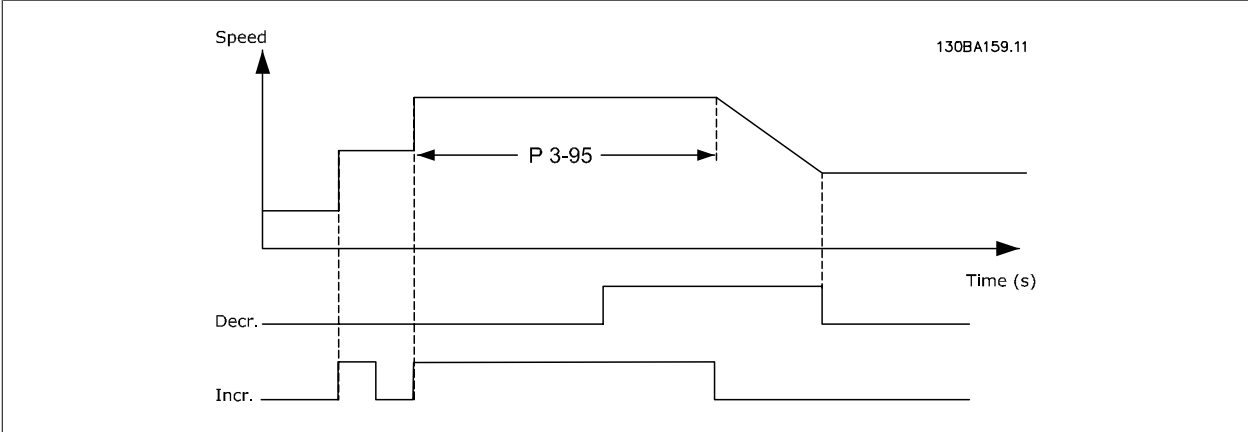
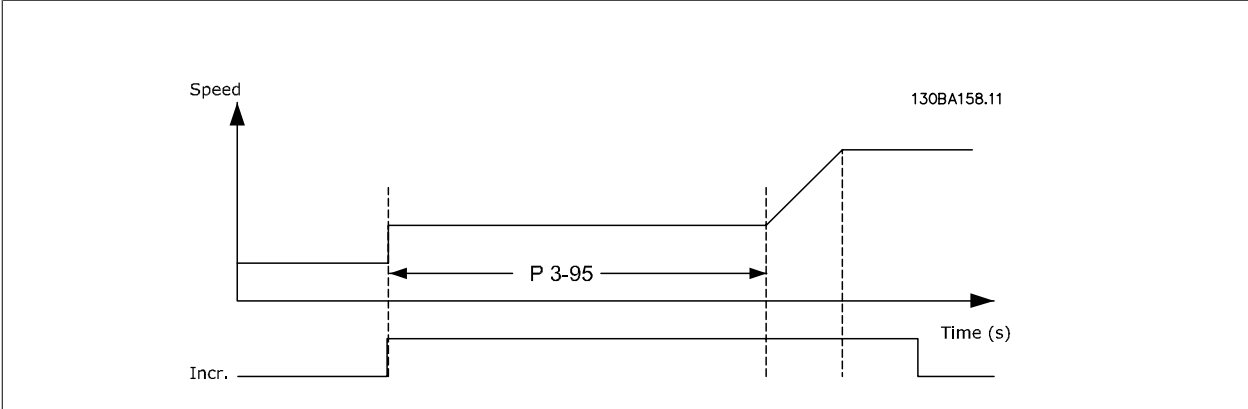

2.6 Main Menu - Limits/Warnings - Group 4

2.6.1 4-** Limits and Warnings

Parameter group for configuring limits and warnings.

2.6.2 4-1* Motor Limits

Define torque, current and speed limits for the motor, and the reaction of the adjustable frequency drive when the limits are exceeded.

A limit may generate a message on the display. A warning will always generate a message on the display or on the serial communication bus. A monitoring function may initiate a warning or a trip, upon which the adjustable frequency drive will stop and generate an alarm message.

4-10 Motor Speed Direction

Option:
Function:

Selects the motor speed direction required. When par. 1-00 Configuration Mode is set to Closed-loop [3], the parameter default is changed to Clockwise [0]. If both directions are chosen, running in counter-clockwise cannot be chosen from the LCP.

[0] * Clockwise

[2] Both directions

Selects the motor speed direction required.

4-11 Motor Speed Low Limit [RPM]

Range:
Function:

0 RPM* [0 - par. 4-13 RPM]

Enter the minimum limit for motor speed. The Motor Speed Low Limit can be set to correspond to the manufacturer's recommended minimum motor speed. The Motor Speed Low Limit must not exceed the setting in par.4-13 *Motor Speed High Limit [RPM]*.

4-12 Motor Speed Low Limit [Hz]

Range:
Function:

0 Hz* [0 - par. 4-14 Hz]

Enter the minimum limit for motor speed. The motor speed low limit can be set to correspond to the minimum output frequency of the motor shaft. The Speed Low Limit must not exceed the setting in par. 4-14 *Motor Speed High Limit [Hz]*.

4-13 Motor Speed High Limit [RPM]

Range:
Function:

1500. RPM* [par. 4-11 - 60000. RPM]

Enter the maximum limit for motor speed. The Motor Speed High Limit can be set to correspond to the manufacturer's maximum rated motor. The Motor Speed High Limit must exceed the setting in par.4-11 *Motor Speed Low Limit [RPM]*. Only par.4-11 *Motor Speed Low Limit [RPM]* or par. 4-12 *Motor Speed Low Limit [Hz]* will be displayed, depending on other parameters in the main menu, and depending on default settings dependant on global location.

NOTE!

The output frequency value of the adjustable frequency drive must not exceed a value higher than 1/10 of the switching frequency.

 **NOTE!**
Any changes in par.4-13 *Motor Speed High Limit [RPM]* will reset the value in par.4-53 *Warning Speed High* to the same value as set in par.4-13 *Motor Speed High Limit [RPM]*.

4-14 Motor Speed High Limit [Hz]

Range:
Size related* [0–1000 Hz]

Function:
Enter the maximum limit for motor speed. The motor speed high limit can be set to correspond to the manufacturer’s recommended maximum frequency of the motor shaft. The Motor Speed High Limit must exceed the setting in par. 4-12 *Motor Speed Low Limit [Hz]*. Only par. 4-11 or par. 4-12 will be displayed depending on other parameters set in the main menu and depending on default settings dependant on global geographical location.

 **NOTE!**
Max. output frequency cannot exceed 10% of the inverter switching frequency (par. 14-01).

4-16 Torque Limit Motor Mode

Range:
110.0 %* [0.0 - 1000.0 %]

Function:
Enter the maximum torque limit for motor operation. The torque limit is active in the speed range up to and including the rated motor speed set in par.1-25 *Motor Nominal Speed*. To protect the motor from reaching the stalling torque, the default setting is 1.1 x the rated motor torque (calculated value). See also par.14-25 *Trip Delay at Torque Limit* for further details.
If a setting in par.1-00 *Configuration Mode* to par.1-28 *Motor Rotation Check* is changed, par. 4-16 *Torque Limit Motor Mode* is not automatically reset to the default setting.

4-17 Torque Limit Generator Mode

Range:
100.0 %* [0.0 - 1000.0 %]

Function:
Enter the maximum torque limit for generator mode operation. The torque limit is active in the speed range up to and including the rated motor speed (par.1-25 *Motor Nominal Speed*). Refer to par. 14-25 *Trip Delay at Torque Limit* for further details.
If a setting in par.1-00 *Configuration Mode* to par.1-28 *Motor Rotation Check* is changed, par. 4-17 *Torque Limit Generator Mode* is not automatically reset to the default settings.

4-18 Current Limit

Range:
110 %* [1 - 1000 %]

Function:
Enter the current limit for motor and generator operation. To protect the motor from reaching the stalling torque, the default setting is 1.1 x the rated motor torque (calculated value). If a setting in par. 1-00 to par. 1-26 is changed, par. 4-18 is not automatically reset to the default setting.

4-19 Max Output Frequency

Range:
100.0 Hz* [1.0 - 1000.0 Hz]

Function:
Enter the maximum output frequency value. par.4-19 *Max Output Frequency* specifies the absolute limit on the adjustable frequency drive output frequency for improved safety in applications where accidental overspeeding must be avoided. This absolute limit applies to all configurations and is independent of the setting in par.1-00 *Configuration Mode*. This parameter cannot be adjusted while the motor is running.

2.6.3 4-5* Adj. Warnings

Define adjustable warning limits for current, speed, reference and feedback.

2

**NOTE!**

Not visible in display, only in VLT Motion Control Tool, MCT 10.

Warnings are shown on display, programmed output or serial bus.

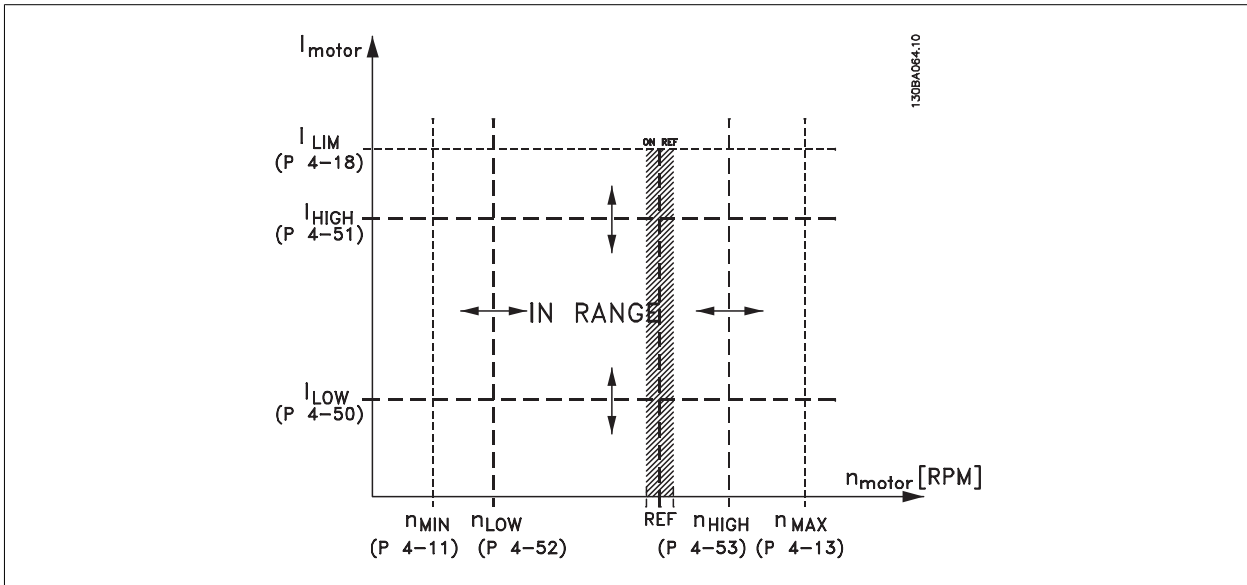

4-50 Warning Current Low

Range:

0.00 A* [0.00 - par. 4-51 A]

Function:

Enter the I_{LOW} value. When the motor current falls below this limit (I_{LOW}), the display reads CURRENT LOW. The signal outputs can be programmed to produce a status signal on terminal 27 or 29, and on relay output 01 or 02. Refer to the drawing in this section.

4-51 Warning Current High

Range:

par. 16-37 [par. 4-50 - par. 16-37 A]
A*

Function:

Enter the I_{HIGH} value. When the motor current exceeds this limit (I_{HIGH}), the display reads CURRENT HIGH. The signal outputs can be programmed to produce a status signal on terminal 27 or 29, and on relay output 01 or 02. Refer to the drawing in this section.

4-52 Warning Speed Low

Range:

0 RPM* [0 - par. 4-53 RPM]

Function:

Enter the n_{LOW} value. When the motor speed falls below this limit (n_{LOW}), the display reads SPEED LOW. The signal outputs can be programmed to produce a status signal on terminal 27 or 29, and on relay output 01 or 02. Program the lower signal limit of the motor speed, n_{LOW} , within the normal working range of the adjustable frequency drive. Refer to the drawing in this section.

4-53 Warning Speed High

Range:

par. 4-13 [par. 4-52 - par. 4-13 RPM]
RPM*

Function:

Enter the n_{HIGH} value. When the motor speed exceeds this limit (n_{HIGH}), the display reads SPEED HIGH. The signal outputs can be programmed to produce a status signal on terminal 27 or 29, and on relay output 01 or 02. Program the upper signal limit of the motor speed, n_{HIGH}, within the normal working range of the adjustable frequency drive. Refer to the drawing in this section.



NOTE!

Any changes in par.4-13 *Motor Speed High Limit [RPM]* will reset the value in par.4-53 *Warning Speed High* to the same value as set in par.4-13 *Motor Speed High Limit [RPM]*.

If a different value is needed in par.4-53 *Warning Speed High*, it must be set after programming of par.4-13 *Motor Speed High Limit [RPM]*.

4-54 Warning Reference Low

Range:

-999999.99 [-999999.999 - par. 4-55 N/A]
9 N/A*

Function:

Enter the lower reference limit. When the actual reference falls below this limit, the display indicates Ref Low. The signal outputs can be programmed to produce a status signal on terminal 27 or 29, and on relay output 01 or 02.

4-55 Warning Reference High

Range:

999999.999 [par. 4-54 - 999999.999 N/A]
N/A*

Function:

Enter the upper reference limit. When the actual reference exceeds this limit, the display reads Ref High. The signal outputs can be programmed to produce a status signal on terminal 27 or 29, and on relay output 01 or 02.

4-56 Warning Feedback Low

Range:

-999999.99 [-999999.999 - par. 4-57 Proc-
9 Proc-essCtrlUnit]
essCtrlU-
nit*

Function:

Enter the lower feedback limit. When the feedback falls below this limit, the display reads Feedb Low. The signal outputs can be programmed to produce a status signal on terminal 27 or 29, and on relay output 01 or 02.

4-57 Warning Feedback High

Range:

999999.999 [par. 4-56 - 999999.999 ProcessCtr-
ProcessCtr- lUnit]
lUnit*

Function:

Enter the upper feedback limit. When the feedback exceeds this limit, the display reads Feedb High. The signal outputs can be programmed to produce a status signal on terminal 27 or 29, and on relay output 01 or 02.

4-58 Missing Motor Phase Function

Option:

Function:

Displays an alarm in the event of a missing motor phase.

Select 100 ms to have a short detection time and alarm in the event of a missing motor phase. 100 ms is recommended for hoisting applications.

[0] Off

No alarm is displayed if a missing motor phase occurs.

[1] * On

An alarm is displayed if a missing motor phase occurs.

**NOTE!**

This parameter cannot be adjusted while the motor is running.

2

2.6.4 4-6* Speed Bypass

Define the speed bypass areas for the ramps.

Some systems call for avoiding certain output frequencies or speeds due to resonance problems in the system. A maximum of four frequency or speed ranges can be avoided.

4-60 Bypass Speed From [RPM]

Array [4]

Range:

0 RPM* [0 - par. 4-13 RPM]

Function:

Some systems call for avoiding certain output speeds due to resonance problems in the system. Enter the lower limits of the speeds to be avoided.

4-61 Bypass Speed From [Hz]

Array [4]

Range:

0 Hz* [0.0 - par. 4-14 Hz]

Function:

Some systems call for avoiding certain output speeds due to resonance problems in the system. Enter the lower limits of the speeds to be avoided.

4-62 Bypass Speed to [RPM]

Array [4]

Range:

0 RPM* [0 - par. 4-13 RPM]

Function:

Some systems call for avoiding certain output speeds due to resonance problems in the system. Enter the upper limits of the speeds to be avoided.

4-63 Bypass Speed To [Hz]

Array [4]

Range:

0 Hz* [0.0 - par. 4-14 Hz]

Function:

Some systems call for avoiding certain output speeds due to resonance problems in the system. Enter the upper limits of the speeds to be avoided.

2.6.5 Semi-Automatic Bypass Speed Set-up

The Semi-Automatic Bypass Speed Set-up can be used to facilitate the programming of the frequencies to be skipped due to resonances in the system.

The following process is to be carried out:

1. Stop the motor.
2. Select Enabled in par.4-64 *Semi-Auto Bypass Set-up*.
3. Press *Hand On* on the Local Control Panel to start the search for frequency bands causing resonances. The motor will ramp up according to the ramp set.

4. When sweeping through a resonance band, press *OK* on the Local Control Panel when leaving the band. The actual frequency will be stored as the first element in par.4-62 *Bypass Speed to [RPM]* or par.4-63 *Bypass Speed To [Hz]* (array). Repeat this for each resonance band identified at the ramp up (a maximum of four can be adjusted).
5. When maximum speed has been reached, the motor will automatically begin to ramp down. Repeat the above procedure when speed is leaving the resonance bands during the deceleration. The actual frequencies registered when pressing *OK* will be stored in par.4-60 *Bypass Speed From [RPM]* or par.4-61 *Bypass Speed From [Hz]*.
6. When the motor has ramped down to stop, press *OK*. The par.4-64 *Semi-Auto Bypass Set-up* will automatically reset to Off. The adjustable frequency drive will stay in *Hand On* mode until *Off* or *Auto On* are pressed on the LCP.

If the frequencies for a certain resonance band are not registered in the right order (frequency values stored in *By Pass Speed To* are higher than those in *By Pass Speed From*) or if they do not have the same numbers of registrations for the *By Pass From* and *By Pass To*, all registrations will be cancelled and the following message is displayed: *Collected speed areas overlapping or not completely determined. Press [Cancel] to abort.*

4-64 Semi-Auto Bypass Set-up

Option:		Function:
[0] *	OFF	No function
[1]	Enabled	Starts the semi-automatic bypass set-up and continue with the procedure described above.

2.7 Main Menu - Digital In/Out - Group 5

2.7.1 5-** Digital In/Out

Parameter group for configuring the digital input and output.

2.7.2 5-0* Digital I/O Mode

Parameters for configuring the input and output using NPN and PNP.

5-00 Digital I/O Mode

Option:	Function:
	Digital inputs and programmed digital outputs are pre-programmable for operation either in PNP or NPN systems.
[0] * PNP - Active at 24 V	Action on positive directional pulses (0). PNP systems are pulled down to GND.
[1] NPN - Active at 0V	Action on negative directional pulses (1). NPN systems are pulled up to + 24 V, internally in the adjustable frequency drive.



NOTE!

This parameter cannot be adjusted while the motor is running.

5-01 Terminal 27 Mode

Option:	Function:
[0] * Input	Defines terminal 27 as a digital input.
[1] Output	Defines terminal 27 as a digital output.

Please note that this parameter cannot be adjusted while the motor is running.

5-02 Terminal 29 Mode

Option:	Function:
[0] * Input	Defines terminal 29 as a digital input.
[1] Output	Defines terminal 29 as a digital output.

This parameter cannot be adjusted while the motor is running.

2.7.3 5-1* Digital Inputs

Parameters for configuring the input functions for the input terminals.

The digital inputs are used for selecting various functions in the adjustable frequency drive. All digital inputs can be set to the following functions:

Digital input function	Select	Terminal
No operation	[0]	All *term 32, 33
Reset	[1]	All
Coast inverse	[2]	All
Coast and reset inverse	[3]	All
DC brake inverse	[5]	All
Stop inverse	[6]	All
External interlock	[7]	All
Start	[8]	All *term 18
Latched start	[9]	All
Reversing	[10]	All *term 19
Start reversing	[11]	All
Jog	[14]	All *term 29
Preset reference on	[15]	All
Preset ref bit 0	[16]	All
Preset ref bit 1	[17]	All
Preset ref bit 2	[18]	All
Freeze reference	[19]	All
Freeze output	[20]	All
Speed up	[21]	All
Slow	[22]	All
Set-up select bit 0	[23]	All
Set-up select bit 1	[24]	All
Pulse input	[32]	term 29, 33
Ramp bit 0	[34]	All
Line failure inverse	[36]	All
Run Permissive	[52]	
Hand start	[53]	
Auto-start	[54]	
DigiPot Increase	[55]	All
DigiPot Decrease	[56]	All
DigiPot Clear	[57]	All
Counter A (up)	[60]	29, 33
Counter A (down)	[61]	29, 33
Reset Counter A	[62]	All
Counter B (up)	[63]	29, 33
Counter B (down)	[64]	29, 33
Reset Counter B	[65]	All
Sleep Mode	[66]	
Reset Maintenance Word	[78]	
Lead Pump Start	[120]	
Lead Pump Alternation	[121]	
Pump 1 Interlock	[130]	
Pump 2 Interlock	[131]	
Pump 3 Interlock	[132]	

All = Terminals 18, 19, 27, 29, 32, X30/2, X30/3, X30/4. X30/ are the terminals on MCB 101.

Functions dedicated to only one digital input are stated in the associated parameter.

All digital inputs can be programmed to these functions:

[0]	No operation	No reaction to signals transmitted to terminal.
[1]	Reset	Resets adjustable frequency drive after a TRIP/ALARM. Not all alarms can be reset.
[2]	Coast inverse	Leaves motor in free mode. Logic '0' => coasting stop. (Default Digital input 27): Coasting stop, inverted input (NC).
[3]	Coast and reset inverse	Reset and coasting stop Inverted input (NC). Leaves motor in free mode and resets the adjustable frequency drive. Logic '0' => coasting stop and reset.
[5]	DC brake inverse	Inverted input for DC braking (NC).

Stops motor by energizing it with a DC current for a certain time period. See par. 2-01 to par. 2-03. The function is only active when the value in par. 2-02 is different from 0. Logic "0" => DC braking.

[6] Stop inverse

Stop Inverted function. Generates a stop function when the selected terminal goes from logical level '1' to '0'. The stop is performed according to the selected ramp time (par. 3-42, par. 3-52, par. 3-62, par. 3-72).



NOTE!

When the adjustable frequency drive is at the torque limit and has received a stop command, it may not stop by itself. To ensure that the adjustable frequency drive stops, configure a digital output to *Torque limit & stop* [27] and connect this digital output to a digital input that is configured as coast.

[7] External Interlock

Same function as Coasting stop, inverse, but External Interlock generates the alarm message 'external fault' on the display when the terminal which is programmed for Coast Inverse is logic '0'. The alarm message will also be active via digital outputs and relay outputs if programmed for external interlock. The alarm can be reset using a digital input or the [RESET] key if the cause for the external interlock has been removed. A delay can be programmed in par. 22-00, External Interlock Time. After applying a signal to the input, the reaction described above will be delayed with the time set in par. 22-00.

[8] Start

Select start for a start/stop command. Logic '1' = start, logic '0' = stop.
(Default Digital input 18)

[9] Latched start

The motor starts if a pulse is applied for at least 2 ms. The motor stops when stop inverse is activated

[10] Reversing

Changes direction of motor shaft rotation. Select Logic '1' to reverse. The reverse signal only changes the direction of rotation. It does not activate the start function. Select both directions in par. 4-10 *Motor Speed Direction*.
(Default Digital input 19).

[11] Start reversing

Used for start/stop and for reversing on the same wire. Signals on start are not allowed at the same time.

[14] Jog

Used for activating jog speed. See par. 3-11.
(Default Digital input 29)

[15] Preset reference on

Used for shifting between external reference and preset reference. It is assumed that *External/preset* [1] has been selected in par. 3-04. Logic '0' = external reference active; logic '1' = one of the eight preset references is active.

[16] Preset ref bit 0

Enables a choice between one of the eight preset references according to the table below.

[17] Preset ref bit 1

Enables a choice between one of the eight preset references according to the table below.

[18] Preset ref bit 2

Enables a choice between one of the eight preset references according to the table below.

Preset ref. bit	2	1	0
Preset ref. 0	0	0	0
Preset ref. 1	0	0	1
Preset ref. 2	0	1	0
Preset ref. 3	0	1	1
Preset ref. 4	1	0	0
Preset ref. 5	1	0	1
Preset ref. 6	1	1	0
Preset ref. 7	1	1	1

[19] Freeze ref.

Freezes actual reference. The frozen reference is now the point of enable/condition for Speed up and Slow to be used. If Speed up/down is used, the speed change always follows ramp 2 (par. 3-51 and 3-52) in the range 0 - par. 3-03 *Maximum Reference*.

[20] Freeze output

Freezes actual motor frequency (Hz). The frozen motor frequency is now the point of enable/condition for Speed up and Slow to be used. If Speed up/down is used, the speed change always follows ramp 2 (par. 3-51 and 3-52) in the range 0 - par. 1-23 *Motor Frequency*.

 **NOTE!**
 When Freeze output is active, the adjustable frequency drive cannot be stopped via a low 'start [13]' signal. Stop the adjustable frequency drive via a terminal programmed for Coasting inverse [2] or Coast and reset, inverse [3].

[21]	Speed up	For digital control of the up/down speed is desired (motor potentiometer). Activate this function by selecting either Freeze reference or Freeze output. When Speed up is activated for less than 400 msec., the resulting reference will be increased by 0.1%. If Speed up is activated for more than 400 msec., the resulting reference will ramp according to Ramp 1 in par. 3-41.
[22]	Slow	Same as Speed up [21].
[23]	Set-up select bit 0	Selects one of the four set-ups. Set par. 0-10 <i>Active Set-up</i> to Multi Set-up.
[24]	Set-up select bit 1	Same as Set-up select bit 0 [23]. (Default Digital input 32)
[32]	Pulse input	Select Pulse input when using a pulse sequence as either reference or feedback. Scaling is done in par. group 5-5*.
[34]	Ramp bit 0	Select which ramp to use. Logic "0" will select ramp 1 while logic "1" will select ramp 2.
[36]	Line failure inverse	Activates par. 14-10 <i>Line Failure</i> . Line failure inverse is active in the Logic "0" situation.
[52]	Run Permissive	The input terminal for which run permissive has been programmed must be logic "1" before a start command can be accepted. Run permissive has a logic 'AND' function related to the terminal which is programmed for <i>START</i> [8], <i>Jog</i> [14] or <i>Freeze Output</i> [20], which means that in order to start running the motor, both conditions must be fulfilled. If run permissive is programmed on multiple terminals, it needs only be logic '1' on one of the terminals for the function to be carried out. The digital output signal for Run Request (<i>Start</i> [8], <i>Jog</i> [14] or <i>Freeze output</i> [20]) programmed in par. 5-3* Digital outputs, or par. 5-4* Relays, will not be affected by run permissive.
[53]	Hand start	A signal applied will put the adjustable frequency drive into hand mode as if the button <i>Hand On</i> on the LCP has been pressed; a normal stop command will be overridden. If disconnecting the signal, the motor will stop. To make any other start commands valid, another digital input must be assign to <i>Auto Start</i> and a signal applied to this. The <i>Hand On</i> and <i>Auto On</i> buttons on the LCP have no effect. The <i>Off</i> button on the LCP will override <i>Hand Start</i> and <i>Auto Start</i> . Press either the <i>Hand On</i> or <i>Auto On</i> button to reactivate <i>Hand Start</i> and <i>Auto Start</i> . If there is no signal on either <i>Hand Start</i> or <i>Auto Start</i> , the motor will stop regardless of any normal start command applied. If a signal applied to both <i>Hand Start</i> and <i>Auto Start</i> , the function will be <i>Auto Start</i> . If you press the <i>Off</i> button on the LCP, the motor will stop regardless of the signals on <i>Hand Start</i> and <i>Auto Start</i> .
[54]	Auto-start	A signal applied will put the adjustable frequency drive into auto mode as if the LCP button <i>Auto On</i> has been pressed. See also <i>Hand Start</i> [53]
[55]	DigiPot Increase	Uses the input as an INCREASE signal to the digital potentiometer function described in parameter group 3-9*.
[56]	DigiPot Decrease	Uses the input as a DECREASE signal to the digital potentiometer function described in parameter group 3-9*.
[57]	DigiPot Clear	Uses the input to CLEAR the digital potentiometer reference described in parameter group 3-9*.
[60]	Counter A (up)	(Terminal 29 or 33 only) Input for increment counting in the SLC counter.
[61]	Counter A (down)	(Terminal 29 or 33 only) Input for decrement counting in the SLC counter.
[62]	Reset Counter A	Input for reset of counter A.
[63]	Counter B (up)	(Terminal 29 and 33 only) Input for increment counting in the SLC counter.
[64]	Counter B (down)	(Terminal 29 and 33 only) Input for decrement counting in the SLC counter.
[65]	Reset Counter B	Input for reset of counter B.
[66]	Sleep Mode	Forces the adjustable frequency drive into sleep mode (see par. 22-4*, Sleep Mode). Reacts to the rising edge of signal applied!
[78]	Reset Preventive Maintenance Word	Resets all data in par. 16-96, Preventive Maintenance Word, to 0.

The setting options below are all related to the cascade controller. For wiring diagrams and settings for parameter, see group 25-** for more details.

2

[120]	Lead Pump Start	Starts/stops the lead pump (controlled by the adjustable frequency drive). A start requires a system start signal also be applied, e.g., to one of the digital inputs set for <i>Start</i> [8]!
[121]	Lead Pump Alternation	Forces the alternation of the lead pump in a cascade controller. <i>Lead Pump Alternation</i> , par. 25-50, must be set to either <i>At Command</i> [2] or <i>At Staging or At Command</i> [3]. <i>Alternation Event</i> , par. 25-51, can be set to any of the four options.
[130 - 138]	Pump1 Interlock - Pump9 Interlock	For the above 9 setting options, par. 25-10, Pump Interlock, must be set to <i>On</i> [1]. The function will also depend on the setting in par. 25-06, Fixed Lead Pump. If set to <i>No</i> [0], Pump1 refers to the pump controlled by relay RELAY1, etc. If set to <i>Yes</i> [1], Pump1 refers to the pump controlled by the adjustable frequency drive only (without any of the built-in relays involved) and Pump2 to the pump controlled by the relay RELAY1. Variable speed pump (lead) cannot be interlocked in the basic cascade controller. See table below:

Setting in Par. 5-1*	Setting in Par. 25-06	
	[0] No	[1] Yes
[130] Pump1 Interlock	Controlled by RELAY1 (only if not lead pump)	Adjustable frequency drive controlled (cannot be interlocked)
[131] Pump2 Interlock	Controlled by RELAY2	Controlled by RELAY1
[132] Pump3 Interlock	Controlled by RELAY3	Controlled by RELAY2
[133] Pump4 Interlock	Controlled by RELAY4	Controlled by RELAY3
[134] Pump5 Interlock	Controlled by RELAY5	Controlled by RELAY4
[135] Pump6 Interlock	Controlled by RELAY6	Controlled by RELAY5
[136] Pump7 Interlock	Controlled by RELAY7	Controlled by RELAY6
[137] Pump8 Interlock	Controlled by RELAY8	Controlled by RELAY7
[138] Pump9 Interlock	Controlled by RELAY9	Controlled by RELAY8

5-10 Terminal 18 Digital Input

Option:	Function:
[0]	No operation
[1]	Reset
[2]	Coast inverse
[3]	Coast and Reset Inv
[5]	DC brake inverse
[6]	Stop inverse
[7]	External interlock
[8] *	Start Same options and functions as par. 5-1*, except for <i>Pulse input</i> .
[9]	Latched start
[10]	Reverse
[11]	Start reverse
[14]	Jog
[15]	Preset reference on
[16]	Preset ref bit 0
[17]	Preset ref bit 1
[18]	Preset ref bit 2

[19]	Freeze reference
[20]	Freeze output
[21]	Speed up
[22]	Slow
[23]	Set-up select bit 0
[24]	Set-up select bit 1
[34]	Ramp bit 0
[36]	Mains failure inverse
[37]	Fire Mode
[52]	Run permissive
[53]	Hand start
[54]	Auto-start
[55]	DigiPot increase
[56]	DigiPot decrease
[57]	DigiPot clear
[62]	Reset Counter A
[65]	Reset Counter B
[66]	Sleep Mode
[78]	Reset Preventive Maintenance Word
[120]	Lead Pump Start
[121]	Lead Pump Alternation
[130]	Pump 1 Interlock
[131]	Pump 2 Interlock
[132]	Pump 3 Interlock

5-11 Terminal 19 Digital Input

Option:	Function:
[0] *	No operation Same options and functions as par. 5-1*, except for <i>Pulse input</i> .
[1]	Reset
[2]	Coast inverse
[3]	Coast and Reset Inv
[5]	DC brake inverse
[6]	Stop inverse
[7]	External interlock
[8]	Start
[9]	Latched start
[10]	Reverse
[11]	Start reverse
[14]	Jog
[15]	Preset reference on
[16]	Preset ref bit 0
[17]	Preset ref bit 1
[18]	Preset ref bit 2
[19]	Freeze reference

[20] Freeze output

[21] Speed up

[22] Slow

[23] Set-up select bit 0

[24] Set-up select bit 1

[34] Ramp bit 0

[36] Mains failure inverse

[37] Fire Mode

[52] Run permissive

[53] Hand start

[54] Auto-start

[55] DigiPot increase

[56] DigiPot decrease

[57] DigiPot clear

[62] Reset Counter A

[65] Reset Counter B

[66] Sleep Mode

[78] Reset Preventive Maintenance Word

[120] Lead Pump Start

[121] Lead Pump Alternation

[130] Pump 1 Interlock

[131] Pump 2 Interlock

[132] Pump 3 Interlock

5-12 Terminal 27 Digital Input

Option:
Function:

 Same options and functions as par. 5-1*, except for *Pulse input*.

[0] * No operation

[1] Reset

[2] Coast inverse

[3] Coast and Reset Inv

[5] DC brake inverse

[6] Stop inverse

[7] External interlock

[8] Start

[9] Latched start

[10] Reverse

[11] Start reverse

[14] Jog

[15] Preset reference on

[16] Preset ref bit 0

[17] Preset ref bit 1

[18] Preset ref bit 2

[19] Freeze reference

[20]	Freeze output
[21]	Speed up
[22]	Slow
[23]	Set-up select bit 0
[24]	Set-up select bit 1
[34]	Ramp bit 0
[36]	Mains failure inverse
[37]	Fire Mode
[52]	Run permissive
[53]	Hand start
[54]	Auto-start
[55]	DigiPot increase
[56]	DigiPot decrease
[57]	DigiPot clear
[62]	Reset Counter A
[65]	Reset Counter B
[66]	Sleep Mode
[78]	Reset Preventive Maintenance Word
[120]	Lead Pump Start
[121]	Lead Pump Alternation
[130]	Pump 1 Interlock
[131]	Pump 2 Interlock
[132]	Pump 3 Interlock

5-13 Terminal 29 Digital Input

Option: **Function:**

[0]	No operation	
[1]	Reset	
[2]	Coast inverse	
[3]	Coast and Reset Inv	
[5]	DC brake inverse	
[6]	Stop inverse	
[7]	External interlock	
[8]	Start	
[9]	Latched start	
[10]	Reverse	
[11]	Start reverse	
[14] *	Jog	Same options and functions as par. 5-1*.
[15]	Preset reference on	
[16]	Preset ref bit 0	
[17]	Preset ref bit 1	
[18]	Preset ref bit 2	
[19]	Freeze reference	
[20]	Freeze output	

[21]	Speed up
[22]	Slow
[23]	Set-up select bit 0
[24]	Set-up select bit 1
[30]	Counter input
[32]	Pulse input
[34]	Ramp bit 0
[36]	Mains failure inverse
[37]	Fire Mode
[52]	Run permissive
[53]	Hand start
[54]	Auto-start
[55]	DigiPot increase
[56]	DigiPot decrease
[57]	DigiPot clear
[60]	Counter A (up)
[61]	Counter A (down)
[62]	Reset Counter A
[63]	Counter B (up)
[64]	Counter B (down)
[65]	Reset Counter B
[66]	Sleep Mode
[78]	Reset Preventive Maintenance Word
[120]	Lead Pump Start
[121]	Lead Pump Alternation
[130]	Pump 1 Interlock
[131]	Pump 2 Interlock
[132]	Pump 3 Interlock

5-14 Terminal 32 Digital Input

Option:
Function:

[0] *	No operation	Same options and functions as par. 5-1*, except for <i>Pulse input</i> .
[1]	Reset	
[2]	Coast inverse	
[3]	Coast and Reset Inv	
[5]	DC brake inverse	
[6]	Stop inverse	
[7]	External interlock	
[8]	Start	
[9]	Latched start	
[10]	Reverse	
[11]	Start reverse	
[14]	Jog	
[15]	Preset reference on	

[16]	Preset ref bit 0
[17]	Preset ref bit 1
[18]	Preset ref bit 2
[19]	Freeze reference
[20]	Freeze output
[21]	Speed up
[22]	Slow
[23]	Set-up select bit 0
[24]	Set-up select bit 1
[34]	Ramp bit 0
[36]	Mains failure inverse
[37]	Fire Mode
[52]	Run permissive
[53]	Hand start
[54]	Auto-start
[55]	DigiPot increase
[56]	DigiPot decrease
[57]	DigiPot clear
[62]	Reset Counter A
[65]	Reset Counter B
[66]	Sleep Mode
[78]	Reset Preventive Maintenance Word
[120]	Lead Pump Start
[121]	Lead Pump Alternation
[130]	Pump 1 Interlock
[131]	Pump 2 Interlock
[132]	Pump 3 Interlock

5-15 Terminal 33 Digital Input

Option:	Function:
[0] *	No operation Same options and functions as par. 5-1* Digital Inputs.
[1]	Reset
[2]	Coast inverse
[3]	Coast and Reset Inv
[5]	DC brake inverse
[6]	Stop inverse
[7]	External interlock
[8]	Start
[9]	Latched start
[10]	Reverse
[11]	Start reverse
[14]	Jog
[15]	Preset reference on
[16]	Preset ref bit 0

[17]	Preset ref bit 1
[18]	Preset ref bit 2
[19]	Freeze reference
[20]	Freeze output
[21]	Speed up
[22]	Slow
[23]	Set-up select bit 0
[24]	Set-up select bit 1
[30]	Counter input
[32]	Pulse input
[34]	Ramp bit 0
[36]	Mains failure inverse
[37]	Fire Mode
[52]	Run permissive
[53]	Hand start
[54]	Auto-start
[55]	DigiPot increase
[56]	DigiPot decrease
[57]	DigiPot clear
[60]	Counter A (up)
[61]	Counter A (down)
[62]	Reset Counter A
[63]	Counter B (up)
[64]	Counter B (down)
[65]	Reset Counter B
[66]	Sleep Mode
[78]	Reset Preventive Maintenance Word
[120]	Lead Pump Start
[121]	Lead Pump Alternation
[130]	Pump 1 Interlock
[131]	Pump 2 Interlock
[132]	Pump 3 Interlock

5-16 Terminal X30/2 Digital Input

Option:
Function:

[0] *	No operation	This parameter is active when option module MCB 101 is installed in the adjustable frequency drive. It has the same options and functions as par. 5-1* except for <i>Pulse input</i> [32].
[1]	Reset	
[2]	Coast inverse	
[3]	Coast and Reset Inv	
[5]	DC brake inverse	
[6]	Stop inverse	
[7]	External interlock	
[8]	Start	

[9]	Latched start
[10]	Reverse
[11]	Start reverse
[14]	Jog
[15]	Preset reference on
[16]	Preset ref bit 0
[17]	Preset ref bit 1
[18]	Preset ref bit 2
[19]	Freeze reference
[20]	Freeze output
[21]	Speed up
[22]	Slow
[23]	Set-up select bit 0
[24]	Set-up select bit 1
[34]	Ramp bit 0
[36]	Mains failure inverse
[37]	Fire Mode
[52]	Run permissive
[53]	Hand start
[54]	Auto-start
[55]	DigiPot increase
[56]	DigiPot decrease
[57]	DigiPot clear
[62]	Reset Counter A
[65]	Reset Counter B
[66]	Sleep Mode
[78]	Reset Preventive Maintenance Word
[120]	Lead Pump Start
[121]	Lead Pump Alternation
[130]	Pump 1 Interlock
[131]	Pump 2 Interlock
[132]	Pump 3 Interlock

5-17 Terminal X30/3 Digital Input

Option:	Function:
[0] *	No operation This parameter is active when option module MCB 101 is installed in the adjustable frequency drive. It has the same options and functions as par. 5-1* except for <i>Pulse input</i> [32].
[1]	Reset
[2]	Coast inverse
[3]	Coast and Reset Inv
[5]	DC brake inverse
[6]	Stop inverse
[7]	External interlock
[8]	Start

[9]	Latched start
[10]	Reverse
[11]	Start reverse
[14]	Jog
[15]	Preset reference on
[16]	Preset ref bit 0
[17]	Preset ref bit 1
[18]	Preset ref bit 2
[19]	Freeze reference
[20]	Freeze output
[21]	Speed up
[22]	Slow
[23]	Set-up select bit 0
[24]	Set-up select bit 1
[34]	Ramp bit 0
[36]	Mains failure inverse
[37]	Fire Mode
[52]	Run permissive
[53]	Hand start
[54]	Auto-start
[55]	DigiPot increase
[56]	DigiPot decrease
[57]	DigiPot clear
[62]	Reset Counter A
[65]	Reset Counter B
[66]	Sleep Mode
[78]	Reset Preventive Maintenance Word
[120]	Lead Pump Start
[121]	Lead Pump Alternation
[130]	Pump 1 Interlock
[131]	Pump 2 Interlock
[132]	Pump 3 Interlock

5-18 Terminal X30/4 Digital Input

Option:
Function:

[0] *	No operation	This parameter is active when option module MCB 101 is installed in the adjustable frequency drive. It has the same options and functions as par. 5-1* except for <i>Pulse input</i> [32].
[1]	Reset	
[2]	Coast inverse	
[3]	Coast and Reset Inv	
[5]	DC brake inverse	
[6]	Stop inverse	
[7]	External interlock	
[8]	Start	

[9]	Latched start
[10]	Reverse
[11]	Start reverse
[14]	Jog
[15]	Preset reference on
[16]	Preset ref bit 0
[17]	Preset ref bit 1
[18]	Preset ref bit 2
[19]	Freeze reference
[20]	Freeze output
[21]	Speed up
[22]	Slow
[23]	Set-up select bit 0
[24]	Set-up select bit 1
[34]	Ramp bit 0
[36]	Mains failure inverse
[37]	Fire Mode
[52]	Run permissive
[53]	Hand start
[54]	Auto-start
[55]	DigiPot increase
[56]	DigiPot decrease
[57]	DigiPot clear
[62]	Reset Counter A
[65]	Reset Counter B
[66]	Sleep Mode
[78]	Reset Preventive Maintenance Word
[120]	Lead Pump Start
[121]	Lead Pump Alternation
[130]	Pump 1 Interlock
[131]	Pump 2 Interlock
[132]	Pump 3 Interlock

2.7.4 5-3* Digital Outputs

Parameters for configuring the output functions for the output terminals. The two solid state digital outputs are common for terminals 27 and 29. Set the I/O function for terminal 27 in par. 5-01 *Terminal 27 Mode*, and set the I/O function for terminal 29 in par. 5-02 *Terminal 29 Mode*.

These parameters cannot be adjusted while the motor is running.

The digital outputs can be programmed with these functions:

[0]	No operation	<i>Default for all digital outputs and relay outputs</i>
[1]	Control ready	The control board receives supply voltage.

[2]	Drive ready	The adjustable frequency drive is ready for operation and applies a supply signal to the control board.
[3]	Drive ready/remote control	The adjustable frequency drive is ready for operation and is in Auto On mode.
[4]	Stand-by/no warning	The adjustable frequency drive is ready for operation. No start or stop command has been given (start/disable). There are no warnings.
[5]	Running	Motor is running.
[6]	Running/no warning	The output speed is higher than the speed set in par. 1-81 <i>Min Speed for Function at Stop [RPM]</i> . The motor is running and there are no warnings.
[8]	Run on reference/no warning	Motor runs at reference speed.
[9]	Alarm	An alarm activates the output. There are no warnings.
[10]	Alarm or warning	An alarm or a warning activates the output.
[11]	At torque limit	The torque limit set in par. 4-16 or par. 1-17 has been exceeded.
[12]	Out of current range	The motor current is outside the range set in par. 4-18.
[13]	Below current, low	Motor current is lower than set in par. 4-50.
[14]	Above current, high	Motor current is higher than set in par. 4-51.
[15]	Out of speed range	Output speed is outside the range set in par. 4-52 and 4-53.
[16]	Below speed, low	Output speed is lower than the setting in par. 4-52.
[17]	Above speed, high	Output speed is higher than the setting in par. 4-53.
[18]	Out of feedback range	Feedback is outside the range set in par. 4-56 and 4-57.
[19]	Below feedback, low	Feedback is below the limit set in par. 4-56 Warning Feedback Low.
[20]	Above feedback, high	The feedback is above the limit set in par. 4-57 <i>Warning Feedback High</i> .
[21]	Thermal warning	The thermal warning turns on when the temperature exceeds the limit in the motor, the adjustable frequency drive, the brake resistor or the thermistor.
[25]	Reverse	<i>Reversing. Logic '1' = relay activated, 24 V DC when CW rotation of the motor. Logic '0' = relay not activated, no signal, when CCW rotation of the motor.</i>
[26]	Bus OK	Active communication (no timeout) via the serial communication port.
[27]	Torque limit and stop	Used in performing a coasting stop and in torque limit condition. If the adjustable frequency drive has received a stop signal and is at the torque limit, the signal is logic "0."
[28]	Brake, no warning	The brake is active and there are no warnings.
[29]	Brake ready, no fault	The brake is ready for operation and there are no faults.
[30]	Brake fault (IGBT)	The output is Logic '1' when the brake IGBT is short-circuited. Use this function to protect the adjustable frequency drive if there is a fault on the brake modules. Use the output/relay to cut out the line voltage from the adjustable frequency drive.
[35]	External Interlock	The external Interlock function has been activated via one of the digital inputs.
[40]	Out of ref range	
[41]	Below reference, low	
[42]	Above reference, high	
[45]	Bus Ctrl	
[46]	Bus Ctrl 1 if timeout	
[47]	Bus Ctrl 0 if timeout	
[55]	Pulse output	
[60]	Comparator 0	See par. group 13-1*. If Comparator 0 is evaluated as TRUE, the output will be high. Otherwise, it will be low.
[61]	Comparator 1	See par. group 13-1*. If Comparator 2 is evaluated as TRUE, the output will be high. Otherwise, it will be low.

[62]	Comparator 2	See par. group 13-1*. If Comparator 2 is evaluated as TRUE, the output will be high. Otherwise, it will be low.
[63]	Comparator 3	See par. group 13-1*. If Comparator 3 is evaluated as TRUE, the output will be high. Otherwise, it will be low.
[64]	Comparator 4	See par. group 13-1*. If Comparator 4 is evaluated as TRUE, the output will be high. Otherwise, it will be low.
[65]	Comparator 5	See par. group 13-1*. If Comparator 4 is evaluated as TRUE, the output will be high. Otherwise, it will be low.
[70]	Logic Rule 0	See par. group 13-4*. If logic rule 0 is evaluated as TRUE, the output will be high. Otherwise, it will be low.
[71]	Logic Rule 1	See par. group 13-4*. If logic rule 1 is evaluated as TRUE, the output will be high. Otherwise, it will be low.
[72]	Logic Rule 2	See par. group 13-4*. If logic rule 2 is evaluated as TRUE, the output will be high. Otherwise, it will be low.
[73]	Logic Rule 3	See par. group 13-4*. If logic rule 3 is evaluated as TRUE, the output will be high. Otherwise, it will be low.
[74]	Logic Rule 4	See par. group 13-4*. If logic rule 4 is evaluated as TRUE, the output will be high. Otherwise, it will be low.
[75]	Logic Rule 5	See par. group 13-4*. If logic rule 5 is evaluated as TRUE, the output will be high. Otherwise, it will be low.
[80]	SL Digital Output A	See par. 13-52 <i>SL Control Action</i> . The input will go high whenever the smart logic action [38] <i>Set dig. out. A high</i> is executed. The input will go low whenever the smart logic action [32] <i>Set dig. out. A low</i> is executed.
[81]	SL Digital Output B	See par. 13-52 <i>SL Control Action</i> . The input will go high whenever the smart logic action [39] <i>Set dig. out. A high</i> is executed. The input will go low whenever the smart logic action [33] <i>Set dig. out. A low</i> is executed.
[82]	SL Digital Output C	See par. 13-52 <i>SL Control Action</i> . The input will go high whenever the smart logic action [40] <i>Set dig. out. A high</i> is executed. The input will go low whenever the smart logic action [34] <i>Set dig. out. A low</i> is executed.
[83]	SL Digital Output D	See par. 13-52 <i>SL Control Action</i> . The input will go high whenever the smart logic action [41] <i>Set dig. out. A high</i> is executed. The input will go low whenever the smart logic action [35] <i>Set dig. out. A low</i> is executed.
[84]	SL Digital Output E	See par. 13-52 <i>SL Control Action</i> . The input will go high whenever the smart logic action [42] <i>Set dig. out. A high</i> is executed. The input will go low whenever the smart logic action [36] <i>Set dig. out. A low</i> is executed.
[85]	SL Digital Output F	See par. 13-52 <i>SL Control Action</i> . The input will go high whenever the smart logic action [43] <i>Set dig. out. A high</i> is executed. The input will go low whenever the smart logic action [37] <i>Set dig. out. A low</i> is executed.
[160]	No alarm	Output is high when no alarm is present.
[161]	Running reverse	The output is high when the adjustable frequency drive is running counter-clockwise (the logical product of the status bits 'running' AND 'reverse').
[165]	Local reference active	Output is high when par. 3-13 <i>Reference Site</i> = [2] Local or when par. 3-13 <i>Reference Site</i> = [0] <i>Linked to hand auto</i> at the same time as the LCP is in hand on mode.
[166]	Remote reference active	Output is high when par. 3-13 <i>Reference Site</i> = Remote [1] or <i>Linked to hand/auto</i> [0] while the LCP is in [Auto on] mode.
[167]	Start cmd. active	Output is high when there is an active start command. (i.e. [Auto On] and a start command via digital input or bus is active, or [Hand On]).

NOTE!

All inverse Stop/Coast commands must be inactive.

[168]	Drive in hand mode	Output is high when the adjustable frequency drive is in hand on mode (as indicated by the LED light above [Hand on]).
[169]	Drive in auto mode	Output is high when the adjustable frequency drive is in hand on mode (as indicated by the LED light above [Auto on]).
[180]	Clock Fault	The clock function has been reset to default (2000-01-01) because of a power failure.
[181]	Preventive Maintenance	One or more of the preventive maintenance events programmed in par. 23-10, Preventive Maintenance Item, has exceeded the time for the specified action in par. 23-11, Maintenance Action.
[190]	No-Flow	A no-flow situation or minimum speed situation has been detected if enabled in <i>Minimum Speed Detection</i> , par. 22-21 and/or <i>No-Flow Detection</i> , par. 22-22.
[191]	Dry Pump	A dry pump condition has been detected. This function must be enabled in par. 22-26, Dry Pump Function.
[192]	End of Curve	Active when an end of curve condition is present.
[193]	Sleep Mode	The adjustable frequency drive/system has entered sleep mode. See <i>Sleep mode</i> , par. 22-4*.
[194]	Broken Belt	A broken belt condition has been detected. This function must be enabled in par. 22-60, Broken Belt Detection.

[195] Bypass Valve Control

The bypass valve control (Digital/Relay output) in the adjustable frequency drive is used for compressor systems to unload the compressor during start-up by using a bypass valve. After the start command is given the bypass valve will be open until the adjustable frequency drive reaches *Motor speed low limit*, par. 4 -11) . After the limit has been reached, the bypass valve will be closed, allowing the compressor to operate normally. This procedure will not be activated again until a new start is initiated, and the adjustable frequency drive speed is zero when receiving a start signal. *Start Delay*, par. 1-71 can be used in order to delay the motor start. The bypass valve control principle:

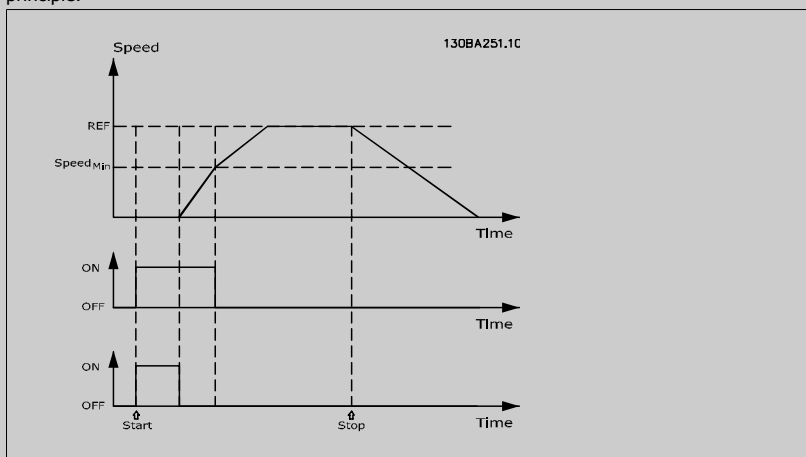

The setting options below are all related to the cascade controller.
 For wiring diagrams and settings for parameter, see group 25-** for more details.

[199]	Pipe Filling	Active when the pipe fill function is operating. See par. 29-0*.
[200]	Full Capacity	All pumps running and at full speed
[201]	Pump1 Running	One or more of the pumps controlled by the cascade controller are running. The function will also depend on the setting of in <i>Fixed Lead Pump</i> , par. 25-06. If set to <i>No</i> [0], Pump 1 refers to the pump controlled by relay RELAY1, etc. If set to <i>Yes</i> [1], Pump 1 refers to the pump controlled by

the adjustable frequency drive only (without any of the built-in relays involved) and Pump 2 to the pump controlled by the relay RELAY1. See table below:

[202] Pump2 Running See [201]

[203] Pump3 Running See [201]

Setting in Par. 5-3*	Setting in Par. 25-06	
	[0] No	[1] Yes
[200] Pump 1 Running	Controlled by RELAY1	Adjustable Frequency Drive Controlled
[201] Pump 2 Running	Controlled by RELAY2	Controlled by RELAY1
[203] Pump 3 Running	Controlled by RELAY3	Controlled by RELAY2

5-30 Terminal 27 Digital Output

Option:

Function:

[0] * No operation Same options and functions as par. 5-3*.

[1] Control ready

[2] Drive ready

[3] Drive rdy/rem ctrl

[4] Stand-by / no warning

[5] Running

[6] Running / no warning

[8] Run on ref/no warn

[9] Alarm

[10] Alarm or warning

[11] At torque limit

[12] Out of current range

[13] Below current, low

[14] Above current, high

[15] Out of speed range

[16] Below speed, low

[17] Above speed, high

[18] Out of feedb. range

[19] Below feedback, low

[20] Above feedback, high

[21] Thermal warning

[25] Reverse

[26] Bus OK

[27] Torque limit stop

[28] Brake: No Brake War

[29] Brake ready, no fault

[30] Brake fault (IGBT)

[35] External Interlock

[40] Out of ref range

[41] Below reference, low

[42] Above ref, high

[45] Bus ctrl.

[46]	Bus ctrl, 1 if timeout
[47]	Bus ctrl, 0 if timeout
[55]	Pulse output
[60]	Comparator 0
[61]	Comparator 1
[62]	Comparator 2
[63]	Comparator 3
[64]	Comparator 4
[65]	Comparator 5
[70]	Logic rule 0
[71]	Logic rule 1
[72]	Logic rule 2
[73]	Logic rule 3
[74]	Logic rule 4
[75]	Logic rule 5
[80]	SL digital output A
[81]	SL digital output B
[82]	SL digital output C
[83]	SL digital output D
[84]	SL digital output E
[85]	SL digital output F
[160]	No alarm
[161]	Running reverse
[165]	Local ref active
[166]	Remote ref active
[167]	Start cmd. active
[168]	Hand mode
[169]	Auto mode
[180]	Clock Fault
[181]	Prev. Maintenance
[190]	No-Flow
[191]	Dry Pump
[192]	End Of Curve
[193]	Sleep Mode
[194]	Broken Belt
[195]	Bypass Valve Control
[196]	Fire Mode Active
[197]	Fire Mode Was Active
[198]	Bypass Mode Active
[200]	Full capacity
[201]	Pump 1 running
[202]	Pump 2 running
[203]	Pump 3 running

5-31 Terminal 29 digital Output

Option:

Function:

[0] *	No operation	Same options and functions as par. 5-3*, Digital Outputs.
[1]	Control ready	
[2]	Drive ready	
[3]	Drive rdy/rem ctrl	
[4]	Stand-by / no warning	
[5]	Running	
[6]	Running / no warning	
[8]	Run on ref/no warn	
[9]	Alarm	
[10]	Alarm or warning	
[11]	At torque limit	
[12]	Out of current range	
[13]	Below current, low	
[14]	Above current, high	
[15]	Out of speed range	
[16]	Below speed, low	
[17]	Above speed, high	
[18]	Out of feedb. range	
[19]	Below feedback, low	
[20]	Above feedback, high	
[21]	Thermal warning	
[25]	Reverse	
[26]	Bus OK	
[27]	Torque limit stop	
[28]	Brake: No Brake War	
[29]	Brake ready, no fault	
[30]	Brake fault (IGBT)	
[35]	External Interlock	
[40]	Out of ref range	
[41]	Below reference, low	
[42]	Above ref, high	
[45]	Bus ctrl.	
[46]	Bus ctrl, 1 if timeout	
[47]	Bus ctrl, 0 if timeout	
[55]	Pulse output	
[60]	Comparator 0	
[61]	Comparator 1	
[62]	Comparator 2	
[63]	Comparator 3	
[64]	Comparator 4	
[65]	Comparator 5	

[70]	Logic rule 0
[71]	Logic rule 1
[72]	Logic rule 2
[73]	Logic rule 3
[74]	Logic rule 4
[75]	Logic rule 5
[80]	SL digital output A
[81]	SL digital output B
[82]	SL digital output C
[83]	SL digital output D
[84]	SL digital output E
[85]	SL digital output F
[160]	No alarm
[161]	Running reverse
[165]	Local ref active
[166]	Remote ref active
[167]	Start cmd. active
[168]	Hand mode
[169]	Auto mode
[180]	Clock Fault
[181]	Prev. Maintenance
[190]	No-Flow
[191]	Dry Pump
[192]	End Of Curve
[193]	Sleep Mode
[194]	Broken Belt
[195]	Bypass Valve Control
[196]	Fire Mode Active
[197]	Fire Mode Was Active
[198]	Bypass Mode Active
[200]	Full capacity
[201]	Pump 1 running
[202]	Pump 2 running
[203]	Pump 3 running

5-32 Term X30/6 Digi Out (MCB 101)

Option:
Function:

[0] *	No operation	This parameter is active when option module MCB 101 is mounted in the adjustable frequency drive.
[1]	Control ready	
[2]	Drive ready	
[3]	Drive rdy/rem ctrl	
[4]	Stand-by / no warning	
[5]	Running	
[6]	Running / no warning	

[8]	Run on ref/no warn
[9]	Alarm
[10]	Alarm or warning
[11]	At torque limit
[12]	Out of current range
[13]	Below current, low
[14]	Above current, high
[15]	Out of speed range
[16]	Below speed, low
[17]	Above speed, high
[18]	Out of feedb. range
[19]	Below feedback, low
[20]	Above feedback, high
[21]	Thermal warning
[25]	Reverse
[26]	Bus OK
[27]	Torque limit stop
[28]	Brake: No Brake War
[29]	Brake ready, no fault
[30]	Brake fault (IGBT)
[35]	External Interlock
[40]	Out of ref range
[41]	Below reference, low
[42]	Above ref, high
[45]	Bus ctrl.
[46]	Bus ctrl, 1 if timeout
[47]	Bus ctrl, 0 if timeout
[55]	Pulse output
[60]	Comparator 0
[61]	Comparator 1
[62]	Comparator 2
[63]	Comparator 3
[64]	Comparator 4
[65]	Comparator 5
[70]	Logic rule 0
[71]	Logic rule 1
[72]	Logic rule 2
[73]	Logic rule 3
[74]	Logic rule 4
[75]	Logic rule 5
[80]	SL digital output A
[81]	SL digital output B
[82]	SL digital output C

[83]	SL digital output D
[84]	SL digital output E
[85]	SL digital output F
[160]	No alarm
[161]	Running reverse
[165]	Local ref active
[166]	Remote ref active
[167]	Start cmd. active
[168]	Hand mode
[169]	Auto mode
[180]	Clock Fault
[181]	Prev. Maintenance
[190]	No-Flow
[191]	Dry Pump
[192]	End Of Curve
[193]	Sleep Mode
[194]	Broken Belt
[195]	Bypass Valve Control
[196]	Fire Mode Active
[197]	Fire Mode Was Active
[198]	Bypass Mode Active
[200]	Full capacity
[201]	Pump 1 running
[202]	Pump 2 running
[203]	Pump 3 running

5-33 Term X30/7 Digi Out (MCB 101)

Option:
Function:

Option:	Function:
[0] *	No operation This parameter is active when option module MCB 101 is mounted in the adjustable frequency drive.
[1]	Control ready
[2]	Drive ready
[3]	Drive rdy/rem ctrl
[4]	Stand-by / no warning
[5]	Running
[6]	Running / no warning
[8]	Run on ref/no warn
[9]	Alarm
[10]	Alarm or warning
[11]	At torque limit
[12]	Out of current range
[13]	Below current, low
[14]	Above current, high
[15]	Out of speed range
[16]	Below speed, low

[17]	Above speed, high
[18]	Out of feedb. range
[19]	Below feedback, low
[20]	Above feedback, high
[21]	Thermal warning
[25]	Reverse
[26]	Bus OK
[27]	Torque limit stop
[28]	Brake: No Brake War
[29]	Brake ready, no fault
[30]	Brake fault (IGBT)
[35]	External Interlock
[40]	Out of ref range
[41]	Below reference, low
[42]	Above ref, high
[45]	Bus ctrl.
[46]	Bus ctrl, 1 if timeout
[47]	Bus ctrl, 0 if timeout
[60]	Comparator 0
[61]	Comparator 1
[62]	Comparator 2
[63]	Comparator 3
[64]	Comparator 4
[65]	Comparator 5
[70]	Logic rule 0
[71]	Logic rule 1
[72]	Logic rule 2
[73]	Logic rule 3
[74]	Logic rule 4
[75]	Logic rule 5
[80]	SL digital output A
[81]	SL digital output B
[82]	SL digital output C
[83]	SL digital output D
[84]	SL digital output E
[85]	SL digital output F
[160]	No alarm
[161]	Running reverse
[165]	Local ref active
[166]	Remote ref active
[167]	Start cmd. active
[168]	Hand mode
[169]	Auto mode

[180]	Clock Fault
[181]	Prev. Maintenance
[190]	No-Flow
[191]	Dry Pump
[192]	End Of Curve
[193]	Sleep Mode
[194]	Broken Belt
[195]	Bypass Valve Control
[200]	Full capacity
[201]	Pump 1 running
[202]	Pump 2 running
[203]	Pump 3 running

2.7.5 5-4* Relays

Parameters for configuring the timing and the output functions for the relays.

5-40 Function Relay

Array [8]

(Relay 1 [0], Relay 2 [1], Relay 7 [6], Relay 8 [7], Relay 9 [8])

Select options to define the function of the relays.

The selection of each mechanical relay is realized in an array parameter.

[0]	No Operation
[1]	Control Ready
[2]	Drive Ready
[3]	Drive Ready/Remote
[4]	Stand-by/No Warning
[5] *	Running
[6]	Running/No Warning
[8]	Run on Ref./No Warning
[9]	Alarm
[10]	Alarm or Warning
[11]	At Torque Limit
[12]	Out of Current Range
[13]	Below Current, low
[14]	Above Current, high
[15]	Out of Speed Range
[16]	Below Speed, low
[17]	Above Speed, high
[18]	Out of Feedb. Range
[19]	Below Feedback, low
[20]	Above Feedback, high
[21]	Thermal Warning

[25]	Reverse
[26]	Bus OK
[27]	Torque Limit & Stop
[28]	Brake, No Warning
[29]	Brake Ready, No Fault
[30]	Brake Fault (IGBT)
[35]	External Interlock
[36]	Control Word Bit 11
[37]	Control Word Bit 12
[40]	Out of Ref. Range
[41]	Below Reference, low
[42]	Above Ref. high
[45]	Bus ctrl
[46]	Bus ctrl, 1 if timeout
[47]	Bus ctrl, 0 if timeout
[60]	Comparator 0
[61]	Comparator 1
[62]	Comparator 2
[63]	Comparator 3
[64]	Comparator 4
[65]	Comparator 5
[70]	Logic Rule 0
[71]	Logic Rule 1
[72]	Logic Rule 2
[73]	Logic Rule 3
[74]	Logic Rule 4
[75]	Logic Rule 5
[80]	SL Digital Output A
[81]	SL Digital Output B
[82]	SL Digital Output C
[83]	SL Digital Output D
[84]	SL Digital Output E
[85]	SL Digital Output F
[160]	No Alarm
[161]	Running Reverse
[165]	Local Ref. Active
[166]	Remote Ref. Active
[167]	Start Cmd. Active
[168]	Drive in Hand Mode
[169]	Drive in Auto Mode
[180]	Clock Fault
[181]	Prev. Maintenance
[190]	No-Flow

[191]	Dry Pump
[192]	End of Curve
[193]	Sleep Mode
[194]	Broken Belt
[195]	Bypass Valve Control
[199]	Pipe Filling
[211]	Cascade Pump1
[212]	Cascade Pump2
[213]	Cascade Pump3
[223]	Alarm, Trip-locked
[224]	Bypass Mode Active

5-41 On Delay, Relay

Array [8] (Relay 1 [0], Relay 2 [1], Relay 3 [2], Relay 4 [3], Relay 5 [4], Relay 6 [5], Relay 7 [6], Relay 8 [7], Relay 9 [8])

Range:	Function:
0.01 s* [0.01 - 600.00 s]	Enter the delay of the relay cut-in time. Select one of available mechanical relays and MCO 105 in an array function. See par. 5-40 <i>Function Relay</i> . Relay 3-6 are included in MCB 112 (ATEX).

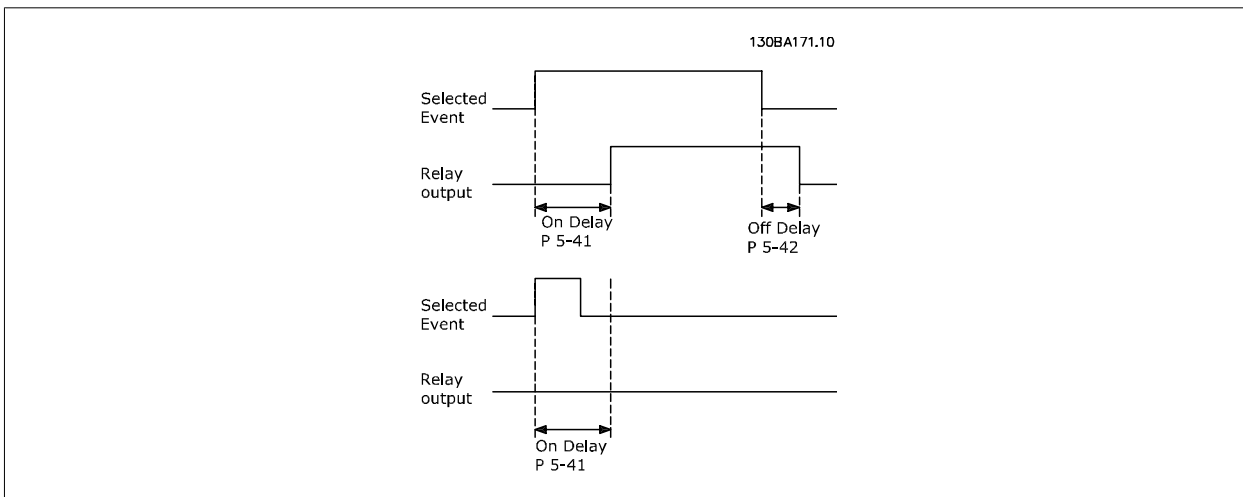

5-42 Off Delay, Relay

Array [8] (Relay 1 [0], Relay 2 [1], Relay 3 [2], Relay 4 [3], Relay 5 [4], Relay 6 [5], Relay 7 [6], Relay 8 [7], Relay 9 [8])

Range:	Function:
0.01 s* [0.01 - 600.00 s]	Enter the delay of the relay cut-out time. Select one of available mechanical relays and MCO 105 in an array function. See par. 5-40 <i>Function Relay</i> .

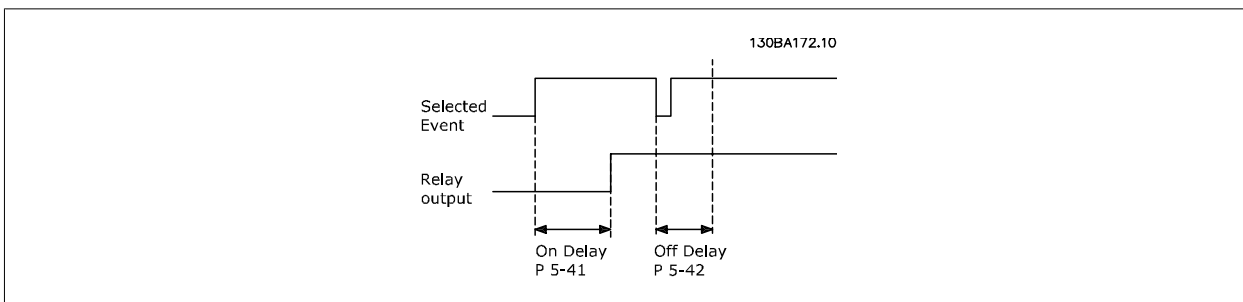

If the selected event condition changes before the on or off delay timer expires, the relay output is unaffected.

2.7.6 5-5* Pulse Input

The pulse input parameters are used to define an appropriate window for the impulse reference area by configuring the scaling and filter settings for the pulse inputs. Input terminals 29 or 33 act as frequency reference inputs. Set terminal 29 (par.5-13 *Terminal 29 Digital Input*) or terminal 33 (par. 5-15 *Terminal 33 Digital Input*) to *Pulse input* [32]. If terminal 29 is used as an input, then set par.5-02 *Terminal 29 Mode to Input* [0].

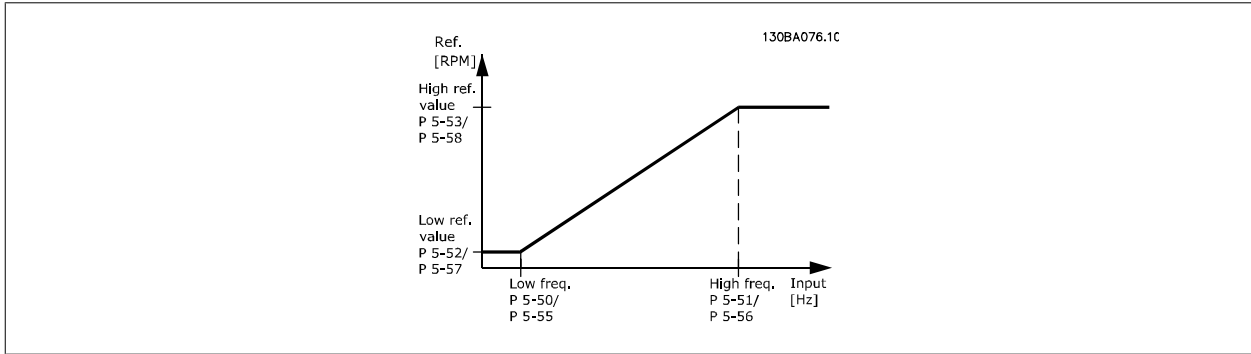

5-50 Term. 29 Low Frequency

Range:

100 Hz* [0 - 110000 Hz]

Function:

Enter the low frequency limit corresponding to the low motor shaft speed (i.e., low reference value) in par.5-52 *Term. 29 Low Ref./Feedb. Value*. Refer to the diagram in this section.

5-51 Term. 29 High Frequency

Range:

100 Hz* [0 - 110000 Hz]

Function:

Enter the high frequency limit corresponding to the high motor shaft speed (i.e. high reference value) in par.5-53 *Term. 29 High Ref./Feedb. Value*.

5-52 Term. 29 Low Ref./Feedb. Value

Range:

0.000 N/A* [-999999.999 - 999999.999 N/A]

Function:

Enter the low reference value limit for the motor shaft speed [RPM]. This is also the lowest feedback value, see also par.5-57 *Term. 33 Low Ref./Feedb. Value*.

5-53 Term. 29 High Ref./Feedb. Value

Range:

100.000 N/A* [-999999.999 - 999999.999 N/A]

Function:

Enter the high reference value [RPM] for the motor shaft speed and the high feedback value, see also par.5-58 *Term. 33 High Ref./Feedb. Value*.

5-54 Pulse Filter Time Constant #29

Range:

100 ms* [1 - 1000 ms]

Function:

Enter the pulse filter time constant. The pulse filter dampens oscillations of the feedback signal, which is an advantage if there is a lot of noise in the system. A high time constant value results in better damping, but also increases the time delay through the filter. This parameter cannot be adjusted while the motor is running.

5-55 Term. 33 Low Frequency**Range:**

100 Hz* [0 - 110000 Hz]

Function:Enter the low frequency corresponding to the low motor shaft speed (i.e., low reference value) in par.5-57 *Term. 33 Low Ref./Feedb. Value*.**5-56 Term. 33 High Frequency****Range:**

100 Hz* [0 - 110000 Hz]

Function:Enter the high frequency corresponding to the high motor shaft speed (i.e., high reference value) in par.5-58 *Term. 33 High Ref./Feedb. Value*.**5-57 Term. 33 Low Ref./Feedb. Value****Range:**

0.000 N/A* [-999999.999 - 999999.999 N/A]

Function:Enter the low reference value [RPM] for the motor shaft speed. This is also the low feedback value, see also par.5-52 *Term. 29 Low Ref./Feedb. Value*.**5-58 Term. 33 High Ref./Feedb. Value****Range:**

100.000 N/ A* [-999999.999 - 999999.999 N/A]

Function:Enter the high reference value [RPM] for the motor shaft speed. See also par.5-53 *Term. 29 High Ref./Feedb. Value*.**5-59 Pulse Filter Time Constant #33****Range:**

100 ms* [1 - 1000 ms]

Function:

Enter the pulse filter time constant. The low-pass filter reduces the influence on, and dampens oscillations in, the feedback signal from the control.

This is an advantage, if, for example, there is a great amount of noise in the system. This parameter cannot be adjusted while the motor is running.

2.7.7 5-6* Pulse Outputs

Parameters for configuring the scaling and output functions of pulse outputs. The pulse outputs are designated for terminals 27 or 29. Select terminal 27 output in par. 5-01 and terminal 29 output in par. 5-02.

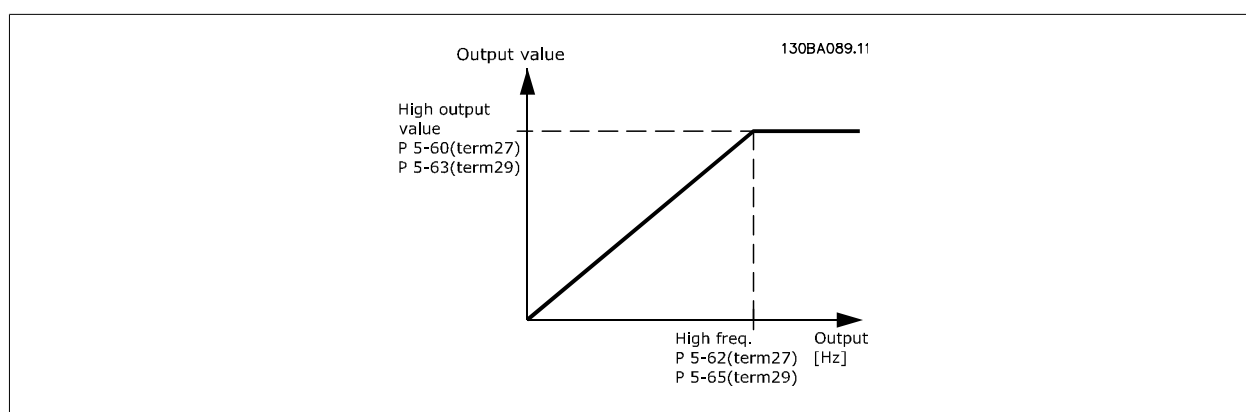

Options for readout output variables:

[0] * No operation

[45]	Bus ctrl.
[48]	Bus ctrl., timeout
[100]	Output frequency
[101]	Reference
[102]	Feedback
[103]	Motor current
[104]	Torque relative to limit
[105]	Torque relative to rated
[106]	Power
[107]	Speed
[108]	Torque
[113]	Ext. Closed-loop 1
[114]	Ext. Closed-loop 2
[115]	Ext. Closed-loop 3

5-60 Terminal 27 Pulse Output Variable

Option:	Function:
[0] * No operation	Same options and functions as par. 5-6*. Select the operation variable assigned for terminal 27 readouts. This parameter cannot be adjusted while the motor is running.

[45]	Bus ctrl.
[48]	Bus ctrl., timeout
[100]	Output frequency
[101]	Reference
[102]	Feedback
[103]	Motor current
[104]	Torque rel to limit
[105]	Torq relate to rated
[106]	Power
[107]	Speed
[113]	Ext. Closed-loop 1
[114]	Ext. Closed-loop 2
[115]	Ext. Closed-loop 3

5-62 Pulse Output Max Freq #27

Range:	Function:
5000 Hz* [0 - 32000 Hz]	Set the maximum frequency for terminal 27, corresponding to the output variable selected in par. 5-60 <i>Terminal 27 Pulse Output Variable</i> . This parameter cannot be adjusted while the motor is running.

5-63 Terminal 29 Pulse Output Variable

Option:	Function:
[0] * No operation	Select the variable for viewing on the terminal 29 display. This parameter cannot be adjusted while the motor is running.
[45]	Bus ctrl.

[48]	Bus ctrl., timeout
[100]	Output frequency
[101]	Reference
[102]	Feedback
[103]	Motor current
[104]	Torque rel to limit
[105]	Torq relate to rated
[106]	Power
[107]	Speed
[113]	Ext. Closed-loop 1
[114]	Ext. Closed-loop 2
[115]	Ext. Closed-loop 3

5-65 Pulse Output Max Freq #29

Range:

5000 Hz* [0 - 32000 Hz]

Function:

Set the maximum frequency for terminal 29 corresponding to the output variable set in par. 5-63 *Terminal 29 Pulse Output Variable*.
This parameter cannot be adjusted while the motor is running.

5-66 Terminal X30/6 Pulse Output Variable

Option:

[0] * No operation

Function:

Select the variable for readout on terminal X30/6.
This parameter cannot be adjusted while the motor is running.
This parameter is active when option module MCB 101 is installed in the adjustable frequency drive.

[45]	Bus ctrl.
[48]	Bus ctrl., timeout
[100]	Output frequency
[101]	Reference
[102]	Feedback
[103]	Motor current
[104]	Torque rel to limit
[105]	Torq relate to rated
[106]	Power
[107]	Speed
[113]	Ext. Closed-loop 1
[114]	Ext. Closed-loop 2
[115]	Ext. Closed-loop 3

5-68 Pulse Output Max Freq #X30/6

Range:

5000 Hz* [0 - 32000 Hz]

Function:

Select the maximum frequency on terminal X30/6 referring to the output variable in par.5-66 *Terminal X30/6 Pulse Output Variable*. This parameter cannot be adjusted while the motor is running.
This parameter is active when option module MCB 101 is mounted in the adjustable frequency drive.

2.7.8 5-9*Bus Controlled

This parameter group selects digital and relay outputs via a serial communication bus setting.

5-90 Digital & Relay Bus Control

Range:	Function:
0 N/A* [0 - 2147483647 N/A]	This parameter holds the state of the digital outputs and relays that are controlled by the bus. A logical '1' indicates that the output is high or active. A logical '0' indicates that the output is low or inactive.

Bit 0	CC Digital Output Terminal 27
Bit 1	CC Digital Output Terminal 29
Bit 2	GPIO Digital Output Terminal X 30/6
Bit 3	GPIO Digital Output Terminal X 30/7
Bit 4	CC Relay 1 output terminal
Bit 5	CC Relay 2 output terminal
Bit 6	Option B Relay 1 output terminal
Bit 7	Option B Relay 2 output terminal
Bit 8	Option B Relay 3 output terminal
Bit 9-15	Reserved for future terminals
Bit 16	Option C Relay 1 output terminal
Bit 17	Option C Relay 2 output terminal
Bit 18	Option C Relay 3 output terminal
Bit 19	Option C Relay 4 output terminal
Bit 20	Option C Relay 5 output terminal
Bit 21	Option C Relay 6 output terminal
Bit 22	Option C Relay 7 output terminal
Bit 23	Option C Relay 8 output terminal
Bit 24-31	Reserved for future terminals

5-93 Pulse Out #27 Bus Control

Range:	Function:
0.00 %* [0.00 - 100.00 %]	Contains the frequency to apply to the digital output terminal 27, when it is configured as [Bus Controlled].

5-94 Pulse Out #27 Timeout Preset

Range:	Function:
0.00 %* [0.00 - 100.00 %]	Contains the frequency to apply to the digital output terminal 27 when it is configured as [Bus Controlled Timeout] and timeout is detected.

5-95 Pulse Out #29 Bus Control

Range:	Function:
0.00 %* [0.00 - 100.00 %]	Contains the frequency to apply to the digital output terminal 29 when it is configured as [Bus Controlled].

5-96 Pulse Out #29 Timeout Preset

Range:	Function:
0.00 %* [0.00 - 100.00 %]	Contains the frequency to apply to the digital output terminal 29 when it is configured as [Bus Controlled Timeout] and timeout is detected

5-97 Pulse Out #X30/6 Bus Control

Range:	Function:
0.00 %* [0.00 - 100.00 %]	Contains the frequency to apply to the digital output terminal 27 when it is configured as [Bus Controlled].

5-98 Pulse Out #X30/6 Timeout Preset**Range:**

0.00 %* [0.00 - 100.00 %]

Function:

Contains the frequency to apply to the digital output terminal 6 when it is configured as [Bus Controlled Timeout] and timeout is detected.

2.8 Main Menu - Analog In/Out - Group 6

2.8.1 6-** Analog In/Out

Parameter group for configuring the analog input and output.

2.8.2 6-0* Analog I/O Mode

Parameter group for setting up the analog I/O configuration.

The adjustable frequency drive is equipped with 2 analog inputs: Terminal 53 and 54. The analog inputs can freely be allocated to either voltage (0–10 V) or current input (0/4–20 mA)



NOTE!
Thermistors may be connected to either an analog or a digital input.

6-00 Live Zero Timeout Time

Range:	Function:	
10 s* [1 - 99 s]		Enter the Live Zero Timeout time period. Live Zero Timeout Time is active for analog inputs, (i.e., terminal 53 or terminal 54), allocated to current and used as reference or feedback sources. If the reference signal value associated with the selected current input falls below 50% of the value set in par.6-10 <i>Terminal 53 Low Voltage</i> , par.6-12 <i>Terminal 53 Low Current</i> , par.6-20 <i>Terminal 54 Low Voltage</i> or par.6-22 <i>Terminal 54 Low Current</i> for a time period longer than the time set in par. 6-00 <i>Live Zero Timeout Time</i> , the function selected in par.6-01 <i>Live Zero Timeout Function</i> will be activated.

6-01 Live Zero Timeout Function

Option:	Function:
	<p>Select the timeout function. The function set in par.6-01 <i>Live Zero Timeout Function</i> will be activated if the input signal on terminal 53 or 54 is below 50% of the value in par.6-10 <i>Terminal 53 Low Voltage</i>, par.6-12 <i>Terminal 53 Low Current</i>, par.6-20 <i>Terminal 54 Low Voltage</i> or par.6-22 <i>Terminal 54 Low Current</i> for a time period defined in par.6-00 <i>Live Zero Timeout Time</i>. If several timeouts occur simultaneously, the adjustable frequency drive prioritizes the timeout functions as follows:</p> <ol style="list-style-type: none"> 1. par.6-01 <i>Live Zero Timeout Function</i> 2. par.8-04 <i>Control Timeout Function</i> <p>The output frequency of the adjustable frequency drive can be:</p> <ul style="list-style-type: none"> • [1] frozen at the present value • [2] overruled to stop • [3] overruled to jog speed • [4] overruled to max. speed • [5] overruled to stop with subsequent trip <p>If you select set-up 1-4, par.0-10 <i>Active Set-up</i> must be set to <i>Multi Set-up</i>, [9].</p> <p>This parameter cannot be adjusted while the motor is running.</p>

[0] *	Off
[1]	Freeze output

- [2] Stop
- [3] Jogging
- [4] Max. speed
- [5] Stop and trip

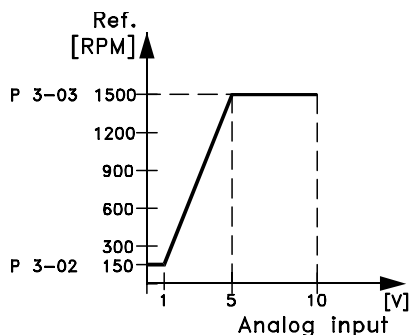

6-02 Fire Mode Live Zero Timeout Function

Option:
Function:

The function set in par.6-01 *Live Zero Timeout Function* will be activated if the input signal on analog inputs is below 50% of the value in par. "Terminal xx Low Current/Voltage" for a time period defined in par.6-00 *Live Zero Timeout Time*.

- [0] * Off
- [1] Freeze output
- [2] Stop
- [3] Jogging
- [4] Max. speed

2.8.3 6-1* Analog Input 1

Parameters for configuring the scaling and limits for analog input 1 (terminal 53).

6-10 Terminal 53 Low Voltage

Range:

0.07 V* [0.00 - par. 6-11 V]

Function:

Enter the low voltage value. This analog input scaling value should correspond to the low reference/feedback value set in par.6-14 *Terminal 53 Low Ref./Feedb. Value*.

6-11 Terminal 53 High Voltage

Range:

10.00 V* [par. 6-10 - 10.00 V]

Function:

Enter the high voltage value. This analog input scaling value should correspond to the high reference/feedback value set in par.6-15 *Terminal 53 High Ref./Feedb. Value*.

6-12 Terminal 53 Low Current

Range:

4.00 mA* [0.00 - par. 6-13 mA]

Function:

Enter the low current value. This reference signal should correspond to the low reference/feedback value, set in par.6-14 *Terminal 53 Low Ref./Feedb. Value*. The value must be set at >2 mA in order to activate the Live Zero Timeout Function in par.6-01 *Live Zero Timeout Function*.

6-13 Terminal 53 High Current

Range:	Function:
20.00 mA* [par. 6-12 - 20.00 mA]	Enter the high current value corresponding to the high reference/feedback set in par.6-15 <i>Terminal 53 High Ref./Feedb. Value</i> .

6-14 Terminal 53 Low Ref./Feedb. Value

Range:	Function:
0.000 N/A* [-999999.999 - 999999.999 N/A]	Enter the analog input scaling value that corresponds to the low voltage/low current set in par. 6-10 <i>Terminal 53 Low Voltage</i> and par.6-12 <i>Terminal 53 Low Current</i> .

6-15 Terminal 53 High Ref./Feedb. Value

Range:	Function:
50.000 N/ A* [-999999.999 - 999999.999 N/A]	Enter the analog input scaling value that corresponds to the high voltage/high current value set in par.6-11 <i>Terminal 53 High Voltage</i> and par.6-13 <i>Terminal 53 High Current</i> .

6-16 Terminal 53 Filter Time Constant

Range:	Function:
0.001 s* [0.001 - 10.000 s]	Enter the time constant. This is a first-order digital low pass filter time constant for suppressing electrical noise in terminal 53. A high time constant value improves damping, but also increases the time delay through the filter. This parameter cannot be adjusted while the motor is running.

6-17 Terminal 53 Live Zero

Option:	Function:
	This parameter makes it possible to disable the live zero monitoring. For example, it is to be used if the analog outputs are used as part of a decentral I/O system (for example, when not part of any adjustable frequency drive related control functions, but feeding an external control system with data).

[0]	Disabled
[1] *	Enabled

2.8.4 6-2* Analog Input 2

Parameters for configuring the scaling and limits for analog input 2 (terminal 54).

6-20 Terminal 54 Low Voltage

Range:	Function:
0.07 V* [0.00 - par. 6-21 V]	Enter the low voltage value. This analog input scaling value should correspond to the low reference/feedback value, set in par.6-24 <i>Terminal 54 Low Ref./Feedb. Value</i> .

6-21 Terminal 54 High Voltage

Range:	Function:
10.00 V* [par. 6-20 - 10.00 V]	Enter the high voltage value. This analog input scaling value should correspond to the high reference/feedback value set in par.6-25 <i>Terminal 54 High Ref./Feedb. Value</i> .

6-22 Terminal 54 Low Current

Range:

4.00 mA* [0.00 - par. 6-23 mA]

Function:

Enter the low current value. This reference signal should correspond to the low reference/feedback value, set in par.6-24 *Terminal 54 Low Ref./Feedb. Value*. The value must be set at >2 mA in order to activate the Live Zero Timeout Function in par.6-01 *Live Zero Timeout Function*.

6-23 Terminal 54 High Current

Range:

20.00 mA* [par. 6-22 - 20.00 mA]

Function:

Enter the high current value corresponding to the high reference/feedback value set in par. 6-25 *Terminal 54 High Ref./Feedb. Value*.

6-24 Terminal 54 Low Ref./Feedb. Value

Range:

0.000 N/A* [-999999.999 - 999999.999 N/A]

Function:

Enter the analog input scaling value that corresponds to the low voltage/low current value set in par.6-20 *Terminal 54 Low Voltage* and par.6-22 *Terminal 54 Low Current*.

6-25 Terminal 54 High Ref./Feedb. Value

Range:

100.000 N/A* [-999999.999 - 999999.999 N/A]

Function:

Enter the analog input scaling value that corresponds to the high voltage/high current value set in par.6-21 *Terminal 54 High Voltage* and par.6-23 *Terminal 54 High Current*.

6-26 Terminal 54 Filter Time Constant

Range:

0.001 s* [0.001 - 10.000 s]

Function:

Enter the time constant. This is a first-order digital low pass filter time constant for suppressing electrical noise in terminal 54. A high time constant value improves damping, but also increases the time delay through the filter.

This parameter cannot be adjusted while the motor is running.

6-27 Terminal 54 Live Zero

Option:**Function:**

This parameter makes it possible to disable the live zero monitoring. For example, it is to be used if the analog outputs are used as part of a decentral I/O system (for example, when not part of any adjustable frequency drive related control functions, but feeding an external control system with data).

[0] Disabled

[1]* Enabled

2.8.5 6-3* Analog Input 3 (MCB 101)

Parameter group used for configuring the scale and limiting analog input 3 (X30/11) placed on option module MCB 101.

6-30 Terminal X30/11 Low Voltage

Range:

0.07 V* [0.00 - par. 6-31 V]

Function:

Sets the analog input scaling value to correspond to the low reference/feedback value (set in par. 6-34 *Term. X30/11 Low Ref./Feedb. Value*).

6-31 Terminal X30/11 High Voltage

Range:	Function:
10.00 V* [par. 6-30 - 10.00 V]	Sets the analog input scaling value to correspond to the high reference/feedback value (set in par. 6-35 <i>Term. X30/11 High Ref./Feedb. Value</i>).

6-34 Term. X30/11 Low Ref./Feedb. Value

Range:	Function:
0.000 N/A* [-999999.999 - 999999.999 N/A]	Sets the analog input scaling value to correspond to the low voltage value (set in par.6-30 <i>Terminal X30/11 Low Voltage</i>).

6-35 Term. X30/11 High Ref./Feedb. Value

Range:	Function:
100.000 N/ A* [-999999.999 - 999999.999 N/A]	Sets the analog input scaling value to correspond to the high voltage value (set in par.6-31 <i>Terminal X30/11 High Voltage</i>).

6-36 Term. X30/11 Filter Time Constant

Range:	Function:
0.001 s* [0.001 - 10.000 s]	A 1 st order digital low pass filter time constant for suppressing electrical noise on terminal X30/11. par.6-36 <i>Term. X30/11 Filter Time Constant</i> cannot be changed while the motor is running.

6-37 Term. X30/11 Live Zero

Option:	Function:
	This parameter makes it possible to disable the live zero monitoring. For example, it is to be used if the analog outputs are used as part of a decentral I/O system (for example, when not part of any adjustable frequency drive related control functions, but feeding an external control system with data).

[0] *	Disabled
[1]	Enabled

2.8.6 6-4* Analog Input 4 (MCB 101)

Parameter group used for configuring the scale and limiting analog input 3 (X30/12) placed on option module MCB 101.

6-40 Terminal X30/12 Low Voltage

Range:	Function:
0.07 V* [0.00 - par. 6-41 V]	Sets the analog input scaling value to correspond to the low reference/feedback value set in par. 6-44 <i>Term. X30/12 Low Ref./Feedb. Value</i> .

6-41 Terminal X30/12 High Voltage

Range:	Function:
10.00 V* [par. 6-40 - 10.00 V]	Sets the analog input scaling value to correspond to the high reference/feedback value set in par. 6-45 <i>Term. X30/12 High Ref./Feedb. Value</i> .

6-44 Term. X30/12 Low Ref./Feedb. Value

Range:	Function:
0.000 N/A* [-999999.999 - 999999.999 N/A]	Sets the analog output scaling value to correspond to the low voltage value set in par.6-40 <i>Terminal X30/12 Low Voltage</i> .

6-45 Term. X30/12 High Ref./Feedb. Value

Range:100.000 N/ [-999999.999 - 999999.999 N/A]
A***Function:**Sets the analog input scaling value to correspond to the high voltage value set in par.6-41 *Terminal X30/12 High Voltage*.

6-46 Term. X30/12 Filter Time Constant

Range:

0.001 s* [0.001 - 10.000 s]

Function:A 1st order digital low pass filter time constant for suppressing electrical noise on terminal X30/12. par.6-46 *Term. X30/12 Filter Time Constant* cannot be changed while the motor is running.

6-47 Term. X30/12 Live Zero

Option:[0] * Disabled
[1] Enabled**Function:**

This parameter makes it possible to disable the live zero monitoring. For example, it is to be used if the analog outputs are used as part of a decentral I/O system (for example, when not part of any adjustable frequency drive related control functions, but feeding an external control system with data).

2.8.7 6-5* Analog Output 1

Parameters for configuring the scaling and limits for analog output 1, i.e., Terminal 42. Analog outputs are current outputs: 0/4–20 mA. Common terminal (terminal 39) is the same terminal and has the same electrical potential for analog common and digital common connection. Resolution on analog output is 12 bit.

6-50 Terminal 42 Output

Range:

0	[No operation]
[100] *	Output frequency
[101]	Reference
[102]	Feedback
[103]	Motor current
[104]	Torque rel to lim
[105]	Torque rel to rated
[106]	Power
[107]	Speed
[108]	Torque
[113]	Ext. closed-loop 1
[114]	Ext. closed-loop 2
[115]	Ext. closed-loop 3
[116]	PID Reference
[130]	Output freq. 4-20 mA
[131]	Reference 4-20 mA
[132]	Feedback 4-20 mA
[133]	Motor cur. 4-20 mA

Function:

Select the function of terminal 42 as an analog current output.

[134]	Torque % lim. 4-20 mA
[135]	Torque % nom 4-20 mA
[136]	Power 4-20 mA
[137]	Speed 4-20 mA
[138]	Torque 4-20 mA
[139]	Bus ctrl. 0-20 mA
[140]	Bus ctrl. 4-20 mA
[141]	Bus ctrl. 0-20 mA, timeout
[142]	Bus ctrl. 4-20 mA, timeout
[143]	Ext. Closed-loop 1, 4-20 mA
[144]	Ext. Closed-loop 2, 4-20 mA
[145]	Ext. Closed-loop 3, 4-20 mA

6-51 Terminal 42 Output Min Scale

Range:

0.00 %* [0.00 - 200.00 %]

Function:

Scale for the minimum output (0 or 4 mA) of the analog signal at terminal 42. Set the value to be the **percentage** of the full range of the variable selected in par. 6-50 *Terminal 42 Output*.

6-52 Terminal 42 Output Max Scale

Range:

100.00 %* [0.00 - 200.00 %]

Function:

EXAMPLE 1:

Variable value= OUTPUT FREQUENCY, range = 0–100 Hz

Range needed for output = 0–50 Hz

Output signal 0 or 4 mA is needed at 0 Hz (0% of range) - set par.6-51 *Terminal 42 Output Min Scale* to 0%

Output signal 20 mA is needed at 50 Hz (50% of range) - set par.6-52 *Terminal 42 Output Max Scale* to 50%

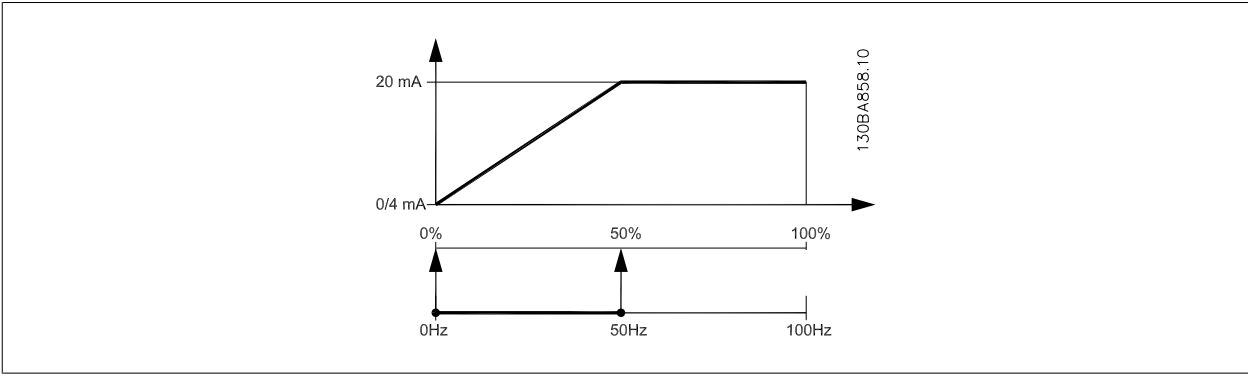

EXAMPLE 2:

Variable= FEEDBACK, range= -200% to +200%

Range needed for output= 0–100%

Output signal 0 or 4 mA is needed at 0% (50% of range) - set par.6-51 *Terminal 42 Output Min Scale* to 50%

Output signal 20 mA is needed at 100% (75% of range) - set par.6-52 *Terminal 42 Output Max Scale* to 75%

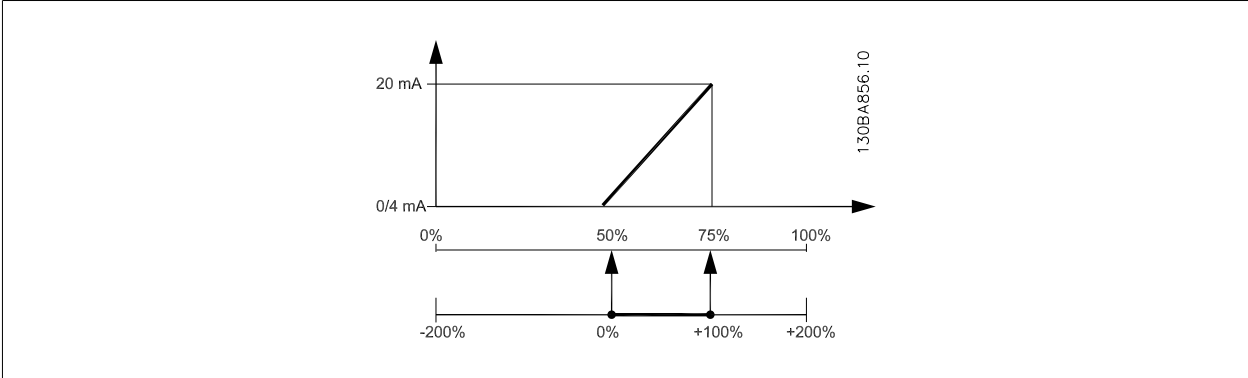

EXAMPLE 3:

Variable value= REFERENCE, range= Min ref - Max ref

Range needed for output= Min ref (0%) - Max ref (100%), 0–10 mA

Output signal 0 or 4 mA is needed at Min ref - set par.6-51 *Terminal 42 Output Min Scale* to 0%

Output signal 10 mA is needed at Max ref (100% of range) - set par.6-52 *Terminal 42 Output Max Scale* to 200%

(20 mA / 10 mA x 100%=200%).

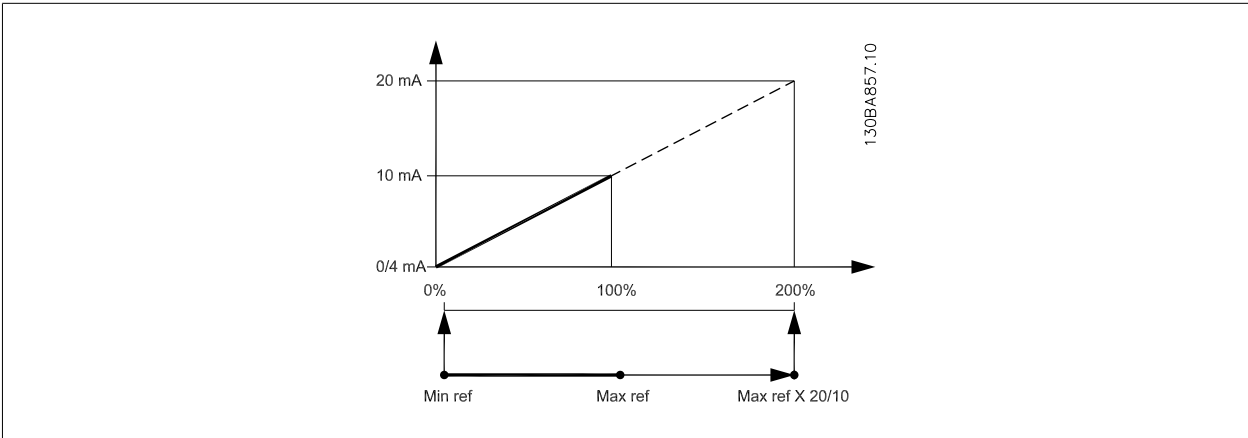

6-53 Terminal 42 Output Bus Control

Range:	Function:
0.00 %* [0.00 - 100.00 %]	Holds the level of Output 42 if controlled by bus.

6-54 Terminal 42 Output Timeout Preset

Range:	Function:
0.00 %* [0.00 - 100.00 %]	Holds the preset level of Output 42. In case of a bus timeout and a timeout function is selected in par. 6-50 <i>Terminal 42 Output</i> , the output will preset to this level.

2.8.8 6-6* Analog Output 2 (MCB 101)

Analog outputs are current outputs: 0/4–20 mA. Common terminal (terminal X30/8) is the same terminal and electrical potential for analog common connection. Resolution on analog output is 12 bit.

6-60 Terminal X30/8 Output

Option:	Function:
[0] *	No operation
[100]	Output frequency
[101]	Reference
[102]	Feedback
[103]	Motor current
[104]	Torque rel to limit
[105]	Torq relate to rated
[106]	Power
[107]	Speed
[113]	Ext. Closed-loop 1
[114]	Ext. Closed-loop 2
[115]	Ext. Closed-loop 3
[130]	Output freq. 4-20mA
[131]	Reference 4-20mA
[132]	Feedback 4-20mA
[133]	Motor cur. 4-20mA
[134]	Torq.% lim 4-20 mA
[135]	Torq.% nom 4-20 mA
[136]	Power 4-20mA
[137]	Speed 4-20mA
[139]	Bus ctrl.
[140]	Bus ctrl. 4-20 mA
[141]	Bus ctrl t.o.
[142]	Bus ctrl 4-20mA t.o.
[143]	Ext. Closed-loop 1 4-20 mA
[144]	Ext. Closed-loop 2 4-20 mA
[145]	Ext. Closed-loop 3 4-20 mA

6-61 Terminal X30/8 Min. Scale

Range:	Function:
0.00 %* [0.00 - 200.00 %]	<p>Scales the minimum output of the selected analog signal on terminal X30/8. Scale the minimum value as a percentage of the maximum signal value, i.e., 0 mA (or 0 Hz) is desired at 25% of the maximum output value and 25% is programmed. The value can never be higher than the corresponding setting in par.6-62 <i>Terminal X30/8 Max. Scale</i> if value is below 100%.</p> <p>This parameter is active when option module MCB 101 is mounted in the adjustable frequency drive.</p>

6-62 Terminal X30/8 Max. Scale

Range:	Function:
100.00 %* [0.00 - 200.00 %]	<p>Scales the maximum output of the selected analog signal on terminal X30/8. Scale the value to the desired maximum value of the current signal output. Scale the output to give a current lower than</p>

20 mA at full scale, or 20 mA at an output below 100% of the maximum signal value. If 20 mA is the desired output current at a value between 0–100% of the full-scale output, program the percentage value in the parameter, i.e. 50% = 20 mA. If a current between 4 and 20 mA is desired at maximum output (100%), calculate the percentage value as follows:

$$20 \text{ mA} / \text{desired maximum current} \times 100 \%$$

$$\text{i.e. } 10 \text{ mA} : \frac{20 \text{ mA}}{10 \text{ mA}} \times 100 \% = 200 \%$$

2

6-63 Terminal X30/8 Output Bus Control

Range:

0.00 %* [0.00 - 100.00 %]

Function:

Contains the value to apply to the output terminal when it is configured as [Bus Controlled].

6-64 Terminal X30/8 Output Timeout Preset

Range:

0.00 %* [0.00 - 100.00 %]

Function:

Contains the value to apply to the output terminal when it is configured as [Bus Controlled Timeout] and timeout is detected.

2.9 Main Menu - Communications and Options - Group 8

2.9.1 8-** Comm. and Options

Parameter group for configuring communications and options.

2.9.2 8-0* General Settings

General settings for communications and options.

8-01 Control Site		
Option:		Function:
		The setting in this parameter overrides the settings in par.8-50 <i>Coasting Select</i> to par.8-56 <i>Preset Reference Select</i> .
[0] *	Digital and ctrl. word	Control by using both digital input and control word.
[1]	Digital only	Control by using digital inputs only.
[2]	Control word only	Control by using control word only.
8-02 Control Word Source		
Option:		Function:
		Select the source of the control word: one of two serial interfaces or four installed options. During initial power-up, the adjustable frequency drive automatically sets this parameter to <i>Option A</i> [3] if it detects a valid serial communication option installed in slot A. If the option is removed, the adjustable frequency drive detects a change in the configuration, sets par. 8-02 back to default setting <i>FC Port</i> , and the adjustable frequency drive then trips. If an option is installed after initial power-up, the setting of par. 8-02 will not change, but the adjustable frequency drive will trip and display: <i>Alarm 67 Option Changed</i> . This parameter cannot be adjusted while the motor is running.
[0]	None	
[1]	FC Port	
[2]	FC USB	
[3]	Option A	
[4]	Option B	
[5]	Option C0	
[6]	Option C1	
8-03 Control Timeout Time		
Range:		Function:
60.0 s*	[1.0 - 18000.0 s]	Enter the maximum time expected to pass between the reception of two consecutive messages. If this time is exceeded, it indicates that the serial communication has stopped. The function selected in par.8-04 <i>Control Timeout Function Control Timeout Function</i> will then be carried out. In LonWorks, the following variables will trigger the Control Word Time parameter: nviStartStop nviReset Fault nviControlWord

nviDrvSpeedStpt
nviRefPcnt
nviRefHz

8-04 Control Timeout Function

Option: **Function:**
 Select the timeout function. The timeout function is activated when the control word fails to be updated within the time period specified in par.8-03 *Control Timeout Time*. Choice [20] only appears after setting the N2 protocol.

[0] *	Off
[1]	Freeze output
[2]	Stop
[3]	Jogging
[4]	Max. speed
[5]	Stop and trip
[7]	Select setup 1
[8]	Select setup 2
[9]	Select setup 3
[10]	Select setup 4
[20]	N2 Override Release

In LonWorks, the timeout function is also activated when the following SNVTs fail to be updated within the time period specified in par.8-03 *Control Timeout Time*:

nviStartStop	nviDrvSpeedStpt
nviReset Fault	nviRefPcnt
nviControlWord	nviRefHz

8-05 End-of-Timeout Function

Option: **Function:**
 Select the action after receiving a valid control word following a timeout. This parameter is active only when par.8-04 *Control Timeout Function* is set to [Set-up 1-4].

[0]	Hold set-up	Retains the set-up selected in par.8-04 <i>Control Timeout Function</i> and displays a warning, until par. 8-06 <i>Reset Control Timeout</i> toggles. Then the adjustable frequency drive resumes its original set-up.
[1] *	Resume set-up	Resumes the set-up active prior to the timeout.

8-06 Reset Control Timeout

Option: **Function:**
 This parameter is active only when the choice *Hold set-up* [0] has been selected in par.8-05 *End-of-Timeout Function*.

[0] *	Do not reset	Retains the set-up specified in par.8-04 <i>Control Timeout Function</i> , [Select set-up 1-4] following a control timeout.
[1]	Do reset	Returns the adjustable frequency drive to the original set-up following a control word timeout. When the value is set to <i>Do reset</i> [1], the adjustable frequency drive performs the reset and then immediately reverts to the <i>Do not reset</i> [0] setting.

8-07 Diagnosis Trigger

Option:

Function:

This parameter has no function for LonWorks.

- [0] * Disable
- [1] Trigger on alarms
- [2] Trigger alarm/warn.

2.9.3 8-1* Ctrl. Word Settings

Parameters for configuring the option control word profile.

8-10 Control Profile

Option:

Function:

Select the interpretation of the control and status words corresponding to the installed serial communication bus. Only the selections valid for the serial communication bus installed in slot A will be visible in the LCP display.

- [0] * FC profile
- [1] PROFIdrive profile
- [5] ODVA
- [7] CANopen DSP 402

8-13 Configurable Status Word STW

Option:

Function:

This parameter enables configuration of bits 12 – 15 in the status word.

- [0] No function
- [1] * Profile Default Function corresponds to the profile default selected in par.8-10 *Control Profile*.
- [2] Alarm 68 Only Only set in case of an Alarm 68.
- [3] Trip excl Alarm 68 Set in case of a trip, except if the trip is executed by an Alarm 68.
- [16] T37 DI status The bit indicates the status of terminal 37.
 "0" indicates T37 is low (safe stop)
 "1" indicates T37 is high (normal)

2.9.4 8-3* FC Port Settings

Parameters for configuring the FC Port.

8-30 Protocol

Option:

Function:

Protocol selection for the integrated FC (standard) Port (RS-485) on the control card.

- [0] * FC Communication according to the FC Protocol as described in *RS-485 Installation and Set-up*.
- [1] FC MC Same as FC[0], but to be used when downloading SW to the adjustable frequency drive or uploading a dll file (with information regarding parameters available in the adjustable frequency drive and their interdependencies) to the Motion Control Tool MCT10.
- [2] Modbus RTU Communication according to the modbus RTU protocol.
- [9] FC option

8-31 Address

Range:

1. N/A* [1. - 126. N/A]

Function:

Enter the address for the FC (standard) port.
Valid range: 1–126.

8-32 Baud Rate

Option:

[0] 2400 Baud

[1] 4800 Baud

[2] * 9600 Baud

[3] 19200 Baud

[4] 38400 Baud

[5] 57600 Baud

[6] 76800 Baud

[7] 115200 Baud

Function:

Baud rate selection depends on Protocol selection in par. 8-30 *Protocol*.

Default refers to the FC protocol.

8-33 Parity / Stop Bits

Option:

[0] * Even Parity, 1 Stop Bit

[1] Odd Parity, 1 Stop Bit

[2] No Parity, 1 Stop Bit

[3] No Parity, 2 Stop Bits

Function:

Parity and Stop Bits for the protocol par. 8-30 *Protocol* using the FC Port. For some of the protocols, not all options will be visible. Default depends on the protocol selected.

8-35 Minimum Response Delay

Range:

10. ms* [5. - 10000. ms]

Function:

Specify the minimum delay time between receiving a request and transmitting a response. This is used for overcoming modem turnaround delays.

8-36 Max Response Delay

Range:

10001. ms* [11. - 10001. ms]

Function:

Specify the maximum permissible delay time between transmitting a request and receiving a response. Exceeding this delay time will cause control word timeout.

8-37 Max Inter-Char Delay

Range:

25.00 ms* [0.00 - 35.00 ms]

Function:

Specify the maximum permissible time interval between receiving two bytes. This parameter activates timeout if transmission is interrupted.

8-40 Telegram selection

Option:	Function:
	Enables use of freely configurable messages or standard messages for the FC port.
[1] *	Standard telegram 1
[101]	PPO 1
[102]	PPO 2
[103]	PPO 3
[104]	PPO 4
[105]	PPO 5
[106]	PPO 6
[107]	PPO 7
[108]	PPO 8
[200]	Custom telegram 1

2.9.5 8-5* Digital/Bus

Parameters for configuring the control word Digital/Bus merging.

8-50 Coasting Select

Option:	Function:
	Select control of the coasting function via the terminals (digital input) and/or via the bus.
[0]	Digital input
[1]	Bus
[2]	Logic AND
[3] *	Logic OR



NOTE!

This parameter is active only when par.8-01 *Control Site* is set to [0] *Digital and control word*.

8-52 DC Brake Select

Option:	Function:
	Select control of the DC brake via the terminals (digital input) and/or via the serial communication bus.
[0]	Digital input
[1]	Bus
[2]	Logic AND
[3] *	Logic OR



NOTE!

This parameter is active only when par.8-01 *Control Site* is set to [0] *Digital and control word*.

8-53 Start Select

Option:
Function:

Select control of the adjustable frequency drive start function via the terminals (digital input) and/or via the serial communication bus.

[0]	Digital input	Activates Start command via a digital input.
[1]	Bus	Activates the start command via the serial communication port or serial communication option.
[2]	Logic AND	Activates the start command via the serial communication port, AND additionally via one of the digital inputs.
[3] *	Logic OR	Activates the start command via the serial communication port OR via one of the digital inputs.

NOTE!

This parameter is active only when par.8-01 *Control Site* is set to [0] *Digital and control word*.

8-54 Reverse Select

Option:
Function:

Select control of the adjustable frequency drive reverse function via the terminals (digital input) and/or via the serial communication bus.

[0] *	Digital input	Activates Reverse command via a digital input.
[1]	Bus	Activates reverse command via the serial communication port or serial communication option.
[2]	Logic AND	Activates reverse command via the serial communication bus/serial communication port, AND additionally via one of the digital inputs.
[3]	Logic OR	Activates reverse command via the serial communication bus/serial communication port OR via one of the digital inputs.

NOTE!

This parameter is active only when par.8-01 *Control Site* is set to [0] *Digital and control word*.

8-55 Set-up Select

Option:
Function:

Select control of the adjustable frequency drive set-up selection via the terminals (digital input) and/or via the serial communication bus.

[0]	Digital input	Activates the set-up selection via a digital input.
[1]	Bus	Activates the set-up selection via the serial communication port or serial communication option.
[2]	Logic AND	Activates the set-up selection via the serial communication port, AND additionally via one of the digital inputs.
[3] *	Logic OR	Activate the set-up selection via the serial communication port OR via one of the digital inputs.



NOTE!
This parameter is active only when par.8-01 *Control Site* is set to [0] *Digital and control word*.

8-56 Preset Reference Select

Option:	Function:
	Select control of the adjustable frequency drive Preset Reference selection via the terminals (digital input) and/or via the serial communication bus.
[0] Digital input	Activates Preset Reference selection via a digital input.
[1] Bus	Activates the Preset Reference selection via the serial communication port or serial communication option.
[2] Logic AND	Activates the Preset Reference selection via the serial communication port, AND additionally via one of the digital inputs.
[3] * Logic OR	Activates the Preset Reference selection via the serial communication port OR via one of the digital inputs.



NOTE!
This parameter is active only when par.8-01 *Control Site* is set to [0] *Digital and control word*.

2.9.6 8-8* FC Port Diagnostics

These parameters are used for monitoring the bus communication via the FC port.

8-80 Bus Message Count

Range:	Function:
0 N/A* [0 - 0 N/A]	This parameter shows the number of valid messages detected on the bus.

8-81 Bus Error Count

Range:	Function:
0 N/A* [0 - 0 N/A]	This parameter shows the number of messages with faults (e.g. CRC fault) detected on the bus.

8-82 Slave Message Count

Range:	Function:
0 N/A* [0 - 0 N/A]	This parameter shows the number of valid messages addressed to the slave, sent by the adjustable frequency drive.

8-83 Slave Error Count

Range:	Function:
0 N/A* [0 - 0 N/A]	This parameter shows the number of error messages, which could not be executed by the adjustable frequency drive.

2.9.7 8-9* Bus Jog

Parameters for configuring the bus jog.

8-90 Bus Jog 1 Speed

Range:

100 RPM* [0 - par. 4-13 RPM]

Function:

Enter the jog speed. This is a fixed jog speed activated via the serial port or serial communication option.

8-91 Bus Jog 2 Speed

Range:

200 RPM* [0 - par. 4-13 RPM]

Function:

Enter the jog speed. This is a fixed jog speed activated via the serial port or serial communication option.

8-94 Bus Feedback 1

Range:

0 N/A* [-200 - 200 N/A]

Function:

Write a feedback to this parameter via the serial communication port or serial communication option. This parameter must be selected in par.20-00 *Feedback 1 Source*, par.20-03 *Feedback 2 Source* or par.20-06 *Feedback 3 Source* as a feedback source.

8-95 Bus Feedback 2

Range:

0 N/A* [-200 - 200 N/A]

Function:

See par.8-94 *Bus Feedback 1* for further details.

8-96 Bus Feedback 3

Range:

0 N/A* [-200 - 200 N/A]

Function:

See par.8-94 *Bus Feedback 1* for further details.

2.10 Main Menu - Profibus - Group 9

2.10.1 9-** Profibus

Parameter group for all Profibus-specific parameters. Only available if Profibus option is mounted

9-15 PCD Write Configuration

Array [10]

Option:

Function:

Select the parameters to be assigned to PCDs 3 to 10 of the messages. The number of available PCDs depends on the message type. The values in PCDs 3 to 10 will then be written to the selected parameters as data values. Alternatively, specify a standard Profibus message in par.9-22 *Telegram Selection*.

[0] *	None
[302]	Minimum Reference
[303]	Maximum Reference
[341]	Ramp 1 Ramp-up Time
[342]	Ramp 1 Ramp-down Time
[351]	Ramp 2 Ramp-up Time
[352]	Ramp 2 Ramp-down Time
[380]	Jog Ramp Time
[381]	Quick Stop Ramp Time
[411]	Motor Speed Low Limit [RPM]
[413]	Motor Speed High Limit [RPM]
[416]	Torque Limit Motor Mode
[417]	Torque Limit Generator Mode
[590]	Digital & Relay Bus Control
[593]	Pulse Out #27 Bus Control
[595]	Pulse Out #29 Bus Control
[597]	Pulse Out #X30/6 Bus Control
[653]	Terminal 42 Output Bus Control
[663]	Terminal X30/8 Output Bus Control
[890]	Bus Jog 1 Speed
[891]	Bus Jog 2 Speed
[894]	Bus Feedback 1
[895]	Bus Feedback 2
[896]	Bus Feedback 3
[1680]	Fieldbus CTW 1
[1682]	Fieldbus REF 1
[2013]	
[2014]	
[2643]	Terminal X42/7 Output Bus Control
[2653]	Terminal X42/9 Output Bus Control
[2663]	Terminal X42/11 Output Bus Control

9-16 PCD Read Configuration

Array [10]

Option:**Function:**

Select the parameters to be assigned to PCDs 3 to 10 of the messages. The number of available PCDs depends on the message type. PCDs 3 to 10 contain the actual data values of the selected parameters. For standard Profibus message, see par.9-22 *Telegram Selection*.

2

[0] *	None
[894]	Bus Feedback 1
[895]	Bus Feedback 2
[896]	Bus Feedback 3
[1600]	Control Word
[1601]	Reference [Unit]
[1602]	Reference %
[1603]	Status Word
[1605]	Main Actual Value [%]
[1609]	Custom Readout
[1610]	Power [kW]
[1611]	Power [hp]
[1612]	Motor voltage
[1613]	Frequency
[1614]	Motor Current
[1615]	Frequency [%]
[1616]	Torque [Nm]
[1617]	Speed [RPM]
[1618]	Motor Thermal
[1622]	Torque [%]
[1630]	DC Link Voltage
[1632]	Brake Energy /s
[1633]	Brake Energy /2 min
[1634]	Heatsink Temp.
[1635]	Inverter Thermal
[1638]	SL Controller State
[1639]	Control Card Temp.
[1650]	External Reference
[1652]	Feedback [Unit]
[1653]	Digi Pot Reference
[1654]	Feedback 1 [Unit]
[1655]	Feedback 2 [Unit]
[1656]	Feedback 3 [Unit]
[1660]	Digital Input
[1661]	Terminal 53 Switch Setting
[1662]	Analog Input 53
[1663]	Terminal 54 Switch Setting
[1664]	Analog Input 54

- [1665] Analog Output 42 [mA]
- [1666] Digital Output [bin]
- [1667] Pulse Input #29 [Hz]
- [1668] Pulse Input #33 [Hz]
- [1669] Pulse Output #27 [Hz]
- [1670] Pulse Output #29 [Hz]
- [1671] Relay Output [bin]
- [1672] Counter A
- [1673] Counter B
- [1675] Analog In X30/11
- [1676] Analog In X30/12
- [1677] Analog Out X30/8 [mA]
- [1684] Comm. Option Status
- [1685] FC Port CTW 1
- [1690] Alarm Word
- [1691] Alarm word 2
- [1692] Warning Word
- [1693] Warning word 2
- [1694] Ext. Status Word
- [1695] Ext. Status Word 2
- [1696] Maintenance Word
- [1830] Analog Input X42/1
- [1831] Analog Input X42/3
- [1832] Analog Input X42/5
- [1833] Analog Out X42/7 [V]
- [1834] Analog Out X42/9 [V]
- [1835] Analog Out X42/11 [V]

9-18 Node Address

Range:	Function:
126 N/A* [0 - 126. N/A]	Enter the station address in this parameter, or alternatively in the hardware switch. In order to adjust the station address in par.9-18 <i>Node Address</i> , the hardware switch must be set to 126 or 127 (i.e. all switches set to 'on'). Otherwise, this parameter will display the actual setting of the switch.

9-22 Telegram Selection

Option:	Function:
	Select a standard Profibus message configuration for the adjustable frequency drive as an alternative to using the freely configurable messages in par.9-15 <i>PCD Write Configuration</i> and par. 9-16 <i>PCD Read Configuration</i> .

- [1] Standard telegram 1
- [101] PPO 1
- [102] PPO 2
- [103] PPO 3
- [104] PPO 4

[105] PPO 5

[106] PPO 6

[107] PPO 7

[108] * PPO 8

[200] Custom telegram 1

9-23 Parameters for Signals

Array [1000]

Option:
Function:

This parameter contains a list of signals available for selection in par.9-15 *PCD Write Configuration* and par.9-16 *PCD Read Configuration*.

[0] * None

[302] Minimum Reference

[303] Maximum Reference

[341] Ramp 1 Ramp-up Time

[342] Ramp 1 Ramp-down Time

[351] Ramp 2 Ramp-up Time

[352] Ramp 2 Ramp-down Time

[380] Jog Ramp Time

[381] Quick Stop Ramp Time

[411] Motor Speed Low Limit [RPM]

[413] Motor Speed High Limit [RPM]

[416] Torque Limit Motor Mode

[417] Torque Limit Generator Mode

[590] Digital & Relay Bus Control

[593] Pulse Out #27 Bus Control

[595] Pulse Out #29 Bus Control

[597] Pulse Out #X30/6 Bus Control

[653] Terminal 42 Output Bus Control

[663] Terminal X30/8 Output Bus Control

[890] Bus Jog 1 Speed

[891] Bus Jog 2 Speed

[894] Bus Feedback 1

[895] Bus Feedback 2

[896] Bus Feedback 3

[1600] Control Word

[1601] Reference [Unit]

[1602] Reference %

[1603] Status Word

[1605] Main Actual Value [%]

[1609] Custom Readout

[1610] Power [kW]

[1611] Power [hp]

[1612] Motor voltage

[1613]	Frequency
[1614]	Motor Current
[1615]	Frequency [%]
[1616]	Torque [Nm]
[1617]	Speed [RPM]
[1618]	Motor Thermal
[1622]	Torque [%]
[1630]	DC Link Voltage
[1632]	Brake Energy /s
[1633]	Brake Energy /2 min
[1634]	Heatsink Temp.
[1635]	Inverter Thermal
[1638]	SL Controller State
[1639]	Control Card Temp.
[1650]	External Reference
[1652]	Feedback [Unit]
[1653]	Digi Pot Reference
[1654]	Feedback 1 [Unit]
[1655]	Feedback 2 [Unit]
[1656]	Feedback 3 [Unit]
[1660]	Digital Input
[1661]	Terminal 53 Switch Setting
[1662]	Analog Input 53
[1663]	Terminal 54 Switch Setting
[1664]	Analog Input 54
[1665]	Analog Output 42 [mA]
[1666]	Digital Output [bin]
[1667]	Pulse Input #29 [Hz]
[1668]	Pulse Input #33 [Hz]
[1669]	Pulse Output #27 [Hz]
[1670]	Pulse Output #29 [Hz]
[1671]	Relay Output [bin]
[1672]	Counter A
[1673]	Counter B
[1675]	Analog In X30/11
[1676]	Analog In X30/12
[1677]	Analog Out X30/8 [mA]
[1680]	Fieldbus CTW 1
[1682]	Fieldbus REF 1
[1684]	Comm. Option Status
[1685]	FC Port CTW 1
[1690]	Alarm Word
[1691]	Alarm word 2

[1692]	Warning Word
[1693]	Warning word 2
[1694]	Ext. Status Word
[1695]	Ext. Status Word 2
[1696]	Maintenance Word
[1830]	Analog Input X42/1
[1831]	Analog Input X42/3
[1832]	Analog Input X42/5
[1833]	Analog Out X42/7 [V]
[1834]	Analog Out X42/9 [V]
[1835]	Analog Out X42/11 [V]
[2013]	
[2014]	
[2643]	Terminal X42/7 Output Bus Control
[2653]	Terminal X42/9 Output Bus Control
[2663]	Terminal X42/11 Output Bus Control

9-27 Parameter Edit

Option:	Function:
	Parameters can be edited via Profibus, the standard RS485 interface, or the LCP.
[0]	Disabled
[1] *	Enabled

9-28 Process Control

Option:	Function:
	Process control (setting of control word, speed reference and process data) is possible via either Profibus or standard serial communication bus, but not both simultaneously. Local control is always possible via the LCP. Control via process control is possible via either terminals or serial communication bus depending on the settings in par.8-50 <i>Coasting Select</i> to par.8-56 <i>Preset Reference Select</i> .
[0]	Disable
[1] *	Enable cyclic master

9-53 Profibus Warning Word

Range:	Function:
0 N/A* [0 - 65535 N/A]	This parameter displays Profibus communication warnings. Please refer to the <i>Profibus Instruction Manual</i> for further information.

Read only

Bit:	Meaning:
0	Connection with DP master is not ok
1	Not used
2	FDL (Fieldbus [or Serial Communication Bus] Link Layer) is not ok
3	Clear data command received
4	Actual value is not updated
5	Baudrate search
6	PROFIBUS ASIC is not transmitting
7	Initializing of PROFIBUS is not ok
8	The adjustable frequency drive is tripped.
9	Internal CAN error
10	Wrong configuration data from PLC
11	Wrong ID sent by PLC
12	Internal error occurred
13	Not configured
14	Timeout active
15	Warning 34 active

9-63 Actual Baud Rate

Option:

Function:

This parameter displays the actual Profibus baud rate. The Profibus Master automatically sets the baud rate.

- [0] 9.6 kbit/s
- [1] 19.2 kbit/s
- [2] 93.75 kbit/s
- [3] 187.5 kbit/s
- [4] 500 kbit/s
- [6] 1500 kbit/s
- [7] 3000 kbit/s
- [8] 6000 kbit/s
- [9] 12000 kbit/s
- [10] 31.25 kbit/s
- [11] 45.45 kbit/s
- [255] * No baud rate found

9-65 Profile Number

Range:

0 N/A* [0 - 0 N/A]

Function:

This parameter contains the profile identification. Byte 1 contains the profile number, and byte 2 the version number of the profile.



NOTE!

This parameter is not visible via LCP.

9-70 Programming Set-up

Option:

Function:

Select the set-up to be edited.

- [0] Factory setup
Uses default data. This option can be used as a data source to return the other set-ups to a known state.
- [1] Set-up 1
Edits Set-up 1.

[2]	Set-up 2	Edits Set-up 2.
[3]	Set-up 3	Edits Set-up 3.
[4]	Set-up 4	Edits Set-up 4.
[9] *	Active Set-up	Follows the active set-up selected in par.0-10 <i>Active Set-up</i> .

This parameter is unique to LCP and serial communication busses. See also par.0-11 *Programming Set-up*.

9-71 Profibus Save Data Values

Option:
Function:

Parameter values changed via Profibus are not automatically stored in non-volatile memory. Use this parameter to activate a function that stores parameter values in the EEPROM non-volatile memory, so that changed parameter values will be retained at power-down.

[0] *	Off	Deactivates the non-volatile storage function.
[1]	Store edit setup	Stores all parameter values in the set-up selected in par. 9-70 <i>Edit Set-up</i> in the non-volatile memory. The selection returns to Off [0] when all values have been stored.
[2]	Store all setups	Stores all parameter values for all set-ups in the non-volatile memory. The selection returns to Off [0] when all parameter values have been stored.

9-72 ProfibusDriveReset

Option:
Function:

[0] *	No action	
[1]	Power-on reset	Resets the adjustable frequency drive upon power-up, as for power-cycle.
[3]	Comm option reset	Resets the Profibus option only, useful after changing certain settings in parameter group 9-**, e.g. par.9-18 <i>Node Address</i> . When reset, the adjustable frequency drive disappears from the serial communication bus, which may cause a communication error from the master.

9-80 Defined Parameters (1)

Array [116]
No LCP access
Read only

Range:
Function:

0 N/A*	[0 - 9999 N/A]	This parameter displays a list of all the defined adjustable frequency drive parameters available for Profibus.
--------	----------------	---

9-81 Defined Parameters (2)

Array [116]
No LCP access
Read only

Range:
Function:

0 N/A*	[0 - 9999 N/A]	This parameter displays a list of all the defined adjustable frequency drive parameters available for Profibus.
--------	----------------	---

9-82 Defined Parameters (3)

Array [116]
 No LCP access
 Read only

Range:

0 N/A* [0 - 9999 N/A]

Function:

This parameter displays a list of all the defined adjustable frequency drive parameters available for Profibus.

9-83 Defined Parameters (4)

Array [116]
 No LCP access
 Read only

Range:

0 N/A* [0 - 9999 N/A]

Function:

This parameter displays a list of all the defined adjustable frequency drive parameters available for Profibus.

9-90 Changed Parameters (1)

Array [116]
 No LCP access
 Read only

Range:

0 N/A* [0 - 9999 N/A]

Function:

This parameter displays a list of all the adjustable frequency drive parameters deviating from default setting.

9-91 Changed Parameters (2)

Array [116]
 No LCP access
 Read only

Range:

0 N/A* [0 - 9999 N/A]

Function:

This parameter displays a list of all the adjustable frequency drive parameters deviating from default setting.

9-92 Changed Parameters (3)

Array [116]
 No LCP access
 Read only

Range:

0 N/A* [0 - 9999 N/A]

Function:

This parameter displays a list of all the adjustable frequency drive parameters deviating from default setting.

9-94 Changed parameters (5)

Array [116]
 No LCP Address
 Read only

Range:

0 N/A* [0 - 9999 N/A]

Function:

This parameter displays a list of all the adjustable frequency drive parameters deviating from default setting.

2.11 Main Menu - CAN Serial Communication Bus - Group 10

2.11.1 10-** DeviceNet and CAN Serial Communication Bus

Parameter group for DeviceNet CAN serial communication bus parameters.

2.11.2 10-0* Common Settings

Parameter group for configuring common settings for CAN serial communication options.

10-00 CAN Protocol

Option:	Function:
[1] * DeviceNet	View the active CAN protocol.



NOTE!

The options depend on installed option

10-01 Baud Rate Select

Option:	Function:
	Select the serial communication bus transmission speed. The selection must correspond to the transmission speed of the master and the other serial communication bus nodes.

[16]	10 Kbps
[17]	20 Kbps
[18]	50 Kbps
[19]	100 Kbps
[20] *	125 Kbps
[21]	250 Kbps
[22]	500 Kbps
[23]	800 Kbps
[24]	1000 Kbps

10-02 MAC ID

Range:	Function:
63. N/A* [0 - 63. N/A]	Selection of station address. Every station connected to the same DeviceNet network must have an unambiguous address.

10-05 Readout Transmit Error Counter

Range:	Function:
0 N/A* [0 - 255 N/A]	View the number of CAN control transmission errors since the last power-up.

10-06 Readout Receive Error Counter

Range:	Function:
0 N/A* [0 - 255 N/A]	View the number of CAN control receipt errors since the last power-up.

10-07 Readout Bus Off Counter

Range:	Function:
0 N/A* [0 - 255 N/A]	View the number of bus-off events since the last power-up.

2.11.3 10-1* DeviceNet

Parameters specific to the DeviceNet serial communication bus.

10-10 Process Data Type Selection

Option:	Function:
	Select the instance (message) for data transmission. The instances available are dependent upon the setting of par.8-10 <i>Control Profile</i> . When par.8-10 <i>Control Profile</i> is set to [0] <i>FC profile</i> , par.10-10 <i>Process Data Type Selection</i> options [0] and [1] are available. When par.8-10 <i>Control Profile</i> is set to [5] <i>ODVA</i> , par.10-10 <i>Process Data Type Selection</i> options [2] and [3] are available. Instances 100/150 and 101/151 are Danfoss-specific. Instances 20/70 and 21/71 are ODVA-specific AC drive profiles. For guidelines in message selection, please refer to the DeviceNet Instruction Manual. Note that a change to this parameter will be executed immediately.

[0] *	INSTANCE 100/150
[1]	INSTANCE 101/151
[2]	INSTANCE 20/70
[3]	INSTANCE 21/71

10-11 Process Data Config Write

Option:	Function:
	Select the process write data for I/O assembly instances 101/151. Elements [2] and [3] of this array can be selected. Elements [0] and [1] of the array are fixed.

[0] *	None
[302]	Minimum Reference
[303]	Maximum Reference
[341]	Ramp 1 Ramp-up Time
[342]	Ramp 1 Ramp-down Time
[351]	Ramp 2 Ramp-up Time
[352]	Ramp 2 Ramp-down Time
[380]	Jog Ramp Time
[381]	Quick Stop Ramp Time
[411]	Motor Speed Low Limit [RPM]
[413]	Motor Speed High Limit [RPM]
[416]	Torque Limit Motor Mode
[417]	Torque Limit Generator Mode
[590]	Digital & Relay Bus Control
[593]	Pulse Out #27 Bus Control
[595]	Pulse Out #29 Bus Control
[597]	Pulse Out #X30/6 Bus Control

[653]	Terminal 42 Output Bus Control
[663]	Terminal X30/8 Output Bus Control
[890]	Bus Jog 1 Speed
[891]	Bus Jog 2 Speed
[894]	Bus Feedback 1
[895]	Bus Feedback 2
[896]	Bus Feedback 3
[1680]	Fieldbus CTW 1
[1682]	Fieldbus REF 1
[2013]	
[2014]	
[2643]	Terminal X42/7 Output Bus Control
[2653]	Terminal X42/9 Output Bus Control
[2663]	Terminal X42/11 Output Bus Control

10-12 Process Data Config Read

Option:
Function:

Select the process read data for I/O assembly instances 101/151. Elements [2] and [3] of this array can be selected. Elements [0] and [1] of the array are fixed.

[0] *	None
[894]	Bus Feedback 1
[895]	Bus Feedback 2
[896]	Bus Feedback 3
[1600]	Control Word
[1601]	Reference [Unit]
[1602]	Reference %
[1603]	Status Word
[1605]	Main Actual Value [%]
[1609]	Custom Readout
[1610]	Power [kW]
[1611]	Power [hp]
[1612]	Motor voltage
[1613]	Frequency
[1614]	Motor Current
[1615]	Frequency [%]
[1616]	Torque [Nm]
[1617]	Speed [RPM]
[1618]	Motor Thermal
[1622]	Torque [%]
[1630]	DC Link Voltage
[1632]	Brake Energy /s
[1633]	Brake Energy /2 min
[1634]	Heatsink Temp.
[1635]	Inverter Thermal

[1638]	SL Controller State
[1639]	Control Card Temp.
[1650]	External Reference
[1652]	Feedback [Unit]
[1653]	Digi Pot Reference
[1654]	Feedback 1 [Unit]
[1655]	Feedback 2 [Unit]
[1656]	Feedback 3 [Unit]
[1660]	Digital Input
[1661]	Terminal 53 Switch Setting
[1662]	Analog Input 53
[1663]	Terminal 54 Switch Setting
[1664]	Analog Input 54
[1665]	Analog Output 42 [mA]
[1666]	Digital Output [bin]
[1667]	Pulse Input #29 [Hz]
[1668]	Pulse Input #33 [Hz]
[1669]	Pulse Output #27 [Hz]
[1670]	Pulse Output #29 [Hz]
[1671]	Relay Output [bin]
[1672]	Counter A
[1673]	Counter B
[1675]	Analog In X30/11
[1676]	Analog In X30/12
[1677]	Analog Out X30/8 [mA]
[1684]	Comm. Option Status
[1685]	FC Port CTW 1
[1690]	Alarm Word
[1691]	Alarm word 2
[1692]	Warning Word
[1693]	Warning word 2
[1694]	Ext. Status Word
[1695]	Ext. Status Word 2
[1696]	Maintenance Word
[1830]	Analog Input X42/1
[1831]	Analog Input X42/3
[1832]	Analog Input X42/5
[1833]	Analog Out X42/7 [V]
[1834]	Analog Out X42/9 [V]
[1835]	Analog Out X42/11 [V]

10-13 Warning Parameter

Range:

0 N/A* [0 - 65535 N/A]

Function:

View a DeviceNet-specific warning word. One bit is assigned to every warning. Please refer to the DeviceNet Instruction Manual (MG.33.DX.YY) for further information.

Bit:	Meaning:
0	Bus not active
1	Explicit connection timeout
2	I/O connection
3	Retry limit reached
4	Actual is not updated
5	CAN bus off
6	I/O send error
7	Initialization error
8	No bus supply
9	Bus off
10	Error passive
11	Error warning
12	Duplicate MAC ID Error
13	RX queue overrun
14	TX queue overrun
15	CAN overrun

10-14 Net Reference

Read only from LCP

Option:
Function:

Select the reference source in instance 21/71 and 20/70.

[0] * Off

Enables reference via analog/digital inputs.

[1] On

Enables reference via the serial communication bus.

10-15 Net Control

Read only from LCP

Option:
Function:

Select the control source in instance 21/71 and 20-70.

[0] * Off

Enables control via analog/digital inputs.

[1] On

Enable control via the serial communication bus.

2.11.4 10-2* COS Filters

Parameters for configuring COS filter settings.

10-20 COS Filter 1

Range:

0 N/A* [0 - 65535 N/A]

Function:

Enter the value for COS Filter 1 to set up the filter mask for the status word. When operating in COS (change-of-state), this function filters out bits in the status word that should not be sent if they change.

10-21 COS Filter 2

Range:

0 N/A* [0 - 65535 N/A]

Function:

Enter the value for COS Filter 2 to set up the filter mask for the main actual value. When operating in COS (change-of-state), this function filters out bits in the main actual value that should not be sent if they change.

10-22 COS Filter 3

Range:	Function:
0 N/A* [0 - 65535 N/A]	Enter the value for COS Filter 3 in order to set up the filter mask for PCD 3. When operating in COS (change-of-state), this function filters out bits in PCD 3 that should not be sent if they change.

10-23 COS Filter 4

Range:	Function:
0 N/A* [0 - 65535 N/A]	Enter the value for COS Filter 4 to set up the filter mask for PCD 4. When operating in COS (change-of-state), this function filters out bits in PCD 4 that should not be sent if they change.

2.11.5 10-3* Parameter Access

Parameter group providing access to indexed parameters and defining programming set-up.

10-30 Array Index

Range:	Function:
0 N/A* [0 - 255 N/A]	View array parameters. This parameter is valid only when a DeviceNet serial communication bus is installed.

10-31 Store Data Values

Option:	Function:
[0] * Off	Parameter values changed via DeviceNet are not automatically stored in non-volatile memory. Use this parameter to activate a function that stores parameter values in the EEPROM non-volatile memory, so that changed parameter values will be retained at power-down. Deactivates the non-volatile storage function.
[1] Store edit setup	Stores all parameter values from the active set-up in the non-volatile memory. The selection returns to Off [0] when all values have been stored.
[2] Store all setups	Stores all parameter values for all set-ups in the non-volatile memory. The selection returns to Off [0] when all parameter values have been stored.

10-32 Devicenet Revision

Range:	Function:
0 N/A* [0 - 65535 N/A]	View the DeviceNet revision number. This parameter is used for EDS file creation.

10-33 Store Always

Option:	Function:
[0] * Off	Deactivates non-volatile storage of data.
[1] On	Stores parameter data received via DeviceNet in EEPROM non-volatile memory as default.

10-39 Devicenet F Parameters

Array [1000]
No LCP access

Range:	Function:
0 N/A* [0 - 0 N/A]	This parameter is used to configure the adjustable frequency drive via DeviceNet and build the EDS file.

2.12 Main Menu - Smart Logic - Group 13

2.12.1 13-** Prog. Features

2

Smart Logic Control (SLC) is essentially a sequence of user defined actions (see par.13-52 *SL Controller Action [x]*) executed by the SLC when the associated user defined *event* (see par.13-51 *SL Controller Event [x]*) is evaluated as TRUE by the SLC. Events and *actions* are each numbered and linked together in pairs. This means that when *event* [0] is fulfilled (attains the value TRUE), *action* [0] is executed. After this, the conditions of *event* [1] will be evaluated, and if evaluated as TRUE, *action* [1] will be executed and so on. Only one *event* will be evaluated at any time. If an *event* is evaluated as FALSE, nothing happens (in the SLC) during the current scan interval, and no other *events* will be evaluated. This means that when the SLC starts, it evaluates *event* [0] (and only *event* [0]) at each scan interval. Only when *event* [0] is evaluated as TRUE will the SLC execute *action* [0] and start evaluating *event* [1]. It is possible to program from 1 to 20 *events* and *actions*.

When the last *event/action* has been executed, the sequence starts over again from *event* [0]/*action* [0]. The illustration shows an example with three *events/actions*:

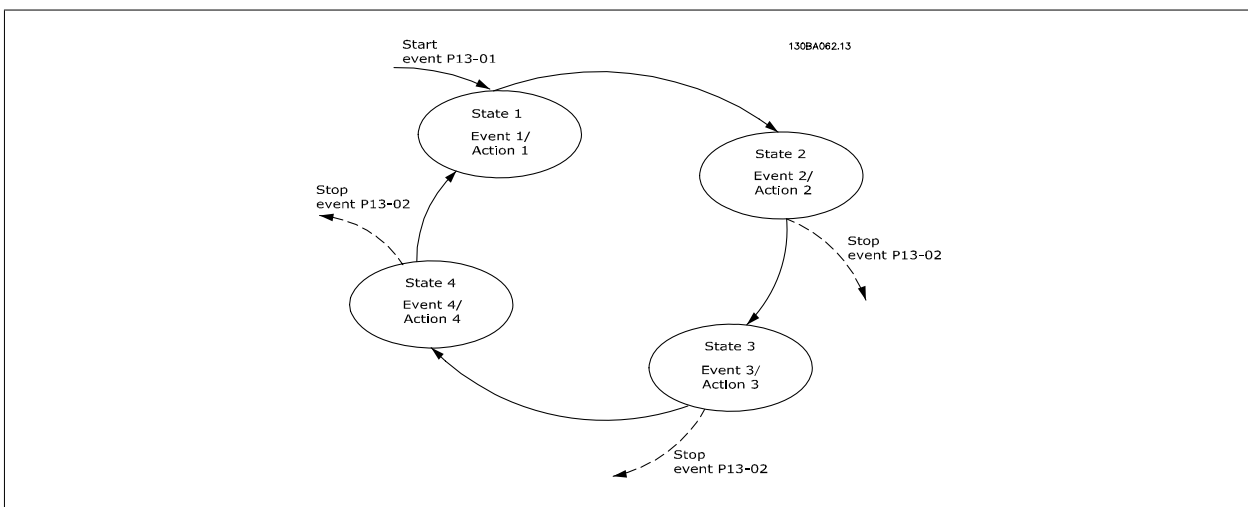

Starting and stopping the SLC:

Starting and stopping the SLC can be done by selecting *On* [1] or *Off* [0] in par.13-00 *SL Controller Mode*. The SLC always starts in state 0 (where it evaluates *event* [0]). The SLC starts when the *Start Event* (defined in par.13-01 *Start Event*) is evaluated as TRUE (provided that *On* [1] is selected in par.13-00 *SL Controller Mode*). The SLC stops when the *Stop Event* (par.13-02 *Stop Event*) is TRUE. par.13-03 *Reset SLC* resets all SLC parameters and starts programming from scratch.

2.12.2 13-0* SLC Settings

Use the SLC settings to activate, deactivate and reset the Smart Logic Control.

13-00 SL Controller Mode

Option:	Function:
[0] * Off	Disables the Smart Logic Controller.
[1] On	Enables the Smart Logic Controller.

13-01 Start Event

Option:	Function:
	Select the Boolean (TRUE or FALSE) input to activate Smart Logic Control.

[0] *	FALSE	Enters the fixed value of FALSE in the logic rule.
[1]	TRUE	Enters the fixed value TRUE in the logic rule.
[2]	Running	See parameter group 5-3* for further description.
[3]	In range	See parameter group 5-3* for further description.
[4]	On reference	See parameter group 5-3* for further description.
[5]	Torque limit	See parameter group 5-3* for further description.
[6]	Current limit	See parameter group 5-3* for further description.
[7]	Out of current range	See parameter group 5-3* for further description.
[8]	Below I low	See parameter group 5-3* for further description.
[9]	Above I high	See parameter group 5-3* for further description.
[10]	Out of speed range	
[11]	Below speed low	See parameter group 5-3* for further description.
[12]	Above speed high	See parameter group 5-3* for further description.
[13]	Out of feedb. range	
[14]	Below feedb. low	
[15]	Above feedb. high	
[16]	Thermal warning	See parameter group 5-3* for further description.
[17]	Mains out of range	See parameter group 5-3* for further description.
[18]	Reverse	See parameter group 5-3* for further description.
[19]	Warning	See parameter group 5-3* for further description.
[20]	Alarm (trip)	See parameter group 5-3* for further description.
[21]	Alarm (trip lock)	See parameter group 5-3* for further description.
[22]	Comparator 0	Use the result of comparator 0 in the logic rule.
[23]	Comparator 1	Use the result of comparator 1 in the logic rule.
[24]	Comparator 2	Use the result of comparator 2 in the logic rule.
[25]	Comparator 3	Use the result of comparator 3 in the logic rule.
[26]	Logic rule 0	Use the result of logic rule 0 in the logic rule.
[27]	Logic rule 1	Use the result of logic rule 1 in the logic rule.
[28]	Logic rule 2	Use the result of logic rule 2 in the logic rule.
[29]	Logic rule 3	Use the result of logic rule 3 in the logic rule.
[33]	Digital input DI18	Use the value of DI18 in the logic rule (High = TRUE).
[34]	Digital input DI19	Use the value of DI19 in the logic rule (High = TRUE).
[35]	Digital input DI27	Use the value of DI27 in the logic rule (High = TRUE).
[36]	Digital input DI29	Use the value of DI29 in the logic rule (High = TRUE).
[37]	Digital input DI32	Use the value of DI32 in the logic rule (High = TRUE).
[38]	Digital input DI33	Use the value of DI33 in the logic rule (High = TRUE).

[39]	Start command	This event is TRUE if the adjustable frequency drive is started by any means (either via digital input, serial communication bus or other).
[40]	Drive stopped	This event is TRUE if the adjustable frequency drive is stopped or coasted by any means (either via digital input, serial communication bus or other).
[41]	Reset Trip	This event is TRUE if the adjustable frequency drive is tripped (but not trip-locked) and the reset button is pressed.
[42]	Auto Reset Trip	This event is TRUE if the adjustable frequency drive is tripped (but not trip-locked) and an automatic reset is issued.
[43]	OK Key	This event is TRUE if the OK key on the LCP is pressed.
[44]	Reset Key	This event is TRUE if the Reset key on the LCP is pressed.
[45]	Left Key	This event is TRUE if the Left key on the LCP is pressed.
[46]	Right Key	This event is TRUE if the Right key on the LCP is pressed.
[47]	Up Key	This event is TRUE if the Up key on the LCP is pressed.
[48]	Down Key	This event is TRUE if the Down key on the LCP is pressed.
[50]	Comparator 4	Use the result of comparator 4 in the logic rule.
[51]	Comparator 5	Use the result of comparator 5 in the logic rule.
[60]	Logic rule 4	Use the result of logic rule 4 in the logic rule.
[61]	Logic rule 5	Use the result of logic rule 5 in the logic rule.

13-02 Stop Event

Option:	Function:
	Select the Boolean (TRUE or FALSE) input to deactivate Smart Logic Control.
[0] * FALSE	Enters the fixed value of FALSE in the logic rule.
[1] TRUE	Enters the fixed value TRUE in the logic rule.
[2] Running	See parameter group 5-3* for further description.
[3] In range	See parameter group 5-3* for further description.
[4] On reference	See parameter group 5-3* for further description.
[5] Torque limit	See parameter group 5-3* for further description.
[6] Current limit	See parameter group 5-3* for further description.
[7] Out of current range	See parameter group 5-3* for further description.
[8] Below I low	See parameter group 5-3* for further description.
[9] Above I high	See parameter group 5-3* for further description.
[10] Out of speed range	See parameter group 5-3* for further description.
[11] Below speed low	See parameter group 5-3* for further description.
[12] Above speed high	See parameter group 5-3* for further description.
[13] Out of feedb. range	See parameter group 5-3* for further description.
[14] Below feedb. low	See parameter group 5-3* for further description.
[15] Above feedb. high	See parameter group 5-3* for further description.

[16]	Thermal warning	See parameter group 5-3* for further description.
[17]	Mains out of range	See parameter group 5-3* for further description.
[18]	Reverse	See parameter group 5-3* for further description.
[19]	Warning	See parameter group 5-3* for further description.
[20]	Alarm (trip)	See parameter group 5-3* for further description.
[21]	Alarm (trip lock)	See parameter group 5-3* for further description.
[22]	Comparator 0	Use the result of comparator 0 in the logic rule.
[23]	Comparator 1	Use the result of comparator 1 in the logic rule.
[24]	Comparator 2	Use the result of comparator 2 in the logic rule.
[25]	Comparator 3	Use the result of comparator 3 in the logic rule.
[26]	Logic rule 0	Use the result of logic rule 0 in the logic rule.
[27]	Logic rule 1	Use the result of logic rule 1 in the logic rule.
[28]	Logic rule 2	Use the result of logic rule 2 in the logic rule.
[29]	Logic rule 3	Use the result of logic rule 3 in the logic rule.
[30]	SL Timeout 0	Use the result of timer 0 in the logic rule.
[31]	SL Timeout 1	Use the result of timer 1 in the logic rule.
[32]	SL Timeout 2	Use the result of timer 2 in the logic rule.
[33]	Digital input DI18	Use the value of DI18 in the logic rule (High = TRUE).
[34]	Digital input DI19	Use the value of DI19 in the logic rule (High = TRUE).
[35]	Digital input DI27	Use the value of DI27 in the logic rule (High = TRUE).
[36]	Digital input DI29	Use the value of DI29 in the logic rule (High = TRUE).
[37]	Digital input DI32	Use the value of DI32 in the logic rule (High = TRUE).
[38]	Digital input DI33	Use the value of DI33 in the logic rule (High = TRUE).
[39]	Start command	This event is TRUE if the adjustable frequency drive is started by any means (either via digital input, serial communication bus or other).
[40]	Drive stopped	This event is TRUE if the adjustable frequency drive is stopped or coasted by any means (either via digital input, serial communication bus or other).
[41]	Reset Trip	This event is TRUE if the adjustable frequency drive is tripped (but not trip-locked) and the reset button is pressed.
[42]	Auto Reset Trip	This event is TRUE if the adjustable frequency drive is tripped (but not trip-locked) and an automatic reset is issued.
[43]	OK Key	This event is TRUE if the OK key on the LCP is pressed.
[44]	Reset Key	This event is TRUE if the Reset key on the LCP is pressed.
[45]	Left Key	This event is TRUE if the Left key on the LCP is pressed.
[46]	Right Key	This event is TRUE if the Right key on the LCP is pressed.
[47]	Up Key	This event is TRUE if the Up key on the LCP is pressed.

[48]	Down Key	This event is TRUE if the Down key on the LCP is pressed.
[50]	Comparator 4	Use the result of comparator 4 in the logic rule.
[51]	Comparator 5	Use the result of comparator 5 in the logic rule.
[60]	Logic rule 4	Use the result of logic rule 4 in the logic rule.
[61]	Logic rule 5	Use the result of logic rule 5 in the logic rule.
[70]	SL Timeout 3	Use the result of timer 3 in the logic rule.
[71]	SL Timeout 4	Use the result of timer 4 in the logic rule.
[72]	SL Timeout 5	Use the result of timer 5 in the logic rule.
[73]	SL Timeout 6	Use the result of timer 6 in the logic rule.
[74]	SL Timeout 7	Use the result of timer 7 in the logic rule.
[80]	No Flow	
[81]	Dry Pump	
[82]	End of Curve	
[83]	Broken Belt	

13-03 Reset SLC

Option:	Function:
[0] * Do not reset SLC	Retains programmed settings in all group 13 parameters (13-*).
[1] Reset SLC	Resets all group 13 parameters (13-*) to default settings.

2.12.3 13-1* Comparators

Comparators are used for comparing continuous variables (i.e., output frequency, output current, analog input, etc.) to fixed preset values. In addition, there are digital values that will be compared to fixed time values. See explanation in par.13-10 *Comparator Operand*. Comparators are evaluated once in each scan interval. Use the result (TRUE or FALSE) directly. All parameters in this parameter group are array parameters with index 0 to 5. Select index 0 to program Comparator 0, select index 1 to program Comparator 1, etc.

13-10 Comparator Operand

Array [4]

Option:	Function:
	Select the variable to be monitored by the comparator.
[0] * DISABLED	
[1] Reference	
[2] Feedback	
[3] Motor speed	
[4] Motor current	
[5] Motor torque	
[6] Motor power	
[7] Motor voltage	
[8] DC-link voltage	
[9] Motor thermal	
[10] VLT temp.	

[11]	Heat sink temp.
[12]	Analog input AI53
[13]	Analog input AI54
[14]	Analog input AIFB10
[15]	Analog input AIS24V
[17]	Analog input AICCT
[18]	Pulse input FI29
[19]	Pulse input FI33
[20]	Alarm number
[30]	Counter A
[31]	Counter B

13-11 Comparator Operator

Array [6]

Option:

Function:

[0] *	<	Select < [0] for the result of the evaluation to be TRUE, when the variable selected in par. 13-10 <i>Comparator Operand</i> is smaller than the fixed value in par.13-12 <i>Comparator Value</i> . The result will be FALSE, if the variable selected in par.13-10 <i>Comparator Operand</i> is greater than the fixed value in par.13-12 <i>Comparator Value</i> .
[1]	= (equal)	Select ≈ [1] for the result of the evaluation to be TRUE, when the variable selected in par. 13-10 <i>Comparator Operand</i> is approximately equal to the fixed value in par.13-12 <i>Comparator Value</i> .
[2]	>	Select > [2] for the inverse logic of option < [0].

13-12 Comparator Value

Array [6]

Range:

Function:

0 N/A*	[-100000.000 - 100000.000 N/A]	Enter the 'trigger level' for the variable that is monitored by this comparator. This is an array parameter containing comparator values 0 to 5.
--------	--------------------------------	--

2.12.4 13-2* Timers

This parameter group consists of timer parameters.

Use the result (TRUE or FALSE) from *timers* directly to define an *event* (see par.13-51 *SL Controller Event*), or as Boolean input in a *logic rule* (see par. 13-40 *Logic Rule Boolean 1*, par.13-42 *Logic Rule Boolean 2* or par.13-44 *Logic Rule Boolean 3*). A timer is only FALSE when started by an action (i.e., Start timer 1 [29]) until the timer value entered in this parameter is elapsed. Then it becomes TRUE again.

All parameters in this parameter group are array parameters with index 0 to 2. Select index 0 to program Timer 0, select index 1 to program Timer 1, and so on.

13-20 SL Controller Timer

Array [3]

Range:

Function:

0 N/A*	[0.000 - 360000.000 N/A]	Enter the value to define the duration of the FALSE output from the programmed timer. A timer is only FALSE if it is started by an action (i.e., <i>Start timer 1</i> [29]) and until the given timer value has elapsed.
--------	--------------------------	--

2.12.5 13-4* Logic Rules

Combine up to three boolean inputs (TRUE / FALSE inputs) from timers, comparators, digital inputs, status bits and events using the logical operators AND, OR, and NOT. Select Boolean inputs for the calculation in par.13-40 *Logic Rule Boolean 1*, par.13-42 *Logic Rule Boolean 2* and par.13-44 *Logic Rule Boolean 3*. Define the operators used to logically combine the selected inputs in par.13-41 *Logic Rule Operator 1* and par.13-43 *Logic Rule Operator 2*.

Priority of calculation

The results of par.13-40 *Logic Rule Boolean 1*, par.13-41 *Logic Rule Operator 1* and par.13-42 *Logic Rule Boolean 2* are calculated first. The outcome (TRUE / FALSE) of this calculation is combined with the settings of par.13-43 *Logic Rule Operator 2* and par.13-44 *Logic Rule Boolean 3*, yielding the final result (TRUE / FALSE) of the logic rule.

13-40 Logic Rule Boolean 1

Array [6]

Option:	Function:
[0] * FALSE	Enters the fixed value of FALSE in the logic rule.
[1] TRUE	Enters the fixed value TRUE in the logic rule.
[2] Running	See parameter group 5-3* for further description.
[3] In range	See parameter group 5-3* for further description.
[4] On reference	See parameter group 5-3* for further description.
[5] Torque limit	See parameter group 5-3* for further description.
[6] Current limit	See parameter group 5-3* for further description.
[7] Out of current range	See parameter group 5-3* for further description.
[8] Below I low	See parameter group 5-3* for further description.
[9] Above I high	See parameter group 5-3* for further description.
[10] Out of speed range	
[11] Below speed low	See parameter group 5-3* for further description.
[12] Above speed high	See parameter group 5-3* for further description.
[13] Out of feedb. range	See parameter group 5-3* for further description.
[14] Below feedb. low	See parameter group 5-3* for further description.
[15] Above feedb. high	See parameter group 5-3* for further description.
[16] Thermal warning	See parameter group 5-3* for further description.
[17] Mains out of range	See parameter group 5-3* for further description.
[18] Reverse	See parameter group 5-3* for further description.
[19] Warning	See parameter group 5-3* for further description.
[20] Alarm (trip)	See parameter group 5-3* for further description.
[21] Alarm (trip lock)	See parameter group 5-3* for further description.
[22] Comparator 0	Use the result of comparator 0 in the logic rule.
[23] Comparator 1	Use the result of comparator 1 in the logic rule.
[24] Comparator 2	Use the result of comparator 2 in the logic rule.
[25] Comparator 3	Use the result of comparator 3 in the logic rule.

[26]	Logic rule 0	Use the result of logic rule 0 in the logic rule.
[27]	Logic rule 1	Use the result of logic rule 1 in the logic rule.
[28]	Logic rule 2	Use the result of logic rule 2 in the logic rule.
[29]	Logic rule 3	Use the result of logic rule 3 in the logic rule.
[30]	SL Timeout 0	Use the result of timer 0 in the logic rule.
[31]	SL Timeout 1	Use the result of timer 1 in the logic rule.
[32]	SL Timeout 2	Use the result of timer 2 in the logic rule.
[33]	Digital input DI18	Use the value of DI18 in the logic rule (High = TRUE).
[34]	Digital input DI19	Use the value of DI19 in the logic rule (High = TRUE).
[35]	Digital input DI27	Use the value of DI27 in the logic rule (High = TRUE).
[36]	Digital input DI29	Use the value of DI29 in the logic rule (High = TRUE).
[37]	Digital input DI32	Use the value of DI32 in the logic rule (High = TRUE).
[38]	Digital input DI33	Use the value of DI33 in the logic rule (High = TRUE).
[39]	Start command	This logic rule is TRUE if the adjustable frequency drive is started by any means (either via digital input, serial communication bus or other).
[40]	Drive stopped	This logic rule is TRUE if the adjustable frequency drive is stopped or coasted by any means (either via digital input, serial communication bus or other).
[41]	Reset Trip	This logic rule is TRUE if the adjustable frequency drive is tripped (but not trip-locked) and the reset button is pressed.
[42]	Auto Reset Trip	This logic rule is TRUE if the adjustable frequency drive is tripped (but not trip-locked) and an automatic reset is issued.
[43]	OK Key	This logic rule is TRUE if the OK key on the LCP is pressed.
[44]	Reset Key	This logic rule is TRUE if the Reset key on the LCP is pressed.
[45]	Left Key	This logic rule is TRUE if the Left key on the LCP is pressed.
[46]	Right Key	This logic rule is TRUE if the Right key on the LCP is pressed.
[47]	Up Key	This logic rule is TRUE if the Up key on the LCP is pressed.
[48]	Down Key	This logic rule is TRUE if the Down key on the LCP is pressed.
[50]	Comparator 4	Use the result of comparator 4 in the logic rule.
[51]	Comparator 5	Use the result of comparator 5 in the logic rule.
[60]	Logic rule 4	Use the result of logic rule 4 in the logic rule.
[61]	Logic rule 5	Use the result of logic rule 5 in the logic rule.
[70]	SL Timeout 3	Use the result of timer 3 in the logic rule.
[71]	SL Timeout 4	Use the result of timer 4 in the logic rule.
[72]	SL Timeout 5	Use the result of timer 5 in the logic rule.
[73]	SL Timeout 6	Use the result of timer 6 in the logic rule.
[74]	SL Timeout 7	Use the result of timer 7 in the logic rule.
[80]	No Flow	

[81]	Dry Pump
[82]	End of Curve
[83]	Broken Belt

2

13-41 Logic Rule Operator 1

Array [6]

Option:**Function:**

Select the first logical operator to use on the Boolean inputs from par.13-40 *Logic Rule Boolean 1* and par.13-42 *Logic Rule Boolean 2*.

[13 -XX] signifies the Boolean input of par. 13-*.

[0] *	DISABLED	Ignores par. , par.13-43 <i>Logic Rule Operator 2</i> , and par.13-44 <i>Logic Rule Boolean 3</i> .
[1]	AND	evaluates the expression [13-40] AND [13-42].
[2]	OR	evaluates the expression [13-40] OR [13-42].
[3]	AND NOT	evaluates the expression [13-40] AND NOT [13-42].
[4]	OR NOT	evaluates the expression [13-40] OR NOT [13-42].
[5]	NOT AND	evaluates the expression NOT [13-40] AND [13-42].
[6]	NOT OR	evaluates the expression NOT [13-40] OR [13-42].
[7]	NOT AND NOT	evaluates the expression NOT [13-40] AND NOT [13-42].
[8]	NOT OR NOT	evaluates the expression NOT [13-40] OR NOT [13-42].

13-42 Logic Rule Boolean 2

Array [6]

Option:**Function:**

Select the second Boolean (TRUE or FALSE) input for the selected logic rule.

See par.13-40 *Logic Rule Boolean 1* for further descriptions of choices and their functions.

[0] *	FALSE
[1]	TRUE
[2]	Running
[3]	In range
[4]	On reference
[5]	Torque limit
[6]	Current limit
[7]	Out of current range
[8]	Below I low
[9]	Above I high
[10]	Out of speed range
[11]	Below speed low
[12]	Above speed high
[13]	Out of feedb. range
[14]	Below feedb. low
[15]	Above feedb. high
[16]	Thermal warning

[17]	Mains out of range
[18]	Reverse
[19]	Warning
[20]	Alarm (trip)
[21]	Alarm (trip lock)
[22]	Comparator 0
[23]	Comparator 1
[24]	Comparator 2
[25]	Comparator 3
[26]	Logic rule 0
[27]	Logic rule 1
[28]	Logic rule 2
[29]	Logic rule 3
[30]	SL Timeout 0
[31]	SL Timeout 1
[32]	SL Timeout 2
[33]	Digital input DI18
[34]	Digital input DI19
[35]	Digital input DI27
[36]	Digital input DI29
[37]	Digital input DI32
[38]	Digital input DI33
[39]	Start command
[40]	Drive stopped
[41]	Reset Trip
[42]	Auto Reset Trip
[43]	OK Key
[44]	Reset Key
[45]	Left Key
[46]	Right Key
[47]	Up Key
[48]	Down Key
[50]	Comparator 4
[51]	Comparator 5
[60]	Logic rule 4
[61]	Logic rule 5
[70]	SL Timeout 3
[71]	SL Timeout 4
[72]	SL Timeout 5
[73]	SL Timeout 6
[74]	SL Timeout 7
[80]	No Flow
[81]	Dry Pump

[82] End of Curve

[83] Broken Belt

13-43 Logic Rule Operator 2

Array [6]

2

Option:**Function:**

Select the second logical operator to be used on the Boolean input calculated in par.13-40 *Logic Rule Boolean 1*, par.13-41 *Logic Rule Operator 1*, and par.13-42 *Logic Rule Boolean 2*, and the Boolean input coming from par.13-42 *Logic Rule Boolean 2*.

[13-44] signifies the Boolean input of par.13-44 *Logic Rule Boolean 3*.

[13-40/13-42] signifies the Boolean input calculated in par.13-40 *Logic Rule Boolean 1*, par.13-41 *Logic Rule Operator 1*, and par.13-42 *Logic Rule Boolean 2*. DISABLED [0] (factory setting).

Select this option to ignore par.13-44 *Logic Rule Boolean 3*.

[0] * DISABLED

[1] AND

[2] OR

[3] AND NOT

[4] OR NOT

[5] NOT AND

[6] NOT OR

[7] NOT AND NOT

[8] NOT OR NOT

13-44 Logic Rule Boolean 3

Array [6]

Option:**Function:**

Select the third Boolean (TRUE or FALSE) input for the selected logic rule.

See par.13-40 *Logic Rule Boolean 1* for further descriptions of choices and their functions.

[0] * FALSE

[1] TRUE

[2] Running

[3] In range

[4] On reference

[5] Torque limit

[6] Current limit

[7] Out of current range

[8] Below I low

[9] Above I high

[10] Out of speed range

[11] Below speed low

[12] Above speed high

[13] Out of feedb. range

[14] Below feedb. low

[15] Above feedb. high

[16] Thermal warning

[17]	Mains out of range
[18]	Reverse
[19]	Warning
[20]	Alarm (trip)
[21]	Alarm (trip lock)
[22]	Comparator 0
[23]	Comparator 1
[24]	Comparator 2
[25]	Comparator 3
[26]	Logic rule 0
[27]	Logic rule 1
[28]	Logic rule 2
[29]	Logic rule 3
[30]	SL Timeout 0
[31]	SL Timeout 1
[32]	SL Timeout 2
[33]	Digital input DI18
[34]	Digital input DI19
[35]	Digital input DI27
[36]	Digital input DI29
[37]	Digital input DI32
[38]	Digital input DI33
[39]	Start command
[40]	Drive stopped
[41]	Reset Trip
[42]	Auto Reset Trip
[43]	OK Key
[44]	Reset Key
[45]	Left Key
[46]	Right Key
[47]	Up Key
[48]	Down Key
[50]	Comparator 4
[51]	Comparator 5
[60]	Logic rule 4
[61]	Logic rule 5
[70]	SL Timeout 3
[71]	SL Timeout 4
[72]	SL Timeout 5
[73]	SL Timeout 6
[74]	SL Timeout 7
[80]	No Flow
[81]	Dry Pump

[82] End of Curve

[83] Broken Belt

2

2.12.6 13-5* States

Parameters for programming the Smart Logic Controller.

13-51 SL Controller Event

Array [20]

Option:**Function:**

Select the boolean input (TRUE or FALSE) to define the smart logic controller event.

See par.13-02 *Stop Event* for further descriptions of choices and their functions.

[0] * FALSE

[1] TRUE

[2] Running

[3] In range

[4] On reference

[5] Torque limit

[6] Current limit

[7] Out of current range

[8] Below I low

[9] Above I high

[10] Out of speed range

[11] Below speed low

[12] Above speed high

[13] Out of feedb. range

[14] Below feedb. low

[15] Above feedb. high

[16] Thermal warning

[17] Mains out of range

[18] Reverse

[19] Warning

[20] Alarm (trip)

[21] Alarm (trip lock)

[22] Comparator 0

[23] Comparator 1

[24] Comparator 2

[25] Comparator 3

[26] Logic rule 0

[27] Logic rule 1

[28] Logic rule 2

[29] Logic rule 3

[30] SL Timeout 0

[31] SL Timeout 1

[32]	SL Timeout 2
[33]	Digital input DI18
[34]	Digital input DI19
[35]	Digital input DI27
[36]	Digital input DI29
[37]	Digital input DI32
[38]	Digital input DI33
[39]	Start command
[40]	Drive stopped
[41]	Reset Trip
[42]	Auto Reset Trip
[43]	OK Key
[44]	Reset Key
[45]	Left Key
[46]	Right Key
[47]	Up Key
[48]	Down Key
[50]	Comparator 4
[51]	Comparator 5
[60]	Logic rule 4
[61]	Logic rule 5
[70]	SL Timeout 3
[71]	SL Timeout 4
[72]	SL Timeout 5
[73]	SL Timeout 6
[74]	SL Timeout 7
[80]	No Flow
[81]	Dry Pump
[82]	End of Curve
[83]	Broken Belt

13-52 SL Controller Action

Array [20]

Option:

Function:

Select the action corresponding to the SLC event. Actions are executed when the corresponding event (defined in par.13-51 *SL Controller Event*) is evaluated as true. The following actions are available for selection:

[0] *	DISABLED	
[1]	No action	
[2]	Select set-up 1	Changes the active set-up (par.0-10 <i>Active Set-up</i>) to '1'.
[3]	Select set-up 2	Changes the active set-up (par.0-10 <i>Active Set-up</i>) to '2'.
[4]	Select set-up 3	Changes the active set-up (par.0-10 <i>Active Set-up</i>) to '3'.

[5]	Select set-up 4	Changes the active set-up (par.0-10 <i>Active Set-up</i>) to '4'. If the set-up is changed, it will merge with other set-up commands coming from either the digital inputs or via a serial communication bus.
[10]	Select preset ref 0	Selects preset reference 0.
[11]	Select preset ref 1	Selects preset reference 1.
[12]	Select preset ref 2	Selects preset reference 2.
[13]	Select preset ref 3	Selects preset reference 3.
[14]	Select preset ref 4	Selects preset reference 4.
[15]	Select preset ref 5	Selects preset reference 5.
[16]	Select preset ref 6	Selects preset reference 6.
[17]	Select preset ref 7	Selects preset reference 7. If the active preset reference is changed, it will merge with other preset reference commands coming from either the digital inputs or via a serial communication bus.
[18]	Select ramp 1	Selects ramp 1
[19]	Select ramp 2	Selects ramp 2
[22]	Run	Issues a start command to the adjustable frequency drive.
[23]	Run reverse	Issues a start reverse command to the adjustable frequency drive.
[24]	Stop	Issues a stop command to the adjustable frequency drive.
[26]	Dcstop	Issues a DC stop command to the adjustable frequency drive.
[27]	Coast	The adjustable frequency drive coasts immediately. All stop commands (including the coast command) stop the SLC.
[28]	Freeze output	Freezes the output frequency of the adjustable frequency drive.
[29]	Start timer 0	Starts timer 0, see par.13-20 <i>SL Controller Timer</i> for further description.
[30]	Start timer 1	Starts timer 1, see par.13-20 <i>SL Controller Timer</i> for further description.
[31]	Start timer 2	Starts timer 2, see par.13-20 <i>SL Controller Timer</i> for further description.
[32]	Set digital out A low	Any output with 'digital output 1' selected is low (off).
[33]	Set digital out B low	Any output with 'digital output 2' selected is low (off).
[34]	Set digital out C low	Any output with 'digital output 3' selected is low (off).
[35]	Set digital out D low	Any output with 'digital output 4' selected is low (off).
[36]	Set digital out E low	Any output with 'digital output 5' selected is low (off).
[37]	Set digital out F low	Any output with 'digital output 6' selected is low (off).
[38]	Set digital out A high	Any output with 'digital output 1' selected is high (closed).
[39]	Set digital out B high	Any output with 'digital output 2' selected is high (closed).
[40]	Set digital out C high	Any output with 'digital output 3' selected is high (closed).
[41]	Set digital out D high	Any output with 'digital output 4' selected is high (closed).
[42]	Set digital out E high	Any output with 'digital output 5' selected is high (closed).
[43]	Set digital out F high	Any output with 'digital output 6' selected is high (closed).
[60]	Reset Counter A	Resets Counter A to zero.

[61]	Reset Counter B	Resets Counter A to zero.
[70]	Start Timer 3	Starts timer 3, see par.13-20 <i>SL Controller Timer</i> for further description.
[71]	Start Timer 4	Starts timer 4, see par.13-20 <i>SL Controller Timer</i> for further description.
[72]	Start Timer 5	Starts timer 5, see par.13-20 <i>SL Controller Timer</i> for further description.
[73]	Start Timer 6	Starts timer 6, see par.13-20 <i>SL Controller Timer</i> for further description.
[74]	Start Timer 7	Starts timer 7, see par.13-20 <i>SL Controller Timer</i> for further description.
[80]	Sleep Mode	

2.13 Main Menu - Special Functions - Group 14

2.13.1 14-** Special Functions

Parameter group for configuring special adjustable frequency drive functions.

2.13.2 Inverter Switching 14-0*

Parameters for configuring the inverter switching.

14-00 Switching Pattern

Option:
Function:

Select the switching pattern: 60° AVM or SFAVM.

[0] * 60 AVM

[1] SFAVM

14-01 Switching Frequency

Option:
Function:

Select the inverter switching frequency. Changing the switching frequency can help to reduce acoustic noise from the motor.

NOTE!

The output frequency value of the adjustable frequency drive must never exceed 1/10 of the switching frequency. When the motor is running, adjust the switching frequency in par.14-01 *Switching Frequency* until the motor is as noiseless as possible. See also par.14-00 *Switching Pattern* and the section *Derating*.

[0] 1.0 kHz

[1] 1.5 kHz

[2] 2.0 kHz

[3] 2.5 kHz

[4] 3.0 kHz

[5] 3.5 kHz

[6] 4.0 kHz

[7] * 5.0 kHz

[8] 6.0 kHz

[9] 7.0 kHz

[10] 8.0 kHz

[11] 10.0 kHz

[12] 12.0 kHz

[13] 14.0 kHz

[14] 16.0 kHz

14-03 Overmodulation

Option:	Function:
[0] Off	Selects no overmodulation of the output voltage in order to avoid torque ripple on the motor shaft.
[1] * On	Sets the overmodulation function for the output voltage, to obtain an output voltage of up to 15% higher than the AC line voltage.

14-04 PWM Random

Option:	Function:
[0] * Off	No change of the acoustic motor switching noise.
[1] On	Transforms the acoustic motor switching noise from a clear ringing tone to a less noticeable 'white' noise. This is achieved by slightly and randomly altering the synchronism of the pulse width modulated output phases.

2.13.3 Line Supply On/Off, 14-1 *

Parameters for configuring line failure monitoring and handling.

14-12 Function at Mains Imbalance

Option:	Function:
[0] * Trip	Operating under severe line imbalance conditions reduces the lifetime of the motor. Conditions are considered severe if the motor operates continuously near nominal load (such as when a pump or fan runs near full speed). When a severe line imbalance is detected: Select <i>Trip</i> [0] to trip the adjustable frequency drive.
[1] Warning	Select <i>Warning</i> [1] to issue a warning.
[2] Disabled	select <i>Disabled</i> [2] for no action.
[3] Derate	Select <i>Derate</i> [3] for derating the adjustable frequency drive.

2.13.4 Trip Reset, 14-2 *

Parameters for configuring auto reset handling, special trip handling and control card self test or initialization.

14-20 Reset Mode

Option:	Function:
[0] Manual reset	
[1] Automatic reset x 1	
[2] Automatic reset x 2	
[3] Automatic reset x 3	
[4] Automatic reset x 4	
[5] Automatic reset x 5	
[6] Automatic reset x 6	
[7] Automatic reset x 7	
[8] Automatic reset x 8	
[9] Automatic reset x 9	

[10] * Automatic reset x 10

[11] Automatic reset x 15

[12] Automatic reset x 20

[13] Infinite Automatic Reset

Select the reset function after tripping. Once reset, the adjustable frequency drive can be restarted. Select *Manual reset* [0] to perform a reset via [RESET] or via the digital inputs.

Select *Automatic reset x 1...x20* [1]-[12] to perform between one and twenty automatic resets after tripping.

Select *Infinite Automatic Reset* [13] for continuous resetting after tripping.

**NOTE!**

The motor may start without warning. If the specified number of AUTOMATIC RESETs is reached within 10 minutes, the adjustable frequency drive enters Manual reset [0] mode. After the manual reset is performed, the setting of par. 14-20 reverts to the original selection. If the number of automatic resets is not reached within 10 minutes, or when a manual reset is performed, the internal AUTOMATIC RESET counter returns to zero.

14-21 Automatic Restart Time**Range:**

10 s* [0 - 600 s]

Function:

Enter the time interval from trip to start of the automatic reset function. This parameter is active when par. 14-20 *Reset Mode* is set to *Automatic reset* [1] - [13].

14-22 Operation Mode**Option:****Function:**

Use this parameter to specify normal operation, to perform tests or to initialize all parameters except par.15-03 *Power-ups*, par.15-04 *Over Temps* and par.15-05 *Over Volts*. This function is active only when the power is cycled (power off-power on) to the adjustable frequency drive.

[0] * Normal operation

Select *Normal operation* [0] for normal operation of the adjustable frequency drive with the motor in the selected application.

[1] Control card test

Select *Control card test* [1] to test the analog and digital inputs and outputs and the +10 V control voltage. The test requires a test connector with internal connections.

Use the following procedure for the control card test:

1. Select *Control card test* [1].
2. Disconnect the line power supply and wait for the light in the display to go out.
3. Set switches S201 (A53) and S202 (A54) = 'ON' / I.
4. Insert the test plug (see below).
5. Connect to line power supply.
6. Carry out various tests.
7. The results are displayed on the LCP and the adjustable frequency drive moves into an infinite loop.
8. par.14-22 *Operation Mode* is automatically set to normal operation. Carry out a power cycle to start up in normal operation after a control card test.

If the test is OK:

LCP readout: Control Card OK.

Disconnect the line power supply and remove the test plug. The green LED on the control card will light up.

If the test fails:

LCP readout: Control Card I/O failure.

Replace the adjustable frequency drive or control card. The red LED on the control card is turned on. To test the plugs, connect/group the following terminals as shown below: (18 - 27 - 32), (19 - 29 - 33) and (42 - 53 - 54).

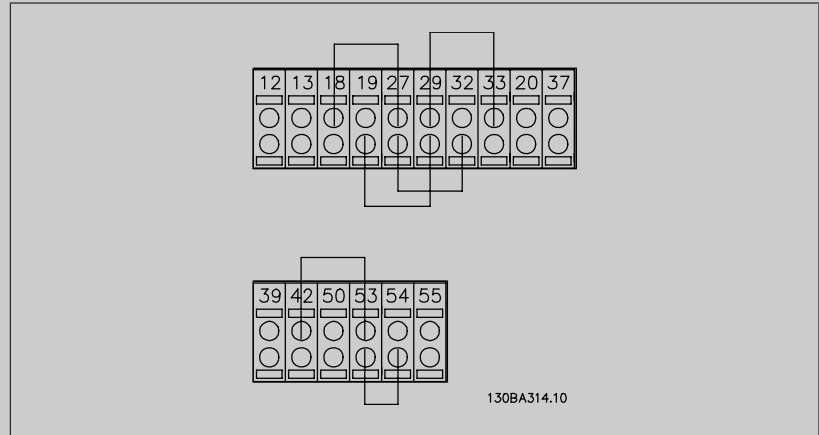

[2] Initialization

Select *Initialization* [2] to reset all parameter values to default settings, except for par.15-03 *Power-ups*, par.15-04 *Over Temps* and par.15-05 *Over Volts*. The adjustable frequency drive will reset during the next power-up. par.14-22 *Operation Mode* will also revert to the default setting *Normal operation* [0].

[3] Boot mode

14-25 Trip Delay at Torque Limit

Range:

60 s* [0 - 60 s]

Function:

Enter the torque limit trip delay in seconds. When the output torque reaches the torque limits (par. 4-16 *Torque Limit Motor Mode* and par.4-17 *Torque Limit Generator Mode*), a warning is triggered. When the torque limit warning has been continuously present for the period specified in this parameter, the adjustable frequency drive trips. Disable the trip delay by setting the parameter to 60 s = OFF. Thermal adjustable frequency drive monitoring will still remain active.

14-26 Trip Delay at Inverter Fault

Range:

0. s* [0 - 35 s]

Function:

When the adjustable frequency drive detects an overvoltage in the set time, tripping will be affected after the set time.

14-29 Service Code

Range:

0 N/A* [-2147483647 - 2147483647 N/A]

Function:

Service use only.

2.13.5 Current Limit Control, 14-3*

The adjustable frequency drive features an integral current limit controller that is activated when the motor current, and thus the torque, is higher than the torque limits set in par. 4-16 and 4-17.

When the current limit is reached during motor operation or regenerative operation, the adjustable frequency drive will try to reduce torque below the preset torque limits as quickly as possible without losing control of the motor.

While the current control is active, the adjustable frequency drive can only be stopped by setting a digital input to *Coast inverse* [2] or *Coast and reset inv.* [3]. Any signal on terminals 18 to 33 will not be active until the adjustable frequency drive is no longer near the current limit.

By using a digital input set to *Coast inverse* [2] or *Coast and reset inv.* [3], the motor does not use the ramp-down time, since the adjustable frequency drive is coasted.

14-30 Current Lim Cont, Proportional Gain

Range:

100 %* [0 - 500 %]

Function:

Enter the proportional gain value for the current limit controller. Selection of a high value makes the controller react faster. Too high a setting leads to controller instability.

14-31 Current Lim Contr, Integration Time

Range:

0.020 s* [0.002 - 2.000 s]

Function:

Controls the current limit control integration time. Setting it to a lower value makes it react faster. A setting too low leads to control instability.

2.13.6 Energy Optimizing, 14-4*

Parameters for adjusting the energy optimization level in both variable torque (VT) and automatic energy optimization (AEO) mode.

Automatic Energy Optimization is only active if par.1-03, Torque Characteristics, is set for either *Auto Energy Optim. CT* [2] or *Auto Energy Optim. VT* [3].

14-40 VT Level

Range:

66 %* [40 - 90 %]

Function:

Enter the level of motor magnetization at low speed. Selection of a low value reduces energy loss in the motor, but also reduces load capability.
This parameter cannot be adjusted while the motor is running.

14-41 AEO Minimum Magnetization

Range:

40. %* [40 - 75 %]

Function:

Enter the minimum allowable magnetization for AEO. Selection of a low value reduces energy loss in the motor, but can also reduce resistance to sudden load changes.

14-42 Minimum AEO Frequency

Range:

10 Hz* [5 - 40 Hz]

Function:

Enter the minimum frequency at which Automatic Energy Optimization (AEO) is to be active.

14-43 Motor Cos-Phi

Range:

0.66* [0.40 - 0.95]

Function:

The Cos(phi) setpoint is automatically set for optimum AEO performance during AMA. This parameter should normally not be altered. However, in some situations it may be necessary to enter a new value to fine tune.

2.13.7 Environment, 14-5*

These parameters help the adjustable frequency drive to operate under special environmental conditions.

14-50 RFI 1

Option:

[0] Off

Function:

[1]* On

Select *On* [1] to ensure the adjustable frequency drive complies with EMC standards.

Select *Off* [0] only when the adjustable frequency drive is supplied from an isolated line power source, i.e., IT line power. In this mode, the internal RFI capacities (filter capacitors) between chassis and the Line Power RFI Filter Circuit are cut off to avoid damage to the intermediate circuit and to reduce the ground capacity currents (according to IEC 61800-3).

14-52 Fan Control

Option:	Function:
	Select the minimum speed of the main fan.
[0] * Auto	Select Auto [0] to run the fan only when the internal temperature of the adjustable frequency drive is in the range 95°F [35°C] to approximately 131°F [55°C]. The fan will run at low speed at +95°F [35°C] and at full speed at approximately +131°F [55°C].
[1] On 50%	
[2] On 75%	
[3] On 100%	

14-53 Fan Monitor

Option:	Function:
	Select which action the adjustable frequency drive should take in case a fan fault is detected.
[0] Disabled	
[1] * Warning	
[2] Trip	

2.13.8 Auto Derate, 14-6*

This group contains parameters for derating the adjustable frequency drive in case of high temperature.

14-60 Function at Overtemperature

Option:	Function:
[0] Trip	
[1] * Derate	<p>If either heatsink or control card temperature exceeds a programmed temperature limit, a warning will be activated. If the temperature increases further, select whether the adjustable frequency drive should trip (trip lock) or derate the output current.</p> <p><i>Trip</i> [0]: The adjustable frequency drive will trip (trip lock) and generate an alarm. Power must be cycled to reset the alarm, but will not allow restart of the motor until the heatsink temperature has dropped below the alarm limit.</p> <p><i>Derate</i> [1]: If the critical temperature is exceeded, the output current will be reduced until the allowable temperature has been reached.</p>

2.13.9 No Trip at Inverter Overload

In some pump systems, the adjustable frequency drive has not been sized properly to yield the current needed in all points of the operational flow-head characteristic. At these points, the pump will need a current higher than the rated current of the adjustable frequency drive. The adjustable frequency drive can yield 110% of the rated current continuously for 60 sec. If still overloaded, the adjustable frequency drive will normally trip (causing the pump to stop by coasting) and provide an alarm.

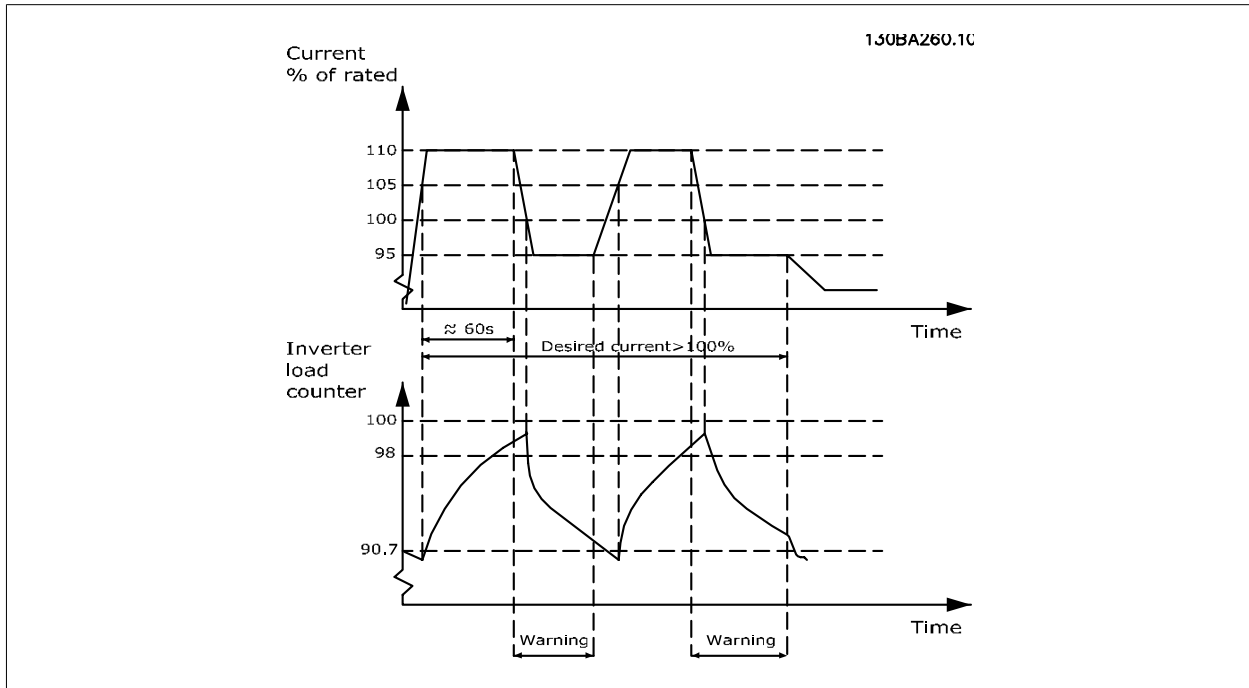

It may be preferable to run the pump at reduced speed for a while in case it is not possible to run continuously at demanded capacity.

Select *Function at Inverter Overload*, par. 14-61 *Function at Inverter Overload* to automatically reduce pump speed until the output current is below 100% of the rated current (set in par.14-62 *Inv. Overload Derate Current*).

The *Function at Inverter Overload* is an alternative to letting the adjustable frequency drive trip.

The adjustable frequency drive estimates the load on the power section by means of an inverter load counter, which will cause a warning at 98% and a reset of the warning at 90%. At the value 100%, the adjustable frequency drive trips and provides an alarm.

Status for the counter can be read in par.16-35 *Inverter Thermal*.

If par. 14-61 *Function at Inverter Overload* is set to Derate, the pump speed will be reduced when the counter exceeds 98, and stay reduced until the counter has dropped below 90.7.

If par.14-62 *Inv. Overload Derate Current* is set, for example, to 95% a steady overload will cause the pump speed to fluctuate between values corresponding to 110% and 95% of rated output current for the adjustable frequency drive.

14-61 Function at Inverter Overload

Option:

[0] Trip

[1] * Derate

Function:

Is used in case of steady overload beyond the thermal limits (110% for 60 sec.).

Choose *Trip* [0] to make the adjustable frequency drive trip and provide an alarm or *Derate* [1] to reduce pump speed in order to decrease the load on the power section and allowing this to cool down.

14-62 Inv. Overload Derate Current

Range:

95 %* [50 - 100 %]

Function:

Defines the desired current level (in % of rated output current for the adjustable frequency drive) when running with reduced pump speed after load on the adjustable frequency drive has exceeded the allowable limit (110% for 60 sec.).

2.14 Main Menu - Adjustable Frequency Drive Information - Group 15

2.14.1 15-** Drive Information

Parameter group containing adjustable frequency drive information such as operating data, hardware configuration and software versions.

2.14.2 15-0* Operating Data

Parameter group containing operating data, such as operating hours, kWh counters, power-ups, etc.

15-00 Operating Hours		
Range:		Function:
0 h*	[0 - 2147483647 h]	View how many hours the adjustable frequency drive has run. The value is saved when the adjustable frequency drive is turned off.
15-01 Running Hours		
Range:		Function:
0 h*	[0 - 2147483647 h]	View how many hours the motor has run. Reset the counter in par.15-07 <i>Reset Running Hours Counter</i> . The value is saved when the adjustable frequency drive is turned off.
15-02 kWh Counter		
Range:		Function:
0 kWh*	[0 - 2147483647 kWh]	Registering the power consumption of the motor as a mean value over one hour. Reset the counter in par.15-06 <i>Reset kWh Counter</i> .
15-03 Power-ups		
Range:		Function:
0 N/A*	[0 - 2147483647 N/A]	View the number of times the adjustable frequency drive has been powered up.
15-04 Over Temps		
Range:		Function:
0 N/A*	[0 - 65535 N/A]	View the number of adjustable frequency drive temperature faults that have occurred.
15-05 Over Volts		
Range:		Function:
0 N/A*	[0 - 65535 N/A]	View the number of adjustable frequency drive overvoltages that have occurred.
15-06 Reset kWh Counter		
Option:		Function:
[0] *	Do not reset	Select <i>Do not reset</i> [0] if no reset of the kWh counter is desired.
[1]	Reset counter	Select <i>Reset</i> [1] and press [OK] to reset the kWh counter to zero (see par.15-02 <i>kWh Counter</i>).



NOTE!
The reset is carried out by pressing [OK].

15-07 Reset Running Hours Counter

Option:
Function:

[0] *	Do not reset	Select <i>Do not reset</i> [0] if no reset of the Running Hours counter is desired.
[1]	Reset counter	Select <i>Reset counter</i> [1] and press [OK] to reset the Running Hours counter (par.15-01 <i>Running Hours</i>) and par.15-08 <i>Number of Starts</i> to zero (see also par.15-01 <i>Running Hours</i>).

15-08 Number of Starts

Range:
Function:

0 N/A*	[0 - 2147483647 N/A]	This is a readout parameter only. The counter shows the numbers of starts and stops caused by a normal start/stop command and/or when entering/leaving sleep mode.
--------	----------------------	--

NOTE!

This parameter will be reset when resetting par.15-07 *Reset Running Hours Counter*.

2.14.3 Data Log Settings, 15-1 *

The data log enables continuous logging of up to 4 data sources (par. 15-10 *Logging Source*) at individual rates (par.15-11 *Logging Interval*). A trigger event (par.15-12 *Trigger Event*) and window (par.15-14 *Samples Before Trigger*) are used to start and stop the logging conditionally.

15-10 Logging Source

Array [4]

Select which variables are to be logged.

None

[1600]	Control Word
[1601]	Reference [Unit]
[1602]	Reference %
[1603]	Status Word
[1610]	Power [kW]
[1611]	Power [hp]
[1612]	Motor Voltage
[1613]	Frequency
[1614]	Motor Current
[1616]	Torque [Nm]
[1617]	Speed [RPM]
[1618]	Thermal Motor Load
[1622]	Torque [%]
[1630]	DC Link Voltage
[1632]	Braking Energy / s
[1633]	Braking Energy/2 min
[1634]	Heatsink Temp.
[1635]	Thermal Drive Load
[1650]	External Reference

[1652]	Feedback [Unit]
[1654]	Feedback 1 [Unit]
[1655]	Feedback 2 [Unit]
[1656]	Feedback 3 [Unit]
[1659]	Adjusted Setpoint
[1660]	Digital Input
[1662]	Analog Input 53
[1664]	Analog Input 54
[1665]	Analog Output 42 [mA]
[1666]	Digital Output [bin]
[1675]	Analog In X30/11
[1676]	Analog In X30/12
[1677]	Analog Out X30/8 [mA]
[1690]	Alarm Word
[1691]	Alarm Word 2
[1692]	Warning Word
[1693]	Warning Word 2
[1694]	Ext. Status Word
[1695]	Ext. Status Word 2
[1820]	Analog Input X42/1
[1821]	Analog Input X42/3
[1822]	Analog Input X42/5
[1823]	Analog Out X42/7 [mA]
[1824]	Analog Out X42/9 [mA]
[1825]	Analog Out X42/11 [mA]

15-11 Logging Interval

Range:	Function:
0 N/A* [0 - 86400.000 N/A]	Enter the interval in milliseconds between each sampling of the variables to be logged.

15-12 Trigger Event

Option:	Function:
	Selects the trigger event. When the trigger event occurs, a window is applied to freeze the log. The log will then retain a specified percentage of samples before the occurrence of the trigger event (par.15-14 <i>Samples Before Trigger</i>).

[0] *	FALSE
[1]	TRUE
[2]	Running
[3]	In range
[4]	On reference
[5]	Torque limit
[6]	Current limit
[7]	Out of current range
[8]	Below I low
[9]	Above I high

[10]	Out of speed range
[11]	Below speed low
[12]	Above speed high
[13]	Out of feedb. range
[14]	Below feedb. low
[15]	Above feedb. high
[16]	Thermal warning
[17]	Mains out of range
[18]	Reverse
[19]	Warning
[20]	Alarm (trip)
[21]	Alarm (trip lock)
[22]	Comparator 0
[23]	Comparator 1
[24]	Comparator 2
[25]	Comparator 3
[26]	Logic rule 0
[27]	Logic rule 1
[28]	Logic rule 2
[29]	Logic rule 3
[33]	Digital input DI18
[34]	Digital input DI19
[35]	Digital input DI27
[36]	Digital input DI29
[37]	Digital input DI32
[38]	Digital input DI33
[50]	Comparator 4
[51]	Comparator 5
[60]	Logic rule 4
[61]	Logic rule 5

15-13 Logging Mode

Option:
Function:

[0] *	Log always	Select <i>Log always</i> [0] for continuous logging.
[1]	Log once on trigger	Select <i>Log once on trigger</i> [1] to conditionally start and stop logging using par.15-12 <i>Trigger Event</i> and par.15-14 <i>Samples Before Trigger</i> .

15-14 Samples Before Trigger

Range:
Function:

50 N/A*	[0 - 100 N/A]	Enter the percentage of all samples prior to trigger events, which are to be retained in the log. See also par.15-12 <i>Trigger Event</i> and par.15-13 <i>Logging Mode</i> .
---------	---------------	---

2.14.4 Historic Log, 15-2*

View up to 50 logged data items via the array parameters in this parameter group. For all parameters in the group, [0] is the most recent data and [49] the oldest data. Data is logged every time an *event* occurs (not to be confused with SLC events). *Events* in this context are defined as a change in one of the following areas:

1. Digital input
2. Digital outputs (not monitored in this SW release)
3. Warning word
4. Alarm word
5. Status word
6. Control word
7. Extended status word

Events are logged with value, and time stamp in msec. The time interval between two events depends on how often *events* occur (maximum once every scan time). Data logging is continuous, but if an alarm occurs, the log is saved, and the values can be viewed on the display. This feature is useful, for example, when carrying out service following a trip. View the historic log contained in this parameter via the serial communication port or via the display.

15-20 Historic Log: Event

Array [50]

Range:

0 N/A* [0 - 255 N/A]

Function:

View the event type of the logged events.

15-21 Historic Log: Value

Array [50]

Range:

0 N/A* [0 - 2147483647 N/A]

Function:

View the value of the logged event. Interpret the event values according to this table:

Digital input	Decimal value. See par. 16-60 <i>Digital Input</i> for description after converting to binary value.
Digital output (not monitored in this SW release)	Decimal value. See par. 16-66 <i>Digital Output [bin]</i> for description after converting to binary value.
Warning word	Decimal value. See par. 16-92 for description.
Alarm word	Decimal value. See par. 16-90 for description.
Status word	Decimal value. See par.16-03 <i>Status Word</i> for description after converting to binary value.
Control word	Decimal value. See par.16-00 <i>Control Word</i> for description.
Extended status word	Decimal value. See par. 16-94 <i>Ext. Status Word</i> for description.

15-22 Historic Log: Time

Array [50]

Range:

0 ms* [0 - 2147483647 ms]

Function:

View the time at which the logged event occurred. Time is measured in ms, from the time the adjustable frequency drive was started. The max. value corresponds to approx. 24 days, which means that the count will restart at zero after this time period.

2.14.5 Alarm Log, 15-3*

Parameters in this group are array parameters, where up to 10 fault logs can be viewed. [0] is the most recent logged data, and [9] the oldest. Error codes, values and time stamp can be viewed for all logged data.

15-30 Alarm Log: Error Code

Array [10]

Range:

0 N/A* [0 - 255 N/A]

Function:View the error code and look up its meaning in the *Troubleshooting* chapter.**15-31 Alarm Log: Value**

Array [10]

Range:

0 N/A* [-32767 - 32767 N/A]

Function:

View an extra description of the error. This parameter is mostly used in combination with alarm 38, 'internal fault.'

15-32 Alarm Log: Time

Array [10]

Range:

0 s* [0 - 2147483647 s]

Function:

View the time when the logged event occurred. Time is measured in seconds, from the time the adjustable frequency drive was started.

2.14.6 Drive Identification, 15-4*

Parameters containing read only information about the hardware and software configuration of the adjustable frequency drive.

15-40 FC Type**Option:****Function:**

View the FC type. The readout is identical to the VLT AQUA Drive Series power field of the type code definition, characters 1-6.

15-41 Power Section**Option:****Function:**

View the FC type. The readout is identical to the VLT AQUA Drive Series power field of the type code definition, characters 7-10.

15-42 Voltage**Option:****Function:**

View the FC type. The readout is identical to the VLT AQUA Drive Series power field of the type code definition, characters 11-12.

15-43 Software Version**Range:**

0 N/A* [0 - 0 N/A]

Function:

View the combined SW version (or 'package version') consisting of power SW and control SW.

15-44 Ordered Typecode String**Range:**

0 N/A* [0 - 0 N/A]

Function:

View the type code string used for re-ordering the adjustable frequency drive in its original configuration.

15-45 Actual Typecode String**Range:**

0 N/A* [0 - 0 N/A]

Function:

View the actual type code string.

15-46 Adj Freq Dr Ordering No.		
Range:		Function:
0 N/A* [0 - 0 N/A]		View the 8-digit ordering number used for re-ordering the adjustable frequency drive in its original configuration.
15-47 Power Card Ordering No.		
Range:		Function:
0 N/A* [0 - 0 N/A]		View the power card ordering number.
15-48 LCP ID Num.		
Range:		Function:
0 N/A* [0 - 0 N/A]		View the LCP ID number.
15-49 SW ID Control Card		
Range:		Function:
0 N/A* [0 - 0 N/A]		View the control card software version number.
15-50 SW ID Power Card		
Range:		Function:
0 N/A* [0 - 0 N/A]		View the power card software version number.
15-51 Adj Freq Dr Serial No.		
Range:		Function:
0 N/A* [0 - 0 N/A]		View the adjustable frequency drive serial number.
15-53 Power Card Serial Number		
Range:		Function:
0 N/A* [0 - 0 N/A]		View the power card serial number.

2.14.7 Option Ident. 15-6*

This read-only parameter group contains information about the hardware and software configuration of the options installed in slots A, B C0 and C1.

15-60 Option Mounted		
Range:		Function:
0 N/A* [0 - 0 N/A]		View the installed option type.
15-61 Option SW Version		
Range:		Function:
0 N/A* [0 - 0 N/A]		View the installed option software version.
15-62 Option Ordering No		
Range:		Function:
0 N/A* [0 - 0 N/A]		Shows the ordering number for the installed options.

15-63 Option Serial No

Range:

0 N/A* [0 - 0 N/A]

Function:

View the installed option serial number.

2

2.14.8 Parameter Info, 15-9*

Parameter lists

15-92 Defined Parameters

Array [1000]

Range:

0 N/A* [0 - 9999 N/A]

Function:

View a list of all defined parameters in the adjustable frequency drive. The list ends with 0.

15-93 Modified Parameters

Array [1000]

Range:

0 N/A* [0 - 9999 N/A]

Function:

View a list of the parameters that have been changed from their default settings. The list ends with 0. Changes may not be visible until up to 30 seconds after implementation.

15-99 Parameter Metadata

Array [23]

Range:

0 N/A* [0 - 9999 N/A]

Function:

This parameter contains data used by the MCT10 software tool.

2.15 Main Menu - Data Readouts - Group 16

2.15.1 16-** Data Readouts

Parameter group for data readouts, such as current references, voltages, control, alarm, warning and status words.

2.15.2 16-0* General Status

Parameters for reading the general status, such as the calculated reference, the active control word and status.

16-00 Control Word

Range:

0 N/A* [0 - 65535 N/A]

Function:

View the control word sent from the adjustable frequency drive via the serial communication port in hex code.

16-01 Reference [Unit]

Range:

0.000 Ref- [-999999.000 - 999999.000 Refer-
erenceFeed-enceFeedbackUnit]
backUnit*

Function:

View the present reference value applied on impulse or analog basis in the unit resulting from the configuration selected in par.1-00 *Configuration Mode* (Hz, Nm or RPM).

16-02 Reference %

Range:

0.0 %* [-200.0 - 200.0 %]

Function:

View the total reference. The total reference is the sum of the digital, analog, preset, bus and freeze references, plus catch-up and slow-down.

16-03 Status Word

Range:

0 N/A* [0 - 65535 N/A]

Function:

View the status word sent from the adjustable frequency drive via the serial communication port in hex code.

16-05 Main Actual Value [%]

Range:

0.00%* [-100.00% - 100.00%]

Function:

View the two-byte word sent with the status word to the bus master reporting the main actual value. Please refer to the Profibus Instruction Manual MG.33.CX.YY for a detailed description.

16-09 Custom Readout

Range:

0.00 Cus- [-999999.99 - 999999.99 Custom-
tomReadou-ReadoutUnit]
tUnit*

Function:

View the user-defined readouts as defined in par.0-30 *Custom Readout Unit*, par.0-31 *Custom Readout Min Value* and par.0-32 *Custom Readout Max Value*.

2.15.3 16-1* Motor Status

Parameters for reading the motor status values.

16-10 Power [kW]**Range:**

0.00 kW* [0.00 - 1000.00 kW]

Function:

View the motor power in kW. The value shown is calculated on the basis of the actual motor voltage and motor current. The value is filtered, and therefore approx. 30 ms may pass from when an input value changes to when the data readout values change.

16-11 Power [hp]**Range:**

0.00 hp* [0.00 - 1000.00 hp]

Function:

View the motor power in HP. The value shown is calculated on the basis of the actual motor voltage and motor current. The value is filtered, and therefore approximately 30 ms may pass from when an input value changes to when the data readout values change.

16-12 Motor voltage**Range:**

0.0 V* [0.0 - 6000.0 V]

Function:

View the motor voltage, which is a calculated value used for controlling the motor.

16-13 Frequency**Range:**

0.0 Hz* [0.0 - 6500.0 Hz]

Function:

View the motor frequency, without resonance dampening.

16-14 Motor Current**Range:**

0.00 A* [0.00 - 1856.00 A]

Function:

View the motor current measured as a mean value, IRMS. The value is filtered, and thus approximately 30 ms may pass from when an input value changes to when the data readout values change.

16-15 Frequency [%]**Range:**

0.00 %* [-100.00 - 100.00 %]

Function:

View a two-byte word reporting the actual motor frequency (without resonance dampening) as a percentage (scale 0000–4000 Hex) of par.4-19 *Max Output Frequency*. Set par.9-16 *PCD Read Configuration* index 1 to send it with the status word instead of the MAV.

16-16 Torque [Nm]**Range:**

0.0 Nm* [-30000.0 - 30000.0 Nm]

Function:

View the torque value with sign, applied to the motor shaft. Linearity is not exact between 110% motor current and torque in relation to the rated torque. Some motors supply more than 160% torque. Consequently, the minimum and maximum values will depend on the maximum motor current, as well as the motor type being used. The value is filtered, and thus, approximately 1.3 seconds may pass from when an input changes value to when the data readout values change.

16-17 Speed [RPM]**Range:**

0 RPM* [-30000 - 30000 RPM]

Function:

View the actual motor RPM.

16-18 Motor Thermal**Range:**

0 %* [0 - 100 %]

Function:

View the calculated thermal load on the motor. The cut-out limit is 100%. The basis for calculation is the ETR function selected in par.1-90 *Motor Thermal Protection*.

16-22 Torque [%]

Range:

0 %* [-200 - 200 %]

Function:

This is a readout parameter only.

Shows the actual torque yielded in percentage of the rated torque, based on the setting of the motor size and rated speed in par.1-20 *Motor Power [kW]* or par.1-21 *Motor Power [HP]* and par. 1-25 *Motor Nominal Speed*.

This is the value monitored by the *Broken Belt Function* set in par. 22-6*.

2.15.4 16-3* Drive Status

Parameters for reporting the status of the adjustable frequency drive.

16-30 DC Link Voltage

Range:

0 V* [0 - 10000 V]

Function:

View a measured value. The value is filtered with a 30 ms time constant.

16-32 Brake Energy /s

Range:

0.000 kW* [0.000 - 675000.000 kW]

Function:

View the braking energy transmitted to an external brake resistor, stated as an instantaneous value.

16-33 Brake Energy /2 min

Range:

0.000 kW* [0.000 - 500.000 kW]

Function:

View the braking energy transmitted to an external brake resistor. The mean power is calculated on an average basis for the most recent 120 seconds.

16-34 Heatsink Temp.

Range:

0 C* [0 - 255 C]

Function:

View the adjustable frequency drive heatsink temperature. The cut-out limit is $203^{\circ} \pm 9^{\circ}\text{F}$ [$90^{\circ} \pm 5^{\circ}\text{C}$], and the motor cuts back in at $158^{\circ} \pm 9^{\circ}\text{F}$ [$60^{\circ} \pm 5^{\circ}\text{C}$].

16-35 Inverter Thermal

Range:

0 %* [0 - 100 %]

Function:

View the percentage load on the inverter.

16-36 Inv. Nom. Current

Range:

10.00 A* [0.01 - 10000.00 A]

Function:

View the inverter nominal current, which should match the nameplate data on the connected motor. The data is used for motor protection, calculating torque, etc.

16-37 Inv. Max. Current

Range:

16.00 A* [0.01 - 10000.00 A]

Function:

View the inverter maximum current, which should match the nameplate data on the connected motor. The data is used for motor protection, calculating torque, etc.

16-38 SL Controller State

Range:

0 N/A* [0 - 100 N/A]

Function:

View the state of the event under execution by the SL controller.

16-39 Control Card Temp.**Range:**

0 C* [0 - 100 C]

Function:

View the temperature on the control card, stated in °C.

16-40 Logging Buffer Full**Option:**

[0]* No

[1] Yes

Function:View whether the logging buffer is full (see par. 15-1*). The logging buffer will never be full when par.15-13 *Logging Mode* is set to *Log always* [0].**2.15.5 16-5* Ref. & Feedb.**

Parameters for reporting the reference and feedback input.

16-50 External Reference**Range:**

0.0 N/A* [-200.0 - 200.0 N/A]

Function:

View the total reference, the sum of digital, analog, preset, bus and freeze references, plus catch-up and slow-down.

16-52 Feedback [Unit]**Range:**0.000 Proc- [-999999.999 - 999999.999 Proc-
essCtrlU- essCtrlUnit]
nit***Function:**View value of resulting feedback value after processing of Feedback 1-3 (see par.16-54 *Feedback 1 [Unit]*, par.16-55 *Feedback 2 [Unit]* and par.15-13 *Logging Mode*) in the feedback manager.See par. 20-0* *Feedback*.The value is limited by settings in par.15-13 *Logging Mode* and par.15-13 *Logging Mode*. Units as set in par. 20-12 *Reference/Feedback Unit*.**16-53 Digi Pot Reference****Range:**

0.00 N/A* [-200.00 - 200.00 N/A]

Function:

View the contribution of the digital potentiometer to the actual reference.

16-54 Feedback 1 [Unit]**Range:**0.000 Proc- [-999999.999 - 999999.999 Proc-
essCtrlU- essCtrlUnit]
nit***Function:**View value of Feedback 1, see par. 20-0* *Feedback*.Value is limited by settings in par. 20-12 *Reference/Feedback Unit* and par.3-03 *Maximum Reference*. Units as set in par. 20-12 *Reference/Feedback Unit*.**16-55 Feedback 2 [Unit]****Range:**0.000 Proc- [-999999.999 - 999999.999 Proc-
essCtrlU- essCtrlUnit]
nit***Function:**View value of Feedback 2, see par. 20-0* *Feedback*.Value is limited by settings in par.3-02 *Minimum Reference* and par.3-03 *Maximum Reference*. Units as set in par. 20-12 *Reference/Feedback Unit*.

16-56 Feedback 3 [Unit]

Range: 0.000 Proc- [-999999.999 - 999999.999 Proc-
essCtrlU- essCtrlUnit]
nit*

Function: View value of Feedback 3, see par. 20-0* *Feedback*.
Value is limited by settings in par.3-02 *Minimum Reference* and par.3-03 *Maximum Reference*. Units as set in par. 20-12 *Reference/Feedback Unit*.

16-59 Adjusted Setpoint

Option:

Function: View value of the adjusted setpoint according to par.20-29.

2.15.6 16-6* Inputs and Outputs

Parameters for reporting the digital and analog IO ports.

16-60 Digital Input

Range: 0* [0 - 63]

Function: View the signal states from the active digital inputs. Input 18 corresponds for example to bit 5. '0' = NO signal, '1' = connected signal.

Bit 0	Digital input term. 33
Bit 1	Digital input term. 32
Bit 2	Digital input term. 29
Bit 3	Digital input term. 27
Bit 4	Digital input term. 19
Bit 5	Digital input term. 18
Bit 6	Digital input term. 37
Bit 7	Digital input GP I/O term. X30/2
Bit 8	Digital input GP I/O term. X30/3
Bit 9	Digital input GP I/O term. X30/4
Bit 10-63	Reserved for future terminals

16-61 Terminal 53 Switch Setting

Option:

Function: View the setting of input terminal 53. Current = 0; Voltage = 1.

[0] * Current

[1] Voltage

[2] Pt 1000 [°C]

[3] Pt 1000 [°F]

[4] Ni 1000 [°C]

[5] Ni 1000 [°F]

16-62 Analog Input 53

Range: 0.000 N/A* [-20.000 - 20.000 N/A]

Function: View the actual value at input 53.

16-63 Terminal 54 Switch Setting

Option:
Function:

View the setting of input terminal 54. Current = 0; Voltage = 1.

[0] * Current

[1] Voltage

[2] Pt 1000 [°C]

[3] Pt 1000 [°F]

[4] Ni 1000 [°C]

[5] Ni 1000 [°F]

16-64 Analog Input 54

Range:
Function:

0.000 N/A* [-20.000 - 20.000 N/A]

View the actual value at input 54.

16-65 Analog Output 42 [mA]

Range:
Function:

0.000 N/A* [0.000 - 30.000 N/A]

View the actual value at output 42 in mA. The value shown reflects the selection in par. 6-50 *Terminal 42 Output*.

16-66 Digital Output [bin]

Range:
Function:

0 N/A* [0 - 15 N/A]

View the binary value of all digital outputs.

16-67 Freq. Input #29 [Hz]

Range:
Function:

0* [0 - 0]

View the actual frequency rate on terminal 29.

16-68 Freq. Input #33 [Hz]

Range:
Function:

0* [0 - 0]

View the actual frequency rate on terminal 33.

16-69 Pulse Output #27 [Hz]

Range:
Function:

0* [0 - 0]

View the actual value on terminal 27 in digital output mode.

16-70 Pulse Output #29 [Hz]

Range:
Function:

0* [0 - 0]

View the actual value of pulses on terminal 29 in digital output mode.

16-71 Relay Output [bin]

Range:	Function:
0 N/A* [0 - 31 N/A]	View the settings of all relays.

Readout choice [P16-71]:
Relay output [bin]: 00000 bin

- OptionB card relay 09
- OptionB card relay 08
- OptionB card relay 07
- Power card relay 02
- Power card relay 01

130BA195.10

16-72 Counter A

Range:	Function:
0 N/A* [-2147483648 - 2147483647 N/A]	View the present value of Counter A. Counters are useful as comparator operands, see par. 13-10 <i>Comparator Operand</i> . The value can be reset or changed either via digital inputs (parameter group 5-1*) or by using an SLC action (par.13-52 <i>SL Controller Action</i>).

16-73 Counter B

Range:	Function:
0 N/A* [-2147483648 - 2147483647 N/A]	View the present value of Counter B. Counters are useful as comparator operands (par.13-10 <i>Comparator Operand</i>). The value can be reset or changed either via digital inputs (parameter group 5-1*) or by using an SLC action (par.13-52 <i>SL Controller Action</i>).

16-74 Precise Stop Counter

Option:	Function:
[0] * -2147483648 - 2147483648	Returns the actual counter value of precise counter.

16-75 Analog In X30/11

Range:	Function:
0.000 N/A* [-20.000 - 20.000 N/A]	View the actual value at input X30/11 of MCB 101.

16-76 Analog In X30/12

Range:	Function:
0.000 N/A* [-20.000 - 20.000 N/A]	View the actual value at input X30/12 of MCB 101.

16-77 Analog Out X30/8 [mA]

Range:	Function:
0.000 N/A* [0.000 - 30.000 N/A]	View the actual value at input X30/8 in mA.

2.15.7 16-8* Ser. Com. Bus & FC Port

Parameters for reporting the BUS references and control words.

16-80 Fieldbus CTW 1**Range:**

0 N/A* [0 - 65535 N/A]

Function:

View the two-byte control word (CTW) received from the bus master. Interpretation of the control word depends on the serial communication option installed and the control word profile selected in par.8-10 *Control Profile*.

For more information, please refer to the relevant serial communication bus manual.

16-82 Fieldbus REF 1**Range:**

0 N/A* [-200 - 200 N/A]

Function:

View the two-byte word sent with the control word from the bus master to set the reference value.

For more information, please refer to the relevant serial communication bus manual.

16-84 Comm. Option Status**Range:**

0 N/A* [0 - 65535 N/A]

Function:

View the extended ser. com. bus option status word.

For more information, please refer to the relevant serial communication bus manual.

16-85 FC Port CTW 1**Range:**

0 N/A* [0 - 65535 N/A]

Function:

View the two-byte control word (CTW) received from the bus master. Interpretation of the control word depends on the serial communication option installed and the control word profile selected in par.8-10 *Control Profile*.

16-86 FC Port REF 1**Range:**

0 N/A* [-200 - 200 N/A]

Function:

View the two-byte status word (STW) sent to the bus master. Interpretation of the status word depends on the serial communication option installed and the control word profile selected in par. 8-10 *Control Profile*.

2.15.8 16-9* Diagnosis Readout

Parameters displaying alarm, warning and extended status words.

16-90 Alarm Word**Range:**

0 N/A* [0 - 4294967295 N/A]

Function:

View the alarm word sent via the serial communication port in hex code.

16-91 Alarm word 2**Range:**

0 N/A* [0 - 4294967295 N/A]

Function:

View the alarm word 2 sent via the serial communication port in hex code.

16-92 Warning Word**Range:**

0 N/A* [0 - 4294967295 N/A]

Function:

View the warning word sent via the serial communication port in hex code.

16-93 Warning word 2**Range:**

0 N/A* [0 - 4294967295 N/A]

Function:

View the warning word 2 sent via the serial communication port in hex code.

16-94 Ext. Status Word

Range:

0 N/A* [0 - 4294967295 N/A]

Function:

Returns the extended status word sent via the serial communication port in hex code.

16-95 Ext. Status Word 2

Range:

0 N/A* [0 - 4294967295 N/A]

Function:

Returns the extended warning word 2 sent via the serial communication port in hex code.

16-96 Maintenance Word

Range:

0 N/A* [0 - 4294967295 N/A]

Function:

Readout of the Preventive Maintenance Word. The bits reflect the status for the programmed preventive maintenance events in parameter group 23-1*. 13 bits represent combinations of all the possible items:

- Bit 0: Motor bearings
- Bit 1: Pump bearings
- Bit 2: Fan bearings
- Bit 3: Valve
- Bit 4: Pressure transmitter
- Bit 5: Flow transmitter
- Bit 6: Temperature transmitter
- Bit 7: Pump seals
- Bit 8: Fan belt
- Bit 9: Filter
- Bit 10: Drive cooling fan
- Bit 11: Drive system health check
- Bit 12: Warranty
- Bit 13: Maintenance Text 0
- Bit 14: Maintenance Text 1
- Bit 15: Maintenance Text 2
- Bit 16: Maintenance Text 3
- Bit 17: Maintenance Text 4

2

Position 4→	Valve	Fan bearings	Pump bearings	Motor bearings
Position 3 →	Pump seals	Temperature transmitter	Flow transmitter	Pressure transmitter
Position 2 →	Drive system health check	Drive cooling fan	Filter	Fan belt
Position 1→				Warranty
0 _{hex}	-	-	-	-
1 _{hex}	-	-	-	+
2 _{hex}	-	-	+	-
3 _{hex}	-	-	+	+
4 _{hex}	-	+	-	-
5 _{hex}	-	+	-	+
6 _{hex}	-	+	+	-
7 _{hex}	-	+	+	+
8 _{hex}	+	-	-	-
9 _{hex}	+	-	-	+
A _{hex}	+	-	+	-
B _{hex}	+	-	+	+
C _{hex}	+	+	-	-
D _{hex}	+	+	-	+
E _{hex}	+	+	+	-
F _{hex}	+	+	+	+

Example:

The preventive maintenance word shows 040Ahex.

Position	1	2	3	4
hex value	0	4	0	A

The first digit 0 indicates that no items from the fourth row require maintenance

The second digit 4 refers to the third row, indicating that the drive cooling fan requires maintenance

The third digit 0 indicates that no items from the second row require maintenance



The fourth digit A refers to the top row indicating that the valve and the pump bearings require maintenance

2.16 Main Menu - Data Readouts 2 - Group 18

2.16.1 18-0* Maintenance Log

This group contains the last 10 preventive maintenance logs. Maintenance Log 0 is the latest log and Maintenance Log 9 the oldest. By selecting one of the logs and pressing OK, the Maintenance Item, Action and time of the occurrence can be found in par.18-00 *Maintenance Log: Item* – par.18-03 *Maintenance Log: Date and Time*.

The Alarm log button on the LCP allows access to both the alarm log and maintenance log.

18-00 Maintenance Log: Item		
Array [10]		
Range:		Function:
0 N/A* [0 - 255 N/A]		Locate the meaning of the Maintenance Item in the description of par.23-10 <i>Maintenance Item</i> .
18-01 Maintenance Log: Action		
Array [10]		
Range:		Function:
0 N/A* [0 - 255 N/A]		Locate the meaning of the Maintenance Item in the description of par.23-11 <i>Maintenance Action</i>
18-02 Maintenance Log: Time		
Array [10]		
Range:		Function:
0 s* [0 - 2147483647 s]		Shows when the logged event occurred. Time is measured in seconds since last power-up.
18-03 Maintenance Log: Date and Time		
Array [10]		
Range:		Function:
0 N/A* [0 - 0 N/A]		Shows when the logged event occurred.
<div style="border: 1px solid black; padding: 5px; margin-top: 10px;">  <p>NOTE! This requires that the date and time is programmed in par. 0-70 <i>Set Date and Time</i>.</p> </div> <p style="margin-top: 10px;">Date format depends on the setting in par. 0-71 <i>Date Format</i>, while the time format depends on the setting in par.0-72 <i>Time Format</i>.</p> <div style="border: 1px solid black; padding: 5px; margin-top: 10px;">  <p>NOTE! The adjustable frequency drive has no backup of the clock function and the set date/time will reset to default (2000-01-01 00:00) after a power-down unless a Real Time Clock module with backup is installed. In par.0-79 <i>Clock Fault</i> it is possible to program for a warning in case the clock has not been set properly, e.g., after a power-down. Incorrect setting of the clock will affect the time stamps for the maintenance events.</p> </div>		

**NOTE!**

When mounting an Analog I/O MCB 109 option card, a battery backup of date and time is included.

2

18-30 Analog Input X42/1**Range:**

0.000 N/A* [-20.000 - 20.000 N/A]

Function:

Readout of the value of the signal applied to terminal X42/1 on the analog I/O card.
The units of the value shown in the LCP will correspond to the mode selected in par.26-00, Terminal X/42-1 Mode.

18-31 Analog Input X42/3**Range:**

0.000 N/A* [-20.000 - 20.000 N/A]

Function:

Readout of the value of the signal applied to terminal X42/3 on the analog I/O card.
The units of the value shown in the LCP will correspond to the mode selected in par.26-01 *Terminal X42/3 Mode*.

18-32 Analog Input X42/5**Range:**

0.000 N/A* [-20.000 - 20.000 N/A]

Function:

Readout of the value of the signal applied to terminal X42/5 on the analog I/O card.
The units of the value shown in the LCP will correspond to the mode selected in par.26-02 *Terminal X42/5 Mode*.

18-33 Analog Out X42/7 [V]**Range:**

0.000 N/A* [0.000 - 30.000 N/A]

Function:

Readout of the value of the signal applied to terminal X42/7 on the analog I/O card.
The value shown reflects the selection in par.26-40 *Terminal X42/7 Output*.

18-34 Analog Out X42/9 [V]**Range:**

0.000 N/A* [0.000 - 30.000 N/A]

Function:

Readout of the value of the signal applied to terminal X42/9 on the analog I/O card.
The value shown reflects the selection in par.26-50 *Terminal X42/9 Output*.

18-35 Analog Out X42/11 [V]**Range:**

0.000 N/A* [0.000 - 30.000 N/A]

Function:

Readout of the value of the signal applied to terminal X42/11 on the analog I/O card.
The value shown reflects the selection in par.26-60 *Terminal X42/11 Output*.

2.17 Main Menu - FC Closed-loop - Group 20

2.17.1 Drive Closed-loop, 20-**

This parameter group is used for configuring the closed-loop PID controller, which controls the output frequency of the adjustable frequency drive.

2.17.2 Feedback, 20-0*

This parameter group is used to configure the feedback signal for the adjustable frequency drive's closed-loop PID controller. Whether the adjustable frequency drive is in closed-loop mode or open-loop mode, the feedback signals can be shown on the adjustable frequency drive's display. It can also be used to control an adjustable frequency drive analog output, and to be transmitted over various serial communication protocols.

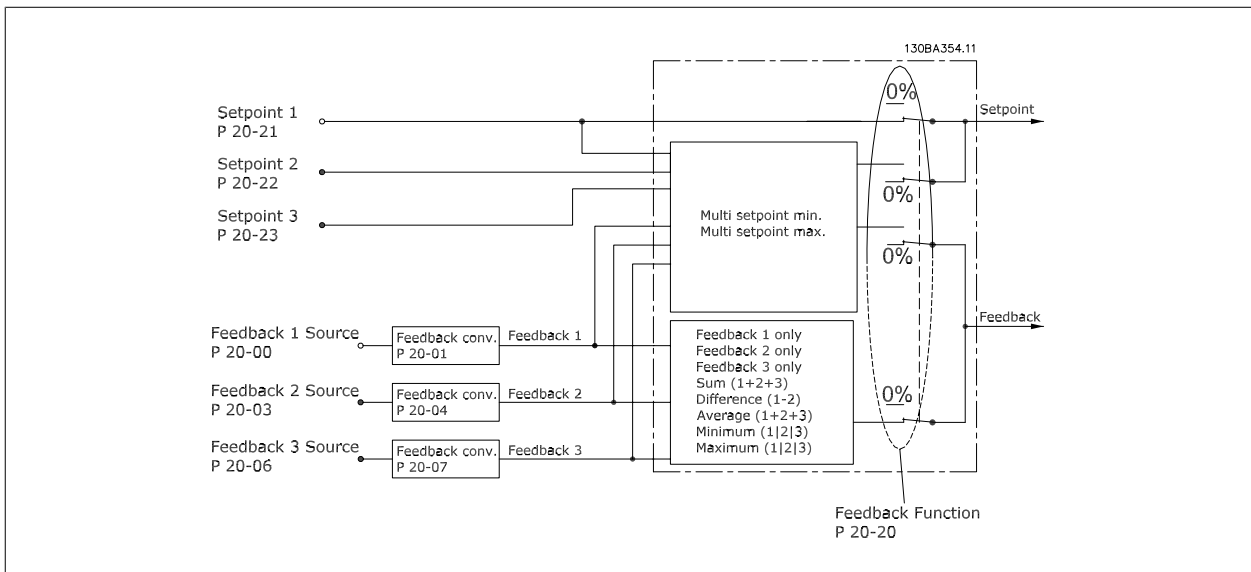

20-00 Feedback 1 Source

Option:

Function:

Up to three different feedback signals can be used to provide the feedback signal for the adjustable frequency drive's PID controller.

This parameter defines which input will be used as the source of the first feedback signal.

Analog input X30/11 and Analog input X30/12 refer to inputs on the optional general purpose I/O board.

[0] No function

[1] Analog input 53

[2] * Analog input 54

[3] Pulse input 29

[4] Pulse input 33

[7] Analog input X30/11

[8] Analog input X30/12

[9] Analog Input X42/1

[10] Analog Input X42/3

[11] Analog Input X42/5

- [100] Bus feedback 1
- [101] Bus feedback 2
- [102] Bus feedback 3

**NOTE!**

If a feedback is not used, its source must be set to *No Function* [0]. par. 20-20 *Feedback Function* determines how the three possible feedbacks will be used by the PID controller.

20-01 Feedback 1 Conversion

Option:**Function:**

[0] * Linear

[1] Square root

This parameter allows a conversion function to be applied to Feedback 1.

Linear [0] has no effect on the feedback.

Square root [1] is commonly used when a pressure sensor is used to provide flow feedback ($flow \propto \sqrt{pressure}$).

20-03 Feedback 2 Source

Option:**Function:**

See par.20-00 *Feedback 1 Source* for details.

[0] * No function

[1] Analog input 53

[2] Analog input 54

[3] Pulse input 29

[4] Pulse input 33

[7] Analog input X30/11

[8] Analog input X30/12

[9] Analog Input X42/1

[10] Analog Input X42/3

[11] Analog Input X42/5

[100] Bus feedback 1

[101] Bus feedback 2

[102] Bus feedback 3

20-04 Feedback 2 Conversion

Option:**Function:**

See par. 20-01 *Feedback 1 Conversion* for details.

[0] * Linear

[1] Square root

[2] Pressure to temperature

20-06 Feedback 3 Source

Option:

Function:

See par.20-00 *Feedback 1 Source* for details.

- [0] * No function
- [1] Analog input 53
- [2] Analog input 54
- [3] Pulse input 29
- [4] Pulse input 33
- [7] Analog input X30/11
- [8] Analog input X30/12
- [9] Analog Input X42/1
- [10] Analog Input X42/3
- [11] Analog Input X42/5
- [100] Bus feedback 1
- [101] Bus feedback 2
- [102] Bus feedback 3

20-07 Feedback 3 Conversion

Option:

Function:

See par. 20-01 *Feedback 1 Conversion* for details.

- [0] * Linear
- [1] Square root
- [2] Pressure to temperature

20-12 Reference/Feedback Unit

Option:

Function:

- [0] None
- [1] * %
- [5] PPM
- [10] 1/min
- [11] RPM
- [12] Pulse/s
- [20] l/s
- [21] l/min
- [22] l/h
- [23] m³/s
- [24] m³/min
- [25] m³/h
- [30] kg/s
- [31] kg/min
- [32] kg/h
- [33] t/min
- [34] t/h
- [40] m/s

[41]	m/min	
[45]	m	
[60]	°C	
[70]	mbar	
[71]	bar	
[72]	Pa	
[73]	kPa	
[74]	m WG	
[75]	mm Hg	
[80]	kW	
[120]	GPM	
[121]	gal/s	
[122]	gal/min	
[123]	gal/h	
[124]	CFM	
[125]	ft ³ /s	
[126]	ft ³ /min	
[127]	ft ³ /h	
[130]	lb/s	
[131]	lb/min	
[132]	lb/h	
[140]	ft/s	
[141]	ft/min	
[145]	ft	
[160]	°F	
[170]	psi	
[171]	lb/in ²	
[172]	in WG	
[173]	ft WG	
[174]	in Hg	
[180]	HP	This parameter determines the unit that is used for the setpoint reference and feedback that the PID controller will use for controlling the output frequency of the adjustable frequency drive.

2.17.3 20-2* Feedback & Setpoint

This parameter group is used to determine how the adjustable frequency drive's PID controller will use the three possible feedback signals to control the output frequency of the adjustable frequency drive. This group is also used to store the three internal setpoint references.

20-20 Feedback Function

Option:

Function:

[0]	Sum
[1]	Difference
[2]	Average
[3] *	Minimum

- [4] Maximum
- [5] Multi-setpoint min
- [6] Multi-setpoint max

This parameter determines how the three possible feedbacks will be used to control the output frequency of the adjustable frequency drive.

NOTE!
Any unused feedback must be set to "No function" in its Feedback Source parameter: 20-00, 20-03 or 20-06.

The feedback resulting from the function selected in par. 20-20 will be used by the PID Controller to control the output frequency of the adjustable frequency drive. This feedback can also: be shown on the adjustable frequency drive's display, be used to control an adjustable frequency drive's analog output, and be transmitted over various serial communication protocols.

The adjustable frequency drive can be configured to handle multi-zone applications. Two different multi-zone applications are supported:

- Multi-zone, single setpoint
- Multi-zone, multi setpoint

The difference between the two is illustrated by the following examples:

Example 1: Multi-zone, single setpoint

In an office building, a VAV (variable air volume) water system must ensure a minimum pressure at selected VAV boxes. Due to the varying pressure losses in each duct, the pressure at each VAV box cannot be assumed to be the same. The minimum pressure required is the same for all VAV boxes. This control method can be set up by setting *Feedback Function*, par. 20-20 to option [3], Minimum, and entering the desired pressure in par. 20-21. The PID Controller will increase the speed of the fan if any one feedback is below the setpoint, and decrease the speed of the fan if all feedbacks are above the setpoint.

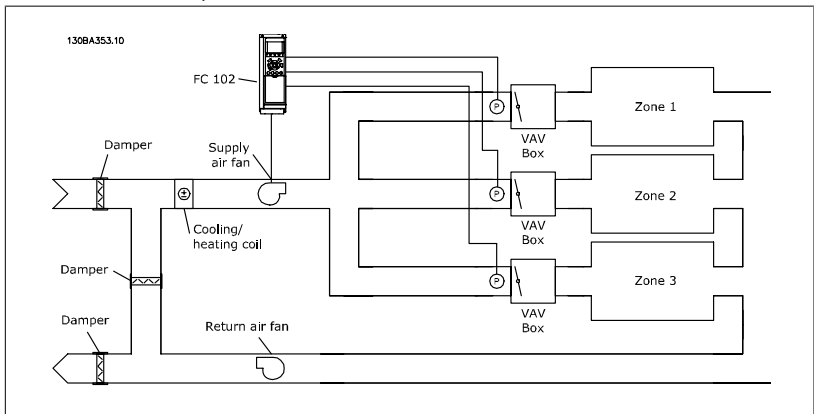

Example 2 – Multi-zone, multi setpoint

The previous example can be used to illustrate the use of multi-zone, multi-setpoint control. If the zones require different pressures for each VAV box, each setpoint may be specified in par. 20-21, 20-22 and 20-23. By selecting *Multi-setpoint minimum*, [5], in par. 20-20, Feedback Function, the PID Controller will increase the speed of the fan if any one of the feedbacks is below its setpoint and decrease the speed of the fan if all feedbacks are above their individual setpoints.

Sum [0] sets up the PID controller to use the sum of Feedback 1, Feedback 2 and Feedback 3 as the feedback.

NOTE!
Any unused feedback results must be set to *No Function* in par. 20-00, 20-03, or 20-06.

The sum of Setpoint 1 and any other references that are enabled (see par. group 3-1*) will be used as the PID controller's setpoint reference.

Difference [1] sets up the PID controller to use the difference between Feedback 1 and Feedback 2 as the feedback. Feedback 3 will not be used with this selection. Only setpoint 1 will be used. The sum of Setpoint 1 and any other references that are enabled (see par. group 3-1*) will be used as the PID controller's setpoint reference.

Average [2] sets up the PID controller to use the average of Feedback 1, Feedback 2 and Feedback 3 as the feedback.

**NOTE!**

Any unused feedback results must be set to *No Function* in par. 20-00, 20-03, or 20-06. The sum of Setpoint 1 and any other references that are enabled (see par. group 3-1*) will be used as the PID controller's setpoint reference.

Minimum [3] sets up the PID controller to compare Feedback 1, Feedback 2 and Feedback 3 and use the lowest value as the feedback.

**NOTE!**

Any unused feedback results must be set to *No Function* in par. 20-00, 20-03, or 20-06. Only setpoint 1 will be used. The sum of Setpoint 1 and any other references that are enabled (see par. group 3-1*) will be used as the PID controller's setpoint reference.

Maximum [4] sets up the PID controller to compare Feedback 1, Feedback 2 and Feedback 3 and use the highest value as the feedback.

**NOTE!**

Any unused feedback results must be set to *No Function* in par. 20-00, 20-03, or 20-06.

Only Setpoint 1 will be used. The sum of Setpoint 1 and any other references that are enabled (see par. group 3-1*) will be used as the PID controller's setpoint reference.

Multi-setpoint minimum [5] sets up the PID controller to calculate the difference between Feedback 1 and Setpoint 1, Feedback 2 and Setpoint 2, and Feedback 3 and Setpoint 3. It will use the feedback/setpoint pair in which the feedback is the farthest below its corresponding setpoint reference. If all feedback signals are above their corresponding setpoints, the PID controller will use the feedback/setpoint pair in which the difference between the feedback and setpoint is the least.

**NOTE!**

If only two feedback signals are used, the feedback that is not to be used must be set to *No Function* in par. 20-00, 20-03 or 20-06. Note that each setpoint reference will be the sum of its respective parameter value (20-11, 20-12 and 20-13) and any other references that are enabled (see par. group 3-1*).

Multi-setpoint maximum [6] sets up the PID Controller to calculate the difference between Feedback 1 and Setpoint 1, Feedback 2 and Setpoint 2, and Feedback 3 and Setpoint 3. It will use the feedback/setpoint pair in which the feedback is farthest above its corresponding setpoint reference. If all feedback signals are below their corresponding setpoints, the PID controller will use the feedback/setpoint pair in which the difference between the feedback and the setpoint reference is the least.

**NOTE!**

If only two feedback signals are used, the feedback that is not to be used must be set to *No Function* in par. 20-00, 20-03 or 20-06. Note that each setpoint reference will be the sum of its respective parameter value (20-21, 20-22 and 20-23) and any other references that are enabled (see par. group 3-1*).

20-21 Setpoint 1

Range:

0.000 Proc- [-999999.999 - 999999.999 Proc-
essCtrlU- essCtrlUnit]
nit*

Function:

Setpoint 1 is used in closed-loop mode to enter a setpoint reference that is used by the adjustable frequency drive's PID controller. See the description of par. 20-20 *Feedback Function*.



NOTE!

Setpoint reference entered here is added to any other references that are enabled (see par. group 3-1*).

20-22 Setpoint 2

Range:

0.000 Proc- [-999999.999 - 999999.999 Proc-
essCtrlU- essCtrlUnit]
nit*

Function:

Setpoint 2 is used in closed-loop mode to enter a setpoint reference that may be used by the adjustable frequency drive's PID controller. See the description of *Feedback Function*, par. 20-20 *Feedback Function*.



NOTE!

The setpoint reference entered here is added to any other references that are enabled (see par. group 3-1*).

20-23 Setpoint 3

Range:

0.000* [Ref_{MIN} - Ref_{MAX} UNIT (from par.
20-12)]

Function:

Setpoint 3 is used in closed-loop mode to enter a setpoint reference that may be used by the adjustable frequency drive's PID controller. See the description of par. 20-20 *Feedback Function*.



NOTE!

If the min and max references are altered, a new PI - Autotune may be needed.



NOTE!

The setpoint reference entered here is added to any other references that are enabled (see par. group 3-1*).

2.17.4 20-7* PID autotuning

The adjustable frequency drive PID closed-loop controller (parameters 20-**, FC Closed-loop) can be autotuned, simplifying and saving time during commissioning, while ensuring accurate PID control adjustment. To use autotuning it is necessary for the adjustable frequency drive to be configured for closed-loop in par 1-00 Configuration Mode.

A Graphical Local Control Panel (LCP) must be used in order to react on messages during the autotuning sequence.

Enabling autotuning par 20-79 puts the adjustable frequency drive into autotuning mode. The LCP then directs the user with on-screen instructions.

The fan/pump is started by pressing [Auto On] button on the LCP and applying a start signal. The speed is adjusted manually by pressing the [▲] or [▼] navigation keys on the LCP to a level where the feedback is around the system setpoint.

**NOTE!**

It is not possible to run the motor at maximum or minimum speed, when manually adjusting the motor speed due to the need of giving the motor a step in the speed during autotuning.

2

PID autotuning functions by introducing step changes while operating at a steady state and then monitoring the feedback. From the feedback response, the required values for par.20-93 *PID Proportional Gain* and par.20-94 *Integral Time* are calculated. Par.20-95 *PID Differentiation Time* is set to value 0 (zero). par.20-81 *PID Normal/ Inverse Control* is determined during tuning process.

These calculated values are presented on the LCP and the user can decide whether to accept or reject them. Once accepted, the values are written to the relevant parameters and autotuning mode is disabled in par.20-79. Depending on the system being controlled, the time required to carry out autotuning could be several minutes.

It is advised to set the ramp times in par.3-41 *Ramp 1 Ramp-up Time*, par.3-42 *Ramp 1 Ramp-down Time* or par.3-51 *Ramp 2 Ramp-up Time* and par.3-52 *Ramp 2 Ramp-down Time* according to the load inertia before carrying out PID autotuning. If PID autotuning is carried out with slow ramp times, the autotuned parameters will typically result in very slow control. Excessive feedback sensor noise should be removed using the input filter (parameter groups 6-*, 5-5* and 26-*, Terminal 53/54 Filter Time Constant/Pulse Filter Time Constant #29/33) before activating PID autotuning. In order to obtain the most accurate controller parameters, it is advised to carry out PID autotuning, when the application is running in typical operation, i.e. with a typical load.

20-70 Closed-loop Type

Option:**Function:**

This parameter defines the application response. The default mode should be sufficient for most applications. If the application response speed is known, it can be selected here. This will decrease the time needed for carrying out PID autotuning. The setting has no impact on the value of the tuned parameters and is used only for the autotuning sequence.

- [0] * Auto
- [1] Fast Pressure
- [2] Slow Pressure
- [3] Fast Temperature
- [4] Slow Temperature

2.17.5 20-70 Closed-loop Type

20-70 Closed-loop Type

Option:**Function:**

This parameter defines the application response. The default mode should be sufficient for most applications. If the application response speed is known, it can be selected here. This will decrease the time needed for carrying out PID autotuning. The setting has no impact on the value of the tuned parameters and is used only for the autotuning sequence.

- [0] * Auto
Suitable for pressure control in fan systems, especially where the pressure sensor may be located some distance from the fan.
- [1] Fast Pressure
Generally used in pumping system, where a faster control response is desirable.
- [2] Slow Pressure
- [3] Fast Temperature
- [4] Slow Temperature

20-72 PID Output Change

Range:	Function:
0.10 N/A* [0.01 - 0.50 N/A]	This parameter sets the magnitude of step change during autotuning. The value is a percentage of full speed. This means that if maximum output frequency in par. 4-13 <i>Motor Speed High Limit [RPM]</i> / par. 4-14 <i>Motor Speed High Limit [Hz]</i> is set to 50Hz, 0.10 is 10% of 50Hz, which is 5Hz. This parameter should be set to a value resulting in feedback changes of between 10% and 20% for best tuning accuracy.

20-73 Minimum Feedback Level

Range:	Function:
-999999.00 [-999999.999 - par. 20-74 ProcessCtrlUnit]	The minimum allowable feedback level should be entered here in user units as defined in par. 20-12 <i>Reference/Feedback Unit</i> . If the level falls below par. 20-73 <i>Minimum Feedback Level</i> , autotuning is aborted and an error message will appear on the LCP.

20-74 Maximum Feedback Level

Range:	Function:
999999.000 [par. 20-73 - 999999.999 ProcessCtrlUnit]	The maximum allowable feedback level should be entered here in user units as defined in par. 20-12 <i>Reference/Feedback Unit</i> . If the level rises above par. 20-74 <i>Maximum Feedback Level</i> , autotuning is aborted and an error message will appear on the LCP.

20-79 PID Auto Tuning

Option:	Function:
[0] * Disabled	This parameter starts the PID autotuning sequence. Once the autotuning has successfully completed and the settings have been accepted or rejected by the user, by pressing [OK] or [Cancel] buttons on the LCP at the end of tuning, this parameter is reset to [0] Disabled.
[1] Enabled	

2.17.6 20-8* Basic Settings

This parameter group is used to configure the basic operation of the adjustable frequency drive's PID controller, including how it responds to feedback that is above or below the setpoint, the speed at which it first starts functioning, and when it will indicate that the system has reached the setpoint.

20-81 PID Normal/Inverse Control

Option:	Function:
[0] * Normal	<i>Normal</i> [0] causes the adjustable frequency drive's output frequency to decrease when the feedback is greater than the setpoint reference. This is common for pressure-controlled supply fan and pump applications. <i>Inverse</i> [1] causes the adjustable frequency drive's output frequency to increase when the feedback is greater than the setpoint reference.
[1] Inverse	

20-82 PID Start Speed [RPM]**Range:**

0 RPM* [0 - par. 4-13 RPM]

Function:

When the adjustable frequency drive is first started, it initially ramps up to this output speed in open-loop mode, following the active ramp-up time. When the output speed programmed here is reached, the adjustable frequency drive will automatically switch to closed-loop mode and the PID controller will begin to function. This is useful in applications in which the driven load must first quickly accelerate to a minimum speed when it is started.

**NOTE!**

This parameter will only be visible if par.0-02 *Motor Speed Unit* is set to [0], RPM.

20-83 PID Start Speed [Hz]**Range:**

0 Hz* [0.0 - par. 4-14 Hz]

Function:

When the adjustable frequency drive is first started, it initially ramps up to this output frequency in open-loop mode, following the active ramp-up time. When the output frequency programmed here is reached, the adjustable frequency drive will automatically switch to closed-loop mode and the PID controller will begin to function. This is useful in applications in which the driven load must first quickly accelerate to a minimum speed when it is started.

**NOTE!**

This parameter will only be visible if par.0-02 *Motor Speed Unit* is set to [1], Hz.

20-84 On Reference Bandwidth**Range:**

5 %* [0 - 200 %]

Function:

When the difference between the feedback and the setpoint reference is less than the value of this parameter, the adjustable frequency drive's display will show "Run on Reference". This status can be communicated externally by programming the function of a digital output for *Run on Reference/No Warning* [8]. In addition, for serial communications, the On Reference status bit of the adjustable frequency drive's status word will be high (1).

The *On Reference Bandwidth* is calculated as a percentage of the setpoint reference.

2.17.7 PID Controller, 20-9*

This group provides the ability to manually adjust this PID controller. By adjusting the PID controller parameters, the control performance may be improved. See section on *PID* in the chapter *Introduction to VLT AQUA Drive* in the *VLT AQUA Drive Design Guide* for guidelines on adjusting the PID controller parameters.

20-91 PID Anti Windup

Option:

Function:

[0] Off

Off[0] causes the PID controller to continue to integrate (add) the error between the feedback and setpoint reference even though the adjustable frequency drive cannot adjust its output frequency to correct this error. In this case, the integral term of the PID controller may become quite large. When the PID controller can again control the adjustable frequency drive's output frequency, it may attempt to initially make a large change in the adjustable frequency drive's output frequency. This should generally be avoided.

[1] * On

On [1] stops the PID controller from integrating (adding) the error between the feedback and the setpoint reference if it is not possible to adjust the output frequency of the adjustable frequency drive to correct the error. This can occur when the adjustable frequency drive has reached its minimum or maximum output frequency, or when the adjustable frequency drive is stopped.

20-93 PID Proportional Gain

Range:

Function:

0.50 N/A* [0.00 - 10.00 N/A]

When the difference between the feedback and the setpoint reference is less than the value of this parameter, the adjustable frequency drive's display will show "Run on Reference". This status can be communicated externally by programming the function of a digital output for *Run on Reference/No Warning* [8]. In addition, for serial communications, the On Reference status bit of the adjustable frequency drive's status word will be high (1).
The *On Reference Bandwidth* is calculated as a percentage of the setpoint reference.

20-94 PID Integral Time

Range:

Function:

20.00 s* [0.01 - 10000.00 s]

Over time, the integrator adds (integrates) the error between the feedback and the setpoint reference. This is required to ensure that the error approaches zero. Quick adjustable frequency drive speed adjustment is obtained when this value is small. However, if a value that is too small is used, the adjustable frequency drive's output frequency may become unstable.

20-95 PID Differentiation Time

Range:

Function:

0.0 s* [0.00 = Off - 10.00 s]

The differentiator monitors the rate of change of the feedback. If the feedback is changing too quickly, it will adjust the output of the PID controller to reduce the rate. The quick PID controller response is obtained when this value is large. However, if a value that is too large is used, the adjustable frequency drive's output frequency may become unstable.
Differentiation time is useful in situations where extremely fast adjustable frequency drive response and precise speed control are required. It can be difficult to adjust this for proper system control. Differentiation time is not commonly used in water/wastewater applications. It is therefore generally best to leave this parameter at 0 or OFF.

20-96 PID Diff. Gain Limit

Range:

Function:

5.0 N/A* [1.0 - 50.0 N/A]

The differentiator of a PID controller responds to the rate of change of the feedback. As a result, an abrupt change in the feedback can cause the differentiator to make a very large change in the PID controller's output. This parameter limits the maximum effect that the PID controller's differentiator can produce. A smaller value reduces the maximum effect of the PID controller's differentiator.

This parameter is only active when par. 20-95 *PID Differentiation Time* is not set to OFF (0 s).

2.18 Main Menu - Extended Closed-loop - Group 21

2.18.1 21-** Ext. Closed-loop

The FC 102 offers 3 extended closed-loop PID controllers in addition to the PID controller. They can be configured independently to control either external servo (valves, dampers, etc.), or be used together with the internal PID controller to improve the dynamic responses to setpoint changes or load disturbances.

The extended closed-loop PID controllers may be interconnected or connected to the PID closed-loop controller to form a dual loop configuration.

In order to control a modulating device (e.g., a valve motor), this device must be a positioning servo motor with built-in electronics accepting either a 0–10 V (signal from the analog I/O card MCB 109) or a 0/4–20 mA (signal from the control card and/or general purpose I/O card MCB 101) control signal. The output function can be programmed in the following parameters:

- Control Card, terminal 42: par. 6-50 *Terminal 42 Output* (setting [113]...[115] or [149]...[151], Ext. Closed-loop 1/2/3
- General Purpose I/O card MCB 101, terminal X30/8: par.6-60 *Terminal X30/8 Output*, (setting [113]...[115] or [149]...[151], Ext. Closed-loop 1/2/3
- Analog I/O card MCB 109, terminal X42/7...11: par.26-40 *Terminal X42/7 Output*, par.26-50 *Terminal X42/9 Output*, par.26-60 *Terminal X42/11 Output* (setting [113]...[115], Ext. Closed-loop 1/2/3

The general purpose I/O card and analog I/O card are optional cards.

2.18.2 21-0* Extended CL autotuning

The extended PID Closed-loop PID controllers (*par. 21-**, Ext. Closed-loop*) can each be autotuned, simplifying and saving time during commissioning, while ensuring accurate PID control adjustment.

To use PID autotuning it is necessary for the relevant extended PID controller to have been configured for the application.

A Graphical Local Control Panel (LCP) must be used in order to react on messages during the autotuning sequence.

Enabling autotuning par.21-09 *PID Auto Tuning* puts the relevant PID controller into PID autotuning mode. The LCP then directs the user with on-screen instructions.

PID autotuning functions by introducing step changes and then monitoring the feedback. From the feedback response, the required values for PID Proportional Gain, par.21-21 *Ext. 1 Proportional Gain* for EXT CL 1, par.21-41 *Ext. 2 Proportional Gain* for EXT CL 2 and par.21-61 *Ext. 3 Proportional Gain* for EXT CL 3 and Integral Time, par.21-22 *Ext. 1 Integral Time* for EXT CL 1, par.21-42 *Ext. 2 Integral Time* for EXT CL 2 and par.21-62 *Ext. 3 Integral Time* for EXT CL 3 are calculated. PID Differentiation Time, par.21-23 *Ext. 1 Differentiation Time* for EXT CL 1, par.21-43 *Ext. 2 Differentiation Time* for EXT CL 2 and par.21-63 *Ext. 3 Differentiation Time* for EXT CL 3 are set to value 0 (zero). Normal / Inverse, par.21-20 *Ext. 1 Normal/Inverse Control* for EXT CL 1, par.21-40 *Ext. 2 Normal/Inverse Control* for EXT CL 2 and par.21-60 *Ext. 3 Normal/Inverse Control* for EXT CL 3 are determined during the tuning process.

These calculated values are presented on the LCP and the user can decide whether to accept or reject them. Once accepted, the values are written to the relevant parameters and PID autotuning mode is disabled in par.21-09 *PID Auto Tuning*. Depending on the system being controlled, the time required to carry out PID autotuning could be several minutes.

Excessive feedback sensor noise should be removed using the input filter (parameter groups 6*, 5.5* and 26*, Terminal 53/54 Filter Time Constant/Pulse Filter Time Constant #29/33) before activating PID autotuning.

21-00 Closed-loop Type

Option:

Function:

This parameter defines the application response. The default mode should be sufficient for most applications. If the relative application speed is known, it can be selected here. This will decrease the time needed for carrying out PID autotuning. The setting has no impact on the value of the tuned parameters and is used only for the PID autotuning sequence.

- [0] * Auto
- [1] Fast Pressure
- [2] Slow Pressure
- [3] Fast Temperature
- [4] Slow Temperature

21-01 Tuning Mode

Option:

Function:

- [0] * Normal
Normal setting of this parameter will be suitable for pressure control in fan systems.
- [1] Fast
Fast setting would generally be used in pumping systems, where a faster control response is desirable.

21-02 PID Output Change

Range:

Function:

- 0.10 N/A* [0.01 - 0.50 N/A]
This parameter sets the magnitude of step change during autotuning. The value is a percentage of full operating range. This means that if maximum analog output voltage is set to 10 V, 0.10 is 10% of 10 V, which is 1 V. This parameter should be set to a value resulting in feedback changes of between 10% and 20% for best tuning accuracy.

21-03 Minimum Feedback Level

Range:

Function:

- 999999.00 [-999999.999 - par. 21-04 N/A]
0 N/A*
The minimum allowable feedback level should be entered here in user units as defined in par. 21-10 *Ext. 1 Ref./Feedback Unit* for EXT CL 1, par.21-30 *Ext. 2 Ref./Feedback Unit* for EXT CL 2 or par.21-50 *Ext. 3 Ref./Feedback Unit* for EXT CL 3. If the level falls below par.21-03 *Minimum Feedback Level*, PID autotuning is aborted and an error message will appear on the LCP.

21-04 Maximum Feedback Level

Range:

Function:

- 999999.000 [par. 21-03 - 999999.999 N/A]
N/A*
The maximum allowable feedback level should be entered here in user units as defined in par. 21-10 *Ext. 1 Ref./Feedback Unit* for EXT CL 1, par.21-30 *Ext. 2 Ref./Feedback Unit* for EXT CL 2 or par.21-50 *Ext. 3 Ref./Feedback Unit* for EXT CL 3. If the level rises above par.21-04 *Maximum Feedback Level*, PID autotuning is aborted and an error message will appear on the LCP.

21-09 PID Auto Tuning

Option:

Function:

This parameter enables selection of the extended PID controller to be autotuned and starts the PID autotuning for that controller. Once the autotuning has successfully completed and the settings have been accepted or rejected by the user, by pressing [OK] or [Cancel] buttons on the LCP at the end of tuning, this parameter is reset to [0] Disabled.

- [0] * Disabled
- [1] Enabled Ext PID 1
- [2] Enabled Ext PID 2

[3] Enabled Ext PID 3

2.18.3 21-1* Closed-loop 1 Ref/Feedback

2

Configure Extended Closed-loop 1 Controller reference and feedback.

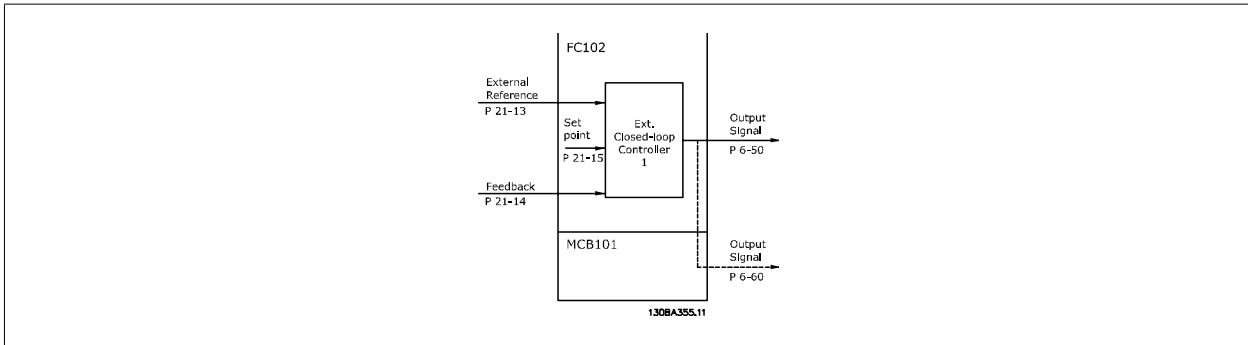

21-10 Ext. 1 Ref./Feedback Unit

Option:

Function:

Select the unit for the reference and feedback.

[0]

[1] * %

[5] PPM

[10] min

[11] RPM

[12] PULSE/s

[20] liter / sec.

[21] liter / min

[22] liter / hr.

[23] m³ / sec.

[24] m³/min

[25] m³ / hr.

[30] kg / sec.

[31] kg/min

[32] kg / hr.

[33] ton / min

[34] ton / hr.

[40] m / sec.

[41] m/min

[45] m

[60] °C

[70] mbar

[71] bar

[72] Pa

[73]	kPa
[74]	m WG
[75]	
[80]	kW
[120]	GPM
[121]	gal / sec.
[122]	gal/min
[123]	gal / hr.
[124]	CFM
[125]	ft ³ /s
[126]	ft ³ /min
[127]	ft ³ /h
[130]	lbs / sec.
[131]	lbs / min.
[132]	lbs / hr.
[140]	ft/s
[141]	ft/min
[145]	ft
[160]	°F
[170]	psi
[171]	lb/in ²
[172]	in. wtr. gage
[173]	ft WG
[174]	
[180]	HP

21-11 Ext. 1 Minimum Reference

Range: 0.000 Ex- [-999999.999 - par. 21-12 Ex- tPID1Unit* tPID1Unit]
Function: Select the minimum for the closed-loop 1 controller.

21-12 Ext. 1 Maximum Reference

Range: 100.000 Ex- [par. 21-11 - 999999.999 Ex- tPID1Unit* tPID1Unit]
Function: Select the maximum for the closed-loop 1 controller.

21-13 Ext. 1 Reference Source**Option:****Function:**

This parameter defines which input on the adjustable frequency drive should be treated as the source of the reference signal for the closed-loop 1 controller. Analog input X30/11 and Analog input X30/12 refer to inputs on the general purpose I/O.

[0] *	No function
[1]	Analog input 53
[2]	Analog input 54
[7]	Pulse input 29
[8]	Pulse input 33
[20]	Digital pot.meter
[21]	Analog input X30/11
[22]	Analog input X30/12
[23]	Analog Input X42/1
[24]	Analog Input X42/3
[25]	Analog Input X42/5
[30]	Ext. Closed-loop 1
[31]	Ext. Closed-loop 2
[32]	Ext. Closed-loop 3

21-14 Ext. 1 Feedback Source**Option:****Function:**

This parameter defines which input on the adjustable frequency drive should be treated as the source of the feedback signal for the closed-loop 1 controller. Analog input X30/11 and Analog input X30/12 refer to inputs on the general purpose I/O .

[0] *	No function
[1]	Analog input 53
[2]	Analog input 54
[3]	Pulse input 29
[4]	Pulse input 33
[7]	Analog input X30/11
[8]	Analog input X30/12
[9]	Analog Input X42/1
[10]	Analog Input X42/3
[11]	Analog Input X42/5
[100]	Bus feedback 1
[101]	Bus feedback 2
[102]	Bus feedback 3

21-15 Ext. 1 Setpoint**Range:****Function:**

0.000 Ex- [par. 21-11 - par. 21-12 Ex- tPID1Unit* tPID1Unit]

The setpoint reference is used in extended 1 closed-loop. Ext.1 Setpoint is added to the value from the Ext.1 Reference source selected in par.21-13 *Ext. 1 Reference Source*.

21-17 Ext. 1 Reference [Unit]

Range: 0.000 Ex- [-999999.999 - 999999.999 Ex- tPID1Unit* tPID1Unit]
Function: Readout of the reference value for the closed-loop 1 controller.

21-18 Ext. 1 Feedback [Unit]

Range: 0.000 Ex- [-999999.999 - 999999.999 Ex- tPID1Unit* tPID1Unit]
Function: Readout of the feedback value for the closed-loop 1 controller.

21-19 Ext. 1 Output [%]

Range: 0 %* [0 - 100 %]
Function: Readout of the output value for the closed-loop 1 controller.

2.18.4 21-2* Closed-loop 1 PID

Configure the closed-loop 1 PID controller.

21-20 Ext. 1 Normal/Inverse Control

Option: [0] * Normal
Function: Select *Normal* [0] if the output should be reduced when feedback is higher than the reference.
 [1] Inverse
Function: Select *Inverse* [1] if the output should be increased when feedback is higher than the reference.

21-21 Ext. 1 Proportional Gain

Range: 0.01 N/A* [0.00 - 10.00 N/A]
Function: The proportional gain indicates the number of times the error between the set point and the feedback signal is to be applied.

21-22 Ext. 1 Integral Time

Range: 10000.00 s* [0.01 - 10000.00 s]
Function: The integrator provides an increasing gain at a constant error between the setpoint and the feedback signal. The integral time is the time needed by the integrator to reach the same gain as the proportional gain.

21-23 Ext. 1 Differentiation Time

Range: 0.00 s* [0.00 - 10.00 s]
Function: The differentiator does not react to a constant error. It only provides a gain when the feedback changes. The quicker the feedback changes, the stronger the gain from the differentiator.

21-24 Ext. 1 Dif. Gain Limit

Range: 5.0 N/A* [1.0 - 50.0 N/A]
Function: Set a limit for the differentiator gain (DG). The DG will increase if there are fast changes. Limit the DG to obtain a pure differentiator gain at slow changes, and a constant differentiator gain where quick changes occur.

2.18.5 21-3* Closed-loop 2 Ref/Fb

Configure extended closed-loop 2 controller reference and feedback.

21-30 Ext. 2 Ref./Feedback Unit
Option:
Function:

 See par.21-10 *Ext. 1 Ref./Feedback Unit* for details

[0]

[1] * %

[5] PPM

[10] min

[11] RPM

[12] PULSE/s

[20] liter / sec.

[21] liter / min

[22] liter / hr.

[23] m³ / sec.[24] m³/min[25] m³ / hr.

[30] kg / sec.

[31] kg/min

[32] kg / hr.

[33] ton / min

[34] ton / hr.

[40] m / sec.

[41] m/min

[45] m

[60] °C

[70] mbar

[71] bar

[72] Pa

[73] kPa

[74] m WG

[75]

[80] kW

[120] GPM

[121] gal / sec.

[122] gal/min

[123] gal / hr.

[124] CFM

[125] ft³/s[126] ft³/min[127] ft³/h

[130] lbs / sec.

[131] lbs / min.

[132] lbs / hr.

[140] ft/s

[141] ft/min

[145] ft

[160] °F

[170] psi

[171] lb/in²

[172] in. wtr. gage

[173] ft WG

[174]

[180] HP

21-31 Ext. 2 Minimum Reference

Range: **Function:**

0.000 Ex- [-999999.999 - par. 21-32 Ex- See par.21-11 *Ext. 1 Minimum Reference* for details.
tPID2Unit* tPID2Unit]

21-32 Ext. 2 Maximum Reference

Range: **Function:**

100.000 Ex- [par. 21-31 - 999999.999 Ex- See par.21-12 *Ext. 1 Maximum Reference* for details.
tPID2Unit* tPID2Unit]

21-33 Ext. 2 Reference Source

Option: **Function:**

See par.21-13 *Ext. 1 Reference Source* for details.

[0] * No function

[1] Analog input 53

[2] Analog input 54

[7] Pulse input 29

[8] Pulse input 33

[20] Digital pot.meter

[21] Analog input X30/11

[22] Analog input X30/12

[23] Analog Input X42/1

[24] Analog Input X42/3

[25] Analog Input X42/5

[30] Ext. Closed-loop 1

[31] Ext. Closed-loop 2

[32] Ext. Closed-loop 3

21-34 Ext. 2 Feedback Source

Option:
Function:

 See par.21-14 *Ext. 1 Feedback Source* for details.

[0] *	No function
[1]	Analog input 53
[2]	Analog input 54
[3]	Pulse input 29
[4]	Pulse input 33
[7]	Analog input X30/11
[8]	Analog input X30/12
[9]	Analog Input X42/1
[10]	Analog Input X42/3
[11]	Analog Input X42/5
[100]	Bus feedback 1
[101]	Bus feedback 2
[102]	Bus feedback 3

21-35 Ext. 2 Setpoint

Range:
Function:

 0.000 Ex- [par. 21-31 - par. 21-32 Ex- tPID2Unit* tPID2Unit] See par.21-15 *Ext. 1 Setpoint* for details.

21-37 Ext. 2 Reference [Unit]

Range:
Function:

 0.000 Ex- [-999999.999 - 999999.999 Ex- tPID2Unit* tPID2Unit] See par.21-17 *Ext. 1 Reference [Unit]*, *Ext. 1 Reference [Unit]*, for details.

21-38 Ext. 2 Feedback [Unit]

Range:
Function:

 0.000 Ex- [-999999.999 - 999999.999 Ex- tPID2Unit* tPID2Unit] See par.21-18 *Ext. 1 Feedback [Unit]* for details.

21-39 Ext. 2 Output [%]

Range:
Function:

 0 %* [0 - 100 %] See par.21-19 *Ext. 1 Output [%]* for details.

2.18.6 21-4* Closed-loop 2 PID

Configure the closed-loop 2 PID controller.

21-40 Ext. 2 Normal/Inverse Control

Option:
Function:

 See par.21-20 *Ext. 1 Normal/Inverse Control* for details.

[0] *	Normal
[1]	Inverse

21-41 Ext. 2 Proportional Gain

Range:	Function:
0.01 N/A* [0.00 - 10.00 N/A]	See par.21-21 <i>Ext. 1 Proportional Gain</i> for details.

21-42 Ext. 2 Integral Time

Range:	Function:
10000.00 s* [0.01 - 10000.00 s]	See par.21-22 <i>Ext. 1 Integral Time</i> for details.

21-43 Ext. 2 Differentiation Time

Range:	Function:
0.00 s* [0.00 - 10.00 s]	See par.21-23 <i>Ext. 1 Differentiation Time</i> for details.

21-44 Ext. 2 Dif. Gain Limit

Range:	Function:
5.0 N/A* [1.0 - 50.0 N/A]	See par.21-24 <i>Ext. 1 Dif. Gain Limit</i> for details.

2.18.7 21-5* Closed-loop 3 Ref/Fb

Configure extended closed-loop 3 controller reference and feedback.

21-50 Ext. 3 Ref./Feedback Unit

Option:	Function:
[0]	See par.21-10 <i>Ext. 1 Ref./Feedback Unit</i> for details.
[1] * %	
[5] PPM	
[10] min	
[11] RPM	
[12] PULSE/s	
[20] liter / sec.	
[21] liter / min	
[22] liter / hr.	
[23] m ³ / sec.	
[24] m ³ /min	
[25] m ³ / hr.	
[30] kg / sec.	
[31] kg/min	
[32] kg / hr.	
[33] ton / min	
[34] ton / hr.	
[40] m / sec.	
[41] m/min	
[45] m	
[60] °C	

[70]	mbar
[71]	bar
[72]	Pa
[73]	kPa
[74]	m WG
[75]	
[80]	kW
[120]	GPM
[121]	gal / sec.
[122]	gal/min
[123]	gal / hr.
[124]	CFM
[125]	ft ³ /s
[126]	ft ³ /min
[127]	ft ³ /h
[130]	lbs / sec.
[131]	lbs / min.
[132]	lbs / hr.
[140]	ft/s
[141]	ft/min
[145]	ft
[160]	°F
[170]	psi
[171]	lb/in ²
[172]	in. wtr. gage
[173]	ft WG
[174]	
[180]	HP

21-51 Ext. 3 Minimum Reference**Range:****Function:**

0.000 Ex- [-999999.999 - par. 21-52 Ex- See par.21-11 *Ext. 1 Minimum Reference* for details.
tPID3Unit* tPID3Unit]

21-52 Ext. 3 Maximum Reference**Range:****Function:**

100.000 Ex- [par. 21-51 - 999999.999 Ex- See par.21-12 *Ext. 1 Maximum Reference* for details.
tPID3Unit* tPID3Unit]

21-53 Ext. 3 Reference Source

Option:

Function:

See par.21-13 *Ext. 1 Reference Source* for details.

[0] * No function

[1] Analog input 53

[2] Analog input 54

[7] Pulse input 29

[8] Pulse input 33

[20] Digital pot.meter

[21] Analog input X30/11

[22] Analog input X30/12

[23] Analog Input X42/1

[24] Analog Input X42/3

[25] Analog Input X42/5

[30] Ext. Closed-loop 1

[31] Ext. Closed-loop 2

[32] Ext. Closed-loop 3

21-54 Ext. 3 Feedback Source

Option:

Function:

See par.21-14 *Ext. 1 Feedback Source* for details.

[0] * No function

[1] Analog input 53

[2] Analog input 54

[3] Pulse input 29

[4] Pulse input 33

[7] Analog input X30/11

[8] Analog input X30/12

[9] Analog Input X42/1

[10] Analog Input X42/3

[11] Analog Input X42/5

[100] Bus feedback 1

[101] Bus feedback 2

[102] Bus feedback 3

21-55 Ext. 3 Setpoint

Range:

Function:

0.000 Ex- [par. 21-51 - par. 21-52 Ex- See par.21-15 *Ext. 1 Setpoint* for details.
tPID3Unit* tPID3Unit]

21-57 Ext. 3 Reference [Unit]

Range:

Function:

0.000 Ex- [-999999.999 - 999999.999 Ex- See par.21-17 *Ext. 1 Reference [Unit]* for details.
tPID3Unit* tPID3Unit]

21-58 Ext. 3 Feedback [Unit]**Range:**

0.000 Ex- [-999999.999 - 999999.999 Ex- tPID3Unit* tPID3Unit]

Function:See par.21-18 *Ext. 1 Feedback [Unit]* for details.**21-59 Ext. 3 Output [%]****Range:**

0 %* [0 - 100 %]

Function:See par.21-19 *Ext. 1 Output [%]* for details.**2.18.8 21-6* Closed-loop 3 PID**

Configure the closed-loop 3 PID controller.

21-60 Ext. 3 Normal/Inverse Control**Option:**[0] * Normal
[1] Inverse**Function:**See par.21-20 *Ext. 1 Normal/Inverse Control* for details.**21-61 Ext. 3 Proportional Gain****Range:**

0.01 N/A* [0.00 - 10.00 N/A]

Function:See par.21-21 *Ext. 1 Proportional Gain* for details.**21-62 Ext. 3 Integral Time****Range:**10000.00 [0.01 - 10000.00 s]
s***Function:**See par.21-22 *Ext. 1 Integral Time* for details.**21-63 Ext. 3 Differentiation Time****Range:**

0.00 s* [0.00 - 10.00 s]

Function:See par.21-23 *Ext. 1 Differentiation Time* for details.**21-64 Ext. 3 Dif. Gain Limit****Range:**

5.0 N/A* [1.0 - 50.0 N/A]

Function:See par.21-24 *Ext. 1 Dif. Gain Limit* for details.

2.19 Main Menu - Application Functions - Group 22

2.19.1 22-** Miscellaneous

This group contains parameters used for monitoring water/wastewater applications.

22-00 External Interlock Delay		Function:
Range:		
0 s* [0 - 600 s]		Only relevant if one of the digital inputs in par. 5-1* has been programmed for <i>External Interlock</i> [7]. The external interlock timer will introduce a delay after the signal has been removed from the digital input programmed for External Interlock, before a reaction takes place.

2.19.2 No-Flow Detection, 22-2*

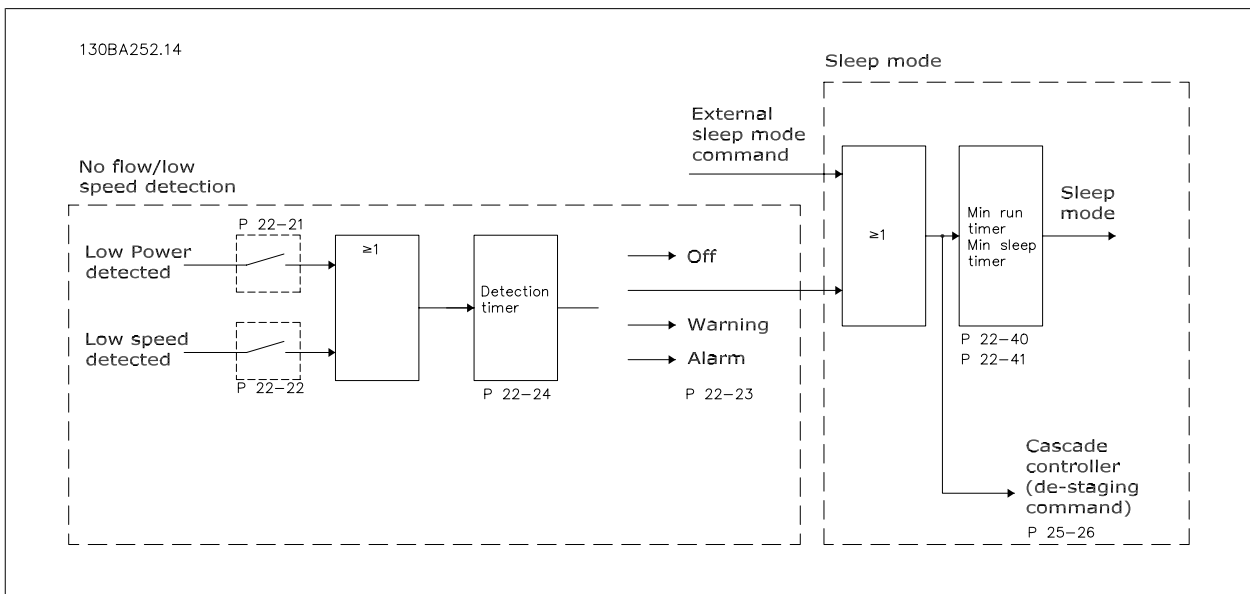

The VLT AQUA Drive includes functions for detecting if the load conditions in the system allow the motor to be stopped:

*Low Power Detection

*Low Speed Detection

One of these two signals must be active for a set time (No-Flow Delay par. 22-24) before the selected action takes place. Possible actions to select (par. 22-23): No action, Warning, Alarm, Sleep Mode.

No-Flow Detection:

This function is used for detecting a no-flow situation in pump systems where all valves can be closed. Can be used both when controlled by the integrated PI controller in VLT AQUA Drive or an external PI controller. Actual configuration must be programmed in par. 1-00, *Configuration Mode*.

Configuration mode for

- Integrated PI Controller: Closed-loop
- External PI Controller: Open-loop



Carry out no-flow tuning before setting the PI controller parameters!

2

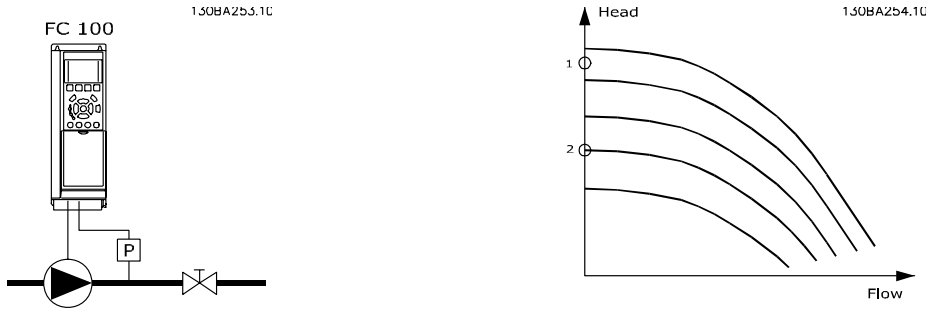

No Flow Detection is based on the measurement of speed and power. For a certain speed, the adjustable frequency drive calculates the power at no-flow.

This coherence is based on the adjustment of two sets of speed and associated power at no-flow. By monitoring the power, it is possible to detect no-flow conditions in systems with fluctuating suction pressure, or if the pump has a flat characteristic towards low speed.

The two sets of data must be based on measurement of power at approximately 50% and 85% of maximum speed with the valve(s) closed. The data are programmed in the par. 22-3*. It is also possible to run a *Low Power Auto Set Up* (par. 22-20), automatically stepping through the commissioning process and also automatically storing the data measured. The adjustable frequency drive must be set for open-loop in par. 1-00, *Configuration Mode*, when carrying out the auto set-up (See No Flow Tuning par. 22-3*).



If using the integrated PI controller, carry out no-flow tuning before setting the PI controller parameters!

Low speed detection:

Low Speed Detection gives a signal if the motor is operating with minimum speed as set in par. 4-11 or 4-12, *Motor Low Limit*. Actions are common with no-flow detection (individual selection not possible).

The use of low speed detection is not limited to systems with a no-flow situation, but can be used in any system where operation at minimum speed allows for a stop of the motor until the load calls for a speed higher than minimum speed, such as in systems with fans and compressors, for example.



In pump systems, ensure that the minimum speed in par. 4-11 or 4-12 has been set high enough for detection, as the pump can run at a rather high speed, even when the valves are closed.

Dry pump detection:

No Flow Detection can also be used for detecting if the pump has run dry (low power consumption-high speed). Can be used with both the integrated PI controller and an external PI controller.

The condition for the dry pump signal:

- Power consumption below no-flow level

and

- Pump running at maximum speed or maximum reference open-loop, whichever is lowest.

The signal must be active for a set time (*Dry Pump Delay* par. 22-27) before selected the action takes place.

Possible actions to select (par. 22-26):

- Warning
- Alarm

No Flow Detection must be enabled (par. 22-23, *No Flow Function*) and commissioned (par. 22-3*, *No Power Tuning*).

22-20 Low Power Auto Set-up

Option:

Function:

When set for *Enabled*, an auto set-up sequence is activated, automatically setting speed to approx. 50% and 85% of rated motor speed (par.4-13 *Motor Speed High Limit [RPM]*, par. 4-14 *Motor Speed High Limit [Hz]*). At those two speeds, the power consumption is automatically measured and stored. Before enabling Auto Set-up:

1. Close valve(s) in order to create a no-flow condition
2. The adjustable frequency drive must be set for open-loop (par.1-00 *Configuration Mode*). Note that it is important also to set par. 1-03 *Torque Characteristics*.

[0] * OFF

[1] Enabled



NOTE!

Auto set-up must be done when the system has reached normal operating temperature!



NOTE!

It is important that the par.4-13 *Motor Speed High Limit [RPM]* or par. 4-14 *Motor Speed High Limit [Hz]* is set to the max. operational speed of the motor!

It is important to do the auto set-up before configuring the integrated PI controller as settings will be reset when changing from closed to open-loop in par.1-00 *Configuration Mode*.



NOTE!

Carry out the tuning with the same settings in par. 1-03 *Torque Characteristics*, as for operation after the tuning.

22-21 Low Power Detection

Option:

Function:

[0] * Disabled

[1] Enabled

If selecting Enabled, the low power detection commissioning must be carried out in order to set the parameters in group 22-3* for proper operation!

22-22 Low Speed Detection

Option:

Function:

[0] * Disabled

[1] Enabled

Select Enabled for detecting when the motor operates with a speed as set in par.4-11 *Motor Speed Low Limit [RPM]* or par.4-12 *Motor Speed Low Limit [Hz]*.

22-23 No-Flow Function

Option:
Function:

Common actions for low power detection and low speed detection (Individual selections not possible).

[0] *	OFF	
[1]	Sleep Mode	
[2]	Warning	Messages in the Local Control Panel display (if mounted) and/or signal via a relay or a digital output.
[3]	Alarm	The adjustable frequency drive trips and the motor stays stopped until reset.

22-24 No-Flow Delay

Range:
Function:

10 s* [1 - 600 s] Set the time. Low Power/Low Speed must remain detected to activate signal for actions. If detection disappears before the timer runs out, the timer will be reset.

22-26 Dry Pump Function

Option:
Function:

Low Power Detection must be Enabled (par.22-21 *Low Power Detection*) and commissioned (using either par. 22-3*, *No Flow Power Tuning*, or par.22-20 *Low Power Auto Set-up*) in order to use Dry Pump Detection.

[0] *	OFF	
[1]	Warning	Messages in the Local Control Panel display (if mounted) and/or signal via a relay or a digital output.
[2]	Alarm	The adjustable frequency drive trips and the motor stays stopped until reset.

22-27 Dry Pump Delay

Range:
Function:

10 s* [0 - 600 s] Defines for how long the dry pump condition must be active before activating a warning or alarm.

2.19.3 No-Flow Power Tuning, 22-3*

Tuning Sequence, if not choosing *Auto Set-up* in par.22-20 *Low Power Auto Set-up*:

1. Close the main valve to stop flow.
2. Run with motor until the system has reached normal operating temperature
3. Press the hand on button on the Local Control Panel and adjust speed for approx. 85% of rated speed. Note the exact speed.
4. Read power consumption either by looking for actual power in the data line in the Local Control Panel or call par.16-10 *Power [kW]* or par. 16-11 *Power [hp]* in the main menu. Note the power readout
5. Change speed to approximately 50% of rated speed. Note the exact speed.
6. Read power consumption either by looking for actual power in the data line in the Local Control Panel or call par.16-10 *Power [kW]* or par. 16-11 *Power [hp]* in the main menu. Note the power readout.
7. Program the speeds used in par.22-32 *Low Speed [RPM]*, par.22-33 *Low Speed [Hz]*, par.22-36 *High Speed [RPM]* and par.22-37 *High Speed [Hz]*
8. Program the associated power values in par.22-34 *Low Speed Power [kW]*, par.22-35 *Low Speed Power [HP]*, par.22-38 *High Speed Power [kW]* and par.22-39 *High Speed Power [HP]*
9. Switch back by means of *Auto On* or *Off*



NOTE!

Set par. 1-03 *Torque Characteristics* before tuning takes place.

22-30 No-Flow Power

Range:

0.00 kW* [0.00 - 0.00 kW]

Function:

Readout of calculated no-flow power at actual speed. If power drops to the display value, the adjustable frequency drive will consider the condition as a no-flow situation.

22-31 Power Correction Factor

Range:

100 %* [1 - 400 %]

Function:

Make corrections to the calculated power at par.22-30 *No-Flow Power*.
If No Flow is detected when it should not be detected, the setting should be decreased. However, if No Flow is not detected when it should be detected, the setting should be increased to above 100%.

22-32 Low Speed [RPM]

Range:

0 RPM* [0 - par. 22-36 RPM]

Function:

To be used if par.0-02 *Motor Speed Unit* has been set for RPM (parameter not visible if Hz selected).
Set used speed to the 50% level.
This function is used for storing values needed to tune No-flow Detection.

22-33 Low Speed [Hz]

Range:

0 Hz* [0.0 - par. 22-37 Hz]

Function:

To be used if par.0-02 *Motor Speed Unit* has been set for Hz (parameter not visible if RPM selected).
Set used speed to the 50% level.
The function is used for storing values needed to tune No-flow Detection.

22-34 Low Speed Power [kW]

Range:

0 kW* [0.00 - 0.00 kW]

Function:

To be used if par.0-03 *Regional Settings* has been set for International (parameter not visible if North America selected).
Set power consumption to 50% speed level.
This function is used for storing values needed to tune No-flow Detection.

22-35 Low Speed Power [HP]

Range:

0 hp* [0.00 - 0.00 hp]

Function:

To be used if par.0-03 *Regional Settings* has been set for North America (parameter not visible if International selected).
Set power consumption to 50% speed level.
This function is used for storing values needed to tune No-flow Detection.

22-36 High Speed [RPM]

Range:

0 RPM* [0 - par. 4-13 RPM]

Function:

To be used if par.0-02 *Motor Speed Unit* has been set for RPM (parameter not visible if Hz selected).
Set used speed for the 85% level.
The function is used for storing values needed to tune No-flow Detection.

22-37 High Speed [Hz]**Range:**

0.0 Hz* [0.0 - par. 4-14 Hz]

Function:

To be used if par.0-02 *Motor Speed Unit* has been set for Hz (parameter not visible if RPM selected).
Set used speed for the 85% level.
The function is used for storing values needed to tune No-flow Detection.

22-38 High Speed Power [kW]**Range:**

0 kW* [0.00 - 0.00 kW]

Function:

To be used if par.0-03 *Regional Settings* has been set for International (parameter not visible if North America selected).
Set power consumption to 85% speed level.
This function is used for storing values needed to tune No-flow Detection.

22-39 High Speed Power [HP]**Range:**

0 hp* [0.00 - 0.00 hp]

Function:

To be used if par.0-03 *Regional Settings* has been set for North America (parameter not visible if International selected).
Set power consumption to 85% speed level.
This function is used for storing values needed to tune No-flow Detection.

2.19.4 Sleep Mode, 22-4*

If the load on the system allows for stop of the motor and the load is monitored, the motor can be stopped by activating the sleep mode function. This is not a normal stop command, but ramps the motor down to 0 RPM and stops energizing the motor. When in sleep mode, certain conditions are monitored to find out when load has been applied to the system again.

Sleep mode can be activated either from the No Flow Detection/Minimum Speed Detection or via an external signal applied to one of the digital inputs (must be programmed via the parameters for configuration of the digital inputs, par. 5-1* selecting Sleep Mode).

To make it possible to use, for example, an electro-mechanical flow switch to detect a no-flow condition and activate sleep mode, the action takes place at raising edge of the external signal applied (otherwise the adjustable frequency drive would never come out of sleep mode again, as the signal would be steady connected).

If par. 25-26, *De-stage at No-Flow*, is set for Enabled activating sleep mode will apply a command to the cascade controller (if enabled) to start de-staging of lag pumps (fixed speed) before stopping the lead pump (variable speed).

When entering sleep mode, the lower status line in the Local Control Panel shows Sleep Mode.

See also signal flow chart in section 22-2* *No Flow Detection*.

The sleep mode function can be used in three different ways:

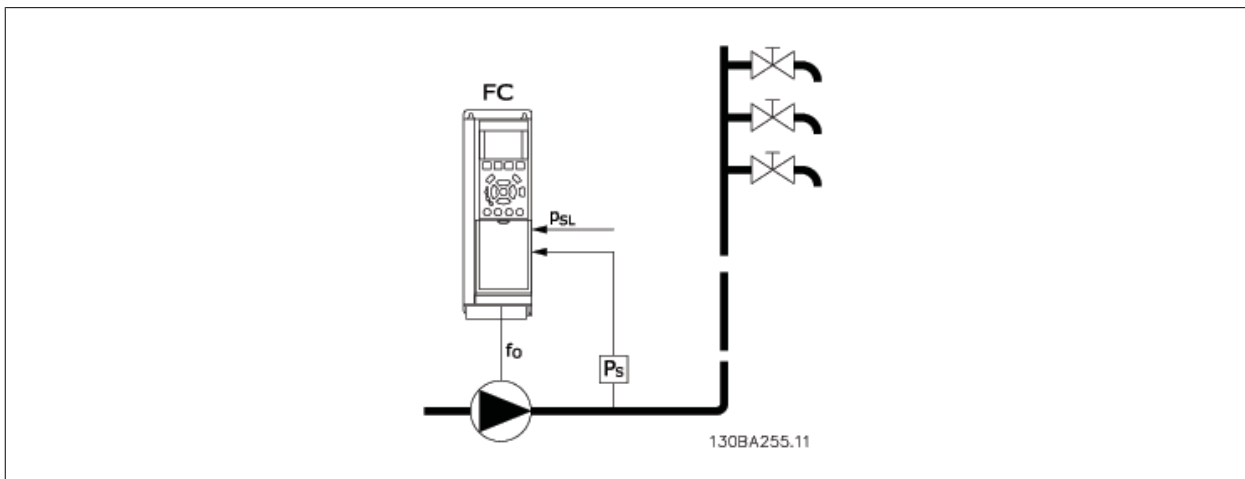

1) Systems where the integrated PI controller is used for controlling pressure or temperature, such as boost systems with a pressure feed back signal applied to the adjustable frequency drive from a pressure transducer, for example. Par. 1-00, *Configuration Mode*, must be set for closed-loop and the PI controller configured for desired reference and feedback signals.

Example: Boost system.

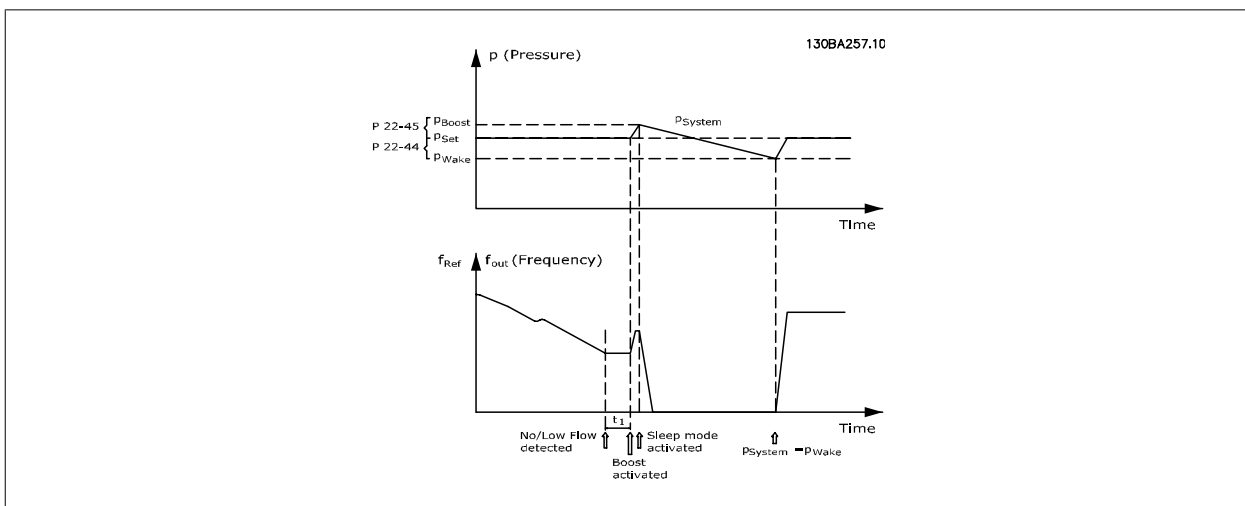

If no flow is detected, the adjustable frequency drive will increase the setpoint for pressure to ensure a slight overpressure in the system (boost to be set in par. 22-45, *Setpoint Boost*).

The feedback from the pressure transducer is monitored, and when this pressure has dropped with a set percentage below the normal setpoint for pressure (Pset), the motor will ramp up again and pressure will be controlled for reaching the set value (Pset).

2

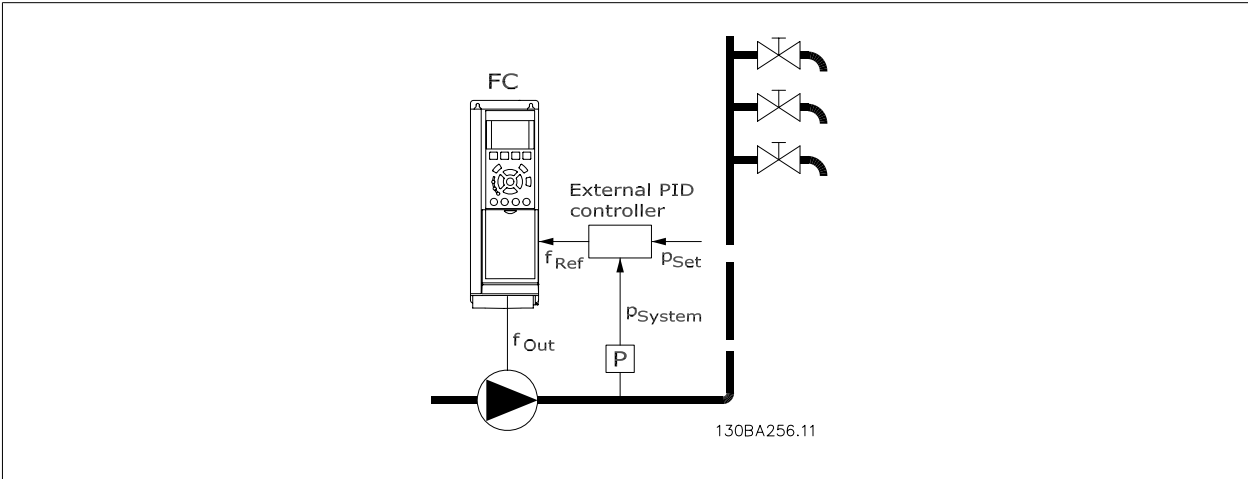

2) In systems where the pressure or temperature is controlled by an external PI controller, the wake up conditions cannot be based on feedback from the pressure/temperature transducer, as the setpoint is not known. In the example with a boost system, desired pressure P_{set} is not known. Par. 1-00, *Configuration mode*, must be set for open-loop.
 Example: Boost system.

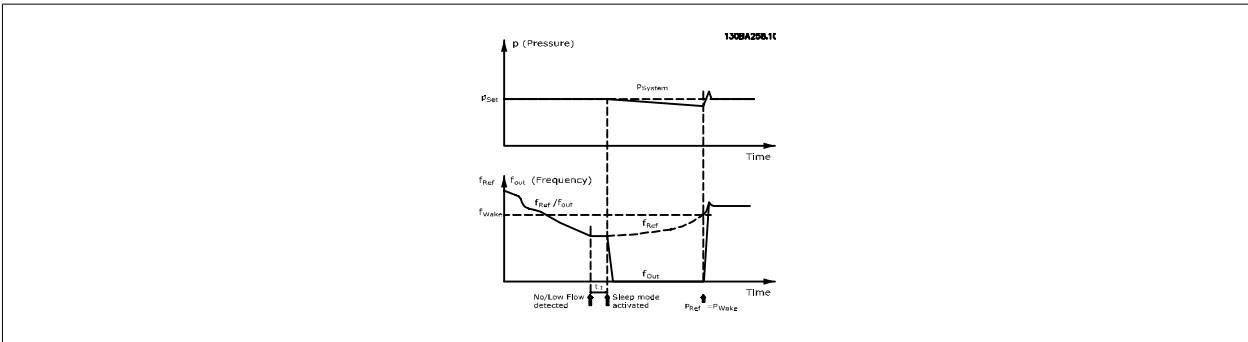

When low power or low speed is detected the motor is stopped, but the reference signal (f_{ref}) from the external controller is still monitored and because of the low pressure created, the controller will increase the reference signal to gain pressure. When the reference signal has reached a set value f_{wake} , the motor restarts.

The speed is set manually by an external reference signal (Remote Reference). The settings (par. 22-3*) for tuning of the no-flow function must be set to default.

Configuration possibilities, overview:

	Internal PI Controller (Par. 1-00: Closed-loop)		External PI controller or manual control (Par. 1-00: Open-loop)	
	Sleep mode	Wake up	Sleep mode	Wake up
No-flow detection (pumps only)	Yes		Yes (except manual setting of speed)	
Low speed detection	Yes		Yes	
External signal	Yes		Yes	
Pressure/Temperature (transmitter connected)		Yes		No
Output frequency		No		Yes

	<p>NOTE! Sleep mode will not be active when Local Reference is active (set speed manually by means of arrow buttons on the Local Control Panel). See Par. 3-13, <i>Reference Site</i>. Does not work in hand mode. Auto set-up in open-loop must be carried out before setting input/output in closed-loop.</p>
--	--

22-40 Minimum Run Time

Range:	Function:
10 s* [0 - 600 s]	Set the desired minimum running time for the motor after a start command (digital input or bus) before entering sleep mode.

22-41 Minimum Sleep Time

Range:	Function:
10 s* [0 - 600 s]	Set the desired minimum time for staying in sleep mode. This will override any wake-up conditions.

22-42 Wake-up Speed [RPM]

Range:	Function:
0 RPM* [par. 4-11 - par. 4-13 RPM]	To be used if par.0-02 <i>Motor Speed Unit</i> has been set for RPM (parameter not visible if Hz selected). Only to be used if par.1-00 <i>Configuration Mode</i> is set for open-loop and speed reference is applied by an external controller. Set the reference speed at which sleep mode should be canceled.

22-43 Wake-up Speed [Hz]

Range:	Function:
0 Hz* [par. 4-12 - par. 4-14 Hz]	To be used if par.0-02 <i>Motor Speed Unit</i> has been set for Hz (parameter not visible if RPM selected). Only to be used if par.1-00 <i>Configuration Mode</i> is set for open-loop and speed reference is applied by an external controller controlling the pressure. Set the reference speed at which sleep mode should be canceled.

22-44 Wake-up Ref./FB Difference

Range:	Function:
10%* [0-100%]	Only to be used if par. 1-00, <i>Configuration Mode</i> , is set for closed-loop and the integrated PI controller is used for controlling the pressure. Set the pressure drop allowed as a percentage of the setpoint for the pressure (Pset) before canceling sleep mode.

	<p>NOTE! If used in application where the integrated PI controller is set for inverse control in par. 20-71, <i>PID, Normal/Inverse Control</i>, the value set in par. 22-44 will automatically be added.</p>
--	---

22-45 Setpoint Boost

Range:	Function:
0 %* [-100 - 100 %]	Only to be used if par.1-00 <i>Configuration Mode</i> , is set for closed-loop and the integrated PI controller is used. For example, in systems with constant pressure control, it is advantageous to increase the system pressure before the motor is stopped. This will extend the time during which the motor is stopped and help to avoid frequent start/stop. Set the desired over pressure/temperature as a percentage of the setpoint for the pressure (Pset)/temperature before entering sleep mode. If set at 5%, the boost pressure will be Pset*1.05. The negative values can be used, for example, for cooling tower control, where a negative change is needed.

22-46 Maximum Boost Time

Range:

60 s* [0 - 600 s]

Function:

Only to be used if par.1-00 *Configuration Mode* is set for closed-loop and the integrated PI controller is used for controlling the pressure.

Set the maximum time for which boost mode will be allowed. If the set time is exceeded, sleep mode will be entered and will not wait for the set boost pressure to be reached.

2.19.5 End of Curve, 22-5*

The end of curve conditions occur when a pump is yielding a volume that is too large to ensure the set pressure. This can occur if there is a leakage in the distribution pipe system after the pump causing the pump to operate at the end of the pump characteristic, valid for the max. speed set in par. 4-13 *Motor Speed High Limit [RPM]* or par. 4-14 *Motor Speed High Limit [Hz]*.

In case the feed back is 2.5% of the programmed value in par.3-03 *Maximum Reference* (or numerical value of par.3-02 *Minimum Reference* whichever is highest) below the setpoint for the desired pressure for a set time (par.22-51 *End of Curve Delay*), and the pump is running with max. speed set in par.4-13 *Motor Speed High Limit [RPM]* or par. 4-14 *Motor Speed High Limit [Hz]*, - the function selected in par.22-50 *End of Curve Function* will take place.

It is possible to get a signal on one of the digital outputs by selecting End of Curve [192] in par. 5-3* *Digital Outputs* and/or par. 5-4* *Relays*. The signal will be present when an End of Curve condition occurs and the selection in par.22-50 *End of Curve Function* is different from Off. The end of curve function can only be used when operating with the built-in PID controller (closed-loop in par.1-00 *Configuration Mode*).

22-50 End of Curve Function

Option:

[0]* OFF

[1] Warning

[2] Alarm

Function:

End of Curve monitoring not active.

A warning is issued in the display [W94].

An alarm is issued and the adjustable frequency drive trips. A message [A94] appears in the display.

NOTE!

Automatic restart will reset the alarm and start the system again.

22-51 End of Curve Delay

Range:

10 s* [0 - 600 s]

Function:

When an end of curve condition is detected, a timer is activated. When the time set in this parameter expires and the End of Curve condition has been steady in the entire period, the function set in par. 22-50 *End of Curve Function* will be activated. If the condition disappears before the timer expires, the timer will be reset.

2.19.6 Broken Belt Detection, 22-6*

The broken belt detection can be used in both closed-loop and open-loop systems for pumps and fans. If the estimated motor torque is below the broken belt torque value (par. 22-61) and the adjustable frequency drive output frequency is above or equal to 15 Hz, the broken belt function (par. 22-60) is performed

22-60 Broken Belt Function

Option:

Function:

Selects the action to be performed if the broken belt condition is detected.

[0] * OFF

[1] Warning

[2] Trip

22-61 Broken Belt Torque

Range:

Function:

10 %* [0 - 100 %]

Sets the broken belt torque as a percentage of the rated motor torque.

22-62 Broken Belt Delay

Range:

Function:

10 s [0 - 600 s]

Sets the time for which the broken belt conditions must be active before carrying out the action selected in par.22-60 *Broken Belt Function*.

2.19.7 22-7* Short Cycle Protection

In some applications, there will often be a need for limiting the numbers of starts. One way to do this is to ensure a minimum run time (time between a start and a stop) and a minimum interval between starts.

This means that any normal stop command can be overridden by the *Minimum Run Time* function (par. 22-77) and any normal start command (Start/Jog/Freeze) can be overridden by the *Interval Between Starts* function (par. 22-76).

None of the two functions are active if *Hand On* or *Off* modes have been activated via the LCP. If selecting *Hand On* or *Off*, the two timers will be reset to 0, and do not start counting until *Auto* is pressed and an active start command applied.

22-75 Short Cycle Protection

Option:

Function:

[0] * Disabled

Timer set in par.22-76 *Interval between Starts* is disabled.

[1] Enabled

Timer set in par.22-76 *Interval between Starts* is enabled.

22-76 Interval between Starts

Range:

Function:

par. 22-77 [par. 22-77 - 3600 s]
s*

Sets the time desired as the minimum time between two starts. Any normal start command (Start/Jog/Freeze) will be disregarded until the timer has expired.

22-77 Minimum Run Time

Range:

Function:

0 s* [0 - par. 22-76 s]

Sets the time desired as minimum run time after a normal start command (Start/Jog/Freeze). Any normal stop command will be disregarded until the set time has expired. The timer will start counting following a normal start command (Start/Jog/Freeze).

The timer will be overridden by a coast (inverse) or an external interlock command.



NOTE!

Does not work in cascade mode.

2

2.19.8 Flow Compensation, 22-8*

It is sometimes the case that it is not possible for a pressure transducer to be placed at a remote point in the system, and it can only be located close to the fan/pump outlet. Flow compensation operates by adjusting the setpoint according to the output frequency, which is almost proportional to flow, thus compensating for higher losses at higher flow rates.

H_{DESIGN} (required pressure) is the setpoint for closed-loop (PI) operation of the adjustable frequency drive and is set as for closed-loop operation without flow compensation.

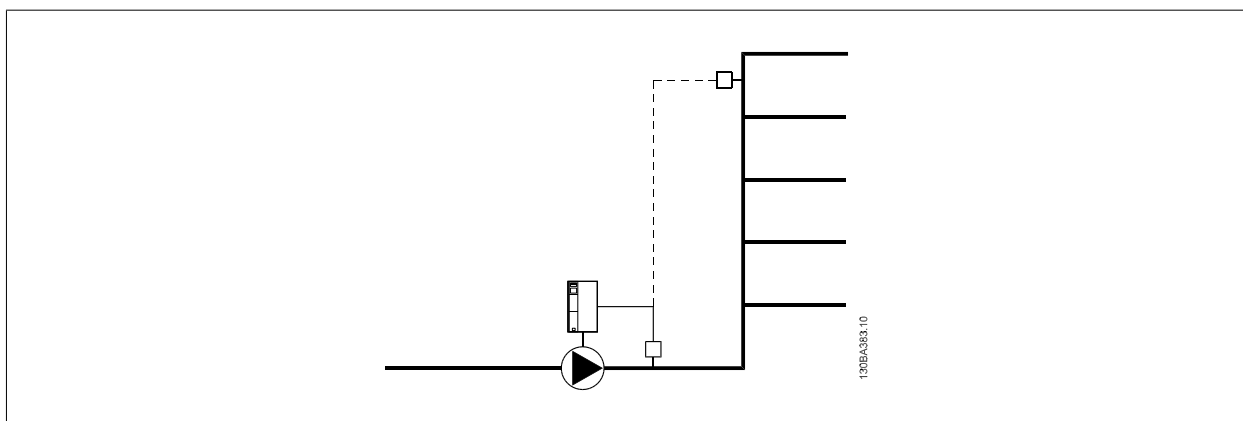

There are two methods that can be employed, depending upon whether or not the speed at system design working point is known.

Parameter used	Parameter number	Speed at Design Point KNOWN	Speed at Design Point UNKNOWN
Flow Compensation	(Par 22-80)	+	+
Square-Linear Curve Approximation	(Par 22-81)	+	+
Work Point Calculation	(Par 22-82)	+	+
Speed at No-Flow	(Par 22-83/84)	+	+
Speed at Design Point	(Par 22-85/86)	+	-
Pressure at No-Flow	(Par 22-87)	+	+
Pressure at Rated Speed	(Par 22-88)	-	+
Flow at Design Point	(Par 22-89)	-	+
Flow at Rated Speed	(Par 22-90)	-	+

22-80 Flow Compensation

Option:	Function:
[0] * Disabled	[0] <i>Disabled:</i> Setpoint compensation not active.
[1] Enabled	[1] <i>Enabled:</i> Setpoint compensation is active. Enabling this parameter allows the Flow Compensated Setpoint operation.

22-81 Square-linear Curve Approximation

Range:	Function:
100 %* [0 - 100 %]	<p>Example 1: Adjustment of this parameter allows the shape of the control curve to be adjusted. 0 = Linear 100% = Ideal shape (theoretical).</p>

 **NOTE!**
Please note: Not visible when running in cascade.

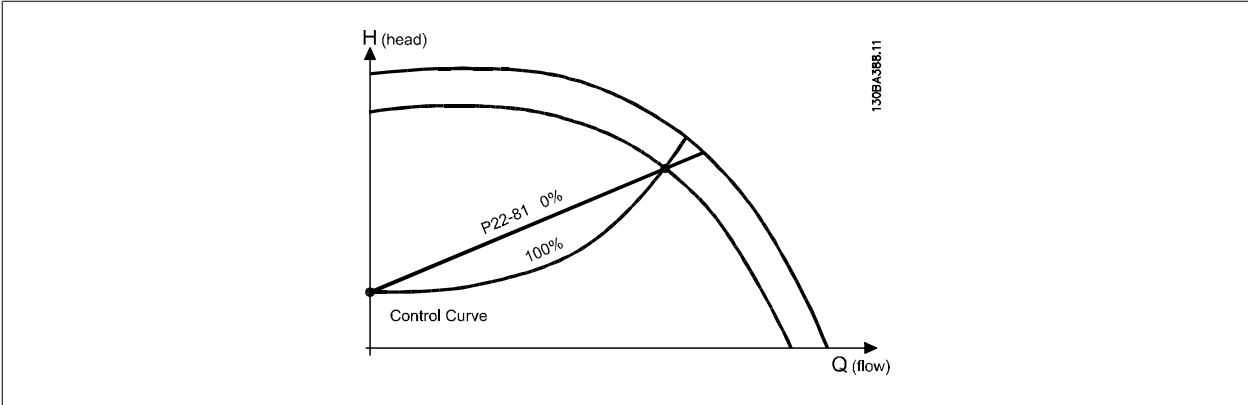

22-82 Work Point Calculation

Option:

Function:

Example 1: Speed at System Design Working Point is known:

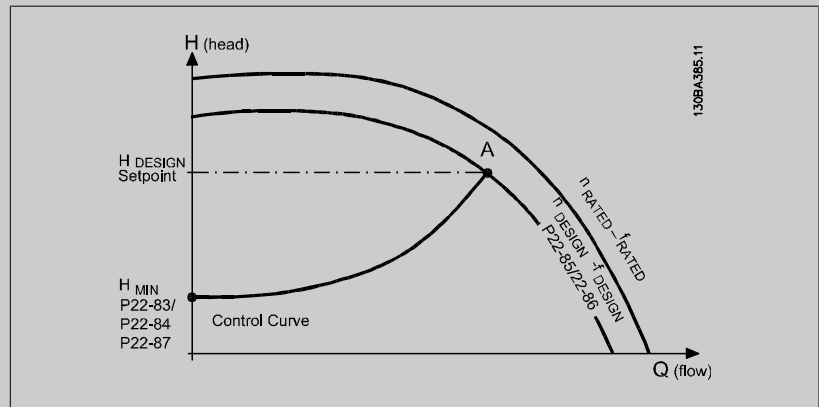

From the data sheet showing characteristics for the specific equipment at different speeds, simply reading across from the H_{DESIGN} point and the Q_{DESIGN} point allows us to find point A, which is the system design working point. The pump characteristics at this point should be identified and the associated speed programmed. Closing the valves and adjusting the speed until H_{MIN} has been achieved allows the speed at the no flow point to be identified.

Adjustment of par.22-81 *Square-linear Curve Approximation* then allows the shape of the control curve to be adjusted infinitely.

Example 2:

Speed at System Design Working Point is not known: Where the Speed at System Design Working Point is unknown, another reference point on the control curve needs to be determined by means of the data sheet. By looking at the curve for the rated speed and plotting the design pressure (H_{DESIGN} , Point C), the flow at that pressure Q_{RATED} can be determined. Similarly, by plotting the design flow (Q_{DESIGN} , Point D), the pressure H_D at that flow can be determined. Knowing these two points on the pump curve, along with H_{MIN} described above, allows the adjustable frequency drive to calculate the reference point B and thus to plot the control curve that will also include the system design working point A.

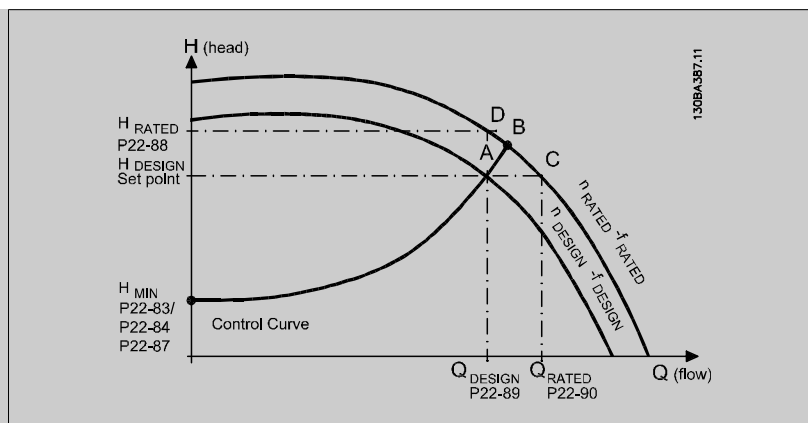

[0] *	Disabled	<i>Disabled [0]:</i> Work Point Calculation not active. To be used if speed at design point is known (see table above).
[1]	Enabled	<i>Enabled [1]:</i> Work Point Calculation is active. Enabling this parameter allows the calculation of the unknown System Design Working Point at 50/60 Hz speed, from the input data set in par. 22-83 <i>Speed at No-Flow [RPM]</i> par.22-84 <i>Speed at No-Flow [Hz]</i> , par.22-87 <i>Pressure at No-Flow Speed</i> , par.22-88 <i>Pressure at Rated Speed</i> , par. 22-89 <i>Flow at Design Point</i> and par.22-90 <i>Flow at Rated Speed</i> .

22-83 Speed at No-Flow [RPM]

Range:

300. RPM* [0 - par. 22-85 RPM]

Function:

Resolution 1 RPM.

The speed of the motor at which the flow is zero and the minimum pressure H_{MIN} is achieved should be entered here in RPM. Alternatively, the speed in Hz can be entered in par.22-84 *Speed at No-Flow [Hz]*. If it has been decided to use RPM in par.0-02 *Motor Speed Unit*, then par.22-85 *Speed at Design Point [RPM]* should also be used. Closing the valves and reducing the speed until minimum pressure H_{MIN} is achieved will determine this value.

22-84 Speed at No-Flow [Hz]

Range:

50.0 Hz* [0.0 - par. 22-86 Hz]

Function:

Resolution 0.033 Hz.

The speed of the motor at which flow has effectively stopped and minimum pressure H_{MIN} is achieved should be entered here in Hz. Alternatively, the speed in RPM can be entered in par.22-83 *Speed at No-Flow [RPM]*. If it has been decided to use Hz in par.0-02 *Motor Speed Unit*, then par. 22-86 *Speed at Design Point [Hz]* should also be used. Closing the valves and reducing the speed until minimum pressure H_{MIN} is achieved will determine this value.

22-85 Speed at Design Point [RPM]

Range:

1500. RPM* [par. 22-83 - 60000. RPM]

Function:

Resolution 1 RPM.

Only visible when par.22-82 *Work Point Calculation* is set to *Disable*. The speed of the motor at which the system design working point is achieved should be entered here in RPM. Alternatively, the speed in Hz can be entered in par.22-86 *Speed at Design Point [Hz]*. If it has been decided to use RPM in par.0-02 *Motor Speed Unit*, then par.22-83 *Speed at No-Flow [RPM]* should also be used.

22-86 Speed at Design Point [Hz]

Range:

50/60.0 [par. 22-84 - par. 4-19 Hz]
Hz*

Function:

Resolution 0.033 Hz.
Only visible when par.22-82 *Work Point Calculation* is set to *Disable*. The speed of the motor at which the system design working point is achieved should be entered here in Hz. Alternatively, the speed in RPM can be entered in par.22-85 *Speed at Design Point [RPM]*. If it has been decided to use Hz in par.0-02 *Motor Speed Unit*, then par.22-83 *Speed at No-Flow [RPM]* should also be used.

22-87 Pressure at No-Flow Speed

Range:

0.000 N/A* [0.000 - par. 22-88 N/A]

Function:

Enter the pressure H_{MIN} corresponding to speed at no-flow in reference/feedback units.

22-88 Pressure at Rated Speed

Range:

999999.999 [par. 22-87 - 999999.999 N/A]
N/A*

Function:

Enter the value corresponding to the pressure at rated speed in reference/feedback units. This value can be defined using the pump datasheet.

22-90 Flow at Rated Speed

Range:

0.000 N/A* [0.000 - 999999.999 N/A]

Function:

Enter the value corresponding to flow at rated speed. This value can be defined using the pump datasheet.

2.20 Main Menu - Time-based Functions - Group 23

2.20.1 Timed Actions, 23-0*

Use *Timed Actions* for actions needing to be performed on a daily or weekly basis, e.g., different references for working hours / non-working hours. Up to 10 timed actions can be programmed in the adjustable frequency drive. The Timed Action number is selected from the list when entering parameter group 23-0* from the Local Control Panel. par.23-00 *ON Time* – par.23-04 *Occurrence* then refer to the selected Timed Action number. Each timed action is divided into an ON time and an OFF time, in which two different actions may be performed.



NOTE!

The clock (parameter group 0-7*) must be correctly programmed for timed actions to function correctly.



NOTE!

When mounting an Analog I/O MCB109 option card, a battery back-up of the date and time is included.

23-00 ON Time

Array [10]

Range:

0 N/A* [0 - 0 N/A]

Function:

Sets the ON time for the timed action.



NOTE!

The adjustable frequency drive has no back-up of the clock function, and the set date/time will reset to default (2000-01-01 00:00) after a power-down unless a Real Time Clock module with back-up is installed. In par.0-79 *Clock Fault* it is possible to program for a warning in case the clock has not been set properly, e.g., after a power-down.

23-01 ON Action

Arra [10]

Option:

Function:

Select the action during ON Time. See par.13-52 *SL Controller Action* for descriptions of the options.

[0] * DISABLED

[1] No action

[2] Select set-up 1

[3] Select set-up 2

[4] Select set-up 3

[5] Select set-up 4

[10] Select preset ref 0

[11] Select preset ref 1

[12] Select preset ref 2

[13] Select preset ref 3

[14] Select preset ref 4

[15]	Select preset ref 5
[16]	Select preset ref 6
[17]	Select preset ref 7
[18]	Select ramp 1
[19]	Select ramp 2
[22]	Run
[23]	Run reverse
[24]	Stop
[26]	Dcstop
[27]	Coast
[28]	Freeze output
[29]	Start timer 0
[30]	Start timer 1
[31]	Start timer 2
[32]	Set digital out A low
[33]	Set digital out B low
[34]	Set digital out C low
[35]	Set digital out D low
[36]	Set digital out E low
[37]	Set digital out F low
[38]	Set digital out A high
[39]	Set digital out B high
[40]	Set digital out C high
[41]	Set digital out D high
[42]	Set digital out E high
[43]	Set digital out F high
[60]	Reset Counter A
[61]	Reset Counter B
[70]	Start Timer 3
[71]	Start Timer 4
[72]	Start Timer 5
[73]	Start Timer 6
[74]	Start Timer 7

23-02 OFF Time

Array [10]

Range:

0 N/A* [0 - 0 N/A]

Function:

Sets the OFF time for the timed action.



NOTE!

The adjustable frequency drive has no back-up of the clock function, and the set date/time will reset to default (2000-01-01 00:00) after a power-down unless a Real Time Clock module with back-up is installed. In par.0-79 *Clock Fault* it is possible to program for a warning in case the clock has not been set properly, e.g., after a power-down.

23-03 OFF Action

Array [10]

Option:**Function:**Select the action during OFF Time. See par.13-52 *SL Controller Action* for descriptions of the options.

[0] * DISABLED

[1] No action

[2] Select set-up 1

[3] Select set-up 2

[4] Select set-up 3

[5] Select set-up 4

[10] Select preset ref 0

[11] Select preset ref 1

[12] Select preset ref 2

[13] Select preset ref 3

[14] Select preset ref 4

[15] Select preset ref 5

[16] Select preset ref 6

[17] Select preset ref 7

[18] Select ramp 1

[19] Select ramp 2

[22] Run

[23] Run reverse

[24] Stop

[26] Dcstop

[27] Coast

[28] Freeze output

[29] Start timer 0

[30] Start timer 1

[31] Start timer 2

[32] Set digital out A low

[33] Set digital out B low

[34] Set digital out C low

[35] Set digital out D low

[36] Set digital out E low

[37] Set digital out F low

[38] Set digital out A high

[39] Set digital out B high

[40] Set digital out C high

[41] Set digital out D high

[42] Set digital out E high

[43] Set digital out F high

[60] Reset Counter A

[61] Reset Counter B

[70]	Start Timer 3
[71]	Start Timer 4
[72]	Start Timer 5
[73]	Start Timer 6
[74]	Start Timer 7

23-04 Occurrence

Array [10]

Option:

Function:

Select the day(s) to which the timed action applies. Specify working/non-working days in par. 0-81 *Working Days*, par.0-82 *Additional Working Days* and par.0-83 *Additional Non-Working Days*.

[0] *	All days
[1]	Working days
[2]	Non-working days
[3]	Monday
[4]	Tuesday
[5]	Wednesday
[6]	Thursday
[7]	Friday
[8]	Saturday
[9]	Sunday

2.20.2 23-1* Maintenance

Wear and tear calls for periodic inspection and service of elements in the application, such as motor bearings, feedback sensors and seals or filters. With preventive maintenance, service intervals may be programmed into the adjustable frequency drive. The adjustable frequency drive will give a message when maintenance is required. 20 preventive maintenance events can be programmed into the adjustable frequency drive. For each event, the following must be specified:

- Maintenance item (e.g., "Motor Bearings")
- Maintenance action (e.g., "Replace")
- Maintenance Time Base (e.g., "Running Hours" or a specific date and time)
- Maintenance Time Interval or the date and time of next maintenance



NOTE!
To disable a preventive maintenance event, the associated par.23-12 *Maintenance Time Base* must be set to *Disabled*[0].

Preventive maintenance can be programmed from the LCP, but using the PC-based VLT Motion Control Tool MCT10 is recommended.

2

ID	Name	Setup 1	Setup 2	Setup 3	Setup 4
2310.0	Maintenance Item	Motor bearings	Motor bearings	Motor bearings	Motor bearings
2310.1	Maintenance Item	Motor bearings	Motor bearings	Motor bearings	Motor bearings
2310.2	Maintenance Item	Motor bearings	Motor bearings	Motor bearings	Motor bearings
2310.3	Maintenance Item	Motor bearings	Motor bearings	Motor bearings	Motor bearings
2310.4	Maintenance Item	Motor bearings	Motor bearings	Motor bearings	Motor bearings
2310.5	Maintenance Item	Motor bearings	Motor bearings	Motor bearings	Motor bearings
2310.6	Maintenance Item	Motor bearings	Motor bearings	Motor bearings	Motor bearings
2310.7	Maintenance Item	Motor bearings	Motor bearings	Motor bearings	Motor bearings
2310.8	Maintenance Item	Motor bearings	Motor bearings	Motor bearings	Motor bearings
2310.9	Maintenance Item	Motor bearings	Motor bearings	Motor bearings	Motor bearings
2310.10	Maintenance Item	Motor bearings	Motor bearings	Motor bearings	Motor bearings
2310.11	Maintenance Item	Motor bearings	Motor bearings	Motor bearings	Motor bearings
2310.12	Maintenance Item	Motor bearings	Motor bearings	Motor bearings	Motor bearings
2310.13	Maintenance Item	Motor bearings	Motor bearings	Motor bearings	Motor bearings
2310.14	Maintenance Item	Motor bearings	Motor bearings	Motor bearings	Motor bearings
2310.15	Maintenance Item	Motor bearings	Motor bearings	Motor bearings	Motor bearings
2310.16	Maintenance Item	Motor bearings	Motor bearings	Motor bearings	Motor bearings
2310.17	Maintenance Item	Motor bearings	Motor bearings	Motor bearings	Motor bearings
2310.18	Maintenance Item	Motor bearings	Motor bearings	Motor bearings	Motor bearings
2310.19	Maintenance Item	Motor bearings	Motor bearings	Motor bearings	Motor bearings
2311.0	Maintenance Action	Lubricate	Lubricate	Lubricate	Lubricate
2311.1	Maintenance Action	Lubricate	Lubricate	Lubricate	Lubricate
2311.2	Maintenance Action	Lubricate	Lubricate	Lubricate	Lubricate
2311.3	Maintenance Action	Lubricate	Lubricate	Lubricate	Lubricate
2311.4	Maintenance Action	Lubricate	Lubricate	Lubricate	Lubricate
2311.5	Maintenance Action	Lubricate	Lubricate	Lubricate	Lubricate
2311.6	Maintenance Action	Lubricate	Lubricate	Lubricate	Lubricate

1308A492.10

The LCP indicates (with a wrench icon and an “M”) when it is time for a preventive maintenance action and can be programmed to be indicated on a digital output in parameter group 5-3*. The Preventive Maintenance Status may be read in par.16-96 *Maintenance Word*. A preventive maintenance indication can be reset from a digital input, the FC bus or manually from the Local Control Panel through par.23-15 *Reset Maintenance Word*.

A maintenance log with the latest 10 loggings can be read from parameter group 18-0* and via the Alarm log button on the LCP after selecting maintenance log.

23-10 Maintenance Item

Option:

Function:

Select the item to be associated with the preventive maintenance event.

- [1] * Motor bearings
- [2] Fan bearings
- [3] Pump bearings
- [4] Valve
- [5] Pressure transmitter
- [6] Flow transmitter
- [7] Temperature transmitter
- [8] Pump seals
- [9] Fan belt
- [10] Filter
- [11] Drive cooling fan
- [12] Drive system health check
- [13] Warranty

[20]	User-defined 1
[21]	User-defined 2
[22]	User-defined 3
[23]	User-defined 4
[24]	User-defined 5
[25]	user-defined 6

 **NOTE!**
 The preventive maintenance events are defined in a 20-element array. Hence, each preventive maintenance event must use the same array element index in par.23-10 *Maintenance Item* to par.23-14 *Maintenance Date and Time*.

23-11 Maintenance Action

Option:	Function:
	Select the action to be associated with the preventive maintenance event.
[1] *	Lubricate
[2]	Clean
[3]	Replace
[4]	Inspect/Check
[5]	Overhaul
[6]	Renew
[7]	Check
[20]	
[21]	
[22]	
[23]	
[24]	
[25]	user-defined 6

23-12 Maintenance Time Base

Option:	Function:
	Select the time base to be associated with the preventive maintenance event.
[0] *	<i>Disabled</i> [0] must be used when disabling the preventive maintenance event.
[1]	<i>Running Hours</i> [1] is the number of hours the motor has been running. Running hours are not reset at power-on. The <i>Maintenance Time Interval</i> must be specified in par.23-13 <i>Maintenance Time Interval</i> .
[2]	<i>Operating Hours</i> [2] is the number of hours the adjustable frequency drive has been running. Operating hours are not reset at power-on. The <i>Maintenance Time Interval</i> must be specified in par. 23-13 <i>Maintenance Time Interval</i> .
[3]	<i>Date & Time</i> [3] uses the internal clock. The date and time of the next maintenance occurrence must be specified in par.23-14 <i>Maintenance Date and Time</i> .

23-13 Maintenance Time Interval

Range:

1 h* [1 - 2147483647 h]

Function:

Set the interval associated with the current preventive maintenance event. This parameter is only used if *Running Hours* [1] or *Operating Hours* [2] is selected in par.23-12 *Maintenance Time Base*. The timer is reset from par.23-15 *Reset Maintenance Word*.

Example:

A preventive maintenance event is set up for Monday at 8:00. par.23-12 *Maintenance Time Base* is *Operating hours* [2] and par.23-13 *Maintenance Time Interval* is 7 x 24 hours=168 hours. The next maintenance event will be indicated the following Monday at 8:00. If this maintenance event is not reset until Tuesday at 9:00, the next occurrence will be the following Tuesday at 9:00.

23-14 Maintenance Date and Time

Range:

0 N/A* [0 - 0 N/A]

Function:

Set the date and time for next maintenance occurrence if the preventive maintenance event is based on date/time. Date format depends on the setting in par. 0-71 *Date Format* while the time format depends on the setting in par.0-72 *Time Format*.

NOTE!

The adjustable frequency drive has no back up of the clock function and the set date/time will reset to default (2000-01-01 00:00) after a power-down. In par. 0-79 *Clock Fault* it is possible to program for a warning in case the clock has not been set properly, e.g. after a power-down.

The time set must be at least one hour from the actual time!

NOTE!

When mounting an Analog I/O MCB109 option card, a battery back-up of the date and time is included.

23-15 Reset Maintenance Word

Option:

[0] * Do not reset

[1] Do reset

Function:

Set this parameter to *Do reset* [1] to reset the Maintenance Word in par.16-96 *Maintenance Word* and reset the message displayed in the LCP. This parameter will change back to *Do not reset* [0] when pressing OK.

NOTE!

When messages are reset - Maintenance Item, Action and Maintenance Date/Time are not cancelled. par.23-12 *Maintenance Time Base* is set to Disabled [0].

2.20.3 Energy Log, 23-5*

The adjustable frequency drive is continuously accumulating the consumption of the motor controlled, based on the actual power yielded by the adjustable frequency drive.

These data can be used for an energy log function allowing the user to compare and structure the information about the energy consumption related to time.

There are basically two functions:

- Data related to a pre-programmed period, defined by a set date and time for start
- Data related to a predefined period back in time, such as the last seven days within the pre-programmed period, for example.

For each of the above two functions, the data are stored in a number of counters allowing for selecting time frame and a split in hours, days or weeks. The period/split (resolution) can be set in par.23-50 *Energy Log Resolution*.

The data are based on the value registered by the kWh counter in the adjustable frequency drive. This counter value can be read in par.15-02 *kWh Counter* containing the accumulated value since the first power-up or latest reset of the counter (par.15-06 *Reset kWh Counter*).

All data for the energy log are stored in counters which can be read from par.23-53 *Energy Log*.

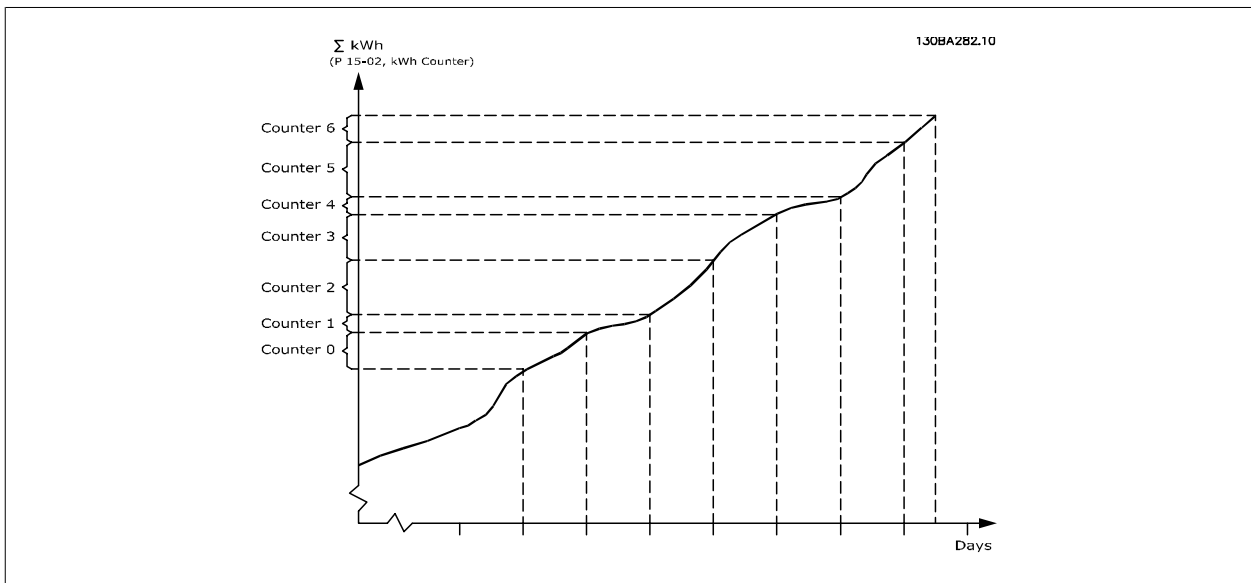

Counter 00 will always contain the oldest data. A counter will cover a period from XX:00 to XX:59 if hours or 00:00 to 23:59 if days. If logging either the last hours or last days, the counters will shift contents at XX:00 every hour or at 00:00 every day. Counter with highest index will always be subject to update (containing data for the actual hour since XX:00 or the actual day since 00:00).

The contents of counters can be displayed as bars on LCP. Select *Quick Menu, Loggings, Energy Log: Trending Continued Bin / Trending Timed Bin / Trending Comparison*.

23-50 Energy Log Resolution

Option:

Function:

Select the desired type of period for logging of consumption. Hour of Day [0], Day of Week [1] or Day of Month [2]. The counters contain the logging data from the programmed date/time for start (par.23-51 *Period Start*) and the numbers of hours/days as programmed for (par.23-50 *Energy Log Resolution*).

The logging will start on the date programmed in par.23-51 *Period Start*, and continue until one day/week/month has gone. Last 24 Hours [5], Last 7 Days [6] or Last 5 Weeks [7]. The counters contain data for the previous day, week or five-week period, and up to the present time.

The logging will start at the date programmed in par.23-51 *Period Start*. In all cases, the period split will refer to operating hours (the time during which the adjustable frequency drive is powered up).

[0]	Hour of Day
[1]	Day of Week
[2]	Day of Month
[5] *	Last 24 Hours
[6]	Last 7 Days
[7]	Last 5 Weeks

**NOTE!**

The adjustable frequency drive has no backup of the clock function, and the set date/time will reset to default (2000-01-01 00:00) after a power-down unless a real time clock module with backup is installed. Consequently, the logging will be stopped until date/time is readjusted in par. 0-70 *Set Date and Time*. In par.0-79 *Clock Fault*, it is possible to program for a warning in case the clock has not been set properly, e.g. after a power-down.

23-51 Period Start**Range:**

0 N/A* [0 - 0 N/A]

Function:

Set the date and time at which the energy log is begin updating the counters. First data will be stored in the counter [00] and start at the time/date programmed in this parameter.

Date format will depend on setting in par. 0-71 *Date Format* and time format on setting in par. 0-72 *Time Format*.

**NOTE!**

When mounting an Analog I/O MCB109 option card, a battery back-up of the date and time is included.

23-52 Period Stop**Range:**

2000-01-01 [2000-01-01 00:00 - 2099-12-31 00:00* 23:59]

Function:

Set the date and time at which the energy log must stop updating the counters.

If the period defined by par. 23-51 and 23-52 is longer than 24 hours/7 days/31 days (depending on selection in par. 23-50), the logging will stop when all buffers are used.

23-53 Energy Log

Range:

0 N/A* [0 - 4294967295 N/A]

Function:

Array with a number of elements equal to the number of counters ([00]-[xx] below parameter number in display). Press OK and Step between elements by means of ▲ and ▼ buttons on the Local Control Panel.

Array elements:

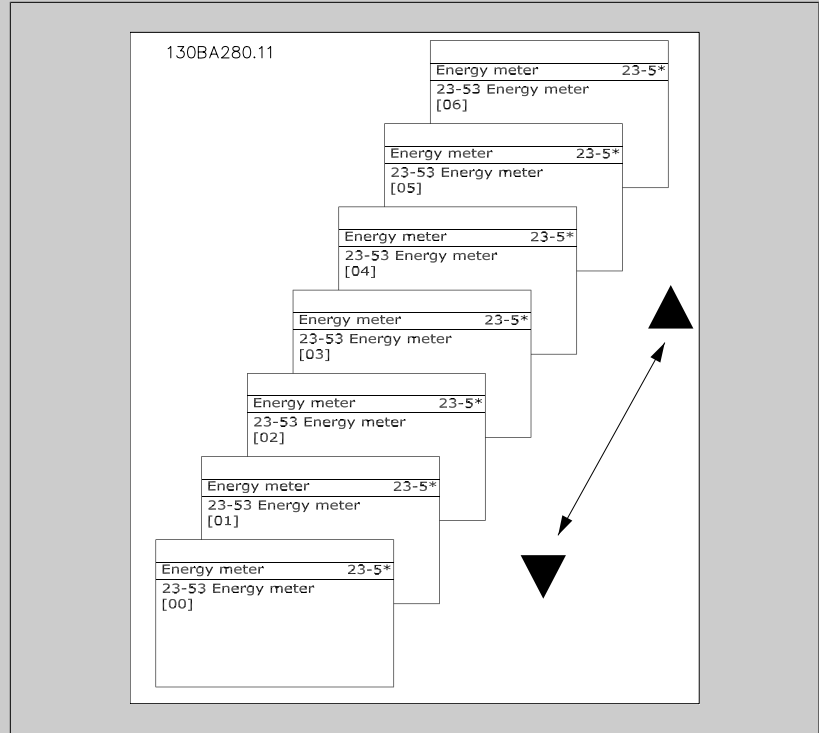

Data from latest period is stored in the counter with the highest index.
At power-down, all counter values are stored and resumed at next power-up.



NOTE!

All counters are automatically reset when changing the setting in par.23-50 *Energy Log Resolution*. At overflow, the update of the counters will stop at maximum value.



NOTE!

When mounting an Analog I/O MCB109 option card, a battery back-up of the date and time is included.

23-54 Reset Energy Log

Option:

Function:

Select *Do reset* [1] to reset all values in the Energy Log counters shown in par.23-53 *Energy Log*. After pressing OK, the setting of the parameter value will automatically change to *Do not reset* [0].

[0] * Do not reset

[1] Do reset

2.20.4 Trending, 23-6*

Trending is used to monitor a process variable over a given period of time and to record how often the data falls into each of the ten user-defined data ranges. This is a convenient tool to gain a quick overview of potential areas of operational improvement.

2

Two sets of data for trending can be created in order to make it possible to compare current values for a selected operating variable with data for a certain reference period and for the same variable. This reference period can be pre-programmed (par.23-63 *Timed Period Start* and par.23-64 *Timed Period Stop*). The two sets of data can be read from par.23-61 *Continuous Bin Data* (current) and par.23-62 *Timed Bin Data* (reference).

It is possible to create trending for the following operation variables:

- Power
- Current
- Output frequency
- Motor Speed

The trending function includes ten counters (forming a bin) for each set of data containing the numbers of registrations, reflecting how often the operating variable is within each of ten pre-defined intervals. The sorting is based on a relative value of the variable.

The relative value for the operating variable is

Actual/Rated * 100%.

for Power and Current and

Actual/Max * 100%

for Output Frequency and Motor Speed.

The size of each interval can be adjusted individually, but the default level will be 10% for each. Power and current can exceed rated value, but those registrations will be included in the 90%–100% (MAX) counter.

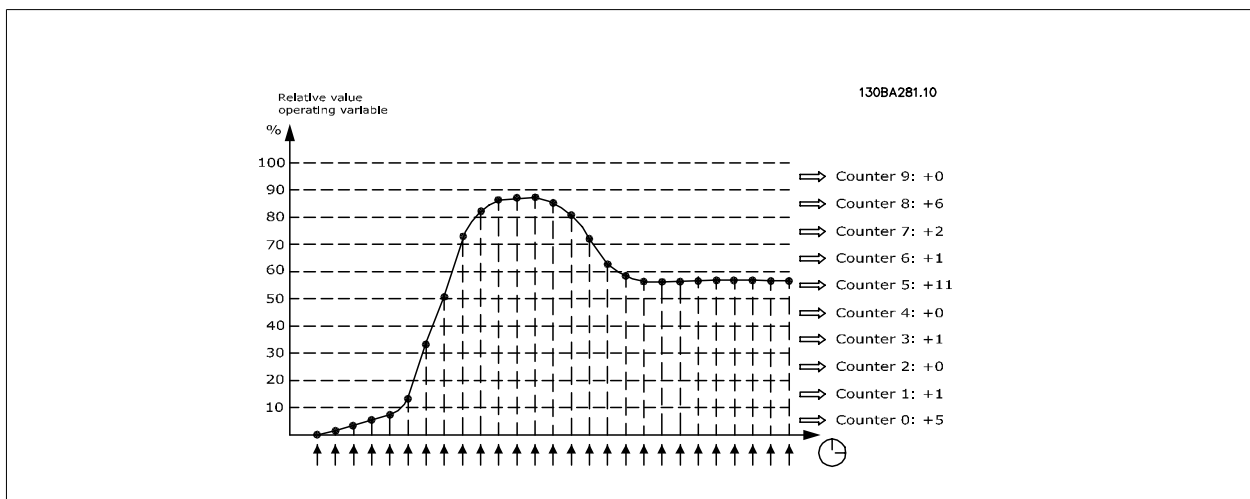

The value of the operating variable selected is registered once every second. If a value has been registered to equal 13%, the counter "10%–<20%" will be updated with the value "1". If the value stays at 13% for 10 s, then "10" will be added to the counter value.

The contents of counters can be displayed as bars on LCP. Select *Quick Menu > Loggings: Trending Continued Bin / Trending Timed Bin / Trending Comparison*.

NOTE!
The counters starts counting whenever the adjustable frequency drive is powered-up. Power cycle shortly after a reset will zero the counters. EEPROM data are updated once per hour.

23-60 Trend Variable

Option:	Function:
	Select the desired operating variable to be monitored for trending.
[0] * Power [kW]	Power yielded to the motor. Reference for the relative value is the rated motor power programmed in par.1-20 <i>Motor Power [kW]</i> or par.1-21 <i>Motor Power [HP]</i> . Actual value can be read in par. 16-10 <i>Power [kW]</i> or par.16-11 <i>Power [hp]</i> .
[1] Current [A]	Output current to the motor. Reference for the relative value is the rated motor current programmed in par.1-24 <i>Motor Current</i> . Actual value can be read in par.16-14 <i>Motor Current</i> .
[2] Frequency [Hz]	Output frequency to the motor. Reference for the relative value is the maximum output frequency programmed in par. 4-14 <i>Motor Speed High Limit [Hz]</i> . Actual value can be read in par. 16-13 <i>Frequency</i> .
[3] Motor Speed [RPM]	Speed of the motor. Reference for relative value is the maximum motor speed programmed in par. 4-13 <i>Motor Speed High Limit [RPM]</i> .

23-61 Continuous Bin Data

Range:	Function:
0 N/A* [0 - 4294967295 N/A]	<p>Array with 10 elements ([0]–[9] below parameter number in display). Press OK and step between elements by means of ▲ and ▼ buttons on the LCP.</p> <p>10 counters with the frequency of occurrence for the operating variable monitored, sorted according to the following intervals:</p> <ul style="list-style-type: none"> Counter [0]: 0%–<10% Counter [1]: 10%–<20% Counter [2]: 20%–<30% Counter [3]: 30%–<40% Counter [4]: 40%–<50% Counter [5]: 50%–<60% Counter [6]: 60%–<70% Counter [7]: 70%–<80% Counter [8]: 80%–<90% Counter [9]: 90%–<100% or Max <p>The above minimum limits for the intervals are the default limits. These can be changed in par. 23-65 <i>Minimum Bin Value</i>.</p> <p>Starts to count when the adjustable frequency drive is powered up for the first time. All counters can be reset to 0 in par.23-66 <i>Reset Continuous Bin Data</i>.</p>

23-62 Timed Bin Data**Range:**

0 N/A* [0 - 4294967295 N/A]

Function:

Array with 10 elements ([0]–[9] below parameter number in display). Press OK and step between elements by means of ▲ and ▼ buttons on the LCP.

10 counters with the frequency of occurrence for the operating data monitored sorted according to the intervals as for par.23-61 *Continuous Bin Data*.

Starts to count at the date/time programmed in par.23-63 *Timed Period Start*, and stops at the time/date programmed in par.23-64 *Timed Period Stop*. All counters can be reset to 0 in par.23-67 *Reset Timed Bin Data*.

23-63 Timed Period Start**Range:**

0 N/A* [0 - 0 N/A]

Function:

Set the date and time at which the trending starts the update of the timed bin counters.

Date format will depend on setting in par. 0-71 *Date Format*, and time format on setting in par. 0-72 *Time Format*.

**NOTE!**

The adjustable frequency drive has no back-up of the clock function, and the set date/time will reset to default (2000-01-01 00:00) after a power-down unless a Real Time Clock module with back-up is installed. Consequently the logging will be stopped until date/time is readjusted in par. 0-70 *Set Date and Time*. In par.0-79 *Clock Fault* it is possible to program for a warning in case the clock has not been set properly, e.g. after a power-down.

**NOTE!**

When mounting an Analog I/O MCB109 option card, a battery back-up of the date and time is included.

23-64 Timed Period Stop**Range:**

0 N/A* [0 - 0 N/A]

Function:

Set the date and time at which the trend analyses must stop the update of the timed bin counters.

Date format will depend on setting in par. 0-71 *Date Format*, and time format on setting in par. 0-72 *Time Format*.

**NOTE!**

When mounting an Analog I/O MCB109 option card, a battery back-up of the date and time is included.

23-65 Minimum Bin Value**Range:**

0 %* [0 - 100. %]

Function:

Array with 10 elements ([0]–[9] below parameter number in display). Press OK and step between elements by means of ▲ and ▼ buttons on the LCP.

Set the minimum limit for each interval in par.23-61 *Continuous Bin Data* and par.23-62 *Timed Bin Data*. Example: if selecting *counter*[1] and changing setting from 10% to 12%, *counter*[0] will be based on the interval 0%–<12% and *counter*[1] on interval 12%–<20%.

23-66 Reset Continuous Bin Data

Option:

Function:

Select *Do reset* [1] to reset all values in par.23-61 *Continuous Bin Data*.
After pressing OK, the setting of the parameter value will automatically change to *Do not reset* [0].

[0] * Do not reset

[1] Do reset

23-67 Reset Timed Bin Data

Option:

Function:

Select *Do reset* [1] to reset all counters in par.23-62 *Timed Bin Data*.
After pressing OK, the setting of the parameter value will automatically change to *Do not reset* [0].

[0] * Do not reset

[1] Do reset

2.20.5 23-8* Payback counter

The VLT AQUA Drive includes a feature that can provide a rough calculation of payback in cases in which the adjustable frequency drive has been installed in an existing plant to ensure energy saving by changing from fixed to variable speed control. Reference for savings is a set value that represents the average power yielded before the upgrade with variable speed control.

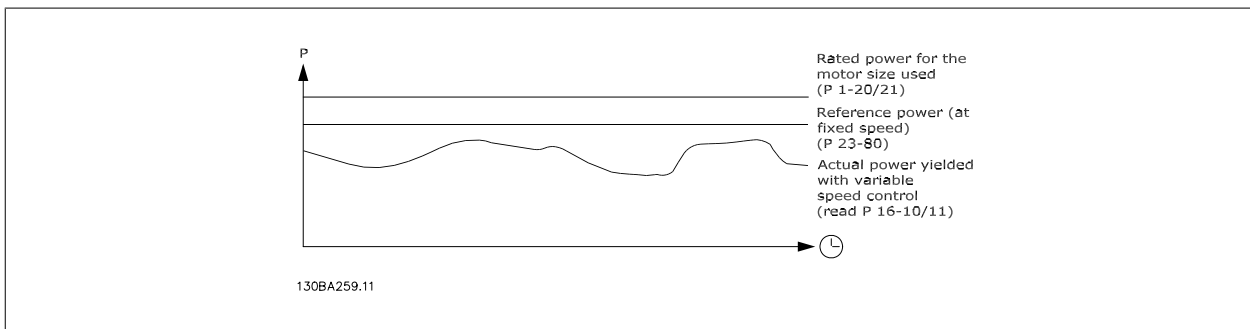

The difference between the reference power at fixed speed and the actual power yielded with speed control represents the actual savings.

As a value for the fixed speed case, the rated motor size (kW) is multiplied by a factor (set as a %) representing the power yielded at fixed speed. The difference between this reference power and the actual power is accumulated and stored. The difference in energy can be read in par. 23-83, *Energy Savings*.

The accumulated value for the difference in power consumption is multiplied by the energy cost in local currency, and the investment is then subtracted. This calculation for cost savings can also be read in par. 23-84, *Cost Savings*.

$$\text{Cost Savings} = (\sum(\text{Reference Power} - \text{Actual Power})) * \text{Energy Cost} - \text{Additional Cost}$$

Break even (payback) occurs when the value read in the parameter turns from negative to positive.

It is not possible to reset the energy savings counter, but the counter can be stopped any time by setting par. 28-80, *Power Reference Factor*, to 0.

Parameter overview:

Parameter for settings		Parameters for readout	
Rated Motor Power	Par. 1-20	Energy Savings	Par. 23-83
Power Reference Factor in %	Par. 23-80	Actual Power	Par. 16-10/11
Energy Cost per kWh	Par. 23-81	Cost Savings	Par. 23-84
Investment	Par. 23-82		

2

23-80 Power Reference Factor

Range:

100 %* [0 - 100 %]

Function:

Set the percentage of the rated motor size (set in par.1-20 *Motor Power [kW]* or par.1-21 *Motor Power [HP]*) which is supposed to represent the average power yielded at the time running with fixed speed (before upgrade with variable speed control).
Must be set to a value different from zero to start counting.

23-81 Energy Cost

Range:

1.00 N/A* [0.00 - 999999.99 N/A]

Function:

Set the actual cost for a kWh in local currency. If the energy cost is changed later on, it will impact the calculation for the entire period!

23-82 Investment

Range:

0 N/A* [0 - 999999999 N/A]

Function:

Set the value of the investment spent on upgrading the plant with speed control, in the same currency as used in par.23-81 *Energy Cost*.

23-83 Energy Savings

Range:

0 kWh* [0 - 0 kWh]

Function:

This parameter allows for a readout of the accumulated difference between the reference power and the actual output power.
If the motor size is set in HP (par.1-21 *Motor Power [HP]*), the equivalent kW value will be used for the Energy Savings.

23-84 Cost Savings

Range:

0 N/A* [0 - 2147483647 N/A]

Function:

This parameter allows for a readout of the calculation based on the above equation (in local currency).

2.21 Main Menu - Cascade Controller - Group 25

2.21.1 25-** Cascade Controller

Parameters for configuring the basic cascade controller for sequence control of multiple pumps. For a more application-oriented description and wiring examples, see section *Application Examples, Basic Cascade Controller*.

To configure the Cascade Controller to the actual system and the desired control strategy, it is recommended to follow the sequence below, starting with par. 25-0* *System Settings* and next par. 25-5* *Alternation Settings*. These parameter can normally be set in advance.

Parameters in 25-2* *Bandwidth Settings* and 25-4* *Staging settings*, will often be dependent on the dynamics of the system and final adjustment to be done at the commissioning of the plant.

NOTE!

The Cascade Controller is supposed to operate in closed-loop controlled by the built-in PI controller (Closed-loop selected in *Configuration Mode*, par.1-00 *Configuration Mode*). If *Open-loop* is selected in par.1-00 *Configuration Mode*, all fixed speed pumps will be de-staged, but the variable speed pump will still be controlled by the adjustable frequency drive, now as an open-loop configuration:

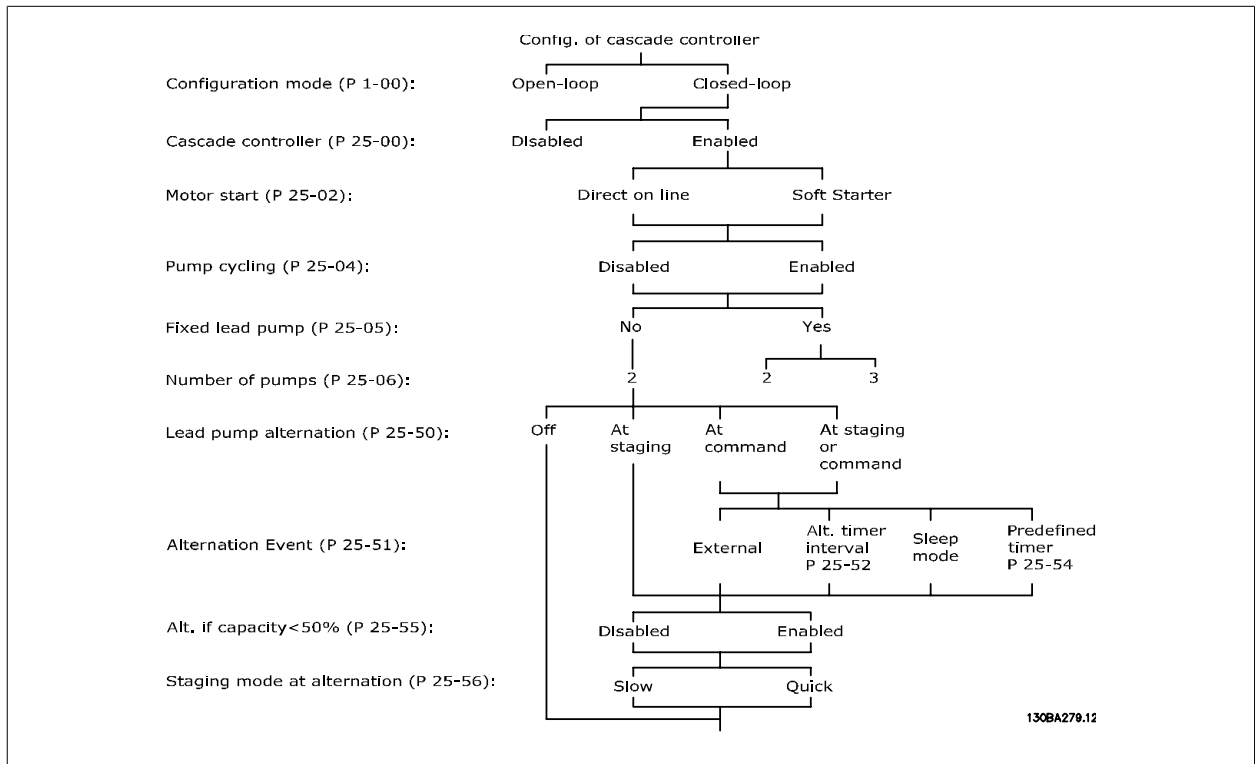

2.21.2 25-0* System Settings

Parameters related to control principles and configuration of the system.

25-00 Cascade Controller

Option:
Function:

For operation of multiple devices (pump/fan) systems where capacity is adapted to actual load by means of speed control combined with on/off control of the devices. For simplicity, only pump systems are described.

[0] * Disabled

The Cascade Controller is not active. All built-in relays assigned to pump motors in the cascade function will be de-energized. If a variable speed pump is connected to the adjustable frequency drive directly (not controlled by a built-in relay); this pump/fan will be controlled as a single pump system.

[1] Enabled

The Cascade Controller is active and will stage/de-stage pumps according to load on the system.

25-02 Motor Start

Option:
Function:

Motors are directly connected to the line power with a contactor or a soft starter. When the value of par.25-02 *Motor Start* is set to an option other than *Direct on Line* [0], then par.25-50 *Lead Pump Alternation* is automatically set to the default of *Direct on Line* [0].

[0] * Direct on Line

Each fixed speed pump is directly connected to line via a contactor.

[1] Soft Starter

Each fixed speed pump is connected to line via a soft starter.

[2]

25-04 Pump Cycling

Option:
Function:

To provide equal hours of operation with fixed speed pumps, the pump use can be cycled. The selection of pump cycling is either "first in – last out" or equal running hours for each pump.

[0] * Disabled

The fixed speed pumps will be connected in the order 1 – 2 and disconnected in the order 2 – 1. (First in – last out).

[1] Enabled

The fixed speed pumps will be connected/disconnected to have equal running hours for each pump.

25-05 Fixed Lead Pump

Option:
Function:

Fixed Lead Pump means that the variable speed pump is connected directly to the adjustable frequency drive, and if a contactor is applied between adjustable frequency drive and pump, this contactor will not be controlled by the adjustable frequency drive.

If operating with par.25-50 *Lead Pump Alternation* set to other than *Off* [0], this parameter must be set to *No* [0].

[0] No

The lead pump function can alternate between the pumps controlled by the two built in relays. One pump must be connected to the built-in RELAY 1, and the other pump to RELAY 2. The pump function (Cascade Pump1 and Cascade Pump2) will automatically be assigned to the relays (maximum two pumps can in this case be controlled from the adjustable frequency drive).

[1] * Yes

The lead pump will be fixed (no alternation) and connected directly to the adjustable frequency drive. The par.25-50 *Lead Pump Alternation* is automatically set to *Off* [0]. Built-in relays Relay 1 and Relay 2 can be assigned to separate fixed speed pumps. A total of three pumps can be controlled by the adjustable frequency drive.

25-06 Number Of Pumps

Range:

2 N/A* [2 - 9. N/A]

Function:

The number of pumps connected to the cascade controller including the variable speed pump. If the variable speed pump is connected directly to the adjustable frequency drive, and the other fixed speed pumps (lag pumps) are controlled by the two built in relays, three pumps can be controlled. If both the variable speed and fixed speed pumps are to be controlled by built-in relays, only two pumps can be connected.

If *par.25-05 Fixed Lead Pump, Fixed Lead Pump*, is set to *No* [0]: one variable speed pump and one fixed speed pump; both are controlled by the built-in relay. If *par.25-05 Fixed Lead Pump, Fixed Lead Pump*, is set to *Yes* [1]: one variable speed pump and one fixed speed pump is controlled by the built-in relay.

One lead pump, see *par.25-05 Fixed Lead Pump*. Two fixed speed pumps controlled by built-in relays.

2.21.3 25-2* Bandwidth Manager

Parameters for setting the bandwidth within which the pressure will be allowed to operate before staging/de-staging fixed speed pumps. Also includes various timers to stabilize the control.

25-20 Staging Bandwidth

Range:

10 %* [1 - par. 25-21 %]

Function:

Set the staging bandwidth (SBW) percentage to accommodate normal system pressure fluctuation. In cascade control systems, to avoid frequent switching of fixed speed pumps, the desired system pressure is typically kept within a bandwidth rather than at a constant level.

The SBW is programmed as a percentage of *par.3-02 Minimum Reference* and *par.3-03 Maximum Reference*. For example, if the setpoint is 5 bar and the SBW is set to 10%, a system pressure between 4.5 and 5.5 bar is tolerated. No staging or de-staging will occur within this bandwidth.

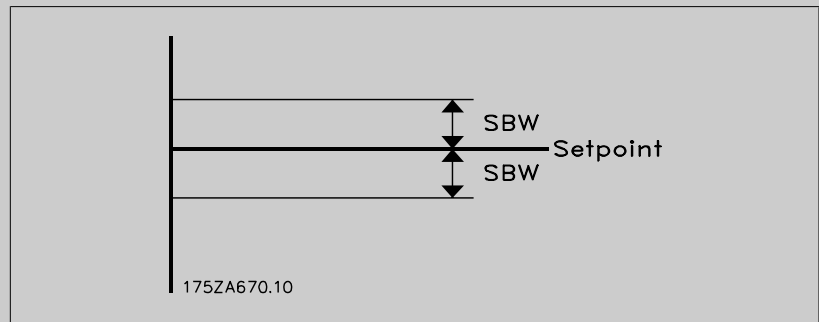

25-21 Override Bandwidth

Range:

100 %* [par. 25-20 - 100 %]

Function:

When a large and quick change in the system demand occurs (such as a sudden water demand), the system pressure rapidly changes, and an immediate staging or de-staging of a fixed speed pump becomes necessary to match the requirement. The override bandwidth (OBW) is programmed to override the staging/de-staging timer (*par.25-23 SBW Staging Delay* and *par.25-24 SBW De-staging Delay*) for immediate response.

The OBW must always be programmed to a higher value than the value set in *Staging Bandwidth* (SBW), *par.25-20 Staging Bandwidth*. The OBW is a percentage of *par.* and *par.* .

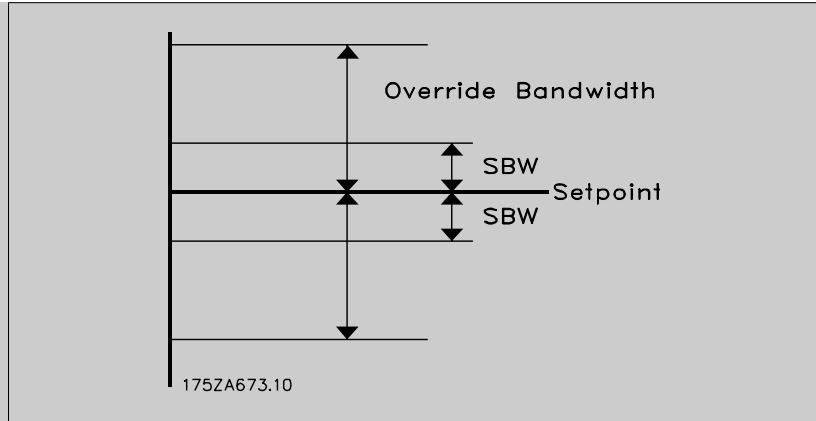

Setting the OBW too close to the SBW could defeat the purpose in the event of frequent staging at momentary pressure changes. Setting the OBW too high might lead to unacceptably high or low pressures in the system while the SBW timers are running. The value can be optimized with increased familiarity with the system. See par.25-25 *OBW Time*.

To avoid unintended staging during the commissioning phase and fine tuning of the controller, initially leave the OBW at the factory setting of 100% (Off). When the fine tuning is completed, the OBW should be set to the desired value. An initial value of 10% is suggested.

25-22 Fixed Speed Bandwidth

Range:

par. 25-20 [par. 25-20 - par. 25-21 %]
%*

Function:

When the cascade control system is running normally and the adjustable frequency drive issues a trip alarm, it is important to maintain the system head. The cascade controller does this by continuing to stage/de-stage the fixed speed pump on and off. Due to the fact that keeping the head at the setpoint would require frequent staging and de-staging when only a fixed speed pump is running, a wider fixed speed bandwidth (FSBW) is used instead of SBW. It is possible to stop the fixed speed pumps, in case of an alarm situation, by pressing the LCP OFF or HAND ON keys or if the signal programmed for Start on digital input goes low.

In case the issued alarm is a trip-lock alarm, the cascade controller must stop the system immediately by cutting out all the fixed speed pumps. This is basically the same as an emergency stop (coast/coast inverse command) for the cascade controller.

25-23 SBW Staging Delay

Range:

15 s* [0 - 3000 s]

Function:

Immediate staging of a fixed speed pump is not desirable when a momentary pressure drop in the system exceeds the staging bandwidth (SBW). Staging is delayed by the length of time programmed. If the pressure increases to within the SBW before the timer has elapsed, the timer is reset.

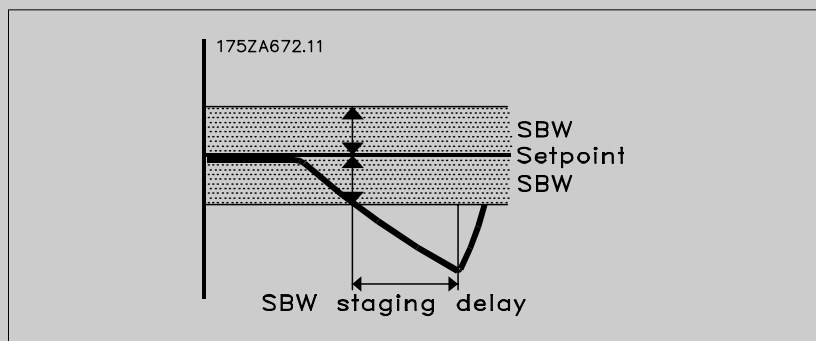

25-24 SBW De-staging Delay

Range:

15 s* [0 - 3000 s]

Function:

Immediate de-staging of a fixed speed pump is not desirable during a momentary pressure increase in the system that exceeds the staging bandwidth (SBW). De-staging is delayed by the length of time programmed. If the pressure decreases to within the SBW before the timer has elapsed, the timer is reset.

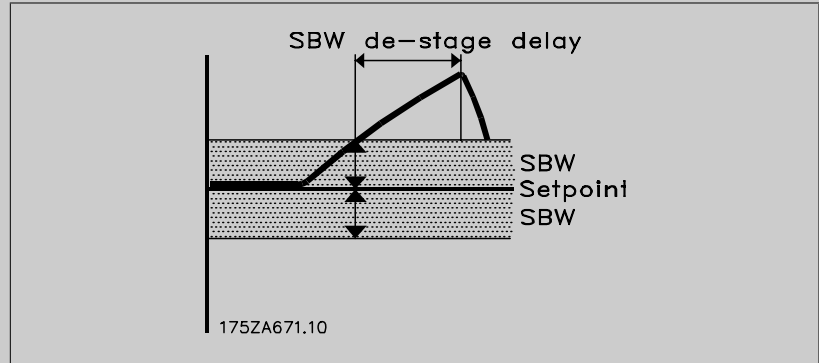

25-25 OBW Time

Range:

10 s* [0 - 300 s]

Function:

Staging a fixed speed pump creates a momentary pressure peak in the system, which might exceed the override bandwidth (OBW). It is not desirable to de-stage a pump in response to a staging pressure peak. The OBW time can be programmed to prevent staging until the system pressure has stabilized and normal control has been established. Set the timer to a value that allows the system to stabilize after staging. The 10-second factory setting is appropriate in most applications. In highly dynamic systems, a shorter time may be desirable.

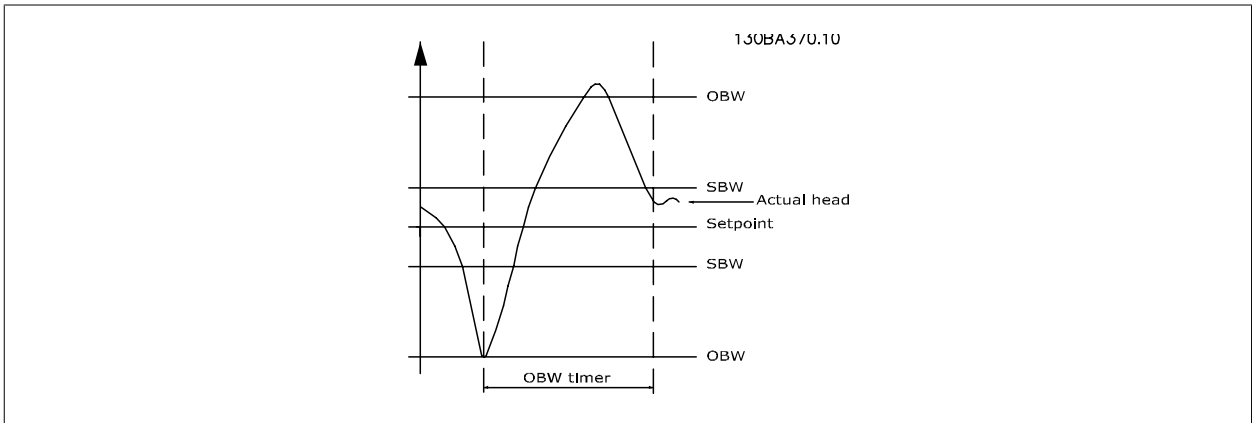

25-26 Destage At No-Flow

Option:

Function:

The de-stage at the no-flow parameter ensures that when a no-flow situation occurs, the fixed speed pumps will be de-staged one-by-one until the no-flow signal disappears. This requires that no-flow detection is active. See par. 22-2*.

If De-stage at No-Flow is disabled the Cascade Controller does not change the normal behavior of the system.

[0] * Disabled

[1] Enabled

25-27 Stage Function**Option:**

[0] Disabled

[1] * Enabled

Function:

If the stage function is set to *Disabled* [0], par.25-28 *Stage Function Time* will not be activated.

25-28 Stage Function Time**Range:**

15 s* [0 - 300 s]

Function:

Stage function time is programmed to avoid frequent staging of the fixed speed pumps. The stage function time starts if it is *Enabled* [1] by par.25-27 *Stage Function*, and when the variable speed pump is running at *Motor Speed High Limit*, par.4-13 *Motor Speed High Limit [RPM]* or par. 4-14 *Motor Speed High Limit [Hz]*, with at least one fixed speed pump in the stop position. When the programmed value of the timer expires, a fixed speed pump is staged.

25-29 Destage Function**Option:**

[0] Disabled

[1] * Enabled

Function:

The de-stage function ensures that the lowest number of pumps are running to save energy and to avoid dead head water circulation in the variable speed pump. If the de-stage function is set to *Disabled* [0], the par.25-30 *Destage Function Time* will not be activated.

25-30 Destage Function Time**Range:**

15 s* [0 - 300 s]

Function:

The de-stage function timer is programmable to avoid frequent staging/de-staging of the fixed speed pumps. The de-stage function time starts when the adjustable speed pump is running at par. 4-11 *Motor Speed Low Limit [RPM]* or par.4-12 *Motor Speed Low Limit [Hz]*, with one or more fixed speed pumps in operation and system requirements satisfied. In this situation, the adjustable speed pump contributes a little to the system. When the programmed value of the timer expires, a stage is removed, avoiding dead head water circulation in the adjustable speed pump.

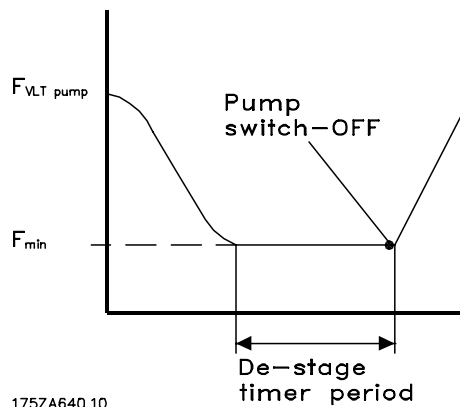
**2.21.4 25-4* Staging Settings**

Parameters determining conditions for staging/de-staging the pumps.

25-40 Ramp-down Delay

Range:

10.0 s* [0.0 - 120.0 s]

Function:

When adding a fixed speed pump controlled by a soft starter, it is possible to delay the ramp-down of the lead pump until a preset time following the start of the fixed speed pump in order to eliminate pressure surges or water hammering in the system.

Only to be used if *Soft Starter* [1] is selected in par.25-02 *Motor Start*.

25-41 Ramp-up Delay

Range:

2.0 s* [0.0 - 12.0 s]

Function:

When removing a fixed speed pump controlled by a soft starter, it is possible to delay the ramp up of the lead pump until a preset time after stopping the fixed speed pump to eliminate pressure surges or water hammer in the system.

Only to be used if *Soft Starter* [1] is selected in par.25-02 *Motor Start*.

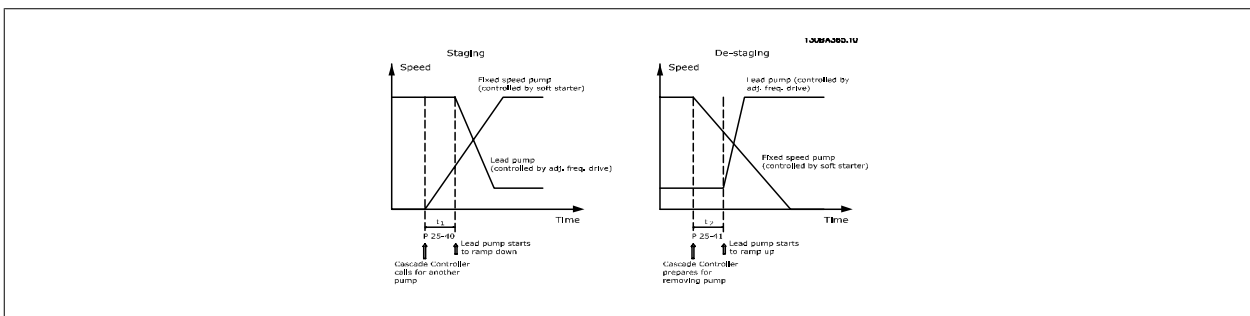

25-42 Staging Threshold

Range:

0 %* [0 - 100 %]

Function:

When adding a fixed speed pump, in order to prevent an overshoot of pressure, the variable speed pump ramps down to a lower speed. When the variable speed pump reaches the "Staging Speed", the fixed speed pump is staged on. The staging threshold is used to calculate the speed of the variable speed pump when the "cut-in point" of the fixed speed pump occurs. The calculation of the staging threshold is the ratio of par.4-11 *Motor Speed Low Limit [RPM]* or par.4-12 *Motor Speed Low Limit [Hz]*, to the par.4-13 *Motor Speed High Limit [RPM]* or par. 4-14 *Motor Speed High Limit [Hz]*, expressed in percent.

$$\text{Staging threshold must range from } \text{STAGE\%} = \frac{\text{LOW}}{\text{HIGH}} \times 100 \%$$

to 100%, where n_{LOW} is Motor Speed Low Limit and n_{HIGH} is Motor Speed High Limit.

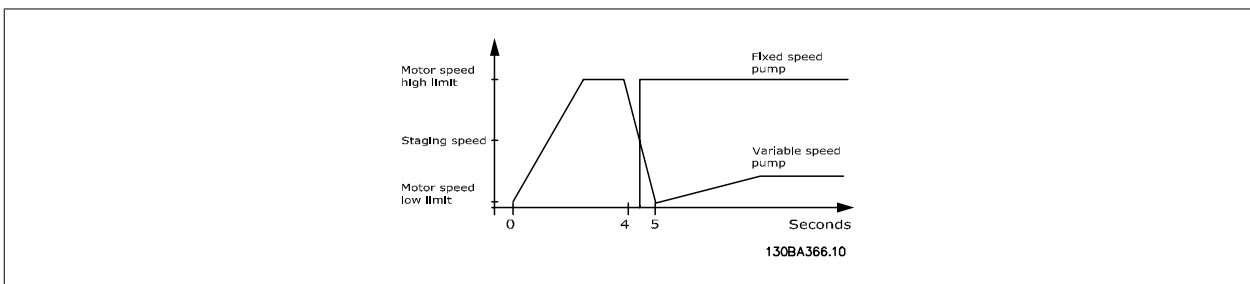

25-43 De-staging Threshold**Range:**

0 %* [0 - 100 %]

Function:

When removing a fixed speed pump, in order to prevent an undershoot of pressure, the variable speed pump ramps up to a higher speed. When the variable speed pump reaches the "De-staging Speed", the fixed speed pump is de-staged. The de-staging threshold is used to calculate the speed of the variable speed pump when the de-staging of the fixed speed pump occurs. The calculation of the de-staging threshold is the ratio of par.4-11 *Motor Speed Low Limit [RPM]* or par.4-12 *Motor Speed Low Limit [Hz]*, to the par.4-13 *Motor Speed High Limit [RPM]* or par. 4-14 *Motor Speed High Limit [Hz]*, expressed in percent.

De-staging threshold must range from $STAGE\% = \frac{LOW}{HIGH} \times 100\%$ to 100%, where n_{LOW} is Motor Speed Low Limit and n_{HIGH} is Motor Speed High Limit.

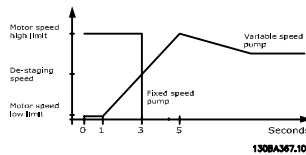
**25-44 Staging Speed [RPM]****Range:**

0 RPM* [0 - 0 RPM]

Function:

Readout of the below calculated value for the staging speed. When adding a fixed speed pump, in order to prevent an overshoot of pressure, the variable speed pump ramps down to a lower speed. When the variable speed pump reaches the "Staging Speed", the fixed speed pump is staged on. Staging Speed calculation is based on par.25-42 *Staging Threshold* and par.4-13 *Motor Speed High Limit [RPM]*.

Staging speed is calculated by using the following formula:

$$STAGE = HIGH \frac{STAGE\%}{100}$$

where n_{HIGH} is Motor Speed High Limit and $n_{STAGE100\%}$ is the value of Staging Threshold.

25-45 Staging Speed [Hz]**Range:**

0.0 Hz* [0.0 - 0.0 Hz]

Function:

Readout of the below calculated value for the staging speed. When adding a fixed speed pump, in order to prevent an overshoot of pressure, the variable speed pump ramps down to a lower speed. When the variable speed pump reaches the "Staging Speed", the fixed speed pump is staged on. Staging speed calculation is based on par.25-42 *Staging Threshold* and par. 4-14 *Motor Speed High Limit [Hz]*.

Staging speed is calculated by using the following formula:

$$STAGE = HIGH \frac{STAGE\%}{100} \text{ where } n_{HIGH} \text{ is Motor Speed High Limit and } n_{STAGE100\%} \text{ is the value of Staging Threshold.}$$

25-46 De-staging Speed [RPM]

Range:

0 RPM* [0 - 0 RPM]

Function:

Readout of the below calculated value for the de-staging speed. When removing a fixed speed pump, in order to prevent an undershoot of pressure, the variable speed pump ramps up to a higher speed. When the variable speed pump reaches the "De-staging Speed", the fixed speed pump is de-staged. De-staging speed is calculated based on par.25-43 *De-staging Threshold* and par. 4-13 *Motor Speed High Limit [RPM]*.

The de-staging speed is calculated with the following formula:

$$DE-STAGE = HIGH \frac{DE-STAGE\%}{100}$$

where n_{HIGH} is Motor Speed High Limit and n_{DE-STAGE100%} is the value of De-staging Threshold.

25-47 De-staging Speed [Hz]

Range:

0.0 Hz* [0.0 - 0.0 Hz]

Function:

Readout of the below calculated value for the de-staging speed. When removing a fixed speed pump, in order to prevent an undershoot of pressure, the variable speed pump ramps up to a higher speed. When the variable speed pump reaches the "De-staging Speed", the fixed speed pump is de-staged. De-staging speed is calculated based on par.25-43 *De-staging Threshold* and par. 4-14 *Motor Speed High Limit [Hz]*.

The de-staging speed is calculated by using the following formula:

$$DE-STAGE = HIGH \frac{DE-STAGE\%}{100}$$

where n_{HIGH} is Motor Speed High Limit and n_{DE-STAGE100%} is the value of De-staging Threshold.

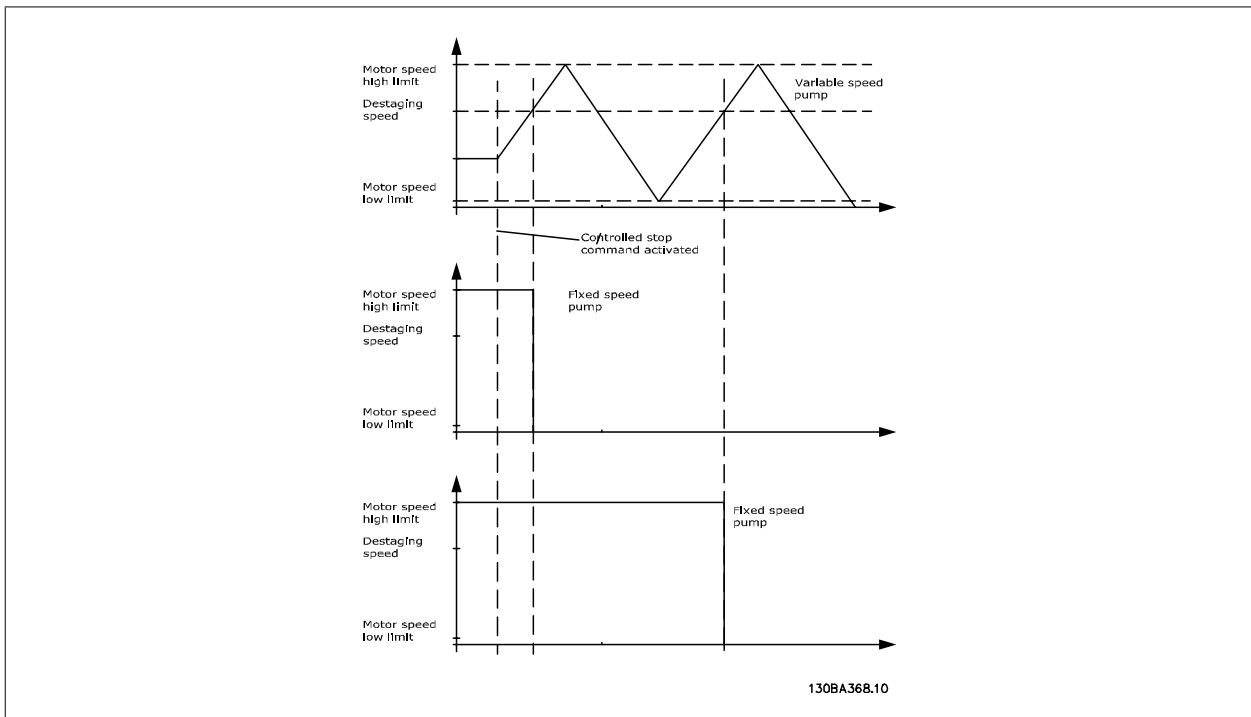

2.21.5 25-5* Alternation Settings

Parameters for defining the conditions for alternation of the variable speed pump (lead) if selected as part of the control strategy.

25-50 Lead Pump Alternation

Option:	Function:
[0] * OFF	Lead pump alternation equalizes the use of pumps by periodically changing the pump that is speed controlled. This ensures that pumps are equally used over time. Alternation equalizes the usage of pumps by always choosing the pump with the lowest number of used hours to stage on next.
[1] At staging	No alternation of lead pump function will take place. It is not possible to set this parameter to options other than <i>Off</i> [0] if par.25-02 <i>Motor Start</i> is set other than <i>Direct on Line</i> [0].
[2] At command	Alternation of the lead pump function will take place when staging another pump.
[3] At staging or at command	Alternation of the lead pump function will take place at an external command signal or a pre-programmed event. See par.25-51 <i>Alternation Event</i> for available options.
[3] At staging or at command	Alternation of the variable speed (lead) pump will take place at staging or the "At Command" signal. (See above.)

**NOTE!**

It is not possible to select other than *Off*[0] if par.25-05 *Fixed Lead Pump* is set to *Yes* [1].

25-51 Alternation Event

Option:	Function:
[0] * External	This parameter is only active if the options <i>At Command</i> [2] or <i>At Staging or Command</i> [3] have been selected in par.25-50 <i>Lead Pump Alternation</i> . If an alternation event is selected, the alternation of lead pump takes place every time the event occurs.
[1] Alternation Time Interval	Alternation takes place when a signal is applied to one of the digital inputs on the terminal strip and this input has been assigned to <i>Lead Pump Alternation</i> [121] in par. 5-1*, <i>Digital Inputs</i> .
[2] Sleep Mode	Alternation takes place every time par.25-52 <i>Alternation Time Interval</i> expires.
[3] Predefined Time	Alternation takes place each time the lead pump goes into sleep mode. par. 20-23 <i>Setpoint 3</i> must be set to <i>Sleep Mode</i> [1] or an external signal applied for this function.
[3] Predefined Time	Alternation takes place at a defined time of the day. If par.25-54 <i>Alternation Predefined Time</i> is set, the alternation is carried out every day at the specified time. Default time is midnight (00:00 or 12:00 AM depending on the time format).

25-52 Alternation Time Interval

Range:	Function:
24 h* [1 - 999 h]	If <i>Alternation Time Interval</i> [1] option in par.25-51 <i>Alternation Event</i> is selected, the alternation of the variable speed pump takes place every time the Alternation Time Interval expires (can be checked out in par.25-53 <i>Alternation Timer Value</i>).

25-53 Alternation Timer Value

Range:	Function:
0 N/A* [0 - 0 N/A]	Readout parameter for the Alternation Time Interval value set in par.25-52 <i>Alternation Time Interval</i> .

25-54 Alternation Predefined Time

Range:	Function:
0 N/A* [0 - 0 N/A]	If option <i>Predefined Time</i> [3] in par.25-51 <i>Alternation Event</i> is selected, the variable speed pump alternation is carried out every day at the specified time set in <i>Alternation Predefined Time</i> . Default time is midnight (00:00 or 12:00 AM depending on the time format).

25-55 Alternate if Load < 50%

Option:	Function:
	<p>If <i>Alternation If Capacity < 50%</i> is enabled, the pump alternation can only occur if the capacity is equal to or below 50%. The capacity calculation is the ratio of running pumps (including the variable speed pump) to the total number of available pumps (including variable speed pump, but not those interlocked).</p> $Capacity = \frac{N_{RUNNING}}{N_{TOTAL}} \times 100 \%$ <p>For the basic cascade controller, all pumps are equal size.</p>

[0]	Disabled	The lead pump alternation will take place at any pump capacity.
[1] *	Enabled	The lead pump function will be alternated only if the numbers of pumps running are providing less than 50% of total pump capacity.

NOTE!
Only valid if par.25-50 *Lead Pump Alternation* is different from *Off*[0].

25-56 Staging Mode at Alternation

Option:	Function:
[0] * Slow	<p>This parameter is only active if the option selected in <i>Lead Pump Alternation</i>, par. 25-50, is different from <i>Off</i>[0]</p> <p>Two types of staging and de-staging of pumps are possible. Slow transfer makes staging and de-staging smooth. Quick transfer makes staging and de-staging as fast as possible; the variable speed pump is just cut out (coasted).</p> <p><i>Slow</i>[0]: At alternation, the variable speed pump is ramped up to maximum speed and then ramped down to a stand still.</p> <p><i>Quick</i>[1]: At alternation, the variable speed pump is ramped up to maximum speed and then coasted to stand still.</p> <p>The below examples show alternation in both quick and slow configurations.</p>
[1] Quick	

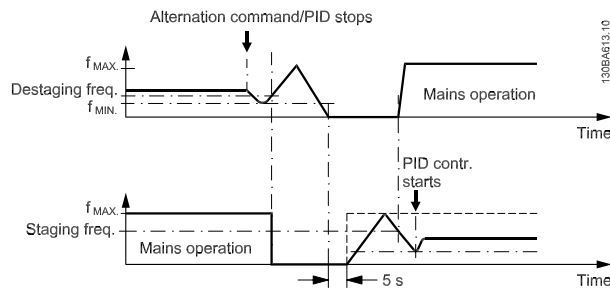

Figure 2.2: Slow Configuration

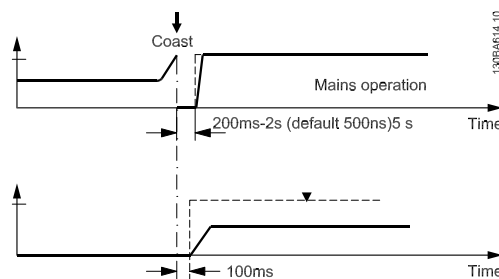

Figure 2.3: Quick Configuration

25-58 Run Next Pump Delay

Range:

0.1 s* [0.1 - 5.0 s]

Function:

This parameter is only active if the option selected in par.25-50 *Lead Pump Alternation*, is different from *Off*[0].

This parameter sets the time between stopping the old variable speed pump and starting another pump as a new variable speed pump. Refer to par. 25-56 *Staging Mode at Alternation*, the illustration for description of staging and alternation.

25-59 Run-on Line Delay

Range:

0.5 s* [par. 25-58 - 5.0 s]

Function:

This parameter is only active if the option selected in par.25-50 *Lead Pump Alternation* is different from *Off*[0].

This parameter sets the time between stopping the old variable speed pump and starting this pump as a new fixed speed pump. Refer to par. 25-56 *Staging Mode at Alternation* the illustration for description of staging and alternation.

2.21.6 25-8* Status

Readout parameters informing about the operating status of the cascade controller and the pumps controlled.

25-80 Cascade Status

Range:

0 N/A* [0 - 0 N/A]

Function:

Readout of the status of the cascade controller.

25-81 Pump Status

Range:	Function:
0 N/A* [0 - 0 N/A]	Pump status shows the status for the number of pumps selected in par.25-06 <i>Number Of Pumps</i> . It is a readout of the status for each of the pumps showing a string, which consists of pump number and the current status of the pump. Example: Readout is with the abbreviation like "1:D 2:0". This means that pump 1 is running and speed controlled by the adjustable frequency drive and pump 2 is stopped.

25-82 Lead Pump

Range:	Function:
0 N/A* [0 - par. 25-06 N/A]	Readout parameter for the actual variable speed pump in the system. The lead pump parameter is updated to reflect the current variable speed pump in the system when an alternation takes place. If no lead pump is selected (Cascade Controller disabled or all pumps interlocked) the display will show NONE.

25-83 Relay Status

Array [2]

Range:	Function:
0 N/A* [0 - 0 N/A]	Readout of the status for each of the relays assigned to control the pumps. Every element in the array represents a relay. If a relay is activated, the corresponding element is set to "On". If a relay is deactivated, the corresponding element is set to "Off".

25-84 Pump ON Time

Array [2]

Range:	Function:
0 h* [0 - 2147483647 h]	Readout of the value for pump ON Time. The Cascade Controller has separate counters for the pumps and for the relays that control the pumps. Pump ON time monitors the "operating hours" of each pump. The value of each pump ON time counter can be reset to 0 by writing in the parameter, such as when the pump is replaced in case of service, for example.

25-85 Relay ON Time

Array [2]

Range:	Function:
0 h* [0 - 2147483647 h]	Readout of the value for relay ON time. The Cascade Controller has separate counters for the pumps and for the relays that control the pumps. Pump cycling is always done based on the relay counters, otherwise it would always use the new pump if a pump is replaced and its value in par.25-84 <i>Pump ON Time</i> is reset. In order to use par.25-04 <i>Pump Cycling</i> the Cascade Controller is monitoring the Relay ON time.

25-86 Reset Relay Counters

Option:	Function:
	Resets all elements in par.25-85 <i>Relay ON Time</i> counters.
[0] *	Do not reset
[1]	Do reset

2.21.7 25-9* Service

Parameters used in case of service on one or more of the pumps controlled.

25-90 Pump Interlock

Array [2]

Option:

Function:

In this parameter, it is possible to disable one or more of the fixed lead pumps. For example, the pump will not be selected for staging on, even if it is the next pump in the operation sequence. It is not possible to disable the lead pump with the pump interlock command.

The digital input interlocks are selected as *Pump 1-3 Interlock* [130 – 132] in *par. 5-1**, *Digital Inputs*.

[0] * Off

The pump is active for staging/de-staging.

[1] On

The pump interlock command is given. If a pump is running, it is immediately de-staged. If the pump is not running, it is not allowed to stage on.

25-91 Manual Alternation

Range:

0 N/A* [0 - par. 25-06 N/A]

Function:

Readout parameter for the actual variable speed pump in the system. The lead pump parameter is updated to reflect the current variable speed pump in the system when an alternation takes place. If no lead pump is selected (Cascade Controller disabled or all pumps interlocked) the display will show NONE.

2.22 Main Menu - Analog I/O Option MCB 109 - Group 26

2.22.1 Analog I/O Option MCB 109, 26- **

The Analog I/O Option MCB 109 extends the functionality of VLT® AQUA Drive FC 200 Series adjustable frequency drives by adding a number of additional, programmable analog inputs and outputs. This could be especially useful in control installations in which the adjustable frequency drive may be used as decentral I/O, obviating the need for an outstation, and thus reducing cost. It also provides flexibility in project planning.

NOTE!
The maximum current for the analog outputs 0-10 V is 1 mA.

NOTE!
Where live zero monitoring is used, it is important that any analog inputs not being used for the frequency controller, i.e., being used as part of the building management system decentral I/O, have their live zero functions disabled.

Terminal	Parameters	Terminal	Parameters	Terminal	Parameters
Analog inputs		Analog inputs		Relays	
X42/1	26-00, 26-1*	53	6-1*	Relay 1 Term 1, 2, 3	5-4*
X42/3	26-01, 26-2*	54	6-2*	Relay 2 Term 4, 5, 6	5-4*
X42/5	26-02, 26-3*				
Analog outputs		Analog output			
X42/7	26-4*	42	6-5*		
X42/9	26-5*				
X42/11	26-6*				

Table 2.3: Relevant parameters

It is also possible to read the analog inputs, write to the analog outputs and control the relays, using communication via the serial bus. In this instance, these are the relevant parameters.

Terminal	Parameters	Terminal	Parameters	Terminal	Parameters
Analog inputs (read)		Analog inputs (read)		Relays	
X42/1	18-30	53	16-62	Relay 1 Term 1, 2, 3	16-71
X42/3	18-31	54	16-64	Relay 2 Term 4, 5, 6	16-71
X42/5	18-32				
Analog outputs (write)		Analog output			
X42/7	18-33	42	6-63	NOTE! The relay outputs must be enabled via control word bit 11 (Relay 1) and bit 12 (Relay 2)	
X42/9	18-34				
X42/11	18-35				

Table 2.4: Relevant parameters

Setting of the On-board Real Time Clock.

The analog I/O option incorporates a real time clock with battery back-up. This can be used as a back up of the clock function included in the adjustable frequency drive as a standard option. See section Clock Settings, par 0-7*.

The analog I/O option can be used for the control of devices such as actuators or valves, using the extended closed-loop facility, thus removing control from the existing control system. See section Parameters: Ext. Closed-loop – FC 200 par 21-**. There are three independent closed-loop PID controllers.

26-00 Terminal X42/1 Mode

Option:

Function:

Terminal X42/1 can be programmed as an analog input accepting a voltage or input from either Pt 1000 (1000 Ω at 32°F [0°C]) or Ni 1000 (1000 Ω at 32°F [0°C]) temperature sensors. Select the desired mode.

Pt 1000, [2] and *Ni 1000* [4] if operating in Celsius - Pt 1000 [3] and Ni 1000 [5] if operating in Fahrenheit.

Notice: If the input is not in use, it must be set for Voltage!

If set for temperature and used as feedback, the unit must be set for either Celsius or Fahrenheit (par. 20-12 *Reference/Feedback Unit*, par.21-10 *Ext. 1 Ref./Feedback Unit*, par.21-30 *Ext. 2 Ref./Feedback Unit* or par.21-50 *Ext. 3 Ref./Feedback Unit*).

[1] * Voltage

[2] Pt 1000 [°C]

[3] Pt 1000 [°F]

[4] Ni 1000 [°C]

[5] Ni 1000 [°F]

26-01 Terminal X42/3 Mode

Option:

Function:

Terminal X42/3 can be programmed as an analog input accepting a voltage or input from either Pt 1000 or Ni 1000 temperature sensors. Select the desired mode.

Pt 1000, [2] and Ni 1000, [4] if operating in Celsius - Pt 1000, [3] and Ni 1000, [5] if operating in Fahrenheit.

Notice: If the input is not in use, it must be set for Voltage!

If set for temperature and used as feedback, the unit must be set for either Celsius or Fahrenheit (par. 20-12 *Reference/Feedback Unit*, par.21-10 *Ext. 1 Ref./Feedback Unit*, par.21-30 *Ext. 2 Ref./Feedback Unit* or par.21-50 *Ext. 3 Ref./Feedback Unit*).

[1] * Voltage

[2] Pt 1000 [°C]

[3] Pt 1000 [°F]

[4] Ni 1000 [°C]

[5] Ni 1000 [°F]

26-02 Terminal X42/5 Mode

Option:

Function:

Terminal X42/5 can be programmed as an analog input accepting a voltage or input from either Pt 1000 (1000 Ω at 0° C) or Ni 1000 (1000 Ω at 0° C) temperature sensors. Select the desired mode.

Pt 1000, [2] and Ni 1000, [4] if operating in Celsius - Pt 1000, [3] and Ni 1000, [5] if operating in Fahrenheit.

Notice: If the input is not in use, it must be set for Voltage!

If set for temperature and used as feedback, the unit must be set for either Celsius or Fahrenheit (par. 20-12 *Reference/Feedback Unit*, par.21-10 *Ext. 1 Ref./Feedback Unit*, par.21-30 *Ext. 2 Ref./Feedback Unit* or par.21-50 *Ext. 3 Ref./Feedback Unit*).

[1] * Voltage

[2] Pt 1000 [°C]

[3] Pt 1000 [°F]

[4]	Ni 1000 [°C]
[5]	Ni 1000 [°F]

26-10 Terminal X42/1 Low Voltage

Range:	Function:
0.07 V* [0.00 - par. 6-31 V]	Enter the low voltage value. This analog input scaling value should correspond to the low reference/feedback value set in par.26-14 <i>Term. X42/1 Low Ref./Feedb. Value.</i>

26-11 Terminal X42/1 High Voltage

Range:	Function:
10.00 V* [par. 6-30 - 10.00 V]	Enter the high voltage value. This analog input scaling value should correspond to the high reference/feedback value set in par.26-15 <i>Term. X42/1 High Ref./Feedb. Value.</i>

26-14 Term. X42/1 Low Ref./Feedb. Value

Range:	Function:
0.000 N/A* [-999999.999 - 999999.999 N/A]	Enter the analog input scaling value that corresponds to the low voltage value set in par. 26-10 <i>Terminal X42/1 Low Voltage.</i>

26-15 Term. X42/1 High Ref./Feedb. Value

Range:	Function:
100.000 N/A* [-999999.999 - 999999.999 N/A]	Enter the analog input scaling value that corresponds to the high voltage value set in par. 26-11 <i>Terminal X42/1 High Voltage.</i>

26-16 Term. X42/1 Filter Time Constant

Range:	Function:
0.001 s* [0.001 - 10.000 s]	Enter the time constant. This is a first-order digital low pass filter time constant for suppressing noise in terminal X42/1. A high time constant value improves dampening but also increases the time delay through the filter. This parameter cannot be adjusted while the motor is running.

26-17 Term. X42/1 Live Zero

Option:	Function:
	This parameter makes it possible to enable the live zero monitoring, for example where the analog input is a part of the adjustable frequency drive control, rather than being used as part of a decentral I/O system, such as a building management system.
[0]	Disabled
[1] *	Enabled

26-20 Terminal X42/3 Low Voltage

Range:	Function:
0.07 V* [0.00 - par. 6-31 V]	Enter the low voltage value. This analog input scaling value should correspond to the low reference/feedback value set in par.26-24 <i>Term. X42/3 Low Ref./Feedb. Value.</i>

26-21 Terminal X42/3 High Voltage

Range:	Function:
10.00 V* [par. 6-30 - 10.00 V]	Enter the high voltage value. This analog input scaling value should correspond to the high reference/feedback value set in par.26-25 <i>Term. X42/3 High Ref./Feedb. Value.</i>

26-24 Term. X42/3 Low Ref./Feedb. Value

Range:	Function:
0.000 N/A* [-999999.999 - 999999.999 N/A]	Enter the analog input scaling value that corresponds to the low voltage value set in par. 26-20 <i>Terminal X42/3 Low Voltage</i> .

26-25 Term. X42/3 High Ref./Feedb. Value

Range:	Function:
100.000 N/A* [-999999.999 - 999999.999 N/A]	Enter the analog input scaling value that corresponds to the high voltage value set in par. 26-21 <i>Terminal X42/3 High Voltage</i> .

26-26 Term. X42/3 Filter Time Constant

Range:	Function:
0.001 s* [0.001 - 10.000 s]	Enter the time constant. This is a first-order digital low pass filter time constant for suppressing noise in terminal X42/3. A high time constant value improves dampening but also increases the time delay through the filter. This parameter cannot be adjusted while the motor is running.

26-27 Term. X42/3 Live Zero

Option:	Function:
	This parameter makes it possible to enable the live zero monitoring, for example where the analog input is a part of the adjustable frequency drive control, rather than being used as part of a decentral I/O system, such as a building management system.
[0] Disabled	
[1] * Enabled	

26-30 Terminal X42/5 Low Voltage

Range:	Function:
0.07 V* [0.00 - par. 6-31 V]	Enter the low voltage value. This analog input scaling value should correspond to the low reference/feedback value set in par. 26-34 <i>Term. X42/5 Low Ref./Feedb. Value</i> .

26-31 Terminal X42/5 High Voltage

Range:	Function:
10.00 V* [par. 6-30 - 10.00 V]	Enter the high voltage value. This analog input scaling value should correspond to the high reference/feedback value set in par. 26-35 <i>Term. X42/5 High Ref./Feedb. Value</i> .

26-34 Term. X42/5 Low Ref./Feedb. Value

Range:	Function:
0.000 N/A* [-999999.999 - 999999.999 N/A]	Enter the analog input scaling value that corresponds to the low voltage value set in par. 26-30 <i>Terminal X42/5 Low Voltage</i> .

26-35 Term. X42/5 High Ref./Feedb. Value

Range:	Function:
100.000 N/A* [-999999.999 - 999999.999 N/A]	Enter the analog input scaling value that corresponds to the high voltage value set in par. 26-21 <i>Terminal X42/3 High Voltage</i> .

26-36 Term. X42/5 Filter Time Constant

Range:	Function:
0.001 s* [0.001 - 10.000 s]	Enter the time constant. This is a first-order digital low pass filter time constant for suppressing noise in terminal X42/5. A high time constant value improves dampening but also increases the time delay through the filter. This parameter cannot be adjusted while the motor is running.

26-37 Term. X42/5 Live Zero

Option:

Function:

This parameter makes it possible to enable the live zero monitoring, for example where the analog input is a part of the adjustable frequency drive control, rather than being used as part of a decentral I/O system, such as a building management system.

[0] Disabled

[1] * Enabled

26-40 Terminal X42/7 Output

Option:

Function:

Set the function of terminal X42/7 as an analog voltage output.

[0] * No operation

[100] Output frequency

[101] Reference

[102] Feedback

[103] Motor current

[104] Torque rel to limit

[105] Torq relate to rated

[106] Power

[107] Speed

[113] Ext. Closed-loop 1

[114] Ext. Closed-loop 2

[115] Ext. Closed-loop 3

[139] Bus ctrl.

[141] Bus ctrl t.o.

26-41 Terminal X42/7 Min. Scale

Range:

Function:

0.00 %* [0.00 - 200.00 %]

Scale the minimum output of the selected analog signal at terminal X42/7, as a percentage of the maximum signal level, for example if a 0 V (or 0 Hz) is desired at 25% of the maximum output value. Then program 25%. Scaling values up to 100% can never be higher than the corresponding setting in par.26-42 *Terminal X42/7 Max. Scale*.
See principle graph for par.6-51 *Terminal 42 Output Min Scale*.

26-42 Terminal X42/7 Max. Scale

Range:

Function:

100.00 %* [0.00 - 200.00 %]

Scale the maximum output of the selected analog signal at terminal X42/7. Set the value to the maximum value of the voltage signal output. Scale the output to give a voltage lower than 10 V at full scale; or 10 V at an output below 100% of the maximum signal value. If 10 V is the desired output current at a value between 0–100% of the full-scale output, program the percentage value in the parameter, i.e. 50% = 10 V. If a voltage between 0 and 10 V is desired at maximum output, calculate the percentage as follows:

$$\left(\frac{10V}{\text{desired maximum voltage}} \right) \times 100\%$$

i.e.

$$5V : \frac{10V}{5V} \times 100\% = 200\%$$

See principle graph for par.6-52 *Terminal 42 Output Max Scale*.

26-43 Terminal X42/7 Output Bus Control**Range:**

0.00 %* [0.00 - 100.00 %]

Function:

Holds the level of terminal X42/7 if controlled by the bus.

26-44 Terminal X42/7 Output Timeout Preset**Range:**

0.00 %* [0.00 - 100.00 %]

Function:

Holds the preset level of terminal X42/7.

In case of a bus timeout and a timeout function is selected in par.26-50 *Terminal X42/9 Output*, the output will preset to this level.

26-50 Terminal X42/9 Output**Option:****Function:**

Set the function of terminal X42/9.

[0] * No operation

[100] Output frequency

[101] Reference

[102] Feedback

[103] Motor current

[104] Torque rel to limit

[105] Torq relate to rated

[106] Power

[107] Speed

[113] Ext. Closed-loop 1

[114] Ext. Closed-loop 2

[115] Ext. Closed-loop 3

[139] Bus ctrl.

[141] Bus ctrl t.o.

26-51 Terminal X42/9 Min. Scale**Range:**

0.00 %* [0.00 - 200.00 %]

Function:

Scale the minimum output of the selected analog signal at terminal X42/9, as a percentage of the maximum signal level, for example if a 0 V is desired at 25% of the maximum output value. Then program 25%. Scaling values up to 100% can never be higher than the corresponding setting in par.26-52 *Terminal X42/9 Max. Scale*.

See principle graph for par.6-51 *Terminal 42 Output Min Scale*.

26-52 Terminal X42/9 Max. Scale

Range:

100.00 %* [0.00 - 200.00 %]

Function:

Scale the maximum output of the selected analog signal at terminal X42/9. Set the value to the maximum value of the voltage signal output. Scale the output to give a voltage lower than 10 V at full scale; or 10 V at an output below 100% of the maximum signal value. If 10 V is the desired output current at a value between 0–100% of the full-scale output, program the percentage value in the parameter, i.e. 50% = 10 V. If a voltage between 0 and 10 V is desired at maximum output, calculate the percentage as follows:

$$\left(\frac{10V}{\text{desired maximum voltage}} \right) \times 100\%$$

i.e.

$$5V : \frac{10V}{5V} \times 100\% = 200\%$$

See principle graph for par.6-52 *Terminal 42 Output Max Scale*.

26-53 Terminal X42/9 Output Bus Control

Range:

0.00 %* [0.00 - 100.00 %]

Function:

Holds the level of terminal X42/9 if controlled by bus.

26-54 Terminal X42/9 Output Timeout Preset

Range:

0.00 %* [0.00 - 100.00 %]

Function:

Holds the preset level of terminal X42/9.
In case of a bus timeout and a timeout function is selected in par.26-60 *Terminal X42/11 Output* the output will preset to this level.

26-60 Terminal X42/11 Output

Option:

Function:

Set the function of terminal X42/11.

[0] * No operation

[100] Output frequency

[101] Reference

[102] Feedback

[103] Motor current

[104] Torque rel to limit

[105] Torq relate to rated

[106] Power

[107] Speed

[113] Ext. Closed-loop 1

[114] Ext. Closed-loop 2

[115] Ext. Closed-loop 3

[139] Bus ctrl.

[141] Bus ctrl t.o.

26-61 Terminal X42/11 Min. Scale**Range:**

0.00 %* [0.00 - 200.00 %]

Function:

Scale the minimum output of the selected analog signal at terminal X42/11, as a percentage of the maximum signal level, for example if a 0 V is desired at 25% of the maximum output value. Then program 25%. Scaling values up to 100% can never be higher than the corresponding setting in par.26-62 *Terminal X42/11 Max. Scale*.

See principle graph for par.6-51 *Terminal 42 Output Min Scale*.

26-62 Terminal X42/11 Max. Scale**Range:**

100.00 %* [0.00 - 200.00 %]

Function:

Scale the maximum output of the selected analog signal at terminal X42/9. Set the value to the maximum value of the voltage signal output. Scale the output to give a voltage lower than 10 V at full scale; or 10 V at an output below 100% of the maximum signal value. If 10 V is the desired output current at a value between 0–100% of the full-scale output, program the percentage value in the parameter, i.e. 50% = 10 V. If a voltage between 0 and 10 V is desired at maximum output, calculate the percentage as follows:

$$\left(\frac{10 \text{ V}}{\text{desired maximum voltage}} \right) \times 100 \%$$

i.e.

$$5 \text{ V} : \frac{10 \text{ V}}{5 \text{ V}} \times 100 \% = 200 \%$$

See principle graph for par.6-52 *Terminal 42 Output Max Scale*.

26-63 Terminal X42/11 Output Bus Control**Range:**

0.00 %* [0.00 - 100.00 %]

Function:

Holds the level of terminal X42/11 if controlled by bus.

26-64 Terminal X42/11 Output Timeout Preset**Range:**

0.00 %* [0.00 - 100.00 %]

Function:

Holds the preset level of terminal X42/11.

In case a bus timeout and a timeout function are selected, the output will preset to this level.

2.23 Main menu – Water application – Group 29

2.23.1 Water Application Functions, 29-**

The group contains parameters used for monitoring water/wastewater applications.

2.23.2 Pipe Fill function, 29-0*

In water supply systems, water hammering can occur when filling the pipes too fast. It is therefore desirable to limit the filling rate. Pipe Fill Mode eliminates the occurrence of water hammering associated with the rapid exhausting of air from the piping system by filling the pipes at a low rate. This function is used in horizontal, vertical and mixed piping systems. Due to the fact that the pressure in horizontal pipe systems does not climb as the system fills, filling horizontal pipe systems requires a user specified speed to fill, for a user specified time and/or until a user specified pressure setpoint is reached.

The best way to fill a vertical pipe system is to use the PID function to ramp the pressure at a user specified rate between the motor speed low limit and a user specified pressure.

The pipe fill function uses a combination of above to ensure a safe filling in any system.

No matter which system - the pipe fill mode will start using the constant speed set in par. 29-01 until the pipe fill time in par. 29-03 has expired, thereafter filling will continue with the filling ramp set in par. 29-04 until the filling setpoint specified in par. 29-05 is reached.

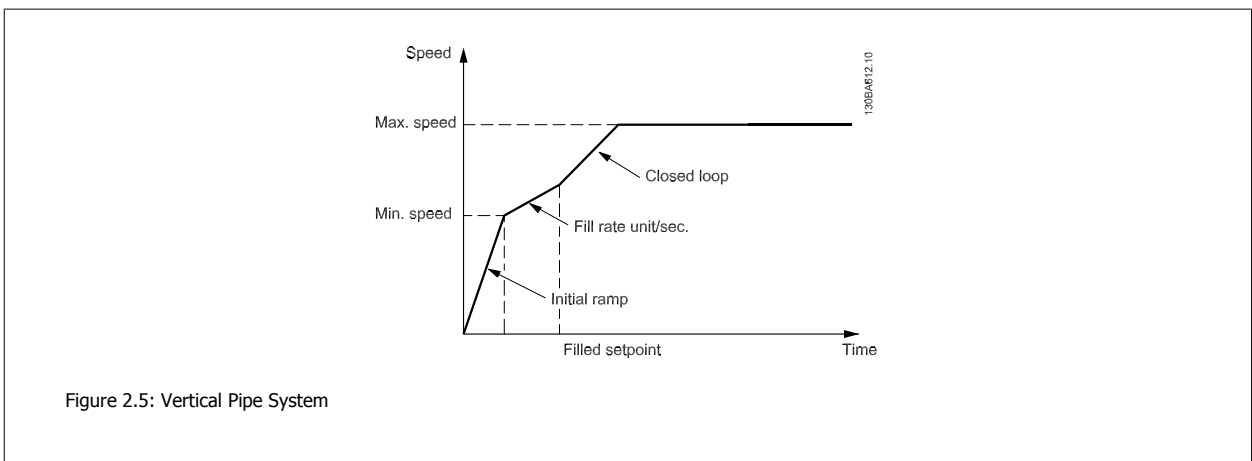
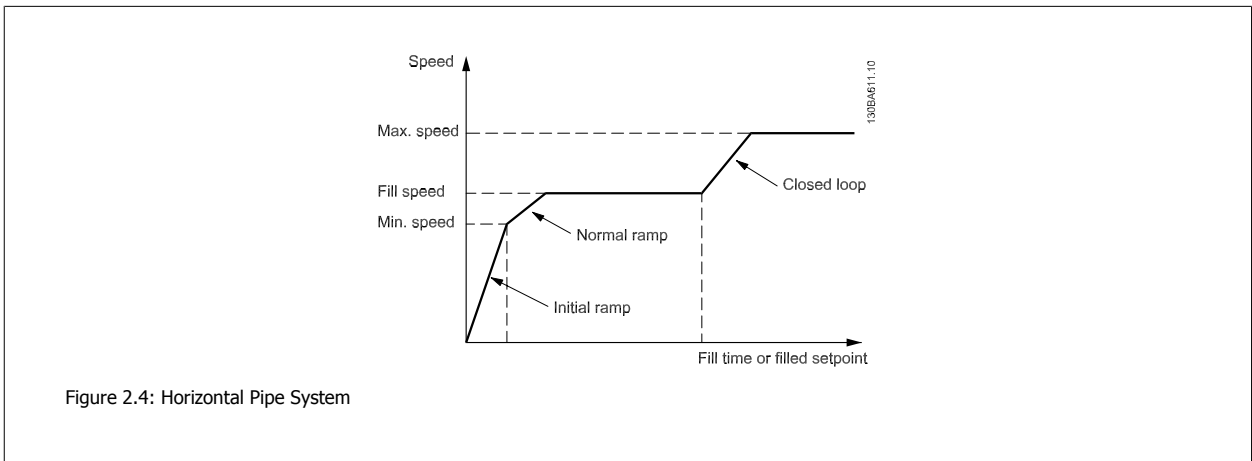

29-00 Pipe Fill Enable

Option:

[0] * Disabled

[1] Enabled

Function:

Select Enabled to fill pipes at a user-specified rate.

Select Enabled to fill pipes with a user specified rate.

29-01 Pipe Fill Speed [RPM]

Range:

 Speed Low [Speed Low Limit - Speed High Lim-
Limit* it]

Function:

Set the filling speed for filling horizontal pipe systems. The speed can be selected in Hz or RPM depending on the choices made in par. 4-11 / par. 4-13 (RPM) or in par. 4-12 / par. 4-14 (Hz).

29-02 Pipe Fill Speed [Hz]

Range:

 Motor [Speed Low Limit - Speed High Lim-
Speed Low it]
Limit*

Function:

Set the filling speed for filling horizontal pipe systems. The speed can be selected in Hz or RPM depending on the choices made in par. 4-11 / par. 4-13 (RPM) or in par. 4-12 / par. 4-14 (Hz).

29-03 Pipe Fill Time

Range:

0 s* [0–3600 s]

Function:

Set the specified time for pipe filling of horizontal pipe systems.

29-04 Pipe Fill Rate

Range:

 0.001 units/ [0.001–999999.999 units/s]
s*

Function:

Specifies the filling rate in units/second using the PI controller. Filling rate units are feedback units/second. This function is used for filling vertical pipe systems but will be active when the filling time has expired, no matter what, until the pipe fill setpoint set in par. 29-05 is reached.

29-05 Filled Setpoint

Range:

0 s* [0–999999,999 s]

Function:

Specifies the filled setpoint at which the pipe fill function will be disabled and the PID controller will take control. This function can be used both for horizontal and vertical pipe systems.

2.24 Main Menu - Bypass Option - Group 31

2.24.1 31-** Bypass Option

Parameter group for the configuration of the electronically controlled bypass option board, MCO-104.

31-00 Bypass Mode

Option:

[0] * Drive

Function:

[1] Bypass feature: Bypass

Select the operating mode of the bypass:

[0] Drive: the motor is operated by the drive.

[1] Bypass: motor can be run at full speed in bypass mode.

31-01 Bypass Start Time Delay

Range:

30 s* [0 - 60 s]

Function:

Set the time delay within the time when the bypass receives a run command and the time when it starts the motor at full speed. A countdown timer will display time left.

31-02 Bypass Trip Time Delay

Range:

0 s* [0 - 300 s]

Function:

Set the time delay from between the time that the drive experiences an alarm that stops it, and the time when the motor is automatically switched to bypass control. If the time delay is set to zero, then a drive alarm will not automatically switch the motor to bypass control.

31-03 Test Mode Activation

Option:

[0] * Disabled

Function:

[1] Enabled

[0] Disabled, means that the test mode is disabled.

[1] Enabled, means that the motor runs in bypass, while the drive can be tested in an open circuit. In this mode, the keypad will not control the start/stop of the bypass.

31-10 Bypass Status Word

Range:

0* [0 - 65535]

Function:

Views the status of the bypass as a hexadecimal value.

31-11 Bypass Running Hours

Range:

0 hr* [0 - 2,147,483,647 hrs]

Function:

Views the number of hours during which the motor has run in bypass mode. The counter can be reset in par. 15-07. The value is saved when the adjustable frequency drive is turned off.

31-19 Remote Bypass Activation

Option:

[0] * Disabled

Function:

[1] Enabled

Feature: Unknown.

3 Parameter Lists

3.1 Parameter Options

3.1.1 Default settings

Changes during operation:

"TRUE" means that the parameter can be changed while the adjustable frequency drive is in operation, and "FALSE" means that the adjustable frequency drive must be stopped before a change can be made.

4 set-up:

'All set-up': the parameter can be set individually in each of the four set-ups, i. e., one single parameter can have four different data values.

'1 set-up': data value will be the same in all set-ups.

SR:

Size related

N/A:

No default value available.

Conversion index:

This number refers to a conversion figure used when writing or reading by means of an adjustable frequency drive.

Conv. index	100	67	6	5	4	3	2	1	0	-1	-2	-3	-4	-5	-6
Conv. factor	1	1/60	1000000	100000	10000	1000	100	10	1	0.1	0.01	0.001	0.0001	0.00001	0.000001

Data type	Description	Type
2	Integer 8	Int8
3	Integer 16	Int16
4	Integer 32	Int32
5	Unsigned 8	UInt8
6	Unsigned 16	UInt16
7	Unsigned 32	UInt32
9	Visible String	VisStr
33	Normalized value 2 bytes	N2
35	Bit sequence of 16 Boolean variables	V2
54	Time difference w/out date	TimD

3.1.2 0-**-** Operation/Display

Par. No. #	Parameter description	Default value	4-set-up	Change during operation	Conversion index	Type
0-0* Basic Settings						
0-01	Language	[0] English	1 set-up	TRUE	-	Uint8
0-02	Motor Speed Unit	[0] RPM	2 set-ups	FALSE	-	Uint8
0-03	Regional Settings	[0] International	2 set-ups	FALSE	-	Uint8
0-04	Operating State at Power-up	[0] Resume	All set-ups	TRUE	-	Uint8
0-05	Local Mode Unit	[0] As Motor Speed Unit	2 set-ups	FALSE	-	Uint8
0-1* Set-up Operations						
0-10	Active Set-up	[1] Set-up 1	1 set-up	TRUE	-	Uint8
0-11	Programming Set-up	[9] Active Set-up	All set-ups	TRUE	-	Uint8
0-12	This Set-up Linked to	[0] Not linked	All set-ups	FALSE	-	Uint8
0-13	Readout: Linked Set-ups	0 N/A	All set-ups	FALSE	0	Uint16
0-14	Readout: Prog. Set-ups / Channel	0 N/A	All set-ups	TRUE	0	Int32
0-2* LCP Display						
0-20	Display Line 1.1 Small	1601	All set-ups	TRUE	-	Uint16
0-21	Display Line 1.2 Small	1662	All set-ups	TRUE	-	Uint16
0-22	Display Line 1.3 Small	1614	All set-ups	TRUE	-	Uint16
0-23	Display Line 2 Large	1613	All set-ups	TRUE	-	Uint16
0-24	Display Line 3 Large	1652	All set-ups	TRUE	-	Uint16
0-25	My Personal Menu	ExpressionLimit	1 set-up	TRUE	0	Uint16
0-3* LCP Cust. Readout						
0-30	Custom Readout Unit	[1] %	All set-ups	TRUE	-	Uint8
0-31	Custom Readout Min Value	ExpressionLimit	All set-ups	TRUE	-2	Int32
0-32	Custom Readout Max Value	100.00 CustomReadoutUnit	All set-ups	TRUE	-2	Int32
0-37	Display Text 1	0 N/A	1 set-up	TRUE	0	VisStr[25]
0-38	Display Text 2	0 N/A	1 set-up	TRUE	0	VisStr[25]
0-39	Display Text 3	0 N/A	1 set-up	TRUE	0	VisStr[25]
0-4* LCP Keypad						
0-40	[Hand on] Key on LCP	[1] Enabled	All set-ups	TRUE	-	Uint8
0-41	[Off] Key on LCP	[1] Enabled	All set-ups	TRUE	-	Uint8
0-42	[Auto on] Key on LCP	[1] Enabled	All set-ups	TRUE	-	Uint8
0-43	[Reset] Key on LCP	[1] Enabled	All set-ups	TRUE	-	Uint8
0-44	[Off/Reset] Key on LCP	[1] Enabled	All set-ups	TRUE	-	Uint8
0-45	[Drive Bypass] Key on LCP	[1] Enabled	All set-ups	TRUE	-	Uint8

Par. No. #	Parameter description	Default value	4-set-up	Change during operation	Conversion index	Type
0-5* Copy/Save						
0-50	LCP Copy	[0] No copy	All set-ups	FALSE	-	Uint8
0-51	Set-up Copy	[0] No copy	All set-ups	FALSE	-	Uint8
0-6* Password						
0-60	Main Menu Password	100 N/A	1 set-up	TRUE	0	Uint16
0-61	Access to Main Menu w/o Password	[0] Full access	1 set-up	TRUE	-	Uint8
0-65	Personal Menu Password	200 N/A	1 set-up	TRUE	0	Uint16
0-66	Access to Personal Menu w/o Password	[0] Full access	1 set-up	TRUE	-	Uint8
0-7* Clock Settings						
0-70	Date and Time	ExpressionLimit	All set-ups	TRUE	0	TimeOfDay
0-71	Date Format	[0] YYYY-MM-DD	1 set-up	TRUE	-	Uint8
0-72	Time Format	[0] 24 h	1 set-up	TRUE	-	Uint8
0-74	DST/Summertime	[0] OFF	1 set-up	TRUE	-	Uint8
0-76	DST/Summertime Start	ExpressionLimit	1 set-up	TRUE	0	TimeOfDay
0-77	DST/Summertime End	ExpressionLimit	1 set-up	TRUE	0	TimeOfDay
0-79	Clock Fault	null	1 set-up	TRUE	-	Uint8
0-81	Working Days	null	1 set-up	TRUE	-	Uint8
0-82	Additional Working Days	ExpressionLimit	1 set-up	TRUE	0	TimeOfDay
0-83	Additional Non-Working Days	ExpressionLimit	1 set-up	TRUE	0	TimeOfDay
0-89	Date and Time Readout	0 N/A	All set-ups	TRUE	0	VisStr[25]

3.1.3 1- * Load/Motor

Par. No. #	Parameter description	Default value	4-set-up	Change during operation	Conversion Index	Type
1-0* General Settings						
1-00	Configuration Mode	null	All set-ups	TRUE	-	UInt8
1-01	Motor Control Principle	null	All set-ups	FALSE	-	UInt8
1-03	Torque Characteristics	[3] Auto Energy Optim. VT	All set-ups	TRUE	-	UInt8
1-1* Motor Selection						
1-10	Motor Construction	[0] Asynchronous	All set-ups	FALSE	-	UInt8
1-2* Motor Data						
1-20	Motor Power [kW]	ExpressionLimit	All set-ups	FALSE	1	UInt32
1-21	Motor Power [HP]	ExpressionLimit	All set-ups	FALSE	-2	UInt32
1-22	Motor Voltage	ExpressionLimit	All set-ups	FALSE	0	UInt16
1-23	Motor Frequency	ExpressionLimit	All set-ups	FALSE	0	UInt16
1-24	Motor Current	ExpressionLimit	All set-ups	FALSE	-2	UInt32
1-25	Motor Nominal Speed	ExpressionLimit	All set-ups	FALSE	67	UInt16
1-28	Motor Rotation Check	[0] OFF	All set-ups	FALSE	-	UInt8
1-29	Automatic Motor Adaptation (AMA)	[0] Off	All set-ups	FALSE	-	UInt8
1-3* Addl. Motor Data						
1-30	Stator Resistance (Rs)	ExpressionLimit	All set-ups	FALSE	-4	UInt32
1-31	Rotor Resistance (Rr)	ExpressionLimit	All set-ups	FALSE	-4	UInt32
1-32	Stator Reactance (Xs)	ExpressionLimit	All set-ups	FALSE	-4	UInt32
1-33	Stator Leakage Reactance (X1)	ExpressionLimit	All set-ups	FALSE	-4	UInt32
1-34	Rotor Leakage Reactance (X2)	ExpressionLimit	All set-ups	FALSE	-4	UInt32
1-35	Main Reactance (Xh)	ExpressionLimit	All set-ups	FALSE	-4	UInt32
1-36	Iron Loss Resistance (Rfe)	ExpressionLimit	All set-ups	FALSE	-3	UInt32
1-39	Motor Poles	ExpressionLimit	All set-ups	FALSE	0	UInt8
1-5* Load-Indep. Setting						
1-50	Motor Magnetization at Zero Speed	100 %	All set-ups	TRUE	0	UInt16
1-51	Min Speed Normal Magnetizing [RPM]	ExpressionLimit	All set-ups	TRUE	67	UInt16
1-52	Min Speed Normal Magnetizing [Hz]	ExpressionLimit	All set-ups	TRUE	-1	UInt16
1-55	U/f Characteristic - U	ExpressionLimit	All set-ups	TRUE	-1	UInt16
1-56	U/f Characteristic - F	ExpressionLimit	All set-ups	TRUE	-1	UInt16
1-6* Load-Depend. Settg.						
1-60	Low Speed Load Compensation	100 %	All set-ups	TRUE	0	Int16
1-61	High Speed Load Compensation	100 %	All set-ups	TRUE	0	Int16
1-62	Slip Compensation	0 %	All set-ups	TRUE	0	Int16
1-63	Slip Compensation Time Constant	ExpressionLimit	All set-ups	TRUE	-2	UInt16
1-64	Resonance Dampening	100 %	All set-ups	TRUE	0	UInt16
1-65	Resonance Dampening Time Constant	5 ms	All set-ups	TRUE	-3	UInt8
1-7* Start Adjustments						
1-71	Start Delay	0.0 s	All set-ups	TRUE	-1	UInt16
1-73	Flying Start	[0] Disabled	All set-ups	FALSE	-	UInt8
1-74	Start Speed [RPM]	ExpressionLimit	All set-ups	TRUE	67	UInt16
1-75	Start Speed [Hz]	ExpressionLimit	All set-ups	TRUE	-1	UInt16
1-76	Start Current	0.00 A	All set-ups	TRUE	-2	UInt32

3.1.4 2- ** Brakes

Par. No. #	Parameter description	Default value	4-set-up	Change during operation	Conversion index	Type
2-0* DC Brake						
2-00	DC Hold/Preheat Current	50 %	All set-ups	TRUE	0	Uint8
2-01	DC Brake Current	50 %	All set-ups	TRUE	0	Uint16
2-02	DC Braking Time	10.0 s	All set-ups	TRUE	-1	Uint16
2-03	DC Brake Cut-in Speed [RPM]	ExpressionLimit	All set-ups	TRUE	67	Uint16
2-04	DC Brake Cut-in Speed [Hz]	ExpressionLimit	All set-ups	TRUE	-1	Uint16
2-1* Brake Energy Funct.						
2-10	Brake Function	[0] Off	All set-ups	TRUE	-	Uint8
2-11	Brake Resistor (ohm)	ExpressionLimit	All set-ups	TRUE	0	Uint16
2-12	Brake Power Limit (kW)	ExpressionLimit	All set-ups	TRUE	0	Uint32
2-13	Brake Power Monitoring	[0] Off	All set-ups	TRUE	-	Uint8
2-15	Brake Check	[0] Off	All set-ups	TRUE	-	Uint8
2-16	AC Brake Max. Current	100.0 %	All set-ups	TRUE	-1	Uint32
2-17	Over-voltage Control	[2] Enabled	All set-ups	TRUE	-	Uint8

3.1.5 3- * Reference / Ramps

Par. No. #	Parameter description	Default value	4-set-up	Change during operation	Conversion index	Type
3-0* Reference Limits						
3-02	Minimum Reference	ExpressionLimit	All set-ups	TRUE	-3	Int32
3-03	Maximum Reference	ExpressionLimit	All set-ups	TRUE	-3	Int32
3-04	Reference Function	[0] Sum	All set-ups	TRUE	-	UInt8
3-1* References						
3-10	Preset Reference	0.00 %	All set-ups	TRUE	-2	Int16
3-11	Jog Speed [Hz]	ExpressionLimit	All set-ups	TRUE	-1	UInt16
3-13	Reference Site	[0] Linked to Hand / Auto	All set-ups	TRUE	-	UInt8
3-14	Preset Relative Reference	0.00 %	All set-ups	TRUE	-2	Int32
3-15	Reference 1 Source	[1] Analog input 53	All set-ups	TRUE	-	UInt8
3-16	Reference 2 Source	[0] No function	All set-ups	TRUE	-	UInt8
3-17	Reference 3 Source	[0] No function	All set-ups	TRUE	-	UInt8
3-19	Jog Speed [RPM]	ExpressionLimit	All set-ups	TRUE	67	UInt16
3-4* Ramp 1						
3-41	Ramp 1 Ramp-up Time	ExpressionLimit	All set-ups	TRUE	-2	UInt32
3-42	Ramp 1 Ramp-down Time	ExpressionLimit	All set-ups	TRUE	-2	UInt32
3-5* Ramp 2						
3-51	Ramp 2 Ramp-up Time	ExpressionLimit	All set-ups	TRUE	-2	UInt32
3-52	Ramp 2 Ramp-down Time	ExpressionLimit	All set-ups	TRUE	-2	UInt32
3-8* Other Ramps						
3-80	Jog Ramp Time	ExpressionLimit	All set-ups	TRUE	-2	UInt32
3-81	Quick Stop Ramp Time	ExpressionLimit	2 set-ups	TRUE	-2	UInt32
3-84	Initial Ramp Time	0.00 s	All set-ups	TRUE	-2	UInt16
3-85	Check Valve Ramp Time	0.00 s	All set-ups	TRUE	-2	UInt16
3-86	Check Valve Ramp End Speed [RPM]	ExpressionLimit	All set-ups	TRUE	67	UInt16
3-87	Check Valve Ramp End Speed [Hz]	ExpressionLimit	All set-ups	TRUE	-1	UInt16
3-88	Final Ramp Time	0.00 s	All set-ups	TRUE	-2	UInt16
3-9* Digital Pot. meter						
3-90	Step Size	0.10 %	All set-ups	TRUE	-2	UInt16
3-91	Ramp Time	1.00 s	All set-ups	TRUE	-2	UInt32
3-92	Power Restore	[0] Off	All set-ups	TRUE	-	UInt8
3-93	Maximum Limit	100 %	All set-ups	TRUE	0	Int16
3-94	Minimum Limit	0 %	All set-ups	TRUE	0	Int16
3-95	Ramp Delay	ExpressionLimit	All set-ups	TRUE	-3	TimD

3.1.6 4- ** Limits / Warnings

Par. No. #	Parameter description	Default value	4-set-up	Change during operation	Conversion index	Type
4-1 * Motor Limits						
4-10	Motor Speed Direction	[0] Clockwise	All set-ups	FALSE	-	Uint8
4-11	Motor Speed Low Limit [RPM]	ExpressionLimit	All set-ups	TRUE	67	Uint16
4-12	Motor Speed Low Limit [Hz]	ExpressionLimit	All set-ups	TRUE	-1	Uint16
4-13	Motor Speed High Limit [RPM]	ExpressionLimit	All set-ups	TRUE	67	Uint16
4-14	Motor Speed High Limit [Hz]	ExpressionLimit	All set-ups	TRUE	-1	Uint16
4-16	Torque Limit Motor Mode	ExpressionLimit	All set-ups	TRUE	-1	Uint16
4-17	Torque Limit Generator Mode	100.0 %	All set-ups	TRUE	-1	Uint16
4-18	Current Limit	ExpressionLimit	All set-ups	TRUE	-1	Uint32
4-19	Max Output Frequency	ExpressionLimit	All set-ups	FALSE	-1	Uint16
4-5 * Adj. Warnings						
4-50	Warning Current Low	0.00 A	All set-ups	TRUE	-2	Uint32
4-51	Warning Current High	ImaxVLT (P1637)	All set-ups	TRUE	-2	Uint32
4-52	Warning Speed Low	0 RPM	All set-ups	TRUE	67	Uint16
4-53	Warning Speed High	outputSpeedHighLimit (P413)	All set-ups	TRUE	67	Uint16
4-54	Warning Reference Low	-999999.999 N/A	All set-ups	TRUE	-3	Int32
4-55	Warning Reference High	999999.999 N/A	All set-ups	TRUE	-3	Int32
4-56	Warning Feedback Low	-999999.999 ReferenceFeedbackUnit	All set-ups	TRUE	-3	Int32
4-57	Warning Feedback High	999999.999 ReferenceFeedbackUnit	All set-ups	TRUE	-3	Int32
4-58	Missing Motor Phase Function	[2] Trip 1000 ms	All set-ups	TRUE	-	Uint8
4-6 * Speed Bypass						
4-60	Bypass Speed From [RPM]	ExpressionLimit	All set-ups	TRUE	67	Uint16
4-61	Bypass Speed From [Hz]	ExpressionLimit	All set-ups	TRUE	-1	Uint16
4-62	Bypass Speed To [RPM]	ExpressionLimit	All set-ups	TRUE	67	Uint16
4-63	Bypass Speed To [Hz]	ExpressionLimit	All set-ups	TRUE	-1	Uint16
4-64	Semi-Auto Bypass Set-up	[0] OFF	All set-ups	FALSE	-	Uint8

3.1.7 5- * * Digital In/Out

Par. No. #	Parameter description	Default value	4-set-up	Change during operation	Conversion index	Type
5-0* Digital I/O mode						
5-00	Digital I/O Mode	[0] PNP - Active at 24 V	All set-ups	FALSE	-	Uint8
5-01	Terminal 27 Mode	[0] Input	All set-ups	TRUE	-	Uint8
5-02	Terminal 29 Mode	[0] Input	All set-ups	TRUE	-	Uint8
5-1* Digital Inputs						
5-10	Terminal 18 Digital Input	[8] Start	All set-ups	TRUE	-	Uint8
5-11	Terminal 19 Digital Input	[0] No operation	All set-ups	TRUE	-	Uint8
5-12	Terminal 27 Digital Input	null	All set-ups	TRUE	-	Uint8
5-13	Terminal 29 Digital Input	[0] No operation	All set-ups	TRUE	-	Uint8
5-14	Terminal 32 Digital Input	[0] No operation	All set-ups	TRUE	-	Uint8
5-15	Terminal 33 Digital Input	[0] No operation	All set-ups	TRUE	-	Uint8
5-16	Terminal X30/2 Digital Input	[0] No operation	All set-ups	TRUE	-	Uint8
5-17	Terminal X30/3 Digital Input	[0] No operation	All set-ups	TRUE	-	Uint8
5-18	Terminal X30/4 Digital Input	[0] No operation	All set-ups	TRUE	-	Uint8
5-3* Digital Outputs						
5-30	Terminal 27 Digital Output	[0] No operation	All set-ups	TRUE	-	Uint8
5-31	Terminal 29 digital Output	[0] No operation	All set-ups	TRUE	-	Uint8
5-32	Term X30/6 Digi Out (MCB 101)	[0] No operation	All set-ups	TRUE	-	Uint8
5-33	Term X30/7 Digi Out (MCB 101)	[0] No operation	All set-ups	TRUE	-	Uint8
5-4* Relays						
5-40	Function Relay	null	All set-ups	TRUE	-	Uint8
5-41	On Delay, Relay	0.01 s	All set-ups	TRUE	-2	Uint16
5-42	Off Delay, Relay	0.01 s	All set-ups	TRUE	-2	Uint16
5-5* Pulse Input						
5-50	Term. 29 Low Frequency	100 Hz	All set-ups	TRUE	0	Uint32
5-51	Term. 29 High Frequency	100 Hz	All set-ups	TRUE	0	Uint32
5-52	Term. 29 Low Ref./Feedb. Value	0.000 N/A	All set-ups	TRUE	-3	Int32
5-53	Term. 29 High Ref./Feedb. Value	100.000 N/A	All set-ups	TRUE	-3	Int32
5-54	Pulse Filter Time Constant #29	100 ms	All set-ups	FALSE	-3	Uint16
5-55	Term. 33 Low Frequency	100 Hz	All set-ups	TRUE	0	Uint32
5-56	Term. 33 High Frequency	100 Hz	All set-ups	TRUE	0	Uint32
5-57	Term. 33 Low Ref./Feedb. Value	0.000 N/A	All set-ups	TRUE	-3	Int32
5-58	Term. 33 High Ref./Feedb. Value	100.000 N/A	All set-ups	TRUE	-3	Int32
5-59	Pulse Filter Time Constant #33	100 ms	All set-ups	FALSE	-3	Uint16
5-6* Pulse Output						
5-60	Terminal 27 Pulse Output Variable	[0] No operation	All set-ups	TRUE	-	Uint8
5-62	Pulse Output Max Freq #27	5000 Hz	All set-ups	TRUE	0	Uint32
5-63	Terminal 29 Pulse Output Variable	[0] No operation	All set-ups	TRUE	-	Uint8
5-65	Pulse Output Max Freq #29	5000 Hz	All set-ups	TRUE	0	Uint32
5-66	Terminal X30/6 Pulse Output Variable	[0] No operation	All set-ups	TRUE	-	Uint8
5-68	Pulse Output Max Freq #X30/6	5000 Hz	All set-ups	TRUE	0	Uint32

Par. No. #	Parameter description	Default value	4-set-up	Change during operation	Conversion index	Type
5-9* Bus Controlled						
5-90	Digital & Relay Bus Control	0 N/A	All set-ups	TRUE	0	Uint32
5-93	Pulse Out #27 Bus Control	0.00 %	All set-ups	TRUE	-2	IN2
5-94	Pulse Out #27 Timeout Preset	0.00 %	1 set-up	TRUE	-2	Uint16
5-95	Pulse Out #29 Bus Control	0.00 %	All set-ups	TRUE	-2	IN2
5-96	Pulse Out #29 Timeout Preset	0.00 %	1 set-up	TRUE	-2	Uint16
5-97	Pulse Out #X30/6 Bus Control	0.00 %	All set-ups	TRUE	-2	IN2
5-98	Pulse Out #X30/6 Timeout Preset	0.00 %	1 set-up	TRUE	-2	Uint16

3.1.8 6- ** Analog In/Out

Par. No. #	Parameter description	Default value	4-set-up	Change during operation	Conversion Index	Type
6-0* Analog I/O Mode						
6-00	Live Zero Timeout Time	10 s	All set-ups	TRUE	0	Uint8
6-01	Live Zero Timeout Function	[0] Off	All set-ups	TRUE	-	Uint8
6-1* Analog Input 53						
6-10	Terminal 53 Low Voltage	0.07 V	All set-ups	TRUE	-2	Int16
6-11	Terminal 53 High Voltage	10.00 V	All set-ups	TRUE	-2	Int16
6-12	Terminal 53 Low Current	4.00 mA	All set-ups	TRUE	-5	Int16
6-13	Terminal 53 High Current	20.00 mA	All set-ups	TRUE	-5	Int16
6-14	Terminal 53 Low Ref./Feedb. Value	0.000 N/A	All set-ups	TRUE	-3	Int32
6-15	Terminal 53 High Ref./Feedb. Value	ExpressionLimit	All set-ups	TRUE	-3	Int32
6-16	Terminal 53 Filter Time Constant	0.001 s	All set-ups	TRUE	-3	Uint16
6-17	Terminal 53 Live Zero	[1] Enabled	All set-ups	TRUE	-	Uint8
6-2* Analog Input 54						
6-20	Terminal 54 Low Voltage	0.07 V	All set-ups	TRUE	-2	Int16
6-21	Terminal 54 High Voltage	10.00 V	All set-ups	TRUE	-2	Int16
6-22	Terminal 54 Low Current	4.00 mA	All set-ups	TRUE	-5	Int16
6-23	Terminal 54 High Current	20.00 mA	All set-ups	TRUE	-5	Int16
6-24	Terminal 54 Low Ref./Feedb. Value	0.000 N/A	All set-ups	TRUE	-3	Int32
6-25	Terminal 54 High Ref./Feedb. Value	100.000 N/A	All set-ups	TRUE	-3	Int32
6-26	Terminal 54 Filter Time Constant	0.001 s	All set-ups	TRUE	-3	Uint16
6-27	Terminal 54 Live Zero	[1] Enabled	All set-ups	TRUE	-	Uint8
6-3* Analog Input X30/11						
6-30	Terminal X30/11 Low Voltage	0.07 V	All set-ups	TRUE	-2	Int16
6-31	Terminal X30/11 High Voltage	10.00 V	All set-ups	TRUE	-2	Int16
6-34	Term. X30/11 Low Ref./Feedb. Value	0.000 N/A	All set-ups	TRUE	-3	Int32
6-35	Term. X30/11 High Ref./Feedb. Value	100.000 N/A	All set-ups	TRUE	-3	Int32
6-36	Term. X30/11 Filter Time Constant	0.001 s	All set-ups	TRUE	-3	Uint16
6-37	Term. X30/11 Live Zero	[1] Enabled	All set-ups	TRUE	-	Uint8
6-4* Analog Input X30/12						
6-40	Terminal X30/12 Low Voltage	0.07 V	All set-ups	TRUE	-2	Int16
6-41	Terminal X30/12 High Voltage	10.00 V	All set-ups	TRUE	-2	Int16
6-44	Term. X30/12 Low Ref./Feedb. Value	0.000 N/A	All set-ups	TRUE	-3	Int32
6-45	Term. X30/12 High Ref./Feedb. Value	100.000 N/A	All set-ups	TRUE	-3	Int32
6-46	Term. X30/12 Filter Time Constant	0.001 s	All set-ups	TRUE	-3	Uint16
6-47	Term. X30/12 Live Zero	[1] Enabled	All set-ups	TRUE	-	Uint8
6-5* Analog Output 42						
6-50	Terminal 42 Output	[100] Output freq. 0-100	All set-ups	TRUE	-	Uint8
6-51	Terminal 42 Output Min Scale	0.00 %	All set-ups	TRUE	-2	Int16
6-52	Terminal 42 Output Max Scale	100.00 %	All set-ups	TRUE	-2	Int16
6-53	Terminal 42 Output Bus Control	0.00 %	All set-ups	TRUE	-2	N2
6-54	Terminal 42 Output Timeout Preset	0.00 %	1 set-up	TRUE	-2	Uint16

Par. No. #	Parameter description	Default value	4-set-up	Change during operation	Conversion index	Type
6-6* Analog Output X30/8						
6-60	Terminal X30/8 Output	[0] No operation	All set-ups	TRUE	-	Uint8
6-61	Terminal X30/8 Min. Scale	0.00 %	All set-ups	TRUE	-2	Int16
6-62	Terminal X30/8 Max. Scale	100.00 %	All set-ups	TRUE	-2	Int16
6-63	Terminal X30/8 Output Bus Control	0.00 %	All set-ups	TRUE	-2	IN2
6-64	Terminal X30/8 Output Timeout Preset	0.00 %	1 set-up	TRUE	-2	Uint16

3.1.9 8- * * Comm. and Options

Par. No. #	Parameter description	Default value	4-set-up	Change during operation	Conversion index	Type
8-0* General Settings						
8-01	Control Site	null	All set-ups	TRUE	-	UInt8
8-02	Control Source	null	All set-ups	TRUE	-	UInt8
8-03	Control Timeout Time	ExpressionLimit	1 set-up	TRUE	-1	UInt32
8-04	Control Timeout Function	[0] Off	1 set-up	TRUE	-	UInt8
8-05	End-of-Timeout Function	[1] Resume set-up	1 set-up	TRUE	-	UInt8
8-06	Reset Control Timeout	[0] Do not reset	All set-ups	TRUE	-	UInt8
8-07	Diagnosis Trigger	[0] Disable	2 set-ups	TRUE	-	UInt8
8-1* Control Settings						
8-10	Control Profile	[0] FC profile	All set-ups	TRUE	-	UInt8
8-13	Configurable Status Word STW	[1] Profile Default	All set-ups	TRUE	-	UInt8
8-14	Configurable Control Word CTW	[1] Profile default	All set-ups	TRUE	-	UInt8
8-3* FC Port Settings						
8-30	Protocol	null	1 set-up	TRUE	-	UInt8
8-31	Address	ExpressionLimit	1 set-up	TRUE	0	UInt8
8-32	Baud Rate	null	1 set-up	TRUE	-	UInt8
8-33	Parity / Stop Bits	null	1 set-up	TRUE	-	UInt8
8-35	Minimum Response Delay	ExpressionLimit	1 set-up	TRUE	-3	UInt16
8-36	Max Response Delay	ExpressionLimit	1 set-up	TRUE	-3	UInt16
8-37	Maximum Inter-Char Delay	ExpressionLimit	1 set-up	TRUE	-5	UInt16
8-4* FC MC protocol set						
8-40	Telegram selection	[1] Standard telegram 1	2 set-ups	TRUE	-	UInt8
8-5* Digital/Bus						
8-50	Coasting Select	[3] Logic OR	All set-ups	TRUE	-	UInt8
8-52	DC Brake Select	[3] Logic OR	All set-ups	TRUE	-	UInt8
8-53	Start Select	[3] Logic OR	All set-ups	TRUE	-	UInt8
8-54	Reverse Select	null	All set-ups	TRUE	-	UInt8
8-55	Set-up Select	[3] Logic OR	All set-ups	TRUE	-	UInt8
8-56	Preset Reference Select	[3] Logic OR	All set-ups	TRUE	-	UInt8
8-7* BACnet						
8-70	BACnet Device Instance	1 N/A	1 set-up	TRUE	0	UInt32
8-72	MS/TP Max Masters	127 N/A	1 set-up	TRUE	0	UInt8
8-73	MS/TP Max Info Frames	1 N/A	1 set-up	TRUE	0	UInt16
8-74	"Startup 1 am"	[0] Send at power-up	1 set-up	TRUE	-	UInt8
8-75	Initialization Password	ExpressionLimit	1 set-up	TRUE	0	VisStr[20]
8-8* FC Port Diagnostics						
8-80	Bus Message Count	0 N/A	All set-ups	TRUE	0	UInt32
8-81	Bus Error Count	0 N/A	All set-ups	TRUE	0	UInt32
8-82	Slave Message Rcvd	0 N/A	All set-ups	TRUE	0	UInt32
8-83	Slave Error Count	0 N/A	All set-ups	TRUE	0	UInt32
8-9* Bus Jog						
8-90	Bus Jog 1 Speed	100 RPM	All set-ups	TRUE	67	UInt16
8-91	Bus Jog 2 Speed	200 RPM	All set-ups	TRUE	67	UInt16
8-94	Bus Feedback 1	0 N/A	1 set-up	TRUE	0	N2
8-95	Bus Feedback 2	0 N/A	1 set-up	TRUE	0	N2
8-96	Bus Feedback 3	0 N/A	1 set-up	TRUE	0	N2

3.1.10 9- ** Profibus

Par. No. #	Parameter description	Default value	4-set-up	Change during operation	Conversion index	Type
9-00	Setpoint	0 N/A	All set-ups	TRUE	0	Uint16
9-07	Actual Value	0 N/A	All set-ups	FALSE	0	Uint16
9-15	PCD Write Configuration	ExpressionLimit	2 set-ups	TRUE	-	Uint16
9-16	PCD Read Configuration	ExpressionLimit	2 set-ups	TRUE	-	Uint16
9-18	Node Address	126 N/A	1 set-up	TRUE	0	Uint8
9-22	Telegram Selection	[108] PPO 8	1 set-up	TRUE	-	Uint16
9-23	Parameters for Signals	0	All set-ups	TRUE	-	Uint16
9-27	Parameter Edit	[1] Enabled	2 set-ups	FALSE	-	Uint16
9-28	Process Control	[1] Enable cyclic master	2 set-ups	FALSE	-	Uint8
9-44	Fault Message Counter	0 N/A	All set-ups	TRUE	0	Uint16
9-45	Fault Code	0 N/A	All set-ups	TRUE	0	Uint16
9-47	Fault Number	0 N/A	All set-ups	TRUE	0	Uint16
9-52	Fault Situation Counter	0 N/A	All set-ups	TRUE	0	Uint16
9-53	Profibus Warning Word	0 N/A	All set-ups	TRUE	0	Uint16
9-63	Actual Baud Rate	[255] No baud rate found	All set-ups	TRUE	-	V2
9-64	Device Identification	0 N/A	All set-ups	TRUE	0	Uint16
9-65	Profile Number	0 N/A	All set-ups	TRUE	0	OctStr[2]
9-67	Control Word 1	0 N/A	All set-ups	TRUE	0	V2
9-68	Status Word 1	0 N/A	All set-ups	TRUE	0	V2
9-71	Profibus Save Data Values	[0] Off	All set-ups	TRUE	-	Uint8
9-72	ProfibusDriveReset	[0] No action	1 set-up	FALSE	-	Uint8
9-80	Defined Parameters (1)	0 N/A	All set-ups	FALSE	0	Uint16
9-81	Defined Parameters (2)	0 N/A	All set-ups	FALSE	0	Uint16
9-82	Defined Parameters (3)	0 N/A	All set-ups	FALSE	0	Uint16
9-83	Defined Parameters (4)	0 N/A	All set-ups	FALSE	0	Uint16
9-84	Defined Parameters (5)	0 N/A	All set-ups	FALSE	0	Uint16
9-90	Changed Parameters (1)	0 N/A	All set-ups	FALSE	0	Uint16
9-91	Changed Parameters (2)	0 N/A	All set-ups	FALSE	0	Uint16
9-92	Changed Parameters (3)	0 N/A	All set-ups	FALSE	0	Uint16
9-93	Changed Parameters (4)	0 N/A	All set-ups	FALSE	0	Uint16
9-94	Changed parameters (5)	0 N/A	All set-ups	FALSE	0	Uint16

3.1.11 10-* CAN Ser. Com. Bus

Par. No. #	Parameter description	Default value	4-set-up	Change during operation	Conversion Index	Type
10-0* Common Settings						
10-00	CAN Protocol	null	2 set-ups	FALSE	-	Uint8
10-01	Baud Rate Select	null	2 set-ups	TRUE	-	Uint8
10-02	MAC ID	ExpressionLimit	2 set-ups	TRUE	0	Uint8
10-05	Readout Transmit Error Counter	0 N/A	All set-ups	TRUE	0	Uint8
10-06	Readout Receive Error Counter	0 N/A	All set-ups	TRUE	0	Uint8
10-07	Readout Bus Off Counter	0 N/A	All set-ups	TRUE	0	Uint8
10-1* DeviceNet						
10-10	Process Data Type Selection	null	All set-ups	TRUE	-	Uint8
10-11	Process Data Config Write	ExpressionLimit	2 set-ups	TRUE	-	Uint16
10-12	Process Data Config Read	ExpressionLimit	2 set-ups	TRUE	-	Uint16
10-13	Warning Parameter	0 N/A	All set-ups	TRUE	0	Uint16
10-14	Net Reference	[0] Off	2 set-ups	TRUE	-	Uint8
10-15	Net Control	[0] Off	2 set-ups	TRUE	-	Uint8
10-2* COS Filters						
10-20	COS Filter 1	0 N/A	All set-ups	FALSE	0	Uint16
10-21	COS Filter 2	0 N/A	All set-ups	FALSE	0	Uint16
10-22	COS Filter 3	0 N/A	All set-ups	FALSE	0	Uint16
10-23	COS Filter 4	0 N/A	All set-ups	FALSE	0	Uint16
10-3* Parameter Access						
10-30	Array Index	0 N/A	2 set-ups	TRUE	0	Uint8
10-31	Store Data Values	[0] Off	All set-ups	TRUE	-	Uint8
10-32	DeviceNet Revision	ExpressionLimit	All set-ups	TRUE	0	Uint16
10-33	Store Always	[0] Off	1 set-up	TRUE	-	Uint8
10-34	DeviceNet Product Code	130 N/A	1 set-up	TRUE	0	Uint16
10-39	DeviceNet F Parameters	0 N/A	All set-ups	TRUE	0	Uint32

3.1.12 13- ** Smart Logic

Par. No. #	Parameter description	Default value	4-set-up	Change during operation	Conversion Index	Type
13-0* SLC Settings						
13-00	SL Controller Mode	null	2 set-ups	TRUE	-	Uint8
13-01	Start Event	null	2 set-ups	TRUE	-	Uint8
13-02	Stop Event	null	2 set-ups	TRUE	-	Uint8
13-03	Reset SLC	[0] Do not reset SLC	All set-ups	TRUE	-	Uint8
13-1* Comparators						
13-10	Comparator Operand	null	2 set-ups	TRUE	-	Uint8
13-11	Comparator Operator	null	2 set-ups	TRUE	-	Uint8
13-12	Comparator Value	ExpressionLimit	2 set-ups	TRUE	-3	Int32
13-2* Timers						
13-20	SL Controller Timer	ExpressionLimit	1 set-up	TRUE	-3	TimD
13-4* Logic Rules						
13-40	Logic Rule Boolean 1	null	2 set-ups	TRUE	-	Uint8
13-41	Logic Rule Operator 1	null	2 set-ups	TRUE	-	Uint8
13-42	Logic Rule Boolean 2	null	2 set-ups	TRUE	-	Uint8
13-43	Logic Rule Operator 2	null	2 set-ups	TRUE	-	Uint8
13-44	Logic Rule Boolean 3	null	2 set-ups	TRUE	-	Uint8
13-5* States						
13-51	SL Controller Event	null	2 set-ups	TRUE	-	Uint8
13-52	SL Controller Action	null	2 set-ups	TRUE	-	Uint8

3.1.13 14-.* Special Functions

Par. No. #	Parameter description	Default value	4-set-up	Change during operation	Conversion index	Type
14-0* Inverter Switching						
14-00	Switching Pattern	null	All set-ups	TRUE	-	Uint8
14-01	Switching Frequency	null	All set-ups	TRUE	-	Uint8
14-03	Overmodulation	[1] On	All set-ups	FALSE	-	Uint8
14-04	PWM Random	[0] Off	All set-ups	TRUE	-	Uint8
14-1* Mains On/Off						
14-10	Line Failure	[0] No function	All set-ups	FALSE	-	Uint8
14-11	Line Voltage at Line Fault	ExpressionLimit	All set-ups	TRUE	0	Uint16
14-12	Function at Mains Imbalance	[3] Derate	All set-ups	TRUE	-	Uint8
14-2* Reset Functions						
14-20	Reset Mode	[10] Automatic reset x 10	All set-ups	TRUE	-	Uint8
14-21	Automatic Restart Time	10 s	All set-ups	TRUE	0	Uint16
14-22	Operation Mode	[0] Normal operation	All set-ups	TRUE	-	Uint8
14-23	Typecode Setting	null	2 set-ups	FALSE	-	Uint8
14-25	Trip Delay at Torque Limit	60 s	All set-ups	TRUE	0	Uint8
14-26	Trip Delay at Inverter Fault	ExpressionLimit	All set-ups	TRUE	0	Uint8
14-28	Production Settings	[0] No action	All set-ups	TRUE	-	Uint8
14-29	Service Code	0 N/A	All set-ups	TRUE	0	Int32
14-3* Current Limit Ctrl.						
14-30	Current Lim Cont, Proportional Gain	100 %	All set-ups	FALSE	0	Uint16
14-31	Current Lim Contr, Integration Time	0.020 s	All set-ups	FALSE	-3	Uint16
14-32	Current Lim Ctrl, Filter Time	27.0 ms	All set-ups	FALSE	-4	Uint16
14-4* Energy Optimizing						
14-40	VT Level	66 %	All set-ups	FALSE	0	Uint8
14-41	AEO Minimum Magnetization	ExpressionLimit	All set-ups	TRUE	0	Uint8
14-42	Minimum AEO Frequency	10 Hz	All set-ups	TRUE	0	Uint8
14-43	Motor Cos-Phi	ExpressionLimit	All set-ups	TRUE	-2	Uint16
14-5* Environment						
14-50	RFI 1	[1] On	1 set-up	FALSE	-	Uint8
14-52	Fan Control	[0] Auto	All set-ups	TRUE	-	Uint8
14-53	Fan Monitor	[1] Warning	All set-ups	TRUE	-	Uint8
14-55	Output Filter	[0] No Filter	1 set-up	FALSE	-	Uint8
14-59	Actual Number of Inverter Units	ExpressionLimit	1 set-up	FALSE	0	Uint8
14-6* Auto Derate						
14-60	Function at Overtemperature	[1] Derate	All set-ups	TRUE	-	Uint8
14-61	Function at Inverter Overload	[1] Derate	All set-ups	TRUE	-	Uint8
14-62	Inv. Overload Derate Current	95 %	All set-ups	TRUE	0	Uint16
14-8* Options						
14-80	Option Supplied by External 24VDC	[0] No	2 set-ups	FALSE	-	Uint8

3.1.14 15- ** FC Information

Par. No. #	Parameter description	Default value	4-set-up	Change during operation	Conversion index	Type
15-0* Operating Data						
15-00	Operating Hours	0 h	All set-ups	FALSE	74	Ujnt32
15-01	Running Hours	0 h	All set-ups	FALSE	74	Ujnt32
15-02	kWh Counter	0 kWh	All set-ups	FALSE	75	Ujnt32
15-03	Power-ups	0 N/A	All set-ups	FALSE	0	Ujnt32
15-04	Over Temps	0 N/A	All set-ups	FALSE	0	Ujnt16
15-05	Over Volts	0 N/A	All set-ups	FALSE	0	Ujnt16
15-06	Reset kWh Counter	[0] Do not reset	All set-ups	TRUE	-	Ujnt8
15-07	Reset Running Hours Counter	[0] Do not reset	All set-ups	TRUE	-	Ujnt8
15-08	Number of Starts	0 N/A	All set-ups	FALSE	0	Ujnt32
15-1* Data Log Settings						
15-10	Logging Source	0	2 set-ups	TRUE	-	Ujnt16
15-11	Logging Interval	ExpressionLimit	2 set-ups	TRUE	-3	TimD
15-12	Trigger Event	[0] FALSE	1 set-up	TRUE	-	Ujnt8
15-13	Logging Mode	[0] Log always	2 set-ups	TRUE	-	Ujnt8
15-14	Samples Before Trigger	50 N/A	2 set-ups	TRUE	0	Ujnt8
15-2* Historic Log						
15-20	Historic Log: Event	0 N/A	All set-ups	FALSE	0	Ujnt8
15-21	Historic Log: Value	0 N/A	All set-ups	FALSE	0	Ujnt32
15-22	Historic Log: Time	0 ms	All set-ups	FALSE	-3	Ujnt32
15-23	Historic Log: Date and Time	ExpressionLimit	All set-ups	FALSE	0	TimeOfDay
15-3* Alarm Log						
15-30	Alarm Log: Error Code	0 N/A	All set-ups	FALSE	0	Ujnt16
15-31	Alarm Log: Value	0 N/A	All set-ups	FALSE	0	Ujnt16
15-32	Alarm Log: Time	0 s	All set-ups	FALSE	0	Ujnt32
15-33	Alarm Log: Date and Time	ExpressionLimit	All set-ups	FALSE	0	TimeOfDay
15-34	Alarm Log: Setpoint	0.000 ProcessCtrlUnit	All set-ups	FALSE	-3	Int32
15-35	Alarm Log: Feedback	0.000 ProcessCtrlUnit	All set-ups	FALSE	-3	Int32
15-36	Alarm Log: Current Demand	0 %	All set-ups	FALSE	0	Ujnt8
15-37	Alarm Log: Process Ctrl Unit	[0]	All set-ups	FALSE	-	Ujnt8
15-4* Drive Identification						
15-40	FC Type	0 N/A	All set-ups	FALSE	0	VisStrf[6]
15-41	Power Section	0 N/A	All set-ups	FALSE	0	VisStrf[20]
15-42	Voltage	0 N/A	All set-ups	FALSE	0	VisStrf[20]
15-43	Software Version	0 N/A	All set-ups	FALSE	0	VisStrf[5]
15-44	Ordered Typecode String	0 N/A	All set-ups	FALSE	0	VisStrf[40]
15-45	Actual Typecode String	0 N/A	All set-ups	FALSE	0	VisStrf[40]
15-46	Adj Freq Dr Ordering No.	0 N/A	All set-ups	FALSE	0	VisStrf[8]
15-47	Power Card Ordering No.	0 N/A	All set-ups	FALSE	0	VisStrf[8]
15-48	LCP ID Num.	0 N/A	All set-ups	FALSE	0	VisStrf[20]
15-49	SW ID Control Card	0 N/A	All set-ups	FALSE	0	VisStrf[20]
15-50	SW ID Power Card	0 N/A	All set-ups	FALSE	0	VisStrf[20]
15-51	Adj Freq Dr Serial No.	0 N/A	All set-ups	FALSE	0	VisStrf[10]
15-53	Power Card Serial Number	0 N/A	All set-ups	FALSE	0	VisStrf[19]

Par. No. #	Parameter description	Default value	4-set-up	Change during operation	Conver- sion index	Type
15-6* Option Ident						
15-60	Option Mounted	0 N/A	All set-ups	FALSE	0	VisStr[30]
15-61	Option SW Version	0 N/A	All set-ups	FALSE	0	VisStr[20]
15-62	Option Ordering No	0 N/A	All set-ups	FALSE	0	VisStr[8]
15-63	Option Serial No	0 N/A	All set-ups	FALSE	0	VisStr[18]
15-70	Option in Slot A	0 N/A	All set-ups	FALSE	0	VisStr[30]
15-71	Slot A Option SW Version	0 N/A	All set-ups	FALSE	0	VisStr[20]
15-72	Option in Slot B	0 N/A	All set-ups	FALSE	0	VisStr[30]
15-73	Slot B Option SW Version	0 N/A	All set-ups	FALSE	0	VisStr[20]
15-74	Option in Slot C0	0 N/A	All set-ups	FALSE	0	VisStr[30]
15-75	Slot C0 Option SW Version	0 N/A	All set-ups	FALSE	0	VisStr[20]
15-76	Option in Slot C1	0 N/A	All set-ups	FALSE	0	VisStr[30]
15-77	Slot C1 Option SW Version	0 N/A	All set-ups	FALSE	0	VisStr[20]
15-9* Parameter Info						
15-92	Defined Parameters	0 N/A	All set-ups	FALSE	0	Ujnt16
15-93	Modified Parameters	0 N/A	All set-ups	FALSE	0	Ujnt16
15-98	Drive Identification	0 N/A	All set-ups	FALSE	0	VisStr[40]
15-99	Parameter Metadata	0 N/A	All set-ups	FALSE	0	Ujnt16

3.1.15 16- ** Data Readouts

Par. No. #	Parameter description	Default value	4-set-up	Change during operation	Conversion index	Type
16-0* General Status						
16-00	Control Word	0 N/A	All set-ups	TRUE	0	V2
16-01	Reference [Unit]	0.000 ReferenceFeedbackUnit	All set-ups	TRUE	-3	Int32
16-02	Reference %	0.0 %	All set-ups	TRUE	-1	Int16
16-03	Status Word	0 N/A	All set-ups	TRUE	0	V2
16-05	Main Actual Value [%]	0.00 %	All set-ups	TRUE	-2	N2
16-09	Custom Readout	0.00 CustomReadoutUnit	All set-ups	TRUE	-2	Int32
16-1* Motor Status						
16-10	Power [kW]	0.00 kW	All set-ups	TRUE	1	Int32
16-11	Power [hp]	0.00 hp	All set-ups	TRUE	-2	Int32
16-12	Motor voltage	0.0 V	All set-ups	TRUE	-1	Uint16
16-13	Frequency	0.0 Hz	All set-ups	TRUE	-1	Uint16
16-14	Motor Current	0.00 A	All set-ups	TRUE	-2	Int32
16-15	Frequency [%]	0.00 %	All set-ups	TRUE	-2	N2
16-16	Torque [Nm]	0.0 Nm	All set-ups	TRUE	-1	Int32
16-17	Speed [RPM]	0 RPM	All set-ups	TRUE	67	Int32
16-18	Motor Thermal	0 %	All set-ups	TRUE	0	Uint8
16-22	Torque [%]	0 %	All set-ups	TRUE	0	Int16
16-3* Drive Status						
16-30	DC Link Voltage	0 V	All set-ups	TRUE	0	Uint16
16-32	Brake Energy /s	0.000 kW	All set-ups	TRUE	0	Int32
16-33	Brake Energy /2 min	0.000 kW	All set-ups	TRUE	0	Int32
16-34	Heatsink Temp.	0 °C	All set-ups	TRUE	100	Uint8
16-35	Inverter Thermal	0 %	All set-ups	TRUE	0	Uint8
16-36	Inv. Nom. Current	ExpressionLimit	All set-ups	TRUE	-2	Int32
16-37	Inv. Max. Current	ExpressionLimit	All set-ups	TRUE	-2	Int32
16-38	SL Controller State	0 N/A	All set-ups	TRUE	0	Uint8
16-39	Control Card Temp.	0 °C	All set-ups	TRUE	100	Uint8
16-40	Logging Buffer Full	[0] No	All set-ups	TRUE	-	Uint8
16-5* Ref. & Feedb.						
16-50	External Reference	0.0 N/A	All set-ups	TRUE	-1	Int16
16-52	Feedback [Unit]	0.000 ProcessCtrlUnit	All set-ups	TRUE	-3	Int32
16-53	Digi Pot Reference	0.00 N/A	All set-ups	TRUE	-2	Int16
16-54	Feedback 1 [Unit]	0.000 ProcessCtrlUnit	All set-ups	TRUE	-3	Int32
16-55	Feedback 2 [Unit]	0.000 ProcessCtrlUnit	All set-ups	TRUE	-3	Int32
16-56	Feedback 3 [Unit]	0.000 ProcessCtrlUnit	All set-ups	TRUE	-3	Int32
16-58	PID Output [%]	0.0 %	All set-ups	TRUE	-1	Int16
16-59	Adjusted Setpoint	0.000 ProcessCtrlUnit	All set-ups	TRUE	-3	Int32

Par. No. #	Parameter description	Default value	4-set-up	Change during operation	Conver- sion index	Type
16-6* Inputs & Outputs						
16-60	Digital Input	0 N/A	All set-ups	TRUE	0	Uint16
16-61	Terminal 53 Switch Setting	[0] Current	All set-ups	TRUE	-	Uint8
16-62	Analog Input 53	0.000 N/A	All set-ups	TRUE	-3	Int32
16-63	Terminal 54 Switch Setting	[0] Current	All set-ups	TRUE	-	Uint8
16-64	Analog Input 54	0.000 N/A	All set-ups	TRUE	-3	Int32
16-65	Analog Output 42 [mA]	0.000 N/A	All set-ups	TRUE	-3	Int16
16-66	Digital Output [bin]	0 N/A	All set-ups	TRUE	0	Int16
16-67	Pulse Input #29 [Hz]	0 N/A	All set-ups	TRUE	0	Int32
16-68	Pulse Input #33 [Hz]	0 N/A	All set-ups	TRUE	0	Int32
16-69	Pulse Output #27 [Hz]	0 N/A	All set-ups	TRUE	0	Int32
16-70	Pulse Output #29 [Hz]	0 N/A	All set-ups	TRUE	0	Int32
16-71	Relay Output [bin]	0 N/A	All set-ups	TRUE	0	Uint16
16-72	Counter A	0 N/A	All set-ups	TRUE	0	Int32
16-73	Counter B	0 N/A	All set-ups	TRUE	0	Int32
16-75	Analog In X30/11	0.000 N/A	All set-ups	TRUE	-3	Int32
16-76	Analog In X30/12	0.000 N/A	All set-ups	TRUE	-3	Int32
16-77	Analog Out X30/8 [mA]	0.000 N/A	All set-ups	TRUE	-3	Int16
16-8* Fieldbus & FC Port						
16-80	Fieldbus CTW 1	0 N/A	All set-ups	TRUE	0	V2
16-82	Fieldbus REF 1	0 N/A	All set-ups	TRUE	0	N2
16-84	Comm. Option Status	0 N/A	All set-ups	TRUE	0	V2
16-85	FC Port CTW 1	0 N/A	All set-ups	TRUE	0	V2
16-86	FC Port REF 1	0 N/A	All set-ups	TRUE	0	N2
16-9* Diagnosis Readouts						
16-90	Alarm Word	0 N/A	All set-ups	TRUE	0	Uint32
16-91	Alarm word 2	0 N/A	All set-ups	TRUE	0	Uint32
16-92	Warning Word	0 N/A	All set-ups	TRUE	0	Uint32
16-93	Warning word 2	0 N/A	All set-ups	TRUE	0	Uint32
16-94	Ext. Status Word	0 N/A	All set-ups	TRUE	0	Uint32
16-95	Ext. Status Word 2	0 N/A	All set-ups	TRUE	0	Uint32
16-96	Maintenance Word	0 N/A	All set-ups	TRUE	0	Uint32

3.1.16 18- ** Data Readouts 2

Par. No. #	Parameter description	Default value	4-set-up	Change during operation	Conversion index	Type
18-0* Maintenance Log						
18-00	Maintenance Log: Item	0 N/A	All set-ups	FALSE	0	Uint8
18-01	Maintenance Log: Action	0 N/A	All set-ups	FALSE	0	Uint8
18-02	Maintenance Log: Time	0 s	All set-ups	FALSE	0	Uint32
18-03	Maintenance Log: Date and Time	ExpressionLimit	All set-ups	FALSE	0	TimeOfDay
18-3* Inputs & Outputs						
18-30	Analog Input X42/1	0.000 N/A	All set-ups	FALSE	-3	Int32
18-31	Analog Input X42/3	0.000 N/A	All set-ups	FALSE	-3	Int32
18-32	Analog Input X42/5	0.000 N/A	All set-ups	FALSE	-3	Int32
18-33	Analog Out X42/7 [V]	0.000 N/A	All set-ups	FALSE	-3	Int16
18-34	Analog Out X42/9 [V]	0.000 N/A	All set-ups	FALSE	-3	Int16
18-35	Analog Out X42/11 [V]	0.000 N/A	All set-ups	FALSE	-3	Int16

3.1.17 20- ** FC Closed-loop

Par. No. #	Parameter description	Default value	4-set-up	Change during operation	Conversion index	Type
20-0* Feedback						
20-00	Feedback 1 Source	[2] Analog input 54	All set-ups	TRUE	-	Uint8
20-01	Feedback 1 Conversion	[0] Linear	All set-ups	FALSE	-	Uint8
20-02	Feedback 1 Source Unit	null	All set-ups	TRUE	-	Uint8
20-03	Feedback 2 Source	[0] No function	All set-ups	TRUE	-	Uint8
20-04	Feedback 2 Conversion	[0] Linear	All set-ups	FALSE	-	Uint8
20-05	Feedback 2 Source Unit	null	All set-ups	TRUE	-	Uint8
20-06	Feedback 3 Source	[0] No function	All set-ups	TRUE	-	Uint8
20-07	Feedback 3 Conversion	[0] Linear	All set-ups	FALSE	-	Uint8
20-08	Feedback 3 Source Unit	null	All set-ups	TRUE	-	Uint8
20-12	Reference/Feedback Unit	null	All set-ups	TRUE	-	Uint8
20-2* Feedback/Setpoint						
20-20	Feedback Function	[4] Maximum	All set-ups	TRUE	-	Uint8
20-21	Setpoint 1	0.000 ProcessCtrlUnit	All set-ups	TRUE	-3	Int32
20-22	Setpoint 2	0.000 ProcessCtrlUnit	All set-ups	TRUE	-3	Int32
20-23	Setpoint 3	0.000 ProcessCtrlUnit	All set-ups	TRUE	-3	Int32
20-7* PID Auto-tuning						
20-70	Closed-loop Type	[0] Auto	2 set-ups	TRUE	-	Uint8
20-71	PID Performance	[0] Normal	2 set-ups	TRUE	-	Uint8
20-72	PID Output Change	0.10 N/A	2 set-ups	TRUE	-2	Uint16
20-73	Minimum Feedback Level	-999999.000 ProcessCtrlUnit	2 set-ups	TRUE	-3	Int32
20-74	Maximum Feedback Level	999999.000 ProcessCtrlUnit	2 set-ups	TRUE	-3	Int32
20-79	PID Auto-tuning	[0] Disabled	All set-ups	TRUE	-	Uint8
20-8* PID Basic Settings						
20-81	PID Normal/ Inverse Control	[0] Normal	All set-ups	TRUE	-	Uint8
20-82	PID Start Speed [RPM]	ExpressionLimit	All set-ups	TRUE	67	Uint16
20-83	PID Start Speed [Hz]	ExpressionLimit	All set-ups	TRUE	-1	Uint16
20-84	On Reference Bandwidth	5 %	All set-ups	TRUE	0	Uint8
20-9* PID Controller						
20-91	PID Anti Windup	[1] On	All set-ups	TRUE	-	Uint8
20-93	PID Proportional Gain	2.00 N/A	All set-ups	TRUE	-2	Uint16
20-94	PID Integral Time	8.00 s	All set-ups	TRUE	-2	Uint32
20-95	PID Differentiation Time	0.00 s	All set-ups	TRUE	-2	Uint16
20-96	PID Diff. Gain Limit	5.0 N/A	All set-ups	TRUE	-1	Uint16

3.1.18 21- Ext. Closed-loop**

Par. No. #	Parameter description	Default value	4-set-up	Change during operation	Conversion index	Type
21-0* Ext. CL Autotuning						
21-00	Closed-loop Type	[0] Auto	2 set-ups	TRUE	-	Uint8
21-01	PID Performance	[0] Normal	2 set-ups	TRUE	-	Uint8
21-02	PID Output Change	0.10 N/A	2 set-ups	TRUE	-2	Uint16
21-03	Minimum Feedback Level	-999999.000 N/A	2 set-ups	TRUE	-3	Int32
21-04	Maximum Feedback Level	999999.000 N/A	2 set-ups	TRUE	-3	Int32
21-09	PID Auto Tuning	[0] Disabled	All set-ups	TRUE	-	Uint8
21-1* Ext. CL 1 Ref./Fb.						
21-10	Ext. 1 Ref./Feedback Unit	[0]	All set-ups	TRUE	-	Uint8
21-11	Ext. 1 Minimum Reference	0.000 ExtPID1Unit	All set-ups	TRUE	-3	Int32
21-12	Ext. 1 Maximum Reference	100.000 ExtPID1Unit	All set-ups	TRUE	-3	Int32
21-13	Ext. 1 Reference Source	[0] No function	All set-ups	TRUE	-	Uint8
21-14	Ext. 1 Feedback Source	[0] No function	All set-ups	TRUE	-	Uint8
21-15	Ext. 1 Setpoint	0.000 ExtPID1Unit	All set-ups	TRUE	-3	Int32
21-17	Ext. 1 Reference [Unit]	0.000 ExtPID1Unit	All set-ups	TRUE	-3	Int32
21-18	Ext. 1 Feedback [Unit]	0.000 ExtPID1Unit	All set-ups	TRUE	-3	Int32
21-19	Ext. 1 Output [%]	0 %	All set-ups	TRUE	0	Int32
21-2* Ext. CL 1 PID						
21-20	Ext. 1 Normal/Inverse Control	[0] Normal	All set-ups	TRUE	-	Uint8
21-21	Ext. 1 Proportional Gain	0.50 N/A	All set-ups	TRUE	-2	Uint16
21-22	Ext. 1 Integral Time	20.00 s	All set-ups	TRUE	-2	Uint32
21-23	Ext. 1 Differentiation Time	0.00 s	All set-ups	TRUE	-2	Uint16
21-24	Ext. 1 Dif. Gain Limit	5.0 N/A	All set-ups	TRUE	-1	Uint16
21-3* Ext. CL 2 Ref./Fb.						
21-30	Ext. 2 Ref./Feedback Unit	[0]	All set-ups	TRUE	-	Uint8
21-31	Ext. 2 Minimum Reference	0.000 ExtPID2Unit	All set-ups	TRUE	-3	Int32
21-32	Ext. 2 Maximum Reference	100.000 ExtPID2Unit	All set-ups	TRUE	-3	Int32
21-33	Ext. 2 Reference Source	[0] No function	All set-ups	TRUE	-	Uint8
21-34	Ext. 2 Feedback Source	[0] No function	All set-ups	TRUE	-	Uint8
21-35	Ext. 2 Setpoint	0.000 ExtPID2Unit	All set-ups	TRUE	-3	Int32
21-37	Ext. 2 Reference [Unit]	0.000 ExtPID2Unit	All set-ups	TRUE	-3	Int32
21-38	Ext. 2 Feedback [Unit]	0.000 ExtPID2Unit	All set-ups	TRUE	-3	Int32
21-39	Ext. 2 Output [%]	0 %	All set-ups	TRUE	0	Int32
21-4* Ext. CL 2 PID						
21-40	Ext. 2 Normal/Inverse Control	[0] Normal	All set-ups	TRUE	-	Uint8
21-41	Ext. 2 Proportional Gain	0.50 N/A	All set-ups	TRUE	-2	Uint16
21-42	Ext. 2 Integral Time	20.00 s	All set-ups	TRUE	-2	Uint32
21-43	Ext. 2 Differentiation Time	0.00 s	All set-ups	TRUE	-2	Uint16
21-44	Ext. 2 Dif. Gain Limit	5.0 N/A	All set-ups	TRUE	-1	Uint16

Par. No. #	Parameter description	Default value	4-set-up	Change during operation	Conversion index	Type
21-5*	Ext. CL 3 Ref./Fb.					
21-50	Ext. 3 Ref./Feedback Unit	[0]	All set-ups	TRUE	-	Uint8
21-51	Ext. 3 Minimum Reference	0.000 ExtPID3Unit	All set-ups	TRUE	-3	Int32
21-52	Ext. 3 Maximum Reference	100.000 ExtPID3Unit	All set-ups	TRUE	-3	Int32
21-53	Ext. 3 Reference Source	[0] No function	All set-ups	TRUE	-	Uint8
21-54	Ext. 3 Feedback Source	[0] No function	All set-ups	TRUE	-	Uint8
21-55	Ext. 3 Setpoint	0.000 ExtPID3Unit	All set-ups	TRUE	-3	Int32
21-57	Ext. 3 Reference [Unit]	0.000 ExtPID3Unit	All set-ups	TRUE	-3	Int32
21-58	Ext. 3 Feedback [Unit]	0.000 ExtPID3Unit	All set-ups	TRUE	-3	Int32
21-59	Ext. 3 Output [%]	0 %	All set-ups	TRUE	0	Int32
21-6*	Ext. CL 3 PID					
21-60	Ext. 3 Normal/Inverse Control	[0] Normal	All set-ups	TRUE	-	Uint8
21-61	Ext. 3 Proportional Gain	0.50 N/A	All set-ups	TRUE	-2	Uint16
21-62	Ext. 3 Integral Time	20.00 s	All set-ups	TRUE	-2	Uint32
21-63	Ext. 3 Differentiation Time	0.00 s	All set-ups	TRUE	-2	Uint16
21-64	Ext. 3 Dif. Gain Limit	5.0 N/A	All set-ups	TRUE	-1	Uint16

3.1.19 22- ** Application Functions

Par. No. #	Parameter description	Default value	4-set-up	Change during operation	Conversion index	Type
22-0* Miscellaneous						
22-00	External Interlock Delay	0 s	All set-ups	TRUE	0	Uint16
22-2* No-Flow Detection						
22-20	Low Power Auto Set-up	[0] OFF	All set-ups	FALSE	-	Uint8
22-21	Low Power Detection	[0] Disabled	All set-ups	TRUE	-	Uint8
22-22	Low Speed Detection	[0] Disabled	All set-ups	TRUE	-	Uint8
22-23	No-Flow Function	[0] OFF	All set-ups	TRUE	-	Uint8
22-24	No-Flow Delay	10 s	All set-ups	TRUE	0	Uint16
22-26	Dry Pump Function	[0] OFF	All set-ups	TRUE	-	Uint8
22-27	Dry Pump Delay	10 s	All set-ups	TRUE	0	Uint16
22-28	No-Flow Low Speed [RPM]	ExpressionLimit	All set-ups	TRUE	67	Uint16
22-29	No-Flow Low Speed [Hz]	ExpressionLimit	All set-ups	TRUE	-1	Uint16
22-3* No-Flow Power Tuning						
22-30	No-Flow Power	0.00 kW	All set-ups	TRUE	1	Uint32
22-31	Power Correction Factor	100 %	All set-ups	TRUE	0	Uint16
22-32	Low Speed [RPM]	ExpressionLimit	All set-ups	TRUE	67	Uint16
22-33	Low Speed [Hz]	ExpressionLimit	All set-ups	TRUE	-1	Uint16
22-34	Low Speed Power [kW]	ExpressionLimit	All set-ups	TRUE	1	Uint32
22-35	Low Speed Power [HP]	ExpressionLimit	All set-ups	TRUE	-2	Uint32
22-36	High Speed [RPM]	ExpressionLimit	All set-ups	TRUE	67	Uint16
22-37	High Speed [Hz]	ExpressionLimit	All set-ups	TRUE	-1	Uint16
22-38	High Speed Power [kW]	ExpressionLimit	All set-ups	TRUE	1	Uint32
22-39	High Speed Power [HP]	ExpressionLimit	All set-ups	TRUE	-2	Uint32
22-4* Sleep Mode						
22-40	Minimum Run Time	60 s	All set-ups	TRUE	0	Uint16
22-41	Minimum Sleep Time	30 s	All set-ups	TRUE	0	Uint16
22-42	Wake-up Speed [RPM]	ExpressionLimit	All set-ups	TRUE	67	Uint16
22-43	Wake-up Speed [Hz]	ExpressionLimit	All set-ups	TRUE	-1	Uint16
22-44	Wake-up Ref./FB Difference	10 %	All set-ups	TRUE	0	Int8
22-45	Setpoint Boost	0 %	All set-ups	TRUE	0	Int8
22-46	Maximum Boost Time	60 s	All set-ups	TRUE	0	Uint16
22-5* End of Curve						
22-50	End of Curve Function	[0] OFF	All set-ups	TRUE	-	Uint8
22-51	End of Curve Delay	10 s	All set-ups	TRUE	0	Uint16
22-6* Broken Belt Detection						
22-60	Broken Belt Function	[0] OFF	All set-ups	TRUE	-	Uint8
22-61	Broken Belt Torque	10 %	All set-ups	TRUE	0	Uint8
22-62	Broken Belt Delay	10 s	All set-ups	TRUE	0	Uint16
22-7* Short Cycle Protection						
22-75	Short Cycle Protection	[0] Disabled	All set-ups	TRUE	-	Uint8
22-76	Interval between Starts	start_to_start_min_on_time (P2277)	All set-ups	TRUE	0	Uint16
22-77	Minimum Run Time	0 s	All set-ups	TRUE	0	Uint16

Par. No. #	Parameter description	Default value	4-set-up	Change during operation	Conversion index	Type
22-8* Flow Compensation						
22-80	Flow Compensation	[0] Disabled	All set-ups	TRUE	-	Uint8
22-81	Square-linear Curve Approximation	100 %	All set-ups	TRUE	0	Uint8
22-82	Work Point Calculation	[0] Disabled	All set-ups	TRUE	-	Uint8
22-83	Speed at No-Flow [RPM]	ExpressionLimit	All set-ups	TRUE	67	Uint16
22-84	Speed at No-Flow [Hz]	ExpressionLimit	All set-ups	TRUE	-1	Uint16
22-85	Speed at Design Point [RPM]	ExpressionLimit	All set-ups	TRUE	67	Uint16
22-86	Speed at Design Point [Hz]	ExpressionLimit	All set-ups	TRUE	-1	Uint16
22-87	Pressure at No-Flow Speed	0.000 N/A	All set-ups	TRUE	-3	Int32
22-88	Pressure at Rated Speed	999999.999 N/A	All set-ups	TRUE	-3	Int32
22-89	Flow at Design Point	0.000 N/A	All set-ups	TRUE	-3	Int32
22-90	Flow at Rated Speed	0.000 N/A	All set-ups	TRUE	-3	Int32

3.1.20 23- ** Timed Actions

Par. No. #	Parameter description	Default value	4-set-up	Change during operation	Conversion Index	Type
23-0* Timed Actions						
23-00	ON Time	ExpressionLimit	2 set-ups	TRUE	0	TimeOfDay- WoDate UInt8
23-01	ON Action	[0] DISABLED	2 set-ups	TRUE	-	TimeOfDay- WoDate UInt8
23-02	OFF Time	ExpressionLimit	2 set-ups	TRUE	0	TimeOfDay- WoDate UInt8
23-03	OFF Action	[0] DISABLED	2 set-ups	TRUE	-	TimeOfDay- WoDate UInt8
23-04	Occurrence	[0] All days	2 set-ups	TRUE	-	UInt8
23-1* Maintenance						
23-10	Maintenance Item	[1] Motor bearings	1 set-up	TRUE	-	UInt8
23-11	Maintenance Action	[1] Lubricate	1 set-up	TRUE	-	UInt8
23-12	Maintenance Time Base	[0] Disabled	1 set-up	TRUE	-	UInt8
23-13	Maintenance Time Interval	1 h	1 set-up	TRUE	74	UInt32
23-14	Maintenance Date and Time	ExpressionLimit	1 set-up	TRUE	0	TimeOfDay
23-1* Maintenance Reset						
23-15	Reset Maintenance Word	[0] Do not reset	All set-ups	TRUE	-	UInt8
23-16	Maintenance Text	0 N/A	1 set-up	TRUE	0	VisStr[20]
23-5* Energy Log						
23-50	Energy Log Resolution	[5] Last 24 Hours	2 set-ups	TRUE	-	UInt8
23-51	Period Start	ExpressionLimit	2 set-ups	TRUE	0	TimeOfDay
23-53	Energy Log	0 N/A	All set-ups	TRUE	0	UInt32
23-54	Reset Energy Log	[0] Do not reset	All set-ups	TRUE	-	UInt8
23-6* Trending						
23-60	Trend Variable	[0] Power [kW]	2 set-ups	TRUE	-	UInt8
23-61	Continuous Bin Data	0 N/A	All set-ups	TRUE	0	UInt32
23-62	Timed Bin Data	0 N/A	All set-ups	TRUE	0	UInt32
23-63	Timed Period Start	ExpressionLimit	2 set-ups	TRUE	0	TimeOfDay
23-64	Timed Period Stop	ExpressionLimit	2 set-ups	TRUE	0	TimeOfDay
23-65	Minimum Bin Value	ExpressionLimit	2 set-ups	TRUE	0	UInt8
23-66	Reset Continuous Bin Data	[0] Do not reset	All set-ups	TRUE	-	UInt8
23-67	Reset Timed Bin Data	[0] Do not reset	All set-ups	TRUE	-	UInt8
23-8* Payback Counter						
23-80	Power Reference Factor	100 %	2 set-ups	TRUE	0	UInt8
23-81	Energy Cost	1.00 N/A	2 set-ups	TRUE	-2	UInt32
23-82	Investment	0 N/A	2 set-ups	TRUE	0	UInt32
23-83	Energy Savings	0 kWh	All set-ups	TRUE	75	Int32
23-84	Cost Savings	0 N/A	All set-ups	TRUE	0	Int32

3.1.21 25- ** Cascade Controller

Par. No. #	Parameter description	Default value	4-set-up	Change during operation	Conversion index	Type
25-0* System Settings						
25-00	Cascade Controller	null	2 set-ups	FALSE	-	Uint8
25-02	Motor Start	[0] Direct on Line	2 set-ups	FALSE	-	Uint8
25-04	Pump Cycling	null	All set-ups	TRUE	-	Uint8
25-05	Fixed Lead Pump	null	2 set-ups	FALSE	-	Uint8
25-06	Number Of Pumps	2 N/A	2 set-ups	FALSE	0	Uint8
25-2* Bandwidth Settings						
25-20	Staging Bandwidth	ExpressionLimit	All set-ups	TRUE	0	Uint8
25-21	Override Bandwidth	100 %	All set-ups	TRUE	0	Uint8
25-22	Fixed Speed Bandwidth	casco_staging_bandwidth (P2520)	All set-ups	TRUE	0	Uint8
25-23	SBW Staging Delay	15 s	All set-ups	TRUE	0	Uint16
25-24	SBW De-staging Delay	15 s	All set-ups	TRUE	0	Uint16
25-25	OBW Time	10 s	All set-ups	TRUE	0	Uint16
25-26	Destage At No-Flow	[0] Disabled	All set-ups	TRUE	-	Uint8
25-27	Stage Function	null	All set-ups	TRUE	-	Uint8
25-28	Stage Function Time	15 s	All set-ups	TRUE	0	Uint16
25-29	Destage Function	null	All set-ups	TRUE	-	Uint8
25-30	Destage Function Time	15 s	All set-ups	TRUE	0	Uint16
25-4* Staging Settings						
25-40	Ramp-down Delay	10.0 s	All set-ups	TRUE	-1	Uint16
25-41	Ramp-up Delay	2.0 s	All set-ups	TRUE	-1	Uint16
25-42	Staging Threshold	ExpressionLimit	All set-ups	TRUE	0	Uint8
25-43	De-staging Threshold	ExpressionLimit	All set-ups	TRUE	0	Uint8
25-44	Staging Speed [RPM]	0 RPM	All set-ups	TRUE	67	Uint16
25-45	Staging Speed [Hz]	0.0 Hz	All set-ups	TRUE	-1	Uint16
25-46	De-staging Speed [RPM]	0 RPM	All set-ups	TRUE	67	Uint16
25-47	De-staging Speed [Hz]	0.0 Hz	All set-ups	TRUE	-1	Uint16
25-5* Alternation Settings						
25-50	Lead Pump Alternation	null	All set-ups	TRUE	-	Uint8
25-51	Alternation Event	[0] External	All set-ups	TRUE	-	Uint8
25-52	Alternation Time Interval	24 h	All set-ups	TRUE	74	Uint16
25-53	Alternation Timer Value	0 N/A	All set-ups	TRUE	0	VisSrr[7]
25-54	Alternation Predefined Time	ExpressionLimit	All set-ups	TRUE	0	TimeOfDayWoDate
25-55	Alternate if Load < 50%	[1] Enabled	All set-ups	TRUE	-	Uint8
25-56	Staging Mode at Alternation	[0] Slow	All set-ups	TRUE	-	Uint8
25-58	Run Next Pump Delay	0.1 s	All set-ups	TRUE	-1	Uint16
25-59	Run-on Line Delay	0.5 s	All set-ups	TRUE	-1	Uint16

Par. No. #	Parameter description	Default value	4-set-up	Change during operation	Conversion index	Type
25-8* Status						
25-80	Cascade Status	0 N/A	All set-ups	TRUE	0	VisStr[25]
25-81	Pump Status	0 N/A	All set-ups	TRUE	0	VisStr[25]
25-82	Lead Pump	0 N/A	All set-ups	TRUE	0	Uint8
25-83	Relay Status	0 N/A	All set-ups	TRUE	0	VisStr[4]
25-84	Pump ON Time	0 h	All set-ups	TRUE	74	Uint32
25-85	Relay ON Time	0 h	All set-ups	TRUE	74	Uint32
25-86	Reset Relay Counters	[0] Do not reset	All set-ups	TRUE	-	Uint8
25-9* Service						
25-90	Pump Interlock	[0] Off	All set-ups	TRUE	-	Uint8
25-91	Manual Alternation	0 N/A	All set-ups	TRUE	0	Uint8

3.1.22 26- ** Analog I/O Option MCB 109

Par. No. #	Parameter description	Default value	4-set-up	Change during operation	Conversion Index	Type
26-0* Analog I/O Mode						
26-00	Terminal X42/1 Mode	[1] Voltage	All set-ups	TRUE	-	Uint8
26-01	Terminal X42/3 Mode	[1] Voltage	All set-ups	TRUE	-	Uint8
26-02	Terminal X42/5 Mode	[1] Voltage	All set-ups	TRUE	-	Uint8
26-1* Analog Input X42/1						
26-10	Terminal X42/1 Low Voltage	0.07 V	All set-ups	TRUE	-2	Int16
26-11	Terminal X42/1 High Voltage	10.00 V	All set-ups	TRUE	-2	Int16
26-14	Term. X42/1 Low Ref./Feedb. Value	0.000 N/A	All set-ups	TRUE	-3	Int32
26-15	Term. X42/1 High Ref./Feedb. Value	100.000 N/A	All set-ups	TRUE	-3	Int32
26-16	Term. X42/1 Filter Time Constant	0.001 s	All set-ups	TRUE	-3	Uint16
26-17	Term. X42/1 Live Zero	[1] Enabled	All set-ups	TRUE	-	Uint8
26-2* Analog Input X42/3						
26-20	Terminal X42/3 Low Voltage	0.07 V	All set-ups	TRUE	-2	Int16
26-21	Terminal X42/3 High Voltage	10.00 V	All set-ups	TRUE	-2	Int16
26-24	Term. X42/3 Low Ref./Feedb. Value	0.000 N/A	All set-ups	TRUE	-3	Int32
26-25	Term. X42/3 High Ref./Feedb. Value	100.000 N/A	All set-ups	TRUE	-3	Int32
26-26	Term. X42/3 Filter Time Constant	0.001 s	All set-ups	TRUE	-3	Uint16
26-27	Term. X42/3 Live Zero	[1] Enabled	All set-ups	TRUE	-	Uint8
26-3* Analog Input X42/5						
26-30	Terminal X42/5 Low Voltage	0.07 V	All set-ups	TRUE	-2	Int16
26-31	Terminal X42/5 High Voltage	10.00 V	All set-ups	TRUE	-2	Int16
26-34	Term. X42/5 Low Ref./Feedb. Value	0.000 N/A	All set-ups	TRUE	-3	Int32
26-35	Term. X42/5 High Ref./Feedb. Value	100.000 N/A	All set-ups	TRUE	-3	Int32
26-36	Term. X42/5 Filter Time Constant	0.001 s	All set-ups	TRUE	-3	Uint16
26-37	Term. X42/5 Live Zero	[1] Enabled	All set-ups	TRUE	-	Uint8
26-4* Analog Out X42/7						
26-40	Terminal X42/7 Output	[0] No operation	All set-ups	TRUE	-	Uint8
26-41	Terminal X42/7 Min. Scale	0.00 %	All set-ups	TRUE	-2	Int16
26-42	Terminal X42/7 Max. Scale	100.00 %	All set-ups	TRUE	-2	Int16
26-43	Terminal X42/7 Bus Control	0.00 %	All set-ups	TRUE	-2	N2
26-44	Terminal X42/7 Timeout Preset	0.00 %	1 set-up	TRUE	-2	Uint16
26-5* Analog Out X42/9						
26-50	Terminal X42/9 Output	[0] No operation	All set-ups	TRUE	-	Uint8
26-51	Terminal X42/9 Min. Scale	0.00 %	All set-ups	TRUE	-2	Int16
26-52	Terminal X42/9 Max. Scale	100.00 %	All set-ups	TRUE	-2	Int16
26-53	Terminal X42/9 Bus Control	0.00 %	All set-ups	TRUE	-2	N2
26-54	Terminal X42/9 Timeout Preset	0.00 %	1 set-up	TRUE	-2	Uint16
26-6* Analog Out X42/11						
26-60	Terminal X42/11 Output	[0] No operation	All set-ups	TRUE	-	Uint8
26-61	Terminal X42/11 Min. Scale	0.00 %	All set-ups	TRUE	-2	Int16
26-62	Terminal X42/11 Max. Scale	100.00 %	All set-ups	TRUE	-2	Int16
26-63	Terminal X42/11 Bus Control	0.00 %	All set-ups	TRUE	-2	N2
26-64	Terminal X42/11 Timeout Preset	0.00 %	1 set-up	TRUE	-2	Uint16

3.1.23 Cascade CTL Option 27- **

Par. No. #	Parameter description	Default value	4-set-up	Change during operation	Conversion index	Type
27-0* Control & Status						
27-01	Pump Status	[0] Ready	All set-ups	TRUE	-	UInt8
27-02	Manual Pump Control	[0] No Operation	2 set-ups	TRUE	-	UInt8
27-03	Current Runtime Hours	0 h	All set-ups	TRUE	74	UInt32
27-04	Pump Total Lifetime Hours	0 h	All set-ups	TRUE	74	UInt32
27-1* Configuration						
27-10	Cascade Controller	[0] Disabled	2 set-ups	FALSE	-	UInt8
27-11	Number Of Drives	1 N/A	2 set-ups	FALSE	0	UInt8
27-12	Number Of Pumps	ExpressionLimit	2 set-ups	FALSE	0	UInt8
27-14	Pump Capacity	100 %	2 set-ups	FALSE	0	UInt16
27-16	Runtime Balancing	[0] Balanced Priority 1	2 set-ups	TRUE	-	UInt8
27-17	Motor Starters	[0] Direct Online	2 set-ups	FALSE	-	UInt8
27-18	Spin Time for Unused Pumps	ExpressionLimit	All set-ups	TRUE	0	UInt16
27-19	Reset Current Runtime Hours	[0] Do not reset	All set-ups	TRUE	-	UInt8
27-2* Bandwidth Settings						
27-20	Normal Operating Range	ExpressionLimit	All set-ups	TRUE	0	UInt8
27-21	Override Limit	100 %	All set-ups	TRUE	0	UInt8
27-22	Fixed Speed Only Operating Range	ExpressionLimit	All set-ups	TRUE	0	UInt8
27-23	Staging Delay	15 s	All set-ups	TRUE	0	UInt16
27-24	Destaging Delay	15 s	All set-ups	TRUE	0	UInt16
27-25	Override Hold Time	10 s	All set-ups	TRUE	0	UInt16
27-27	Min Speed Destage Delay	ExpressionLimit	All set-ups	TRUE	0	UInt16
27-3* Staging Speed						
27-30	Auto Tune Staging Speeds	[1] Enabled	All set-ups	TRUE	-	UInt8
27-31	Stage On Speed [RPM]	ExpressionLimit	All set-ups	TRUE	67	UInt16
27-32	Stage On Speed [Hz]	ExpressionLimit	All set-ups	TRUE	-1	UInt16
27-33	Stage Off Speed [RPM]	ExpressionLimit	All set-ups	TRUE	67	UInt16
27-34	Stage Off Speed [Hz]	ExpressionLimit	All set-ups	TRUE	-1	UInt16
27-4* Staging Settings						
27-40	Auto Tune Staging Settings	[0] Disabled	All set-ups	TRUE	-	UInt8
27-41	Ramp Down Delay	10.0 s	All set-ups	TRUE	-1	UInt16
27-42	Ramp Up Delay	2.0 s	All set-ups	TRUE	-1	UInt16
27-43	Staging Threshold	ExpressionLimit	All set-ups	TRUE	0	UInt8
27-44	Destaging Threshold	ExpressionLimit	All set-ups	TRUE	0	UInt8
27-45	Staging Speed [RPM]	0 RPM	All set-ups	TRUE	67	UInt16
27-46	Staging Speed [Hz]	0.0 Hz	All set-ups	TRUE	-1	UInt16
27-47	Destaging Speed [RPM]	0 RPM	All set-ups	TRUE	67	UInt16
27-48	Destaging Speed [Hz]	0.0 Hz	All set-ups	TRUE	-1	UInt16
27-5* Alternate Settings						
27-50	Automatic Alternation	[0] Disabled	All set-ups	FALSE	-	UInt8
27-51	Alternation Event	null	All set-ups	TRUE	-	UInt8
27-52	Alternation Time Interval	0 min	All set-ups	TRUE	70	UInt16
27-53	Alternation Timer Value	0 min	All set-ups	TRUE	70	UInt16
27-54	Alternation At Time of Day	[0] Disabled	All set-ups	TRUE	-	UInt8
27-55	Alternation Predefined Time	ExpressionLimit	All set-ups	TRUE	0	WoDate
27-56	Alternate Capacity is <	0 %	All set-ups	TRUE	0	UInt8
27-58	Run Next Pump Delay	0.1 s	All set-ups	TRUE	-1	UInt16

Par. No. #	Parameter description	Default value	4-set-up	Change during operation	Conversion index	Type
27-6* Digital Inputs						
27-60	Terminal X66/1 Digital Input	[0] No operation	All set-ups	TRUE	-	Uint8
27-61	Terminal X66/3 Digital Input	[0] No operation	All set-ups	TRUE	-	Uint8
27-62	Terminal X66/5 Digital Input	[0] No operation	All set-ups	TRUE	-	Uint8
27-63	Terminal X66/7 Digital Input	[0] No operation	All set-ups	TRUE	-	Uint8
27-64	Terminal X66/9 Digital Input	[0] No operation	All set-ups	TRUE	-	Uint8
27-65	Terminal X66/11 Digital Input	[0] No operation	All set-ups	TRUE	-	Uint8
27-66	Terminal X66/13 Digital Input	[0] No operation	All set-ups	TRUE	-	Uint8
27-7* Connections						
27-70	Relay	[0] Standard Relay	2 set-ups	FALSE	-	Uint8
27-9* Readouts						
27-91	Cascade Reference	0.0 %	All set-ups	TRUE	-1	Int16
27-92	% Of Total Capacity	0 %	All set-ups	TRUE	0	Uint16
27-93	Cascade Option Status	[0] Disabled	All set-ups	TRUE	-	Uint8
27-94	Cascade System Status	0 N/A	All set-ups	TRUE	0	VisStr[25]

3.1.24 29- ** Water Application Functions

Par. No. #	Parameter description	Default value	4-set-up	Change during operation	Conversion index	Type
29-0* Pipe Fill						
29-00	Pipe Fill Enable	[0] Disabled	2 set-ups	FALSE	-	UInt8
29-01	Pipe Fill Speed [RPM]	ExpressionLimit	All set-ups	TRUE	67	UInt16
29-02	Pipe Fill Speed [Hz]	ExpressionLimit	All set-ups	TRUE	-1	UInt16
29-03	Pipe Fill Time	0.00 s	All set-ups	TRUE	-2	UInt32
29-04	Pipe Fill Rate	0.001 ProcessCtrlUnit	All set-ups	TRUE	-3	Int32
29-05	Filled Setpoint	0.000 ProcessCtrlUnit	All set-ups	TRUE	-3	Int32

3.1.25 31-.* Bypass Option

Par. No. #	Parameter description	Default value	4-set-up	Change during operation	Conversion index	Type
31-00	Bypass Mode	[0] Drive	All set-ups	TRUE	-	Uint8
31-01	Bypass Start Time Delay	30 s	All set-ups	TRUE	0	Uint16
31-02	Bypass Trip Time Delay	0 s	All set-ups	TRUE	0	Uint16
31-03	Test Mode Activation	[0] Disabled	All set-ups	TRUE	-	Uint8
31-10	Bypass Status Word	0 N/A	All set-ups	FALSE	0	V2
31-11	Bypass Running Hours	0 h	All set-ups	FALSE	74	Uint32
31-19	Remote Bypass Activation	[0] Disabled	2 set-ups	TRUE	-	Uint8

Index

0

0-** Operation/display	3-2
------------------------------	-----

1

1-** Load/motor	3-4
1-3* Addl. Motor Data	2-20
13-** Smart Logic	3-15
14-** Special Functions	3-16
15-** Fc Information	3-17
16-** Data Readouts	3-19
[1-75 Start Speed Hz]	2-24
18-** Data Readouts 2	3-21
18-0* Maintenance Log	2-153

2

2-** Brakes	3-5
20-** Fc Closed-loop	3-22
20-2* Feedback & Setpoint	2-158
20-7* Pid Autotuning	2-161
20-8* Basic Settings	2-163
21-** Ext. Closed-loop	3-23
21-0* Extended Cl Autotuning	2-166
22-** Application Functions	3-25
23-** Timed Actions	3-27
25-** Cascade Controller	2-209, 3-28

3

3-** Reference / Ramps	3-6
------------------------------	-----

4

4-** Limits / Warnings	3-7
------------------------------	-----

5

5-** Digital In/out	3-8
---------------------------	-----

6

6-** Analog In/out	3-10
6-0* Analog I/o Mode	2-79

8

8-** Comm. And Options	3-12
------------------------------	------

9

9-** Profibus	3-13
---------------------	------

A

Acceleration Time	2-35
Access To Main Menu W/o Password 0-61	2-14
Access To Personal Menu W/o Password 0-66	2-14
Active Set-up 0-10	2-3
Actual Baud Rate 9-63	2-103
Actual Typecode String 15-45	2-140
Additional Non-working Days 0-83	2-16

Additional Working Days 0-82	2-16
Address 8-31	2-92
Adj Freq Dr Ordering No. 15-46	2-141
Adj Freq Dr Serial No. 15-51	2-141
Aeo Minimum Magnetization 14-41	2-132
Alarm Log	2-139
Alarm Log: Error Code 15-30	2-140
Alarm Log: Time 15-32	2-140
Alarm Log: Value 15-31	2-140
Alarm Word 16-90	2-150
Alarm Word 2 16-91	2-150
Alternate If Load < 50% 25-55	2-219
Alternation Event 25-51	2-218
Alternation Predefined Time 25-54	2-219
Alternation Time Interval 25-52	2-218
Alternation Timer Value 25-53	2-218
Analog I/o Option Mcb 109, 26-**	2-223
Analog In X30/11 16-75	2-149
Analog In X30/12 16-76	2-149
Analog Input 53 16-62	2-147
Analog Input 54 16-64	2-148
Analog Input Scaling Value	2-226
Analog Input X42/1 18-30	2-154
Analog Input X42/3 18-31	2-154
Analog Input X42/5 18-32	2-154
[Analog Out X30/8 Ma] 16-77	2-149
[Analog Out X42/11 V] 18-35	2-154
[Analog Out X42/7 V] 18-33	2-154
[Analog Out X42/9 V] 18-34	2-154
[Analog Output 42 Ma] 16-65	2-148
Array Index 10-30	2-111
Auto Derate, 14-6*	2-133
Auto Energy Optim. Ct	2-17
Auto Energy Optim. Vt	2-17
[Auto On] Key On Lcp 0-42	2-13
Automatic Motor Adaptation (ama) 1-29	2-20
Automatic Restart Time 14-21	2-130

B

Baud Rate 8-32	2-92
Baud Rate Select 10-01	2-106
Brake Check 2-15	2-30
Brake Energy /2 Min 16-33	2-145
Brake Energy /s 16-32	2-145
Brake Function 2-10	2-29
Brake Power Limit (kw) 2-12	2-29
Brake Power Monitoring 2-13	2-29
Brake Resistor (ohm) 2-11	2-29
Broken Belt Delay 22-62	2-189
Broken Belt Detection, 22-6*	2-188
Broken Belt Function 22-60	2-189
Broken Belt Torque 22-61	2-189
Bus Controlled	2-77
Bus Error Count 8-81	2-95
Bus Feedback 1 8-94	2-96
Bus Feedback 2 8-95	2-96
Bus Feedback 3 8-96	2-96
Bus Jog 1 Speed 8-90	2-96
Bus Jog 2 Speed 8-91	2-96
Bus Message Count 8-80	2-95
Bypass Mode, 31-00	2-233
Bypass Running Hours, 31-11	2-233
[Bypass Speed From Hz] 4-61	2-44

[Bypass Speed From Rpm] 4-60	2-44
[Bypass Speed To Hz] 4-63	2-44
[Bypass Speed To Rpm] 4-62	2-44
Bypass Start Time Delay, 31-01	2-233
Bypass Status Word, 31-10	2-233
Bypass Trip Time Delay, 31-02	2-233
C	
Can Protocol 10-00	2-106
Cascade Controller 25-00	2-210
Cascade Ctl Option	3-31
Cascade Status 25-80	2-220
Changed Parameters (1) 9-90	2-105
Changed Parameters (2) 9-91	2-105
Changed Parameters (3) 9-92	2-105
Changed Parameters (5) 9-94	2-105
Changing A Group Of Numeric Data Values	1-14
Changing A Text Value	1-14
Changing Data	1-14
Changing Data Values	1-15
[Check Valve Ramp End Speed Hz] 3-87	2-37
[Check Valve Ramp End Speed Rpm] 3-86	2-37
Check Valve Ramp Time 3-85	2-37
Clock Fault 0-79	2-16
Clock Settings, 0-7*	2-14
Clockwise	2-40
Closed-loop Type 20-70	2-162, 2-167
Coasting	1-5
Coasting Select 8-50	2-93
Comm. Option Status 16-84	2-150
Comparator Operand 13-10	2-116
Comparator Operator 13-11	2-117
Comparator Value 13-12	2-117
Configurable Status Word Stw 8-13	2-91
Configuration	2-91
Configuration Mode 1-00	2-17
Continuous Bin Data 23-61	2-205
Control Card Temp. 16-39	2-146
Control Profile 8-10	2-91
Control Site 8-01	2-89
Control Timeout Function 8-04	2-90
Control Timeout Time 8-03	2-89
Control Word 16-00	2-143
Control Word Source, 8-02	2-89
Cooling	2-26
Cos Filter 1 10-20	2-110
Cos Filter 2 10-21	2-110
Cos Filter 3 10-22	2-111
Cos Filter 4 10-23	2-111
Cost Savings 23-84	2-208
Counter A 16-72	2-149
Counter B 16-73	2-149
Current Lim Cont, Proportional Gain 14-30	2-132
Current Lim Contr, Integration Time 14-31	2-132
Current Limit Control, 14-3*	2-131
Current Limit, 4-18	2-41
Custom Readout 16-09	2-143
Custom Readout Max Value 0-32	2-11
Custom Readout Min Value 0-31	2-11
Custom Readout Unit 0-30	2-10

D

Data Log Settings, 15-1*	2-136
Date And Time Readout 0-89	2-16
Dc Brake Current 2-01	2-28
[Dc Brake Cut-in Speed Rpm] 2-03	2-28
Dc Brake Select 8-52	2-93
Dc Braking Time 2-02	2-28
Dc Hold/preheat Current 2-00	2-28
Dc Link Voltage 16-30	2-145
Default Settings	3-1
Default Settings	1-15
Defined Parameters 15-92	2-142
Defined Parameters (1) 9-80	2-104
Defined Parameters (2) 9-81	2-104
Defined Parameters (3) 9-82	2-105
Defined Parameters (4) 9-83	2-105
Destage At No-flow 25-26	2-213
Destage Function 25-29	2-214
Destage Function Time 25-30	2-214
[De-staging Speed Hz] 25-47	2-217
[De-staging Speed Rpm] 25-46	2-217
De-staging Threshold 25-43	2-216
Devicenet	2-107
Devicenet And Can Serial Communication Bus	2-106
Devicenet F Parameters 10-39	2-111
Devicenet Revision 10-32	2-111
Diagnosis Trigger 8-07	2-91
Digi Pot Reference 16-53	2-146
Digital & Relay Bus Control 5-90	2-77
Digital I/o Mode 5-00	2-46
[Digital Output Bin] 16-66	2-148
Display Line 1.1 Small, 0-20	2-6
Display Line 1.2 Small, 0-21	2-8
Display Line 1.3 Small, 0-22	2-8
Display Line 2 Large, 0-23	2-8
Display Line 3 Large, 0-24	2-9
Display Mode	1-7
Display Mode - Selection Of Displayed Variables	1-7
Display Text 1 0-37	2-11
Display Text 2 0-38	2-12
Display Text 3 0-39	2-12
Drive Closed-loop, 20-**	2-155
Drive Identification, 15-4*	2-140
Drive Information	2-135
Dry Pump Delay 22-27	2-182
Dry Pump Function 22-26	2-182
Dst/summertime 0-74	2-15
Dst/summertime End 0-77	2-15
Dst/summertime Start 0-76	2-15

E

Efficient Parameter Set-up For Water Applications	1-10
End Of Curve Delay 22-51	2-188
End Of Curve Function 22-50	2-188
End Of Curve, 22-5*	2-188
End-of-timeout Function 8-05	2-90
Energy Cost 23-81	2-208
Energy Log 23-53	2-203
Energy Log Resolution 23-50	2-201
Energy Log, 23-5*	2-200
Energy Optimizing, 14-4*	2-132

Energy Savings 23-83	2-208
Environment, 14-5*	2-132
Etr	2-144
Ext. 1 Dif. Gain Limit 21-24	2-171
Ext. 1 Differentiation Time 21-23	2-171
Ext. 1 Feedback Source 21-14	2-170
[Ext. 1 Feedback Unit] 21-18	2-171
Ext. 1 Integral Time 21-22	2-171
Ext. 1 Maximum Reference 21-12	2-169
Ext. 1 Minimum Reference 21-11	2-169
Ext. 1 Normal/inverse Control 21-20	2-171
[Ext. 1 Output %] 21-19	2-171
Ext. 1 Proportional Gain 21-21	2-171
Ext. 1 Ref./feedback Unit 21-10	2-168
Ext. 1 Reference Source 21-13	2-170
[Ext. 1 Reference Unit] 21-17	2-171
Ext. 1 Setpoint 21-15	2-170
Ext. 2 Dif. Gain Limit 21-44	2-175
Ext. 2 Differentiation Time 21-43	2-175
Ext. 2 Feedback Source 21-34	2-174
[Ext. 2 Feedback Unit] 21-38	2-174
Ext. 2 Integral Time 21-42	2-175
Ext. 2 Maximum Reference 21-32	2-173
Ext. 2 Minimum Reference 21-31	2-173
Ext. 2 Normal/inverse Control 21-40	2-174
[Ext. 2 Output %] 21-39	2-174
Ext. 2 Proportional Gain 21-41	2-175
Ext. 2 Ref./feedback Unit 21-30	2-172
Ext. 2 Reference Source 21-33	2-173
[Ext. 2 Reference Unit] 21-37	2-174
Ext. 2 Setpoint 21-35	2-174
Ext. 3 Dif. Gain Limit 21-64	2-178
Ext. 3 Differentiation Time 21-63	2-178
Ext. 3 Feedback Source 21-54	2-177
[Ext. 3 Feedback Unit] 21-58	2-178
Ext. 3 Integral Time 21-62	2-178
Ext. 3 Maximum Reference 21-52	2-176
Ext. 3 Minimum Reference 21-51	2-176
Ext. 3 Normal/inverse Control 21-60	2-178
[Ext. 3 Output %] 21-59	2-178
Ext. 3 Proportional Gain 21-61	2-178
Ext. 3 Ref./feedback Unit 21-50	2-175
Ext. 3 Reference Source 21-53	2-177
[Ext. 3 Reference Unit] 21-57	2-177
Ext. 3 Setpoint 21-55	2-177
Ext. Status Word 16-94	2-151
Ext. Status Word 2 16-95	2-151
External Interlock Delay 22-00	2-179
External Reference 16-50	2-146
 F	
Fan Control 14-52	2-133
Fan Monitor 14-53	2-133
Fc Port Ctw 1 16-85	2-150
Fc Port Ref 1 16-86	2-150
Fc Type, 15-40	2-140
Feedback 1 Conversion, 20-01	2-156
Feedback 1 Source 20-00	2-155
[Feedback 1 Unit] 16-54	2-146
Feedback 2 Conversion 20-04	2-156
Feedback 2 Source 20-03	2-156
[Feedback 2 Unit] 16-55	2-146
Feedback 3 Conversion 20-07	2-157

Feedback 3 Source 20-06	2-157
[Feedback 3 Unit] 16-56	2-147
Feedback Function, 20-20	2-158
[Feedback Unit] 16-52	2-146
Feedback, 20-0*	2-155
Fieldbus Ctw 1 16-80	2-150
Fieldbus Ref 1 16-82	2-150
Filled Setpoint, 29-05	2-232
Final Ramp Time 3-88	2-38
Fire Mode Live Zero Timeout Function 6-02	2-80
Fixed Lead Pump 25-05	2-210
Fixed Speed Bandwidth 25-22	2-212
Flow At Rated Speed 22-90	2-193
Flow Compensation 22-80	2-190
Flow Compensation, 22-8*	2-190
Flying Start 1-73	2-24
[Freq. Input #29 Hz] 16-67	2-148
[Freq. Input #33 Hz] 16-68	2-148
Frequency 16-13	2-144
[Frequency %] 16-15	2-144
Function At Inverter Overload, Par 14-61	2-134
Function At Mains Imbalance 14-12	2-129
Function At Overtemperature, Par 14-60	2-133
Function At Stop 1-80	2-25
Function Relay, 5-40	2-70

G

General Settings, 1-0*	2-17
Graphical Display	1-1

H

[Hand On] Key On Lcp 0-40	2-12
Heatsink Temp. 16-34	2-145
[High Speed Hz] 22-37	2-184
High Speed Load Compensation 1-61	2-23
[High Speed Power Hp] 22-39	2-184
[High Speed Power Kw] 22-38	2-184
[High Speed Rpm] 22-36	2-183
Historic Log,15-2*	2-139
Historic Log: Event 15-20	2-139
Historic Log: Time 15-22	2-139
Historic Log: Value 15-21	2-139
How To Operate The Graphical Lcp (glcp)	1-1

I

Indexed Parameters	1-15
Initial Ramp Time, 3-84	2-36
Initialization	1-15
Interval Between Starts 22-76	2-189
Inv. Max. Current 16-37	2-145
Inv. Nom. Current 16-36	2-145
Inv. Overload Derate Current 14-62	2-134
Inverter Thermal 16-35	2-145
Investment 23-82	2-208
Iron Loss Resistance (rfe) 1-36	2-21
It Line Power	2-133

J

Jog Ramp Time 3-80	2-36
[Jog Speed Hz] 3-11	2-32

[Jog Speed Rpm] 3-19	2-35
----------------------	------

K

Keypad, 0-4*	2-12
Kwh Counter 15-02	2-135

L

Language 0-01	2-2
Lcp 102	1-1
Lcp Copy 0-50	2-13
Lcp Id Num. 15-48	2-141
Lead Pump 25-82	2-221
Lead Pump Alternation 25-50	2-218
Leds	1-1
Leds:	1-3
Line Power Rfi Filter Circuit	2-133
Line Supply On/off, 14-1*	2-129
Live Zero Timeout Function 6-01	2-79
Live Zero Timeout Time 6-00	2-79
Local Reference	2-3
Logging Buffer Full 16-40	2-146
Logging Interval 15-11	2-137
Logging Mode 15-13	2-138
Logging Source, 15-10	2-136
Logic Rule Boolean 1 13-40	2-118
Logic Rule Boolean 2 13-42	2-120
Logic Rule Boolean 3 13-44	2-122
Logic Rule Operator 1 13-41	2-120
Logic Rule Operator 2 13-43	2-122
Low Power Auto Set-up 22-20	2-181
Low Power Detection 22-21	2-181
Low Speed Detection 22-22	2-181
[Low Speed Hz] 22-33	2-183
Low Speed Load Compensation 1-60	2-23
[Low Speed Power Hp] 22-35	2-183
[Low Speed Power Kw] 22-34	2-183
[Low Speed Rpm] 22-32	2-183

M

Mac Id 10-02	2-106
Main Menu	2-1
Main Menu - Adjustable Frequency Drive Information - Group 15	2-135
Main Menu Mode	1-4, 1-10
Main Menu Mode	1-13
Main Menu Password 0-60	2-14
Main Reactance	2-20
Main Reactance (xh) 1-35	2-21
Maintenance Action 23-11	2-199
Maintenance Date And Time 23-14	2-200
Maintenance Item 23-10	2-198
Maintenance Log: Action 18-01	2-153
Maintenance Log: Date And Time 18-03	2-153
Maintenance Log: Item 18-00	2-153
Maintenance Log: Time 18-02	2-153
Maintenance Time Base 23-12	2-199
Maintenance Time Interval 23-13	2-200
Maintenance Word 16-96	2-151
Manual Alternation 25-91	2-222
Manual Initialization	1-16
Max Inter-char Delay 8-37	2-92
Max Output Frequency 4-19	2-41

Max Response Delay 8-36	2-92
Maximum Boost Time 22-46	2-188
Maximum Feedback Level 20-74	2-163, 2-167
Maximum Limit 3-93	2-39
Maximum Reference 3-03	2-31
[Min Speed For Function At Stop Hz] 1-82	2-25
[Min Speed For Function At Stop Rpm] 1-81	2-25
[Min Speed Normal Magnetizing Hz] 1-52	2-22
[Min Speed Normal Magnetizing Rpm] 1-51	2-22
Minimum Aeo Frequency 14-42	2-132
Minimum Bin Value 23-65	2-206
Minimum Feedback Level 20-73	2-163, 2-167
Minimum Limit 3-94	2-39
Minimum Reference 3-02	2-31
Minimum Response Delay 8-35	2-92
Minimum Run Time 22-40	2-187, 2-189
Minimum Sleep Time 22-41	2-187
Missing Motor Phase Function 4-58	2-43
Modified Parameters 15-93	2-142
Motor Cos-phi, 14-43	2-132
Motor Current 1-24	2-19, 2-144
Motor External Fan 1-91	2-26
Motor Frequency 1-23	2-18
Motor Magnetization At Zero Speed 1-50	2-22
Motor Nominal Speed 1-25	2-19
Motor Poles 1-39	2-22
[Motor Power Hp] 1-21	2-18
[Motor Power Kw] 1-20	2-18
Motor Protection	2-25
Motor Rotation Check 1-28	2-19
Motor Speed Direction, 4-10	2-40
[Motor Speed High Limit Hz], 4-14	2-41
[Motor Speed High Limit Rpm] 4-13	2-40
[Motor Speed Low Limit Hz] 4-12	2-40
[Motor Speed Low Limit Rpm] 4-11	2-40
Motor Speed Unit 0-02	2-2
Motor Start 25-02	2-210
Motor Status	2-143
Motor Thermal 16-18	2-144
Motor Thermal Protection 1-90	2-25
Motor Voltage 16-12	2-144
Motor Voltage 1-22	2-18
Motor Voltage, 1-22	2-18
My Personal Menu 0-25	2-9

N

Net Control 10-15	2-110
Net Reference 10-14	2-110
Nlcp	1-8
No Trip At Inverter Overload	2-133
Node Address 9-18	2-99
No-flow Delay 22-24	2-182
No-flow Function 22-23	2-182
No-flow Power 22-30	2-183
Number Of Pumps 25-06	2-211
Number Of Starts 15-08	2-136

O

Obw Time 25-25	2-213
Occurrence 23-04	2-197
Off Action 23-03	2-196
Off Delay, Relay 5-42	2-72

Off Time 23-02	2-195
[Off] Key On Lcp 0-41	2-12
On Action 23-01	2-194
On Delay, Relay 5-41	2-72
On Reference Bandwidth 20-84	2-164
On Time 23-00	2-194
Operating Hours 15-00	2-135
Operating Mode	2-3
Operating State At Power-up 0-04	2-3
Operation Mode 14-22	2-130
Option Ident. 15-6*	2-141
Option Mounted 15-60	2-141
Option Ordering No 15-62	2-141
Option Serial No 15-63	2-142
Option Sw Version 15-61	2-141
Ordered Typecode String 15-44	2-140
Over Temps 15-04	2-135
Over Volts 15-05	2-135
Overmodulation 14-03	2-129
Override Bandwidth 25-21	2-211
Over-voltage Control 2-17	2-30

P

Parameter Access	2-111
Parameter Edit 9-27	2-102
Parameter Info, 15-9*	2-142
Parameter Metadata 15-99	2-142
Parameter Options	3-1
Parameter Selection	1-13, 2-1
Parameter Set-up	1-10, 2-1
Parameters For Signals 9-23	2-100
Parity / Stop Bits 8-33	2-92
Pcd Read Configuration 9-16	2-98
Pcd Write Configuration 9-15	2-97
Period Start 23-51	2-202
Period Stop, 23-52	2-202
Personal Menu Password 0-65	2-14
Pid Anti Windup 20-91	2-165
Pid Auto Tuning 20-79	2-163, 2-167
Pid Controller, 20-9*	2-164
Pid Diff. Gain Limit 20-96	2-165
Pid Differentiation Time, 20-95	2-165
Pid Integral Time 20-94	2-165
Pid Normal/inverse Control, 20-81	2-163
Pid Output Change 20-72	2-163, 2-167
Pid Proportional Gain 20-93	2-165
[Pid Start Speed Hz] 20-83	2-164
[Pid Start Speed Rpm] 20-82	2-164
Pipe Fill Enable, 29-00	2-231
Pipe Fill Function, 29-0*	2-231
Pipe Fill Mode	2-231
Pipe Fill Rate, 29-04	2-232
[Pipe Fill Speed Hz], 29-02	2-232
[Pipe Fill Speed Rpm], 29-01	2-232
Pipe Fill Time, 29-03	2-232
Power Card Ordering No. 15-47	2-141
Power Card Serial Number 15-53	2-141
Power Correction Factor 22-31	2-183
[Power Hp] 16-11	2-144
[Power Kw] 16-10	2-144
Power Reference Factor 23-80	2-208
Power Restore 3-92	2-38
Power Section, 15-41	2-140

Power-ups 15-03	2-135
Precise Stop Counter 16-74	2-149
Preset Reference 3-10	2-32
Preset Reference Select 8-56	2-95
Preset Relative Reference 3-14	2-33
Pressure At No-flow Speed 22-87	2-193
Pressure At Rated Speed 22-88	2-193
Process Control 9-28	2-102
Process Data Config Read 10-12	2-108
Process Data Config Write 10-11	2-107
Process Data Type Selection 10-10	2-107
Profibus Save Data Values 9-71	2-104
Profibus Warning Word 9-53	2-102
Profibusdrivereset 9-72	2-104
Profile Number 9-65	2-103
Programming Set-up 0-11	2-4, 2-103
Protocol, 8-30	2-91
Pulse Filter Time Constant #29 5-54	2-73
Pulse Filter Time Constant #33 5-59	2-74
Pulse Out #27 Bus Control 5-93	2-77
Pulse Out #27 Timeout Preset 5-94	2-77
Pulse Out #29 Bus Control 5-95	2-77
Pulse Out #29 Timeout Preset 5-96	2-77
Pulse Out #x30/6 Bus Control 5-97	2-77
Pulse Out #x30/6 Timeout Preset 5-98	2-78
Pulse Output Max Freq #27 5-62	2-75
Pulse Output Max Freq #29 5-65	2-76
Pulse Output Max Freq #x30/6 5-68	2-76
Pump Cycling 25-04	2-210
Pump Interlock 25-90	2-222
Pump On Time 25-84	2-221
Pump Status 25-81	2-221
Pwm Random 14-04	2-129

Q

Q3 Function Set-ups	1-11
Quick Menu	1-3, 1-10, 2-1
Quick Menu Mode	1-4, 1-10
Quick Transfer Of Parameter Settings Between Multiple Adjustable Frequency Drives	1-6

R

Ramp 1 Ramp-down Time 3-42	2-35
Ramp 1 Ramp-up Time 3-41	2-35
Ramp 2 Ramp-down Time 3-52	2-36
Ramp 2 Ramp-up Time 3-51	2-36
Ramp Delay 3-95	2-39
Ramp Time 3-91	2-38
Ramp-down Delay 25-40	2-215
Ramp-up Delay 25-41	2-215
Readout Bus Off Counter 10-07	2-107
Readout Receive Error Counter 10-06	2-106
Readout Transmit Error Counter 10-05	2-106
Readout: Linked Set-ups 0-13	2-5
Readout: Prog. Set-ups / Channel 0-14	2-5
Reference % 16-02	2-143
Reference 1 Source 3-15	2-33
Reference 2 Source 3-16	2-34
Reference 3 Source 3-17	2-34
Reference Function 3-04	2-31
Reference Site 3-13	2-32
[Reference Unit] 16-01	2-143
Reference/feedback Unit, 20-12	2-157

Regional Settings 0-03	2-2
Relay On Time 25-85	2-221
[Relay Output Bin] 16-71	2-149
Relay Outputs	2-59
Relay Status 25-83	2-221
Remote Bypass Activation, 31-19	2-233
Reset	1-5
Reset Continuous Bin Data 23-66	2-207
Reset Control Timeout 8-06	2-90
Reset Energy Log 23-54	2-203
Reset Kwh Counter 15-06	2-135
Reset Maintenance Word 23-15	2-200
Reset Mode, 14-20	2-129
Reset Relay Counters 25-86	2-221
Reset Running Hours Counter 15-07	2-136
Reset Slc 13-03	2-116
Reset Timed Bin Data 23-67	2-207
[Reset] Key On Lcp 0-43	2-13
Resonance Dampening 1-64	2-24
Resonance Dampening Time Constant 1-65	2-24
Reverse Select 8-54	2-94
Rfi, 14-50	2-132
Run Next Pump Delay 25-58	2-220
Running Hours 15-01	2-135
Run-on Line Delay 25-59	2-220

S

Samples Before Trigger 15-14	2-138
Sbw De-staging Delay 25-24	2-213
Sbw Staging Delay 25-23	2-212
Semi-auto Bypass Set-up 4-64	2-45
Service Code 14-29	2-131
Set Date And Time, 0-70	2-15
Setpoint 1 20-21	2-161
Setpoint 2 20-22	2-161
Setpoint 3, 20-23	2-161
Setpoint Boost 22-45	2-187
Set-up Copy 0-51	2-13
Set-up Select 8-55	2-94
Short Cycle Protection	2-189
SI Controller Action 13-52	2-125
SI Controller Event 13-51	2-124
SI Controller Mode 13-00	2-112
SI Controller State 16-38	2-145
SI Controller Timer 13-20	2-117
Slave Error Count 8-83	2-95
Slave Message Count 8-82	2-95
Sleep Mode, 22-4*	2-184
Slip Compensation 1-62	2-23
Slip Compensation Time Constant 1-63	2-24
Software Version 15-43	2-140
Special Functions	2-128
[Speed At Design Point Hz] 22-86	2-193
[Speed At Design Point Rpm] 22-85	2-192
[Speed At No-flow Hz] 22-84	2-192
[Speed At No-flow Rpm] 22-83	2-192
[Speed Rpm] 16-17	2-144
Square-linear Curve Approximation 22-81	2-190
Stage Function 25-27	2-214
Stage Function Time 25-28	2-214
Staging Bandwidth 25-20	2-211
[Staging Speed Hz] 25-45	2-216
[Staging Speed Rpm] 25-44	2-216

Staging Threshold 25-42	2-215
Start Current 1-76	2-25
Start Delay 1-71	2-24
Start Event 13-01	2-112
Start Select 8-53	2-94
[Start Speed Hz] 1-75	2-25
[Start Speed Rpm] 1-74	2-24
Stator Leakage Reactance	2-20
Stator Resistance (rs) 1-30	2-21
Status	1-3
Status Messages	1-1
Status Word 16-03	2-143
Step Size 3-90	2-38
Step-by-step	1-15
Stop Event 13-02	2-114
Store Always 10-33	2-111
Store Data Values 10-31	2-111
Sw Id Control Card 15-49	2-141
Sw Id Power Card 15-50	2-141
Switching Frequency 14-01	2-128
Switching Pattern 14-00	2-128

T

Telegram Selection 8-40	2-93
Telegram Selection 9-22	2-99
Term. X30/6 Digi Out (mcb 101) 5-32	2-66
Term. X30/7 Digi Out (mcb 101) 5-33	2-68
Term. 29 High Frequency 5-51	2-73
Term. 29 High Ref./feedb. Value 5-53	2-73
Term. 29 Low Frequency 5-50	2-73
Term. 29 Low Ref./feedb. Value 5-52	2-73
Term. 33 High Frequency 5-56	2-74
Term. 33 High Ref./feedb. Value 5-58	2-74
Term. 33 Low Frequency 5-55	2-74
Term. 33 Low Ref./feedb. Value 5-57	2-74
Term. X30/11 Filter Time Constant 6-36	2-83
Term. X30/11 High Ref./feedb. Value 6-35	2-83
Term. X30/11 Low Ref./feedb. Value 6-34	2-83
Term. X30/12 Filter Time Constant 6-46	2-84
Term. X30/12 High Ref./feedb. Value 6-45	2-84
Term. X30/12 Low Ref./feedb. Value 6-44	2-83
Term. X42/1 Filter Time Constant 26-16	2-225
Term. X42/1 High Ref./feedb. Value 26-15	2-225
Term. X42/1 Live Zero 26-17	2-225
Term. X42/1 Low Ref./feedb. Value 26-14	2-225
Term. X42/3 Filter Time Constant 26-26	2-226
Term. X42/3 High Ref./feedb. Value 26-25	2-226
Term. X42/3 Live Zero 26-27	2-226
Term. X42/3 Low Ref./feedb. Value 26-24	2-226
Term. X42/5 Filter Time Constant 26-36	2-226
Term. X42/5 High Ref./feedb. Value 26-35	2-226
Term. X42/5 Live Zero 26-37	2-227
Term. X42/5 Low Ref./feedb. Value 26-34	2-226
Terminal 18 Digital Input 5-10	2-50
Terminal 19 Digital Input 5-11	2-51
Terminal 27 Digital Input 5-12	2-52
Terminal 27 Digital Output 5-30	2-63
Terminal 27 Mode 5-01	2-46
Terminal 27 Pulse Output Variable 5-60	2-75
Terminal 29 Digital Input 5-13	2-53
Terminal 29 Digital Output 5-31	2-65
Terminal 29 Mode 5-02	2-46
Terminal 29 Pulse Output Variable 5-63	2-75

Terminal 32 Digital Input 5-14	2-54
Terminal 33 Digital Input 5-15	2-55
Terminal 42 Output Bus Control 6-53	2-86
Terminal 42 Output Max Scale 6-52	2-85
Terminal 42 Output Min Scale 6-51	2-85
Terminal 42 Output Timeout Preset 6-54	2-86
Terminal 42 Output, 6-50	2-84
Terminal 53 Filter Time Constant 6-16	2-81
Terminal 53 High Current 6-13	2-81
Terminal 53 High Ref./feedb. Value 6-15	2-81
Terminal 53 High Voltage 6-11	2-80
Terminal 53 Low Current 6-12	2-80
Terminal 53 Low Ref./feedb. Value 6-14	2-81
Terminal 53 Low Voltage 6-10	2-80
Terminal 53 Switch Setting 16-61	2-147
Terminal 54 Filter Time Constant 6-26	2-82
Terminal 54 High Current 6-23	2-82
Terminal 54 High Ref./feedb. Value 6-25	2-82
Terminal 54 High Voltage 6-21	2-81
Terminal 54 Low Current 6-22	2-82
Terminal 54 Low Ref./feedb. Value 6-24	2-82
Terminal 54 Low Voltage 6-20	2-81
Terminal 54 Switch Setting 16-63	2-148
Terminal X30/11 High Voltage 6-31	2-83
Terminal X30/11 Low Voltage 6-30	2-82
Terminal X30/12 High Voltage 6-41	2-83
Terminal X30/12 Low Voltage 6-40	2-83
Terminal X30/2 Digital Input 5-16	2-56
Terminal X30/3 Digital Input 5-17	2-57
Terminal X30/4 Digital Input 5-18	2-58
Terminal X30/6 Pulse Output Variable 5-66	2-76
Terminal X30/8 Max. Scale 6-62	2-87
Terminal X30/8 Min. Scale 6-61	2-87
Terminal X30/8 Output 6-60	2-87
Terminal X30/8 Output Bus Control 6-63	2-88
Terminal X30/8 Output Timeout Preset 6-64	2-88
Terminal X42/1 High Voltage 26-11	2-225
Terminal X42/1 Low Voltage 26-10	2-225
Terminal X42/1 Mode 26-00	2-224
Terminal X42/11 Max. Scale 26-62	2-230
Terminal X42/11 Min. Scale 26-61	2-230
Terminal X42/11 Output 26-60	2-229
Terminal X42/11 Output Bus Control 26-63	2-230
Terminal X42/11 Output Timeout Preset 26-64	2-230
Terminal X42/3 High Voltage 26-21	2-225
Terminal X42/3 Low Voltage 26-20	2-225
Terminal X42/3 Mode 26-01	2-224
Terminal X42/5 High Voltage 26-31	2-226
Terminal X42/5 Low Voltage 26-30	2-226
Terminal X42/5 Mode 26-02	2-224
Terminal X42/7 Max. Scale 26-42	2-227
Terminal X42/7 Min. Scale 26-41	2-227
Terminal X42/7 Output 26-40	2-227
Terminal X42/7 Output Bus Control 26-43	2-228
Terminal X42/7 Output Timeout Preset 26-44	2-228
Terminal X42/9 Max. Scale 26-52	2-229
Terminal X42/9 Min. Scale 26-51	2-228
Terminal X42/9 Output 26-50	2-228
Terminal X42/9 Output Bus Control 26-53	2-229
Terminal X42/9 Output Timeout Preset 26-54	2-229
Test Mode Activation, 31-03	2-233
Thermal Load	2-22, 2-144
Thermistor	2-26

Thermistor Source 1-93	2-27
This Set-up Linked To 0-12	2-4
Time Format 0-72	2-15
Time Zone Offset, 0-73	2-15
Timed Actions, 23-0*	2-194
Timed Bin Data 23-62	2-206
Timed Period Start 23-63	2-206
Timed Period Stop 23-64	2-206
[Torque %] 16-22	2-145
Torque Characteristics, 1-03	2-17
Torque Limit Generator Mode 4-17	2-41
Torque Limit Motor Mode 4-16	2-41
[Torque Nm] 16-16	2-144
Trend Variable 23-60	2-205
Trending, 23-6*	2-204
Trigger Event 15-12	2-137
Trip Delay At Inverter Fault 14-26	2-131
Trip Delay At Torque Limit 14-25	2-131
Trip Reset, 14-2*	2-129
Tuning Mode 21-01	2-167

V

Variable Torque	2-17
Voltage, 15-42	2-140
Vt Level 14-40	2-132

W

Wake-up Ref./fb Difference 22-44	2-187
[Wake-up Speed Hz] 22-43	2-187
[Wake-up Speed Rpm] 22-42	2-187
Warning Current High 4-51	2-42
Warning Current Low 4-50	2-42
Warning Feedback High 4-57	2-43
Warning Feedback Low 4-56	2-43
Warning Parameter 10-13	2-110
Warning Reference High 4-55	2-43
Warning Reference Low 4-54	2-43
Warning Speed High 4-53	2-43
Warning Speed Low 4-52	2-42
Warning Word 16-92	2-150
Warning Word 2 16-93	2-150
Water Application Functions, 29-***	2-231
Work Point Calculation 22-82	2-191
Working Days 0-81	2-16