

## Contents

|                                                    |           |
|----------------------------------------------------|-----------|
| Safety Note .....                                  | 3         |
| <b>Introduction</b> .....                          | <b>4</b>  |
| About this Manual .....                            | 4         |
| Technical Overview .....                           | 4         |
| Assumptions .....                                  | 5         |
| Hardware .....                                     | 5         |
| Background Knowledge .....                         | 5         |
| FC 300-related Literature .....                    | 5         |
| CiA Conformance .....                              | 5         |
| Abbreviations .....                                | 6         |
| <b>How to Install</b> .....                        | <b>7</b>  |
| The CANopen option .....                           | 7         |
| LED Behaviour .....                                | 8         |
| Module Status (MS), red .....                      | 8         |
| Network Status (NS), green .....                   | 8         |
| Hardware switches .....                            | 8         |
| Cabling .....                                      | 9         |
| Cable Specifications .....                         | 9         |
| Connection of the Cable Screen .....               | 9         |
| Earth Connection .....                             | 9         |
| CANopen Connector .....                            | 9         |
| CANopen Termination .....                          | 10        |
| EMC Precautions .....                              | 11        |
| How to Install Option in Frequency Converter ..... | 12        |
| <b>How to Configure the System</b> .....           | <b>13</b> |
| Object Model .....                                 | 13        |
| Communication in CANopen .....                     | 14        |
| COB-Identifiers (ID) .....                         | 14        |
| Controlling the Network .....                      | 15        |
| Network Management (NMT) .....                     | 15        |
| Error control .....                                | 16        |
| Emergency object (EMCY) .....                      | 16        |
| Bus Error counters .....                           | 17        |
| SDO Communication .....                            | 18        |
| Saving OD entries .....                            | 18        |
| Restoring OD entries .....                         | 18        |
| Setting up CANopen master .....                    | 19        |
| EDS file .....                                     | 19        |
| Configuring the CANopen master .....               | 19        |
| Configuring the FC 300 .....                       | 21        |
| VLT Parameters .....                               | 21        |
| <b>How to Control the FC300</b> .....              | <b>22</b> |
| PDO Communication .....                            | 22        |
| PDO Mapping Syntax .....                           | 23        |
| PDO Transmission Modes .....                       | 24        |
| PDO Triggering Modes .....                         | 24        |
| Inhibit Time .....                                 | 24        |
| Event Timer .....                                  | 24        |
| Control Profile .....                              | 25        |
| DSP 402 State Machine .....                        | 25        |
| DSP 402 state transitions .....                    | 26        |
| DSP 402 Control Profile .....                      | 27        |
| Danfoss FC control profile .....                   | 30        |
| Reference Handling .....                           | 34        |
| <b>How to Access FC 300 Parameters</b> .....       | <b>35</b> |
| Danfoss Specific Objects (2000h-5FFFh) .....       | 35        |

|                                                |           |
|------------------------------------------------|-----------|
| <b>Parameters</b>                              | <b>36</b> |
| Parameter List.....                            | 41        |
| Conversion index                               | 42        |
| <b>Object Directory</b>                        | <b>43</b> |
| Communication Profile Area (1000h-1FFFh) ..... | 43        |
| Communication object overview                  | 43        |
| <b>Troubleshooting</b>                         | <b>47</b> |
| Troubleshooting.....                           | 47        |
| SDO Abort Codes                                | 48        |
| EMCY error code                                | 49        |
| Alarm Word and Warning Word .....              | 50        |
| Index .....                                    | 54        |

**Copyright, Limitation of Liability and Revision Rights**

This publication contains information proprietary to Danfoss A/S. By accepting and using this manual the user agrees that the information contained herein will be used solely for operating equipment from Danfoss A/S or equipment from other vendors provided that such equipment is intended for communication with Danfoss equipment over a Ethernet serial communication link. This publication is protected under the Copyright laws of Denmark and most other countries.

Danfoss A/S does not warrant that a software program produced according to the guidelines provided in this manual will function properly in every physical, hardware or software environment.

Although Danfoss A/S has tested and reviewed the documentation within this manual, Danfoss A/S makes no warranty or representation, either express or implied, with respect to this documentation, including its quality, performance, or fitness for a particular purpose.

In no event shall Danfoss A/S be liable for direct, indirect, special, incidental, or consequential damages arising out of the use, or the inability to use information contained in this manual, even if advised of the possibility of such damages. In particular, Danfoss A/S is not responsible for any costs including but not limited to those incurred as a result of lost profits or revenue, loss or damage of equipment, loss of computer programs, loss of data, the costs to substitute these, or any claims by third parties.

Danfoss A/S reserves the right to revise this publication at any time and to make changes in its contents without prior notice or any obligation to notify previous users of such revisions or changes.

## Safety Note



The voltage of the frequency converter is dangerous whenever connected to mains. Incorrect installation of the motor, frequency converter or fieldbus may cause damage to the equipment, serious personal injury or death. Consequently, the instructions in this manual, as well as national and local rules and safety regulations, must be complied with.

### Safety Regulations

1. The frequency converter must be disconnected from mains if repair work is to be carried out. Check that the mains supply has been disconnected and that the necessary time has passed before removing motor and mains plugs.
2. The [OFF] key on the control panel of the frequency converter does not disconnect the equipment from mains and is thus not to be used as a safety switch.
3. Correct protective earthing of the equipment must be established, the user must be protected against supply voltage, and the motor must be protected against overload in accordance with applicable national and local regulations.
4. The earth leakage currents are higher than 3.5 mA.
5. Protection against motor overload is not included in the factory setting. If this function is desired, set par. 1-90 to data value *ETR trip* or data value *ETR warning*.  
Note: The function is initialised at 1.16 x rated motor current and rated motor frequency. For the North American market: The ETR functions provide class 20 motor overload protection in accordance with NEC.
6. Do not remove the plugs for the motor and mains supply while the frequency converter is connected to mains. Check that the mains supply has been disconnected and that the necessary time has passed before removing motor and mains plugs.
7. Please note that the frequency converter has more voltage inputs than L1, L2 and L3, when load sharing (linking of DC intermediate circuit) and external 24 V DC have been installed. Check that all voltage inputs have been disconnected and that the necessary time has passed before commencing repair work.

### Warning against Unintended Start

1. The motor can be brought to a stop by means of digital commands, bus commands, references or a local stop, while the frequency converter is connected to mains. If personal safety considerations make it necessary to ensure that no unintended start occurs, these stop functions are not sufficient.
2. While parameters are being changed, the motor may start. Consequently, the stop key [STOP/RESET] must always be activated; following which data can be modified.
3. A motor that has been stopped may start if faults occur in the electronics of the frequency converter, or if a temporary overload or a fault in the supply mains or the motor connection ceases.



### Warning:

Touching the electrical parts may be fatal - even after the equipment has been disconnected from mains.

Also make sure that other voltage inputs have been disconnected, such as external 24 V DC, load sharing (linkage of DC intermediate circuit), as well as the motor connection for kinetic back up.

Refer to FC 300 Operating Instructions (MG.33.Ax.yy) for further safety guidelines.

## Introduction

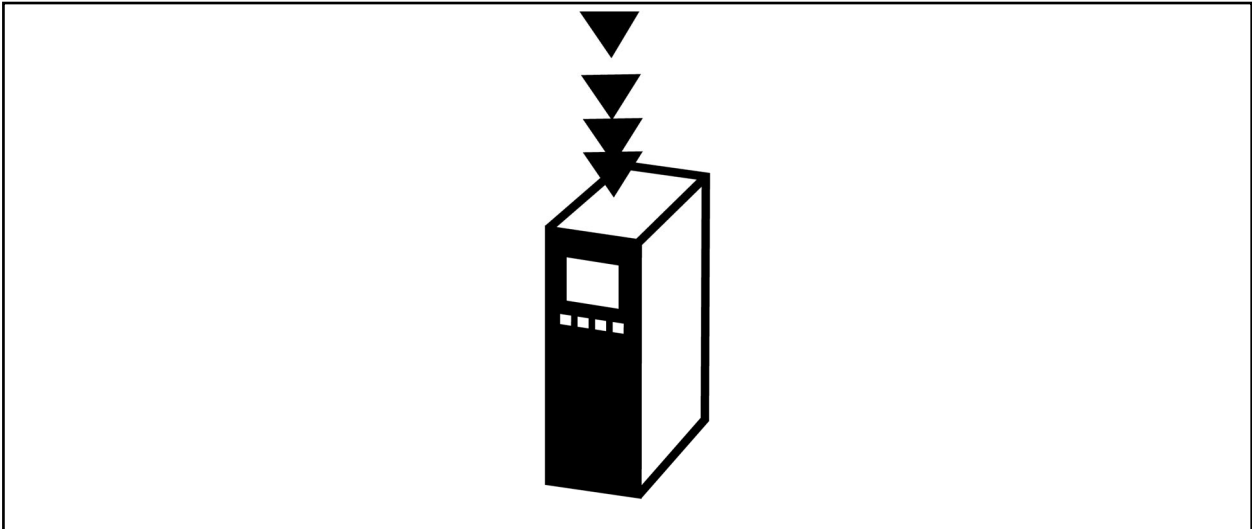

### About this Manual

First time users can obtain the most essential information for quick installation and set-up in these chapters:

*Introduction*  
*How to Install*  
*How to Configure the System*  
*Application Examples*

For more detailed information including the full range of set-up options and diagnosis tools please refer to the chapters:

*How to Control the FC 300*  
*How to Access FC 300 Parameters*  
*Parameters*  
*Troubleshooting*

### Technical Overview

CANopen is a low-level network that standardizes communications between industrial devices (sensors, limit switches, motor controls) and high-level devices (controllers). CANopen follows the Open Systems Interconnection (OSI) model and is based on CAN technology for Media Access Control and Physical Signalling.

CANopen is designed on the basis of three standards: DS102 *CAN Physical Layer for Industrial Applications*, DS 301 *CANopen Communication Profile for Industrial Systems* and DSP 402 *Device Profile Drives and Motion Control*.

CANopen systems can be configured to operate in a master-slave or a distributed control architecture using peer-to-peer communication. Up to 127 nodes in a multi-drop network topology are supported, and communication options can be powered directly from the bus, using the same cable for communication.

Nodes can be removed or inserted without powering down the network.

## - I n t r o d u c t i o n -

Each node on the network has its own unique Communication Object Identifier (COB-ID) to distinguish it on the network. The access control is based on the CSMA/CA (Carrier Sense Multiple Access / Collision Avoidance) principle, meaning that all nodes may have access to the network at the same time. If two nodes attempt to get control of the network bus simultaneously, the CAN protocol resolves the issue by arbitration. In this way collisions on the network are avoided.

CANopen defines device profiles for devices belonging to specific classes. For other devices, a custom class must be defined in order to make it CANopen compatible. This further enhances the interchangeability and interoperability of the network.

## Assumptions

These operating instructions assume that you are using a Danfoss FC 300 frequency converter with CANopen. It is also assumed that as master you are using a PLC or PC equipped with a serial communication card supporting all the CANopen communication services required by your application. Furthermore, it is assumed that all requirements stipulated in the CANopen standard as well as those set up in the AC Drive Profile and those pertaining to the VLT frequency converter are strictly observed as well as all limitations therein fully respected

## Hardware

These operating instructions relate to the CANopen option MCA 105 type no. 130B1103 uncoated and 130B1205 coated

## Background Knowledge

The Danfoss CANopen option is designed to communicate with any master abiding by the CANopen standard. It is therefore assumed that you have full knowledge of the PC or PLC you intend to use as a master in your system. Any questions pertaining to hardware or software produced by any other manufacturer is beyond the scope of these operating instructions and is of no concern to Danfoss. If you have questions about how to set up master - master communication or communication to a non-Danfoss slave, please consult the appropriate documentation.

## FC 300-related Literature

The following literature is available for the FC 300 series.

| Title                         | Literature no. |
|-------------------------------|----------------|
| FC 300 Operating Instructions | MG.33.AX.YY    |
| FC 300 Design Guide           | MG.33.BX.YY    |

Please also refer to:

<http://www.danfoss.com/BusinessAreas/DrivesSolutions/>

-for additional information.

## CiA Conformance

The CANopen option is designed to conformance against:

- CAN in Automation: "Application Layer and Communication Profile"  
CiA Draft Standard 301; Version 4.02 13.2.2002
- CAN in Automation: "CANopen Device Profile for Drives and Motion Control"  
CiA Draft standard Proposal 402; Revision 1.1 from 08.10.1998

## Abbreviations

|        |                                                                  |
|--------|------------------------------------------------------------------|
| CAN    | Controller Area Network                                          |
| CiA    | CAN in Automation                                                |
| COB    | Communication Object                                             |
| COB-ID | Communication Object Identifier                                  |
| CTW    | Control Word                                                     |
| EDS    | Electronic Data Sheet                                            |
| EMC    | Electromagnetic Compatibility                                    |
| EMCY   | Emergency message                                                |
| I/O    | Input/Output                                                     |
| LCP    | Local Control Panel                                              |
| LED    | Light Emitting Diode                                             |
| LSB    | Least Significant Bit                                            |
| MAV    | Main Actual Value                                                |
| MRV    | Main Reference Value                                             |
| MSB    | Most Significant Bit                                             |
| NMT    | Network Management                                               |
| N/A    | Not Applicable                                                   |
| OD     | Object Directory                                                 |
| PCD    | Process Data                                                     |
| PDO    | Process Data Object                                              |
| PLC    | Programmable Logic Control                                       |
| PNU    | Parameter Number                                                 |
| RPDO   | Receive Process Data Object                                      |
| RPM    | Revolutions per minutes; unit for the speed of a revolving motor |
| RTR    | Remote Transmission Request frame                                |
| RX     | Receive data                                                     |
| STW    | Status Word                                                      |
| SDO    | Service Data Object                                              |
| SYNC   | Object for synchronization of process data                       |
| TPDO   | Transmit Process Data Object                                     |
| TX     | Transmit Data                                                    |

## How to Install

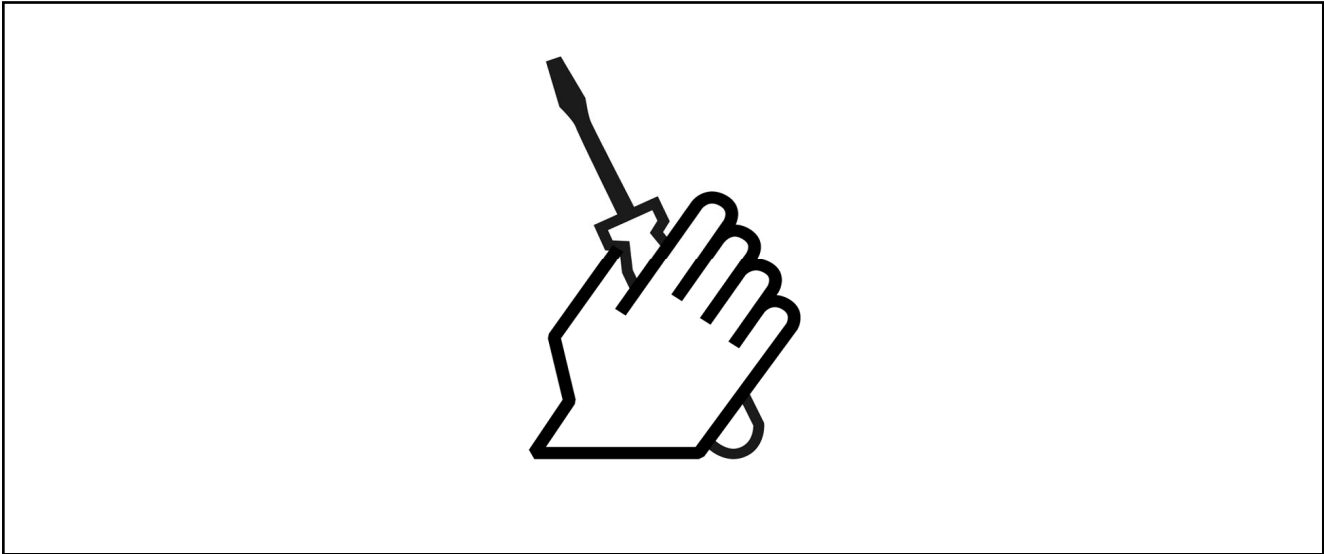



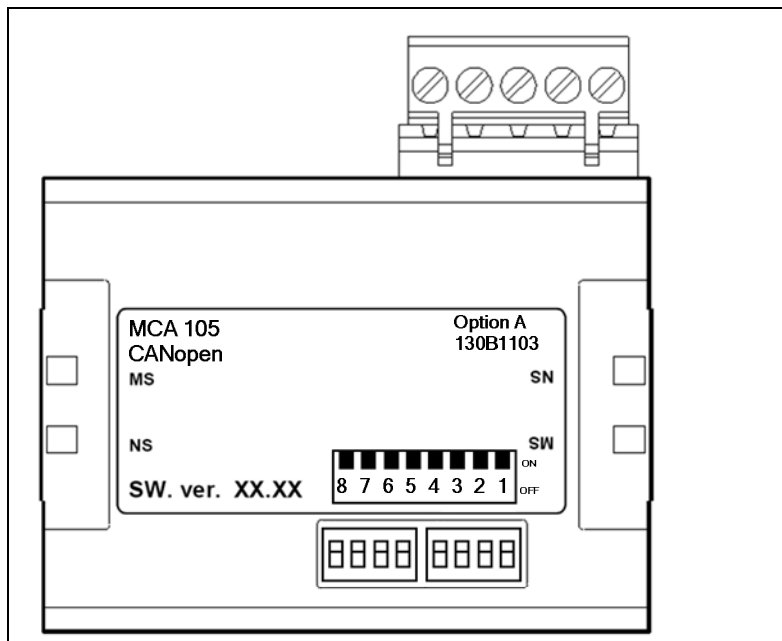

### The CANopen option

The MCA105 CANopen option is in a standard A-option form. It features two LED's: MS (Module Status) and NS (Network Status) for status information and troubleshooting. The hardware switches can be used for setting baudrate and Node ID.





## LED Behaviour

### Module Status (MS), red

| State                 | LED                                                                               |              | Description                                                                  |
|-----------------------|-----------------------------------------------------------------------------------|--------------|------------------------------------------------------------------------------|
| No Error              |  | Off          | No error                                                                     |
| Warning limit reached |  | Single Flash | CAN error counter(s) has reached / exceeded warning level                    |
| Error control event   |  | Double flash | Node guard event has occurred                                                |
| Sync Error            |  | Triple flash | Sync message has not been received within configured timeout (object 0x1006) |
| Bus Off               |  | On           | Device in Bus Off-state                                                      |

### Network Status (NS), green

| State           | LED                                                                                 |              | Description                        |
|-----------------|-------------------------------------------------------------------------------------|--------------|------------------------------------|
| Stopped         |  | Single flash | Device is in stopped state         |
| Pre-operational |  | Blinking     | Device is in pre-operational state |
| Operational     |  | On           | Device is in Operational state     |

## Hardware switches

The hardware switches enables setting of baudrate and Node ID:

- Switch 8 and 7 is for setting the baudrate for either: 125, 250 or 500 Kbps.
- Switch 6 to 1 is for setting the node address in the range 1 to 62.

| Switch |     | Baudrate          |
|--------|-----|-------------------|
| 8      | 7   |                   |
| On     | On  | <i>Par. 10-01</i> |
| On     | Off | 500 kbps          |
| Off    | On  | 250 kbps          |
| Off    | Off | 125 kbps          |

| Switch |     |     |     |     |     | Node ID           |
|--------|-----|-----|-----|-----|-----|-------------------|
| 6      | 5   | 4   | 3   | 2   | 1   |                   |
| On     | On  | On  | On  | On  | On  | <i>Par. 10-02</i> |
| On     | On  | On  | On  | On  | Off | 62                |
| Off    | Off | Off | Off | Off | On  | 1                 |

By setting both switch 8 and 7 on, baudrates can be selected via par. 10-01 *Baud Rate Select*: 10, 20, 50, 100, 125, 250 and 500 kbps.

By setting switches 6 to 1 on, Node ID can be selected via par. 10-02 *MAC ID* in the range: 1 - 127



- H o w t o I n s t a l l -

### Cabling

Recommended guidelines for cabling in CANopen systems:

| Baudrate | Max. cable length | Resistance [mΩ/ m] | Cable cross section [mm <sup>2</sup> ] | Termination resistor |
|----------|-------------------|--------------------|----------------------------------------|----------------------|
| 500 kbps | 100 m             | < 60               | 0.34 – 0.6                             | 120 Ω                |
| 250 kbps | 250 m             |                    |                                        |                      |
| 125 kbps | 500 m             |                    |                                        |                      |
| 100 kbps | 700 m             | < 40               | 0.5 – 0.6                              |                      |
| 50 kbps  | 1000 m            |                    |                                        |                      |
| 20 kbps  | 1000 m            | < 26               | 0.75 – 0.8                             |                      |
| 10 kbps  | 1000 m            |                    |                                        |                      |

### Cable Specifications

The cable used should always be according to the specifications. Be aware that the "Flat Cable" and other unshielded cable-types are not suited for use with frequency converters.

### Connection of the Cable Screen

It is recommended that the cable-screen is connected to ground at both ends of the cable at every CANopen node.

Low impedance ground connection of the screen is very important, especially at high frequencies. Achieve this by connecting the surface of the screen to ground, for example by means of a cable clamp or a conductive cable gland. The frequency converter package includes various clamps and brackets to enable a proper ground connection of the CANopen cable screen.

### Earth Connection

It is important that all stations connected to the CANopen network are connected to the same earth potential. Each earth connection must have low HF (high frequency) impedance. This can be achieved by connecting a large surface area of the cabinet to ground, for example by mounting the VLT frequency converter on a conductive rear plate.



**N.B.:**

Particularly when there are long distances between the stations in a CANopen network, it may be necessary to use additional potential equalizing cables, connecting the individual stations to the same earth potential.

### CANopen Connector

The CANopen option is provided with a pluggable connector. The connector has the following layout:

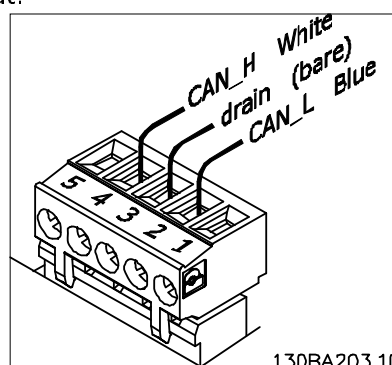

| Pin no. | Terminal     | Colour | Name            |
|---------|--------------|--------|-----------------|
| 1       | -            | -      | Not used        |
| 2       | <b>CAN_L</b> | Blue   | <b>CAN LOW</b>  |
| 3       | Drain        | (bare) | Screen          |
| 4       | <b>CAN_H</b> | White  | <b>CAN HIGH</b> |
| 5       | -            | -      | Not used        |



**NB!:** Install wires only when the network is inactive. This will prevent problems such as shorting the network supply or disrupting communications.

### CANopen Termination

It is essential to terminate the bus line properly. A mismatch of impedance may result in reflections on the line that will corrupt data transmission.

Termination resistors should be installed at each end of the bus line only.

The resistors must be mounted between terminal 2 (CAN\_L) and terminal 4 (CAN\_H) and should have the following specification: 120 Ohm, 1 % Metal film, 1/4 Watt

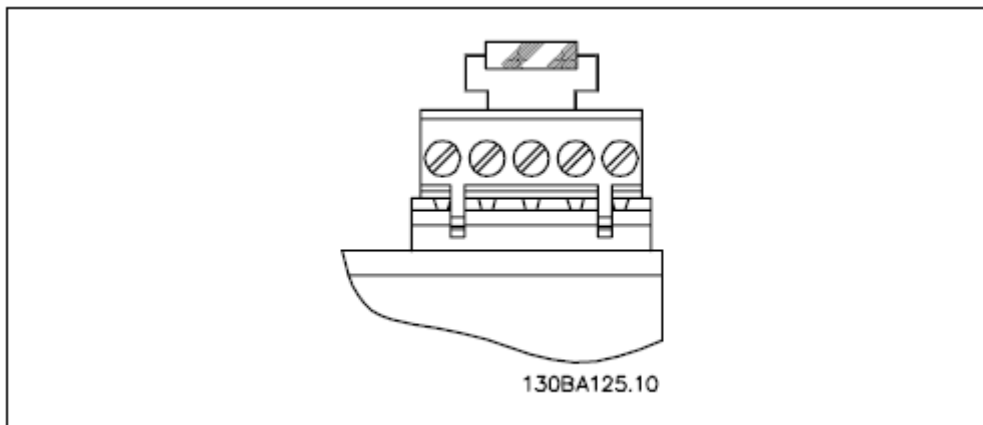

## EMC Precautions

The following EMC precautions are recommended in order to achieve interference-free operation of the Ethernet network. Additional EMC information is available in the FC 300 series Design Guide.

**N.B.:**

Relevant national and local regulations, for example regarding protective earth connection, must be observed.

The CANopen communication cable must be kept away from motor and brake resistor cables to avoid coupling of high frequency noise from one cable to the other. Normally a distance of 200 mm (8 inches) is sufficient, but maintaining the greatest possible distance between the cables is recommended, especially where cables run in parallel over long distances. When crossing is unavoidable, the CANopen cable must cross motor and brake resistor cables at an angle of 90 degrees.

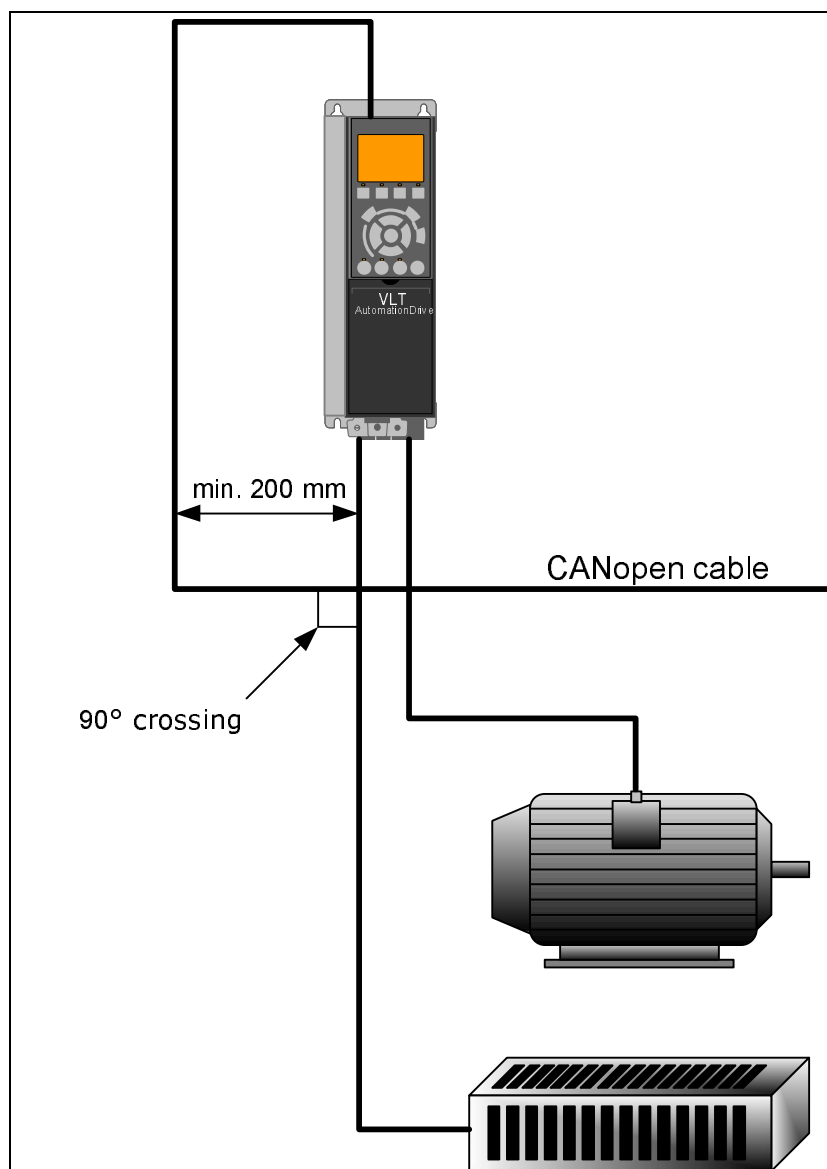

## How to Install Option in Frequency Converter

Items required installing a fieldbus option in the frequency converter:

- The fieldbus option
- Fieldbus option adaptor frame for the FC 300. This frame is deeper than the standard frame, to allow space for the fieldbus option beneath
- Strain relief (only for A1 and A2 enclosures)

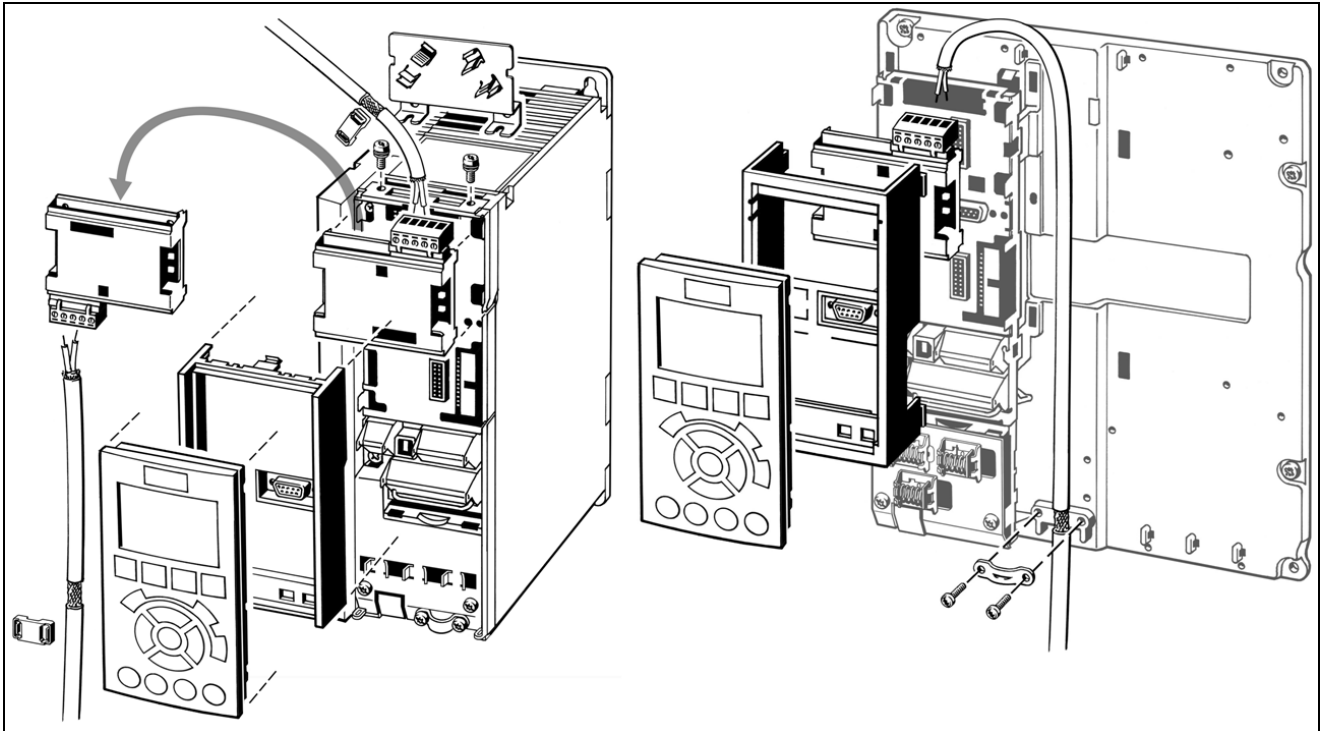

Instructions:

- Remove LCP panel from the FC 300
- Remove the frame located beneath and discard
- Push the fieldbus option adaptor frame for the FC 300 into place
- Replace the LCP and attach cable

## How to Configure the System

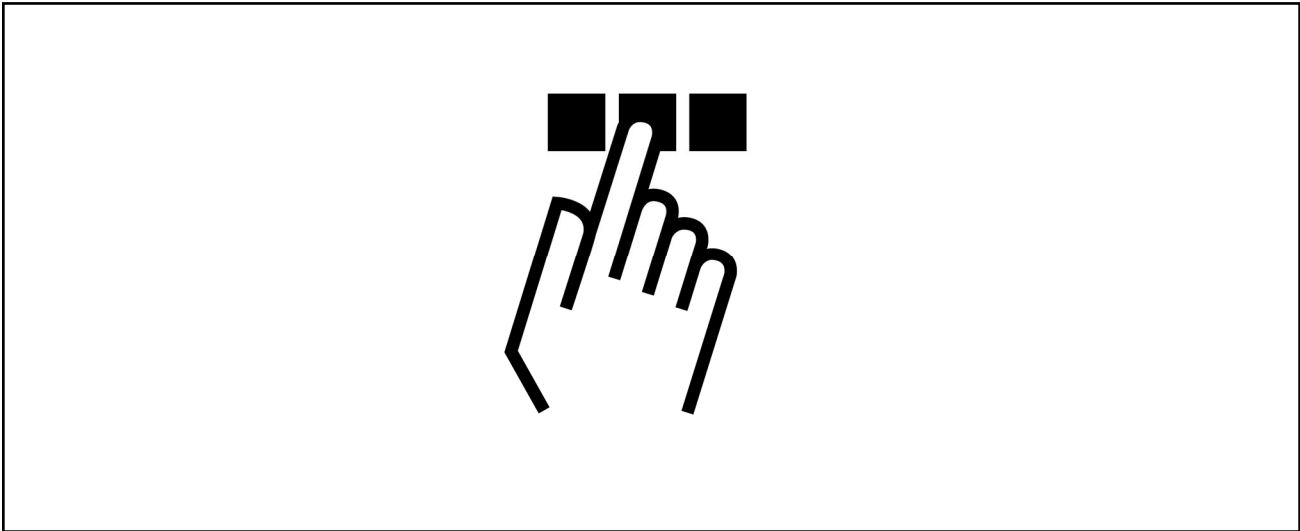

### Object Model

The functional principle of CANopen nodes are illustrated below:

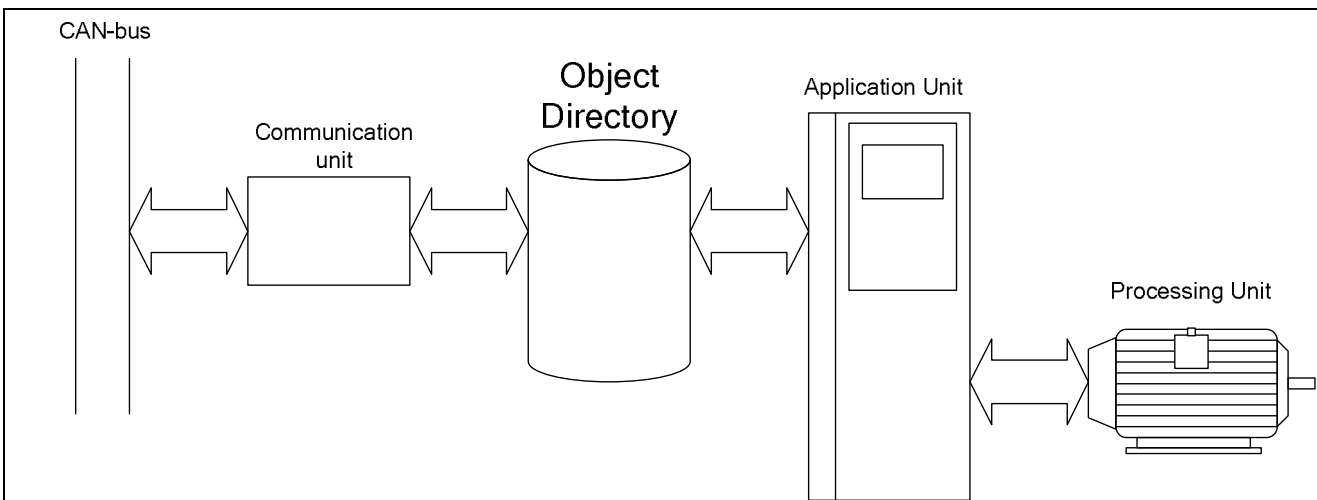

All information accessible via the CAN-bus are stored in the Object Directory (OD). The contents of the OD are organized in the following way:

| Object Directory Index Range | Object Type                      |
|------------------------------|----------------------------------|
| 0000h                        | Not used                         |
| 0001h - 025Fh                | Data Types                       |
| 0260h - 0FFFh                | Reserved                         |
| 1000h - 1FFFh                | Communication Object Area        |
| 2000h - 5FFFh                | Manufacturer Specific Area       |
| 6000h - 9FFFh                | Standardised Device Profile Area |
| A000h - FFFFh                | Reserved                         |

For a complete overview of the supported objects in the OD, please refer to section: *Object Directory*.

## Communication in CANopen

Communication with the frequency converter in CANopen is achieved via Service Data Objects (SDOs), Process Data Objects (PDOs) and Network Management (NMT).

- **PDO's** represent real-time process data with high priority. Is only possible if node is in "operational" state
- **SDO's** represent non-time-critical data and are used to configure the frequency converter. Is possible if node is in both "operational" and "pre-operational" state.
- **NMT** functions monitor the network stability and include synchronisation, detection of faults and emergency message transmission.

### COB-Identifiers (ID)

Each communication object has a unique identity (COB-ID) comprising the function code and the node ID (node address):

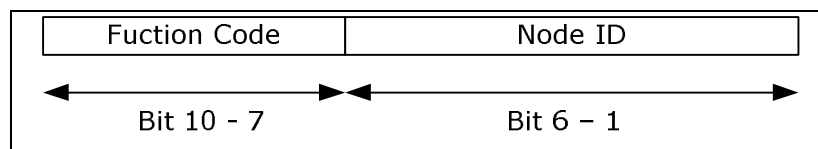

| Object                           | Function Code (binary) | Resulting COB-ID          | Comm. par. in OD    |
|----------------------------------|------------------------|---------------------------|---------------------|
| NMT                              | 0000                   | 0                         | -                   |
| SYNC                             | 0001                   | 128                       | (1005h)             |
| Time stamp                       | 0010                   | 256                       | -                   |
| EMERGENCY                        | 0001                   | 129 (81h) - 255 (FFh)     | 1014h               |
| PDO1 (tx)                        | 0011                   | 385 (181h) - 511 (1FFh)   | 1800h               |
| PDO1 (rx)                        | 0100                   | 513 (201h) - 639 (27Fh)   | 1400h               |
| PDO2 (tx)                        | 0101                   | 641 (281h) - 767(2FFh)    | 1801h               |
| PDO2 (rx)                        | 0110                   | 769 (301h) - 895 (37Fh)   | 1401h               |
| PDO3 (tx)                        | 0111                   | 897 (381h) - 1023 (3FFh)  | 1802h               |
| PDO3 (rx)                        | 1000                   | 1025 (401h) - 1151 (47Fh) | 1402h               |
| PDO4 (tx)                        | 1001                   | 1153 (481h) - 1279 (4FFh) | 1803h               |
| PDO4 (rx)                        | 1010                   | 1281 (501h) - 1407 (57Fh) | 1403h               |
| SDO (tx)                         | 1011                   | 1409 (581h) - 1535 (5FFh) | 1200h - ...         |
| SDO (rx)                         | 1100                   | 1537 (601h) - 1663 (67Fh) | 1200h - ...         |
| NMT error control (Nodeguarding) | 1110                   | 1793 (701h)-1919 (77Fh)   | 1016h,1017h (100Eh) |

Transmit and receive is always seen from the Node's point of view:

- RX = Node's receiving data (Controller -> Node)
- TX = Node's transmitting data (Node -> Controller)

### Example:

- COB-ID 383 = PDO3 transmit, from node address 3.
- COB-ID 185 = PDO1 transmit, from node address 5.
- COB-ID 604 = SDO receive, to node address 4.

## Controlling the Network

### Network Management (NMT)

In each CANopen node a state machine controls the different states of the node.

After power-up the Node will transmit a Boot-up message with the COB-ID: 700h + Node ID, and go from "Initialization" to "Pre-operational" state.

In this state SDO communication is possible, but not PDO communication.

The node must have a "Start Network"– command from a NMT-Master to enter the Operational state.

In Operational state both SDO and PDO communication are possible.

The NMT-state of the node is displayed with the green NS LED:

- Blinking = Pre-operational
- Solid on = Operational
- Single flash = Stopped

A "Reset Node" or "Reset Communication"– command from the NMT-master will make the node jump to "Initialization"– state, and automatically go to "Pre-operational"– state.

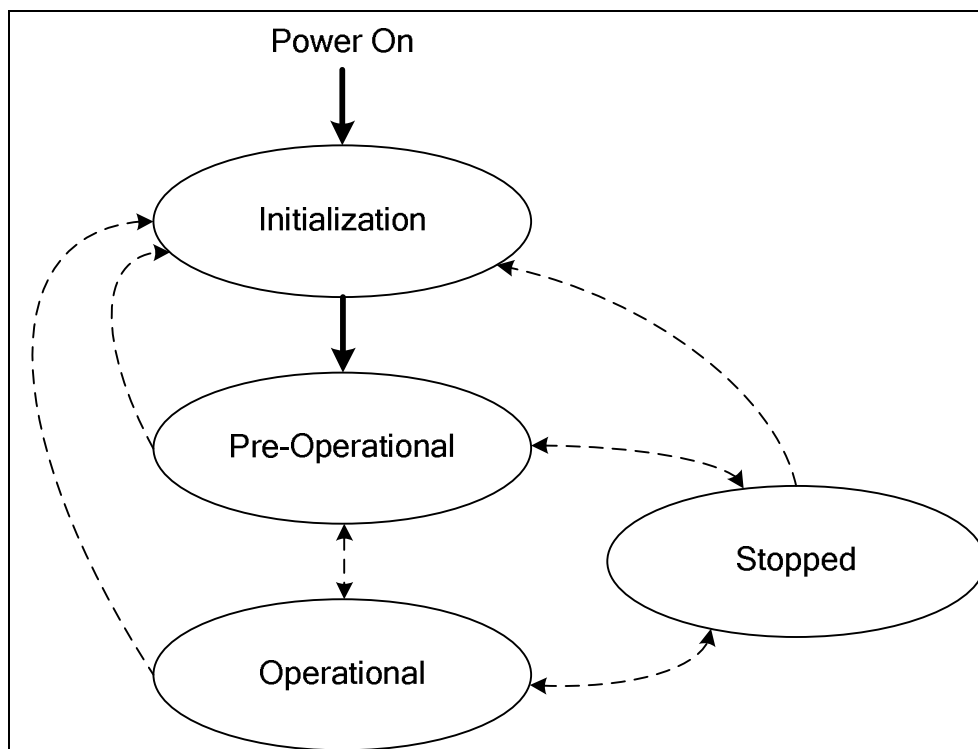

## Error control

CANopen offers two ways of error-control: "Node Guarding" and "Heartbeat".

In **Node Guarding**, the NMT-master sends cyclically a Remote-frame (RTR): 700 + node ID.

The node will reply with it's actual status.

The Node (drive) will monitor the reception of the RTR-frames, and thereby monitor the presence of the NMT-master.

The monitoring of the NMT-master can be configured via:

- **OD: 100C** *Guard Time* in [ms]
- **OD: 100D** *Life Time Factor*

If the time:  $\text{Guard Time} \times \text{Life Time Factor}$  is expired, the action programmed in par. 8-04 *Control Word Timeout Function* is being executed.

The option can also be configured as **Heartbeat producer** via:

- **OD: 1017** *Producer Heartbeat time* [ms]

The option will continuous transmit heartbeats (RTR's with the drives actual status) that can be monitored by e.g. a NMT-master.



**N.B.:**

The MCA105 option does not support the heartbeat consumer function.

### Emergency object (EMCY)

The emergency object is used to signal error states, and is sent automatically if an alarm in the drive occurs containing the data described below. If the alarm is removed, another emergency telegram is sent out with the contents 0, signalling the end of the drive's alarm state.

The behaviour of the EMCY object can be configured via par. 8-07 *Diagnosis Trigger*.

If par. 8-07 *Diagnosis Trigger* is set to "OFF", then the EMCY will not be sent at all; if it is set to "trigger alarms", then it is sent if an alarm occurs; if it is set to "trigger alarms and warnings" then it is sent if an alarm or a warning occurs.

OD 1014h contains the COB-ID of the node's EMCY message. This is fixed to 80h + node ID.

The EMCY always consists of 8 bytes with the full data as described below:

| byte 0                       | byte 1 | byte 2       | byte 3                      | byte 4 | byte 5 | byte 6 | byte 7 |
|------------------------------|--------|--------------|-----------------------------|--------|--------|--------|--------|
| EMCY code*<br>(OD: 1003 [1]) |        | OD:<br>1001h | Vendor specific information |        |        |        |        |

\*= For more information on EMCY codes, please refer to section: *Troubleshooting*.

| Byte 3 description                                          |
|-------------------------------------------------------------|
| Bit0 = 1, Alarm word 1 has an active Alarm (Par. 16-90)     |
| Bit1 = 1, Alarm word 2 has an active Alarm (Par. 16-91)     |
| Bit2 = 0, Reserved                                          |
| Bit3 = 1, Warning word 1 has an active Warning (Par. 16-92) |
| Bit4 = 1, Warning word 2 has an active Warning (Par. 16-93) |
| Bit5-7 = 0, Reserved                                        |



## Bus Error counters

The drive contains two CAN-bus error counters:

- Par. 10-05 *Transmit Error Counter* (TEC)
- Par. 10-06 *Receive Error Counter* (REC)

These counters determine the error-state of the CANopen node.

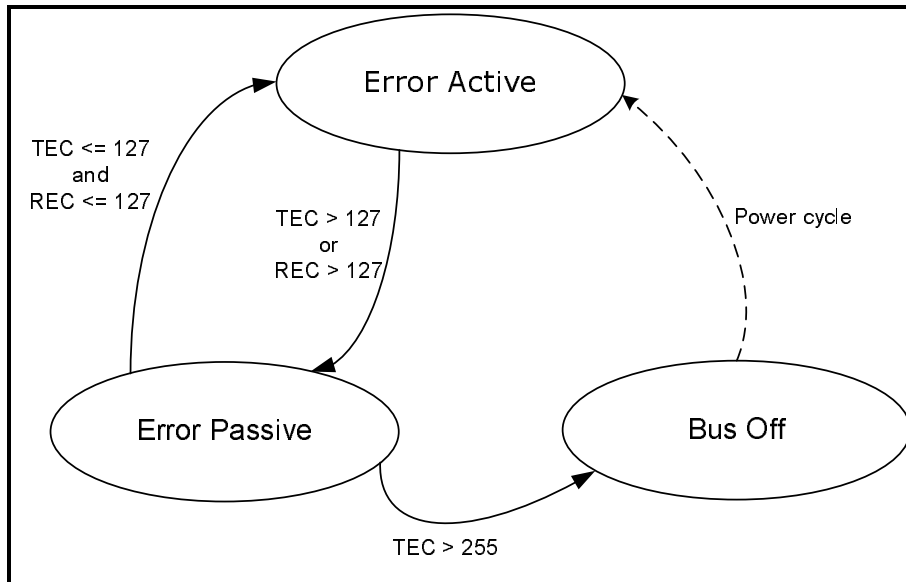

TEC is incremented with 8 if a transmit-error occurs and decremented with 1 if a transmission is successful.

REC is incremented with 1 if a receive error is detected (8 if the transmitting node is in "Error Active"-mode) and decremented with 1 if a reception is successful.

In normal operation is the node in "Error Active" – state.

If the TEC or REC exceeds the value: 127, the node enters "Error Passive" –state.

In "Error Passive" - state the Error-Flag is not transmitted dominant but recessive.

This means that an "Error Passive" node can as receiver not block communication from other nodes.

A node in "Error Passive" - state will have a lower prioritized access to the bus.

If the TEC exceeds 255 (248 + 8) the node enters "Bus Off" -state.

In "Bus Off" -state the MS LED turns solid red, and a Warning 34 is issued.

The drive must be power-cycled to leave the "Bus Off" -state.

## SDO Communication

All CANopen objects and drive parameters can be accessed via SDO's (Service Data Objects). For a description of supported SDO abort codes, please refer to section: Troubleshooting.

COB-ID's for SDO communication:

| COB-ID       |                           |                |
|--------------|---------------------------|----------------|
| Transmit SDO | 1409 (581h) - 1535 (5FFh) | 580h + Node ID |
| Receive SDO  | 1537 (601h) - 1663 (67Fh) | 600h + Node ID |

The structure of a SDO-message (request) is like this:

| COB-ID | CS        | OD- Index | Sub-ind. | Data |    |    |    |
|--------|-----------|-----------|----------|------|----|----|----|
| 600+ID | See below | 01        | 20       | 00   | 00 | 00 | 00 |

The "CS-field" contains the command specifier.

| Command               | CS  |
|-----------------------|-----|
| Write request 4 bytes | 23h |
| Write request 2 bytes | 2Bh |
| Write request 1 byte  | 2Fh |
| Read request (any)    | 40h |

| Response              | CS  |
|-----------------------|-----|
| Write response (any)  | 60h |
| Read response 4 bytes | 43h |
| Read response 2 bytes | 4Bh |
| Read response 1 byte  | 4Fh |
| Error response        | 80h |

### Saving OD entries

In standard configuration all parameters + OD entries, are stored in volatile (RAM) memory only. To store current network configuration in non-volatile memory OD index 1010h can be used.

To save parameters the value "**65766173**" (save) must be written to the appropriated sub-index in OD: 1010h

| OD Index | Sub-index | Description                                    |
|----------|-----------|------------------------------------------------|
| 1010h    | 0         | Number of entries                              |
|          | 1         | Save all parameters + OD entries               |
|          | 2         | Save all communication parameters + OD entries |
|          | 3         | Reserved                                       |
|          | 4         | Save "edit setup" (Danfoss specific)           |

### Restoring OD entries

To restore factory defaults OD index 1011h can be used.

To restore default parameters the value "**64616F6C**" (load) must be written to the appropriated sub-index in OD: 1011h

| OD Index | Sub-index | Description                                                   |
|----------|-----------|---------------------------------------------------------------|
| 1011h    | 0         | Number of entries                                             |
|          | 1         | Restore all Drive parameters + OD entries to factory default* |
|          | 2         | Restore communication parameters + OD entries**               |



\* Drive will display Alarm 80 "Drive initialised" after restore.

\*\* Only the following parameters are restored to factory default:

10-01 Baud Rate Select

10-02 Drive Node ID

10-05 Transmit Error Counter

10-06 Receive Error Counter

10-33 Store Always

10-50 CANopen Process Data, Write

10-51 CANopen Process Data, Read

# Setting up CANopen master

## EDS file

A large part area of the system configuration is the setting of application related parameters. EDS (Electronic Data Sheet) files simplify the setting up of most of the CANopen configurable parameters. The EDS file contains all supported communication specific objects (OD 1000h + 1FFFh) and a selected number of manufacturer specific objects (drive parameters) in the OD range 2000h - 5FFFh.

Danfoss provides a generic English EDS file covering all voltage and power sizes, for off-line configuration.

The EDS file can be downloaded from:

[http://www.danfoss.com/BusinessAreas/DrivesSolutions/SoftwareDownload/DDFieldbus\\_Setup\\_Files.htm](http://www.danfoss.com/BusinessAreas/DrivesSolutions/SoftwareDownload/DDFieldbus_Setup_Files.htm)



### N.B.:

The EDS-files does not contain all parameters but a selected, limited number of parameters with generic min., max. and default values.

## Configuring the CANopen master

This example shows the details in setting up the CANopen configuration on a Moeller XC-CPU201 PLC.

Setting up the baudrate and Node-ID on the CanMaster (CANopen scanner):

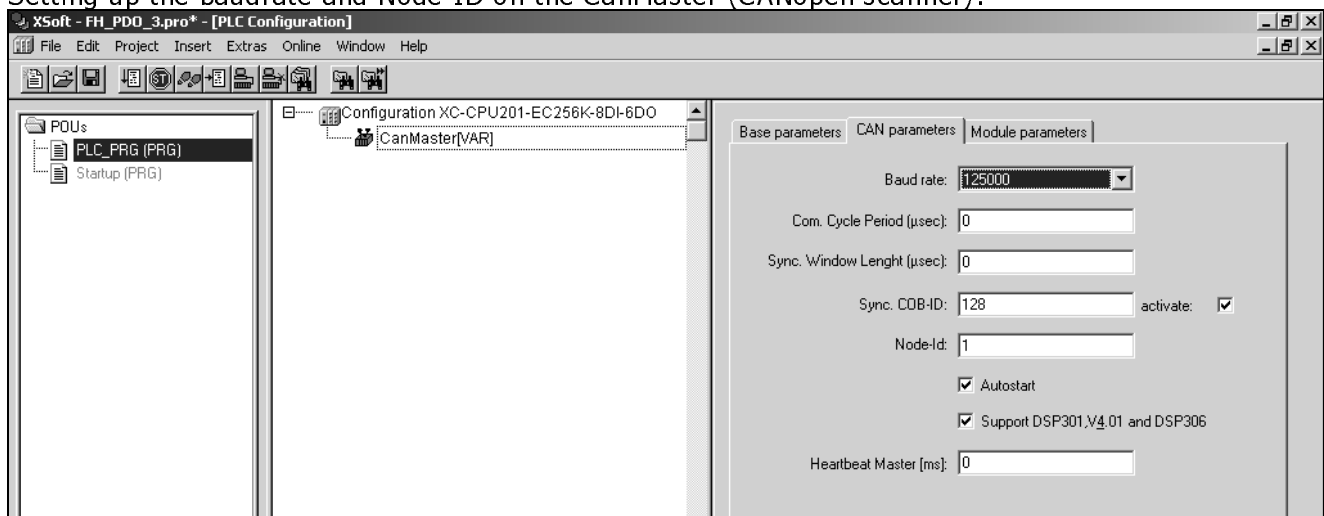

Appending a CANopen node (sub-element), from EDS-file library, by right clicking on CanMaster:

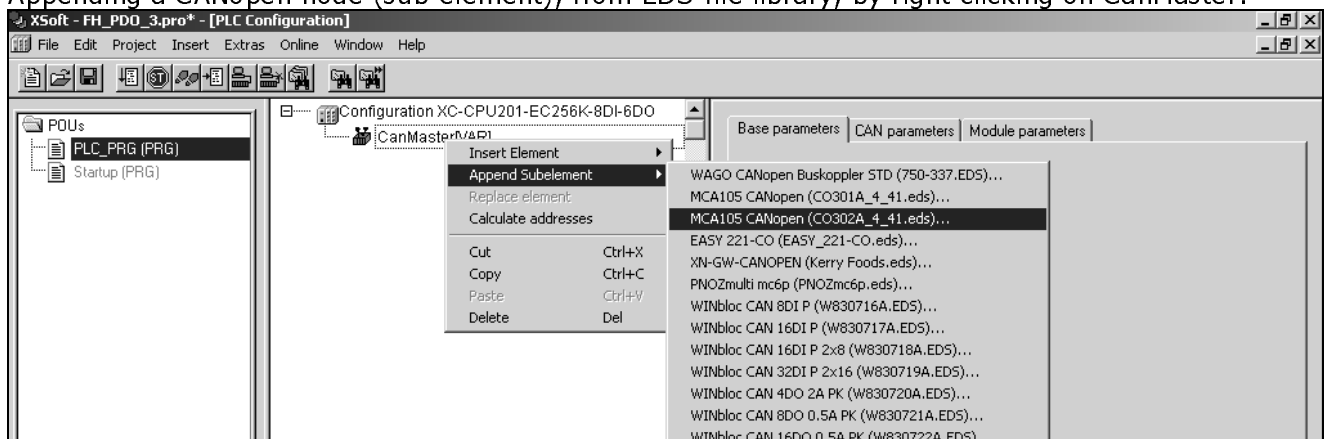

Configuring the CAN parameters like: Node-ID, Node-guarding, Heartbeat etc. on node:

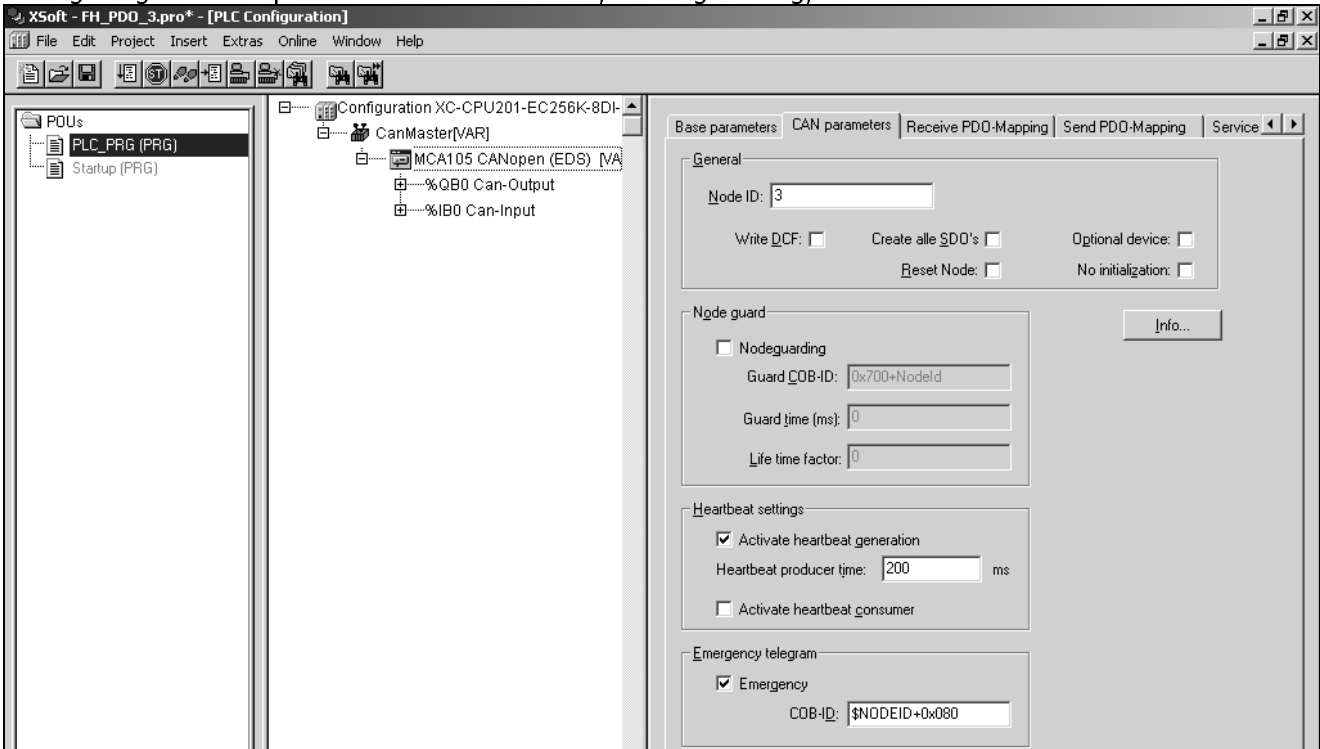

Configuring receive and transmit PDO-mapping. Here PDO 1402 with par. 3-12 and 4-11.

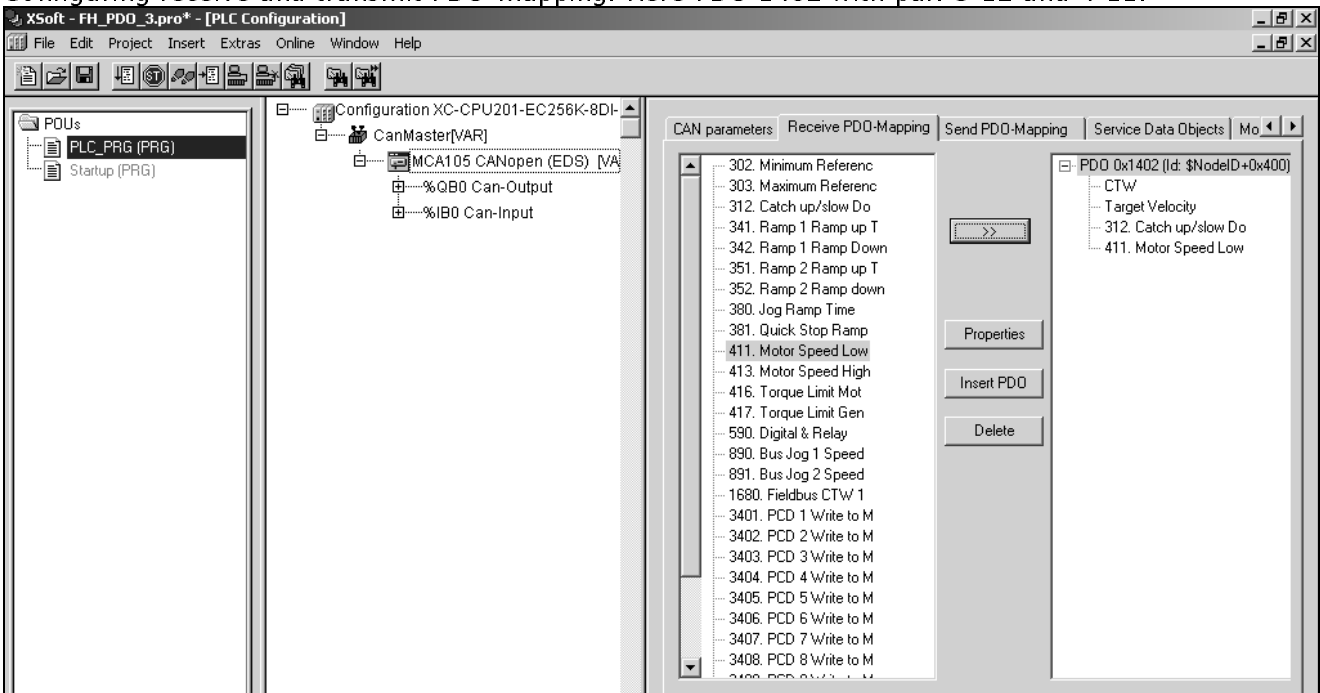

## PLC memory mapping:

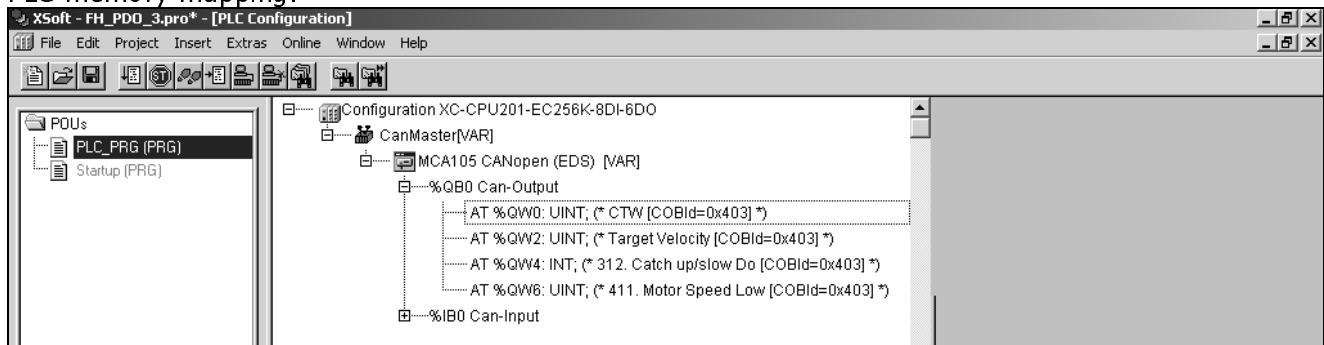

## Configuring the FC 300

### VLT Parameters

Pay particular attention to the following parameters when configuring an FC 300 with a CANopen interface. Please refer to the Parameters chapter for more details of each parameter:

#### **Parameter 0-40 [Hand on] key on LCP.**

If the Hand button on the FC 300 is activated, control of the drive via the CANopen interface is disabled.

#### **Parameter 8-02 Control Word Source.**

After initial power-up the FC 300 will automatically detect whether a fieldbus option is installed in slot A, and set parameter 8-02 *Control word source* to [Option A]. If an option is added to, changed in or removed from an already commissioned drive, it will not change par. 8-02.

#### **Parameter 8-10 Control word profile** (see section: *How to Control the FC300*).

Choose between the Danfoss FC Profile and the DSP 402 profile for CANopen.

#### **Parameters 8-01 and 8-50 to 8-56** (see *Parameters* section).

Selection of how to gate the CANopen control commands with digital input command of the control card.

Par. 8-01 *Control Site* should be set to: [2] Controlword only or [0] Digital and ctrl. word



#### **N.B.:**

When parameter 8-01 *Control Site* is set to [2] *Control word only*, then the settings in parameters 8-50 to 8-56 will be overruled, and will all act on Bus-control.

**Parameters 8-03 to 8-05.** The reaction in the event of a bus time out is set via these parameters.

**Parameter 10-01 Baud rate.** Default is 125 kbps.

**Parameter 10-02 MAC ID.** Default is 127.

## How to Control the FC300

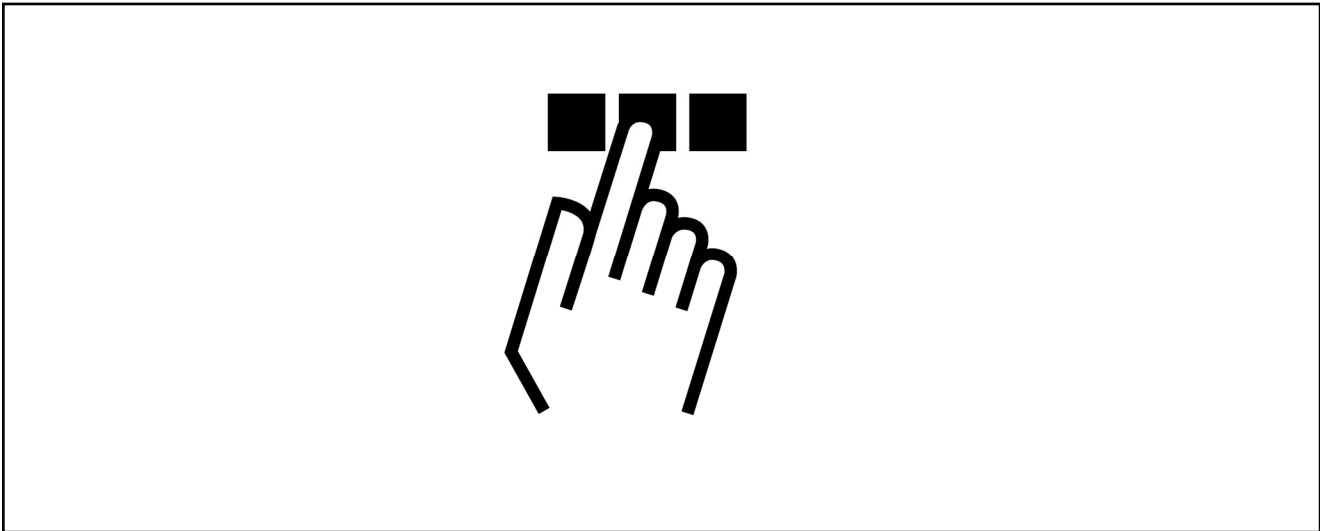

### PDO Communication

The real-time data transfer is performed by means of "Process Data Objects (PDO)". The PDOs correspond to entries in the device Object Dictionary and provide the interface to the application objects.

The following PDO-types are defined for the MCA105 CANopen option:

|            |                  |                  |                  |                                |
|------------|------------------|------------------|------------------|--------------------------------|
| PDO 1 (rx) | CTW              |                  |                  |                                |
| PDO 1 (tx) | STW              |                  |                  |                                |
| PDO 2 (rx) | CTW              | REF              |                  |                                |
| PDO 2 (tx) | STW              | MAV              |                  |                                |
| PDO 3 (rx) | CTW              | REF              | ...<br>CANopen 2 | ...<br>CANopen 3<br>Par. 10-50 |
| PDO 3 (tx) | STW              | MAV              | ...<br>CANopen 2 | ...<br>CANopen 3<br>Par. 10-51 |
| PDO 4 (rx) | ...<br>CANopen 4 | ...<br>CANopen 5 | ...<br>CANopen 6 | ...<br>CANopen 7<br>Par. 10-50 |
| PDO 4 (tx) | ...<br>CANopen 4 | ...<br>CANopen 5 | ...<br>CANopen 6 | ...<br>CANopen 7<br>Par. 10-51 |



**N.B.:**

Controlword (CTW), Status word (STW), Reference (REF) and Main Actual Value (MAV) are fixed in PDO-type 1 to 3. PDO-type 4 is free configurable.

All receive and transmit PDO's can be configured via the OD.

Mapping of process data into receive and transmit PDO's can be mapped via par. 10-50 and 10-51 or via OD: 1600 – 1603, for receive PDO's and OD: 1A00 – 1A03, for transmit PDO's respectively.

## - How to Control the FC 300 -

**Receive PDO configuration:**

| Index | Name                                                               | Sub-Ind. | Description                                                                               | Value Sub-ind. 2 | Trans. Type |
|-------|--------------------------------------------------------------------|----------|-------------------------------------------------------------------------------------------|------------------|-------------|
| 1400h | 1 <sup>st</sup> receive PDO (PDO 1)                                | 0        | Number of entries                                                                         | 1...240          | SYNC        |
| 1401h | 2 <sup>nd</sup> receive PDO (PDO 2)                                | 1        | COB ID*                                                                                   |                  |             |
| 1402h | 3 <sup>rd</sup> receive PDO (PDO 3)                                | 2        | Transmission type                                                                         |                  |             |
| 1403h | 4 <sup>th</sup> receive PDO (PDO 4)                                |          |                                                                                           |                  |             |
|       |                                                                    |          |                                                                                           | 254...255        | COS         |
| 1600h | 1 <sup>st</sup> receive PDO mapping (PDO 1)<br>*COB-ID 201h - 27Fh | 0        | Number of entries                                                                         |                  |             |
|       |                                                                    | 1        | 1 <sup>st</sup> mapped object (60400010h Control Word, <b>fixed</b> ) (par. 10-50 [0])    |                  |             |
| 1601h | 2 <sup>nd</sup> receive PDO mapping (PDO 2)<br>*COB-ID 301h - 37Fh | 0        | Number of entries                                                                         |                  |             |
|       |                                                                    | 1        | 1 <sup>st</sup> mapped object (60400010h Control Word, <b>fixed</b> ) (par. 10-50 [0])    |                  |             |
|       |                                                                    | 2        | 2 <sup>nd</sup> mapped object (60420010h Target Velocity, <b>fixed</b> ) (par. 10-50 [1]) |                  |             |
| 1602h | 3 <sup>rd</sup> receive PDO mapping (PDO 3)<br>*COB-ID 401h - 47Fh | 0        | Number of entries                                                                         |                  |             |
|       |                                                                    | 1        | 1 <sup>st</sup> mapped object (60400010h Control Word, <b>fixed</b> ) (par. 10-50 [0])    |                  |             |
|       |                                                                    | 2        | 2 <sup>nd</sup> mapped object (60420010h Target Velocity, <b>fixed</b> ) (par. 10-50 [1]) |                  |             |
|       |                                                                    | 3        | 3 <sup>rd</sup> mapped object (2000h + parameter number) (par. 10-50 [2])                 |                  |             |
|       |                                                                    | 4        | 4 <sup>th</sup> mapped object (2000h + parameter number) (par. 10-50 [3])                 |                  |             |
| 1603h | 4 <sup>th</sup> receive PDO mapping (PDO 4)<br>*COB-ID 501h - 57Fh | 0        | Number of entries                                                                         |                  |             |
|       |                                                                    | 1        | 5 <sup>th</sup> mapped object (2000h + parameter number) (par. 10-50 [4])                 |                  |             |
|       |                                                                    | 2        | 6 <sup>th</sup> mapped object (2000h + parameter number) (par. 10-50 [5])                 |                  |             |
|       |                                                                    | 3        | 7 <sup>th</sup> mapped object (2000h + parameter number) (par. 10-50 [6])                 |                  |             |
|       |                                                                    | 4        | 8 <sup>th</sup> mapped object (2000h + parameter number) (par. 10-50 [7])                 |                  |             |

**Transmit PDO configuration:**

| Index | Name                                                                 | Sub-Ind. | Description                                                                              | Value Sub-ind. 2 | Trans. Type      |
|-------|----------------------------------------------------------------------|----------|------------------------------------------------------------------------------------------|------------------|------------------|
|       |                                                                      | 0        | Number of entries                                                                        | 0                | SYNC, non cyclic |
| 1800h | 1 <sup>st</sup> transmit PDO (PPO 1)                                 | 1        | COB ID**                                                                                 |                  |                  |
| 1801h | 2 <sup>nd</sup> transmit PDO (PPO 2)                                 | 2        | Transmission type                                                                        |                  |                  |
| 1802h | 3 <sup>rd</sup> transmit PDO (PPO 3)                                 | 3        | Inhibit time                                                                             |                  |                  |
| 1803h | 4 <sup>th</sup> transmit PDO (PPO 4)                                 | 4        | Reserved                                                                                 | 254, 255         | COS              |
|       |                                                                      | 5        | Event timer                                                                              |                  |                  |
| 1A00h | 1 <sup>st</sup> transmit PDO mapping (PDO 1)<br>**COB-ID 181h - 1FFh | 0        | Number of entries                                                                        |                  |                  |
|       |                                                                      | 1        | 1 <sup>st</sup> mapped object (60410010h Status Word, <b>fixed</b> ) (par. 10-51 [0])    |                  |                  |
| 1A01h | 2 <sup>nd</sup> transmit PDO mapping (PDO 2)<br>**COB-ID 281h - 2FFh | 0        | Number of entries                                                                        |                  |                  |
|       |                                                                      | 1        | 1 <sup>st</sup> mapped object (60410010h Status Word, <b>fixed</b> ) (par. 10-51 [0])    |                  |                  |
|       |                                                                      | 2        | 2 <sup>nd</sup> mapped object (60440010h Control Effort, <b>fixed</b> ) (par. 10-51 [1]) |                  |                  |
| 1A02h | 3 <sup>rd</sup> transmit PDO mapping (PDO 3)<br>**COB-ID 381h - 3FFh | 0        | Number of entries                                                                        |                  |                  |
|       |                                                                      | 1        | 1 <sup>st</sup> mapped object (60410010h Status Word, <b>fixed</b> ) (par. 10-51 [0])    |                  |                  |
|       |                                                                      | 2        | 2 <sup>nd</sup> mapped object (60440010h Control Effort, <b>fixed</b> ) (par. 10-51 [1]) |                  |                  |
|       |                                                                      | 3        | 3 <sup>rd</sup> mapped object (2000h + parameter number) (par. 10-51 [2])                |                  |                  |
|       |                                                                      | 4        | 4 <sup>th</sup> mapped object (2000h + parameter number) (par. 10-51 [3])                |                  |                  |
| 1A03h | 4 <sup>th</sup> transmit PDO mapping (PDO 4)<br>**COB-ID 481h - 4FFh | 0        | Number of entries                                                                        |                  |                  |
|       |                                                                      | 1        | 5 <sup>th</sup> mapped object (2000h + parameter number) (par. 10-51 [4])                |                  |                  |
|       |                                                                      | 2        | 6 <sup>th</sup> mapped object (2000h + parameter number) (par. 10-51 [5])                |                  |                  |
|       |                                                                      | 3        | 7 <sup>th</sup> mapped object (2000h + parameter number) (par. 10-51 [6])                |                  |                  |
|       |                                                                      | 4        | 8 <sup>th</sup> mapped object (2000h + parameter number) (par. 10-51 [7])                |                  |                  |

**PDO Mapping Syntax**

Sub-index 1 to 4 contains the mapped objects.

Example: Object 6041 *Status Word* is fixed in PDO 1 and PDO 2 as the first transmit-word.

I.e. OD 1A00h and 1A01h sub-index 1 holds the value of 60410010 (6041 = object number, 00 = Sub-index, 10 = length of data = 16 bits)

Example: To map parameter 16-14 *Motor Current* (32-bit data) in PDO 3, it must be mapped in two PDO-words. Par. 1614 is according to manufacturer object 264E.

1A02h [3] = 264E0020 (264E = object number, 00 = Sub-index, 20 = length of data = 32 bits)

1A02h [4] = 264E0020 (264E = object number, 00 = Sub-index, 20 = length of data = 32 bits)

### PDO Transmission Modes

Sub-index 2 contains the setting of the transmission mode.

The following PDO transmission modes are distinguished:

- Synchronous Transmission
- Asynchronous Transmission

### PDO Triggering Modes

The CANopen Communication Profile distinguishes two message triggering modes, Event Driven and Remotely Requested:

#### Event Driven

Message transmission is triggered by the occurrence of an object specific event.

For synchronous PDO's this is the expiration of the specified transmission period, synchronised by the reception of the SYNC object.

For a-cyclically transmitted synchronous PDO's and asynchronous PDO's, the triggering of a message transmission is an application specific event specified in the device profile.

#### Remotely requested

The transmission of asynchronous PDO's may be initiated on receipt of a remote request initiated by another device.

| Transmission type | PDO transmission |          |              |               |          |
|-------------------|------------------|----------|--------------|---------------|----------|
|                   | Cyclic           | A-cyclic | Synchronous* | A-synchronous | RTR only |
| 0                 |                  | X        | X            |               |          |
| 1-240             | X                |          | X            |               |          |
| 241-251           | Reserved         |          |              |               |          |
| 252               | Not supported    |          |              |               |          |
| 253               |                  |          |              |               |          |
| 254               |                  |          |              | X             |          |
| 255               |                  |          |              | X             |          |



\* Please note. A minimum SYNC-interval of 5 ms is supported.

### Inhibit Time

Sub-index 3 contains the inhibit time.

This time defines a minimum interval for PDO transmission. The value is defined as multiple of 0.1 ms.

Default value is 300 = 30 ms.

Minimum value is 0.

Maximum value is 32,767 = 3.2 s.

Data length = 2 bytes.

### Event Timer

Sub-index 5 contains the inhibit time, for transmit PDO's.

If an event timer is configured for a TPDO (value not equal to 0) the elapsed timer will cause the transmission of this TPDO.

The event timer can be configured as multiple of 1 ms.

Default value is 0

Maximum value is 32,767 = 32 s.

Data length = 2 bytes.



## Control Profile

In par. 8-10 *Control Profile* it is possible to select between:

- \*FC profile [0]
- CANopen DSP 402 [5]

*FC Profile* is the default control profile for VLT® drives, whereas *CANopen DP 402* is the CiA standardized control profile, featuring the special DSP 402 transition state machine.

### DSP 402 State Machine

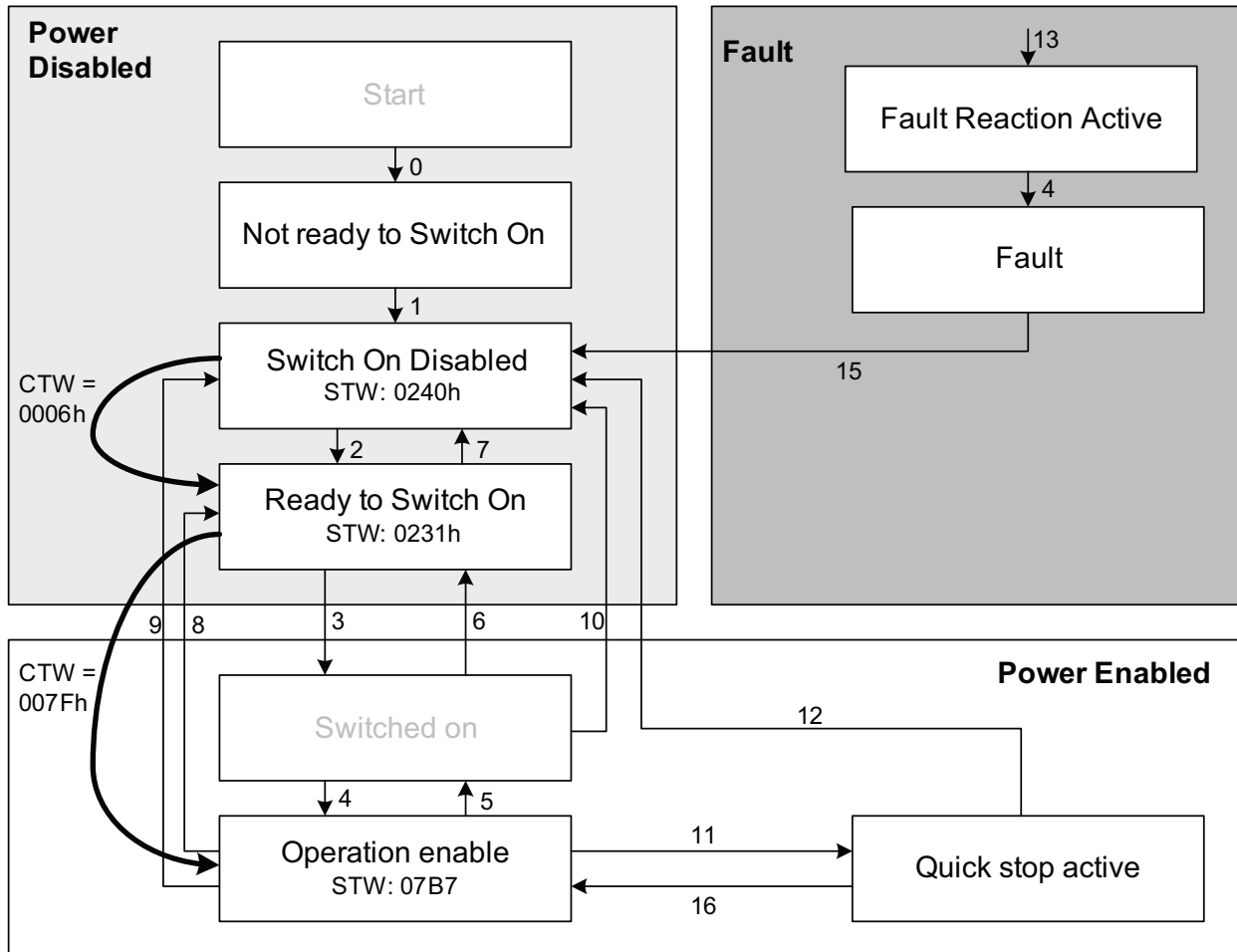

## - How to Control the FC 300 -

**DSP 402 state transitions**

| Transition | State                                                 | Control word  | Status word | Action                                                                                      |
|------------|-------------------------------------------------------|---------------|-------------|---------------------------------------------------------------------------------------------|
| -          | Start condition                                       | 0000          | 0000        | -                                                                                           |
| 0          | Start-up -> Not Ready to Switch On                    | 0000          | 0200        | -                                                                                           |
| 1          | Not Ready to Switch On -> Switch On Disabled          | 0000,<br>0001 | 0240        | -                                                                                           |
| 2          | Switch On Disabled -> Ready to Switch On              | 0006          | 0231        | -                                                                                           |
| 3          | Ready to Switch On -> Switched On                     | 0007          | 0233        | -                                                                                           |
| 4          | Switched On -> Operation Enabled                      | 000F          | 0237        | -                                                                                           |
| 5          | Operation Enabled -> Switched On                      | 0007          | 0233        | Motor ramps to 0 RPM with programmed ramp down parameter                                    |
| 6          | Switched On -> Ready to Switch On                     | 0006          | 0231        | -                                                                                           |
| 7          | Ready to Switch On -> Switch On Disable               | 0001,<br>0000 | 0240        | -                                                                                           |
| 8          | Operation Enable -> Ready to Switch On                | 0006          | 0231        | The power section is switched off immediately, and the motor is free to rotate if un-braked |
| 9          | Operation Enable -> Switch on Disable                 | 0001,<br>0000 | 0240        | The power section is switched off immediately, and the motor is free to rotate if un-braked |
| 10         | Switched On -> Switched On Disable                    | 0001,<br>0000 | 0240        | The power section is switched off immediately, and the motor is free to rotate if un-braked |
| 11         | Operation Enabled -> Quick Stop Active                | 0002          | 0207        | Motor ramps to 0 RPM with programmed quick ramp parameter                                   |
| 11         | Operation Enabled -> Quick Stop Active                | 0003          | 0217        | Motor ramps to 0 RPM with programmed quick ramp parameter                                   |
| 12         | Quick Stop Active -> Switch On Disabled               | 0001,<br>0000 | 0240        | The power section is switched off immediately, and the motor is free to rotate if un-braked |
| 13         | All states -> Fault Reaction Active                   | xxxx          | 023F        | -                                                                                           |
| 14         | Fault Reaction Active -> Fault                        | xxxx          | 023F        | -                                                                                           |
| 15         | Fault -> Switch On Disabled                           | 0000          | 0240        | -                                                                                           |
| 16         | Quick Stop Active -> Operation Enable (not supported) | -             | -           | -                                                                                           |

## DSP 402 Control Profile

**Control Word according to DSP 402 profile.** (Par. 8-10 = DSP 402 profile)

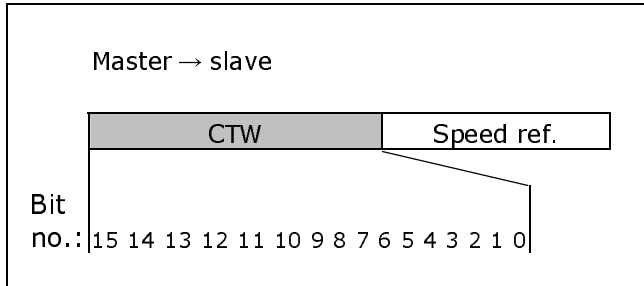

| Bit | Bit value = 0      | Bit value = 1    |
|-----|--------------------|------------------|
| 00  | Switch off         | Switch on        |
| 01  | Disable voltage    | Enable voltage   |
| 02  | Quick stop         | run              |
| 03  | Disable operation  | Enable operation |
| 04  | Disable ramp       | Enable ramp      |
| 05  | Freeze             | Run enable       |
| 06  | Ramp stop          | Start            |
| 07  | No function        | Reset            |
| 08  | Reserved           |                  |
| 09  | Reserved           |                  |
| 10  | Reserved           |                  |
| 11  | Jog 1 OFF          | Jog1 ON          |
| 12  | Reserved           |                  |
| 13  | Setup select (LSB) |                  |
| 14  | Setup select (MSB) |                  |
| 15  | Forward            | Reversing        |

### Explanation of the Bits:

#### Bit 00, Switch OFF/ON:

Bit 00= "0" execute transition 2, 6 or 8.  
 Bit 00 = "1" execute transition 3.

#### Bit 01, Disable/Enable Voltage:

Bit 01= "0" execute transition 9, 10 or 12.  
 Bit 01 = "1" = "Enable Voltage".

#### Bit 02, Quick stop/Run:

Bit 02= "0" execute transition 7, 10 or 11.  
 Bit 02 = "1" = Quick stop not active.

#### Bit 03, Disable/enable Operation:

Bit 03= "0" execute transition 5.  
 Bit 03 = "1" = "Enable operation".

#### Bit 04, Quick-stop/ramp:

Bit 04= "0" execute transition 7 or 11, Quick stop.  
 Bit 04 = "1" = Enable ramp.

#### Bit 05, Freeze output frequency/run enable:

Bit 05 = "0" means that the given output frequency is maintained even if the reference is changed.  
 Bit 05 = "1" means that the frequency converter is again able to regulate, and the given reference is followed.

#### Bit 06, Ramp stop/start:

Bit06= "0" The VLT controls the motor down to stop.  
 Bit 06 = "1" = Start command to the VLT is given.

#### Bit 07, No function/reset:

Reset of trip.  
 Bit 07 = "0" means that there is no reset.  
 Bit 07 = "1" means that a trip is reset.

#### Bit 08, 09 and 10:

DSP402 reserved.

#### Bit 11, Jog 1 OFF/ON:

Activation of pre-programmed speed in parameter 8-90 (Bus JOG 1).  
 JOG 1 is only possible if Bit 04 = "0", and bit 00 to 03 = "1".

#### Bit 12:

Danfoss reserved.

#### Bits 13/14, Selection of Setup:

Bits 13 and 14 are used for choosing among the four menu Setups in accordance with the following table:

| Bit 14 | Bit 13 | Setup |
|--------|--------|-------|
| 0      | 0      | 1     |
| 0      | 1      | 2     |
| 1      | 0      | 3     |
| 1      | 1      | 4     |

#### Bit 15, Forward/reversing:

Bit 15 = "0" leads to no reversing.  
 Bit 15 = "1" leads to reversing.

Note: In factory setting reversing is set to [digital] in par. 8-54 *Reversing select*.

- How to Control the FC 300 -

**Status Word according to DSP 402 profile.**

(Par. 8-10 = DSP 402 profile)

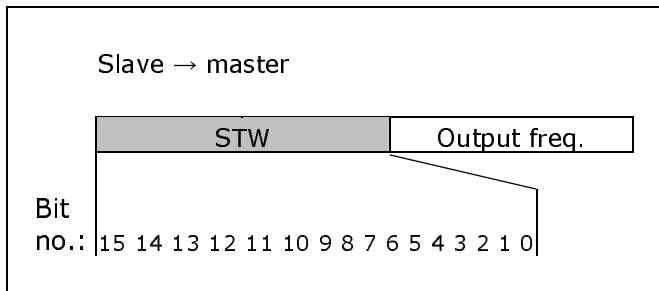

| Bit | Bit value = 0          | Bit value = 1      |
|-----|------------------------|--------------------|
| 00  | Not ready to switch ON | Ready to switch ON |
| 01  | Switched OFF           | Switched ON        |
| 02  | Operation disabled     | Operation enabled  |
| 03  | No malfunction         | Malfunction        |
| 04  | Voltage disabled       | Voltage enabled    |
| 05  | Quick stop             | Run                |
| 06  | Switch on disable      | Switch on enable   |
| 07  | No warning             | Warning            |
| 08  | Reserved               |                    |
| 09  | Remote disabled        | Remote enabled     |
| 10  | Set point not reached  | Set point reached  |
| 11  | Speed limit not active | Speed limit active |
| 12  | Reserved               |                    |
| 13  | Reserved               |                    |
| 14  | Not running            | Running            |
| 15  | Reserved               |                    |

**Explanation of the Bits:**

Bit 00, Not ready to switch on/Ready to switch on:

Bit 00 = "0" state less than "Ready to switch on".  
 Bit 00 = "1" state at least = "Ready to Switch on".

Bit 01, Switch off/Switch on:

Bit 00 = "0" state less than "Switched on".  
 Bit 00 = "1" state at least = "Switched on".

Bit 02, Operation disable/Operation enable:

Bit 00 = "0" state less than "Operation enable".  
 Bit 00 = "1" state at least = "Operation enable".

Bit 03, No fault/trip:

Bit 03 = "0" means that the drive is not in a fault condition.

Bit 03 = "1" means that the drive has tripped and needs a reset signal in order to run.

Bit 04, Voltage disable/Voltage enable:

Bit 04 = "0" means that control word bit 01 = "1".

Bit 04 = "1" means that control word bit 01 = "0".

Bit 05, Quick stop/Run:

Bit 05 = "0" means that control word bit 02 = "1".

Bit 05 = "1" means that control word bit 02 = "0".

Bit 06, Start enable/Start disable:

Bit 06 = "0" state is not "Switch on disable".

Bit 06 = "1" state = "Switch on enable".

Bit 07, No warning/Warning:

Bit 07 = "0" means that there is no warning situation.

Bit 07 = "1" means that a warning has occurred.

Bit 08, Danfoss reserved:

Bit 09, Remote disable/Remote enable:

Bit 09 = "0" means that the drive has been stopped by means of the stop key on the LCP, or that [Local] has been selected in parameter 3-13 *Reference site*.

Bit 09 = "1" means that it is possible to control the drive converter via the serial port.

Bit 10, Set point not reached/Set point reached:

Bit 10 = "0" means that the actual motor speed is different from the speed reference set. This can be the case while the speed is ramped up/down during start/stop.

Bit 10 = "1" means that the present motor speed equals the speed reference set.

Bit 11, Speed limit not active/speed limit active:

Bit 11 = "0" means that the output frequency is out of the range set in par. 4-11/4-12 *Motor Speed low Limit RPM/Hz* or par. 4-13/4-14 *Motor Speed high Limit RPM/Hz*.

Bit 11 = "1" means that the output frequency is within the mentioned range.

Bit 12, DSP 402 reserved.

Bit 13, DSP 402 reserved.

Bit 14, Running/Not running:

Bit 14 = "0" means that the motor is not running.

Bit 14 = "1" means that the drive has a valid start signal or that the output frequency is greater than 0 Hz.

Bit 15, Danfoss reserved.

## Danfoss FC control profile

### Control Word according to FC Profile

(Par. 8-10 = FC profile)

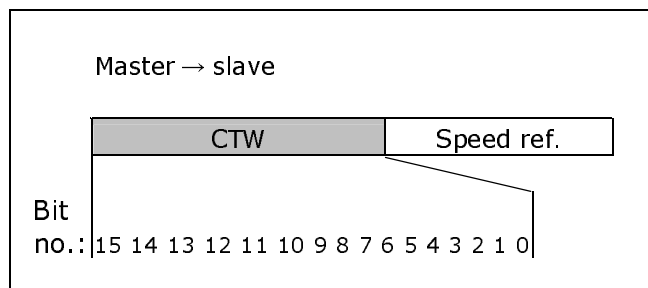

| Bit | Bit value = 0         | Bit value = 1          |
|-----|-----------------------|------------------------|
| 00  | Reference value       | external selection lsb |
| 01  | Reference value       | external selection msb |
| 02  | DC brake              | Ramp                   |
| 03  | Coasting              | No coasting            |
| 04  | Quick stop            | Ramp                   |
| 05  | Hold output frequency | Use ramp               |
| 06  | Ramp stop             | Start                  |
| 07  | No function           | Reset                  |
| 08  | No function           | Jog                    |
| 09  | Ramp 1                | Ramp 2                 |
| 10  | Data invalid          | Data valid             |
| 11  | No function           | Relay 01 active        |
| 12  | No function           | Relay 04 active        |
| 13  | Parameter set-up      | selection lsb          |
| 14  | Parameter set-up      | selection msb          |
| 15  | No function           | Reverse                |

### Explanation of the Control Bits

#### Bits 00/01

Bits 00 and 01 are used to choose between the four reference values, which are pre-programmed in parameter 3-10 *Preset reference* according to the following table:

| Programmed ref. value | Parameter | Bit 01 | Bit 00 |
|-----------------------|-----------|--------|--------|
| 1                     | 3-10 [0]  | 0      | 0      |
| 2                     | 3-10 [1]  | 0      | 1      |
| 3                     | 3-10 [2]  | 1      | 0      |
| 4                     | 3-10 [3]  | 1      | 1      |



**N.B.:** In parameter 8-56 *Preset reference select* a selection is made to define how Bit

00/01 gates with the corresponding function on the digital inputs.

#### Bit 02, DC brake:

Bit 02 = '0' leads to DC braking and stop. Braking current and duration are set in parameters 2-01 *DC Brake current* and 2-02 *DC Braking time*.

Bit 02 = '1' leads to ramping.

#### Bit 03, Coasting:

Bit 03 = '0' causes the frequency converter to immediately "let go" of the motor (the output transistors are "shut off"), so that it coasts to a standstill.

Bit 03 = '1' enables the frequency converter to start the motor if the other starting conditions have been fulfilled.



#### N.B.:

In parameter 8-50 *Coasting select* a selection is made to define how Bit 03 gates with the corresponding function on a digital input.

#### Bit 04, Quick stop:

Bit 04 = '0' causes a stop, in which the motor speed is ramped down to stop via parameter 3-81 *Quick stop ramp time*.

#### Bit 05, Hold output frequency:

Bit 05 = '0' causes the present output frequency (in Hz) to freeze. The frozen output frequency can then be changed only by means of the digital inputs (par. 5-10 to 5-15) programmed to *Speed up* and *Speed down*.



#### N.B.:

If *Freeze output* is active, the frequency converter can only be stopped by the following:

- Bit 03 Coasting stop
- Bit 02 DC braking
- Digital input (par. 5-10 to 5-15) programmed to *DC braking*, *Coasting stop* or *Reset and coasting stop*.

#### Bit 06, Ramp stop/start:

Bit 06 = '0' causes a stop, in which the motor speed is ramped down to stop via the selected *ramp down* parameter.

Bit 06 = '1' permits the frequency converter to start the motor, if the other starting conditions have been fulfilled.

**N.B.:**  
 In parameter 8-53 *Start select* a selection is made to define how Bit 06 Ramp stop/start gates with the corresponding function on a digital input.

**Bit 07, Reset:**  
 Bit 07 = '0' does not cause a reset.  
 Bit 07 = '1' causes the reset of a trip. Reset is activated on the signal's leading edge, i.e. when changing from logic '0' to logic '1'.

**Bit 08, Jog:**  
 Bit 08 = '1' causes the output frequency to be determined by parameter 3-19 *Jog speed*.

**Bit 09, Selection of ramp 1/2:**  
 Bit 09 = "0" means that ramp 1 is active (parameters 3-40 to 3-47). Bit 09 = "1" means that ramp 2 (parameters 3-50 to 3-57) is active.

**Bit 10, Data not valid/Data valid:**  
 Is used to tell the frequency converter whether the control word is to be used or ignored. Bit 10 = '0' causes the control word to be ignored, Bit 10 = '1' causes the control word to be used. This function is relevant, because the control word is always contained in the telegram, regardless of which type of telegram is used, i.e. it is possible to turn off the control word if you do not wish to use it in connection with updating or reading parameters.

**Bit 11, Relay 01:**  
 Bit 11 = "0" Relay not activated.  
 Bit 11 = "1" Relay 01 activated, provided *Control word bit 11* has been chosen in parameter 5-40 *Function relay*.

**Bit 12, Relay 04:**  
 Bit 12 = "0" Relay 04 has not been activated.  
 Bit 12 = "1" Relay 04 has been activated, provided *Control word bit 12* has been chosen in parameter 5-40 *Function relay*.

**Bit 13/14, Selection of set-up:**  
 Bits 13 and 14 are used to choose from the four menu set-ups according to the following table:

| Set-up | Bit 14 | Bit 13 |
|--------|--------|--------|
| 1      | 0      | 0      |
| 2      | 0      | 1      |
| 3      | 1      | 0      |
| 4      | 1      | 1      |

The function is only possible when *Multi-Set-ups* is selected in parameter 0-10 *Active Set-up*.

**N.B.:**  
 In parameter 8-55 *Set-up select* a selection is made to define how Bit 13/14 gates with the corresponding function on the digital inputs.

**Bit 15 Reverse:**  
 Bit 15 = '0' causes no reversing.  
 Bit 15 = '1' causes reversing.  
 Note: In the factory setting reversing is set to *digital* in parameter 8-54 *Reversing select*. Bit 15 causes reversing only when *Ser. communication, Logic or or Logic and* is selected.

- How to Control the FC 300 -

**Status Word according to FC Profile**

(Par. 8-10 = FC profile)

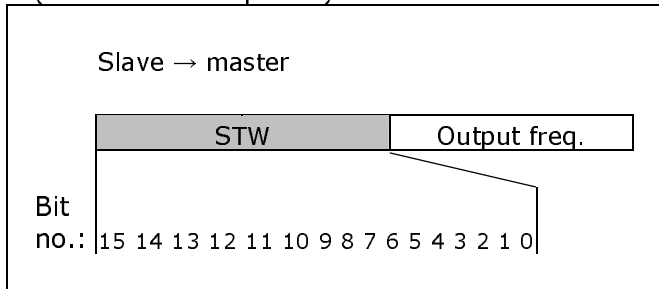

| Bit | Bit = 0                | Bit = 1            |
|-----|------------------------|--------------------|
| 00  | Control not ready      | Control ready      |
| 01  | Drive not ready        | Drive ready        |
| 02  | Coasting               | Enable             |
| 03  | No error               | Trip               |
| 04  | No error               | Error (no trip)    |
| 05  | Reserved               | -                  |
| 06  | No error               | Triplock           |
| 07  | No warning             | Warning            |
| 08  | Speed ≠ reference      | Speed = reference  |
| 09  | Local operation        | Bus control        |
| 10  | Out of frequency limit | Frequency limit ok |
| 11  | No operation           | In operation       |
| 12  | Drive ok               | Stopped, autostart |
| 13  | Voltage ok             | Voltage exceeded   |
| 14  | Torque ok              | Torque exceeded    |
| 15  | Timer ok               | Timer exceeded     |

**Explanation of the Status Bits**

Bit 00, Control not ready/ready:

Bit 00 = '0' means that the frequency converter has tripped.  
 Bit 00 = '1' means that the frequency converter controls are ready, but that the power component is not necessarily receiving any power supply (in case of external 24 V supply to controls).

Bit 01, Drive ready:

Bit 01 = '1'. The frequency converter is ready for operation.

Bit 02, Coasting stop:

Bit 02 = '0'. The frequency converter has released the motor.  
 Bit 02 = '1'. The frequency converter can start the motor when a start command is given.

Bit 03, No error/trip:

Bit 03 = '0' means that the frequency converter is not in fault mode.  
 Bit 03 = '1' means that the frequency converter is tripped, and that a reset signal is required to re-establish operation.

Bit 04, No error/error (no trip):

Bit 04 = '0' means that the frequency converter is not in fault mode.  
 Bit 04 = "1" means that there is a frequency converter error but no trip.

Bit 05, Not used:

Bit 05 is not used in the status word.

Bit 06, No error / triplock:

Bit 06 = '0' means that the frequency converter is not in fault mode.  
 Bit 06 = "1" means that the frequency converter is tripped, and locked.

Bit 07, No warning/warning:

Bit 07 = '0' means that there are no warnings.  
 Bit 07 = '1' means that a warning has occurred.

Bit 08, Speed≠ reference/speed = reference:

Bit 08 = '0' means that the motor is running, but that the present speed is different from the preset speed reference. It might, for example, be the case while the speed is being ramped up/down during start/stop.  
 Bit 08 = '1' means that the present motor present speed matches the preset speed reference.

Bit 09, Local operation/bus control:

Bit 09 = '0' means that [STOP/RESET] is activated on the control unit, or that *Local control* in parameter 3-13 *Reference site* is selected. It is not possible to control the frequency converter via serial communication.  
 Bit 09 = '1' means that it is possible to control the frequency converter via the fieldbus/ serial communication.

Bit 10, Out of frequency limit:

Bit 10 = '0', if the output frequency has reached the value in parameter 4-11 *Motor speed low limit* or parameter 4-13 *Motor speed high limit*.  
 Bit 10 = "1" means that the output frequency is within the defined limits.

Bit 11, No operation/in operation:

Bit 11 = '0' means that the motor is not running.



## - H o w t o C o n t r o l t h e F C 3 0 0 -

Bit 11 = '1' means that the frequency converter has a start signal or that the output frequency is greater than 0 Hz.

Bit 12, Drive OK/stopped, autostart:

Bit 12 = '0' means that there is no temporary over temperature on the inverter.

Bit 12 = '1' means that the inverter has stopped because of over temperature, but that the unit has not tripped and will resume operation once the over temperature stops.

Bit 13, Voltage OK/limit exceeded:

Bit 13 = '0' means that there are no voltage warnings.

Bit 13 = '1' means that the DC voltage in the frequency converter's intermediate circuit is too low or too high.

Bit 14, Torque OK/limit exceeded:

Bit 14 = '0' means that the motor current is lower than the torque limit selected in parameter 4-18 *Current limit*.

Bit 14 = '1' means that the torque limit in parameter 4-18 *Current limit* has been exceeded.

Bit 15, Timer OK/limit exceeded:

Bit 15 = '0' means that the timers for motor thermal protection and VLT thermal protection, respectively, have not exceeded 100%.

Bit 15 = '1' means that one of the timers has exceeded 100%.

## Reference Handling

In both FC-Profile and CANopen DSP 402, the reference is scaled as a normalized relative value in percent. The value is transmitted in hexadecimal:

- 0% = 0hex
- 100% = 4000hex
- 100% = C000hex

Depending of the setting of par. 3-00 *Reference Range*, the reference is scaled from - Max. to + Max. or from Min. to Max.

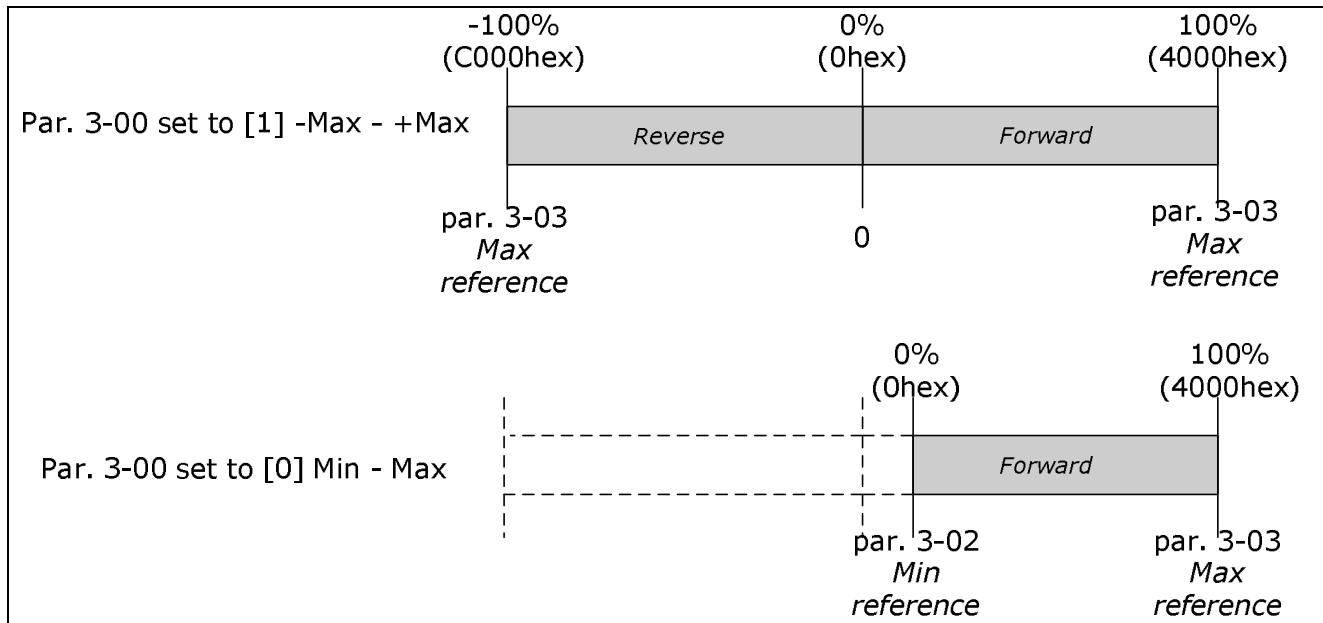

The actual reference [Ref. %] in the VLT depends on the settings in the following parameters:

- Parameter 1-23 *Motor frequency*
- Parameter 1-25 *Motor nominal speed*
- Parameter 3-02 *Minimum reference*
- Parameter 3-03 *Maximum reference*

All references provided to the frequency converter are added to the total reference value. If a reference is to be controlled by the fieldbus only, ensure that all other reference inputs are zero.

This means that digital and analogue input terminals should not be used for reference signals. The default setting (0%) should be maintained for preset references in par. 3-10 *Preset Reference*.

Note that if the bus speed reference is negative, and the control word contains a run reverse signal, the drive will run clockwise (- is +).

MAV is scaled in the same way as the reference.

## How to Access FC 300 Parameters

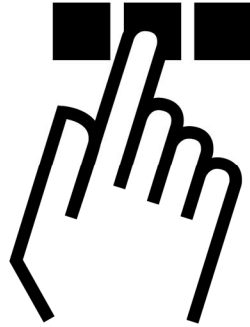

### Danfoss Specific Objects (2000h-5FFFh)

All drive-parameters are accessible as OD-entries:

**OD index = Drive-parameter + 2000h.**

Example of converting of drive parameters:

| Drive Parameter | CANopen OD index |
|-----------------|------------------|
| 1               | 2001h            |
| 2               | 2002h            |
| ...             | ...              |
| 0-10            | 200Ah            |
| 0-11            | 200Bh            |
| ...             | ...              |
| 1-00            | 2064h            |
| 1-01            | 2065h            |
| ...             | ...              |
| 10-00           | 23E8h            |
| 10-01           | 23E9h            |
| ...             | ...              |

Indexed parameters are accessed by accessing the appropriate sub-index of the OD index.

## Parameters

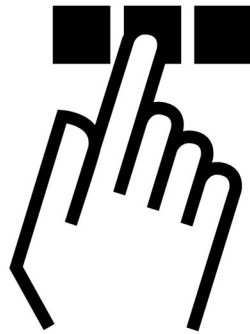

### 8-01 Control Site

#### Option:

|                         |     |
|-------------------------|-----|
| *Digital and ctrl. word | [0] |
| Digital only            | [1] |
| Control word only       | [2] |

#### Function:

Specifies the control as either *Digital* inputs, *Control* word or both. This parameter overrules the settings in par. 8-50 to 8-56.

### 8-02 Control Word Source

#### Option:

|           |     |
|-----------|-----|
| None      | [0] |
| *FC RS485 | [1] |
| FC USB    | [2] |
| Option A  | [3] |
| Option B  | [4] |
| Option C0 | [5] |
| Option C1 | [6] |

#### Function:

Specifies the source of the control word, serial interface or installed option. During initial power-up, the FC 300 automatically sets this parameter to *Option A* if it detects a valid bus option installed in this slot. If the option is removed, the frequency converter detects a change in the configuration and sets par. 8-02 back to the default setting *FC RS485*. The frequency converter trips. If an option is installed after initial power-up, the setting of par. 8-02 does not change, but the drive will be tripped and display: Alarm 67 *Option changed*. Par. 8-02 cannot be changed while the motor is running.

### 8-03 Control Word Timeout Time

#### Range:

|                 |
|-----------------|
| 0.1 - 18000.0 s |
| * 1.0 s         |

#### Function:

No function for CANopen. Network timeout functions must in CANopen be configured via Node Guarding (OD 100C and 100D)

### 8-04 Control Word Timeout Function

#### Option:

|                 |      |
|-----------------|------|
| *Off            | [0]  |
| Freeze Output   | [1]  |
| Stop            | [2]  |
| Jogging         | [3]  |
| Max. Speed      | [4]  |
| Stop and trip   | [5]  |
| Select set-up 1 | [7]  |
| Select set-up 2 | [8]  |
| Select set-up 3 | [9]  |
| Select set-up 4 | [10] |

#### Function:

A valid control word triggers the time-out counter. Acyclic DP V1 does not trigger the time-out counter. The *time-out* function is activated if the control word is not updated within the time specified in par. 8-03 *Control Word Timeout Time*.

- *Off*: Control via serial bus (Fieldbus or standard) resumes and uses the most recent control word.
- *Freeze output frequency*: Freeze output frequency until communication resumes.
- *Stop with auto restart*: Stop with auto restart when communication resumes.

## - Parameters -

- *Output frequency = JOG freq.*: The motor runs at JOG frequency until communication resumes.
- *Output frequency = Max. freq.*: The motor runs at maximum frequency until communication resumes.
- *Stop with trip*: The motor stops. You need to reset the frequency converter, see explanation above.

Select set-up x:

This type of time-out function is used for changing set-up on a control word time-out. If communication resumes causing the time-out situation to disappear, par. 8-05 *End-of-time-out Function* defines whether to resume the set-up used before the time-out or to hold the set-up endorsed by the time-out function.

Note that the following parameters have to be configured for the set-up change to occur on a time-out. Par. 0-10 *Active set-up* has to be set to *Multi set-up* along with the relevant linking set in par. 0-12 *This Set-up Linked To*.

### 8-05 End-of-timeout Function

#### Option:

|               |     |
|---------------|-----|
| *Hold set-up  | [0] |
| Resume set-up | [1] |

#### Function:

Defines the action after receiving a valid control word upon a time-out. This only applies if set-up 1-4 has been selected in par. 8-04.

*Hold*: The drive holds the set-up selected in par. 8-04 and displays a warning, until par. 8-06 toggles. Then the drive resumes its original set-up.

*Resume*: The drive resumes the original set-up.

### 8-06 Reset Control Word Timeout

#### Option:

|               |     |
|---------------|-----|
| *Do not reset | [0] |
| Do reset      | [1] |

#### Function:

Used for returning the drive to the original set-up after a Control word timeout. After setting the value to "Do Reset"[1], it returns to "Do not reset"[0].

### 8-07 Diagnosis Trigger

#### Option:

|                      |     |
|----------------------|-----|
| *Disable             | [0] |
| Trigger on alarms    | [1] |
| Trigger alarms/warn. | [2] |

#### Function:

Controls the trigger of Emergency Telegrams (EMCY)

Please refer to section: *Error Control* for more information.

### 8-10 Control Word Profile

#### Option:

|                 |     |
|-----------------|-----|
| *FC profile     | [0] |
| CANopen DSP 402 | [5] |

#### Function:

Selects the interpretation of the control and status words. The installed option in slot A determines the valid selection.

### 8-50 Coasting Select

#### Option:

|               |     |
|---------------|-----|
| Digital input | [0] |
| Bus           | [1] |
| Logic AND     | [2] |
| *Logic OR     | [3] |

#### Function:

Allows a choice between controlling the coasting function via the terminals (digital input) and/ or via the bus.



**NB!** This parameter is active only when par. 8-01 *Control site* is set to [0] *Digital and control word*.

### 8-51 Quick Stop Select

#### Option:

|               |     |
|---------------|-----|
| Digital input | [0] |
| Bus           | [1] |
| Logic AND     | [2] |
| *Logic OR     | [3] |

#### Function:

Allows a choice between controlling the Quick Stop function via the terminals (digital input) and/or via the bus.



**NB!** This parameter is active only when parameter 8-01 *Control site* is set to [0] *Digital and control word*.

### 8-52 DC brake select

#### Option:

|               |     |
|---------------|-----|
| Digital input | [0] |
| Bus           | [1] |
| Logic AND     | [2] |
| *Logic OR     | [3] |

#### Function:

Allows a choice between controlling the DC brake via the terminals (digital input) and/or via the bus.

## - Parameters -

 **NB!** This parameter is active only when par. 8-01 *Control site* is set to [0] *Digital and control word*.

**8-53 Start Select****Option:**

|               |     |
|---------------|-----|
| Digital input | [0] |
| Bus           | [1] |
| Logic AND     | [2] |
| *Logic OR     | [3] |

**Function:**

Choose between controlling the drive via the terminals (digital input) and/or via the bus. If you select *Bus*, you can only activate the Start command if it is transmitted via the serial communication port or fieldbus option. If you select *Logic AND*, you must also activate the command via one of the digital inputs. If you select *Logic OR*, you can also activate the Start command via one of the digital inputs.

 **NB!** This parameter is active only when par. 8-01 *Control site* is set to [0] *Digital and control word*.

**8-54 Reversing Select****Option:**

|               |     |
|---------------|-----|
| Digital input | [0] |
| Bus           | [1] |
| Logic AND     | [2] |
| *Logic OR     | [3] |

**Function:**

Choose between controlling the drive via the terminals (digital input) and/or via the bus. If you select *Bus*, you can only activate the Reversing command if it is transmitted via the serial communication port or fieldbus option. If you select *Logic AND*, you must also activate the command via one of the digital inputs. If you select *Logic OR*, you can also activate the Reversing command via one of the digital inputs.

 **NB!** This parameter is active only when par. 8-01 *Control site* is set to [0] *Digital and control word*.

**8-55 Set-up Select****Option:**

|               |     |
|---------------|-----|
| Digital input | [0] |
| Bus           | [1] |
| Logic AND     | [2] |
| *Logic OR     | [3] |

**Function:**

Choose between controlling the drive via the terminals (digital input) and/or via the bus. If you select *Bus*, you can only activate Selection of Setup if it is transmitted via the serial

communication port or fieldbus option. If you select *Logic AND*, you must also activate the command via one of the digital inputs. If you select *Logic OR*, you can also activate the Set-up command via one of the digital inputs.

 **NB!** This parameter is active only when par. 8-01 *Control site* is set to [0] *Digital and control word*.

**8-56 Preset Reference Select****Option:**

|               |     |
|---------------|-----|
| Digital input | [0] |
| Bus           | [1] |
| Logic AND     | [2] |
| *Logic OR     | [3] |

**Function:**

Choose between controlling the drive via the terminals (digital input) and/or via the bus. If you select *Bus*, you can only activate the Preset Reference command if it is transmitted via the serial communication port or fieldbus option. If you select *Logic AND*, you must also activate the command via one of the digital inputs. If you select *Logic OR*, you can also activate the Preset Reference command via one of the digital inputs.

 **NB!** This parameter is active only when par. 8-01 *Control site* is set to [0] *Digital and control word*.

**8-90 Bus Jog 1 Speed****Option:**

0 – par. 4-13 RPM \* 100 RPM

**Function:**

Sets a fixed speed (jog) activated via the serial port or bus option.

**8-91 Bus Jog 2 Speed****Option:**

0 – par. 4-13 RPM \* 200 RPM

**Function:**

Sets a fixed speed (jog) activated via the serial port or bus option.

## - Parameters -

**10-00 CAN Protocol****Option:**

Read only from LCP.  
\*CANopen [0]

**Function:**

Indicates the CAN protocol.

**10-01 Baud rate select****Option:**

10 kbps [16]  
20 kbps [17]  
50 kbps [18]  
100 kbps [19]  
\*125 kbps [20]  
250 kbps [21]  
500 kbps [22]

**Function:**

Selection of the CANopen transmission speed. The selection must correspond to the transmission speed of the master and the other CANopen nodes.

**10-02 Drive Node ID****Range:**

Bus Address 0 - 127 \* 127

**Function:**

Selection of station address. Every station connected to the same CANopen network must have an unambiguous address.

**10-05 Readout Transmit Error Counter****Range:**

0 - 255 \* 0

**Function:**

Displays the Transmit Error Counter of the CAN controller since the last power-up.

**10-06 Readout Receive Error Counter****Range:**

0 - 255 \* 0

**Function:**

Displays the Receive Error Counter of the CAN controller since the last power-up.

**10-31 Store Data Values****Option:**

\*Off [0]  
Store all setups [1]

**Function:**

Par. 10-31 is used to activate storing of data in non-volatile memory.

**10-33 Store Always****Option:**

\*Off [0]  
On [1]

**Function:**

This parameter is used to select whether parameter data received via the CANopen option should always be stored in EEPROM as default.

**10-50 CANopen Process Data Config. Write****Option:**

\*0 None [0]  
16-80 Fieldbus CTW 1 [1]  
16-82 Fieldbus REF 1 [2]  
3-02 Minimum reference [3]  
3-03 Maximum reference [4]  
3-12 Catch up/slow down value [5]  
3-41 Ramp 1 ramp up time [6]  
3-42 Ramp 1 ramp down time [7]  
3-51 Ramp 2 ramp up time [8]  
3-52 Ramp 2 ramp down time [9]  
3-80 Jog ramp time [10]  
3-81 Quick stop ramp time [11]  
4-11 Motor speed low limit (RPM) [12]  
4-13 Motor speed high limit (RPM) [13]  
4-16 Torque limit motor mode [14]  
4-17 Torque limit generator mode [15]  
8-90 Bus Jog 1 Speed [16]  
8-91 Bus Jog 2 Speed [17]

**Function:**

Only elements [2] and [3] of this array can be selected ([0] and [1] are fixed).

**10-51 CANopen Process Data Config. Read****Option:**

\*0 None  
16-03 Status word  
16-05 Main actual value (%)  
16-00 Control Word  
16-01 Reference (Unit)  
16-02 Reference %  
16-04 Main actual value (Unit)

- Parameters -

- 16-91 Alarm word 2
- 16-92 Warning word
- 16-90 Alarm word
- 16-93 Warning word 2
- 16-94 Ext. status word
- 16-95 Ext. status word 2
- 16-10 Power (kW)
- 16-11 Power (hp)
- 16-12 Motor voltage
- 16-13 Frequency
- 16-14 Motor current
- 16-16 Torque
- 16-17 Speed (RPM)
- 16-18 Motor thermal
- 16-19 KTY sensor temperature
- 16-20 Phase angle
- 16-30 DC link Voltage
- 16-32 Brake energy/s
- 16-33 Brake energy/2 min
- 16-34 Heatsink temp.
- 16-35 Inverter thermal
- 16-38 SL controller state
- 16-39 Controlcard temp.
- 16-50 External reference
- 16-51 Pulse reference
- 16-52 Feedback (Unit)
- 16-53 Digi pot reference
- 16-60 Digital input
- 16-61 Terminal 53 switch setting
- 16-62 Analog input 53
- 16-63 Terminal 54 switch setting
- 16-64 Analog input 54
- 16-65 Analog output 42 (mA)
- 16-66 Digital output (bin)
- 16-67 Freq. input #29 (Hz)
- 16-68 Freq. input #33 (Hz)
- 16-69 Pulse output #27 (Hz)
- 16-70 Pulse output #29 (Hz)
- 16-84 Comm. option STW
- 16-85 FC port CTW 1
- 16-09 Custom readout

**Function:**  
 Only elements [2] and [3] of this array can be selected ([0] and [1] are fixed).

**15-60 Option mounted**  
**Option:**

Read only from LCP.  
 \* MCA105 CANopen

**Function:**  
 Shows the option type installed.

**16-84 Com Option STW**  
**Option:**

**Function:**

| Bit: | Description:                         |
|------|--------------------------------------|
| 0    | Software overrun (rx-queue)          |
| 1    | CAN controller: Overrun              |
| 2    | CAN controller: Bus-off              |
| 3    | CAN controller: error-status-bit set |
| 4    | CAN: error-status-bit set            |
| 5    | Tx-queue full                        |
| 8    | Node started                         |
| 9    | Node stopped                         |
| 10   | No guarding within life-time         |
| 11   | Guarded again after no guard         |
| 12   | Preoperational requested             |
| 13   | Reset communication requested        |
| 14   | Reset node requested                 |
| 15   | PDO with invalid length received     |

**16-90 Alarm Word**  
**Range:**  
 0 - FFFF  
 \* 0

**Function:**  
 Returns the alarm word sent via the serial communication port in hex code.

**16-92 Warning Word**  
**Range:**  
 0 - FFFF  
 \* 0

**Function:**  
 Returns the warning word sent via the serial communication port in hex code.



## - Parameters -

## Parameter List

| PNU #        | Parameter Name                     | Default value           | Range        | Conv. index | Data Type        |
|--------------|------------------------------------|-------------------------|--------------|-------------|------------------|
| <b>8-0x</b>  | <b>Communication and options</b>   |                         |              |             |                  |
| 8-01         | Control Site                       | Dig. and ctrl. word [0] | [0 - 2]      | -           | Unsigned 8       |
| 8-02         | Control Word Source                | FC RS485 [1]            | [0 - 6]      | -           | Unsigned 8       |
| 8-03         | Control Word Timeout Time          | 1.0 s                   | 0.1 - 18000  | -1          | Unsigned 32      |
| 8-04         | Control Word Timeout Func.         | Off [0]                 | [0 - 10]     | -           | Unsigned 8       |
| 8-05         | End-of-timeout Function            | Hold set-up [0]         | [0 - 1]      | -           | Unsigned 8       |
| 8-06         | Reset Control Word Timeout         | Do not reset [0]        | [0 - 1]      | -           | Unsigned 8       |
| 8-07         | Diagnosis Trigger                  | Disable [0]             | [0 - 3]      | -           | Unsigned 8       |
| 8-10         | Control Word Profile               | FC profile [0]          | [0 - x]      | -           | Unsigned 8       |
| 8-50         | Coasting Select                    | Logic OR [3]            | [0 - 3]      | -           | Unsigned 8       |
| 8-51         | Quick Stop Select                  | Logic OR [3]            | [0 - 3]      | -           | Unsigned 8       |
| 8-52         | DC Brake Select                    | Logic OR [3]            | [0 - 3]      | -           | Unsigned 8       |
| 8-53         | Start Select                       | Logic OR [3]            | [0 - 3]      | -           | Unsigned 8       |
| 8-54         | Reversing Select                   | Logic OR [3]            | [0 - 3]      | -           | Unsigned 8       |
| 8-55         | Set-up Select                      | Logic OR [3]            | [0 - 3]      | -           | Unsigned 8       |
| 8-56         | Preset Reference Select            | Logic OR [3]            | [0 - 3]      | -           | Unsigned 8       |
| 8-90         | Bus Jog 1 Speed                    | 100 rpm                 | 0 - par.4-13 | 67          | Unsigned 16      |
| 8-91         | Bus Jog 2 Speed                    | 200 rpm                 | 0 - par.4-13 | 67          | Unsigned 16      |
| <b>10-xx</b> | <b>CAN Fieldbus</b>                |                         |              |             |                  |
| 10-00        | CAN Protocol                       | CANopen [0]             | [0]          | -           | Unsigned 8       |
| 10-01        | Baud Rate Select                   | 125 Kbps [20]           | [16 - 22]    | -           | Unsigned 8       |
| 10-02        | Drive Node ID                      | 127                     | 0 - 127      | -           | Unsigned 8       |
| 10-05        | Transmit Error Counter             | 0                       | 0 - 255      | 0           | Unsigned 8       |
| 10-06        | Receive Error Counter              | 0                       | 0 - 255      | 0           | Unsigned 8       |
| 10-31        | Store Data Values                  | Off [0]                 | [0 - 2]      | -           | Unsigned 8       |
| 10-33        | Store Always                       | Off [0]                 | [0 - 1]      | -           | Unsigned 8       |
| 10-50        | CANopen Process Data Config. Write | None [0]                | [0 - 17]     | -           | Unsigned 16      |
| 10-51        | CANopen Process Data Config. Read  | None [0]                | [0 - 48]     | -           | Unsigned 16      |
| <b>15-xx</b> | <b>Drive Information</b>           |                         |              |             |                  |
| 15-60        | Option Mounted                     | MCA105 CANopen          | -            | -           | VisibleString 30 |
| <b>16-xx</b> | <b>Data Readouts</b>               |                         |              |             |                  |
| 16-84        | Com Option STW                     | 0                       | 0 - FF       | -           | Unsigned 16      |
| 16-90        | Alarm Word                         | 0                       | 0 - FFFF     | -           | Unsigned 32      |
| 16-92        | Warning Word                       | 0                       | 0 - FFFF     | -           | Unsigned 32      |

## - Parameters -

### Conversion index

This number refers to a conversion figure used when writing or reading to parameters.

| Conversion index | Conversion factor |
|------------------|-------------------|
| 100              | 1                 |
| 67               | 1/60              |
| 6                | 1000000           |
| 5                | 100000            |
| 4                | 10000             |
| 3                | 1000              |
| 2                | 100               |
| 1                | 10                |
| 0                | 1                 |
| -1               | 0.1               |
| -2               | 0.01              |
| -3               | 0.001             |
| -4               | 0.0001            |
| -5               | 0.00001           |
| -6               | 0.000001          |

## Object Directory

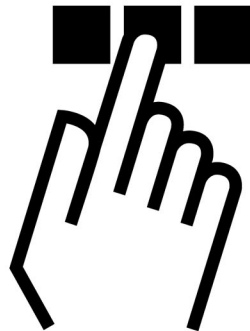

### Communication Profile Area (1000h-1FFFh)

This section describes the general layout of the CANopen communication area which is supported. The process data objects are defined in this area.

#### Communication object overview

| OD Index (hex) | Name                                    | Type           | Access     |
|----------------|-----------------------------------------|----------------|------------|
| 1000           | Device type                             | UNSIGNED32     | Read only  |
| 1001           | Error register                          | UNSIGNED8      | Read only  |
| 1002           | Manufacturer status register            | UNSIGNED32     | Read only  |
| 1003           | Pre-defined error field                 | UNSIGNED32     | Read only  |
| 1005           | COB-ID SYNC                             | UNSIGNED32     | Read/write |
| 1008           | Manufacturer device name                | VISIBLE_STRING | Read only  |
| 1009           | Manufacturer hardware version           | VISIBLE_STRING | Read only  |
| 100A           | Manufacturer software version           | VISIBLE_STRING | Read only  |
| 100C           | Guard time                              | UNSIGNED16     | Read/write |
| 100D           | Life time factor                        | UNSIGNED8      | Read/write |
| 1010           | Store parameters                        | UNSIGNED32     | Read/write |
| 1011           | Restore default parameters              | UNSIGNED32     | Read/write |
| 1014           | COB-ID EMCY                             | UNSIGNED32     | Read only  |
| 1017           | Producer heartbeat time                 | UNSIGNED16     | Read/write |
| 1018           | Identity Object                         | Identity (23h) | Read only  |
|                |                                         |                |            |
| 1400           | 1 <sup>st</sup> Receive PDO description | PDO Comm. Par. | Read/write |
| 1401           | 2 <sup>nd</sup> Receive PDO description | PDO Comm. Par. | Read/write |
| 1402           | 3 <sup>rd</sup> Receive PDO description | PDO Comm. Par. | Read/write |
| 1403           | 4 <sup>th</sup> Receive PDO description | PDO Comm. Par. | Read/write |
|                |                                         |                |            |
| 1600           | 1 <sup>st</sup> Receive PDO mapping     | PDO Mapping    | Read/write |
| 1601           | 2 <sup>nd</sup> Receive PDO mapping     | PDO Mapping    | Read/write |
| 1602           | 3 <sup>rd</sup> Receive PDO mapping     | PDO Mapping    | Read/write |
| 1603           | 4 <sup>th</sup> Receive PDO mapping     | PDO Mapping    | Read/write |
|                |                                         |                |            |

## - Object Directory -

|      |                                          |                |            |
|------|------------------------------------------|----------------|------------|
| 1800 | 1 <sup>st</sup> Transmit PDO description | PDO Comm. Par. | Read/write |
| 1801 | 2 <sup>nd</sup> Transmit PDO description | PDO Comm. Par. | Read/write |
| 1802 | 3 <sup>rd</sup> Transmit PDO description | PDO Comm. Par. | Read/write |
| 1803 | 4 <sup>th</sup> Transmit PDO description | PDO Comm. Par. | Read/write |
|      |                                          |                |            |
| 1A00 | 1 <sup>st</sup> Transmit PDO mapping     | PDO Mapping    | Read/write |
| 1A01 | 2 <sup>nd</sup> Transmit PDO mapping     | PDO Mapping    | Read/write |
| 1A02 | 3 <sup>rd</sup> Transmit PDO mapping     | PDO Mapping    | Read/write |
| 1A03 | 4 <sup>th</sup> Transmit PDO mapping     | PDO Mapping    | Read/write |
|      |                                          |                |            |

**1000h Device type**

This object describes the type of device and its functionality. It is composed of a 16-bit field describing the device profile used, and a second 16-bit field providing additional information about optional functionality of the device.

| Additional Information |                                   | Device Profile Number |
|------------------------|-----------------------------------|-----------------------|
| Mode bits              | Type bits                         | Bits                  |
| 31.. 24                | 23.. 16                           | 15.. 0                |
| 0                      | 1 ( <i>frequency converters</i> ) | 402( <i>dec.</i> )    |

**1001h Error register**

This object is the error register of the device. The device can map internal errors in this byte. This entry is mandatory for all devices, and is a part of the Emergency Object. Each bit of the error register is reserved for a specified group of errors (alarms). Only bit 0 is supported. The other error information can be read with object 603Fh, Error Code.

Content of error register:

| Bit | Meaning       |
|-----|---------------|
| 0   | generic error |

**1002h Manufacturer status register**

The contents of this object are completely manufacturer specific, and inform of the state of the drive network:

| Value | Meaning         |
|-------|-----------------|
| 2     | Stopped         |
| 3     | Pre-operational |
| 4     | Operational     |

**1003h Predefined error field**

Holds errors/alarms that has occurred on the drive. Setting index 0 to 0 will erase the field. Disabling the diagnosis trigger (Par. 8-07) will also disable the display of values in this object

| Sub-index | Meaning                 |
|-----------|-------------------------|
| 0         | Number of stored errors |
| 1         | Current error           |
| 2         | Last error              |

Values:

| Byte 3                | Byte 2                | Byte 1                | Byte 0                |
|-----------------------|-----------------------|-----------------------|-----------------------|
| byte 4 of EMCY object | byte 3 of EMCY object | byte 1 of EMCY object | byte 0 of EMCY object |

## - Object Directory -

**1005h COB-ID Sync Message object**

This index defines the COB-ID of the Synchronization Object (SYNC). It also defines whether the device generates the SYNC.

The structure of the SYNC COB-ID is:

| Bit        | Value | Meaning                                       |
|------------|-------|-----------------------------------------------|
| 31 (MSB)   | X     | do not care                                   |
| 30         | 0     | Device does not generate SYNC message         |
|            | 1     | Device generates SYNC message (not supported) |
| 29         | 0     | 11-bit ID (CAN 2.0A)                          |
|            | 1     | 29-bit ID (CAN 2.0B)                          |
| 28 - 11    | 0     | if bit 29=0                                   |
|            | X     | if bit 29=1: bits 28-11 of 29-bit-COB-ID      |
| 10-0 (LSB) | X     | bits 10-0 of COB-ID                           |

Bits 29, 30 must be static (not changeable). If a device is not able to generate SYNC messages, an attempt to set bit 30 will generate an abort message (abort code: 0609 0030h).

Devices supporting the standard CAN frame type only will either ignore attempts to change bit 29 or respond with an abort message (abort code: 0609 0030h).

The first transmission of SYNC object starts within 1 sync cycle after setting Bit 30 to 1.

**1008h Manufacturer Device Name**

This object contains the device name as defined in par.15-40

**1009h Manufacturer Hardware Version**

This object contains the MCA105 hardware version.

**100Ah Manufacturer Software Version**

This object contains the Danfoss software version as displayed in par.15-49.

**100Ch Guard time**

This object is used in node guarding, an error control service used in addition to the heartbeat mechanism to detect failure in the CAN network.

Node guarding provides the only possible verification of the master's availability on the bus, for the drive's timeout functionality.

This object contains the gap between two master requests in ms.

**100Dh Life time factor**

This object contains the lifetime factor used in node guarding. This factor multiplied with the contents of 100Ch defines the time after which the slave has to be polled by the master's node guarding request. If this time has elapsed without the slave being polled by a guard telegram, a warning 34 will be issued by the slave.

**1010h Store parameters**

In the standard configuration, the contents of parameters written via fieldbus are stored in volatile memory, i.e. the changed data will be lost after a power cycle. This index permits non-volatile storage of all drive parameters which have been changed.

| Sub-index | Meaning                                                      |
|-----------|--------------------------------------------------------------|
| 0         | Number of entries                                            |
| 1         | Save all parameters + OD entries                             |
| 2         | Save all communication parameters + OD entries (All Set-ups) |
| 3         | Reserved                                                     |
| 4         | Save "edit setup" (Danfoss specific)                         |

## - Object Directory -

Writing the value "save" (0x65766c173) to sub-index 1 will save all drive parameters of all set-ups into non-volatile memory. Sub-index 4 will do the same for the Edit Set-up. This is handled via par. 10-31 *Store data values*.

### 1011h Restore default parameters

Use this object to set the drive to factory default, by writing the value "load" (0x64616F6C) to sub-indexes.

The parameters will be set to default after the next power cycle, which has to be initiated manually.

| sub-index | Meaning                                                        |
|-----------|----------------------------------------------------------------|
| 0         | Number of entries                                              |
| 1         | Restores all Drive parameters + OD entries to factory default* |
| 2         | Restores communication parameters + OD entries**               |



\* Drive will display Alarm 80 "Drive initialised" after restore.

\*\* The following parameters are restored to factory default:

10-01 Baud Rate Select  
 10-02 Drive Note ID  
 10-05 Transmit Error Counter  
 10-06 Receive Error Counter  
 10-33 Store Always  
 10-50 CANopen Process Data, Write  
 10-51 CANopen Process Data, Read

### 1014h COB ID emergency object

This object defines the COB-ID under which the emergency object (EMCY) is sent.

### 1017h Producer Heartbeat Time

The heartbeat acts as an error control service to detect a failure in the CAN network. The heartbeat mechanism for a device is established through cyclically transmitting a message by a heartbeat producer. One or more devices in the network are aware of this heartbeat message. If the heartbeat cycle fails for the heartbeat producer the local application on the heartbeat consumer will be informed about that event.

The producer heartbeat time defines the cycle time of the heartbeat. The producer heartbeat time remains at default 0 if it is not used.

### 1018h Identity object

This object contains general information about the device.

The Vendor ID (sub-index 1h) contains a unique value allocated to each manufacturer.

The manufacturer-specific Product code (sub-index 2h) identifies a specific device version.

The manufacturer-specific Revision number (sub-index 3h) consists of a major revision number and a minor revision number.

| sub-index | Meaning                                                           |
|-----------|-------------------------------------------------------------------|
| 0         | Number of entries                                                 |
| 1         | Vendor ID (200008 dec.)                                           |
| 2         | Product code                                                      |
| 3         | Revision number (major revision number and minor revision number) |
| 4         | Serial number                                                     |

# Troubleshooting

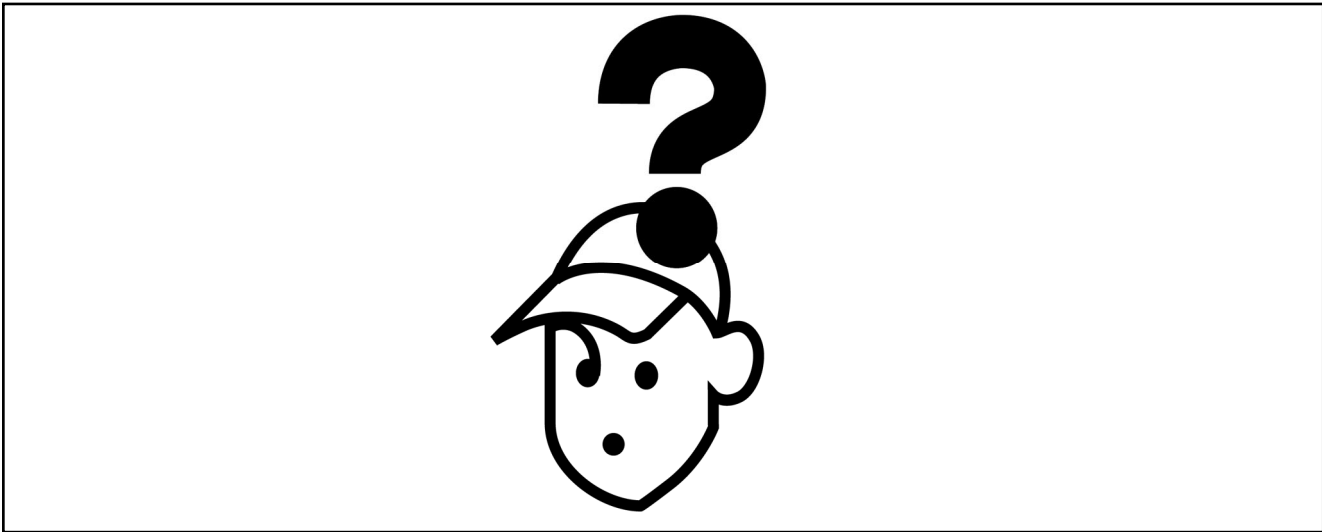

## Troubleshooting

### Check 1: LED's

The CANopen option contains two LED's to indicate the state of the device and the network. The green LED indicates network status (NS):

|                 |  |              |                                    |
|-----------------|--|--------------|------------------------------------|
| Stopped         |  | Single flash | Device is in stopped state         |
| Pre-operational |  | Blinking     | Device is in pre-operational state |
| Operational     |  | On           | Device is in Operational state     |

### Check 2: Error Counters

Check the values of the TEC and REC in par. 10-05 and 10-06 respectively. Refer to section *Error Control* for further information.

### No Communication with the Drive?

If there is no communication with the drive, proceed with the following checks:

#### Check 3: Is the cabling correct?

Check that the cables are connected to the correct terminals as shown in the diagram.

| Pin no. | Terminal | Colour | Name     |
|---------|----------|--------|----------|
| 1       | -        | -      | Reserved |
| 2       | CAN_L    | Blue   | CAN LOW  |
| 3       | Drain    | (bare) | Screen   |
| 4       | CAN_H    | White  | CAN HIGH |
| 5       | -        | -      | Reserved |

#### Check 4: Is the correct EDS file installed?

Download the correct EDS file from <http://www.danfoss.com/drives>.  
[http://www.danfoss.com/BusinessAreas/DrivesSolutions/SoftwareDownload/DDFieldbus\\_Setup\\_Files.htm](http://www.danfoss.com/BusinessAreas/DrivesSolutions/SoftwareDownload/DDFieldbus_Setup_Files.htm)

#### Check 5: Is the bus connection terminated at both ends?

If not, terminate the bus connection with termination resistors at the initial and final nodes. Termination is performed between terminal 2 (CAN\_L) and 4 (CAN\_H) with a resistor: 121 Ohm, 1% metal film, ¼ Watt.

### SDO Abort Codes

The abort code describes the error code when an SDO generates a failure.

| Abort Code | Description                                                                                                                                                                  |
|------------|------------------------------------------------------------------------------------------------------------------------------------------------------------------------------|
| 0503 0000h | Toggle bit not alternated.                                                                                                                                                   |
| 0504 0000h | SDO protocol timed out.                                                                                                                                                      |
| 0504 0001h | Client/server command specifier not valid or unknown.                                                                                                                        |
| 0504 0002h | Invalid block size (block mode only).                                                                                                                                        |
| 0504 0003h | Invalid sequence number (block mode only).                                                                                                                                   |
| 0504 0004h | CRC error (block mode only).                                                                                                                                                 |
| 0504 0005h | Out of memory.                                                                                                                                                               |
| 0601 0000h | Unsupported access to an object.                                                                                                                                             |
| 0601 0001h | Attempt to read a write only object.                                                                                                                                         |
| 0601 0002h | Attempt to write a read only object.                                                                                                                                         |
| 0602 0000h | Object does not exist in the object dictionary.                                                                                                                              |
| 0604 0041h | Object cannot be mapped to the PDO.                                                                                                                                          |
| 0604 0042h | The number and length of the objects to be mapped would exceed PDO length.                                                                                                   |
| 0604 0043h | General parameter incompatibility reason.                                                                                                                                    |
| 0604 0047h | General internal incompatibility in the device.                                                                                                                              |
| 0606 0000h | Access failed due to an hardware error.                                                                                                                                      |
| 0607 0010h | Data type does not match, length of service parameter does not match                                                                                                         |
| 0607 0012h | Data type does not match, length of service parameter too high                                                                                                               |
| 0607 0013h | Data type does not match, length of service parameter too low                                                                                                                |
| 0609 0011h | Sub-index does not exist.                                                                                                                                                    |
| 0609 0030h | Value range of parameter exceeded (only for write access).                                                                                                                   |
| 0609 0031h | Value of parameter written too high.                                                                                                                                         |
| 0609 0032h | Value of parameter written too low.                                                                                                                                          |
| 0609 0036h | Maximum value is less than minimum value.                                                                                                                                    |
| 0800 0000h | general error                                                                                                                                                                |
| 0800 0020h | Data cannot be transferred or stored to the application.                                                                                                                     |
| 0800 0021h | Data cannot be transferred or stored to the application because of local control.                                                                                            |
| 0800 0022h | Data cannot be transferred or stored to the application because of the present device state.                                                                                 |
| 0800 0023h | Object dictionary dynamic generation fails or no object dictionary is present (e.g. object dictionary is generated from file and generation fails because of an file error). |



**EMCY error code**

(OD: 1003)

| Code (hex) | Description                           |
|------------|---------------------------------------|
| 0          | No fault                              |
| 1000       | General fault                         |
| 2130       | Short Circuit                         |
| 2213       | Over current during start-up          |
| 2240       | Short to earth                        |
| 2310       | Continuous over-current               |
| 2311       | Current inside the device             |
| 3100       | Mains Voltage                         |
| 3130       | Phase Failure                         |
| 3210       | Over voltage inside the device        |
| 3220       | Under voltage inside the Device       |
| 3300       | Output voltage                        |
| 4210       | Exceed Device Temperature             |
| 4310       | Excess Drive Temperature              |
| 5110       | Low voltage power supply              |
| 5112       | +24V Power supply                     |
| 5210       | Measurement Circuit                   |
| 6100       | Internal software fault               |
| 7110       | Brake Chopper                         |
| 8100       | Communication                         |
| 8110       | CAN overrun (objects lost)            |
| 8120       | CAN in error (Passive mode)           |
| 8130       | Life Guard error or heartbeat error   |
| 8140       | Recovered from Bus Off                |
| 8150       | Transmit COB-ID collision             |
| 8210       | PDO not processed due to length error |
| 8220       | PDO length exceeded                   |
| 8302       | Torque limiting                       |
| FFxx       | Vendor specific                       |

## Alarm Word and Warning Word

Alarm word and warning word are shown in the display in Hex format. If there is more than one warning or alarm, a sum of all warnings or alarms will be shown. Warning word and alarm word are displayed in par. 16-90 to 16-95.

For more information on the individual alarms and warnings, please refer to: *FC300 Design Guide*

### Warning and Alarm Messages

There is a clear distinction between alarms and warnings. In the event of an alarm, the frequency converter will enter a fault condition. After the cause for the alarm has been cleared, the master must acknowledge the alarm message in order to start operation of the frequency converter again. A warning, on the other hand, may appear when a warning condition arises, then disappear when conditions return to normal without interfering with the process.

### Warnings

All warnings within the frequency converter are represented by a single bit within a warning word. A warning word is always an action parameter. Bit status FALSE [0] means no warning, while bit status TRUE [1] means warning. Each bit status has a corresponding text string message. In addition to the warning word message the master will also be notified via a change in the status word.

### Alarms

Following an alarm message the frequency converter will enter a fault condition. Only after the fault has been rectified and the master has acknowledged the alarm message by a bit in the Control Word, can the VLT resume operation. All alarms within the VLT are represented by a single bit within an alarm word. An alarm word is always an action parameter. Bit status FALSE [0] means no alarm, while bit status TRUE [1] means alarm.

| <b>Bit<br/>(Hex)</b> | <b>Alarm word<br/>(Par. 16-90)</b> |
|----------------------|------------------------------------|
| 00000001             | Brake check                        |
| 00000002             | Power card over temperature        |
| 00000004             | Earth fault                        |
| 00000008             | Ctrl. card over temperature        |
| 00000010             | Control word timeout               |
| 00000020             | Over current                       |
| 00000040             | Torque limit                       |
| 00000080             | Motor thermistor over temp.        |
| 00000100             | Motor ETR over temperature         |
| 00000200             | Inverter overloaded                |
| 00000400             | DC link under voltage              |
| 00000800             | DC link over voltage               |
| 00001000             | Short circuit                      |
| 00002000             | Inrush fault                       |
| 00004000             | Mains phase loss                   |
| 00008000             | AMA not OK                         |
| 00010000             | Live zero error                    |
| 00020000             | Internal fault                     |
| 00040000             | Brake overload                     |
| 00080000             | Motor phase U is missing           |
| 00100000             | Motor phase V is missing           |
| 00200000             | Motor phase W is missing           |
| 00400000             | Fieldbus fault                     |
| 00800000             | 24V supply fault                   |
| 01000000             | Mains failure                      |
| 02000000             | 1.8V supply fault                  |
| 04000000             | Brake resistor short circuit       |
| 08000000             | Brake chopper fault                |
| 10000000             | Option change                      |
| 20000000             | Drive initialized                  |
| 40000000             | Safe Stop                          |
| 80000000             | Mech. Brake low                    |

| Bit<br>(Hex) | Alarm word 2<br>(Par 16-91)      | Bit<br>(Hex) | Warning word<br>(Par 16-92)   |
|--------------|----------------------------------|--------------|-------------------------------|
| 00000001     | Service Trip, Read/Write         | 00000001     | Brake check                   |
| 00000002     | Reserved                         | 00000002     | Power card over temperature   |
| 00000004     | Service Trip, Typecode/Sparepart | 00000004     | Earth fault                   |
| 00000008     | Reserved                         | 00000008     | Control card over temperature |
| 00000010     | Reserved                         | 00000010     | Control word timeout          |
| 00000020     | No Flow                          | 00000020     | Over current                  |
| 00000040     | Dry Pump                         | 00000040     | Torque limit                  |
| 00000080     | End of Curve                     | 00000080     | Motor thermistor over temp.   |
| 00000100     | Broken Belt                      | 00000100     | Motor ERT over temperature    |
| 00000200     | Discharge high                   | 00000200     | Inverter overloaded           |
| 00000400     | Start failed                     | 00000400     | DC link under voltage         |
| 00000800     | Speed limit                      | 00000800     | DC link over voltage          |
| 00001000     | Reserved                         | 00001000     | DC link voltage low           |
| 00002000     | Reserved                         | 00002000     | DC link voltage high          |
| 00004000     | Reserved                         | 00004000     | Mains phase loss              |
| 00008000     | Reserved                         | 00008000     | No motor                      |
| 00010000     | Reserved                         | 00010000     | Live zero error               |
| 00020000     | KTY error                        | 00020000     | 10V low                       |
| 00040000     | Fans error                       | 00040000     | Brake resistor power limit    |
| 00080000     | ECB error                        | 00080000     | Brake resistor short circuit  |
| 00100000     | Reserved                         | 00100000     | Brake chopper fault           |
| 00200000     | Reserved                         | 00200000     | Speed limit                   |
| 00400000     | Reserved                         | 00400000     | Fieldbus comm. fault          |
| 00800000     | Reserved                         | 00800000     | 24V supply fault              |
| 01000000     | Reserved                         | 01000000     | Mains failure                 |
| 02000000     | Reserved                         | 02000000     | Current limit                 |
| 04000000     | Reserved                         | 04000000     | Low temperature               |
| 08000000     | Reserved                         | 08000000     | Voltage limit                 |
| 10000000     | Reserved                         | 10000000     | Encoder loss                  |
| 20000000     | Reserved                         | 20000000     | Output frequency limit        |
| 40000000     | PTC thermistor                   | 40000000     | Safe stop                     |
| 80000000     | Dangerous failure                | 80000000     | Extended status word          |

| Bit<br>(Hex) | Warning word 2<br>(Par 16-93) |
|--------------|-------------------------------|
| 00000001     | Start Delayed                 |
| 00000002     | Stop Delayed                  |
| 00000004     | Clock Failure                 |
| 00000008     | Firemode was active           |
| 00000010     | Reserved                      |
| 00000020     | No Flow                       |
| 00000040     | Dry Pump                      |
| 00000080     | End of Curve                  |
| 00000100     | Broken Belt                   |
| 00000200     | Discharge high                |
| 00000400     | Reserved                      |
| 00000800     | Reserved                      |
| 00001000     | Reserved                      |
| 00002000     | Reserved                      |
| 00004000     | Reserved                      |
| 00008000     | Reserved                      |
| 00010000     | Reserved                      |
| 00020000     | KTY warning                   |
| 00040000     | Fans warning                  |
| 00080000     | ECB warning                   |
| 00100000     | Reserved                      |
| 00200000     | Reserved                      |
| 00400000     | Reserved                      |
| 00800000     | Reserved                      |
| 01000000     | Reserved                      |
| 02000000     | Reserved                      |
| 04000000     | Reserved                      |
| 08000000     | Reserved                      |
| 10000000     | Reserved                      |
| 20000000     | Reserved                      |
| 40000000     | PTC thermistor                |
| 80000000     | Reserved                      |

## Index

|                          |    |                             |    |
|--------------------------|----|-----------------------------|----|
| <b>A</b>                 |    | <b>P</b>                    |    |
| Abbreviations            | 6  | Parameters                  | 35 |
| Abort codes              | 47 | PDO communication           | 22 |
| Alarm word               | 49 | PLC                         | 19 |
| Assumptions              | 5  |                             |    |
| <b>B</b>                 |    | <b>R</b>                    |    |
| Baud rate                | 8  | Reference handling          | 33 |
|                          |    | Restoring                   | 18 |
| <b>C</b>                 |    | <b>S</b>                    |    |
| Cabling                  | 9  | Saving                      | 18 |
| CiA                      | 5  | Safety note                 |    |
| COB-ID                   | 14 | Setting the CANopen address |    |
| Comm. objects            | 42 | SDO communication           | 18 |
| Control profile          | 25 | Switches                    | 8  |
| Conversion index         | 41 |                             |    |
| Connector                | 9  | <b>T</b>                    |    |
| <b>D</b>                 |    | Termination (network)       | 10 |
| Danfoss FC Profile       | 29 | Troubleshooting             | 46 |
| Danfoss objects          | 34 |                             |    |
| DSP 402 Profile          | 26 | <b>V</b>                    |    |
| DSP 402 State machine    | 25 | VLT parameters              | 21 |
| DIP switches             | 8  |                             |    |
| <b>E</b>                 |    | <b>W</b>                    |    |
| EDS file                 | 19 | Warning word                | 49 |
| EMC precautions          | 11 |                             |    |
| EMCY error code          | 48 |                             |    |
| EMCY message             | 16 |                             |    |
| Error control            | 16 |                             |    |
| Error counters           | 17 |                             |    |
| <b>H</b>                 |    |                             |    |
| Hardware                 | 5  |                             |    |
| <b>I</b>                 |    |                             |    |
| Installation             | 12 |                             |    |
| <b>L</b>                 |    |                             |    |
| LEDs                     | 8  |                             |    |
| <b>N</b>                 |    |                             |    |
| Network Management (NMT) | 15 |                             |    |
| Node address             | 8  |                             |    |
| <b>M</b>                 |    |                             |    |
| Master (PLC)             | 19 |                             |    |
| <b>O</b>                 |    |                             |    |
| Object directory         | 42 |                             |    |
| Object model             | 13 |                             |    |