

Contents

| | |
|---|-----------|
| 1 Introduction | 3 |
| Approvals | 3 |
| Symbols | 3 |
| Abbreviations | 4 |
| Definitions | 4 |
| Electrical wiring - control cables | 10 |
| 2 How to Programme | 15 |
| The Graphical and Numerical Local Control Panels | 15 |
| How to Programme on the Graphical LCP | 15 |
| The LCD-Display | 15 |
| Display Mode | 18 |
| Display Mode - Selection of Read-Outs | 19 |
| Parameter Set-Up | 20 |
| Quick Menu Key Functions | 21 |
| Main Menu Mode | 23 |
| Parameter Selection | 23 |
| Infinitely Variable Change of Numeric Data Value | 24 |
| Read-out and Programming of Indexed Parameters | 25 |
| How to Programme on the Numerical Local Control Panel | 26 |
| Local Control Keys | 27 |
| Initialisation to Default Settings | 28 |
| 3 Parameter descriptions | 29 |
| Parameters: Operation and Display | 30 |
| Parameters: Load and Motor | 45 |
| Parameters: Brakes | 63 |
| 2-18 Brake Check Condition | 66 |
| Parameters: Reference/Ramps | 69 |
| Parameters: Limits/Warnings | 83 |
| Parameters: Digital In/Out | 89 |
| 5-97 Pulse Out #X30/6 Bus Control | 107 |
| 5-98 Pulse Out #X30/6 Timeout Preset | 107 |
| Parameters: Analog In/Out | 107 |
| 6-55 Terminal 42 Output Filter | 114 |
| 6-63 Terminal X30/8 Bus Control | 116 |
| 6-64 Terminal X30/8 Output Timeout Preset | 116 |
| Parameters: Controllers | 119 |
| Parameters: Communications and Options | 125 |
| Parameters: Profibus | 133 |

| | |
|------------------------------------|------------|
| Parameters: DeviceNet CAN Fieldbus | 145 |
| Parameters: Smart Logic Control | 152 |
| Parameters: Special Functions | 168 |
| 14-35 Stall Protection | 174 |
| Parameters: Drive Information | 177 |
| Parameters: Data Read-outs | 184 |
| Parameters: Encoder Input | 192 |
| Parameters: Data Readouts 2 | 195 |
| 4 Parameter Lists | 199 |
| Parameter Lists | 199 |
| 5 Troubleshooting | 229 |
| Warnings/Alarm Messages | 229 |
| Index | 236 |

1 Introduction

Programming Guide
Software version: 5.5x

This Programming Guide can be used for all FC 300 frequency converters with software version 5.5x.
The software version number can be seen from par.15-43 *Software Version*.

1.1.1 Approvals



1.1.2 Symbols

Symbols used in this guide.

 **NB!**
Indicates something to be noted by the reader.

 Indicates a general warning.

 Indicates a high-voltage warning.

* Indicates default setting

1.1.3 Abbreviations

1

| | |
|--|---------------|
| Alternating current | AC |
| American wire gauge | AWG |
| Ampere/AMP | A |
| Automatic Motor Adaptation | AMA |
| Current limit | I_{LIM} |
| Degrees Celsius | °C |
| Direct current | DC |
| Drive Dependent | D-TYPE |
| Electro Magnetic Compatibility | EMC |
| Electronic Thermal Relay | ETR |
| Drive | FC |
| Gram | g |
| Hertz | Hz |
| Kilohertz | kHz |
| Local Control Panel | LCP |
| Meter | m |
| Millihenry Inductance | mH |
| Milliampere | mA |
| Millisecond | ms |
| Minute | min |
| Motion Control Tool | MCT |
| Nanofarad | nF |
| Newton Meters | Nm |
| Nominal motor current | $I_{M,N}$ |
| Nominal motor frequency | $f_{M,N}$ |
| Nominal motor power | $P_{M,N}$ |
| Nominal motor voltage | $U_{M,N}$ |
| Parameter | par. |
| Protective Extra Low Voltage | PELV |
| Printed Circuit Board | PCB |
| Rated Inverter Output Current | I_{INV} |
| Revolutions Per Minute | RPM |
| Regenerative terminals | Regen |
| Second | s |
| Synchronous Motor Speed | n_s |
| Torque limit | T_{LIM} |
| Volts | V |
| The maximum output current | $I_{VLT,MAX}$ |
| The rated output current supplied by the frequency converter | $I_{VLT,N}$ |

1.1.4 Definitions

Frequency converter:

D-TYPE

Size and type of the connected frequency converter (dependencies).

$I_{VLT,MAX}$

The maximum output current.

$I_{VLT,N}$

The rated output current supplied by the frequency converter.

$U_{VLT,MAX}$

The maximum output voltage.

Input:

Control command

You can start and stop the connected motor by means of LCP and the digital inputs.

Functions are divided into two groups.

Functions in group 1 have higher priority than functions in group 2.

Motor:

f_{JOG}

The motor frequency when the jog function is activated (via digital terminals).

f_M

The motor frequency.

| | |
|---------|--|
| Group 1 | Reset, Coasting stop, Reset and Coasting stop, Quick-stop, DC braking, Stop and the "Off" key. |
| Group 2 | Start, Pulse start, Reversing, Start reversing, Jog and Freeze output |

f_{MAX}

The maximum motor frequency.

f_{MIN}

The minimum motor frequency.

$f_{M,N}$

The rated motor frequency (nameplate data).

I_M

The motor current.

$I_{M,N}$

The rated motor current (nameplate data).

M-TYPE

Size and type of the connected motor (dependencies).

$n_{M,N}$

The rated motor speed (nameplate data).

n_s

Synchronous motor speed

$$n_s = \frac{2 \times par. 1 - 23 \times 60 s}{par. 1 - 39}$$

$P_{M,N}$

The rated motor power (nameplate data).

$T_{M,N}$

The rated torque (motor).

U_M

The instantaneous motor voltage.

$U_{M,N}$

The rated motor voltage (nameplate data).

Break-away torque

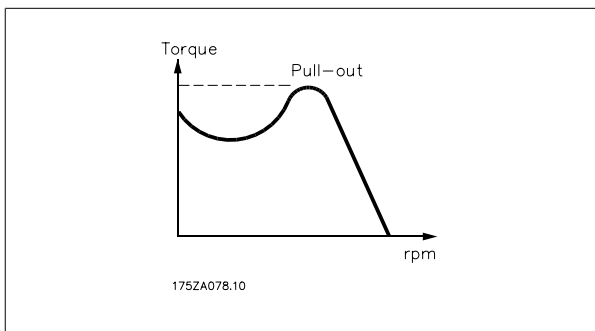

η_{VLT}

The efficiency of the frequency converter is defined as the ratio between the power output and the power input.

Start-disable command

A stop command belonging to the group 1 control commands - see this group.

Stop command

See Control commands.

References:Analog Reference

A signal transmitted to the analog inputs 53 or 54, can be voltage or current.

Binary Reference

A signal transmitted to the serial communication port.

Preset Reference

A defined preset reference to be set from -100% to +100% of the reference range. Selection of eight preset references via the digital terminals.

Pulse Reference

A pulse frequency signal transmitted to the digital inputs (terminal 29 or 33).

Ref_{MAX}

Determines the relationship between the reference input at 100% full scale value (typically 10 V, 20mA) and the resulting reference. The maximum reference value set in par.3-03 *Maximum Reference*.

Ref_{MIN}

Determines the relationship between the reference input at 0% value (typically 0V, 0mA, 4mA) and the resulting reference. The minimum reference value set in par.3-02 *Minimum Reference*.

Miscellaneous:Analog Inputs

The analog inputs are used for controlling various functions of the frequency converter.

There are two types of analog inputs:

Current input, 0-20 mA and 4-20 mA

Voltage input, 0-10 V DC ()

Voltage input, -10 - +10 V DC (FC 302).

Analog Outputs

The analog outputs can supply a signal of 0-20 mA, 4-20 mA.

Automatic Motor Adaptation, AMA

AMA algorithm determines the electrical parameters for the connected motor at standstill.

Brake Resistor

The brake resistor is a module capable of absorbing the brake power generated in regenerative braking. This regenerative braking power increases the intermediate circuit voltage and a brake chopper ensures that the power is transmitted to the brake resistor.

CT Characteristics

Constant torque characteristics used for all applications such as conveyor belts, displacement pumps and cranes.

Digital Inputs

The digital inputs can be used for controlling various functions of the frequency converter.

Digital Outputs

The frequency converter features two Solid State outputs that can supply a 24 V DC (max. 40 mA) signal.

DSP

Digital Signal Processor.

ETR

Electronic Thermal Relay is a thermal load calculation based on present load and time. Its purpose is to estimate the motor temperature.

Hiperface®

Hiperface® is a registered trademark by Stegmann.

Initialising

If initialising is carried out (par.14-22 *Operation Mode*), the frequency converter returns to the default setting.

Intermittent Duty Cycle

An intermittent duty rating refers to a sequence of duty cycles. Each cycle consists of an on-load and an off-load period. The operation can be either periodic duty or non-periodic duty.

LCP

The Local Control Panel (LCP) makes up a complete interface for control and programming of the frequency converter. The control panel is detachable and can be installed up to 3 metres from the frequency converter, i.e. in a front panel by means of the installation kit option.

lsb

Least significant bit.

msb

Most significant bit.

MCM

Short for Mille Circular Mil, an American measuring unit for cable cross-section. 1 MCM = 0.5067 mm².

On-line/Off-line Parameters

Changes to on-line parameters are activated immediately after the data value is changed. Changes to off-line parameters are not activated until you enter [OK] on the LCP.

Process PID

The PID regulator maintains the desired speed, pressure, temperature, etc. by adjusting the output frequency to match the varying load.

PCD

Process Data

Pulse Input/Incremental Encoder

An external, digital pulse transmitter used for feeding back information on motor speed. The encoder is used in applications where great accuracy in speed control is required.

RCD

Residual Current Device.

Set-up

You can save parameter settings in four Set-ups. Change between the four parameter Set-ups and edit one Set-up, while another Set-up is active.

SFAVM

Switching pattern called Stator Flux oriented Asynchronous Vector Modulation (par.14-00 *Switching Pattern*).

Slip Compensation

The frequency converter compensates for the motor slip by giving the frequency a supplement that follows the measured motor load keeping the motor speed almost constant..

Smart Logic Control (SLC)

The SLC is a sequence of user defined actions executed when the associated user defined events are evaluated as true by the Smart Logic Controller. (Parameter group 13-xx Smart Logic Control (SLC))

The SLC is a sequence of user defined actions executed when the associated user defined events are evaluated as true by the Smart Logic Controller. (Parameter group 13-xx).

STW

Status Word

FC Standard Bus

Includes RS 485 bus with FC protocol or MC protocol. See par.8-30 *Protocol*.

Thermistor:

A temperature-dependent resistor placed where the temperature is to be monitored (frequency converter or motor).

Trip

A state entered in fault situations, e.g. if the frequency converter is subject to an over-temperature or when the frequency converter is protecting the motor, process or mechanism. Restart is prevented until the cause of the fault has disappeared and the trip state is cancelled by activating reset or, in some cases, by being programmed to reset automatically. Trip may not be used for personal safety.

Trip Locked

A state entered in fault situations when the frequency converter is protecting itself and requiring physical intervention, e.g. if the frequency converter is subject to a short circuit on the output. A locked trip can only be cancelled by cutting off mains, removing the cause of the fault, and reconnecting the frequency converter. Restart is prevented until the trip state is cancelled by activating reset or, in some cases, by being programmed to reset automatically. Trip may not be used for personal safety.

VT Characteristics

Variable torque characteristics used for pumps and fans.

VVC^{plus}

If compared with standard voltage/frequency ratio control, Voltage Vector Control (VVC^{plus}) improves the dynamics and the stability, both when the speed reference is changed and in relation to the load torque.

60° AVM

Switching pattern called 60°Asynchronous Vector Modulation (par.14-00 *Switching Pattern*).

Power Factor

The power factor is the relation between I_1 and I_{RMS} .

$$\text{Power factor} = \frac{\sqrt{3} \times U \times I_1 \cos\varphi}{\sqrt{3} \times U \times I_{RMS}}$$

The power factor for 3-phase control:

$$= \frac{I_1 \times \cos\varphi}{I_{RMS}} = \frac{I_1}{I_{RMS}} \text{ since } \cos\varphi = 1$$

The power factor indicates to which extent the frequency converter imposes a load on the mains supply.

$$I_{RMS} = \sqrt{I_1^2 + I_5^2 + I_7^2 + \dots + I_n^2}$$

The lower the power factor, the higher the I_{RMS} for the same kW performance.

In addition, a high power factor indicates that the different harmonic currents are low.

The frequency converters' built-in DC coils produce a high power factor, which minimizes the imposed load on the mains supply.

1.1.5 Safety Precautions



The voltage of the frequency converter is dangerous whenever connected to mains. Incorrect installation of the motor, frequency converter or fieldbus may cause damage to the equipment, serious personal injury or death. Consequently, the instructions in this manual, as well as national and local rules and safety regulations, must be complied with.

Safety Regulations

1. The mains supply to the frequency converter must be disconnected whenever repair work is to be carried out. Check that the mains supply has been disconnected and that the necessary time has elapsed before removing motor and mains supply plugs.
2. The [OFF] button on the control panel of the frequency converter does not disconnect the mains supply and consequently it must not be used as a safety switch.
3. The equipment must be properly earthed, the user must be protected against supply voltage and the motor must be protected against overload in accordance with applicable national and local regulations.
4. The earth leakage current exceeds 3.5 mA.
5. Protection against motor overload is not included in the factory setting. If this function is desired, set par.1-90 *Motor Thermal Protection* to data value ETR trip 1 [4] or data value ETR warning 1 [3].
6. Do not remove the plugs for the motor and mains supply while the frequency converter is connected to mains. Check that the mains supply has been disconnected and that the necessary time has elapsed before removing motor and mains plugs.
7. Please note that the frequency converter has more voltage sources than L1, L2 and L3, when load sharing (linking of DC intermediate circuit) or external 24 V DC are installed. Check that all voltage sources have been disconnected and that the necessary time has elapsed before commencing repair work.

Warning against unintended start

1. The motor can be brought to a stop by means of digital commands, bus commands, references or a local stop, while the frequency converter is connected to mains. If personal safety considerations (e.g. risk of personal injury caused by contact with moving machine parts following an unintentional start) make it necessary to ensure that no unintended start occurs, these stop functions are not sufficient. In such cases the mains supply must be disconnected or the *Safe Stop* function must be activated.
2. The motor may start while setting the parameters. If this means that personal safety may be compromised (e.g. personal injury caused by contact with moving machine parts), motor starting must be prevented, for instance by use of the *Safe Stop* function or secure disconnection of the motor connection.
3. A motor that has been stopped with the mains supply connected, may start if faults occur in the electronics of the frequency converter, through temporary overload or if a fault in the power supply grid or motor connection is remedied. If unintended start must be prevented for personal safety reasons (e.g. risk of injury caused by contact with moving machine parts), the normal stop functions of the frequency converter are not sufficient. In such cases the mains supply must be disconnected or the *Safe Stop* function must be activated.



NB!

When using the *Safe Stop* function, always follow the instructions in the *Safe Stop* section of the VLT AutomationDrive Design Guide.

4. Control signals from, or internally within, the frequency converter may in rare cases be activated in error, be delayed or fail to occur entirely. When used in situations where safety is critical, e.g. when controlling the electromagnetic brake function of a hoist application, these control signals must not be relied on exclusively.



Touching the electrical parts may be fatal - even after the equipment has been disconnected from mains.

Also make sure that other voltage inputs have been disconnected, such as external 24 V DC, load sharing (linkage of DC intermediate circuit), as well as the motor connection for kinetic back up.

Systems where frequency converters are installed must, if necessary, be equipped with additional monitoring and protective devices according to the valid safety regulations, e.g. law on mechanical tools, regulations for the prevention of accidents etc. Modifications on the frequency converters by means of the operating software are allowed.

Hoisting applications:

The frequency converter functions for controlling mechanical brakes cannot be considered as a primary safety circuit. There must always be a redundancy for controlling external brakes.

Protection Mode

Once a hardware limit on motor current or dc-link voltage is exceeded the drive will enter "Protection mode". "Protection mode" means a change of the PWM modulation strategy and a low switching frequency to minimize losses. This continues 10 sec after the last fault and increases the reliability and the robustness of the drive while re-establishing full control of the motor.

In hoist applications "Protection mode" is not usable because the drive will usually not be able to leave this mode again and therefore it will extend the time before activating the brake – which is not recommendable.

The "Protection mode" can be disabled by setting par.14-26 *Trip Delay at Inverter Fault* to zero which means that the drive will trip immediately if one of the hardware limits is exceeded.



NB!
It is recommended to disable protection mode in hoisting applications (par.14-26 *Trip Delay at Inverter Fault* = 0)

1.1.6 Electrical wiring - control cables

1

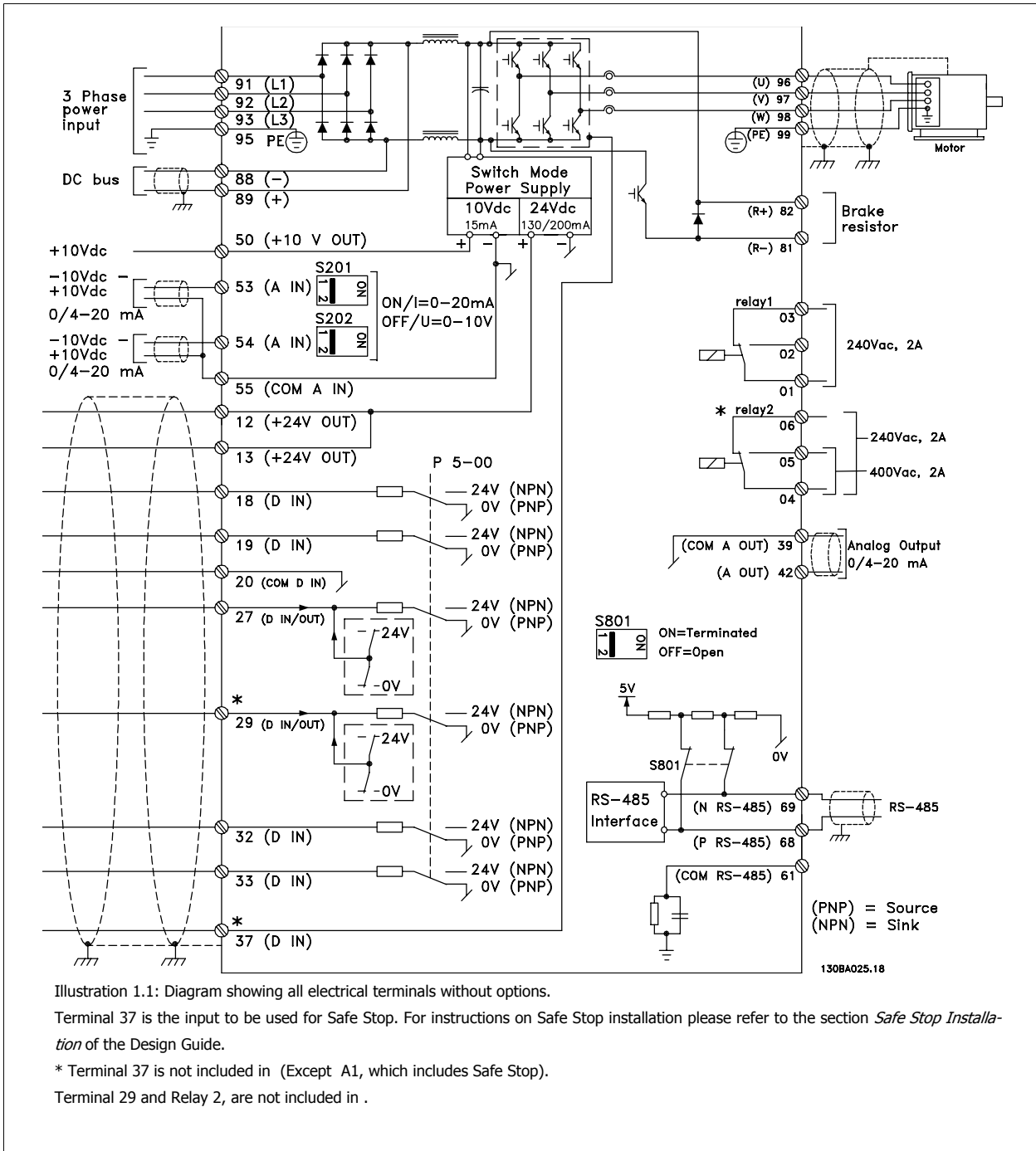



Very long control cables and analogue signals may in rare cases and depending on installation result in 50/60 Hz earth loops due to noise from mains supply cables.

If this occurs, it may be necessary to break the screen or insert a 100 nF capacitor between screen and chassis.

The digital and analogue inputs and outputs must be connected separately to the common inputs (terminal 20, 55, 39) of the frequency converter to avoid ground currents from both groups to affect other groups. For example, switching on the digital input may disturb the analog input signal.

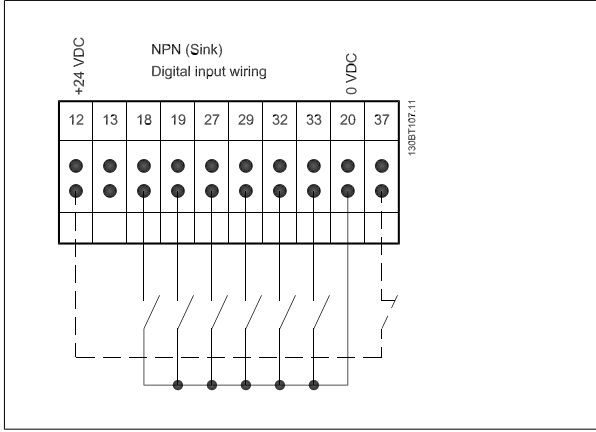
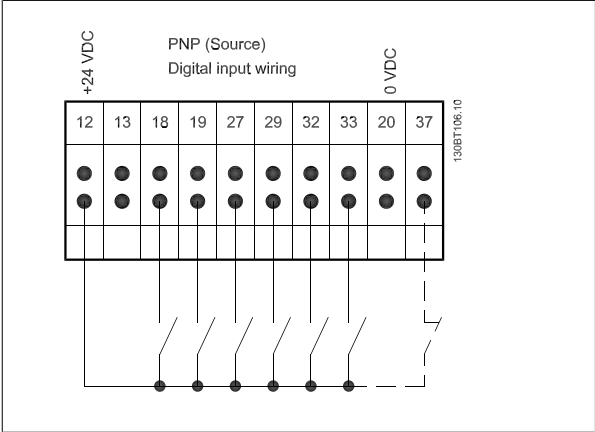
Input polarity of control terminals



 **NB!**
Control cables must be screened/armoured.

See section entitled *Earthing of Screened/Armoured Control Cables* for the correct termination of control cables.

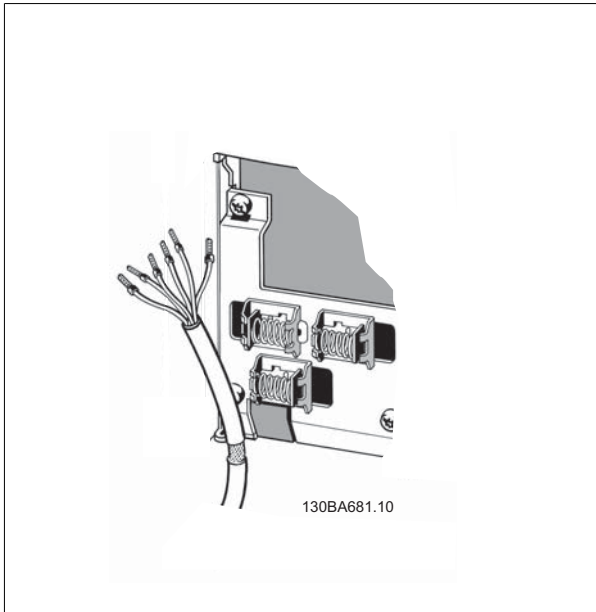

1.1.7 Start/Stop

1

- Terminal 18 = par. 5-10 *Terminal 18 Digital Input* [8] *Start*
- Terminal 27 = par. 5-12 *Terminal 27 Digital Input* [0] *No operation (Default coast inverse)*
- Terminal 37 = Safe stop (where available!)

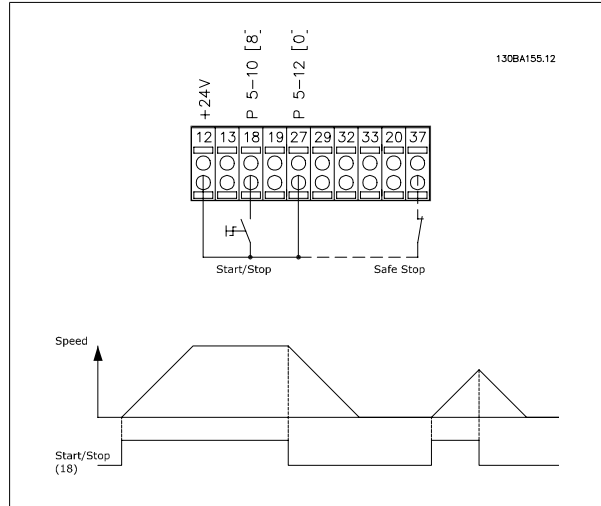

1.1.8 Pulse Start/Stop

- Terminal 18 = par. 5-10 *Terminal 18 Digital Input* Latched start, [9]
- Terminal 27 = par. 5-12 *Terminal 27 Digital Input* Stop inverse, [6]
- Terminal 37 = Safe stop (where available!)

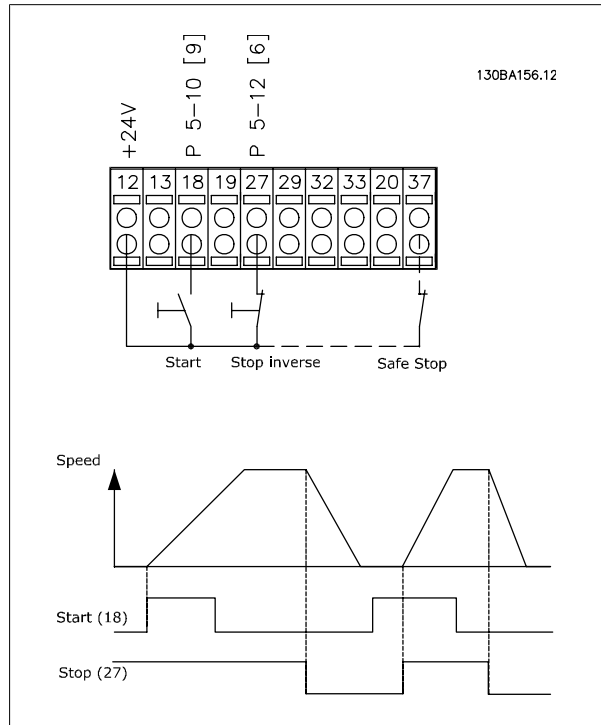

1.1.9 Speed Up/Down

Terminals 29/32 = Speed up/down:

Terminal 18 = par. 5-10 *Terminal 18 Digital Input* Start [9] (default)

Terminal 27 = par. 5-12 *Terminal 27 Digital Input* Freeze reference [19]

Terminal 29 = par. 5-13 *Terminal 29 Digital Input* Speed up [21]

Terminal 32 = par. 5-14 *Terminal 32 Digital Input* Speed down [22]

Note: Terminal 29 only in FC x02 (x=series type).

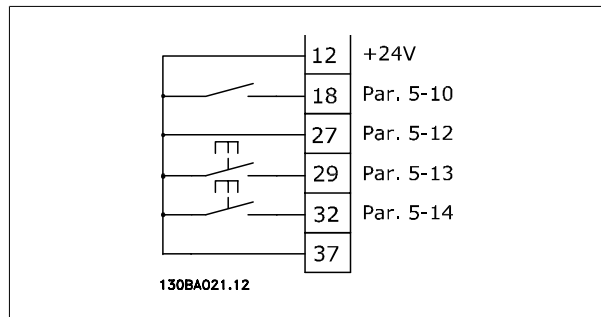

1.1.10 Potentiometer Reference

Voltage reference via a potentiometer:

Reference Source 1 = [1] *Analog input 53* (default)

Terminal 53, Low Voltage = 0 Volt

Terminal 53, High Voltage = 10 Volt

Terminal 53, Low Ref./Feedback = 0 RPM

Terminal 53, High Ref./Feedback = 1500 RPM

Switch S201 = OFF (U)

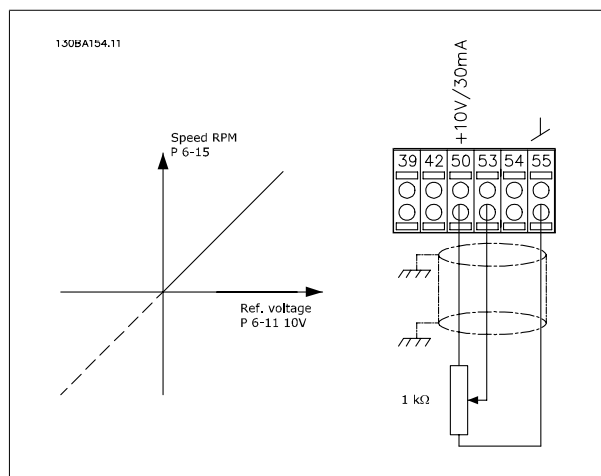

2

2 How to Programme

2.1 The Graphical and Numerical Local Control Panels

The easiest programming of the frequency converter is performed by the Graphical LCP (102). It is necessary to consult the frequency converter Design Guide, when using the Numeric Local Control Panel (LCP 101).

2.1.1 How to Programme on the Graphical LCP

The following instructions are valid for the graphical LCP (LCP 102):

The control panel is divided into four functional groups:

1. Graphical display with Status lines.
2. Menu keys and indicator lights - changing parameters and switching between display functions.
3. Navigation keys and indicator lights (LEDs).
4. Operation keys and indicator lights (LEDs).

All data is displayed in a graphical LCP display, which can show up to five items of operating data while displaying [Status].

Display lines:

- a. **Status line:** Status messages displaying icons and graphic.
- b. **Line 1-2:** Operator data lines displaying data defined or chosen by the user. By pressing the [Status] key, up to one extra line can be added.
- c. **Status line:** Status messages displaying text.

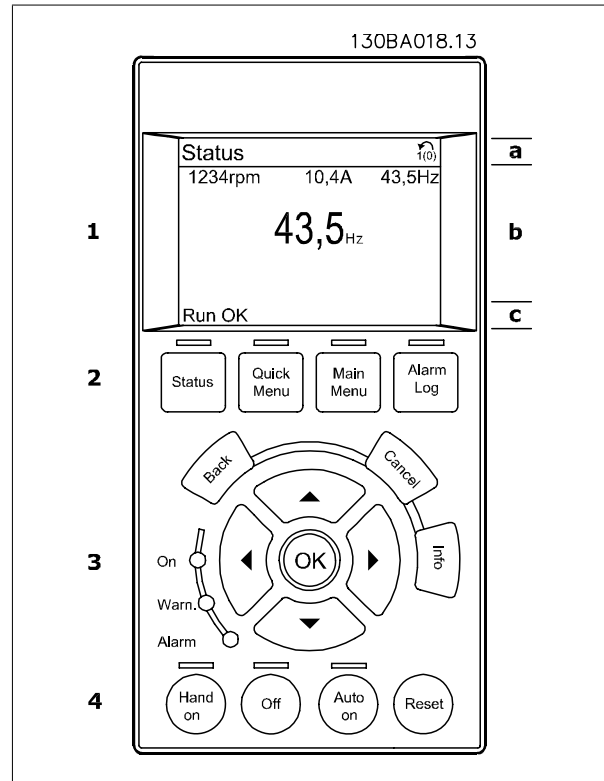

2.1.2 The LCD-Display

The LCD-display has back light and a total of 6 alpha-numeric lines. The display lines show the direction of rotation (arrow), the chosen Set-up as well as the programming Set-up. The display is divided into 3 sections:

Top section shows up to 2 measurements in normal operating status.

The top line in the **Middle section** shows up to 5 measurements with related unit, regardless of status (except in the case of alarm/warning).

Bottom section always shows the state of the frequency converter in Status mode.

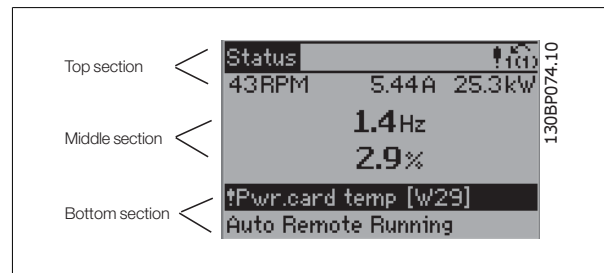

The Active Set-up (selected as the Active Set-up in par.0-10 *Active Set-up*) is shown. When programming another Set-up than the Active Set-up, the number of the programmed Set-up appears to the right.

Display Contrast Adjustment

Press [status] and [▲] for darker display

Press [status] and [▼] for brighter display

Most parameter set-ups can be changed immediately via the control panel, unless a password has been created via par.0-60 *Main Menu Password* or via par.0-65 *Quick Menu Password*.

Indicator lights (LEDs):

If certain threshold values are exceeded, the alarm and/or warning LED lights up. A status and alarm text appear on the control panel.

The ON LED is activated when the frequency converter receives mains voltage or via a DC bus terminal or 24 V external supply. At the same time, the back light is on.

- Green LED/On: Control section is working.
- Yellow LED/Warn.: Indicates a warning.
- Flashing Red LED/Alarm: Indicates an alarm.

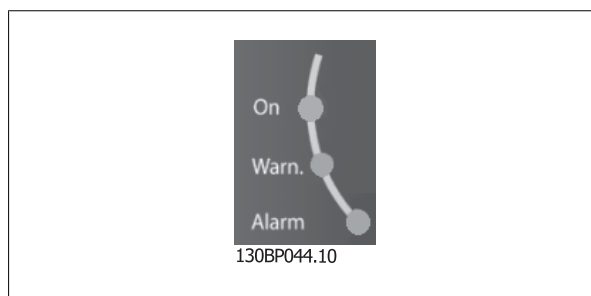

LCP keys

The control keys are divided into functions. The keys below the display and indicator lamps are used for parameter Set-up, including choice of display indication during normal operation.

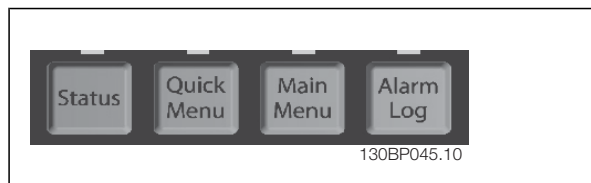

[Status] indicates the status of the frequency converter and/or the motor. You can choose between 3 different readouts by pressing the [Status] key: 5 line readouts, 4 line readouts or Smart Logic Control.

Use [Status] for selecting the mode of display or for changing back to Display mode from either the Quick Menu mode, the Main Menu mode or Alarm mode. Also use the [Status] key to toggle single or double read-out mode.

[Quick Menu] allows quick access to different Quick Menus such as:

- My Personal Menu
- Quick Set-up
- Changes Made
- Loggings

Use [Quick Menu] for programming the parameters belonging to the Quick Menu. It is possible to switch directly between Quick Menu mode and Main Menu mode.

[Main Menu] is used for programming all parameters.

It is possible to switch directly between Main Menu mode and Quick Menu mode.

Parameter shortcut can be carried out by pressing down the [Main Menu] key for 3 seconds. The parameter shortcut allows direct access to any parameter.

[Alarm Log] displays an Alarm list of the five latest alarms (numbered A1-A5). To obtain additional details about an alarm, use the arrow keys to manoeuvre to the alarm number and press [OK]. You will now receive information about the condition of your frequency converter right before entering the alarm mode.

[Back] takes you to the previous step or layer in the navigation structure.

[Cancel] annuls your last change or command as long as the display has not been changed.

[Info] supplies information about a command, parameter, or function in any display window. [Info] provides detailed information whenever help is needed.

Exit info mode by pressing either [Info], [Back], or [Cancel].



Navigation Keys

The four navigation arrows are used to navigate between the different choices available in [Quick Menu], [Main Menu] and [Alarm Log]. Use the keys to move the cursor.

[OK] is used for choosing a parameter marked by the cursor and for enabling the change of a parameter.

Local Control Key for local control are found at the bottom of the control panel.



[Hand On] enables control of the frequency converter via the LCP. [Hand on] also starts the motor, and it is now possible to enter the motor speed data by means of the arrow keys. The key can be selected as Enable [1] or Disable [0] via par.0-40 [Hand on] Key on LCP

External stop signals activated by means of control signals or a serial bus will override a "start" command via the LCP.

The following control signals will still be active when [Hand on] is activated:

- [Hand on] - [Off] - [Auto on]
- Reset
- Coasting stop inverse
- Reversing
- Set-up select bit 0- Set-up select bit 1
- Stop command from serial communication
- Quick stop
- DC brake

[Off] stops the connected motor. The key can be selected as Enable [1] or Disable [0] via par.0-41 [Off] Key on LCP. If no external stop function is selected and the [Off] key is inactive the motor can be stopped by disconnecting the voltage.

[Auto On] enables the frequency converter to be controlled via the control terminals and/or serial communication. When a start signal is applied on the control terminals and/or the bus, the frequency converter will start. The key can be selected as Enable [1] or Disable [0] via par.0-42 [Auto on] Key on LCP.

NB!
An active HAND-OFF-AUTO signal via the digital inputs has higher priority than the control keys [Hand on] – [Auto on].

[Reset] is used for resetting the frequency converter after an alarm (trip). It can be selected as Enable [1] or Disable [0] via par.0-43 [Reset] Key on LCP.

The parameter shortcut can be carried out by holding down the [Main Menu] key for 3 seconds. The parameter shortcut allows direct access to any parameter.

2.1.3 Quick Transfer of Parameter Settings between Multiple Frequency Converters

Once the set-up of a frequency converter is complete, we recommend that you store the data in the LCP or on a PC via MCT 10 Set-up Software Tool.

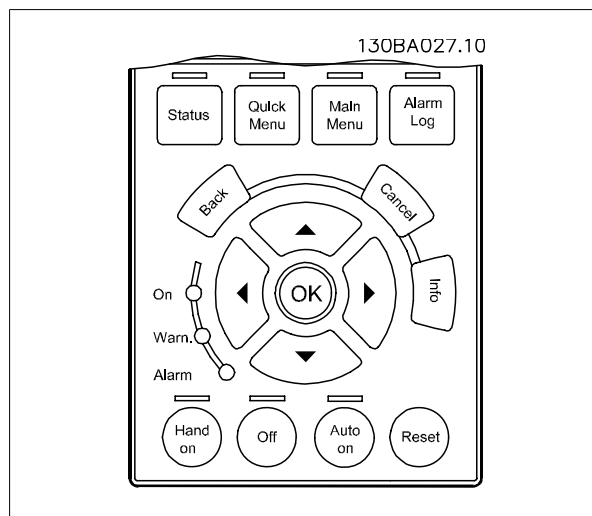

Data storage in LCP:

1. Go to par. 0-50 *LCP Copy*
2. Press the [OK] key
3. Select "All to LCP"
4. Press the [OK] key

All parameter settings are now stored in the LCP indicated by the progress bar. When 100% is reached, press [OK].



NB!

Stop the motor before performing this operation.

You can now connect the LCP to another frequency converter and copy the parameter settings to this frequency converter as well.

Data transfer from LCP to frequency converter:

1. Go to par. 0-50 *LCP Copy*
2. Press the [OK] key
3. Select "All from LCP"
4. Press the [OK] key

The parameter settings stored in the LCP are now transferred to the frequency converter indicated by the progress bar. When 100% is reached, press [OK].



NB!

Stop the motor before performing this operation.

2.1.4 Display Mode

In normal operation, up to 5 different operating variables can be indicated continuously in the middle section: 1.1, 1.2, and 1.3 as well as 2 and 3.

2.1.5 Display Mode - Selection of Read-Outs

It is possible to toggle between three status read-out screens by pressing the [Status] key.

Operating variables with different formatting are shown in each status screen - see below.

The table shows the measurements you can link to each of the operating variables. When Options are mounted, additional measurements are available. Define the links via par.0-20 *Display Line 1.1 Small*, par. 0-21 *Display Line 1.2 Small*, par. 0-22 *Display Line 1.3 Small*, par. 0-23 *Display Line 2 Large*, and par. 0-24 *Display Line 3 Large*.

Each readout parameter selected in par.0-20 *Display Line 1.1 Small* to par. 0-24 *Display Line 3 Large* has its own scale and digits after a possible decimal point. By larger numeric value of a parameter fewer digits are displayed after the decimal point.

Ex.: Current readout
5.25 A; 15.2 A 105 A.

| Operating variable: | Unit: |
|---|--------|
| par.16-00 <i>Control Word</i> | hex |
| par.16-01 <i>Reference [Unit]</i> | [unit] |
| par.16-02 <i>Reference [%]</i> | % |
| par.16-03 <i>Status Word</i> | hex |
| par.16-05 <i>Main Actual Value [%]</i> | % |
| par.16-10 <i>Power [kW]</i> | [kW] |
| par.16-11 <i>Power [hp]</i> | [HP] |
| par.16-12 <i>Motor Voltage</i> | [V] |
| par.16-13 <i>Frequency</i> | [Hz] |
| par.16-14 <i>Motor Current</i> | [A] |
| par.16-16 <i>Torque [Nm]</i> | Nm |
| par.16-17 <i>Speed [RPM]</i> | [RPM] |
| par.16-18 <i>Motor Thermal</i> | % |
| par.16-20 <i>Motor Angle</i> | |
| par.16-30 <i>DC Link Voltage</i> | V |
| par.16-32 <i>Brake Energy /s</i> | kW |
| par.16-33 <i>Brake Energy /2 min</i> | kW |
| par.16-34 <i>Heatsink Temp.</i> | C |
| par.16-35 <i>Inverter Thermal</i> | % |
| par.16-36 <i>Inv. Nom. Current</i> | A |
| par.16-37 <i>Inv. Max. Current</i> | A |
| par.16-38 <i>SL Controller State</i> | |
| par.16-39 <i>Control Card Temp.</i> | C |
| par.16-40 <i>Logging Buffer Full</i> | |
| par.16-50 <i>External Reference</i> | |
| par.16-51 <i>Pulse Reference</i> | |
| par.16-52 <i>Feedback [Unit]</i> | [Unit] |
| par.16-53 <i>Digi Pot Reference</i> | |
| par.16-60 <i>Digital Input</i> | bin |
| par.16-61 <i>Terminal 53 Switch Setting</i> | V |
| par.16-62 <i>Analog Input 53</i> | |
| par.16-63 <i>Terminal 54 Switch Setting</i> | V |
| par.16-64 <i>Analog Input 54</i> | |
| par.16-65 <i>Analog Output 42 [mA]</i> | [mA] |
| par.16-66 <i>Digital Output [bin]</i> | [bin] |
| par.16-67 <i>Pulse Input #29 [Hz]</i> | [Hz] |
| par.16-68 <i>Freq. Input #33 [Hz]</i> | [Hz] |
| par.16-69 <i>Pulse Output #27 [Hz]</i> | [Hz] |
| par.16-70 <i>Pulse Output #29 [Hz]</i> | [Hz] |
| par.16-71 <i>Relay Output [bin]</i> | |
| par.16-72 <i>Counter A</i> | |
| par.16-73 <i>Counter B</i> | |
| par. 16-80 <i>Fieldbus CTW 1</i> | hex |
| par. 16-82 <i>Fieldbus REF 1</i> | hex |
| par. 16-84 <i>Comm. Option STW</i> | hex |
| par. 16-85 <i>FC Port CTW 1</i> | hex |
| par. 16-86 <i>FC Port REF 1</i> | hex |
| par. 16-90 <i>Alarm Word</i> | |
| par. 16-92 <i>Warning Word</i> | |
| par.16-94 <i>Ext. Status Word</i> | |

2

Status screen I:

This read-out state is standard after start-up or initialization. Use [INFO] to obtain information about the measurement links to the displayed operating variables (1.1, 1.2, 1.3, 2 and 3). See the operating variables shown in the screen in this illustration.

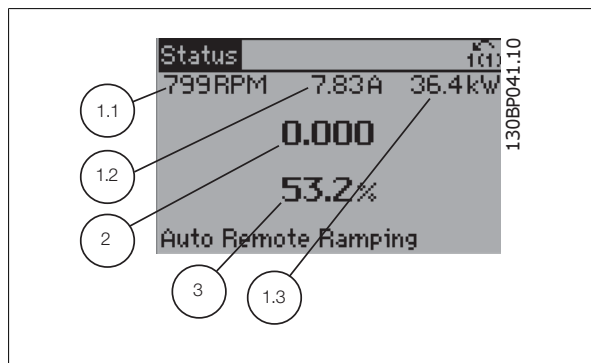

Status screen II:

See the operating variables (1.1, 1.2, 1.3 and 2) shown in the screen in this illustration. In the example, Speed, Motor current, Motor power and Frequency are selected as variables in the first and second.

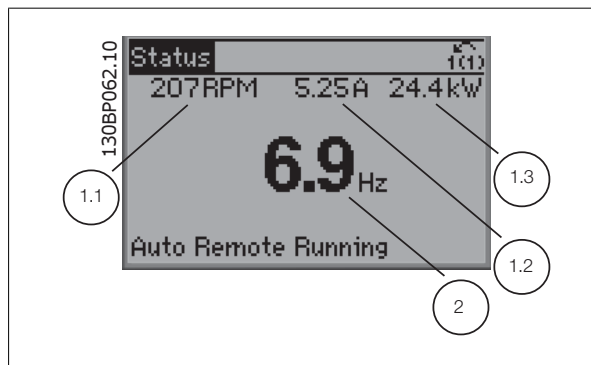

Status screen III:

This state displays the event and action of the Smart Logic Control. For further information, see section *Smart Logic Control*.

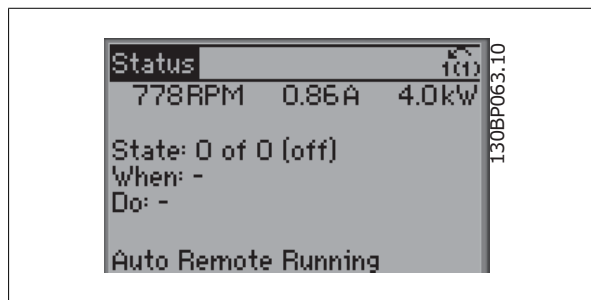

2.1.6 Parameter Set-Up

The frequency converter can be used for practically all assignments, which is why the number of parameters is quite large. The frequency converter offers a choice between two programming modes - a Main Menu and a Quick Menu mode. The former provides access to all parameters. The latter takes the user through a few parameters making it possible to start operating the frequency converter. Regardless of the mode of programming, you can change a parameter both in the Main Menu mode and in the Quick Menu mode.

2.1.7 Quick Menu Key Functions

Pressing [Quick Menus] The list indicates the different areas contained in the Quick menu.

Select *My Personal Menu* to display the chosen personal parameters. These parameters are selected in par.0-25 *My Personal Menu*. Up to 20 different parameters can be added in this menu.

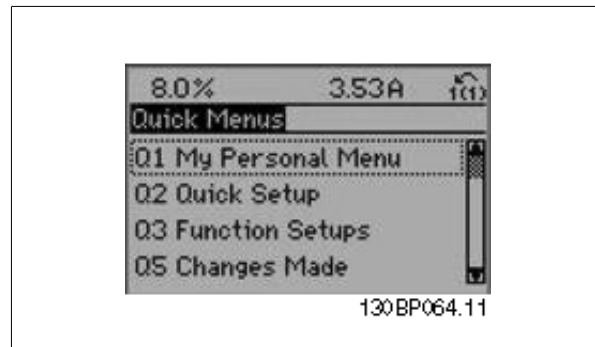

Select *Quick setup* to go through a limited amount of parameters to get the motor running almost optimally. The default setting for the other parameters considers the desired control functions and the configuration of signal inputs/outputs (control terminals).

The selection of parameter is effected by means of the arrow keys. The parameters in the following table are accessible.

| Parameter | Setting |
|--|-------------------------|
| par.0-01 <i>Language</i> | |
| par.1-20 <i>Motor Power [kW]</i> | [kW] |
| par.1-22 <i>Motor Voltage</i> | [V] |
| par.1-23 <i>Motor Frequency</i> | [Hz] |
| par.1-24 <i>Motor Current</i> | [A] |
| par.1-25 <i>Motor Nominal Speed</i> | [rpm] |
| par. 5-12 <i>Terminal 27 Digital Input</i> | [0] No function* |
| par.1-29 <i>Automatic Motor Adaptation (AMA)</i> | [1] Enable complete AMA |
| par.3-02 <i>Minimum Reference</i> | [rpm] |
| par.3-03 <i>Maximum Reference</i> | [rpm] |
| par.3-41 <i>Ramp 1 Ramp up Time</i> | [sec] |
| par.3-42 <i>Ramp 1 Ramp Down Time</i> | [sec] |
| par.3-13 <i>Reference Site</i> | |

* If terminal 27 is set to "no function", no connection to +24 V on terminal 27 is necessary.

Select *Changes made* to get information about:

- the last 10 changes. Use the [▲] [▼] navigation keys to scroll between the last 10 changed parameters.
- the changes made since default setting.

Select *Loggings* to get information about the display line read-outs. The information is shown as graphs.

Only display parameters selected in par.0-20 *Display Line 1.1 Small* and par. 0-24 *Display Line 3 Large* can be viewed. It is possible to store up to 120 samples in the memory for later reference.

2.1.8 Initial Commissioning

The easiest way of carrying out the initial commissioning is by using the Quick Menu button and follow the quick set-up procedure using LCP 102 (read table from left to right). The example applies to open loop applications:

2

| Press | | | |
|--|--|---|------|
| | | Q2 Quick Menu | |
| par.0-01 <i>Language</i> | | Set language | |
| par.1-20 <i>Motor Power [kW]</i> | | Set Motor nameplate power | |
| par.1-22 <i>Motor Voltage</i> | | Set Nameplate voltage | |
| par.1-23 <i>Motor Frequency</i> | | Set Nameplate frequency | |
| par.1-24 <i>Motor Current</i> | | Set Nameplate current | |
| par.1-25 <i>Motor Nominal Speed</i> | | Set Nameplate speed in RPM | |
| par. 5-12 <i>Terminal 27 Digital Input</i> | | If terminal default is <i>Coast inverse</i> it is possible to change this setting to <i>No function</i> . No connection to terminal 27 is then needed for running AMA | |
| par.1-29 <i>Automatic Motor Adaptation (AMA)</i> | | Set desired AMA function. Enable complete AMA is recommended | |
| par.3-02 <i>Minimum Reference</i> | | Set the minimum speed of the motor shaft | |
| par.3-03 <i>Maximum Reference</i> | | Set the maximum speed of the motor shaft | |
| par.3-41 <i>Ramp 1 Ramp up Time</i> | | Set the ramping up time with reference to synchronous motor speed, n_s | |
| par.3-42 <i>Ramp 1 Ramp Down Time</i> | | Set the ramping down time with reference to synchronous motor speed, n_s | |
| par.3-13 <i>Reference Site</i> | | Set the site from where the reference must work | |

2.1.9 Main Menu Mode

Start the Main Menu mode by pressing the [Main Menu] key. The read-out shown to the right appears on the display.

The middle and bottom sections on the display show a list of parameter groups which can be chosen by toggling the up and down buttons.

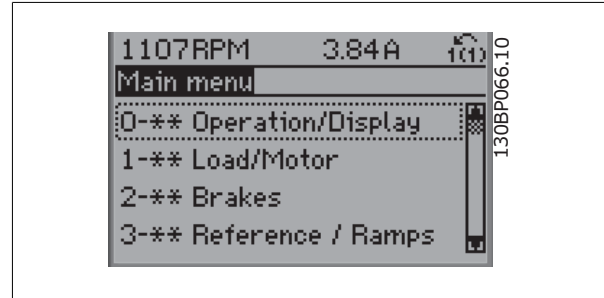

Each parameter has a name and number which remain the same regardless of the programming mode. In the Main Menu mode, the parameters are divided into groups. The first digit of the parameter number (from the left) indicates the parameter group number.

All parameters can be changed in the Main Menu. However, depending on the choice of configuration (par.1-00 *Configuration Mode*), some parameters can be "missing". E.g. open loop hides all the PID parameters, and other enabled options make more parameter groups visible.

2.1.10 Parameter Selection

In the Main menu mode, the parameters are divided into groups. You select a parameter group by means of the navigation keys.

The following parameter groups are accessible:

| Group no. | Parameter group: |
|-----------|---------------------|
| 0 | Operation/Display |
| 1 | Load/Motor |
| 2 | Brakes |
| 3 | References/Ramps |
| 4 | Limits/Warnings |
| 5 | Digital In/Out |
| 6 | Analog In/Out |
| 7 | Controls |
| 8 | Comm. and Options |
| 9 | Profibus |
| 10 | CAN Fieldbus |
| 11 | Reserved Com. 1 |
| 12 | Reserved Com. 2 |
| 13 | Smart Logic |
| 14 | Special Functions |
| 15 | Drive Information |
| 16 | Data Readouts |
| 17 | Motor Feedb. Option |
| 18 | Data Readouts 2 |
| 30 | Special Features |
| 32 | MCO Basic Settings |
| 33 | MCO Adv. Settings |
| 34 | MCO Data Readouts |

After selecting a parameter group, choose a parameter by means of the navigation keys.

The middle section on the display shows the parameter number and name as well as the selected parameter value.

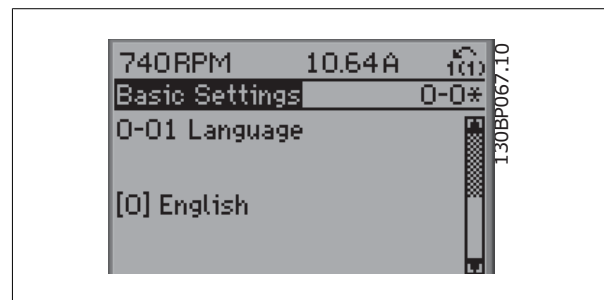

2.1.11 Changing Data

The procedure for changing data is the same whether you select a parameter in the Quick menu or the Main menu mode. Press [OK] to change the selected parameter.

The procedure for changing data depends on whether the selected parameter represents a numerical data value or a text value.

2.1.12 Changing a Text Value

If the selected parameter is a text value, change the text value by means of the [▲] [▼] navigation keys.

The up key increases the value, and the down key decreases the value. Place the cursor on the value you want to save and press [OK].

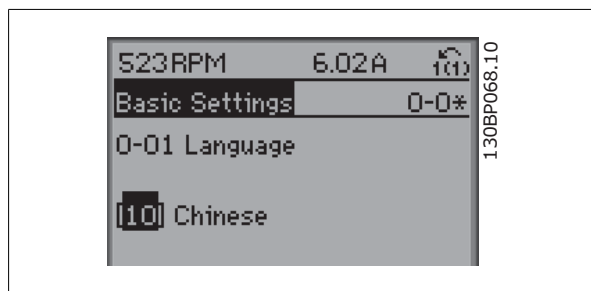

2.1.13 Changing a Group of Numeric Data Values

If the chosen parameter represents a numeric data value, change the chosen data value by means of the [◀] [▶] navigation keys as well as the [▲] [▼] navigation keys. Use the [◀] [▶] navigation keys to move the cursor horizontally.

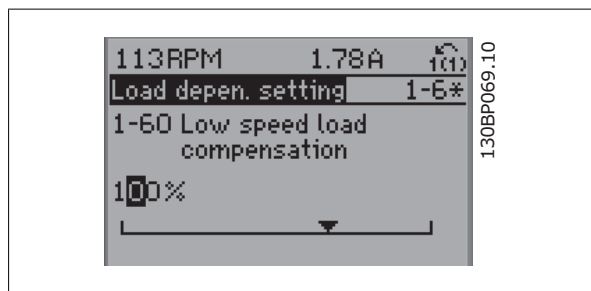

Use the [▲] [▼] navigation keys to change the data value. The up key enlarges the data value, and the down key reduces the data value. Place the cursor on the value you want to save and press [OK].

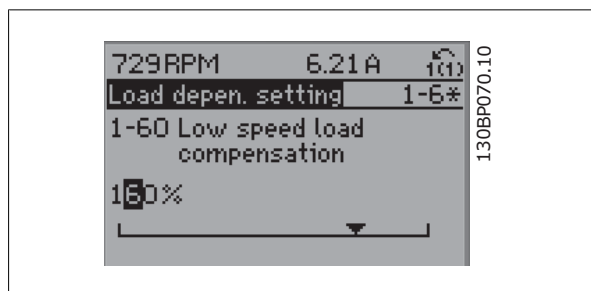

2.1.14 Infinitely Variable Change of Numeric Data Value

If the chosen parameter represents a numeric data value, select a digit by means of the [◀] [▶] navigation keys.

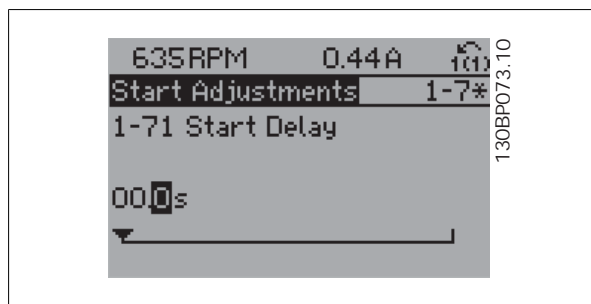

Change the selected digit infinitely variably by means of the [▲] [▼] navigation keys.

The chosen digit is indicated by the cursor. Place the cursor on the digit you want to save and press [OK].

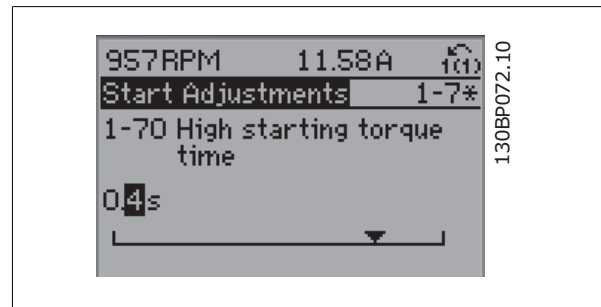

2

2.1.15 Changing a Data Value, Step-by-Step

Certain parameters can be changed step by step or infinitely varying. This applies to par. 1-20 *Motor Power [kW]*, par. 1-22 *Motor Voltage* and par. 1-23 *Motor Frequency*.

The parameters are changed both as a group of numeric data values and as numeric data values infinitely varying.

2.1.16 Read-out and Programming of Indexed Parameters

Parameters are indexed when placed in a rolling stack.

par.15-30 *Fault Log: Error Code* to par.15-32 *Alarm Log: Time* contain a fault log which can be read out. Choose a parameter, press [OK], and use the [▲] [▼] navigation keys to scroll through the value log.

Use par.3-10 *Preset Reference* as another example:

Choose the parameter, press [OK], and use the [▲] [▼] navigation keys to scroll through the indexed values. To change the parameter value, select the indexed value and press [OK]. Change the value by using the [▲] [▼] keys. Press [OK] to accept the new setting. Press [CANCEL] to abort. Press [Back] to leave the parameter.

2

2.1.17 How to Programme on the Numerical Local Control Panel

The following instructions are valid for the Numerical LCP (LCP 101).
The control panel is divided into four functional groups:

1. Numerical display.
2. Menu keys and indicator lights - changing parameters and switching between display functions.
3. Navigation keys and indicator lights (LEDs).
4. Operation keys and indicator lights (LEDs).

Display line: Status messages displaying icons and numeric value.

Indicator lights (LEDs):

- Green LED/On: Indicates if control section is on.
- Yellow LED/Wrn.: Indicates a warning.
- Flashing red LED/Alarm: Indicates an alarm.

LCP keys

[Menu] Select one of the following modes:

- Status
- Quick Setup
- Main Menu

Status Mode: Displays the status of the frequency converter or the motor.

If an alarm occurs the NLCP automatically switches to status mode.

A number of alarms can be displayed.

NB!
Parameter copy is not possible with LCP 101 Numerical Local Control Panel.

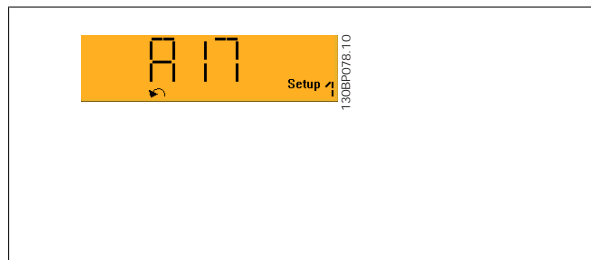
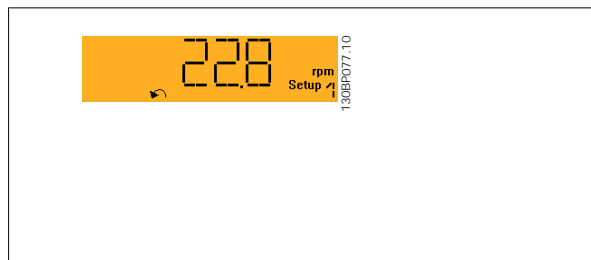
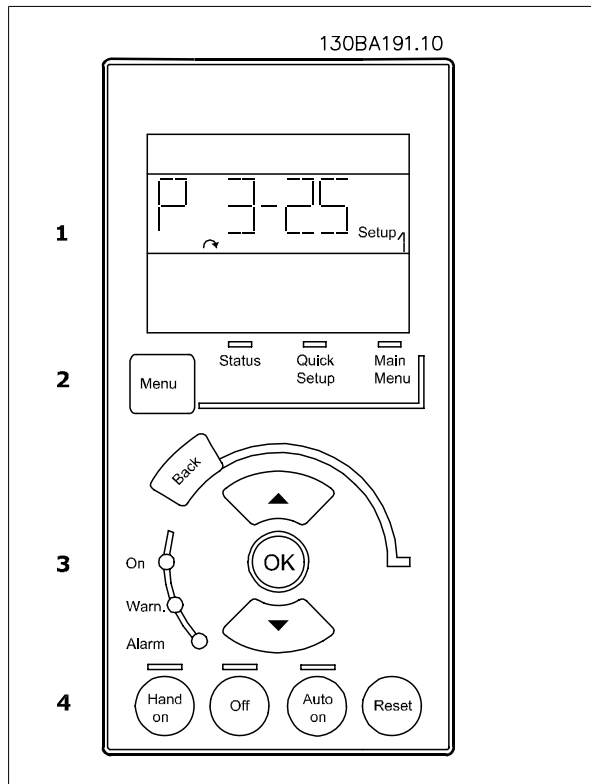

Main Menu/ Quick Setup is used for programming all parameters or only the parameters in the Quick Meny (see also description of the LCP 102 earlier in this chapter).

The parameter values can be changed using the [▲] [▼] keys when the value is flashing.

Select Main Menu by pressing [Menu] key a number of times.

Select the parameter group [xx-__] and press [OK]

Select the parameter [__-xx] and press [OK]

If the parameter is an array parameter select the array number and press [OK]

Select the wanted data value and press [OK]

Parameters with functional choices display values such as [1], [2], etc.

For a description of the different choices, see the individual description of the parameters in the *Parameter Selection* section



[Back] for stepping backwards

Arrow [▲] [▼] keys are used for manoeuvring between commands and within parameters.

2.1.18 Local Control Keys

Keys for local control are found at the bottom of the LCP.

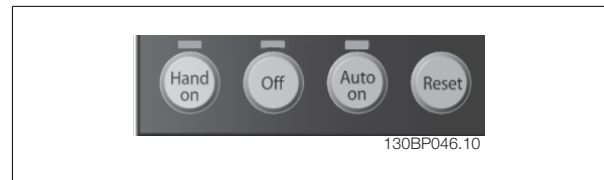

[Hand on] enables control of the frequency converter via the LCP. [Hand on] also starts the motor and it is now possible to enter the motor speed data by means of the arrow keys. The key can be selected as Enable [1] og Disable [0] via par.0-40 *[Hand on] Key on LCP*.

External stop signals activated by means of control signals or a serial bus will override a 'start' command via the LCP.

The following control signals will still be active when [Hand on] is activated:

- [Hand on] - [Off] - [Auto on]
- Reset
- Coasting stop inverse
- Reversing
- Set-up select lsb - Set-up select msb
- Stop command from serial communication
- Quick stop
- DC brake

[Off] stops the connected motor. The key can be selected as Enable [1] or Disable [0] via par.0-41 *[Off] Key on LCP*.

If no external stop function is selected and the [Off] key is inactive the motor can be stopped by disconnecting the voltage.

[Auto on] enables the frequency converter to be controlled via the control terminals and/or serial communication. When a start signal is applied on the control terminals and/or the bus, the frequency converter will start. The key can be selected as Enable [1] or Disable [0] via par.0-42 *[Auto on] Key on LCP*.

NB!
An active HAND-OFF-AUTO signal via the digital inputs has higher priority than the control keys [Hand on] [Auto on].

[Reset] is used for resetting the frequency converter after an alarm (trip). It can be selected as Enable [1] or Disable [0] via par.0-43 [Reset] Key on LCP.

2

2.1.19 Initialisation to Default Settings

Initialise the frequency converter to default settings in two ways:

Recommended initialisation (via par.14-22 *Operation Mode*)

1. Select par. 14-22 *Operation Mode*
2. Press [OK]
3. Select "Initialisation"
4. Press [OK]
5. Cut off the mains supply and wait until the display turns off.
6. Reconnect the mains supply - the frequency converter is now reset.

par. 14-22 *Operation Mode* initialises all except:

- par.14-50 *RFI Filter*
- par.8-30 *Protocol*
- par.8-31 *Address*
- par.8-32 *FC Port Baud Rate*
- par.8-35 *Minimum Response Delay*
- par.8-36 *Max Response Delay*
- par.8-37 *Max Inter-Char Delay*
- par.15-00 *Operating Hours* to par.15-05 *Over Volt's*
- par.15-20 *Historic Log: Event* to par.15-22 *Historic Log: Time*
- par.15-30 *Fault Log: Error Code* to par.15-32 *Alarm Log: Time*

Manual initialisation

1. Disconnect from mains and wait until the display turns off.
- 2a. Press [Status] - [Main Menu] - [OK] at the same time while power up for LCP 102, Graphical Display
- 2b. Press [Menu] while power up for LCP 101, Numerical Display
3. Release the keys after 5 s.
4. The frequency converter is now programmed according to default settings.

This procedure initialises all except:

- par.15-00 *Operating Hours*
- par.15-03 *Power Up's*
- par.15-04 *Over Temp's*
- par.15-05 *Over Volt's*



NB!

When you carry out manual initialisation, you also reset serial communication, RFI filter settings (par.14-50 *RFI Filter*) and fault log settings.

3 Parameter descriptions

3.1 Parameter Selection

Parameters for FC 300 are grouped into various parameter groups for easy selection of the correct parameters for optimized operation of the frequency converter.

0-xx Operation and Display parameters

- Basic Settings, set-up handling
- Display and Local Control Panel parameters for choosing readouts, setting up selections and copying functions

1-xx Load and Motor parameters includes all load and motor related parameters

2-xx Brake parameters

- DC brake
- Dynamic brake (Resistor brake)
- Mechanical brake
- Over Voltage Control

3-xx References and ramping parameters includes DigiPot function

4-xx Limits Warnings; setting of limits and warning parameters

5-xx Digital inputs and outputs includes relay controls

6-xx Analog inputs and outputs

7-xx Controls; Setting parameters for speed and process controls

8-xx Communication and option parameters for setting of FC RS485 and FC USB port parameters.

9-xx Profibus parameters

10-xx DeviceNet and CAN Fieldbus parameters

13-xx Smart Logic Control parameters

14-xx Special function parameters

15-xx Drive information parameters

16-xx Readout parameters

17-xx Encoder Option parameters

18-xx Readout 2 parameters

30-xx Special Features

3.2 Parameters: Operation and Display

3.2.1 0-** Operation / Display

Parameters related to the fundamental functions of the frequency converter, function of the LCP buttons and configuration of the LCP display.

3

3.2.2 0-0* Basic Settings

Parameter group for basic frequency converter settings.

0-01 Language

Option:

Function:

Defines the language to be used in the display. The frequency converter can be delivered with 4 different language packages. English and German are included in all packages. English cannot be erased or manipulated.

| | | |
|-------|------------------|---------------------------------|
| [0] * | English | Part of Language packages 1 - 4 |
| [1] | Deutsch | Part of Language packages 1 - 4 |
| [2] | Francais | Part of Language package 1 |
| [3] | Dansk | Part of Language package 1 |
| [4] | Spanish | Part of Language package 1 |
| [5] | Italiano | Part of Language package 1 |
| [6] | Svenska | Part of Language package 1 |
| [7] | Nederlands | Part of Language package 1 |
| [10] | Chinese | Part of Language package 2 |
| [20] | Suomi | Part of Language package 1 |
| [22] | English US | Part of Language package 4 |
| [27] | Greek | Part of Language package 4 |
| [28] | Bras.port | Part of Language package 4 |
| [36] | Slovenian | Part of Language package 3 |
| [39] | Korean | Part of Language package 2 |
| [40] | Japanese | Part of Language package 2 |
| [41] | Turkish | Part of Language package 4 |
| [42] | Trad.Chinese | Part of Language package 2 |
| [43] | Bulgarian | Part of Language package 3 |
| [44] | Srpski | Part of Language package 3 |
| [45] | Romanian | Part of Language package 3 |
| [46] | Magyar | Part of Language package 3 |
| [47] | Czech | Part of Language package 3 |
| [48] | Polski | Part of Language package 4 |
| [49] | Russian | Part of Language package 3 |
| [50] | Thai | Part of Language package 2 |
| [51] | Bahasa Indonesia | Part of Language package 2 |

0-02 Motor Speed Unit

Option:
Function:

This parameter cannot be adjusted while the motor is running.

The display showing depends on settings in par.0-02 *Motor Speed Unit* and par. 0-03 *Regional Settings*. The default setting of par.0-02 *Motor Speed Unit* and par. 0-03 *Regional Settings* depends on which region of the world the frequency converter is supplied to, but can be re-programmed as required.

NB!

Changing the *Motor Speed Unit* will reset certain parameters to their initial value. It is recommended to select the motor speed unit first, before modifying other parameters.

| | | |
|-------|-----|---|
| [0] | RPM | Selects display of motor speed variables and parameters (i.e. references, feedbacks and limits) in terms of motor speed (RPM). |
| [1] * | Hz | Selects display of motor speed variables and parameters (i.e. references, feedbacks and limits) in terms of output frequency to the motor (Hz). |

0-03 Regional Settings

Option:
Function:

| | | |
|-------|---------------|---|
| [0] * | International | Activates par.1-20 <i>Motor Power [kW]</i> for setting the motor power in kW and sets the default value of par.1-23 <i>Motor Frequency</i> to 50 Hz. |
| [1] | US | Activates par.1-62 <i>Slip Compensation</i> for setting the motor power in HP and sets the default value of par.1-23 <i>Motor Frequency</i> to 60 Hz. |

This parameter cannot be adjusted while the motor is running.

0-04 Operating State at Power-up (Hand)

Option:
Function:

Selects the operating mode upon reconnection of the frequency converter to mains voltage after power down in Hand (local) operation mode.

| | | |
|-------|----------------------|---|
| [0] | Resume | Restarts the frequency converter maintaining the same local reference and the same start/stop settings (applied by [HAND ON/OFF]) as before the frequency converter was powered down. |
| [1] * | Forced stop, ref=old | Restarts the frequency converter with a saved local reference, after mains voltage reappears and after pressing [HAND ON]. |
| [2] | Forced stop, ref=0 | Resets the local reference to 0 upon restarting the frequency converter. |

3.2.3 0-1* Set-up Operations

Define and control the individual parameter setups.

The frequency converter has four parameter setups that can be programmed independently of each other. This makes the frequency converter very flexible and able to solve advanced control functionality problems, often saving the cost of external control equipment. For example these can be used to program the frequency converter to operate according to one control scheme in one setup (e.g. motor 1 for horizontal movement) and another control scheme in another setup (e.g. motor 2 for vertical movement). Alternatively they can be used by an OEM machine builder to identically program all their factory fitted frequency converters for different machine types within a range to have the same parameters and then during production/commissioning simply select a specific setup depending on which machine the frequency converter is installed on.

The active setup (i.e. the setup in which the frequency converter is currently operating) can be selected in par.0-10 *Active Set-up* and is displayed in the LCP. Using Multi set-up it is possible to switch between setups with the frequency converter running or stopped, via digital input or serial communication commands. If it is necessary to change setups whilst running, ensure par.0-12 *This Set-up Linked to* is programmed as required. Using par.0-11 *Edit Set-up* it is possible to edit parameters within any of the setups whilst continuing the frequency converter operation in its Active Setup which can be a different setup to that being edited. Using par.0-51 *Set-up Copy* it is possible to copy parameter settings between the setups to enable quicker commissioning if similar parameter settings are required in different setups.

0-10 Active Set-up

| Option: | Function: |
|-------------------|--|
| | Select the set-up to control the frequency converter functions. |
| [0] Factory setup | Cannot be changed. It contains the Danfoss data set, and can be used as a data source when returning the other set-ups to a known state. |
| [1] * Set-up 1 | <i>Set-up 1</i> [1] to <i>Set-up 4</i> [4] are the four separate parameter set-ups within which all parameters can be programmed. |
| [2] Set-up 2 | |
| [3] Set-up 3 | |
| [4] Set-up 4 | |
| [9] Multi Set-up | Remote selection of set-ups using digital inputs and the serial communication port. This set-up uses the settings from par.0-12 <i>This Set-up Linked to</i> . Stop the frequency converter before making changes to open- and closed loop functions |

Use par.0-51 *Set-up Copy* to copy a set-up to one or all other set-ups. Stop the frequency converter before switching between set-ups where parameters marked 'not changeable during operation' have different values. To avoid conflicting settings of the same parameter within two different set-ups, link the set-ups together using par.0-12 *This Set-up Linked to*. Parameters which are 'not changeable during operation' are marked FALSE in the parameter lists in the section *Parameter Lists*.

0-11 Edit Set-up

| Option: | Function: |
|-------------------|--|
| | Select the set-up to be edited (i.e. programmed) during operation; either the active set-up or one of the inactive set-ups. |
| [0] Factory setup | Cannot be edited but it is useful as a data source to return the other set-ups to a known state. |
| [1] * Set-up 1 | <i>Set-up 1</i> [1] to <i>Set-up 4</i> [4] can be edited freely during operation, independently of the active set-up. |
| [2] Set-up 2 | |
| [3] Set-up 3 | |
| [4] Set-up 4 | |
| [9] Active Set-up | Can also be edited during operation. Edit the chosen set-up from a range of sources: LCP, FC RS485, FC USB or up to five fieldbus sites. |

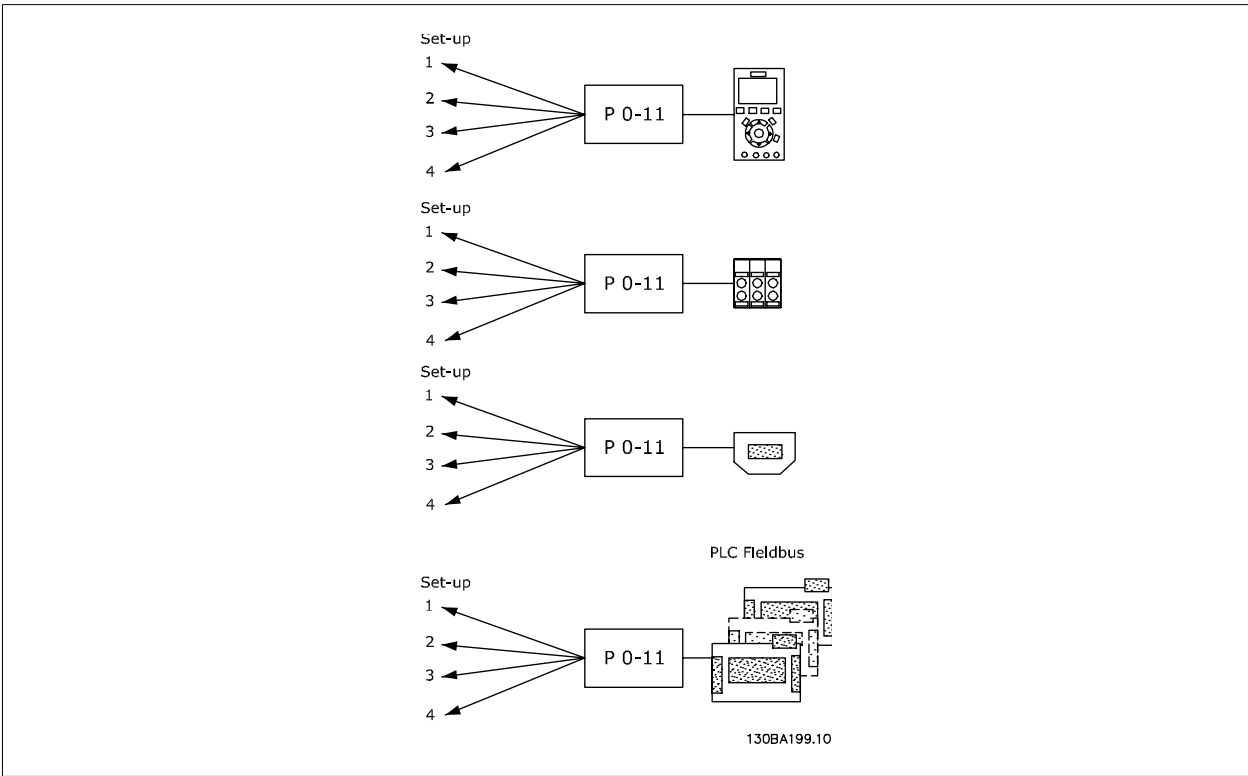

0-12 This Set-up Linked to

Option:

Function:

To enable conflict-free changes from one set-up to another during operation, link set-ups containing parameters which are not changeable during operation. The link will ensure synchronising of the 'not changeable during operation' parameter values when moving from one set-up to another during operation. 'Not changeable during operation' parameters can be identified by the label FALSE in the parameter lists in the section *Parameter Lists*.

par.0-12 *This Set-up Linked to* is used by Multi set-up in par.0-10 *Active Set-up*. Multi set-up is used to move from one set-up to another during operation (i.e. while the motor is running).

Example:

Use Multi set-up to shift from Set-up 1 to Set-up 2 whilst the motor is running. Programme in Set-up 1 first, then ensure that Set-up 1 and Set-up 2 are synchronised (or 'linked'). Synchronisation can be performed in two ways:

1. Change the edit set-up to *Set-up 2*[2] in par.0-11 *Edit Set-up* and set par.0-12 *This Set-up Linked to* to *Set-up 1* [1]. This will start the linking (synchronising) process.

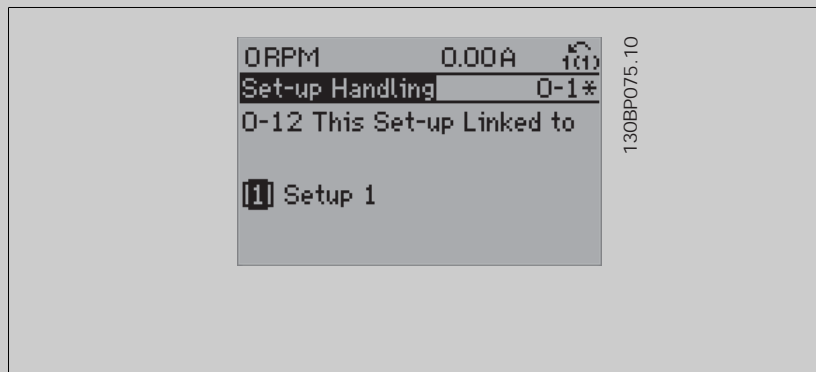

OR

2. While still in Set-up 1, copy Set-up 1 to Set-up 2. Then set par.0-12 *This Set-up Linked to* to *Set-up 2*[2]. This will start the linking process.

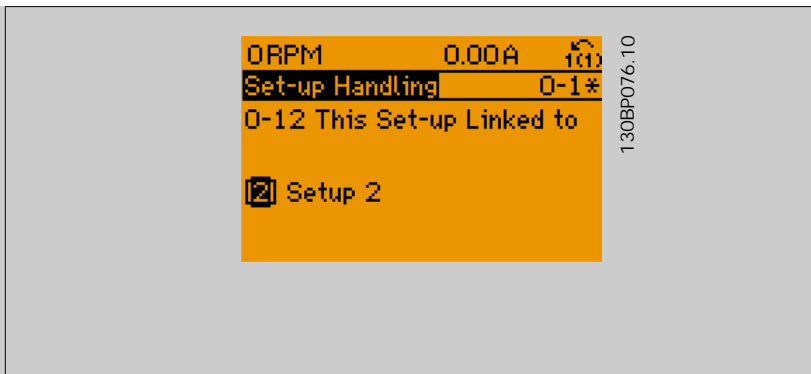

After the link is complete, par.0-13 *Readout: Linked Set-ups* will read {1,2} to indicate that all 'not changeable during operation' parameters are now the same in Set-up 1 and Set-up 2. If there are changes to a 'not changeable during operation' parameter, e.g. par.1-30 *Stator Resistance (Rs)*, in Set-up 2, they will also be changed automatically in Set-up 1. A switch between Set-up 1 and Set-up 2 during operation is now possible.

- [0] * Not linked
- [1] Set-up 1
- [2] Set-up 2
- [3] Set-up 3
- [4] Set-up 4

0-13 Readout: Linked Set-ups

Array [5]

Range:

0 N/A* [0 - 255 N/A]

Function:

View a list of all the set-ups linked by means of par. 0-12 *This Set-up Linked to*. The parameter has one index for each parameter set-up. The parameter value displayed for each index represents which setups are linked to that parameter setup.

| Index | LCP value |
|-------|-----------|
| 0 | {0} |
| 1 | {1,2} |
| 2 | {1,2} |
| 3 | {3} |
| 4 | {4} |

Table 3.2: Example: Set-up 1 and Set-up 2 are linked

0-14 Readout: Edit Set-ups / Channel

Range:

0 N/A* [-2147483648 - 2147483647 N/A]

Function:

View the setting of par.0-11 *Edit Set-up* for each of the four different communication channels. When the number is displayed in hex, as it is in the LCP, each number represents one channel. Numbers 1-4 represent a set-up number; 'F' means factory setting; and 'A' means active set-up. The channels are, from right to left: LCP, FC-bus, USB, HPFB1-5. Example: The number AAAAAA21h means that the FC bus selected Set-up 2 in par.0-11 *Edit Set-up*, the LCP selected Set-up 1 and all others used the active set-up.

3.2.4 0-2* LCP Display

Define the variables displayed in the Graphical Local Control Panel.

**NB!**

Please refer to par. 0-37 *Display Text 1*, par. 0-38 *Display Text 2* and par. 0-39 *Display Text 3* for information on how to write display texts

0-20 Display Line 1.1 Small

Option:**Function:**

| Option: | Function: |
|----------|---|
| | Select a variable for display in line 1, left position. |
| [0] | None No display value selected. |
| [953] | Profibus Warning Word |
| [1005] | Readout Transmit Error Counter |
| [1006] | Readout Receive Error Counter |
| [1007] | Readout Bus Off Counter |
| [1013] | Warning Parameter |
| [1230] | Warning Parameter |
| [1472] | VLT Alarm Word |
| [1473] | VLT Warning Word |
| [1474] | VLT Ext. Status Word |
| [1501] | Running Hours |
| [1502] | kWh Counter |
| [1600] | Control Word Present control word |
| [1601] | Reference [Unit] Total reference (sum of digital/analog/preset/bus/freeze ref./catch up and slow-down) in selected unit. |
| [1602] | Reference % Total reference (sum of digital/analog/preset/bus/freeze ref./catch up and slow-down) in percent. |
| [1603] | Status Word Present status word. |
| [1605] | Main Actual Value [%] Actual value as a percentage. |
| [1609] | Custom Readout |
| [1610] | Power [kW] Actual power consumed by the motor in kW. |
| [1611] | Power [hp] Actual power consumed by the motor in HP. |
| [1612] | Motor Voltage Voltage supplied to the motor. |
| [1613] | Frequency Motor frequency, i.e. the output frequency from the frequency converter in Hz |
| [1614] | Motor Current Phase current of the motor measured as effective value. |
| [1615] | Frequency [%] Motor frequency, i.e. the output frequency from the frequency converter in percent. |
| [1616] | Torque [Nm] |
| [1617] * | Speed [RPM] Speed in RPM (revolutions per minute) i.e. the motor shaft speed in closed loop. |
| [1618] | Motor Thermal Thermal load on the motor, calculated by the ETR function. |
| [1619] | KTY sensor temperature |
| [1620] | Motor Angle |
| [1622] | Torque [%] |
| [1625] | Torque [Nm] High |
| [1630] | DC Link Voltage Intermediate circuit voltage in the frequency converter. |
| [1632] | Brake Energy /s |
| [1633] | Brake Energy /2 min |

| | | |
|--------|----------------------------|---|
| [1634] | Heatsink Temp. | Present heat sink temperature of the frequency converter. The cut-out limit is 95 ± 5 °C; cutting back in occurs at 70 ± 5 °C. |
| [1635] | Inverter Thermal | Percentage load of the inverters. |
| [1636] | Inv. Nom. Current | Nominal current of the frequency converter. |
| [1637] | Inv. Max. Current | Maximum current of the frequency converter. |
| [1638] | SL Controller State | |
| [1639] | Control Card Temp. | Temperature of the control card. |
| [1650] | External Reference | Sum of the external reference as a percentage, i.e. the sum of analog/pulse/bus. |
| [1651] | Pulse Reference | Frequency in Hz connected to the digital inputs (18, 19 or 32, 33). |
| [1652] | Feedback [Unit] | Reference value from programmed digital input(s). |
| [1653] | Digi Pot Reference | |
| [1660] | Digital Input | Signal states from the 6 digital terminals (18, 19, 27, 29, 32 and 33). Input 18 corresponds to the bit at the far left. Signal low = 0; Signal high = 1. |
| [1661] | Terminal 53 Switch Setting | Setting of input terminal 54. Current = 0; Voltage = 1. |
| [1662] | Analog Input 53 | Actual value at input 53 either as a reference or protection value. |
| [1663] | Terminal 54 Switch Setting | Setting of input terminal 54. Current = 0; Voltage = 1. |
| [1664] | Analog Input 54 | Actual value at input 54 either as reference or protection value. |
| [1665] | Analog Output 42 [mA] | Actual value at output 42 in mA. Use par.6-50 <i>Terminal 42 Output</i> to select the value to be shown. |
| [1666] | Digital Output [bin] | Binary value of all digital outputs. |
| [1667] | Freq. Input #29 [Hz] | Actual value of the frequency applied at terminal 29 as an impulse input. |
| [1668] | Freq. Input #33 [Hz] | Actual value of the frequency applied at terminal 33 as an impulse input. |
| [1669] | Pulse Output #27 [Hz] | Actual value of impulses applied to terminal 27 in digital output mode. |
| [1670] | Pulse Output #29 [Hz] | Actual value of impulses applied to terminal 29 in digital output mode. |
| [1671] | Relay Output [bin] | |
| [1672] | Counter A | Application dependent (e.g. SLC Control) |
| [1673] | Counter B | Application dependent (e.g. SLC Control) |
| [1674] | Prec. Stop Counter | Display the actual counter value. |
| [1675] | Analog In X30/11 | |
| [1676] | Analog In X30/12 | |
| [1677] | Analog Out X30/8 [mA] | |
| [1678] | Analog Out X45/1 [mA] | |
| [1679] | Analog Out X45/3 [mA] | |
| [1680] | Fieldbus CTW 1 | Control word (CTW) received from the Bus Master. |
| [1682] | Fieldbus REF 1 | Main reference value sent with control word from the Bus Master. |
| [1684] | Comm. Option STW | Extended fieldbus communication option status word. |
| [1685] | FC Port CTW 1 | Control word (CTW) received from the Bus Master. |
| [1686] | FC Port REF 1 | Status word (STW) sent to the Bus Master. |
| [1690] | Alarm Word | One or more alarms in a Hex code. |
| [1691] | Alarm Word 2 | One or more alarms in a Hex code. |
| [1692] | Warning Word | One or more warnings in a Hex code. |

| | | |
|--------|--------------------------------|--|
| [1693] | Warning Word 2 | One or more warnings in a Hex code. |
| [1694] | Ext. Status Word | One or more status conditions in a Hex code. |
| [1890] | Process PID Error | |
| [1891] | Process PID Output | |
| [1892] | Process PID Clamped Output | |
| [1893] | Process PID Gain Scaled Output | |
| [3019] | Wobble Delta Freq. Scaled | |
| [3401] | PCD 1 Write to MCO | |
| [3402] | PCD 2 Write to MCO | |
| [3403] | PCD 3 Write to MCO | |
| [3404] | PCD 4 Write to MCO | |
| [3405] | PCD 5 Write to MCO | |
| [3406] | PCD 6 Write to MCO | |
| [3407] | PCD 7 Write to MCO | |
| [3408] | PCD 8 Write to MCO | |
| [3409] | PCD 9 Write to MCO | |
| [3410] | PCD 10 Write to MCO | |
| [3421] | PCD 1 Read from MCO | |
| [3422] | PCD 2 Read from MCO | |
| [3423] | PCD 3 Read from MCO | |
| [3424] | PCD 4 Read from MCO | |
| [3425] | PCD 5 Read from MCO | |
| [3426] | PCD 6 Read from MCO | |
| [3427] | PCD 7 Read from MCO | |
| [3428] | PCD 8 Read from MCO | |
| [3429] | PCD 9 Read from MCO | |
| [3430] | PCD 10 Read from MCO | |
| [3440] | Digital Inputs | |
| [3441] | Digital Outputs | |
| [3450] | Actual Position | |
| [3451] | Commanded Position | |
| [3452] | Actual Master Position | |
| [3453] | Slave Index Position | |
| [3454] | Master Index Position | |
| [3455] | Curve Position | |
| [3456] | Track Error | |
| [3457] | Synchronizing Error | |
| [3458] | Actual Velocity | |
| [3459] | Actual Master Velocity | |
| [3460] | Synchronizing Status | |
| [3461] | Axis Status | |
| [3462] | Program Status | |
| [3464] | MCO 302 Status | |
| [3465] | MCO 302 Control | |
| [3470] | MCO Alarm Word 1 | |
| [3471] | MCO Alarm Word 2 | |

[9913] Idle time

[9914] Paramdb requests in queue

[9920] HS Temp. (PC1)

[9921] HS Temp. (PC2)

[9922] HS Temp. (PC3)

[9923] HS Temp. (PC4)

[9924] HS Temp. (PC5)

[9925] HS Temp. (PC6)

[9926] HS Temp. (PC7)

[9927] HS Temp. (PC8)

0-21 Display Line 1.2 Small

Option:

[1614] * Motor Current

Function:

Select a variable for display in line 1, middle position. The options are the same as listed for par. 0-20.

0-22 Display Line 1.3 Small

Option:

[1610] * Power [kW]

Function:

Select a variable for display in line 1, right position. The options are the same as listed for par. 0-20.

0-23 Display Line 2 Large

Option:

[1613] * Frequency

Function:

Select a variable for display in line 2. The options are the same as listed for par. 0-20.

0-24 Display Line 3 Large

Option:

[1602] * Reference %

Function:

Select a variable for display in line 3. The options are the same as listed for par. 0-20.

0-25 My Personal Menu

Range:

0 N/A* [0 - 9999 N/A]

Function:

3.2.5 0-3*LCP Custom Readout

It is possible to customize the display elements for various purposes: *Custom Readout. Value proportional to speed (Linear, squared or cubed depending on unit selected in par. 0-30 *Custom Readout Unit*) *Display Text. Text string stored in a parameter.

Custom Readout

The calculated value to be displayed is based on settings in par. 0-30 *Custom Readout Unit*, par. 0-31 *Custom Readout Min Value* (linear only), par. 0-32 *Custom Readout Max Value*, par. 4-13 *Motor Speed High Limit [RPM]*, par.4-14 *Motor Speed High Limit [Hz]* and actual speed.

3

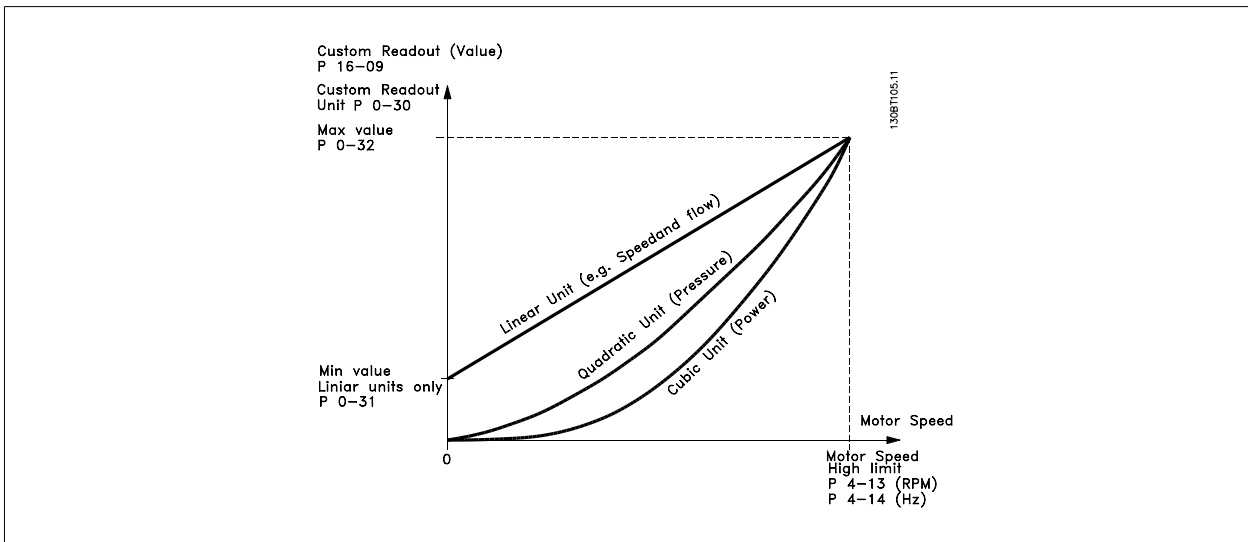

The relation will depend on the type of unit selected in par. 0-30 *Custom Readout Unit*.

| Unit Type | Speed Relation |
|---------------|----------------|
| Dimensionless | Linear |
| Speed | |
| Flow, volume | |
| Flow, mass | |
| Velocity | |
| Length | |
| Temperature | |
| Pressure | Quadratic |
| Power | Cubic |

0-30 Unit for User-defined Readout

Option: **Function:**

It is possible to program a value to be shown in the display of the LCP. The value will have a linear, squared or cubed relation to speed. This relation will depend on the unit selected (see table above). The actual calculated value can be read in par.16-09 *Custom Readout*, and/or shown in the display by selecting Custom Readout [16-09] in par.0-20 *Display Line 1.1 Small* to par. 0-24 *Display Line 3 Large*.

- [0] * None
- [1] %
- [5] PPM
- [10] 1/min
- [11] rpm
- [12] Pulse/s
- [20] l/s
- [21] l/min
- [22] l/h
- [23] m³/s
- [24] m³/min
- [25] m³/h
- [30] kg/s
- [31] kg/min
- [32] kg/h

| | |
|-------|----------------------|
| [33] | t/min |
| [34] | t/h |
| [40] | m/s |
| [41] | m/min |
| [45] | m |
| [60] | °C |
| [70] | mbar |
| [71] | bar |
| [72] | Pa |
| [73] | kPa |
| [74] | m WG |
| [80] | kW |
| [120] | GPM |
| [121] | gal/s |
| [122] | gal/min |
| [123] | gal/h |
| [124] | CFM |
| [125] | ft ³ /s |
| [126] | ft ³ /min |
| [127] | ft ³ /h |
| [130] | lb/s |
| [131] | lb/min |
| [132] | lb/h |
| [140] | ft/s |
| [141] | ft/min |
| [145] | ft |
| [160] | °F |
| [170] | psi |
| [171] | lb/in ² |
| [172] | in WG |
| [173] | ft WG |
| [180] | HP |

0-31 Min Value of User-defined Readout

| | |
|---|--|
| Range: | Function: |
| 0.00 Cus- [-999999.99 - par. 0-32 CustomReadout-ReadoutUnit] tUnit* | This parameter sets the min. value of the custom defined readout (occurs at zero speed). Only possible to set different from 0 is when selecting a linear unit in par.0-30 <i>Unit for User-defined Readout</i> . For Quadratic and Cubic units the minimum value will be 0. |

0-32 Custom Readout Max Value

| | |
|---|---|
| Range: | Function: |
| 100.00 Cus- [par. 0-31 - 999999.99 CustomReadout-doutUnit] tUnit* | This parameter sets the max value to be shown when the speed of the motor has reached the set value for par. 4-13 <i>Motor Speed High Limit [RPM]</i> or par.4-14 <i>Motor Speed High Limit [Hz]</i> (depends on setting in par. 0-02). |

3.2.6 LCP Keypad, 0-4*

Enable, disable and password protect individual keys on the LCP.

0-40 [Hand on] Key on LCP

| Option: | Function: |
|---------|--|
| [0] | Disabled No function |
| [1] * | Enabled [Hand on] Key enabled |
| [2] | Password Avoid unauthorized start in Hand mode. If par.0-40 [Hand on] Key on LCPs included in the My Personal Menu, then define the password in par. 0-65 <i>Personal Menu Password</i> . Otherwise define the password in par.0-60 <i>Main Menu Password</i> . |

0-41 [Off] Key on LCP

| Option: | Function: |
|---------|---|
| [0] * | Disabled Avoids accidental stop of the frequency converter. |
| [1] * | Enabled |
| [2] | Password Avoids unauthorised stop. If par.0-41 [Off] Key on LCP is included in the Quick Menu, then define the password in par.0-65 <i>Quick Menu Password</i> . |
| [3] | Hand Off/On |
| [4] | Hand Off/On w. Passw. |

0-42 [Auto on] Key on LCP

| Option: | Function: |
|---------|---|
| [0] * | Disabled avoid accidental start of the frequency converter in Auto mode. |
| [1] * | Enabled |
| [2] | Password Avoids unauthorised start in Auto mode. If par.0-42 [Auto on] Key on LCP is included in the Quick Menu, then define the password in par.0-65 <i>Quick Menu Password</i> . |
| [3] | Hand Off/On |
| [4] | Hand Off/On w. Passw. |

0-43 [Reset] Key on LCP

| Option: | Function: |
|---------|--|
| [0] * | Disabled Avoids accidental alarm reset. |
| [1] * | Enabled |
| [2] | Password Avoids unauthorised resetting. If par.0-43 [Reset] Key on LCP is included in the Quick Menu, then define the password in par.0-65 <i>Quick Menu Password</i> . |
| [3] | Hand Off/On |
| [4] | Hand Off/On w. Passw. |

3.2.7 0-5* Copy / Save

Copy parameter settings between set-ups and to/from the LCP.

0-50 LCP Copy

| Option: | Function: |
|---------|---|
| [0] * | No copy |
| [1] | All to LCP Copies all parameters in all set-ups from the frequency converter memory to the LCP memory. |
| [2] | All from LCP Copies all parameters in all set-ups from the LCP memory to the frequency converter memory. |

[3] Size indep. from LCP copy only the parameters that are independent of the motor size. The latter selection can be used to programme several frequency converters with the same function without disturbing motor data.

[4] File from MCO to LCP

[5] File from LCP to MCO

This parameter cannot be adjusted while the motor is running.

0-51 Set-up Copy

Option:

Function:

[0] * No copy

No function

[1] Copy to set-up 1

Copies all parameters in the present Programming Set-up (defined in par. 0-11 *Programming Set-up*) to Set-up 1.

[2] Copy to set-up 2

Copies all parameters in the present Programming Set-up (defined in par. 0-11 *Programming Set-up*) to Set-up 2.

[3] Copy to set-up 3

Copies all parameters in the present Programming Set-up (defined in par. 0-11 *Programming Set-up*) to Set-up 3.

[4] Copy to set-up 4

Copies all parameters in the present Programming Set-up (defined in par. 0-11 *Programming Set-up*) to Set-up 4.

[9] Copy to all

Copies the parameters in the present set-up over to each of the set-ups 1 to 4.

3.2.8 0-6* Password

Define password access to menus.

0-60 Main Menu Password

Range:

Function:

100 N/A* [0 - 999 N/A]

Define the password for access to the Main Menu via the [Main Menu] key. If par. 0-61 *Access to Main Menu w/o Password* is set to *Full access* [0], this parameter will be ignored.

0-61 Access to Main Menu w/o Password

Option:

Function:

[0] * Full access

Disables password defined in par.0-60 *Main Menu Password*.

[1] LCP: Read only

Prevent unauthorized editing of Main Menu parameters.

[2] LCP: No access

Prevent unauthorized viewing and editing of Main Menu parameters.

[3] Bus: Read only

Read-only functions for parameters on fieldbus and/or FC standard bus.

[4] Bus: No access

No access to parameters is allowed via fieldbus and/or FC standard bus.

[5] All: Read only

Read-only function for parameters on LCP, fieldbus or FC standard bus.

[6] All: No access

No access from LCP, fieldbus or FC standard bus is allowed.

If *Full access* [0] is selected then par.0-60 *Main Menu Password*, par. 0-65 *Personal Menu Password* and par. 0-66 *Access to Personal Menu w/o Password* will be ignored.

0-65 Quick Menu Password

Range:

Function:

200 N/A* [-9999 - 9999 N/A]

Define the password for access to the Quick Menu via the [Quick Menu] key. If par.0-66 *Access to Quick Menu w/o Password* is set to *Full access* [0], this parameter will be ignored.

0-66 Access to Quick Menu w/o Password

| Option: | Function: |
|--------------------|---|
| [0] * Full access | Disables the password defined in par.0-65 <i>Quick Menu Password</i> . |
| [1] LCP: Read only | Prevents unauthorised editing of Quick Menu parameters. |
| [2] LCP: No access | Prevents unauthorised viewing and editing of Quick Menu parameters. |
| [3] Bus: Read only | Read only functions for Quick Menu parameters on fieldbus and/ or FC standard bus. |
| [4] Bus: No access | No access to Quick Menu parameters is allowed via fieldbus and/ or FC standard bus. |
| [5] All: Read only | read only function for Quick Menu parameters on LCP, fieldbus or FC standard bus. |
| [6] All: No access | No access from LCP, fieldbus or FC standard bus is allowed. |

If par. 0-61 *Access to Main Menu w/o Password* is set to *Full access* [0] then this parameter will be ignored.

0-67 Bus Password Access

| Range: | Function: |
|-----------------------|--|
| 0 N/A* [0 - 9999 N/A] | Writing to this parameter enables users to unlock the frequency converter from bus/ MCT10. |

3.3 Parameters: Load and Motor

3.3.1 1-0* General Settings

Define whether the frequency converter operates in speed mode or torque mode; and whether the internal PID control should be active or not.

| 1-00 Configuration Mode | | |
|-------------------------|-----------------------|--|
| Option: | | Function: |
| | | Select the application control principle to be used when a Remote Reference (i.e. via analog input or fieldbus) is active. A Remote Reference can only be active when par.3-13 <i>Reference Site</i> is set to [0] or [1]. |
| [0] * | Speed open loop | Enables speed control (without feedback signal from motor) with automatic slip compensation for almost constant speed at varying loads. Compensations are active but can be disabled in the Load/Motor par. group 1-0*. |
| [1] | Speed closed loop | Enables encoder feedback from motor. Obtain full holding torque at 0 RPM. For increased speed accuracy, provide a feedback signal and set the speed PID control. |
| [2] | Torque | Connects the encoder speed feedback signal to the encoder input. Only possible with "Flux with motor feedback" option, par.1-01 <i>Motor Control Principle</i> . |
| [3] | Process | Enables the use of process control in the frequency converter. The process control parameters are set in par. groups 7-2* and 7-3*. |
| [4] | Torque open loop | Enables the use of torque open loop in VVC+ mode (par.1-01 <i>Motor Control Principle</i>). The torque PID parameters are set in par. group 7-1*. |
| [5] | Wobble | |
| [6] | Surface Winder | |
| [7] | Extended PID Speed OL | |
| [8] | Extended PID Speed CL | |

| 1-01 Motor Control Principle | | |
|------------------------------|---------------------|--|
| Option: | | Function: |
| | | Select which motor control principle to employ. |
| [0] * | U/f | special motor mode, for parallel connected motors in special motor applications. When U/f is selected the characteristic of the control principle can be edited in par.1-55 <i>U/f Characteristic - U</i> and par.1-56 <i>U/f Characteristic - F</i> . |
| [1] | VVC+ | |
| [2] | Flux sensorless | Flux Vector control without encoder feedback, for simple installation and robustness against sudden load changes. |
| [3] | Flux w/ motor feedb | very high accuracy speed and torque control, suitable for the most demanding applications. |

The best shaft performance is normally achieved using either of the two Flux Vector control modes *Flux sensorless* [2] and *Flux with encoder feedback* [3].

This parameter cannot be adjusted while the motor is running.

| 1-02 Flux Motor Feedback Source | | |
|---------------------------------|--------------------|--|
| Option: | | Function: |
| | | Select the interface at which to receive feedback from the motor. |
| [0] | Motor feedb. P1-02 | |
| [1] * | 24V encoder | A and B channel encoder, which can be connected to the digital input terminals 32/33 only. Terminals 32/33 must be programmed to <i>No operation</i> . |

| | | |
|-----|--------------------|---|
| [2] | MCB 102 | Encoder module option which can be configured in par. group 17-1* This parameter appears in FC 302 only. |
| [3] | MCB 103 | Optional resolver interface module which can be configured in parameter group 17-5* |
| [5] | MCO Encoder 2 | encoder interface 2 of the optional programmable motion controller MCO 305. |
| [6] | Analog input 53 | |
| [7] | Analog input 54 | |
| [8] | Frequency input 29 | |
| [9] | Frequency input 33 | |

This parameter cannot be adjusted while the motor is running.

1-03 Torque Characteristics

Option:

Function:

Select the torque characteristic required.
VT and AEO are both energy saving operations.

| | | |
|-------|--------------------|---|
| [0] * | Constant torque | Motor shaft output provides constant torque under variable speed control. |
| [1] | Variable torque | Motor shaft output provides variable torque under variable speed control. Set the variable torque level in par.14-40 <i>VT Level</i> . |
| [2] | Auto Energy Optim. | Automatically optimises energy consumption by minimising magnetisation and frequency via par. 14-41 <i>AEO Minimum Magnetisation</i> and par.14-42 <i>Minimum AEO Frequency</i> . |

This parameter cannot be adjusted while the motor is running.

1-04 Overload Mode

Option:

Function:

| | | |
|-------|---------------|--|
| [0] * | High torque | Allows up to 160% over torque. |
| [1] | Normal torque | For oversized motor - allows up to 110% over torque. |

This parameter cannot be adjusted while the motor is running.

1-05 Local Mode Configuration

Option:

Function:

Select which application configuration mode (par.1-00 *Configuration Mode*), i.e. application control principle, to use when a Local (LCP) Reference is active. A Local Reference can be active only when par.3-13 *Reference Site* is set to [0] or [2]. By default the local reference is active in Hand Mode only.

| | |
|-------|-------------------|
| [0] | Speed open loop |
| [1] | Speed closed loop |
| [2] * | As mode par 1-00 |

3.3.2 1-1* Motor selection

Parameter group for setting general motor data.

This parameter group cannot be adjusted while the motor is running.

1-10 Motor Construction

Option:

Function:

Select the motor construction type.

| | | |
|-------|---------------------|--------------------------|
| [0] * | Asynchron | For asynchronous motors. |
| [1] | PM, non salient SPM | |

Motor construction can either be asynchronous or permanent magnet (PM) motor.

3.3.3 1-2* Motor Data

Parameter group 1-2* comprises input data from the nameplate on the connected motor. Parameters in parameter group 1-2* cannot be adjusted while the motor is running.



NB!
Changing the value of these parameters affects the setting of other parameters.

1-20 Motor Power [kW]

| | |
|------------------------------|---|
| Range: | Function: |
| 4.00 kW* [0.09 - 3000.00 kW] | Enter the nominal motor power in kW according to the motor nameplate data. The default value corresponds to the nominal rated output of the unit. This parameter cannot be adjusted while the motor is running. This parameter is visible in LCP if par.0-03 <i>Regional Settings</i> is <i>International</i> [0]. |



NB!
Four sizes down, one size up from nominal VLT rating.

1-21 Motor Power [HP]

| | |
|------------------------------|---|
| Range: | Function: |
| 4.00 hp* [0.09 - 3000.00 hp] | Enter the nominal motor power in HP according to the motor nameplate data. The default value corresponds to the nominal rated output of the unit. This parameter is visible in LCP if par. 0-03 <i>Regional Settings</i> is <i>US</i> [1] |

1-22 Motor Voltage

| | |
|-------------------------|---|
| Range: | Function: |
| 500. V* [10. - 1000. V] | Enter the nominal motor voltage according to the motor nameplate data. The default value corresponds to the nominal rated output of the unit. |

1-23 Motor Frequency

| | |
|------------------------|--|
| Range: | Function: |
| 50. Hz* [20 - 1000 Hz] | Min - Max motor frequency: 20 - 1000 Hz. Select the motor frequency value from the motor nameplate data. If a value different from 50 Hz or 60 Hz is selected, it is necessary to adapt the load independent settings in par.1-50 <i>Motor Magnetisation at Zero Speed</i> to par.1-53 <i>Model Shift Frequency</i> . For 87 Hz operation with 230/400 V motors, set the nameplate data for 230 V/50 Hz. Adapt par.4-13 <i>Motor Speed High Limit [RPM]</i> and par.3-03 <i>Maximum Reference</i> to the 87 Hz application. |

1-24 Motor Current

| | |
|-----------------------------|--|
| Range: | Function: |
| 7.20 A* [0.10 - 10000.00 A] | Enter the nominal motor current value from the motor nameplate data. The data are used for calculating torque, motor protection etc. |

1-25 Motor Nominal Speed

Range:

1420. RPM* [10 - 60000 RPM]

Function:

Enter the nominal motor speed value from the motor nameplate data. The data are used for calculating motor compensations.

**NB!**

Motor speed must always be lower than synchronous speed

1-26 Motor Cont. Rated Torque

Range:

0 Nm* [0.1 - 10000.0 Nm]

Function:

Enter the value from the motor nameplate data. The default value corresponds to the nominal rated output. This parameter is available when par.1-10 *Motor Construction* is set to *PM, non salient SPM* [1], i.e. the parameter is valid for PM and non-salient SPM motors only.

1-29 Automatic Motor Adaptation (AMA)

Option:**Function:**

The AMA function optimises dynamic motor performance by automatically optimising the advanced motor parameters (par.1-30 *Stator Resistance (Rs)* to par.1-35 *Main Reactance (Xh)*) at motor standstill.

Activate the AMA function by pressing [Hand on] after selecting [1] or [2]. See also the section *Automatic Motor Adaptation* in the Design Guide. After a normal sequence, the display will read: "Press [OK] to finish AMA". After pressing the [OK] key the frequency converter is ready for operation.

This parameter cannot be adjusted while the motor is running.

[0] * Off

[1] Enable complete AMA

Performs AMA of the stator resistance R_s , the rotor resistance R_r , the stator leakage reactance X_1 , the rotor leakage reactance X_2 and the main reactance X_h . Do *not* select this option if an LC filter is used between the frequency converter and the motor.

FC 301: The Complete AMA does not include X_h measurement for FC 301. Instead, the X_h value is determined from the motor database. R_s is the best adjustment method (see 1-3* *Adv. Motor Data*).

[2] Enable reduced AMA

Performs a reduced AMA of the stator resistance R_s in the system only.

Note:

- For the best adaptation of the frequency converter, run AMA on a cold motor.
- AMA cannot be performed while the motor is running.
- AMA cannot be performed on permanent magnet motors.

**NB!**

It is important to set motor par. 1-2* correctly, since these form part of the AMA algorithm. An AMA must be performed to achieve optimum dynamic motor performance. It may take up to 10 min, depending on the power rating of the motor.

**NB!**

Avoid generating external torque during AMA.

NB!
If one of the settings in par. 1-2* is changed, par.1-30 *Stator Resistance (Rs)* to par.1-39 *Motor Poles*, the advanced motor parameters, will return to default setting.

NB!
AMA will work problem-free on 1 motor size down, typically work on 2 motor sizes down, rarely work on 3 sizes down and never work on 4 sizes down. Please keep in mind that the accuracy of the measured motor data will be poorer when you operate on motors smaller than nominal VLT size.

3.3.4 1-3* Adv. Motor Data

Parameters for advanced motor data. The motor data in par.1-30 *Stator Resistance (Rs)* to par.1-39 *Motor Poles* must match the relevant motor in order to run the motor optimally. The default settings are figures based on common motor parameter values from standard motors. If the motor parameters are not set correctly, a malfunction of the frequency converter system may occur. If the motor data is not known, running an AMA (Automatic Motor Adaptation) is recommended. See the *Automatic Motor Adaptation* section in the Design Guide. The AMA sequence will adjust all motor parameters except the moment of inertia of the rotor and the iron loss resistance (par.1-36 *Iron Loss Resistance (Rfe)*).

Par. 1-3* and par. 1-4* cannot be adjusted while the motor is running.

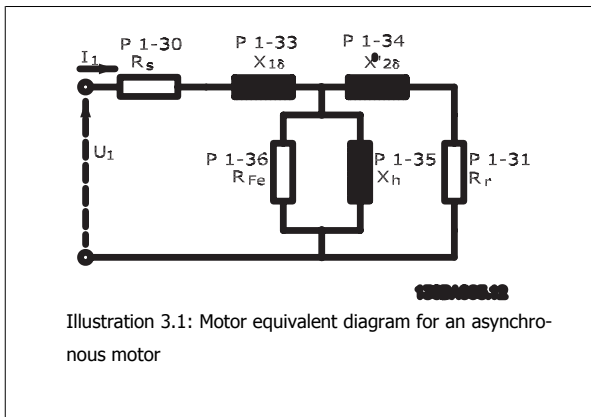

1-30 Stator Resistance (Rs)

| Range: | Function: |
|-------------------------------------|---|
| 1.4000 [0.0140 - 140.0000 Ohm] Ohm* | Set the stator resistance value. Enter the value from a motor data sheet or perform an AMA on a cold motor. |

1-31 Rotor Resistance (Rr)

| Range: | Function: |
|-------------------------------------|--|
| 1.0000 [0.0100 - 100.0000 Ohm] Ohm* | Fine-tuning R _r will improve shaft performance. Set the rotor resistance value using one of these methods: <ol style="list-style-type: none"> Run an AMA on a cold motor. The frequency converter will measure the value from the motor. All compensations are reset to 100%. Enter the R_r value manually. Obtain the value from the motor supplier. Use the R_r default setting. The frequency converter establishes the setting on the basis of the motor nameplate data. |

1-33 Stator Leakage Reactance (X1)

| Range: | Function: |
|-------------------------------------|---|
| 4.0000 [0.0400 - 400.0000 Ohm] Ohm* | Set the stator leakage reactance of the motor using one of these methods: |

1. Run an AMA on a cold motor. The frequency converter will measure the value from the motor.
2. Enter the X_1 value manually. Obtain the value from the motor supplier.
3. Use the X_1 default setting. The frequency converter establishes the setting on the basis of the motor name plate data.

1-34 Rotor Leakage Reactance (X_2)

Range:

4.0000 [0.0400 - 400.0000 Ohm]
Ohm*

Function:

Set the rotor leakage reactance of the motor using one of these methods:

1. Run an AMA on a cold motor. The frequency converter will measure the value from the motor.
2. Enter the X_2 value manually. Obtain the value from the motor supplier.
3. Use the X_2 default setting. The frequency converter establishes the setting on the basis of the motor name plate data.

1-35 Main Reactance (X_h)

Range:

100.0000 [1.0000 - 10000.0000 Ohm]
Ohm*

Function:

Set the main reactance of the motor using one of these methods:

1. Run an AMA on a cold motor. The frequency converter will measure the value from the motor.
2. Enter the X_h value manually. Obtain the value from the motor supplier.
3. Use the X_h default setting. The frequency converter establishes the setting on the basis of the motor name plate data.

1-36 Iron Loss Resistance (R_{fe})

Range:

10000.000 [0 - 10000.000 Ohm]
Ohm*

Function:

Enter the equivalent iron loss resistance (R_{Fe}) value to compensate for iron loss in the motor.

The R_{Fe} value cannot be found by performing an AMA.

The R_{Fe} value is especially important in torque control applications. If R_{Fe} is unknown, leave par. 1-36 *Iron Loss Resistance (Rfe)* on default setting.

1-37 d-axis Inductance (L_d)

Range:

0 mH* [0 - 1000.0 mH]

Function:

Enter the value of the d-axis inductance. Obtain the value from the permanent magnet motor data sheet.

This parameter is only active when par.1-10 *Motor Construction* has the value *PM, non-salient SPM* [1] (Permanent Magnet Motor).

For a selection with one decimal, use this parameter. For a selection with three decimals, use par. 30-80 *d-axis Inductance (Ld)*.

This parameter is available for FC 302 only.

1-39 Motor Poles

Range:

4. N/A* [2 - 100 N/A]

Function:

Enter the number of motor poles.

| Poles | $\sim n_n$ @ 50 Hz | $\sim n_n$ @60 Hz |
|-------|--------------------|-------------------|
| 2 | 2700 - 2880 | 3250 - 3460 |
| 4 | 1350 - 1450 | 1625 - 1730 |
| 6 | 700 - 960 | 840 - 1153 |

The table shows the number of poles for normal speed ranges of various motor types. Define motors designed for other frequencies separately. The motor pole value is always an even number, because it refers to the total number of poles, not pairs of poles. The frequency converter creates the initial setting of par.1-39 *Motor Poles* based on par.1-23 *Motor Frequency* and par.1-25 *Motor Nominal Speed*.

1-40 Back EMF at 1000 RPM

Range:

500. V* [10. - 9000 V]

Function:

Set the nominal back EMF for the motor when running at 1000 RPM. This parameter is only active when par.1-10 *Motor Construction* is set to *PM motor* [1] (Permanent Magnet Motor). This parameter is available for FC 302 only.



NB!
When using PM motors, it is recommended to use brake resistors.

1-41 Motor Angle Offset

Range:

0 N/A* [-32768 - 32767 N/A]

Function:

Enter the correct offset angle between the PM motor and the index position (single-turn) of the attached encoder or resolver. The value range of 0 - 32768 corresponds to 0 - 2 * pi (radians). To obtain the offset angle value: After frequency converter start-up apply DC-hold and enter the value of par.16-20 *Motor Angle* into this parameter. This parameter is only active when par.1-10 *Motor Construction* is set to *PM, non-salient SPM* [1] (Permanent Magnet Motor).

3.3.5 1-5* Load Indep. Setting

Parameters for setting the load-independent motor settings.

1-50 Motor Magnetisation at Zero Speed

Range:

100 %* [0 - 300 %]

Function:

Use this parameter along with par.1-51 *Min Speed Normal Magnetising [RPM]* to obtain a different thermal load on the motor when running at low speed. Enter a value which is a percentage of the rated magnetizing current. If the setting is too low, the torque on the motor shaft may be reduced.

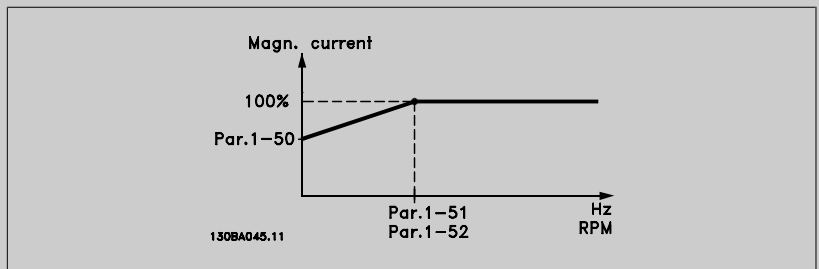

1-51 Min Speed Normal Magnetising [RPM]

Range:

15. RPM* [10 - 300 RPM]

Function:

Set the required speed for normal magnetising current. If the speed is set lower than the motor slip speed, par.1-50 *Motor Magnetisation at Zero Speed* and par.1-51 *Min Speed Normal Magnetising [RPM]* are of no significance. Use this parameter along with par.1-50 *Motor Magnetisation at Zero Speed*. See drawing for par. 1-50 *Motor Magnetisation at Zero Speed*.

1-52 Min Speed Normal Magnetising [Hz]

Range:

12.5 Hz* [0 - 250.0 Hz]

Function:

Set the required frequency for normal magnetising current. If the frequency is set lower than the motor slip frequency, par.1-50 *Motor Magnetisation at Zero Speed* is inactive.

Use this parameter along with par.1-50 *Motor Magnetisation at Zero Speed*. See drawing for par. 1-50 *Motor Magnetisation at Zero Speed*.

1-53 Model Shift Frequency

Range:

0 Hz* [4.0 - 0 Hz]

Function:

Flux Model shift

Enter the frequency value for shift between two models for determining motor speed. Choose the value based on settings in par.1-00 *Configuration Mode* and par.1-01 *Motor Control Principle*. There are two options: shift between Flux model 1 and Flux model 2; or shift between Variable Current mode and Flux model 2. This parameter is available for FC 302 only.

This parameter cannot be adjusted while the motor is running.

Flux Model 1 – Flux model 2

This model is used when par.1-00 *Configuration Mode* is set to *Speed closed loop* [1] or *Torque* [2] and par.1-01 *Motor Control Principle* is set to *Flux w/motor feedback* [3]. With this parameter it is possible to make an adjustment of the shifting point where FC 302 changes between Flux model 1 and Flux model 2, which is useful in some sensitive speed and torque control applications.

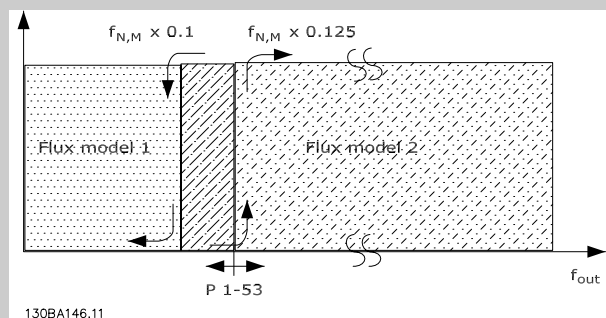

Illustration 3.4: par.1-00 *Configuration Mode* = [1] Speed closed loop or [2] Torque and par.1-01 *Motor Control Principle* = [3] Flux w/motor feedback

Variable Current - Flux model - Sensorless

This model is used when par.1-00 *Configuration Mode* is set to *Speed open loop* [0] and par.1-01 *Motor Control Principle* is set to *Flux sensorless* [2].

In speed open loop in flux mode, the speed is determined from the current measurement.

Below $f_{norm} \times 0.1$, the frequency converter runs on a Variable Current model. Above $f_{norm} \times 0.125$ the frequency converter runs on a Flux model.

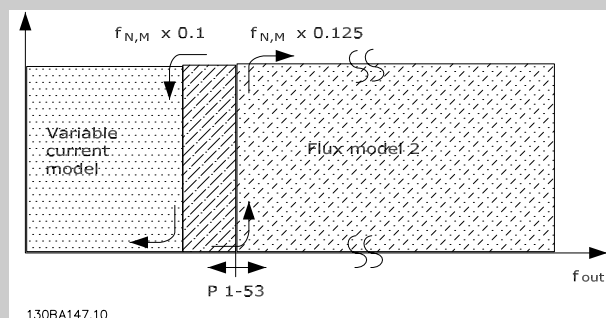

Illustration 3.5: par.1-00 *Configuration Mode* = [0] Speed open loop, par.1-01 *Motor Control Principle* = [2] Flux sensorless

1-55 U/f Characteristic - U

Range:

0 V* [0.0 - 1000.0 V]

Function:

Enter the voltage at each frequency point to manually form a U/f characteristic matching the motor.

The frequency points are defined in par.1-56 *U/f Characteristic - F*.
 This parameter is an array parameter [0-5] and is only accessible when par.1-01 *Motor Control Principle* is set to *U/f*[0].

1-56 U/f Characteristic - F

Range: 0 Hz* [0 - 1000.0 Hz]
Function: Enter the frequency points to manually form a U/f-characteristic matching the motor.
 The voltage at each point is defined in par.1-55 *U/f Characteristic - U*.
 This parameter is an array parameter [0-5] and is only accessible when par.1-01 *Motor Control Principle* is set to *U/f*[0].

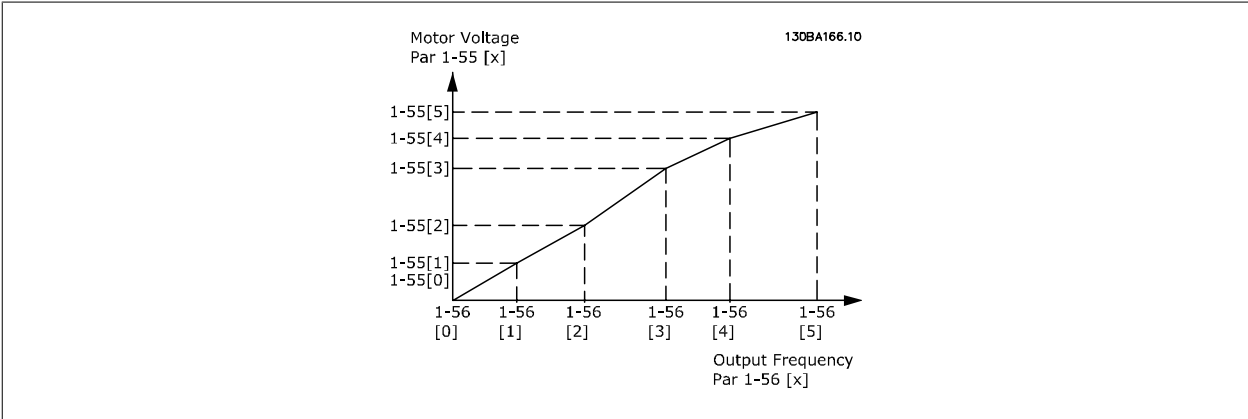

3.3.6 1-6* Load Depend. Setting

Parameters for adjusting the load-dependent motor settings.

1-60 Low Speed Load Compensation

Range: 100 %* [0 - 300 %]
Function: Enter the % value to compensate voltage in relation to load when the motor is running at low speed and obtain the optimum U/f characteristic. The motor size determines the frequency range within which this parameter is active.

| | |
|------------------|-------------|
| Motor size | Change over |
| 0.25 kW - 7.5 kW | < 10 Hz |

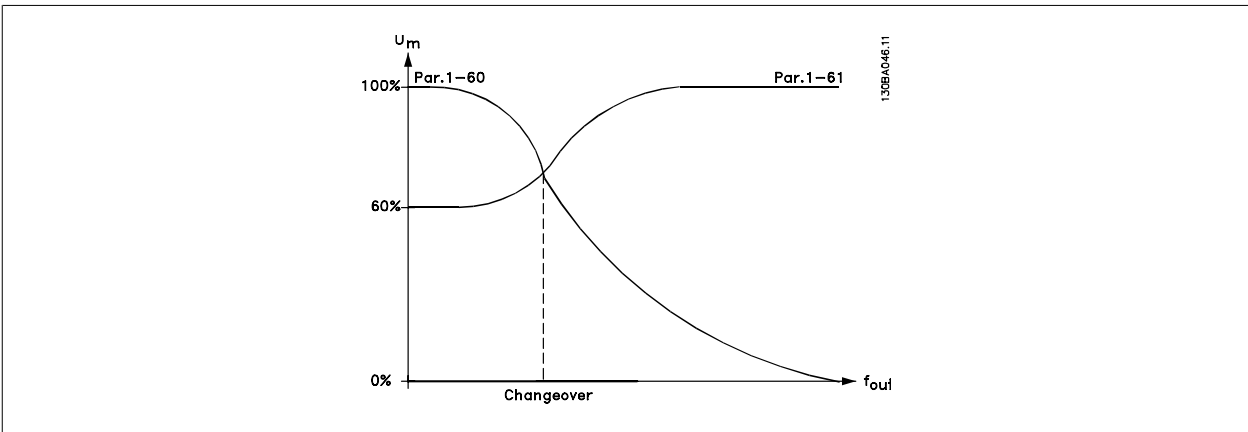

1-61 High Speed Load Compensation**Range:**

100 %* [0 - 300 %]

Function:

Enter the % value to compensate voltage in relation to load when the motor is running at high speed and obtain the optimum U/f characteristic. The motor size determines the frequency range within which this parameter is active.

| | |
|------------------|-------------|
| Motor size | Change-over |
| 0.25 kW - 7.5 kW | > 10 Hz |

1-62 Slip Compensation**Range:**

100. %* [-500 - 500 %]

Function:

Enter the % value for slip compensation, to compensate for tolerances in the value of $n_{M,N}$. Slip compensation is calculated automatically, i.e. on the basis of the rated motor speed $n_{M,N}$. This function is not active when par.1-00 *Configuration Mode* is set to *Speed closed loop* [1] or *Torque* [2] Torque control with speed feedback or when par.1-01 *Motor Control Principle* is set to *U/f*[0] special motor mode.

1-63 Slip Compensation Time Constant**Range:**

0.10 s* [0.05 - 5.00 s]

Function:

Enter the slip compensation reaction speed. A high value results in slow reaction, and a low value results in quick reaction. If low-frequency resonance problems arise, use a longer time setting.

1-64 Resonance Dampening**Range:**

100 %* [0 - 500 %]

Function:

Enter the resonance dampening value. Set par.1-64 *Resonance Dampening* and par.1-65 *Resonance Dampening Time Constant* to help eliminate high-frequency resonance problems. To reduce resonance oscillation, increase the value of par.1-64 *Resonance Dampening*.

1-65 Resonance Dampening Time Constant**Range:**

5 ms* [5 - 50 ms]

Function:

Set par.1-64 *Resonance Dampening* and par.1-65 *Resonance Dampening Time Constant* to help eliminate high-frequency resonance problems. Enter the time constant that provides the best dampening.

1-66 Min. Current at Low Speed**Range:**

100 %* [1. - 200. %]

Function:

Enter the minimum motor current at low speed, see par.1-53 *Model Shift Frequency*. Increasing this current improves motor torque at low speed.

par.1-66 *Min. Current at Low Speed* is enabled when par.1-00 *Configuration Mode* = *Speed open loop* [0] only. The frequency converter runs with constant current through motor for speeds below 10 Hz.

For speeds above 10 Hz, the motor flux model in the frequency converter controls the motor. par.4-16 *Torque Limit Motor Mode* and | or par.4-17 *Torque Limit Generator Mode* automatically adjust par.1-66 *Min. Current at Low Speed*. The parameter with the highest value adjusts par.1-66 *Min. Current at Low Speed*. The current setting in par.1-66 *Min. Current at Low Speed* is composed of the torque generating current and the magnetizing current.

Example: Set par.4-16 *Torque Limit Motor Mode* to 100% and set par.4-17 *Torque Limit Generator Mode* to 60%. par.1-66 *Min. Current at Low Speed* automatically adjusts to about 127%, depending on the motor size.

This parameter is available for FC 302 only.

1-67 Load Type**Option:**

[0] * Passive load

Function:

For conveyers, fan and pump applications.

[1] Active load For hoisting applications. When *Active Load* [1] is selected, set par.1-66 *Min. Current at Low Speed* to a level which corresponds to maximum torque.

This parameter is available for FC 302 only.

1-68 Minimum Inertia

| Range: | Function: |
|--------------------------------------|--|
| 0.0048 [0.0001 - par. 1-69 kgm] kgm* | Enter the minimum moment of inertia of the mechanical system. par.1-68 <i>Minimum Inertia</i> and par. 1-69 <i>Maximum Inertia</i> are used for pre-adjustment of the Proportional Gain in the speed control, see par.30-83 <i>Speed PID Proportional Gain</i> . This parameter is available for FC 302 only. |

This parameter cannot be adjusted while motor is running.

1-69 Maximum Inertia

| Range: | Function: |
|--------------------------------------|--|
| 0.0048 [par. 1-68 - 0.4800 kgm] kgm* | Enter the maximum moment of inertia of the mechanical system. par.1-68 <i>Minimum Inertia</i> and par.1-69 <i>Maximum Inertia</i> are used for pre-adjustment of the Proportional Gain in the speed control, see par.7-02 <i>Speed PID Proportional Gain</i> . This parameter is available for FC 302 only. |

This parameter cannot be adjusted while motor is running.

3.3.7 1-7* Start Adjustments

Parameters for setting special motor start features.

1-71 Start Delay

| Range: | Function: |
|-----------------------|---|
| 0.0 s* [0.0 - 10.0 s] | This parameter refers to the start function selected in par.1-72 <i>Start Function</i> . Enter the time delay required before commencing acceleration. |

1-72 Start Function

| Option: | Function: |
|--------------------------|--|
| | Select the start function during start delay. This parameter is linked to par.1-71 <i>Start Delay</i> . |
| [0] DC Hold/delay time | Energizes motor with a DC holding current (par.2-00 <i>DC Hold Current</i>) during the start delay time. |
| [1] DC Brake/delay time | Energizes motor with a DC braking current (par.2-01 <i>DC Brake Current</i>) during the start delay time. |
| [2] * Coast/delay time | Releases shaft coasted converter during the start delay time (inverter off). |
| [3] Start speed cw | Only possible with VVC+Advanced Vector Control. Connect the function described in par.1-74 <i>Start Speed [RPM]</i> and par.1-76 <i>Start Current</i> in the start delay time. Regardless of the value applied by the reference signal, the output speed applies the setting of the start speed in par.1-74 <i>Start Speed [RPM]</i> or par.1-75 <i>Start Speed [Hz]</i> and the output current corresponds to the setting of the start current in par.1-76 <i>Start Current</i> . This function is typically used in hoisting applications without counterweight and especially in applications with a Cone-motor, where the start is clockwise, followed by rotation in the reference direction. |
| [4] Horizontal operation | Only possible with VVC+Advanced Vector Control. For obtaining the function described in par.1-74 <i>Start Speed [RPM]</i> and par.1-76 <i>Start Current</i> during the start delay time. The motor rotates in the reference direction. If the reference signal equals zero (0), par.1-74 <i>Start Speed [RPM]</i> is ignored and the output speed equals zero (0). The output current corresponds to the setting of the start current in par.1-76 <i>Start Current</i> . |
| [5] VVC+/Flux clockwise | for the function described in par.1-74 <i>Start Speed [RPM]</i> only. The start current is calculated automatically. This function uses the start speed in the start delay time only. Regardless of the value set by the reference signal, the output speed equals the setting of the start speed in par.1-74 <i>Start</i> |

Speed [RPM]. Start speed/current clockwise [3] and VVCplus/Flux clockwise [5] are typically used in hoisting applications. Start speed/current in reference direction [4] is particularly used in applications with counterweight and horizontal movement.

[6] Hoist Mech. Brake Rel For utilizing mechanical brake control functions, par.2-24 *Stop Delay* to par.2-28 *Gain Boost Factor*. This parameter is only active when par.1-01 *Motor Control Principle* is set to [3] *Flux w/ motor feedback (FC 302 only)*.

3

1-73 Flying Start

Option:**Function:**

This function makes it possible to catch a motor which is spinning freely due to a mains drop-out.

[0] * Disabled

No function

[1] Enabled

[2] Enabled Always

This parameter cannot be adjusted while motor is running.

**NB!**

This function is not recommended for hoisting applications.

1-74 Start Speed [RPM]

Range:**Function:**

0 RPM* [0 - 600 RPM]

Set a motor start speed. After the start signal, the output speed leaps to set value. Set the start function in par.1-72 *Start Function* to [3], [4] or [5], and set a start delay time in par.1-71 *Start Delay*.

1-75 Start Speed [Hz]

Range:**Function:**

0 Hz* [0.0 - 500.0 Hz]

Set a motor start speed. After the start signal, the output speed leaps to set value. Set the start function in par.1-72 *Start Function* to [3], [4] or [5], and set a start delay time in par.1-71 *Start Delay*.

1-76 Start Current

Range:**Function:**

0.00 A* [0.00 - par. 1-24 A]

Some motors, e.g. cone rotor motors, need extra current/starting speed to disengage the rotor. To obtain this boost, set the required current in par.1-76 *Start Current*. Set par.1-74 *Start Speed [RPM]*. Set par.1-72 *Start Function* to [3] or [4], and set a start delay time in par.1-71 *Start Delay*.

This parameter can be used for hoist applications (cone rotor).

3.3.8 1-8* Stop Adjustments

Parameters for setting special stop features for the motor.

1-80 Function at Stop

Option:**Function:**

Select the frequency converter function after a stop command or after the speed is ramped down to the settings in par.1-81 *Min Speed for Function at Stop [RPM]*.

[0] * Coast

Leaves motor in free mode. The motor is disconnected from the from the frequency converter.

[1] DC hold

Energizes motor with a DC holding current (see par.2-00 *DC Hold Current*).

| | | |
|-----|-----------------|--|
| [2] | Motor check | Checks if a motor has been connected. |
| [3] | Pre-magnetizing | Builds up a magnetic field while the motor is stopped. The motor can now produce a quick torque build-up at start. Asynchronous motors only. |
| [4] | DC Voltage U0 | |

1-81 Min Speed for Function at Stop [RPM]

| | |
|-----------------------|--|
| Range: | Function: |
| 3. RPM* [0 - 600 RPM] | Set the speed at which to activate par. 1-80 <i>Function at Stop</i> . |

1-82 Min Speed for Function at Stop [Hz]

| | |
|-------------------------|---|
| Range: | Function: |
| 0.1 Hz* [0.0 - 20.0 Hz] | Set the output frequency at which to activate par. 1-80 <i>Function at Stop</i> . |

1-83 Precise Stop Function

| | |
|-------------------------|--|
| Option: | Function: |
| [0] * Precise ramp stop | Achieves high repetitive precision at the stopping point. |
| [1] Cnt stop with reset | Runs the frequency converter from receipt of a pulse start signal until the number of pulses programmed by the user in par.1-84 <i>Precise Stop Counter Value</i> has been received at input terminal 29 or input terminal 33. An internal stop signal will activate the normal ramp down time (par.3-42 <i>Ramp 1 Ramp Down Time</i> , par.3-52 <i>Ramp 2 Ramp down Time</i> , par.3-62 <i>Ramp 3 Ramp down Time</i> or par.3-72 <i>Ramp 4 Ramp Down Time</i>). The counter function is activated (starts timing) at the edge of the start signal (when it changes from stop to start). After each precise stop the number of pulses counted during ramp down 0 rpm is reset. |
| [2] Cnt stop w/o reset | Same as [1] but the number of pulses counted during ramp down to 0 rpm is deducted from the counter value in par.1-84 <i>Precise Stop Counter Value</i> . |
| [3] Speed comp stop | Stops at precisely the same point, regardless of the present speed, the stop signal is delayed internally when the present speed is lower than the maximum speed (set in par.4-19 <i>Max Output Frequency</i>). |
| [4] Com cnt stop w/rst | Same as [3] but after each precise stop the number of pulses counted during ramp down 0 rpm is reset. |
| [5] Comp cnt stop w/o r | Same as [3] but the number of pulses counted during ramp down to 0 rpm is deducted from the counter value in par.1-84 <i>Precise Stop Counter Value</i> . |

This parameter cannot be adjusted while the motor is running.

1-84 Precise Stop Counter Value

| | |
|----------------------------------|---|
| Range: | Function: |
| 100000 N/ A* [0 - 999999999 N/A] | Enter the counter value to be used in the integrated precise stop function, par.1-83 <i>Precise Stop Function</i> . The maximum permissible frequency at terminal 29 or 33 is 110 kHz. |

1-85 Precise Stop Speed Compensation Delay

| | |
|---------------------|---|
| Range: | Function: |
| 10 ms* [0 - 100 ms] | Enter the delay time for sensors, PLCs, etc. for use in par.1-83 <i>Precise Stop Function</i> . In speed compensated stop mode, the delay time at different frequencies has a major influence on the stop function. |

3.3.9 1-9* Motor Temperature

Parameters for setting the temperature protection features for the motor.

1-90 Motor Thermal Protection

Option:

Function:

The frequency converter determines the motor temperature for motor protection in two different ways:

- Via a thermistor sensor connected to one of the analog or digital inputs (par.1-93 *Thermistor Source*).
- Via calculation (ETR = Electronic Terminal Relay) of the thermal load, based on the actual load and time. The calculated thermal load is compared with the rated motor current $I_{M,N}$ and the rated motor frequency $f_{M,N}$. The calculations estimate the need for a lower load at lower speed due to less cooling from the fan incorporated in the motor.

| | | |
|-------|--------------------|---|
| [0] * | No protection | Continuously overloaded motor, when no warning or trip of the frequency converter is required. |
| [1] | Thermistor warning | Activates a warning when the connected thermistor or KTY-sensor in the motor reacts in the event of motor over-temperature. |
| [2] | Thermistor trip | Stops (trips) frequency converter when connected thermistor in motor reacts in the event of motor over-temperature. The thermistor cut-out value must be $> 3 \text{ k}\Omega$. Integrate a thermistor (PTC sensor) in the motor for winding protection. |
| [3] | ETR warning 1 | Please see detailed description below |
| [4] | ETR trip 1 | |
| [5] | ETR warning 2 | |
| [6] | ETR trip 2 | |
| [7] | ETR warning 3 | |
| [8] | ETR trip 3 | |
| [9] | ETR warning 4 | |
| [10] | ETR trip 4 | |

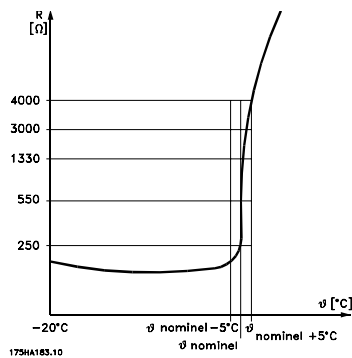

Motor protection can be implemented using a range of techniques: PTC or KTY sensor (see also section *KTY Sensor Connection*) in motor windings; mechanical thermal switch (Klixon type); or Electronic Thermal Relay (ETR).

Using a digital input and 24 V as power supply:

Example: The frequency converter trips when the motor temperature is too high

Parameter set-up:

Set par.1-90 *Motor Thermal Protection* to *Thermistor Trip* [2]

Set par.1-93 *Thermistor Source* to *Digital Input* [6]

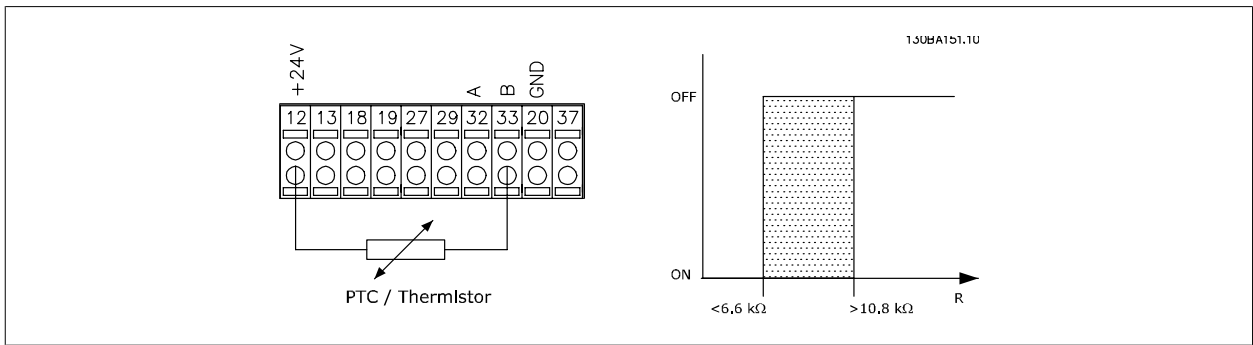

Using a digital input and 10 V as power supply:

Example: The frequency converter trips when the motor temperature is too high.

Parameter set-up:

Set par.1-90 *Motor Thermal Protection* to *Thermistor Trip* [2]

Set par.1-93 *Thermistor Source* to *Digital Input* [6]

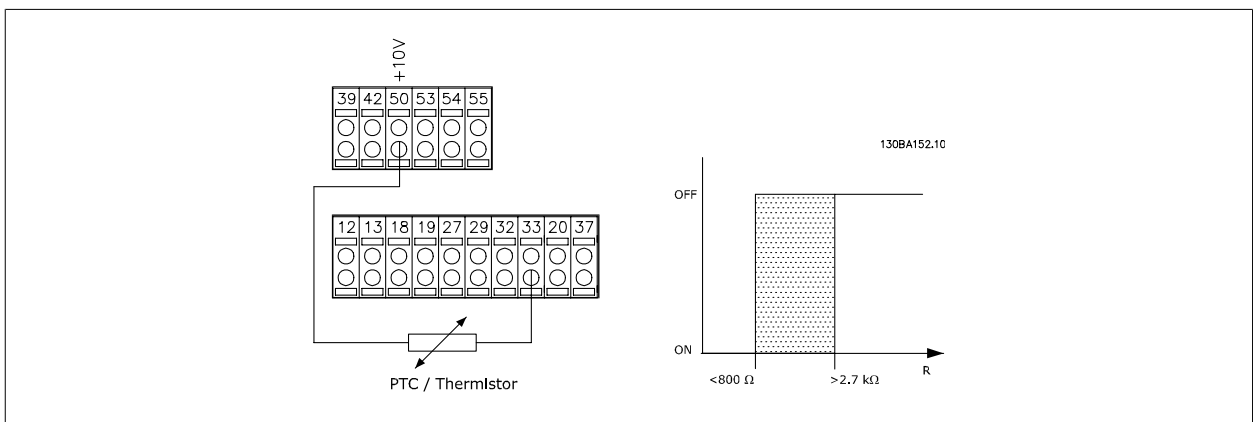

Using an analog input and 10 V as power supply:

Example: The frequency converter trips when the motor temperature is too high.

Parameter set-up:

Set par.1-90 *Motor Thermal Protection* to *Thermistor Trip* [2]

Set par.1-93 *Thermistor Source* to *Analog Input 54* [2]

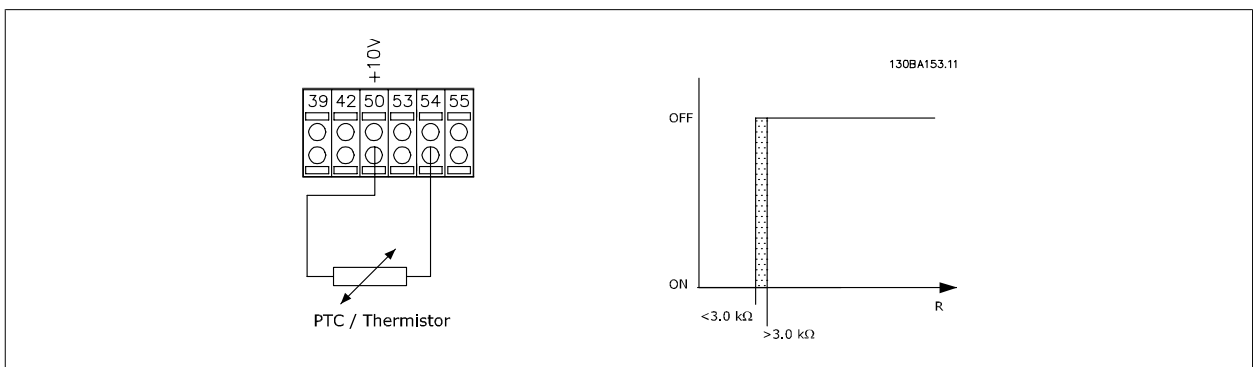

| Input | Supply Voltage | Threshold |
|----------------|----------------|----------------------|
| Digital/analog | Volt | Cut-out Values |
| Digital | 24 V | < 6.6 kΩ - > 10.8 kΩ |
| Digital | 10 V | < 800Ω - > 2.7 kΩ |
| Analog | 10 V | < 3.0 kΩ - > 3.0 kΩ |



NB!

Check that the chosen supply voltage follows the specification of the used thermistor element.

Select *ETR Warning 1-4*, to activate a warning on the display when the motor is overloaded.

Select *ETR Trip 1-4* to trip the frequency converter when the motor is overloaded.

Programme a warning signal via one of the digital outputs. The signal appears in the event of a warning and if the frequency converter trips (thermal warning).

ETR (Electronic Terminal Relay) functions 1-4 will calculate the load when the set-up where they were selected is active. For example ETR starts calculating when setup 3 is selected. For the North American market: The ETR functions provide class 20 motor overload protection in accordance with NEC.

3

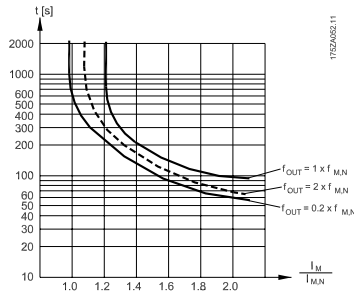

1-91 Motor External Fan

Option:

Function:

[0] * No

No external fan is required, i.e. the motor is derated at low speed.

[1] Yes

Applies an external motor fan (external ventilation), so no derating of the motor is required at low speed. The graph below is followed if the motor current is lower than nominal motor current (see par. 1-24 *Motor Current*). If the motor current exceeds nominal current, the operation time still decreases as if no fan were installed.

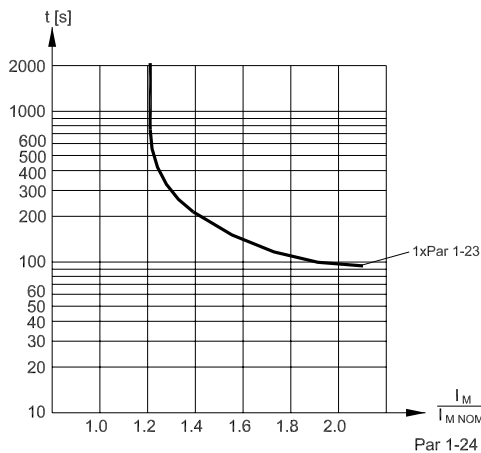

1-93 Thermistor Source

Option:

Function:

Select the input to which the thermistor (PTC sensor) should be connected. An analog input option [1] or [2] cannot be selected if the analog input is already in use as a reference source (selected in par. 3-15 *Reference 1 Source*, par. 3-16 *Reference 2 Source* or par. 3-17 *Reference 3 Source*). When using MCB112, choice [0] *None* must always be selected.

- [0] * None
- [1] Analog input 53
- [2] Analog input 54
- [3] Digital input 18
- [4] Digital input 19
- [5] Digital input 32
- [6] Digital input 33

NB!
This parameter cannot be adjusted while the motor is running.

NB!
Digital inputs should be set to "No operation" - see par. 5-1*.

3.3.10 KTY Sensor Connection

(FC 302 only)

KTY sensors are used especially in Permanent Magnet Servo Motors (PM motors) for dynamic adjusting of motor parameters as stator resistance (par. 1-30 *Stator Resistance (Rs)*) for PM motors and also rotor resistance (par.1-31 *Rotor Resistance (Rr)*) for asynchronous motors, depending on winding temperature. The calculation is:

$$R_s = R_{s20^{\circ}C} \times (1 + \alpha_{cu} \times \Delta T) [\Omega] \text{ where } \alpha_{cu} = 0.00393$$

KTY sensors can be used for motor protecting (par.1-97 *KTY Threshold level*).

FC 302 can handle three types of KTY sensors, defined in par.1-95 *KTY Sensor Type*. The actual sensor temperature can be read out from par. 16-19 *KTY sensor temperature*.

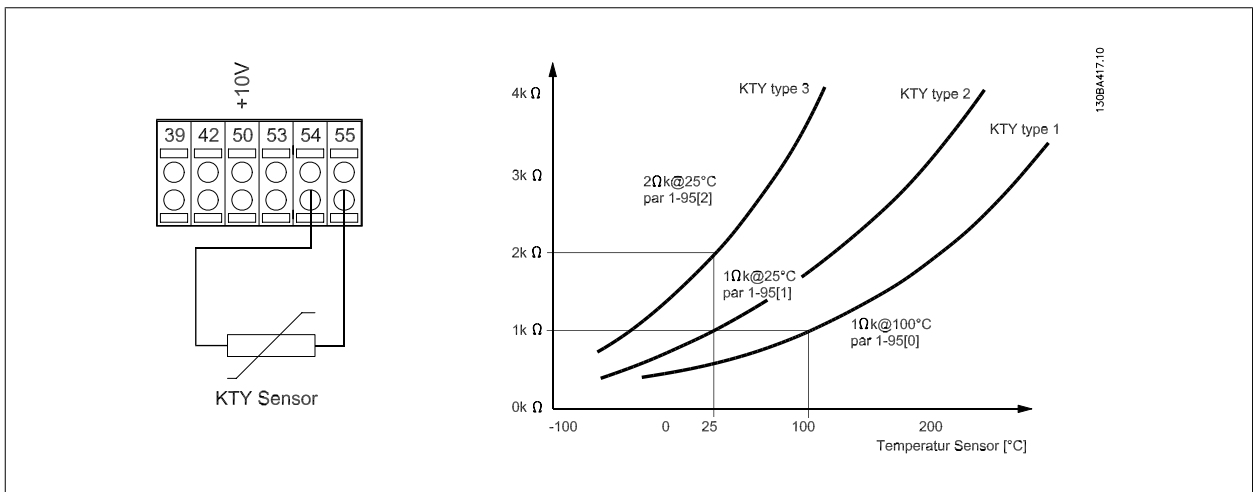

NB!
If the temperature of the motor is utilized through a thermistor or KTY sensor the PELV is not complied with in case of short circuits between motor windings and sensor. In order to comply with PELV the sensor must be extra isolated.

1-95 KTY Sensor Type

Option:
Function:

Select the used type of KTY sensor. This parameter is available for FC 302 only.

| | | |
|-------|--------------|------------------------|
| [0] * | KTY Sensor 1 | 1 k Ω at 100° C |
| [1] | KTY Sensor 2 | 1 k Ω at 25° C |
| [2] | KTY Sensor 3 | 2 k Ω at 25° C |

1-96 KTY Thermistor Resource

Option:
Function:

Selecting analog input terminal 54 to be used as KTY sensor input. Terminal 54 cannot be selected as KTY source if otherwise used as reference (see par.3-15 *Reference Resource 1* to par. 3-17 *Reference Resource 3*).

This parameter is available for FC 302 only.

NB!

Connection of KTY-sensor between term. 54 and 55 (GND). See picture in section *KTY Sensor Connection*.

| | |
|-------|-----------------|
| [0] * | None |
| [2] | Analog input 54 |

1-97 KTY Threshold level

Range:
Function:

80 C* [-40 - 140 C]

Select the KTY sensor threshold level for motor thermal protection.
This parameter is available for FC 302 only.

3.4 Parameters: Brakes

3.4.1 2-** Brakes

Parameter group for setting brake features in the frequency converter.

3.4.2 2-0* DC-Brakes

Parameter group for configuring the DC brake and DC hold functions.

2-00 DC Hold Current

| Range: | Function: |
|--------------------|---|
| 50 %* [0 - 160. %] | <p>Enter a value for holding current as a percentage of the rated motor current $I_{M,N}$ set in par. 1-24 <i>Motor Current</i>. 100% DC holding current corresponds to $I_{M,N}$.</p> <p>This parameter holds the motor function (holding torque) or pre-heats the motor.</p> <p>This parameter is active if <i>DC hold</i> is selected in par.1-72 <i>Start Function</i> [0] or par.1-80 <i>Function at Stop</i> [1].</p> |

NB!
The maximum value depends on the rated motor current.

NB!
Avoid 100 % current for too long. It may damage the motor.

2-01 DC Brake Current

| Range: | Function: |
|---------------------|--|
| 50 %* [0 - 1000. %] | <p>Enter a value for current as a percentage of the rated motor current $I_{M,N}$, see par.1-24 <i>Motor Current</i>. 100% DC braking current corresponds to $I_{M,N}$.</p> <p>DC brake current is applied on a stop command, when the speed is lower than the limit set in par. 2-03 <i>DC Brake Cut In Speed [RPM]</i>; when the DC Brake Inverse function is active; or via the serial communication port. The braking current is active during the time period set in par.2-02 <i>DC Braking Time</i>.</p> |

NB!
The maximum value depends on the rated motor current.

NB!
Avoid 100 % current for too long. It may damage the motor.

2-02 DC Braking Time

| Range: | Function: |
|------------------------|---|
| 10.0 s* [0.0 - 60.0 s] | Set the duration of the DC braking current set in par. 2-01 <i>DC Brake Current</i> , once activated. |

2-03 DC Brake Cut In Speed [RPM]

| Range: | Function: |
|----------------------------|---|
| 0 RPM* [0 - par. 4-13 RPM] | Set the DC brake cut-in speed for activation of the DC braking current set in par.2-01 <i>DC Brake Current</i> , upon a stop command. |

2-04 DC Brake Cut In Speed [Hz]

| Range: | Function: |
|------------------------------|---|
| 0.0 Hz* [0.0 - par. 4-14 Hz] | Set the DC brake cut-in speed for activation of the DC braking current set in par.2-01 <i>DC Brake Current</i> , upon a stop command. |

3.4.3 2-1* Brake Energy Funct.

Parameter group for selecting dynamic braking parameters. Only valid for drives with brake chopper.

2-10 Brake Function

| Option: | Function: |
|--------------------|--|
| [0] * Off | No brake resistor is installed. |
| [1] Resistor brake | A brake resistor is incorporated in the system, for dissipation of surplus brake energy as heat. Connecting a brake resistor allows a higher DC link voltage during braking (generating operation). The Resistor brake function is only active in frequency converters with an integral dynamic brake. |
| [2] AC brake | Is selected to improve braking without using a brake resistor. This parameter controls an overmagnetization of the motor when running with a generative load. This function can improve the OVC-function. Increasing the electrical losses in the motor allows the OVC function to increase the braking torque without exceeding the over voltage limit. Please note that AC brake is not as effective as dynamic braking with resistor. AC brake is for VVC ⁺ and flux mode in both open and closed loop. |

2-11 Brake Resistor (ohm)

| Range: | Function: |
|-------------------------------------|---|
| 50.00 [5.00 - 65535.00 Ohm] Ohm* | Set the brake resistor value in Ohms. This value is used for monitoring the power to the brake resistor in par. 2-13 <i>Brake Power Monitoring</i> . This parameter is only active in frequency converters with an integral dynamic brake. Use this parameter for values without decimals. For a selection with two decimals, use par 30-81. |

2-12 Brake Power Limit (kW)

| Range: | Function: |
|---------------------------------|---|
| 5.000 kW* [0.001 - 2000.000 kW] | Set the monitoring limit of the brake power transmitted to the resistor. The monitoring limit is a product of the maximum duty cycle (120 sec.) and the maximum power of the brake resistor at that duty cycle. See the formula below. |

| | |
|------------------------|---|
| For 200 - 240 V units: | $P_{resistor} = \frac{390^2 \times dutytime}{R \times 120}$ |
| For 380 - 480 V units | $P_{resistor} = \frac{778^2 \times dutytime}{R \times 120}$ |
| For 380 - 500 V units | $P_{resistor} = \frac{810^2 \times dutytime}{R \times 120}$ |
| For 575 - 600 V units | $P_{resistor} = \frac{943^2 \times dutytime}{R \times 120}$ |

This parameter is only active in frequency converters with an integral dynamic brake.

2-13 Brake Power Monitoring

| Option: | Function: |
|----------------------|---|
| [0] * Off | No brake power monitoring required. |
| [1] Warning | This parameter is only active in frequency converters with an integral dynamic brake. This parameter enables monitoring of the power to the brake resistor. The power is calculated on the basis of the resistance (par.2-11 <i>Brake Resistor (ohm)</i>), the DC link voltage, and the resistor duty time. Activates a warning on the display when the power transmitted over 120 s exceeds 100% of the monitoring limit (par.2-12 <i>Brake Power Limit (kW)</i>). The warning disappears when the transmitted power falls below 80% of the monitoring limit. |
| [2] Trip | Trips frequency converter and displays an alarm when the calculated power exceeds 100% of the monitoring limit. |
| [3] Warning and trip | |

If power monitoring is set to *Off*[0] or *Warning* [1], the brake function remains active, even if the monitoring limit is exceeded. This may lead to thermal overload of the resistor. It is also possible to generate a warning via a relay/digital outputs. The measuring accuracy of the power monitoring depends on the accuracy of the resistance of the resistor (better than $\pm 20\%$).

2-15 Brake Check

Option:

Function:

Select type of test and monitoring function to check the connection to the brake resistor, or whether a brake resistor is present, and then display a warning or an alarm in the event of a fault.



NB!

The brake resistor disconnection function is tested during power-up. However the brake IGBT test is performed when there is no braking. A warning or trip disconnects the brake function.

The testing sequence is as follows:

1. The DC link ripple amplitude is measured for 300 ms without braking.
2. The DC link ripple amplitude is measured for 300 ms with the brake turned on.
3. If the DC link ripple amplitude while braking is lower than the DC link ripple amplitude before braking + 1 %: *Brake check has failed by returning a warning or alarm.*
4. If the DC link ripple amplitude while braking is higher than the DC link ripple amplitude before braking + 1 %: *Brake check is OK.*

[0] * Off Monitors brake resistor and brake IGBT for a short-circuit during operation. If a short-circuit occurs, warning 25 appears.

[1] Warning Monitors brake resistor and brake IGBT for a short-circuit, and runs a test for brake resistor disconnection during power-up.

[2] Trip Monitors for a short-circuit or disconnection of the brake resistor, or a short-circuit of the brake IGBT. If a fault occurs, the frequency converter cuts out while displaying an alarm (trip locked).

[3] Stop and trip Monitors for a short-circuit or disconnection of the brake resistor, or a short-circuit of the brake IGBT. If a fault occurs, the frequency converter ramps down to coast and then trips. A trip lock alarm is displayed (e.g. warning 25, 27 or 28).

[4] AC brake Monitors for a short-circuit or disconnection of the brake resistor, or a short-circuit of the brake IGBT. If a fault occurs, the frequency converter performs a controlled ramp down. This option is available for FC 302 only.

[5] Trip Lock



NB!

Remove a warning arising in connection with *Off*[0] or *Warning* [1] by cycling the mains supply. The fault must be corrected first. For *Off*[0] or *Warning* [1], the frequency converter keeps running even if a fault is located.

This parameter is only active in frequency converters with an integral dynamic brake.

2-16 AC brake Max. Current

Range:

100.0 %* [0.0 - 1000.0 %]

Function:

Enter the maximum permissible current when using AC brake to avoid overheating of motor windings. The AC brake function is available in Flux mode only (FC 302 only).

2-17 Over-voltage Control

Option:

Function:

Over-voltage control (OVC) reduces the risk of the frequency converter tripping due to an over voltage on the DC link caused by generative power from the load.

[0] * Disabled No OVC required.

| | | |
|-----|-----------------------|--|
| [1] | Enabled (not at stop) | Activates OVC except when using a stop signal to stop the frequency converter. |
| [2] | Enabled | Activates OVC. |

**NB!**

OVC must not be enabled in hoisting applications.

3

3.4.4 2-18 Brake Check Condition

2-18 Brake Check Condition

Option:**Function:**

| | | |
|-------|------------------------|--|
| [0] * | At Power Up | Brake check will be performed at power up |
| [1] | After Coast Situations | Brake check will be performed after coast situations |

3.4.5 2-2* Mechanical Brake

Parameters for controlling operation of an electro-magnetic (mechanical) brake, typically required in hoisting applications.

To control a mechanical brake, a relay output (relay 01 or relay 02) or a programmed digital output (terminal 27 or 29) is required. Normally this output must be closed during periods when the frequency converter is unable to 'hold' the motor, e.g. due to an excessive load. Select *Mechanical Brake Control* [32] for applications with an electro-magnetic brake in par.5-40 *Function Relay*, par. 5-30 *Terminal 27 Digital Output*, or par. 5-31 *Terminal 29 Digital Output*. When selecting *Mechanical brake control* [32], the mechanical brake is closed from start up until the output current is above the level selected in par.2-20 *Release Brake Current*. During stop, the mechanical brake activates when the speed falls below the level specified in par.2-21 *Activate Brake Speed [RPM]*. If the frequency converter enters an alarm condition or an over-current or over-voltage situation, the mechanical brake immediately cuts in. This is also the case during safe stop.

**NB!**

Protection mode and trip delay features (par.14-25 *Trip Delay at Torque Limit* and par.14-26 *Trip Delay at Inverter Fault*) may delay the activation of the mechanical brake in an alarm condition. These features must be disabled in hoisting applications.

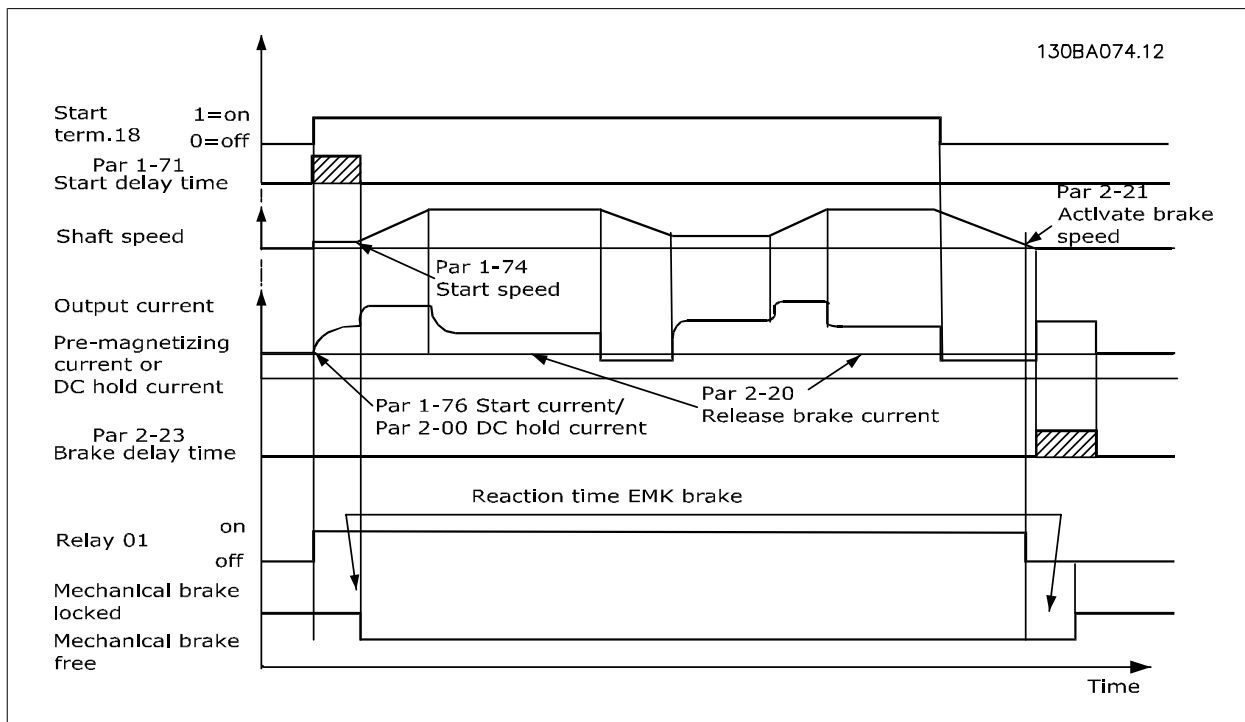

2-20 Release Brake Current

Range:

par. 16-37 [0.00 - par. 16-37 A] A*

Function:

Set the motor current for release of the mechanical brake, when a start condition is present. The upper limit is specified in par.16-37 *Inv. Max. Current*.

2-21 Activate Brake Speed [RPM]

Range:

0 RPM* [0 - 30000 RPM]

Function:

Set the motor speed for activation of the mechanical brake, when a stop condition is present. The upper speed limit is specified in par.4-53 *Warning Speed High*.

2-22 Activate Brake Speed [Hz]

Range:

0 Hz* [0.0 - 5000.0 Hz]

Function:

Set the motor frequency for activation of the mechanical brake, when a stop condition is present.

2-23 Activate Brake Delay

Range:

0.0 s* [0.0 - 5.0 s]

Function:

Enter the brake delay time of the coast after ramp-down time. The shaft is held at zero speed with full holding torque. Ensure that the mechanical brake has locked the load before the motor enters coast mode. See *Mechanical Brake Control* section in the Design Guide.

2-24 Stop Delay

Range:

0.0 s* [0.0 - 5.0 s]

Function:

Set the time interval from the moment when the motor is stopped until the brake closes. This parameter is a part of the stopping function.

2-25 Brake Release Time

Range:

0.20 s* [0.00 - 5.00 s]

Function:

This value defines the time it takes for the mechanical brake to open/ close. This parameter must act as a time-out when brake feedback is activated.

2-26 Torque Ref**Range:**

0.00 %* [0 - 0 %]

Function:

The value defines the torque applied against the closed mechanical brake, before release

2-27 Torque Ramp Time**Range:**

0.2 s* [0.0 - 5.0 s]

Function:

The value defines the duration of the torque ramp in clockwise direction.

2-28 Gain Boost Factor**Range:**

1.00 N/A* [1.00 - 4.00 N/A]

Function:

Only active in flux closed loop. The function ensures a smooth transition from torque control mode to speed control mode when the motor takes over the load from the brake.

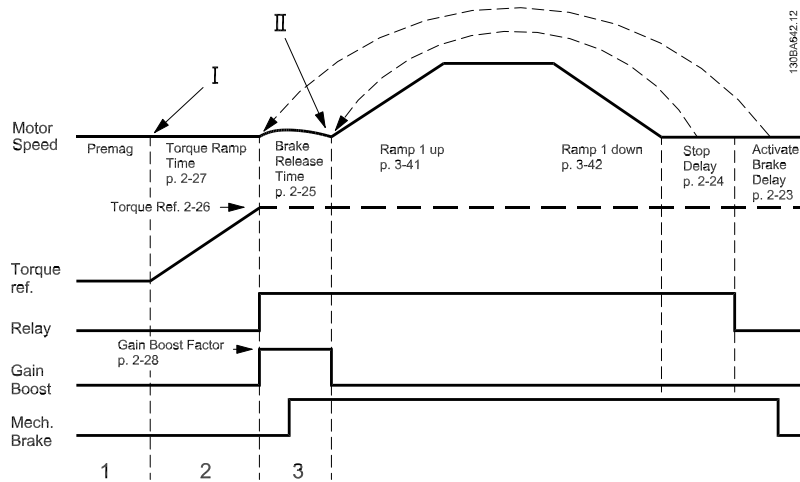

Illustration 3.6: Brake release sequence for hoist mechanical brake control

I) *Activate brake delay*: The frequency converter starts again from the *mechanical brake engaged* position.II) *Stop delay*: When the time between successive starts is shorter than the setting in par.2-24 *Stop Delay*, the frequency converter starts without applying the mechanical brake (e.g. reversing).

3.5 Parameters: Reference/Ramps

3.5.1 3-** Reference/Reference Limits/Ramps

Parameters for reference handling, definition of limitations, and configuration of the reaction of the frequency converter to changes.

3.5.2 3-0* Reference Limits

Parameters for setting the reference unit, limits and ranges.

3-00 Reference Range

| Option: | Function: |
|-------------------|--|
| | Select the range of the reference signal and the feedback signal. Signal values can be positive only, or positive and negative. The minimum limit may have a negative value, unless <i>Speed closed loop</i> [1] control or <i>Process</i> [3] is selected in par.1-00 <i>Configuration Mode</i> . |
| [0] Min - Max | Select the range of the reference signal and the feedback signal. Signal values can be positive only, or positive and negative. The minimum limit may have a negative value, unless <i>Speed closed loop</i> [1] control or <i>Process</i> [3] is selected in par.1-00 <i>Configuration Mode</i> . |
| [1] * -Max - +Max | For both positive and negative values (both directions, relative to par.4-10 <i>Motor Speed Direction</i>). |

3-01 Reference/Feedback Unit

| Option: | Function: |
|--------------------------|---|
| | Select the unit to be used in Process PID Control references and feedbacks. |
| [0] * None | |
| [1] % | |
| [2] RPM | |
| [3] Hz | |
| [4] Nm | |
| [5] PPM | |
| [10] 1/min | |
| [12] Pulse/s | |
| [20] l/s | |
| [21] l/min | |
| [22] l/h | |
| [23] m ³ /s | |
| [24] m ³ /min | |
| [25] m ³ /h | |
| [30] kg/s | |
| [31] kg/min | |
| [32] kg/h | |
| [33] t/min | |
| [34] t/h | |
| [40] m/s | |
| [41] m/min | |
| [45] m | |
| [60] °C | |
| [70] mbar | |
| [71] bar | |

| | |
|-------|----------------------|
| [72] | Pa |
| [73] | kPa |
| [74] | m WG |
| [80] | kW |
| [120] | GPM |
| [121] | gal/s |
| [122] | gal/min |
| [123] | gal/h |
| [124] | CFM |
| [125] | ft ³ /s |
| [126] | ft ³ /min |
| [127] | ft ³ /h |
| [130] | lb/s |
| [131] | lb/min |
| [132] | lb/h |
| [140] | ft/s |
| [141] | ft/min |
| [145] | ft |
| [150] | lb ft |
| [160] | °F |
| [170] | psi |
| [171] | lb/in ² |
| [172] | in WG |
| [173] | ft WG |
| [180] | HP |

3-02 Minimum Reference

Range:

0 Referen- [-999999.999 - par. 3-03 Referen-
ceFeedback-ceFeedbackUnit]
Unit*

Function:

Enter the Minimum Reference. The Minimum Reference is the lowest value obtainable by summing all references.

Minimum Reference is active only when par.3-00 *Reference Range* is set to *Min. - Max.* [0].

The Minimum Reference unit matches:

- The choice of configuration in par.1-00 *Configuration Mode Configuration Mode*: for *Speed closed loop* [1], RPM; for *Torque* [2], Nm.
- The unit selected in par.3-01 *Reference/Feedback Unit*.

3-03 Maximum Reference

Range:

1500.000 [par. 3-02 - 999999.999 Referen-
Reference- ceFeedbackUnit]
FeedbackU-
nit*

Function:

Enter the Maximum Reference. The Maximum Reference is the highest value obtainable by summing all references.

The Maximum Reference unit matches:

- The choice of configuration in par.1-00 *Configuration Mode*: for *Speed closed loop* [1], RPM; for *Torque* [2], Nm.
- The unit selected in par.3-00 *Reference Range*.

3-04 Reference Function

Option:

[0] * Sum
[1] External/Preset

Function:

Sums both external and preset reference sources.

Use either the preset or the external reference source.

Shift between external and preset via a command on a digital input.

3.5.3 3-1* References

Parameters for setting up the reference sources.

Select the preset reference(s). *Select Preset ref. bit 0 / 1 / 2* [16], [17] or [18] for the corresponding digital inputs in parameter group 5.1*.

3-10 Preset Reference

Array [8]

Range: 0-7

Range:

0.00 %* [-100.00 - 100.00 %]

Function:

Enter up to eight different preset references (0-7) in this parameter, using array programming. The preset reference is stated as a percentage of the value Ref_{MAX} (par.3-03 *Maximum Reference*) If a Ref_{MIN} different from 0 (par.3-02 *Minimum Reference*) is programmed, the preset reference is calculated as a percentage of the full reference range, i.e. on the basis of the difference between Ref_{MAX} and Ref_{MIN}. Afterwards, the value is added to Ref_{MIN}. When using preset references, select Preset ref. bit 0 / 1 / 2 [16], [17] or [18] for the corresponding digital inputs in parameter group 5-1*.

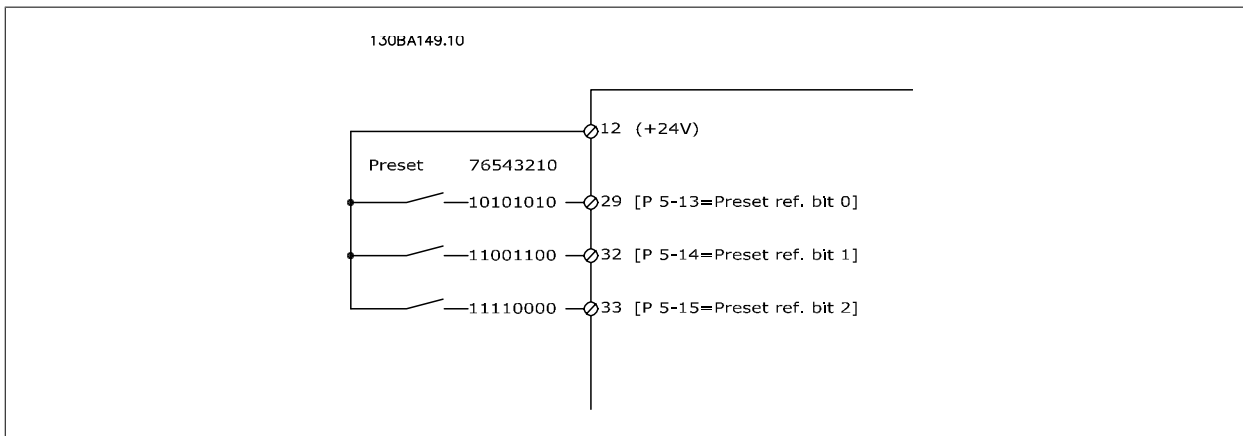

| Preset ref. bit | 2 | 1 | 0 |
|-----------------|---|---|---|
| Preset ref. 0 | 0 | 0 | 0 |
| Preset ref. 1 | 0 | 0 | 1 |
| Preset ref. 2 | 0 | 1 | 0 |
| Preset ref. 3 | 0 | 1 | 1 |
| Preset ref. 4 | 1 | 0 | 0 |
| Preset ref. 5 | 1 | 0 | 1 |
| Preset ref. 6 | 1 | 1 | 0 |
| Preset ref. 7 | 1 | 1 | 1 |

3-11 Jog Speed [Hz]

Range:

0 Hz* [0.0 - par. 4-14 Hz]

Function:

The jog speed is a fixed output speed at which the frequency converter is running when the jog function is activated.
See also par.3-80 *Jog Ramp Time*.

3-12 Catch up/slow Down Value

Range:

0.00 %* [0.00 - 100.00 %]

Function:

Enter a percentage (relative) value to be either added to or deducted from the actual reference for Catch up or Slow down respectively. If *Catch up* is selected via one of the digital inputs (par. 5-10 *Terminal 18 Digital Input* to par. 5-15 *Terminal 33 Digital Input*), the percentage (relative) value is added to the total reference. If *Slow down* is selected via one of the digital inputs

(par. 5-10 *Terminal 18 Digital Input* to par. 5-15 *Terminal 33 Digital Input*), the percentage (relative) value is deducted from the total reference. Obtain extended functionality with the DigiPot function. See parameter group 3-9* *Digital Potentiometer*.

3-13 Reference Site

| Option: | Function: |
|----------------------------------|---|
| | Select which reference site to activate. |
| [0] * Linked to Hand / Auto | Use local reference when in Hand mode; or remote reference when in Auto mode. |
| [1] Remote | Use remote reference in both Hand mode and Auto mode. |
| [2] Local | Use local reference in both Hand mode and Auto mode. |



NB!

When set to Local [2], the frequency converter will start with this setting again following a 'power down'.

3

3-14 Preset Relative Reference

| Range: | Function: |
|-----------------------------------|--|
| 0.00 %* [-100.00 - 100.00 %] | The actual reference, X, is increased or decreased with the percentage Y, set in par.3-14 <i>Preset Relative Reference</i> . This results in the actual reference Z. Actual reference (X) is the sum of the inputs selected in par. 3-15 <i>Reference 1 Source</i> , par. 3-16 <i>Reference 2 Source</i> , par. 3-17 <i>Reference 3 Source</i> and par. 8-02 <i>Control Source</i> . |

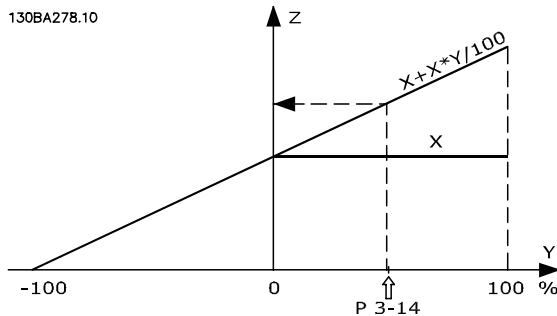
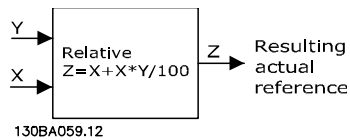

3-15 Reference Resource 1

| Option: | Function: |
|-----------------------------|---|
| | Select the reference input to be used for the first reference signal. par.3-15 <i>Reference Resource 1</i> , par.3-16 <i>Reference Resource 2</i> and par.3-17 <i>Reference Resource 3</i> define up to three different reference signals. The sum of these reference signals defines the actual reference. |
| [0] No function | |
| [1] * Analog input 53 | |
| [2] Analog input 54 | |
| [7] Frequency input 29 | |
| [8] Frequency input 33 | |

| | | |
|------|---------------------|-------------------------------------|
| [11] | Local bus reference | |
| [20] | Digital pot.meter | |
| [21] | Analog input X30-11 | (General Purpose I/O Option Module) |
| [22] | Analog input X30-12 | (General Purpose I/O Option Module) |

3-16 Reference Resource 2

Option: **Function:**
 Select the reference input to be used for the second reference signal. par.3-15 *Reference Resource 1*, par.3-16 *Reference Resource 2* and par.3-17 *Reference Resource 3* define up to three different reference signals. The sum of these reference signals defines the actual reference.

| | |
|--------|---------------------|
| [0] | No function |
| [1] | Analog input 53 |
| [2] | Analog input 54 |
| [7] | Frequency input 29 |
| [8] | Frequency input 33 |
| [11] | Local bus reference |
| [20] * | Digital pot.meter |
| [21] | Analog input X30-11 |
| [22] | Analog input X30-12 |

3-17 Reference Resource 3

Option: **Function:**
 Select the reference input to be used for the third reference signal. par.3-15 *Reference Resource 1*, par.3-16 *Reference Resource 2* and par.3-17 *Reference Resource 3* define up to three different reference signals. The sum of these reference signals defines the actual reference.

| | |
|--------|---------------------|
| [0] | No function |
| [1] | Analog input 53 |
| [2] | Analog input 54 |
| [7] | Frequency input 29 |
| [8] | Frequency input 33 |
| [11] * | Local bus reference |
| [20] | Digital pot.meter |
| [21] | Analog input X30-11 |
| [22] | Analog input X30-12 |

3-18 Relative Scaling Reference Resource

Option: **Function:**
 Select a variable value to be added to the fixed value (defined in par.3-14 *Preset Relative Reference*). The sum of the fixed and variable values (labelled Y in the illustration below) is multiplied with the actual reference (labelled X in the illustration below). This product is then added to the actual reference ($X+X*Y/100$) to give the resultant actual reference.

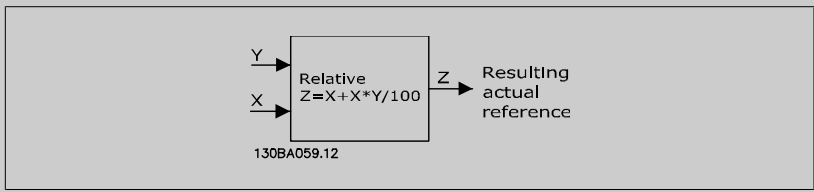

This parameter cannot be adjusted while the motor is running.

| | |
|-------|-------------|
| [0] * | No function |
|-------|-------------|

| | |
|------|---------------------|
| [1] | Analog input 53 |
| [2] | Analog input 54 |
| [7] | Frequency input 29 |
| [8] | Frequency input 33 |
| [11] | Local bus reference |
| [20] | Digital pot.meter |
| [21] | Analog input X30-11 |
| [22] | Analog input X30-12 |

3-19 Jog Speed [RPM]

Range:

150. RPM* [0 - par. 4-13 RPM]

Function:

Enter a value for the jog speed n_{JOG} , which is a fixed output speed. The frequency converter runs at this speed when the jog function is activated. The maximum limit is defined in par.4-13 *Motor Speed High Limit [RPM]*.

See also par.3-80 *Jog Ramp Time*.

3.5.4 Ramps

3-4* Ramp 1

For each of four ramps (par. 3-4*, par. 3-5*, par. 3-6* and par. 3-7*) configure the ramp parameters: ramp type, ramping times (duration of acceleration and deceleration) and level of jerk compensation for S ramps.

Start by setting the linear ramping times corresponding to the figures.

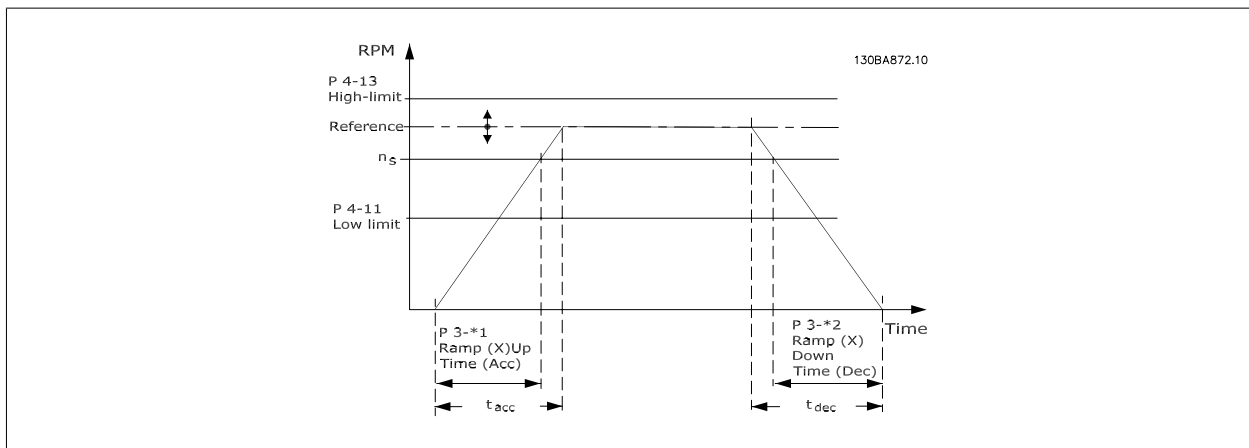

If S-ramps are selected then set the level of non-linear jerk compensation required. Set jerk compensation by defining the proportion of ramp-up and ramp-down times where acceleration and deceleration are variable (i.e. increasing or decreasing). The S-ramp acceleration and deceleration settings are defined as a percentage of the actual ramp time.

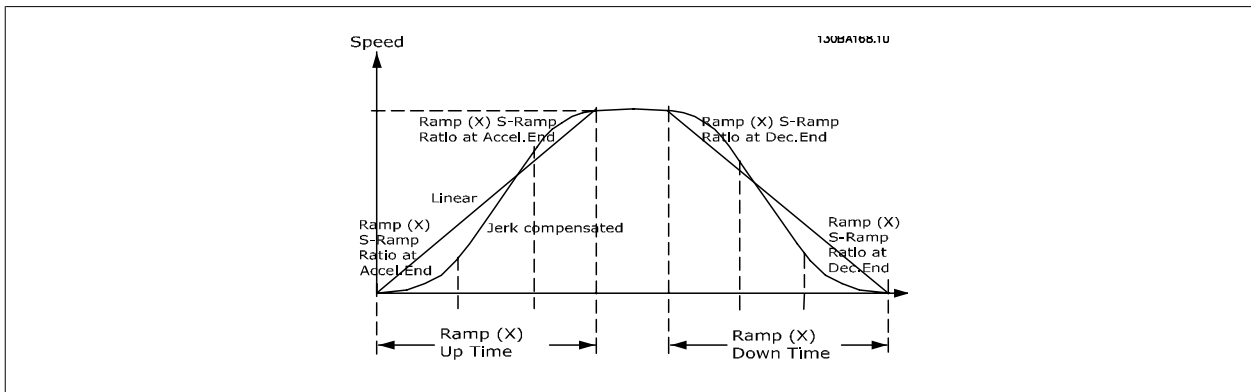

3-40 Ramp 1 Type

Option: **Function:**
 Select the ramp type, depending on requirements for acceleration/deceleration. A linear ramp will give constant acceleration during ramping. An S-ramp will give non-linear acceleration, compensating for jerk in the application.

- [0] * Linear
- [1] S-ramp Const Jerk Acceleration with lowest possible jerk.
- [2] S-ramp Const Time S-ramp based on the values set in par.3-41 *Ramp 1 Ramp up Time* and par.3-42 *Ramp 1 Ramp Down Time*.

NB!
 If S-ramp [1] is selected and the reference during ramping is changed the ramp time may be prolonged in order to realize a jerk free movement which may result in a longer start or stop time. Additional adjustment of the S-ramp ratios or switching initiators may be necessary.

3-41 Ramp 1 Ramp up Time

Range: 3.00 s* [0.01 - 3600.00 s] **Function:** Enter the ramp-up time, i.e. the acceleration time from 0 RPM to the synchronous motor speed n_s . Choose a ramp-up time such that the output current does not exceed the current limit in par. 4-18 *Current Limit* during ramping. The value 0.00 corresponds to 0.01 sec. in speed mode. See ramp-down time in par.3-42 *Ramp 1 Ramp Down Time*.

$$Par. 3 - 41 = \frac{t_{acc} [s] \times n_s [RPM]}{ref [RPM]}$$

3-42 Ramp 1 Ramp Down Time

Range: 3.00 s* [0.01 - 3600.00 s] **Function:** Enter the ramp-down time, i.e. the deceleration time from the synchronous motor speed n_s to 0 RPM. Choose a ramp-down time such that no over-voltage arises in the inverter due to regenerative operation of the motor, and such that the generated current does not exceed the current limit set in par.4-18 *Current Limit*. The value 0.00 corresponds to 0.01 s in speed mode. See ramp-up time in par.3-41 *Ramp 1 Ramp up Time*.

$$Par. 3 - 42 = \frac{t_{dec} [s] \times n_s [RPM]}{ref [RPM]}$$

3-45 Ramp 1 S-ramp Ratio at Accel. Start

Range: 50 %* [1 - 99. %] **Function:** Enter the proportion of the total ramp-up time (par.3-41 *Ramp 1 Ramp up Time*) in which the acceleration torque increases. The larger the percentage value, the greater the jerk compensation achieved, and thus the lower the torque jerks occurring in the application.

3-46 Ramp 1 S-ramp Ratio at Accel. End**Range:**

50 %* [1 - 99. %]

Function:

Enter the proportion of the total ramp-up time (par.3-41 *Ramp 1 Ramp up Time*) in which the acceleration torque decreases. The larger the percentage value, the greater the jerk compensation achieved, and thus the lower the torque jerks in the application.

3-47 Ramp 1 S-ramp Ratio at Decel. Start**Range:**

50 %* [1 - 99. %]

Function:

Enter the proportion of the total ramp-down time (par.3-42 *Ramp 1 Ramp Down Time*) where the deceleration torque increases. The larger the percentage value, the greater the jerk compensation achieved, and thus the lower the torque jerks in the application.

3-48 Ramp 1 S-ramp Ratio at Decel. End**Range:**

50 %* [1 - 99. %]

Function:

Enter the proportion of the total ramp-down time (par.3-42 *Ramp 1 Ramp Down Time*) where the deceleration torque decreases. The larger the percentage value, the greater the jerk compensation achieved, and thus the lower the torque jerks in the application.

3.5.5 3-5* Ramp 2

Choosing ramp parameters, see 3-4*.

3-50 Ramp 2 Type**Option:**

[0] * Linear

[1] S-ramp Const Jerk

[2] S-ramp Const Time

Function:

Select the ramp type, depending on requirements for acceleration/deceleration. A linear ramp will give constant acceleration during ramping. An S-ramp will give non-linear acceleration, compensating for jerk in the application.

Acceleration with lowest possible jerk

S-ramp based on the values set in par.3-51 *Ramp 2 Ramp up Time* and par.3-52 *Ramp 2 Ramp down Time*

**NB!**

If S-ramp [1] is selected and the reference during ramping is changed the ramp time may be prolonged in order to realize a jerk free movement which may result in a longer start or stop time.

Additional adjustment of the S-ramp ratios or switching initiators may be necessary.

3-51 Ramp 2 Ramp up Time**Range:**

3.00 s* [0.01 - 3600.00 s]

Function:

Enter the ramp-up time, i.e. the acceleration time from 0 RPM to the rated motor speed n_s . Choose a ramp-up time such that the output current does not exceed the current limit in par.4-18 *Current Limit* during ramping. The value 0.00 corresponds to 0.01 sec. in speed mode. See ramp-down time in par.3-52 *Ramp 2 Ramp down Time*.

$$Par. 3 - 51 = \frac{t_{acc}[s] \times n_s[RPM]}{ref[RPM]}$$

3-52 Ramp 2 Ramp down Time**Range:**

3.00 s* [0.01 - 3600.00 s]

Function:

Enter the ramp-down time, i.e. the deceleration time from the rated motor speed n_s to 0 RPM. Choose a ramp-down time such that no over-voltage arises in the inverter due to regenerative operation of the motor, and such that the generated current does not exceed the current limit set

in par.4-18 *Current Limit*. The value 0.00 corresponds to 0.01 s in speed mode. See ramp-up time in par.3-51 *Ramp 2 Ramp up Time*.

$$Par. 3 - 52 = \frac{t_{dec} [s] \times n_s [RPM]}{ref [RPM]}$$

3-55 Ramp 2 S-ramp Ratio at Accel. Start

| | |
|-------------------|--|
| Range: | Function: |
| 50 %* [1 - 99. %] | Enter the proportion of the total ramp-up time (par.3-51 <i>Ramp 2 Ramp up Time</i>) in which the acceleration torque increases. The larger the percentage value, the greater the jerk compensation achieved, and thus the lower the torque jerks in the application. |

3-56 Ramp 2 S-ramp Ratio at Accel. End

| | |
|-------------------|--|
| Range: | Function: |
| 50 %* [1 - 99. %] | Enter the proportion of the total ramp-up time (par.3-51 <i>Ramp 2 Ramp up Time</i>) in which the acceleration torque decreases. The larger the percentage value, the greater the jerk compensation achieved, and thus the lower the torque jerks in the application. |

3-57 Ramp 2 S-ramp Ratio at Decel. Start

| | |
|-------------------|---|
| Range: | Function: |
| 50 %* [1 - 99. %] | Enter the proportion of the total ramp-down time (par.3-52 <i>Ramp 2 Ramp down Time</i>) where the deceleration torque increases. The larger the percentage value, the greater the jerk compensation achieved, and thus the lower the torque jerks in the application. |

3-58 Ramp 2 S-ramp Ratio at Decel. End

| | |
|-------------------|---|
| Range: | Function: |
| 50 %* [1 - 99. %] | Enter the proportion of the total ramp-down time (par.3-52 <i>Ramp 2 Ramp down Time</i>) where the deceleration torque decreases. The larger the percentage value, the greater the jerk compensation achieved, and thus the lower the torque jerks in the application. |

3.5.6 3-6* Ramp 3

Configure ramp parameters, see 3-4*.

3-60 Ramp 3 Type

| | |
|-----------------------|---|
| Option: | Function: |
| | Select the ramp type, depending on requirements for acceleration and deceleration. A linear ramp will give constant acceleration during ramping. An S-ramp will give non-linear acceleration, compensating for jerk in the application. |
| [0] * Linear | |
| [1] S-ramp Const Jerk | Accelerates with lowest possible jerk. |
| [2] S-ramp Const Time | S-ramp based on the values set in par.3-61 <i>Ramp 3 Ramp up Time</i> and par.3-62 <i>Ramp 3 Ramp down Time</i> |



NB!

If S-ramp [1] is selected and the reference during ramping is changed the ramp time may be prolonged in order to realize a jerk free movement which may result in a longer start or stop time.
Additional adjustment of the S-ramp ratios or switching initiators may be necessary.

3-61 Ramp 3 Ramp up Time**Range:**

3.00 s* [0.01 - 3600.00 s]

Function:

Enter the ramp-up time, i.e. the acceleration time from 0 RPM to the rated motor speed n_s . Choose a ramp-up time such that the output current does not exceed the current limit in par.4-18 *Current Limit* during ramping. The value 0.00 corresponds to 0.01 sec. in speed mode. See ramp-down time in par.3-62 *Ramp 3 Ramp down Time*.

3-62 Ramp 3 Ramp down Time**Range:**

3.00 s* [0.01 - 3600.00 s]

Function:

Enter the ramp-down time, i.e. the deceleration time from the rated motor speed n_s to 0 RPM. Choose a ramp-down time such that no over-voltage arises in the inverter due to regenerative operation of the motor, and such that the generated current does not exceed the current limit set in par.4-18 *Current Limit*. The value 0.00 corresponds to 0.01 s in speed mode. See ramp-up time in par.3-61 *Ramp 3 Ramp up Time*.

$$\text{Par. 3 - 62} = \frac{t_{dec} [s] \times n_s [RPM]}{ref [RPM]}$$

3-65 Ramp 3 S-ramp Ratio at Accel. Start**Range:**

50 %* [1 - 99. %]

Function:

Enter the proportion of the total ramp-up time (par.3-61 *Ramp 3 Ramp up Time*) in which the acceleration torque increases. The larger the percentage value, the greater the jerk compensation achieved, and thus the lower the torque jerks in the application.

3-66 Ramp 3 S-ramp Ratio at Accel. End**Range:**

50 %* [1 - 99. %]

Function:

Enter the proportion of the total ramp-up time (par.3-61 *Ramp 3 Ramp up Time*) in which the acceleration torque decreases. The larger the percentage value, the greater the jerk compensation achieved, and thus the lower the torque jerks in the application.

3-67 Ramp 3 S-ramp Ratio at Decel. Start**Range:**

50 %* [1 - 99. %]

Function:

Enter the proportion of the total ramp-down time (par.3-62 *Ramp 3 Ramp down Time*) where the deceleration torque increases. The larger the percentage value, the greater the jerk compensation achieved, and thus the lower the torque jerks in the application.

3-68 Ramp 3 S-ramp Ratio at Decel. End**Range:**

50 %* [1 - 99. %]

Function:

Enter the proportion of the total ramp-downdecel time (par.3-62 *Ramp 3 Ramp down Time*) where the deceleration torque decreases. The larger the percentage value, the greater the jerk compensation achieved, and thus the lower the torque jerks in the application.

3.5.7 3-7* Ramp 4

Configure ramp parameters, see 3-4*.

3-70 Ramp 4 Type**Option:**

[0] * Linear

[1] S-ramp Const Jerk

Function:

Select the ramp type, depending on requirements for acceleration and deceleration. A linear ramp will give constant acceleration during ramping. An S-ramp will give non-linear acceleration, compensating for jerk in the application

Accelerates with lowest possible jerk.

[2] S-ramp Const Time S-ramp based on the values set in par.3-71 *Ramp 4 Ramp up Time* and par.3-72 *Ramp 4 Ramp Down Time*.

NB!
 If S-ramp [1] is selected and the reference during ramping is changed the ramp time may be prolonged in order to realize a jerk free movement which may result in a longer start or stop time.
 Additional adjustment of the S-ramp ratios or switching initiators may be necessary.

3-71 Ramp 4 Ramp up Time

| | | |
|----------------------------|---|--|
| Range: | Function: | |
| 3.00 s* [0.01 - 3600.00 s] | Enter the ramp-up time, i.e. the acceleration time from 0 RPM to the rated motor speed n_s . Choose a ramp-up time such that the output current does not exceed the current limit in par.4-18 <i>Current Limit</i> during ramping. The value 0.00 corresponds to 0.01 sec. in speed mode. See ramp-down time in par.3-72 <i>Ramp 4 Ramp Down Time</i> . | |
| | | $Par. 3 - 71 = \frac{t_{acc} [s] \times n_s [RPM]}{ref [RPM]}$ |

3-72 Ramp 4 Ramp Down Time

| | | |
|----------------------------|---|--|
| Range: | Function: | |
| 3.00 s* [0.01 - 3600.00 s] | Enter the ramp-down time, i.e. the deceleration time from the rated motor speed n_s to 0 RPM. Choose a ramp-down time such that no over-voltage arises in the inverter due to regenerative operation of the motor, and such that the generated current does not exceed the current limit set in par.4-18 <i>Current Limit</i> . The value 0.00 corresponds to 0.01 s in speed mode. See ramp-up time in par.3-71 <i>Ramp 4 Ramp up Time</i> . | |
| | | $Par. 3 - 72 = \frac{t_{dec} [s] \times n_s [RPM]}{ref [RPM]}$ |

3-75 Ramp 4 S-ramp Ratio at Accel. Start

| | | |
|-------------------|--|--|
| Range: | Function: | |
| 50 %* [1 - 99. %] | Enter the proportion of the total ramp-up time (par.3-71 <i>Ramp 4 Ramp up Time</i>) in which the acceleration torque increases. The larger the percentage value, the greater the jerk compensation achieved, and thus the lower the torque jerks in the application. | |

3-76 Ramp 4 S-ramp Ratio at Accel. End

| | | |
|-------------------|--|--|
| Range: | Function: | |
| 50 %* [1 - 99. %] | Enter the proportion of the total ramp-up time (par.3-71 <i>Ramp 4 Ramp up Time</i>) in which the acceleration torque decreases. The larger the percentage value, the greater the jerk compensation achieved, and thus the lower the torque jerks in the application. | |

3-77 Ramp 4 S-ramp Ratio at Decel. Start

| | | |
|-------------------|---|--|
| Range: | Function: | |
| 50 %* [1 - 99. %] | Enter the proportion of the total ramp-down time (par.3-72 <i>Ramp 4 Ramp Down Time</i>) where the deceleration torque increases. The larger the percentage value, the greater the jerk compensation achieved, and thus the lower the torque jerks in the application. | |

3-78 Ramp 4 S-ramp Ratio at Decel. End

| | | |
|-------------------|---|--|
| Range: | Function: | |
| 50 %* [1 - 99. %] | Enter the proportion of the total ramp-down time (par.3-72 <i>Ramp 4 Ramp Down Time</i>) where the deceleration torque decreases. The larger the percentage value, the greater the jerk compensation achieved, and thus the lower the torque jerks in the application. | |

3.5.8 3-8* Other Ramps

Configure parameters for special ramps e.g. Jog or Quick Stop.

3-80 Jog Ramp Time

Range:

3.00 s* [0.01 - 3600.00 s]

Function:

Enter the jog ramp time, i.e. the acceleration/deceleration time between 0 RPM and the rated motor frequency n_s . Ensure that the resultant output current required for the given jog ramp time does not exceed the current limit in par.4-18 *Current Limit*. The jog ramp time starts upon activation of a jog signal via the control panel, a selected digital input, or the serial communication port.

3

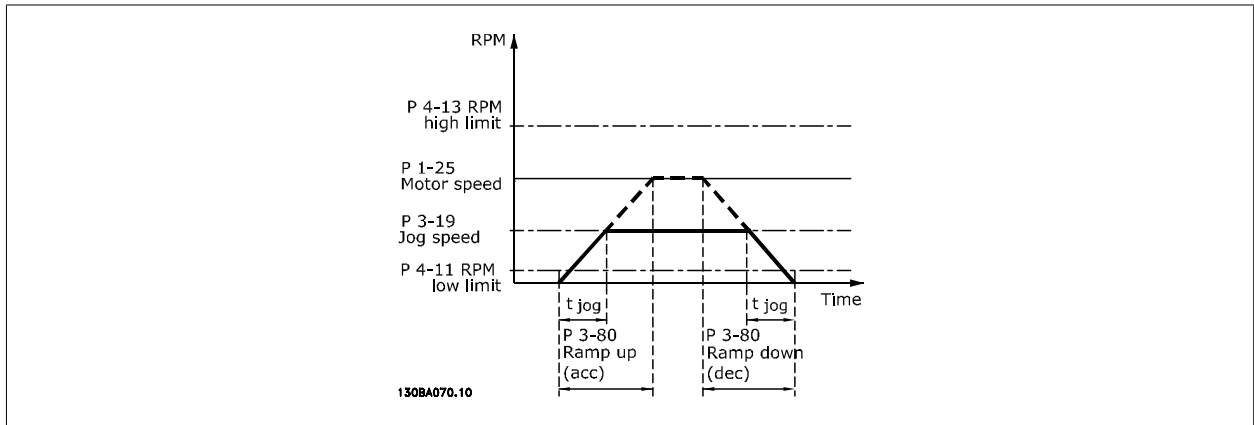

$$Par. 3 - 80 = \frac{t_{jog} [s] \times n_s [RPM]}{\Delta \log \text{ speed} (par. 3 - 19) [RPM]}$$

3-81 Quick Stop Ramp Time

Range:

3.00 s* [0.01 - 3600.00 s]

Function:

Enter the quick-stop ramp-down time, i.e. the deceleration time from the synchronous motor speed to 0 RPM. Ensure that no resultant over-voltage will arise in the inverter due to regenerative operation of the motor required to achieve the given ramp-down time. Ensure also that the generated current required to achieve the given ramp-down time does not exceed the current limit (set in par. 4-18 *Current Limit*). Quick-stop is activated by means of a signal on a selected digital input, or via the serial communication port.

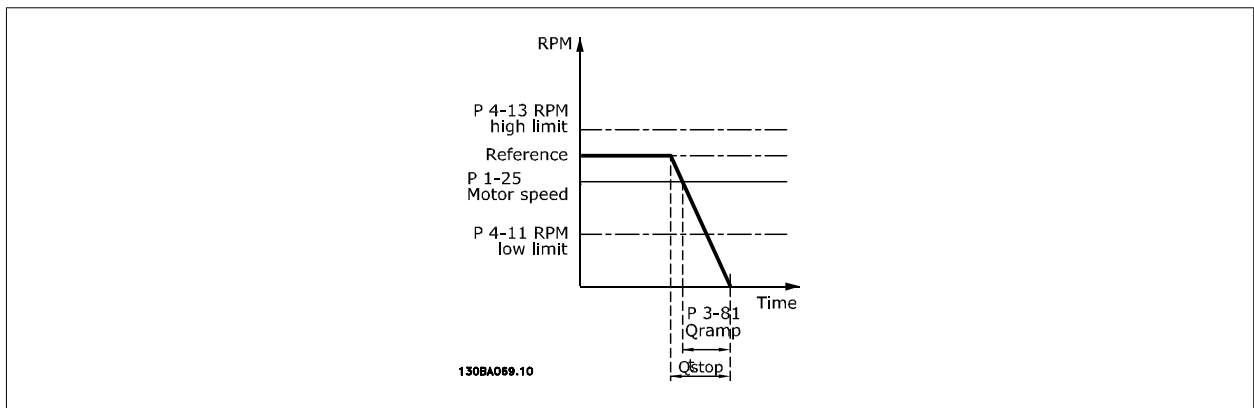

$$Par. 3 - 81 = \frac{t_{Qstop} [s] \times n_s [RPM]}{\Delta \log \text{ ref} (par. 3 - 19) [RPM]}$$

3-82 Quick Stop Ramp Type

Option:

Function:

Select the ramp type, depending on requirements for acceleration and deceleration. A linear ramp will give constant acceleration during ramping. An S-ramp will give non-linear acceleration, compensating for jerk in the application.

- [0] * Linear
- [1] S-ramp Const Jerk
- [2] S-ramp Const Time

3-83 Quick Stop S-ramp Ratio at Decel. Start

Range:

Function:

50 %* [1 - 99. %]

Enter the proportion of the total ramp-down time (par. 3-42) where the deceleration torque increases. The larger the percentage value, the greater the jerk compensation achieved, and thus the lower the torque jerks in the application.

3-84 Quick Stop S-ramp Ratio at Decel. End

Range:

Function:

50 %* [1 - 99. %]

Enter the proportion of the total ramp-down time (par. 3-42) where the deceleration torque decreases. The larger the percentage value, the greater the jerk compensation achieved, and thus the lower the torque jerks in the application.

3.5.9 3-9* Digital Pot.Meter

The digital potentiometer function allows the user to increase or decrease the actual reference by adjusting the set-up of the digital inputs using the functions *Increase*, *Decrease* or *Clear*. To activate the function, at least one digital input must be set up to *Increase* or *Decrease*.

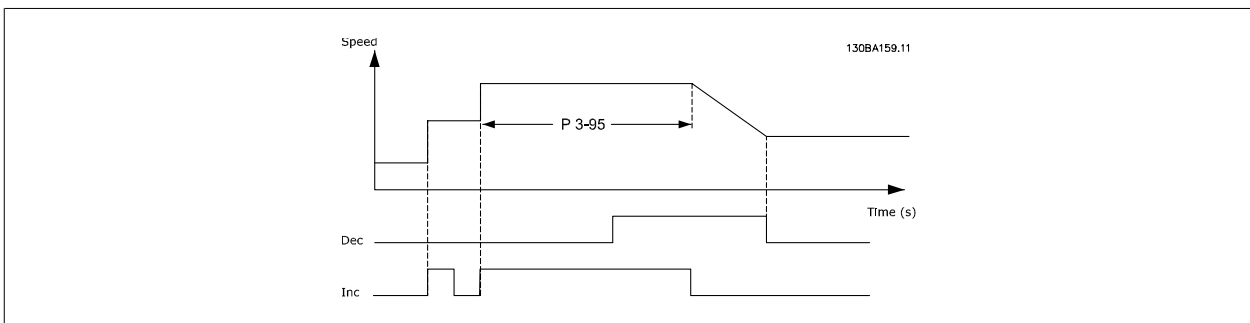
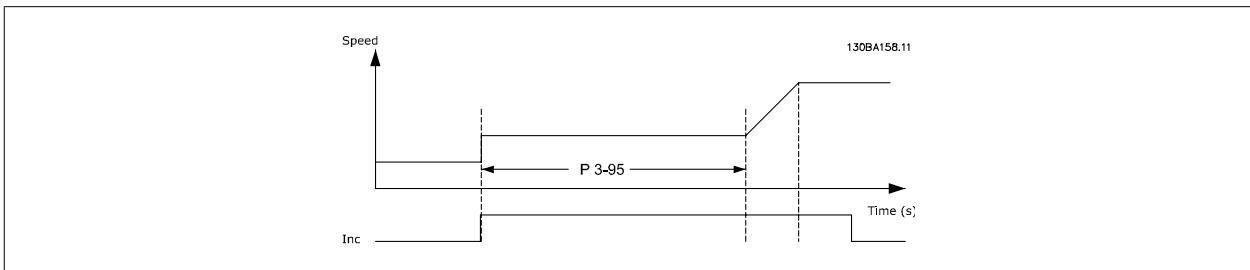

3-90 Step Size

Range:

Function:

0.10 %* [0.01 - 200.00 %]

Enter the increment size required for INCREASE/DECREASE, as a percentage of the synchronous motor speed, n_s . If INCREASE/ DECREASE is activated the resulting reference will be increased / decreased by the amount set in this parameter.

3-91 Ramp Time**Range:**

1.00 s* [0.00 - 3600.00 s]

Function:

Enter the ramp time, i.e. the time for adjustment of the reference from 0% to 100% of the specified digital potentiometer function (Increase, Decrease or Clear).

If Increase/ Decrease is activated for longer than the ramp delay period specified in par.3-95 *Ramp Delay* the actual reference will be ramped up / down according to this ramp time. The ramp time is defined as the time used to adjust the reference by the step size specified in par.3-90 *Step Size*.

3-92 Power Restore**Option:**

[0] * Off

Function:

Resets the Digital Potentiometer reference to 0% after power up.

[1] On

Restores the most recent Digital Potentiometer reference at power up.

3-93 Maximum Limit**Range:**

100 %* [-200 - 200 %]

Function:

Set the maximum permissible value for the resultant reference. This is advisable if the Digital Potentiometer is used for fine tuning of the resulting reference.

3-94 Minimum Limit**Range:**

-100 %* [-200 - 200 %]

Function:

Set the minimum permissible value for the resultant reference. This is advisable if the Digital Potentiometer is used for fine tuning of the resulting reference.

3-95 Ramp Delay**Range:**

0 N/A* [0 - 0 N/A]

Function:

Enter the delay required from activation of the digital potentiometer function until the frequency converter starts to ramp the reference. With a delay of 0 ms, the reference starts to ramp as soon as INCREASE/ DECREASE is activated. See also par.3-91 *Ramp Time*.

3.6 Parameters: Limits/Warnings

3.6.1 4-** Limits and Warnings

Parameter group for configuring limits and warnings.

3.6.2 4-1* Motor Limits

Define torque, current and speed limits for the motor, and the reaction of the frequency converter when the limits are exceeded.

A limit may generate a message on the display. A warning will always generate a message on the display or on the fieldbus. A monitoring function may initiate a warning or a trip, upon which the frequency converter will stop and generate an alarm message.

4-10 Motor Speed Direction

| Option: | Function: |
|---------|---|
| | Select the motor speed direction(s) required. Use this parameter to prevent unwanted reversing. When par.1-00 <i>Configuration Mode</i> is set to <i>Process</i> [3], par.4-10 <i>Motor Speed Direction</i> is set to <i>Clockwise</i> [0] as default. The setting in par.4-10 <i>Motor Speed Direction</i> does not limit options for setting par.4-13 <i>Motor Speed High Limit</i> [RPM]. This parameter cannot be adjusted while the motor is running. |

- [0] * Clockwise
- [1] Counter clockwise
- [2] Both directions

4-11 Motor Speed Low Limit [RPM]

| Range: | Function: |
|----------------------------|---|
| 0 RPM* [0 - par. 4-13 RPM] | Enter the minimum limit for motor speed. The Motor Speed Low Limit can be set to correspond to the manufacturer's recommended minimum motor speed. The Motor Speed Low Limit must not exceed the setting in par.4-13 <i>Motor Speed High Limit</i> [RPM]. |

4-12 Motor Speed Low Limit [Hz]

| Range: | Function: |
|----------------------------|---|
| 0 Hz* [0.0 - par. 4-14 Hz] | Enter the minimum limit for motor speed. The Motor Speed Low Limit can be set to correspond to the minimum output frequency of the motor shaft. The Motor Speed Low Limit must not exceed the setting in par.4-14 <i>Motor Speed High Limit</i> [Hz]. |

4-13 Motor Speed High Limit [RPM]

| Range: | Function: |
|-------------------------------------|--|
| 3600. RPM* [par. 4-11 - 60000. RPM] | Enter the maximum limit for motor speed. The Motor Speed High Limit can be set to correspond to the manufacturer's maximum rated motor speed. The Motor Speed High Limit must exceed the setting in par.4-11 <i>Motor Speed Low Limit</i> [RPM]. |

NB!
Max. output frequency cannot exceed 10% of the inverter switching frequency (par.14-01 *Switching Frequency*).

4-14 Motor Speed High Limit [Hz]**Range:**50/60.0 [par. 4-12 - par. 4-19 Hz]
Hz***Function:**

Enter the maximum limit for motor speed. The Motor Speed High Limit can be set to correspond to the manufacturer's recommended maximum of the motor shaft. The Motor Speed High Limit must exceed the in par. 4-12 *Motor Speed Low Limit [Hz]*. Only par. 4-11 *Motor Speed Low Limit [RPM]* or par. 4-12 *Motor Speed Low Limit [Hz]* will be displayed depending on other parameters in the Main Menu and depending on default settings dependant on global location.

**NB!**

Max. output frequency cannot exceed 10% of the inverter switching frequency (par. 14-01 *Switching Frequency*).

4-16 Torque Limit Motor Mode**Range:**

160.0 %* [0.0 - 1000.0 %]

Function:

This is a true torque limit function that can run into the oversynchronous range above nominal motor speed.
Motor magnetisation drop is automatically compensated by a current increase.



Changing par.4-16 *Torque Limit Motor Mode* when par.1-00 *Configuration Mode* is set to *Speed open loop [0]*, par.1-66 *Min. Current at Low Speed* is automatically readjusted.

4-17 Torque Limit Generator Mode**Range:**

100.0 %* [0.0 - 1000.0 %]

Function:

This is a true torque limit function that can run into the oversynchronous range above nominal motor speed.
Motor magnetisation drop is automatically compensated by a current increase.

4-18 Current Limit**Range:**

160.0 %* [1.0 - 1000.0 %]

Function:

This is a true current limit function that continues in the oversynchronous range, however due to field weakening the motor torque at current limit will drop accordingly when the voltage increase stops above the synchronised speed of the motor.

4-19 Max Output Frequency**Range:**

132.0 Hz* [1.0 - 1000.0 Hz]

Function:

Provides a final limit on the output frequency for improved safety in applications where you want to avoid accidental over-speeding. This limit is final in all configurations (independent of the setting in par.1-00 *Configuration Mode*).

**NB!**

Max. output frequency cannot exceed 10% of the inverter switching frequency (par.14-01 *Switching Frequency*).

par.4-19 *Max Output Frequency* cannot be adjusted while the motor is running.

4-20 Torque Limit Factor Source**Option:****Function:**

Select an analog input for scaling the settings in par.4-16 *Torque Limit Motor Mode* and par. 4-17 *Torque Limit Generator Mode* from 0% to 100% (or inverse). The signal levels corresponding

to 0% and 100% are defined in the analog input scaling, e.g. par. group 6-1*. This parameter is only active when par.1-00 *Configuration Mode* is in *Speed Open Loop* or *Speed Closed Loop*.

| | |
|-------|----------------------|
| [0] * | No function |
| [2] | Analog in 53 |
| [4] | Analog in 53 inv |
| [6] | Analog in 54 |
| [8] | Analog in 54 inv |
| [10] | Analog in X30-11 |
| [12] | Analog in X30-11 inv |
| [14] | Analog in X30-12 |
| [16] | Analog in X30-12 inv |

4-21 Speed Limit Factor SourceOption

Option:

Function:

Select an analog input for scaling the settings in par. 4-19 from 0% to 100% (or vice versa). The signal levels corresponding to 0% and 100% are defined in the analog input scaling, e.g. par. group 6-1*. This parameter is only active when par. 1-00 *Configuration Mode* is in *Torque Mode*.

| | |
|-------|-------------------------|
| [0] * | No function |
| [2] | Analog input 53 |
| [4] | Analog input 53 inv |
| [6] | Analog input 54 |
| [8] | Analog input 54 inv |
| [10] | Analog input X30-11 |
| [12] | Analog input X30-11 inv |
| [14] | Analog input X30-12 |
| [16] | Analog input X30-12 inv |

3.6.3 4-3* Motor Feedback Monitoring

The parameter group includes monitoring and handling of motor feedback devices as encoders, resolvers etc.

4-30 Motor Feedback Loss Function

Option:

Function:

Select which reaction the frequency converter should take if a feedback fault is detected. The selected action is to take place when the feedback signal differs from the output speed where its range is specified in par.4-31 *Motor Feedback Speed Error* during its time frame set in par.4-32 *Motor Feedback Loss Timeout*.

| | |
|-------|---------------------|
| [0] | Disabled |
| [1] | Warning |
| [2] * | Trip |
| [3] | Jog |
| [4] | Freeze Output |
| [5] | Max Speed |
| [6] | Switch to Open Loop |
| [7] | Select Setup 1 |
| [8] | Select Setup 2 |
| [9] | Select Setup 3 |
| [10] | Select Setup 4 |
| [11] | stop & trip |

4-31 Motor Feedback Speed Error**Range:**

300 RPM* [1 - 600 RPM]

Function:

Select the max allowed tracking error in speed from the calculated and the actual mechanical shaft output speed.

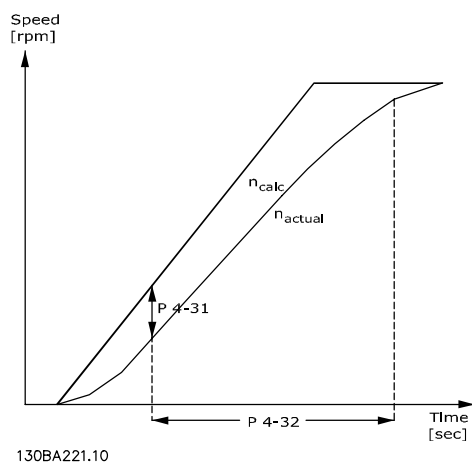
**4-32 Motor Feedback Loss Timeout****Range:**

0.05 s* [0.00 - 60.00 s]

Function:Set the timeout value allowing the speed error set in par.4-31 *Motor Feedback Speed Error* to be exceeded.**4-34 Tracking Error Function****Option:****Function:**

Select how the drive should react when a tracking error is detected, i.e. when the motor speed differs from the output of the ramp.

[0] * Disable

[1] Warning

[2] Trip

[3] Trip after stop

4-35 Tracking Error**Range:**

10 RPM* [1 - 600 RPM]

Function:

Enter the maximum permissible speed error between the motor speed and the output of the ramp when not ramping. In open loop the motor speed is estimated and in closed loop it is the feedback from encoder/resolver.

4-36 Tracking Error Timeout**Range:**

1.00 s* [0.00 - 60.00 s]

Function:

Enter the time-out period during which an error greater than the value set in par. 4-35 Tracking Error is permissible.

4-37 Tracking Error Ramping**Range:**

100 RPM* [1 - 600 RPM]

Function:

Enter the maximum permissible speed error between the motor speed and the output of the ramp when ramping. In open loop the motor speed is estimated and in closed loop it is the feedback from encoder/resolver.

4-38 Tracking Error Ramping Timeout

Range:

1.00 s* [0.00 - 60.00 s]

Function:

Enter the time-out period during which an error greater than the value set in par. 4-37 Tracking Error while Ramping is permissible.

4-39 Tracking Error After Ramping Timeout

Range:

5.00 s* [0.00 - 60.00 s]

Function:

Enter the time-out period after ramping where parameter 4-37 and 4-38 are still active.

3.6.4 4-5* Adjustable Warnings

This is where adjustable warning limits for current, speed, reference and feedback can be defined. Warnings that are shown on the display can be programmed as an output or sent via serial bus.

Warnings are shown on display, programmed output or serial bus.

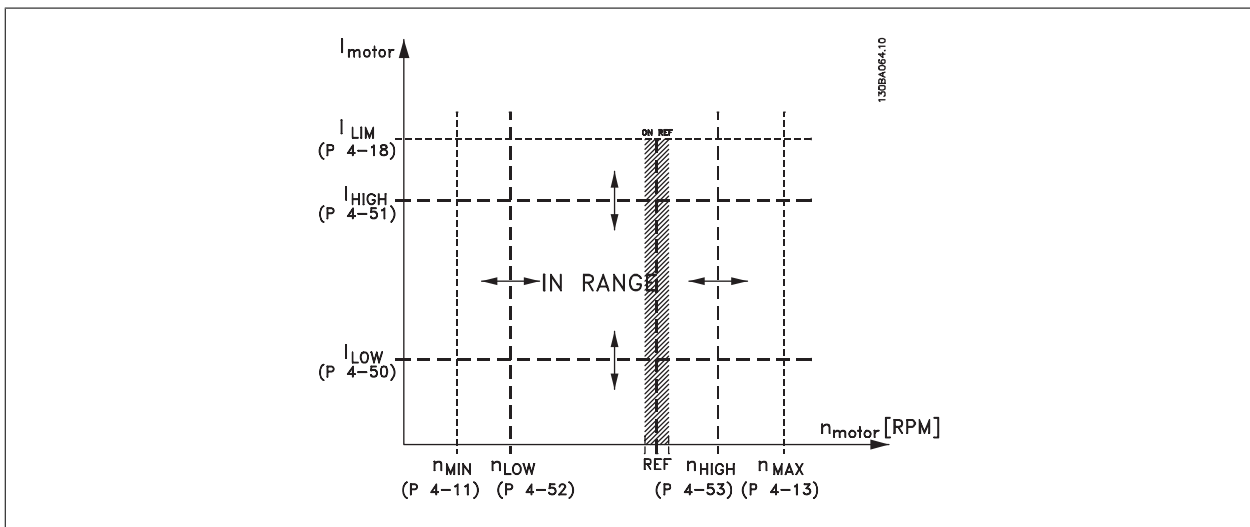

4-50 Warning Current Low

Range:

0.00 A* [0.00 - par. 4-51 A]

Function:

Enter the I_{LOW} value. When the motor current falls below this limit, the display reads *Current Low*. The signal outputs can be programmed to produce a status signal on terminal 27 or 29 (FC 302 only) and on relay output 01 or 02 (FC 302 only). Refer to the drawing in this section.

4-51 Warning Current High

Range:

par. 16-37 [par. 4-50 - par. 16-37 A]
A*

Function:

Enter the I_{HIGH} value. When the motor current exceeds this limit, the display reads *Current High*. The signal outputs can be programmed to produce a status signal on terminal 27 or 29 (FC 302 only) and on relay output 01 or 02 (FC 302 only). Refer to the drawing in this section.

4-52 Warning Speed Low

Range:

0 RPM* [0 - par. 4-53 RPM]

Function:

Enter the n_{LOW} value. When the motor speed exceeds this limit, the display reads *Speed Low*. The signal outputs can be programmed to produce a status signal on terminal 27 or 29 (FC 302 only) and on relay output 01 or 02 (FC 302 only).

4-53 Warning Speed High

Range:

par. 4-13 [par. 4-52 - par. 4-13 RPM]
RPM*

Function:

Enter the n_{HIGH} value. When the motor speed exceeds this limit, the display reads *Speed High*. The signal outputs can be programmed to produce a status signal on terminal 27 or 29 (FC 302 only) and on relay output 01 or 02 (FC 302 only). Programme the upper signal limit of the motor speed, n_{HIGH} , within the normal working range of the frequency converter. Refer to the drawing in this section.

4-54 Warning Reference Low

Range:

-999999.99 [-999999.999 - par. 4-55 N/A]
9 N/A*

Function:

Enter the lower reference limit. When the actual reference falls below this limit, the display indicates *Ref Low*. The signal outputs can be programmed to produce a status signal on terminal 27 or 29 (FC 302 only) and on relay output 01 or 02 (FC 302 only).

4-55 Warning Reference High

Range:

999999.999 [par. 4-54 - 999999.999 N/A]
N/A*

Function:

Enter the upper reference limit. When the actual reference exceeds this limit, the display reads *Ref High*. The signal outputs can be programmed to produce a status signal on terminal 27 or 29 (FC 302 only) and on relay output 01 or 02 (FC 302 only).

4-56 Warning Feedback Low

Range:

-999999.99 [-999999.999 - par. 4-57 Referen-
9 Referen- ceFeedbackUnit]
ceFeedback-
Unit*

Function:

Enter the lower feedback limit. When the feedback falls below this limit, the display reads *Feedb Low*. The signal outputs can be programmed to produce a status signal on terminal 27 or 29 (FC 302 only) and on relay output 01 or 02 (FC 302 only).

4-57 Warning Feedback High

Range:

999999.999 [par. 4-56 - 999999.999 Referen-
Reference- ceFeedbackUnit]
FeedbackU-
nit*

Function:

Enter the upper feedback limit. When the feedback exceeds this limit, the display reads *Feedb High*. The signal outputs can be programmed to produce a status signal on terminal 27 or 29 (FC 302 only) and on relay output 01 or 02 (FC 302 only).

4-58 Missing Motor Phase Function

Option:

[0] Disabled

[2] * Trip 1000 ms

Function:

Displays an alarm in the event of a missing motor phase.

Select 100 ms to have a short detection time and alarm in the event of a missing motor phase. 100 ms is recommended for hoisting applications.

No alarm is displayed if a missing motor phase occurs.

NB!

This parameter cannot be adjusted while the motor is running.

3.6.5 4-6* Speed Bypass

Define the Speed Bypass areas for the ramps.

Some systems call for avoiding certain output frequencies or speeds, due to resonance problems in the system. A maximum of four frequency or speed ranges can be avoided.

4-60 Bypass Speed From [RPM]

Array [4]

Range:

0 RPM* [0 - par. 4-13 RPM]

Function:

Some systems call for avoiding certain output speeds due to resonance problems in the system. Enter the lower limits of the speeds to be avoided.

4-61 Bypass Speed From [Hz]

Array [4]

Range:

0 Hz* [0.0 - par. 4-14 Hz]

Function:

Some systems call for avoiding certain output speeds due to resonance problems in the system. Enter the lower limits of the speeds to be avoided.

4-62 Bypass Speed To [RPM]

Array [4]

Range:

0 RPM* [0 - par. 4-13 RPM]

Function:

Some systems call for avoiding certain output speeds due to resonance problems in the system. Enter the upper limits of the speeds to be avoided.

4-63 Bypass Speed To [Hz]

Array [4]

Range:

0 Hz* [0.0 - par. 4-14 Hz]

Function:

Some systems call for avoiding certain output speeds due to resonance problems in the system. Enter the upper limits of the speeds to be avoided.

3.7 Parameters: Digital In/Out

3.7.1 5-** Digital In/Out

Parameter group for configuring the digital input and output.

3.7.2 5-0* Digital I/O Mode

Parameters for configuring the input and output using NPN and PNP.

5-00 Digital I/O Mode

Option:

[0] * PNP

[1] NPN

Function:

Digital inputs and programmed digital outputs are pre-programmable for operation either in PNP or NPN systems.

Action on positive directional pulses (†). PNP systems are pulled down to GND.

Action on negative directional pulses (†). NPN systems are pulled up to + 24 V, internally in the frequency converter.

NB!
Once this parameter has been changed, it must be activated by performing a power cycle.

This parameter cannot be adjusted while the motor is running.

5-01 Terminal 27 Mode

| Option: | Function: |
|-------------|--|
| [0] * Input | Defines terminal 27 as a digital input. |
| [1] Output | Defines terminal 27 as a digital output. |

Please note that this parameter cannot be adjusted while the motor is running.

5-02 Terminal 29 Mode

| Option: | Function: |
|-------------|--|
| [0] * Input | Defines terminal 29 as a digital input. |
| [1] Output | Defines terminal 29 as a digital output. |

This parameter is available for FC 302 only.

This parameter cannot be adjusted while the motor is running.

3

3.7.3 5-1* Digital Inputs

Parameters for configuring the input functions for the input terminals.

The digital inputs are used for selecting various functions in the frequency converter. All digital inputs can be set to the following functions:

| Digital input function | Select | Terminal |
|------------------------------|--------|------------------|
| No operation | [0] | All *term 32, 33 |
| Reset | [1] | All |
| Coast inverse | [2] | All *term 27 |
| Coast and reset inverse | [3] | All |
| Quick stop inverse | [4] | All |
| DC-brake inverse | [5] | All |
| Stop inverse | [6] | All |
| Start | [8] | All *term 18 |
| Latched start | [9] | All |
| Reversing | [10] | All *term 19 |
| Start reversing | [11] | All |
| Enable start forward | [12] | All |
| Enable start reverse | [13] | All |
| Jog | [14] | All *term 29 |
| Preset reference on | [15] | All |
| Preset ref bit 0 | [16] | All |
| Preset ref bit 1 | [17] | All |
| Preset ref bit 2 | [18] | All |
| Freeze reference | [19] | All |
| Freeze output | [20] | All |
| Speed up | [21] | All |
| Speed down | [22] | All |
| Set-up select bit 0 | [23] | All |
| Set-up select bit 1 | [24] | All |
| Precise stop inverse | [26] | 18, 19 |
| Precises start, stop | [27] | 18, 19 |
| Catch up | [28] | All |
| Slow down | [29] | All |
| Counter input | [30] | 29, 33 |
| Pulse input | [32] | 29, 33 |
| Ramp bit 0 | [34] | All |
| Ramp bit 1 | [35] | All |
| Mains failure inverse | [36] | All |
| Latched precise start | [40] | 18, 19 |
| Latched precise stop inverse | [41] | 18, 19 |
| DigiPot Increase | [55] | All |
| DigiPot Decrease | [56] | All |
| DigiPot Clear | [57] | All |
| Counter A (up) | [60] | 29, 33 |
| Counter A (down) | [61] | 29, 33 |
| Reset Counter A | [62] | All |
| Counter B (up) | [63] | 29, 33 |
| Counter B (down) | [64] | 29, 33 |
| Reset Counter B | [65] | All |
| Mech. Brake Feedb. | [70] | All |
| Mech. Brake Feedb. Inv. | [71] | All |
| PID enable | [74] | All |
| MCO Specific | [75] | All |
| PTC Card 1 | [80] | All |

FC 300 standard terminals are 18, 19, 27, 29, 32 and 33. MCB 101 terminals are X30/2, X30/3 and X30/4.

Terminal 29 functions as an output only in FC 302.

Functions dedicated to only one digital input are stated in the associated parameter.

All digital inputs can be programmed to these functions:

| | | |
|--|-------------------------|--|
| [0] | No operation | No reaction to signals transmitted to the terminal. |
| [1] | Reset | Resets frequency converter after a TRIP/ALARM. Not all alarms can be reset. |
| [2] | Coast inverse | (Default Digital input 27): Coasting stop, inverted input (NC). The frequency converter leaves the motor in free mode. Logic '0' => coasting stop. |
| [3] | Coast and reset inverse | Reset and coasting stop Inverted input (NC). Leaves motor in free mode and resets frequency converter. Logic '0' => coasting stop and reset. |
| [4] | Quick stop inverse | Inverted input (NC). Generates a stop in accordance with quick-stop ramp time set in par.3-81 <i>Quick Stop Ramp Time</i> . When motor stops, the shaft is in free mode. Logic '0' => Quick-stop. |
| [5] | DC-brake inverse | Inverted input for DC braking (NC). Stops motor by energizing it with a DC current for a certain time period. See par.2-01 <i>DC Brake Current</i> to par.2-03 <i>DC Brake Cut In Speed [RPM]</i> . The function is only active when the value in par.2-02 <i>DC Braking Time</i> is different from 0. Logic '0' => DC braking. |
| [6] | Stop inverse | Stop Inverted function. Generates a stop function when the selected terminal goes from logical level '1' to '0'. The stop is performed according to the selected ramp time (par.3-42 <i>Ramp 1 Ramp Down Time</i> , par.3-52 <i>Ramp 2 Ramp down Time</i> , par.3-62 <i>Ramp 3 Ramp down Time</i> , par.3-72 <i>Ramp 4 Ramp Down Time</i>). |
| <div style="border: 1px solid black; padding: 5px;">  <p>NB! When the frequency converter is at the torque limit and has received a stop command, it may not stop by itself. To ensure that the frequency converter stops, configure a digital output to <i>Torque limit & stop</i> [27] and connect this digital output to a digital input that is configured as coast.</p> </div> | | |
| [8] | Start | (Default Digital input 18): Select start for a start/stop command. Logic '1' = start, logic '0' = stop. |
| [9] | Latched start | The motor starts, if a pulse is applied for min. 2 ms. The motor stops when Stop inverse is activated. |
| [10] | Reversing | (Default Digital input 19). Change the direction of motor shaft rotation. Select Logic '1' to reverse. The reversing signal only changes the direction of rotation. It does not activate the start function. Select both directions in par.4-10 <i>Motor Speed Direction</i> . The function is not active in process closed loop. |
| [11] | Start reversing | Used for start/stop and for reversing on the same wire. Signals on start are not allowed at the same time. |
| [12] | Enable start forward | Disengages the counterclockwise movement and allows for the clockwise direction. |
| [13] | Enable start reverse | Disengages the clockwise movement and allows for the counterclockwise direction. |
| [14] | Jog | (Default Digital input 29): Use to activate jog speed. See par.3-11 <i>Jog Speed [Hz]</i> . |
| [15] | Preset reference on | Shifts between external reference and preset reference. It is assumed that <i>External/preset</i> [1] has been selected in par.3-04 <i>Reference Function</i> . Logic '0' = external reference active; logic '1' = one of the eight preset references is active. |
| [16] | Preset ref bit 0 | Preset ref. bit 0,1, and 2 enables a choice between one of the eight preset references according to the table below. |
| [17] | Preset ref bit 1 | Same as Preset ref bit 0 [16]. |
| [18] | Preset ref bit 2 | Same as Preset ref bit 0 [16]. |

| Preset ref. bit | 2 | 1 | 0 |
|-----------------|---|---|---|
| Preset ref. 0 | 0 | 0 | 0 |
| Preset ref. 1 | 0 | 0 | 1 |
| Preset ref. 2 | 0 | 1 | 0 |
| Preset ref. 3 | 0 | 1 | 1 |
| Preset ref. 4 | 1 | 0 | 0 |
| Preset ref. 5 | 1 | 0 | 1 |
| Preset ref. 6 | 1 | 1 | 0 |
| Preset ref. 7 | 1 | 1 | 1 |

3

[19] Freeze ref
Freezes the actual reference, which is now the point of enable/condition for Speed up and Speed down to be used. If Speed up/down is used, the speed change always follows ramp 2 (par. 3-51 *Ramp 2 Ramp up Time* and par.3-52 *Ramp 2 Ramp down Time*) in the range 0 - par. 3-03 *Maximum Reference*.

[20] Freeze output
Freezes the actual motor frequency (Hz), which is now the point of enable/condition for Speed up and Speed down to be used. If Speed up/down is used, the speed change always follows ramp 2 (par.3-51 *Ramp 2 Ramp up Time* and par.3-52 *Ramp 2 Ramp down Time*) in the range 0 - par. 1-23 *Motor Frequency*.

NB!
When Freeze output is active, the frequency converter cannot be stopped via a low 'start [8]' signal. Stop the frequency converter via a terminal programmed for Coasting inverse [2] or Coast and reset, inverse.

[21] Speed up
Select Speed up and Speed down if digital control of the up/down speed is desired (motor potentiometer). Activate this function by selecting either Freeze reference or Freeze output. When Speed up/ down is activated for less than 400 msec. the resulting reference will be increased/ decreased by 0.1 %. If Speed up/ down is activated for more than 400 msec. the resulting reference will follow the setting in ramping up/ down parameter 3-x1/ 3-x2.

| | Shut down | Catch up |
|----------------------|-----------|----------|
| Unchanged speed | 0 | 0 |
| Reduced by %-value | 1 | 0 |
| Increased by %-value | 0 | 1 |
| Reduced by %-value | 1 | 1 |

[22] Speed down
Same as Speed up [21].

[23] Set-up select bit 0
Select Set-up select bit 0 or Select Set-up select bit 1 to select one of the four set-ups. Set par. 0-10 *Active Set-up* to Multi Set-up.

[24] Set-up select bit 1
(Default Digital input 32): Same as Set-up select bit 0 [23].

[26] Precise stop inv.
Prolongs stop signal to give a precise stop independent of speed.
Sends an inverted stop signal when the precise stop function is activated in par.1-83 *Precise Stop Function*.
Precise stop inverse function is available for terminals 18 or 19.

[27] Precise start, stop
Use when Precise ramp stop [0] is selected in par 1-83.

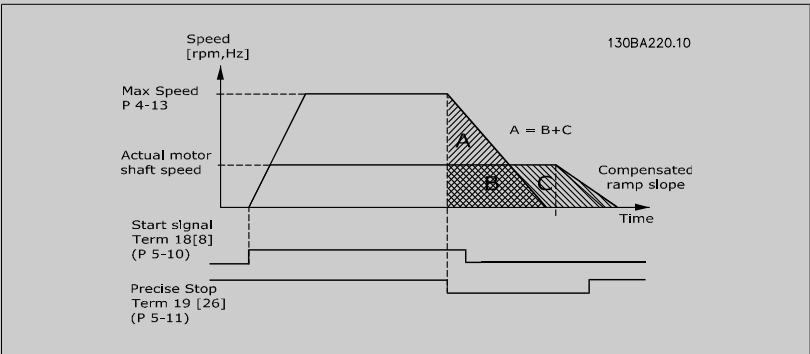

[28] Catch up
Increases reference value by percentage (relative) set in par.3-12 *Catch up/slow Down Value*.

[29] Slow down
Reduces reference value by percentage (relative) set in par.3-12 *Catch up/slow Down Value*.

[30] Counter input
Precise stop function in par.1-83 *Precise Stop Function* acts as Counter stop or speed compensated counter stop with or without reset. The counter value must be set in par.1-84 *Precise Stop Counter Value*.

[32] Pulse input
Use pulse sequence as either reference or feedback. Scaling is done in par. group 5-5*.

[34] Ramp bit 0
Enables a choice between one of the 4 ramps available, according to the table below.

[35] Ramp bit 1
Same as Ramp bit 0.

| | | |
|-----------------|---|---|
| Preset ramp bit | 1 | 0 |
| Ramp 1 | 0 | 0 |
| Ramp 2 | 0 | 1 |
| Ramp 3 | 1 | 0 |
| Ramp 4 | 1 | 1 |

| | | |
|------|------------------------------|---|
| [36] | Mains failure inverse | Activates par.14-10 <i>Mains Failure</i> . Mains failure inverse is active in the Logic .0. situation. |
| [41] | Latched Precise Stop inverse | Sends a latched stop signal when the precise stop function is activated in par.1-83 <i>Precise Stop Function</i> . The Latched Precise stop inverse function is available for terminals 18 or 19. |
| [55] | DigiPot Increase | INCREASE signal to the Digital Potentiometer function described in parameter group 3-9* |
| [56] | DigiPot Decrease | DECREASE signal to the Digital Potentiometer function described in parameter group 3-9* |
| [57] | DigiPot Clear | Clears the Digital Potentiometer reference described in parameter group 3-9* |
| [60] | Counter A | (Terminal 29 or 33 only) Input for increment counting in the SLC counter. |
| [61] | Counter A | (Terminal 29 or 33 only) Input for decrement counting in the SLC counter. |
| [62] | Reset Counter A | Input for reset of counter A. |
| [63] | Counter B | (Terminal 29 or 33 only) Input for increment counting in the SLC counter. |
| [64] | Counter B | (Terminal 29 or 33 only) Input for decrement counting in the SLC counter. |
| [65] | Reset Counter B | Input for reset of counter B. |
| [70] | Mech. Brake Feedback | Brake feedback for hoisting applications |
| [71] | Mech. Brake Feedback inv. | Inverted brake feedback for hoisting applications |
| [74] | PID enable | |
| [75] | MCO Specific | |
| [80] | PTC Card 1 | All Digital Inputs can be set to PTC Card 1 [80]. However, only one Digital Input must be set to this choice. |

5-10 Terminal 18 Digital Input

| | |
|----------------|------------------------------------|
| Option: | Function: |
| [8] * Start | Functions are described under 5-1* |

5-11 Terminal 19 Digital Input

| | |
|------------------|------------------------------------|
| Option: | Function: |
| [10] * Reversing | Functions are described under 5-1* |

5-12 Terminal 27 Digital Input

| | |
|---------------------|------------------------------------|
| Option: | Function: |
| [2] * Coast inverse | Functions are described under 5-1* |

5-13 Terminal 29 Digital Input

| | |
|----------------|---|
| Option: | Function: |
| | Select the function from the available digital input range and the additional options [60], [61], [63] and [64]. Counters are used in Smart Logic Control functions. This parameter is available for FC 302 only. |
| [14] * Jog | Functions are described under 5-1* |

5-14 Terminal 32 Digital Input

| | |
|--------------------|--|
| Option: | Function: |
| | Select the function from the available digital input range and the additional options [60], [61], [63] and [64]. Counters are used in Smart Logic Control functions. |
| [0] * No operation | Functions are described under 5-1* |

5-15 Terminal 33 Digital Input

| Option: | Function: |
|--------------------|--|
| [0] * No operation | Select the function from the available digital input range and the additional options [60], [61], [63] and [64]. Counters are used in Smart Logic Control functions. |

[0] * Functions are described under 5-1*

5-16 Terminal X30/2 Digital Input

| Option: | Function: |
|--------------------|--|
| [0] * No operation | This parameter is active when option module MCB101 is installed in the frequency converter. Functions are described under 5-1* |

5-17 Terminal X30/3 Digital Input

| Option: | Function: |
|--------------------|--|
| [0] * No operation | This parameter is active when option module MCB101 is installed in the frequency converter. Functions are described under 5-1* |

5-18 Terminal X30/4 Digital Input

| Option: | Function: |
|--------------------|--|
| [0] * No operation | This parameter is active when option module MCB101 is installed in the frequency converter. Functions are described under 5-1* |

5-19 Terminal 37 Safe Stop

| Option: | Function: |
|-----------------------|---|
| [1] * Safe Stop Alarm | Coasts frequency converter when safe stop is activated. Manual reset from LCP, digital input or fieldbus. |
| [3] Safe Stop Warning | Coasts frequency converter when safe stop is activated (term 37 off). When safe stop circuit is reestablished, the frequency converter will continue without manual reset. |
| [4] PTC 1 Alarm | Coasts frequency converter when safe stop is activated. Manual reset from LCP, digital input or fieldbus. Choice 4 is only available when the MCB 112 PTC Thermistor Card is connected. |
| [5] PTC 1 Warning | Coasts frequency converter when safe stop is activated (term 37 off). When safe stop circuit is reestablished, the frequency converter will continue without manual reset, unless a Digital Input set to PTC Card 1 [80] is still enabled. Choice 5 is only available when the MCB 112 PTC Thermistor Card is connected. |
| [6] PTC 1 & Relay A | This choice is used when the PTC option is gated together with a Stop button through a Safety relay to T-37. Coasts frequency converter when safe stop is activated. Manual reset from LCP, digital input or fieldbus. Choice 6 is only available when the MCB 112 PTC Thermistor Card is connected. |
| [7] PTC 1 & Relay W | This choice is used when the PTC option is gated together with a Stop button through a Safety relay to T-37. Coasts frequency converter when safe stop is activated (term 37 off). When safe stop circuit is reestablished, the frequency converter will continue without manual reset, unless a Digital Input set to PTC Card 1 [80] is (still) enabled. Choice 7 is only available when the MCB 112 PTC Thermistor Card is connected. |
| [8] PTC 1 & Relay A/W | This choice makes it possible to use a combination of Alarm and Warning. Choice 8 is only available when the MCB 112 PTC Thermistor Card is connected. |
| [9] PTC 1 & Relay W/A | This choice makes it possible to use a combination of Alarm and Warning. Choice 9 is only available when the MCB 112 PTC Thermistor Card is connected. |

Choices 4 - 9 are only available when the MCB 112 PTC Thermistor Card is connected.



NB!

When Auto Reset/ Warning is selected the frequency converter opens up for automatic restart.

Overview of functions, alarms and warnings

| Function | No. | PTC | Relay |
|-------------------|------|-----------------------|-----------------|
| No Function | [0] | - | - |
| Safe Stop Alarm | [1]* | - | Safe Stop [A68] |
| Safe Stop Warning | [3] | - | Safe Stop [W68] |
| PTC 1 Alarm | [4] | PTC 1 Safe Stop [A71] | - |
| PTC 1 Warning | [5] | PTC 1 Safe Stop [W71] | - |
| PTC 1 & Relay A | [6] | PTC 1 Safe Stop [A71] | Safe Stop [A68] |
| PTC 1 & Relay W | [7] | PTC 1 Safe Stop [W71] | Safe Stop [W68] |
| PTC 1 & Relay A/W | [8] | PTC 1 Safe Stop [A71] | Safe Stop [W68] |
| PTC 1 & Relay W/A | [9] | PTC 1 Safe Stop [W71] | Safe Stop [A68] |

W means warning and A means alarm. For further information, see Alarms and Warnings in section *Troubleshooting* in the Design Guide or the Operating Instructions

A dangerous failure related to Safe Stop will give Alarm: Dangerous Failure [A72].

Please refer to the section *Description of Alarm Word, Warning Word and extended Status Word* in the chapter *Troubleshooting*.

5-20 Terminal X46/1 Digital Input

Option:

[0] * No operation

Function:

This parameter is active when option module MCB 113 is installed in the frequency converter. Functions are described under 5-1*

5-21 Terminal X46/3 Digital Input

Option:

[0] * No operation

Function:

This parameter is active when option module MCB 113 is installed in the frequency converter. Functions are described under 5-1*

5-22 Terminal X46/5 Digital Input

Option:

[0] * No operation

Function:

This parameter is active when option module MCB 113 is installed in the frequency converter. Functions are described under 5-1*

5-23 Terminal X46/7 Digital Input

Option:

[0] * No operation

Function:

This parameter is active when option module MCB 113 is installed in the frequency converter. Functions are described under 5-1*

5-24 Terminal X46/9 Digital Input

Option:

[0] * No operation

Function:

This parameter is active when option module MCB 113 is installed in the frequency converter. Functions are described under 5-1*

5-25 Terminal X46/11 Digital Input

Option:

[0] * No operation

Function:

This parameter is active when option module MCB 113 is installed in the frequency converter. Functions are described under 5-1*

5-26 Terminal X46/13 Digital Input

Option:

[0] * No operation

Function:

This parameter is active when option module MCB 113 is installed in the frequency converter. Functions are described under 5-1*

3.7.4 5-3* Digital Outputs

Parameters for configuring the output functions for the output terminals. The 2 solid-state digital outputs are common for terminals 27 and 29. Set the I/O function for terminal 27 in par.5-01 *Terminal 27 Mode*, and set the I/O function for terminal 29 in par.5-02 *Terminal 29 Mode*. These parameters cannot be adjusted while the motor is running.

| | | |
|------|-----------------------------------|---|
| [0] | No operation | <i>Default for all digital outputs and relay outputs</i> |
| [1] | Control ready | The control board receives supply voltage. |
| [2] | Drive ready | The frequency converter is ready for operation and applies a supply signal on the control board. |
| [3] | Drive ready / remote control | The frequency converter is ready for operation and is in Auto On mode. |
| [4] | Enable / no warning | Ready for operation. No start or stop command is been given (start/disable). There are no warnings. |
| [5] | VLT running | Motor is running. |
| [6] | Running / no warning | Output speed is higher than the speed set in par.1-81 <i>Min Speed for Function at Stop [RPM]</i> . The motor is running and there are no warnings. |
| [7] | Run in range / no warning | Motor is running within the programmed current and speed ranges set in par.4-50 <i>Warning Current Low</i> to par.4-53 <i>Warning Speed High</i> . There are no warnings. |
| [8] | Run on reference / no warning | Motor runs at reference speed. |
| [9] | Alarm | An alarm activates the output. There are no warnings. |
| [10] | Alarm or warning | An alarm or a warning activates the output. |
| [11] | At torque limit | The torque limit set in par.4-16 <i>Torque Limit Motor Mode</i> or par. 1-17 has been exceeded. |
| [12] | Out of current range | The motor current is outside the range set in par.4-18 <i>Current Limit</i> . |
| [13] | Below current, low | Motor current is lower than set in par.4-50 <i>Warning Current Low</i> . |
| [14] | Above current, high | Motor current is higher than set in par.4-51 <i>Warning Current High</i> . |
| [15] | Out of range | Output frequency is outside the frequency range set in par.4-50 <i>Warning Current Low</i> and par. 4-51 <i>Warning Current High</i> . |
| [16] | Below speed, low | Output speed is lower than the setting in par.4-52 <i>Warning Speed Low</i> . |
| [17] | Above speed, high | Output speed is higher than the setting in par.4-53 <i>Warning Speed High</i> . |
| [18] | Out of feedback range | Feedback is outside the range set in par.4-56 <i>Warning Feedback Low</i> and par.4-57 <i>Warning Feedback High</i> . |
| [19] | Below feedback low | Feedback is below the limit set in par.4-56 <i>Warning Feedback Low</i> . |
| [20] | Above feedback high | Feedback is above the limit set in par.4-57 <i>Warning Feedback High</i> . |
| [21] | Thermal warning | The thermal warning turns on when the temperature exceeds the limit in the motor, the frequency converter, the brake resistor, or the thermistor. |
| [22] | Ready, no thermal warning | Frequency converter is ready for operation and there is no over-temperature warning. |
| [23] | Remote, ready, no thermal warning | Frequency converter is ready for operation and is in Auto On mode. There is no over-temperature warning. |
| [24] | Ready, no over-/ under voltage | Frequency converter is ready for operation and the mains voltage is within the specified voltage range (see <i>General Specifications</i> section). |
| [25] | Reverse | <i>Reversing. Logic '1' when CW rotation of the motor. Logic '0' when CCW rotation of the motor. If the motor is not rotating the output will follow the reference.</i> |
| [26] | Bus OK | Active communication (no time-out) via the serial communication port. |
| [27] | Torque limit and stop | Use in performing a coasting stop and in torque limit condition. If the frequency converter has received a stop signal and is at the torque limit, the signal is Logic '0'. |
| [28] | Brake, no brake warning | Brake is active and there are no warnings. |
| [29] | Brake ready, no fault | Brake is ready for operation and there are no faults. |
| [30] | Brake fault (IGBT) | Output is Logic '1' when the brake IGBT is short-circuited. Use this function to protect the frequency converter if there is a fault on the brake modules. Use the output/relay to cut out the main voltage from the frequency converter. |
| [31] | Relay 123 | Relay is activated when Control Word [0] is selected in parameter group 8-**. |

| | | |
|------|-----------------------------------|---|
| [32] | Mechanical brake control | Enables control of an external mechanical brake, see description in the section <i>Control of Mechanical Brake</i> , and par. group 2-2* |
| [33] | Safe stop activated (FC 302 only) | Indicates that the safe stop on terminal 37 has been activated. |
| [40] | Out of ref range | |
| [41] | Below reference low | |
| [42] | Above reference high | |
| [45] | Bus Ctrl | Controls output via bus. The state of the output is set in par.5-90 <i>Digital & Relay Bus Control</i> . The output state is retained in the event of bus time-out. |
| [46] | Bus Ctrl On at timeout | Controls output via bus. The state of the output is set in par.5-90 <i>Digital & Relay Bus Control</i> . In the event of bus time-out the output state is set high (On). |
| [47] | Bus Ctrl Off at timeout | Controls output via bus. The state of the output is set in par.5-90 <i>Digital & Relay Bus Control</i> . In the event of bus time-out the output state is set low (Off). |
| [51] | MCO controlled | |
| [55] | Pulse output | |
| [60] | Comparator 0 | See par. group 13-1*. If Comparator 0 is evaluated as TRUE, the output will go high. Otherwise, it will be low. |
| [61] | Comparator 1 | See par. group 13-1*. If Comparator 1 is evaluated as TRUE, the output will go high. Otherwise, it will be low. |
| [62] | Comparator 2 | See par. group 13-1*. If Comparator 2 is evaluated as TRUE, the output will go high. Otherwise, it will be low. |
| [63] | Comparator 3 | See par. group 13-1*. If Comparator 3 is evaluated as TRUE, the output will go high. Otherwise, it will be low. |
| [64] | Comparator 4 | See par. group 13-1*. If Comparator 4 is evaluated as TRUE, the output will go high. Otherwise, it will be low. |
| [65] | Comparator 5 | See par. group 13-1*. If Comparator 5 is evaluated as TRUE, the output will go high. Otherwise, it will be low. |
| [70] | Logic Rule 0 | See par. group 13-4*. If Logic Rule 0 is evaluated as TRUE, the output will go high. Otherwise, it will be low. |
| [71] | Logic Rule 1 | See par. group 13-4*. If Logic Rule 1 is evaluated as TRUE, the output will go high. Otherwise, it will be low. |
| [72] | Logic Rule 2 | See par. group 13-4*. If Logic Rule 2 is evaluated as TRUE, the output will go high. Otherwise, it will be low. |
| [73] | Logic Rule 3 | See par. group 13-4*. If Logic Rule 3 is evaluated as TRUE, the output will go high. Otherwise, it will be low. |
| [74] | Logic Rule 4 | See par. group 13-4*. If Logic Rule 4 is evaluated as TRUE, the output will go high. Otherwise, it will be low. |
| [75] | Logic Rule 5 | See par. group 13-4*. If Logic Rule 5 is evaluated as TRUE, the output will go high. Otherwise, it will be low. |
| [80] | SL Digital Output A | See par.13-52 <i>SL Controller Action</i> . The output will go high whenever the Smart Logic Action [38] <i>Set dig. out. A high</i> is executed. The output will go low whenever the Smart Logic Action [32] <i>Set dig. out. A low</i> is executed. |
| [81] | SL Digital Output B | See par.13-52 <i>SL Controller Action</i> . The input will go high whenever the Smart Logic Action [39] <i>Set dig. out. A high</i> is executed. The input will go low whenever the Smart Logic Action [33] <i>Set dig. out. A low</i> is executed. |
| [82] | SL Digital Output C | See par.13-52 <i>SL Controller Action</i> . The input will go high whenever the Smart Logic Action [40] <i>Set dig. out. A high</i> is executed. The input will go low whenever the Smart Logic Action [34] <i>Set dig. out. A low</i> is executed. |
| [83] | SL Digital Output D | See par.13-52 <i>SL Controller Action</i> . The input will go high whenever the Smart Logic Action [41] <i>Set dig. out. A high</i> is executed. The input will go low whenever the Smart Logic Action [35] <i>Set dig. out. A low</i> is executed. |

| | | |
|-------|-------------------------|---|
| [84] | SL Digital Output E | See par.13-52 <i>SL Controller Action</i> . The input will go high whenever the Smart Logic Action [42] <i>Set dig. out. A high</i> is executed. The input will go low whenever the Smart Logic Action [36] <i>Set dig. out. A low</i> is executed. |
| [85] | SL Digital Output F | See par.13-52 <i>SL Controller Action</i> . The input will go high whenever the Smart Logic Action [43] <i>Set dig. out. A high</i> is executed. The input will go low whenever the Smart Logic Action [37] <i>Set dig. out. A low</i> is executed. |
| [120] | Local reference active | Output is high when par.3-13 <i>Reference Site</i> = [2] Local or when par.3-13 <i>Reference Site</i> = [0] <i>Linked to hand auto</i> at the same time as the LCP is in Hand on mode. |
| [121] | Remote reference active | Output is high when par.3-13 <i>Reference Site</i> = Remote [1] or <i>Linked to hand/auto</i> [0] while the LCP is in [Auto on] mode. |
| [122] | No alarm | Output is high when no alarm is present. |
| [123] | Start command active | Output is high when there is an active Start command (i.e. via digital input bus connection or [Hand on] or [Auto on]), and no Stop or Start command is active. |
| [124] | Running reverse | Output is high when the frequency converter is running counter clockwise (the logical product of the status bits 'running' AND 'reverse'). |
| [125] | Drive in hand mode | Output is high when the frequency converter is in Hand on mode (as indicated by the LED light above [Hand on]). |
| [126] | Drive in auto mode | Output is high when the frequency converter is in Hand on mode (as indicated by the LED light above [Auto on]). |

5-30 Terminal 27 Digital Output

Option:

[0] * No operation

Function:

Functions are described under 5-3*

5-31 Terminal 29 Digital Output

Option:

[0] * No operation

Function:

 Functions are described under 5-3*
 This parameter only applies to FC 302

5-32 Term X30/6 Digi Out (MCB 101)

Option:

[0] * No operation

Function:

 This parameter is active when option module MCB 101 is mounted in the frequency converter.
 Functions are described under 5-3*

5-33 Term X30/7 Digi Out (MCB 101)

Option:

[0] * No operation

Function:

 This parameter is active when option module MCB 101 is mounted in the frequency converter.
 Functions are described under 5-3*

3.7.5 5-4* Relays

Parameters for configuring the timing and the output functions for the relays.

5-40 Function Relay

Array [9]

(Relay 1 [0], Relay 2 [1], Relay 3 [2], Relay 4 [3], Relay 5 [4], Relay 6 [5], Relay 6 [5], Relay 7 [6], Relay 8 [7], Relay 9 [8])

Option:

[0] * No operation

Function:

[1] Control ready

[2] Drive ready

[3] Drive rdy/rem ctrl

[4] Enable / no warning

[5] VLT running

| | |
|------|------------------------|
| [6] | Running / no warning |
| [7] | Run in range/no warn |
| [8] | Run on ref/no warn |
| [9] | Alarm |
| [10] | Alarm or warning |
| [11] | At torque limit |
| [12] | Out of current range |
| [13] | Below current, low |
| [14] | Above current, high |
| [15] | Out of speed range |
| [16] | Below speed, low |
| [17] | Above speed, high |
| [18] | Out of feedb. range |
| [19] | Below feedback, low |
| [20] | Above feedback, high |
| [21] | Thermal warning |
| [22] | Ready,no thermal W |
| [23] | Remote,ready,no TW |
| [24] | Ready, Voltage OK |
| [25] | Reverse |
| [26] | Bus OK |
| [27] | Torque limit & stop |
| [28] | Brake, no brake war |
| [29] | Brake ready, no fault |
| [30] | Brake fault (IGBT) |
| [31] | Relay 123 |
| [32] | Mech brake ctrl |
| [33] | Safe stop active |
| [36] | Control word bit 11 |
| [37] | Control word bit 12 |
| [38] | Motor feedback error |
| [39] | Tracking error |
| [40] | Out of ref range |
| [41] | Below reference, low |
| [42] | Above ref, high |
| [43] | Extended PID Limit |
| [45] | Bus ctrl. |
| [46] | Bus ctrl, 1 if timeout |
| [47] | Bus ctrl, 0 if timeout |
| [51] | MCO controlled |
| [60] | Comparator 0 |
| [61] | Comparator 1 |
| [62] | Comparator 2 |
| [63] | Comparator 3 |
| [64] | Comparator 4 |
| [65] | Comparator 5 |
| [70] | Logic rule 0 |

| | |
|-------|---------------------|
| [71] | Logic rule 1 |
| [72] | Logic rule 2 |
| [73] | Logic rule 3 |
| [74] | Logic rule 4 |
| [75] | Logic rule 5 |
| [80] | SL digital output A |
| [81] | SL digital output B |
| [82] | SL digital output C |
| [83] | SL digital output D |
| [84] | SL digital output E |
| [85] | SL digital output F |
| [120] | Local ref active |
| [121] | Remote ref active |
| [122] | No alarm |
| [123] | Start command activ |
| [124] | Running reverse |
| [125] | Drive in hand mode |
| [126] | Drive in auto mode |

5-41 On Delay, Relay

Array [8](Relay 1 [0], Relay 2 [1], Relay 3 [2], Relay 4 [3], Relay 5 [4], Relay 6 [5], Relay 7 [6], Relay 8 [7], Relay 9 [8])

Range:

0.01 s* [0.01 - 600.00 s]

Function:

Enter the delay of the relay cut-in time. Select one of available mechanical relays and MCO 105 in an array function. See par. 5-40 *Function Relay*. Relay 3-6 are included in MCB 112 (ATEX).

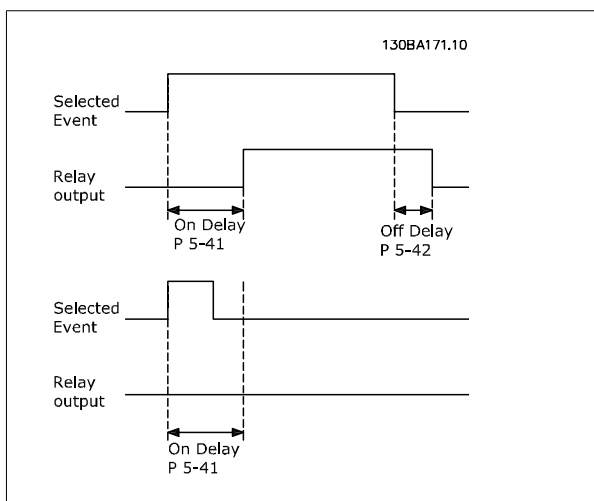

5-42 Off Delay, Relay

Array [8] (Relay 1 [0], Relay 2 [1], Relay 3 [2], Relay 4 [3], Relay 5 [4], Relay 6 [5], Relay 7 [6], Relay 8 [7], Relay 9 [8])

Range:

0.01 s* [0.01 - 600.00 s]

Function:

Enter the delay of the relay cut-out time. Select one of available mechanical relays and MCO 105 in an array function. See par. 5-40 *Function Relay*.

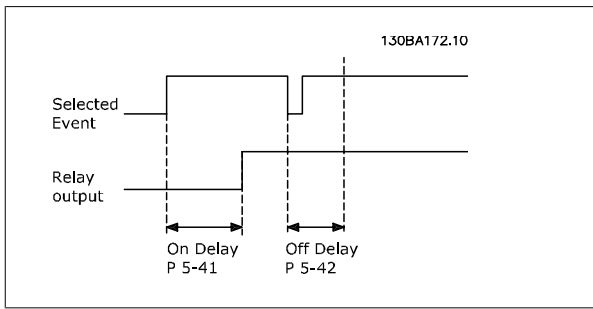

If the selected Event condition changes before the on- or off delay timer expires, the relay output is unaffected.

3.7.6 5-5* Pulse Input

The pulse input parameters are used to define an appropriate window for the impulse reference area by configuring the scaling and filter settings for the pulse inputs. Input terminals 29 or 33 act as frequency reference inputs. Set terminal 29 (par. 5-13 *Terminal 29 Digital Input*) or terminal 33 (par. 5-15 *Terminal 33 Digital Input*) to *Pulse input* [32]. If terminal 29 is used as an input, then set par.5-01 *Terminal 27 Mode* to *Input* [0].

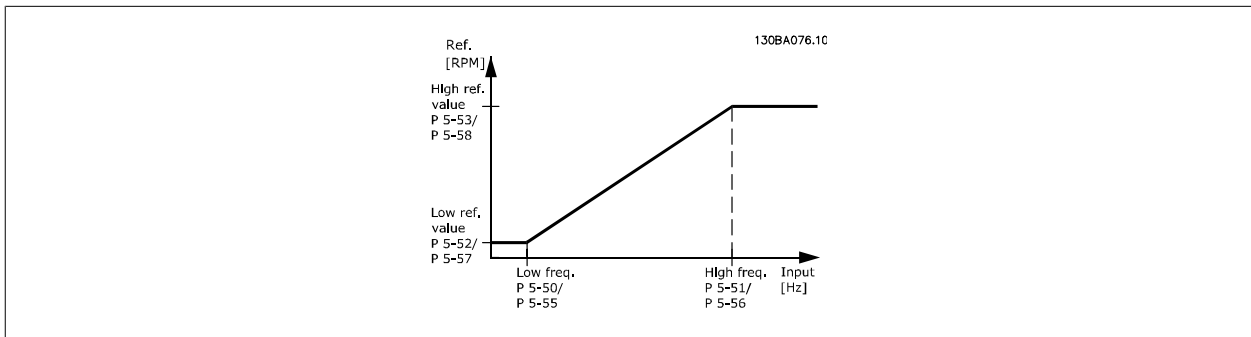

5-50 Term. 29 Low Frequency

Range:

100 Hz* [0 - 110000 Hz]

Function:

Enter the low frequency limit corresponding to the low motor shaft speed (i.e. low reference value) in par.5-52 *Term. 29 Low Ref./Feedb. Value*. Refer to the diagram in this section. This parameter is available for FC 302 only.

5-51 Term. 29 High Frequency

Range:

100 Hz* [0 - 110000 Hz]

Function:

Enter the high frequency limit corresponding to the high motor shaft speed (i.e. high reference value) in par.5-53 *Term. 29 High Ref./Feedb. Value*. This parameter is available for FC 302 only.

5-52 Term. 29 Low Ref./Feedb. Value

Range:

0.000 Ref- [-999999.999 - 999999.999 ReferenceFeed-enceFeedbackUnit] backUnit*

Function:

Enter the low reference value limit for the motor shaft speed [RPM]. This is also the lowest feedback value, see also par.5-57 *Term. 33 Low Ref./Feedb. Value*. Set terminal 29 to digital input (par. 5-02 *Terminal 29 Mode = input* [0] (default) and par. 5-13 *Terminal 29 Digital Input* = applicable value). This parameter is available for FC 302 only.

5-53 Term. 29 High Ref./Feedb. Value

Range:

1500.000 [-999999.999 - 999999.999 Reference- enceFeedbackUnit]

Function:

Enter the high reference value [RPM] for the motor shaft speed and the high feedback value, see also par.5-58 *Term. 33 High Ref./Feedb. Value*. Select terminal 29 as a digital input (par.

FeedbackUnit* 5-02 *Terminal 29 Mode = input* [0] (default) and par. 5-13 *Terminal 29 Digital Input* = applicable value).
This parameter is available for FC 302 only.

5-54 Pulse Filter Time Constant #29

Range: 100 ms* [1 - 1000 ms]
Function: Enter the pulse filter time constant. The pulse filter dampens oscillations of the feedback signal, which is an advantage if there is a lot of noise in the system. A high time constant value results in better dampening but also increases the time delay through the filter. This parameter is available for FC 302 only.
This parameter cannot be adjusted while the motor is running.

5-55 Term. 33 Low Frequency

Range: 100 Hz* [0 - 110000 Hz]
Function: Enter the low frequency corresponding to the low motor shaft speed (i.e. low reference value) in par.5-57 *Term. 33 Low Ref./Feedb. Value*.

5-56 Term. 33 High Frequency

Range: 100 Hz* [0 - 110000 Hz]
Function: Enter the high frequency corresponding to the high motor shaft speed (i.e. high reference value) in par. 5-58 *Term. 33 High Ref./Feedb. Value*.

5-57 Term. 33 Low Ref./Feedb. Value

Range: 0.000 N/A* [-999999.999 - 999999.999 N/A]
Function: Enter the low reference value [RPM] for the motor shaft speed. This is also the low feedback value, see also par. 5-52 *Term. 29 Low Ref./Feedb. Value*.

5-58 Term. 33 High Ref./Feedb. Value

Range: 1500.000 [-999999.999 - 999999.999 ReferenceFeedbackUnit]
Function: Enter the high reference value [RPM] for the motor shaft speed. See also par.5-53 *Term. 29 High Ref./Feedb. Value*.
FeedbackUnit*

5-59 Pulse Filter Time Constant #33

Range: 100 ms* [1 - 1000 ms]
Function: Enter the pulse filter time constant. The low-pass filter reduces the influence on and dampens oscillations on the feedback signal from the control.
This is an advantage, e.g. if there is a great amount on noise in the system. This parameter cannot be adjusted while the motor is running.

3.7.7 5-6* Pulse Outputs

These parameters are to configure pulse outputs with their functions and scaling. Terminal 27 and 29 are allocated to pulse output via par.5-01 *Terminal 27 Mode* and par.5-02 *Terminal 29 Mode*, respectively.

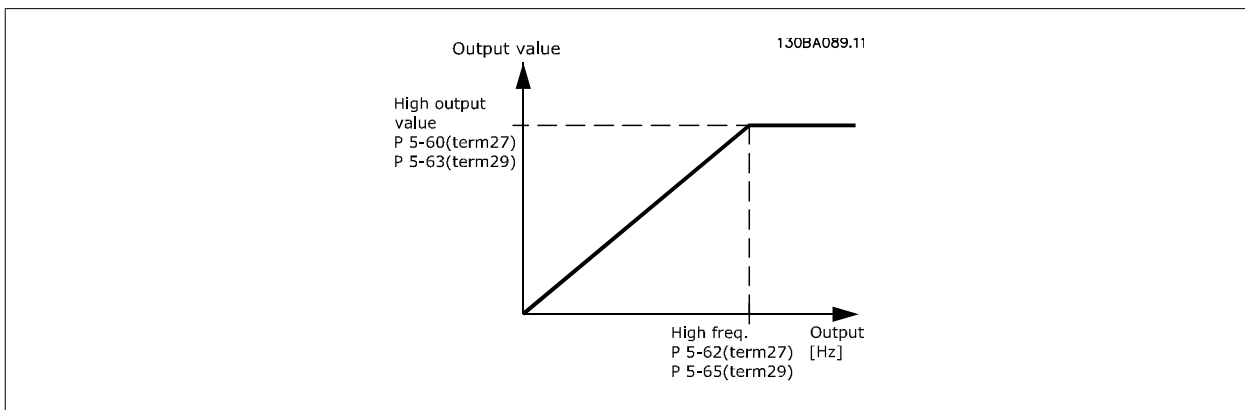

Options for readout output variables:

Parameters for configuring the scaling and output functions of pulse outputs. The pulse outputs are designated to terminals 27 or 29. Select terminal 27 output in par.5-01 *Terminal 27 Mode* and terminal 29 output in par.5-02 *Terminal 29 Mode*.

- [0] No operation
- [45] Bus control
- [48] Bus control time-out
- [51] MCO controlled
- [100] Output frequency
- [101] Reference
- [102] Feedback
- [103] Motor current
- [104] Torque relative to limit
- [105] Torque relative to rated
- [106] Power
- [107] Speed
- [108] Torque
- [109] Max Out Freq

5-60 Terminal 27 Pulse Output Variable

| Option: | Function: |
|----------------------------|---|
| [0] * No operation | Select the desired display output for terminal 27. This parameter cannot be adjusted while the motor is running. |
| [45] Bus ctrl. | |
| [48] Bus ctrl., timeout | |
| [51] MCO controlled | |
| [100] Output frequency | |
| [101] Reference | |
| [102] Feedback | |
| [103] Motor current | |
| [104] Torque rel to limit | |
| [105] Torq relate to rated | |
| [106] Power | |
| [107] Speed | |
| [108] Torque | |
| [109] Max Out Freq | |

[119] Torque % lim

5-62 Pulse Output Max Freq #27

Range:

5000. Hz* [0 - 32000 Hz]

Function:

Set the maximum frequency for terminal 27, corresponding to the output variable selected in par. 5-60 *Terminal 27 Pulse Output Variable*.

This parameter cannot be adjusted while the motor is running.

3

5-63 Terminal 29 Pulse Output Variable

Option:

[0] * No operation

Function:

Select the desired display output for terminal 29. This parameter is available for FC 302 only.

This parameter cannot be adjusted while the motor is running.

[45] Bus ctrl.

[48] Bus ctrl., timeout

[51] MCO controlled

[100] Output frequency

[101] Reference

[102] Feedback

[103] Motor current

[104] Torque rel to limit

[105] Torq relate to rated

[106] Power

[107] Speed

[108] Torque

[109] Max Out Freq

[119] Torque % lim

5-65 Pulse Output Max Freq #29

Range:

5000 Hz* [0 - 32000 Hz]

Function:

Set the maximum frequency for terminal 29 corresponding to the output variable set in par. 5-63 *Terminal 29 Pulse Output Variable*.

This parameter cannot be adjusted while the motor is running.

5-66 Terminal X30/6 Pulse Output Variable

Option:

[0] * No operation

Function:

Select the variable for read-out on terminal X30/6.

This parameter cannot be adjusted while the motor is running.

This parameter is active when option module MCB 101 is installed in the frequency converter.

[45] Bus ctrl.

[48] Bus ctrl., timeout

[100] Output freq. 0-100

[101] Reference Min-Max

[102] Feedback +-200%

[103] Motor cur. 0-Imax

[104] Torque 0-Tlim

[105] Torque 0-Tnom

[106] Power 0-Pnom

[107] Speed 0-HighLim

[113] Ext. Closed Loop 1

[114] Ext. Closed Loop 2

[115] Ext. Closed Loop 3

5-68 Pulse Output Max Freq #X30/6

Range:

5000. Hz* [0 - 32000 Hz]

Function:

Select the maximum frequency on terminal X30/6 referring to the output variable in par.5-66 *Terminal X30/6 Pulse Output Variable*. This parameter cannot be adjusted while the motor is running.

This parameter is active when option module MCB 101 is mounted in the frequency converter.

3.7.8 5-7* 24 V Encoder Input

Parameters for configuring the 24 V encoder.

Connect the 24 V encoder to terminal 12 (24 V DC supply), terminal 32 (Channel A), terminal 33 (Channel B), and terminal 20 (GND). The digital inputs 32/33 are active for encoder inputs when 24 V encoder is selected in par.1-02 *Flux Motor Feedback Source* and par.7-00 *Speed PID Feedback Source*. The encoder used is a dual channel (A and B) 24 V type. Max input frequency: 110 kHz.

Encoder Connection to the frequency converter

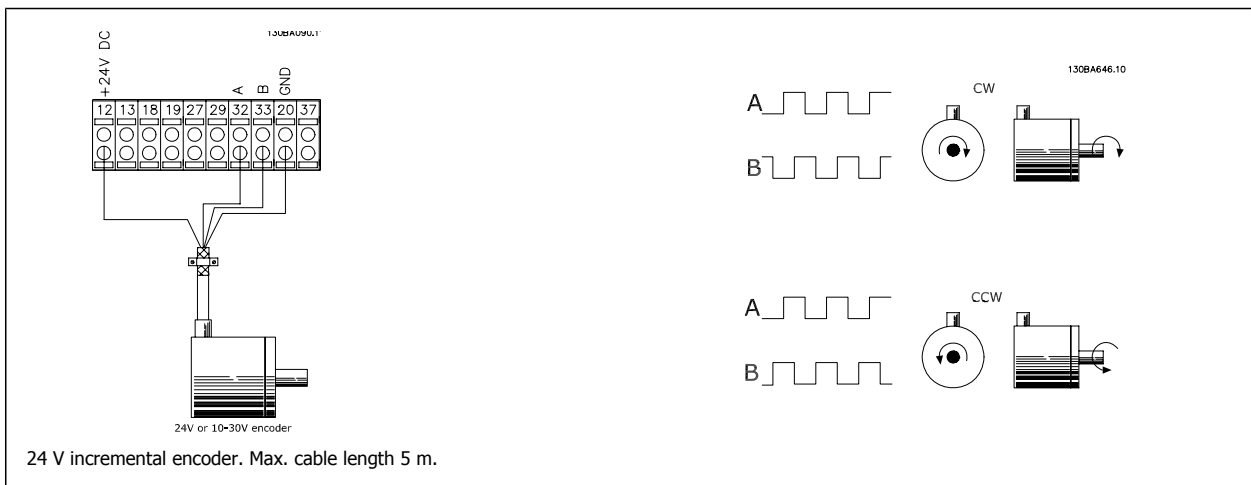

5-70 Term 32/33 Pulses per Revolution**Range:**

1024 N/A* [1 - 4096 N/A]

Function:

Set the encoder pulses per revolution on the motor shaft. Read the correct value from the encoder. This parameter cannot be adjusted while the motor is running.

5-71 Term 32/33 Encoder Direction**Option:**

[0] * Clockwise

Function:

Change the detected encoder rotation direction without changing the wiring to the encoder.

Sets channel A 90° (electrical degrees) behind channel B upon clockwise rotation of the encoder shaft.

[1] Counter clockwise

Sets channel A 90° (electrical degrees) ahead of channel B upon clockwise rotation of the encoder shaft.

This parameter cannot be adjusted while the motor is running.

3.7.9 5-9*Bus Controlled

This parameter group selects digital and relay outputs via a fieldbus setting.

5-90 Digital & Relay Bus Control**Range:**

0 N/A* [0 - 2147483647 N/A]

Function:

This parameter holds the state of the digital outputs and relays that is controlled by bus. A logical '1' indicates that the output is high or active. A logical '0' indicates that the output is low or inactive.

| | |
|-----------|----------------------------------|
| Bit 0 | Digital Output Terminal 27 |
| Bit 1 | Digital Output Terminal 29 |
| Bit 2 | Digital Output Terminal X 30/6 |
| Bit 3 | Digital Output Terminal X 30/7 |
| Bit 4 | Relay 1 output terminal |
| Bit 5 | Relay 2 output terminal |
| Bit 6 | Option B Relay 1 output terminal |
| Bit 7 | Option B Relay 2 output terminal |
| Bit 8 | Option B Relay 3 output terminal |
| Bit 9-15 | Reserved for future terminals |
| Bit 16 | Option C Relay 1 output terminal |
| Bit 17 | Option C Relay 2 output terminal |
| Bit 18 | Option C Relay 3 output terminal |
| Bit 19 | Option C Relay 4 output terminal |
| Bit 20 | Option C Relay 5 output terminal |
| Bit 21 | Option C Relay 6 output terminal |
| Bit 22 | Option C Relay 7 output terminal |
| Bit 23 | Option C Relay 8 output terminal |
| Bit 24-31 | Reserved for future terminals |

5-93 Pulse Out #27 Bus Control**Range:**

0.00 %* [0.00 - 100.00 %]

Function:

Set the output frequency transferred to the output terminal 27 when the terminal is configured as 'Bus Controlled' in par.5-60 *Terminal 27 Pulse Output Variable* [45].

5-94 Pulse Out #27 Timeout Preset**Range:**

0.00 %* [0.00 - 100.00 %]

Function:

Set the output frequency transferred to the output terminal 27 when the terminal is configured as 'Bus Ctrl Timeout' in par.5-60 *Terminal 27 Pulse Output Variable* [48]. And a time-out is detected.

5-95 Pulse Out #29 Bus Control

| | |
|---------------------------|--|
| Range: | Function: |
| 0.00 %* [0.00 - 100.00 %] | Set the output frequency transferred to the output terminal 29 when the terminal is configured as 'Bus Controlled' in par.5-60 <i>Terminal 27 Pulse Output Variable</i> [45]. This parameter only applies for FC 302. |

5-96 Pulse Out #29 Timeout Preset

| | |
|---------------------------|---|
| Range: | Function: |
| 0.00 %* [0.00 - 100.00 %] | Set the output frequency transferred to the output terminal 29 when the terminal is configured as 'Bus Ctrl Timeout' in par.5-60 <i>Terminal 27 Pulse Output Variable</i> [48]. And a time-out is detected. <i>This parameter only applies for FC 302.</i> |

3.7.10 5-97 Pulse Out #X30/6 Bus Control

5-97 Pulse Out #X30/6 Bus Control

| | |
|---------------------------|--|
| Range: | Function: |
| 0.00 %* [0.00 - 100.00 %] | Set the output frequency transferred to the output terminal X30/6 when the terminal is configured as 'Bus Controlled' in par. 5-66, Terminal X30/6 Pulse Output Variable [45]. |

3.7.11 5-98 Pulse Out #X30/6 Timeout Preset

5-98 Pulse Out #X30/6 Timeout Preset

| | |
|---------------------------|--|
| Range: | Function: |
| 0.00 %* [0.00 - 100.00 %] | Set the output frequency transferred to the output terminal X30/6 when the terminal is configured as 'Bus Ctrl Timeout' in par. 5-66, Terminal X30/6 Pulse Output Variable [48]. And a time-out is detected. |

3.8 Parameters: Analog In/Out

3.8.1 6-* Analog In/Out**

Parameter group for configuration of the analog input and output.

3.8.2 6-0* Analog I/O Mode

The analog inputs can freely be allocated to be either voltage (FC 301: 0..10 V, FC 302: 0..+/- 10V) or current (FC 301/FC 302: 0/4..20 mA) input.



NB!
Thermistors may be connected to either an analog or a digital input.

6-00 Live Zero Timeout Time

Range:

10 s* [1 - 99 s]

Function:

Enter the Live Zero Time-out time period. Live Zero Time-out Time is active for analog inputs, i.e. terminal 53 or terminal 54, used as reference or feedback sources. If the reference signal value associated with the selected current input falls below 50% of the value set in par. 6-10 *Terminal 53 Low Voltage*, par. 6-12 *Terminal 53 Low Current*, par. 6-20 *Terminal 54 Low Voltage* or par. 6-22 *Terminal 54 Low Current* for a time period longer than the time set in par.6-00 *Live Zero Timeout Time*, the function selected in par. 6-01 *Live Zero Timeout Function* will be activated.

6-01 Live Zero Timeout Function

Option:
Function:

Select the time-out function. The function set in par.6-01 *Live Zero Timeout Function* will be activated if the input signal on terminal 53 or 54 is below 50% of the value in par.6-10 *Terminal 53 Low Voltage*, par.6-12 *Terminal 53 Low Current*, par.6-20 *Terminal 54 Low Voltage* or par. 6-22 *Terminal 54 Low Current* for a time period defined in par.6-00 *Live Zero Timeout Time*. If several time-outs occur simultaneously, the frequency converter prioritises the time-out functions as follows:

1. par.6-01 *Live Zero Timeout Function*
2. Par. 5-74
3. par.8-04 *Control Word Timeout Function*

[0] * Off

[1] Freeze output Frozen at the present value

[2] Stop Overruled to stop

[3] Jogging Overruled to jog speed

[4] Max. speed Overruled to max. speed

[5] Stop and trip Overruled to stop with subsequent trip

[20] Coast

[21] Coast and trip

3.8.3 6-1* Analog Input 1

Parameters for configuring the scaling and limits for analog input 1 (terminal 53).

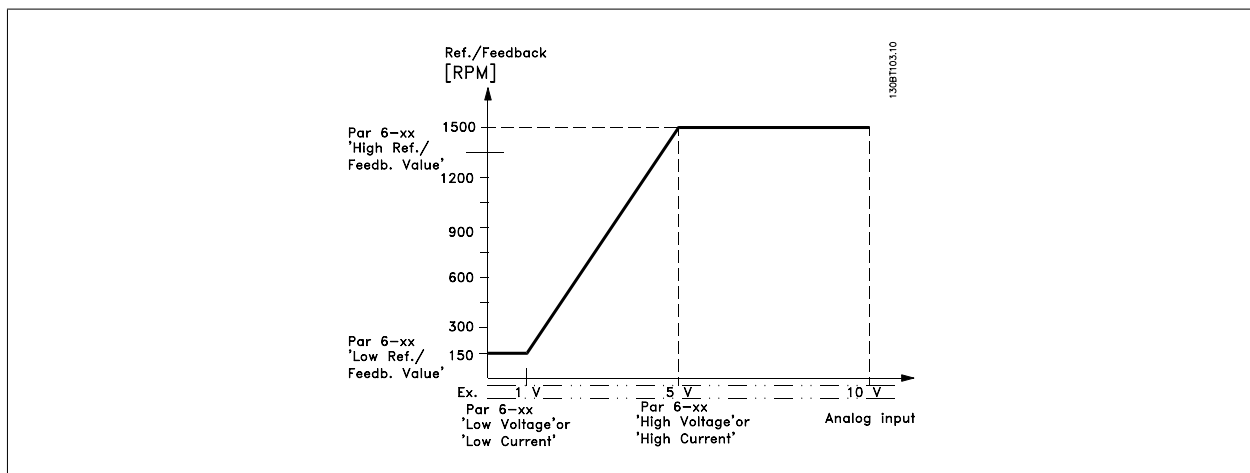

6-10 Terminal 53 Low Voltage**Range:**

0.07 V* [-10.00 - par. 6-11 V]

Function:

Enter the low voltage value. This analog input scaling value should correspond to the minimum reference value, set in par.6-14 *Terminal 53 Low Ref./Feedb. Value*. See also the section *Reference Handling*.

6-11 Terminal 53 High Voltage**Range:**

10.00 V* [par. 6-10 - 10.00 V]

Function:

Enter the high voltage value. This analog input scaling value should correspond to the high reference/feedback value set in par. 6-15 *Terminal 53 High Ref./Feedb. Value*.

6-12 Terminal 53 Low Current**Range:**

0.14 mA* [0.00 - par. 6-13 mA]

Function:

Enter the low current value. This reference signal should correspond to the minimum reference value, set in par.3-02 *Minimum Reference*. The value must be set at >2 mA in order to activate the Live Zero Time-out Function in par.6-01 *Live Zero Timeout Function*.

6-13 Terminal 53 High Current**Range:**

20.00 mA* [par. 6-12 - 20.00 mA]

Function:

Enter the high current value corresponding to the high reference/feedback set in par. 6-15 *Terminal 53 High Ref./Feedb. Value*.

6-14 Terminal 53 Low Ref./Feedb. Value**Range:**

0.000 N/A* [-999999.999 - 999999.999 N/A]

Function:

Enter the analog input scaling value that corresponds to the low voltage/low current set in par. 6-10 *Terminal 53 Low Voltage* and par. 6-12 *Terminal 53 Low Current*.

6-15 Terminal 53 High Ref./Feedb. Value**Range:**1500.000 [-999999.999 - 999999.999 Reference-
Reference-
FeedbackU-
nit*]**Function:**

Enter the analog input scaling value that corresponds to the maximum reference feedback value set in par.6-11 *Terminal 53 High Voltage* and par.6-13 *Terminal 53 High Current*.

6-16 Terminal 53 Filter Time Constant**Range:**

0.001 s* [0.001 - 10.000 s]

Function:

Enter the time constant. This is a first-order digital low pass filter time constant for suppressing electrical noise in terminal 53. A high time constant value improves dampening but also increases the time delay through the filter.

This parameter cannot be adjusted while the motor is running.

3.8.4 6-2* Analog Input 2

Parameters for configuring the scaling and limits for analog input 2 (terminal 54).

6-20 Terminal 54 Low Voltage**Range:**

0.07 V* [-10.00 - par. 6-21 V]

Function:

Enter the low voltage value. This analog input scaling value should correspond to the minimum reference value, set in par.3-02 *Minimum Reference*. See also the section *Reference Handling*.

6-21 Terminal 54 High Voltage**Range:**

10.00 V* [par. 6-20 - 10.00 V]

Function:

Enter the high voltage value. This analog input scaling value should correspond to the high reference/feedback value set in par. 6-25 *Terminal 54 High Ref./Feedb. Value*.

6-22 Terminal 54 Low Current**Range:**

0.14 mA* [0.00 - par. 6-23 mA]

Function:

Enter the low current value. This reference signal should correspond to the minimum reference value, set in par.3-02 *Minimum Reference*. The value must be set at >2 mA in order to activate the Live Zero Time-out Function in par.6-01 *Live Zero Timeout Function*.

6-23 Terminal 54 High Current**Range:**

20.00 mA* [par. 6-22 - 20.00 mA]

Function:

Enter the high current value corresponding to the high reference/feedback value set in par. 6-25 *Terminal 54 High Ref./Feedb. Value*.

6-24 Terminal 54 Low Ref./Feedb. Value**Range:**

0 Reference- [-999999.999 - 999999.999 ReferenceFeedbackUnit] Unit*

Function:

Enter the analog input scaling value that corresponds to the minimum reference feedback value set in par.3-02 *Minimum Reference*.

6-25 Terminal 54 High Ref./Feedb. Value**Range:**

1500.000 [-999999.999 - 999999.999 ReferenceFeedbackUnit] FeedbackUnit*

Function:

Enter the analog input scaling value that corresponds to the maximum reference feedback value set in par.3-03 *Maximum Reference*.

6-26 Terminal 54 Filter Time Constant**Range:**

0.001 s* [0.001 - 10.000 s]

Function:

Enter the time constant. This is a first-order digital low pass filter time constant for suppressing electrical noise in terminal 54. A high time constant value improves dampening but also increases the time delay through the filter.

This parameter cannot be adjusted while the motor is running.

3.8.5 6-3* Analog Input 3 MCB 101

Parameter group for configuring the scale and limits for analog input 3 (X30/11) placed on option module MCB 101.

6-30 Terminal X30/11 Low Voltage**Range:**

0.07 V* [0.00 - par. 6-31 V]

Function:

Sets the analog input scaling value to correspond to the low reference/feedback value (set in par. 6-34 *Term. X30/11 Low Ref./Feedb. Value*).

6-31 Terminal X30/11 High Voltage**Range:**

10.00 V* [par. 6-30 - 10.00 V]

Function:

Sets the analog input scaling value to correspond to the high reference/feedback value (set in par. 6-35 *Term. X30/11 High Ref./Feedb. Value*).

| 6-34 Term. X30/11 Low Ref./Feedb. Value | | |
|---|---|--|
| Range: | Function: | |
| 0.000 N/A* [-999999.999 - 999999.999 N/A] | Sets the analog input scaling value to correspond to the low voltage value (set in par.6-30 <i>Terminal X30/11 Low Voltage</i>). | |

| 6-35 Term. X30/11 High Ref./Feedb. Value | | |
|---|---|--|
| Range: | Function: | |
| 100.000 N/A* [-999999.999 - 999999.999 N/A] | Sets the analog input scaling value to correspond to the high voltage value (set in par.6-31 <i>Terminal X30/11 High Voltage</i>). | |

| 6-36 Term. X30/11 Filter Time Constant | | |
|--|--|--|
| Range: | Function: | |
| 0.001 s* [0.001 - 10.000 s] | A 1 st order digital low pass filter time constant for suppressing electrical noise on terminal X30/11. par.6-36 <i>Term. X30/11 Filter Time Constant</i> cannot be changed while the motor is running. | |

3.8.6 6-4* Analog Input 4 MCB 101

Parameter group for configuring the scale and limits for analog input 4 (X30/12) placed on option module MCB 101.

| 6-40 Terminal X30/12 Low Voltage | | |
|----------------------------------|--|--|
| Range: | Function: | |
| 0.07 V* [0.00 - par. 6-41 V] | Sets the analog input scaling value to correspond to the low reference/feedback value set in par. 6-44 <i>Term. X30/12 Low Ref./Feedb. Value</i> . | |

| 6-41 Terminal X30/12 High Voltage | | |
|-----------------------------------|--|--|
| Range: | Function: | |
| 10.00 V* [par. 6-40 - 10.00 V] | Sets the analog input scaling value to correspond to the high reference/feedback value set in par. 6-45 <i>Term. X30/12 High Ref./Feedb. Value</i> . | |

| 6-44 Term. X30/12 Low Ref./Feedb. Value | | |
|---|--|--|
| Range: | Function: | |
| 0.000 N/A* [-999999.999 - 999999.999 N/A] | Sets the analog output scaling value to correspond to the low voltage value set in par.6-40 <i>Terminal X30/12 Low Voltage</i> . | |

| 6-45 Term. X30/12 High Ref./Feedb. Value | | |
|---|---|--|
| Range: | Function: | |
| 100.000 N/A* [-999999.999 - 999999.999 N/A] | Sets the analog input scaling value to correspond to the high voltage value set in par.6-41 <i>Terminal X30/12 High Voltage</i> . | |

| 6-46 Term. X30/12 Filter Time Constant | | |
|--|--|--|
| Range: | Function: | |
| 0.001 s* [0.001 - 10.000 s] | A 1 st order digital low pass filter time constant for suppressing electrical noise on terminal X30/12. par.6-46 <i>Term. X30/12 Filter Time Constant</i> cannot be changed while the motor is running. | |

3.8.7 6-5* Analog Output 1

Parameters for configuring the scaling and limits for analog output 1, i.e. Terminal 42. Analog outputs are current outputs: 0/4 – 20 mA. Common terminal (terminal 39) is the same terminal and has the same electrical potential for analog common and digital common connection. Resolution on analog output is 12 bit.

| 6-50 Terminal 42 Output | | |
|-------------------------|--|--|
| Option: | Function: | |
| | Select the function of Terminal 42 as an analog current output. Depending on the selection the output is either a 0-20 mA or 4-20 mA output. The current value can be read out in LCP in par. 16-65 <i>Analog Output 42 [mA]</i> . | |
| [0] * | No operation | When no signal on the analog output. |
| [52] | MCO 0-20mA | |
| [53] | MCO 4-20mA | |
| [100] | Output frequency | 0 Hz = 0 mA; 100 Hz = 20 mA. |
| [101] | Reference | par.3-00 <i>Reference Range</i> [Min - Max] 0% = 0 mA; 100% = 20 mA par.3-00 <i>Reference Range</i> [-Max - Max] -100% = 0 mA; 0% = 10 mA; +100% = 20 mA |
| [102] | Feedback | |
| [103] | Motor current | Value is taken from par.16-37 <i>Inv. Max. Current</i> . Inverter max. current (160% current) is equal to 20 mA. Example: Inverter norm current (11 kW) = 24 A. 160 % = 38.4 A. Motor norm current = 22 A Read-out 11.46 mA. $\frac{20 \text{ mA} \times 22 \text{ A}}{38.4 \text{ A}} = 11.46 \text{ mA}$ In case the norm motor current is equal to 20 mA, the output setting of par.6-52 <i>Terminal 42 Output Max Scale</i> is: $\frac{I_{VLT \text{ Max}} \times 100}{I_{\text{Motor Norm}}} = \frac{38.4 \times 100}{22} = 175 \%$ |
| [104] | Torque rel to limit | The torque setting is related to setting in par.4-16 <i>Torque Limit Motor Mode</i> |
| [105] | Torq relate to rated | The torque is related to the motor torque setting. |
| [106] | Power | Taken from par.1-20 <i>Motor Power [kW]</i> . |
| [107] | Speed | Taken from par.3-03 <i>Maximum Reference</i> . 20 mA = value in par.3-03 <i>Maximum Reference</i> |
| [108] | Torque | Torque reference related to 160% torque. |
| [109] | Max Out Freq | In relation to par.4-19 <i>Max Output Frequency</i> . |
| [113] | PID Clamped Output | |
| [119] | Torque % lim | |
| [130] | Output freq. 4-20mA | 0 Hz = 4 mA, 100 Hz = 20 mA |
| [131] | Reference 4-20mA | par.3-00 <i>Reference Range</i> [Min-Max] 0% = 4 mA; 100% = 20 mA par.3-00 <i>Reference Range</i> [-Max-Max] -100% = 4mA; 0% = 12 mA; +100% = 20 mA |
| [132] | Feedback 4-20mA | |
| [133] | Motor cur. 4-20mA | Value is taken from par.16-37 <i>Inv. Max. Current</i> . Inverter max. current (160% current) is equal to 20 mA. Example: Inverter norm current (11 kW) = 24 A. 160 % = 38.4 A. Motor norm current = 22 A Read-out 11.46 mA. $\frac{16 \text{ mA} \times 22 \text{ A}}{38.4 \text{ A}} + 4 \text{ mA} = 13.17 \text{ mA}$ In case the norm motor current is equal to 20 mA, the output setting of par.6-62 <i>Terminal X30/8 Max. Scale</i> is: $\frac{I_{VLT \text{ Max}} \times 100}{I_{\text{Motor Norm}}} = \frac{38.4 \times 100}{22} = 175 \%$ |
| [134] | Torq.% lim 4-20 mA | The torque setting is related to setting in par.4-16 <i>Torque Limit Motor Mode</i> . |

| | | |
|-------|----------------------|---|
| [135] | Torq.% nom 4-20 mA | The torque setting is related to the motor torque setting. |
| [136] | Power 4-20mA | Taken from par.1-20 <i>Motor Power [kW]</i> |
| [137] | Speed 4-20mA | Taken from par.3-03 <i>Maximum Reference</i> . 20 mA = Value in par.3-03 <i>Maximum Reference</i> . |
| [138] | Torque 4-20mA | Torque reference related to 160% torque. |
| [139] | Bus ctrl. 0-20 mA | An output value set from fieldbus process data. The output will work independently of internal functions in the frequency converter. |
| [140] | Bus ctrl. 4-20 mA | An output value set from fieldbus process data. The output will work independently of internal functions in the frequency converter. |
| [141] | Bus ctrl 0-20mA t.o. | par.4-54 <i>Warning Reference Low</i> defines the behaviour of the analog output in case of bus time-out. |
| [142] | Bus ctrl 4-20mA t.o. | par.4-54 <i>Warning Reference Low</i> defines the behaviour of the analog output in case of bus time-out. |
| [149] | Torque % lim 4-20mA | Torque % Lim 4-20mA: Torque reference. par.3-00 <i>Reference Range</i> [Min-Max] 0% = 4 mA; 100% = 20mA par.3-00 <i>Reference Range</i> [-Max - Max] -100% = 4 mA; 0% = 12mA; +100% = 20mA |
| [150] | Max Out Fr 4-20mA | In relation to par.4-19 <i>Max Output Frequency</i> . |

6-51 Terminal 42 Output Min Scale

| | |
|---------------------------|---|
| Range: | Function: |
| 0.00 %* [0.00 - 200.00 %] | Scale for the minimum output (0 or 4 mA) of the analogue signal at terminal 42. Set the value to be the percentage of the full range of the variable selected in par. 6-50 <i>Terminal 42 Output</i> . |

6-52 Terminal 42 Output Max Scale

| | |
|-----------------------------|---|
| Range: | Function: |
| 100.00 %* [0.00 - 200.00 %] | Scale the maximum output of the selected analog signal at terminal 42. Set the value to the maximum value of the current signal output. Scale the output to give a current lower than 20 mA at full scale; or 20 mA at an output below 100% of the maximum signal value. If 20 mA is the desired output current at a value between 0 - 100% of the full-scale output, programme the percentage value in the parameter, i.e. 50% = 20 mA. If a current between 4 and 20 mA is desired at maximum output (100%), calculate the percentage value as follows: |

$20 \text{ mA} \mid \text{desired maximum current} \times 100 \%$

$i.e. 10 \text{ mA} : \frac{20}{10} \times 100 = 200 \%$

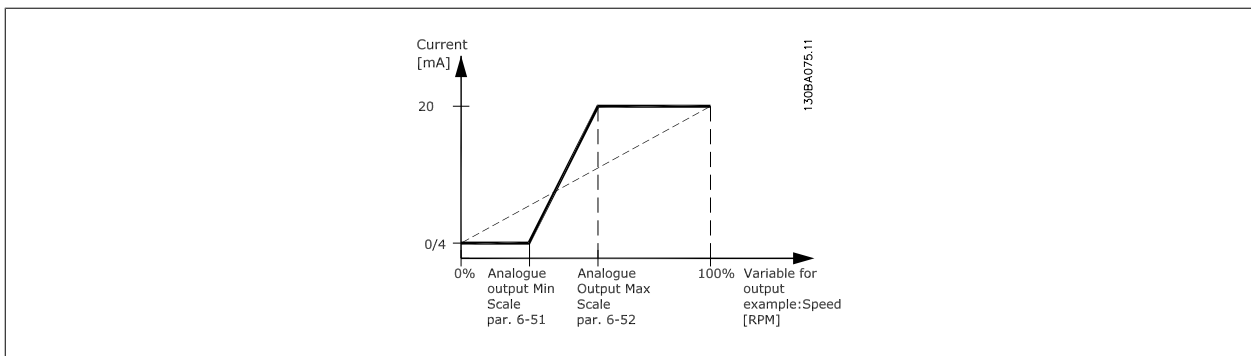

6-53 Terminal 42 Output Bus Control

| | |
|---------------------------|--|
| Range: | Function: |
| 0.00 %* [0.00 - 100.00 %] | Holds the level of Output 42 if controlled by bus. |

6-54 Terminal 42 Output Timeout Preset

Range:

0.00 %* [0.00 - 100.00 %]

Function:

Holds the preset level of Output 42.

In case of a bus timeout and a timeout function is selected in par. 6-50 *Terminal 42 Output* the output will preset to this level.

3

3.8.8 6-55 Terminal 42 Output Filter

6-55 Terminal 42 Output Filter

Option:

[0] * Off

[1] On

Function:

The following readout analogue parameters from selection in par. 6-50 have a filter selected when par. 6-55 is on:

| Selection | 0-20 mA | 4-20 mA |
|---------------------------------------|---------|---------|
| Motor current (0 - I _{max}) | [103] | [133] |
| Torque limit (0 - T _{lim}) | [104] | [134] |
| Rated torque (0 - T _{nom}) | [105] | [135] |
| Power (0 - P _{nom}) | [106] | [136] |
| Speed (0 - Speedmax) | [107] | [137] |

3.8.9 6-6* Analog Output 2 MCB 101

Analog outputs are current outputs: 0/4 - 20 mA. Common terminal (terminal X30/8) is the same terminal and electrical potential for analog common connection. Resolution on analog output is 12 bit.

6-60 Terminal X30/8 Output

Option:

[0] * No operation

[52] MCO 0-20mA

[100] Output frequency

[101] Reference

[102] Feedback

[103] Motor current

[104] Torque rel to limit

Function:

Select the function of Terminal X30/8 as an analog current output. Depending on the selection the output is either a 0-20 mA or 4-20 mA output. The current value can be read out in LCP in par. 16-65 *Analog Output 42 [mA]*.

When no signal on the analog output.

0 Hz = 0 mA; 100 Hz = 20 mA.

par.3-00 *Reference Range* [Min - Max] 0% = 0 mA; 100% = 20 mA
 par.3-00 *Reference Range* [-Max - Max] -100% = 0 mA; 0% = 10 mA; +100% = 20 mA

Value is taken from par.16-37 *Inv. Max. Current*. Inverter max. current (160% current) is equal to 20 mA.

Example: Inverter norm current (11 kW) = 24 A. 160 % = 38.4 A. Motor norm current = 22 A Read-out 11.46 mA.

$$\frac{20 \text{ mA} \times 22 \text{ A}}{38.4 \text{ A}} = 11.46 \text{ mA}$$

In case the norm motor current is equal to 20 mA, the output setting of par.6-62 *Terminal X30/8 Max. Scale* is:

$$\frac{I_{VLT \text{ Max}} \times 100}{I_{\text{Motor Norm}}} = \frac{38.4 \times 100}{22} = 175 \%$$

The torque setting is related to setting in par.4-16 *Torque Limit Motor Mode*.

| | | |
|-------|----------------------|--|
| [105] | Torq relate to rated | The torque is related to the motor torque setting. |
| [106] | Power | Taken from par.1-20 <i>Motor Power [kW]</i> . |
| [107] | Speed | Taken from par.3-03 <i>Maximum Reference</i> . 20 mA = value in par.3-03 <i>Maximum Reference</i> |
| [108] | Torque | Torque reference related to 160% torque. |
| [109] | Max Out Freq | In relation to par.4-19 <i>Max Output Frequency</i> . |
| [113] | PID Clamped Output | |
| [119] | Torque % lim | |
| [130] | Output freq. 4-20mA | 0 Hz = 4 mA, 100 Hz = 20 mA |
| [131] | Reference 4-20mA | par.3-00 <i>Reference Range</i> [Min-Max] 0% = 4 mA; 100% = 20 mA par.3-00 <i>Reference Range</i> [-Max-Max] -100% = 4mA; 0% = 12 mA; +100% = 20 mA |
| [132] | Feedback 4-20mA | |
| [133] | Motor cur. 4-20mA | Value is taken from par.16-37 <i>Inv. Max. Current</i> . Inverter max. current (160% current) is equal to 20 mA. Example: Inverter norm current (11 kW) = 24 A. 160 % = 38.4 A. Motor norm current = 22 A Read-out 11.46 mA. $\frac{16 \text{ mA} \times 22 \text{ A}}{38.4 \text{ A}} = 9.17 \text{ mA}$ In case the norm motor current is equal to 20 mA, the output setting of par.6-62 <i>Terminal X30/8 Max. Scale</i> is: $\frac{I_{VLT \text{ Max}} \times 100}{I_{\text{Motor Norm}}} = \frac{38.4 \times 100}{22} = 175 \%$ |
| [134] | Torq.% lim 4-20 mA | The torque setting is related to setting in par.4-16 <i>Torque Limit Motor Mode</i> . |
| [135] | Torq.% nom 4-20 mA | The torque setting is related to the motor torque setting. |
| [136] | Power 4-20mA | Taken from par.1-20 <i>Motor Power [kW]</i> |
| [137] | Speed 4-20mA | Taken from par.3-03 <i>Maximum Reference</i> . 20 mA = Value in par.3-03 <i>Maximum Reference</i> . |
| [138] | Torque 4-20mA | Torque reference related to 160% torque. |
| [139] | Bus ctrl. 0-20 mA | An output value set from fieldbus process data. The output will work independently of internal functions in the frequency converter. |
| [140] | Bus ctrl. 4-20 mA | An output value set from fieldbus process data. The output will work independently of internal functions in the frequency converter. |
| [141] | Bus ctrl 0-20mA t.o. | par.4-54 <i>Warning Reference Low</i> defines the behaviour of the analog output in case of bus time-out. |
| [142] | Bus ctrl 4-20mA t.o. | par.4-54 <i>Warning Reference Low</i> defines the behaviour of the analog output in case of bus time-out. |
| [149] | Torque % lim 4-20mA | Torque % Lim 4-20mA: Torque reference. par.3-00 <i>Reference Range</i> [Min-Max] 0% = 4 mA; 100% = 20mA par.3-00 <i>Reference Range</i> [-Max - Max] -100% = 4 mA; 0% = 12mA; +100% = 20mA |
| [150] | Max Out Fr 4-20mA | In relation to par.4-19 <i>Max Output Frequency</i> . |

6-61 Terminal X30/8 Min. Scale

Range:

0.00 %* [0.00 - 200.00 %]

Function:

Scales the minimum output of the selected analog signal on terminal X30/8. Scale the minimum value as a percentage of the maximum signal value, i.e. 0 mA (or 0 Hz) is desired at 25% of the maximum output value and 25% is programmed. The value can never be higher than the corresponding setting in par. 6-62 *Terminal X30/8 Max. Scale* if value is below 100%.
This parameter is active when option module MCB 101 is mounted in the frequency converter.

6-62 Terminal X30/8 Max. Scale**Range:**

100.00 %* [0.00 - 200.00 %]

Function:

Scales the maximum output of the selected analog signal on terminal X30/8. Scale the value to the desired maximum value of the current signal output. Scale the output to give a lower current than 20 mA at full scale or 20 mA at an output below 100% of the maximum signal value. If 20 mA is the desired output current at a value between 0 - 100% of the full-scale output, program the percentage value in the parameter, i.e. 50% = 20 mA. If a current between 4 and 20 mA is desired at maximum output (100%), calculate the percentage value as follows:

$$20 \text{ mA} / \text{desired maximum current} \times 100 \%$$

$$\text{i.e. } 10 \text{ mA} : \frac{20 - 4}{10} \times 100 = 160 \%$$

3.8.10 6-63 Terminal X30/8 Bus Control**6-63 Terminal X30/8 Bus Control****Range:**

0.00 %* [0.00 - 100.00 %]

Function:

Holds the level of Output X30/8 if controlled by bus.

3.8.11 6-64 Terminal X30/8 Output Timeout Preset**6-64 Terminal X30/8 Output Timeout Preset****Range:**

0.00 %* [0.00 - 100.00 %]

Function:

Holds the preset level of Output X30/8.
In case of a bus timeout and a timeout function is selected in par. 6-60, Terminal X30/8 Output, the output will preset to this level.

3.8.12 6-7* Analog Output 3

Parameters for configuring the scaling and limits for analog output 3, Terminal X45/1 and X45/2. Analog outputs are current outputs: 0/4 – 20 mA. Resolution on analog output is 11 bit.

6-70 Terminal X45/1 Output**Option:**

[0] No operation

[52] MCO 305 0-20 mA

[53] MCO 305 4-20 mA

[100] Output frequency 0-20 mA

[101] Reference 0-20 mA

[102] Feedback

[103] Motor current 0-20 mA

[104] Torque rel to lim 0-20 mA

Function:

Select the function of Terminal X45/1 as an analog current output.

When no signal on the analog output.

0 Hz = 0 mA; 100 Hz = 20 mA.

Par. 3-00 [Min - Max] 0% = 0 mA; 100% = 20 mA

Par. 3-00 [-Max - Max] -100% = 0 mA; 0% = 10 mA; +100% = 20 mA

Value is taken from par. 16-37. Inverter max. current (160% current) is equal to 20 mA.

Example: Inverter norm current (11 kW) = 24 A. 160% = 38.4 A. Motor norm current = 22 A Read-out 11.46 mA.

$$\frac{20 \text{ mA} \times 22 \text{ A}}{38.4 \text{ A}} = 11.46 \text{ mA}$$

In case the norm motor current is equal to 20 mA, the output setting of par. 6-52 is:

$$\frac{I_{VLT \text{ Max}} \times 100}{I_{\text{Motor Norm}}} = \frac{38.4 \times 100}{22} = 175 \%$$

The torque setting is related to setting in par. 4-16

| | | |
|-------|--|--|
| [105] | Torque rel to rated motor torque 0-20 mA | The torque is related to the motor torque setting. |
| [106] | Power 0-20 mA | Taken from par. 1-20. |
| [107] | Speed 0-20 mA | Taken from par. 3-03. 20 mA = value in par. 3-03 |
| [108] | Torque ref. 0-20 mA | Torque reference related to 160% torque. |
| [109] | Max Out Freq 0-20 mA | In relation to par. 4-19. |
| [130] | Output freq. 4-20 mA | 0 Hz = 4 mA, 100 Hz = 20 mA |
| [131] | Reference 4-20 mA | Par. 3-00 [Min-Max] 0% = 4 mA; 100% = 20 mA Par. 3-00 [-Max-Max] -100% = 4mA; 0% = 12 mA; +100% = 20 mA |
| [132] | Feedback 4-20 mA | |
| [133] | Motor cur. 4-20 mA | Value is taken from par. 16-37. Inverter max. current (160% current) is equal to 20 mA. Example: Inverter norm current (11 kW) = 24 A. 160 % = 38.4 A. Motor norm current = 22 A Read-out 11.46 mA. $\frac{16 \text{ mA} \times 22 \text{ A}}{38.4 \text{ A}} = 9.17 \text{ mA}$ In case the norm motor current is equal to 20 mA, the output setting of par. 6-52 is: $\frac{I_{VLT_Max} \times 100}{I_{Motor_Norm}} = \frac{38.4 \times 100}{22} = 175 \%$ |
| [134] | Torque % lim. 4-20 mA | The torque setting is related to setting in par. 4-16. |
| [135] | Torque % nom 4-20 mA | The torque setting is related to the motor torque setting. |
| [136] | Power 4-20 mA | Taken from par. 1-20 |
| [137] | Speed 4-20 mA | Taken from par. 3-03. 20 mA = Value in par. 3-03. |
| [138] | Torque 4-20 mA | Torque reference related to 160% torque. |
| [139] | Bus ctrl. 0-20 mA | An output value set from fieldbus process data. The output will work independently of internal functions in the frequency converter. |
| [140] | Bus ctrl. 4-20 mA | An output value set from fieldbus process data. The output will work independently of internal functions in the frequency converter. |
| [141] | Bus ctrl. 0-20 mA, timeout | Par. 4-54 defines the behaviour of the analog output in case of bus time-out. |
| [142] | Bus ctrl. 4-20 mA, timeout | Par. 4-54 defines the behaviour of the analog output in case of bus time-out. |
| [150] | Max Out Freq 4-20 mA | In relation to par. 4-19. |

6-71 Terminal X45/1 Output Min Scale

Range:

0.00%* [0.00 - 200.00%]

Function:

Scale the minimum output of the selected analog signal at terminal X45/1, as a percentage of the maximum signal value. E.g. if 0 mA (or 0 Hz) is desired at 25% of the maximum output value, then programme 25%. Scaling values up to 100% can never be higher than the corresponding setting in par. 6-72.

6-72 Terminal X45/1 Output Max Scale

Range:

100%* [0.00 - 200.00%]

Function:

Scale the maximum output of the selected analog signal at terminal X45/1. Set the value to the maximum value of the current signal output. Scale the output to give a current lower than 20 mA at full scale; or 20 mA at an output below 100% of the maximum signal value. If 20 mA is the desired output current at a value between 0 - 100% of the full-scale output, programme the percentage value in the parameter, i.e. 50% = 20 mA. If a current between 4 and 20 mA is desired at maximum output (100%), calculate the percentage value as follows (example where desired max. output is 10 mA):

$$\frac{I_{RANGE} [mA]}{I_{DESIRED MAX} [mA]} \times 100\% = \frac{20 - 4 \text{ mA}}{10 \text{ mA}} \times 100\% = 160\%$$

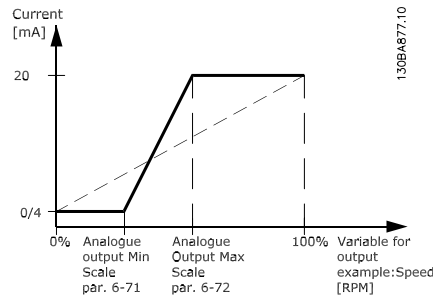

6-73 Terminal X45/1 Output Bus Control

Range:

0.00%* [0.00 - 100.00%]

Function:

Holds the level of Analog Output 3 (terminal X45/1) if controlled by bus.

6-74 Terminal X45/1 Output Timeout Preset

Range:

0.00%* [0.00 - 100.00%]

Function:

Holds the preset level of Analog Output 3 (terminal X45/1).

In case of a bus timeout and a timeout function is selected in par. 6-70 the output will preset to this level.

3.8.13 6-8* Analog Output 4

Parameters for configuring the scaling and limits for analog output 4. Terminal X45/3 and X45/4. Analog outputs are current outputs: 0/4 – 20 mA. Resolution on analog output is 11 bit.

6-80 Terminal X45/3 Output

Option:

[0] * No operation

Function:

Select the function of Terminal X45/3 as an analog current output.

Same selections available as for par. 6-70

6-81 Terminal X45/3 Output Min Scale

Option:

[0.00%]* 0.00 - 200.00%

Function:

Scales the minimum output of the selected analog signal on terminal X45/3. Scale the minimum value as a percentage of the maximum signal value, i.e. 0 mA (or 0 Hz) is desired at 25% of the maximum output value and 25% is programmed. The value can never be higher than the corresponding setting in par. 6-82 if value is below 100%.

This parameter is active when option module MCB 113 is mounted in the frequency converter.

6-82 Terminal X45/3 Output Max Scale

Option:

[0.00%]* 0.00 - 200.00%

Function:

Scales the maximum output of the selected analog signal on terminal X45/3. Scale the value to the desired maximum value of the current signal output. Scale the output to give a lower current than 20 mA at full scale or 20 mA at an output below 100% of the maximum signal value. If 20 mA is the desired output current at a value between 0 - 100% of the full-scale output, program the percentage value in the parameter, i.e. 50% = 20 mA. If a current between 4 and 20 mA is desired at maximum output (100%), calculate the percentage value as follows (example where desired max. output is 10 mA):

$$\frac{I_{RANGE} [mA]}{I_{DESIRED MAX} [mA]} \times 100\% = \frac{20 - 4 \text{ mA}}{10 \text{ mA}} \times 100\% = 160\%$$

6-83 Terminal X45/3 Output Bus Control

Option:

[0.00%] * 0.00 - 100.00%

Function:

Holds the level of output 4 (X45/3) if controlled by bus.

6-84 Terminal X45/3 Output Timeout Preset

Option:

[0.00%] * 0.00 - 100.00%

Function:

Holds the present level of output 4 (X45/3). In case of a bus timeout and a timeout function is selected in par. 6-80 the output will preset to this level.

3.9 Parameters: Controllers

3.9.1 7-** Controllers

Parameter group for configuring application controls.

3.9.2 7-0* Speed PID Ctrl.

Parameters for configuring the speed PID control.

7-00 Speed PID Feedback Source

Option:

- [0] * Motor feedb. P1-02
- [1] 24V encoder
- [2] MCB 102
- [3] MCB 103
- [5] MCO Encoder 2
- [6] Analog input 53
- [7] Analog input 54
- [8] Frequency input 29
- [9] Frequency input 33

Function:

Select the encoder for closed loop feedback.
 The feedback may come from a different encoder (typically mounted on the application itself) than the motor mounted encoder feedback selected in par.1-02 *Flux Motor Feedback Source*.
 This parameter cannot be adjusted while the motor is running.



NB!

If separate encoders are used (FC 302 only) the ramp settings parameters in the following groups: 3-4*, 3-5*, 3-6*, 3-7* and 3-8* must be adjusted according to the gear ratio between the two encoders.

7-02 Speed PID Proportional Gain

Range:

0 N/A* [0.000 - 1.000 N/A]

Function:

Enter the speed controller proportional gain. The proportional gain amplifies the error (i.e. the deviation between the feedback signal and the set-point). This parameter is used with par. 1-00 *Configuration Mode Speed open loop* [0] and *Speed closed loop* [1] control. Quick control is obtained at high amplification. However if the amplification is too great, the process may become unstable.
 Use this parameter for values with three decimals. For a selection with four decimals, use par. 3-83.

7-03 Speed PID Integral Time**Range:**

8.0 ms* [2.0 - 20000.0 ms]

Function:

Enter the speed controller integral time, which determines the time the internal PID control takes to correct errors. The greater the error, the more quickly the gain increases. The integral time causes a delay of the signal and therefore a dampening effect, and can be used to eliminate steady state speed error. Obtain quick control through a short integral time, though if the integral time is too short, the process becomes unstable. An excessively long integral time disables the integral action, leading to major deviations from the required reference, since the process regulator takes too long to regulate errors. This parameter is used with *Speed open loop* [0] and *Speed closed loop* [1] control, set in par.1-00 *Configuration Mode*.

7-04 Speed PID Differentiation Time**Range:**

30.0 ms* [0.0 - 200.0 ms]

Function:

Enter the speed controller differentiation time. The differentiator does not react to constant error. It provides gain proportional to the rate of change of the speed feedback. The quicker the error changes, the stronger the gain from the differentiator. The gain is proportional with the speed at which errors change. Setting this parameter to zero disables the differentiator. This parameter is used with par.1-00 *Configuration Mode Speed closed loop* [1] control.

7-05 Speed PID Diff. Gain Limit**Range:**

5.0 N/A* [1.0 - 20.0 N/A]

Function:

Set a limit for the gain provided by the differentiator. Since the differential gain increases at higher frequencies, limiting the gain may be useful. For example, set up a pure D-link at low frequencies and a constant D-link at higher frequencies. This parameter is used with par.1-00 *Configuration Mode Speed closed loop* [1] control.

7-06 Speed PID Lowpass Filter Time**Range:**

10.0 ms* [1.0 - 100.0 ms]

Function:

Set a time constant for the speed control low-pass filter. The low-pass filter improves steady-state performance and dampens oscillations on the feedback signal. This is an advantage if there is a great amount on noise in the system, see illustration below. For example, if a time constant (τ) of 100 ms is programmed, the cut-off frequency for the low-pass filter will be $1/0.1 = 10$ RAD/sec., corresponding to $(10/2 \times \pi) = 1.6$ Hz. The PID regulator only regulates a feedback signal that varies by a frequency of less than 1.6 Hz. If the feedback signal varies by a higher frequency than 1.6 Hz, the PID regulator does not react.

Practical settings of par.7-06 *Speed PID Lowpass Filter Time* taken from the number of pulses per revolutions from encoder:

| Encoder PPR | par.7-06 <i>Speed PID Lowpass Filter Time</i> |
|-------------|---|
| 512 | 10 ms |
| 1024 | 5 ms |
| 2048 | 2 ms |
| 4096 | 1 ms |

Note that severe filtering can be detrimental to dynamic performance.

This parameter is used with par.1-00 *Configuration Mode Speed closed loop* [1] and *Torque* [2] control.

The filter time in flux sensorless must be adjusted to 3-5 ms.

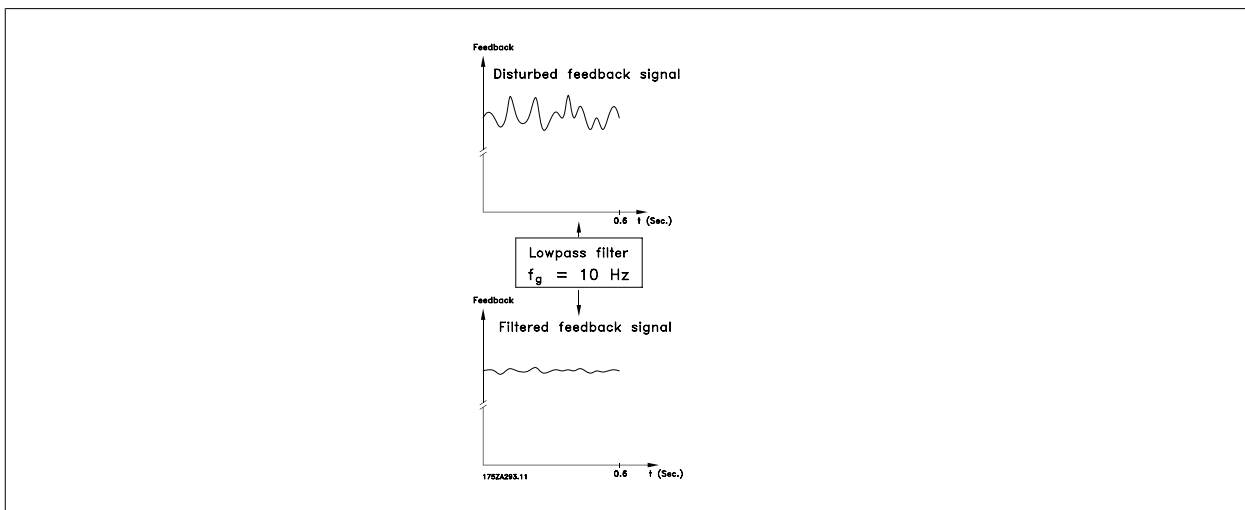

7-07 Speed PID Feedback Gear Ratio

Range: 1.0000 N/ [0.0001 - 32.0000 N/A]
Function: A*

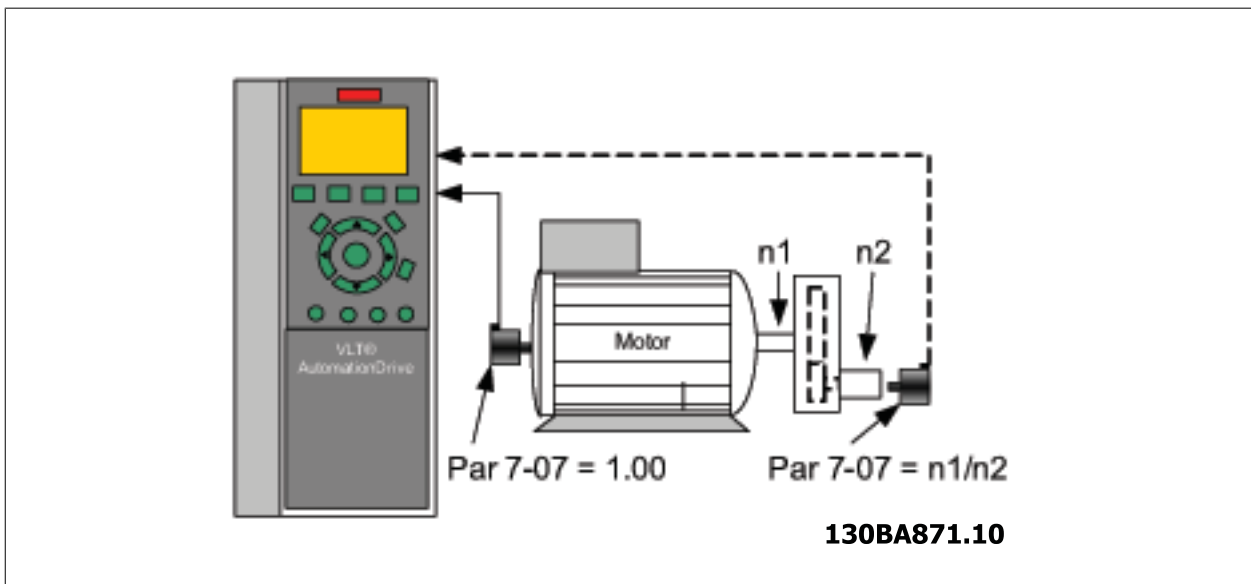

7-08 Speed PID Feed Forward Factor

Range: 0 %* [0 - 500 %]
Function: The reference signal bypasses the speed controller by the amount specified. This feature increases the dynamic performance of the speed control loop.

3.9.3 7.1* Torque PI Control

Parameters for configuring the torque PI control in torque open loop (par.1-00 Configuration Mode).

7-12 Torque PI Proportional Gain

Range: 100 %* [0 - 500 %]
Function: Enter the proportional gain value for the torque controller. Selection of a high value makes the controller react faster. Too high a setting leads to controller instability.

7-13 Torque PI Integration Time

Range:

0.020 s* [0.002 - 2.000 s]

Function:

Enter the integration time for the torque controller. Selection of a low value makes the controller react faster. Too low a setting leads to control instability.

3

3.9.4 7-2* Process Ctrl. Feedb.

Select the feedback sources for the Process PID Control, and how this feedback should be handled.

7-20 Process CL Feedback 1 Resource

Option:
Function:

The effective feedback signal is made up of the sum of up to two different input signals. Select which frequency converter input should be treated as the source of the first of these signals. The second input signal is defined in par.7-22 *Process CL Feedback 2 Resource*.

| | |
|-------|---------------------|
| [0] * | No function |
| [1] | Analog input 53 |
| [2] | Analog input 54 |
| [3] | Frequency input 29 |
| [4] | Frequency input 33 |
| [7] | Analog input X30/11 |
| [8] | Analog input X30/12 |

7-22 Process CL Feedback 2 Resource

Option:
Function:

The effective feedback signal is made up of the sum of up to two different input signals. Select which frequency converter input should be treated as the source of the second of these signals. The first input signal is defined in par. 7-21.

| | |
|-------|---------------------|
| [0] * | No function |
| [1] | Analog input 53 |
| [2] | Analog input 54 |
| [3] | Frequency input 29 |
| [4] | Frequency input 33 |
| [7] | Analog input X30/11 |
| [8] | Analog input X30/12 |

3.9.5 7-3* Process PID Ctrl.

Parameters for configuring the Process PID control.

7-30 Process PID Normal/ Inverse Control

Option:
Function:

Normal and inverse control are implemented by introducing a difference between the reference signal and the feedback signal.

| | | |
|-------|---------|--|
| [0] * | Normal | Sets process control to increase the output frequency. |
| [1] | Inverse | Sets process control to reduce the output frequency. |

7-31 Process PID Anti Windup

Option:
Function:

| | | |
|-----|-----|--|
| [0] | Off | Ceases regulation of an error when the output frequency can no longer be adjusted. |
|-----|-----|--|

[1] * On Continues regulation of an error even when the output frequency cannot be increased or decreased.

7-32 Process PID Start Speed

| | |
|-----------------------|--|
| Range: | Function: |
| 0 RPM* [0 - 6000 RPM] | Enter the motor speed to be attained as a start signal for commencement of PID control. When the power is switched on, the frequency converter will commence ramping and then operate under speed open loop control. Thereafter, when the Process PID start speed is reached, the frequency converter will change over to Process PID control. |

7-33 Process PID Proportional Gain

| | |
|------------------------------|--|
| Range: | Function: |
| 0.01 N/A* [0.00 - 10.00 N/A] | Enter the PID proportional gain. The proportional gain multiplies the error between the set point and the feedback signal. |

7-34 Process PID Integral Time

| | |
|---------------------------------|--|
| Range: | Function: |
| 10000.00 s* [0.01 - 10000.00 s] | Enter the PID integral time. The integrator provides an increasing gain at a constant error between the set point and the feedback signal. The integral time is the time needed by the integrator to reach the same gain as the proportional gain. |

7-35 Process PID Differentiation Time

| | |
|--------------------------|--|
| Range: | Function: |
| 0.00 s* [0.00 - 10.00 s] | Enter the PID differentiation time. The differentiator does not react to a constant error, but provides a gain only when the error changes. The shorter the PID differentiation time, the stronger the gain from the differentiator. |

7-36 Process PID Diff. Gain Limit

| | |
|---------------------------|--|
| Range: | Function: |
| 5.0 N/A* [1.0 - 50.0 N/A] | Enter a limit for the differentiator gain (DG). If there is no limit, the DG will increase when there are fast changes. Limit the DG to obtain a pure differentiator gain at slow changes and a constant differentiator gain where fast changes occur. |

7-38 Process PID Feed Forward Factor

| | |
|------------------|---|
| Range: | Function: |
| 0 %* [0 - 500 %] | Enter the PID feed forward (FF) factor. The FF factor sends a constant fraction of the reference signal to bypass the PID control, so the PID control only affects the remaining fraction of the control signal. Any change to this parameter will thus affect the motor speed. When the FF factor is activated it provides less overshoot, and high dynamics when changing the set point. par.7-38 <i>Process PID Feed Forward Factor</i> is active when par.1-00 <i>Configuration Mode</i> is set to [3] Process. |

7-39 On Reference Bandwidth

| | |
|------------------|---|
| Range: | Function: |
| 5 %* [0 - 200 %] | Enter the On Reference bandwidth. When the PID Control Error (the difference between the reference and the feedback) is less than the set value of this parameter the On Reference status bit is high, i.e. =1. |

3.9.6 7-4* Advanced Process PID Ctrl.

7-40 Process PID I-part Reset

| | |
|----------------|------------------|
| Option: | Function: |
| [0] * No | |

[1] Yes Select Yes [1] to reset the I-part of the process PID controller. The selection will automatically revert to No [0].

7-41 Process PID Output Neg. Clamp

Range: -100 %* [-100 - par. 7-42 %]
Function: Enter a negative limit for the process PID controller output.

7-42 Process PID Output Pos. Clamp

Range: 100 %* [par. 7-41 - 100 %]
Function: Enter a positive limit for the process PID controller output.

7-43 Process PID Gain Scale at Min. Ref.

Range: 100 %* [0 - 100 %]
Function: Enter a scaling percentage to apply to the process PID output when operating at the minimum reference. The scaling percentage will be adjusted linearly between the scale at min. ref. (par. 7-43) and the scale at max. ref. (par. 7-44).

7-44 Process PID Gain Scale at Max. Ref.

Range: 100 %* [0 - 100 %]
Function: Enter a scaling percentage to apply to the process PID output when operating at the maximum reference. The scaling percentage will be adjusted linearly between the scale at min. ref. (par. 7-43) and the scale at max. ref. (par. 7-44).

7-45 Process PID Feed Fwd Resource

Option: [0] * No function
Function: Select which drive input should be used as the feed forward factor. The FF factor is added directly to the output of the PID controller. This increases dynamic performance.

[1] Analog input 53

[2] Analog input 54

[7] Frequency input 29

[8] Frequency input 33

[11] Local bus reference

[20] Digital pot.meter

[21] Analog input X30-11

[22] Analog input X30-12

7-46 Process PID Feed Fwd Normal/ Inv. Ctrl.

Option: [0] * Normal
Function: Select Normal [0] to set the feed forward factor to treat the FF resource as a positive value.
 [1] Inverse
 Select Inverse [1] to treat the FF resource as a negative value.

7-49 Process PID Output Normal/ Inv. Ctrl.

Option: [0] * Normal
Function: Select Normal [0] to use the resulting output from the process PID controller as is.
 [1] Inverse
 Select Inverse [1] to invert the resulting output from the process PID controller. This operation is performed after the feed forward factor is applied.

3.9.7 7-5* Position PID Ctrl.

| 7-50 Process PID Extended PID | | |
|-------------------------------|----------|--------------------------------------|
| Option: | | Function: |
| [0] | Disabled | Disables the process PID controller. |
| [1] * | Enabled | Enables the process PID controller. |

| 7-51 Process PID Feed Fwd Gain | | |
|--------------------------------|---------------------|-----------|
| Range: | | Function: |
| 1.00 N/A* | [0.00 - 100.00 N/A] | |

| 7-52 Process PID Feed Fwd Ramp up | | |
|-----------------------------------|------------------|-----------|
| Range: | | Function: |
| 0.01 s* | [0.01 - 10.00 s] | |

| 7-53 Process PID Feed Fwd Ramp down | | |
|-------------------------------------|------------------|-----------|
| Range: | | Function: |
| 0.01 s* | [0.01 - 10.00 s] | |

| 7-56 Process PID Ref. Filter Time | | |
|-----------------------------------|-------------------|--|
| Range: | | Function: |
| 0.001 s* | [0.001 - 1.000 s] | Set a time constant for the reference first order low-pass filter. The low-pass filter improves steady-state performance and dampens oscillations on the reference/feedback signals. However severe filtering can be detrimental to dynamic performance. |

| 7-57 Process PID Fb. Filter Time | | |
|----------------------------------|-------------------|---|
| Range: | | Function: |
| 0.001 s* | [0.001 - 1.000 s] | Set a time constant for the feedback first order low-pass filter. The low-pass filter improves steady-state performance and dampens oscillations on the reference/feedback signals. However severe filtering can be detrimental to dynamic performance. |

3.10 Parameters: Communications and Options

3.10.1 8-** Comm. and Options

Parameter group for configuring communications and options.

3.10.2 8-0* General Settings

General settings for communications and options.

| 8-01 Control Site | | |
|-------------------|-----------------------|--|
| Option: | | Function: |
| | | The setting in this parameter overrides the settings in par.8-50 <i>Coasting Select</i> to par.8-56 <i>Preset Reference Select</i> . |
| [0] * | Digital and ctrl.word | Control by using both digital input and control word. |
| [1] | Digital only | Control by using digital inputs only. |
| [2] | Controlword only | Control by using control word only. |

8-02 Control Word Source

Select the source of the control word: one of two serial interfaces or four installed options. During initial power-up, the frequency converter automatically sets this parameter to *Option A* [3] if it detects a valid fieldbus option installed in slot A. If the option is removed, the frequency converter detects a change in the configuration, sets par.8-02 *Control Word Source* back to default setting *FC RS485*, and the frequency converter then trips. If an option is installed after initial power-up, the setting of par.8-02 *Control Word Source* will not change but the frequency converter will trip and display: Alarm 67 *Option Changed*.

This parameter cannot be adjusted while the motor is running.

| Option: | Function: |
|---------|--------------|
| [0] | None |
| [1] | FC RS485 |
| [2] | FC USB |
| [3] * | Option A |
| [4] | Option B |
| [5] | Option C0 |
| [6] | Option C1 |
| [30] | External Can |

8-03 Control Word Timeout Time

| Range: | Function: |
|--------------------------|---|
| 1.0 s* [0.1 - 18000.0 s] | Enter the maximum time expected to pass between the reception of two consecutive telegrams. If this time is exceeded, it indicates that the serial communication has stopped. The function selected in par.8-04 <i>Control Word Timeout Function</i> will then be carried out. The time-out counter is triggered by a valid control word. |

8-04 Control Word Timeout Function

Select the time-out function. The time-out function activates when the control word fails to be updated within the time period specified in par. 8-03 *Control Word Timeout Time*.

| Option: | Function: | |
|---------|----------------|--|
| [0] * | Off | Resumes control via serial bus (Fieldbus or standard) using the most recent control word. |
| [1] | Freeze output | Freezes output frequency until communication resumes. |
| [2] | Stop | Stops with auto restart when communication resumes. |
| [3] | Jogging | Runs the motor at JOG frequency until communication resumes. |
| [4] | Max. speed | Runs the motor at maximum frequency until communication resumes. |
| [5] | Stop and trip | Stops the motor, then resets the frequency converter in order to restart: via the fieldbus, via the reset button on the LCP or via a digital input. |
| [7] | Select setup 1 | Changes the set-up upon reestablishment of communication following a control word time-out. If communication resumes causing the time-out situation to disappear, par.8-05 <i>End-of-Timeout Function</i> defines whether to resume the set-up used before the time-out or to retain the set-up endorsed by the time-out function. |
| [8] | Select setup 2 | See [7] <i>Select setup 1</i> |
| [9] | Select setup 3 | See [7] <i>Select setup 1</i> |
| [10] | Select setup 4 | See [7] <i>Select setup 1</i> |



NB!

The following configuration is required in order to change the set-up after a time-out:

Set par.0-10 *Active Set-up* to [9] *Multi set-up* and select the relevant link in par.0-12 *This Set-up Linked to*.

8-05 End-of-Timeout Function

| Option: | Function: |
|---------------------|---|
| [0] Hold set-up | Select the action after receiving a valid control word following a time-out. This parameter is active only when par. 8-04 <i>Control Timeout Function</i> is set to [Set-up 1-4]. Retains the set-up selected in par. 8-04 <i>Control Timeout Function</i> and displays a warning, until par. 8-06 <i>Reset Control Timeout</i> toggles. Then the frequency converter resumes its original set-up. |
| [1] * Resume set-up | Resumes the set-up active prior to the time-out. |

8-06 Reset Control Word Timeout

This parameter is active only when *Hold set-up* [0] has been selected in par.8-05 *End-of-Timeout Function*.

| Option: | Function: |
|--------------------|--|
| [0] * Do not reset | Retains the set-up specified in par.8-04 <i>Control Word Timeout Function</i> , following a control word time-out. |
| [1] Do reset | Returns the frequency converter to the original set-up following a control word time-out. The frequency converter performs the reset and then immediately reverts to the <i>Do not reset</i> [0] setting |

8-07 Diagnosis Trigger

Option: **Function:**
This parameter enables and controls the frequency converter diagnosis function and permits expansion of the diagnosis data to 24 byte.



NB!
This is only valid for Profibus.

- *Disable* [0]: Do not send extended diagnosis data even if they appear in the frequency converter.
- *Trigger on alarms* [1]: Send extended diagnosis data when one or more alarms appear in alarm par. 16-90 *Alarm Word* or par.9-53 *Profibus Warning Word*.
- *Trigger alarms/warn.* [2]: Send extended diagnosis data if one or more alarms or warnings appear in alarm par. 16-90 *Alarm Word*, par.9-53 *Profibus Warning Word*, or warning par. 16-92 *Warning Word*.

The content of the extended diagnosis frame is as follows:

| Byte | Content | Description |
|---------|---|---------------------------------------|
| 0 - 5 | Standard DP Diagnose Data | Standard DP Diagnose Data |
| 6 | PDU length xx | Header of extended diagnostic data |
| 7 | Status type = 0x81 | Header of extended diagnostic data |
| 8 | Slot = 0 | Header of extended diagnostic data |
| 9 | Status info = 0 | Header of extended diagnostic data |
| 10 - 13 | VLT par. 16-92 <i>Warning Word</i> | VLT warning word |
| 14 - 17 | VLT par.16-03 <i>Status Word</i> | VLT status word |
| 18 - 21 | VLT par. 16-90 <i>Alarm Word</i> | VLT alarm word |
| 22 - 23 | VLT par.9-53 <i>Profibus Warning Word</i> | Communication warning word (Profibus) |

Enabling diagnosis may cause increased bus traffic. Diagnosis functions are not supported by all fieldbus types.

- [0] * Disable
- [1] Trigger on alarms
- [2] Trigger alarm/warn.

3.10.3 8-1* Ctrl. Word Settings

Parameters for configuring the option control word profile.

8-10 Control Word Profile

Select the interpretation of the control and status words corresponding to the installed fieldbus. Only the selections valid for the fieldbus installed in slot A will be visible in the LCP display.

For guidelines in selection of *FC profile* [0] and *PROFIdrive profile* [1] please refer to the *Serial communication via RS 485 Interface* section.

For additional guidelines in the selection of *PROFIdrive profile* [1], *ODVA* [5] and *CANopen DSP 402* [7], please refer to the Operating Instructions for the installed fieldbus.

Option:

Function:

- [0] * FC profile
- [1] PROFIdrive profile
- [5] ODVA
- [7] CANopen DSP 402
- [8] MCO

8-13 Configurable Status Word STW

Option:

Function:

This parameter enables configuration of bits 12 – 15 in the status word.

- [0] No function
- [1] * Profile Default
Function corresponds to the profile default selected in par. 8-10 *Control Profile*.
- [2] Alarm 68 Only
Only set in case of an Alarm 68.
- [3] Trip excl Alarm 68
Set in case of a trip, except if the trip is executed by an Alarm 68.
- [16] T37 DI status
The bit indicates the status of terminal 37.
"0" indicates T37 is low (safe stop)
"1" indicates T37 is high (normal)

8-14 Configurable Control Word CTW

Option:

Function:

Selection of control word bit 10 if it is active low or active high

- [0] None
- [1] * Profile default

[2] CTW Valid, active low

3.10.4 8-3* FC Port Settings

Parameters for configuring the FC Port.

| 8-30 Protocol | | |
|-----------------------------|---------------------|---|
| Option: | | Function: |
| [0] * | FC | |
| [1] | FC MC | Select the protocol for the FC (standard) port. |
| [2] | Modbus RTU | |
| 8-31 Address | | |
| Range: | | Function: |
| 1. N/A* | [1. - 126. N/A] | Enter the address for the FC (standard) port. Valid range: 1 - 126. |
| 8-32 FC Port Baud Rate | | |
| Option: | | Function: |
| [0] | 2400 Baud | Baud rate selection for the FC (standard) port. |
| [1] | 4800 Baud | |
| [2] * | 9600 Baud | |
| [3] | 19200 Baud | |
| [4] | 38400 Baud | |
| [5] | 57600 Baud | |
| [6] | 76800 Baud | |
| [7] | 115200 Baud | |
| 8-35 Minimum Response Delay | | |
| Range: | | Function: |
| 10 ms* | [1 - 10000. ms] | Specify the minimum delay time between receiving a request and transmitting a response. This is used for overcoming modem turnaround delays. |
| 8-36 Max Response Delay | | |
| Range: | | Function: |
| 10001. ms* | [11. - 10001 ms] | Specify the maximum permissible delay time between transmitting a request and receiving a response. Exceeding this delay time will cause control word time-out. |
| 8-37 Max Inter-Char Delay | | |
| Range: | | Function: |
| 25.00 ms* | [0.00 - 35.00 ms] | Specify the maximum permissible time interval between receipt of two bytes. This parameter activates time-out if transmission is interrupted. This parameter is active only when par.8-30 <i>Protocol</i> is set to <i>FC MC</i> [1] protocol. |
| 8-40 Telegram selection | | |
| Option: | | Function: |
| [1] * | Standard telegram 1 | |
| [101] | PPO 1 | Enables use of freely configurable telegrams or standard telegrams for the FC port. |
| [102] | PPO 2 | |
| [103] | PPO 3 | |
| [104] | PPO 4 | |

| | |
|-------|-------------------|
| [105] | PPO 5 |
| [106] | PPO 6 |
| [107] | PPO 7 |
| [108] | PPO 8 |
| [200] | Custom telegram 1 |

3

3.10.5 8-5* Digital/Bus

Parameters for configuring the control word Digital/Bus merging.

8-50 Coasting Select

| Option: | Function: |
|---------|---|
| | Select control of the coasting function via the terminals (digital input) and/or via the bus. |
| [0] | Digital input |
| [1] | Bus |
| [2] | Logic AND |
| [3] * | Logic OR |

**NB!**

This parameter is active only when par.8-01 *Control Site* is set to [0] *Digital and control word*.

8-51 Quick Stop Select

Select control of the Quick Stop function via the terminals (digital input) and/or via the bus.

| Option: | Function: |
|---------|---------------|
| [0] | Digital input |
| [1] | Bus |
| [2] | Logic AND |
| [3] * | Logic OR |

**NB!**

This parameter is active only when par.8-01 *Control Site* is set to [0] *Digital and control word*.

8-52 DC Brake Select

| Option: | Function: |
|---------|---|
| | Select control of the DC brake via the terminals (digital input) and/or via the fieldbus. |
| [0] | Digital input |
| [1] | Bus |
| [2] | Logic AND |
| [3] * | Logic OR |



NB!
This parameter is active only when par.8-01 *Control Site* is set to [0] *Digital and control word*.

8-53 Start Select

| Option: | Function: |
|-------------------|---|
| | Select control of the frequency converter start function via the terminals (digital input) and/or via the fieldbus. |
| [0] Digital input | Activates Start command via a digital input. |
| [1] Bus | Activates Start command via the serial communication port or fieldbus option. |
| [2] Logic AND | Activates Start command via the fieldbus/serial communication port, AND additionally via one of the digital inputs. |
| [3] * Logic OR | Activates Start command via the fieldbus/serial communication port OR via one of the digital inputs. |



NB!
This parameter is active only when par.8-01 *Control Site* is set to [0] *Digital and control word*.

8-54 Reversing Select

| Option: | Function: |
|-------------------|---|
| | Select control of the frequency converter reverse function via the terminals (digital input) and/or via the fieldbus. |
| [0] Digital input | Select control of the frequency converter reverse function via the terminals (digital input) and/or via the fieldbus. |
| [1] Bus | Activates the Reverse command via the serial communication port or fieldbus option. |
| [2] Logic AND | Activates the Reverse command via the fieldbus/serial communication port, AND additionally via one of the digital inputs. |
| [3] * Logic OR | Activates the Reverse command via the fieldbus/serial communication port OR via one of the digital inputs. |



NB!
This parameter is only active when par. 8-01 *Control Site* is set to [0] *Digital and control word*.

8-55 Set-up Select

| Option: | Function: |
|-------------------|--|
| | Select control of the frequency converter set-up selection via the terminals (digital input) and/or via the fieldbus. |
| [0] Digital input | Activates the set-up selection via a digital input. |
| [1] Bus | Activates the set-up selection via the serial communication port or fieldbus option. |
| [2] Logic AND | Activates the set-up selection via the fieldbus/serial communication port, AND additionally via one of the digital inputs. |
| [3] * Logic OR | Activate the set-up selection via the fieldbus/serial communication port OR via one of the digital inputs. |

**NB!**

This parameter is active only when par.8-01 *Control Site* is set to [0] *Digital and control word*.

8-56 Preset Reference Select

Option:**Function:**

| Option: | Function: |
|-------------------|--|
| [0] Digital input | Select control of the frequency converter Preset Reference selection via the terminals (digital input) and/or via the fieldbus. Activates Preset Reference selection via a digital input. |
| [1] Bus | Activates Preset Reference selection via the serial communication port or fieldbus option. |
| [2] Logic AND | Activates Preset Reference selection via the fieldbus/serial communication port, AND additionally via one of the digital inputs. |
| [3] * Logic OR | Activates the Preset Reference selection via the fieldbus/serial communication port OR via one of the digital inputs. |

**NB!**

This parameter is active only when par.8-01 *Control Site* is set to [0] *Digital and control word*.

3.10.6 8-9* Bus Jog

Parameters for configuring the Bus Jog.

8-90 Bus Jog 1 Speed

Range:

100 RPM* [0 - par. 4-13 RPM]

Function:

Enter the jog speed. This is a fixed jog speed activated via the serial port or fieldbus option.

8-91 Bus Jog 2 Speed

Range:

200 RPM* [0 - par. 4-13 RPM]

Function:

Enter the jog speed. This is a fixed jog speed activated via the serial port or fieldbus option.

3.11 Parameters: Profibus

3.11.1 9-** Profibus

Parameter group for all Profibus-specific parameters.

9-00 Setpoint

| Range: | Function: |
|------------------------|---|
| 0 N/A* [0 - 65535 N/A] | This parameter receives cyclical reference from a Master Class 2. If the control priority is set to Master Class 2, the reference for the frequency converter is taken from this parameter, whereas the cyclical reference will be ignored. |

9-07 Actual Value

| Range: | Function: |
|------------------------|--|
| 0 N/A* [0 - 65535 N/A] | This parameter delivers the MAV for a Master Class 2. The parameter is valid if the control priority is set to Master Class 2. |

9-15 PCD Write Configuration

Array [10]

| Option: | Function: |
|---------|--|
| | Select the parameters to be assigned to PCD 3 to 10 of the telegrams. The number of available PCDs depends on the telegram type. The values in PCD 3 to 10 will then be written to the selected parameters as data values. Alternatively, specify a standard Profibus telegram in par.9-22 <i>Telegram Selection</i> . |

- [0] * None
- [302] Minimum Reference
- [303] Maximum Reference
- [312] Catch up/slow Down Value
- [341] Ramp 1 Ramp up Time
- [342] Ramp 1 Ramp Down Time
- [351] Ramp 2 Ramp up Time
- [352] Ramp 2 Ramp down Time
- [380] Jog Ramp Time
- [381] Quick Stop Ramp Time
- [411] Motor Speed Low Limit [RPM]
- [412] Motor Speed Low Limit [Hz]
- [413] Motor Speed High Limit [RPM]
- [414] Motor Speed High Limit [Hz]
- [416] Torque Limit Motor Mode
- [417] Torque Limit Generator Mode
- [590] Digital & Relay Bus Control
- [593] Pulse Out #27 Bus Control
- [595] Pulse Out #29 Bus Control
- [597] Pulse Out #X30/6 Bus Control
- [653] Terminal 42 Output Bus Control
- [663] Terminal X30/8 Bus Control
- [673] Terminal X45/1 Bus Control
- [683] Terminal X45/3 Bus Control
- [890] Bus Jog 1 Speed

| | |
|--------|---------------------|
| [891] | Bus Jog 2 Speed |
| [1293] | Cable Error Length |
| [1680] | Fieldbus CTW 1 |
| [1682] | Fieldbus REF 1 |
| [3401] | PCD 1 Write to MCO |
| [3402] | PCD 2 Write to MCO |
| [3403] | PCD 3 Write to MCO |
| [3404] | PCD 4 Write to MCO |
| [3405] | PCD 5 Write to MCO |
| [3406] | PCD 6 Write to MCO |
| [3407] | PCD 7 Write to MCO |
| [3408] | PCD 8 Write to MCO |
| [3409] | PCD 9 Write to MCO |
| [3410] | PCD 10 Write to MCO |

9-16 PCD Read Configuration

Array [10]

Option:

Function:

Select the parameters to be assigned to PCD 3 to 10 of the telegrams. The number of available PCDs depends on the telegram type. PCDs 3 to 10 contain the actual data values of the selected parameters. For standard Profibus telegrams, see par.9-22 *Telegram Selection*.

| | |
|--------|------------------------|
| [0] * | None |
| [1472] | VLT Alarm Word |
| [1473] | VLT Warning Word |
| [1474] | VLT Ext. Status Word |
| [1500] | Operating Hours |
| [1501] | Running Hours |
| [1502] | kWh Counter |
| [1600] | Control Word |
| [1601] | Reference [Unit] |
| [1602] | Reference % |
| [1603] | Status Word |
| [1605] | Main Actual Value [%] |
| [1609] | Custom Readout |
| [1610] | Power [kW] |
| [1611] | Power [hp] |
| [1612] | Motor Voltage |
| [1613] | Frequency |
| [1614] | Motor Current |
| [1615] | Frequency [%] |
| [1616] | Torque [Nm] |
| [1617] | Speed [RPM] |
| [1618] | Motor Thermal |
| [1619] | KTY sensor temperature |
| [1620] | Motor Angle |
| [1622] | Torque [%] |
| [1625] | Torque [Nm] High |
| [1630] | DC Link Voltage |

| | |
|--------|----------------------------|
| [1632] | Brake Energy /s |
| [1633] | Brake Energy /2 min |
| [1634] | Heatsink Temp. |
| [1635] | Inverter Thermal |
| [1638] | SL Controller State |
| [1639] | Control Card Temp. |
| [1650] | External Reference |
| [1651] | Pulse Reference |
| [1652] | Feedback [Unit] |
| [1653] | Digi Pot Reference |
| [1660] | Digital Input |
| [1661] | Terminal 53 Switch Setting |
| [1662] | Analog Input 53 |
| [1663] | Terminal 54 Switch Setting |
| [1664] | Analog Input 54 |
| [1665] | Analog Output 42 [mA] |
| [1666] | Digital Output [bin] |
| [1667] | Freq. Input #29 [Hz] |
| [1668] | Freq. Input #33 [Hz] |
| [1669] | Pulse Output #27 [Hz] |
| [1670] | Pulse Output #29 [Hz] |
| [1671] | Relay Output [bin] |
| [1672] | Counter A |
| [1673] | Counter B |
| [1674] | Prec. Stop Counter |
| [1675] | Analog In X30/11 |
| [1676] | Analog In X30/12 |
| [1677] | Analog Out X30/8 [mA] |
| [1678] | Analog Out X45/1 [mA] |
| [1679] | Analog Out X45/3 [mA] |
| [1684] | Comm. Option STW |
| [1685] | FC Port CTW 1 |
| [1690] | Alarm Word |
| [1691] | Alarm Word 2 |
| [1692] | Warning Word |
| [1693] | Warning Word 2 |
| [1694] | Ext. Status Word |
| [3421] | PCD 1 Read from MCO |
| [3422] | PCD 2 Read from MCO |
| [3423] | PCD 3 Read from MCO |
| [3424] | PCD 4 Read from MCO |
| [3425] | PCD 5 Read from MCO |
| [3426] | PCD 6 Read from MCO |
| [3427] | PCD 7 Read from MCO |
| [3428] | PCD 8 Read from MCO |
| [3429] | PCD 9 Read from MCO |
| [3430] | PCD 10 Read from MCO |

| | |
|--------|------------------------|
| [3440] | Digital Inputs |
| [3441] | Digital Outputs |
| [3450] | Actual Position |
| [3451] | Commanded Position |
| [3452] | Actual Master Position |
| [3453] | Slave Index Position |
| [3454] | Master Index Position |
| [3455] | Curve Position |
| [3456] | Track Error |
| [3457] | Synchronizing Error |
| [3458] | Actual Velocity |
| [3459] | Actual Master Velocity |
| [3460] | Synchronizing Status |
| [3461] | Axis Status |
| [3462] | Program Status |
| [3464] | MCO 302 Status |
| [3465] | MCO 302 Control |
| [3470] | MCO Alarm Word 1 |
| [3471] | MCO Alarm Word 2 |

9-18 Node Address

Range:

126 N/A* [0 - 126. N/A]

Function:

Enter the station address in this parameter or alternatively in the hardware switch. In order to adjust the station address in par.9-18 *Node Address*, the hardware switch must be set to 126 or 127 (i.e. all switches set to 'on'). Otherwise this parameter will display the actual setting of the switch.

9-22 Telegram Selection

Displays the Profibus telegram configuration.

Option:

[1] Standard telegram 1

[101] PPO 1

[102] PPO 2

[103] PPO 3

[104] PPO 4

[105] PPO 5

[106] PPO 6

[107] PPO 7

[108] * PPO 8

Read only.

[200] Custom telegram 1

9-23 Parameters for Signals

Array [1000]

Read only

Option:

Function:

This parameter contains a list of signals available for selection in par.9-15 *PCD Write Configuration* and par.9-16 *PCD Read Configuration*.

- [0] * None
- [302] Minimum Reference
- [303] Maximum Reference
- [312] Catch up/slow Down Value
- [341] Ramp 1 Ramp up Time
- [342] Ramp 1 Ramp Down Time
- [351] Ramp 2 Ramp up Time
- [352] Ramp 2 Ramp down Time
- [380] Jog Ramp Time
- [381] Quick Stop Ramp Time
- [411] Motor Speed Low Limit [RPM]
- [412] Motor Speed Low Limit [Hz]
- [413] Motor Speed High Limit [RPM]
- [414] Motor Speed High Limit [Hz]
- [416] Torque Limit Motor Mode
- [417] Torque Limit Generator Mode
- [590] Digital & Relay Bus Control
- [593] Pulse Out #27 Bus Control
- [595] Pulse Out #29 Bus Control
- [597] Pulse Out #X30/6 Bus Control
- [653] Terminal 42 Output Bus Control
- [663] Terminal X30/8 Bus Control
- [673] Terminal X45/1 Bus Control
- [683] Terminal X45/3 Bus Control
- [890] Bus Jog 1 Speed
- [891] Bus Jog 2 Speed
- [1293] Cable Error Length
- [1472] VLT Alarm Word
- [1473] VLT Warning Word
- [1474] VLT Ext. Status Word
- [1500] Operating Hours
- [1501] Running Hours
- [1502] kWh Counter
- [1600] Control Word
- [1601] Reference [Unit]
- [1602] Reference %
- [1603] Status Word
- [1605] Main Actual Value [%]
- [1609] Custom Readout
- [1610] Power [kW]
- [1611] Power [hp]

| | |
|--------|----------------------------|
| [1612] | Motor Voltage |
| [1613] | Frequency |
| [1614] | Motor Current |
| [1615] | Frequency [%] |
| [1616] | Torque [Nm] |
| [1617] | Speed [RPM] |
| [1618] | Motor Thermal |
| [1619] | KTY sensor temperature |
| [1620] | Motor Angle |
| [1622] | Torque [%] |
| [1625] | Torque [Nm] High |
| [1630] | DC Link Voltage |
| [1632] | Brake Energy /s |
| [1633] | Brake Energy /2 min |
| [1634] | Heatsink Temp. |
| [1635] | Inverter Thermal |
| [1638] | SL Controller State |
| [1639] | Control Card Temp. |
| [1650] | External Reference |
| [1651] | Pulse Reference |
| [1652] | Feedback [Unit] |
| [1653] | Digi Pot Reference |
| [1660] | Digital Input |
| [1661] | Terminal 53 Switch Setting |
| [1662] | Analog Input 53 |
| [1663] | Terminal 54 Switch Setting |
| [1664] | Analog Input 54 |
| [1665] | Analog Output 42 [mA] |
| [1666] | Digital Output [bin] |
| [1667] | Freq. Input #29 [Hz] |
| [1668] | Freq. Input #33 [Hz] |
| [1669] | Pulse Output #27 [Hz] |
| [1670] | Pulse Output #29 [Hz] |
| [1671] | Relay Output [bin] |
| [1672] | Counter A |
| [1673] | Counter B |
| [1674] | Prec. Stop Counter |
| [1675] | Analog In X30/11 |
| [1676] | Analog In X30/12 |
| [1677] | Analog Out X30/8 [mA] |
| [1678] | Analog Out X45/1 [mA] |
| [1679] | Analog Out X45/3 [mA] |
| [1680] | Fieldbus CTW 1 |
| [1682] | Fieldbus REF 1 |
| [1684] | Comm. Option STW |
| [1685] | FC Port CTW 1 |
| [1690] | Alarm Word |

| | |
|--------|------------------------|
| [1691] | Alarm Word 2 |
| [1692] | Warning Word |
| [1693] | Warning Word 2 |
| [1694] | Ext. Status Word |
| [3401] | PCD 1 Write to MCO |
| [3402] | PCD 2 Write to MCO |
| [3403] | PCD 3 Write to MCO |
| [3404] | PCD 4 Write to MCO |
| [3405] | PCD 5 Write to MCO |
| [3406] | PCD 6 Write to MCO |
| [3407] | PCD 7 Write to MCO |
| [3408] | PCD 8 Write to MCO |
| [3409] | PCD 9 Write to MCO |
| [3410] | PCD 10 Write to MCO |
| [3421] | PCD 1 Read from MCO |
| [3422] | PCD 2 Read from MCO |
| [3423] | PCD 3 Read from MCO |
| [3424] | PCD 4 Read from MCO |
| [3425] | PCD 5 Read from MCO |
| [3426] | PCD 6 Read from MCO |
| [3427] | PCD 7 Read from MCO |
| [3428] | PCD 8 Read from MCO |
| [3429] | PCD 9 Read from MCO |
| [3430] | PCD 10 Read from MCO |
| [3440] | Digital Inputs |
| [3441] | Digital Outputs |
| [3450] | Actual Position |
| [3451] | Commanded Position |
| [3452] | Actual Master Position |
| [3453] | Slave Index Position |
| [3454] | Master Index Position |
| [3455] | Curve Position |
| [3456] | Track Error |
| [3457] | Synchronizing Error |
| [3458] | Actual Velocity |
| [3459] | Actual Master Velocity |
| [3460] | Synchronizing Status |
| [3461] | Axis Status |
| [3462] | Program Status |
| [3464] | MCO 302 Status |
| [3465] | MCO 302 Control |
| [3470] | MCO Alarm Word 1 |
| [3471] | MCO Alarm Word 2 |

9-27 Parameter Edit**Option:****Function:**

Parameters can be edited via Profibus, the standard RS485 interface, or the LCP.

[0] Disabled

Disables editing via Profibus.

[1] * Enabled

Enables editing via Profibus.

9-28 Process Control**Option:****Function:**

Process control (setting of Control Word, speed reference, and process data) is possible via either Profibus or standard fieldbus but not both simultaneously. Local control is always possible via the LCP. Control via process control is possible via either terminals or fieldbus depending on the settings in par.8-50 *Coasting Select* to par.8-56 *Preset Reference Select*.

[0] Disable

Disables process control via Profibus, and enables process control via standard fieldbus or Profibus Master class 2.

[1] * Enable cyclic master

Enables process control via Profibus Master Class 1, and disables process control via standard fieldbus or Profibus Master class 2.

9-44 Fault Message Counter**Range:****Function:**

0 N/A* [0 - 65535 N/A]

This parameter displays the number of error events stored in par.9-45 *Fault Code* and par. 9-47 *Fault Number*. The maximum buffer capacity is eight error events. The buffer and counter are set to 0 upon reset or power-up.

9-45 Fault Code**Range:****Function:**

0 N/A* [0 - 0 N/A]

This buffer contains the alarm word for all alarms and warnings that have occurred since last reset or power-up. The maximum buffer capacity is eight error events.

9-47 Fault Number**Range:****Function:**

0 N/A* [0 - 0 N/A]

This buffer contains the alarm number (e.g. 2 for live zero error, 4 for mains phase loss) for all alarms and warnings that have occurred since last reset or power-up. The maximum buffer capacity is eight error events.

9-52 Fault Situation Counter**Range:****Function:**

0 N/A* [0 - 1000 N/A]

This parameter displays the number of error events which have occurred since last reset of power-up.

9-53 Profibus Warning Word**Range:****Function:**

0 N/A* [0 - 65535 N/A]

This parameter displays Profibus communication warnings. Please refer to the *Profibus Operating Instructions* for further information.

Read only

| Bit: | Meaning: |
|------|---|
| 0 | Connection with DP-master is not ok |
| 1 | Not used |
| 2 | FDLNDL (Fieldbus Data link Layer) is not ok |
| 3 | Clear data command received |
| 4 | Actual value is not updated |
| 5 | Baudrate search |
| 6 | PROFIBUS ASIC is not transmitting |
| 7 | Initializing of PROFIBUS is not ok |
| 8 | Frequency converter is tripped |
| 9 | Internal CAN error |
| 10 | Wrong configuration data from PLC |
| 11 | Wrong ID sent by PLC |
| 12 | Internal error occurred |
| 13 | Not configured |
| 14 | Timeout active |
| 15 | Warning 34 active |

9-63 Actual Baud Rate

| Option: | Function: |
|---------|--|
| | This parameter displays the actual Profibus baud rate. The Profibus Master automatically sets the baud rate. |
| [0] | 9,6 kbit/s |
| [1] | 19,2 kbit/s |
| [2] | 93,75 kbit/s |
| [3] | 187,5 kbit/s |
| [4] | 500 kbit/s |
| [6] | 1500 kbit/s |
| [7] | 3000 kbit/s |
| [8] | 6000 kbit/s |
| [9] | 12000 kbit/s |
| [10] | 31,25 kbit/s |
| [11] | 45,45 kbit/s |
| [255] * | No baudrate found |

9-64 Device Identification

| Range: | Function: |
|--------------------|---|
| 0 N/A* [0 - 0 N/A] | This parameter displays the device identification. Please refer to the <i>Operating Instructions for Profibus</i> , MG33CXYY for further explanation. |

9-65 Profile Number

| Range: | Function: |
|--------------------|--|
| 0 N/A* [0 - 0 N/A] | This parameter contains the profile identification. Byte 1 contains the profile number and byte 2 the version number of the profile. |

NB!
This parameter is not visible via LCP.

9-67 Control Word 1

| Range: | Function: |
|------------------------|--|
| 0 N/A* [0 - 65535 N/A] | This parameter accepts the Control Word from a Master Class 2 in the same format as PCD 1. |

9-68 Status Word 1**Range:**

0 N/A* [0 - 65535 N/A]

Function:

This parameter delivers the Status Word for a Master Class 2 in the same format as PCD 2.

9-70 Programming Set-up**Option:****Function:**

Select the set-up to be edited.

[0] Factory setup

Uses default data. This option can be used as a data source to return the other set-ups to a known state.

[1] Set-up 1

Edits Set-up 1.

[2] Set-up 2

Edits Set-up 2.

[3] Set-up 3

Edits Set-up 3.

[4] Set-up 4

Edits Set-up 4.

[9] * Active Set-up

Follows the active set-up selected in par. 0-10 *Active Set-up*.This parameter is unique to LCP and fieldbuses. See also par. 0-11 *Programming Set-up*.**9-71 Profibus Save Data Values****Option:****Function:**

Parameter values changed via Profibus are not automatically stored in non-volatile memory. Use this parameter to activate a function that stores parameter values in the EEPROM non-volatile memory, so changed parameter values will be retained at power-down.

[0] * Off

Deactivates the non-volatile storage function.

[1] Store all setups

Stores all parameter values for all set-ups in the non-volatile memory. The selection returns to *Off*[0] when all parameter values have been stored.

[2] Store all setups

Stores all parameter values for all set-ups in the non-volatile memory. The selection returns to *Off*[0] when all parameter values have been stored.**9-72 ProfibusDriveReset****Option:****Function:**

[0] * No action

[1] Power-on reset

Resets frequency converter upon power-up, as for power-cycle.

[3] Comm option reset

Resets the Profibus option only, useful after changing certain settings in parameter group 9-**, e.g. par.9-18 *Node Address*.

When reset, the frequency converter disappears from the fieldbus, which may cause a communication error from the master.

9-80 Defined Parameters (1)

Array [116]

No LCP access

Read only

Range:

0 N/A* [0 - 9999 N/A]

Function:

This parameter displays a list of all the defined frequency converter parameters available for Profibus.

9-81 Defined Parameters (2)

Array [116]
 No LCP access
 Read only

Range:

0 N/A* [0 - 9999 N/A]

Function:

This parameter displays a list of all the defined frequency converter parameters available for Profibus.

9-82 Defined Parameters (3)

Array [116]
 No LCP access
 Read only

Range:

0 N/A* [0 - 9999 N/A]

Function:

This parameter displays a list of all the defined frequency converter parameters available for Profibus.

9-83 Defined Parameters (4)

Array [116]
 No LCP access
 Read only

Range:

0 N/A* [0 - 9999 N/A]

Function:

This parameter displays a list of all the defined frequency converter parameters available for Profibus.

9-84 Defined Parameters (5)

Range:

0 N/A* [0 - 9999 N/A]

Function:

This parameter displays a list of all the defined frequency converter parameters available for Profibus.

9-90 Changed Parameters (1)

Array [116]
 No LCP access
 Read only

Range:

0 N/A* [0 - 9999 N/A]

Function:

This parameter displays a list of all the frequency converter parameters deviating from default setting.

9-91 Changed Parameters (2)

Array [116]
 No LCP access
 Read only

Range:

0 N/A* [0 - 9999 N/A]

Function:

This parameter displays a list of all the frequency converter parameters deviating from default setting.

9-92 Changed Parameters (3)

Array [116]
 No LCP access
 Read only

Range:

0 N/A* [0 - 9999 N/A]

Function:

This parameter displays a list of all the frequency converter parameters deviating from default setting.

9-94 Changed Parameters (5)

Array [116]

No LCP Address

Read only

Range:

0 N/A* [0 - 9999 N/A]

Function:

This parameter displays a list of all the frequency converter parameters deviating from default setting.

3.12 Parameters: DeviceNet CAN Fieldbus

3.12.1 10-** DeviceNet and CAN Fieldbus

Parameter group for DeviceNet CAN fieldbus parameters.

3.12.2 10-0* Common Settings

Parameter group for configuring common settings for CAN fieldbus options.

10-00 CAN Protocol

| Option: | Function: |
|-----------------|-------------------------------|
| [0] CANopen | |
| [1] * DeviceNet | View the active CAN protocol. |



NB!
The options depend on installed option.

10-01 Baud Rate Select

Select the fieldbus transmission speed. The selection must correspond to the transmission speed of the master and the other fieldbus nodes.

| Option: | Function: |
|-----------------|-----------|
| [16] 10 Kbps | |
| [17] 20 Kbps | |
| [18] 50 Kbps | |
| [19] 100 Kbps | |
| [20] * 125 Kbps | |
| [21] 250 Kbps | |
| [22] 500 Kbps | |

10-02 MAC ID

| Range: | Function: |
|------------------------|---|
| 63. N/A* [0 - 63. N/A] | Selection of station address. Every station connected to the same network must have an unambiguous address. |

10-05 Readout Transmit Error Counter

| Range: | Function: |
|----------------------|---|
| 0 N/A* [0 - 255 N/A] | View the number of CAN control transmission errors since the last power-up. |

10-06 Readout Receive Error Counter

| Range: | Function: |
|----------------------|--|
| 0 N/A* [0 - 255 N/A] | View the number of CAN control receipt errors since the last power-up. |

10-07 Readout Bus Off Counter

| Range: | Function: |
|----------------------|--|
| 0 N/A* [0 - 255 N/A] | View the number of Bus Off events since the last power-up. |

3.12.3 10-1* DeviceNet

Parameters specific to the DeviceNet fieldbus.

10-10 Process Data Type Selection

Option:
Function:

Select the Instance (telegram) for data transmission. The Instances available are dependent upon the setting of par. 8-10 *Control Profile*.

When par. 8-10 *Control Profile* is set to [0] *FC profile*, par.10-10 *Process Data Type Selection* options [0] and [1] are available.

When par. 8-10 *Control Profile* is set to [5] *ODVA*, par.10-10 *Process Data Type Selection* options [2] and [3] are available.

Instances 100/150 and 101/151 are Danfoss-specific. Instances 20/70 and 21/71 are ODVA-specific AC Drive profiles.

For guidelines in telegram selection, please refer to the DeviceNet Operating Instructions.

Note that a change to this parameter will be executed immediately.

[0] * INSTANCE 100/150

[1] INSTANCE 101/151

[2] INSTANCE 20/70

[3] INSTANCE 21/71

10-11 Process Data Config Write

Select the process write data for I/O Assembly Instances 101/151. Elements [2] and [3] of this array can be selected. Elements [0] and [1] of the array are fixed.

Option:
Function:

[0] * None

[302] Minimum Reference

[303] Maximum Reference

[312] Catch up/slow Down Value

[341] Ramp 1 Ramp up Time

[342] Ramp 1 Ramp Down Time

[351] Ramp 2 Ramp up Time

[352] Ramp 2 Ramp down Time

[380] Jog Ramp Time

[381] Quick Stop Ramp Time

[411] Motor Speed Low Limit [RPM]

[412] Motor Speed Low Limit [Hz]

[413] Motor Speed High Limit [RPM]

[414] Motor Speed High Limit [Hz]

[416] Torque Limit Motor Mode

[417] Torque Limit Generator Mode

[590] Digital & Relay Bus Control

[593] Pulse Out #27 Bus Control

[595] Pulse Out #29 Bus Control

[597] Pulse Out #X30/6 Bus Control

[653] Terminal 42 Output Bus Control

[663] Terminal X30/8 Bus Control

[673] Terminal X45/1 Bus Control

[683] Terminal X45/3 Bus Control

[890] Bus Jog 1 Speed

- [891] Bus Jog 2 Speed
- [1293] Cable Error Length
- [1680] Fieldbus CTW 1
- [1682] Fieldbus REF 1
- [3401] PCD 1 Write to MCO
- [3402] PCD 2 Write to MCO
- [3403] PCD 3 Write to MCO
- [3404] PCD 4 Write to MCO
- [3405] PCD 5 Write to MCO
- [3406] PCD 6 Write to MCO
- [3407] PCD 7 Write to MCO
- [3408] PCD 8 Write to MCO
- [3409] PCD 9 Write to MCO
- [3410] PCD 10 Write to MCO

10-12 Process Data Config Read

Select the process read data for I/O Assembly Instances 101/151. Elements [2] and [3] of this array can be selected. Elements [0] and [1] of the array are fixed.

Option: **Function:**

- [0] * None
- [1472] VLT Alarm Word
- [1473] VLT Warning Word
- [1474] VLT Ext. Status Word
- [1500] Operating Hours
- [1501] Running Hours
- [1502] kWh Counter
- [1600] Control Word
- [1601] Reference [Unit]
- [1602] Reference %
- [1603] Status Word
- [1605] Main Actual Value [%]
- [1609] Custom Readout
- [1610] Power [kW]
- [1611] Power [hp]
- [1612] Motor Voltage
- [1613] Frequency
- [1614] Motor Current
- [1615] Frequency [%]
- [1616] Torque [Nm]
- [1617] Speed [RPM]
- [1618] Motor Thermal
- [1619] KTY sensor temperature
- [1620] Motor Angle
- [1622] Torque [%]
- [1625] Torque [Nm] High
- [1630] DC Link Voltage
- [1632] Brake Energy /s
- [1633] Brake Energy /2 min

| | |
|--------|----------------------------|
| [1634] | Heatsink Temp. |
| [1635] | Inverter Thermal |
| [1638] | SL Controller State |
| [1639] | Control Card Temp. |
| [1650] | External Reference |
| [1651] | Pulse Reference |
| [1652] | Feedback [Unit] |
| [1653] | Digi Pot Reference |
| [1660] | Digital Input |
| [1661] | Terminal 53 Switch Setting |
| [1662] | Analog Input 53 |
| [1663] | Terminal 54 Switch Setting |
| [1664] | Analog Input 54 |
| [1665] | Analog Output 42 [mA] |
| [1666] | Digital Output [bin] |
| [1667] | Freq. Input #29 [Hz] |
| [1668] | Freq. Input #33 [Hz] |
| [1669] | Pulse Output #27 [Hz] |
| [1670] | Pulse Output #29 [Hz] |
| [1671] | Relay Output [bin] |
| [1672] | Counter A |
| [1673] | Counter B |
| [1674] | Prec. Stop Counter |
| [1675] | Analog In X30/11 |
| [1676] | Analog In X30/12 |
| [1677] | Analog Out X30/8 [mA] |
| [1678] | Analog Out X45/1 [mA] |
| [1679] | Analog Out X45/3 [mA] |
| [1684] | Comm. Option STW |
| [1685] | FC Port CTW 1 |
| [1690] | Alarm Word |
| [1691] | Alarm Word 2 |
| [1692] | Warning Word |
| [1693] | Warning Word 2 |
| [1694] | Ext. Status Word |
| [3421] | PCD 1 Read from MCO |
| [3422] | PCD 2 Read from MCO |
| [3423] | PCD 3 Read from MCO |
| [3424] | PCD 4 Read from MCO |
| [3425] | PCD 5 Read from MCO |
| [3426] | PCD 6 Read from MCO |
| [3427] | PCD 7 Read from MCO |
| [3428] | PCD 8 Read from MCO |
| [3429] | PCD 9 Read from MCO |
| [3430] | PCD 10 Read from MCO |
| [3440] | Digital Inputs |
| [3441] | Digital Outputs |

| | |
|--------|------------------------|
| [3450] | Actual Position |
| [3451] | Commanded Position |
| [3452] | Actual Master Position |
| [3453] | Slave Index Position |
| [3454] | Master Index Position |
| [3455] | Curve Position |
| [3456] | Track Error |
| [3457] | Synchronizing Error |
| [3458] | Actual Velocity |
| [3459] | Actual Master Velocity |
| [3460] | Synchronizing Status |
| [3461] | Axis Status |
| [3462] | Program Status |
| [3464] | MCO 302 Status |
| [3465] | MCO 302 Control |
| [3470] | MCO Alarm Word 1 |
| [3471] | MCO Alarm Word 2 |

10-13 Warning Parameter

Range:

0 N/A* [0 - 65535 N/A]

Function:

View a DeviceNet-specific Warning word. One bit is assigned to every warning. Please refer to the DeviceNet Operating Instructions (MG.33.DX.YY) for further information.

| Bit: | Meaning: |
|------|-----------------------------|
| 0 | Bus not active |
| 1 | Explicit connection timeout |
| 2 | I/O connection |
| 3 | Retry limit reached |
| 4 | Actual is not updated |
| 5 | CAN bus off |
| 6 | I/O send error |
| 7 | Initialization error |
| 8 | No bus supply |
| 9 | Bus off |
| 10 | Error passive |
| 11 | Error warning |
| 12 | Duplicate MAC ID Error |
| 13 | RX queue overrun |
| 14 | TX queue overrun |
| 15 | CAN overrun |

10-14 Net Reference

Read only from LCP

Option:

Function:

Select the reference source in Instance 21/71 and 20/70.

| | | |
|-------|-----|--|
| [0] * | Off | Enables reference via analog/digital inputs. |
| [1] | On | Enables reference via the fieldbus. |

10-15 Net Control

Read only from LCP

Option:

Function:

Select the control source in Instance 21/71 and 20/70.

| | | |
|-------|-----|--|
| [0] * | Off | Enables control via analog/digital inputs. |
| [1] | On | Enable control via the fieldbus. |

3.12.4 10-2* COS Filters

Parameters for configuring COS filter settings.

10-20 COS Filter 1

Range:

0 N/A* [0 - 65535 N/A]

Function:

Enter the value for COS Filter 1 to set up the filter mask for the Status Word. When operating in COS (Change-Of-State), this function filters out bits in the Status Word that should not be sent if they change.

10-21 COS Filter 2

Range:

0 N/A* [0 - 65535 N/A]

Function:

Enter the value for COS Filter 2, to set up the filter mask for the Main Actual Value. When operating in COS (Change-Of-State), this function filters out bits in the Main Actual Value that should not be sent if they change.

10-22 COS Filter 3

Range:

0 N/A* [0 - 65535 N/A]

Function:

Enter the value for COS Filter 3, to set up the filter mask for PCD 3. When operating in COS (Change-Of-State), this function filters out bits in PCD 3 that should not be sent if they change.

10-23 COS Filter 4

Range:

0 N/A* [0 - 65535 N/A]

Function:

Enter the value for COS Filter 4 to set up the filter mask for PCD 4. When operating in COS (Change-Of-State), this function filters out bits in PCD 4 that should not be sent if they change.

3.12.5 10-3* Parameter Access

Parameter group providing access to indexed parameters and defining programming set-up.

10-30 Array Index

Range:

0 N/A* [0 - 255 N/A]

Function:

View array parameters. This parameter is valid only when a DeviceNet fieldbus is installed.

10-31 Store Data Values

Option:

[0] * Off

Function:

Parameter values changed via DeviceNet are not automatically stored in non-volatile memory. Use this parameter to activate a function that stores parameter values in the EEPROM non-volatile memory, so changed parameter values will be retained at power-down.

[1] Store all setups

Stores all parameter values from the active set-up in the non-volatile memory. The selection returns to Off [0] when all values have been stored.

[2] Store all setups

Stores all parameter values for all set-ups in the non-volatile memory. The selection returns to Off [0] when all parameter values have been stored.

10-32 Devicenet Revision

Range:

0 N/A* [0 - 65535 N/A]

Function:

View the DeviceNet revision number. This parameter is used for EDS file creation.

10-33 Store Always

Option:

Function:

[0] * Off

Deactivates non-volatile storage of data.

[1] On

Stores parameter data received via DeviceNet in EEPROM non-volatile memory as default.

10-39 Devicenet F Parameters

Array [1000]

No LCP access

Range:

Function:

0 N/A* [0 - 0 N/A]

This parameter is used to configure the frequency converter via DeviceNet and build the EDS-file.

3.13 Parameters: Smart Logic Control

3.13.1 13-** Prog. Features

Smart Logic Control (SLC) is essentially a sequence of user defined actions (see par.13-52 *SL Controller Action [x]*) executed by the SLC when the associated user defined *event* (see par.13-51 *SL Controller Event [x]*) is evaluated as TRUE by the SLC. Events and *actions* are each numbered and linked together in pairs (states). This means that when *event [0]* is fulfilled (attains the value TRUE), *action [0]* is executed. After this, the conditions of *event [1]* will be evaluated and if evaluated TRUE, *action [1]* will be executed and so on. Only one *event* will be evaluated at any time. If an *event* is evaluated as FALSE, nothing happens (in the SLC) during the current scan interval and no other *events* will be evaluated. This means that when the SLC starts, it evaluates *event [0]* (and only *event [0]*) each scan interval. Only when *event [0]* is evaluated TRUE, will the SLC execute *action [0]* and start evaluating *event [1]*. It is possible to programme from 1 to 20 *events* and *actions*.

When the last *event / action* has been executed, the sequence starts over again from *event [0] / action [0]*. The illustration shows an example with three event / actions:

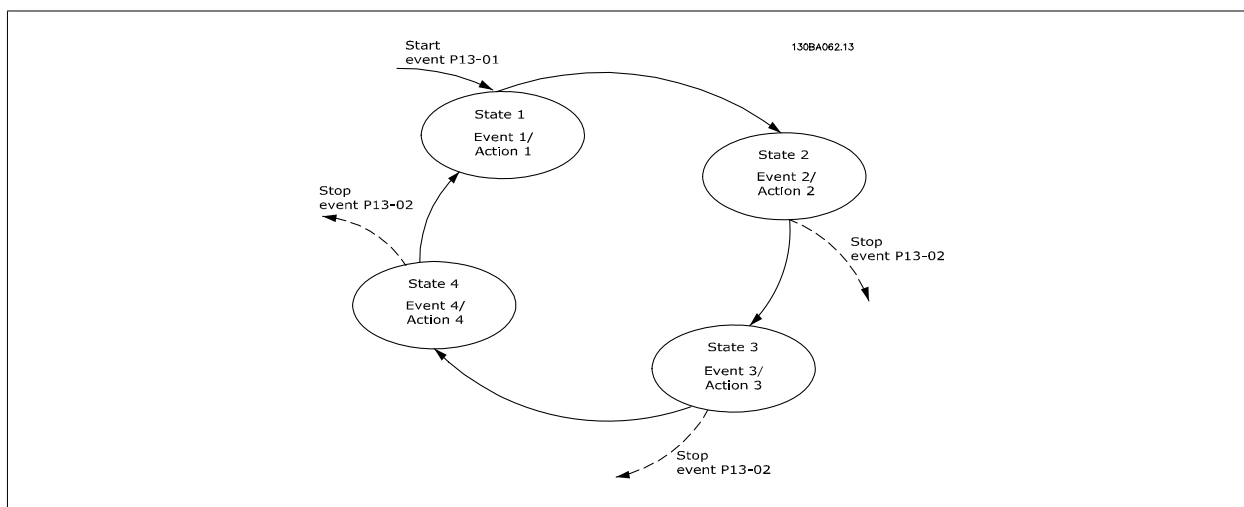

Starting and stopping the SLC:

Starting and stopping the SLC can be done by selecting `.On [1]`, or `.Off [0]`, in par.13-00 *SL Controller Mode*. The SLC always starts in state 0 (where it evaluates *event [0]*). The SLC starts when the Start Event (defined in par.13-01 *Start Event*) is evaluated as TRUE (provided that `On [1]` is selected in par.13-00 *SL Controller Mode*). The SLC stops when the *Stop Event* (par.13-02 *Stop Event*) is TRUE. par.13-03 *Reset SLC* resets all SLC parameters and start programming from scratch.

3.13.2 13-0* SLC Settings

Use the SLC settings to activate, deactivate and reset the Smart Logic Control.

13-00 SL Controller Mode

| Option: | Function: |
|-----------|--------------------------------------|
| [0] * Off | Disables the Smart Logic Controller. |
| [1] On | Enables the Smart Logic Controller. |

13-01 Start Event

| Option: | Function: |
|-------------|--|
| [0] * False | Select the boolean (TRUE or FALSE) input to activate Smart Logic Control. <i>False [0]</i> enters the fixed value - FALSE |
| [1] True | <i>True [1]</i> enters the fixed value - TRUE. |
| [2] Running | <i>Running [2]</i> The motor is running. |

| | | |
|------|----------------------|--|
| [3] | In range | <i>In range</i> [3] The motor is running within the programmed current and speed ranges set in par. 4-50 <i>Warning Current Low</i> to par.4-53 <i>Warning Speed High</i> . |
| [4] | On reference | <i>On reference</i> [4] The motor is running on reference. |
| [5] | Torque limit | <i>Torque limit</i> [5] The torque limit, set in par.4-16 <i>Torque Limit Motor Mode</i> or par.4-17 <i>Torque Limit Generator Mode</i> , has been exceeded. |
| [6] | Current limit | <i>Current limit</i> [6] The motor current limit, set in par.4-18 <i>Current Limit</i> , has been exceeded. |
| [7] | Out of current range | <i>Out of current range</i> [7] The motor current is outside the range set in par.4-18 <i>Current Limit</i> . |
| [8] | Below I low | <i>Below I low</i> [8] The motor current is lower than set in par.4-50 <i>Warning Current Low</i> . |
| [9] | Above I high | <i>Above I high</i> [9] The motor current is higher than set in par.4-51 <i>Warning Current High</i> . |
| [10] | Out of speed range | <i>Out of speed range</i> [10] The speed is outside the range set in par.4-52 <i>Warning Speed Low</i> and par.4-53 <i>Warning Speed High</i> . |
| [11] | Below speed low | <i>Below speed low</i> [11] The output speed is lower than the setting in par.4-52 <i>Warning Speed Low</i> . |
| [12] | Above speed high | <i>Above speed high</i> [12] The output speed is higher than the setting in par.4-53 <i>Warning Speed High</i> . |
| [13] | Out of feedb. range | <i>Out of feedb. Range</i> [13] The feedback is outside the range set in par.4-56 <i>Warning Feedback Low</i> and par.4-57 <i>Warning Feedback High</i> . |
| [14] | Below feedb. low | <i>Below feedb. Low</i> [14] The feedback is below the limit set in par.4-56 <i>Warning Feedback Low</i> . |
| [15] | Above feedb. high | <i>Above feedb. High</i> [15] The feedback is above the limit set in par.4-57 <i>Warning Feedback High</i> . |
| [16] | Thermal warning | <i>Thermal warning</i> [16] The thermal warning turns on when the temperature exceeds the limit in the motor, the frequency converter, the brake resistor or the thermistor. |
| [17] | Mains out of range | <i>Mains out of range</i> [17] The mains voltage is outside the specified voltage range. |
| [18] | Reversing | <i>Reversing</i> [18] The output is high when the frequency converter is running counter clockwise (the logical product of the status bits "running" AND "reverse"). |
| [19] | Warning | <i>Warning</i> [19] A warning is active. |
| [20] | Alarm (trip) | <i>Alarm (trip)</i> [20] A (trip) alarm is active. |
| [21] | Alarm (trip lock) | <i>Alarm (trip lock)</i> [21] A (Trip lock) alarm is active. |
| [22] | Comparator 0 | <i>Comparator 0</i> [22] Use the result of comparator 0. |
| [23] | Comparator 1 | <i>Comparator 1</i> [23] Use the result of comparator 1. |
| [24] | Comparator 2 | <i>Comparator 2</i> [24] Use the result of comparator 2. |
| [25] | Comparator 3 | <i>Comparator 3</i> [25] Use the result of comparator 3. |
| [26] | Logic rule 0 | <i>Logic rule 0</i> [26] Use the result of logic rule 0. |
| [27] | Logic rule 1 | <i>Logic rule 1</i> [27] Use the result of logic rule 1. |
| [28] | Logic rule 2 | <i>Logic rule 2</i> [28] Use the result of logic rule 2. |
| [29] | Logic rule 3 | <i>Logic rule 3</i> [29] Use the result of logic rule 3. |
| [33] | Digital input DI18 | <i>Digital input DI18</i> [33] Use the result of digital input 18. |
| [34] | Digital input DI19 | <i>Digital input DI19</i> [34] Use the result of digital input 19. |
| [35] | Digital input DI27 | <i>Digital input DI27</i> [35] Use the result of digital input 27. |
| [36] | Digital input DI29 | <i>Digital input DI27</i> [35] Use the result of digital input 29. |
| [37] | Digital input DI32 | <i>Digital input DI32</i> [37] Use the result of digital input 32. |
| [38] | Digital input DI33 | <i>Digital input DI33</i> [38] Use the result of digital input 33. |

| | | |
|------|-----------------|--|
| [39] | Start command | <i>Start command</i> [39] A start command is issued. |
| [40] | Drive stopped | <i>Drive stopped</i> [40] A stop command (Jog, Stop, Qstop, Coast) is issued – and not from the SLC itself. |
| [41] | Reset Trip | <i>Reset Trip</i> [41] A reset is issued |
| [42] | Auto-reset Trip | <i>Auto-reset Trip</i> [42] An Auto reset is performed. |
| [43] | Ok key | <i>OK key</i> [43] The Ok key is pressed. |
| [44] | Reset key | <i>Reset key</i> [44] The reset key is pressed. |
| [45] | Left key | <i>Left key</i> [45] The left key is pressed. |
| [46] | Right key | <i>Right key</i> [46] The right key is pressed. |
| [47] | Up key | <i>Up key</i> [47] The up key is pressed. |
| [48] | Down key | <i>Down key</i> [48] The down key is pressed. |
| [50] | Comparator 4 | <i>Comparator 4</i> [50] Use the result of comparator 4. |
| [51] | Comparator 5 | <i>Comparator 5</i> [51] Use the result of comparator 5. |
| [60] | Logic rule 4 | <i>Logic rule 4</i> [60] Use the result of logic rule 4. |
| [61] | Logic rule 5 | <i>Logic rule 5</i> [61] Use the result of logic rule 5. |

13-02 Stop Event

Select the boolean (TRUE or FALSE) input to activate Smart Logic Control.

Option:

Function:

| | | |
|-------|----------------------|---|
| [0] * | False | For descriptions [0] - [61], see par.13-01 <i>Start Event Start Event</i> |
| [1] | True | |
| [2] | Running | |
| [3] | In range | |
| [4] | On reference | |
| [5] | Torque limit | |
| [6] | Current limit | |
| [7] | Out of current range | |
| [8] | Below I low | |
| [9] | Above I high | |
| [10] | Out of speed range | |
| [11] | Below speed low | |
| [12] | Above speed high | |
| [13] | Out of feedb. range | |
| [14] | Below feedb. low | |
| [15] | Above feedb. high | |
| [16] | Thermal warning | |
| [17] | Mains out of range | |
| [18] | Reversing | |
| [19] | Warning | |
| [20] | Alarm (trip) | |
| [21] | Alarm (trip lock) | |
| [22] | Comparator 0 | |
| [23] | Comparator 1 | |
| [24] | Comparator 2 | |

| | | |
|------|---------------------|---|
| [25] | Comparator 3 | |
| [26] | Logic rule 0 | |
| [27] | Logic rule 1 | |
| [28] | Logic rule 2 | |
| [29] | Logic rule 3 | |
| [30] | SL Time-out 0 | |
| [31] | SL Time-out 1 | |
| [32] | SL Time-out 2 | |
| [33] | Digital input DI18 | |
| [34] | Digital input DI19 | |
| [35] | Digital input DI27 | |
| [36] | Digital input DI29 | |
| [37] | Digital input DI32 | |
| [38] | Digital input DI33 | |
| [39] | Start command | |
| [40] | Drive stopped | |
| [41] | Reset Trip | |
| [42] | Auto-reset Trip | |
| [43] | Ok key | |
| [44] | Reset key | |
| [45] | Left key | |
| [46] | Right key | |
| [47] | Up key | |
| [48] | Down key | |
| [50] | Comparator 4 | |
| [51] | Comparator 5 | |
| [60] | Logic rule 4 | |
| [61] | Logic rule 5 | |
| [70] | SL Time-out 3 | <i>SL Time-out 3</i> [70] Smart logic controller timer 3 is timed out. |
| [71] | SL Time-out 4 | <i>SL Time-out 4</i> [71] Smart logic controller timer 4 is timed out. |
| [72] | SL Time-out 5 | <i>SL Time-out 5</i> [72] Smart logic controller timer 5 is timed out. |
| [73] | SL Time-out 6 | <i>SL- Time-out 6</i> [73] Smart logic controller timer 6 is timed out. |
| [74] | SL Time-out 7 | <i>SL Time-out 7</i> [74] Smart logic controller timer 7 is timed out. |
| [75] | Start command given | |
| [76] | Digital input x30 2 | |
| [77] | Digital input x30 3 | |
| [78] | Digital input x30 4 | |

13-03 Reset SLC

| Option: | Function: | |
|----------------|------------------|--|
| [0] * | Do not reset SLC | Retains programmed settings in all group 13 parameters (13-*). |
| [1] | Reset SLC | Resets all group 13 parameters (13-*) to default settings. |

3.13.3 13-1* Comparators

Comparators are used for comparing continuous variables (i.e. output frequency, output current, analog input etc.) to fixed preset values. In addition, there are digital values that will be compared to fixed time values. See explanation in par. 13-10 *Comparator Operand*. Comparators are evaluated once in each scan interval. Use the result (TRUE or FALSE) directly. All parameters in this parameter group are array parameters with index 0 to 5. Select index 0 to programme Comparator 0, select index 1 to programme Comparator 1, and so on.

13-10 Comparator Operand

Array [6]

Option:

Function:

Choice [1] to [31] are variables which will be compared based on their values. Choice [50] to [186] are digital values (TRUE/FALSE) where the comparison is based on the amount of time during which they are set to TRUE or FALSE, respectively. See par. 13-11 *Comparator Operator*.
Select the variable to be monitored by the comparator.

| | | |
|-------|---------------------|---|
| [0] * | DISABLED | <i>DISABLED</i> [0] The comparator is disabled. |
| [1] | Reference | <i>Reference</i> [1] The resulting remote reference (not local) as a percentage. |
| [2] | Feedback | <i>Feedback</i> [2] In the unit [RPM] or [Hz] |
| [3] | Motor speed | <i>Motor speed</i> [3] [RPM] or [Hz] |
| [4] | Motor current | <i>Motor current</i> [4] [A] |
| [5] | Motor torque | <i>Motor torque</i> [5] [Nm] |
| [6] | Motor power | <i>Motor power</i> [6] [kW] or [hp] |
| [7] | Motor voltage | <i>Motor voltage</i> [7] [V] |
| [8] | DC-link voltage | <i>DC-link voltage</i> [8] [V] |
| [9] | Motor thermal | <i>Motor thermal</i> [9] Expressed as a percentage. |
| [10] | VLT thermal | <i>VLT thermal</i> [10] Expressed as a percentage. |
| [11] | Heat sink temp. | <i>Heat sink temp</i> [11] Expressed as a percentage. |
| [12] | Analog input AI53 | <i>Analog input AI53</i> [12] Expressed as a percentage. |
| [13] | Analog input AI54 | <i>Analog input AI54</i> [13] Expressed as a percentage. |
| [14] | Analog input AIFB10 | <i>Analog input AIFB10</i> [14] [V]. AIFB10 is internal 10 V supply. |
| [15] | Analog input AIS24V | <i>Analog input AIS24V</i> [15] [V] Analog input AICCT [17] [°]. AIS24V is switch mode power supply: SMPS 24 V. |
| [17] | Analog input AICCT | Analog input AICCT [17] [°]. AICCT is control card temperature. |
| [18] | Pulse input FI29 | <i>Pulse input FI29</i> [18] Expressed as a percentage. |
| [19] | Pulse input FI33 | <i>Pulse input FI33</i> [19] Expressed as a percentage. |
| [20] | Alarm number | <i>Alarm number</i> [20] The error number. |
| [21] | Warning number | |
| [22] | Analog input x30 11 | |
| [23] | Analog input x30 12 | |
| [30] | Counter A | <i>Counter A</i> [30] Number of counts |
| [31] | Counter B | <i>Counter B</i> [31] Number of counts |
| [50] | FALSE | <i>False</i> [50] Enters the fixed value of false in the comparator. |
| [51] | TRUE | <i>True</i> [51] Enters the fixed value of true in the comparator. |
| [52] | Control ready | <i>Control ready</i> [52] The control board receives supply voltage |

| | | |
|-------|----------------------|--|
| [53] | Drive ready | <i>Drive ready</i> [53] The frequency converter is ready for operation and applies a supply signal on the control board. |
| [54] | Running | <i>Running</i> [54] The motor is running. |
| [55] | Reversing | <i>Reversing</i> [55] The output is high when the frequency converter is running counter clockwise (the logical product of the status bits "running" AND "reverse") |
| [56] | In range | <i>In range</i> [56] The motor is running within the programmed current and speed ranges set in par. 4-50 <i>Warning Current Low</i> to par.4-53 <i>Warning Speed High</i> . |
| [60] | On reference | <i>On reference</i> [60] The motor is running on reference. |
| [61] | Below reference, low | <i>Below reference, low</i> [61] The motor is running below the value given in par.4-54 <i>Warning Reference Low</i> |
| [62] | Above ref, high | <i>Above reference, high</i> [62] The motor is running above the value given in par.4-55 <i>Warning Reference High</i> |
| [65] | Torque limit | <i>Torque limit</i> [65] The torque limit, set in par.4-16 <i>Torque Limit Motor Mode</i> or par.4-17 <i>Torque Limit Generator Mode</i> , has been exceeded. |
| [66] | Current limit | <i>Current limit</i> [66] The motor current limit, set in par.4-18 <i>Current Limit</i> , has been exceeded. |
| [67] | Out of current range | <i>Out of current range</i> [67] The motor current is outside the range set in par.4-18 <i>Current Limit</i> . |
| [68] | Below I low | <i>Below I low</i> [68] The motor current is lower than set in par.4-50 <i>Warning Current Low</i> . |
| [69] | Above I high | <i>Above I high</i> [69] The motor current is higher than set in par.4-51 <i>Warning Current High</i> . |
| [70] | Out of speed range | <i>Out of speed range</i> [70] The speed is outside the range set in par.4-52 <i>Warning Speed Low</i> and par.4-53 <i>Warning Speed High</i> . |
| [71] | Below speed low | <i>Below speed low</i> [71] The output speed is lower than the setting in par.4-52 <i>Warning Speed Low</i> . |
| [72] | Above speed high | <i>Above speed high</i> [72] The output speed is higher than the setting in par.4-53 <i>Warning Speed High</i> . |
| [75] | Out of feedb. range | <i>Out of feedb. Range</i> [75] The feedback is outside the range set in par.4-56 <i>Warning Feedback Low</i> and par.4-57 <i>Warning Feedback High</i> . |
| [76] | Below feedb. low | <i>Below feedb. Low</i> [76] The feedback is below the limit set in par. par.4-56 <i>Warning Feedback Low</i> . |
| [77] | Above feedb. high | <i>Above feedb. High</i> [77] The feedback is above the limit set in par.4-57 <i>Warning Feedback High</i> . |
| [80] | Thermal warning | <i>Thermal warning</i> [80] The thermal warning turns on when the temperature exceeds the limit in the motor, the frequency converter, the brake resistor or thermistor. |
| [82] | Mains out of range | <i>Mains out of range</i> [82] The mains voltage is outside the specified voltage range. |
| [85] | Warning | <i>Warning</i> [85] A warning is active. |
| [86] | Alarm (trip) | <i>Alarm (trip)</i> [86] A (trip) alarm is active. |
| [87] | Alarm (trip lock) | <i>Alarm (trip lock)</i> [87] A (Trip lock) alarm is active. |
| [90] | Bus OK | <i>Bus OK</i> [90] Active communication (no time-out) via the serial communication port. |
| [91] | Torque limit & stop | <i>Torque limit & stop</i> [91] If the frequency converter has received a stop signal and is at the torque limit, the signal is logic "0". |
| [92] | Brake fault (IGBT) | <i>Brake fault (IGBT)</i> [92] The brake IGBT is short circuited. |
| [93] | Mech. brake control | <i>Mech. brake control</i> [93] The mechanical brake is active. |
| [94] | Safe stop active | |
| [100] | Comparator 0 | <i>Comparator 0</i> [100] The result of comparator 0. |
| [101] | Comparator 1 | <i>Comparator 1</i> [101] The result of comparator 1. |

| | | |
|-------|---------------------|--|
| [102] | Comparator 2 | <i>Comparator 2</i> [102] The result of comparator 2. |
| [103] | Comparator 3 | <i>Comparator 3</i> [103] The result of comparator 3. |
| [104] | Comparator 4 | <i>Comparator 4</i> [104] The result of comparator 4. |
| [105] | Comparator 5 | <i>Comparator 5</i> [105] The result of comparator 5. |
| [110] | Logic rule 0 | <i>Logic rule 0</i> [110] The result of Logic rule 0. |
| [111] | Logic rule 1 | <i>Logic rule 1</i> [111] The result of Logic rule 1. |
| [112] | Logic rule 2 | <i>Logic rule 2</i> [112] The result of Logic rule 2. |
| [113] | Logic rule 3 | <i>Logic rule 3</i> [113] The result of Logic rule 3. |
| [114] | Logic rule 4 | <i>Logic rule 4</i> [114] The result of Logic rule 4. |
| [115] | Logic rule 5 | <i>Logic rule 5</i> [115] The result of Logic rule 5. |
| [120] | SL Time-out 0 | <i>SL Time-out 0</i> [120] The result of SLC timer 0. |
| [121] | SL Time-out 1 | <i>SL Time-out 1</i> [121] The result of SLC timer 1. |
| [122] | SL Time-out 2 | <i>SL Time-out 2</i> [122] The result of SLC timer 2. |
| [123] | SL Time-out 3 | <i>SL Time-out 3</i> [123] The result of SLC timer 3. |
| [124] | SL Time-out 4 | <i>SL Time-out 4</i> [124] The result of SLC timer 4. |
| [125] | SL Time-out 5 | <i>SL Time-out 5</i> [125] The result of SLC timer 5. |
| [126] | SL Time-out 6 | <i>SL Time-out 6</i> [126] The result of SLC timer 6. |
| [127] | SL Time-out 7 | <i>SL Time-out 7</i> [127] The result of SLC timer 7. |
| [130] | Digital input DI18 | <i>Digital input DI18</i> [130] Digital input 18. High = True. |
| [131] | Digital input DI19 | <i>Digital input DI19</i> [131] Digital input 19. High = True. |
| [132] | Digital input DI27 | <i>Digital input DI27</i> [132] Digital input 27. High = True. |
| [133] | Digital input DI29 | <i>Digital input DI29</i> [133] Digital input 29. High = True. |
| [134] | Digital input DI32 | <i>Digital input DI32</i> [134] Digital input 32. High = True. |
| [135] | Digital input DI33 | <i>Digital input DI33</i> [135] Digital input 33. High = True. |
| [150] | SL digital output A | <i>SL digital output A</i> [150] Use the result of the SLC output A. |
| [151] | SL digital output B | <i>SL digital output B</i> [151] Use the result of the SLC output B. |
| [152] | SL digital output C | <i>SL digital output C</i> [152] Use the result of the SLC output C. |
| [153] | SL digital output D | <i>SL digital output D</i> [153] Use the result of the SLC output D. |
| [154] | SL digital output E | <i>SL digital output E</i> [154] Use the result of the SLC output E. |
| [155] | SL digital output F | <i>SL digital output F</i> [155] Use the result of the SLC output F. |
| [160] | Relay 1 | <i>Relay 1</i> [160] Relay 1 is active |
| [161] | Relay 2 | <i>Relay 2</i> [161] Relay 2 is active |
| [180] | Local ref. active | <i>Local ref. active</i> [180] High when par. 3-13 <i>Reference Site</i> = [2] Local or when par. 3-13 <i>Reference Site</i> is [0] Linked to hand Auto, at the same time as the LCP is in Hand on mode. |
| [181] | Remote ref. active | <i>Remote ref. active</i> [181] High when par. 3-13 <i>Reference Site</i> = [1] Remote or [0] Linked to hand/ auto, while the LCP is in Auto on mode. |
| [182] | Start command | <i>Start command</i> [182] High when there is an active start command, and no stop command. |
| [183] | Drive stopped | <i>Drive stopped</i> [183] A stop command (Jog, Stop, Qstop, Coast) is issued – and not from the SLC itself. |

| | | |
|-------|---------------------|--|
| [185] | Drive in hand mode | <i>Drive in hand mode</i> [185] High when the frequency converter is in hand mode. |
| [186] | Drive in auto mode | <i>Drive in auto mode</i> [186] High when the frequency converter is in auto mode. |
| [187] | Start command given | |
| [190] | Digital input x30 2 | |
| [191] | Digital input x30 3 | |
| [192] | Digital input x30 4 | |

13-11 Comparator Operator

Array [6]

Option:

Function:

[0] * < Select < [0] for the result of the evaluation to be TRUE, when the variable selected in par. 13-10 *Comparator Operand* is smaller than the fixed value in par.13-12 *Comparator Value*. The result will be FALSE, if the variable selected in par. 13-10 *Comparator Operand* is greater than the fixed value in par.13-12 *Comparator Value*.

[1] ≈ (equal) Select ≈ [1] for the result of the evaluation to be TRUE, when the variable selected in par. 13-10 *Comparator Operand* is approximately equal to the fixed value in par.13-12 *Comparator Value*.

[2] > Select > [2] for the inverse logic of option < [0].

13-12 Comparator Value

Array [6]

Range:

Function:

0 N/A* [-100000.000 - 100000.000 N/A] Enter the 'trigger level' for the variable that is monitored by this comparator. This is an array parameter containing comparator values 0 to 5.

3.13.4 13-2* Timers

This parameter group consists of timer parameters.

Use the result (TRUE or FALSE) from *timers* directly to define an *event* (see par. 13-51 *SL Controller Event*), or as boolean input in a *logic rule* (see par. 13-40 *Logic Rule Boolean 1*, par. 13-42 *Logic Rule Boolean 2* or par. 13-44 *Logic Rule Boolean 3*). A timer is only FALSE when started by an action (i.e. Start timer 1 [29]) until the timer value entered in this parameter is elapsed. Then it becomes TRUE again.

All parameters in this parameter group are array parameters with index 0 to 2. Select index 0 to program Timer 0, select index 1 to program Timer 1, and so on.

13-20 SL Controller Timer

Range:

Function:

0.000 N/A* [0.000 - 0.000 N/A] Enter the value to define the duration of the FALSE output from the programmed timer. A timer is only FALSE if it is started by an action (i.e. *Start timer 1 [29]*) and until the given timer value has elapsed.

3.13.5 13-4* Logic Rules

Combine up to three boolean inputs (TRUE / FALSE inputs) from timers, comparators, digital inputs, status bits and events using the logical operators AND, OR, and NOT. Select boolean inputs for the calculation in par. 13-40 *Logic Rule Boolean 1*, par. 13-42 *Logic Rule Boolean 2* and par. 13-44 *Logic Rule Boolean 3*. Define the operators used to logically combine the selected inputs in par.13-41 *Logic Rule Operator 1* and par.13-43 *Logic Rule Operator 2*.

Priority of calculation

The results of par. 13-40 *Logic Rule Boolean 1*, par.13-41 *Logic Rule Operator 1* and par. 13-42 *Logic Rule Boolean 2* are calculated first. The outcome (TRUE / FALSE) of this calculation is combined with the settings of par.13-43 *Logic Rule Operator 2* and par. 13-44 *Logic Rule Boolean 3*, yielding the final result (TRUE / FALSE) of the logic rule.

13-40 Logic Rule Boolean 1

Array [6]

Option:**Function:**

| Option | Function |
|--------------------------|---|
| [0] * False | Select the first boolean (TRUE or FALSE) input for the selected logic rule. See par.13-01 <i>Start Event</i> ([0] - [61]) and par.13-02 <i>Stop Event</i> ([70] - [75]) for further description. |
| [1] True | |
| [2] Running | |
| [3] In range | |
| [4] On reference | |
| [5] Torque limit | |
| [6] Current limit | |
| [7] Out of current range | |
| [8] Below I low | |
| [9] Above I high | |
| [10] Out of speed range | |
| [11] Below speed low | |
| [12] Above speed high | |
| [13] Out of feedb. range | |
| [14] Below feedb. low | |
| [15] Above feedb. high | |
| [16] Thermal warning | |
| [17] Mains out of range | |
| [18] Reversing | |
| [19] Warning | |
| [20] Alarm (trip) | |
| [21] Alarm (trip lock) | |
| [22] Comparator 0 | |
| [23] Comparator 1 | |
| [24] Comparator 2 | |
| [25] Comparator 3 | |
| [26] Logic rule 0 | |
| [27] Logic rule 1 | |
| [28] Logic rule 2 | |
| [29] Logic rule 3 | |
| [30] SL Time-out 0 | |
| [31] SL Time-out 1 | |
| [32] SL Time-out 2 | |
| [33] Digital input DI18 | |
| [34] Digital input DI19 | |
| [35] Digital input DI27 | |
| [36] Digital input DI29 | |
| [37] Digital input DI32 | |
| [38] Digital input DI33 | |
| [39] Start command | |
| [40] Drive stopped | |
| [41] Reset Trip | |
| [42] Auto-reset Trip | |

| | |
|------|---------------------|
| [43] | Ok key |
| [44] | Reset key |
| [45] | Left key |
| [46] | Right key |
| [47] | Up key |
| [48] | Down key |
| [50] | Comparator 4 |
| [51] | Comparator 5 |
| [60] | Logic rule 4 |
| [61] | Logic rule 5 |
| [70] | SL Time-out 3 |
| [71] | SL Time-out 4 |
| [72] | SL Time-out 5 |
| [73] | SL Time-out 6 |
| [74] | SL Time-out 7 |
| [75] | Start command given |
| [76] | Digital input x30 2 |
| [77] | Digital input x30 3 |
| [78] | Digital input x30 4 |

13-41 Logic Rule Operator 1

Array [6]

| Option: | Function: |
|-----------------|--|
| | Select the first logical operator to use on the Boolean inputs from par. 13-40 <i>Logic Rule Boolean 1</i> and par. 13-42 <i>Logic Rule Boolean 2</i> . [13 -XX] signifies the boolean input of par. 13-* |
| [0] * DISABLED | Ignores par. , par.13-43 <i>Logic Rule Operator 2</i> , and par. 13-44 <i>Logic Rule Boolean 3</i> . |
| [1] AND | Evaluates the expression [13-40] AND [13-42]. |
| [2] OR | evaluates the expression [13-40] OR [13-42]. |
| [3] AND NOT | evaluates the expression [13-40] AND NOT [13-42]. |
| [4] OR NOT | evaluates the expression [13-40] OR NOT [13-42]. |
| [5] NOT AND | evaluates the expression NOT [13-40] AND [13-42]. |
| [6] NOT OR | evaluates the expression NOT [13-40] OR [13-42]. |
| [7] NOT AND NOT | evaluates the expression NOT [13-40] AND NOT [13-42]. |
| [8] NOT OR NOT | evaluates the expression NOT [13-40] OR NOT [13-42]. |

13-42 Logic Rule Boolean 2

Array [6]

| Option: | Function: |
|------------------|---|
| [0] * False | Select the second boolean (TRUE or FALSE) input for the selected logic rule. See par.13-01 <i>Start Event</i> ([0] - [61]) and par.13-02 <i>Stop Event</i> ([70] - [75]) for further description. |
| [1] True | |
| [2] Running | |
| [3] In range | |
| [4] On reference | |
| [5] Torque limit | |

| | |
|------|----------------------|
| [6] | Current limit |
| [7] | Out of current range |
| [8] | Below I low |
| [9] | Above I high |
| [10] | Out of speed range |
| [11] | Below speed low |
| [12] | Above speed high |
| [13] | Out of feedb. range |
| [14] | Below feedb. low |
| [15] | Above feedb. high |
| [16] | Thermal warning |
| [17] | Mains out of range |
| [18] | Reversing |
| [19] | Warning |
| [20] | Alarm (trip) |
| [21] | Alarm (trip lock) |
| [22] | Comparator 0 |
| [23] | Comparator 1 |
| [24] | Comparator 2 |
| [25] | Comparator 3 |
| [26] | Logic rule 0 |
| [27] | Logic rule 1 |
| [28] | Logic rule 2 |
| [29] | Logic rule 3 |
| [30] | SL Time-out 0 |
| [31] | SL Time-out 1 |
| [32] | SL Time-out 2 |
| [33] | Digital input DI18 |
| [34] | Digital input DI19 |
| [35] | Digital input DI27 |
| [36] | Digital input DI29 |
| [37] | Digital input DI32 |
| [38] | Digital input DI33 |
| [39] | Start command |
| [40] | Drive stopped |
| [41] | Reset Trip |
| [42] | Auto-reset Trip |
| [43] | Ok key |
| [44] | Reset key |
| [45] | Left key |
| [46] | Right key |
| [47] | Up key |
| [48] | Down key |
| [50] | Comparator 4 |
| [51] | Comparator 5 |
| [60] | Logic rule 4 |
| [61] | Logic rule 5 |

[70] SL Time-out 3

[71] SL Time-out 4

[72] SL Time-out 5

[73] SL Time-out 6

[74] SL Time-out 7

[75] Start command given

[76] Digital input x30 2

[77] Digital input x30 3

[78] Digital input x30 4

13-43 Logic Rule Operator 2

Array [6]

Option:

Function:

Select the second logical operator to be used on the boolean input calculated in par. 13-40 *Logic Rule Boolean 1*, par.13-41 *Logic Rule Operator 1*, and par. 13-42 *Logic Rule Boolean 2*, and the boolean input coming from par. 13-42 *Logic Rule Boolean 2*.
 [13-44] signifies the boolean input of par. 13-44 *Logic Rule Boolean 3*.
 [13-40/13-42] signifies the boolean input calculated in par. 13-40 *Logic Rule Boolean 1*, par. 13-41 *Logic Rule Operator 1*, and par. 13-42 *Logic Rule Boolean 2*. DISABLED [0] (factory setting). select this option to ignore par. 13-44 *Logic Rule Boolean 3*.

[0] * DISABLED

[1] AND

[2] OR

[3] AND NOT

[4] OR NOT

[5] NOT AND

[6] NOT OR

[7] NOT AND NOT

[8] NOT OR NOT

13-44 Logic Rule Boolean 3

Array [6]

Option:

Function:

[0] * False Select the third boolean (TRUE or FALSE) input for the selected logic rule. See par. 13-01 ([0] - [61]) and par. 13-02 ([70] - [75]) for further description.

[1] True

[2] Running

[3] In range

[4] On reference

[5] Torque limit

[6] Current limit

[7] Out of current range

[8] Below I low

[9] Above I high

[10] Out of speed range

[11] Below speed low

[12] Above speed high

[13] Out of feedb. range

[14] Below feedb. low

| | |
|------|---------------------|
| [15] | Above feedb. high |
| [16] | Thermal warning |
| [17] | Mains out of range |
| [18] | Reversing |
| [19] | Warning |
| [20] | Alarm (trip) |
| [21] | Alarm (trip lock) |
| [22] | Comparator 0 |
| [23] | Comparator 1 |
| [24] | Comparator 2 |
| [25] | Comparator 3 |
| [26] | Logic rule 0 |
| [27] | Logic rule 1 |
| [28] | Logic rule 2 |
| [29] | Logic rule 3 |
| [30] | SL Time-out 0 |
| [31] | SL Time-out 1 |
| [32] | SL Time-out 2 |
| [33] | Digital input DI18 |
| [34] | Digital input DI19 |
| [35] | Digital input DI27 |
| [36] | Digital input DI29 |
| [37] | Digital input DI32 |
| [38] | Digital input DI33 |
| [39] | Start command |
| [40] | Drive stopped |
| [41] | Reset Trip |
| [42] | Auto-reset Trip |
| [43] | Ok key |
| [44] | Reset key |
| [45] | Left key |
| [46] | Right key |
| [47] | Up key |
| [48] | Down key |
| [50] | Comparator 4 |
| [51] | Comparator 5 |
| [60] | Logic rule 4 |
| [61] | Logic rule 5 |
| [70] | SL Time-out 3 |
| [71] | SL Time-out 4 |
| [72] | SL Time-out 5 |
| [73] | SL Time-out 6 |
| [74] | SL Time-out 7 |
| [75] | Start command given |
| [76] | Digital input x30 2 |
| [77] | Digital input x30 3 |
| [78] | Digital input x30 4 |

3.13.6 13-5* States

Parameters for programming the Smart Logic Controller.

13-51 SL Controller Event

Array [20]

Option:

Function:

| | | |
|-------|----------------------|---|
| [0] * | False | Select the boolean input (TRUE or FALSE) to define the Smart Logic Controller event. See par. 13-01 <i>Start Event</i> ([0] - [61]) and par. 13-02 <i>Stop Event</i> ([70] - [74]) for further description. |
| [1] | True | |
| [2] | Running | |
| [3] | In range | |
| [4] | On reference | |
| [5] | Torque limit | |
| [6] | Current limit | |
| [7] | Out of current range | |
| [8] | Below I low | |
| [9] | Above I high | |
| [10] | Out of speed range | |
| [11] | Below speed low | |
| [12] | Above speed high | |
| [13] | Out of feedb. range | |
| [14] | Below feedb. low | |
| [15] | Above feedb. high | |
| [16] | Thermal warning | |
| [17] | Mains out of range | |
| [18] | Reversing | |
| [19] | Warning | |
| [20] | Alarm (trip) | |
| [21] | Alarm (trip lock) | |
| [22] | Comparator 0 | |
| [23] | Comparator 1 | |
| [24] | Comparator 2 | |
| [25] | Comparator 3 | |
| [26] | Logic rule 0 | |
| [27] | Logic rule 1 | |
| [28] | Logic rule 2 | |
| [29] | Logic rule 3 | |
| [30] | SL Time-out 0 | |
| [31] | SL Time-out 1 | |
| [32] | SL Time-out 2 | |
| [33] | Digital input DI18 | |
| [34] | Digital input DI19 | |
| [35] | Digital input DI27 | |
| [36] | Digital input DI29 | |
| [37] | Digital input DI32 | |
| [38] | Digital input DI33 | |

| | |
|------|---------------------|
| [39] | Start command |
| [40] | Drive stopped |
| [41] | Reset Trip |
| [42] | Auto-reset Trip |
| [43] | Ok key |
| [44] | Reset key |
| [45] | Left key |
| [46] | Right key |
| [47] | Up key |
| [48] | Down key |
| [50] | Comparator 4 |
| [51] | Comparator 5 |
| [60] | Logic rule 4 |
| [61] | Logic rule 5 |
| [70] | SL Time-out 3 |
| [71] | SL Time-out 4 |
| [72] | SL Time-out 5 |
| [73] | SL Time-out 6 |
| [74] | SL Time-out 7 |
| [75] | Start command given |
| [76] | Digital input x30 2 |
| [77] | Digital input x30 3 |
| [78] | Digital input x30 4 |

13-52 SL Controller Action

Array [20]

Option:

Function:

| | | |
|-------|---------------------|---|
| [0] * | DISABLED | Select the action corresponding to the SLC event. Actions are executed when the corresponding event (defined in par.13-51 <i>SL Controller Event</i>) is evaluated as true. The following actions are available for selection: <i>*DISABLED</i> [0] |
| [1] | No action | <i>No action</i> [1] |
| [2] | Select set-up 1 | <i>Select set-up 1</i> [2] - changes the active set-up (par. 0-10) to '1'. |
| [3] | Select set-up 2 | <i>Select set-up 2</i> [3] - changes the active set-up (par. 0-10) to '2'. |
| [4] | Select set-up 3 | <i>Select set-up 3</i> [4] - changes the active set-up (par. 0-10) to '3'. |
| [5] | Select set-up 4 | <i>Select set-up 4</i> [5] - changes the active set-up (par. 0-10) to '4'. If the set-up is changed, it will merge with other set-up commands coming from either the digital inputs or via a fieldbus. |
| [10] | Select preset ref 0 | <i>Select preset reference 0</i> [10] – selects preset reference 0. |
| [11] | Select preset ref 1 | <i>Select preset reference 1</i> [11] – selects preset reference 1. |
| [12] | Select preset ref 2 | <i>Select preset reference 2</i> [12] – selects preset reference 2. |
| [13] | Select preset ref 3 | <i>Select preset reference 3</i> [13] – selects preset reference 3. |
| [14] | Select preset ref 4 | <i>Select preset reference 4</i> [14] – selects preset reference 4. |
| [15] | Select preset ref 5 | <i>Select preset reference 5</i> [15] – selects preset reference 5. |
| [16] | Select preset ref 6 | <i>Select preset reference 6</i> [16] – selects preset reference 6. |

| | | |
|------|------------------------|--|
| [17] | Select preset ref 7 | <i>Select preset reference 7</i> [17] - selects preset reference 7. If the active preset reference is changed, it will merge with other preset reference commands coming from either the digital inputs or via a fieldbus. |
| [18] | Select ramp 1 | <i>Select ramp 1</i> [18] - selects ramp 1. |
| [19] | Select ramp 2 | <i>Select ramp 2</i> [19] - selects ramp 2. |
| [20] | Select ramp 3 | <i>Select ramp 3</i> [20] - selects ramp 3. |
| [21] | Select ramp 4 | <i>Select ramp 4</i> [21] - selects ramp 4. |
| [22] | Run | <i>Run</i> [22] - issues a start command to the frequency converter. |
| [23] | Run reverse | <i>Run reverse</i> [23] - issues a start reverse command to the frequency converter. |
| [24] | Stop | <i>Stop</i> [24] - issues a stop command to the frequency converter. |
| [25] | Qstop | <i>Qstop</i> [25] - issues a quick stop command to the frequency converter. |
| [26] | Dcstop | <i>Dcstop</i> [26] - issues a DC stop command to the frequency converter. |
| [27] | Coast | <i>Coast</i> [27] - the frequency converter coasts immediately. All stop commands including the coast command stop the SLC. |
| [28] | Freeze output | <i>Freeze output</i> [28] - freezes the output frequency of the frequency converter. |
| [29] | Start timer 0 | <i>Start timer 0</i> [29] - starts timer 0, see par. 13-20 for further description. |
| [30] | Start timer 1 | <i>Start timer 1</i> [30] - starts timer 1, see par. 13-20 for further description. |
| [31] | Start timer 2 | <i>Start timer 2</i> [31] - starts timer 2, see par. 13-20 for further description. |
| [32] | Set digital out A low | <i>Set digital output A low</i> [32] - any output with SL output A will be low. |
| [33] | Set digital out B low | <i>Set digital output B low</i> [33] - any output with SL output B will be low. |
| [34] | Set digital out C low | <i>Set digital output C low</i> [34] - any output with SL output C will be low. |
| [35] | Set digital out D low | <i>Set digital output D low</i> [35] - any output with SL output D will be low. |
| [36] | Set digital out E low | <i>Set digital output E low</i> [36] - any output with SL output E will be low. |
| [37] | Set digital out F low | <i>Set digital output F low</i> [37] - any output with SL output F will be low. |
| [38] | Set digital out A high | <i>Set digital output A high</i> [38] - any output with SL output A will be high. |
| [39] | Set digital out B high | <i>Set digital output B high</i> [39] - any output with SL output B will be high. |
| [40] | Set digital out C high | <i>Set digital output C high</i> [40] - any output with SL output C will be high. |
| [41] | Set digital out D high | <i>Set digital output D high</i> [41] - any output with SL output D will be high. |
| [42] | Set digital out E high | <i>Set digital output E high</i> [42] - any output with SL output E will be high. |
| [43] | Set digital out F high | <i>Set digital output F high</i> [43] - any output with SL output F will be high. |
| [60] | Reset Counter A | <i>Reset Counter A</i> [60] - resets Counter A to zero. |
| [61] | Reset Counter B | <i>Reset Counter B</i> [61] - resets Counter B to zero. |
| [70] | Start timer 3 | <i>Start Timer 3</i> [70] - Start Timer 3, see par. 13-20 for further description. |
| [71] | Start timer 4 | <i>Start Timer 4</i> [71] - Start Timer 4, see par. 13-20 for further description. |
| [72] | Start timer 5 | <i>Start Timer 5</i> [72] - Start Timer 5, see par. 13-20 for further description. |
| [73] | Start timer 6 | <i>Start Timer 6</i> [73] - Start Timer 6, see par. 13-20 for further description. |
| [74] | Start timer 7 | <i>Start Timer 7</i> [74] - Start Timer 7, see par. 13-20 for further description. |

3.14 Parameters: Special Functions

3.14.1 14-** Special Functions

Parameter group for configuring special frequency converter functions.

3

3.14.2 Inverter Switching 14-0*

Parameters for configuring the inverter switching.

14-00 Switching Pattern

| Option: | Function: |
|-------------|---|
| [0] 60 AVM | Select the switching pattern: 60° AVM or SFAVM. |
| [1] * SFAVM | |



NB!

The output frequency value of the frequency converter must never exceed 1/10 of the switching frequency. When the motor is running, adjust the switching frequency in par.4-11 *Motor Speed Low Limit [RPM]* until the motor is as noiseless as possible. See also par. 14-00 *Switching Pattern* and the section *Special conditions* in the FC 300 Design Guide.



NB!

Switching frequencies higher than 5.0 kHz lead to automatic derating of the maximum output of the frequency converter.

14-01 Switching Frequency

Select the inverter switching frequency. Changing the switching frequency can help to reduce acoustic noise from the motor. Default depend on power size.

| Option: | Function: |
|---------------|-----------|
| [0] 1.0 kHz | |
| [1] 1.5 kHz | |
| [2] 2.0 kHz | |
| [3] 2.5 kHz | |
| [4] 3.0 kHz | |
| [5] 3.5 kHz | |
| [6] 4.0 kHz | |
| [7] * 5.0 kHz | |
| [8] 6.0 kHz | |
| [9] 7.0 kHz | |
| [10] 8.0 kHz | |
| [11] 10.0 kHz | |
| [12] 12.0 kHz | |
| [13] 14.0 kHz | |
| [14] 16.0 kHz | |



NB!

The output frequency value of the frequency converter must never exceed 1/10 of the switching frequency. When the motor is running, adjust the switching frequency in par.4-11 *Motor Speed Low Limit [RPM]* until the motor is as noiseless as possible. See also par. 14-00 *Switching Pattern* and the section *Special conditions* in the VLT AutomationDrive Design Guide.



NB!

Switching frequencies higher than 5.0 kHz lead to automatic derating of the maximum output of the frequency converter.

14-03 Overmodulation

Option:

[0] Off

Function:

Select *On* [1] to connect the overmodulation function for the output voltage, to obtain an output voltage up to 15% greater than the mains voltage.

Select *Off* [0] for no overmodulation of the output voltage, in order to avoid torque ripple on the motor shaft. This feature may be useful for applications such as grinding machines.

[1] * On

14-04 PWM Random

Option:

[0] * Off

Function:

No change of the acoustic motor switching noise.

[1] On

Transforms the acoustic motor switching noise from a clear ringing tone to a less noticeable 'white' noise. This is achieved by slightly and randomly altering the synchronism of the pulse width modulated output phases.

3

3.14.3 14-1* Mains On/Off

Parameters for configuring mains failure monitoring and handling. If a mains failure appears, the frequency converter will try to continue in a controlled way until the power in the DC link has been exhausted.

14-10 Mains Failure

Option:

Function:

Function: Select the function to which the frequency converter must act when the threshold in par. 14-11 *Mains Voltage at Mains Fault* has been reached.

par.14-10 *Mains Failure* cannot be changed while motor is running.

Controlled ramp down:

The frequency converter will perform a controlled ramp down. If par.2-10 *Brake Function* is *Off* [0] or *AC brake* [2], the ramp will follow the Over Voltage Ramping. If par.2-10 *Brake Function* is [1] *Resistor Brake* the ramp will follow the setting in par.3-81 *Quick Stop Ramp Time*.

Controlled ramp-down [1]:

After power-up the frequency converter is ready for start. Controlled ramp-down and trip [2]: After power-up the frequency converter needs a reset for starting.

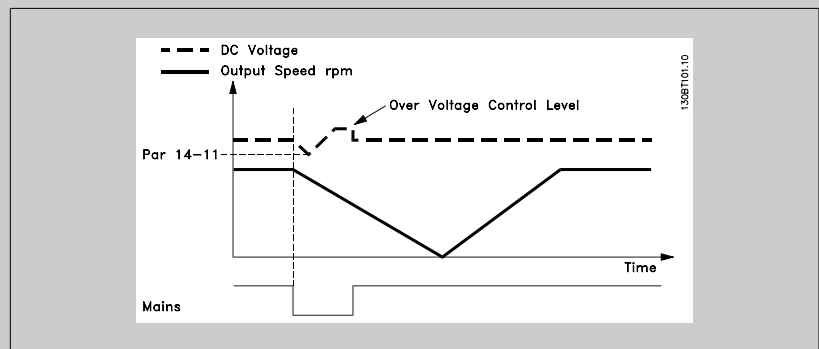

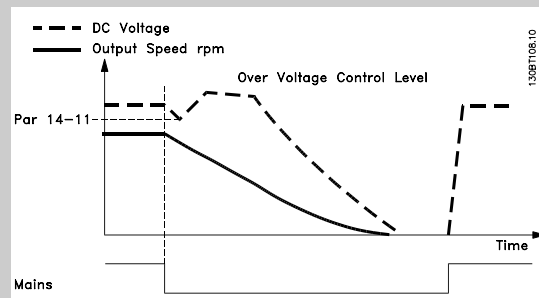

1. The power is back before the energy from DC /moment of inertia from load is too low. The frequency converter will perform a controlled ramp down when par.14-11 *Mains Voltage at Mains Fault* level has been reached.
2. The frequency converter will perform a controlled ramp down as long as energy in the DC link is present. After this point the motor will be coasted.

Kinetic back-up:

The frequency converter will perform a Kinetic back-up. If par.2-10 *Brake Function* is *Off*[0] or *AC brake*[2], the ramp will follow the Over Voltage Ramping. If par.2-10 *Brake Function* is [1] *Resistor Brake* the ramp will follow the setting in par.3-81 *Quick Stop Ramp Time*.

Kinetic Back-up [4]: The frequency converter will keep on running as long as there is energy in the system due to the moment of inertia produced by the load.

Kinetic Back-up [5]: The frequency converter will ride through on speed as long as the energy is present from moment of inertia from the load. If the DC voltage goes below par.14-11 *Mains Voltage at Mains Fault* the frequency converter will perform a trip.

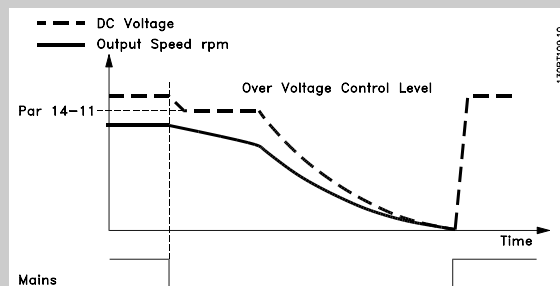
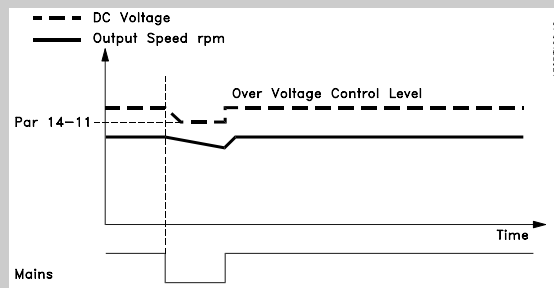

[0] * No function

[1] Ctrl. ramp-down

[2] Ctrl. ramp-down, trip

[3] Coasting

[4] Kinetic back-up

[5] Kinetic back-up, trip

[6] Alarm

14-11 Mains Voltage at Mains Fault

Range:

342. V* [180 - 600 V]

Function:

This parameter defines the threshold voltage at which the selected function in par. 14-10 *Mains Failure* should be activated.

14-12 Function at Mains Imbalance

Operation under severe main imbalance conditions reduces the lifetime of the motor. Conditions are considered severe if the motor is operated continuously near nominal load (e.g. a pump or fan running near full speed).

Option:

[0] * Trip

Function:

Trips the frequency converter

[1] Warning

Issues a warning

[2] Disabled

No action

3.14.4 14-2* Trip Reset

Parameters for configuring auto reset handling, special trip handling and control card self test or initialisation.

14-20 Reset Mode

Option:

[0] * Manual reset

Function:

Select the reset function after tripping. Once reset, the frequency converter can be restarted.

Select *Manual reset* [0], to perform a reset via [RESET] or via the digital inputs.

[1] Automatic reset x 1

Select *Automatic reset x 1...x20* [1]-[12] to perform between one and twenty automatic resets after tripping.

[2] Automatic reset x 2

[3] Automatic reset x 3

[4] Automatic reset x 4

[5] Automatic reset x 5

[6] Automatic reset x 6

[7] Automatic reset x 7

[8] Automatic reset x 8

[9] Automatic reset x 9

[10] Automatic reset x 10

[11] Automatic reset x 15

[12] Automatic reset x 20

[13] Infinite auto reset

Select *Infinite Automatic Reset* [13] for continuous resetting after tripping.



NB!

The motor may start without warning. If the specified number of AUTOMATIC RESETs is reached within 10 minutes, the frequency converter enters Manual reset [0] mode. After the Manual reset is performed, the setting of par.14-20 *Reset Mode* reverts to the original selection. If the number of automatic resets is not reached within 10 minutes, or when a Manual reset is performed, the internal AUTOMATIC RESET counter returns to zero.



NB!

Automatic reset will also be active for resetting safe stop function in firmware version < 4.3x.

**NB!**

The setting in par.14-20 *Reset Mode* is disregarded in case of Fire Mode being active (see par. 24-0*, Fire Mode).

14-21 Automatic Restart Time

Range:

10 s* [0 - 600 s]

Function:

Enter the time interval from trip to start of the automatic reset function. This parameter is active when par.14-20 *Reset Mode* is set to *Automatic reset* [1] - [13].

14-22 Operation Mode

Option:**Function:**

Use this parameter to specify normal operation; to perform tests; or to initialise all parameters except par.15-03 *Power Up's*, par.15-04 *Over Temp's* and par.15-05 *Over Volt's*. This function is active only when the power is cycled to the frequency converter.

Select *Normal operation* [0] for normal operation of the frequency converter with the motor in the selected application.

Select *Control card test* [1] to test the analog and digital inputs and outputs and the +10 V control voltage. The test requires a test connector with internal connections. Use the following procedure for the control card test:

1. Select *Control card test* [1].
2. Disconnect the mains supply and wait for the light in the display to go out.
3. Set switches S201 (A53) and S202 (A54) = 'ON' / I.
4. Insert the test plug (see below).
5. Connect to mains supply.
6. Carry out various tests.
7. The results are displayed on the LCP and the frequency converter moves into an infinite loop.
8. par.14-22 *Operation Mode* is automatically set to Normal operation. Carry out a power cycle to start up in Normal operation after a control card test.

If the test is OK:

LCP read-out: Control Card OK.

Disconnect the mains supply and remove the test plug. The green LED on the Control Card will light up.

If the test fails:

LCP read-out: Control Card I/O failure.

Replace the frequency converter or Control card. The red LED on the Control Card is turned on. Test plugs (connect the following terminals to each other): 18 - 27 - 32; 19 - 29 - 33; 42 - 53 - 54

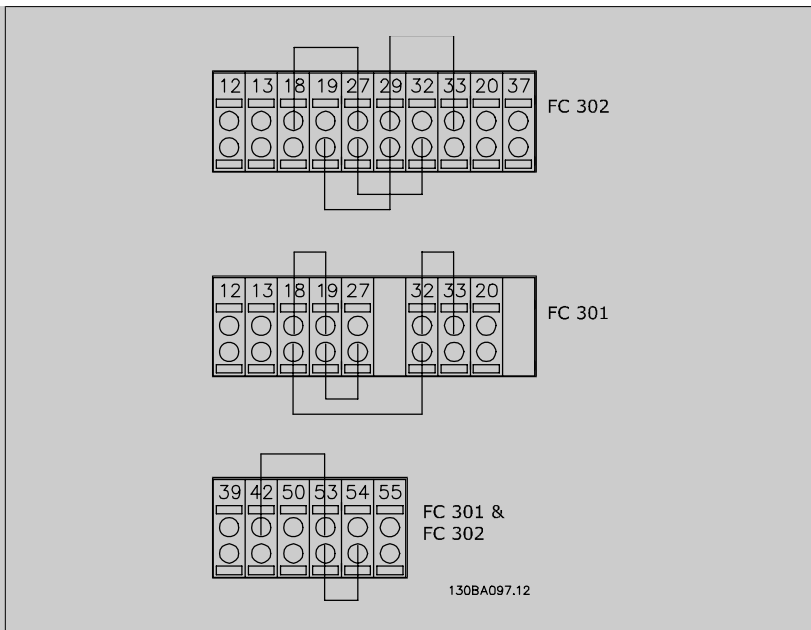

Select *Initialization* [2] to reset all parameter values to default settings, except for par.15-03 *Power Up's*, par.15-04 *Over Temp's*, and par.15-05 *Over Volt's*. The frequency converter will reset during the next power-up.
par.14-22 *Operation Mode* will also revert to the default setting *Normal operation* [0].

- [0] * Normal operation
- [1] Control card test
- [2] Initialisation
- [3] Boot mode

14-24 Trip Delay at Current Limit

Range:

60 s* [0 - 60 s]

Function:

Enter the current limit trip delay in seconds. When the output current reaches the current limit (par. 4-18 *Current Limit*), a warning is triggered. When the current limit warning has been continuously present for the period specified in this parameter, the frequency converter trips. Disable the trip delay by setting the parameter to 60 s = OFF. Thermal monitoring of the frequency converter will still remain active.

14-25 Trip Delay at Torque Limit

Range:

60 s* [0 - 60 s]

Function:

Enter the torque limit trip delay in seconds. When the output torque reaches the torque limits (par. 4-16 *Torque Limit Motor Mode* and par.4-17 *Torque Limit Generator Mode*), a warning is triggered. When the torque limit warning has been continuously present for the period specified in this parameter, the frequency converter trips. Disable the trip delay by setting the parameter to 60 s = OFF. Thermal monitoring of the frequency converter will still remain active.

14-26 Trip Delay at Inverter Fault

Range:

0. s* [0 - 35 s]

Function:

When the frequency converter detects an over-voltage in the set time trip will be effected after the set time.
If value = 0, *protection mode* is disabled

**NB!**

It is recommended to disable *protection mode* in hoisting applications.

14-29 Service Code**Range:**

0 N/A*

[-2147483647 - 2147483647 N/A]

Function:

For internal service only.

3

3.14.5 14-3* Current Limit Control

The frequency converter features an integral Current Limit Controller which is activated when the motor current, and thus the torque, is higher than the torque limits set in par.4-16 *Torque Limit Motor Mode* and par.4-17 *Torque Limit Generator Mode*.

When the current limit is reached during motor operation or regenerative operation, the frequency converter will try to reduce torque below the preset torque limits as quickly as possible without losing control of the motor.

While the current control is active, the frequency converter can only be stopped by setting a digital input to *Coast inverse* [2] or *Coast and reset inv.* [3].

Any signal on terminals 18 to 33 will not be active until the frequency converter is no longer near the current limit.

By using a digital input set to *Coast inverse* [2] or *Coast and reset inv.* [3], the motor does not use the ramp-down time, since the frequency converter is coasted. If a quick stop is necessary, use the mechanical brake control function along with an external electro-mechanical brake attached to the application.

14-30 Current Lim Ctrl, Proportional Gain**Range:**

100 %*

[0 - 500 %]

Function:

Enter the proportional gain value for the current limit controller. Selection of a high value makes the controller react faster. Too high a setting leads to controller instability.

14-31 Current Lim Ctrl, Integration Time**Range:**

0.020 s*

[0.002 - 2.000 s]

Function:

Controls the current limit control integration time. Setting it to a lower value makes it react faster. A setting too low leads to control instability.

14-32 Current Lim Ctrl, Filter Time**Range:**

1.0 ms*

[1.0 - 100.0 ms]

Function:**3.14.6 14-35 Stall Protection****14-35 Stall Protection****Option:**

[0]

Disabled

Function:

Select Enable [1] to enable the stall protection in field-weakening in flux mode. Select Disable [0] if you desire to disable it. This might cause the motor to be lost. Par 14-35 is active in Flux mode only.

[1] *

Enabled

3.14.7 14-4* Energy Optimising

Parameters for adjusting the energy optimisation level in both Variable Torque (VT) and Automatic Energy Optimization (AEO) mode in par.1-03 *Torque Characteristics*.

14-40 VT Level

| Range: | Function: |
|-------------------|--|
| 66 %* [40 - 90 %] | Enter the level of motor magnetisation at low speed. Selection of a low value reduces energy loss in the motor, but also reduces load capability. This parameter cannot be adjusted while the motor is running. |

14-41 AEO Minimum Magnetisation

| Range: | Function: |
|--------------------|--|
| 40. %* [40 - 75 %] | Enter the minimum allowable magnetisation for AEO. Selection of a low value reduces energy loss in the motor, but can also reduce resistance to sudden load changes. |

14-42 Minimum AEO Frequency

| Range: | Function: |
|--------------------|---|
| 10 Hz* [5 - 40 Hz] | Enter the minimum frequency at which the Automatic Energy Optimisation (AEO) is to be active. |

14-43 Motor Cosphi

| Range: | Function: |
|-----------------------------|--|
| 0.66 N/A* [0.40 - 0.95 N/A] | The Cos(phi) setpoint is automatically set for optimum AEO performance. This parameter should normally not be altered. However in some situations it may be necessary to enter a new value to fine-tune. |

3.14.8 14-5* Environment

These parameters help the frequency converter to operate under special environmental conditions.

14-50 RFI Filter

| Option: | Function: |
|----------|--|
| [0] Off | Select <i>Off</i> [0] only if the frequency converter is fed by an isolated mains source, i.e. from a special IT mains source. In this mode, the internal RFI filter capacitors between chassis and the mains RFI filter circuit are cut-out to avoid damage of the intermediate circuit and to reduce the ground capacity currents according to IEC 61800-3. |
| [1] * On | Select <i>On</i> [1] to ensure that the frequency converter complies with EMC standards. |

14-52 Fan Control

Select minimum speed of the main fan.
Select *Auto*[0] to run fan only when internal temperature in frequency converter is in range 35° C to approx. 55° C.
Fan runs at low speed below 35° C, and at full speed at approx. 55° C.

| Option: | Function: |
|-------------|-----------|
| [0] * Auto | |
| [1] On 50% | |
| [2] On 75% | |
| [3] On 100% | |

14-53 Fan Monitor

| Option: | Function: |
|---------------|--|
| | Select which reaction the frequency converter should take in case a fan fault is detected. |
| [0] Disabled | |
| [1] * Warning | |
| [2] Trip | |

14-55 Output Filter

Option:
Function:

Select the type of output filter connected. This parameter cannot be adjusted while motor is running.

[0] * No Filter

[1] Sine-Wave Filter

14-56 Capacitance Output Filter

Range:

2.0 uF* [0.1 - 6500.0 uF]

Function:

Set the capacitance of the output filter. The value can be found on the filter label.

NB!

This is required for correct compensation in Flux mode (par.1-01 *Motor Control Principle*)

14-57 Inductance Output Filter

Range:

7.000 mH* [0.001 - 65.000 mH]

Function:

Set the inductance of the output filter. The value can be found on the filter label.

NB!

This is required for correct compensation in Flux mode (par.1-01 *Motor Control Principle*)

3.14.9 14-6* Options

14-80 Option Supplied by External 24VDC

Option:
Function:

[0] No

Select No [0] to use the drive's 24 V DC supply.

[1] * Yes

Select Yes [1] if an external 24 V DC supply will be used to power the option. I/O will be galvanically isolated from the drive when operated from an external supply.

3.14.10 14-7* Compatibility

This parameter is for setting of compatibility for VLT 3000, VLT 5000 to FC 300

14-72 VLT Alarm Word

Option:
Function:

[0] 0 - 4294967295

Read out the alarm word corresponding to VLT 3000 or VLT 5000

14-73 VLT Warning Word

Option:
Function:

[0] 0 - 4294967295

Read out the warning word corresponding to VLT 3000 or VLT 5000

14-74 VLT Ext. Status Word

Range:
Function:

0 N/A* [0 - 4294967295 N/A]

Read out the ext. status word corresponding to VLT 3000 or VLT 5000

3.15 Parameters: Drive Information

3.15.1 15-** Drive Information

Parameter group containing frequency converter information such as operating data, hardware configuration and software versions.

3.15.2 15-0* Operating Data

Parameter group containing operating data e.g. Operating Hours, kWh counters, Power Ups, etc.

| 15-00 Operating Hours | | |
|--|----------------------|--|
| Range: | | Function: |
| 0 h* | [0 - 2147483647 h] | View how many hours the frequency converter has run. The value is saved when the frequency converter is turned off. |
| 15-01 Running Hours | | |
| Range: | | Function: |
| 0 h* | [0 - 2147483647 h] | View how many hours the motor has run. Reset the counter in par. 15-07 <i>Reset Running Hours Counter</i> . The value is saved when the frequency converter is turned off. |
| 15-02 kWh Counter | | |
| Range: | | Function: |
| 0 kWh* | [0 - 2147483647 kWh] | Registering the power consumption of the motor as a mean value over one hour. Reset the counter in par.15-06 <i>Reset kWh Counter</i> . |
| 15-03 Power Up's | | |
| Range: | | Function: |
| 0 N/A* | [0 - 2147483647 N/A] | View the number of times the frequency converter has been powered up. |
| 15-04 Over Temp's | | |
| Range: | | Function: |
| 0 N/A* | [0 - 65535 N/A] | View the number of frequency converter temperature faults which have occurred. |
| 15-05 Over Volt's | | |
| Range: | | Function: |
| 0 N/A* | [0 - 65535 N/A] | View the number of frequency converter overvoltages which have occurred. |
| 15-06 Reset kWh Counter | | |
| Option: | | Function: |
| [0] * | Do not reset | Select <i>Do not reset</i> [0] if no reset of the kWh counter is desired. |
| [1] | Reset counter | Select <i>Reset</i> [1] and press [OK] to reset the kWh counter to zero (see par.15-02 <i>kWh Counter</i>). |
|  <p>NB! The reset is carried out by pressing [OK].</p> | | |
| 15-07 Reset Running Hours Counter | | |
| Option: | | Function: |
| [0] * | Do not reset | |

- [1] Reset counter Select *Reset* [1] and press [OK] to reset the Running Hours counter to zero (see par.15-01 *Running Hours*). This parameter cannot be selected via the serial port, RS 485.
Select *Do not reset* [0] if no reset of the Running Hours counter is desired.

3.15.3 15-1* Data Log Settings

The Data Log enables continuous logging of up to 4 data sources (par. 15-10 *Logging Source*) at individual rates (par.15-11 *Logging Interval*). A trigger event (par. 15-12 *Trigger Event*) and window (par. 15-14 *Samples Before Trigger*) are used to start and stop the logging conditionally.

15-10 Logging Source

Array [4]

Option:

Function:

Select which variables are to be logged.

| | |
|--------|-----------------------|
| [0] * | None |
| [1472] | VLT Alarm Word |
| [1473] | VLT Warning Word |
| [1474] | VLT Ext. Status Word |
| [1600] | Control Word |
| [1601] | Reference [Unit] |
| [1602] | Reference % |
| [1603] | Status Word |
| [1610] | Power [kW] |
| [1611] | Power [hp] |
| [1612] | Motor Voltage |
| [1613] | Frequency |
| [1614] | Motor Current |
| [1616] | Torque [Nm] |
| [1617] | Speed [RPM] |
| [1618] | Motor Thermal |
| [1622] | Torque [%] |
| [1625] | Torque [Nm] High |
| [1630] | DC Link Voltage |
| [1632] | Brake Energy /s |
| [1633] | Brake Energy /2 min |
| [1634] | Heatsink Temp. |
| [1635] | Inverter Thermal |
| [1650] | External Reference |
| [1651] | Pulse Reference |
| [1652] | Feedback [Unit] |
| [1660] | Digital Input |
| [1662] | Analog Input 53 |
| [1664] | Analog Input 54 |
| [1665] | Analog Output 42 [mA] |
| [1666] | Digital Output [bin] |
| [1675] | Analog In X30/11 |
| [1676] | Analog In X30/12 |
| [1677] | Analog Out X30/8 [mA] |
| [1690] | Alarm Word |

- [1692] Warning Word
- [1694] Ext. Status Word
- [3470] MCO Alarm Word 1
- [3471] MCO Alarm Word 2

15-11 Logging Interval

Range:

0.000 N/A* [0.000 - 0.000 N/A]

Function:

Enter the interval in milliseconds between each sampling of the variables to be logged.

15-12 Trigger Event

Select the trigger event. When the trigger event occurs, a window is applied to freeze the log. The log will then retain a specified percentage of samples before the occurrence of the trigger event (par.15-14 *Samples Before Trigger*).

Option:

Function:

- [0] * False
- [1] True
- [2] Running
- [3] In range
- [4] On reference
- [5] Torque limit
- [6] Current limit
- [7] Out of current range
- [8] Below I low
- [9] Above I high
- [10] Out of speed range
- [11] Below speed low
- [12] Above speed high
- [13] Out of feedb. range
- [14] Below feedb. low
- [15] Above feedb. high
- [16] Thermal warning
- [17] Mains out of range
- [18] Reversing
- [19] Warning
- [20] Alarm (trip)
- [21] Alarm (trip lock)
- [22] Comparator 0
- [23] Comparator 1
- [24] Comparator 2
- [25] Comparator 3
- [26] Logic rule 0
- [27] Logic rule 1
- [28] Logic rule 2
- [29] Logic rule 3
- [33] Digital input DI18
- [34] Digital input DI19
- [35] Digital input DI27
- [36] Digital input DI29
- [37] Digital input DI32

[38] Digital input DI33

[50] Comparator 4

[51] Comparator 5

[60] Logic rule 4

[61] Logic rule 5

15-13 Logging Mode**Option:****Function:**

[0] * Log always

Select *Log always* [0] for continuous logging.

[1] Log once on trigger

Select *Log once on trigger* [1] to conditionally start and stop logging using par. 15-12 *Trigger Event* and par. 15-14 *Samples Before Trigger*.**15-14 Samples Before Trigger****Range:****Function:**

50 N/A* [0 - 100 N/A]

Enter the percentage of all samples prior to a trigger event which are to be retained in the log. See also par.15-12 *Trigger Event* and par.15-13 *Logging Mode*.

3

3.15.4 15-2* Historic Log

View up to 50 logged data items via the array parameters in this parameter group. For all parameters in the group, [0] is the most recent data and [49] the oldest data. Data is logged every time an *event* occurs (not to be confused with SLC events). *Events* in this context are defined as a change in one of the following areas:

1. Digital input
2. Digital outputs (not monitored in this SW release)
3. Warning word
4. Alarm word
5. Status word
6. Control word
7. Extended status word

Events are logged with value, and time stamp in msec. The time interval between two events depends on how often *events* occur (maximum once every scan time). Data logging is continuous but if an alarm occurs, the log is saved and the values can be viewed on the display. This feature is useful, for example when carrying out service following a trip. View the historic log contained in this parameter via the serial communication port or via the display.

15-20 Historic Log: Event

Array [50]

Range:**Function:**

0 N/A* [0 - 255 N/A]

View the event type of the logged events.

15-21 Historic Log: Value

Array [50]

Range:

0 N/A* [0 - 2147483647 N/A]

Function:

View the value of the logged event. Interpret the event values according to this table:

| | |
|---|--|
| Digital input | Decimal value. See par.16-60 <i>Digital Input</i> for description after converting to binary value. |
| Digital output (not monitored in this SW release) | Decimal value. See par.16-66 <i>Digital Output [bin]</i> for description after converting to binary value. |
| Warning word | Decimal value. See par. 16-92 <i>Warning Word</i> for description. |
| Alarm word | Decimal value. See par. 16-90 <i>Alarm Word</i> for description. |
| Status word | Decimal value. See par.16-03 <i>Status Word</i> for description after converting to binary value. |
| Control word | Decimal value. See par.16-00 <i>Control Word</i> for description. |
| Extended status word | Decimal value. See par.16-94 <i>Ext. Status Word</i> for description. |

15-22 Historic Log: Time

Array [50]

Range:

0 ms* [0 - 2147483647 ms]

Function:

View the time at which the logged event occurred. Time is measured in ms since frequency converter start. The max. value corresponds to approx. 24 days which means that the count will restart at zero after this time period.

3.15.5 15-3* Alarm Log

Parameters in this group are array parameters, where up to 10 fault logs can be viewed. [0] is the most recent logged data, and [9] the oldest. Error codes, values, and time stamp can be viewed for all logged data.

15-30 Fault Log: Error Code

Array [10]

Range:

0 N/A* [0 - 255 N/A]

Function:

View the error code and look up its meaning in the *Troubleshooting* chapter of the FC 300 Design Guide.

15-31 Alarm Log: Value

Array [10]

Range:

0 N/A* [-32767 - 32767 N/A]

Function:

View an extra description of the error. This parameter is mostly used in combination with alarm 38 'internal fault'.

15-32 Alarm Log: Time

Array [10]

Range:

0 s* [0 - 2147483647 s]

Function:

View the time when the logged event occurred. Time is measured in seconds from frequency converter start-up.

3.15.6 15-4* Drive Identification

Parameters containing read only information about the hardware and software configuration of the frequency converter.

15-40 FC Type**Range:**

0 N/A* [0 - 0 N/A]

Function:

View the FC type. The read-out is identical to the FC 300 Series power field of the type code definition, characters 1-6.

15-41 Power Section**Range:**

0 N/A* [0 - 0 N/A]

Function:

View the FC type. The read-out is identical to the FC 300 Series power field of the type code definition, characters 7-10.

15-42 Voltage**Range:**

0 N/A* [0 - 0 N/A]

Function:

View the FC type. The read-out is identical to the FC 300 Series power field of the type code definition, characters 11-12.

15-43 Software Version**Range:**

0 N/A* [0 - 0 N/A]

Function:

View the combined SW version (or 'package version') consisting of power SW and control SW.

15-44 Ordered Typecode String**Range:**

0 N/A* [0 - 0 N/A]

Function:

View the type code string used for re-ordering the frequency converter in its original configuration.

15-45 Actual Typecode String**Range:**

0 N/A* [0 - 0 N/A]

Function:

View the actual type code string.

15-46 Frequency Converter Ordering No**Range:**

0 N/A* [0 - 0 N/A]

Function:

View the 8-digit ordering number used for re-ordering the frequency converter in its original configuration.

15-47 Power Card Ordering No**Range:**

0 N/A* [0 - 0 N/A]

Function:

View the power card ordering number.

15-48 LCP Id No**Range:**

0 N/A* [0 - 0 N/A]

Function:

View the LCP ID number.

15-49 SW ID Control Card**Range:**

0 N/A* [0 - 0 N/A]

Function:

View the control card software version number.

15-50 SW ID Power Card**Range:**

0 N/A* [0 - 0 N/A]

Function:

View the power card software version number.

15-51 Frequency Converter Serial Number**Range:**

0 N/A* [0 - 0 N/A]

Function:

View the frequency converter serial number.

15-53 Power Card Serial Number

| Range: | Function: |
|--------------------|------------------------------------|
| 0 N/A* [0 - 0 N/A] | View the power card serial number. |

3.15.7 15-6* Option Ident.

This read-only parameter group contains information about the hardware and software configuration of the options installed in slots A, B C0 and C1.

15-60 Option Mounted

| Range: | Function: |
|--------------------|---------------------------------|
| 0 N/A* [0 - 0 N/A] | View the installed option type. |

15-61 Option SW Version

| Range: | Function: |
|--------------------|---|
| 0 N/A* [0 - 0 N/A] | View the installed option software version. |

15-62 Option Ordering No

| Range: | Function: |
|--------------------|--|
| 0 N/A* [0 - 0 N/A] | Shows the ordering number for the installed options. |

15-63 Option Serial No

| Range: | Function: |
|--------------------|--|
| 0 N/A* [0 - 0 N/A] | View the installed option serial number. |

3.15.8 15-9* Parameter Info

Parameter lists

15-92 Defined Parameters

Array [1000]

| Range: | Function: |
|-----------------------|---|
| 0 N/A* [0 - 9999 N/A] | View a list of all defined parameters in the frequency converter. The list ends with 0. |

15-93 Modified Parameters

Array [1000]

| Range: | Function: |
|-----------------------|--|
| 0 N/A* [0 - 9999 N/A] | View a list of the parameters that have been changed from their default setting. The list ends with 0. Changes may not be visible until up to 30 seconds after implementation. |

15-99 Parameter Metadata

Array [30]

| Range: | Function: |
|-----------------------|---|
| 0 N/A* [0 - 9999 N/A] | This parameter contains data used by the MCT10 software tool. |

3.16 Parameters: Data Read-outs

3.16.1 16-** Data Readouts

Parameter group for data read-outs, e.g. actual references, voltages, control, alarm, warning and status words.

3

3.16.2 16-0* General Status

Parameters for reading the general status, e.g. the calculated reference, the active control word, status.

16-00 Control Word

| Range: | Function: |
|------------------------|--|
| 0 N/A* [0 - 65535 N/A] | View the Control word sent from the frequency converter via the serial communication port in hex code. |

16-01 Reference [Unit]

| Range: | Function: |
|--|---|
| 0.000 Ref- [-999999.000 - 999999.000 ReferenceFeed-enceFeedUnit] backUnit* | View the present reference value applied on impulse or analog basis in the unit resulting from the configuration selected in par. 1-00 <i>Configuration Mode</i> (Hz, Nm or RPM). |

16-02 Reference [%]

| Range: | Function: |
|---------------------------|---|
| 0.0 %* [-200.0 - 200.0 %] | View the total reference. The total reference is the sum of digital, analog, preset, bus, and freeze references, plus catch-up and slow-down. |

16-03 Status Word

| Range: | Function: |
|------------------------|---|
| 0 N/A* [0 - 65535 N/A] | View the Status word sent from the frequency converter via the serial communication port in hex code. |

16-05 Main Actual Value [%]

| Range: | Function: |
|------------------------------|---|
| 0.00 %* [-100.00 - 100.00 %] | View the two-byte word sent with the Status word to the bus Master reporting the Main Actual Value. |

16-09 Custom Readout

| Range: | Function: |
|---|---|
| 0.00 Cus- [0.00 - 0.00 CustomReadoutUnit] tomReadoutUnit* | View the value of custom readout from par.0-30 <i>Unit for User-defined Readout</i> to par.0-32 <i>Custom Readout Max Value</i> |

3.16.3 16-1* Motor Status

Parameters for reading the motor status values.

16-10 Power [kW]

| Range: | Function: |
|-------------------------------|---|
| 0.00 kW* [0.00 - 10000.00 kW] | View the motor power in kW. The value shown is calculated on the basis of the actual motor voltage and motor current. The value is filtered, and therefore approx. 30 ms may pass from when an input value changes to when the data read-out values change. |

16-11 Power [hp]**Range:**

0.00 hp* [0.00 - 10000.00 hp]

Function:

View the motor power in HP. The value shown is calculated on the basis of the actual motor voltage and motor current. The value is filtered, and therefore approximately 30 ms may pass from when an input value changes to when the data read-out values change.

16-12 Motor Voltage**Range:**

0.0 V* [0.0 - 6000.0 V]

Function:

View the motor voltage, a calculated value used for controlling the motor.

16-13 Frequency**Range:**

0.0 Hz* [0.0 - 6500.0 Hz]

Function:

View the motor frequency, without resonance dampening.

16-14 Motor Current**Range:**

0.00 A* [0.00 - 10000.00 A]

Function:

View the motor current measured as a mean value, IRMS. The value is filtered, and thus approximately 30 ms may pass from when an input value changes to when the data read-out values change.

16-15 Frequency [%]**Range:**

0.00 %* [-100.00 - 100.00 %]

Function:

View a two-byte word reporting the actual motor frequency (without resonance dampening) as a percentage (scale 0000-4000 Hex) of par.4-19 *Max Output Frequency*. Set par.9-16 *PCD Read Configuration* index 1 to send it with the Status Word instead of the MAV.

16-16 Torque [Nm]**Range:**

0.0 Nm* [-3000.0 - 3000.0 Nm]

Function:

View the torque value with sign, applied to the motor shaft. Linearity is not exact between 160% motor current and torque in relation to the rated torque. Some motors supply more than 160% torque. Consequently, the min. value and the max. value will depend on the max. motor current as well as the motor used. The value is filtered, and thus approx. 30 ms may pass from when an input changes value to when the data read-out values change.

16-17 Speed [RPM]**Range:**

0 RPM* [-30000 - 30000 RPM]

Function:

View the actual motor RPM. In open loop or closed loop process control the motor RPM is estimated. In speed closed loop modes the motor RPM is measured.

16-18 Motor Thermal**Range:**

0 %* [0 - 100 %]

Function:

View the calculated thermal load on the motor. The cut-out limit is 100%. The basis for calculation is the ETR function selected in par. 1-90 *Motor Thermal Protection*.

16-19 KTY sensor temperature**Range:**

0 C* [0 - 0 C]

Function:

Returning the actual temperature on KTY sensor built into the motor.
See par. 1-9*.

16-20 Motor Angle**Range:**

0 N/A* [0 - 65535 N/A]

Function:

View the current encoder/resolver angle offset relative to the index position. The value range of 0-65535 corresponds to 0-2*pi (radians).

16-22 Torque [%]**Range:**

0 %* [-200 - 200 %]

Function:

Value shown is the torque in percent of nominal torque, with sign, applied to the motor shaft.

16-25 Torque [Nm] High**Range:**

0.0 Nm* [-200000000.0 - 200000000.0 Nm]

Function:View the torque value with sign, applied to the motor shaft. Some motors supply more than 160% torque. Consequently, the min. value and the max. value will depend on the max. motor current as well as the motor used. This specific readout has been adapted to be able to show higher values than the standard readout in par.16-16 *Torque [Nm]*.**3.16.4 16-3* Drive Status**

Parameters for reporting the status of the frequency converter.

16-30 DC Link Voltage**Range:**

0 V* [0 - 10000 V]

Function:

View a measured value. The value is filtered with an 30 ms time constant.

16-32 Brake Energy /s**Range:**

0.000 kW* [0.000 - 10000.000 kW]

Function:

View the brake power transmitted to an external brake resistor, stated as an instantaneous value.

16-33 Brake Energy /2 min**Range:**

0.000 kW* [0.000 - 10000.000 kW]

Function:

View the brake power transmitted to an external brake resistor. The mean power is calculated on an average basis for the most recent 120 seconds.

16-34 Heatsink Temp.**Range:**

0 C* [0 - 255 C]

Function:View the frequency converter heatsink temperature. The cut-out limit is 90 ± 5 °C, and the motor cuts back in at 60 ± 5 °C.**16-35 Inverter Thermal****Range:**

0 %* [0 - 100 %]

Function:

View the percentage load on the inverter.

16-36 Inv. Nom. Current**Range:**

10.00 A* [0.01 - 10000.00 A]

Function:

View the inverter nominal current, which should match the nameplate data on the connected motor. The data are used for calculation of torque, motor protection, etc.

16-37 Inv. Max. Current**Range:**

16.00 A* [0.01 - 10000.00 A]

Function:

View the inverter maximum current, which should match the nameplate data on the connected motor. The data are used for calculation of torque, motor protection, etc.

16-38 SL Controller State**Range:**

0 N/A* [0 - 100 N/A]

Function:

View the state of the event under execution by the SL controller.

16-39 Control Card Temp.

| Range: | Function: |
|------------------|---|
| 0 C* [0 - 100 C] | View the temperature on the control card, stated in °C. |

16-40 Logging Buffer Full

| Option: | Function: |
|----------|---|
| [0] * No | View whether the logging buffer is full (see par. 15-1*). The logging buffer will never be full when par.15-13 <i>Logging Mode</i> is set to <i>Log always</i> [0]. |
| [1] Yes | |

3.16.5 16-5* Ref. & Feedb.

Parameters for reporting the reference and feedback input.

16-50 External Reference

| Range: | Function: |
|-------------------------------|---|
| 0.0 N/A* [-200.0 - 200.0 N/A] | View the total reference, the sum of digital, analog, preset, bus and freeze references, plus catch-up and slow-down. |

16-51 Pulse Reference

| Range: | Function: |
|-------------------------------|--|
| 0.0 N/A* [-200.0 - 200.0 N/A] | View the reference value from programmed digital input(s). The read-out can also reflect the impulses from an incremental encoder. |

16-52 Feedback [Unit]

| Range: | Function: |
|--|--|
| 0.000 Ref- [-999999.999 - 999999.999 ReferenceFeed-enceFeedbackUnit] backUnit* | View the feedback unit resulting from the selection of unit and scaling in par.3-00 <i>Reference Range</i> , par.3-01 <i>Reference/Feedback Unit</i> , par.3-02 <i>Minimum Reference</i> and par.3-03 <i>Maximum Reference</i> . |

16-53 Digi Pot Reference

| Range: | Function: |
|----------------------------------|---|
| 0.00 N/A* [-200.00 - 200.00 N/A] | View the contribution of the Digital Potentiometer to the actual reference. |

3.16.6 16-6* Inputs and Outputs

Parameters for reporting the digital and analog IO ports.

3

16-60 Digital Input

Range:

0 N/A* [0 - 1023 N/A]

Function:

View the signal states from the active digital inputs. Example: Input 18 corresponds to bit no. 5, '0' = no signal, '1' = connected signal. Bit 6 works in the opposite way, on = '0', off = '1' (safe stop input).

| | |
|-----------|----------------------------------|
| Bit 0 | Digital input term. 33 |
| Bit 1 | Digital input term. 32 |
| Bit 2 | Digital input term. 29 |
| Bit 3 | Digital input term. 27 |
| Bit 4 | Digital input term. 19 |
| Bit 5 | Digital input term. 18 |
| Bit 6 | Digital input term. 37 |
| Bit 7 | Digital input GP I/O term. X30/4 |
| Bit 8 | Digital input GP I/O term. X30/3 |
| Bit 9 | Digital input GP I/O term. X30/2 |
| Bit 10-63 | Reserved for future terminals |

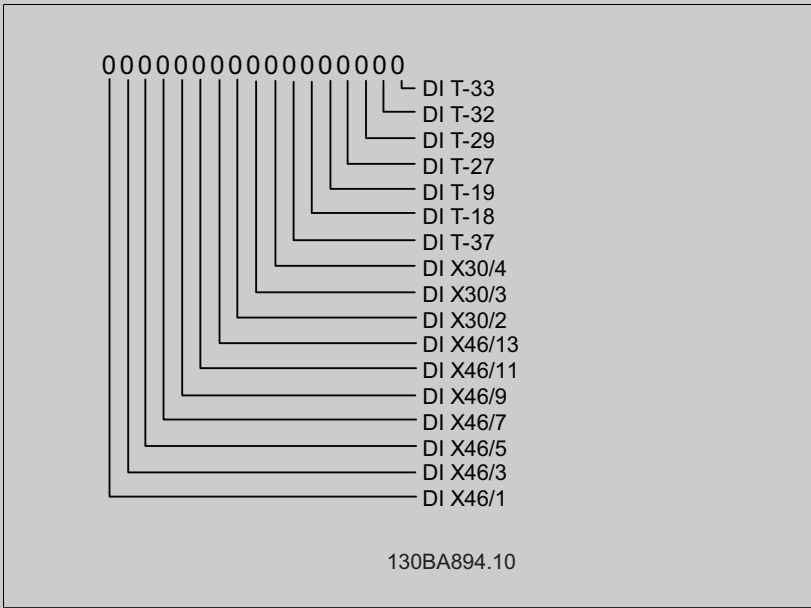

16-61 Terminal 53 Switch Setting

Option:

- [0] * Current
- [1] Voltage
- [2] Pt 1000 [°C]
- [3] Pt 1000 [°F]
- [4] Ni 1000 [°C]
- [5] Ni 1000 [°F]

Function:

View the setting of input terminal 53. Current = 0; Voltage = 1.

16-62 Analog Input 53

Range:

0.000 N/A* [-20.000 - 20.000 N/A]

Function:

View the actual value at input 53.

16-63 Terminal 54 Switch Setting

Option:

Function:

View the setting of input terminal 54. Current = 0; Voltage = 1.

[0] * Current

[1] Voltage

[2] Pt 1000 [°C]

[3] Pt 1000 [°F]

[4] Ni 1000 [°C]

[5] Ni 1000 [°F]

16-64 Analog Input 54

Range:

Function:

0.000 N/A* [-20.000 - 20.000 N/A]

View the actual value at input 54.

16-65 Analog Output 42 [mA]

Range:

Function:

0.000 N/A* [0.000 - 30.000 N/A]

View the actual value at output 42 in mA. The value shown reflects the selection in par.6-50 *Terminal 42 Output*.

16-66 Digital Output [bin]

Range:

Function:

0 N/A* [0 - 15 N/A]

View the binary value of all digital outputs.

16-67 Pulse Input #29 [Hz]

Range:

Function:

0 N/A* [0 - 130000 N/A]

View the actual frequency rate on terminal 29.

16-68 Freq. Input #33 [Hz]

Range:

Function:

0 N/A* [0 - 130000 N/A]

View the actual value of the frequency applied at terminal 33 as an impulse input.

16-69 Pulse Output #27 [Hz]

Range:

Function:

0 N/A* [0 - 40000 N/A]

View the actual value of pulses applied to terminal 27 in digital output mode.

16-70 Pulse Output #29 [Hz]

Range:

Function:

0 N/A* [0 - 40000 N/A]

View the actual value of pulses at terminal 29 in digital output mode.
This parameter is available for FC 302 only.

16-71 Relay Output [bin]

Range:

Function:

0 N/A* [0 - 511 N/A]

View the settings of all relays.

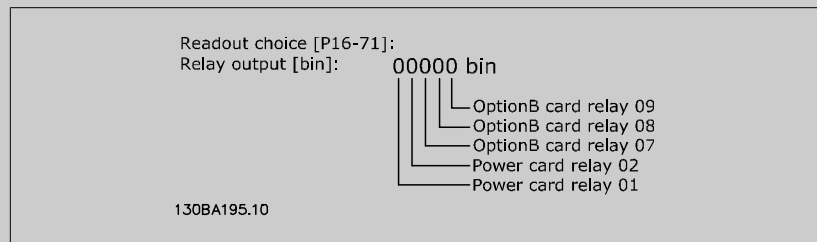

16-72 Counter A**Range:**

0 N/A* [-2147483648 - 2147483647 N/A]

Function:View the present value of Counter A. Counters are useful as comparator operands, see par. 13-10 *Comparator Operand*.The value can be reset or changed either via digital inputs (parameter group 5-1*) or by using an SLC action (par.13-52 *SL Controller Action*).**16-73 Counter B****Range:**

0 N/A* [-2147483648 - 2147483647 N/A]

Function:View the present value of Counter B. Counters are useful as comparator operands (par.13-10 *Comparator Operand*).The value can be reset or changed either via digital inputs (parameter group 5-1*) or by using an SLC action (par.13-52 *SL Controller Action*).**16-74 Prec. Stop Counter****Range:**

0 N/A* [0 - 2147483647 N/A]

Function:Returns the actual counter value of precise counter (par.1-84 *Precise Stop Counter Value*).**16-75 Analog In X30/11****Range:**

0.000 N/A* [-20.000 - 20.000 N/A]

Function:

View the actual value at input X30/11 of MCB 101.

16-76 Analog In X30/12**Range:**

0.000 N/A* [-20.000 - 20.000 N/A]

Function:

View the actual value at input X30/12 of MCB 101.

16-77 Analog Out X30/8 [mA]**Range:**

0.000 N/A* [0.000 - 30.000 N/A]

Function:

View the actual value at input X30/8 in mA.

16-78 Analog Out X45/1 [mA]**Range:**

0.000 N/A* [0.000 - 30.000 N/A]

Function:View the actual value at output X45/1. The value shown reflects the selection in par. 6-70 *Terminal X45/1 Output*.**16-79 Analog Out X45/3 [mA]****Range:**

0.000 N/A* [0.000 - 30.000 N/A]

Function:View the actual value at output X45/3. The value shown reflects the selection in par. 6-80 *Terminal X45/3 Output*.**3.16.7 16-8* Fieldbus & FC Port**

Parameters for reporting the BUS references and control words.

16-80 Fieldbus CTW 1**Range:**

0 N/A* [0 - 65535 N/A]

Function:View the two-byte Control word (CTW) received from the Bus-Master. Interpretation of the Control word depends on the fieldbus option installed and the Control word profile selected in par. 8-10 *Control Profile*.

For more information please refer to the relevant fieldbus manual.

| 16-82 Fieldbus REF 1 | | |
|-----------------------------|--|--|
| Range: | | Function: |
| 0 N/A* [-200 - 200 N/A] | | View the two-byte word sent with the control word from the Bus-Master to set the reference value. For more information please refer to the relevant fieldbus manual. |
| 16-84 Comm. Option STW | | |
| Range: | | Function: |
| 0 N/A* [0 - 65535 N/A] | | View the extended fieldbus comm. option status word. For more information please refer to the relevant fieldbus manual. |
| 16-85 FC Port CTW 1 | | |
| Range: | | Function: |
| 0 N/A* [0 - 65535 N/A] | | View the two-byte Control word (CTW) received from the Bus-Master. Interpretation of the control word depends on the fieldbus option installed and the Control word profile selected in par. 8-10 <i>Control Profile</i> . |
| 16-86 FC Port REF 1 | | |
| Range: | | Function: |
| 0 N/A* [-200 - 200 N/A] | | View the two-byte Status word (STW) sent to the Bus-Master. Interpretation of the Status word depends on the fieldbus option installed and the Control word profile selected in par. 8-10 <i>Control Profile</i> . |

3.16.8 16-9* Diagnosis Read-Outs

Parameters displaying alarm, warning and extended status words.

| 16-90 Alarm Word | | |
|---------------------------------|--|---|
| Range: | | Function: |
| 0 N/A* [0 - 4294967295 N/A] | | View the alarm word sent via the serial communication port in hex code. |
| 16-91 Alarm Word 2 | | |
| Range: | | Function: |
| 0 N/A* [0 - 4294967295 N/A] | | View the alarm word sent via the serial communication port in hex code. |
| 16-92 Warning Word | | |
| Range: | | Function: |
| 0 N/A* [0 - 4294967295 N/A] | | View the warning word sent via the serial communication port in hex code. |
| 16-93 Warning Word 2 | | |
| Range: | | Function: |
| 0 N/A* [0 - 4294967295 N/A] | | View the warning word sent via the serial communication port in hex code. |
| 16-94 Ext. Status Word | | |
| Range: | | Function: |
| 0 N/A* [0 - 4294967295 N/A] | | Returns the extended warning word sent via the serial communication port in hex code. |

3.17 Parameters: Encoder Input

3.17.1 17-** Motor Feedb. Option

Additional parameters to configure the Encoder (MCB102) or the Resolver (MCB103) Feedback Option.

3.17.2 17-1* Inc. Enc. Interface

Parameters in this group configure the incremental interface of the MCB102 option. Note that both the incremental and absolute interfaces are active at the same time.

17-10 Signal Type

Select the incremental type (A/B channel) of the encoder in use. Find the information on the encoder data sheet.

Select *None* [0] if the feedback sensor is an absolute encoder only.

This parameter cannot be adjusted while the motor is running.

Option: **Function:**

[0] None

[1] * RS422 (5V TTL)

[2] Sinusoidal 1Vpp

17-11 Resolution (PPR)

Range: **Function:**

1024 N/A* [10 - 10000 N/A]

Enter the resolution of the incremental track, i.e. the number of pulses or periods per revolution.
This parameter cannot be adjusted while the motor is running.

3.17.3 17-2* Abs. Enc. Interface

Parameters in this group configure the absolute interface of the MCB102 option. Note that both the incremental and absolute interfaces are active at the same time.

17-20 Protocol Selection

Select *HIPERFACE* [1] if the encoder is absolute only.

Select *None* [0] if the feedback sensor is an incremental encoder only.

This parameter cannot be adjusted while the motor is running.

Option: **Function:**

[0] * None

[1] HIPERFACE

[2] EnDat

[4] SSI

17-21 Resolution (Positions/Rev)

Select the resolution of the absolute encoder, i.e. the number of counts per revolution.

This parameter cannot be adjusted while the motor is running. The value depends on setting in par.17-20 *Protocol Selection*.

Range: **Function:**

8192. N/A* [4. - 131072. N/A]

17-24 SSI Data Length

Range: **Function:**

13 N/A* [13 - 25 N/A]

Set the number of bits for the SSI telegram. Choose 13 bits for single-turn encoders and 25 bits for multi-turn encoder.

17-25 Clock Rate

| Range: | Function: |
|----------------------|--|
| 0 kHz* [100 - 0 kHz] | Set the SSI clock rate. With long encoder cables the clock rate must be reduced. |

17-26 SSI Data Format

| Option: | Function: |
|-----------------|--|
| [0] * Gray code | Set the data format of the SSI data. Choose between Gray or Binary format. |
| [1] Binary code | |

17-34 HIPERFACE Baudrate

Select the baud rate of the attached encoder.
 This parameter cannot be adjusted while the motor is running. The parameter is only accessible when par.17-20 *Protocol Selection* is set to HIPERFACE [1].

| Option: | Function: |
|------------|-----------|
| [0] 600 | |
| [1] 1200 | |
| [2] 2400 | |
| [3] 4800 | |
| [4] * 9600 | |
| [5] 19200 | |
| [6] 38400 | |

3.17.4 17-5* Resolver Interface

Parameter group 17-5* is used for setting parameters for the MCB 103 Resolver Option.
 Usually the resolver feedback is used as motor feedback from Permanent Magnet motors with par.1-01 *Motor Control Principle* set to Flux with motor feedback.
 Resolver parameters cannot be adjusted while the motor is running.

17-50 Poles

| Range: | Function: |
|--------------------|--|
| 2 N/A* [2 - 2 N/A] | Set the number of poles on the resolver. The value is stated in the data sheet for resolvers. |

17-51 Input Voltage

| Range: | Function: |
|----------------------|---|
| 7.0 V* [2.0 - 8.0 V] | Set the input voltage to the resolver. The voltage is stated as RMS value. The value is stated in the data sheet for resolvers |

17-52 Input Frequency

| Range: | Function: |
|----------------------------|--|
| 10.0 kHz* [2.0 - 15.0 kHz] | Set the input frequency to the resolver. The value is stated in the data sheet for resolvers. |

17-53 Transformation Ratio

| Range: | Function: |
|--------------------------|--|
| 0.5 N/A* [0.1 - 1.1 N/A] | Set the transformation ratio for the resolver. The transformation ration is: $T_{ratio} = \frac{V_{Out}}{V_{In}}$ The value is stated in the data sheet for resolvers. |

17-59 Resolver Interface

Activate the MCB 103 resolver option when the resolver parameters are selected.

To avoid damage to resolvers par.17-50 *Poles* – par.17-53 *Transformation Ratio* must be adjusted before activating this parameter.

Option: **Function:**

| | |
|-------|----------|
| [0] * | Disabled |
| [1] | Enabled |

3

3.17.5 17-6* Monitoring and Application

This parameter group is for selecting additional functions when MCB 102 Encoder option or MCB 103 Resolver option is fitted into option slot B as speed feedback.

Monitoring and Application parameters cannot be adjusted while the motor is running.

17-60 Feedback Direction

Change the detected encoder rotation direction without changing the wiring to the encoder.

This parameter cannot be adjusted while the motor is running.

Option: **Function:**

| | |
|-------|-------------------|
| [0] * | Clockwise |
| [1] | Counter clockwise |

17-61 Feedback Signal Monitoring

Select which reaction the frequency converter should take in case a faulty encoder signal is detected.

The encoder function in par.17-61 *Feedback Signal Monitoring* is an electrical check of the hardware circuit in the encoder system.

Option: **Function:**

| | |
|-------|---------------------|
| [0] | Disabled |
| [1] * | Warning |
| [2] | Trip |
| [3] | Jog |
| [4] | Freeze Output |
| [5] | Max Speed |
| [6] | Switch to Open Loop |
| [7] | Select Setup 1 |
| [8] | Select Setup 2 |
| [9] | Select Setup 3 |
| [10] | Select Setup 4 |
| [11] | stop & trip |

3.18 Parameters: Data Readouts 2

| 18-90 Process PID Error | |
|--------------------------------------|------------------|
| Range: | Function: |
| 0.0 %* [-200.0 - 200.0 %] | |
| 18-91 Process PID Output | |
| Range: | Function: |
| 0.0 %* [-200.0 - 200.0 %] | |
| 18-92 Process PID Clamped Output | |
| Range: | Function: |
| 0.0 %* [-200.0 - 200.0 %] | |
| 18-93 Process PID Gain Scaled Output | |
| Range: | Function: |
| 0.0 %* [-200.0 - 200.0 %] | |

3.19 30-** Special Features

3.19.1 Wobble Function

The wobble function is primarily used for synthetic yarn winding applications. The wobble option is to be installed in the frequency converter controlling the traverse drive. The traverse drive frequency converter will move the yarn back and forth in a diamond pattern across the surface of the yarn package. To prevent a buildup of yarn at the same points at the surface, this pattern must be altered. The wobble option can accomplish this by continuously varying the traverse velocity in a programmable cycle. The wobble function is created by superimposing a delta frequency around a center frequency. To compensate for the inertia in the system a quick frequency jump can be included. Especially suitable for elastic yarn applications the option features a randomized wobble ratio.

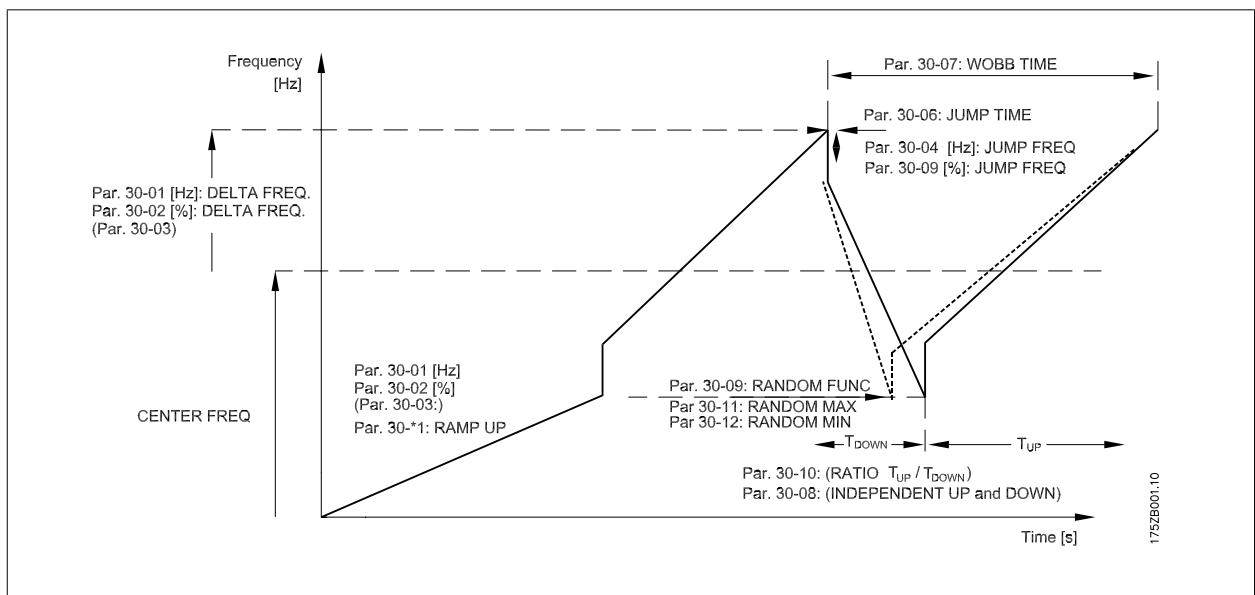

30-00 Wobble Mode

| | |
|----------------|---|
| Option: | Function: |
| | The standard speed open loop mode in par. 1-00 is extended with a wobble function . In this parameter it is possible to select which method to be used for the wobblers. The frequency parameters |

can be set as absolute values (direct frequencies) or as relative values (percentage of other parameter) . The wobble cycle time can be set as an absolute value or as independent up- and down times. When using an absolute cycle time, the up- and down times are configured through the wobble ratio.

| | |
|-------|---------------------------|
| [0] * | Abs. Freq., Abs. Time |
| [1] | Abs. Freq., Up/ Down Time |
| [2] | Rel. Freq., Abs. Time |
| [3] | Rel. Freq., Up/ Down Time |



This parameter can be set while running.



NB!

The setting of "Center Frequency" takes place via the normal reference handling parameters, 3-1*

30-01 Wobble Delta Frequency [Hz]

Range:

5.0 Hz* [0.0 - 25.0 Hz]

Function:

The delta frequency is determining the magnitude of the wobble frequency. The delta frequency is superimposed on the center frequency. Parameter 30-01 is selecting both the positive and negative delta frequency. The setting of parameter 30-01 must thus not be higher than the setting of the center frequency. The initial ramp up time from standstill until the wobble sequence is running is determined by parameters 3-1*.

30-02 Wobble Delta Frequency [%]

Range:

25 %* [0 - 100 %]

Function:

The delta frequency can also be expressed as percentage of the center frequency and can thus be maximum 100%. The function is the same as for par. 30-01.

30-03 Wobble Delta Freq. Scaling Resource

Option:

Function:

Select which drive input should be used to scale the delta frequency setting.

| | |
|-------|---------------------|
| [0] * | No function |
| [1] | Analog input 53 |
| [2] | Analog input 54 |
| [3] | Frequency input 29 |
| [4] | Frequency input 33 |
| [7] | Analog input X30/11 |
| [8] | Analog input X30/12 |

FC 302 only

30-04 Wobble Jump Frequency [Hz]

Range:

0.0 Hz* [0.0 - 0.0 Hz]

Function:

The jump frequency is used to compensate for the inertia in the traverse system. If a jump in the output frequency is required in the top and in the bottom of the wobble sequence, the frequency jump is set in this parameter. If the traverse system has a very high inertia a high jump frequency may create a torque limit warning or trip (warning/alarm 12) or an over voltage warning or trip (warning/alarm 7). This parameter can only be changed in stop-mode

30-05 Wobble Jump Frequency [%]**Range:**

0 %* [0 - 100 %]

Function:

The jump frequency can also be expressed as percentage of the center frequency. The function is the same as for par. 30-04.

30-06 Wobble Jump Time**Range:**

0.005 s* [0.005 - s]

Function:

This parameter determines the slope of the jump ramp at the max. and min. wobble frequency.

30-07 Wobble Sequence Time**Range:**

10.0 s* [1.0 - 1000.0 s]

Function:

This parameter determines the wobble sequence period. This parameter can only be changed in stop-mode.

Wobble time = $t_{up} + t_{down}$

30-08 Wobble Up/ Down Time**Range:**

5.0 s* [0.1 - 1000.0 s]

Function:

Defines the individual up- and down times for each wobble cycle.

30-09 Wobble Random Function**Option:**

[0] * Off

[1] On

Function:**30-10 Wobble Ratio****Range:**

1.0 N/A* [0.1 - 0.0 N/A]

Function:

If the ratio 0.1 is selected: t_{down} is 10 times greater than t_{up} .

If the ratio 10 is selected: t_{up} is 10 times greater than t_{down} .

30-11 Wobble Random Ratio Max.**Range:**

10.0 N/A* [par. 17-53 - 10.0 N/A]

Function:

Enter the maximum allowed wobble ratio.

30-12 Wobble Random Ratio Min.**Range:**

0.1 N/A* [0.1 - par. 30-11 N/A]

Function:

Enter the minimum allowed wobble ratio.

30-19 Wobble Delta Freq. Scaled**Range:**

0.0 Hz* [0.0 - 1000.0 Hz]

Function:

Readout parameter. View the actual wobble delta frequency after scaling has been applied.

3.19.2 30-8* Compatibility**30-80 d-axis Inductance (Ld)****Range:**

0 mH* [0 - 0.000 mH]

Function:

Enter the value of the d-axis inductance. Obtain the value from the permanent magnet motor data sheet. The d-axis inductance cannot be found by performing an AMA.

30-81 Brake Resistor (ohm)**Range:**50.00 [0.01 - 32000.0 Ohm]
Ohm***Function:**

Set the brake resistor value in Ohms. This value is used for monitoring the power to the brake resistor in par.2-13 *Brake Power Monitoring*. This parameter is only active in drives with an integral dynamic brake.

30-83 Speed PID Proportional Gain**Range:**

0 N/A* [0.0000 - 1.0000 N/A]

Function:

Enter the speed controller proportional gain. Quick control is obtained at high amplification. However if amplification is too great, the process may become unstable.

30-84 Process PID Proportional Gain**Range:**

0.100 N/A* [0.000 - 10.000 N/A]

Function:

Enter the process controller proportional gain. Quick control is obtained at high amplification. However if amplification is too great, the process may become unstable.

4 Parameter Lists

4.1 Parameter Lists

FC Series

All = valid for FC 301 and FC 302 series

01 = valid for FC 301 only

02 = valid for FC 302 only

Changes during operation

"TRUE" means that the parameter can be changed while the frequency converter is in operation and "FALSE" means that the frequency converter must be stopped before a change can be made.

4-Set-up

'All set-ups': the parameter can be set individually in each of the four set-ups, i. e. one single parameter can have four different data values.

'1 set-up': data value will be the same in all set-ups.

Conversion index

This number refers to a conversion figure used when writing or reading by means of a frequency converter.

| | | | | | | | | | | | | | | | |
|---------------------|-----|------|---------|--------|-------|------|-----|----|---|-----|------|-------|--------|---------|----------|
| Conv. index | 100 | 67 | 6 | 5 | 4 | 3 | 2 | 1 | 0 | -1 | -2 | -3 | -4 | -5 | -6 |
| Conv. factor | 1 | 1/60 | 1000000 | 100000 | 10000 | 1000 | 100 | 10 | 1 | 0.1 | 0.01 | 0.001 | 0.0001 | 0.00001 | 0.000001 |

| Data type | Description | Type |
|-----------|--------------------------------------|--------|
| 2 | Integer 8 | Int8 |
| 3 | Integer 16 | Int16 |
| 4 | Integer 32 | Int32 |
| 5 | Unsigned 8 | UInt8 |
| 6 | Unsigned 16 | UInt16 |
| 7 | Unsigned 32 | UInt32 |
| 9 | Visible String | VisStr |
| 33 | Normalized value 2 bytes | N2 |
| 35 | Bit sequence of 16 boolean variables | V2 |
| 54 | Time difference w/o date | TimD |

4.1.1 0- ** Operation/Display

| Par. No. # | Parameter description | Default value | 4-set-up | FC 302 only | Change during operation | Conversion index | Type |
|--------------------------------|------------------------------------|--------------------------|-------------|-------------|-------------------------|------------------|--------|
| 0-0* Basic Settings | | | | | | | |
| 0-01 | Language | [0] English | 1 set-up | | TRUE | - | Ujnt8 |
| 0-02 | Motor Speed Unit | [0] RPM | 2 set-ups | | FALSE | - | Ujnt8 |
| 0-03 | Regional Settings | [0] International | 2 set-ups | | FALSE | - | Ujnt8 |
| 0-04 | Operating State at Power-up (Hand) | [1] Forced stop, ref=old | All set-ups | | TRUE | - | Ujnt8 |
| 0-1* Set-up Operations | | | | | | | |
| 0-10 | Active Set-up | [1] Set-up 1 | 1 set-up | | TRUE | - | Ujnt8 |
| 0-11 | Edit Set-up | [1] Set-up 1 | All set-ups | | TRUE | - | Ujnt8 |
| 0-12 | This Set-up Linked to | [0] Not linked | All set-ups | | FALSE | - | Ujnt8 |
| 0-13 | Readout: Linked Set-ups | 0 N/A | All set-ups | | FALSE | 0 | Ujnt16 |
| 0-14 | Readout: Edit Set-ups / Channel | 0 N/A | All set-ups | | TRUE | 0 | Int32 |
| 0-2* LCP Display | | | | | | | |
| 0-20 | Display Line 1.1 Small | 1617 | All set-ups | | TRUE | - | Ujnt16 |
| 0-21 | Display Line 1.2 Small | 1614 | All set-ups | | TRUE | - | Ujnt16 |
| 0-22 | Display Line 1.3 Small | 1610 | All set-ups | | TRUE | - | Ujnt16 |
| 0-23 | Display Line 2 Large | 1613 | All set-ups | | TRUE | - | Ujnt16 |
| 0-24 | Display Line 3 Large | 1602 | All set-ups | | TRUE | - | Ujnt16 |
| 0-25 | My Personal Menu | SR | 1 set-up | | TRUE | 0 | Ujnt16 |
| 0-3* LCP Custom Readout | | | | | | | |
| 0-30 | Unit for User-defined Readout | [0] None | All set-ups | | TRUE | - | Ujnt8 |
| 0-31 | Min Value of User-defined Readout | 0.00 CustomReadoutUnit | All set-ups | | TRUE | -2 | Int32 |
| 0-32 | Max Value of User-defined Readout | 100.00 CustomReadoutUnit | All set-ups | | TRUE | -2 | Int32 |
| 0-4* LCP Keypad | | | | | | | |
| 0-40 | [Hand on] Key on LCP | null | All set-ups | | TRUE | - | Ujnt8 |
| 0-41 | [Off] Key on LCP | null | All set-ups | | TRUE | - | Ujnt8 |
| 0-42 | [Auto on] Key on LCP | null | All set-ups | | TRUE | - | Ujnt8 |
| 0-43 | [Reset] Key on LCP | null | All set-ups | | TRUE | - | Ujnt8 |
| 0-5* Copy/Save | | | | | | | |
| 0-50 | LCP Copy | [0] No copy | All set-ups | | FALSE | - | Ujnt8 |
| 0-51 | Set-up Copy | [0] No copy | All set-ups | | FALSE | - | Ujnt8 |
| 0-6* Password | | | | | | | |
| 0-60 | Main Menu Password | 100 N/A | 1 set-up | | TRUE | 0 | Int16 |
| 0-61 | Access to Main Menu w/o Password | [0] Full access | 1 set-up | | TRUE | - | Ujnt8 |
| 0-65 | Quick Menu Password | 200 N/A | 1 set-up | | TRUE | 0 | Int16 |
| 0-66 | Access to Quick Menu w/o Password | [0] Full access | 1 set-up | | TRUE | - | Ujnt8 |
| 0-67 | Bus Password Access | 0 N/A | All set-ups | | TRUE | 0 | Ujnt16 |

4.1.2 1- * Load/Motor

| Par. No. # | Parameter description | Default value | 4-set-up | FC 302 only | Change during operation | Conversion index | Type |
|---------------------------------|------------------------------------|----------------------|-------------|-------------|-------------------------|------------------|--------|
| 1-0* General Settings | | | | | | | |
| 1-00 | Configuration Mode | null | All set-ups | | TRUE | - | Uint8 |
| 1-01 | Motor Control Principle | null | All set-ups | | FALSE | - | Uint8 |
| 1-02 | Flux Motor Feedback Source | [1] 24V encoder | All set-ups | x | FALSE | - | Uint8 |
| 1-03 | Torque Characteristics | [0] Constant torque | All set-ups | | TRUE | - | Uint8 |
| 1-04 | Overload Mode | [0] High torque | All set-ups | | FALSE | - | Uint8 |
| 1-05 | Local Mode Configuration | [2] As mode par 1-00 | All set-ups | | TRUE | - | Uint8 |
| 1-1* Motor Selection | | | | | | | |
| 1-10 | Motor Construction | [0] Asynchron | All set-ups | | FALSE | - | Uint8 |
| 1-2* Motor Data | | | | | | | |
| 1-20 | Motor Power [kW] | SR | All set-ups | | FALSE | 1 | Uint32 |
| 1-21 | Motor Power [HP] | SR | All set-ups | | FALSE | -2 | Uint32 |
| 1-22 | Motor Voltage | SR | All set-ups | | FALSE | 0 | Uint16 |
| 1-23 | Motor Frequency | SR | All set-ups | | FALSE | 0 | Uint16 |
| 1-24 | Motor Current | SR | All set-ups | | FALSE | -2 | Uint32 |
| 1-25 | Motor Nominal Speed | SR | All set-ups | | FALSE | 67 | Uint16 |
| 1-26 | Motor Cont. Rated Torque | SR | All set-ups | | FALSE | -1 | Uint32 |
| 1-29 | Automatic Motor Adaptation (AMA) | [0] Off | All set-ups | | FALSE | - | Uint8 |
| 1-3* Adv. Motor Data | | | | | | | |
| 1-30 | Stator Resistance (Rs) | SR | All set-ups | | FALSE | -4 | Uint32 |
| 1-31 | Rotor Resistance (Rr) | SR | All set-ups | | FALSE | -4 | Uint32 |
| 1-33 | Stator Leakage Reactance (X1) | SR | All set-ups | | FALSE | -4 | Uint32 |
| 1-34 | Rotor Leakage Reactance (X2) | SR | All set-ups | | FALSE | -4 | Uint32 |
| 1-35 | Main Reactance (Xh) | SR | All set-ups | | FALSE | -4 | Uint32 |
| 1-36 | Iron Loss Resistance (Rfe) | SR | All set-ups | | FALSE | -3 | Uint32 |
| 1-37 | d-axis Inductance (Ld) | SR | All set-ups | x | FALSE | -4 | Int32 |
| 1-39 | Motor Poles | SR | All set-ups | | FALSE | 0 | Uint8 |
| 1-40 | Back EMF at 1000 RPM | SR | All set-ups | x | FALSE | 0 | Uint16 |
| 1-41 | Motor Angle Offset | 0 N/A | All set-ups | | FALSE | 0 | Int16 |
| 1-5* Load Indep. Setting | | | | | | | |
| 1-50 | Motor Magnetisation at Zero Speed | 100 % | All set-ups | | TRUE | 0 | Uint16 |
| 1-51 | Min Speed Normal Magnetising [RPM] | SR | All set-ups | | TRUE | 67 | Uint16 |
| 1-52 | Min Speed Normal Magnetising [Hz] | SR | All set-ups | | TRUE | -1 | Uint16 |
| 1-53 | Model Shift Frequency | SR | All set-ups | x | FALSE | -1 | Uint16 |
| 1-55 | U/f Characteristic - U | SR | All set-ups | | TRUE | -1 | Uint16 |
| 1-56 | U/f Characteristic - F | SR | All set-ups | | TRUE | -1 | Uint16 |

| Par. No. # | Parameter description | Default value | 4-set-up | FC 302 only | Change during operation | Conversion index | Type |
|---------------------------------|---------------------------------------|-----------------------|-------------|-------------|-------------------------|------------------|--------|
| 1-6* Load Depen. Setting | | | | | | | |
| 1-60 | Low Speed Load Compensation | 100 % | All set-ups | | TRUE | 0 | Int16 |
| 1-61 | High Speed Load Compensation | 100 % | All set-ups | | TRUE | 0 | Int16 |
| 1-62 | Slip Compensation | SR | All set-ups | | TRUE | 0 | Int16 |
| 1-63 | Slip Compensation Time Constant | SR | All set-ups | | TRUE | -2 | UInt16 |
| 1-64 | Resonance Dampening | 100 % | All set-ups | | TRUE | 0 | UInt16 |
| 1-65 | Resonance Dampening Time Constant | 5 ms | All set-ups | | TRUE | -3 | UInt8 |
| 1-66 | Min. Current at Low Speed | 100 % | All set-ups | x | TRUE | 0 | UInt8 |
| 1-67 | Load Type | [0] Passive load | All set-ups | x | TRUE | - | UInt8 |
| 1-68 | Minimum Inertia | SR | All set-ups | x | FALSE | -4 | UInt32 |
| 1-69 | Maximum Inertia | SR | All set-ups | x | FALSE | -4 | UInt32 |
| 1-7* Start Adjustments | | | | | | | |
| 1-71 | Start Delay | 0.0 s | All set-ups | | TRUE | -1 | UInt8 |
| 1-72 | Start Function | [2] Coast/delay time | All set-ups | | TRUE | - | UInt8 |
| 1-73 | Flying Start | [0] Disabled | All set-ups | | FALSE | - | UInt8 |
| 1-74 | Start Speed [RPM] | SR | All set-ups | | TRUE | 67 | UInt16 |
| 1-75 | Start Speed [Hz] | SR | All set-ups | | TRUE | -1 | UInt16 |
| 1-76 | Start Current | 0.00 A | All set-ups | | TRUE | -2 | UInt32 |
| 1-8* Stop Adjustments | | | | | | | |
| 1-80 | Function at Stop | [0] Coast | All set-ups | | TRUE | - | UInt8 |
| 1-81 | Min Speed for Function at Stop [RPM] | SR | All set-ups | | TRUE | 67 | UInt16 |
| 1-82 | Min Speed for Function at Stop [Hz] | SR | All set-ups | | TRUE | -1 | UInt16 |
| 1-83 | Precise Stop Function | [0] Precise ramp stop | All set-ups | | FALSE | - | UInt8 |
| 1-84 | Precise Stop Counter Value | 100000 N/A | All set-ups | | TRUE | 0 | UInt32 |
| 1-85 | Precise Stop Speed Compensation Delay | 10 ms | All set-ups | | TRUE | -3 | UInt8 |
| 1-9* Motor Temperature | | | | | | | |
| 1-90 | Motor Thermal Protection | [0] No protection | All set-ups | | TRUE | - | UInt8 |
| 1-91 | Motor External Fan | [0] No | All set-ups | | TRUE | - | UInt16 |
| 1-93 | Thermistor Resource | [0] None | All set-ups | | TRUE | - | UInt8 |
| 1-95 | KTY Sensor Type | [0] KTY Sensor 1 | All set-ups | x | TRUE | - | UInt8 |
| 1-96 | KTY Thermistor Resource | [0] None | All set-ups | x | TRUE | - | UInt8 |
| 1-97 | KTY Threshold level | 80 °C | 1 set-up | x | TRUE | 100 | Int16 |

4.1.3 2- ** Brakes

| Par. No. # | Parameter description | Default value | 4-set-up | FC 302 only | Change during operation | Conversion index | Type |
|---------------------------------|-----------------------------|------------------------------|-------------|-------------|-------------------------|------------------|--------|
| 2-0* DC-Brake | | | | | | | |
| 2-00 | DC Hold Current | 50 % | All set-ups | | TRUE | 0 | Ujnt8 |
| 2-01 | DC Brake Current | 50 % | All set-ups | | TRUE | 0 | Ujnt16 |
| 2-02 | DC Braking Time | 10.0 s | All set-ups | | TRUE | -1 | Ujnt16 |
| 2-03 | DC Brake Cut In Speed [RPM] | SR | All set-ups | | TRUE | 67 | Ujnt16 |
| 2-04 | DC Brake Cut In Speed [Hz] | SR | All set-ups | | TRUE | -1 | Ujnt16 |
| 2-1* Brake Energy Funct. | | | | | | | |
| 2-10 | Brake Function | null | All set-ups | | TRUE | - | Ujnt8 |
| 2-11 | Brake Resistor (ohm) | SR | All set-ups | | TRUE | 0 | Ujnt16 |
| 2-12 | Brake Power Limit (kW) | SR | All set-ups | | TRUE | 0 | Ujnt32 |
| 2-13 | Brake Power Monitoring | [0] Off | All set-ups | | TRUE | - | Ujnt8 |
| 2-15 | Brake Check | [0] Off | All set-ups | | TRUE | - | Ujnt8 |
| 2-16 | AC brake Max. Current | 100.0 % | All set-ups | | TRUE | -1 | Ujnt32 |
| 2-17 | Over-voltage Control | [0] Disabled | All set-ups | | TRUE | - | Ujnt8 |
| 2-18 | Brake Check Condition | [0] At Power Up | All set-ups | | TRUE | - | Ujnt8 |
| 2-2* Mechanical Brake | | | | | | | |
| 2-20 | Release Brake Current | I _{max} VLT (P1637) | All set-ups | | TRUE | -2 | Ujnt32 |
| 2-21 | Activate Brake Speed [RPM] | SR | All set-ups | | TRUE | 67 | Ujnt16 |
| 2-22 | Activate Brake Speed [Hz] | SR | All set-ups | | TRUE | -1 | Ujnt16 |
| 2-23 | Activate Brake Delay | 0.0 s | All set-ups | | TRUE | -1 | Ujnt8 |
| 2-24 | Stop Delay | 0.0 s | All set-ups | | TRUE | -1 | Ujnt8 |
| 2-25 | Brake Release Time | 0.20 s | All set-ups | | TRUE | -2 | Ujnt16 |
| 2-26 | Torque Ref | 0.00 % | All set-ups | | TRUE | -2 | Int16 |
| 2-27 | Torque Ramp Time | 0.2 s | All set-ups | | TRUE | -1 | Ujnt8 |
| 2-28 | Gain Boost Factor | 1.00 N/A | All set-ups | | TRUE | -2 | Ujnt16 |

4.1.4 3- ** Reference / Ramps

| Par. No. # | Parameter description | Default value | 4-set-up | FC 302 only | Change during operation | Conversion index | Type |
|------------------------------|-------------------------------------|---------------------------|-------------|-------------|-------------------------|------------------|--------|
| 3-0* Reference Limits | | | | | | | |
| 3-00 | Reference Range | null | All set-ups | | TRUE | - | Ujnt8 |
| 3-01 | Reference/Feedback Unit | null | All set-ups | | TRUE | - | Ujnt8 |
| 3-02 | Minimum Reference | SR | All set-ups | | TRUE | -3 | Int32 |
| 3-03 | Maximum Reference | SR | All set-ups | | TRUE | -3 | Int32 |
| 3-04 | Reference Function | [0] Sum | All set-ups | | TRUE | - | Ujnt8 |
| 3-1* References | | | | | | | |
| 3-10 | Preset Reference | 0.00 % | All set-ups | | TRUE | -2 | Int16 |
| 3-11 | Jog Speed [Hz] | SR | All set-ups | | TRUE | -1 | Ujnt16 |
| 3-12 | Catch up/slow Down Value | 0.00 % | All set-ups | | TRUE | -2 | Int16 |
| 3-13 | Reference Site | [0] Linked to Hand / Auto | All set-ups | | TRUE | - | Ujnt8 |
| 3-14 | Preset Relative Reference | 0.00 % | All set-ups | | TRUE | -2 | Int32 |
| 3-15 | Reference Resource 1 | null | All set-ups | | TRUE | - | Ujnt8 |
| 3-16 | Reference Resource 2 | null | All set-ups | | TRUE | - | Ujnt8 |
| 3-17 | Reference Resource 3 | null | All set-ups | | TRUE | - | Ujnt8 |
| 3-18 | Relative Scaling Reference Resource | [0] No function | All set-ups | | TRUE | - | Ujnt8 |
| 3-19 | Jog Speed [RPM] | SR | All set-ups | | TRUE | 67 | Ujnt16 |
| 3-4* Ramp 1 | | | | | | | |
| 3-40 | Ramp 1 Type | [0] Linear | All set-ups | | TRUE | - | Ujnt8 |
| 3-41 | Ramp 1 Ramp up Time | SR | All set-ups | | TRUE | -2 | Ujnt32 |
| 3-42 | Ramp 1 Ramp Down Time | SR | All set-ups | | TRUE | -2 | Ujnt32 |
| 3-43 | Ramp 1 S-ramp Ratio at Accel. Start | 50 % | All set-ups | | TRUE | 0 | Ujnt8 |
| 3-44 | Ramp 1 S-ramp Ratio at Decel. Start | 50 % | All set-ups | | TRUE | 0 | Ujnt8 |
| 3-45 | Ramp 1 S-ramp Ratio at Accel. End | 50 % | All set-ups | | TRUE | 0 | Ujnt8 |
| 3-46 | Ramp 1 S-ramp Ratio at Decel. End | 50 % | All set-ups | | TRUE | 0 | Ujnt8 |
| 3-5* Ramp 2 | | | | | | | |
| 3-50 | Ramp 2 Type | [0] Linear | All set-ups | | TRUE | - | Ujnt8 |
| 3-51 | Ramp 2 Ramp up Time | SR | All set-ups | | TRUE | -2 | Ujnt32 |
| 3-52 | Ramp 2 Ramp down Time | SR | All set-ups | | TRUE | -2 | Ujnt32 |
| 3-53 | Ramp 2 S-ramp Ratio at Accel. Start | 50 % | All set-ups | | TRUE | 0 | Ujnt8 |
| 3-54 | Ramp 2 S-ramp Ratio at Decel. Start | 50 % | All set-ups | | TRUE | 0 | Ujnt8 |
| 3-55 | Ramp 2 S-ramp Ratio at Accel. End | 50 % | All set-ups | | TRUE | 0 | Ujnt8 |
| 3-56 | Ramp 2 S-ramp Ratio at Decel. End | 50 % | All set-ups | | TRUE | 0 | Ujnt8 |
| 3-57 | Ramp 2 S-ramp Ratio at Accel. Start | 50 % | All set-ups | | TRUE | 0 | Ujnt8 |
| 3-58 | Ramp 2 S-ramp Ratio at Decel. End | 50 % | All set-ups | | TRUE | 0 | Ujnt8 |

| Par. No. # | Parameter description | Default value | 4-set-up | FC 302 only | Change during operation | Conversion index | Type |
|--------------------------------|---|---------------|-------------|-------------|-------------------------|------------------|--------|
| 3-6* Ramp 3 | | | | | | | |
| 3-60 | Ramp 3 Type | [0] Linear | All set-ups | | TRUE | - | Ujnt8 |
| 3-61 | Ramp 3 Ramp up Time | SR | All set-ups | | TRUE | -2 | Ujnt32 |
| 3-62 | Ramp 3 Ramp down Time | SR | All set-ups | | TRUE | -2 | Ujnt32 |
| 3-65 | Ramp 3 S-ramp Ratio at Accel. Start | 50 % | All set-ups | | TRUE | 0 | Ujnt8 |
| 3-66 | Ramp 3 S-ramp Ratio at Accel. End | 50 % | All set-ups | | TRUE | 0 | Ujnt8 |
| 3-67 | Ramp 3 S-ramp Ratio at Decel. Start | 50 % | All set-ups | | TRUE | 0 | Ujnt8 |
| 3-68 | Ramp 3 S-ramp Ratio at Decel. End | 50 % | All set-ups | | TRUE | 0 | Ujnt8 |
| 3-7* Ramp 4 | | | | | | | |
| 3-70 | Ramp 4 Type | [0] Linear | All set-ups | | TRUE | - | Ujnt8 |
| 3-71 | Ramp 4 Ramp up Time | SR | All set-ups | | TRUE | -2 | Ujnt32 |
| 3-72 | Ramp 4 Ramp Down Time | SR | All set-ups | | TRUE | -2 | Ujnt32 |
| 3-75 | Ramp 4 S-ramp Ratio at Accel. Start | 50 % | All set-ups | | TRUE | 0 | Ujnt8 |
| 3-76 | Ramp 4 S-ramp Ratio at Accel. End | 50 % | All set-ups | | TRUE | 0 | Ujnt8 |
| 3-77 | Ramp 4 S-ramp Ratio at Decel. Start | 50 % | All set-ups | | TRUE | 0 | Ujnt8 |
| 3-78 | Ramp 4 S-ramp Ratio at Decel. End | 50 % | All set-ups | | TRUE | 0 | Ujnt8 |
| 3-8* Other Ramps | | | | | | | |
| 3-80 | Jog Ramp Time | SR | All set-ups | | TRUE | -2 | Ujnt32 |
| 3-81 | Quick Stop Ramp Time | SR | 2 set-ups | | TRUE | -2 | Ujnt32 |
| 3-82 | Quick Stop Ramp Type | [0] Linear | All set-ups | | TRUE | - | Ujnt8 |
| 3-83 | Quick Stop S-ramp Ratio at Decel. Start | 50 % | All set-ups | | TRUE | 0 | Ujnt8 |
| 3-84 | Quick Stop S-ramp Ratio at Decel. End | 50 % | All set-ups | | TRUE | 0 | Ujnt8 |
| 3-9* Digital Pot. Meter | | | | | | | |
| 3-90 | Step Size | 0.10 % | All set-ups | | TRUE | -2 | Ujnt16 |
| 3-91 | Ramp Time | 1.00 s | All set-ups | | TRUE | -2 | Ujnt32 |
| 3-92 | Power Restore | [0] Off | All set-ups | | TRUE | - | Ujnt8 |
| 3-93 | Maximum Limit | 100 % | All set-ups | | TRUE | 0 | Int16 |
| 3-94 | Minimum Limit | -100 % | All set-ups | | TRUE | 0 | Int16 |
| 3-95 | Ramp Delay | SR | All set-ups | | TRUE | -3 | TimD |

4.1.5 4- * Limits / Warnings

| Par. No. # | Parameter description | Default value | 4-set-up | FC 302 only | Change during operation | Conversion index | Type |
|------------------------------|--------------------------------------|-----------------------------------|-------------|-------------|-------------------------|------------------|--------|
| 4-1* Motor Limits | | | | | | | |
| 4-10 | Motor Speed Direction | null | All set-ups | | FALSE | - | Uint8 |
| 4-11 | Motor Speed Low Limit [RPM] | SR | All set-ups | | TRUE | 67 | Uint16 |
| 4-12 | Motor Speed Low Limit [Hz] | SR | All set-ups | | TRUE | -1 | Uint16 |
| 4-13 | Motor Speed High Limit [RPM] | SR | All set-ups | | TRUE | 67 | Uint16 |
| 4-14 | Motor Speed High Limit [Hz] | SR | All set-ups | | TRUE | -1 | Uint16 |
| 4-16 | Torque Limit Motor Mode | SR | All set-ups | | TRUE | -1 | Uint16 |
| 4-17 | Torque Limit Generator Mode | 100.0 % | All set-ups | | TRUE | -1 | Uint16 |
| 4-18 | Current Limit | SR | All set-ups | | TRUE | -1 | Uint32 |
| 4-19 | Max Output Frequency | 132.0 Hz | All set-ups | | FALSE | -1 | Uint16 |
| 4-2* Limit Factors | | | | | | | |
| 4-20 | Torque Limit Factor Source | [0] No function | All set-ups | | TRUE | - | Uint8 |
| 4-21 | Speed Limit Factor Source | [0] No function | All set-ups | | TRUE | - | Uint8 |
| 4-3* Motor Speed Mon. | | | | | | | |
| 4-30 | Motor Feedback Loss Function | [2] Trip | All set-ups | | TRUE | - | Uint8 |
| 4-31 | Motor Feedback Speed Error | 300 RPM | All set-ups | | TRUE | 67 | Uint16 |
| 4-32 | Motor Feedback Loss Timeout | 0.05 s | All set-ups | | TRUE | -2 | Uint16 |
| 4-34 | Tracking Error Function | [0] Disable | All set-ups | | TRUE | - | Uint8 |
| 4-35 | Tracking Error | 10 RPM | All set-ups | | TRUE | 67 | Uint16 |
| 4-36 | Tracking Error Timeout | 1.00 s | All set-ups | | TRUE | -2 | Uint16 |
| 4-37 | Tracking Error Ramping | 100 RPM | All set-ups | | TRUE | 67 | Uint16 |
| 4-38 | Tracking Error Ramping Timeout | 1.00 s | All set-ups | | TRUE | -2 | Uint16 |
| 4-39 | Tracking Error After Ramping Timeout | 5.00 s | All set-ups | | TRUE | -2 | Uint16 |
| 4-5* Adj. Warnings | | | | | | | |
| 4-50 | Warning Current Low | 0.00 A | All set-ups | | TRUE | -2 | Uint32 |
| 4-51 | Warning Current High | ImaxVLT (P1637) | All set-ups | | TRUE | -2 | Uint32 |
| 4-52 | Warning Speed Low | 0 RPM | All set-ups | | TRUE | 67 | Uint16 |
| 4-53 | Warning Speed High | outputSpeedHighLimit (P413) | All set-ups | | TRUE | 67 | Uint16 |
| 4-54 | Warning Reference Low | -999999.999 N/A | All set-ups | | TRUE | -3 | Int32 |
| 4-55 | Warning Reference High | 999999.999 N/A | All set-ups | | TRUE | -3 | Int32 |
| 4-56 | Warning Feedback Low | -999999.999 ReferenceFeedbackUnit | All set-ups | | TRUE | -3 | Int32 |
| 4-57 | Warning Feedback High | 999999.999 ReferenceFeedbackUnit | All set-ups | | TRUE | -3 | Int32 |
| 4-58 | Missing Motor Phase Function | null | All set-ups | | TRUE | - | Uint8 |
| 4-6* Speed Bypass | | | | | | | |
| 4-60 | Bypass Speed From [RPM] | SR | All set-ups | | TRUE | 67 | Uint16 |
| 4-61 | Bypass Speed From [Hz] | SR | All set-ups | | TRUE | -1 | Uint16 |
| 4-62 | Bypass Speed To [RPM] | SR | All set-ups | | TRUE | 67 | Uint16 |
| 4-63 | Bypass Speed To [Hz] | SR | All set-ups | | TRUE | -1 | Uint16 |

4.1.6 5- * * Digital In/Out

| Par. No. # | Parameter description | Default value | 4-set-up | FC 302 only | Change during operation | Conversion index | Type |
|------------------------------|-------------------------------|---------------------|-------------|-------------|-------------------------|------------------|--------|
| 5-0* Digital I/O mode | | | | | | | |
| 5-00 | Digital I/O Mode | [0] PNP | All set-ups | | FALSE | - | Ujnt8 |
| 5-01 | Terminal 27 Mode | [0] Input | All set-ups | | TRUE | - | Ujnt8 |
| 5-02 | Terminal 29 Mode | [0] Input | All set-ups | x | TRUE | - | Ujnt8 |
| 5-1* Digital Inputs | | | | | | | |
| 5-10 | Terminal 18 Digital Input | null | All set-ups | | TRUE | - | Ujnt8 |
| 5-11 | Terminal 19 Digital Input | null | All set-ups | | TRUE | - | Ujnt8 |
| 5-12 | Terminal 27 Digital Input | null | All set-ups | | TRUE | - | Ujnt8 |
| 5-13 | Terminal 29 Digital Input | null | All set-ups | x | TRUE | - | Ujnt8 |
| 5-14 | Terminal 32 Digital Input | null | All set-ups | | TRUE | - | Ujnt8 |
| 5-15 | Terminal 33 Digital Input | null | All set-ups | | TRUE | - | Ujnt8 |
| 5-16 | Terminal X30/2 Digital Input | null | All set-ups | | TRUE | - | Ujnt8 |
| 5-17 | Terminal X30/3 Digital Input | null | All set-ups | | TRUE | - | Ujnt8 |
| 5-18 | Terminal X30/4 Digital Input | null | All set-ups | | TRUE | - | Ujnt8 |
| 5-19 | Terminal 37 Safe Stop | [1] Safe Stop Alarm | 1 set-up | | TRUE | - | Ujnt8 |
| 5-20 | Terminal X46/1 Digital Input | [0] No operation | All set-ups | | TRUE | - | Ujnt8 |
| 5-21 | Terminal X46/3 Digital Input | [0] No operation | All set-ups | | TRUE | - | Ujnt8 |
| 5-22 | Terminal X46/5 Digital Input | [0] No operation | All set-ups | | TRUE | - | Ujnt8 |
| 5-23 | Terminal X46/7 Digital Input | [0] No operation | All set-ups | | TRUE | - | Ujnt8 |
| 5-24 | Terminal X46/9 Digital Input | [0] No operation | All set-ups | | TRUE | - | Ujnt8 |
| 5-25 | Terminal X46/11 Digital Input | [0] No operation | All set-ups | | TRUE | - | Ujnt8 |
| 5-26 | Terminal X46/13 Digital Input | [0] No operation | All set-ups | | TRUE | - | Ujnt8 |
| 5-3* Digital Outputs | | | | | | | |
| 5-30 | Terminal 27 Digital Output | null | All set-ups | | TRUE | - | Ujnt8 |
| 5-31 | Terminal 29 Digital Output | null | All set-ups | x | TRUE | - | Ujnt8 |
| 5-32 | Term X30/6 Digi Out (MCB 101) | null | All set-ups | | TRUE | - | Ujnt8 |
| 5-33 | Term X30/7 Digi Out (MCB 101) | null | All set-ups | | TRUE | - | Ujnt8 |
| 5-4* Relays | | | | | | | |
| 5-40 | Function Relay | null | All set-ups | | TRUE | - | Ujnt8 |
| 5-41 | On Delay, Relay | 0.01 s | All set-ups | | TRUE | -2 | Ujnt16 |
| 5-42 | Off Delay, Relay | 0.01 s | All set-ups | | TRUE | -2 | Ujnt16 |

| Par. No. # | Parameter description | Default value | 4-set-up | FC 302 only | Change during operation | Conversion index | Type |
|--|--------------------------------------|-----------------------------|-------------|-------------|-------------------------|------------------|--------|
| 5-5* Pulse Input | | | | | | | |
| 5-50 | Term. 29 Low Frequency | 100 Hz | All set-ups | x | TRUE | 0 | Uint32 |
| 5-51 | Term. 29 High Frequency | 100 Hz | All set-ups | x | TRUE | 0 | Uint32 |
| 5-52 | Term. 29 Low Ref./Feedb. Value | 0.000 ReferenceFeedbackUnit | All set-ups | x | TRUE | -3 | Int32 |
| 5-53 | Term. 29 High Ref./Feedb. Value | SR | All set-ups | x | TRUE | -3 | Int32 |
| 5-54 | Pulse Filter Time Constant #29 | 100 ms | All set-ups | x | FALSE | -3 | Uint16 |
| 5-55 | Term. 33 Low Frequency | 100 Hz | All set-ups | | TRUE | 0 | Uint32 |
| 5-56 | Term. 33 High Frequency | 100 Hz | All set-ups | | TRUE | 0 | Uint32 |
| 5-57 | Term. 33 Low Ref./Feedb. Value | 0.000 ReferenceFeedbackUnit | All set-ups | | TRUE | -3 | Int32 |
| 5-58 | Term. 33 High Ref./Feedb. Value | SR | All set-ups | | TRUE | -3 | Int32 |
| 5-59 | Pulse Filter Time Constant #33 | 100 ms | All set-ups | | FALSE | -3 | Uint16 |
| 5-6* Pulse Output | | | | | | | |
| 5-60 | Terminal 27 Pulse Output Variable | null | All set-ups | | TRUE | - | Uint8 |
| 5-62 | Pulse Output Max Freq #27 | SR | All set-ups | | TRUE | 0 | Uint32 |
| 5-63 | Terminal 29 Pulse Output Variable | null | All set-ups | x | TRUE | - | Uint8 |
| 5-65 | Pulse Output Max Freq #29 | SR | All set-ups | x | TRUE | 0 | Uint32 |
| 5-66 | Terminal X30/6 Pulse Output Variable | null | All set-ups | | TRUE | - | Uint8 |
| 5-68 | Pulse Output Max Freq #X30/6 | SR | All set-ups | | TRUE | 0 | Uint32 |
| 5-7* 24V Encoder Input | | | | | | | |
| 5-70 | Term 32/33 Pulses per Revolution | 1024 N/A | All set-ups | | FALSE | 0 | Uint16 |
| 5-71 | Term 32/33 Encoder Direction | [0] Clockwise | All set-ups | | FALSE | - | Uint8 |
| 5-9* Bus Controlled | | | | | | | |
| Digital & Relay Bus Control | | | | | | | |
| 5-93 | Pulse Out #27 Bus Control | 0 N/A | All set-ups | | TRUE | 0 | Uint32 |
| 5-94 | Pulse Out #27 Timeout Preset | 0.00 % | All set-ups | | TRUE | -2 | N2 |
| 5-95 | Pulse Out #29 Bus Control | 0.00 % | 1 set-up | | TRUE | -2 | Uint16 |
| 5-96 | Pulse Out #29 Timeout Preset | 0.00 % | All set-ups | x | TRUE | -2 | N2 |
| 5-97 | Pulse Out #X30/6 Bus Control | 0.00 % | 1 set-up | | TRUE | -2 | Uint16 |
| 5-98 | Pulse Out #X30/6 Timeout Preset | 0.00 % | All set-ups | x | TRUE | -2 | N2 |
| | | | 1 set-up | | TRUE | -2 | Uint16 |

4.1.7 6- ** Analog In/Out

| Par. No. # | Parameter description | Default value | 4-set-up | FC 302 only | Change during operation | Conversion index | Type |
|-----------------------------|-------------------------------------|-------------------------|-------------|-------------|-------------------------|------------------|--------|
| 6-0* Analog I/O Mode | | | | | | | |
| 6-00 | Live Zero Timeout Time | 10 s | All set-ups | | TRUE | 0 | Ujnt8 |
| 6-01 | Live Zero Timeout Function | [0] Off | All set-ups | | TRUE | - | Ujnt8 |
| 6-1* Analog Input 1 | | | | | | | |
| 6-10 | Terminal 53 Low Voltage | 0.07 V | All set-ups | | TRUE | -2 | Int16 |
| 6-11 | Terminal 53 High Voltage | 10.00 V | All set-ups | | TRUE | -2 | Int16 |
| 6-12 | Terminal 53 Low Current | 0.14 mA | All set-ups | | TRUE | -5 | Int16 |
| 6-13 | Terminal 53 High Current | 20.00 mA | All set-ups | | TRUE | -5 | Int16 |
| 6-14 | Terminal 53 Low Ref./Feedb. Value | 0 ReferenceFeedbackUnit | All set-ups | | TRUE | -3 | Int32 |
| 6-15 | Terminal 53 High Ref./Feedb. Value | SR | All set-ups | | TRUE | -3 | Int32 |
| 6-16 | Terminal 53 Filter Time Constant | 0.001 s | All set-ups | | TRUE | -3 | Ujnt16 |
| 6-2* Analog Input 2 | | | | | | | |
| 6-20 | Terminal 54 Low Voltage | 0.07 V | All set-ups | | TRUE | -2 | Int16 |
| 6-21 | Terminal 54 High Voltage | 10.00 V | All set-ups | | TRUE | -2 | Int16 |
| 6-22 | Terminal 54 Low Current | 0.14 mA | All set-ups | | TRUE | -5 | Int16 |
| 6-23 | Terminal 54 High Current | 20.00 mA | All set-ups | | TRUE | -5 | Int16 |
| 6-24 | Terminal 54 Low Ref./Feedb. Value | 0 ReferenceFeedbackUnit | All set-ups | | TRUE | -3 | Int32 |
| 6-25 | Terminal 54 High Ref./Feedb. Value | SR | All set-ups | | TRUE | -3 | Int32 |
| 6-26 | Terminal 54 Filter Time Constant | 0.001 s | All set-ups | | TRUE | -3 | Ujnt16 |
| 6-3* Analog Input 3 | | | | | | | |
| 6-30 | Terminal X30/11 Low Voltage | 0.07 V | All set-ups | | TRUE | -2 | Int16 |
| 6-31 | Terminal X30/11 High Voltage | 10.00 V | All set-ups | | TRUE | -2 | Int16 |
| 6-34 | Term. X30/11 Low Ref./Feedb. Value | 0 ReferenceFeedbackUnit | All set-ups | | TRUE | -3 | Int32 |
| 6-35 | Term. X30/11 High Ref./Feedb. Value | SR | All set-ups | | TRUE | -3 | Int32 |
| 6-36 | Term. X30/11 Filter Time Constant | 0.001 s | All set-ups | | TRUE | -3 | Ujnt16 |
| 6-4* Analog Input 4 | | | | | | | |
| 6-40 | Terminal X30/12 Low Voltage | 0.07 V | All set-ups | | TRUE | -2 | Int16 |
| 6-41 | Terminal X30/12 High Voltage | 10.00 V | All set-ups | | TRUE | -2 | Int16 |
| 6-44 | Term. X30/12 Low Ref./Feedb. Value | 0 ReferenceFeedbackUnit | All set-ups | | TRUE | -3 | Int32 |
| 6-45 | Term. X30/12 High Ref./Feedb. Value | SR | All set-ups | | TRUE | -3 | Int32 |
| 6-46 | Term. X30/12 Filter Time Constant | 0.001 s | All set-ups | | TRUE | -3 | Ujnt16 |
| 6-5* Analog Output 1 | | | | | | | |
| 6-50 | Terminal 42 Output | null | All set-ups | | TRUE | - | Ujnt8 |
| 6-51 | Terminal 42 Output Min Scale | 0.00 % | All set-ups | | TRUE | -2 | Int16 |
| 6-52 | Terminal 42 Output Max Scale | 100.00 % | All set-ups | | TRUE | -2 | Int16 |
| 6-53 | Terminal 42 Output Bus Control | 0.00 % | All set-ups | | TRUE | -2 | N2 |
| 6-54 | Terminal 42 Output Timeout Preset | 0.00 % | 1 set-up | | TRUE | -2 | Ujnt16 |
| 6-55 | Terminal 42 Output Filter | [0] Off | 1 set-up | | TRUE | - | Ujnt8 |

| Par. No. # | Parameter description | Default value | 4-set-up | FC 302 only | Change during operation | Conversion index | Type |
|-----------------------------|--------------------------------------|---------------|-------------|-------------|-------------------------|------------------|--------|
| 6-6* Analog Output 2 | | | | | | | |
| 6-60 | Terminal X30/8 Output | null | All set-ups | | TRUE | - | Uint8 |
| 6-61 | Terminal X30/8 Min. Scale | 0.00 % | All set-ups | | TRUE | -2 | Int16 |
| 6-62 | Terminal X30/8 Max. Scale | 100.00 % | All set-ups | | TRUE | -2 | Int16 |
| 6-63 | Terminal X30/8 Bus Control | 0.00 % | All set-ups | | TRUE | -2 | N2 |
| 6-64 | Terminal X30/8 Output Timeout Preset | 0.00 % | 1 set-up | | TRUE | -2 | Uint16 |
| 6-7* Analog Output 3 | | | | | | | |
| 6-70 | Terminal X45/1 Output | null | All set-ups | | TRUE | - | Uint8 |
| 6-71 | Terminal X45/1 Min. Scale | 0.00 % | All set-ups | | TRUE | -2 | Int16 |
| 6-72 | Terminal X45/1 Max. Scale | 100.00 % | All set-ups | | TRUE | -2 | Int16 |
| 6-73 | Terminal X45/1 Bus Control | 0.00 % | All set-ups | | TRUE | -2 | N2 |
| 6-74 | Terminal X45/1 Output Timeout Preset | 0.00 % | 1 set-up | | TRUE | -2 | Uint16 |
| 6-8* Analog Output 4 | | | | | | | |
| 6-80 | Terminal X45/3 Output | null | All set-ups | | TRUE | - | Uint8 |
| 6-81 | Terminal X45/3 Min. Scale | 0.00 % | All set-ups | | TRUE | -2 | Int16 |
| 6-82 | Terminal X45/3 Max. Scale | 100.00 % | All set-ups | | TRUE | -2 | Int16 |
| 6-83 | Terminal X45/3 Bus Control | 0.00 % | All set-ups | | TRUE | -2 | N2 |
| 6-84 | Terminal X45/3 Output Timeout Preset | 0.00 % | 1 set-up | | TRUE | -2 | Uint16 |

4.1.8 7- * Controllers

| Par. No. # | Parameter description | Default value | 4-set-up | FC 302 only | Change during operation | Conversion index | Type |
|--|---|-----------------|-------------|-------------|-------------------------|------------------|--------|
| 7-0* Speed PID Ctrl. | | | | | | | |
| 7-00 | Speed PID Feedback Source | null | All set-ups | | FALSE | - | Ujnt8 |
| 7-02 | Speed PID Proportional Gain | SR | All set-ups | | TRUE | -3 | Ujnt16 |
| 7-03 | Speed PID Integral Time | SR | All set-ups | | TRUE | -4 | Ujnt32 |
| 7-04 | Speed PID Differentiation Time | SR | All set-ups | | TRUE | -4 | Ujnt16 |
| 7-05 | Speed PID Diff. Gain Limit | 5.0 N/A | All set-ups | | TRUE | -1 | Ujnt16 |
| 7-06 | Speed PID Lowpass Filter Time | 10.0 ms | All set-ups | | TRUE | -4 | Ujnt16 |
| 7-07 | Speed PID Feedback Gear Ratio | 1.0000 N/A | All set-ups | | FALSE | -4 | Ujnt32 |
| 7-08 | Speed PID Feed Forward Factor | 0 % | All set-ups | | FALSE | 0 | Ujnt16 |
| 7-1* Torque PI Ctrl. | | | | | | | |
| 7-12 | Torque PI Proportional Gain | 100 % | All set-ups | | TRUE | 0 | Ujnt16 |
| 7-13 | Torque PI Integration Time | 0.020 s | All set-ups | | TRUE | -3 | Ujnt16 |
| 7-2* Process Ctrl. Feeds | | | | | | | |
| 7-20 | Process CL Feedback 1 Resource | [0] No function | All set-ups | | TRUE | - | Ujnt8 |
| 7-22 | Process CL Feedback 2 Resource | [0] No function | All set-ups | | TRUE | - | Ujnt8 |
| 7-3* Process PID Ctrl. | | | | | | | |
| 7-30 | Process PID Normal/ Inverse Control | [0] Normal | All set-ups | | TRUE | - | Ujnt8 |
| 7-31 | Process PID Anti Windup | [1] On | All set-ups | | TRUE | - | Ujnt8 |
| 7-32 | Process PID Start Speed | 0 RPM | All set-ups | | TRUE | 67 | Ujnt16 |
| 7-33 | Process PID Proportional Gain | 0.01 N/A | All set-ups | | TRUE | -2 | Ujnt16 |
| 7-34 | Process PID Integral Time | 10000.00 s | All set-ups | | TRUE | -2 | Ujnt32 |
| 7-35 | Process PID Differentiation Time | 0.00 s | All set-ups | | TRUE | -2 | Ujnt16 |
| 7-36 | Process PID Diff. Gain Limit | 5.0 N/A | All set-ups | | TRUE | -1 | Ujnt16 |
| 7-38 | Process PID Feed Forward Factor | 0 % | All set-ups | | TRUE | 0 | Ujnt16 |
| 7-39 | On Reference Bandwidth | 5 % | All set-ups | | TRUE | 0 | Ujnt8 |
| 7-4* Advanced Process PID Ctrl. | | | | | | | |
| 7-40 | Process PID I-part Reset | [0] No | All set-ups | | TRUE | - | Ujnt8 |
| 7-41 | Process PID Output Neg. Clamp | -100 % | All set-ups | | TRUE | 0 | Int16 |
| 7-42 | Process PID Output Pos. Clamp | 100 % | All set-ups | | TRUE | 0 | Int16 |
| 7-43 | Process PID Gain Scale at Min. Ref. | 100 % | All set-ups | | TRUE | 0 | Int16 |
| 7-44 | Process PID Gain Scale at Max. Ref. | 100 % | All set-ups | | TRUE | 0 | Int16 |
| 7-45 | Process PID Feed Fwd Resource | [0] No function | All set-ups | | TRUE | - | Ujnt8 |
| 7-46 | Process PID Feed Fwd Normal/ Inv. Ctrl. | [0] Normal | All set-ups | | TRUE | - | Ujnt8 |
| 7-49 | Process PID Output Normal/ Inv. Ctrl. | [0] Normal | All set-ups | | TRUE | - | Ujnt8 |
| 7-5* Position PID Ctrl. | | | | | | | |
| 7-50 | Process PID Extended PID | [1] Enabled | All set-ups | | TRUE | - | Ujnt8 |
| 7-51 | Process PID Feed Fwd Gain | 1.00 N/A | All set-ups | | TRUE | -2 | Ujnt16 |
| 7-52 | Process PID Feed Fwd Ramp up | 0.01 s | All set-ups | | TRUE | -2 | Ujnt32 |
| 7-53 | Process PID Feed Fwd Ramp down | 0.01 s | All set-ups | | TRUE | -2 | Ujnt32 |
| 7-56 | Process PID Ref. Filter Time | 0.001 s | All set-ups | | TRUE | -3 | Ujnt16 |
| 7-57 | Process PID Fb. Filter Time | 0.001 s | All set-ups | | TRUE | -3 | Ujnt16 |

4.1.9 8- ** Comm. and Options

| Par. No. # | Parameter description | Default value | 4-set-up | FC 302 only | Change during operation | Conversion index | Type |
|---------------------------------|-------------------------------|-----------------------------|-------------|-------------|-------------------------|------------------|--------|
| 8-0* General Settings | | | | | | | |
| 8-01 | Control Site | [0] Digital and ctrl.word | All set-ups | | TRUE | - | Ujnt8 |
| 8-02 | Control Word Source | null | All set-ups | | TRUE | - | Ujnt8 |
| 8-03 | Control Word Timeout Time | 1.0 s | 1 set-up | | TRUE | -1 | Ujnt32 |
| 8-04 | Control Word Timeout Function | null | 1 set-up | | TRUE | - | Ujnt8 |
| 8-05 | End-of-Timeout Function | [1] Resume set-up | 1 set-up | | TRUE | - | Ujnt8 |
| 8-06 | Reset Control Word Timeout | [0] Do not reset | All set-ups | | TRUE | - | Ujnt8 |
| 8-07 | Diagnosis Trigger | [0] Disable | 2 set-ups | | TRUE | - | Ujnt8 |
| 8-1* Ctrl. Word Settings | | | | | | | |
| 8-10 | Control Word Profile | [0] FC profile | All set-ups | | TRUE | - | Ujnt8 |
| 8-13 | Configurable Status Word STW | null | All set-ups | | TRUE | - | Ujnt8 |
| 8-14 | Configurable Control Word CTW | [1] Profile default | All set-ups | | TRUE | - | Ujnt8 |
| 8-3* FC Port Settings | | | | | | | |
| 8-30 | Protocol | [0] FC | 1 set-up | | TRUE | - | Ujnt8 |
| 8-31 | Address | 1 N/A | 1 set-up | | TRUE | 0 | Ujnt8 |
| 8-32 | FC Port Baud Rate | null | 1 set-up | | TRUE | - | Ujnt8 |
| 8-33 | Parity / Stop Bits | [0] Even Parity, 1 Stop Bit | 1 set-up | | TRUE | - | Ujnt8 |
| 8-35 | Minimum Response Delay | 10 ms | All set-ups | | TRUE | -3 | Ujnt16 |
| 8-36 | Max Response Delay | SR | 1 set-up | | TRUE | -3 | Ujnt16 |
| 8-37 | Max Inter-Char Delay | SR | 1 set-up | | TRUE | -5 | Ujnt16 |
| 8-4* FC MC protocol set | | | | | | | |
| 8-40 | Telegram selection | [1] Standard telegram 1 | 2 set-ups | | TRUE | - | Ujnt8 |
| 8-5* Digital/Bus | | | | | | | |
| 8-50 | Coasting Select | [3] Logic OR | All set-ups | | TRUE | - | Ujnt8 |
| 8-51 | Quick Stop Select | [3] Logic OR | All set-ups | | TRUE | - | Ujnt8 |
| 8-52 | DC Brake Select | [3] Logic OR | All set-ups | | TRUE | - | Ujnt8 |
| 8-53 | Start Select | [3] Logic OR | All set-ups | | TRUE | - | Ujnt8 |
| 8-54 | Reversing Select | [3] Logic OR | All set-ups | | TRUE | - | Ujnt8 |
| 8-55 | Set-up Select | [3] Logic OR | All set-ups | | TRUE | - | Ujnt8 |
| 8-56 | Preset Reference Select | [3] Logic OR | All set-ups | | TRUE | - | Ujnt8 |
| 8-8* FC Port Diagnostics | | | | | | | |
| 8-80 | Bus Message Count | 0 N/A | All set-ups | | TRUE | 0 | Ujnt32 |
| 8-81 | Bus Error Count | 0 N/A | All set-ups | | TRUE | 0 | Ujnt32 |
| 8-82 | Slave Messages Rcvd | 0 N/A | All set-ups | | TRUE | 0 | Ujnt32 |
| 8-83 | Slave Error Count | 0 N/A | All set-ups | | TRUE | 0 | Ujnt32 |
| 8-9* Bus Jog | | | | | | | |
| 8-90 | Bus Jog 1 Speed | 100 RPM | All set-ups | | TRUE | 67 | Ujnt16 |
| 8-91 | Bus Jog 2 Speed | 200 RPM | All set-ups | | TRUE | 67 | Ujnt16 |

4.1.10 9- * * Profibus

| Par. No. # | Parameter description | Default value | 4-set-up | FC 302 only | Change during operation | Conversion index | Type |
|------------|---------------------------|--------------------------|-------------|-------------|-------------------------|------------------|--------|
| 9-00 | Setpoint | 0 N/A | All set-ups | | TRUE | 0 | Uint16 |
| 9-07 | Actual Value | 0 N/A | All set-ups | | FALSE | 0 | Uint16 |
| 9-15 | PCD Write Configuration | SR | 2 set-ups | | TRUE | - | Uint16 |
| 9-16 | PCD Read Configuration | SR | 2 set-ups | | TRUE | - | Uint16 |
| 9-18 | Node Address | 126 N/A | 1 set-up | | TRUE | 0 | Uint8 |
| 9-22 | Telegram Selection | [108] PPO 8 | 1 set-up | | TRUE | - | Uint8 |
| 9-23 | Parameters for Signals | 0 | All set-ups | | TRUE | - | Uint16 |
| 9-27 | Parameter Edit | [1] Enabled | 2 set-ups | | FALSE | - | Uint16 |
| 9-28 | Process Control | [1] Enable cyclic master | 2 set-ups | | FALSE | - | Uint8 |
| 9-31 | Safe Address | 0 N/A | 1 set-up | | TRUE | 0 | Uint16 |
| 9-44 | Fault Message Counter | 0 N/A | All set-ups | | TRUE | 0 | Uint16 |
| 9-45 | Fault Code | 0 N/A | All set-ups | | TRUE | 0 | Uint16 |
| 9-47 | Fault Number | 0 N/A | All set-ups | | TRUE | 0 | Uint16 |
| 9-52 | Fault Situation Counter | 0 N/A | All set-ups | | TRUE | 0 | Uint16 |
| 9-53 | Profibus Warning Word | 0 N/A | All set-ups | | TRUE | 0 | Uint16 |
| 9-63 | Actual Baud Rate | 0 N/A | All set-ups | | TRUE | 0 | V2 |
| 9-64 | Device Identification | [255] No baudrate found | All set-ups | | TRUE | - | Uint8 |
| 9-65 | Profile Number | 0 N/A | All set-ups | | TRUE | 0 | Uint16 |
| 9-67 | Control Word 1 | 0 N/A | All set-ups | | TRUE | 0 | V2 |
| 9-68 | Status Word 1 | 0 N/A | All set-ups | | TRUE | 0 | V2 |
| 9-71 | Profibus Save Data Values | [0] Off | All set-ups | | TRUE | - | Uint8 |
| 9-72 | ProfibusDriveReset | [0] No action | 1 set-up | | FALSE | - | Uint8 |
| 9-80 | Defined Parameters (1) | 0 N/A | All set-ups | | FALSE | 0 | Uint16 |
| 9-81 | Defined Parameters (2) | 0 N/A | All set-ups | | FALSE | 0 | Uint16 |
| 9-82 | Defined Parameters (3) | 0 N/A | All set-ups | | FALSE | 0 | Uint16 |
| 9-83 | Defined Parameters (4) | 0 N/A | All set-ups | | FALSE | 0 | Uint16 |
| 9-84 | Defined Parameters (5) | 0 N/A | All set-ups | | FALSE | 0 | Uint16 |
| 9-90 | Changed Parameters (1) | 0 N/A | All set-ups | | FALSE | 0 | Uint16 |
| 9-91 | Changed Parameters (2) | 0 N/A | All set-ups | | FALSE | 0 | Uint16 |
| 9-92 | Changed Parameters (3) | 0 N/A | All set-ups | | FALSE | 0 | Uint16 |
| 9-93 | Changed parameters (4) | 0 N/A | All set-ups | | FALSE | 0 | Uint16 |
| 9-94 | Changed parameters (5) | 0 N/A | All set-ups | | FALSE | 0 | Uint16 |
| 9-99 | Profibus Revision Counter | 0 N/A | All set-ups | | TRUE | 0 | Uint16 |

4.1.11 10- * * CAN Fieldbus

| Par. No. # | Parameter description | Default value | 4-set-up | FC 302 only | Change during operation | Conversion index | Type |
|-------------------------------|--------------------------------|---------------|-------------|-------------|-------------------------|------------------|--------|
| 10-0* Common Settings | | | | | | | |
| 10-00 | CAN Protocol | null | 2 set-ups | | FALSE | - | Ujnt8 |
| 10-01 | Baud Rate Select | null | 2 set-ups | | TRUE | - | Ujnt8 |
| 10-02 | MAC ID | SR | 2 set-ups | | TRUE | 0 | Ujnt8 |
| 10-05 | Readout Transmit Error Counter | 0 N/A | All set-ups | | TRUE | 0 | Ujnt8 |
| 10-06 | Readout Receive Error Counter | 0 N/A | All set-ups | | TRUE | 0 | Ujnt8 |
| 10-07 | Readout Bus Off Counter | 0 N/A | All set-ups | | TRUE | 0 | Ujnt8 |
| 10-1* DeviceNet | | | | | | | |
| 10-10 | Process Data Type Selection | null | All set-ups | | TRUE | - | Ujnt8 |
| 10-11 | Process Data Config Write | SR | All set-ups | | TRUE | - | Ujnt16 |
| 10-12 | Process Data Config Read | SR | All set-ups | | TRUE | - | Ujnt16 |
| 10-13 | Warning Parameter | 0 N/A | All set-ups | | TRUE | 0 | Ujnt16 |
| 10-14 | Net Reference | [0] Off | 2 set-ups | | TRUE | - | Ujnt8 |
| 10-15 | Net Control | [0] Off | 2 set-ups | | TRUE | - | Ujnt8 |
| 10-2* COS Filters | | | | | | | |
| 10-20 | COS Filter 1 | 0 N/A | All set-ups | | FALSE | 0 | Ujnt16 |
| 10-21 | COS Filter 2 | 0 N/A | All set-ups | | FALSE | 0 | Ujnt16 |
| 10-22 | COS Filter 3 | 0 N/A | All set-ups | | FALSE | 0 | Ujnt16 |
| 10-23 | COS Filter 4 | 0 N/A | All set-ups | | FALSE | 0 | Ujnt16 |
| 10-3* Parameter Access | | | | | | | |
| 10-30 | Array Index | 0 N/A | 2 set-ups | | TRUE | 0 | Ujnt8 |
| 10-31 | Store Data Values | [0] Off | All set-ups | | TRUE | - | Ujnt8 |
| 10-32 | DeviceNet Revision | SR | All set-ups | | TRUE | 0 | Ujnt16 |
| 10-33 | Store Always | [0] Off | 1 set-up | | TRUE | - | Ujnt8 |
| 10-34 | DeviceNet Product Code | SR | 1 set-up | | TRUE | 0 | Ujnt16 |
| 10-39 | DeviceNet F Parameters | 0 N/A | All set-ups | | TRUE | 0 | Ujnt32 |
| 10-5* CANopen | | | | | | | |
| 10-50 | Process Data Config Write. | SR | 2 set-ups | | TRUE | - | Ujnt16 |
| 10-51 | Process Data Config Read. | SR | 2 set-ups | | TRUE | - | Ujnt16 |

4.1.12 12- ** Ethernet

| Par. No. # | Parameter description | Default value | 4-set-up | FC 302 only | Change during operation | Conversion index | Type |
|---|---------------------------------|--------------------|-------------|-------------|-------------------------|------------------|------------|
| 12-0* IP Settings | | | | | | | |
| 12-00 | IP Address Assignment | [0] MANUAL | All set-ups | | TRUE | - | Ujnt8 |
| 12-01 | IP Address | 0 N/A | All set-ups | | TRUE | 0 | OctStr[4] |
| 12-02 | Subnet Mask | 0 N/A | All set-ups | | TRUE | 0 | OctStr[4] |
| 12-03 | Default Gateway | 0 N/A | All set-ups | | TRUE | 0 | OctStr[4] |
| 12-04 | DHCP Server | 0 N/A | All set-ups | | TRUE | 0 | OctStr[4] |
| 12-05 | Lease Expires | SR | All set-ups | | TRUE | 0 | TimD |
| 12-06 | Name Servers | 0 N/A | All set-ups | | TRUE | 0 | OctStr[4] |
| 12-07 | Domain Name | 0 N/A | All set-ups | | TRUE | 0 | VisStr[48] |
| 12-08 | Host Name | 0 N/A | All set-ups | | TRUE | 0 | VisStr[48] |
| 12-09 | Physical Address | 0 N/A | All set-ups | | TRUE | 0 | VisStr[17] |
| 12-1* Ethernet Link Parameters | | | | | | | |
| 12-10 | Link Status | [0] No Link | All set-ups | | TRUE | - | Ujnt8 |
| 12-11 | Link Duration | SR | All set-ups | | TRUE | 0 | TimD |
| 12-12 | Auto Negotiation | [1] On | All set-ups | | TRUE | - | Ujnt8 |
| 12-13 | Link Speed | [0] None | All set-ups | | TRUE | - | Ujnt8 |
| 12-14 | Link Duplex | [1] Full Duplex | All set-ups | | TRUE | - | Ujnt8 |
| 12-2* Process Data | | | | | | | |
| 12-20 | Control Instance | SR | All set-ups | | TRUE | 0 | Ujnt8 |
| 12-21 | Process Data Config Write | SR | 2 set-ups | | TRUE | - | Ujnt16 |
| 12-22 | Process Data Config Read | SR | 2 set-ups | | TRUE | - | Ujnt16 |
| 12-28 | Store Data Values | [0] Off | All set-ups | | TRUE | - | Ujnt8 |
| 12-29 | Store Always | [0] Off | 1 set-up | | TRUE | - | Ujnt8 |
| 12-3* EtherNet/IP | | | | | | | |
| 12-30 | Warning Parameter | 0 N/A | All set-ups | | TRUE | 0 | Ujnt16 |
| 12-31 | Net Reference | [0] Off | All set-ups | | TRUE | - | Ujnt8 |
| 12-32 | Net Control | [0] Off | All set-ups | | TRUE | - | Ujnt8 |
| 12-33 | CIP Revision | SR | All set-ups | | TRUE | 0 | Ujnt16 |
| 12-34 | CIP Product Code | SR | 1 set-up | | TRUE | 0 | Ujnt16 |
| 12-35 | EDS Parameter | 0 N/A | All set-ups | | TRUE | 0 | Ujnt32 |
| 12-37 | COS Inhibit Timer | 0 N/A | All set-ups | | TRUE | 0 | Ujnt16 |
| 12-38 | COS Filter | 0 N/A | All set-ups | | TRUE | 0 | Ujnt16 |
| 12-8* Other Ethernet Services | | | | | | | |
| 12-80 | FTP Server | [0] Disabled | All set-ups | | TRUE | - | Ujnt8 |
| 12-81 | HTTP Server | [0] Disabled | All set-ups | | TRUE | - | Ujnt8 |
| 12-82 | SMTP Service | [0] Disabled | All set-ups | | TRUE | - | Ujnt8 |
| 12-89 | Transparent Socket Channel Port | 0 N/A | All set-ups | | TRUE | 0 | Ujnt16 |
| 12-9* Advanced Ethernet Services | | | | | | | |
| 12-90 | Cable Diagnostic | [0] Disabled | All set-ups | | TRUE | - | Ujnt8 |
| 12-91 | MDI-X | [1] Enabled | All set-ups | | TRUE | - | Ujnt8 |
| 12-92 | IGMP Snooping | [1] Enabled | All set-ups | | TRUE | - | Ujnt8 |
| 12-93 | Cable Error Length | 0 N/A | All set-ups | | TRUE | 0 | Ujnt16 |
| 12-94 | Broadcast Storm Protection | -1 % | All set-ups | | TRUE | 0 | Int8 |
| 12-95 | Broadcast Storm Filter | [0] Broadcast only | All set-ups | | TRUE | - | Ujnt8 |
| 12-98 | Interface Counters | 0 N/A | All set-ups | | TRUE | 0 | Ujnt16 |
| 12-99 | Media Counters | 0 N/A | All set-ups | | TRUE | 0 | Ujnt16 |

4.1.13 13- ** Smart Logic

| Par. No. # | Parameter description | Default value | 4-set-up | FC 302 only | Change during operation | Conversion index | Type |
|---------------------------|-----------------------|----------------------|-------------|-------------|-------------------------|------------------|-------|
| 13-0* SLC Settings | | | | | | | |
| 13-00 | SL Controller Mode | null | 2 set-ups | | TRUE | - | Ujnt8 |
| 13-01 | Start Event | null | 2 set-ups | | TRUE | - | Ujnt8 |
| 13-02 | Stop Event | null | 2 set-ups | | TRUE | - | Ujnt8 |
| 13-03 | Reset SLC | [0] Do not reset SLC | All set-ups | | TRUE | - | Ujnt8 |
| 13-1* Comparators | | | | | | | |
| 13-10 | Comparator Operand | null | 2 set-ups | | TRUE | - | Ujnt8 |
| 13-11 | Comparator Operator | null | 2 set-ups | | TRUE | - | Ujnt8 |
| 13-12 | Comparator Value | SR | 2 set-ups | | TRUE | -3 | Int32 |
| 13-2* Timers | | | | | | | |
| 13-20 | SL Controller Timer | SR | 1 set-up | | TRUE | -3 | TimD |
| 13-4* Logic Rules | | | | | | | |
| 13-40 | Logic Rule Boolean 1 | null | 2 set-ups | | TRUE | - | Ujnt8 |
| 13-41 | Logic Rule Operator 1 | null | 2 set-ups | | TRUE | - | Ujnt8 |
| 13-42 | Logic Rule Boolean 2 | null | 2 set-ups | | TRUE | - | Ujnt8 |
| 13-43 | Logic Rule Operator 2 | null | 2 set-ups | | TRUE | - | Ujnt8 |
| 13-44 | Logic Rule Boolean 3 | null | 2 set-ups | | TRUE | - | Ujnt8 |
| 13-5* States | | | | | | | |
| 13-51 | SL Controller Event | null | 2 set-ups | | TRUE | - | Ujnt8 |
| 13-52 | SL Controller Action | null | 2 set-ups | | TRUE | - | Ujnt8 |

4.1.14 14- ** Special Functions

| Par. No. # | Parameter description | Default value | 4-set-up | FC 302 only | Change during operation | Conversion index | Type |
|----------------------------------|-------------------------------------|----------------------|-------------|-------------|-------------------------|------------------|--------|
| 14-0* Inverter Switching | | | | | | | |
| 14-00 | Switching Pattern | [1] SFAYM | All set-ups | | TRUE | - | Ujnt8 |
| 14-01 | Switching Frequency | null | All set-ups | | TRUE | - | Ujnt8 |
| 14-03 | Overmodulation | [1] On | All set-ups | | FALSE | - | Ujnt8 |
| 14-04 | PWM Random | [0] Off | All set-ups | | TRUE | - | Ujnt8 |
| 14-1* Mains On/Off | | | | | | | |
| 14-10 | Mains Failure | [0] No function | All set-ups | | FALSE | - | Ujnt8 |
| 14-11 | Mains Voltage at Mains Fault | SR | All set-ups | | TRUE | 0 | Ujnt16 |
| 14-12 | Function at Mains Imbalance | [0] Trip | All set-ups | | TRUE | - | Ujnt8 |
| 14-2* Trip Reset | | | | | | | |
| 14-20 | Reset Mode | [0] Manual reset | All set-ups | | TRUE | - | Ujnt8 |
| 14-21 | Automatic Restart Time | 10 s | All set-ups | | TRUE | 0 | Ujnt16 |
| 14-22 | Operation Mode | [0] Normal operation | All set-ups | | TRUE | - | Ujnt8 |
| 14-23 | Typecode Setting | null | 2 set-ups | | FALSE | - | Ujnt8 |
| 14-24 | Trip Delay at Current Limit | 60 s | All set-ups | | TRUE | 0 | Ujnt8 |
| 14-25 | Trip Delay at Torque Limit | 60 s | All set-ups | | TRUE | 0 | Ujnt8 |
| 14-26 | Trip Delay at Inverter Fault | SR | All set-ups | | TRUE | 0 | Ujnt8 |
| 14-28 | Production Settings | [0] No action | All set-ups | | TRUE | - | Ujnt8 |
| 14-29 | Service Code | 0 N/A | All set-ups | | TRUE | 0 | Int32 |
| 14-3* Current Limit Ctrl. | | | | | | | |
| 14-30 | Current Lim Ctrl, Proportional Gain | 100 % | All set-ups | | FALSE | 0 | Ujnt16 |
| 14-31 | Current Lim Ctrl, Integration Time | 0.020 s | All set-ups | | FALSE | -3 | Ujnt16 |
| 14-32 | Current Lim Ctrl, Filter Time | 1.0 ms | All set-ups | | TRUE | -4 | Ujnt16 |
| 14-35 | Stall Protection | [1] Enabled | All set-ups | | FALSE | - | Ujnt8 |
| 14-4* Energy Optimising | | | | | | | |
| 14-40 | VT Level | 66 % | All set-ups | | FALSE | 0 | Ujnt8 |
| 14-41 | AEO Minimum Magnetisation | SR | All set-ups | | TRUE | 0 | Ujnt8 |
| 14-42 | Minimum AEO Frequency | 10 Hz | All set-ups | | TRUE | 0 | Ujnt8 |
| 14-43 | Motor Cosphi | SR | All set-ups | | TRUE | -2 | Ujnt16 |
| 14-5* Environment | | | | | | | |
| 14-50 | RFI Filter | [1] On | 1 set-up | x | FALSE | - | Ujnt8 |
| 14-52 | Fan Control | [0] Auto | All set-ups | | TRUE | - | Ujnt8 |
| 14-53 | Fan Monitor | [1] Warning | All set-ups | | TRUE | - | Ujnt8 |
| 14-55 | Output Filter | [0] No Filter | All set-ups | | FALSE | - | Ujnt8 |
| 14-56 | Capacitance Output Filter | 2.0 uF | All set-ups | | FALSE | -7 | Ujnt16 |
| 14-57 | Inductance Output Filter | 7.000 mH | All set-ups | | FALSE | -6 | Ujnt16 |
| 14-59 | Actual Number of Inverter Units | SR | 1 set-up | | FALSE | 0 | Ujnt8 |
| 14-7* Compatibility | | | | | | | |
| 14-72 | VLT Alarm Word | 0 N/A | All set-ups | | FALSE | 0 | Ujnt32 |
| 14-73 | VLT Warning Word | 0 N/A | All set-ups | | FALSE | 0 | Ujnt32 |
| 14-74 | VLT Ext. Status Word | 0 N/A | All set-ups | | FALSE | 0 | Ujnt32 |
| 14-8* Options | | | | | | | |
| 14-80 | Option Supplied by External 24VDC | [1] Yes | 2 set-ups | | FALSE | - | Ujnt8 |

4.1.15 15- * * Drive Information

| Par. No. # | Parameter description | Default value | 4-set-up | FC 302 only | Change during operation | Conversion index | Type |
|-----------------------------------|-----------------------------------|------------------|-------------|-------------|-------------------------|------------------|------------|
| 15-0* Operating Data | | | | | | | |
| 15-00 | Operating Hours | 0 h | All set-ups | | FALSE | 74 | Ujnt32 |
| 15-01 | Running Hours | 0 h | All set-ups | | FALSE | 74 | Ujnt32 |
| 15-02 | kWh Counter | 0 kWh | All set-ups | | FALSE | 75 | Ujnt32 |
| 15-03 | Power Up's | 0 N/A | All set-ups | | FALSE | 0 | Ujnt32 |
| 15-04 | Over Temp's | 0 N/A | All set-ups | | FALSE | 0 | Ujnt16 |
| 15-05 | Over Volt's | 0 N/A | All set-ups | | FALSE | 0 | Ujnt16 |
| 15-06 | Reset kWh Counter | [0] Do not reset | All set-ups | | TRUE | - | Ujnt8 |
| 15-07 | Reset Running Hours Counter | [0] Do not reset | All set-ups | | TRUE | - | Ujnt8 |
| 15-1* Data Log Settings | | | | | | | |
| 15-10 | Logging Source | 0 | 2 set-ups | | TRUE | - | Ujnt16 |
| 15-11 | Logging Interval | SR | 2 set-ups | | TRUE | -3 | TimD |
| 15-12 | Trigger Event | [0] False | 1 set-up | | TRUE | - | Ujnt8 |
| 15-13 | Logging Mode | [0] Log always | 2 set-ups | | TRUE | - | Ujnt8 |
| 15-14 | Samples Before Trigger | 50 N/A | 2 set-ups | | TRUE | 0 | Ujnt8 |
| 15-2* Historic Log | | | | | | | |
| 15-20 | Historic Log: Event | 0 N/A | All set-ups | | FALSE | 0 | Ujnt8 |
| 15-21 | Historic Log: Value | 0 N/A | All set-ups | | FALSE | 0 | Ujnt32 |
| 15-22 | Historic Log: Time | 0 ms | All set-ups | | FALSE | -3 | Ujnt32 |
| 15-3* Fault Log | | | | | | | |
| 15-30 | Fault Log: Error Code | 0 N/A | All set-ups | | FALSE | 0 | Ujnt8 |
| 15-31 | Fault Log: Value | 0 N/A | All set-ups | | FALSE | 0 | Int16 |
| 15-32 | Fault Log: Time | 0 s | All set-ups | | FALSE | 0 | Ujnt32 |
| 15-4* Drive Identification | | | | | | | |
| 15-40 | FC Type | 0 N/A | All set-ups | | FALSE | 0 | VisStr[6] |
| 15-41 | Power Section | 0 N/A | All set-ups | | FALSE | 0 | VisStr[20] |
| 15-42 | Voltage | 0 N/A | All set-ups | | FALSE | 0 | VisStr[20] |
| 15-43 | Software Version | 0 N/A | All set-ups | | FALSE | 0 | VisStr[15] |
| 15-44 | Ordered Typecode String | 0 N/A | All set-ups | | FALSE | 0 | VisStr[40] |
| 15-45 | Actual Typecode String | 0 N/A | All set-ups | | FALSE | 0 | VisStr[40] |
| 15-46 | Frequency Converter Ordering No | 0 N/A | All set-ups | | FALSE | 0 | VisStr[8] |
| 15-47 | Power Card Ordering No | 0 N/A | All set-ups | | FALSE | 0 | VisStr[8] |
| 15-48 | LCP Id No | 0 N/A | All set-ups | | FALSE | 0 | VisStr[8] |
| 15-49 | SW ID Control Card | 0 N/A | All set-ups | | FALSE | 0 | VisStr[20] |
| 15-50 | SW ID Power Card | 0 N/A | All set-ups | | FALSE | 0 | VisStr[20] |
| 15-51 | Frequency Converter Serial Number | 0 N/A | All set-ups | | FALSE | 0 | VisStr[20] |
| 15-53 | Power Card Serial Number | 0 N/A | All set-ups | | FALSE | 0 | VisStr[19] |

| Par. No. # | Parameter description | Default value | 4-set-up | FC 302 only | Change during operation | Conversion index | Type |
|-----------------------------|---------------------------|---------------|-------------|-------------|-------------------------|------------------|------------|
| 15-6* Option Ident | | | | | | | |
| 15-60 | Option Mounted | 0 N/A | All set-ups | | FALSE | 0 | VisStr[30] |
| 15-61 | Option SW Version | 0 N/A | All set-ups | | FALSE | 0 | VisStr[20] |
| 15-62 | Option Ordering No | 0 N/A | All set-ups | | FALSE | 0 | VisStr[8] |
| 15-63 | Option Serial No | 0 N/A | All set-ups | | FALSE | 0 | VisStr[18] |
| 15-70 | Option in Slot A | 0 N/A | All set-ups | | FALSE | 0 | VisStr[30] |
| 15-71 | Slot A Option SW Version | 0 N/A | All set-ups | | FALSE | 0 | VisStr[20] |
| 15-72 | Option in Slot B | 0 N/A | All set-ups | | FALSE | 0 | VisStr[30] |
| 15-73 | Slot B Option SW Version | 0 N/A | All set-ups | | FALSE | 0 | VisStr[20] |
| 15-74 | Option in Slot C0 | 0 N/A | All set-ups | | FALSE | 0 | VisStr[30] |
| 15-75 | Slot C0 Option SW Version | 0 N/A | All set-ups | | FALSE | 0 | VisStr[20] |
| 15-76 | Option in Slot C1 | 0 N/A | All set-ups | | FALSE | 0 | VisStr[30] |
| 15-77 | Slot C1 Option SW Version | 0 N/A | All set-ups | | FALSE | 0 | VisStr[20] |
| 15-9* Parameter Info | | | | | | | |
| 15-92 | Defined Parameters | 0 N/A | All set-ups | | FALSE | 0 | Uint16 |
| 15-93 | Modified Parameters | 0 N/A | All set-ups | | FALSE | 0 | Uint16 |
| 15-98 | Drive Identification | 0 N/A | All set-ups | | FALSE | 0 | VisStr[40] |
| 15-99 | Parameter Metadata | 0 N/A | All set-ups | | FALSE | 0 | Uint16 |

4.1.16 16- ** Data Readouts

| Par. No. # | Parameter description | Default value | 4-set-up | FC 302 only | Change during operation | Conversion index | Type |
|--------------------------------|------------------------|-----------------------------|-------------|-------------|-------------------------|------------------|--------|
| 16-0* General Status | | | | | | | |
| 16-00 | Control Word | 0 N/A | All set-ups | | FALSE | 0 | V2 |
| 16-01 | Reference [Unit] | 0.000 ReferenceFeedbackUnit | All set-ups | | FALSE | -3 | Int32 |
| 16-02 | Reference % | 0.0 % | All set-ups | | FALSE | -1 | Int16 |
| 16-03 | Status Word | 0 N/A | All set-ups | | FALSE | 0 | V2 |
| 16-05 | Main Actual Value [%] | 0.00 % | All set-ups | | FALSE | -2 | N2 |
| 16-09 | Custom Readout | 0.00 CustomReadoutUnit | All set-ups | | FALSE | -2 | Int32 |
| 16-1* Motor Status | | | | | | | |
| 16-10 | Power [kW] | 0.00 kW | All set-ups | | FALSE | 1 | Int32 |
| 16-11 | Power [hp] | 0.00 hp | All set-ups | | FALSE | -2 | Int32 |
| 16-12 | Motor Voltage | 0.0 V | All set-ups | | FALSE | -1 | Uint16 |
| 16-13 | Frequency | 0.0 Hz | All set-ups | | FALSE | -1 | Uint16 |
| 16-14 | Motor Current | 0.00 A | All set-ups | | FALSE | -2 | Int32 |
| 16-15 | Frequency [%] | 0.00 % | All set-ups | | FALSE | -2 | N2 |
| 16-16 | Torque [Nm] | 0.0 Nm | All set-ups | | FALSE | -1 | Int16 |
| 16-17 | Speed [RPM] | 0 RPM | All set-ups | | FALSE | 67 | Int32 |
| 16-18 | Motor Thermal | 0 % | All set-ups | | FALSE | 0 | Uint8 |
| 16-19 | KTY sensor temperature | 0 °C | All set-ups | | FALSE | 100 | Int16 |
| 16-20 | Motor Angle | 0 N/A | All set-ups | | TRUE | 0 | Uint16 |
| 16-22 | Torque [%] | 0 % | All set-ups | | FALSE | 0 | Int16 |
| 16-25 | Torque [Nm] High | 0.0 Nm | All set-ups | | FALSE | -1 | Int32 |
| 16-3* Drive Status | | | | | | | |
| 16-30 | DC Link Voltage | 0 V | All set-ups | | FALSE | 0 | Uint16 |
| 16-32 | Brake Energy /s | 0.000 kW | All set-ups | | FALSE | 0 | Uint32 |
| 16-33 | Brake Energy /2 min | 0.000 kW | All set-ups | | FALSE | 0 | Uint32 |
| 16-34 | Heatsink Temp. | 0 °C | All set-ups | | FALSE | 100 | Uint8 |
| 16-35 | Inverter Thermal | 0 % | All set-ups | | FALSE | 0 | Uint8 |
| 16-36 | Inv. Nom. Current | SR | All set-ups | | FALSE | -2 | Uint32 |
| 16-37 | Inv. Max. Current | SR | All set-ups | | FALSE | -2 | Uint32 |
| 16-38 | Sl. Controller State | 0 N/A | All set-ups | | FALSE | 0 | Uint8 |
| 16-39 | Control Card Temp. | 0 °C | All set-ups | | FALSE | 100 | Uint8 |
| 16-40 | Logging Buffer Full | [0] No | All set-ups | | TRUE | - | Uint8 |
| 16-5* Ref. & Feedb. | | | | | | | |
| 16-50 | External Reference | 0.0 N/A | All set-ups | | FALSE | -1 | Int16 |
| 16-51 | Pulse Reference | 0.0 N/A | All set-ups | | FALSE | -1 | Int16 |
| 16-52 | Feedback [Unit] | 0.000 ReferenceFeedbackUnit | All set-ups | | FALSE | -3 | Int32 |
| 16-53 | Digi Pot Reference | 0.00 N/A | All set-ups | | FALSE | -2 | Int16 |

| Par. No. # | Parameter description | Default value | 4-set-up | FC 302 only | Change during operation | Conversion index | Type |
|-------------------------------------|----------------------------|---------------|-------------|-------------|-------------------------|------------------|--------|
| 16-6* Inputs & Outputs | | | | | | | |
| 16-60 | Digital Input | 0 N/A | All set-ups | | FALSE | 0 | Uint16 |
| 16-61 | Terminal 53 Switch Setting | [0] Current | All set-ups | | FALSE | - | Uint8 |
| 16-62 | Analog Input 53 | 0.000 N/A | All set-ups | | FALSE | -3 | Int32 |
| 16-63 | Terminal 54 Switch Setting | [0] Current | All set-ups | | FALSE | - | Uint8 |
| 16-64 | Analog Input 54 | 0.000 N/A | All set-ups | | FALSE | -3 | Int32 |
| 16-65 | Analog Output 42 [mA] | 0.000 N/A | All set-ups | | FALSE | -3 | Int16 |
| 16-66 | Digital Output [bin] | 0 N/A | All set-ups | | FALSE | 0 | Int16 |
| 16-67 | Freq. Input #29 [Hz] | 0 N/A | All set-ups | x | FALSE | 0 | Int32 |
| 16-68 | Freq. Input #33 [Hz] | 0 N/A | All set-ups | | FALSE | 0 | Int32 |
| 16-69 | Pulse Output #27 [Hz] | 0 N/A | All set-ups | | FALSE | 0 | Int32 |
| 16-70 | Pulse Output #29 [Hz] | 0 N/A | All set-ups | x | FALSE | 0 | Int32 |
| 16-71 | Relay Output [bin] | 0 N/A | All set-ups | | FALSE | 0 | Int16 |
| 16-72 | Counter A | 0 N/A | All set-ups | | TRUE | 0 | Int32 |
| 16-73 | Counter B | 0 N/A | All set-ups | | TRUE | 0 | Int32 |
| 16-74 | Prec. Stop Counter | 0 N/A | All set-ups | | TRUE | 0 | Uint32 |
| 16-75 | Analog In X30/11 | 0.000 N/A | All set-ups | | FALSE | -3 | Int32 |
| 16-76 | Analog In X30/12 | 0.000 N/A | All set-ups | | FALSE | -3 | Int32 |
| 16-77 | Analog Out X30/8 [mA] | 0.000 N/A | All set-ups | | FALSE | -3 | Int16 |
| 16-78 | Analog Out X45/1 [mA] | 0.000 N/A | All set-ups | | FALSE | -3 | Int16 |
| 16-79 | Analog Out X45/3 [mA] | 0.000 N/A | All set-ups | | FALSE | -3 | Int16 |
| 16-8* Fieldbus & FC Port | | | | | | | |
| 16-80 | Fieldbus CTW 1 | 0 N/A | All set-ups | | FALSE | 0 | V2 |
| 16-82 | Fieldbus REF 1 | 0 N/A | All set-ups | | FALSE | 0 | N2 |
| 16-84 | Comm. Option STW | 0 N/A | All set-ups | | FALSE | 0 | V2 |
| 16-85 | FC Port CTW 1 | 0 N/A | All set-ups | | FALSE | 0 | V2 |
| 16-86 | FC Port REF 1 | 0 N/A | All set-ups | | FALSE | 0 | N2 |
| 16-9* Diagnosis Readouts | | | | | | | |
| 16-90 | Alarm Word | 0 N/A | All set-ups | | FALSE | 0 | Uint32 |
| 16-91 | Alarm Word 2 | 0 N/A | All set-ups | | FALSE | 0 | Uint32 |
| 16-92 | Warning Word | 0 N/A | All set-ups | | FALSE | 0 | Uint32 |
| 16-93 | Warning Word 2 | 0 N/A | All set-ups | | FALSE | 0 | Uint32 |
| 16-94 | Ext. Status Word | 0 N/A | All set-ups | | FALSE | 0 | Uint32 |

4.1.17 17- * * Motor Feedb.Option

| Par. No. # | Parameter description | Default value | 4-set-up | FC 302 only | Change during operation | Conversion index | Type |
|----------------------------------|----------------------------|--------------------|-------------|-------------|-------------------------|------------------|--------|
| 17-1* Inc. Enc. Interface | | | | | | | |
| 17-10 | Signal Type | [1] RS422 (5V TTL) | All set-ups | | FALSE | - | Ujnt8 |
| 17-11 | Resolution (PPR) | 1024 N/A | All set-ups | | FALSE | 0 | Ujnt16 |
| 17-2* Abs. Enc. Interface | | | | | | | |
| 17-20 | Protocol Selection | [0] None | All set-ups | | FALSE | - | Ujnt8 |
| 17-21 | Resolution (Positions/Rev) | SR | All set-ups | | FALSE | 0 | Ujnt32 |
| 17-24 | SSI Data Length | 13 N/A | All set-ups | | FALSE | 0 | Ujnt8 |
| 17-25 | Clock Rate | SR | All set-ups | | FALSE | 3 | Ujnt16 |
| 17-26 | SSI Data Format | [0] Gray code | All set-ups | | FALSE | - | Ujnt8 |
| 17-34 | HIPERFACE Baudrate | [4] 9600 | All set-ups | | FALSE | - | Ujnt8 |
| 17-5* Resolver Interface | | | | | | | |
| 17-50 | Poles | 2 N/A | 1 set-up | | FALSE | 0 | Ujnt8 |
| 17-51 | Input Voltage | 7.0 V | 1 set-up | | FALSE | -1 | Ujnt8 |
| 17-52 | Input Frequency | 10.0 kHz | 1 set-up | | FALSE | 2 | Ujnt8 |
| 17-53 | Transformation Ratio | 0.5 N/A | 1 set-up | | FALSE | -1 | Ujnt8 |
| 17-59 | Resolver Interface | [0] Disabled | All set-ups | | FALSE | - | Ujnt8 |
| 17-6* Monitoring and App. | | | | | | | |
| 17-60 | Feedback Direction | [0] Clockwise | All set-ups | | FALSE | - | Ujnt8 |
| 17-61 | Feedback Signal Monitoring | [1] Warning | All set-ups | | TRUE | - | Ujnt8 |

4.1.18 18- ** Data Readouts 2

| Par. No. # | Parameter description | Default value | 4-set-up | FC 302 only | Change during operation | Conversion index | Type |
|---------------------------|--------------------------------|---------------|-------------|-------------|-------------------------|------------------|-------|
| 18-90 PID Readouts | | | | | | | |
| 18-90 | Process PID Error | 0.0 % | All set-ups | | FALSE | -1 | Int16 |
| 18-91 | Process PID Output | 0.0 % | All set-ups | | FALSE | -1 | Int16 |
| 18-92 | Process PID Clamped Output | 0.0 % | All set-ups | | FALSE | -1 | Int16 |
| 18-93 | Process PID Gain Scaled Output | 0.0 % | All set-ups | | FALSE | -1 | Int16 |

4.1.19 30- * * Special Features

| Par. No. # | Parameter description | Default value | 4-set-up | FC 302 only | Change during operation | Conversion index | Type |
|--------------------------------|-------------------------------------|---------------------------|-------------|-------------|-------------------------|------------------|--------|
| 30-0* | Wobbler | | | | | | |
| 30-00 | Wobbler Mode | [0] Abs. Freq., Abs. Time | All set-ups | | FALSE | - | Uint8 |
| 30-01 | Wobble Delta Frequency [Hz] | 5.0 Hz | All set-ups | | TRUE | -1 | Uint8 |
| 30-02 | Wobble Delta Frequency [%] | 25 % | All set-ups | | TRUE | 0 | Uint8 |
| 30-03 | Wobble Delta Freq. Scaling Resource | [0] No function | All set-ups | | TRUE | - | Uint8 |
| 30-04 | Wobble Jump Frequency [Hz] | 0.0 Hz | All set-ups | | TRUE | -1 | Uint8 |
| 30-05 | Wobble Jump Frequency [%] | 0 % | All set-ups | | TRUE | 0 | Uint8 |
| 30-06 | Wobble Jump Time | SR | All set-ups | | TRUE | -3 | Uint16 |
| 30-07 | Wobble Sequence Time | 10.0 s | All set-ups | | TRUE | -1 | Uint16 |
| 30-08 | Wobble Up/ Down Time | 5.0 s | All set-ups | | TRUE | -1 | Uint16 |
| 30-09 | Wobble Random Function | [0] Off | All set-ups | | TRUE | - | Uint8 |
| 30-10 | Wobble Ratio | 1.0 N/A | All set-ups | | TRUE | -1 | Uint8 |
| 30-11 | Wobble Random Ratio Max. | 10.0 N/A | All set-ups | | TRUE | -1 | Uint8 |
| 30-12 | Wobble Random Ratio Min. | 0.1 N/A | All set-ups | | TRUE | -1 | Uint8 |
| 30-19 | Wobble Delta Freq. Scaled | 0.0 Hz | All set-ups | | FALSE | -1 | Uint16 |
| 30-8* Compatibility (1) | | | | | | | |
| 30-80 | d-axis Inductance (Ld) | SR | All set-ups | | FALSE | -6 | Int32 |
| 30-81 | Brake Resistor (ohm) | SR | All set-ups | | TRUE | -2 | Uint32 |
| 30-83 | Speed PID Proportional Gain | SR | All set-ups | | TRUE | -4 | Uint32 |
| 30-84 | Process PID Proportional Gain | 0.100 N/A | All set-ups | | TRUE | -3 | Uint16 |

4.1.20 32- ** MCO Basic Settings

| Par. No. # | Parameter description | Default value | 4-set-up | FC 302 only | Change during operation | Conversion index | Type |
|------------------------------------|---|-----------------------|-----------|-------------|-------------------------|------------------|--------|
| 32-0* Encoder 2 | | | | | | | |
| 32-00 | Incremental Signal Type | [1] RS422 (5V TTL) | 2 set-ups | | TRUE | - | Ujnt8 |
| 32-01 | Incremental Resolution | 1024 N/A | 2 set-ups | | TRUE | 0 | Ujnt32 |
| 32-02 | Absolute Protocol | [0] None | 2 set-ups | | TRUE | - | Ujnt8 |
| 32-03 | Absolute Resolution | 8192 N/A | 2 set-ups | | TRUE | 0 | Ujnt32 |
| 32-05 | Absolute Encoder Data Length | 25 N/A | 2 set-ups | | TRUE | 0 | Ujnt8 |
| 32-06 | Absolute Encoder Clock Frequency | 262,000 KHz | 2 set-ups | | TRUE | 0 | Ujnt32 |
| 32-07 | Absolute Encoder Clock Generation | [1] On | 2 set-ups | | TRUE | - | Ujnt8 |
| 32-08 | Absolute Encoder Cable Length | 0 m | 2 set-ups | | TRUE | 0 | Ujnt16 |
| 32-09 | Encoder Monitoring | [0] Off | 2 set-ups | | TRUE | - | Ujnt8 |
| 32-10 | Rotational Direction | [1] No action | 2 set-ups | | TRUE | - | Ujnt8 |
| 32-11 | User Unit Denominator | 1 N/A | 2 set-ups | | TRUE | 0 | Ujnt32 |
| 32-12 | User Unit Numerator | 1 N/A | 2 set-ups | | TRUE | 0 | Ujnt32 |
| 32-3* Encoder 1 | | | | | | | |
| 32-30 | Incremental Signal Type | [1] RS422 (5V TTL) | 2 set-ups | | TRUE | - | Ujnt8 |
| 32-31 | Incremental Resolution | 1024 N/A | 2 set-ups | | TRUE | 0 | Ujnt32 |
| 32-32 | Absolute Protocol | [0] None | 2 set-ups | | TRUE | - | Ujnt8 |
| 32-33 | Absolute Resolution | 8192 N/A | 2 set-ups | | TRUE | 0 | Ujnt32 |
| 32-35 | Absolute Encoder Data Length | 25 N/A | 2 set-ups | | TRUE | 0 | Ujnt8 |
| 32-36 | Absolute Encoder Clock Frequency | 262,000 KHz | 2 set-ups | | TRUE | 0 | Ujnt32 |
| 32-37 | Absolute Encoder Clock Generation | [1] On | 2 set-ups | | TRUE | - | Ujnt8 |
| 32-38 | Absolute Encoder Cable Length | 0 m | 2 set-ups | | TRUE | 0 | Ujnt16 |
| 32-39 | Encoder Monitoring | [0] Off | 2 set-ups | | TRUE | - | Ujnt8 |
| 32-40 | Encoder Termination | [1] On | 2 set-ups | | TRUE | - | Ujnt8 |
| 32-5* Feedback Source | | | | | | | |
| 32-50 | Source Slave | [2] Encoder 2 | 2 set-ups | | TRUE | - | Ujnt8 |
| 32-51 | MCO 302 Last Will | [1] Trip | 2 set-ups | | TRUE | - | Ujnt8 |
| 32-6* PID Controller | | | | | | | |
| 32-60 | Proportional factor | 30 N/A | 2 set-ups | | TRUE | 0 | Ujnt32 |
| 32-61 | Derivative factor | 0 N/A | 2 set-ups | | TRUE | 0 | Ujnt32 |
| 32-62 | Integral factor | 0 N/A | 2 set-ups | | TRUE | 0 | Ujnt32 |
| 32-63 | Limit Value for Integral Sum | 1000 N/A | 2 set-ups | | TRUE | 0 | Ujnt16 |
| 32-64 | PID Bandwidth | 1000 N/A | 2 set-ups | | TRUE | 0 | Ujnt16 |
| 32-65 | Velocity Feed-Forward | 0 N/A | 2 set-ups | | TRUE | 0 | Ujnt32 |
| 32-66 | Acceleration Feed-Forward | 0 N/A | 2 set-ups | | TRUE | 0 | Ujnt32 |
| 32-67 | Max. Tolerated Position Error | 20000 N/A | 2 set-ups | | TRUE | 0 | Ujnt32 |
| 32-68 | Reverse Behavior for Slave | [0] Reversing allowed | 2 set-ups | | TRUE | - | Ujnt8 |
| 32-69 | Sampling Time for PID Control | 1 ms | 2 set-ups | | TRUE | -3 | Ujnt16 |
| 32-70 | Scan Time for Profile Generator | 1 ms | 2 set-ups | | TRUE | -3 | Ujnt8 |
| 32-71 | Size of the Control Window (Activation) | 0 N/A | 2 set-ups | | TRUE | 0 | Ujnt32 |
| 32-72 | Size of the Control Window (Deactiv.) | 0 N/A | 2 set-ups | | TRUE | 0 | Ujnt32 |
| 32-8* Velocity & Accel. | | | | | | | |
| 32-80 | Maximum Velocity (Encoder) | 1500 RPM | 2 set-ups | | TRUE | 67 | Ujnt32 |
| 32-81 | Shortest Ramp | 1.000 s | 2 set-ups | | TRUE | -3 | Ujnt32 |
| 32-82 | Ramp Type | [0] Linear | 2 set-ups | | TRUE | - | Ujnt8 |
| 32-83 | Velocity Resolution | 100 N/A | 2 set-ups | | TRUE | 0 | Ujnt32 |
| 32-84 | Default Velocity | 50 N/A | 2 set-ups | | TRUE | 0 | Ujnt32 |
| 32-85 | Default Acceleration | 50 N/A | 2 set-ups | | TRUE | 0 | Ujnt32 |
| 32-9* Development | | | | | | | |
| 32-90 | Debug Source | [0] Controlcard | 2 set-ups | | TRUE | - | Ujnt8 |

4.1.21 33- * * MCO Adv. Settings

| Par. No. # | Parameter description | Default value | 4-set-up | FC 302 only | Change during operation | Conversion index | Type |
|------------------------------|-------------------------------------|------------------------|-----------|-------------|-------------------------|------------------|--------|
| 33-0* Home Motion | | | | | | | |
| 33-00 | Force HOME | [0] Home not forced | 2 set-ups | | TRUE | - | Uint8 |
| 33-01 | Zero Point Offset from Home Pos. | 0 N/A | 2 set-ups | | TRUE | 0 | Int32 |
| 33-02 | Ramp for Home Motion | 10 N/A | 2 set-ups | | TRUE | 0 | Uint32 |
| 33-03 | Velocity of Home Motion | 10 N/A | 2 set-ups | | TRUE | 0 | Int32 |
| 33-04 | Behaviour during HomeMotion | [0] Revers and index | 2 set-ups | | TRUE | - | Uint8 |
| 33-1* Synchronization | | | | | | | |
| 33-10 | Synchronization Factor Master (M:S) | 1 N/A | 2 set-ups | | TRUE | 0 | Int32 |
| 33-11 | Synchronization Factor Slave (M:S) | 1 N/A | 2 set-ups | | TRUE | 0 | Int32 |
| 33-12 | Position Offset for Synchronization | 0 N/A | 2 set-ups | | TRUE | 0 | Int32 |
| 33-13 | Accuracy Window for Position Sync. | 1000 N/A | 2 set-ups | | TRUE | 0 | Int32 |
| 33-14 | Relative Slave Velocity Limit | 0 % | 2 set-ups | | TRUE | 0 | Uint8 |
| 33-15 | Marker Number for Master | 1 N/A | 2 set-ups | | TRUE | 0 | Uint16 |
| 33-16 | Marker Number for Slave | 1 N/A | 2 set-ups | | TRUE | 0 | Uint16 |
| 33-17 | Master Marker Distance | 4096 N/A | 2 set-ups | | TRUE | 0 | Uint32 |
| 33-18 | Slave Marker Distance | 4096 N/A | 2 set-ups | | TRUE | 0 | Uint32 |
| 33-19 | Master Marker Type | [0] Encoder Z positive | 2 set-ups | | TRUE | - | Uint8 |
| 33-20 | Slave Marker Type | [0] Encoder Z positive | 2 set-ups | | TRUE | - | Uint8 |
| 33-21 | Master Marker Tolerance Window | 0 N/A | 2 set-ups | | TRUE | 0 | Uint32 |
| 33-22 | Slave Marker Tolerance Window | 0 N/A | 2 set-ups | | TRUE | 0 | Uint32 |
| 33-23 | Start Behaviour for Marker Sync | [0] Start Function 1 | 2 set-ups | | TRUE | - | Uint16 |
| 33-24 | Marker Number for Fault | 10 N/A | 2 set-ups | | TRUE | 0 | Uint16 |
| 33-25 | Marker Number for Ready | 1 N/A | 2 set-ups | | TRUE | 0 | Uint16 |
| 33-26 | Velocity Filter | 0 us | 2 set-ups | | TRUE | -6 | Int32 |
| 33-27 | Offset Filter Time | 0 ms | 2 set-ups | | TRUE | -3 | Uint32 |
| 33-28 | Marker Filter Configuration | [0] Marker filter 1 | 2 set-ups | | TRUE | - | Uint8 |
| 33-29 | Filter Time for Marker Filter | 0 ms | 2 set-ups | | TRUE | -3 | Int32 |
| 33-30 | Maximum Marker Correction | 0 N/A | 2 set-ups | | TRUE | 0 | Uint32 |
| 33-31 | Synchronisation Type | [0] Standard | 2 set-ups | | TRUE | - | Uint8 |
| 33-4* Limit Handling | | | | | | | |
| 33-40 | Behaviour atEnd Limit Switch | [0] Call error handler | 2 set-ups | | TRUE | - | Uint8 |
| 33-41 | Negative Software End Limit | -500000 N/A | 2 set-ups | | TRUE | 0 | Int32 |
| 33-42 | Positive Software End Limit | 500000 N/A | 2 set-ups | | TRUE | 0 | Int32 |
| 33-43 | Negative Software End Limit Active | [0] Inactive | 2 set-ups | | TRUE | - | Uint8 |
| 33-44 | Positive Software End Limit Active | [0] Inactive | 2 set-ups | | TRUE | - | Uint8 |
| 33-45 | Time in Target Window | 0 ms | 2 set-ups | | TRUE | -3 | Uint8 |
| 33-46 | Target Window LimitValue | 1 N/A | 2 set-ups | | TRUE | 0 | Uint16 |
| 33-47 | Size of Target Window | 0 N/A | 2 set-ups | | TRUE | 0 | Uint16 |

| Par. No. # | Parameter description | Default value | 4-set-up | FC 302 only | Change during operation | Conversion index | Type |
|--------------------------------|--------------------------------|---------------------|-----------|-------------|-------------------------|------------------|-------|
| 33-5* I/O Configuration | | | | | | | |
| 33-50 | Terminal X57/1 Digital Input | [0] No function | 2 set-ups | | TRUE | - | Ujnt8 |
| 33-51 | Terminal X57/2 Digital Input | [0] No function | 2 set-ups | | TRUE | - | Ujnt8 |
| 33-52 | Terminal X57/3 Digital Input | [0] No function | 2 set-ups | | TRUE | - | Ujnt8 |
| 33-53 | Terminal X57/4 Digital Input | [0] No function | 2 set-ups | | TRUE | - | Ujnt8 |
| 33-54 | Terminal X57/5 Digital Input | [0] No function | 2 set-ups | | TRUE | - | Ujnt8 |
| 33-55 | Terminal X57/6 Digital Input | [0] No function | 2 set-ups | | TRUE | - | Ujnt8 |
| 33-56 | Terminal X57/7 Digital Input | [0] No function | 2 set-ups | | TRUE | - | Ujnt8 |
| 33-57 | Terminal X57/8 Digital Input | [0] No function | 2 set-ups | | TRUE | - | Ujnt8 |
| 33-58 | Terminal X57/9 Digital Input | [0] No function | 2 set-ups | | TRUE | - | Ujnt8 |
| 33-59 | Terminal X57/10 Digital Input | [0] No function | 2 set-ups | | TRUE | - | Ujnt8 |
| 33-60 | Terminal X59/1 and X59/2 Mode | [1] Output | 2 set-ups | | FALSE | - | Ujnt8 |
| 33-61 | Terminal X59/1 Digital Input | [0] No function | 2 set-ups | | TRUE | - | Ujnt8 |
| 33-62 | Terminal X59/2 Digital Input | [0] No function | 2 set-ups | | TRUE | - | Ujnt8 |
| 33-63 | Terminal X59/1 Digital Output | [0] No function | 2 set-ups | | TRUE | - | Ujnt8 |
| 33-64 | Terminal X59/2 Digital Output | [0] No function | 2 set-ups | | TRUE | - | Ujnt8 |
| 33-65 | Terminal X59/3 Digital Output | [0] No function | 2 set-ups | | TRUE | - | Ujnt8 |
| 33-66 | Terminal X59/4 Digital Output | [0] No function | 2 set-ups | | TRUE | - | Ujnt8 |
| 33-67 | Terminal X59/5 Digital Output | [0] No function | 2 set-ups | | TRUE | - | Ujnt8 |
| 33-68 | Terminal X59/6 Digital Output | [0] No function | 2 set-ups | | TRUE | - | Ujnt8 |
| 33-69 | Terminal X59/7 Digital Output | [0] No function | 2 set-ups | | TRUE | - | Ujnt8 |
| 33-70 | Terminal X59/8 Digital Output | [0] No function | 2 set-ups | | TRUE | - | Ujnt8 |
| 33-8* Global Parameters | | | | | | | |
| 33-80 | Activated Program Number | -1 N/A | 2 set-ups | | TRUE | 0 | Int8 |
| 33-81 | Power-up State | [1] Motor on | 2 set-ups | | TRUE | - | Ujnt8 |
| 33-82 | Drive Status Monitoring | [1] On | 2 set-ups | | TRUE | - | Ujnt8 |
| 33-83 | Behaviour afterError | [0] Coast | 2 set-ups | | TRUE | - | Ujnt8 |
| 33-84 | Behaviour afterEsc. | [0] Controlled stop | 2 set-ups | | TRUE | - | Ujnt8 |
| 33-85 | MCO Supplied by External 24VDC | [0] No | 2 set-ups | | TRUE | - | Ujnt8 |

4.1.22 34- * MCO Data Readouts

| Par. No. # | Parameter description | Default value | 4-set-up | FC 302 only | Change during operation | Conversion index | Type |
|-----------------------------------|------------------------|---------------|-------------|-------------|-------------------------|------------------|--------|
| 34-0* PCD Write Par. | | | | | | | |
| 34-01 | PCD 1 Write to MCO | 0 N/A | All set-ups | | TRUE | 0 | Uint16 |
| 34-02 | PCD 2 Write to MCO | 0 N/A | All set-ups | | TRUE | 0 | Uint16 |
| 34-03 | PCD 3 Write to MCO | 0 N/A | All set-ups | | TRUE | 0 | Uint16 |
| 34-04 | PCD 4 Write to MCO | 0 N/A | All set-ups | | TRUE | 0 | Uint16 |
| 34-05 | PCD 5 Write to MCO | 0 N/A | All set-ups | | TRUE | 0 | Uint16 |
| 34-06 | PCD 6 Write to MCO | 0 N/A | All set-ups | | TRUE | 0 | Uint16 |
| 34-07 | PCD 7 Write to MCO | 0 N/A | All set-ups | | TRUE | 0 | Uint16 |
| 34-08 | PCD 8 Write to MCO | 0 N/A | All set-ups | | TRUE | 0 | Uint16 |
| 34-09 | PCD 9 Write to MCO | 0 N/A | All set-ups | | TRUE | 0 | Uint16 |
| 34-10 | PCD 10 Write to MCO | 0 N/A | All set-ups | | TRUE | 0 | Uint16 |
| 34-2* PCD Read Par. | | | | | | | |
| 34-21 | PCD 1 Read from MCO | 0 N/A | All set-ups | | TRUE | 0 | Uint16 |
| 34-22 | PCD 2 Read from MCO | 0 N/A | All set-ups | | TRUE | 0 | Uint16 |
| 34-23 | PCD 3 Read from MCO | 0 N/A | All set-ups | | TRUE | 0 | Uint16 |
| 34-24 | PCD 4 Read from MCO | 0 N/A | All set-ups | | TRUE | 0 | Uint16 |
| 34-25 | PCD 5 Read from MCO | 0 N/A | All set-ups | | TRUE | 0 | Uint16 |
| 34-26 | PCD 6 Read from MCO | 0 N/A | All set-ups | | TRUE | 0 | Uint16 |
| 34-27 | PCD 7 Read from MCO | 0 N/A | All set-ups | | TRUE | 0 | Uint16 |
| 34-28 | PCD 8 Read from MCO | 0 N/A | All set-ups | | TRUE | 0 | Uint16 |
| 34-29 | PCD 9 Read from MCO | 0 N/A | All set-ups | | TRUE | 0 | Uint16 |
| 34-30 | PCD 10 Read from MCO | 0 N/A | All set-ups | | TRUE | 0 | Uint16 |
| 34-4* Inputs & Outputs | | | | | | | |
| 34-40 | Digital Inputs | 0 N/A | All set-ups | | TRUE | 0 | Uint16 |
| 34-41 | Digital Outputs | 0 N/A | All set-ups | | TRUE | 0 | Uint16 |
| 34-5* Process Data | | | | | | | |
| 34-50 | Actual Position | 0 N/A | All set-ups | | TRUE | 0 | Int32 |
| 34-51 | Commanded Position | 0 N/A | All set-ups | | TRUE | 0 | Int32 |
| 34-52 | Actual Master Position | 0 N/A | All set-ups | | TRUE | 0 | Int32 |
| 34-53 | Slave Index Position | 0 N/A | All set-ups | | TRUE | 0 | Int32 |
| 34-54 | Master Index Position | 0 N/A | All set-ups | | TRUE | 0 | Int32 |
| 34-55 | Curve Position | 0 N/A | All set-ups | | TRUE | 0 | Int32 |
| 34-56 | Track Error | 0 N/A | All set-ups | | TRUE | 0 | Int32 |
| 34-57 | Synchronizing Error | 0 N/A | All set-ups | | TRUE | 0 | Int32 |
| 34-58 | Actual Velocity | 0 N/A | All set-ups | | TRUE | 0 | Int32 |
| 34-59 | Actual Master Velocity | 0 N/A | All set-ups | | TRUE | 0 | Int32 |
| 34-60 | Synchronizing Status | 0 N/A | All set-ups | | TRUE | 0 | Int32 |
| 34-61 | Axis Status | 0 N/A | All set-ups | | TRUE | 0 | Int32 |
| 34-62 | Program Status | 0 N/A | All set-ups | | TRUE | 0 | Int32 |
| 34-64 | MCO 302 Status | 0 N/A | All set-ups | | TRUE | 0 | Int32 |
| 34-65 | MCO 302 Control | 0 N/A | All set-ups | | TRUE | 0 | Uint16 |
| 34-7* Diagnosis readouts | | | | | | | |
| 34-70 | MCO Alarm Word 1 | 0 N/A | All set-ups | | FALSE | 0 | Uint32 |
| 34-71 | MCO Alarm Word 2 | 0 N/A | All set-ups | | FALSE | 0 | Uint32 |

5 Troubleshooting

5.1.1 Warnings/Alarm Messages

A warning or an alarm is signalled by the relevant LED on the front of the frequency converter and indicated by a code on the display.

A warning remains active until its cause is no longer present. Under certain circumstances operation of the motor may still be continued. Warning messages may be critical, but are not necessarily so.

In the event of an alarm, the frequency converter will have tripped. Alarms must be reset to restart operation once their cause has been rectified.

This may be done in three ways:

1. By using the [RESET] control button on the LCP control panel.
2. Via a digital input with the "Reset" function.
3. Via serial communication/optional fieldbus.



NB!

After a manual reset using the [RESET] button on the LCP, the [AUTO ON] button must be pressed to restart the motor.

If an alarm cannot be reset, the reason may be that its cause has not been rectified, or the alarm is trip-locked (see also table on following page).

Alarms that are trip-locked offer additional protection, meaning that the mains supply must be switched off before the alarm can be reset. After being switched back on, the frequency converter is no longer blocked and may be reset as described above once the cause has been rectified.

Alarms that are not trip-locked can also be reset using the automatic reset function in par.14-20 *Reset Mode* (Warning: automatic wake-up is possible!)

If a warning and alarm is marked against a code in the table on the following page, this means that either a warning occurs before an alarm, or else that you can specify whether it is a warning or an alarm that is to be displayed for a given fault.

This is possible, for instance, in par.1-90 *Motor Thermal Protection*. After an alarm or trip, the motor carries on coasting, and the alarm and warning flash. Once the problem has been rectified, only the alarm continues flashing until the frequency converter is reset.

| No. | Description | Warning | Alarm/Trip | Alarm/Trip Lock | Parameter Reference |
|-----|--|---------|------------|-----------------|---|
| 1 | 10 Volts low | X | | | |
| 2 | Live zero error | (X) | (X) | | par.6-01 <i>Live Zero Time-out Function</i> |
| 3 | No motor | (X) | | | par.1-80 <i>Function at Stop</i> |
| 4 | Mains phase loss | (X) | (X) | (X) | par.14-12 <i>Function at Mains Imbalance</i> |
| 5 | DC link voltage high | X | | | |
| 6 | DC link voltage low | X | | | |
| 7 | DC over-voltage | X | X | | |
| 8 | DC under voltage | X | X | | |
| 9 | Inverter overloaded | X | X | | |
| 10 | Motor ETR over temperature | (X) | (X) | | par.1-90 <i>Motor Thermal Protection</i> |
| 11 | Motor thermistor over temperature | (X) | (X) | | par.1-90 <i>Motor Thermal Protection</i> |
| 12 | Torque limit | X | X | | |
| 13 | Over Current | X | X | X | |
| 14 | Earth Fault | X | X | X | |
| 15 | Hardware mismatch | | X | X | |
| 16 | Short Circuit | | X | X | |
| 17 | Control word time-out | (X) | (X) | | par.8-04 <i>Control Word Timeout Function</i> |
| 22 | Hoist Mech. Brake | | | | |
| 23 | Internal Fan Fault | X | | | |
| 24 | External Fan Fault | X | | | par.14-53 <i>Fan Monitor</i> |
| 25 | Brake resistor short-circuited | X | | | |
| 26 | Brake resistor power limit | (X) | (X) | | par.2-13 <i>Brake Power Monitoring</i> |
| 27 | Brake chopper short-circuited | X | X | | |
| 28 | Brake check | (X) | (X) | | par.2-15 <i>Brake Check</i> |
| 29 | Heatsink temp | X | X | X | |
| 30 | Motor phase U missing | (X) | (X) | (X) | par.4-58 <i>Missing Motor Phase Function</i> |
| 31 | Motor phase V missing | (X) | (X) | (X) | par.4-58 <i>Missing Motor Phase Function</i> |
| 32 | Motor phase W missing | (X) | (X) | (X) | par.4-58 <i>Missing Motor Phase Function</i> |
| 33 | Inrush Fault | | X | X | |
| 34 | Fieldbus communication fault | X | X | | |
| 36 | Mains failure | X | X | | |
| 37 | Phase imbalance | | X | | |
| 38 | Internal Fault | | X | X | |
| 39 | Heatsink sensor | | X | X | |
| 40 | Overload of Digital Output Terminal 27 | (X) | | | par.5-00 <i>Digital I/O Mode</i> , par.5-01 <i>Terminal 27 Mode</i> |
| 41 | Overload of Digital Output Terminal 29 | (X) | | | par.5-00 <i>Digital I/O Mode</i> , par.5-02 <i>Terminal 29 Mode</i> |
| 42 | Overload of Digital Output On X30/6 | (X) | | | par. 5-32 <i>Term X30/6 Digi Out (MCB 101)</i> |
| 42 | Overload of Digital Output On X30/7 | (X) | | | par. 5-33 <i>Term X30/7 Digi Out (MCB 101)</i> |
| 46 | Pwr. card supply | | X | X | |
| 47 | 24 V supply low | X | X | X | |
| 48 | 1.8 V supply low | | X | X | |
| 49 | Speed limit | X | | | |
| 50 | AMA calibration failed | | X | | |
| 51 | AMA check U_{nom} and I_{nom} | | X | | |
| 52 | AMA low I_{nom} | | X | | |
| 53 | AMA motor too big | | X | | |

Table 5.1: Alarm/Warning code list

| No. | Description | Warning | Alarm/Trip | Alarm/Trip Lock | Parameter Reference |
|---------|--|---------|-------------------|-----------------|---|
| 54 | AMA motor too small | | X | | |
| 55 | AMA parameter out of range | | X | | |
| 56 | AMA interrupted by user | | X | | |
| 57 | AMA time-out | | X | | |
| 58 | AMA internal fault | X | X | | |
| 59 | Current limit | X | | | |
| 61 | Tracking Error | (X) | (X) | | par.4-30 <i>Motor Feedback Loss Function</i> |
| 62 | Output Frequency at Maximum Limit | X | | | |
| 63 | Mechanical Brake Low | | (X) | | par.2-20 <i>Release Brake Current</i> |
| 64 | Voltage Limit | X | | | |
| 65 | Control Board Over-temperature | X | X | X | |
| 66 | Heat sink Temperature Low | X | | | |
| 67 | Option Configuration has Changed | | X | | |
| 68 | Safe Stop | (X) | (X) ¹⁾ | | par.5-19 <i>Terminal 37 Safe Stop</i> |
| 69 | Pwr. Card Temp | | X | X | |
| 70 | Illegal FC configuration | | | X | |
| 71 | PTC 1 Safe Stop | X | X ¹⁾ | | par.5-19 <i>Terminal 37 Safe Stop</i> |
| 72 | Dangerous Failure | | | X ¹⁾ | par.5-19 <i>Terminal 37 Safe Stop</i> |
| 73 | Safe Stop Auto Restart | | | | |
| 77 | Reduced power mode | X | | | par. 14-59 <i>Actual Number of Inverter Units</i> |
| 78 | Tracking Error | | | | |
| 79 | Illegal PS config | | X | X | |
| 80 | Drive Initialized to Default Value | | X | | |
| 81 | CSIV corrupt | | | | |
| 82 | CSIV parameter error | | | | |
| 85 | Profibus/Profisafe Error | | | | |
| 90 | Encoder Loss | (X) | (X) | | par.17-61 <i>Feedback Signal Monitoring S202</i> |
| 91 | Analogue input 54 wrong settings | | | X | |
| 100-199 | See Operating Instructions for MCO 305 | | | | |
| 243 | Brake IGBT | X | X | | |
| 244 | Heatsink temp | X | X | X | |
| 245 | Heatsink sensor | | X | X | |
| 246 | Pwr.card supply | | X | X | |
| 247 | Pwr.card temp | | X | X | |
| 248 | Illegal PS config | | X | X | |
| 250 | New spare part | | | X | par. 14-23 <i>Typecode Setting</i> |
| 251 | New Type Code | | X | X | |

Table 5.2: Alarm/Warning code list

(X) Dependent on parameter

1) Can not be Auto reset via par.14-20 *Reset Mode*

A trip is the action when an alarm has appeared. The trip will coast the motor and can be reset by pressing the reset button or make a reset by a digital input (Par. 5-1* [1]). The origin event that caused an alarm cannot damage the frequency converter or cause dangerous conditions. A trip lock is an action when an alarm occurs, which may cause damage to frequency converter or connected parts. A Trip Lock situation can only be reset by a power cycling.

| <i>LED indication</i> | |
|-----------------------|----------------|
| Warning | yellow |
| Alarm | flashing red |
| Trip locked | yellow and red |

| Alarm Word Extended Status Word | | | | | | | |
|---------------------------------|----------|------------|-------------------------|----------------------------------|-------------------------|-----------------------|----------------------|
| Bit | Hex | Dec | Alarm Word | Alarm Word 2 | Warning Word | Warning Word 2 | Extended Status Word |
| 0 | 00000001 | 1 | Brake Check (A28) | ServiceTrip, Read/Write | Brake Check (W28) | | Ramping |
| 1 | 00000002 | 2 | Pwr. Card Temp (A69) | ServiceTrip, (reserved) | Pwr. Card Temp (W69) | | AMA Running |
| 2 | 00000004 | 4 | Earth Fault (A14) | ServiceTrip, Type-code/Sparepart | Earth Fault (W14) | | Start CW/CCW |
| 3 | 00000008 | 8 | Ctrl.Card Temp (A65) | ServiceTrip, (reserved) | Ctrl.Card Temp (W65) | | Slow Down |
| 4 | 00000010 | 16 | Ctrl. Word TO (A17) | ServiceTrip, (reserved) | Ctrl. Word TO (W17) | | Catch Up |
| 5 | 00000020 | 32 | Over Current (A13) | | Over Current (W13) | | Feedback High |
| 6 | 00000040 | 64 | Torque Limit (A12) | | Torque Limit (W12) | | Feedback Low |
| 7 | 00000080 | 128 | Motor Th Over (A11) | | Motor Th Over (W11) | | Output Current High |
| 8 | 00000100 | 256 | Motor ETR Over (A10) | | Motor ETR Over (W10) | | Output Current Low |
| 9 | 00000200 | 512 | Inverter Overld. (A9) | | Inverter Overld (W9) | | Output Freq High |
| 10 | 00000400 | 1024 | DC under Volt (A8) | | DC under Volt (W8) | | Output Freq Low |
| 11 | 00000800 | 2048 | DC over Volt (A7) | | DC over Volt (W7) | | Brake Check OK |
| 12 | 00001000 | 4096 | Short Circuit (A16) | | DC Voltage Low (W6) | | Braking Max |
| 13 | 00002000 | 8192 | Inrush Fault (A33) | | DC Voltage High (W5) | | Braking |
| 14 | 00004000 | 16384 | Mains ph. Loss (A4) | | Mains ph. Loss (W4) | | Out of Speed Range |
| 15 | 00008000 | 32768 | AMA Not OK | | No Motor (W3) | | OVC Active |
| 16 | 00010000 | 65536 | Live Zero Error (A2) | | Live Zero Error (W2) | | AC Brake |
| 17 | 00020000 | 131072 | Internal Fault (A38) | KTY error | 10V Low (W1) | KTY Warn | Password Timelock |
| 18 | 00040000 | 262144 | Brake Overload (A26) | Fans error | Brake Overload (W26) | Fans Warn | Password Protection |
| 19 | 00080000 | 524288 | U phase Loss (A30) | ECB error | Brake Resistor (W25) | ECB Warn | |
| 20 | 00100000 | 1048576 | V phase Loss (A31) | | Brake IGBT (W27) | | |
| 21 | 00200000 | 2097152 | W phase Loss (A32) | | Speed Limit (W49) | | |
| 22 | 00400000 | 4194304 | Fieldbus Fault (A34) | | Fieldbus Fault (W34) | | Unused |
| 23 | 00800000 | 8388608 | 24 V Supply Low (A47) | | 24V Supply Low (W47) | | Unused |
| 24 | 01000000 | 16777216 | Mains Failure (A36) | | Mains Failure (W36) | | Unused |
| 25 | 02000000 | 33554432 | 1.8V Supply Low (A48) | | Current Limit (W59) | | Unused |
| 26 | 04000000 | 67108864 | Brake Resistor (A25) | | Low Temp (W66) | | Unused |
| 27 | 08000000 | 134217728 | Brake IGBT (A27) | | Voltage Limit (W64) | | Unused |
| 28 | 10000000 | 268435456 | Option Change (A67) | | Encoder loss (W90) | | Unused |
| 29 | 20000000 | 536870912 | Drive Initial-ized(A80) | | Output freq. lim. (W62) | | Unused |
| 30 | 40000000 | 1073741824 | Safe Stop (A68) | PTC 1 Safe Stop (A71) | Safe Stop (W68) | PTC 1 Safe Stop (W71) | Unused |
| 31 | 80000000 | 2147483648 | Mech. brake low (A63) | Dangerous Failure (A72) | Extended Status Word | | Unused |

Table 5.3: Description of Alarm Word, Warning Word and Extended Status Word

The alarm words, warning words and extended status words can be read out via serial bus or optional fieldbus for diagnose. See also par.16-94 *Ext. Status Word*.

WARNING 1, 10 Volts low:

The 10 V voltage from terminal 50 on the control card is below 10 V. Remove some of the load from terminal 50, as the 10 V supply is overloaded. Max. 15 mA or minimum 590 Ω.

WARNING/ALARM 2, Live zero error:

The signal on terminal 53 or 54 is less than 50% of the value set in par. 6-10 *Terminal 53 Low Voltage*, par.6-12 *Terminal 53 Low Current*, par. 6-20 *Terminal 54 Low Voltage*, or par.6-22 *Terminal 54 Low Current* respectively.

WARNING/ALARM 3, No motor:

No motor has been connected to the output of the frequency converter.

WARNING/ALARM 4, Mains phase loss:

A phase is missing on the supply side, or the mains voltage imbalance is too high.

This message also appears in case of a fault in the input rectifier on the frequency converter.

Check the supply voltage and supply currents to the frequency converter.

WARNING 5, DC link voltage high:

The intermediate circuit voltage (DC) is higher than the overvoltage limit of the control system. The frequency converter is still active.

WARNING 6, DC link voltage low

The intermediate circuit voltage (DC) is below the undervoltage limit of the control system. The frequency converter is still active.

WARNING/ALARM 7, DC over voltage:

If the intermediate circuit voltage exceeds the limit, the frequency converter trips after a time.

Possible corrections:

Connect a brake resistor

Extend the ramp time

Activate functions in par.2-10 *Brake Function*

Increase par.14-26 *Trip Delay at Inverter Fault*

| Alarm/warning limits: | | | |
|--|-----------------|-----------------|-----------------|
| | 3 x 200 - 240 V | 3 x 380 - 500 V | 3 x 525 - 600 V |
| | [VDC] | [VDC] | [VDC] |
| Undervoltage | 185 | 373 | 532 |
| Voltage warning low | 205 | 410 | 585 |
| Voltage warning high (w/o brake - w/brake) | 390/405 | 810/840 | 943/965 |
| Overvoltage | 410 | 855 | 975 |

The voltages stated are the intermediate circuit voltage of the frequency converter with a tolerance of ± 5 %. The corresponding mains voltage is the intermediate circuit voltage (DC-link) divided by 1.35

WARNING/ALARM 8, DC under voltage:

If the intermediate circuit voltage (DC) drops below the "voltage warning low" limit (see table above), the frequency converter checks if 24 V backup supply is connected.

If no 24 V backup supply is connected, the frequency converter trips after a given time depending on the unit.

To check whether the supply voltage matches the frequency converter, see *General Specifications*.

WARNING/ALARM 9, Inverter overloaded:

The frequency converter is about to cut out because of an overload (too high current for too long). The counter for electronic, thermal inverter protection gives a warning at 98% and trips at 100%, while giving an alarm. You cannot reset the frequency converter until the counter is below 90%.

The fault is that the frequency converter is overloaded by more than 100% for too long.

WARNING/ALARM 10, Motor ETR over temperature:

According to the electronic thermal protection (ETR), the motor is too hot. You can choose if you want the frequency converter to give a warning or an alarm when the counter reaches 100% in par.1-90 *Motor Thermal Protection*. The fault is that the motor is overloaded by more than 100% for too long. Check that the motor par.1-24 *Motor Current* is set correctly.

WARNING/ALARM 11, Motor thermistor over temp:

The thermistor or the thermistor connection is disconnected. You can choose if you want the frequency converter to give a warning or an alarm when the counter reaches 100% in par.1-90 *Motor Thermal Protection*. Check that the thermistor is connected correctly between terminal 53 or 54 (analog voltage input) and terminal 50 (+ 10 V supply), or between terminal 18 or 19 (digital input PNP only) and terminal 50. If aKTY sensor is used, check for correct connection between terminal 54 and 55.

WARNING/ALARM 12, Torque limit:

The torque is higher than the value in par.4-16 *Torque Limit Motor Mode* (in motor operation) or the torque is higher than the value in par.4-17 *Torque Limit Generator Mode* (in regenerative operation).

WARNING/ALARM 13, Over Current:

The inverter peak current limit (approx. 200% of the rated current) is exceeded. The warning will last approx. 8-12 sec., then the frequency converter trips and issues an alarm. Turn off the frequency converter and check if the motor shaft can be turned and if the motor size matches the frequency converter.

If extended mechanical brake control is selected, trip can be reset externally.

ALARM 14, Earth fault:

There is a discharge from the output phases to earth, either in the cable between the frequency converter and the motor or in the motor itself. Turn off the frequency converter and remove the earth fault.

ALARM 15, Incomplete hardware:

A fitted option is not handled by the present control board (hardware or software).

ALARM 16, Short-circuit

There is short-circuiting in the motor or on the motor terminals. Turn off the frequency converter and remove the short-circuit.

WARNING/ALARM 17, Control word timeout:

There is no communication to the frequency converter. The warning will only be active when par.8-04 *Control Word Timeout Function* is NOT set to OFF.

If par.8-04 *Control Word Timeout Function* is set to *Stop* and *Trip*, a warning appears and the frequency converter ramps down until it trips, while giving an alarm.

par.8-03 *Control Word Timeout Time* could possibly be increased.

WARNING 23, Internal fan fault:

The fan warning function is an extra protection function that checks if the fan is running / mounted. The fan warning can be disabled in par.14-53 *Fan Monitor* (set to [0] Disabled).

WARNING 24, External fan fault:

The fan warning function is an extra protection function that checks if the fan is running / mounted. The fan warning can be disabled in par.14-53 *Fan Monitor* (set to [0] Disabled).

WARNING 25, Brake resistor short-circuited:

The brake resistor is monitored during operation. If it short-circuits, the brake function is disconnected and the warning appears. The frequency converter still works, but without the brake function. Turn off the frequency converter and replace the brake resistor (see par.2-15 *Brake Check*).

ALARM/WARNING 26, Brake resistor power limit:

The power transmitted to the brake resistor is calculated as a percentage, as a mean value over the last 120 s, on the basis of the resistance value of the brake resistor (par.2-11 *Brake Resistor (ohm)*) and the intermediate circuit voltage. The warning is active when the dissipated braking power is higher than 90%. If *Trip[2]* has been selected in par.2-13 *Brake Power Monitoring*, the frequency converter cuts out and issues this alarm, when the dissipated braking power is higher than 100%.

ALARM/ WARNING 27, Brake chopper fault:

The brake transistor is monitored during operation and if it short-circuits, the brake function disconnects and the warning comes up. The frequency converter is still able to run, but since the brake transistor has short-circuited, substantial power is transmitted to the brake resistor, even if it is inactive.

Turn off the frequency converter and remove the brake resistor.

This alarm/ warning could also occur should the brake resistor overheat. Terminal 104 to 106 are available as brake resistor. Klixon inputs, see section Brake Resistor Temperature Switch.

Warning: There is a risk of substantial power being transmitted to the brake resistor if the brake transistor is short-circuited.

ALARM/WARNING 28, Brake check failed:

Brake resistor fault: the brake resistor is not connected/working.

ALARM 29, Drive over temperature:

If the enclosure is IP 20 or IP 21/Type 1, the cut-out temperature of the heat-sink is 95 °C ±5 °C. The temperature fault cannot be reset, until the temperature of the heatsink is below 70 °C ±5 °C.

The fault could be:

- Ambient temperature too high
- Too long motor cable

ALARM 30, Motor phase U missing:

Motor phase U between the frequency converter and the the motor is missing.

Turn off the frequency converter and check motor phase U.

ALARM 31, Motor phase V missing:

Motor phase V between the frequency converter and the motor is missing.

Turn off the frequency converter and check motor phase V.

ALARM 32, Motor phase W missing:

Motor phase W between the frequency converter and the motor is missing.

Turn off the frequency converter and check motor phase W.

ALARM 33, Inrush fault:

Too many power ups have occurred within a short time period. See the chapter *General Specifications* for the allowed number of power ups within one minute.

WARNING/ALARM 34, Fieldbus communication fault:

The fieldbus on the communication option card is not working correctly. Please check parameters associated with the module and make sure module is properly inserted in Slot A of the drive. Check the wiring for fieldbus.

WARNING/ALARM 36, Mains failure:

This warning/alarm is only active if the supply voltage to the frequency converter is lost and par.14-10 *Mains Failure* is NOT set to OFF. Possible correction: check the fuses to the frequency converter

ALARM 37, Phase imbalance:

There is a current imbalance between the power units

ALARM 38, Internal fault:

By this alarm it may be necessary to contact your Danfoss supplier. Some typical alarm messages:

| | |
|------|--|
| 0 | The serial port cannot be initialized. Serious hardware failure |
| 256 | The power EEPROM data is defect or too old |
| 512 | The control board EEPROM data is defect or too old |
| 513 | Communication time out Reading EEPROM data |
| 514 | Communication time out Reading EEPROM data |
| 515 | The Application Orientated Control cannot recognize the EEPROM data |
| 516 | Cannot write write to the EEPROM because a write command is on progress |
| 517 | The write command is under time out |
| 518 | Failure in the EEPROM |
| 519 | Missing or invalid BarCode data in EEPROM 1024 – 1279 CAN telegram cannot be sent. (1027 indicate a possible hardware failure) |
| 1281 | Digital Signal Processor flash time-out |
| 1282 | Power micro software version mismatch |
| 1283 | Power EEPROM data version mismatch |
| 1284 | Cannot read Digital Signal Processor software version |
| 1299 | Option SW in slot A is too old |
| 1300 | Option SW in slot B is too old |
| 1311 | Option SW in slot C0 is too old |

| | |
|-------|--|
| 1312 | Option SW in slot C1 is too old |
| 1315 | Option SW in slot A is not supported (not allowed) |
| 1316 | Option SW in slot B is not supported (not allowed) |
| 1317 | Option SW in slot C0 is not supported (not allowed) |
| 1318 | Option SW in slot C1 is not supported (not allowed) |
| 1536 | An exception in the Application Orientated Control is registered. Debug information written in LCP |
| 1792 | DSP watchdog is active. Debugging of power part data Motor Orientated Control data not transferred correctly |
| 2049 | Power data restarted |
| 2315 | Missing SW version from power unit |
| 2816 | Stack overflow Control board module |
| 2817 | Scheduler slow tasks |
| 2818 | Fast tasks |
| 2819 | Parameter thread |
| 2820 | LCP stack overflow |
| 2821 | Serial port overflow |
| 2822 | USB port overflow |
| 3072- | Parameter value is outside its limits. Perform a initialization. Parameter number causing the alarm: Subtract the code from 3072. Ex Error code 3238: 3238-3072 = 166 is outside the limit |
| 5122 | |
| 5123 | Option in slot A: Hardware incompatible with Control board hardware |
| 5124 | Option in slot B: Hardware incompatible with Control board hardware |
| 5125 | Option in slot C0: Hardware incompatible with Control board hardware |
| 5126 | Option in slot C1: Hardware incompatible with Control board hardware |
| 5376- | Out of memory |
| 6231 | |

WARNING 40, Overload of Digital Output Terminal 27

Check the load connected to terminal 27 or remove short-circuit connection. Check par.5-00 *Digital I/O Mode* and par.5-01 *Terminal 27 Mode*.

WARNING 41, Overload of Digital Output Terminal 29:

Check the load connected to terminal 29 or remove short-circuit connection. Check par.5-00 *Digital I/O Mode* and par.5-02 *Terminal 29 Mode*.

WARNING 42, Overload of Digital Output On X30/6 :

Check the load connected to X30/6 or remove short-circuit connection. Check par. 5-32 *Term X30/6 Digi Out (MCB 101)*.

WARNING 42, Overload of Digital Output On X30/7 :

Check the load connected to X30/7 or remove short-circuit connection. Check par. 5-33 *Term X30/7 Digi Out (MCB 101)*.

WARNING 47, 24 V supply low:

The external 24 V DC backup power supply may be overloaded, otherwise Contact your Danfoss supplier.

WARNING 48, 1.8 V supply low:

Contact your Danfoss supplier.

WARNING 49, Speed limit:

The speed is not within the specified range in par.4-11 *Motor Speed Low Limit [RPM]* and par.4-13 *Motor Speed High Limit [RPM]*.

ALARM 50, AMA calibration failed:

Contact your Danfoss supplier.

ALARM 51, AMA check Unom and Inom:

The setting of motor voltage, motor current, and motor power is presumably wrong. Check the settings.

ALARM 52, AMA low Inom:

The motor current is too low. Check the settings.

ALARM 53, AMA motor too big:

The motor is too big for the AMA to be carried out.

ALARM 54, AMA motor too small:

The motor is too small for the AMA to be carried out.

ALARM 55, AMA par. out of range:

The motor parameter values found from the motor are outside acceptable range.

ALARM 56, AMA interrupted by user:

The AMA has been interrupted by the user.

ALARM 57, AMA timeout:

Try to start the AMA again a number of times, until the AMA is carried out. Please note that repeated runs may heat the motor to a level where the resistance Rs and Rr are increased. In most cases, however, this is not critical.

ALARM 58, AMA internal fault:

Contact your Danfoss supplier.

WARNING 59, Current limit:

The current is higher than the value in par.4-18 *Current Limit*.

ALARM/WARNING 61, Tracking Error:

An error between calculated speed and speed measurement from feedback device. The function Warning/Alarm/Disabling setting is in par. 4-30 *Motor Feedback Loss Function*. Accepted error setting in par. 4-31 *Motor Feedback Speed Error* and the allowed time the error occur setting in par.4-32 *Motor Feedback Loss Timeout*. During a commissioning procedure the function may be effective.

WARNING 62, Output Frequency at Maximum Limit:

The output frequency is higher than the value set in par.4-19 *Max Output Frequency*. This is a warning in VVC+ mode and an alarm (trip) in Flux mode.

ALARM 63, Mechanical Brake Low:

The actual motor current has not exceeded the "release brake" current within the "Start delay" time window.

WARNING 64, Voltage Limit:

The load and speed combination demands a motor voltage higher than the actual DC link voltage.

WARNING/ALARM/TRIP 65, Control Card Over Temperature:

Control card over temperature: The cut-out temperature of the control card is 80° C.

WARNING 66, Heatsink Temperature Low:

The heat sink temperature is measured as 0° C. This could indicate that the temperature sensor is defect and thus the fan speed is increased to the maximum in case the power part or control card is very hot.

ALARM 67, Option Configuration has Changed:

One or more options has either been added or removed since the last power down.

ALARM 68, Safe Stop:

Safe Stop has been activated. To resume normal operation, apply 24 V DC to T-37. Press reset button on LCP.

WARNING 68, Safe Stop:

Safe Stop has been activated. Normal operation is resumed when Safe Stop is disabled. Warning: Automatic Restart!

ALARM 70, Illegal FC Configuration:

Actual combination of control board and power board is illegal.

ALARM 71, PTC 1 Safe Stop:

Safe Stop has been activated from the MCB 112 PTC Thermistor Card (motor too warm). Normal operation can be resumed when the MCB 112 applies 24 V DC to T-37 again (when the motor temperature reaches an acceptable level) and when the Digital Input from the MCB 112 is deac-

tivated. When that happens, a reset signal must be is be sent (via Bus, Digital I/O, or by pressing [RESET]).

WARNING 71, PTC 1 Safe Stop:

Safe Stop has been activated from the MCB 112 PTC Thermistor Card (motor too warm). Normal operation can be resumed when the MCB 112 applies 24 V DC to T-37 again (when the motor temperature reaches an acceptable level) and when the Digital Input from the MCB 112 is deactivated. Warning: Automatic Restart.

ALARM 72, Dangerous Failure:

Safe Stop with Trip Lock. The Dangerous Failure Alarm is issued if the combination of safe stop commands is unexpected. This is the case if the MCB 112 VLT PTC Thermistor Card enables X44/ 10 but safe stop is somehow not enabled. Furthermore, if the MCB 112 is the only device using safe stop (specified through selection [4] or [5] in par. 5-19), an unexpected combination is activation of safe stop without the X44/ 10 being activated. The following table summarizes the unexpected combinations that lead to Alarm 72. Note that if X44/ 10 is activated in selection 2 or 3, this signal is ignored! However, the MCB 112 will still be able to activate Safe Stop.

| Function | No. | X44/ 10 (DI) | Safe Stop T37 |
|-------------------|-----|--------------|---------------|
| PTC 1 Warning | [4] | + | - |
| | | - | + |
| PTC 1 Alarm | [5] | + | - |
| | | - | + |
| PTC 1 & Relay A | [6] | + | - |
| PTC 1 & Relay W | [7] | + | - |
| PTC 1 & RelayA/ W | [8] | + | - |
| PTC 1 & Relay W/A | [9] | + | - |

+: activated
-: Not activated

ALARM 78, Tracking Error:

Please contact Danfoss

ALARM 80, Drive Initialised to Default Value:

Parameter settings are initialised to default setting after a manual (three-finger) reset.

ALARM 90, Encoder loss:

Check the connection to encoder option and eventually replace the MCB 102or MCB 103.

ALARM 91, Analogue Input 54 Wrong Settings:

Switch S202 has to be set in position OFF (voltage input) when a KTY sensor is connected to analogue input terminal 54.

ALARM 250, New Spare Part:

The power or Switch Mode Power Supply has been exchanged. The frequency converter type code must be restored in the EEPROM. Select the correct type code in par. 14-23 *Typecode Setting* according to the label on unit. Remember to select 'Save to EEPROM' to complete.

ALARM 251, New Type Code:

The Frequency Converter has got a new type code.

Index

A

| | |
|--|-----|
| Abbreviations | 4 |
| Ac Brake Max. Current 2-16 | 65 |
| Access To Main Menu W/o Password 0-61 | 43 |
| Access To Quick Menu W/o Password 0-66 | 44 |
| Activate Brake Delay 2-23 | 67 |
| [Activate Brake Speed Hz] 2-22 | 67 |
| [Activate Brake Speed Rpm] 2-21 | 67 |
| Active Set-up 0-10 | 33 |
| Actual Baud Rate 9-63 | 141 |
| Actual Typecode String 15-45 | 182 |
| Actual Value 9-07 | 133 |
| Address 8-31 | 129 |
| Aeo Minimum Magnetisation 14-41 | 175 |
| Alarm Log | 181 |
| Alarm Log: Time 15-32 | 181 |
| Alarm Log: Value 15-31 | 181 |
| Alarm Messages | 229 |
| Alarm Word | 128 |
| Alarm Word 16-90 | 191 |
| Alarm Word 2 16-91 | 191 |
| Analog In X30/11 16-75 | 190 |
| Analog In X30/12 16-76 | 190 |
| Analog Input 53 16-62 | 188 |
| Analog Input 54 16-64 | 189 |
| Analog Inputs | 6 |
| [Analog Out X30/8 Ma] 16-77 | 190 |
| [Analog Out X45/1 Ma] 16-78 | 190 |
| [Analog Out X45/3 Ma] 16-79 | 190 |
| [Analog Output 42 Ma] 16-65 | 189 |
| Array Index 10-30 | 150 |
| [Auto On] Key On Lcp 0-42 | 42 |
| Automatic Motor Adaptation (ama) 1-29 | 48 |
| Automatic Restart Time 14-21 | 172 |

B

| | |
|------------------------------|---------|
| Back Emf At 1000 Rpm 1-40 | 51 |
| Baud Rate Select 10-01 | 145 |
| Brake Check 2-15 | 65 |
| Brake Check Condition 2-18 | 66 |
| Brake Control | 233 |
| Brake Energy /2 Min 16-33 | 186 |
| Brake Energy /s 16-32 | 186 |
| Brake Function 2-10 | 64 |
| Brake Power | 6 |
| Brake Power Limit (kw) 2-12 | 64 |
| Brake Power Monitoring 2-13 | 64 |
| Brake Release Time 2-25 | 67 |
| Brake Resistor (ohm) 2-11 | 64, 198 |
| Break-away Torque | 5 |
| Bus Controlled | 106 |
| Bus Jog 1 Speed 8-90 | 132 |
| Bus Jog 2 Speed 8-91 | 132 |
| Bus Password Access 0-67 | 44 |
| [Bypass Speed From Hz] 4-61 | 89 |
| [Bypass Speed From Rpm] 4-60 | 89 |
| [Bypass Speed To Hz] 4-63 | 89 |
| [Bypass Speed To Rpm] 4-62 | 89 |

C

| | |
|---------------------------------|-----|
| Can Protocol 10-00 | 145 |
| Capacitance Output Filter 14-56 | 176 |
| Catch Up | 92 |

| | |
|---|----------|
| Catch Up/slow Down Value 3-12 | 71 |
| Changed Parameters (1) 9-90 | 143 |
| Changed Parameters (2) 9-91 | 143 |
| Changed Parameters (3) 9-92 | 143 |
| Changed Parameters (5) 9-94 | 144 |
| Changing A Data Value | 25 |
| Changing A Group Of Numeric Data Values | 24 |
| Changing A Text Value | 24 |
| Changing Data | 23 |
| Clock Rate 17-25 | 193 |
| Clockwise | 56 |
| Coasting | 4, 17 |
| Coasting Select 8-50 | 130 |
| Comm. Option Stw 16-84 | 191 |
| Communication Option | 234 |
| Comparator Operand 13-10 | 156 |
| Comparator Operator 13-11 | 159 |
| Comparator Value 13-12 | 159 |
| Configurable Control Word Ctw 8-14 | 128 |
| Configurable Status Word Stw 8-13 | 128 |
| Configuration | 126, 128 |
| Configuration Mode 1-00 | 45 |
| Control Cables | 11 |
| Control Card Temp. 16-39 | 187 |
| Control Site 8-01 | 125 |
| Control Word 16-00 | 184 |
| Control Word 1 9-67 | 141 |
| Control Word Profile 8-10 | 128 |
| Control Word Source 8-02 | 126 |
| Control Word Timeout Function 8-04 | 126 |
| Control Word Timeout Time 8-03 | 126 |
| Cooling | 58 |
| Cos Filter 1 10-20 | 150 |
| Cos Filter 2 10-21 | 150 |
| Cos Filter 3 10-22 | 150 |
| Cos Filter 4 10-23 | 150 |
| Counter A 16-72 | 190 |
| Counter B 16-73 | 190 |
| Current Lim Ctrl, Filter Time 14-32 | 174 |
| Current Lim Ctrl, Integration Time 14-31 | 174 |
| Current Lim Ctrl, Proportional Gain 14-30 | 174 |
| Current Limit 4-18 | 84 |
| Custom Readout 16-09 | 184 |
| Custom Readout Max Value 0-32 | 41 |

D

| | |
|----------------------------------|---------|
| Data Log Settings | 178 |
| D-axis Inductance (Id) 1-37 | 50, 197 |
| Dc Brake Current 2-01 | 63 |
| [Dc Brake Cut In Speed Hz] 2-04 | 63 |
| [Dc Brake Cut In Speed Rpm] 2-03 | 63 |
| Dc Brake Select 8-52 | 130 |
| Dc Braking Time 2-02 | 63 |
| Dc Hold Current 2-00 | 63 |
| Dc Link | 232 |
| Dc Link Voltage 16-30 | 186 |
| Default Settings | 199 |
| Default Settings | 1 |
| Defined Parameters 15-92 | 183 |
| Defined Parameters (1) 9-80 | 142 |
| Defined Parameters (2) 9-81 | 143 |
| Defined Parameters (3) 9-82 | 143 |
| Defined Parameters (4) 9-83 | 143 |
| Defined Parameters (5) 9-84 | 143 |
| Definitions | 4 |
| Device Identification 9-64 | 141 |
| Devicenet | 146 |

| | |
|---------------------------------------|-----|
| Devicenet And Can Fieldbus | 145 |
| Devicenet F Parameters 10-39 | 151 |
| Devicenet Revision 10-32 | 150 |
| Diagnosis Trigger 8-07 | 127 |
| Digi Pot Reference 16-53 | 187 |
| Digital & Relay Bus Control 5-90 | 106 |
| Digital I/o Mode 5-00 | 89 |
| Digital Input 16-60 | 188 |
| [Digital Output Bin] 16-66 | 189 |
| Display Line 1.1 Small 0-20 | 36 |
| Display Mode | 18 |
| Display Mode - Selection Of Read-outs | 19 |
| Drive Identification | 181 |
| Drive Information | 177 |

E

| | |
|------------------------------|----------|
| Edit Set-up 0-11 | 33 |
| Electrical Terminals | 10 |
| Electronic Terminal Relay | 60 |
| Encoder Pulses | 106 |
| End-of-timeout Function 8-05 | 127 |
| Environment | 175 |
| Etr | 185, 233 |
| Ext. Status Word 16-94 | 191 |
| External Reference 16-50 | 187 |

F

| | |
|---|-----|
| Fan Control 14-52 | 175 |
| Fan Monitor 14-53 | 175 |
| Fault Code 9-45 | 140 |
| Fault Log: Error Code 15-30 | 181 |
| Fault Message Counter 9-44 | 140 |
| Fault Number 9-47 | 140 |
| Fault Situation Counter 9-52 | 140 |
| Fc Port Baud Rate 8-32 | 129 |
| Fc Port Ctw 1 16-85 | 191 |
| Fc Port Ref 1 16-86 | 191 |
| Fc Profile | 128 |
| Fc Type 15-40 | 182 |
| Feedback Direction 17-60 | 194 |
| Feedback Signal Monitoring 17-61 | 194 |
| [Feedback Unit] 16-52 | 187 |
| Fieldbus Ctw 1 16-80 | 190 |
| Fieldbus Ref 1 16-82 | 191 |
| Flux Motor Feedback Source 1-02 | 45 |
| Flying Start 1-73 | 56 |
| Freeze Output | 4 |
| [Freq. Input #33 Hz] 16-68 | 189 |
| Frequency 16-13 | 185 |
| [Frequency %] 16-15 | 185 |
| Frequency Converter Ordering No 15-46 | 182 |
| Frequency Converter Serial Number 15-51 | 182 |
| Function At Mains Imbalance 14-12 | 171 |
| Function At Stop 1-80 | 56 |
| Function Relay 5-40 | 98 |

G

| | |
|------------------------|----|
| Gain Boost Factor 2-28 | 68 |
| General Warning | 3 |
| Graphical Display | 15 |

H

| | |
|-----------------------------------|-----|
| [Hand On] Key On Lcp 0-40 | 42 |
| Heatsink Temp. 16-34 | 186 |
| High Speed Load Compensation 1-61 | 54 |

| | |
|--|-----|
| Hiperface Baudrate 17-34 | 193 |
| Historic Log | 180 |
| Historic Log: Event 15-20 | 180 |
| Historic Log: Time 15-22 | 181 |
| Historic Log: Value 15-21 | 181 |
| I | |
| Incremental Encoder | 187 |
| Indexed Parameters | 25 |
| Indicator Lights | 16 |
| Inductance Output Filter 14-57 | 176 |
| Infinitely Variable Change Of Numeric Data Value | 24 |
| Initialisation | 1 |
| Input Frequency 17-52 | 193 |
| Input Voltage 17-51 | 193 |
| Intermediate Circuit | 232 |
| Inv. Max. Current 16-37 | 186 |
| Inv. Nom. Current 16-36 | 186 |
| Inverter Thermal 16-35 | 186 |
| Iron Loss Resistance (rfe) 1-36 | 50 |
| J | |
| Jog | 4 |
| Jog Ramp Time 3-80 | 80 |
| [Jog Speed Hz] 3-11 | 71 |
| [Jog Speed Rpm] 3-19 | 74 |
| K | |
| Keypad, 0-4* | 42 |
| Kty Sensor | 233 |
| Kty Sensor Temperature 16-19 | 185 |
| Kty Sensor Type 1-95 | 62 |
| Kty Thermistor Resource 1-96 | 62 |
| Kty Threshold Level 1-97 | 62 |
| Kwh Counter 15-02 | 177 |
| L | |
| Language 0-01 | 31 |
| Language Package 1 | 31 |
| Language Package 2 | 31 |
| Language Package 3 | 31 |
| Language Package 4 | 31 |
| Lcp | 26 |
| Lcp Copy 0-50 | 42 |
| Lcp Id No 15-48 | 182 |
| Leds | 15 |
| Live Zero Timeout Function 6-01 | 108 |
| Live Zero Timeout Time 6-00 | 108 |
| Load Type 1-67 | 54 |
| Local Control Keys | 1 |
| Local Mode Configuration 1-05 | 46 |
| Local Reference | 32 |
| Logging Buffer Full 16-40 | 187 |
| Logging Interval 15-11 | 179 |
| Logging Mode 15-13 | 180 |
| Logging Source 15-10 | 178 |
| Logic Rule Boolean 1 13-40 | 160 |
| Logic Rule Boolean 2 13-42 | 161 |
| Logic Rule Boolean 3 13-44 | 163 |
| Logic Rule Operator 1 13-41 | 161 |
| Logic Rule Operator 2 13-43 | 163 |
| Low Speed Load Compensation 1-60 | 53 |

M

| | |
|---|---------|
| Mac Id 10-02 | 145 |
| [Main Actual Value %] 16-05 | 184 |
| Main Menu | 20 |
| Main Menu Mode | 16 |
| Main Menu Mode | 23 |
| Main Menu Password 0-60 | 43 |
| Main Reactance | 48 |
| Main Reactance (xh) 1-35 | 50 |
| Mains Failure 14-10 | 169 |
| Mains Supply | 8 |
| Mains Voltage At Mains Fault 14-11 | 171 |
| Max Inter-char Delay 8-37 | 129 |
| Max Output Frequency 4-19 | 84 |
| Max Response Delay 8-36 | 129 |
| Maximum Inertia 1-69 | 55 |
| Maximum Limit 3-93 | 82 |
| Maximum Reference 3-03 | 70 |
| [Min Speed For Function At Stop Hz] 1-82 | 57 |
| [Min Speed For Function At Stop Rpm] 1-81 | 57 |
| [Min Speed Normal Magnetising Hz] 1-52 | 51 |
| [Min Speed Normal Magnetising Rpm] 1-51 | 51 |
| Min Value Of User-defined Readout 0-31 | 41 |
| Min. Current At Low Speed 1-66 | 54 |
| Minimum Ae0 Frequency 14-42 | 175 |
| Minimum Inertia 1-68 | 55 |
| Minimum Limit 3-94 | 82 |
| Minimum Reference 3-02 | 70 |
| Minimum Response Delay 8-35 | 129 |
| Missing Motor Phase Function 4-58 | 88 |
| Model Shift Frequency 1-53 | 52 |
| Modified Parameters 15-93 | 183 |
| Motor Angle 16-20 | 185 |
| Motor Angle Offset 1-41 | 51 |
| Motor Construction 1-10 | 46 |
| Motor Cont. Rated Torque 1-26 | 48 |
| Motor Control Principle 1-01 | 45 |
| Motor Cosphi 14-43 | 175 |
| Motor Current 1-24 | 47, 185 |
| Motor External Fan 1-91 | 60 |
| Motor Feedback Loss Function 4-30 | 85 |
| Motor Feedback Loss Timeout 4-32 | 86 |
| Motor Feedback Speed Error 4-31 | 86 |
| Motor Frequency 1-23 | 47 |
| Motor Magnetisation At Zero Speed 1-50 | 51 |
| Motor Nominal Speed 1-25 | 48 |
| Motor Poles 1-39 | 50 |
| [Motor Power Hp] 1-21 | 47 |
| [Motor Power Kw] 1-20 | 47 |
| Motor Protection | 58 |
| Motor Speed Direction 4-10 | 83 |
| [Motor Speed High Limit Hz] 4-14 | 84 |
| [Motor Speed High Limit Rpm] 4-13 | 83 |
| [Motor Speed Low Limit Hz] 4-12 | 83 |
| [Motor Speed Low Limit Rpm] 4-11 | 83 |
| Motor Speed Unit 0-02 | 32 |
| Motor Status | 184 |
| Motor Thermal 16-18 | 185 |
| Motor Thermal Protection 1-90 | 58 |
| Motor Voltage 1-22 | 47, 185 |
| My Personal Menu 0-25 | 39 |

N

| | |
|---------------------|-----|
| Net Control 10-15 | 149 |
| Net Reference 10-14 | 149 |

| | |
|--|-----|
| Node Address 9-18 | 136 |
| Numerical Local Control Panel | 26 |
| | |
| O | |
| Off Delay, Relay 5-42 | 100 |
| [Off] Key On Lcp 0-41 | 42 |
| On Delay, Relay 5-41 | 100 |
| On Reference Bandwidth 7-39 | 123 |
| Operating Hours 15-00 | 177 |
| Operating Mode | 32 |
| Operating State At Power-up (hand) 0-04 | 32 |
| Operation Mode 14-22 | 172 |
| Option Ident. | 183 |
| Option Mounted 15-60 | 183 |
| Option Ordering No 15-62 | 183 |
| Option Serial No 15-63 | 183 |
| Option Supplied By External 24vdc 14-80 | 176 |
| Option Sw Version 15-61 | 183 |
| Ordered Typecode String 15-44 | 182 |
| Output Filter 14-55 | 176 |
| Output Speed | 55 |
| Over Temp's 15-04 | 177 |
| Over Volt's 15-05 | 177 |
| Overload Mode 1-04 | 46 |
| Overmodulation 14-03 | 169 |
| Over-voltage Control 2-17 | 65 |
| | |
| P | |
| Parameter Access | 150 |
| Parameter Edit 9-27 | 140 |
| Parameter Info | 183 |
| Parameter Metadata 15-99 | 183 |
| Parameter Selection | 23 |
| Parameter Set-up | 20 |
| Parameters For Signals 9-23 | 137 |
| Pcd Read Configuration 9-16 | 134 |
| Pcd Write Configuration 9-15 | 133 |
| Poles 17-50 | 193 |
| Potentiometer Reference | 13 |
| Power Card Ordering No 15-47 | 182 |
| Power Card Serial Number 15-53 | 183 |
| [Power Hp] 16-11 | 185 |
| [Power Kw] 16-10 | 184 |
| Power Restore 3-92 | 82 |
| Power Section 15-41 | 182 |
| Power Up's 15-03 | 177 |
| Prec. Stop Counter 16-74 | 190 |
| Precise Stop Counter Value 1-84 | 57 |
| Precise Stop Function 1-83 | 57 |
| Precise Stop Speed Compensation Delay 1-85 | 57 |
| Preset Reference 3-10 | 71 |
| Preset Reference Select 8-56 | 132 |
| Preset Relative Reference 3-14 | 72 |
| Process Cl Feedback 1 Resource 7-20 | 122 |
| Process Cl Feedback 2 Resource 7-22 | 122 |
| Process Control 9-28 | 140 |
| Process Data Config Read 10-12 | 147 |
| Process Data Config Write 10-11 | 146 |
| Process Data Type Selection 10-10 | 146 |
| Process Pid Anti Windup 7-31 | 122 |
| Process Pid Clamped Output 18-92 | 195 |
| Process Pid Diff. Gain Limit 7-36 | 123 |
| Process Pid Differentiation Time 7-35 | 123 |
| Process Pid Error 18-90 | 195 |
| Process Pid Extended Pid 7-50 | 125 |
| Process Pid Fb. Filter Time 7-57 | 125 |
| Process Pid Feed Forward Factor 7-38 | 123 |

| | |
|--|----------|
| Process Pid Feed Fwd Gain 7-51 | 125 |
| Process Pid Feed Fwd Normal/ Inv. Ctrl. 7-46 | 124 |
| Process Pid Feed Fwd Ramp Down 7-53 | 125 |
| Process Pid Feed Fwd Ramp Up 7-52 | 125 |
| Process Pid Feed Fwd Resource 7-45 | 124 |
| Process Pid Gain Scale At Max. Ref. 7-44 | 124 |
| Process Pid Gain Scale At Min. Ref. 7-43 | 124 |
| Process Pid Gain Scaled Output 18-93 | 195 |
| Process Pid Integral Time 7-34 | 123 |
| Process Pid I-part Reset 7-40 | 123 |
| Process Pid Normal/ Inverse Control 7-30 | 122 |
| Process Pid Output 18-91 | 195 |
| Process Pid Output Neg. Clamp 7-41 | 124 |
| Process Pid Output Normal/ Inv. Ctrl. 7-49 | 124 |
| Process Pid Output Pos. Clamp 7-42 | 124 |
| Process Pid Proportional Gain 7-33 | 123, 198 |
| Process Pid Ref. Filter Time 7-56 | 125 |
| Process Pid Start Speed 7-32 | 123 |
| Profibus Save Data Values 9-71 | 142 |
| Profibus Warning Word 9-53 | 140 |
| Profibusdrivereset 9-72 | 142 |
| Profile Number 9-65 | 141 |
| Programming Set-up 9-70 | 142 |
| Protection Mode | 9 |
| Protocol 8-30 | 129 |
| Protocol Selection 17-20 | 192 |
| Pulse Filter Time Constant #29 5-54 | 102 |
| Pulse Filter Time Constant #33 5-59 | 102 |
| [Pulse Input #29 Hz] 16-67 | 189 |
| Pulse Out #27 Bus Control 5-93 | 106 |
| Pulse Out #27 Timeout Preset 5-94 | 106 |
| Pulse Out #29 Bus Control 5-95 | 107 |
| Pulse Out #29 Timeout Preset 5-96 | 107 |
| Pulse Out #x30/6 Bus Control 5-97 | 107 |
| Pulse Out #x30/6 Timeout Preset 5-98 | 107 |
| [Pulse Output #27 Hz] 16-69 | 189 |
| [Pulse Output #29 Hz] 16-70 | 189 |
| Pulse Output Max Freq #27 5-62 | 104 |
| Pulse Output Max Freq #29 5-65 | 104 |
| Pulse Output Max Freq #x30/6 5-68 | 105 |
| Pulse Reference 16-51 | 187 |
| Pulse Start/stop | 12 |
| Pwm Random 14-04 | 169 |

Q

| | |
|--|--------|
| Quick Menu | 16, 21 |
| Quick Menu Mode | 16, 20 |
| Quick Menu Password 0-65 | 43 |
| Quick Stop Ramp Time 3-81 | 80 |
| Quick Stop Ramp Type 3-82 | 81 |
| Quick Stop Select 8-51 | 130 |
| Quick Stop S-ramp Ratio At Decel. End 3-84 | 81 |
| Quick Stop S-ramp Ratio At Decel. Start 3-83 | 81 |
| Quick Transfer Of Parameter Settings Between Multiple Frequency Converters | 18 |

R

| | |
|--|----|
| Ramp 1 Ramp Down Time 3-42 | 75 |
| Ramp 1 Ramp Up Time 3-41 | 75 |
| Ramp 1 S-ramp Ratio At Accel. End 3-46 | 76 |
| Ramp 1 S-ramp Ratio At Accel. Start 3-45 | 75 |
| Ramp 1 S-ramp Ratio At Decel. End 3-48 | 76 |
| Ramp 1 S-ramp Ratio At Decel. Start 3-47 | 76 |
| Ramp 1 Type 3-40 | 75 |
| Ramp 2 Ramp Down Time 3-52 | 76 |
| Ramp 2 Ramp Up Time 3-51 | 76 |
| Ramp 2 S-ramp Ratio At Accel. End 3-56 | 77 |
| Ramp 2 S-ramp Ratio At Accel. Start 3-55 | 77 |

| | |
|--|-----|
| Ramp 2 S-ramp Ratio At Decel. End 3-58 | 77 |
| Ramp 2 S-ramp Ratio At Decel. Start 3-57 | 77 |
| Ramp 2 Type 3-50 | 76 |
| Ramp 3 Ramp Down Time 3-62 | 78 |
| Ramp 3 Ramp Up Time 3-61 | 78 |
| Ramp 3 S-ramp Ratio At Accel. End 3-66 | 78 |
| Ramp 3 S-ramp Ratio At Accel. Start 3-65 | 78 |
| Ramp 3 S-ramp Ratio At Decel. End 3-68 | 78 |
| Ramp 3 S-ramp Ratio At Decel. Start 3-67 | 78 |
| Ramp 3 Type 3-60 | 77 |
| Ramp 4 Ramp Down Time 3-72 | 79 |
| Ramp 4 Ramp Up Time 3-71 | 79 |
| Ramp 4 S-ramp Ratio At Accel. End 3-76 | 79 |
| Ramp 4 S-ramp Ratio At Accel. Start 3-75 | 79 |
| Ramp 4 S-ramp Ratio At Decel. End 3-78 | 79 |
| Ramp 4 S-ramp Ratio At Decel. Start 3-77 | 79 |
| Ramp 4 Type 3-70 | 78 |
| Ramp Delay 3-95 | 82 |
| Ramp Time 3-91 | 82 |
| Rated Motor Speed | 5 |
| Rcd | 7 |
| Readout Bus Off Counter 10-07 | 145 |
| Readout Receive Error Counter 10-06 | 145 |
| Readout Transmit Error Counter 10-05 | 145 |
| Readout: Edit Set-ups / Channel 0-14 | 35 |
| Readout: Linked Set-ups 0-13 | 35 |
| [Reference %] 16-02 | 184 |
| Reference Function 3-04 | 70 |
| Reference Range 3-00 | 69 |
| Reference Resource 1 3-15 | 72 |
| Reference Resource 2 3-16 | 73 |
| Reference Resource 3 3-17 | 73 |
| Reference Site 3-13 | 72 |
| [Reference Unit] 16-01 | 184 |
| Reference/feedback Unit 3-01 | 69 |
| Regional Settings 0-03 | 32 |
| Relative Scaling Reference Resource 3-18 | 73 |
| [Relay Output Bin] 16-71 | 189 |
| Relay Outputs | 96 |
| Release Brake Current 2-20 | 67 |
| Reset | 17 |
| Reset Control Word Timeout 8-06 | 127 |
| Reset Kwh Counter 15-06 | 177 |
| Reset Mode 14-20 | 171 |
| Reset Running Hours Counter 15-07 | 177 |
| Reset Slic 13-03 | 155 |
| [Reset] Key On Lcp 0-43 | 42 |
| Resolution (positions/rev) 17-21 | 192 |
| Resolution (ppr) 17-11 | 192 |
| Resolver Interface 17-59 | 194 |
| Resonance Dampening 1-64 | 54 |
| Resonance Dampening Time Constant 1-65 | 54 |
| Reversing Select 8-54 | 131 |
| Rfi Filter 14-50 | 175 |
| Rotor Leakage Reactance (x2) 1-34 | 50 |
| Rotor Resistance (rr) 1-31 | 49 |
| Running Hours 15-01 | 177 |

S

| | |
|------------------------------|-----|
| Safety Precautions | 8 |
| Samples Before Trigger 15-14 | 180 |
| Screened/armoured | 11 |
| Serial Communication | 6 |
| Service Code 14-29 | 174 |
| Setpoint 9-00 | 133 |
| Set-up Copy 0-51 | 43 |
| Set-up Select 8-55 | 131 |

| | |
|--------------------------------------|----------|
| Signal Type 17-10 | 192 |
| SI Controller Action 13-52 | 166 |
| SI Controller Event 13-51 | 165 |
| SI Controller Mode 13-00 | 152 |
| SI Controller State 16-38 | 186 |
| SI Controller Timer 13-20 | 159 |
| Slip Compensation 1-62 | 54 |
| Slip Compensation Time Constant 1-63 | 54 |
| Software Version 15-43 | 182 |
| Special Functions | 168 |
| Speed Pid Diff. Gain Limit 7-05 | 120 |
| Speed Pid Differentiation Time 7-04 | 120 |
| Speed Pid Feed Forward Factor 7-08 | 121 |
| Speed Pid Feedback Gear Ratio 7-07 | 121 |
| Speed Pid Feedback Source 7-00 | 119 |
| Speed Pid Integral Time 7-03 | 120 |
| Speed Pid Lowpass Filter Time 7-06 | 120 |
| Speed Pid Proportional Gain 7-02 | 119, 198 |
| [Speed Rpm] 16-17 | 185 |
| Speed Up/down | 13 |
| Ssi Data Format 17-26 | 193 |
| Ssi Data Length 17-24 | 192 |
| Stall Protection 14-35 | 174 |
| Start Current 1-76 | 56 |
| Start Delay | 55 |
| Start Delay 1-71 | 55 |
| Start Event 13-01 | 152 |
| Start Function | 55 |
| Start Function 1-72 | 55 |
| Start Select 8-53 | 131 |
| [Start Speed Hz] 1-75 | 56 |
| [Start Speed Rpm] 1-74 | 56 |
| Start/stop | 12 |
| Stator Leakage Reactance | 48 |
| Stator Leakage Reactance (x1) 1-33 | 49 |
| Stator Resistance (rs) 1-30 | 49 |
| Status | 16 |
| Status Messages | 15 |
| Status Word 16-03 | 184 |
| Status Word 1 9-68 | 142 |
| Step Size 3-90 | 81 |
| Step-by-step | 25 |
| Stop Delay 2-24 | 67 |
| Stop Event 13-02 | 154 |
| Store Always 10-33 | 151 |
| Store Data Values 10-31 | 150 |
| Sw Id Control Card 15-49 | 182 |
| Sw Id Power Card 15-50 | 182 |
| Switching Frequency 14-01 | 168 |
| Switching Pattern 14-00 | 168 |
| Synchronous Motor Speed | 5 |

T

| | |
|--|-----|
| Telegram Selection 8-40 | 129 |
| Telegram Selection 9-22 | 136 |
| Term 32/33 Encoder Direction 5-71 | 106 |
| Term 32/33 Pulses Per Revolution 5-70 | 106 |
| Term. 29 High Frequency 5-51 | 101 |
| Term. 29 High Ref./feedb. Value 5-53 | 101 |
| Term. 29 Low Frequency 5-50 | 101 |
| Term. 29 Low Ref./feedb. Value 5-52 | 101 |
| Term. 33 High Frequency 5-56 | 102 |
| Term. 33 High Ref./feedb. Value 5-58 | 102 |
| Term. 33 Low Frequency 5-55 | 102 |
| Term. 33 Low Ref./feedb. Value 5-57 | 102 |
| Term. X30/11 Filter Time Constant 6-36 | 111 |
| Term. X30/11 High Ref./feedb. Value 6-35 | 111 |

| | |
|---|---------|
| Term. X30/11 Low Ref./feedb. Value 6-34 | 111 |
| Term. X30/12 Filter Time Constant 6-46 | 111 |
| Term. X30/12 High Ref./feedb. Value 6-45 | 111 |
| Term. X30/12 Low Ref./feedb. Value 6-44 | 111 |
| Terminal 27 Mode 5-01 | 90 |
| Terminal 27 Pulse Output Variable 5-60 | 103 |
| Terminal 29 Mode 5-02 | 90 |
| Terminal 29 Pulse Output Variable 5-63 | 104 |
| Terminal 37 Safe Stop 5-19 | 94 |
| Terminal 42 Output 6-50 | 112 |
| Terminal 42 Output Bus Control 6-53 | 113 |
| Terminal 42 Output Filter 6-55 | 114 |
| Terminal 42 Output Max Scale 6-52 | 113 |
| Terminal 42 Output Min Scale 6-51 | 113 |
| Terminal 42 Output Timeout Preset 6-54 | 114 |
| Terminal 53 Filter Time Constant 6-16 | 109 |
| Terminal 53 High Current 6-13 | 109 |
| Terminal 53 High Ref./feedb. Value 6-15 | 109 |
| Terminal 53 High Voltage 6-11 | 109 |
| Terminal 53 Low Current 6-12 | 109 |
| Terminal 53 Low Ref./feedb. Value 6-14 | 109 |
| Terminal 53 Low Voltage 6-10 | 109 |
| Terminal 53 Switch Setting 16-61 | 188 |
| Terminal 54 Filter Time Constant 6-26 | 110 |
| Terminal 54 High Current 6-23 | 110 |
| Terminal 54 High Ref./feedb. Value 6-25 | 110 |
| Terminal 54 High Voltage 6-21 | 110 |
| Terminal 54 Low Current 6-22 | 110 |
| Terminal 54 Low Ref./feedb. Value 6-24 | 110 |
| Terminal 54 Low Voltage 6-20 | 109 |
| Terminal 54 Switch Setting 16-63 | 189 |
| Terminal X30/11 High Voltage 6-31 | 110 |
| Terminal X30/11 Low Voltage 6-30 | 110 |
| Terminal X30/12 High Voltage 6-41 | 111 |
| Terminal X30/12 Low Voltage 6-40 | 111 |
| Terminal X30/6 Pulse Output Variable 5-66 | 105 |
| Terminal X30/8 Bus Control 6-63 | 116 |
| Terminal X30/8 Max. Scale 6-62 | 116 |
| Terminal X30/8 Min. Scale 6-61 | 115 |
| Terminal X30/8 Output 6-60 | 114 |
| Terminal X30/8 Output Timeout Preset 6-64 | 116 |
| Terminal X45/1 Output Min Scale, 6-71 | 117 |
| Terminal X45/3 Output Min Scale, 6-81 | 118 |
| Thermal Load | 51, 185 |
| Thermistor | 58 |
| Thermistor | 7 |
| Thermistor Source 1-93 | 60 |
| This Set-up Linked To 0-12 | 34 |
| [Torque %] 16-22 | 186 |
| Torque Characteristics 1-03 | 46 |
| Torque Limit Factor Source 4-20 | 84 |
| Torque Limit Generator Mode 4-17 | 84 |
| Torque Limit Motor Mode 4-16 | 84 |
| [Torque Nm] 16-16 | 185 |
| [Torque Nm] High 16-25 | 186 |
| Torque Pi Integration Time 7-13 | 122 |
| Torque Pi Proportional Gain 7-12 | 121 |
| Torque Ramp Time 2-27 | 68 |
| Torque Ref 2-26 | 68 |
| Tracking Error 4-35 | 86 |
| Tracking Error After Ramping Timeout 4-39 | 87 |
| Tracking Error Function 4-34 | 86 |
| Tracking Error Ramping 4-37 | 86 |
| Tracking Error Ramping Timeout 4-38 | 87 |
| Tracking Error Timeout 4-36 | 86 |
| Transformation Ratio 17-53 | 193 |
| Trigger Event 15-12 | 179 |
| Trip Delay At Current Limit 14-24 | 173 |

| | |
|------------------------------------|-----|
| Trip Delay At Inverter Fault 14-26 | 173 |
| Trip Delay At Torque Limit 14-25 | 173 |
| Trip Reset | 171 |

U

| | |
|------------------------------------|----|
| U/f Characteristic - F 1-56 | 53 |
| U/f Characteristic - U 1-55 | 52 |
| Unit For User-defined Readout 0-30 | 40 |

V

| | |
|---------------------------------------|-----|
| Vlt Ext. Status Word 14-74 | 176 |
| Voltage 15-42 | 182 |
| Voltage Reference Via A Potentiometer | 13 |
| Vt Level 14-40 | 175 |
| Vvcplus | 7 |

W

| | |
|---|-----|
| Warning Current High 4-51 | 87 |
| Warning Current Low 4-50 | 87 |
| Warning Feedback High 4-57 | 88 |
| Warning Feedback Low 4-56 | 88 |
| Warning Parameter 10-13 | 149 |
| Warning Reference High 4-55 | 88 |
| Warning Reference Low 4-54 | 88 |
| Warning Speed High 4-53 | 88 |
| Warning Speed Low 4-52 | 87 |
| Warning Word | 128 |
| Warning Word 16-92 | 191 |
| Warning Word 2 16-93 | 191 |
| Warnings | 229 |
| Wobble Delta Freq. Scaled 30-19 | 197 |
| Wobble Delta Freq. Scaling Resource 30-03 | 196 |
| [Wobble Delta Frequency %] 30-02 | 196 |
| [Wobble Delta Frequency Hz] 30-01 | 196 |
| [Wobble Jump Frequency %] 30-05 | 197 |
| [Wobble Jump Frequency Hz] 30-04 | 196 |
| Wobble Jump Time 30-06 | 197 |
| Wobble Mode 30-00 | 195 |
| Wobble Random Function 30-09 | 197 |
| Wobble Random Ratio Max. 30-11 | 197 |
| Wobble Random Ratio Min. 30-12 | 197 |
| Wobble Ratio 30-10 | 197 |
| Wobble Sequence Time 30-07 | 197 |
| Wobble Up/ Down Time 30-08 | 197 |