

Contents

1 Introduction	3
1.1.1 Approvals	3
1.1.2 Symbols	3
1.1.3 Abbreviations	3
1.1.4 Definitions	4
1.1.5 Electrical Wiring - Control Cables	8
2 How to Programme	12
2.1 The Graphical and Numerical Local Control Panels	12
2.1.1 How to Programme on the Graphical LCP	12
2.1.2 The LCD-Display	13
2.1.4 Display Mode	15
2.1.5 Display Mode - Selection of Read-Outs	15
2.1.6 Parameter Set-Up	17
2.1.7 Quick Menu Key Functions	17
2.1.9 Main Menu Mode	19
2.1.10 Parameter Selection	19
2.1.14 Infinitely Variable Change of Numeric Data Value	20
2.1.16 Read-out and Programming of Indexed Parameters	20
2.1.17 How to Programme on the Numerical Local Control Panel	20
2.1.18 Local Control Keys	22
2.1.19 Initialisation to Default Settings	22
3 Parameter Descriptions	23
3.2 Parameters: 0-** Operation and Display	23
3.3 Parameters: 1-** Load and Motor	33
3.4 Parameters: 2-** Brakes	47
3.5 Parameters: 3-** Reference/Ramps	52
3.6 Parameters: 4-** Limits/Warnings	62
3.7 Parameters: 5-** Digital In/Out	67
3.8 Parameters: 6-** Analog In/Out	85
3.9 Parameters: 7-** Controllers	94
3.10 Parameters: 8-** Communications and Options	99
3.11 Parameters: 9-** Profibus	108
3.12 Parameters: 10-** DeviceNet CAN Fieldbus	114
3.13 Parameters: 12-** Ethernet	118
3.14 Parameters: 13-** Smart Logic Control	122
3.15 Parameters: 14-** Special Functions	134
3.16 Parameters: 15-** Drive Information	142
3.17 Parameters: 16-** Data Read-outs	146

3.18 Parameters: 17-** Motor Feedb. Option	152
3.19 Parameters: 18-** Data Readouts 2	154
3.20 Parameters: 30-** Special Features	154
3.21 Parameters: 35-** Sensor Input Option	157
4 Parameter Lists	159
5 Troubleshooting	190
5.1.1 Warnings/Alarm Messages	190
Index	199

1 Introduction

Programming Guide
Software version: 6.1x

This Programming Guide can be used for all FC 300 frequency converters with software version 6.1x.
The software version number can be seen from par. 15-43 *Software Version*.

1.1.1 Approvals



1.1.2 Symbols

Symbols used in this guide.

NOTE

Indicates something to be noted by the reader.



Indicates a general warning.



Indicates a high-voltage warning.

* Indicates default setting

1.1.3 Abbreviations

Alternating current	AC
American wire gauge	AWG
Ampere/AMP	A
Automatic Motor Adaptation	AMA
Current limit	I _{LIM}
Degrees Celsius	°C
Direct current	DC
Drive Dependent	D-TYPE
Electro Magnetic Compatibility	EMC
Electronic Thermal Relay	ETR
Frequency Converter	FC
Gram	g
Hertz	Hz
Kilohertz	kHz
Local Control Panel	LCP
Meter	m
Millihenry Inductance	mH
Milliamper	mA
Millisecond	ms
Minute	min
Motion Control Tool	MCT
Nanofarad	nF
Newton Meters	Nm
Nominal motor current	I _{M,N}
Nominal motor frequency	f _{M,N}
Nominal motor power	P _{M,N}
Nominal motor voltage	U _{M,N}
Parameter	par.
Protective Extra Low Voltage	PELV
Printed Circuit Board	PCB
Rated Inverter Output Current	I _{INV}
Revolutions Per Minute	RPM
Regenerative terminals	Regen
Second	s
Synchronous Motor Speed	n _s
Torque limit	T _{LIM}
Volts	V
The maximum output current	I _{VLT,MAX}
The rated output current supplied by the frequency converter	I _{VLT,N}

1.1.4 Definitions

Frequency converter:

I_{VLT,MAX}

Maximum output current.

I_{VLT,N}

Rated output current supplied by the frequency converter.

U_{VLT,MAX}

Maximum output voltage.

Input:

Control command

Start and stop the connected motor by means of LCP and digital inputs.

Functions are divided into two groups.

Functions in group 1 have higher priority than functions in group 2.

Group 1	Reset, Coasting stop, Reset and Coasting stop, Quick-stop, DC braking, Stop and the [OFF] key.
Group 2	Start, Pulse start, Reversing, Start reversing, Jog and Freeze output

Motor:

Motor Running

Torque generated on output shaft and speed from zero rpm to max. speed on motor.

f_{JOG}

Motor frequency when the jog function is activated (via digital terminals).

f_M

Motor frequency.

f_{MAX}

Maximum motor frequency.

f_{MIN}

Minimum motor frequency.

f_{M,N}

Rated motor frequency (nameplate data).

I_M

Motor current (actual).

I_{M,N}

Rated motor current (nameplate data).

n_{M,N}

Rated motor speed (nameplate data).

n_s

Synchronous motor speed

$$n_s = \frac{2 \times \text{par. 1} - 23 \times 60 \text{ s}}{\text{par. 1} - 39}$$

P_{M,N}

Rated motor power (nameplate data in kW or HP).

T_{M,N}

Rated torque (motor).

U_M

Instantaneous motor voltage.

U_{M,N}

Rated motor voltage (nameplate data).

Break-away torque

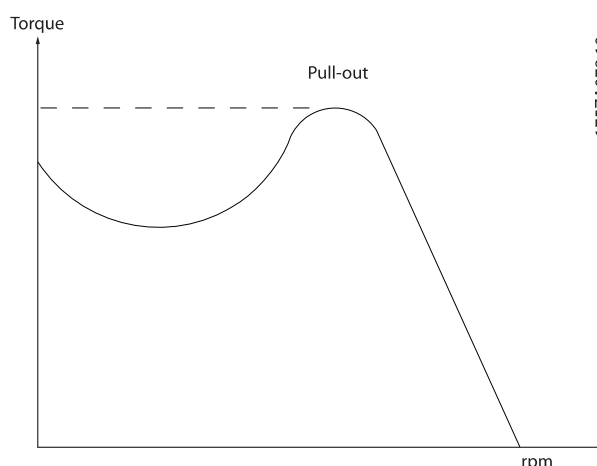

η_{VLT}

The efficiency of the frequency converter is defined as the ratio between the power output and the power input.

Start-disable command

A stop command belonging to the group 1 control commands - see this group.

Stop command

See Control commands.

References:

Analog Reference

A signal transmitted to the analog inputs 53 or 54, can be voltage or current.

Binary Reference

A signal transmitted to the serial communication port.

Preset Reference

A defined preset reference to be set from -100% to +100% of the reference range. Selection of eight preset references via the digital terminals.

Pulse Reference

A pulse frequency signal transmitted to the digital inputs (terminal 29 or 33).

Ref_{MAX}

Determines the relationship between the reference input at 100% full scale value (typically 10 V, 20mA) and the resulting reference. The maximum reference value set in par. 3-03 *Maximum Reference*.

Ref_{MIN}

Determines the relationship between the reference input at 0% value (typically 0V, 0mA, 4mA) and the resulting reference. The minimum reference value set in par. 3-02 *Minimum Reference*.

Miscellaneous:Analog Inputs

The analog inputs are used for controlling various functions of the frequency converter.

There are two types of analog inputs:

Current input, 0-20 mA and 4-20 mA

Voltage input, 0-10 V DC (FC 301)

Voltage input, -10 - +10 V DC (FC 302).

Analog Outputs

The analog outputs can supply a signal of 0-20 mA, 4-20 mA.

Automatic Motor Adaptation, AMA

AMA algorithm determines the electrical parameters for the connected motor at standstill.

Brake Resistor

The brake resistor is a module capable of absorbing the brake power generated in regenerative braking. This regenerative braking power increases the intermediate circuit voltage and a brake chopper ensures that the power is transmitted to the brake resistor.

CT Characteristics

Constant torque characteristics used for all applications such as conveyor belts, displacement pumps and cranes.

Digital Inputs

The digital inputs can be used for controlling various functions of the frequency converter.

Digital Outputs

The frequency converter features two Solid State outputs that can supply a 24 V DC (max. 40 mA) signal.

DSP

Digital Signal Processor.

ETR

Electronic Thermal Relay is a thermal load calculation based on present load and time. Its purpose is to estimate the motor temperature.

Hiperface®

Hiperface® is a registered trademark by Stegmann.

Initialising

If initialising is carried out (par. 14-22 *Operation Mode*), the frequency converter returns to the default setting.

Intermittent Duty Cycle

An intermittent duty rating refers to a sequence of duty cycles. Each cycle consists of an on-load and an off-load period. The operation can be either periodic duty or non-periodic duty.

LCP

The Local Control Panel makes up a complete interface for control and programming of the frequency converter. The control panel is detachable and can be installed up to 3

metres from the frequency converter, i.e. in a front panel by means of the installation kit option.

lsb

Least significant bit.

msb

Most significant bit.

MCM

Short for Mille Circular Mil, an American measuring unit for cable cross-section. 1 MCM = 0.5067 mm².

On-line/Off-line Parameters

Changes to on-line parameters are activated immediately after the data value is changed. Changes to off-line parameters are not activated until you enter [OK] on the LCP.

Process PID

The PID control maintains the desired speed, pressure, temperature, etc. by adjusting the output frequency to match the varying load.

PCD

Process Control Data

Power Cycle

Switch off the mains until display (LCP) is dark – then turn power on again

Pulse Input/Incremental Encoder

An external, digital pulse transmitter used for feeding back information on motor speed. The encoder is used in applications where great accuracy in speed control is required.

RCD

Residual Current Device.

Set-up

You can save parameter settings in four Set-ups. Change between the four parameter Set-ups and edit one Set-up, while another Set-up is active.

SFAVM

Switching pattern called Stator Flux oriented Asynchronous Vector Modulation (par. 14-00 *Switching Pattern*).

Slip Compensation

The frequency converter compensates for the motor slip by giving the frequency a supplement that follows the measured motor load keeping the motor speed almost constant.

Smart Logic Control (SLC)

The SLC is a sequence of user defined actions executed when the associated user defined events are evaluated as true by the Smart Logic Controller. (Par. group 13-** Smart Logic Control (SLC)).

STW

Status Word

FC Standard Bus

Includes RS 485 bus with FC protocol or MC protocol. See par. 8-30 *Protocol*.

Thermistor:

A temperature-dependent resistor placed where the temperature is to be monitored (frequency converter or motor).

Trip

A state entered in fault situations, e.g. if the frequency converter is subject to an over-temperature or when the frequency converter is protecting the motor, process or mechanism. Restart is prevented until the cause of the fault has disappeared and the trip state is cancelled by activating reset or, in some cases, by being programmed to reset automatically. Trip may not be used for personal safety.

Trip Locked

A state entered in fault situations when the frequency converter is protecting itself and requiring physical intervention, e.g. if the frequency converter is subject to a short circuit on the output. A locked trip can only be cancelled by cutting off mains, removing the cause of the fault, and reconnecting the frequency converter. Restart is prevented until the trip state is cancelled by activating reset or, in some cases, by being programmed to reset automatically. Trip may not be used for personal safety.

VT Characteristics

Variable torque characteristics used for pumps and fans.

VVC^{plus}

If compared with standard voltage/frequency ratio control, Voltage Vector Control (VVC^{plus}) improves the dynamics and the stability, both when the speed reference is changed and in relation to the load torque.

60° AVM

Switching pattern called 60° Asynchronous Vector Modulation (par. 14-00 *Switching Pattern*).

Power Factor

The power factor is the relation between I_1 and I_{RMS} .

$$\text{Power factor} = \frac{\sqrt{3} \times U \times I_1 \cos\varphi}{\sqrt{3} \times U \times I_{RMS}}$$

The power factor for 3-phase control:

$$= \frac{I_1 \times \cos\varphi_1}{I_{RMS}} = \frac{I_1}{I_{RMS}} \text{ since } \cos\varphi_1 = 1$$

The power factor indicates to which extent the frequency converter imposes a load on the mains supply.

The lower the power factor, the higher the I_{RMS} for the same kW performance.

$$I_{RMS} = \sqrt{I_1^2 + I_5^2 + I_7^2 + \dots + I_n^2}$$

In addition, a high power factor indicates that the different harmonic currents are low.

The frequency converters' built-in DC coils produce a high power factor, which minimizes the imposed load on the mains supply.



WARNING!

The voltage of the frequency converter is dangerous whenever connected to mains. Incorrect installation of the motor, frequency converter or fieldbus may cause death, serious personal injury or damage to the equipment. Consequently, the instructions in this manual, as well as national and local rules and safety regulations, must be complied with.

Safety Regulations

1. The mains supply to the frequency converter must be disconnected whenever repair work is to be carried out. Check that the mains supply has been disconnected and that the necessary time has elapsed before removing motor and mains supply plugs.
2. The [OFF] button on the control panel of the frequency converter does not disconnect the mains supply and consequently it must not be used as a safety switch.
3. The equipment must be properly earthed, the user must be protected against supply voltage and the motor must be protected against overload in accordance with applicable national and local regulations.
4. The earth leakage current exceeds 3.5 mA.
5. Protection against motor overload is not included in the factory setting. If this function is desired, set par. 1-90 *Motor Thermal Protection* to data value ETR trip 1 [4] or data value ETR warning 1 [3].
6. Do not remove the plugs for the motor and mains supply while the frequency converter is connected to mains. Check that the mains supply has been disconnected and that the necessary time has elapsed before removing motor and mains plugs.
7. Please note that the frequency converter has more voltage sources than L1, L2 and L3, when load sharing (linking of DC intermediate circuit) or external 24 V DC are installed. Check that all voltage sources have been disconnected and that the necessary time has elapsed before commencing repair work.

Warning against unintended start

1. The motor can be brought to a stop by means of digital commands, bus commands, references or a local stop, while the frequency converter is connected to mains. If personal safety considerations (e.g. risk of personal injury caused by contact with moving machine parts following an unintentional start) make it necessary to ensure that no unintended start occurs, these stop functions are not sufficient. In such cases the mains supply must be disconnected or the *Safe Stop* function must be activated.
2. The motor may start while setting the parameters. If this means that personal safety may be compromised (e.g. personal injury caused by contact with moving machine parts), motor starting must be prevented, for instance by use of the *Safe Stop* function or secure disconnection of the motor connection.
3. A motor that has been stopped with the mains supply connected, may start if faults occur in the electronics of the frequency converter, through temporary overload or if a fault in the power supply grid or motor connection is remedied. If unintended start must be prevented for personal safety reasons (e.g. risk of injury caused by contact with moving machine parts), the normal stop functions of the frequency converter are not sufficient. In such cases the mains supply must be disconnected or the *Safe Stop* function must be activated.

NOTE

When using the *Safe Stop* function, always follow the instructions in the *Safe Stop* section of the VLT AutomationDrive FC 300 Design Guide.

4. Control signals from, or internally within, the frequency converter may in rare cases be activated in error, be delayed or fail to occur entirely. When used in situations where safety is critical, e.g. when controlling the electromagnetic brake function of a hoist application, these control signals must not be relied on exclusively.

**High Voltage**

Touching the electrical parts may be fatal - even after the equipment has been disconnected from mains. Also make sure that other voltage inputs have been disconnected, such as external 24 V DC, load sharing (linkage of DC intermediate circuit), as well as the motor connection for kinetic back up.

Systems where frequency converters are installed must, if necessary, be equipped with additional monitoring and protective devices according to the valid safety regulations, e.g. law on mechanical tools, regulations for the prevention of accidents etc. Modifications on the frequency converters by means of the operating software are allowed.

NOTE

Hazardous situations shall be identified by the machine builder/ integrator who is responsible for taking necessary preventive means into consideration. Additional monitoring and protective devices may be included, always according to valid national safety regulations, e.g. law on mechanical tools, regulations for the prevention of accidents.

NOTE

Crane, Lifts and Hoists:

The controlling of external brakes must always have a redundant system. The frequency converter can in no circumstances be the primary safety circuit. Comply with relevant standards, e.g.

Hoists and cranes: IEC 60204-32

Lifts: EN 81

Protection Mode

Once a hardware limit on motor current or dc-link voltage is exceeded the frequency converter will enter "Protection mode". "Protection mode" means a change of the PWM modulation strategy and a low switching frequency to minimize losses. This continues 10 sec after the last fault and increases the reliability and the robustness of the frequency converter while re-establishing full control of the motor. In hoist applications "Protection mode" is not usable because the frequency converter will usually not be able to leave this mode again and therefore it will extend the time before activating the brake - which is not recommendable. The "Protection mode" can be disabled by setting par. 14-26 *Trip Delay at Inverter Fault* to zero which means that the frequency converter will trip immediately if one of the hardware limits is exceeded.

NOTE

It is recommended to disable protection mode in hoisting applications (par. 14-26 *Trip Delay at Inverter Fault* = 0)

1.1.5 Electrical Wiring - Control Cables

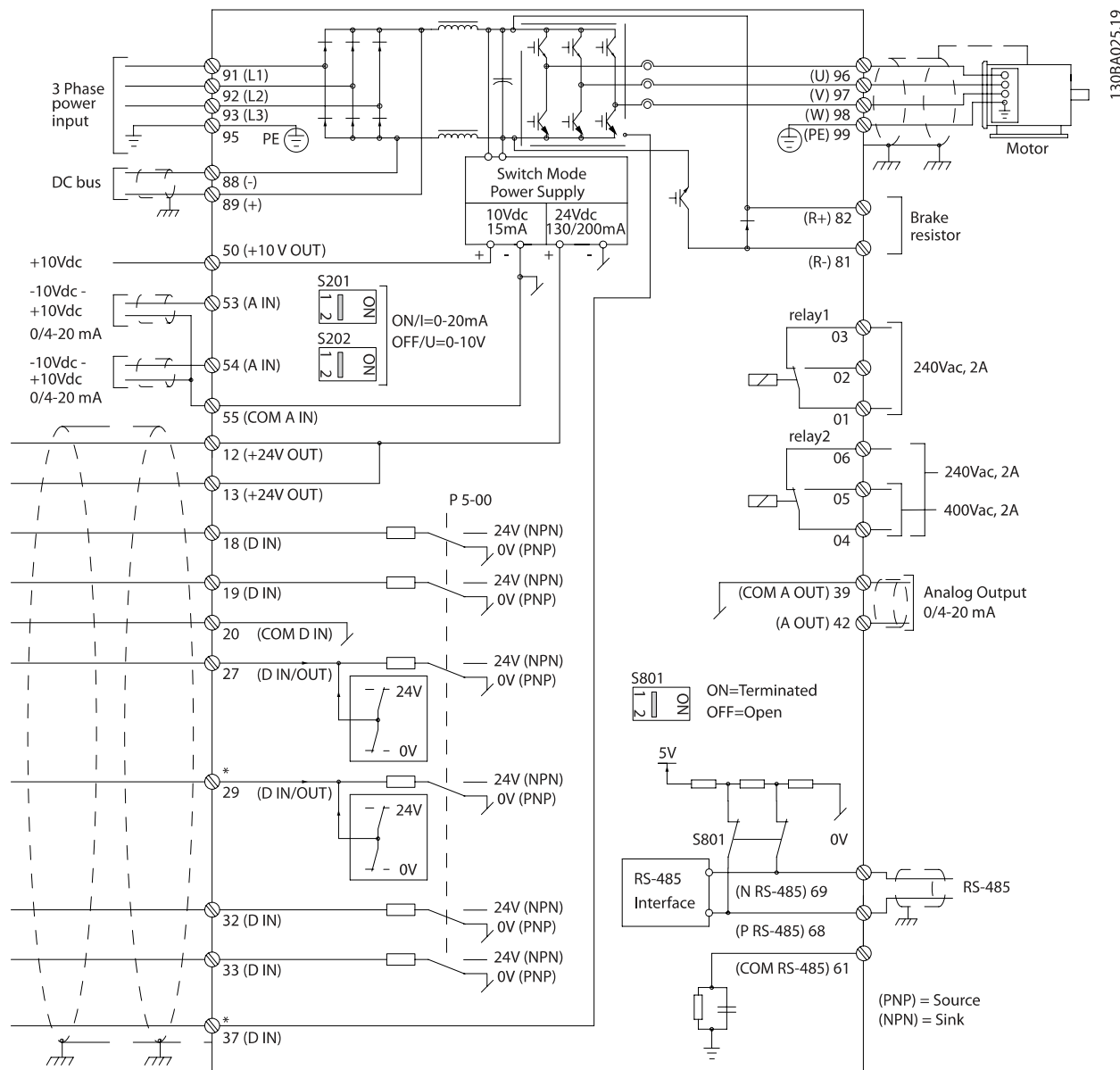

Illustration 1.1: Diagram showing all electrical terminals without options.

Terminal 37 is the input to be used for Safe Stop. For instructions on Safe Stop installation please refer to the section *Safe Stop Installation of the Design Guide*.

* Terminal 37 is not included in FC 301 (Except FC 301 A1, which includes Safe Stop).

Terminal 29 and Relay 2, are not included in FC 301.

Very long control cables and analogue signals may in rare cases and depending on installation result in 50/60 Hz earth loops due to noise from mains supply cables.

If this occurs, it may be necessary to break the screen or insert a 100 nF capacitor between screen and chassis.

The digital and analogue inputs and outputs must be connected separately to the common inputs (terminal 20, 55, 39) of the frequency converter to avoid ground currents from both groups to affect other groups. For example, switching on the digital input may disturb the analog input signal.

Input polarity of control terminals

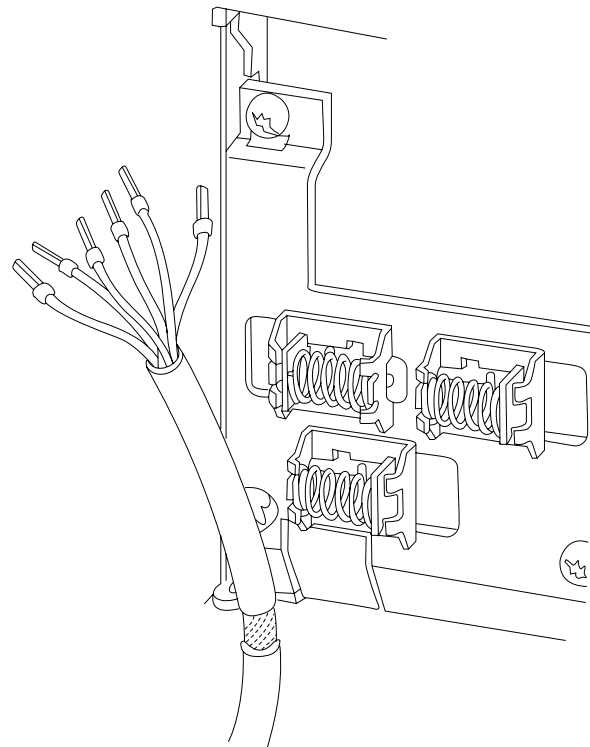
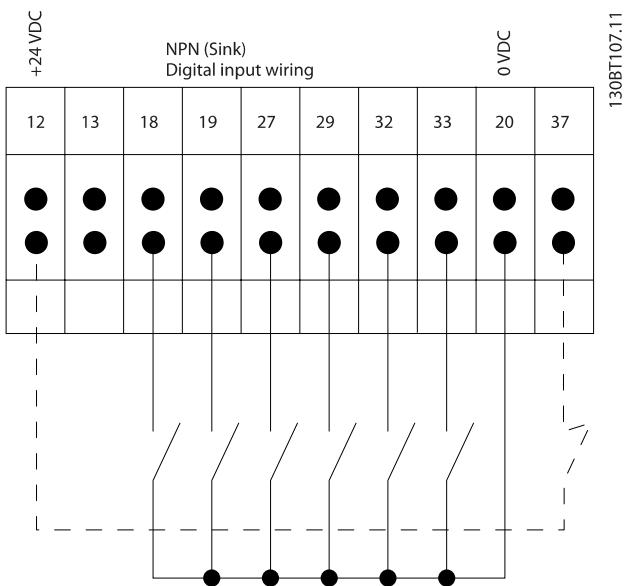
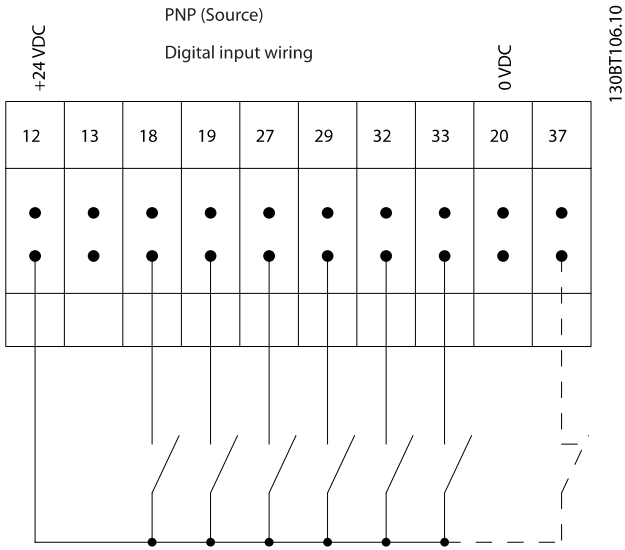

1.1.6 Start/Stop

Terminal 18 = par. 5-10 Terminal 18 Digital Input [8] Start
Terminal 27 = par. 5-12 Terminal 27 Digital Input [0] No operation (Default coast inverse)
Terminal 37 = Safe stop (where available!)

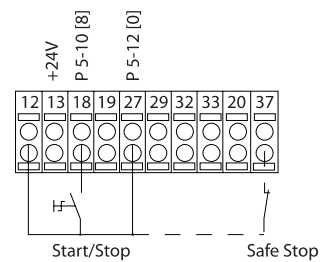

NOTE

Control cables must be screened/armoured.

See section entitled *Earthing of Screened/Armoured Control Cables* for the correct termination of control cables.

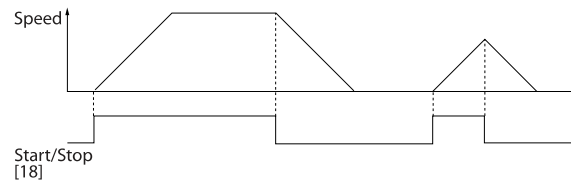

1.1.7 Pulse Start/Stop

Terminal 18 = par. 5-10 Terminal 18 Digital Input Latched start, [9]

Terminal 27 = par. 5-12 Terminal 27 Digital Input Stop inverse, [6]

Terminal 37 = Safe stop (where available!)

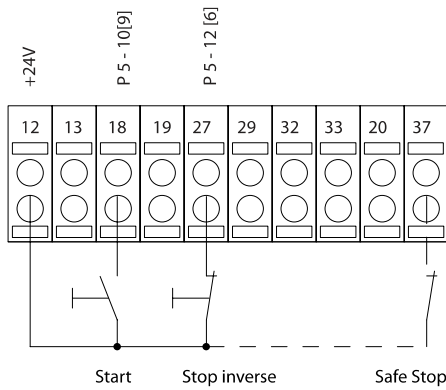

130BA156.12

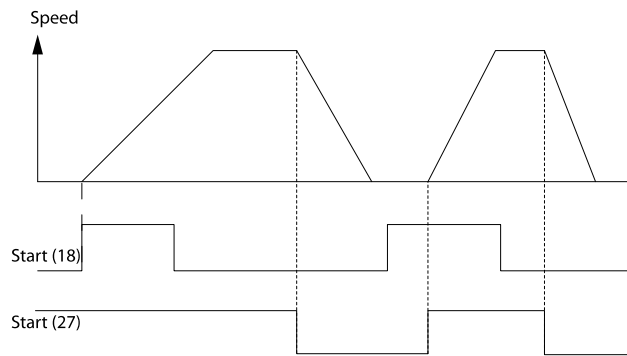

1.1.8 Speed Up/Down

Terminals 29/32 = Speed up/down:

Terminal 18 = par. 5-10 Terminal 18 Digital Input Start [9] (default)

Terminal 27 = par. 5-12 Terminal 27 Digital Input Freeze reference [19]

Terminal 29 = par. 5-13 Terminal 29 Digital Input Speed up [21]

Terminal 32 = par. 5-14 Terminal 32 Digital Input Speed down [22]

NOTE: Terminal 29 only in FC x02 (x=series type).

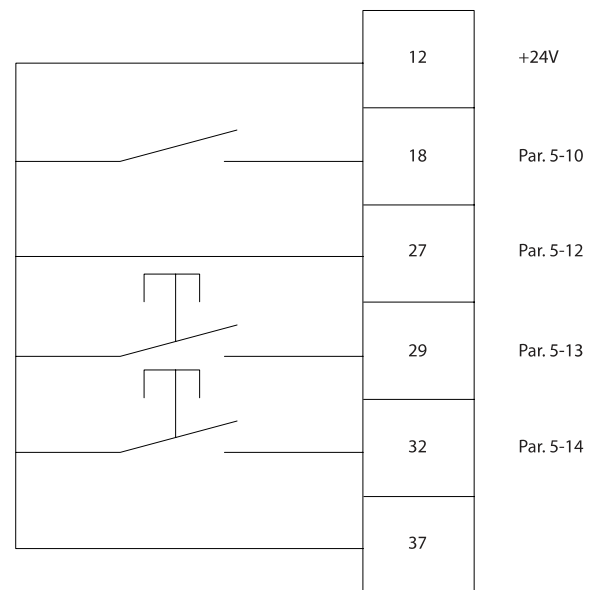

130BA021.12

1.1.9 Potentiometer Reference

Voltage reference via a potentiometer:

Reference Source 1 = [1] *Analog input 53* (default)

Terminal 53, Low Voltage = 0 Volt

Terminal 53, High Voltage = 10 Volt

Terminal 53, Low Ref./Feedback = 0 RPM

Terminal 53, High Ref./Feedback = 1500 RPM

Switch S201 = OFF (U)

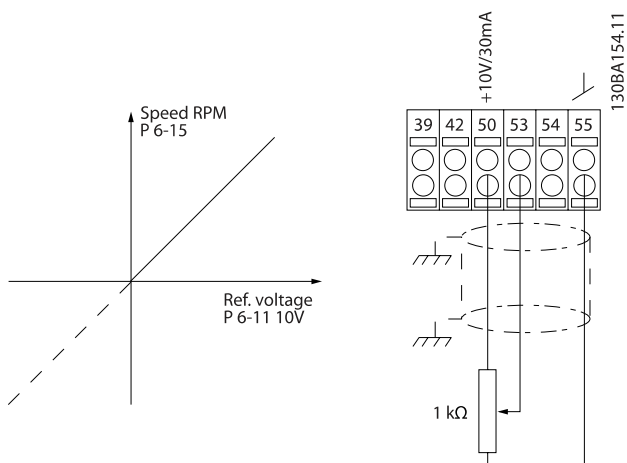

2

2 How to Programme

2.1 The Graphical and Numerical Local Control Panels

The easiest programming of the frequency converter is performed by the Graphical LCP (LCP 102). It is necessary to consult the frequency converter Design Guide, when using the Numeric Local Control Panel (LCP 101).

2.1.1 How to Programme on the Graphical LCP

The following instructions are valid for the graphical LCP (LCP 102):

The control panel is divided into four functional groups:

1. Graphical display with Status lines.
2. Menu keys and indicator lights - changing parameters and switching between display functions.
3. Navigation keys and indicator lights (LEDs).
4. Operation keys and indicator lights (LEDs).

All data is displayed in a graphical LCP display, which can show up to five items of operating data while displaying [Status].

Display lines:

- a. **Status line:** Status messages displaying icons and graphic.
- b. **Line 1-2:** Operator data lines displaying data defined or chosen by the user. By pressing the [Status] key, up to one extra line can be added.
- c. **Status line:** Status messages displaying text.

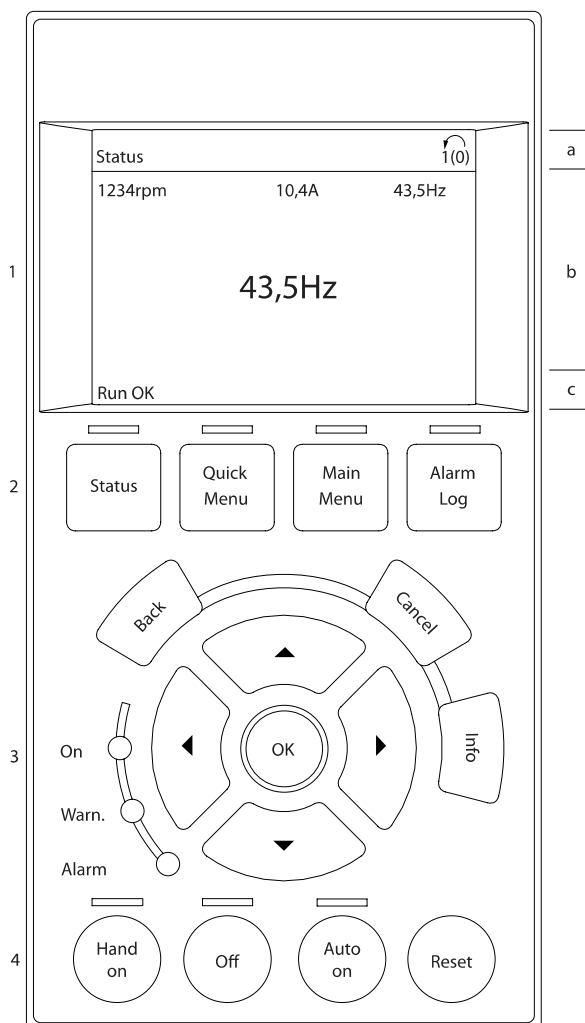

130BA018:13

2.1.2 The LCD-Display

The LCD-display has back light and a total of 6 alpha-numeric lines. The display lines show the direction of rotation (arrow), the chosen Set-up as well as the programming Set-up. The display is divided into 3 sections:

Top section shows up to 2 measurements in normal operating status.

The top line in the **Middle section** shows up to 5 measurements with related unit, regardless of status (except in the case of alarm/warning).

Bottom section always shows the state of the frequency converter in Status mode.

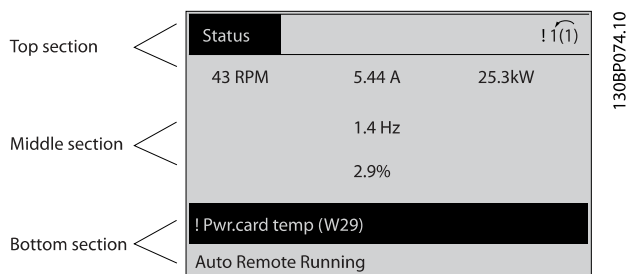

The Active Set-up (selected as the Active Set-up in par. 0-10 *Active Set-up*) is shown. When programming another Set-up than the Active Set-up, the number of the programmed Set-up appears to the right.

Display Contrast Adjustment

Press [status] and [▲] for darker display
 Press [status] and [▼] for brighter display

Most parameter set-ups can be changed immediately via the LCP, unless a password has been created via par. 0-60 *Main Menu Password* or via par. 0-65 *Quick Menu Password*.

Indicator lights (LEDs):

If certain threshold values are exceeded, the alarm and/or warning LED lights up. A status and alarm text appear on the LCP.

The ON LED is activated when the frequency converter receives mains voltage or via a DC bus terminal or 24 V external supply. At the same time, the back light is on.

- Green LED/On: Control section is working.
- Yellow LED/Warn.: Indicates a warning.
- Flashing Red LED/Alarm: Indicates an alarm.

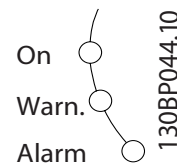

LCP Keys

The control keys are divided into functions. The keys below the display and indicator lamps are used for parameter Set-up, including choice of display indication during normal operation.

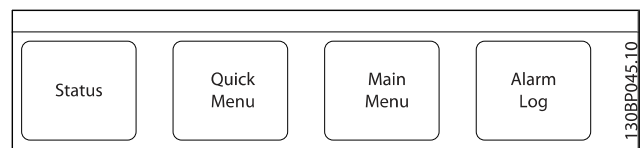

[Status] indicates the status of the frequency converter and/or the motor. You can choose between 3 different readouts by pressing the [Status] key:

5 line readouts, 4 line readouts or Smart Logic Control. Use **[Status]** for selecting the mode of display or for changing back to Display mode from either the Quick Menu mode, the Main Menu mode or Alarm mode. Also use the [Status] key to toggle single or double read-out mode.

[Quick Menu] allows quick access to different Quick Menus such as:

- My Personal Menu
- Quick Set-up
- Changes Made
- Loggings

Use **[Quick Menu]** for programming the parameters belonging to the Quick Menu. It is possible to switch directly between Quick Menu mode and Main Menu mode.

[Main Menu] is used for programming all parameters.

It is possible to switch directly between Main Menu mode and Quick Menu mode.

Parameter shortcut can be carried out by pressing down the **[Main Menu]** key for 3 seconds. The parameter shortcut allows direct access to any parameter.

[Alarm Log] displays an Alarm list of the five latest alarms (numbered A1-A5). To obtain additional details about an alarm, use the arrow keys to manoeuvre to the alarm number and press [OK]. You will now receive information about the condition of your frequency converter right before entering the alarm mode.

[Back] takes you to the previous step or layer in the navigation structure.

[Cancel] annuls your last change or command as long as the display has not been changed.

[Info] supplies information about a command, parameter, or function in any display window. [Info] provides detailed information whenever help is needed.

Exit info mode by pressing either [Info], [Back], or [Cancel].

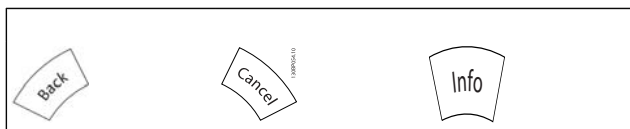

Navigation Keys

The four navigation arrows are used to navigate between the different choices available in **[Quick Menu]**, **[Main Menu]** and **[Alarm Log]**. Use the keys to move the cursor.

[OK] is used for choosing a parameter marked by the cursor and for enabling the change of a parameter.

Local Control Key for local control are found at the bottom of the LCP.

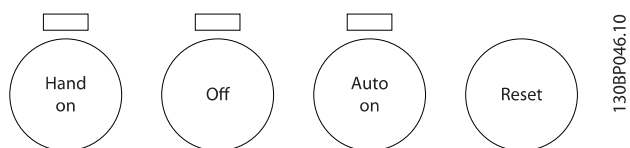

[Hand On] enables control of the frequency converter via the LCP. [Hand on] also starts the motor, and it is now possible to enter the motor speed data by means of the arrow keys. The key can be selected as Enable [1] or Disable [0] via par. 0-40 *[Hand on] Key on LCP*

External stop signals activated by means of control signals or a serial bus will override a "start" command via the LCP.

The following control signals will still be active when [Hand on] is activated:

- [Hand on] - [Off] - [Auto on]
- Reset
- Coasting stop inverse
- Reversing
- Set-up select bit 0- Set-up select bit 1
- Stop command from serial communication
- Quick stop
- DC brake

[Off] stops the connected motor. The key can be selected as Enable [1] or Disable [0] via par. 0-41 *[Off] Key on LCP*. If no external stop function is selected and the [Off] key is inactive the motor can be stopped by disconnecting the voltage.

[Auto On] enables the frequency converter to be controlled via the control terminals and/or serial communication. When a start signal is applied on the control terminals and/or the bus, the frequency converter will start. The key can be selected as Enable [1] or Disable [0] via par. 0-42 *[Auto on] Key on LCP*.

NOTE

An active HAND-OFF-AUTO signal via the digital inputs has higher priority than the control keys [Hand on] – [Auto on].

[Reset] is used for resetting the frequency converter after an alarm (trip). It can be selected as *Enable [1] or Disable [0] via par. 0-43 [Reset] Key on LCP.*

The parameter shortcut can be carried out by holding down the [Main Menu] key for 3 seconds. The parameter shortcut allows direct access to any parameter.

2.1.3 Quick Transfer of Parameter Settings between Multiple Frequency Converters

Once the set-up of a frequency converter is complete, we recommend that you store the data in the LCP or on a PC via MCT 10 Set-up Software Tool.

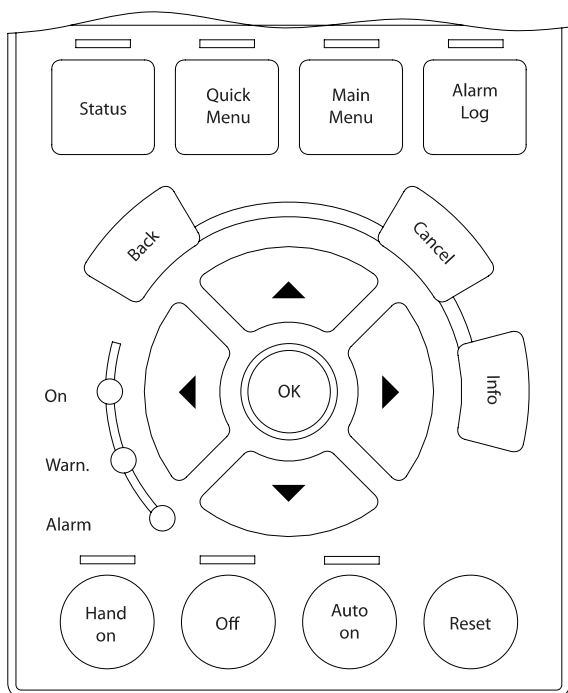

Data storage in LCP:

1. Go to par. 0-50 *LCP Copy*
2. Press the [OK] key
3. Select "All to LCP"
4. Press the [OK] key

All parameter settings are now stored in the LCP indicated by the progress bar. When 100% is reached, press [OK].

NOTE

Stop the motor before performing this operation.

You can now connect the LCP to another frequency converter and copy the parameter settings to this frequency converter as well.

Data transfer from LCP to frequency converter:

1. Go to par. 0-50 *LCP Copy*
2. Press the [OK] key
3. Select "All from LCP"
4. Press the [OK] key

The parameter settings stored in the LCP are now transferred to the frequency converter indicated by the progress bar. When 100% is reached, press [OK].

NOTE

Stop the motor before performing this operation.

2.1.4 Display Mode

In normal operation, up to 5 different operating variables can be indicated continuously in the middle section: 1.1, 1.2, and 1.3 as well as 2 and 3.

2.1.5 Display Mode - Selection of Read-Outs

It is possible to toggle between three status read-out screens by pressing the [Status] key. Operating variables with different formatting are shown in each status screen - see below.

The table shows the measurements you can link to each of the operating variables. When Options are mounted, additional measurements are available. Define the links via par. 0-20 *Display Line 1.1 Small*, par. 0-21 *Display Line 1.2 Small*, par. 0-22 *Display Line 1.3 Small*, par. 0-23 *Display Line 2 Large*, and par. 0-24 *Display Line 3 Large*.

Each readout parameter selected in par. 0-20 *Display Line 1.1 Small* to par. 0-24 *Display Line 3 Large* has its own scale and digits after a possible decimal point. By larger numeric value of a parameter fewer digits are displayed after the decimal point.

Ex.: Current readout
5.25 A; 15.2 A 105 A.

Operating variable:	Unit:
Par. 16-00 Control Word	hex
Par. 16-01 Reference [Unit]	[unit]
Par. 16-02 Reference [%]	%
Par. 16-03 Status Word	hex
Par. 16-05 Main Actual Value [%]	%
Par. 16-10 Power [kW]	[kW]
Par. 16-11 Power [hp]	[HP]
Par. 16-12 Motor Voltage	[V]
Par. 16-13 Frequency	[Hz]
Par. 16-14 Motor Current	[A]
Par. 16-16 Torque [Nm]	Nm
Par. 16-17 Speed [RPM]	[RPM]
Par. 16-18 Motor Thermal	%
Par. 16-20 Motor Angle	
Par. 16-30 DC Link Voltage	V
Par. 16-32 Brake Energy /s	kW
Par. 16-33 Brake Energy /2 min	kW
Par. 16-34 Heatsink Temp.	C
Par. 16-35 Inverter Thermal	%
Par. 16-36 Inv. Nom. Current	A
Par. 16-37 Inv. Max. Current	A
Par. 16-38 SL Controller State	
par. 16-39 Control Card Temp.	C
Par. 16-40 Logging Buffer Full	
Par. 16-50 External Reference	
Par. 16-51 Pulse Reference	
Par. 16-52 Feedback [Unit]	[Unit]
Par. 16-53 Digi Pot Reference	
Par. 16-60 Digital Input	bin
Par. 16-61 Terminal 53 Switch Setting	V
Par. 16-62 Analog Input 53	
Par. 16-63 Terminal 54 Switch Setting	V
Par. 16-64 Analog Input 54	
par. 16-65 Analog Output 42 [mA]	[mA]
Par. 16-66 Digital Output [bin]	[bin]
Par. 16-67 Pulse Input #29 [Hz]	[Hz]
Par. 16-68 Freq. Input #33 [Hz]	[Hz]
Par. 16-69 Pulse Output #27 [Hz]	[Hz]
Par. 16-70 Pulse Output #29 [Hz]	[Hz]
Par. 16-71 Relay Output [bin]	
Par. 16-72 Counter A	
Par. 16-73 Counter B	
Par. 16-80 Fieldbus CTW 1	hex
Par. 16-82 Fieldbus REF 1	hex
Par. 16-84 Comm. Option STW	hex
Par. 16-85 FC Port CTW 1	hex
Par. 16-86 FC Port REF 1	hex
Par. 16-90 Alarm Word	
Par. 16-92 Warning Word	
Par. 16-94 Ext. Status Word	

Status screen I:

This read-out state is standard after start-up or initialization. Use [INFO] to obtain information about the measurement links to the displayed operating variables (1.1, 1.2, 1.3, 2 and 3). See the operating variables shown in the screen in this illustration.

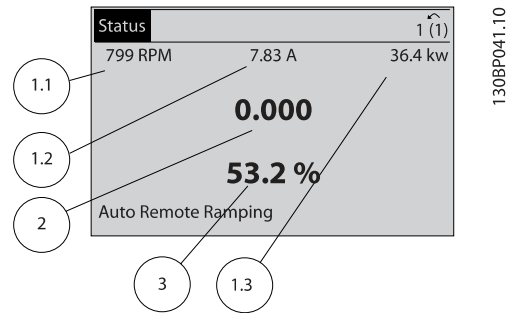

Status screen II:

See the operating variables (1.1, 1.2, 1.3 and 2) shown in the screen in this illustration. In the example, Speed, Motor current, Motor power and Frequency are selected as variables in the first and second.

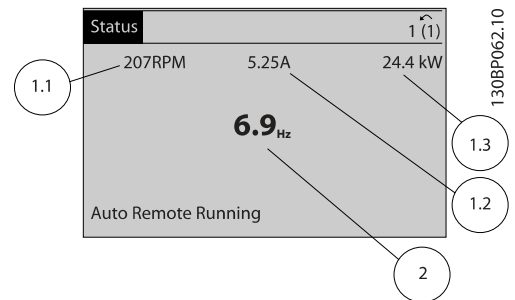

Status screen III:

This state displays the event and action of the Smart Logic Control. For further information, see section *Smart Logic Control*.

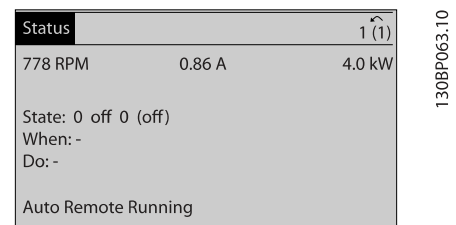

2.1.6 Parameter Set-Up

The frequency converter can be used for practically all assignments, which is why the number of parameters is quite large. The frequency converter offers a choice between two programming modes - a Main Menu and a Quick Menu mode.

The former provides access to all parameters. The latter takes the user through a few parameters making it possible to start operating the frequency converter.

Regardless of the mode of programming, you can change a parameter both in the Main Menu mode and in the Quick Menu mode.

2.1.7 Quick Menu Key Functions

Pressing [Quick Menus] The list indicates the different areas contained in the Quick menu.

Select *My Personal Menu* to display the chosen personal parameters. These parameters are selected in par. 0-25 *My Personal Menu*. Up to 20 different parameters can be added in this menu.

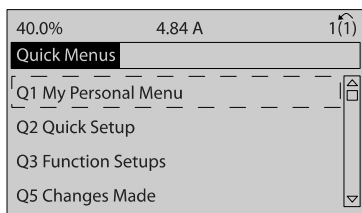

130BP064.10

Select *Quick setup* to go through a limited amount of parameters to get the motor running almost optimally. The default setting for the other parameters considers the desired control functions and the configuration of signal inputs/outputs (control terminals).

The selection of parameter is effected by means of the arrow keys. The parameters in the following table are accessible.

Parameter	Setting
Par. 0-01 <i>Language</i>	
Par. 1-20 <i>Motor Power [kW]</i>	[kW]
Par. 1-22 <i>Motor Voltage</i>	[V]
Par. 1-23 <i>Motor Frequency</i>	[Hz]
Par. 1-24 <i>Motor Current</i>	[A]
Par. 1-25 <i>Motor Nominal Speed</i>	[rpm]
Par. 5-12 <i>Terminal 27 Digital Input</i>	[0] No function*
Par. 1-29 <i>Automatic Motor Adaptation (AMA)</i>	[1] Enable complete AMA
Par. 3-02 <i>Minimum Reference</i>	[rpm]
Par. 3-03 <i>Maximum Reference</i>	[rpm]
Par. 3-41 <i>Ramp 1 Ramp up Time</i>	[sec]
Par. 3-42 <i>Ramp 1 Ramp Down Time</i>	[sec]
Par. 3-13 <i>Reference Site</i>	

* If terminal 27 is set to "no function", no connection to +24 V on terminal 27 is necessary.

Select *Changes made* to get information about:

- the last 10 changes. Use the [▲] [▼] navigation keys to scroll between the last 10 changed parameters.
- the changes made since default setting.

Select *Loggings* to get information about the display line read-outs. The information is shown as graphs.

Only display parameters selected in par. 0-20 *Display Line 1.1 Small* and par. 0-24 *Display Line 3 Large* can be viewed. It is possible to store up to 120 samples in the memory for later reference.

2.1.8 Initial Commissioning

2

The easiest way of carrying out the initial commissioning is by using the Quick Menu button and follow the quick set-up procedure using LCP 102 (read table from left to right). The example applies to open loop applications:

Press			
		Q2 Quick Menu	
Par. 0-01 <i>Language</i>		Set language	
Par. 1-20 <i>Motor Power [kW]</i>		Set Motor nameplate power	
Par. 1-22 <i>Motor Voltage</i>		Set Nameplate voltage	
Par. 1-23 <i>Motor Frequency</i>		Set Nameplate frequency	
Par. 1-24 <i>Motor Current</i>		Set Nameplate current	
Par. 1-25 <i>Motor Nominal Speed</i>		Set Nameplate speed in RPM	
Par. 5-12 <i>Terminal 27 Digital Input</i>		If terminal default is <i>Coast inverse</i> it is possible to change this setting to <i>No function</i> . No connection to terminal 27 is then needed for running AMA	
Par. 1-29 <i>Automatic Motor Adaptation (AMA)</i>		Set desired AMA function. Enable complete AMA is recommended	
Par. 3-02 <i>Minimum Reference</i>		Set the minimum speed of the motor shaft	
Par. 3-03 <i>Maximum Reference</i>		Set the maximum speed of the motor shaft	
Par. 3-41 <i>Ramp 1 Ramp up Time</i>		Set the ramping up time with reference to synchronous motor speed, n_s	
Par. 3-42 <i>Ramp 1 Ramp Down Time</i>		Set the ramping downdecel time with reference to synchronous motor speed, n_s	
Par. 3-13 <i>Reference Site</i>		Set the site from where the reference must work	

2.1.9 Main Menu Mode

Start the Main Menu mode by pressing the [Main Menu] key. The read-out shown to the right appears on the display. The middle and bottom sections on the display show a list of par. groups which can be chosen by toggling the up and down buttons.

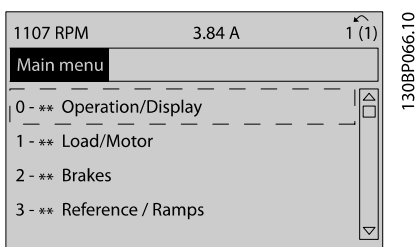

Each parameter has a name and number which remain the same regardless of the programming mode. In the Main Menu mode, the parameters are divided into groups. The first digit of the parameter number (from the left) indicates the par. group number.

All parameters can be changed in the Main Menu. However, depending on the choice of configuration (par. 1-00 *Configuration Mode*), some parameters can be "missing". E.g. open loop hides all the PID parameters, and other enabled options make more par. groups visible.

2.1.10 Parameter Selection

In the Main menu mode, the parameters are divided into groups. You select a par. group by means of the navigation keys.

The following par. groups are accessible:

After selecting a par. group, choose a parameter by means of the navigation keys.

The middle section on the display shows the parameter number and name as well as the selected parameter value.

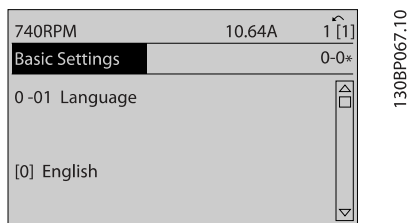

2.1.11 Changing Data

The procedure for changing data is the same whether you select a parameter in the Quick menu or the Main menu mode. Press [OK] to change the selected parameter. The procedure for changing data depends on whether the selected parameter represents a numerical data value or a text value.

2.1.12 Changing a Text Value

If the selected parameter is a text value, change the text value by means of the [▲] [▼] navigation keys. The up key increases the value, and the down key decreases the value. Place the cursor on the value you want to save and press [OK].

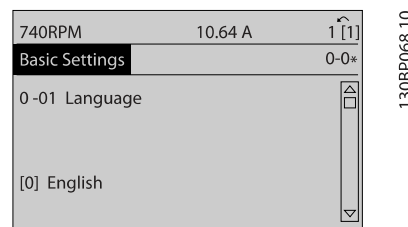

2.1.13 Changing a Group of Numeric Data Values

If the chosen parameter represents a numeric data value, change the chosen data value by means of the [◀] [▶] navigation keys as well as the [▲] [▼] navigation keys. Use the [◀] [▶] navigation keys to move the cursor horizontally.

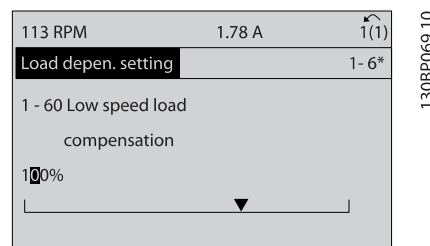

Use the [▲] [▼] navigation keys to change the data value. The up key enlarges the data value, and the down key reduces the data value. Place the cursor on the value you want to save and press [OK].

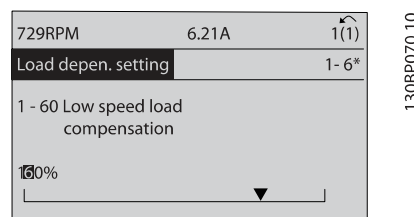

2

2.1.14 Infinitely Variable Change of Numeric Data Value

If the chosen parameter represents a numeric data value, select a digit by means of the [◀] [▶] navigation keys.

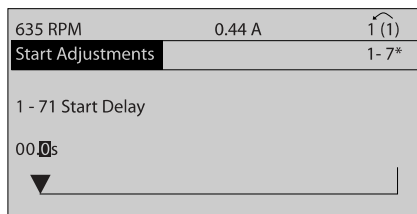

130BP073.10

Change the selected digit infinitely variably by means of the [▲] [▼] navigation keys.

The chosen digit is indicated by the cursor. Place the cursor on the digit you want to save and press [OK].

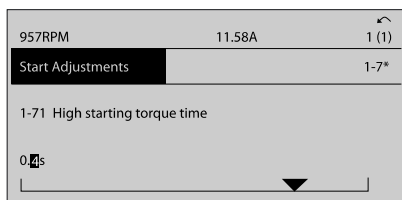

130BP072.10

2.1.15 Value, Step-by-Step

Certain parameters can be changed step by step or infinitely varying. This applies to par. 1-20 *Motor Power [kW]*, par. 1-22 *Motor Voltage* and par. 1-23 *Motor Frequency*. The parameters are changed both as a group of numeric data values and as numeric data values infinitely varying.

2.1.16 Read-out and Programming of Indexed Parameters

Parameters are indexed when placed in a rolling stack. Par. 15-30 *Fault Log: Error Code* to par. 15-32 *Alarm Log: Time* contain a fault log which can be read out. Choose a parameter, press [OK], and use the [▲] [▼] navigation keys to scroll through the value log.

Use par. 3-10 *Preset Reference* as another example: Choose the parameter, press [OK], and use the [▲] [▼] navigation keys to scroll through the indexed values. To change the parameter value, select the indexed value and press [OK]. Change the value by using the [▲] [▼] keys. Press [OK] to accept the new setting. Press [CANCEL] to abort. Press [Back] to leave the parameter.

2.1.17 How to Programme on the Numerical Local Control Panel

The following instructions are valid for the Numerical LCP (LCP 101).

The control panel is divided into four functional groups:

1. Numerical display.
2. Menu keys and indicator lights - changing parameters and switching between display functions.
3. Navigation keys and indicator lights (LEDs).
4. Operation keys and indicator lights (LEDs).

Display line: Status messages displaying icons and numeric value.

Indicator lights (LEDs):

- Green LED/On: Indicates if control section is on.
- Yellow LED/Wrn.: Indicates a warning.
- Flashing red LED/Alarm: Indicates an alarm.

LCP keys

[Menu] Select one of the following modes:

- Status
- Quick Setup
- Main Menu

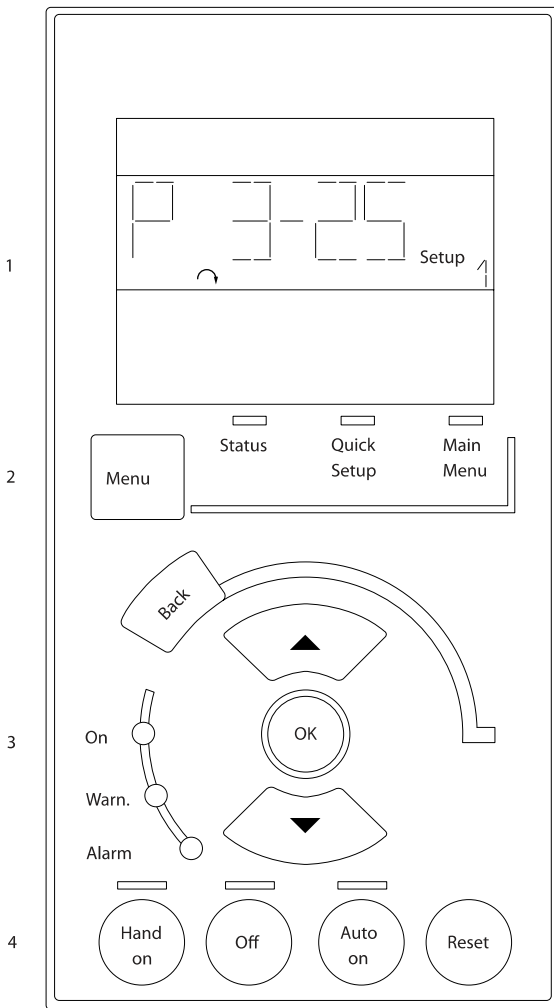

130BA191.10

Main Menu/ Quick Setup is used for programming all parameters or only the parameters in the Quick Meny (see also description of the LCP 102 earlier in this chapter).

The parameter values can be changed using the [▲] [▼] keys when the value is flashing.

Select Main Menu by pressing [Menu] key a number of times.

Select the par. group [xx-] and press [OK]

Select the parameter [-xx] and press [OK]

If the parameter is an array parameter select the array number and press [OK]

Select the wanted data value and press [OK]

Parameters with functional choices display values such as [1], [2], etc. For a description of the different choices, see the individual description of the parameters in the *Parameter Selection* section

[Back] for stepping backwards

Arrow [▲] [▼] keys are used for manoeuvring between commands and within parameters.

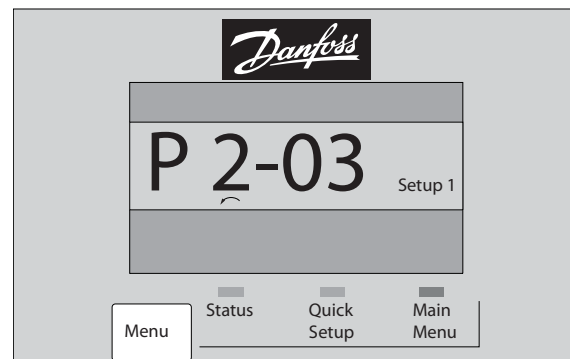

130BP079.10

Status Mode: Displays the status of the frequency converter or the motor.

If an alarm occurs the NLCP automatically switches to status mode.

A number of alarms can be displayed.

NOTE

Parameter copy is not possible with LCP 101 Numerical Local Control Panel.



130BP077.10



130BP078.10

2.1.18 Local Control Keys

Keys for local control are found at the bottom of the LCP.

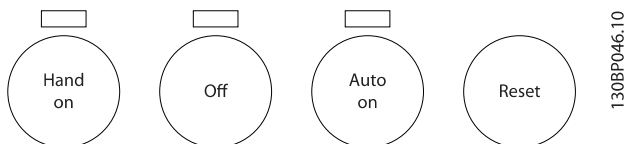

[Hand on] enables control of the frequency converter via the LCP. [Hand on] also starts the motor and it is now possible to enter the motor speed data by means of the arrow keys. The key can be selected as Enable [1] og Disable [0] via par. 0-40 *[Hand on] Key on LCP*.

External stop signals activated by means of control signals or a serial bus will override a 'start' command via the LCP.

The following control signals will still be active when [Hand on] is activated:

- [Hand on] - [Off] - [Auto on]
- Reset
- Coasting stop inverse
- Reversing
- Set-up select lsb - Set-up select msb
- Stop command from serial communication
- Quick stop
- DC brake

[Off] stops the connected motor. The key can be selected as Enable [1] or Disable [0] via par. 0-41 *[Off] Key on LCP* . If no external stop function is selected and the [Off] key is inactive the motor can be stopped by disconnecting the voltage.

[Auto on] enables the frequency converter to be controlled via the control terminals and/or serial communication. When a start signal is applied on the control terminals and/or the bus, the frequency converter will start. The key can be selected as Enable [1] or Disable [0] via par. 0-42 *[Auto on] Key on LCP*.

NOTE

An active **HAND-OFF-AUTO** signal via the digital inputs has higher priority than the control keys [Hand on] [Auto on].

[Reset] is used for resetting the frequency converter after an alarm (trip). It can be selected as Enable [1] or Disable [0] via par. 0-43 *[Reset] Key on LCP*.

2.1.19 Initialisation to Default Settings

Initialise the frequency converter to default settings in two ways:

Recommended initialisation (via par. 14-22 *Operation Mode*)

1.	Select par. 14-22 <i>Operation Mode</i>
2.	Press [OK]
3.	Select "Initialisation"
4.	Press [OK]
5.	Cut off the mains supply and wait until the display turns off.
6.	Reconnect the mains supply - the frequency converter is now reset.

Par. 14-22 <i>Operation Mode</i> initialises all except:
Par. 14-50 <i>RFI Filter</i>
Par. 8-30 <i>Protocol</i>
Par. 8-31 <i>Address</i>
Par. 8-32 <i>FC Port Baud Rate</i>
Par. 8-35 <i>Minimum Response Delay</i>
Par. 8-36 <i>Max Response Delay</i>
Par. 8-37 <i>Max Inter-Char Delay</i>
Par. 15-00 <i>Operating Hours</i> to par. 15-05 <i>Over Volt's</i>
Par. 15-20 <i>Historic Log: Event</i> to par. 15-22 <i>Historic Log: Time</i>
Par. 15-30 <i>Fault Log: Error Code</i> to par. 15-32 <i>Alarm Log: Time</i>

Manual initialisation

1.	Disconnect from mains and wait until the display turns off.
2a.	Press [Status] - [Main Menu] - [OK] at the same time while power up for LCP 102, Graphical Display
2b.	Press [Menu] while power up for LCP 101, Numerical Display
3.	Release the keys after 5 s.
4.	The frequency converter is now programmed according to default settings.

This procedure initialises all except:
Par. 15-00 <i>Operating Hours</i>
Par. 15-03 <i>Power Up's</i>
Par. 15-04 <i>Over Temp's</i>
Par. 15-05 <i>Over Volt's</i>

NOTE

When you carry out manual initialisation, you also reset serial communication, RFI filter settings (par. 14-50 *RFI Filter*) and fault log settings.

3 Parameter Descriptions

3.1 Parameter Selection

Parameters for FC 300 are grouped into various par. groups for easy selection of the correct parameters for optimized operation of the frequency converter.

0-** Operation and Display parameters

- Basic Settings, set-up handling
- Display and Local Control Panel parameters for choosing readouts, setting up selections and copying functions

1-** Load and Motor parameters includes all load and motor related parameters

2-** Brake parameters

- DC brake
- Dynamic brake (Resistor brake)
- Mechanical brake
- Over Voltage Control

3-** References and ramping parameters includes DigiPot function

4-** Limits Warnings; setting of limits and warning parameters

5-** Digital inputs and outputs includes relay controls

6-** Analog inputs and outputs

7-** Controls; Setting parameters for speed and process controls

8-** Communication and option parameters for setting of FC RS485 and FC USB port parameters.

9-** Profibus parameters

10-** DeviceNet and CAN Fieldbus parameters

12-** Ethernet parameters

13-** Smart Logic Control parameters

14-** Special function parameters

15-** Drive information parameters

16-** Readout parameters

17-** Encoder Option parameters

18-** Readout 2 parameters

30-** Special Features

32-** MCO Basic Settings parameters

33-** MCO Adv. Settings parameters

34-** MCO Data Readouts

35-** Sensor Input Option parameters

3.2 Parameters: 0-** Operation and Display

Parameters related to the fundamental functions of the frequency converter, function of the LCP buttons and configuration of the LCP display.

3.2.1 0-0* Basic Settings

0-01 Language		
Option:	Function:	
		Defines the language to be used in the display. The frequency converter can be delivered with 4 different language packages. English and German are included in all packages. English cannot be erased or manipulated.
[0] *	English	Part of Language packages 1 - 4
[1]	Deutsch	Part of Language packages 1 - 4
[2]	Francais	Part of Language package 1
[3]	Dansk	Part of Language package 1
[4]	Spanish	Part of Language package 1
[5]	Italiano	Part of Language package 1
	Svenska	Part of Language package 1
[7]	Nederlands	Part of Language package 1
[10]	Chinese	Part of Language package 2
	Suomi	Part of Language package 1
[22]	English US	Part of Language package 4
	Greek	Part of Language package 4
	Bras.port	Part of Language package 4
	Slovenian	Part of Language package 3

0-01 Language		
Option:	Function:	
	Korean	Part of Language package 2
	Japanese	Part of Language package 2
	Turkish	Part of Language package 4
	Trad.Chinese	Part of Language package 2
	Bulgarian	Part of Language package 3
	Srpski	Part of Language package 3
	Romanian	Part of Language package 3
	Magyar	Part of Language package 3
	Czech	Part of Language package 3
	Polski	Part of Language package 4
	Russian	Part of Language package 3
	Thai	Part of Language package 2
	Bahasa Indonesia	Part of Language package 2
[99]	Unknown	

0-02 Motor Speed Unit		
Option:	Function:	
	This parameter cannot be adjusted while the motor is running. The display showing depends on settings in par. 0-02 <i>Motor Speed Unit</i> and par. 0-03 <i>Regional Settings</i> . The default setting of par. 0-02 <i>Motor Speed Unit</i> and par. 0-03 <i>Regional Settings</i> depends on which region of the world the frequency converter is supplied to, but can be re-programmed as required.	
	NOTE Changing the <i>Motor Speed Unit</i> will reset certain parameters to their initial value. It is recommended to select the motor speed unit first, before modifying other parameters.	
[0]	RPM	Selects display of motor speed variables and parameters (i.e. references, feedbacks and limits) in terms of motor speed (RPM).
[1] *	Hz	Selects display of motor speed variables and parameters (i.e. references, feedbacks and limits) in terms of output frequency to the motor (Hz).

0-03 Regional Settings		
Option:	Function:	
[0] *	International	Activates par. 1-20 <i>Motor Power [kW]</i> for setting the motor power in kW and sets the default value of par. 1-23 <i>Motor Frequency</i> to 50 Hz.
[1]	US	Activates par. 1-20 <i>Motor Power [kW]</i> for setting the motor power in HP and sets the default value of par. 1-23 <i>Motor Frequency</i> to 60 Hz.

This parameter cannot be adjusted while the motor is running.

0-04 Operating State at Power-up (Hand)		
Option:	Function:	
		Selects the operating mode upon reconnection of the frequency converter to mains voltage after power down in Hand (local) operation mode.
[0]	Resume	Restarts the frequency converter maintaining the same local reference and the same start/stop settings (applied by [HAND ON/OFF]) as before the frequency converter was powered down.
[1] *	Forced stop, ref=old	Restarts the frequency converter with a saved local reference, after mains voltage reappears and after pressing [HAND ON].
[2]	Forced stop, ref=0	Resets the local reference to 0 upon restarting the frequency converter.

3.2.2 0-1* Set-up Operations

Define and control the individual parameter setups.

The frequency converter has four parameter setups that can be programmed independently of each other. This makes the frequency converter very flexible and able to solve advanced control functionality problems, often saving the cost of external control equipment. For example these can be used to program the frequency converter to operate according to one control scheme in one setup (e.g. motor 1 for horizontal movement) and another control scheme in another setup (e.g. motor 2 for vertical movement). Alternatively they can be used by an OEM machine builder to identically program all their factory fitted frequency converters for different machine types within a range to have the same parameters and then during production/commissioning simply select a specific setup depending on which machine the frequency converter is installed on.

The active setup (i.e. the setup in which the frequency converter is currently operating) can be selected in par. 0-10 *Active Set-up* and is displayed in the LCP. Using Multi set-up it is possible to switch between setups with the frequency converter running or stopped, via digital input or serial communication commands. If it is necessary to change setups whilst running, ensure par. 0-12 *This Set-up Linked to* is programmed as required. Using par. 0-11 *Edit Set-up* it is possible to edit parameters within any of the setups whilst

continuing the frequency converter operation in its Active Setup which can be a different setup to that being edited. Using par. 0-51 *Set-up Copy* it is possible to copy parameter settings between the setups to enable quicker commissioning if similar parameter settings are required in different setups.

0-10 Active Set-up		
Option:	Function:	
		Select the set-up to control the frequency converter functions.
[0]	Factory setup	Cannot be changed. It contains the Danfoss data set, and can be used as a data source when returning the other set-ups to a known state.
[1] *	Set-up 1	<i>Set-up 1</i> [1] to <i>Set-up 4</i> [4] are the four separate parameter set-ups within which all parameters can be programmed.
[2]	Set-up 2	
[3]	Set-up 3	
[4]	Set-up 4	
[9]	Multi Set-up	Remote selection of set-ups using digital inputs and the serial communication port. This set-up uses the settings from par. 0-12 <i>This Set-up Linked to</i> . Stop the frequency converter before making changes to open- and closed loop functions

Use par. 0-51 *Set-up Copy* to copy a set-up to one or all other set-ups. Stop the frequency converter before switching between set-ups where parameters marked 'not changeable during operation' have different values. To avoid conflicting settings of the same parameter within two different set-ups, link the set-ups together using par. 0-12 *This Set-up Linked to*. Parameters which are 'not changeable during operation' are marked FALSE in the parameter lists in the section *Parameter Lists*.

0-11 Edit Set-up		
Option:	Function:	
		Select the set-up to be edited (i.e. programmed) during operation; either the active set-up or one of the inactive set-ups.
[0]	Factory setup	Cannot be edited but it is useful as a data source to return the other set-ups to a known state.
[1] *	Set-up 1	<i>Set-up 1</i> [1] to <i>Set-up 4</i> [4] can be edited freely during operation, independently of the active set-up.
[2]	Set-up 2	
[3]	Set-up 3	
[4]	Set-up 4	
[9]	Active Set-up	Can also be edited during operation. Edit the chosen set-up from a range of sources: LCP, FC RS-485, FC USB or up to five fieldbus sites.

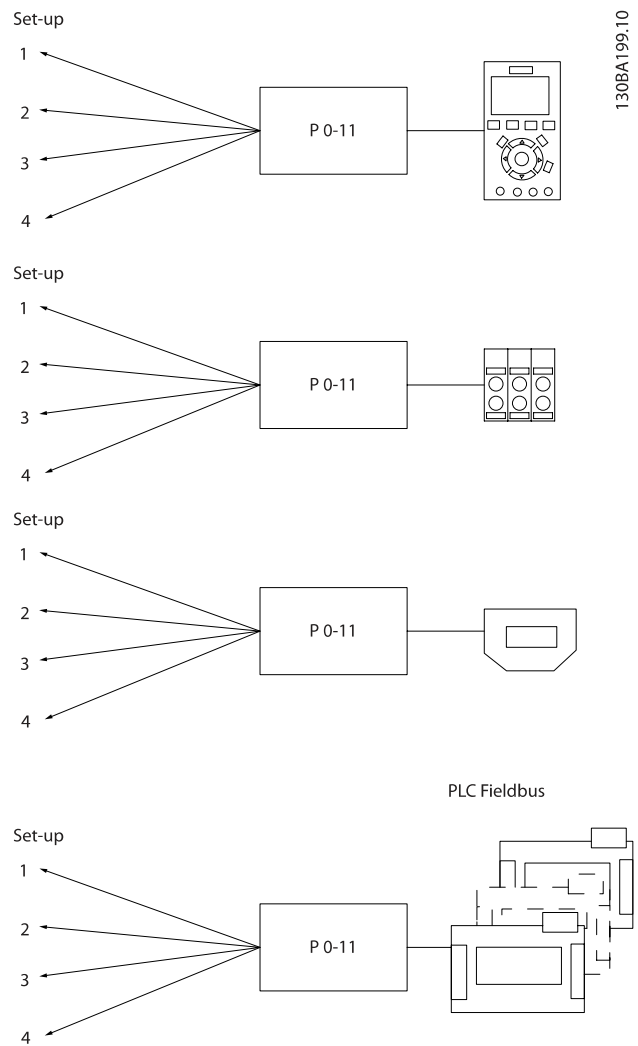

0-12 This Set-up Linked to		
Option:	Function:	
		To enable conflict-free changes from one set-up to another during operation, link set-ups containing parameters which are not changeable during operation. The link will ensure synchronising of the 'not changeable during operation' parameter values when moving from one set-up to another during operation. 'Not changeable during operation' parameters can be identified by the label FALSE in the parameter lists in the section <i>Parameter Lists</i> .
		Par. 0-12 <i>This Set-up Linked to</i> is used by Multi set-up in par. 0-10 <i>Active Set-up</i> . Multi set-up is used to move from one set-up to another during operation (i.e. while the motor is running). Example: Use Multi set-up to shift from Set-up 1 to Set-up 2 whilst the motor is running. Programme in Set-up 1 first, then ensure that Set-up 1 and Set-up 2 are synchronised (or 'linked'). Synchronisation can be performed in two ways:

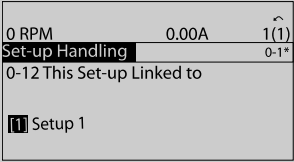
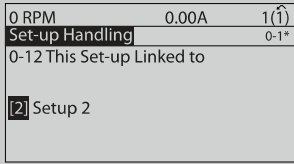
0-12 This Set-up Linked to	
Option:	Function:
	<p>1. Change the edit set-up to <i>Set-up 2</i> [2] in par. 0-11 <i>Edit Set-up</i> and set par. 0-12 <i>This Set-up Linked to</i> to <i>Set-up 1</i> [1]. This will start the linking (synchronising) process.</p>  <p>OR</p> <p>2. While still in <i>Set-up 1</i>, copy <i>Set-up 1</i> to <i>Set-up 2</i>. Then set par. 0-12 <i>This Set-up Linked to</i> to <i>Set-up 2</i> [2]. This will start the linking process.</p>  <p>After the link is complete, par. 0-13 <i>Readout: Linked Set-ups</i> will read {1,2} to indicate that all 'not changeable during operation' parameters are now the same in <i>Set-up 1</i> and <i>Set-up 2</i>. If there are changes to a 'not changeable during operation' parameter, e.g. par. 1-30 <i>Stator Resistance (Rs)</i>, in <i>Set-up 2</i>, they will also be changed automatically in <i>Set-up 1</i>. A switch between <i>Set-up 1</i> and <i>Set-up 2</i> during operation is now possible.</p>
[0] *	Not linked
[1]	Set-up 1
[2]	Set-up 2
[3]	Set-up 3
[4]	Set-up 4

0-13 Readout: Linked Set-ups													
Range:	Function:												
Array [5]													
0 N/A*	[0 - 255] View a list of all the set-ups linked by means of par. 0-12 <i>This Set-up Linked to</i> . The parameter has one index for each parameter set-up. The parameter value displayed for each index represents which setups are linked to that parameter setup.												
	<table border="1"> <thead> <tr> <th>Index</th> <th>LCP value</th> </tr> </thead> <tbody> <tr> <td>0</td> <td>{0}</td> </tr> <tr> <td>1</td> <td>{1,2}</td> </tr> <tr> <td>2</td> <td>{1,2}</td> </tr> <tr> <td>3</td> <td>{3}</td> </tr> <tr> <td>4</td> <td>{4}</td> </tr> </tbody> </table>	Index	LCP value	0	{0}	1	{1,2}	2	{1,2}	3	{3}	4	{4}
Index	LCP value												
0	{0}												
1	{1,2}												
2	{1,2}												
3	{3}												
4	{4}												
Table 3.2: Example: Set-up 1 and Set-up 2 are linked													

0-14 Readout: Edit Set-ups / Channel	
Range:	Function:
0*	[-2147483648 - 2147483647] View the setting of par. 0-11 <i>Edit Set-up</i> for each of the four different communication channels. When the number is displayed in hex, as it is in the LCP, each number represents one channel. Numbers 1-4 represent a set-up number; 'F' means factory setting; and 'A' means active set-up. The channels are, from right to left: LCP, FC-bus, USB, HPFB1-5. Example: The number AAAAAA21h means that the FC bus selected <i>Set-up 2</i> in par. 0-11 <i>Edit Set-up</i> , the LCP selected <i>Set-up 1</i> and all others used the active set-up.

3.2.3 0-2* LCP Display

Define the variables displayed in the Graphical Local Control Panel.

NOTE

Please refer to par. 0-37 *Display Text 1*, par. 0-38 *Display Text 2* and par. 0-39 *Display Text 3* for information on how to write display texts.

0-20 Display Line 1.1 Small		
Option:	Function:	
		Select a variable for display in line 1, left position.
[0]	None	No display value selected.
[9]	Performance Monitor	
[37]	Display Text 1	
[38]	Display Text 2	
[39]	Display Text 3	
[748]	PCD Feed Forward	
[953]	Profibus Warning Word	
[1005]	Readout Transmit Error Counter	
[1006]	Readout Receive Error Counter	
[1007]	Readout Bus Off Counter	
[1013]	Warning Parameter	
[1230]	Warning Parameter	
[1472]	Legacy Alarm Word	
[1473]	Legacy Warning Word	
[1474]	Leg. Ext. Status Word	
[1501]	Running Hours	
[1502]	kWh Counter	
[1600]	Control Word	Present control word
[1601]	Reference [Unit]	Total reference (sum of digital/analog/preset/bus/freeze ref./catch up and slow-down) in selected unit.
[1602]	Reference %	Total reference (sum of digital/analog/preset/bus/freeze ref./catch up and slow-down) in percent.
[1603]	Status Word	Present status word.
[1605]	Main Actual Value [%]	Actual value as a percentage.
[1609]	Custom Readout	

0-20 Display Line 1.1 Small		
Option:	Function:	
[1610]	Power [kW]	Actual power consumed by the motor in kW.
[1611]	Power [hp]	Actual power consumed by the motor in HP.
[1612]	Motor Voltage	Voltage supplied to the motor.
[1613]	Frequency	Motor frequency, i.e. the output frequency from the frequency converter in Hz
[1614]	Motor Current	Phase current of the motor measured as effective value.
[1615]	Frequency [%]	Motor frequency, i.e. the output frequency from the frequency converter in percent.
[1616]	Torque [Nm]	Actual motor torque in Nm
[1617] *	Speed [RPM]	Speed in RPM (revolutions per minute) i.e. the motor shaft speed in closed loop.
[1618]	Motor Thermal	Thermal load on the motor, calculated by the ETR function.
[1619]	KTY sensor temperature	
[1620]	Motor Angle	
[1621]	Torque [%] High Res.	
[1622]	Torque [%]	Present motor load as a percentage of the rated motor torque.
[1625]	Torque [Nm] High	
[1630]	DC Link Voltage	Intermediate circuit voltage in the frequency converter.
[1632]	Brake Energy /s	Present brake power transferred to an external brake resistor. Stated as an instantaneous value.
[1633]	Brake Energy /2 min	Brake power transferred to an external brake resistor. The mean power is calculated continuously for the most recent 120 seconds.
[1634]	Heatsink Temp.	Present heat sink temperature of the frequency converter. The cut-out limit is 95 ±5 °C; cutting back in occurs at 70 ±5° C.
[1635]	Inverter Thermal	Percentage load of the inverters.
[1636]	Inv. Nom. Current	Nominal current of the frequency converter.
[1637]	Inv. Max. Current	Maximum current of the frequency converter.
[1638]	SL Controller State	State of the event executed by the control.

0-20 Display Line 1.1 Small		
Option:	Function:	
[1639]	Control Card Temp.	Temperature of the control card.
[1650]	External Reference	Sum of the external reference as a percentage, i.e. the sum of analog/pulse/bus.
[1651]	Pulse Reference	Frequency in Hz connected to the digital inputs (18, 19 or 32, 33).
[1652]	Feedback [Unit]	Reference value from programmed digital input(s).
[1653]	Digi Pot Reference	
[1657]	Feedback [RPM]	
[1660]	Digital Input	Signal states form the 6 digital terminals (18, 19, 27, 29, 32 and 33). There are 16 bits in total, but only six of them are used. Input 18 corresponds to the leftmost of the used bits. Signal low = 0; Signal high = 1.
[1661]	Terminal 53 Switch Setting	Setting of input terminal 54. Current = 0; Voltage = 1.
[1662]	Analog Input 53	Actual value at input 53 either as a reference or protection value.
[1663]	Terminal 54 Switch Setting	Setting of input terminal 54. Current = 0; Voltage = 1.
[1664]	Analog Input 54	Actual value at input 54 either as reference or protection value.
[1665]	Analog Output 42 [mA]	Actual value at output 42 in mA. Use par. 6-50 <i>Terminal 42 Output</i> to select the value to be shown.
[1666]	Digital Output [bin]	Binary value of all digital outputs.
[1667]	Freq. Input #29 [Hz]	Actual value of the frequency applied at terminal 29 as an impulse input.
[1668]	Freq. Input #33 [Hz]	Actual value of the frequency applied at terminal 33 as an impulse input.
[1669]	Pulse Output #27 [Hz]	Actual value of impulses applied to terminal 27 in digital output mode.
[1670]	Pulse Output #29 [Hz]	Actual value of impulses applied to terminal 29 in digital output mode.
[1671]	Relay Output [bin]	
[1672]	Counter A	Application dependent (e.g. SLC Control)
[1673]	Counter B	Application dependent (e.g. SLC Control)
[1674]	Prec. Stop Counter	Display the actual counter value.
[1675]	Analog In X30/11	Actual value at input X30/11 either as reference or protection value.

0-20 Display Line 1.1 Small		
Option:	Function:	
[1676]	Analog In X30/12	Actual value at input X30/12 either as reference or protection value.
[1677]	Analog Out X30/8 [mA]	Actual value at output X30/8 in mA. Use par. 6-60 <i>Terminal X30/8 Output</i> to select the value to be shown.
[1678]	Analog Out X45/1 [mA]	
[1679]	Analog Out X45/3 [mA]	
[1680]	Fieldbus CTW 1	Control word (CTW) received from the Bus Master.
[1682]	Fieldbus REF 1	Main reference value sent with control word from the Bus Master.
[1684]	Comm. Option STW	Extended fieldbus communication option status word.
[1685]	FC Port CTW 1	Control word (CTW) received from the Bus Master.
[1686]	FC Port REF 1	Status word (STW) sent to the Bus Master.
[1690]	Alarm Word	One or more alarms in a Hex code.
[1691]	Alarm Word 2	One or more alarms in a Hex code.
[1692]	Warning Word	One or more warnings in a Hex code.
[1693]	Warning Word 2	One or more warnings in a Hex code.
[1694]	Ext. Status Word	One or more status conditions in a Hex code.
[1836]	Analog Input X48/2 [mA]	
[1837]	Temp. Input X48/4	
[1838]	Temp. Input X48/7	
[1839]	Temp. Input X48/10	
[1860]	Digital Input 2	
[1890]	Process PID Error	
[1891]	Process PID Output	
[1892]	Process PID Clamped Output	
[1893]	Process PID Gain Scaled Output	
[3019]	Wobble Delta Freq. Scaled	
[3110]	Bypass Status Word	
[3111]	Bypass Running Hours	
[3401]	PCD 1 Write to MCO	
[3402]	PCD 2 Write to MCO	

0-20 Display Line 1.1 Small		
Option:	Function:	
[3403]	PCD 3 Write to MCO	
[3404]	PCD 4 Write to MCO	
[3405]	PCD 5 Write to MCO	
[3406]	PCD 6 Write to MCO	
[3407]	PCD 7 Write to MCO	
[3408]	PCD 8 Write to MCO	
[3409]	PCD 9 Write to MCO	
[3410]	PCD 10 Write to MCO	
[3421]	PCD 1 Read from MCO	
[3422]	PCD 2 Read from MCO	
[3423]	PCD 3 Read from MCO	
[3424]	PCD 4 Read from MCO	
[3425]	PCD 5 Read from MCO	
[3426]	PCD 6 Read from MCO	
[3427]	PCD 7 Read from MCO	
[3428]	PCD 8 Read from MCO	
[3429]	PCD 9 Read from MCO	
[3430]	PCD 10 Read from MCO	
[3440]	Digital Inputs	
[3441]	Digital Outputs	
[3450]	Actual Position	
[3451]	Commanded Position	
[3452]	Actual Master Position	
[3453]	Slave Index Position	
[3454]	Master Index Position	
[3455]	Curve Position	
[3456]	Track Error	
[3457]	Synchronizing Error	
[3458]	Actual Velocity	

0-20 Display Line 1.1 Small		
Option:	Function:	
[3459]	Actual Master Velocity	
[3460]	Synchronizing Status	
[3461]	Axis Status	
[3462]	Program Status	
[3464]	MCO 302 Status	
[3465]	MCO 302 Control	
[3470]	MCO Alarm Word 1	
[3471]	MCO Alarm Word 2	
[9913]	Idle time	
[9914]	Paramdb requests in queue	
[9917]	tCon1 time	
[9918]	tCon2 time	
[9919]	Time Optimize Measure	
[9920]	HS Temp. (PC1)	
[9921]	HS Temp. (PC2)	
[9922]	HS Temp. (PC3)	
[9923]	HS Temp. (PC4)	
[9924]	HS Temp. (PC5)	
[9925]	HS Temp. (PC6)	
[9926]	HS Temp. (PC7)	
[9927]	HS Temp. (PC8)	

0-21 Display Line 1.2 Small		
Option:	Function:	
[1614] *	Motor Current	Select a variable for display in line 1, middle position. The options are the same as listed for par. 0-20.

0-22 Display Line 1.3 Small		
Option:	Function:	
[1610] *	Power [kW]	Select a variable for display in line 1, right position. The options are the same as listed for par. 0-20.

0-23 Display Line 2 Large		
Option:	Function:	
[1613] *	Frequency	Select a variable for display in line 2. The options are the same as listed for par. 0-20.

0-24 Display Line 3 Large		
Select a variable for display in line 3.		
Option:	Function:	
[1502] *	kWh Counter	The options are the same as those listed in par. 0-20 <i>Display Line 1.1 Small</i> .

0-25 My Personal Menu		
Range:	Function:	
Application dependent*	[0 - 9999]	Define up to 50 parameters to appear in the Q1 Personal Menu, accessible via the [Quick Menu] key on the LCP. The parameters will be displayed in the Q1 Personal Menu in the order they are programmed into this array parameter. Delete parameters by setting the value to '0000'. For example, this can be used to provide quick, simple access to just one or up to 50 parameters which require changing on a regular basis (e.g. for plant maintenance reasons) or by an OEM to enable simple commissioning of their equipment.

3.2.4 0-3* LCP Custom Readout

It is possible to customize the display elements for various purposes: *Custom Readout. Value proportional to speed (Linear, squared or cubed depending on unit selected in par. 0-30 Custom Readout Unit) *Display Text. Text string stored in a parameter.

Custom Readout

The calculated value to be displayed is based on settings in par. 0-30 Custom Readout Unit, par. 0-31 Custom Readout Min Value (linear only), par. 0-32 Custom Readout Max Value, par. 4-13 Motor Speed High Limit [RPM], par. 4-14 Motor Speed High Limit [Hz] and actual speed.

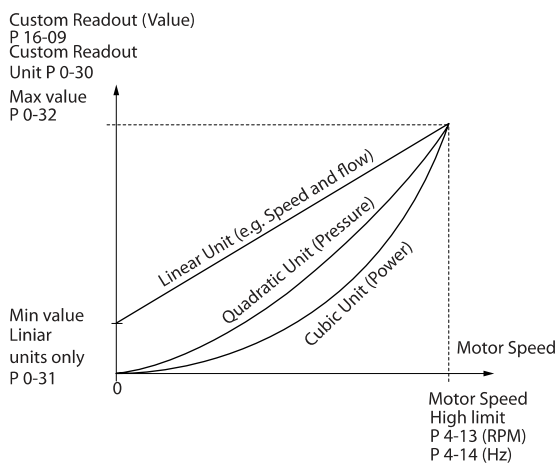

130BT105.11

The relation will depend on the type of unit selected in par. 0-30 Custom Readout Unit:

Unit Type	Speed Relation
Dimensionless	Linear
Speed	
Flow, volume	
Flow, mass	
Velocity	
Length	
Temperature	
Pressure	Quadratic
Power	Cubic

0-30 Unit for User-defined Readout		
Option:	Function:	
		It is possible to program a value to be shown in the display of the LCP. The value will have a linear, squared or cubed relation to speed. This relation will depend on the unit selected (see table above). The actual calculated value can be read in par. 16-09 Custom Readout, and/or shown in the display by selecting Custom Readout [16-09] in par. 0-20 Display Line 1.1 Small to par. 0-24 Display Line 3 Large.
[0] *	None	
[1]	%	
[5]	PPM	
[10]	1/min	
[11]	rpm	
[12]	Pulse/s	
[20]	l/s	
[21]	l/min	
[22]	l/h	
[23]	m ³ /s	
[24]	m ³ /min	
[25]	m ³ /h	
[30]	kg/s	
[31]	kg/min	
[32]	kg/h	
[33]	t/min	
[34]	t/h	
[40]	m/s	
[41]	m/min	
[45]	m	
[60]	°C	
[70]	mbar	
[71]	bar	
[72]	Pa	
[73]	kPa	
[74]	m WG	
[80]	kW	
[120]	GPM	
[121]	gal/s	
[122]	gal/min	
[123]	gal/h	
[124]	CFM	

0-30 Unit for User-defined Readout		
Option:	Function:	
[125]	ft ³ /s	
[126]	ft ³ /min	
[127]	ft ³ /h	
[130]	lb/s	
[131]	lb/min	
[132]	lb/h	
[140]	ft/s	
[141]	ft/min	
[145]	ft	
[160]	°F	
[170]	psi	
[171]	lb/in ²	
[172]	in WG	
[173]	ft WG	
[180]	HP	

0-31 Min Value of User-defined Readout		
Range:	Function:	
0.00 Custom-ReadoutUnit*	[Application dependant]	This parameter sets the min. value of the custom defined readout (occurs at zero speed). Only possible to set different from 0 is when selecting a linear unit in par. 0-30 <i>Unit for User-defined Readout</i> . For Quadratic and Cubic units the minimum value will be 0.

0-32 Custom Readout Max Value		
Range:	Function:	
100.00 CustomReadoutUnit*	[Application dependant]	This parameter sets the max value to be shown when the speed of the motor has reached the set value for par. 4-13 <i>Motor Speed High Limit [RPM]</i> or par. 4-14 <i>Motor Speed High Limit [Hz]</i> (depends on setting in par. 0-02 <i>Motor Speed Unit</i>).

0-37 Display Text 1		
Range:	Function:	
0* [0 - 0]	Enter a text which can be viewed in the graphical display by selecting Display Text 1 [37] in par. 0-20, 0-21, 0-22, 0-23 or 0-24.	

0-38 Display Text 2		
Range:	Function:	
0* [0 - 0]	Enter a text which can be viewed in the graphical display by selecting Display Text 2 [38] in par. 0-20, 0-21, 0-22, 0-23 or 0-24.	

0-39 Display Text 3		
Range:	Function:	
0* [0 - 0]	Enter a text which can be viewed in the graphical display by selecting Display Text 3 [39] in par. 0-20, 0-21, 0-22, 0-23 or 0-24.	

3.2.5 0-4* LCP Keypad

Enable, disable and password protect individual keys on the LCP.

0-40 [Hand on] Key on LCP		
Option:	Function:	
[0]	Disabled	No effect when [Hand on] is pressed. Select [0] Disabled to avoid accidental start of the drive in <i>Hand on</i> mode.
[1] *	Enabled	The LCP switches to <i>Hand on</i> mode directly when [Hand on] is pressed.
[2]	Password	After pressing [Hand on] a password is required. If par. 0-40 is included in <i>My Personal Menu</i> , define the password in par. 0-65, <i>Personal Menu Password</i> . Otherwise define the password in par. 0-60, <i>Main Menu Password</i>
[3]	Hand Off/On	When [Hand on] is pressed once, the LCP switches to <i>Off</i> mode. When pressed again, the LCP switches to <i>Hand on</i> mode.
[4]	Hand Off/On w. Passw.	Same as [3] but a password is required (see [2]).

0-41 [Off] Key on LCP		
Option:	Function:	
[0] *	Disabled	Avoids accidental stop of the frequency converter.
[1] *	Enabled	
[2]	Password	Avoids unauthorised stop. If par. 0-41 <i>[Off] Key on LCP</i> is included in the Quick Menu, then define the password in par. 0-65 <i>Quick Menu Password</i> .

0-42 [Auto on] Key on LCP		
Option:	Function:	
[0] *	Disabled	Avoid accidental start of the frequency converter in Auto mode.
[1] *	Enabled	
[2]	Password	Avoids unauthorised start in Auto mode. If par. 0-42 <i>[Auto on] Key on LCP</i> is included in the Quick Menu, then define the password in par. 0-65 <i>Quick Menu Password</i> .

0-43 [Reset] Key on LCP		
Option:	Function:	
[0] *	Disabled	No effect when [Reset] is pressed. Avoids accidental alarm reset.
[1] *	Enabled	
[2]	Password	Avoids unauthorised resetting. If par. 0-43 [Reset] Key on LCP is included in the Quick Menu, then define the password in par. 0-65 Quick Menu Password.
[7]	Enabled without OFF	Resets the drive without setting it in Off mode.
[8]	Password without OFF	Resets the drive without setting it in Off mode. A password is required when pressing [Reset] (see [2]).

3.2.6 0-5* Copy / Save

Copy parameter settings between set-ups and to/from the LCP.

0-50 LCP Copy		
Option:	Function:	
[0] *	No copy	
[1]	All to LCP	Copies all parameters in all set-ups from the frequency converter memory to the LCP memory.
[2]	All from LCP	Copies all parameters in all set-ups from the LCP memory to the frequency converter memory.
[3]	Size indep. from LCP	Copy only the parameters that are independent of the motor size. The latter selection can be used to programme several frequency converters with the same function without disturbing motor data.
[4]	File from MCO to LCP	
[5]	File from LCP to MCO	
[6]	Data from DYN to LCP	
[7]	Data from LCP to DYN	
[8]	LCP Compare	

This parameter cannot be adjusted while the motor is running.

0-51 Set-up Copy		
Option:	Function:	
[0] *	No copy	No function
[1]	Copy to set-up 1	Copies all parameters in the present Programming Set-up (defined in par. 0-11 Programming Set-up) to Set-up 1.
[2]	Copy to set-up 2	Copies all parameters in the present Programming Set-up (defined in par. 0-11 Programming Set-up) to Set-up 2.
[3]	Copy to set-up 3	Copies all parameters in the present Programming Set-up (defined in par. 0-11 Programming Set-up) to Set-up 3.
[4]	Copy to set-up 4	Copies all parameters in the present Programming Set-up (defined in par. 0-11 Programming Set-up) to Set-up 4.
[9]	Copy to all	Copies the parameters in the present set-up over to each of the set-ups 1 to 4.

3.2.7 0-6* Password

0-60 Main Menu Password		
Range:	Function:	
100 N/A*	[0 - 999 N/A]	Define the password for access to the Main Menu via the [Main Menu] key. If par. 0-61 Access to Main Menu w/o Password is set to Full access [0], this parameter will be ignored.

0-61 Access to Main Menu w/o Password		
Option:	Function:	
[0] *	Full access	Disables password defined in par. 0-60 Main Menu Password.
[1]	LCP: Read only	Prevent unauthorized editing of Main Menu parameters.
[2]	LCP: No access	Prevent unauthorized viewing and editing of Main Menu parameters.
[3]	Bus: Read only	Read-only functions for parameters on fieldbus and/or FC standard bus.
[4]	Bus: No access	No access to parameters is allowed via fieldbus and/or FC standard bus.
[5]	All: Read only	Read-only function for parameters on LCP, fieldbus or FC standard bus.
[6]	All: No access	No access from LCP, fieldbus or FC standard bus is allowed.

If Full access [0] is selected then par. 0-60 Main Menu Password, par. 0-65 Personal Menu Password and par. 0-66 Access to Personal Menu w/o Password will be ignored.

0-65 Quick Menu Password		
Range:	Function:	
200*	[-9999 - 9999]	Define the password for access to the Quick Menu via the [Quick Menu] key. If par. 0-66 <i>Access to Quick Menu w/o Password</i> is set to <i>Full access</i> [0], this parameter will be ignored.

0-66 Access to Quick Menu w/o Password		
Option:	Function:	
[0] *	Full access	Disables the password defined in par. 0-65 <i>Quick Menu Password</i> .
[1]	LCP: Read only	Prevents unauthorised editing of Quick Menu parameters.
[2]	LCP: No access	Prevents unauthorised viewing and editing of Quick Menu parameters.
[3]	Bus: Read only	Read only functions for Quick Menu parameters on fieldbus and/ or FC standard bus.
[4]	Bus: No access	No access to Quick Menu parameters is allowed via fieldbus and/ or FC standard bus.
[5]	All: Read only	read only function for Quick Menu parameters on LCP, fieldbus or FC standard bus.
[6]	All: No access	No access from LCP, fieldbus or FC standard bus is allowed.

If par. 0-61 *Access to Main Menu w/o Password* is set to *Full access* [0] then this parameter will be ignored.

0-67 Bus Password Access		
Range:	Function:	
0*	[0 - 9999]	Writing to this parameter enables users to unlock the frequency converter from bus/ MCT10.

3.3 Parameters: 1-** Load and Motor

3.3.1 1-0* General Settings

Define whether the frequency converter operates in speed mode or torque mode; and whether the internal PID control should be active or not.

1-00 Configuration Mode		
Option:	Function:	
		Select the application control principle to be used when a Remote Reference (i.e. via analog input or fieldbus) is active. A Remote Reference can only be active when par. 3-13 <i>Reference Site</i> is set to [0] or [1].
[0] *	Speed open loop	Enables speed control (without feedback signal from motor) with automatic slip compensation for almost constant speed at varying loads. Compensations are active but can be disabled in the Load/Motor par. group 1-0*.
[1]	Speed closed loop	Enables Speed closed loop control with feedback. Obtain full holding torque at 0 RPM. For increased speed accuracy, provide a feedback signal and set the speed PID control.
[2]	Torque	Enables torque closed loop control with feedback. Only possible with "Flux with motor feedback" option, par. 1-01 <i>Motor Control Principle</i> . FC 302 only.
[3]	Process	Enables the use of process control in the frequency converter. The process control parameters are set in par. groups 7-2* and 7-3*.
[4]	Torque open loop	Enables the use of torque open loop in VVC ⁺ mode (par. 1-01 <i>Motor Control Principle</i>). The torque PID parameters are set in par. group 7-1*.
[5]	Wobble	Enables the wobble functionality in par. 30-00 <i>Wobble Mode</i> to par. 30-19 <i>Wobble Delta Freq. Scaled</i> .
[6]	Surface Winder	Enables the surface winder control specific parameters in par. group 7-2* and 7-3*.
[7]	Extended PID Speed OL	Specific parameters in par. group 7-2* to 7-5*.
[8]	Extended PID Speed CL	Specific parameters in par. group 7-2* to 7-5*.

3

1-01 Motor Control Principle		
Option:	Function:	
		Select which motor control principle to employ.
[0] *	U/f	special motor mode, for parallel connected motors in special motor applications. When U/f is selected the characteristic of the control principle can be edited in par. 1-55 <i>U/f Characteristic - U</i> and par. 1-56 <i>U/f Characteristic - F</i> .
[1]	VVC+	Voltage Vector Control principle suitable for most applications. The main benefit of VVC ^{plus} operation is that it uses a robust motor model.
[2]	Flux sensorless	Flux Vector control without encoder feedback, for simple installation and robustness against sudden load changes. FC 302 only.

1-01 Motor Control Principle		
Option:	Function:	
[3]	Flux w/ motor feedb	very high accuracy speed and torque control, suitable for the most demanding applications. FC 302 only.

The best shaft performance is normally achieved using either of the two Flux Vector control modes *Flux sensorless* [2] and *Flux with encoder feedback* [3].

This parameter cannot be adjusted while the motor is running.

Par. 1-01	Par. 1-00								
	[0] Speed OL	[1] Speed CL	[2] Torque	[3] Process	[4] Torque OL	[5] Wobble	[6] Surface Wnd	[7] Ext. PID OL	[8] Ext. PID CL
[0] U/f									
[1] VVC ^{plus}									
[2] Flux sensorless									
[3] Flux w/ motor feedback									

Table 3.3: Overview of possible combinations of the settings in par. 1-00 Configuration Mode and par. 1-01 Motor Control Principle. The gray cells mark the possible combinations.

1-02 Flux Motor Feedback Source		
Option:	Function:	
		Select the interface at which to receive feedback from the motor.
[0]	Motor feedb. P1-02	
[1] *	24V encoder	A and B channel encoder, which can be connected to the digital input terminals 32/33 only. Terminals 32/33 must be programmed to <i>No operation</i> .
[2]	MCB 102	Encoder module option which can be configured in par. group 17-1* This parameter appears in FC 302 only.
[3]	MCB 103	Optional resolver interface module which can be configured in par. group 17-5**
[5]	MCO Encoder 2	encoder interface 2 of the optional programmable motion controller MCO 305.
[6]	Analog input 53	
[7]	Analog input 54	
[8]	Frequency input 29	
[9]	Frequency input 33	

This parameter cannot be adjusted while the motor is running.

1-03 Torque Characteristics		
Option:	Function:	
		Select the torque characteristic required. VT and AEO are both energy saving operations.
[0]	Constant torque	Motor shaft output provides constant torque under variable speed control.
[1]	Variable torque	Motor shaft output provides variable torque under variable speed control. Set the variable torque level in par. 14-40 <i>VT Level</i> .
[2]	Auto Energy Optim.	Automatically optimises energy consumption by minimising magnetisation and frequency via par. 14-41 <i>AEO Minimum Magnetisation</i> and par. 14-42 <i>Minimum AEO Frequency</i> .
[5]	Constant Power	The function provide a constant power in field weakening area. Follows the formula: $P_{constant} = \frac{Torque \times RPM}{9550}$ This selection maybe unavailable depending on drive configuration.

This parameter cannot be adjusted while the motor is running.

1-04 Overload Mode		
Option:	Function:	
[0] *	High torque	Allows up to 160% over torque.
[1]	Normal torque	For oversized motor - allows up to 110% over torque.

This parameter cannot be adjusted while the motor is running.

1-05 Local Mode Configuration		
Option:	Function:	
		Select which application configuration mode (par. 1-00 <i>Configuration Mode</i>), i.e. application control principle, to use when a Local (LCP) Reference is active. A Local Reference can be active only when par. 3-13 <i>Reference Site</i> is set to [0] or [2]. By default the local reference is active in Hand Mode only.
[0]	Speed open loop	
[1]	Speed closed loop	
[2] *	As mode par 1-00	

1-06 Clockwise Direction		
This parameter defines the term "Clockwise" corresponding to the LCP direction arrow. Used for easy change of direction of shaft rotation without swapping motor wires. (Valid from SW version 5.84)		
Option:	Function:	
[0] *	Normal	Motor shaft will turn in clockwise direction when frequency converter is connected U -> U; V -> V, and W -> W to motor.
[1]	Inverse	Motor shaft will turn in counter clockwise direction when frequency converter is connected U -> U; V -> V, and W -> W to motor.

This parameter cannot be changed while the motor is running.

3.3.2 1-1* Motor Selection

This par. group cannot be adjusted while the motor is running.

1-10 Motor Construction		
Option:	Function:	
		Select the motor construction type.
[0] *	Asynchron	For asynchronous motors.
[1]	PM, non salient SPM	For permanent magnet (PM) motors. Note that PM motors are divided into two groups, with either surface mounted (non salient) or interior (salient) magnets.

Motor construction can either be asynchronous or permanent magnet (PM) motor.

3.3.3 1-2* Motor Data

Par. group 1-2* comprises input data from the nameplate on the connected motor.

NOTE

Changing the value of these parameters affects the setting of other parameters.

1-20 Motor Power [kW]		
Range:	Function:	
Application dependent*	[Application dependant]	Enter the nominal motor power in kW according to the motor nameplate data. The default value corresponds to the nominal rated output of the unit. This parameter cannot be adjusted while the motor is running. This parameter is visible in LCP if par. 0-03 <i>Regional Settings</i> is <i>International</i> [0].
NOTE Four sizes down, one size up from nominal unit rating.		

1-21 Motor Power [HP]		
Range:	Function:	
Application dependent*	[Application dependant]	Enter the nominal motor power in HP according to the motor nameplate data. The default value corresponds to the nominal rated output of the unit. This parameter is visible in LCP if par. 0-03 <i>Regional Settings</i> is <i>US</i> [1]

1-22 Motor Voltage		
Range:		Function:
Application dependent*	[Application dependant]	Enter the nominal motor voltage according to the motor nameplate data. The default value corresponds to the nominal rated output of the unit.

1-23 Motor Frequency		
Range:		Function:
Application dependent*	[20 - 1000 Hz]	Min - Max motor frequency: 20 - 1000 Hz. Select the motor frequency value from the motor nameplate data. If a value different from 50 Hz or 60 Hz is selected, it is necessary to adapt the load independent settings in par. 1-50 <i>Motor Magnetisation at Zero Speed</i> to par. 1-53 <i>Model Shift Frequency</i> . For 87 Hz operation with 230/400 V motors, set the nameplate data for 230 V/50 Hz. Adapt par. 4-13 <i>Motor Speed High Limit [RPM]</i> and par. 3-03 <i>Maximum Reference</i> to the 87 Hz application.

1-24 Motor Current		
Range:		Function:
Application dependent*	[Application dependant]	Enter the nominal motor current value from the motor nameplate data. The data are used for calculating torque, motor protection etc.

1-25 Motor Nominal Speed		
Range:		Function:
Application dependent*	[10 - 60000 RPM]	Enter the nominal motor speed value from the motor nameplate data. The data are used for calculating motor compensations. NOTE Motor speed must always be lower than synchronous speed.

1-26 Motor Cont. Rated Torque		
Range:		Function:
Application dependent*	[0.1 - 10000.0 Nm]	Enter the value from the motor nameplate data. The default value corresponds to the nominal rated output. This parameter is available when par. 1-10 <i>Motor Construction</i> is set to <i>PM, non salient SPM</i> [1], i.e. the parameter is valid for PM and non-salient SPM motors only.

1-29 Automatic Motor Adaptation (AMA)		
Option:		Function:
		The AMA function optimises dynamic motor performance by automatically optimising the advanced motor parameters (par. 1-30 <i>Stator Resistance (Rs)</i> to par. 1-35 <i>Main Reactance (Xh)</i>) at motor standstill. Activate the AMA function by pressing [Hand on] after selecting [1] or [2]. See also the section <i>Automatic Motor Adaptation</i> in the Design Guide. After a normal sequence, the display will read: "Press [OK] to finish AMA". After pressing the [OK] key the frequency converter is ready for operation. This parameter cannot be adjusted while the motor is running.
[0] *	Off	
[1]	Enable complete AMA	Performs AMA of the stator resistance R_s , the rotor resistance R_r , the stator leakage reactance X_1 , the rotor leakage reactance X_2 and the main reactance X_h . Do <i>not</i> select this option if an LC filter is used between the frequency converter and the motor. FC 301: The Complete AMA does not include X_h measurement for FC 301. Instead, the X_h value is determined from the motor database. R_s is the best adjustment method (see 1-3* <i>Adv. Motor Data</i>). T4/T5 E and F Frames, T7 D, E and F Frames will only run a Reduced AMA when the complete AMA is selected. It is recommended to obtain the Advanced Motor Data from the motor manufacturer to enter into par. 1-31 through 1-36 for best performance.
[2]	Enable reduced AMA	Performs a reduced AMA of the stator resistance R_s in the system only.

Note:

- For the best adaptation of the frequency converter, run AMA on a cold motor.
- AMA cannot be performed while the motor is running.
- AMA cannot be performed on permanent magnet motors.

NOTE

It is important to set motor par. 1-2* correctly, since these form part of the AMA algorithm. An AMA must be performed to achieve optimum dynamic motor performance. It may take up to 10 min, depending on the power rating of the motor.

NOTE

Avoid generating external torque during AMA.

NOTE

If one of the settings in par. 1-2* is changed, par. 1-30 *Stator Resistance (Rs)* to par. 1-39 *Motor Poles*, the advanced motor parameters, will return to default setting.

NOTE

AMA will work problem-free on 1 motor size down, typically work on 2 motor sizes down, rarely work on 3 sizes down and never work on 4 sizes down. Please keep in mind that the accuracy of the measured motor data will be poorer when you operate on motors smaller than nominal VLT size.

3.3.4 1-3* Adv. Motor Data

Parameters for advanced motor data. The motor data in par. 1-30 *Stator Resistance (Rs)* to par. 1-39 *Motor Poles* must match the relevant motor in order to run the motor optimally. The default settings are figures based on common motor parameter values from standard motors. If the motor parameters are not set correctly, a malfunction of the frequency converter system may occur. If the motor data is not known, running an AMA (Automatic Motor Adaptation) is recommended. See the *Automatic Motor Adaptation* section in the Design Guide. The AMA sequence will adjust all motor parameters except the moment of inertia of the rotor and the iron loss resistance (par. 1-36 *Iron Loss Resistance (Rfe)*). Par. 1-3* and par. 1-4* cannot be adjusted while the motor is running.

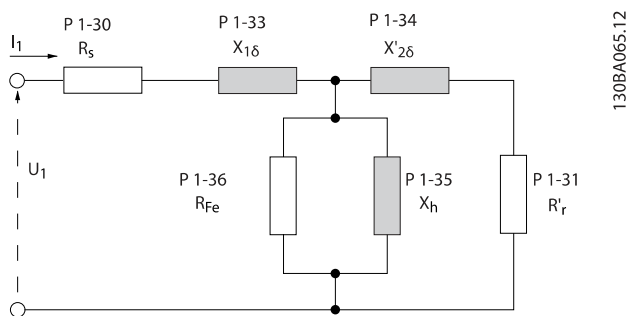

Illustration 3.1: Motor equivalent diagram for an asynchronous motor

130BA065.12

1-30 Stator Resistance (Rs)		
Range:		Function:
Application dependent*	[Application dependant]	Set the stator resistance value. Enter the value from a motor data sheet or perform an AMA on a cold motor.

1-31 Rotor Resistance (Rr)		
Range:		Function:
Application dependent*	[Application dependant]	Fine-tuning R _r will improve shaft performance. Set the rotor resistance value using one of these methods: <ol style="list-style-type: none"> Run an AMA on a cold motor. The frequency converter will measure the value from the motor. All compensations are reset to 100%. Enter the R_r value manually. Obtain the value from the motor supplier. Use the R_r default setting. The frequency converter establishes the setting on the basis of the motor nameplate data.

1-33 Stator Leakage Reactance (X1)		
Range:		Function:
Application dependent*	[Application dependant]	Set the stator leakage reactance of the motor using one of these methods: <ol style="list-style-type: none"> Run an AMA on a cold motor. The frequency converter will measure the value from the motor. Enter the X₁ value manually. Obtain the value from the motor supplier. Use the X₁ default setting. The frequency converter establishes the setting on the basis of the motor name plate data.

1-34 Rotor Leakage Reactance (X2)		
Range:		Function:
Application dependent*	[Application dependant]	Set the rotor leakage reactance of the motor using one of these methods: <ol style="list-style-type: none"> Run an AMA on a cold motor. The frequency converter will measure the value from the motor. Enter the X₂ value manually. Obtain the value from the motor supplier. Use the X₂ default setting. The frequency converter establishes the setting on the basis of the motor name plate data.

1-35 Main Reactance (Xh)		
Range:		Function:
Application dependent*	[Application dependant]	Set the main reactance of the motor using one of these methods: <ol style="list-style-type: none"> Run an AMA on a cold motor. The frequency converter will measure the value from the motor. Enter the X_h value manually. Obtain the value from the motor supplier. Use the X_h default setting. The frequency converter establishes the setting on the basis of the motor name plate data.

1-36 Iron Loss Resistance (Rfe)		
Range:		Function:
Application dependent*	[Application dependant]	Enter the equivalent iron loss resistance (R _{Fe}) value to compensate for iron loss in the motor. The R _{Fe} value cannot be found by performing an AMA. The R _{Fe} value is especially important in torque control applications. If R _{Fe} is unknown, leave par. 1-36 <i>Iron Loss Resistance (Rfe)</i> on default setting.

1-37 d-axis Inductance (Ld)		
Range:		Function:
Application dependent*	[Application dependant]	Enter the value of the d-axis inductance. Obtain the value from the permanent magnet motor data sheet. This parameter is only active when par. 1-10 <i>Motor Construction</i> has the value <i>PM, non-salient SPM</i> [1] (Permanent Magnet Motor). For a selection with one decimal, use this parameter. For a selection with three decimals, use par. 30-80 <i>d-axis Inductance (Ld)</i> . This parameter is available for FC 302 only.

1-39 Motor Poles		
Range:		Function:
Application dependent*	[2 - 100]	Enter the number of motor poles.

Poles	~n _n @ 50 Hz	~n _n @60 Hz
2	2700 - 2880	3250 - 3460
4	1350 - 1450	1625 - 1730
6	700 - 960	840 - 1153

The table shows the number of poles for normal speed ranges of various motor types. Define motors designed for other frequencies separately. The motor pole value is always an even number, because it refers to the total number of poles, not pairs of poles. The frequency converter creates the initial setting of par. 1-39 *Motor Poles* based on par. 1-23 *Motor Frequency* and par. 1-25 *Motor Nominal Speed*.

1-40 Back EMF at 1000 RPM		
Range:		Function:
Application dependent*	[Application dependant]	Set the nominal back EMF for the motor when running at 1000 RPM. This parameter is only active when par. 1-10 <i>Motor Construction</i> is set to <i>PM motor</i> [1] (Permanent Magnet Motor). This parameter is available for FC 302 only. <p>NOTE When using PM motors, it is recommended to use brake resistors.</p>

1-41 Motor Angle Offset		
Range:		Function:
0*	[-32768 - 32767]	Enter the correct offset angle between the PM motor and the index position (single-turn) of the attached encoder or resolver. The value range of 0 - 32768 corresponds to 0 - 2 * pi (radians). To obtain the offset angle value: After frequency converter start-up apply DC-hold and enter the value of par. 16-20 <i>Motor Angle</i> into this parameter. This parameter is only active when par. 1-10 <i>Motor Construction</i> is set to <i>PM, non-salient SPM</i> [1] (Permanent Magnet Motor).

3.3.5 1-5* Load Indep. Setting

1-50 Motor Magnetisation at Zero Speed		
Range:		Function:
100 %*	[0 - 300 %]	Use this parameter along with par. 1-51 <i>Min Speed Normal Magnetising [RPM]</i> to obtain a different thermal load on the motor when running at low speed. Enter a value which is a percentage of the rated magnetizing current. If the setting is too low, the torque on the motor shaft may be reduced. <div style="text-align: center;"> </div>

1-51 Min Speed Normal Magnetising [RPM]		
Range:	Function:	
Application dependent*	[10 - 300 RPM]	Set the required speed for normal magnetising current. If the speed is set lower than the motor slip speed, par. 1-50 <i>Motor Magnetisation at Zero Speed</i> and par. 1-51 <i>Min Speed Normal Magnetising [RPM]</i> are of no significance. Use this parameter along with par. 1-50 <i>Motor Magnetisation at Zero Speed</i> . See drawing for par. 1-50 <i>Motor Magnetisation at Zero Speed</i> .

1-52 Min Speed Normal Magnetising [Hz]		
Range:	Function:	
Application dependent*	[Application dependant]	Set the required frequency for normal magnetising current. If the frequency is set lower than the motor slip frequency, par. 1-50 <i>Motor Magnetisation at Zero Speed</i> is inactive. Use this parameter along with par. 1-50 <i>Motor Magnetisation at Zero Speed</i> . See drawing for par. 1-50 <i>Motor Magnetisation at Zero Speed</i> .

1-53 Model Shift Frequency		
Range:	Function:	
Application	[Applica- tion]	<p>Flux Model shift</p> <p>Enter the frequency value for shift between two models for determining motor speed. Choose the value based on settings in par. 1-00 <i>Configuration Mode</i> and par. 1-01 <i>Motor Control Principle</i>. There are two options: shift between Flux model 1 and Flux model 2; or shift between Variable Current mode and Flux model 2. This parameter is available for FC 302 only. This parameter cannot be adjusted while the motor is running.</p> <p>Flux Model 1 – Flux model 2</p> <p>This model is used when par. 1-00 <i>Configuration Mode</i> is set to <i>Speed closed loop</i> [1] or <i>Torque</i> [2] and par. 1-01 <i>Motor Control Principle</i> is set to <i>Flux w/motor feedback</i> [3]. With this parameter it is possible to make an adjustment of the shifting point where FC 302 changes between Flux model 1 and Flux model 2, which is useful in some sensitive speed and torque control applications.</p>

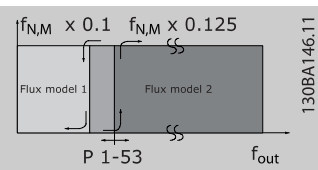
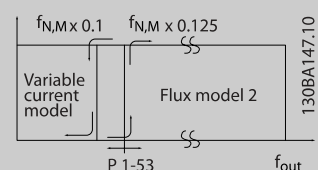
1-53 Model Shift Frequency		
Range:	Function:	
depend- ent*	depend- ant]	 <p>Illustration 3.2: Par. 1-00 Configuration Mode = [1] Speed closed loop or [2] Torque and par. 1-01 Motor Control Principle = [3] Flux w/motor feedback</p> <p>Variable Current - Flux model - Sensorless</p> <p>This model is used when par. 1-00 <i>Configuration Mode</i> is set to <i>Speed open loop</i> [0] and par. 1-01 <i>Motor Control Principle</i> is set to <i>Flux sensorless</i> [2].</p> <p>In speed open loop in flux mode, the speed is determined from the current measurement.</p> <p>Below $f_{norm} \times 0.1$, the frequency converter runs on a Variable Current model. Above $f_{norm} \times 0.125$ the frequency converter runs on a Flux model.</p>  <p>Illustration 3.3: par. 1-00 Configuration Mode = [0] Speed open loop, par. 1-01 Motor Control Principle = [2] Flux sensorless</p>

1-54 Voltage reduction in fieldweakening		
Range:	Function:	
0 V*	[0 - 100 V]	The value of this parameter will reduce the maximal voltage available for the flux of the motor in fieldweakening, giving more voltage available for torque. Be aware that too high value may give stall problems at high speed.

1-55 U/f Characteristic - U		
Range:		Function:
Application dependent*	[0.0 - 1000.0 V]	Enter the voltage at each frequency point to manually form a U/f characteristic matching the motor. The frequency points are defined in par. 1-56 U/f Characteristic - F. This parameter is an array parameter [0-5] and is only accessible when par. 1-01 Motor Control Principle is set to U/f [0].

1-56 U/f Characteristic - F		
Range:		Function:
Application dependent*	[Application dependant]	Enter the frequency points to manually form a U/f-characteristic matching the motor. The voltage at each point is defined in par. 1-55 U/f Characteristic - U. This parameter is an array parameter [0-5] and is only accessible when par. 1-01 Motor Control Principle is set to U/f [0].

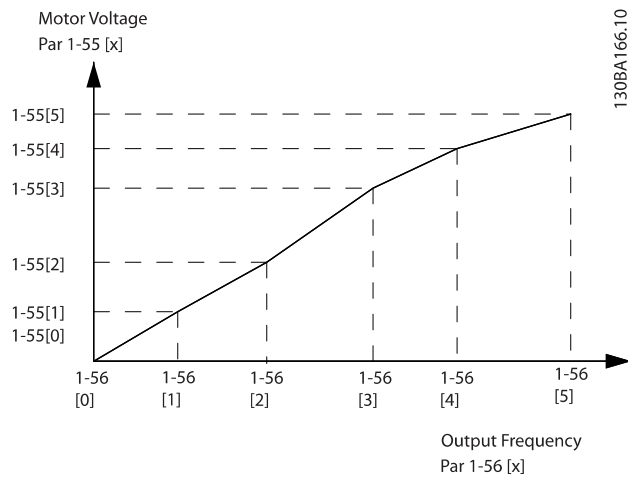

1-59 Flystart Test Pulses Frequency		
Range:		Function:
200 %*	[0 - 500 %]	Control the percentage of the frequency for the pulses used to detect the motor direction. Increasing this value will reduce the generated torque. 100% means 2 times the slip frequency. The parameter is active when par. 1-73 Flying Start is enabled. This parameter is only available in VVC ^{plus} .

3.3.6 1-6* Load Depend. Setting

1-60 Low Speed Load Compensation		
Range:		Function:
100 %*	[0 - 300 %]	Enter the % value to compensate voltage in relation to load when the motor is running at low speed and obtain the optimum U/f characteristic. The motor size determines the frequency range within which this parameter is active.

Motor size	Change over
0.25 kW - 7.5 kW	< 10 Hz

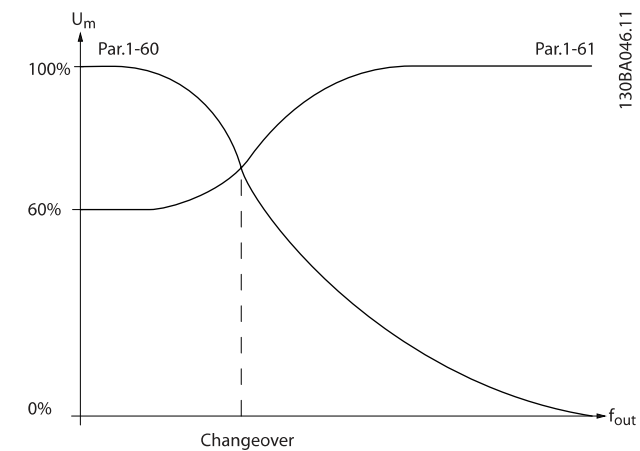

1-58 Flystart Test Pulses Current		
Range:		Function:
30 %*	[0 - 200 %]	Control the percentage of the magnetizing current for the pulses used to detect the motor direction. Reducing this value will reduce the generated torque. 100% means nominal motor current. The parameter is active when par. 1-73 Flying Start is enabled. This parameter is only available in VVC ^{plus} .

1-61 High Speed Load Compensation		
Range:		Function:
100 %*	[0 - 300 %]	Enter the % value to compensate voltage in relation to load when the motor is running at high speed and obtain the optimum U/f characteristic. The motor size determines the frequency range within which this parameter is active.

Motor size	Change-over
0.25 kW - 7.5 kW	> 10 Hz

1-62 Slip Compensation		
Range:		Function:
Application dependent*	[-500 - 500 %]	Enter the % value for slip compensation, to compensate for tolerances in the value of $n_{M,N}$. Slip compensation is calculated automatically, i.e. on the basis of the rated motor speed $n_{M,N}$. This function is not active when par. 1-00 <i>Configuration Mode</i> is set to <i>Speed closed loop</i> [1] or <i>Torque</i> [2] Torque control with speed feedback or when par. 1-01 <i>Motor Control Principle</i> is set to <i>U/f</i> [0] special motor mode.

1-63 Slip Compensation Time Constant		
Range:		Function:
Application dependent*	[0.05 - 5.00 s]	Enter the slip compensation reaction speed. A high value results in slow reaction, and a low value results in quick reaction. If low-frequency resonance problems arise, use a longer time setting.

1-64 Resonance Dampening		
Range:		Function:
100 %*	[0 - 500 %]	Enter the resonance dampening value. Set par. 1-64 <i>Resonance Dampening</i> and par. 1-65 <i>Resonance Dampening Time Constant</i> to help eliminate high-frequency resonance problems. To reduce resonance oscillation, increase the value of par. 1-64 <i>Resonance Dampening</i> .

1-65 Resonance Dampening Time Constant		
Range:		Function:
5 ms*	[5 - 50 ms]	Set par. 1-64 <i>Resonance Dampening</i> and par. 1-65 <i>Resonance Dampening Time Constant</i> to help eliminate high-frequency resonance problems. Enter the time constant that provides the best dampening.

1-66 Min. Current at Low Speed		
Range:		Function:
100 %*	[Application]	Enter the minimum motor current at low speed, see par. 1-53 <i>Model Shift Frequency</i> . Increasing this current improves motor torque at low speed. Par. 1-66 <i>Min. Current at Low Speed</i> is enabled when par. 1-00 <i>Configuration Mode</i> = <i>Speed open loop</i> [0] only. The frequency converter runs with constant current through motor for speeds below 10 Hz. For speeds above 10 Hz, the motor flux model in the frequency converter controls the motor. par. 4-16 <i>Torque Limit Motor Mode</i> and / or

1-66 Min. Current at Low Speed		
Range:		Function:
	dependent]	par. 4-17 <i>Torque Limit Generator Mode</i> automatically adjust par. 1-66 <i>Min. Current at Low Speed</i> . The parameter with the highest value adjusts par. 1-66 <i>Min. Current at Low Speed</i> . The current setting in par. 1-66 <i>Min. Current at Low Speed</i> is composed of the torque generating current and the magnetizing current. Example: Set par. 4-16 <i>Torque Limit Motor Mode</i> to 100% and set par. 4-17 <i>Torque Limit Generator Mode</i> to 60%. par. 1-66 <i>Min. Current at Low Speed</i> automatically adjusts to about 127%, depending on the motor size. This parameter is available for FC 302 only.

1-67 Load Type		
Option:		Function:
[0] *	Passive load	For conveyers, fan and pump applications.
[1]	Active load	For hoisting applications, used in slip compensation at low speed. When <i>Active Load</i> [1] is selected, set par. 1-66 <i>Min. Current at Low Speed</i> to a level which corresponds to maximum torque.

This parameter is available for FC 302 only.

1-68 Minimum Inertia		
Range:		Function:
Application dependent*	[Application dependent]	Needed for average inertia calculation. Enter the minimum moment of inertia of the mechanical system. Par. 1-68 <i>Minimum Inertia</i> and par. 1-69 <i>Maximum Inertia</i> are used for pre-adjustment of the Proportional Gain in the speed control, see par. 30-83 <i>Speed PID Proportional Gain</i> . This parameter is available for FC 302 only.

This parameter cannot be adjusted while motor is running.

1-69 Maximum Inertia		
Range:		Function:
Application dependent*	[Application dependent]	Active in Flux Open Loop only. Used to compute the acceleration torque at low speed. Used in the torque limit controller. This parameter is available for FC 302 only.

This parameter cannot be adjusted while motor is running.

3.3.7 1-7* Start Adjustments

1-71 Start Delay		
Range:		Function:
0.0 s*	[0.0 - 10.0 s]	This parameter refers to the start function selected in par. 1-72 <i>Start Function</i> . Enter the time delay required before commencing acceleration.

1-72 Start Function		
Option:	Function:	
		Select the start function during start delay. This parameter is linked to par. 1-71 <i>Start Delay</i> .
[0]	DC Hold/delay time	Energizes motor with a DC holding current (par. 2-00 <i>DC Hold Current</i>) during the start delay time.
[1]	DC Brake/delay time	Energizes motor with a DC braking current (par. 2-01 <i>DC Brake Current</i>) during the start delay time.
[2]	Coast/delay time *	Motor coasted during the start delay time (inverter off).
[3]	Start speed cw	Only possible with VVC+. Connect the function described in par. 1-74 <i>Start Speed [RPM]</i> and par. 1-76 <i>Start Current</i> in the start delay time. Regardless of the value applied by the reference signal, the output speed applies the setting of the start speed in par. 1-74 <i>Start Speed [RPM]</i> or par. 1-75 <i>Start Speed [Hz]</i> and the output current corresponds to the setting of the start current in par. 1-76 <i>Start Current</i> . This function is typically used in hoisting applications without counterweight and especially in applications with a Cone-motor, where the start is clockwise, followed by rotation in the reference direction.
[4]	Horizontal operation	Only possible with VVC+. For obtaining the function described in par. 1-74 <i>Start Speed [RPM]</i> and par. 1-76 <i>Start Current</i> during the start delay time. The motor rotates in the reference direction. If the reference signal equals zero (0), par. 1-74 <i>Start Speed [RPM]</i> is ignored and the output speed equals zero (0). The output current corresponds to the setting of the start current in par. 1-76 <i>Start Current</i> .
[5]	VVC+/Flux clockwise	for the function described in par. 1-74 <i>Start Speed [RPM]</i> only. The start current is calculated automatically. This function uses the start speed in the start delay time only. Regardless of the value set by the reference signal, the output speed equals the setting of the start speed in par. 1-74 <i>Start Speed [RPM]</i> . <i>Start speed/current clockwise</i> [3] and <i>VVC^{plus}/Flux clockwise</i> [5] are

1-72 Start Function		
Option:	Function:	
		typically used in hoisting applications. <i>Start speed/current in reference direction</i> [4] is particularly used in applications with counterweight and horizontal movement.
[6]	Hoist Mech. Brake Rel	For utilizing mechanical brake control functions, par. 2-24 <i>Stop Delay</i> to par. 2-28 <i>Gain Boost Factor</i> . This parameter is only active when par. 1-01 <i>Motor Control Principle</i> is set to [3] <i>Flux w/ motor feedback (FC 302 only)</i> .
[7]	VVC+/Flux counter-cw	

1-73 Flying Start		
Option:	Function:	
		This function makes it possible to catch a motor which is spinning freely due to a mains drop-out.
[0] *	Disabled	No function
[1]	Enabled	Enables the frequency converter to "catch" and control a spinning motor. When par. 1-73 <i>Flying Start</i> is enabled, par. 1-71 <i>Start Delay</i> and par. 1-72 <i>Start Function</i> have no function.
[2]	Enabled Always	
[3]	Enabled Ref. Dir.	
[4]	Enab. Always Ref. Dir.	

This parameter cannot be adjusted while motor is running.

NOTE

This function is not recommended for hoisting applications.

For power levels above 55kW, flux mode must be used to achieve the best performance.

1-74 Start Speed [RPM]		
Range:		Function:
Application dependent*	[0 - 600 RPM]	Set a motor start speed. After the start signal, the output speed leaps to set value. Set the start function in par. 1-72 <i>Start Function</i> to [3], [4] or [5], and set a start delay time in par. 1-71 <i>Start Delay</i> .

1-75 Start Speed [Hz]		
Range:		Function:
Application dependent*	[Application dependant]	This par can be used for hoist applications (cone rotor). Set a motor start speed. After the start signal, the output speed leaps to set value. Set the start function in par. 1-72 <i>Start Function</i> to [3], [4] or [5], and set a start delay time in par. 1-71 <i>Start Delay</i> .

1-76 Start Current		
Range:		Function:
0.00 A*	[Application dependant]	Some motors, e.g. cone rotor motors, need extra current/starting speed to disengage the rotor. To obtain this boost, set the required current in par. 1-76 <i>Start Current</i> . Set par. 1-74 <i>Start Speed [RPM]</i> . Set par. 1-72 <i>Start Function</i> to [3] or [4], and set a start delay time in par. 1-71 <i>Start Delay</i> . This parameter can be used for hoist applications (cone rotor).

3.3.8 1-8* Stop Adjustments

1-80 Function at Stop		
Option:		Function:
		Select the frequency converter function after a stop command or after the speed is ramped down to the settings in par. 1-81 <i>Min Speed for Function at Stop [RPM]</i> .
[0] *	Coast	Leaves motor in free mode. The motor is disconnected from the frequency converter.
[1]	DC hold	Energizes motor with a DC holding current (see par. 2-00 <i>DC Hold Current</i>).
[2]	Motor check	Checks if a motor has been connected.
[3]	Pre-magnetizing	Builds up a magnetic field while the motor is stopped. The motor can now produce a quick torque build-up at start. Asynchronous motors only.
[4]	DC Voltage U0	
[5]	Coast at low reference	

1-81 Min Speed for Function at Stop [RPM]		
Range:		Function:
Application dependent*	[0 - 600 RPM]	Set the speed at which to activate par. 1-80 <i>Function at Stop</i> .

1-82 Min Speed for Function at Stop [Hz]		
Range:		Function:
Application dependent*	[Application dependant]	Set the output frequency at which to activate par. 1-80 <i>Function at Stop</i> .

1-83 Precise Stop Function		
Option:		Function:
[0] *	Precise ramp stop	Achieves high repetitive precision at the stopping point.
[1]	Cnt stop with reset	Runs the frequency converter from receipt of a pulse start signal until the number of pulses programmed by the user in par. 1-84 <i>Precise Stop Counter Value</i> has been received at input terminal 29 or input terminal 33. An internal stop signal will activate the normal ramp down time (par. 3-42 <i>Ramp 1 Ramp Down Time</i> , par. 3-52 <i>Ramp 2 Ramp down Time</i> , par. 3-62 <i>Ramp 3 Ramp down Time</i> or par. 3-72 <i>Ramp 4 Ramp Down Time</i>). The counter function is activated (starts timing) at the edge of the start signal (when it changes from stop to start). After each precise stop the number of pulses counted during ramp down 0 rpm is reset.
[2]	Cnt stop w/o reset	Same as [1] but the number of pulses counted during ramp down to 0 rpm is deducted from the counter value in par. 1-84 <i>Precise Stop Counter Value</i> .
[3]	Speed comp stop	Stops at precisely the same point, regardless of the present speed, the stop signal is delayed internally when the present speed is lower than the maximum speed (set in par. 4-19 <i>Max Output Frequency</i>).
[4]	Com cnt stop w/rst	Same as [3] but after each precise stop the number of pulses counted during ramp down 0 rpm is reset.
[5]	Comp cnt stop w/o r	Same as [3] but the number of pulses counted during ramp down to 0 rpm is deducted from the counter value in par. 1-84 <i>Precise Stop Counter Value</i> .

This parameter cannot be adjusted while the motor is running.

1-84 Precise Stop Counter Value		
Range:		Function:
100000*	[0 - 999999999]	Enter the counter value to be used in the integrated precise stop function, par. 1-83 <i>Precise Stop Function</i> . The maximum permissible frequency at terminal 29 or 33 is 110 kHz.

1-85 Precise Stop Speed Compensation Delay		
Range:		Function:
10 ms*	[0 - 100 ms]	Enter the delay time for sensors, PLCs, etc. for use in par. 1-83 <i>Precise Stop Function</i> . In speed compensated stop mode, the delay time at different frequencies has a major influence on the stop function.

1-90 Motor Thermal Protection		
Option:		Function:
[7]	ETR warning 3	
[8]	ETR trip 3	
[9]	ETR warning 4	
[10]	ETR trip 4	

3.3.9 1-9* Motor Temperature

1-90 Motor Thermal Protection		
Option:	Function:	
	<p>The frequency converter determines the motor temperature for motor protection in three different ways:</p> <ul style="list-style-type: none"> Via a thermistor sensor connected to one of the analog or digital inputs (par. 1-93 <i>Thermistor Source</i>). See section <i>PTC Thermistor Connection</i>. Via a KTY sensor connected to an analog input (par. 1-96 <i>KTY Thermistor Resource</i>). See section <i>KTY Sensor Connection</i>. Via calculation (ETR = Electronic Terminal Relay) of the thermal load, based on the actual load and time. The calculated thermal load is compared with the rated motor current $I_{M,N}$ and the rated motor frequency $f_{M,N}$. The calculations estimate the need for a lower load at lower speed due to less cooling from the fan incorporated in the motor. 	
[0] *	No protection	Continuously overloaded motor, when no warning or trip of the frequency converter is required.
[1]	Thermistor warning	Activates a warning when the connected thermistor or KTY-sensor in the motor reacts in the event of motor over-temperature.
[2]	Thermistor trip	Stops (trips) frequency converter when connected thermistor or KTY sensor in the motor reacts in the event of motor over-temperature. The thermistor cut-out value must be > 3 kΩ. Integrate a thermistor (PTC sensor) in the motor for winding protection.
[3]	ETR warning 1	Please see detailed description below
[4]	ETR trip 1	
[5]	ETR warning 2	
[6]	ETR trip 2	

Select *ETR Warning 1-4*, to activate a warning on the display when the motor is overloaded.

Select *ETR Trip 1-4* to trip the frequency converter when the motor is overloaded.

Programme a warning signal via one of the digital outputs. The signal appears in the event of a warning and if the frequency converter trips (thermal warning).

ETR (Electronic Terminal Relay) functions 1-4 will calculate the load when the set-up where they were selected is active. For example ETR starts calculating when set-up 3 is selected. For the North American market: The ETR functions provide class 20 motor overload protection in accordance with NEC.

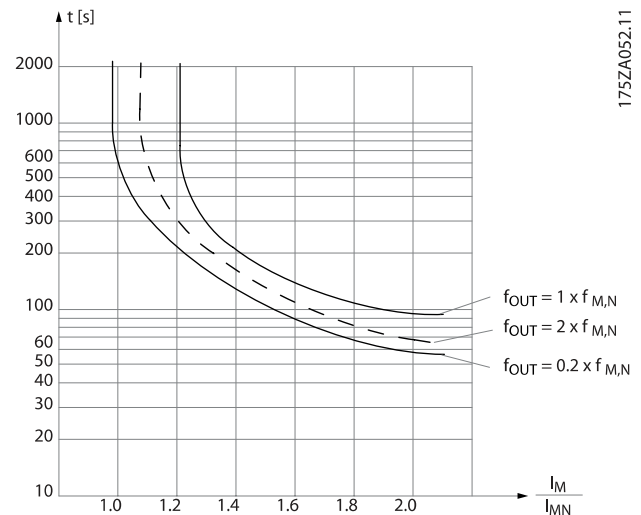

1-91 Motor External Fan		
Option:	Function:	
[0] *	No	No external fan is required, i.e. the motor is derated at low speed.
[1]	Yes	Applies an external motor fan (external ventilation), so no derating of the motor is required at low speed. The graph below is followed if the motor current is lower than nominal motor current (see par. 1-24 <i>Motor Current</i>). If the motor current exceeds nominal current, the operation time still decreases as if no fan were installed.

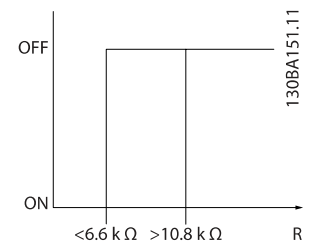
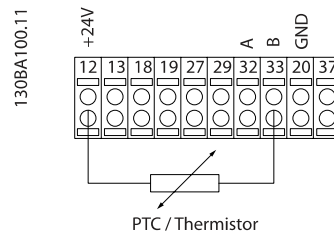
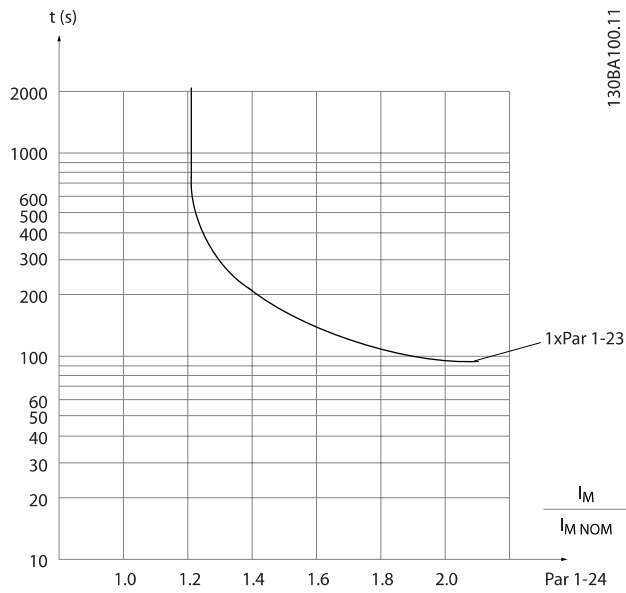

3.3.10 PTC Thermistor Connection

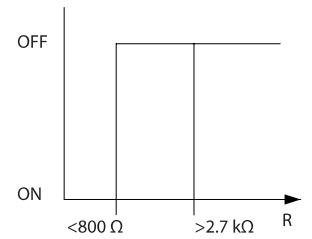
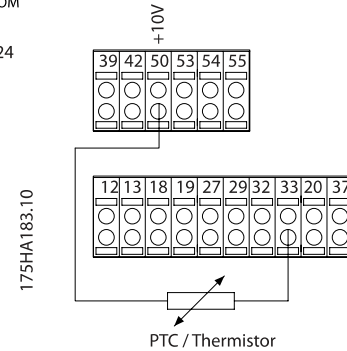
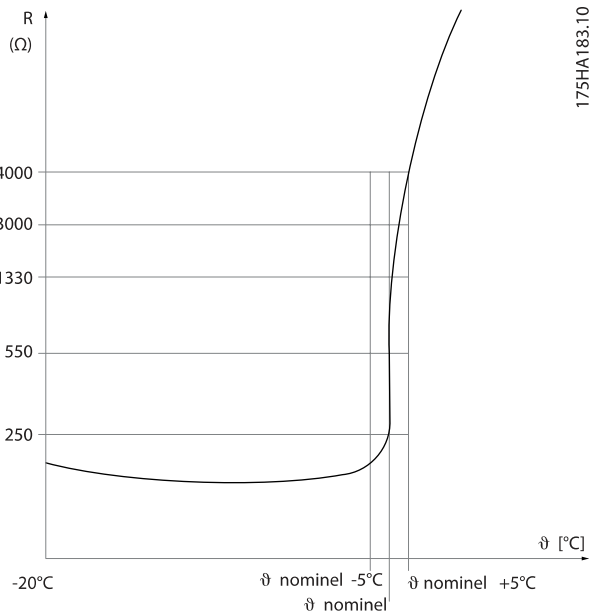

Motor protection can be implemented using a range of techniques: PTC or KTY sensor (see also section *KTY Sensor Connection*) in motor windings; mechanical thermal switch (Klixon type); or Electronic Thermal Relay (ETR).

Using a digital input and 24 V as power supply:
 Example: The frequency converter trips when the motor temperature is too high
 Parameter set-up:
 Set par. 1-90 *Motor Thermal Protection* to *Thermistor Trip* [2]
 Set par. 1-93 *Thermistor Source* to *Digital Input* [6]

Using a digital input and 10 V as power supply:
 Example: The frequency converter trips when the motor temperature is too high.
 Parameter set-up:
 Set par. 1-90 *Motor Thermal Protection* to *Thermistor Trip* [2]
 Set par. 1-93 *Thermistor Source* to *Digital Input* [6]

Using an analog input and 10 V as power supply:
 Example: The frequency converter trips when the motor temperature is too high.
 Parameter set-up:
 Set par. 1-90 *Motor Thermal Protection* to *Thermistor Trip* [2]
 Set par. 1-93 *Thermistor Source* to *Analog Input 54* [2]

Input	Supply Voltage	Threshold
Digital/analog	Volt	Cut-out Values
Digital	24 V	< 6.6 kΩ - > 10.8 kΩ
Digital	10 V	< 800Ω - > 2.7 kΩ
Analog	10 V	< 3.0 kΩ - > 3.0 kΩ

NOTE
 Check that the chosen supply voltage follows the specification of the used thermistor element.

1-93 Thermistor Source	
Option:	Function:
	Select the input to which the thermistor (PTC sensor) should be connected. An analog input option [1] or [2] cannot be selected if the analog input is already in use as a reference source (selected in par. 3-15 <i>Reference 1 Source</i> , par. 3-16 <i>Reference 2 Source</i> or par. 3-17 <i>Reference 3 Source</i>). When using MCB 112, choice [0] <i>None</i> must always be selected.
[0] *	None
[1]	Analog input 53
[2]	Analog input 54
[3]	Digital input 18
[4]	Digital input 19
[5]	Digital input 32
[6]	Digital input 33

NOTE
This parameter cannot be adjusted while the motor is running.

NOTE
Digital input should be set to [0] *PNP - Active at 24V* in par. 5-00.

3.3.11 KTY Sensor Connection

(FC 302 only)

KTY sensors are used especially in Permanent Magnet Servo Motors (PM motors) for dynamic adjusting of motor parameters as stator resistance (par. 1-30 *Stator Resistance (Rs)*) for PM motors and also rotor resistance (par. 1-31 *Rotor Resistance (Rr)*) for asynchronous motors, depending on winding temperature. The calculation is:

$$R_s = R_{s_{20^{\circ}C}} \times (1 + \alpha_{Cu} \times \Delta T) [\Omega] \text{ where } \alpha_{Cu} = 0.00393$$

KTY sensors can be used for motor protecting (par. 1-97 *KTY Threshold level*).

FC 302 can handle three types of KTY sensors, defined in par. 1-95 *KTY Sensor Type*. The actual sensor temperature can be read out from par. 16-19 *KTY sensor temperature*.

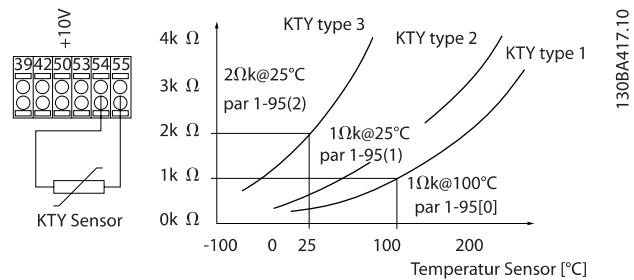

NOTE
If the temperature of the motor is utilized through a thermistor or KTY sensor the PELV is not complied with in case of short circuits between motor windings and sensor. In order to comply with PELV the sensor must be extra isolated.

1-95 KTY Sensor Type	
Option:	Function:
	Select the used type of KTY sensor. This parameter is available for FC 302 only.
[0] *	KTY Sensor 1 1 kΩ at 100° C
[1]	KTY Sensor 2 1 kΩ at 25° C
[2]	KTY Sensor 3 2 kΩ at 25° C

1-96 KTY Thermistor Resource	
Option:	Function:
	Selecting analog input terminal 54 to be used as KTY sensor input. Terminal 54 cannot be selected as KTY source if otherwise used as reference (see par. 3-15 <i>Reference Resource 1</i> to par. 3-17 <i>Reference Resource 3</i>). This parameter is available for FC 302 only.
	NOTE Connection of KTY-sensor between term. 54 and 55 (GND). See picture in section <i>KTY Sensor Connection</i> .
[0] *	None
[2]	Analog input 54

1-97 KTY Threshold level	
Range:	Function:
80 C*	[-40 - 140 C] Select the KTY sensor threshold level for motor thermal protection. This parameter is available for FC 302 only.

3.4 Parameters: 2-** Brakes

3.4.1 2-0* DC-Brakes

Par. group for configuring the DC brake and DC hold functions.

2-00 DC Hold Current		
Range:	Function:	
50 %*	[Application dependant]	Enter a value for holding current as a percentage of the rated motor current $I_{M,N}$ set in par. 1-24 <i>Motor Current</i> . 100% DC holding current corresponds to $I_{M,N}$. This parameter holds the motor function (holding torque) or pre-heats the motor. This parameter is active if <i>DC hold</i> is selected in par. 1-72 <i>Start Function</i> [0] or par. 1-80 <i>Function at Stop</i> [1].

NOTE

The maximum value depends on the rated motor current.

Avoid 100 % current for too long. It may damage the motor.

Low values of DC hold will produce larger than expected currents with larger motor power sizes. This error will increase as the motor power increases.

2-01 DC Brake Current		
Range:	Function:	
50 %*	[Application dependant]	Enter a value for current as a percentage of the rated motor current $I_{M,N}$, see par. 1-24 <i>Motor Current</i> . 100% DC braking current corresponds to $I_{M,N}$. DC brake current is applied on a stop command, when the speed is lower than the limit set in par. 2-03 <i>DC Brake Cut In Speed [RPM]</i> ; when the DC Brake Inverse function is active; or via the serial communication port. The braking current is active during the time period set in par. 2-02 <i>DC Braking Time</i> .

NOTE

The maximum value depends on the rated motor current.

Avoid 100 % current for too long. It may damage the motor.

2-02 DC Braking Time		
Range:	Function:	
10.0 s*	[0.0 - 60.0 s]	Set the duration of the DC braking current set in par. 2-01 <i>DC Brake Current</i> , once activated.

2-03 DC Brake Cut In Speed [RPM]		
Range:	Function:	
Application dependent*	[Application dependant]	Set the DC brake cut-in speed for activation of the DC braking current set in par. 2-01 <i>DC Brake Current</i> , upon a stop command.

2-04 DC Brake Cut In Speed [Hz]		
Range:	Function:	
Application dependent*	[Application dependant]	Set the DC brake cut-in speed for activation of the DC braking current set in par. 2-01 <i>DC Brake Current</i> , upon a stop command.

3.4.2 2-1* Brake Energy Funct.

Par. group for selecting dynamic braking parameters. Only valid for drives with brake chopper.

2-10 Brake Function		
Option:	Function:	
[0] *	Off	No brake resistor is installed.
[1]	Resistor brake	A brake resistor is incorporated in the system, for dissipation of surplus brake energy as heat. Connecting a brake resistor allows a higher DC link voltage during braking (generating operation). The Resistor brake function is only active in frequency converters with an integral dynamic brake.
[2]	AC brake	Is selected to improve braking without using a brake resistor. This parameter controls an overmagnetization of the motor when running with a generative load. This function can improve the OVC-function. Increasing the electrical losses in the motor allows the OVC function to increase the braking torque without exceeding the over voltage limit. Please note that AC brake is not as effective as dynamic braking with resistor. AC brake is for VVC ⁺ and flux mode in both open and closed loop.

2-11 Brake Resistor (ohm)		
Range:	Function:	
Application dependent*	[Application dependant]	Set the brake resistor value in Ohms. This value is used for monitoring the power to the brake resistor in par. 2-13 <i>Brake Power Monitoring</i> . This parameter is only active in frequency converters with an integral dynamic brake. Use this parameter for values without decimals. For a selection with two decimals, use par. 30-81 <i>Brake Resistor (ohm)</i> .

2-12 Brake Power Limit (kW)		
Range:		Function:
Application dependent*	[Application dependant]	Set the monitoring limit of the brake power transmitted to the resistor. The monitoring limit is a product of the maximum duty cycle (120 sec.) and the maximum power of the brake resistor at that duty cycle. See the formula below.

For 200 - 240 V units:	$P_{resistor} = \frac{390^2 \times dutytime}{R \times 120} \text{ [W]}$
For 380 - 480 V units	$P_{resistor} = \frac{778^2 \times dutytime}{R \times 120} \text{ [W]}$
For 380 - 500 V units	$P_{resistor} = \frac{810^2 \times dutytime}{R \times 120} \text{ [W]}$
For 575 - 600 V units	$P_{resistor} = \frac{943^2 \times dutytime}{R \times 120} \text{ [W]}$

This parameter is only active in frequency converters with an integral dynamic brake.

2-13 Brake Power Monitoring		
Option:		Function:
		This parameter is only active in frequency converters with an integral dynamic brake. This parameter enables monitoring of the power to the brake resistor. The power is calculated on the basis of the resistance (par. 2-11 <i>Brake Resistor (ohm)</i>), the DC link voltage, and the resistor duty time.
[0] *	Off	No brake power monitoring required.
[1]	Warning	Activates a warning on the display when the power transmitted over 120 s exceeds 100% of the monitoring limit (par. 2-12 <i>Brake Power Limit (kW)</i>). The warning disappears when the transmitted power falls below 80% of the monitoring limit.
[2]	Trip	Trips frequency converter and displays an alarm when the calculated power exceeds 100% of the monitoring limit.
[3]	Warning and trip	Activates both of the above, including warning, trip and alarm.

If power monitoring is set to *Off* [0] or *Warning* [1], the brake function remains active, even if the monitoring limit is exceeded. This may lead to thermal overload of the resistor. It is also possible to generate a warning via a relay/digital outputs. The measuring accuracy of the power monitoring depends on the accuracy of the resistance of the resistor (better than $\pm 20\%$).

2-15 Brake Check		
Option:		Function:
		Select type of test and monitoring function to check the connection to the brake resistor, or whether a brake resistor is present, and then display a warning or an alarm in the event of a fault. NOTE The brake resistor disconnection function is tested during power-up. However the brake IGBT test is performed when there is no braking. A warning or trip disconnects the brake function. The testing sequence is as follows: <ol style="list-style-type: none"> 1. The DC link ripple amplitude is measured for 300 ms without braking. 2. The DC link ripple amplitude is measured for 300 ms with the brake turned on. 3. If the DC link ripple amplitude while braking is lower than the DC link ripple amplitude before braking + 1 %: <i>Brake check has failed by returning a warning or alarm.</i> 4. If the DC link ripple amplitude while braking is higher than the DC link ripple amplitude before braking + 1 %: <i>Brake check is OK.</i>
[0]	Off	Monitors brake resistor and brake IGBT for a short-circuit during operation. If a short-circuit occurs, warning 25 appears.
[1]	Warning	Monitors brake resistor and brake IGBT for a short-circuit, and runs a test for brake resistor disconnection during power-up.
[2]	Trip	Monitors for a short-circuit or disconnection of the brake resistor, or a short-circuit of the brake IGBT. If a fault occurs, the frequency converter cuts out while displaying an alarm (trip locked).
[3]	Stop and trip	Monitors for a short-circuit or disconnection of the brake resistor, or a short-circuit of the brake IGBT. If a fault occurs, the frequency converter ramps down to coast and then trips. A trip lock alarm is displayed (e.g. warning 25, 27 or 28).
[4]	AC brake	Monitors for a short-circuit or disconnection of the brake resistor, or a short-circuit of the brake IGBT. If a fault occurs, the frequency converter performs a controlled ramp-down. This option is available for FC 302 only.
[5]	Trip Lock	

NOTE

Remove a warning arising in connection with *Off* [0] or *Warning* [1] by cycling the mains supply. The fault must be corrected first. For *Off* [0] or *Warning* [1], the frequency converter keeps running even if a fault is located.

This parameter is only active in frequency converters with an integral dynamic brake.

2-16 AC brake Max. Current		
Range:		Function:
100.0 %*	[Application dependant]	Enter the maximum permissible current when using AC brake to avoid overheating of motor windings. The AC brake function is available in Flux mode only (FC 302 only).

2-17 Over-voltage Control		
Option:	Function:	
		Over-voltage control (OVC) reduces the risk of the frequency converter tripping due to an over voltage on the DC link caused by generative power from the load.
[0] *	Disabled	No OVC required.
[1]	Enabled (not at stop)	Activates OVC except when using a stop signal to stop the frequency converter.
[2]	Enabled	Activates OVC.

NOTE

OVC must not be enabled in hoisting applications.

2-18 Brake Check Condition		
Range:		Function:
[0] *	At Power Up	Brake check will be performed at power up
[1]	After Coast Situations	Brake check will be performed after coast situations

2-19 Over-voltage Gain

Range:		Function:
100 %*	[0 - 200 %]	Select over-voltage gain.

3.4.3 2-2* Mechanical Brake

Parameters for controlling operation of an electro-magnetic (mechanical) brake, typically required in hoisting applications. To control a mechanical brake, a relay output (relay 01 or relay 02) or a programmed digital output (terminal 27 or 29) is required. Normally this output must be closed during periods when the frequency converter is unable to 'hold' the motor, e.g. due to an excessive load. Select *Mechanical Brake Control* [32] for applications with an electro-magnetic brake in par. 5-40 *Function Relay*, par. 5-30 *Terminal 27 Digital Output*, or par. 5-31 *Terminal 29 Digital Output*. When selecting *Mechanical brake control* [32], the mechanical brake is closed from start up until the output current is above the level selected in par. 2-20 *Release Brake Current*. During stop, the mechanical brake activates when the speed falls below the level specified in par. 2-21 *Activate Brake Speed [RPM]*. If the frequency converter enters an alarm condition or an over-current or over-voltage situation, the mechanical brake immediately cuts in. This is also the case during safe stop.

NOTE

Protection mode and trip delay features (par. 14-25 *Trip Delay at Torque Limit* and par. 14-26 *Trip Delay at Inverter Fault*) may delay the activation of the mechanical brake in an alarm condition. These features must be disabled in hoisting applications.

3

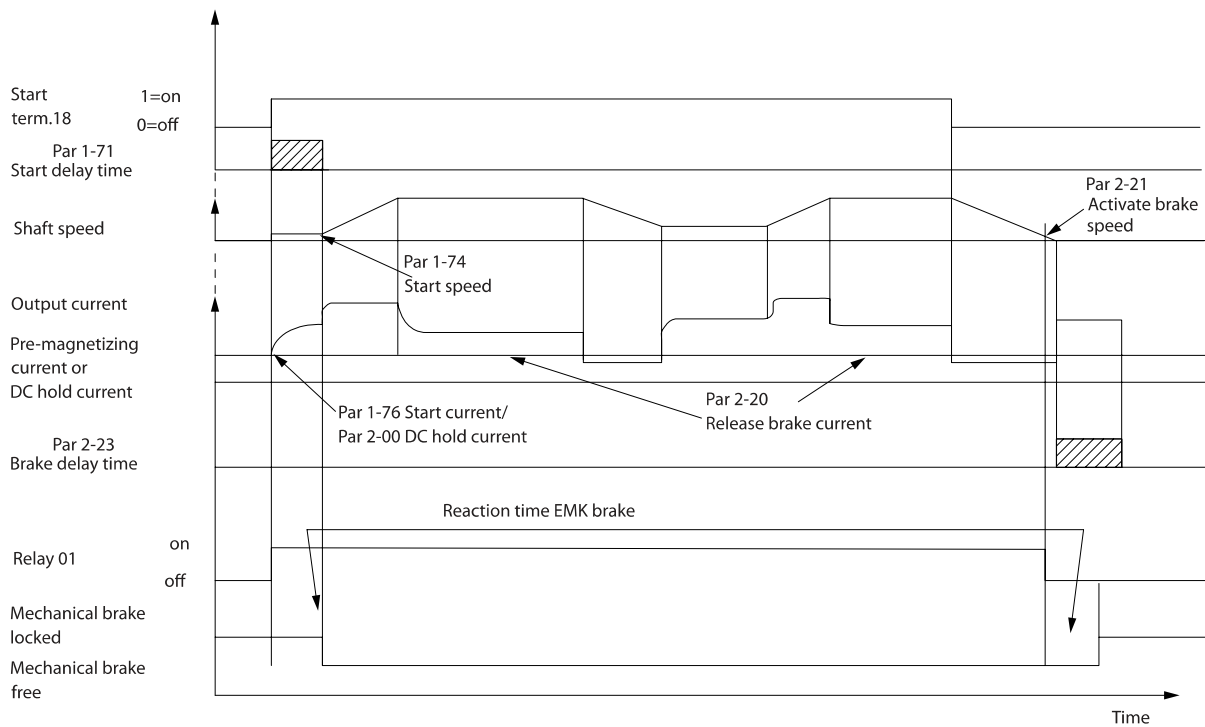

130BA074.12

2-20 Release Brake Current		
Range:		Function:
Application dependent*	[Application dependant]	Set the motor current for release of the mechanical brake, when a start condition is present. The default value is the maximum current the inverter can provide for the particular power size. The upper limit is specified in par. 16-37 <i>Inv. Max. Current</i> .
<p>NOTE When Mechanical brake control output is selected but no mechanical brake is connected, the function will not work by default setting due to too low motor current.</p>		

2-21 Activate Brake Speed [RPM]		
Range:		Function:
Application dependent*	[0 - 30000 RPM]	Set the motor speed for activation of the mechanical brake, when a stop condition is present. The upper speed limit is specified in par. 4-53 <i>Warning Speed High</i> .

2-22 Activate Brake Speed [Hz]		
Range:		Function:
Application dependent*	[Application dependant]	Set the motor frequency for activation of the mechanical brake, when a stop condition is present.

2-23 Activate Brake Delay		
Range:		Function:
0.0 s*	[0.0 - 5.0 s]	Enter the brake delay time of the coast after ramp-down time. The shaft is held at zero speed with full holding torque. Ensure that the mechanical brake has locked the load before the motor enters coast mode. See <i>Mechanical Brake Control</i> section in the Design Guide.

2-24 Stop Delay		
Range:		Function:
0.0 s*	[0.0 - 5.0 s]	Set the time interval from the moment when the motor is stopped until the brake closes. This parameter is a part of the stopping function.

2-25 Brake Release Time		
Range:	Function:	
0.20 s* [0.00 - 5.00 s]	This value defines the time it takes for the mechanical brake to open. This parameter must act as a time-out when brake feedback is activated.	

2-26 Torque Ref		
Range:	Function:	
0.00 %* [Application dependant]	The value defines the torque applied against the closed mechanical brake, before release	

2-27 Torque Ramp Time		
Range:	Function:	
0.2 s* [0.0 - 5.0 s]	The value defines the duration of the torque ramp in clockwise direction.	

2-28 Gain Boost Factor		
Range:	Function:	
1.00* [1.00 - 4.00]	Only active in flux closed loop. The function ensures a smooth transition from torque control mode to speed control mode when the motor takes over the load from the brake.	

3

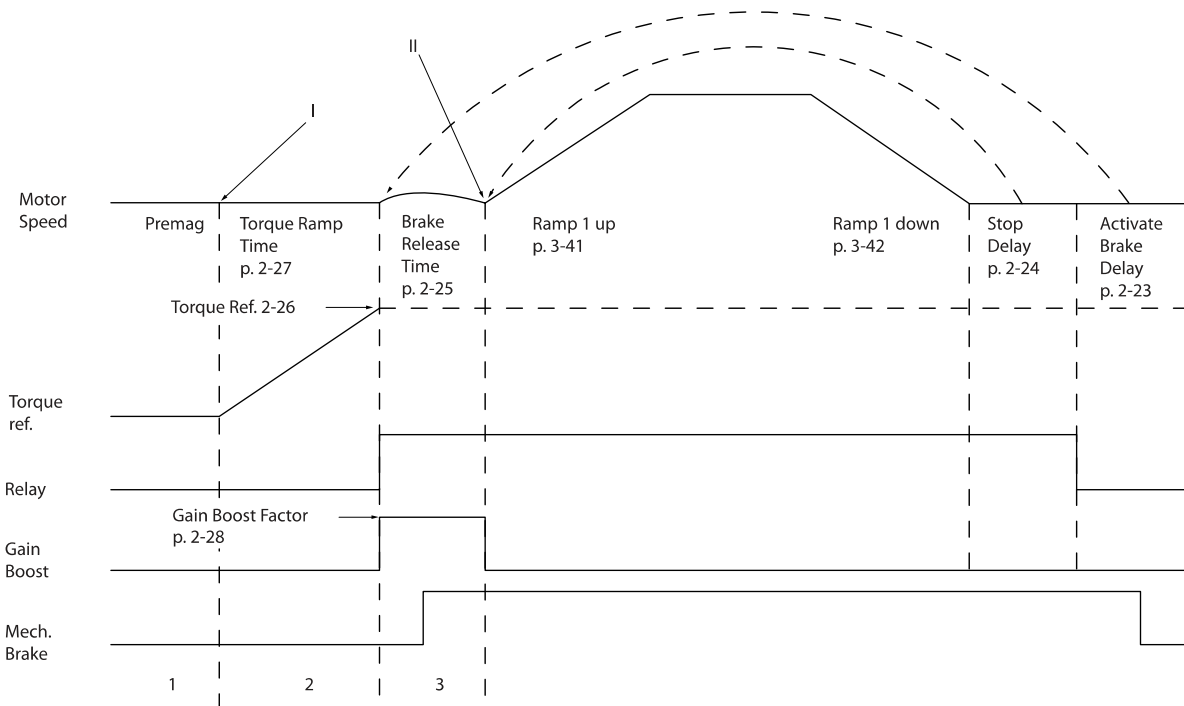

Illustration 3.4: Brake release sequence for hoist mechanical brake control

- I) **Activate brake delay:** The frequency converter starts again from the *mechanical brake engaged* position.
- II) **Stop delay:** When the time between successive starts is shorter than the setting in par. 2-24 *Stop Delay*, the frequency converter starts without applying the mechanical brake (e.g. reversing).

3.5 Parameters: 3-** Reference/Ramps

Parameters for reference handling, definition of limitations, and configuration of the reaction of the frequency converter to changes.

3.5.1 3-0* Reference Limits

3-00 Reference Range		
Option:	Function:	
		Select the range of the reference signal and the feedback signal. Signal values can be positive only, or positive and negative. The minimum limit may have a negative value, unless <i>Speed closed loop</i> [1] control or <i>Process</i> [3] is selected in par. 1-00 <i>Configuration Mode</i> .
[0]	Min - Max	Select the range of the reference signal and the feedback signal. Signal values can be positive only, or positive and negative. The minimum limit may have a negative value, unless <i>Speed closed loop</i> [1] control or <i>Process</i> [3] is selected in par. 1-00 <i>Configuration Mode</i> .
[1] *	-Max - +Max	For both positive and negative values (both directions, relative to par. 4-10 <i>Motor Speed Direction</i>).

3-01 Reference/Feedback Unit		
Option:	Function:	
		Select the unit to be used in Process PID Control references and feedbacks. Par. 1-00 <i>Configuration Mode</i> must be either [3] <i>Process</i> or [8] <i>Extended PID Control</i> .
[0] *	None	
[1]	%	
[2]	RPM	
[3]	Hz	
[4]	Nm	
[5]	PPM	
[10]	1/min	
[12]	Pulse/s	
[20]	l/s	
[21]	l/min	
[22]	l/h	
[23]	m ³ /s	
[24]	m ³ /min	
[25]	m ³ /h	
[30]	kg/s	
[31]	kg/min	
[32]	kg/h	
[33]	t/min	
[34]	t/h	
[40]	m/s	

3-01 Reference/Feedback Unit		
Option:	Function:	
[41]	m/min	
[45]	m	
[60]	°C	
[70]	mbar	
[71]	bar	
[72]	Pa	
[73]	kPa	
[74]	m WG	
[80]	kW	
[120]	GPM	
[121]	gal/s	
[122]	gal/min	
[123]	gal/h	
[124]	CFM	
[125]	ft ³ /s	
[126]	ft ³ /min	
[127]	ft ³ /h	
[130]	lb/s	
[131]	lb/min	
[132]	lb/h	
[140]	ft/s	
[141]	ft/min	
[145]	ft	
[150]	lb ft	
[160]	°F	
[170]	psi	
[171]	lb/in ²	
[172]	in WG	
[173]	ft WG	
[180]	HP	

3-02 Minimum Reference		
Range:	Function:	
Application dependent*	[Application dependent]	Enter the Minimum Reference. The Minimum Reference is the lowest value obtainable by summing all references. Minimum Reference is active only when par. 3-00 <i>Reference Range</i> is set to <i>Min.-Max.</i> [0]. The Minimum Reference unit matches: <ul style="list-style-type: none"> The choice of configuration in par. 1-00 <i>Configuration Mode Configuration Mode</i>: for <i>Speed closed loop</i> [1], RPM; for <i>Torque</i> [2], Nm. The unit selected in par. 3-01 <i>Reference/Feedback Unit</i>.

3-03 Maximum Reference		
Range:		Function:
Application dependent*	[Application dependant]	Enter the Maximum Reference. The Maximum Reference is the highest value obtainable by summing all references. The Maximum Reference unit matches: <ul style="list-style-type: none"> The choice of configuration in par. 1-00 <i>Configuration Mode</i>: for <i>Speed closed loop</i> [1], RPM; for <i>Torque</i> [2], Nm. The unit selected in par. 3-00 <i>Reference Range</i>.

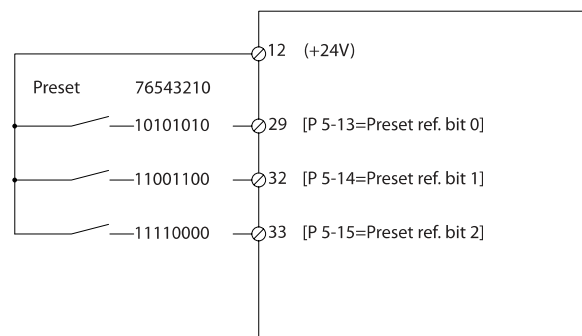

Preset ref. bit	2	1	0
Preset ref. 0	0	0	0
Preset ref. 1	0	0	1
Preset ref. 2	0	1	0
Preset ref. 3	0	1	1
Preset ref. 4	1	0	0
Preset ref. 5	1	0	1
Preset ref. 6	1	1	0
Preset ref. 7	1	1	1

3-04 Reference Function		
Option:		Function:
[0] *	Sum	Sums both external and preset reference sources.
[1]	External/ Preset	Use either the preset or the external reference source. Shift between external and preset via a command on a digital input.

3-11 Jog Speed [Hz]		
Range:		Function:
Application dependent*	[Application dependant]	The jog speed is a fixed output speed at which the frequency converter is running when the jog function is activated. See also par. 3-80 <i>Jog Ramp Time</i> .

3.5.2 3-1* References

Select the preset reference(s). *Select Preset ref. bit 0 / 1 / 2* [16], [17] or [18] for the corresponding digital inputs in par. group 5-1*.

3-10 Preset Reference		
Array [8] Range: 0-7		
Range:		Function:
0.00 %*	[-100.00 - 100.00 %]	Enter up to eight different preset references (0-7) in this parameter, using array programming. The preset reference is stated as a percentage of the value Ref _{MAX} (par. 3-03 <i>Maximum Reference</i>) If a Ref _{MIN} different from 0 (par. 3-02 <i>Minimum Reference</i>) is programmed, the preset reference is calculated as a percentage of the full reference range, i.e. on the basis of the difference between Ref _{MAX} and Ref _{MIN} . Afterwards, the value is added to Ref _{MIN} . When using preset references, select Preset ref. bit 0 / 1 / 2 [16], [17] or [18] for the corresponding digital inputs in par. group 5-1*.

3-12 Catch up/slow Down Value		
Range:		Function:
0.00 %*	[0.00 - 100.00 %]	Enter a percentage (relative) value to be either added to or deducted from the actual reference for Catch up or Slow down respectively. If <i>Catch up</i> is selected via one of the digital inputs (par. 5-10 <i>Terminal 18 Digital Input</i> to par. 5-15 <i>Terminal 33 Digital Input</i>), the percentage (relative) value is added to the total reference. If <i>Slow down</i> is selected via one of the digital inputs (par. 5-10 <i>Terminal 18 Digital Input</i> to par. 5-15 <i>Terminal 33 Digital Input</i>), the percentage (relative) value is deducted from the total reference. Obtain extended functionality with the DigiPot function. See par. group 3-9* <i>Digital Potentiometer</i> .

3-13 Reference Site		
Option:	Function:	
		Select which reference site to activate.
[0] *	Linked to Hand / Auto	Use local reference when in Hand mode; or remote reference when in Auto mode.
[1]	Remote	Use remote reference in both Hand mode and Auto mode.
[2]	Local	Use local reference in both Hand mode and Auto mode.

NOTE
When set to Local [2], the frequency converter will start with this setting again following a 'power down'.

3-14 Preset Relative Reference		
Range:	Function:	
0.00 %*	[-100.00 - 100.00 %]	The actual reference, X, is increased or decreased with the percentage Y, set in par. 3-14 <i>Preset Relative Reference</i> . This results in the actual reference Z. Actual reference (X) is the sum of the inputs selected in par. 3-15 <i>Reference 1 Source</i> , par. 3-16 <i>Reference 2 Source</i> , par. 3-17 <i>Reference 3 Source</i> and par. 8-02 <i>Control Source</i> .

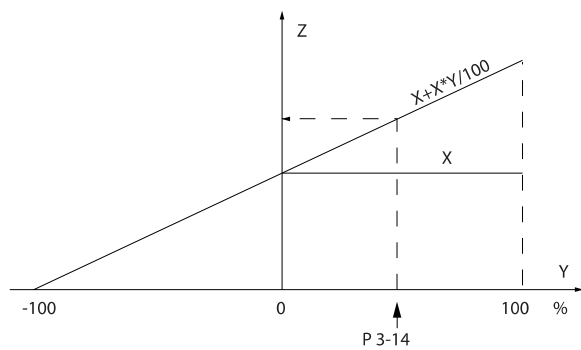
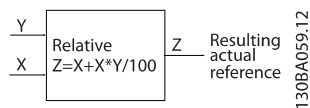

130BA278:10

3-15 Reference Resource 1		
Option:	Function:	
		Select the reference input to be used for the first reference signal. par. 3-15 <i>Reference Resource 1</i> , par. 3-16 <i>Reference Resource 2</i> and par. 3-17 <i>Reference Resource 3</i> define up to three different reference signals. The sum of these reference signals defines the actual reference.
[0]	No function	
[1] *	Analog input 53	
[2]	Analog input 54	
[7]	Frequency input 29	
[8]	Frequency input 33	
[11]	Local bus reference	
[20]	Digital pot.meter	
[21]	Analog input X30-11	(General Purpose I/O Option Module)
[22]	Analog input X30-12	(General Purpose I/O Option Module)
[29]	Analog Input X48/2	

3-16 Reference Resource 2		
Option:	Function:	
		Select the reference input to be used for the second reference signal. par. 3-15 <i>Reference Resource 1</i> , par. 3-16 <i>Reference Resource 2</i> and par. 3-17 <i>Reference Resource 3</i> define up to three different reference signals. The sum of these reference signals defines the actual reference.
[0]	No function	
[1]	Analog input 53	
[2]	Analog input 54	
[7]	Frequency input 29	
[8]	Frequency input 33	
[11]	Local bus reference	
[20] *	Digital pot.meter	
[21]	Analog input X30-11	
[22]	Analog input X30-12	
[29]	Analog Input X48/2	

3-17 Reference Resource 3		
Option:	Function:	
		Select the reference input to be used for the third reference signal. par. 3-15 <i>Reference Resource 1</i> , par. 3-16 <i>Reference Resource 2</i> and par. 3-17 <i>Reference Resource 3</i> define up to three different reference signals. The sum of these reference signals defines the actual reference.
[0]	No function	
[1]	Analog input 53	

3-17 Reference Resource 3		
Option:	Function:	
[2]	Analog input 54	
[7]	Frequency input 29	
[8]	Frequency input 33	
[11] *	Local bus reference	
[20]	Digital pot.meter	
[21]	Analog input X30-11	
[22]	Analog input X30-12	
[29]	Analog Input X48/2	

3-18 Relative Scaling Reference Resource		
Option:	Function:	
		<p>Select a variable value to be added to the fixed value (defined in par. 3-14 <i>Preset Relative Reference</i>). The sum of the fixed and variable values (labelled Y in the illustration below) is multiplied with the actual reference (labelled X in the illustration below). This product is then added to the actual reference ($X+X*Y/100$) to give the resultant actual reference.</p> <div style="text-align: center;"> <p>130BA059.12</p> </div> <p>This parameter cannot be adjusted while the motor is running.</p>
[0] *	No function	
[1]	Analog input 53	
[2]	Analog input 54	
[7]	Frequency input 29	
[8]	Frequency input 33	
[11]	Local bus reference	
[20]	Digital pot.meter	
[21]	Analog input X30-11	
[22]	Analog input X30-12	
[29]	Analog Input X48/2	

3-19 Jog Speed [RPM]		
Range:	Function:	
Application dependent*	[Application dependant]	<p>Enter a value for the jog speed n_{JOG}, which is a fixed output speed. The frequency converter runs at this speed when the jog function is activated. The maximum limit is defined in par. 4-13 <i>Motor Speed High Limit [RPM]</i>. See also par. 3-80 <i>Jog Ramp Time</i>.</p>

3.5.3 Ramps 3-4* Ramp 1

For each of four ramps (par. group 3-4*, 3-5*, 3-6* and 3-7*) configure the ramp parameters: ramp type, ramping times (duration of acceleration and deceleration) and level of jerk compensation for S ramps.

Start by setting the linear ramping times corresponding to the figures.

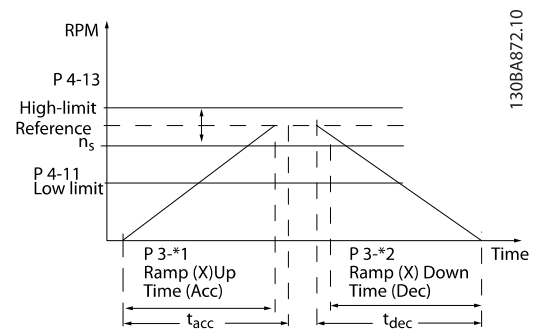

If S-ramps are selected then set the level of non-linear jerk compensation required. Set jerk compensation by defining the proportion of ramp-up and ramp-down times where acceleration and deceleration are variable (i.e. increasing or decreasing). The S-ramp acceleration and deceleration settings are defined as a percentage of the actual ramp time.

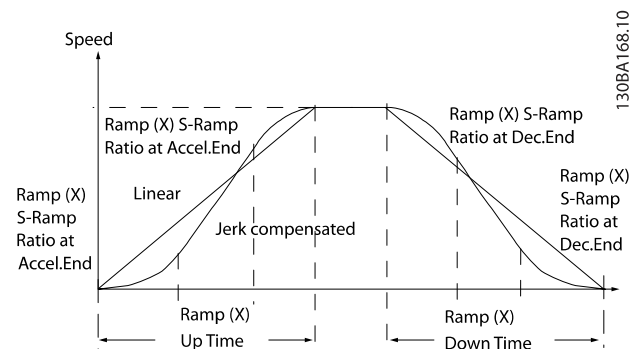

3-40 Ramp 1 Type		
Option:	Function:	
		Select the ramp type, depending on requirements for acceleration/deceleration. A linear ramp will give constant acceleration during ramping. An S-ramp will give non-linear acceleration, compensating for jerk in the application.
[0] *	Linear	
[1]	S-ramp Const Jerk	Acceleration with lowest possible jerk.
[2]	S-ramp Const Time	S-ramp based on the values set in par. 3-41 <i>Ramp 1 Ramp up Time</i> and par. 3-42 <i>Ramp 1 Ramp Down Time</i> .

NOTE

If S-ramp [1] is selected and the reference during ramping is changed the ramp time may be prolonged in order to realize a jerk free movement which may result in a longer start or stop time.

Additional adjustment of the S-ramp ratios or switching initiators may be necessary.

3-41 Ramp 1 Ramp up Time		
Range:	Function:	
Application dependant*	[Application dependant]	Enter the ramp-up time, i.e. the acceleration time from 0 RPM to the synchronous motor speed n_s . Choose a ramp-up time such that the output current does not exceed the current limit in par. 4-18 <i>Current Limit</i> during ramping. The value 0.00 corresponds to 0.01 sec. in speed mode. See ramp-down time in par. 3-42 <i>Ramp 1 Ramp Down Time</i> .
		$Par. 3 - 41 = \frac{t_{acc} [s] \times n_s [RPM]}{ref [RPM]}$

3-42 Ramp 1 Ramp Down Time		
Range:	Function:	
Application dependant*	[Application dependant]	Enter the ramp-down time, i.e. the deceleration time from the synchronous motor speed n_s to 0 RPM. Choose a ramp-down time such that no over-voltage arises in the inverter due to regenerative operation of the motor, and such that the generated current does not exceed the current limit set in par. 4-18 <i>Current Limit</i> . The value 0.00 corresponds to 0.01 s in speed mode. See ramp-up time in par. 3-41 <i>Ramp 1 Ramp up Time</i> .
		$Par. 3 - 42 = \frac{t_{dec} [s] \times n_s [RPM]}{ref [RPM]}$

3-45 Ramp 1 S-ramp Ratio at Accel. Start		
Range:	Function:	
50 %*	[Application dependant]	Enter the proportion of the total ramp-up time (par. 3-41 <i>Ramp 1 Ramp up Time</i>) in which the acceleration torque increases. The larger the percentage value, the greater the jerk compensation achieved, and thus the lower the torque jerks occurring in the application.

3-46 Ramp 1 S-ramp Ratio at Accel. End		
Range:	Function:	
50 %*	[Application dependant]	Enter the proportion of the total ramp-up time (par. 3-41 <i>Ramp 1 Ramp up Time</i>) in which the acceleration torque decreases. The larger the percentage value, the greater the jerk compensation achieved, and thus the lower the torque jerks in the application.

3-47 Ramp 1 S-ramp Ratio at Decel. Start		
Range:	Function:	
50 %*	[Application dependant]	Enter the proportion of the total ramp-down time (par. 3-42 <i>Ramp 1 Ramp Down Time</i>) where the deceleration torque increases. The larger the percentage value, the greater the jerk compensation achieved, and thus the lower the torque jerks in the application.

3-48 Ramp 1 S-ramp Ratio at Decel. End		
Range:	Function:	
50 %*	[Application dependant]	Enter the proportion of the total ramp-down time (par. 3-42 <i>Ramp 1 Ramp Down Time</i>) where the deceleration torque decreases. The larger the percentage value, the greater the jerk compensation achieved, and thus the lower the torque jerks in the application.

3.5.4 3-5* Ramp 2

Choosing ramp parameters, see 3-4*.

3-50 Ramp 2 Type		
Option:	Function:	
		Select the ramp type, depending on requirements for acceleration/deceleration. A linear ramp will give constant acceleration during ramping. An S-ramp will give non-linear acceleration, compensating for jerk in the application.
[0] *	Linear	
[1]	S-ramp Const Jerk	Acceleration with lowest possible jerk
[2]	S-ramp Const Time	S-ramp based on the values set in par. 3-51 <i>Ramp 2 Ramp up Time</i> and par. 3-52 <i>Ramp 2 Ramp down Time</i>

NOTE

If S-ramp [1] is selected and the reference during ramping is changed the ramp time may be prolonged in order to realize a jerk free movement which may result in a longer start or stop time.

Additional adjustment of the S-ramp ratios or switching initiators may be necessary.

3-51 Ramp 2 Ramp up Time		
Range:	Function:	
Application dependant*	[Application dependant]	Enter the ramp-up time, i.e. the acceleration time from 0 RPM to the rated motor speed n_s . Choose a ramp-up time such that the output current does not exceed the current limit in par. 4-18 <i>Current Limit</i> during ramping. The value 0.00 corresponds to 0.01 sec. in speed mode. See ramp-down time in par. 3-52 <i>Ramp 2 Ramp down Time</i> .
$Par. 3 - 51 = \frac{t_{acc} [s] \times n_s [RPM]}{ref [RPM]}$		

3-52 Ramp 2 Ramp down Time		
Range:	Function:	
Application dependant*	[Application dependant]	Enter the ramp-down time, i.e. the deceleration time from the rated motor speed n_s to 0 RPM. Choose a ramp-down time such that no over-voltage arises in the inverter due to regenerative operation of the motor, and such that the generated current does not exceed the current limit set in par. 4-18 <i>Current Limit</i> . The value 0.00 corresponds to 0.01 s in speed mode. See ramp-up time in par. 3-51 <i>Ramp 2 Ramp up Time</i> .
$Par. 3 - 52 = \frac{t_{dec} [s] \times n_s [RPM]}{ref [RPM]}$		

3-55 Ramp 2 S-ramp Ratio at Accel. Start		
Range:	Function:	
50 %*	[Application dependant]	Enter the proportion of the total ramp-up time (par. 3-51 <i>Ramp 2 Ramp up Time</i>) in which the acceleration torque increases. The larger the percentage value, the greater the jerk compensation achieved, and thus the lower the torque jerks in the application.

3-56 Ramp 2 S-ramp Ratio at Accel. End		
Range:	Function:	
50 %*	[Application dependant]	Enter the proportion of the total ramp-up time (par. 3-51 <i>Ramp 2 Ramp up Time</i>) in which the acceleration torque decreases. The larger the percentage value, the greater the jerk compensation achieved, and thus the lower the torque jerks in the application.

3-57 Ramp 2 S-ramp Ratio at Decel. Start		
Range:	Function:	
50 %*	[Application dependant]	Enter the proportion of the total ramp-down time (par. 3-52 <i>Ramp 2 Ramp down Time</i>) where the deceleration torque increases. The larger the percentage value, the greater the jerk compensation achieved, and thus the lower the torque jerks in the application.

3-58 Ramp 2 S-ramp Ratio at Decel. End		
Range:	Function:	
50 %*	[Application dependant]	Enter the proportion of the total ramp-down time (par. 3-52 <i>Ramp 2 Ramp down Time</i>) where the deceleration torque decreases. The larger the percentage value, the greater the jerk compensation achieved, and thus the lower the torque jerks in the application.

3.5.5 3-6* Ramp 3

Configure ramp parameters, see 3-4*.

3-60 Ramp 3 Type		
Option:	Function:	
		Select the ramp type, depending on requirements for acceleration and deceleration. A linear ramp will give constant acceleration during ramping. An S-ramp will give non-linear acceleration, compensating for jerk in the application.
[0] *	Linear	
[1]	S-ramp Const Jerk	Accelerates with lowest possible jerk.

3-60 Ramp 3 Type		
Option:	Function:	
[2]	S-ramp Const Time	S-ramp based on the values set in par. 3-61 <i>Ramp 3 Ramp up Time</i> and par. 3-62 <i>Ramp 3 Ramp down Time</i>

NOTE

If S-ramp [1] is selected and the reference during ramping is changed the ramp time may be prolonged in order to realize a jerk free movement which may result in a longer start or stop time.

Additional adjustment of the S-ramp ratios or switching initiators may be necessary.

3-61 Ramp 3 Ramp up Time		
Range:	Function:	
Application dependent*	[Application dependant]	Enter the ramp-up time, i.e. the acceleration time from 0 RPM to the rated motor speed n_s . Choose a ramp-up time such that the output current does not exceed the current limit in par. 4-18 <i>Current Limit</i> during ramping. The value 0.00 corresponds to 0.01 sec. in speed mode. See ramp-down time in par. 3-62 <i>Ramp 3 Ramp down Time</i> .

3-62 Ramp 3 Ramp down Time		
Range:	Function:	
Application dependent*	[Application dependant]	Enter the ramp-down time, i.e. the deceleration time from the rated motor speed n_s to 0 RPM. Choose a ramp-down time such that no over-voltage arises in the inverter due to regenerative operation of the motor, and such that the generated current does not exceed the current limit set in par. 4-18 <i>Current Limit</i> . The value 0.00 corresponds to 0.01 s in speed mode. See ramp-up time in par. 3-61 <i>Ramp 3 Ramp up Time</i> .
$Par. 3 - 62 = \frac{t_{dec} [s] \times n_s [RPM]}{ref [RPM]}$		

3-65 Ramp 3 S-ramp Ratio at Accel. Start		
Range:	Function:	
50 %*	[Application dependant]	Enter the proportion of the total ramp-up time (par. 3-61 <i>Ramp 3 Ramp up Time</i>) in which the acceleration torque increases. The larger the percentage value, the greater the jerk compensation achieved, and thus the lower the torque jerks in the application.

3-66 Ramp 3 S-ramp Ratio at Accel. End		
Range:	Function:	
50 %*	[Application dependant]	Enter the proportion of the total ramp-up time (par. 3-61 <i>Ramp 3 Ramp up Time</i>) in which the acceleration torque decreases. The larger the percentage value, the greater the jerk compensation achieved, and thus the lower the torque jerks in the application.

3-67 Ramp 3 S-ramp Ratio at Decel. Start		
Range:	Function:	
50 %*	[Application dependant]	Enter the proportion of the total ramp-down time (par. 3-62 <i>Ramp 3 Ramp down Time</i>) where the deceleration torque increases. The larger the percentage value, the greater the jerk compensation achieved, and thus the lower the torque jerks in the application.

3-68 Ramp 3 S-ramp Ratio at Decel. End		
Range:	Function:	
50 %*	[Application dependant]	Enter the proportion of the total ramp-down decel time (par. 3-62 <i>Ramp 3 Ramp down Time</i>) where the deceleration torque decreases. The larger the percentage value, the greater the jerk compensation achieved, and thus the lower the torque jerks in the application.

3.5.6 3-7* Ramp 4

Configure ramp parameters, see 3-4*.

3-70 Ramp 4 Type		
Option:	Function:	
[0] *	Linear	Select the ramp type, depending on requirements for acceleration and deceleration. A linear ramp will give constant acceleration during ramping. An S-ramp will give non-linear acceleration, compensating for jerk in the application
[1]	S-ramp Const Jerk	Accelerates with lowest possible jerk.
[2]	S-ramp Const Time	S-ramp based on the values set in par. 3-71 <i>Ramp 4 Ramp up Time</i> and par. 3-72 <i>Ramp 4 Ramp Down Time</i> .

NOTE

If S-ramp [1] is selected and the reference during ramping is changed the ramp time may be prolonged in order to realize a jerk free movement which may result in a longer start or stop time.

Additional adjustment of the S-ramp ratios or switching initiators may be necessary.

3-71 Ramp 4 Ramp up Time		
Range:		Function:
Application dependant*	[Application dependant]	Enter the ramp-up time, i.e. the acceleration time from 0 RPM to the rated motor speed n_s . Choose a ramp-up time such that the output current does not exceed the current limit in par. 4-18 <i>Current Limit</i> during ramping. The value 0.00 corresponds to 0.01 sec. in speed mode. See ramp-down time in par. 3-72 <i>Ramp 4 Ramp Down Time</i> . $Par. 3 - 71 = \frac{t_{acc} [s] \times n_s [RPM]}{ref [RPM]}$

3-72 Ramp 4 Ramp Down Time		
Range:		Function:
Application dependant*	[Application dependant]	Enter the ramp-down time, i.e. the deceleration time from the rated motor speed n_s to 0 RPM. Choose a ramp-down time such that no over-voltage arises in the inverter due to regenerative operation of the motor, and such that the generated current does not exceed the current limit set in par. 4-18 <i>Current Limit</i> . The value 0.00 corresponds to 0.01 s in speed mode. See ramp-up time in par. 3-71 <i>Ramp 4 Ramp up Time</i> . $Par. 3 - 72 = \frac{t_{dec} [s] \times n_s [RPM]}{ref [RPM]}$

3-75 Ramp 4 S-ramp Ratio at Accel. Start		
Range:		Function:
50 %*	[Application dependant]	Enter the proportion of the total ramp-up time (par. 3-71 <i>Ramp 4 Ramp up Time</i>) in which the acceleration torque increases. The larger the percentage value, the greater the jerk compensation achieved, and thus the lower the torque jerks in the application.

3-76 Ramp 4 S-ramp Ratio at Accel. End		
Range:		Function:
50 %*	[Application dependant]	Enter the proportion of the total ramp-up time (par. 3-71 <i>Ramp 4 Ramp up Time</i>) in which the acceleration torque decreases. The larger the percentage value, the greater the jerk compensation achieved, and thus the lower the torque jerks in the application.

3-77 Ramp 4 S-ramp Ratio at Decel. Start		
Range:		Function:
50 %*	[Application dependant]	Enter the proportion of the total ramp-down time (par. 3-72 <i>Ramp 4 Ramp Down Time</i>) where the deceleration torque increases. The larger the percentage value, the greater the jerk compensation achieved, and thus the lower the torque jerks in the application.

3-78 Ramp 4 S-ramp Ratio at Decel. End		
Range:		Function:
50 %*	[Application dependant]	Enter the proportion of the total ramp-down time (par. 3-72 <i>Ramp 4 Ramp Down Time</i>) where the deceleration torque decreases. The larger the percentage value, the greater the jerk compensation achieved, and thus the lower the torque jerks in the application.

3.5.7 3-8* Other Ramps

3-80 Jog Ramp Time		
Range:		Function:
Application dependant*	[0.01 - 3600.00 s]	Enter the jog ramp time, i.e. the acceleration/deceleration time between 0 RPM and the rated motor frequency n_s . Ensure that the resultant output current required for the given jog ramp time does not exceed the current limit in par. 4-18 <i>Current Limit</i> . The jog ramp time starts upon activation of a jog signal via the LCP, a selected digital input, or the serial communication port. When jog state is disabled then the normal ramping times are valid.

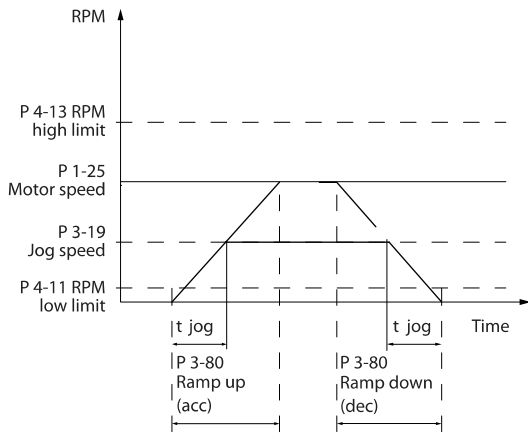

130BA070.10

$$Par. 3 - 80 = \frac{t_{jog} [s] \times n_s [RPM]}{\Delta \log speed (par. 3 - 19) [RPM]}$$

3-81 Quick Stop Ramp Time		
Range:	Function:	
Application dependant*	[0.01 - 3600.00 s]	Enter the quick-stop ramp-down time, i.e. the deceleration time from the synchronous motor speed to 0 RPM. Ensure that no resultant over-voltage will arise in the inverter due to regenerative operation of the motor required to achieve the given ramp-down time. Ensure also that the generated current required to achieve the given ramp-down time does not exceed the current limit (set in par. 4-18 <i>Current Limit</i>). Quick-stop is activated by means of a signal on a selected digital input, or via the serial communication port.

3-82 Quick Stop Ramp Type		
Option:	Function:	
[0] *	Linear	Select the ramp type, depending on requirements for acceleration and deceleration. A linear ramp will give constant acceleration during ramping. An S-ramp will give non-linear acceleration, compensating for jerk in the application.
[1]	S-ramp Const Jerk	
[2]	S-ramp Const Time	

3-83 Quick Stop S-ramp Ratio at Decel. Start		
Range:	Function:	
50 %*	[Application dependant]	Enter the proportion of the total ramp-down time (par. 3-42) where the deceleration torque increases. The larger the percentage value, the greater the jerk compensation achieved, and thus the lower the torque jerks in the application.

3-84 Quick Stop S-ramp Ratio at Decel. End		
Range:	Function:	
50 %*	[Application dependant]	Enter the proportion of the total ramp-down time (par. 3-42 <i>Ramp 1 Ramp Down Time</i>) where the deceleration torque decreases. The larger the percentage value, the greater the jerk compensation achieved, and thus the lower the torque jerks in the application.

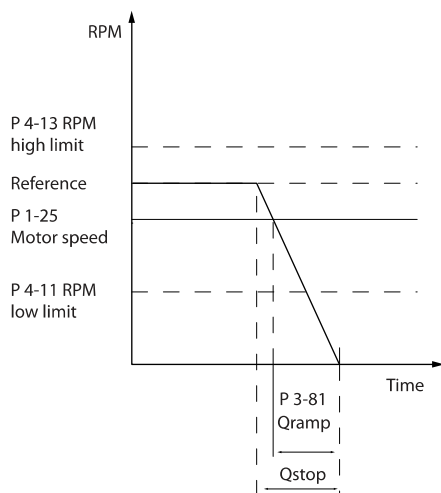

130BA069.10

$$Par. 3 - 81 = \frac{t_{Qstop} [s] \times n_s [RPM]}{\Delta jog ref (par. 3 - 19) [RPM]}$$

3.5.8 3-9* Digital Pot.Meter

The digital potentiometer function allows the user to increase or decrease the actual reference by adjusting the set-up of the digital inputs using the functions *Increase*, *Decrease* or *Clear*. To activate the function, at least one digital input must be set up to *Increase* or *Decrease*.

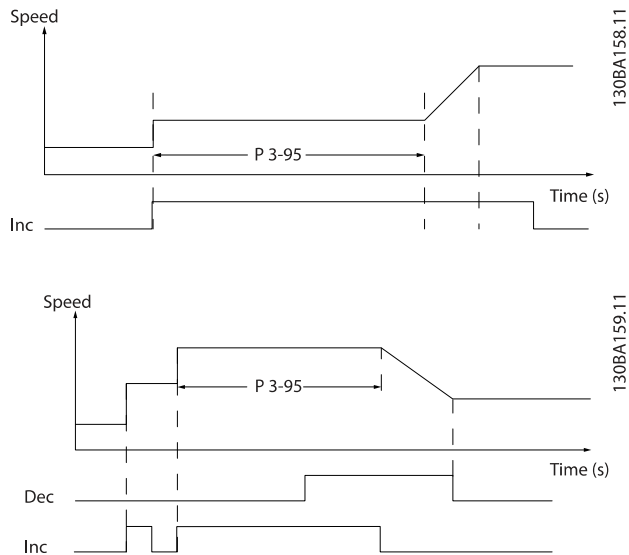

3-90 Step Size		
Range:	Function:	
0.10 %*	[0.01 - 200.00 %]	Enter the increment size required for INCREASE/DECREASE, as a percentage of the synchronous motor speed, n_s . If INCREASE/ DECREASE is activated the resulting reference will be increased / decreased by the amount set in this parameter.

3-91 Ramp Time		
Range:	Function:	
1.00 s*	[0.00 - 3600.00 s]	Enter the ramp time, i.e. the time for adjustment of the reference from 0% to 100% of the specified digital potentiometer function (Increase, Decrease or Clear). If Increase/ Decrease is activated for longer than the ramp delay period specified in par. 3-95 <i>Ramp Delay</i> the actual reference will be ramped up / down according to this ramp time. The ramp time is defined as the time used to adjust the reference by the step size specified in par. 3-90 <i>Step Size</i> .

3-92 Power Restore		
Option:	Function:	
[0] *	Off	Resets the Digital Potentiometer reference to 0% after power up.
[1]	On	Restores the most recent Digital Potentiometer reference at power up.

3-93 Maximum Limit		
Range:	Function:	
100 %*	[-200 - 200 %]	Set the maximum permissible value for the resultant reference. This is advisable if the Digital Potentiometer is used for fine tuning of the resulting reference.

3-94 Minimum Limit		
Range:	Function:	
-100 %*	[-200 - 200 %]	Set the minimum permissible value for the resultant reference. This is advisable if the Digital Potentiometer is used for fine tuning of the resulting reference.

3-95 Ramp Delay		
Range:	Function:	
Application dependent*	[Application dependant]	Enter the delay required from activation of the digital potentiometer function until the frequency converter starts to ramp the reference. With a delay of 0 ms, the reference starts to ramp as soon as INCREASE/ DECREASE is activated. See also par. 3-91 <i>Ramp Time</i> .

3

3.6 Parameters: 4-** Limits/Warnings

3.6.1 4-1* Motor Limits

3

Define torque, current and speed limits for the motor, and the reaction of the frequency converter when the limits are exceeded.

A limit may generate a message on the display. A warning will always generate a message on the display or on the fieldbus. A monitoring function may initiate a warning or a trip, upon which the frequency converter will stop and generate an alarm message.

4-10 Motor Speed Direction		
Option:	Function:	
		Select the motor speed direction(s) required. Use this parameter to prevent unwanted reversing. When par. 1-00 <i>Configuration Mode</i> is set to <i>Process</i> [3], par. 4-10 <i>Motor Speed Direction</i> is set to <i>Clockwise</i> [0] as default. The setting in par. 4-10 <i>Motor Speed Direction</i> does not limit options for setting par. 4-13 <i>Motor Speed High Limit [RPM]</i> . This parameter cannot be adjusted while the motor is running.
[0] *	Clockwise	The reference is set to CW rotation. Reversing input (Default term 19) must be open.
[1]	Counter clockwise	The reference is set to CCW rotation. Reversing input (Default term 19) must be closed. If Reversing is required with 'Reverse' input is open the motor direction can be changed by par. 1-06 <i>Clockwise Direction</i>
[2]	Both directions	Allows the motor to rotate in both directions.

4-11 Motor Speed Low Limit [RPM]		
Range:	Function:	
Application dependent*	[Application dependant]	Enter the minimum limit for motor speed. The Motor Speed Low Limit can be set to correspond to the manufacturer's recommended minimum motor speed. The Motor Speed Low Limit must not exceed the setting in par. 4-13 <i>Motor Speed High Limit [RPM]</i> .

4-12 Motor Speed Low Limit [Hz]		
Range:	Function:	
Application dependent*	[Application dependant]	Enter the minimum limit for motor speed. The Motor Speed Low Limit can be set to correspond to the minimum output frequency of the motor shaft. The Motor Speed Low Limit must not exceed the setting in par. 4-14 <i>Motor Speed High Limit [Hz]</i> .
Application dependent*	[Application dependant]	Enter the minimum limit for motor speed. The Motor Speed Low Limit can be set to correspond to the minimum output frequency of the motor shaft. The Motor Speed Low Limit must not exceed the setting in par. 4-14 <i>Motor Speed High Limit [Hz]</i> .

4-13 Motor Speed High Limit [RPM]		
Range:	Function:	
Application dependent*	[Application dependant]	Enter the maximum limit for motor speed. The Motor Speed High Limit can be set to correspond to the manufacturer's maximum rated motor speed. The Motor Speed High Limit must exceed the setting in par. 4-11 <i>Motor Speed Low Limit [RPM]</i> .

NOTE

Max. output frequency cannot exceed 10% of the inverter switching frequency (par. 14-01 *Switching Frequency*).

4-14 Motor Speed High Limit [Hz]		
Range:	Function:	
Application dependent*	[Application dependant]	Enter the maximum limit for motor speed. The Motor Speed High Limit can be set to correspond to the manufacturer's recommended maximum of the motor shaft. The Motor Speed High Limit must exceed the in par. 4-12 <i>Motor Speed Low Limit [Hz]</i> . Only par. 4-11 <i>Motor Speed Low Limit [RPM]</i> or par. 4-12 <i>Motor Speed Low Limit [Hz]</i> will be displayed depending on other parameters in the Main Menu and depending on default settings dependant on global location.

NOTE

Max. output frequency cannot exceed 10% of the inverter switching frequency (par. 14-01 *Switching Frequency*).

4-16 Torque Limit Motor Mode		
Range:		Function:
Application dependent*	[Application dependant]	This function limits the torque on the shaft to protect the mechanical installation. A drop in motor magnetisation is automatically compensated by an increase in current to maintain motor magnetisation.

NOTE

Changing par. 4-16 *Torque Limit Motor Mode* when par. 1-00 *Configuration Mode* is set to *Speed open loop* [0], par. 1-66 *Min. Current at Low Speed* is automatically readjusted.

NOTE

The torque limit reacts on the actual, non-filtrated torque, including torque spikes. This is not the torque that is seen from the LCP or the Fieldbus as that is filtered.

4-17 Torque Limit Generator Mode		
Range:		Function:
100.0 %*	[Application dependant]	This function limits the torque on the shaft to protect the mechanical installation. A drop in motor magnetisation is automatically compensated by an increase in current to maintain motor magnetisation.

NOTE

The torque limit reacts on the actual, non-filtrated torque, including torque spikes. This is not the torque that is seen from the LCP or the Fieldbus as that is filtered.

4-18 Current Limit		
Range:		Function:
Application dependent*	[Application dependant]	This is a true current limit function that continues in the oversynchronous range, however due to field weakening the motor torque at current limit will drop accordingly when the voltage increase stops above the synchronised speed of the motor.

4-19 Max Output Frequency		
Range:		Function:
132.0 Hz*	[1.0 - 1000.0 Hz]	Provides a final limit on the output frequency for improved safety in applications where you want to avoid accidental over-speeding. This limit is final in all configurations (independent of the setting in par. 1-00 <i>Configuration Mode</i>).

NOTE

Max. output frequency cannot exceed 10% of the inverter switching frequency (par. 14-01 *Switching Frequency*).

Par. 4-19 *Max Output Frequency* cannot be adjusted while the motor is running.

4-20 Torque Limit Factor Source		
Option:		Function:
		Select an analog input for scaling the settings in par. 4-16 <i>Torque Limit Motor Mode</i> and par. 4-17 <i>Torque Limit Generator Mode</i> from 0% to 100% (or inverse). The signal levels corresponding to 0% and 100% are defined in the analog input scaling, e.g. par. group 6-1*. This parameter is only active when par. 1-00 <i>Configuration Mode</i> is in <i>Speed Open Loop</i> or <i>Speed Closed Loop</i> .
[0] *	No function	
[2]	Analog in 53	
[4]	Analog in 53 inv	
[6]	Analog in 54	
[8]	Analog in 54 inv	
[10]	Analog in X30-11	
[12]	Analog in X30-11 inv	
[14]	Analog in X30-12	
[16]	Analog in X30-12 inv	

4-21 Speed Limit Factor SourceOption		
Option:		Function:
		Select an analog input for scaling the settings in par. 4-19 from 0% to 100% (or vice versa). The signal levels corresponding to 0% and 100% are defined in the analog input scaling, e.g. par. group 6-1*. This parameter is only active when par. 1-00 <i>Configuration Mode</i> is in <i>Torque Mode</i> .
[0] *	No function	
[2]	Analog input 53	
[4]	Analog input 53 inv	
[6]	Analog input 54	

4-21 Speed Limit Factor SourceOption		
Option:	Function:	
[8]	Analog input 54 inv	
[10]	Analog input X30-11	
[12]	Analog input X30-11 inv	
[14]	Analog input X30-12	
[16]	Analog input X30-12 inv	

3.6.2 4-3* Motor Feedback Monitoring

The par. group includes monitoring and handling of motor feedback devices as encoders, resolvers etc.

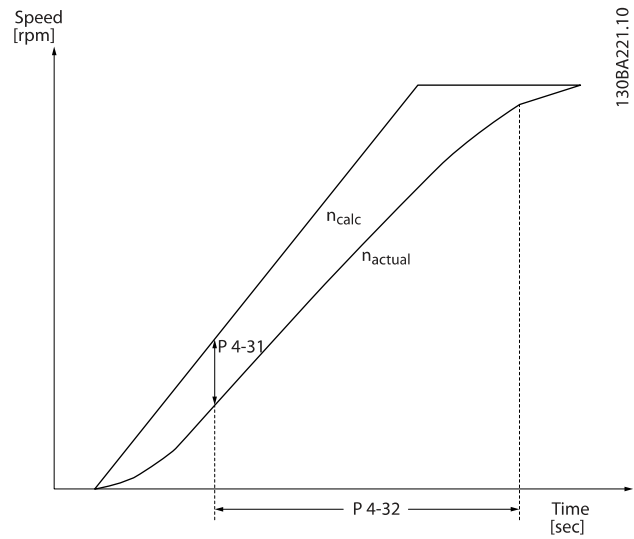

4-30 Motor Feedback Loss Function		
Option:	Function:	
		Select which reaction the frequency converter should take if a feedback fault is detected. The selected action is to take place when the feedback signal differs from the output speed where its range is specified in par. 4-31 <i>Motor Feedback Speed Error</i> during its time frame set in par. 4-32 <i>Motor Feedback Loss Timeout</i> .
[0]	Disabled	
[1]	Warning	
[2] *	Trip	
[3]	Jog	
[4]	Freeze Output	
[5]	Max Speed	
[6]	Switch to Open Loop	
[7]	Select Setup 1	
[8]	Select Setup 2	
[9]	Select Setup 3	
[10]	Select Setup 4	
[11]	stop & trip	

4-31 Motor Feedback Speed Error		
Range:	Function:	
300 RPM*	[1 - 600 RPM]	Select the max allowed tracking error in speed from the calculated and the actual mechanical shaft output speed.

4-32 Motor Feedback Loss Timeout		
Range:	Function:	
0.05 s*	[0.00 - 60.00 s]	Set the timeout value allowing the speed error set in par. 4-31 <i>Motor Feedback Speed Error</i> to be exceeded.

4-34 Tracking Error Function		
Option:	Function:	
		Select which reaction the frequency converter should take if a tracking error is detected. Closed Loop: The tracking error is measured between the output from the ramp generator and the speed feedback (filtered). Open Loop: The tracking error is measured between the output from the ramp generator - compensated for slip - and the frequency that is sent to the motor (16-13). The reaction will be activated if the measured difference is more than specified in par. 4-35 for the time specified in par. 4-36. A tracking error in closed loop does not imply that there is a problem with the feedback signal! A tracking error can be the result of torque limit at too big loads.
[0] *	Disable	
[1]	Warning	
[2]	Trip	
[3]	Trip after stop	

4-35 Tracking Error		
Range:		Function:
10 RPM*	[1 - 600 RPM]	Enter the maximum permissible speed error between the motor speed and the output of the ramp when not ramping. In open loop the motor speed is estimated and in closed loop it is the feedback from encoder/resolver.

4-36 Tracking Error Timeout		
Range:		Function:
1.00 s*	[0.00 - 60.00 s]	Enter the time-out period during which an error greater than the value set in par. 4-35 <i>Tracking Error</i> is permissible.

4-37 Tracking Error Ramping		
Range:		Function:
100 RPM*	[1 - 600 RPM]	Enter the maximum permissible speed error between the motor speed and the output of the ramp when ramping. In open loop the motor speed is estimated and in closed loop it is the feedback from encoder/resolver.

4-38 Tracking Error Ramping Timeout		
Range:		Function:
1.00 s*	[0.00 - 60.00 s]	Enter the time-out period during which an error greater than the value set in par. 4-37 <i>Tracking Error Ramping</i> while Ramping is permissible.

4-39 Tracking Error After Ramping Timeout		
Range:		Function:
5.00 s*	[0.00 - 60.00 s]	Enter the time-out period after ramping where par. 4-37 <i>Tracking Error Ramping</i> and par. 4-38 <i>Tracking Error Ramping Timeout</i> are still active.

3.6.3 4-5* Adjustable Warnings

Use these parameters to adjust warning limits for current, speed, reference and feedback. Warnings that are shown on the display can be programmed as an output or sent via serial bus.

Warnings are shown on display, programmed output or serial bus.

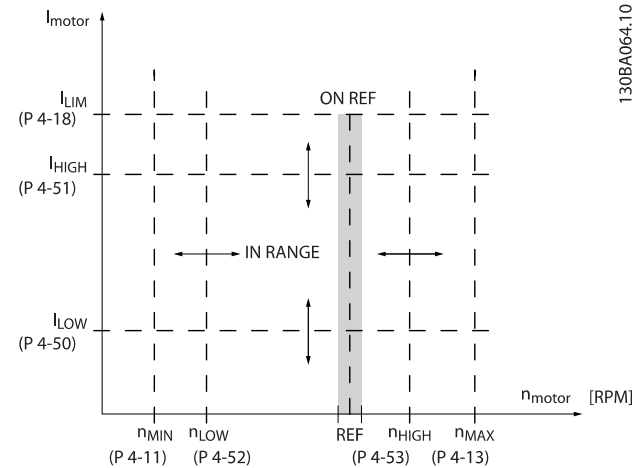

4-50 Warning Current Low		
Range:		Function:
0.00 A*	[Application dependant]	Enter the I_{LOW} value. When the motor current falls below this limit, the display reads <i>Current Low</i> . The signal outputs can be programmed to produce a status signal on terminal 27 or 29 (FC 302 only) and on relay output 01 or 02 (FC 302 only). Refer to the drawing in this section.

4-51 Warning Current High		
Range:		Function:
Application dependent*	[Application dependant]	Enter the I_{HIGH} value. When the motor current exceeds this limit, the display reads <i>Current High</i> . The signal outputs can be programmed to produce a status signal on terminal 27 or 29 (FC 302 only) and on relay output 01 or 02 (FC 302 only). Refer to the drawing in this section.

4-52 Warning Speed Low		
Range:		Function:
0 RPM*	[Application dependant]	Enter the n_{LOW} value. When the motor speed exceeds this limit, the display reads <i>Speed Low</i> . The signal outputs can be programmed to produce a status signal on terminal 27 or 29 (FC 302 only) and on relay output 01 or 02 (FC 302 only).

4-53 Warning Speed High		
Range:		Function:
Application dependant*	[Application dependant]	Enter the n_{HIGH} value. When the motor speed exceeds this limit, the display reads <i>Speed High</i> . The signal outputs can be programmed to produce a status signal on terminal 27 or 29 (FC 302 only) and on relay output 01 or 02 (FC 302 only). Programme the upper signal limit of the motor speed, n_{HIGH} , within the normal working range of the frequency converter. Refer to the drawing in this section.

4-54 Warning Reference Low		
Range:		Function:
-999999.999*	[Application dependant]	Enter the lower reference limit. When the actual reference falls below this limit, the display indicates <i>Ref Low</i> . The signal outputs can be programmed to produce a status signal on terminal 27 or 29 (FC 302 only) and on relay output 01 or 02 (FC 302 only).

4-55 Warning Reference High		
Range:		Function:
999999.999*	[Application dependant]	Enter the upper reference limit. When the actual reference exceeds this limit, the display reads <i>Ref High</i> . The signal outputs can be programmed to produce a status signal on terminal 27 or 29 (FC 302 only) and on relay output 01 or 02 (FC 302 only).

4-56 Warning Feedback Low		
Range:		Function:
-999999.999 ReferenceFeed-backUnit*	[Application dependant]	Enter the lower feedback limit. When the feedback falls below this limit, the display reads <i>Feedb Low</i> . The signal outputs can be programmed to produce a status signal on terminal 27 or 29 (FC 302 only) and on relay output 01 or 02 (FC 302 only).

4-57 Warning Feedback High		
Range:		Function:
999999.999 ReferenceFeed-backUnit*	[Application dependant]	Enter the upper feedback limit. When the feedback exceeds this limit, the display reads <i>Feedb High</i> . The signal outputs can be programmed to produce a status signal on terminal 27 or 29 (FC 302 only) and on relay output 01 or 02 (FC 302 only).

4-58 Missing Motor Phase Function		
Displays an alarm in the event of a missing motor phase (alarm 30, 31 or 32). Select disabled for no missing motor phase alarm. It is strongly recommended to make an active setting to avoid motor damage.		
Option:		Function:
[0]	Disabled	No alarm is displayed if a missing motor phase occurs.
[1]	Trip 100 ms	Trips after 100ms. Select 100 ms for fast detection of missing motor phase.
[2]	Trip 1000 ms	Trips after 1000 ms. Select 1000 ms for slow detection of missing motor phase.
[3]	Trip 100ms 3ph detec.	

NOTE
This parameter cannot be adjusted while the motor is running.

3.6.4 4-6* Speed Bypass

Some systems call for avoiding certain output frequencies or speeds, due to resonance problems in the system. A maximum of four frequency or speed ranges can be avoided.

4-60 Bypass Speed From [RPM]		
Array [4]		
Range:		Function:
Application dependent*	[Application dependant]	Some systems call for avoiding certain output speeds due to resonance problems in the system. Enter the lower limits of the speeds to be avoided.

4-61 Bypass Speed From [Hz]		
Array [4]		
Range:		Function:
Application dependent*	[Application dependant]	Some systems call for avoiding certain output speeds due to resonance problems in the system. Enter the lower limits of the speeds to be avoided.

4-62 Bypass Speed To [RPM]		
Array [4]		
Range:		Function:
Application dependent*	[Application dependant]	Some systems call for avoiding certain output speeds due to resonance problems in the system. Enter the upper limits of the speeds to be avoided.

4-63 Bypass Speed To [Hz]		
Array [4]		
Range:		Function:
Application dependent*	[Application dependant]	Some systems call for avoiding certain output speeds due to resonance problems in the system. Enter the upper limits of the speeds to be avoided.

3.7 Parameters: 5-** Digital In/Out

3.7.1 5-0* Digital I/O Mode

Parameters for configuring the input and output using NPN and PNP.

These parameters cannot be adjusted while motor is running.

5-00 Digital I/O Mode		
Option:	Function:	
		Digital inputs and programmed digital outputs are pre-programmable for operation either in PNP or NPN systems.
[0] *	PNP	Action on positive directional pulses (↑). PNP systems are pulled down to GND.
[1]	NPN	Action on negative directional pulses (↓). NPN systems are pulled up to + 24 V, internally in the frequency converter.

NOTE

Once this parameter has been changed, it must be activated by performing a power cycle.

5-01 Terminal 27 Mode		
Option:	Function:	
[0] *	Input	Defines terminal 27 as a digital input.
[1]	Output	Defines terminal 27 as a digital output.

5-02 Terminal 29 Mode		
Option:	Function:	
[0] *	Input	Defines terminal 29 as a digital input.
[1]	Output	Defines terminal 29 as a digital output.

This parameter is available for FC 302 only.

3.7.2 5-1* Digital Inputs

The digital inputs are used for selecting various functions in the frequency converter. All digital inputs can be set to the following functions:

Digital input function	Select	Terminal
No operation	[0]	All *term 32, 33
Reset	[1]	All
Coast inverse	[2]	All *term 27
Coast and reset inverse	[3]	All
Quick stop inverse	[4]	All
DC-brake inverse	[5]	All
Stop inverse	[6]	All
Start	[8]	All *term 18
Latched start	[9]	All
Reversing	[10]	All *term 19
Start reversing	[11]	All
Enable start forward	[12]	All
Enable start reverse	[13]	All
Jog	[14]	All *term 29
Preset reference on	[15]	All
Preset ref bit 0	[16]	All
Preset ref bit 1	[17]	All
Preset ref bit 2	[18]	All
Freeze reference	[19]	All
Freeze output	[20]	All
Speed up	[21]	All
Speed down	[22]	All
Set-up select bit 0	[23]	All
Set-up select bit 1	[24]	All
Precise stop inverse	[26]	18, 19
Precises start, stop	[27]	18, 19
Catch up	[28]	All
Slow down	[29]	All
Counter input	[30]	29, 33
Pulse input Edge Triggered	[31]	29, 33
Pulse input Time Based	[32]	29, 33
Ramp bit 0	[34]	All
Ramp bit 1	[35]	All
Mains failure inverse	[36]	All
Latched precise start	[40]	18, 19
Latched precise stop inverse	[41]	18, 19
DigiPot Increase	[55]	All
DigiPot Decrease	[56]	All
DigiPot Clear	[57]	All
Digipot Hoist	[58]	All
Counter A (up)	[60]	29, 33
Counter A (down)	[61]	29, 33
Reset Counter A	[62]	All
Counter B (up)	[63]	29, 33
Counter B (down)	[64]	29, 33
Reset Counter B	[65]	All

Mech. Brake Feedb.	[70]	All
Mech. Brake Feedb. Inv.	[71]	All
PID Error Inv.	[72]	All
PID Reset I-part	[73]	All
PID enable	[74]	All
PTC Card 1	[80]	All

FC 300 standard terminals are 18, 19, 27, 29, 32 and 33. MCB 101 terminals are X30/2, X30/3 and X30/4.

Terminal 29 functions as an output only in FC 302.

Functions dedicated to only one digital input are stated in the associated parameter.

All digital inputs can be programmed to these functions:

[0]	No operation	No reaction to signals transmitted to the terminal.
[1]	Reset	Resets frequency converter after a TRIP/ALARM. Not all alarms can be reset.
[2]	Coast inverse	(Default Digital input 27): Coasting stop, inverted input (NC). The frequency converter leaves the motor in free mode. Logic '0' => coasting stop.
[3]	Coast and reset inverse	Reset and coasting stop Inverted input (NC). Leaves motor in free mode and resets frequency converter. Logic '0' => coasting stop and reset.
[4]	Quick stop inverse	Inverted input (NC). Generates a stop in accordance with quick-stop ramp time set in par. 3-81 <i>Quick Stop Ramp Time</i> . When motor stops, the shaft is in free mode. Logic '0' => Quick-stop.
[5]	DC-brake inverse	Inverted input for DC braking (NC). Stops motor by energizing it with a DC current for a certain time period. See par. 2-01 <i>DC Brake Current</i> to par. 2-03 <i>DC Brake Cut In Speed [RPM]</i> . The function is only active when the value in par. 2-02 <i>DC Braking Time</i> is different from 0. Logic '0' => DC braking.
[6]	Stop inverse	Stop Inverted function. Generates a stop function when the selected terminal goes from logical level '1' to '0'. The stop is performed according to the selected ramp time (par. 3-42 <i>Ramp 1 Ramp Down Time</i> , par. 3-52 <i>Ramp 2 Ramp down Time</i> , par. 3-62 <i>Ramp 3 Ramp down Time</i> , par. 3-72 <i>Ramp 4 Ramp Down Time</i>). NOTE When the frequency converter is at the torque limit and has received a stop command, it may not stop by itself. To ensure that the frequency converter stops, configure a digital output to <i>Torque limit & stop</i> [27] and connect this digital output to a digital input that is configured as coast.

[8]	Start	(Default Digital input 18): Select start for a start/stop command. Logic '1' = start, logic '0' = stop.
[9]	Latched start	The motor starts, if a pulse is applied for min. 2 ms. The motor stops when Stop inverse is activated.
[10]	Reversing	(Default Digital input 19). Change the direction of motor shaft rotation. Select Logic '1' to reverse. The reversing signal only changes the direction of rotation. It does not activate the start function. Select both directions in par. 4-10 <i>Motor Speed Direction</i> . The function is not active in process closed loop.
[11]	Start reversing	Used for start/stop and for reversing on the same wire. Signals on start are not allowed at the same time.
[12]	Enable start forward	Disengages the counterclockwise movement and allows for the clockwise direction.
[13]	Enable start reverse	Disengages the clockwise movement and allows for the counterclockwise direction.
[14]	Jog	(Default Digital input 29): Use to activate jog speed. See par. 3-11 <i>Jog Speed [Hz]</i> .
[15]	Preset reference on	Shifts between external reference and preset reference. It is assumed that <i>External/preset</i> [1] has been selected in par. 3-04 <i>Reference Function</i> . Logic '0' = external reference active; logic '1' = one of the eight preset references is active.
[16]	Preset ref bit 0	Preset ref. bit 0,1, and 2 enables a choice between one of the eight preset references according to the table below.
[17]	Preset ref bit 1	Same as Preset ref bit 0 [16].
[18]	Preset ref bit 2	Same as Preset ref bit 0 [16].

Preset ref. bit	2	1	0
Preset ref. 0	0	0	0
Preset ref. 1	0	0	1
Preset ref. 2	0	1	0
Preset ref. 3	0	1	1
Preset ref. 4	1	0	0
Preset ref. 5	1	0	1
Preset ref. 6	1	1	0
Preset ref. 7	1	1	1

[19]	Freeze ref	Freezes the actual reference, which is now the point of enable/condition for Speed up and Speed down to be used. If Speed up/down is used, the speed change always follows ramp 2 (par. 3-51 <i>Ramp 2 Ramp up Time</i> and par. 3-52 <i>Ramp 2 Ramp down Time</i>) in the range 0 - par. 3-03 <i>Maximum Reference</i> .
[20]	Freeze output	Freezes the actual motor frequency (Hz), which is now the point of enable/condition for Speed up and Speed down to be used. If Speed up/down is used, the speed change always follows ramp 2 (par. 3-51 <i>Ramp 2 Ramp up Time</i> and par. 3-52 <i>Ramp</i>

		2 <i>Ramp down Time</i>) in the range 0 - par. 1-23 <i>Motor Frequency</i> . NOTE When Freeze output is active, the frequency converter cannot be stopped via a low 'start [8]' signal. Stop the frequency converter via a terminal programmed for Coasting inverse [2] or Coast and reset, inverse.
[21]	Speed up	Select Speed up and Speed down if digital control of the up/down speed is desired (motor potentiometer). Activate this function by selecting either Freeze reference or Freeze output. When Speed up/ down is activated for less than 400 msec. the resulting reference will be increased/ decreased by 0.1 %. If Speed up/ down is activated for more than 400 msec. the resulting reference will follow the setting in ramping up/ down parameter 3-x1/ 3-x2.

	Shut down	Catch up
Unchanged speed	0	0
Reduced by %-value	1	0
Increased by %-value	0	1
Reduced by %-value	1	1

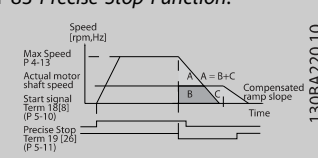
[22]	Speed down	Same as Speed up [21].
[23]	Set-up select bit 0	Select Set-up select bit 0 or Select Set-up select bit 1 to select one of the four set-ups. Set par. 0-10 <i>Active Set-up to Multi Set-up</i> .
[24]	Set-up select bit 1	(Default Digital input 32): Same as Set-up select bit 0 [23].
[26]	Precise stop inv.	Prolongs stop signal to give a precise stop independent of speed. Sends an inverted stop signal when the precise stop function is activated in par. 1-83 <i>Precise Stop Function</i> . Precise stop inverse function is available for terminals 18 or 19.
[27]	Precise start, stop	Use when Precise ramp stop [0] is selected in par. 1-83 <i>Precise Stop Function</i> . 
[28]	Catch up	Increases reference value by percentage (relative) set in par. 3-12 <i>Catch up/slow Down Value</i> .
[29]	Slow down	Reduces reference value by percentage (relative) set in par. 3-12 <i>Catch up/slow Down Value</i> .
[30]	Counter input	Precise stop function in par. 1-83 <i>Precise Stop Function</i> acts as Counter stop or speed compensated counter stop with or without reset. The counter value must be set in par. 1-84 <i>Precise Stop Counter Value</i> .

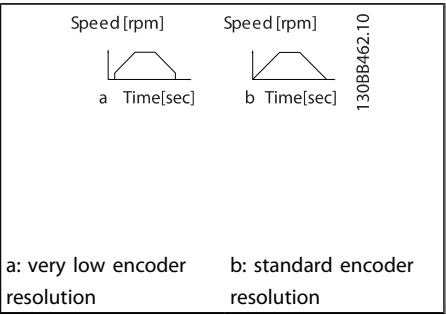
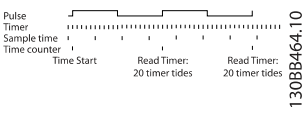
[31]	Pulse edge triggered	Edge triggered pulse input counts number of pulse flanks per sample time. This gives a higher resolution at high frequencies, but is not as precise at lower frequencies. Use this pulse principle for encoders with very low resolution (e.g. 30 ppr). 
[32]	Pulse time based	Time based pulse input measures the duration between flanks. This gives a higher resolution at lower frequencies, but is not as precise at higher frequencies. This principle has a cut-off frequency which makes it unsuited for encoders with very low resolutions (e.g. 30 ppr) at low speeds.  
[34]	Ramp bit 0	Enables a choice between one of the 4 ramps available, according to the table below.
[35]	Ramp bit 1	Same as Ramp bit 0.

Preset ramp bit	1	0
Ramp 1	0	0
Ramp 2	0	1
Ramp 3	1	0
Ramp 4	1	1

[36]	Mains failure inverse	Activates par. 14-10 <i>Mains Failure</i> . Mains failure inverse is active in the Logic .0. situation.
[41]	Latched Precise Stop inverse	Sends a latched stop signal when the precise stop function is activated in par. 1-83 <i>Precise Stop Function</i> . The Latched Precise stop inverse function is available for terminals 18 or 19.
[55]	DigiPot Increase	INCREASE signal to the Digital Potentiometer function described in par. group 3-9*
[56]	DigiPot Decrease	DECREASE signal to the Digital Potentiometer function described in par. group 3-9*
[57]	DigiPot Clear	Clears the Digital Potentiometer reference described in par. group 3-9*

[60]	Counter A	(Terminal 29 or 33 only) Input for increment counting in the SLC counter.
[61]	Counter A	(Terminal 29 or 33 only) Input for decrement counting in the SLC counter.
[62]	Reset Counter A	Input for reset of counter A.
[63]	Counter B	(Terminal 29 or 33 only) Input for increment counting in the SLC counter.
[64]	Counter B	(Terminal 29 or 33 only) Input for decrement counting in the SLC counter.
[65]	Reset Counter B	Input for reset of counter B.
[70]	Mech. Brake Feedback	Brake feedback for hoisting applications: Set par. 1-01 <i>Motor Control Principle</i> to [3] <i>flux w/ motor feedback</i> ; set par. 1-72 <i>Start Function</i> to [6] <i>Hoist mech brake Ref</i> .
[71]	Mech. Brake Feedback inv.	Inverted brake feedback for hoisting applications
[72]	PID error inverse	When enabled, it inverts the resulting error from the process PID controller. Available only if "Configuration Mode" is set to "Surface Winder", "Extended PID Speed OL" or "Extended PID Speed CL".
[73]	PID reset I-part	When enabled, resets the I-part of the Process PID controller. Equivalent to par. 7-40 <i>Process PID I-part Reset</i> . Available only if "Configuration Mode" is set to "Surface Winder", "Extended PID Speed OL" or "Extended PID Speed CL".
[74]	PID enable	When enabled, enables the extended process PID controller. Equivalent to par. 7-50 <i>Process PID Extended PID</i> . Available only if "Configuration Mode" is set "Extended PID Speed OL" or "Extended PID Speed CL".
[80]	PTC Card 1	All Digital Inputs can be set to PTC Card 1 [80]. However, only one Digital Input must be set to this choice.

5-10 Terminal 18 Digital Input

Option: Function:

[8] *	Start	Functions are described under 5-1* <i>Digital Inputs</i>
-------	-------	--

5-11 Terminal 19 Digital Input

Option: Function:

[10] *	Reversing	Functions are described under 5-1* <i>Digital Inputs</i>
--------	-----------	--

5-12 Terminal 27 Digital Input

Option: Function:

[2] *	Coast inverse	Functions are described under 5-1* <i>Digital Inputs</i>
-------	---------------	--

5-13 Terminal 29 Digital Input

Option: Function:

		Select the function from the available digital input range and the additional options [60], [61], [63] and [64]. Counters are used in Smart Logic Control functions. This parameter is available for FC 302 only.
[14] *	Jog	Functions are described under 5-1* <i>Digital Inputs</i>

5-14 Terminal 32 Digital Input

Option: Function:

		Select the function from the available digital input range and the additional options [60], [61], [63] and [64]. Counters are used in Smart Logic Control functions.
[0] *	No operation	Functions are described under 5-1* <i>Digital Inputs</i>

5-15 Terminal 33 Digital Input

Option: Function:

		Select the function from the available digital input range and the additional options [60], [61], [63] and [64]. Counters are used in Smart Logic Control functions.
[0] *	No operation	Functions are described under 5-1* <i>Digital Inputs</i>

5-16 Terminal X30/2 Digital Input

Option: Function:

[0] *	No operation	This parameter is active when option module MCB101 is installed in the frequency converter. Functions are described under 5-1* <i>Digital Inputs</i>
-------	--------------	--

5-17 Terminal X30/3 Digital Input

Option: Function:

[0] *	No operation	This parameter is active when option module MCB101 is installed in the frequency converter. Functions are described under 5-1* <i>Digital Inputs</i>
-------	--------------	--

5-18 Terminal X30/4 Digital Input

Option: Function:

[0] *	No operation	This parameter is active when option module MCB101 is installed in the frequency converter. Functions are described under 5-1* <i>Digital Inputs</i>
-------	--------------	--

5-19 Terminal 37 Safe Stop

Option: Function:

[1] *	Safe Stop Alarm	Coasts frequency converter when safe stop is activated. Manual reset from LCP, digital input or fieldbus.
[3]	Safe Stop Warning	Coasts frequency converter when safe stop is activated (T-37 off). When safe stop circuit is reestablished, the frequency converter will continue without manual reset.

5-19 Terminal 37 Safe Stop

Option: Function:

[4]	PTC 1 Alarm	Coasts frequency converter when safe stop is activated. Manual reset from LCP, digital input or fieldbus. Choice 4 is only available when the MCB 112 PTC Thermistor Card is connected.
[5]	PTC 1 Warning	Coasts frequency converter when safe stop is activated (T-37 off). When safe stop circuit is reestablished, the frequency converter will continue without manual reset, unless a Digital Input set to PTC Card 1 [80] is still enabled. Choice 5 is only available when the MCB 112 PTC Thermistor Card is connected.
[6]	PTC 1 & Relay A	This choice is used when the PTC option is gated together with a Stop button through a Safety relay to T-37. Coasts frequency converter when safe stop is activated. Manual reset from LCP, digital input or fieldbus. Choice 6 is only available when the MCB 112 PTC Thermistor Card is connected.
[7]	PTC 1 & Relay W	This choice is used when the PTC option is gated together with a Stop button through a Safety relay to T-37. Coasts frequency converter when safe stop is activated (T-37 off). When safe stop circuit is reestablished, the frequency converter will continue without manual reset, unless a Digital Input set to PTC Card 1 [80] is (still) enabled. Choice 7 is only available when the MCB 112 PTC Thermistor Card is connected.
[8]	PTC 1 & Relay A/W	This choice makes it possible to use a combination of Alarm and Warning. Choice 8 is only available when the MCB 112 PTC Thermistor Card is connected.
[9]	PTC 1 & Relay W/A	This choice makes it possible to use a combination of Alarm and Warning. Choice 9 is only available when the MCB 112 PTC Thermistor Card is connected.

Choices 4 - 9 are only available when the MCB 112 PTC Thermistor Card is connected.

NOTE

When Auto Reset/ Warning is selected the frequency converter opens up for automatic restart.

Overview of functions, alarms and warnings

Function	No.	PTC	Relay
No Function	[0]	-	-
Safe Stop Alarm	[1]*	-	Safe Stop [A68]
Safe Stop Warning	[3]	-	Safe Stop [W68]
PTC 1 Alarm	[4]	PTC 1 Safe Stop [A71]	-
PTC 1 Warning	[5]	PTC 1 Safe Stop [W71]	-
PTC 1 & Relay A	[6]	PTC 1 Safe Stop [A71]	Safe Stop [A68]
PTC 1 & Relay W	[7]	PTC 1 Safe Stop [W71]	Safe Stop [W68]
PTC 1 & Relay A/W	[8]	PTC 1 Safe Stop [A71]	Safe Stop [W68]
PTC 1 & Relay W/A	[9]	PTC 1 Safe Stop [W71]	Safe Stop [A68]

W means warning and A means alarm. For further information, see Alarms and Warnings in section *Troubleshooting* in the Design Guide or the Operating Instructions

A dangerous failure related to Safe Stop will give Alarm: Dangerous Failure [A72].

Please refer to the section *Description of Alarm Word, Warning Word and extended Status Word* in the chapter *Troubleshooting*.

5-20 Terminal X46/1 Digital Input

Option: **Function:**

[0] *	No operation	This parameter is active when option module MCB 113 is installed in the frequency converter. Functions are described under 5-1* <i>Digital Inputs</i>
-------	--------------	---

5-21 Terminal X46/3 Digital Input

Option: **Function:**

[0] *	No operation	This parameter is active when option module MCB 113 is installed in the frequency converter. Functions are described under 5-1* <i>Digital Inputs</i>
-------	--------------	---

5-22 Terminal X46/5 Digital Input

Option: **Function:**

[0] *	No operation	This parameter is active when option module MCB 113 is installed in the frequency converter. Functions are described under 5-1* <i>Digital Inputs</i>
-------	--------------	---

5-23 Terminal X46/7 Digital Input

Option: **Function:**

[0] *	No operation	This parameter is active when option module MCB 113 is installed in the frequency converter. Functions are described under 5-1* <i>Digital Inputs</i>
-------	--------------	---

5-24 Terminal X46/9 Digital Input

Option: **Function:**

[0] *	No operation	This parameter is active when option module MCB 113 is installed in the frequency converter. Functions are described under 5-1* <i>Digital Inputs</i>
-------	--------------	---

5-25 Terminal X46/11 Digital Input

Option: **Function:**

[0] *	No operation	This parameter is active when option module MCB 113 is installed in the frequency converter. Functions are described under 5-1* <i>Digital Inputs</i>
-------	--------------	---

5-26 Terminal X46/13 Digital Input

Option: **Function:**

[0] *	No operation	This parameter is active when option module MCB 113 is installed in the frequency converter. Functions are described under 5-1* <i>Digital Inputs</i>
-------	--------------	---

3.7.3 5-3* Digital Outputs

The 2 solid-state digital outputs are common for terminals 27 and 29. Set the I/O function for terminal 27 in par. 5-01 *Terminal 27 Mode*, and set the I/O function for terminal 29 in par. 5-02 *Terminal 29 Mode*. These parameters cannot be adjusted while the motor is running.

[0]	No operation	Default for all digital outputs and relay outputs
[1]	Control ready	The control card is ready. E.g.: Feedback from a drive where the control is supplied by an external 24 V (MCB 107) and the main power to drive is not detected.
[2]	Drive ready	The frequency converter is ready for operation and applies a supply signal on the control board.
[3]	Drive ready / remote control	The frequency converter is ready for operation and is in Auto On mode.
[4]	Enable / no warning	Ready for operation. No start or stop command is been given (start/disable). No warnings are active.
[5]	VLT running	Motor is running and shaft torque present.
[6]	Running / no warning	Output speed is higher than the speed set in par. 1-81 <i>Min Speed for Function at Stop [RPM]</i> . The motor is running and there are no warnings.

[7]	Run in range / no warning	Motor is running within the programmed current and speed ranges set in par. 4-50 <i>Warning Current Low</i> to par. 4-53 <i>Warning Speed High</i> . There are no warnings.
[8]	Run on reference / no warning	Motor runs at reference speed. No warnings.
[9]	Alarm	An alarm activates the output. There are no warnings.
[10]	Alarm or warning	An alarm or a warning activates the output.
[11]	At torque limit	The torque limit set in par. 4-16 <i>Torque Limit Motor Mode</i> or par. 4-17 <i>Torque Limit Generator Mode</i> has been exceeded.
[12]	Out of current range	The motor current is outside the range set in par. 4-18 <i>Current Limit</i> .
[13]	Below current, low	Motor current is lower than set in par. 4-50 <i>Warning Current Low</i> .
[14]	Above current, high	Motor current is higher than set in par. 4-51 <i>Warning Current High</i> .
[15]	Out of range	Output frequency is outside the frequency range set in par. 4-52 <i>Warning Speed Low</i> and par. 4-53 <i>Warning Speed High</i> .
[16]	Below speed, low	Output speed is lower than the setting in par. 4-52 <i>Warning Speed Low</i> .
[17]	Above speed, high	Output speed is higher than the setting in par. 4-53 <i>Warning Speed High</i> .
[18]	Out of feedback range	Feedback is outside the range set in par. 4-56 <i>Warning Feedback Low</i> and par. 4-57 <i>Warning Feedback High</i> .
[19]	Below feedback low	Feedback is below the limit set in par. 4-56 <i>Warning Feedback Low</i> .
[20]	Above feedback high	Feedback is above the limit set in par. 4-57 <i>Warning Feedback High</i> .
[21]	Thermal warning	The thermal warning turns on when the temperature exceeds the limit in the motor, the frequency converter, the brake resistor, or the thermistor.
[22]	Ready, no thermal warning	Frequency converter is ready for operation and there is no over-temperature warning.
[23]	Remote, ready, no thermal warning	Frequency converter is ready for operation and is in Auto On mode. There is no over-temperature warning.
[24]	Ready, no over-/ under voltage	Frequency converter is ready for operation and the mains voltage is within the specified voltage range (see <i>General Specifications</i> section in the Designn Guide).
[25]	Reverse	<i>Reversing</i> . Logic '1' when CW rotation of the motor. Logic '0' when CCW rotation of the motor. If the motor is not rotating the output will follow the reference.
[26]	Bus OK	Active communication (no time-out) via the serial communication port.

[27]	Torque limit and stop	Use in performing a coasting stop and in torque limit condition. If the frequency converter has received a stop signal and is at the torque limit, the signal is Logic '0'.
[28]	Brake, no brake warning	Brake is active and there are no warnings.
[29]	Brake ready, no fault	Brake is ready for operation and there are no faults.
[30]	Brake fault (IGBT)	Output is Logic '1' when the brake IGBT is short-circuited. Use this function to protect the frequency converter if there is a fault on the brake modules. Use the output/relay to cut out the main voltage from the frequency converter.
[31]	Relay 123	Relay is activated when Control Word [0] is selected in par. group 8-**.
[32]	Mechanical brake control	Enables control of an external mechanical brake, see description in the section <i>Control of Mechanical Brake</i> , and par. group 2-2*
[33]	Safe stop activated (FC 302 only)	Indicates that the safe stop on terminal 37 has been activated.
[40]	Out of ref range	Active when the actual speed is outside settings in par. 4-52 <i>Warning Speed Low</i> to par. 4-55 <i>Warning Reference High</i> .
[41]	Below reference low	Active when actual speed is below speed reference setting.
[42]	Above reference high	Active when actual speed is above speed reference setting
[43]	Extended PID Limit	
[45]	Bus Ctrl	Controls output via bus. The state of the output is set in par. 5-90 <i>Digital & Relay Bus Control</i> . The output state is retained in the event of bus time-out.
[46]	Bus Ctrl On at timeout	Controls output via bus. The state of the output is set in par. 5-90 <i>Digital & Relay Bus Control</i> . In the event of bus time-out the output state is set high (On).
[47]	Bus Ctrl Off at timeout	Controls output via bus. The state of the output is set in par. 5-90 <i>Digital & Relay Bus Control</i> . In the event of bus time-out the output state is set low (Off).
[51]	MCO controlled	Active when a MCO 302 or MCO 305 is connected. The output is controlled from option.
[55]	Pulse output	
[60]	Comparator 0	See par. group 13-1*. If Comparator 0 is evaluated as TRUE, the output will go high. Otherwise, it will be low.
[61]	Comparator 1	See par. group 13-1*. If Comparator 1 is evaluated as TRUE, the output will go high. Otherwise, it will be low.
[62]	Comparator 2	See par. group 13-1*. If Comparator 2 is evaluated as TRUE, the output will go high. Otherwise, it will be low.

[63]	Comparator 3	See par. group 13-1*. If Comparator 3 is evaluated as TRUE, the output will go high. Otherwise, it will be low.
[64]	Comparator 4	See par. group 13-1*. If Comparator 4 is evaluated as TRUE, the output will go high. Otherwise, it will be low.
[65]	Comparator 5	See par. group 13-1*. If Comparator 5 is evaluated as TRUE, the output will go high. Otherwise, it will be low.
[70]	Logic Rule 0	See par. group 13-4*. If Logic Rule 0 is evaluated as TRUE, the output will go high. Otherwise, it will be low.
[71]	Logic Rule 1	See par. group 13-4*. If Logic Rule 1 is evaluated as TRUE, the output will go high. Otherwise, it will be low.
[72]	Logic Rule 2	See par. group 13-4*. If Logic Rule 2 is evaluated as TRUE, the output will go high. Otherwise, it will be low.
[73]	Logic Rule 3	See par. group 13-4*. If Logic Rule 3 is evaluated as TRUE, the output will go high. Otherwise, it will be low.
[74]	Logic Rule 4	See par. group 13-4*. If Logic Rule 4 is evaluated as TRUE, the output will go high. Otherwise, it will be low.
[75]	Logic Rule 5	See par. group 13-4*. If Logic Rule 5 is evaluated as TRUE, the output will go high. Otherwise, it will be low.
[80]	SL Digital Output A	See par. 13-52 <i>SL Controller Action</i> . The output will go high whenever the Smart Logic Action [38] <i>Set dig. out. A high</i> is executed. The output will go low whenever the Smart Logic Action [32] <i>Set dig. out. A low</i> is executed.
[81]	SL Digital Output B	See par. 13-52 <i>SL Controller Action</i> . The input will go high whenever the Smart Logic Action [39] <i>Set dig. out. A high</i> is executed. The input will go low whenever the Smart Logic Action [33] <i>Set dig. out. A low</i> is executed.
[82]	SL Digital Output C	See par. 13-52 <i>SL Controller Action</i> . The input will go high whenever the Smart Logic Action [40] <i>Set dig. out. A high</i> is executed. The input will go low whenever the Smart Logic Action [34] <i>Set dig. out. A low</i> is executed.
[83]	SL Digital Output D	See par. 13-52 <i>SL Controller Action</i> . The input will go high whenever the Smart Logic Action [41] <i>Set dig. out. A high</i> is executed. The input will go low whenever the Smart Logic Action [35] <i>Set dig. out. A low</i> is executed.
[84]	SL Digital Output E	See par. 13-52 <i>SL Controller Action</i> . The input will go high whenever the Smart Logic Action [42] <i>Set dig. out. A high</i> is executed. The input will go low whenever the Smart Logic Action [36] <i>Set dig. out. A low</i> is executed.

[85]	SL Digital Output F	See par. 13-52 <i>SL Controller Action</i> . The input will go high whenever the Smart Logic Action [43] <i>Set dig. out. A high</i> is executed. The input will go low whenever the Smart Logic Action [37] <i>Set dig. out. A low</i> is executed.																								
[120]	Local reference active	Output is high when par. 3-13 <i>Reference Site</i> = [2] Local or when par. 3-13 <i>Reference Site</i> = [0] <i>Linked to hand auto</i> at the same time as the LCP is in Hand on mode. <table border="1" style="margin-top: 10px;"> <thead> <tr> <th>Reference site set in par. 3-13 <i>Reference Site</i></th> <th>Local reference active [120]</th> <th>Remote reference active [121]</th> </tr> </thead> <tbody> <tr> <td>Reference site: Local par. 3-13 <i>Reference Site</i> [2]</td> <td>1</td> <td>0</td> </tr> <tr> <td>Reference site: Remote par. 3-13 <i>Reference Site</i> [1]</td> <td>0</td> <td>1</td> </tr> <tr> <td>Reference site: Linked to Hand/ Auto</td> <td></td> <td></td> </tr> <tr> <td>Hand</td> <td>1</td> <td>0</td> </tr> <tr> <td>Hand -> off</td> <td>1</td> <td>0</td> </tr> <tr> <td>Auto -> off</td> <td>0</td> <td>0</td> </tr> <tr> <td>Auto</td> <td>0</td> <td>1</td> </tr> </tbody> </table>	Reference site set in par. 3-13 <i>Reference Site</i>	Local reference active [120]	Remote reference active [121]	Reference site: Local par. 3-13 <i>Reference Site</i> [2]	1	0	Reference site: Remote par. 3-13 <i>Reference Site</i> [1]	0	1	Reference site: Linked to Hand/ Auto			Hand	1	0	Hand -> off	1	0	Auto -> off	0	0	Auto	0	1
Reference site set in par. 3-13 <i>Reference Site</i>	Local reference active [120]	Remote reference active [121]																								
Reference site: Local par. 3-13 <i>Reference Site</i> [2]	1	0																								
Reference site: Remote par. 3-13 <i>Reference Site</i> [1]	0	1																								
Reference site: Linked to Hand/ Auto																										
Hand	1	0																								
Hand -> off	1	0																								
Auto -> off	0	0																								
Auto	0	1																								
[121]	Remote reference active	Output is high when par. 3-13 <i>Reference Site</i> = <i>Remote</i> [1] or <i>Linked to hand/auto</i> [0] while the LCP is in [Auto on] mode. See above.																								
[122]	No alarm	Output is high when no alarm is present.																								
[123]	Start command active	Output is high when there is an active Start command (i.e. via digital input bus connection or [Hand on] or [Auto on]), and no Stop or Start command is active.																								
[124]	Running reverse	Output is high when the frequency converter is running counter clockwise (the logical product of the status bits 'running' AND 'reverse').																								
[125]	Drive in hand mode	Output is high when the frequency converter is in Hand on mode (as indicated by the LED light above [Hand on]).																								
[126]	Drive in auto mode	Output is high when the frequency converter is in Hand on mode (as indicated by the LED light above [Auto on]).																								

5-30 Terminal 27 Digital Output

Option: **Function:**

[0] *	No operation	Functions are described under 5-3* <i>Digital Outputs</i>
-------	--------------	---

5-31 Terminal 29 Digital Output

Option:	Function:
[0] * No operation	Functions are described under 5-3* <i>Digital Outputs</i> This parameter only applies to FC 302

5-32 Term X30/6 Digi Out (MCB 101)

Option:	Function:
[0] * No operation	This parameter is active when option module MCB 101 is mounted in the frequency converter. Functions are described under 5-3* <i>Digital Outputs</i>
[1] Control ready	
[2] Drive ready	
[3] Drive rdy/rem ctrl	
[4] Enable / no warning	
[5] Running	
[6] Running / no warning	
[7] Run in range/no warn	
[8] Run on ref/no warn	
[9] Alarm	
[10] Alarm or warning	
[11] At torque limit	
[12] Out of current range	
[13] Below current, low	
[14] Above current, high	
[15] Out of speed range	
[16] Below speed, low	
[17] Above speed, high	
[18] Out of feedb. range	
[19] Below feedback, low	
[20] Above feedback, high	
[21] Thermal warning	
[22] Ready,no thermal W	
[23] Remote,ready,no TW	
[24] Ready, Voltage OK	
[25] Reverse	
[26] Bus OK	
[27] Torque limit & stop	
[28] Brake, no brake war	
[29] Brake ready, no fault	
[30] Brake fault (IGBT)	
[31] Relay 123	
[32] Mech brake ctrl	
[33] Safe stop active	
[38] Motor feedback error	
[39] Tracking error	
[40] Out of ref range	
[41] Below reference, low	
[42] Above ref, high	
[43] Extended PID Limit	
[45] Bus ctrl.	
[46] Bus ctrl, 1 if timeout	

5-32 Term X30/6 Digi Out (MCB 101)

Option:	Function:
[47] Bus ctrl, 0 if timeout	
[51] MCO controlled	
[55] Pulse output	
[60] Comparator 0	
[61] Comparator 1	
[62] Comparator 2	
[63] Comparator 3	
[64] Comparator 4	
[65] Comparator 5	
[70] Logic rule 0	
[71] Logic rule 1	
[72] Logic rule 2	
[73] Logic rule 3	
[74] Logic rule 4	
[75] Logic rule 5	
[80] SL digital output A	
[81] SL digital output B	
[82] SL digital output C	
[83] SL digital output D	
[84] SL digital output E	
[85] SL digital output F	
[120] Local ref active	
[121] Remote ref active	
[122] No alarm	
[123] Start command activ	
[124] Running reverse	
[125] Drive in hand mode	
[126] Drive in auto mode	

5-33 Term X30/7 Digi Out (MCB 101)

Option:	Function:
[0] * No operation	This parameter is active when option module option module MCB 101 is mounted in the frequency converter. Functions are described under 5-3* <i>Digital Outputs</i>
[1] Control ready	
[2] Drive ready	
[3] Drive rdy/rem ctrl	
[4] Enable / no warning	
[5] Running	
[6] Running / no warning	
[7] Run in range/no warn	
[8] Run on ref/no warn	
[9] Alarm	
[10] Alarm or warning	
[11] At torque limit	
[12] Out of current range	
[13] Below current, low	
[14] Above current, high	
[15] Out of speed range	
[16] Below speed, low	

5-33 Term X30/7 Digi Out (MCB 101)		
Option:	Function:	
[17]	Above speed, high	
[18]	Out of feedb. range	
[19]	Below feedback, low	
[20]	Above feedback, high	
[21]	Thermal warning	
[22]	Ready,no thermal W	
[23]	Remote,ready,no TW	
[24]	Ready, Voltage OK	
[25]	Reverse	
[26]	Bus OK	
[27]	Torque limit & stop	
[28]	Brake, no brake war	
[29]	Brake ready, no fault	
[30]	Brake fault (IGBT)	
[31]	Relay 123	
[32]	Mech brake ctrl	
[33]	Safe stop active	
[39]	Tracking error	
[40]	Out of ref range	
[41]	Below reference, low	
[42]	Above ref, high	
[43]	Extended PID Limit	
[45]	Bus ctrl.	
[46]	Bus ctrl, 1 if timeout	
[47]	Bus ctrl, 0 if timeout	
[51]	MCO controlled	
[60]	Comparator 0	
[61]	Comparator 1	
[62]	Comparator 2	
[63]	Comparator 3	
[64]	Comparator 4	
[65]	Comparator 5	
[70]	Logic rule 0	
[71]	Logic rule 1	
[72]	Logic rule 2	
[73]	Logic rule 3	
[74]	Logic rule 4	
[75]	Logic rule 5	
[80]	SL digital output A	
[81]	SL digital output B	
[82]	SL digital output C	
[83]	SL digital output D	
[84]	SL digital output E	
[85]	SL digital output F	
[120]	Local ref active	
[121]	Remote ref active	
[122]	No alarm	
[123]	Start command activ	
[124]	Running reverse	
[125]	Drive in hand mode	
[126]	Drive in auto mode	

3.7.4 5-4* Relays

Parameters for configuring the timing and the output functions for the relays.

5-40 Function Relay		
Array [9] (Relay 1 [0], Relay 2 [1], Relay 3 [2] (MCB 113), Relay 4 [3] (MCB 113), Relay 5 [4] (MCB 113), Relay 6 [5] (MCB 113), Relay 7 [6] (MCB 105), Relay 8 [7] (MCB 105), Relay 9 [8] (MCB 105))		
Option:	Function:	
[0] *	No operation	All digital and relay outputs are default set to "No Operation".
[1]	Control ready	The control card is ready. E.g.: Feedback from a drive where the control is supplied by an external 24 V (MCB 107) and the main power to drive is not detected.
[2]	Drive ready	Drive is ready to operate. Mains and control supplies are OK.
[3]	Drive rdy/rem ctrl	The frequency converter is ready for operation and is in Auto On mode
[4]	Enable / no warning	Ready for operation. No start or stop commands have been applied (start/disable). No warnings are active.
[5]	Running	Motor is running, and shaft torque present.
[6]	Running / no warning	Output speed is higher than the speed set in par. 1-81 <i>Min Speed for Function at Stop [RPM]</i> Min Speed for Function at Stop [RPM]. The motor is running and no warnings.
[7]	Run in range/no warn	Motor is running within the programmed current and speed ranges set in par. 4-50 <i>Warning Current Low</i> and par. 4-53 <i>Warning Speed High</i> . No warnings.
[8]	Run on ref/no warn	Motor runs at reference speed. No warnings.
[9]	Alarm	An alarm activates the output. No warnings
[10]	Alarm or warning	An alarm or a warning activates the output.
[11]	At torque limit	The torque limit set in par. 4-16 <i>Torque Limit Motor Mode</i> or par. 4-17 <i>Torque Limit Generator Mode</i> has been exceeded.
[12]	Out of current range	The motor current is outside the range set in par. 4-18 <i>Current Limit</i> .
[13]	Below current, low	Motor current is lower than set in par. 4-50 <i>Warning Current Low</i> .

5-40 Function Relay		
Array [9] (Relay 1 [0], Relay 2 [1], Relay 3 [2] (MCB 113), Relay 4 [3] (MCB 113), Relay 5 [4] (MCB 113), Relay 6 [5] (MCB 113), Relay 7 [6] (MCB 105), Relay 8 [7] (MCB 105), Relay 9 [8] (MCB 105))		
Option:	Function:	
[14]	Above current, high	Motor current is higher than set in par. 4-51 <i>Warning Current High</i> .
[15]	Out of speed range	Output speed/frequency is outside the frequency range set in par. 4-52 <i>Warning Speed Low</i> and par. 4-53 <i>Warning Speed High</i> .
[16]	Below speed, low	Output speed is lower than the setting in par. 4-52 <i>Warning Speed Low</i>
[17]	Above speed, high	Output speed is higher than the setting in par. 4-53 <i>Warning Speed High</i> .
[18]	Out of feedb. range	Feedback is outside the range set in par. 4-56 <i>Warning Feedback Low</i> and par. 4-57 <i>Warning Feedback High</i> .
[19]	Below feedback, low	Feedback is below the limit set in par. 4-56 <i>Warning Feedback Low</i> .
[20]	Above feedback, high	Feedback is above the limit set in par. 4-57 <i>Warning Feedback High</i> .
[21]	Thermal warning	Thermal warning turns on when the temperature exceeds the limit either in motor, frequency converter, brake resistor, or connected thermistor.
[22]	Ready,no thermal W	Frequency converter is ready for operation and there is no over-temperature warning.
[23]	Remote,ready,no TW	Frequency converter is ready for operation and is in Auto On mode. There is no over-temperature warning.
[24]	Ready, Voltage OK	Frequency converter is ready for operation and the mains voltage is within the specified voltage range (see General Specifications section in Design Guide).
[25]	Reverse	Logic '1' when CW rotation of the motor. Logic '0' when CCW rotation of the motor. If the motor is not rotating the output will follow the reference.
[26]	Bus OK	Active communication (no time-out) via the serial communication port.
[27]	Torque limit & stop	Use in performing a coasted stop and frequency converter in torque limit condition. If the frequency converter has received a stop signal and is in torque limit, the signal is Logic '0'.

5-40 Function Relay		
Array [9] (Relay 1 [0], Relay 2 [1], Relay 3 [2] (MCB 113), Relay 4 [3] (MCB 113), Relay 5 [4] (MCB 113), Relay 6 [5] (MCB 113), Relay 7 [6] (MCB 105), Relay 8 [7] (MCB 105), Relay 9 [8] (MCB 105))		
Option:	Function:	
[28]	Brake, no brake war	Brake is active and there are no warnings.
[29]	Brake ready, no fault	Brake is ready for operation and there are no faults.
[30]	Brake fault (IGBT)	Output is Logic '1' when the brake IGBT is short-circuited. Use this function to protect the frequency converter if there is a fault on the brake module. Use the digital output/relay to cut out the main voltage from the frequency converter.
[31]	Relay 123	Digital output/relay is activated when Control Word [0] is selected in par. group 8-**.
[32]	Mech brake ctrl	Selection of mechanical brake control. When selected parameters in par. group 2-2* are active. The output must be reinforced to carry the current for the coil in the brake. Usually solved by connecting an external relay to the selected digital output.
[33]	Safe stop active	(FC 302 only) Indicates that the safe stop on terminal 37 has been activated.
[36]	Control word bit 11	Activate relay 1 by control word from fieldbus. No other functional impact in the frequency converter. Typical application: controlling auxiliary device from fieldbus. The function is valid when FC profile [0] in par. 8-10 <i>Control Word Profile</i> is selected.
[37]	Control word bit 12	Activate relay 2 (FC 302 only) by control word from fieldbus. No other functional impact in the frequency converter. Typical application: controlling auxiliary device from fieldbus. The function is valid when FC profile [0] in par. 8-10 <i>Control Word Profile</i> is selected.
[38]	Motor feedback error	Failure in the speed feedback loop from motor running in closed loop. The output can eventually be used to prepare switching the drive in open loop in emergency case.
[39]	Tracking error	When the difference between calculated speed and actual speed in

5-40 Function Relay		
Array [9] (Relay 1 [0], Relay 2 [1], Relay 3 [2] (MCB 113), Relay 4 [3] (MCB 113), Relay 5 [4] (MCB 113), Relay 6 [5] (MCB 113), Relay 7 [6] (MCB 105), Relay 8 [7] (MCB 105), Relay 9 [8] (MCB 105))		
Option:		Function:
		par. 4-35 <i>Tracking Error</i> is larger than selected the digital output/relay is active.
[40]	Out of ref range	Active when the actual speed is outside settings in par. 4-52 <i>Warning Speed Low</i> to par. 4-55 <i>Warning Reference High</i> .
[41]	Below reference, low	Active when actual speed is below speed reference setting.
[42]	Above ref, high	Active when actual speed is above speed reference setting.
[43]	Extended PID Limit	
[45]	Bus ctrl.	Controls digital output/relay via bus. The state of the output is set in par. 5-90 <i>Digital & Relay Bus Control</i> . The output state is retained in the event of bus time-out.
[46]	Bus ctrl, 1 if timeout	Controls output via bus. The state of the output is set in par. 5-90 <i>Digital & Relay Bus Control</i> . In the event of bus time-out the output state is set high (On).
[47]	Bus ctrl, 0 if timeout	Controls output via bus. The state of the output is set in par. 5-90 <i>Digital & Relay Bus Control</i> . In the event of bus time-out the output state is set low (Off).
[51]	MCO controlled	Active when a MCO 302 or MCO 305 is connected. The output is controlled from option.
[60]	Comparator 0	See par. group 13-1* (Smart Logic Control). If Comparator 0 in SLC is TRUE, the output will go high. Otherwise, it will be low.
[61]	Comparator 1	See par. group 13-1* (Smart Logic Control). If Comparator 1 in SLC is TRUE, the output will go high. Otherwise, it will be low.
[62]	Comparator 2	See par. group 13-1* (Smart Logic Control). If Comparator 2 in SLC is TRUE, the output will go high. Otherwise, it will be low.
[63]	Comparator 3	See par. group 13-1* (Smart Logic Control). If Comparator 3 in SLC is TRUE, the output will go high. Otherwise, it will be low.

5-40 Function Relay		
Array [9] (Relay 1 [0], Relay 2 [1], Relay 3 [2] (MCB 113), Relay 4 [3] (MCB 113), Relay 5 [4] (MCB 113), Relay 6 [5] (MCB 113), Relay 7 [6] (MCB 105), Relay 8 [7] (MCB 105), Relay 9 [8] (MCB 105))		
Option:		Function:
[64]	Comparator 4	See par. group 13-1* (Smart Logic Control). If Comparator 4 in SLC is TRUE, the output will go high. Otherwise, it will be low.
[65]	Comparator 5	See par. group 13-1* (Smart Logic Control). If Comparator 5 in SLC is TRUE, the output will go high. Otherwise, it will be low.
[70]	Logic rule 0	See par. group 13-4*(Smart Logic Control). If Logic Rule 0 in SLC is TRUE, the output will go high. Otherwise, it will be low.
[71]	Logic rule 1	See par. group 13-4*(Smart Logic Control). If Logic Rule 1 in SLC is TRUE, the output will go high. Otherwise, it will be low.
[72]	Logic rule 2	See par. group 13-4*(Smart Logic Control). If Logic Rule 2 in SLC is TRUE, the output will go high. Otherwise, it will be low.
[73]	Logic rule 3	See par. group 13-4*(Smart Logic Control). If Logic Rule 3 in SLC is TRUE, the output will go high. Otherwise, it will be low.
[74]	Logic rule 4	See par. group 13-4*(Smart Logic Control). If Logic Rule 4 in SLC is TRUE, the output will go high. Otherwise, it will be low.
[75]	Logic rule 5	See par. group 13-4*(Smart Logic Control). If Logic Rule 5 in SLC is TRUE, the output will go high. Otherwise, it will be low.
[80]	SL digital output A	See par. 13-52 <i>SL Controller Action</i> . Output A is low on Smart Logic Action [32]. Output A is high on Smart Logic Action [38].
[81]	SL digital output B	See par. 13-52 <i>SL Controller Action</i> . Output B is low on Smart Logic Action [33]. Output B is high on Smart Logic Action [39].
[82]	SL digital output C	See par. 13-52 <i>SL Controller Action</i> . Output C is low on Smart Logic Action [34]. Output C is high on Smart Logic Action [40].
[83]	SL digital output D	See par. 13-52 <i>SL Controller Action</i> . Output D is low on Smart Logic Action

5-40 Function Relay		
Array [9] (Relay 1 [0], Relay 2 [1], Relay 3 [2] (MCB 113), Relay 4 [3] (MCB 113), Relay 5 [4] (MCB 113), Relay 6 [5] (MCB 113), Relay 7 [6] (MCB 105), Relay 8 [7] (MCB 105), Relay 9 [8] (MCB 105))		
Option:	Function:	
	[35]. Output D is high on Smart Logic Action [41]	
[84]	SL digital output E	See par. 13-52 <i>SL Controller Action</i> . Output E is low on Smart Logic Action [36]. Output E is high on Smart Logic Action [42].
[85]	SL digital output F	See par. 13-52 <i>SL Controller Action</i> . Output F is low on Smart Logic Action [37]. Output F is high on Smart Logic Action [43].
[120]	Local ref active	Output is high when par. 3-13 <i>Reference Site</i> = [2] Local or when par. 3-13 <i>Reference Site</i> = [0] Linked to hand auto at the same time as the LCP is in Hand on mode.
	Reference site set in par. 3-13 <i>Reference Site</i>	Local reference active [120]
	Reference site: Local par. 3-13 <i>Reference Site</i> [2]	0
	Reference site: Remote par. 3-13 <i>Reference Site</i> [1]	1
	Reference site: Linked to Hand/Auto	
	Hand	1
	Hand -> off	1
	Auto -> off	0
	Auto	0
[121]	Remote ref active	Output is high when par. 3-13 <i>Reference Site</i> = Remote [1] or Linked to hand/auto [0] while the LCP is in [Auto on] mode. See above.
[122]	No alarm	Output is high when no alarm is present.
[123]	Start command activ	Output is high when the Start command high (i.e. via digital input, bus connection or [Hand on] or [Auto on]), and a Stop has been last command.

5-40 Function Relay		
Array [9] (Relay 1 [0], Relay 2 [1], Relay 3 [2] (MCB 113), Relay 4 [3] (MCB 113), Relay 5 [4] (MCB 113), Relay 6 [5] (MCB 113), Relay 7 [6] (MCB 105), Relay 8 [7] (MCB 105), Relay 9 [8] (MCB 105))		
Option:	Function:	
[124]	Running reverse	Output is high when the frequency converter is running counter clockwise (the logical product of the status bits 'running' AND 'reverse').
[125]	Drive in hand mode	Output is high when the frequency converter is in Hand on mode (as indicated by the LED light above [Hand on]).
[126]	Drive in auto mode	Output is high when the frequency converter is in 'Auto' mode (as indicated by LED on above [Auto On]).

5-41 On Delay, Relay		
Array [9], (Relay 1 [0], Relay 2 [1], Relay 3 [2], Relay 4 [3], Relay 5 [4], Relay 6 [5], Relay 7 [6], Relay 8 [7], Relay 9 [8])		
Range:	Function:	
0.01 s*	[0.01 - 600.00 s]	Enter the delay of the relay cut-in time. Select one of available mechanical relays and MCB 105 in an array function. See par. 5-40 <i>Function Relay</i> . Relay 3-6 are included in MCB 113.

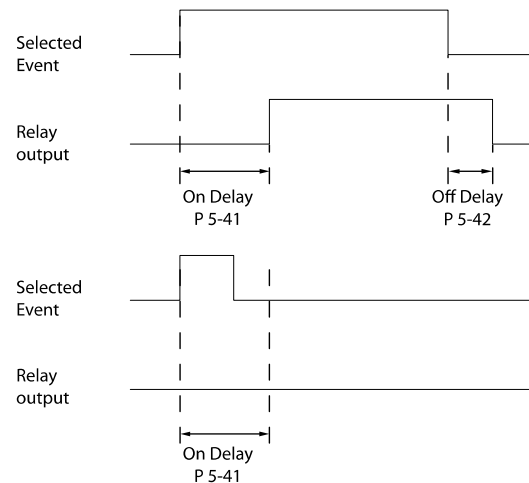

5-42 Off Delay, Relay		
Array [9] (Relay 1 [0], Relay 2 [1], Relay 3 [2], Relay 4 [3], Relay 5 [4], Relay 6 [5], Relay 7 [6], Relay 8 [7], Relay 9 [8])		
Range:	Function:	
0.01 s*	[0.01 - 600.00 s]	Enter the delay of the relay cut-out time. Select one of available mechanical relays and MCB 105 in an array function. See par. 5-40 <i>Function Relay</i> .

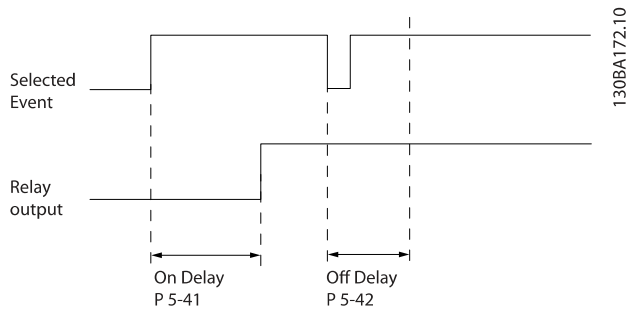

If the selected Event condition changes before the on- or off delay timer expires, the relay output is unaffected.

3.7.5 5-5* Pulse Input

The pulse input parameters are used to define an appropriate window for the impulse reference area by configuring the scaling and filter settings for the pulse inputs. Input terminals 29 or 33 act as frequency reference inputs. Set terminal 29 (par. 5-13 *Terminal 29 Digital Input*) or terminal 33 (par. 5-15 *Terminal 33 Digital Input*) to *Pulse input* [32]. If terminal 29 is used as an input, then set par. 5-01 *Terminal 27 Mode to Input* [0].

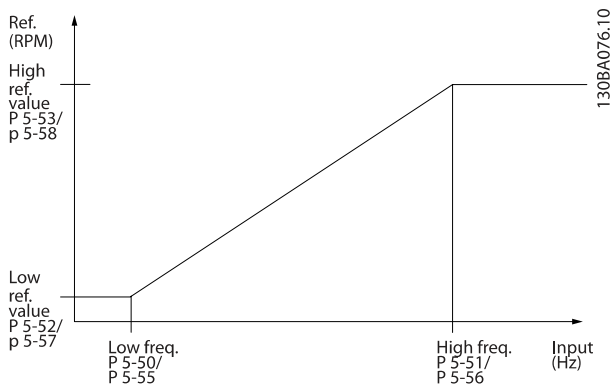

5-50 Term. 29 Low Frequency		
Range:	Function:	
100 Hz* [0 - 110000 Hz]	Enter the low frequency limit corresponding to the low motor shaft speed (i.e. low reference value) in par. 5-52 <i>Term. 29 Low Ref./Feedb. Value</i> . Refer to the diagram in this section. This parameter is available for FC 302 only.	

5-51 Term. 29 High Frequency		
Range:	Function:	
100 Hz* [0 - 110000 Hz]	Enter the high frequency limit corresponding to the high motor shaft speed (i.e. high reference value) in par. 5-53 <i>Term. 29 High Ref./Feedb. Value</i> . This parameter is available for FC 302 only.	

5-52 Term. 29 Low Ref./Feedb. Value		
Range:	Function:	
0.000 Reference-FeedbackUnit* [-999999.999 - 999999.999 ReferenceFeed-backUnit]	Enter the low reference value limit for the motor shaft speed [RPM]. This is also the lowest feedback value, see also par. 5-57 <i>Term. 33 Low Ref./Feedb. Value</i> . Set terminal 29 to digital input (par. 5-02 <i>Terminal 29 Mode =input</i> [0] (default) and par. 5-13 <i>Terminal 29 Digital Input = applicable value</i>). This parameter is available for FC 302 only.	

5-53 Term. 29 High Ref./Feedb. Value		
Range:	Function:	
Application dependent* [-999999.999 - 999999.999 ReferenceFeed-backUnit]	Enter the high reference value [RPM] for the motor shaft speed and the high feedback value, see also par. 5-58 <i>Term. 33 High Ref./Feedb. Value</i> . Select terminal 29 as a digital input (par. 5-02 <i>Terminal 29 Mode =input</i> [0] (default) and par. 5-13 <i>Terminal 29 Digital Input = applicable value</i>). This parameter is available for FC 302 only.	

5-54 Pulse Filter Time Constant #29		
Range:	Function:	
100 ms* [1 - 1000 ms]	Enter the pulse filter time constant. The pulse filter dampens oscillations of the feedback signal, which is an advantage if there is a lot of noise in the system. A high time constant value results in better dampening but also increases the time delay through the filter. This parameter is available for FC 302 only. This parameter cannot be adjusted while the motor is running.	

5-55 Term. 33 Low Frequency		
Range:	Function:	
100 Hz* [0 - 110000 Hz]	Enter the low frequency corresponding to the low motor shaft speed (i.e. low reference value) in par. 5-57 <i>Term. 33 Low Ref./Feedb. Value</i> .	

5-56 Term. 33 High Frequency		
Range:	Function:	
100 Hz* [0 - 110000 Hz]	Enter the high frequency corresponding to the high motor shaft speed (i.e. high reference value) in par. 5-58 <i>Term. 33 High Ref./Feedb. Value</i> .	

5-57 Term. 33 Low Ref./Feedb. Value		
Range:		Function:
0.000 N/A*	[-999999.999 - 999999.999 N/A]	Enter the low reference value [RPM] for the motor shaft speed. This is also the low feedback value, see also par. 5-52 Term. 29 Low Ref./Feedb. Value.

5-58 Term. 33 High Ref./Feedb. Value		
Range:		Function:
Application dependent*	[-999999.999 - 999999.999 ReferenceFeed-backUnit]	Enter the high reference value [RPM] for the motor shaft speed. See also par. 5-53 Term. 29 High Ref./Feedb. Value.

5-59 Pulse Filter Time Constant #33		
Range:		Function:
100 ms*	[1 - 1000 ms]	Enter the pulse filter time constant. The low-pass filter reduces the influence on and dampens oscillations on the feedback signal from the control. This is an advantage, e.g. if there is a great amount on noise in the system. This parameter cannot be adjusted while the motor is running.

3.7.6 5-6* Pulse Outputs

These parameters are to configure pulse outputs with their functions and scaling. Terminal 27 and 29 are allocated to pulse output via par. 5-01 Terminal 27 Mode and par. 5-02 Terminal 29 Mode, respectively.

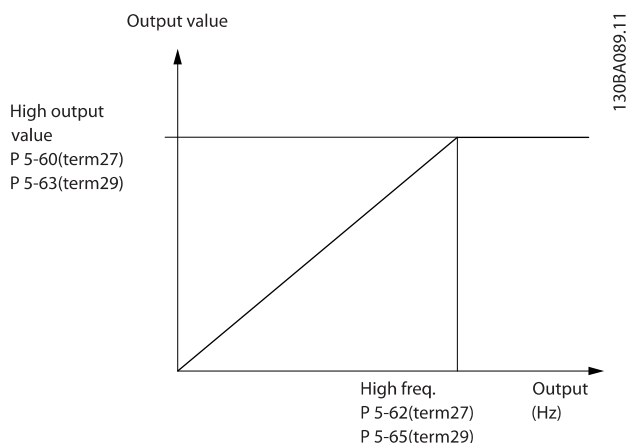

Options for readout output variables:

Option:	Function:
[0]	No operation
[45]	Bus control
[48]	Bus control time-out
[51]	MCO controlled
[100]	Output frequency
[101]	Reference
[102]	Feedback
[103]	Motor current
[104]	Torque relative to limit
[105]	Torque relative to rated
[106]	Power
[107]	Speed
[108]	Torque
[109]	Max Out Freq

5-60 Terminal 27 Pulse Output Variable		
Option:	Function:	
[0]	No operation	Select the desired display output for terminal 27. This parameter cannot be adjusted while the motor is running.
[45]	Bus ctrl.	
[48]	Bus ctrl., timeout	
[51]	MCO controlled	
[100]	Output frequency	
[101]	Reference	
[102]	Feedback	
[103]	Motor current	
[104]	Torque rel to limit	
[105]	Torq relate to rated	
[106]	Power	
[107]	Speed	
[108]	Torque	
[109]	Max Out Freq	
[119]	Torque % lim	

5-62 Pulse Output Max Freq #27		
Range:		Function:
Application dependent*	[0 - 32000 Hz]	Set the maximum frequency for terminal 27, corresponding to the output variable selected in par. 5-60 <i>Terminal 27 Pulse Output Variable</i> . This parameter cannot be adjusted while the motor is running.

5-63 Terminal 29 Pulse Output Variable		
Option:		Function:
[0] *	No operation	Select the desired display output for terminal 29. This parameter is available for FC 302 only. This parameter cannot be adjusted while the motor is running.
[45]	Bus ctrl.	
[48]	Bus ctrl., timeout	
[51]	MCO controlled	
[100]	Output frequency	
[101]	Reference	
[102]	Feedback	
[103]	Motor current	
[104]	Torque rel to limit	
[105]	Torq relate to rated	
[106]	Power	
[107]	Speed	
[108]	Torque	
[109]	Max Out Freq	
[119]	Torque % lim	

5-65 Pulse Output Max Freq #29		
Set the maximum frequency for terminal 29 corresponding to the output variable set in par. 5-63 <i>Terminal 29 Pulse Output Variable</i> . This parameter cannot be adjusted while the motor is running.		
Range:		Function:
5000 Hz*	[0 - 32000 Hz]	

5-66 Terminal X30/6 Pulse Output Variable		
Select the variable for read-out on terminal X30/6. This parameter cannot be adjusted while the motor is running. This parameter is active when option module MCB 101 is installed in the frequency converter. Same options and functions as par. group 5-6*.		
Option:		Function:
[0] *	No operation	
[45]	Bus ctrl.	
[48]	Bus ctrl., timeout	
[51]	MCO controlled	
[100]	Output frequency	
[101]	Reference	
[102]	Feedback	
[103]	Motor current	

5-66 Terminal X30/6 Pulse Output Variable		
Select the variable for read-out on terminal X30/6. This parameter cannot be adjusted while the motor is running. This parameter is active when option module MCB 101 is installed in the frequency converter. Same options and functions as par. group 5-6*.		
Option:		Function:
[104]	Torque rel to limit	
[105]	Torq relate to rated	
[106]	Power	
[107]	Speed	
[108]	Torque	
[109]	Max Out Freq	
[119]	Torque % lim	

5-68 Pulse Output Max Freq #X30/6		
Select the maximum frequency on terminal X30/6 referring to the output variable in par. 5-66 <i>Terminal X30/6 Pulse Output Variable</i> . This parameter cannot be adjusted while the motor is running. This parameter is active when option module MCB 101 is mounted in the frequency converter.		
Range:		Function:
Application dependent*	[0 - 32000 Hz]	

3.7.7 5-7* 24 V Encoder Input

Connect the 24 V encoder to terminal 12 (24 V DC supply), terminal 32 (Channel A), terminal 33 (Channel B), and terminal 20 (GND). The digital inputs 32/33 are active for encoder inputs when 24 V encoder is selected in par. 1-02 Flux Motor Feedback Source and par. 7-00 Speed PID Feedback Source. The encoder used is a dual channel (A and B) 24 V type. Max input frequency: 110 kHz.

Encoder Connection to the frequency converter

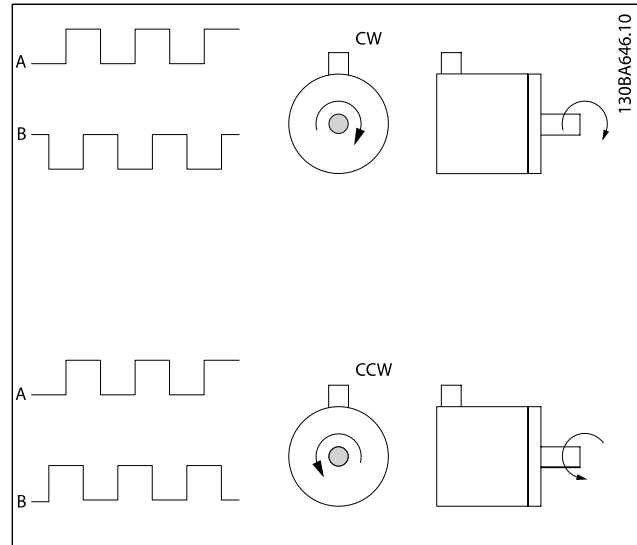
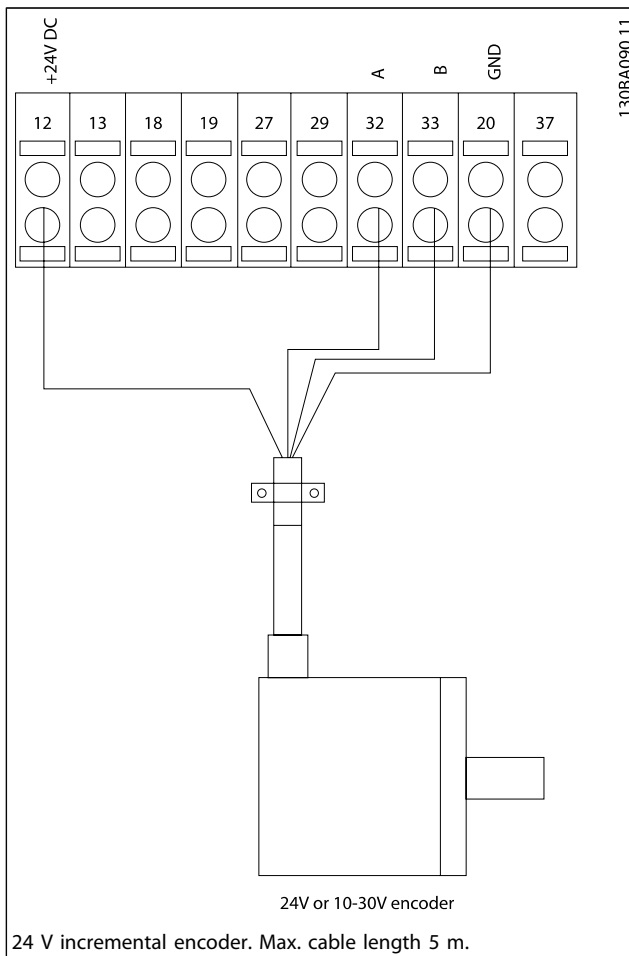

5-70 Term 32/33 Pulses per Revolution

Range:	Function:
1024* [1 - 4096]	Set the encoder pulses per revolution on the motor shaft. Read the correct value from the encoder. This parameter cannot be adjusted while the motor is running.

5-71 Term 32/33 Encoder Direction

Option:	Function:
	Change the detected encoder rotation direction without changing the wiring to the encoder.
[0] *	Clockwise Sets channel A 90° (electrical degrees) behind channel B upon clockwise rotation of the encoder shaft.
[1]	Counter clockwise Sets channel A 90° (electrical degrees) ahead of channel B upon clockwise rotation of the encoder shaft.

This parameter cannot be adjusted while the motor is running.

3.7.8 5-9* Bus Controlled

This par. group selects digital and relay outputs via a fieldbus setting.

5-90 Digital & Relay Bus Control		
Range:	Function:	
0* [0 - 2147483647]	This parameter holds the state of the digital outputs and relays that is controlled by bus. A logical '1' indicates that the output is high or active. A logical '0' indicates that the output is low or inactive.	

Bit 0	Digital Output Terminal 27
Bit 1	Digital Output Terminal 29
Bit 2	Digital Output Terminal X 30/6
Bit 3	Digital Output Terminal X 30/7
Bit 4	Relay 1 output terminal
Bit 5	Relay 2 output terminal
Bit 6	Option B Relay 1 output terminal
Bit 7	Option B Relay 2 output terminal
Bit 8	Option B Relay 3 output terminal
Bit 9-15	Reserved for future terminals
Bit 16	Option C Relay 1 output terminal
Bit 17	Option C Relay 2 output terminal
Bit 18	Option C Relay 3 output terminal
Bit 19	Option C Relay 4 output terminal
Bit 20	Option C Relay 5 output terminal
Bit 21	Option C Relay 6 output terminal
Bit 22	Option C Relay 7 output terminal
Bit 23	Option C Relay 8 output terminal
Bit 24-31	Reserved for future terminals

5-93 Pulse Out #27 Bus Control		
Range:	Function:	
0.00 %* [0.00 - 100.00 %]	Set the output frequency transferred to the output terminal 27 when the terminal is configured as 'Bus Controlled' in par. 5-60 <i>Terminal 27 Pulse Output Variable</i> [45].	

5-94 Pulse Out #27 Timeout Preset		
Range:	Function:	
0.00 %* [0.00 - 100.00 %]	Set the output frequency transferred to the output terminal 27 when the terminal is configured as 'Bus Ctrl Timeout' in par. 5-60 <i>Terminal 27 Pulse Output Variable</i> [48]. And a time-out is detected.	

5-95 Pulse Out #29 Bus Control		
Range:	Function:	
0.00 %* [0.00 - 100.00 %]	Set the output frequency transferred to the output terminal 29 when the terminal is configured as 'Bus Controlled' in par. 5-63 <i>Terminal 29 Pulse Output Variable</i> [45]. This parameter only applies for FC 302.	

5-96 Pulse Out #29 Timeout Preset		
Range:	Function:	
0.00 %* [0.00 - 100.00 %]	Set the output frequency transferred to the output terminal 29 when the terminal is configured as 'Bus Ctrl Timeout' in par. 5-63 <i>Terminal 29 Pulse Output Variable</i> [48]. And a time-out is detected. <i>This parameter only applies for FC 302.</i>	

5-97 Pulse Out #X30/6 Bus Control		
Range:	Function:	
0.00 %* [0.00 - 100.00 %]	Set the output frequency transferred to the output terminal X30/6 when the terminal is configured as 'Bus Controlled' in par. 5-66 <i>Terminal X30/6 Pulse Output Variable, Terminal X30/6 Pulse Output Variable</i> [45].	

5-98 Pulse Out #X30/6 Timeout Preset		
Range:	Function:	
0.00 %* [0.00 - 100.00 %]	Set the output frequency transferred to the output terminal X30/6 when the terminal is configured as 'Bus Ctrl Timeout' in par. 5-66 <i>Terminal X30/6 Pulse Output Variable</i> [48]. And a time-out is detected.	

3.8 Parameters: 6-** Analog In/Out

3.8.1 6-0* Analog I/O Mode

The analog inputs can freely be allocated to be either voltage (FC 301: 0..10 V, FC 302: 0..+/- 10V) or current (FC 301/FC 302: 0/4..20 mA) input.

NOTE

Thermistors may be connected to either an analog or a digital input.

6-00 Live Zero Timeout Time		
Range:	Function:	
10 s* [1 - 99 s]	Enter the Live Zero Time-out time period. Live Zero Time-out Time is active for analog inputs, i.e. terminal 53 or terminal 54, used as reference or feedback sources. If the reference signal value associated with the selected current input falls below 50% of the value set in par. 6-10 Terminal 53 Low Voltage, par. 6-12 Terminal 53 Low Current, par. 6-20 Terminal 54 Low Voltage or par. 6-22 Terminal 54 Low Current for a time period longer than the time set in par. 6-00 Live Zero Timeout Time, the function selected in par. 6-01 Live Zero Timeout Function will be activated.	

6-01 Live Zero Timeout Function		
Option:	Function:	
[2]	Coast and trip	
[0] *	Off	
[1]	Freeze output	Frozen at the present value
[2]	Stop	Overruled to stop
[3]	Jogging	Overruled to jog speed
[4]	Max. speed	Overruled to max. speed
[5]	Stop and trip	Overruled to stop with subsequent trip
[20]	Coast	

6-01 Live Zero Timeout Function		
Option:	Function:	
[2]	Coast and trip	

3.8.2 6-1* Analog Input 1

Parameters for configuring the scaling and limits for analog input 1 (terminal 53).

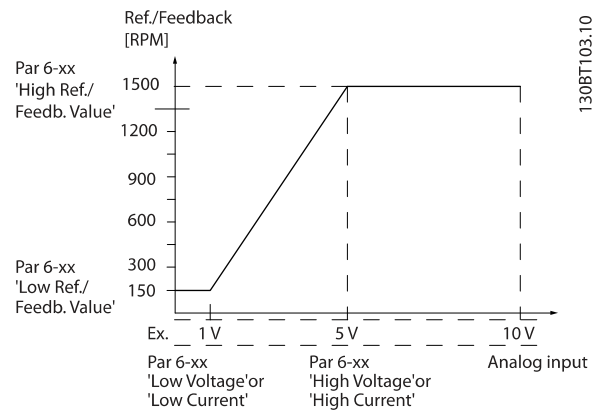

6-10 Terminal 53 Low Voltage		
Range:	Function:	
0.07 V*	[Application dependant]	Enter the low voltage value. This analog input scaling value should correspond to the minimum reference value, set in par. 6-14 Terminal 53 Low Ref./Feedb. Value. See also the section Reference Handling.

6-11 Terminal 53 High Voltage		
Range:	Function:	
10.00 V*	[Application dependant]	Enter the high voltage value. This analog input scaling value should correspond to the high reference/ feedback value set in par. 6-15 Terminal 53 High Ref./Feedb. Value.

6-12 Terminal 53 Low Current		
Range:	Function:	
0.14 mA*	[Application dependant]	Enter the low current value. This reference signal should correspond to the minimum reference value, set in par. 3-02 Minimum Reference. The value must be set at >2 mA in order to activate the Live Zero Time-out Function in par. 6-01 Live Zero Timeout Function.

6-13 Terminal 53 High Current		
Range:		Function:
20.00 mA*	[Application dependant]	Enter the high current value corresponding to the high reference/feedback set in par. 6-15 <i>Terminal 53 High Ref./Feedb. Value</i> .

6-14 Terminal 53 Low Ref./Feedb. Value		
Range:		Function:
0.000 N/A*	[-999999.999 - 999999.999 N/A]	Enter the analog input scaling value that corresponds to the low voltage/low current set in par. 6-10 <i>Terminal 53 Low Voltage</i> and par. 6-12 <i>Terminal 53 Low Current</i> .

6-15 Terminal 53 High Ref./Feedb. Value		
Range:		Function:
Application dependent*	[-999999.999 - 999999.999 ReferenceFeed-backUnit]	Enter the analog input scaling value that corresponds to the maximum reference feedback value set in par. 6-11 <i>Terminal 53 High Voltage</i> and par. 6-13 <i>Terminal 53 High Current</i> .

6-16 Terminal 53 Filter Time Constant		
Range:		Function:
0.001 s*	[0.001 - 10.000 s]	Enter the time constant. This is a first-order digital low pass filter time constant for suppressing electrical noise in terminal 53. A high time constant value improves dampening but also increases the time delay through the filter. This parameter cannot be adjusted while the motor is running.

3.8.3 6-2* Analog Input 2

Parameters for configuring the scaling and limits for analog input 2 (terminal 54).

6-20 Terminal 54 Low Voltage		
Range:		Function:
0.07 V*	[Application dependant]	Enter the low voltage value. This analog input scaling value should correspond to the minimum reference value, set in par. 3-02 <i>Minimum Reference</i> . See also the section <i>Reference Handling</i> .

6-21 Terminal 54 High Voltage		
Range:		Function:
10.00 V*	[Application dependant]	Enter the high voltage value. This analog input scaling value should correspond to the high reference/feedback value set in par. 6-25 <i>Terminal 54 High Ref./Feedb. Value</i> .

6-22 Terminal 54 Low Current		
Range:		Function:
0.14 mA*	[Application dependant]	Enter the low current value. This reference signal should correspond to the minimum reference value, set in par. 3-02 <i>Minimum Reference</i> . The value must be set at >2 mA in order to activate the Live Zero Time-out Function in par. 6-01 <i>Live Zero Timeout Function</i> .

6-23 Terminal 54 High Current		
Range:		Function:
20.00 mA*	[Application dependant]	Enter the high current value corresponding to the high reference/feedback value set in par. 6-25 <i>Terminal 54 High Ref./Feedb. Value</i> .

6-24 Terminal 54 Low Ref./Feedb. Value		
Range:		Function:
0 Reference-FeedbackUnit*	[-999999.999 - 999999.999 ReferenceFeed-backUnit]	Enter the analog input scaling value that corresponds to the minimum reference feedback value set in par. 3-02 <i>Minimum Reference</i> .

6-25 Terminal 54 High Ref./Feedb. Value		
Range:		Function:
Application dependent*	[-999999.999 - 999999.999 ReferenceFeed-backUnit]	Enter the analog input scaling value that corresponds to the maximum reference feedback value set in par. 3-03 <i>Maximum Reference</i> .

6-26 Terminal 54 Filter Time Constant		
Range:		Function:
0.001 s*	[0.001 - 10.000 s]	Enter the time constant. This is a first-order digital low pass filter time constant for suppressing electrical noise in terminal 54. A high time constant value improves dampening but also increases the time delay through the filter. This parameter cannot be adjusted while the motor is running.

3.8.4 6-3* Analog Input 3 MCB 101

Par. group for configuring the scale and limits for analog input 3 (X30/11) placed on option module MCB 101.

6-30 Terminal X30/11 Low Voltage		
Range:	Function:	
0.07 V* [Application dependant]	Sets the analog input scaling value to correspond to the low reference/ feedback value (set in par. 6-34 <i>Term. X30/11 Low Ref./Feedb. Value</i>).	

6-31 Terminal X30/11 High Voltage		
Range:	Function:	
10.00 V* [Application dependant]	Sets the analog input scaling value to correspond to the high reference/ feedback value (set in par. 6-35 <i>Term. X30/11 High Ref./Feedb. Value</i>).	

6-34 Term. X30/11 Low Ref./Feedb. Value		
Range:	Function:	
0.000 N/A* [-999999.999 - 999999.999 N/A]	Sets the analog input scaling value to correspond to the low voltage value (set in par. 6-30 <i>Terminal X30/11 Low Voltage</i>).	

6-35 Term. X30/11 High Ref./Feedb. Value		
Range:	Function:	
100.000 N/A* [-999999.999 - 999999.999 N/A]	Sets the analog input scaling value to correspond to the high voltage value (set in par. 6-31 <i>Terminal X30/11 High Voltage</i>).	

6-36 Term. X30/11 Filter Time Constant		
Range:	Function:	
0.001 s* [0.001 - 10.000 s]	A 1 st order digital low pass filter time constant for suppressing electrical noise on terminal X30/11. Par. 6-36 <i>Term. X30/11 Filter Time Constant</i> cannot be changed while the motor is running.	

3.8.5 6-4* Analog Input 4 MCB 101

Par. group for configuring the scale and limits for analog input 4 (X30/12) placed on option module MCB 101.

6-40 Terminal X30/12 Low Voltage		
Range:	Function:	
0.07 V* [Application dependant]	Sets the analog input scaling value to correspond to the low reference/ feedback value set in par. 6-44 <i>Term. X30/12 Low Ref./Feedb. Value</i> .	

6-41 Terminal X30/12 High Voltage		
Range:	Function:	
10.00 V* [Application dependant]	Sets the analog input scaling value to correspond to the high reference/ feedback value set in par. 6-45 <i>Term. X30/12 High Ref./Feedb. Value</i> .	

6-44 Term. X30/12 Low Ref./Feedb. Value		
Range:	Function:	
0.000 N/A* [-999999.999 - 999999.999 N/A]	Sets the analog output scaling value to correspond to the low voltage value set in par. 6-40 <i>Terminal X30/12 Low Voltage</i> .	

6-45 Term. X30/12 High Ref./Feedb. Value		
Range:	Function:	
100.000 N/A* [-999999.999 - 999999.999 N/A]	Sets the analog input scaling value to correspond to the high voltage value set in par. 6-41 <i>Terminal X30/12 High Voltage</i> .	

6-46 Term. X30/12 Filter Time Constant		
Range:	Function:	
0.001 s* [0.001 - 10.000 s]	A 1 st order digital low pass filter time constant for suppressing electrical noise on terminal X30/12. Par. 6-46 <i>Term. X30/12 Filter Time Constant</i> cannot be changed while the motor is running.	

3.8.6 6-5* Analog Output 1

Parameters for configuring the scaling and limits for analog output 1, i.e. Terminal 42. Analog outputs are current outputs: 0/4 – 20 mA. Common terminal (terminal 39) is the same terminal and has the same electrical potential for analog common and digital common connection. Resolution on analog output is 12 bit.

6-50 Terminal 42 Output		
Option:	Function:	
		Select the function of Terminal 42 as an analog current output. Depending on the selection the output is either a 0-20 mA or 4-20 mA output. The current value can be read out in LCP in par. 16-65 <i>Analog Output 42 [mA]</i> .
[0] *	No operation	When no signal on the analog output.
[52]	MCO 0-20mA	
[53]	MCO 4-20mA	
[100]	Output frequency	0 Hz = 0 mA; 100 Hz = 20 mA.
[101]	Reference	Par. 3-00 <i>Reference Range</i> [Min - Max] 0% = 0 mA; 100% = 20 mA Par. 3-00 <i>Reference Range</i> [-Max - Max] -100% = 0 mA; 0% = 10 mA; +100% = 20 mA
[102]	Feedback	
[103]	Motor current	Value is taken from par. 16-37 <i>Inv. Max. Current</i> . Inverter max. current (160% current) is equal to 20 mA. Example: Inverter norm current (11 kW) = 24 A. 160 % = 38.4 A. Motor norm current = 22 A Read-out 11.46 mA. $\frac{20 \text{ mA} \times 22 \text{ A}}{38.4 \text{ A}} = 11.46 \text{ mA}$ In case the norm motor current is equal to 20 mA, the output setting of par. 6-52 <i>Terminal 42 Output Max Scale</i> is: $\frac{I_{VLT\text{Max}} \times 100}{I_{Motor\text{Norm}}} = \frac{38.4 \times 100}{22} = 175 \%$
[104]	Torque rel to limit	The torque setting is related to setting in par. 4-16 <i>Torque Limit Motor Mode</i>
[105]	Torq relate to rated	The torque is related to the motor torque setting.
[106]	Power	Taken from par. 1-20 <i>Motor Power [kW]</i> .
[107]	Speed	Taken from par. 3-03 <i>Maximum Reference</i> . 20 mA = value in par. 3-03 <i>Maximum Reference</i>
[108]	Torque	Torque reference related to 160% torque.
[109]	Max Out Freq	In relation to par. 4-19 <i>Max Output Frequency</i> .

6-50 Terminal 42 Output		
Option:	Function:	
[113]	PID Clamped Output	
[119]	Torque % lim	
[130]	Output freq. 4-20mA	0 Hz = 4 mA, 100 Hz = 20 mA
[131]	Reference 4-20mA	Par. 3-00 <i>Reference Range</i> [Min-Max] 0% = 4 mA; 100% = 20 mA Par. 3-00 <i>Reference Range</i> [-Max-Max] -100% = 4mA; 0% = 12 mA; +100% = 20 mA
[132]	Feedback 4-20mA	
[133]	Motor cur. 4-20mA	Value is taken from par. 16-37 <i>Inv. Max. Current</i> . Inverter max. current (160% current) is equal to 20 mA. Example: Inverter norm current (11 kW) = 24 A. 160 % = 38.4 A. Motor norm current = 22 A Read-out 11.46 mA. $\frac{16 \text{ mA} \times 22 \text{ A}}{38.4 \text{ A}} + 4 \text{ mA} = 13.17 \text{ mA}$ In case the norm motor current is equal to 20 mA, the output setting of par. 6-62 <i>Terminal X30/8 Max. Scale</i> is: $\frac{I_{VLT\text{Max}} \times 100}{I_{Motor\text{Norm}}} = \frac{38.4 \times 100}{22} = 175 \%$
[134]	Torq.% lim 4-20 mA	The torque setting is related to setting in par. 4-16 <i>Torque Limit Motor Mode</i> .
[135]	Torq.% nom 4-20 mA	The torque setting is related to the motor torque setting.
[136]	Power 4-20mA	Taken from par. 1-20 <i>Motor Power [kW]</i>
[137]	Speed 4-20mA	Taken from par. 3-03 <i>Maximum Reference</i> . 20 mA = Value in par. 3-03 <i>Maximum Reference</i> .
[138]	Torque 4-20mA	Torque reference related to 160% torque.
[139]	Bus ctrl. 0-20 mA	An output value set from fieldbus process data. The output will work independently of internal functions in the frequency converter.
[140]	Bus ctrl. 4-20 mA	An output value set from fieldbus process data. The output will work independently of internal functions in the frequency converter.
[141]	Bus ctrl 0-20mA t.o.	Par. 4-54 <i>Warning Reference Low</i> defines the behaviour of the analog output in case of bus time-out.

6-50 Terminal 42 Output		
Option:	Function:	
[142]	Bus ctrl 4-20mA t.o.	Par. 4-54 <i>Warning Reference Low</i> defines the behaviour of the analog output in case of bus time-out.
[149]	Torque % lim 4-20mA	Analogue output at zero torque = 12 mA. Motoric torque will increase the output current to max torque limit 20 mA (set in par. 4-16 <i>Torque Limit Motor Mode</i>). Generative torque will decrease the output to torque limit Generator Mode (set in par. 4-17 <i>Torque Limit Generator Mode</i>) Ex: par. 4-16 <i>Torque Limit Motor Mode</i> : 200% and par. 4-17 <i>Torque Limit Generator Mode</i> : 200%. 20 mA = 200% Motoric and 4 mA = 200% Generative. <div style="text-align: center;"> <p>0mA 4mA 12 mA 20 mA ↑ ↑ ↑ ↑ Par 4-17 0% Torque Par 4-16 (200%) (200%) 130BB372.10</p> </div>
[150]	Max Out Fr 4-20mA	In relation to par. 4-19 <i>Max Output Frequency</i> .

6-51 Terminal 42 Output Min Scale		
Range:	Function:	
0.00 %*	[0.00 - 200.00 %]	Scale for the minimum output (0 or 4 mA) of the analogue signal at terminal 42. Set the value to be the percentage of the full range of the variable selected in par. 6-50 <i>Terminal 42 Output</i> .

6-52 Terminal 42 Output Max Scale		
Range:	Function:	
100.00 %*	[0.00 - 200.00 %]	Scale the maximum output of the selected analog signal at terminal 42. Set the value to the maximum value of the current signal output. Scale the output to give a current lower than 20 mA at full scale; or 20 mA at an output below 100% of the maximum signal value. If 20 mA is the desired output current at a value between 0 - 100% of the full-scale output, programme the percentage value in the parameter, i.e. 50% = 20 mA. If a current between 4 and 20 mA is desired at maximum output (100%), calculate the percentage value as follows:

$20 \text{ mA} / \text{desired maximum current} \times 100 \%$

i.e. $10 \text{ mA} : \frac{20}{10} \times 100 = 200 \%$

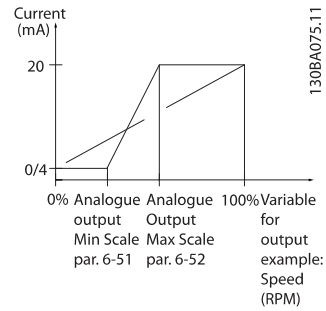

3

6-53 Terminal 42 Output Bus Control		
Range:	Function:	
0.00 %*	[0.00 - 100.00 %]	Holds the level of Output 42 if controlled by bus.

6-54 Terminal 42 Output Timeout Preset		
Range:	Function:	
0.00 %*	[0.00 - 100.00 %]	Holds the preset level of Output 42. In case of a bus timeout and a timeout function is selected in par. 6-50 <i>Terminal 42 Output</i> the output will preset to this level.

6-55 Analog Output Filter																				
Option:	Function:																			
	The following readout analogue parameters from selection in par. 6-50 <i>Terminal 42 Output</i> have a filter selected when par. 6-55 <i>Analog Output Filter</i> is on:																			
	<table border="1" style="width: 100%; border-collapse: collapse;"> <thead> <tr> <th style="text-align: left;">Selection</th> <th style="text-align: center;">0-20 mA</th> <th style="text-align: center;">4-20 mA</th> </tr> </thead> <tbody> <tr> <td>Motor current (0 - I_{max})</td> <td style="text-align: center;">[103]</td> <td style="text-align: center;">[133]</td> </tr> <tr> <td>Torque limit (0 - T_{lim})</td> <td style="text-align: center;">[104]</td> <td style="text-align: center;">[134]</td> </tr> <tr> <td>Rated torque (0 - T_{nom})</td> <td style="text-align: center;">[105]</td> <td style="text-align: center;">[135]</td> </tr> <tr> <td>Power (0 - P_{nom})</td> <td style="text-align: center;">[106]</td> <td style="text-align: center;">[136]</td> </tr> <tr> <td>Speed (0 - Speedmax)</td> <td style="text-align: center;">[107]</td> <td style="text-align: center;">[137]</td> </tr> </tbody> </table>		Selection	0-20 mA	4-20 mA	Motor current (0 - I_{max})	[103]	[133]	Torque limit (0 - T_{lim})	[104]	[134]	Rated torque (0 - T_{nom})	[105]	[135]	Power (0 - P_{nom})	[106]	[136]	Speed (0 - Speedmax)	[107]	[137]
Selection	0-20 mA	4-20 mA																		
Motor current (0 - I_{max})	[103]	[133]																		
Torque limit (0 - T_{lim})	[104]	[134]																		
Rated torque (0 - T_{nom})	[105]	[135]																		
Power (0 - P_{nom})	[106]	[136]																		
Speed (0 - Speedmax)	[107]	[137]																		
[0] *	Off	Filter off																		
[1]	On	Filter on																		

3.8.7 6-6* Analog Output 2 MCB 101

Analog outputs are current outputs: 0/4 - 20 mA. Common terminal (terminal X30/8) is the same terminal and electrical potential for analog common connection. Resolution on analog output is 12 bit.

6-60 Terminal X30/8 Output		
Option:	Function:	
		Select the function of Terminal X30/8 as an analog current output. Depending on the selection the output is either a 0-20 mA or 4-20 mA output. The current value can be read out in LCP in par. 16-65 <i>Analog Output 42 [mA]</i> .
[0] *	No operation	When no signal on the analog output.
[52]	MCO 0-20mA	
[100]	Output frequency	0 Hz = 0 mA; 100 Hz = 20 mA.
[101]	Reference	Par. 3-00 <i>Reference Range</i> [Min - Max] 0% = 0 mA; 100% = 20 mA Par. 3-00 <i>Reference Range</i> [-Max - Max] -100% = 0 mA; 0% = 10 mA; +100% = 20 mA
[102]	Feedback	
[103]	Motor current	Value is taken from par. 16-37 <i>Inv. Max. Current</i> . Inverter max. current (160% current) is equal to 20 mA. Example: Inverter norm current (11 kW) = 24 A. 160% = 38.4 A. Motor norm current = 22 A Read-out 11.46 mA. $\frac{20 \text{ mA} \times 22 \text{ A}}{38.4 \text{ A}} = 11.46 \text{ mA}$ In case the norm motor current is equal to 20 mA, the output setting of par. 6-62 <i>Terminal X30/8 Max. Scale</i> is: $\frac{I_{VLT \text{ Max}} \times 100}{I_{\text{Motor Norm}}} = \frac{38.4 \times 100}{22} = 175 \%$
[104]	Torque rel to limit	The torque setting is related to setting in par. 4-16 <i>Torque Limit Motor Mode</i> .
[105]	Torq relate to rated	The torque is related to the motor torque setting.
[106]	Power	Taken from par. 1-20 <i>Motor Power [kW]</i> .
[107]	Speed	Taken from par. 3-03 <i>Maximum Reference</i> . 20 mA = value in par. 3-03 <i>Maximum Reference</i>
[108]	Torque	Torque reference related to 160% torque.
[109]	Max Out Freq	In relation to par. 4-19 <i>Max Output Frequency</i> .
[113]	PID Clamped Output	

6-60 Terminal X30/8 Output		
Option:	Function:	
[119]	Torque % lim	
[130]	Output freq. 4-20mA	0 Hz = 4 mA, 100 Hz = 20 mA
[131]	Reference 4-20mA	Par. 3-00 <i>Reference Range</i> [Min-Max] 0% = 4 mA; 100% = 20 mA Par. 3-00 <i>Reference Range</i> [-Max-Max] -100% = 4mA; 0% = 12 mA; +100% = 20 mA
[132]	Feedback 4-20mA	
[133]	Motor cur. 4-20mA	Value is taken from par. 16-37 <i>Inv. Max. Current</i> . Inverter max. current (160% current) is equal to 20 mA. Example: Inverter norm current (11 kW) = 24 A. 160% = 38.4 A. Motor norm current = 22 A Read-out 11.46 mA. $\frac{16 \text{ mA} \times 22 \text{ A}}{38.4 \text{ A}} = 9.17 \text{ mA}$ In case the norm motor current is equal to 20 mA, the output setting of par. 6-62 <i>Terminal X30/8 Max. Scale</i> is: $\frac{I_{VLT \text{ Max}} \times 100}{I_{\text{Motor Norm}}} = \frac{38.4 \times 100}{22} = 175 \%$
[134]	Torq.% lim 4-20 mA	The torque setting is related to setting in par. 4-16 <i>Torque Limit Motor Mode</i> .
[135]	Torq.% nom 4-20 mA	The torque setting is related to the motor torque setting.
[136]	Power 4-20mA	Taken from par. 1-20 <i>Motor Power [kW]</i>
[137]	Speed 4-20mA	Taken from par. 3-03 <i>Maximum Reference</i> . 20 mA = Value in par. 3-03 <i>Maximum Reference</i> .
[138]	Torque 4-20mA	Torque reference related to 160% torque.
[139]	Bus ctrl. 0-20 mA	An output value set from fieldbus process data. The output will work independently of internal functions in the frequency converter.
[140]	Bus ctrl. 4-20 mA	An output value set from fieldbus process data. The output will work independently of internal functions in the frequency converter.
[141]	Bus ctrl 0-20mA t.o.	Par. 4-54 <i>Warning Reference Low</i> defines the behaviour of the analog output in case of bus time-out.
[142]	Bus ctrl 4-20mA t.o.	Par. 4-54 <i>Warning Reference Low</i> defines the behaviour of the analog output in case of bus time-out.

6-60 Terminal X30/8 Output		
Option:	Function:	
[149] Torque % lim 4-20mA	Torque % Lim 4-20mA: Torque reference. par. 3-00 <i>Reference Range</i> [Min-Max] 0% = 4 mA; 100% = 20mA Par. 3-00 <i>Reference Range</i> [-Max - Max] -100% = 4 mA; 0% = 12mA; +100% = 20mA	
[150] Max Out Fr 4-20mA	In relation to par. 4-19 <i>Max Output Frequency</i> .	

6-61 Terminal X30/8 Min. Scale		
Range:	Function:	
0.00 %*	[0.00 - 200.00 %]	Scales the minimum output of the selected analog signal on terminal X30/8. Scale the minimum value as a percentage of the maximum signal value, i.e. 0 mA (or 0 Hz) is desired at 25% of the maximum output value and 25% is programmed. The value can never be higher than the corresponding setting in par. 6-62 <i>Terminal X30/8 Max. Scale</i> if value is below 100%. This parameter is active when option module MCB 101 is mounted in the frequency convert- er.

6-62 Terminal X30/8 Max. Scale		
Range:	Function:	
100.00 %*	[0.00 - 200.00 %]	Scales the maximum output of the selected analog signal on terminal X30/8. Scale the value to the desired maximum value of the current signal output. Scale the output to give a lower current than 20 mA at full scale or 20 mA at an output below 100% of the maximum signal value. If 20 mA is the desired output current at a value between 0 - 100% of the full-scale output, program the percent- age value in the parameter, i.e. 50% = 20 mA. If a current between 4 and 20 mA is desired at maximum output (100%), calculate the percentage value as follows:

$20 \text{ mA} / \text{desired maximum current} \times 100 \%$

i.e. $10 \text{ mA} : \frac{20 - 4}{10} \times 100 = 160 \%$

6-63 Terminal X30/8 Bus Control		
Range:	Function:	
0.00 %*	[0.00 - 100.00 %]	Holds the level of Output X30/8 if controlled by bus.

6-64 Terminal X30/8 Output Timeout Preset		
Range:	Function:	
0.00 %*	[0.00 - 100.00 %]	Holds the preset level of Output X30/8. In case of a bus timeout and a timeout function is selected in par. 6-60 <i>Terminal X30/8 Output</i> , the output will preset to this level.

3.8.8 6-7* Analog Output 3 MCB 113

Parameters for configuring the scaling and limits for analog output 3, Terminal X45/1 and X45/2. Analog outputs are current outputs: 0/4 – 20 mA. Resolution on analog output is 11 bit.

6-70 Terminal X45/1 Output		
Option:	Function:	
		Select the function of Terminal X45/1 as an analog current output.
[0]	No operation	When no signal on the analog output.
[52]	MCO 305 0-20 mA	
[53]	MCO 305 4-20 mA	
[100]	Output frequency 0-20 mA	0 Hz = 0 mA; 100 Hz = 20 mA.
[101]	Reference 0-20 mA	Par. 3-00 [Min - Max] 0% = 0 mA; 100% = 20 mA Par. 3-00 [-Max - Max] -100% = 0 mA; 0% = 10 mA; +100% = 20 mA
[102]	Feedback	
[103]	Motor current 0-20 mA	Value is taken from par. 16-37 <i>Inv. Max. Current</i> . Inverter max. current (160% current) is equal to 20 mA. Example: Inverter norm current (11 kW) = 24 A. 160 % = 38.4 A. Motor norm current = 22 A Read-out 11.46 mA. $\frac{20 \text{ mA} \times 22 \text{ A}}{38.4 \text{ A}} = 11.46 \text{ mA}$ In case the norm motor current is equal to 20 mA, the output setting of par. 6-52 <i>Terminal 42 Output Max Scale</i> is: $\frac{I_{VLT \text{ Max}} \times 100}{I_{\text{Motor Norm}}} = \frac{38.4 \times 100}{22} = 175 \%$
[104]	Torque rel to lim 0-20 mA	The torque setting is related to setting in par. 4-16 <i>Torque Limit Motor Mode</i>
[105]	Torque rel to rated motor torque 0-20 mA	The torque is related to the motor torque setting.
[106]	Power 0-20 mA	Taken from par. 1-20 <i>Motor Power [kW]</i> .

6-70 Terminal X45/1 Output		
Option:	Function:	
[107] Speed 0-20 mA	Taken from par. 3-03 <i>Maximum Reference</i> . 20 mA = value in par. 3-03 <i>Maximum Reference</i>	
[108] Torque ref. 0-20 mA	Torque reference related to 160% torque.	
[109] Max Out Freq 0-20 mA	In relation to par. 4-19 <i>Max Output Frequency</i> .	
[130] Output freq. 4-20 mA	0 Hz = 4 mA, 100 Hz = 20 mA	
[131] Reference 4-20 mA	Par. 3-00 [Min-Max] 0% = 4 mA; 100% = 20 mA Par. 3-00 [-Max-Max] -100% = 4mA; 0% = 12 mA; +100% = 20 mA	
[132] Feedback 4-20 mA		
[133] Motor cur. 4-20 mA	Value is taken from par. 16-37 <i>Inv. Max. Current</i> . Inverter max. current (160% current) is equal to 20 mA. Example: Inverter norm current (11 kW) = 24 A. 160 % = 38.4 A. Motor norm current = 22 A Read-out 11.46 mA. $\frac{16 \text{ mA} \times 22 \text{ A}}{38.4 \text{ A}} = 9.17 \text{ mA}$ In case the norm motor current is equal to 20 mA, the output setting of par. 6-52 <i>Terminal 42 Output Max Scale</i> is: $\frac{I_{VLT \text{ Max}} \times 100}{I_{Motor \text{ Norm}}} = \frac{38.4 \times 100}{22} = 175 \%$	
[134] Torque % lim. 4-20 mA	The torque setting is related to setting in par. 4-16 <i>Torque Limit Motor Mode</i> .	
[135] Torque % nom 4-20 mA	The torque setting is related to the motor torque setting.	
[136] Power 4-20 mA	Taken from par. 1-20 <i>Motor Power [kW]</i>	
[137] Speed 4-20 mA	Taken from par. 3-03 <i>Maximum Reference</i> . 20 mA = Value in par. 3-03 <i>Maximum Reference</i> .	
[138] Torque 4-20 mA	Torque reference related to 160% torque.	
[139] Bus ctrl. 0-20 mA	An output value set from fieldbus process data. The output will work independently of internal functions in the frequency converter.	
[140] Bus ctrl. 4-20 mA	An output value set from fieldbus process data. The output will work independently of internal functions in the frequency converter.	
[141] Bus ctrl. 0-20 mA, timeout	Par. 4-54 <i>Warning Reference Low</i> defines the behaviour of the analog output in case of bus time-out.	
[142] Bus ctrl. 4-20 mA, timeout	Par. 4-54 <i>Warning Reference Low</i> defines the behaviour of the analog output in case of bus time-out.	

6-70 Terminal X45/1 Output		
Option:	Function:	
[150] Max Out Freq 4-20 mA	In relation to par. 4-19 <i>Max Output Frequency</i> .	

6-71 Terminal X45/1 Output Min Scale		
Range:	Function:	
0.00%* [0.00 - 200.00%]	Scale the minimum output of the selected analog signal at terminal X45/1, as a percentage of the maximum signal value. E.g. if 0 mA (or 0 Hz) is desired at 25% of the maximum output value, then programme 25%. Scaling values up to 100% can never be higher than the corresponding setting in par. 6-72 <i>Terminal X45/1 Max. Scale</i> .	

6-72 Terminal X45/1 Output Max Scale		
Range:	Function:	
100%* [0.00 - 200.00%]	Scale the maximum output of the selected analog signal at terminal X45/1. Set the value to the maximum value of the current signal output. Scale the output to give a current lower than 20 mA at full scale; or 20 mA at an output below 100% of the maximum signal value. If 20 mA is the desired output current at a value between 0 - 100% of the full-scale output, programme the percentage value in the parameter, i.e. 50% = 20 mA. If a current between 4 and 20 mA is desired at maximum output (100%), calculate the percentage value as follows (example where desired max. output is 10 mA):	
	$\frac{I_{RANGE} [mA]}{I_{DESIRED \text{ MAX}} [mA]} \times 100 \%$ $= \frac{20 - 4 \text{ mA}}{10 \text{ mA}} \times 100 \% = 160 \%$	

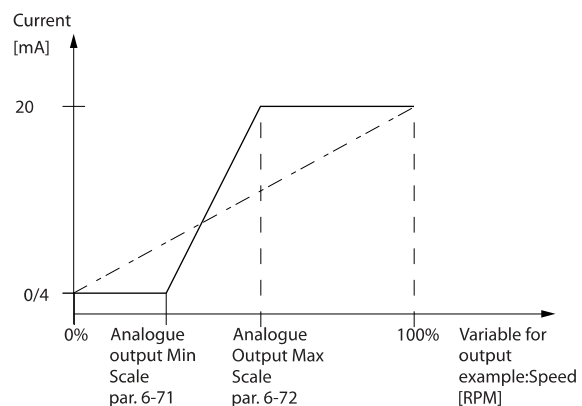

130BA877.10

6-73 Terminal X45/1 Output Bus Control		
Range:	Function:	
0.00%* [0.00 - 100.00%]	Holds the level of Analog Output 3 (terminal X45/1) if controlled by bus.	

6-74 Terminal X45/1 Output Timeout Preset		
Range:	Function:	
0.00%* [0.00 - 100.00%]	Holds the preset level of Analog Output 3 (terminal X45/1). In case of a bus timeout and a timeout function is selected in par. 6-70 <i>Terminal X45/1 Output</i> the output will preset to this level.	

3.8.9 6-8* Analog Output 4 MCB 113

Parameters for configuring the scaling and limits for analog output 4. Terminal X45/3 and X45/4. Analog outputs are current outputs: 0/4 – 20 mA. Resolution on analog output is 11 bit.

6-80 Terminal X45/3 Output		
Option:	Function:	
		Select the function of Terminal X45/3 as an analog current output.
[0] *	No operation	Same selections available as for par. 6-70 <i>Terminal X45/1 Output</i>

6-81 Terminal X45/3 Output Min Scale		
Option:	Function:	
[0.00%] * 0.00 - 200.00%	Scales the minimum output of the selected analog signal on terminal X45/3. Scale the minimum value as a percentage of the maximum signal value, i.e. 0 mA (or 0 Hz) is desired at 25% of the maximum output value and 25% is programmed. The value can never be higher than the corresponding setting in par. 6-82 <i>Terminal X45/3 Max. Scale</i> if value is below 100%. This parameter is active when option module MCB 113 is mounted in the frequency converter.	

6-82 Terminal X45/3 Output Max Scale		
Option:	Function:	
[0.00%] * 0.00 - 200.00%	Scales the maximum output of the selected analog signal on terminal X45/3. Scale the value to the desired maximum value of the current signal output. Scale the output to give a lower current than 20 mA at full scale or 20 mA at an output below 100% of the maximum signal value. If 20 mA is the desired output current at a value between 0 - 100% of the full-scale output, program the percentage value in the parameter, i.e. 50% = 20 mA. If a current between 4 and 20 mA is desired at maximum output (100%), calculate the percentage value as follows (example where desired max. output is 10 mA):	

6-82 Terminal X45/3 Output Max Scale		
Option:	Function:	
	$\frac{I_{RANGE} [mA]}{I_{DESIRED MAX} [mA]} \times 100 \%$ $= \frac{20 - 4 mA}{10 mA} \times 100 \% = 160 \%$	

6-83 Terminal X45/3 Output Bus Control		
Option:	Function:	
[0.00%] * 0.00 - 100.00%	Holds the level of output 4 (X45/3) if controlled by bus.	

6-84 Terminal X45/3 Output Timeout Preset		
Option:	Function:	
[0.00%] * 0.00 - 100.00%	Holds the present level of output 4 (X45/3). In case of a bus timeout and a timeout function is selected in par. 6-80 <i>Terminal X45/3 Output</i> the output will preset to this level.	

3.9 Parameters: 7-** Controllers

3.9.1 7-0* Speed PID Ctrl.

7-00 Speed PID Feedback Source		
Option:	Function:	
		Select the encoder for closed loop feedback. The feedback may come from a different encoder (typically mounted on the application itself) than the motor mounted encoder feedback selected in par. 1-02 <i>Flux Motor Feedback Source</i> . This parameter cannot be adjusted while the motor is running.
[0] *	Motor feedb. P1-02	
[1]	24V encoder	
[2]	MCB 102	
[3]	MCB 103	
[5]	MCO Encoder 2	
[6]	Analog input 53	
[7]	Analog input 54	
[8]	Frequency input 29	
[9]	Frequency input 33	

NOTE

If separate encoders are used (FC 302 only) the ramp settings parameters in the following groups: 3-4*, 3-5*, 3-6*, 3-7* and 3-8* must be adjusted according to the gear ratio between the two encoders.

7-02 Speed PID Proportional Gain		
Range:	Function:	
Application dependent*	[0.000 - 1.000]	Enter the speed controller proportional gain. The proportional gain amplifies the error (i.e. the deviation between the feedback signal and the set-point). This parameter is used with par. 1-00 <i>Configuration Mode Speed open loop</i> [0] and <i>Speed closed loop</i> [1] control. Quick control is obtained at high amplification. However if the amplification is too great, the process may become unstable. Use this parameter for values with three decimals. For a selection with four decimals, use par. 3-83 <i>Quick Stop S-ramp Ratio at Decel. Start</i> .

7-03 Speed PID Integral Time		
Range:	Function:	
Application dependent*	[2.0 - 20000.0 ms]	Enter the speed controller integral time, which determines the time the internal PID control takes to correct errors. The greater the error, the more quickly the gain increases. The integral time causes a delay of the signal and therefore a dampening effect, and can be used to eliminate steady state speed error. Obtain quick control through a short integral time, though if the integral time is too short, the process becomes unstable. An excessively long integral time disables the integral action, leading to major deviations from the required reference, since the process regulator takes too long to regulate errors. This parameter is used with <i>Speed open loop</i> [0] and <i>Speed closed loop</i> [1] control, set in par. 1-00 <i>Configuration Mode</i> .

7-04 Speed PID Differentiation Time		
Range:	Function:	
Application dependent*	[0.0 - 200.0 ms]	Enter the speed controller differentiation time. The differentiator does not react to constant error. It provides gain proportional to the rate of change of the speed feedback. The quicker the error changes, the stronger the gain from the differentiator. The gain is proportional with the speed at which errors change. Setting this parameter to zero disables the differentiator. This parameter is used with par. 1-00 <i>Configuration Mode Speed closed loop</i> [1] control.

7-05 Speed PID Diff. Gain Limit		
Range:	Function:	
5.0*	[1.0 - 20.0]	Set a limit for the gain provided by the differentiator. Since the differential gain increases at higher frequencies, limiting the gain may be useful. For example, set up a pure D-link at low frequencies and a constant D-link at higher frequencies. This parameter is used with par. 1-00 <i>Configuration Mode Speed closed loop</i> [1] control.

7-06 Speed PID Lowpass Filter Time												
Range:	Function:											
Application dependent*	[1.0 - 100.0 ms]	<p>Set a time constant for the speed control low-pass filter. The low-pass filter improves steady-state performance and dampens oscillations on the feedback signal. This is an advantage if there is a great amount on noise in the system, see illustration below. For example, if a time constant (τ) of 100 ms is programmed, the cut-off frequency for the low-pass filter will be $1/0.1 = 10 \text{ RAD/sec.}$, corresponding to $(10/2 \times \pi) = 1.6 \text{ Hz}$. The PID regulator only regulates a feedback signal that varies by a frequency of less than 1.6 Hz. If the feedback signal varies by a higher frequency than 1.6 Hz, the PID regulator does not react.</p> <p>Practical settings of par. 7-06 <i>Speed PID Lowpass Filter Time</i> taken from the number of pulses per revolutions from encoder:</p> <table border="1"> <thead> <tr> <th>Encoder PPR</th> <th>Par. 7-06 Speed PID Lowpass Filter Time</th> </tr> </thead> <tbody> <tr> <td>512</td> <td>10 ms</td> </tr> <tr> <td>1024</td> <td>5 ms</td> </tr> <tr> <td>2048</td> <td>2 ms</td> </tr> <tr> <td>4096</td> <td>1 ms</td> </tr> </tbody> </table> <p>Note that severe filtering can be detrimental to dynamic performance.</p> <p>This parameter is used with par. 1-00 <i>Configuration Mode Speed closed loop</i> [1] and <i>Torque</i> [2] control.</p> <p>The filter time in flux sensorless must be adjusted to 3-5 ms.</p>	Encoder PPR	Par. 7-06 Speed PID Lowpass Filter Time	512	10 ms	1024	5 ms	2048	2 ms	4096	1 ms
Encoder PPR	Par. 7-06 Speed PID Lowpass Filter Time											
512	10 ms											
1024	5 ms											
2048	2 ms											
4096	1 ms											

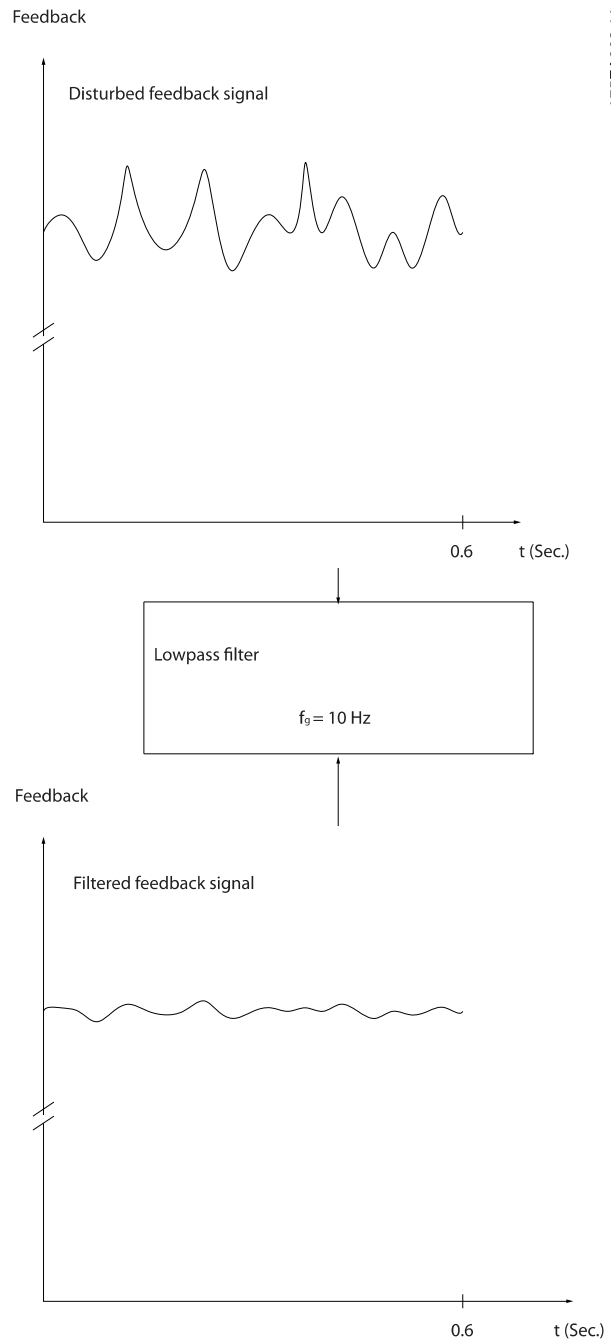

175ZA293.11

7-07 Speed PID Feedback Gear Ratio	
Range:	Function:
1.0000*	[Application dependant]

7-08 Speed PID Feed Forward Factor	
Range:	Function:
0 %*	[0 - 500 %]
The reference signal bypasses the speed controller by the amount specified. This feature increases the dynamic performance of the speed control loop.	

3.9.2 7-1* Torque PI Control

Parameters for configuring the torque PI control in torque open loop (par. 1-00 Configuration Mode).

7-12 Torque PI Proportional Gain	
Range:	Function:
100 %*	[0 - 500 %]
Enter the proportional gain value for the torque controller. Selection of a high value makes the controller react faster. Too high a setting leads to controller instability.	

7-13 Torque PI Integration Time	
Range:	Function:
0.020 s*	[0.002 - 2.000 s]
Enter the integration time for the torque controller. Selection of a low value makes the controller react faster. Too low a setting leads to control instability.	

3.9.3 7-2* Process Ctrl. Feedb.

Select the feedback sources for the Process PID Control, and how this feedback should be handled.

7-20 Process CL Feedback 1 Resource	
Option:	Function:
	The effective feedback signal is made up of the sum of up to two different input signals. Select which frequency converter input should be treated as the source

7-20 Process CL Feedback 1 Resource	
Option:	Function:
	of the first of these signals. The second input signal is defined in par. 7-22 Process CL Feedback 2 Resource.
[0] *	No function
[1]	Analog input 53
[2]	Analog input 54
[3]	Frequency input 29
[4]	Frequency input 33
[7]	Analog input X30/11
[8]	Analog input X30/12
[15]	Analog Input X48/2

7-22 Process CL Feedback 2 Resource	
Option:	Function:
	The effective feedback signal is made up of the sum of up to two different input signals. Select which frequency converter input should be treated as the source of the second of these signals. The first input signal is defined in par. 7-21.
[0] *	No function
[1]	Analog input 53
[2]	Analog input 54
[3]	Frequency input 29
[4]	Frequency input 33
[7]	Analog input X30/11
[8]	Analog input X30/12
[15]	Analog Input X48/2

3.9.4 7-3* Process PID Ctrl.

7-30 Process PID Normal/ Inverse Control	
Option:	Function:
	Normal and inverse control are implemented by introducing a difference between the reference signal and the feedback signal.
[0] *	Normal Sets process control to increase the output frequency.
[1]	Inverse Sets process control to reduce the output frequency.

7-31 Process PID Anti Windup	
Option:	Function:
[0]	Off Ceases regulation of an error when the output frequency can no longer be adjusted.
[1] *	On Continues regulation of an error even when the output frequency cannot be increased or decreased.

7-32 Process PID Start Speed		
Range:	Function:	
0 RPM* [0 - 6000 RPM]	Enter the motor speed to be attained as a start signal for commencement of PID control. When the power is switched on, the frequency converter will commence ramping and then operate under speed open loop control. Thereafter, when the Process PID start speed is reached, the frequency converter will change over to Process PID control.	

7-33 Process PID Proportional Gain		
Range:	Function:	
0.01* [0.00 - 10.00]	Enter the PID proportional gain. The proportional gain multiplies the error between the set point and the feedback signal.	

7-34 Process PID Integral Time		
Range:	Function:	
10000.00 s* [0.01 - 10000.00 s]	Enter the PID integral time. The integrator provides an increasing gain at a constant error between the set point and the feedback signal. The integral time is the time needed by the integrator to reach the same gain as the proportional gain.	

7-35 Process PID Differentiation Time		
Range:	Function:	
0.00 s* [0.00 - 10.00 s]	Enter the PID differentiation time. The differentiator does not react to a constant error, but provides a gain only when the error changes. The shorter the PID differentiation time, the stronger the gain from the differentiator.	

7-36 Process PID Diff. Gain Limit		
Range:	Function:	
5.0* [1.0 - 50.0]	Enter a limit for the differentiator gain (DG). If there is no limit, the DG will increase when there are fast changes. Limit the DG to obtain a pure differentiator gain at slow changes and a constant differentiator gain where fast changes occur.	

7-38 Process PID Feed Forward Factor		
Range:	Function:	
0 %* [0 - 200 %]	Enter the PID feed forward (FF) factor. The FF factor sends a constant fraction of the reference signal to bypass the PID control, so the PID control only affects the remaining fraction of the control signal. Any change to this parameter will thus affect the motor speed. When the FF factor is activated it provides less overshoot, and high dynamics when	

7-38 Process PID Feed Forward Factor		
Range:	Function:	
	changing the set point. par. 7-38 <i>Process PID Feed Forward Factor</i> is active when par. 1-00 <i>Configuration Mode</i> is set to [3] <i>Process</i> .	

7-39 On Reference Bandwidth		
Range:	Function:	
5 %* [0 - 200 %]	Enter the On Reference bandwidth. When the PID Control Error (the difference between the reference and the feedback) is less than the set value of this parameter the On Reference status bit is high, i.e. =1.	

3.9.5 7-4* Advanced Process PID Ctrl.

7-40 Process PID I-part Reset		
Option:	Function:	
[0] * No		
[1] Yes	Select Yes [1] to reset the I-part of the process PID controller. The selection will automatically revert to No [0]. Resetting the I-part makes it possible to start from a welldefined point after changing something in the process, e.g. changing a textile roll.	

7-41 Process PID Output Neg. Clamp		
Range:	Function:	
-100 %* [Application dependent]	Enter a negative limit for the process PID controller output.	

7-42 Process PID Output Pos. Clamp		
Range:	Function:	
100 %* [Application dependent]	Enter a positive limit for the process PID controller output.	

7-43 Process PID Gain Scale at Min. Ref.		
Range:	Function:	
100 %* [0 - 100 %]	Enter a scaling percentage to apply to the process PID output when operating at the minimum reference. The scaling percentage will be adjusted linearly between the scale at min. ref. (par. 7-43 <i>Process PID Gain Scale at Min. Ref.</i>) and the scale at max. ref. (par. 7-44 <i>Process PID Gain Scale at Max. Ref.</i>).	

7-44 Process PID Gain Scale at Max. Ref.		
Range:	Function:	
100 %* [0 - 100 %]	Enter a scaling percentage to apply to the process PID output when operating at the maximum reference. The scaling percentage will be adjusted linearly between the scale at min. ref. (par. 7-43 <i>Process PID Gain Scale at Min. Ref.</i>) and the scale at max. ref. (par. 7-44 <i>Process PID Gain Scale at Max. Ref.</i>).	

7-45 Process PID Feed Fwd Resource		
Option:	Function:	
[0] *	No function	Select which drive input should be used as the feed forward factor. The FF factor is added directly to the output of the PID controller. This increases dynamic performance.
[1]	Analog input 53	
[2]	Analog input 54	
[7]	Frequency input 29	
[8]	Frequency input 33	
[11]	Local bus reference	
[20]	Digital pot.meter	
[21]	Analog input X30-11	
[22]	Analog input X30-12	
[32]	Bus PCD	Selects a bus reference configured by Par. 8-02 Control Word Source. Change PCD Write Configuration for the bus used in order to make the feed-forward available. Use index 1 for feed-forward [748] (and index 2 for reference [1682]).

7-46 Process PID Feed Fwd Normal/ Inv. Ctrl.		
Option:	Function:	
[0] *	Normal	Select Normal [0] to set the feed forward factor to treat the FF resource as a positive value.
[1]	Inverse	Select Inverse [1] to treat the FF resource as a negative value.

7-48 PCD Feed Forward		
Range:	Function:	
0*	[0 - 65535]	Read-out parameter where the Fieldbus PCD feed-forward can be read.

7-49 Process PID Output Normal/ Inv. Ctrl.		
Option:	Function:	
[0] *	Normal	Select Normal [0] to use the resulting output from the process PID controller as is.
[1]	Inverse	Select Inverse [1] to invert the resulting output from the process PID controller. This operation is performed after the feed forward factor is applied.

3.9.6 7-5* Process PID Ctrl.

7-50 Process PID Extended PID		
Option:	Function:	
[0]	Disabled	Disables the extended parts of the process PID controller.
[1] *	Enabled	Enables the extended parts of the PID controller.

7-51 Process PID Feed Fwd Gain		
Range:	Function:	
1.00*	[0.00 - 100.00]	The feed forward is used to obtain the desired level, based on a well-known signal available. The PID controller then only takes care of the smaller part of the control, necessary because of unknown characters. The standard feed fwd factor in par. 7-38 is always related to the reference whereas 7-51 has more choices. In winder applications, the feed fwd factor will typically be the line speed of the system.

7-52 Process PID Feed Fwd Ramp up		
Range:	Function:	
0.01 s*	[0.01 - 10.00 s]	Controls the dynamics of the feed forward signal when ramping up.

7-53 Process PID Feed Fwd Ramp down		
Range:	Function:	
0.01 s*	[0.01 - 10.00 s]	Controls the dynamics of the feed forward signal when ramping down.

7-56 Process PID Ref. Filter Time		
Range:	Function:	
0.001 s*	[0.001 - 1.000 s]	Set a time constant for the reference first order low-pass filter. The low-pass filter improves steady-state performance and dampens oscillations on the reference/ feedback signals. However severe filtering can be detrimental to dynamic performance.

7-57 Process PID Fb. Filter Time		
Range:	Function:	
0.001 s*	[0.001 - 1.000 s]	Set a time constant for the feedback first order low-pass filter. The low-pass filter improves steady-state performance and dampens oscillations on the reference/ feedback signals. However severe filtering can be detrimental to dynamic performance.

3.10 Parameters: 8-** Communications and Options

3.10.1 8-0* General Settings

8-01 Control Site		
Option:	Function:	
		The setting in this parameter overrides the settings in par. 8-50 <i>Coasting Select</i> to par. 8-56 <i>Preset Reference Select</i> .
[0] *	Digital and ctrl.word	Control by using both digital input and control word.
[1]	Digital only	Control by using digital inputs only.
[2]	Controlword only	Control by using control word only.

8-02 Control Word Source		
Select the source of the control word: one of two serial interfaces or four installed options. During initial power-up, the frequency converter automatically sets this parameter to <i>Option A</i> [3] if it detects a valid fieldbus option installed in slot A. If the option is removed, the frequency converter detects a change in the configuration, sets par. 8-02 <i>Control Word Source</i> back to default setting <i>FC RS-485</i> , and the frequency converter then trips. If an option is installed after initial power-up, the setting of par. 8-02 <i>Control Word Source</i> will not change but the frequency converter will trip and display: <i>Alarm 67 Option Changed</i> . This parameter cannot be adjusted while the motor is running.		
Option:	Function:	
[0]	None	
[1]	FC RS485	
[2]	FC USB	
[3] *	Option A	
[4]	Option B	
[5]	Option C0	
[6]	Option C1	
[30]	External Can	

8-03 Control Word Timeout Time		
Range:	Function:	
1.0 s*	[Application dependant]	Enter the maximum time expected to pass between the reception of two consecutive telegrams. If this time is exceeded, it indicates that the serial communication has stopped. The function selected in par. 8-04 <i>Control Word Timeout Function</i> will then be carried out. The time-out counter is triggered by a valid control word.

8-04 Control Word Timeout Function		
Option:	Function:	
[0] *	Off	Resumes control via serial bus (Fieldbus or standard) using the most recent control word.
[1]	Freeze output	Freezes output frequency until communication resumes.
[2]	Stop	Stops with auto restart when communication resumes.
[3]	Jogging	Runs the motor at JOG frequency until communication resumes.
[4]	Max. speed	Runs the motor at maximum frequency until communication resumes.
[5]	Stop and trip	Stops the motor, then resets the frequency converter in order to restart: via the fieldbus, via the reset button on the LCP or via a digital input.
[7]	Select setup 1	Changes the set-up upon reestablishment of communication following a control word time-out. If communication resumes causing the time-out situation to disappear, par. 8-05 <i>End-of-Timeout Function</i> defines whether to resume the set-up used before the time-out or to retain the set-up endorsed by the time-out function.
[8]	Select setup 2	See [7] <i>Select setup 1</i>
[9]	Select setup 3	See [7] <i>Select setup 1</i>
[10]	Select setup 4	See [7] <i>Select setup 1</i>
[26]	Trip	

NOTE

The following configuration is required in order to change the set-up after a time-out:

Set par. 0-10 *Active Set-up* to [9] *Multi set-up* and select the relevant link in par. 0-12 *This Set-up Linked to*.

8-05 End-of-Timeout Function		
Option:	Function:	
		Select the action after receiving a valid control word following a time-out. This parameter is active only when par. 8-04 <i>Control Timeout Function</i> is set to [Set-up 1-4].
[0]	Hold set-up	Retains the set-up selected in par. 8-04 <i>Control Timeout Function</i> and displays a warning, until par. 8-06 <i>Reset Control Timeout</i> toggles. Then the frequency converter resumes its original set-up.
[1] *	Resume set-up	Resumes the set-up active prior to the time-out.

8-06 Reset Control Word Timeout		
This parameter is active only when <i>Hold set-up</i> [0] has been selected in par. 8-05 <i>End-of-Timeout Function</i> .		
Option:		Function:
[0] *	Do not reset	Retains the set-up specified in par. 8-04 <i>Control Word Timeout Function</i> , following a control word time-out.
[1]	Do reset	Returns the frequency converter to the original set-up following a control word time-out. The frequency converter performs the reset and then immediately reverts to the <i>Do not reset</i> [0] setting

8-07 Diagnosis Trigger		
Option:		Function:
		This parameter enables and controls the frequency converter diagnosis function and permits expansion of the diagnosis data to 24 byte.
NOTE This is only valid for Profibus.		
<ul style="list-style-type: none"> - <i>Disable</i> [0]: Do not send extended diagnosis data even if they appear in the frequency converter. - <i>Trigger on alarms</i> [1]: Send extended diagnosis data when one or more alarms appear in alarm par. 16-90 <i>Alarm Word</i> or par. 9-53 <i>Profibus Warning Word</i>. - <i>Trigger alarms/warn.</i> [2]: Send extended diagnosis data if one or more alarms or warnings appear in alarm par. 16-90 <i>Alarm Word</i>, par. 9-53 <i>Profibus Warning Word</i>, or warning par. 16-92 <i>Warning Word</i>. 		
The content of the extended diagnosis frame is as follows:		
Byte	Content	Description
0 - 5	Standard DP Diagnose Data	Standard DP Diagnose Data
6	PDU length xx	Header of extended diagnostic data
7	Status type = 0x81	Header of extended diagnostic data
8	Slot = 0	Header of extended diagnostic data
9	Status info = 0	Header of extended diagnostic data
10 - 13	VLT par. 16-92 <i>Warning Word</i>	VLT warning word

8-07 Diagnosis Trigger			
Option:		Function:	
		14 - 17 VLT par. 16-03 <i>Status Word</i>	VLT status word
		18 - 21 VLT par. 16-90 <i>Alarm Word</i>	VLT alarm word
		22 - 23 VLT par. 9-53 <i>Profibus Warning Word</i>	Communication warning word (Profibus)
Enabling diagnosis may cause increased bus traffic. Diagnosis functions are not supported by all fieldbus types.			
[0] *	Disable		
[1]	Trigger on alarms		
[2]	Trigger alarm/warn.		

8-08 Readout Filtering		
The function is used if the speed feedback value readouts on fieldbus are fluctuating. Select filtered if the function is required. A power-cycle is required for changes to take effect.		
Option:		Function:
[0] *	Motor Data Std-Filt.	Select [0] for normal bus readouts.
[1]	Motor Data LP-Filter	Select [1] for filtered bus readouts of the following parameters: Par. 16-10 <i>Power [kW]</i> Par. 16-11 <i>Power [hp]</i> Par. 16-12 <i>Motor Voltage</i> Par. 16-14 <i>Motor Current</i> Par. 16-16 <i>Torque [Nm]</i> Par. 16-17 <i>Speed [RPM]</i> Par. 16-22 <i>Torque [%]</i> Par. 16-25 <i>Torque [Nm] High</i>

3.10.2 8-1* Ctrl. Word Settings

8-10 Control Word Profile		
Select the interpretation of the control and status words corresponding to the installed fieldbus. Only the selections valid for the fieldbus installed in slot A will be visible in the LCP display. For guidelines in selection of <i>FC profile</i> [0] and <i>PROFdrive profile</i> [1] please refer to the <i>Serial communication via RS 485 Interface</i> section. For additional guidelines in the selection of <i>PROFdrive profile</i> [1], <i>ODVA</i> [5] and <i>CANopen DSP 402</i> [7], please refer to the Operating Instructions for the installed fieldbus.		
Option:	Function:	
[0] *	FC profile	
[1]	PROFdrive profile	
[5]	ODVA	
[7]	CANopen DSP 402	
[8]	MCO	

8-13 Configurable Status Word STW		
Option:	Function:	
		This parameter enables configuration of bits 12 – 15 in the status word.
[0]	No function	The input is always low.
[1] *	Profile Default	Depended on the profile set in Parameter 8-10.
[2]	Alarm 68 Only	The input will go high whenever Alarm 68 is active and will go low whenever no alarm 68 is active
[3]	Trip excl Alarm 68	The input will go high whenever Trip on other Alarms then Alarm 68 is active.
[10]	T18 DI status.	The input will go high whenever T18 has 24V and will go low whenever T18 has 0V
[11]	T19 DI status.	The input will go high whenever T19 has 24V and will go low whenever T19 has 0V
[12]	T27 DI status.	The input will go high whenever T27 has 24V and will go low whenever T27 has 0V
[13]	T29 DI status.	The input will go high whenever T29 has 24V and will go low whenever T29 has 0V
[14]	T32 DI status.	The input will go high whenever T32 has 24V and will go low whenever T32 has 0V
[15]	T33 DI status.	The input will go high whenever T33 has 24V and will go low whenever T33 has 0V
[16]	T37 DI status	The input will go high whenever T37 has 0V and will go low whenever T37 has 24V
[21]	Thermal warning	The thermal warning turns on when the temperature exceeds the limit in the motor, the frequency converter, the brake resistor, or the thermistor..
[30]	Brake fault (IGBT)	Will go high when the brake IGBT is short-circuited.
[40]	Out of ref range	If Comparator 0 is evaluated as TRUE, the input will go high. Otherwise, it will be low.
[60]	Comparator 0	If Comparator 0 is evaluated as TRUE, the input will go high. Otherwise, it will be low.

8-13 Configurable Status Word STW		
Option:	Function:	
[61]	Comparator 1	If Comparator 1 is evaluated as TRUE, the input will go high. Otherwise, it will be low.
[62]	Comparator 2	If Comparator 2 is evaluated as TRUE, the input will go high. Otherwise, it will be low.
[63]	Comparator 3	If Comparator 3 is evaluated as TRUE, the input will go high. Otherwise, it will be low.
[64]	Comparator 4	If Comparator 4 is evaluated as TRUE, the input will go high. Otherwise, it will be low.
[65]	Comparator 5	If Comparator 5 is evaluated as TRUE, the input will go high. Otherwise, it will be low.
[70]	Logic Rule 0	If Logic Rule 0 is evaluated as TRUE, the input will go high. Otherwise, it will be low.
[71]	Logic Rule 1	If Logic Rule 1 is evaluated as TRUE, the input will go high. Otherwise, it will be low.
[72]	Logic Rule 2	If Logic Rule 2 is evaluated as TRUE, the input will go high. Otherwise, it will be low.
[73]	Logic Rule 3	If Logic Rule 3 is evaluated as TRUE, the input will go high. Otherwise, it will be low.
[74]	Logic Rule 4	If Logic Rule 4 is evaluated as TRUE, the input will go high. Otherwise, it will be low.
[75]	Logic Rule 5	If Logic Rule 5 is evaluated as TRUE, the input will go high. Otherwise, it will be low.
[80]	SL Digital Output A	SL Controller Action. The input will go high whenever the Smart Logic Action [38] Set dig. out. A high is executed. The input will go low whenever the Smart Logic Action [32] Set dig. out. A low is executed.
[81]	SL Digital Output B	SL Controller Action. The input will go high whenever the Smart Logic Action [39] Set dig. out. A high is executed. The input will go low whenever the Smart Logic Action [33] Set dig. out. A low is executed.
[82]	SL Digital Output C	SL Controller Action. The input will go high whenever the Smart Logic Action [40] Set dig. out. A high is executed. The input will go low whenever the Smart Logic Action [34] Set dig. out. A low is executed.
[83]	SL Digital Output D	SL Controller Action. The input will go high whenever the Smart Logic Action [41] Set dig. out. A high is executed. The input will go low whenever the Smart Logic Action [35] Set dig. out. A low is executed.
[84]	SL Digital Output E	SL Controller Action. The input will go high whenever the Smart Logic Action [42] Set dig. out. A high is executed. The input will go low whenever the Smart Logic Action [36] Set dig. out. A low is executed.
[85]	SL Digital Output F	SL Controller Action. The input will go high whenever the Smart Logic Action [43] Set dig. out. A high is executed. The input will go low whenever the Smart Logic Action [37] Set dig. out. A low is executed

8-14 Configurable Control Word CTW		
Option:	Function:	
		Selection of control word bit 10 if it is active low or active high
[0]	None	
[1] *	Profile default	
[2]	CTW Valid, active low	

3.10.3 8-3* FC Port Settings

8-30 Protocol		
Option:	Function:	
[0] *	FC	
[1]	FC MC	Select the protocol for the FC (standard) port.
[2]	Modbus RTU	

8-31 Address		
Range:	Function:	
Application dependent*	[Application dependant]	Enter the address for the FC (standard) port. Valid range: 1 - 126.

8-32 FC Port Baud Rate		
Option:	Function:	
[0]	2400 Baud	Baud rate selection for the FC (standard) port.
[1]	4800 Baud	
[2] *	9600 Baud	
[3]	19200 Baud	
[4]	38400 Baud	
[5]	57600 Baud	
[6]	76800 Baud	
[7]	115200 Baud	

8-33 Parity / Stop Bits		
Option:	Function:	
[0] *	Even Parity, 1 Stop Bit	
[1]	Odd Parity, 1 Stop Bit	
[2]	No Parity, 1 Stop Bit	
[3]	No Parity, 2 Stop Bits	

8-34 Estimated cycle time		
Range:	Function:	
0 ms*	[0 - 1000000 ms]	In a noisy environments, the interface may be blocked by due to overload of bad frames. This parameter specifies the time between two consecutive frames on the network. If the interface does not detect valid frames in that time it flushes the receive buffer.

8-35 Minimum Response Delay		
Range:	Function:	
10 ms*	[Application dependant]	Specify the minimum delay time between receiving a request and transmitting a response. This is used for overcoming modem turnaround delays.

8-36 Max Response Delay		
Range:	Function:	
Application dependent*	[Application dependant]	Specify the maximum permissible delay time between transmitting a request and receiving a response. Exceeding this delay time will cause control word time-out.

8-37 Max Inter-Char Delay		
Range:	Function:	
Application dependent*	[Application dependant]	Specify the maximum permissible time interval between receipt of two bytes. This parameter activates time-out if transmission is interrupted. This parameter is active only when par. 8-30 Protocol is set to FC MC [1] protocol.

3.10.4 8-4* FC MC protocol set

8-40 Telegram selection		
Option:	Function:	
[1] *	Standard telegram 1	Enables use of freely configurable telegrams or standard telegrams for the FC port.
[100]	None	
[101]	PPO 1	
[102]	PPO 2	
[103]	PPO 3	
[104]	PPO 4	
[105]	PPO 5	
[106]	PPO 6	
[107]	PPO 7	
[108]	PPO 8	
[200]	Custom telegram 1	Enables use of freely configurable telegrams or standard telegrams for the FC port.
[202]	Custom telegram 3	

8-41 Parameters for signals		
Option:	Function:	
[0] *	None	This parameter contains a list of signals available for selection in par. 8-42 <i>PCD write configuration</i> and par. 8-43 <i>PCD read configuration</i> .
[302]	Minimum Reference	
[303]	Maximum Reference	
[312]	Catch up/slow Down Value	
[341]	Ramp 1 Ramp up Time	
[342]	Ramp 1 Ramp Down Time	
[351]	Ramp 2 Ramp up Time	
[352]	Ramp 2 Ramp down Time	
[380]	Jog Ramp Time	
[381]	Quick Stop Ramp Time	
[411]	Motor Speed Low Limit [RPM]	
[412]	Motor Speed Low Limit [Hz]	
[413]	Motor Speed High Limit [RPM]	
[414]	Motor Speed High Limit [Hz]	
[416]	Torque Limit Motor Mode	
[417]	Torque Limit Generator Mode	
[590]	Digital & Relay Bus Control	
[593]	Pulse Out #27 Bus Control	
[595]	Pulse Out #29 Bus Control	
[597]	Pulse Out #X30/6 Bus Control	
[653]	Terminal 42 Output Bus Control	
[663]	Terminal X30/8 Bus Control	
[673]	Terminal X45/1 Bus Control	
[683]	Terminal X45/3 Bus Control	
[748]	PCD Feed Forward	
[890]	Bus Jog 1 Speed	
[891]	Bus Jog 2 Speed	
[1472]	Legacy Alarm Word	
[1473]	Legacy Warning Word	
[1474]	Leg. Ext. Status Word	
[1500]	Operating Hours	
[1501]	Running Hours	
[1502]	kWh Counter	
[1600]	Control Word	
[1601]	Reference [Unit]	
[1602]	Reference %	
[1603]	Status Word	
[1605]	Main Actual Value [%]	
[1609]	Custom Readout	
[1610]	Power [kW]	
[1611]	Power [hp]	
[1612]	Motor Voltage	
[1613]	Frequency	
[1614]	Motor Current	
[1615]	Frequency [%]	

8-41 Parameters for signals		
Option:	Function:	
[1616]	Torque [Nm]	
[1617]	Speed [RPM]	
[1618]	Motor Thermal	
[1619]	KTY sensor temperature	
[1620]	Motor Angle	
[1621]	Torque [%] High Res.	
[1622]	Torque [%]	
[1625]	Torque [Nm] High	
[1630]	DC Link Voltage	
[1632]	Brake Energy /s	
[1633]	Brake Energy /2 min	
[1634]	Heatsink Temp.	
[1635]	Inverter Thermal	
[1638]	SL Controller State	
[1639]	Control Card Temp.	
[1650]	External Reference	
[1651]	Pulse Reference	
[1652]	Feedback [Unit]	
[1653]	Digi Pot Reference	
[1657]	Feedback [RPM]	
[1660]	Digital Input	
[1661]	Terminal 53 Switch Setting	
[1662]	Analog Input 53	
[1663]	Terminal 54 Switch Setting	
[1664]	Analog Input 54	
[1665]	Analog Output 42 [mA]	
[1666]	Digital Output [bin]	
[1667]	Freq. Input #29 [Hz]	
[1668]	Freq. Input #33 [Hz]	
[1669]	Pulse Output #27 [Hz]	
[1670]	Pulse Output #29 [Hz]	
[1671]	Relay Output [bin]	
[1672]	Counter A	
[1673]	Counter B	
[1674]	Prec. Stop Counter	
[1675]	Analog In X30/11	
[1676]	Analog In X30/12	
[1677]	Analog Out X30/8 [mA]	
[1678]	Analog Out X45/1 [mA]	
[1679]	Analog Out X45/3 [mA]	
[1680]	Fieldbus CTW 1	
[1682]	Fieldbus REF 1	
[1684]	Comm. Option STW	
[1685]	FC Port CTW 1	
[1686]	FC Port REF 1	
[1690]	Alarm Word	
[1691]	Alarm Word 2	
[1692]	Warning Word	
[1693]	Warning Word 2	
[1694]	Ext. Status Word	
[1860]	Digital Input 2	
[3310]	Synchronization Factor Master (M:S)	

8-41 Parameters for signals		
Option:	Function:	
[3311]	Synchronization Factor Slave (M:S)	
[3401]	PCD 1 Write to MCO	
[3402]	PCD 2 Write to MCO	
[3403]	PCD 3 Write to MCO	
[3404]	PCD 4 Write to MCO	
[3405]	PCD 5 Write to MCO	
[3406]	PCD 6 Write to MCO	
[3407]	PCD 7 Write to MCO	
[3408]	PCD 8 Write to MCO	
[3409]	PCD 9 Write to MCO	
[3410]	PCD 10 Write to MCO	
[3421]	PCD 1 Read from MCO	
[3422]	PCD 2 Read from MCO	
[3423]	PCD 3 Read from MCO	
[3424]	PCD 4 Read from MCO	
[3425]	PCD 5 Read from MCO	
[3426]	PCD 6 Read from MCO	
[3427]	PCD 7 Read from MCO	
[3428]	PCD 8 Read from MCO	
[3429]	PCD 9 Read from MCO	
[3430]	PCD 10 Read from MCO	
[3440]	Digital Inputs	
[3441]	Digital Outputs	
[3450]	Actual Position	
[3451]	Commanded Position	
[3452]	Actual Master Position	
[3453]	Slave Index Position	
[3454]	Master Index Position	
[3455]	Curve Position	
[3456]	Track Error	
[3457]	Synchronizing Error	
[3458]	Actual Velocity	
[3459]	Actual Master Velocity	
[3460]	Synchronizing Status	
[3461]	Axis Status	
[3462]	Program Status	
[3464]	MCO 302 Status	
[3465]	MCO 302 Control	
[3470]	MCO Alarm Word 1	
[3471]	MCO Alarm Word 2	

8-42 PCD write configuration		
Option:	Function:	
[0]	None	Select the parameters to be assigned to PCD's telegrams. The number of available PCDs depends on the telegram type. The values in PCD's will then be written to

8-42 PCD write configuration		
Option:	Function:	
		the selected parameters as data values.
[302]	Minimum Reference	
[303]	Maximum Reference	
[312]	Catch up/slow Down Value	
[341]	Ramp 1 Ramp up Time	
[342]	Ramp 1 Ramp Down Time	
[351]	Ramp 2 Ramp up Time	
[352]	Ramp 2 Ramp down Time	
[380]	Jog Ramp Time	
[381]	Quick Stop Ramp Time	
[411]	Motor Speed Low Limit [RPM]	
[412]	Motor Speed Low Limit [Hz]	
[413]	Motor Speed High Limit [RPM]	
[414]	Motor Speed High Limit [Hz]	
[416]	Torque Limit Motor Mode	
[417]	Torque Limit Generator Mode	
[590]	Digital & Relay Bus Control	
[593]	Pulse Out #27 Bus Control	
[595]	Pulse Out #29 Bus Control	
[597]	Pulse Out #X30/6 Bus Control	
[653]	Terminal 42 Output Bus Control	
[663]	Terminal X30/8 Bus Control	
[673]	Terminal X45/1 Bus Control	
[683]	Terminal X45/3 Bus Control	
[748]	PCD Feed Forward	
[890]	Bus Jog 1 Speed	
[891]	Bus Jog 2 Speed	
[1680]	Fieldbus CTW 1	
[1682]	Fieldbus REF 1	
[1685]	FC Port CTW 1	
[1686]	FC Port REF 1	
[3310]	Synchronization Factor Master (M:S)	
[3311]	Synchronization Factor Slave (M:S)	
[3401]	PCD 1 Write to MCO	
[3402]	PCD 2 Write to MCO	
[3403]	PCD 3 Write to MCO	
[3404]	PCD 4 Write to MCO	
[3405]	PCD 5 Write to MCO	
[3406]	PCD 6 Write to MCO	
[3407]	PCD 7 Write to MCO	
[3408]	PCD 8 Write to MCO	
[3409]	PCD 9 Write to MCO	
[3410]	PCD 10 Write to MCO	

8-43 PCD read configuration		
Option:	Function:	
[0]	None	Select the parameters to be assigned to PCD's of the telegrams. The number of available PCDs depends on the telegram type. PCDs contain the actual data values of the selected parameters.
[1472]	Legacy Alarm Word	
[1473]	Legacy Warning Word	
[1474]	Leg. Ext. Status Word	
[1500]	Operating Hours	
[1501]	Running Hours	
[1502]	kWh Counter	
[1600]	Control Word	
[1601]	Reference [Unit]	
[1602]	Reference %	
[1603]	Status Word	
[1605]	Main Actual Value [%]	
[1609]	Custom Readout	
[1610]	Power [kW]	
[1611]	Power [hp]	
[1612]	Motor Voltage	
[1613]	Frequency	
[1614]	Motor Current	
[1615]	Frequency [%]	
[1616]	Torque [Nm]	
[1617]	Speed [RPM]	
[1618]	Motor Thermal	
[1619]	KTY sensor temperature	
[1620]	Motor Angle	
[1621]	Torque [%] High Res.	
[1622]	Torque [%]	
[1625]	Torque [Nm] High	
[1630]	DC Link Voltage	
[1632]	Brake Energy /s	
[1633]	Brake Energy /2 min	
[1634]	Heatsink Temp.	
[1635]	Inverter Thermal	
[1638]	SL Controller State	
[1639]	Control Card Temp.	
[1650]	External Reference	
[1651]	Pulse Reference	
[1652]	Feedback [Unit]	
[1653]	Digi Pot Reference	
[1657]	Feedback [RPM]	
[1660]	Digital Input	
[1661]	Terminal 53 Switch Setting	
[1662]	Analog Input 53	
[1663]	Terminal 54 Switch Setting	
[1664]	Analog Input 54	
[1665]	Analog Output 42 [mA]	
[1666]	Digital Output [bin]	

8-43 PCD read configuration		
Option:	Function:	
[1667]	Freq. Input #29 [Hz]	
[1668]	Freq. Input #33 [Hz]	
[1669]	Pulse Output #27 [Hz]	
[1670]	Pulse Output #29 [Hz]	
[1671]	Relay Output [bin]	
[1672]	Counter A	
[1673]	Counter B	
[1674]	Prec. Stop Counter	
[1675]	Analog In X30/11	
[1676]	Analog In X30/12	
[1677]	Analog Out X30/8 [mA]	
[1678]	Analog Out X45/1 [mA]	
[1679]	Analog Out X45/3 [mA]	
[1684]	Comm. Option STW	
[1690]	Alarm Word	
[1691]	Alarm Word 2	
[1692]	Warning Word	
[1693]	Warning Word 2	
[1694]	Ext. Status Word	
[1860]	Digital Input 2	
[3421]	PCD 1 Read from MCO	
[3422]	PCD 2 Read from MCO	
[3423]	PCD 3 Read from MCO	
[3424]	PCD 4 Read from MCO	
[3425]	PCD 5 Read from MCO	
[3426]	PCD 6 Read from MCO	
[3427]	PCD 7 Read from MCO	
[3428]	PCD 8 Read from MCO	
[3429]	PCD 9 Read from MCO	
[3430]	PCD 10 Read from MCO	
[3440]	Digital Inputs	
[3441]	Digital Outputs	
[3450]	Actual Position	
[3451]	Commanded Position	
[3452]	Actual Master Position	
[3453]	Slave Index Position	
[3454]	Master Index Position	
[3455]	Curve Position	
[3456]	Track Error	
[3457]	Synchronizing Error	
[3458]	Actual Velocity	
[3459]	Actual Master Velocity	
[3460]	Synchronizing Status	
[3461]	Axis Status	
[3462]	Program Status	
[3464]	MCO 302 Status	
[3465]	MCO 302 Control	
[3470]	MCO Alarm Word 1	
[3471]	MCO Alarm Word 2	

3.10.5 8-5* Digital/Bus

Parameters for configuring the control word Digital/Bus merging.

3

NOTE

These parameters are active only when par. 8-01 *Control Site* is set to [0] *Digital and control word*.

8-50 Coasting Select		
Option:	Function:	
		Select control of the coasting function via the terminals (digital input) and/or via the bus.
[0]	Digital input	Activates Start command via a digital input.
[1]	Bus	Activates Start command via the serial communication port or fieldbus option.
[2]	Logic AND	Activates Start command via the fieldbus/serial communication port, AND additionally via one of the digital inputs.
[3] *	Logic OR	Activates Start command via the fieldbus/serial communication port OR via one of the digital inputs.

8-51 Quick Stop Select		
Option:	Function:	
[0]	Digital Input	
[1]	Bus	
[2]	Logic AND	
[3] *	Logic OR	

Select control of the Quick Stop function via the terminals (digital input) and/or via the bus.

8-52 DC Brake Select		
Option:	Function:	
		Select control of the DC brake via the terminals (digital input) and/or via the fieldbus.
[0]	Digital input	Activates Start command via a digital input.
[1]	Bus	Activates Start command via the serial communication port or fieldbus option.
[2]	Logic AND	Activates Start command via the fieldbus/serial communication port, AND additionally via one of the digital inputs.
[3] *	Logic OR	Activates Start command via the fieldbus/serial communication port OR via one of the digital inputs.

8-53 Start Select		
Option:	Function:	
		Select control of the frequency converter start function via the terminals (digital input) and/or via the fieldbus.
[0]	Digital input	Activates Start command via a digital input.
[1]	Bus	Activates Start command via the serial communication port or fieldbus option.
[2]	Logic AND	Activates Start command via the fieldbus/serial communication port, AND additionally via one of the digital inputs.
[3] *	Logic OR	Activates Start command via the fieldbus/serial communication port OR via one of the digital inputs.

8-54 Reversing Select		
Option:	Function:	
[0]	Digital input	Select control of the frequency converter reverse function via the terminals (digital input) and/or via the fieldbus.
[1]	Bus	Activates the Reverse command via the serial communication port or fieldbus option.
[2]	Logic AND	Activates the Reverse command via the fieldbus/serial communication port, AND additionally via one of the digital inputs.
[3] *	Logic OR	Activates the Reverse command via the fieldbus/serial communication port OR via one of the digital inputs.

8-55 Set-up Select		
Option:	Function:	
		Select control of the frequency converter set-up selection via the terminals (digital input) and/or via the fieldbus.
[0]	Digital input	Activates the set-up selection via a digital input.
[1]	Bus	Activates the set-up selection via the serial communication port or fieldbus option.
[2]	Logic AND	Activates the set-up selection via the fieldbus/serial communication port, AND additionally via one of the digital inputs.
[3] *	Logic OR	Activate the set-up selection via the fieldbus/serial communication port OR via one of the digital inputs.

8-56 Preset Reference Select		
Option:	Function:	
		Select control of the frequency converter Preset Reference selection via the terminals (digital input) and/or via the fieldbus.
[0]	Digital input	Activates Preset Reference selection via a digital input.
[1]	Bus	Activates Preset Reference selection via the serial communication port or fieldbus option.
[2]	Logic AND	Activates Preset Reference selection via the fieldbus/serial communication port, AND additionally via one of the digital inputs.
[3] *	Logic OR	Activates the Preset Reference selection via the fieldbus/serial communication port OR via one of the digital inputs.

8-57 Profdrive OFF2 Select		
Select control of the drive OFF2 selection via the terminals (digital input) and/or via the fieldbus. This parameter is active only when par. 8-01 Control Site is set to [0] Digital and ctrl. word and par. 8-10 is set to [1] Profdrive profile.		
Option:	Function:	
[0]	Digital input	
[1]	Bus	
[2]	Logic AND	
[3] *	Logic OR	

8-58 Profdrive OFF3 Select		
Select control of the drive OFF3 selection via the terminals (digital input) and/or via the fieldbus. This parameter is active only when par. 8-01 Control Site is set to [0] Digital and control word and par. 8-10 is set to [1] Profdrive profile.		
Option:	Function:	
[0]	Digital input	
[1]	Bus	
[2]	Logic AND	
[3] *	Logic OR	

3.10.6 8-8* FC Port Diagnostics

These parameters are used for monitoring the Bus communication via the Port.

8-80 Bus Message Count		
Range:	Function:	
0 N/A*	[0 - 0 N/A]	This parameter shows the number of valid telegrams detected on the bus.

8-81 Bus Error Count		
Range:	Function:	
0 N/A*	[0 - 0 N/A]	This parameter shows the number of telegrams with faults (e.g. CRC fault), detected on the bus.

8-82 Slave Messages Rcvd		
Range:	Function:	
0 N/A*	[0 - 0 N/A]	This parameter shows the number of valid telegrams addressed to the slave, sent by the frequency converter.

8-83 Slave Error Count		
Range:	Function:	
0 N/A*	[0 - 0 N/A]	This parameter shows the number of error telegrams, which could not be executed by the frequency converter.

3.10.7 8-9* Bus Jog

8-90 Bus Jog 1 Speed		
Range:	Function:	
100 RPM*	[Application dependant]	Enter the jog speed. This is a fixed jog speed activated via the serial port or fieldbus option.

8-91 Bus Jog 2 Speed		
Range:	Function:	
200 RPM*	[Application dependant]	Enter the jog speed. This is a fixed jog speed activated via the serial port or fieldbus option.

3.11 Parameters: 9-** Profibus

9-00 Setpoint		
Range:	Function:	
0* [0 - 65535]	This parameter receives cyclical reference from a Master Class 2. If the control priority is set to Master Class 2, the reference for the frequency converter is taken from this parameter, whereas the cyclical reference will be ignored.	

9-07 Actual Value		
Range:	Function:	
0* [0 - 65535]	This parameter delivers the MAV for a Master Class 2. The parameter is valid if the control priority is set to Master Class 2.	

9-15 PCD Write Configuration		
Array [10]		
Option:	Function:	
	Select the parameters to be assigned to PCD 3 to 10 of the telegrams. The number of available PCDs depends on the telegram type. The values in PCD 3 to 10 will then be written to the selected parameters as data values. Alternatively, specify a standard Profibus telegram in par. 9-22 <i>Telegram Selection</i> .	
[0] *	None	
[302]	Minimum Reference	
[303]	Maximum Reference	
[312]	Catch up/slow Down Value	
[341]	Ramp 1 Ramp up Time	
[342]	Ramp 1 Ramp Down Time	
[351]	Ramp 2 Ramp up Time	
[352]	Ramp 2 Ramp down Time	
[380]	Jog Ramp Time	
[381]	Quick Stop Ramp Time	
[411]	Motor Speed Low Limit [RPM]	
[412]	Motor Speed Low Limit [Hz]	
[413]	Motor Speed High Limit [RPM]	
[414]	Motor Speed High Limit [Hz]	
[416]	Torque Limit Motor Mode	
[417]	Torque Limit Generator Mode	
[590]	Digital & Relay Bus Control	
[593]	Pulse Out #27 Bus Control	
[595]	Pulse Out #29 Bus Control	
[597]	Pulse Out #X30/6 Bus Control	
[653]	Terminal 42 Output Bus Control	

9-15 PCD Write Configuration		
Array [10]		
Option:	Function:	
[663]	Terminal X30/8 Bus Control	
[673]	Terminal X45/1 Bus Control	
[683]	Terminal X45/3 Bus Control	
[748]	PCD Feed Forward	
[890]	Bus Jog 1 Speed	
[891]	Bus Jog 2 Speed	
[1680]	Fieldbus CTW 1	
[1682]	Fieldbus REF 1	
[1685]	FC Port CTW 1	
[1686]	FC Port REF 1	
[3310]	Synchronization Factor Master (M:S)	
[3311]	Synchronization Factor Slave (M:S)	
[3401]	PCD 1 Write to MCO	
[3402]	PCD 2 Write to MCO	
[3403]	PCD 3 Write to MCO	
[3404]	PCD 4 Write to MCO	
[3405]	PCD 5 Write to MCO	
[3406]	PCD 6 Write to MCO	
[3407]	PCD 7 Write to MCO	
[3408]	PCD 8 Write to MCO	
[3409]	PCD 9 Write to MCO	
[3410]	PCD 10 Write to MCO	

9-16 PCD Read Configuration		
Array [10]		
Option:	Function:	
	Select the parameters to be assigned to PCD 3 to 10 of the telegrams. The number of available PCDs depends on the telegram type. PCDs 3 to 10 contain the actual data values of the selected parameters. For standard Profibus telegrams, see par. 9-22 <i>Telegram Selection</i> .	
[0] *	None	
[1472]	Legacy Alarm Word	
[1473]	Legacy Warning Word	
[1474]	Leg. Ext. Status Word	
[1500]	Operating Hours	
[1501]	Running Hours	
[1502]	kWh Counter	
[1600]	Control Word	
[1601]	Reference [Unit]	
[1602]	Reference %	
[1603]	Status Word	
[1605]	Main Actual Value [%]	
[1609]	Custom Readout	

9-16 PCD Read Configuration		
Array [10]		
Option:	Function:	
[1610]	Power [kW]	
[1611]	Power [hp]	
[1612]	Motor Voltage	
[1613]	Frequency	
[1614]	Motor Current	
[1615]	Frequency [%]	
[1616]	Torque [Nm]	
[1617]	Speed [RPM]	
[1618]	Motor Thermal	
[1619]	KTY sensor temperature	
[1620]	Motor Angle	
[1621]	Torque [%] High Res.	
[1622]	Torque [%]	
[1625]	Torque [Nm] High	
[1630]	DC Link Voltage	
[1632]	Brake Energy /s	
[1633]	Brake Energy /2 min	
[1634]	Heatsink Temp.	
[1635]	Inverter Thermal	
[1638]	SL Controller State	
[1639]	Control Card Temp.	
[1650]	External Reference	
[1651]	Pulse Reference	
[1652]	Feedback [Unit]	
[1653]	Digi Pot Reference	
[1657]	Feedback [RPM]	
[1660]	Digital Input	
[1661]	Terminal 53 Switch Setting	
[1662]	Analog Input 53	
[1663]	Terminal 54 Switch Setting	
[1664]	Analog Input 54	
[1665]	Analog Output 42 [mA]	
[1666]	Digital Output [bin]	
[1667]	Freq. Input #29 [Hz]	
[1668]	Freq. Input #33 [Hz]	
[1669]	Pulse Output #27 [Hz]	
[1670]	Pulse Output #29 [Hz]	
[1671]	Relay Output [bin]	
[1672]	Counter A	
[1673]	Counter B	
[1674]	Prec. Stop Counter	
[1675]	Analog In X30/11	
[1676]	Analog In X30/12	
[1677]	Analog Out X30/8 [mA]	
[1678]	Analog Out X45/1 [mA]	
[1679]	Analog Out X45/3 [mA]	
[1684]	Comm. Option STW	
[1690]	Alarm Word	
[1691]	Alarm Word 2	
[1692]	Warning Word	
[1693]	Warning Word 2	

9-16 PCD Read Configuration		
Array [10]		
Option:	Function:	
[1694]	Ext. Status Word	
[1860]	Digital Input 2	
[3421]	PCD 1 Read from MCO	
[3422]	PCD 2 Read from MCO	
[3423]	PCD 3 Read from MCO	
[3424]	PCD 4 Read from MCO	
[3425]	PCD 5 Read from MCO	
[3426]	PCD 6 Read from MCO	
[3427]	PCD 7 Read from MCO	
[3428]	PCD 8 Read from MCO	
[3429]	PCD 9 Read from MCO	
[3430]	PCD 10 Read from MCO	
[3440]	Digital Inputs	
[3441]	Digital Outputs	
[3450]	Actual Position	
[3451]	Commanded Position	
[3452]	Actual Master Position	
[3453]	Slave Index Position	
[3454]	Master Index Position	
[3455]	Curve Position	
[3456]	Track Error	
[3457]	Synchronizing Error	
[3458]	Actual Velocity	
[3459]	Actual Master Velocity	
[3460]	Synchronizing Status	
[3461]	Axis Status	
[3462]	Program Status	
[3464]	MCO 302 Status	
[3465]	MCO 302 Control	
[3470]	MCO Alarm Word 1	
[3471]	MCO Alarm Word 2	

9-18 Node Address		
Range:	Function:	
126 N/A*	[Application dependant]	Enter the station address in this parameter or alternatively in the hardware switch. In order to adjust the station address in par. 9-18 <i>Node Address</i> , the hardware switch must be set to 126 or 127 (i.e. all switches set to 'on'). Otherwise this parameter will display the actual setting of the switch.

9-22 Telegram Selection		
Displays the Profibus telegram configuration.		
Option:	Function:	
[1]	Standard telegram 1	
[100] *	None	
[101]	PPO 1	
[102]	PPO 2	
[103]	PPO 3	
[104]	PPO 4	

9-22 Telegram Selection		
Displays the Profibus telegram configuration.		
Option:		Function:
[105]	PPO 5	
[106]	PPO 6	
[107]	PPO 7	
[108] *	PPO 8	Read only.
[200]	Custom telegram 1	
[202]	Custom telegram 3	

9-23 Parameters for Signals		
Array [1000]		
Read only		
Option:		Function:
		This parameter contains a list of signals available for selection in par. 9-15 <i>PCD Write Configuration</i> and par. 9-16 <i>PCD Read Configuration</i> .
[0] *	None	
[302]	Minimum Reference	
[303]	Maximum Reference	
[312]	Catch up/slow Down Value	
[341]	Ramp 1 Ramp up Time	
[342]	Ramp 1 Ramp Down Time	
[351]	Ramp 2 Ramp up Time	
[352]	Ramp 2 Ramp down Time	
[380]	Jog Ramp Time	
[381]	Quick Stop Ramp Time	
[411]	Motor Speed Low Limit [RPM]	
[412]	Motor Speed Low Limit [Hz]	
[413]	Motor Speed High Limit [RPM]	
[414]	Motor Speed High Limit [Hz]	
[416]	Torque Limit Motor Mode	
[417]	Torque Limit Generator Mode	
[590]	Digital & Relay Bus Control	
[593]	Pulse Out #27 Bus Control	
[595]	Pulse Out #29 Bus Control	
[597]	Pulse Out #X30/6 Bus Control	
[653]	Terminal 42 Output Bus Control	
[663]	Terminal X30/8 Bus Control	
[673]	Terminal X45/1 Bus Control	
[683]	Terminal X45/3 Bus Control	
[748]	PCD Feed Forward	
[890]	Bus Jog 1 Speed	
[891]	Bus Jog 2 Speed	
[1472]	Legacy Alarm Word	
[1473]	Legacy Warning Word	
[1474]	Leg. Ext. Status Word	
[1500]	Operating Hours	
[1501]	Running Hours	
[1502]	kWh Counter	

9-23 Parameters for Signals		
Array [1000]		
Read only		
Option:		Function:
[1600]	Control Word	
[1601]	Reference [Unit]	
[1602]	Reference %	
[1603]	Status Word	
[1605]	Main Actual Value [%]	
[1609]	Custom Readout	
[1610]	Power [kW]	
[1611]	Power [hp]	
[1612]	Motor Voltage	
[1613]	Frequency	
[1614]	Motor Current	
[1615]	Frequency [%]	
[1616]	Torque [Nm]	
[1617]	Speed [RPM]	
[1618]	Motor Thermal	
[1619]	KTY sensor temperature	
[1620]	Motor Angle	
[1621]	Torque [%] High Res.	
[1622]	Torque [%]	
[1625]	Torque [Nm] High	
[1630]	DC Link Voltage	
[1632]	Brake Energy /s	
[1633]	Brake Energy /2 min	
[1634]	Heatsink Temp.	
[1635]	Inverter Thermal	
[1638]	SL Controller State	
[1639]	Control Card Temp.	
[1650]	External Reference	
[1651]	Pulse Reference	
[1652]	Feedback [Unit]	
[1653]	Digi Pot Reference	
[1657]	Feedback [RPM]	
[1660]	Digital Input	
[1661]	Terminal 53 Switch Setting	
[1662]	Analog Input 53	
[1663]	Terminal 54 Switch Setting	
[1664]	Analog Input 54	
[1665]	Analog Output 42 [mA]	
[1666]	Digital Output [bin]	
[1667]	Freq. Input #29 [Hz]	
[1668]	Freq. Input #33 [Hz]	
[1669]	Pulse Output #27 [Hz]	
[1670]	Pulse Output #29 [Hz]	
[1671]	Relay Output [bin]	
[1672]	Counter A	
[1673]	Counter B	
[1674]	Prec. Stop Counter	
[1675]	Analog In X30/11	
[1676]	Analog In X30/12	
[1677]	Analog Out X30/8 [mA]	

9-23 Parameters for Signals		
Array [1000]		
Read only		
Option:	Function:	
[1678]	Analog Out X45/1 [mA]	
[1679]	Analog Out X45/3 [mA]	
[1680]	Fieldbus CTW 1	
[1682]	Fieldbus REF 1	
[1684]	Comm. Option STW	
[1685]	FC Port CTW 1	
[1686]	FC Port REF 1	
[1690]	Alarm Word	
[1691]	Alarm Word 2	
[1692]	Warning Word	
[1693]	Warning Word 2	
[1694]	Ext. Status Word	
[1860]	Digital Input 2	
[3310]	Synchronization Factor Master (M:S)	
[3311]	Synchronization Factor Slave (M:S)	
[3401]	PCD 1 Write to MCO	
[3402]	PCD 2 Write to MCO	
[3403]	PCD 3 Write to MCO	
[3404]	PCD 4 Write to MCO	
[3405]	PCD 5 Write to MCO	
[3406]	PCD 6 Write to MCO	
[3407]	PCD 7 Write to MCO	
[3408]	PCD 8 Write to MCO	
[3409]	PCD 9 Write to MCO	
[3410]	PCD 10 Write to MCO	
[3421]	PCD 1 Read from MCO	
[3422]	PCD 2 Read from MCO	
[3423]	PCD 3 Read from MCO	
[3424]	PCD 4 Read from MCO	
[3425]	PCD 5 Read from MCO	
[3426]	PCD 6 Read from MCO	
[3427]	PCD 7 Read from MCO	
[3428]	PCD 8 Read from MCO	
[3429]	PCD 9 Read from MCO	
[3430]	PCD 10 Read from MCO	
[3440]	Digital Inputs	
[3441]	Digital Outputs	
[3450]	Actual Position	
[3451]	Commanded Position	
[3452]	Actual Master Position	
[3453]	Slave Index Position	
[3454]	Master Index Position	
[3455]	Curve Position	
[3456]	Track Error	
[3457]	Synchronizing Error	
[3458]	Actual Velocity	
[3459]	Actual Master Velocity	
[3460]	Synchronizing Status	

9-23 Parameters for Signals		
Array [1000]		
Read only		
Option:	Function:	
[3461]	Axis Status	
[3462]	Program Status	
[3464]	MCO 302 Status	
[3465]	MCO 302 Control	
[3470]	MCO Alarm Word 1	
[3471]	MCO Alarm Word 2	

9-27 Parameter Edit		
Option:	Function:	
	Parameters can be edited via Profibus, the standard RS485 interface, or the LCP.	
[0]	Disabled	Disables editing via Profibus.
[1] *	Enabled	Enables editing via Profibus.

9-28 Process Control		
Option:	Function:	
	Process control (setting of Control Word, speed reference, and process data) is possible via either Profibus or standard fieldbus but not both simultaneously. Local control is always possible via the LCP. Control via process control is possible via either terminals or fieldbus depending on the settings in par. 8-50 <i>Coasting Select</i> to par. 8-56 <i>Preset Reference Select</i> .	
[0]	Disable	Disables process control via Profibus, and enables process control via standard fieldbus or Profibus Master class 2.
[1] *	Enable cyclic master	Enables process control via Profibus Master Class 1, and disables process control via standard fieldbus or Profibus Master class 2.

9-44 Fault Message Counter		
Range:	Function:	
0*	[0 - 65535]	This parameter displays the number of error events stored in par. 9-45 <i>Fault Code</i> and par. 9-47 <i>Fault Number</i> . The maximum buffer capacity is eight error events. The buffer and counter are set to 0 upon reset or power-up.

9-45 Fault Code		
Range:	Function:	
0*	[0 - 0]	This buffer contains the alarm word for all alarms and warnings that have occurred since last reset or power-up. The maximum buffer capacity is eight error events.

9-47 Fault Number		
Range:	Function:	
0*	[0 - 0]	This buffer contains the alarm number (e.g. 2 for live zero error, 4 for mains phase loss) for all alarms and warnings that have occurred since last reset or power-up. The maximum buffer capacity is eight error events.

9-52 Fault Situation Counter		
Range:	Function:	
0*	[0 - 1000]	This parameter displays the number of error events which have occurred since last reset of power-up.

9-53 Profibus Warning Word		
Range:	Function:	
0 N/A*	[0 - 65535 N/A]	This parameter displays Profibus communication warnings. Please refer to the <i>Profibus Operating Instructions</i> for further information.

Read only

Bit:	Meaning:
0	Connection with DP-master is not ok
1	Not used
2	FDLNDL (Fieldbus Data link Layer) is not ok
3	Clear data command received
4	Actual value is not updated
5	Baudrate search
6	PROFIBUS ASIC is not transmitting
7	Initialisation of PROFIBUS is not ok
8	Frequency converter is tripped
9	Internal CAN error
10	Wrong configuration data from PLC
11	Wrong ID sent by PLC
12	Internal error occurred
13	Not configured
14	Timeout active
15	Warning 34 active

9-63 Actual Baud Rate		
Option:	Function:	
		This parameter displays the actual Profibus baud rate. The Profibus Master automatically sets the baud rate.
[0]	9,6 kbit/s	
[1]	19,2 kbit/s	
[2]	93,75 kbit/s	
[3]	187,5 kbit/s	
[4]	500 kbit/s	
[6]	1500 kbit/s	
[7]	3000 kbit/s	

9-63 Actual Baud Rate		
Option:	Function:	
[8]	6000 kbit/s	
[9]	12000 kbit/s	
[10]	31,25 kbit/s	
[11]	45,45 kbit/s	
[255] *	No baudrate found	

9-64 Device Identification		
Range:	Function:	
0*	[0 - 0]	This parameter displays the device identification. Please refer to the <i>Operating Instructions for Profibus</i> , MG.33.CX.YY for further explanation.

9-65 Profile Number		
Range:	Function:	
0 N/A*	[0 - 0 N/A]	This parameter contains the profile identification. Byte 1 contains the profile number and byte 2 the version number of the profile.

NOTE

This parameter is not visible via LCP.

9-67 Control Word 1		
Range:	Function:	
0*	[0 - 65535]	This parameter accepts the Control Word from a Master Class 2 in the same format as PCD 1.

9-68 Status Word 1		
Range:	Function:	
0*	[0 - 65535]	This parameter delivers the Status Word for a Master Class 2 in the same format as PCD 2.

9-70 Programming Set-up		
Option:	Function:	
		Select the set-up to be edited.
[0]	Factory setup	Uses default data. This option can be used as a data source to return the other set-ups to a known state.
[1]	Set-up 1	Edits Set-up 1.
[2]	Set-up 2	Edits Set-up 2.
[3]	Set-up 3	Edits Set-up 3.
[4]	Set-up 4	Edits Set-up 4.
[9] *	Active Set-up	Follows the active set-up selected in par. 0-10 <i>Active Set-up</i> .

This parameter is unique to LCP and fieldbuses. See also par. 0-11 *Programming Set-up*.

9-71 Profibus Save Data Values		
Option:	Function:	
		Parameter values changed via Profibus are not automatically stored in non-volatile memory. Use this parameter to activate a function that stores parameter values in the EEPROM non-volatile memory, so changed parameter values will be retained at power-down.
[0] *	Off	Deactivates the non-volatile storage function.
[1]	Store all setups	Stores all parameter values for all set-ups in the non-volatile memory. The selection returns to <i>Off</i> [0] when all parameter values have been stored.
[2]	Store all setups	Stores all parameter values for all set-ups in the non-volatile memory. The selection returns to <i>Off</i> [0] when all parameter values have been stored.

9-72 ProfibusDriveReset		
Option:	Function:	
[0] *	No action	
[1]	Power-on reset	Resets frequency converter upon power-up, as for power-cycle.
[3]	Comm option reset	Resets the Profibus option only, useful after changing certain settings in par. group 9-**, e.g. par. 9-18 <i>Node Address</i> . When reset, the frequency converter disappears from the fieldbus, which may cause a communication error from the master.

9-75 DO Identification		
Range:	Function:	
0*	[0 - 65535]	Provides information about the DO (Drive Object).

9-80 Defined Parameters (1)		
Array [116] No LCP access Read only		
Range:	Function:	
0 N/A*	[0 - 9999 N/A]	This parameter displays a list of all the defined frequency converter parameters available for Profibus.

9-81 Defined Parameters (2)		
Array [116] No LCP access Read only		
Range:	Function:	
0 N/A*	[0 - 9999 N/A]	This parameter displays a list of all the defined frequency converter parameters available for Profibus.

9-82 Defined Parameters (3)		
Array [116] No LCP access Read only		
Range:	Function:	
0 N/A*	[0 - 9999 N/A]	This parameter displays a list of all the defined frequency converter parameters available for Profibus.

9-83 Defined Parameters (4)		
Array [116] No LCP access Read only		
Range:	Function:	
0 N/A*	[0 - 9999 N/A]	This parameter displays a list of all the defined frequency converter parameters available for Profibus.

9-84 Defined Parameters (5)		
Range:	Function:	
0*	[0 - 9999]	This parameter displays a list of all the defined frequency converter parameters available for Profibus.

9-90 Changed Parameters (1)		
Array [116] No LCP access Read only		
Range:	Function:	
0 N/A*	[0 - 9999 N/A]	This parameter displays a list of all the frequency converter parameters deviating from default setting.

9-91 Changed Parameters (2)		
Array [116] No LCP access Read only		
Range:	Function:	
0 N/A*	[0 - 9999 N/A]	This parameter displays a list of all the frequency converter parameters deviating from default setting.

9-92 Changed Parameters (3)		
Array [116] No LCP access Read only		
Range:	Function:	
0 N/A*	[0 - 9999 N/A]	This parameter displays a list of all the frequency converter parameters deviating from default setting.

9-94 Changed Parameters (5)		
Array [116] No LCP Address Read only		
Range:		Function:
0 N/A*	[0 - 9999 N/A]	This parameter displays a list of all the frequency converter parameters deviating from default setting.

3.12 Parameters: 10-** DeviceNet CAN Fieldbus

3.12.1 10-0* Common Settings

10-00 CAN Protocol		
Option:		Function:
[0]	CANopen	
[1] *	DeviceNet	View the active CAN protocol.

NOTE

The options depend on installed option.

10-01 Baud Rate Select		
Select the fieldbus transmission speed. The selection must correspond to the transmission speed of the master and the other fieldbus nodes.		
Option:		Function:
[16]	10 Kbps	
[17]	20 Kbps	
[18]	50 Kbps	
[19]	100 Kbps	
[20] *	125 Kbps	
[21]	250 Kbps	
[22]	500 Kbps	

10-02 MAC ID		
Range:		Function:
Application dependent*	[Application dependant]	Selection of station address. Every station connected to the same network must have an unambiguous address.

10-05 Readout Transmit Error Counter		
Range:		Function:
0 N/A*	[0 - 255 N/A]	View the number of CAN control transmission errors since the last power-up.

10-06 Readout Receive Error Counter		
Range:		Function:
0 N/A*	[0 - 255 N/A]	View the number of CAN control receipt errors since the last power-up.

10-07 Readout Bus Off Counter		
Range:		Function:
0*	[0 - 255]	View the number of Bus Off events since the last power-up.

3.12.2 10-1* DeviceNet

Parameters specific to the DeviceNet fieldbus.

10-10 Process Data Type Selection		
Option:		Function:
		Select the Instance (telegram) for data transmission. The Instances available are dependent upon the setting of par. 8-10 <i>Control Profile</i> . When par. 8-10 <i>Control Profile</i> is set to [0] <i>FC profile</i> , par. 10-10 <i>Process Data Type Selection</i> options [0] and [1] are available. When par. 8-10 <i>Control Profile</i> is set to [5] <i>ODVA</i> , par. 10-10 <i>Process Data Type Selection</i> options [2] and [3] are available. Instances 100/150 and 101/151 are Danfoss-specific. Instances 20/70 and 21/71 are ODVA-specific AC Drive profiles. For guidelines in telegram selection, please refer to the DeviceNet Operating Instructions. Note that a change to this parameter will be executed immediately.
[0] *	INSTANCE 100/150	
[1]	INSTANCE 101/151	
[2]	INSTANCE 20/70	
[3]	INSTANCE 21/71	

10-11 Process Data Config Write		
Select the process write data for I/O Assembly Instances 101/151. Elements [2] and [3] of this array can be selected. Elements [0] and [1] of the array are fixed.		
Option:		Function:
[0]	None	
[302]	Minimum Reference	
[303]	Maximum Reference	
[312]	Catch up/slow Down Value	
[341]	Ramp 1 Ramp up Time	
[342]	Ramp 1 Ramp Down Time	
[351]	Ramp 2 Ramp up Time	
[352]	Ramp 2 Ramp down Time	
[380]	Jog Ramp Time	
[381]	Quick Stop Ramp Time	
[411]	Motor Speed Low Limit [RPM]	
[412]	Motor Speed Low Limit [Hz]	
[413]	Motor Speed High Limit [RPM]	

10-11 Process Data Config Write		
Select the process write data for I/O Assembly Instances 101/151. Elements [2] and [3] of this array can be selected. Elements [0] and [1] of the array are fixed.		
Option:	Function:	
[414]	Motor Speed High Limit [Hz]	
[416]	Torque Limit Motor Mode	
[417]	Torque Limit Generator Mode	
[590]	Digital & Relay Bus Control	
[593]	Pulse Out #27 Bus Control	
[595]	Pulse Out #29 Bus Control	
[597]	Pulse Out #X30/6 Bus Control	
[653]	Terminal 42 Output Bus Control	
[663]	Terminal X30/8 Bus Control	
[673]	Terminal X45/1 Bus Control	
[683]	Terminal X45/3 Bus Control	
[748]	PCD Feed Forward	
[890]	Bus Jog 1 Speed	
[891]	Bus Jog 2 Speed	
[1680]	Fieldbus CTW 1	
[1682]	Fieldbus REF 1	
[1685]	FC Port CTW 1	
[1686]	FC Port REF 1	
[3310]	Synchronization Factor Master (M:S)	
[3311]	Synchronization Factor Slave (M:S)	
[3401]	PCD 1 Write to MCO	
[3402]	PCD 2 Write to MCO	
[3403]	PCD 3 Write to MCO	
[3404]	PCD 4 Write to MCO	
[3405]	PCD 5 Write to MCO	
[3406]	PCD 6 Write to MCO	
[3407]	PCD 7 Write to MCO	
[3408]	PCD 8 Write to MCO	
[3409]	PCD 9 Write to MCO	
[3410]	PCD 10 Write to MCO	

10-12 Process Data Config Read		
Select the process read data for I/O Assembly Instances 101/151. Elements [2] and [3] of this array can be selected. Elements [0] and [1] of the array are fixed.		
Option:	Function:	
[0] *	None	
[1472]	Legacy Alarm Word	
[1473]	Legacy Warning Word	
[1474]	Leg. Ext. Status Word	
[1500]	Operating Hours	
[1501]	Running Hours	
[1502]	kWh Counter	
[1600]	Control Word	
[1601]	Reference [Unit]	
[1602]	Reference %	
[1603]	Status Word	
[1605]	Main Actual Value [%]	

10-12 Process Data Config Read		
Select the process read data for I/O Assembly Instances 101/151. Elements [2] and [3] of this array can be selected. Elements [0] and [1] of the array are fixed.		
Option:	Function:	
[1609]	Custom Readout	
[1610]	Power [kW]	
[1611]	Power [hp]	
[1612]	Motor Voltage	
[1613]	Frequency	
[1614]	Motor Current	
[1615]	Frequency [%]	
[1616]	Torque [Nm]	
[1617]	Speed [RPM]	
[1618]	Motor Thermal	
[1619]	KTY sensor temperature	
[1620]	Motor Angle	
[1621]	Torque [%] High Res.	
[1622]	Torque [%]	
[1625]	Torque [Nm] High	
[1630]	DC Link Voltage	
[1632]	Brake Energy /s	
[1633]	Brake Energy /2 min	
[1634]	Heatsink Temp.	
[1635]	Inverter Thermal	
[1638]	SL Controller State	
[1639]	Control Card Temp.	
[1650]	External Reference	
[1651]	Pulse Reference	
[1652]	Feedback [Unit]	
[1653]	Digi Pot Reference	
[1657]	Feedback [RPM]	
[1660]	Digital Input	
[1661]	Terminal 53 Switch Setting	
[1662]	Analog Input 53	
[1663]	Terminal 54 Switch Setting	
[1664]	Analog Input 54	
[1665]	Analog Output 42 [mA]	
[1666]	Digital Output [bin]	
[1667]	Freq. Input #29 [Hz]	
[1668]	Freq. Input #33 [Hz]	
[1669]	Pulse Output #27 [Hz]	
[1670]	Pulse Output #29 [Hz]	
[1671]	Relay Output [bin]	
[1672]	Counter A	
[1673]	Counter B	
[1674]	Prec. Stop Counter	
[1675]	Analog In X30/11	
[1676]	Analog In X30/12	
[1677]	Analog Out X30/8 [mA]	
[1678]	Analog Out X45/1 [mA]	
[1679]	Analog Out X45/3 [mA]	
[1684]	Comm. Option STW	
[1690]	Alarm Word	

10-12 Process Data Config Read		
Select the process read data for I/O Assembly Instances 101/151. Elements [2] and [3] of this array can be selected. Elements [0] and [1] of the array are fixed.		
Option:		Function:
[1691]	Alarm Word 2	
[1692]	Warning Word	
[1693]	Warning Word 2	
[1694]	Ext. Status Word	
[1860]	Digital Input 2	
[3421]	PCD 1 Read from MCO	
[3422]	PCD 2 Read from MCO	
[3423]	PCD 3 Read from MCO	
[3424]	PCD 4 Read from MCO	
[3425]	PCD 5 Read from MCO	
[3426]	PCD 6 Read from MCO	
[3427]	PCD 7 Read from MCO	
[3428]	PCD 8 Read from MCO	
[3429]	PCD 9 Read from MCO	
[3430]	PCD 10 Read from MCO	
[3440]	Digital Inputs	
[3441]	Digital Outputs	
[3450]	Actual Position	
[3451]	Commanded Position	
[3452]	Actual Master Position	
[3453]	Slave Index Position	
[3454]	Master Index Position	
[3455]	Curve Position	
[3456]	Track Error	
[3457]	Synchronizing Error	
[3458]	Actual Velocity	
[3459]	Actual Master Velocity	
[3460]	Synchronizing Status	
[3461]	Axis Status	
[3462]	Program Status	
[3464]	MCO 302 Status	
[3465]	MCO 302 Control	
[3470]	MCO Alarm Word 1	
[3471]	MCO Alarm Word 2	

10-13 Warning Parameter																																				
Range:		Function:																																		
0*	[0 - 65535]	View a DeviceNet-specific Warning word. One bit is assigned to every warning. Please refer to the DeviceNet Operating Instructions (MG.33.DX.YY) for further information.																																		
		<table border="1"> <thead> <tr> <th>Bit:</th> <th>Meaning:</th> </tr> </thead> <tbody> <tr><td>0</td><td>BusNetwork not active</td></tr> <tr><td>1</td><td>Explicit connection timeout</td></tr> <tr><td>2</td><td>I/O connection</td></tr> <tr><td>3</td><td>Retry limit reached</td></tr> <tr><td>4</td><td>Actual is not updated</td></tr> <tr><td>5</td><td>CAN bus off</td></tr> <tr><td>6</td><td>I/O send error</td></tr> <tr><td>7</td><td>Initialization error</td></tr> <tr><td>8</td><td>No bus supply</td></tr> <tr><td>9</td><td>Bus off</td></tr> <tr><td>10</td><td>Error passive</td></tr> <tr><td>11</td><td>Error warning</td></tr> <tr><td>12</td><td>Duplicate MAC ID Error</td></tr> <tr><td>13</td><td>RX queue overrun</td></tr> <tr><td>14</td><td>TX queue overrun</td></tr> <tr><td>15</td><td>CAN overrun</td></tr> </tbody> </table>	Bit:	Meaning:	0	BusNetwork not active	1	Explicit connection timeout	2	I/O connection	3	Retry limit reached	4	Actual is not updated	5	CAN bus off	6	I/O send error	7	Initialization error	8	No bus supply	9	Bus off	10	Error passive	11	Error warning	12	Duplicate MAC ID Error	13	RX queue overrun	14	TX queue overrun	15	CAN overrun
Bit:	Meaning:																																			
0	BusNetwork not active																																			
1	Explicit connection timeout																																			
2	I/O connection																																			
3	Retry limit reached																																			
4	Actual is not updated																																			
5	CAN bus off																																			
6	I/O send error																																			
7	Initialization error																																			
8	No bus supply																																			
9	Bus off																																			
10	Error passive																																			
11	Error warning																																			
12	Duplicate MAC ID Error																																			
13	RX queue overrun																																			
14	TX queue overrun																																			
15	CAN overrun																																			

10-14 Net Reference		
Read only from LCP		
		Option: Function:
		Select the reference source in Instance 21/71 and 20/70.
[0] *	Off	Enables reference via analog/digital inputs.
[1]	On	Enables reference via the fieldbus.

10-15 Net Control		
Read only from LCP		
		Option: Function:
		Select the control source in Instance 21/71 and 20/70.
[0] *	Off	Enables control via analog/digital inputs.
[1]	On	Enable control via the fieldbus.

3.12.3 10-2* COS Filters

10-20 COS Filter 1		
Range:	Function:	
0* [0 - 65535]	Enter the value for COS Filter 1 to set up the filter mask for the Status Word. When operating in COS (Change-Of-State), this function filters out bits in the Status Word that should not be sent if they change.	

10-21 COS Filter 2		
Range:	Function:	
0* [0 - 65535]	Enter the value for COS Filter 2, to set up the filter mask for the Main Actual Value. When operating in COS (Change-Of-State), this function filters out bits in the Main Actual Value that should not be sent if they change.	

10-22 COS Filter 3		
Range:	Function:	
0* [0 - 65535]	Enter the value for COS Filter 3, to set up the filter mask for PCD 3. When operating in COS (Change-Of-State), this function filters out bits in PCD 3 that should not be sent if they change.	

10-23 COS Filter 4		
Range:	Function:	
0* [0 - 65535]	Enter the value for COS Filter 4 to set up the filter mask for PCD 4. When operating in COS (Change-Of-State), this function filters out bits in PCD 4 that should not be sent if they change.	

3.12.4 10-3* Parameter Access

Par. group providing access to indexed parameters and defining programming set-up.

10-30 Array Index		
Range:	Function:	
0* [0 - 255]	View array parameters. This parameter is valid only when a DeviceNet fieldbus is installed.	

10-31 Store Data Values		
Option:	Function:	
		Parameter values changed via DeviceNet are not automatically stored in non-volatile memory. Use this parameter to activate a function that stores parameter values in the EEPROM non-volatile memory, so changed parameter values will be retained at power-down.
[0] *	Off	Deactivates the non-volatile storage function.
[1]	Store all setups	Stores all parameter values from the active set-up in the non-volatile memory. The selection returns to Off [0] when all values have been stored.

10-31 Store Data Values		
Option:	Function:	
[2]	Store all setups	Stores all parameter values for all set-ups in the non-volatile memory. The selection returns to <i>Off</i> [0] when all parameter values have been stored.

10-32 Devicenet Revision		
Range:	Function:	
Application dependent*	[0 - 65535]	View the DeviceNet revision number. This parameter is used for EDS file creation.

10-33 Store Always		
Option:	Function:	
[0] *	Off	Deactivates non-volatile storage of data.
[1]	On	Stores parameter data received via DeviceNet in EEPROM non-volatile memory as default.

10-39 Devicenet F Parameters		
Range:	Function:	
Array [1000] No LCP access		
0 N/A*	[0 - 0 N/A]	This parameter is used to configure the frequency converter via DeviceNet and build the EDS-file.

3.13 Parameters: 12-** Ethernet

3.13.1 12-0* IP Settings

12-00 IP Address Assignment

Option: **Function:**

		Selects the IP Address assignment method.
[0] *	Manual	IP-address can be set in par. 12-01 IP Address.
[1]	DHCP	IP-address is assigned via DHCP server.
[2]	BOOTP	IP-address is assigned via BOOTP server.

12-01 IP Address

Range: **Function:**

[000.000.000.000 - 255.255.255.255]	Configure the IP address of the option. Read-only if par. 12-00 set to DHCP or BOOTP.
-------------------------------------	---

12-02 Subnet Mask

Range: **Function:**

[000.000.000.000 - 255.255.255.255]	Configure the IP subnet mask of the option. Read-only if par. 12-00 set to DHCP or BOOTP.
-------------------------------------	---

12-03 Default Gateway

Range: **Function:**

[000.000.000.000 - 255.255.255.255]	Configure the IP default gateway of the option. Read-only if par. 12-00 set to DHCP or BOOTP.
-------------------------------------	---

12-04 DHCP Server

Range: **Function:**

[000.000.000.000 - 255.255.255.255]	Read only. Displays the IP address of the found DHCP or BOOTP server.
-------------------------------------	---

NOTE

A power-cycle is necessary after setting the IP parameters manually.

12-05 Lease Expires

Range: **Function:**

[dd:hh:mm:ss]	Read only. Displays the lease-time left for the current DHCP-assigned IP address.
---------------	---

12-06 Name Servers

Option: **Function:**

		IP addresses of Domain Name Servers. Can be automatically assigned when using DHCP.
[0]	Primary DNS	
[1]	Secondary DNS	

12-07 Domain Name

Range: **Function:**

Blank	[0-19 characters]	Domain name of the attached network. Can be automatically assigned when using DHCP.
-------	-------------------	---

12-08 Host Name

Range: **Function:**

Blank	[0-19 characters]	Logical (given) name of option.
-------	-------------------	---------------------------------

12-09 Physical Address

Range: **Function:**

[00:1B:08:00:00:00 - 00:1B:08:FF:FF:FF]	Read only Displays the Physical (MAC) address of the option.
---	--

3.13.2 12-1* Ethernet Link Parameters

12-1* Ethernet Link Parameters

Option: **Function:**

		Applies for whole Par. group.
[0]	Port 1	
[1]	Port 2	

12-10 Link Status

Option: **Function:**

		Read only. Displays the link status of the Ethernet ports.
[0]	No link	
[1]	Link	

12-11 Link Duration

Option: **Function:**

Link Duration Port 1 (dd:hh:mm:ss)	Read only. Displays the duration of the present link on each port in dd:hh:mm:ss.
------------------------------------	---

12-12 Auto Negotiation

Option: **Function:**

		Configures Auto Negotiation of Ethernet link parameters, for each port: ON or OFF.
[0]	Off	Link Speed and Link Duplex can be configured in par. 12-13 and 12-14.
[1]	On	

12-13 Link Speed

Option: **Function:**

		Forces the link speed for each port in 10 or 100 Mbps. If par. 12-12 is set to: ON, this parameter is read only and displays the actual link speed. "None" is displayed if no link is present.
[0] *	None	
[1]	10 Mbps	
[2]	100 Mbps	

12-14 Link Duplex

Option: **Function:**

		Forces the duplex for each port to Full or Half duplex. If par. 12-12 is set to: ON, this parameter is read only.
[0]	Half duplex	
[1] *	Full duplex	

3.13.3 12-2* Process Data

12-20 Control Instance	
Range:	Function:
[None, 20, 21, 100, 101, 103]	Read only. Displays the originator-to-target connection point. If no CIP connection is present "None" is displayed.

12-21 Process Data Config Write	
Range:	Function:
[[0 - 9] PCD read 0 - 9]	Configuration of readable process data.

NOTE
For configuration of 2-word (32-bit) parameter read/write, use 2 consecutive arrays in par. 12-21 and 12-22.

12-22 Process Data Config Read	
Range:	Function:
[[0 - 9] PCD read 0 - 9]	Configuration of readable process data.

12-28 Store Data Values	
Option:	Function:
	This parameter activates a function that stores all parameter values in the non-volatile memory (EEPROM) thus retaining parameter values at power-down. The parameter returns to "Off".
[0] * Off	The store function is inactive.
[1] Store All set-ups	All parameter value will be stored in the non-volatile memory, in all four setups.

12-29 Store Always	
Option:	Function:
	Activates function that will always store received parameter data in non-volatile memory (EEPROM).
[0] * Off	
[1] On	

3.13.4 12-3* EtherNet/IP

12-30 Warning Parameter																																			
Range:	Function:																																		
[0000 – FFFF hex]	Read only. Displays the EtherNet/IP specific 16-bit Status-word.																																		
	<table border="1"> <thead> <tr> <th>Bit</th> <th>Description</th> </tr> </thead> <tbody> <tr><td>0</td><td>Owned</td></tr> <tr><td>1</td><td>Not used</td></tr> <tr><td>2</td><td>Configured</td></tr> <tr><td>3</td><td>Not used</td></tr> <tr><td>4</td><td>Not used</td></tr> <tr><td>5</td><td>Not used</td></tr> <tr><td>6</td><td>Not used</td></tr> <tr><td>7</td><td>Not used</td></tr> <tr><td>8</td><td>Minor recoverable fault</td></tr> <tr><td>9</td><td>Minor unrecoverable fault</td></tr> <tr><td>10</td><td>Major recoverable fault</td></tr> <tr><td>11</td><td>Major unrecoverable fault</td></tr> <tr><td>12</td><td>Not used</td></tr> <tr><td>13</td><td>Not used</td></tr> <tr><td>14</td><td>Not used</td></tr> <tr><td>15</td><td>Not used</td></tr> </tbody> </table>	Bit	Description	0	Owned	1	Not used	2	Configured	3	Not used	4	Not used	5	Not used	6	Not used	7	Not used	8	Minor recoverable fault	9	Minor unrecoverable fault	10	Major recoverable fault	11	Major unrecoverable fault	12	Not used	13	Not used	14	Not used	15	Not used
Bit	Description																																		
0	Owned																																		
1	Not used																																		
2	Configured																																		
3	Not used																																		
4	Not used																																		
5	Not used																																		
6	Not used																																		
7	Not used																																		
8	Minor recoverable fault																																		
9	Minor unrecoverable fault																																		
10	Major recoverable fault																																		
11	Major unrecoverable fault																																		
12	Not used																																		
13	Not used																																		
14	Not used																																		
15	Not used																																		

12-31 Net Reference	
Option:	Function:
	Read only. Displays the reference source in Instance 21/71.
[0] * Off	Reference from the network is not active.
[1] On	Reference from the network is active.

12-32 Net Control	
Option:	Function:
	Read only. Displays the control source in Instance 21/71.
[0] * Off	Control via the network is not active.
[1] On	Control via the network is active

12-33 CIP Revision	
Option:	Function:
	Read only. Displays the CIP-version of the option software.
[0] Major version (00 - 99)	
[1] Minor version (00 - 99)	

12-34 CIP Product Code	
Range:	Function:
1100 (FC 302) 1110 (FC 301)*	[0 – 9999] Read only. Displays the CIP product code.

12-37 COS Inhibit Timer

Range: **Function:**

[0 – 65.535 ms]	Read only Change-Of-State inhibit timer. If the option is configured for COS operation, this inhibit timer can be configured in the Forward Open telegram to prevent that continuously changing PCD data generates extensive network traffic. The inhibit time is in milliseconds, 0 = disabled.
-----------------	--

12-38 COS Filters

Range: **Function:**

[[0 - 9] Filter 0 – 9 (0000 - FFFFhex)]	Change-Of-State PCD filters. Sets up a filter mask for each word of process data when operating in COS-mode. Single bits in the PCD's can be filtered in/out.
---	---

3.13.5 12-8* Other Ethernet Services

12-80 FTP Server

Option: **Function:**

[0] *	Disable	Disables the built-in FTP server.
[1]	Enable	Enables the built-in FTP server.

12-81 HTTP Server

Option: **Function:**

[0] *	Disable	Disables the build-in HTTP (web) server.
[1]	Enable	Enables the build-in HTTP (web) server.

12-82 SMTP Service

Option: **Function:**

[0] *	Disable	Disables the SMTP (e-mail) service on the option.
[1]	Enable	Enables the SMTP (e-mail) service on the option.

12-89 Transparent Socket Channel Port

Range: **Function:**

0*	[0 – 9999]	Configures the TCP port-number for the transparent socket channel. This enables FC-telegrams to be sent transparently on Ethernet via TCP. Default value is 4000, 0 means disabled.
----	------------	---

3.13.6 12-9* Advanced Ethernet Settings

12-90 Cable Diagnostics

Option: **Function:**

		Enables/disables advanced Cable diagnosis function. If enabled, the distance to cable errors can be read out in par. 12-93. The parameter resumes to the default setting of Disable after the diagnostics have finished.
[0] *	Disable	
[1]	Enable	

NOTE

The cable diagnostics function will only be issued on ports where there is no link (see par. 12-10, *Link Status*)

12-91 Auto Cross-Over

Option: **Function:**

[0]	Disable	Disables the auto cross-over function.
[1] *	Enable	Enables the auto cross-over function.

NOTE

Disabling of the auto cross-over function will require crossed Ethernet cables for daisy-chaining the options.

12-92 IGMP Snooping

Option: **Function:**

		This prevents flooding of the Ethernet protocol stack by only forwarding multicast packets to ports that are a member of the multicast group
[0]	Disable	Disables the IGMP snooping function.
[1] *	Enable	Enables the IGMP snooping function.

12-93 Cable Error Length

Option: **Function:**

		If Cable Diagnostics is enabled in par. 12-90, the built-in switch is able via Time Domain Reflectometry (TDR). This is a measurement technique which detects common cabling problems such as open circuits, short circuits and impedance mismatches or breaks in transmission cables. The distance from the option to the error is displayed in meters with an accuracy of +/- 2m. The value 0 means no errors detected.
[0]	Error length Port 1 (0 – 200m)	
[1]	Error length Port 2 (0 – 200m)	

12-94 Broadcast Storm Protection

Option:	Function:
	<p>The built-in switch is capable of protecting the switch system from receiving too many broadcast packages, which can use up network resources. The value indicates a percentage of the total bandwidth that is allowed for broadcast messages.</p> <p>Example: The "OFF" means that the filter is disabled –all broadcast messages will be passed through. The value "0%" means that no broadcast messages will be passed through. A value of "10%" means that 10% of the total bandwidth is allowed for broadcast messages, if the amount of broadcast messages increases above the 10% threshold, they will be blocked.</p>
[0] Protection Value Port 1 (*Off – 20%)	
[1] Protection Value Port 2 (*Off – 20%)	

12-95 Broadcast Storm Filter

Option:	Function:
	Applies to par. 12-94; if the Broadcast Storm Protection should also include Multicast telegrams.
[0] Broadcast only	
[1] Broadcast & Multicast	

12-96 Port Mirroring

Enables/disables port-mirroring function. For troubleshooting with a network analyzer tool.

Option:	Function:
[0] *	Disable No port-mirroring
[1]	Port 1 to Port 2 All network traffic on port 1 will be mirrored to port 2.
[2]	Port 2 to Port 1 All network traffic on port 2 will be mirrored to port 1.
[254]	Int. Port to Port 1
[255]	Int. Port to Port 2

12-98 Interface Counters

Option:	Function:
	Read only. Advanced Interface counters, from build-in switch, can be used for low-level trouble-shooting, The parameter shows a sum of port 1 + port 2.
[0] In Octets	
[1] In Unicast Packets	
[2] In Non-Unicast Packets	
[3] In Discards	
[4] In Errors	
[5] In Unknown Protocols	
[6] Out Octets	
[7] Out Unicast Packets	
[8] Out Non-Unicast Packets	
[9] Out Discards	
[10] Out Errors	

12-99 Media Counters

Option:	Function:
	Read only. Advanced Interface counters, from build-in switch, can be used for low-level trouble-shooting, The parameter shows a sum of port 1 + port 2.
[0] Alignment Errors	
[1] FCS Errors	
[2] Single Collisions	
[3] Multiple Collisions	
[4] SQE Test Errors	
[5] Deferred Errors	
[6] Late Collisions	
[7] Excessive Collisions	
[8] MAC Transmit Errors	
[9] Carrier Sense Errors	
[10] Frame Too Long	
[11] MAC Receive Errors	

3.14 Parameters: 13-** Smart Logic Control

3.14.1 Prog. Features

Smart Logic Control (SLC) is essentially a sequence of user defined actions (see par. 13-52 *SL Controller Action* [x]) executed by the SLC when the associated user defined *event* (see par. 13-51 *SL Controller Event* [x]) is evaluated as TRUE by the SLC. Events and *actions* are each numbered and linked together in pairs (states). This means that when *event* [0] is fulfilled (attains the value TRUE), *action* [0] is executed. After this, the conditions of *event* [1] will be evaluated and if evaluated TRUE, *action* [1] will be executed and so on. Only one *event* will be evaluated at any time. If an *event* is evaluated as FALSE, nothing happens (in the SLC) during the current scan interval and no other *events* will be evaluated. This means that when the SLC starts, it evaluates *event* [0] (and only *event* [0]) each scan interval. Only when *event* [0] is evaluated TRUE, will the SLC execute *action* [0] and start evaluating *event* [1]. It is possible to programme from 1 to 20 *events* and *actions*. When the last *event* / *action* has been executed, the sequence starts over again from *event* [0] / *action* [0]. The illustration shows an example with three event / actions:

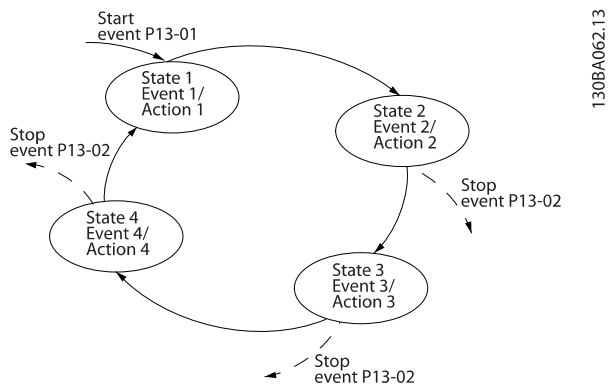

130BA062.13

Starting and stopping the SLC:

Starting and stopping the SLC can be done by selecting .On [1]. or .Off [0]. in par. 13-00 *SL Controller Mode*. The SLC always starts in state 0 (where it evaluates *event* [0]). The SLC starts when the Start Event (defined in par. 13-01 *Start Event*) is evaluated as TRUE (provided that On [1] is selected in par. 13-00 *SL Controller Mode*). The SLC stops when the Stop Event (par. 13-02 *Stop Event*) is TRUE. par. 13-03 *Reset SLC* resets all SLC parameters and start programming from scratch.

3.14.2 13-0* SLC Settings

Use the SLC settings to activate, deactivate and reset the Smart Logic Control sequence. The logic functions and comparators are always running in the background, which opens for separate control of digital inputs and outputs. .

13-00 SL Controller Mode		
Option:	Function:	
[0]	Off	Disables the Smart Logic Controller.
[1]	On	Enables the Smart Logic Controller.

13-01 Start Event		
Option:	Function:	
[0] *	False	Select the boolean (TRUE or FALSE) input to activate Smart Logic Control. <i>False</i> [0] enters the fixed value - FALSE
[1]	True	<i>True</i> [1] enters the fixed value - TRUE.
[2]	Running	<i>Running</i> [2] The motor is running.
[3]	In range	<i>In range</i> [3] The motor is running within the programmed current and speed ranges set in par. 4-50 <i>Warning Current Low</i> to par. 4-53 <i>Warning Speed High</i> .
[4]	On reference	<i>On reference</i> [4] The motor is running on reference.
[5]	Torque limit	<i>Torque limit</i> [5] The torque limit, set in par. 4-16 <i>Torque Limit Motor Mode</i> or par. 4-17 <i>Torque Limit Generator Mode</i> , has been exceeded.
[6]	Current limit	<i>Current limit</i> [6] The motor current limit, set in par. 4-18 <i>Current Limit</i> , has been exceeded.
[7]	Out of current range	<i>Out of current range</i> [7] The motor current is outside the range set in par. 4-18 <i>Current Limit</i> .
[8]	Below I low	<i>Below I low</i> [8] The motor current is lower than set in par. 4-50 <i>Warning Current Low</i> .
[9]	Above I high	<i>Above I high</i> [9] The motor current is higher than set in par. 4-51 <i>Warning Current High</i> .
[10]	Out of speed range	<i>Out of speed range</i> [10] The speed is outside the range set in par. 4-52 <i>Warning Speed Low</i> and par. 4-53 <i>Warning Speed High</i> .
[11]	Below speed low	<i>Below speed low</i> [11] The output speed is lower than the setting in par. 4-52 <i>Warning Speed Low</i> .
[12]	Above speed high	<i>Above speed high</i> [12] The output speed is higher than the setting in par. 4-53 <i>Warning Speed High</i> .
[13]	Out of feedb. range	<i>Out of feedb. Range</i> [13] The feedback is outside the range set in par. 4-56 <i>Warning</i>

13-01 Start Event		
Option:	Function:	
		<i>Feedback Low</i> and par. 4-57 <i>Warning Feedback High</i> .
[14]	Below feedb. low	<i>Below feedb. Low</i> [14] The feedback is below the limit set in par. 4-56 <i>Warning Feedback Low</i> .
[15]	Above feedb. high	<i>Above feedb. High</i> [15] The feedback is above the limit set in par. 4-57 <i>Warning Feedback High</i> .
[16]	Thermal warning	<i>Thermal warning</i> [16] The thermal warning turns on when the temperature exceeds the limit in the motor, the frequency converter, the brake resistor or the thermistor.
[17]	Mains out of range	<i>Mains out of range</i> [17] The mains voltage is outside the specified voltage range.
[18]	Reversing	<i>Reversing</i> [18] The output is high when the frequency converter is running counter clockwise (the logical product of the status bits "running" AND "reverse").
[19]	Warning	<i>Warning</i> [19] A warning is active.
[20]	Alarm (trip)	<i>Alarm (trip)</i> [20] A (trip) alarm is active.
[21]	Alarm (trip lock)	<i>Alarm (trip lock)</i> [21] A (Trip lock) alarm is active.
[22]	Comparator 0	<i>Comparator 0</i> [22] Use the result of comparator 0.
[23]	Comparator 1	<i>Comparator 1</i> [23] Use the result of comparator 1.
[24]	Comparator 2	<i>Comparator 2</i> [24] Use the result of comparator 2.
[25]	Comparator 3	<i>Comparator 3</i> [25] Use the result of comparator 3.
[26]	Logic rule 0	<i>Logic rule 0</i> [26] Use the result of logic rule 0.
[27]	Logic rule 1	<i>Logic rule 1</i> [27] Use the result of logic rule 1.
[28]	Logic rule 2	<i>Logic rule 2</i> [28] Use the result of logic rule 2.
[29]	Logic rule 3	<i>Logic rule 3</i> [29] Use the result of logic rule 3.
[33]	Digital input DI18	<i>Digital input DI18</i> [33] Use the result of digital input 18.
[34]	Digital input DI19	<i>Digital input DI19</i> [34] Use the result of digital input 19.
[35]	Digital input DI27	<i>Digital input DI27</i> [35] Use the result of digital input 27.
[36]	Digital input DI29	<i>Digital input DI27</i> [35] Use the result of digital input 29.

13-01 Start Event		
Option:	Function:	
[37]	Digital input DI32	<i>Digital input DI32</i> [37] Use the result of digital input 32.
[38]	Digital input DI33	<i>Digital input DI33</i> [38] Use the result of digital input 33.
[39]	Start command	<i>Start command</i> [39] A start command is issued.
[40]	Drive stopped	<i>Drive stopped</i> [40] A stop command (Jog, Stop, Qstop, Coast) is issued – and not from the SLC itself.
[41]	Reset Trip	<i>Reset Trip</i> [41] A reset is issued
[42]	Auto-reset Trip	<i>Auto-reset Trip</i> [42] An Auto reset is performed.
[43]	Ok key	<i>OK key</i> [43] The Ok key is pressed.
[44]	Reset key	<i>Reset key</i> [44] The reset key is pressed.
[45]	Left key	<i>Left key</i> [45] The left key is pressed.
[46]	Right key	<i>Right key</i> [46] The right key is pressed.
[47]	Up key	<i>Up key</i> [47] The up key is pressed.
[48]	Down key	<i>Down key</i> [48] The down key is pressed.
[50]	Comparator 4	<i>Comparator 4</i> [50] Use the result of comparator 4.
[51]	Comparator 5	<i>Comparator 5</i> [51] Use the result of comparator 5.
[60]	Logic rule 4	<i>Logic rule 4</i> [60] Use the result of logic rule 4.
[61]	Logic rule 5	<i>Logic rule 5</i> [61] Use the result of logic rule 5.

13-02 Stop Event		
Select the boolean (TRUE or FALSE) input to activate Smart Logic Control.		
Option:	Function:	
[0] *	False	For descriptions [0] - [61], see par. 13-01 <i>Start Event Start Event</i>
[1]	True	
[2]	Running	
[3]	In range	
[4]	On reference	
[5]	Torque limit	
[6]	Current limit	
[7]	Out of current range	
[8]	Below I low	
[9]	Above I high	
[10]	Out of speed range	
[11]	Below speed low	
[12]	Above speed high	
[13]	Out of feedb. range	
[14]	Below feedb. low	

13-02 Stop Event		
Select the boolean (TRUE or FALSE) input to activate Smart Logic Control.		
Option:	Function:	
[15]	Above feedb. high	
[16]	Thermal warning	
[17]	Mains out of range	
[18]	Reversing	
[19]	Warning	
[20]	Alarm (trip)	
[21]	Alarm (trip lock)	
[22]	Comparator 0	
[23]	Comparator 1	
[24]	Comparator 2	
[25]	Comparator 3	
[26]	Logic rule 0	
[27]	Logic rule 1	
[28]	Logic rule 2	
[29]	Logic rule 3	
[30]	SL Time-out 0	
[31]	SL Time-out 1	
[32]	SL Time-out 2	
[33]	Digital input DI18	
[34]	Digital input DI19	
[35]	Digital input DI27	
[36]	Digital input DI29	
[37]	Digital input DI32	
[38]	Digital input DI33	
[39]	Start command	
[40]	Drive stopped	
[41]	Reset Trip	
[42]	Auto-reset Trip	
[43]	Ok key	
[44]	Reset key	
[45]	Left key	
[46]	Right key	
[47]	Up key	
[48]	Down key	
[50]	Comparator 4	
[51]	Comparator 5	
[60]	Logic rule 4	
[61]	Logic rule 5	
[70]	SL Time-out 3	<i>SL Time-out 3</i> [70] Smart Logic Controller timer 3 is timed out.
[71]	SL Time-out 4	<i>SL Time-out 4</i> [71] Smart Logic Controller timer 4 is timed out.
[72]	SL Time-out 5	<i>SL Time-out 5</i> [72] Smart Logic Controller timer 5 is timed out.
[73]	SL Time-out 6	<i>SL- Time-out 6</i> [73] Smart Logic Controller timer 6 is timed out.
[74]	SL Time-out 7	<i>SL Time-out 7</i> [74] Smart Logic Controller timer 7 is timed out.
[75]	Start command given	

13-02 Stop Event		
Select the boolean (TRUE or FALSE) input to activate Smart Logic Control.		
Option:	Function:	
[76]	Digital input x30/2	
[77]	Digital input x30/3	
[78]	Digital input x30/4	
[79]	Digital input x46/1	
[80]	Digital input x46/3	
[81]	Digital input x46/5	
[82]	Digital input x46/7	
[83]	Digital input x46/9	
[84]	Digital input x46/11	
[85]	Digital input x46/13	

13-03 Reset SLC		
Option:	Function:	
[0] *	Do not reset SLC	Retains programmed settings in all group 13 parameters (13-*).
[1]	Reset SLC	Resets all group 13 parameters (13-*) to default settings.

3.14.3 13-1* Comparators

Comparators are used for comparing continuous variables (i.e. output frequency, output current, analog input etc.) to fixed preset values. In addition, there are digital values that will be compared to fixed time values. See explanation in par. 13-10 *Comparator Operand*. Comparators are evaluated once in each scan interval. Use the result (TRUE or FALSE) directly. All parameters in this Par. group are array parameters with index 0 to 5. Select index 0 to programme Comparator 0, select index 1 to programme Comparator 1, and so on.

13-10 Comparator Operand		
Array [6]		
Option:	Function:	
		Choice [1] to [31] are variables which will be compared based on their values. Choice [50] to [186] are digital values (TRUE/FALSE) where the comparison is based on the amount of time during which they are set to TRUE or FALSE, respectively. See par. 13-11 <i>Comparator Operator</i> . Select the variable to be monitored by the comparator.
[0] *	DISABLED	<i>DISABLED</i> [0] The comparator is disabled.
[1]	Reference	<i>Reference</i> [1] The resulting remote reference (not local) as a percentage.
[2]	Feedback	<i>Feedback</i> [2] In the unit [RPM] or [Hz]
[3]	Motor speed	<i>Motor speed</i> [3] [RPM] or [Hz]
[4]	Motor current	<i>Motor current</i> [4] [A]

13-10 Comparator Operand		
Array [6]		
Option:	Function:	
[5]	Motor torque	<i>Motor torque</i> [5] [Nm]
[6]	Motor power	<i>Motor power</i> [6] [kW] or [hp]
[7]	Motor voltage	<i>Motor voltage</i> [7] [V]
[8]	DC-link voltage	<i>DC-link voltage</i> [8] [V]
[9]	Motor thermal	<i>Motor thermal</i> [9] Expressed as a percentage.
[10]	Drive thermal	<i>VLT thermal</i> [10] Expressed as a percentage.
[11]	Heat sink temp.	<i>Heat sink temp</i> [11] Expressed as a percentage.
[12]	Analog input AI53	<i>Analog input AI53</i> [12] Expressed as a percentage.
[13]	Analog input AI54	<i>Analog input AI54</i> [13] Expressed as a percentage.
[14]	Analog input AIFB10	<i>Analog input AIFB10</i> [14] [V]. AIFB10 is internal 10 V supply.
[15]	Analog input AIS24V	<i>Analog input AIS24V</i> [15] [V] Analog input AICCT [17] [°]. AIS24V is switch mode power supply: SMPS 24 V.
[17]	Analog input AICCT	Analog input AICCT [17] [°]. AICCT is control card temperature.
[18]	Pulse input FI29	<i>Pulse input FI29</i> [18] Expressed as a percentage.
[19]	Pulse input FI33	<i>Pulse input FI33</i> [19] Expressed as a percentage.
[20]	Alarm number	<i>Alarm number</i> [20] The error number.
[21]	Warning number	
[22]	Analog input x30 11	
[23]	Analog input x30 12	
[30]	Counter A	<i>Counter A</i> [30] Number of counts
[31]	Counter B	<i>Counter B</i> [31] Number of counts
[50]	FALSE	<i>False</i> [50] Enters the fixed value of false in the comparator.
[51]	TRUE	<i>True</i> [51] Enters the fixed value of true in the comparator.
[52]	Control ready	<i>Control ready</i> [52] The control board receives supply voltage
[53]	Drive ready	<i>Drive ready</i> [53] The frequency converter is ready for operation and applies a supply signal on the control board.
[54]	Running	<i>Running</i> [54] The motor is running.
[55]	Reversing	<i>Reversing</i> [55] The output is high when the frequency converter is running counter

13-10 Comparator Operand		
Array [6]		
Option:	Function:	
		clockwise (the logical product of the status bits "running" AND "reverse")
[56]	In range	<i>In range</i> [56] The motor is running within the programmed current and speed ranges set in par. 4-50 <i>Warning Current Low</i> to par. 4-53 <i>Warning Speed High</i> .
[60]	On reference	<i>On reference</i> [60] The motor is running on reference.
[61]	Below reference, low	<i>Below reference, low</i> [61] The motor is running below the value given in par. 4-54 <i>Warning Reference Low</i>
[62]	Above ref, high	<i>Above reference, high</i> [62] The motor is running above the value given in par. 4-55 <i>Warning Reference High</i>
[65]	Torque limit	<i>Torque limit</i> [65] The torque limit, set in par. 4-16 <i>Torque Limit Motor Mode</i> or par. 4-17 <i>Torque Limit Generator Mode</i> , has been exceeded.
[66]	Current limit	<i>Current limit</i> [66] The motor current limit, set in par. 4-18 <i>Current Limit</i> , has been exceeded.
[67]	Out of current range	<i>Out of current range</i> [67] The motor current is outside the range set in par. 4-18 <i>Current Limit</i> .
[68]	Below I low	<i>Below I low</i> [68] The motor current is lower than set in par. 4-50 <i>Warning Current Low</i> .
[69]	Above I high	<i>Above I high</i> [69] The motor current is higher than set in par. 4-51 <i>Warning Current High</i> .
[70]	Out of speed range	<i>Out of speed range</i> [70] The speed is outside the range set in par. 4-52 <i>Warning Speed Low</i> and par. 4-53 <i>Warning Speed High</i> .
[71]	Below speed low	<i>Below speed low</i> [71] The output speed is lower than the setting in par. 4-52 <i>Warning Speed Low</i> .
[72]	Above speed high	<i>Above speed high</i> [72] The output speed is higher than the setting in par. 4-53 <i>Warning Speed High</i> .
[75]	Out of feedb. range	<i>Out of feedb. Range</i> [75] The feedback is outside the range set in par. 4-56 <i>Warning Feedback Low</i> and par. 4-57 <i>Warning Feedback High</i> .
[76]	Below feedb. low	<i>Below feedb. Low</i> [76] The feedback is below the limit set in par. par. 4-56 <i>Warning Feedback Low</i> .
[77]	Above feedb. high	<i>Above feedb. High</i> [77] The feedback is above the limit set in par. 4-57 <i>Warning Feedback High</i> .

13-10 Comparator Operand		
Array [6]		
Option:	Function:	
[80]	Thermal warning	<i>Thermal warning</i> [80] The thermal warning turns on when the temperature exceeds the limit in the motor, the frequency converter, the brake resistor or thermistor.
[82]	Mains out of range	<i>Mains out of range</i> [82] The mains voltage is outside the specified voltage range.
[85]	Warning	<i>Warning</i> [85] A warning is active.
[86]	Alarm (trip)	<i>Alarm (trip)</i> [86] A (trip) alarm is active.
[87]	Alarm (trip lock)	<i>Alarm (trip lock)</i> [87] A (Trip lock) alarm is active.
[90]	Bus OK	<i>Bus OK</i> [90] Active communication (no time-out) via the serial communication port.
[91]	Torque limit & stop	<i>Torque limit & stop</i> [91] If the frequency converter has received a stop signal and is at the torque limit, the signal is logic "0".
[92]	Brake fault (IGBT)	<i>Brake fault (IGBT)</i> [92] The brake IGBT is short circuited.
[93]	Mech. brake control	<i>Mech. brake control</i> [93] The mechanical brake is active.
[94]	Safe stop active	
[100]	Comparator 0	<i>Comparator 0</i> [100] The result of comparator 0.
[101]	Comparator 1	<i>Comparator 1</i> [101] The result of comparator 1.
[102]	Comparator 2	<i>Comparator 2</i> [102] The result of comparator 2.
[103]	Comparator 3	<i>Comparator 3</i> [103] The result of comparator 3.
[104]	Comparator 4	<i>Comparator 4</i> [104] The result of comparator 4.
[105]	Comparator 5	<i>Comparator 5</i> [105] The result of comparator 5.
[110]	Logic rule 0	<i>Logic rule 0</i> [110] The result of Logic rule 0.
[111]	Logic rule 1	<i>Logic rule 1</i> [111] The result of Logic rule 1.
[112]	Logic rule 2	<i>Logic rule 2</i> [112] The result of Logic rule 2.
[113]	Logic rule 3	<i>Logic rule 3</i> [113] The result of Logic rule 3.
[114]	Logic rule 4	<i>Logic rule 4</i> [114] The result of Logic rule 4.
[115]	Logic rule 5	<i>Logic rule 5</i> [115] The result of Logic rule 5.
[120]	SL Time-out 0	<i>SL Time-out 0</i> [120] The result of SLC timer 0.
[121]	SL Time-out 1	<i>SL Time-out 1</i> [121] The result of SLC timer 1.

13-10 Comparator Operand		
Array [6]		
Option:	Function:	
[122]	SL Time-out 2	<i>SL Time-out 2</i> [122] The result of SLC timer 2.
[123]	SL Time-out 3	<i>SL Time-out 3</i> [123] The result of SLC timer 3.
[124]	SL Time-out 4	<i>SL Time-out 4</i> [124] The result of SLC timer 4.
[125]	SL Time-out 5	<i>SL Time-out 5</i> [125] The result of SLC timer 5.
[126]	SL Time-out 6	<i>SL Time-out 6</i> [126] The result of SLC timer 6.
[127]	SL Time-out 7	<i>SL Time-out 7</i> [127] The result of SLC timer 7.
[130]	Digital input DI18	<i>Digital input DI18</i> [130] Digital input 18. High = True.
[131]	Digital input DI19	<i>Digital input DI19</i> [131] Digital input 19. High = True.
[132]	Digital input DI27	<i>Digital input DI27</i> [132] Digital input 27. High = True.
[133]	Digital input DI29	<i>Digital input DI29</i> [133] Digital input 29. High = True.
[134]	Digital input DI32	<i>Digital input DI32</i> [134] Digital input 32. High = True.
[135]	Digital input DI33	<i>Digital input DI33</i> [135] Digital input 33. High = True.
[150]	SL digital output A	<i>SL digital output A</i> [150] Use the result of the SLC output A.
[151]	SL digital output B	<i>SL digital output B</i> [151] Use the result of the SLC output B.
[152]	SL digital output C	<i>SL digital output C</i> [152] Use the result of the SLC output C.
[153]	SL digital output D	<i>SL digital output D</i> [153] Use the result of the SLC output D.
[154]	SL digital output E	<i>SL digital output E</i> [154] Use the result of the SLC output E.
[155]	SL digital output F	<i>SL digital output F</i> [155] Use the result of the SLC output F.
[160]	Relay 1	<i>Relay 1</i> [160] Relay 1 is active
[161]	Relay 2	<i>Relay 2</i> [161] Relay 2 is active
[180]	Local ref. active	<i>Local ref. active</i> [180] High when par. 3-13 <i>Reference Site</i> = [2] Local or when par. 3-13 <i>Reference Site</i> is [0] Linked to hand Auto, at the same time as the LCP is in Hand on mode.
[181]	Remote ref. active	<i>Remote ref. active</i> [181] High when par. 3-13 <i>Reference Site</i> = [1] Remote or [0]

13-10 Comparator Operand		
Array [6]		
Option:	Function:	
		Linked to hand/auto, while the LCP is in Auto on mode.
[182]	Start command	<i>Start command</i> [182] High when there is an active start command, and no stop command.
[183]	Drive stopped	<i>Drive stopped</i> [183] A stop command (Jog, Stop, Qstop, Coast) is issued – and not from the SLC itself.
[185]	Drive in hand mode	<i>Drive in hand mode</i> [185] High when the frequency converter is in hand mode.
[186]	Drive in auto mode	<i>Drive in auto mode</i> [186] High when the frequency converter is in auto mode.
[187]	Start command given	
[190]	Digital input x30 2	
[191]	Digital input x30 3	
[192]	Digital input x30 4	
[193]	Digital input x46 1	
[194]	Digital input x46 2	
[195]	Digital input x46 3	
[196]	Digital input x46 4	
[197]	Digital input x46 5	
[198]	Digital input x46 6	
[199]	Digital input x46 7	

13-11 Comparator Operator		
Array [6]		
Option:	Function:	
		Select the operator to be used in the comparison. This is an array parameter containing comparator operators 0 to 5.
[0]	<	Select < [0] for the result of the evaluation to be TRUE, when the variable selected in par. 13-10 <i>Comparator Operand</i> is smaller than the fixed value in par. 13-12 <i>Comparator Value</i> . The result will be FALSE, if the variable selected in par. 13-10 <i>Comparator Operand</i> is greater than the fixed value in par. 13-12 <i>Comparator Value</i> .
[1] *	≈ (equal)	Select ≈ [1] for the result of the evaluation to be TRUE, when the variable selected in par. 13-10 <i>Comparator Operand</i> is approximately equal to the fixed value in par. 13-12 <i>Comparator Value</i> .
[2]	>	Select > [2] for the inverse logic of option < [0].
[5]	TRUE longer than..	
[6]	FALSE longer than..	
[7]	TRUE shorter than..	
[8]	FALSE shorter than..	

13-12 Comparator Value		
Array [6]		
Range:	Function:	
Application dependent*	[-100000.000 - 100000.000 N/A]	Enter the 'trigger level' for the variable that is monitored by this comparator. This is an array parameter containing comparator values 0 to 5.

3.14.4 13-2* Timers

Use the result (TRUE or FALSE) from *timers* directly to define an *event* (see par. 13-51 *SL Controller Event*), or as boolean input in a *logic rule* (see par. 13-40 *Logic Rule Boolean 1*, par. 13-42 *Logic Rule Boolean 2* or par. 13-44 *Logic Rule Boolean 3*). A timer is only FALSE when started by an action (i.e. Start timer 1 [29]) until the timer value entered in this parameter is elapsed. Then it becomes TRUE again.

All parameters in this Par. group are array parameters with index 0 to 2. Select index 0 to program Timer 0, select index 1 to program Timer 1, and so on.

13-20 SL Controller Timer		
Range:		Function:
Application dependent*	[Application dependant]	Enter the value to define the duration of the FALSE output from the programmed timer. A timer is only FALSE if it is started by an action (i.e. <i>Start timer 1 [29]</i>) and until the given timer value has elapsed.

3.14.5 13-4* Logic Rules

Combine up to three boolean inputs (TRUE / FALSE inputs) from timers, comparators, digital inputs, status bits and events using the logical operators AND, OR, and NOT. Select boolean inputs for the calculation in par. 13-40 *Logic Rule Boolean 1*, par. 13-42 *Logic Rule Boolean 2* and par. 13-44 *Logic Rule Boolean 3*. Define the operators used to logically combine the selected inputs in par. 13-41 *Logic Rule Operator 1* and par. 13-43 *Logic Rule Operator 2*.

Priority of calculation

The results of par. 13-40 *Logic Rule Boolean 1*, par. 13-41 *Logic Rule Operator 1* and par. 13-42 *Logic Rule Boolean 2* are calculated first. The outcome (TRUE / FALSE) of this calculation is combined with the settings of par. 13-43 *Logic Rule Operator 2* and par. 13-44 *Logic Rule Boolean 3*, yielding the final result (TRUE / FALSE) of the logic rule.

13-40 Logic Rule Boolean 1		
Array [6]		
Option:		Function:
[0] *	False	Select the first boolean (TRUE or FALSE) input for the selected logic rule. See par. 13-01 <i>Start Event</i> ([0] - [61]) and par. 13-02 <i>Stop Event</i> ([70] - [75]) for further description.
[1]	True	
[2]	Running	
[3]	In range	
[4]	On reference	
[5]	Torque limit	

13-40 Logic Rule Boolean 1		
Array [6]		
Option:		Function:
[6]	Current limit	
[7]	Out of current range	
[8]	Below I low	
[9]	Above I high	
[10]	Out of speed range	
[11]	Below speed low	
[12]	Above speed high	
[13]	Out of feedb. range	
[14]	Below feedb. low	
[15]	Above feedb. high	
[16]	Thermal warning	
[17]	Mains out of range	
[18]	Reversing	
[19]	Warning	
[20]	Alarm (trip)	
[21]	Alarm (trip lock)	
[22]	Comparator 0	
[23]	Comparator 1	
[24]	Comparator 2	
[25]	Comparator 3	
[26]	Logic rule 0	
[27]	Logic rule 1	
[28]	Logic rule 2	
[29]	Logic rule 3	
[30]	SL Time-out 0	
[31]	SL Time-out 1	
[32]	SL Time-out 2	
[33]	Digital input DI18	
[34]	Digital input DI19	
[35]	Digital input DI27	
[36]	Digital input DI29	
[37]	Digital input DI32	
[38]	Digital input DI33	
[39]	Start command	
[40]	Drive stopped	
[41]	Reset Trip	
[42]	Auto-reset Trip	
[43]	Ok key	
[44]	Reset key	
[45]	Left key	
[46]	Right key	
[47]	Up key	
[48]	Down key	
[50]	Comparator 4	
[51]	Comparator 5	
[60]	Logic rule 4	
[61]	Logic rule 5	
[70]	SL Time-out 3	
[71]	SL Time-out 4	
[72]	SL Time-out 5	
[73]	SL Time-out 6	

13-40 Logic Rule Boolean 1		
Array [6]		
Option:	Function:	
[74]	SL Time-out 7	
[75]	Start command given	
[76]	Digital input x30/2	
[77]	Digital input x30/3	
[78]	Digital input x30/4	
[79]	Digital input x46/1	
[80]	Digital input x46/3	
[81]	Digital input x46/5	
[82]	Digital input x46/7	
[83]	Digital input x46/9	
[84]	Digital input x46/11	
[85]	Digital input x46/13	

13-41 Logic Rule Operator 1		
Array [6]		
Option:	Function:	
		Select the first logical operator to use on the Boolean inputs from par. 13-40 <i>Logic Rule Boolean 1</i> and par. 13-42 <i>Logic Rule Boolean 2</i> . [13 -XX] signifies the boolean input of par. group 13-*
[0] *	DISABLED	Ignores par. 13-42 <i>Logic Rule Boolean 2</i> , par. 13-43 <i>Logic Rule Operator 2</i> , and par. 13-44 <i>Logic Rule Boolean 3</i> .
[1]	AND	Evaluates the expression [13-40] AND [13-42].
[2]	OR	evaluates the expression [13-40] OR[13-42].
[3]	AND NOT	evaluates the expression [13-40] AND NOT [13-42].
[4]	OR NOT	evaluates the expression [13-40] OR NOT [13-42].
[5]	NOT AND	evaluates the expression NOT [13-40] AND [13-42].
[6]	NOT OR	evaluates the expression NOT [13-40] OR [13-42].
[7]	NOT AND NOT	evaluates the expression NOT [13-40] AND NOT [13-42].
[8]	NOT OR NOT	evaluates the expression NOT [13-40] OR NOT [13-42].

13-42 Logic Rule Boolean 2		
Array [6]		
Option:	Function:	
[0] *	False	Select the second boolean (TRUE or FALSE) input for the selected logic rule. See par. 13-01 <i>Start Event</i> ([0] - [61]) and par. 13-02 <i>Stop Event</i> ([70] - [75]) for further description.
[1]	True	
[2]	Running	
[3]	In range	
[4]	On reference	
[5]	Torque limit	
[6]	Current limit	
[7]	Out of current range	
[8]	Below I low	
[9]	Above I high	
[10]	Out of speed range	
[11]	Below speed low	
[12]	Above speed high	
[13]	Out of feedb. range	
[14]	Below feedb. low	
[15]	Above feedb. high	
[16]	Thermal warning	
[17]	Mains out of range	
[18]	Reversing	
[19]	Warning	
[20]	Alarm (trip)	
[21]	Alarm (trip lock)	
[22]	Comparator 0	
[23]	Comparator 1	
[24]	Comparator 2	
[25]	Comparator 3	
[26]	Logic rule 0	
[27]	Logic rule 1	
[28]	Logic rule 2	
[29]	Logic rule 3	
[30]	SL Time-out 0	
[31]	SL Time-out 1	
[32]	SL Time-out 2	
[33]	Digital input DI18	
[34]	Digital input DI19	
[35]	Digital input DI27	
[36]	Digital input DI29	
[37]	Digital input DI32	
[38]	Digital input DI33	
[39]	Start command	
[40]	Drive stopped	
[41]	Reset Trip	
[42]	Auto-reset Trip	
[43]	Ok key	
[44]	Reset key	
[45]	Left key	
[46]	Right key	

13-42 Logic Rule Boolean 2		
Array [6]		
Option:	Function:	
[47]	Up key	
[48]	Down key	
[50]	Comparator 4	
[51]	Comparator 5	
[60]	Logic rule 4	
[61]	Logic rule 5	
[70]	SL Time-out 3	
[71]	SL Time-out 4	
[72]	SL Time-out 5	
[73]	SL Time-out 6	
[74]	SL Time-out 7	
[75]	Start command given	
[76]	Digital input x30/2	
[77]	Digital input x30/3	
[78]	Digital input x30/4	
[79]	Digital input x46/1	
[80]	Digital input x46/3	
[81]	Digital input x46/5	
[82]	Digital input x46/7	
[83]	Digital input x46/9	
[84]	Digital input x46/11	
[85]	Digital input x46/13	

13-43 Logic Rule Operator 2		
Array [6]		
Option:	Function:	
	Select the second logical operator to be used on the boolean input calculated in par. 13-40 <i>Logic Rule Boolean 1</i> , par. 13-41 <i>Logic Rule Operator 1</i> , and par. 13-42 <i>Logic Rule Boolean 2</i> , and the boolean input coming from par. 13-42 <i>Logic Rule Boolean 2</i> . [13-44] signifies the boolean input of par. 13-44 <i>Logic Rule Boolean 3</i> . [13-40/13-42] signifies the boolean input calculated in par. 13-40 <i>Logic Rule Boolean 1</i> , par. 13-41 <i>Logic Rule Operator 1</i> , and par. 13-42 <i>Logic Rule Boolean 2</i> . DISABLED [0] (factory setting). select this option to ignore par. 13-44 <i>Logic Rule Boolean 3</i> .	
[0] *	DISABLED	
[1]	AND	
[2]	OR	
[3]	AND NOT	
[4]	OR NOT	
[5]	NOT AND	
[6]	NOT OR	
[7]	NOT AND NOT	
[8]	NOT OR NOT	

13-44 Logic Rule Boolean 3		
Array [6]		
Option:	Function:	
[0] *	False	Select the third boolean (TRUE or FALSE) input for the selected logic rule. See par. 13-01 ([0] - [61]) and par. 13-02 ([70] - [75]) for further description.
[1]	True	
[2]	Running	
[3]	In range	
[4]	On reference	
[5]	Torque limit	
[6]	Current limit	
[7]	Out of current range	
[8]	Below I low	
[9]	Above I high	
[10]	Out of speed range	
[11]	Below speed low	
[12]	Above speed high	
[13]	Out of feedb. range	
[14]	Below feedb. low	
[15]	Above feedb. high	
[16]	Thermal warning	
[17]	Mains out of range	
[18]	Reversing	
[19]	Warning	
[20]	Alarm (trip)	
[21]	Alarm (trip lock)	
[22]	Comparator 0	
[23]	Comparator 1	
[24]	Comparator 2	
[25]	Comparator 3	
[26]	Logic rule 0	
[27]	Logic rule 1	
[28]	Logic rule 2	
[29]	Logic rule 3	
[30]	SL Time-out 0	
[31]	SL Time-out 1	
[32]	SL Time-out 2	
[33]	Digital input DI18	
[34]	Digital input DI19	
[35]	Digital input DI27	
[36]	Digital input DI29	
[37]	Digital input DI32	
[38]	Digital input DI33	
[39]	Start command	
[40]	Drive stopped	
[41]	Reset Trip	
[42]	Auto-reset Trip	
[43]	Ok key	
[44]	Reset key	
[45]	Left key	
[46]	Right key	

13-44 Logic Rule Boolean 3		
Array [6]		
Option:	Function:	
[47]	Up key	
[48]	Down key	
[50]	Comparator 4	
[51]	Comparator 5	
[60]	Logic rule 4	
[61]	Logic rule 5	
[70]	SL Time-out 3	
[71]	SL Time-out 4	
[72]	SL Time-out 5	
[73]	SL Time-out 6	
[74]	SL Time-out 7	
[75]	Start command given	
[76]	Digital input x30/2	
[77]	Digital input x30/3	
[78]	Digital input x30/4	
[79]	Digital input x46/1	
[80]	Digital input x46/3	
[81]	Digital input x46/5	
[82]	Digital input x46/7	
[83]	Digital input x46/9	
[84]	Digital input x46/11	
[85]	Digital input x46/13	

3.14.6 13-5* States

13-51 SL Controller Event		
Array [20]		
Option:	Function:	
[0] *	False	Select the boolean input (TRUE or FALSE) to define the Smart Logic Controller event. See par. 13-01 <i>Start Event</i> ([0] - [61]) and par. 13-02 <i>Stop Event</i> ([70] - [74]) for further description.
[1]	True	
[2]	Running	
[3]	In range	
[4]	On reference	
[5]	Torque limit	
[6]	Current limit	
[7]	Out of current range	
[8]	Below I low	
[9]	Above I high	
[10]	Out of speed range	
[11]	Below speed low	
[12]	Above speed high	
[13]	Out of feedb. range	
[14]	Below feedb. low	
[15]	Above feedb. high	
[16]	Thermal warning	

13-51 SL Controller Event		
Array [20]		
Option:	Function:	
[17]	Mains out of range	
[18]	Reversing	
[19]	Warning	
[20]	Alarm (trip)	
[21]	Alarm (trip lock)	
[22]	Comparator 0	
[23]	Comparator 1	
[24]	Comparator 2	
[25]	Comparator 3	
[26]	Logic rule 0	
[27]	Logic rule 1	
[28]	Logic rule 2	
[29]	Logic rule 3	
[30]	SL Time-out 0	
[31]	SL Time-out 1	
[32]	SL Time-out 2	
[33]	Digital input DI18	
[34]	Digital input DI19	
[35]	Digital input DI27	
[36]	Digital input DI29	
[37]	Digital input DI32	
[38]	Digital input DI33	
[39]	Start command	
[40]	Drive stopped	
[41]	Reset Trip	
[42]	Auto-reset Trip	
[43]	Ok key	
[44]	Reset key	
[45]	Left key	
[46]	Right key	
[47]	Up key	
[48]	Down key	
[50]	Comparator 4	
[51]	Comparator 5	
[60]	Logic rule 4	
[61]	Logic rule 5	
[70]	SL Time-out 3	
[71]	SL Time-out 4	
[72]	SL Time-out 5	
[73]	SL Time-out 6	
[74]	SL Time-out 7	
[75]	Start command given	
[76]	Digital input x30/2	
[77]	Digital input x30/3	
[78]	Digital input x30/4	
[79]	Digital input x46/1	
[80]	Digital input x46/3	
[81]	Digital input x46/5	
[82]	Digital input x46/7	
[83]	Digital input x46/9	
[84]	Digital input x46/11	

13-51 SL Controller Event		
Array [20]		
Option:		Function:
[85]	Digital input x46/13	
13-52 SL Controller Action		
Array [20]		
Option:		Function:
[0] *	DISABLED	Select the action corresponding to the SLC event. Actions are executed when the corresponding event (defined in par. 13-51 <i>SL Controller Event</i>) is evaluated as true. The following actions are available for selection: *DISABLED [0]
[1]	No action	No action [1]
[2]	Select set-up 1	Select set-up 1 [2] - changes the active set-up (par. 0-10) to '1'. If the set-up is changed, it will merge with other set-up commands coming from either the digital inputs or via a fieldbus.
[3]	Select set-up 2	Select set-up 2 [3] - changes the active set-up (par. 0-10) to '2'. If the set-up is changed, it will merge with other set-up commands coming from either the digital inputs or via a fieldbus.
[4]	Select set-up 3	Select set-up 3 [4] - changes the active set-up (par. 0-10) to '3'. If the set-up is changed, it will merge with other set-up commands coming from either the digital inputs or via a fieldbus.
[5]	Select set-up 4	Select set-up 4 [5] - changes the active set-up (par. 0-10) to '4'. If the set-up is changed, it will merge with other set-up commands coming from either the digital inputs or via a fieldbus.
[10]	Select preset ref 0	Select preset reference 0 [10] - selects preset reference 0. If the active preset reference is changed, it will merge with other preset reference commands coming from either the digital inputs or via a fieldbus.
[11]	Select preset ref 1	Select preset reference 1 [11] - selects preset reference 1. If the active preset reference is changed, it will merge with other preset reference commands coming from either the digital inputs or via a fieldbus.
[12]	Select preset ref 2	Select preset reference 2 [12] - selects preset reference 2. If the active preset reference is changed, it will merge with other preset reference

13-52 SL Controller Action		
Array [20]		
Option:		Function:
		commands coming from either the digital inputs or via a fieldbus.
[13]	Select preset ref 3	Select preset reference 3 [13] - selects preset reference 3. If the active preset reference is changed, it will merge with other preset reference commands coming from either the digital inputs or via a fieldbus.
[14]	Select preset ref 4	Select preset reference 4 [14] - selects preset reference 4. If the active preset reference is changed, it will merge with other preset reference commands coming from either the digital inputs or via a fieldbus.
[15]	Select preset ref 5	Select preset reference 5 [15] - selects preset reference 5. If the active preset reference is changed, it will merge with other preset reference commands coming from either the digital inputs or via a fieldbus.
[16]	Select preset ref 6	Select preset reference 6 [16] - selects preset reference 6. If the active preset reference is changed, it will merge with other preset reference commands coming from either the digital inputs or via a fieldbus.
[17]	Select preset ref 7	Select preset reference 7 [17] - selects preset reference 7. If the active preset reference is changed, it will merge with other preset reference commands coming from either the digital inputs or via a fieldbus.
[18]	Select ramp 1	Select ramp 1 [18] - selects ramp 1.
[19]	Select ramp 2	Select ramp 2 [19] - selects ramp 2.
[20]	Select ramp 3	Select ramp 3 [20] - selects ramp 3.
[21]	Select ramp 4	Select ramp 4 [21] - selects ramp 4.
[22]	Run	Run [22] - issues a start command to the frequency converter.
[23]	Run reverse	Run reverse [23] - issues a start reverse command to the frequency converter.
[24]	Stop	Stop [24] - issues a stop command to the frequency converter.
[25]	Qstop	Qstop [25] - issues a quick stop command to the frequency converter.
[26]	Dcstop	Dcstop [26] - issues a DC stop command to the frequency converter.

13-52 SL Controller Action		
Array [20]		
Option:	Function:	
[27]	Coast	<i>Coast</i> [27] - the frequency converter coasts immediately. All stop commands including the coast command stop the SLC.
[28]	Freeze output	<i>Freeze output</i> [28] - freezes the output frequency of the frequency converter.
[29]	Start timer 0	<i>Start timer 0</i> [29] - starts timer 0, see par. 13-20 for further description.
[30]	Start timer 1	<i>Start timer 1</i> [30] - starts timer 1, see par. 13-20 for further description.
[31]	Start timer 2	<i>Start timer 2</i> [31] - starts timer 2, see par. 13-20 for further description.
[32]	Set digital out A low	<i>Set digital output A low</i> [32] - any output with SL output A will be low.
[33]	Set digital out B low	<i>Set digital output B low</i> [33] - any output with SL output B will be low.
[34]	Set digital out C low	<i>Set digital output C low</i> [34] - any output with SL output C will be low.
[35]	Set digital out D low	<i>Set digital output D low</i> [35] - any output with SL output D will be low.
[36]	Set digital out E low	<i>Set digital output E low</i> [36] - any output with SL output E will be low.
[37]	Set digital out F low	<i>Set digital output F low</i> [37] - any output with SL output F will be low.
[38]	Set digital out A high	<i>Set digital output A high</i> [38] - any output with SL output A will be high.
[39]	Set digital out B high	<i>Set digital output B high</i> [39] - any output with SL output B will be high.
[40]	Set digital out C high	<i>Set digital output C high</i> [40] - any output with SL output C will be high.
[41]	Set digital out D high	<i>Set digital output D high</i> [41] - any output with SL output D will be high.
[42]	Set digital out E high	<i>Set digital output E high</i> [42] - any output with SL output E will be high.
[43]	Set digital out F high	<i>Set digital output F high</i> [43] - any output with SL output F will be high.
[60]	Reset Counter A	<i>Reset Counter A</i> [60] - resets Counter A to zero.
[61]	Reset Counter B	<i>Reset Counter B</i> [61] - resets Counter B to zero.
[70]	Start timer 3	<i>Start Timer 3</i> [70] - Start Timer 3, see par. 13-20 for further description.
[71]	Start timer 4	<i>Start Timer 4</i> [71] - Start Timer 4, see par. 13-20 for further description.
[72]	Start timer 5	<i>Start Timer 5</i> [72] - Start Timer 5, see par. 13-20 for further description.

13-52 SL Controller Action		
Array [20]		
Option:	Function:	
[73]	Start timer 6	<i>Start Timer 6</i> [73] - Start Timer 6, see par. 13-20 for further description.
[74]	Start timer 7	<i>Start Timer 7</i> [74] - Start Timer 7, see par. 13-20 for further description.

3.15 Parameters: 14-** Special Functions

3.15.1 14-0* Inverter Switching

14-00 Switching Pattern		
Option:	Function:	
[0] *	60 AVM	Select the switching pattern: 60° AVM or SFAVM.
[1] *	SFAVM	

NOTE

The output frequency value of the frequency converter must never exceed 1/10 of the switching frequency. When the motor is running, adjust the switching frequency in par. 4-11 *Motor Speed Low Limit [RPM]* until the motor is as noiseless as possible. See also par. 14-00 *Switching Pattern* and the section *Special conditions* in the FC 300 Design Guide.

14-01 Switching Frequency		
Select the inverter switching frequency. Changing the switching frequency can help to reduce acoustic noise from the motor. Default depend on power size.		
Option:	Function:	
[0]	1.0 kHz	
[1]	1.5 kHz	Default switching frequency for 355-1200 kW, 690V
[2]	2.0 kHz	Default switching frequency for 250-800 kW, 400V and 37-315 kW, 690V
[3]	2.5 kHz	
[4]	3.0 kHz	Default switching frequency for 18.5-37 kW, 200V and 37-200 kW, 400V
[5]	3.5 kHz	
[6]	4.0 kHz	Default switching frequency for 5.5 – 15 kW, 200V and 11-30 kW, 400V
[7] *	5.0 kHz	Default switching frequency for 0.25 – 3,7 k W, 200V and 0.37-7.5 kW, 400V
[8]	6.0 kHz	
[9]	7.0 kHz	
[10]	8.0 kHz	
[11]	10.0 kHz	
[12]	12.0 kHz	
[13]	14.0 kHz	
[14]	16.0 kHz	

NOTE

The output frequency value of the frequency converter must never exceed 1/10 of the switching frequency. When the motor is running, adjust the switching frequency in par. 4-11 *Motor Speed Low Limit [RPM]* until the motor is as noiseless as possible. See also par. 14-00 *Switching Pattern* and the section *Special conditions* in the VLT AutomationDrive FC 300 Design Guide.

NOTE

Switching frequencies higher than 5.0 kHz lead to automatic derating of the maximum output of the frequency converter.

14-03 Overmodulation		
Option:	Function:	
[0]	Off	Select <i>On</i> [1] to connect the overmodulation function for the output voltage, to obtain an output voltage up to 15% greater than the mains voltage. Select <i>Off</i> [0] for no overmodulation of the output voltage, in order to avoid torque ripple on the motor shaft. This feature may be useful for applications such as grinding machines.
[1] *	On	
[2]	Optimal	

14-04 PWM Random		
Option:	Function:	
[0] *	Off	No change of the acoustic motor switching noise.
[1]	On	Transforms the acoustic motor switching noise from a clear ringing tone to a less noticeable 'white' noise. This is achieved by slightly and randomly altering the synchronism of the pulse width modulated output phases.

14-06 Dead Time Compensation		
Option:	Function:	
[0]	Off	No compensation.
[1] *	On	Activates dead time compensation.

3.15.2 14-1* Mains On/Off

Parameters for configuring mains failure monitoring and handling. If a mains failure appears, the frequency converter will try to continue in a controlled way until the power in the DC link has been exhausted.

14-10 Mains Failure	
<p>Par. 14-10 <i>Mains Failure</i> is typically used where very short mains interruptions (voltage dips) are present. At 100% load and a short voltage interruption, the DC voltage on the main capacitors drops quickly. For larger drives it only takes a few milliseconds before the DC level is down to about 373 V DC and the main IGBT cuts off and loses the control over the motor. When the mains is restored, and the IGBT starts again, the output frequency and voltage vector does not correspond to the speed/frequency of the motor, and the result is normally an overvoltage or overcurrent, mostly resulting in a trip lock. Par. 14-10 <i>Mains Failure</i> can be programmed to avoid this situation.</p>	
Option:	Function:
	<p>Function: Select the function to which the frequency converter must act when the threshold in par. 14-11 <i>Mains Voltage at Mains Fault</i> has been reached.</p> <p>Par. 14-10 <i>Mains Failure</i> cannot be changed while motor is running.</p> <p><i>Controlled ramp down:</i> The frequency converter will perform a controlled ramp down. If par. 2-10 <i>Brake Function</i> is Off [0] or AC brake [2], the ramp will follow the Over Voltage Ramping. If par. 2-10 <i>Brake Function</i> is [1] <i>Resistor Brake</i> the ramp will follow the setting in par. 3-81 <i>Quick Stop Ramp Time</i>.</p> <p><i>Controlled ramp down [1]:</i> After power-up the frequency converter is ready for start. Controlled ramp down and trip [2]: After power-up the frequency converter needs a reset for starting.</p>

14-10 Mains Failure	
<p>Par. 14-10 <i>Mains Failure</i> is typically used where very short mains interruptions (voltage dips) are present. At 100% load and a short voltage interruption, the DC voltage on the main capacitors drops quickly. For larger drives it only takes a few milliseconds before the DC level is down to about 373 V DC and the main IGBT cuts off and loses the control over the motor. When the mains is restored, and the IGBT starts again, the output frequency and voltage vector does not correspond to the speed/frequency of the motor, and the result is normally an overvoltage or overcurrent, mostly resulting in a trip lock. Par. 14-10 <i>Mains Failure</i> can be programmed to avoid this situation.</p>	
Option:	Function:
	<ol style="list-style-type: none"> The power is back before the energy from DC /moment of inertia from load is too low. The frequency converter will perform a controlled ramp down when par. 14-11 <i>Mains Voltage at Mains Fault</i> level has been reached. The frequency converter will perform a controlled ramp down as long as energy in the DC link is present. After this point the motor will be coasted. <p>Kinetic back-up: The frequency converter will perform a Kinetic back-up. If par. 2-10 <i>Brake Function</i> is Off [0] or AC brake [2], the ramp will follow the Over Voltage Ramping. If par. 2-10 <i>Brake Function</i> is [1] <i>Resistor Brake</i> the ramp will follow the setting in par. 3-81 <i>Quick Stop Ramp Time</i>.</p> <p>Kinetic Back-up [4]: The frequency converter will keep on running as long as there is energy in the system due to the moment of inertia produced by the load.</p> <p>Kinetic Back-up [5]: The frequency converter will ride through on speed as long as the energy is present from moment of inertia from the load. If the DC voltage goes below par. 14-11 <i>Mains Voltage at Mains Fault</i> the frequency converter will perform a trip.</p>

14-10 Mains Failure		
<p>Par. 14-10 <i>Mains Failure</i> is typically used where very short mains interruptions (voltage dips) are present. At 100% load and a short voltage interruption, the DC voltage on the main capacitors drops quickly. For larger drives it only takes a few milliseconds before the DC level is down to about 373 V DC and the main IGBT cuts off and loses the control over the motor. When the mains is restored, and the IGBT starts again, the output frequency and voltage vector does not correspond to the speed/frequency of the motor, and the result is normally an overvoltage or overcurrent, mostly resulting in a trip lock. Par. 14-10 <i>Mains Failure</i> can be programmed to avoid this situation.</p>		
Option:	Function:	
[0] *	No function	This selection does not present a danger to the frequency converter, but a trip lock would normally be the result of the short voltage interruptions.
[1]	Ctrl. ramp-down	This selection will keep the output frequency following the motor speed. The IGBT will not lose the connection to the motor, but will follow the speed down. This is particularly useful in pump applications, where the inertia is low and the friction is high. When the mains is restored, the output frequency will ramp the motor up to the reference speed (if the mains interruption is prolonged, the controlled ramp down might take the output frequency all the way down to 0 rpm, and when the mains is restored, the application is ramped up from 0 rpm to the previous reference speed via the normal ramp up).
[2]	Ctrl. ramp-down, trip	
[3]	Coasting	Centrifuges can run for an hour without power supply. In those situations it is possible to select a coast function at mains interruption, together with a flying start which occurs when the mains is restored.
[4]	Kinetic back-up	Kinetic back up will maintain the DC level as long as possible, by converting the mechanical energy from the motor to the DC level supply. Fans normally can extend the mains interruptions for several seconds. Pumps can normally only extend the interruptions for 1-2

14-10 Mains Failure		
<p>Par. 14-10 <i>Mains Failure</i> is typically used where very short mains interruptions (voltage dips) are present. At 100% load and a short voltage interruption, the DC voltage on the main capacitors drops quickly. For larger drives it only takes a few milliseconds before the DC level is down to about 373 V DC and the main IGBT cuts off and loses the control over the motor. When the mains is restored, and the IGBT starts again, the output frequency and voltage vector does not correspond to the speed/frequency of the motor, and the result is normally an overvoltage or overcurrent, mostly resulting in a trip lock. Par. 14-10 <i>Mains Failure</i> can be programmed to avoid this situation.</p>		
Option:	Function:	
	seconds or fractions of seconds. Compressors only for fractions of seconds.	
[5]	Kinetic back-up, trip	
[6]	Alarm	

14-11 Mains Voltage at Mains Fault		
Range:	Function:	
Application dependent*	[180 - 600 V]	This parameter defines the threshold voltage at which the selected function in par. 14-10 <i>Mains Failure</i> should be activated. The detection level is at a factor $\sqrt{2}$ of the value in 14-11.
<p>NOTE Note for converting between VLT 5000 and FC 300: Even though the setting of the Mains Voltage at Mains Fault is the same for VLT 5000 and FC 300, the detection level is different. Use the following formula to obtain the same detection level as in VLT 5000: $14-11 \text{ (VLT 5000 level)} = \text{Value used in VLT 5000} * 1,35/\sqrt{2}$.</p>		

14-12 Function at Mains Imbalance		
<p>Operation under severe main imbalance conditions reduces the lifetime of the motor. Conditions are considered severe if the motor is operated continuously near nominal load (e.g. a pump or fan running near full speed).</p>		
Option:	Function:	
[0] *	Trip	Trips the frequency converter
[1]	Warning	Issues a warning
[2]	Disabled	No action

14-14 Kin. Backup Time Out		
Range:	Function:	
60 s*	[0 - 60 s]	This parameter defines the Kinetic Backup Time Out in flux mode when running on low voltage grids. If the supply voltage does not increase above the value defined in P14-11 + 5% within the specified time, the drive will then automatically run a controlled ramp-down profile prior to stop.

3.15.3 14-2* Trip Reset

Parameters for configuring auto reset handling, special trip handling and control card self test or initialisation.

14-20 Reset Mode		
Option:	Function:	
		Select the reset function after tripping. Once reset, the frequency converter can be restarted.
[0] *	Manual reset	Select <i>Manual reset</i> [0], to perform a reset via [RESET] or via the digital inputs.
[1]	Automatic reset x 1	Select <i>Automatic reset x 1...x20</i> [1]-[12] to perform between one and twenty automatic resets after tripping.
[2]	Automatic reset x 2	
[3]	Automatic reset x 3	
[4]	Automatic reset x 4	
[5]	Automatic reset x 5	
[6]	Automatic reset x 6	
[7]	Automatic reset x 7	
[8]	Automatic reset x 8	
[9]	Automatic reset x 9	
[10]	Automatic reset x 10	
[11]	Automatic reset x 15	
[12]	Automatic reset x 20	
[13]	Infinite auto reset	Select <i>Infinite Automatic Reset</i> [13] for continuous resetting after tripping.
[14]	Reset at power-up	

NOTE

The motor may start without warning. If the specified number of AUTOMATIC RESETs is reached within 10 minutes, the frequency converter enters Manual reset [0] mode. After the Manual reset is performed, the setting of par. 14-20 *Reset Mode* reverts to the original selection. If the number of automatic resets is not reached within 10 minutes, or when a Manual reset is performed, the internal AUTOMATIC RESET counter returns to zero.

NOTE

Automatic reset will also be active for resetting safe stop function in firmware version < 4.3x.

14-21 Automatic Restart Time		
Range:	Function:	
10 s*	[0 - 600 s]	Enter the time interval from trip to start of the automatic reset function. This parameter is active when par. 14-20 <i>Reset Mode</i> is set to <i>Automatic reset</i> [1] - [13].

14-22 Operation Mode		
Option:	Function:	
		Use this parameter to specify normal operation; to perform tests; or to initialise all parameters except par. 15-03 <i>Power Up's</i> , par. 15-04 <i>Over Temp's</i> and par. 15-05 <i>Over Volt's</i> . This function is active only when the power is cycled to the frequency converter. Select <i>Normal operation</i> [0] for normal operation of the frequency converter with the motor in the selected application. Select <i>Control card test</i> [1] to test the analog and digital inputs and outputs and the +10 V control voltage. The test requires a test connector with internal connections. Use the following procedure for the control card test:
		<ol style="list-style-type: none"> 1. Select <i>Control card test</i> [1]. 2. Disconnect the mains supply and wait for the light in the display to go out. 3. Set switches S201 (A53) and S202 (A54) = 'ON' / I. 4. Insert the test plug (see below). 5. Connect to mains supply. 6. Carry out various tests. 7. The results are displayed on the LCP and the frequency converter moves into an infinite loop. 8. Par. 14-22 <i>Operation Mode</i> is automatically set to Normal operation. Carry out a power cycle to start up in Normal operation after a control card test.
		<p>If the test is OK: LCP read-out: Control Card OK. Disconnect the mains supply and remove the test plug. The green LED on the Control Card will light up.</p> <p>If the test fails: LCP read-out: Control Card I/O failure. Replace the frequency converter or Control card. The red LED on the Control Card is turned</p>

14-22 Operation Mode	
Option:	Function:
	<p>on. Test plugs (connect the following terminals to each other): 18 - 27 - 32; 19 - 29 - 33; 42 - 53 - 54</p> <p>Select <i>Initialization</i> [2] to reset all parameter values to default settings, except for par. 15-03 <i>Power Up's</i>, par. 15-04 <i>Over Temp's</i>, and par. 15-05 <i>Over Volt's</i>. The frequency converter will reset during the next power-up. Par. 14-22 <i>Operation Mode</i> will also revert to the default setting <i>Normal operation</i> [0].</p>
[0] *	Normal operation
[1]	Control card test
[2]	Initialisation
[3]	Boot mode

14-24 Trip Delay at Current Limit	
Range:	Function:
60 s* [0 - 60 s]	Enter the current limit trip delay in seconds. When the output current reaches the current limit (par. 4-18 <i>Current Limit</i>), a warning is triggered. When the current limit warning has been continuously present for the period specified in this parameter, the frequency converter trips. Disable the trip delay by setting the parameter to 60 s = OFF. Thermal monitoring of the frequency converter will still remain active.

14-25 Trip Delay at Torque Limit	
Range:	Function:
60 s* [0 - 60 s]	Enter the torque limit trip delay in seconds. When the output torque reaches the torque limits (par. 4-16 <i>Torque Limit Motor Mode</i> and par. 4-17 <i>Torque Limit Generator Mode</i>), a warning is triggered. When the torque limit warning has been continuously present for the period specified in this parameter, the frequency converter trips. Disable the trip delay by setting the parameter to 60 s = OFF. Thermal monitoring of the frequency converter will still remain active.

14-26 Trip Delay at Inverter Fault	
Range:	Function:
Application dependent* [0 - 35 s]	When the frequency converter detects an over-voltage in the set time trip will be effected after the set time. If value = 0, <i>protection mode</i> is disabled
<p>NOTE It is recommended to disable <i>protection mode</i> in hoisting applications.</p>	

14-29 Service Code	
Range:	Function:
0* [-2147483647 - 2147483647]	For internal service only.

3.15.4 14-3* Current Limit Control

The frequency converter features an integral Current Limit Controller which is activated when the motor current, and thus the torque, is higher than the torque limits set in par. 4-16 *Torque Limit Motor Mode* and par. 4-17 *Torque Limit Generator Mode*.

When the current limit is reached during motor operation or regenerative operation, the frequency converter will try to reduce torque below the preset torque limits as quickly as possible without losing control of the motor.

While the current control is active, the frequency converter can only be stopped by setting a digital input to *Coast inverse* [2] or *Coast and reset inv.* [3]. Any signal on terminals 18 to 33 will not be active until the frequency converter is no longer near the current limit.

By using a digital input set to *Coast inverse* [2] or *Coast and reset inv.* [3], the motor does not use the ramp-down time, since the frequency converter is coasted. If a quick stop is necessary, use the mechanical brake control function along with an external electro-mechanical brake attached to the application.

14-30 Current Lim Ctrl, Proportional Gain		
Range:		Function:
100 %*	[0 - 500 %]	Enter the proportional gain value for the current limit controller. Selection of a high value makes the controller react faster. Too high a setting leads to controller instability.

14-31 Current Lim Ctrl, Integration Time		
Range:		Function:
0.020 s*	[0.002 - 2.000 s]	Controls the current limit control integration time. Setting it to a lower value makes it react faster. A setting too low leads to control instability.

14-32 Current Lim Ctrl, Filter Time		
Range:		Function:
1.0 ms*	[1.0 - 100.0 ms]	

14-35 Stall Protection		
Option:	Function:	
		Select Enable [1] to enable the stall protection in field-weakening in flux mode. Select Disable [0] if you desire to disable it. This might cause the motor to be lost. Par. 14-35 <i>Stall Protection</i> is active in Flux mode only.
[0]	Disabled	
[1] *	Enabled	

3.15.5 14-4* Energy Optimising

Parameters for adjusting the energy optimisation level in both Variable Torque (VT) and Automatic Energy Optimization (AEO) mode in par. 1-03 *Torque Characteristics*.

14-40 VT Level		
Range:		Function:
66 %*	[40 - 90 %]	Enter the level of motor magnetisation at low speed. Selection of a low value reduces energy loss in the motor, but also reduces load capability. This parameter cannot be adjusted while the motor is running.

14-41 AEO Minimum Magnetisation		
Range:		Function:
Application dependent*	[40 - 75 %]	Enter the minimum allowable magnetisation for AEO. Selection of a low value reduces energy loss in the motor, but can also reduce resistance to sudden load changes.

14-42 Minimum AEO Frequency		
Range:		Function:
10 Hz*	[5 - 40 Hz]	Enter the minimum frequency at which the Automatic Energy Optimisation (AEO) is to be active.

14-43 Motor Cosphi		
Range:		Function:
Application dependent*	[0.40 - 0.95]	The Cos(phi) setpoint is automatically set for optimum AEO performance. This parameter should normally not be altered. However in some situations it may be necessary to enter a new value to fine-tune.

3.15.6 14-5* Environment

These parameters help the frequency converter to operate under special environmental conditions.

14-50 RFI Filter		
Option:	Function:	
[0]	Off	Select <i>Off</i> [0] only if the frequency converter is fed by an isolated mains source (IT mains). In this mode, the internal RFI filter capacitors between chassis and the mains RFI filter circuit are cut-out to reduce the ground capacity currents.
[1] *	On	Select <i>On</i> [1] to ensure that the frequency converter complies with EMC standards.

14-51 DC Link Compensation		
Option:	Function:	
[0]	Off	Disables DC Link Compensation.
[1] *	On	Enables DC Link Compensation.

14-52 Fan Control		
Select minimum speed of the main fan. Select <i>Auto</i> [0] to run fan only when internal temperature in frequency converter is in range 35° C to approx. 55° C. Fan runs at low speed below 35° C, and at full speed at approx. 55° C.		
Option:	Function:	
[0] *	Auto	
[1]	On 50%	
[2]	On 75%	
[3]	On 100%	

14-53 Fan Monitor		
Option:	Function:	
		Select which reaction the frequency converter should take in case a fan fault is detected.
[0]	Disabled	
[1] *	Warning	
[2]	Trip	

14-55 Output Filter		
Option:	Function:	
		Select the type of output filter connected. This parameter cannot be adjusted while motor is running.
[0] *	No Filter	
[1]	Sine-Wave Filter	
[2]	Sine-Wave Filter Fixed	

14-56 Capacitance Output Filter		
Compensation function of the LC-filter requires the per phase equivalent star connected capacitance of the filter (3 times the capacity between two phases when capacitance is 'Delta' connection).		
Range:	Function:	
2.0 uF*	[0.1 - 6500.0 uF]	Set the capacitance of the output filter. The value can be found on the filter label. NOTE This is required for correct compensation in Flux mode (par. 1-01 <i>Motor Control Principle</i>)

14-57 Inductance Output Filter		
Range:	Function:	
7.000 mH*	[0.001 - 65.000 mH]	Set the inductance of the output filter. The value can be found on the filter label. NOTE This is required for correct compensation in Flux mode (par. 1-01 <i>Motor Control Principle</i>)

3.15.7 14-7* Compatibility

The parameters in this group are for setting of compatibility for VLT 3000, VLT 5000 to FC 300

14-72 VLT Alarm Word		
Option:	Function:	
[0]	0 - 4294967295	Read out the alarm word corresponding to VLT 5000

14-73 VLT Warning Word		
Option:	Function:	
[0]	0 - 4294967295	Read out the warning word corresponding to VLT 5000

14-74 Leg. Ext. Status Word		
Range:	Function:	
0*	[0 - 4294967295]	Read out the ext. status word corresponding to VLT 5000

3.15.8 14-8* Options

14-80 Option Supplied by External 24VDC		
Option:	Function:	
[0]	No	Select No [0] to use the drive's 24 V DC supply.
[1] *	Yes	Select Yes [1] if an external 24 V DC supply will be used to power the option. Inputs/Outputs will be galvanically isolated from the drive when operated from an external supply.

NOTE
This parameter is only changing function by performing a power cycle.

14-89 Option Detection		
Selects the behaviour of the frequency converter when a change in the option configuration is detected.		
Option:	Function:	
[0] *	Frozen Configuration	Freezes the current settings and prevents unwanted changes when missing or defective options are detected.
[1]	Enable Option Change	Changes drive settings and is used when modifying the system configuration. This Parameter setting will return to [0] after an Option Change.

14-90 Fault Level	
Option:	Function:
[0] *	Off Use this parameter to customize Fault levels. Use [0] "Off" with caution as it will ignore all Warnings & Alarms for the chosen source.
[1]	Warning
[2]	Trip
[3]	Trip Lock

Failure	Alarm	Off	Warning	Trip	Trip Lock
10V low	1	X	X *		
24V low	47	X			X*
1.8V supply low	48	X			X*
Voltage limit	64	X	X*		
Earth fault during ramping	14			X*	X
Earth fault 2 during cont. operation	45			X*	X
Torque Limit	12	X	X*		

Table 3.4: Table for selection of choice of action when selected alarm appear:

3.16 Parameters: 15-** Drive Information

3.16.1 15-0* Operating Data

15-00 Operating Hours		
Range:	Function:	
0 h*	[0 - 2147483647 h]	View how many hours the frequency converter has run. The value is saved when the frequency converter is turned off.

15-01 Running Hours		
Range:	Function:	
0 h*	[0 - 2147483647 h]	View how many hours the motor has run. Reset the counter in par. 15-07 <i>Reset Running Hours Counter</i> . The value is saved when the frequency converter is turned off.

15-02 kWh Counter		
Range:	Function:	
0 kWh*	[0 - 2147483647 kWh]	Registering the power consumption of the motor as a mean value over one hour. Reset the counter in par. 15-06 <i>Reset kWh Counter</i> .

15-03 Power Up's		
Range:	Function:	
0 N/A*	[0 - 2147483647 N/A]	View the number of times the frequency converter has been powered up.

15-04 Over Temp's		
Range:	Function:	
0 N/A*	[0 - 65535 N/A]	View the number of frequency converter temperature faults which have occurred.

15-05 Over Volt's		
Range:	Function:	
0 N/A*	[0 - 65535 N/A]	View the number of frequency converter overvoltages which have occurred.

15-06 Reset kWh Counter		
Option:	Function:	
[0] *	Do not reset	Select <i>Do not reset</i> [0] if no reset of the kWh counter is desired.
[1]	Reset counter	Select <i>Reset</i> [1] and press [OK] to reset the kWh counter to zero (see par. 15-02 <i>kWh Counter</i>).

NOTE

The reset is carried out by pressing [OK].

15-07 Reset Running Hours Counter		
Option:	Function:	
[0] *	Do not reset	
[1]	Reset counter	Select <i>Reset</i> [1] and press [OK] to reset the Running Hours counter to zero (see par. 15-01 <i>Running Hours</i>). This parameter cannot be selected via the serial port, RS-485. Select <i>Do not reset</i> [0] if no reset of the Running Hours counter is desired.

3.16.2 15-1* Data Log Settings

The Data Log enables continuous logging of up to 4 data sources (par. 15-10 *Logging Source*) at individual rates (par. 15-11 *Logging Interval*). A trigger event (par. 15-12 *Trigger Event*) and window (par. 15-14 *Samples Before Trigger*) are used to start and stop the logging conditionally.

15-10 Logging Source		
Array [4]		
Option:	Function:	
		Select which variables are to be logged.
[0] *	None	
[1472]	Legacy Alarm Word	
[1473]	Legacy Warning Word	
[1474]	Leg. Ext. Status Word	
[1600]	Control Word	
[1601]	Reference [Unit]	
[1602]	Reference %	
[1603]	Status Word	
[1610]	Power [kW]	
[1611]	Power [hp]	
[1612]	Motor Voltage	
[1613]	Frequency	
[1614]	Motor Current	
[1616]	Torque [Nm]	
[1617]	Speed [RPM]	
[1618]	Motor Thermal	
[1621]	Torque [%] High Res.	
[1622]	Torque [%]	
[1625]	Torque [Nm] High	
[1630]	DC Link Voltage	
[1632]	Brake Energy /s	
[1633]	Brake Energy /2 min	
[1634]	Heatsink Temp.	
[1635]	Inverter Thermal	
[1650]	External Reference	
[1651]	Pulse Reference	
[1652]	Feedback [Unit]	
[1657]	Feedback [RPM]	

15-10 Logging Source		
Array [4]		
Option:	Function:	
[1660]	Digital Input	
[1662]	Analog Input 53	
[1664]	Analog Input 54	
[1665]	Analog Output 42 [mA]	
[1666]	Digital Output [bin]	
[1675]	Analog In X30/11	
[1676]	Analog In X30/12	
[1677]	Analog Out X30/8 [mA]	
[1690]	Alarm Word	
[1692]	Warning Word	
[1694]	Ext. Status Word	
[1860]	Digital Input 2	
[3110]	Bypass Status Word	
[3470]	MCO Alarm Word 1	
[3471]	MCO Alarm Word 2	

15-11 Logging Interval		
Range:	Function:	
Application dependent*	[Application dependant]	Enter the interval in milliseconds between each sampling of the variables to be logged.

15-12 Trigger Event		
Select the trigger event. When the trigger event occurs, a window is applied to freeze the log. The log will then retain a specified percentage of samples before the occurrence of the trigger event (par. 15-14 <i>Samples Before Trigger</i>).		
Option:	Function:	
[0] *	False	
[1]	True	
[2]	Running	
[3]	In range	
[4]	On reference	
[5]	Torque limit	
[6]	Current limit	
[7]	Out of current range	
[8]	Below I low	
[9]	Above I high	
[10]	Out of speed range	
[11]	Below speed low	
[12]	Above speed high	
[13]	Out of feedb. range	
[14]	Below feedb. low	
[15]	Above feedb. high	
[16]	Thermal warning	
[17]	Mains out of range	
[18]	Reversing	
[19]	Warning	
[20]	Alarm (trip)	
[21]	Alarm (trip lock)	
[22]	Comparator 0	

15-12 Trigger Event		
Select the trigger event. When the trigger event occurs, a window is applied to freeze the log. The log will then retain a specified percentage of samples before the occurrence of the trigger event (par. 15-14 <i>Samples Before Trigger</i>).		
Option:	Function:	
[23]	Comparator 1	
[24]	Comparator 2	
[25]	Comparator 3	
[26]	Logic rule 0	
[27]	Logic rule 1	
[28]	Logic rule 2	
[29]	Logic rule 3	
[33]	Digital input DI18	
[34]	Digital input DI19	
[35]	Digital input DI27	
[36]	Digital input DI29	
[37]	Digital input DI32	
[38]	Digital input DI33	
[50]	Comparator 4	
[51]	Comparator 5	
[60]	Logic rule 4	
[61]	Logic rule 5	

15-13 Logging Mode		
Option:	Function:	
[0] *	Log always	Select <i>Log always</i> [0] for continuous logging.
[1]	Log once on trigger	Select <i>Log once on trigger</i> [1] to conditionally start and stop logging using par. 15-12 <i>Trigger Event</i> and par. 15-14 <i>Samples Before Trigger</i> .

15-14 Samples Before Trigger		
Range:	Function:	
50*	[0 - 100]	Enter the percentage of all samples prior to a trigger event which are to be retained in the log. See also par. 15-12 <i>Trigger Event</i> and par. 15-13 <i>Logging Mode</i> .

3.16.3 15-2* Historic Log

View up to 50 logged data items via the array parameters in this par. group. For all parameters in the group, [0] is the most recent data and [49] the oldest data. Data is logged every time an *event* occurs (not to be confused with SLC events). *Events* in this context are defined as a change in one of the following areas:

1. Digital input
2. Digital outputs (not monitored in this SW release)
3. Warning word
4. Alarm word
5. Status word
6. Control word
7. Extended status word

Events are logged with value, and time stamp in msec. The time interval between two events depends on how often *events* occur (maximum once every scan time). Data logging is continuous but if an alarm occurs, the log is saved and the values can be viewed on the display. This feature is useful, for example when carrying out service following a trip. View the historic log contained in this parameter via the serial communication port or via the display.

15-20 Historic Log: Event		
Array [50]		
Range:		Function:
0 N/A*	[0 - 255 N/A]	View the event type of the logged events.

15-21 Historic Log: Value		
Array [50]		
Range:		Function:
0 N/A*	[0 - 2147483647 N/A]	View the value of the logged event. Interpret the event values according to this table:

15-21 Historic Log: Value		
Array [50]		
Range:		Function:
	Digital input	Decimal value. See par. 16-60 <i>Digital Input</i> for description after converting to binary value.
	Digital output (not monitored in this SW release)	Decimal value. See par. 16-66 <i>Digital Output [bin]</i> for description after converting to binary value.
	Warning word	Decimal value. See par. 16-92 <i>Warning Word</i> for description.
	Alarm word	Decimal value. See par. 16-90 <i>Alarm Word</i> for description.
	Status word	Decimal value. See par. 16-03 <i>Status Word</i> for description after converting to binary value.
	Control word	Decimal value. See par. 16-00 <i>Control Word</i> for description.
	Extended status word	Decimal value. See par. 16-94 <i>Ext. Status Word</i> for description.

15-22 Historic Log: Time		
Array [50]		
Range:		Function:
0 ms*	[0 - 2147483647 ms]	View the time at which the logged event occurred. Time is measured in ms since frequency converter start. The max. value corresponds to approx. 24 days which means that the count will restart at zero after this time period.

3.16.4 15-3* Alarm Log

Parameters in this group are array parameters, where up to 10 fault logs can be viewed. [0] is the most recent logged data, and [9] the oldest. Error codes, values, and time stamp can be viewed for all logged data.

15-30 Fault Log: Error Code		
Array [10]		
Range:	Function:	
0*	[0 - 255]	View the error code and look up its meaning in the <i>Troubleshooting</i> chapter of the FC 300 Design Guide.

15-31 Alarm Log: Value		
Array [10]		
Range:	Function:	
0 N/A*	[-32767 - 32767 N/A]	View an extra description of the error. This parameter is mostly used in combination with alarm 38 'internal fault'.

15-32 Alarm Log: Time		
Array [10]		
Range:	Function:	
0 s*	[0 - 2147483647 s]	View the time when the logged event occurred. Time is measured in seconds from frequency converter start-up.

3.16.5 15-4* Drive Identification

Parameters containing read only information about the hardware and software configuration of the frequency converter.

15-40 FC Type		
Range:	Function:	
0*	[0 - 0]	View the FC type. The read-out is identical to the FC 300 Series power field of the type code definition, characters 1-6.

15-41 Power Section		
Range:	Function:	
0*	[0 - 0]	View the FC type. The read-out is identical to the FC 300 Series power field of the type code definition, characters 7-10.

15-42 Voltage		
Range:	Function:	
0*	[0 - 0]	View the FC type. The read-out is identical to the FC 300 Series power field of the type code definition, characters 11-12.

15-43 Software Version		
Range:	Function:	
0 N/A*	[0 - 0 N/A]	View the combined SW version (or 'package version') consisting of power SW and control SW.

15-44 Ordered Typecode String		
Range:	Function:	
0 N/A*	[0 - 0 N/A]	View the type code string used for re-ordering the frequency converter in its original configuration.

15-45 Actual Typecode String		
Range:	Function:	
0 N/A*	[0 - 0 N/A]	View the actual type code string.

15-46 Frequency Converter Ordering No		
Range:	Function:	
0 N/A*	[0 - 0 N/A]	View the 8-digit ordering number used for re-ordering the frequency converter in its original configuration.

15-47 Power Card Ordering No		
Range:	Function:	
0 N/A*	[0 - 0 N/A]	View the power card ordering number.

15-48 LCP Id No		
Range:	Function:	
0 N/A*	[0 - 0 N/A]	View the LCP ID number.

15-49 SW ID Control Card		
Range:	Function:	
0 N/A*	[0 - 0 N/A]	View the control card software version number.

15-50 SW ID Power Card		
Range:	Function:	
0 N/A*	[0 - 0 N/A]	View the power card software version number.

15-51 Frequency Converter Serial Number		
Range:	Function:	
0 N/A*	[0 - 0 N/A]	View the frequency converter serial number.

15-53 Power Card Serial Number		
Range:	Function:	
0 N/A*	[0 - 0 N/A]	View the power card serial number.

15-59 CSIV Filename		
Range:	Function:	
Application dependent*	[0 - 0]	Shows the currently used CSIV (Customer Specific Initial Values) filename.

3.16.6 15-6* Option Ident.

This read-only par. group contains information about the hardware and software configuration of the options installed in slots A, B C0 and C1.

15-60 Option Mounted		
Range:	Function:	
0 N/A*	[0 - 0 N/A]	View the installed option type.

15-61 Option SW Version		
Range:	Function:	
0 N/A*	[0 - 0 N/A]	View the installed option software version.

15-62 Option Ordering No		
Range:	Function:	
0 N/A*	[0 - 0 N/A]	Shows the ordering number for the installed options.

15-63 Option Serial No		
Range:	Function:	
0 N/A*	[0 - 0 N/A]	View the installed option serial number.

3.16.7 15-9* Parameter Info

15-92 Defined Parameters		
Array [1000]		
Range:	Function:	
0 N/A*	[0 - 9999 N/A]	View a list of all defined parameters in the frequency converter. The list ends with 0.

15-93 Modified Parameters		
Array [1000]		
Range:	Function:	
0 N/A*	[0 - 9999 N/A]	View a list of the parameters that have been changed from their default setting. The list ends with 0. Changes may not be visible until up to 30 seconds after implementation.

15-99 Parameter Metadata		
Array [30]		
Range:	Function:	
0*	[0 - 9999]	This parameter contains data used by the MCTæ10 software tool.

3.17 Parameters: 16-** Data Read-outs

3.17.1 16-0* General Status

16-00 Control Word		
Range:	Function:	
0 N/A*	[0 - 65535 N/A]	View the Control word sent from the frequency converter via the serial communication port in hex code.

16-01 Reference [Unit]		
Range:	Function:	
0.000 Reference-FeedbackUnit*	[-999999.000 - 999999.000 ReferenceFeed-backUnit]	View the present reference value applied on impulse or analog basis in the unit resulting from the configuration selected in par. 1-00 <i>Configuration Mode</i> (Hz, Nm or RPM).

16-02 Reference [%]		
Range:	Function:	
0.0 %*	[-200.0 - 200.0 %]	View the total reference. The total reference is the sum of digital, analog, preset, bus, and freeze references, plus catch-up and slow-down.

16-03 Status Word		
Range:	Function:	
0 N/A*	[0 - 65535 N/A]	View the Status word sent from the frequency converter via the serial communication port in hex code.

16-05 Main Actual Value [%]		
Range:	Function:	
0.00 %*	[-100.00 - 100.00 %]	View the two-byte word sent with the Status word to the bus Master reporting the Main Actual Value.

16-09 Custom Readout		
Range:	Function:	
0.00 Custom-ReadoutUnit*	[0.00 - 0.00 CustomRead-outUnit]	View the value of custom readout from par. 0-30 <i>Unit for User-defined Readout</i> to par. 0-32 <i>Custom Readout Max Value</i>

3.17.2 16-1* Motor Status

16-10 Power [kW]		
Range:		Function:
0.00 kW*	[0.00 - 10000.00 kW]	Displays motor power in kW. The value shown is calculated on the basis of the actual motor voltage and motor current. The value is filtered, and therefore approx. 30 ms may pass from when an input value changes to when the data read-out values change. The resolution of read-out value on fieldbus is in 10 W steps.

16-11 Power [hp]		
Range:		Function:
0.00 hp*	[0.00 - 10000.00 hp]	View the motor power in HP. The value shown is calculated on the basis of the actual motor voltage and motor current. The value is filtered, and therefore approximately 30 ms may pass from when an input value changes to when the data read-out values change.

16-12 Motor Voltage		
Range:		Function:
0.0 V*	[0.0 - 6000.0 V]	View the motor voltage, a calculated value used for controlling the motor.

16-13 Frequency		
Range:		Function:
0.0 Hz*	[0.0 - 6500.0 Hz]	View the motor frequency, without resonance dampening.

16-14 Motor Current		
Range:		Function:
0.00 A*	[0.00 - 10000.00 A]	View the motor current measured as a mean value, IRMS. The value is filtered, and thus approximately 30 ms may pass from when an input value changes to when the data read-out values change.

16-15 Frequency [%]		
Range:		Function:
0.00 %*	[-100.00 - 100.00 %]	View a two-byte word reporting the actual motor frequency (without resonance dampening) as a percentage (scale 0000-4000 Hex) of par. 4-19 <i>Max Output Frequency</i> . Set par. 9-16 <i>PCD Read Configuration</i> index 1 to send it with the Status Word instead of the MAV.

16-16 Torque [Nm]		
Range:		Function:
0.0 Nm*	[-3000.0 - 3000.0 Nm]	View the torque value with sign, applied to the motor shaft. Linearity is not exact between 160% motor current and torque in relation to the rated torque. Some motors supply more than 160% torque. Consequently, the min. value and the max. value will depend on the max. motor current as well as the motor used. The value is filtered, and thus approx. 30 ms may pass from when an input changes value to when the data read-out values change.

16-17 Speed [RPM]		
Range:		Function:
0 RPM*	[-30000 - 30000 RPM]	View the actual motor RPM. In open loop or closed loop process control the motor RPM is estimated. In speed closed loop modes the motor RPM is measured.

16-18 Motor Thermal		
Range:		Function:
0 %*	[0 - 100 %]	View the calculated thermal load on the motor. The cut-out limit is 100%. The basis for calculation is the ETR function selected in par. 1-90 <i>Motor Thermal Protection</i> .

16-19 KTY sensor temperature		
Range:		Function:
0 C*	[0 - 0 C]	Returning the actual temperature on KTY sensor built into the motor. See par. 1-9*.

16-20 Motor Angle		
Range:		Function:
0*	[0 - 65535]	View the current encoder/resolver angle offset relative to the index position. The value range of 0-65535 corresponds to 0-2*pi (radians).

16-21 Torque [%] High Res.		
Range:		Function:
0.0 %*	[-200.0 - 200.0 %]	The value shown is the torque in percent of nominal torque, with sign and 0.1% resolution, applied to the motor shaft.

16-22 Torque [%]		
Range:		Function:
0 %*	[-200 - 200 %]	Value shown is the torque in percent of nominal torque, with sign, applied to the motor shaft.

16-25 Torque [Nm] High		
Range:		Function:
0.0 Nm*	[-200000000.0 - 200000000.0 Nm]	View the torque value with sign, applied to the motor shaft. Some motors supply more than 160% torque. Consequently, the min. value and the max. value will depend on the max. motor current as well as the motor used. This specific readout has been adapted to be able to show higher values than the standard readout in par. 16-16 <i>Torque [Nm]</i> .

3.17.3 16-3* Drive Status

16-30 DC Link Voltage		
Range:		Function:
0 V*	[0 - 10000 V]	View a measured value. The value is filtered with an 30 ms time constant.

16-32 Brake Energy /s		
Range:		Function:
0.000 kW*	[0.000 - 10000.000 kW]	View the brake power transmitted to an external brake resistor, stated as an instantaneous value.

16-33 Brake Energy /2 min		
Range:		Function:
0.000 kW*	[0.000 - 10000.000 kW]	View the brake power transmitted to an external brake resistor. The mean power is calculated on an average basis for the most recent 120 seconds.

16-34 Heatsink Temp.		
Range:		Function:
0 C*	[0 - 255 C]	View the frequency converter heatsink temperature. The cut-out limit is 90 ± 5 °C, and the motor cuts back in at 60 ± 5 °C.

16-35 Inverter Thermal		
Range:		Function:
0 %*	[0 - 100 %]	View the percentage load on the inverter.

16-36 Inv. Nom. Current		
Range:		Function:
Application dependent*	[0.01 - 10000.00 A]	View the inverter nominal current, which should match the nameplate data on the connected motor. The data are used for calculation of torque, motor protection, etc.

16-37 Inv. Max. Current		
Range:		Function:
Application dependent*	[0.01 - 10000.00 A]	View the inverter maximum current, which should match the nameplate data on the connected motor. The data are used for calculation of torque, motor protection, etc.

16-38 SL Controller State		
Range:		Function:
0*	[0 - 100]	View the state of the event under execution by the SL controller.

16-39 Control Card Temp.		
Range:		Function:
0 C*	[0 - 100 C]	View the temperature on the control card, stated in °C.

16-40 Logging Buffer Full		
Option:		Function:
		View whether the logging buffer is full (see par. group 15-1*). The logging buffer will never be full when par. 15-13 <i>Logging Mode</i> is set to <i>Log always</i> [0].
[0] *	No	
[1]	Yes	

16-49 Current Fault Source		
Range:		Function:
0*	[0 - 8]	Value indicates source of current faults including short circuit, over current, and phase imbalance (from left): 1-4 Inverter 5-8 Rectifier 0 No fault recorded

3.17.4 16-5* Ref. & Feedb.

16-50 External Reference		
Range:		Function:
0.0*	[-200.0 - 200.0]	View the total reference, the sum of digital, analog, preset, bus and freeze references, plus catch-up and slow-down.

16-51 Pulse Reference		
Range:		Function:
0.0*	[-200.0 - 200.0]	View the reference value from programmed digital input(s). The read-out can also reflect the impulses from an incremental encoder.

16-52 Feedback [Unit]		
Range:	Function:	
0.000 Reference- FeedbackU- nit*	[-999999.999 - 999999.999 ReferenceFeed- backUnit]	View the feedback unit resulting from the selection of unit and scaling in par. 3-00 <i>Reference Range</i> , par. 3-01 <i>Reference/Feedback Unit</i> , par. 3-02 <i>Minimum Reference</i> and par. 3-03 <i>Maximum Reference</i> .

16-53 Digi Pot Reference		
Range:	Function:	
0.00*	[-200.00 - 200.00]	View the contribution of the Digital Potentiometer to the actual reference.

16-57 Feedback [RPM]		
Range:	Function:	
0 RPM*	[-30000 - 30000 RPM]	Read-out parameter where the actual motor RPM from the feed-back source can be read in both closed loop and open loop. The feed-back source is selected by par. 7-00.

3.17.5 16-6* Inputs and Outputs

16-60 Digital Input		
Range:	Function:	
0 N/ A*	[0 - 1023 N/A]	View the signal states from the active digital inputs. Example: Input 18 corresponds to bit no. 5, '0' = no signal, '1' = connected signal. Bit 6 works in the opposite way, on = '0', off = '1' (safe stop input).
	Bit 0	Digital input term. 33
	Bit 1	Digital input term. 32
	Bit 2	Digital input term. 29
	Bit 3	Digital input term. 27
	Bit 4	Digital input term. 19
	Bit 5	Digital input term. 18
	Bit 6	Digital input term. 37
	Bit 7	Digital input GP I/O term. X30/4
	Bit 8	Digital input GP I/O term. X30/3
	Bit 9	Digital input GP I/O term. X30/2
	Bit 10-63	Reserved for future terminals

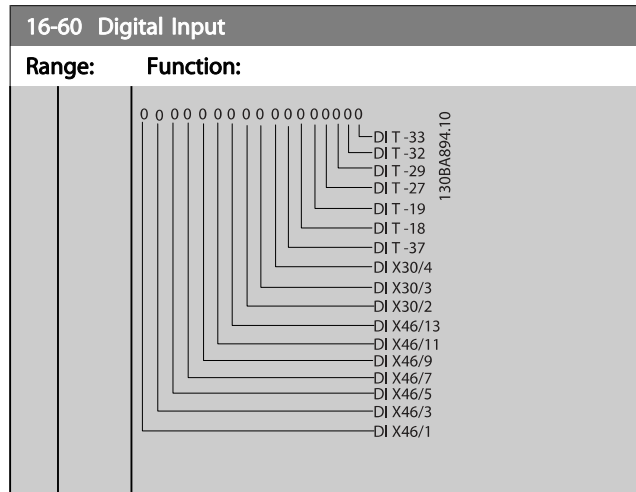

16-61 Terminal 53 Switch Setting		
Option:	Function:	
		View the setting of input terminal 53. Current = 0; Voltage = 1.
[0] *	Current	
[1]	Voltage	
[2]	Pt 1000 [°C]	
[3]	Pt 1000 [°F]	
[4]	Ni 1000 [°C]	
[5]	Ni 1000 [°F]	

16-62 Analog Input 53		
Range:	Function:	
0.000*	[-20.000 - 20.000]	View the actual value at input 53.

16-63 Terminal 54 Switch Setting		
Option:	Function:	
		View the setting of input terminal 54. Current = 0; Voltage = 1.
[0] *	Current	
[1]	Voltage	
[2]	Pt 1000 [°C]	
[3]	Pt 1000 [°F]	
[4]	Ni 1000 [°C]	
[5]	Ni 1000 [°F]	

16-64 Analog Input 54		
Range:	Function:	
0.000*	[-20.000 - 20.000]	View the actual value at input 54.

16-65 Analog Output 42 [mA]		
Range:	Function:	
0.000*	[0.000 - 30.000]	View the actual value at output 42 in mA. The value shown reflects the selection in par. 6-50 <i>Terminal 42 Output</i> .

16-66 Digital Output [bin]		
Range:	Function:	
0* [0 - 15]	View the binary value of all digital outputs.	

16-67 Pulse Input #29 [Hz]		
Range:	Function:	
0 N/A* [0 - 130000 N/A]	View the actual frequency rate on terminal 29.	

16-68 Freq. Input #33 [Hz]		
Range:	Function:	
0* [0 - 130000]	View the actual value of the frequency applied at terminal 33 as an impulse input.	

16-69 Pulse Output #27 [Hz]		
Range:	Function:	
0* [0 - 40000]	View the actual value of pulses applied to terminal 27 in digital output mode.	

16-70 Pulse Output #29 [Hz]		
Range:	Function:	
0* [0 - 40000]	View the actual value of pulses at terminal 29 in digital output mode. This parameter is available for FC 302 only.	

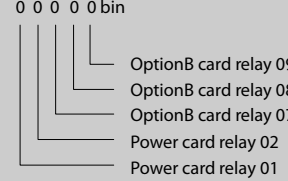
16-71 Relay Output [bin]		
Range:	Function:	
0 N/A* [0 - 511 N/A]	View the settings of all relays.	
	Readout choice (Par. 16-71): Relay output (bin): 0 0 0 0 bin 	

16-72 Counter A		
Range:	Function:	
0* [-2147483648 - 2147483647]	View the present value of Counter A. Counters are useful as comparator operands, see par. 13-10 <i>Comparator Operand</i> . The value can be reset or changed either via digital inputs (par. group 5-1*) or by using an SLC action (par. 13-52 <i>SL Controller Action</i>).	

16-73 Counter B		
Range:	Function:	
0* [-2147483648 - 2147483647]	View the present value of Counter B. Counters are useful as comparator operands (par. 13-10 <i>Comparator Operand</i>). The value can be reset or changed either via digital inputs (par. group 5-1*) or by using an SLC action (par. 13-52 <i>SL Controller Action</i>).	

16-74 Prec. Stop Counter		
Range:	Function:	
0* [0 - 2147483647]	Returns the actual counter value of precise counter (par. 1-84 <i>Precise Stop Counter Value</i>).	

16-75 Analog In X30/11		
Range:	Function:	
0.000 N/A* [-20.000 - 20.000 N/A]	View the actual value at input X30/11 of MCB 101.	

16-76 Analog In X30/12		
Range:	Function:	
0.000 N/A* [-20.000 - 20.000 N/A]	View the actual value at input X30/12 of MCB 101.	

16-77 Analog Out X30/8 [mA]		
Range:	Function:	
0.000 N/A* [0.000 - 30.000 N/A]	View the actual value at input X30/8 in mA.	

16-78 Analog Out X45/1 [mA]		
Range:	Function:	
0.000* [0.000 - 30.000]	View the actual value at output X45/1. The value shown reflects the selection in par. 6-70 <i>Terminal X45/1 Output</i> .	

16-79 Analog Out X45/3 [mA]		
Range:	Function:	
0.000* [0.000 - 30.000]	View the actual value at output X45/3. The value shown reflects the selection in par. 6-80 <i>Terminal X45/3 Output</i> .	

3.17.6 16-8* Fieldbus & FC Port

Parameters for reporting the BUS references and control words.

16-80 Fieldbus CTW 1		
Range:		Function:
0 N/A*	[0 - 65535 N/A]	View the two-byte Control word (CTW) received from the Bus-Master. Interpretation of the Control word depends on the fieldbus option installed and the Control word profile selected in par. 8-10 <i>Control Profile</i> . For more information please refer to the relevant fieldbus manual.

16-82 Fieldbus REF 1		
Range:		Function:
0 N/A*	[-200 - 200 N/A]	View the two-byte word sent with the control word from the Bus-Master to set the reference value. For more information please refer to the relevant fieldbus manual.

16-84 Comm. Option STW		
Range:		Function:
0 N/A*	[0 - 65535 N/A]	View the extended fieldbus comm. option status word. For more information please refer to the relevant fieldbus manual.

16-85 FC Port CTW 1		
Range:		Function:
0 N/A*	[0 - 65535 N/A]	View the two-byte Control word (CTW) received from the Bus-Master. Interpretation of the control word depends on the fieldbus option installed and the Control word profile selected in par. 8-10 <i>Control Profile</i> .

16-86 FC Port REF 1		
Range:		Function:
0 N/A*	[-200 - 200 N/A]	View the two-byte Status word (STW) sent to the Bus-Master. Interpretation of the Status word depends on the fieldbus option installed and the Control word profile selected in par. 8-10 <i>Control Profile</i> .

3.17.7 16-9* Diagnosis Read-Outs

16-90 Alarm Word		
Range:		Function:
0 N/A*	[0 - 4294967295 N/A]	View the alarm word sent via the serial communication port in hex code.

16-91 Alarm Word 2		
Range:		Function:
0*	[0 - 4294967295]	View the alarm word sent via the serial communication port in hex code.

16-92 Warning Word		
Range:		Function:
0 N/A*	[0 - 4294967295 N/A]	View the warning word sent via the serial communication port in hex code.

16-93 Warning Word 2		
Range:		Function:
0*	[0 - 4294967295]	View the warning word sent via the serial communication port in hex code.

16-94 Ext. Status Word		
Range:		Function:
0*	[0 - 4294967295]	Returns the extended warning word sent via the serial communication port in hex code.

16-95 Ext. Status Word 2		
Range:		Function:
0 N/A*	[0 - 4294967295 N/A]	Returns the extended warning word 2 sent via the serial communication port in hex code.

16-96 Maintenance Word		
Range:		Function:
0 N/A*	[0 - 4294967295 N/A]	

3.18 Parameters: 17-** Motor Feedb. Option

Additional parameters to configure the Encoder (MCB 102) or the Resolver (MCB 103) Feedback Option.

3.18.1 17-1* Inc. Enc. Interface

Parameters in this group configure the incremental interface of the MCB 102 option. Note that both the incremental and absolute interfaces are active at the same time.

17-10 Signal Type		
Select the incremental type (A/B channel) of the encoder in use. Find the information on the encoder data sheet.		
Select <i>None</i> [0] if the feedback sensor is an absolute encoder only. This parameter cannot be adjusted while the motor is running.		
Option:	Function:	
[0]	None	
[1] *	RS422 (5V TTL)	
[2]	Sinusoidal 1Vpp	

17-11 Resolution (PPR)		
Range:	Function:	
1024*	[10 - 10000]	Enter the resolution of the incremental track, i.e. the number of pulses or periods per revolution. This parameter cannot be adjusted while the motor is running.

3.18.2 17-2* Abs. Enc. Interface

Parameters in this group configure the absolute interface of the MCB 102 option. Note that both the incremental and absolute interfaces are active at the same time.

17-20 Protocol Selection		
Select <i>HIPERFACE</i> [1] if the encoder is absolute only. Select <i>None</i> [0] if the feedback sensor is an incremental encoder only. This parameter cannot be adjusted while the motor is running.		
Option:	Function:	
[0] *	None	
[1]	HIPERFACE	
[2]	EnDat	
[4]	SSI	

17-21 Resolution (Positions/Rev)		
Select the resolution of the absolute encoder, i.e. the number of counts per revolution. This parameter cannot be adjusted while the motor is running. The value depends on setting in par. 17-20 <i>Protocol Selection</i> .		
Range:	Function:	
Application depend-ent*	[Application dependant]	

17-24 SSI Data Length		
Range:	Function:	
13*	[13 - 25]	Set the number of bits for the SSI telegram. Choose 13 bits for single-turn encoders and 25 bits for multi-turn encoder.

17-25 Clock Rate		
Range:	Function:	
Application dependent*	[Application dependant]	Set the SSI clock rate. With long encoder cables the clock rate must be reduced.

17-26 SSI Data Format		
Option:	Function:	
[0] *	Gray code	
[1]	Binary code	Set the data format of the SSI data. Choose between Gray or Binary format.

17-34 HIPERFACE Baudrate		
Select the baud rate of the attached encoder. This parameter cannot be adjusted while the motor is running. The parameter is only accessible when par. 17-20 <i>Protocol Selection</i> is set to HIPERFACE [1].		
Option:	Function:	
[0]	600	
[1]	1200	
[2]	2400	
[3]	4800	
[4] *	9600	
[5]	19200	
[6]	38400	

3.18.3 17-5* Resolver Interface

Par. group 17-5* is used for setting parameters for the MCB 103 Resolver Option.

Usually the resolver feedback is used as motor feedback from Permanent Magnet motors with par. 1-01 *Motor Control Principle* set to Flux with motor feedback.

Resolver parameters cannot be adjusted while the motor is running.

17-50 Poles		
Range:	Function:	
2*	[2 - 2]	Set the number of poles on the resolver. The value is stated in the data sheet for resolvers.

17-51 Input Voltage		
Range:	Function:	
7.0 V*	[2.0 - 8.0 V]	Set the input voltage to the resolver. The voltage is stated as RMS value. The value is stated in the data sheet for resolvers

17-52 Input Frequency		
Range:	Function:	
10.0 kHz*	[2.0 - 15.0 kHz]	Set the input frequency to the resolver. The value is stated in the data sheet for resolvers.

17-53 Transformation Ratio		
Range:	Function:	
0.5*	[0.1 - 1.1]	Set the transformation ratio for the resolver. The transformation ration is: $T_{ratio} = \frac{V_{Out}}{V_{In}}$ The value is stated in the data sheet for resolvers.

17-56 Encoder Sim. Resolution		
Set the resolution and activate the encoder emulation function (generation of encoder signals from the measured position from a resolver). Needed when necessary to transfer the speed or position information from one drive to another. To disable the function, select [0].		
Option:	Function:	
[0] *	Disabled	
[1]	512	
[2]	1024	
[3]	2048	
[4]	4096	

17-59 Resolver Interface		
Activate the MCB 103 resolver option when the resolver parameters are selected.		
To avoid damage to resolvers par. 17-50 <i>Poles</i> – par. 17-53 <i>Transformation Ratio</i> must be adjusted before activating this parameter.		
Option:	Function:	
[0] *	Disabled	
[1]	Enabled	

3.18.4 17-6* Monitoring and Application

This par. group is for selecting additional functions when MCB 102 Encoder option or MCB 103 Resolver option is fitted into option slot B as speed feedback.

Monitoring and Application parameters cannot be adjusted while the motor is running.

17-60 Feedback Direction		
Change the detected encoder rotation direction without changing the wiring to the encoder.		
This parameter cannot be adjusted while the motor is running.		
Option:	Function:	
[0] *	Clockwise	
[1]	Counter clockwise	

17-61 Feedback Signal Monitoring		
Select which reaction the frequency converter should take in case a faulty encoder signal is detected.		
The encoder function in par. 17-61 <i>Feedback Signal Monitoring</i> is an electrical check of the hardware circuit in the encoder system.		
Option:	Function:	
[0]	Disabled	
[1] *	Warning	
[2]	Trip	
[3]	Jog	
[4]	Freeze Output	
[5]	Max Speed	
[6]	Switch to Open Loop	
[7]	Select Setup 1	
[8]	Select Setup 2	
[9]	Select Setup 3	
[10]	Select Setup 4	
[11]	stop & trip	

3.19 Parameters: 18-** Data Readouts 2

18-36 Analog Input X48/2 [mA]		
Range:	Function:	
0.000* [-20.000 - 20.000]	View the actual current measured at input X48/2.	

18-37 Temp. Input X48/4		
Range:	Function:	
0* [-500 - 500]	View the actual temperature measured at input X48/4. The temperature unit is based on the selection in par. 35-00.	

18-38 Temp. Input X48/7		
Range:	Function:	
0* [-500 - 500]	View the actual temperature measured at input X48/7. The temperature unit is based on the selection in par. 35-02.	

18-39 Temp. Input X48/10		
Range:	Function:	
0* [-500 - 500]	View the actual temperature measured at input X48/10. The temperature unit is based on the selection in par. 35-04.	

18-60 Digital Input 2		
Range:	Function:	
0* [0 - 65535]	View the signal states from the active digital inputs. '0' = no signal, '1' = connected signal.	

18-90 Process PID Error		
Range:	Function:	
0.0 %* [-200.0 - 200.0 %]		

18-91 Process PID Output		
Range:	Function:	
0.0 %* [-200.0 - 200.0 %]		

18-92 Process PID Clamped Output		
Range:	Function:	
0.0 %* [-200.0 - 200.0 %]		

18-93 Process PID Gain Scaled Output		
Range:	Function:	
0.0 %* [-200.0 - 200.0 %]		

3.20 Parameters: 30-** Special Features

3.20.1 30-0* Wobble Function

The wobble function is primarily used for synthetic yarn winding applications. The wobble option is to be installed in the frequency converter controlling the traverse drive. The traverse drive frequency converter will move the yarn back and forth in a diamond pattern across the surface of the yarn package. To prevent a buildup of yarn at the same points at the surface, this pattern must be altered. The wobble option can accomplish this by continuously varying the traverse velocity in a programmable cycle. The wobble function is created by superimposing a delta frequency around a center frequency. To compensate for the inertia in the system a quick frequency jump can be included. Especially suitable for elastic yarn applications the option features a randomized wobble ratio.

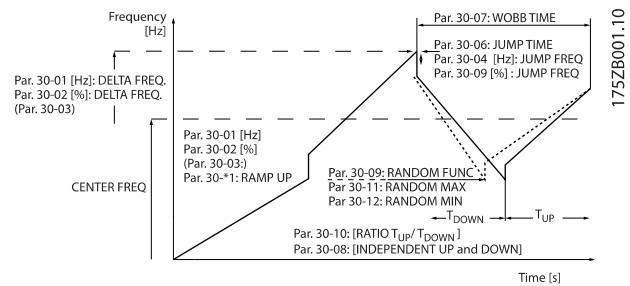

30-00 Wobble Mode		
Option:	Function:	
	The standard speed open loop mode in par. 1-00 is extended with a wobble function . In this parameter it is possible to select which method to be used for the wobbler. The frequency parameters can be set as absolute values (direct frequencies) or as relative values (percentage of other parameter) . The wobble cycle time can be set as an absolute alue or as independent up- and down times. When using an absolute cycle time, the up- and down times are configured through the wobble ratio.	
[0] *	Abs. Freq., Abs. Time	
[1]	Abs. Freq., Up/ Down Time	
[2]	Rel. Freq., Abs. Time	
[3]	Rel. Freq., Up/ Down Time	

NOTE

This parameter can be set while running.

NOTE

The setting of "Center Frequency" takes place via the normal reference handling parameters, 3-1*

30-01 Wobble Delta Frequency [Hz]		
Range:		Function:
5.0 Hz*	[0.0 - 25.0 Hz]	The delta frequency is determining the magnitude of the wobble frequency. The delta frequency is superimposed on the center frequency. Parameter 30-01 is selecting both the positive and negative delta frequency. The setting of parameter 30-01 must thus not be higher than the setting of the center frequency. The initial ramp up time from standstill until the wobble sequence is running is determined by parameters 3-1*.

30-02 Wobble Delta Frequency [%]		
Range:		Function:
25 %*	[0 - 100 %]	The delta frequency can also be expressed as percentage of the center frequency and can thus be maximum 100%. The function is the same as for par. 30-01.

30-03 Wobble Delta Freq. Scaling Resource		
Option:		Function:
		Select which drive input should be used to scale the delta frequency setting.
[0] *	No function	
[1]	Analog input 53	
[2]	Analog input 54	
[3]	Frequency input 29	FC 302 only
[4]	Frequency input 33	
[7]	Analog input X30/11	
[8]	Analog input X30/12	
[15]	Analog Input X48/2	

30-04 Wobble Jump Frequency [Hz]		
Range:		Function:
0.0 Hz*	[Application dependant]	The jump frequency is used to compensate for the inertia in the traverse system. If a jump in the output frequency is required in the top and in the bottom of the wobble sequence, the frequency jump is set in this parameter. If the traverse system has a very high inertia a high jump frequency may create a torque limit warning or trip (warning/alarm 12) or an over voltage warning or trip (warning/alarm 7). This

30-04 Wobble Jump Frequency [Hz]		
Range:		Function:
		parameter can only be changed in stop-mode

30-05 Wobble Jump Frequency [%]		
Range:		Function:
0 %*	[0 - 100 %]	The jump frequency can also be expressed as percentage of the center frequency. The function is the same as for par. 30-04.

30-06 Wobble Jump Time		
Range:		Function:
Application dependent*	[Application dependant]	This parameter determines the slope of the jump ramp at the max. and min. wobble frequency.

30-07 Wobble Sequence Time		
Range:		Function:
10.0 s*	[1.0 - 1000.0 s]	This parameter determines the wobble sequence period. This parameter can only be changed in stop-mode. Wobble time = $t_{up} + t_{down}$

30-08 Wobble Up/ Down Time		
Range:		Function:
5.0 s*	[0.1 - 1000.0 s]	Defines the individual up- and down times for each wobble cycle.

30-09 Wobble Random Function		
Option:		Function:
[0] *	Off	
[1]	On	

30-10 Wobble Ratio		
Range:		Function:
1.0*	[Application dependant]	If the ratio 0.1 is selected: t_{down} is 10 times greater than t_{up} . If the ratio 10 is selected: t_{up} is 10 times greater than t_{down} .

30-11 Wobble Random Ratio Max.		
Range:		Function:
10.0*	[Application dependant]	Enter the maximum allowed wobble ratio.

30-12 Wobble Random Ratio Min.		
Range:		Function:
0.1*	[Application dependant]	Enter the minimum allowed wobble ratio.

30-19 Wobble Delta Freq. Scaled		
Range:		Function:
0.0 Hz*	[0.0 - 1000.0 Hz]	Readout parameter. View the actual wobble delta frequency after scaling has been applied.

3.20.2 30-2* Adv. Start Adjust

30-20 High Starting Torque Time [s]		
Range:		Function:
0.00 s*	[0.00 - 0.50 s]	High starting torque time for PM-Motor in Flux mode without feedback. This parameter is available for FC 302 only.

30-21 High Starting Torque Current [%]		
Range:		Function:
100.0 %*	[Application dependant]	High starting torque current for PM-Motor in Flux mode without feedback. This parameter is available for FC 302 only.

30-22 Locked Rotor Protection		
Locked Rotor Protection for PM-Motor in Flux mode without feedback. This parameter is available for FC 302 only.		
Option:		Function:
[0] *	Off	
[1]	On	

30-23 Locked Rotor Detection Time [s]		
Locked Rotor Detection Time for PM-Motor in Flux mode without feedback. This parameter is available for FC 302 only.		
Range:		Function:
0.10 s*	[0.05 - 1.00 s]	

3.20.3 30-8* Compatibility

30-80 d-axis Inductance (Ld)		
Range:		Function:
Application dependent*	[Application dependant]	Enter the value of the d-axis inductance. Obtain the value from the permanent magnet motor data sheet. The d-axis inductance cannot be found by performing an AMA.

30-81 Brake Resistor (ohm)		
Range:		Function:
Application dependent*	[Application dependant]	Set the brake resistor value in Ohms. This value is used for monitoring the power to the brake resistor in par. 2-13 <i>Brake Power Monitoring</i> . This parameter is only active in drives with an integral dynamic brake.

30-83 Speed PID Proportional Gain		
Range:		Function:
Application dependent*	[0.0000 - 1.0000]	Enter the speed controller proportional gain. Quick control is obtained at high amplification. However if amplification is too great, the process may become unstable.

30-84 Process PID Proportional Gain		
Range:		Function:
0.100*	[0.000 - 10.000]	Enter the process controller proportional gain. Quick control is obtained at high amplification. However if amplification is too great, the process may become unstable.

3.21 Parameters: 35-** Sensor Input Option

3.21.1 35-0* Temp. Input Mode (MCB 114)

35-00 Term. X48/4 Temp. Unit		
Select the unit to be used with temperature input X48/4 settings and readouts:		
Option:	Function:	
[60] *	°C	
[160]	°F	

35-01 Term. X48/4 Input Type		
View the temperature sensor type detected at input X48/4:		
Option:	Function:	
[0] *	Not Connected	
[1]	PT100 2-wire	
[3]	PT1000 2-wire	
[5]	PT100 3-wire	
[7]	PT1000 3-wire	

35-02 Term. X48/7 Temp. Unit		
Select the unit to be used with temperature input X48/7 settings and readouts:		
Option:	Function:	
[60] *	°C	
[160]	°F	

35-03 Term. X48/7 Input Type		
View the temperature sensor type detected at input X48/7:		
Option:	Function:	
[0] *	Not Connected	
[1]	PT100 2-wire	
[3]	PT1000 2-wire	
[5]	PT100 3-wire	
[7]	PT1000 3-wire	

35-04 Term. X48/10 Temp. Unit		
Select the unit to be used with temperature input X48/10 settings and readouts:		
Option:	Function:	
[60] *	°C	
[160]	°F	

35-05 Term. X48/10 Input Type		
View the temperature sensor type detected at input X48/10:		
Option:	Function:	
[0] *	Not Connected	
[1]	PT100 2-wire	
[3]	PT1000 2-wire	
[5]	PT100 3-wire	
[7]	PT1000 3-wire	

35-06 Temperature Sensor Alarm Function		
Select the alarm function:		
Option:	Function:	
[0]	Off	
[2]	Stop	
[5] *	Stop and trip	

3.21.2 35-1* Temp. Input X48/4 (MCB 114)

35-14 Term. X48/4 Filter Time Constant		
Range:	Function:	
0.001 s* [0.001 - 10.000 s]	Enter the filter time constant. This is a first-order digital low pass filter time constant for suppressing electrical noise in terminal X48/4. A high time constant value improves dampening but also increases the time delay through the filter.	

35-15 Term. X48/4 Temp. Monitor		
This parameter gives the possibility of enabling or disabling the temperature monitor for terminal X48/4. The temperature limits can be set in par. 35-16 and par. 35-17.		
Option:	Function:	
[0] *	Disabled	
[1]	Enabled	

35-16 Term. X48/4 Low Temp. Limit		
Range:	Function:	
Application dependent*	[Application dependant]	Enter the minimum temperature reading that is expected for normal operation of the temperature sensor at terminal X48/4.

35-17 Term. X48/4 High Temp. Limit		
Range:	Function:	
Application dependent*	[Application dependant]	Enter the maximum temperature reading that is expected for normal operation of the temperature sensor at terminal X48/4.

3.21.3 35-2* Temp. Input X48/7 (MCB 114)

35-24 Term. X48/7 Filter Time Constant		
Range:	Function:	
0.001 s* [0.001 - 10.000 s]	Enter the filter time constant. This is a first-order digital low pass filter time constant for suppressing electrical noise in terminal X48/7. A high time constant value improves dampening but also increases the time delay through the filter.	

35-25 Term. X48/7 Temp. Monitor

This parameter gives the possibility of enabling or disabling the temperature monitor for terminal X48/7. The temperature limits can be set in par. 35-26 and 35-27.

Option: **Function:**

[0] *	Disabled	
[1]	Enabled	

35-26 Term. X48/7 Low Temp. Limit

Range: **Function:**

Application dependent*	[Application dependant]	Enter the minimum temperature reading that is expected for normal operation of the temperature sensor at terminal X48/7.
------------------------	-------------------------	--

35-27 Term. X48/7 High Temp. Limit

Range: **Function:**

Application dependent*	[Application dependant]	Enter the maximum temperature reading that is expected for normal operation of the temperature sensor at terminal X48/7.
------------------------	-------------------------	--

3.21.4 35-3* Temp. Input X48/10 (MCB 114)
35-34 Term. X48/10 Filter Time Constant

Range: **Function:**

0.001 s*	[0.001 - 10.000 s]	Enter the filter time constant. This is a first-order digital low pass filter time constant for suppressing electrical noise in terminal X48/10. A high time constant value improves dampening but also increases the time delay through the filter.
----------	--------------------	--

35-35 Term. X48/10 Temp. Monitor

This parameter gives the possibility of enabling or disabling the temperature monitor for terminal X48/10. The temperature limits can be set in pars. 35-36/37.

Option: **Function:**

[0] *	Disabled	
[1]	Enabled	

35-36 Term. X48/10 Low Temp. Limit

Range: **Function:**

Application dependent*	[Application dependant]	Enter the minimum temperature reading that is expected for normal operation of the temperature sensor at terminal X48/10.
------------------------	-------------------------	---

35-37 Term. X48/10 High Temp. Limit

Range: **Function:**

Application dependent*	[Application dependant]	Enter the maximum temperature reading that is expected for normal operation of the temperature sensor at terminal X48/10.
------------------------	-------------------------	---

3.21.5 35-4* Analog Input X48/2 (MCB 114)
35-42 Term. X48/2 Low Current

Range: **Function:**

4.00 mA*	[Application dependant]	Enter the current (mA) that corresponds to the low reference value, set in par. 35-44. The value must be set at > 2 mA in order to activate the Live Zero Time-out Function in par. 6-01.
----------	-------------------------	---

35-43 Term. X48/2 High Current

Range: **Function:**

20.00 mA*	[Application dependant]	Enter the current (mA) that corresponds to the high reference value (set in par. 35-45).
-----------	-------------------------	--

35-44 Term. X48/2 Low Ref./Feedb. Value

Range: **Function:**

0.000*	[-999999.999 - 999999.999]	Enter the reference or feedback value (in RPM, Hz, bar, etc.) that corresponds to the voltage or current set in par. 35-42.
--------	-----------------------------	---

35-45 Term. X48/2 High Ref./Feedb. Value

Range: **Function:**

100.000*	[-999999.999 - 999999.999]	Enter the reference or feedback value (in RPM, Hz, bar, etc.) that corresponds to the voltage or current set in par. 35-43.
----------	-----------------------------	---

35-46 Term. X48/2 Filter Time Constant

Range: **Function:**

0.001 s*	[0.001 - 10.000 s]	Enter the filter time constant. This is a first-order digital low pass filter time constant for suppressing electrical noise in terminal X48/2. A high time constant value improves dampening but also increases the time delay through the filter.
----------	--------------------	---

4 Parameter Lists

FC Series

All = valid for FC 301 and FC 302 series

01 = valid for FC 301 only

02 = valid for FC 302 only

Changes during operation

“TRUE” means that the parameter can be changed while the frequency converter is in operation and “FALSE” means that the frequency converter must be stopped before a change can be made.

4-Set-up

'All set-ups': the parameter can be set individually in each of the four set-ups, i. e. one single parameter can have four different data values.

'1 set-up': data value will be the same in all set-ups.

Conversion index

This number refers to a conversion figure used when writing or reading by means of a frequency converter.

Conv. index	100	67	6	5	4	3	2	1	0	-1	-2	-3	-4	-5	-6
Conv. factor	1	1/60	1000000	100000	10000	1000	100	10	1	0.1	0.01	0.001	0.0001	0.00001	0.000001

Data type	Description	Type
2	Integer 8	Int8
3	Integer 16	Int16
4	Integer 32	Int32
5	Unsigned 8	UInt8
6	Unsigned 16	UInt16
7	Unsigned 32	UInt32
9	Visible String	VisStr
33	Normalized value 2 bytes	N2
35	Bit sequence of 16 boolean variables	V2
54	Time difference w/o date	TimD

4.1.1 0-** Operation/Display

Par. No. #	Parameter description	Default value	4-set-up	FC 302 only	Change during operation	Conversion index	Type
0-0* Basic Settings							
0-01	Language	[0] English	1 set-up		TRUE	-	Uint8
0-02	Motor Speed Unit	[0] RPM	2 set-ups		FALSE	-	Uint8
0-03	Regional Settings	[0] International	2 set-ups		FALSE	-	Uint8
0-04	Operating State at Power-up (Hand)	[1] Forced stop, ref=old	All set-ups		TRUE	-	Uint8
0-09	Performance Monitor	0.0 %	All set-ups		TRUE	-1	Uint16
0-1* Set-up Operations							
0-10	Active Set-up	[1] Set-up 1	1 set-up		TRUE	-	Uint8
0-11	Edit Set-up	[1] Set-up 1	All set-ups		TRUE	-	Uint8
0-12	This Set-up Linked to	[0] Not linked	All set-ups		FALSE	-	Uint8
0-13	Readout: Linked Set-ups	0 N/A	All set-ups		FALSE	0	Uint16
0-14	Readout: Edit Set-ups / Channel	0 N/A	All set-ups		TRUE	0	Int32
0-2* LCP Display							
0-20	Display Line 1.1 Small	1617	All set-ups		TRUE	-	Uint16
0-21	Display Line 1.2 Small	1614	All set-ups		TRUE	-	Uint16
0-22	Display Line 1.3 Small	1610	All set-ups		TRUE	-	Uint16
0-23	Display Line 2 Large	1613	All set-ups		TRUE	-	Uint16
0-24	Display Line 3 Large	1602	All set-ups		TRUE	-	Uint16
0-25	My Personal Menu	SR	1 set-up		TRUE	0	Uint16
0-3* LCP Custom Readout							
0-30	Unit for User-defined Readout	[0] None	All set-ups		TRUE	-	Uint8
0-31	Min Value of User-defined Readout	0.00 CustomReadoutUnit	All set-ups		TRUE	-2	Int32
0-32	Max Value of User-defined Readout	100.00 CustomReadoutUnit	All set-ups		TRUE	-2	Int32
0-37	Display Text 1	0 N/A	1 set-up		TRUE	0	VisStr[25]
0-38	Display Text 2	0 N/A	1 set-up		TRUE	0	VisStr[25]
0-39	Display Text 3	0 N/A	1 set-up		TRUE	0	VisStr[25]
0-4* LCP Keypad							
0-40	[Hand on] Key on LCP	null	All set-ups		TRUE	-	Uint8
0-41	[Off] Key on LCP	null	All set-ups		TRUE	-	Uint8
0-42	[Auto on] Key on LCP	null	All set-ups		TRUE	-	Uint8
0-43	[Reset] Key on LCP	null	All set-ups		TRUE	-	Uint8
0-44	[Off/Reset] Key on LCP	null	All set-ups		TRUE	-	Uint8
0-45	[Drive Bypass] Key on LCP	null	All set-ups		TRUE	-	Uint8
0-5* Copy/Save							
0-50	LCP Copy	[0] No copy	All set-ups		FALSE	-	Uint8
0-51	Set-up Copy	[0] No copy	All set-ups		FALSE	-	Uint8
0-6* Password							
0-60	Main Menu Password	100 N/A	1 set-up		TRUE	0	Int16
0-61	Access to Main Menu w/o Password	[0] Full access	1 set-up		TRUE	-	Uint8
0-65	Quick Menu Password	200 N/A	1 set-up		TRUE	0	Int16
0-66	Access to Quick Menu w/o Password	[0] Full access	1 set-up		TRUE	-	Uint8
0-67	Bus Password Access	0 N/A	All set-ups		TRUE	0	Uint16

4.1.2 1-** Load/Motor

Par. No. #	Parameter description	Default value	4-set-up	FC 302 only	Change during operation	Conversion index	Type
1-0* General Settings							
1-00	Configuration Mode	null	All set-ups		TRUE	-	Uint8
1-01	Motor Control Principle	null	All set-ups		FALSE	-	Uint8
1-02	Flux Motor Feedback Source	[1] 24V encoder	All set-ups	x	FALSE	-	Uint8
1-03	Torque Characteristics	[0] Constant torque	All set-ups		TRUE	-	Uint8
1-04	Overload Mode	[0] High torque	All set-ups		FALSE	-	Uint8
1-05	Local Mode Configuration	[2] As mode par 1-00	All set-ups		TRUE	-	Uint8
1-06	Clockwise Direction	[0] Normal	All set-ups		FALSE	-	Uint8
1-1* Motor Selection							
1-10	Motor Construction	[0] Asynchron	All set-ups		FALSE	-	Uint8
1-2* Motor Data							
1-20	Motor Power [kW]	SR	All set-ups		FALSE	-2	Uint32
1-21	Motor Power [HP]	SR	All set-ups		FALSE	-2	Uint32
1-22	Motor Voltage	SR	All set-ups		FALSE	0	Uint16
1-23	Motor Frequency	SR	All set-ups		FALSE	0	Uint16
1-24	Motor Current	SR	All set-ups		FALSE	-2	Uint32
1-25	Motor Nominal Speed	SR	All set-ups		FALSE	67	Uint16
1-26	Motor Cont. Rated Torque	SR	All set-ups		FALSE	-1	Uint32
1-29	Automatic Motor Adaptation (AMA)	[0] Off	All set-ups		FALSE	-	Uint8
1-3* Adv. Motor Data							
1-30	Stator Resistance (Rs)	SR	All set-ups		FALSE	-4	Uint32
1-31	Rotor Resistance (Rr)	SR	All set-ups		FALSE	-4	Uint32
1-33	Stator Leakage Reactance (X1)	SR	All set-ups		FALSE	-4	Uint32
1-34	Rotor Leakage Reactance (X2)	SR	All set-ups		FALSE	-4	Uint32
1-35	Main Reactance (Xh)	SR	All set-ups		FALSE	-4	Uint32
1-36	Iron Loss Resistance (Rfe)	SR	All set-ups		FALSE	-3	Uint32
1-37	d-axis Inductance (Ld)	SR	All set-ups	x	FALSE	-4	Int32
1-39	Motor Poles	SR	All set-ups		FALSE	0	Uint8
1-40	Back EMF at 1000 RPM	SR	All set-ups	x	FALSE	0	Uint16
1-41	Motor Angle Offset	0 N/A	All set-ups		FALSE	0	Int16
1-5* Load Indep. Setting							
1-50	Motor Magnetisation at Zero Speed	100 %	All set-ups		TRUE	0	Uint16
1-51	Min Speed Normal Magnetising [RPM]	SR	All set-ups		TRUE	67	Uint16
1-52	Min Speed Normal Magnetising [Hz]	SR	All set-ups		TRUE	-1	Uint16
1-53	Model Shift Frequency	SR	All set-ups	x	FALSE	-1	Uint16
1-54	Voltage reduction in fieldweakening	0 V	All set-ups		FALSE	0	Uint8
1-55	U/f Characteristic - U	SR	All set-ups		TRUE	-1	Uint16
1-56	U/f Characteristic - F	SR	All set-ups		TRUE	-1	Uint16
1-58	Flystart Test Pulses Current	30 %	All set-ups		FALSE	0	Uint16
1-59	Flystart Test Pulses Frequency	200 %	All set-ups		FALSE	0	Uint16
1-6* Load Depen. Setting							
1-60	Low Speed Load Compensation	100 %	All set-ups		TRUE	0	Int16
1-61	High Speed Load Compensation	100 %	All set-ups		TRUE	0	Int16
1-62	Slip Compensation	SR	All set-ups		TRUE	0	Int16
1-63	Slip Compensation Time Constant	SR	All set-ups		TRUE	-2	Uint16
1-64	Resonance Dampening	100 %	All set-ups		TRUE	0	Uint16
1-65	Resonance Dampening Time Constant	5 ms	All set-ups		TRUE	-3	Uint8
1-66	Min. Current at Low Speed	100 %	All set-ups	x	TRUE	0	Uint8
1-67	Load Type	[0] Passive load	All set-ups	x	TRUE	-	Uint8

Par. No. #	Parameter description	Default value	4-set-up	FC 302 only	Change during operation	Conversion index	Type
1-68	Minimum Inertia	SR	All set-ups	x	FALSE	-4	Uint32
1-69	Maximum Inertia	SR	All set-ups	x	FALSE	-4	Uint32
1-7* Start Adjustments							
1-71	Start Delay	0.0 s	All set-ups		TRUE	-1	Uint8
1-72	Start Function	[2] Coast/delay time	All set-ups		TRUE	-	Uint8
1-73	Flying Start	[0] Disabled	All set-ups		FALSE	-	Uint8
1-74	Start Speed [RPM]	SR	All set-ups		TRUE	67	Uint16
1-75	Start Speed [Hz]	SR	All set-ups		TRUE	-1	Uint16
1-76	Start Current	0.00 A	All set-ups		TRUE	-2	Uint32
1-8* Stop Adjustments							
1-80	Function at Stop	[0] Coast	All set-ups		TRUE	-	Uint8
1-81	Min Speed for Function at Stop [RPM]	SR	All set-ups		TRUE	67	Uint16
1-82	Min Speed for Function at Stop [Hz]	SR	All set-ups		TRUE	-1	Uint16
1-83	Precise Stop Function	[0] Precise ramp stop	All set-ups		FALSE	-	Uint8
1-84	Precise Stop Counter Value	100000 N/A	All set-ups		TRUE	0	Uint32
1-85	Precise Stop Speed Compensation Delay	10 ms	All set-ups		TRUE	-3	Uint8
1-9* Motor Temperature							
1-90	Motor Thermal Protection	[0] No protection	All set-ups		TRUE	-	Uint8
1-91	Motor External Fan	[0] No	All set-ups		TRUE	-	Uint16
1-93	Thermistor Resource	[0] None	All set-ups		TRUE	-	Uint8
1-95	KTY Sensor Type	[0] KTY Sensor 1	All set-ups	x	TRUE	-	Uint8
1-96	KTY Thermistor Resource	[0] None	All set-ups	x	TRUE	-	Uint8
1-97	KTY Threshold level	80 °C	1 set-up	x	TRUE	100	Int16

4.1.3 2-** Brakes

Par. No. #	Parameter description	Default value	4-set-up	FC 302 only	Change during operation	Conversion index	Type
2-0* DC-Brake							
2-00	DC Hold Current	50 %	All set-ups		TRUE	0	Uint8
2-01	DC Brake Current	50 %	All set-ups		TRUE	0	Uint16
2-02	DC Braking Time	10.0 s	All set-ups		TRUE	-1	Uint16
2-03	DC Brake Cut In Speed [RPM]	SR	All set-ups		TRUE	67	Uint16
2-04	DC Brake Cut In Speed [Hz]	SR	All set-ups		TRUE	-1	Uint16
2-05	Maximum Reference	MaxReference (P303)	All set-ups		TRUE	-3	Int32
2-1* Brake Energy Funct.							
2-10	Brake Function	null	All set-ups		TRUE	-	Uint8
2-11	Brake Resistor (ohm)	SR	All set-ups		TRUE	0	Uint16
2-12	Brake Power Limit (kW)	SR	All set-ups		TRUE	0	Uint32
2-13	Brake Power Monitoring	[0] Off	All set-ups		TRUE	-	Uint8
2-15	Brake Check	[0] Off	All set-ups		TRUE	-	Uint8
2-16	AC brake Max. Current	100.0 %	All set-ups		TRUE	-1	Uint32
2-17	Over-voltage Control	[0] Disabled	All set-ups		TRUE	-	Uint8
2-18	Brake Check Condition	[0] At Power Up	All set-ups		TRUE	-	Uint8
2-19	Over-voltage Gain	100 %	All set-ups		TRUE	0	Uint16
2-2* Mechanical Brake							
2-20	Release Brake Current	ImaxVLT (P1637)	All set-ups		TRUE	-2	Uint32
2-21	Activate Brake Speed [RPM]	SR	All set-ups		TRUE	67	Uint16
2-22	Activate Brake Speed [Hz]	SR	All set-ups		TRUE	-1	Uint16
2-23	Activate Brake Delay	0.0 s	All set-ups		TRUE	-1	Uint8
2-24	Stop Delay	0.0 s	All set-ups		TRUE	-1	Uint8
2-25	Brake Release Time	0.20 s	All set-ups		TRUE	-2	Uint16
2-26	Torque Ref	0.00 %	All set-ups		TRUE	-2	Int16
2-27	Torque Ramp Time	0.2 s	All set-ups		TRUE	-1	Uint8
2-28	Gain Boost Factor	1.00 N/A	All set-ups		TRUE	-2	Uint16

4.1.4 3-** Reference/Ramps

4

Par. No. #	Parameter description	Default value	4-set-up	FC 302 only	Change during operation	Conversion index	Type
3-0* Reference Limits							
3-00	Reference Range	null	All set-ups		TRUE	-	Uint8
3-01	Reference/Feedback Unit	null	All set-ups		TRUE	-	Uint8
3-02	Minimum Reference	SR	All set-ups		TRUE	-3	Int32
3-03	Maximum Reference	SR	All set-ups		TRUE	-3	Int32
3-04	Reference Function	[0] Sum	All set-ups		TRUE	-	Uint8
3-1* References							
3-10	Preset Reference	0.00 %	All set-ups		TRUE	-2	Int16
3-11	Jog Speed [Hz]	SR	All set-ups		TRUE	-1	Uint16
3-12	Catch up/slow Down Value	0.00 %	All set-ups		TRUE	-2	Int16
3-13	Reference Site	[0] Linked to Hand / Auto	All set-ups		TRUE	-	Uint8
3-14	Preset Relative Reference	0.00 %	All set-ups		TRUE	-2	Int32
3-15	Reference Resource 1	null	All set-ups		TRUE	-	Uint8
3-16	Reference Resource 2	null	All set-ups		TRUE	-	Uint8
3-17	Reference Resource 3	null	All set-ups		TRUE	-	Uint8
3-18	Relative Scaling Reference Resource	[0] No function	All set-ups		TRUE	-	Uint8
3-19	Jog Speed [RPM]	SR	All set-ups		TRUE	67	Uint16
3-4* Ramp 1							
3-40	Ramp 1 Type	[0] Linear	All set-ups		TRUE	-	Uint8
3-41	Ramp 1 Ramp up Time	SR	All set-ups		TRUE	-2	Uint32
3-42	Ramp 1 Ramp Down Time	SR	All set-ups		TRUE	-2	Uint32
3-45	Ramp 1 S-ramp Ratio at Accel. Start	50 %	All set-ups		TRUE	0	Uint8
3-46	Ramp 1 S-ramp Ratio at Accel. End	50 %	All set-ups		TRUE	0	Uint8
3-47	Ramp 1 S-ramp Ratio at Decel. Start	50 %	All set-ups		TRUE	0	Uint8
3-48	Ramp 1 S-ramp Ratio at Decel. End	50 %	All set-ups		TRUE	0	Uint8
3-5* Ramp 2							
3-50	Ramp 2 Type	[0] Linear	All set-ups		TRUE	-	Uint8
3-51	Ramp 2 Ramp up Time	SR	All set-ups		TRUE	-2	Uint32
3-52	Ramp 2 Ramp down Time	SR	All set-ups		TRUE	-2	Uint32
3-55	Ramp 2 S-ramp Ratio at Accel. Start	50 %	All set-ups		TRUE	0	Uint8
3-56	Ramp 2 S-ramp Ratio at Accel. End	50 %	All set-ups		TRUE	0	Uint8
3-57	Ramp 2 S-ramp Ratio at Decel. Start	50 %	All set-ups		TRUE	0	Uint8
3-58	Ramp 2 S-ramp Ratio at Decel. End	50 %	All set-ups		TRUE	0	Uint8
3-6* Ramp 3							
3-60	Ramp 3 Type	[0] Linear	All set-ups		TRUE	-	Uint8
3-61	Ramp 3 Ramp up Time	SR	All set-ups		TRUE	-2	Uint32
3-62	Ramp 3 Ramp down Time	SR	All set-ups		TRUE	-2	Uint32
3-65	Ramp 3 S-ramp Ratio at Accel. Start	50 %	All set-ups		TRUE	0	Uint8
3-66	Ramp 3 S-ramp Ratio at Accel. End	50 %	All set-ups		TRUE	0	Uint8
3-67	Ramp 3 S-ramp Ratio at Decel. Start	50 %	All set-ups		TRUE	0	Uint8
3-68	Ramp 3 S-ramp Ratio at Decel. End	50 %	All set-ups		TRUE	0	Uint8
3-7* Ramp 4							
3-70	Ramp 4 Type	[0] Linear	All set-ups		TRUE	-	Uint8
3-71	Ramp 4 Ramp up Time	SR	All set-ups		TRUE	-2	Uint32
3-72	Ramp 4 Ramp Down Time	SR	All set-ups		TRUE	-2	Uint32
3-75	Ramp 4 S-ramp Ratio at Accel. Start	50 %	All set-ups		TRUE	0	Uint8
3-76	Ramp 4 S-ramp Ratio at Accel. End	50 %	All set-ups		TRUE	0	Uint8
3-77	Ramp 4 S-ramp Ratio at Decel. Start	50 %	All set-ups		TRUE	0	Uint8
3-78	Ramp 4 S-ramp Ratio at Decel. End	50 %	All set-ups		TRUE	0	Uint8

Par. No. #	Parameter description	Default value	4-set-up	FC 302 only	Change during operation	Conversion index	Type
3-8* Other Ramps							
3-80	Jog Ramp Time	SR	All set-ups		TRUE	-2	Uint32
3-81	Quick Stop Ramp Time	SR	2 set-ups		TRUE	-2	Uint32
3-82	Quick Stop Ramp Type	[0] Linear	All set-ups		TRUE	-	Uint8
3-83	Quick Stop S-ramp Ratio at Decel. Start	50 %	All set-ups		TRUE	0	Uint8
3-84	Quick Stop S-ramp Ratio at Decel. End	50 %	All set-ups		TRUE	0	Uint8
3-9* Digital Pot.Meter							
3-90	Step Size	0.10 %	All set-ups		TRUE	-2	Uint16
3-91	Ramp Time	1.00 s	All set-ups		TRUE	-2	Uint32
3-92	Power Restore	[0] Off	All set-ups		TRUE	-	Uint8
3-93	Maximum Limit	100 %	All set-ups		TRUE	0	Int16
3-94	Minimum Limit	-100 %	All set-ups		TRUE	0	Int16
3-95	Ramp Delay	SR	All set-ups		TRUE	-3	TimD

4.1.5 4-** Limits / Warnings

Par. No. #	Parameter description	Default value	4-set-up	FC 302 only	Change during operation	Conversion index	Type
4-1* Motor Limits							
4-10	Motor Speed Direction	null	All set-ups		FALSE	-	Uint8
4-11	Motor Speed Low Limit [RPM]	SR	All set-ups		TRUE	67	Uint16
4-12	Motor Speed Low Limit [Hz]	SR	All set-ups		TRUE	-1	Uint16
4-13	Motor Speed High Limit [RPM]	SR	All set-ups		TRUE	67	Uint16
4-14	Motor Speed High Limit [Hz]	SR	All set-ups		TRUE	-1	Uint16
4-16	Torque Limit Motor Mode	SR	All set-ups		TRUE	-1	Uint16
4-17	Torque Limit Generator Mode	100.0 %	All set-ups		TRUE	-1	Uint16
4-18	Current Limit	SR	All set-ups		TRUE	-1	Uint32
4-19	Max Output Frequency	132.0 Hz	All set-ups		FALSE	-1	Uint16
4-2* Limit Factors							
4-20	Torque Limit Factor Source	[0] No function	All set-ups		TRUE	-	Uint8
4-21	Speed Limit Factor Source	[0] No function	All set-ups		TRUE	-	Uint8
4-3* Motor Speed Mon.							
4-30	Motor Feedback Loss Function	[2] Trip	All set-ups		TRUE	-	Uint8
4-31	Motor Feedback Speed Error	300 RPM	All set-ups		TRUE	67	Uint16
4-32	Motor Feedback Loss Timeout	0.05 s	All set-ups		TRUE	-2	Uint16
4-34	Tracking Error Function	null	All set-ups		TRUE	-	Uint8
4-35	Tracking Error	10 RPM	All set-ups		TRUE	67	Uint16
4-36	Tracking Error Timeout	1.00 s	All set-ups		TRUE	-2	Uint16
4-37	Tracking Error Ramping	100 RPM	All set-ups		TRUE	67	Uint16
4-38	Tracking Error Ramping Timeout	1.00 s	All set-ups		TRUE	-2	Uint16
4-39	Tracking Error After Ramping Timeout	5.00 s	All set-ups		TRUE	-2	Uint16
4-5* Adj. Warnings							
4-50	Warning Current Low	0.00 A	All set-ups		TRUE	-2	Uint32
4-51	Warning Current High	I _{maxVLT} (P1637)	All set-ups		TRUE	-2	Uint32
4-52	Warning Speed Low	0 RPM	All set-ups		TRUE	67	Uint16
4-53	Warning Speed High	outputSpeedHighLimit (P413)	All set-ups		TRUE	67	Uint16
4-54	Warning Reference Low	-999999.999 N/A	All set-ups		TRUE	-3	Int32
4-55	Warning Reference High	999999.999 N/A	All set-ups		TRUE	-3	Int32
4-56	Warning Feedback Low	-999999.999 Reference-FeedbackUnit	All set-ups		TRUE	-3	Int32
4-57	Warning Feedback High	999999.999 Reference-FeedbackUnit	All set-ups		TRUE	-3	Int32
4-58	Missing Motor Phase Function	null	All set-ups		TRUE	-	Uint8
4-6* Speed Bypass							
4-60	Bypass Speed From [RPM]	SR	All set-ups		TRUE	67	Uint16
4-61	Bypass Speed From [Hz]	SR	All set-ups		TRUE	-1	Uint16
4-62	Bypass Speed To [RPM]	SR	All set-ups		TRUE	67	Uint16
4-63	Bypass Speed To [Hz]	SR	All set-ups		TRUE	-1	Uint16

4.1.6 5-** Digital In/Out

Par. No. #	Parameter description	Default value	4-set-up	FC 302 only	Change during operation	Conversion index	Type
5-0* Digital I/O mode							
5-00	Digital I/O Mode	[0] PNP	All set-ups		FALSE	-	Uint8
5-01	Terminal 27 Mode	[0] Input	All set-ups		TRUE	-	Uint8
5-02	Terminal 29 Mode	[0] Input	All set-ups	x	TRUE	-	Uint8
5-1* Digital Inputs							
5-10	Terminal 18 Digital Input	null	All set-ups		TRUE	-	Uint8
5-11	Terminal 19 Digital Input	null	All set-ups		TRUE	-	Uint8
5-12	Terminal 27 Digital Input	null	All set-ups		TRUE	-	Uint8
5-13	Terminal 29 Digital Input	null	All set-ups	x	TRUE	-	Uint8
5-14	Terminal 32 Digital Input	null	All set-ups		TRUE	-	Uint8
5-15	Terminal 33 Digital Input	null	All set-ups		TRUE	-	Uint8
5-16	Terminal X30/2 Digital Input	null	All set-ups		TRUE	-	Uint8
5-17	Terminal X30/3 Digital Input	null	All set-ups		TRUE	-	Uint8
5-18	Terminal X30/4 Digital Input	null	All set-ups		TRUE	-	Uint8
5-19	Terminal 37 Safe Stop	[1] Safe Stop Alarm	1 set-up		TRUE	-	Uint8
5-20	Terminal X46/1 Digital Input	[0] No operation	All set-ups		TRUE	-	Uint8
5-21	Terminal X46/3 Digital Input	[0] No operation	All set-ups		TRUE	-	Uint8
5-22	Terminal X46/5 Digital Input	[0] No operation	All set-ups		TRUE	-	Uint8
5-23	Terminal X46/7 Digital Input	[0] No operation	All set-ups		TRUE	-	Uint8
5-24	Terminal X46/9 Digital Input	[0] No operation	All set-ups		TRUE	-	Uint8
5-25	Terminal X46/11 Digital Input	[0] No operation	All set-ups		TRUE	-	Uint8
5-26	Terminal X46/13 Digital Input	[0] No operation	All set-ups		TRUE	-	Uint8
5-3* Digital Outputs							
5-30	Terminal 27 Digital Output	null	All set-ups		TRUE	-	Uint8
5-31	Terminal 29 Digital Output	null	All set-ups	x	TRUE	-	Uint8
5-32	Term X30/6 Digi Out (MCB 101)	null	All set-ups		TRUE	-	Uint8
5-33	Term X30/7 Digi Out (MCB 101)	null	All set-ups		TRUE	-	Uint8
5-4* Relays							
5-40	Function Relay	null	All set-ups		TRUE	-	Uint8
5-41	On Delay, Relay	0.01 s	All set-ups		TRUE	-2	Uint16
5-42	Off Delay, Relay	0.01 s	All set-ups		TRUE	-2	Uint16
5-5* Pulse Input							
5-50	Term. 29 Low Frequency	100 Hz	All set-ups	x	TRUE	0	Uint32
5-51	Term. 29 High Frequency	100 Hz	All set-ups	x	TRUE	0	Uint32
5-52	Term. 29 Low Ref./Feedb. Value	0.000 ReferenceFeedback-Unit	All set-ups	x	TRUE	-3	Int32
5-53	Term. 29 High Ref./Feedb. Value	SR	All set-ups	x	TRUE	-3	Int32
5-54	Pulse Filter Time Constant #29	100 ms	All set-ups	x	FALSE	-3	Uint16
5-55	Term. 33 Low Frequency	100 Hz	All set-ups		TRUE	0	Uint32
5-56	Term. 33 High Frequency	100 Hz	All set-ups		TRUE	0	Uint32
5-57	Term. 33 Low Ref./Feedb. Value	0.000 ReferenceFeedback-Unit	All set-ups		TRUE	-3	Int32
5-58	Term. 33 High Ref./Feedb. Value	SR	All set-ups		TRUE	-3	Int32
5-59	Pulse Filter Time Constant #33	100 ms	All set-ups		FALSE	-3	Uint16
5-6* Pulse Output							
5-60	Terminal 27 Pulse Output Variable	null	All set-ups		TRUE	-	Uint8
5-62	Pulse Output Max Freq #27	SR	All set-ups		TRUE	0	Uint32
5-63	Terminal 29 Pulse Output Variable	null	All set-ups	x	TRUE	-	Uint8
5-65	Pulse Output Max Freq #29	SR	All set-ups	x	TRUE	0	Uint32

Par. No. #	Parameter description	Default value	4-set-up	FC 302 only	Change during operation	Conversion index	Type
5-66	Terminal X30/6 Pulse Output Variable	null	All set-ups		TRUE	-	Uint8
5-68	Pulse Output Max Freq #X30/6	SR	All set-ups		TRUE	0	Uint32
5-7* 24V Encoder Input							
5-70	Term 32/33 Pulses per Revolution	1024 N/A	All set-ups		FALSE	0	Uint16
5-71	Term 32/33 Encoder Direction	[0] Clockwise	All set-ups		FALSE	-	Uint8
5-9* Bus Controlled							
5-90	Digital & Relay Bus Control	0 N/A	All set-ups		TRUE	0	Uint32
5-93	Pulse Out #27 Bus Control	0.00 %	All set-ups		TRUE	-2	N2
5-94	Pulse Out #27 Timeout Preset	0.00 %	1 set-up		TRUE	-2	Uint16
5-95	Pulse Out #29 Bus Control	0.00 %	All set-ups	x	TRUE	-2	N2
5-96	Pulse Out #29 Timeout Preset	0.00 %	1 set-up	x	TRUE	-2	Uint16
5-97	Pulse Out #X30/6 Bus Control	0.00 %	All set-ups		TRUE	-2	N2
5-98	Pulse Out #X30/6 Timeout Preset	0.00 %	1 set-up		TRUE	-2	Uint16

4.1.7 6-** Analog In/Out

Par. No. #	Parameter description	Default value	4-set-up	FC 302 only	Change during operation	Conversion index	Type
6-0* Analog I/O Mode							
6-00	Live Zero Timeout Time	10 s	All set-ups		TRUE	0	Uint8
6-01	Live Zero Timeout Function	[0] Off	All set-ups		TRUE	-	Uint8
6-1* Analog Input 1							
6-10	Terminal 53 Low Voltage	0.07 V	All set-ups		TRUE	-2	Int16
6-11	Terminal 53 High Voltage	10.00 V	All set-ups		TRUE	-2	Int16
6-12	Terminal 53 Low Current	0.14 mA	All set-ups		TRUE	-5	Int16
6-13	Terminal 53 High Current	20.00 mA	All set-ups		TRUE	-5	Int16
6-14	Terminal 53 Low Ref./Feedb. Value	0 ReferenceFeedbackUnit	All set-ups		TRUE	-3	Int32
6-15	Terminal 53 High Ref./Feedb. Value	SR	All set-ups		TRUE	-3	Int32
6-16	Terminal 53 Filter Time Constant	0.001 s	All set-ups		TRUE	-3	Uint16
6-2* Analog Input 2							
6-20	Terminal 54 Low Voltage	0.07 V	All set-ups		TRUE	-2	Int16
6-21	Terminal 54 High Voltage	10.00 V	All set-ups		TRUE	-2	Int16
6-22	Terminal 54 Low Current	0.14 mA	All set-ups		TRUE	-5	Int16
6-23	Terminal 54 High Current	20.00 mA	All set-ups		TRUE	-5	Int16
6-24	Terminal 54 Low Ref./Feedb. Value	0 ReferenceFeedbackUnit	All set-ups		TRUE	-3	Int32
6-25	Terminal 54 High Ref./Feedb. Value	SR	All set-ups		TRUE	-3	Int32
6-26	Terminal 54 Filter Time Constant	0.001 s	All set-ups		TRUE	-3	Uint16
6-3* Analog Input 3							
6-30	Terminal X30/11 Low Voltage	0.07 V	All set-ups		TRUE	-2	Int16
6-31	Terminal X30/11 High Voltage	10.00 V	All set-ups		TRUE	-2	Int16
6-34	Term. X30/11 Low Ref./Feedb. Value	0 ReferenceFeedbackUnit	All set-ups		TRUE	-3	Int32
6-35	Term. X30/11 High Ref./Feedb. Value	SR	All set-ups		TRUE	-3	Int32
6-36	Term. X30/11 Filter Time Constant	0.001 s	All set-ups		TRUE	-3	Uint16
6-4* Analog Input 4							
6-40	Terminal X30/12 Low Voltage	0.07 V	All set-ups		TRUE	-2	Int16
6-41	Terminal X30/12 High Voltage	10.00 V	All set-ups		TRUE	-2	Int16
6-44	Term. X30/12 Low Ref./Feedb. Value	0 ReferenceFeedbackUnit	All set-ups		TRUE	-3	Int32
6-45	Term. X30/12 High Ref./Feedb. Value	SR	All set-ups		TRUE	-3	Int32
6-46	Term. X30/12 Filter Time Constant	0.001 s	All set-ups		TRUE	-3	Uint16
6-5* Analog Output 1							
6-50	Terminal 42 Output	null	All set-ups		TRUE	-	Uint8
6-51	Terminal 42 Output Min Scale	0.00 %	All set-ups		TRUE	-2	Int16
6-52	Terminal 42 Output Max Scale	100.00 %	All set-ups		TRUE	-2	Int16
6-53	Terminal 42 Output Bus Control	0.00 %	All set-ups		TRUE	-2	N2
6-54	Terminal 42 Output Timeout Preset	0.00 %	1 set-up		TRUE	-2	Uint16
6-55	Analog Output Filter	[0] Off	1 set-up		TRUE	-	Uint8
6-6* Analog Output 2							
6-60	Terminal X30/8 Output	null	All set-ups		TRUE	-	Uint8
6-61	Terminal X30/8 Min. Scale	0.00 %	All set-ups		TRUE	-2	Int16
6-62	Terminal X30/8 Max. Scale	100.00 %	All set-ups		TRUE	-2	Int16
6-63	Terminal X30/8 Bus Control	0.00 %	All set-ups		TRUE	-2	N2
6-64	Terminal X30/8 Output Timeout Preset	0.00 %	1 set-up		TRUE	-2	Uint16
6-7* Analog Output 3							
6-70	Terminal X45/1 Output	null	All set-ups		TRUE	-	Uint8
6-71	Terminal X45/1 Min. Scale	0.00 %	All set-ups		TRUE	-2	Int16
6-72	Terminal X45/1 Max. Scale	100.00 %	All set-ups		TRUE	-2	Int16
6-73	Terminal X45/1 Bus Control	0.00 %	All set-ups		TRUE	-2	N2

Par. No. #	Parameter description	Default value	4-set-up	FC 302 only	Change during operation	Conversion index	Type
6-74	Terminal X45/1 Output Timeout Preset	0.00 %	1 set-up		TRUE	-2	Uint16
6-8* Analog Output 4							
6-80	Terminal X45/3 Output	null	All set-ups		TRUE	-	Uint8
6-81	Terminal X45/3 Min. Scale	0.00 %	All set-ups		TRUE	-2	Int16
6-82	Terminal X45/3 Max. Scale	100.00 %	All set-ups		TRUE	-2	Int16
6-83	Terminal X45/3 Bus Control	0.00 %	All set-ups		TRUE	-2	N2
6-84	Terminal X45/3 Output Timeout Preset	0.00 %	1 set-up		TRUE	-2	Uint16

4.1.8 7-** Controllers

Par. No. #	Parameter description	Default value	4-set-up	FC 302 only	Change during operation	Conversion index	Type
7-0* Speed PID Ctrl.							
7-00	Speed PID Feedback Source	null	All set-ups		FALSE	-	Uint8
7-02	Speed PID Proportional Gain	SR	All set-ups		TRUE	-3	Uint16
7-03	Speed PID Integral Time	SR	All set-ups		TRUE	-4	Uint32
7-04	Speed PID Differentiation Time	SR	All set-ups		TRUE	-4	Uint16
7-05	Speed PID Diff. Gain Limit	5.0 N/A	All set-ups		TRUE	-1	Uint16
7-06	Speed PID Lowpass Filter Time	SR	All set-ups		TRUE	-4	Uint16
7-07	Speed PID Feedback Gear Ratio	1.0000 N/A	All set-ups		FALSE	-4	Uint32
7-08	Speed PID Feed Forward Factor	0 %	All set-ups		FALSE	0	Uint16
7-1* Torque PI Ctrl.							
7-12	Torque PI Proportional Gain	100 %	All set-ups		TRUE	0	Uint16
7-13	Torque PI Integration Time	0.020 s	All set-ups		TRUE	-3	Uint16
7-2* Process Ctrl. Feedb							
7-20	Process CL Feedback 1 Resource	[0] No function	All set-ups		TRUE	-	Uint8
7-22	Process CL Feedback 2 Resource	[0] No function	All set-ups		TRUE	-	Uint8
7-3* Process PID Ctrl.							
7-30	Process PID Normal/ Inverse Control	[0] Normal	All set-ups		TRUE	-	Uint8
7-31	Process PID Anti Windup	[1] On	All set-ups		TRUE	-	Uint8
7-32	Process PID Start Speed	0 RPM	All set-ups		TRUE	67	Uint16
7-33	Process PID Proportional Gain	0.01 N/A	All set-ups		TRUE	-2	Uint16
7-34	Process PID Integral Time	10000.00 s	All set-ups		TRUE	-2	Uint32
7-35	Process PID Differentiation Time	0.00 s	All set-ups		TRUE	-2	Uint16
7-36	Process PID Diff. Gain Limit	5.0 N/A	All set-ups		TRUE	-1	Uint16
7-38	Process PID Feed Forward Factor	0 %	All set-ups		TRUE	0	Uint16
7-39	On Reference Bandwidth	5 %	All set-ups		TRUE	0	Uint8
7-4* Adv. Process PID I							
7-40	Process PID I-part Reset	[0] No	All set-ups		TRUE	-	Uint8
7-41	Process PID Output Neg. Clamp	-100 %	All set-ups		TRUE	0	Int16
7-42	Process PID Output Pos. Clamp	100 %	All set-ups		TRUE	0	Int16
7-43	Process PID Gain Scale at Min. Ref.	100 %	All set-ups		TRUE	0	Int16
7-44	Process PID Gain Scale at Max. Ref.	100 %	All set-ups		TRUE	0	Int16
7-45	Process PID Feed Fwd Resource	[0] No function	All set-ups		TRUE	-	Uint8
7-46	Process PID Feed Fwd Normal/ Inv. Ctrl.	[0] Normal	All set-ups		TRUE	-	Uint8
7-48	PCD Feed Forward	0 N/A	All set-ups	x	TRUE	0	Uint16
7-49	Process PID Output Normal/ Inv. Ctrl.	[0] Normal	All set-ups		TRUE	-	Uint8
7-5* Adv. Process PID II							
7-50	Process PID Extended PID	[1] Enabled	All set-ups		TRUE	-	Uint8
7-51	Process PID Feed Fwd Gain	1.00 N/A	All set-ups		TRUE	-2	Uint16
7-52	Process PID Feed Fwd Ramp up	0.01 s	All set-ups		TRUE	-2	Uint32
7-53	Process PID Feed Fwd Ramp down	0.01 s	All set-ups		TRUE	-2	Uint32
7-56	Process PID Ref. Filter Time	0.001 s	All set-ups		TRUE	-3	Uint16
7-57	Process PID Fb. Filter Time	0.001 s	All set-ups		TRUE	-3	Uint16

4.1.9 8-** Comm. and Options

4

Par. No. #	Parameter description	Default value	4-set-up	FC 302 only	Change during operation	Conversion index	Type
8-0* General Settings							
8-01	Control Site	[0] Digital and ctrl.word	All set-ups		TRUE	-	Uint8
8-02	Control Word Source	null	All set-ups		TRUE	-	Uint8
8-03	Control Word Timeout Time	1.0 s	1 set-up		TRUE	-1	Uint32
8-04	Control Word Timeout Function	null	1 set-up		TRUE	-	Uint8
8-05	End-of-Timeout Function	[1] Resume set-up	1 set-up		TRUE	-	Uint8
8-06	Reset Control Word Timeout	[0] Do not reset	All set-ups		TRUE	-	Uint8
8-07	Diagnosis Trigger	[0] Disable	2 set-ups		TRUE	-	Uint8
8-08	Readout Filtering	null	All set-ups		TRUE	-	Uint8
8-1* Ctrl. Word Settings							
8-10	Control Word Profile	[0] FC profile	All set-ups		TRUE	-	Uint8
8-13	Configurable Status Word STW	null	All set-ups		TRUE	-	Uint8
8-14	Configurable Control Word CTW	[1] Profile default	All set-ups		TRUE	-	Uint8
8-3* FC Port Settings							
8-30	Protocol	[0] FC	1 set-up		TRUE	-	Uint8
8-31	Address	1 N/A	1 set-up		TRUE	0	Uint8
8-32	FC Port Baud Rate	null	1 set-up		TRUE	-	Uint8
8-33	Parity / Stop Bits	[0] Even Parity, 1 Stop Bit	1 set-up		TRUE	-	Uint8
8-34	Estimated cycle time	0 ms	2 set-ups		TRUE	-3	Uint32
8-35	Minimum Response Delay	10 ms	All set-ups		TRUE	-3	Uint16
8-36	Max Response Delay	SR	1 set-up		TRUE	-3	Uint16
8-37	Max Inter-Char Delay	SR	1 set-up		TRUE	-5	Uint16
8-4* FC MC protocol set							
8-40	Telegram selection	[1] Standard telegram 1	2 set-ups		TRUE	-	Uint8
8-41	Parameters for signals	0	All set-ups		FALSE	-	Uint16
8-42	PCD write configuration	SR	All set-ups		TRUE	-	Uint16
8-43	PCD read configuration	SR	All set-ups		TRUE	-	Uint16
8-5* Digital/Bus							
8-50	Coasting Select	[3] Logic OR	All set-ups		TRUE	-	Uint8
8-51	Quick Stop Select	[3] Logic OR	All set-ups		TRUE	-	Uint8
8-52	DC Brake Select	[3] Logic OR	All set-ups		TRUE	-	Uint8
8-53	Start Select	[3] Logic OR	All set-ups		TRUE	-	Uint8
8-54	Reversing Select	[3] Logic OR	All set-ups		TRUE	-	Uint8
8-55	Set-up Select	[3] Logic OR	All set-ups		TRUE	-	Uint8
8-56	Preset Reference Select	[3] Logic OR	All set-ups		TRUE	-	Uint8
8-57	Profidrive OFF2 Select	[3] Logic OR	All set-ups		TRUE	-	Uint8
8-58	Profidrive OFF3 Select	[3] Logic OR	All set-ups		TRUE	-	Uint8
8-8* FC Port Diagnostics							
8-80	Bus Message Count	0 N/A	All set-ups		TRUE	0	Uint32
8-81	Bus Error Count	0 N/A	All set-ups		TRUE	0	Uint32
8-82	Slave Messages Rcvd	0 N/A	All set-ups		TRUE	0	Uint32
8-83	Slave Error Count	0 N/A	All set-ups		TRUE	0	Uint32
8-9* Bus Jog							
8-90	Bus Jog 1 Speed	100 RPM	All set-ups		TRUE	67	Uint16
8-91	Bus Jog 2 Speed	200 RPM	All set-ups		TRUE	67	Uint16

4.1.10 9-** Profibus

Par. No. #	Parameter description	Default value	4-set-up	FC 302 only	Change during operation	Conversion index	Type
9-00	Setpoint	0 N/A	All set-ups		TRUE	0	Uint16
9-07	Actual Value	0 N/A	All set-ups		FALSE	0	Uint16
9-15	PCD Write Configuration	SR	2 set-ups		TRUE	-	Uint16
9-16	PCD Read Configuration	SR	2 set-ups		TRUE	-	Uint16
9-18	Node Address	126 N/A	1 set-up		TRUE	0	Uint8
9-22	Telegram Selection	[100] None	1 set-up		TRUE	-	Uint8
9-23	Parameters for Signals	0	All set-ups		TRUE	-	Uint16
9-27	Parameter Edit	[1] Enabled	2 set-ups		FALSE	-	Uint16
9-28	Process Control	[1] Enable cyclic master	2 set-ups		FALSE	-	Uint8
9-44	Fault Message Counter	0 N/A	All set-ups		TRUE	0	Uint16
9-45	Fault Code	0 N/A	All set-ups		TRUE	0	Uint16
9-47	Fault Number	0 N/A	All set-ups		TRUE	0	Uint16
9-52	Fault Situation Counter	0 N/A	All set-ups		TRUE	0	Uint16
9-53	Profibus Warning Word	0 N/A	All set-ups		TRUE	0	V2
9-63	Actual Baud Rate	[255] No baudrate found	All set-ups		TRUE	-	Uint8
9-64	Device Identification	0 N/A	All set-ups		TRUE	0	Uint16
9-65	Profile Number	0 N/A	All set-ups		TRUE	0	OctStr[2]
9-67	Control Word 1	0 N/A	All set-ups		TRUE	0	V2
9-68	Status Word 1	0 N/A	All set-ups		TRUE	0	V2
9-71	Profibus Save Data Values	[0] Off	All set-ups		TRUE	-	Uint8
9-72	ProfibusDriveReset	[0] No action	1 set-up		FALSE	-	Uint8
9-75	DO Identification	0 N/A	All set-ups		TRUE	0	Uint16
9-80	Defined Parameters (1)	0 N/A	All set-ups		FALSE	0	Uint16
9-81	Defined Parameters (2)	0 N/A	All set-ups		FALSE	0	Uint16
9-82	Defined Parameters (3)	0 N/A	All set-ups		FALSE	0	Uint16
9-83	Defined Parameters (4)	0 N/A	All set-ups		FALSE	0	Uint16
9-84	Defined Parameters (5)	0 N/A	All set-ups		FALSE	0	Uint16
9-90	Changed Parameters (1)	0 N/A	All set-ups		FALSE	0	Uint16
9-91	Changed Parameters (2)	0 N/A	All set-ups		FALSE	0	Uint16
9-92	Changed Parameters (3)	0 N/A	All set-ups		FALSE	0	Uint16
9-93	Changed parameters (4)	0 N/A	All set-ups		FALSE	0	Uint16
9-94	Changed parameters (5)	0 N/A	All set-ups		FALSE	0	Uint16
9-99	Profibus Revision Counter	0 N/A	All set-ups		TRUE	0	Uint16

4.1.11 10-** CAN Fieldbus

Par. No. #	Parameter description	Default value	4-set-up	FC 302 only	Change during operation	Conversion index	Type
10-0* Common Settings							
10-00	CAN Protocol	null	2 set-ups		FALSE	-	Uint8
10-01	Baud Rate Select	null	2 set-ups		TRUE	-	Uint8
10-02	MAC ID	SR	2 set-ups		TRUE	0	Uint8
10-05	Readout Transmit Error Counter	0 N/A	All set-ups		TRUE	0	Uint8
10-06	Readout Receive Error Counter	0 N/A	All set-ups		TRUE	0	Uint8
10-07	Readout Bus Off Counter	0 N/A	All set-ups		TRUE	0	Uint8
10-1* DeviceNet							
10-10	Process Data Type Selection	null	All set-ups		TRUE	-	Uint8
10-11	Process Data Config Write	SR	All set-ups		TRUE	-	Uint16
10-12	Process Data Config Read	SR	All set-ups		TRUE	-	Uint16
10-13	Warning Parameter	0 N/A	All set-ups		TRUE	0	Uint16
10-14	Net Reference	[0] Off	2 set-ups		TRUE	-	Uint8
10-15	Net Control	[0] Off	2 set-ups		TRUE	-	Uint8
10-2* COS Filters							
10-20	COS Filter 1	0 N/A	All set-ups		FALSE	0	Uint16
10-21	COS Filter 2	0 N/A	All set-ups		FALSE	0	Uint16
10-22	COS Filter 3	0 N/A	All set-ups		FALSE	0	Uint16
10-23	COS Filter 4	0 N/A	All set-ups		FALSE	0	Uint16
10-3* Parameter Access							
10-30	Array Index	0 N/A	2 set-ups		TRUE	0	Uint8
10-31	Store Data Values	[0] Off	All set-ups		TRUE	-	Uint8
10-32	Devicenet Revision	SR	All set-ups		TRUE	0	Uint16
10-33	Store Always	[0] Off	1 set-up		TRUE	-	Uint8
10-34	DeviceNet Product Code	SR	1 set-up		TRUE	0	Uint16
10-39	Devicenet F Parameters	0 N/A	All set-ups		TRUE	0	Uint32
10-5* CANopen							
10-50	Process Data Config Write.	SR	2 set-ups		TRUE	-	Uint16
10-51	Process Data Config Read.	SR	2 set-ups		TRUE	-	Uint16

4.1.12 12-** Ethernet

Par. No. #	Parameter description	Default value	4-set-up	FC 302 only	Change during operation	Conversion index	Type
12-0* IP Settings							
12-00	IP Address Assignment	null	2 set-ups		TRUE	-	UInt8
12-01	IP Address	0 N/A	1 set-up		TRUE	0	OctStr[4]
12-02	Subnet Mask	0 N/A	1 set-up		TRUE	0	OctStr[4]
12-03	Default Gateway	0 N/A	1 set-up		TRUE	0	OctStr[4]
12-04	DHCP Server	0 N/A	2 set-ups		TRUE	0	OctStr[4]
12-05	Lease Expires	SR	All set-ups		TRUE	0	TimD
12-06	Name Servers	0 N/A	1 set-up		TRUE	0	OctStr[4]
12-07	Domain Name	0 N/A	1 set-up		TRUE	0	VisStr[48]
12-08	Host Name	0 N/A	1 set-up		TRUE	0	VisStr[48]
12-09	Physical Address	0 N/A	1 set-up		TRUE	0	VisStr[17]
12-1* Ethernet Link Parameters							
12-10	Link Status	[0] No Link	1 set-up		TRUE	-	UInt8
12-11	Link Duration	SR	All set-ups		TRUE	0	TimD
12-12	Auto Negotiation	[1] On	2 set-ups		TRUE	-	UInt8
12-13	Link Speed	[0] None	2 set-ups		TRUE	-	UInt8
12-14	Link Duplex	[1] Full Duplex	2 set-ups		TRUE	-	UInt8
12-2* Process Data							
12-20	Control Instance	SR	1 set-up		TRUE	0	UInt8
12-21	Process Data Config Write	SR	All set-ups		TRUE	-	UInt16
12-22	Process Data Config Read	SR	All set-ups		TRUE	-	UInt16
12-28	Store Data Values	[0] Off	All set-ups		TRUE	-	UInt8
12-29	Store Always	[0] Off	1 set-up		TRUE	-	UInt8
12-3* EtherNet/IP							
12-30	Warning Parameter	0 N/A	All set-ups		TRUE	0	UInt16
12-31	Net Reference	[0] Off	2 set-ups		TRUE	-	UInt8
12-32	Net Control	[0] Off	2 set-ups		TRUE	-	UInt8
12-33	CIP Revision	SR	All set-ups		TRUE	0	UInt16
12-34	CIP Product Code	SR	1 set-up		TRUE	0	UInt16
12-35	EDS Parameter	0 N/A	All set-ups		TRUE	0	UInt32
12-37	COS Inhibit Timer	0 N/A	All set-ups		TRUE	0	UInt16
12-38	COS Filter	0 N/A	All set-ups		TRUE	0	UInt16
12-4* Modbus TCP							
12-40	Status Parameter	0 N/A	All set-ups		TRUE	0	UInt16
12-41	Slave Message Count	0 N/A	All set-ups		TRUE	0	UInt32
12-42	Slave Exception Message Count	0 N/A	All set-ups		TRUE	0	UInt32

Par. No. #	Parameter description	Default value	4-set-up	FC 302 only	Change during operation	Conversion index	Type
12-8* Other Ethernet Services							
12-80	FTP Server	[0] Disabled	2 set-ups		TRUE	-	UInt8
12-81	HTTP Server	[0] Disabled	2 set-ups		TRUE	-	UInt8
12-82	SMTP Service	[0] Disabled	2 set-ups		TRUE	-	UInt8
12-89	Transparent Socket Channel Port	SR	2 set-ups		TRUE	0	UInt16
12-9* Advanced Ethernet Services							
12-90	Cable Diagnostic	[0] Disabled	2 set-ups		TRUE	-	UInt8
12-91	MDI-X	[1] Enabled	2 set-ups		TRUE	-	UInt8
12-92	IGMP Snooping	[1] Enabled	2 set-ups		TRUE	-	UInt8
12-93	Cable Error Length	0 N/A	1 set-up		TRUE	0	UInt16
12-94	Broadcast Storm Protection	-1 %	2 set-ups		TRUE	0	Int8
12-95	Broadcast Storm Filter	[0] Broadcast only	2 set-ups		TRUE	-	UInt8
12-96	Port Mirroring	[0] Disable	2 set-ups		TRUE	-	UInt8
12-98	Interface Counters	4000 N/A	All set-ups		TRUE	0	UInt16
12-99	Media Counters	0 N/A	All set-ups		TRUE	0	UInt16

4.1.13 13-** Smart Logic

Par. No. #	Parameter description	Default value	4-set-up	FC 302 only	Change during operation	Conversion index	Type
13-0* SLC Settings							
13-00	SL Controller Mode	null	2 set-ups		TRUE	-	UInt8
13-01	Start Event	null	2 set-ups		TRUE	-	UInt8
13-02	Stop Event	null	2 set-ups		TRUE	-	UInt8
13-03	Reset SLC	[0] Do not reset SLC	All set-ups		TRUE	-	UInt8
13-1* Comparators							
13-10	Comparator Operand	null	2 set-ups		TRUE	-	UInt8
13-11	Comparator Operator	null	2 set-ups		TRUE	-	UInt8
13-12	Comparator Value	SR	2 set-ups		TRUE	-3	Int32
13-2* Timers							
13-20	SL Controller Timer	SR	1 set-up		TRUE	-3	TimD
13-4* Logic Rules							
13-40	Logic Rule Boolean 1	null	2 set-ups		TRUE	-	UInt8
13-41	Logic Rule Operator 1	null	2 set-ups		TRUE	-	UInt8
13-42	Logic Rule Boolean 2	null	2 set-ups		TRUE	-	UInt8
13-43	Logic Rule Operator 2	null	2 set-ups		TRUE	-	UInt8
13-44	Logic Rule Boolean 3	null	2 set-ups		TRUE	-	UInt8
13-5* States							
13-51	SL Controller Event	null	2 set-ups		TRUE	-	UInt8
13-52	SL Controller Action	null	2 set-ups		TRUE	-	UInt8

4.1.14 14-** Special Functions

Par. No. #	Parameter description	Default value	4-set-up	FC 302 only	Change during operation	Conversion index	Type
14-0* Inverter Switching							
14-00	Switching Pattern	null	All set-ups		TRUE	-	Uint8
14-01	Switching Frequency	null	All set-ups		TRUE	-	Uint8
14-03	Overmodulation	[1] On	All set-ups		FALSE	-	Uint8
14-04	PWM Random	[0] Off	All set-ups		TRUE	-	Uint8
14-06	Dead Time Compensation	[1] On	All set-ups		TRUE	-	Uint8
14-1* Mains On/Off							
14-10	Mains Failure	[0] No function	All set-ups		FALSE	-	Uint8
14-11	Mains Voltage at Mains Fault	SR	All set-ups		TRUE	0	Uint16
14-12	Function at Mains Imbalance	[0] Trip	All set-ups		TRUE	-	Uint8
14-13	Mains Failure Step Factor	1.0 N/A	All set-ups		TRUE	-1	Uint8
14-14	Kin. Backup Time Out	60 s	All set-ups		TRUE	0	Uint8
14-2* Trip Reset							
14-20	Reset Mode	[0] Manual reset	All set-ups		TRUE	-	Uint8
14-21	Automatic Restart Time	10 s	All set-ups		TRUE	0	Uint16
14-22	Operation Mode	[0] Normal operation	All set-ups		TRUE	-	Uint8
14-23	Typecode Setting	null	2 set-ups		FALSE	-	Uint8
14-24	Trip Delay at Current Limit	60 s	All set-ups		TRUE	0	Uint8
14-25	Trip Delay at Torque Limit	60 s	All set-ups		TRUE	0	Uint8
14-26	Trip Delay at Inverter Fault	SR	All set-ups		TRUE	0	Uint8
14-28	Production Settings	[0] No action	All set-ups		TRUE	-	Uint8
14-29	Service Code	0 N/A	All set-ups		TRUE	0	Int32
14-3* Current Limit Ctrl.							
14-30	Current Lim Ctrl, Proportional Gain	100 %	All set-ups		FALSE	0	Uint16
14-31	Current Lim Ctrl, Integration Time	0.020 s	All set-ups		FALSE	-3	Uint16
14-32	Current Lim Ctrl, Filter Time	1.0 ms	All set-ups		TRUE	-4	Uint16
14-35	Stall Protection	[1] Enabled	All set-ups		FALSE	-	Uint8
14-4* Energy Optimising							
14-40	VT Level	66 %	All set-ups		FALSE	0	Uint8
14-41	AEO Minimum Magnetisation	SR	All set-ups		TRUE	0	Uint8
14-42	Minimum AEO Frequency	10 Hz	All set-ups		TRUE	0	Uint8
14-43	Motor Cosphi	SR	All set-ups		TRUE	-2	Uint16
14-5* Environment							
14-50	RFI Filter	[1] On	1 set-up	x	FALSE	-	Uint8
14-51	DC Link Compensation	[1] On	1 set-up		TRUE	-	Uint8
14-52	Fan Control	[0] Auto	All set-ups		TRUE	-	Uint8
14-53	Fan Monitor	[1] Warning	All set-ups		TRUE	-	Uint8
14-55	Output Filter	[0] No Filter	All set-ups		FALSE	-	Uint8
14-56	Capacitance Output Filter	2.0 uF	All set-ups		FALSE	-7	Uint16
14-57	Inductance Output Filter	7.000 mH	All set-ups		FALSE	-6	Uint16
14-59	Actual Number of Inverter Units	SR	1 set-up	x	FALSE	0	Uint8

Par. No. #	Parameter description	Default value	4-set-up	FC 302 only	Change during operation	Conversion index	Type
14-7* Compatibility							
14-72	Legacy Alarm Word	0 N/A	All set-ups		FALSE	0	Uint32
14-73	Legacy Warning Word	0 N/A	All set-ups		FALSE	0	Uint32
14-74	Leg. Ext. Status Word	0 N/A	All set-ups		FALSE	0	Uint32
14-8* Options							
14-80	Option Supplied by External 24VDC	[1] Yes	2 set-ups		FALSE	-	Uint8
14-89	Option Detection	[0] Frozen Configuration	1 set-up		TRUE	-	Uint8
14-9* Fault Settings							
14-90	Fault Level	null	1 set-up		TRUE	-	Uint8

4.1.15 15-** Drive Information

Par. No. #	Parameter description	Default value	4-set-up	FC 302 only	Change during operation	Conversion index	Type
15-0* Operating Data							
15-00	Operating Hours	0 h	All set-ups		FALSE	74	UInt32
15-01	Running Hours	0 h	All set-ups		FALSE	74	UInt32
15-02	kWh Counter	0 kWh	All set-ups		FALSE	75	UInt32
15-03	Power Up's	0 N/A	All set-ups		FALSE	0	UInt32
15-04	Over Temp's	0 N/A	All set-ups		FALSE	0	UInt16
15-05	Over Volt's	0 N/A	All set-ups		FALSE	0	UInt16
15-06	Reset kWh Counter	[0] Do not reset	All set-ups		TRUE	-	UInt8
15-07	Reset Running Hours Counter	[0] Do not reset	All set-ups		TRUE	-	UInt8
15-1* Data Log Settings							
15-10	Logging Source	0	2 set-ups		TRUE	-	UInt16
15-11	Logging Interval	SR	2 set-ups		TRUE	-3	TimD
15-12	Trigger Event	[0] False	1 set-up		TRUE	-	UInt8
15-13	Logging Mode	[0] Log always	2 set-ups		TRUE	-	UInt8
15-14	Samples Before Trigger	50 N/A	2 set-ups		TRUE	0	UInt8
15-2* Historic Log							
15-20	Historic Log: Event	0 N/A	All set-ups		FALSE	0	UInt8
15-21	Historic Log: Value	0 N/A	All set-ups		FALSE	0	UInt32
15-22	Historic Log: Time	0 ms	All set-ups		FALSE	-3	UInt32
15-3* Fault Log							
15-30	Fault Log: Error Code	0 N/A	All set-ups		FALSE	0	UInt8
15-31	Fault Log: Value	0 N/A	All set-ups		FALSE	0	Int16
15-32	Fault Log: Time	0 s	All set-ups		FALSE	0	UInt32
15-4* Drive Identification							
15-40	FC Type	0 N/A	All set-ups		FALSE	0	VisStr[6]
15-41	Power Section	0 N/A	All set-ups		FALSE	0	VisStr[20]
15-42	Voltage	0 N/A	All set-ups		FALSE	0	VisStr[20]
15-43	Software Version	0 N/A	All set-ups		FALSE	0	VisStr[5]
15-44	Ordered Typecode String	0 N/A	All set-ups		FALSE	0	VisStr[40]
15-45	Actual Typecode String	0 N/A	All set-ups		FALSE	0	VisStr[40]
15-46	Frequency Converter Ordering No	0 N/A	All set-ups		FALSE	0	VisStr[8]
15-47	Power Card Ordering No	0 N/A	All set-ups		FALSE	0	VisStr[8]
15-48	LCP Id No	0 N/A	All set-ups		FALSE	0	VisStr[20]
15-49	SW ID Control Card	0 N/A	All set-ups		FALSE	0	VisStr[20]
15-50	SW ID Power Card	0 N/A	All set-ups		FALSE	0	VisStr[20]
15-51	Frequency Converter Serial Number	0 N/A	All set-ups		FALSE	0	VisStr[10]
15-53	Power Card Serial Number	0 N/A	All set-ups		FALSE	0	VisStr[19]
15-59	CSIV Filename	SR	1 set-up		FALSE	0	VisStr[16]
15-6* Option Ident							
15-60	Option Mounted	0 N/A	All set-ups		FALSE	0	VisStr[30]
15-61	Option SW Version	0 N/A	All set-ups		FALSE	0	VisStr[20]
15-62	Option Ordering No	0 N/A	All set-ups		FALSE	0	VisStr[8]
15-63	Option Serial No	0 N/A	All set-ups		FALSE	0	VisStr[18]
15-70	Option in Slot A	0 N/A	All set-ups		FALSE	0	VisStr[30]
15-71	Slot A Option SW Version	0 N/A	All set-ups		FALSE	0	VisStr[20]
15-72	Option in Slot B	0 N/A	All set-ups		FALSE	0	VisStr[30]
15-73	Slot B Option SW Version	0 N/A	All set-ups		FALSE	0	VisStr[20]

Par. No. #	Parameter description	Default value	4-set-up	FC 302 only	Change during operation	Conver- sion index	Type
15-74	Option in Slot C0	0 N/A	All set-ups		FALSE	0	VisStr[30]
15-75	Slot C0 Option SW Version	0 N/A	All set-ups		FALSE	0	VisStr[20]
15-76	Option in Slot C1	0 N/A	All set-ups		FALSE	0	VisStr[30]
15-77	Slot C1 Option SW Version	0 N/A	All set-ups		FALSE	0	VisStr[20]
15-9* Parameter Info							
15-92	Defined Parameters	0 N/A	All set-ups		FALSE	0	Uint16
15-93	Modified Parameters	0 N/A	All set-ups		FALSE	0	Uint16
15-98	Drive Identification	0 N/A	All set-ups		FALSE	0	VisStr[40]
15-99	Parameter Metadata	0 N/A	All set-ups		FALSE	0	Uint16

4.1.16 16-** Data Readouts

Par. No. #	Parameter description	Default value	4-set-up	FC 302 only	Change during operation	Conversion index	Type
16-0* General Status							
16-00	Control Word	0 N/A	All set-ups		FALSE	0	V2
16-01	Reference [Unit]	0.000 ReferenceFeedbackUnit	All set-ups		FALSE	-3	Int32
16-02	Reference %	0.0 %	All set-ups		FALSE	-1	Int16
16-03	Status Word	0 N/A	All set-ups		FALSE	0	V2
16-05	Main Actual Value [%]	0.00 %	All set-ups		FALSE	-2	N2
16-09	Custom Readout	0.00 CustomReadoutUnit	All set-ups		FALSE	-2	Int32
16-1* Motor Status							
16-10	Power [kW]	0.00 kW	All set-ups		FALSE	-2	Int32
16-11	Power [hp]	0.00 hp	All set-ups		FALSE	-2	Int32
16-12	Motor Voltage	0.0 V	All set-ups		FALSE	-1	UInt16
16-13	Frequency	0.0 Hz	All set-ups		FALSE	-1	UInt16
16-14	Motor Current	0.00 A	All set-ups		FALSE	-2	Int32
16-15	Frequency [%]	0.00 %	All set-ups		FALSE	-2	N2
16-16	Torque [Nm]	0.0 Nm	All set-ups		FALSE	-1	Int16
16-17	Speed [RPM]	0 RPM	All set-ups		FALSE	67	Int32
16-18	Motor Thermal	0 %	All set-ups		FALSE	0	UInt8
16-19	KTY sensor temperature	0 °C	All set-ups		FALSE	100	Int16
16-20	Motor Angle	0 N/A	All set-ups		TRUE	0	UInt16
16-21	Torque [%] High Res.	0.0 %	All set-ups		FALSE	-1	Int16
16-22	Torque [%]	0 %	All set-ups		FALSE	0	Int16
16-25	Torque [Nm] High	0.0 Nm	All set-ups		FALSE	-1	Int32
16-3* Drive Status							
16-30	DC Link Voltage	0 V	All set-ups		FALSE	0	UInt16
16-32	Brake Energy /s	0.000 kW	All set-ups		FALSE	0	UInt32
16-33	Brake Energy /2 min	0.000 kW	All set-ups		FALSE	0	UInt32
16-34	Heatsink Temp.	0 °C	All set-ups		FALSE	100	UInt8
16-35	Inverter Thermal	0 %	All set-ups		FALSE	0	UInt8
16-36	Inv. Nom. Current	SR	All set-ups		FALSE	-2	UInt32
16-37	Inv. Max. Current	SR	All set-ups		FALSE	-2	UInt32
16-38	SL Controller State	0 N/A	All set-ups		FALSE	0	UInt8
16-39	Control Card Temp.	0 °C	All set-ups		FALSE	100	UInt8
16-40	Logging Buffer Full	[0] No	All set-ups		TRUE	-	UInt8
16-41	LCP Bottom Statusline	0 N/A	All set-ups		TRUE	0	VisStr[50]
16-49	Current Fault Source	0 N/A	All set-ups	x	TRUE	0	UInt8
16-5* Ref. & Feedb.							
16-50	External Reference	0.0 N/A	All set-ups		FALSE	-1	Int16
16-51	Pulse Reference	0.0 N/A	All set-ups		FALSE	-1	Int16
16-52	Feedback [Unit]	0.000 ReferenceFeedbackUnit	All set-ups		FALSE	-3	Int32
16-53	Digi Pot Reference	0.00 N/A	All set-ups		FALSE	-2	Int16
16-57	Feedback [RPM]	0 RPM	All set-ups		FALSE	67	Int32
16-6* Inputs & Outputs							
16-60	Digital Input	0 N/A	All set-ups		FALSE	0	UInt16
16-61	Terminal 53 Switch Setting	[0] Current	All set-ups		FALSE	-	UInt8
16-62	Analog Input 53	0.000 N/A	All set-ups		FALSE	-3	Int32
16-63	Terminal 54 Switch Setting	[0] Current	All set-ups		FALSE	-	UInt8
16-64	Analog Input 54	0.000 N/A	All set-ups		FALSE	-3	Int32

Par. No. #	Parameter description	Default value	4-set-up	FC 302 only	Change during operation	Conversion index	Type
16-65	Analog Output 42 [mA]	0.000 N/A	All set-ups		FALSE	-3	Int16
16-66	Digital Output [bin]	0 N/A	All set-ups		FALSE	0	Int16
16-67	Freq. Input #29 [Hz]	0 N/A	All set-ups	x	FALSE	0	Int32
16-68	Freq. Input #33 [Hz]	0 N/A	All set-ups		FALSE	0	Int32
16-69	Pulse Output #27 [Hz]	0 N/A	All set-ups		FALSE	0	Int32
16-70	Pulse Output #29 [Hz]	0 N/A	All set-ups	x	FALSE	0	Int32
16-71	Relay Output [bin]	0 N/A	All set-ups		FALSE	0	Int16
16-72	Counter A	0 N/A	All set-ups		TRUE	0	Int32
16-73	Counter B	0 N/A	All set-ups		TRUE	0	Int32
16-74	Prec. Stop Counter	0 N/A	All set-ups		TRUE	0	UInt32
16-75	Analog In X30/11	0.000 N/A	All set-ups		FALSE	-3	Int32
16-76	Analog In X30/12	0.000 N/A	All set-ups		FALSE	-3	Int32
16-77	Analog Out X30/8 [mA]	0.000 N/A	All set-ups		FALSE	-3	Int16
16-78	Analog Out X45/1 [mA]	0.000 N/A	All set-ups		FALSE	-3	Int16
16-79	Analog Out X45/3 [mA]	0.000 N/A	All set-ups		FALSE	-3	Int16
16-8* Fieldbus & FC Port							
16-80	Fieldbus CTW 1	0 N/A	All set-ups		FALSE	0	V2
16-82	Fieldbus REF 1	0 N/A	All set-ups		FALSE	0	N2
16-84	Comm. Option STW	0 N/A	All set-ups		FALSE	0	V2
16-85	FC Port CTW 1	0 N/A	All set-ups		FALSE	0	V2
16-86	FC Port REF 1	0 N/A	All set-ups		FALSE	0	N2
16-9* Diagnosis Readouts							
16-90	Alarm Word	0 N/A	All set-ups		FALSE	0	UInt32
16-91	Alarm Word 2	0 N/A	All set-ups		FALSE	0	UInt32
16-92	Warning Word	0 N/A	All set-ups		FALSE	0	UInt32
16-93	Warning Word 2	0 N/A	All set-ups		FALSE	0	UInt32
16-94	Ext. Status Word	0 N/A	All set-ups		FALSE	0	UInt32

4.1.17 17-** Motor Feedb.Option

Par. No. #	Parameter description	Default value	4-set-up	FC 302 only	Change during operation	Conversion index	Type
17-1* Inc. Enc. Interface							
17-10	Signal Type	[1] RS422 (5V TTL)	All set-ups		FALSE	-	Uint8
17-11	Resolution (PPR)	1024 N/A	All set-ups		FALSE	0	Uint16
17-2* Abs. Enc. Interface							
17-20	Protocol Selection	[0] None	All set-ups		FALSE	-	Uint8
17-21	Resolution (Positions/Rev)	SR	All set-ups		FALSE	0	Uint32
17-24	SSI Data Length	13 N/A	All set-ups		FALSE	0	Uint8
17-25	Clock Rate	SR	All set-ups		FALSE	3	Uint16
17-26	SSI Data Format	[0] Gray code	All set-ups		FALSE	-	Uint8
17-34	HIPERFACE Baudrate	[4] 9600	All set-ups		FALSE	-	Uint8
17-5* Resolver Interface							
17-50	Poles	2 N/A	1 set-up		FALSE	0	Uint8
17-51	Input Voltage	7.0 V	1 set-up		FALSE	-1	Uint8
17-52	Input Frequency	10.0 kHz	1 set-up		FALSE	2	Uint8
17-53	Transformation Ratio	0.5 N/A	1 set-up		FALSE	-1	Uint8
17-56	Encoder Sim. Resolution	[0] Disabled	1 set-up		FALSE	-	Uint8
17-59	Resolver Interface	[0] Disabled	All set-ups		FALSE	-	Uint8
17-6* Monitoring and App.							
17-60	Feedback Direction	[0] Clockwise	All set-ups		FALSE	-	Uint8
17-61	Feedback Signal Monitoring	[1] Warning	All set-ups		TRUE	-	Uint8

4.1.18 18-** Data Readouts 2

Par. No. #	Parameter description	Default value	4-set-up	FC 302 only	Change during operation	Conversion index	Type
18-3* Analog Readouts							
18-36	Analog Input X48/2 [mA]	0.000 N/A	All set-ups		TRUE	-3	Int32
18-37	Temp. Input X48/4	0 N/A	All set-ups		TRUE	0	Int16
18-38	Temp. Input X48/7	0 N/A	All set-ups		TRUE	0	Int16
18-39	Temp. Input X48/10	0 N/A	All set-ups		TRUE	0	Int16
18-6* Inputs & Outputs 2							
18-60	Digital Input 2	0 N/A	All set-ups		FALSE	0	UInt16
18-90 PID Readouts							
18-90	Process PID Error	0.0 %	All set-ups		FALSE	-1	Int16
18-91	Process PID Output	0.0 %	All set-ups		FALSE	-1	Int16
18-92	Process PID Clamped Output	0.0 %	All set-ups		FALSE	-1	Int16
18-93	Process PID Gain Scaled Output	0.0 %	All set-ups		FALSE	-1	Int16

4.1.19 30-** Special Features

Par. No. #	Parameter description	Default value	4-set-up	FC 302 only	Change during operation	Conversion index	Type
30-0* Wobbler							
30-00	Wobble Mode	[0] Abs. Freq., Abs. Time	All set-ups		FALSE	-	UInt8
30-01	Wobble Delta Frequency [Hz]	5.0 Hz	All set-ups		TRUE	-1	UInt8
30-02	Wobble Delta Frequency [%]	25 %	All set-ups		TRUE	0	UInt8
30-03	Wobble Delta Freq. Scaling Resource	[0] No function	All set-ups		TRUE	-	UInt8
30-04	Wobble Jump Frequency [Hz]	0.0 Hz	All set-ups		TRUE	-1	UInt8
30-05	Wobble Jump Frequency [%]	0 %	All set-ups		TRUE	0	UInt8
30-06	Wobble Jump Time	SR	All set-ups		TRUE	-3	UInt16
30-07	Wobble Sequence Time	10.0 s	All set-ups		TRUE	-1	UInt16
30-08	Wobble Up/ Down Time	5.0 s	All set-ups		TRUE	-1	UInt16
30-09	Wobble Random Function	[0] Off	All set-ups		TRUE	-	UInt8
30-10	Wobble Ratio	1.0 N/A	All set-ups		TRUE	-1	UInt8
30-11	Wobble Random Ratio Max.	10.0 N/A	All set-ups		TRUE	-1	UInt8
30-12	Wobble Random Ratio Min.	0.1 N/A	All set-ups		TRUE	-1	UInt8
30-19	Wobble Delta Freq. Scaled	0.0 Hz	All set-ups		FALSE	-1	UInt16
30-2* Adv. Start Adjust							
30-20	High Starting Torque Time [s]	0.00 s	All set-ups	x	TRUE	-2	UInt8
30-21	High Starting Torque Current [%]	100.0 %	All set-ups	x	TRUE	-1	UInt32
30-22	Locked Rotor Protection	[0] Off	All set-ups	x	TRUE	-	UInt8
30-23	Locked Rotor Detection Time [s]	0.10 s	All set-ups	x	TRUE	-2	UInt8
30-8* Compatibility (I)							
30-80	d-axis Inductance (Ld)	SR	All set-ups	x	FALSE	-6	Int32
30-81	Brake Resistor (ohm)	SR	1 set-up		TRUE	-2	UInt32
30-83	Speed PID Proportional Gain	SR	All set-ups		TRUE	-4	UInt32
30-84	Process PID Proportional Gain	0.100 N/A	All set-ups		TRUE	-3	UInt16

4.1.20 32-** MCO Basic Settings

Par. No. #	Parameter description	Default value	4-set-up	FC 302 only	Change during operation	Conversion index	Type
32-0* Encoder 2							
32-00	Incremental Signal Type	[1] RS422 (5V TTL)	2 set-ups		TRUE	-	Uint8
32-01	Incremental Resolution	1024 N/A	2 set-ups		TRUE	0	Uint32
32-02	Absolute Protocol	[0] None	2 set-ups		TRUE	-	Uint8
32-03	Absolute Resolution	8192 N/A	2 set-ups		TRUE	0	Uint32
32-05	Absolute Encoder Data Length	25 N/A	2 set-ups		TRUE	0	Uint8
32-06	Absolute Encoder Clock Frequency	262.000 kHz	2 set-ups		TRUE	0	Uint32
32-07	Absolute Encoder Clock Generation	[1] On	2 set-ups		TRUE	-	Uint8
32-08	Absolute Encoder Cable Length	0 m	2 set-ups		TRUE	0	Uint16
32-09	Encoder Monitoring	[0] Off	2 set-ups		TRUE	-	Uint8
32-10	Rotational Direction	[1] No action	2 set-ups		TRUE	-	Uint8
32-11	User Unit Denominator	1 N/A	2 set-ups		TRUE	0	Uint32
32-12	User Unit Numerator	1 N/A	2 set-ups		TRUE	0	Uint32
32-3* Encoder 1							
32-30	Incremental Signal Type	[1] RS422 (5V TTL)	2 set-ups		TRUE	-	Uint8
32-31	Incremental Resolution	1024 N/A	2 set-ups		TRUE	0	Uint32
32-32	Absolute Protocol	[0] None	2 set-ups		TRUE	-	Uint8
32-33	Absolute Resolution	8192 N/A	2 set-ups		TRUE	0	Uint32
32-35	Absolute Encoder Data Length	25 N/A	2 set-ups		TRUE	0	Uint8
32-36	Absolute Encoder Clock Frequency	262.000 kHz	2 set-ups		TRUE	0	Uint32
32-37	Absolute Encoder Clock Generation	[1] On	2 set-ups		TRUE	-	Uint8
32-38	Absolute Encoder Cable Length	0 m	2 set-ups		TRUE	0	Uint16
32-39	Encoder Monitoring	[0] Off	2 set-ups		TRUE	-	Uint8
32-40	Encoder Termination	[1] On	2 set-ups		TRUE	-	Uint8
32-5* Feedback Source							
32-50	Source Slave	[2] Encoder 2	2 set-ups		TRUE	-	Uint8
32-51	MCO 302 Last Will	[1] Trip	2 set-ups		TRUE	-	Uint8
32-6* PID Controller							
32-60	Proportional factor	30 N/A	2 set-ups		TRUE	0	Uint32
32-61	Derivative factor	0 N/A	2 set-ups		TRUE	0	Uint32
32-62	Integral factor	0 N/A	2 set-ups		TRUE	0	Uint32
32-63	Limit Value for Integral Sum	1000 N/A	2 set-ups		TRUE	0	Uint16
32-64	PID Bandwidth	1000 N/A	2 set-ups		TRUE	0	Uint16
32-65	Velocity Feed-Forward	0 N/A	2 set-ups		TRUE	0	Uint32
32-66	Acceleration Feed-Forward	0 N/A	2 set-ups		TRUE	0	Uint32
32-67	Max. Tolerated Position Error	20000 N/A	2 set-ups		TRUE	0	Uint32
32-68	Reverse Behavior for Slave	[0] Reversing allowed	2 set-ups		TRUE	-	Uint8
32-69	Sampling Time for PID Control	1 ms	2 set-ups		TRUE	-3	Uint16
32-70	Scan Time for Profile Generator	1 ms	2 set-ups		TRUE	-3	Uint8
32-71	Size of the Control Window (Activation)	0 N/A	2 set-ups		TRUE	0	Uint32
32-72	Size of the Control Window (Deactiv.)	0 N/A	2 set-ups		TRUE	0	Uint32

Par. No. #	Parameter description	Default value	4-set-up	FC 302 only	Change during operation	Conversion index	Type
32-8* Velocity & Accel.							
32-80	Maximum Velocity (Encoder)	1500 RPM	2 set-ups		TRUE	67	Uint32
32-81	Shortest Ramp	1.000 s	2 set-ups		TRUE	-3	Uint32
32-82	Ramp Type	[0] Linear	2 set-ups		TRUE	-	Uint8
32-83	Velocity Resolution	100 N/A	2 set-ups		TRUE	0	Uint32
32-84	Default Velocity	50 N/A	2 set-ups		TRUE	0	Uint32
32-85	Default Acceleration	50 N/A	2 set-ups		TRUE	0	Uint32
32-9* Development							
32-90	Debug Source	[0] Controlcard	2 set-ups		TRUE	-	Uint8

4.1.21 33-** MCO Adv. Settings

Par. No. #	Parameter description	Default value	4-set-up	FC 302 only	Change during operation	Conversion index	Type
33-0* Home Motion							
33-00	Force HOME	[0] Home not forced	2 set-ups		TRUE	-	Uint8
33-01	Zero Point Offset from Home Pos.	0 N/A	2 set-ups		TRUE	0	Int32
33-02	Ramp for Home Motion	10 N/A	2 set-ups		TRUE	0	Uint32
33-03	Velocity of Home Motion	10 N/A	2 set-ups		TRUE	0	Int32
33-04	Behaviour during HomeMotion	[0] Revers and index	2 set-ups		TRUE	-	Uint8
33-1* Synchronization							
33-10	Synchronization Factor Master (M:S)	1 N/A	2 set-ups		TRUE	0	Int32
33-11	Synchronization Factor Slave (M:S)	1 N/A	2 set-ups		TRUE	0	Int32
33-12	Position Offset for Synchronization	0 N/A	2 set-ups		TRUE	0	Int32
33-13	Accuracy Window for Position Sync.	1000 N/A	2 set-ups		TRUE	0	Int32
33-14	Relative Slave Velocity Limit	0 %	2 set-ups		TRUE	0	Uint8
33-15	Marker Number for Master	1 N/A	2 set-ups		TRUE	0	Uint16
33-16	Marker Number for Slave	1 N/A	2 set-ups		TRUE	0	Uint16
33-17	Master Marker Distance	4096 N/A	2 set-ups		TRUE	0	Uint32
33-18	Slave Marker Distance	4096 N/A	2 set-ups		TRUE	0	Uint32
33-19	Master Marker Type	[0] Encoder Z positive	2 set-ups		TRUE	-	Uint8
33-20	Slave Marker Type	[0] Encoder Z positive	2 set-ups		TRUE	-	Uint8
33-21	Master Marker Tolerance Window	0 N/A	2 set-ups		TRUE	0	Uint32
33-22	Slave Marker Tolerance Window	0 N/A	2 set-ups		TRUE	0	Uint32
33-23	Start Behaviour for Marker Sync	[0] Start Function 1	2 set-ups		TRUE	-	Uint16
33-24	Marker Number for Fault	10 N/A	2 set-ups		TRUE	0	Uint16
33-25	Marker Number for Ready	1 N/A	2 set-ups		TRUE	0	Uint16
33-26	Velocity Filter	0 us	2 set-ups		TRUE	-6	Int32
33-27	Offset Filter Time	0 ms	2 set-ups		TRUE	-3	Uint32
33-28	Marker Filter Configuration	[0] Marker filter 1	2 set-ups		TRUE	-	Uint8
33-29	Filter Time for Marker Filter	0 ms	2 set-ups		TRUE	-3	Int32
33-30	Maximum Marker Correction	0 N/A	2 set-ups		TRUE	0	Uint32
33-31	Synchronisation Type	[0] Standard	2 set-ups		TRUE	-	Uint8
33-4* Limit Handling							
33-40	Behaviour atEnd Limit Switch	[0] Call error handler	2 set-ups		TRUE	-	Uint8
33-41	Negative Software End Limit	-500000 N/A	2 set-ups		TRUE	0	Int32
33-42	Positive Software End Limit	500000 N/A	2 set-ups		TRUE	0	Int32
33-43	Negative Software End Limit Active	[0] Inactive	2 set-ups		TRUE	-	Uint8
33-44	Positive Software End Limit Active	[0] Inactive	2 set-ups		TRUE	-	Uint8
33-45	Time in Target Window	0 ms	2 set-ups		TRUE	-3	Uint8

Par. No. #	Parameter description	Default value	4-set-up	FC 302 only	Change during operation	Conversion index	Type
33-46	Target Window LimitValue	1 N/A	2 set-ups		TRUE	0	Uint16
33-47	Size of Target Window	0 N/A	2 set-ups		TRUE	0	Uint16
33-5* I/O Configuration							
33-50	Terminal X57/1 Digital Input	[0] No function	2 set-ups		TRUE	-	Uint8
33-51	Terminal X57/2 Digital Input	[0] No function	2 set-ups		TRUE	-	Uint8
33-52	Terminal X57/3 Digital Input	[0] No function	2 set-ups		TRUE	-	Uint8
33-53	Terminal X57/4 Digital Input	[0] No function	2 set-ups		TRUE	-	Uint8
33-54	Terminal X57/5 Digital Input	[0] No function	2 set-ups		TRUE	-	Uint8
33-55	Terminal X57/6 Digital Input	[0] No function	2 set-ups		TRUE	-	Uint8
33-56	Terminal X57/7 Digital Input	[0] No function	2 set-ups		TRUE	-	Uint8
33-57	Terminal X57/8 Digital Input	[0] No function	2 set-ups		TRUE	-	Uint8
33-58	Terminal X57/9 Digital Input	[0] No function	2 set-ups		TRUE	-	Uint8
33-59	Terminal X57/10 Digital Input	[0] No function	2 set-ups		TRUE	-	Uint8
33-60	Terminal X59/1 and X59/2 Mode	[1] Output	2 set-ups		FALSE	-	Uint8
33-61	Terminal X59/1 Digital Input	[0] No function	2 set-ups		TRUE	-	Uint8
33-62	Terminal X59/2 Digital Input	[0] No function	2 set-ups		TRUE	-	Uint8
33-63	Terminal X59/1 Digital Output	[0] No function	2 set-ups		TRUE	-	Uint8
33-64	Terminal X59/2 Digital Output	[0] No function	2 set-ups		TRUE	-	Uint8
33-65	Terminal X59/3 Digital Output	[0] No function	2 set-ups		TRUE	-	Uint8
33-66	Terminal X59/4 Digital Output	[0] No function	2 set-ups		TRUE	-	Uint8
33-67	Terminal X59/5 Digital Output	[0] No function	2 set-ups		TRUE	-	Uint8
33-68	Terminal X59/6 Digital Output	[0] No function	2 set-ups		TRUE	-	Uint8
33-69	Terminal X59/7 Digital Output	[0] No function	2 set-ups		TRUE	-	Uint8
33-70	Terminal X59/8 Digital Output	[0] No function	2 set-ups		TRUE	-	Uint8
33-8* Global Parameters							
33-80	Activated Program Number	-1 N/A	2 set-ups		TRUE	0	Int8
33-81	Power-up State	[1] Motor on	2 set-ups		TRUE	-	Uint8
33-82	Drive Status Monitoring	[1] On	2 set-ups		TRUE	-	Uint8
33-83	Behaviour afterError	[0] Coast	2 set-ups		TRUE	-	Uint8
33-84	Behaviour afterEsc.	[0] Controlled stop	2 set-ups		TRUE	-	Uint8
33-85	MCO Supplied by External 24VDC	[0] No	2 set-ups		TRUE	-	Uint8
33-86	Terminal at alarm	[0] Relay 1	2 set-ups		TRUE	-	Uint8
33-87	Terminal state at alarm	[0] Do nothing	2 set-ups		TRUE	-	Uint8
33-88	Status word at alarm	0 N/A	2 set-ups		TRUE	0	Uint16

4.1.22 34-** MCO Data Readouts

Par. No. #	Parameter description	Default value	4-set-up	FC 302 only	Change during operation	Conversion index	Type
34-0* PCD Write Par.							
34-01	PCD 1 Write to MCO	0 N/A	All set-ups		TRUE	0	Uint16
34-02	PCD 2 Write to MCO	0 N/A	All set-ups		TRUE	0	Uint16
34-03	PCD 3 Write to MCO	0 N/A	All set-ups		TRUE	0	Uint16
34-04	PCD 4 Write to MCO	0 N/A	All set-ups		TRUE	0	Uint16
34-05	PCD 5 Write to MCO	0 N/A	All set-ups		TRUE	0	Uint16
34-06	PCD 6 Write to MCO	0 N/A	All set-ups		TRUE	0	Uint16
34-07	PCD 7 Write to MCO	0 N/A	All set-ups		TRUE	0	Uint16
34-08	PCD 8 Write to MCO	0 N/A	All set-ups		TRUE	0	Uint16
34-09	PCD 9 Write to MCO	0 N/A	All set-ups		TRUE	0	Uint16
34-10	PCD 10 Write to MCO	0 N/A	All set-ups		TRUE	0	Uint16
34-2* PCD Read Par.							
34-21	PCD 1 Read from MCO	0 N/A	All set-ups		TRUE	0	Uint16
34-22	PCD 2 Read from MCO	0 N/A	All set-ups		TRUE	0	Uint16
34-23	PCD 3 Read from MCO	0 N/A	All set-ups		TRUE	0	Uint16
34-24	PCD 4 Read from MCO	0 N/A	All set-ups		TRUE	0	Uint16
34-25	PCD 5 Read from MCO	0 N/A	All set-ups		TRUE	0	Uint16
34-26	PCD 6 Read from MCO	0 N/A	All set-ups		TRUE	0	Uint16
34-27	PCD 7 Read from MCO	0 N/A	All set-ups		TRUE	0	Uint16
34-28	PCD 8 Read from MCO	0 N/A	All set-ups		TRUE	0	Uint16
34-29	PCD 9 Read from MCO	0 N/A	All set-ups		TRUE	0	Uint16
34-30	PCD 10 Read from MCO	0 N/A	All set-ups		TRUE	0	Uint16
34-4* Inputs & Outputs							
34-40	Digital Inputs	0 N/A	All set-ups		TRUE	0	Uint16
34-41	Digital Outputs	0 N/A	All set-ups		TRUE	0	Uint16
34-5* Process Data							
34-50	Actual Position	0 N/A	All set-ups		TRUE	0	Int32
34-51	Commanded Position	0 N/A	All set-ups		TRUE	0	Int32
34-52	Actual Master Position	0 N/A	All set-ups		TRUE	0	Int32
34-53	Slave Index Position	0 N/A	All set-ups		TRUE	0	Int32
34-54	Master Index Position	0 N/A	All set-ups		TRUE	0	Int32
34-55	Curve Position	0 N/A	All set-ups		TRUE	0	Int32
34-56	Track Error	0 N/A	All set-ups		TRUE	0	Int32
34-57	Synchronizing Error	0 N/A	All set-ups		TRUE	0	Int32
34-58	Actual Velocity	0 N/A	All set-ups		TRUE	0	Int32
34-59	Actual Master Velocity	0 N/A	All set-ups		TRUE	0	Int32
34-60	Synchronizing Status	0 N/A	All set-ups		TRUE	0	Int32
34-61	Axis Status	0 N/A	All set-ups		TRUE	0	Int32
34-62	Program Status	0 N/A	All set-ups		TRUE	0	Int32
34-64	MCO 302 Status	0 N/A	All set-ups		TRUE	0	Uint16
34-65	MCO 302 Control	0 N/A	All set-ups		TRUE	0	Uint16
34-7* Diagnosis readouts							
34-70	MCO Alarm Word 1	0 N/A	All set-ups		FALSE	0	Uint32
34-71	MCO Alarm Word 2	0 N/A	All set-ups		FALSE	0	Uint32

4.1.23 35-** Sensor Input Option

Par. No. #	Parameter description	Default value	4-set-up	FC 302 only	Change during operation	Conversion index	Type
35-0* Temp. Input Mode							
35-00	Term. X48/4 Temp. Unit	[60] °C	All set-ups		TRUE	-	UInt8
35-01	Term. X48/4 Input Type	[0] Not Connected	All set-ups		TRUE	-	UInt8
35-02	Term. X48/7 Temp. Unit	[60] °C	All set-ups		TRUE	-	UInt8
35-03	Term. X48/7 Input Type	[0] Not Connected	All set-ups		TRUE	-	UInt8
35-04	Term. X48/10 Temp. Unit	[60] °C	All set-ups		TRUE	-	UInt8
35-05	Term. X48/10 Input Type	[0] Not Connected	All set-ups		TRUE	-	UInt8
35-06	Temperature Sensor Alarm Function	[5] Stop and trip	All set-ups		TRUE	-	UInt8
35-1* Temp. Input X48/4							
35-14	Term. X48/4 Filter Time Constant	0.001 s	All set-ups		TRUE	-3	UInt16
35-15	Term. X48/4 Temp. Monitor	[0] Disabled	All set-ups		TRUE	-	UInt8
35-16	Term. X48/4 Low Temp. Limit	ExpressionLimit	All set-ups		TRUE	0	Int16
35-17	Term. X48/4 High Temp. Limit	ExpressionLimit	All set-ups		TRUE	0	Int16
35-2* Temp. Input X48/7							
35-24	Term. X48/7 Filter Time Constant	0.001 s	All set-ups		TRUE	-3	UInt16
35-25	Term. X48/7 Temp. Monitor	[0] Disabled	All set-ups		TRUE	-	UInt8
35-26	Term. X48/7 Low Temp. Limit	ExpressionLimit	All set-ups		TRUE	0	Int16
35-27	Term. X48/7 High Temp. Limit	ExpressionLimit	All set-ups		TRUE	0	Int16
35-3* Temp. Input X48/10							
35-34	Term. X48/10 Filter Time Constant	0.001 s	All set-ups		TRUE	-3	UInt16
35-35	Term. X48/10 Temp. Monitor	[0] Disabled	All set-ups		TRUE	-	UInt8
35-36	Term. X48/10 Low Temp. Limit	ExpressionLimit	All set-ups		TRUE	0	Int16
35-37	Term. X48/10 High Temp. Limit	ExpressionLimit	All set-ups		TRUE	0	Int16
35-4* Analog Input X48/2							
35-42	Term. X48/2 Low Current	4.00 mA	All set-ups		TRUE	-5	Int16
35-43	Term. X48/2 High Current	20.00 mA	All set-ups		TRUE	-5	Int16
35-44	Term. X48/2 Low Ref./Feedb. Value	0.000 N/A	All set-ups		TRUE	-3	Int32
35-45	Term. X48/2 High Ref./Feedb. Value	100.000 N/A	All set-ups		TRUE	-3	Int32
35-46	Term. X48/2 Filter Time Constant	0.001 s	All set-ups		TRUE	-3	UInt16

5 Troubleshooting

5.1.1 Warnings/Alarm Messages

A warning or an alarm is signalled by the relevant LED on the front of the frequency converter and indicated by a code on the display.

A warning remains active until its cause is no longer present. Under certain circumstances operation of the motor may still be continued. Warning messages may be critical, but are not necessarily so.

In the event of an alarm, the frequency converter will have tripped. Alarms must be reset to restart operation once their cause has been rectified.

This may be done in three ways:

1. By using the [RESET] control button on the LCP.
2. Via a digital input with the "Reset" function.
3. Via serial communication/optional fieldbus.

NOTE

After a manual reset using the [RESET] button on the LCP, the [AUTO ON] button must be pressed to restart the motor.

If an alarm cannot be reset, the reason may be that its cause has not been rectified, or the alarm is trip-locked (see also table on following page).

Alarms that are trip-locked offer additional protection, meaning that the mains supply must be switched off before the alarm can be reset. After being switched back on, the frequency converter is no longer blocked and may be reset as described above once the cause has been rectified.

Alarms that are not trip-locked can also be reset using the automatic reset function in par. 14-20 *Reset Mode* (Warning: automatic wake-up is possible!)

If a warning and alarm is marked against a code in the table on the following page, this means that either a warning occurs before an alarm, or else that you can specify whether it is a warning or an alarm that is to be displayed for a given fault.

This is possible, for instance, in par. 1-90 *Motor Thermal Protection*. After an alarm or trip, the motor carries on coasting, and the alarm and warning flash. Once the problem has been rectified, only the alarm continues flashing until the frequency converter is reset.

No.	Description	Warning	Alarm/Trip	Alarm/Trip Lock	Parameter Reference
1	10 Volts low	X			
2	Live zero error	(X)	(X)		Par. 6-01 <i>Live Zero Timeout Function</i>
3	No motor	(X)			Par. 1-80 <i>Function at Stop</i>
4	Mains phase loss	(X)	(X)	(X)	Par. 14-12 <i>Function at Mains Imbalance</i>
5	DC link voltage high	X			
6	DC link voltage low	X			
7	DC over-voltage	X	X		
8	DC under voltage	X	X		
9	Inverter overloaded	X	X		
10	Motor ETR over temperature	(X)	(X)		Par. 1-90 <i>Motor Thermal Protection</i>
11	Motor thermistor over temperature	(X)	(X)		Par. 1-90 <i>Motor Thermal Protection</i>
12	Torque limit	X	X		
13	Over Current	X	X	X	
14	Earth Fault	X	X	X	
15	Hardware mismatch		X	X	
16	Short Circuit		X	X	
17	Control word time-out	(X)	(X)		Par. 8-04 <i>Control Word Timeout Function</i>
22	Hoist Mech. Brake	(X)	(X)		Par. group 2-2*
23	Internal Fan Fault	X			
24	External Fan Fault	X			Par. 14-53 <i>Fan Monitor</i>
25	Brake resistor short-circuited	X			
26	Brake resistor power limit	(X)	(X)		Par. 2-13 <i>Brake Power Monitoring</i>
27	Brake chopper short-circuited	X	X		
28	Brake check	(X)	(X)		Par. 2-15 <i>Brake Check</i>
29	Heatsink temp	X	X	X	
30	Motor phase U missing	(X)	(X)	(X)	Par. 4-58 <i>Missing Motor Phase Function</i>
31	Motor phase V missing	(X)	(X)	(X)	Par. 4-58 <i>Missing Motor Phase Function</i>
32	Motor phase W missing	(X)	(X)	(X)	Par. 4-58 <i>Missing Motor Phase Function</i>
33	Inrush Fault		X	X	
34	Fieldbus communication fault	X	X		
36	Mains failure	X	X		
37	Phase imbalance		X		
38	Internal Fault		X	X	
39	Heatsink sensor		X	X	
40	Overload of Digital Output Terminal 27	(X)			Par. 5-00 <i>Digital I/O Mode</i> , par. 5-01 <i>Terminal 27 Mode</i>
41	Overload of Digital Output Terminal 29	(X)			Par. 5-00 <i>Digital I/O Mode</i> , par. 5-02 <i>Terminal 29 Mode</i>
42	Overload of Digital Output On X30/7	(X)			Par. 5-33 <i>Term X30/7 Digi Out (MCB 101)</i>
45	Earth Fault 2	X	X	X	
46	Pwr. card supply		X	X	
47	24 V supply low	X	X	X	
48	1.8 V supply low		X	X	
49	Speed limit	X			
50	AMA calibration failed		X		
51	AMA check U_{nom} and I_{nom}		X		
52	AMA low I_{nom}		X		
53	AMA motor too big		X		

Table 5.1: Alarm/Warning code list

(X) Dependent on parameter

 1) Can not be Auto reset via par. 14-20 *Reset Mode*

A trip is the action when an alarm has appeared. The trip will coast the motor and can be reset by pressing the reset button or make a reset by a digital input (par. group 5-1* [1]). The origin event that caused an alarm cannot damage the frequency converter or cause dangerous conditions. A trip lock is an action when an alarm occurs, which may cause damage to frequency converter or connected parts. A Trip Lock situation can only be reset by a power cycling.

LED indication	
Warning	yellow
Alarm	flashing red
Trip locked	yellow and red

5

Alarm Word Extended Status Word							
Bit	Hex	Dec	Alarm Word	Alarm Word 2	Warning Word	Warning Word 2	Extended Status Word
0	00000001	1	Brake Check (A28)	ServiceTrip, Read/Write	Brake Check (W28)	reserved	Ramping
1	00000002	2	Heatsink temp. (A29)	ServiceTrip, (reserved)	Heatsink temp. (W29)	reserved	AMA Running
2	00000004	4	Earth Fault (A14)	ServiceTrip, Typecode/ Sparepart	Earth Fault (W14)	reserved	Start CW/CCW
3	00000008	8	Ctrl.Card Temp (A65)	ServiceTrip, (reserved)	Ctrl.Card Temp (W65)	reserved	Slow Down
4	00000010	16	Ctrl. Word TO (A17)	ServiceTrip, (reserved)	Ctrl. Word TO (W17)		Catch Up
5	00000020	32	Over Current (A13)	reserved	Over Current (W13)	reserved	Feedback High
6	00000040	64	Torque Limit (A12)	reserved	Torque Limit (W12)	reserved	Feedback Low
7	00000080	128	Motor Th Over (A11)	reserved	Motor Th Over (W11)	reserved	Output Current High
8	00000100	256	Motor ETR Over (A10)	reserved	Motor ETR Over (W10)	reserved	Output Current Low
9	00000200	512	Inverter Overld. (A9)	reserved	Inverter Overld (W9)	reserved	Output Freq High
10	00000400	1024	DC under Volt (A8)	reserved	DC under Volt (W8)		Output Freq Low
11	00000800	2048	DC over Volt (A7)	reserved	DC over Volt (W7)		Brake Check OK
12	00001000	4096	Short Circuit (A16)	reserved	DC Voltage Low (W6)	reserved	Braking Max
13	00002000	8192	Inrush Fault (A33)	reserved	DC Voltage High (W5)		Braking
14	00004000	16384	Mains ph. Loss (A4)	reserved	Mains ph. Loss (W4)		Out of Speed Range
15	00008000	32768	AMA Not OK	reserved	No Motor (W3)		OVC Active
16	00010000	65536	Live Zero Error (A2)	reserved	Live Zero Error (W2)		AC Brake
17	00020000	131072	Internal Fault (A38)	KTY error	10V Low (W1)	KTY Warn	Password Timelock
18	00040000	262144	Brake Overload (A26)	Fans error	Brake Overload (W26)	Fans Warn	Password Protection
19	00080000	524288	U phase Loss (A30)	ECB error	Brake Resistor (W25)	ECB Warn	
20	00100000	1048576	V phase Loss (A31)	reserved	Brake IGBT (W27)	reserved	
21	00200000	2097152	W phase Loss (A32)	reserved	Speed Limit (W49)	reserved	
22	00400000	4194304	Fieldbus Fault (A34)	reserved	Fieldbus Fault (W34)	reserved	Unused
23	00800000	8388608	24 V Supply Low (A47)	reserved	24V Supply Low (W47)	reserved	Unused
24	01000000	16777216	Mains Failure (A36)	reserved	Mains Failure (W36)	reserved	Unused
25	02000000	33554432	1.8V Supply Low (A48)	reserved	Current Limit (W59)	reserved	Unused
26	04000000	67108864	Brake Resistor (A25)	reserved	Low Temp (W66)	reserved	Unused
27	08000000	134217728	Brake IGBT (A27)	reserved	Voltage Limit (W64)	reserved	Unused
28	10000000	268435456	Option Change (A67)	reserved	Encoder loss (W90)	reserved	Unused
29	20000000	536870912	Drive Initialized(A80)	Feedback Fault (A61, A90)	Feedback Fault (W61, W90)		Unused
30	40000000	1073741824	Safe Stop (A68)	PTC 1 Safe Stop (A71)	Safe Stop (W68)	PTC 1 Safe Stop (W71)	Unused
31	80000000	2147483648	Mech. brake low (A63)	Dangerous Failure (A72)	Extended Status Word		Unused

Table 5.2: Description of Alarm Word, Warning Word and Extended Status Word

The alarm words, warning words and extended status words can be read out via serial bus or optional fieldbus for diagnose. See also par. 16-94 *Ext. Status Word*.

WARNING 1, 10 Volts low:

The 10 V voltage from terminal 50 on the control card is below 10 V.

Remove some of the load from terminal 50, as the 10 V supply is overloaded. Max. 15 mA or minimum 590 Ω.

WARNING/ALARM 2, Live zero error:

The signal on terminal 53 or 54 is less than 50% of the value set in par. 6-10 *Terminal 53 Low Voltage*, par. 6-12 *Terminal 53 Low Current*, par. 6-20 *Terminal 54 Low Voltage*, or par. 6-22 *Terminal 54 Low Current* respectively.

WARNING/ALARM 3, No motor:

No motor has been connected to the output of the frequency converter.

WARNING/ALARM 4, Mains phase loss:

A phase is missing on the supply side, or the mains voltage imbalance is too high.

This message also appears in case of a fault in the input rectifier on the frequency converter.

Check the supply voltage and supply currents to the frequency converter.

WARNING 5, DC link voltage high:

The intermediate circuit voltage (DC) is higher than the overvoltage limit of the control system. The frequency converter is still active.

WARNING 6, DC link voltage low

The intermediate circuit voltage (DC) is below the undervoltage limit of the control system. The frequency converter is still active.

WARNING/ALARM 7, DC over voltage:

If the intermediate circuit voltage exceeds the limit, the frequency converter trips after a time.

Possible corrections:

- Connect a brake resistor
- Extend the ramp time
- Activate functions in par. 2-10 *Brake Function*
- Increase par. 14-26 *Trip Delay at Inverter Fault*

Alarm/warning limits:			
	3 x 200 - 240 V	3 x 380 - 500 V	3 x 525 - 600 V
	[VDC]	[VDC]	[VDC]
Undervoltage	185	373	532
Voltage warning low	205	410	585
Voltage warning high (w/o brake - w/ brake)	390/405	810/840	943/965
Overvoltage	410	855	975
The voltages stated are the intermediate circuit voltage of the frequency converter with a tolerance of ± 5 %. The corresponding mains voltage is the intermediate circuit voltage (DC-link) divided by 1,35			

WARNING/ALARM 8, DC under voltage:

If the intermediate circuit voltage (DC) drops below the “voltage warning low” limit (see table above), the frequency converter checks if 24 V backup supply is connected. If no 24 V backup supply is connected, the frequency converter trips after a given time depending on the unit. To check whether the supply voltage matches the frequency converter, see *General Specifications*.

WARNING/ALARM 9, Inverter overloaded:

The frequency converter is about to cut out because of an overload (too high current for too long). The counter for electronic, thermal inverter protection gives a warning at 98% and trips at 100%, while giving an alarm. You cannot reset the frequency converter until the counter is below 90%. The fault is that the frequency converter is overloaded by more than 100% for too long.

WARNING/ALARM 10, Motor ETR over temperature:

According to the electronic thermal protection (ETR), the motor is too hot. You can choose if you want the frequency converter to give a warning or an alarm when the counter reaches 100% in par. 1-90 *Motor Thermal Protection*. The fault is that the motor is overloaded by more than 100% for too long. Check that the motor par. 1-24 *Motor Current* is set correctly.

WARNING/ALARM 11, Motor thermistor over temp:

The thermistor or the thermistor connection is disconnected. You can choose if you want the frequency converter to give a warning or an alarm when the counter reaches 100% in par. 1-90 *Motor Thermal Protection*. Check that the thermistor is connected correctly between terminal 53 or 54 (analog voltage input) and terminal 50 (+ 10 V supply), or between terminal 18 or 19 (digital input PNP only) and terminal 50. If aKTY sensor is used, check for correct connection between terminal 54 and 55.

WARNING/ALARM 12, Torque limit:

The torque is higher than the value in par. 4-16 *Torque Limit Motor Mode* (in motor operation) or the torque is higher than the value in par. 4-17 *Torque Limit Generator Mode* (in regenerative operation).

WARNING/ALARM 13, Over Current:

The inverter peak current limit (approx. 200% of the rated current) is exceeded. The warning will last approx. 8-12 sec., then the frequency converter trips and issues an alarm. Turn off the frequency converter and check if the motor shaft can be turned and if the motor size matches the frequency converter.

If extended mechanical brake control is selected, trip can be reset externally.

ALARM 14, Earth fault:

There is a discharge from the output phases to earth, either in the cable between the frequency converter and the motor or in the motor itself.

Turn off the frequency converter and remove the earth fault.

ALARM 15, Incomplete hardware:

A fitted option is not handled by the present control board (hardware or software).

ALARM 16, Short-circuit

There is short-circuiting in the motor or on the motor terminals.

Turn off the frequency converter and remove the short-circuit.

WARNING/ALARM 17, Control word timeout:

There is no communication to the frequency converter.

The warning will only be active when par. 8-04 *Control Word Timeout Function* is NOT set to OFF.

If par. 8-04 *Control Word Timeout Function* is set to Stop and Trip, a warning appears and the frequency converter ramps down until it trips, while giving an alarm.

Par. 8-03 *Control Word Timeout Time* could possibly be increased.

WARNING/ALARM 22, Hoist Mechanical Brake:

Report value will show what kind it is. 0 = The torque ref. was not reached before timeout. 1 = There was no brake feedback before timeout.

WARNING 23, Internal fan fault:

The fan warning function is an extra protection function that checks if the fan is running / mounted. The fan warning can be disabled in par. 14-53 *Fan Monitor* (set to [0] Disabled).

WARNING 24, External fan fault:

The fan warning function is an extra protection function that checks if the fan is running / mounted. The fan warning can be disabled in par. 14-53 *Fan Monitor* (set to [0] Disabled).

WARNING 25, Brake resistor short-circuited:

The brake resistor is monitored during operation. If it short-circuits, the brake function is disconnected and the warning appears. The frequency converter still works, but without the brake function. Turn off the frequency converter and replace the brake resistor (see par. 2-15 *Brake Check*).

WARNING/ALARM 26, Brake resistor power limit:

The power transmitted to the brake resistor is calculated as a percentage, as a mean value over the last 120 s, on the basis of the resistance value of the brake resistor (par. 2-11 *Brake Resistor (ohm)*) and the intermediate circuit voltage. The warning is active when the dissipated braking power is higher

than 90%. If Trip [2] has been selected in par. 2-13 *Brake Power Monitoring*, the frequency converter cuts out and issues this alarm, when the dissipated braking power is higher than 100%.

WARNING/ALARM 27, Brake chopper fault:

The brake transistor is monitored during operation and if it short-circuits, the brake function disconnects and the warning comes up. The frequency converter is still able to run, but since the brake transistor has short-circuited, substantial power is transmitted to the brake resistor, even if it is inactive. Turn off the frequency converter and remove the brake resistor.

This alarm/ warning could also occur should the brake resistor overheat. Terminal 104 to 106 are available as brake resistor. Klixon inputs, see section Brake Resistor Temperature Switch.

CAUTION

Warning: There is a risk of substantial power being transmitted to the brake resistor if the brake transistor is short-circuited.

WARNING/ALARM 28, Brake check failed:

Brake resistor fault: the brake resistor is not connected/ working.

ALARM 29, Drive over temperature:

If the enclosure is IP 20 or IP 21/Type 1, the cut-out temperature of the heat-sink is 95 °C ±5 °C. The temperature fault cannot be reset, until the temperature of the heatsink is below 70 °C ±5 °C.

The fault could be:

- Ambient temperature too high
- Too long motor cable

ALARM 30, Motor phase U missing:

Motor phase U between the frequency converter and the the motor is missing.

Turn off the frequency converter and check motor phase U.

ALARM 31, Motor phase V missing:

Motor phase V between the frequency converter and the motor is missing.

Turn off the frequency converter and check motor phase V.

ALARM 32, Motor phase W missing:

Motor phase W between the frequency converter and the motor is missing.

Turn off the frequency converter and check motor phase W.

ALARM 33, Inrush fault:

Too many power ups have occurred within a short time period. See the chapter *General Specifications* for the allowed number of power ups within one minute.

WARNING/ALARM 34, Fieldbus communication fault:

The fieldbus on the communication option card is not working correctly. Please check parameters associated with the module and make sure module is properly inserted in Slot A of the drive. Check the wiring for fieldbus.

WARNING/ALARM 36, Mains failure:

This warning/alarm is only active if the supply voltage to the frequency converter is lost and par. 14-10 *Mains Failure* is NOT set to OFF. Possible correction: check the fuses to the frequency converter

ALARM 37, Phase imbalance:

There is a current imbalance between the power units

ALARM 38, Internal fault:

By this alarm it may be necessary to contact your Danfoss supplier. Some typical alarm messages:

0	The serial port cannot be initialized. Serious hardware failure
256	The power EEPROM data is defect or too old
512	The control board EEPROM data is defect or too old
513	Communication time out Reading EEPROM data
514	Communication time out Reading EEPROM data
515	The Application Orientated Control cannot recognize the EEPROM data
516	Cannot write write to the EEPROM because a write command is on progress
517	The write command is under time out
518	Failure in the EEPROM
519	Missing or invalid BarCode data in EEPROM 1024 – 1279 CAN telegram cannot be sent. (1027 indicate a possible hardware failure)
1281	Digital Signal Processor flash time-out
1282	Power micro software version mismatch
1283	Power EEPROM data version mismatch
1284	Cannot read Digital Signal Processor software version
1299	Option SW in slot A is too old
1300	Option SW in slot B is too old
1311	Option SW in slot C0 is too old
1312	Option SW in slot C1 is too old
1315	Option SW in slot A is not supported (not allowed)
1316	Option SW in slot B is not supported (not allowed)
1317	Option SW in slot C0 is not supported (not allowed)
1318	Option SW in slot C1 is not supported (not allowed)
1536	An exception in the Application Orientated Control is registered. Debug information written in LCP
1792	DSP watchdog is active. Debugging of power part data Motor Orientated Control data not transferred correctly
2049	Power data restarted
2315	Missing SW version from power unit
2816	Stack overflow Control board module
2817	Scheduler slow tasks
2818	Fast tasks
2819	Parameter thread
2820	LCP stack overflow
2821	Serial port overflow
2822	USB port overflow

3072-5122	Parameter value is outside its limits. Perform a initialization. Parameter number causing the alarm: Subtract the code from 3072. Ex Error code 3238: 3238-3072 = 166 is outside the limit
5123	Option in slot A: Hardware incompatible with Control board hardware
5124	Option in slot B: Hardware incompatible with Control board hardware
5125	Option in slot C0: Hardware incompatible with Control board hardware
5126	Option in slot C1: Hardware incompatible with Control board hardware
5376-6231	Out of memory

ALARM 39, Heatsink sensor

No feedback from the heatsink temperature sensor.

The signal from the IGBT thermal sensor is not available on the power card. The problem could be on the power card, on the gate drive card, or the ribbon cable between the power card and gate drive card.

WARNING 40, Overload of Digital Output Terminal 27

Check the load connected to terminal 27 or remove short-circuit connection. Check par. 5-00 *Digital I/O Mode* and par. 5-01 *Terminal 27 Mode*.

WARNING 41, Overload of Digital Output Terminal 29:

Check the load connected to terminal 29 or remove short-circuit connection. Check par. 5-00 *Digital I/O Mode* and par. 5-02 *Terminal 29 Mode*.

WARNING 42, Overload of Digital Output On X30/6 :

Check the load connected to X30/6 or remove short-circuit connection. Check par. 5-32 *Term X30/6 Digi Out (MCB 101)*.

WARNING 42, Overload of Digital Output On X30/7 :

Check the load connected to X30/7 or remove short-circuit connection. Check par. 5-33 *Term X30/7 Digi Out (MCB 101)*.

ALARM 45, Earth fault 2:

There is a discharge from the output phases to earth, either in the cable between the frequency converter and the motor or in the motor itself. Turn off the frequency converter and remove the earth fault. This alarm is detected under the start-up test sequence.

ALARM 46, Power card supply

The supply on the power card is out of range.

There are three power supplies generated by the switch mode power supply (SMPS) on the power card: 24 V, 5V, +/- 18V. When powered with 24 VDC with the MCB 107 option, only the 24 V and 5 V supplies are monitored. When powered with three phase mains voltage, all three supplied are monitored.

WARNING 47, 24 V supply low:

The external 24 V DC backup power supply may be overloaded, otherwise Contact your Danfoss supplier.

WARNING 48, 1.8 V supply low:

Contact your Danfoss supplier.

WARNING 49, Speed limit:

The speed is not within the specified range in par. 4-11 *Motor Speed Low Limit [RPM]* and par. 4-13 *Motor Speed High Limit [RPM]*.

ALARM 50, AMA calibration failed:

The motor is not suitable for the particular size of drive. Start the AMA procedure once again by par. 1-29 *Automatic Motor Adaptation (AMA)*, eventually with a reduced AMA function. If still failing; check the motor data.

ALARM 51, AMA check Unom and Inom:

The setting of motor voltage, motor current, and motor power is presumably wrong. Check the settings.

ALARM 52, AMA low Inom:

The motor current is too low. Check the settings.

ALARM 53, AMA motor too big:

The motor is too big for the AMA to be carried out.

ALARM 54, AMA motor too small:

The motor is too small for the AMA to be carried out.

ALARM 55, AMA par. out of range:

The motor parameter values found from the motor are outside acceptable range.

ALARM 56, AMA interrupted by user:

The AMA has been interrupted by the user.

ALARM 57, AMA timeout:

Try to start the AMA again a number of times, until the AMA is carried out. Please note that repeated runs may heat the motor to a level where the resistance R_s and R_r are increased. In most cases, however, this is not critical.

ALARM 58, AMA internal fault:

Contact your Danfoss supplier.

WARNING 59, Current limit:

The current is higher than the value in par. 4-18 *Current Limit*.

WARNING 60, External interlock

External interlock has been activated. To resume normal operation, apply 24 V DC to the terminal programmed for external interlock and reset the frequency converter (via serial communication, digital I/O, or by pressing reset button on keypad).

WARNING/ALARM 61, Feedback Error:

An error between calculated speed and speed measurement from feedback device. The function Warning/Alarm/Disabling setting is in par. 4-30 *Motor Feedback Loss Function*. Accepted error setting in par. 4-31 *Motor Feedback Speed Error* and the allowed time the error occur setting in par. 4-32 *Motor Feedback Loss Timeout*. During a commissioning procedure the function may be effective.

WARNING 62, Output Frequency at Maximum Limit:

The output frequency is higher than the value set in par. 4-19 *Max Output Frequency*. This is a warning in VVC^{plus} mode and an alarm (trip) in Flux mode.

ALARM 63, Mechanical Brake Low:

The actual motor current has not exceeded the "release brake" current within the "Start delay" time window.

WARNING 64, Voltage Limit:

The load and speed combination demands a motor voltage higher than the actual DC link voltage.

WARNING/ALARM/TRIP 65, Control Card Over Temperature:

Control card over temperature: The cut-out temperature of the control card is 80° C.

WARNING 66, Heatsink Temperature Low:

The heat sink temperature is measured as 0° C. This could indicate that the temperature sensor is defect and thus the fan speed is increased to the maximum in case the power part or control card is very hot.

ALARM 67, Option Configuration has Changed:

One or more options has either been added or removed since the last power down.

ALARM 68, Safe Stop:

Safe Stop has been activated. To resume normal operation, apply 24 V DC to T-37. Press reset button on LCP.

WARNING 68, Safe Stop:

Safe Stop has been activated. Normal operation is resumed when Safe Stop is disabled. Warning: Automatic Restart!

ALARM 69, Power card temperature

The temperature sensor on the power card is either too hot or too cold.

Troubleshooting:

Check the operation of the door fans.

Check that the filters for the door fans are not blocked.

Check that the gland plate is properly installed on IP 21 and IP 54 (NEMA 1 and NEMA 12) drives.

ALARM 70, Illegal FC Configuration:

Actual combination of control board and power board is illegal.

ALARM 71, PTC 1 Safe Stop:

Safe Stop has been activated from the MCB 112 PTC Thermistor Card (motor too warm). Normal operation can be resumed when the MCB 112 applies 24 V DC to T-37 again (when the motor temperature reaches an acceptable level) and when the Digital Input from the MCB 112 is deactivated. When that happens, a reset signal must be sent (via Bus, Digital I/O, or by pressing [RESET]).

WARNING 71, PTC 1 Safe Stop:

Safe Stop has been activated from the MCB 112 PTC Thermistor Card (motor too warm). Normal operation can be resumed when the MCB 112 applies 24 V DC to T-37 again (when the motor temperature reaches an acceptable level) and when the Digital Input from the MCB 112 is deactivated. Warning: Automatic Restart.

ALARM 72, Dangerous Failure:

Safe Stop with Trip Lock. The Dangerous Failure Alarm is issued if the combination of safe stop commands is unexpected. This is the case if the MCB 112 VLT PTC Thermistor Card enables X44/ 10 but safe stop is somehow not enabled. Furthermore, if the MCB 112 is the only device using safe stop (specified through selection [4] or [5] in par. 5-19), an unexpected combination is activation of safe stop without the X44/ 10 being activated. The following table summarizes the unexpected combinations that lead to Alarm 72. Note that if X44/ 10 is activated in selection 2 or 3, this signal is ignored! However, the MCB 112 will still be able to activate Safe Stop.

Function	No.	X44/ 10 (DI)	Safe Stop T37
PTC 1 Warning	[4]	+	-
		-	+
PTC 1 Alarm	[5]	+	-
		-	+
PTC 1 & Relay A	[6]	+	-
PTC 1 & Relay W	[7]	+	-
PTC 1 & RelayA/ W	[8]	+	-
PTC 1 & Relay W/A	[9]	+	-

+ = activated
 - = Not activated

WARNING 73, Safe stop auto restart

Safe stopped. Note that with automatic restart enabled, the motor may start when the fault is cleared.

WARNING 76, Power Unit Setup

The required number of power units does not match the detected number of active power units.

Troubleshooting:

When replacing an F-frame module, this will occur if the power specific data in the module power card does not match the rest of the drive. Please confirm the spare part and its power card are the correct part number.

WARNING 77, Reduced power mode:

This warning indicates that the drive is operating in reduced power mode (i.e. less than the allowed number of inverter sections). This warning will be generated on power cycle when the drive is set to run with fewer inverters and will remain on.

ALARM 78, Tracking Error:

The difference between set point value and actual value has exceeded the value in par. 4-35 *Tracking Error*. Disable the function by par. 4-34 *Tracking Error Function* or select an alarm/warning also in par. 4-34 *Tracking Error Function*. Investigate the mechanics around the load and motor, Check feedback connections from motor – encoder – to drive. Select motor feedback function in par. 4-30 *Motor Feedback Loss Function*. Adjust tracking error band in par. 4-35 *Tracking Error* and par. 4-37 *Tracking Error Ramping*.

ALARM 79, Illegal power section configuration

The scaling card is the incorrect part number or not installed. Also MK102 connector on the power card could not be installed.

ALARM 80, Drive Initialised to Default Value:

Parameter settings are initialised to default setting after a manual (three-finger) reset.

ALARM 81, CSIV corrupt:

CSIV file has syntax errors.

ALARM 82, CSIV parameter error:

CSIV failed to init a parameter.

ALARM 85, Dang fail PB:

Profibus/Profisafe Error.

ALARM 86, Dang fail DI:

Sensor Error.

ALARM 90, Feedback Monitor:

Check the connection to encoder/ resolver option and eventually replace the MCB 102or MCB 103.

ALARM 91, Analogue Input 54 Wrong Settings:

Switch S202 has to be set in position OFF (voltage input) when a KTY sensor is connected to analogue input terminal 54.

ALARM 243, Brake IGBT

This alarm is only for F Frame drives. It is equivalent to Alarm 27. The report value in the alarm log indicates which power module generated the alarm:

- 1 = left most inverter module.
- 2 = middle inverter module in F2 or F4 drive.
- 2 = right inverter module in F1 or F3 drive.
- 3 = right inverter module in F2 or F4 drive.
- 5 = rectifier module.

ALARM 244, Heatsink temperature

This alarm is only for F Frame drives. It is equivalent to Alarm 29. The report value in the alarm log indicates which power module generated the alarm:

- 1 = left most inverter module.
- 2 = middle inverter module in F2 or F4 drive.
- 2 = right inverter module in F1 or F3 drive.
- 3 = right inverter module in F2 or F4 drive.
- 5 = rectifier module.

ALARM 245, Heatsink sensor

This alarm is only for F Frame drives. It is equivalent to Alarm 39. The report value in the alarm log indicates which power module generated the alarm:

- 1 = left most inverter module.
- 2 = middle inverter module in F2 or F4 drive.
- 2 = right inverter module in F1 or F3 drive.
- 3 = right inverter module in F2 or F4 drive.
- 5 = rectifier module.

ALARM 246, Power card supply

This alarm is only for F Frame drives. It is equivalent to Alarm 46. The report value in the alarm log indicates which power module generated the alarm:

- 1 = left most inverter module.
- 2 = middle inverter module in F2 or F4 drive.
- 2 = right inverter module in F1 or F3 drive.
- 3 = right inverter module in F2 or F4 drive.
- 5 = rectifier module.

ALARM 247, Power card temperature

This alarm is only for F Frame drives. It is equivalent to Alarm 69. The report value in the alarm log indicates which power module generated the alarm:

- 1 = left most inverter module.
- 2 = middle inverter module in F2 or F4 drive.
- 2 = right inverter module in F1 or F3 drive.
- 3 = right inverter module in F2 or F4 drive.
- 5 = rectifier module.

ALARM 248, Illegal power section configuration

This alarm is only for F Frame drives. It is equivalent to Alarm 79. The report value in the alarm log indicates which power module generated the alarm:

- 1 = left most inverter module.
- 2 = middle inverter module in F2 or F4 drive.
- 2 = right inverter module in F1 or F3 drive.
- 3 = right inverter module in F2 or F4 drive.
- 5 = rectifier module.

ALARM 250, New Spare Part:

The power or Switch Mode Power Supply has been exchanged. The frequency converter type code must be restored in the EEPROM. Select the correct type code in par. 14-23 *Typecode Setting* according to the label on unit. Remember to select 'Save to EEPROM' to complete.

ALARM 251, New Type Code:

The Frequency Converter has got a new type code.

Index

A

Abbreviations	3
AC brake Max. Current 2-16	49
Access To Main Menu W/o Password 0-61	32
Access To Quick Menu W/o Password 0-66	33
Activate Brake Delay 2-23	50
[Activate Brake Speed Hz] 2-22	50
[Activate Brake Speed Rpm] 2-21	50
Active Set-up 0-10	25
Actual Baud Rate 9-63	112
Actual Typecode String 15-45	145
Actual Value 9-07	108
Address 8-31	102
AEO Minimum Magnetisation 14-41	139
Alarm Log	145
Alarm Log: Time 15-32	145
Alarm Log: Value 15-31	145
Alarm Messages	190
Alarm Word	100, 151
Alarm Word 2 16-91	151
Analog In X30/11 16-75	150
Analog In X30/12 16-76	150
Analog Input 53 16-62	149
Analog Input 54 16-64	149
[Analog Input X48/2 Ma] 18-36	154
Analog Inputs	4
[Analog Out X30/8 Ma] 16-77	150
[Analog Out X45/1 Ma] 16-78	150
[Analog Out X45/3 Ma] 16-79	150
[Analog Output 42 Ma] 16-65	149
Analog Output Filter 6-55	89
Array Index 10-30	117
[Auto On] Key On Lcp 0-42	31
Automatic Motor Adaptation (ama) 1-29	36
Automatic Restart Time 14-21	137

B

Back EMF at 1000 RPM 1-40	38
Baud Rate Select 10-01	114
Brake Check 2-15	48
Brake Check Condition 2-18	49
Brake Control	194
Brake Energy /2 Min 16-33	148
Brake Energy /s 16-32	148
Brake Function 2-10	47
Brake Power	5
Brake Power Limit (kw) 2-12	48
Brake Power Monitoring 2-13	48
Brake Release Time 2-25	51
Brake Resistor (ohm) 2-11	47, 156
Break-away Torque	4
Bus Controlled	84
Bus Error Count 8-81	107
Bus Jog 1 Speed 8-90	107
Bus Jog 2 Speed 8-91	107
Bus Message Count 8-80	107
Bus Password Access 0-67	33
[Bypass Speed From Hz] 4-61	67
[Bypass Speed From Rpm] 4-60	67
[Bypass Speed To Hz] 4-63	67
[Bypass Speed To Rpm] 4-62	67

C

Cabling	120
CAN Protocol 10-00	114
Capacitance Output Filter 14-56	140
Catch Up	69
Catch Up/slow Down Value 3-12	53
Changed Parameters (1) 9-90	113
Changed Parameters (2) 9-91	113
Changed Parameters (3) 9-92	113
Changed Parameters (5) 9-94	114
Change-of-state	120
Changing A Group Of Numeric Data Values	19
Changing A Text Value	19
Changing Data	19
Clock Rate 17-25	152
Clockwise	42
Clockwise Direction 1-06	35
Coasting	4, 14
Coasting Select 8-50	106
Comm. Option Stw 16-84	151
Communication Option	194
Comparator Operand 13-10	124
Comparator Operator 13-11	127
Comparator Value 13-12	127
Configurable Control Word Ctw 8-14	102
Configuration	99, 101, 119
Configuration Mode 1-00	33
Control Cables	9
Control Card Temp. 16-39	148
Control Site 8-01	99
Control Word 16-00	146
Control Word 1 9-67	112
Control Word Profile 8-10	101
Control Word Source 8-02	99
Control Word Timeout Function 8-04	99
Control Word Timeout Time 8-03	99
Cooling	44
COS Filter 1 10-20	117
COS Filter 2 10-21	117
COS Filter 3 10-22	117
COS Filter 4 10-23	117
Counter A 16-72	150
Counter B 16-73	150
CSIV Filename 15-59	145
Current Fault Source 16-49	148
Current Lim Ctrl, Filter Time 14-32	139
Current Lim Ctrl, Integration Time 14-31	139
Current Lim Ctrl, Proportional Gain 14-30	139
Current Limit 4-18	63
Custom Readout 16-09	146
Custom Readout Max Value 0-32	31

D

Data Log Settings	142
D-axis Inductance (ld) 1-37	38, 156
DC Brake Current 2-01	47
[DC Brake Cut In Speed Hz] 2-04	47
[DC Brake Cut In Speed RPM] 2-03	47
DC Brake Select 8-52	106
DC Braking Time 2-02	47
DC Hold Current 2-00	47
DC link	193
DC Link Compensation 14-51	139
DC Link Voltage 16-30	148

Dead Time Compensation 14-06	134
Default Settings	1, 159
Defined Parameters 15-92	146
Defined Parameters (1) 9-80	113
Defined Parameters (2) 9-81	113
Defined Parameters (3) 9-82	113
Defined Parameters (4) 9-83	113
Defined Parameters (5) 9-84	113
Definitions	4
Device Identification 9-64	112
Devicenet	114
Devicenet F Parameters 10-39	117
Devicenet Revision 10-32	117
Diagnosis Trigger 8-07	100
Digi Pot Reference 16-53	149
Digital & Relay Bus Control 5-90	84
Digital I/o Mode 5-00	67
Digital Input 16-60	149
Digital Input 2 18-60	154
[Digital Output Bin] 16-66	150
Display Line 1.1 Small 0-20	27
Display Mode	15
Display Mode - Selection Of Read-outs	15
Display Text 1 0-37	31
Display Text 2 0-38	31
Display Text 3 0-39	31
DO Identification 9-75	113
Drive Identification	145
E	
Edit Set-up 0-11	25
Electrical Terminals	8
Electronic Terminal Relay	44
Encoder Pulses	83
Encoder Sim. Resolution 17-56	153
End-of-timeout Function 8-05	99
Environment	139
Estimated Cycle Time 8-34	102
Ethernet	118, 120
Ethernet/ip	119
ETR	147, 193
Ext. Status Word 16-94	151
Ext. Status Word 2 16-95	151
External Reference 16-50	148
F	
Fan Control 14-52	139
Fan Monitor 14-53	140
Fault Code 9-45	111
Fault Level 14-90	141
Fault Log: Error Code 15-30	145
Fault Message Counter 9-44	111
Fault Number 9-47	112
Fault Situation Counter 9-52	112
FC Port Baud Rate 8-32	102
FC Port CTW 1 16-85	151
FC Port REF 1 16-86	151
FC Type 15-40	145
Feedback Direction 17-60	153
[Feedback RPM] 16-57	149
Feedback Signal Monitoring 17-61	153
[Feedback Unit] 16-52	149
Fieldbus CTW 1 16-80	151
Fieldbus REF 1 16-82	151
Flux Motor Feedback Source 1-02	34

Flying Start 1-73	42
Flystart Test Pulses Current 1-58	40
Flystart Test Pulses Frequency 1-59	40
Forward Open	120
Freeze Output	4
[Freq. Input #33 Hz] 16-68	150
Frequency 16-13	147
[Frequency %] 16-15	147
Frequency Converter Ordering No 15-46	145
Frequency Converter Serial Number 15-51	145
Function At Mains Imbalance 14-12	136
Function At Stop 1-80	43
Function Relay 5-40	76

G

Gain Boost Factor 2-28	51
General Warning	3
Graphical Display	12

H

[Hand On] Key On Lcp 0-40	31
Heatsink Temp. 16-34	148
High Speed Load Compensation 1-61	40
[High Starting Torque Current %] 30-21	156
[High Starting Torque Time S] 30-20	156
HIPERFACE Baudrate 17-34	152
Historic Log	144
Historic Log: Event 15-20	144
Historic Log: Time 15-22	144
Historic Log: Value 15-21	144

I

IGMP	120
Incremental Encoder	148
Indexed Parameters	20
Indicator Lights	13
Inductance Output Filter 14-57	140
Infinitely Variable Change Of Numeric Data Value	20
Initialisation	1
Input Frequency 17-52	153
Input Voltage 17-51	153
Intermediate Circuit	193
Inv. Max. Current 16-37	148
Inv. Nom. Current 16-36	148
Inverter Thermal 16-35	148
Iron Loss Resistance (rfe) 1-36	38

J

Jog	4
Jog Ramp Time 3-80	59
[Jog Speed Hz] 3-11	53
[Jog Speed Rpm] 3-19	55

K

Kin. Backup Time Out 14-14	137
KTY sensor	193
KTY sensor temperature 16-19	147
KTY Sensor Type 1-95	46
KTY Thermistor Resource 1-96	46
KTY Threshold level 1-97	46
kWh Counter 15-02	142

L

Language 0-01	23
Language Package 1	23
Language Package 2	23
Language Package 3	23
Language Package 4	23
LCP	20
LCP Copy 0-50	32
LCP Id No 15-48	145
LEDs	12
Leg. Ext. Status Word 14-74	140
Live Zero Timeout Function 6-01	85
Live Zero Timeout Time 6-00	85
Load Type 1-67	41
Local Control Keys	1
Local Mode Configuration 1-05	35
Local Reference	24
[Locked Rotor Detection Time S] 30-23	156
Locked Rotor Protection 30-22	156
Logging Buffer Full 16-40	148
Logging Interval 15-11	143
Logging Mode 15-13	143
Logging Source 15-10	142
Logic Rule Boolean 1 13-40	128
Logic Rule Boolean 2 13-42	129
Logic Rule Boolean 3 13-44	130
Logic Rule Operator 1 13-41	129
Logic Rule Operator 2 13-43	130
Low Speed Load Compensation 1-60	40

M

MAC ID 10-02	114
[Main Actual Value %] 16-05	146
Main Menu	17
Main Menu Mode	14, 19
Main Menu Password 0-60	32
Main Reactance	36
Main Reactance (xh) 1-35	38
Mains Failure 14-10	135
Mains Supply	6
Mains Voltage At Mains Fault 14-11	136
Maintenance Word 16-96	151
Max Inter-char Delay 8-37	102
Max Output Frequency 4-19	63
Max Response Delay 8-36	102
Maximum Inertia 1-69	41
Maximum Limit 3-93	61
Maximum Reference 3-03	53
MCB 113	72, 76, 91, 93
MCB 114	157
[Min Speed For Function At Stop Hz] 1-82	43
[Min Speed For Function At Stop Rpm] 1-81	43
[Min Speed Normal Magnetising Hz] 1-52	39
[Min Speed Normal Magnetising Rpm] 1-51	39
Min Value Of User-defined Readout 0-31	31
Min. Current At Low Speed 1-66	41
Minimum AEO Frequency 14-42	139
Minimum Inertia 1-68	41
Minimum Limit 3-94	61
Minimum Reference 3-02	52
Minimum Response Delay 8-35	102
Missing Motor Phase Function 4-58	66
Model Shift Frequency 1-53	39
Modified Parameters 15-93	146

Motor Angle 16-20	147
Motor Angle Offset 1-41	38
Motor Construction 1-10	35
Motor Cont. Rated Torque 1-26	36
Motor Control Principle 1-01	34
Motor Cosphi 14-43	139
Motor Current 1-24	36, 147
Motor External Fan 1-91	44
Motor Feedback Loss Function 4-30	64
Motor Feedback Loss Timeout 4-32	64
Motor Feedback Speed Error 4-31	64
Motor Frequency 1-23	36
Motor Magnetisation At Zero Speed 1-50	38
Motor Nominal Speed 1-25	36
Motor Poles 1-39	38
[Motor Power Hp] 1-21	35
[Motor Power Kw] 1-20	35
Motor Protection	44
Motor Speed Direction 4-10	62
[Motor Speed High Limit Hz] 4-14	62
[Motor Speed High Limit Rpm] 4-13	62
[Motor Speed Low Limit Hz] 4-12	62
[Motor Speed Low Limit Rpm] 4-11	62
Motor Speed Unit 0-02	24
Motor Status	147
Motor Thermal 16-18	147
Motor Thermal Protection 1-90	44
Motor Voltage 1-22	36, 147
Multicast	121
My Personal Menu 0-25	30

N

Net Control 10-15	116
Net Reference 10-14	116
Network	118, 119, 120, 121
Node Address 9-18	109
Numerical Local Control Panel	20

O

Off Delay, Relay 5-42	79
[Off] Key On Lcp 0-41	31
On Delay, Relay 5-41	79
On Reference Bandwidth 7-39	97
Operating Hours 15-00	142
Operating Mode	24
Operating State At Power-up (hand) 0-04	24
Operation Mode 14-22	137
Option Detection 14-89	140
Option Ident.	146
Option Mounted 15-60	146
Option Ordering No 15-62	146
Option Serial No 15-63	146
Option Supplied By External 24vdc 14-80	140
Option SW Version 15-61	146
Ordered Typecode String 15-44	145
Output Filter 14-55	140
Output Speed	42
Over Temp's 15-04	142
Over Volt's 15-05	142
Overload Mode 1-04	35
Overmodulation 14-03	134
Over-voltage Control 2-17	49
Over-voltage Gain 2-19	49

P

Parameter Access 117

Parameter Edit 9-27 111

Parameter Info 146

Parameter Metadata 15-99 146

Parameter Selection 19

Parameter Set-up 17

Parameters For Signals 8-41 103, 110

Parity / Stop Bits 8-33 102

PCD Feed Forward 7-48 98

PCD read configuration 8-43 105, 108

PCD write configuration 8-42 104, 108

Poles 17-50 153

Port Mirroring 12-96 121

Potentiometer Reference 11

Power Card Ordering No 15-47 145

Power Card Serial Number 15-53 145

[Power Hp] 16-11 147

[Power kW] 16-10 147

Power Restore 3-92 61

Power Section 15-41 145

Power Up's 15-03 142

Prec. Stop Counter 16-74 150

Precise Stop Counter Value 1-84 43

Precise Stop Function 1-83 43

Precise Stop Speed Compensation Delay 1-85 44

Preset Reference 3-10 53

Preset Reference Select 8-56 107

Preset Relative Reference 3-14 54

Process CL Feedback 1 Resource 7-20 96

Process CL Feedback 2 Resource 7-22 96

Process Control 9-28 111

Process Data Config Read 10-12 115

Process Data Config Write 10-11 114

Process Data Type Selection 10-10 114

Process PID Anti Windup 7-31 96

Process PID Clamped Output 18-92 154

Process PID Diff. Gain Limit 7-36 97

Process PID Differentiation Time 7-35 97

Process PID Error 18-90 154

Process PID Extended PID 7-50 98

Process PID Fb. Filter Time 7-57 98

Process PID Feed Forward Factor 7-38 97

Process PID Feed Fwd Gain 7-51 98

Process PID Feed Fwd Normal/ Inv. Ctrl. 7-46 98

Process PID Feed Fwd Ramp down 7-53 98

Process PID Feed Fwd Ramp up 7-52 98

Process PID Feed Fwd Resource 7-45 98

Process PID Gain Scale at Max. Ref. 7-44 97

Process PID Gain Scale at Min. Ref. 7-43 97

Process PID Gain Scaled Output 18-93 154

Process PID Integral Time 7-34 97

Process PID I-part Reset 7-40 97

Process PID Normal/ Inverse Control 7-30 96

Process PID Output 18-91 154

Process PID Output Neg. Clamp 7-41 97

Process PID Output Normal/ Inv. Ctrl. 7-49 98

Process PID Output Pos. Clamp 7-42 97

Process PID Proportional Gain 7-33 97, 156

Process PID Ref. Filter Time 7-56 98

Process PID Start Speed 7-32 97

Profibus Save Data Values 9-71 113

Profibus Warning Word 9-53 112

Profibusdrivereset 9-72 113

Profidrive OFF2 Select 8-57 107

Profidrive OFF3 Select 8-58 107

Profile Number 9-65 112

Programming Set-up 9-70 112

Protection Mode 7

Protocol 8-30 102

Protocol Selection 17-20 152

Pulse Filter Time Constant #29 5-54 80

Pulse Filter Time Constant #33 5-59 81

[Pulse Input #29 Hz] 16-67 150

Pulse Out #27 Bus Control 5-93 84

Pulse Out #27 Timeout Preset 5-94 84

Pulse Out #29 Bus Control 5-95 84

Pulse Out #29 Timeout Preset 5-96 84

Pulse Out #x30/6 Bus Control 5-97 84

Pulse Out #x30/6 Timeout Preset 5-98 84

[Pulse Output #27 Hz] 16-69 150

[Pulse Output #29 Hz] 16-70 150

Pulse Output Max Freq #27 5-62 82

Pulse Output Max Freq #29 5-65 82

Pulse Output Max Freq #x30/6 5-68 82

Pulse Reference 16-51 148

Pulse Start/stop 10

PWM Random 14-04 134

Q

Quick Menu 13, 17

Quick Menu Mode 13, 17

Quick Menu Password 0-65 33

Quick Stop Ramp Time 3-81 60

Quick Stop Ramp Type 3-82 60

Quick Stop S-ramp Ratio At Decel. End 3-84 60

Quick Stop S-ramp Ratio At Decel. Start 3-83 60

Quick Transfer Of Parameter Settings Between Multiple Frequency Converters 15

R

Ramp 1 Ramp Down Time 3-42 56

Ramp 1 Ramp Up Time 3-41 56

Ramp 1 S-ramp Ratio At Accel. End 3-46 56

Ramp 1 S-ramp Ratio At Accel. Start 3-45 56

Ramp 1 S-ramp Ratio At Decel. End 3-48 56

Ramp 1 S-ramp Ratio At Decel. Start 3-47 56

Ramp 1 Type 3-40 56

Ramp 2 Ramp Down Time 3-52 57

Ramp 2 Ramp Up Time 3-51 57

Ramp 2 S-ramp Ratio At Accel. End 3-56 57

Ramp 2 S-ramp Ratio At Accel. Start 3-55 57

Ramp 2 S-ramp Ratio At Decel. End 3-58 57

Ramp 2 S-ramp Ratio At Decel. Start 3-57 57

Ramp 2 Type 3-50 57

Ramp 3 Ramp Down Time 3-62 58

Ramp 3 Ramp Up Time 3-61 58

Ramp 3 S-ramp Ratio At Accel. End 3-66 58

Ramp 3 S-ramp Ratio At Accel. Start 3-65 58

Ramp 3 S-ramp Ratio At Decel. End 3-68 58

Ramp 3 S-ramp Ratio At Decel. Start 3-67 58

Ramp 3 Type 3-60 57

Ramp 4 Ramp Down Time 3-72 59

Ramp 4 Ramp Up Time 3-71 59

Ramp 4 S-ramp Ratio At Accel. End 3-76 59

Ramp 4 S-ramp Ratio At Accel. Start 3-75 59

Ramp 4 S-ramp Ratio At Decel. End 3-78 59

Ramp 4 S-ramp Ratio At Decel. Start 3-77 59

Ramp 4 Type 3-70 58

Ramp Delay 3-95 61

Ramp Time 3-91 61

Rated Motor Speed	4
RCD	5
Readout Bus Off Counter 10-07	114
Readout Filtering 8-08	100
Readout Receive Error Counter 10-06	114
Readout Transmit Error Counter 10-05	114
Readout: Edit Set-ups / Channel 0-14	26
Readout: Linked Set-ups 0-13	26
Reference	119
[Reference %] 16-02	146
Reference Function 3-04	53
Reference Range 3-00	52
Reference Resource 1 3-15	54
Reference Resource 2 3-16	54
Reference Resource 3 3-17	54
Reference Site 3-13	54
[Reference Unit] 16-01	146
Reference/feedback Unit 3-01	52
Regional Settings 0-03	24
Relative Scaling Reference Resource 3-18	55
[Relay Output Bin] 16-71	150
Relay Outputs	72
Release Brake Current 2-20	50
Reset	14
Reset Control Word Timeout 8-06	100
Reset kWh Counter 15-06	142
Reset Mode 14-20	137
Reset Running Hours Counter 15-07	142
Reset SLC 13-03	124
[Reset] Key On Lcp 0-43	32
Resolution (Positions/Rev) 17-21	152
Resolution (PPR) 17-11	152
Resolver Interface 17-59	153
Resonance Dampening 1-64	41
Resonance Dampening Time Constant 1-65	41
Reversing Select 8-54	106
RFI Filter 14-50	139
Rotor Leakage Reactance (x2) 1-34	37
Rotor Resistance (rr) 1-31	37
Running Hours 15-01	142
S	
Safety Precautions	6
Samples Before Trigger 15-14	143
Screened/armoured	9
Serial Communication	4
Service Code 14-29	138
Setpoint 9-00	108
Set-up Copy 0-51	32
Set-up Select 8-55	106
Signal Type 17-10	152
SL Controller Action 13-52	132
SL Controller Event 13-51	131
SL Controller Mode 13-00	122
SL Controller State 16-38	148
SL Controller Timer 13-20	128
Slave Error Count 8-83	107
Slave Messages Rcvd 8-82	107
Slip Compensation 1-62	41
Slip Compensation Time Constant 1-63	41
Software Version 15-43	145
Speed PID Diff. Gain Limit 7-05	94
Speed PID Differentiation Time 7-04	94
Speed PID Feed Forward Factor 7-08	96
Speed PID Feedback Gear Ratio 7-07	96
Speed PID Feedback Source 7-00	94

Speed PID Integral Time 7-03	94
Speed PID Lowpass Filter Time 7-06	95
Speed PID Proportional Gain 7-02	94, 156
[Speed RPM] 16-17	147
Speed Up/down	10
SSI Data Format 17-26	152
SSI Data Length 17-24	152
Stall Protection 14-35	139
Start Current 1-76	43
Start Delay	42
Start Event 13-01	122
Start Function	42
Start Select 8-53	106
[Start Speed Hz] 1-75	43
[Start Speed Rpm] 1-74	42
Start/stop	9
Stator Leakage Reactance	36
Stator Leakage Reactance (x1) 1-33	37
Stator Resistance (rs) 1-30	37
Status	13
Status Messages	12
Status Word 16-03	146
Status Word 1 9-68	112
Step Size 3-90	61
Step-by-step	20
Stop Delay 2-24	50
Stop Event 13-02	123
Store Always 10-33	117
Store Data Values 10-31	117
SW ID Control Card 15-49	145
SW ID Power Card 15-50	145
Switching Frequency 14-01	134
Switching Pattern 14-00	134
Synchronous Motor Speed	4

T

Telegram Selection 8-40	102, 109
Temp. Input X48/10 18-39	154
Temp. Input X48/4 18-37	154
Temp. Input X48/7 18-38	154
Temperature Sensor Alarm Function 35-06	157
Term 32/33 Encoder Direction 5-71	83
Term 32/33 Pulses Per Revolution 5-70	83
Term X30/6 Digi Out (mcb 101) 5-32	75
Term X30/7 Digi Out (mcb 101) 5-33	75
Term. 29 High Frequency 5-51	80
Term. 29 High Ref./feedb. Value 5-53	80
Term. 29 Low Frequency 5-50	80
Term. 29 Low Ref./feedb. Value 5-52	80
Term. 33 High Frequency 5-56	80
Term. 33 High Ref./feedb. Value 5-58	81
Term. 33 Low Frequency 5-55	80
Term. 33 Low Ref./feedb. Value 5-57	81
Term. X30/11 Filter Time Constant 6-36	87
Term. X30/11 High Ref./feedb. Value 6-35	87
Term. X30/11 Low Ref./feedb. Value 6-34	87
Term. X30/12 Filter Time Constant 6-46	87
Term. X30/12 High Ref./feedb. Value 6-45	87
Term. X30/12 Low Ref./feedb. Value 6-44	87
Term. X48/10 Filter Time Constant 35-34	158
Term. X48/10 High Temp. Limit 35-37	158
Term. X48/10 Input Type 35-05	157
Term. X48/10 Low Temp. Limit 35-36	158
Term. X48/10 Temp. Monitor 35-35	158
Term. X48/10 Temp. Unit 35-04	157
Term. X48/2 Filter Time Constant 35-46	158

Term. X48/2 High Current 35-43 158

Term. X48/2 High Ref./feedb. Value 35-45 158

Term. X48/2 Low Current 35-42 158

Term. X48/2 Low Ref./feedb. Value 35-44 158

Term. X48/4 Filter Time Constant 35-14 157

Term. X48/4 High Temp. Limit 35-17 157

Term. X48/4 Input Type 35-01 157

Term. X48/4 Low Temp. Limit 35-16 157

Term. X48/4 Temp. Monitor 35-15 157

Term. X48/4 Temp. Unit 35-00 157

Term. X48/7 Filter Time Constant 35-24 157

Term. X48/7 High Temp. Limit 35-27 158

Term. X48/7 Input Type 35-03 157

Term. X48/7 Low Temp. Limit 35-26 158

Term. X48/7 Temp. Monitor 35-25 158

Term. X48/7 Temp. Unit 35-02 157

Terminal 27 Mode 5-01 67

Terminal 27 Pulse Output Variable 5-60 81

Terminal 29 Mode 5-02 67

Terminal 29 Pulse Output Variable 5-63 82

Terminal 37 Safe Stop 5-19 71

Terminal 42 Output 6-50 88

Terminal 42 Output Bus Control 6-53 89

Terminal 42 Output Max Scale 6-52 89

Terminal 42 Output Min Scale 6-51 89

Terminal 42 Output Timeout Preset 6-54 89

Terminal 53 Filter Time Constant 6-16 86

Terminal 53 High Current 6-13 86

Terminal 53 High Ref./feedb. Value 6-15 86

Terminal 53 High Voltage 6-11 85

Terminal 53 Low Current 6-12 85

Terminal 53 Low Ref./feedb. Value 6-14 86

Terminal 53 Low Voltage 6-10 85

Terminal 53 Switch Setting 16-61 149

Terminal 54 Filter Time Constant 6-26 86

Terminal 54 High Current 6-23 86

Terminal 54 High Ref./feedb. Value 6-25 86

Terminal 54 High Voltage 6-21 86

Terminal 54 Low Current 6-22 86

Terminal 54 Low Ref./feedb. Value 6-24 86

Terminal 54 Low Voltage 6-20 86

Terminal 54 Switch Setting 16-63 149

Terminal X30/11 High Voltage 6-31 87

Terminal X30/11 Low Voltage 6-30 87

Terminal X30/12 High Voltage 6-41 87

Terminal X30/12 Low Voltage 6-40 87

Terminal X30/6 Pulse Output Variable 5-66 82

Terminal X30/8 Bus Control 6-63 91

Terminal X30/8 Max. Scale 6-62 91

Terminal X30/8 Min. Scale 6-61 91

Terminal X30/8 Output 6-60 90

Terminal X30/8 Output Timeout Preset 6-64 91

Terminal X45/1 Output Min Scale, 6-71 92

Terminal X45/3 Output Min Scale, 6-81 93

Thermal Load 38, 147

Thermistor 44

Thermistor Source 1-93 46

This Set-up Linked To 0-12 25

[Torque %] 16-22 147

[Torque %] High Res. 16-21 147

Torque Characteristics 1-03 34

Torque Limit Factor Source 4-20 63

Torque Limit Generator Mode 4-17 63

Torque Limit Motor Mode 4-16 63

[Torque Nm] 16-16 147

[Torque Nm] High 16-25 148

Torque PI Integration Time 7-13 96

Torque PI Proportional Gain 7-12 96

Torque Ramp Time 2-27 51

Torque Ref 2-26 51

Tracking Error 4-35 65

Tracking Error After Ramping Timeout 4-39 65

Tracking Error Function 4-34 64

Tracking Error Ramping 4-37 65

Tracking Error Ramping Timeout 4-38 65

Tracking Error Timeout 4-36 65

Transformation Ratio 17-53 153

Trigger Event 15-12 143

Trip Delay At Current Limit 14-24 138

Trip Delay At Inverter Fault 14-26 138

Trip Delay At Torque Limit 14-25 138

Trip Reset 137

U

U/f Characteristic - F 1-56 40

U/f Characteristic - U 1-55 40

Unit For User-defined Readout 0-30 30

V

Value 20

Voltage 15-42 145

Voltage Reduction In Fieldweakening 1-54 39

Voltage Reference Via A Potentiometer 11

VT Level 14-40 139

VVCplus 6

W

Warning Current High 4-51 65

Warning Current Low 4-50 65

Warning Feedback High 4-57 66

Warning Feedback Low 4-56 66

Warning Parameter 10-13 116

Warning Reference High 4-55 66

Warning Reference Low 4-54 66

Warning Speed High 4-53 66

Warning Speed Low 4-52 65

Warning Word 100, 151

Warning Word 2 16-93 151

Warnings 190

Wobble Delta Freq. Scaled 30-19 156

Wobble Delta Freq. Scaling Resource 30-03 155

[Wobble Delta Frequency %] 30-02 155

[Wobble Delta Frequency Hz] 30-01 155

[Wobble Jump Frequency %] 30-05 155

[Wobble Jump Frequency Hz] 30-04 155

Wobble Jump Time 30-06 155

Wobble Mode 30-00 154

Wobble Random Function 30-09 155

Wobble Random Ratio Max. 30-11 155

Wobble Random Ratio Min. 30-12 155

Wobble Ratio 30-10 155

Wobble Sequence Time 30-07 155

Wobble Up/ Down Time 30-08 155