

## Contents

Safety Note .....	3
<b>Introduction .....</b>	<b>4</b>
About this Manual .....	4
Technical Overview .....	5
Constrains .....	6
Hardware .....	7
FC 300-related Literature .....	7
Abbreviations .....	8
<b>How to Install .....</b>	<b>9</b>
The MCA114 PROFIBUS converter Option .....	9
<b>How to Configure the System .....</b>	<b>11</b>
Configure the PROFIBUS Network .....	11
LED Behaviour .....	13
EMC Precautions .....	14
<b>Parameter Mapping List .....</b>	<b>15</b>
VLT® 5000 Group 0 .....	15
VLT® 5000 Group 1 .....	18
VLT® 5000 Group 2 .....	24
VLT® 5000 Group 3 .....	28
VLT® 5000 Group 4 .....	39
VLT® 5000 Group 5 .....	46
VLT® 5000 Group 6 .....	50
VLT® 5000 Group 8 .....	53
VLT® 5000 Group 9 .....	54
<b>Troubleshooting .....</b>	<b>58</b>
Step-by-step troubleshooting .....	58
<b>Index .....</b>	<b>59</b>

### **Copyright, Limitation of Liability and Revision Rights**

This publication contains information proprietary to Danfoss A/S. By accepting and using this manual the user agrees that the information contained herein will be used solely for operating equipment from Danfoss A/S or equipment from other vendors provided that such equipment is intended for communication with Danfoss equipment over an PROFIBUS serial communication link. This publication is protected under the Copyright laws of Denmark and most other countries.

Danfoss A/S does not warrant that a software program produced according to the guidelines provided in this manual will function properly in every physical, hardware or software environment.

Although Danfoss A/S has tested and reviewed the documentation within this manual, Danfoss A/S makes no warranty or representation, either express or implied, with respect to this documentation, including its quality, performance, or fitness for a particular purpose.

In no event shall Danfoss A/S be liable for direct, indirect, special, incidental, or consequential damages arising out of the use, or the inability to use information contained in this manual, even if advised of the possibility of such damages. In particular, Danfoss A/S is not responsible for any costs including but not limited to those incurred as a result of lost profits or revenue, loss or damage of equipment, loss of computer programs, loss of data, the costs to substitute these, or any claims by third parties.

Danfoss A/S reserves the right to revise this publication at any time and to make changes in its contents without prior notice or any obligation to notify previous users of such revisions or changes.

## Safety Note



The voltage of the frequency converter is dangerous whenever connected to mains. Incorrect installation of the motor, frequency converter or fieldbus may cause damage to the equipment, serious personal injury or death. Consequently, the instructions in this manual, as well as national and local rules and safety regulations, must be complied with.

### Safety Regulations

1. The frequency converter must be disconnected from mains if repair work is to be carried out. Check that the mains supply has been disconnected and that the necessary time has passed before removing motor and mains plugs.
2. The [OFF] key on the control panel of the frequency converter does not disconnect the equipment from mains and is thus not to be used as a safety switch.
3. Correct protective earthing or grounding of the equipment must be established, the user must be protected against supply voltage, and the motor must be protected against overload in accordance with applicable national and local regulations.
4. The earth leakage currents are higher than 3.5 mA.
5. Protection against motor overload is not included in the factory setting. If this function is desired, set par. 1-90 to data value *ETR trip* or data value *ETR warning*.  
Note: The function is initialised at 1.16 x rated motor current and rated motor frequency. For the North American market; the ETR functions provide class 20 motor overload protection in accordance with NEC.
6. Do not remove the plugs for the motor and mains supply while the frequency converter is connected to mains. Check that the mains supply has been disconnected and that the necessary time has passed before removing motor and mains plugs.
7. Please note that the frequency converter has more voltage inputs than L1, L2 and L3, when load sharing (linking of DC intermediate circuit) and external 24 V DC have been installed. Check that all voltage inputs have been disconnected and that the necessary time has passed before commencing repair work.

### Warning against Unintended Start

1. The motor can be brought to a stop by means of digital commands, bus commands, references or a local stop, while the frequency converter is connected to mains.  
If personal safety considerations make it necessary to ensure that no unintended start occurs, these stop functions are not sufficient.
2. While parameters are being changed, the motor may start. Consequently, the [OFF] key must always be activated.
3. A motor that has been stopped may start if faults occur in the electronics of the frequency converter, or if a temporary overload or a fault in the supply mains or the motor connection ceases.



#### Warning:

Touching the electrical parts may be fatal - even after the equipment has been disconnected from mains.

Also make sure that other voltage inputs have been disconnected, such as external 24 V DC, load sharing (linkage of DC intermediate circuit), as well as the motor connection for kinetic back up.

Please take note of discharge times and further safety guidelines from the section: "Safety and conformity", in the respective Design Guide (MG.33.Ax.yy).

## Introduction

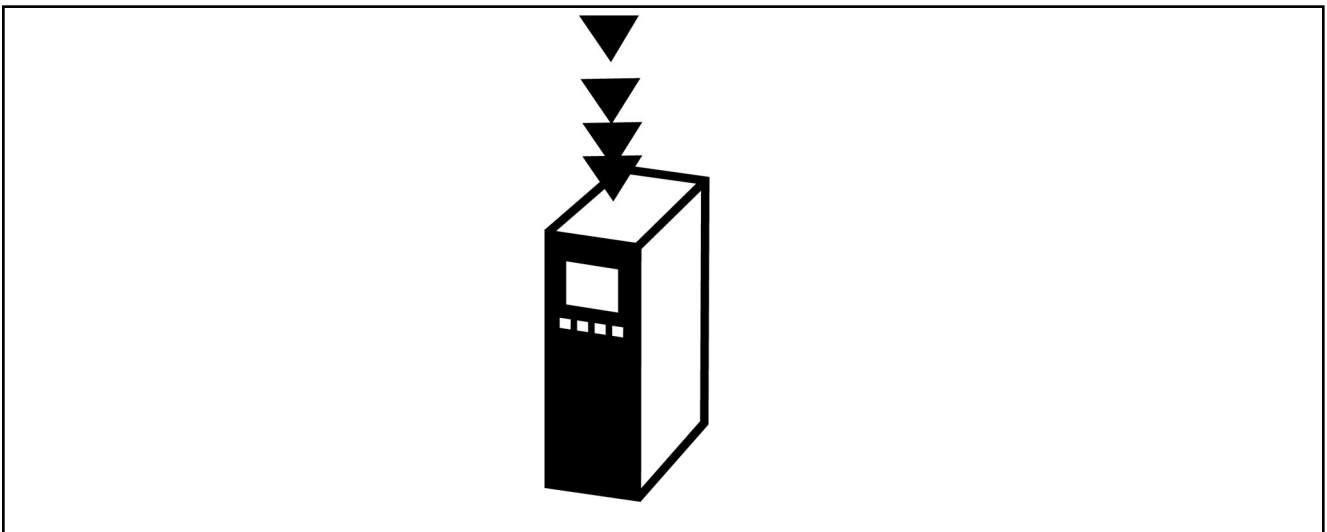

### **About this Manual**

First time users can obtain the most essential information for quick installation and set-up in these chapters:

*Technical Overview*

*Constraints*

*How to Install*

For more detailed information including the full range of set-up options and diagnosis tools please refer to the chapters:

*How to Configure the System*

*Parameter Mapping List*

## Technical Overview

This VLT® 5000 to FC 302 converter (MCA114) is a option intended for replacing a VLT® 5000 with a FC 302 Automation Drive, in a PROFIBUS network.

With this PROFIBUS converter option the FC 302 will react as a VLT® 5000 on the PROFIBUS network; it means that it will in most cases not be necessary to change anything in the PLC programming or configuration.

The FC 302 will identify itself as a VLT® 5000 drive on the PROFIBUS network, and a write command to e.g. *Ramp Up Time* in VLT® 5000 is automatically linked to the corresponding ramp up time parameter in FC 302.

**N.B.:**

Some parameters in the VLT® 5000 are not supported in the FC 302 and some FC 302 parameters can not be accessed via the PROFIBUS converter Option MCA114.

Please refer to the section: *Parameter Mapping List* for more information.

If ad write request is attempted to a parameter selection not supported, the converter will discard the value and issue a positive reply.

Only parameters and functions described in this manual are supported.

**N.B.:**

The replacement drive must match the power-size, or be bigger than the replaced VLT® 5000 drive. Also observe that the choice of brake-chopper matches the replaced drive.

**N.B.:**

Please observe local rules and regulations when replacing drives in existing installations.

## Constrains

### Software versions

- The converter requires a FC 302 with a minimum drive-software version 5.5X.
- The converter software is based on a VLT® 5000 ver. 3.9x software and PROFIBUS ver. 4.5 software.

### Hardware

- MCA114 only supports FC 302 only.
- There is no support for PROFIBUS FMS networks.
- The FC 302 has fewer digital I/O's and analogue output signals compared to VLT® 5000. These signal is mapped to MCB101 *General I/O* option that must be mounted in the FC 302 in order to utilize all I/O's.
- Terminal mapping:

VLT® 5000		FC 302	
Terminal	Function	Terminal	Function
16	Digital input	X30/2*	Digital input
17	Digital input	X3/3*	Digital input
18	Digital input	18	Digital input
19	Digital input	19	Digital input
27	Digital input	27	Digital input
29	Digital input	29	Digital input
32	Digital input	32	Digital input
33	Digital input	33	Digital input
20	GND Digital input	20	GND Digital input
53	Analogue input voltage	53	Analogue input voltage**
54	Analogue input voltage	X30/11*	Analogue input voltage
60	Analogue input current	54	Analogue input current***
55	GND analogue/digital input	55	GND analogue/digital input
42	Analogue/Digital output	42	Analogue output 0/4-20mA
		X30/6*	Digital output
		X30/7*	Pulse output
39	GND analogue/digital output	39	GND analogue/digital output
4-5	Relay	4-6	Relay
1-3	Relay	1-3	Relay
68	RS-485-P	68	RS-485-P
69	RS-485-N	69	RS-485-N
61	GND RS-485	61	GND RS-485
12	24 Volt out	12	24 Volt out
13	24 Volt out	13	24 Volt out
50	10 Volt out	50	10 Volt out



#### N.B:

- \* = MCB101 *General I/O* option
- \*\* = Switch "S201" must be OFF
- \*\*\* = Switch "S202" must be ON

# VLT® AutomationDrive PROFIBUS converter

## - Introduction -

### Performance

- Main Actual Value (MAV) is calculated different, compared to VLT® 5000.
- The motor control algorithm of the FC 300 is still used and will result in a better motor performance compared to VLT® 5000.



#### N.B. Factory values:

After initialisation most parameters are set to match the factory settings of the VLT® 5000 parameters.



#### N.B. Linked Setups:

To achieve compatible functionality with regards to setup change with running motor, FC 302 setups must be linked. This is done on the FC 302 using par. 0-12.

## Hardware

This manual relates to the following hardware:

- MCA114 VLT® 5000 to FC 302 PROFIBUS converter option, type no. 130B1246.
- MCB101 General I/O option, type no. 130B1125 (uncoated), 130B1212 (coated)
- MCB107 External 24 Volt DC Supply, type no. 130B1108 (uncoated), 130B1208 (coated)
- PROFIBUS adaptor Sub-D9 connector, type no. 130B1112.

### Mechanical adaptation

The following mechanical adapter plates are available:

Ordering #	VLT® 5000 style	Height [mm]	Width [mm]	VLT® 5000 type
130B0183	Bookstyle, IP20	395	90	5001-5003 200-240V 5001-5005 380-500V
130B0184	Bookstyle, IP20	395	130	5004-5006 200-240V 5006-5011 380-500V
130B0185	Compact, IP20	395	220	5001-5003 200-240V 5001-5005 380-500V 5004-5006 200-240V 5006-5011 380-500V 5001-5011 550-600V

## FC 300-related Literature

The following literature is available for the FC 300 series:

Title	Literature no.
FC 300 Operating Instructions	MG.33.Ax.yy
FC 300 Design Guide	MG.33.Bx.yy

Please also refer to:

<http://www.danfoss.com/BusinessAreas/DrivesSolutions/>

-for additional information.

## Abbreviations

AOC	Application oriented control	PLC	Programmable Logic Controller
CTW	Control word	PNU	Parameter NUmber
EMC	Electromagnetic Compatibility	PPO	Parameter Process Data Object
I/O	Input/Output	PPO1	Telegram of PCV, control word and reference
LED	Light Emitting Diode	PPO3	Telegram of control word and reference
LSB	Least Significant Bit	PU	Power Unit
MAV	Main Actual Value (actual output)	REF	Reference (= MRV)
MOC	Motor oriented control	STW	Status Word
MSB	Most Significant Bit		
MRV	Main Reference Value		
N/A	Not applicable		
PCD	Peripherals Communication Data (process data)		
PCV	Parameter Characteristics (Parameter channel)		



## How to Install

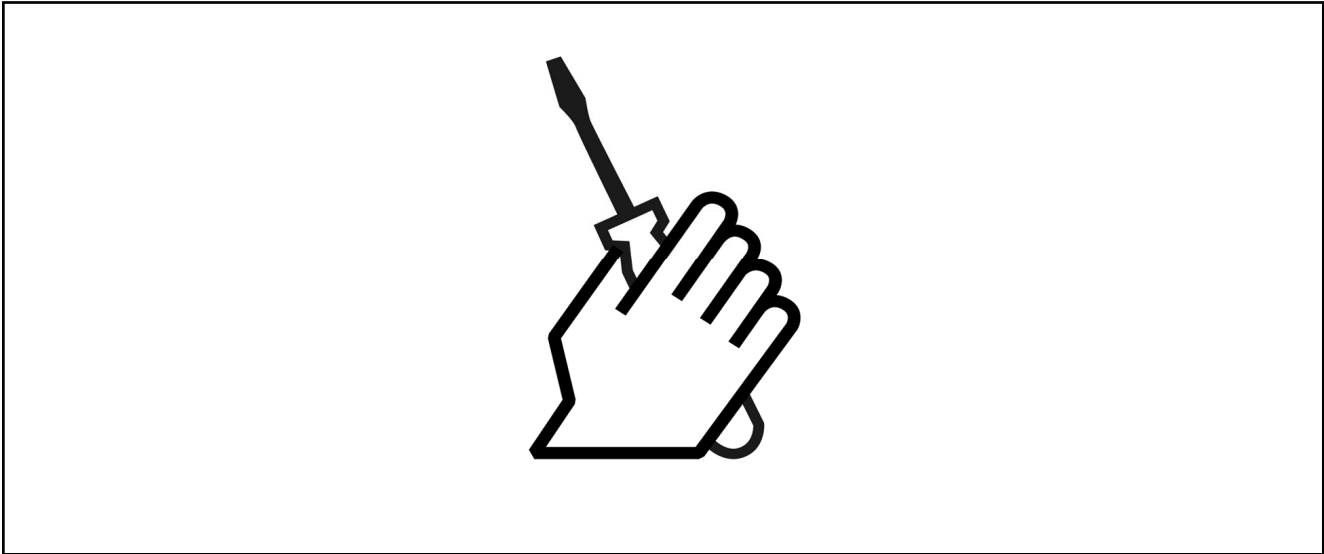

### The MCA114 PROFIBUS converter Option

#### Connecting the Bus Line

Proper termination of the bus line is essential. A mismatch of impedance may result in reflections on the line that will corrupt data transmission.

- The PROFIBUS Option Card has a suitable termination, activated by switch 1 located on the PROFIBUS converter option. The switches must be on to terminate the bus. The factory setting is off.
- Nodes at the physical ends of each segment must be terminated.



**N.B.:**

Please pay special attention to the pin-numbering vs. colour coding on the PROFIBUS connector if exchanging the PROFIBUS connector.

On FC 302 the PROFIBUS connectors are colour-coded, but not on the VLT® 5000, which could have lead to swapping of the bus wires.

Correct colour-coding:

62 = RxD/TxD – Positive, Red cable (PROFIBUS B)

63 = RxD/TxD – Negative, Green cable (PROFIBUS A)

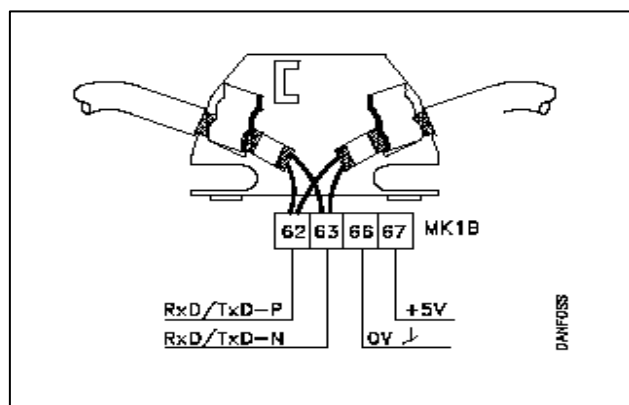

## How to Install Option in Frequency Converter

To install a fieldbus option in the drive you will need:

- The fieldbus option
- Fieldbus option adaptor frame for the FC 300. This frame is deeper than the standard frame, to allow space for the fieldbus option beneath.
- Cable holders

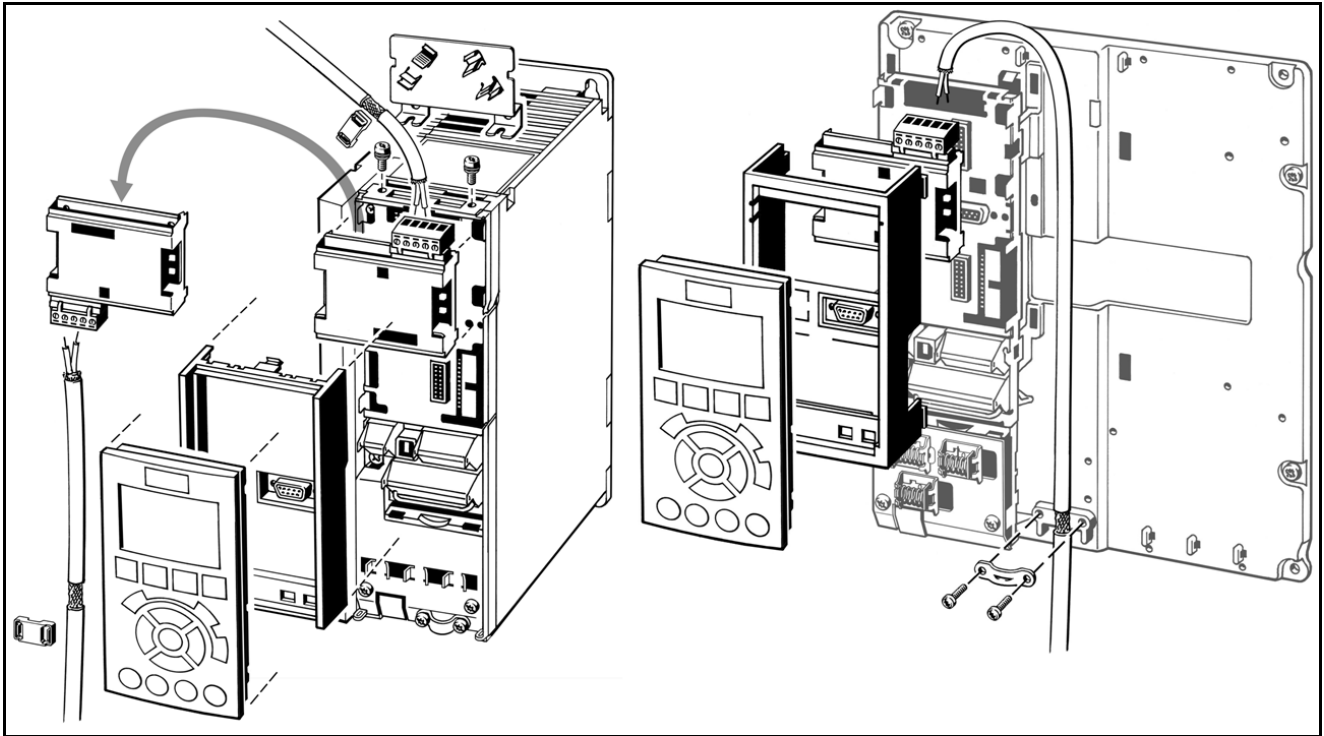

### Instructions:

- Remove the LCD panel from the FC 300.
- Remove the frame located beneath and discard.
- Push the option into place. Two positions are possible, with cable terminal facing either up or down. The cable up position is often most suitable when several frequency converters are installed side by side in a rack, as this position permits shorter cable lengths.
- Push the fieldbus option adaptor frame for the FC 300 into place.
- Replace the LCD panel.
- Attach cable.
- Fasten the cable in place using cable holders.



### N.B.:

After installing the MCA114 option, be aware of the following parameter settings:

- Par. 8-02 *Control Word Source* = [3] Option A

## How to Configure the System

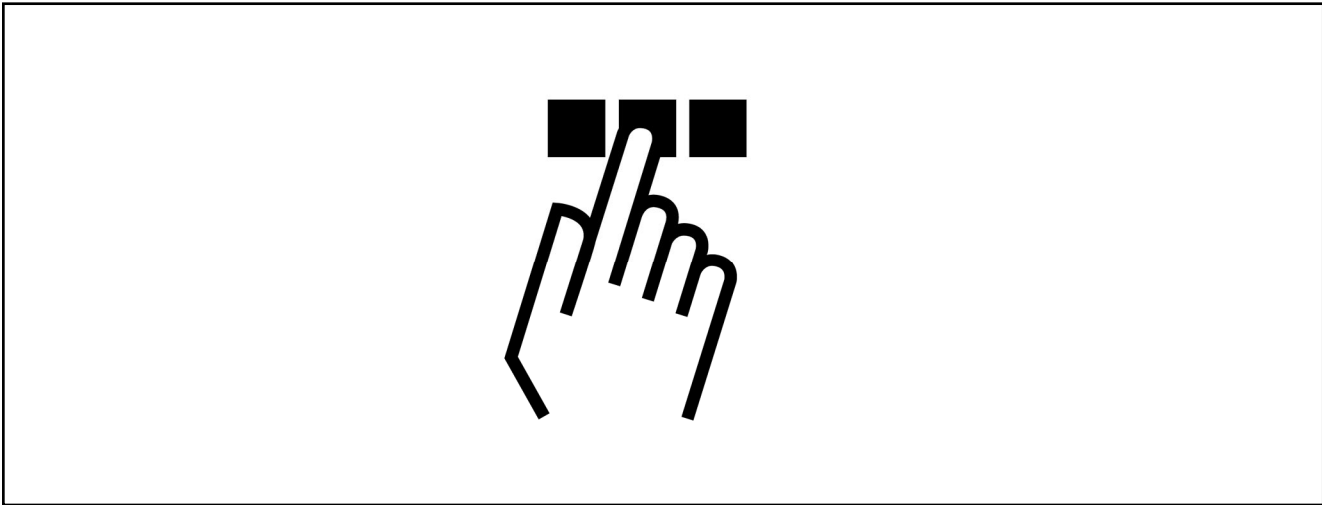

### Configure the PROFIBUS Network

All PROFIBUS stations that are connected to the same bus network must have a unique station address.

Before a VLT® 5000 can be replaced with a FC 302 with MCA114, only the station address needs to be configured in the FC 302.

The PROFIBUS address of the FC 302 can be selected via:

- Hardware switches
- Parameter 9-18 *Node address*

### Setting the PROFIBUS Address using the Hardware Switches

Using the hardware switches it is possible to select an address range from 0 to 125 (factory setting 127) according to the table below: ON = 1, OFF = 0

Switch	VLT® 5000								FC 302							
	1	2	3	4	5	6	7	8	8	7	6	5	4	3	2	1
Address	+1	+2	+4	+8	+16	+32	+64	-	-	+64	+32	+16	+8	+4	+2	+1
Examples:																
1	1	0	0	0	0	0	0	-	-	0	0	0	0	0	0	1
35	1	1	0	0	0	1	0	-	-	0	1	0	0	0	1	1
82	0	1	0	0	1	0	1	-	-	1	0	1	0	0	1	0

**N.B.:** Switch off the power supply before changing the hardware switches.

The address change will come into effect at the next power-up, and can be read in parameter 9-18 *Node address*.

Note the location and sequence of the hardware switches as illustrated in the table above.

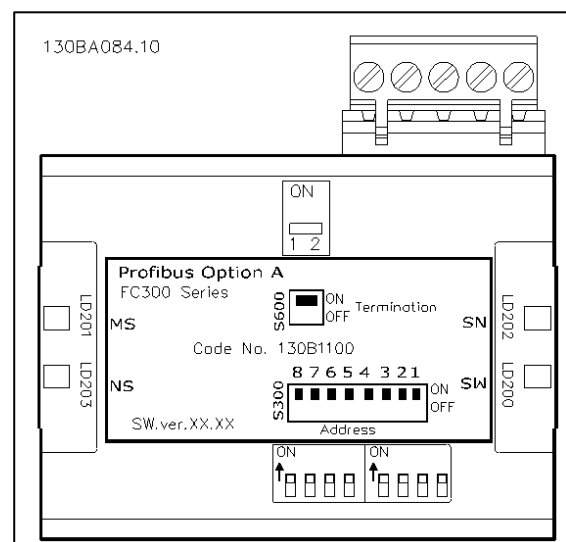

**Setting the PROFIBUS Address via Parameter 9-18 Node address:**

Setting the address via parameter 9-18 *Node address* or the PROFIBUS SSA-command is possible, if the hardware switches are set to 126 or 127 (factory switch setting). The address change will come into effect at the next power-up.

**Commissioning**

After copying the station address from the VLT<sup>®</sup> 5000 to the FC 302, power must be cycled to the FC 302.

The master/PLC should now recognize FC 302, as a VLT<sup>®</sup> 5000, and the NS LED on the MCA114 option should now be solid green which indicates that communication between master and slave is established.

If the NS LED flashes, the master/PLC has not recognized the FC 302.

For more information please refer to section: *Troubleshooting*.

## LED Behaviour

The option has 2 bi-coloured LED's:

LED label	Description
NS	Network Status
MS	Module Status (DP-V1 communication)

### NS: Net Status

State	LED	Description
Power On	Red:	Solid red The option is defect. Contact Danfoss Drives
	Green:	Flashing green The option is OK.
Baud rate search	Green:	Flashing green Searching for the baud rate. Check the connection to the master if the option stays in this state.
Wait Parameterizing	Green:	Long green flash Baud rate found - waiting for parameters from the master.
	Red:	Long red flash Wrong parameters from the master.
Wait Configuration	Green:	Short green flash Parameters from master OK – waiting for configuration data.
	Red:	Short red flash Wrong Configuration data from the master.
Data Exchange	Green:	Solid green Data Exchange between the master and the FC 300 is active.
	Red:	Flashing red Clear State. Warning 34 is active and a bus reaction in par. 8-04 is executed.

### MS: Module status (DP-V1 communication)

LED	Description
Off	No PROFIBUS DPV1 communication is active.
Green:	Short green flash DP V1 communication from a Master Class 1 (PLC) is active.
Green:	Long green flash DP V1 communication from a Master Class 2 (MCT 10, FDT) is active.
Green:	Steady green DP V1 communication from a Master Class 1 and 2 is active.
Red:	Flashing red Internal error.



**N.B.:**

Please note: The LED's are not compatible with the VLT® 5000 PROFIBUS LED's.

## EMC Precautions

The following EMC precautions are recommended in order to achieve interference-free operation of the PROFIBUS. Additional EMC information is available in the FC 300 series Design Guide.

**N.B.:**

Relevant national and local regulations, for example regarding protective earth connection, must be observed.

The PROFIBUS communication cable must be kept away from motor and brake resistor cables to avoid coupling of high frequency noise from one cable to the other. Normally a distance of 200 mm (8 inches) is sufficient, but maintaining the greatest possible distance between the cables is recommended, especially where cables run in parallel over long distances. When crossing is unavoidable, the PROFIBUS cable must cross motor and brake resistor cables at an angle of 90 degrees.

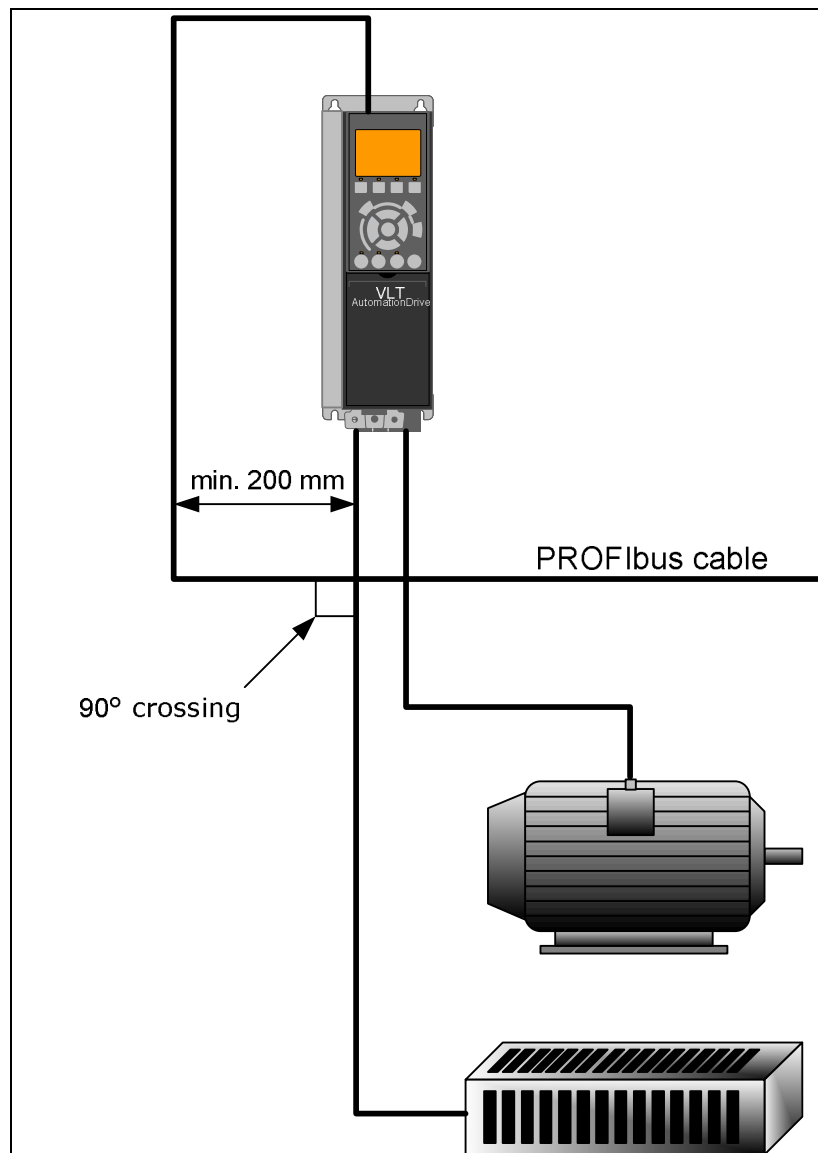

## Parameter Mapping List

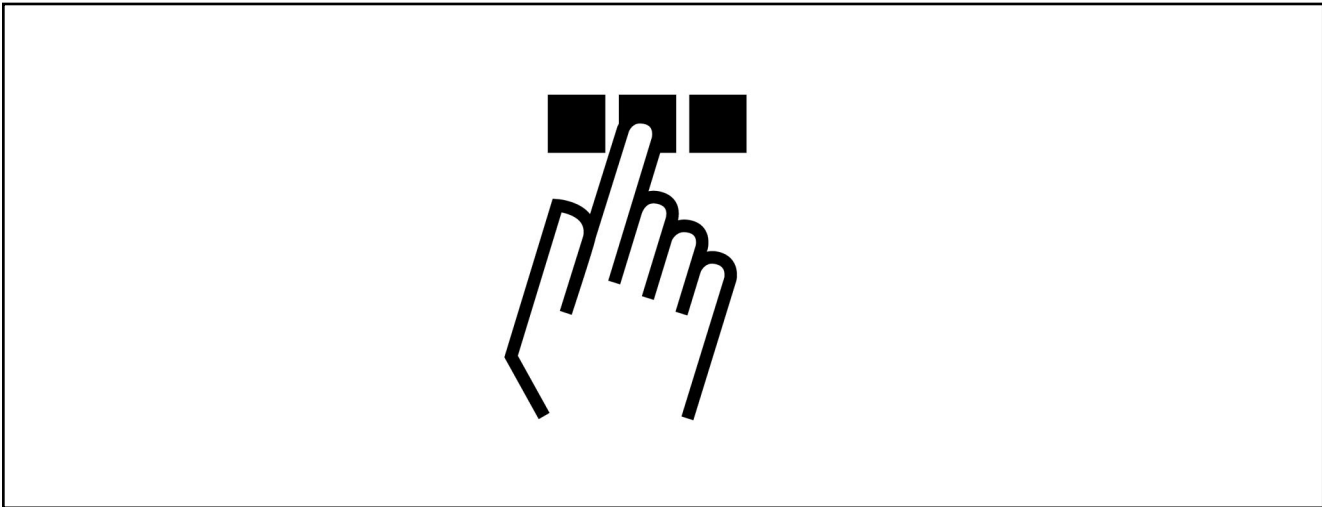

### VLT® 5000 Group 0

	5000 series	FC 300 series
Parameter number	001	001
Parameter name	Language Select	Language
Data values	[0] English	[0] English
	[1] Deutsch	[1] Deutsch
	[2] French	[2] French
	[3] Dansk	[3] Dansk
	[4] Spanish	[4] Spanish
	[5] Italian	[5] Italian

	5000 series	FC 300 series
Parameter number	002	Not converted
Parameter name	Local/remote control	
Data values	[0] Remote	
	[1] Local with External Stop	
	[2] Local	

	5000 series	FC 300 series
Parameter number	003	Not converted
Parameter name	Local reference	
Data values		

	5000 series	FC 300 series
Parameter number	004	010
Parameter name	Active Set-up	Active Set-up
Data values	[0] Factory Setup	[0] Factory Setup
	[1] Setup 1	[1] Setup 1
	[2] Setup 2	[2] Setup 2
	[3] Setup 3	[3] Setup 3
	[4] Setup 4	[4] Setup 4
	[5] Multi Setup	[9] Multi Setup

## - Parameter Mapping List -

	<b>5000 series</b>	<b>FC 300 series</b>
Parameter number	005	970
Parameter name	Set-up Selection, Programming	Edit Set-up
Data values	[0] Factory Set-up	[0] Factory Set-up
	[1] Set-up 1	[1] Set-up 1
	[2] Set-up 2	[2] Set-up 2
	[3] Set-up 3	[3] Set-up 3
	[4] Set-up 4	[4] Set-up 4
	[5] Active Set-up	[9] Active Set-up

	<b>5000 series</b>	<b>FC 300 series</b>
Parameter number	006	Not converted
Parameter name	Setup Copy	

	<b>5000 series</b>	<b>FC 300 series</b>
Parameter number	007	Not converted
Parameter name	LCP Copy	LCP Copy

	<b>5000 series</b>	<b>FC 300 series</b>
Parameter number	008	Not converted
Parameter name	Display scaling of motor frequency	

	<b>5000 series</b>	<b>FC 300 series</b>
Parameter number	009	023
Parameter number	010	020
Parameter number	011	021
Parameter number	012	022
Parameter name	Display line	Display line 2
Data values	[0] None	[0] None
	[1] Reference %	[1602] Reference %
	[2] Reference [Unit]	[1601] Reference [Unit]
	[3] Feedback [Unit]	[1652] Feedback [Unit]
	[4] Frequency [Hz]	[1613] Frequency [Hz]
	[5] Frequency x scale	[1609] Custom readout
	[6] Motor current [A]	[1614] Motor current [A]
	[7] Torque [%]	[1622] Torque [%]
	[8] Power [kW]	[1610] Power [kW]
	[9] Power [HP]	[1611] Power [HP]
	[10] Output energy [kWh]	[1502] kWh counter [kWh]
	[11] Motor voltage [V]	[1612] Motor voltage [V]
	[12] DC link voltage [V]	[1630] DC link voltage [V]
	[13] Thermal load, motor [%]	[1618] Thermal load, motor [%]
	[14] Thermal load, VLT® [%]	[1635] Inverter thermal [%]
	[15] Running hours [hours]	[1501] Running hours [hours]
	[16] Digital input	[1660] Digital input
	[17] Analogue input 53 [V]	[1662] Analogue input 53 [V]
	[18] Analogue input 54 [V]	[1664] Analogue input 54 [V]
[19] Analogue input 60 [mA]	[1662] Analogue input 53	



## - Parameter Mapping List -

		[mA]
[20] Pulse reference [Hz]		[1651] Pulse reference [Hz]
[21] Ext. reference [%]		[1650] Ext. reference [%]
[22] Status word [hex]		[1603] Status word [hex]
[23] Brake effect/2 min [kW]		[1633] Brake effect/2 min [kW]
[24] Brake effect/sec [kW]		[1632] Brake effect/sec [kW]
[25] Heat sink temp.		[1634] Heat sink temp.
[26] Alarm word [hex]		
[27] Control word [hex]		[1600] Control word [hex]
[28] Warning word 1 [hex]		
[29] Warning word 2 [hex]		
[30] Com. Option warning [hex]		[953] Com. Option warning [hex]
[31] Rpm [min]		[1617] Speed rpm [min]
[32] Rpm x scaling [min]		[1609] Custom readout
[33] LCP display text		Not possible

	5000 series	FC 300 series
Parameter number	013	Not converted
Parameter name	Local Ctrl./config	

	5000 series	FC 300 series
Parameter number	014	041
Parameter name	Local Stop key	Off (Stop) key
Data values	[0] Disable	[0] Disable
	[1] Enable	[1] Enable
		[2] Password

	5000 series	FC 300 series
Parameter number	015	Not converted
Parameter name	Local Jogging	
Data values	[0] Disable	
	[1] Enable	

	5000 series	FC 300 series
Parameter number	016	Not converted
Parameter name	Local Reversing	
Data values	[0] Disable	
	[1] Enable	

	5000 series	FC 300 series
Parameter number	017	043
Parameter name	Local Reset	Reset key on LCP
Data values	[0] Disable	[0] Disable
	[1] Enable	[1] Enable
		[2] Password

	5000 series	FC 300 series
Parameter number	018	061
Parameter name	Lock for data change	Access to Main Menu

- Parameter Mapping List -

Data values	[0] Not locked	[0] Full access
	[1] Lock	[1] LCP: Read only

	<b>5000 series</b>	<b>FC 300 series</b>
Parameter number	019	004
Parameter name	Power-Up Mode	Operating state at power up
Data values	[0] Auto Restart, use saved ref.	[0] Resume
	[1] Forced stop, use saved ref.	[1] Forced stop, use saved ref.
	[2] Forced stop, set ref = 0.	[2] Forced stop, set ref = 0

	<b>5000 series</b>	<b>FC 300 series</b>
Parameter number	027	Not converted
Parameter name	Warning readout line	
Data values	[0] Warning in line 1/2	
	[1] Warning in line 3/4	

## VLT® 5000 Group 1

	<b>5000 series</b>	<b>FC 300 series</b>
Parameter number	100	100, 101
Parameter name	Configuration	Configuration
Data values	[0] Speed control, open loop	Par. 100 = [0] Speed open loop Par. 101 = [1] VVC+
	[1] Speed control, closed loop	Par. 100 = [1] Speed closed loop Par. 101 = [1] VVC+
	[3] Process control, closed loop	Par. 100 = [3] Process Par. 101 = [1] VVC+
	[4] Torque control, open loop	Par. 100 = [4] Torque open loop Par. 101 = [1] VVC+
	[5] Torque control, speed feedback	Par. 100 = [2] Torque close loop Par. 101 = [3] Flux with motor fb

	<b>5000 series</b>	<b>FC 300 series</b>
Parameter number	101	103, 104, 1440
Parameter name	Torque characteristic	Torque characteristic
Data values	[1] High constant torque	Par. 103 = [0] Constant torque Par. 104 Over load = High [0]
	[2] High variable torque low	Par. 103 = [1] Variable torque Par. 1440 VT level = 45% Par. 104 Over load = High [0]
	[3] High variable torque medium	Par. 103 = [1] Variable torque Par. 1440 VT level = 66%

- Parameter Mapping List -

	Par. 104 Over load = High [0]
[4] High variable torque high	Par. 103 = [1] Variable torque Par. 1440 VT level = 85% Par. 104 Over load = High [0]
[5] High special motor characteristic	Par. 101 = [0] U/f Par. 104 Over load = High [0]
[6] High variable torque with low starting torque	Par. 103 = [1] Variable torque Par. 1440 VT level = 45% Par. 104 Over load = High [0]
[7] High variable torque with medium starting torque	Par. 103 = [1] Variable torque Par. 1440 VT level = 66% Par. 104 Over load = High [0]
[8] High variable torque with high starting torque	Par. 103 = [1] Variable torque Par. 1440 VT level = 85% Par. 104 Over load = High [0]
[11] Normal constant torque	Par. 103 = [0] Constant torque Par. 104 Over load = Normal [1]
[12] Normal variable torque low	Par. 103 = [1] Variable torque Par. 1440 VT level = 45% Par. 104 Over load = Normal [1]
[13] Normal variable torque medium	Par. 103 = [1] Variable torque Par. 1440 VT level = 66% Par. 104 Over load = Normal [1]
[14] Normal variable torque high	Par. 103 = [1] Variable torque Par. 1440 VT level = 85% Par. 104 Over load = Normal [1]
[15] Normal special motor characteristic	Par. 101 = [0] U/f Par. 104 Over load = Normal [1]
[16] Normal variable torque with low constant starting torque	Par. 103 = [1] Variable torque Par. 1440 VT level = 45% Par. 104 Over load = Normal [1]
[17] Normal variable torque with medium constant starting torque	Par. 103 = [1] Variable torque Par. 1440 VT level = 66% Par. 104 Over load = Normal [1]
[18] Normal variable torque	Par. 103 = [1] Variable

## - Parameter Mapping List -

	with high constant starting torque	torque Par. 1440 VT level = 85% Par. 104 Over load = Normal [1]
--	------------------------------------	-----------------------------------------------------------------------

	<b>5000 series</b>	<b>FC 300 series</b>
Parameter number	102	120
Parameter name	Motor Power	Motor Power
Data range	0.18 – 600 kW	0.09 – 3000 kW

	<b>5000 series</b>	<b>FC 300 series</b>
Parameter number	103	122
Parameter name	Motor Voltage	Motor Voltage
Data range	200 – 600 Volt	50 – 1000 Volt

	<b>5000 series</b>	<b>FC 300 series</b>
Parameter number	104	123
Parameter name	Motor frequency	Motor frequency
Data range	20 -1000 Hz	20 -1000 Hz

	<b>5000 series</b>	<b>FC 300 series</b>
Parameter number	105	124
Parameter name	Motor Current	Motor Current
Data range	Power Unit dependable	Power Unit dependable

	<b>5000 series</b>	<b>FC 300 series</b>
Parameter number	106	125
Parameter name	Rated motor speed	Motor nominal speed
Data range	100 – 60000	10 – 60000

	<b>5000 series</b>	<b>FC 300 series</b>
Parameter number	107	129
Parameter name	Automatic motor adaptation	Automatic motor adaptation
Data values	[0] Adaptation off	[0] Off
	[1] Adaptation on, Rs and Xs	[1] Enable complete AMA
	[2] Adaptation on, RS	[2] Enable reduce AMA

	<b>5000 series</b>	<b>FC 300 series</b>
Parameter number	108	130
Parameter name	Stator resistor	Stator resistance (Rs)
Data range	Power Unit dependable	0.0140 – 140.0000

	<b>5000 series</b>	<b>FC 300 series</b>
Parameter number	109	135
Parameter name	Stator reactance	Main reactance
Data range	Power Unit dependable	1.0000 – 10000.0000

	<b>5000 series</b>	<b>FC 300 series</b>
Parameter number	110	150
Parameter name	Motor magnetizing, 0 rpm	Motor magnetizing at 0 rpm
Data range	0 – 300 %	0 – 300 %

	<b>5000 series</b>	<b>FC 300 series</b>
Parameter number	111	152
Parameter name	Min. frequency normal magnetizing	Min Speed Normal Magnetising [Hz]

## - Parameter Mapping List -

Data range	0.1 – 10.0 Hz	0.3 – 10.0 Hz
------------	---------------	---------------

	<b>5000 series</b>	<b>FC 300 series</b>
Parameter number	113	160
Parameter name	Load compensation at low speed	Low Speed Load Compensation
Data range	0 – 300 %	0 – 300 %

	<b>5000 series</b>	<b>FC 300 series</b>
Parameter number	114	161
Parameter name	Load compensation at high speed	High Speed Load Compensation
Data range	0 – 300 %	0 – 300 %

	<b>5000 series</b>	<b>FC 300 series</b>
Parameter number	115	162
Parameter name	Slip Compensation	Slip Compensation
Data range	-500 - 500%	-500 - 500%

	<b>5000 series</b>	<b>FC 300 series</b>
Parameter number	116	163
Parameter name	Slip Compensation Time constant	Slip Compensation Time constant
Data range	0.05 – 1.00 sec	0.05 – 5.00 sec

	<b>5000 series</b>	<b>FC 300 series</b>
Parameter number	117	164
Parameter name	Resonance dampening	Resonance Dampening
Data range	0 - 500%	0 - 500%

	<b>5000 series</b>	<b>FC 300 series</b>
Parameter number	118	165
Parameter name	Resonance dampening time constant	Resonance Dampening Time Constant
Data range	5 – 50 msec	5 – 50 msec

	<b>5000 series</b>	<b>FC 300 series</b>
Parameter number	119	Not converted
Parameter name	High starting torque	

	<b>5000 series</b>	<b>FC 300 series</b>
Parameter number	120	171
Parameter name	Start delay	Start delay
Data range	0.0 – 10.0 sec	0.0 – 10.0 sec

	<b>5000 series</b>	<b>FC 300 series</b>
--	--------------------	----------------------

## - Parameter Mapping List -

Parameter number	121	172
Parameter name	Start function	Start function
Data values	[0] DC hold in start delay time	[0] DC hold/delay time
	[1] DC brake in start delay time	[1] DC Brake/delay time
	[2] Coasting in start delay time	[2] Coast/delay time
	[3] Start frequency/voltage clockwise	[3] Start speed cw
	[4] Start frequency/voltage in reference direction	[4] Horizontal operation
	[5] VVC+ clockwise	[5] VVC+/Flux clockwise

	5000 series	FC 300 series
Parameter number	122	180
Parameter name	Function at stop	Function at stop
Data values	[0] Coasting	[0] Coast
	[1] DC hold	[1] DC hold
	[2] Motor check	[2] Motor check
	[3] Pre-magnetizing	[3] Pre-magnetizing

	5000 series	FC 300 series
Parameter number	123	182
Parameter name	Min frequency for function at stop	Min Speed for Function at Stop [Hz]
Data range	0.0 – 10.0 Hz	0.0 – 20.0 Hz

	5000 series	FC 300 series
Parameter number	124	200
Parameter name	DC holding current	DC Hold Current
Data range	0 - 100 %	0 - 160 % (motor depending)

	5000 series	FC 300 series
Parameter number	125	201
Parameter name	DC braking current	DC brake current
Data range	0 - 100 %	0 - 160 % P.U depending

	5000 series	FC 300 series
Parameter number	126	202
Parameter name	DC braking time	DC Braking Time
Data range	0.0 – 60.0 sec	0.0 – 60.0 sec

	5000 series	FC 300 series
Parameter number	127	204
Parameter name	DC brake cut-in frequency	DC Brake Cut In Speed [Hz]
Data range	0.0 (Off) – fmax (par. 202)	0.0 (Off) – fmax (par. 414)

## - Parameter Mapping List -

	<b>5000 series</b>	<b>FC 300 series</b>
Parameter number	128	190
Parameter name	Motor thermal protection	Motor thermal protection
Data values	[0] No protection	[0] No protection
	[1] Thermistor warning	[1] Thermistor warning
	[2] Thermistor trip	[2] Thermistor trip
	[3] ETR warning 1	[3] ETR warning 1
	[4] ETR trip 1	[4] ETR trip 1
	[5] ETR warning 2	[5] ETR warning 2
	[6] ETR trip 2	[6] ETR trip 2
	[7] ETR warning 3	[7] ETR warning 3
	[8] ETR trip 3	[8] ETR trip 3
	[9] ETR warning 4	[9] ETR warning 4
[10] ETR trip 4	[10] ETR trip 4	

	<b>5000 series</b>	<b>FC 300 series</b>
Parameter number	129	191
Parameter name	External motor fan	Motor External Fan
Data values	[0] No	[0] No
	[1] Yes	[1] Yes

	<b>5000 series</b>	<b>FC 300 series</b>
Parameter number	130	175
Parameter name	Start frequency	Start Speed [Hz]
Data range	0.0 - 10.0 Hz	0.0 - 500 Hz P.U depending

	<b>5000 series</b>	<b>FC 300 series</b>
Parameter number	131	Not converted
Parameter name	Initial voltage	

	<b>5000 series</b>	<b>FC 300 series</b>
Parameter number	145	Not converted
Parameter name	Minimum DC brake time	

## VLT® 5000 Group 2

	<b>5000 series</b>	<b>FC 300 series</b>
Parameter number	200	410
Parameter name	Output Frequency Range/Direction	Motor Speed Direction
Data values	[0] Only clockwise, 0 – 132 Hz	[0] Clockwise
	[1] Both directions, 0 – 132 Hz	[2] Both directions
	[2] Only clockwise, 0 – 1000 Hz	[0] Clockwise
	[3] Both directions, 0 – 1000 Hz	[2] Both directions
	[4] Only counter clockwise, 0 – 132 Hz	[1] Counter clockwise
	[5] Only counter clockwise, 0 – 1000 Hz	[1] Counter clockwise

	<b>5000 series</b>	<b>FC 300 series</b>
Parameter number	201	412
Parameter name	Output frequency low limit	Motor speed Low Limit, Hz
Data range	0.0 – par. 202 Fmax	0 – par. 414 Fmax [Hz]

	<b>5000 series</b>	<b>FC 300 series</b>
Parameter number	202	414, 419
Parameter name	Output frequency high limit	Motor speed High Limit, Hz
Data range	0.0 – 132/1000 Hz	0 – 1000 Hz

	<b>5000 series</b>	<b>FC 300 series</b>
Parameter number	203	300
Parameter name	Reference/feedback area	Reference Range
Data values	[0] Min – Max	[0] Min – Max
	[1] - Max - +Max	[1] - Max - +Max

	<b>5000 series</b>	<b>FC 300 series</b>
Parameter number	204	302, 614, 625, 552, 557
Parameter name	Minimum reference	Minimum reference
Data range	-100,000.000 – par. 205 Ref max	-100,000.000 – par. 303 Ref max

	<b>5000 series</b>	<b>FC 300 series</b>
Parameter number	205	303, 615, 625, 553, 558
Parameter name	Maximum reference	Maximum reference
Data range	Par. 204 Refmin – 100,000.000	Par. 302 Refmin – 100,000.000



## - Parameter Mapping List -

	<b>5000 series</b>	<b>FC 300 series</b>
Parameter number	206	340, 350, 382
Parameter name	Ramp Type	Ramp Type
Data Values:	[0] Linear	[0] Linear. Write to p.340, 350 and 382
	[1] Sine shape (S1)	Par. 345 = 1% Par. 346 = 25% Par. 347 = 1% Par. 348 = 25% Par. 350 = 2 Par. 355 = 1% Par. 356 = 25% Par. 357 = 1% Par. 348 = 25% Par. 382 = 2 Par. 383 = 1% Par. 384 = 25%
	[2] Sin <sup>2</sup> Shape (S2)	Par. 345 = 25% Par. 346 = 25% Par. 347 = 25% Par. 348 = 25% Par. 350 = 2 Par. 355 = 25% Par. 356 = 25% Par. 357 = 25% Par. 348 = 25% Par. 382 = 2 Par. 383 = 25% Par. 384 = 25%
	[3] Sin <sup>3</sup> Shape (S3)	Par. 345 = 50% Par. 346 = 50% Par. 347 = 50% Par. 348 = 50% Par. 350 = 2 Par. 355 = 50% Par. 356 = 50% Par. 357 = 50% Par. 348 = 50% Par. 382 = 2 Par. 383 = 50% Par. 384 = 50%
	[4] Sin <sup>2</sup> filter	Par. 345 = 1% Par. 346 = 25% Par. 347 = 1% Par. 348 = 25% Par. 350 = 2 Par. 355 = 1% Par. 356 = 25% Par. 357 = 1% Par. 348 = 25% Par. 382 = 2 Par. 383 = 1% Par. 384 = 25%

	<b>5000 series</b>	<b>FC 300 series</b>
Parameter number	207	341
Parameter name	Ramp up Time 1	Ramp up Time 1
Data range	0.05 – 3600.00 sec	0.01 – 3600.00 sec

VLT® AutomationDrive PROFIBUS converter  
- Parameter Mapping List -

	<b>5000 series</b>	<b>FC 300 series</b>
Parameter number	208	342
Parameter name	Ramp down Time 1	Ramp down Time 1
Data range	0.05 – 3600.00 sec	0.01 – 3600.00 sec

	<b>5000 series</b>	<b>FC 300 series</b>
Parameter number	209	351
Parameter name	Ramp up Time 2	Ramp up Time 2
Data range	0.05 – 3600.00 sec	0.01 – 3600.00 sec

	<b>5000 series</b>	<b>FC 300 series</b>
Parameter number	210	352
Parameter name	Ramp down Time 2	Ramp down Time 2
Data range	0.05 – 3600.00 sec	0.01 – 3600.00 sec

	<b>5000 series</b>	<b>FC 300 series</b>
Parameter number	211	380
Parameter name	Jog ramp time	Jog ramp time
Data range	0.05 – 3600.00 sec	0.01 – 3600.00 sec

	<b>5000 series</b>	<b>FC 300 series</b>
Parameter number	212	381
Parameter name	Quick stop ramp time	Quick stop ramp time
Data range	0.05 – 3600.00 sec	0.01 – 3600.00 sec

	<b>5000 series</b>	<b>FC 300 series</b>
Parameter number	213	311
Parameter name	Jog Frequency	Jog speed [Hz]
Data range	0.0 – par. 202	0.0 – par. 414

	<b>5000 series</b>	<b>FC 300 series</b>
Parameter number	214	304
Parameter name	Reference function	Reference function
Data Values:	[0] Sum	[0] Sum
	[1] Relative	See comment below*
	[2] External/Preset	[1] External/preset

\*= Relative reference is added to the MRV from PROFIBUS.

	<b>5000 series</b>	<b>FC 300 series</b>
Parameter number	215	310 index 0
Parameter name	Preset Reference 1	Preset Reference 1..8
Data range	-100.00 – 100.00 %	-100.00 – 100.00 %

	<b>5000 series</b>	<b>FC 300 series</b>
Parameter number	216	310 index 1
Parameter name	Preset Reference 2	Preset Reference 1..8
Data range	-100.00 – 100.00 %	-100.00 – 100.00 %

	<b>5000 series</b>	<b>FC 300 series</b>
Parameter number	217	310 index 2
Parameter name	Preset Reference 3	Preset Reference 1..8
Data range	-100.00 – 100.00 %	-100.00 – 100.00 %

	<b>5000 series</b>	<b>FC 300 series</b>
Parameter number	218	310 index 3
Parameter name	Preset Reference 4	Preset Reference 1..8

## - Parameter Mapping List -

Data range	-100,00 - 100,00 %	-100,00 - 100,00 %
------------	--------------------	--------------------

	<b>5000 series</b>	<b>FC 300 series</b>
Parameter number	219	312
Parameter name	Catch up/slow down value	Catch up/slow down value
Data range	0.00 - 100 %	0.00 - 100 %

	<b>5000 series</b>	<b>FC 300 series</b>
Parameter number	221	416
Parameter name	Torque limit for motor mode	Torque limit for motor mode
Data range	0.0 - Max. torque %	0.0 - Max. torque %

	<b>5000 series</b>	<b>FC 300 series</b>
Parameter number	222	417
Parameter name	Torque limit for generating mode	Torque limit for generating mode
Data range	0.0 - Max. torque %	0.0 - Max. torque %

	<b>5000 series</b>	<b>FC 300 series</b>
Parameter number	223	450
Parameter name	Warning: Current Low	Warning: Low Current
Data range	0.0 - par. 224 Current High	0.00 - par. 451

	<b>5000 series</b>	<b>FC 300 series</b>
Parameter number	224	451
Parameter name	Warning: Current High	Warning: Current High
Data range	Power Unit dependable	Power Unit dependable

	<b>5000 series</b>	<b>FC 300 series</b>
Parameter number	225	452
Parameter name	Warning Low Frequency	Warning: Low Speed
Data range	0,0 - par. 226	0,0 - Par. 453

	<b>5000 series</b>	<b>FC 300 series</b>
Parameter number	226	453
Parameter name	Warning High Frequency	Warning Speed High
Data range	par. 225 - par. 202	Par. 452 - par. 413

	<b>5000 series</b>	<b>FC 300 series</b>
Parameter number	227	456
Parameter name	Warning Low Feedback	Warning: Feedback Low
Data range	-100,000.000 - par. 228	-999,999.999 - par. 457

	<b>5000 series</b>	<b>FC 300 series</b>
Parameter number	228	457
Parameter name	Warning High Feedback	Warning High Feedback
Data range	par. 227 - 100,000.000	Par. 456 - 999,999.999

	<b>5000 series</b>	<b>FC 300 series</b>
Parameter number	229	Converted to EEprom
Parameter name	Frequency bypass, bandwidth	
Data range	0 - 100 %	

## - Parameter Mapping List -

	<b>5000 series</b>	<b>FC 300 series</b>
Parameter number	230	461 index 0, 463 index 0
Parameter name	Frequency Bypass 1	Frequency Bypass 1
Data range	0 – par. 200	0 – par. 414

	<b>5000 series</b>	<b>FC 300 series</b>
Parameter number	231	461 index 1, 463 index 1
Parameter name	Frequency Bypass 2	Frequency Bypass 2
Data range	0 – par. 200	0 – par. 414

	<b>5000 series</b>	<b>FC 300 series</b>
Parameter number	232	461 index 2, 463 index 2
Parameter name	Frequency Bypass 3	Frequency Bypass 3
Data range	0 – par. 200	0 – par. 414

	<b>5000 series</b>	<b>FC 300 series</b>
Parameter number	233	461 index 3, 463 index 3
Parameter name	Frequency Bypass 4	Frequency Bypass 4
Data range	0 – par. 200	0 – par. 414

	<b>5000 series</b>	<b>FC 300 series</b>
Parameter number	234	458
Parameter name	Motor phase monitor	Missing motor phase function
Data Values:	[0] Enable [1] Disable	[2] Trip 1000 ms [0] Disable

**VLT® 5000 Group 3**

	<b>5000 series</b>	<b>FC 300 series</b>
Parameter number	300	516 (MCB 101)
Parameter name	Terminal 16, input	Terminal X30/2 Digital Input
Data values	[0] No function [1] Reset [2] Stop inverse [3] Only start clockwise, on [4] Jog [5] Preset reference, on [6] Preset reference, lsb [7] Freeze reference [8] Freeze output [9] Speed up [10] Choice of setup, lsb [11] Catch-up [12] Ramp 2 [13] Mains failure inverted [29] Data change lock	[0] No operation [1] Reset [6] Stop inverse [12] Enable start forward [14] Jog [15] Preset reference, on [16] Preset reference bit 0 [17] Freeze reference [20] Freeze output [21] Speed up [23] Setup select bit 0 [28] Catch-up [34] Ramp bit 0 Not supported Not supported
Comments	FC 300 doesn't have a digital input 16, so this is linked to par. 516 Terminal X30/2 on MCB 101	

## - Parameter Mapping List -

	<b>5000 series</b>	<b>FC 300 series</b>
Parameter number	301	517 (MCB 101)
Parameter name	Terminal 17, input	Terminal X30/3 Digital Input
Data values	[0] No function	[0] No operation
	[1] Reset	[1] Reset
	[2] Stop inverse	[6] Stop inverse
	[3] Only start anti-clockwise, on	[13] Enable start reverse
	[4] Jog	[14] Jog
	[5] Preset reference, on	[15] Preset reference, on
	[6] Preset reference, msb	[17] Preset reference bit 1
	[7] Freeze reference	[19] Freeze reference
	[8] Freeze output	[20] Freeze output
	[9] Speed down	[22] Speed down
	[10] Choice of setup, msb	[24] Setup select bit 1
	[11] Slow down	[29] Slow down
	[12] Ramp 2	[34] Ramp bit 0
	[13] Mains failure inverted	Not supported
	[23] Pulse reference	[32] Pulse input
	[24] Safety interlock	Not supported
	[29] Data change lock	Not supported
Comments	FC 300 doesn't have a digital input 17, so this is linked to par. 516 Terminal X30/3 MCB 101	

	<b>5000 series</b>	<b>FC 300 series</b>
Parameter number	302	510
Parameter name	Terminal 18, input	Terminal 18 Digital input
Data values	[0] No function	[0] No operation
	[1] Start	[8] Start
	[2] Latched start	[9] Latched start
	[3] Only start clockwise, on	[12] Enable start forward

	<b>5000 series</b>	<b>FC 300 series</b>
Parameter number	303	511
Parameter name	Terminal 19, input	Terminal 19 Digital input
Data values	[0] No function	[0] No operation
	[1] Reversing	[10] Reversing
	[2] Start reversing	[11] Start reversing
	[3] Only start anti-clockwise, on	[13] Enable start reverse

	<b>5000 series</b>	<b>FC 300 series</b>
Parameter number	304	512
Parameter name	Terminal 27, input	Terminal 27 Digital input
Data values	[0] Coasting stop, inverse	[2] Coast inverse
	[1] Reset and Coasting stop, inv.	[3] Coast and reset inv stop, inv.
	[2] Quick-stop, inverse	[4] Quick stop inverse
	[3] DC-braking, inverse	[5] DC-brake inverse
	[4] Stop inverse	[6] Stop inverse

## - Parameter Mapping List -

	<b>5000 series</b>	<b>FC 300 series</b>
Parameter number	305	513
Parameter name	Terminal 29, input	Terminal 29 Digital input
Data values	[0] No function	[0] No operation
	[1] Reset	[1] Reset
	[2] Stop inverse	[6] Stop inverse
	[3] Only start clockwise, on	[12] Enable start forward
	[4] Only start anti-clockwise, on	[13] Enable start reverse
	[5] Jog	[14] Jog
	[6] Preset reference, on	[15] Preset reference, on
	[7] Preset reference, lsb	[16] Preset reference bit 0
	[8] Preset reference, msb	[17] Preset reference bit 1
	[9] Freeze reference	[19] Freeze reference
	[10] Freeze output	[20] Freeze output
	[11] Speed up	[21] Speed up
	[12] Speed down	[22] Slow down
	[13] Choice of Setup, lsb	[23] Setup select bit 0
	[14] Choice of Setup, msb	[24] Setup select bit 1
	[15] Catch up	[28] Catch up
	[16] Slow down	[29] Slow down
	[17] Ramp 2	[34] Ramp bit 0
	[18] Mains failure inverted	Not supported
	[28] Pulse reference	[32] Pulse input
	[29] Data change lock	Not supported

	<b>5000 series</b>	<b>FC 300 series</b>
Parameter number	306	514
Parameter name	Terminal 32, input	Terminal 32 Digital input
Data values	[0] No function	[0] No operation
	[1] Reset	[1] Reset
	[2] Stop inverse	[6] Stop inverse
	[3] Only start clockwise, on	[12] Enable start forward
	[4] Jog	[14] Jog
	[5] Preset reference, on	[15] Preset reference, on
	[6] Preset reference, lsb	[16] Preset reference bit 0
	[7] Freeze reference	[19] Freeze reference
	[8] Freeze output	[20] Freeze output
	[9] Speed up	[21] Speed up
	[10] Choice of Setup, lsb	[23] Setup select bit 0
	[11] Choice of Setup, msb / Speed up	Not supported
	[12] Catch up	[28] Catch up
	[13] Ramp 2	[34] Ramp bit 0
	[14] Mains failure inverted	Not supported
	[24] Encoder input 2A	[0] No operation
	[29] Data change lock	Not supported

	<b>5000 series</b>	<b>FC 300 series</b>
Parameter number	307	515
Parameter name	Terminal 33, input	Terminal 33 Digital input
Data values	[0] No function	[0] No operation
	[1] Reset	[1] Reset
	[2] Stop inverse	[6] Stop inverse

## - Parameter Mapping List -

[3] Only start anti-clockwise, on	[13] Enable start reverse
[4] Jog	[14] Jog
[5] Preset reference, on	[15] Preset reference, on
[6] Preset reference, msb	[17] Preset reference bit 1
[7] Freeze reference	[19] Freeze reference
[8] Freeze output	[20] Freeze output
[9] Speed down	[22] Speed down
[10] Choice of Setup, msb	[24] Setup select bit 1
[11] Choice of Setup, msb / Speed down	Not supported
[12] Slow down	[29] Slow down
[13] Ramp 2	[34] Ramp bit 0
[14] Mains failure inverted	Not supported
[24] Pulse feedback	[32] Pulse input <sup>1)</sup>
[25] Encoder input 2B	[0] No operation
[29] Data change lock	Not supported

	5000 series	FC 300 series
Parameter number	308	315, 700, 193, 420
Parameter name	Terminal 53, Analogue Input Voltage	315 Reference resource 1 700 Speed PID Feedback Source 420 Torque Limit Factor Source 193 Thermistor Ressource
Data values	[0] No Operation	Par. 315 <i>Reference resource 1</i> set to [0] No function
	[1] Reference	Par. 315 <i>Reference resource 1</i> set to [1] Analog input 53
	[2] Feedback signal	Par. 315 <i>Reference resource 1</i> set to [1] Analog input 53 Par. 700 <i>Speed PID Feedback Source</i> set to [6] Analog input 53
	[3] Torque limit	Par. 315 <i>Reference resource 1</i> set to [1] Analog input 53 Par. 420 <i>Torque Limit Factor Source</i> set to [2] Analog in 53
	[4] Thermistor	Par. 315 <i>Reference resource 1</i> set to [0] No function Par. 193 <i>Thermistor Ressource</i> set to [1] Analog input 53

	5000 series	FC 300 series
Parameter number	309	610
Parameter name	Terminal 53, min. scaling	Terminal 53 Low Voltage
Data range	0 - 10.0 Volt	-10.00 - Par. 611

	5000 series	FC 300 series
Parameter number	310	611
Parameter name	Terminal 53, max. scaling	Terminal 53 High Voltage
Data range	0 - 10.0 Volt	Par. 610 - 10.00 Volt

## - Parameter Mapping List -

	<b>5000 series</b>	<b>FC 300 series</b>
Parameter number	311	316, 420, 193, 421
Parameter name	Terminal 54, Analogue Input Voltage	316 Reference resource 2 700 Speed PID Feedback Source 420 Torque Limit Factor Source 193 Thermistor Resource 421 Speed Limit Factor Source
Data values	[0] No Operation	Par. 316 <i>Reference resource 2</i> set to [0] No function
	[1] Reference	Par. 316 <i>Reference resource 1</i> set to [2] Analog input 53
	[2] Torque limit	Par. 420 <i>Torque Limit Factor Source</i> set to [6] Analog in 54
	[3] Thermistor	Par. 193 <i>Thermistor Ressource</i> set to [2] Analog input 54
	[4] Relative reference	Not supported
	[5] Max. torque frequency	Par. 421 <i>Speed Limit Factor Source</i> set to [6] Analog in 54

	<b>5000 series</b>	<b>FC 300 series</b>
Parameter number	312	620
Parameter name	Terminal 54, min. scaling	Terminal 54 Low Voltage
Data range	0 – 10.0 Volt	-10.00 – Par. 621

	<b>5000 series</b>	<b>FC 300 series</b>
Parameter number	313	621
Parameter name	Terminal 54, max. scaling	Terminal 54 High Voltage
Data range	0 – 10.0 Volt	Par. 620 - 10.00 Volt

	<b>5000 series</b>	<b>FC 300 series</b>
Parameter number	314	317, 700, 193, 420
Parameter name	Terminal 60, Analogue Input current	317 Reference resource 1 700 Speed PID Feedback Source 420 Torque Limit Factor Source 193 Thermistor Resource
Data values	[0] No Operation	Par. 317 <i>Reference resource 3</i> set to [0] No function
	[1] Reference	Par. 317 <i>Reference resource 3</i> set to [2] Analog input 54
	[2] Feedback signal	Par. 700 <i>Speed PID Feedback Source</i> set to [7] Analog input 54
	[3] Torque limit	Par. 420 <i>Torque Limit Factor Source</i> set to [6] Analog in 54
	[4] Relative reference	Not supported
Comments	The HW switch S202 for analogue input 54 must be set to current (ON).	



- Parameter Mapping List -

	<b>5000 series</b>	<b>FC 300 series</b>
Parameter number	315	622
Parameter name	Terminal 60, min. scaling	Terminal 54 Low Current
Data range	0.0 – 20.0 mA	0.00 – Par. 623

	<b>5000 series</b>	<b>FC 300 series</b>
Parameter number	316	623
Parameter name	Terminal 60, max. scaling	Terminal 54 High Current
Data range	0.0 – 20.0 mA	Par. 622 - 20.00 mA

	<b>5000 series</b>	<b>FC 300 series</b>
Parameter number	317	600
Parameter name	Time Out	Live zero Time Out
Data range	0 – 99 sec	0 – 99 s

	<b>5000 series</b>	<b>FC 300 series</b>
Parameter number	318	601
Parameter name	Function after time out	Function after Time Out
Data values	[0] Off	[0] Off
	[1] Freeze output frequency	[1] Freeze Output Frequency
	[2] Stop	[2] Stop
	[3] Jogging	[3] Jog
	[4] Max Speed, p202	[4] Max Speed
	[5] Stop and trip	[5] Stop and trip

	<b>5000 series</b>	<b>FC 300 series</b>
Parameter number	319	Digital = Par. 532 DO X30/7 (MCB 101) Analogue values= Par. 650 AO 42 Pulse = Par. 566 DO X30/6
Parameter number	321	Digital = Par. 533 DO X30/7 (MCB 101) Analogue values= Par. 660 AO X30/8 Pulse = Par. 566 DO X30/6
Parameter name	Terminal 42, Output Terminal 45, Output	
Data values	[0] No function	Par. 532 = [0] No operation
	[1] Control Ready	Par. 532 = [1] Control Ready
	[2] Ready signal	Par. 532 = [2] Drive ready
	[3] Ready - Remote Control	Par. 532 = [3] Drive rdy/rem ctrl
	[4] Enabled, no warning	Par. 532 = [4] Enable / no warning
	[5] Running	Par. 532 = [5] VLT® running
	[6] Running, no Warning	Par. 532 = [6] Running / no warning
	[7] Running within range, no warning	Par. 532 = [7] Run in range/no warn
	[8] Run at reference, no Warning	Par. 532 = [8] Run on ref/no warn

## - Parameter Mapping List -

[9] Alarm	Par. 532 = [9] Alarm
[10] Alarm or Warning	Par. 532 = [10] Alarm or Warning
[11] Torque limit	Par. 532 = [11] At torque limit
[12] Out of current range	Par. 532 = [12] Out of current range
[13] Above I low	Par. 532 = [13] Below current, low <sup>1)</sup>
[14] Under I high	Par. 532 = [14] Above current, high <sup>1)</sup>
[15] Out of frequency range	Par. 532 = [15] Out of speed range
[16] Over f low	Par. 532 = [16] Below speed low <sup>1)</sup>
[17] Under f high	Par. 532 = [17] Above speed high <sup>1)</sup>
[18] Out of feedback range	Par. 532 = [18] Out of feedb. Range
[19] Over feedback low	Par. 532 = [19] Below feedback low <sup>1)</sup>
[20] Under feedback high	Par. 532 = [20] Above feedback high <sup>1)</sup>
[21] Thermal warning	Par. 532 = [21] Thermal warning
[22] Ready, no thermal warning	Par. 532 = [12] Ready, no thermal W
[23] Ready - remote control - no thermal warning	Par. 532 = [23] Remote, ready, no TW
[24] Ready - mains voltage within range	Par. 532 = [24] Ready, Voltage OK
[25] Reversing	Par. 532 = [25] Reverse
[26] Bus OK	Par. 532 = [26] Bus OK
[27] Torque limit and stop	Par. 532 = [27] Torque limit & stop
[28] Brake, no brake warning	Par. 532 = [28] Brake, no brake warning
[29] Brake ready, no fault	Par. 532 = [29] Brake ready, no fault
[30] Brake fault	Par. 532 = [30] Brake fault (IGBT)
[31] Relay 123	Par. 532 = [31] Relay 123
[32] Mechanical brake control	Par. 532 = [32] Mech brake ctrl
[34] Extended mechanical brake control	Par. 532 = [32] Mech brake ctrl
[35] Safety Interlock	Not supported
[36] 0 - 100 Hz => 0 - 20 mA	Not supported
[37] 0 - 100 Hz => 4 - 20 mA	Not supported
[38] 0 - 100 Hz => 0 - 32000 p	Not supported
[39] 0 - f max => 0 - 20 mA	Par. 650 = [109] Max Out freq. 0 - 20 mA
[40] 0 - f max => 4 - 20 mA	Par. 650 = [130] Max Out freq. 4 - 20 mA
[41] 0 - f max => 0 -	Par. 566 = [109] Max Out

## - Parameter Mapping List -

32000 p	freq. 0 – 32000p Par. 568 = 32000
[42] Ref min – Ref max => 0 – 20 mA	Par. 650 = [101] Reference 0 -20 mA
[43] Ref min – Ref max => 4 – 20 mA	Par. 650 = [131] Reference 4 -20 mA
[44] Ref min – Ref max => 0 – 32000 p	Par. 566 = [101] Reference 0 – 32000p Par. 568 = 32000
[45] FB min – FB max => 0 – 20 mA	Par. 650 = [102] Feedback 0 -20 mA
[46] FB min – FB max => 4 – 20 mA	Par. 650 = [132] Feedback 4 -20 mA
[47] FB min – FB max => 0 – 32000 p	Par. 566 = [102] Feedback 0 – 32000p Par. 568 = 32000
[48] 0 – I max => 0 – 20 mA	Par. 650 = [103] Motor current 0 -20 mA
[49] 0 – I max => 4 – 20 mA	Par. 650 = [133] Motor current 4 -20 mA
[50] 0 – I max => 0 – 32000 p	Par. 566 = [103] Motor current 0 - 32000p Par. 568 = 32000
[51] 0 – T lim => 0 – 20 mA	Par. 650 = [104] Torque related to limit 0 - 20 mA
[52] 0 – T lim => 4 – 20 mA	Par. 650 = [134] Torque related to limit 4 - 20 mA
[53] 0 – T lim => 0 – 32000 p	Par. 566 = [104] Torque related to limit 0 – 32000p Par. 568 = 32000
[54] 0 – T nom => 0 – 20 mA	Par. 650 = [105] Torque related to norm 0 - 20 mA
[55] 0 – T nom => 4 – 20 mA	Par. 650 = [135] Torque related to norm 4 - 20 mA
[56] 0 – T nom => 0 – 32000 p	Par. 566 = [105] Torque related to norm 0 – 32000p Par. 568 = 32000
[57] 0 – P nom => 0 – 20 mA	Par. 650 = [106] Power related to norm 0 - 20 mA
[58] 0 – P nom => 4 – 20 mA	Par. 650 = [136] Power related to norm 4 - 20 mA
[59] 0 – P nom => 0 – 32000 p	Par. 566 = [106] Power related to norm 0 – 32000p Par. 568 = 32000
[60] 0 – SyncRPM => 0 – 20 mA	Not supported
[61] 0 – SyncRPM => 4 – 20 mA	Not supported
[62] 0 – SyncRPM => 0 – 32000 p	Not supported
[63] RPM at F max => 0 – 20 mA	Par. 650 = [107] Speed related to norm 0 - 20 mA
[64] RPM at F max => 4 – 20 mA	Par. 650 = [137] Speed related to norm 4 - 20 mA
[65] RPM at F max => 0 – 32000 p	Par. 566 = [107] Speed related to norm 0 – 32000p Par. 568 = 32000

## - Parameter Mapping List -

	<b>5000 series</b>	<b>FC 300 series</b>
Parameter number	320	568
Parameter name	Terminal 42 Output, pulse scaling	Pulse Output Max Freq #X30/6 (MCB 101)
Data range	1 – 32000 Hz	0 – 32000 Hz

	<b>5000 series</b>	<b>FC 300 series</b>
Parameter number	322	568
Parameter name	Terminal 45 Output, pulse scaling	Pulse Output Max Freq #X30/6 (MCB 101)
Data range	1 – 32000 Hz	0 – 32000 Hz

	<b>5000 series</b>	<b>FC 300 series</b>
Parameter number	323	540 Index 0
Parameter number	326	540 Index 1
Parameter name	01 Relay 04 Relay	Relay 1 Relay 2
Data values	[0] No function	Par. 540.0 = [0] No operation
	[1] Control Ready	Par. 540.0 = [1] Control Ready
	[2] Ready signal	Par. 540.0 = [2] Drive ready
	[3] Ready - Remote Control	Par. 540.0 = [3] Drive rdy/rem ctrl
	[4] Enabled, no warning	Par. 540.0 = [4] Enable / no warning
	[5] Running	Par. 540.0 = [5] VLT® running
	[6] Running, no Warning	Par. 540.0 = [6] Running / no warning
	[7] Running within range, no warning	Par. 540.0 = [7] Run in range/no warn
	[8] Run at reference, no Warning	Par. 540.0 = [8] Run on ref/no warn
	[9] Alarm	Par. 540.0 = [9] Alarm
	[10] Alarm or Warning	Par. 540.0 = [10] Alarm or Warning
	[11] Torque limit	Par. 540.0 = [11] At torque limit
	[12] Out of current range	Par. 540.0 = [12] Out of current range
	[13] Above I low	Par. 540.0 = [13] Below current, low <sup>1)</sup>
	[14] Under I high	Par. 540.0 = [14] Above current, high <sup>1)</sup>
	[15] Out of frequency range	Par. 540.0 = [15] Out of speed range
	[16] Over f low	Par. 540.0 = [16] Below speed low <sup>1)</sup>
	[17] Under f high	Par. 540.0 = [17] Above speed high <sup>1)</sup>
	[18] Out of feedback range	Par. 540.0 = [18] Out of feedb. Range
[19] Over feedback low	Par. 540.0 = [16] Below	

## - Parameter Mapping List -

	feedback low <sup>1)</sup>
[20] Under feedback high	Par. 540.0 = [17] Above feedback high <sup>1)</sup>
[21] Thermal warning	Par. 540.0 = [21] Thermal warning
[22] Ready, no thermal warning	Par. 540.0 = [12] Ready, no thermal W
[23] Ready - remote control - no thermal warning	Par. 540.0 = [23] Remote, ready, no TW
[24] Ready - mains voltage within range	Par. 540.0 = [24] Ready, Voltage OK
[25] Reversing	Par. 540.0 = [25] Reverse
[26] Bus OK	Par. 540.0 = [26] Bus OK
[27] Torque limit and stop	Par. 540.0 = [27] Torque limit & stop
[28] Brake, no brake warning	Par. 540.0 = [28] Brake, no brake warning
[29] Brake ready, no fault	Par. 540.0 = [29] Brake ready, no fault
[30] Brake fault	Par. 540.0 = [30] Brake fault (IGBT)
[31] Relay 123	Par. 540.0 = [31] Relay 123
[32] Mechanical brake control	Par. 540.0 = [32] Mech brake ctrl
[33] Control word bit 11/12	Par. 540.0 = [36] Control word bit 11 Par. 540.1 = [37] Control word bit 12
[34] Extended mechanical brake control	Par. 540.0 = [32] Mech brake ctrl
[35] Safety Interlock	Not supported

1) = Note that the function is reversed in FC302 compared to VLT® 5000

	<b>5000 series</b>	<b>FC 300 series</b>
Parameter number	324	541 index 0
Parameter name	Relay 01, ON delay	On Delay, Relay
Data range	0.00 – 600.00 sec	0.01 – 600.00 sec

	<b>5000 series</b>	<b>FC 300 series</b>
Parameter number	325	542 index 0
Parameter name	Relay 01, OFF delay	Off Delay, Relay
Data range	0.00 – 600.00 sec	0.01 – 600.00 sec

	<b>5000 series</b>	<b>FC 300 series</b>
Parameter number	327	551
Parameter name	Pulse reference, max. freq.	Term. 29 High Frequency
Data range	100 – 65000 Hz	0 – 110000 Hz

	<b>5000 series</b>	<b>FC 300 series</b>
Parameter number	328	558
Parameter name	Pulse feedback, max. freq.	Term. 33 High Frequency
Data range	100 – 65000 Hz	0 – 110000 Hz

	<b>5000 series</b>	<b>FC 300 series</b>
Parameter number	329	570
Parameter name	Encoder feedback pulse/rev.	Term 32/33 Pulses per

## - Parameter Mapping List -

		Revolution
Data range	1 - 4096 pulses	1 - 4096 pulses

	<b>5000 series</b>	<b>FC 300 series</b>
Parameter number	330	Not converted
Parameter name	Freeze ref. /output function	

	<b>5000 series</b>	<b>FC 300 series</b>
Parameter number	345	432
Parameter name	Encoder loss timeout	Motor Feedback Loss Timeout
Data range	0.0 - 60.0 sec	0.00 - 60.00 sec

	<b>5000 series</b>	<b>FC 300 series</b>
Parameter number	346	430
Parameter name	Encoder loss function	Motor Feedback Loss Function
Data values	[0] Off	[0] Disable
	[1] Freeze output frequency	[4] Freeze output frequency
	[3] Jog	[3] Jog
	[4] Max speed	[5] Max speed
	[5] Stop and trip	[11] Stop and trip
	[7] Select setup 4	[10] Select setup 4

	<b>5000 series</b>	<b>FC 300 series</b>
Parameter number	357	651
Parameter name	Term. 42, Output min. scale	Terminal 42 Output Min Scale
Data range	0 - 100%	0 - 200%

	<b>5000 series</b>	<b>FC 300 series</b>
Parameter number	358	652
Parameter name	Term. 42, Output max. scale	Terminal 42 Output Max Scale
Data range	0 - 500%	0 - 200%

	<b>5000 series</b>	<b>FC 300 series</b>
Parameter number	359	661
Parameter name	Term. 45, Output min. scale	Terminal X30/8 Min. Scale
Data range	0 - 100%	0 - 200%

	<b>5000 series</b>	<b>FC 300 series</b>
Parameter number	360	662
Parameter name	Term. 45, Output max. scale	Terminal X30/8 Max. Scale
Data range	0 - 500%	0 - 200%

	<b>5000 series</b>	<b>FC 300 series</b>
Parameter number	361	431
Parameter name	Encoder loss threshold	Motor Feedback Speed Error
Data range	0 - 600%	1 - 600 rpm

VLT® AutomationDrive PROFIBUS converter  
- Parameter Mapping List -

### VLT® 5000 Group 4

	<b>5000 series</b>	<b>FC 300 series</b>
Parameter number	400	210, 217
Parameter name	Brake function/over voltage cont.	Brake Function, Over voltage con
Data values	[0] Off	[0] Off
	[1] Resistor brake	[1] Resistor brake
	[2] Over voltage control	<i>Par. 217 = [1] Enable</i>
	[3] Over voltage control and stop	Par. 217 = [2] Enable not at stop

	<b>5000 series</b>	<b>FC 300 series</b>
Parameter number	401	3081
Parameter name	Brake resistor, ohm	Brake resistor, ohm
Data range	Power unit dependable	Power unit dependable

	<b>5000 series</b>	<b>FC 300 series</b>
Parameter number	402	212
Parameter name	Brake power limit, kW	Brake Power Limit (kW)
Data range	Depends on unit	Depends on unit

	<b>5000 series</b>	<b>FC 300 series</b>
Parameter number	403	213
Parameter name	Power monitoring	Brake Function, Over voltage con
Data values	[0] Off	[0] Off
	[1] Warning	[1] Warning
	[2] Trip	[2] Trip

	<b>5000 series</b>	<b>FC 300 series</b>
Parameter number	404	215
Parameter name	Brake check	Brake check
Data values	[0] Off	[0] Off
	[1] Warning	[1] Warning
	[2] Trip	[2] Trip

	<b>5000 series</b>	<b>FC 300 series</b>
Parameter number	405	14-20
Parameter name	Reset	Reset Mode
Data values	[0] Manual reset	[0] Off
	[1] Automatic reset x 1	[1] Automatic reset x 1
	[2] Automatic reset x 2	[2] Automatic reset x 2
	[3] Automatic reset x 3	[3] Automatic reset x 3
	[4] Automatic reset x 4	[4] Automatic reset x 4
	[5] Automatic reset x 5	[5] Automatic reset x 5
	[6] Automatic reset x 6	[6] Automatic reset x 6
	[7] Automatic reset x 7	[7] Automatic reset x 7
	[8] Automatic reset x 8	[8] Automatic reset x 8
	[9] Automatic reset x 9	[9] Automatic reset x 9
	[10] Automatic reset x 10	[10] Automatic reset x 10

## - Parameter Mapping List -

	<b>5000 series</b>	<b>FC 300 series</b>
Parameter number	406	14-21
Parameter name	Automatic restart time	Automatic Restart Time
Data range	0 – 10 sec	0 – 600 sec

	<b>5000 series</b>	<b>FC 300 series</b>
Parameter number	407	14-10
Parameter name	Mains failure	Mains Failure
Data values	[0] No function	[0] No function
	[1] Controlled ramp down	[1] Controlled ramp down
	[2] Controlled ramp down and trip	[2] Controlled ramp down and trip
	[3] Coast	[3] Coast
	[4] Kinetic back-up	[4] Kinetic back-up
	[5] Controlled alarm suppression	[5] Kinetic back-up, trip

	<b>5000 series</b>	<b>FC 300 series</b>
Parameter number	408	Not converted
Parameter name	Quick discharge	

	<b>5000 series</b>	<b>FC 300 series</b>
Parameter number	409	14-25
Parameter name	Trip delay torque	Trip delay torque
Data range	0 – 60 sec (60=OFF)	0 – 60 sec (60=OFF)

	<b>5000 series</b>	<b>FC 300 series</b>
Parameter number	410	14-26
Parameter name	Trip delay inverter	Trip Delay at Inverter Fault
Data range	0 – 35 sec	0 – 35 sec

	<b>5000 series</b>	<b>FC 300 series</b>
Parameter number	411	14-01
Parameter name	Switching frequency	Switching Frequency
Parameter type	Unsigned 16 (6)	Unsigned 8 (5)
Data range	1.5 – 14 kHz	< 2.3 => 2.0 kHz [2] 2.3 > 2.7 => 2.5 kHz [3] 2.8 > 3.2 => 3.0 kHz [4] 3.3 > 3.7 => 3.5 kHz [5] 3.8 > 4.5 => 4.0 kHz [6] 4.6 > 5.5 => 5.0 kHz [7] 5.6 > 6.5 => 6.0 kHz [8] 6.6 > 7.5 => 7.0 kHz [9] 7.6 > 9.0 => 8.0 kHz [10] 9.1 > => 10.0 kHz [11]

	<b>5000 series</b>	<b>FC 300 series</b>
Parameter number	412	Not converted
Parameter name	Output frequency dependent switching frequency	



- Parameter Mapping List -

	<b>5000 series</b>	<b>FC 300 series</b>
Parameter number	413	14-03
Parameter name	Over modulation function	Over modulation function
Data values	[0] Off [1] On	[0] Off [1] On
Factory setting	[0] Off	[1] On

	<b>5000 series</b>	<b>FC 300 series</b>
Parameter number	414	Not converted
Parameter name	Minimum feedback	

	<b>5000 series</b>	<b>FC 300 series</b>
Parameter number	415	Not converted
Parameter name	Maximum feedback	

	<b>5000 series</b>	<b>FC 300 series</b>
Parameter number	416	301
Parameter name	Feedback Unit	Reference/feedback Unit
Data Value	[0] None [1] % [2] PPM [3] rpm [4] bar [5] Cycle/min [6] Pulse/s [7] Unit s/s [8] Unit s/min [9] Unit s/h [10] °C [11] Pa [12] l/s [13] m <sup>3</sup> /s [14] l/min [15] m <sup>3</sup> /min [16] l/h [17] m <sup>3</sup> /h [18] kg/s [19] kg/min [20] kg/h [21] t/min [22] t/h [23] m [24] Nm [25] m/s [26] m/min [27] °F [28] in wg [29] gal/s [30] ft <sup>3</sup> /s [31] gal/min	[0] None [1] % [5] PPM [2] RPM [71] bar Not supported [12] Pulse/s Not supported Not supported Not supported [60] °C [72] Pa [20] l/s [23] m <sup>3</sup> /s [21] l/min [24] m <sup>3</sup> /min [22] l/h [25] m <sup>3</sup> /h [30] kg/s [31] kg/min [32] kg/h [33] t/min [34] t/h [45] m [4] Nm [40] m/s [41] m/min [160] °F [172] in wg [121] gal/s [125] ft <sup>3</sup> /s [122] gal/min

## - Parameter Mapping List -

	[32] ft <sup>3</sup> /min	[126] ft <sup>3</sup> /min
	[33] gal/h	[123] gal/h
	[34] ft <sup>3</sup> /h	[127] ft <sup>3</sup> /h
	[35] lb/s	[130] lb/s
	[36] lb/min	[131] lb/min
	[37] lb/h	[132] lb/h
	[38] lb ft	[150] lb ft
	[39] ft/s	[140] ft/s
	[40] ft/min	[141] ft/min

	5000 series	FC 300 series
Parameter number	417	702
Parameter name	Speed PID proportional gain	Speed PID proportional gain
Data range	0.000 – 0.150	0.000 – 1.000

	5000 series	FC 300 series
Parameter number	418	703
Parameter name	Speed PID integral time	Speed PID Integral Time
Data range	2.00 – 999.99	2.00 – 20000.00

	5000 series	FC 300 series
Parameter number	419	704
Parameter name	Speed PID differential time	Speed PID Differentiation Time
Data range	0.00 – 200.00	0.00 – 200.00

	5000 series	FC 300 series
Parameter number	420	705
Parameter name	Speed PID D-gain limit	Speed PID Diff. Gain Limit
Data range	5.0 – 50.0	1.0 – 20.0

	5000 series	FC 300 series
Parameter number	421	706
Parameter name	Speed PID low-pass filter	Speed PID Lowpass Filter Time
Data range	5.0 – 200.0 ms	1.0 – 100.0

	5000 series	FC 300 series
Parameter number	422	155 index 0
Parameter name	U0 voltage at 0 Hz	U0 voltage
Data range	0.0 – par. 103	0.0 – 1000.0 V

	5000 series	FC 300 series
Parameter number	423	155 index 1
Parameter name	U1 voltage	U1 voltage
Data range	0.0 – par. 103	0.0 – 1000.0 V

	5000 series	FC 300 series
Parameter number	424	156 index 1
Parameter name	F1 frequency	F1 frequency
Data range	0.0 – par. 104	0.0 – 1000.0 Hz

	5000 series	FC 300 series
Parameter number	425	155 index 2
Parameter name	U2 voltage	U2 voltage
Data range	0.0 – par. 103	0.0 – 1000.0 V

## - Parameter Mapping List -

	<b>5000 series</b>	<b>FC 300 series</b>
Parameter number	426	156 index 2
Parameter name	F2 frequency	F2 frequency
Data range	0.0 – par. 104	0.0 – 1000.0 Hz

	<b>5000 series</b>	<b>FC 300 series</b>
Parameter number	427	155 index 2
Parameter name	U3 voltage	U3 voltage
Data range	0.0 – par. 103	0.0 – 1000.0 V

	<b>5000 series</b>	<b>FC 300 series</b>
Parameter number	428	156 index 3
Parameter name	F3 frequency	F3 frequency
Data range	0.0 – par. 104	0.0 – 1000.0 Hz

	<b>5000 series</b>	<b>FC 300 series</b>
Parameter number	429	155 index 4
Parameter name	U4 voltage	U4 voltage
Data range	0.0 – par. 103	0.0 – 1000.0 V

	<b>5000 series</b>	<b>FC 300 series</b>
Parameter number	430	156 index 4
Parameter name	F4 frequency	F4 frequency
Data range	0.0 – par. 104	0.0 – 1000.0 Hz

	<b>5000 series</b>	<b>FC 300 series</b>
Parameter number	431	155 index 5
Parameter name	U5 voltage	U5 voltage
Data range	0.0 – par. 103	0.0 – 1000.0 V

	<b>5000 series</b>	<b>FC 300 series</b>
Parameter number	432	156 index 5
Parameter name	F5 frequency	F5 frequency
Data range	0.0 – par. 104	0.0 – 1000.0 Hz

	<b>5000 series</b>	<b>FC 300 series</b>
Parameter number	433	712
Parameter name	Torque control, open loop proportional gain	Torque PI Proportional Gain
Data range	0 (Off) – 500%	0 (Off) – 500%

	<b>5000 series</b>	<b>FC 300 series</b>
Parameter number	434	713
Parameter name	Torque control, open loop integral time	Torque PI Integration Time
Data range	0.002 – 2.000 sec	0.002 – 2.000 sec

	<b>5000 series</b>	<b>FC 300 series</b>
Parameter number	437	730
Parameter name	Process PID Normal/Inverse contr	Process PID Normal/Inverse Control
Data values	[0] Normal	[0] Normal
	[1] Inverse	[1] Inverse

	<b>5000 series</b>	<b>FC 300 series</b>
--	--------------------	----------------------

## - Parameter Mapping List -

Parameter number	438	731
Parameter name	Process PID Anti windup	Process PID Anti Windup
Data values	[0] Off	[0] Off
	[1] On	[1] On

	5000 series	FC 300 series
Parameter number	439	732
Parameter name	Process PID start frequency	Process PID Start Speed
Data range	Fmin – fmax	0 – 6000 rpm

	5000 series	FC 300 series
Parameter number	440	733
Parameter name	Process PID proportional gain	Process PID proportional gain
Data range	0.00 – 10.00	0.00 – 10.00

	5000 series	FC 300 series
Parameter number	441	734
Parameter name	Process PID integral time	Process PID integral time
Data range	0.01 – 9999.99	0.01 – 10000.00

	5000 series	FC 300 series
Parameter number	442	735
Parameter name	Process PID differentiation time	Process PID Differentiation Time
Data range	0.00 – 10.00	0.00 – 10.00

	5000 series	FC 300 series
Parameter number	443	736
Parameter name	Process PID diff. gain limit	Process PID Differentiation Time
Data range	5.0 – 50.0	0.00 – 10.00

	5000 series	FC 300 series
Parameter number	444	Not converted
Parameter name	Process PID lowpass filter time	

	5000 series	FC 300 series
Parameter number	445	173
Parameter name	Flying start	Flying Start
Data values	[0] Off	[0] Disable
	[1] On	[1] Enable

	5000 series	FC 300 series
Parameter number	446	1400
Parameter name	Switching pattern	Switching Pattern
Data values	[0] 60 AVM	[0] 60 AVM
	[1] SFAVM	[1] SFAVM

	5000 series	FC 300 series
Parameter number	447	Not converted
Parameter name	Torque compensation	

	5000 series	FC 300 series
--	-------------	---------------

## - Parameter Mapping List -

Parameter number	448	Not converted
Parameter name	Gear ratio	

	<b>5000 series</b>	<b>FC 300 series</b>
Parameter number	449	Not converted
Parameter name	Friction loss	

	<b>5000 series</b>	<b>FC 300 series</b>
Parameter number	450	14-11
Parameter name	Mains voltage at mains fault	Mains Voltage at Mains Fault
Data range	180 – 690 Volt	100 – 800 Volt

	<b>5000 series</b>	<b>FC 300 series</b>
Parameter number	453	707
Parameter name	Gear ratio, speed close loop	Speed PID Feedback Gear Ratio
Data range	0.01 – 100.00	0.0001 – 32.0000

	<b>5000 series</b>	<b>FC 300 series</b>
Parameter number	454	Not converted
Parameter name	Dead time compensation	

	<b>5000 series</b>	<b>FC 300 series</b>
Parameter number	455	Not converted
Parameter name	Frequency range monitor	

	<b>5000 series</b>	<b>FC 300 series</b>
Parameter number	457	14-12
Parameter name	Phase loss functions	Function at Mains Imbalance
Data values	[0] Trip	[0] Trip
	[1] Warning	[1] Warning
		[2] Disable

	<b>5000 series</b>	<b>FC 300 series</b>
Parameter number	483	Not converted
Parameter name	Dynamic DC link compensation	

## VLT® 5000 Group 5

	<b>5000 series</b>	<b>FC 300 series</b>
Parameter number	500	831
Parameter name	Address	Address
Data range	0 – 126	0 – 126

	<b>5000 series</b>	<b>FC 300 series</b>
Parameter number	501	832
Parameter name	Baud rate	Baud rate
Data values	[0] 300	Not supported
	[1] 600	Not supported
	[2] 1200	Not supported
	[3] 2400	[0] 2400
	[4] 4800	[1] 4800
	[5] 9600	[2] 9600

	<b>5000 series</b>	<b>FC 300 series</b>
Parameter number	502	850
Parameter name	Coasting	Coasting
Parameter number	503	851
Parameter name	Quick-stop	Quick-stop
Parameter number	504	852
Parameter name	DC brake	DC brake
Parameter number	505	853
Parameter name	Start	Start
Parameter number	506	854
Parameter name	Reversing	Reversing
Parameter number	507	855
Parameter name	Setup select	Setup select
Parameter number	508	856
Parameter name	Preset reference select	Preset reference select
Parameter type	Unsigned 8 (5)	Unsigned 8 (5)
Data values	[0] Digital input	[0] Digital input
	[1] Bus	[1] Bus
	[2] Logic AND	[2] Logic AND
	[3] Logic OR	[3] Logic OR

	<b>5000 series</b>	<b>FC 300 series</b>
Parameter number	509	890
Parameter name	Bus Jog 1	Bus Jog 1
Data range	0.0 – par. 202	0.0 – par. 413

	<b>5000 series</b>	<b>FC 300 series</b>
Parameter number	510	891
Parameter name	Bus Jog 2	Bus Jog 2
Data range	0.0 – par. 202	0.0 – par. 413

	<b>5000 series</b>	<b>FC 300 series</b>
Parameter number	512	810
Parameter name	Telegram Profile	Control word Profile
Data values	[0] Fieldbus profile	[1] ProfiDrive profile
	[1] FC profile	[0] FC profile

VLT® AutomationDrive PROFIBUS converter  
- Parameter Mapping List -

	<b>5000 series</b>	<b>FC 300 series</b>
Parameter number	513	Not converted
Parameter name	Bus time interval	

	<b>5000 series</b>	<b>FC 300 series</b>
Parameter number	514	Not converted
Parameter name	Bus time interval function	

	<b>5000 series</b>	<b>FC 300 series</b>
Parameter number	515	16-02
Parameter name	Reference %	Reference %

	<b>5000 series</b>	<b>FC 300 series</b>
Parameter number	516	16-01
Parameter name	Reference Unit	Reference Unit

	<b>5000 series</b>	<b>FC 300 series</b>
Parameter number	517	16-52
Parameter name	Feedback	Feedback Unit

	<b>5000 series</b>	<b>FC 300 series</b>
Parameter number	518	16-13
Parameter name	Frequency	Frequency

	<b>5000 series</b>	<b>FC 300 series</b>
Parameter number	519	Not converted
Parameter name	Frequency x scaling	

	<b>5000 series</b>	<b>FC 300 series</b>
Parameter number	520	16-14
Parameter name	Current	Motor current

	<b>5000 series</b>	<b>FC 300 series</b>
Parameter number	521	16-22
Parameter name	Torque	Torque %

	<b>5000 series</b>	<b>FC 300 series</b>
Parameter number	522	16-10
Parameter name	Power, kW	Power, kW

	<b>5000 series</b>	<b>FC 300 series</b>
Parameter number	523	16-11
Parameter name	Power, HP	Power, HP

	<b>5000 series</b>	<b>FC 300 series</b>
Parameter number	524	16-12
Parameter name	Motor voltage	Motor voltage

	<b>5000 series</b>	<b>FC 300 series</b>
Parameter number	525	16-30
Parameter name	DC link voltage	DC link voltage

	<b>5000 series</b>	<b>FC 300 series</b>
Parameter number	526	16-18
Parameter name	Motor temp.	Motor temp.

## - Parameter Mapping List -

	<b>5000 series</b>	<b>FC 300 series</b>
Parameter number	527	16-35
Parameter name	VLT® temp.	VLT® temp.

	<b>5000 series</b>	<b>FC 300 series</b>
Parameter number	528	16-60
Parameter name	Digital input	Digital input
Data values	Term. 16 (binary 0000 0001)	Term. X30/2 (binary )
	Term. 17 (binary 0000 0010)	Term. X30/3 (binary )
	Term. 18 (binary 0000 0100)	Term. 18 (binary )
	Term. 19 (binary 0000 1000)	Term. 19 (binary )
	Term. 27 (binary 0001 0000)	Term. 27 (binary )
	Term. 32 (binary 0010 0000)	Term. 32 (binary )
	Term. 33 (binary 0100 0000)	Term. 33 (binary )

	<b>5000 series</b>	<b>FC 300 series</b>
Parameter number	529	16-62
Parameter name	Analogue input 53	Analogue input 53*

\* = Switch "S201" must be OFF

	<b>5000 series</b>	<b>FC 300 series</b>
Parameter number	530	16-64
Parameter name	Analogue input 54	Analogue input 54**

\*\* = Switch "S202" must be OFF

	<b>5000 series</b>	<b>FC 300 series</b>
Parameter number	531	16-64
Parameter name	Analogue input 60	Analogue input 54***

\*\*\* = Switch "S202" must be ON

	<b>5000 series</b>	<b>FC 300 series</b>
Parameter number	532	16-51
Parameter name	Pulse reference	Pulse reference

	<b>5000 series</b>	<b>FC 300 series</b>
Parameter number	533	16-50
Parameter name	External reference %	External reference %

	<b>5000 series</b>	<b>FC 300 series</b>
Parameter number	534	16-03
Parameter name	Status word, binary	Status Word

	<b>5000 series</b>	<b>FC 300 series</b>
Parameter number	535	16-33
Parameter name	Brake power/2 min	Brake Energy / 2 min

	<b>5000 series</b>	<b>FC 300 series</b>
Parameter number	536	16-32
Parameter name	Brake power/sec	Brake Energy /s



## - Parameter Mapping List -

	<b>5000 series</b>	<b>FC 300 series</b>
Parameter number	537	16-34
Parameter name	Heat sink temp	Heat sink Temp.

	<b>5000 series</b>	<b>FC 300 series</b>
Parameter number	538	14-72
Parameter name	Alarm word	VLT® Alarm word

	<b>5000 series</b>	<b>FC 300 series</b>
Parameter number	539	16-00
Parameter name	VLT® Control word	Control word

	<b>5000 series</b>	<b>FC 300 series</b>
Parameter number	540	14-73
Parameter name	Warning word	VLT® Warning word

	<b>5000 series</b>	<b>FC 300 series</b>
Parameter number	541	14-74
Parameter name	Extended status word	VLT® Ext. Status Word

	<b>5000 series</b>	<b>FC 300 series</b>
Parameter number	553	Not converted
Parameter name	Display text 1	

	<b>5000 series</b>	<b>FC 300 series</b>
Parameter number	554	Not converted
Parameter name	Display text 2	

	<b>5000 series</b>	<b>FC 300 series</b>
Parameter number	557	16-17
Parameter name	Motor rpm	Motor rpm

	<b>5000 series</b>	<b>FC 300 series</b>
Parameter number	558	Not converted
Parameter name	Motor rpm x scaling	

	<b>5000 series</b>	<b>FC 300 series</b>
Parameter number	580	Not converted
Parameter name	Define parameter	

	<b>5000 series</b>	<b>FC 300 series</b>
Parameter number	581	Not converted
Parameter name	Define parameter	

	<b>5000 series</b>	<b>FC 300 series</b>
Parameter number	582	Not converted
Parameter name	Define parameter	

## VLT® 5000 Group 6

	<b>5000 series</b>	<b>FC 300 series</b>
Parameter number	600	15-00
Parameter name	Operating hours	Operating hours

	<b>5000 series</b>	<b>FC 300 series</b>
Parameter number	601	15-01
Parameter name	Hours run	Running Hours

	<b>5000 series</b>	<b>FC 300 series</b>
Parameter number	602	15-02
Parameter name	kWh counter	kWh counter

	<b>5000 series</b>	<b>FC 300 series</b>
Parameter number	603	15-03
Parameter name	Numbers of power up	Power Up's

	<b>5000 series</b>	<b>FC 300 series</b>
Parameter number	604	15-04
Parameter name	Numbers of over temp.	Over Temp's

	<b>5000 series</b>	<b>FC 300 series</b>
Parameter number	605	15-05
Parameter name	Numbers of over voltage	Over voltage

	<b>5000 series</b>	<b>FC 300 series</b>
Parameter number	606	Not converted
Parameter name	Data log: Digital input	

	<b>5000 series</b>	<b>FC 300 series</b>
Parameter number	607	Not converted
Parameter name	Data log: Bus commands	

	<b>5000 series</b>	<b>FC 300 series</b>
Parameter number	608	Not converted
Parameter name	Data log: Status word	

	<b>5000 series</b>	<b>FC 300 series</b>
Parameter number	609	Not converted
Parameter name	Data log: Reference	

	<b>5000 series</b>	<b>FC 300 series</b>
Parameter number	610	Not converted
Parameter name	Data log: Feedback	

	<b>5000 series</b>	<b>FC 300 series</b>
Parameter number	611	Not converted
Parameter name	Data log: Motor frequency	

	<b>5000 series</b>	<b>FC 300 series</b>
Parameter number	612	Not converted
Parameter name	Data log: Motor voltage	

VLT® AutomationDrive PROFIBUS converter  
- Parameter Mapping List -

	<b>5000 series</b>	<b>FC 300 series</b>
Parameter number	613	Not converted
Parameter name	Data log: Motor current	

	<b>5000 series</b>	<b>FC 300 series</b>
Parameter number	614	Not converted
Parameter name	Data log: DC link voltage	

	<b>5000 series</b>	<b>FC 300 series</b>
Parameter number	615	15-30
Parameter name	Fault log: Error code	Fault log: Error code

	<b>5000 series</b>	<b>FC 300 series</b>
Parameter number	616	15-32
Parameter name	Fault log: Time	Fault log: Time

	<b>5000 series</b>	<b>FC 300 series</b>
Parameter number	617	15-31
Parameter name	Fault log: Value	Fault log: Value

	<b>5000 series</b>	<b>FC 300 series</b>
Parameter number	618	15-06
Parameter name	Reset of kWh counter	Reset kWh Counter
Data value	[0] No reset	[0] Do not reset
	[1] Reset	[1] Reset counter

	<b>5000 series</b>	<b>FC 300 series</b>
Parameter number	619	15-07
Parameter name	Reset of Hours run	Reset Running Hours Counter
Data value	[0] No reset	[0] Do not reset
	[1] Reset	[1] Reset counter

	<b>5000 series</b>	<b>FC 300 series</b>
Parameter number	620	14-22
Parameter name	Operation mode	Operation Mode
Data value	[0] Normal operation	[0] Normal operation
	[1] Function with deactivated inverter	Not supported
	[2] Control card test	[1] Control card test
	[3] Initialisation	[2] Initialisation

	<b>5000 series</b>	<b>FC 300 series</b>
Parameter number	621	Not converted
Parameter name	Name plate: VLT® type	

	<b>5000 series</b>	<b>FC 300 series</b>
Parameter number	622	Not converted
Parameter name	Name plate: Power section	

	<b>5000 series</b>	<b>FC 300 series</b>
Parameter number	623	Not converted
Parameter name	Name plate: VLT® ordering no.	

## - Parameter Mapping List -

	<b>5000 series</b>	<b>FC 300 series</b>
Parameter number	624	Not converted
Parameter name	Name plate: Software version no.	

	<b>5000 series</b>	<b>FC 300 series</b>
Parameter number	625	Not converted
Parameter name	Name plate: LCP ID no	

	<b>5000 series</b>	<b>FC 300 series</b>
Parameter number	626	Not converted
Parameter name	Name plate: Data base ID	

	<b>5000 series</b>	<b>FC 300 series</b>
Parameter number	627	Not converted
Parameter name	Name plate: Power ID no.	

	<b>5000 series</b>	<b>FC 300 series</b>
Parameter number	628	Not converted
Parameter name	Name plate: Application type	

	<b>5000 series</b>	<b>FC 300 series</b>
Parameter number	629	Not converted
Parameter name	Name plate: Application type no.	

	<b>5000 series</b>	<b>FC 300 series</b>
Parameter number	630	Not converted
Parameter name	Name plate: Com. type	

	<b>5000 series</b>	<b>FC 300 series</b>
Parameter number	631	Not converted
Parameter name	Name plate: Com. Type no.	

VLT® AutomationDrive PROFIBUS converter  
- Parameter Mapping List -

## VLT® 5000 Group 8

	<b>5000 series</b>	<b>FC 300 series</b>
Parameter number	800	Not converted
Parameter name	PROFIBUS DP	

	<b>5000 series</b>	<b>FC 300 series</b>
Parameter number	801	Not converted
Parameter name	Baud rate selection	

	<b>5000 series</b>	<b>FC 300 series</b>
Parameter number	802	Not converted
Parameter name	Minimum station delay	

	<b>5000 series</b>	<b>FC 300 series</b>
Parameter number	803	803
Parameter name	Time out after bus error	Control Word Timeout Time
Data range	1 – 99	0.1 – 18000.0

	<b>5000 series</b>	<b>FC 300 series</b>
Parameter number	804	804
Parameter name	Response after bus time out	Control Word Timeout Function
Data value	[0] Off	[0] Off
	[1] Freeze output frequency	[1] Freeze output frequency
	[2] Stop	[2] Stop
	[3] Jogging	[3] Jogging
	[4] Max speed	[4] Max speed
	[5] Stop and trip	[5] Stop and trip
	[6] No com. option control	Par. 802 to RS485
	[7] Select set up 4	[10] Select set up 4

	<b>5000 series</b>	<b>FC 300 series</b>
Parameter number	805	814
Parameter name	Function of control word bit 10	Configurable Control Word CTW
Data value	[0] No function	[0] None
	[1] Bit 10 = 1 => CTW active	[1] Profile default
	[2] Bit 10 = 0 => CTW active	[2] CTW Valid, active low
	[3] Bit 10 = 1 => Time out	[1] Profile default

	<b>5000 series</b>	<b>FC 300 series</b>
Parameter number	806	Not converted
Parameter name	SAP selection (FMS)	

	<b>5000 series</b>	<b>FC 300 series</b>
Parameter number	808	Not converted
Parameter name	ProfiDrives status word	

VLT® AutomationDrive PROFIBUS converter  
- Parameter Mapping List -

	<b>5000 series</b>	<b>FC 300 series</b>
Parameter number	849	807
Parameter name	Extended diagnose	Diagnosis Trigger
Data value	[0] Disable	[0] Disable
	[1] Alarm	[1] Trigger on alarm
	[2] Alarm and warnings	[2] Trigger on alarm/warn.

## VLT® 5000 Group 9

	<b>5000 series</b>	<b>FC 300 series</b>
Parameter number	900	Not converted
Parameter name	Write PPO type 1	

	<b>5000 series</b>	<b>FC 300 series</b>
Parameter number	901	Not converted
Parameter name	Write PPO type 2	

	<b>5000 series</b>	<b>FC 300 series</b>
Parameter number	902	Not converted
Parameter name	Write PPO type 3	

	<b>5000 series</b>	<b>FC 300 series</b>
Parameter number	903	Not converted
Parameter name	Write PPO type 4	

	<b>5000 series</b>	<b>FC 300 series</b>
Parameter number	904	Not converted
Parameter name	PPO type select for DP	

	<b>5000 series</b>	<b>FC 300 series</b>
Parameter number	907	Not converted
Parameter name	Read PPO type 1	

	<b>5000 series</b>	<b>FC 300 series</b>
Parameter number	908	Not converted
Parameter name	Read PPO type 2	

	<b>5000 series</b>	<b>FC 300 series</b>
Parameter number	909	Not converted
Parameter name	Read PPO type 3	

	<b>5000 series</b>	<b>FC 300 series</b>
Parameter number	910	Not converted
Parameter name	Read PPO type 4	

	<b>5000 series</b>	<b>FC 300 series</b>
Parameter number	911	Not converted
Parameter name	PPO type for FMS read	

	<b>5000 series</b>	<b>FC 300 series</b>
Parameter number	913	Not converted
Parameter name	Broadcast index	

## - Parameter Mapping List -

	<b>5000 series</b>	<b>FC 300 series</b>
Parameter number	914	Not converted
Parameter name	Broadcast off-set	

	<b>5000 series</b>	<b>FC 300 series</b>
Parameter number	915	915
Parameter name	PCD config write	PCD Write Configuration
Data value	[0] None	[0] None
	[204] Minimum Reference	[302] Minimum Reference
	[205] Maximum Reference	[203] Maximum Reference
	[219] Catch up/slow Down Value	[312] Catch up/slow Down Value
	[207] Ramp 1 Ramp up Time	[341] Ramp 1 Ramp up Time
	[208] Ramp 1 Ramp Down Time	[342] Ramp 1 Ramp Down Time
	[209] Ramp 2 Ramp up Time	[351] Ramp 2 Ramp up Time
	[210] Ramp 2 Ramp down Time	[352] Ramp 2 Ramp down Time
	[211] Jog Ramp Time	[380] Jog Ramp Time
	[212] Quick Stop Ramp Time	[381] Quick Stop Ramp Time
	[201] Motor Low Limit [Hz]	[412] Motor Speed Low Limit [Hz]
	[202] Motor High Limit [Hz]	[413] Motor Speed High Limit [Hz]
	[221] Torque Limit Motor Mode	[416] Torque Limit Motor Mode
	[222] Torque Limit Generator Mode	[417] Torque Limit Generator Mode
	[509] Bus Jog 1 Speed	[890] Bus Jog 1 Speed
	[510] Bus Jog 2 Speed	[891] Bus Jog 2 Speed
Comments	VLT® 5000 supports more write signals. If a not-supported signal is written then the corresponding signal will be set to [0] None.	

	<b>5000 series</b>	<b>FC 300 series</b>
Parameter number	916	916
Parameter name	PCD config read	PCD read Configuration
Data value	[0] None	[0] None
	[538] Alarm word	[1472] VLT® Alarm Word
	[540] Warning word	[1473] VLT® Warning Word
	[541] Ext. status word	[1474] VLT® Ext. status Word
	[600] Operating hours	[1500] Operating hours
	[601] Running hours	[1501] Running hours
	[602] kWh Counter	[1502] kWh Counter
	[539] Control word	[1600] Control word
	[516] Reference [Unit]	[1601] Reference [Unit]
	[515] Reference %	[1602] Reference %
	[534] Status word	[1603] Status word
	[522] Power [kW]	[1610] Power [kW]
	[523] Power [HP]	[1611] Power [HP]
	[524] Motor voltage	[1612] Motor voltage
	[518] Motor frequency	[1613] Motor frequency

## - Parameter Mapping List -

[520] Motor current	[1614] Motor current
[557] Motor RPM	[1617] Motor speed
[526] Motor thermal	[1618] Motor thermal
[521] Torque	[1622] Torque %
[525] DC link voltage	[1630] DC link voltage
[536] Brake energy/s	[1632] Brake energy/s
[535] Brake energy/2 min	[1633] Brake energy/2 min
[537] Heat sink temp.	[1634] Heat sink temp.
[527] Inverter Thermal	[1635] Inverter Thermal
[533] External reference	[1650] External reference
[532] Pulse reference	[1651] Pulse reference
[517] Feedback [Unit]	[1652] Feedback [Unit]
[528] Digital input	[1660] Digital input
[529] Analog input 53	[1662] Analog input 53
[530] Analog input 54	[1664] Analog input 54
[531] Analog input 60	[1664] Analog input 54

	5000 series	FC 300 series
Parameter number	917	Not converted
Parameter name	Spontaneous messages	

	5000 series	FC 300 series
Parameter number	918	918
Parameter name	Station address	Node Address
Data range	0 - 125	0 - 125

	5000 series	FC 300 series
Parameter number	927	927
Parameter name	Parameter edit	Parameter edit
Data value	[0] Disable [1] Enable	[0] Disable [1] Enable

	5000 series	FC 300 series
Parameter number	928	928
Parameter name	Control authority	Process Control
Data value	[0] Disable [1] Enable	[0] Disable [1] Enable cyclic master

	5000 series	FC 300 series
Parameter number	953	953
Parameter name	Warning parameter	PROFIBUS Warning Word

	5000 series	FC 300 series
Parameter number	964	964
Parameter name	Identification	Device Identification

	5000 series	FC 300 series
Parameter number	965	965
Parameter name	Profile number	Profile number

	5000 series	FC 300 series
Parameter number	967	Not converted
Parameter name	Control word (FMS)	

	5000 series	FC 300 series
Parameter number	968	Not converted



## - Parameter Mapping List -

Parameter name	Status word (FMS)	
	<b>5000 series</b>	<b>FC 300 series</b>
Parameter number	970	970
Parameter name	Parameter setup selection	Edit Set-up
Data value	[0] Factory setting	[0] Factory setting
	[1] Parameter setup 1	[1] Parameter setup 1
	[2] Parameter setup 2	[2] Parameter setup 2
	[3] Parameter setup 3	[3] Parameter setup 3
	[4] Parameter setup 4	[4] Parameter setup 4
	[5] Active setup	[5] Active setup

	<b>5000 series</b>	<b>FC 300 series</b>
Parameter number	971	971
Parameter name	Save data values	PROFIBUS Save Data Values
Parameter type	Unsigned 8 (5)	Unsigned 8 (5)
Data value	[0] Not active	[0] Off
	[1] Save active setup	[1] Store all setups
	[2] Save edit setup	[1] Store all setups
	[3] Save all setups	[1] Store all setups

	<b>5000 series</b>	<b>FC 300 series</b>
Parameter number	980	Not converted
Parameter name	Defined parameters	

	<b>5000 series</b>	<b>FC 300 series</b>
Parameter number	981	Not converted
Parameter name	Defined parameters	

	<b>5000 series</b>	<b>FC 300 series</b>
Parameter number	982	Not converted
Parameter name	Defined parameters	

	<b>5000 series</b>	<b>FC 300 series</b>
Parameter number	990	Not converted
Parameter name	Modified parameters	

	<b>5000 series</b>	<b>FC 300 series</b>
Parameter number	990	Not converted
Parameter name	Modified parameters	

	<b>5000 series</b>	<b>FC 300 series</b>
Parameter number	990	Not converted
Parameter name	Modified parameters	

## Troubleshooting



### Step-by-step troubleshooting

After copying the station address from the VLT® 5000 to the FC 302, power must be cycled to the FC 302. The master/PLC should now recognize FC 302, as a VLT® 5000, and the NS LED on the MCA114 option should now be solid green which indicates that communication between master and slave is established.

- If the NS LED flashes, the master/PLC has not recognized the FC 302.
- Check if station address is the same in the FC 302 as the replaced VLT® 5000.
- Check par. 9-63 *Actual Baudrate*. If the drive has a connection to the master this parameter will display the detected baudrate. If not master has been detected the parameter will display: "No baud rate found".
- Check par. 9-53 *PROFIBUS Warning Word*.

Bit	Warn. Word (Hex)	Description
0	0001	Connection with DP-master is not O.K.
1	0002	Unused
2	0004	FDL (Field-bus Data link Layer) is not O.K.
3	0008	Clear data command received
4	0010	Actual value is not updated
5	0020	Baudrate search
6	0040	PROFIBUS ASIC is not transmitting
7	0080	Initialising of PROFIBUS is not ok
8	0100	Drive is tripped
9	0200	Internal CAN error
10	0400	Wrong configuration data from PLC
11	0800	Wrong ID sent by PLC
12	1000	Internal error occurred
13	2000	Not configured
14	4000	Timeout active
15	8000	Warning 34 active

- Check the section *Constraints* for more information on limitations.

## Index

<b>A</b>	
Abbreviations	8
<b>B</b>	
Brake chopper	5
<b>C</b>	
Commissioning	12
Configuration	11
Constrains	6
<b>D</b>	
DIP switches	11
<b>E</b>	
EMC precautions	14
<b>H</b>	
Hardware	7
<b>I</b>	
Installation	9
<b>L</b>	
Linked setups	7
Literature	7
LEDs	13
<b>M</b>	
MCA114	9
Mechanical adaptation	7
<b>N</b>	
Node address	11
<b>O</b>	
Overview (technical)	5
<b>P</b>	
Parameters (mapping list)	15
Performance	7
Power size	5
<b>S</b>	
Safety	3
<b>T</b>	
Terminals	6
Troubleshooting	58
<b>W</b>	
Warning word	58