

Contents

1 Safety	3
Warnings	3
Symbols Used in This Manual	3
Operator's Safety	3
Avoid Filter Module Damage	4
2 Ordering Numbers	5
Description	5
Ordering Numbers, 380 - 415V, 50Hz	6
Ordering Numbers, 380 - 415V, 60Hz	6
Ordering Numbers, 440 - 480V, 60Hz	7
Ordering Numbers, 500 - 525V, 50Hz	7
Ordering Numbers, 690V, 50Hz	8
Calculation of the Exact Filter Size Needed	8
3 Specifications	9
General Technical Data	9
Environmental Data	9
Dimensions/Weight	10
Dimension Diagrams	11
4 Installation	15
Mechanical Installation	15
Ventilation	16
Cable lengths and cross sections	16
Capacitor Disconnect	18
Fuses	21
Over Temperature Switch	22
Operation on Different Mains Type	23
Typical Installation in a Panel or Other Enclosures	23
5 Commissioning	25
6 Appendix: Safety and Application Notes	27
General	27
Application as Directed	27
Transport and Storage	27
Installation	27
Electrical Installation	28
Operation	28
Maintenance and Service	28

Index	29
--------------	----

1 Safety

1

1.1.1 Warnings

 The Danfoss harmonic filter AHF 005 and AHF 010 contain dangerous voltages when connected to mains voltages. Only a competent electrician should carry out the electrical installation. Improper installation of the filter or the connected frequency converter may cause equipment failure, serious injury or death. Follow this manual and install according to National Electrical Codes and local safety codes. Operation of the harmonic filter is only allowed when the filters housing lid, door or cover is closed.

1.1.2 Symbols Used in This Manual

This manual contains different symbols that require special attention. The symbols used are the following:

 Warning of hazardous electrical voltage.

 Warning of a general danger.

 **NB!**
This note designates general, useful notes. If you observe it, handling of the filter/drive system is made easier.

1.1.3 Operator's Safety

 After mains disconnections, the power terminals X1.1, X1.2, X1.3, X3.1, X3.2, X3.3, X4.1, X4.2 and X4.3 remain live for minimum 4 minutes.

 The filters have to be installed in a way, that they fulfil their function and don't expose persons to danger. They have to be mounted correctly and used in accordance with their purpose.

 AB terminals are not Protected Extra Low Voltage (PELV).

1**1.1.4 Avoid Filter Module Damage**

1. The filter modules may only be used with Danfoss frequency converters.
2. Do not use the drive system (frequency converter, motor load and filter) if the equipment has been damaged.
3. Modifications of the filters are not allowed.

2 Ordering Numbers

2.1.1 Description

The Danfoss harmonic filters AHF 005 and AHF 010 are ensuring near sinusoidal mains current, minimising the harmonic current emission into the mains supply. The Danfoss AHF 005 and AHF 010 are advanced harmonic filters not to be compared with traditional harmonic trap filters. The Danfoss harmonic filters have been specially designed to match all the Danfoss frequency converters. The filters AHF 010 and AHF 005 are available in five voltage versions.

- 380 - 415 V AC, 50 Hz
- 380 - 415 V AC, 60 Hz
- 440 - 480 V AC, 60 Hz
- 500 - 525 V AC, 50 Hz
- 690 V AC, 50 Hz

The Danfoss AHF 010 and AHF 005 have the following characteristics:

- Small compact housing that fits into a panel
- Easy to use in retrofit applications
- AHF 010 reduces the total harmonic current distortion to 10%*
- AHF 005 reduces the total harmonic current distortion to 5%*
- Current rating from 10A - 370A
- AHF Filters can be paralleled for higher power modules
- One filter module can be used for several frequency converters
- High efficiency (> 0.98)
- User-friendly commissioning - no adjustment necessary
- No routine maintenance required

* THiD of 10% or 5% will be achieved when the following conditions are met:

- THvD of the system without the drive operating is less than 2%
- Filter is operating at nominal load

If these conditions are not fulfilled, a significant reduction of the harmonic distortion can still be achieved, but the rated THiD values may not be achieved. The mains quality has to be according to EN61000-2-4 level 3, allowing a maximum THvD level of 10%.

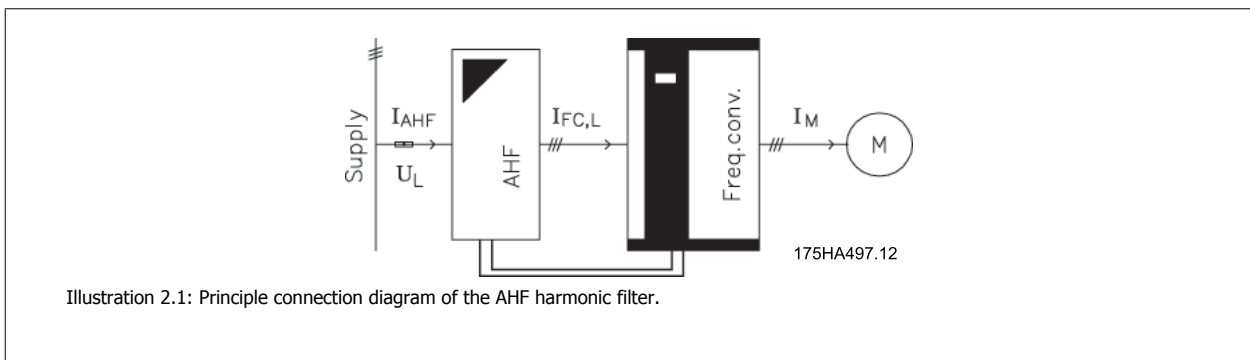

U_L :	Mains voltage
I_{AHF} :	Input current of the filter AHF
$I_{FC,L}$:	Input current to the frequency converter
I_M :	Motor current

Table 2.1: Legends (as used throughout this manual):

2.1.2 Ordering Numbers, 380 - 415V, 50Hz

Danfoss Frequency converter series *		Ordering Number		I _{AHF,N}
AQUA, HVAC, Automation HO	Automation NO	AHF 005	AHF 010	[AMP]
PK37 - P4K		175G6600	175G6622	10 A
P5K5 - P7K5		175G6601	175G6623	19 A
P11K		175G6602	175G6624	26 A
P15K-P18K	P11K-P15K	175G6603	175G6625	35 A
P22K	P18K	175G6604	175G6626	43 A
P30K-P37K	P22K-P30K	175G6605	175G6627	72 A
P45K-P55K	P37K-P45K	175G6606	175G6628	101 A
P75K	P55K	175G6607	175G6629	144 A
P90K	P75K	175G6608	175G6630	180 A
P110	P90K	175G6609	175G6631	217 A
P132	P110	175G6610	175G6632	289 A
P160	P132	175G6611	175G6633	324 A
P200	P160	175G6688	175G6691	370 A
P250	P200	175G6609 + 175G6610	175G6631 + 175G6632	506 A
P315	P250	2 x 175G6610	2 x 175G6632	578 A
P355	P315	2 x 175G6611	2 x 175G6633	648 A

Table 2.2: AHF 005 and AHF 010, 380V - 415V, 50Hz

* Please note that the matching of the typical Danfoss frequency converter and filter is pre-calculated based on 400V and assuming typical motor load (4 or 2 pole motor). (FC 300 is based on an 160% torque application, while FC 100 and FC 200 Series are based on 110% torque application.) The pre-calculated filter current may be different than the input current ratings of FC 100, FC 200 and FC 300 series as stated in the respective operating instructions, as these numbers are based on different operating conditions.

2.1.3 Ordering Numbers, 380 - 415V, 60Hz

Danfoss Frequency converter series *		Ordering Number		I _{AHF,N}
AQUA, HVAC, Automation HO	Automation NO	AHF 005	AHF 010	[AMP]
PK37-P4K		130B2540	130B2541	10 A
P5K5 - P7K5		130B2460	130B2472	19 A
P11K		130B2461	130B2473	26 A
P15K-P18K	P11K-P15K	130B2462	130B2474	35 A
P22K	P18K	130B2463	130B2475	43 A
P30K-P37K	P22K-P30K	130B2464	130B2476	72 A
P45K-P55K	P37K-P45K	130B2465	130B2477	101 A
P75K	P55K	130B2466	130B2478	144 A
P90K	P75K	130B2467	130B2479	180 A
P110	P90K	130B2468	130B2480	217 A
P132	P110	130B2469	130B2481	289 A
P160	P132	130B2470	130B2482	324 A
P200	P160	130B2471	130B2483	370 A
P250	P200	130B2468 + 130B2469	130B2480 + 130B2481	506 A
P315	P250	2 x 130B2469	2 x 130B2481	578 A
P355	P315	2 x 130B2470	2 x 130B2482	648 A

Table 2.3: AHF 005 and AHF 010, 380V - 415V, 60Hz

* Please note that the matching of the typical Danfoss frequency converter and filter is pre-calculated based on 400V and assuming typical motor load (4 or 2 pole motor). (FC 300 is based on an 160% torque application, while FC 100 and FC 200 Series are based on 110% torque application.) The pre-calculated filter current may be different than the input current ratings of FC 100, FC 200 and FC 300 series as stated in the respective operating instructions, as these numbers are based on different operating conditions.

2.1.4 Ordering Numbers, 440 - 480V, 60Hz

Danfoss Frequency Converter Series *		Ordering Number		I _{AHF,N}
AQUA, HVAC, Automation HO	Automation NO	AHF 005	AHF 010	[AMP]
PK37-P7K5		130B2538	130B2539	10 A
P11K		175G6612	175G6634	19 A
P15K	P11K	175G6613	175G6635	26 A
P18K-P22K	P15K	175G6614	175G6636	35 A
P30K	P18K-P22K	175G6615	175G6637	43 A
P37K-P45K	P30K-P37K	175G6616	175G6638	72 A
P55K	P45K	175G6617	175G6639	101 A
P75K-P90K	P55K-P75K	175G6618	175G6640	144 A
P110K	P90K	175G6619	175G6641	180 A
P132	P110	175G6620	175G6642	217 A
P160	P132	175G6621	175G6643	289 A
P200	P160	175G6689	175G6692	324 A
		175G6690	175G6693	370 A
P250	P200	2 x 175G6620	2 x 175G6642	434 A
P315-P355	P250-P315	2 x 175G6621	2 x 175G6643	578 A
P400	P355	175G6690 + 175G6621	175G6693 + 175G6643	659 A

Table 2.4: AHF005 and AHF010, 440 - 480V, 60Hz

* Please note that the matching of the typical Danfoss frequency converter and filter is pre-calculated based on 480V and assuming typical motor load. FC 300 is based on an 160% torque application, while FC 100 and FC 200 series are based on 110% torque application. The pre-calculated filter current may be varying from the input current ratings of FC 100, FC 200 and FC 300 series as stated in the respective operating instructions, as these numbers are based on different operating conditions.

2.1.5 Ordering Numbers, 500 - 525V, 50Hz

Danfoss Frequency Converter Series *		Ordering Number		I _{AHF,N}
AQUA, HVAC, Automation HO	Automation NO	AHF 005	AHF 010	[AMP]
PK75-P5K5		175G6644	175G6656	10 A
P7K5-P11K		175G6645	175G6657	19 A
P15K-P18K	P11K-P15K	175G6646	175G6658	26 A
P22K	P18K	175G6647	175G6659	35 A
P30K	P22K	175G6648	175G6660	43 A
P37K-P45K	P30K-P37K	175G6649	175G6661	72 A
P55K-P75K	P45K-P55K	175G6650	175G6662	101 A
P90K-P110	P75K-P90K	175G6651	175G6663	144 A
P132	P110	175G6652	175G6664	180 A
P160	P132	175G6653	175G6665	217 A
P200	P160	175G6654	175G6666	289 A
P250	P200	175G6655	175G6667	324 A
P315-P400	P250-P315	2 x 175G6653	2 x 175G6665	370 A
	P355	175G6652 + 175G6654	175G6664 + 175G6666	506 A
P500-P560	P400-P500	2 x 175G6654	2 x 175G6666	578 A

Table 2.5: AHF005 and AHF 010, 500-525V, 50Hz

* Please note that the matching of the typical Danfoss frequency converter and filter is pre-calculated based on 500V and assuming typical motor load. FC 300 is based on an 160% torque application, while FC 100 and FC 200 series are based on 110% torque application. The pre-calculated filter current may be varying from the input current ratings of FC 100, FC 200 and FC 300 series as stated in the respective operating instructions, as these numbers are based on different operating conditions.

2

2.1.6 Ordering Numbers, 690V, 50Hz

Danfoss Frequency Converter Series *		Ordering Number		I _{AHF,N}
AQUA, HVAC, Automation HO	Automation NO	AHF 005	AHF 010	[AMP]
		130B2328	130B2293	43 A
P37K-P45K	P37K	130B2330	130B2295	72 A
P55-P75K	P45K-P55K	130B2331	130B2296	101 A
P90K-P110	P75K-P90K	130B2333	130B2298	144 A
P132	P110	130B2334	130B2299	180 A
P160	P132	130B2335	130B2300	217 A
P200	P160	130B2331 + 130B2333	130B2301	289 A
P250	P200	130B2333 + 130B2334	130B2302	324 A
P315	P250	130B2331+ 130B2335	130B2304	370 A

Table 2.6: AHF005 and AHF010, 690V, 50Hz

* Please note that the matching of the typical Danfoss frequency converter and filter is pre-calculated based on 690V and assuming typical motor load. FC 300 is based on an 160% torque application, while FC 100 and FC 200 series are based on 110% torque application. The pre-calculated filter current may be varying from the input current ratings of FC 100, FC 200 and FC 300 series as stated in the respective operating instructions, as these numbers are based on different operating conditions.

2.1.7 Calculation of the Exact Filter Size Needed



NB!

For optimal performance the harmonic filter should be sized for the mains input current to the frequency converter, i.e. the input current drawn based on the expected load of the frequency converter and not the size of the frequency converter itself!

The mains input current to the frequency converter ($I_{FC,L}$) can be calculated using the nominal motor current ($I_{M,N}$) and displacement power factor ($\cos \varphi$) of the motor. Both data are normally printed on the nameplate of the motor. In the case where the nominal motor voltage ($U_{M,N}$) is unequal to the actual mains voltage (U_L) the calculated current must be corrected with the ratio between these voltages as shown in the equation below.

$$I_{FC,L} = 1.1 \times I_{M,N} \times \cos(\varphi) \times \left(\frac{U_{M,N}}{U_L} \right)$$

The harmonic filter chosen must have a nominal current ($I_{AHF,N}$) equal to or larger than the calculated frequency converter mains input current ($I_{FC,L}$).

If several frequency converters are to be connected to the same filter, the harmonic filter must be sized according to the sum of the calculated mains currents.



If the harmonic filter is sized for the load, and the motor of the corresponding frequency converter is changed, the current must be re-calculated to avoid overload of the harmonic filter.

3 Specifications

3.1.1 General Technical Data

		AHF 0xx	AHF 0xx	AHF 0xx	AHF 0xx	AHF 0xx
Nominal supply voltage	$U_{L,N}$ [V]	$380 \leq U_{L,N} \leq 415$	$380 \leq U_{L,N} \leq 415$	$440 \leq U_{L,N} \leq 480$	500 V	690 V
Tolerance of the actual supply voltage	U_L [V]	$342 \leq U_L \leq 456$	$342 \leq U_L \leq 456$	$396 \leq U_L \leq 528$	$450 \leq U_L \leq 550$	$621 \leq U_L \leq 759$
Supply frequency	$f_{L,N}$ [Hz]	$50 \pm 5 \%$	$60 \pm 5 \%$	$60 \pm 5 \%$	$50 \pm 5 \%$	$50 \pm 5 \%$
Overload capability				1,6 for 60s		
Efficiency	η [%]			$\sim 98,8 \%$		
THiD	[%]			AHF 005 < 5% AHF 010 < 10%		
$\cos \phi$ of I_L		0.5 cap 0.8 cap 0.85 cap 0.99 cap 1.00		at 25% $I_{AHF,N}$ at 50% $I_{AHF,N}$ at 75% $I_{AHF,N}$ at 100% $I_{AHF,N}$ at 150% $I_{AHF,N}$		
Power derating	$[\%/C]$ $[\%/m]$	$40^\circ C < T_a < 55^\circ C \Rightarrow 3\%/C$ 1000m altitude above sea level. < $h \leq 2500m$ altitude above sea level $\Rightarrow 5\%/1000m$				



NB!

The reduction of the low harmonic current emission to the rated THiD implies, that the THvD of the non-influenced mains voltage is lower than 2% and the ratio of short circuit power to installed load (R_{SCE}) is at least 66. Under these conditions the THiD of the mains current of the frequency converter is reduced to 10% or 5% (typical values at nominal load). If these conditions are not or only partially fulfilled, a significant reduction of the harmonic components can still be achieved, but the rated THiD values may not be achieved.

3.1.2 Environmental Data

Permissible temperature range*	During transport of the unit: -25°C...+70°C (to EN 50178) During storage of the unit: -25°C...+55°C (to EN 50178) During operation of the unit: 5°C...+40°C without power derating 5°C...+55°C with power derating
Humidity class*	Humidity class F without condensation (5% - 85% relative humidity)
Installation height h*	H ≤ 1000 m altitude above sea level without power derating 1000 m < h ≤ 2500 m altitude above sea level with power derating
Degree of pollution	VDE 0110 Part 2 degree 2
Insulation strength	Overvoltage category III according to VDE 0110
Packaging	DIN 55468 for transport packaging materials
Type of protection	IP 20
Approvals	CE: Low-Voltage Directive; UL

Table 3.1: Environmental data

*climatic conditions according to class 3K3 (EN 50178 Part 6.1)

3.1.3 Dimensions/Weight

The AHF modules are available in seven frame sizes (size B to H).

For dimensions see the drawings on the following pages

3

AHF 005, 380 – 415 V AC, 50Hz			AHF 010, 380– 415 V AC, 50Hz		
I _{AHF,N}	Frame size	Weight	I _{AHF,N}	Frame size	Weight
10 A	B	20 Kg (44 lbs)	10 A	B	15 Kg (33 lbs)
19 A	C	31 Kg (68 lbs)	19 A	B	19 Kg (42 lbs)
26 A	C	31 Kg (68 lbs)	26 A	B	24 Kg (52 lbs)
35 A	C	49 Kg (108 lbs)	35 A	C	38 Kg (84 lbs)
43 A	D	60 Kg (132 lbs)	43 A	C	45 Kg (99 lbs)
72 A	D	81 Kg (178 lbs)	72 A	D	64 Kg (141 lbs)
101 A	E	128 Kg (282 lbs)	101 A	D	80 Kg (176 lbs)
144 A	E	165 Kg (364 lbs)	144 A	D	101 Kg (222 lbs)
180 A	F	197 Kg (434 lbs)	180 A	E	134 Kg (295 lbs)
217 A	F	228 Kg (503 lbs)	217 A	E	159 Kg (350 lbs)
289 A	G	269 Kg (593 lbs)	289 A	F	180 Kg (396 lbs)
324 A	G	309 Kg (681 lbs)	324 A	F	233 Kg (513 lbs)
370 A	H	345 Kg (760 lbs)	370 A	G	252 Kg (555 lbs)

AHF 005, 380 – 415 V AC, 60Hz			AHF 010, 380 – 415 V AC, 60Hz		
I _{AHF,N}	Frame size	Weight	I _{AHF,N}	Frame size	Weight
10 A	B	20 kg (44 lbs)	10 A	B	15 kg (33 lbs)
19 A	C	32 kg (71 lbs)	19 A	B	20 kg (44 lbs)
26 A	C	43 kg (95 lbs)	26 A	B	25 kg (55 lbs)
35 A	C	50 kg (110 lbs)	35 A	C	38 kg (84 lbs)
43 A	D	60 kg (132 lbs)	43 A	C	45 kg (99 lbs)
72 A	D	82 kg (181 lbs)	72 A	D	64 kg (141 lbs)
101 A	E	129 kg (284 lbs)	101 A	D	81 kg (178 lbs)
144 A	E	167 kg (368 lbs)	144 A	D	103 kg (227 lbs)
180 A	F	200 kg (441 lbs)	180 A	E	135 kg (297 lbs)
217 A	F	230 kg (507 lbs)	217 A	E	161 kg (355 lbs)
289 A	G	272 kg (600 lbs)	289 A	F	191 kg (421 lbs)
324 A	G	306 kg (675 lbs)	324 A	F	232 kg (511 lbs)
370 A	H	348 kg (767 lbs)	370 A	G	245 kg (540 lbs)

AHF 005, 440 – 480 V AC, 60Hz			AHF 010, 440 – 480 V AC, 60Hz		
I _{AHF,N}	Frame size	Weight	I _{AHF,N}	Frame size	Weight
10 A	B	20 kg (44 lbs)	10 A	B	15 kg (33 lbs)
19 A	C	32 kg (71 lbs)	19 A	B	20 kg (44 lbs)
26 A	C	43 kg (95 lbs)	26 A	B	25 kg (55 lbs)
35 A	C	50 kg (110 lbs)	35 A	C	38 kg (84 lbs)
43 A	D	60 kg (132 lbs)	43 A	C	45 kg (99 lbs)
72 A	D	82 kg (181 lbs)	72 A	D	64 kg (141 lbs)
101 A	E	129 kg (284 lbs)	101 A	D	81 kg (178 lbs)
144 A	E	167 kg (368 lbs)	144 A	D	103 kg (227 lbs)
180 A	F	200 kg (441 lbs)	180 A	E	135 kg (297 lbs)
217 A	F	230 kg (507 lbs)	217 A	E	161 kg (355 lbs)
289 A	G	272 kg (600 lbs)	289 A	F	191 kg (421 lbs)
324 A	G	306 kg (675 lbs)	324 A	F	232 kg (511 lbs)
370 A	H	348 kg (767 lbs)	370 A	G	245 kg (540 lbs)

AHF 005, 500 - 525 V AC, 50Hz			AHF 010, 500 - 525 V AC, 50Hz		
I _{AHF,N}	Frame size	Weight	I _{AHF,N}	Frame size	Weight
10 A	B	22 Kg (48 lbs)	10 A	B	17 Kg (37 lbs)
19 A	C	35 Kg (77 lbs)	19 A	B	21 Kg (46 lbs)
26 A	C	49 Kg (108 lbs)	26 A	B	28 Kg (62 lbs)
35 A	C	55 Kg (121 lbs)	35 A	C	42 Kg (93 lbs)
43 A	D	67 Kg (147 lbs)	43 A	D	47 Kg (104 lbs)
72 A	E	82 Kg (181 lbs)	72 A	D	69 Kg (152 lbs)
101 A	E	144 Kg (317 lbs)	101 A	D	91 Kg (200 lbs)
144 A	E	187 Kg (412 lbs)	144 A	E	131 Kg (289 lbs)
180 A	F	226 Kg (498 lbs)	180 A	E	147 Kg (324 lbs)
217 A	F	262 Kg (578 lbs)	217 A	F	185 Kg (408 lbs)
289 A	G	309 Kg (681 lbs)	289 A	F	209 Kg (461 lbs)
324 A	G	348 Kg (767 lbs)	324 A	G	256 Kg (564 lbs)

AHF 005, 690V AC, 50Hz			AHF 010, 690 V AC, 50Hz		
IAHF,N	Frame size	Weight	IAHF,N	Frame size	Weight
43 A	D	85 kg (187 lbs)	43 A	D	65 kg (143 lbs)
72 A	E	100 kg (220 lbs)	72 A	D	75 kg (165 lbs)
101 A	F	130 kg (287 lbs)	101 A	E	95 kg (209 lbs)
144 A	G	160 kg (353 lbs)	144 A	E	125 kg (275 lbs)
180 A	G	200 kg (441 lbs)	180 A	F	140 kg (309 lbs)
217 A	H	300 kg (661 lbs)	217 A	G	180 kg (397 lbs)
			289 A	G	200 kg (441 lbs)
			324 A	H	250 kg (551 lbs)
			370 A	H	300 kg (661 lbs)

3.1.4 Dimension Diagrams

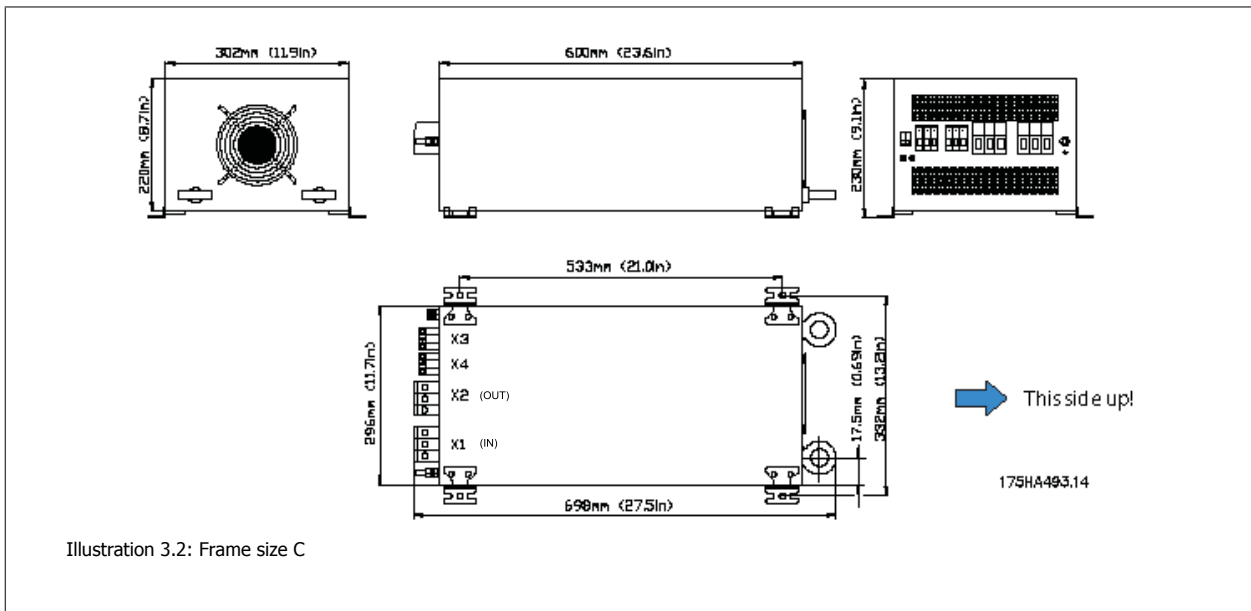
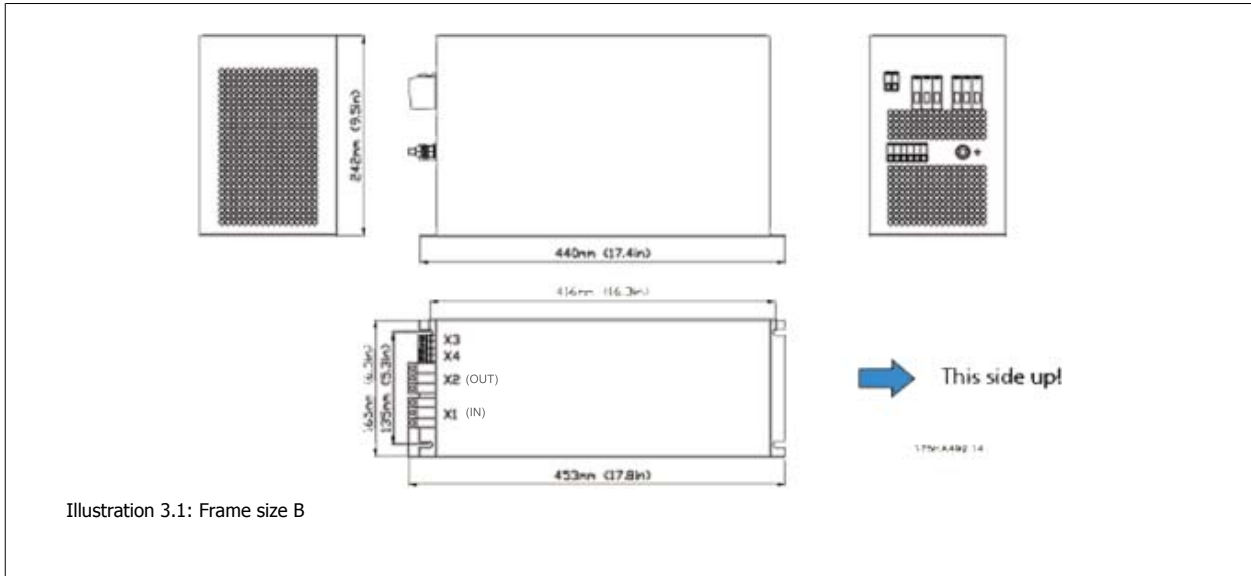

3

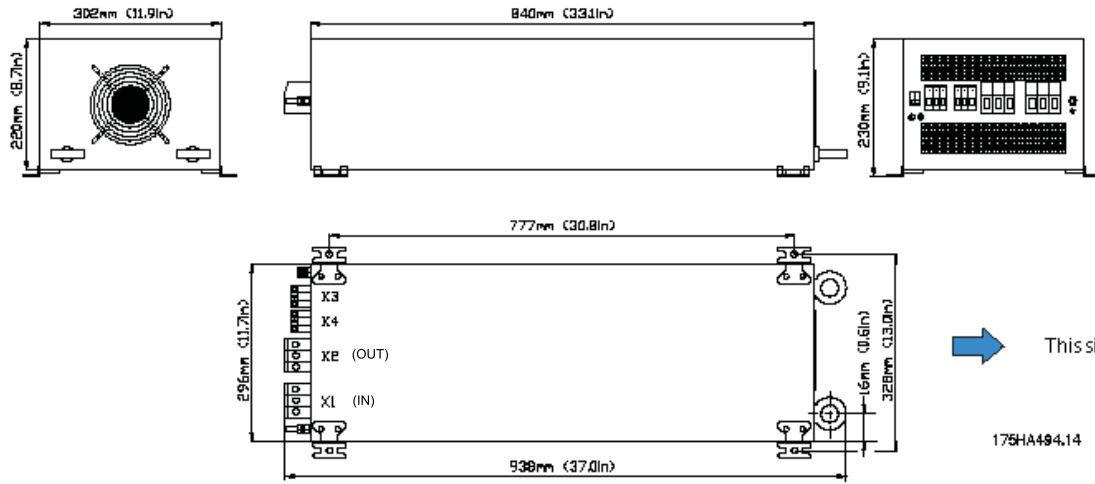

Illustration 3.3: Frame size D

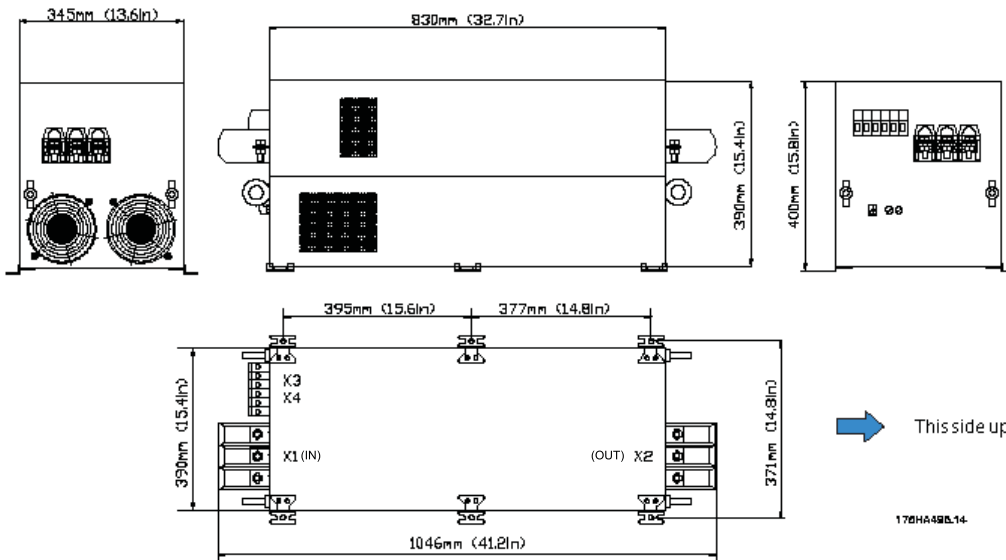
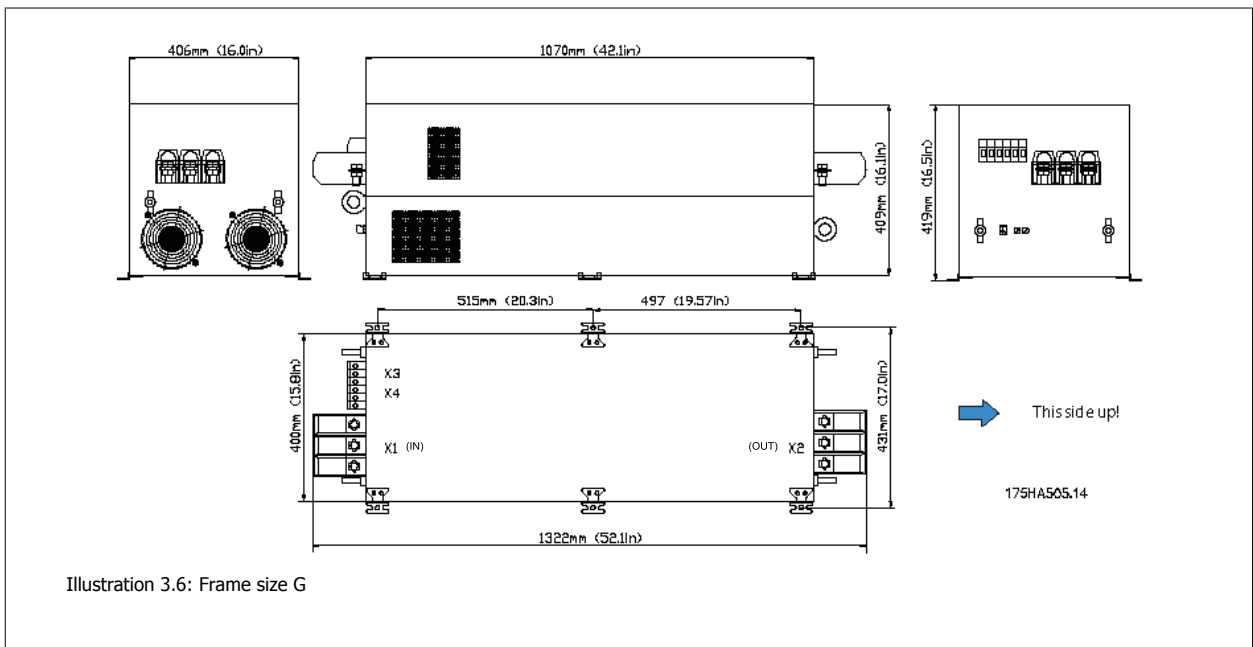
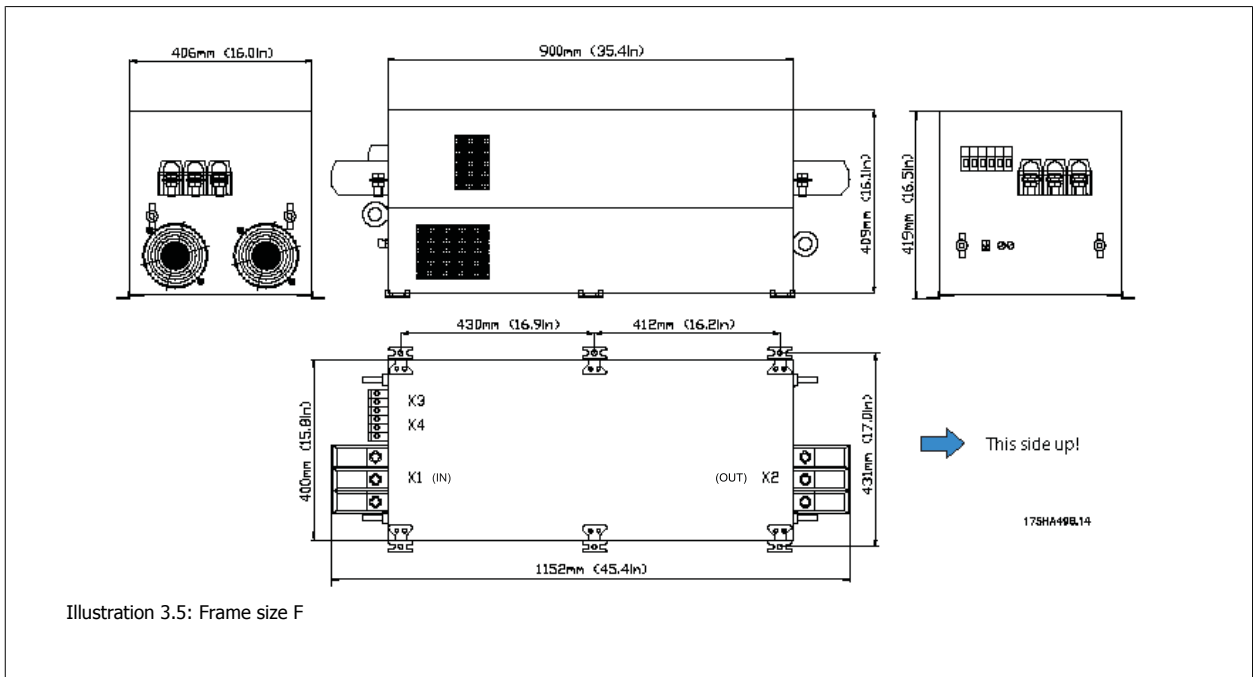

Illustration 3.4: Frame size E



3

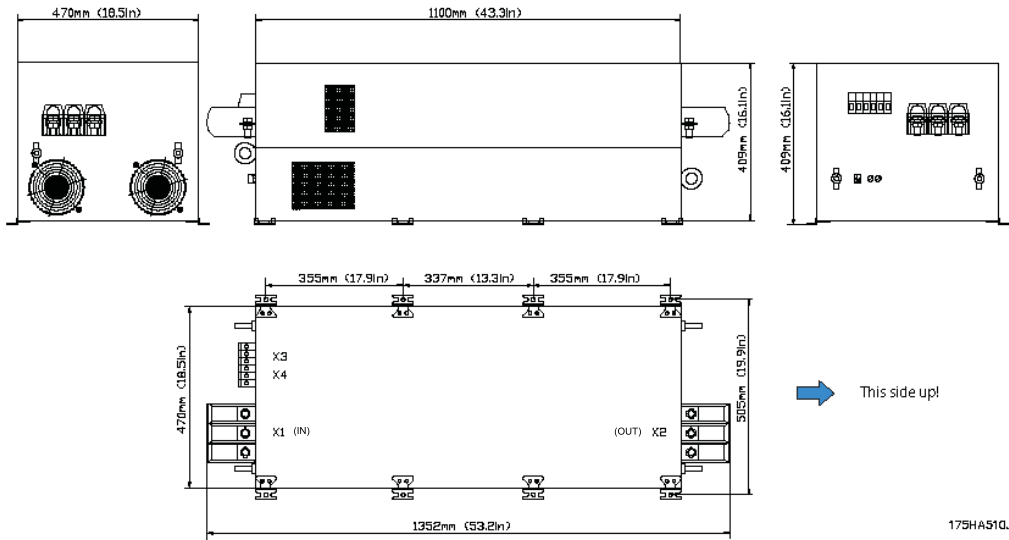

Illustration 3.7: Frame size H

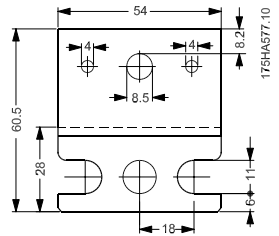

Illustration 3.8: Detailed drawing of mounting feet.



NB!
Please allow an additional 30 mm of depth of the filter for the mounting feet.



NB!
Filter frame E-H should only be transported upright, i.e. by using the lifting hooks.

4 Installation

4.1.1 Mechanical Installation

The encapsulation of the filters have an IP 20 rating. The filters can be mounted side by side with 60 mm (2,36 inches) clearance.

To other components and to the cabinet walls keep a horizontal clearance of at least 70 mm (2,76 inches) and a vertical clearance of at least 150 mm (5,91 inches).

Only vertical installation is allowed (mains terminal at bottom).

For versions with bus bars (frame size E – H) it is necessary to mount the added covers to the connectors in order to achieve the protection type IP 20.

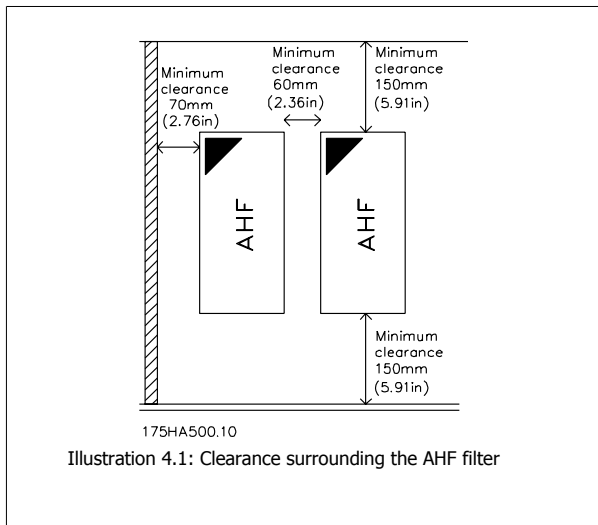

4

Below picture series shows mounting principles. All filters in frame E to H have to be mounted with an added terminal kit to comply with IP20 enclosure rating. Please make sure that the terminal plastic cover back plate (see photo below) is mounted and fixed correctly before adding the terminal cover.

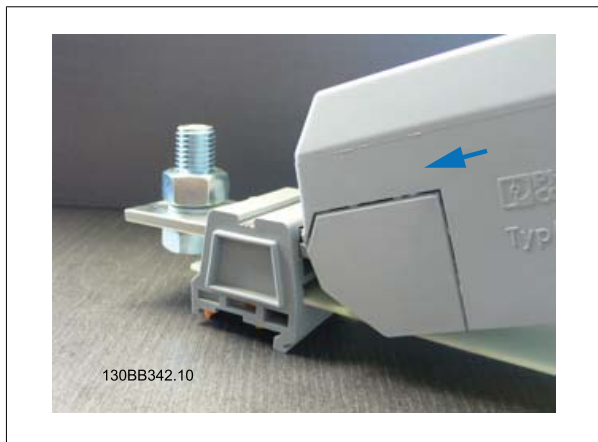
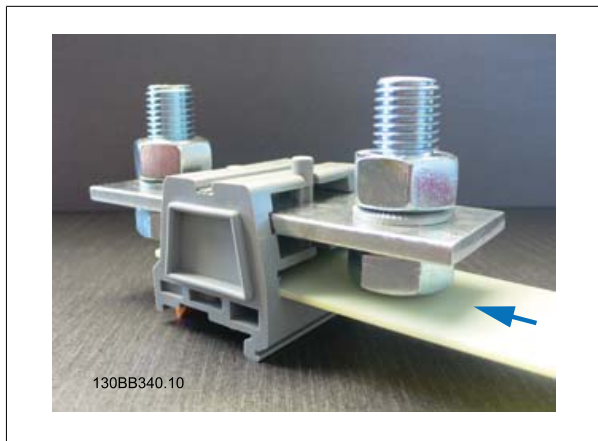
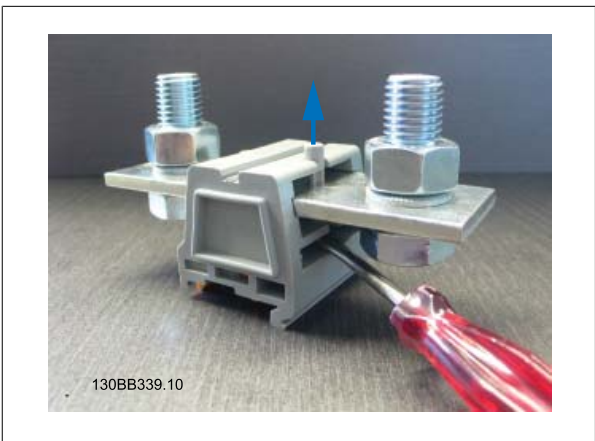

**NB!**

Unit does not comply with IP20 rating if plastic back plate or terminal cover is omitted.

4.1.2 Ventilation

The filters are cooled by means of air circulation. Consequently, the air needs to be able to move freely above and below the filter module. The efficiency of the filter modules is greater than 0.98. When installing a filter module in a panel or another enclosure, ensure there is sufficient airflow through the enclosure to limit heat rise in the enclosure.

4

	AHF 0xx, 380 – 415V, 50 Hz Max. Heat	AHF 0xx, 380 – 415V, 60 Hz Max. Heat	AHF 0xx, 440 – 480V, 60 Hz Max. Heat	AHF 0xx, 500V - 525V, 50 Hz Max. Heat	AHF 0xx, 690V, 50 Hz Max. Heat
10 A	83 W			104 W	
19 A	158 W	190 W	190 W	197 W	
26 A	216 W	259 W	259 W	270 W	
35 A	290 W	349 W	349 W	364 W	
43 A	358 W	429 W	429 W	447 W	617 W
72 A	599 W	718 W	718 W	748 W	1033 W
101 A	840 W	1008 W	1008 W	1050 W	1448 W
144 A	1197 W	1437 W	1437 W	1496 W	2065 W
180 A	1496 W	1796 W	1796 W	1871 W	2581 W
217 A	1804 W	2165 W	2165 W	2255 W	3112 W
289 A	2403 W	2883 W	2883 W	3003 W	4145 W
324 A	2694 W	3232 W	3232 W	3367 W	4646 W
370 A	3076 W	3691 W	3691 W		5306 W

Table 4.1: Max. heat losses at full load under-voltage.

**NB!**

If other heat sources (e.g. Danfoss frequency converters) are installed in an enclosure with the harmonic filter AHF 0xx, this heat generation must also be considered when calculating required airflow

**NB!**

If the cooling air is polluted (dust, dirt swirl, grease, aggressive gas) the function of the filter module may be impeded. Ensure sufficient countermeasures, e.g. separate cooling air, mounting of air filters, periodical cleaning.

4.1.3 Cable lengths and cross sections

The installation of our frequency converters in combination with AHF filters allow for a high freedom of installation flexibility. Cable cross section has to be in accordance with data in the table below and cable length has to be limited to 50 meters. It is advised to use unscreened cables between the AHF filter and the drive.

Power wiring

Standard connection

Supply voltage must be connected to the terminals X1.1, X1.2 and X1.3. The frequency converter supply terminals L1, L2 and L3 must be connected to the filter module terminals X2.1, X2.2 and X2.3.

Paralleling of FC's

If several frequency converters are to be connected to the harmonic filter, the connection is similar to the standard connection - The supply terminals L1, L2 and L3 of several frequency converters must be connected to the filter module terminals X2.1, X2.2 and X2.3.



NB!
If several VLT frequency converters are to be connected to the same filter, the harmonic filter must be sized according to the sum of the calculated input current to the VLT frequency converters.

Filters in parallel

If the mains input current of the frequency converter exceeds the nominal current of the largest harmonic filter, several harmonic filters can be paralleled to achieve the necessary rating. Supply voltage must be connected to the terminals X1.1, X1.2 and X1.3 of the filters. The frequency converter supply terminals L1, L2 and L3 must be connected to the filter modules terminals X2.1, X2.2 and X2.3.



NB!
Filters of different current ratings can be wired in parallel. The rating of the filter becomes the sum of the individual current ratings.

Power wiring size

Enclosure	Max. cable size mm ²	AWG	Type	Nom. Fix Torque [Nm]
B	16	6	Connector	2
C and D	50	1	Connector	6
E	*	*	Bus bars	25
F, G and H	*	*	Bus bars	25

Table 4.2: Power wiring size

Enclosure	Max. cable size mm ²	AWG	Type	Nom. Fix Torque [Nm]
B - H	4		Connector	0.6

Table 4.3: Overheat contactor (copper)

NB!
Please consult the drive design guide to find the maximum allowed cable length between a terminal protection (PTC) and the drive input.

Enclosure	Max. cable size mm ²	AWG	Type	Nom. Fix Torque
B	4	10	Connector	0.6 Nm
C and D	16	6	Connector	2 Nm
E, F, G and H	50	1	Connector	6 Nm

Table 4.4: Capacitor disconnect (copper)

NB!
The cable length between the filter and the capacitor disconnect contactor has to be as short as possible in order to reduce the impedance influence of the cable. A maximum cable length of 2 meters are allowed between filter and contactor.

* Power wiring used for connection of the filter AHF 005 and AHF 010 in enclosure size E, F and G must be terminated with cable lugs that can be attached to the input and output bus bars terminals. This type of termination imposes no specifications of the minimum and maximum cable size suitable for connection. Power terminal details regarding the bus bars can be found in the figures below.



NB!
Do not fix the nut without using a second wrench for the screw.
If this is not observed, it might be possible to tear out the terminal when fixing the nut.

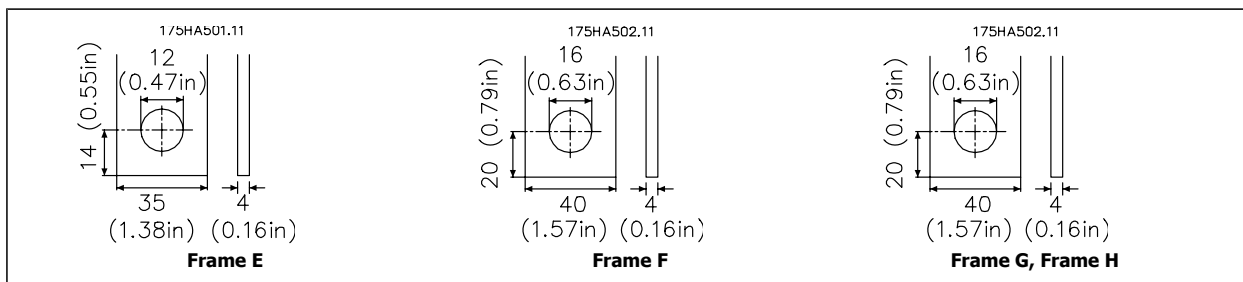

4



NB!
For UL approval use copper conductor only.

4.1.4 Capacitor Disconnect

The power factor of the harmonic filter AHF 005/010 is decreasing with decreasing load. At zero load the Power Factor becomes zero and the capacitors produce approximately 30% leading current compared to the rated current of the filter. The reactive current generated by the filter at partial load is normally not of any concern, mainly because of the small current compared to the system capacity (max. 30%) as well as the fact that other load normally compensates the capacitive current.

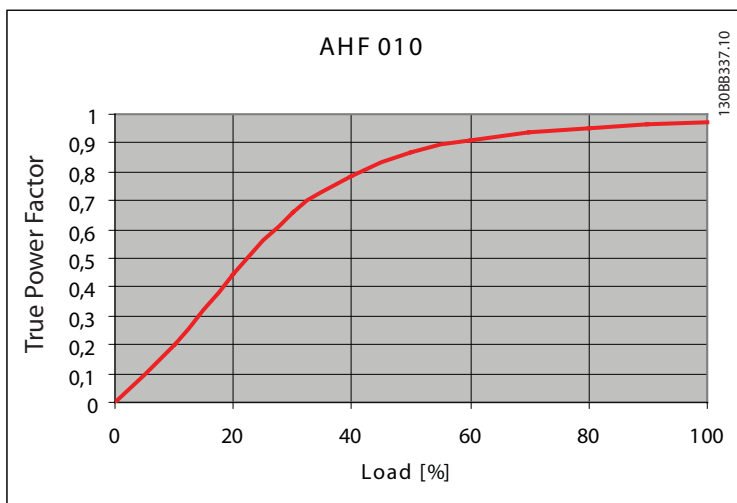

Illustration 4.2: Power Factor as a function of load.

In applications where this reactive current may not be accepted, Terminals X3.1, X3.2, X3.3 and X4.1, X4, X4.3 are giving access to the filter capacitors. As default (on delivery) the wiring will shorten Terminal X3.1 with X4.1, X3.2 with X4.2 and X3.3 with X4.3. In the case of that no capacitor disconnect is required no changes should be made. If capacitor disconnect is required a three-phase contactor should be placed between terminals X3 and X4.

Size the contactor and wiring according to below table. It is recommended only to use contactors with damping resistors.



NB!
It is not allowed to use one common 3 poled contactor in several paralleled AHF at once to disconnect the capacitors.

I _{AHF,N}	380 - 415V	380 - 415V	440 - 480V	500 - 525V	690V
	50Hz	60Hz	60Hz	50Hz	50Hz
	Contactor Rating	Contactor Rating	Contactor Rating	Contactor Rating	Contactor Rating
	kVAr	kVAr	kVAr	kVAr	kVAr
10 A	2			2	
19 A	4	5	5	4	
26 A	6	7	7	6	
35 A	7	9	10	8	
43 A	9	11	12	11	16
72 A	15	18	20	18	27
101 A	22	26	27	25	34
144 A	29	35	39	35	50
180 A	37	44	51	46	61
217 A	44	53	69	53	79
289 A	58	70	78	74	101
324 A	66	79	87	85	121
370 A	73	88	99		135

Table 4.5: Capacitor disconnect ratings.



NB!
Only switch the contactor at less than 20% output power. Allow minimum 240 seconds for the capacitors to discharge before turning on again.



Only use cables complying with local regulations.

4

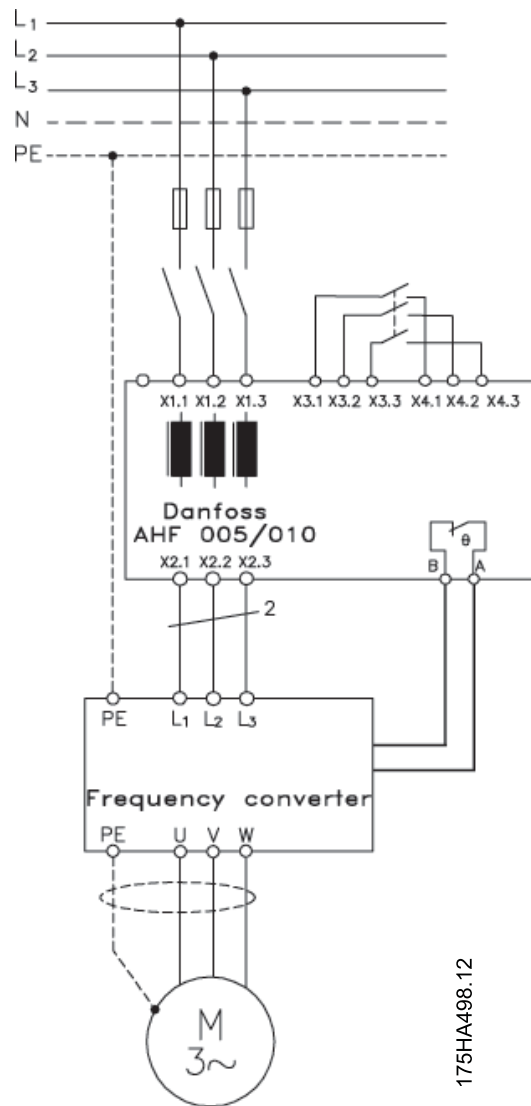

Illustration 4.3: Connection diagram of filter and frequency converter assembly.



AB terminals are not Protected Extra Low Voltage (PELV).

4.1.5 Fuses

In order to protect the installation against electrical and fire hazards, all filters in an installation must be short-circuited and over-current protected according to national/international regulations. The filter must be protected against short-circuit and overload to avoid electrical or fire hazard and to protect cables and filter from overheating. Danfoss recommends using fuses mentioned below to protect service personnel and equipment in case of an internal failure in the filter.

Both filter and drive have to be connected against overload. If several frequency converters are to be connected to the one common harmonic filter, it might be necessary to install fuses in front of both filter and drives.

In case of paralleled filter installation it might be necessary to install filters in front of each drive as well as in front of the entire installation to protect both individual filters and drives.



I_{AHF,N} [Amp]	Ordering Number AHF 005	Ordering Number AHF 010	Max Fuse Rating [Amp]
10	175G6600	175G6622	16
19	175G6601	175G6623	35
26	175G6602	175G6624	50
35	175G6603	175G6625	50
43	175G6604	175G6626	63
72	175G6605	175G6627	125
101	175G6606	175G6628	160
144	175G6607	175G6629	250
180	175G6608	175G6630	315
217	175G6609	175G6631	315
289	175G6610	175G6632	500
324	175G6611	175G6633	500
370	175G6688	175G6691	630

Table 4.6: AHF005 and AHF010, 380-415V, 50Hz

I_{AHF,N} [Amp]	Ordering Number AHF 005	Ordering Number AHF 010	Max Fuse Rating [Amp]
19	130B2460	130B2472	35
26	130B2461	130B2473	50
35	130B2462	130B2474	50
43	130B2463	130B2475	63
72	130B2464	130B2476	125
101	130B2465	130B2477	160
144	130B2466	130B2478	250
180	130B2467	130B2479	315
217	130B2468	130B2480	315
289	130B2469	130B2481	500
324	130B2470	130B2482	500
370	130B2471	130B2483	630

Table 4.7: AHF005 and AHF010, 380-415V, 60Hz

I_{AHF,N} [Amp]	Ordering Number AHF 005	Ordering nNumber AHF 010	Max Fuse Rating [Amp]
19	175G6612	175G6634	35
26	175G6613	175G6635	50
35	175G6614	175G6636	50
43	175G6615	175G6637	63
72	175G6616	175G6638	125
101	175G6617	175G6639	160
144	175G6618	175G6640	250
180	175G6619	175G6641	315
217	175G6620	175G6642	315
289	175G6621	175G6643	500
324	175G6689	175G6692	500
370	175G6690	175G6693	630

Table 4.8: AHF005 and AHF010, 440-480V, 60Hz

4

I_{AHF,N} [Amp]	Ordering Number AHF 005	Ordering Number AHF 010	Max Fuse Rating [Amp]
10	175G6644	175G6656	16
19	175G6645	175G6657	35
26	175G6646	175G6658	50
35	175G6647	175G6659	50
43	175G6648	175G6660	63
72	175G6649	175G6661	125
101	175G6650	175G6662	160
144	175G6651	175G6663	250
180	175G6652	175G6664	315
217	175G6653	175G6665	315
289	175G6654	175G6666	500
324	175G6655	175G6667	500

Table 4.9: AHF005 and AHF010, 500-525V, 50Hz

I_{AHF,N} [Amp]	Ordering Number AHF 005	Ordering Number AHF 010	Max Fuse Rating [Amp]
43	130B2328	130B2293	63
72	130B2330	130B2295	125
101	130B2331	130B2296	160
144	130B2333	130B2298	250
180	130B2334	130B2299	315
217	130B2335	130B2300	315
289		130B2301	500
324		130B2302	500
370		130B2304	630

Table 4.10: AHF005 and AHF010, 690V, 50Hz



NB!
See the section on fuses in the *Design Guide*.

4.1.6 Over Temperature Switch

The Danfoss harmonic filters AHF 005 and AHF 010 are equipped with a galvanic isolated thermal switch (not PELV), that is closed under normal operating conditions and open if the filter is overheated.

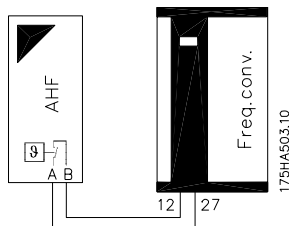

Example: Connect terminal A of the harmonic filter to terminal 12 or 13 (voltage supply digital input, 24V) of the Danfoss frequency converter and terminal B to terminal 27 (digital input "Coast Inverse") the frequency converter will let go of the motor (coasting) and thereby unload the filter if an over temperature is detected.



When connecting the A/B terminals directly to terminal 12 and 27 of the drive, Protective Extra Low Voltage (PELV) can no longer be guaranteed!



NB!
A controlled ramp down within 30 s is allowed without causing overheat damage to the filter.

The maximum rating of the over temperature contactor is 250V AC and 10A.

The switch must be used to prevent damage to the filter caused by over temperature.

4

4.1.7 Operation on Different Mains Type

Mains type		Operation of the filter module
TN/TT	Directly grounded star point	Allowed
TN	Indirectly grounded star point	Allowed
IT	Isolated net star/delta point	Allowed

Table 4.11: Different mains types

The filter has been designed completely symmetrically for three phase operation and without reference to the star point or protective earth.

4.1.8 Typical Installation in a Panel or Other Enclosures

To avoid high frequency noise coupling keep a minimum distance of 150 mm (5.91 inches) to:

- a) mains/supply wires
- b) motor wires of frequency converter
- c) control- and signal wires (voltage range < 48 V)

To obtain low resistive HF-connections, grounding, screening and other metallic connections (e. g. mounting plates, mounted units) should have a surface as large as possible to metallic ground. Use grounding and potential equalisation wires with a cross section as large as possible (min. 10mm²) or thick grounding tapes.

Use copper or tinned copper screened wires only, as steel screened wires are not suitable for high frequency applications. Connect the screen with metal clamps or metal glands to the equalisation bars or PE-connections.

Inductive switching units (relay, magnetic contactor etc.) must always be equipped with varistors, RC-circuits or suppressor diodes.

4

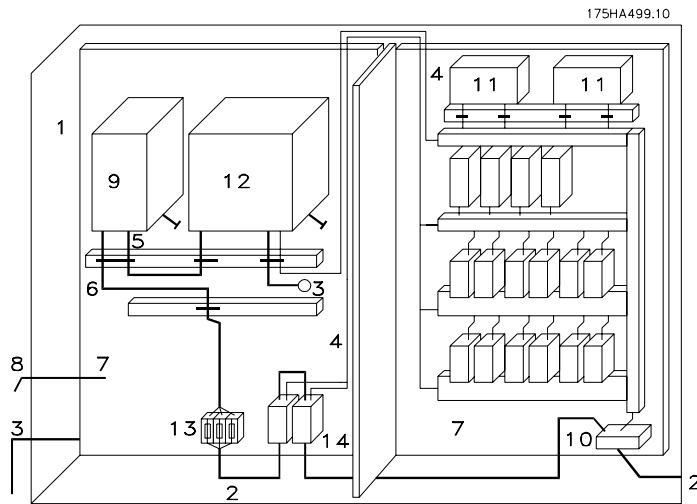

Illustration 4.4: Typical panel installation

1. Panel
2. Mains supply wire
3. Motor wiring
4. Control wiring
5. Wiring between harmonic filter and frequency converter
6. Mains supply wire of filter module
7. Mounting plate (common star point)
8. Potential equalisation
9. Filter AHF 0xx
10. Mains connection
11. PLC
12. Frequency converter
13. Mains fuses
14. Mains circuit breaker

5 Commissioning



Prior to initial switch-on of the filter check the wiring for completeness, short-circuit and earth fault.



If the wiring is not correct, a non-intended operation of controller and/or filter is possible.

First powering up

1. Switch on mains supply :
 - The filter is ready for operation at once.
2. Check the readiness of the frequency converter:
 - Proceed in accordance with the operating instructions of the frequency converter.

6

6 Appendix: Safety and Application Notes

6.1.1 General

During operation, filter module units may have, according to their type of protection, live, bare, in some cases also movable or rotating parts as well as internal hot surfaces.

Non - authorized removal of required cover, inappropriate use, incorrect installation or operation, creates the risk of severe injury to persons or damage to material assets.

Further information can be obtained from the documentation.

All operations concerning transport, installation and commissioning as well as maintenance must be carried out by qualified, skilled personnel (IEC 60364 and CENELEC HD 384 or IEC 60364 and IEC-Report 664 or DIN VDE 0110 and national regulations for the preventions of accidents must be observed).

According to this basic safety information qualified skilled personnel are persons who are familiar with the erection, assembly, commissioning and operation of the product and who have the qualifications necessary for their occupation .

6

6.1.2 Application as Directed

Filters are components, which are designed for installation in electrical systems or machinery.

When installing in machines, commissioning of the filter modules (i.e. the starting of operation as directed) is prohibited until it is proven, that the machine corresponds to the regulations of the EC Directive 83/392/EEC (Machinery Directive); EN 60204 must be observed.

Commissioning (i.e. starting operation as directed) is only allowed when there is compliance with the EMC-Directive 89/336/EEC.

The filter modules meet the requirements of the Low-Voltage Directive 73/23/EEC. The technical data and information on the connection conditions must be obtained from the nameplate and the documentation and must be observed in all cases.

6.1.3 Transport and Storage

Notes on transport, storage and appropriate handling must be observed.

The filter modules have to be protected from inadmissible stress. In particular; during transport and handling: Components are not allowed to be bent. Distance between isolation must not be altered. The units are equipped with electrostatic sensitive devices, which may be damaged by improper handling. Therefore it has to be avoided to get in contact with electronic components. If electronic components are damaged mechanically the unit must not be put into operation, as it cannot be ensured, that all relevant standards are observed. Climatic conditions must be observed according to EN 50178.

6.1.4 Installation

The devices must be erected and cooled according to the regulations of the corresponding documentation.

The filters must be protected from inappropriate loads. In particular; during transport and handling: Components are not allowed to be bent. Distance between isolation must not be altered. Touching of electronic components and contacts must be avoided.

Filters contain electro-static sensitive components, which can be easily damaged by inappropriate handling. Electrical components must not be damaged or destroyed mechanically (health risks are possible!).

6.1.5 Electrical Installation

When working on live filters, the valid national regulations for the prevention of accidents (e.g. VBG 4) must be observed. Before any installation or connection works, the plant has to be switched off and to be secured properly.

The electrical installation must be carried out according to the appropriate regulations (e.g. cable cross-sections, fuses, PE-connection). More detailed information is included in the documentation. When using the filter module with frequency converters without safe separation from the supply line (to VDE 0100) all control wiring has to be included in further protective measures (e.g. double insulated or shielded, grounded and insulated).

6.1.6 Operation

Systems where filter modules are installed, if applicable, have to be equipped with additional monitoring and protective devices according to the valid safety regulations e.g. law on technical tools, regulations for the prevention of accidents, etc.

After disconnecting the filter module from the supply voltage, live parts of the filter module and power connections must not be touched immediately, due to the possibility of charged capacitors.

6

During operation, all covers and doors must be closed.

6.1.7 Maintenance and Service

The manufacturer's documentation must be observed.

This safety information must be kept!

The product-specific safety and application notes in these Operating Instructions must also be observed!

Index

A

Application As Directed	27
Avoid Filter Module Damage	4

C

Cable Lengths And Cross Sections	16
Calculation Of The Exact Filter Size Needed	8
Capacitor Disconnect	18
Capacitor Disconnect (copper)	17
Capacitor Disconnect Ratings	19
Commissioning	25

D

Description	5
Dimension Diagrams	11
Dimensions/weight	10

E

Electrical Installation	28
Environmental Data	9

F

Filters In Parallel	17
Fuses	21

G

General	27
General Technical Data	9

I

Installation	27
--------------	----

M

Maintenance And Service	28
Mechanical Installation	15
Mounting Sequence Terminal Covers	15

O

Operation	28
Operation On Different Mains Type	23
Operator's Safety	3
Ordering Numbers, 380 - 415v, 50hz	6
Ordering Numbers, 380 - 415v, 60hz	6
Ordering Numbers, 440 - 480v, 60hz	7
Ordering Numbers, 500 - 525v, 50hz	7
Ordering Numbers, 690v, 50hz	8
Over Temperature Switch	22
Overheat Contactor (copper)	17

P

Power Wiring	16
Principle Connection Diagram Of The Ahf Harmonic Filter.	5

S

Specifications	9
Symbols Used In This Manual	3

T

Transport And Storage	27
Typical Installation In A Panel Or Other Enclosures	23

V

Ventilation	16
-------------	----

W

Warnings	3
----------	---