

Chapter 1	<ul style="list-style-type: none"> ■ Introduction 3 About this manual 3 Assumptions 3 Background knowledge 3 Additional literature 4
Chapter 2	<ul style="list-style-type: none"> ■ Quick start 5 Profibus DP 5
Chapter 3	<ul style="list-style-type: none"> ■ The PROFIBUS option card 6 Master-controlled drives 6 Cable lengths and number of nodes 6 Physical connection 7 LEDs 9 Address switches 10
Chapter 4	<ul style="list-style-type: none"> ■ Timing 12 VLT response time behaviour 12 Time behaviour during system updates 12
Chapter 5	<ul style="list-style-type: none"> ■ PPO description 13 Communication connections 13 PPO description (overview) 13
Chapter 6	<ul style="list-style-type: none"> ■ PCA interface 14
Chapter 7	<ul style="list-style-type: none"> ■ Parameters and data type structures 15
Chapter 8	<ul style="list-style-type: none"> ■ Spontaneous messages 17
Chapter 9	<ul style="list-style-type: none"> ■ SYNC and FREEZE 17
Chapter 10	<ul style="list-style-type: none"> ■ Control word/status word 19
Chapter 11	<ul style="list-style-type: none"> ■ Bus reference value 24
Chapter 12	<ul style="list-style-type: none"> ■ Examples 25 Example 1: PCV portion and control word / reference value 25 Example 2: Process data from the VLT 27 Example 3: Array treatment 28
Chapter 13	<ul style="list-style-type: none"> ■ GSD file 29
Chapter 14	<ul style="list-style-type: none"> ■ Parameters 30
Chapter 15	<ul style="list-style-type: none"> ■ Warning and alarm messages 38 Warning and alarm messages 38 Spontaneous messages 38 Additional display readings 39
Chapter 16	<ul style="list-style-type: none"> ■ Parameter list 40
Chapter 17	<ul style="list-style-type: none"> ■ Appendix 47 Glossary 47 Abbreviations used 48 Subject index 49

■ Introduction

Copyrights, Limitation of Liability and Revision Rights

This publication contains information proprietary to Danfoss A/S. By accepting and using this manual the user agrees that the information contained herein will be used solely for operating equipment of Danfoss A/S or equipment from other vendors provided that such equipment is intended for communication with Danfoss equipment over a INTERBUS serial communication link. This publication is protected under the Copyright laws of Denmark and most other countries.

Danfoss A/S does not warrant that a software program produced according to the guidelines provided in this manual will function properly in every physical, hardware or software environment.

Although Danfoss A/S has tested and reviewed the documentation within this manual, Danfoss A/S makes no warranty or representation, either express or implied, with respect to this documentation, including its quality, performance, or fitness for a particular purpose.

In no event shall Danfoss A/S be liable for direct, indirect, special, incidental, or consequential damages arising out of the use, or the inability to use information contained in this manual, even if advised of the possibility of such damages. In particular, Danfoss A/S is not responsible for any costs including but not limited to those incurred as a result of lost profits or revenue, loss or damage of equipment, loss of computer programs, loss of data, the costs to substitute these, or any claims by third parties.

Danfoss A/S reserves the right to revise this publication at any time and to make changes in its contents without prior notice or any obligation to notify previous users of such revisions or changes.

**NB!**

Note regarding Profibus FMS

This manual does not deal with Profibus FMS, only with Profibus DP. However, in the event that the communication is to be built up through Profibus FMS, you should request the description MG.10.E3.yy "Profibus Product Manual" which also contains a description of the Profibus FMS functions of the Profibus option card.

■ About this manual

This manual is intended as both an instruction manual and a reference guide. It only broaches the basics of the PROFIBUS DP protocol, and only when it is necessary to provide a sufficient understanding of the PROFIDRIVE implementation of the PROFIBUS profile for variable speed drives (version 2, PNO) and of the PROFIBUS option card for the series VLT 5000/VLT 5000 Flux/VLT 6000 HVAC/VLT 8000 AQUA by DANFOSS.

In addition, the manual is intended to serve as a guidebook for the specification and optimization of the existing communication system.

It is suggested that readers who are not completely familiar with PROFIBUS DP or the profile for variable speed drives review the relevant literature on these subjects.

Even experienced PROFIBUS programmers should read the entire manual prior to programming, since every chapter of the manual contains important information.

Chapter 2 deals with the quick start of the communication parameters for the DP communication.

Chapter 3 contains details regarding the PROFIBUS option card and the establishment of the physical connection.

Please refer to chapter 4 for information regarding the time behaviour.

Chapter 5 presents an overview of the PPOs (informative data telegrams).

The PCA interface as a parameter interface in the PPO is explained in chapter 6.

Chapter 7 contains the description of the parameter and data structure.

Chapter 8 contains a description of spontaneous messages.

The response to the "Sync" and "Freeze" commands is explained in chapter 9.

The control word and status word as essential elements of the PPOs for the operational control, as well as the bus reference value are explained in chapter 11.

Chapter 12 contains examples for the use of the PPOs. It is recommended that readers review the examples for a better understanding of the PPOs.

Comments regarding the GSD file can be found in chapter 13.

Chapter 14 contains the VLT parameters specific to the Profibus.

Warning and alarm messages and display readings specific to the Profibus are described in chapter 15.

A parameter listing as an overview of all VLT 5000/VLT 5000 Flux/VLT 6000 HVAC/VLT 8000 AQUA parameters can be found in chapter 16.

In chapter 17 you will find the abbreviations used in this manual. The manual concludes with a short glossary and a detailed index for quick navigation.

If you are interested in learning more about the PROFIBUS protocol in general, we recommend that you consult the relevant, very comprehensive literature for this purpose.

■ Assumptions

The manual assumes that you are using a DANFOSS PROFIBUS option card with field bus, together with a DANFOSS VLT frequency converter, that you are using a PLC or a PC with a serial interface as master which supports all communication services for PROFIBUS, and that all requirements are met and all limitations are observed which arise from the PROFIBUS standard, the PROFIBUS profile of variable speed drives, and the company-specific implementation of PROFIDRIVE, or those of the VLT drives.

■ Background knowledge

The DANFOSS PROFIBUS option card is designed for the communication with all masters that comply with the PROFIBUS standard. Thus, the assumption is made that you are familiar with the PC or PLC to be used as a master on your system. Any questions regarding the hardware or software of other suppliers are beyond the scope of this manual and outside the responsibility of DANFOSS.

In the event of questions concerning the configuration of the master-to-master communication or the configuration with a slave not manufactured by DANFOSS, you should refer to the information in the respective manuals.

■ Quick start

Details regarding the programming of the usual VLT parameters may be gathered from the manual for the VLT 5000/VLT 5000 Flux/VLT 6000 HVAC/VLT 8000 AQUA series.

The communication is established by setting the parameters indicated below.

Details regarding the adjustment of the master are provided by the master manual and by those chapters in this manual that deal with the particulars of the VLT PROFIBUS interface.



The required GSD file is available on the internet at <http://www.danfoss-sc.de>.

■ Profibus DP**Parameter 904**

This selects the desired informative data telegram (PPO).

Parameter 918

This sets the address of the VLT station – one specific address per VLT.

Parameter 801

This determines the transmission speed in bit/s. The standard setting is 1.5 MBaud.

Parameter 502 = "BUS".

As an alternative to the switching of terminal 27, the parameter 502 may be set to "BUS" in the factory setting before the motor can even be started.

Please note the logic links of the parameters 502-508 to the clamping functions which are also active in the Profibus. (See operations manual for an explanation.)



The VLT must be switched off/on once after the Profibus parameters have been set.



When configuring the PPO types, a distinction is made between module consistency and word consistency:

Module consistency means that a specific portion of the PPO is defined as a connected module. The parameter interface (PCV, length of 8 bytes) of the PPO always has module consistency.

Word consistency means that a specific portion of the PPO is divided into individual data sectors of word length (16 bits).

The process data of the PPO may have either module consistency or word consistency, as desired.

Some PLCs, such as Siemens S7, require special functions to call modules that are longer than 4 bytes (in the case of Siemens: "SFC", see master manual).

This means that the PCV interfaces of the PPOs can only be called through the SFC functions in the case of Siemens (S7).

■ **Master-controlled drives**

The PROFIBUS option card allows an enormous flexibility of the control, diagnosis and parameterization of variable speed drives. The PROFIBUS card behaves like a part of the VLT and enables access to all parameters that are important for the respective application. The variable speed drive always acts as slave and is capable of exchanging a multitude of commands and pieces of information together with the master. Control signals such as "speed reference value", "start/stop" of the motor, "reversion" are transmitted by the master in the form of telegrams.

The VLT confirms the receipt by transmitting status signals such as "operation enabled", "reference value reached", "motor stopped" etc. to the master. The drive can also report errors and transmit alarm and warning messages, e.g. "VLT error" or "excess current".

The PROFIBUS option card transmits signals in accordance with the *PROFIBUS field bus standard, EN 50170, part 3*. It can thus exchange data with all masters that meet this standard; however, this does not mean that all services available in the PROFIBUS standard are supported. The *PROFIBUS profile for variable speed drives* (version 2, PNO) is a part of PROFIBUS which supports only those services that concern applications with speed control.

PROFIDRIVE is an implementation of the profile developed by DANFOSS and several other firms.

Communications partner

The variable speed drive always acts as slave in a control system and may thus exchange data with one or more masters, depending on the type of the application. The master may be a PLC or a PC with a PROFIBUS communications

■ **Cable lengths and number of nodes**

The maximum cable length of a segment depends on the transmission speed. The total cable length includes stub lines, if applicable. A stub line is the connection from the main bus cable to each node if a "T" connection exists instead of a direct connection of the main bus cable to the nodes; cf. the stub line length. The following table shows the maximum permitted cable lengths and the maximum number of nodes or VLTs with 1, 2, 3 or 4 bus segments.

Please note that a repeater switched between two segments represents a node in both segments. The number of VLTs is based on a system with only one master. In the case of multiple masters, the number of VLTs must be reduced accordingly.

The total stub line length of a segment is limited as follows:

Stub line length	
Transmission speed	Max. stub line length per segment [m]
9,6-93,75 kBaud	96
187,5 kBaud	75
500 kBaud	30
1,5 MBaud	10
3-12 MBaud	none

Maximum total bus cable length

	1 segment: 32 nodes (31 VLTs)	2 segments: 64 nodes (1 repeater, 61 VLTs)	3 segments: 96 nodes (2 repeater, 91 VLTs)	4 segments: 128 nodes (3 repeater, 121 VLTs)
Transmission speed	[m]	[m]	[m]	[m]
9,6-187,5 kBaud	1000	2000	3000	4000
500 kBaud	400	800	1200	1600
1,5 MBaud	200	400	600	800
3-12 MBaud	100	200	300	400

The indicated lengths in the tables are valid on the condition that bus cables with the following properties are used:

- Impedance: 135 to 165 Ohm at a measuring frequency of 3 to 20 MHz
- Resistance: < 110 Ohm/km
- Capacity: < 30 pF/m
- Damping: max. 9 dB across the entire cable length
- Cross-section: max. 0,34 mm pursuant to AWG 22
- Wire type: twisted pair, 1 x 2 or 2 x 2 or 1 x 4 conductors
- Shielding: copper-braided or braided and foil laminated

It is recommended to use the same cable type throughout the entire network in order to avoid mismatches of the impedance.

The figures in the following description indicate the maximum permitted number of stations in each segment. These figures do not refer to the station addresses, since each station in the network must have an unambiguous address.

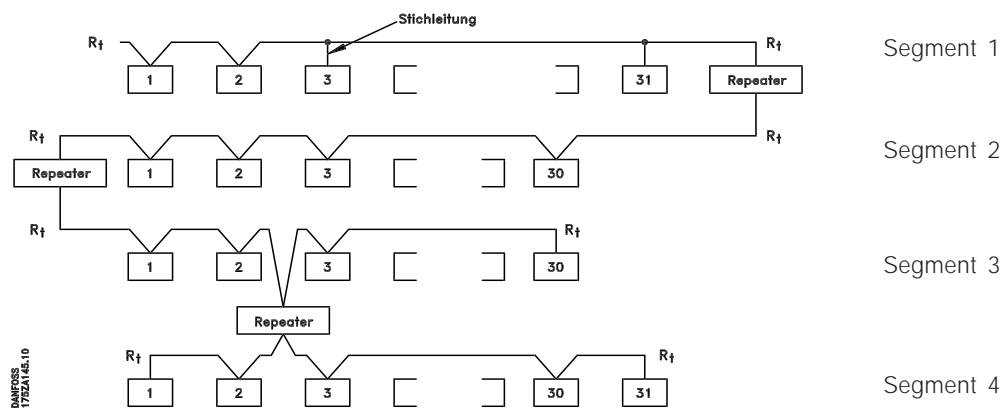

■ Physical connection

The PROFIBUS option card will be connected to the bus line (data line) at terminals 62 and 63. Data line "B" (TxD/RxD-P) will be connected to terminal 62 and data line "A" (TxD/RxD-N) to terminal 63. A master with a voltaically insulated bus driver and overvoltage protection (e.g. Z diode) is recommended.

Protective measures for EMC

It is recommended to carry out the following protective measures for EMC in order to ensure a trouble-free operation of the PROFIBUS network. Additional notes concerning the subject of EMC can be found in the project manual for the VLT5000 series (MG.50.Cx.yy) and in the manual for the Profibus master.



The applicable national and local regulations, for example with respect to protective earthing, must be observed.

Cable setup

The PROFIBUS communications cable must be kept at a distance from the motor and braking resistance cables in order to avoid high-frequency line failures from one cable to another. As a rule, a distance of 200 mm is sufficient. In general, it is a good idea to keep the greatest possible distance between the cables, especially if they run parallel for an extended distance.

If the PROFIBUS cable has to cross a motor and braking resistance cable, it should occur at a 90 degree angle.

Connection of the cable screening

The shielding of the PROFIBUS cable always needs to be of a large-area, low-impedance type on both sides. As a matter of principle, the screen should be put up with a large area and low impedance at all PROFIBUS stations. It is very important to have an earth connection with low impedance even at high frequencies. This can be achieved by connecting the shield surface to earth, for example with the help of a cable bow or a conductive cable connector.

The VLT is equipped with various terminals and supports in order to provide a flawless shielding of the PROFIBUS cable. The shield connection is shown in the following diagram.

Earthing

It is important to connect all stations linked to the PROFIBUS network to the same earth potential. The earthing must have a low high-frequency impedance. This can be achieved by connecting a protective housing surface which is as large as possible to earth, for example by mounting the VLT to a conductive rear wall.

Especially in the case of large distances between the stations of a PROFIBUS network, the additional use of potential equalization cables to connect the individual stations to the same earth potential may be necessary.

4

Bus connection

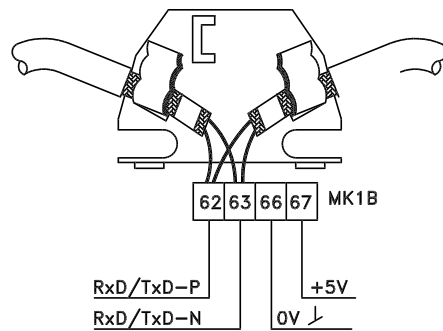

Diagram, bus connection

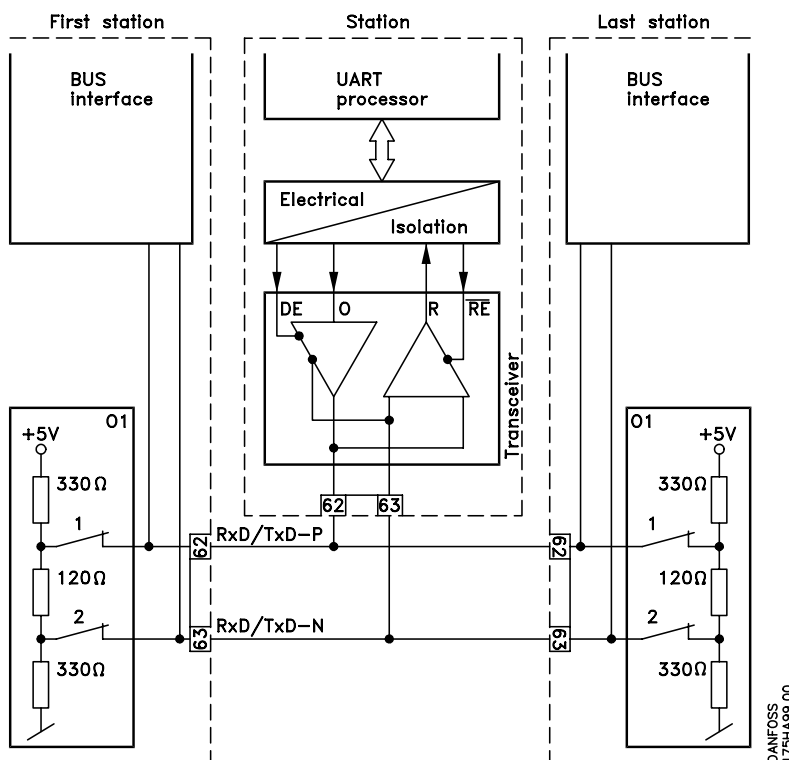

It is important to terminate the bus line correctly. Mismatches of the impedance may lead to reflections in the line and cause incorrect transmissions.

- The PROFIBUS option card is equipped with a suitable termination which can be activated by the switches 1 and 2 at the switch block S1 directly to the right above the terminal block MK 1B. The bus termination is active when the switch is in the "ON" position.

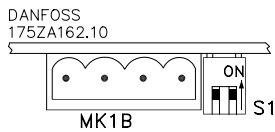

The switches must *never* be set in opposite directions. Both switches must be set to ON or OFF.

- Most masters and repeaters are equipped with their own termination.
- If an internal termination circuit in the form of three resistors is connected to the bus line, a 5 V direct voltage must be used. Attention: please make sure that it is voltaically separated from the power supply cable.

■ LEDs

There are four LEDs on the PROFIBUS option card:

LD1 and LD4: Flickering (very rapid blinking), when data are being exchanged through the option card.

Comment: with each "flicker" of the LEDs, the VLT is receiving a telegram.

LD2 and LD3: Shining, when the option card is initialized and ready for the data exchange, or when data are already being exchanged.

Blinking, when the function for the automatic baud rate determination attempts to determine the current baud rate.

Note: a faulty connection of the data line may also cause blinking of the LEDs. (see "Physical connection").

The PROFIBUS option card

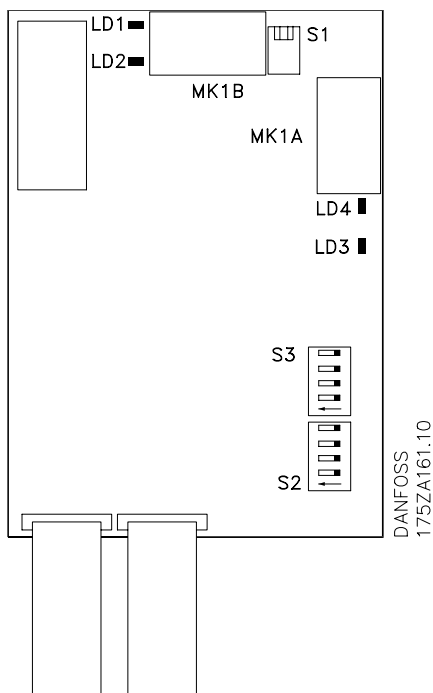

■ Address switches

The station address can be set in parameter 918 or through a hardware switch (S2, 1-4 and S3, 5-7 on the PROFIBUS option card).

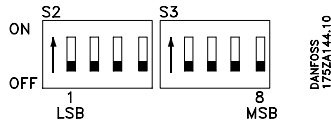

The setting of an address through parameter 918 is only possible when the address switches are set to 0 or > 126.

Each slave must have an unambiguous address. The address is the binary value set for the switches, cf. the table below. The modification of the address switches occurs during the next turn-on procedure.

Address	Switches 1-7 (switch 8 is not used)						
	1	2	3	4	5	6	7
	switch position (1 = ON, 0 = OFF)						
0	0	0	0	0	0	0	0
1	1	0	0	0	0	0	0
2	0	1	0	0	0	0	0
3	1	1	0	0	0	0	0
4	0	0	1	0	0	0	0
5	1	0	1	0	0	0	0
6	0	1	1	0	0	0	0
7	1	1	1	0	0	0	0
8	0	0	0	1	0	0	0
9	1	0	0	1	0	0	0
10	0	1	0	1	0	0	0
11	1	1	0	1	0	0	0
12	0	0	1	1	0	0	0
13	1	0	1	1	0	0	0
14	0	1	1	1	0	0	0
15	1	1	1	1	0	0	0
16	0	0	0	0	1	0	0
17	1	0	0	0	1	0	0
18	0	1	0	0	1	0	0
19	1	1	0	0	1	0	0
20	0	0	1	0	1	0	0
21	1	0	1	0	1	0	0
22	0	1	1	0	1	0	0
23	1	1	1	0	1	0	0
24	0	0	0	1	1	0	0

Address	Switches 1-7 (switch 8 is not used)						
	1	2	3	4	5	6	7
	switch position (1 = ON, 0 = OFF)						
25	1	0	0	1	1	0	0
26	0	1	0	1	1	0	0
27	1	1	0	1	1	0	0
28	0	0	1	1	1	0	0
29	1	0	1	1	1	0	0
30	0	1	1	1	1	0	0
31	1	1	1	1	1	0	0
32	0	0	0	0	0	1	0
33	1	0	0	0	0	1	0
34	0	1	0	0	0	1	0
35	1	1	0	0	0	1	0
36	0	0	1	0	0	1	0
37	1	0	1	0	0	1	0
38	0	1	1	0	0	1	0
39	1	1	1	0	0	1	0
40	0	0	0	1	0	1	0
41	1	0	0	1	0	1	0
42	0	1	0	1	0	1	0
43	1	1	0	1	0	1	0
44	0	0	1	1	0	1	0
45	1	0	1	1	0	1	0
46	0	1	1	1	0	1	0
47	1	1	1	1	0	1	0
48	0	0	0	0	1	1	0
49	1	0	0	0	1	1	0
50	0	1	0	0	1	1	0
51	1	1	0	0	1	1	0
52	0	0	1	0	1	1	0
53	1	0	1	0	1	1	0
54	0	1	1	0	1	1	0
55	1	1	1	0	1	1	0
56	0	0	0	1	1	1	0
57	1	0	0	1	1	1	0
58	0	1	0	1	1	1	0
59	1	1	0	1	1	1	0
60	0	0	1	1	1	1	0
61	1	0	1	1	1	1	0
62	0	1	1	1	1	1	0
63	1	1	1	1	1	1	0
64	0	0	0	0	0	0	1
65	1	0	0	0	0	0	1



VLT® 5000/5000 Flux/6000 HVAC/8000 AQUA PROFIBUS

The PROFIBUS option card

Address	Switches 1-7 (switch 8 is not used)						
	1	2	3	4	5	6	7
66	0	1	0	0	0	0	1
67	1	1	0	0	0	0	1
68	0	0	1	0	0	0	1
69	1	0	1	0	0	0	1
70	0	1	1	0	0	0	1
71	1	1	1	0	0	0	1
72	0	0	0	1	0	0	1
73	1	0	0	1	0	0	1
74	0	1	0	1	0	0	1
75	1	1	0	1	0	0	1
76	0	0	1	1	0	0	1
77	1	0	1	1	0	0	1
78	0	1	1	1	0	0	1
79	1	1	1	1	0	0	1
80	0	0	0	0	1	0	1
81	1	0	0	0	1	0	1
82	0	1	0	0	1	0	1
83	1	1	0	0	1	0	1
84	0	0	1	0	1	0	1
85	1	0	1	0	1	0	1
86	0	1	1	0	1	0	1
87	1	1	1	0	1	0	1
88	0	0	0	1	1	0	1
89	1	0	0	1	1	0	1
90	0	1	0	1	1	0	1
91	1	1	0	1	1	0	1
92	0	0	1	1	1	0	1
93	1	0	1	1	1	0	1
94	0	1	1	1	1	0	1
95	1	1	1	1	1	0	1
96	0	0	0	0	0	1	1
97	1	0	0	0	0	1	1
98	0	1	0	0	0	1	1
99	1	1	0	0	0	1	1
100	0	0	1	0	0	1	1
101	1	0	1	0	0	1	1
102	0	1	1	0	0	1	1
103	1	1	1	0	0	1	1
104	0	0	0	1	0	1	1
105	1	0	0	1	0	1	1
106	0	1	0	1	0	1	1

Address	Switches 1-7 (switch 8 is not used)						
	1	2	3	4	5	6	7
107	1	1	0	1	0	1	1
108	0	0	1	1	0	1	1
109	1	0	1	1	0	1	1
110	0	1	1	1	0	1	1
111	1	1	1	1	0	1	1
112	0	0	0	0	1	1	1
113	1	0	0	0	1	1	1
114	0	1	0	0	1	1	1
115	1	1	0	0	1	1	1
116	0	0	1	0	1	1	1
117	1	0	1	0	1	1	1
118	0	1	1	0	1	1	1
119	1	1	1	0	1	1	1
120	0	0	0	1	1	1	1
121	1	0	0	1	1	1	1
122	0	1	0	1	1	1	1
123	1	1	0	1	1	1	1
124	0	0	1	1	1	1	1
125	1	0	1	1	1	1	1
126	0	1	1	1	1	1	1
127	1	1	1	1	1	1	1

■ Timing

■ VLT response time behaviour

The period for the update through the PROFIBUS connection can be subdivided into two portions:

- 1) The communication period, i.e. the time required to transmit data from the master to the slave (VLT with PROFIBUS option), and
- 2) the internal update period, i.e. the time required to transmit data between the VLT control card and the PROFIBUS option card.

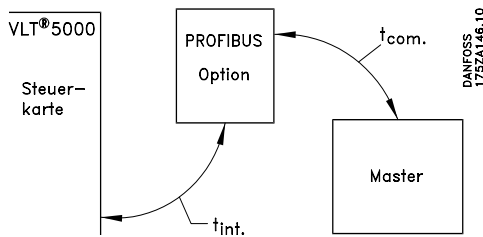

The communication period (t_{com}) depends on the respective transmission speed (baud rate) and the type of master being used. The shortest achievable communication period is approximately 30 μ sec per slave with the VLT PROFIBUS option when DP communication with a data quantity of 4 bytes (PPO type 3) at 12 Mbaud is used. The communication period increases with more data or lower transmission speeds.

The internal update period (t_{int}) depends on the respective data as there are different channels for the transmission of data, with time-critical data, such as the control word, being given the highest priority. The internal update time for the respective data types is listed below.

Data	Update time, t_{int}
Control word/main reference value (Part of PPO)	2 msec.
Status word/respective output frequency (Part of PPO)	2 msec.
Read parameter through PCD portion of PPO	
Write parameter through PCD portion of PPO	

■ Time behaviour during system update

The system update period is the time required to update all slaves of the network when cyclical communication is used.

The update time of a single slave is composed of both the communication period (depending on the baud rate) and the station delay (TSDR) in the slave, and of the delay in the master associated with the station.

The station delay (TSDR) is the delay time from the moment when a station receives the last bit of a telegram to the moment when it sends the first bit of the next telegram. The station delay is defined by two parameters: the minimum station delay ($TSDR_{min}$) and the maximum station delay ($TSDR_{max}$).

Current station delay for the VLT PROFIBUS option:

- DP: 11 bit times

Current master station delay:

- This information must be provided by the manufacturer of the respective PROFIBUS master.

Example

- DP master with 1.5 Mbaud and PPO type 3 (4 byte data); the assumption here is for 50 bit times as master TSDR.

Time [msec]	Action
0	Master starts data transmission
	Last bit received in slave
	Slave station delay
	Slave starts data transmission
	Last bit received in master
	Master station delay (50 bit times \approx 0.033)
	Master ready for data transmission to next slave

■ PPO description

■ Communication connections

Communication pursuant to PROFIBUS DP, i.e. EN50170 part 3, is supported when *DP* is selected in parameter 800.

Accordingly, a master must be used that supports PROFIBUS DP.

One of the PPOs described below must be used in the case of DP communication.

■ PPO description (Overview)

A feature of the PROFIBUS profile for variable speed drives is a communications object designated as "PPO", i.e. "parameter process data object".

All cyclical informative data are transmitted via PPOs. Thus, PPOs form the framework for the data traffic.

The selection of the PPO type takes place in parameter 904.

A PPO may consist of a parameter portion and a process data portion. The parameter portion may be used for reading and/or updating of parameters (successively).

The process data portion consists of a fixed part (4 bytes) and a parameterizable part (8 or 16 bytes). The control word and speed reference value are transmitted to the VLT in the fixed portion, whereas the status word and current output frequency are transmitted by the VLT. In the parameterizable portion, the user selects which parameters are to be transmitted to the VLT (parameter 915) and which are to be transmitted by the VLT (parameter 916).

Type 1, 2 and 5 consist of the parameter portion and 4, 12 and 20 bytes of process data respectively.

Type 3 and 4 consist of 4 and 12 bytes of process data respectively.

PPO, Parameter Process Data Object

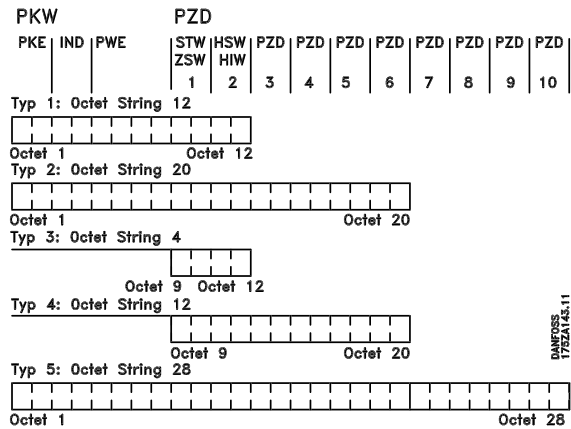

- PCD Process Data
- PCV Parameter Characteristics Value
- PCA Parameter Characteristics (bytes 1, 2);
PCA processing see next chapter.
- IND Subindex (byte 3), (byte 4 is not used)
- PVA Parameter Value (bytes 5 to 8)
- CTW Control Word
- STW Status Word
- MRV Main Reference Value
- MAV Main Actual Value

DANFOSS
17521145-11

■ PCA processing

The master controls and monitors VLT parameters through the PCA portion of the PPOs type 1, 2 and 5 and requests a response from the VLT (slave). In addition to the parameter processing, the VLT can also transmit a spontaneous message.

Requests and responses involve an acknowledgement exchange (a so-called handshake) which cannot be worked off in stack operation. This means that the master, when sending a *read/write* request, must wait for the response before sending a new request. A request or response is limited to a maximum of 4 bytes, i.e. no text strings can be transmitted.

PCA - Parameter description

15	14	13	12	11	10	9	8	7	6	5	4	3	2	1	0
RC				MSP	PNU										

RC: Request/Response Characteristics (Sector: 0-15)

SPM: Toggle bit for spontaneous messages

PNU: Parameter Number (Sector: 1-990)

Request and response

In the RC portion of the PCA word the requests of the master to the slave are triggered. The other two PCV fields IND and PVA must be evaluated as well.

The PVA portion transmits parameter values in word size with the bytes 7 and 8; double words require the bytes 5-8, i.e. 32 bits.

If the request or response contains array elements, the array subindex will be in IND (byte 3). In the event of a parameter description, IND contains the record subindex.

RC content

Request	Function
0	No request
1	Request parameter value
2	Change parameter value (word)
3	Change parameter value (double word)
4	Request description element
5	Change description element
6	Request parameter value (array)
7	Change parameter value (array word)
8	Change parameter value (array double word)
9	Request number of array elements
10-15	Not assigned

Response	Function
0	No response
1	Transmit parameter value (word)
2	Transmit parameter value (double word)
3	Transmit description element
4	Transmit parameter value (array word)
5	Transmit parameter value (array double word)
6	Transmit number of array elements
7	Request not executable (with error number, see below)
8	No operating authority for PCV interface
9	Spontaneous message (word)
10	Spontaneous message (double word)
11	Spontaneous message (array word)
12	Spontaneous message (array double word)
13-15	Not assigned

If a request from the master is not executed by the slave, the RC word in the PPO-Read has the value 7. The error number is in bytes 7 and 8 of the PVA element.

Error no.	Meaning
0	Improper PNU
1	Parameter value not changeable
2	Upper or lower value passed
3	Faulty subindex
4	No array
5	Wrong data type
6	Setting not permitted (resettable only)
7	Description element not changeable
8	No PPO-Write for IR
9	Description data not available
10	Access group
11	No parameter operating authority
12	Keyword missing
13	Text not readable in cyclical traffic
14	Name not readable in cyclical traffic
15	Text array not available
16	PPO-Write missing
17	Request temporarily unexecutable
18	Other error
19	Data not readable in cyclical traffic

■ Parameters and data type structures

Parameter description

Parameters which are accessible through the parameter number (PNU) have additional attributes that are a component of the accompanying descriptive element.

Writing/reading of a parameter description occurs through the PCV portion by means of the RC commands 4/5 and the subindex of the desired descriptive element (see accompanying diagram).

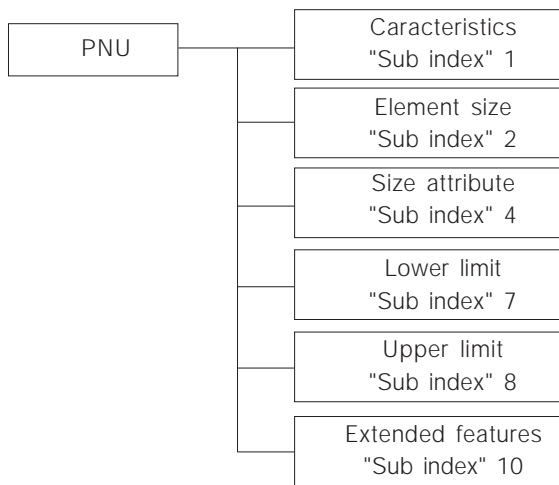

Characteristics

The "characteristics" subindex extends the definition of the parameter description. The individual bits 9 to 15 have the values TRUE [1] or FALSE [0] (see table below).

Bit	Meaning
15	Active parameter
14	Array
13	Parameter value resettable only
12	Factory setting of parameter changed
11	Text available
10	Additional text array available
9	No write access (read only)
8	Lower and upper limit. Standardization and size attribute not relevant.
0-7	Data type of the parameter corresponds to OD

The low byte (bit 0-7) indicates the data type of the parameter (see following table).

The "data type" for each parameter can be found in the corresponding column in the chapter parameter listing.

Data types supported by VLT

Data type	Object	Short form	Description
3	5	12	Integer 16
4	5	12	Integer 32
5	5		Unsigned 8
6	5	O2	Unsigned 16
7	5	O4	Unsigned 32
9	5		Visible string
10	5		Byte string
13	5		Time difference ¹⁾
33	5	N2	Standardized value (16 bit) ¹⁾
35	5	V2	Bit sequence

¹⁾ See following page for details

Example: Data type 5 = Unsigned 8

Size attribute

The size attribute is 2 bytes long. Byte 1 incorporates the physical unit of measurement (size index), byte 2 the conversion index.

The "conversion index" for each parameter can be found in the corresponding column in the chapter parameter listing.

The "conversion index" produces the conversion factor for each parameter.

Example:
 Parameter 205: Conversion index = -3 <=> (10E-3)
 Conversion factor: 0.001
 15200 = 15.200 Hz

An excerpt from the PROFIDRIVE profile with respect to the assignment of the size index and the conversion index to the physical size can be found on the following page.



VLT® 5000/5000 Flux/6000 HVAC/8000 AQUA PROFIBUS

Time difference (to table "Objects and data types supported by the VLT")

The data type *time difference* is a measure of time in milliseconds.

Notation: Time difference
 Value range: $0 \leq i \leq (2^{32} - 1)$ milliseconds [ms]
 Coding: The time is represented as a binary 32 bit value (4 bytes). The first 4 (MSB) bits are always zero (see table below).

Data coding of the data type *time difference*

Bit	Byte 4	Byte 3	Byte 2	Byte 1
8	0 ms	2^{23} ms	2^{15} ms	2^7 ms
7	0 ms	2^{22} ms	2^{14} ms	2^6 ms
6	0 ms	2^{21} ms	2^{13} ms	2^5 ms
5	0 ms	2^{20} ms	2^{12} ms	2^4 ms
4	2^{27} ms	2^{19} ms	2^{11} ms	2^3 ms
3	2^{26} ms	2^{18} ms	2^{10} ms	2^2 ms
2	2^{25} ms	2^{17} ms	2^9 ms	2^1 ms
1	2^{24} ms	2^{16} ms	2^8 ms	2^0 ms

Standardized value

A linear value

0% = 0 (0h), 100% are 2^{14} (4000h)

Data type	N 2
Range	-200% ... 200% - 2^{-14}
Resolution	$2^{-14} = 0,0061\%$
Length	2 bytes

Note: Two's complement notation
 MSB is the first bit after the sign bit of the first byte.

Sign bit = 0 = positive number

Sign bit = 1 = negative number

Bit	8	7	6	5	4	3	2	1
Byte 2	SIGN	2^{14}	2^{13}	2^{12}	2^{11}	2^{10}	2^9	2^8
Byte 1	2^7	2^6	2^5	2^4	2^3	2^2	2^1	2^0

Physical size	Size index	Unit of measurement	Abbreviation	Conversion index	Conversion factor
	0	No dimension		0	1
		Second	s	0	1
				-1	0,1
				-2	0,01
Time	4	Millisecond	ms	-3	0,001
		Minute	min	70	60
		Hour	h	74	3600
		Day	d	77	86400
Energy	8	Watt-hour	Wh	0	1
		Kilowatt-hour	kWh	3	1000
		Megawatt-hour	MWh	6	10^6
Power	9	Milliwatt	mW	-3	0,001
		Watt	W	0	1
		Kilowatt	kW	3	1000
		Megawatt	MW	6	10^6
Rotation	11	Revolutions per minute	RPM	0	1
Torque	16	Newtonmeter	Nm	0	1
		Kilonewtonmeter	kNm	3	1000
Temperature	17	Degree Celsius	°C	0	1
Voltage	21	Millivolt	mV	-3	0,001
		Volt	V	0	1
		Kilovolt	kV	3	1000
Current	22	Milliampere	mA	-3	0,001
		Ampere	A	0	1
		Kiloampere	kA	3	1000
Resistance	23	Milliohm	mOhm	-3	0,001
		Ohm	Ohm	0	1
		Kiloohm	kOhm	3	1000
Relation	24	Percent	%	0	1
Relative change	27	Percent	%	0	1
Frequency	28	Hertz	Hz	0	1
		Kilohertz	kHz	3	1000
		Megahertz	MHz	6	10^6

■ Spontaneous messages

The spontaneous message is triggered by the active parameters 538, 540 or 953.

The PCV response indicates the parameter number (PNU) and the parameter value (PVA) of the modified active parameter that triggered the message.

Spontaneous messages are generated when active parameters are changed, i.e. a message occurs when a warning appears and when a warning disappears.

At the same time, the VLT modifies the SPM bit (11) of the PCV word (see "PCA processing").

The spontaneous messages are transmitted until the master has confirmed the receipt of the message and changed the SPM bit.



Spontaneous messages are only activated when the parameter 917 is in the "ON" position.

In the event of an activated spontaneous message, the parameter channel is blocked until the spontaneous message has been acknowledged by the master.

Example of a spontaneous message

Observation of the parameter channel (PCV) from the PPO (without index field):

PCV (Hex)	PVA (Hex)	from Master	from VLT	Description
12 08	00 00 00 00	x		the master requests the current of the VLT
12 08	00 00 00 F0		x	VLT current value: 2.4 Amp (parameter 520)
12 08	00 00 00 00	x		the master requests the current of the VLT
AC 1A	00 00 00 0A		x	VLT has a spontaneous message, the spontaneous message bit is set, the PNU 538 (alarm word) has the value 000A (Hex)
1C 08	00 00 00 00	x		the master requests the current of the VLT and acknowledges the spontaneous message by "toggling" the SPM in the PCV
1C 08	00 00 00 F0		x	VLT current value: 2.4 Amp, the spontaneous message bit remains at "1" until the next spontaneous message; the spontaneous message is acknowledged.

The VLT saves up to 16 consecutively transmitted SPMs in a FIFO buffer. If only one SPM is in the FIFO buffer, the VLT immediately resumes normal operations after the master has acknowledged it (and the cause of the SPM has been eliminated). If there is more than one SPM in the FIFO buffer, the transmission takes place one after the other following the acknowledgement. Additional SPMs that are generated while the buffer is full will be ignored.

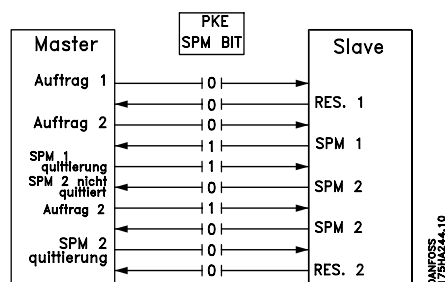

■ SYNC and FREEZE

The control commands SYNC/UNSYNC (SYNCHRONIZE/CANCEL SYNCHRONIZATION) and FREEZE/UNFREEZE are broadcast functions. SYNC/UNSYNC is used to transmit synchronized control commands and/or speed reference values to all connected slaves. FREEZE/UNFREEZE is used to freeze the status actual value in the slaves in order to receive a synchronized actual value from all connected slaves.

The SYNC and FREEZE commands refer to the PCD and PCV portions of the PPO.

SYNC/UNSYNC

By using SYNC/UNSYNC, simultaneous responses of several slaves can be generated, e.g. synchronized start, stop, or change of the speed. In the event of a SYNC command, the current control word and the speed reference value are frozen. Incoming process data are saved, but are only applied when a new SYNC command or an UNSYNC command is made.

The following example shows the speed reference value sent by the master in the left column and the respective effective speed reference value for the three slaves in the three columns to the right.

From DP master to address:	Current speed reference value slave		
	VLT Address 3	VLT Address 4	VLT Address 5
1. Speed reference value = 50% to address 3	⇒ 50 %	0 %	0 %
2. Speed reference value = 50% to address 4	50 %	⇒ 50 %	0 %
3. Speed reference value = 50% to address 5	50 %	50 %	⇒ 50 %
4. SYNC command to all addresses	⇒ 50 %	⇒ 50 %	⇒ 50 %
5. Speed reference value = 75% to address 3	⇒ 50 %	50 %	50 %
6. Speed reference value = 75% to address 4	50 %	⇒ 50 %	50 %
7. Speed reference value = 75% to address 5	50 %	50 %	⇒ 50 %
8. SYNC command to all addresses	⇒ 75 %	⇒ 75 %	⇒ 75 %
9. Speed reference value = 100% to address 3	⇒ 75 %	75 %	75 %
10. Speed reference value = 50% to address 4	75 %	⇒ 75 %	75 %
11. Speed reference value = 25% to address 5	75 %	75 %	⇒ 75 %
12. UNSYNC command to all addresses	⇒ 100 %	⇒ 50 %	⇒ 25 %
13. Speed reference = 0% to address 3	⇒ 0 %	50 %	25 %
14. Speed reference = 0% to address 4	0 %	⇒ 0 %	25 %
15. Speed reference = 0% to address 5	0 %	0 %	⇒ 0 %

FREEZE/UNFREEZE

By using FREEZE/UNFREEZE, simultaneous reading of process data, e.g. output current, by several slaves can be brought about. At a FREEZE command, the actual current values are frozen. When instructed, the slave will send back the value in effect at the time the FREEZE command

was issued. The respective values are updated when a new FREEZE command or an UNFREEZE command is issued.

The following example shows the current values read by the master in the left column and the respective effective value of the output current for the three slaves in the three columns to the right.

DP master reads address:	Actual output current slave		
	VLT Address 3	VLT Address 4	VLT Address 5
1. Address 3 output current = 2 A	⇐ 2 A	3 A	4 A
2. Address 4 output current = 5 A	2 A	⇐ 5 A	2 A
3. Address 5 output current = 3 A	3 A	2 A	⇐ 3 A
4. FREEZE command to all addresses	⇒ 1 A	⇒ 3 A	⇒ 3 A
5. Address 3 output current = 1 A	⇐ 4 A	2 A	5 A
6. Address 4 output current = 3 A	2 A	⇐ 2 A	2 A
7. Address 5 output current = 3 A	3 A	1 A	⇐ 2 A
8. UNFREEZE command to all addresses	⇒ 2 A	⇒ 3 A	⇒ 4 A

Readout same as for 1, 2 and 3

■ **Control word / status word**

The bits of the "control word" tell the VLT how to respond, while the status of the bits in the "status word" transmits information about the VLT to the master.

One can select through parameter 512 whether the control word and status word are to be defined according to "Profidrive" (field bus) or according to "FC Drive (Danfoss)". "FC Drive (Danfoss)" is the factory setting.

■ **Control word according to Profidrive standard**
(Parameter 512 = field bus)

The control word is used to send commands from a master (e.g. a PC) to a slave.

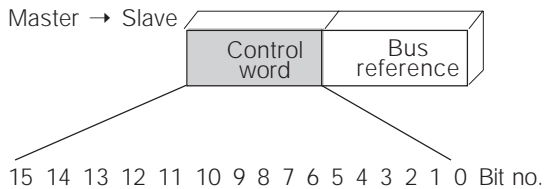

Bit	Bit = 0	Bit = 1
00	OFF 1	ON 1
01	OFF 2	ON 2
02	OFF 3	ON 3
03	Coasting	No coasting
04	Quick stop	Ramp
05	Save output frequency	Ramp possible
06	Ramp stop	Start
07	Without function	Reset
08	Jogging speed 1 OFF	ON
09	Jogging speed 2 OFF	ON
10	Data not valid	Valid
11	Without function	Frequ. correction DOWN (reduce)
12	Without function	Frequ. correction UP (increase ref. value)
13	Selection setup 1 (lsb)	
14	Selection setup 2 (msb)	
15	Without function	Reversion

If "Profidrive" has been selected, then a two-part start command has to be observed when the start is released (turn-on lock-out: bit 0).

For this it is necessary to first predetermine Hex 047E and then Hex 047F in the control word, for example.

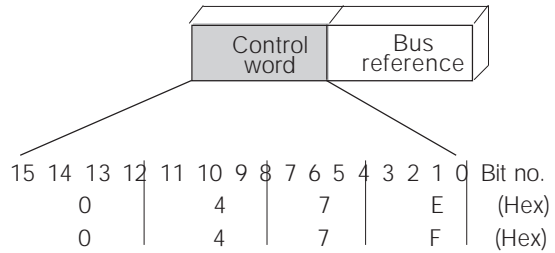

Bit 00, OFF 1/ON 1

Normal ramp stop using the ramp times of the parameters 207/208 or 209/210.

Bit 00 = "0" leads to the stop and activation of the output relay 01 or 04 if the output frequency is 0 Hz if *Relay 123* has been selected in parameter 323 or 326.

In the case of bit 00 = "1", the frequency converter can start if the other start conditions are satisfied.

Bit 01, OFF 2/ON 2

Coasting stop

In the case of bit 01 = "0", a coasting stop and activation of the output relay 01 or 04 occurs if the output frequency is 0 Hz if *Relay 123* has been selected in parameter 323 or 326.

In the case of bit 01 = "1", the frequency converter can start if the other start conditions are satisfied.

Bit 02, OFF 3/ON 3

Quick stop using the ramp time of parameter 212.

In the case of bit 02 = "0", a quick stop and activation of the output relay 01 or 04 occurs if the output frequency is 0 Hz if *Relay 123* has been selected in parameter 323 or 326.

In the case of bit 02 = "1", the frequency converter can start if the other start conditions are satisfied.

Bit 03, Coasting/No coasting

Coasting stop

Bit 03 = "0" leads to a stop.

In the case of bit 03 = "1", the frequency converter can start if the other start conditions are satisfied.

Note: The selection in parameter 502 determines how bit 03 is linked with the corresponding function of the digital inputs.

Bit 04, Quick stop/Ramp

Quick stop using the ramp time of parameter 212.

In the case of bit 04 = "0", a quick stop occurs.

In the case of bit 04 = "1", the frequency converter can start if the other start conditions are satisfied.

Note: The selection in parameter 503 determines how bit 04 is linked with the corresponding function of the digital inputs.

Bit 05, Save output frequency/Ramp possible

In the case of bit 05 = "0", the current output frequency is being maintained even if the reference value is modified.

In the case of bit 05 = "1", the frequency converter can perform its regulating function again; operation occurs according to the respective reference value.

Bit 06, Ramp stop/Start

Normal ramp stop using the ramp times of the parameters 207/208 or 209/210.

In addition, activation of the output relay 01 or 04 if the output frequency is 0 Hz if *Relay 123* has been selected in parameter 323 or 326.

Bit 06 = "0" leads to a stop.

In the case of bit 06 = "1", the frequency converter can start if the other start conditions are satisfied.

Note: The selection in parameter 505 determines how bit 06 is linked with the corresponding function of the digital inputs.

Bit 07, Without function/Reset

Reset after switching off.

In the case of bit 07 = "0", no reset occurs.

In the case of a slope change of bit 07 to "1", a reset occurs after switching off.

Bit 08, Fixed speed 1 OFF/ON

Activation of the preprogrammed speed in parameter 509 (bus JOG 1). JOG 1 is only possible if bit 04 = "0" and bit 00 - 03 = "1".

Bit 09, Fixed speed 2 OFF/ON

Activation of the preprogrammed speed in parameter 510 (bus JOG 2). JOG 2 is only possible if bit 04 = "0" and bit 00 - 03 = "1".

If both JOG 1 and JOG 2 are activated (bit 08 and 09 = "1"), then JOG 1 has the higher priority, i.e. the speed programmed in parameter 509 will be used.

Bit 10, Data not valid/valid

Is used to notify the VLT5000 series whether the process data channel (PCD) should respond to modifications by the master (bit 10 = 1) or not. The function can be inverted in parameter 805.



NB!

In the case of bit 10 = 0, the VLT does not respond to the control word or the main reference value.

Bit 11, Without function/Frequency correction DOWN

Is used to reduce the speed reference value by the amount given in parameter 219.

In the case of bit 11 = "0", no modification of the reference value occurs.

In the case of bit 11 = "1", the reference value is reduced.

Bit 12, Without function/Frequency correction UP

Is used to increase the speed reference value by the amount given in parameter 219.

In the case of bit 12 = "0", no modification of the reference value occurs.

In the case of bit 12 = "1", the reference value is increased.

If both – slowing down and accelerating – are activated (bit 11 and 12 = "1"), slowing down has priority, i.e. the speed reference value will be reduced.

Bit 13/14, Setup selection

Bit 13 and 14 are used to choose between the four parameter setups according to the following table:

Setup	Bit 14	Bit 13
1	0	0
2	0	1
3	1	0
4	1	1

The function is only possible if *External Selection* has been chosen in parameter 004.

The selection in parameter 507 determines how bit 13/14 is linked with the corresponding function of the digital inputs.

Bit 15, Without function/Reversion

Reversion of the rotational direction of the motor.

In the case of bit 15 = "0", no reversion occurs.

In the case of bit 15 = "1", a reversion takes place.

Please note that the reversion in the factory setting in parameter 506 has been selected as "terminal". Bit 15 only causes a reversion if *bus*, *bus or terminal* or *bus and terminal* has been selected (*bus and terminal* only in connection with terminal 9, however).



NB!

Unless otherwise indicated, the bit of the control word is linked with the corresponding function of the digital inputs as a logical "or" function.

■ Status word according to Profidrive standard

The status word is used to notify a master (e.g. a PC) about the status of a slave

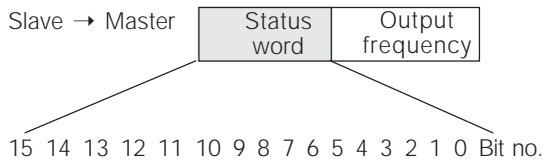

Bit	Bit = 0	Bit = 1
00	Control not ready	Ready
01	VLT not ready	Ready
02	Coasting	Enable
03	No error	Trip
04	ON 2	OFF 2
05	ON 3	OFF 3
06	Start possible	Start not possible
07	No warning	Warning
08	Speed ≠ reference	Speed = reference
09	Local operation	Bus control
10	Not in operating range	Frequency limit OK
11	No operation	Operation
12	VLT OK	Stopped, autostart
13	Voltage OK	Limit exceeded
14	Torque OK	Limit exceeded
15	Timer OK	Limit exceeded

Bit 00, Control not ready/ready

In the case of bit 00 = "0", bit 00, 01 or 02 of the control word is "0" (OFF 1, OFF 2 or OFF 3) – or the frequency converter has switched off (trip).
 In the case of bit 00 = "1", the frequency converter control is ready, but there is not necessarily a supply to the power unit present (in the case of external 24 V supply of the control system).

Bit 01, VLT not ready/ready

Same significance as bit 00, however, there is a supply of the power unit. The frequency converter is ready when it receives the necessary start signals.

Bit 02, Coasting/Enable

In the case of bit 02 = "0", bit 00, 01 or 02 of the control word is "0" (OFF 1, OFF 2 or OFF 3 or coasting) – or the frequency converter has switched off (trip).
 In the case of bit 02 = "1", bit 00, 01 or 02 of the control word is "1"; the frequency converter has not tripped.

Bit 03, No error/Trip

In the case of bit 03 = "0", no error condition of the frequency converter exists.
 In the case of bit 03 = "1", the frequency converter has tripped and requires a reset signal before it can start.

Bit 04, ON 2/OFF 2

In the case of bit 04 = "0", bit 01 of the control word is "1"
 In the case of bit 04 = "1", bit 01 of the control word is "0"

Bit 05, ON 3/OFF 3

In the case of bit 05 = "0", bit 02 of the control word is "1"
 In the case of bit 05 = "1", bit 02 of the control word is "0"

Bit 06, Start possible/Start not possible

Bit 06 is always "0" if *FC Drive* has been selected in parameter 512. If *Profidrive* has been selected in parameter 512, bit 06 will be "1" after a switch-off acknowledgement, after activation of OFF2 or OFF3, and after switching on the mains voltage. *Start not possible* will be reset, with bit 00 of the control word being set to "0" and bit 01, 02 and 10 being set to "1".

Bit 07, No warning/Warning

In the case of bit 07 = "0", no unusual situation exists. In the case of bit 07 = "1", an unusual status of the frequency converter has occurred. All warnings are described in the operations manual.

Bit 08, Speed ≠ reference / Speed = reference

In the case of bit 08 = "0", the current speed of the motor deviates from the set speed reference value. This may occur, for example, when the speed is being changed during start/stop through ramp up/down.
 In the case of bit 08 = "1", the current speed of the motor corresponds to the set speed reference value.

Bit 09, Local operation/Bus control

Bit 09 = "0" indicates that the frequency converter has been stopped by means of the stop switch of the control panel, or that *Local* has been selected in parameter 002.
 In the case of bit 09 = "1", the frequency converter can be controlled through the serial interface.

Bit 10, Not in operating range/Frequency limit OK

In the case of bit 10 = "0", the output frequency is outside the limits set in parameter 225 and parameter 226 (Warnings: frequency low or frequency high).

In the case of bit 10 = "1", the output frequency is within the indicated limits.

Bit 11, No operation/Operation

In the case of bit 11 = "0", the motor does not turn. In the case of bit 11 = "1", the frequency converter has a start signal, or the output frequency is higher than 0 Hz.

Bit 12, VLT OK/Stopped, autostart

In the case of bit 12 = "0", there is no temporary overloading of the inverter.

In the case of bit 12 = "1", the inverter has stopped due to overloading. However, the frequency converter has not switched off (trip) and will start again after the overloading has ended.

Bit 13, Voltage OK/Limit exceeded

In the case of bit 13 = "0", the voltage limits of the frequency converter are not exceeded.

In the case of bit 13 = "1", the direct voltage in the intermediate circuit of the frequency converter is too low or too high.

Bit 14, Moment OK/Limit exceeded

In the case of bit 14 = "0", the motor current is below the moment limit selected in parameter 221.

In the case of bit 14 = "1", the moment limit selected in parameter 221 is exceeded.

Bit 15, Timer OK/Limit exceeded

In the case of bit 15 = "0", the timers for the thermal motor protection and thermal VLT protection (description on page 67) have not exceeded 100%.

In the case of bit 15 = "1", one of the timers has exceeded 100%.

Control word according to VLT standard (Parameter 512 = FC Drive)

The control word is used to send commands from a master (e.g. a PC) to a slave.

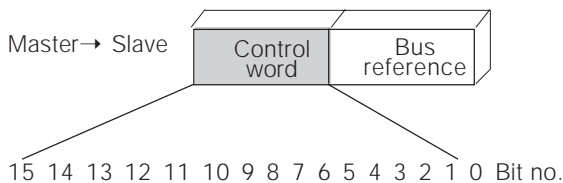

Bit	Bit = 0	Bit = 1
00	Reference value external selection lsb	
01	Reference value external selection msb	
02	DC brake	Ramp
03	Freewheel	No freewheel
04	Quick stop	Ramp
05	Holding	Ramp possible
06	Ramp stop	Start
07	Without function	Reset
08	Without function	Jog
09	Ramp 1	Ramp 2
10	Data not valid	Valid
11	Without function	Relay 01 active
12	Without function	Relay 04 active
13	Parameter setup selection lsb	
14	Parameter setup selection msb	
15	Without function	Reversion

Bit 00/01

The bits 00 and 01 are used to choose between the four preprogrammed reference values (parameters 215-218)

according to the following table:

Progr. ref. val.	Parameter	Bit 01	Bit 00
1	215	0	0
2	216	0	1
3	217	1	0
4	218	1	1

Bit 02, DC brake

Bit 02 = "0" leads to direct voltage braking and stop. Braking current and duration are set in parameter 125 and 126.

Bit 02 = "1" results in *Ramp*.

Bit 08, Activation of the fixed speed in parameter 213
 In the case of bit 08 = "0", the fixed speed will not be activated.
 In the case of bit 08 = "1", the motor runs at the fixed speed.

Bit 09, Ramp selection 1/2
 In the case of bit 09 = "0", ramp 1 is active (parameter 207/208).
 In the case of bit 09 = "1", ramp 2 is active (parameter 209/210).

Bit 11, Relay 01
 Bit 11 = "0": Relay 01 is not activated.
 Bit 11 = "1": Relay 01 is activated, on the pre-condition that *control word bit* was selected in parameter 323.

Bit 12, Relay 04
 Bit 12 = "0": Relay 04 is not activated.
 Bit 12 = "1": Relay 04 is activated, on the pre-condition that *control word bit* was selected in parameter 326.



The description of the other bits can be found in the section "control word according to Profidrive".

■ **Status word according to VLT standard**

The status word is used to notify a master (e.g. a PC) about the status of a slave.

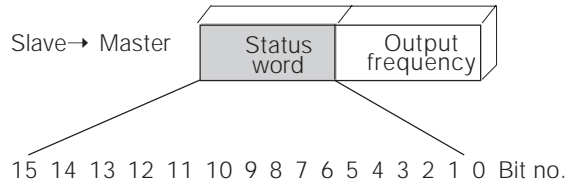

Bit	Bit = 0	Bit = 1
00	Control not ready	Ready
01	VLT not ready	Ready
02	Coasting	Enable
03	No error	Trip
04	R e s e r v e d	
05	R e s e r v e d	
06	R e s e r v e d	
07	No warning	Warning
08	Speed ≠ reference	Speed = reference
09	Local operation	Bus control
10	Not in operating range	Frequency limit OK
11	No operation	Operation
12	VLT OK	Stopped, autostart
13	Voltage OK	Limit exceeded
14	Torque OK	Limit exceeded
15	Timer OK	Limit exceeded

Bit 00, Control not ready/ready
 Bit 00 = "0" means that the frequency converter has switched off due to malfunction.
 Bit 00 = "1" means that the frequency converter control is ready, but that there is not necessarily a supply to the power unit present (in the case of external 24 V supply of the control card).

Bit 02, Coasting/Enable
 Bit 02 = "0" means that the bit 03 of the control word is "0" (Coasting) or that the frequency converter has tripped.
 Bit 02 = "1" means that the bit 03 of the control word is "1" and that the frequency converter has not tripped.



The description of the other bits can be found in the section "status word according to Profidrive".

■ Bus reference value

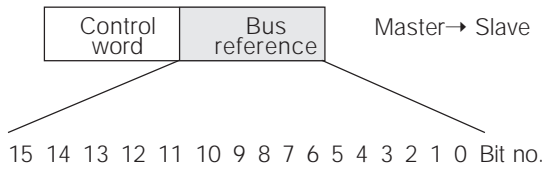

The frequency reference value is transmitted to the frequency converter in the form of a 16-bit word. The value is transmitted in integers (0-32767). 16384 (4000 Hex) corresponds to 100%. (Negative numbers are formed with the aid of the two's complement.)

The bus reference value has the following format:
Parameter 203 = "0"

"ref_{MIN}-ref_{MAX}"

0-16384 (4000 Hex) ~ 0-100% ~ ref_{MIN} - ref_{MAX}

Parameter 203 = "1"

-ref_{MAX} - +ref_{MAX}

-16384 (. . . Hex) - +16384 (4000 Hex) ~
-100 - +100% ~ -ref_{MAX} - +ref_{MAX}

Current output frequency

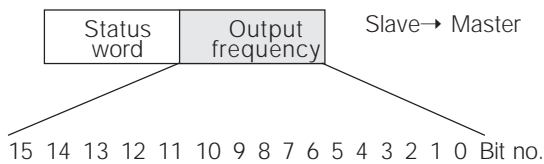

The value of the current output frequency of the frequency converter is transmitted in the form of a 16-bit word. The value is transmitted in integers (0-32767). 16384 (4000 Hex) corresponds to 100%. (Negative numbers are formed with the aid of the two's complement.)

■ **Examples**

■ **Example 1: PCV portion and control word / reference value**

Example for the application of type 1 PPOs to modify the ramp rise build-up time (parameter 207) to 10 s and to trigger a start and a speed control of 50% (parameter 512: FC profile = factory setting).



NB!

Modified parameters are only stored permanently (protected against a mains failure) in the EEPROM of the VLT if parameter 971 is triggered after the parameter modification.

PPO, Parameter Process Data Object

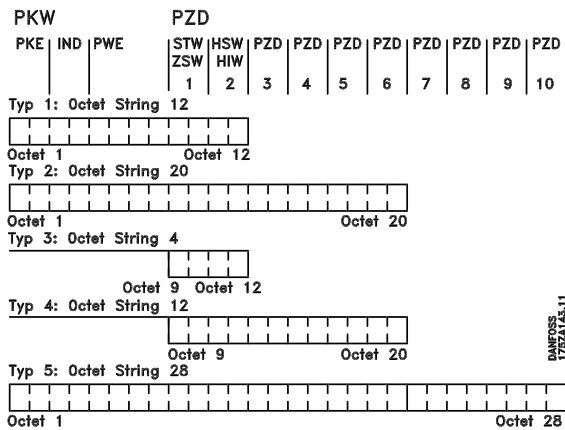

- PCD Process Data
- PCV Parameter Characteristics Value
- PCA Parameter Characteristics (bytes 1, 2)
PCA processing see below
- IND Subindex (byte 3), (byte 4 not utilized)
- PVA Parameter Value (bytes 5 to 8)
- CTW Control Word
- STW Status Word
- MRV Main Reference Value
- MAV Main Actual Value

PCV

PCA Parameter characteristics

15 14 13 12	11	10 9 8 7 6 5 4 3 2 1 0
RC	SPM	PNU

- RC: Request/Response Characteristics (Range: 0-15)
- SPM: Toggle bit for spontaneous messages
- PNU: Parameter Number (Range: 1-990)

PCA portion (byte 1-2)

The RC portion determines what the PCV portion is to be used for.

If a parameter needs to be changed, value 2 or 3 must be selected; here, 3 was selected since parameter 207 refers to a double word (32 bits).

SPM bit

In the example, the function "spontaneous messages" is not needed (parameter 917 = OFF) and thus the SPM bit is set to 0.

PNU = Parameter Number

The parameter number is set to: 207 = CF Hex. This means that the value for the entire PCA portion is 30CF Hex.

IND (bytes 3-4)

This is used in reading/changing of parameters with subindex, e.g. in the case of parameter 915. In the example, the bytes 3 and 4 are set to 00Hex.

PVA (bytes 5-8)

Changing the data value of parameter 207 to 10.00 s. The transmitted value must be 1000, since the conversion index for parameter 207 is -2, i.e. the value received by the VLT is divided by 100 so that the VLT "understands" 1000 as 10.00. 1000 corresponds to 03E8Hex.

PCD (Process Data)

CTW (Control Word)

The following bit patterns set all necessary start commands:

- 150 <=> Bit number
- 0 000 0100 0111 111 1 <=> 047FHex.

MRV (Main Reference Value)

Speed reference value, the data format is "standardized value".

0Hex = 0% and 4000Hex = 100%.

For example, 2000Hex correspond to 50% of the maximum frequency (parameter 202).

The entire PPO being sent from the master to the VLT thus has the following hexadecimal values:

		Byte	Value
PCV	PCA	1 and 2	30CF
	IND	3 and 4	0000
	PVA	5 and 6	0000
	PVA	7 and 8	03E8
PCD	CTW	9 and 10	047F
	MRV	11 and 12	2000

The process data within the PCD portion have a direct effect on the VLT and can be updated by the master in the quickest possible way.

The PCV portion is a process with an exchange of acknowledgements (so-called handshake), i.e. the VLT must confirm the command before a new one can be written.

A positive response of the VLT to the above example might look like this:

		Byte	Value
PCV	PCA	1 and 2	20CF
	IND	3 and 4	0000
	PVA	5 and 6	0000
	PVA	7 and 8	03E8
PCD	STW	9 and 10	0F07
	MAV	11 and 12	2000

The response of the PCD portion depends on the status and the parameterization of the VLT.

The PCV portion responds as follows:

PCA

like the request telegram, but with the RC portion assuming the characteristics for "transmit double word" (HEX 2 for the RC portion).

IND

is not used in this example.

PVA

03E8Hex in the low-byte of the PVA portion indicates that the value of the parameter in question (207) is 1000, which corresponds to 10.00.

The high-byte portion of the PVA is HEX 0000.

STW

0F07Hex means that the motor is running and that no warnings or errors are present (further details can be found in the status word table).

MAV

2000Hex indicates that the output frequency is 50% of the maximum frequency.

A negative response of the VLT might look like this:

		Byte	Value
PCV	PCA	1 and 2	70CF
	IND	3 and 4	0000
	PVA	5 and 6	0000
	PVA	7 and 8	0002
PCD	STW	9 and 10	0F07
	MAV	11 and 12	2000

RC is HEX 7 which means that the request is not executable. The corresponding error number is in the low-byte portion of the PVA.

In this case, the error number 2 means that the upper or lower warning limit of the parameter has been passed (see table of error numbers in "PCA processing").

■ **Example 2: Process data from the VLT**

Example for filling the variable process data in PPO 4.

Assumption: the VLT is operating as in the previous example. At the same time, the motor current (PCD1), the status of the digital inputs (PCD2), the frequency value in Hz (PCD3), and the voltage at terminal 53 (PCD4) are to be indicated.

Fixing the process data on the display unit

The process data from the VLT are read. Therefore, the parameter 916 (PCD-Read) must be used for the configuration of the PCD.

- A) The parameter number for displaying the motor current is entered on the display unit of the VLT under the index number <1>: 520.
- B) The parameter number for displaying the digital inputs is entered under the index number <2>: 528.
- C) Index number <3> = 518 (display of the frequency)
- D) Index number <4> = 529 (display of the voltage at input 53)

VLT response PPO type 4

For example, the VLT response of a PPO 4 telegram after the configuration might look like this:

		Byte	Value (Hex)
	STW	1 and 2	0F07
	MAV	3 and 4	2000
PCD	PCD1	5 and 6	00F6
	PCD2	7 and 8	0028
	PCD3	9 and 10	00FA
	PCD4	11 and 12	02F8

STW

0F07Hex means that the motor is running and that no warnings or errors are present (further details can be found in the status word table).

MAV

2000Hex indicates that the output frequency is 50% of the maximum frequency.

PCD1

HEX F6 = 246 decimal. The conversion index for parameter 520 is -2, i.e. the value must be divided by 100. Thus, the present motor current is: 2.46 A

PCD2

Hex 28 = 0010 1000 binary. The allocation of the digits:



This means that input 18 and input 27 of the VLT are switched.

PCD 3

Hex FA = 250 decimal. The conversion index for parameter 518 is -1, i.e. the value must be divided by 10. Thus, the instantaneous frequency is 25.0 Hz.

PCD4

Hex 2F8 = 760 decimal. The conversion index for parameter 529 is -2, i.e. the value must be divided by 100. Thus, the instantaneous voltage at terminal 53 of the VLT is: 7.60 Volt.



Information concerning the conversion index for each parameter can be found in the parameter list.

The explanation of the column headings for the parameter table can be found in the section "Parameter and data structures" (keyword: size attribute).

■ **Example 3: Array treatment**

Example for addressing an array parameter.
 Assumption: as in the previous examples, the VLT is running. Now, the variable process data are not to be preconfigured on the display, but are to be configured through the PCV portion (of the PPO2) instead.
 For example, only the PCD 1 will be configured for the display of the motor current.

Master telegram (PPO2)

The master sends the following telegram to the VLT:

		Byte	Value (Hex)
PCV	PCA	1 and 2	7394
	IND	3 and 4	0100
	PVA	5 and 6	0000
	PVA	7 and 8	0208
PCD	CTW	9 and 10	047F
	MRV	11 and 12	2000
	PCD 1	13 and 14	0000
	PCD 2	15 and 16	0000
	PCD 3	17 and 18	0000
	PCD 4	19 and 20	0000

PCA

Hex 7 corresponds to "change parameter value (array word)" in the RC portion of the PCA. Hex 394 = 916 decimal.

The parameter 916 is used to configure the PCD-Read. Since a subindex is required to configure the parameter, the parameter 916 is an array.

IND

Hex 01 in byte 3 is used for the assignment to PCD 1. The byte 4 is not used and is thus filled with Hex 00 by the master.

PVA

In the high portion of the PVA is Hex 0000. In the low portion of the PVA is Hex 0208 = 520 decimal. The parameter number for the display of the of the motor current is thus assigned to the PCD 1.

CTW and MRV

For an explanation of the control word and of the main reference value see example 1.

PCD 1 to 4

Since PPO 2 is used, PCD1-4 must be transmitted by the master (filled with zeros as the PCD-Write are not defined).

VLT response telegram (PPO2)

The VLT might send back the following telegram to the master:

		Byte	Value (Hex)
PCV	PCA	1 and 2	4394
	IND	3 and 4	0100
	PVA	5 and 6	0000
	PVA	7 and 8	0208
PCD	STW	9 and 10	0F07
	MAV	11 and 12	2000
	PCD 1	13 and 14	00F6
	PCD 2	15 and 16	0000
	PCD 3	17 and 18	0000
	PCD 4	19 and 20	0000

PCA

Hex 4 corresponds to "transmit parameter value (array word)" in the RC portion of the PCA. Hex 394 = 916 decimal. The VLT repeats the parameter number sent by the master (for handshake control).

IND

The VLT repeats the subindex sent by the master (for handshake control).

PVA (high word and low word)

The VLT repeats the parameter number sent by the master (for handshake control).

STW and MAV

For an explanation of the status word and of the main actual value see example 1.

PCD1

HEX F6 = 246 decimal. The conversion index for parameter 520 is -2, i.e. the value must be divided by 100. Thus, the present motor current is: 2.46 A

PCD 2 to PCD 4

Since the PCD in this example are not configured yet, the VLT will fill the individual PCD with Hex 0000.



Please note that modified parameters are only saved permanently (protected against the event of a mains failure) in the EEPROM of the VLT if parameter 971 is activated after the parameter modification. This is not done in the example, i.e. the configuration of the PCD data is lost after switching the mains current off/on.

■ GSD file

The GSD file is a "standard" DP text file which contains the necessary data for the configuration of DP slaves within a standard DP master.

```
#Profibus_DP
Vendor_Name = „DANFOSS A/S“;
Model_name = „VLT® 5000/6000“;
Revision = „01“;
Ident_Number = 0x0402;
Protocol_Ident = 0;
Station_type = 0;
FMS_supp = 0;
Hardware_Release = „4.0“;
Software_Release = „2.04“;
9.6_supp = 1;
19.2_supp = 1;
93.75_supp = 1;
187.5_supp = 1;
500_supp = 1;
1.5M_supp = 1;
3M_supp = 1;
6M_supp = 1;
12M_supp = 1;
MaxTsdr_9.6 = 60;
MaxTsdr_19.2 = 60;
MaxTsdr_93.75 = 60;
MaxTsdr_187.5 = 60;
MaxTsdr_500 = 100;
MaxTsdr_1.5M = 150;
MaxTsdr_3M = 250;
MaxTsdr_6M = 450;
MaxTsdr_12M = 800;
Redundancy = 0;
Repeater_Ctr_Sig = 0;
24V_Pins = 0;
Freeze_Mode_supp = 1;
Sync_Mode_supp = 1;
Auto_Baud_supp = 1;
Set_Slave_add_supp = 0;
Usr_Prm_Data_Len = 0;
Min_Slave_Intervall = 06;
Modular_Station = 1;
Max_Module = 2;
Max_Input_Len = 28;
Max_Output_Len = 28;
Max_Data_Len = 56;
Max_Diag_Data_Len = 8;
Unit_Diag_Bit(1) = „Overflow SPM-FIFO“;
Unit_Diag_Bit(2) = „Actual value is not updated“;
Module = „PPO 1 Module consistent PCD“ 0xF3, 0xF1;
EndModule;
Module = „PPO 1 Word consistent PCD“ , 0xF3, 0x71;
EndModule;
Module = „PPO 2 Module consistent PCD“ 0xF3, 0xF5;
EndModule;
Module = „PPO 2 Word consistent PCD“ , 0xF3, 0x75;
EndModule;
Module = „PPO 3 Module consistent PCD“ 0xF1;
EndModule;
Module = „PPO 3 Word consistent PCD“ , 0x71;
EndModule;
Module = „PPO 4 Module consistent PCD“ 0xF5;
EndModule;
Module = „PPO 4 Word consistent PCD“ , 0x75;
EndModule;
Module = „PPO 5 Module consistent PCD“ 0xF3, 0xF9;
EndModule;
Module = „PPO 5 Word consistent PCD“ , 0xF3, 0x79;
EndModule;
```



The required GSD file is available on the internet at <http://www.danfoss-sc.de>.

In the configuration of the PPO types (informative data telegrams), a distinction is made between module consistency and word consistency:

Module consistency means that a particular portion of the PPO is defined as a connected module.

The parameter interface (PCV, length 8 byte) of the PPO always has module consistency.

Word consistency means that a particular portion of the PPO is divided into individual data sectors of word size (16 bit).

The process data (PCD) of the PPO can have either module consistency or word consistency, as desired.

Some PLCs, such as the Siemens S7, require special functions to address modules that are longer than 4 byte (in the case of Siemens: "SFC", see Master Manual).

This means that, in the case of Siemens (S7), the PCV interface of the PPOs can only be addressed through the SFC functions.

■ VLT parameters

Only the parameters (800-806 and 900, 901, 9..) specific to the PROFIBUS are described in this manual. For any other parameters of the VLT5000 series/VLT 5000 Flux, VLT 6000 HVAC/VLT 8000 AQUA and their functions, please refer to the VLT 5000/5000 Flux/6000 HVAC/8000 AQUA series operations manual.



Please pay special attention to the following parameters which are not described in this manual:

- 002: In the case of local operation, a control via PROFIBUS is not possible.
- 502-508: Selection of how the PROFIBUS control commands are to be linked with the control commands of the digital inputs of the control card.
- 512: Control word profile, selection of a control word according to PROFIDRIVE or according to a control word specified by Danfoss.
- 515-538: Data output parameters which can be used for the display of a variety of current data of the VLT, e.g. current status of the analog and digital inputs of the control card and, therefore, their usage as inputs for the master.

■ Parameters specific to PROFIBUS

800 Protocol selection (PROTOCOL SELECT)

Value	
PROFIBUS FMS	[0]
★ PROFIBUS DP	[1]

Function

Selection of the PROFIBUS protocol supported by the master.

Description of the selection

FMS: Communication according to DIN 19245, part 2
DP: Communication according to EN 50170, part 3



In the event of an update of parameter 800, even with an unchanged data value, the PROFIBUS option is initialized, which means that all communication parameters 801, 802, ..., e.g. slave address, baud rate, PPO type etc., are being updated.

801 Baud rate selection (BAUD RATE SELECT)

Value		
Auto (AUTO DETECTION)		[0]
9.6 kBaud	(9.6 kBAUD)	[1]
19.2 kBaud	(19.2 kBAUD)	[2]
93.75 kBaud	(93.75 kBAUD)	[3]
187.5 kBaud	(187.5 kBAUD)	[4]
500 kBaud	(500 kBAUD)	[5]
★ 1500 kBaud	(1500 kBAUD)	[6]
3000 kBaud*	(3000 kBAUD)	[7]
6000 kBaud*	(6000 kBAUD)	[8]
12000 kBaud*	(12000 kBAUD)	[9]

*only DP

Function

Selection of the PROFIBUS transmission speed. It must correspond to the transmission speed of the master and the other PROFIBUS nodes.

Description of the selection

Auto: The current PROFIBUS transmission speed is determined automatically when the connected bus is active.

9.6-12000 kBaud: When a fixed baud rate is selected, the duration of the turn-on phase is reduced, since it can take a few seconds to determine the current baud rate.



During an update of parameter 800 or during the next turn-on procedure, the parameter 801 changes too.

802 Minimum station delay

(MIN. STAT. DELAY)

Value	
25 - 2000 bit times	★1500

Function

The minimum response time of the VLT, i.e. the minimum time from the receipt of a telegram to the dispatch of the reply, can be adjusted between 25 and 1000 bit times.



Parameter 802 is only active when *FMS* has been selected in parameter 800. The station delay time is fixed at 11 bit times when *DP* has been selected.

★ Factory settings

Description of the selection

Normally, the minimum station delay has to be as short as possible since communication will occur fastest that way. However, some masters are unable to deal with overly short delays. In this case, the minimum station delay needs to be increased. Please check your master manual regarding the power of your master.



During an update of parameter 800 or during the next turn-on procedure, the parameter 802 changes too.

803 Time after bus error (BUS TIME OUT)

Selection

1 - 99 sec. ★ 1 sec.

804 Response after bus error

(TIME OUT FUNCT.)

Value

★ Off (OFF)	[0]
Freeze output frequency (FREEZE OUTPUT)	[1]
Stop with auto restart (STOP)	[2]
Output frequency = JOG frequency (JOGGING)	[3]
Output freq. = Max. freq. (MAX SPEED)	[4]
Stop with trip (STOP AND TRIP)	[5]
Control without PROFIBUS (NO COM OPT CONTROL)	[6]
Select set up 4 (SELECT SETUP 4)	[7]

Function

The timeout counter is activated at the first receipt of a valid control word, i.e. bit 10 = OK, if DP or the cyclical FMS communication have been selected. In the case of acyclical FMS communication, the timeout counter will not be triggered.

The *Timeout* function can be activated in two ways:

1. CTW is not updated within the specified time.
2. Parameter 805 = "Bit 10 = 0 ⇒ Timeout" and bit 10 = "0".

The VLT remains in the timeout status until one of the following four conditions occurs.

1. A valid control word (bit 10 = OK) is received and a reset (bus, terminals or control panel) is activated (reset is only necessary if the timeout function *Stop with trip* was selected) ⇒ control via PROFIBUS is resumed with the current control word.
2. Parameter 002 = *Local operation* ⇒ local control through control panel is active.
3. Parameter 928 = *Not active* ⇒ normal control through terminals and RS 485 is active.



NB!

The timeout counter is reset and needs to be triggered by a valid control word before a new timeout can be activated.

4. Parameter 804 = *Off* ⇒ control via PROFIBUS is resumed, with the control word used last being taken.

Description of the selection

- *Save output frequency*: Save ('freeze') the output frequency until communication resumes.
- *Stop with auto restart*: Stop with automatic restart on resumption of communication.
- *Output frequency = Fixed speed frequency*: Motor runs with fixed speed frequency until resumption of communication.
- *Output frequency = max. frequency*: Motor runs with the maximum frequency until resumption of communication.
- *Stop with trip*: Motor has stopped, a reset is necessary for a restart, see explanation above.
- *Control without PROFIBUS*: Control via PROFIBUS is inactive; control is possible via the terminals and/or the RS 485 standard interface until communication resumes.
- *Selection parameter setup 4*: Parameter setup 4 is selected in parameter 004; the settings of parameter setup 4 are used. Parameter 004 is not reset to the original value upon resumption of communication.

805 Function control word bit 10 (BIT 10 FUNCTION)	
Value	
Without function (NO FUNCTION)	[0]
★ Bit 10 = 1 ⇒ CTW active (BIT 10 = 1 ⇒ CTW AKTIVE)	[1]
Bit 10 = 0 ⇒ CTW active (BIT 10 = 0 ⇒ CTW ACTIVE)	[2]
Bit 10 = 0 ⇒ Timeout (BIT 10 = 0 ⇒ TIMEOUT)	[3]

Function

According to the PROFIDRIVE profile, the control word and speed reference value are ignored when bit 10 of the control word is 0. However, a modification of the function of bit 10 is possible through parameter 805.

This is sometimes necessary since some masters set all bits to 0 in different error situations. In these cases it makes sense to change the function of bit 10 so that the command to stop (coasting) goes to the VLT if all bits are 0.

Description of the selection

- *Bit 10 = 1 ⇒ CTW active*: If bit 10 = 0, the control word and speed reference value are ignored.
- *Bit 10 = 0 ⇒ CTW active*: If bit 10 = 1, the control word and speed reference value are ignored. If all bits of the control word are 0, the VLT will switch to coasting in response hereto.
- *Bit 10 = 0 ⇒ Timeout*: If bit 10 = 0, the timeout function selected in parameter 804 is activated.
- Without function: Bit 10 is ignored, i.e. the control word and speed reference value are always valid.

 During an update of parameter 800 or during the next turn-on procedure, the parameter 805 changes too.

806 SAP selection (SAP # SELECT)	
Value	
★ SAP 63 (SAP 63)	[0]
SAP 48 (SAP 48)	[1]
SAP 49 (SAP 49)	[2]
SAP 50 (SAP 50)	[3]
SAP 51 (SAP 51)	[4]
SAP 52 (SAP 52)	[5]
SAP 53 (SAP 53)	[6]
SAP 54 (SAP 54)	[7]
SAP 55 (SAP 55)	[8]
SAP 56 (SAP 56)	[9]

Function

With the selection of the SAP number, an assignment of the VLT to a *Multicast* group is made. When the master creates a broadcast telegram with a multicast SAP number, the telegram is only read by slaves (VLTs) with this SAP number.

 Broadcast/multicast is only possible if FMS has been selected in parameter 800.

Description of the selection

- *SAP 63* is the broadcast SAP
- *SAP 48-56*: Eight multicast SAP numbers, with the help of which eight VLT groups can be defined.

 During an update of parameter 800 or during the next turn-on procedure, the parameter 806 changes too.

900 Write PPO type 1 (WRITE PPO TYPE 1)	
Value	
12 bytes	[0]
No control panel access	

901 Write PPO type 2 (WRITE PPO TYPE 2)	
Value	
20 bytes	[0]
No control panel access	

902 Write PPO type 3 (WRITE PPO TYPE 3)	
Value	
4 bytes	[0]
No control panel access	

★ *Factory settings*

903 Write PPO type 4 (WRITE PPO TYPE 4)

Value	
12 bytes	[0]
No control panel access	

Function

When PPO communication with FMS is used, the PPO must be sent as a data value with the help of a write instruction to one of the parameters 900-903 or 905, depending on the type of PPO. A description of the PPO types can be found on page 13.

904 PPO selection for DP (PPO TYPE SELECT)

Value	
★ PPO type 1 (PPO TYPE 1)	900
PPO type 2 (PPO TYPE 2)	901
PPO type 3 (PPO TYPE 3)	902
PPO type 4 (PPO TYPE 4)	903
PPO type 5 (PPO TYPE 5)	905

Function

The PPO type to be used must be selected if *DP* has been selected in parameter 800. The function is valid for read and write functions, i.e. the same PPO type must be used for both read and write. In the case of an *FMS* communication, parameter 904 indicates the PPO type last used for write.

Description of the selection

- PPO type 1: 12 byte PPO with parameter channel for writing and reading of parameters and 4 bytes process data (control/status word and reference value/output frequency actual value). PPO type 2: 20 byte PPO, like PPO type 1 with eight additional bytes of selectable process data.
- PPO type 3: 4 byte process data (control/status word and reference value/output frequency actual value).
- PPO type 4: 12 byte process data, like the process data portion of PPO type 2.
- PPO type 5: 28 bytes, like PPO type 2 with eight additional bytes of selectable process data.

A comprehensive description of the PPO types can be found on page 13.



During the update of parameter 800 or during the next turn-on procedure, the parameter 904 changes too.

907 Read PPO type 1 (READ PPO TYPE 1)

Value	
Read only, 12 bytes	[0]
No control panel access	

908 Read PPO type 2 (READ PPO TYPE 2)

Value	
Read only, 20 bytes	[0]
No control panel access	

909 Read PPO type 3 (READ PPO TYPE 3)

Value	
Read only, 4 bytes	[0]
No control panel access	

910 Read PPO type 4 (READ PPO TYPE 4)

Value	
Read only, 12 bytes	[0]
No control panel access	

Function

When PPO communication with *FMS* is used, the PPO must be read as a data value with the help of a read instruction from one of the parameters 907-910, depending on the type of PPO. A description of the PPO types can be found on page 13.

911 PPO type for FMS read (PPO READ TYPE)

Value	
★ PPO type 1 (PPO TYPE 1)	907
PPO type 2 (PPO TYPE 2)	908
PPO type 3 (PPO TYPE 3)	909
PPO type 4 (PPO TYPE 4)	910

Function

When *FMS* communication is used, parameter 911 indicates the PPO type last used for read (parameter 800 = *FMS*). The parameter is without function if *DP* or *DP with 1 byte PPO* has been selected.

913 Broadcast index (BROADCAST INDEX)	
Value	
0 - 32767	★0

Function

The broadcast index can be used to divide the VLTs into multicast groups, since only the VLTs with the same broadcast index as the master will read the broadcast telegram. The same function can be achieved with the help of the SAP numbers in parameter 806.

 Broadcast/multicast is only possible if FMS has been selected in parameter 806. During an update of parameter 800 or during the next turn-on procedure, the parameter 913 changes too.

914 Broadcast offset (BROADCAST OFFSET)	
Value	
0 - 244 bytes	
★ 0	

Function

The broadcast telegram *Information Report* (IR) may contain PPOs of several VLTs. Parameter 914 indicates to the VLT where to fetch the PPO from the information report.

 Broadcast/multicast is only possible if FMS has been selected in parameter 806.

Description of the selection

During the selection of the number of bytes, the PPO will be displaced by the header (3 bytes) of the IR (see page 53). 0 indicates that the PPO will be arranged in the IR from byte 4 on. Several VLTs may have the same offset if they are to use the same PPO. The adjustment of the offset depends on the PPO length which, in turn, is determined by the selection of the PPO type in parameter 904.

 During an update of parameter 800 or during the next turn-on procedure, the parameter 913 changes too.

915 PCD write configuration		
(PCD CONFIG WRITE)		
Value		

Subindex 1	(PCD 1)	Parameter number
Subindex 2		Parameter number
Subindex 3		Parameter number
Subindex 4		Parameter number
Subindex 5		Parameter number
Subindex 6		Parameter number
Subindex 7		Parameter number
Subindex 8		Parameter number

Function

Different parameters may be assigned to the PCD 1-8 of the PPOs (the number of the PCD depends on the PPO type). The values in PCD 1-8 are written to the selected parameters in the form of data values.

Control panel read only (Read only); write access through PROFIBUS or standard RS485.

Description of the selection

The sequence of the subindices corresponds to the sequence of the PCD in the PPO, i.e. subindex 1 ≈ PCD 1, subindex 2 ≈ PCD 2 etc. Each subindex may contain the number of any VLT parameter. However, only 2-byte values (bytes with the lowest weight) can be written to parameters with 4-byte data values, since 1 PCD consists of only 2 bytes.

916 PCD read configuration		
(PCD CONFIG READ)		
Value		

Subindex 1	(PCD 1)	Parameter number
Subindex 2		Parameter number
Subindex 3		Parameter number
Subindex 4		Parameter number
Subindex 5		Parameter number
Subindex 6		Parameter number
Subindex 7		Parameter number
Subindex 8		Parameter number

Function

Various parameters may be assigned to PCD 1-8 of the PPOs (the number of the PCDs depends on the PPO type). PCD 1-8 contain the current data values of the selected parameters.

Control panel read only (Read only); write access through PROFIBUS or standard RS485.

★ Factory settings

Description of the selection
 The sequence of the subindices corresponds to the sequence of the PCD in the PPO, i.e. subindex 1 ≈ PCD 1, subindex 2 ≈ PCD 2 etc. Each subindex may contain the number of any VLT parameter. However, only 2-byte values (bytes with the lowest weight) can be written to parameters with 4-byte data values, since 1 PCD consists of only 2 bytes.

917 Spontaneous/event messages (SPONT. MESSAGE)	
Value	
★ Off (OFF)	[0]
On (ON)	[1]

Function
 The spontaneous and event messages may be switched if the VLT is to report a message in the event of a warning or alarm status. A description of the spontaneous and event messages can be found on page 17.

Description of the selection

- *OFF*: The VLT does not report a spontaneous or event message in the warning or alarm status.
- *ON*: When PPOs are used (*DP* or *FMS*), the VLT reports a spontaneous message in the event of a warning or alarm status. When *FMS* is used without PPOs, the VLT reports an event message in the event of a warning or alarm status.

918 User address (STATION ADDRESS)	
Value	
1-126	★0

Function
 Every station connected to the same bus must have an unambiguous address. The station address can be set in parameter 918 or by means of a hardware switch, see page 10. The address can only be set in parameter 918 if the hardware switch is set to 0 or > 126. If the setting of the hardware switch is ≠ 0, the parameter will indicate the current setting of the switch. During an update of parameter 800 or during the next turn-on procedure, the parameter 918 changes too.

927 PCV operating authority (PARAMETER EDIT)	
Value	
Without PROFIBUS	[0]
★ With PROFIBUS	[1]

Function
 The parameter channel PCV may be blocked so that the modification of parameters through this channel is not possible. Access through the standard RS 485 interface is still possible.

 When parameters 927 and 928 are deactivated, the "Warning 34" in the display of the VLT will also be suppressed.

Description of the selection

- *Without PROFIBUS*: Parameter processing through the PROFIBUS is not active.
- *With PROFIBUS*: Parameter processing through the PROFIBUS is active.

928 Control authority (PROCESS CONTROL)	
Value	
Without PROFIBUS	[0]
★ With PROFIBUS	[1]

Function
 The process control (adjustment of control word and speed reference value and of the following variable PCD) can be blocked. Control through the control card terminals is still possible via the terminals, depending on how the parameters 502-508 have been set. Access through the standard RS 485 is also still possible.

 When parameters 927 and 928 are deactivated, the "Warning 34" in the display of the VLT will also be suppressed.

Description of the selection

- *Without PROFIBUS*: Process control through the PROFIBUS is not active.
- *With PROFIBUS*: Process control through the PROFIBUS is active.

 The motor may start without advance warning when parameter 928 is being changed and start commands are present.

953 Warning messages (WARNING PARAM.)

Value
 Read only (16 bit binary code)
 No control panel access

Function

A bit is assigned to every warning (see the following list).

Bit	In the following cases, bit is = "1":	
0	LSB	Connection to the DP master is not OK
1		Connection to the FMS master is not OK
2		FDL (field bus data security layer) is not OK
3		Command to erase data received
4		Current value not updated
5		FIFO overflow of the spontaneous messages
6		PROFIBUS ASIC does not transmit
7		Initialization of the PROFIBUS option is not OK
8		Not used
9		Not used
10		Not used
11		Not used
12		Not used
13		Not used
14		Not used
15	MSB	Not used

967 Control word (CONTROL WORD FMS)

Value
 16 bit binary code
 No control panel access

Function

Parameter 967 is dedicated to sending a control word to the VLT when FMS with acyclical communication (without PPOs) is used. The dispatch of a control word takes place through the FMS-Write service to parameter 967 (Index 4967).

968 Status word (STATUS WORD FMS)

Value
 Read only (16 bit binary code)
 No control panel access

Function

Parameter 968 is dedicated to reading the status word from the VLT when FMS with acyclical communication or cyclical reading on KR 5 (without PPOs) are used. The reading of the status word takes place through the FMS-Read service from parameter 968 (Index 4968).

970 Parameter setup selection (EDIT SETUP SELECT)

Value

Factory setting	[0]
Parameter setup 1 (SETUP1)	[1]
Parameter setup 2 (SETUP 2)	[2]
Parameter setup 3 (SETUP 3)	[3]
Parameter setup 4 (SETUP 4)	[4]
★ Active set up (ACTIVE SETUP)	[5]

Function

Like parameter 005 (described in the product manual for the VLT 5000 series).

971 Save data values (STORE DATA VALUE)

Value

★ Not active (OFF)	[0]
Save operations setup (STORE ACTIVE SETUP)	[1]
Save program setup (STORE EDIT SETUP)	[2]
Save all setups (STORE ALL SETUPS)	[3]

Function

Parameter values modified through PROFIBUS are only saved in RAM, i.e. the modifications are lost in the event of a power failure. This parameter is used to activate a function by means of which all parameter values are saved in EEPROM, preserving them even in the case of a power failure.

★ *Factory settings*

Description of the selection

- *Not active*: The function is not active.
- *Save operations setup*: All parameter setups of the active setup are saved in EEPROM. The value returns to *Not active* after all parameter values have been saved.
- *Save program setup*: All parameter setups of the setup being processed are saved in EEPROM. The value returns to *Not active* after all parameter values have been saved.
- *Save all setups*: All parameter setups in all setups are saved in EEPROM. The value returns to *Not active* after all parameter values have been saved.

980-982 Defined parameters

(DEFINED PARAM.)

Value

Read only

Function

The three parameters contain a list of all parameters defined in the VLT. Every one of the three parameters can be read as an array with subindex 255 with the help of the acyclical FMS-*Read* service. When the corresponding subindex is used, individual elements from the list can also be read by means of DP and cyclical/acyclical FMS. The subindices begin with 1 and follow the sequence of the parameter numbers.

Each parameter contains up to 116 elements (parameter numbers). The number of parameters that are in use (980, 981 and 982) depends on the respective VLT configuration.

When a 0 is issued as a parameter number, the list ends.

990-992 Modified parameters

(MODIFI. PARAM.)

Value

Read only

Function

The three parameters contain a list of all parameters that have been changed from the factory setting. Every one of the three parameters can be read as an array with the help of the acyclical FMS-*Read* service. When the corresponding subindex is used, individual elements from the list can also be read by means of DP and cyclical/acyclical FMS. The subindices begin with 1 and follow the sequence of the parameter numbers. Each parameter contains up to 116 elements (parameter numbers). The number of parameters that are in use (990, 991 and 992) depends on how many parameters have been modified in comparison with the factory setting.

Pure read parameters (Read only), such as data output parameters, are not logged as modified even if they are changing.

When a 0 is issued as a parameter number, the list ends.

■ Warning and alarm messages

There is a clear distinction between alarm messages and warnings. In the event of a fault (alarm), the VLT issues an error condition and responds in the manner predetermined in the control word. As soon as the cause of the fault has been repaired, the master must confirm the fault message for the VLT in order to start again. A warning is issued as soon as a warning condition occurs. This ceases as soon as the normal operating conditions have been re-established without the operation being disrupted.

Warnings

Every warning within the VLT is represented by a single bit in a warning word. A warning word is always an active parameter. The bit status FALSE [0] means no warning, the bit status TRUE [1] means warning.

Every change of a bit in the warning word generates a spontaneous message.

Apart from the notification by the warning word, the master is also being informed by a change in bit 7 of the status word.

Fault messages

After a fault message (alarm), the VLT issues an error condition (bit 3 in the status word). The VLT can resume operations only after the fault has been repaired and the master has confirmed the fault message by a change of bit 7 in the control word (positive slope from "0" to "1").

Every fault within the VLT is represented by a single bit in an alarm word. The alarm word is always an active parameter. The bit status FALSE [0] means no alarm, the bit status TRUE [1] means alarm.

Every change of a bit in the alarm word generates a spontaneous message.

■ Spontaneous messages

If a fault or warning condition occurs, the VLT issues a spontaneous message provided that the spontaneous message in parameter 917 has been activated. Instead of responding to the request from the master, the VLT replaces the requested response by the fault or warning message.



Explanations regarding the individual bits of the warning words and of the alarm word can be found in the operations manual of the VLT 5000/VLT 5000 Flux/6000 HVAC/8000 AQUA.

■ **Additional display readings**

If a VLT is equipped with a PROFIBUS interface, it can display the following readings in addition to the messages described in the VLT 5000/5000 Flux/6000 HVAC/8000 AQUA product manual:

Warnings

WARN. 34

PROFIBUS COMM. FAULT

- There is no connection to the master. The reason could be that the master has stopped (or is in an error status), or that the PROFIBUS connection to the VLT is interrupted.
- There is an SPM overflow in the FIFO buffer for spontaneous messages.
(see "Example of a spontaneous message")



When parameters 927 and 928 are deactivated, the "Warning 34" in the display of the VLT will also be suppressed.

Alarm conditions

ALARM

PROFIBUS OPT. FAULT

- The option card has been destroyed by electrical interference, or the option card is defective and needs to be replaced.



VLT® 5000/5000 Flux/6000 HVAC/8000 AQUA PROFIBUS

Parameter list VLT 5000 Flux

PNU #	Parameter description	Factory setting	Range	Changes during operation	4-Setup	Conversion Index	Data type
001	Language	English		Yes	No	0	5
002	Local/remote control	Remote control		Yes	Yes	0	5
003	Local reference	000.000		Yes	Yes	-3	4
004	Active setup	Setup 1		Yes	No	0	5
005	Programming setup	Active setup		Yes	No	0	5
006	Copying of setups	No copying		No	No	0	5
007	LCP copy	No copying		No	No	0	5
008	Display scaling speed	1	0.01 - 100.00	Yes	Yes	-2	6
009	Display line 2	Speed [Rpm]		Yes	Yes	0	5
010	Display line 1.1	Reference [%]		Yes	Yes	0	5
011	Display line 1.2	Motor current [A]		Yes	Yes	0	5
012	Display line 1.3	Power [kW]		Yes	Yes	0	5
013	Local operation mode	LCP control		Yes	Yes	0	5
014	Local stop	Enable		Yes	Yes	0	5
015	Local jog	Not possible		Yes	Yes	0	5
016	Local reversing	Not possible		Yes	Yes	0	5
017	Local reset of trip	Possible		Yes	Yes	0	5
018	Lock for data change	Not locked		Yes	Yes	0	5
019	Operating state at power-up, local control	Forced stop, use saved ref.		Yes	Yes	0	5
024	Userdefined Quick Menu	Not active		Yes	No	0	5
025	Quick Menu Setup	000	0-999	Yes	No	0	6
100	Configuration	Speed control, closed loop		No	Yes	0	5
101	Torque characteristics	High - constant torque		Yes	Yes	0	5
102	Motor power	Depends on the unit	0.18-500 kW	No	Yes	1	6
103	Motor voltage	Depends on the unit	200 - 575 V	No	Yes	0	6
104	Motor frequency	50 Hz		No	Yes	0	6
105	Motor current	Depends on the unit	0.01- I _{VLTMAX}	No	Yes	-2	7
106	Rated motor speed	Depends on the unit	100-60000 rpm	No	Yes	0	6
107	Automatic motor adaptation, AMA	Adaptation off		No	No	0	5
119	High starting torque	0.0 sec.	0.0 - 0.5 s	Yes	Yes	-1	5
120	Start delay	0.0 sec.	0.0 - 10.0 s	Yes	Yes	-1	5
121	Start function	Coasting in start delay time		Yes	Yes	0	5
122	Function at stop	Coasting		Yes	Yes	0	5
123	Min. speed for activating function at stop	0.0 rpm	0 - 600 rpm	Yes	Yes	-1	5
124	DC holding current	50 %	0 - 100 %	Yes	Yes	0	6
125	DC braking current	50 %	0 - 160 %	Yes	Yes	0	6
126	DC braking time	10.0 sec.	0.0 - 60.0 sec.	Yes	Yes	-1	6
127	DC brake cut-in frequency	Off	0.0-par. 202	Yes	Yes	-1	6
128	Motor thermal protection	No protection		Yes	Yes	0	5
129	External motor fan	No		Yes	Yes	0	5
130	Start speed	0.0 rpm	0.0-600 rpm	Yes	Yes	-1	5
131	Initial current	0.0 Amp	0.0-par. 105	Yes	Yes	-1	6
150	Stator resistance	Depends on unit	Ohm	No	Yes	-4	7
151	Rotor resistance	Depends on unit	Ohm	No	Yes	-4	7
152	Stator leakage reactance	Depends on unit	Ohm	No	Yes	-3	7
153	Rotor leakage reactance	Depends on unit	Ohm	No	Yes	-3	7
154	Main reactance	Depends on unit	Ohm	No	Yes	-3	7
156	Pole number	4-pole motor	2-100	No	Yes	0	5
158	Ironloss resistance	10000Ω	1-10000Ω	No	Yes	0	6
161	Minimum inertia	Depends on unit	Kgm ²	No	Yes	-4	7
162	Maximum inertia	Depends on unit	Kgm ²	No	Yes	-4	7

■ Parameter list VLT 5000 Flux

PNU #	Parameter description	Factory setting	Range	Changes during operation	4-Setup	Conversion Index	Data type
200	Output speed range/direction	Only clockwise, 0-4500 rpm		No	Yes	0	5
201	Output speed low limit	0.0 rpm	0.0 - n_{MAX}	Yes	Yes	-1	6
202	Output speed high limit	30000 rpm	n_{MIN} - par. 200	Yes	Yes	-1	6
203	Reference range	Min - max		Yes	Yes	0	5
204	Minimum reference	0.000	-100,000.000- Ref_{MAX}	Yes	Yes	-3	4
205	Maximum reference	1500.000	Ref_{MIN} -100,000.000	Yes	Yes	-3	4
206	Ramp type	Linear		Yes	Yes	0	5
207	Ramp-up time 1	Depends on unit	0.01 - 3600	Yes	Yes	-2	7
208	Ramp-down time 1	Depends on unit	0.01 - 3600	Yes	Yes	-2	7
209	Ramp-up time 2	Depends on unit	0.01 - 3600	Yes	Yes	-2	7
210	Ramp-down time 2	Depends on unit	0.01 - 3600	Yes	Yes	-2	7
211	Jog ramp time	Depends on unit	0.01 - 3600	Yes	Yes	-2	7
212	Quick stop ramp-down time	Depends on unit	0.01 - 3600	Yes	Yes	-2	7
213	Jog speed	200 rpm	0.0 - par. 202	Yes	Yes	-1	6
214	Reference function	Sum		Yes	Yes	0	5
215	Preset reference 1	0.00 %	- 100.00 - 100.00 %	Yes	Yes	-2	3
216	Preset reference 2	0.00 %	- 100.00 - 100.00 %	Yes	Yes	-2	3
217	Preset reference 3	0.00 %	- 100.00 - 100.00 %	Yes	Yes	-2	3
218	Preset reference 4	0.00 %	- 100.00 - 100.00 %	Yes	Yes	-2	3
219	Catch up/slow down value	0.00 %	0.00 - 100 %	Yes	Yes	-2	6
221	Torque limit for motor mode	160 %	0.0 % - xxx %	Yes	Yes	-1	6
222	Torque limit for regenerative operation	160 %	0.0 % - xxx %	Yes	Yes	-1	6
223	Warning: Low current	0.0 A	0.0 - par. 224	Yes	Yes	-1	6
224	Warning: High current	$I_{VLT,MAX}$	Par. 223 - $I_{VLT,MAX}$	Yes	Yes	-1	6
225	Warning: Low speed	0.0 rpm	0.0 - par. 226	Yes	Yes	-1	6
226	Warning: High speed	100.000 rpm	Par. 225 - par. 202	Yes	Yes	-1	6
234	Motor phase monitor	Enable		Yes	Yes	0	5
235	Phase loss monitor	Enable		No	No	0	5



VLT® 5000/5000 Flux/6000 HVAC/8000 AQUA PROFIBUS

Parameter list VLT 5000 Flux

PNU #	Parameter description	Factory setting	Range	Changes during operation	4-Setup	Conversion Index	Data type
300	Terminal 16, input	Reset		Yes	Yes	0	5
301	Terminal 17, input	Freeze reference		Yes	Yes	0	5
302	Terminal 18 Start, input	Start		Yes	Yes	0	5
303	Terminal 19, input	Reversing		Yes	Yes	0	5
304	Terminal 27, input	Coasting stop, inverse		Yes	Yes	0	5
305	Terminal 29, input	Jog		Yes	Yes	0	5
306	Terminal 32, input	Choice of setup, msb/speed up		Yes	Yes	0	5
307	Terminal 33, input	Choice of setup, lsb/speed down		Yes	Yes	0	5
308	Terminal 53, analog input voltage	Reference		Yes	Yes	0	5
309	Terminal 53, min. scaling	0.0 V	0.0 - 10.0 V	Yes	Yes	-1	5
310	Terminal 53, max. scaling	10.0 V	0.0 - 10.0 V	Yes	Yes	-1	5
311	Terminal 54, analog input voltage	No operation		Yes	Yes	0	5
312	Terminal 54, min. scaling	0.0 V	0.0 - 10.0 V	Yes	Yes	-1	5
313	Terminal 54, max. scaling	10.0 V	0.0 - 10.0 V	Yes	Yes	-1	5
314	Terminal 60, analog input current	Reference		Yes	Yes	0	5
315	Terminal 60, min. scaling	0.0 mA	0.0 - 20.0 mA	Yes	Yes	-4	5
316	Terminal 60, max. scaling	20.0 mA	0.0 - 20.0 mA	Yes	Yes	-4	5
317	Time out	10 sec.	1 - 99 sec.	Yes	Yes	0	5
318	Function after time out	Off		Yes	Yes	0	5
319	Terminal 42, output	0 - I _{MAX} P 0-20 mA		Yes	Yes	0	5
321	Terminal 45, output	0 - f _{MAX} P 0-20 mA		Yes	Yes	0	5
323	Relay 01, output	No operation		Yes	Yes	0	5
324	Relay 01, ON delay	0.00 sec.	0.00 - 600 sec.	Yes	Yes	-2	6
325	Relay 01, OFF delay	0.00 sec.	0.00 - 600 sec.	Yes	Yes	-2	6
326	Relay 04, output	No operation		Yes	Yes	0	5
327	Pulse reference, max. frequency	100-65000 Hz	5000 Hz	Yes	Yes	0	6
329	Encoder feedback pulse/rev.	1024 pulses/rev.	1 - 4096 pulses/rev.	Yes	Yes	0	6
341	Terminal 46, digital output	No operation		Yes	Yes	0	5
342	Terminal 46, output, pulse scaling	5000 Hz	1-50000 Hz	Yes	Yes	0	6
345	Encoder loss timeout	0 sec.	0 - 60 sec	No	Yes	0	6
350	Encoder monitoring	OFF		No	No	0	5
351	Encoder direction	Normal		No	Yes	0	5
355	Terminal 26, digital output	No operation		Yes	Yes	0	5
356	Terminal 26, output, pulse scaling	5000 Hz	1-50000 Hz	Yes	Yes	0	6
357	Terminal 42, Output min. scaling	0%	000-100%	Yes	Yes	0	6
358	Terminal 42, Output max. scaling	100 %	000-500%	Yes	Yes	0	6
359	Terminal 45, Output min. scaling	0%	000-100%	Yes	Yes	0	6
360	Terminal 45, Output max. scaling	100%	000-500%	Yes	Yes	0	6

Parameter list

■ Parameter list VLT 5000 Flux

PNU #	Parameter description	Factory setting	Range	Changes during operation	4-Setup	Conversion Index	Data type
400	Brake function/overvoltage control	Off		Yes	No	0	5
401	Brake resistor, ohm	Depends on the unit		Yes	No	-1	6
402	Brake power limit, kW	Depends on the unit		Yes	No	2	6
403	Power monitoring	Warning		Yes	No	0	5
404	Brake check	Off		Yes	No	0	5
405	Reset function	Manual reset		Yes	Yes	0	5
406	Automatic restart time	5 sec.	0 - 10 sec.	Yes	Yes	0	5
409	Trip delay torque	5 sec.	0 - 10 sec.				
417	Speed PID proportional gain	0.015	0.000 - 5000	Yes	Yes	-3	6
418	Speed PID integration time	200 ms	2.00 - 20.000 ms	Yes	Yes	-4	7
419	Speed PID differentiation time	0 ms	0.00 - 200.00 ms	Yes	Yes	-4	6
420	Speed PID diff. gain ratio	10.0	5.0 - 50.0	Yes	Yes	-1	6
421	Speed PID low-pass filter	2 ms	1-10 ms	Yes	Yes	-4	6
445	Flying start	Disable		Yes	Yes	0	5
458	LC-filter connected	No	0-1	No	Yes	0	5
459	Capacity LC-filter	2 µF	0.1-100 µF	No	Yes	-1	6
460	Inductance LC-filter	7 mH	0.1-100 mH	No	Yes	-1	6



VLT® 5000/5000 Flux/6000 HVAC/8000 AQUA PROFIBUS

■ Parameter list VLT 5000 Flux

PNU #	Parameter description	Factory setting	Range	Changes during operation	4-Setup	Conversion Index	Data type
500	Address	1	1 - 126	Yes	No	0	6
501	Baudrate	9600 Baud		Yes	No	0	5
502	Coasting	Logic or		Yes	Yes	0	5
503	Quick-stop	Logic or		Yes	Yes	0	5
504	DC-brake	Logic or		Yes	Yes	0	5
505	Start	Logic or		Yes	Yes	0	5
506	Reversing	Logic or		Yes	Yes	0	5
507	Selection of setup	Logic or		Yes	Yes	0	5
508	Selection of speed	Logic or		Yes	Yes	0	5
509	Bus jog 1	200 rpm	0.0 - parameter 202	Yes	Yes	-1	6
510	Bus jog 2	200 rpm	0.0 - parameter 202	Yes	Yes	-1	6
512	Telegram profile	FC Drive		No	Yes	0	5
513	Bus time interval	1 sec.	1 - 99 s	Yes	Yes	0	5
514	Bus time interval function	Off		Yes	Yes	0	5
515	Data read-out: Reference %			No	No	-1	3
516	Data read-out: Reference unit			No	No	-3	4
518	Data read-out: Frequency			No	No	-1	6
520	Data read-out: Current			No	No	-2	7
521	Data read-out: Torque			No	No	-1	3
522	Data read-out: Power, kW			No	No	-1	7
523	Data read-out: Power, HP			No	No	-2	7
524	Data read-out: Motor voltage			No	No	-1	6
525	Data read-out: DC link voltage			No	No	0	6
526	Data read-out: Motor temp.			No	No	0	5
527	Data read-out: VLT temp.			No	No	0	5
528	Data read-out: Digital input			No	No	0	5
529	Data read-out: Terminal 53, analogue input			No	No	-2	3
530	Data read-out: Terminal 54, analogue input			No	No	-2	3
531	Data read-out: Terminal 60, analogue input			No	No	-5	3
532	Data read-out: Pulse reference			No	No	-1	7
533	Data read-out: External reference %			No	No	-1	3
534	Data read-out: Status word, binary			No	No	0	6
535	Data read-out: Brake power/2 min.			No	No	2	6
536	Data read-out: Brake power/sec.			No	No	2	6
537	Data read-out: Heat sink temperature			No	No	0	5
538	Data read-out: Alarm word, binary			No	No	0	7
539	Data read-out: VLT control word, binary			No	No	0	6
540	Data read-out: Warning word, 1			No	No	0	7
541	Data read-out: Extended status word			No	No	0	7
557	Data read-out: Motor RPM			No	No	0	4
558	Data read-out: Motor RPMxscaling			No	No	-2	4

Parameter list



VLT® 5000/5000 Flux/6000 HVAC/8000 AQUA PROFIBUS

Parameter list

■ Parameter list VLT 5000 Flux

PNU #	Parameter description	Factory setting	Range	Changes during operation	4-Setup	Conversion Index	Data type
600	Operating data: Operating hours			No	No	74	7
601	Operating data: Hours run			No	No	74	7
602	Operating data: kWh counter			No	No	1	7
603	Operating data: Number of power-up's			No	No	0	6
604	Operating data: Number of overtemperatures			No	No	0	6
605	Operating data: Number of overvoltages			No	No	0	6
606	Data log: Digital input			No	No	0	5
607	Data log: Bus commands			No	No	0	6
608	Data log: Bus status word			No	No	0	6
609	Data log: Reference			No	No	-1	3
611	Data log: Motor frequency			No	No	-1	3
612	Data log: Motor voltage			No	No	-1	6
613	Data log: Motor current			No	No	-2	3
614	Data log: DC link voltage			No	No	0	6
615	Fault log: Error code			No	No	0	5
616	Fault log: Time			No	No	-1	7
617	Fault log: Value			No	No	0	3
618	Reset of kWh counter	No reset		Yes	No	0	5
619	Reset of hours-run counter	No reset		Yes	No	0	5
620	Operating mode Normal function	Normal function		No	No	0	5
621	Nameplate: VLT type			No	No	0	9
622	Nameplate: Power section			No	No	0	9
623	Nameplate: VLT ordering number			No	No	0	9
624	Nameplate: Software version no.			No	No	0	9
625	Nameplate: LCP identification no.			No	No	0	9
626	Nameplate: Database identification no.			No	No	-2	9
627	Nameplate: Power section identification no.			No	No	0	9
628	Nameplate: Application option type			No	No	0	9
629	Nameplate: Application option ordering no.			No	No	0	9
630	Nameplate: Communication option type			No	No	0	9
631	Nameplate: Communication option ordering no.			No	No	0	9
639	Flash test	Off		Yes	No	0	5
650	Protection level	Password level 2		Yes	No	0	7

■ Parameter list VLT 6000

PNU #	Parameter description	Factory setting	Range	Changes during operation			Data type
				4-Setup	Conversion index		
001	Language	English		Yes	No	0	5
002	Active Setup	Setup 1		Yes	No	0	5
003	Copying of Setups	No copying		No	No	0	5
004	LCP copy	No copying		No	No	0	5
005	Max value of user-defined readout	100.00	0 - 999.999,99	Yes	Yes	-2	4
006	Unit for user-defined readout	No unit		Yes	Yes	0	5
007	Big display readout	Frequency, Hz		Yes	Yes	0	5
008	Small display readout 1.1	Reference , Unit		Yes	Yes	0	5
009	Small display readout 1.2	Motor current, A		Yes	Yes	0	5
010	Small display readout 1.3	Power, kW		Yes	Yes	0	5
011	Unit of local reference	Hz		Yes	Yes	0	5
012	Hand start on LCP	Enable		Yes	Yes	0	5
013	OFF/STOP on LCP	Enable		Yes	Yes	0	5
014	Auto start on LCP	Enable		Yes	Yes	0	5
015	Reset on LCP	Enable		Yes	Yes	0	5
016	Lock for data change	Not locked		Yes	Yes	0	5
017	Operating state at power-up, local control	Auto restart		Yes	Yes	0	5
100	Configuration	Open loop		No	Yes	0	5
101	Torque characteristics	Automatic Energy Optimisation		No	Yes	0	5
102	Motor power, $P_{M,N}$	Depends on the unit	0.25-500 kW	No	Yes	1	6
103	Motor voltage, $U_{M,N}$	Depends on the unit	200 - 500 V	No	Yes	0	6
104	Motor frequency, $f_{M,N}$	50 Hz	24-1000 Hz	No	Yes	0	6
105	Motor current, $I_{M,N}$	Depends on the unit	0.01 - $I_{VLT,MAX}$	No	Yes	-2	7
106	Rated motor speed, $n_{M,N}$	Depends on par. 102 Motor power	100-60000 rpm	No	Yes	0	6
107	Automatic motor adaptation, AMA	Optimisation disable		No	No	0	5
108	Start voltage of parallel motors	Depends on par. 103	0.0 - par. 103	Yes	Yes	-1	6
109	Resonance dampening	100 %	0 - 500 %	Yes	Yes	0	6
110	High break-away torque	OFF	0.0 - 0.5 sec.	Yes	Yes	-1	5
111	Start delay	0.0 sec.	0.0 - 120.0 sec.	Yes	Yes	-1	6
112	Motor preheater	Disable		Yes	Yes	0	5
113	Motor preheater DC current	50 %	0 - 100 %	Yes	Yes	0	6
114	DC braking current	50 %	0 - 100 %	Yes	Yes	0	6
115	DC braking time	OFF	0.0 - 60.0 sec.	Yes	Yes	-1	6
116	DC brake cut-in frequency	OFF	0.0-par. 202	Yes	Yes	-1	6
117	Motor thermal protection	ETR Trip 1		Yes	Yes	0	5

Parameter list VLT 6000

PNU #	Parameter description	Factory setting	Range	Changes 4-Setup during operation		Conversion index	
200	Output frequency range	0 - 120 Hz	0 - 1000 Hz	No	Yes	0	5
201	Output frequency low limit, f_{MIN}	0.0 Hz	0.0 - f_{MAX}	Yes	Yes	-1	6
202	Output frequency high limit, f_{MAX}	50 Hz	f_{MIN} - par. 200	Yes	Yes	-1	6
203	Reference site	Hand/Auto linked reference		Yes	Yes	0	5
204	Minimum reference, Ref_{MIN}	0.000	0.000-par. 100	Yes	Yes	-3	4
205	Maximum reference, Ref_{MAX}	50.000	par. 100-999.999,999	Yes	Yes	-3	4
206	Ramp-up time	Depends on the unit	1 - 3600	Yes	Yes	0	7
207	Ramp-down time	Depends on the unit	1 - 3600	Yes	Yes	0	7
208	Automatic ramp-up/down	Enable		Yes	Yes	0	5
209	Jog frequency	10.0 Hz	0.0 - par. 100	Yes	Yes	-1	6
210	Reference type	Sum		Yes	Yes	0	5
211	Preset reference 1	0.00 %	-100.00 - 100.00 %	Yes	Yes	-2	3
212	Preset reference 2	0.00 %	-100.00 - 100.00 %	Yes	Yes	-2	3
213	Preset reference 3	0.00 %	-100.00 - 100.00 %	Yes	Yes	-2	3
214	Preset reference 4	0.00 %	-100,00 - 100,00 %	Yes	Yes	-2	3
215	Current limit, I_{LIM}	$1.0 \times I_{VLT,N}$ [A]	0,1-1,1 x $I_{VLT,N}$ [A]	Yes	Yes	-1	6
216	Frequency bypass, bandwidth	0 Hz	0 - 100 Hz	Yes	Yes	0	6
217	Frequency bypass 1	120 Hz	0.0 - par. 200	Yes	Yes	-1	6
218	Frequency bypass 2	120 Hz	0.0 - par. 200	Yes	Yes	-1	6
219	Frequency bypass 3	120 Hz	0.0 - par. 200	Yes	Yes	-1	6
220	Frequency bypass 4	120 Hz	0.0 - par. 200	Yes	Yes	-1	6
221	Warning: Low current, I_{LOW}	0.0 A	0.0 - par. 222	Yes	Yes	-1	6
222	Warning: High current, I_{HIGH}	$I_{VLT,MAX}$	Par. 221 - $I_{VLT,MAX}$	Yes	Yes	-1	6
223	Warning: Low frequency, f_{LOW}	0.0 Hz	0.0 - par. 224	Yes	Yes	-1	6
224	Warning: High frequency, f_{HIGH}	120.0 Hz	Par. 223 - par. 200/202	Yes	Yes	-1	6
225	Warning: Low reference, Ref_{LOW}	-999,999.999	-999,999.999 - par. 226	Yes	Yes	-3	4
226	Warning: High reference, Ref_{HIGH}	999,999.999	Par. 225 - 999,999.999	Yes	Yes	-3	4
227	Warning: Low feedback, FB_{LOW}	-999,999.999	-999,999.999 - par. 228	Yes	Yes	-3	4
228	Warning: High feedback, FB_{HIGH}	999,999.999	Par. 227 - 999,999.999	Yes	Yes	-3	4

Changes during operation:

"Yes" means that the parameter can be changed, while the VLT frequency converter is in operation.
 "No" means that the VLT frequency converter must be stopped before a change can be made.

4-Setup:

"Yes" means that the parameter can be programmed individually in each of the four setups, i.e. the same parameter can have four different data values. "No" means that the data value will be the same in all four setups.

Conversion index:

This number refers to a conversion figure to be used when writing or reading to or from a VLT frequency converter by means of serial communication.

Conversion index	Conversion factor
74	0.1
2	100
1	10
0	1
-1	0.1
-2	0.01
-3	0.001
-4	0.0001

Data type:

Data type shows the type and length of the telegram.

Data type	Description
3	Integer 16
4	Integer 32
5	Unsigned 8
6	Unsigned 16
7	Unsigned 32
9	Text string



VLT® 5000/5000 Flux/6000 HVAC/8000 AQUA PROFIBUS

Parameter list VLT 6000

PNU #	Parameter description	Factory setting	Range	Changes 4-Setup during operation		Conversion index	Data type
300	Terminal 16 Digital input	Reset		Yes	Yes	0	5
301	Terminal 17 Digital input	Freeze output		Yes	Yes	0	5
302	Terminal 18 Digital input	Start		Yes	Yes	0	5
303	Terminal 19 Digital input	Reversing		Yes	Yes	0	5
304	Terminal 27 Digital input	Coasting stop, inverse		Yes	Yes	0	5
305	Terminal 29 Digital input	Jog		Yes	Yes	0	5
306	Terminal 32 Digital input	No operation		Yes	Yes	0	5
307	Terminal 33 Digital input	No operation		Yes	Yes	0	5
308	Terminal 53, analogue input voltage	Reference		Yes	Yes	0	5
309	Terminal 53, min. scaling	0.0 V	0.0 - 10.0 V	Yes	Yes	-1	5
310	Terminal 53, max. scaling	10.0 V	0.0 - 10.0 V	Yes	Yes	-1	5
311	Terminal 54, analogue input voltage	No operation		Yes	Yes	0	5
312	Terminal 54, min. scaling	0.0 V	0.0 - 10.0 V	Yes	Yes	-1	5
313	Terminal 54, max. scaling	10.0 V	0.0 - 10.0 V	Yes	Yes	-1	5
314	Terminal 60, analogue input current	Reference		Yes	Yes	0	5
315	Terminal 60, min. scaling	4.0 mA	0.0 - 20.0 mA	Yes	Yes	-4	5
316	Terminal 60, max. scaling	20.0 mA	0.0 - 20.0 mA	Yes	Yes	-4	5
317	Time out	10 sec.	1 - 99 sec.	Yes	Yes	0	5
318	Function after time out	Off		Yes	Yes	0	5
319	Terminal 42, output	0 - I _{MAX} ⇒ 0-20 mA		Yes	Yes	0	5
320	Terminal 42, output, pulse scaling	5000 Hz	1 - 32000 Hz	Yes	Yes	0	6
321	Terminal 45, output	0 - I _{MAX} ⇒ 0-20 mA		Yes	Yes	0	5
322	Terminal 45, output, pulse scaling	5000 Hz	1 - 32000 Hz	Yes	Yes	0	6
323	Relay 1, output function	Alarm		Yes	Yes	0	5
324	Relay 01, ON delay	0.00 sec.	0 - 600 sec.	Yes	Yes	0	6
325	Relay 01, OFF delay	0.00 sec.	0 - 600 sec.	Yes	Yes	0	6
326	Relay 2, output function	Running		Yes	Yes	0	5
327	Pulse reference, max. frequency	5000 Hz	Depends on input terminal	Yes	Yes	0	6
328	Pulse feedback, max. frequency	25000 Hz	0 - 65000 Hz	Yes	Yes	0	6

Changes during operation:

"Yes" means that the parameter can be changed, while the VLT frequency converter is in operation.
 "No" means that the VLT frequency converter must be stopped before a change can be made.

4-Setup:

"Yes" means that the parameter can be programmed individually in each of the four setups, i.e. the same parameter can have four different data values. "No" means that the data value will be the same in all four setups.

Conversion index:

This number refers to a conversion figure to be used when writing or reading to or from a VLT frequency converter by means of serial communication.

Conversion index	Conversion factor
74	0.1
2	100
1	10
0	1
-1	0.1
-2	0.01
-3	0.001
-4	0.0001

Data type:

Data type shows the type and length of the telegram.

Data type	Description
3	Integer 16
4	Integer 32
5	Unsigned 8
6	Unsigned 16
7	Unsigned 32
9	Text string

■ Parameter list VLT 6000

PNU #	Parameter description	Factory setting	Range	Changes during operation	4-Setup	Conversion index
400	Reset function	Manual reset		Yes	Yes	0
401	Automatic restart time	10 sec.	0 - 600 sec.	Yes	Yes	0
402	Flying start	Disable		Yes	Yes	-1
403	Sleep mode timer	Off	0 - 300 sec.	Yes	Yes	0
404	Sleep frequency	0 Hz	f_{MIN} - Par. 405	Yes	Yes	-1
405	Wake up frequency	50 Hz	Par. 404 - f_{MAX}	Yes	Yes	-1
406	Boost setpoint	100%	1 - 200 %	Yes	Yes	0
407	Switching frequency	Depends on the unit	3.0 - 14.0 kHz	Yes	Yes	2
408	Interference reduction method	ASFM		Yes	Yes	0
409	Function in case of no load	Warning		Yes	Yes	0
410	Function at mains failure	Trip		Yes	Yes	0
411	Function at overtemperature	Trip		Yes	Yes	0
412	Trip delay overcurrent, I_{LIM}	60 sec	0 - 60 sec.	Yes	Yes	0
413	Minimum feedback, FB_{MIN}	0.000	-999,999.999 - FB_{MIN}	Yes	Yes	-3
414	Maximum feedback, FB_{MAX}	100.000	FB_{MIN} - 999,999.999	Yes	Yes	-3
415	Units relating to closed loop	%		Yes	Yes	-1
416	Feedback conversion	Linear		Yes	Yes	0
417	Feedback calculation	Maximum		Yes	Yes	0
418	Setpoint 1	0.000	FB_{MIN} - FB_{MAX}	Yes	Yes	-3
419	Setpoint 2	0.000	FB_{MIN} - FB_{MAX}	Yes	Yes	-3
420	PID normal/inverse control	Normal		Yes	Yes	0
421	PID anti windup	On		Yes	Yes	0
422	PID start-up frequency	0 Hz	f_{MIN} - f_{MAX}			-1
423	PID proportional gain	0.01	0.00 - 10.00	Yes	Yes	-2
424	PID integration time	Off	0.01 - 9999.00 s. (Off)	Yes	Yes	-2
425	PID differentiation time	Off	0.0 (Off) - 10.00 sec.	Yes	Yes	-2
426	PID differentiator gain limit	5.0	5.0 - 50.0	Yes	Yes	-1
427	PID lowpass filter time	0.01	0.01 - 10.00	Yes	Yes	-2



VLT® 5000/5000 Flux/6000 HVAC/8000 AQUA PROFIBUS

■ Parameter list VLT 6000

PNU	Parameter	Factory setting	Range	Changes	4-Setup	Conversion Data	
#	description			during operation		index	type
500	Protocol	FC protocol		Yes	Yes	0	5
501	Address	1	Depends on par. 500	Yes	No	0	6
502	Baudrate	9600 Baud		Yes	No	0	5
503	Coasting	Logic or		Yes	Yes	0	5
504	DC-brake	Logic or		Yes	Yes	0	5
505	Start	Logic or		Yes	Yes	0	5
506	Direction of rotation	Logic or		Yes	Yes	0	5
507	Selection of Setup	Logic or		Yes	Yes	0	5
508	Selection of preset reference	Logic or		Yes	Yes	0	5
509	Data read-out: Reference %			No	No	-1	3
510	Data read-out: Reference unit			No	No	-3	4
511	Data read-out: Feedback			No	No	-3	4
512	Data read-out: Frequency			No	No	-1	6
513	User defined read-out			No	No	-2	7
514	Data read-out: Current			No	No	-2	7
515	Data read-out: Power, kW			No	No	1	7
516	Data read-out: Power, HP			No	No	-2	7
517	Data read-out: Motor voltage			No	No	-1	6
518	Data read-out: DC link voltage			No	No	0	6
519	Data read-out: Motor temp.			No	No	0	5
520	Data read-out: VLT temp.			No	No	0	5
521	Data read-out: Digital input			No	No	0	5
522	Data read-out: Terminal 53, analogue input			No	No	-1	3
523	Data read-out: Terminal 54, analogue input			No	No	-1	3
524	Data read-out: Terminal 60, analogue input			No	No	4	3
525	Data read-out: Pulse reference			No	No	-1	7
526	Data read-out: External reference %			No	No	-1	3
527	Data read-out: Status word, hex			No	No	0	6
528	Data read-out: Heat sink temperature			No	No	0	5
529	Data read-out: Alarm word, hex			No	No	0	7
530	Data read-out: Control word, hex			No	No	0	6
531	Data read-out: Warning word, hex			No	No	0	7
532	Data read-out: Extended status word, hex			No	No	0	7
533	Display text 1			No	No	0	9
534	Display text 2			No	No	0	9
535	Busfeedback 1			No	No	0	3
536	Busfeedback 2			No	No	0	3
537	Data read-out: Relay status			No	No	0	5
555	Bus time interval	1 sec.	1 - 99 sec.	Yes	Yes	0	5
556	Bus time interval function	OFF		Yes	Yes	0	5
560	N2 Override release time	OFF	1 - 65534 sec.	Yes	No	0	6
565	FLN Bus time interval	60 sec.	1 - 65534 sec.	Yes	Yes	0	6
566	FLN Bus time interval function	OFF		Yes	Yes	0	5

Parameter list



VLT® 5000/5000 Flux/6000 HVAC/8000 AQUA PROFIBUS

■ Parameter list VLT 6000

PNU #	Parameter description	Factory setting	Range	Changes during operation	4-Setup	Conversion index	Data type
600	Operating data: Operating hours			No	No	74	7
601	Operating data: Hours run			No	No	74	7
602	Operating data: kWh counter			No	No	3	7
603	Operating data: No. of cut-ins			No	No	0	6
604	Operating data: No. of overtemps			No	No	0	6
605	Operating data: No. of overvoltages			No	No	0	6
606	Data log: Digital input			No	No	0	5
607	Data log: Control word			No	No	0	6
608	Data log: Status word			No	No	0	6
609	Data log: Reference			No	No	-1	3
610	Data log: Feedback			No	No	-3	4
611	Data log: Output frequency			No	No	-1	3
612	Data log: Output voltage			No	No	-1	6
613	Data log: Output current			No	No	-2	3
614	Data log: DC link voltage			No	No	0	6
615	Fault log: Error code			No	No	0	5
616	Fault log: Time			No	No	0	7
617	Fault log: Value			No	No	0	3
618	Reset of kWh counter	No reset		Yes	No	0	5
619	Reset of hours-run counter	No reset		Yes	No	0	5
620	Operating mode	Normal function		Yes	No	0	5
621	Nameplate: Unit type			No	No	0	9
622	Nameplate: Power component			No	No	0	9
623	Nameplate: VLT ordering no.			No	No	0	9
624	Nameplate: Software version no.			No	No	0	9
625	Nameplate: LCP identification no.			No	No	0	9
626	Nameplate: Database identification no.			No	No	-2	9
627	Nameplate: Power component identification no.			No	No	0	9
628	Nameplate: Application option type			No	No	0	9
629	Nameplate: Application option ordering no			No	No	0	9
630	Nameplate: Communication option type			No	No	0	9
631	Nameplate: Communication option ordering no.			No	No	0	9

Changes during operation:

"Yes" means that the parameter can be changed, while the VLT frequency converter is in operation.
 "No" means that the VLT frequency converter must be stopped before a change can be made.

4-Setup:

"Yes" means that the parameter can be programmed individually in each of the four setups, i.e. the same parameter can have four different data values. "No" means that the data value will be the same in all four setups.

Conversion index:

This number refers to a conversion figure to be used when writing or reading to or from a VLT frequency converter by means of serial communication.

Conversion index	Conversion factor
74	0.1
2	100
1	10
0	1
-1	0.1
-2	0.01
-3	0.001
-4	0.0001

Data type:

Data type shows the type and length of the telegram.

Data type	Description
3	Integer 16
4	Integer 32
5	Unsigned 8
6	Unsigned 16
7	Unsigned 32
9	Text string



VLT® 5000/5000 Flux/6000 HVAC/8000 AQUA PROFIBUS

■ VLT 8000 AQUA

PNU #	Parameter description	Factory setting	Range	Changes 4-Setup during operation		Conversion index	Data type
001	Language	English		Yes	No	0	5
002	Active Setup	Setup 1		Yes	No	0	5
003	Copying of Setups	No copying		No	No	0	5
004	LCP copy	No copying		No	No	0	5
005	Max value of user-defined readout	100.00	0 - 999.999,99	Yes	Yes	-2	4
006	Unit for user-defined readout	No unit		Yes	Yes	0	5
007	Big display readout	Frequency, % of max.		Yes	Yes	0	5
008	Small display readout 1.1	Reference , Unit		Yes	Yes	0	5
009	Small display readout 1.2	Motor current, A		Yes	Yes	0	5
010	Small display readout 1.3	Power, HP		Yes	Yes	0	5
011	Unit of local reference	Hz		Yes	Yes	0	5
012	Hand start on LCP	Enable		Yes	Yes	0	5
013	OFF/STOP on LCP	Enable		Yes	Yes	0	5
014	Auto start on LCP	Enable		Yes	Yes	0	5
015	Reset on LCP	Enable		Yes	Yes	0	5
016	Lock for data change	Not locked		Yes	Yes	0	5
017	Operating state at power-up, local control	Auto restart		Yes	Yes	0	5
100	Configuration	Open loop		No	Yes	0	5
101	Torque characteristics	Automatic Energy Optimisation		No	Yes	0	5
102	Motor power, P _{M,N}	Depends on the unit	5 - 600 HP	No	Yes	1	6
103	Motor voltage, U _{M,N}	Depends on the unit	208/460 V	No	Yes	0	6
104	Motor frequency, f _{M,N}	60/50 Hz	24-120 Hz	No	Yes	0	6
105	Motor current, I _{M,N}	Depends on the unit	0.01 - I _{VLT,MAX}	No	Yes	-2	7
106	Rated motor speed, n _{M,N}	Depends on par. 102 Motor power	100-60000 rpm	No	Yes	0	6
107	Automatic motor adaptation, AMA	Optimisation disable		No	No	0	5
108	VT start voltage	Depends on par. 103	0.0 - par. 103	Yes	Yes	-1	6
109	Resonance dampening	100 %	0 - 500 %	Yes	Yes	0	6
110	High brake-away torque	0.0 sec.	0.0 - 0.5 sec.	Yes	Yes	-1	5
111	Start delay	0.0 sec.	0.0 - 120.0 sec.	Yes	Yes	-1	6
112	Motor preheater	Disable		Yes	Yes	0	5
113	Motor preheater DC current	50 %	0 - 100 %	Yes	Yes	0	6
114	DC braking current	50 %	0 - 100 %	Yes	Yes	0	6
115	DC braking time	OFF	0.0 - 60.0 sec.	Yes	Yes	-1	6
116	DC brake cut-in frequency	OFF	0.0-par. 202	Yes	Yes	-1	6
117	Motor thermal protection	ETR trip 1		Yes	Yes	0	5

Parameter list



VLT® 5000/5000 Flux/6000 HVAC/8000 AQUA PROFIBUS

Parameter list

■ VLT 8000 AQUA

PNU #	Parameter description	Factory setting	Range	Changes 4-Setup during operation		Conversion index	Data type
				No	Yes		
200	Output frequency range	0 -120 Hz	0 - 1000 Hz	No	Yes	0	5
201	Output frequency low limit, f_{MIN}	0.0 Hz	0.0 - f_{MAX}	Yes	Yes	-1	6
202	Output frequency high limit, f_{MAX}	60 Hz	f_{MIN} - par. 200	Yes	Yes	-1	6
203	Reference site	Hand/Auto linked reference		Yes	Yes	0	5
204	Minimum reference, Ref_{MIN}	0.000	0.000-par. 100	Yes	Yes	-3	4
205	Maximum reference, Ref_{MAX}	60 Hz	par. 100-999.999,999	Yes	Yes	-3	4
206	Ramp-up time	Depends on the unit	1 - 3600	Yes	Yes	0	7
207	Ramp-down time	Depends on the unit	1 - 3600	Yes	Yes	0	7
208	Automatic ramp-up/down	Enable		Yes	Yes	0	5
209	Jog frequency	10.0 Hz	0.0 - par. 100	Yes	Yes	-1	6
210	Reference type	Sum ¹⁾ /Preset reference ²⁾		Yes	Yes	0	5
211	Preset reference 1	0.00 %	-100.00 - 100.00 %	Yes	Yes	-2	3
212	Preset reference 2	0.00 %	-100.00 - 100.00 %	Yes	Yes	-2	3
213	Preset reference 3	0.00 %	-100.00 - 100.00 %	Yes	Yes	-2	3
214	Preset reference 4	0.00 %	-100.00 - 100.00 %	Yes	Yes	-2	3
215	Current limit, I_{LIM}	1.0 x $I_{VLT,N}$ [A]	0,1-1,1 x $I_{VLT,N}$ [A]	Yes	Yes	-1	6
216	Frequency bypass, bandwidth	0 Hz	0 - 100 Hz	Yes	Yes	0	6
217	Frequency bypass 1	120 Hz	0.0 - par. 200	Yes	Yes	-1	6
218	Frequency bypass 2	120 Hz	0.0 - par. 200	Yes	Yes	-1	6
219	Frequency bypass 3	120 Hz	0.0 - par. 200	Yes	Yes	-1	6
220	Frequency bypass 4	120 Hz	0.0 - par. 200	Yes	Yes	-1	6
221	Warning: Low current, I_{LOW}	0.0 A	0.0 - par. 222	Yes	Yes	-1	6
222	Warning: High current, I_{HIGH}	$I_{VLT,MAX}$	Par. 221 - $I_{VLT,MAX}$	Yes	Yes	-1	6
223	Warning: Low frequency, f_{LOW}	0.0 Hz	0.0 - par. 224	Yes	Yes	-1	6
224	Warning: High frequency, f_{HIGH}	120.0 Hz	Par. 223 - par. 200/202	Yes	Yes	-1	6
225	Warning: Low reference, Ref_{LOW}	999,999.999	-999,999.999 - par. 226	Yes	Yes	-3	4
226	Warning: High reference, Ref_{HIGH}	999,999.999	Par. 225 - 999,999.999	Yes	Yes	-3	4
227	Warning: Low feedback, FB_{LOW}	999,999.999	-999,999.999 - par. 228	Yes	Yes	-3	4
228	Warning: High feedback, FB_{HIGH}	999,999.999	Par. 227 - 999,999.999	Yes	Yes	-3	4

1) Sum = Global

2) Preset reference = North America

Changes during operation:

"Yes" means that the parameter can be changed, while the VLT AFD is in operation. "No" means that the VLT AFD must be stopped before a change can be made.

4-Setup:

"Yes" means that the parameter can be programmed individually in each of the four setups, i.e. the same parameter can have four different data values. "No" means that the data value will be the same in all four setups.

Conversion index:

This number refers to a conversion figure to be used when writing or reading to or from a VLT AFD by means of serial communication.

Conversion index	Conversion factor
74	0.1
2	100
1	10
0	1
-1	0.1
-2	0.01
-3	0.001
-4	0.0001

Data type:

Data type shows the type and length of the telegram.

Data type Description

3	Integer 16
4	Integer 32
5	Unsigned 8
6	Unsigned 16
7	Unsigned 32
9	Text string



VLT® 5000/5000 Flux/6000 HVAC/8000 AQUA PROFIBUS

■ VLT 8000 AQUA

Parameter list

PNU #	Parameter description	Factory setting	Range	Changes 4-Setup during operation		Conversion index	Data type
				Yes	Yes		
300	Terminal 16 Digital input	Reset		Yes	Yes	0	5
301	Terminal 17 Digital input	No operation		Yes	Yes	0	5
302	Terminal 18 Digital input	Start		Yes	Yes	0	5
303	Terminal 19 Digital input	Reversing		Yes	Yes	0	5
304	Terminal 27 Digital input	Coasting stop, inverse		Yes	Yes	0	5
305	Terminal 29 Digital input	Jog		Yes	Yes	0	5
306	Terminal 32 Digital input	No operation		Yes	Yes	0	5
307	Terminal 33 Digital input	No operation		Yes	Yes	0	5
308	Terminal 53, analog input voltage	No operation		Yes	Yes	0	5
309	Terminal 53, min. scaling	0.0 V	0.0 - 10.0 V	Yes	Yes	-1	5
310	Terminal 53, max. scaling	10.0 V	0.0 - 10.0 V	Yes	Yes	-1	5
311	Terminal 54, analog input voltage	No operation		Yes	Yes	0	5
312	Terminal 54, min. scaling	0.0 V	0.0 - 10.0 V	Yes	Yes	-1	5
313	Terminal 54, max. scaling	10.0 V	0.0 - 10.0 V	Yes	Yes	-1	5
314	Terminal 60, analog input current	Reference		Yes	Yes	0	5
315	Terminal 60, min. scaling	4.0 mA	0.0 - 20.0 mA	Yes	Yes	-4	5
316	Terminal 60, max. scaling	20.0 mA	0.0 - 20.0 mA	Yes	Yes	-4	5
317	Time out	10 sec.	1 - 99 sec.	Yes	Yes	0	5
318	Function after time out	Off		Yes	Yes	0	5
319	Terminal 42, output	0 - I _{MAX} ⇒ 4-20 mA		Yes	Yes	0	5
320	Terminal 42, output, pulse scaling	5000 Hz	1 - 32000 Hz	Yes	Yes	0	6
321	Terminal 45, output	0 - f _{MAX} ⇒ 0-20 mA		Yes	Yes	0	5
322	Terminal 45, output, pulse scaling	5000 Hz	1 - 32000 Hz	Yes	Yes	0	6
323	Relay 1, output function	No alarm		Yes	Yes	0	5
324	Relay 01, ON delay	0.00 sec.	0 - 600 sec.	Yes	Yes	0	6
325	Relay 01, OFF delay	2.00 sec.	0 - 600 sec.	Yes	Yes	0	6
326	Relay 2, output function	Running		Yes	Yes	0	5
327	Pulse reference, max. frequency	5000 Hz	Depends on input terminal	Yes	Yes	0	6
328	Pulse feedback, max. frequency	25000 Hz	0 - 65000 Hz	Yes	Yes	0	6

Changes during operation:

"Yes" means that the parameter can be changed, while the VLT AFD is in operation. "No" means that the VLT AFD must be stopped before a change can be made.

4-Setup:

"Yes" means that the parameter can be programmed individually in each of the four setups, i.e. the same parameter can have four different data values. "No" means that the data value will be the same in all four setups.

Conversion index:

This number refers to a conversion figure to be used when writing or reading to or from a VLT AFD by means of serial communication.

Conversion index	Conversion factor
74	0.1
2	100
1	10
0	1
-1	0.1
-2	0.01
-3	0.001
-4	0.0001

Data type:

Data type shows the type and length of the telegram.

Data type	Description
3	Integer 16
4	Integer 32
5	Unsigned 8
6	Unsigned 16
7	Unsigned 32
9	Text string



VLT® 5000/5000 Flux/6000 HVAC/8000 AQUA PROFIBUS

Parameter list

■ VLT 8000 AQUA

PNU #	Parameter description	Factory setting	Range	Changes 4-Setup during operation		Conversion index	Data type
400	Reset function	Infinite Automatic		Yes	Yes	0	5
401	Automatic restart time	10 sec.	0 - 600 sec.	Yes	Yes	0	6
402	Flying start	Enable		Yes	Yes	-1	5
403	Sleep mode timer	Off	0 - 300 sec.	Yes	Yes	0	6
404	Sleep frequency	0 Hz	f_{MIN} - Par. 405	Yes	Yes	-1	6
405	Wake up frequency	50/60 Hz	Par. 404 - f_{MAX}	Yes	Yes	-1	6
406	Boost setpoint	100%	1 - 200 %	Yes	Yes	0	6
407	Switching frequency	Depends on the unit	3.0 - 14.0 kHz	Yes	Yes	2	5
408	Interference reduction method	ASF		Yes	Yes	0	5
409	Function in case of no load	Warning		Yes	Yes	0	5
410	Function at main failure	Trip		Yes	Yes	0	5
411	Function at overtemperature	Trip		Yes	Yes	0	5
412	Trip delay overcurrent, I_{LIM}	60 sec	0 - 60 sec.	Yes	Yes	0	5
413	Minimum feedback, FB_{MIN}	0.000	-999,999.999 - FB_{MIN}	Yes	Yes	-3	4
414	Maximum feedback, FB_{MAX}	100.000	FB_{MIN} - 999,999.999	Yes	Yes	-3	4
415	Units relating to closed loop	%		Yes	Yes	-1	5
416	Feedback conversion	Linear		Yes	Yes	0	5
417	Feedback calculation	Maximum		Yes	Yes	0	5
418	Setpoint 1	0.000	FB_{MIN} - FB_{MAX}	Yes	Yes	-3	4
419	Setpoint 2	0.000	FB_{MIN} - FB_{MAX}	Yes	Yes	-3	4
420	PID normal/inverse control	Normal		Yes	Yes	0	5
421	PID anti windup	On		Yes	Yes	0	5
422	PID start-up frequency	0 Hz	f_{MIN} - f_{MAX}			-1	6
423	PID proportional gain	0.01	0.00 - 10.00	Yes	Yes	-2	6
424	PID start-up frequency	Off	0.01 - 9999.00 s. (Off)	Yes	Yes	-2	7
425	PID differentiation time	Off	0.0 (Off) - 10.00 sec.	Yes	Yes	-2	6
426	PID differentiator gain limit	5.0	5.0 - 50.0	Yes	Yes	-1	6
427	PID lowpass filter time	0.01	0.01 - 10.00	Yes	Yes	-2	6
433	Motor alternation time	0 (OFF)	0 - 999 hrs	Yes	Yes	74 (?)	6
434	Motor alternation function	Ramp	Ramp/Coast	Yes	Yes	?	?



VLT® 5000/5000 Flux/6000 HVAC/8000 AQUA PROFIBUS

■ VLT 8000 AQUA

PNU #	Parameter description	Factory setting	Range	Changes during operation	4-Setup	Conversion Index	Data Type
500	Protocol	FC		Yes	Yes	0	5
501	Address	001	Depends on par. 500	Yes	No	0	5
502	Baudrate	9600 Baud		Yes	No	0	5
503	Coasting	Logic or		Yes	Yes	0	5
504	DC-brake	Logic or		Yes	Yes	0	5
505	Start	Logic or		Yes	Yes	0	5
506	Reversing	Digital Input		Yes	Yes	0	5
507	Selection of setup	Logic or		Yes	Yes	0	5
508	Selection of Preset Reference	Logic or		Yes	Yes	0	5
509	Data Read-out: Reference %			No	No	-1	3
510	Data Read-out: Reference unit			No	No	-3	4
511	Data Read-out: Feedback			No	No	-3	4
512	Data Read-out: Frequency			No	No	-1	6
513	User Defined Read-out			No	No	-2	7
514	Data Read-out: Current			No	No	-2	7
515	Data Read-out: Power, kW			No	No	1	7
516	Data Read-out: Power, HP			No	No	-2	7
517	Data Read-out: Motor Voltage			No	No	-1	6
518	Data Read-out: DC Link Voltage			No	No	0	6
519	Data Read-out: Motor Temp.			No	No	0	5
520	Data Read-out: VLT Temp.			No	No	0	5
521	Data Read-out: Digital Input			No	No	0	5
522	Data Read-out: Terminal 53, Analog Input			No	No	-1	3
523	Data Read-out: Terminal 54, Analog Input			No	No	-1	3
524	Data Read-out: Terminal 60, Analog Input			No	No	4	3
525	Data Read-out: Pulse Reference			No	No	-1	7
526	Data Read-out: External Reference %			No	No	-1	3
527	Data Read-out: Status Word, Hex			No	No	0	6
528	Data Read-out: Heat Sink Temperature			No	No	0	5
529	Data Read-out: Alarm Word, Hex			No	No	0	7
530	Data Read-out: Control Word, Hex			No	No	0	6
531	Data Read-out: Warning Word, Hex			No	No	0	7
532	Data Read-out: Extended Status Word, Hex			No	No	0	7
533	Display Text 1			No	No	0	9
534	Display Text 2			No	No	0	9
535	Bus Feedback 1	00000		No	No	0	3
536	Bus Feedback 2	00000		No	No	0	3
537	Data Read-out: Relay Status			No	No	0	5
555	Bus Time Interval	60 sec.	1 to 99 sec.	Yes	Yes	0	5
556	Bus Time Interval Function	No Function		Yes	Yes	0	5
560	N2 Override Release Time	OFF	1 to 65534 sec.	Yes	Yes	0	5
565	FLN Bus Time Interval	60 sec.	1 to 65534 sec.	Yes	Yes	0	5
566	FLN Bus Time Interval Function	OFF		Yes	Yes	0	5

Parameter list

■ VLT 8000 AQUA

PNU #	Parameter description	Factory setting	Range	Changes during operation	4-Setup	Conversion index	Data type
600	Operating data: Operating hours			No	No	74	7
601	Operating data: Hours run			No	No	74	7
602	Operating data: kWh counter			No	No	2	7
603	Operating data: No. of cut-ins			No	No	0	6
604	Operating data: No. of overtemps			No	No	0	6
605	Operating data: No. of overvoltages			No	No	0	6
606	Data log: Digital input			No	No	0	5
607	Data log: Control word			No	No	0	6
608	Data log: Status word			No	No	0	6
609	Data log: Reference			No	No	-1	3
610	Data log: Feedback			No	No	-3	4
611	Data log: Output frequency			No	No	-1	3
612	Data log: Output voltage			No	No	-1	6
613	Data log: Output current			No	No	-2	3
614	Data log: DC link voltage			No	No	0	6
615	Fault log: Error code			No	No	0	5
616	Fault log: Time			No	No	0	7
617	Fault log: Value			No	No	0	3
618	Reset of kWh counter	No reset		Yes	No	0	5
619	Reset of hours-run counter	No reset		Yes	No	0	5
620	Operating mode	Normal function		Yes	No	0	5
621	Nameplate: Unit type			No	No	0	9
622	Nameplate: Power component			No	No	0	9
623	Nameplate: VLT ordering no.			No	No	0	9
624	Nameplate: Software version no.			No	No	0	9
625	Nameplate: LCP identification no.			No	No	0	9
626	Nameplate: Database identification no.			No	No	-2	9
627	Nameplate: Power component identification no.			No	No	0	9
628	Nameplate: Application option type			No	No	0	9
629	Nameplate: Application option ordering no.			No	No	0	9
630	Nameplate: Communication option type			No	No	0	9
631	Nameplate: Communication option ordering no.			No	No	0	9

Changes during operation:
 "Yes" means that the parameter can be changed, while the VLT AFD is in operation. "No" means that the VLT AFD must be stopped before a change can be made.

4-Setup:
 "Yes" means that the parameter can be programmed individually in each of the four setups, i.e. the same parameter can have four different data values. "No" means that the data value will be the same in all four setups.

Conversion index:
 This number refers to a conversion figure to be used when writing or reading to or from a VLT AFD by means of serial communication.

Conversion index	Conversion factor
74	0.1
2	100
1	10
0	1
-1	0.1
-2	0.01
-3	0.001
-4	0.0001

Data type:
 Data type shows the type and length of the telegram.

Data type	Description
3	Integer 16
4	Integer 32
5	Unsigned 8
6	Unsigned 16
7	Unsigned 32
9	Text string



VLT® 5000/5000 Flux/6000 HVAC/8000 AQUA PROFIBUS

■ VLT 8000 AQUA

PNU #	Parameter description	Factory setting	Range	Changes during operation	4-Setup	Conversion index	Data type
700	Relay 6, Output Function	Running		Yes	Yes	0	5
701	Relay 6, On Delay	000 sec.	0 to 600 sec.	Yes	Yes	0	6
702	Relay 6, Off Delay	000 sec.	0 to 600 sec.	Yes	Yes	0	6
703	Relay 7, Output Function	No Function		Yes	Yes	0	5
704	Relay 7, On Delay	000 sec.	0 to 600 sec.	Yes	Yes	0	6
705	Relay 7, Off Delay	000 sec.	0 to 600 sec.	Yes	Yes	0	6
706	Relay 8, Output Function	No Function		Yes	Yes	0	5
707	Relay 8, On Delay	000 sec.	0 to 600 sec.	Yes	Yes	0	6
708	Relay 8, Off Delay	000 sec.	0 to 600 sec.	Yes	Yes	0	6
709	Relay 9, Output Function	No Function		Yes	Yes	0	5
710	Relay 9, On Delay	000 sec.	0 to 600 sec.	Yes	Yes	0	6
711	Relay 9, Off Delay	000 sec.	0 to 600 sec.	Yes	Yes	0	6

Parameter list

■ Parameter list VLT 5000

PNU #	Parameter description	Factory setting	Range	Changes during operation	4-Setup	Conversion Index	Data type
001	Language	English		Yes	No	0	5
002	Local/remote control	Remote control		Yes	Yes	0	5
003	Local reference	000.000		Yes	Yes	-3	4
004	Active setup	Setup 1		Yes	No	0	5
005	Programming setup	Active setup		Yes	No	0	5
006	Copying of setups	No copying		No	No	0	5
007	LCP copy	No copying		No	No	0	5
008	Display scaling of motor frequency	1	0.01 - 100.00	Yes	Yes	-2	6
009	Display line 2	Frequency [Hz]		Yes	Yes	0	5
010	Display line 1.1	Reference [%]		Yes	Yes	0	5
011	Display line 1.2	Motor current [A]		Yes	Yes	0	5
012	Display line 1.3	Power [kW]		Yes	Yes	0	5
013	Local control/configuration	LCP digital control/as par.100		Yes	Yes	0	5
014	Local stop	Possible		Yes	Yes	0	5
015	Local jog	Not possible		Yes	Yes	0	5
016	Local reversing	Not possible		Yes	Yes	0	5
017	Local reset of trip	Possible		Yes	Yes	0	5
018	Lock for data change	Not locked		Yes	Yes	0	5
019	Operating state at power-up, local control	Forced stop, use saved ref.		Yes	Yes	0	5
100	Configuration	Speed control, open loop		No	Yes	0	5
101	Torque characteristics	High - constant torque		Yes	Yes	0	5
102	Motor power	Depends on the unit	0.18-500 kW	No	Yes	1	6
103	Motor voltage	Depends on the unit	200 - 500 V	No	Yes	0	6
104	Motor frequency	50 / 60 Hz		No	Yes	0	6
105	Motor current	Depends on the unit	0.01- I_{VLTMAX}	No	Yes	-2	7
106	Rated motor speed	Depends on the unit	100-60000 rpm	No	Yes	0	6
107	Automatic motor adaptation, AMA	Adaptation off		No	No	0	5
108	Stator resistor	Depends on the unit		No	Yes	-4	7
109	Stator reactance	Depends on the unit		No	Yes	-2	7
110	Motor magnetizing, 0 rpm	100 %	0 - 300 %	Yes	Yes	0	6
111	Min. frequency normal magnetizing	1.0 Hz	0.1 - 10.0 Hz	Yes	Yes	-1	6
113	Load compensation at low speed	100 %	0 - 300 %	Yes	Yes	0	6
114	Load compensation at high speed	100 %	0 - 300 %	Yes	Yes	0	6
115	Slip compensation	100 %	-500 - 500 %	Yes	Yes	0	3
116	Slip compensation time constant	0.50 s	0.05 - 1.00 s	Yes	Yes	-2	6
117	Resonance dampening	100 %	0 - 500 %	Yes	Yes	0	6
118	Resonance dampening time constant	5 ms	5 - 50 ms	Yes	Yes	-3	6
119	High starting torque	0.0 sec.	0.0 - 0.5 s	Yes	Yes	-1	5
120	Start delay	0.0 sec.	0.0 - 10.0 s	Yes	Yes	-1	5
121	Start function	Coasting in start delay time		Yes	Yes	0	5
122	Function at stop	Coasting		Yes	Yes	0	5
123	Min. frequency for activating function at stop	0.0 Hz	0.0 - 10.0 Hz	Yes	Yes	-1	5
124	DC holding current	50 %	0 - 100 %	Yes	Yes	0	6
125	DC braking current	50 %	0 - 100 %	Yes	Yes	0	6
126	DC braking time	10.0 sec.	0.0 - 60.0 sec.	Yes	Yes	-1	6
127	DC brake cut-in frequency	Off	0.0-par. 202	Yes	Yes	-1	6
128	Motor thermal protection	No protection		Yes	Yes	0	5
129	External motor fan	No		Yes	Yes	0	5
130	Start frequency	0.0 Hz	0.0-10.0 Hz	Yes	Yes	-1	5
131	Initial voltage	0.0 V	0.0-par. 103	Yes	Yes	-1	6



VLT® 5000/5000 Flux/6000 HVAC/8000 AQUA PROFIBUS

Parameter list VLT 5000

PNU #	Parameter description	Factory setting	Range	Changes during operation	4-Setup	Conversion Index	Data type
200	Output frequency range/direction	Only clockwise, 0-132 Hz		No	Yes	0	5
201	Output frequency low limit	0.0 Hz	0.0 - f_{MAX}	Yes	Yes	-1	6
202	Output frequency high limit	66 / 132 Hz	f_{MIN} - par. 200	Yes	Yes	-1	6
203	Reference/feedback area	Min - max		Yes	Yes	0	5
204	Minimum reference	0.000	-100,000.000- Ref_{MAX}	Yes	Yes	-3	4
205	Maximum reference	50.000	Ref_{MIN} -100,000.000	Yes	Yes	-3	4
206	Ramp type	Linear		Yes	Yes	0	5
207	Ramp-up time 1	Depends on unit	0.05 - 3600	Yes	Yes	-2	7
208	Ramp-down time 1	Depends on unit	0.05 - 3600	Yes	Yes	-2	7
209	Ramp-up time 2	Depends on unit	0.05 - 3600	Yes	Yes	-2	7
210	Ramp-down time 2	Depends on unit	0.05 - 3600	Yes	Yes	-2	7
211	Jog ramp time	Depends on unit	0.05 - 3600	Yes	Yes	-2	7
212	Quick stop ramp-down time	Depends on unit	0.05 - 3600	Yes	Yes	-2	7
213	Jog frequency	10.0 Hz	0.0 - par. 202	Yes	Yes	-1	6
214	Reference function	Sum		Yes	Yes	0	5
215	Preset reference 1	0.00 %	- 100.00 - 100.00 %	Yes	Yes	-2	3
216	Preset reference 2	0.00 %	- 100.00 - 100.00 %	Yes	Yes	-2	3
217	Preset reference 3	0.00 %	- 100.00 - 100.00 %	Yes	Yes	-2	3
218	Preset reference 4	0.00 %	- 100.00 - 100.00 %	Yes	Yes	-2	3
219	Catch up/slow down value	0.00 %	0.00 - 100 %	Yes	Yes	-2	6
220							
221	Torque limit for motor mode	160 %	0.0 % - xxx %	Yes	Yes	-1	6
222	Torque limit for regenerative operation	160 %	0.0 % - xxx %	Yes	Yes	-1	6
223	Warning: Low current	0.0 A	0.0 - par. 224	Yes	Yes	-1	6
224	Warning: High current	I_{VLTMAX}	Par. 223 - I_{VLTMAX}	Yes	Yes	-1	6
225	Warning: Low frequency	0.0 Hz	0.0 - par. 226	Yes	Yes	-1	6
226	Warning: High frequency	132.0 Hz	Par. 225 - par. 202	Yes	Yes	-1	6
227	Warning: Low feedback	-4000.000	-100,000.000 - par. 228		Yes	-3	4
228	Warning: High feedback	4000.000	Par. 227 - 100,000.000		Yes	-3	4
229	Frequency bypass, bandwidth	OFF	0 - 100 %	Yes	Yes	0	6
230	Frequency bypass 1	0.0 Hz	0.0 - par. 200	Yes	Yes	-1	6
231	Frequency bypass 2	0.0 Hz	0.0 - par. 200	Yes	Yes	-1	6
232	Frequency bypass 3	0.0 Hz	0.0 - par. 200	Yes	Yes	-1	6
233	Frequency bypass 4	0.0 Hz	0.0 - par. 200	Yes	Yes	-1	6
234	Motor phase monitor	Enable		Yes	Yes	0	5

■ Parameter list VLT 5000

PNU #	Parameter description	Factory setting	Range	Changes during operation	4-Setup	Conversion Index	Data type
300	Terminal 16, input	Reset		Yes	Yes	0	5
301	Terminal 17, input	Freeze reference		Yes	Yes	0	5
302	Terminal 18 Start, input	Start		Yes	Yes	0	5
303	Terminal 19, input	Reversing		Yes	Yes	0	5
304	Terminal 27, input	Coasting stop, inverse		Yes	Yes	0	5
305	Terminal 29, input	Jog		Yes	Yes	0	5
306	Terminal 32, input	Choice of setup, msb/speed up		Yes	Yes	0	5
307	Terminal 33, input	Choice of setup, lsb/speed down		Yes	Yes	0	5
308	Terminal 53, analog input voltage	Reference		Yes	Yes	0	5
309	Terminal 53, min. scaling	0.0 V	0.0 - 10.0 V	Yes	Yes	-1	5
310	Terminal 53, max. scaling	10.0 V	0.0 - 10.0 V	Yes	Yes	-1	5
311	Terminal 54, analog input voltage	No operation		Yes	Yes	0	5
312	Terminal 54, min. scaling	0.0 V	0.0 - 10.0 V	Yes	Yes	-1	5
313	Terminal 54, max. scaling	10.0 V	0.0 - 10.0 V	Yes	Yes	-1	5
314	Terminal 60, analog input current	Reference		Yes	Yes	0	5
315	Terminal 60, min. scaling	0.0 mA	0.0 - 20.0 mA	Yes	Yes	-4	5
316	Terminal 60, max. scaling	20.0 mA	0.0 - 20.0 mA	Yes	Yes	-4	5
317	Time out	10 sec.	1 - 99 sec.	Yes	Yes	0	5
318	Function after time out	Off		Yes	Yes	0	5
319	Terminal 42, output	0 - I _{MAX} P 0-20 mA		Yes	Yes	0	5
320	Terminal 42, output, pulse scaling	5000 Hz	1 - 32000 Hz	Yes	Yes	0	6
321	Terminal 45, output	0 - f _{MAX} P 0-20 mA		Yes	Yes	0	5
322	Terminal 45, output, pulse scaling	5000 Hz	1 - 32000 Hz	Yes	Yes	0	6
323	Relay 01, output	Ready - no thermal warning		Yes	Yes	0	5
324	Relay 01, ON delay	0.00 sec.	0.00 - 600 sec.	Yes	Yes	-2	6
325	Relay 01, OFF delay	0.00 sec.	0.00 - 600 sec.	Yes	Yes	-2	6
326	Relay 04, output	Ready - remote control		Yes	Yes	0	5
327	Pulse reference, max. frequency	5000 Hz		Yes	Yes	0	6
328	Pulse feedback, max. frequency	25000 Hz		Yes	Yes	0	6
329	Encoder feedback pulse/rev.	1024 pulses/rev.	1 - 4096 pulses/rev.	Yes	Yes	0	6
330	Freeze reference/output function	No operation		Yes	No	0	5
345	Encoder loss timeout	0 sec.	0 - 60 sec	No	Yes	-1	6
346	Encoder loss function	OFF		Yes	Yes	0	5

Changes during operation

"Yes" means that the parameter can be changed, while the VLT frequency converter is in operation.
 "No" means that the VLT frequency converter must be stopped before a change can be made.

4-Setup

"Yes" means that the parameter can be programmed individually in each of the four setups, i.e. the same parameter can have four different data values.

"No" means that the data value will be the same in all four setups.

Conversion index

This number refers to a conversion figure to be used when writing or reading by means of a VLT frequency converter.

Conversion index	Conversion factor
74	0.1
2	100
1	10
0	1
-1	0.1
-2	0.01
-3	0.001
-4	0.0001

Data type

... shows the type and length of the telegram.

Data type	Description
3	Integer 16
4	Integer 32
5	Unsigned 8
6	Unsigned 16
7	Unsigned 32
9	Text string



VLT® 5000/5000 Flux/6000 HVAC/8000 AQUA PROFIBUS

■ Parameter list VLT 5000

PNU #	Parameter description	Factory setting	Range	Changes during operation	4-Setup	Conversion Index	Data type
400	Brake function/overvoltage control	Off		Yes	No	0	5
401	Brake resistor, ohm	Depends on the unit		Yes	No	-1	6
402	Brake power limit, kW	Depends on the unit		Yes	No	2	6
403	Power monitoring	On		Yes	No	0	5
404	Brake check	Off		Yes	No	0	5
405	Reset function	Manual reset		Yes	Yes	0	5
406	Automatic restart time	5 sec.	0 - 10 sec.	Yes	Yes	0	5
407	Mains Failure	No function		Yes	Yes	0	5
408	Quick discharge	Not possible		Yes	Yes	0	5
409	Trip delay torque	Off	0 - 60 sec.	Yes	Yes	0	5
410	Trip delay-inverter	Depends on type of unit	0 - 35 sec.	Yes	Yes	0	5
411	Switching frequency	Depends on type of unit	3 - 14 kHz	Yes	Yes	2	6
412	Output frequency dependent switching frequency	Not possible		Yes	Yes	0	5
413	Overmodulation function	On		Yes	Yes	-1	5
414	Minimum feedback	0.000	FB _{HIGH} - 100,000.000	Yes	Yes	-3	4
415	Maximum feedback	1500.000	FB _{LOW} - 100,000.000	Yes	Yes	-3	4
416	Process unit	%		Yes	Yes	0	5
417	Speed PID proportional gain	0.015	0.000 - 0.150	Yes	Yes	-3	6
418	Speed PID integration time	8 ms	2.00 - 999.99 ms	Yes	Yes	-4	7
419	Speed PID differentiation time	30 ms	0.00 - 200.00 ms	Yes	Yes	-4	6
420	Speed PID diff. gain ratio	5.0	5.0 - 50.0	Yes	Yes	-1	6
421	Speed PID low-pass filter	10 ms	5 - 200 ms	Yes	Yes	-4	6
422	U 0 voltage at 0 Hz	20.0 V	0.0 - parameter 103	Yes	Yes	-1	6
423	U 1 voltage	parameter 103	0.0 - U _{VLT,MAX}	Yes	Yes	-1	6
424	F 1 frequency	parameter 104	0.0 - parameter 426	Yes	Yes	-1	6
425	U 2 voltage	parameter 103	0.0 - U _{VLT,MAX}	Yes	Yes	-1	6
426	F 2 frequency	parameter 104	par.424-par.428	Yes	Yes	-1	6
427	U 3 voltage	parameter 103	0.0 - U _{VLT,MAX}	Yes	Yes	-1	6
428	F 3 frequency	parameter 104	par.426 -par.430	Yes	Yes	-1	6
429	U 4 voltage	parameter 103	0.0 - U _{VLT,MAX}	Yes	Yes	-1	6
430	F 4 frequency	parameter 104	par.426-par.432	Yes	Yes	-1	6
431	U 5 voltage	parameter 103	0.0 - U _{VLT,MAX}	Yes	Yes	-1	6
432	F 5 frequency	parameter 104	par.426 - 1000 Hz	Yes	Yes	-1	6
433	Torque proportional gain	100%	0 (OFF) - 500%	Yes	Yes	0	6
434	Torque integral time	0.02 sec.	0.002 - 2.000 sec.	Yes	Yes	-3	7
437	Process PID Normal/inverse control	Normal		Yes	Yes	0	5
438	Process PID anti windup	On		Yes	Yes	0	5
439	Process PID start frequency	parameter 201	f _{MIN} - f _{MAX}	Yes	Yes	-1	6
440	Process PID proportional gain	0.01	0.00 - 10.00	Yes	Yes	-2	6
441	Process PID integral time	9999.99 sec. (OFF)	0.01 - 9999.99 sec.	Yes	Yes	-2	7
442	Process PID differentiation time	0.00 sec. (OFF)	0.00 - 10.00 sec.	Yes	Yes	-2	6
443	Process PID diff. gain limit	5.0	5.0 - 50.0	Yes	Yes	-1	6
444	Process PID lowpass filter time	0.01	0.01 - 10.00	Yes	Yes	-2	6
445	Flying start	Disable		Yes	Yes	0	5
446	Switching pattern	SFAVM		Yes	Yes	0	5
447	Torque compensation	100%	-100 - +100%	Yes	Yes	0	3
448	Gear ratio	1	0.001 - 100.000	No	Yes	-2	4
449	Friction loss	0%	0 - 50%	No	Yes	-2	6
450	Mains voltage at mains fault	Depends on unit	Depends on unit	Yes	Yes	0	6
453	Speed closed loop gear ratio	1	0.01-100	No	Yes	0	4
454	Dead time compensation	ON		No	No	0	5

■ Parameter list VLT 5000

PNU #	Parameter description	Factory setting	Range	Changes during operation	4-Setup	Conversion Index	Data type
500	Address	1	0 - 126	Yes	No	0	6
501	Baudrate	9600 Baud		Yes	No	0	5
502	Coasting	Logic or		Yes	Yes	0	5
503	Quick-stop	Logic or		Yes	Yes	0	5
504	DC-brake	Logic or		Yes	Yes	0	5
505	Start	Logic or		Yes	Yes	0	5
506	Reversing	Logic or		Yes	Yes	0	5
507	Selection of setup	Logic or		Yes	Yes	0	5
508	Selection of speed	Logic or		Yes	Yes	0	5
509	Bus jog 1	10.0 Hz	0.0 - parameter 202	Yes	Yes	-1	6
510	Bus jog 2	10.0 Hz	0.0 - parameter 202	Yes	Yes	-1	6
511							
512	Telegram profile	Drivecom		No	Yes	0	5
513	Bus time interval	1 sec.	1 - 99 s	Yes	Yes	0	5
514	Bus time interval function	Off		Yes	Yes	0	5
515	Data read-out: Reference %			No	No	-1	3
516	Data read-out: Reference unit			No	No	-3	4
517	Data read-out: Feedback			No	No	-3	4
518	Data read-out: Frequency			No	No	-1	6
519	Data read-out: Frequency x Scaling			No	No	-2	7
520	Data read-out: Current			No	No	-2	7
521	Data read-out: Torque			No	No	-1	3
522	Data read-out: Power, kW			No	No	-1	7
523	Data read-out: Power, HP			No	No	-2	7
524	Data read-out: Motor voltage			No	No	-1	6
525	Data read-out: DC link voltage			No	No	0	6
526	Data read-out: Motor temp.			No	No	0	5
527	Data read-out: VLT temp.			No	No	0	5
528	Data read-out: Digital input			No	No	0	5
529	Data read-out: Terminal 53, analogue input			No	No	-2	3
530	Data read-out: Terminal 54, analogue input			No	No	-2	3
531	Data read-out: Terminal 60, analogue input			No	No	-5	3
532	Data read-out: Pulse reference			No	No	-1	7
533	Data read-out: External reference %			No	No	-1	3
534	Data read-out: Status word, binary			No	No	0	6
535	Data read-out: Brake power/2 min.			No	No	2	6
536	Data read-out: Brake power/sec.			No	No	2	6
537	Data read-out: Heat sink temperature			No	No	0	5
538	Data read-out: Alarm word, binary			No	No	0	7
539	Data read-out: VLT control word, binary			No	No	0	6
540	Data read-out: Warning word, 1			No	No	0	7
541	Data read-out: Warning word, 2			No	No	0	7



VLT® 5000/5000 Flux/6000 HVAC/8000 AQUA PROFIBUS

■ Parameter list VLT 5000

PNU #	Parameter description	Factory setting	Range	Changes during operation	4-Setup	Conversion Index	Data type
600	Operating data: Operating hours			No	No	74	7
601	Operating data: Hours run			No	No	74	7
602	Operating data: kWh counter			No	No	2	7
603	Operating data: Number of power-up's			No	No	0	6
604	Operating data: Number of overtemperatures			No	No	0	6
605	Operating data: Number of overvoltages			No	No	0	6
606	Data log: Digital input			No	No	0	5
607	Data log: Bus commands			No	No	0	6
608	Data log: Bus status word			No	No	0	6
609	Data log: Reference			No	No	-1	3
610	Data log: Feedback			No	No	-3	4
611	Data log: Motor frequency			No	No	-1	3
612	Data log: Motor voltage			No	No	-1	6
613	Data log: Motor current			No	No	-2	3
614	Data log: DC link voltage			No	No	0	6
615	Fault log: Error code			No	No	0	5
616	Fault log: Time			No	No	-1	7
617	Fault log: Value			No	No	0	3
618	Reset of kWh counter	No reset		Yes	No	0	5
619	Reset of hours-run counter	No reset		Yes	No	0	5
620	Operating mode Normal function	Normal function		No	No	0	5
621	Nameplate: VLT type			No	No	0	9
622	Nameplate: Power section			No	No	0	9
623	Nameplate: VLT ordering number			No	No	0	9
624	Nameplate: Software version no.			No	No	0	9
625	Nameplate: LCP identification no.			No	No	0	9
626	Nameplate: Database identification no.			No	No	-2	9
627	Nameplate: Power section identification no.			No	No	0	9
628	Nameplate: Application option type			No	No	0	9
629	Nameplate: Application option ordering no.			No	No	0	9
630	Nameplate: Communication option type			No	No	0	9
631	Nameplate: Communication option ordering no.			No	No	0	9

Parameter list

■ Parameter list VLT 5000

PNU #	Parameter description	Factory setting	Range	Changes during operation	4-Setup	Conversion Index	Data type
800	Protocol selection	1 (= DP)	0-1	yes	no	0	5
801	Baud rate selection	500 kBaud (6)	0-9	yes	no	0	5
802	Minimum station delay	35 (1)	0-1	yes	no	0	5
803	Time after bus error	1	1-99	yes	yes	0	5
804	Response after bus error	Off (0)	0-7	yes	yes	0	5
805	Function control word bit 10	Bit 10 = 1 => CTW active (1)	0-3	yes	yes	0	5
806	SAP selection	SAP 63 (0)	0-9	yes	yes	0	5
900	Write PPO type 1		12 bytes	yes	yes	0	5
901	Write PPO type 2		20 bytes	no	no	0	5
902	Write PPO type 3		4 bytes	no	no	0	5
903	Write PPO type 4		12 bytes	no	no	0	5
904	PPO selection for DP	900 (= PPO1)	900-903	yes	yes	0	6
907	Read PPO type 1		12 bytes	no	no	0	5
908	Read PPO type 2		20 bytes	no	no	0	5
909	Read PPO type 3		4 bytes	no	no	0	5
910	Read PPO type 4		12 bytes	no	no	0	5
911	PPO type for FMS read	907 (= PPO1)	907-910	yes	yes	0	6
913	Broadcast index	0	0-32767	yes	yes	0	6
914	Broadcast offset	0	0-244	yes	yes	0	6
915	PCD write configuration			yes	yes	0	6
916	PCD read configuration			yes	yes	0	6
917 ⁴	Spontaneous/event messages	OFF (0)	ON/OFF	yes	yes	0	6
918	User address	0	1-126	yes	no	0	6
927	PCV operating authority	With PROFIBUS (1)	0 - 1	yes	yes	0	6
928	Control authority	With PROFIBUS (1)	0 - 1	yes	yes	0	6
953	Warning messages			no	no	0	6
967	Control word		16 Bit	yes	no	0	
968	Status word		16 Bit	no	no	0	6
969	Time difference			no	no	0	6
970	Parameter setup selection	Active setup = P001	0 - 6	yes	yes	0	5
971 ⁵	Save data values	OFF (0)	ON/OFF	yes	no	0	5
980	Defined parameters			no	no	0	6
981							
982							
990	Modified parameters			no	no	0	6
991							
992							

* Automatic reset to (0).

⁴) Available in all 4 setups.

⁵) Only in stop mode

■ **Appendix**

■ **Glossar**

Changes during operation

"Yes" means that the parameter can be changed, while the VLT frequency converter is in operation.

"No" means that the VLT frequency converter must be stopped before a change can be made.

4-Setup

"Yes" means that the parameter can be programmed individually in each of the four setups, i.e. the same parameter can have four different data values.

"No" means that the data value will be the same in all four setups.

Conversion index

This number refers to a conversion figure to be used when writing or reading by means of a VLT frequency converter.

Conversion index	Conversion factor
74	0.1
2	100
1	10
0	1
-1	0.1
-2	0.01
-3	0.001
-4	0.0001

Data type

The data type shows the type and length of the telegram.

Data type	Description
3	Integer 16
4	Integer 32
5	Unsigned 8
6	Unsigned 16
7	Unsigned 32
9	Text string

■ Abbreviations used

Englisch	German	Description
ALI	-	Application Layer Interface
ATTR	-	Connection Attribute
CTW	STW	Control Word
DP	-	Decentralized Periphery
EIA	-	Electronic Industries Association: Author of the EIA standard RS 485-A
EMC	EMV	Electromagnetic Compatibility
FIFO	-	First In First Out
FMS	-	Fieldbus Message Specification
Hd	-	Hamming Distance
HPFB	-	High Performance Field Bus
IND	-	Subindex
I/O	E/A	Input/Output
ISO	-	International Standards Organization
LSB	-	Lowest Significant Bit
MSB	-	Most Significant Bit
MAP	-	Manufacturing Automation Protocol
MAV	HIW	Main Actual Value
MMS	-	Manufacturing Message Specification
MRV	HSW	Main Reference Value
OD	OV	Object Directory
PC	-	Personal Computer
PCA	PKE	Parameter Characteristics
PCD	PZD	Process Data
PCV	PKW	Parameter Characteristics Value
PDU	-	Protocol Data Unit
PLC	SPS	Programmable Logic Control
PNU	-	Parameter Number
PPO	-	Parameter Process Data Object
PVA	PWE	Parameter Value
RC	AK	Request/Response Characteristics
SPM	-	Spontaneous Message
STW	ZSW	Status Word
TSDR	-	Station Delay
TRT	-	Target Rotation Time
VDE	-	Verein Deutscher Elektrotechniker
VDI	-	Verein Deutscher Elektroingenieure
VSD	FU	Variable Speed Drive

■ Index

Symbols

4-Setup 42, 47

800 Protocol selection 30

801 Baud rate selection 30

802 Minimum station delay 30

803 Time after bus error 31

805 Function control word bit 10 32

806 SAP selection 32

900 Write PPO type 1 32

901 Write PPO type 2 32

902 Write PPO type 3 32

903 Write PPO type 4 33

904 PPO selection for DP 33

907 Read PPO type 1 33

908 Read PPO type 2 33

909 Read PPO type 3 33

910 Read PPO type 4 33

911 PPO type for FMS read 33

913 Broadcast index 34

914 Broadcast offset 34

915 PCD write configuration 34

916 PCD read configuration 34

917 Spontaneous/event messages 35

918 User address 35

927 PCV operating authority 35

928 Control authority 35

953 Warning messages 36

967 Control word 36

968 Status word 36

970 Parameter setup selection 36

971 Save data values 36

980-982 Defined parameters 37

990-992 Modified parameters 37

A

Abbreviations used 48

About this manual 3

Additional display readings 39

Address switches 10

ALARM 39

Alarm messages 38

Assumptions 3

B

Background knowledge 3

Bus connection 8

 Diagramm 8

Bus reference value 24

C

Cable

 lengths 6

 number of nodes 6

 setup 7

Cable screening

 connection 8

Changes during operation 42, 47

Characteristics 15

Communication connections 13

Connection of the cable screening 8

Control word 19

 according to Profidrive standard 19

 according to VLT standard 22

Conversion factor 42

Conversion index 42, 47

Copyrights 2

CTW 48

Current output frequency 24

D

Data coding of the data type time difference 16

Data type 42, 47

Data type structures 15

Data types supported by VLT 15

Display readings 39

E

Earthing 8

EMC 7

Examples

 Array treatment 28

 PCV portion and control word / reference value 25

 Process data from the VLT 27

F

Factory settings 40

Fault messages 38

FMS 2

FREEZE 18

G

Glossar 47

GSD file 29

L

LEDs 9

Limitation of Liability 2

Literature 4

M

Master-controlled drives	6
MAV	48
Messages	
Fault messages	38
spontaneous	17, 38
Warnings	38
MRV	48

P

Parameter 502	5
Parameter 801	5
Parameter 904	5
Parameter 918	5
Parameter description	15
Parameter list	40
Parameter Process Data Object	13
Parameterliste	40
Parameters	15
Parameters specific to PROFIBUS	30
PCA	48
PCA - Parameter description	14
PCA interface	14
PCA processing	14
PCD	48
Physical connection	7
PPO description	13
Profibus DP	5
Profibus FMS	2
PROFIBUS option card	9
Protective measures for EMC	7
PVA	48

Q

Quick start	5
-------------------	---

R

RC content	14
Request and response	14
Revision Rights	2

S

Size attribute	15
Spontaneous messages	17, 38
Example	17
Standardized value	16
Status word	19
according to Profidrive standard	21
according to VLT standard	23
STW	48
SYNC	18

T

Time behaviour during system update	12
Timing	12

U

UNFREEZE	18
UNSYNC	18

V

VLT parameters	30
VLT response time behaviour	12
VSD	48

W

WARN. 34	39
Warning messages	38