

Contents

1 Safety	3
Safety Note	3
Safety Regulations	3
Warning against Unintended Start	4
2 Introduction	5
About this Manual	5
Technical Overview	5
Assumptions	5
Hardware	5
Background Knowledge	5
Available Literature	6
Abbreviations	6
3 How to Install	7
How to Install Option in Frequency Converter	7
Network	8
PROFINET Cables	8
LED Behaviour	9
Topology	11
Recommended Design Rules	13
EMC Precautions	14
4 How to Configure	15
IP Settings	15
Ethernet Link Parameters	16
5 How to Configure the System	17
Configure the PROFINET Network	17
Configure the Controller	17
GSD File	17
Configure the Frequency Converter	21
VLT Parameters	21
6 How to Control the Frequency Converter	23
PPO Types	23
Process Data	24
Reference Handling	24
Process Control Operation	26
Control Profile	26
PROFIdrive Control Profile	27

Danfoss FC Control Profile	33
7 Parameters	37
Parameter Group 0-** Operation/Display	37
Parameter Group 8-** Communication and Option	37
Parameter Group 9-** PROFIdrive	43
Parameter Group 12-** Ethernet	53
12-1* Ethernet Link Parameters	54
PROFINET-specific Parameter List	58
Object and Data Types Supported	59
8 Application Examples	61
E.g.: Process Data with PPO Type 6	61
E.g.: Control Word Telegram using Standard Telegram 1 / PPO3	63
E.g.: Status Word Telegram using Standard Telegram 1 / PPO3	64
E.g.: PLC Programming	65
9 Troubleshooting	67
Troubleshooting	67
LED Status	67
No Communication with the Drive	69
Warning 34 Appears even though Communication is Established	70
Drive Will Not Respond to Control Signals	70
Alarm and Warning Words	73
10 Warnings and Alarms	75
Status Messages	75
Warnings/Alarm Messages	75
Alarm List	76
Index	79

1 Safety

1

1.1.1 Copyright, Limitation of Liability and Revision Rights

This publication contains information proprietary to Danfoss. By accepting and using this manual the user agrees that the information contained herein will be used solely for operating equipment from Danfoss or equipment from other vendors provided that such equipment is intended for communication with Danfoss equipment over an PROFINET serial communication link. This publication is protected under the Copyright laws of Denmark and most other countries.

Danfoss does not guarantee that a software program produced according to the guidelines provided in this manual will function properly in every physical, hardware or software environment.

Although Danfoss has tested and reviewed the documentation within this manual, Danfoss makes no warranty or representation, either express or implied, with respect to this documentation, including its quality, performance, or fitness for a particular purpose.

In no event shall Danfoss be liable for direct, indirect, special, incidental, or consequential damages arising out of the use, or the inability to use information contained in this manual, even if advised of the possibility of such damages. In particular, Danfoss is not responsible for any costs including but not limited to those incurred as a result of lost profits or revenue, loss or damage of equipment, loss of computer programs, loss of data, the costs to substitute these, or any claims by third parties.

Danfoss reserves the right to revise this publication at any time and to make changes in its contents without prior notice or any obligation to notify previous users of such revisions or changes.

1.1.2 Safety Note



The voltage of the frequency converter is dangerous whenever connected to mains. Incorrect installation of the motor, frequency converter or fieldbus may cause damage to the equipment, serious personal injury or death. Consequently, the instructions in this manual, as well as national and local rules and safety regulations, must be complied with.

1.1.3 Safety Regulations

1. The frequency converter must be disconnected from mains if repair work is to be carried out. Check that the mains supply has been disconnected and that the necessary time has passed before removing motor and mains plugs.
2. The [OFF] key on the LCP of the frequency converter does not disconnect the equipment from mains and is thus not to be used as a safety switch.
3. Correct protective earthing or grounding of the equipment must be established, the user must be protected against supply voltage, and the motor must be protected against overload in accordance with applicable national and local regulations.
4. The earth leakage currents are higher than 3.5 mA.
5. Protection against motor overload is not included in the factory setting. If this function is desired, set par. 1-90 *Motor Thermal Protection* to data value ETR trip or data value ETR warning.



NB!

The function is initialised at 1.16 x rated motor current and rated motor frequency. For the North American market; the ETR functions provide class 20 motor overload protection in accordance with NEC.

6. Do not remove the plugs for the motor and mains supply while the frequency converter is connected to mains. Check that the mains supply has been disconnected and that the necessary time has passed before removing motor and mains plugs.
7. Please note that the frequency converter has more voltage inputs than L1, L2 and L3, when load sharing (linking of DC intermediate circuit) and external 24 V DC have been installed. Check that all voltage inputs have been disconnected and that the necessary time has passed before commencing repair work.

1**1.1.4 Warning against Unintended Start**

1. The motor can be brought to a stop by means of digital commands, bus commands, references or a local stop, while the frequency converter is connected to mains. If personal safety considerations make it necessary to ensure that no unintended start occurs, these stop functions are not sufficient.
2. While parameters are being changed, the motor may start. Consequently, the [OFF] key must always be activated.
3. A motor that has been stopped may start if faults occur in the electronics of the frequency converter, or if a temporary overload or a fault in the supply mains or the motor connection ceases.



Touching the electrical parts may be fatal - even after the equipment has been disconnected from mains.

Also make sure that other voltage inputs have been disconnected, such as external 24 V DC, load sharing (linkage of DC intermediate circuit), as well as the motor connection for kinetic back up.

Please take note of discharge times and further safety guidelines from the section: "Safety and conformity", in the respective Design Guide (MG.33.Ax.yy).

2 Introduction

2

2.1.1 About this Manual

First time users can obtain the most essential information for quick installation and set-up in these chapters:

Introduction

How to Install

How to Configure the System

For more detailed information including the full range of set-up options and diagnosis tools please refer to the chapters:

How to Configure the System

How to Control the FC102/FC 202/FC301/FC302

How to Access FC102/FC 202/FC301/FC302 Parameters

Parameters

Troubleshooting

Terminology:

In this manual several terms for Ethernet is used.

- **PROFINET**, is the term used to describe the PROFINET protocol.
- **Ethernet**, is a common term used to describe the physical layer of the network and does not relate to the application protocol.

2.1.2 Technical Overview

Since its introduction in 2001, PROFINET has been updated to handle low and medium performance requirement supported by PROFINET RT (Real Time) up to High end servo performance in PROFINET IRT (Isochronous Real Time). With this, PROFINET is the Ethernet Based Fieldbus offering the most scalable and versatile technology today.

PROFINET provides users with the network tools to deploy standard Ethernet technology for manufacturing applications while enabling Internet and enterprise connectivity.

2.1.3 Assumptions

These operating instructions are under the conditions that the Danfoss PROFINET option is used in conjunction with a Danfoss FC 102/FC 202/FC 301/FC 302 frequency converter. It is also assumed that the installed controller supports the interfaces described in this document and that all the requirements stipulated in the controller, as well as the frequency converter, are strictly observed along with all limitations herein.

2.1.4 Hardware

This manual relates to the PROFINET option MCA 120, type no. 130B1135 (un-coated) and 130B1235 (conformal coated).

2.1.5 Background Knowledge

The Danfoss PROFINET Option Card is designed to communicate with any system complying with the PROFINET standard. Familiarity with this technology is assumed. Issues regarding hardware or software produced by other manufacturers, including commissioning tools, are beyond the scope of this manual, and are not the responsibility of Danfoss.

For information regarding commissioning tools, or communication to a non-Danfoss node, please consult the appropriate manuals.

2.1.6 Available Literature

Available Literature for FC 102/FC 202/FC 301/FC 302

- The VLT AutomationDrive Operating Instructions provide the necessary information for getting the drive up and running.
- The VLT AutomationDrive Design Guide entails all technical information about the drive design and applications including encoder, resolver and relay options.
- The VLT AutomationDrive Profibus Operating Instructions provide the information required for controlling, monitoring and programming the drive via a Profibus fieldbus.
- The VLT AutomationDrive Operating Instructions provide the information required for controlling, monitoring and programming the drive via a DeviceNet fieldbus.
- The VLT AutomationDrive MCT 10 Operating Instructions provide information for installation and use of the software on a PC.
- The VLT AutomationDrive IP21 / Type 1 Instruction provides information for installing the IP21 / Type 1 option.
- The VLT AutomationDrive 24 V DC Backup Instruction provides information for installing the 24 V DC Backup option.
- The VLT AutomationDrive CanOpen Operating Instructions
- The VLT AutomationDrive Modbus TCP Operating Instructions
- The MCA 121 Ethernet/IP

Danfoss Drives technical literature is also available online at <http://www.danfoss.com/BusinessAreas/DrivesSolutions/>.

2.1.7 Abbreviations

Abbreviation	Definition
API	Actual Packet Interval
CC	Control Card
CTW	Control Word
DCP	Discovery and Configuration Protocol
DHCP	Dynamic Host Configuration Protocol
EMC	Electromagnetic Compatibility
I/O	Input/Output
IP	Internet Protocol
GSD	Generic station description
LCP	Local Control Panel
LED	Light Emitting Diode
LSB	Least Significant Bit
MAV	Main Actual Value (actual output)
MSB	Most Significant Bit
MRV	Main Reference Value
N/A	Not applicable
PC	Personal Computer
PCD	Process Control Data
PLC	Programmable Logic Controller
PNU	Parameter Number
REF	Reference (= MRV)
RT	Real Time
RTC	Real Time Clock
STP	Spanning tree Protocol
STW	Status Word

3 How to Install

3.1.1 How to Install Option in Frequency Converter

Items required for installing a fieldbus option in the frequency converter:

- The fieldbus option
- Fieldbus option adaptor frame for the FC 102/FC 202/FC 301/FC 302. This frame is deeper than the standard frame, to allow space for the fieldbus option beneath
- Strain relief (only for A1 and A2 enclosures)

3

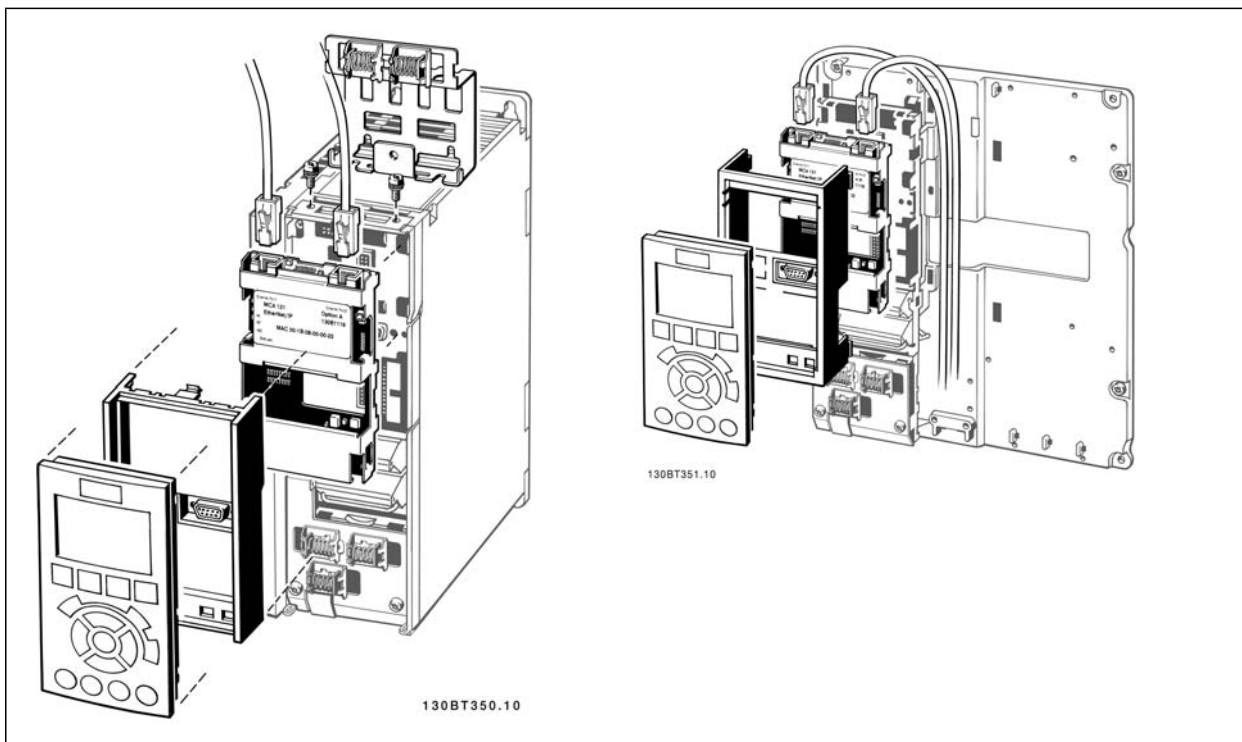

Instructions:

- Remove LCP panel from the FC 102/FC 202/FC 301/FC 302.
- Remove the frame located beneath and discard it.
- Push the option into place. The Ethernet connectors must be facing upwards.
- Remove both knock-outs on the fieldbus option adaptor frame.
- Push the fieldbus option adaptor frame for the FC 102/FC 202/FC 301/FC 302 into place.
- Replace the LCP and attach cable

NB!
Do not strip the Ethernet cable and ground it via the strain relief-plate! The grounding of screened Ethernet cable is done through the RJ-45 connector on the option.

NB!
After installing the MCA 120 option, be aware of the following parameter settings:
par. 8-01 *Control Site*: [2] *Controlword only* or [0] *Digital and ctrl. word*
par. 8-02 *Control Word Source*: [3] *Option A*

3.1.2 Network

It is of high importance that the media chosen for Ethernet data transmission are suitable. Usually CAT 5e and 6 cables are recommended for industrial applications. Both types of cable are available as Unshielded Twisted Pair and Shielded Twisted Pair. Generally shielded cables are recommended for use in industrial environments and with frequency converters.

A maximum cable-length of 100 m is allowed between switches.

Optical fibres can be used for gapping longer distances and providing galvanic isolation.

For connecting PROFINET RT devices both hubs and switches can be used. It is, however, recommended always to use suitable industrial graded Ethernet switches. Danfoss recommends always to use PROFINET compliant switches

3.1.3 PROFINET Cables

PROFINET cables used are based electrically on category 5 balanced LAN cables according to ISO/IEC 11801 Edition 2.0.Class D.

In special applications (e.g. the use of trailing cables and frequently moved machine parts), cables are permitted whose design and mechanical parameters can deviate from the specifications of type A and type B cable, while retaining most of the electrical parameters (impedance levels etc.). These cables are type C cables. Highly flexible copper cables generally have the finest stranded conductors and, for example, a highly resistant polyurethane outer sheath.

Various outer sheath materials are permitted in order to meet the various demands with regard to resistance of industrial environments and exterior/underground laying (natural and synthetic oil, grease, coolants/lubricants, chemicals, high and low temperatures, UV radiation).

All balanced cables used shall comply with the following parameters:

Cable types:

Cable Type	Application Type A	Application Type B	Application Type C
Design	Data Cable	Data Cable	Data Cable
Cable Installation Type	Stationary, no movement after installation	Flexible, occasional movement or vibration	Special Applications (e.g. highly flexible, permanent movement, vibration or torsion)
Cable Marking	PROFINET Type A	PROFINET Type B	PROFINET Type C
Core Cross Section	AWG 22/1	AWG 22/7	AWG 22/..
Outer Diameter	5,5 - 8,0 mm		Application
Core Diameter	1,5 +/- 0,1 mm		Application
Colour (Outer Sheath)	Green RAL6018		Application
Core Identification (colours) star quad 2 pair	white, yellow, blue, orange	Pair 1: white (RXD+), blue (RXD-)	Pair 2: yellow(TXD+), orange(TXT-)
Number of Cores	4		
Cable Design	2 pairs or 1 star quad		
Shielding Design Type	Aluminum Foil + Cu braiding		Application
Which Plug for which Cable Type	RJ45 (IP 20 or IP 65/67) / M12		

Transmission Performance Requirements:

Relevant Standard	ISO/IEC 11801 Edition 2.0, IEC 61156 (minimum Category 5)
Delay Skew:	<=20ns/100m
Transfer Impedance	<=50 mOhm/m at 10 MHz

3.1.4 LED Behaviour

The option has 3 bi-coloured LEDs that allow a fast and detailed diagnosis. The three LEDs are each linked to its unique part of the PROFINET option:

LED Label	Description
MS	Module Status, reflects the activity on the PROFINET stack
NS1	Network Status 1, reflects the activity on port 1
NS2	Network Status 2, reflects the activity on port 2

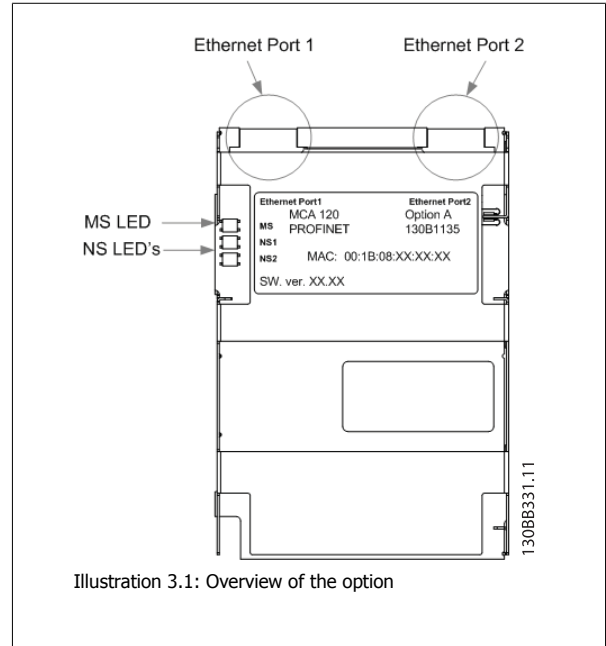

3

Illustration 3.1: Overview of the option

Module Status

Status	Tri-colour LED
No IP Address assigned	Off
No Communication to PROFINET module. Module is waiting on configuration telegram from Controller.	Green: 130BB373.10
IO AR established	Green: 130BB374.10
Supervisor AR established, No IO AR.	Green: 130BB374.10
Internal Error	Red: 130BB375.10
Wink	Yellow: 130BB375.10

Table 3.1: MS: Module Status

Network Status

Phases	Status	Tri-colour LED
Power Off.	No Power or No Link on the corresponding port	Off
Power On.	IP Address Conflict	Red:
	Waiting for configuration	Green: 130BB375.10
Running	In Data Exchange Mode	Green:
	Wrong Configuration	Red: 130BB374.10
Data exchange	No increment in "In Octets" counter of corresponding port in last 60 Sec.	Yellow: 130BB375.10

Table 3.2: Indication on Network Status LED

During normal operation the MS and at least one NS LED will show a constant green light.

Wink command

The option will responds to a Wink command from the network by yellow flashing of all three LED's simultaneous

3

3.1.5 Topology

The PROFINET module features a built-in Ethernet-switch, thus having two Ethernet RJ-45 connectors. This enables the possibility for connecting several PROFINET options in a line topology as an alternative to the typical star-topology.

The two ports are equal, in the sense that they are transparent for the option. If only one connector is used, both port can be used.

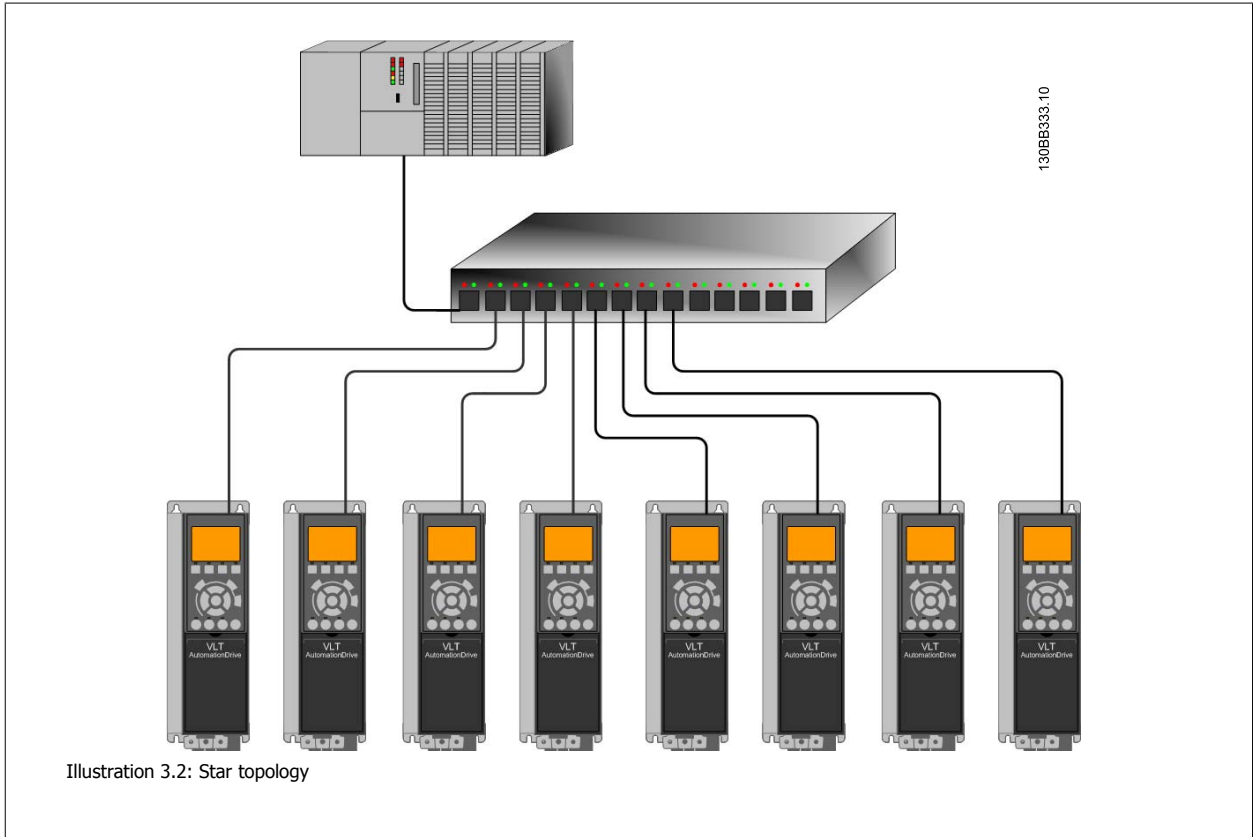

Illustration 3.2: Star topology

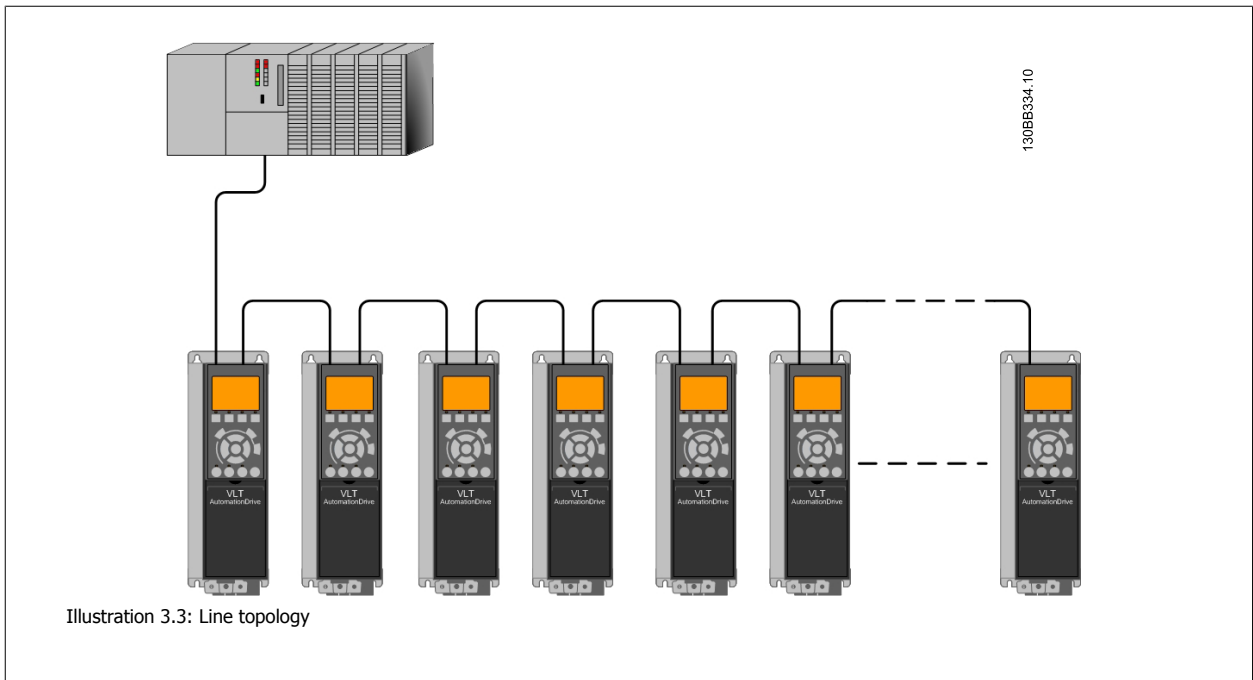

Illustration 3.3: Line topology

**NB!**

In a line topology all drives must be powered, either by mains or by their 24 V DC option cards, for the built-in switch to work. Please observe that mounting drives of different power-sizes in a line topology may result in unwanted power-off behavior, while using controlword timeout (par. 8-02 *Control Word Source* to par. 8-06 *Reset Control Word Timeout*). It is recommended to mount the drives with the longest discharge time first in the line topology.

3

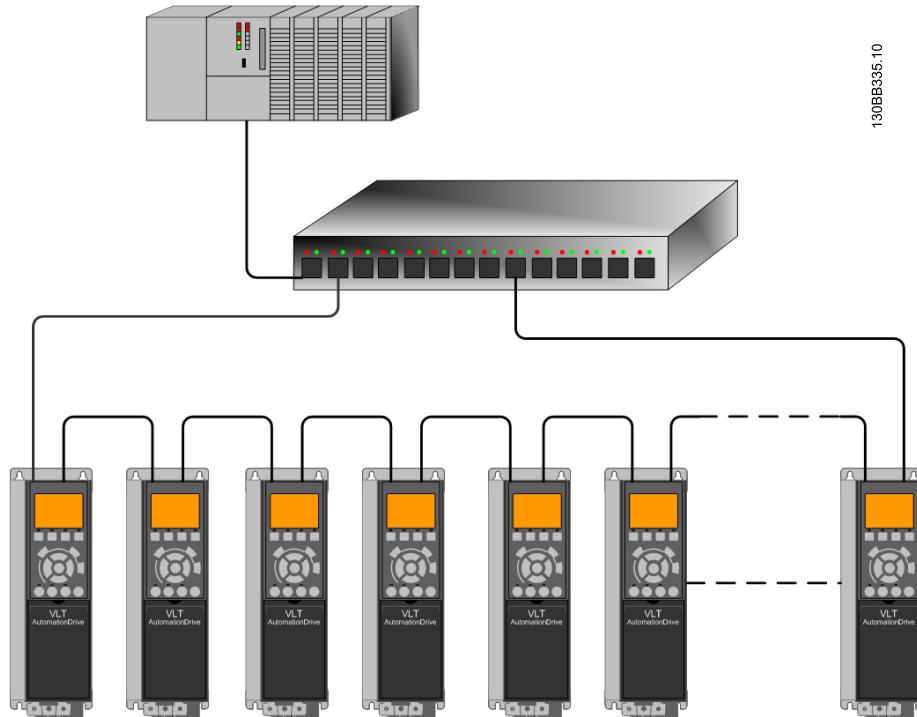

Illustration 3.4: Ring/redundant line topology

**NB!**

For this type of topology it is crucial that the network switch supports detection of loss of line topology. In some cases the detection. The switch inside the PROFINET option does not support this, but it must be supported in the switch that connects the ring to the controller/network. Please consult the manual of the switch for more information.

3.1.6 Recommended Design Rules

While designing Ethernet networks special attention and caution must be taken regarding active network components. While designing a network for line topology it is important to notice that a small delay is added with each every switch in the line.

It is not recommended to connect more than 32 drives in a line. Exceeding the recommended design rules, may result in unstable or faulted communication.

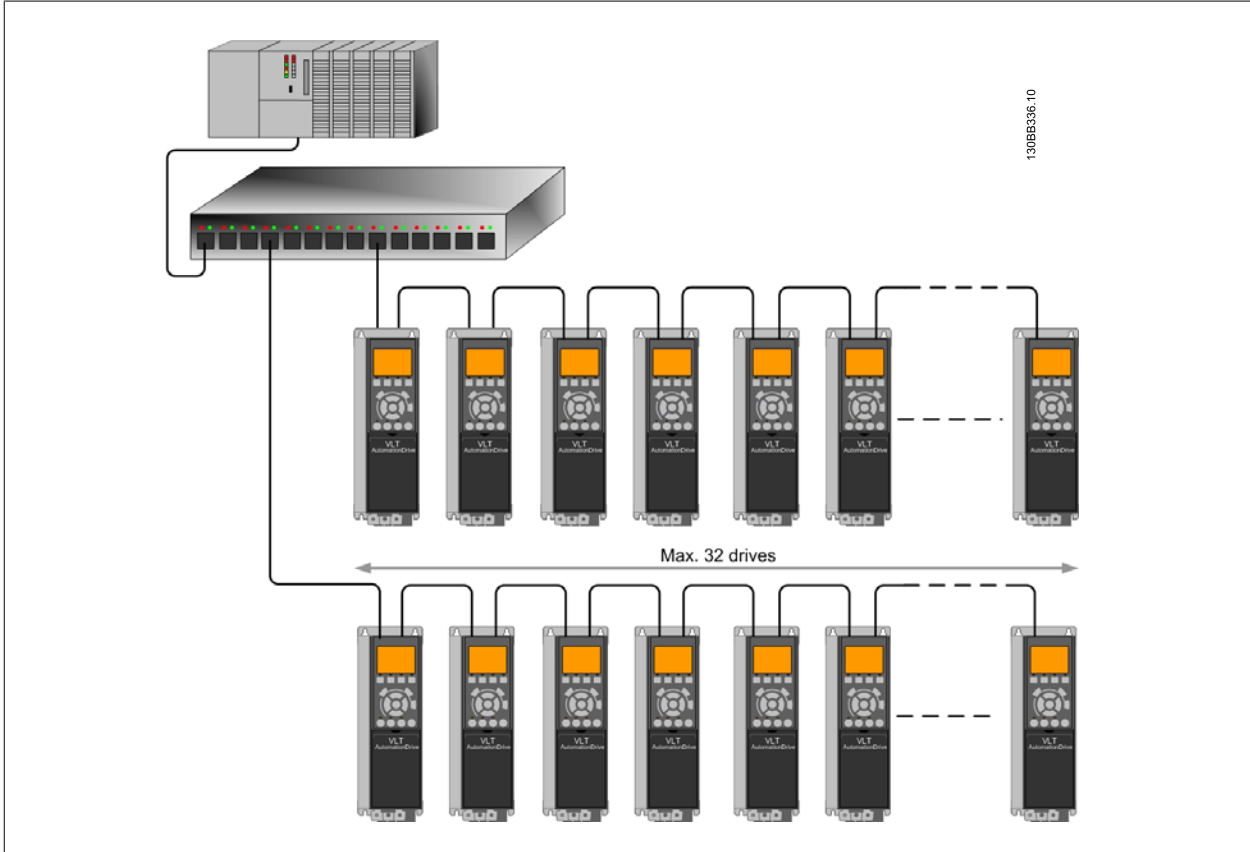

3.1.7 EMC Precautions

The following EMC precautions are recommended in order to achieve interference-free operation of the Ethernet network. Additional EMC information is available in the FC 102/FC 202/FC 301/FC 302 series Design Guide.

**NB!**

Relevant national and local regulations, for example regarding protective earth connection, must be observed.

3

The Ethernet communication cable must be kept away from motor and brake resistor cables to avoid coupling of high frequency noise from one cable to the other. Normally a distance of 200 mm (8 inches) is sufficient, but maintaining the greatest possible distance between the cables is recommended, especially where cables run in parallel over long distances. When crossing is unavoidable, the Ethernet cable must cross motor and brake resistor cables at an angle of 90 degrees.

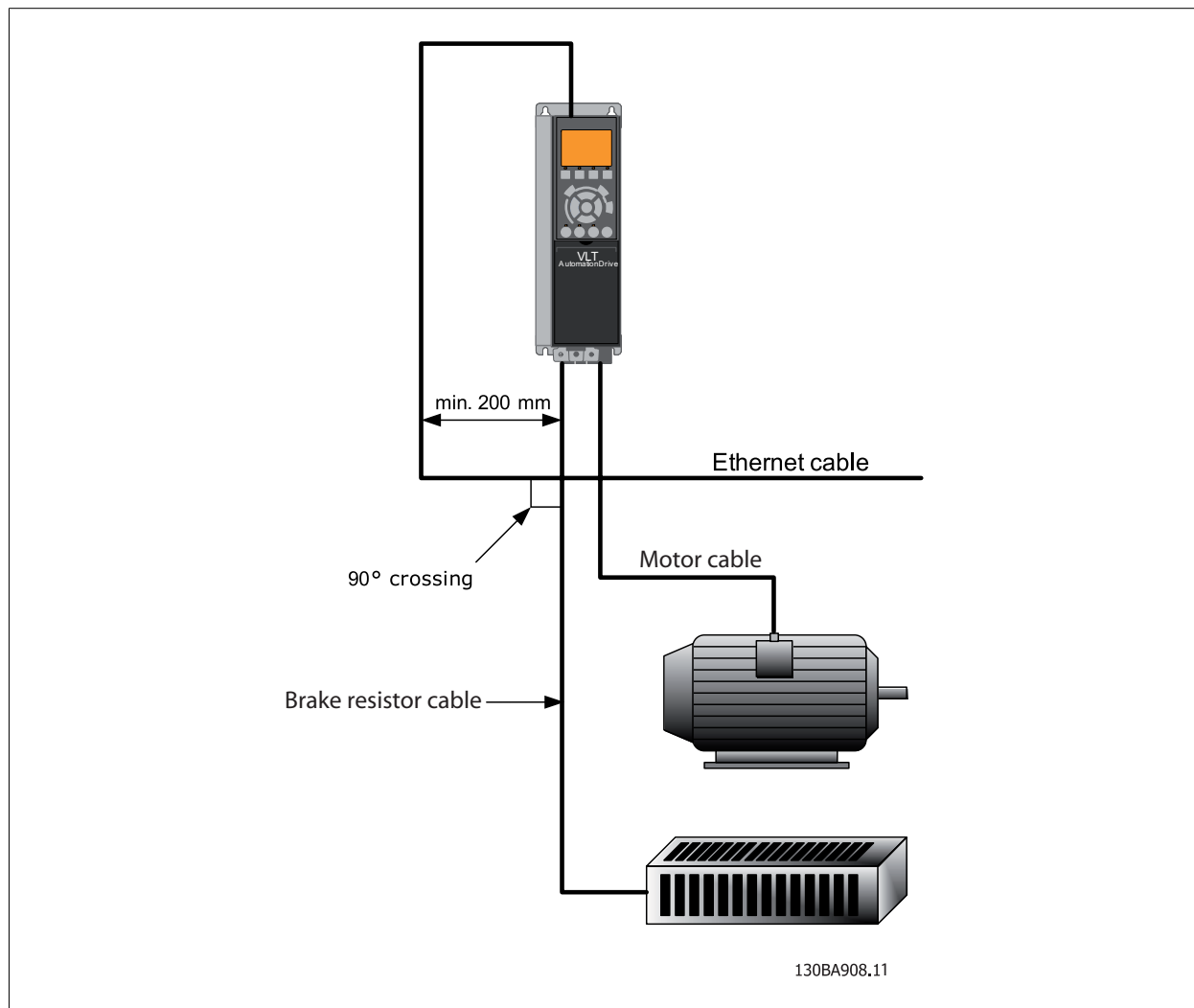

4 How to Configure

4.1.1 IP Settings

All IP-related parameters are located in parameter group 12-0*: The parameters are all set to PROFINET standard values, so that only a minimum change is necessary.

12-00	IP Address Assignment
12-01	IP Address
12-02	Subnet Mask
12-03	Default Gateway
12-04	DHCP Server
12-05	Lease Expires
12-06	Name Servers
12-07	Domain Name
12-08	Host Name
12-09	Physical Address

The PROFINET option offers several ways of IP address assignment.

Setting up drive with manual assigned IP address:

Par.	Name	Value
12-00	<i>IP Address Assignment</i>	[0] MANUAL
12-01	<i>IP Address</i>	192.168.0.003*
12-02	<i>Subnet Mask</i>	255.255.255.0*
12-03	<i>Default Gateway</i>	optional

*= Class C IP address example. Any valid IP address can be entered.

Setting up drive with automatic (BOOTP/DHCP) assigned IP address:

Par.	Name	Value
12-00	<i>IP Address Assignment</i>	[0] MANUAL/[1] DHCP/[2] BOOTP/[10] DCP
12-01	<i>IP Address</i>	Read only
12-02	<i>Subnet Mask</i>	Read only
12-03	<i>Default Gateway</i>	Read only

By IP address assigned by DHCP/BOOTP/DCP server, the assigned *IP Address* and *Subnet Mask* can be read out in par. 12-01 and 12-02. In par. 12-04 *DHCP Server*, the IP address of the found DHCP or BOOTP server is displayed. For DHCP only: The remaining lease-time can be read-out in par. 12-05 *Lease Expires*. If lease time is set to 0 (zero) the timer will never expire.

Par. 12-09, *Physical Address* reads out the MAC address of option, which is also printed on the label of the option. If using fixed leases together with DHCP or BOOTP, the physical MAC address is linked with a fixed IP address.



NB!

If no DHCP or BOOTP reply has been received after 4 attempts (e.g. if the DHCP/BOOTP server has been powered off), the option will fallback to the last good known IP address.

Par. 12-03, *Default Gateway* is optional and only used in routed networks.

Par. 12-06, *Name Servers*

Par. 12-07, *Domain Name*

Par. 12-08, *Host Name*

Are used with Domain Name Server systems and are all optional. If DHCP or BOOTP is selected as IP address assignment, these parameters are read only.



NB!

It is only possible to assign valid class A, B and C IP address to the option. The valid ranges are shown in the below table:

Class A	1.0.0.1 - 126.255.255.254
Class B	128.1.0.1 - 191.255.255.254
Class C	192.0.1.1 - 223.255.254.254

4

4.1.2 Ethernet Link Parameters

Parameter group 12-1* holds information Ethernet Link information:

12-10	Link Status
12-11	Link Duration
12-12	Auto Negotiation
12-13	Link Speed
12-14	Link Duplex

Please note the Ethernet Link Parameters are unique per port.

Par. 12-10, *Link Status* and par. 12-11, *Link Duration* displays information on the link status, per port.

Par. 12-10, *Link Status* will display Link or No Link according to the status of the present port.

Par. 12-11, *Link Duration* will display the duration of the link on the present port. If the link is broken the counter will be reset.

Par. 12-12, *Auto Negotiation* – is a feature that enables two connected Ethernet devices to choose common transmission parameters, such as speed and duplex mode. In this process, the connected devices first share their capabilities as for these parameters and then choose the fastest transmission mode they both support.

Incapability between the connected devices, may lead to decreased communication performance.

To prevent this, Auto Negotiation can be disabled.

If par. 12-12 is set to OFF, link speed and duplex mode can be configured manually in par. 12-13 and 12-14.

Par. 12-13, *Link Speed* – displays/sets the link speed per port. "None" is displayed if no link is present.

Par. 12-14, *Link Duplex* – displays/sets the duplex mode per port.

Half-duplex provides communication in both directions, but only in one direction at a time (not simultaneously).

Full-duplex allows communication in both directions, and unlike half-duplex, allows for this to happen simultaneously.

5 How to Configure the System

5.1 Configure the PROFINET Network

All PROFINET devices that are connected to the same bus network must have a unique device name.

The PROFINET device name of the frequency converter can be set via:

- Par. 12-08 *Host Name*

5.2 Configure the Controller

5.2.1 GSD File

In order to configure a PROFINET Controller, the configuration tool needs a GSD file for each type of slave on the network. The GSD file is a PROFINET standard text file containing the necessary communications setup data for a slave. Download the GSD file for the FC 100, 200 and 300 drives at <http://www.danfoss.com/BusinessAreas/DrivesSolutions/>. The name of the GSD file may vary compared to this manual. Please download the latest version from the above website.

Profibus SW Version (par. 15-61)	GSD file
1.x	GSDML-V2.2-Danfoss-FC-20090620

The first step in configuration of the PROFINET Controller is to import the GSD file in the configuration tool. The steps outlined below show how to add a new GSD file to the Simatic Manager software tool. For each drive series, a GSD file is typically imported once only, following the initial installation of the software tool.

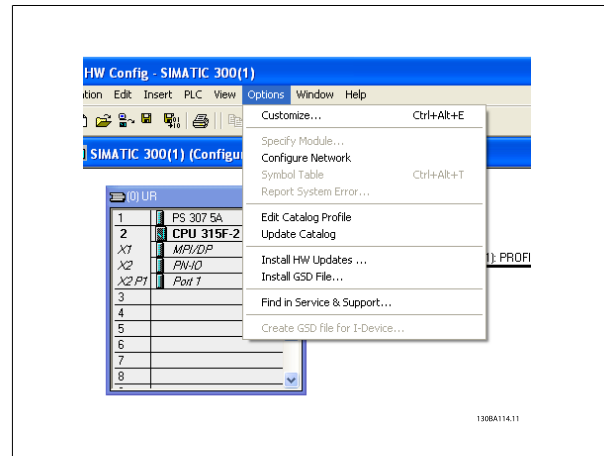

5

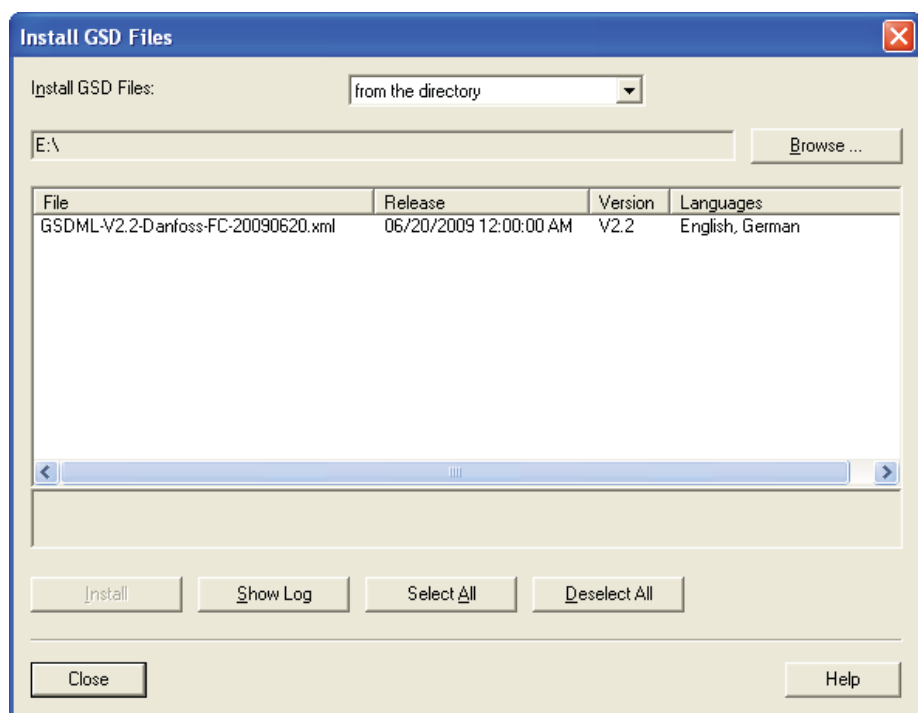

130BA567.12

The FC 102/FC 202/FC 301/FC 302 GSD file is now imported and will be accessible via the following path in the Hardware catalogue:

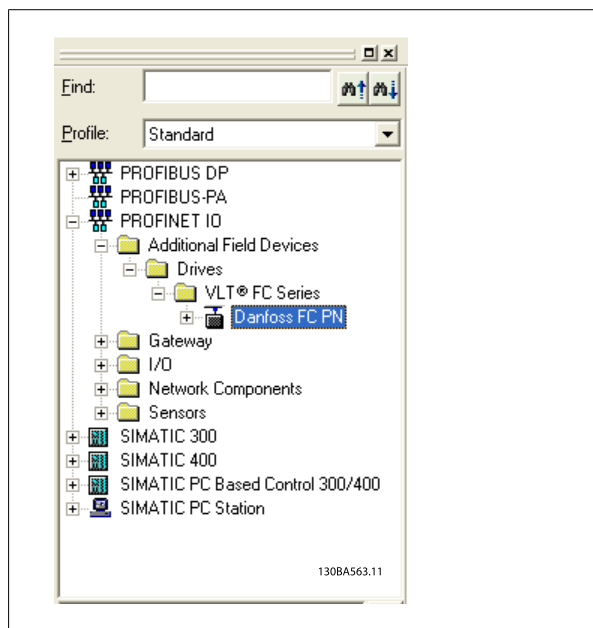

130BA563.11

Open a Project, set up the Hardware and add a PROFINET Master system. Select Danfoss FC PN then drag and drop it onto the PROFINET IO system.

A window for the Device name of the FC 102/FC 202/FC 301/FC 302 now appears. Type the name into the field. Note that the name must match the name in par. 12-08 *Host Name*. If the checkmark *Assign IP address via the IO controller* is set, the controller will download the IP address to the IO device that has the corresponding device name. The IP address is stored in the non volatile memory of the FC 102/FC 202/FC 301/FC 302.

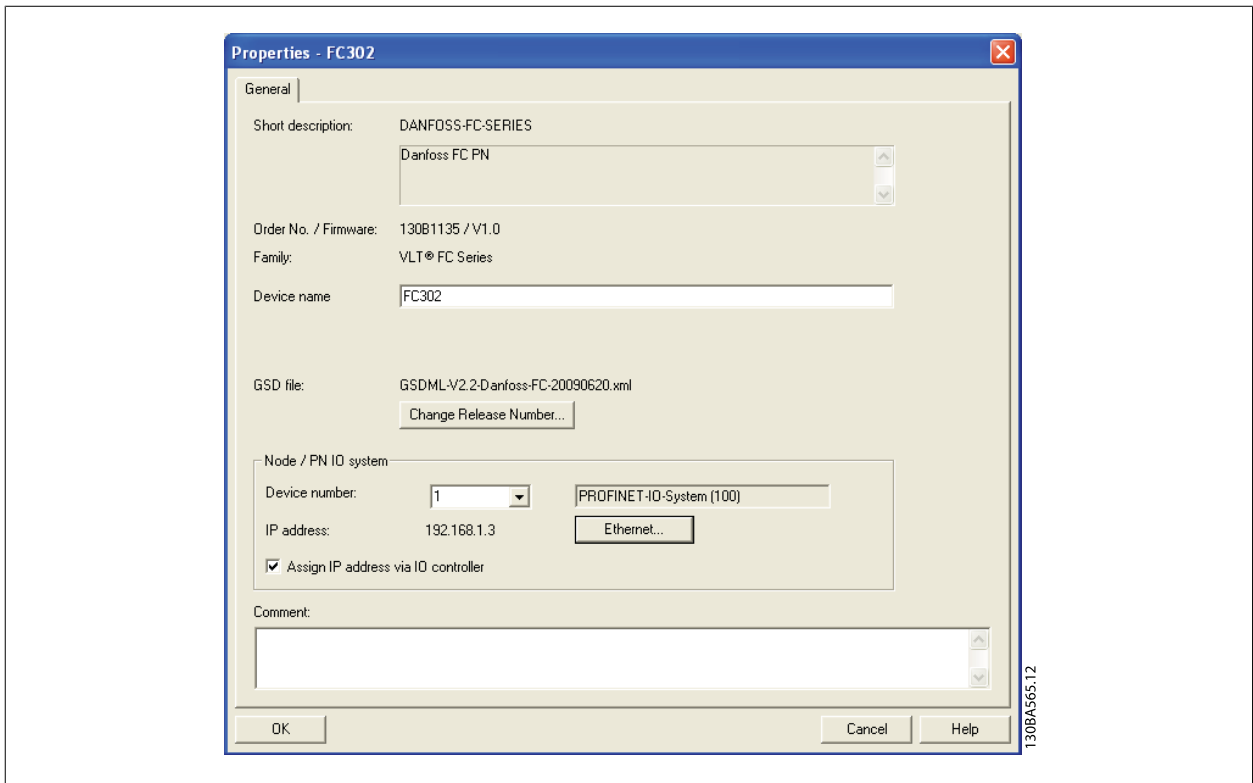

5

The next step is to set up the peripheral input and output data. Data set up in the peripheral area is transmitted cyclically via telegrams/PPO types. In the example below, a PPO type 6 is dragged and dropped to the slot 1.

See the PPO types section in *How to Control the Frequency Converter* for more information.

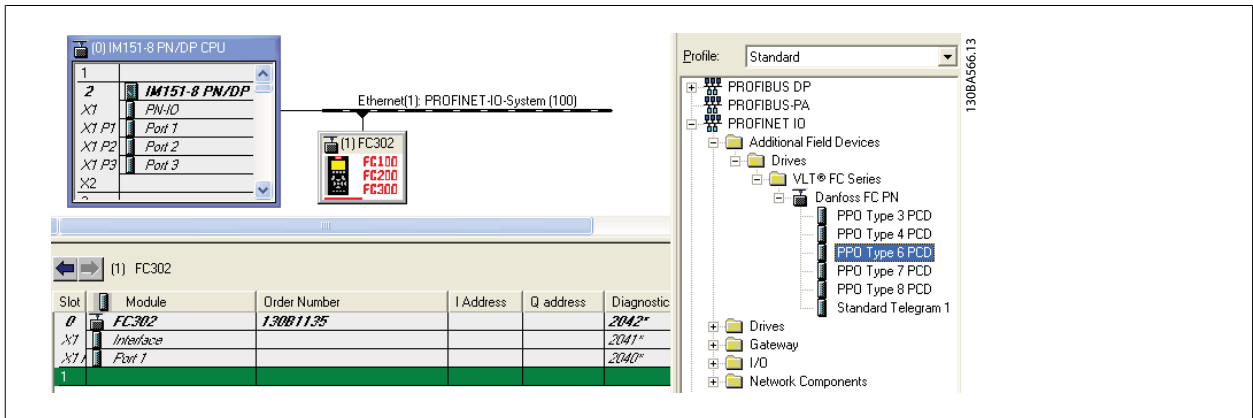

The configuration tool automatically assigns addresses in the peripheral address area. In this example the input and output area have the following configuration:

PPO type 6:

PCD word number	0	1	2	3
Input address	256-257	258-259	260-261	262-263
Set-up	STW	MAV	Par. 9-16.2	Par. 9-16.3

Table 5.1: PCD read (VLT to PLC)

PCD word number	0	1	2	3
Output address	256-257	258-259	260-261	262-263
Set-up	CTW	MRV	Par. 9-15.2	Par. 9-15.3

Table 5.2: PCD write (PLC to VLT)

5

The PCD's has to be assigned via par. 9-16 *PCD Read Configuration* for inputs and par. 9-15 *PCD Write Configuration* for outputs.

Download the configuration file to the PLC. The PROFINET system should be able to go online and it will start to exchange data when the PLC is set to Run mode.

5.3 Configure the Frequency Converter

5.3.1 VLT Parameters

Pay particular attention to the following parameters when configuring the frequency converter with a PROFINET interface.

- Par. 0-40 *[Hand on] Key on LCP*. If the Hand button on the frequency converter is activated, control of the drive via the PROFINET interface is disabled
- After an initial power up the frequency converter will automatically detect whether a fieldbus option is installed in slot A, and set par. 8-02 *Control Word Source* to [Option A]. If an option is added, changed or removed from an already commissioned drive, it will not change par. 8-02 *Control Word Source* but enter Trip Mode, and the drive will display an error
- Par. 8-10 *Control Word Profile*. Choose between the Danfoss FC Profile and the PROFIdrive profile
- Par. 8-50 *Coasting Select* to par. 8-56 *Preset Reference Select*. Selection of how to gate PROFINET control commands with digital input command of the control card.

**NB!**

When par. 8-01 *Control Site* is set to [2] *Control word only*, then the settings in par. 8-50 *Coasting Select* to par. 8-56 *Preset Reference Select* will be overruled, and all act on Bus-control.

- Par. 8-03 *Control Word Timeout Time* to par. 8-05 *End-of-Timeout Function*. The reaction in the event of a bus time out is set via these parameters
- par. 12-00 *IP Address Assignment*
- par. 12-08 *Host Name*

6

6 How to Control the Frequency Converter

6.1 PPO Types

The PROFIdrive profile for frequency converters specifies a number of communication objects (Parameter Process data Objects, PPO), which are suitable for data exchange between a process controller, such as a PLC, and frequency converters. All PPOs are defined for cyclic data transfer, so that process data (PCD) can be transferred from the controller to the slave and vice versa. The figure below shows the PPO types available for the FC 102/FC 202/FC 301/FC 302.

PPO types 3, 4, 6, 7 and 8 are pure process data objects for applications requiring no cyclic parameter access. The PLC sends out process control data, and the frequency converter then responds with a PPO of the same length, containing process status data. The first two bytes of the process data area (PCD 1) comprise a fixed part present in all PPO types. The first two words of the process data area (PCD 0 and PCD1) comprise a fixed part present in all PPO types. The following data (PCD 2 to PCD 9) are flexible for PCD write entries (par. 9-15 *PCD Write Configuration*, and for PCD read entries (par. 9-16 *PCD Read Configuration*). The to parameters can be parameterised with process signals from the list on par. 9-23 *Parameters for Signals*.

Select the signals for transmission from the master to the frequency converter in par. 9-15 *PCD Write Configuration* (request from master to the frequency converter). Select the signals for transmission from the frequency converter to the master in par. 9-16 *PCD Read Configuration* (response: FC -> master).

The choice of PPO type is made in the master configuration, and is then automatically recorded in the frequency converter. No manual setting of PPO types in the frequency converter is required. The current PPO type can be read in par. 9-22 *Telegram Selection*.

Selection [1] *Standard telegram 1* is equivalent to PPO type 3.

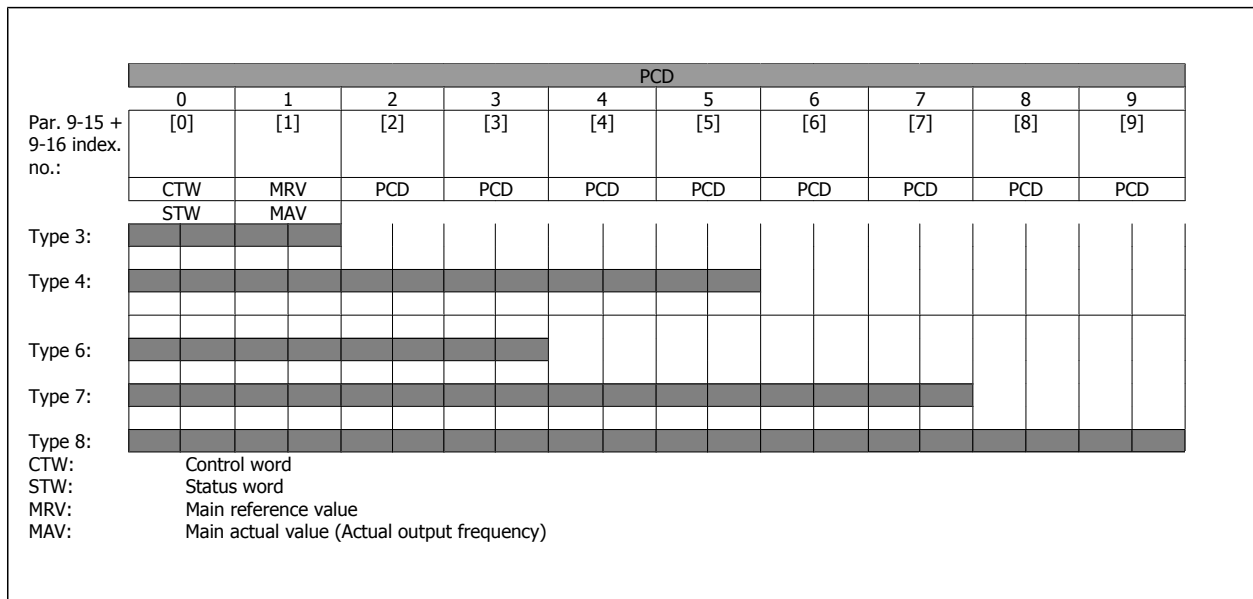

6.2 Process Data

Use the process data part of the PPO for controlling and monitoring the frequency converter via the PROFINET.

6.2.1 Process Control Data

Process data sent from the PLC to the frequency converter is defined as Process Control Data (PCD).

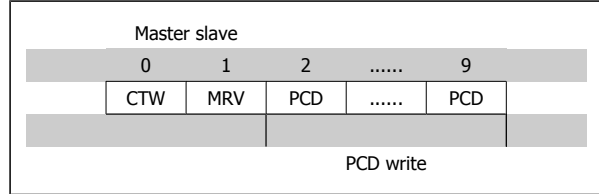

PCD 0 contains a 16-bit control word, where each bit controls a specific function of the frequency converter, see section *Control Profile*. PCD 1 contains a 16-bit speed set point in percentage format. See section *Reference Handling*

6

The content of PCD 2 to PCD 9 is programmed in par. 9-15 *PCD Write Configuration* and par. 9-16 *PCD Read Configuration*.

6.2.2 Process Status Data

Process data sent from the frequency converter contains information about the current state of the drive.

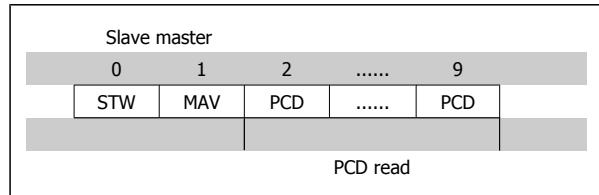

PCD 0 contains a 16-bit status word, where each bit contains information regarding a possible state of the frequency converter. PCD 1 contains per default the value of the current speed of the frequency converter in percentage format (see section *Reference Handling*).

The content of PCD 2 to PCD 9 is programmed in par. 9-16 *PCD Read Configuration*.

6.2.3 Reference Handling

The reference handling in FC 102/FC 202/FC 301/FC 302 is an advanced mechanism that sums up references from different sources.

For more information on reference handling, please refer to the FC 102/FC 202/FC 301/FC 302 Design Guides.

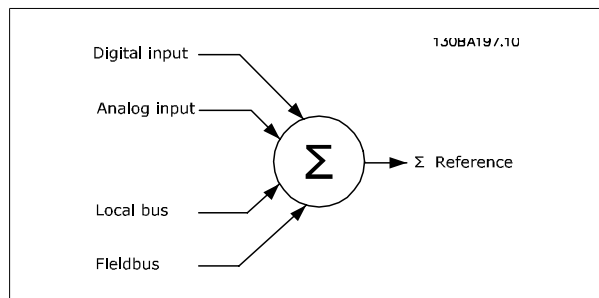

The reference, or speed set point (MRV, send via PROFINET is always transmitted to the frequency converter in percentage format as integers represented in hexadecimal (0-4000 hex).

Depending on the setting of par. 3-00 *Reference Range* the reference and MAV are scaled accordingly:

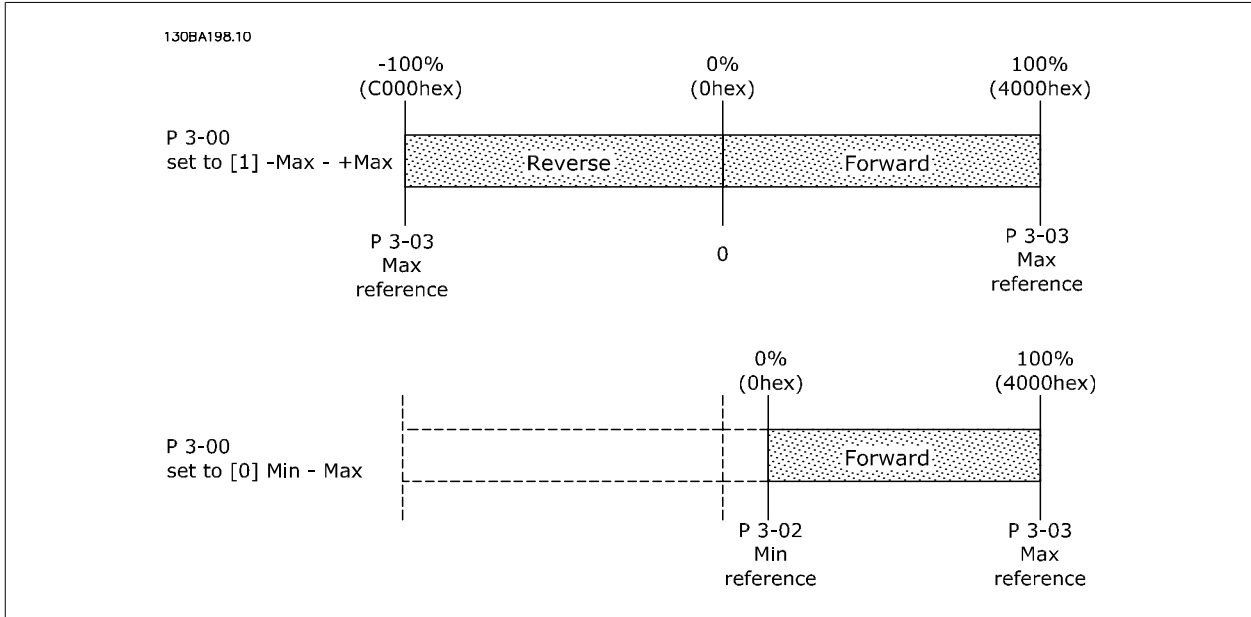

6

NB!
 If par. 3-00 *Reference Range* is set to [0] *Min - Max*, a negative reference will be handled as 0%.

The actual output of the frequency converter is limited by the speed limit parameters *Motor Low/High Speed Limit [RPM/Hz]* in par. 4-11 *Motor Speed Low Limit [RPM]* to par. 4-14 *Motor Speed High Limit [Hz]*.
 The final speed limit is set by par. 4-19 *Max Output Frequency*.

The reference and the MAV have the format which appears from the table

MRV / MAV	Integer in hex	Integer in decimal
100%	4000	16.384
75%	3000	12.288
50%	2000	8.192
25%	1000	4.096
0%	0	0
-25%	F000	-4.096
-50%	E000	-8.192
-75%	D000	-12.288
-100%	C000	-16.384

NB!
 Negative numbers are formed as two's complement.

NB!
 The data type for MRV and MAV is a N2 16 bit standardised value, meaning it can express a range from -200% to +200% (8001 to 7FFF).

par. 1-00 *Configuration Mode* set to [0] *Speed open loop*.

par. 3-00 *Reference Range* set to [0] *Min - Max*.

par. 3-02 *Minimum Reference* set to 100 RPM.

par. 3-03 *Maximum Reference* set to 3000 RPM.

MRV / MAV		Actual Speed
0%	0 hex	100 RPM
25%	1000 hex	825 RPM
50%	2000 hex	1550 RPM
75%	3000 hex	2275 RPM
100%	4000 hex	3000 RPM

6.2.4 Process Control Operation

6

In process control operation par. 1-00 *Configuration Mode* is set to [3] *Process*.

The reference range in par. 3-00 *Reference Range* is always [0] *Min - Max*.

- MRV represents the process setpoint.
- MAV expresses the actual process feedback (range +/- 200%).

6.2.5 Influence of the Digital Input Terminals upon FC Control Mode , par. 8-50 *Coasting Select* to par. 8-56 *Preset Reference Select*

The influence of the digital input terminals upon control of the frequency converter can be programmed in par. 8-50 *Coasting Select* to par. 8-56 *Preset Reference Select*. Please note the par. 8-01 *Control Site* overrules the settings in par. 8-50 *Coasting Select* to par. 8-56 *Preset Reference Select*, and Terminal 37 *Coasting Stop (safe)* overrules any parameter.

Each of the digital input signals can be programmed to logic AND, logic OR, or to have no relation to the corresponding bit in the control word. In this way a specific control command i.e. stop / coast, can be initiated by fieldbus only, fieldbus AND Digital Input, or Ether Fieldbus OR Digital input terminal.



In order to control the frequency converter via PROFINET, par. 8-50 *Coasting Select* must be set to either Bus [1], or to Logic AND [2], and par. 8-01 *Control Site* must be set to [0] or [2].

More detailed information and examples of logical relationship options are provided in the *Troubleshooting chapter*.

6.3 Control Profile

The frequency converter can be controlled according to the PROFIdrive profile, or the Danfoss FC profile. Select the desired control profile in par. 8-10 *Control Word Profile*. The choice of profile affects the control and status word only.

The *PROFIdrive control profile* and *Danfoss FC control profile* sections provide a detailed description of control and status data.

6.4 PROFIdrive Control Profile

This section describes the functionality of the control word and status word in the PROFIdrive profile. Select this profile by setting par. 8-10 *Control Word Profile*.

6.4.1 Control Word according to PROFIdrive Profile (CTW)

The Control word is used to send commands from a master (e.g. a PC) to a slave.

Bit	Bit = 0	Bit = 1
00	OFF 1	ON 1
01	OFF 2	ON 2
02	OFF 3	ON 3
03	Coasting	No coasting
04	Quick stop	Ramp
05	Hold frequency output	Use ramp
06	Ramp stop	Start
07	No function	Reset
08	Jog 1 OFF	Jog 1 ON
09	Jog 2 OFF	Jog 2 ON
10	Data invalid	Data valid
11	No function	Slow down
12	No function	Catch up
13	Parameter set-up	Selection lsb
14	Parameter set-up	Selection msb
15	No function	Reverse

Explanation of the Control Bits

Bit 00, OFF 1/ON 1

Normal ramp stop using the ramp times of the actual selected ramp.

Bit 00 = "0" leads to the stop and activation of the output relay 1 or 2 if the output frequency is 0 Hz and if [Relay 123] has been selected in par. 5-40 *Function Relay*.

When bit 00 = "1", the frequency converter is in State 1: "Switching on inhibited".

Please refer to the PROFIdrive State Transition Diagram, at the end of this section.

Bit 01, OFF 2/ON 2

Coasting stop

When bit 01 = "0", a coasting stop and activation of the output relay 1 or 2 occurs if the output frequency is 0 Hz and if [Relay 123] has been selected in par. 5-40 *Function Relay*.

When bit 01 = "1", the frequency converter is in State 1: "Switching on inhibited". Please refer to the PROFIdrive State Transition Diagram, at the end of this section.

Bit 02, OFF 3/ON 3

Quick stop using the ramp time of par. 3-81 *Quick Stop Ramp Time*. When bit 02 = "0", a quick stop and activation of the output relay 1 or 2 occurs if the output frequency is 0 Hz and if [Relay 123] has been selected in par. 5-40 *Function Relay*.

When bit 02 = "1", the frequency converter is in State 1: "Switching on inhibited".

Please refer to the PROFIdrive State Transition Diagram, at the end of this section.

Bit 03, Coasting/No coasting

Coasting stop Bit 03 = "0" leads to a stop. When bit 03 = "1", the frequency converter can start if the other start conditions are satisfied.

**NB!**

The selection in par. 8-50 *Coasting Select* Coasting select determines how bit 03 is linked with the corresponding function of the digital inputs.

Bit 04, Quick stop/Ramp

Quick stop using the ramp time of par. 3-81 *Quick Stop Ramp Time*.

When bit 04 = "0", a quick stop occurs.

When bit 04 = "1", the frequency converter can start if the other start conditions are satisfied.

**NB!**

The selection in par. 8-51 *Quick Stop Select* determines how bit 04 is linked with the corresponding function of the digital inputs.

6**Bit 05, Hold frequency output/Use ramp**

When bit 05 = "0", the current output frequency is being maintained even if the reference value is modified.

When bit 05 = "1", the frequency converter can perform its regulating function again; operation occurs according to the respective reference value.

Bit 06, Ramp stop/Start

Normal ramp stop using the ramp times of the actual ramp as selected. In addition, activation of the output relay 01 or 04 if the output frequency is 0 Hz if Relay 123 has been selected in par. 5-40 *Function Relay*. Bit 06 = "0" leads to a stop. When bit 06 = "1", the frequency converter can start if the other start conditions are satisfied.

**NB!**

The selection in par. 8-53 *Start Select* determines how bit 06 is linked with the corresponding function of the digital inputs.

Bit 07, No function/Reset

Reset after switching off.
 Acknowledges event in fault buffer.
 When bit 07 = "0", no reset occurs.
 When there is a slope change of bit 07 to "1", a reset occurs after switching off.

Bit 08, Jog 1 OFF/ON

Activation of the pre-programmed speed in par. 8-90 *Bus Jog 1 Speed*. JOG 1 is only possible if bit 04 = "0" and bit 00 - 03 = "1".

Bit 09, Jog 2 OFF/ON

Activation of the pre-programmed speed in par. 8-91 *Bus Jog 2 Speed*. JOG 2 is only possible if bit 04 = "0" and bit 00 - 03 = "1".

Bit 10, Data invalid/valid

Is used to tell the frequency converter whether the control word is to be used or ignored. Bit 10 = "0" causes the control word to be ignored, Bit 10 = "1" causes the control word to be used. This function is relevant, because the control word is always contained in the telegram, regardless of which type of telegram is used, i.e. it is possible to turn off the control word if you do not wish to use it in connection with updating or reading parameters.

Bit 11, No function/Slow down

Is used to reduce the speed reference value by the amount given in par. 3-12 *Catch up/slow Down Value* value. When bit 11 = "0", no modification of the reference value occurs. When bit 11 = "1", the reference value is reduced.

Bit 12, No function/Catch up

Is used to increase the speed reference value by the amount given in par. 3-12 *Catch up/slow Down Value*.
 When bit 12 = "0", no modification of the reference value occurs.
 When bit 12 = "1", the reference value is increased.
 If both - slowing down and accelerating - are activated (bit 11 and 12 = "1"), slowing down has priority, i.e. the speed reference value will be reduced.

Bits 13/14, Set-up selection

Bits 13 and 14 are used to choose between the four parameter set-ups according to the following table:

Set-up	Bit 13	Bit 14
1	0	0
2	1	0
3	0	1
4	1	1

The function is only possible if *Multi Set-up* has been chosen in par. 0-10 *Active Set-up*. The selection in par. 8-55 *Set-up Select* determines how bits 13 and 14 are linked with the corresponding function of the digital inputs. Changing set-up while running is only possible if the set-ups have been linked in par. 0-12 *This Set-up Linked to*.

Bit 15, No function/Reverse

Bit 15 = "0" causes no reversing.
 Bit 15 = "1" causes reversing.
 Note: In the factory setting reversing is set to *digital* in par. 8-54 *Reversing Select*.

NB!
 Bit 15 causes reversing only when *Ser. communication, Logic or or Logic and* is selected.

6.4.2 Status Word according to PROFIdrive Profile (STW)

The Status word is used to notify a master (e.g. a PC) about the status of a slave.

Bit	Bit = 0	Bit = 1
00	Control not ready	Control ready
01	Drive not ready	Drive ready
02	Coasting	Enable
03	No error	Trip
04	OFF 2	ON 2
05	OFF 3	ON 3
06	Start possible	Start not possible
07	No warning	Warning
08	Speed \neq reference	Speed = reference
09	Local operation	Bus control
10	Out of frequency limit	Frequency limit ok
11	No operation	In operation
12	Drive OK	Stopped, autostart
13	Voltage OK	Voltage exceeded
14	Torque OK	Torque exceeded
15	Timer OK	Timer exceeded

Explanation of the Status Bits

Bit 00, Control not ready/ready

When bit 00 = "0", bit 00, 01 or 02 of the Control word is "0" (OFF 1, OFF 2 or OFF 3) - or the frequency converter is switched off (trip).

When bit 00 = "1", the frequency converter control is ready, but there is not necessarily power supply to the unit present (in the event of external 24 V supply of the control system).

Bit 01, VLT not ready/ready

Same significance as bit 00, however, there is a supply of the power unit. The frequency converter is ready when it receives the necessary start signals.

Bit 02, Coasting/Enable

When bit 02 = "0", bit 00, 01 or 02 of the Control word is "0" (OFF 1, OFF 2 or OFF 3 or coasting) - or the frequency converter is switched off (trip).

When bit 02 = "1", bit 00, 01 or 02 of the Control word is "1"; the frequency converter has not tripped.

Bit 03, No error/Trip

When bit 03 = "0", no error condition of the frequency converter exists.

When bit 03 = "1", the frequency converter has tripped and requires a reset signal before it can start.

Bit 04, ON 2/OFF 2

When bit 01 of the Control word is "0", then bit 04 = "0".

When bit 01 of the Control word is "1", then bit 04 = "1".

Bit 05, ON 3/OFF 3

When bit 02 of the Control word is "0", then bit 05 = "0".

When bit 02 of the Control word is "1", then bit 05 = "1".

Bit 06, Start possible/Start not possible

If PROFIdrive has been selected in par. 8-10 *Control Word Profile*, bit 06 will be "1" after a switch-off acknowledgement, after activation of OFF2 or OFF3, and after switching on the mains voltage. Start not possible will be reset, with bit 00 of the Control word being set to "0" and bit 01, 02 and 10 being set to "1".

Bit 07, No warning/Warning

Bit 07 = "0" means that there are no warnings.

Bit 07 = "1" means that a warning has occurred.

Bit 08, Speed ≠ reference / Speed = reference

When bit 08 = "0", the current speed of the motor deviates from the set speed reference value. This may occur, for example, when the speed is being changed during start/stop through ramp up/down.

When bit 08 = "1", the current speed of the motor corresponds to the set speed reference value.

Bit 09, Local operation/Bus control

Bit 09 = "0" indicates that the frequency converter has been stopped by means of the stop button on the LCP, or that [Linked to hand] or [Local] has been selected in par. 3-13 *Reference Site*.

When bit 09 = "1", the frequency converter can be controlled through the serial interface.

Bit 10, Out of frequency limit/Frequency limit OK

When bit 10 = "0", the output frequency is outside the limits set in par. 4-52 *Warning Speed Low* and par. 4-53 *Warning Speed High*. When bit 10 = "1", the output frequency is within the indicated limits.

Bit 11, No operation/Operation

When bit 11 = "0", the motor does not turn.

When bit 11 = "1", the frequency converter has a start signal, or the output frequency is higher than 0 Hz.

Bit 12, Drive OK/Stopped, autostart

When bit 12 = "0", there is no temporary overloading of the inverter.

When bit 12 = "1", the inverter has stopped due to overloading. However, the frequency converter has not switched off (trip) and will start again after the overloading has ended.

Bit 13, Voltage OK/Voltage exceeded

When bit 13 = "0", the voltage limits of the frequency converter are not exceeded.

When bit 13 = "1", the direct voltage in the intermediate circuit of the frequency converter is too low or too high.

Bit 14, Torque OK/Torque exceeded

When bit 14 = "0", the motor torque is below the limit selected in par. 4-16 *Torque Limit Motor Mode* and par. 4-17 *Torque Limit Generator Mode*. When bit 14 = "1", the limit selected in par. 4-16 *Torque Limit Motor Mode* or par. 4-17 *Torque Limit Generator Mode* is exceeded.

Bit 15, Timer OK/Timer exceeded

When bit 15 = "0", the timers for the thermal motor protection and thermal frequency converter protection have not exceeded 100%.

When bit 15 = "1", one of the timers has exceeded 100%.

6.4.3 PROFIdrive State - Transition Diagram

In the PROFIdrive Control profile, the control bits 0 to 3 perform the basic start-up / power down functions, whereas the control bits 4 to 15 perform application-oriented control.

The figure below shows the basic state-transition diagram, where control bits 0 to 3 control the transitions, and the corresponding status bit indicates the actual state. The black bullets indicate the priority of the control signals, where fewer bullets indicate lower priority, and more bullets indicate higher priority.

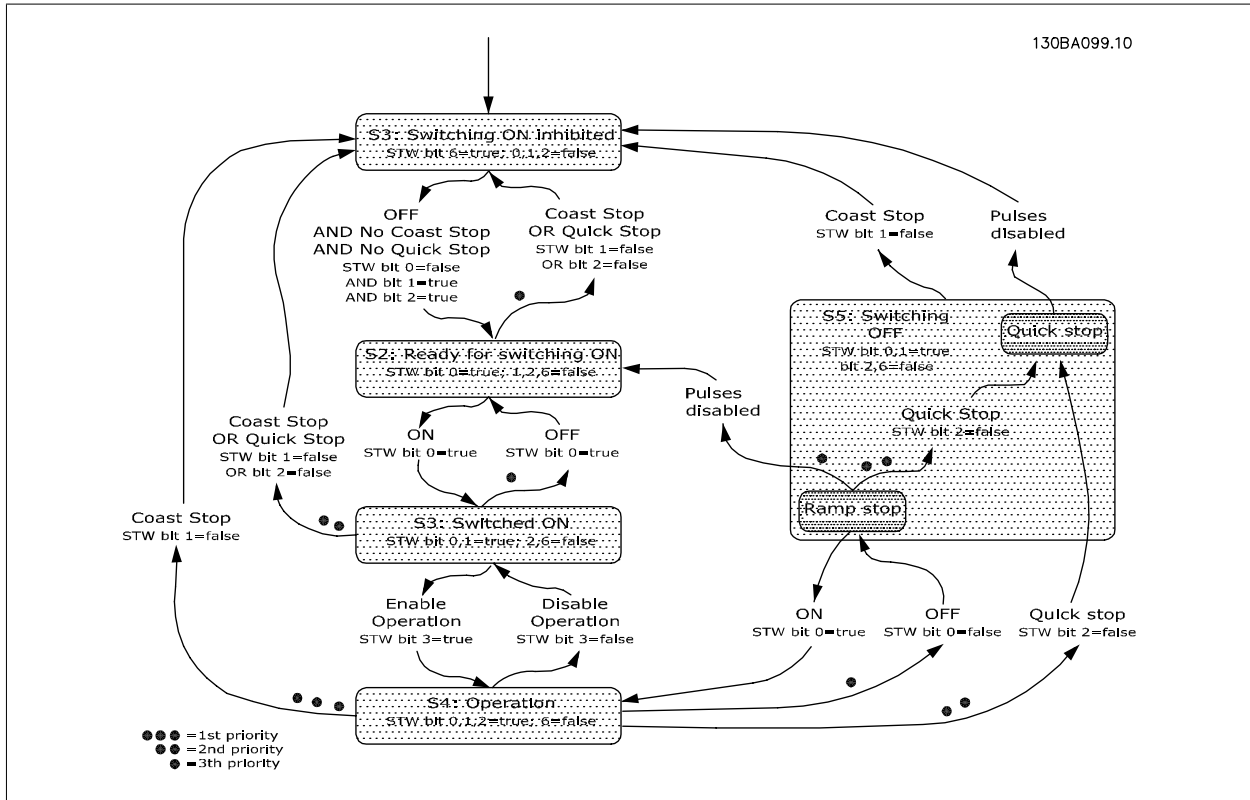

6.5 Danfoss FC Control Profile

6.5.1 Control Word according to FC Profile (CTW)

To select Danfoss FC protocol in the control word, par. 8-10 *Control Word Profile* must be set to Danfoss FC protocol [0]. The control word is used to send commands from a master (PLC or PC) to a slave (frequency converter).

Please refer to *Application Examples* for an example of a control word telegram using PPO type 3.

Bit	Bit value = 0	Bit value = 1
00	Reference value	external selection lsb
01	Reference value	external selection msb
02	DC brake	Ramp
03	Coasting	No coasting
04	Quick stop	Ramp
05	Hold output frequency	Use ramp
06	Ramp stop	Start
07	No function	Reset
08	No function	Jog
09	Ramp 1	Ramp 2
10	Data invalid	Data valid
11	No function	Relay 01 active
12	No function	Relay 04 active
13	Parameter set-up	selection lsb
14	Parameter set-up	selection msb
15	No function	Reverse

Explanation of the Control Bits

Bits 00/01 Reference value

Bits 00 and 01 are used to choose between the four reference values, which are pre-programmed in par. 3-10 *Preset Reference* according to the following table:

NB!
In par. 8-56 *Preset Reference Select* a selection is made to define how Bit 00/01 gates with the corresponding function on the digital inputs.

Programmed ref. value	Parameter	Bit 01	Bit 00
1	3-10 [0]	0	0
2	3-10 [1]	0	1
3	3-10 [2]	1	0
4	3-10 [3]	1	1

Bit 02, DC brake

Bit 02 = 0 leads to DC braking and stop. Braking current and duration are set in par. 2-01 *DC Brake Current* and par. 2-02 *DC Braking Time*. Bit 02 = 1 leads to ramping.

Bit 03, Coasting

Bit 03 = 0 causes the frequency converter to immediately "let go" of the motor (the output transistors are "shut off"), so that it coasts to a standstill. Bit 03 = 1 enables the frequency converter to start the motor if the other starting conditions have been fulfilled.

**NB!**

In par. 8-50 *Coasting Select* a selection is made to define how Bit 03 gates with the corresponding function on a digital input.

Bit 04, Quick stop

Bit 04 = 0 causes a stop, in which the motor speed is ramped down to stop via par. 3-81 *Quick Stop Ramp Time*.

Bit 05, Hold output frequency

Bit 05 = 0 causes the present output frequency (in Hz) to freeze. The frozen output frequency can then be changed only by means of the digital inputs (par. 5-10 *Terminal 18 Digital Input* to par. 5-15 *Terminal 33 Digital Input*) programmed to *Speed up* and *Speed down*.

**NB!**

If *Freeze output* is active, the frequency converter can only be stopped by the following:

- Bit 03 Coasting stop
- Bit 02 DC braking
- Digital input (par. 5-10 *Terminal 18 Digital Input* to par. 5-15 *Terminal 33 Digital Input*) programmed to *DC braking*, *Coasting stop* or *Reset and coasting stop*.

6

Bit 06, Ramp stop/start:

Bit 06 = 0 causes a stop, in which the motor speed is ramped down to stop via the selected *ramp down* parameter.

Bit 06 = "1" permits the frequency converter to start the motor, if the other starting conditions have been fulfilled.

**NB!**

In par. 8-53 *Start Select* a selection is made to define how Bit 06 Ramp stop/start gates with the corresponding function on a digital input.

Bit 07, Reset

Bit 07 = "0" does not cause a reset. Bit 07 = "1" causes the reset of a trip. Reset is activated on the signals leading edge, i.e. when changing from logic "0" to logic "1".

Bit 08, Jog

Bit 08 = "1" causes the output frequency to be determined by par. 3-19 *Jog Speed [RPM]*.

Bit 09, Selection of ramp 1/2

Bit 09 = "0" means that ramp 1 is active (par. 3-40 *Ramp 1 Type* to par. 3-47 *Ramp 1 S-ramp Ratio at Decel. Start*).

Bit 09 = "1" means that ramp 2 (par. 3-50 *Ramp 2 Type* to par. 3-57 *Ramp 2 S-ramp Ratio at Decel. Start*) is active.

Bit 10, Data not valid/Data valid

Is used to tell the frequency converter whether the control word is to be used or ignored. Bit 10 = "0" causes the control word to be ignored.

Bit 10 = "1" causes the control word to be used. This function is relevant, because the control word is always contained in the telegram, regardless of which type of telegram is used, i.e. it is possible to turn off the control word if you do not wish to use it in connection with updating or reading parameters.

Bit 11, Relay 01

Bit 11 = "0" Relay not activated.

Bit 11 = "1" Relay 01 activated, provided Control word bit 11 has been chosen in par. 5-40 *Function Relay*.

Bit 12, Relay 04

Bit 12 = "0" Relay 04 has not been activated.

Bit 12 = "1" Relay 04 has been activated, provided *Control word bit 12* has been chosen in par. 5-40 *Function Relay*.

Bit 13/14, Selection of set-up

Bits 13 and 14 are used to choose from the four menu set-ups according to the following table:

Set-up	Bit 14	Bit 13
1	0	0
2	0	1
3	1	0
4	1	1

The function is only possible when *Multi-Set-ups* is selected in par. 0-10 *Active Set-up*.

NB!
In par. 8-55 *Set-up Select* a selection is made to define how Bit 13/14 gates with the corresponding function on the digital inputs.

Bit 15 Reverse

Bit 15 = "0" causes no reversing.

Bit 15 = "1" causes reversing.

6.5.2 Status Word according to FC Profile (STW)

The status word is used to inform the master (e.g. a PC) of the operation mode of the slave (frequency converter).

Please refer to Application examples for an example of a status word telegram using PPO type 3.

Explanation of the Status Bits

Bit 00, Control not ready/ready

Bit 00 = "0" means that the frequency converter has tripped.

Bit 00 = "1" means that the frequency converter controls are ready, but that the power component is not necessarily receiving any power supply (in case of external 24 V supply to controls).

Bit 01, Drive ready

Bit 01 = "1". The frequency converter is ready for operation, but there is an active coasting command via the digital inputs or via serial communication.

Bit 02, Coasting stop

Bit 02 = "0". The frequency converter has released the motor.

Bit 02 = "1". The frequency converter can start the motor when a start command is given.

Bit 03, No error/trip

Bit 03 = "0" means that the frequency converter is not in fault mode.

Bit 03 = "1" means that the frequency converter is tripped, and that a reset signal is required to re-establish operation.

Bit 04, No error/error (no trip)

Bit 04 = "0" means that the frequency converter is not in fault mode.

Bit 04 = 1 means that there is a frequency converter error but no trip.

Bit 05, Not used

Bit 05 is not used in the status word.

Bit	Bit = 0	Bit = 1
00	Control not ready	Control ready
01	Drive not ready	Drive ready
02	Coasting	Enable
03	No error	Trip
04	No error	Error (no trip)
05	Reserved	-
06	No error	Triplock
07	No warning	Warning
08	Speed reference	Speed = reference
09	Local operation	Bus control
10	Out of frequency limit	Frequency limit ok
11	No operation	In operation
12	Drive OK	Stopped, autostart
13	Voltage OK	Voltage exceeded
14	Torque OK	Torque exceeded
15	Timer OK	Timer exceeded

Bit 06, No error / triplock

Bit 06 = "0" means that the frequency converter is not in fault mode.

Bit 06 = 1 means that the frequency converter is tripped, and locked.

Bit 07, No warning/warning

Bit 07 = "0" means that there are no warnings.

Bit 07 = "1" means that a warning has occurred.

Bit 08, Speed reference/speed = reference

Bit 08 = "0" means that the motor is running, but that the present speed is different from the preset speed reference. It might, for example, be the case while the speed is being ramped up/down during start/stop.

Bit 08 = "1" means that the present motor present speed matches the preset speed reference.

Bit 09, Local operation/bus control

Bit 09 = "0" means that [STOP/RESET] is activated on the control unit, or that *Local control* in par. 3-13 *Reference Site* is selected. It is not possible to control the frequency converter via serial communication.

Bit 09 = "1" means that it is possible to control the frequency converter via the fieldbus/ serial communication.

Bit 10, Out of frequency limit

Bit 10 = "0", if the output frequency has reached the value in par. 4-11 *Motor Speed Low Limit [RPM]* or par. 4-13 *Motor Speed High Limit [RPM]*.

Bit 10 = "1" means that the output frequency is within the defined limits.

Bit 11, No operation/in operation

Bit 11 = "0" means that the motor is not running.

Bit 11 = "1" means that the frequency converter has a start signal or that the output frequency is greater than 0 Hz.

Bit 12, Drive OK/stopped, autostart

Bit 12 = "0" means that there is no temporary over temperature on the inverter.

Bit 12 = "1" means that the inverter has stopped because of over temperature, but that the unit has not tripped and will resume operation once the over temperature stops.

Bit 13, Voltage OK/limit exceeded

Bit 13 = "0" means that there are no voltage warnings.

Bit 13 = "1" means that the DC voltage in the frequency converters intermediate circuit is too low or too high.

Bit 14, Torque OK/limit exceeded

Bit 14 = "0" means that the motor current is lower than the torque limit selected in par. 4-16 *Torque Limit Motor Mode* or par. 4-17 *Torque Limit Generator Mode*.

Bit 14 = "1" means that the torque limit in par. 4-16 *Torque Limit Motor Mode* and par. 4-17 *Torque Limit Generator Mode* has been exceeded.

Bit 15, Timer OK/limit exceeded

Bit 15 = "0" means that the timers for motor thermal protection and VLT thermal protection, respectively, have not exceeded 100%.

Bit 15 = "1" means that one of the timers has exceeded 100%.

7 Parameters

7.1 Parameter Group 0-** Operation/Display

0-37 Display Text 1

Range:

0 N/A* [0 - 0 N/A]

Function:

In this parameter it is possible to write an individual text string for display in the LCP or to be read via serial communication. If to be displayed permanently select Display Text 1 in par. 0-20 *Display Line 1.1 Small*, par. 0-21 *Display Line 1.2 Small*, par. 0-22 *Display Line 1.3 Small*, par. 0-23 *Display Line 2 Large* or par. 0-24 *Display Line 3 Large*. Use the ▲ or ▼ buttons on the LCP to change a character. Use the ◀ and ▶ buttons to move the cursor. When a character is highlighted by the cursor, it can be changed. Use the ▲ or ▼ buttons on the LCP to change a character. A character can be inserted by placing the cursor between two characters and pressing ▲ or ▼.

7.2 Parameter Group 8-** Communication and Option

8-01 Control Site

Option:
Function:

The setting in this parameter overrides the settings in par. 8-50 *Coasting Select* to par. 8-56 *Preset Reference Select*.

[0] *	Digital and ctrl.word	Control by using both digital input and control word.
[1]	Digital only	Control by using digital inputs only.
[2]	Controlword only	Control by using control word only.

8-02 Control Word Source

Select the source of the control word: one of two serial interfaces or four installed options. During initial power-up, the frequency converter automatically sets this parameter to *Option A* [3] if it detects a valid fieldbus option installed in slot A. If the option is removed, the frequency converter detects a change in the configuration, sets par. 8-02 *Control Word Source* back to default setting *FCRS485*, and the frequency converter then trips. If an option is installed after initial power-up, the setting of par. 8-02 *Control Word Source* will not change but the frequency converter will trip and display: Alarm 67 *Option Changed*.

This parameter cannot be adjusted while the motor is running.

Option:
Function:

[0]	None
[1]	FC RS485
[2]	FC USB
[3] *	Option A
[4]	Option B
[5]	Option C0
[6]	Option C1

8-03 Control Word Timeout Time

Range:

1.0 s* [0.1 - 18000.0 s]

Function:

Enter the maximum time expected to pass between the reception of two consecutive telegrams. If this time is exceeded, it indicates that the serial communication has stopped. The function selected in par. 8-04 *Control Word Timeout Function* will then be carried out. The time-out counter is triggered by a valid control word.

8-04 Control Word Timeout Function

Select the time-out function. The time-out function activates when the control word fails to be updated within the time period specified in par. 8-03 *Control Word Timeout Time*.

Option:	Function:
[0] * Off	Resumes control via serial bus (Fieldbus or standard) using the most recent control word.
[1] Freeze output	Freezes output frequency until communication resumes.
[2] Stop	Stops with auto restart when communication resumes.
[3] Jogging	Runs the motor at JOG frequency until communication resumes.
[4] Max. speed	Runs the motor at maximum frequency until communication resumes.
[5] Stop and trip	Stops the motor, then resets the frequency converter in order to restart: via the fieldbus, via the reset button on the LCP or via a digital input.
[7] Select setup 1	Changes the set-up upon reestablishment of communication following a control word time-out. If communication resumes causing the time-out situation to disappear, par. 8-05 <i>End-of-Timeout Function</i> defines whether to resume the set-up used before the time-out or to retain the set-up endorsed by the time-out function.
[8] Select setup 2	See [7] <i>Select setup 1</i>
[9] Select setup 3	See [7] <i>Select setup 1</i>
[10] Select setup 4	See [7] <i>Select setup 1</i>



NB!

The following configuration is required in order to change the set-up after a time-out:
Set par. 0-10 *Active Set-up* to [9] *Multi set-up* and select the relevant link in par. 0-12 *This Set-up Linked to*.

8-05 End-of-Timeout Function

Option:	Function:
	Select the action after receiving a valid control word following a time-out. This parameter is active only when par. 8-04 <i>Control Timeout Function</i> is set to [Set-up 1-4].
[0] Hold set-up	Retains the set-up selected in par. 8-04 <i>Control Timeout Function</i> and displays a warning, until par. 8-06 <i>Reset Control Timeout</i> toggles. Then the frequency converter resumes its original set-up.
[1] * Resume set-up	Resumes the set-up active prior to the time-out.

8-06 Reset Control Word Timeout

This parameter is active only when *Hold set-up* [0] has been selected in par. 8-05 *End-of-Timeout Function*.

Option:	Function:
[0] * Do not reset	Retains the set-up specified in par. 8-04 <i>Control Word Timeout Function</i> , following a control word time-out.
[1] Do reset	Returns the frequency converter to the original set-up following a control word time-out. The frequency converter performs the reset and then immediately reverts to the <i>Do not reset</i> [0] setting

8-10 Control Word Profile

Select the interpretation of the control and status words corresponding to the installed fieldbus. Only the selections valid for the fieldbus installed in slot A will be visible in the LCP display.

For guidelines in selection of *FC profile* [0] and *PROFIdrive profile* [1] please refer to the *Serial communication via RS 485 Interface* section.

For additional guidelines in the selection of *PROFIdrive profile* [1], *ODVA* [5] and *CANopen DSP 402* [7], please refer to the Operating Instructions for the installed fieldbus.

Option:

Function:

[0] * FC profile

[1] PROFIdrive profile

[5] ODVA

[7] CANopen DSP 402

[8] MCO

8-13 Configurable Status Word STW

Option:

Function:

This parameter enables configuration of bits 12 – 15 in the status word.

[0] No function

The input is always low.

[1] * Profile Default

Depended on the profile set in Parameter 8-10.

[2] Alarm 68 Only

The input will go high whenever Alarm 68 is active and will go low whenever no alarm 68 is active

[3] Trip excl Alarm 68

The input will go high whenever Trip on other Alarms then Alarm 68 is active.

[10] T18 DI status.

The input will go high whenever T18 has 24V and will go low whenever T18 has 0V

[11] T19 DI status.

The input will go high whenever T19 has 24V and will go low whenever T19 has 0V

[12] T27 DI status.

The input will go high whenever T27 has 24V and will go low whenever T27 has 0V

[13] T29 DI status.

The input will go high whenever T29 has 24V and will go low whenever T29 has 0V

[14] T32 DI status.

The input will go high whenever T32 has 24V and will go low whenever T32 has 0V

[15] T33 DI status.

The input will go high whenever T33 has 24V and will go low whenever T33 has 0V

[16] T37 DI status

The input will go high whenever T37 has 0V and will go low whenever T37 has 24V

[21] Thermal warning

The thermal warning turns on when the temperature exceeds the limit in the motor, the frequency converter, the brake resistor, or the thermistor..

[30] Brake fault (IGBT)

Will go high when the brake IGBT is short-circuited.

[40] Out of ref range

If Comparator 0 is evaluated as TRUE, the input will go high. Otherwise, it will be low.

[60] Comparator 0

If Comparator 0 is evaluated as TRUE, the input will go high. Otherwise, it will be low.

[61] Comparator 1

If Comparator 1 is evaluated as TRUE, the input will go high. Otherwise, it will be low.

[62] Comparator 2

If Comparator 2 is evaluated as TRUE, the input will go high. Otherwise, it will be low.

[63] Comparator 3

If Comparator 3 is evaluated as TRUE, the input will go high. Otherwise, it will be low.

[64] Comparator 4

If Comparator 4 is evaluated as TRUE, the input will go high. Otherwise, it will be low.

[65] Comparator 5

If Comparator 5 is evaluated as TRUE, the input will go high. Otherwise, it will be low.

[70] Logic Rule 0

If Logic Rule 0 is evaluated as TRUE, the input will go high. Otherwise, it will be low.

[71] Logic Rule 1

If Logic Rule 1 is evaluated as TRUE, the input will go high. Otherwise, it will be low.

[72] Logic Rule 2

If Logic Rule 2 is evaluated as TRUE, the input will go high. Otherwise, it will be low.

[73] Logic Rule 3

If Logic Rule 3 is evaluated as TRUE, the input will go high. Otherwise, it will be low.

[74] Logic Rule 4

If Logic Rule 4 is evaluated as TRUE, the input will go high. Otherwise, it will be low.

[75] Logic Rule 5

If Logic Rule 5 is evaluated as TRUE, the input will go high. Otherwise, it will be low.

[80] SL Digital Output A

SL Controller Action. The input will go high whenever the Smart Logic Action [38] Set dig. out. A high is executed. The input will go low whenever the Smart Logic Action [32] Set dig. out. A low is executed.

[81] SL Digital Output B

SL Controller Action. The input will go high whenever the Smart Logic Action [39] Set dig. out. A high is executed. The input will go low whenever the Smart Logic Action [33] Set dig. out. A low is executed.

[82]	SL Digital Output C	SL Controller Action. The input will go high whenever the Smart Logic Action [40] Set dig. out. A high is executed. The input will go low whenever the Smart Logic Action [34] Set dig. out. A low is executed.
[83]	SL Digital Output D	SL Controller Action. The input will go high whenever the Smart Logic Action [41] Set dig. out. A high is executed. The input will go low whenever the Smart Logic Action [35] Set dig. out. A low is executed.
[84]	SL Digital Output E	SL Controller Action. The input will go high whenever the Smart Logic Action [42] Set dig. out. A high is executed. The input will go low whenever the Smart Logic Action [36] Set dig. out. A low is executed.
[85]	SL Digital Output F	SL Controller Action. The input will go high whenever the Smart Logic Action [43] Set dig. out. A high is executed. The input will go low whenever the Smart Logic Action [37] Set dig. out. A low is executed.

8-50 Coasting Select

Option:
Function:

		Select control of the coasting function via the terminals (digital input) and/or via the bus.
[0]	Digital input	Activates Start command via a digital input.
[1]	Bus	Activates Start command via the serial communication port or fieldbus option.
[2]	Logic AND	Activates Start command via the fieldbus/serial communication port, AND additionally via one of the digital inputs.
[3] *	Logic OR	Activates Start command via the fieldbus/serial communication port OR via one of the digital inputs.

NB!

This parameter is active only when par. 8-01 *Control Site* is set to [0] *Digital and control word*.

8-51 Quick Stop Select

Select control of the Quick Stop function via the terminals (digital input) and/or via the bus.

Option:
Function:

[0]	Digital Input	
[1]	Bus	
[2]	Logic AND	
[3] *	Logic OR	

NB!

This parameter is active only when par. 8-01 *Control Site* is set to [0] *Digital and control word*.

8-52 DC Brake Select

Option:

Function:

		Select control of the DC brake via the terminals (digital input) and/or via the fieldbus.
[0]	Digital input	Activates Start command via a digital input.
[1]	Bus	Activates Start command via the serial communication port or fieldbus option.
[2]	Logic AND	Activates Start command via the fieldbus/serial communication port, AND additionally via one of the digital inputs.
[3] *	Logic OR	Activates Start command via the fieldbus/serial communication port OR via one of the digital inputs.



NB!

This parameter is active only when par. 8-01 *Control Site* is set to [0] *Digital and control word*.

8-53 Start Select

Option:

Function:

		Select control of the frequency converter start function via the terminals (digital input) and/or via the fieldbus.
[0]	Digital input	Activates Start command via a digital input.
[1]	Bus	Activates Start command via the serial communication port or fieldbus option.
[2]	Logic AND	Activates Start command via the fieldbus/serial communication port, AND additionally via one of the digital inputs.
[3] *	Logic OR	Activates Start command via the fieldbus/serial communication port OR via one of the digital inputs.



NB!

This parameter is active only when par. 8-01 *Control Site* is set to [0] *Digital and control word*.

8-54 Reversing Select

Option:

Function:

[0]	Digital input	Select control of the frequency converter reverse function via the terminals (digital input) and/or via the fieldbus.
[1]	Bus	Activates the Reverse command via the serial communication port or fieldbus option.
[2]	Logic AND	Activates the Reverse command via the fieldbus/serial communication port, AND additionally via one of the digital inputs.
[3] *	Logic OR	Activates the Reverse command via the fieldbus/serial communication port OR via one of the digital inputs.



NB!

This parameter is only active when par. 8-01 *Control Site* is set to [0] *Digital and control word*.

8-55 Set-up Select

Option:
Function:

Select control of the frequency converter set-up selection via the terminals (digital input) and/or via the fieldbus.

[0]	Digital input	Activates the set-up selection via a digital input.
[1]	Bus	Activates the set-up selection via the serial communication port or fieldbus option.
[2]	Logic AND	Activates the set-up selection via the fieldbus/serial communication port, AND additionally via one of the digital inputs.
[3] *	Logic OR	Activate the set-up selection via the fieldbus/serial communication port OR via one of the digital inputs.

NB!

This parameter is active only when par. 8-01 *Control Site* is set to [0] *Digital and control word*.

8-90 Bus Jog 1 Speed

Range:
Function:

100 RPM* [Application dependant] Enter the jog speed. This is a fixed jog speed activated via the serial port or fieldbus option.

8-91 Bus Jog 2 Speed

Range:
Function:

200 RPM* [Application dependant] Enter the jog speed. This is a fixed jog speed activated via the serial port or fieldbus option.

7.3 Parameter Group 9-** PROFIdrive

9-15 PCD Write Configuration

Array [10]

Option:

Function:

Select the parameters to be assigned to PCD 3 to 10 of the telegrams. The number of available PCDs depends on the telegram type. The values in PCD 3 to 10 will then be written to the selected parameters as data values. Alternatively, specify a standard Profibus telegram in par. 9-22 *Telegram Selection*.

[0] *	None
[302]	Minimum Reference
[303]	Maximum Reference
[312]	Catch up/slow Down Value
[341]	Ramp 1 Ramp up Time
[342]	Ramp 1 Ramp Down Time
[351]	Ramp 2 Ramp up Time
[352]	Ramp 2 Ramp down Time
[380]	Jog Ramp Time
[381]	Quick Stop Ramp Time
[411]	Motor Speed Low Limit [RPM]
[412]	Motor Speed Low Limit [Hz]
[413]	Motor Speed High Limit [RPM]
[414]	Motor Speed High Limit [Hz]
[416]	Torque Limit Motor Mode
[417]	Torque Limit Generator Mode
[590]	Digital & Relay Bus Control
[593]	Pulse Out #27 Bus Control
[595]	Pulse Out #29 Bus Control
[597]	Pulse Out #X30/6 Bus Control
[653]	Terminal 42 Output Bus Control
[663]	Terminal X30/8 Bus Control
[673]	Terminal X45/1 Bus Control
[683]	Terminal X45/3 Bus Control
[890]	Bus Jog 1 Speed
[891]	Bus Jog 2 Speed
[1293]	Cable Error Length
[1680]	Fieldbus CTW 1
[1682]	Fieldbus REF 1
[3401]	PCD 1 Write to MCO
[3402]	PCD 2 Write to MCO
[3403]	PCD 3 Write to MCO
[3404]	PCD 4 Write to MCO
[3405]	PCD 5 Write to MCO
[3406]	PCD 6 Write to MCO
[3407]	PCD 7 Write to MCO
[3408]	PCD 8 Write to MCO

[3409] PCD 9 Write to MCO

[3410] PCD 10 Write to MCO

9-16 PCD Read Configuration

Array [10]

Option:**Function:**

Select the parameters to be assigned to PCD 3 to 10 of the telegrams. The number of available PCDs depends on the telegram type. PCDs 3 to 10 contain the actual data values of the selected parameters. For standard Profibus telegrams, see par. 9-22 *Telegram Selection*.

[0] * None

[1472] VLT Alarm Word

[1473] VLT Warning Word

[1474] VLT Ext. Status Word

[1500] Operating Hours

[1501] Running Hours

[1502] kWh Counter

[1600] Control Word

[1601] Reference [Unit]

[1602] Reference %

[1603] Status Word

[1605] Main Actual Value [%]

[1609] Custom Readout

[1610] Power [kW]

[1611] Power [hp]

[1612] Motor Voltage

[1613] Frequency

[1614] Motor Current

[1615] Frequency [%]

[1616] Torque [Nm]

[1617] Speed [RPM]

[1618] Motor Thermal

[1619] KTY sensor temperature

[1620] Motor Angle

[1622] Torque [%]

[1625] Torque [Nm] High

[1630] DC Link Voltage

[1632] Brake Energy /s

[1633] Brake Energy /2 min

[1634] Heatsink Temp.

[1635] Inverter Thermal

[1638] SL Controller State

[1639] Control Card Temp.

[1650] External Reference

[1651] Pulse Reference

[1652] Feedback [Unit]

[1653] Digi Pot Reference

[1660] Digital Input

[1661] Terminal 53 Switch Setting

[1662]	Analog Input 53
[1663]	Terminal 54 Switch Setting
[1664]	Analog Input 54
[1665]	Analog Output 42 [mA]
[1666]	Digital Output [bin]
[1667]	Freq. Input #29 [Hz]
[1668]	Freq. Input #33 [Hz]
[1669]	Pulse Output #27 [Hz]
[1670]	Pulse Output #29 [Hz]
[1671]	Relay Output [bin]
[1672]	Counter A
[1673]	Counter B
[1674]	Prec. Stop Counter
[1675]	Analog In X30/11
[1676]	Analog In X30/12
[1677]	Analog Out X30/8 [mA]
[1678]	Analog Out X45/1 [mA]
[1679]	Analog Out X45/3 [mA]
[1684]	Comm. Option STW
[1685]	FC Port CTW 1
[1690]	Alarm Word
[1691]	Alarm Word 2
[1692]	Warning Word
[1693]	Warning Word 2
[1694]	Ext. Status Word
[3421]	PCD 1 Read from MCO
[3422]	PCD 2 Read from MCO
[3423]	PCD 3 Read from MCO
[3424]	PCD 4 Read from MCO
[3425]	PCD 5 Read from MCO
[3426]	PCD 6 Read from MCO
[3427]	PCD 7 Read from MCO
[3428]	PCD 8 Read from MCO
[3429]	PCD 9 Read from MCO
[3430]	PCD 10 Read from MCO
[3440]	Digital Inputs
[3441]	Digital Outputs
[3450]	Actual Position
[3451]	Commanded Position
[3452]	Actual Master Position
[3453]	Slave Index Position
[3454]	Master Index Position
[3455]	Curve Position
[3456]	Track Error
[3457]	Synchronizing Error
[3458]	Actual Velocity
[3459]	Actual Master Velocity

[3460]	Synchronizing Status
[3461]	Axis Status
[3462]	Program Status
[3464]	MCO 302 Status
[3465]	MCO 302 Control
[3470]	MCO Alarm Word 1
[3471]	MCO Alarm Word 2

9-22 Telegram Selection

Option:

Function:

Select a standard Profibus telegram configuration for the frequency converter, as an alternative to using the freely configurable telegrams in par. 9-15 *PCD Write Configuration* and par. 9-16 *PCD Read Configuration*.

[1]	Standard Telegram 1
[103]	PPO 3
[104]	PPO 4
[106]	PPO 6
[107]	PPO 7
[108] *	PPO 8

9-23 Parameters for Signals

Array [1000]

Read only

Option:

Function:

This parameter contains a list of signals available for selection in par. 9-15 *PCD Write Configuration* and par. 9-16 *PCD Read Configuration*.

[0] *	None
[302]	Minimum Reference
[303]	Maximum Reference
[312]	Catch up/slow Down Value
[341]	Ramp 1 Ramp up Time
[342]	Ramp 1 Ramp Down Time
[351]	Ramp 2 Ramp up Time
[352]	Ramp 2 Ramp down Time
[380]	Jog Ramp Time
[381]	Quick Stop Ramp Time
[411]	Motor Speed Low Limit [RPM]
[412]	Motor Speed Low Limit [Hz]
[413]	Motor Speed High Limit [RPM]
[414]	Motor Speed High Limit [Hz]
[416]	Torque Limit Motor Mode
[417]	Torque Limit Generator Mode
[590]	Digital & Relay Bus Control
[593]	Pulse Out #27 Bus Control
[595]	Pulse Out #29 Bus Control
[597]	Pulse Out #X30/6 Bus Control
[653]	Terminal 42 Output Bus Control
[663]	Terminal X30/8 Bus Control
[673]	Terminal X45/1 Bus Control

[683]	Terminal X45/3 Bus Control
[890]	Bus Jog 1 Speed
[891]	Bus Jog 2 Speed
[1293]	Cable Error Length
[1472]	VLT Alarm Word
[1473]	VLT Warning Word
[1474]	VLT Ext. Status Word
[1500]	Operating Hours
[1501]	Running Hours
[1502]	kWh Counter
[1600]	Control Word
[1601]	Reference [Unit]
[1602]	Reference %
[1603]	Status Word
[1605]	Main Actual Value [%]
[1609]	Custom Readout
[1610]	Power [kW]
[1611]	Power [hp]
[1612]	Motor Voltage
[1613]	Frequency
[1614]	Motor Current
[1615]	Frequency [%]
[1616]	Torque [Nm]
[1617]	Speed [RPM]
[1618]	Motor Thermal
[1619]	KTY sensor temperature
[1620]	Motor Angle
[1622]	Torque [%]
[1625]	Torque [Nm] High
[1630]	DC Link Voltage
[1632]	Brake Energy /s
[1633]	Brake Energy /2 min
[1634]	Heatsink Temp.
[1635]	Inverter Thermal
[1638]	SL Controller State
[1639]	Control Card Temp.
[1650]	External Reference
[1651]	Pulse Reference
[1652]	Feedback [Unit]
[1653]	Digi Pot Reference
[1660]	Digital Input
[1661]	Terminal 53 Switch Setting
[1662]	Analog Input 53
[1663]	Terminal 54 Switch Setting
[1664]	Analog Input 54
[1665]	Analog Output 42 [mA]
[1666]	Digital Output [bin]

[1667]	Freq. Input #29 [Hz]
[1668]	Freq. Input #33 [Hz]
[1669]	Pulse Output #27 [Hz]
[1670]	Pulse Output #29 [Hz]
[1671]	Relay Output [bin]
[1672]	Counter A
[1673]	Counter B
[1674]	Prec. Stop Counter
[1675]	Analog In X30/11
[1676]	Analog In X30/12
[1677]	Analog Out X30/8 [mA]
[1678]	Analog Out X45/1 [mA]
[1679]	Analog Out X45/3 [mA]
[1680]	Fieldbus CTW 1
[1682]	Fieldbus REF 1
[1684]	Comm. Option STW
[1685]	FC Port CTW 1
[1690]	Alarm Word
[1691]	Alarm Word 2
[1692]	Warning Word
[1693]	Warning Word 2
[1694]	Ext. Status Word
[3401]	PCD 1 Write to MCO
[3402]	PCD 2 Write to MCO
[3403]	PCD 3 Write to MCO
[3404]	PCD 4 Write to MCO
[3405]	PCD 5 Write to MCO
[3406]	PCD 6 Write to MCO
[3407]	PCD 7 Write to MCO
[3408]	PCD 8 Write to MCO
[3409]	PCD 9 Write to MCO
[3410]	PCD 10 Write to MCO
[3421]	PCD 1 Read from MCO
[3422]	PCD 2 Read from MCO
[3423]	PCD 3 Read from MCO
[3424]	PCD 4 Read from MCO
[3425]	PCD 5 Read from MCO
[3426]	PCD 6 Read from MCO
[3427]	PCD 7 Read from MCO
[3428]	PCD 8 Read from MCO
[3429]	PCD 9 Read from MCO
[3430]	PCD 10 Read from MCO
[3440]	Digital Inputs
[3441]	Digital Outputs
[3450]	Actual Position
[3451]	Commanded Position
[3452]	Actual Master Position

[3453]	Slave Index Position
[3454]	Master Index Position
[3455]	Curve Position
[3456]	Track Error
[3457]	Synchronizing Error
[3458]	Actual Velocity
[3459]	Actual Master Velocity
[3460]	Synchronizing Status
[3461]	Axis Status
[3462]	Program Status
[3464]	MCO 302 Status
[3465]	MCO 302 Control
[3470]	MCO Alarm Word 1
[3471]	MCO Alarm Word 2

9-27 Parameter Edit

Option:

Function:

Parameters can be edited via Profibus, the standard RS485 interface, or the LCP.

[0]	Disabled	Disables editing via Profibus.
[1] *	Enabled	Enables editing via Profibus.

9-28 Process Control

Option:

Function:

Process control (setting of Control Word, speed reference, and process data) is possible via either Profibus or standard fieldbus but not both simultaneously. Local control is always possible via the LCP. Control via process control is possible via either terminals or fieldbus depending on the settings in par. 8-50 *Coasting Select* to par. 8-56 *Preset Reference Select*.

[0]	Disable	Disables process control via Profibus, and enables process control via standard fieldbus or PROFINET IO-Supervisor.
[1] *	Enable cyclic master	Enables process control via Profibus Master Class 1, and disables process control via standard fieldbus or PROFINET IO-Supervisor..



9-53 Profibus Warning Word

Range:	Function:
0 N/A* [0 - 65535 N/A]	This parameter displays Profibus communication warnings. Please refer to the <i>Profibus Operating Instructions</i> for further information.

Read only

Bit	Condition when bit is active
0	Connection with IO Controller is not ok
1	Reserved for status of connection with second IO Controller
2	Not used
3	Clear data command received
4	Actual value is not updated
5	No Link on both port
6	Not used
7	Initializing of PROFINET is not ok
8	Drive is tripped
9	Internal CAN error
10	Wrong configuration data from IO Controller
11	Not used
12	Internal error occurred
13	Not configured
14	Timeout active
15	Warning 34 active

9-65 Profile Number

Range:	Function:
0 N/A* [0 - 0 N/A]	This parameter contains the profile identification. Byte 1 contains the profile number and byte 2 the version number of the profile.

NB!
This parameter is not visible via LCP.

9-70 Programming Set-up

Option:	Function:
	Select the set-up to be edited.
[0] Factory setup	Uses default data. This option can be used as a data source to return the other set-ups to a known state.
[1] Set-up 1	Edits Set-up 1.
[2] Set-up 2	Edits Set-up 2.
[3] Set-up 3	Edits Set-up 3.
[4] Set-up 4	Edits Set-up 4.
[9] * Active Set-up	Follows the active set-up selected in par. 0-10 <i>Active Set-up</i> .

This parameter is unique to LCP and fieldbuses. See also par. 0-11 *Programming Set-up*.

9-71 Profibus Save Data Values

Option:

Function:

Parameter values changed via Profibus are not automatically stored in non-volatile memory. Use this parameter to activate a function that stores parameter values in the EEPROM non-volatile memory, so changed parameter values will be retained at power-down.

[0] *	Off	Deactivates the non-volatile storage function.
[1]	Store all setups	Stores all parameter values for all set-ups in the non-volatile memory. The selection returns to <i>Off</i> [0] when all parameter values have been stored.
[2]	Store all setups	Stores all parameter values for all set-ups in the non-volatile memory. The selection returns to <i>Off</i> [0] when all parameter values have been stored.

9-72 ProfibusDriveReset

Option:

Function:

[0] *	No action	
[1]	Power-on reset	Resets frequency converter upon power-up, as for power-cycle.
[3]	Comm option reset	Resets the PROFINET option only, the PROFIBUS option will go through a powerup sequence. When reset, the frequency converter disappears from the fieldbus, which may cause a communication error from the master.

9-80 Defined Parameters (1)

Array [116]
No LCP access
Read only

Range:

Function:

0 N/A*	[0 - 9999 N/A]	This parameter displays a list of all the defined frequency converter parameters available for PROFINET.
--------	----------------	--

9-81 Defined Parameters (2)

Array [116]
No LCP access
Read only

Range:

Function:

0 N/A*	[0 - 9999 N/A]	This parameter displays a list of all the defined frequency converter parameters available for PROFINET.
--------	----------------	--

9-82 Defined Parameters (3)

Array [116]
No LCP access
Read only

Range:

Function:

0 N/A*	[0 - 9999 N/A]	This parameter displays a list of all the defined frequency converter parameters available for PROFINET.
--------	----------------	--

9-83 Defined Parameters (4)

Array [116]
No LCP access
Read only

Range:

Function:

0 N/A*	[0 - 9999 N/A]	This parameter displays a list of all the defined frequency converter parameters available for PROFINET.
--------	----------------	--



9-84 Defined Parameters (5)

Array [115]
No LCP access
Read only

Range:

0 N/A* [0 - 9999 N/A]

Function:

This parameter displays a list of all the defined frequency converter parameters available for PROFINET.

9-90 Changed Parameters (1)

Array [116]
No LCP access
Read only

Range:

0 N/A* [0 - 9999 N/A]

Function:

This parameter displays a list of all the frequency converter parameters deviating from default setting.

9-91 Changed Parameters (2)

Array [116]
No LCP access
Read only

Range:

0 N/A* [0 - 9999 N/A]

Function:

This parameter displays a list of all the frequency converter parameters deviating from default setting.

9-92 Changed Parameters (3)

Array [116]
No LCP access
Read only

Range:

0 N/A* [0 - 9999 N/A]

Function:

This parameter displays a list of all the frequency converter parameters deviating from default setting.

9-94 Changed Parameters (5)

Array [116]
No LCP Address
Read only

Range:

0 N/A* [0 - 9999 N/A]

Function:

This parameter displays a list of all the frequency converter parameters deviating from default setting.

7.4 Parameter Group 12-** Ethernet

7.4.1 12-0* IP Settings

12-00 IP Address Assignment

Option:	Function:
	Selects the IP Address assignment method.
[0] Manual	IP-address can be set in par. 12-01 IP Address.
[1] DHCP	IP-address is assigned via DHCP server.
[2] BOOTP	IP-address is assigned via BOOTP server.
[10] * DCP	DCP Assigned vis the DCP protocol.

12-01 IP Address

Range:	Function:
[000.000.000.000 255.255.255.255]	- Configure the IP address of the option. Read-only if par. 12-00 set to DHCP or BOOTP.

12-02 Subnet Mask

Range:	Function:
[000.000.000.000 255.255.255.255]	- Configure the IP subnet mask of the option. Read-only if par. 12-00 set to DHCP or BOOTP.

12-03 Default Gateway

Range:	Function:
[000.000.000.000 255.255.255.255]	- Configure the IP default gateway of the option. Read-only if par. 12-00 set to DHCP or BOOTP. In a non routed network this address is set to the IP address of the IO Device

12-04 DHCP Server

Range:	Function:
[000.000.000.000 255.255.255.255]	- Read only. Displays the IP address of the found DHCP or BOOTP server.

12-05 Lease Expires

Range:	Function:
[dd:hh:mm:ss]	Read only. Displays the lease-time left for the current DHCP-assigned IP address.

12-06 Name Servers

Option:	Function:
	IP addresses of Domain Name Servers. Can be automatically assigned when using DHCP.
[0] Primary DNS	
[1] Secondary DNS	

12-07 Domain Name

Range:	Function:
Blank [0-19 characters]	Domain name of the attached network. Can be automatically assigned when using DHCP.

12-08 Host Name**Range:**

Blank [0-48 characters]

Function:

Logical (given) name of option.

**NB!**

Please note that the display of the drive will only show the first 19 characters, but the remaining characters are stored in the drive.

12-09 Physical Address**Range:**

[00:1B:08:00:00:00 – 00:1B:08:FF:FF:FF]

Function:

Read only Displays the Physical (MAC) address of the option.

7.4.2 12-1* Ethernet Link Parameters**12-1* Ethernet Link Parameters****Option:**

[0] Port 1

[1] Port 2

Function:

Applies for whole parameter group.

12-10 Link Status**Option:**

[0] No link

[1] Link

Function:

Read only. Displays the link status of the Ethernet ports.

12-11 Link Duration**Option:**

Link Duration Port 1 (dd:hh:mm:ss)

Function:

Read only. Displays the duration of the present link on each port in dd:hh:mm:ss.

12-12 Auto Negotiation**Option:**

[0] * Off

[1] On

Function:

Configures Auto Negotiation of Ethernet link parameters, for each port: ON or OFF.

Link Speed and *Link Duplex* can be configured in par. 12-13 and 12-14.**NB!**It is recommended to set par. 12-12 *Auto Negotiation* to OFF [0] for the PROFINET option and for the connected port. This will ensure that the connected ports will be set to an optimized Link Speed with Link Duplex setting. If only one of the ports in a link is set to Auto Negotiation ON, it can cause the ports to switch to half duplex, resulting in poor network performance. Most switches today have Auto negotiation set, but this can lead to a longer time to establish a connection.

12-13 Link Speed**Option:****Function:**

Forces the link speed for each port in 10 or 100 Mbps. If par. 12-12 is set to: ON, this parameter is read only and displays the actual link speed. "None" is displayed if no link is present.

[0]	None
[1]	10 Mbps
[2] *	100 Mbps

12-14 Link Duplex**Option:****Function:**

Forces the duplex for each port to Full or Half duplex. If par. 12-12 is set to: ON, this parameter is read only.

[0]	Half duplex
[1] *	Full duplex

7.4.3 12-8* Other Ethernet Services**12-80 FTP Server****Option:****Function:**

[0] *	Disable	Disables the built-in FTP server.
[1]	Enable	Enables the built-in FTP server.

12-81 HTTP Server**Option:****Function:**

[0] *	Disable	Disables the build-in HTTP (web) server.
[1]	Enable	Enables the build-in HTTP (web) server.

12-82 SMTP Service**Option:****Function:**

[0] *	Disable	Disables the SMTP (e-mail) service on the option.
[1]	Enable	Enables the SMTP (e-mail) service on the option.

12-89 Transparent Socket Channel Port**Range:****Function:**

4000* [0 – 9999]

Configures the TCP port-number for the transparent socket channel. This enables FC-telegrams to be sent transparently on Ethernet via TCP. Default value is 4000, 0 means disabled. This port is used by the MCT10 setup software.

7.4.4 12-9* Advanced Ethernet Settings**12-90 Cable Diagnostics****Option:****Function:**

Enables/disables advanced Cable diagnosis function. If enabled, the distance to cable errors can be read out in par. 12-93. The parameter resumes to the default setting of Disable after the diagnostics have finished.

[0] *	Disable
[1]	Enable

**NB!**

The cable diagnostics function will only be issued on ports where there is no link (see par. 12-10, *Link Status*)

12-91 Auto Cross-Over

Option:	Function:
[0] Disable	Disables the auto cross-over function.
[1] * Enable	Enables the auto cross-over function.

12-92 IGMP Snooping

Option:	Function:
[0] Disable	This prevents flooding of the Ethernet protocol stack by only forwarding multicast packets to ports that are a member of the multicast group. In PROFINET this function is disabled.
[1] * Enable	Disables the IGMP snooping function.
[1] * Enable	Enables the IGMP snooping function.

12-93 Cable Error Length

Option:	Function:
[0] Error length Port 1 (0 – 200m)	If Cable Diagnostics is enabled in par. 12-90, the built-in switch is able via Time Domain Reflectometry (TDR). This is a measurement technique which detects common cabling problems such as open circuits, short circuits and impedance mismatches or breaks in transmission cables. The distance from the option to the error is displayed in meters with an accuracy of +/- 2m. The value 0 means no errors detected.
[1] Error length Port 2 (0 – 200m)	

12-94 Broadcast Storm Protection

Option:	Function:
[0] Protection Value Port 1 (*Off – 20%)	The built-in switch is capable of protecting the switch system from receiving too many broadcast packages, which can use up network resources. The value indicates a percentage of the total bandwidth that is allowed for broadcast messages. Example: The "OFF" means that the filter is disabled –all broadcast messages will be passed through. The value "0%" means that no broadcast messages will be passed through. A value of "10%" means that 10% of the total bandwidth is allowed for broadcast messages, if the amount of broadcast messages increases above the 10% threshold, they will be blocked.
[1] Protection Value Port 2 (*Off – 20%)	

12-95 Broadcast Storm Filter

Option:	Function:
[0] Broadcast only	Applies to par. 12-94; if the Broadcast Storm Protection should also include Multicast telegrams.
[1] Broadcast & Multicast	

12-96 Port Mirroring

Enables/disables port-mirroring function. For troubleshooting with a network analyzer tool.

Option:	Function:
[0] * Disable	No port-mirroring
[1] Port 1 to Port 2	All network traffic on port 1 will be mirrored to port 2.
[2] Port 2 to Port 1	All network traffic on port 2 will be mirrored to port 1.

12-98 Interface Counters

Option:

Function:

Read only. Advanced Interface counters, from build-in switch, can be used for low-level troubleshooting, The parameter shows a sum of port 1 + port 2.

[0] In Octets

[1] In Unicast Packets

[2] In Non-Unicast Packets

[3] In Discards

[4] In Errors

[5] In Unknown Protocols

[6] Out Octets

[7] Out Unicast Packets

[8] Out Non-Unicast Packets

[9] Out Discards

[10] Out Errors

12-99 Media Counters

Option:

Function:

Read only. Advanced Interface counters, from build-in switch, can be used for low-level troubleshooting, The parameter shows a sum of port 1 + port 2.

[0] Alignment Errors

[1] FCS Errors

[2] Single Collisions

[3] Multiple Collisions

[4] SQE Test Errors

[5] Deferred Errors

[6] Late Collisions

[7] Excessive Collisions

[8] MAC Transmit Errors

[9] Carrier Sense Errors

[10] Frame Too Long

[11] MAC Receive Errors

7.5 PROFINET-specific Parameter List

Parameter	Default value	Range	Conversion index	Data type
Par. 8-01 <i>Control Site</i>	Dig. & ctrl. word [0]	[0 - 2]	-	UInt8
Par. 8-02 <i>Control Word Source</i>	FC RS485 [0]	[0 - 4]	-	UInt8
Par. 8-03 <i>Control Word Timeout Time</i>	1	0.1-18000	-1	UInt32
Par. 8-04 <i>Control Word Timeout Function</i>	Off [0]	[0 - 10]	-	UInt8
Par. 8-05 <i>End-of-Timeout Function</i>	Hold set-up [0]	[0 - 1]	-	UInt8
Par. 8-06 <i>Reset Control Word Timeout</i>	Do not reset [0]	[0 - 1]	-	UInt8
Par. 8-07 <i>Diagnosis Trigger</i>	Disable [0]	[0 - 3]	-	UInt8
Par. 8-10 <i>Control Word Profile</i>	FC profile [0]	[0 - x]	-	UInt8
Par. 8-13 <i>Configurable Status Word STW</i>				
Par. 8-50 <i>Coasting Select</i>	*Logic OR [3]	[0 - 3]	-	UInt8
Par. 8-51 <i>Quick Stop Select</i>	*Logic OR [3]	[0 - 3]	-	UInt8
Par. 8-52 <i>DC Brake Select</i>	*Logic OR [3]	[0 - 3]	-	UInt8
Par. 8-53 <i>Start Select</i>	*Logic OR [3]	[0 - 3]	-	UInt8
Par. 8-54 <i>Reversing Select</i>	*Logic OR [3]	[0 - 3]	-	UInt8
Par. 8-55 <i>Set-up Select</i>	*Logic OR [3]	[0 - 3]	-	UInt8
Par. 8-56 <i>Preset Reference Select</i>	*Logic OR [3]	[0 - 3]	-	UInt8
Par. 8-90 <i>Bus Jog 1 Speed</i>	100 rpm	0 - par. 4-13	67	UInt16
Par. 8-91 <i>Bus Jog 2 Speed</i>	200 rpm	0 - par. 4-13	67	UInt16
Par. 9-15 <i>PCD Write Configuration</i>	-	-	-	UInt16
Par. 9-16 <i>PCD Read Configuration</i>	-	-	-	UInt16
Par. 9-22 <i>Telegram Selection</i>	-	[0 - 108]	-	UInt8
Par. 9-23 <i>Parameters for Signals</i>	-	0 - 573	-	UInt16
Par. 9-27 <i>Parameter Edit</i>	Enabled [1]	[0 - 1]	-	UInt16
Par. 9-28 <i>Process Control</i>	Enable cyclic master [1]	[0 - 1]	-	UInt16
Par. 9-44 <i>Fault Message Counter</i>	0	[0 - 8]	0	UInt16
Par. 9-45 <i>Fault Code</i>	0	-	-	UInt16
Par. 9-47 <i>Fault Number</i>	0	-	-	UInt16
Par. 9-52 <i>Fault Situation Counter</i>	0	0 - 1000	0	UInt16
Par. 9-53 <i>Profibus Warning Word</i>	0	16 bits	0	V2
Par. 9-64 <i>Device Identification</i>	0	[0 - 10]	0	UInt16
Par. 9-65 <i>Profile Number</i>	0	8 bits	0	UInt8
Par. 9-70 <i>Edit Set-up</i>	Active set-up [9]	[0 - 9]	-	UInt8
Par. 9-71 <i>Profibus Save Data Values</i>	Off [0]	[0 - 2]	-	UInt8
Par. 9-72 <i>ProfibusDriveReset</i>	No action [0]	[0 - 2]	-	UInt8
Par. 9-80 <i>Defined Parameters (1)</i>	-	0-115	0	UInt16
Par. 9-81 <i>Defined Parameters (2)</i>	-	0-115	0	UInt16
Par. 9-82 <i>Defined Parameters (3)</i>	-	0-115	0	UInt16
Par. 9-83 <i>Defined Parameters (4)</i>	-	0-115	0	UInt16
Par. 9-90 <i>Changed Parameters (1)</i>	-	0-115	0	UInt16
Par. 9-91 <i>Changed Parameters (2)</i>	-	0-115	0	UInt16
Par. 9-92 <i>Changed Parameters (3)</i>	-	0-115	0	UInt16
Par. 9-93 <i>Changed parameters (4)</i>	-	0-115	0	UInt16
par. 12-00 <i>IP Address Assignment</i>	0.0.0.0	0 - 255	-	Unsigned 8
par. 12-01 <i>IP Address</i>	0.0.0.0	0 - 255	-	Oct. string 4
Par. 12-02 <i>Subnet Mask</i>	0.0.0.0	0 - 255	-	Oct. string 4
Par. 12-03 <i>Default Gateway</i>	0.0.0.0	0 - 255	-	Oct. string 4
Par. 12-04 <i>DHCP Server</i>	0.0.0.0	0 - 255	-	Oct. string 4
Par. 12-05 <i>Lease Expires</i>	00:00:00:00	-	-	Time diff. w/ date
Par. 12-06 <i>Name Servers</i>	0.0.0.0	0 - 255	-	Oct. string 4
Par. 12-07 <i>Domain Name</i>	-	max. 19 ch.	-	Visible string 48
Par. 12-08 <i>Host Name</i>	-	max. 19 ch.	-	Visible string 48
Par. 12-09 <i>Physical Address</i>	00:1B:08:00:00:00	-	-	Visible string 17
Par. 12-10 <i>Link Status</i>	No Link [0]	[0 - 1]	-	Unsigned 8
Par. 12-11 <i>Link Duration</i>	00:00:00:00	-	-	Time diff. w/ date
Par. 12-12 <i>Auto Negotiation</i>	On [1]	[0 - 1]	-	Unsigned 8
Par. 12-13 <i>Link Speed</i>	None [0]	[0 - 2]	-	Unsigned 8
Par. 12-14 <i>Link Duplex</i>	Full Duplex [1]	[0 - 1]	-	Unsigned 8
Par. 12-80 <i>FTP Server</i>	Disable [0]	[0 - 1]	-	Unsigned 8
Par. 12-81 <i>HTTP Server</i>	Disable [0]	[0 - 1]	-	Unsigned 8
Par. 12-82 <i>SMTP Service</i>	Disable [0]	[0 - 1]	-	Unsigned 8
Par. 12-89 <i>Transparent Socket Channel Port</i>	Disable [0]	[0 - 1]	-	Unsigned 8
Par. 12-90 <i>Cable Diagnostic</i>	Disable [0]	[0 - 1]	-	Unsigned 8
Par. 12-91 <i>MDI-X</i>	Enable [0]	[0 - 1]	-	Unsigned 8
Par. 12-92 <i>IGMP Snooping</i>	Enable [0]	[0 - 1]	-	Unsigned 8
Par. 12-93 <i>Cable Error Length</i>	0	0 - 200	0	Unsigned 16
Par. 12-94 <i>Broadcast Storm Protection</i>	0	Off - 20%	-	Unsigned 16
Par. 12-95 <i>Broadcast Storm Filter</i>	Enable [1]	[0 - 1]	-	Unsigned 8
Par. 12-98 <i>Interface Counters</i>	0	0 - 65535	-	Unsigned 16
Par. 12-99 <i>Media Counters</i>	0	0 - 65535	-	Unsigned 16
Par. 16-84 <i>Comm. Option STW</i>	0	0 - FFFF	0	V2
Par. 16-90 <i>Alarm Word</i>	0	0 - FFFF	0	UInt32
Par. 16-92 <i>Warning Word</i>	0	0 - FFFF	0	UInt32

Please refer to the relevant Operating Instructions for a comprehensive parameter list.

7.6 Object and Data Types Supported

7.6.1 Parameter and Data Type Structure Description

7.6.2 Parameter Description

PROFINET has a number of describing attributes.

7.6.3 Size Attribute

The size index and the conversion index for each parameter can be taken from the parameter list in the respective Operating Instructions.

Physical unit	Size index	Measuring unit	Designation	Conversion index	Conversion factor
	0	No dimension			
Time	4	second	s	0	1
				-1	0.1
				-2	0.01
		millisecond	ms	-3	0.001
		minute	min	70	60
		hour	h	74	3600
		day	d	77	86400
Energy	8	watthour	Wh	0	1
		kilowatthour	kWh	3	1000
		megawatthour	MWh	6	10 ⁶
Power	9	milliwatt	mW	-3	0.001
		watt	W	0	1
		kilowatt	kW	3	1000
		megawatt	MW	6	10 ⁶
Rotation	11	rotation per minute	RPM	67	1
Torque	16	newtonmeter	Nm	0	1
		kilonewtonmeter	kNm	3	1000
Temperature	17	degree Celsius	°C	0	1
Voltage	21	millivolt	mV	-3	0.001
		volt	V	0	1
		kilovolt	kV	3	1000
Current	22	milliampere	mA	-3	0.001
		ampere	A	0	1
		kiloampere	kA	3	1000
Resistance	23	milliohm	mOhm	-3	0.001
		ohm	Ohm	0	1
		kiloohm	kOhm	3	1000
Ratio	24	per cent	%	0	1
Relative change	27	per cent	%	0	1
Frequency	28	hertz	Hz	0	1
		kilohertz	kHz	3	1000
		megahertz	MHz	6	10 ⁶
		gigahertz	GHz	9	10 ⁹



7.6.4 Object and Data Types Supported

Data types supported

Data type	Short name	Description
3	I2	Integer 16
4	I4	Integer 32
5	-	Unsigned 8
6	O2	Unsigned 16
7	O4	Unsigned 32
9	-	Visible string
10	-	Byte string
33	N2	Standardized value (16 bit)
35	V2	Bit sequence
54	-	Time difference without date indication

8 Application Examples

8.1 E.g.: Process Data with PPO Type 6

This example shows how to work with PPO type 6, which consists of Control Word/Status Word and Reference/Main Actual Value. The PPO also has two additional words, which can be programmed to monitor process signals:

		PCD							
		0		1		2		3	
		CTW		MRV		PCD[2]		PCD	
From Controller		04	7C	20	00	00	00	00	00
		STW		MAV		PCD[2]		PCD[3]	
From Drive		0F	07	20	00	3F	A6	00	08
Byte #		1	2	3	4	5	6	7	8

The application requires monitoring of the motor torque and digital input, so PCD 2 is set up to read the current motor torque. PCD 3 is set up to monitor the state of an external sensor via the process signal digital input. The sensor is connected to digital input 18.

An external device is also controlled via control word bit 11 and the built-in relay of the frequency converter. Reversing is permitted only when the reversing bit 15 in the control word and the digital input 19 are set to high.

For safety reasons the frequency converter will stop the motor if the PROFINET cable is broken, the master has a system failure, or the PLC is in stop mode.

8

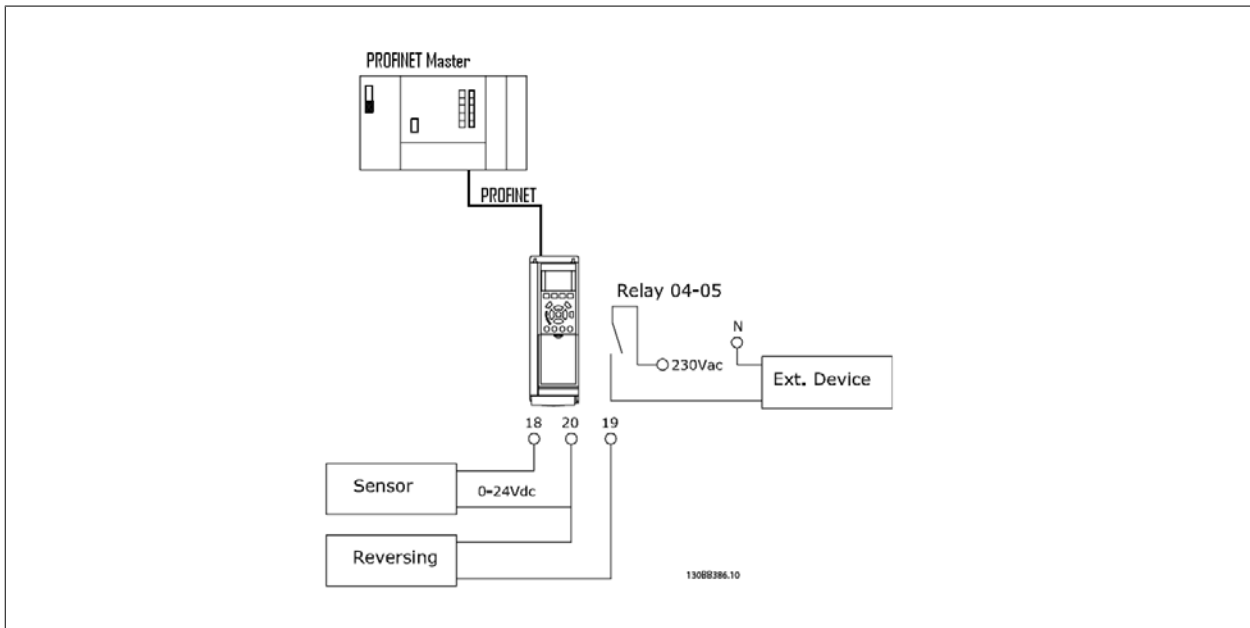

Program the frequency converter as follows:

Parameter	Setting
Par. 4-10 <i>Motor Speed Direction</i>	Both directions [2]
Par. 5-10 <i>Terminal 18 Digital Input</i>	No operation [0]
Par. 5-11 <i>Terminal 19 Digital Input</i>	Reversing [10]
Par. 5-40 <i>Function Relay</i>	Control word bit 11/12 [36/37]
Par. 8-03 <i>Control Word Timeout Time</i>	1 sec
Par. 8-04 <i>Control Word Timeout Function</i>	Stop [2]
Par. 8-10 <i>Control Word Profile</i>	FC Profile [0]
Par. 8-50 <i>Coasting Select</i>	Bus [1]
Par. 8-51 <i>Quick Stop Select</i>	Bus [1]
Par. 8-52 <i>DC Brake Select</i>	Bus [1]
Par. 8-53 <i>Start Select</i>	Bus [1]
Par. 8-54 <i>Reversing Select</i>	Logic AND [2]
Par. 8-55 <i>Set-up Select</i>	Bus [1]
Par. 8-56 <i>Preset Reference Select</i>	Bus [1]
Par. 9-16 <i>PCD Read Configuration</i>	Sub index [2] par. 16-16 <i>Torque [Nm]</i> Sub indes [3] par. 16-60 <i>Digital Input</i>

8.2 E.g.: Control Word Telegram using Standard Telegram 1 / PPO3

This example shows how the control word telegram relates to the controller and the frequency converter, using FC Control Profile.

The control word telegram is sent from the PLC to the frequency converter. Standard Telegram 1 is used in the example in order to demonstrate the full range of modules. All the values shown are arbitrary, and are provided for the purposes of demonstration only.

PCD																																
0	1	2	3																													
CTW	MRV	PCD	PCD																													
04	7C	20	00																													
PQW: 256 258 260 262																																
CTW		MRV																														
Bit no.:	31	30	29	28	27	26	25	24	23	22	21	20	19	18	17	16	15	14	13	12	11	10	9	8	7	6	5	4	3	2	1	0
	0	0	0	0	0	1	0	0	0	1	1	1	1	1	0	0	0	0	0	1	0	0	0	0	0	0	0	0	0	0	0	0
	0				4				7				C				2				0				0				0			

The table above indicates the bits contained within the control word, and how they are presented as process data in Standard Telegram 1 for this example.

The following table indicates which bit functions, and which corresponding bit values are active for this example.

Bit	Bit value = 0	Bit value = 1	Bit value
00	Reference value	External selection lsb	0
01	Reference value	External selection msb	0
02	DC brake	Ramp	1
03	Coasting	Enable	1
04	Quick stop	Ramp	1
05	Freeze output	Ramp enable	1
06	Ramp stop	Start	1
07	No function	Reset	0
08	No function	Jog	0
09	Ramp 1	Ramp 2	0
10	Data not valid	Valid	1
11	No function	Relay 01 active	0
12	No function	Relay 02 active	0
13	Parameter set-up	Selection lsb	0
14	Parameter set-up	Selection msb	0
15	No function	Reversing	0
Function active			
Function inactive			

8.3 E.g.: Status Word Telegram using Standard Telegram 1 / PPO3

This example shows how the control word telegram relates to the PLC and the frequency converter, using FC Control Profile.

The control word telegram is sent from the frequency converter to the controller. Standard Telegram 1 is used in the example in order to demonstrate the full range of modules. All the values shown are arbitrary, and are provided for the purposes of demonstration only.

PCD			
0	1	2	3
STW	MAV	PCD	PCD
0F	07	20	00
PIW:	256	258	260 262
	STW	MAV	

Bit no.:	31	30	29	28	27	26	25	24	23	22	21	20	19	18	17	16	15	14	13	12	11	10	9	8	7	6	5	4	3	2	1	0
	0	0	0	0	0	1	0	0	0	1	1	1	1	1	0	0	0	0	1	0	0	0	0	0	0	0	0	0	0	0	0	0
	0				F				0				7				2				0				0				0			

The table above indicates the bits contained within the statusword, and how they are presented as process data in Standard Telegram 1 for this example.

The following table indicates which bit functions, and which corresponding bit values are active for this example.

8

Bit	Bit value = 0	Bit value = 1	Bit value	
00	Control not ready	Control ready	1	7
01	Drive not ready	Drive ready	1	
02	Coasting	Enable	1	
03	No error	Trip	0	
04	No error	Error (no trip)	0	0
05	Reserved	-	0	
06	No error	Triplock	0	
07	No warning	Warning	0	
08	Speed reference	Speed = reference	1	F
09	Local operation	Bus control	1	
10	Outside frequency range	Within frequency range	1	
11	No operation	In operation	1	
12	Drive ok	Stopped, autostart	0	0
13	Voltage ok	Voltage exceeded	0	
14	Torque ok	Torque exceeded	0	
15	Timers ok	Timers exceeded	0	
Function active		<input type="checkbox"/>		
Function inactive		<input type="checkbox"/>		

8.4 E.g.: PLC Programming

In this example PPO type 6 is placed in the following Input/Output address:

Slot	Module	Order Number	I Address	Q address	Diagnostic address	Comment
0	FC302	13081135			2042*	
X1	Interface				2041*	
X1A	Port 1				2040*	
1	PPO Type 6 PCD	13081135			2039*	
1.1	Parameter Access Point				2038*	
1.2	PPO Type 6 FCD		256...263	256...263		

Input address	256-257	258-259	260-261	262-263	Output address	256-257	258-259	260-261	262-263
Set-up	Status word	MAV	Motor torque	Digital input	Set-up	Control word	Reference	Not used	Not used

This network will send a start command (047C Hex) and a reference (2000 Hex) of 50% to the frequency converter.

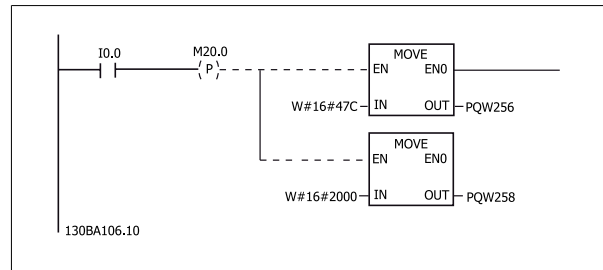

This network reads the motor torque from the frequency converter. A new reference will be sent to the frequency converter because the Motor Torque (86.0%) is higher than the compared value.

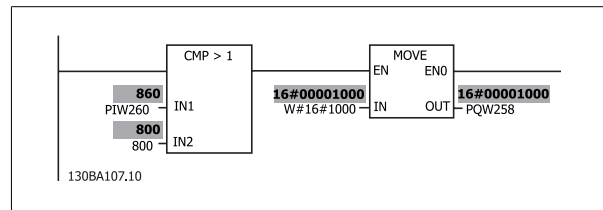

This network reads the status on the digital inputs from the frequency converter. If digital input 18 is On it will stop the frequency converter.

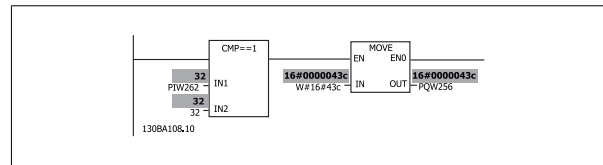

This network will reverse the motor when digital input 19 is ON, because par. 8-54 Reversing Select is programmed to Logic AND.

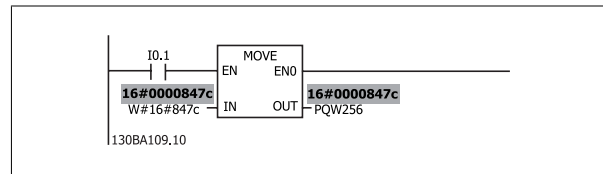

This network will activate the relay 02.

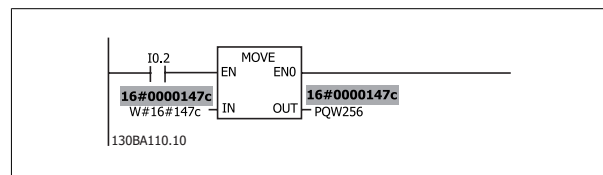

9 Troubleshooting

9.1 Troubleshooting

9.1.1 LED Status

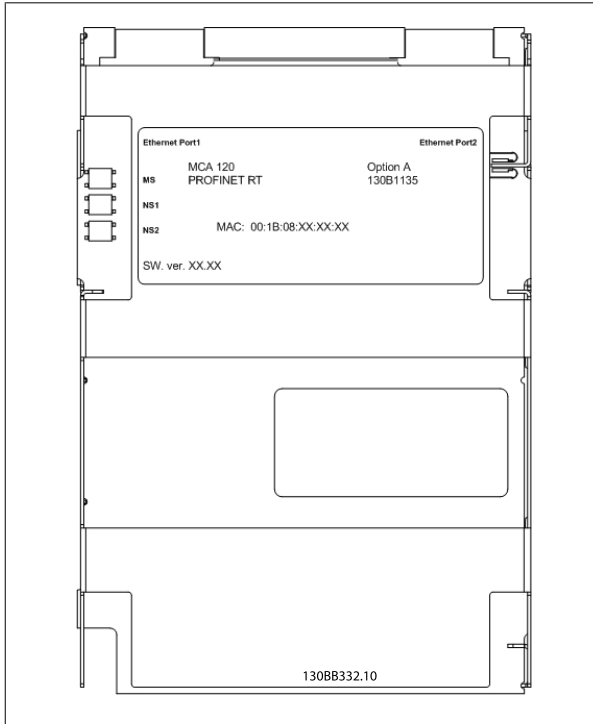

9

Status	Tri-colour LED
No IP Address assigned	Off
No Communication to PROFINET module. Module is waiting on configuration telegram from Controller.	Green: 130BB373.10
IO AR established	Green: 130BB374.10
Supervisor AR established, No IO AR.	Green: 130BB374.10
Internal Error	Red: 130BB375.10
Wink	Yellow: 130BB375.10

Table 9.1: MS: Module Status

Network Status

Phases	Status	Tri-colour LED
Power Off.	No Power or No Link on the corresponding port	Off
Power On.	IP Address Conflict	Red:
	Waiting for configuration	Green: 130BB375.10
Running	In Data Exchange Mode	Green:
	Wrong Configuration	Red: 130BB374.10
Data exchange	No increment in "In Octets" counter of corresponding port in last 60 Sec.	Yellow: 130BB375.10

Table 9.2: Indication on Network Status LED

9.1.2 No Communication with the Drive

If there is no communication with the drive, proceed with the following checks:

Check 1: Is the cabling correct?

Check that the cable is correct mounted. Check if the corresponding Network LED shows link activity. NS1 or NS2

Check 2: Does the hardware config match?

Check that the Hardware config match the value in par. 12-08 *Host Name*

Check 3: Is the correct GSD file installed?

Download the correct GSD file from [http:// www.danfoss.com/BusinessAreas/DrivesSolutions/](http://www.danfoss.com/BusinessAreas/DrivesSolutions/).

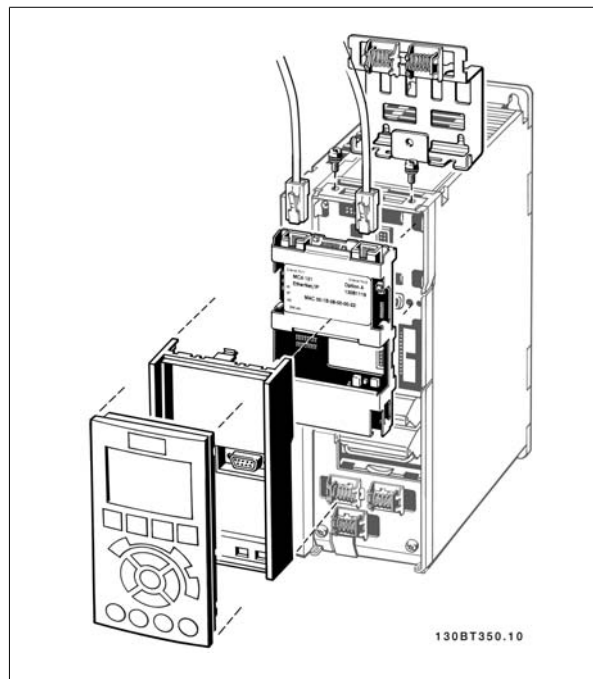

Par. 15-61 <i>Option SW Version</i>	GSDML File
1.x	GSDML-V2.2-Danfoss-FC-20090620

9.1.3 Warning 34 Appears even though Communication is Established

If the controller is in stop mode Warning 34 will appear. Check that the controller is in run mode.

9.1.4 Drive Will Not Respond to Control Signals

Check 1: Is the Control word valid?

If bit 10=0 in the Control word, the drive will not accept the Control word.

Check 2: Is the relationship between bits in the Control word and the terminal I/Os correct?

Check the logical relationship in the drive.

Define the desired logical relationship in par. 8-50 *Coasting Select* to par. 8-56 *Preset Reference Select* according to the following range of options. Select the FC control mode, digital input and/or serial communication, using par. 8-50 *Coasting Select* to par. 8-56 *Preset Reference Select*.

The tables below show the effect upon the frequency converter of a coast command for the full range of par. 8-50 *Coasting Select* settings.

The effect of control mode upon the function of par. 8-50 *Coasting Select*, par. 8-51 *Quick Stop Select* and par. 8-52 *DC Brake Select* is as follows:

If *Digital input* [0] is selected, the terminals will control the Coast and DC Brake functions.



NB!

Please note that Coasting, Quick Stop and DC brake functions are active for logic 0.

Digital input [0]		
Terminal	Bit 02/03/04	Function
0	0	Coast/DC brake/Q-Stop
0	1	Coast/DC brake/Q-Stop
1	0	No Coast/DC brake/Q-Stop
1	1	No Coast/DC brake/Q-Stop

If *Serial communication* [1] is selected, commands will be activated only when given via serial communication.

Serial communication [1]		
Terminal	Bit 02/03/04	Function
0	0	Coast/DC brake/Q-Stop
0	1	No Coast/DC brake/Q-Stop
1	0	Coast/DC brake/Q-Stop
1	1	No Coast/DC brake/Q-Stop

If *Logic AND* [2] is selected, both signals must be activated to perform the function.

Logic AND [2]		
Terminal	Bit 02/03/04	Function
0	0	Coast/DC brake/Q-Stop
0	1	No Coast/DC brake/Q-Stop
1	0	No Coast/DC brake/Q-Stop
1	1	No Coast/DC brake/Q-Stop

If Logic OR [3] is selected, activation of one signal will activate the function.

Logic OR [3]		
Terminal	Bit 02/03/04	Function
0	0	Coast/DC brake/Q-Stop
0	1	Coast/DC brake/Q-Stop
1	0	Coast/DC brake/Q-Stop
1	1	No Coast/DC brake/Q-Stop

The effect of control mode upon the function of par. 8-53 *Start Select* and par. 8-54 *Reversing Select*:

If *Digital input* [0] is selected, the terminals will control the start and reversing functions

Digital input [0]		
Terminal	Bit 06/15	Function
0	0	Stop/Anti-clockwise
0	1	Stop/Anti-clockwise
1	0	Start/Clockwise
1	1	Start/Clockwise

If *Serial communication* [1] is selected, commands will be activated only when given via serial communication.

Serial communication [1]		
Terminal	Bit 02/03/04	Function
0	0	Stop/Anti-clockwise
0	1	Start/Clockwise
1	0	Stop/Anti-clockwise
1	1	Start/Clockwise

If *Logic AND* [2] is selected, both signals must be activated to perform the function.

Logic AND [2]		
Terminal	Bit 02/03/04	Function
0	0	Stop/Anti-clockwise
0	1	Stop/Anti-clockwise
1	0	Stop/Anti-clockwise
1	1	Start/Clockwise

If *Logic OR* [3] is selected, activation of one signal will activate the function.

Logic OR [3]		
Terminal	Bit 02/03/04	Function
0	0	Stop/Anti-clockwise
0	1	Start/Clockwise
1	0	Start/Clockwise
1	1	Start/Clockwise

The effect of control mode upon the function of par. 8-55 *Set-up Select* and par. 8-56 *Preset Reference Select*:

If *Digital input* [0] is selected, the terminals will control the set-up and preset reference functions.

Digital input [0]				
Terminal		Bit 00/01, 13/14		Function
Msb	Lsb	Msb	Lsb	Preset ref., Set-up no.
0	0	0	0	1
0	0	0	1	1
0	0	1	0	1
0	0	1	1	1
0	1	0	0	2
0	1	0	1	2
0	1	1	0	2
0	1	1	1	2
1	0	0	0	3
1	0	0	1	3
1	0	1	0	3
1	0	1	1	3
1	1	0	0	4
1	1	0	1	4
1	1	1	0	4
1	1	1	1	4

If *Serial communication* [1] is selected, commands will be activated only when given via serial communication.

<i>Serial communication</i> [1]				
Terminal		Bit 00/01, 13/14		Function
Msb	Lsb	Msb	Lsb	Preset ref., Set-up no.
0	0	0	0	1
0	0	0	1	2
0	0	1	0	3
0	0	1	1	4
0	1	0	0	1
0	1	0	1	2
0	1	1	0	3
0	1	1	1	4
1	0	0	0	1
1	0	0	1	2
1	0	1	0	3
1	0	1	1	4
1	1	0	0	1
1	1	0	1	2
1	1	1	0	3
1	1	1	1	4

If *Logic AND* [2] is selected, both signals must be activated to perform the function.

<i>Logic AND</i> [2]				
Terminal		Bit 00/01, 13/14		Function
Msb	Lsb	Msb	Lsb	Preset ref., Set-up no.
0	0	0	0	1
0	0	0	1	1
0	0	1	0	1
0	0	1	1	1
0	1	0	0	1
0	1	0	1	2
0	1	1	0	1
0	1	1	1	2
1	0	0	0	1
1	0	0	1	1
1	0	1	0	3
1	0	1	1	3
1	1	0	0	1
1	1	0	1	2
1	1	1	0	3
1	1	1	1	4

If *Logic OR* [3] is selected, activation of one signal will activate the function.

<i>Logic OR</i> [3]				
Terminal		Bit 00/01, 13/14		Function
Msb	Lsb	Msb	Lsb	Preset ref., Set-up no.
0	0	0	0	1
0	0	0	1	2
0	0	1	0	3
0	0	1	1	4
0	1	0	0	2
0	1	0	1	2
0	1	1	0	4
0	1	1	1	4
1	0	0	0	3
1	0	0	1	4
1	0	1	0	3
1	0	1	1	4
1	1	0	0	4
1	1	0	1	4
1	1	1	0	4

9

9.1.5 Alarm and Warning Words

Alarm word, Warning word and PROFINET warning word are shown on the display in Hex format. If there is more than one warning or alarm, a sum of all warnings or alarms will be shown. Alarm word, warning word and PROFINET warning word can also be displayed using the serial bus in par. 16-90 *Alarm Word*, par. 16-92 *Warning Word* and par. 9-53 *Profibus Warning Word*.

FC 102/FC 202/FC 301/FC 302			
Bit (Hex)	Unit diagnosis bit	Alarm word (par. 16-90 <i>Alarm Word</i>)	Alarm no.
00000001	48	Brake check	28
00000002	49	Power card over temperature	29
00000004	50	Earth fault	14
00000008	51	Control card over temperature	65
00000010	52	Control word timeout	18
00000020	53	Over current	13
00000040	54	Torque limit	12
00000080	55	Motor thermistor over temp.	11
00000100	40	Motor ETR over temperature	10
00000200	41	Inverter overloaded	9
00000400	42	DC link under voltage	8
00000800	43	DC link over voltage	7
00001000	44	Short circuit	16
00002000	45	Inrush fault	33
00004000	46	Mains phase loss	4
00008000	47	AMA not OK	50
00010000	32	Live zero error	2
00020000	33	Internal fault	38
00040000	34	Brake overload	26
00080000	35	Motor phase U is missing	30
00100000	36	Motor phase V is missing	31
00200000	37	Motor phase W is missing	32
00400000	38	Fieldbus comm. fault	34
00800000	39	24 V supply fault	47
01000000	24	Mains failure	36
02000000	25	1.8 V supply fault	48
04000000	26	Brake resistor short circuit	25
08000000	27	Brake chopper fault	27
10000000	28	Option change	67
20000000	29	Drive initialisation	80
40000000	30	Safe stop	68
80000000	31	Mechanical brake low	63

FC 102/FC 202/FC 301/FC 302			
Bit (Hex)	Unit diagnosis bit	Warning word (par. 16-92 <i>Warning Word</i>)	Alarm no.
00000001	112	Brake check	28
00000002	113	Power card over temperature	29
00000004	114	Earth fault	14
00000008	115	Control card	65
00000010	116	Control word timeout	18
00000020	117	Over current	13
00000040	118	Torque limit	12
00000080	119	Motor thermistor over temp.	11
00000100	104	Motor ETR over temperature	10
00000200	105	Inverter overloaded	9
00000400	106	DC link under voltage	8
00000800	107	DC link over voltage	7
00001000	108	DC link voltage low	6
00002000	109	DC link voltage high	5
00004000	110	Mains phase loss	4
00008000	111	No motor	3
00010000	96	Live zero error	2
00020000	97	10 V low	1
00040000	98	Brake overload	26
00080000	99	Brake resistor short circuit	25
00100000	100	Brake chopper fault	27
00200000	101	Speed limit	49
00400000	102	Fieldbus comm. fault	34
00800000	103	24 V supply fault	47
01000000	88	Mains failure	36
02000000	89	Current limit	59
04000000	90	Low temperature	66
08000000	91	Voltage limit	64
10000000	92	Encoder loss	61
20000000	93	Output frequency limit	62
40000000	94	Unused	-
80000000	95	Warning word 2 (ext. stat. word)	-

FC 102/FC 202/FC 301/FC 302			
Bit (Hex)	Unit diagnosis bit	PROFIBUS warning word (par. 9-53 <i>Profibus Warning Word</i>)	
00000001	160	Connection with DP-master is not ok	
00000002	161	Unused	
00000004	162	FDL (Fieldbus Data link Layer) is not ok	
00000008	163	Clear data command received	
00000010	164	Actual value is not updated	
00000020	165	Baudrate search	
00000040	166	PROFIBUS ASIC is not transmitting	
00000080	167	Initialising of PROFIBUS is not ok	
00000100	152	Drive is tripped	
00000200	153	Internal CAN error	
00000400	154	Wrong configuration data from PLC	
00000800	155	Wrong ID sent by PLC	
00001000	156	Internal error occurred	
00002000	157	Not configured	
00004000	158	Timeout active	
00008000	159	Warning 34 active	

FC 102/FC 202/FC 301/FC 302	
Bit (Hex)	Comm. option STW (par. 16-84 <i>Comm. Option STW</i>)
00000001	parameterization ok
00000002	configuration ok
00000004	clearmode active
00000008	baudrate search
00000010	waiting for parameterization
00000020	waiting for configuration
00000040	in data exchange
00000080	not used
00000100	not used
00000200	not used
00000400	not used
00000800	MCL2/1 connected
00001000	MCL2/2 connected
00002000	MCL2/3 connected
00004000	data transport active
00008000	not used

 **NB!**
par. 16-84 *Comm. Option STW* is not part of extended diagnosis.

9.1.6 Warning and Alarm Messages

There is a clear distinction between alarms and warnings. When there is an alarm, the frequency converter will enter a fault condition. After the cause for the alarm has been cleared, the master will have to acknowledge the alarm message before the frequency converter can start operating again. A warning, on the other hand, may come when a warning condition appears, then disappear when conditions return to normal, without interfering with the process.

Warnings

Warnings within the frequency converter are represented by a single bit within a warning word. Bit status FALSE [0] means no warning, while bit status TRUE [1] means warning. Any bit change in the warning word will be notified by a change of bit 7 in the status word.

Alarms

Following an alarm message the frequency converter will enter Fault condition. Only after the fault has been alleviated and the controller has acknowledged the alarm message by setting bit 7 in the control word, the frequency converter will resume operation. Alarms within the frequency converter are represented by a single bit within an alarm word. Bit status FALSE [0] means no fault, while bit status TRUE [1] means fault.

10 Warnings and Alarms

10.1 Status Messages

10.1.1 Warnings/Alarm Messages

A warning or an alarm is signalled by the relevant LED on the front of the frequency converter and indicated by a code on the display.

A warning remains active until its cause is no longer present. Under certain circumstances operation of the motor may still be continued. Warning messages may be critical, but are not necessarily so.

In the event of an alarm, the frequency converter will have tripped. Alarms must be reset to restart operation once their cause has been rectified.

This may be done in three ways:

1. By using the [RESET] control button on the LCP control panel.
2. Via a digital input with the "Reset" function.
3. Via serial communication/optional fieldbus.



NB!

After a manual reset using the [RESET] button on the LCP, the [AUTO ON] button must be pressed to restart the motor.

If an alarm cannot be reset, the reason may be that its cause has not been rectified, or the alarm is trip-locked (see also table on following page).

Alarms that are trip-locked offer additional protection, meaning that the mains supply must be switched off before the alarm can be reset. After being switched back on, the frequency converter is no longer blocked and may be reset as described above once the cause has been rectified.

Alarms that are not trip-locked can also be reset using the automatic reset function in par. 14-20 *Reset Mode* (Warning: automatic wake-up is possible!)

If a warning and alarm is marked against a code in the table on the following page, this means that either a warning occurs before an alarm, or else that you can specify whether it is a warning or an alarm that is to be displayed for a given fault.

This is possible, for instance, in par. 1-90 *Motor Thermal Protection*. After an alarm or trip, the motor carries on coasting, and the alarm and warning flash. Once the problem has been rectified, only the alarm continues flashing until the frequency converter is reset.

10.1.2 Alarm List

No.	Description	Warning	Alarm/Trip	Alarm/Trip Lock	Parameter Reference
1	10 Volts low	X			
2	Live zero error	(X)	(X)		par. 6-01 <i>Live Zero Time-out Function</i>
3	No motor	(X)			par. 1-80 <i>Function at Stop</i>
4	Mains phase loss	(X)	(X)	(X)	par. 14-12 <i>Function at Mains Imbalance</i>
5	DC link voltage high	X			
6	DC link voltage low	X			
7	DC over-voltage	X	X		
8	DC under voltage	X	X		
9	Inverter overloaded	X	X		
10	Motor ETR over temperature	(X)	(X)		par. 1-90 <i>Motor Thermal Protection</i>
11	Motor thermistor over temperature	(X)	(X)		par. 1-90 <i>Motor Thermal Protection</i>
12	Torque limit	X	X		
13	Over Current	X	X	X	
14	Earth Fault	X	X	X	
15	Hardware mismatch		X	X	
16	Short Circuit		X	X	
17	Control word time-out	(X)	(X)		par. 8-04 <i>Control Word Timeout Function</i>
22	Hoist Mech. Brake				
23	Internal Fan Fault	X			
24	External Fan Fault	X			par. 14-53 <i>Fan Monitor</i>
25	Brake resistor short-circuited	X			
26	Brake resistor power limit	(X)	(X)		par. 2-13 <i>Brake Power Monitoring</i>
27	Brake chopper short-circuited	X	X		
28	Brake check	(X)	(X)		par. 2-15 <i>Brake Check</i>
29	Heatsink temp	X	X	X	
30	Motor phase U missing	(X)	(X)	(X)	par. 4-58 <i>Missing Motor Phase Function</i>
31	Motor phase V missing	(X)	(X)	(X)	par. 4-58 <i>Missing Motor Phase Function</i>
32	Motor phase W missing	(X)	(X)	(X)	par. 4-58 <i>Missing Motor Phase Function</i>
33	Inrush Fault		X	X	
34	Fieldbus communication fault	X	X		
36	Mains failure	X	X		
38	Internal Fault		X	X	
39	Heatsink sensor		X	X	
40	Overload of Digital Output Terminal 27	(X)			par. 5-00 <i>Digital I/O Mode</i> , par. 5-01 <i>Terminal 27 Mode</i>
41	Overload of Digital Output Terminal 29	(X)			par. 5-00 <i>Digital I/O Mode</i> , par. 5-02 <i>Terminal 29 Mode</i>
42	Overload of Digital Output On X30/6	(X)			par. 5-32 <i>Term X30/6 Digi Out (MCB 101)</i>
42	Overload of Digital Output On X30/7	(X)			par. 5-33 <i>Term X30/7 Digi Out (MCB 101)</i>
46	Pwr. card supply		X	X	
47	24 V supply low	X	X	X	
48	1.8 V supply low		X	X	
49	Speed limit	X			
50	AMA calibration failed		X		
51	AMA check U_{nom} and I_{nom}		X		
52	AMA low I_{nom}		X		
53	AMA motor too big		X		

Table 10.1: Alarm/Warning code list

No.	Description	Warning	Alarm/Trip	Alarm/Trip Lock	Parameter Reference
54	AMA motor too small		X		
55	AMA parameter out of range		X		
56	AMA interrupted by user		X		
57	AMA time-out		X		
58	AMA internal fault	X	X		
59	Current limit	X			
61	Tracking Error	(X)	(X)		par. 4-30 <i>Motor Feedback Loss Function</i>
62	Output Frequency at Maximum Limit	X			
63	Mechanical Brake Low		(X)		par. 2-20 <i>Release Brake Current</i>
64	Voltage Limit	X			
65	Control Board Over-temperature	X	X	X	
66	Heat sink Temperature Low	X			
67	Option Configuration has Changed		X		
68	Safe Stop	(X)	(X) ¹⁾		par. 5-19 <i>Terminal 37 Safe Stop</i>
69	Pwr. Card Temp		X	X	
70	Illegal FC configuration			X	
71	PTC 1 Safe Stop	X	X ¹⁾		par. 5-19 <i>Terminal 37 Safe Stop</i>
72	Dangerous Failure			X ¹⁾	par. 5-19 <i>Terminal 37 Safe Stop</i>
73	Safe Stop Auto Restart				
77	Reduced power mode	X			par. 14-59 <i>Actual Number of Inverter Units</i>
79	Illegal PS config		X	X	
80	Drive Initialized to Default Value		X		
81	CSIV corrupt				
82	CSIV parameter error				
85	Profibus/Profisafe Error				
90	Encoder Loss	(X)	(X)		par. 17-61 <i>Feedback Signal Monitoring S202</i>
91	Analogue input 54 wrong settings			X	
100-199	See Operating Instructions for MCO 305				
243	Brake IGBT	X	X		
244	Heatsink temp	X	X	X	
245	Heatsink sensor		X	X	
246	Pwr.card supply		X	X	
247	Pwr.card temp		X	X	
248	Illegal PS config		X	X	
250	New spare part			X	par. 14-23 <i>Typecode Setting</i>
251	New Type Code		X	X	

Table 10.2: Alarm/Warning code list

(X) Dependent on parameter

1) Can not be Auto reset via par. 14-20 *Reset Mode*

A trip is the action when an alarm has appeared. The trip will coast the motor and can be reset by pressing the reset button or make a reset by a digital input (Par. 5-1* [1]). The origin event that caused an alarm cannot damage the frequency converter or cause dangerous conditions. A trip lock is an action when an alarm occurs, which may cause damage to frequency converter or connected parts. A Trip Lock situation can only be reset by a power cycling.

<i>LED indication</i>	
Warning	yellow
Alarm	flashing red
Trip locked	yellow and red

Alarm Word Extended Status Word							
Bit	Hex	Dec	Alarm Word	Alarm Word 2	Warning Word	Warning Word 2	Extended Status Word
0	00000001	1	Brake Check	ServiceTrip, Read/Write	Brake Check		Ramping
1	00000002	2	Pwr. Card Temp	ServiceTrip, (reserved)	Pwr. Card Temp		AMA Running
2	00000004	4	Earth Fault	ServiceTrip, Type-code/Sparepart	Earth Fault		Start CW/CCW
3	00000008	8	Ctrl.Card Temp	ServiceTrip, (reserved)	Ctrl.Card Temp		Slow Down
4	00000010	16	Ctrl. Word TO	ServiceTrip, (reserved)	Ctrl. Word TO		Catch Up
5	00000020	32	Over Current		Over Current		Feedback High
6	00000040	64	Torque Limit		Torque Limit		Feedback Low
7	00000080	128	Motor Th Over		Motor Th Over		Output Current High
8	00000100	256	Motor ETR Over		Motor ETR Over		Output Current Low
9	00000200	512	Inverter Overld.		Inverter Overld.		Output Freq High
10	00000400	1024	DC under Volt		DC under Volt		Output Freq Low
11	00000800	2048	DC over Volt		DC over Volt		Brake Check OK
12	00001000	4096	Short Circuit		DC Voltage Low		Braking Max
13	00002000	8192	Inrush Fault		DC Voltage High		Braking
14	00004000	16384	Mains ph. Loss		Mains ph. Loss		Out of Speed Range
15	00008000	32768	AMA Not OK		No Motor		OVC Active
16	00010000	65536	Live Zero Error		Live Zero Error		AC Brake
17	00020000	131072	Internal Fault	KTY error	10V Low	KTY Warn	Password Timelock
18	00040000	262144	Brake Overload	Fans error	Brake Overload	Fans Warn	Password Protection
19	00080000	524288	U phase Loss	ECB error	Brake Resistor	ECB Warn	
20	00100000	1048576	V phase Loss		Brake IGBT		
21	00200000	2097152	W phase Loss		Speed Limit		
22	00400000	4194304	Fieldbus Fault		Fieldbus Fault		Unused
23	00800000	8388608	24 V Supply Low		24V Supply Low		Unused
24	01000000	16777216	Mains Failure		Mains Failure		Unused
25	02000000	33554432	1.8V Supply Low		Current Limit		Unused
26	04000000	67108864	Brake Resistor		Low Temp		Unused
27	08000000	134217728	Brake IGBT		Voltage Limit		Unused
28	10000000	268435456	Option Change		Encoder loss		Unused
29	20000000	536870912	Drive Initialized		Output freq. lim.		Unused
30	40000000	1073741824	Safe Stop (A68)	PTC 1 Safe Stop (A71)	Safe Stop (W68)	PTC 1 Safe Stop (W71)	Unused
31	80000000	2147483648	Mech. brake low	Dangerous Failure (A72)	Extended Status Word		Unused

Table 10.3: Description of Alarm Word, Warning Word and Extended Status Word

The alarm words, warning words and extended status words can be read out via serial bus or optional fieldbus for diagnose. See also par. 16-94 *Ext. Status Word*.

Index

A

Abbreviations	6
Alarm Messages	75
Alarm Word	73
Assumptions	5

B

Background Knowledge	5
Bus Jog 1 Speed 8-90	42
Bus Jog 2 Speed 8-91	42

C

Cabling	56
Changed Parameters (1) 9-90	52
Changed Parameters (2) 9-91	52
Changed Parameters (3) 9-92	52
Changed Parameters (5) 9-94	52
Coasting Select 8-50	40
Configuration	37, 39
Configuration	6
Control Profile	26
Control Site 8-01	37
Control Word According To Fc Profile (ctw)	33
Control Word According To Profidrive Profile (ctw)	27
Control Word Profile 8-10	39
Control Word Timeout Function 8-04	38
Control Word Timeout Time 8-03	37

D

Data Types Supported	60
Dc Backup	6
Dc Brake Select 8-52	41
Devicenet	6
Display Text 1 0-37	37
Drive Will Not Respond To Control Signals	70

E

Emc Precautions	14
End-of-timeout Function 8-05	38
Ethernet	14, 16, 54, 55, 56

G

Gsd File	17
----------	----

H

Hardware	3, 5
Hardware	5

I

I/o	6
Igmp	56
Influence Of The Digital Input Terminals Upon Fc Control Mode	26
Installation	3, 5, 6
Installation	7
Ip Settings	15
Ip21 / Type 1	6

L

Led	6
Led Status	67

Literature	6
M	
Multicast	56
N	
Network	5, 14, 53, 56
Network	8, 9
Network Switch	12
No Communication With The Drive	69
O	
Overview	9
P	
Parameter Edit 9-27	49
Parameters	4, 15, 16
Parameters	16
Parameters For Signals 9-23	46
Pcd Read Configuration 9-16	44
Pcd Write Configuration 9-15	43
Ppo Types	23
Process Control Data	24
Process Control Operation	26
Process Data	24
Process Status Data	24
Profibus	6
Profibus Save Data Values 9-71	51
Profibus Warning Word 9-53	50
Profidrive State - Transition Diagram	32
Profile Number 9-65	50
Profinet	5
Programming Set-up 9-70	50
R	
Reference	6
Reference Handling	24
References	4
Reset Control Word Timeout 8-06	38
Reversing Select 8-54	41
S	
Safety	3
Set-up Select 8-55	42
Size Attribute	59
Spanning Tree	6
Start Select 8-53	41
Status Word According To Profidrive Profile (stw)	30
T	
Topology	13
Topology	11
V	
Vlt Parameters	21
W	
Warning 34	70
Warning Word	73
Warnings	75