



NX FREQUENCY CONVERTERS

SYSTEM INTERFACE APPLICATION

APFIFF10

USER'S MANUAL

System Interface Application

INDEX

Document code: ud01079
Software Code: APFIFF10V239
Date: 19.8.2011

1.	INTRODUCTION	4
2.	CONTROL I/O	5
3.	SYSTEM INTERFACE APPLICATION – PARAMETER LISTS.....	6
3.1	Monitoring Values (Control keypad: menu M1)	6
3.2	Basic Parameters (Control keypad: Menu M2 → G2.1).....	9
3.3	Input Signals (Control keypad: Menu M2 → G2.2).....	10
3.4	Output Signals (Control keypad: Menu M2 → G2.3)	12
3.5	Reference Handling (Control keypad: Menu M2 → G2.4).....	13
3.6	Ramp Functions (Control keypad: Menu M2 → G2.5).....	15
3.7	Drive Control (Control keypad: Menu M2 → G2.6).....	16
3.8	Motor Control (Control keypad: Menu M2 → G2.7).....	19
3.9	Limit Settings (Control keypad: Menu M2 → G2.8).....	21
3.10	Speed Control (Control keypad: Menu M2 → G2.9)	22
3.11	Oscillation Damp (Control keypad: Menu M2 → G2.10)	23
3.12	Brake & Fan Control (Control keypad: Menu M2 → G2.11)	23
3.13	Master Follower (Control keypad: Menu M2 → G2.12)	25
3.14	Protections (Control keypad: Menu M2 → G2.13).....	25
3.15	Flux Reference Handling (Control keypad: Menu M2 → G2.14)	28
3.16	Startup Torque (Control keypad: Menu M2 → G2.15).....	28
3.17	Monitor Settings (Control keypad: Menu M2 → G2.16)	28
3.18	Data Mapping (Control keypad: Menu M2 → G2.17).....	29
3.19	PI Control Parameters (Control keypad: Menu M2 → G2.15).....	29
3.20	Keypad Control (Control keypad: Menu M3 → R3.1)	32
3.21	Expander Boards (Control keypad: Menu M7)	32
4.	DESCRIPTION OF THE SYSTEM INTERFACE APPLICATION PARAMETERS	33
4.1	Input Signals	35
4.2	Reference Handling	42
4.3	Ramp Functions	44
4.4	Drive Control	45
4.5	Motor Control	53
4.6	PMSM Control	57
4.7	Limit Settings	58
4.8	Speed control	60
4.9	Oscillation Damp.....	65
4.10	Brake and fan control	65
4.11	Master Follower	66
4.12	Protections	68
4.13	Flux Reference Handling.....	76
4.14	Startup Torque	76
4.15	Monitor Settings.....	77
4.16	Data Mapping	78
4.17	PI Control.....	79

4.18	ID Functions	80
5.	FIELDBUS PROFILE.....	83
5.1	PD Signals from the Overriding system to the Vacon Drive.	83
5.2	PD Signals from the Vacon Drive to the Overriding System	83
5.3	Main Control Word ID1160	83
5.4	Main Status Word ID1162	85
5.5	Auxiliary Control Word ID1161	86
5.6	Auxiliary Status Word ID1163.....	87
5.7	Fault Word 1 ID1172	88
5.8	Fault Word 2 ID1173	89
5.9	Alarm Word 1 ID1174.....	90
5.10	Digital Input Status 1 and 2: ID15 and ID16.....	91
6.	BLOCK DIAGRAMS.....	92
7.	FAULT TRACING	97

SYSTEM INTERFACE APPLICATION (APFIF10)

1. INTRODUCTION

The System Interface Application is typically used in coordinated drives with overriding control system. The recommended interface to control the system is a fieldbus communication through hardwired analogue and digital signals as well as keypad and PC control can be used.

Note! When the drive is controlled through fieldbus, the fieldbus card must be set to Bypass mode.

The System Interface Application utilises most advanced functions in NXP motor control software and is suitable for demanding drive systems like paper machines and drives in metal industry and processing lines. It can also be used for any other standard applications. Following applications are working with this application.

- Pulp and paper machine drives like dryer, press section, wire section, pope reel, winder and unwinder.
- Drives in metal industry like casting machine, melt shop or preparing line
- Standard drives like pump and fan, lifts, cranes, conveyors, etc.

Additional functions:

- Flexible speed and torque reference chains.
- Advanced drive control profile for fieldbus communication
- Flexible fieldbus data connections.
- Adaptive speed controller.
- Inertia compensation and oscillation damping features.
- System Bus support for master follower applications with speed/torque follower.
- Fast and multi drive monitoring tool (NCDrive) support.
- Programmable U/f curve and flux curve.
- Speed /torque-selector options, window control
- Automatic identification run
- Support to permanent magnet motors and multiple winding motors.

2. CONTROL I/O

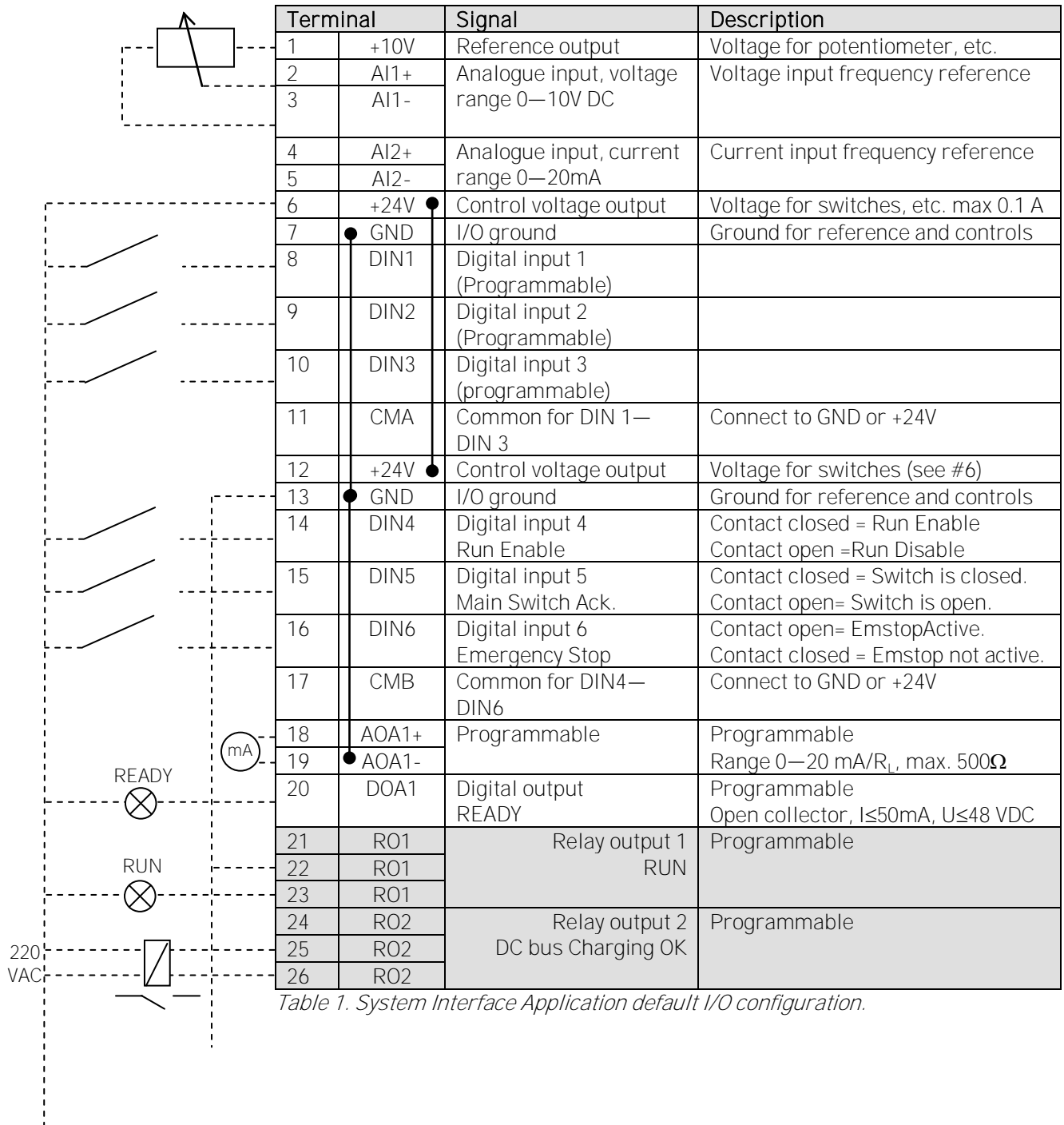

Terminal	Signal	Description
1	+10V	Reference output Voltage for potentiometer, etc.
2	AI1+	Analogue input, voltage range 0—10V DC Voltage input frequency reference
3	AI1-	
4	AI2+	Analogue input, current range 0—20mA Current input frequency reference
5	AI2-	
6	+24V	Control voltage output Voltage for switches, etc. max 0.1 A
7	GND	I/O ground Ground for reference and controls
8	DIN1	Digital input 1 (Programmable)
9	DIN2	Digital input 2 (Programmable)
10	DIN3	Digital input 3 (programmable)
11	CMA	Common for DIN 1— DIN 3 Connect to GND or +24V
12	+24V	Control voltage output Voltage for switches (see #6)
13	GND	I/O ground Ground for reference and controls
14	DIN4	Digital input 4 Run Enable Contact closed = Run Enable Contact open =Run Disable
15	DIN5	Digital input 5 Main Switch Ack. Contact closed = Switch is closed. Contact open= Switch is open.
16	DIN6	Digital input 6 Emergency Stop Contact open= EmstopActive. Contact closed = Emstop not active.
17	CMB	Common for DIN4— DIN6 Connect to GND or +24V
18	AOA1+	Programmable Range 0—20 mA/R _L , max. 500Ω
19	AOA1-	
20	DOA1	Digital output READY Programmable Open collector, I _s ≤50mA, U _s ≤48 VDC
21	RO1	Relay output 1 RUN Programmable
22	RO1	
23	RO1	
24	RO2	Relay output 2 DC bus Charging OK Programmable
25	RO2	
26	RO2	

Table 1. System Interface Application default I/O configuration.

3. SYSTEM INTERFACE APPLICATION – PARAMETER LISTS

On the next pages you will find the lists of monitoring signals and parameters. The parameter descriptions are given on pages 33 to 78.

Column explanations:

Code	=	Location indication on the keypad; Shows the operator the present parameter number
Parameter	=	Name of parameter
Min	=	Minimum value of parameter
Max	=	Maximum value of parameter
Unit	=	Unit of parameter value; given if available
Step	=	Accuracy of smallest possible change of value
Default	=	Value preset by factory
ID	=	ID number of the parameter (used with PC tools)

3.1 Monitoring Values (Control keypad: menu M1)

The monitoring values are the actual values of parameters and signals as well as statuses and measurements. See Vacon NX User's Manual, Chapter 7 for more information.

3.1.1 M1>V1.1 Monitor Page 1

Code	Parameter	Unit	ID	Description
V1.1.1	Output frequency	Hz	1	Frequency output from the drive to the motor.
V1.1.2	Speed	Rpm	2	Motor speed in rpm. In open loop this is the calculated speed of the motor and in closed loop this is the filtered value of the speed measured from the encoder.
V1.1.3	Freq. Reference	Hz	25	Frequency reference to the ramp generator.
V1.1.4	Current	A	3	Filtered motor current.
V1.1.5	Torque	%	4	Filtered motor torque in percentage of motor nominal torque.
V1.1.6	Power	%	5	Power in percentage of motor nominal power.
V1.1.7	Motor voltage	V	6	Motor terminal voltage.
V1.1.8	DC-link voltage	V	7	DC link voltage.
V1.1.9	Unit temperture	°C	8	Heat sink temperature.
V1.1.10	DIN Status Word1		15	See the chapter 5.10
V1.1.11	DIN Status Word2		16	See the chapter 5.10
V1.1.12	MotorTempCalc	%	9	Calculated motor temperature . 100.0% = nominal temperature of the motor.
V1.1.13	Temp sensor 1	°C	50	Temperature of the PT100 or KTY 84 type temperature sensor 1 connected to Analogue input. If OPT-B8 board is used then this value shows temperature of channel 1.
V1.1.14	Temp sensor 2	°C	51	Temperature of the PT100 or KTY 84 type temperature sensor 2 connected to Analogue input. If OPT-B8 board is used then this value shows temperature of channel 2.
V1.1.15	Temp sensor 3	°C	52	If OPT-B8 board is used for temperature measurement then this value shows temperature of channel 3.
V1.1.16	Unit nom. voltage	V	1117	Nominal voltage rating of the drive unit.
V1.1.17	Unit nom. current	A	1118	Nominal current rating of the drive unit. This is same as IL current rating of the unit.
V1.1.18	DC nom. voltage	V	1120	Nominal DC link voltage of the drive unit.
V1.1.19	ID Run status		49	Bitwise status of automatic identification after ID run. B0= Stator resistance and U/f curve B1= Reserved B2= Magnetisation current. B3= Flux linearization curve.
V1.1.20	Analogue Input 1	%	59	Filtered A.1
V1.1.21	Analogue Input 2	%	60	Filtered A.1

Table 2. Monitoring page 1

3.1.2 M1>V1.2 Monitor Page 2

Code	Parameter	Unit	ID	Description
V1.2.1	Speed Measured	rpm	1124	Speed measured from the encoder.
V1.2.2	Torque Unfilt.	%	1125	Unfiltered torque calculated by the drive.100% equals to motor nominal torque.
V1.2.3	Current Unfilt.	%	1113	Unfiltered Motor current in Amperes.
V1.2.4	Speed Reference1	rpm	1126	Speed reference selected as per the control place selection.
V1.2.5	Speed Reference2	rpm	1127	Speed reference after speed share logic.
V1.2.6	Speed Reference3	rpm	1128	Speed reference at the input of the ramp generator.
V1.2.7	Speed Ramp Out	rpm	1129	Final speed reference after Ramp generator
V1.2.8	Speed Reference4	rpm	1130	Speed reference after the speed correction is added to the Speed Ramp Out. 1)
V1.2.9	Used Speed Ref	rpm	1131	Final speed reference after the speed step logic. 1)
V1.2.10	Speed Error	rpm	1132	Speed error=Speed Act -Speed Ref 1)
V1.2.11	SPC OUT	%	1134	Iq Reference from the speed controller output. 1)
V1.2.12	SPC Out P-part	%	1866	Speedcontroller monitoring P-part separately
V1.2.13	SPC Out I-part	%	1865	Speedcontroller monitoring I-part separately
V1.2.14	Speed Limit Pos	rpm	1135	Positive speed limit on the speed reference
V1.2.15	Speed Lim Neg	rpm	1136	Negative speed limit on the speed reference

Code	Parameter	Unit	ID	Description
V1.2.16	TC Speed Lim Pos	rpm	1137	Positive speed limit when Torque Select is 2/3/4/5 and Motor Ctrl Mode =3.
V1.2.17	TC Speed Lim Neg	rpm	1138	Negative speed limit when Torque Select is 2/3/4/5 and Motor Ctrl Mode =3.
V1.2.18	Master TorqueRef	%	1139	Torque reference from Master Drive in case of master Follower comm. -300.0...+300.0% of the motor nominal torque
V1.2.19	FB Torque Ref	%	1140	Torque Reference from the Fieldbus. -300.0...300.0%. of motor nominal torque
V1.2.20	I/O Torque Ref	%	1141	Torque Reference from the analogue Input -300.0...300.0%. of motor nominal torque
V1.2.21	Torque Ref1	%	1142	Torque reference after Torque Reference selector (Master, Fieldbus, analogue I/P)
V1.2.22	Torque Ref2	%	1143	Scaled Torque Reference
V1.2.23	Torque Ref3	%	1144	Torque reference after Load Share logic.
V1.2.24	Used Torque Ref	%	1145	Final, limited torque reference for speed/torque controller
V1.2.25	Acc Comp Out	%	1146	Acceleration compensation used in terms of IqReference.100.0% equals to motor nominal current. 1)
V1.2.26	Droop Speed RPM	rpm	1147	Speed droop used in rpm.
V1.2.27	Startup TorqAct	A	1148	startup torque in use, 100.0 %= motor nominal torque.
V1.2.28	Iq Current Lim +	%	1152	Final upper IqCurrentLimit 100.0 %= motor nominal current (unsigned)
V1.2.29	Iq Current Lim -	%	1153	Final lower IqCurrentLimit 100.0 %= motor nominal current (unsigned)
V1.2.30	Iq Reference	%	1154	Final IqReference, 100.0% = motor nominal current
V1.2.31	Iq Actual	%	1155	Measured Iq 100.0% = motor nominal current
V1.2.32	Id Reference	%	1156	Final IdReference 100.0% = motor nominal current
V1.2.33	Id Actual	%	1157	Measured Id 100.0 %= motor nominal current.
V1.2.34	Flux	%	1158	Estimated rotor flux in percentage of the motor nominal flux.
V1.2.35	Rotor t Const	ms	1159	Rotor Time Constant in ms
V1.2.36	Main Control Word		1160	
V1.2.37	Aux Control Word1		1161	See the chapter 5.5
V1.2.38	Main Status Word		1162	See the chapter 5.4
V1.2.39	Aux Status Word		1163	See the chapter 5.6
V1.2.40	Fault Word 1		1172	See the chapter 5.7
V1.2.41	Fault Word 2		1173	See the chapter 5.8
V1.2.42	Alarm Word 1		1174	See the chapter 5.9
V1.2.43	Max Brake Ramp		1168	Calculated ramp time in constant power emergency stop.
V1.2.44	Shaft Position		1169	Position of the motor shaft in 0...360 Degrees.
V1.2.45	Shaft Rounds		1170	No. of rounds of the motor shaft.
V1.2.46	Pole Pair Number		58	Number of pole pairs in the motor estimated from the motor data.
V1.2.47	Output power		1508	Drive output power
V1.2.48	Last active fault		37	Code of the last active fault

Table 3. Monitoring page 2

3.1.3 M1>V1.3 PI-Controller Monitoring

Code	Parameter	Unit	ID	Description
V1.3.1	PI Reference value		20	PI controller reference value
V1.3.2	PI Actual value		21	PI Controller actual value
V1.3.3	PI Controller output		23	PI Controller output before output scaling
V1.3.4	PI Controller output scaled		1807	PI Controller output after output scaling. This is the value that is written to values selected by P2.18.6

Table 4. PI-Controller monitoring page

3.2 Basic Parameters (Control keypad: Menu M2→ G2.1)

Code	Parameter	Min	Max	Unit	Step	Default	ID	Note
P2.1.1	Supply Voltage	0	1000	V	1	500	1201	Supply Voltage in Volts. If unknown then parameter should be zero.
P2.1.2	Motor Nominal Voltage	180	690	V	1	400	110	Nominal Voltage of the Motor in volts as per Rating Plate
P2.1.3	Motor Nominal Frequency	30.00	320.00	Hz	0.01	50.00	111	Nominal Frequency of the Motor ##. ## Hz as per Rating Plate
P2.1.4	Motor Nominal Current	$0,01 * I_H$	$2 * I_H$	A	0.1	I_H	113	Nominal Current of the Motor. in ####.# A
P2.1.5	Motor Nominal Speed	300	n_s	rpm	1	1440	112	Nominal Speed of the Motor as per Rating Plate
P2.1.6	Motor Cos Phi	0.30	1.00		0.01	0.85	120	Rated value of cos phi as per Rating Plate
P2.1.7	Process Speed	0.0	3200.0	rpm	0.1	14400	1203	Process Speed limit in RPM scale
P2.1.8	Magn. Current	0.0	Motor Nom Current	A	0.1	0.5	612	Nominal magnetizing current of the motor in amps (Current Format)
P2.1.9	Field Weakng Pnt	8.00	320.00	Hz	0.01	50.00	602	Frequency at which Field Weakening should start. Applicable only in Open Loop Control
P2.1.10	Voltage at FWP	5.00	200.00	%	0.01	100.00	603	Motor Voltage Limit in Field weakening. Applicable only in Open Loop Control
P2.1.11	ID Run	0	4		1	0	631	Automatic Identification run for the motor. 0 = None 1 = Identification without motor running. 2 = Identification with motor running. 3 = Encoder ID 4 = Magnetisation current calculation
P2.1.12	Motor Type	0	3		1	0	650	Motor type 0= Induction motor 1= Not Used 2= Permanent magnet motor 3= Not Used

Table 5. Basic parameters G2.1

3.3 Input Signals (Control keypad: Menu M2→ G2.2)

3.3.1 Digital Input (Control keypad: Menu M2→ G2.2.1)

Code	Parameter	Min	Max	Unit	Step	Default	ID	Note
P2.2.1.1	Run Forward	0	Max. No of DIN installed		1	0	1206	Digital input selection for the Run Forward command when the Control Place=IO control.
P2.2.1.2	Run Reverse	0	Max. No of DIN installed		1	0	1207	Digital input selection for Run Reverse command when the control place=IO control
P2.2.1.3	IO Ctrl	0	Max. No of DIN installed		1	0	1404	Digital input selection to activate the IO control.
P2.2.1.4	Reset	0	Max. No of DIN installed		1	0	1208	Digital input Selection for Fault Resetting.
P2.2.1.5	Brake Open	0	Max. No of DIN installed		1	0	1210	Input Selection for Acknowledgement of Motor Mechanical Brake. Off=Brake Closed, On=Brake Opened.
P2.2.1.6	Brake Open Logic	0	1		1	0	1379	The connection type for brake open acknowledgement. 0= Normally Open. 1= Normally closed.
P2.2.1.7	Motor Fan Ack.	0	Max. No of DIN installed		1	0	1211	Input selection for Motor Fan Acknowledgement. If no acknowledgement for 1 Sec after Fan On command then Alarm F56 ``Motor Fan``
P2.2.1.8	Input Switch Ack	0	Max. No of DIN installed		1	5	1209	Input selection for input switch acknowledgement. If not acknowledged then Fault 64 "Input Switch Open"
P2.2.1.9	Run Enable	0	Max. No of DIN installed		1	4	1212	Input selection For Run Enable. If input is missing then warning 26 "Run Disable".
P2.2.1.10	Run Enable Logic	0	1		1	0	1380	Connection type for Run Enable. 0= Normally Open 1= Normally closed.
P2.2.1.11	Emstop	0	Max. No of DIN installed		1	6	1213	Input For Emergency Stop. Low=Emergency stop Active
P2.2.1.12	External Fault	0	Max. No of DIN installed		1	0	1214	Digital input selection for External Fault signal connection.
P2.2.1.13	Ext. Fault Logic	0	1		1	0	1381	Connection type for external fault input connection. 0= Normally open 1= Normally closed.
P2.2.1.14	Motor 1 Or 2 Sel	0	Max. No of DIN installed		1	0	1215	Select parameter set for Motor 1 or Motor 2 with the selected digital input. High=Motor2.Low=Motor1
P2.2.1.15	PI Activation	-1	Max. No of DIN installed		1	0	1804	When HIGH PI Controller is activated. -1 = Forced ON

Table 6. Digital Input parameters, G2.2.1

3.3.2 Analogue Input (Control keypad: Menu M2 → G2.2.2)

Code	Parameter	Min	Max	Unit	Step	Default	ID	Note
P2.2.2.1	I/O SpeedRef Sel	0	5		1	0	1219	Analogue Input selection for Speed reference when Control Place=1 (IO ctrl)
P2.2.2.2	I/O TorqRef Sel	0	3		1	0	1220	Analogue Input selection for Torque reference when Control Place=1 (Local IO Control)
P2.2.2.3	TS 1 AI Sel	0	2		1	0	1221	Analogue Input selection for PT100 or KTY 84 type temperature sensor 1.
P2.2.2.4	TS 1 Sel	0	2		1	0	1222	Number of PT100 or KTY 84 elements in series. 0=1*PT100, 1=2*PT100, 2=3*PT100. 3=1*KTY84-130 4=2*KTY84-130 5=3*KTY84-130
P2.2.2.5	TS 2 AI Sel	0	2		1	0	1223	Analogue Input selection for PT100 or KTY 84 type temperature sensor 2.
P2.2.2.6	TS 2 Sel	0	2		1	0	1224	Number of PT100 elements in series. 0=1*PT100, 1=2*PT100, 2=3*PT100. 3=1*KTY84-130 4=2*KTY84-130 5=3*KTY84-130
P2.2.2.7	AI1 Ref Scale Min	-30000	30000		1	0	1226	Min. value of signal selected for AI1. This corresponds to +0V/0mA/2V/4mA
P2.2.2.8	AI1 RefScale Max	-30000	30000		1	1440	1225	Max. value of signal selected for AI1. This corresponds to +10V/20mA
P2.2.2.9	AI1 Minimum	0	1		1	0	1227	Minimum voltage or Current at AI1. 0=0V/0mA, 1=4mA
P2.2.2.10	AI1 Filter Time	0.01	10.00	s	0.01	1	1228	Filter time for AI1 in ###. ## Sec
P2.2.2.11	AI2 RefScale Min	-30000	30000		1	0	1230	Min. Value of Signal selected for AI2.This corresponds to +0V/0mA/2V/4mA
P2.2.2.12	AI2 RefScale Max	-30000	30000		1	1000	1229	Max. Value of Signal selected for AI2.This corresponds to +10V/20mA
P2.2.2.13	AI2 Minimum	0	1		1	0	1231	Minimum Voltage or Current at AI2.0=0V/0mA, 1=4mA
P2.2.2.14	AI2 Filter Time	0.01	10.00	s	0.01	1	1232	Filter time for AI2 in ###. ## Sec.

Table 7. Analogue Input parameters, G2.2.2

3.4 Output Signals (Control keypad: Menu M2 → G2.3)

3.4.1 Digital Output (Control keypad: Menu M2 → G2.3.1)

Code	Parameter	Min	Max	Unit	Step	Default	ID	Note
P2.3.1.1	DO1 (ID.BitNo.)	0.00	2000.15		0.01	1162.00	1216	Select the signal for controlling DO1.
P2.3.1.2	DO2 (ID.BitNo.)	0.00	2000.15		0.01	1162.00	1217	Select the signal for controlling DO2.
P2.3.1.3	DO3 (ID.BitNo.)	0.00	2000.15		0.01	1163.00	1218	Select the signal for controlling DO3.
P2.3.1.4	DO4 (ID.BitNo.)	0.00	2000.15		0.01	0000.00	1385	Select the signal for controlling DO4.
P2.3.1.5	DO5 (ID.BitNo.)	0.00	2000.15		0.01	0000.00	1386	Select the signal for controlling DO5.
P2.3.1.6	DO6 (ID.BitNo.)	0.00	2000.15		0.01	0000.00	1390	Select the signal for controlling DO6.
P2.3.1.7	DO7 (ID.BitNo.)	0.00	2000.15		0.01	0000.00	1391	Select the signal for controlling DO7.
P2.3.1.8	DO8 (ID.BitNo.)	0.00	2000.15		0.01	0000.00	1395	Select the signal for controlling DO8.
P2.3.1.9	DO9 (ID.BitNo.)	0.00	2000.15		0.01	0000.00	1396	Select the signal for controlling DO9.
P2.3.1.10	DO10 (ID.BitNo.)	0.00	2000.15		0.01	0000.00	1423	Select the signal for controlling DO10.
P2.3.1.11	DO11 (ID.BitNo.)	0.00	2000.15		0.01	0000.00	1427	Select the signal for controlling DO11.
P2.3.1.12	DO12 (ID.BitNo.)	0.00	2000.15		0.01	0000.00	1428	Select the signal for controlling DO12.
P2.3.1.13	DO13 (ID.BitNo.)	0.00	2000.15		0.01	0000.00	1429	Select the signal for controlling DO13.

Table 8 Digital Output parameters, G2.3.1

3.4.2 Analogue Output (Control keypad: Menu M2 → G2.3.2)

Code	Parameter	Min	Max	Unit	Step	Default	ID	Note
P2.3.2.1	AO1 Signal ID	0	2000		1	0	1233	Set the ID no. Of a signal to be connected to AO1.
P2.3.2.2	AO1 Offset	0	1		1	0	1234	Minimum voltage or current at AO1. 0= 0V/0mA. 1= 2V/4mA
P2.3.2.3	AO1 Filter	0.02	10.00	S	0.01	10.00	1235	Filter time for AO1
P2.3.2.4	AO1 Max Value	-30000	30000		1	1500	1236	Maximum value of the signal selected for AO1. This will correspond to +10V/20mA.
P2.3.2.5	AO1 Min Value	-30000	30000		1	0	1237	Minimum value of the signal selected for AO1. This will correspond to 0V/0mA or 2V/4mA depending on AO1 Offset.
P2.3.2.6	AO1 Adjust	-200,00	200,00		0,01	0,00	375	

Table 9 Analogue output parameters, G2.3.2

3.5 Reference Handling (Control keypad: Menu M2 → G2.4)

Code	Parameter	Min	Max	Unit	Step	Default	ID	Note
P2.4.1	Spd Ref Filter	0	5000	ms	1	0	324	Filter time for the speed reference in ms
P2.4.2	Const Ref 1	P2.8.4	P2.8.3	rpm	1	0	1239	Constant speed reference 1. Normally used for forward inching
P2.4.3	Const Ref 2	P2.8.4	P2.8.3	rpm	1	0	1240	Constant speed reference 2. Normally used for reverse inching
P2.4.4	CriticalSpeedLow	0	Max_Speed	Rpm	1	0	509	Low limit for critical speed range
P2.4.5	CriticalSpeedHigh	0	Max_Speed	Rpm	1	0	510	High limit for critical speed range
P2.4.6	Speed Share	-300.00	300.00	%	0.01	100.00	1241	Speed share as percentage of speed reference.
P2.4.7	FBRef Scale	10	30000		1	20000	1242	This will correspond to P2.1.7 (Process Speed).
P2.4.8	Tref Source Sel	0	4		1	0	641	Source for the torque reference. 0=None 1=Master 2=Fieldbus 3=Analogue I/P 4=Master SPC
P2.4.9	Tref Filter	0	5000	ms	1	0	1244	Filter time for the torque reference in ms
P2.4.10	Tref Hysteresis	-300.0	300.0	%	0.1	0.0	1245	Hysteresis for the torque reference in ####.# % 100.0% ~motor nominal torque.
P2.4.11	Tref Dead Zone	-300.0	300.0	%	0.1	0.0	1246	Dead zone in % where the torque reference will be considered as zero. 100.0% ~motor nominal torque.

P2.4.12	TorqueRef Scale	0	1		1	0	1247	The scale for the torque reference chain and all signals related to torque. 0 = 1000 corresponds to motor nominal torque. 1 = 10000 corresponds to motor nominal torque
P2.4.13	Load Share	0.0	400.0	%	0.1	100.0	1248	Load share for the torque reference in %.
P2.4.14	Tref Ramp Time	0.0	30000	ms	1	0	1249	The ramp time in ms for nominal torque reference change.
P2.4.15	Flux Reference	10.0	150.0	%	0.1	100.0	1250	Flux reference in %.100% equals rated flux of the drive.
P2.4.16	Above Spd Limit	0	P2.8.3	rpm	1	0	1251	The speed limit above which bit10 of the status word will be TRUE
P2.4.17	Speed Step	-2000	2000		1	0	1252	Step speed ref. relative to process speed. 20000 = P2.1.7 Process speed
P2.4.18	Torque Step	-300.0	300.0	%	0.1	0.0	1253	Torque step in % of nom. torque of the motor
P2.4.19	Speed Ref Interpolator TC	0	32000	ms	1	10	1184	

Table 10 Ref Handling parameters, G2.4

3.6 Ramp Functions (Control keypad: Menu M2 → G2.5)

Code	Parameter	Min	Max	Unit	Step	Default	ID	Note
P2.5.1	Accel Time 1	0.0	3000.0	s	0.1	10.0	103	Acceleration Time in sec
P2.5.2	Decel Time 1	0.0	3000.0	s	0.1	10.0	104	Deceleration Time in sec
P2.5.3	S Ramp AccDec	0	100	%	1	0	500	Smooth ratio for S curves for Acceleration and Deceleration ramp. 0=Linear Ramps 100=Full Acc/Dec inc/dec times.
P2.5.4	Emstop Ramp	0.0	3000.0	s	0.1	10.0	1256	Deceleration time in Emergency Stop
P2.5.5	Emstop Delay	0.00	320.00	s	0.01	0	1254	Delay in activation of emergency stop ramp after emergency stop is active
P2.5.6	ConstSpd AccTime	0.0	3000.0	s	0.1	5.0	1257	Acceleration time for Constant Speed 1 and 2
P2.5.7	ConstSpd DecTime	0.0	3000.0	s	0.1	5.0	1258	Deceleration time for Constant Speed 1 and 2
P2.5.8	S Ramp Const Spd	0	100	%	1	0	1259	Smooth ratio for S-curves of Const Speed ramp 0=Linear ramps 100=Full Acc/Dec inc/dec 0=linear ramps 100=full acc/dec inc/dec times
P2.5.9	Ramp Time Reference	0	1		1	0	1132	
P2.5.10	Open loop emergency stop limit ramp time	0	3000,0	s	0,1	1,0	1610	

Table 11 Ramp Function parameters, G2.5

3.7 Drive Control (Control keypad: Menu M2 → G2.6)

Code	Parameter	Min	Max	Unit	Step	Default	ID	Note
P2.6.1	Control Place	0	2	1	1	2	125	Place to control the drive operation. 0=FieldBus 1=IO 2=Panel/ PC Tool
P2.6.2	Brake Chopper	0	3		1	0	504	Brake chopper mode selection.
P2.6.3	BrkChopper Level	0	1500	V	1	1.15*nom DC Volt	1267	Brake chopper operation level in volts
P2.6.4	Brk Res Load Lim	0.0	300.0	%	0.1	5.0	1268	Generator side torque limit to avoid overheating of the brake resistor during continuous braking. This is active when Brake Chopper is selected and there is no emergency stop active and drive is not decelerating.
P2.6.7	Restart Delay	0.000	60.000	s	0.001		1424	After coast stop the re-starting of the drive is disabled for this time.
P2.6.8	ControlOptions	0	65535		1	0	1084	This packed bit word is made for enabling/ disabling different control options.
P2.6.9	ControlSlotSel	0	8		1	0	1440	Selects which slot process data is used 0 = All 4 = Slot D 5 = Slot E 6 = Fast comm. Slot D 7 = Fast comm. Slot E
P2.6.10	Modulator Type	0	3		1	1	1516	0 = Hardware 1 = Software 1 2 = Software 2 (DS) 3 = Software 3
P2.6.11	Advanced Options 1	0	65535		1	0	1560	
P2.6.12	Advanced Options 2	0	65535		1	0	1561	
P2.6.13	Advanced Options 4	0	65535		1	0	1563	
P2.6.14	Advanced Options 5	0	65535		1	0	1564	
P2.6.15	Advanced Options 6	0	65535		1	0	1565	

Table 12 Drive Control parameters, G2.6

3.7.1 Drive Control/Open Loop Ctrl (Control keypad: Menu M2 → G2.6.5)

Code	Parameter	Min	Max	Unit	Step	Default	ID	Note
P2.6.5.1	U/f Ratio Select	0	3		1	0	108	U/F ratio selection. 0=Linear 1=Squared 2=Programmable 3=Linear + Flux opt

P2.6.5.2	U/f Zero Point V	0.00	105.00	%	0.01	0.00	606	Motor voltage (%*Motor Nominal Voltage) at programmable U/F curve zero point .
P2.6.5.3	U/f Mid Point V	0.00	105.00	%	0.01	100.00	605	Motor voltage (%*Motor Nominal Voltage) at programmable U/F curve middle point
P2.6.5.4	U/f Mid Freq	0.00	320.00	Hz	0.01	50.00	604	Programmable U/F curve middle point
P2.6.5.5	U/f Opt.	0	1		1	0	109	U/F opt. control
P2.6.5.6	DC Brake Speed	0	MotorNom Speed	rpm	1	0	515	Below this speed DC braking will be active.
P2.6.5.7	DC Brake Current	0	2 * I _H	A			507	DC Braking current
P2.6.5.8	DC Brake Time	0	20000	ms	1	0	508	
P2.6.5.9	Flux Brake	0	1		1	0	520	Flux braking control 0 = Disable 1 = Enable
P2.6.5.10	FluxBrakeCurrent	0	2 * I _H	A		0	519	Flux braking current
P2.6.5.11	TorqStab Kp	0	1000		1		1412	Gain for torque stabilator
P2.6.5.12	TorqStab Damp TC	0	1000		1		1413	Damping time constant for torque stabilator
P2.6.5.13	TorqStab Kp FWP	0	1000		1		1414	Gain for torque stabilator at FWP
P2.6.5.14	Flux Stab Kp	0	32000		1		1410	Gain for flux stabilator
P2.6.5.15	Flux Stab Filt	0	32000		1		1411	Filter time constant for flux stabilator
P2.6.5.16	Make Flux Time	0.000	60.000	s	0.001	0.200	660	Time to magnetise the motor
P2.6.5.17	MakeFluxVoltage	0.00	120.00	%	0.01	2.01	661	Magnetising voltage in ###.## % of motor nominal voltage.
P2.6.5.18	MeasRsVolt Drop	0	65535		1	0	662	Measured voltage drop at stator resistance between two phases with nominal current of the motor. This is estimated during ID Run.
P2.6.5.19	Ir Add Zero Point Voltage	0	30000				664	

Table 13 Drive Control/Open Loop Ctrl parameters, G2.6.5

3.7.2 Drive Control/UV/OV CTRL stab (Control keypad: Menu M2 → G2.6.6)

Code	Parameter	Min	Max	Unit	Step	Default	ID	Note
P2.6.6.1	Undervolt Ctrl	0	1		1	0	608	Under voltage controller 0=Off, 1=On.
P2.6.6.2	Uvolt Ref Sel	0	1		1	1	1260	Selection of under voltage Reference for Under-voltage Controller. 0=UV ref min 1=0.8* EstimatedDCNomVoltage
P2.6.6.3	Undervolt Kp	0	32767		1		1415	Gain for the P term of Under voltage controller
P2.6.6.4	Undervolt Ti	0	32767		1		1416	Gain for I term of under voltage controller

P2.6.6.5	Over volt Ctrl	0	2		1	0	607	Over voltage controller 0=Off, 1=On with no Ramp, 2=On with ramp.
P2.6.6.6	Overvolt Ref Sel	0	2		1	1	1262	Overvoltage reference level depending on the status of the brake chopper
P2.6.6.7	OverVolt Kp	0	32767		1		1468	Gain for P term of over-voltage controller
P2.6.6.8	OverVolt Kp Add	0	32767		1		1425	Addition gain for P term of overvoltage controller till FWP.
P2.6.6.9	OverVolt Ti	0	32767		1		1409	Gain for I term of the over-voltage controller.
P2.6.6.10	VoltStab Kp	0	1000		1		1417	Gain for the voltage stabilator
P2.6.6.11	VoltStab TC	0	1000		1		1418	Damping rate for the voltage stabilator.

Table 14. Drive Control/UV/OV Ctrl, Stab Parameters, G2.6.6

3.8 Motor Control (Control keypad: Menu M2 → G2.7)

Code	Parameter	Min	Max	Unit	Step	Default	ID	Note
P2.7.1	Start Function	0	1		1	0	505	0=Starts from 0-speed, 1=Flying start
P2.7.2	Stop Function	0	1		1	0	506	0=Coast stop 1=Ramp stop
P2.7.3	Emstop Mode	0	3		1	1	1276	Stop function in Emer- gency Stop 0=Coast Stop 1=Ramp stop 2=Torque limit Stop 3=Constant Power Stop
P2.7.4	Motor Ctrl Mode	0	3		1	0	600	0=Open Loop Freq ctrl, 1=Open Loop Speed ctrl 2=Open Loop speed /torque ctrl as per P2.7.5 3=Closed Loop speed/ torque Control as per P2.7.5
P2.7.5	Torque Select	1	5		1	1	1278	1=Speed Control 2=Torque Control 3=Min of torque ref and SPC Out 4=Max of torque ref and SPC Out 5=Window Control
P2.7.6	CurrentControlKp	1	10000		1	4000	617	Current controller p-gain (0 ... 10000)
P2.7.7	CurrentControlTi	0.1	100.0	ms	0.1	1.5	1400	Current controller integrator time constant (0 ... 1000) = 0...100.0 ms
P2.7.8	Switching Freq	1.0	Switching FreqMax	KHz	0.1		601	Switching frequency.
P2.7.9	Dynamic Damp Kp	0.00	100.00	%	0.01	0	1406	Dynamic damping gain when parameter 2.7.5 Torque Select is greater than 1. 1.00 means nomi- nal torque for nominal speed difference.
P2.7.10	Dynamic Damp TC	0	32000	ms	1	0	1407	Bandpass filter time con- stant for dynamic damp- ing. 0 means static damp- ing proportional to fre- quency error.
P2.7.11	DC Magn Current	0.0	Motor Nom Current	A			627	Constant DC Magnetiza- tion Current
P2.7.12	DC Magn Time	0	10000	ms	1	0	628	Constant DC magn. time [ms] in ramp start
P2.7.13	Start 0Speed Time	0	32000	ms	1	100	615	Time of zero speed ref at start in ms, (0 ...32000)
P2.7.14	Stop 0SpeedTime	0	32000	ms	1	100	616	Time of zero speed ref at ramp stop in ms, (0 ...32000)
P2.7.15	Stop State Flux	0	150.0	%	1	100.0	1401	The % of rated flux main- tained after the motor is stopped for the time Flux Off Delay.
P2.7.16	Flux Off Delay	-1	32000	s	1	0	1402	The time in seconds for which the flux will be maintained in the motor.

Code	Parameter	Min	Max	Unit	Step	Default	ID	Note
								Setting this value to -1 will keep the Stop State Flux continuously.
P2.7.17	MotTempCompen	0	3		1	0	1426	Motor temperature compensation. 0= Disabled 1= From TS1 temp 2= From TS2 temp. 3= Internal
P2.7.18	Modulation Index	0	200	%	1	100	655	

Table 15. Motor control parameters, G2.7

3.8.1 PMSM Control (Control keypad: Menu M2 → G2.7.17)

Code	Parameter	Min	Max	Unit	Step	Default	ID	Note
P2.7.18.1	Flux Control Kp	0.00	320.00	%	0.01	5.00	651	Gain for the flux controller in %.
P2.7.18.2	Flux Control Ti	0.0	100.0	ms	0.1	5.0	652	Integral time constant for flux current controller in ms.
P2.7.18.3	RsIdentification	0	1		1	0	654	Stator resistance identification during every start. 0 = Disabled 1 = Enabled.
P2.7.18.4	Modulation Index	0	200	%	1	100	655	Modulation index in % for closed loop operation.
P2.7.18.5	EncAngleOffset	0	65535		1	0	649	Low word of (endat) encoder angle corresponding to shaft 0 position. This parameter is only for monitoring and back up purpose. It is used only with absolute encoders .
P2.7.18.6	Encoder Zero position identification mode	0	2			0	1691	0 = Automatic 1 = Forced 2 = On Power UP
P2.7.18.7	Start positioning current	0,0	200,0	%		50,0	1601	
P2.7.18.8	Polarity pulse current	0,0	200,0	%		0,0	1602	
P2.7.18.9	Ls Voltage Drop	0	3000			512	673	
P2.7.18.10	Motor BEM Voltage	0,00	320,00	%	0,01	90,00	674	
P2.7.18.11	Estimator Kp	0	3000		1	400	1781	

Table 16. PMSM control parameters, G2.7.17

3.9 Limit Settings (Control keypad: Menu M2 → G2.8)

Code	Parameter	Min	Max	Unit	Step	Default	ID	Note
P2.8.1	Zero Speed Level	0	Motor NomSpeed	rpm	1	15	1283	Speed below which Bit 11 of Auxiliary Status Word becomes TRUE
P2.8.2	Zero Speed Mon	0	1		1	1	1284	Monitoring of Zero speed is based on 0=Speed Ref, 1=Speed Actual
P2.8.3	Speed Maximum	-10000	10000	rpm	1	1440	1285	Maximum limit of the Speed reference
P2.8.4	Speed Minimum	-10000	10000	rpm	1	0	1286	Minimum Limit for the Speed Reference
P2.8.5	Current Limit	$0,01 * I_H$	$2 * I_H$	A	0.1		107	Maximum Total Current Limit.
P2.8.6	Torque Limit Mot	0.0	300.0	%	0.1	300.0	1287	Torque limit for the motoring side.
P2.8.7	Torque Limit Gen	0.0	300.0	%	0.1	300.0	1288	Torque limit for the generator side.
P2.8.8	SPC OUT Limit	0.0	300.0	%	0.1	300.0	1382	Absolute maximum limit for the speed controller output in closed loop control in % of motor nominal torque.
P2.8.9	Power Limit Mot	0.0	300.0	%	0.1	300.0	1289	Power limit for motor side
P2.8.10	Power Limit Gen	0.0	300.0	%	0.1	300.0	1290	Power limit for generator side
P2.8.11	PullOutTorque	0.0	1000.0	%	0.1	250.0	1291	Pull Out Torque limit of the motor
P2.8.12	System Inertia	0	30000	kgm ²	1	0	1292	Inertia of the system in kgm ² .
P2.8.13	Max Brake Power	0.000	30.000	kW	0.00 1	0.000	1293	Max Braking Power Limit in Constant Power Emergency Stop
P2.8.14	Max Braking Torq	1	30000	Nm	1	1	1294	Max Braking Torque of the motor in Constant Power Emergency Stop

Table 17 Limit setting parameters, G2.8

3.10 Speed Control (Control keypad: Menu M2 → G2.9)

Code	Parameter	Min	Max	Unit	Step	Default	ID	Note
P2.9.1	SPC Kp	1	1000		1	30	613	Speed controller P gain (0 ...1000)
P2.9.2	SPC Ti	0	32000	ms	1	300	614	Speed controller integrator time constant 0...32000ms
P2.9.3	Kp Min	0	100	%	1	100	1295	Relative gain (%)of SPC Kp if torque is below P2.9.4
P2.9.4	Min Point	0	100.0	%	0.1	0.0	1296	Torque Limit for adaptive SpeedControl_Kp (1000 = nominal)
P2.9.5	Min Filt	0	1000	ms	1	0	1297	Filtering TC for Speed Control_Kp in ms
P2.9.6	SPC Kp FWP	1	200	%	1	100	1298	Relative final gain of speed controller at field weakening in % of SPC Kp. <100 reduces gain, >100 increases gain above FWP
P2.9.7	SPC Kp N0	0	100	%	1	100	1299	Relative gain (%) below SPC Kp N0 Point Init:=100
P2.9.8	N0 Point	P2.8.4	P2.8.3	rpm	1	0	1300	Below this speed N0 the speed controller gain will be SPC Kp N0
P2.9.9	N1Point	P2.8.4	P2.8.3	rpm	1	0	1301	Above this speed N1 speed controller gain will be SPC Kp
P2.9.10	Mech AccComp TC	0.00	300.00	s	0.01	0.00	1302	Mechanical time constant for acceleration compensation in Sec (0...300 s)
P2.9.11	Accel Comp Filt	0	1000	ms	1	0	1303	Filter time constant for Acceleration compensation in ms
P2.9.12	Load Drooping	0.00	100.00	%	0.01	0.00	620	Load Drooping = 0 ... 100.00% of nominal speed at nominal torque
P2.9.13	Drooping Time	0.00	327.67	s	0.01	0.00	656	Load drooping time in ms. Value 0 means static or continuous drooping.
P2.9.14	Window Pos RPM	0	P2.1.5	rpm	1	0	1304	Window width in RPM for positive direction
P2.9.15	Window Neg RPM	0	P2.1.5	rpm	1	0	1305	Window width in RPM for negative direction
P2.9.16	Window Off Pos	0	P2.9.14	rpm	1	0	1306	Window OFF limit in RPM for hysteresis in Window ctrl in positive direction
P2.9.17	Window Off Neg	0	P2.9.15	rpm	1	0	1307	Window OFF limit in RPM for hysteresis in Window ctrl in Negative direction
P2.9.18	Slip Adjust	0	500	%	1	100	619	Slip adjust 0...500%
P2.9.19	Speed Error Filt	0	1000	ms	1	0	1311	Filter time for the speed error
P2.9.20	Speed Act Filter	0.0	250.0	ms	0.1	0.0	1308	Filter time for the measured speed from the encoder.
P2.9.21	SpeedErrLowPass F	-3200,0	3200,0	Hz	0,1	0,0	1185	Speed error LP filter cutoff frequency.
P2.9.22	AntiSwInLowPasT C	-32000	32000	ms	1	0	1186	Lowpass time constant for second order Antiswing lowpass filter.

P2.9.23	AntiSwingGain	-32000	32000	%	1	100	1187	Gain for Antiswing function in % to optimize step response
P2.9.24	AntiSwingTC	-32000	32000	ms	1	0	1188	BandStop/swinging time constant in ms for AntiSwing control to reduce swinging and/or speed overshoot.
P2.9.25	Speed controller P gain (CL)	0	32767		3000		637	
P2.9.26	Speed controller I gain (OL)	0	32767		300		638	
P2.9.27	Load Drooping Removal	0	2		0		1534	0=Normal 1= At zero Freq Lim 2=Linear zero to Fnom

Table 18 Speed control parameters, G2.9

3.11 Oscillation Damp (Control keypad: Menu M2 → G2.10)

Code	Parameter	Min	Max	Unit	Step	Default	ID	Note
P2.10.1	Oscill Damp Sel	0	2		1	0	1310	Resonance damper selector 0 = Not in Use 1 = BandPass 2 = BandStop + BandPass
P2.10.2	Oscill Freq	0.0	450.0	Hz	0.1	0.0	1313	Resonance damper natural frequency 1.0...450.0 Hz 0 = Not in use
P2.10.3	Oscill Damp Gain	0.0	100.0	%	0.1	0.0	1314	Resonance damper damping gain at notch frequency 0 ... 100.0%
P2.10.4	Phase Shift	0	360	Deg	1	0	1315	Resonance Damper Phase shift at Notch frequency 0...360 deg

Table 19. Oscillation damping parameters, G2.10

3.12 Brake & Fan Control (Control keypad: Menu M2 → G2.11)

Code	Parameter	Min	Max	Unit	Step	Default	ID	Note
P2.11.1	Brake In Fault	0	1		1	0	1319	Selection of mechanical brakes closing on fault in drive 0=Brakes applied at zero speed (par. 3.8.1) 1=brakes are applied immediately on Fault
P2.11.2	Brake In Emstop	0	1		1	0	1318	Selection of mechanical brakes closing on emergency stop. 0=Brakes applied at zero speed (P2.8.1) 1=brakes are applied immediately on emergency stop
P2.11.3	Brake Open limit	0.0	3200.0	rpm	0.1	0.0	1535	
P2.11.4	Brake Close Limit	0.0	3200.0	rpm	0.1	0.0	1539	
P2.11.5	Brake Fault Delay	0.0	3200.0	s	0.1	1.0	352	

P2.11.6	Brake mechanical Delay	0.0	3200.0	s	0.1	0.0	1544	
P2.11.7	Brake On/Off current limit	0.0	Imax	A	0.1	0.0	1085	
P2.11.8	Mot Fan OffDelay	0.00	300.00	s	0.01	20.00	1320	Motor fan off delay ###.## Seconds

Table 20. Brake and fan control parameters, G2.11

3.13 Master Follower (Control keypad: Menu M2 → G2.12)

Code	Parameter	Min	Max	Unit	Step	Default	ID	Note
P2.12.1	M/F Mode	0	4		1	0	1324	0=None 1=Master 2=Follower 3= DriveSynch Master 4=DriveSynch Follower
P2.12.2	Follower SpRef	0	2		1	0	1327	Source of speed reference for the drive if Par 2.12.1=2 Follower 0=Drive 's own reference 1=Master speed reference before Ramp 2=Master speed reference after Ramp.(Follower Drive ramp is bypassed in this case)
P2.12.3	Follower Start Delay	0.00	327.67	s	0.10	0.00	1398	Delay in starting the multiple wind current follower after the master is started.
P2.12.4	Follower phase shift	0,0	360,0	Dec	0,0		1518	

Table 21 Master Follower parameters, G2.12

3.14 Protections (Control keypad: Menu M2 → G2.13)

Code	Parameter	Min	Max	Unit	Step	Default	ID	Note
P2.13.1	AI <4mA	0	2		1	0	700	If value of Analogue input is less than it's minimum value
P2.13.2	Panel Commn.	1	2		1	1	1329	Operation in case Control Place=2 and a keypad stops communicating
P2.13.3	External Fault	0	2		1	2	701	Select the action in case of External fault
P2.13.4	Input Ph. Superv	0	2		1	0	730	Operation in case of Input Phase loss.
P2.13.5	Output Ph. Superv	0	2		1	0	702	Operation in case of motor phase loss
P2.13.6	Earth Fault	0	1		1	0	703	Operation in case of Earth Fault
P2.13.7	Earth Fault Curr	0.0	100.0	%	0.1	50.0	1333	Max. level for Earth current in % of unit current.
P2.13.8	Earth Fault Delay	0	5000	ms	1	800	1334	Earth fault wait time in ms
P2.13.9	Motor Stall	0	2		1	1	709	Operation in case of Motor stall.
P2.13.10	Stall Current	0.0	2 * I _H	A	0.1	10.0	710	Current limit of motor stall protection
P2.13.11	Stall Freq Lim	0.00	P2.1.3	Hz	0.01	25.00	712	Max frequency for stall protection, f[Hz] = StallFrequency/FreqScale
P2.13.12	Stall Time Lim	1.00	120.00	s	0.01	15.00	711	Max time for stall protection to operate.
P2.13.13	Thermistor	0	2		1	0	732	Action on thermistor fault
P2.13.14	Encoder Fault	0	3		1	0	1353	Encoder fault

P2.13.15	Mech Brake Fault	1	2		1	2	1316	Action on mechanical brake fault. This fault is enabled only if digital input for mechanical brake acknowledgement is selected. 1= Warning 2= Fault
P2.13.16	Follower TimeOut	0.00	5.00	s	0.01	0.00	1352	Delay time for master follower communication Fault.
P2.13.17	FB WatchdogDelay	0	5.00	s	0.01	1.05	1354	Profibus watchdog delay. If set to 0 watchdog function is disabled.
P2.13.18	PT100 Num In Use	0	5		1	0	739	Select the number of PT100 channels used on OPTB8 board.
P2.13.19	PT100 AlarmLimit	-30	200	°C	1	110	1347	Select the temp. limit for PT100 sensor above which PT100 Temp. alarm is generated. Note that PT100 can be connected through analogue input as explained in the manual or through OPTB8 card for PT100. The limit is common for all.
P2.13.20	PT100 Fault Limit	PT100 Alarm Limit	200	°C	1	120	1348	Select the temp. limit for PT100 sensor above which PT100 Temp. fault is generated. Note that PT100 can be connected through analogue input as explained in the manual or through OPTB8 card for PT100. The limit is common for all.
P2.13.21	Motor CalcTempProt	0	2		1	0	704	Operation in case of Motor thermal protection
P2.13.22	ThermalTime Const	1	200	min	1	45	707	Motor Thermal Time Constant in minutes, (1... 200)
P2.13.23	Zero Spd Cooling	0.0	100.0	%	0.1	40.0	706	Motor cooling ability at zero speed unit in %
P2.13.24	Motor Duty Cycle	0	300	%	1	100	708	Motor Duty Cycle in %
P2.13.25	Underload Prot	0	2		1	0	713	Operation in case of Underload.
P2.13.26	Speed Zero Load	0.0	300.0	%	0.1	0.0	714	Underload load curve at zero freq,unit
P2.13.27	Speed Nom Load	0.0	300.0	%	0.1	0.0	1341	Underload load curve at nominal freq,unit
P2.13.28	UnderLdSpeed Nom	0	Motor NomSpeed Max	rpm	1	1440	1342	Speed limit value for Underload protection
P2.13.29	Auto reset word 1	0	65535		1	0	1171	Select faults that you want to autoreset B0 +1 = Reserved B1 +2 = Reserved B2 +4 = AutoReset Under Voltage Fault

P2.13.30	FB Communication fault response	1	4			2	733	0 = No Action 1 = Warning 2 = Warning; Prev.Freq. 3 = Warning; Preset Freq. 4 = Fault
P2.13.31	FB Fault delay	0,00	320,00	s		0	1430	
P2.13.32	FB Fault speed	-30000	30000	Rpm		0	728	
P2.13.33	Encoder Iq fault limit	0	300	%		100	1800	
P2.13.34	Encoder fast fault freq limit	0,00	320,00	Hz		10,00	1801	
P2.13.35	Parameter Lock	0	1			0	1086	0 = Disabled 1 = Enabled
P2.13.36	Speed Error Mode	0	3		0		752	0=No response 1=Warning 2=Fault,stop acc. to 2.4.7 3=Fault,stop by coasting
P2.13.37	Speed Error Limit	0,0	100,0	%	5,0		753	
P2.13.38	Speed Fault Delay	0,00	100,00	S	0,1		754	

Table 22. Protection parameters, G2.13

3.15 Flux Reference Handling (Control keypad: Menu M2 → G2.14)

Code	Parameter	Min	Max	Unit	Step	Default	ID	Note
P2.14.1	Flux Curve 10%	0.0	250.0	%	0.1	10.0	1355	Flux linearization point 1
P2.14.2	Flux Curve 20%	0.0	250.0	%	0.1	20.0	1356	Flux linearization point 2
P2.14.3	Flux Curve 30%	0.0	250.0	%	0.1	30.0	1357	Flux linearization point 3
P2.14.4	Flux Curve 40%	0.0	250.0	%	0.1	40.0	1358	Flux linearization point 4
P2.14.5	Flux Curve 50%	0.0	250.0	%	0.1	50.0	1359	Flux linearization point 5
P2.14.6	Flux Curve 60%	0.0	250.0	%	0.1	60.0	1360	Flux linearization point 6
P2.14.7	Flux Curve 70%	0.0	250.0	%	0.1	70.0	1361	Flux linearization point 7
P2.14.8	Flux Curve 80%	0.0	250.0	%	0.1	80.0	1362	Flux linearization point 8
P2.14.9	Flux Curve 90%	0.0	250.0	%	0.1	90.0	1363	Flux linearization point 9
P2.14.10	Flux Curve 100%	0.0	250.0	%	0.1	100.0	1364	Flux linearization point 10
P2.14.11	Flux Curve 110%	0.0	250.0	%	0.1	110.0	1365	Flux linearization point 11
P2.14.12	Flux Curve 120%	0.0	250.0	%	0.1	120.0	1366	Flux linearization point 12
P2.14.13	Flux Curve 130%	0.0	250.0	%	0.1	130.0	1367	Flux linearization point 13
P2.14.14	Flux Curve 140%	0.0	250.0	%	0.1	140.0	1368	Flux linearization point 14
P2.14.15	Flux Curve 150%	0.0	250.0	%	0.1	150.0	1369	Flux linearization point 15

Table 23. Flux reference handling parameters, G2.14

3.16 Startup Torque (Control keypad: Menu M2 → G2.15)

Code	Parameter	Min	Max	Unit	Step	Default	ID	Note
P2.15.1	Startup TorqueSel	0	3		1	0	621	0 = Not in use 1 = Torque Memory, 2 = Torque Reference 3 = Startup Torque FWD/REV
P2.15.2	Startup Torque Time	0	10000	ms	1	0	1371	Maximum time for startup torque in ms, (0 ...10000)
P2.15.3	Startup Torque FWD	-300.0	300.0	%	0.1	0.0	633	StartupTorqueReference to forward direction -300.0 ...300.0% of motor nominal torque
P2.15.4	Startup Torque REV	-300.0	300.0	%	0.1	0.0	634	StartupTorqueReference to reverse direction -300.0 ...300.0%.
P2.15.5	Torque Memory Source	0	2		1	1	1374	Source for torque memory. At the next start the same startup torque reference will be used.
P2.15.6	Torque Memory Reference	-300.0	300.0	%	0.1	0.0	1375	Fixed reference for the torque memory

Table 24. Start-up Torque parameters, G2.15

3.17 Monitor Settings (Control keypad: Menu M2 → G2.16)

Code	Parameter	Min	Max	Unit	Step	Default	ID	Note
P2.16.1	Speed Mon Filter	0	32000	ms	1	20	1376	Filter in ms for monitoring signal V1.1.2 Motor Speed.
P2.16.2	Curr Mon Filter	20	2000	ms	1	20	1377	Filter in ms for monitoring signal V1.1.4 Motor Curr
P2.16.3	Torq Mon Filter	20	2000	ms	1	20	1378	Filter in ms for monitoring signal V1.1.5 Motor Torque

Table 25 DAC parameters, PG.16

3.18 Data Mapping (Control keypad: Menu M2 → G2.17)

Code	Parameter	Min	Max	Unit	Step	Default	ID	Note
P2.17.1	PD IN1 ID	0	65535		1	0	876	
P2.17.2	PD IN2 ID	0	65535		1	0	877	
P2.17.3	PD IN3 ID	0	65535		1	0	878	
P2.17.4	PD IN4 ID	0	65535		1	0	879	
P2.17.5	PD IN5 ID	0	65535		1	0	880	
P2.17.6	PD IN6 ID	0	65535		1	0	881	
P2.17.7	PD IN7 ID	0	65535		1	0	882	
P2.17.8	PD IN8 ID	0	65535		1	0	883	
P2.17.9	PD OUT1 ID	0	65535		1	4	852	Torque
P2.17.10	PD OUT2 ID	0	65535		1	1163	853	Aux Control Word
P2.17.11	PD OUT3 ID	0	65535		1	1172	854	Fault Word 1
P2.17.12	PD OUT4 ID	0	65535		1	1173	855	Fault Word 2
P2.17.13	PD OUT5 ID	0	65535		1	15	856	DIN Status Word 1
P2.17.14	PD OUT6 ID	0	65535		1	1174	857	Alarm Word
P2.17.15	PD OUT7 ID	0	65535		1	1170	858	Motor Shaft Rounds
P2.17.16	PD OUT8 ID	0	65535		1	1169	859	Motor Shaft Position

Table 26. Data mapping parameters, G2.17

3.19 PI Control Parameters (Control keypad: Menu M2 → G2.15)

Code	Parameter	Min	Max	Unit	Step	Default	ID	Note
P2.18.1	PI controller gain	0,0	1000,0	%		100,0	118	
P2.18.2	PI controller I-time	0,00	320,00	s		1,00	119	
P2.18.3	PI Reference	-32000	32000			0	167	
P2.18.4	PI controller reference signal ID	0	10000			167	332	Default P2.18.3
P2.18.5	PI Actual value ID	0	10000			0	333	
P2.18.6	PI Controller output ID	0	10000			0	1802	
P2.18.7	PI Controller Scale	-32000	32000			1	340	>= 1 = No inversion <=-1 = Inverted 0 = Illegal value
P2.18.8	PI Low limit	-32000	32000				359	
P2.18.9	PI High limit	-32000	32000	%		10000	360	
P2.18.10	PI Controller Output scale	-3200,0	3200,0	%		100,0	1803	
P2.18.11	PI Stop state value	-32000	32000			0	1806	

Table 27. PI Controller parameters, G2.15

3.19.1 Connect DIN -> ID (Control keypad: Menu M2 → G2.2.3)

Code	Parameter	Min	Max	Unit	Step	Default	ID	Note
P2.19.1.1	DIN Selection	0	Max. No of DIN installed		1	0	1570	Select Digital input which is used to control parameter
P2.19.1.2	ID Selection	0	10000		1	0	1571	Select parameter ID which is controlled with digital input.
P2.19.1.3	DIN Low value	-32000	32000		1	0	1572	This value is set to parameter selected when digital input is LOW

P2.19.1.4	DIN High value	-32000	32000		1	0	1573	This value is set to parameter selected when digital input is HIGH
-----------	----------------	--------	-------	--	---	---	------	--

Table 28. Digital input signal configurations, G2.2.3

3.19.2 Connect DIN -> ID (Control keypad: Menu M2→ G2.2.3)

Code	Parameter	Min	Max	Unit	Step	Default	ID	Note
P2.19.2.1	DIN Selection	0	Max. No of DIN installed		1	0	1574	Select Digital input which is used to control parameter
P2.19.2.2	ID Selection	0	10000		1	0	1575	Select parameter ID which is controlled with digital input.
P2.19.2.3	DIN Low value	-32000	32000		1	0	1576	This value is set to parameter selected when digital input is LOW
P2.19.2.4	DIN High value	-32000	32000		1	0	1577	This value is set to parameter selected when digital input is HIGH

Table 29. Digital input signal configurations, G2.2.3

3.19.3 Connect DIN -> ID (Control keypad: Menu M2→ G2.2.3)

Code	Parameter	Min	Max	Unit	Step	Default	ID	Note
P2.19.3.1	DIN Selection	0	Max. No of DIN installed		1	0	1578	Select Digital input which is used to control parameter
P2.19.3.2	ID Selection	0	10000		1	0	1579	Select parameter ID which is controlled with digital input.
P2.19.3.3	DIN Low value	-32000	32000		1	0	1587	This value is set to parameter selected when digital input is LOW
P2.19.3.4	DIN High value	-32000	32000		1	0	1588	This value is set to parameter selected when digital input is HIGH

Table 30. Digital input signal configurations, G2.2.3

3.19.4 Value Control (Keypad: Menu M2 → G2.2.9)

Code	Parameter	Min	Max	Unit	Default	Cust	ID	Note
P2.19.4.1	Control Input Signal ID	0	10000	ID	0		1580	
P2.19.4.2	Control Input Off Limit	-32000	32000		0		1581	
P2.19.4.3	Control Input On Limit	-32000	32000		0		1582	
P2.19.4.4	Control Output Off Value	-32000	32000		0		1583	
P2.19.4.5	Control Output On Value	-32000	32000		0		1584	
P2.19.4.6	Control Output Signal ID	0	10000	ID	0		1585	
P2.19.4.7	Control Mode	0	5		0		1586	0=SR ABS 1=Scale ABS 2=Scale INV ABS 3=SR 4=Scale 5=Scale INV
P2.19.4.8	Control Output Filtering rime	0,000	32,000	s	0,000		1721	

Table 31. Power reference input signal selection, G2.2.8

3.20 Keypad Control (Control keypad: Menu M3 → R3.1)

The reference from the keypad when control place is selected as keypad is listed below. See the [Keypad control menu](#) in the product's User's Manual.

Code	Parameter	Min	Max	Unit	Step	Default	ID	Note
R2.1	Keypad reference	P2.8.4 Speed Min	P2.8.3 Speed Max	rpm	1			Local speed reference in rpm when control place is keypad.

Table 32. Keypad control parameters, M3

3.21 Expander Boards (Control keypad: Menu M7)

The **M7** menu shows the expander and option boards attached to the control board and board-related information. For more information, see the product's User's Manual.

4. DESCRIPTION OF THE SYSTEM INTERFACE APPLICATION PARAMETERS

P2.1.1 Supply voltage

This parameter sets the incoming line voltage for the drive. The maximum value is 1000 V. Set this parameter to the nominal line voltage at the installation site.

P2.1.2 Motor nominal voltage

Nominal value of motor voltage in volts as per the motor nameplate data.

P2.1.3 Motor nominal frequency

Nominal value of motor frequency in Hz as per the motor nameplate data.

P2.1.4 Motor nominal current

Nominal value of the motor current in amperes as per the motor nameplate data.

P2.1.5 Motor nominal speed

Nominal value of the motor speed in rpm as per the motor nameplate data.

P2.1.6 Motor cos phi

Nominal value of the cos phi as per the motor nameplate data.

P2.1.7 Process speed

This parameter is used to scale the speed signal in terms of the process speed. This speed value corresponds to value of the parameter FBRef Scale (P2.4.7) for the speed reference written from the fieldbus. For e.g. If P2.4.7 = 20000 and P2.1.7 = 1600 then drive will run with the speed reference of 1600 rpm when the speed reference from fieldbus is written as 20000.

P2.1.8 Magnetising current

This parameter defines the nominal magnetising current for the motor corresponding to 100% flux. The value of the parameter (if not known) can be found out by performing following test on the motor.

Please note that the motor must be decoupled from the gearbox and the load while doing the following test.

- Set all the nameplate parameters of the motor (P2.1.2 to P2.1.6).
- Set Motor control mode (P2.7.4) = 0 (Open Loop Frequency control)
- Run the motor with no load on the shaft with approx. 0.66*Rated Frequency. (33Hz for 50Hz motor).
- Wait for 10 seconds and then note the value of signal Motor Current (V1.1.4).
- Set this value to Magnetising current parameter (P2.1.8).

P2.1.9 Field weakening point

The field weakening point is the output frequency at which the motor voltage reaches the value of Voltage at FWP (P2.1.10) in percentage. This parameter is applicable during open loop control of the motor. Normally this parameter is set equal to motor nominal frequency.

P2.1.10 *Voltage at field weakening point*

Percentage value of the motor voltage at the field weakening point defined by P2.1.9. Above the field weakening point frequency the voltage remains at the value set by this parameter. This parameter is applicable during open loop control of the motor. Normally this parameter is set to 100.00% of motor nominal voltage.

P2.1.11 *Identification run*

This parameter defines different modes of the automatic motor identification run. Set the parameter and give a run command within 20 seconds to activate the identification. The result of the identification is seen in **ID Run Status** monitor value (V1.1.19). The parameter is reset to zero (None) after the identification is complete. In case of failure Alarm 57 ID Run Fail is generated.

0 None

1 Identification without motor running

The identification is performed with motor at standstill. In this mode motor stator resistance and parameters for U/F curve are identified. At the end of the identification the parameter U/f Ratio Select (P2.6.5.1) is set equal to 2 (programmable). This identification mode is used when it is not possible to decouple the motor from the gearbox and load. The identification optimises the performance for open loop motor control mode i.e. P2.7.4 = 0/1/2. After the successful identification B0 of variable ID Run Status is set.

2 Identification with motor running

The identification is performed with motor running. It is recommended to decouple the motor from the gearbox and the load. In addition to the motor parameters for open loop motor control, magnetising current (P2.1.8) and flux linearization curve (P2.14.1 to P2.14.15) is identified. After the successful identification B0, B2 and B3 of variable ID Run Status is set.

3 Encoder ID

The motor may rotate during the identification. The function is primarily used to identify the shaft zero position for PMSM motor when absolute encoder is used.

4 Magnetisation current calculation

In this identification, the magnetisation current of the motor for a given motor data (P2.1.2...P2.1.6) is calculated. **Note:** The motor is not subjected to any voltage or current.

P2.1.12 *Motor type*

This parameter defines the type of the motor connected to the frequency converter. It is possible to connect the following motor types to VACON NXP frequency converters.

0 Normal Induction motor

1 Not Used

2 Permanent magnet induction motor

3 Not Used

Note: Please consult with Vacon technical support to use options 1...3.

4.1 Input Signals

4.1.1 Digital Input

P2.2.1.1 Run forward

Select the digital input for starting the motor when Control Place (P2.6.1) =1 (I/O). Drive starts running when digital input is high and it stops when low.

- 0 Not selected
- 1 DIN1
- 2 DIN2

.
.
.

n = DINn where n is the maximum no. of DINs installed.

P2.2.1.2 Run reverse

Select the digital input for reversing the direction of the motor when Control Place (P2.6.1) =1 (I/O). The motor runs with positive speed reference when selected digital input is low and with negative reference when high.

See parameter P2.2.1.1 for the list of values.

P2.2.1.3 IO control

Select a digital input to force control place to I/O terminal.

See parameter P2.2.1.1 for the list of values.

P2.2.1.4 Reset

Select the digital input for resetting the drive fault. The rising edge of the digital input resets the fault if the cause of the fault is disappeared. See parameter P2.2.1.1 for the list of values.

P2.2.1.5 Brake open

This parameter is used to select digital input to acknowledge the status of the motor mechanical brake (if any). The drive can control the brake through relay output (programmable) and external hardware. The status of the brake is wired to digital input selected by this parameter. When a run request to the motor is released, drive first opens the brake through the digital output and keeps the reference at zero. When the brake open acknowledgement is received, drive releases the reference. When the run request to the motor is removed, drive closes the brake at zero speed. In case of an emergency stop and fault the brakes are closed as per the setting of parameters P2.11.2 and P2.11.3. If the acknowledgement is not received to the digital input within the time set by the parameter P2.11.1 after the run request, drive trips on F57 Mech. Brake fault.

See parameter P2.2.1.1 for the list of values.

P2.2.1.6 Brake open logic

This parameter enables to connect the Brake open acknowledgement wiring in normally open (NO) or normally closed (NC) type.

- 0 Normally open
- 1 Normally closed

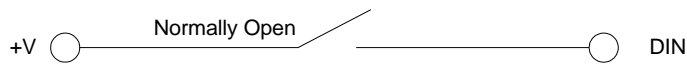

Note: Closed when brake is opened or released.

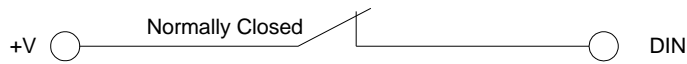

Note: Open when brake is opened or released.

P2.2.1.7 Motor fan acknowledgement

Select the digital input to acknowledge the status of the motor external fan (if any). The drive can start/stop the motor fan through one of the programmable relay outputs. The status of the fan (ON/OFF) is wired to the digital input. With a run request the motor fan starts and if the acknowledgement is not received within 5 seconds after the run request then the drive gives warning **56 Motor Fan**. When the run request is removed the fan stops after the delay set by Mot Fan Off Delay (P2.11.4).

See parameter P2.2.1.1 for the list of values.

P2.2.1.8 Input switch acknowledgement

Selects the digital input to acknowledge the status of input switch. The input switch is normally switch fuse unit or main contactor with which the power is fed to the drive. If the input switch acknowledgement is missing, the drive trips on "F64 Input Switch open" fault. See parameter P2.2.1.1 for the list of values.

P2.2.1.9 Run enable

Selects the digital input to activate the Run Enable in the drive. When run Enable is low, the drive coasts to stop with "OFF" indication on the keypad and "F26 Run Disable" warning. Normally the motor load switch or prevention of false start relay status is used as Run Enable.

See parameter P2.2.1.1 for the list of values.

P2.2.1.10 Run enable logic

This parameter enables to connect the Run Enable wiring in normally open (NO) or normally closed (NC) type.

- 0 Normally open
- 1 Normally closed

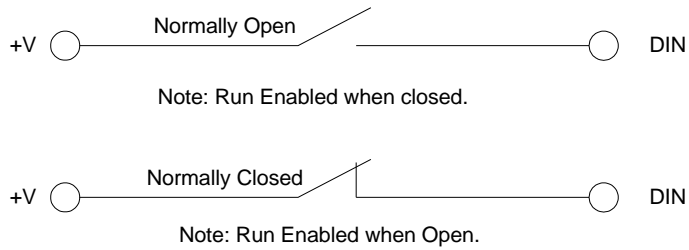

P2.2.1.11 Emergency stop

Select the digital input to activate the emergency stop in the drive. When the digital input is low the drive stops as per the parameter definition of Emergency stop mode (P2.7.3)..

See parameter P2.2.1.1 for the list of values.

P2.2.1.12 External fault

Select the digital input to activate the external fault in the drive. When the selected digital input is high the drive trips on F51External fault and coasts to stop.

See parameter P2.2.1.1 for the list of values.

P2.2.1.13 External fault logic

This parameter enables to connect the external fault wiring in normally open (NO) or normally closed (NC) type.

- 0 Normally open
- 1 Normally closed

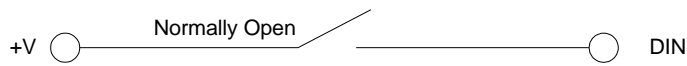

Note: External fault when closed.

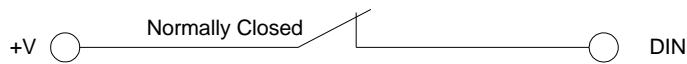

Note: External fault when open.

P2.2.1.14 Motor 1 or 2 selection

Select the digital input to load the parameters from Set1 or Set2.

- Low = Set1
- High = Set2

See parameter P2.2.1.1 for the list of values.

Two sets of parameters can be saved as Set1 and Set2 through system menu S6.3.1 from the keypad. With this feature one drive can be used to run two different motors alternatively.

P2.2.1.15 PI Controller activation

Select the digital input that will activate PI controller. Set selection to -1 and PI controller is activated without external wiring.

4.1.2 Analogue Input

P2.2.2.1 I/O speed reference selection

Select the analogue input for giving the speed reference to the drive when drive is in I/O control i.e. control place = 2.

- 0 Not used
- 1 AI1
- 2 AI2
- 3 AI1 joystick. The internal logic simulates the joystick reference.
- 4 Const Ref 1,2R. Parameter Const Ref1 (P2.4.2) is used as a speed reference when Run Forward Input is active and Const Ref2 (P2.4.3) is used as a speed reference when Run Reverse Input is active.
- 5 Fieldbus. Speed reference coming from fieldbus is used as a speed reference in I/O control.

P2.2.2.2 I/O torque reference selection

Selects the analogue input for giving the torque reference to the drive when the parameter Tref Source Sel (P2.4.8) = 3 (Analogue I/P).

- 0 Not used
- 1 AI1
- 2 AI2
- 3 Fieldbus. Torque reference from fieldbus (V1.2.17) is used.

P2.2.2.3 Temperature sensor 1 AI selection

Selects the analogue input to be used for temperature measurement using PT100 or KTY 84 sensor 1. Two sensors can be connected to NXP to analogue inputs AI1 and AI2. They are referred as TS 1 and TS 2.

- 0 Not used
- 1 AI1
- 2 AI2

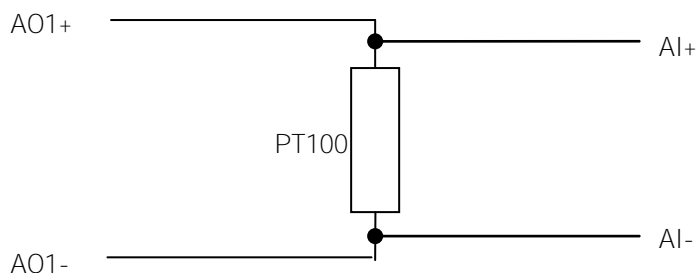

Please note that if temperature measurement using PT100 sensor is selected with analogue input then the A01 is forced internally to generate 10mA and any setting to A01 related parameters is not valid.

P2.2.2.4 Temperature sensor 1 selection

Selects the number of PT100 or KTY84 elements in series for TS 1 sensor.

- 0 1 PT100
- 1 2 PT100
- 2 3 PT100
- 3 1 KTY 84-130
- 4 2 KTY 84-130
- 5 3 KTY 84-130

P2.2.2.5 Temperature sensor 2 AI selection

Selects the analogue input to be used for temperature measurement using TS 2 sensor.

- 0 Not used
- 1 AI1
- 2 AI2

P2.2.2.6 Temperature sensor 2 selection

Selects the number of PT100 or KTY 84 elements in series for TS 2 sensor.

- 0 1 PT100
- 1 2 PT100
- 2 3 PT100
- 3 1 KTY 84-130
- 4 2 KTY 84-130
- 5 3 KTY 84-130

P2.2.2.7, P2.2.2.11 AI1 reference scale min, AI2 reference scale min

Minimum value of the signal selected for AI1 or AI2. This value corresponds to the minimum voltage/current (0V/0mA or 2V/4mA) depending on the setting of the parameter AI1 minimum (P2.2.2.9) or AI2 minimum (P2.2.2.13).

This parameter is not valid if AI1 or AI2 is used for temperature measurement using PT100 sensor.

P2.2.2.8, P2.2.2.12 AI1 reference scale max, AI2 reference scale max

Maximum value of the signal selected for AI1 or AI2. This value corresponds to the maximum voltage/current (10V/20mA) depending on the setting of jumpers on the OPT-A1 board.

This parameter is not valid if AI1 or AI2 is used for temperature measurement using PT100 sensor.

P2.2.2.9, P2.2.2.13 AI1 minimum, AI2 minimum

Minimum voltage or current on the AI1 or AI2 terminal on OPT-A1 board.

- 0 0V/0mA
- 1 2V/4mA

P2.2.2.10, P2.2.2.14 AI1 filter time, AI2 filter time

Filter time in seconds for the filtering of signal connected to AI1 or AI2. The range of the time is 0.01 sec to 10.00 sec.

4.1.3 Digital Output

P2.3.1.1 DO1 (ID BitNo)

Select the signal for controlling the DO1. The parameter is to be set in a format xxxx.yy where xxxx is an ID number of a signal and yy is a bit number. For e.g. Default value for DO1 control is 1162.00 where 1162 is the ID number of main status word. So DO1 is ON when bit number 0 of the main status word (id no. 1162) i.e. Drive ready is high.

P2.3.1.1... P2.3.1.13 DO2 (ID. BitNo)... DO13 (ID. BitNo)

Same as P2.3.1.1.

1.1.1 Analogue output

P2.3.2.1 A01 signal ID

This parameter defines ID number of a signal to be connected to A01. Any analogue signal from the application defined with ID no. can be selected.

Please note that if temperature measurement using PT100 sensor is selected with analogue input then the A01 is forced internally to generate 10mA and any setting to A01 related parameters is not valid.

P2.3.2.2 A01 offset

Minimum voltage or current at A01 terminal.

- 0 0V/0mA
- 1 2V/4mA

P2.3.2.3 A01 filter

Filter time for the signal connected to A01. The range of the time is 0.02 to 10.00 seconds.

P2.3.2.4 A01 max value

Maximum value of the signal connected to A01. This value corresponds to the maximum voltage or current (10V/4mA).

P2.3.2.5 A01 Min value

Minimum value of the signal connected to A01. This value corresponds to minimum voltage or current at A01 depending on the setting of parameter P2.3.2.2. If an option board supports +/-10V at A01, this value corresponds to -10V.

4.2 Reference Handling

P2.4.1 Speed reference filter

Filter time for the speed reference in the range of 0 to 5000 ms. This filtered speed reference is shown in the monitor value Speed reference 3 (V1.2.6).

P2.4.2 Constant reference 1

Constant speed reference for the inching function in the range of the Speed minimum (P2.8.4) to the Speed maximum (P2.8.3) . This is used for Inch1 function through fieldbus when MainControlWord bit8 is set. The same reference can be used as a fixed speed reference when the drive is in IO control.

P2.4.3 Constant reference 2

Constant speed reference for the inching function in the range of Speed minimum (P2.8.4) to Speed maximum (P2.8.3) . This is used for Inch2 function through fieldbus when MainControlWord bit 9 is set. The same reference can be used as a fixed speed reference when the drive is in IO control.

P2.4.4 Critical speed low

This parameter defines a lower limit of the critical speed window for the speed reference. It is to avoid running the drive in a critical speed window in case of mechanical resonance.

P2.4.5 Critical speed high

This parameter defines an upper limit of the critical speed window for the speed reference. It is to avoid running the drive in a critical speed window in case of mechanical resonance.

P2.4.6 Speed share

Percentage of V1.2.4 Speed reference1 to be taken as the speed reference in the speed reference chain. The selected speed reference is seen as V1.2.5 Speed reference 2. With this the two drives with different gear box ratio can have a common speed reference and the individual scaling of the speed reference can be done using this parameter.

P2.4.7 Fieldbus reference scale

The speed reference range from fieldbus is from -32767 to 32767. It can be scaled to the Process speed (P2.1.7) with this parameter. The value of this parameter corresponds to the RPM value in Process speed (P2.1.7). The default value is 20000. Hence the speed reference of 20000 from fieldbus corresponds to Process speed (P2.1.7) rpm reference.

P2.4.8 Torque reference source selection

Select the source of the torque reference for the drive with this parameter.

- 0 None
- 1 Master. The torque reference comes from the speed controller output (with acceleration compensation) of the Master drive through System Bus. This torque reference is seen as Master TorqueRef (V1.2.16) in follower drive.
- 2 Fieldbus
- 3 Analogue I/P
- 4 Master SPC. Master speed controller output. Torque reference from master speed controller output without acceleration compensation.

P2.4.9 *Torque reference filter*

Filter time in 0...5000ms for the torque reference.

P2.4.10 *Torque reference hysteresis*

Hysteresis band for the torque reference in percentage of motor nominal current.

P2.4.11 *Torque reference dead zone*

Dead zone band for the torque reference as percentage of motor nominal torque. Torque reference below this value in both direction (+ve and -ve) is taken as zero torque reference.

P2.4.12 *Torque reference scale*

With this parameter the default resolution of torque reference 1000 = motor nominal torque can be changed to 10000 = motor nominal torque. This function is available for closed loop control only.

- 0 1000
- 1 10000

All the torque related signals and parameters are changed and displayed automatically in the same scale.

P2.4.13 *Load share*

This parameter defines a percentage of the external torque reference to be taken as a torque reference to the drive. Normally this parameter is used by follower drive in case of master follower configuration to share the load torque. An example:

- 100.0% = Torque reference is equal to the external torque reference.
- 50.0% = Torque reference is 50% of the external torque reference.

P2.4.14 *Torque reference ramp time*

Ramp time in ms for the nominal torque reference change.

P2.4.15 *Flux reference*

Flux reference as a percentage of motor nominal flux in closed loop motor control operation.

P2.4.16 *Above speed limit*

When motor speed is above this limit, MainStatusWord Bit10 is set.

P2.4.17 Speed step

Step speed reference in counts (0... FB ref scale (P2.4.7) corresponds to 0... process speed (P2.1.7)). This reference is converted to rpm and added to speed reference after the ramp generator (V1.2.8).

This step reference is normally used to give speed steps during the speed controller tuning in closed loop motor control operation and can also be used as a fast speed correction from fieldbus.

P2.4.18 Torque step

Step torque reference in percentage of motor nominal torque. This reference is added to the Torque reference 3 (V1.2.21).

This step reference is normally used for the inertia/friction compensation of the drive system through fieldbus in fieldbus control. E.g. the inertia compensation for winder or unwinder roll can be written from fieldbus to this parameter.

P2.4.19 Speed Reference Interpolator TC

Set here time on what interval speed reference is updated. This function ramps the reference between updated values.

4.3 Ramp Functions

P2.5.1 Acceleration time

Acceleration ramp time for the speed ramp generator. The drive accelerates in this time from zero to maximum speed.

P2.5.2 Deceleration time

Deceleration time for the speed ramp generator. The drive decelerates in this time from maximum speed to zero.

P2.5.3 S ramp acceleration/deceleration

The start and end of acceleration and deceleration ramp can be smoothed with this parameter. Setting value 0 gives a linear ramp shape which causes acceleration and deceleration to act immediately to the changes in the reference signal.

P2.5.4 Emergency stop ramp

Deceleration ramp time in case of emergency stop. The drive decelerates from maximum speed to zero speed if Emergency stop mode (P2.7.3) = 1 (Ramp stop).

P2.5.5 Emergency stop delay

Delay time in seconds to activate the emergency stop function in the drive after the emergency stop has been activated through digital input. If the drive is in fieldbus

control, it monitors the speed reference from the fieldbus. If the speed reference does not start decelerate within 1000 ms after the emergency stop has been activated, the drive stops with its own Emergency stop sequence defined by Emergency stop ramp (P2.5.4) and Emergency stop mode (P2.7.3). If the drive will not stop within Emergency stop delay time, the drive stops with its own Emergency stop sequence.

P2.5.6 Constant speed acceleration time

Acceleration ramp time for the speed ramp generator. This acceleration time is used when inching function is used from fieldbus or constant speed operation is used in I/O control. The drive accelerates in this time from zero speed to maximum speed.

P2.5.7 Constant speed deceleration time

Deceleration time for the speed ramp generator. This deceleration time is used when inching function is used from the fieldbus or constant speed operation is used in I/O control. The drive decelerates in this time from maximum speed to zero speed.

P2.5.8 S ramp constant speed

The start and end of acceleration and deceleration ramp can be smoothed with this parameter. Setting value 0 gives a linear ramp shape which causes acceleration and deceleration to act immediately to the changes in the reference signal.

This parameter is used when inching function is used from the fieldbus or constant speed operation is used in I/O control.

P2.5.9 Ramp Time Reference

0 = Max Speed

Ramp time is from zero speed to maximum speed. P2.8.3 or P2.8.4.

1 = Process Speed

Ramp time is from zero speed to process speed P2.1.7

P2.5.10 Open loop limit emergency stop ramp time

This parameter defines ramp time on open loop control when fast stop emergency function is used.

4.4 Drive Control

P2.6.1 Control place

Select the control place to control the drive.

0 Fieldbus

1 Remote (I/O)

2 Local (keypad)

The drive can also be controlled from PC tool through NCDrive when PC control box is checked in the operating window. The drive has to be in Keypad control i.e. control place = Local to be able to control the drive from the PC tool.

P2.6.2 Brake chopper

Selects the mode of the brake chopper operation. This parameter is to be set only if internal brake chopper is used.

- 0 No brake chopper used
- 1 Brake chopper in use on Run state (no testing)
- 2 External brake chopper (no testing)
- 3 Brake chopper in use on Run and Ready state (no testing)
- 4 Brake chopper in use and tested when running. Can be tested also in READY state
- 5 Used and tested in READY state and when running

When the frequency converter is decelerating the motor, the inertia of the motor and the load are fed into an external brake resistor. This enables the frequency converter to decelerate the load with a torque equal to that of acceleration (provided that the correct brake resistor has been selected).

The brake chopper test mode generates a pulse to the resistor every second. If the pulse feedback is wrong (resistor or chopper is missing) fault F12 is generated. See separate Brake resistor installation manual.

P2.6.3 *Brake chopper level*

Brake chopper control activation level in volts.

For 400V Supply: $400 \times 1.35 \times 1.18 = 638V$

For 500V Supply: $500 \times 1.35 \times 1.18 = 808V$

For 690V Supply: $690 \times 1.35 \times 1.18 = 1100V$.

Please note that when brake chopper is used, the over voltage controller can be switched OFF or the over voltage reference level can be set above the brake chopper level.

P2.6.4 *Brake resistor load limit*

This parameter value is set as a generator side torque limit to avoid the overheating of brake resistor during continuous braking. This is active only when Brake chopper (P2.6.2) is selected, emergency stop is not active and drive is not decelerating.

P2.6.7 *Restart delay*

Delay time within which the drive cannot be restarted after the coast stop. The time can be set up to 60 seconds.

P2.6.8 *Control options*

This packed bit word is made for enabling/disabling different control options:

B0 = Not used

B1 = Encoder used in OL for slip compensation

B2 = Not used

B3 = Open loop torque control speed limits active

B4 = Droop related to speed reference

B5 = Disable External Acceleration compensation

B10 = Activate OLD Speed Share function for Actual speed for fieldbus

B11 = Activate OLD brake logic

B12 = Disable encoder fault when brake is closed.

P2.6.9 *Control slot selector*

Selects which slot's process data is used for controlling the drive. Value is changed if more than one fieldbus cards have been installed in the drive or fast Profibus is used.

- 0 = ALL
- 4 = D
- 5 = E
- 6 = Fast communication slot D
- 7 = Fast communication slot E

P2.6.10 *Modulator Type*

0 = Standard Hardware modulator
 1-3 = Software modulators, when Drive Synch is used software modulator 1 is activated automatically.

P2.9.5 *Advanced Options 1* *ID1560* *"AdvancedOptions1"*

- b0 = +1= Disable Synchronous modulation
- b1 = +2=Use encoder information to slip compensation in Open Loop Speed control
- b2 = +4=Disable encoder fault
- b3 = +8=Disable slip compensation for reverse direction
- b4 = +16=Reserved
- b5 = +32=Reserved
- b6 = +64= Enable synchronous symmetrical modulation
- b7 = +128=Changes automatically depending on Drive Synch operation
- b8 = +256=Reserved
- b9 = +512=Reserved
- b10 = +1024=Reserved
- b11 = +2048=Reserved
- b12 = +4096=Reserved
- b13 = +8192=Reserved
- b14 = +16384=Reserved
- b15 = +32768=Cosphii = 1 control

This controls the motor reactive power to zero. Possible to use only with PMS motors in closed loop control.

P2.9.6 *Advanced Options 2* *ID1561* *"AdvancedOptions1"*

- b0 = +1= Reserved
- b1 = +2=Reserved
- b2 = +4=Reserved
- b3 = +8=Reserved
- b4 = +16= Enable Start Positioning damping active if PMSM
- b5 = +32=Reserved
- b6 = +64=Reserved
- b7 = +128=Reserved
- b8 = +256= Current optimization for PMS motor

This function activates the current optimization for PMSM motor based on torque calculation and motor parameters. When activated, the optimization starts after 13 % of the motor nominal speed and below this a normal U/f curve is used. The activation of this selection requires a performed identification with run.

b9 = +512= I/f control for PMS motors

PMS motor can be started with I/f control. Used with high power motor when there is low resistance in motor and U/f is difficult to tune to be stable.

b10 = +1024=Reserved

b11 = +2048=Reserved

b12 = +4096=Reserved

b13 = +8192= Changes automatically depending on Drive Synch operation

b14 = +16384=Reserved

b15 = +32768=Reserved

P2.9.7 *Advanced Options 4* *ID1563* *"AdvancedOptions4"*

b0 =+1= Reserved

b1 = +2=Reserved

b2 = +4=Reserved

b3 = +8=Reserved

b4 = +16= Reserved

b5 = +32=Reserved

b6 = +64=Reserved

b7 = +128=Reserved

b8 = +256=Reserved

b9 = +512=Reserved

b10 = +1024=Reserved

b11 = +2048=Reserved

b12 = +4096=Reserved

b13 = +8192= Reserved

b14 = +16384=Reserved

b15 = +32768=Reserved

P2.9.8 *Advanced Options 5* *ID1564* *"AdvancedOptions5"*

b0 =+1= Reserved

b1 = +2=Reserved

b2 = +4=Reserved

b3 = +8=Reserved

b4 = +16= Reserved

b5 = +32=Reserved

b6 = +64=Reserved

b7 = +128=Reserved

b8 = +256=Reserved

b9 = +512=Reserved

b10 = +1024=Reserved

b11 = +2048=Reserved

b12 = +4096=Reserved

b13 = +8192= Reserved

b14 = +16384=Reserved

b15 = +32768=Reserved

P2.9.9 *Advanced Options 6* *ID1565* *“AdvancedOptions6”*

b0 = +1= Reserved

b1 = +2=Reserved

b2 = +4=Reserved

b3 = +8=Reserved

b4 = +16= Reserved

b5 = +32=To reduce aliasing effects in current measurement, it is possible to take an average from all internal samples taken at fast time level. It must be noted, that this mode does not affect the motor control, only monitoring.

b6 = +64=Reserved

b7 = +128=Reserved

b8 = +256=Reserved

b9 = +512=Reserved

b10 = +1024=Reserved

b11 = +2048=Reserved

b12 = +4096=Reserved

b13 = +8192= Reserved

b14 = +16384=Reserved

b15 = +32768=Reserved

4.4.1 Open Loop Control

P2.6.5.1 U/f ratio selection

Select the U/f ratio in case of open loop control operation.

0 = Linear:

The voltage of the motor changes linearly as a function of output frequency from zero frequency voltage (P2.6.5.2) to the field weakening point (FWP) voltage (P2.1.10) at FWP frequency. This default setting should be used if there is no special need for another setting.

1 = Squared:

The voltage of the motor changes from zero point voltage (P2.6.5.2) following a squared curve form from zero to the field weakening point (P2.1.10). The motor runs undermagnetised below the field weakening point and produces less torque. Squared U/f ratio can be used in applications where torque demand is proportional to the square of the speed, e.g. in centrifugal fans and pumps.

2 = Programmable

The U/f curve can be programmed with three different points: Zero frequency voltage (P2.6.5.2), Midpoint voltage/frequency (P2.6.5.3, P2.6.5.4) and Field weakening point (P2.1.9). Programmable U/f curve can be used if more torque is needed at low frequencies. The optimal settings can automatically be achieved with Motor identification run.

3 = Linear with flux optimisation

The frequency converter starts to search for the minimum motor current in order to save energy and to lower the motor noise. This function can be used in applications such as fans, pumps etc.

P2.6.5.2 U/f zero point voltage

Motor voltage as a percentage of motor nominal voltage at zero frequency reference. This can be set to produce motor current equal to 80...100% of nominal magnetising current at zero frequency reference.

P2.6.5.3 U/f mid point voltage

Motor voltage as a percentage of motor nominal voltage at frequency reference equal to U/f mid point frequency (P2.6.5.4). This can be set as $1.41 \cdot$ U/f zero point voltage (P2.6.5.2).

P2.6.5.4 U/f mid point frequency

Mid point frequency reference in case of programmable U/f curve. This can be set as $(\text{U/f zero point voltage (P2.6.5.2)} \cdot \text{Motor nominal frequency (P2.1.3)}) / 100$.

P2.6.5.5 U/f optimisation

Auto torque boost in case of open loop control operation can be enabled with this parameter.

- 0 None
- 1 Auto torque boost (Auto torque boost is enabled).

It is recommended to enable auto torque boost only if successful ID run is performed during the commissioning.

P2.6.5.6 DC brake speed

This parameter defines a speed limit below which the DC braking is activated in open loop motor control operation.

P2.6.5.7 DC brake current

This parameter defines an amount of current that will be injected into the motor when DC braking is active.

P2.6.5.8 DC brake time

This parameter defines a time in ms for which the DC braking will be active when the speed is below DC brake speed (P2.6.5.6).

P2.6.5.9 Flux brake

Instead of DC braking, flux braking is a useful way to raise the braking capacity in cases where additional brake resistors are not needed. When braking is needed, the frequency is reduced and the flux in the motor is increased, which in turn increases the motor's capability to brake. Unlike DC braking, motor speed remains controlled during braking.

The flux braking can be set ON or OFF.

- 0 = Flux braking OFF
- 1 = Flux braking ON

Note: Flux braking converts the energy into heat at the motor, and should be used intermittently to avoid motor damage.

P2.6.5.10 Flux brake current

Defines amount of the flux braking current when the flux braking is active.

P2.6.5.11 Torque stabilator Kp

Gain for the torque stabilator in open loop motor control operation. The range for the gain value is 0...1000.

P2.6.5.12 Torque stabilator damp TC

Defines the damping rate for the torque stabilator in open loop motor control operation. The range is 0...1000.

P2.6.5.13 Torque stab Kp field weakening point

Gain of the torque stabilator at field weakening point in open loop motor control operation. The range is 0...1000.

P2.6.5.14 Flux stabilator Kp

Gain of the flux stabilator in open loop motor control operation. The range is 0...32000.

P2.6.5.15 Flux stabilator filter time

Filter time in ms for flux stabilator in open loop control operation. The range is 0...32000.

P2.6.5.16 Make flux time

Set the time to magnetise the motor so that enough flux is available while starting to run the motor.

P2.6.5.17 Make flux voltage

Magnetising voltage in percentage of motor nominal voltage.

P2.6.5.18 Measured resistance voltage drop

Measured voltage at stator resistance between two phases at nominal motor current value. This is measured by injecting current into the motor at standstill during ID Run.

P2.6.5.19 Ir Add Zero Point Voltage

Defines how much voltage is applied to motor in zero speed when torque boost is used.

4.4.2 Undervoltage/Overvoltage Control, Stabilator

P2.6.6.1 Undervoltage control

Undervoltage controller can be activated with this parameter.

- 0 Off
- 1 On

The drive corrects the frequency reference internally when the DC link voltage falls below the Undervoltage reference level selected by parameter Undervoltage reference selection (P2.6.6.2). The correction in the frequency reference can be seen in Output frequency (V1.1.1) when under voltage controller is active and the DC link voltage is below the undervoltage ref.

P2.6.6.2 Undervoltage reference selection

Selects the undervoltage reference for the undervoltage controller.

- 0 Undervoltage reference min. Minimum undervoltage reference calculated internally by the drive is used as undervoltage reference.
- 1 0.8 estimated DC nom. 80% of estimated DC nominal voltage is used as undervoltage reference for the undervoltage controller.

P2.6.6.3 Undervoltage Kp

Gain for the P-term of the PI type undervoltage controller.

P2.6.6.4 Undervoltage Ti

Gain for the I-term of the PI type undervoltage controller.

P2.6.6.5 *Overvoltage control*

Overvoltage controller can be activated with this parameter.

0 Off

1 On, no ramp. (Overvoltage controller is P type controller)

2 On with ramp. (Overvoltage controller is PI type controller).

The drive corrects the frequency reference internally when the DC link voltage rises above the overvoltage reference level selected by parameter Overvoltage reference selection (P2.6.6.6). The correction in the frequency reference can be seen in Output frequency (V1.1.1) when over voltage controller is active and the DC link voltage is above the overvoltage reference.

P2.6.6.6 *Overvoltage reference selection*

Overvoltage reference level depending on the status of the brake chopper.

P2.6.6.6 Overvoltage reference selection	Brake chopper in use	Brake chopper is not is use
0	Overvoltage reference maximum calculated internally by the drive	Brake chopper level maximum calculated internally by the drive
1	1.25*Estimated DC nominal voltage	1.18*Estimated DC nominal voltage
2	1.07*brake chopper level	Brake chopper level

Table 33. Overvoltage reference handling

P2.6.6.7 *Overvoltage Kp*

Gain of the P-term of the PI type overvoltage controller. The range is 0...32767.

P2.6.6.8 *Overvoltage Kp additional gain*

Additional gain of the P-term of the PI type overvoltage controller at field weakening point.

P2.6.6.9 *Overvoltage Ti*

Gain for the I-term of the PI type overvoltage controller.

P2.6.6.10 *Voltage stabilator Kp*

Gain for the voltage stabilator. The range is 0...1000.

The function of the voltage stabilator is to stabilise the variations in the DC link voltage caused due to load or incoming supply variations.

P2.6.6.11 *Voltage stabilator TC*

Damping rate for the voltage stabilator. The range is 0...1000.

4.5 **Motor Control****P2.7.1** *Start function*

Selects the motor starting mode.

- 0 Normal ramp. The drive is started from zero reference with the acceleration ramp.
- 1 Flying start. The drive finds the motor speed either from encoder speed in closed loop or by performing a fast test and internal calculation in open loop motor control operation.

During normal running Acceleration time 1 (P2.5.1) is used and in constant speed /inching operation Constant speed acceleration time (P2.5.6) is used.

Please note that in closed loop motor control operation the starting of the motor is always like a flying start independent of the parameter settings.

P2.7.2 *Stop function*

Selects the mode of stopping the motor except in case of emergency stop.

- 0 Coast stop. The motor is allowed to stop with it's own inertia. The drive control is stopped and the drive current is zero as soon as the run request is removed.
- 1 Ramp stop. The motor is stopped by the deceleration ramp time selected.

During normal running Deceleration time 1 (P2.5.2) is used and in constant speed or inching operation Constant speed deceleration time (P2.5.7) is used.

P2.7.3 *Emergency stop mode*

Selects the mode of stopping the drive when emergency stop is active.

- 0 Coast stop. The motor is allowed to stop on its own inertia.
- 1 Ramp stop. The motor is stopped by the deceleration ramp time selected by Emergency stop ramp (P2.5.4).
- 2 Torque limit stop. The speed ramp generator output is forced to zero and the drive is allowed to stop against its torque limits.
- 3 Constant power stop. The deceleration ramp time is internally updated so that the drive stops at constant power if the parameters System inertia (P2.8.12) in Kg.m^2 , Max brake power (P2.8.13) in kW and Max braking torque (P2.8.14) in Nm have been set correctly for the system. This stop mode is used to stop the drive as fast as possible in case of emergency stop when braking is done using limited braking power. It can also be used for coordinated emergency stop for common DC bus drives.

P2.7.4 *Motor control mode*

Selects the motor control mode.

- 0 OL frequency. This is normal U/f control mode without encoder.
- 1 OL speed. This is normal U/f control mode without encoder with slip compensation based on the calculated torque of the motor V1.1.5 Torque.
- 2 OL speed/torque. OL speed or torque control which is current vector control with U and f references without encoder. The configuration is selected with Torque Selection parameter (P2.7.5).
- 3 CL speed/torque. This is rotor flux vector control mode and it needs digital encoder connected to the motor shaft. The configuration is selected with Torque Selection parameter (P2.7.5).

P2.7.5 *Torque selection*

Selects the different configurations possible for speed and torque control when P2.7.4 Motor control mode = 2 or 3.

- 1 Speed. Open or Closed loop speed control. The inertia/friction compensation can be given to Torque step (P2.4.18). The Torque reference source selection (P2.4.8) is internally set to zero (None) to avoid any external torque reference.
- 2 Torque. Open or closed loop torque control. Torque reference source selection (P2.4.8) selects the torque reference source. The torque reference can be Master torque reference (V1.2.16) from the master drive in case of master follower application, Fieldbus torque reference (V1.2.17) from fieldbus or I/O torque reference (V1.2.18) from analogue input.
- 3 Min. In this mode minimum of speed controller output SPC OUT (V1.2.11) and external torque reference is selected as final torque reference Used torque reference (V1.2.22). This is typically used in winder control applications. External torque reference is calculated from the required tension and system parameters like roll diameter, gearbox ratio, web width and motor data. The overspend reference is added to the normal web speed reference.
- 4 Max. In this mode maximum of speed controller output SPC OUT (V1.2.11) and external torque reference is selected as final torque reference, Used torque reference (V1.2.22). This is typically used in unwinder control applications. External torque reference is calculated from the required tension and system parameters like roll diameter, gearbox ratio, web width and motor data. The under speed reference is added to the normal web speed reference.
- 5 Window. The drive is allowed to run in torque control as long as the speed is within the speed window around the speed reference. The speed window is defined by parameters Window positive RPM (P2.9.14) and Window negative RPM (P2.9.15). When the speed is out of window the drive is switch to speed control to correct the error between Used speed reference (V1.2.9) and Speed measured (V1.2.1). The drive remains in the speed control till the speed measured falls in a window around the speed reference. The hysteresis for the window is defined by parameters Window off positive (P2.9.16) and Window off negative (P2.9.17).

P2.7.6 *Current control Kp*

Gain for the current controller in closed loop motor control operation. Range 1...10000. Please note that in normal cases the default value is sufficient and there is no need to change this parameter.

P2.7.7 *Current control Ti*

Integral time constant for the current controller in closed loop motor control operations. Range 0...100.0 ms. Please note that in normal cases the default value is sufficient and there is no need to change this parameter.

P2.7.8 *Switching frequency*

Switching frequency in KHz for the IGBTs for the motor control. Please note that the default value is decided by the drive depending on the power size of the drive. For all the drives with 690V supply voltage the maximum switching frequency is 1.5KHz. The switching frequency can be reduced in case of long motor cables (100m for <1.5kW and 300m for >1.5kW) or very small motors.

P2.7.9 *Dynamic damp Kp*

Dynamic damping gain when Torque select (P2.7.5) is either Torque/Min/Max/Window. The value 1.00 means nominal torque for nominal speed difference. Dynamic damping is intended to reduce mechanical resonance by adding damping torque proportional to speed error.

P2.7.10 *Dynamic damp TC*

Decaying time for damping torque in ms.
0= Static damping.

P2.7.11 *DC magnetisation current*

This parameter can be set to quickly magnetise the motor during starting. DC current amount set by this parameter is injected into the motor windings.

P2.7.12 *DC magnetisation time*

The DC magnetisation current set by P2.7.11 is injected into the motor for this time. The speed reference to the ramp generator is then released.

P2.7.13 *Start 0 speed time*

Time delay to release the speed reference to the ramp generator after a run request is given to the drive.

P2.7.14 *Stop 0 speed time*

Time for which the zero speed reference is applied to the drive after ramp stop.

P2.7.15 *Stop state flux*

Amount of a flux, as a percentage of motor nominal flux, maintained in the motor after the drive is stopped. The flux is maintained for the time set by Flux off delay (P2.7.16). This parameter can be used only in closed loop motor control operation.

P2.7.16 *Flux off delay*

The flux defined by Stop state flux parameter (P2.7.15) is maintained in the motor for the time defined with this parameter, after the drive is stopped.

0 No flux after the motor is stopped. Normal stop.

>0 The flux off delay in seconds.

<0 The flux is maintained in the motor after stop till the next run request is given to the drive. After the run request the flux is equal to the Flux reference (P2.4.15).

P2.7.17 *Motor temperature compensation*

Two PT100 temperature sensors can be connected by using analogue inputs AI1 and AI2 and analogue output AO1 (10mA) and they are referred as PT100 (1) and PT100 (2). One of the sensors is used normally to measure the motor winding temperature. This measured temperature can be used to compensate the slip adjust (P2.9.18) internally. This is needed to adjust the motor model for the variation in rotor time constant as a function of temperature to acquire better torque accuracy.

This parameter selects the temperature sensor to be used for compensation.

0 Compensation of slip adjust is not used.

- 1 Motor temperature for the slip adjust compensation is read from PT100 (1) sensor.
- 2 Motor temperature for the slip adjust compensation is read from PT100 (2) sensor.
- 3 Internally calculated compensation

The function work as follows:

For e.g. If Slip adjust (P2.9.18) is set to 100% and Motor temperature compensation (P2.7.17) = 1 (Compensation from PT100(1)sensor).

Internal slip adjust = $[(PT100 (1) \text{ Temp. in celsius} * 40)/100+60] * \text{Slip adjust (P2.9.18)} / 100$.

For temperature varying from 25 to 100 degrees celsius the slip adjust will vary internally from 70 to 100 %.

P2.7.18 Modulation Index

Modulation index in % for open loop operation. Higher value of motor terminal voltage can be achieved by increasing this value.

4.6 PMSM Control

The parameters in this group can be adjusted only when permanent magnet motor is used.

P2.7.18.1 Flux control Kp

Gain for the flux current controller in %. It can be adjusted if instability near or in the field weakening area is observed.

P2.7.18.2 Flux control Ti

Integral time constant for flux current controller in ms.

P2.7.18.3 Resistance identification

Stator resistance identification can be done during every start by enabling this parameter.

P2.7.18.4 Modulation index

Modulation index in % for closed loop operation. Higher value of motor terminal voltage can be achieved by increasing this value.

P2.7.18.5 Encoder angle offset

Low word of absolute encoder angle corresponding to shaft zero position is indicated in this parameter. This parameter is identified during ID Run =3 when absolute encoder is used with PMSM motor. This parameter is only for monitoring and back up purposes and should not be changed manually.

P2.7.18.6 Encoder zero position identification mode

- 0 = Automatic
- 1 = Forced
- 2 = On Power UP

*P2.7.18.7 Start positioning current**P2.7.18.8 Polarity pulse current**P2.7.18.9 Measured Ls voltage drop* *ID673* **"LsVoltageDrop"**

Leakage inductance voltage drop with nominal current and frequency of the motor. This parameter defines the Ls voltage drop between two phases. Use identification run to determine the optimum setting.

P2.7.18.10 Motor BEM Voltage *ID674* **"Motor BEM Voltage"**

Motor-induced back voltage.

P2.7.18.11 Estimator Kp *ID1782* **"Estimator Kp"**

Estimator gain for PMS motor. Identified during identification run.

4.7 Limit Settings*P2.8.1 Zero speed level*

This parameter defines a zero speed level. When the speed goes below this level, the bit 11 of the auxiliary status word is set.

P2.8.2 Zero speed monitoring

This parameter defines if the Zero speed level is compared to the speed ramp out value (V1.2.7) or to actual speed (V1.1.2).

0 Speed ramp out

1 Speed Actual. In case of open loop motor control operation it is calculated motor speed and in case of closed loop motor control operation it is speed measured from the encoder.

P2.8.3 Speed maximum

Defines a maximum speed limit for the drive.

P2.8.4 Speed minimum

Defines a minimum speed limit for the drive.

P2.8.5 Current limit

Defines a current limit of the drive. The default value of this parameter depends on the power size of the drive.

P2.8.6 Motoring torque limit

Motoring side torque limit of the drive as a percentage of the motor nominal torque.

P2.8.7 *Generator torque limit*

Generator side torque limit of the drive as a percentage of the motor nominal torque.

P2.8.8 *Speed controller out max*

Maximum torque limit for the speed controller output as a percentage of the motor nominal torque.

P2.8.9 *Motoring power limit*

Power limit for the motor side operation as a percentage of nominal power of the motor.

P2.8.10 *Generator power limit*

Power limit for the generator side operation as a percentage of nominal power of the motor.

P2.8.11 *Pullout torque*

Amount of maximum torque (breakaway torque) the motor can produce. It is set as a percentage of motor nominal torque.

P2.8.12 *System inertia*

Inertia of the complete drive system in Kg.m² including inertia of motor, gearbox and fixed load. This parameter is set when Emergency stop mode (P2.7.3) has been set "3 = Constant power stop".

P2.8.13 *Max brake power*

Maximum braking power limit in kW in case of emergency stop when Emergency stop mode (P2.7.3) has been set "3 = Constant power stop".

P2.8.14 *Max braking torque*

Maximum braking torque in case of emergency stop when Emergency stop mode (P2.7.3) has been set "3 = Constant power stop".

4.8 Speed control

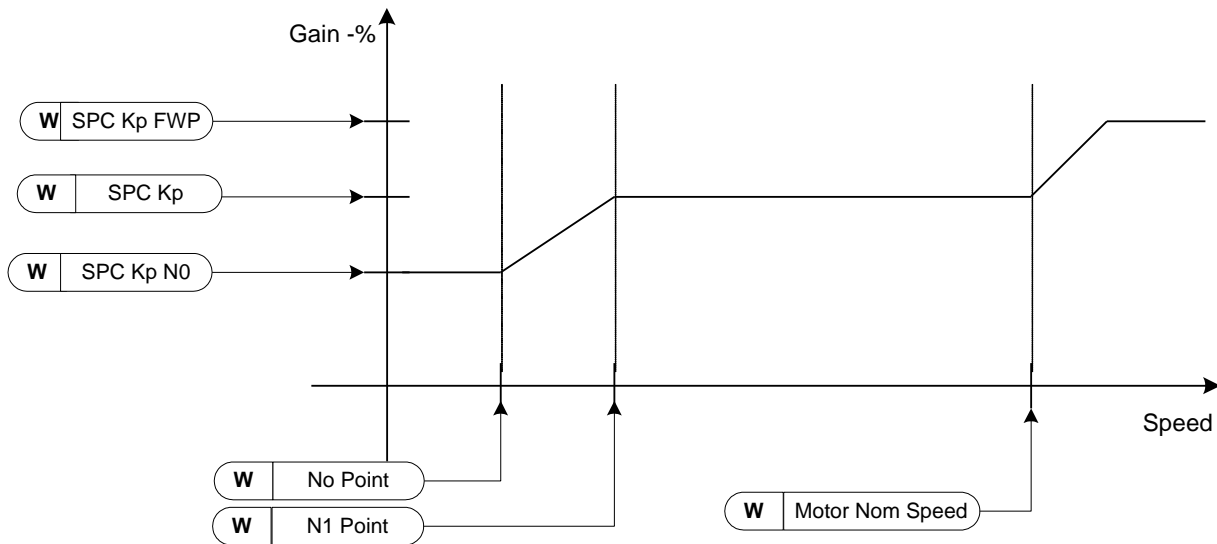

Figure 1. Speed controller adaptive gain

The transfer function for the speed controller is as given below.

$$\text{SPC OUT}(k) = \text{SPC OUT}(k-1) + \text{SPC Kp} * [\text{Speed Error}(k) - \text{Speed Error}(k-1)] + \text{Ki} * \text{Speed error}(k).$$

Where $\text{Ki} = \text{SPC Kp} * \text{Ts} / \text{SPC Ti}$.

P2.9.1 Speed controller Kp

Gain for the speed controller in closed loop motor control operation. Gain value 100 means nominal torque reference is produced at the speed controller output for the frequency error of 1Hz.

P2.9.2 Speed controller Ti

Integral time constant in ms for the speed controller in closed loop motor control operation.

P2.9.3 Kp Min

Relative gain as a percentage of SPC Kp (P2.9.1) of the speed controller when torque reference or speed control output (V1.2.11) is less than Min point (P2.9.4). This parameter is normally used to stabilise the speed controller for a drive system with gear backlash.

P2.9.4 Min point

Level of torque reference or speed controller output (V1.2.11) below which the speed controller gain is changed to Kp Min (P2.9.3) through a filter set by Min filter time (P2.9.5). This is in percentage of motor nominal torque.

P2.9.5 Min filter time

Filter time in ms. Used when the speed controller gain is changed from SPC Kp (P2.9.1) to Kp Min (P2.9.3).

P2.9.6 *Speed controller Kp field weakening point*

Relative gain of the speed controller in field weakening area as a percentage of SPC Kp (P2.9.1).

P2.9.7 *Speed controller Kp N0*

Relative gain of the speed controller as a percentage of SPC Kp (P2.9.1) when the speed is below the level defined by N0 Point (P2.9.8).

P2.9.8 *N0 point*

The speed level in rpm below which the speed controller gain is SPC Kp N0 (P2.9.8).

P2.9.9 *N1 point*

The speed level in rpm above which the speed controller gain is SPC Kp (P2.9.1). From speed defined by N0 point (P2.9.8) to speed defined by N1 Point (P2.9.9), the speed controller gain changes linearly from SPC Kp N0 (P2.9.7) to SPC Kp (P2.9.1) and vice versa.

P2.9.10 *Mech acceleration compensation TC*

Sets the inertia compensation to improve speed response during acceleration and deceleration. The time is defined as acceleration time to nominal speed with nominal torque. Used when inertia of the system is known to achieve best speed accuracy when reference is changed.

$$\text{AccelCompensationTC} = J \cdot \frac{2\pi \cdot f_{\text{nom}}}{T_{\text{nom}}} = J \cdot \frac{(2\pi \cdot f_{\text{nom}})^2}{P_{\text{nom}}}, \text{ where}$$

J = total system inertia in kg*m²

f_{nom} = motor nominal frequency in Hz

T_{nom} = motor nominal torque.

P_{nom} = motor nominal power in kW.

Please note that fixed inertia like Σ(motor inertia, gear box inertia, basic roll inertia) only can be compensated with this parameter. Variable load inertia, like inertia of winder or unwinder, can be compensated by the overriding system through fieldbus.

P2.9.11 *Acceleration compensation filter time*

Filter time constant in ms for the mechanical inertia compensation.

P2.9.12 *Load drooping*

Load drooping as a percentage of nominal speed at nominal torque. Load drooping allows the static speed error as a function of a load torque. For e.g. If Load drooping is set as 10% then for 100% motor torque the drive allows actual speed less than 10% of the nominal speed of the motor. It can be used to smoothen the load torque variation or also to share the load torque between the two drive systems when coupling between drive systems is not rigid.

P2.9.13 *Drooping time*

Load drooping time in ms. When the time is set to zero, the drooping is used as static or continuous drooping. Any non-zero value activates the dynamic drooping and is active for the time specified.

P2.9.14 *Window positive RPM*

This parameter is required to set when Torque select (P2.7.5) = 5. It defines the window area above the speed reference in rpm. The drive remains in torque control as long as speed is within the window area. For the speed out of the window area, the drive is switched to a speed control to correct the error between speed reference and speed measured.

P2.9.15 *Window negative RPM*

This parameter is required to set when Torque select (P2.7.5) = 5. It defines the window area below the speed reference in rpm. The drive remains in torque control as long as speed is within the window area. For the speed out of the window area the drive is switched to a speed control to correct the error between speed reference and speed measured.

P2.9.16 *Window off positive*

This parameter is required to set when Torque select (P2.7.5) = 5. It defines speed controller positive off limit when the speed controller brings speed back to window.

P2.9.17 *Window off negative*

This parameter is required to set when Torque select (P2.7.5) = 5. It defines speed controller negative off limit when the speed controller brings speed back to window.

P2.9.18 *Slip adjust*

This parameter can be tuned to compensate the inaccuracies in the motor nominal speed data on the motor nameplate. Also the Rotor time constant (V1.2.36), estimated by the motor model, can be adjusted with this parameter. The rotor time constant varies with the motor temperature.

The compensation for the rotor time constant, as a function of measured motor temperature using either TS1 or TS2 (PT100 temperature sensor), can be given by setting Motor temperature compensation (P2.9.26.1). The Slip adjust is then internally modified as a function of measured motor temperature.

P2.9.19 *Speed error filter time*

Filter time in ms for the speed error between Used speed reference (V1.2.9) and Speed measured (V1.2.1). The filtered error is then fed to the speed controller.

P2.9.20 *Actual speed filter time*

Filter time in ms for the speed measured from the encoder. The filtered speed is used to calculate a Speed error (V1.2.10), which is fed to the speed controller.

P2.9.21 *Speed error Low Pass filter*

Speed error low pass filter cut-off frequency.

P2.9.22 AntiSwing Low Pass TC

Lowpass time constant for second order AntiSwing low pass filter to reduce swinging and/or speed overshoot.

P2.9.23 AntiSwing Gain

Gain for AntiSwing function in % to optimize step response. 100% is optimal there is low damping. Lower value can be used to optimize normal speed controller step response.

P2.9.24 AntiSwing TC

Swinging time constant in ms for AntiSwing control to reduce swinging and / or speed overshoot.

P2.9.25 Speed controller P gain, Open Loop ID637 "OL Speed Reg P"

Defines the P gain for the speed controlled in Open Loop control mode.

P2.9.26 Speed controller I gain, Open Loop ID638 "OL Speed Reg I"

Defines the I gain for the speed controlled in Open Loop control mode.

P2.9.27 Load Drooping Removal ID1534 "LoadDroopRemoval"

This function defines how load drooping is removed with reference to speed. It is used in lifting situations when it is necessary to keep to load at the same position without closing the brake. When using option 'Normal' the load will slowly come down depending on load and the drooping factor.

Normal

0 Load Drooping factor is constant through the whole speed range.

Removed below zero frequency limit

1 Load drooping is removed linearly below the zero frequency limit (defined in P2.8.1 Zero Speed Level).

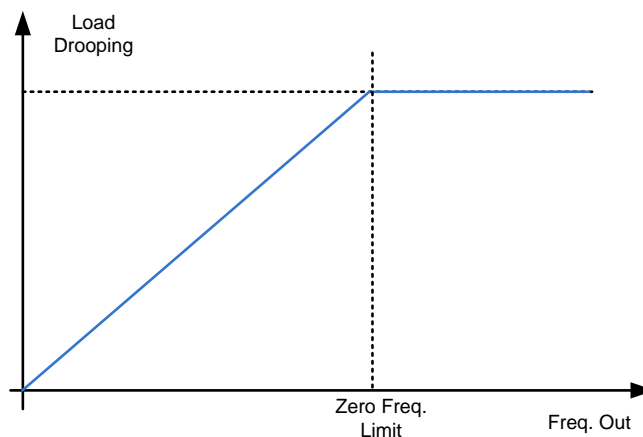

Linearly increased to nominal frequency

2 Load drooping is removed linearly from nominal frequency to zero frequency.

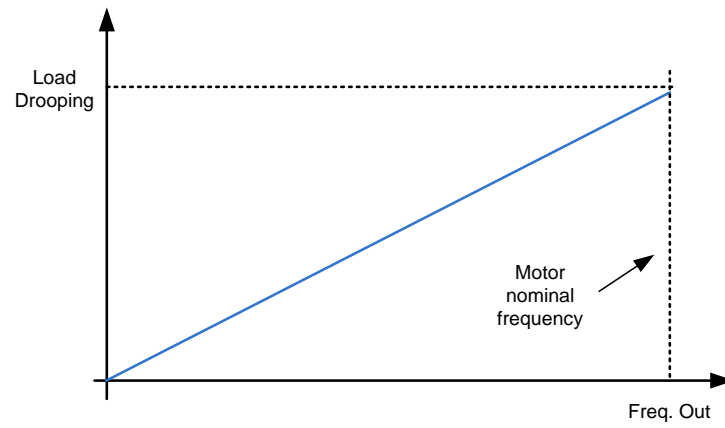

4.9 Oscillation Damp

P2.10.1 Oscillation damp selection

Oscillation damping feature of the drive can be enabled using this parameter. This feature can be used to dampen the constant frequency torque oscillations in the drive system.

- 0 Not in use
- 1 Band pass. Oscillation damping with band pass filter.
- 2 BandStop+BandPass. Oscillation damping with band stop and band pass filter.

P2.10.2 Oscillation frequency

Frequency of torque oscillations to be damped in Hz.

P2.10.3 Oscillation damp gain

The gain for the oscillation damping. This changes amplitude of the compensating signal used for oscillation damping.

P2.10.4 Phase shift

The compensating signal used for oscillation damping can be phase shifted 0 to 360 degrees using this parameter.

4.10 Brake and fan control

P2.11.1 Brake in fault

Defines the action of the mechanical brake controlled through drive in case of fault in the drive.

- 0 At zero speed. The mechanical brake is closed at zero speed after a fault in the drive.
- 1 Immediate. The brake is closed immediately after a fault in the drive.

P2.11.2 Brake in emergency stop

Defines the action of the mechanical brake controlled through drive in case of emergency stop.

- 0 At zero speed. The mechanical brake is closed at zero speed after the emergency stop has been activated.
- 1 Immediate. The brake is closed immediately after the emergency stop has been activated.

P2.11.3 Brake Open Limit

Defines speed limit when brake mechanical delay time has not pass or feedback signal from the brake has not come.

P2.11.4 Brake Close Limit

Defines speed limit when brake will be closed if run request command has been removed.

P2.11.5 Brake fault delay

Delay in receiving the feedback from the mechanical brake after giving a brake open request from the digital/relay output. The speed reference is not released till the brake lift is acknowledged.

If the brake lift acknowledgement does not come within the Brake lift delay time then the drive trips on F57 Mechanical brake.

P2.11.6 Brake mechanical delay

After brake open command is given, speed reference in hold for a defined time. This hold time should be set corresponding to the mechanical brake reaction time. This function is used to avoid current and/or torque spikes.

P2.11.7 Brake On/Off current limit

If motor current falls below this value the brake is closed immediately. It's recommended to set this values to be about half of magnetization current.

P2.11.8 Motor fan off delay

The external fan can be controlled by setting digital or relay output parameters. The fan is started with the run request and stopped when the motor is stopped and the Motor fan off delay time has been elapsed.

4.11 Master Follower

The Master/Follower function is designed for applications in which the system is run by several NXP drives and the motor shafts are coupled to each other via gearing, chain, belt etc. The NXP drives are in closed loop control mode.

The external control signals are connected to the Master NXP only. The Master controls the Follower(s) via a System bus. The Master station is typically speed-controlled and the other drives follow its torque or speed reference.

Torque control of the Follower should be used when the motor shafts of the Master and Follower drives are coupled solidly to each other by gearing, a chain etc., so that no speed difference between the drives is possible.

Speed control of the Follower should be used when the motor shafts of the Master and the Follower drives are coupled flexibly to each other, so that a slight speed difference between the drives is possible. When both the Master and Followers are speed-controlled, drooping is also typically used.

P2.12.1 M/F mode

When a drive is required to be configured in master follower application this parameter is set.

0 None. Drive runs as individual drive.

- 1 Master. Drive runs as a master.
- 2 Follower. Drive runs as follower and share speed, torque or both from the master drive. When the drive is controlled from fieldbus (P2.6.1 = 0), the Main control word (V1.2.34) from the fieldbus is used for controlling the drive. When a Control place (P2.6.1) is 1 = I/O or 2 = Local (Keypad) or 3 = PC Control, the follower drive is controlled by the internal control word from the master drive on the system bus. The follower drive then starts running with the master drive.
- 3 = "DSynchMaster" - Drive Synch Master
Drive number 1 must be selected as the parallel drive configuration master (in redundancy mode drive number 2 can be selected as master but certain diagnostic functions are no longer available).
- 4 = "DSynchFlwr" - Drive Synch Follower
Selection for parallel drive configuration follower drive

P2.12.2 Follower speed reference

Sets the source of speed reference for the follower drive. This parameter is to be set only in the follower drive.

- 0 Follower. Speed reference is generated in the follower drive itself depending on active control place as per Control place parameter (P2.6.1).
- 1 Master reference. Speed reference is taken from master drive's Speed reference 1 (V1.2.4).
- 2 Master ramp. Speed reference is taken from master drive's Used speed reference (V1.2.9). The ramp generator of the follower drive is then bypassed internally.

The parameter settings for the master and follower drives are to be done as per Table 34.

P2.12.3 Follower start delay

The delay time in starting multiple wind follower after the master has been started. As the name suggests, the parameter is valid only if the drive is defined as a follower.

P2.12.4 Follower drive winding phase shift ID1518 "FollPhaseShift"

Windings phase shift between master and follower drive. Used with drive synch operation when the motor has multiple windings.

Parameter	Master	Follower	Remarks
P2.12.1 M/F Mode	1 Master	2 Follower	Sets the MF -mode
P2.7.4 Motor Control mode	= 0 OL Freq = 1 OL Speed = 3 CL Speed/Torq		If set = 0/1 then only speed follower is possible.

P2.7.5 Torque Select		0= None 1= Speed 2 = Torque 3 = Min 4 = Max 5 = Window	To be set as per the application requirement.
P2.4.8 TRef Source Sel		0 = None	External torque reference is not used.
		1 = Master	Torque reference from the master drive.
		2 = Fieldbus	Torque reference from the fieldbus.
		3 = Analogue I/P	Torque reference from the analog I/P 1 or 2.
		4 = Master SPC	Torque reference from master without accel. compensation
P2.12.2 Follower SpRef			This parameter is to be set only in follower drive.
		0 = Follower	Speed reference is generated in the follower drive itself depending on active control place as per P2.6.1 Control Place.
		1 = Master Ref	Speed reference is taken from master drive V1.2.4 Speed Reference 1.
		2= Master Ramp	Speed reference is taken from master drive V1.2.9 Used Speed Ref. The ramp generator of the follower drive is then bypassed internally.
If System software <NXP00002V134	If system software >= NXP00002V134	For system software less than NXP00002V134 the speed is always selected as 12Mbps. For system software greater than equal to NXP00002V134	System software less than NXP00002V134 do not show the parameters for NXOPTD2 card in M7 Expander Boards menu.
P2.12.2 SB Node ID	P7.4.1.2.3 System bus Id		Node ID no. for the master drive. Possible values are 1...63.
P2.12.3 SB Next Node ID	P7.4.1.2.4 System bus NextId		Node ID for the next drive in the master follower communication. Possible values are 1...63.
	P7.4.1.2.1 System bus in use =1		For system software less than NXP00002V134 this signal is internally set to 1 if P2.12.2 and P2.12.3 are non-zero.
	P7.4.1.2.2 System Bus speed		

Table 34. Master Follower parameters

4.12 Protections

P2.13.1 AI<4mA

Action in case of Analogue input fault. If the voltage or current at the analogue input terminal is less than a minimum value specified by AI1 Minimum (P2.2.2.9) and AI2 Minimum (P2.2.2.13), analogue input fault is triggered.

0 No action.

1 Warning. Drive operation continues with F50 AnI_g Lin<4mA. Alarm word 1 Bit9 is set.

- 2 Fault. Drive trips on fault F50 Anlg Lin<4mA and Fault Word 1 Bit15 is set.

P2.13.2 Panel communication

Action in case of loss of communication between drive control unit and keypad.

- 0 No action.
- 1 Warning. Drive operation continues with F52 Keypad communication warning and Alarm word 1 Bit15 is set.
- 2 Fault. The drive trips if Control Place (P2.6.1) = 2 (Local) i.e. if the drive is running from keypad and Fault Word 1 Bit11 is set.

P2.13.3 External fault

Action when an external fault is activated by a digital input.

- 0 No action.
- 1 Warning. Drive operation continues with F51 External fault warning.
- 2 Fault. The drive trips on F51 External fault with fault Word 2 Bit6 is set.

P2.13.4 Input phase supervision

Action in case of loss of one or more input phases of the frequency converter.

- 0 No action.
- 1 Warning. Drive operation continues with F10 Input phase warning and Alarm word 1 Bit3 is set.
- 2 Fault. Drive trips with F10 Input phase fault and Fault Word 1 Bit8 is set.

P2.13.5 Output phase supervision

Action in case of loss of one or more output phases connected between drive output and motor.

- 0 No action.
- 1 Warning. Drive operation continues with warning F11 Output phase and Alarm word 1 Bit4 is set.
- 2 Fault. Drive trips on F11 Output phase and Fault word 2 Bit0 is set.

Please note that this protection cannot find the loss of motor connection in case of multimotor connection to one drive output.

P2.13.6 Earth fault

Action in case of Earth fault in the motor or motor cables.

- 0 No action
- 1 Fault. Drive trips on F3 Earth fault and Fault Word 1 Bit4 is set.

P2.13.7 Earth fault current

If the sum of the motor phase currents is higher than the level set by this parameter, earth fault is triggered and the action is taken as per the setting of Earth fault (P2.13.6) and Earth fault delay (P2.13.8). The typical value for earth fault current monitoring is 5% of drive nominal current (V1.1.17).

P2.13.8 Earth fault delay

Earth fault is triggered if sum of motor phase currents remain higher than the level set by Earth fault current (P2.13.7) for the time set by this parameter.

P2.13.9 Motor stall

Action in case of a motor stall condition. Motor is in stall condition if the motor current is higher than the level set by Stall current (P2.13.10) and output frequency is less than Stall frequency limit (P2.13.11) and motor remains in this condition for a time defined by Stall time limit (P2.13.12).

- 0 No action.
- 1 Warning. The drive continues operation with F15 Motor stall warning and Alarm Word1 Bit0 is set.
- 2 Fault. The drive trips on F15 Motor stall and Fault Word 1. Bit3 is set.

P2.13.10 Stall current

The current level in amperes for monitoring the stall condition of the motor.

P2.13.11 Stall frequency limit

The output frequency level below which monitoring of motor stall condition is active.

P2.13.12 Stall time limit

If a motor remains in stall condition defined by Stall current (P2.13.10) and Stall frequency limit (P2.13.11) for a time defined by this parameter then motor stall fault is triggered.

P2.13.13 Thermistor

This parameter sets the action by the drive in case of motor over temperature through thermistor.

- 0 No action
- 1 Warning. The drive continues its operation with warning F61 Thermistor and Alarm word 1 Bit1 is set.
- 2 Fault. Drive trips on fault F61 Thermistor and Fault word 1 Bit7 is set.

P2.13.14 Encoder fault

The action in case of loss of encoder signal when a drive is running in closed loop control. The drive generates fault or alarm F43 Encoder and Fault Word 2 Bit2 is set if the encoder connected to the drive is faulty or wrongly connected.

- 0 No action
- 1 Warning
- 2 Fault
- 3 Warning

This is used in OL speed control when encoder information is used for slip compensation. When encoder signal is lost drive will give warning and disabled encoder information slip compensation. This function is activated in Control Options.

Following are the sub codes generated with the fault in different fault conditions.

Sub code 1. Channel A is missing

Sub code 2. Channel B is missing
 Sub code 3. Both channels are missing
 Sub code 4. Encoder reversed
 Sub code 5. Card is missing

P2.13.15 Mechanical brake fault

Mechanical brake fault monitoring is automatically enabled if Mechanical brake acknowledgement (P2.2.1.5) is (non zero), set to 1...6 (DIN1...6).

The brakes are lifted through the digital/relay output when a run request is given and 70% of motor flux is generated (only in closed loop motor control operation). If the brake lift acknowledgement will not arrive to selected digital input within time specified by Brake lift delay (P2.11.1), the mechanical brake fault is triggered and drive takes action as per the setting of this parameter.

- 1 Warning. Drive continues operation with warning F57 Mech. brake and Alarm Word 1 Bit14 is set.
- 2 Fault. Drive trips on F57 Mechanical brake and Fault word 2 Bit10 is set.

P2.13.16 Follower timeout

This parameter is set in case of master follower application. The parameter is to be set only in follower drives. The master drive sends a watchdog (1 second ON/OFF square wave) to the follower drive. If the follower drive does not receive the watchdog signal for a time defined by this parameter, the drive trips on fault F55 Follower communication and Fault word 1 Bit13 is set. This indicates that the follower drive has lost the communication with master drive.

Please note that this fault is detected only in follower drive.

P2.13.17 Fieldbus watchdog delay

Delay time to indicate a loss of data on a fieldbus from an overriding system. The overriding system sends a watchdog signal (square wave of 1 second time period) at Main control word Bit11. If the drive does not receive this signal for a time defined by this parameter, the drive trips on fault F53 Fieldbus communication and Fault word 1 Bit12 is set. The fault occurs only if Control place (P2.6.1) = 0 (Fieldbus) i.e. the drive is controlled from fieldbus.

The same watchdog signal is sent back to the overriding system at Main status word Bit15.

Setting this parameter to zero will disable this watchdog monitoring function. In addition to this, the fieldbus option card monitors communication with the fieldbus master. In case of loss of communication with the master, the drive trips on F53 Fieldbus communication fault.

P2.13.18 PT100 number in use

If you have a PT100 input board installed in your frequency converter you can choose here the number of PT100 inputs in use. See also the Vacon I/O boards manual.

Note: If the selected value is greater than the actual number of used PT100 inputs, the display will read 200°C. If the input is short-circuited the displayed value is -30°C.

- 0 = Not used
- 1 = PT100 input 1
- 2 = PT100 input 1 & 2
- 3 = PT100 input 1 & 2 & 3

4 = PT100 input 2 & 3

5 = PT100 input 3

P2.13.19 PT100 alarm limit

Two PT100 temperature sensors can be connected to the drive by using two analogue inputs AI1 and AI2 and analogue output AO1 (10mA). These two sensors are referred as PT100 (1) and PT100 (2). PT100 sensors can also be connected by using OPT-B8 card.

This parameter sets the temperature level in Celsius above which the drive generates the warning F56 PT100 temperature. The drive continues its operation and Alarm word 1 Bit1 is set. Note that the alarm limit is common for all PT100 sensors connected to the system.

P2.13.20 PT100 fault limit

This parameter sets the temperature level in Celsius above which the drive trips on fault F56 PT100 temperature and Fault word 1 Bit7 is set.

P2.13.21 Motor calculated temperature protection

Drive has internal temperature calculation for the motor based on motor data and setting of Thermal time constant (P2.13.22), Zero speed cooling (P2.13.23) and Motor duty cycle (P2.13.24). The calculated motor temperature can be seen in monitor value V1.1.12 as a percentage of motor nominal temperature. The overheating of the motor is monitored by this function. This parameter sets the action in case of motor overheating triggered by the calculated motor temperature.

- 0 No action
- 1 Warning. The drive continues operation with warning F16 Motor overtemperature and Alarm word1 Bit1 is set.
- 2 Fault. Drive trips on F16 Motor overtemperature and Fault word 1 Bit7 is set.

P2.13.22 Thermal time constant

This time can be set between 1 and 200 minutes.

This is the thermal time constant of the motor. The bigger the motor, the bigger the time constant. The time constant is the time within which the calculated thermal stage has reached 63% of its final value.

The motor thermal time is specific to the motor design and it varies between different motor manufacturers. The default value varies from size to size.

If the motor's t_6 -time (t_6 is the time in seconds the motor can safely operate at six times the rated current) is known (given by the motor manufacturer), the time constant parameter can be set based on it. As a rule of thumb, the motor thermal time constant in minutes equals to $2 \times t_6$. If the drive is in stop stage the time constant is internally increased to three times the set parameter value. The cooling in the stop stage is based on convection and the time constant is increased.

P2.13.23 Zero speed cooling

Defines the cooling factor at zero speed in relation to the point where the motor is running at nominal speed without external cooling. The default value is set assuming that there is no external fan cooling the motor. If an external fan is used this parameter can be set to 90% (or even higher).

P2.13.24 Motor duty cycle

Motor duty cycle for internal motor temperature calculation.

Setting value to 130% means that the nominal temperature will be reached with 130% of motor nominal current.

P2.13.25 Underload protection

Action in case of underload condition. The drive is in underload condition if the load is less than the minimum load defined by the parameters Speed zero load (P2.13.26), Speed nominal load (P2.13.27) and Underload speed nominal (P2.13.28).

- 0 No action
- 1 Warning. Drive continues operation with F17 Motor underload warning and Alarm word1 Bit2 is set.
- 2 Fault. Drive trips on F17 Motor underload fault and Fault word 1 Bit5 is set.

P2.13.26 *Speed zero load*

Load level for underload monitoring at zero speed as a percentage of motor nominal torque.

P2.13.27 *Speed nominal load*

Load level for underload monitoring for speed up to nominal speed defined by Underload speed nominal (P2.13.28).

P2.13.28 *Underload speed nominal*

Speed limit below which the underload function is activated.

P2.13.29 *Auto reset word 1*

Select faults that you want to auto reset. Fault situation is reset three times before actual fault signal is given.

B0 +1 = Reserved

B1 +2 = Reserved

B2 +4 = Auto Reset Under Voltage Fault

P2.13.30 *Fieldbus communication fault response*

0 = No Action

No action in case on Fieldbus communication fault. Note: Some Fieldbus board may stop the drive even if no response is selected.

1 = Warning

2 = Warning; Previous Frequency

Only for profibus, drive will run with the previous reference value

3 = Warning; Preset Freq.

Only for profibus, drive will run with the P2.13.32 reference value

4 = Fault

P2.13.31 *Fieldbus communication fault delay*

When using Fieldbus response selections 2 and 3 this time defines delay when fault is activated. Setting this time to zero drive will stay running until communication is established or other means are used to stop the drive.

P2.13.32 *Fieldbus communication fault preset speed*

Speed that is used when Fieldbus communication fault response is 3.

P2.13.33 *Encoder fault Iq limit*

Defines Iq limit when encoder fault is triggered. Used when torque, power or current limit is set to below motor nominal values.

P2.13.34 Encoder fast fault frequency limit

Drive has a two encoder fault detection time. on lower speed time delay is 1000 ms and with higher speed time delay is 200 ms. With this parameter frequency limit for 200 ms detection can be defined.

P2.13.35 Parameter lock

Parameter lock function for all parameters.

Note: password parameter lock function (P6.5.1 and P6.5.2) is not supported by system interface application.

The Speed error monitoring function compares the encoder frequency and the ramp generator output. The function is used with a PMS motor to detect if the motor is off synchronization or to disable the open loop function using the encoder speed for slip compensation. The slip compensation is disabled regardless of the response and needs to be re-activated once a speed error is detected (set parameter again or power down the drive).

P2.11.4.1 Speed error fault function ID752 "Speed Error Mode"

Defines the fault function when the speed reference and the encoder speed are above the set limits.

0 = No response

1 = Warning

2 = Fault, stop mode after fault always by coasting

P2.11.4.2 Speed error maximum difference ID753 "SpeedErrorLimit"

Defines the limit when fault situation is noted. The difference between the speed reference and the encoder speed. Percentage value is in relation to motor nominal frequency.

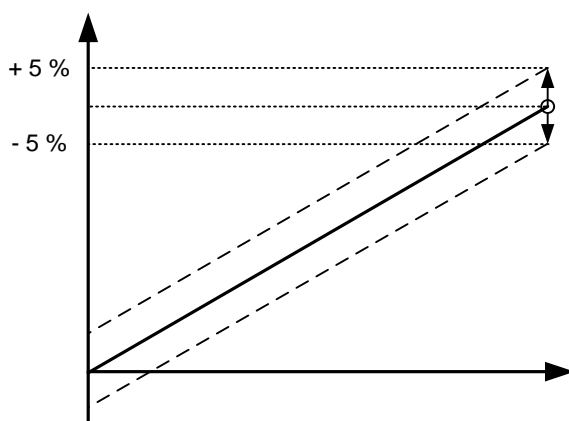
**P2.11.4.3 Speed error delay ID754 "Speed Fault Delay"**

Defines the delay after which a speed error is considered as a fault.

When used to disable open loop slip compensation based on encoder frequency it is recommended to set this time to zero to avoid a speed jump at the time of encoder malfunction.

4.13 Flux Reference Handling

This parameter group is used in closed loop motor control operation to set the flux linearization curve of the motor. If identification run will be made with motor running (P2.1.11 = 2), the parameters in this group are automatically set. These parameters can also be set when flux linearization curve of the motor is done manually as explained below.

Note: There should not be any load connected to the drive including gearbox while doing this test.

1. Set Torque select (P2.7.5) = 1 i.e. Speed control.
2. Set Flux reference (P2.4.16) = 100.0%.
3. Monitor the signals Current (V1.1.4), Motor voltage (V1.1.7) and Output frequency (V1.1.1).
4. Run the motor with 50% of the nominal motor speed.
5. Note the value of the Motor voltage (V1.1.7) → (V100).
6. While keeping the speed reference constant, change Flux reference (P2.4.16) to 90.0% and note the value of Motor voltage (V1.1.7) → (V90).
7. Set Flux curve 9 (P2.14.9) = $(V90/V100) * 100$.
8. Reduce the Flux reference (P2.4.16) in steps of 10% as 80%, 70%,.....,30% and note the value of Motor voltage (V1.1.7) as V80,V70, ...,V30 respectively.
9. Set the values of Flux curve 8 (P2.14.8), Flux curve 7 (P2.14.7),..., Flux curve 3 (P2.14.3) calculating in the same way as in step 7.
10. Repeat previous step by changing Flux reference (P2.4.16) to 110%,120%,130% and note down Motor voltage (V1.1.7) as V110,V120,and V130 respectively.
11. Set Flux curve 11 (P2.14.11), Flux curve 12 (P2.14.12) , Flux curve 13 (P2.14.13) calculating in the same way as in step 7.
12. Interpolate values for 140% - 150% to set parameters P2.14.14 and P2.14.15.

P2.14.1- P2.14.15 Flux curve 10%,, Flux curve 150%

Motor voltage corresponding to 10%....150% of flux as a percentage of Nominal flux voltage.

4.14 Startup Torque

The parameters in this group can be used in closed loop motor control operation. They enable the drive to produce programmable startup torque as soon as run request is given to the drive.

P2.15.1 Startup torque selection

Select the source for producing the startup torque.

- 0 None. Programmable startup torque is not used.
- 1 Torque Memory. The drive memorises Torque (V1.1.5), which was at the previous stop and the same torque is produced when the run request is given again.

- 2 Torque reference. The torque reference for the startup torque is derived from external torque reference selected by Torque reference source selection parameter (P2.4.8).
- 3 FWD/REV. The torque reference for the startup torque is derived from Startup torque FWD (P2.15.3) in forward or positive direction of speed reference and Startup torque REV (P2.15.4) in reverse or negative direction of speed reference.

P2.15.2 Startup torque time

The startup torque is maintained after the run request for the time defined by this parameter in 0.....10000 ms.

P2.15.3 Startup torque FWD

Amount of startup torque to be produced as a percentage of motor nominal torque when the drive is run in forward or positive direction. This parameter is applicable only if Startup torque selection (P2.15.1) = 3 FWD/REV.

P2.15.4 Startup torque REV

Amount of startup torque to be produced as a percentage of motor nominal torque when the drive is run in reverse or negative direction. This parameter is applicable only if Startup torque selection (P2.15.1) = 3 FWD/REV.

P2.15.5 Torque memory source

When Startup torque selection (P2.15.1) = 1 (Torque memory), this parameter selects the source for the memorized torque to be produced at the next run request.

- 0 Actual torque. Torque (V1.1.5) is used as memory source for startup torque reference at the next start.
- 1 Torque reference. This is reserved for the future development and is not used in the present application.
- 2 External torque reference. The value defined by the parameter Torque memory reference (P2.15.6) is used as a memory source for startup torque reference at next start.

P2.15.6 Torque memory reference

When Torque memory source (P2.15.5) = 2, this parameter defines the amount of torque as a percentage of motor nominal torque used as a memory source for startup torque reference at next start.

4.15 Monitor Settings

The parameters in this group are used for testing of the drives. These parameters are for factory use only and are not required to be changed on site.

P2.16.1 Speed monitoring filter

Filter in ms for signal V1.1.2 Speed.

P2.16.2 Current monitoring filter

Filter in ms for signal V1.1.4 Current.

P2.16.3 Torque monitoring filter

Filter in ms for signal V1.2.5 Torque.

4.16 Data Mapping

The parameters in this group are used when the drive has a communication with overriding system. The parameters or signals with ID numbers defined in this application can be connected to the signals to and from the overriding system for reading and writing purposes.

P2.17.1- P2.17.8 PD IN1 ID,, PD IN8 ID

Using these parameters, you can control any parameter value from the fieldbus. Enter the ID number of the item you wish to control for the value of these parameters.

P2.17.9-P2.17.16 PD OUT1 ID,, PD OUT8 ID

Using these parameters, you can monitor any monitoring or parameter value from the fieldbus. Enter the ID number of the item you wish to monitor for the value of these parameters.

4.17 PI Control

PI Control in system interface application uses ID number to make connection between reference, actual value and output.

P2.18.1 PI Controller Gain

This parameter defines the gain of the PID controller. If the value of the parameter is set to 100% a change of 10% in the error value causes the controller output to change by 10%. If the parameter value is set to 0 the PID controller operates as ID-controller.

P2.18.2 PI Controller I time

The parameter ID119 defines the integration time of the PID controller. If this parameter is set to 1,00 second a change of 10% in the error value causes the controller output to change by 10.00%/s. If the parameter value is set to 0.00 s the PID controller will operate as PD controller.

P2.18.3 PI Controller reference

PI controller reference from keypad, used also when reference is controlled from Fieldbus.

P2.18.4 PI Controller reference value ID number

Select ID number of the signal that is used as reference valued for PI controller.

P2.18.5 PI Controller actual value ID number

Select ID number of the signal that is used as actual value for PI controller. PI Actual value can be written from Fieldbus directly to monitoring variable ID21 when this parameters is set to zero.

P2.18.6 PI Controller output ID

Select ID number of parameter of signal that is controlled by PI controller.

P2.18.7 PI Controller Scale

This parameter allows you to invert the error value of the PID controller (and thus the operation of the PID controller).

1 No inversion

-1 Inverted

This value is a multiplier for P and I part of the control thus working as additional gain.

NOTE! Zero is illegal value for PI controller

P2.18.8 PI Controller minimum output***P2.18.9 PI Controller maximum output***

With these parameters you can set the minimum and maximum limits for the PID controller output.

These limits are of importance for example when you define the gain and I-time for the PID controller.

P2.18.10 PI Controller output scale

This parameter is used to scale PI output to have more controlling are for the PI controller. e.g. PI controller maximum limit can be set to 10000 and by setting scaling to 10% PI output can be used directly to e.g. motoring torque limit.

PI Output * Scaling [%] = P2.18.5 -> 10000 * 10 % = 1000, (1000 = 100,0 % of Tn).

P2.18.11 PI Stop state value

This value is forced to PI controller out when controller is not activated by digital input P2.2.1.15.

4.18 ID Functions***P2.19.1.1 DIN Selection******P2.19.2.1 DIN Selection******P2.19.3.1 DIN Selection***

Select digital input that you want to use to control the selected parameter.

P2.19.1.2 ID Selection***P2.19.2.2 ID Selection******P2.19.3.2 ID Selection***

Select parameter ID number that is controlled with DIN Selection

P2.19.1.3 DIN Low Value***P2.19.2.3 DIN Low Value******P2.19.3.3 DIN Low Value***

Give value that is written to parameter ID selected by P2.19.x.2 when selected digital input P2.19.x.1 is low.

P2.19.1.4 DIN High Value***P2.19.2.4 DIN High Value******P2.19.3.4 DIN High Value***

Give value that is written to parameter ID selected by P2.19.x.2 when selected digital input P2.19.x.1 is high.

4.18.1 Value Control

The value control parameters are used to control an input signal parameter.

P2.19.4.1 Control Input Signal ID ID1580 "ContrInSignal ID"

With this parameter you can select what signal is used to control selected parameter.

P2.19.4.2 Control Off Limit ID1581 "Contrl Off Limit"

This parameter defines the limit when the selected parameter value is forced to Off value.

P2.19.4.3 Control On Limit ID1582 "Contrl On Limit"

This parameter defines the limit when the selected parameter value is forced to On value.

P2.19.4.4 Control Off Value ID1583 "Contrl Off Value"

This parameter defines the value that is used when the used input signal is below Off limit.

P2.19.4.5 Control On Value ID1584 "Contrl On Value"

This parameter defines the value that is used when the used input signal is above On limit.

P2.19.4.6 Control Output Signal ID ID1585 "ContrlOutSignID"

This parameter defines which parameter is forced to On and Off values when selected input signal exceeds the set limits.

P2.19.4.7 Control Mode ID1586 "Control Mode"

This parameter defines how the value control output behaves.

0 = SR ABS

Absolute input value is used to make a step change in the output between On and Off values.

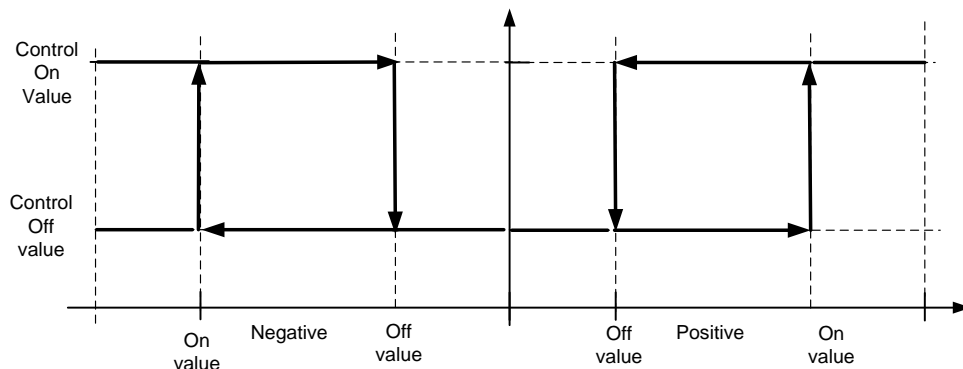

1 = Scale ABS

Absolute input value is scaled linearly between On and Off values.

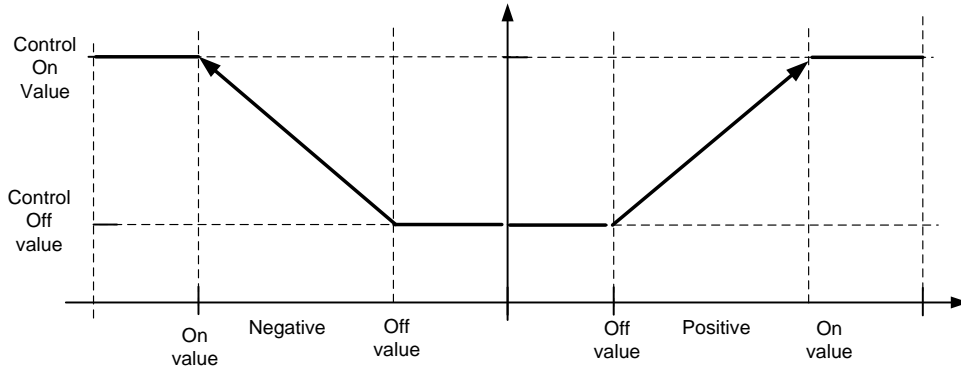

2 = Scale ABS Inverted

Inverted absolute value is scaled linearly between On and Off values.

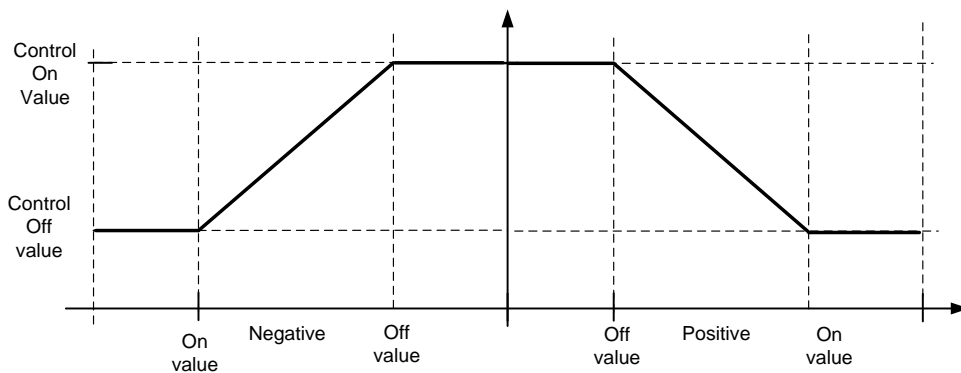

3 = SR

Input value is used to make a step change in the output between On and Off values.

4 = Scale ABS

Input values is scaled linearly between On and Off values.

5 = Scale Inverted

Inverted value is scaled linearly between On and Off values

P2.19.4.8 Control Signal Filtering TC ID1586 "Control Filt TC"

This parameter is used to filter the scaling function output. Used e.g. when unfiltered torque is used to control a parameter that needs stabilization.

5. FIELD BUS PROFILE

Note: The fieldbus card must be set to the bypass mode.

The process data can be freely configured to any parameter or signal defined in the application using ID numbers. The process data configuration shown below is just an example.

5.1 PD Signals from the Overriding system to the Vacon Drive.

Profibus data name	Signal name	Min	Max	Def	FB scale	Scaling description
Main Control Word	Main Control Word					See bitwise description below
Speed Reference	Speed Reference	-32000	32000	0		20000 corresponds to speed defined By param. Process speed
Process Data IN1	Torque Reference	-3000	3000	0	10=1%	100% equals Motor Nominal Torque
Process Data IN2	Aux. Control Word 1					See bitwise description below
Process Data IN3						
Process Data IN4	Load Share	-4000	4000	1000	10=1%	This scales the % of Torque Reference to Follower
Process Data IN5	Torque Step	-3000	3000	0	10=1%	100% equals Motor Nominal Torque
Process Data IN6	Torque Select	0	5	0		0=none,1=speed,2=torque, 3=min,4=max,5=win
Process Data IN7						
Process Data IN8	Master Follower Mode	0	2	0		0=none,1=master,2=slave

Table 35.

5.2 PD Signals from the Vacon Drive to the Overriding System

Profibus data name	Signal name	Min	Max	FB scale	Scaling description
Main Status Word	Main Status Word				See bitwise description below
Motor Speed	Motor Speed				20000 correspond to speed defined by P2.1.7 Process Speed
ProcessDataOut1	Motor Torque			10=1%	100% equals Motor Nominal Torque
ProcessDataOut2	Aux. Status Word				See bit words below
ProcessDataOut3	Fault Word1				See bit words below
ProcessDataOut4	Fault Word2				See bit words below
ProcessDataOut5	Digital Input Status Word				See bit words below
ProcessDataOut6	Alarm Word				See bit words below
ProcessDataOut7	Motor Shaft Rounds	-32768	32767		No of Rounds of the motor Shaft after Pos reset is done
ProcessDataOut8	Motor Shaft Position	0	360		Position of the motor shaft in degrees

Table 36.

5.3 Main Control Word ID1160

	Main Control Word ID1160
--	--------------------------

	Signal	Comment
b0	On	0>1 will reset the Switch On Inhibit state and bring the drive to Rdy Run. Should be reset after fault and EmStop .
b1	Coast Stop	0=Coast stop Active 1=Coast Stop not Active
b2	Emergency Stop	0=Emergency stop active 1=Emergency stop not active EmStop Mode is selected by P2.7.3
b3	Run	0= stops the drive as per Stop Mode P2.7.2 1= Run
b4	Ramp Out Zero	0=Ramp Output forced to 0. 1=Ramp Output is released
b5	Ramp Hold	0=Ramp is hold 1=ramp release
b6	Ramp input Zero	0=Ramp input forced to 0.Stop by Ramp 1=Ramp input is released
b7	Reset	0>1 Reset fault.
b8	Inching 1	0=No Action 1=Run forward with Constant Speed set by P2.4.2
b9	Inching 2	0=No Action 1=Run backward with Constant Speed set by P2.4.3
b10	Fieldbus Control Enable	0=No control from Fieldbus possible 1=Drive control from profibus if P2.6.1 =0 Fieldbus
b11	Watchdog	0>1>0>1...1 sec square wave clock. This is used to check data communication between profibus master and the drive. Used to generate FB Communication. Fault. This monitoring can be switched off by setting P2.14.26 PB Watchdog Delay =0.Drive 's internal communication monitoring is still active at this time.
b12	Low	not used
b13	Low	not used
b14	Low	not used
b15	Low	not used

Table 37.

5.4 Main Status Word ID1162

Main Status Word ID1162		
	Signal	Comment
b0	Rdy On	0=Drive not ready to switch on 1=Drive ready to switch on
b1	Rdy Run	0=Drive not ready to run 1=Drive ready to run
b2	Rdy Ref	0=Drive not running 1=Drive running and ready to release the reference
b3	Fault	0=No active fault 1=Fault is active
b4	Off2 Status	0=Coast Stop Active 1=Coast stop not active
b5	Off3 Status	0=Emergency Stop active 1=Emergency stop not active
b6	Drive Not Ready to Switch On	0=No inhibit 1=drive is out of fault or EmStop state. The ON bit in the main control word is then has to be reset.
b7	Alarm	0=No alarm 1=Alarm active
b8	At Set point	0= Speed Ref and Speed Actual are not same
b9	Fieldbus Control Active	0=Fieldbus control not active 1=Fieldbus control active. Control Place (P2.6.1) =0 and bit 10 of the Main control word is set.
b10	Above Limit	0= Speed is below the limit specified by P2.4.14 1=The speed actual of the drive is above the set speed limit (P2.4.16).
b11	Reserved	
b12	Reserved	
b13	Reserved	
b14	Reserved	
b15	Watchdog	Same as received on bit 11 of the main control word.

Table 38.

5.5 Auxiliary Control Word ID1161

Auxiliary Control Word ID1161		
	Signal	Comment
b0	Data logger restart	
b1	Data logger force trigger	
b2	Ramp bypass	Ramp generator of the drive is bypassed if set high.
b3	Reference from IO when control place is Fieldbus.	
b4	DC Braking Active	When ramp generator output is less than Zero Speed Level (P2.8.1) then DC braking is active if set to high.
b5	Free	
b6	Free	
b7	Mech. Brake Ctrl	Mechanical Brake control through Fieldbus.
b8	Free	
b9	Reset position	Resets the Shaft Position (V1.2.42) & Shaft Rounds (V1.2.43) to zero.
b10	Free	
b11	Free	
b12	Enable inching	When set high, constant speed inching/running can be done with bit 8 and 9 of the Main Control Word
b13	DO1 control	Activates the Digital output 1 if parameter DO1 = 1161.13
b14	DO2 control	Activates the Relay output 1 if parameter DO2 =1161.14
b15	DO3 control	Activates the Relay output 2 if parameter DO3 =1161.15

Table 39.

5.6 Auxiliary Status Word ID1163

Auxiliary Status Word ID1163		
	Signal	Comment
b0	Datalogger triggered	
b1	Window Control active and Speed is out of Window	
b2	Motor/Generator torque/current limit active	
b3	Undervoltage/Overvoltage controller active	
b4	Reverse direction	
b5	IO Control Active	
b6	Motor Fan ON command	
b7	Mechanical brake lift command	
b8	DC Charging OK (Pulse)	
b9	DC Charging OK (continuous)	
b10	Drive in Torque control	
b11	Speed Zero	
b12	Reserved	
b13	Reserved	
b14	Reserved	
b15	Reserved	

Table 40.

5.7 Fault Word 1 ID1172

Fault Word 1 ID1172		
	Signal	Comment
b0	OverCurrent	
b1	Overvoltage	
b2	Undervoltage	
b3	Motor Stall	See parameters P2.13.9, P2.13.10, P2.13.11, P2.13.12
b4	Earth Fault	See parameters P2.13.6, P2.13.7, P2.13.8
b5	UnderLoad	See parameters P2.13.26, P2.13.27, P2.13.28, P2.13.29
b6	Unit Over Temperature	
b7	Motor Temperature	This can be because of the following reasons. Thermistor as set by P2.13.13. -PT100 Temp. measurement using PT100 type sensor. See parameters P2.2.2.3 to P2.2.2.6 and P2.13.18 to P2.13.20 Calculated Overtemperature as set by P2.13.22 to P2.13.24.
b8	Input Phase Loss	See parameter Input phase supervision (P2.13.4)
b9	Internal Brake Resistor Protection	
b10	Device Fault	Device (slot cards) Removed,Added,changed,Unknown
b11	Keypad Communication Fault	See parameter P2.13.2
b12	Fieldbus communication Fault	
b13	Follower communication	Master follower communication. See parameters P2.12.1, P2.12.2, P2.12.3.
b14	Slot communication.	Slot comm. fault. One of the slot cards is faulty.
b15	Analogue Input Fault	See parameter P2.13.1

Table 41.

5.8 Fault Word 2 ID1173

Fault Word 2 ID1173		
	Signal	Comment
b0	Output Phase Fault	See parameter P2.13.5
b1	Charging Switch Fault	
b2	Encoder Fault	See parameter P2.13.14
b3	Drive Hardware fault	
b4	Unit Under Temperature	
b5	EEPROM Fault +Checksum Fault	
b6	External fault	See parameter P2.13.3
b7	Brake chopper fault	
b8	Internal Communication	
b9	IGBT Temperature	
b10	Mechanical Brake Fault	See parameters P2.2.1.5 and P2.13.15
b11	Cooling Fan	
b12	Application fault	
b13	Drive Internal fault	
b14	Input SW Open	
b15	Not used	

Table 42.

5.9 Alarm Word 1 ID1174

Alarm Word ID1174		
	Signal	Comment
b0	Motor stalled	See parameters P2.13.9, P2.13.10, P2.13.11, P2.13.12
b1	Motor over temperature	This can be because of the following reasons. Thermistor as set by P2.13.13. -PT100 Temp. measurement using PT100 type sensor. See parameters P2.2.2.3 to P2.2.2.6 and P2.13.18 to P2.13.20 Calculated Overtemperature as set by P2.13.22 to P2.13.24.
b2	Motor under load	See parameters P2.13.26, P2.13.27, P2.13.28, P2.13.29
b3	Input phase loss	See parameter Input phase supervision (P2.13.4)
b4	output phase loss	See parameter P2.13.5
b5	Safe disable	Warning is also activated if safe disable is active.
b6	Not used	
b7	Not used	
b8	Drive over temperature	
b9	Analogue input < 4mA	See parameter P2.13.1
b10	Motor fan warning	See parameter P2.2.1.7
b11	Emergency stop	See parameter P2.2.1.12
b12	Run disabled	
b13	Inching disabled	
b14	Mechanical Brake	See parameters P2.2.1.5 and P2.13.15
b15	Keypad communication alarm	See parameter P2.13.2

Table 43.

5.10 Digital Input Status 1 and 2: ID15 and ID16

	DIN StatusWord 1 ID15	DIN StatusWord 2 ID16
b0	DIN: A.1	DIN: C.5
b1	DIN: A.2	DIN: C.6
b2	DIN: A.3	DIN: D.1
b3	DIN: A.4	DIN: D.2
b4	DIN: A.5	DIN: D.3
b5	DIN: A.6	DIN: D.4
b6	DIN: B.1	DIN: D.5
b7	DIN: B.2	DIN: D.6
b8	DIN: B.3	DIN: E.1
b9	DIN: B.4	DIN: E.2
b10	DIN: B.5	DIN: E.3
b11	DIN: B.6	DIN: E.4
b12	DIN: C.1	DIN: E.5
b13	DIN: C.2	DIN: E.6
b14	DIN: C.3	
b15	DIN: C.4	

Table 44.

6. BLOCK DIAGRAMS

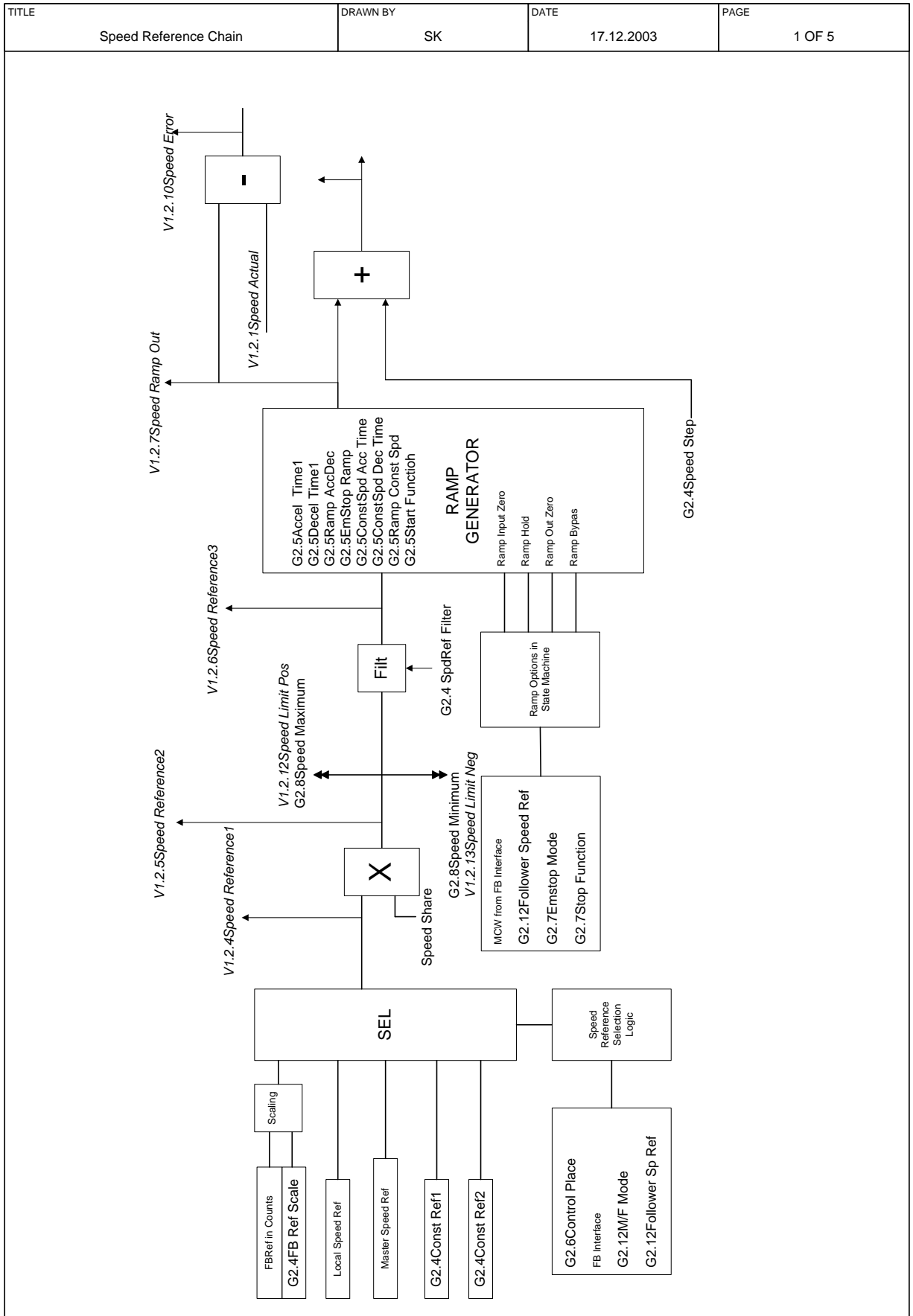

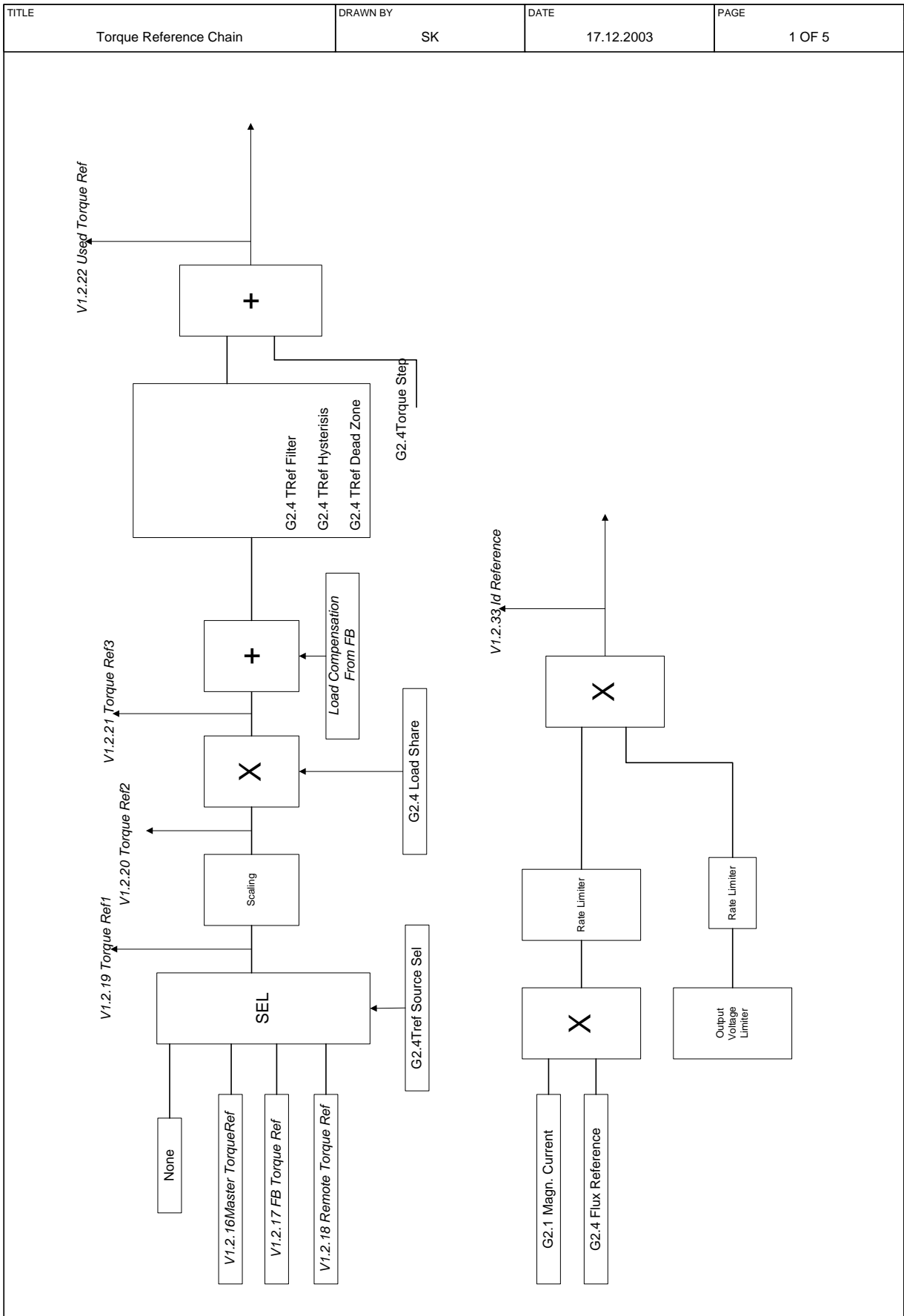

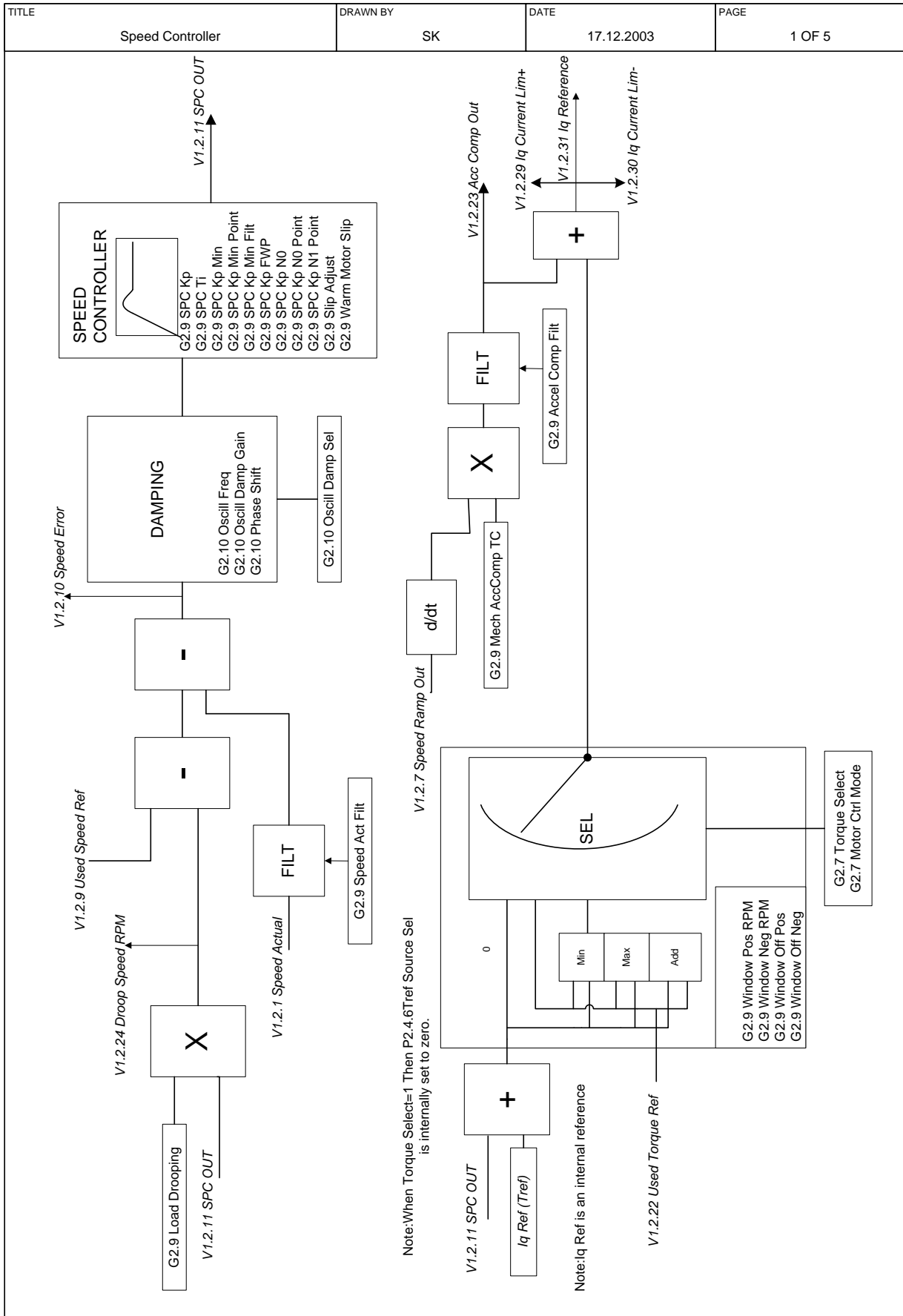

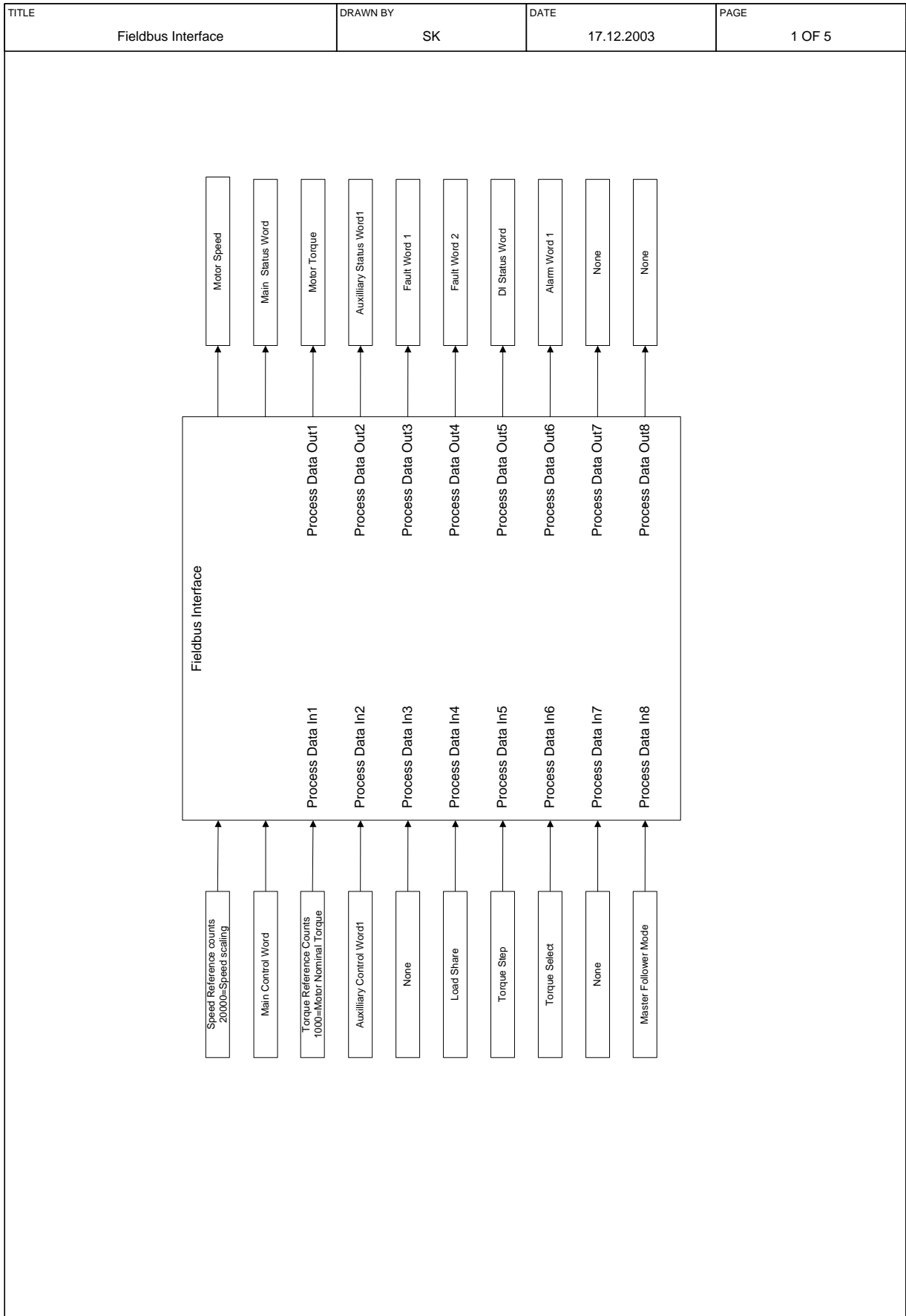

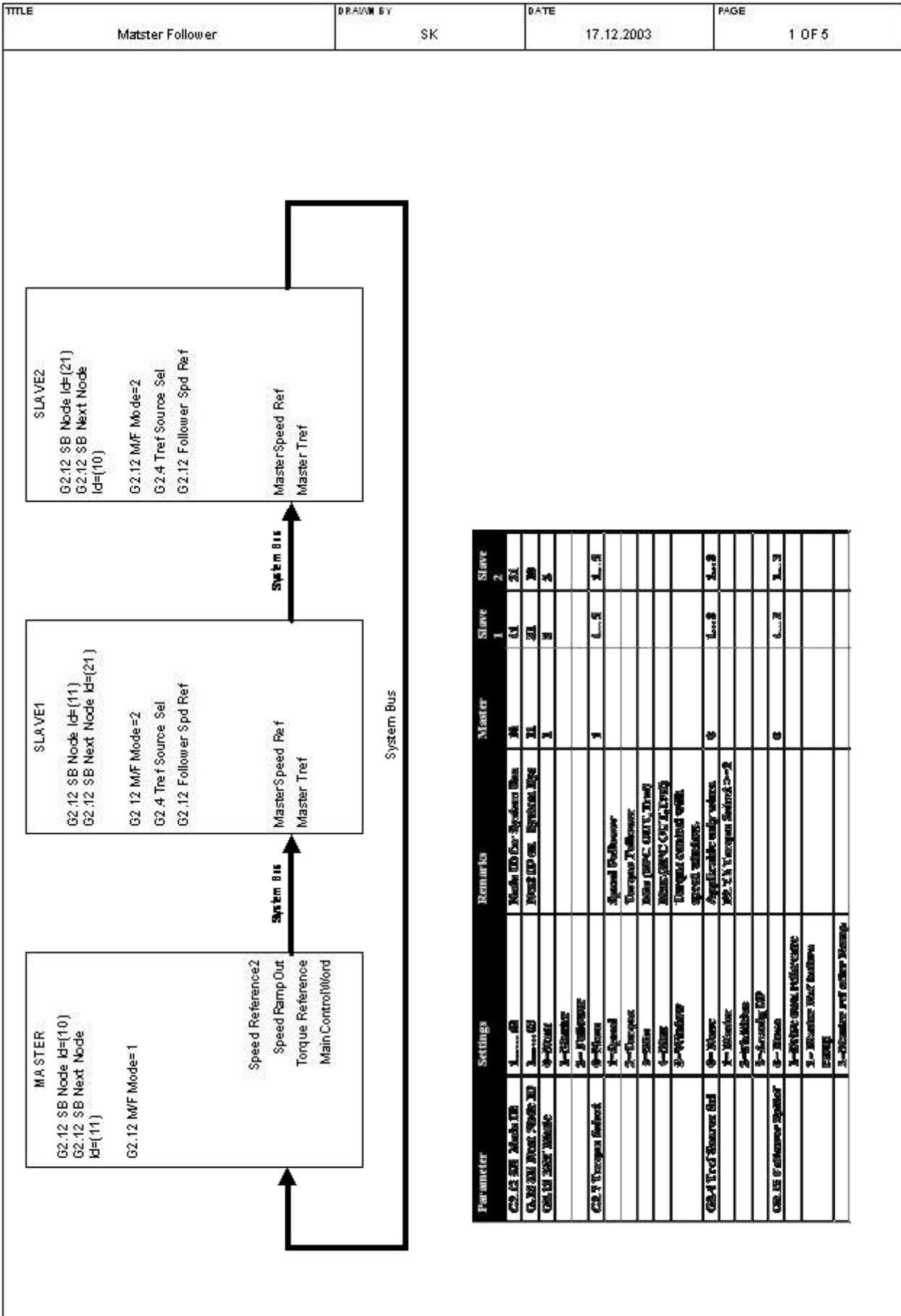

7. FAULT TRACING

When a fault is detected by the frequency converter control electronics, the drive is stopped and the symbol **F** together with the ordinal number of the fault, the fault code and a short fault description appear on the display. The fault can be reset with the *Reset button* on the control keypad or via the I/O terminal. The faults are stored in the fault history which can be browsed. The different fault codes you will find in the table below.

The fault codes, their causes and correcting actions are presented in the table below. The shadowed faults are A faults only. The items written in white on black background present faults for which you can program different responses in the application. See parameter group Protections.

Note: When contacting distributor or factory because of a fault condition, always write down all texts and codes on the keypad display.

Fault code	Fault	Possible cause	Correcting measures
1	Overcurrent	Frequency converter has detected too high a current ($>4 \cdot I_n$) in the motor cable: <ul style="list-style-type: none"> – sudden heavy load increase – short circuit in motor cables – unsuitable motor 	Check loading. Check motor. Check cables.
2	Overvoltage	The DC-link voltage has exceeded the limits. <ul style="list-style-type: none"> – too short a deceleration time – high overvoltage spikes in supply 	Make the deceleration time longer. Use brake chopper or brake resistor (available as options)
3	Earth fault	Current measurement has detected that the sum of motor phase current is not zero. <ul style="list-style-type: none"> – insulation failure in cables or motor 	Check motor cables and motor.
5	Charging switch	The charging switch is open, when the START command has been given. <ul style="list-style-type: none"> – faulty operation – component failure 	Reset the fault and restart. Should the fault re-occur, contact the distributor near to you.
7	Saturation trip	Various causes, e.g. defective component	Cannot be reset from the keypad. Switch off power. DO NOT RE-CONNECT POWER! Contact factory. If this fault appears simultaneously with Fault 1, check motor cables and motor
8	System fault	<ul style="list-style-type: none"> - component failure - faulty operation Note exceptional fault data record.	Reset the fault and restart. Should the fault re-occur, contact the distributor near to you.
9	Undervoltage	DC-link voltage is under the voltage limits. <ul style="list-style-type: none"> – most probable cause: too low a supply voltage – frequency converter internal fault 	In case of temporary supply voltage break reset the fault and restart the frequency converter. Check the supply voltage. If it is adequate, an internal failure has occurred. Contact the distributor near to you.
10	Input line supervision	Input line phase is missing.	Check supply voltage and cable.
11	Output phase supervision	Current measurement has detected that there is no current in one motor phase.	Check motor cable and motor.

12	Brake chopper supervision	<ul style="list-style-type: none"> – no brake resistor installed – brake resistor is broken – brake chopper failure 	Check brake resistor. If the resistor is ok, the chopper is faulty. Contact the distributor near to you.
13	Frequency converter under-temperature	Heat sink temperature is under -10°C	
14	Frequency converter over-temperature	Heat sink temperature is over 90°C . Over temperature warning is issued when the heat sink temperature exceeds 85°C .	Check the correct amount and flow of cooling air. Check the heat sink for dust. Check the ambient temperature. Make sure that the switching frequency is not too high in relation to ambient temperature and motor load.
15	Motor stalled	Motor stall protection has tripped.	Check motor.
16	Motor over temperature	Motor overheating has been detected by frequency converter motor temperature model. Motor is overloaded.	Decrease the motor load. If no motor overload exists, check the temperature model parameters.
17	Motor underload	Motor underload protection has tripped.	
25	Microprocessor watchdog fault	<ul style="list-style-type: none"> – faulty operation – component failure 	Reset the fault and restart. Should the fault re-occur, contact the distributor near to you.
30	Safe disable	Safe Disable inputs SD1 & SD2 are activated through the OPT-AF option board.	See details from Safe Disable & Atex manual ud1066
31	IGBT temperature (hardware)	IGBT Inverter Bridge over temperature protection has detected too high a short term overload current	Check loading. Check motor size.
32	Fan cooling	Cooling fan of the frequency converter does not start, when ON command is given	Contact the distributor near to you.
34	CAN bus communication	Sent message not acknowledged.	Ensure that there is another device on the bus with the same configuration.
35	Application	Application task overload or CPU overload.	Reset the power to the control box.
36	Control unit	NXS control unit can not control NXP Power Unit and vice versa	Change control unit
37	Device changed (same type)	Option board or control unit changed. Same type of board or same power rating of drive.	Reset Note: No fault time data record!
38	Device added (same type)	Option board or drive added. Drive of same power rating or same type of board added.	Reset Note: No fault time data record!
39	Device removed	Option board removed. Drive removed.	Reset Note: No fault time data record!
40	Device unknown	Unknown option board or drive.	Contact the distributor near to you.
41	IGBT temperature	IGBT inverter bridge overtemperature protection has detected too high a short term overload current	Check loading. Check motor size.
42	Brake resistor over temperature	Brake resistor over temperature protection has detected too heavy braking	Set the deceleration time longer. Use external brake resistor.
43	Encoder fault	Note the exceptional fault data record. Additional codes: 1 = Encoder 1 channel A is missing	Check encoder channel connections. Check the encoder board.

		2 = Encoder 1 channel B is missing 3 = Both encoder 1 channels are missing 4 = Encoder reversed	
44	Device changed (different type)	Option board or control unit changed. Option board of different type or different power rating of drive.	Reset Note: No fault time data record! Note: Application parameter values restored to default.
45	Device added (different type)	Option board or drive added. Option board of different type or drive of different power rating added.	Reset Note: No fault time data record! Note: Application parameter values restored to default.
50	Analogue input I_{in} < 4mA (sel. signal range 4 to 20 mA)	Current at the analogue input is < 4mA. – control cable is broken or loose – signal source has failed	Check the current loop circuitry.
51	External fault	Digital input fault.	
52	Keypad communication fault	The connection between the control keypad and the frequency converter is broken.	Check keypad connection and possible keypad cable.
53	Fieldbus fault	The data connection between the fieldbus Master and the fieldbus board is broken	Check installation. If installation is correct contact the nearest Vacon distributor.
54	Slot fault	Defective option board or slot	Check board and slot. Contact the nearest Vacon distributor.
55	Follower communication	This fault can occur only in Follower drive P2.12.1 M/Fmode =2 (Follower). Follower drive is not able to receive data from Master drive on system bus(optical link).	Check the setting of P2.13.25 SBFault Delay. The default is 0.10sec. Check the optical link between MasterFollower and jumper settings on OPT-D2 board in Vacon option board manual. OPT-D2 board can be installed only in slot D or slot E.
56	Meas Temp. overtemperature	PT100 or KTY 84 element/s has sensed overtemperature.	Check the temperature of the part where the temperature sensor is mounted. Check parameters P2.2.2.3 to P2.2.2.6, P2.13.18 to P2.13.20.
57	ID run failure	ID run could not be completed successfully.	Check monitoring signal V1.1.19 ID run status to find out which part of the ID run is failed. Redo the ID run.
58	Mechanical brake fault	Mechanical brake lifted signal is not received within time defined by P2.11.1 Brake life delay after the Run command. The digital input is selected by P2.2.6 Motor brake acknowledgement OR Brake open signal is acknowledged when there is no run command given.	Check the parameters P2.13.28 Mechanical brake fault P2.2.6 Motor brake acknowledgement P2.11.1 Brake lift delay Check the Motor brake circuit.
59	Motor fan fault	Motor fan acknowledgement is not received within 5 seconds after run command.	Check P2.2.1.7 . Check motor fan connection.
61	Thermistor	Thermistor overtemperature. Thermistor is connected to OPT-A3 board in slot B.	Check the temperature of the area where the thermistor is mounted. Check the connection of the thermistor to OPT-A3.
62	Run disabled	Run Enable digital input is gone low.	Check P2.2.1.9,P2.2.1.10. Reset the run enable input.

63	Emergency stop	DIN6 is inactive /low.	Check the emergency stop push button connected to DIN6. Check P2.210 Emergency stop control.
64	Input SW Open	The drive main power is switched off and DIN5 is inactive/low.	Check the main power switch of the drive. Check P2.2.8 Run Enable control as per the description in the manual.

Table 45. Fault codes

VACON

DRIVEN BY DRIVES

Find your nearest Vacon office
on the Internet at:

www.vacon.com