



SEM-SAFE®

The Water Mist Fire Fighting System
for Commercial and Industrial Applications

Danfoss Semco A/S

Total Solution Provider of Certified Fixed Fire Fighting Systems



Danfoss Headquarters - more than 24,000 employees worldwide • production of more than 250,000 components each day • 2,000 patents, of which 15 relate to water mist technology



Fighting fire – as easy as blowing out a match



SEM-SAFE® protected reception area utilizing glass cooling

Imagine a fire fighting system that puts out the fire in seconds, with minimal consumption of water and water damage, giving you the best possible protection. With SEM-SAFE® – the unique high-pressure water mist system from Danfoss Semco – that is what you can get.

Reaching even higher

Simplicity in design, obtained by using the most advanced technologies, results in the highest operation reliability. All of our products are made of first-class materials and in a comprehensively tested design.

The fast growing technology

For centuries, water has been used to fight fires. In 1806, the first patent was filed in London describing a perforated pipe concept for fire protection systems. This was followed in 1860 by the first sprinkler patent. Later, more advanced sprinkler heads were developed, including bulbs. The common feature of this development was the use of water as a fire fighting medium for cooling the fire. As the fire increases the temperature of the water, energy is absorbed from the fire, resulting in a cooling effect.

The breakthrough that water mist represents is to use the same method as traditional sprinklers, but to add the effect of converting the water into steam. This means that the cooling effect is up to seven times higher than for traditional sprinklers. Combined with the oxygen displacement effect, this can reduce water consumption by up to 90% compared to traditional sprinklers.

Water mist technology is now one of the most progressive fire fighting technologies. Danfoss Semco was one of the pioneers in this market and has proven expertise with installations worldwide.

Danfoss Semco is close by

Danfoss Semco and its associates, regional offices and agents constitute a worldwide network that provides comprehensive technical support, installation, commissioning and repair services. This network ensures that our reputation for fire protection excellence is maintained and enhanced.



Did you know that

- Fire kills over 3,000 Europeans and causes over € 10 billion in property damage per year.
- The investment in fixed installed, pure water based fire suppression systems often counts for less than 1% of the total investment in a new building and means a major reduction in insurance premiums, up to 70%.
- In buildings fully protected by pure, water-based fire suppression systems, 99% of fires are controlled by the suppression system alone, and losses are estimated to be less than 10% compared to unprotected buildings.

The intelligent use of water

High-pressure water mist

For a fire to survive, it relies on the presence of the three elements of the 'fire triangle': oxygen, heat and combustible material. The removal of any one of these elements will extinguish a fire.

Oxygen

The very small droplets in a high-pressure water mist system quickly absorb so much energy that the droplets evaporate and transform from water to steam, because of the high surface area relative to the small mass of water. This means that each droplet will expand more than 1,700 times, when getting close to the combustible material, whereby oxygen and combustible gasses will be displaced from the fire, meaning that the combusting process will increasingly lack oxygen.

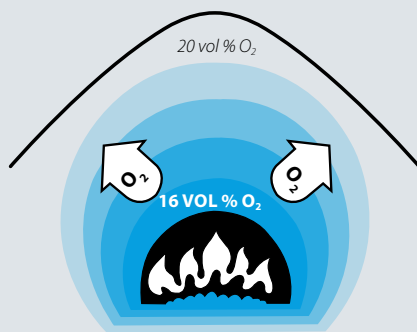

A high-pressure water mist system goes further. It attacks two elements of the fire triangle: oxygen and heat.

Heat

To fight a fire, a traditional sprinkler system spreads water droplets over a given area, which absorb heat to cool the room. Due to their large size and relatively small surface, the main part of the droplets will not absorb enough energy to evaporate, and they quickly fall to the floor as water. The result is a limited cooling effect.

By contrast, high-pressure water mist consists of very small droplets, which fall more slowly. Water mist droplets have a large surface area relative to their mass and, during their slow descent towards the floor, they absorb much more energy. A great amount of the water will follow the saturation line and evaporate, meaning that water mist absorbs much more energy from the surroundings and thus the fire.

That's why high-pressure water mist cools more efficiently per litre of water: up to seven times better than can be obtained with one litre of water used in a traditional sprinkler system.

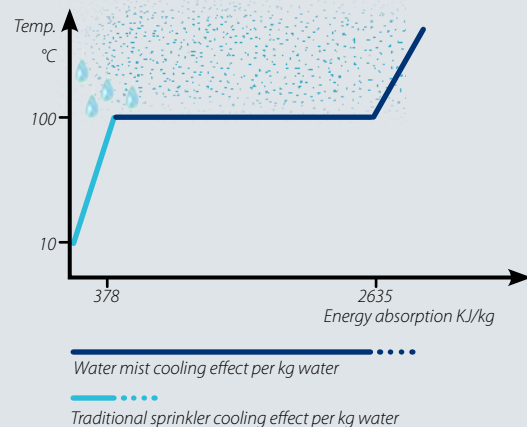

Conclusion

The uniqueness of water mist is that it combines the suppression effect of gas and traditional sprinkler systems. As well as removing the oxygen

like a gas system, it simultaneously cools the fire like a traditional sprinkler. The cooling effect additionally lowers the risk of re-ignition.



20 years of pioneering research and testing

- Nozzles: market's highest spacing (5.5 m) – 100% capacity and spray pattern tested
- Pumps: maintenance-free – market's most compact pump – high-energy efficient – negligible ripple effect
- Valves: stainless steel – dirt resistant – compact

The unique SEM-SAFE® key components

As one of the acknowledged pioneers of high-pressure water mist technology, Danfoss Semco has gained vast experience from its many installations across the world. Danfoss Semco is the only water mist supplier with direct access to its own development and production of all three key components needed for a top performance and cost-effective high-pressure water mist system: nozzles, pumps and valves.

All our products are made of first-class materials and in a comprehensively tested design.

Specially-designed water mist nozzles

The SEM-SAFE® water mist nozzles are based on two different technologies.

One is the technology used in the unique Danfoss simplex micro nozzles that has been a speciality for decades. Thanks to the special form of the simplex micro nozzles, the water gains strong rotary motion in the swirl chamber and is almost instantly transformed into a water mist that is sprayed onto the fire at high-pressure. The wide spray angle and the exclusive spray pattern of the Danfoss micro nozzles enable superior spacing. The droplets formed in the micro nozzle heads are shaped under a pressure of approx. 100 bar and have a size of 10 to 50 micron.

In order to maintain its technology-leading position, Danfoss Semco has also developed a new series of high-pressure water mist nozzles. These improved nozzles are based on a patent-pending method for drilling holes. To enhance the process of turning water into mist, the holes drilled in the nozzles are partly conical and partly cylindrical. The positioning of the holes is designed to direct the water only towards the places where the fire is, this way minimizing water consumption. The patent-pending method for drilling holes in the nozzles allow larger spacing and superior distribution of the water droplets, resulting in improved control when putting out fires. Water is distributed through the drilled nozzle holes at a pressure of 60 bar.

Following a series of intensive fire tests as well as mechanical and materials tests, the nozzles are specially manufactured to deliver a high-pressure water mist. All tests are carried out by independent laboratories to meet and surpass the demands for land use and applications (i.e. VdS) as well as offshore.

Unique pump design

Intensive research has led to the creation of the world's lightest and most compact high-pressure pump. Danfoss pumps are multi-axial piston pumps made in corrosion resistant stainless steel. The unique design uses water as a lubricant, eliminating the need for routine servicing and lubricant replacement. The pump is protected by international patents and is widely used in many different segments. The pumps offer up to 95% energy efficiency and very low pulsation, thus reducing noise.

Highly corrosion-proof valves

Danfoss' high-pressure VDHT valves are made from stainless steel and are highly corrosion-proof and dirt-resistant. The manifold block design makes the valves very compact, which makes them very easy to install and operate. In addition the valves have an IP67/NEMA 4X protection.

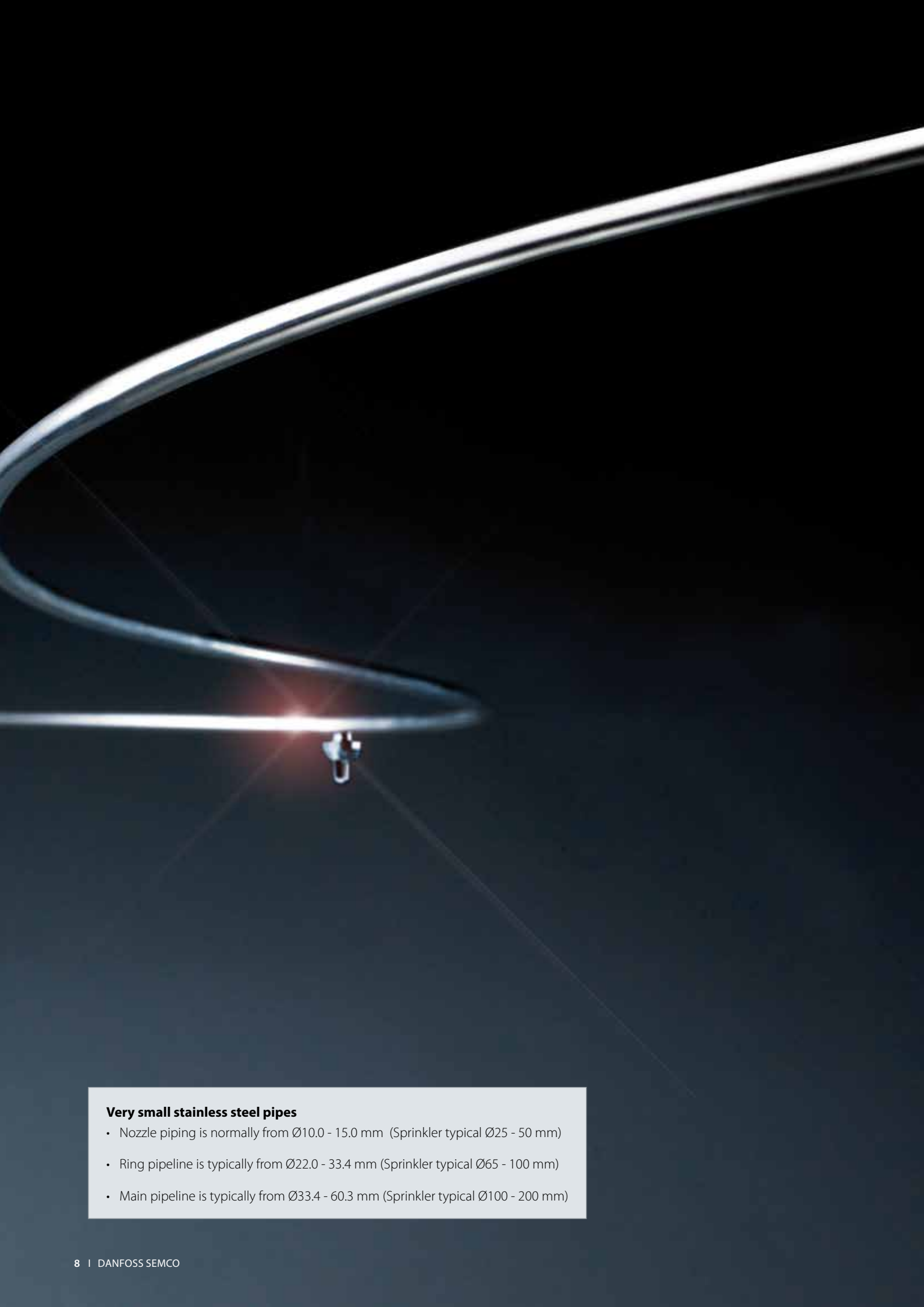

**Very small stainless steel pipes**

- Nozzle piping is normally from $\text{Ø}10.0 - 15.0$ mm (Sprinkler typical $\text{Ø}25 - 50$ mm)
- Ring pipeline is typically from $\text{Ø}22.0 - 33.4$ mm (Sprinkler typical $\text{Ø}65 - 100$ mm)
- Main pipeline is typically from $\text{Ø}33.4 - 60.3$ mm (Sprinkler typical $\text{Ø}100 - 200$ mm)

The power behind SEM-SAFE®

The SEM-SAFE® water mist system is a unique fire fighting system. When water is forced through nozzles, at high-pressure, a super-fine mist is formed that has a two-fold extinguishing effect. As well as cooling the fire like a traditional sprinkler, it simultaneously starves the fire of oxygen like gas systems. When the mist comes into contact with flames, it evaporates and expands minimum 1,700 times. The dense vapour created displaces the flames and quickly extinguishes the fire.

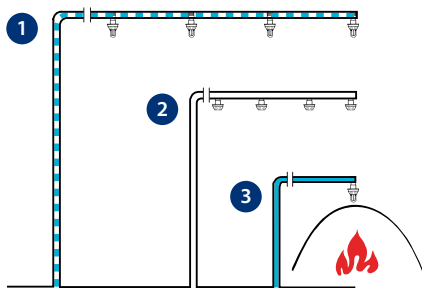

1 SEM-SAFE® WATER MIST SYSTEM WITH CLOSED NOZZLES

On stand-by, the system maintains a pipe pressure of approx. 12 bar. When the temperature exceeds e.g. 57 °C, the heat-sensitive glass bulbs mounted in the nozzle heads melt. At this point, the high-pressure pump is automatically activated and water is forced through nozzles at high-pressure (60 or 100 bar depending on nozzle type) to create a fine mist. Only nozzles with melted bulbs are activated. This means that only the heat-affected area will be actively sprayed. Also available for preaction systems.

2 SEM-SAFE® WATER MIST SYSTEM WITH OPEN NOZZLES

On stand-by, the system has dry piping. This system will activate manually or when sensors have detected heat, smoke or a flame, depending on type and application. The nozzles are grouped in sections and all the nozzles in the activated section will be released.

3 SEM-SAFE® WATER MIST SYSTEM IN OPERATION

During operation, the high-pressure pump draws water from the buffer tank (a non-pressurised stainless steel tank) and forces it through a non-return valve to a high-pressure manifold. From here, it is distributed to the relevant section(s) via the section valve. A pressure relief valve controls the pump pressure and is designed to return the full pump capacity to the buffer tank.

Piping material

The piping material is of high-class stainless steel, always meeting or exceeding AISI 316, an acid-resistant type with Mn contents. The pipe material is so soft that it can be bent. The small sizes can be shaped with hand tools saving a large number of fittings and reducing the risk for leakage.

Water supply

Water is supplied via either pump units or cylinder systems. This covers small systems of just a few nozzles, right up to systems with thousands of nozzles, with or without electrical power.



Small pump unit

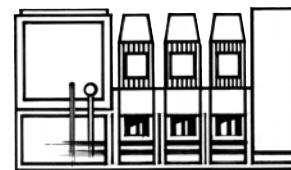

Large pump unit

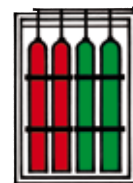

Cylinder system

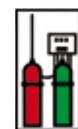

Small cylinder system



Comprehensive nozzle range

A complete nozzle range is available for local applications, public spaces, machinery spaces, turbine enclosures, deep fat fryers and side walls nozzles. Droplet sizes of 10-50 micron.

The benefits of SEM-SAFE®

The benefits of the SEM-SAFE® water mist system are immense. Putting out the fire in seconds, without using any chemical additives and with minimal consumption of water and close to no

water damage, it is one of the most environmentally-friendly and efficient fire fighting systems available, and is totally safe for human beings.

Minimum use of water

- Limited water damage
- Minimal damage in the unlikely event of accidental activation
- Less need for a pre-action system
- An advantage where there is an obligation to catch water
- A reservoir is rarely needed
- Local protection giving you faster fire fighting
- Less downtime due to low fire and water damage
- Reduced risk of losing market shares, as production is quickly up and running again
- Efficient – also for fighting oil fires
- Lower water supply bills or taxes

SEM-SAFE® nozzles

- Cooling ability enables installation of a glass window in the fire door
- High spacing
- Few nozzles – architecturally attractive
- Efficient cooling
- Window cooling – enables purchase of cheaper glass
- Short installation time
- Aesthetic design

Small stainless steel pipes

- Easy to install
- Easy to handle
- Maintenance free
- Attractive design for easier incorporation
- High quality
- High durability
- Cost-effective at piece-work
- Press fitting for quick installation
- Easy to find room for pipes
- Easy to retrofit
- Easy to bend
- Few fittings needed



Minimum use of water



SEM-SAFE® nozzles



Small stainless steel pipes

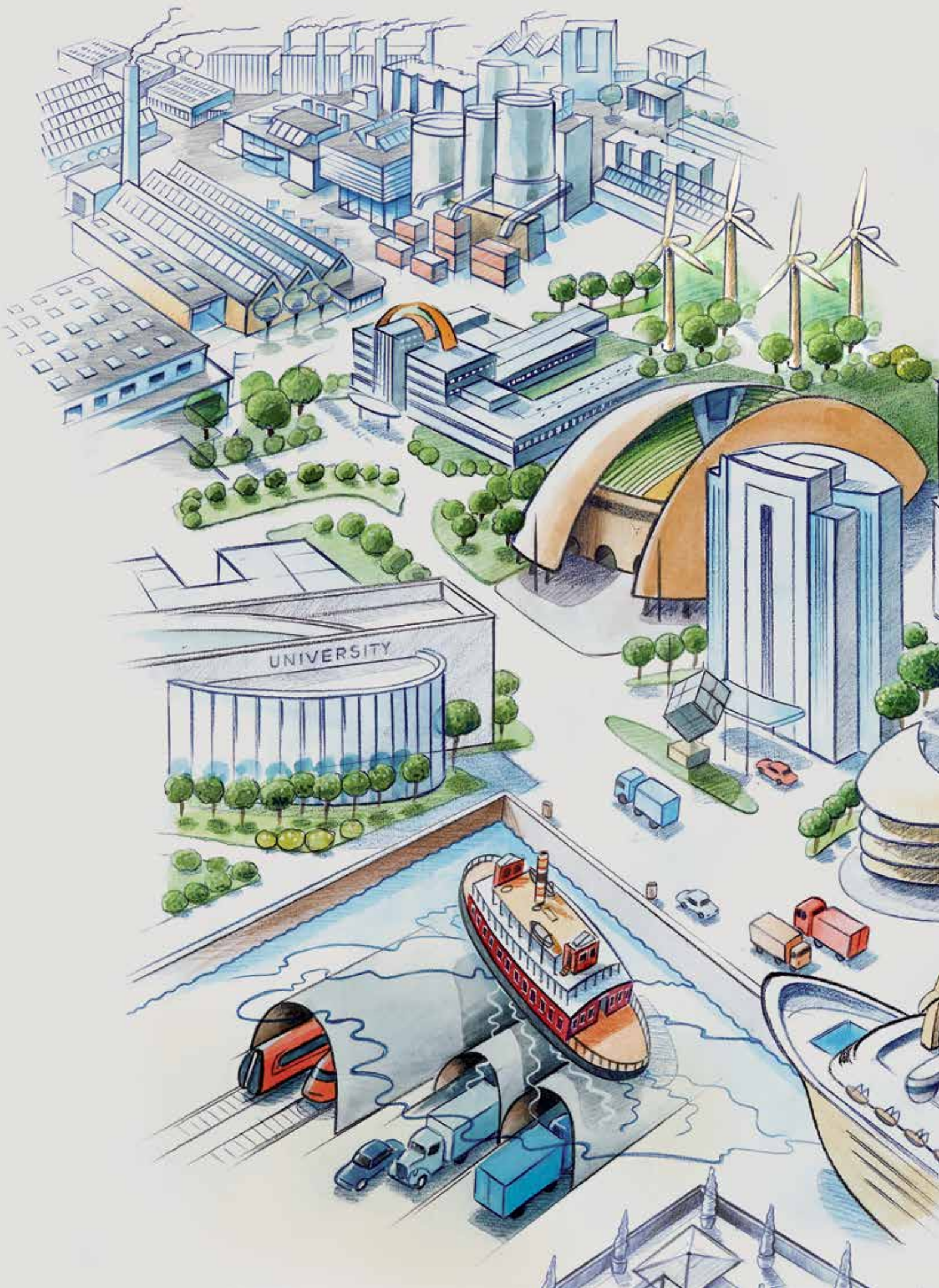

SEM-SAFE® city

- the safest city in the world



Cost-effective fire fighting, everywhere in the city

SEM-SAFE® water mist system

Fire catastrophes are a threat to human life, cultural and industrial assets, private and corporate property and even our environment.

From complex fire suppression systems for museums and heritage sites, to industrial applications over office buildings, universities and wind turbines, Danfoss Semco has a successful track record within commercial and industrial applications using the SEM-SAFE® water mist system.

Why? Because the SEM-SAFE® system provides better protection than existing water systems while being 100 % environmentally-friendly, harmless to users and with far less impact on buildings and interiors. It significantly reduces lifecycle costs, asset damage and operational downtime in all 'business critical' applications, and offers the best protection of irreplaceable valuables. This offers a greatly enhanced cost/benefit ratio when compared to traditional systems.





1 ATRIA

The SEM-SAFE® system atomises the water in front of the glass, thereby removing the risk of thermal stress cracks. By using SEM-SAFE® for window cooling, you can achieve savings up to 500 EUR/m², in addition to being able to build a lighter construction.



2 GALLERIES AND MUSEUMS

Once a part of our heritage is lost, it can never be replaced. SEM-SAFE®'s minimal consumption of water when fighting fires will limit the water damage after a fire and will not harm valuable furniture and fixtures.



3 HOTELS

The architectural design of our pipes and nozzles fit well with a beautiful hotel environment. Due to the small and convenient pipe sizes, the system is easily installed, even if retrofitted. The compact system also leaves more space for money generating activities.



4 GARAGES

Garages are protected with high-pressure water mist to cool the often intense temperature peaks from a rising fuel fire. SEM-SAFE® can extinguish pool fires without spreading the fuel, as is often seen with conventional systems. SEM-SAFE® provides you with excellent protection against fire spread.



5 TUNNELS

High-pressure water mist cools the area so that there is an increased possibility of surviving and protecting the structure of the tunnel. The high-pressure makes it possible to move the water over large distances, and the high-pressure water mist is not as affected by the ventilation system as low-pressure systems. It is possible to design a system without additives.

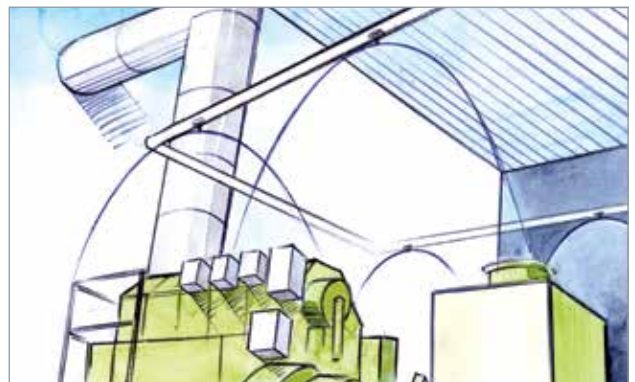

6 ENGINES AND GENERATORS

The local protection system protects engines and generators where the fire hazard actually occurs, catching and extinguishing the fire quickly. The SEM-SAFE® system has been documented to be harmless to electrical equipment, provided that the protection is better than IP22, and it also prevents shock cooling of cast parts.



7 OFFICE BUILDINGS

The minimal consumption of water when fighting fire offers you minimal water damage after the fire. Because of this, your furniture and fixtures are protected in addition to the people who would be present in the office.



8 SCHOOLS

The SEM-SAFE® system is the environmentally responsible and correct answer when looking to protect your school against fires. The system can be released instantly after detecting the fire, without harming people, giving you faster and more efficient fire fighting.

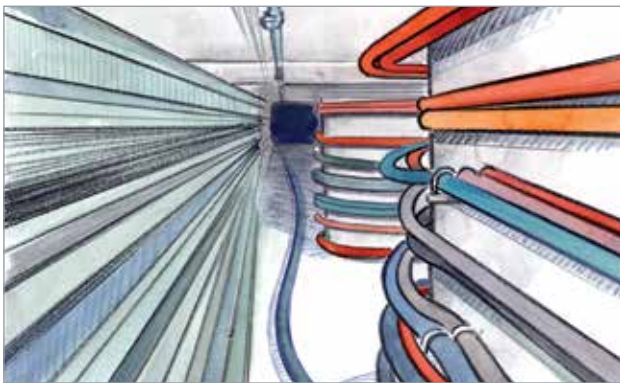

9 CABLE CHANNELS

There is no need for airtight rooms when using high-pressure water mist, making it a good solution for protecting cable channels, for example. It has been documented that our system can protect electrical equipment graded better than IP22 without harming it.



10 INDUSTRIAL PRODUCTION LINES

Our local protection system protects production equipment where the fire risk is greatest, quickly extinguishing the fire and minimising damage. This means minimal production downtime. The SEM-SAFE® system also offers you efficient fire protection without having to put your machinery in an enclosure.



11 INDUSTRIAL DEEP FAT FRYERS

For your food processing equipment, the SEM-SAFE® system is ideal because there are no additives and it is environmentally friendly. With fast extinguishing of the oil fire, you will avoid damaging the oil and minimise downtime.



12 COMMERCIAL DEEP FAT FRYERS

Our system is tested according to ISO 15371, which demands no oil splashes. This gives you increased safety for personnel and limits cleaning afterwards. The extinguishing medium is clean water, which eliminates harmful additives in your kitchen.



13 SPECIAL CONSTRUCTIONS

The SEM-SAFE® solution gives you the opportunity to protect special roof and other constructions. The system is small and compact and the piping can be hidden so that it does not disturb the aesthetic context of a special construction.



14 LIBRARIES AND ARCHIVES

The system's low consumption of water limits water damage, keeping valuable books and other effects unharmed. The small pipe sizes also make the system easy to retrofit, without damaging the environment.



15 WIND TURBINE

Our system has low water consumption and only requires small pipe dimensions. This leads to a weight reduction and also allows installation in smaller spaces. The pump unit is compact, allowing the SEM-SAFE® system to be fully integrated into the nacelle. Finally, our system does not require closed rooms for it to function efficiently.

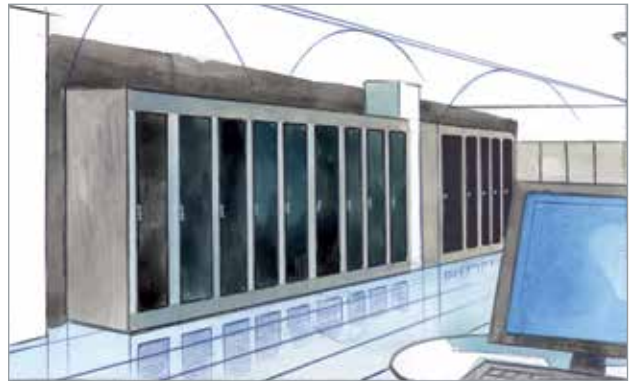

16 COMPUTER ROOMS

The SEM-SAFE® system is harmless to people and is documented not to harm electrical equipment with a protection better than IP22. The quick reaction to a fire also prevents damaging equipment and valuable stored data.

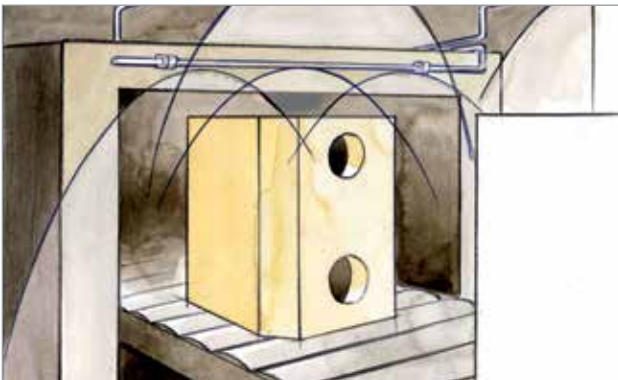

17 PAINT SPRAY BOOTH

The water mist system is efficient even in the context of highly flammable liquids. The local protection system protects the area where the fire risk is greatest, and hereby quickly extinguishes the fire. To achieve this, a specific nozzle design makes it possible to create a 'water curtain' in front of the spraying booth so that the fire does not spread. This reduces production downtime after a fire.



18 TRANSFORMER

The SEM-SAFE® system cools the transformer, thus preventing it from burning hot and damaging the structure. The system does not require closed areas in order to operate efficiently, and the local protection offers quick extinguishing and less damage. This means that it also can be used for outdoor transformer protection.



City hall in Magdeburg, Germany

Built in the renaissance style, Magdeburg's old and beautiful city hall has installed the SEM-SAFE® water mist system. In general, heritage buildings benefit from using a water mist system, due to low water consumption and consequent low water damage, as well as the fact that the small pipes are easily integrated into the surroundings, without harming the irreplaceable building, its interior and fixtures.

Less damage

Water mist versus traditional sprinkler systems

Water mist has many advantages compared to conventional sprinklers.

One of the key benefits is that it often uses only one tenth as much water as traditional sprinklers. In addition, the majority of the water evaporates, causing much less water damage to buildings, furniture, electrical installations, etc.

In industrial applications, the dramatic reduction in direct damage is of great value, but it is usually even more important that the production line or factory will be able to resume manufacturing very quickly after the fire.

A long period of down-time in production means a high risk of losing market share, which often results in a dramatic long-term negative economic effect, far in excess of the original fire damage.

Statistics show that only 4 out of 10 industries are able to start manufacturing goods again after a major fire.

Water mist

Traditional sprinkler

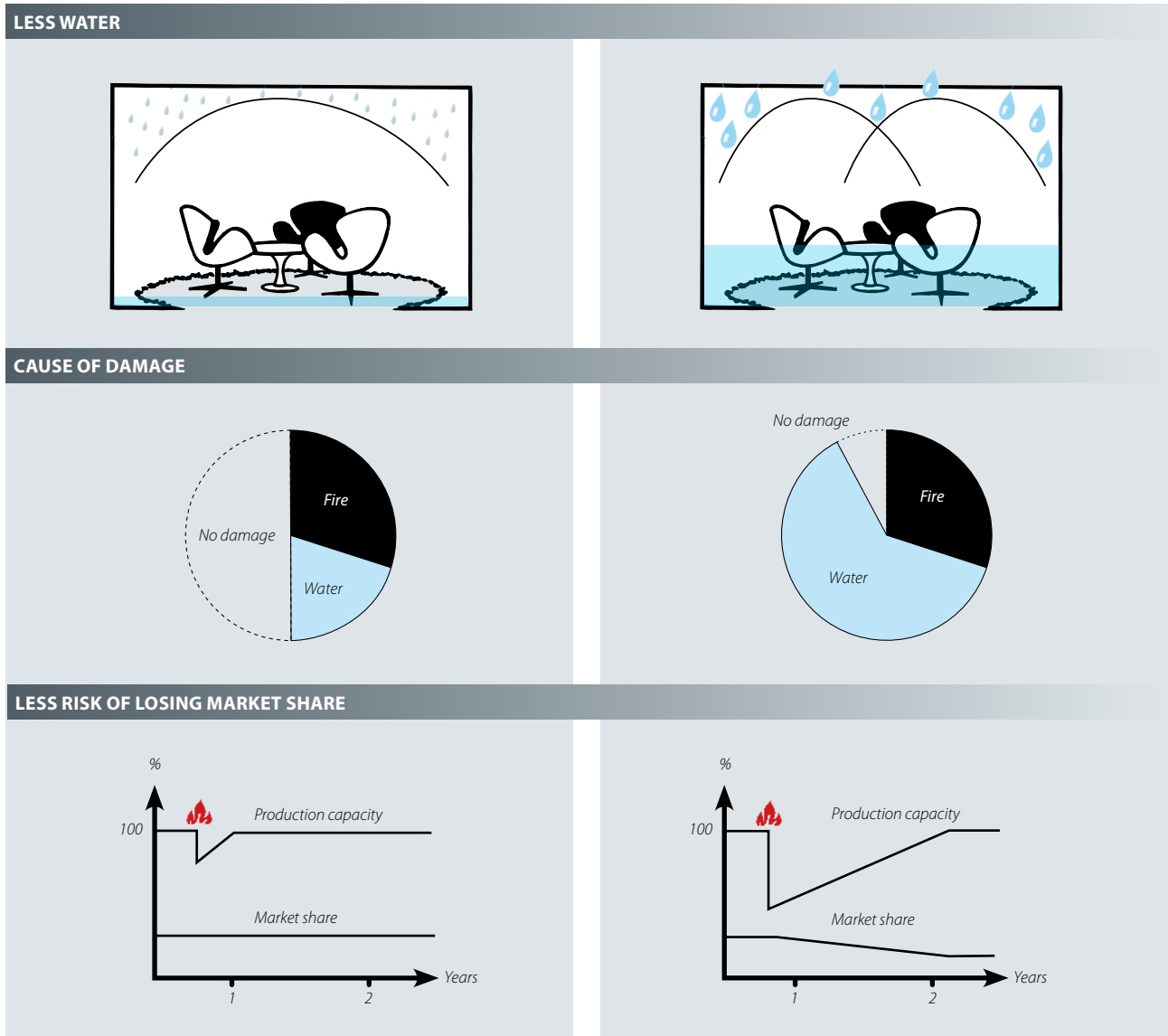



Danfoss headquarters, Nordborg, Denmark

Stainless steel pipes are easily integrated into the surroundings. To bend the pipes, there is no need for fittings. This gives you a result that actually contributes to the architectural integrity of the building.

Unique design concept makes SEM-SAFE® easy to install

The much higher spacing that the SEM-SAFE® system offers, compared to conventional sprinklers, results in a major reduction in the number of nozzles, pipes and fittings that need to be installed. Traditional sprinkler systems need up to 60% more nozzles than a SEM-SAFE® water mist system, as the nozzles with 5.5 meter spacing can cover an area up to 2.5 times larger per nozzle than traditional sprinklers heads. The limited number of nozzles and pipes, and their small sizes, increase architectural freedom and reduce the need for storage space during installation.

In both retrofit installations and new buildings, the small pipe dimensions and ease of handling - due to the low weight of the pipes - have proved to be a major benefit, making installation up to 70% faster.







Due to the compact dimensions and the high-quality material the pipes are made of, a water mist system will not compromise the architectural design. The majority of bends can be made by hand, while press fittings are used on the larger pipes. This means that there is no need to X-ray welds, nor any space problems related to flanges, etc.

When installed, the weight of the water mist pipes, including water, will typically be 85% less than a traditional sprinkler system.

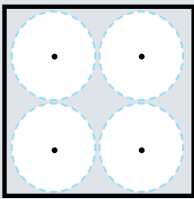
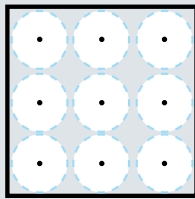
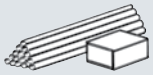
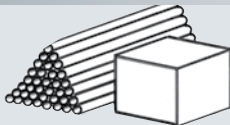
All in all, this results in a very good cost:performance ratio for water mist compared to traditional sprinklers, which explains why the growth rate for this technology is 10 times higher than for traditional sprinklers.

Water mist

Traditional sprinkler

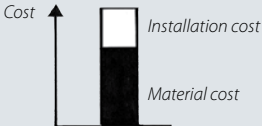
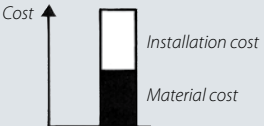
FEWER NOZZLES AND PIPES	
	
SMALL STAINLESS STEEL PIPES AND FEWER FITTINGS	
	
EASY TO INTEGRATE INTO BOTH NEW AND RETROFIT INSTALLATIONS	
	
EASY TO HANDLE	
	
QUICK INSTALLATION	
	
COST-EFFECTIVE SOLUTION	
	



National Library in Beijing, China

The advanced building 'Phase II' of the national library in Beijing has a SEM-SAFE® system with 1,600 nozzles installed. Our high-quality nozzles and pipes contribute architecturally to the high-tech design and offer a safe environment, also for water-sensitive valuables.

More space to make money

Water mist

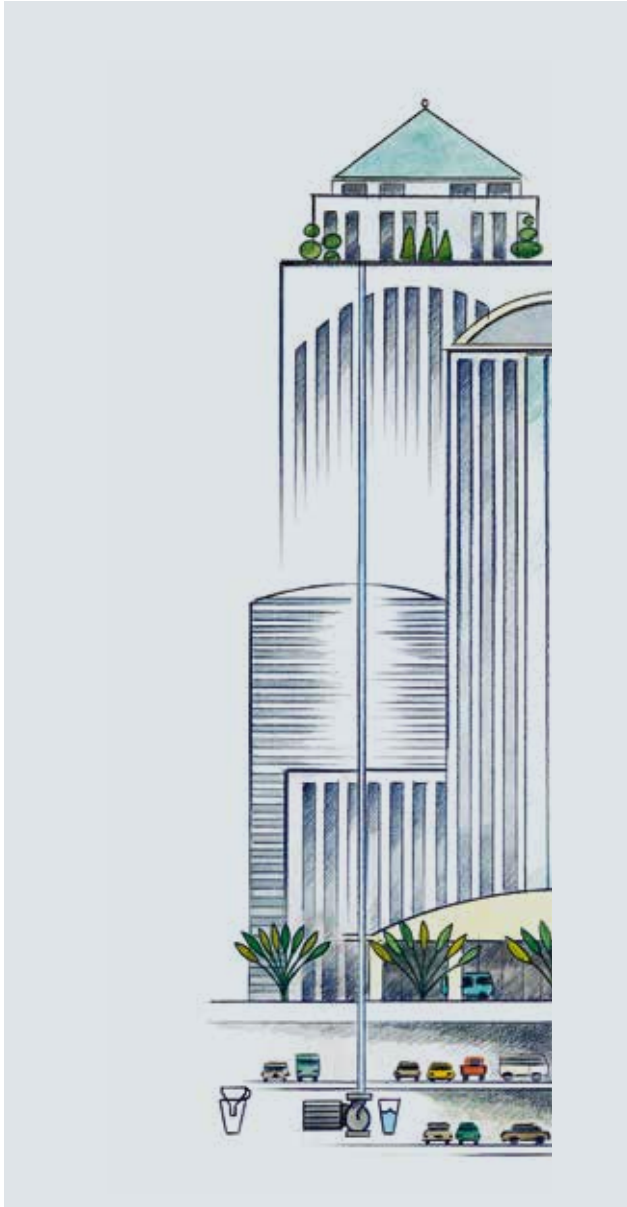

Traditional sprinkler

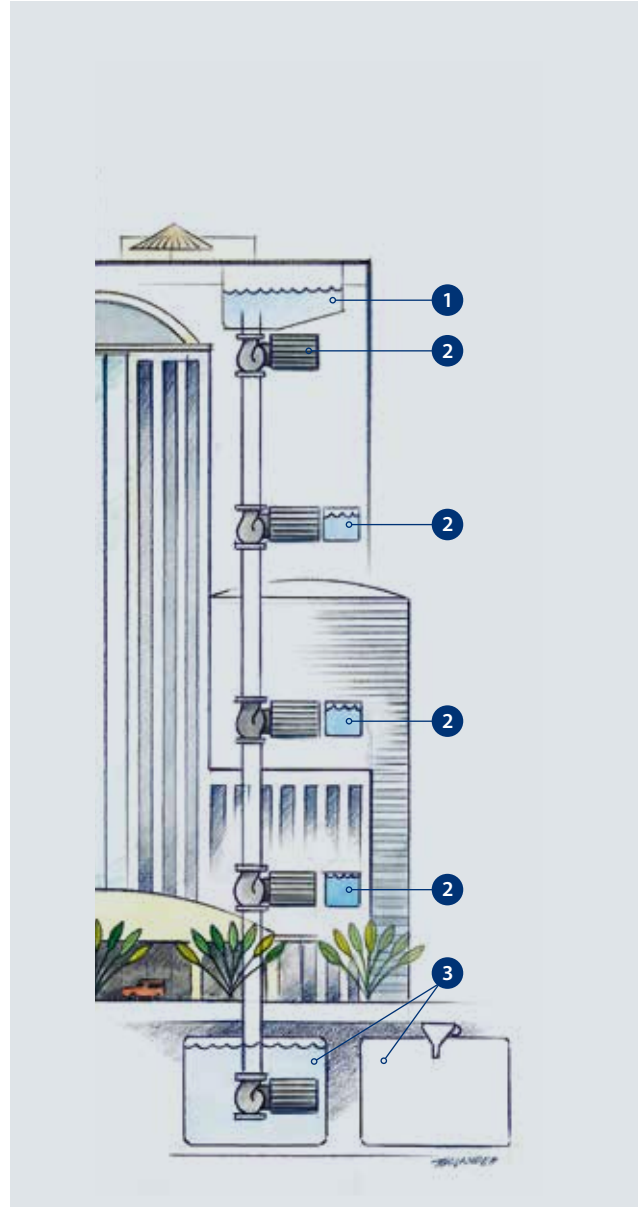

- 1 No need to place a large reservoir/swimming pool on top of the building; you can instead use the top floor for penthouse flats.
- 2 No need for sprinkler units on more floors of the building to prevent pressure loss; the space saved can be used for other money generating purposes.
- 3 No need for large water supply reservoir or for reservoirs to catch the water used by the system; the space saved can be used for an integral garage, for example.

There are several advantages in choosing the SEM-SAFE® water mist system for high-rise buildings. Besides efficient fire fighting, giving the best possible protection, it gives you the freedom to design your building just as you want. The SEM-SAFE® water mist system takes up very little space, allowing you to use the space saved for money-generating activities. In addition, the technology offers the possibility of glass cooling, which presents a major cost-saving potential through the ability to specify thinner glass.

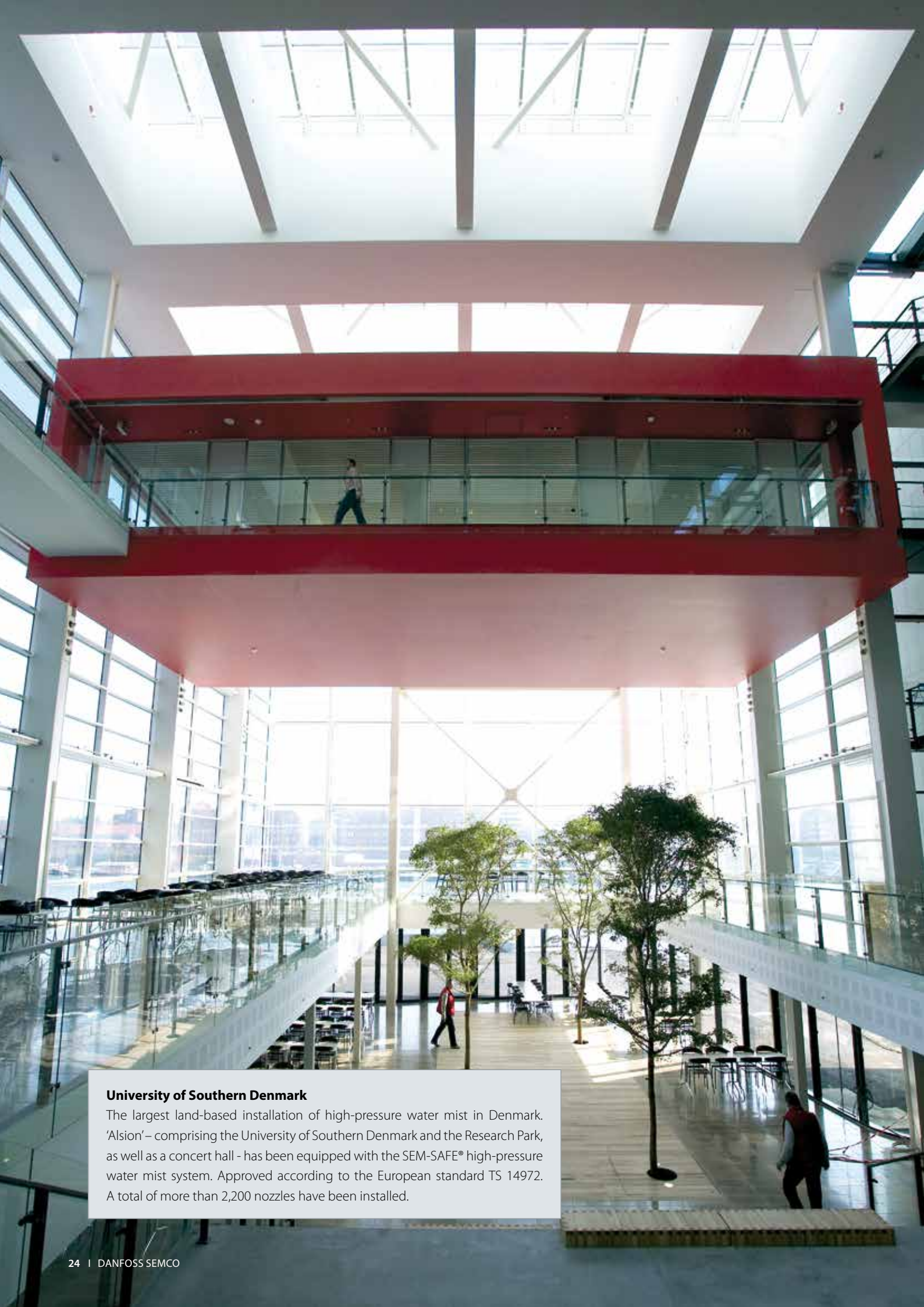

University of Southern Denmark

The largest land-based installation of high-pressure water mist in Denmark. 'Alsion' – comprising the University of Southern Denmark and the Research Park, as well as a concert hall - has been equipped with the SEM-SAFE® high-pressure water mist system. Approved according to the European standard TS 14972. A total of more than 2,200 nozzles have been installed.

The best choice for window cooling

The evidence speaks for itself

The excellent cooling features of the SEM-SAFE® water mist system make it the perfect choice for protecting glass facades. Instead of spraying water on the glass, the SEM-SAFE® system atomises the water in front of the glass. This three-dimensional cooling removes the risk of thermal stress cracks associated with conventional water-based sprinkler systems, and allows the use of a cheaper class of glass.

Cost savings up to 500 Euro/m² as well as lighter construction are key advantages.

Water mist

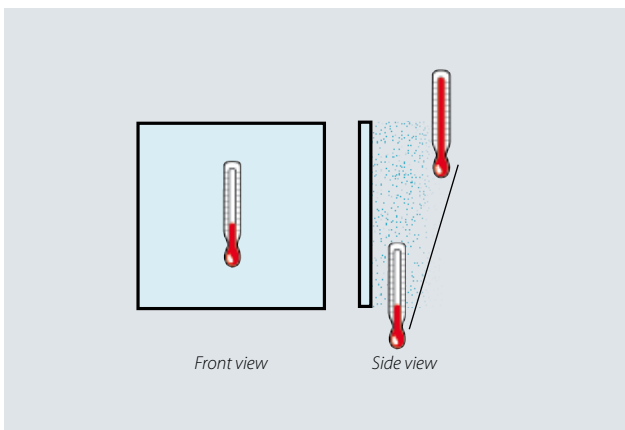

Traditional sprinkler

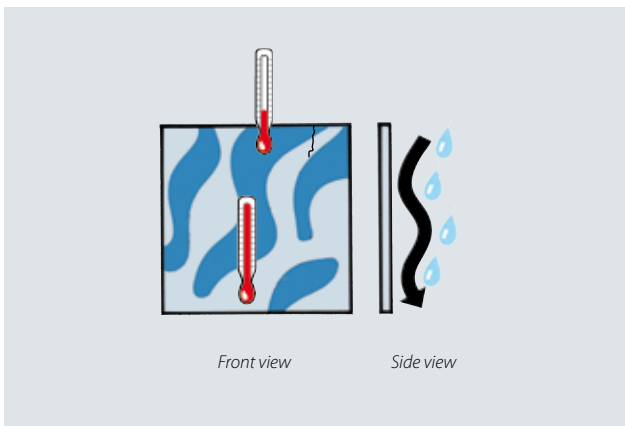

Water mist versus traditional sprinklers

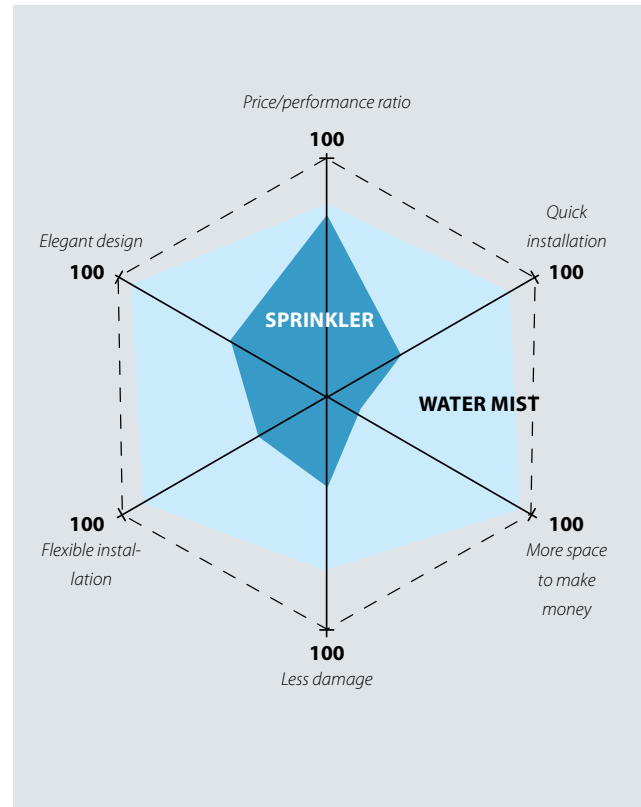





Cargill's production facilities 'Cerestar' in Krefeld, Germany

Cerestar is the leading manufacturer of starches and starch derivatives in Europe and one of the largest in the world. The SEM-SAFE® system protects numerous applications at risk of fire and explosion, including the transformers, diesel engines, filters and cable channels.

The most safe and cost-effective system

Water mist

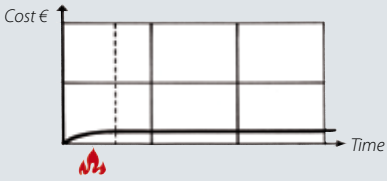
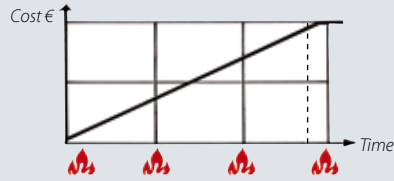



NO EVACUATION TIME	
	
MUCH LOWER COST	
	

Using only pure water, the SEM-SAFE® water mist system gives you the best possible protection of human life. In case of fire, there is no need to evacuate the room before releasing the system.

CO₂

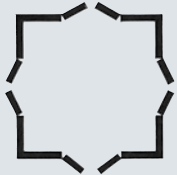
The system can be deployed instantly, resulting in less damage. The reduced amount of damage often means that production can start much faster, saving a lot of money.

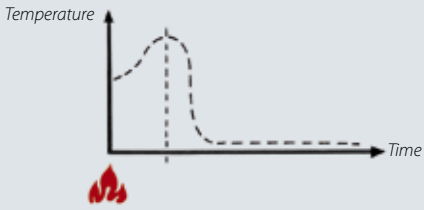
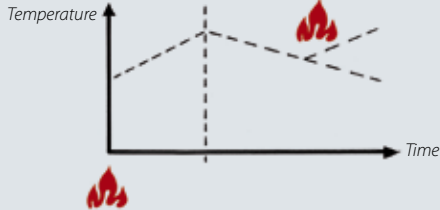
Water mist

NO NEED FOR AIR TIGHT ROOMS/EXTRA INSTALLATION	
	
COOLING EFFECT	
	
SPACE-SAVING	
	

With a water mist system there is no need to install fire doors and ventilation equipment. As water mist both cools and removes oxygen, the temperature is quickly cooled to normal, resulting in quicker fire fighting and avoiding re-ignition.

Gas

The pump unit only takes up little space and needs no special room or safe storage. The water mist pump based system is ready to use immediately after a fire. There is no need to isolate the room or to fill up cylinders, meaning that, for example, production is back working normally much faster, saving substantial costs.

SEM-SAFE[®] in real-life

Pictures from a few of the many applications where the SEM-SAFE[®] high-pressure water mist system is installed.



Transformer, China

Paper mill, Denmark

Diesel generator, Denmark

Diesel engine, Germany



Roof construction, Germany

Mill, Denmark

Turbine enclosure, England

Museum in a hospital, Shanghai



Wind turbine, Japan

Science Park, Denmark

Cable channel, Germany

Glass cooling, Denmark

New unique fire protection opportunities

High-pressure water mist is a unique fire fighting solution, and often the only possible solution for a wide range of special applications.

For instance, in a recent EU project ('UPTUN') for the development of fire protection systems for tunnels in Europe, water mist proved itself the perfect means of preventing tunnel fires.

For more than 15 years, Danfoss Semco has worked successfully with high-pressure water mist for commercial and industrial applications. At present, we have projects in more than 16 countries, with more to come.

Local application

The SEM-SAFE® local application system extinguishes the fire at source. Nozzles are placed so that they point at the risk area, catching the fire quickly and preventing it from spreading while the temperature is reduced. This is a major advantage for industrial applications, as equipment can be cooled and downtime and shock-cooling avoided. This is achieved without covering or closing the area that need to be protected.

Irreplaceable valuables

Water mist is ideal in areas where water damage can be more harmful than fire damage. The mist is so fine that it causes almost no damage to irreplaceable valuables.

This is a significant advantage for architecturally or historically important buildings, and libraries or archives that cannot tolerate the impact of excessive water or chemicals.

Special applications

Water mist is a viable alternative where other fire fighting systems cannot deliver. In special applications, water mist has an advantage because the small pipes can be integrated everywhere without being seen. Water mist does not demand air-tight rooms, and can be integrated into even the most complex constructions and tight corners.



Fire Control Centre, East Midland region, England

When selecting a fire protection system for a major new fire control centre, even the fire brigade was certain that investing in a SEM-SAFE® high-pressure water mist system was the right choice to protect themselves, the new buildings and the interior.

Tested and approved



Danfoss Semco continues to invest heavily in new approvals, as a consequence of new nozzle development as well as the need for adapting to new standards.

These approvals for industrial and commercial applications are obtained by testing according to specifications from, for example, FM, UL and ISO, as well as from the European guideline CEN / TS 14972 and approvals from DIFT, VdS and TÜV.

Danfoss Semco was one of the first to obtain approvals in accordance with the European technical guideline TS 14972 for ordinary hazard with a spacing as high as 5.5 meters, and up to 6 m ceiling height for public spaces. Danfoss Semco is also among the firsts to have VdS certificates for ordinary hazard applications, i.e. OH1 and OH2.

As a major supplier of water mist, Danfoss Semco has been a member and board member of the International Water Mist Association (IWMA) for many years.

In the marine industry, where high-pressure water mist has had a strong foothold for many years, IMO regulations have set the standards for tests and operational functionality from the beginning. These marine standards are still the benchmark for all water mist applications, including those used for the industrial and commercial market.

As one of the leading suppliers to the marine industry, Danfoss Semco's fire fighting systems have been tested and recognised by all leading classification societies and national maritime authorities, including ABS, BV, DNV, FM, GL, KRS, LRS, NK, PRS, CCS, RMRS, RINA and others.

Besides achieving external approvals, Danfoss Semco also use internal test facilities accepted by DNV, LR, and BV for the component testing of nozzles covering tests that include: leak, hydrostatic, vibration, thermal shock, water hammer, vacuum, stress corrosion and coating test.

In addition to external approvals, Danfoss Semco also internally operates a HSE&Q system in accordance with DS/EN ISO 9001:2008, DS/EN ISO 14001:2004, DS/OHSAS 18001:2008.

Danfoss Semco A/S

History

Danfoss Semco A/S is a global leader in the sale, development, production and service/commissioning of certified fixed fire fighting systems. In 2006, two leading firms in the field, Danfoss A/S and Semco Maritime A/S, joined forces to form the present company, with Semco Maritime boasting over half a century of expertise in designing and installing fixed fire fighting systems. All the while, Danfoss has developed and delivered key components for the high-tech systems.

Today, Danfoss Semco is an integral part of the Danfoss Group, Denmark's largest industrial manufacturing company with a daily output of more than 250,000 finished components. With more than 24,000 employees worldwide, Danfoss is truly a global company.

Business areas

Our company is located in Odense, Denmark and operates three main business areas.

Our water mist division comprises two business areas: the marine division and the industrial and commercial division. The former has pushed the boundaries for development and design to offer a wide range of solutions for numerous application areas on almost any type of vessel.

Within the industrial and commercial area, Danfoss Semco has a successful track record with different applications, ranging from complex fire fighting systems for museums and heritage sites to industrial applications, office buildings and universities.

Our gas and foam division is the world's largest low-pressure CO₂ based fire fighting systems supplier for the marine industry. This division supplies gas, foam and dry chemical powder systems worldwide.

In-house manufacturing of key components

Danfoss Semco operates in-house research, development and manufacturing facilities of all critical components to ensure uncompromising performance and cost-effective systems. This puts us in a unique position to maintain our technological leadership in the future.

Proven experience

Danfoss Semco has supplied fire fighting systems for a wide range of commercial and industrial applications, including remarkable projects such as:

- *Metro line* in Shanghai, the fastest-growing rapid transit system in the world
- *Equinix* in The Netherlands, a worldwide renowned data centre
- *Alston* in Denmark, a 28,400 m² building housing a university, concert hall and a research park
- *Isala Clinics* in the Netherlands, a 104,000 m² large, innovative hospital
- *AB6* in Denmark, a unique office block in the heart of Copenhagen
- *Heinrich-Hertz-Institute* in Germany, a high-rise building for leading-edge research and development of IT



Isala Clinics in the Netherlands, famous for its organic style of architecture